

# ETSI TS 136 521-1 V12.7.0 (2015-10)



**LTE;  
Evolved Universal Terrestrial Radio Access (E-UTRA);  
User Equipment (UE) conformance specification;  
Radio transmission and reception;  
Part 1: Conformance testing  
(3GPP TS 36.521-1 version 12.7.0 Release 12)**



---

Reference

RTS/TSGR-0536521-1vc70

---

Keywords

LTE

**ETSI**

650 Route des Lucioles  
F-06921 Sophia Antipolis Cedex - FRANCE

Tel.: +33 4 92 94 42 00 Fax: +33 4 93 65 47 16

Siret N° 348 623 562 00017 - NAF 742 C  
Association à but non lucratif enregistrée à la  
Sous-Préfecture de Grasse (06) N° 7803/88

---

**Important notice**

The present document can be downloaded from:

<http://www.etsi.org/standards-search>

The present document may be made available in electronic versions and/or in print. The content of any electronic and/or print versions of the present document shall not be modified without the prior written authorization of ETSI. In case of any existing or perceived difference in contents between such versions and/or in print, the only prevailing document is the print of the Portable Document Format (PDF) version kept on a specific network drive within ETSI Secretariat.

Users of the present document should be aware that the document may be subject to revision or change of status.

Information on the current status of this and other ETSI documents is available at

<http://portal.etsi.org/tb/status/status.asp>

If you find errors in the present document, please send your comment to one of the following services:

<https://portal.etsi.org/People/CommiteeSupportStaff.aspx>

---

**Copyright Notification**

No part may be reproduced or utilized in any form or by any means, electronic or mechanical, including photocopying and microfilm except as authorized by written permission of ETSI.

The content of the PDF version shall not be modified without the written authorization of ETSI.

The copyright and the foregoing restriction extend to reproduction in all media.

© European Telecommunications Standards Institute 2015.

All rights reserved.

**DECT™**, **PLUGTESTS™**, **UMTS™** and the ETSI logo are Trade Marks of ETSI registered for the benefit of its Members.  
**3GPP™** and **LTE™** are Trade Marks of ETSI registered for the benefit of its Members and of the 3GPP Organizational Partners.  
**GSM®** and the GSM logo are Trade Marks registered and owned by the GSM Association.

---

## Intellectual Property Rights

IPRs essential or potentially essential to the present document may have been declared to ETSI. The information pertaining to these essential IPRs, if any, is publicly available for **ETSI members and non-members**, and can be found in ETSI SR 000 314: "*Intellectual Property Rights (IPRs); Essential, or potentially Essential, IPRs notified to ETSI in respect of ETSI standards*", which is available from the ETSI Secretariat. Latest updates are available on the ETSI Web server (<http://ipr.etsi.org>).

Pursuant to the ETSI IPR Policy, no investigation, including IPR searches, has been carried out by ETSI. No guarantee can be given as to the existence of other IPRs not referenced in ETSI SR 000 314 (or the updates on the ETSI Web server) which are, or may be, or may become, essential to the present document.

---

## Foreword

This Technical Specification (TS) has been produced by ETSI 3rd Generation Partnership Project (3GPP).

The present document may refer to technical specifications or reports using their 3GPP identities, UMTS identities or GSM identities. These should be interpreted as being references to the corresponding ETSI deliverables.

The cross reference between GSM, UMTS, 3GPP and ETSI identities can be found under <http://webapp.etsi.org/key/queryform.asp>.

---

## Modal verbs terminology

In the present document "**shall**", "**shall not**", "**should**", "**should not**", "**may**", "**need not**", "**will**", "**will not**", "**can**" and "**cannot**" are to be interpreted as described in clause 3.2 of the [ETSI Drafting Rules](#) (Verbal forms for the expression of provisions).

"**must**" and "**must not**" are **NOT** allowed in ETSI deliverables except when used in direct citation.

# Contents

Intellectual Property Rights .....	2
Foreword.....	2
Modal verbs terminology.....	2
Foreword.....	48
Introduction .....	48
1 Scope .....	49
2 References .....	50
3 Definitions, symbols and abbreviations .....	51
3.1 Definitions.....	51
3.2 Symbols.....	52
3.3 Abbreviations .....	54
4 General .....	57
4.1 Categorization of test requirements in CA, UL-MIMO, eDL-MIMO and UE category 0 .....	57
4.2 RF requirements in later releases .....	58
5 Frequency bands and channel arrangement.....	59
5.1 General .....	59
5.2 Operating bands.....	59
5.2A Operating bands for CA .....	60
5.2B Operating bands for UL-MIMO .....	67
5.3 TX–RX frequency separation.....	67
5.3A TX–RX frequency separation for CA.....	68
5.4 Channel arrangement.....	68
5.4.1 Channel spacing .....	68
5.4.1A Channel spacing for CA.....	68
5.4.2 Channel bandwidth .....	69
5.4.2.1 Channel bandwidths per operating band .....	69
5.4.2A Channel bandwidth for CA .....	70
5.4.2A.1 Channel bandwidths per operating band for CA .....	73
5.4.2B Channel bandwidth for UL-MIMO.....	86
5.4.2B.1 Channel bandwidths per operating band for UL- MIMO.....	86
5.4.3 Channel raster .....	86
5.4.3A Channel raster for CA .....	86
5.4.4 Carrier frequency and EARFCN.....	86
6 Transmitter Characteristics.....	87
6.1 General .....	87
6.2 Transmit power .....	87
6.2.1 Void .....	87
6.2.2 UE Maximum Output Power .....	88
6.2.2.1 Test purpose .....	88
6.2.2.2 Test applicability.....	88
6.2.2.3 Minimum conformance requirements .....	88
6.2.2.4 Test description .....	90
6.2.2.4.1 Initial condition .....	90
6.2.2.4.2 Test procedure .....	91
6.2.2.4.3 Message contents.....	91
6.2.2.5 Test requirements.....	91
6.2.2_1 Maximum Output Power for HPUE .....	93
6.2.2_1.1 Test purpose .....	93
6.2.2_1.2 Test applicability.....	93
6.2.2_1.3 Minimum conformance requirements .....	93
6.2.2_1.4 Test description .....	93
6.2.2_1.5 Test requirements.....	94



6.2.2A	UE Maximum Output Power for CA .....	94
6.2.2A.1	UE Maximum Output Power for CA (intra-band contiguous DL CA and UL CA).....	94
6.2.2A.1.1	Test purpose .....	94
6.2.2A.1.2	Test applicability .....	95
6.2.2A.1.3	Minimum conformance requirements.....	95
6.2.2A.1.4	Test description .....	95
6.2.2A.1.5	Test Requirements.....	97
6.2.2A.2	UE Maximum Output Power for CA (inter-band DL CA and UL CA) .....	97
6.2.2A.2.1	Test purpose .....	97
6.2.2A.2.2	Test applicability .....	98
6.2.2A.2.3	Minimum conformance requirements.....	98
6.2.2A.2.4	Test description .....	98
6.2.2A.2.5	Test Requirements.....	101
6.2.2A.3	UE Maximum Output Power for CA (intra-band non-contiguous DL CA and UL CA) .....	102
6.2.2B	UE Maximum Output Power for UL-MIMO.....	103
6.2.2B.1	Test purpose .....	103
6.2.2B.2	Test applicability.....	103
6.2.2B.3	Minimum conformance requirements .....	103
6.2.2B.4	Test description .....	105
6.2.2B.4.1	Initial condition .....	105
6.2.2B.4.2	Test procedure .....	106
6.2.2B.4.3	Message contents.....	106
6.2.2B.5	Test requirements .....	106
6.2.2E	UE Maximum Output Power for UE category 0.....	108
6.2.2E.1	Test purpose .....	108
6.2.2E.2	Test applicability.....	108
6.2.2E.3	Minimum conformance requirements .....	108
6.2.2E.4	Test description .....	108
6.2.2E.4.3	Message contents.....	109
6.2.2E.5	Test requirements.....	109
6.2.3	Maximum Power Reduction (MPR) .....	110
6.2.3.1	Test purpose .....	111
6.2.3.2	Test applicability.....	111
6.2.3.3	Minimum conformance requirements .....	111
6.2.3.4	Test description .....	111
6.2.3.4.1	Initial condition .....	111
6.2.3.4.2	Test procedure .....	113
6.2.3.4.3	Message contents.....	113
6.2.3.5	Test requirements.....	113
6.2.3_1	Maximum Power Reduction (MPR) for HPUE .....	115
6.2.3_1.1	Test purpose .....	115
6.2.3_1.2	Test applicability.....	115
6.2.3_1.3	Minimum conformance requirements .....	115
6.2.3_1.4	Test description .....	116
6.2.3_1.5	Test requirements.....	116
6.2.3_2	Maximum Power Reduction (MPR) for Multi-Cluster PUSCH .....	116
6.2.3_2.1	Test purpose .....	116
6.2.3_2.2	Test applicability.....	116
6.2.3_2.3	Minimum conformance requirements .....	116
6.2.3_2.4	Test description .....	117
6.2.3_2.4.1	Initial condition .....	117
6.2.3_2.4.2	Test procedure .....	118
6.2.3_2.4.3	Message contents.....	118
6.2.3_2.5	Test requirements.....	118
6.2.3A	Maximum Power Reduction (MPR) for CA .....	120
6.2.3A.1	Maximum Power Reduction (MPR) for CA (intra-band contiguous DL CA and UL CA).....	120
6.2.3A.1.1	Test purpose .....	120
6.2.3A.1.2	Test applicability .....	120
6.2.3A.1.3	Minimum conformance requirements.....	120
6.2.3A.1.4	Test description .....	121
6.2.3A.1.5	Test Requirements.....	123
6.2.3A.2	Maximum Power Reduction (MPR) for CA (inter-band DL CA and UL CA) .....	125

6.2.3A.2.1	Test purpose .....	125
6.2.3A.2.2	Test applicability .....	125
6.2.3A.2.3	Minimum conformance requirements.....	125
6.2.3A.2.4	Test description .....	126
6.2.3A.2.5	Test Requirements.....	129
6.2.3A.3	Maximum Power Reduction (MPR) for CA (intra-band non-contiguous DL CA and UL CA) .....	131
6.2.3A.3.1	Test purpose .....	131
6.2.3A.3.2	Test applicability .....	131
6.2.3A.3.3	Minimum conformance requirements.....	131
6.2.3A.3.4	Test description .....	132
6.2.3A.3.5	Test Requirements .....	134
6.2.3B	Maximum Power Reduction (MPR) for UL-MIMO.....	134
6.2.3B.1	Test purpose .....	134
6.2.3B.2	Test applicability.....	134
6.2.3B.3	Minimum conformance requirements .....	134
6.2.3B.4	Test description .....	135
6.2.3B.4.1	Initial condition .....	135
6.2.3B.4.2	Test procedure .....	136
6.2.3B.4.3	Message contents.....	137
6.2.3B.5	Test requirements .....	137
6.2.3C	.....	139
6.2.3D	.....	139
6.2.3E	Maximum Power Reduction (MPR) for UE category 0.....	139
6.2.3E.1	Test purpose .....	139
6.2.3E.2	Test applicability.....	139
6.2.3E.3	Minimum conformance requirements .....	140
6.2.3E.4	Test description .....	140
6.2.3E.4.1	Initial condition .....	140
6.2.3E.4.2	Test procedure .....	140
6.2.3E.4.3	Message contents.....	140
6.2.3E.5	Test requirements .....	141
6.2.4	Additional Maximum Power Reduction (A-MPR).....	141
6.2.4.1	Test purpose .....	141
6.2.4.2	Test applicability.....	141
6.2.4.3	Minimum conformance requirements .....	141
6.2.4.4	Test description .....	148
6.2.4.4.1	Initial condition .....	148
6.2.4.4.2	Test procedure .....	168
6.2.4.4.3	Message contents.....	169
6.2.4.5	Test requirements .....	173
6.2.4_1	Additional Maximum Power Reduction (A-MPR) for HPUE.....	195
6.2.4_1.2	Test applicability.....	195
6.2.4_1.3	Minimum conformance requirements .....	195
6.2.4_1.4	Test description .....	195
6.2.4_1.5	Test requirements .....	196
6.2.4A	Additional Maximum Power Reduction (A-MPR) for CA.....	196
6.2.4A.1	Additional Maximum Power Reduction (A-MPR) for CA (intra-band contiguous DL CA and UL CA).....	196
6.2.4A.1.1	Test purpose .....	197
6.2.4A.1.2	Test applicability .....	197
6.2.4A.1.3.5	A-MPR for CA_NS_05 for CA_38C.....	200
6.2.4A.1.3.6	A-MPR for CA_NS_06 for CA_7C.....	201
6.2.4A.1.3.7	A-MPR for CA_NS_07 for CA_39C.....	202
6.2.4A.1.4	Test description .....	202
6.2.4A.1.5	Test requirements .....	209
6.2.4A.2	.....	214
6.2.4A.3	Additional Maximum Power Reduction (A-MPR) for CA (intra-band non-contiguous DL CA and UL CA).....	214
6.2.4B	Additional Maximum Power Reduction (A-MPR) for UL-MIMO.....	214
6.2.4B.1	Test purpose .....	214
6.2.4B.2	Test applicability.....	215
6.2.4B.3	Minimum conformance requirements .....	215

6.2.4B.4	Test description .....	220
6.2.4B.4.1	Initial condition .....	220
6.2.4B.4.2	Test procedure .....	236
6.2.4B.4.3	Message contents.....	236
6.2.4B.5	Test requirements .....	239
6.2.4C	.....	253
6.2.4D	.....	253
6.2.4E	Additional Maximum Power Reduction (A-MPR) for UE category 0 .....	253
6.2.4E.1	Test purpose .....	254
6.2.4E.2	Test applicability .....	254
6.2.4E.3	Minimum conformance requirements .....	254
6.2.4E.4	Test description .....	254
6.2.4E.4.1	Initial condition .....	254
6.2.4E.4.2	Test procedure .....	254
6.2.4E.4.3	Message contents.....	254
6.2.4E.5	Test requirements.....	254
6.2.5	Configured UE transmitted Output Power .....	254
6.2.5.1	Test purpose .....	254
6.2.5.2	Test applicability .....	255
6.2.5.3	Minimum conformance requirements .....	255
6.2.5.4	Test description .....	262
6.2.5.4.1	Initial conditions .....	262
6.2.5.4.2	Test procedure .....	263
6.2.5.4.3	Message contents.....	263
6.2.5.5	Test requirement .....	264
6.2.5_1	Configured UE transmitted Output Power for HPUE.....	264
6.2.5_1.1	Test purpose .....	264
6.2.5_1.2	Test applicability .....	264
6.2.5_1.3	Minimum conformance requirements .....	265
6.2.5_1.4	Test description .....	265
6.2.5_1.4.1	Initial conditions .....	265
6.2.5_1.4.2	Test procedure .....	265
6.2.5_1.4.3	Message contents.....	265
6.2.5_1.5	Test requirement .....	265
6.2.5A	Configured transmitted power for CA .....	266
6.2.5A.1	Configured UE transmitted Output Power for CA (intra-band contiguous DL CA and UL CA) .....	266
6.2.5A.1.1	Test purpose .....	266
6.2.5A.1.2	Test applicability .....	266
6.2.5A.1.3	Minimum conformance requirements.....	266
6.2.5A.1.4	Test description .....	268
6.2.5A.1.5	Test requirement .....	269
6.2.5A.2	Void.....	270
6.2.5A.3	Configured UE transmitted Output Power for CA (inter-band DL CA and UL CA).....	270
6.2.5A.3.1	Test purpose .....	270
6.2.5A.3.2	Test applicability .....	270
6.2.5A.3.3	Minimum conformance requirements.....	270
6.2.5A.3.4	Test description .....	272
6.2.5A.3.5	Test requirement .....	273
6.2.5A.4	Configured UE transmitted Output Power for CA (intra-band non-contiguous DL CA and UL CA).....	274
6.2.5A.4.1	Test purpose .....	274
6.2.5A.4.2	Test applicability .....	274
6.2.5A.4.3	Minimum conformance requirements.....	274
6.2.5A.4.4	Test description .....	275
6.2.5A.4.5	Test requirement .....	277
6.2.5B	Configured UE transmitted Output Power for UL-MIMO .....	278
6.2.5B.1	Test purpose .....	278
6.2.5B.2	Test applicability .....	278
6.2.5B.3	Minimum conformance requirements .....	278
6.2.5B.4	Test description .....	279
6.2.5B.4.1	Initial conditions .....	279
6.2.5B.4.2	Test procedure .....	279

6.2.5B.4.3	Message contents.....	280
6.2.5B.5	Test requirement .....	280
6.3	Output Power Dynamics .....	281
6.3.1	Void.....	281
6.3.2	Minimum Output Power .....	281
6.3.2.1	Test purpose .....	281
6.3.2.2	Test applicability.....	281
6.3.2.3	Minimum conformance requirements .....	281
6.3.2.4	Test description .....	281
6.3.2.4.1	Initial conditions.....	281
6.3.2.4.2	Test procedure .....	282
6.3.2.4.3	Message contents.....	282
6.3.2.5	Test requirement .....	282
6.3.2A	Minimum Output Power for CA .....	283
6.3.2A.1	Minimum Output Power for CA (intra-band contiguous DL CA and UL CA).....	283
6.3.2A.1.1	Test purpose .....	283
6.3.2A.1.2	Test applicability .....	283
6.3.2A.1.3	Minimum conformance requirements.....	283
6.3.2A.1.4	Test description .....	283
6.3.2A.1.4.1	Initial conditions .....	283
6.3.2A.1.4.2	Test procedure.....	284
6.3.2A.1.4.3	Message contents .....	285
6.3.2A.1.5	Test requirements .....	285
6.3.2B	Minimum Output Power for UL-MIMO.....	285
6.3.2B.1	Test purpose .....	285
6.3.2B.2	Test applicability.....	285
6.3.2B.3	Minimum conformance requirements .....	285
6.3.2B.4	Test description .....	286
6.3.2B.4.1	Initial conditions.....	286
6.3.2B.4.2	Test procedure .....	286
6.3.2B.4.3	Message contents.....	287
6.3.3	Transmit OFF power.....	287
6.3.3.1	Test purpose .....	287
6.3.3.2	Test applicability.....	287
6.3.3.3	Minimum conformance requirement.....	287
6.3.3.4	Test description .....	287
6.3.3.5	Test requirement .....	288
6.3.3A	UE Transmit OFF power for CA .....	288
6.3.3A.0	Minimum conformance requirements .....	288
6.3.3A.1	UE Transmit OFF power for CA (intra-band contiguous DL CA and UL CA).....	288
6.3.3A.1.1	Test purpose .....	288
6.3.3A.1.2	Test applicability .....	288
6.3.3A.1.3	Minimum conformance requirements.....	289
6.3.3A.1.4	Test description .....	289
6.3.3A.1.5	Test Requirements .....	289
6.3.3A.2	UE Transmit OFF power for CA (inter-band DL CA and UL CA) .....	289
6.3.3A.2.1	Test purpose .....	289
6.3.3A.2.2	Test applicability .....	289
6.3.3A.2.3	Minimum conformance requirements.....	289
6.3.3A.2.4	Test description .....	289
6.3.3A.2.5	Test Requirements.....	289
6.3.3A.3	UE Transmit OFF power for CA (intra-band non-contiguous DL CA and UL CA).....	290
6.3.3A.3.1	Test purpose .....	290
6.3.3A.3.2	Test applicability .....	290
6.3.3A.3.3	Minimum conformance requirements.....	290
6.3.3A.3.4	Test description .....	290
6.3.3A.3.5	Test Requirements .....	290
6.3.3B	UE Transmit OFF power for UL-MIMO .....	290
6.3.3B.1	Test purpose .....	290
6.3.3B.2	Test applicability.....	291
6.3.3B.3	Minimum conformance requirement.....	291
6.3.3B.4	Test description .....	291

6.3.3B.5	Test requirement .....	291
6.3.4	ON/OFF time mask.....	291
6.3.4.1	General ON/OFF time mask .....	291
6.3.4.1.1	Test purpose .....	291
6.3.4.1.2	Test applicability .....	292
6.3.4.1.3	Minimum conformance requirement .....	292
6.3.4.1.4	Test description .....	292
6.3.4.1.5	Test requirement .....	294
6.3.4.2	PRACH and SRS time mask .....	295
6.3.4.2.1	PRACH time mask .....	295
6.3.4.2.2	SRS time mask .....	298
6.3.4A	ON/OFF time mask for CA .....	303
6.3.4A.0	Minimum conformance requirements .....	303
6.3.4A.1	General ON/OFF time mask for CA .....	303
6.3.4A.1.1	General ON/OFF time mask for CA (intra-band contiguous DL CA and UL CA) .....	303
6.3.4A.1.1.4.2	Test procedure.....	305
6.3.4A.1.1.4.3	Message contents.....	305
6.3.4A.1.1.5	Test requirement.....	306
6.3.4A.1.2	General ON/OFF time mask for CA (inter-band DL CA and UL CA) .....	306
6.3.4A.1.2.4.2	Test procedure.....	307
6.3.4A.1.2.4.3	Message contents.....	308
6.3.4A.1.2.5	Test requirement.....	308
6.3.4A.1.3	General ON/OFF time mask for CA (intra-band non-contiguous DL CA and UL CA).....	308
6.3.4A.1.3.4.2	Test procedure.....	309
6.3.4A.1.3.4.3	Message contents.....	309
6.3.4A.1.3.5	Test requirement.....	310
6.3.4B	ON/OFF time mask for UL-MIMO .....	310
6.3.4B.1	General ON/OFF time mask for UL-MIMO .....	310
6.3.4B.1.1	Test purpose .....	310
6.3.4B.1.2	Test applicability .....	310
6.3.4B.1.3	Minimum conformance requirement .....	310
6.3.4B.1.4	Test description .....	310
6.3.4B.1.5	Test requirement .....	312
6.3.5	Power Control .....	313
6.3.5.1	Power Control Absolute power tolerance .....	313
6.3.5.1.1	Test purpose .....	313
6.3.5.1.2	Minimum conformance requirement .....	313
6.3.5.1.3	Test applicability .....	313
6.3.5.1.4	Test description .....	314
6.3.5.1.5	Test requirement .....	315
6.3.5.2	Power Control Relative power tolerance.....	316
6.3.5.2.1	Test purpose .....	316
6.3.5.2.2	Test applicability .....	316
6.3.5.2.3	Minimum conformance requirement .....	316
6.3.5.2.4	Test description .....	317
6.3.5.2.5	Test requirement .....	324
6.3.5.3	Aggregate power control tolerance .....	334
6.3.5.3.1	Test purpose .....	334
6.3.5.3.2	Test applicability .....	335
6.3.5.3.3	Minimum conformance requirement .....	335
6.3.5.3.4	Test description .....	335
6.3.5.3.5	Test requirement .....	337
6.3.5_1	Power Control for HPUE.....	337
6.3.5_1.1	Power Control Absolute power tolerance for HPUE .....	338
6.3.5_1.1.1	Test purpose .....	338
6.3.5_1.1.2	Test applicability .....	338
6.3.5_1.1.3	Minimum conformance requirement .....	338
6.3.5_1.1.4	Test description .....	338
6.3.5_1.1.5	Test requirement .....	338
6.3.5_1.2	Power Control Relative power tolerance for HPUE.....	339
6.3.5_1.2.1	Test purpose .....	339
6.3.5_1.2.2	Test applicability .....	339

6.3.5_1.2.3	Minimum conformance requirement .....	339
6.3.5_1.2.4	Test description .....	339
6.3.5_1.2.5	Test requirement .....	339
6.3.5_1.3	Aggregate power control tolerance for HPUE .....	339
6.3.5_1.3.1	Test purpose .....	339
6.3.5_1.3.2	Test applicability .....	339
6.3.5_1.3.3	Minimum conformance requirement .....	339
6.3.5_1.3.4	Test description .....	339
6.3.5_1.3.5	Test requirement .....	340
6.3.5A	Power Control for CA .....	340
6.3.5A.1	Power Control Absolute power tolerance for CA .....	340
6.3.5A.1.1	Power Control Absolute power tolerance for CA (intra-band contiguous DL CA and UL CA) ...	340
6.3.5A.1.2	Power Control Absolute power tolerance for CA (inter-band DL CA and UL CA) .....	344
6.3.5A.1.3	Power Control Absolute power tolerance for CA (intra-band non-contiguous DL CA and UL CA) .....	345
6.3.5A.2	Power Control Relative power tolerance for CA .....	346
6.3.5A.2.1	Power Control Relative power tolerance for CA (intra-band contiguous DL CA and UL CA) ....	346
6.3.5A.2.2	Power Control Relative power tolerance for CA (inter-band DL CA and UL CA) .....	352
6.3.5A.2.3	Power Control Relative power tolerance for CA (intra-band non-contiguous DL CA and UL CA) .....	354
6.3.5A.3	Aggregate power control tolerance for CA .....	356
6.3.5A.3.1	Aggregate power control tolerance for CA (intra-band contiguous DL CA and UL CA) .....	356
6.3.5A.3.1.1	Test purpose .....	356
6.3.5A.3.1.2	Test applicability .....	356
6.3.5A.3.1.3	Minimum conformance requirements .....	356
6.3.5B	Power Control for UL- MIMO .....	359
6.3.5B.1	Power Control Absolute Power Tolerance for UL- MIMO .....	359
6.3.5B.1.1	Test purpose .....	359
6.3.5B.1.2	Minimum conformance requirement .....	359
6.3.5B.1.3	Test applicability .....	359
6.3.5B.1.4	Test description .....	359
6.3.5B.1.5	Test requirement .....	361
6.3.5B.2	Power Control Relative power tolerance for UL-MIMO .....	362
6.3.5B.2.1	Test purpose .....	362
6.3.5B.2.2	Test applicability .....	362
6.3.5B.2.3	Minimum conformance requirement .....	362
6.3.5B.2.4	Test description .....	362
6.3.5B.2.5	Test requirement .....	369
6.3.5B.3	Aggregate power control tolerance for UL-MIMO .....	379
6.3.5B.3.1	Test purpose .....	379
6.3.5B.3.2	Test applicability .....	379
6.3.5B.3.3	Minimum conformance requirement .....	379
6.3.5B.3.4	Test description .....	379
6.3.5B.3.5	Test requirement .....	381
6.4	Void .....	382
6.5	Transmit signal quality .....	383
6.5.1	Frequency Error .....	383
6.5.1.1	Test purpose .....	383
6.5.1.2	Test applicability .....	383
6.5.1.3	Minimum conformance requirements .....	383
6.5.1.4	Test description .....	383
6.5.1.4.1	Initial condition .....	383
6.5.1.4.2	Test procedure .....	384
6.5.1.4.3	Message contents .....	385
6.5.1.5	Test requirement .....	385
6.5.1A	Frequency error for CA .....	385
6.5.1A.0	Minimum conformance requirements .....	385
6.5.1A.1	Frequency error for CA (intra-band contiguous DL CA and UL CA) .....	385
6.5.1A.1.1	Test purpose .....	385
6.5.1A.1.2	Test applicability .....	385
6.5.1A.1.3	Minimum conformance requirements .....	385
6.5.1A.1.4	Test description .....	385

6.5.1A.1.5	Test Requirements .....	387
6.5.1A.2	Frequency error for CA (inter-band DL CA and UL CA).....	387
6.5.1A.2.1	Test purpose .....	387
6.5.1A.2.2	Test applicability .....	387
6.5.1A.2.3	Minimum conformance requirements.....	387
6.5.1A.2.4	Test description .....	387
6.5.1A.2.4.3	Message contents.....	388
6.5.1A.2.5	Test requirement .....	388
6.5.1B	Frequency Error for UL-MIMO.....	388
6.5.1B.1	Test purpose .....	388
6.5.1B.2	Test applicability.....	388
6.5.1B.3	Minimum conformance requirements .....	388
6.5.1B.4	Test description .....	388
6.5.1B.4.1	Initial condition .....	388
6.5.1B.4.2	Test procedure .....	389
6.5.1B.4.3	Message contents.....	390
6.5.1B.5	Test requirement .....	390
6.5.2	Transmit modulation.....	390
6.5.2.1	Error Vector Magnitude (EVM).....	390
6.5.2.1.1	Test Purpose .....	390
6.5.2.1.2	Test applicability .....	390
6.5.2.1.3	Minimum conformance requirements.....	390
6.5.2.1.4	Test description .....	391
6.5.2.1.5	Test requirement .....	395
6.5.2.1A	PUSCH-EVM with exclusion period .....	395
6.5.2.1A.1	Test purpose .....	395
6.5.2.1A.2	Test applicability .....	395
6.5.2.1A.3	Minimum conformance requirement .....	395
6.5.2.1A.4	Test description .....	395
6.5.2.1A.5	Test requirement .....	397
6.5.2.2	Carrier leakage .....	398
6.5.2.2.1	Test Purpose .....	398
6.5.2.2.2	Test applicability .....	398
6.5.2.2.3	Minimum conformance requirements.....	398
6.5.2.2.4	Test description .....	398
6.5.2.2.5	Test requirement .....	400
6.5.2.3	In-band emissions for non allocated RB .....	400
6.5.2.3.1	Test Purpose .....	400
6.5.2.3.2	Test applicability .....	400
6.5.2.3.3	Minimum conformance requirements.....	400
6.5.2.3.4	Test description .....	401
6.5.2.3.5	Test requirement .....	403
6.5.2.4	EVM equalizer spectrum flatness .....	404
6.5.2.4.1	Test Purpose .....	404
6.5.2.4.2	Test applicability .....	404
6.5.2.4.3	Minimum conformance requirements.....	405
6.5.2.4.4	Test description .....	406
6.5.2.4.5	Test requirement .....	407
6.5.2A	Transmit modulation for CA.....	408
6.5.2A.1	Error Vector Magnitude (EVM) for CA.....	408
6.5.2A.1.1	Error Vector Magnitude (EVM) for CA (intra-band contiguous DL CA and UL CA) .....	408
6.5.2A.2	Carrier leakage for CA.....	410
6.5.2A.2.1	Carrier leakage for CA (intra-band contiguous DL CA and UL CA).....	410
6.5.2A.3	In-band emissions for non allocated RB for CA .....	412
6.5.2A.3.1	In-band emissions for non allocated RB for CA (intra-band contiguous DL CA and UL CA).....	412
6.5.2B	Transmit modulation for UL- MIMO .....	418
6.5.2B.1	Error Vector Magnitude (EVM) for UL- MIMO .....	418
6.5.2B.1.1	Test Purpose .....	418
6.5.2B.1.2	Test applicability .....	419
6.5.2B.1.3	Minimum conformance requirements.....	419
6.5.2B.1.4	Test description .....	419
6.5.2B.1.5	Test requirement .....	421

6.5.2B.2	Carrier leakage for UL-MIMO.....	422
6.5.2B.2.1	Test Purpose .....	422
6.5.2B.2.2	Test applicability .....	422
6.5.2B.2.3	Minimum conformance requirements.....	422
6.5.2B.2.4	Test description .....	422
6.5.2B.2.5	Test requirement .....	423
6.5.2B.3	In-band emissions for non allocated RB for UL-MIMO.....	423
6.5.2B.3.1	Test Purpose .....	423
6.5.2B.3.2	Test applicability .....	424
6.5.2B.3.3	Minimum conformance requirements.....	424
6.5.2B.3.4	Test description .....	425
6.5.2B.3.5	Test requirement .....	427
6.5.2B.4	EVM equalizer spectrum flatness for UL-MIMO .....	427
6.5.2B.4.1	Test Purpose .....	427
6.5.2B.4.2	Test applicability .....	428
6.5.2B.4.3	Minimum conformance requirements.....	428
6.5.2B.4.4	Test description .....	428
6.5.2B.4.5	Test requirement .....	429
6.6	Output RF spectrum emissions.....	430
6.6.1	Occupied bandwidth .....	431
6.6.1.1	Test purpose .....	431
6.6.1.2	Test applicability .....	431
6.6.1.2	Minimum conformance requirements .....	431
6.6.1.4	Test description .....	431
6.6.1.4.1	Initial conditions .....	431
6.6.1.4.2	Test procedure .....	432
6.6.1.4.3	Message contents.....	432
6.6.1.5	Test requirement .....	432
6.6.1A	Occupied bandwidth for CA .....	432
6.6.1A.0	Minimum conformance requirements .....	432
6.6.1A.1	Occupied bandwidth for CA (intra-band contiguous DL CA and UL CA).....	433
6.6.1A.1.1	Test purpose .....	433
6.6.1A.1.2	Test applicability .....	433
6.6.1A.1.3	Minimum conformance requirements.....	433
6.6.1A.1.4	Test description .....	433
6.6.1A.1.5	Test Requirements .....	435
6.6.1A.2	Occupied bandwidth for CA (inter-band DL CA and UL CA) .....	435
6.6.1A.2.1	Test purpose .....	435
6.6.1A.2.2	Test applicability .....	435
6.6.1A.2.3	Minimum conformance requirements.....	435
6.6.1A.2.4	Test description .....	435
6.6.1A.2.5	Test Requirements .....	437
6.6.1A.3	Occupied bandwidth for CA (intra-band non-contiguous DL CA and UL CA).....	437
6.6.1A.3.1	Test purpose .....	437
6.6.1A.3.2	Test applicability .....	437
6.6.1A.3.3	Minimum conformance requirements.....	437
6.6.1A.3.4	Test description .....	437
6.6.1A.3.5	Test Requirements .....	439
6.6.1B	Occupied bandwidth for UL-MIMO.....	439
6.6.1B.1	Test purpose .....	439
6.6.1B.2	Test applicability.....	439
6.6.1B.3	Minimum conformance requirements .....	439
6.6.1B.4	Test description .....	440
6.6.1B.4.1	Initial conditions .....	440
6.6.1B.4.2	Test procedure .....	441
6.6.1B.4.3	Message contents.....	441
6.6.2	Out of band emission .....	441
6.6.2.1	Spectrum Emission Mask.....	441
6.6.2.1.1	Test purpose .....	441
6.6.2.1.2	Test applicability .....	441
6.6.2.1.3	Minimum conformance requirements.....	441
6.6.2.1.4	Test description .....	442



6.6.2.1.5	Test requirements .....	444
6.6.2.1_1	Spectrum Emission Mask for Multi-Cluster PUSCH.....	445
6.6.2.1_1.1	Test purpose .....	445
6.6.2.1_1.2	Test applicability .....	445
6.6.2.1_1.3	Minimum conformance requirements.....	445
6.6.2.1_1.4	Test description .....	446
6.6.2.1_1.5	Test requirements .....	447
6.6.2.1A	Spectrum emission mask for CA.....	448
6.6.2.1A.0	Minimum conformance requirements.....	448
6.6.2.1A.1	Spectrum emission mask for CA (intra-band contiguous DL CA and UL CA) .....	449
6.6.2.1A.2	Spectrum emission mask for CA (inter-band DL CA and UL CA).....	454
6.6.2.1A.3	Spectrum emission mask for CA (intra-band non-contiguous DL CA and UL CA) .....	462
6.6.2.1B	Spectrum Emission Mask for UL-MIMO .....	465
6.6.2.1B.1	Test purpose .....	465
6.6.2.1B.2	Test applicability .....	465
6.6.2.1B.3	Minimum conformance requirements.....	465
6.6.2.1B.4	Test description .....	465
6.6.2.1B.5	Test requirements .....	467
6.6.2.2	Additional Spectrum Emission Mask.....	468
6.6.2.2.1	Test purpose .....	468
6.6.2.2.2	Test applicability .....	468
6.6.2.2.3	Minimum conformance requirements.....	468
6.6.2.2.4	Test description .....	470
6.6.2.2.5	Test requirements .....	481
6.6.2.2A	Additional Spectrum Emission Mask for CA.....	485
6.6.2.2A.1	Additional Spectrum Emission Mask for CA (intra-band contiguous DL CA and UL CA) .....	485
6.6.2.2B	Additional Spectrum Emission Mask for UL-MIMO .....	488
6.6.2.2B.1	Test purpose .....	488
6.6.2.2B.2	Test applicability .....	489
6.6.2.2B.3	Minimum conformance requirements.....	489
6.6.2.2B.4	Test description .....	490
6.6.2.2B.5	Test requirements .....	497
6.6.2.3	Adjacent Channel Leakage power Ratio.....	501
6.6.2.3.1	Test purpose .....	501
6.6.2.3.2	Test applicability .....	501
6.6.2.3.3	Minimum conformance requirements.....	501
6.6.2.3.4	Test description .....	503
6.6.2.3.5	Test requirement.....	505
6.6.2.3_1	Adjacent Channel Leakage power Ratio for HPUE.....	506
6.6.2.3_1.1	Test purpose .....	506
6.6.2.3_1.2	Test applicability .....	506
6.6.2.3_1.3	Minimum conformance requirements.....	506
6.6.2.3_1.4	Test description .....	507
6.6.2.3_1.5	Test requirement.....	507
6.6.2.3_2	Adjacent Channel Leakage power Ratio for Multi-Cluster PUSCH.....	508
6.6.2.3_2.1	Test purpose .....	508
6.6.2.3_2.2	Test applicability .....	508
6.6.2.3_2.3	Minimum conformance requirements.....	508
6.6.2.3_2.4	Test description .....	510
6.6.2.3_2.5	Test requirement.....	511
6.6.2.3A	Adjacent Channel Leakage power Ratio for CA.....	512
6.6.2.3A.1	Adjacent Channel Leakage power Ratio for CA (intra-band contiguous DL CA and UL CA).....	512
6.6.2.3A.2	Adjacent Channel Leakage power Ratio for CA (inter-band DL CA and UL CA) .....	518
6.6.2.3B	Adjacent Channel Leakage power Ratio for UL-MIMO.....	523
6.6.2.3B.1	Test purpose .....	523
6.6.2.3B.2	Test applicability .....	523
6.6.2.3B.3	Minimum conformance requirements.....	523
6.6.2.3B.4	Test description .....	525
6.6.2.3B.5	Test requirement.....	527
6.6.2.4	Void.....	528
6.6.3	Spurious emissions .....	528
6.6.3.1	Transmitter Spurious emissions .....	528

6.6.3.1.1	Test purpose .....	528
6.6.3.1.2	Test applicability .....	528
6.6.3.1.3	Minimum conformance requirements.....	529
6.6.3.1.4	Test description .....	529
6.6.3.1.5	Test requirement .....	530
6.6.3.1_1	Transmitter Spurious emissions for Multi-Cluster PUSCH .....	531
6.6.3.1_1.1	Test purpose .....	531
6.6.3.1_1.2	Test applicability .....	531
6.6.3.1_1.3	Minimum conformance requirements.....	531
6.6.3.1_1.4	Test description .....	532
6.6.3.1_1.5	Test requirement .....	533
6.6.3.1A	Transmitter Spurious emissions for CA .....	534
6.6.3.1A.0	Minimum conformance requirements.....	534
6.6.3.1A.1	Transmitter Spurious emissions for CA (intra-band contiguous DL CA and UL CA).....	534
6.6.3.1A.2	Transmitter Spurious emissions for CA (inter-band DL CA and UL CA) .....	537
6.6.3.2	Spurious emission band UE co-existence .....	540
6.6.3.2.1	Test purpose .....	540
6.6.3.2.2	Test applicability .....	540
6.6.3.2.3	Minimum conformance requirements.....	540
6.6.3.2.4	Test description .....	560
6.6.3.2.5	Test requirement .....	564
6.6.3.2_1	Void.....	567
6.6.3.2A	Spurious emission band UE co-existence for CA .....	567
6.6.3.2A.0	Minimum conformance requirements.....	567
6.6.3.2A.1	Spurious emission band UE co-existence for CA (intra-band contiguous DL CA and UL CA) ...	575
6.6.3.2A.2	Spurious emission band UE co-existence for CA (inter-band DL CA and UL CA) .....	577
6.6.3.3	Additional spurious emissions .....	580
6.6.3.3.1	Test purpose .....	580
6.6.3.3.2	Test applicability .....	580
6.6.3.3.3	Minimum conformance requirements.....	580
6.6.3.3.4	Test description .....	585
6.6.3.3.5	Test requirement .....	606
6.6.3.3A	Additional spurious emissions for CA .....	612
6.6.3.3A.1	Additional spurious emissions for CA (intra-band contiguous DL CA and UL CA) .....	612
6.6.3.3A.1.4	Test description.....	614
6.6.3.3A.1.4.1	Initial conditions .....	614
6.6.3.3A.1.4.2	Test procedure.....	619
6.6.3.3A.1.4.3	Message contents .....	619
6.6.3.3A.1.5	Test requirement .....	620
6.6.3B	Spurious emission for UL-MIMO .....	623
6.6.3B.1	Transmitter Spurious emissions for UL-MIMO .....	623
6.6.3B.1.1	Test purpose .....	623
6.6.3B.1.2	Test applicability .....	623
6.6.3B.1.3	Minimum conformance requirements.....	623
6.6.3B.1.4	Test description .....	623
6.6.3B.1.5	Test requirement .....	625
6.6.3B.2	Spurious emission band UE co-existence for UL-MIMO .....	625
6.6.3B.2.1	Test purpose .....	625
6.6.3B.2.2	Test applicability .....	625
6.6.3B.2.3	Minimum conformance requirements.....	625
6.6.3B.2.4	Test description .....	626
6.6.3B.2.5	Test requirement .....	628
6.6.3B.3	Additional spurious emissions for UL-MIMO .....	630
6.6.3B.3.1	Test purpose .....	631
6.6.3B.3.2	Test applicability .....	631
6.6.3B.3.3	Minimum conformance requirements.....	631
6.6.3B.3.4	Test description .....	631
6.6.3B.3.5	Test requirement .....	647
6.7	Transmit intermodulation .....	653
6.7.1	Test purpose.....	653
6.7.2	Test applicability .....	653
6.7.3	Minimum conformance requirements.....	653

6.7.4	Test description.....	654
6.7.4.1	Initial conditions .....	654
6.7.4.3	Test procedure.....	654
6.7.4.3	Message contents .....	655
6.7.5	Test requirement .....	655
6.7A	Transmit intermodulation for CA .....	655
6.7A.1	Transmit intermodulation for CA (intra-band contiguous DL CA and UL CA).....	655
6.7A.1.1	Test purpose .....	655
6.7A.1.2	Test applicability.....	655
6.7A.1.3	Minimum conformance requirements .....	655
6.7A.1.4	Test description .....	656
6.7A.1.4.1	Initial conditions.....	656
6.7A.1.4.2	Test procedure .....	657
6.7A.1.4.3	Message contents.....	658
6.7A.1.5	Test requirement .....	658
6.7A.2	Transmit intermodulation for CA (inter-band DL CA and UL CA).....	658
6.7A.2.1	Test purpose .....	658
6.7A.2.2	Test applicability.....	658
6.7A.2.3	Minimum conformance requirements .....	659
6.7A.2.4	Test description .....	659
6.7A.2.4.1	Initial conditions.....	659
6.7A.2.4.2	Test procedure .....	659
6.7A.2.4.3	Message contents.....	659
6.7A.2.5	Test requirement .....	659
6.7B	Transmit intermodulation for UL-MIMO.....	659
6.7B.1	Test purpose.....	659
6.7B.2	Test applicability .....	659
6.7B.3	Minimum conformance requirements .....	660
6.7B.4	Test description.....	660
6.7B.4.1	Initial conditions .....	660
6.7B.4.2	Test procedure.....	661
6.7B.4.3	Message contents .....	661
6.8	Time alignment .....	661
6.8.1	Void .....	662
6.8A	Void.....	662
6.8B	Time alignment error for UL-MIMO .....	662
6.8B.1	Test purpose.....	662
6.8B.2	Test applicability .....	662
6.8B.3	Minimum conformance requirements .....	662
6.8B.4	Test description.....	662
6.8B.4.1	Initial condition .....	662
6.8B.4.2	Test procedure.....	663
6.8B.4.3	Message contents .....	663
6.8B.5	Test requirements.....	663
7	Receiver Characteristics .....	664
7.1	General .....	664
7.2	Diversity characteristics .....	665
7.3	Reference sensitivity level.....	665
7.3.1	Test purpose.....	665
7.3.2	Test applicability .....	665
7.3.3	Minimum conformance requirements .....	666
7.3.4	Test description.....	674
7.3.4.1	Initial conditions .....	674
7.3.4.2	Test procedure.....	675
7.3.4.3	Message contents .....	676
7.3.5	Test requirement .....	677
7.3A	Reference sensitivity level for CA .....	680
7.3A.0	Minimum conformance requirements .....	681
7.3A.1	Reference sensitivity level for CA (intra-band contiguous DL CA and UL CA) .....	694
7.3A.1.1	Test purpose .....	694
7.3A.1.2	Test applicability.....	694

7.3A.1.3	Minimum conformance requirements .....	694
7.3A.1.4	Test description .....	694
7.3A.1.4.1	Initial conditions .....	694
7.3A.1.4.2	Test procedure .....	695
7.3A.1.4.3	Message contents .....	696
7.3A.1.5	Test requirement .....	696
7.3A.2	Reference sensitivity level for CA (intra-band contiguous DL CA without UL CA) .....	697
7.3A.2.1	Test purpose .....	697
7.3A.2.2	Test applicability .....	697
7.3A.2.3	Minimum conformance requirements .....	697
7.3A.2.4	Test description .....	697
7.3A.2.4.1	Initial conditions .....	697
7.3A.2.4.2	Test procedure .....	698
7.3A.2.4.3	Message contents .....	699
7.3A.2.5	Test requirement .....	699
7.3A.3	Reference sensitivity level for CA (inter-band DL CA without UL CA) .....	699
7.3A.3.1	Test purpose .....	699
7.3A.3.2	Test applicability .....	699
7.3A.3.3	Minimum conformance requirements .....	699
7.3A.3.4	Test description .....	699
7.3A.3.4.1	Initial conditions .....	699
7.3A.3.4.2	Test procedure .....	707
7.3A.3.4.3	Message contents .....	707
7.3A.3.5	Test requirement .....	707
7.3A.4	Reference sensitivity level for CA (intra-band non-contiguous DL CA without UL CA) .....	712
7.3A.4.1	Test purpose .....	712
7.3A.4.2	Test applicability .....	712
7.3A.4.3	Minimum conformance requirements .....	712
7.3A.4.4	Test description .....	712
7.3A.4.4.1	Initial conditions .....	712
7.3A.4.4.2	Test procedure .....	714
7.3A.4.4.3	Message contents .....	714
7.3A.4.5	Test requirement .....	715
7.3A.5	Reference sensitivity level for CA (3DL CA without UL CA) .....	716
7.3A.5.1	Test purpose .....	717
7.3A.5.2	Test applicability .....	717
7.3A.5.3	Minimum conformance requirements .....	717
7.3A.5.4	Test description .....	717
7.3A.5.4.1	Initial conditions .....	717
7.3A.5.4.2	Test procedure .....	726
7.3A.5.4.3	Message contents .....	726
7.3A.5.5	Test requirement .....	726
7.3A.6	Reference sensitivity level for CA (inter-band DL CA and UL CA) .....	728
7.3A.6.1	Test purpose .....	729
7.3A.6.2	Test applicability .....	729
7.3A.6.3	Minimum conformance requirements .....	729
7.3A.6.4	Test description .....	729
7.3A.6.4.1	Initial conditions .....	729
7.3A.6.4.2	Test procedure .....	729
7.3A.6.4.3	Message contents .....	729
7.3A.6.5	Test requirement .....	729
7.3B	Reference sensitivity level for UL-MIMO .....	729
7.3B.1	Test purpose .....	729
7.3B.2	Test applicability .....	730
7.3B.3	Minimum conformance requirements .....	730
7.3B.4	Test description .....	730
7.3B.4.1	Initial conditions .....	730
7.3B.4.2	Test procedure .....	731
7.3B.4.3	Message contents .....	731
7.3B.4.3.1	Message contents exceptions (network signalled value "NS_01") .....	732
7.3B.4.3.2	Message contents exceptions (network signalled value "NS_03") .....	732
7.3B.4.3.3	Message contents exceptions (network signalled value "NS_06") .....	732

7.3B.4.3.4	Message contents exceptions (network signalled value "NS_[09]") .....	732
7.3B.5	Test requirement .....	732
7.4	Maximum input level .....	739
7.4.1	Test purpose.....	739
7.4.2	Test applicability .....	739
7.4.3	Minimum conformance requirements .....	739
7.4.4	Test description.....	740
7.4.4.1	Initial conditions .....	740
7.4.4.2	Test procedure.....	742
7.4.4.3	Message contents .....	742
7.4.5	Test requirement .....	742
7.4A	Maximum input level for CA .....	743
7.4A.1	Maximum input level for CA (intra-band contiguous DL CA and UL CA).....	744
7.4A.1.1	Test purpose .....	744
7.4A.1.2	Test applicability.....	744
7.4A.1.3	Minimum conformance requirements .....	744
7.4A.1.4	Test description .....	744
7.4A.1.4.1	Initial conditions .....	744
7.4A.1.4.2	Test procedure .....	746
7.4A.1.4.3	Message contents.....	746
7.4A.1.5	Test requirement .....	747
7.4A.2	Maximum input level for CA (intra-band contiguous DL CA without UL CA).....	747
7.4A.2.1	Test purpose .....	748
7.4A.2.2	Test applicability.....	748
7.4A.2.3	Minimum conformance requirements .....	748
7.4A.2.4	Test description .....	748
7.4A.2.4.1	Initial conditions.....	748
7.4A.2.4.2	Test procedure .....	749
7.4A.2.4.3	Message contents.....	750
7.4A.2.5	Test requirement .....	750
7.4A.3	Maximum input level for CA (inter-band DL CA without UL CA).....	750
7.4A.3.1	Test purpose .....	750
7.4A.3.2	Test applicability.....	750
7.4A.3.3	Minimum conformance requirements .....	751
7.4A.3.4	Test description .....	751
7.4A.3.4.1	Initial conditions.....	751
7.4A.3.4.2	Test procedure .....	752
7.4A.3.4.3	Message contents.....	753
7.4A.3.5	Test requirement .....	753
7.4A.4	Maximum input level for CA (intra band non-contiguous DL CA without UL CA).....	753
7.4A.4.1	Test purpose .....	753
7.4A.4.2	Test applicability.....	753
7.4A.4.3	Minimum conformance requirements .....	753
7.4A.4.4	Test description .....	753
7.4A.4.4.1	Initial conditions .....	753
7.4A.4.4.2	Test procedure .....	755
7.4A.4.4.3	Message contents.....	756
7.4A.4.5	Test requirement .....	756
7.4B	Maximum input level for UL-MIMO.....	763
7.4B.1	Test purpose.....	763
7.4B.2	Test applicability .....	763
7.4B.3	Minimum conformance requirements .....	763
7.4B.4	Test description.....	764
7.4B.4.1	Initial conditions .....	764
7.4B.4.2	Test procedure.....	764
7.4B.4.3	Message contents .....	765
7.4B.5	Test requirement .....	765
7.4E	Maximum input level for UE category 0.....	765
7.4E.1	Test purpose.....	765
7.4E.2	Test applicability .....	766
7.4E.3	Minimum conformance requirements .....	766
7.4E.4	Test description.....	766

7.4E.4.1	Initial conditions .....	766
7.4E.4.2	Test procedure.....	766
7.4E.4.3	Message contents .....	766
7.4E.5	Test requirement .....	767
7.5	Adjacent Channel Selectivity (ACS) .....	767
7.5.1	Test purpose.....	767
7.5.2	Test applicability .....	767
7.5.3	Minimum conformance requirements .....	767
7.5.4	Test description.....	768
7.5.4.1	Initial conditions .....	768
7.5.4.2	Test procedure.....	769
7.5.4.3	Message contents .....	770
7.5.5	Test requirement .....	770
7.5A	Adjacent Channel Selectivity (ACS) for CA.....	771
7.5A.1	Adjacent Channel Selectivity (ACS) for CA (intra-band contiguous DL CA and UL CA).....	773
7.5A.1.1	Test purpose .....	773
7.5A.1.2	Test applicability .....	773
7.5A.1.3	Minimum conformance requirements .....	774
7.5A.1.4	Test description .....	774
7.5A.1.4.1	Initial conditions .....	774
7.5A.1.4.2	Test procedure .....	775
7.5A.1.4.3	Message contents.....	776
7.5A.1.5	Test Requirements.....	776
7.5A.2	Adjacent Channel Selectivity (ACS) for CA (intra-band contiguous DL CA without UL CA) .....	777
7.5A.2.1	Test purpose .....	777
7.5A.2.2	Test applicability .....	777
7.5A.2.3	Minimum conformance requirements .....	777
7.5A.2.4	Test description .....	778
7.5A.2.4.1	Initial conditions.....	778
7.5A.2.4.2	Test procedure .....	778
7.5A.2.4.3	Message contents.....	779
7.5A.2.5	Test Requirements.....	779
7.5A.3	Adjacent Channel Selectivity (ACS) for CA (inter-band DL CA without UL CA).....	780
7.5A.3.1	Test purpose .....	780
7.5A.3.2	Test applicability.....	780
7.5A.3.3	Minimum conformance requirements .....	780
7.5A.3.4	Test description .....	780
7.5A.3.4.1	Initial conditions .....	780
7.5A.3.4.2	Test procedure .....	781
7.5A.3.4.3	Message contents.....	782
7.5A.3.5	Test Requirements.....	782
7.5A.4	Adjacent Channel Selectivity (ACS) for CA (intra-band non-contiguous DL CA without UL CA).....	783
7.5A.4.1	Test purpose .....	783
7.5A.4.2	Test applicability .....	783
7.5A.4.3	Minimum conformance requirements .....	783
7.5A.4.4	Test description .....	783
7.5A.4.4.1	Initial conditions .....	783
7.5A.4.4.2	Test procedure .....	785
7.5A.4.4.3	Message contents.....	786
7.5A.4.5	Test requirement .....	786
7.5A.5	Adjacent Channel Selectivity (ACS) for 3DL CA without UL CA .....	787
7.5B	Adjacent Channel Selectivity (ACS) for UL-MIMO .....	796
7.5B.1	Test purpose.....	796
7.5B.2	Test applicability .....	796
7.5B.3	Minimum conformance requirements .....	797
7.5B.4	Test description.....	797
7.5B.4.1	Initial conditions .....	797
7.5B.4.2	Test procedure.....	798
7.5B.4.3	Message contents .....	798
7.5B.5	Test requirement .....	798
7.5E	Adjacent Channel Selectivity (ACS) for category 0.....	799
7.5E.1	Test purpose.....	799

7.5E.2	Test applicability .....	799
7.5E.3	Minimum conformance requirements .....	799
7.5E.4	Test description.....	800
7.5E.4.1	Initial conditions .....	800
7.5E.4.2	Test procedure.....	800
7.5E.4.3	Message contents .....	800
7.5E.5	Test requirement .....	800
7.6	Blocking characteristics .....	800
7.6.1	In-band blocking.....	801
7.6.1.1	Test Purpose .....	801
7.6.1.2	Test Applicability.....	801
7.6.1.3	Minimum Conformance Requirements .....	801
7.6.1.4	Test Description .....	802
7.6.1.4.1	Initial Conditions .....	802
7.6.1.4.2	Test Procedure.....	803
7.6.1.4.3	Message Contents.....	804
7.6.1.5	Test Requirement .....	804
7.6.1A	In-band blocking for CA.....	805
7.6.1A.0	Minimum conformance requirements .....	805
7.6.1A.1	In-band blocking for CA (intra-band contiguous DL CA and UL CA) .....	807
7.6.1A.1.1	Test Purpose .....	807
7.6.1A.1.2	Test Applicability .....	807
7.6.1A.1.3	Minimum Conformance Requirements .....	807
7.6.1A.1.4	Test Description.....	807
7.6.1A.1.5	Test Requirement.....	810
7.6.1A.2	In-band blocking for CA (intra-band contiguous DL CA without UL CA) .....	811
7.6.1A.2.1	Test Purpose .....	811
7.6.1A.2.2	Test Applicability .....	811
7.6.1A.2.3	Minimum Conformance Requirements .....	811
7.6.1A.2.4	Test Description.....	811
7.6.1A.2.4.1	Initial Conditions .....	811
7.6.1A.2.4.2	Test Procedure .....	812
7.6.1A.2.4.3	Message Contents .....	813
7.6.1A.2.5	Test Requirement.....	813
7.6.1A.3	In-band blocking for CA (inter-band DL CA without UL CA) .....	814
7.6.1A.3.1	Test Purpose .....	814
7.6.1A.3.2	Test Applicability .....	814
7.6.1A.3.3	Minimum Conformance Requirements .....	814
7.6.1A.3.4	Test Description.....	814
7.6.1A.3.4.1	Initial Conditions .....	814
7.6.1A.3.4.2	Test Procedure .....	815
7.6.1A.3.4.3	Message Contents .....	816
7.6.1A.3.5	Test Requirement.....	816
7.6.1A.4	In-band blocking for CA (intra-band non-contiguous DL CA without UL CA).....	817
7.6.1A.4.1	Test Purpose .....	817
7.6.1A.4.2	Test Applicability .....	817
7.6.1A.4.3	Minimum Conformance Requirements .....	817
7.6.1A.4.4	Test description .....	817
7.6.1A.4.4.1	Initial Conditions .....	817
7.6.1A.4.4.2	Test Procedure .....	819
7.6.1A.4.4.3	Message Contents .....	820
7.6.1A.4.5	Test Requirement.....	820
7.6.1A.5	In-band blocking for CA (3DL CA without UL CA).....	821
7.6.1A.5.1	Test Purpose .....	821
7.6.1A.5.2	Test Applicability .....	821
7.6.1A.5.3	Minimum Conformance Requirements .....	821
7.6.1A.5.4	Test Description.....	821
7.6.1A.5.4.1	Initial Conditions .....	821
7.6.1A.5.4.2	Test Procedure .....	826
7.6.1A.5.4.3	Message Contents .....	828
7.6.1A.5.5	Test Requirement.....	828
7.6.1B	In-band blocking for UL-MIMO .....	830

7.6.1B.1	Test Purpose .....	830
7.6.1B.2	Test Applicability.....	830
7.6.1B.3	Minimum Conformance Requirements .....	831
7.6.1B.4	Test Description .....	831
7.6.1B.4.1	Initial Conditions .....	831
7.6.1B.4.2	Test Procedure .....	832
7.6.1B.4.3	Message Contents .....	832
7.6.1B.5	Test Requirement .....	833
7.6.1E	In-band blocking for UE category 0 .....	834
7.6.1E.1	Test Purpose .....	834
7.6.1E.2	Test Applicability.....	834
7.6.1E.3	Minimum Conformance Requirements .....	834
7.6.1E.4	Test Description .....	834
7.6.1E.4.1	Initial Conditions .....	834
7.6.1E.4.2	Test Procedure .....	835
7.6.1E.4.3	Message Contents .....	835
7.6.1E.5	Test Requirement .....	835
7.6.2	Out-of-band blocking.....	835
7.6.2.1	Test Purpose .....	835
7.6.2.2	Test Applicability.....	835
7.6.2.3	Minimum Conformance Requirements .....	836
7.6.2.4	Test Description .....	836
7.6.2.4.1	Initial Conditions .....	836
7.6.2.4.2	Test Procedure .....	837
7.6.2.4.3	Message Contents .....	838
7.6.2.5	Test Requirement .....	838
7.6.2A	Out-of-band blocking for CA.....	839
7.6.2A.0	Minimum conformance requirements .....	839
7.6.2A.1	Out-of-band blocking for CA (intra-band contiguous DL CA and UL CA) .....	841
7.6.2A.1.1	Test Purpose .....	841
7.6.2A.1.2	Test Applicability .....	841
7.6.2A.1.3	Minimum Conformance Requirements .....	841
7.6.2A.1.4	Test Description.....	841
7.6.2A.1.5	Test Requirement.....	843
7.6.2A.2	Out-of-band blocking for CA (intra-band contiguous DL CA without UL CA).....	844
7.6.2A.2.1	Test Purpose .....	844
7.6.2A.2.2	Test Applicability .....	844
7.6.2A.2.3	Minimum Conformance Requirements .....	844
7.6.2A.2.4	Test Description.....	844
7.6.2A.2.4.1	Initial Conditions .....	844
7.6.2A.2.4.2	Test Procedure .....	845
7.6.2A.2.4.3	Message Contents .....	846
7.6.2A.2.5	Test Requirement.....	846
7.6.2A.3	Out-of-band blocking for CA (inter-band DL CA without UL CA) .....	846
7.6.2A.3.1	Test Purpose .....	846
7.6.2A.3.2	Test Applicability .....	846
7.6.2A.3.3	Minimum Conformance Requirements .....	846
7.6.2A.3.4	Test Description.....	846
7.6.2A.3.4.1	Initial Conditions .....	846
7.6.2A.3.4.2	Test Procedure .....	847
7.6.2A.3.4.3	Message Contents .....	848
7.6.2A.3.5	Test Requirement.....	848
7.6.2A.4	Out-of-band blocking for CA (intra-band non-contiguous DL CA without UL CA).....	849
7.6.2A.4.1	Test Purpose .....	849
7.6.2A.4.2	Test Applicability .....	849
7.6.2A.4.3	Minimum Conformance Requirements .....	849
7.6.2A.4.4	Test description .....	849
7.6.2A.4.4.1	Initial Conditions .....	849
7.6.2A.4.4.2	Test Procedure .....	850
7.6.2A.4.4.3	Message Contents .....	851
7.6.2A.4.5	Test Requirement.....	851
7.6.2A.5	Out-of-band blocking for CA (3DL CA without UL CA).....	852



7.6.2A.5.1	Test Purpose .....	852
7.6.2A.5.2	Test Applicability .....	852
7.6.2A.5.3	Minimum Conformance Requirements .....	852
7.6.2A.5.4	Test Description.....	852
7.6.2A.5.4.1	Initial Conditions .....	852
7.6.2A.5.4.2	Test Procedure .....	857
7.6.2A.5.4.3	Message Contents .....	859
7.6.2A.5.5	Test Requirement.....	859
7.6.2B	Out-of-band blocking for UL-MIMO .....	861
7.6.2B.1	Test Purpose .....	861
7.6.2B.2	Test Applicability.....	861
7.6.2B.3	Minimum Conformance Requirements .....	861
7.6.2B.4	Test Description .....	862
7.6.2B.4.1	Initial Conditions .....	862
7.6.2B.4.2	Test Procedure .....	863
7.6.2B.4.3	Message Contents .....	863
7.6.2B.5	Test Requirement .....	863
7.6.2E	Out-of-band blocking for UE category 0 .....	864
7.6.2E.1	Test Purpose .....	864
7.6.2E.2	Test Applicability.....	864
7.6.2E.3	Minimum Conformance Requirements .....	864
7.6.2E.4	Test Description .....	864
7.6.2E.4.1	Initial Conditions .....	864
7.6.2E.4.2	Test Procedure .....	865
7.6.2E.4.3	Message Contents .....	865
7.6.2E.5	Test Requirement .....	865
7.6.3	Narrow band blocking .....	865
7.6.3.1	Test Purpose .....	865
7.6.3.2	Test Applicability.....	865
7.6.3.3	Minimum Conformance Requirements .....	865
7.6.3.4	Test Description .....	866
7.6.3.4.1	Initial Conditions .....	866
7.6.3.4.2	Test Procedure .....	867
7.6.3.4.3	Message Contents .....	868
7.6.3.5	Test Requirement .....	868
7.6.3A	Narrow band blocking for CA .....	868
7.6.3A.0	Minimum conformance requirements .....	868
7.6.3A.1	Narrow band blocking for CA (intra-band contiguous DL CA and UL CA) .....	870
7.6.3A.1.1	Test Purpose .....	870
7.6.3A.1.2	Test Applicability .....	870
7.6.3A.1.3	Minimum Conformance Requirements .....	870
7.6.3A.1.4	Test Description.....	870
7.6.3A.1.5	Test Requirement.....	873
7.6.3A.2	Narrow band blocking for CA (intra-band contiguous DL CA without UL CA).....	873
7.6.3A.2.1	Test Purpose .....	873
7.6.3A.2.2	Test Applicability .....	873
7.6.3A.2.3	Minimum Conformance Requirements .....	873
7.6.3A.2.4	Test Description.....	873
7.6.3A.2.4.1	Initial Conditions .....	873
7.6.3A.2.4.2	Test Procedure .....	874
7.6.3A.2.4.3	Message Contents .....	875
7.6.3A.2.5	Test Requirement.....	875
7.6.3A.3	Narrow band blocking for CA (inter-band DL CA without UL CA).....	875
7.6.3A.3.1	Test Purpose .....	875
7.6.3A.3.2	Test Applicability .....	875
7.6.3A.3.3	Minimum Conformance Requirements .....	875
7.6.3A.3.4	Test Description.....	875
7.6.3A.3.4.1	Initial Conditions .....	875
7.6.3A.3.4.2	Test Procedure .....	876
7.6.3A.3.4.3	Message Contents .....	877
7.6.3A.3.5	Test Requirement.....	877
7.6.3A.4	Narrow band blocking for CA (intra-band non-contiguous DL CA without UL CA) .....	877

7.6.3A.4.1	Test Purpose .....	877
7.6.3A.4.2	Test Applicability .....	878
7.6.3A.4.3	Minimum Conformance Requirements .....	878
7.6.3A.4.4	Test description .....	878
7.6.3A.4.4.1	Initial Conditions .....	878
7.6.3A.4.4.2	Test Procedure .....	879
7.6.3A.4.4.3	Message Contents .....	880
7.6.3A.4.5	Test Requirement.....	880
7.6.3A.5	Narrow band blocking for CA (3DL CA without UL CA) .....	880
7.6.3A.5.1	Test Purpose .....	880
7.6.3A.5.2	Test Applicability .....	881
7.6.3A.5.3	Minimum Conformance Requirements .....	881
7.6.3A.5.4	Test Description.....	881
7.6.3A.5.4.1	Initial Conditions .....	881
7.6.3A.5.4.2	Test Procedure .....	885
7.6.3A.5.4.3	Message Contents .....	887
7.6.3A.5.5	Test Requirement.....	887
7.6.3B	Narrow band blocking for UL-MIMO .....	887
7.6.3B.1	Test Purpose .....	887
7.6.3B.2	Test Applicability.....	888
7.6.3B.3	Minimum Conformance Requirements .....	888
7.6.3B.4	Test Description .....	888
7.6.3B.4.1	Initial Conditions .....	888
7.6.3B.4.2	Test Procedure .....	889
7.6.3B.4.3	Message Contents .....	889
7.6.3B.5	Test Requirement .....	889
7.6.3E	Narrow band blocking for UE category 0 .....	890
7.6.3E.1	Test Purpose .....	890
7.6.3E.2	Test Applicability.....	890
7.6.3E.3	Minimum Conformance Requirements .....	890
7.6.3E.4	Test Description .....	890
7.6.3E.4.1	Initial Conditions .....	890
7.6.3E.4.2	Test Procedure .....	891
7.6.3E.4.3	Message Contents .....	891
7.6.3E.5	Test Requirement .....	891
7.7	Spurious response.....	891
7.7.1	Test Purpose.....	891
7.7.2	Test Applicability .....	891
7.7.3	Minimum Conformance Requirements.....	892
7.7.4	Test Description .....	892
7.7.4.1	Initial Conditions.....	892
7.7.4.2	Test Procedure.....	892
7.7.4.3	Message Contents .....	892
7.7.5	Test Requirement.....	893
7.7A	Spurious response for CA.....	893
7.7A.0	Minimum conformance requirements .....	893
7.7A.1	Spurious response for CA (intra-band contiguous DL CA and UL CA) .....	895
7.7A.1.1	Test Purpose .....	895
7.7A.1.2	Test Applicability.....	895
7.7A.1.3	Minimum Conformance Requirements .....	895
7.7A.1.4	Test Description .....	895
7.7A.1.4.1	Initial Conditions .....	895
7.7A.1.4.2	Test Procedure .....	895
7.7A.1.4.3	Message Contents .....	896
7.7A.1.5	Test Requirement .....	896
7.7A.2	Spurious response for CA (intra-band contiguous DL CA without UL CA) .....	897
7.7A.2.1	Test Purpose.....	897
7.7A.2.2	Test Applicability.....	897
7.7A.2.3	Minimum Conformance Requirements .....	897
7.7A.2.4	Test Description .....	897
7.7A.2.4.1	Initial Conditions .....	897
7.7A.2.4.2	Test Procedure.....	897

7.7A.2.4.3	Message Contents .....	897
7.7A.2.5	Test Requirement .....	897
7.7A.3	Spurious response for CA (inter-band DL CA without UL CA) .....	898
7.7A.3.1	Test Purpose .....	898
7.7A.3.2	Test Applicability .....	898
7.7A.3.3	Minimum Conformance Requirements .....	898
7.7A.3.4	Test Description .....	898
7.7A.3.4.1	Initial Conditions .....	898
7.7A.3.4.2	Test Procedure .....	898
7.7A.3.4.3	Message Contents .....	898
7.7A.3.5	Test Requirement .....	898
7.7A.4	Spurious response for CA (intra-band non-contiguous DL CA without UL CA) .....	899
7.7A.4.1	Test Purpose .....	899
7.7A.4.2	Test Applicability .....	899
7.7A.4.3	Minimum Conformance Requirements .....	899
7.7A.4.4	Test Description .....	899
7.7A.4.4.1	Initial Conditions .....	899
7.7A.4.4.2	Test Procedure .....	899
7.7A.4.4.3	Message Contents .....	900
7.7A.4.5	Test Requirement .....	900
7.7A.5	Spurious response for CA (3DL CA without UL CA) .....	900
7.7A.5.1	Test Purpose .....	900
7.7A.5.2	Test Applicability .....	901
7.7A.5.3	Minimum Conformance Requirements .....	901
7.7A.5.4	Test Description .....	901
7.7A.5.4.1	Initial Conditions .....	901
7.7A.5.4.2	Test Procedure .....	901
7.7A.5.4.3	Message Contents .....	901
7.7A.5.5	Test Requirement .....	901
7.7B	Spurious response for UL-MIMO .....	902
7.7B.1	Test Purpose .....	902
7.7B.2	Test Applicability .....	902
7.7B.3	Minimum Conformance Requirements .....	902
7.7B.4	Test Description .....	903
7.7B.4.1	Initial Conditions .....	903
7.7B.4.2	Test Procedure .....	903
7.7B.4.3	Message Contents .....	903
7.7B.5	Test Requirement .....	903
7.7E	Spurious response for UE category 0 .....	904
7.7E.1	Test Purpose .....	904
7.7E.2	Test Applicability .....	904
7.7E.3	Minimum Conformance Requirements .....	904
7.7E.4	Test Description .....	904
7.7E.4.1	Initial Conditions .....	904
7.7E.4.2	Test Procedure .....	904
7.7E.4.3	Message Contents .....	904
7.7E.5	Test Requirement .....	904
7.8	Intermodulation characteristics .....	905
7.8.1	Wide band Intermodulation .....	905
7.8.1.1	Test purpose .....	905
7.8.1.2	Test applicability .....	905
7.8.1.3	Minimum conformance requirements .....	905
7.8.1.4	Test description .....	906
7.8.1.4.1	Initial condition .....	906
7.8.1.4.2	Test procedure .....	907
7.8.1.4.3	Message contents .....	908
7.8.1.5	Test requirements .....	908
7.8.1A	Wide band Intermodulation for CA .....	909
7.8.1A.0	Minimum conformance requirements .....	909
7.8.1A.1	Wideband intermodulation for CA (intra-band contiguous DL CA and UL CA) .....	910
7.8.1A.1.1	Test purpose .....	910
7.8.1A.1.2	Test applicability .....	911

7.8.1A.1.3	Minimum conformance requirements.....	911
7.8.1A.1.4	Test description .....	911
7.8.1A.1.4.1	Initial condition.....	911
7.8.1A.1.4.2	Test procedure.....	912
7.8.1A.1.4.3	Message contents .....	912
7.8.1A.1.5	Test requirements .....	913
7.8.1A.2	Wideband intermodulation for CA (intra-band contiguous DL CA without UL CA).....	914
7.8.1A.2.1	Test purpose .....	914
7.8.1A.2.2	Test applicability .....	914
7.8.1A.2.3	Minimum conformance requirements.....	914
7.8.1A.2.4	Test description .....	914
7.8.1A.2.4.1	Initial condition.....	914
7.8.1A.2.4.2	Test procedure.....	915
7.8.1A.2.4.3	Message contents .....	916
7.8.1A.2.5	Test requirements .....	916
7.8.1A.3	Wideband intermodulation for CA (inter-band DL CA without UL CA).....	917
7.8.1A.3.1	Test purpose .....	917
7.8.1A.3.2	Test applicability .....	917
7.8.1A.3.3	Minimum conformance requirements.....	917
7.8.1A.3.4	Test description .....	917
7.8.1A.3.4.1	Initial condition.....	917
7.8.1A.3.4.2	Test procedure.....	919
7.8.1A.3.4.3	Message contents .....	919
7.8.1A.3.5	Test requirements .....	919
7.8.1A.4	Wideband intermodulation for CA (intra band non-contiguous DL CA without UL CA).....	920
7.8.1A.4.1	Test purpose .....	920
7.8.1A.4.2	Test applicability .....	920
7.8.1A.4.3	Minimum conformance requirements.....	920
7.8.1A.4.4	Test description .....	920
7.8.1A.4.4.1	Initial condition.....	920
7.8.1A.4.4.2	Test procedure.....	923
7.8.1A.4.4.3	Message contents .....	923
7.8.1A.4.5	Test requirements .....	923
7.8.1A.5	Wideband intermodulation for CA (3DL CA without UL CA) .....	924
7.8.1A.5.1	Test purpose .....	924
7.8.1A.5.2	Test applicability .....	924
7.8.1A.5.3	Minimum conformance requirements.....	924
7.8.1A.5.4	Test description .....	924
7.8.1B	Wide band Intermodulation for UL-MIMO.....	933
7.8.1B.1	Test purpose .....	933
7.8.1B.2	Test applicability.....	933
7.8.1B.3	Minimum conformance requirements .....	933
7.8.1B.4	Test description .....	933
7.8.1B.4.1	Initial condition .....	933
7.8.1B.4.2	Test procedure .....	934
7.8.1B.4.3	Message contents.....	935
7.8.1B.5	Test requirements .....	935
7.8.1E	Wide band Intermodulation for UE category 0.....	936
7.8.1E.1	Test purpose .....	936
7.8.1E.2	Test applicability.....	936
7.8.1E.3	Minimum conformance requirements .....	936
7.8.1E.4	Test description .....	936
7.8.1E.4.1	Initial condition .....	936
7.8.1E.4.2	Test procedure .....	937
7.8.1E.4.3	Message contents.....	937
7.8.1E.5	Test requirements.....	937
7.8.2	Void .....	937
7.9	Spurious emissions .....	937
7.9.1	Test Purpose.....	937
7.9.2	Test Applicability .....	937
7.9.3	Minimum Conformance Requirements.....	938
7.9.4	Test Description .....	938

7.9.4.1	Initial Conditions.....	938
7.9.4.2	Test Procedure.....	939
7.9.4.3	Message Contents .....	939
7.9.5	Test Requirement.....	939
7.9A	Spurious emissions for CA.....	939
7.9A.1	Test Purpose.....	939
7.9A.2	Test Applicability .....	939
7.9A.3	Minimum Conformance Requirements.....	940
7.9A.4	Test Description.....	940
7.9A.4.1	Initial Conditions.....	940
7.9A.4.2	Test Procedure.....	941
7.9A.4.3	Message Contents .....	942
7.9A.5	Test Requirement.....	942
7.9E	Spurious emissions for UE category 0 .....	942
7.9E.1	Test Purpose.....	942
7.9E.2	Test Applicability .....	942
7.9E.3	Minimum Conformance Requirements.....	942
7.9E.4	Test Description.....	942
7.9E.4.1	Initial Conditions.....	942
7.9E.4.2	Test Procedure.....	943
7.9E.4.3	Message Contents .....	943
7.9E.5	Test Requirement.....	943
7.10	Void.....	943
7.10A	Receiver image for CA.....	943
8	Performance Requirement.....	944
8.1	General .....	944
8.1.1	Receiver antenna capability .....	944
8.1.1.1	Simultaneous unicast and MBMS operations.....	945
8.1.1.2	Dual-antenna receiver capability in idle mode.....	945
8.1.2	Applicability of requirements .....	945
8.1.2.1	Applicability of requirements for different channel bandwidths.....	945
8.1.2.2	Definition of CA capability.....	945
8.1.2.3	Applicability and test rules for different CA configurations and bandwidth combination sets.....	947
8.1.2.3A	.....	948
8.1.2.3B	Applicability and test rules for different TDD-FDD CA configurations and bandwidth combination sets.....	948
8.1.2.4	Test coverage for different number of component carriers .....	949
8.2	Demodulation of PDSCH (Cell-Specific Reference Symbols) .....	950
8.2.1	FDD (Fixed Reference Channel) .....	950
8.2.1.1	FDD PDSCH Single Antenna Port Performance (Cell-Specific Reference Symbols).....	951
8.2.1.1.1	FDD PDSCH Single Antenna Port Performance.....	951
8.2.1.1.1_1	FDD PDSCH Single Antenna Port Performance (Release 9 and forward) .....	955
8.2.1.1.1_2	FDD PDSCH Single Antenna Port Performance (Release 10 and forward) .....	957
8.2.1.1.1_A	FDD PDSCH Single Antenna Port Performance for CA.....	959
8.2.1.1.1_A.1	FDD PDSCH Single Antenna Port Performance for CA (2DL CA) .....	959
8.2.1.1.1_A.2	FDD PDSCH Single Antenna Port Performance for CA (3DL CA) .....	961
8.2.1.1.1_A.3	Void.....	965
8.2.1.1.2	FDD PDSCH Single Antenna Port Performance with 1 PRB in presence of MBSFN .....	965
8.2.1.2	FDD PDSCH Transmit Diversity Performance (Cell-Specific Reference Symbols).....	968
8.2.1.2.1_1	FDD PDSCH Transmit Diversity 2x2 (Release 9 and forward).....	970
8.2.1.2.2	FDD PDSCH Transmit Diversity 4x2 .....	971
8.2.1.2.2_1	FDD PDSCH Transmit Diversity 4x2 (Release 9 and forward).....	973
8.2.1.2.3	.....	974
8.2.1.2.3_C	FDD PDSCH Transmit diversity 2x2 for eICIC.....	974
8.2.1.2.3_C.1	FDD PDSCH Transmit diversity 2x2 for eICIC (non-MBSFN ABS).....	974
8.2.1.2.3_D	.....	979
8.2.1.2.3_E	FDD PDSCH Transmit diversity 2x2 for feICIC .....	979
8.2.1.2.3_E.1	FDD PDSCH Transmit diversity 2x2 for feICIC (non-MBSFN ABS) .....	979
8.2.1.2.4	FDD PDSCH Transmit Diversity 2x2 with TM3 Interference Model – Enhanced Performance Requirement Type A .....	985
8.2.1.3	FDD PDSCH Open Loop Spatial Multiplexing Performance (Cell-Specific Reference Symbols) ....	988

8.2.1.3.1	FDD PDSCH Open Loop Spatial Multiplexing 2x2.....	988
8.2.1.3.1_1	FDD PDSCH Open Loop Spatial Multiplexing 2x2 (Release 11 and forward) .....	991
8.2.1.3.1_A	FDD PDSCH Open Loop Spatial Multiplexing 2x2 for CA .....	992
8.2.1.3.1_A.1	FDD PDSCH Open Loop Spatial Multiplexing 2x2 for CA (2DL CA) .....	992
8.2.1.3.1_A.2	FDD PDSCH Open Loop Spatial Multiplexing 2x2 for CA (3DL CA) .....	995
8.2.1.3.1A	FDD Soft buffer management test .....	999
8.2.1.3.1A_A.1	FDD PDSCH Soft buffer management test for CA (2 DL CA).....	999
8.2.1.3.1A_A.2	Void .....	1002
8.2.1.3.1B	FDD PDSCH Open Loop Spatial Multiplexing 2x2 – Enhanced Performance Requirement Type C .....	1002
8.2.1.3.1B.1	Test purpose .....	1003
8.2.1.3.1B.2	Test applicability .....	1003
8.2.1.3.1B.3	Minimum conformance requirements .....	1003
8.2.1.3.1B.4	Test description .....	1003
8.2.1.3.1B.4.1	Initial conditions .....	1003
8.2.1.3.1B.4.2	Test procedure .....	1004
8.2.1.3.1B.4.3	Message contents .....	1004
8.2.1.3.1B.5	Test requirement .....	1004
8.2.1.3.1C.1	Test purpose .....	1005
8.2.1.3.1C.2	Test applicability .....	1005
8.2.1.3.1C.3	Minimum conformance requirements .....	1005
8.2.1.3.1C.4	Test description .....	1006
8.2.1.3.1C.4.1	Initial conditions .....	1006
8.2.1.3.1C.4.2	Test procedure .....	1007
8.2.1.3.1C.4.3	Message contents .....	1007
8.2.1.3.1C.5	Test requirement .....	1007
8.2.1.3.2	FDD PDSCH Open Loop Spatial Multiplexing 4x2.....	1008
8.2.1.3.3_C	FDD PDSCH Open Loop Spatial Multiplexing 2x2 for eICIC .....	1011
8.2.1.3.3_C.1	FDD PDSCH Open Loop Spatial Multiplexing 2x2 for eICIC (non-MBSFN ABS) .....	1011
8.2.1.3.3_C.2	FDD PDSCH Open Loop Spatial Multiplexing 2x2 for eICIC (MBSFN ABS) .....	1017
8.2.1.3.3_D	.....	1023
8.2.1.3.3_E	FDD PDSCH Open Loop Spatial Multiplexing 2x2 for feICIC .....	1023
8.2.1.3.3_E.1	FDD PDSCH Open Loop Spatial Multiplexing 2x2 for feICIC (demodulation subframe overlaps with aggressor cell ABS and CRS assistance information are configured, non-MBSFN ABS) .....	1023
8.2.1.4	FDD PDSCH Closed Loop Spatial Multiplexing Performance (Cell-Specific Reference Symbols) 1030	
8.2.1.4.1	FDD PDSCH Closed Loop Single/Multi Layer Spatial Multiplexing 2x2.....	1030
8.2.1.4.1_1	FDD PDSCH Closed Loop Single/Multi Layer Spatial Multiplexing 2x2 (Release 9 and forward) .....	1034
8.2.1.4.1_A to D	.....	1036
8.2.1.4.1_E	FDD PDSCH Closed Loop Single/Multi Layer Spatial Multiplexing 2x2 for feICIC .....	1036
8.2.1.4.1_E.1	FDD PDSCH Closed Loop Single/Multi Layer Spatial Multiplexing 2x2 for feICIC (non-MBSFN ABS) .....	1036
8.2.1.4.2A	FDD PDSCH Closed Loop Multi Layer Spatial Multiplexing 2x2 – Enhanced Performance Requirement Type C.....	1043
8.2.1.4.2A.1	Test purpose .....	1043
8.2.1.4.2A.2	Test applicability .....	1043
8.2.1.4.2A.3	Minimum conformance requirements .....	1044
8.2.1.4.2A.4	Test description .....	1044
8.2.1.4.2A.4.1	Initial conditions .....	1044
8.2.1.4.2A.4.2	Test procedure .....	1045
8.2.1.4.2A.4.3	Message contents .....	1045
8.2.1.4.2A.5	Test requirement .....	1045
8.2.1.4.2	FDD PDSCH Closed Loop Single/Multi Layer Spatial Multiplexing 4x2.....	1046
8.2.1.4.2_1	FDD PDSCH Closed Loop Single/Multi Layer Spatial Multiplexing 4x2 (Release 9 and forward) .....	1050
8.2.1.4.2_A	FDD PDSCH Closed Loop Multi Layer Spatial Multiplexing 4x2 for CA .....	1051
8.2.1.4.2_A.1	FDD PDSCH Closed Loop Multi Layer Spatial Multiplexing 4x2 for CA (2DL CA) .....	1051
8.2.1.4.2_A.2	FDD PDSCH Closed Loop Multi Layer Spatial Multiplexing 4x2 for CA (3DL CA) .....	1057
8.2.1.4.2_A.3	.....	1062
8.2.1.4.3	FDD PDSCH Closed Loop Single Layer Spatial Multiplexing 2x2 with TM4 Interference Model – Enhanced Performance Requirement Type A .....	1062

8.2.1.5	.....	1067
8.2.1.6	.....	1067
8.2.1.7	Carrier aggregation with power imbalance .....	1067
8.2.1.7_A.1	FDD Carrier aggregation with power imbalance (intra-band contiguous DL CA).....	1067
8.2.2	TDD (Fixed Reference Channel) .....	1070
8.2.2.1	TDD PDSCH Single Antenna Port Performance (Cell-Specific Reference Symbols).....	1072
8.2.2.1.1	TDD PDSCH Single Antenna Port Performance .....	1072
8.2.2.1.1_1	TDD PDSCH Single Antenna Port Performance (Release 9 and forward) .....	1075
8.2.2.1.1_2	TDD PDSCH Single Antenna Port Performance (Release 10 and forward) .....	1077
8.2.2.1.1_A	TDD PDSCH Single Antenna Port Performance for CA .....	1079
8.2.2.1.1_A.1	TDD PDSCH Single Antenna Port Performance for CA (2DL CA).....	1079
8.2.2.1.1_A.2	TDD PDSCH Single Antenna Port Performance for CA (3DL CA).....	1082
8.2.2.1.2	TDD PDSCH Single Antenna Port Performance with 1 PRB in the presence of MBSFN .....	1085
8.2.2.2	TDD PDSCH Transmit Diversity Performance (Cell-Specific Reference Symbols).....	1087
8.2.2.2.1	TDD PDSCH Transmit Diversity 2x2.....	1087
8.2.2.2.1_1	TDD PDSCH Transmit Diversity 2x2 (Release 9 and forward).....	1089
8.2.2.2.2	TDD PDSCH Transmit Diversity 4x2.....	1090
8.2.2.2.2_1	TDD PDSCH Transmit Diversity 4x2 (Release 9 and forward).....	1092
8.2.2.2.3_C	TDD PDSCH Transmit diversity 2x2 for eICIC .....	1093
8.2.2.2.3_C.1	TDD PDSCH Transmit diversity 2x2 for eICIC (non-MBSFN ABS) .....	1093
8.2.2.2.3_D	.....	1098
8.2.2.2.3_E	TDD PDSCH Transmit diversity 2x2 for feICIC .....	1098
8.2.2.2.3_E.1	TDD PDSCH Transmit diversity 2x2 for feICIC (non-MBSFN ABS) .....	1098
8.2.2.2.4	TDD PDSCH Transmit Diversity 2x2 with TM3 Interference Model – Enhanced Performance Requirement Type A .....	1104
8.2.2.3	TDD PDSCH Open Loop Spatial Multiplexing Performance (Cell-Specific Reference Symbols) ..	1108
8.2.2.3.1	TDD PDSCH Open Loop Spatial Multiplexing 2x2 .....	1108
8.2.2.3.1_1	TDD PDSCH Open Loop Spatial Multiplexing 2x2 (Release 11 and forward).....	1110
8.2.2.3.1_A	TDD PDSCH Open Loop Spatial Multiplexing 2x2 for CA .....	1111
8.2.2.3.1_A.1	TDD PDSCH Open Loop Spatial Multiplexing 2x2 for CA (2DL CA).....	1111
8.2.2.3.1_A.2	TDD PDSCH Open Loop Spatial Multiplexing 2x2 for CA (3DL CA).....	1114
8.2.2.3.1A	TDD Soft buffer management test.....	1118
8.2.2.3.1A_A.1	TDD PDSCH Soft buffer management test for CA (2 DL CA).....	1118
8.2.2.3.1A_A.2	Void .....	1121
8.2.2.3.1A_A.3	Void .....	1121
8.2.2.3.1B	TDD PDSCH Open Loop Spatial Multiplexing 2x2 - Enhanced Performance Requirement Type C .....	1121
8.2.2.3.1B.1	Test purpose.....	1121
8.2.2.3.1B.2	Test applicability.....	1121
8.2.2.3.1B.3	Minimum conformance requirements .....	1121
8.2.2.3.1B.4	Test description.....	1122
8.2.2.3.1B.5	Test requirement .....	1123
8.2.2.3.1C.1	Test purpose.....	1123
8.2.2.3.1C.2	Test applicability.....	1123
8.2.2.3.1C.3	Minimum conformance requirements .....	1124
8.2.2.3.1C.4	Test description.....	1124
8.2.2.3.1C.4.1	Initial conditions.....	1124
8.2.2.3.1C.4.2	Test procedure.....	1125
8.2.2.3.1C.4.3	Message contents.....	1125
8.2.2.3.1C.5	Test requirement .....	1125
8.2.2.3.2	TDD PDSCH Open Loop Spatial Multiplexing 4x2 .....	1126
8.2.2.3.3_C	TDD PDSCH Open Loop Spatial Multiplexing 2x2 for eICIC .....	1129
8.2.2.3.3_C.1	TDD PDSCH Open Loop Spatial Multiplexing 2x2 for eICIC (non-MBSFN ABS).....	1129
8.2.2.3.3_C.2	TDD PDSCH Open Loop Spatial Multiplexing 2x2 for eICIC (MBSFN ABS) .....	1135
8.2.2.3.3_D	.....	1141
8.2.2.3.3_E	TDD PDSCH Open Loop Spatial Multiplexing 2x2 for feICIC.....	1141
8.2.2.3.3_E.1	TDD PDSCH Open Loop Spatial Multiplexing 2x2 for feICIC (demodulation subframe overlaps with aggressor cell ABS and CRS assistance information are configured, non- MBSFN ABS) .....	1141
8.2.2.4	TDD PDSCH Closed Loop Spatial Multiplexing Performance (Cell-Specific Reference Symbols) .....	1148
8.2.2.4.1	TDD PDSCH Closed Loop Single/Multi Layer Spatial Multiplexing 2x2.....	1148

8.2.2.4.1_1	TDD PDSCH Closed Loop Single/Multi Layer Spatial Multiplexing 2x2 (Release 9 and forward) .....	1152
8.2.2.4.1_1.4	Test description .....	1153
8.2.2.4.1_A to D	.....	1154
8.2.2.4.1_E	TDD PDSCH Closed Loop Single/Multi Layer Spatial Multiplexing 2x2 for feICIC .....	1154
8.2.2.4.1_E.1	TDD PDSCH Closed Loop Single/Multi Layer Spatial Multiplexing 2x2 for feICIC (non-MBSFN ABS) .....	1154
8.2.2.4.2	TDD PDSCH Closed Loop Single/Multi Layer Spatial Multiplexing 4x2.....	1162
8.2.2.4.2_1	TDD PDSCH Closed Loop Multi Layer Spatial Multiplexing 4x2 (Release 9 and forward).....	1167
8.2.2.4.2_A	TDD PDSCH Closed Loop Multi Layer Spatial Multiplexing 4x2 for CA.....	1168
8.2.2.4.2_A.1	TDD PDSCH Closed Loop Multi Layer Spatial Multiplexing 4x2 for CA (2DL CA) .....	1168
8.2.2.4.2_A.2	TDD PDSCH Closed Loop Multi Layer Spatial Multiplexing 4x2 for CA (3DL CA) .....	1173
8.2.2.4.2A	TDD PDSCH Closed Loop Multi Layer Spatial Multiplexing 2x2 – Enhanced Performance Requirement Type C.....	1179
8.2.2.4.2A.1	Test purpose.....	1179
8.2.2.4.2A.2	Test applicability.....	1179
8.2.2.4.2A.3	Minimum conformance requirements .....	1179
8.2.2.4.2A.4	Test description.....	1180
8.2.2.4.2A.4.1	Initial conditions.....	1180
8.2.2.4.2A.4.2	Test procedure .....	1181
8.2.2.4.2A.4.3	Message contents.....	1181
8.2.2.4.2A.5	Test requirement .....	1182
8.2.2.4.3	TDD PDSCH Closed Loop Single Layer Spatial Multiplexing 2x2 with TM4 Interference Model – Enhanced Performance Requirement Type A .....	1182
8.2.2.5	.....	1187
8.2.2.6	.....	1187
8.2.2.7	Carrier aggregation with power imbalance .....	1187
8.2.2.7_A.1	TDD Carrier aggregation with power imbalance (intra-band contiguous DL CA) .....	1187
8.2.3	TDD FDD CA (Fixed Reference Channel).....	1190
8.2.3.1_A	TDD FDD CA PDSCH Single Antenna Port Performance.....	1191
8.2.3.1_A.1	TDD FDD CA PDSCH Single Antenna Port Performance for FDD PCell (2DL CA) .....	1191
8.2.3.1_A.2	TDD FDD CA PDSCH Single Antenna Port Performance for TDD PCell (2DL CA) .....	1195
8.2.3.1_A.3	TDD FDD CA PDSCH Single Antenna Port Performance for FDD PCell (3DL CA) .....	1198
8.2.3.1_A.4	TDD FDD CA PDSCH Single Antenna Port Performance for TDD PCell (3DL CA) .....	1202
8.2.3.3.2.1	TDD FDD CA PDSCH Closed Loop Multi Layer Spatial Multiplexing 4x2 for TDD PCell (2DL CA) .....	1205
8.2.3.3.2.2	TDD FDD CA PDSCH Closed Loop Multi Layer Spatial Multiplexing 4x2 for TDD PCell (3DL CA) .....	1212
8.3	Demodulation of PDSCH (User-Specific Reference Symbols).....	1214
8.3.1	FDD .....	1214
8.3.1.1	FDD PDSCH Single-layer Spatial Multiplexing Performance (UE-Specific Reference Symbols) ..	1215
8.3.1.1.1_D	FDD PDSCH Single-layer Spatial Multiplexing on antenna ports 7 or 8 without a simultaneous transmission for eDL-MIMO.....	1215
8.3.1.1.1_D.1	Test purpose.....	1215
8.3.1.1.1_D.2	Test applicability.....	1215
8.3.1.1.1_D.3	Minimum conformance requirements .....	1215
8.3.1.1.1_D.4	Test description.....	1217
8.3.1.1.2_D	FDD PDSCH Single-layer Spatial Multiplexing on antenna ports 7 or 8 with a simultaneous transmission for eDL-MIMO.....	1220
8.3.1.1.2_D.1	Test purpose.....	1220
8.3.1.1.2_D.2	Test applicability.....	1220
8.3.1.1.2_D.3	Minimum conformance requirements .....	1220
8.3.1.1.2_D.4	Test description.....	1222
8.3.1.1.3	FDD PDSCH Single-layer Spatial Multiplexing on antenna ports 7 or 8 with TM9 Interference Model - Enhanced Performance Requirement Type A.....	1225
8.3.1.1.3.1	Test purpose.....	1225
8.3.1.1.3.2	Test applicability.....	1225
8.3.1.1.3.3	Minimum conformance requirements .....	1225
8.3.1.1.3.4	Test description.....	1227
8.3.1.2	FDD PDSCH Dual-layer Spatial Multiplexing Performance (UE-Specific Reference Symbols)....	1232
8.3.1.2.1_D	FDD PDSCH Dual-layer Spatial Multiplexing for eDL-MIMO .....	1232
8.3.1.2.1_D.1	Test purpose.....	1232



8.3.1.2.1_D.2	Test applicability.....	1232
8.3.1.2.1_D.3	Minimum conformance requirements .....	1232
8.3.1.2.1_D.4	Test description.....	1233
8.3.1.2.1_D.4.2	Test procedure.....	1234
8.3.1.2.1_D.4.3	Message contents.....	1234
8.3.1.2.1_D.5	Test requirement .....	1235
8.3.1.2.1_D_1	FDD PDSCH Dual-layer Spatial Multiplexing for eDL-MIMO (Release 11 and forward).....	1236
8.3.1.2.1_D_1.1	Test purpose.....	1236
8.3.1.2.1_D_1.2	Test applicability.....	1236
8.3.1.2.1_D_1.3	Minimum conformance requirements .....	1236
8.3.1.2.1_D_1.4	Test description.....	1238
8.3.1.2.1_D_1.4.2	Test procedure.....	1238
8.3.1.2.1_D_1.4.3	Message contents.....	1238
8.3.1.2.1_D_1.5	Test requirement.....	1240
8.3.1.2.2	FDD PDSCH Dual-layer Spatial Multiplexing – Enhanced Performance Requirement Type C.....	1241
8.3.1.2.2.1	Test purpose.....	1242
8.3.1.2.2.2	Test applicability.....	1242
8.3.1.2.2.3	Minimum conformance requirements .....	1242
8.3.1.2.2.4	Test description.....	1243
8.3.1.2.2.4.1	Initial conditions.....	1243
8.3.1.2.2.4.2	Test procedure.....	1244
8.3.1.2.2.4.3	Message contents.....	1244
8.3.1.2.2.5	Test requirement .....	1245
8.3.1.3	FDD PDSCH Performance with DCI format 2D and non Quasi Co-located Antenna Ports .....	1246
8.3.1.3.1_F	FDD PDSCH Performance with DCI format 2D, non Quasi Co-located Antenna Ports, Same Cell ID and single NZP CSI-RS resource for CoMP.....	1246
8.3.1.3.1_F.1	Test purpose.....	1246
8.3.1.3.1_F.2	Test applicability.....	1246
8.3.1.3.1_F.3	Minimum conformance requirements .....	1246
8.3.1.3.1_F.4	Test description.....	1248
8.3.1.3.1_F.4.1	Initial conditions.....	1248
8.3.1.3.1_F.4.2	Test procedure.....	1248
8.3.1.3.1_F.4.3	Message contents.....	1249
8.3.1.3.1_F.5	Test requirement .....	1250
8.3.1.3.2_F	FDD PDSCH Performance with DCI format 2D, non Quasi Co-located Antenna Ports, Same Cell ID and multiple NZP CSI-RS resources for CoMP .....	1251
8.3.1.3.2_F.1	Test purpose.....	1251
8.3.1.3.2_F.2	Test applicability.....	1251
8.3.1.3.2_F.3	Minimum conformance requirements .....	1251
8.3.1.3.2_F.4	Test description.....	1253
8.3.1.3.2_F.4.1	Initial conditions.....	1253
8.3.1.3.2_F.4.2	Test procedure.....	1253
8.3.1.3.2_F.4.3	Message contents.....	1254
8.3.1.3.2_F.5	Test requirements.....	1256
8.3.1.3.3_F	FDD PDSCH Performance with DCI format 2D, non Quasi Co-located Antenna Ports, Different Cell ID, Colliding CRS and single NZP CSI-RS resource for CoMP.....	1257
8.3.1.3.3_F.1	Test purpose.....	1257
8.3.1.3.3_F.2	Test applicability.....	1257
8.3.1.3.3_F.3	Minimum conformance requirements .....	1257
8.3.1.3.3_F.4	Test description.....	1259
8.3.1.3.3_F.4.1	Initial conditions.....	1259
8.3.1.3.3_F.4.2	Test procedure.....	1259
8.3.1.3.3_F.4.3	Message contents.....	1259
8.3.1.3.3_F.5	Test requirements.....	1261
8.3.2	TDD.....	1261
8.3.2.1	TDD PDSCH Single-layer Spatial Multiplexing Performance (UE-Specific Reference Symbols) ..	1262
8.3.2.1.1	TDD PDSCH Single-layer Spatial Multiplexing on antenna port 5 (Release 8 and forward) .....	1262
8.3.2.1.1_1	TDD PDSCH Single-layer Spatial Multiplexing on antenna port 5 (Release 9 and forward) .....	1265
8.3.2.1.2	TDD PDSCH Single-layer Spatial Multiplexing on antenna port 7 or 8 without a simultaneous transmission.....	1267

8.3.2.1.2_D	TDD PDSCH Single-layer Spatial Multiplexing on antenna ports 7 or 8 without a simultaneous transmission for eDL-MIMO.....	1269
8.3.2.1.3	TDD PDSCH Single-layer Spatial Multiplexing on antenna port 7 or 8 with a simultaneous transmission.....	1274
8.3.2.1.3_D	TDD PDSCH Single-layer Spatial Multiplexing on antenna ports 7 or 8 with a simultaneous transmission for eDL-MIMO.....	1276
8.3.2.1.4	TDD PDSCH Single-layer Spatial Multiplexing on antenna ports 7 or 8 with TM9 Interference Model - Enhanced Performance Requirement Type A.....	1281
8.3.2.1.4.1	Test purpose.....	1281
8.3.2.1.4.2	Test applicability.....	1281
8.3.2.1.4.3	Minimum conformance requirements.....	1281
8.3.2.1.4.4	Test description.....	1283
8.3.2.1.4.5	Test requirement.....	1286
8.3.2.2	TDD PDSCH Dual-layer Spatial Multiplexing Performance (UE-Specific Reference Symbols) ....	1288
8.3.2.2.1	TDD PDSCH Dual-layer Spatial Multiplexing .....	1288
8.3.2.2.1_D	TDD PDSCH Dual-layer Spatial Multiplexing for eDL-MIMO .....	1291
8.3.2.2.1_D.1	Test purpose.....	1291
8.3.2.2.1_D.2	Test applicability.....	1291
8.3.2.2.1_D.3	Minimum conformance requirements.....	1291
8.3.2.2.1_D.4	Test description.....	1292
8.3.2.2.1_D.4.2	Test procedure.....	1293
8.3.2.2.1_D.4.3	Message contents.....	1293
8.3.2.2.1_D.5	Test requirement.....	1294
8.3.2.2.1_D_1	TDD PDSCH Dual-layer Spatial Multiplexing for eDL-MIMO (Release 11 and forward).....	1295
8.3.2.2.1_D_1.1	Test purpose.....	1295
8.3.2.2.1_D_1.2	Test applicability.....	1295
8.3.2.2.1_D_1.3	Minimum conformance requirements.....	1295
8.3.2.2.1_D_1.4	Test description.....	1297
8.3.2.2.1_D_1.4.2	Test procedure.....	1297
8.3.2.2.1_D_1.4.3	Message contents.....	1297
8.3.2.2.1_D_1.5	Test requirement.....	1299
8.3.2.2.2	TDD PDSCH Dual-layer Spatial Multiplexing – Enhanced Performance Requirement Type C	1300
8.3.2.2.2.1	Test purpose.....	1301
8.3.2.2.2.2	Test applicability.....	1301
8.3.2.2.2.3	Minimum conformance requirements.....	1301
8.3.2.2.2.4	Test description.....	1302
8.3.2.2.2.4.1	Initial conditions.....	1302
8.3.2.2.2.4.2	Test procedure.....	1302
8.3.2.2.2.4.3	Message contents.....	1302
8.3.2.2.2.5	Test requirement.....	1303
8.3.2.3	Dual-Layer Spatial Multiplexing (with multiple CSI-RS configurations) .....	1303
8.3.2.4	TDD PDSCH Performance with DCI format 2D and non Quasi Co-located Antenna Ports .....	1303
8.3.2.4.1_F	TDD PDSCH Performance with DCI format 2D, non Quasi Co-located Antenna Ports, Same Cell ID and single NZP CSI-RS resource for CoMP.....	1303
8.3.2.4.1_F.1	Test purpose.....	1303
8.3.2.4.1_F.2	Test applicability.....	1304
8.3.2.4.1_F.3	Minimum conformance requirements.....	1304
8.3.2.4.1_F.4	Test description.....	1305
8.3.2.4.1_F.4.1	Initial conditions.....	1305
8.3.2.4.1_F.4.2	Test procedure.....	1306
8.3.2.4.1_F.4.3	Message contents.....	1306
8.3.2.4.1_F.5	Test requirement.....	1307
8.3.2.4.2_F	TDD PDSCH Performance with DCI format 2D, non Quasi Co-located Antenna Ports, Same Cell ID and multiple NZP CSI-RS resources for CoMP .....	1308
8.3.2.4.2_F.1	Test purpose.....	1308
8.3.2.4.2_F.2	Test applicability.....	1308
8.3.2.4.2_F.3	Minimum conformance requirements.....	1308
8.3.2.4.2_F.4	Test description.....	1310
8.3.2.4.2_F.4.1	Initial conditions.....	1310
8.3.2.4.2_F.4.2	Test procedure.....	1310
8.3.2.4.2_F.4.3	Message contents.....	1311
8.3.2.4.2_F.5	Test requirements.....	1313

8.3.2.4.3_F	TDD PDSCH Performance with DCI format 2D, non Quasi Co-located Antenna Ports, Different Cell ID, Colliding CRS and single NZP CSI-RS resource for CoMP.....	1314
8.3.2.4.3_F.1	Test purpose.....	1314
8.3.2.4.3_F.2	Test applicability.....	1314
8.3.2.4.3_F.3	Minimum conformance requirements.....	1314
8.3.2.4.3_F.4	Test description.....	1316
8.3.2.4.3_F.4.1	Initial conditions.....	1316
8.3.2.4.3_F.4.2	Test procedure.....	1316
8.3.2.4.3_F.4.3	Message contents.....	1316
8.3.2.4.3_F.5	Test requirements.....	1318
8.4	Demodulation of PCFICH/PDCCH.....	1319
8.4.1	FDD.....	1319
8.4.1.1	FDD PCFICH/PDCCH Single-antenna Port Performance.....	1319
8.4.1.1.1	Test purpose.....	1319
8.4.1.1.2	Test applicability.....	1319
8.4.1.1.3	Minimum conformance requirements.....	1319
8.4.1.1.4	Test description.....	1320
8.4.1.1.5	Test requirement.....	1320
8.4.1.2	FDD PCFICH/PDCCH Transmit Diversity Performance.....	1321
8.4.1.2.1	FDD PCFICH/PDCCH Transmit Diversity 2x2.....	1321
8.4.1.2.1_1	FDD PCFICH/PDCCH Transmit Diversity 2x2 (Release 9 and forward).....	1323
8.4.1.2.2	FDD PCFICH/PDCCH Transmit Diversity 4x2.....	1326
8.4.1.2.2_1	FDD PCFICH/PDCCH Transmit Diversity 4x2 (Release 9 and forward).....	1328
8.4.1.2.3	.....	1330
8.4.1.2.3_C	FDD PCFICH/PDCCH Transmit Diversity 2x2 for eICIC.....	1330
8.4.1.2.3_C.1	FDD PCFICH/PDCCH Transmit Diversity 2x2 for eICIC (non-MBSFN ABS).....	1330
8.4.1.2.3_C.2	FDD PCFICH/PDCCH Transmit Diversity 2x2 for eICIC (MBSFN ABS).....	1336
8.4.1.2.3_D	.....	1342
8.4.1.2.3_E	FDD PCFICH/PDCCH Transmit Diversity 2x2 for feICIC.....	1342
8.4.1.2.3_E.1	FDD PCFICH/PDCCH Transmit Diversity 2x2 for feICIC (non-MBSFN ABS).....	1342
8.4.1.2.3_E.2	FDD PCFICH/PDCCH Transmit Diversity 2x2 for feICIC (MBSFN ABS).....	1348
8.4.2	TDD.....	1354
8.4.2.1	TDD PCFICH/PDCCH Single-antenna Port Performance.....	1354
8.4.2.1.1	Test purpose.....	1354
8.4.2.1.2	Test applicability.....	1354
8.4.2.1.3	Minimum conformance requirements.....	1354
8.4.2.1.4	Test description.....	1355
8.4.2.1.5	Test requirement.....	1356
8.4.2.2	TDD PCFICH/PDCCH Transmit Diversity Performance.....	1356
8.4.2.2.1	TDD PCFICH/PDCCH Transmit Diversity 2x2.....	1356
8.4.2.2.1_1	TDD PCFICH/PDCCH Transmit Diversity 2x2 (Release 9 and forward).....	1359
8.4.2.2.1_1.2	Test applicability.....	1359
8.4.2.2.2	TDD PCFICH/PDCCH Transmit Diversity 4x2.....	1361
8.4.2.2.2_1	TDD PCFICH/PDCCH Transmit Diversity 4x2 (Release 9 and forward).....	1364
8.4.2.2.3_C	TDD PCFICH/PDCCH Transmit Diversity 2x2 for eICIC.....	1366
8.4.2.2.3_C.1	TDD PCFICH/PDCCH Transmit Diversity 2x2 for eICIC (non-MBSFN ABS).....	1366
8.4.2.2.3_C.2	TDD PCFICH/PDCCH Transmit Diversity 2x2 for eICIC (MBSFN ABS).....	1373
8.4.2.2.3_D	.....	1379
8.4.2.2.3_E	TDD PCFICH/PDCCH Transmit Diversity 2x2 for feICIC.....	1379
8.4.2.2.3_E.1	TDD PCFICH/PDCCH Transmit Diversity 2x2 for feICIC (non-MBSFN ABS).....	1379
8.4.2.2.3_E.2	TDD PCFICH/PDCCH Transmit Diversity 2x2 for feICIC (MBSFN ABS).....	1385
8.5	Demodulation of PHICH.....	1391
8.5.1	FDD.....	1391
8.5.1.1	FDD PHICH Single-antenna Port Performance.....	1391
8.5.1.1.1	Test purpose.....	1391
8.5.1.1.2	Test applicability.....	1391
8.5.1.1.3	Minimum conformance requirements.....	1391
8.5.1.1.4	Test description.....	1392
8.5.1.1.5	Test requirement.....	1393
8.5.1.2	FDD PHICH Transmit Diversity Performance.....	1394
8.5.1.2.1	FDD PHICH Transmit Diversity 2x2.....	1394
8.5.1.2.1_1	FDD PHICH Transmit Diversity 2x2 (Release 9 and forward).....	1397

8.5.1.2.2	FDD PHICH Transmit Diversity 4x2 .....	1399
8.5.1.2.2_1	FDD PHICH Transmit Diversity 4x2 (Release 9 and forward).....	1402
8.5.1.2.3	.....	1404
8.5.1.2.3_A	.....	1404
8.5.1.2.3_B	.....	1404
8.5.1.2.3_C	FDD PHICH Transmit Diversity 2x2 for eICIC.....	1404
8.5.1.2.3_C.1	FDD PHICH Transmit Diversity 2x2 for eICIC (non-MBSFN ABS).....	1404
8.5.1.2.3_D	1410	
8.5.1.2.3_E	FDD PHICH Transmit Diversity 2x2 for feICIC .....	1410
8.5.1.2.3_E.1	FDD PHICH Transmit Diversity 2x2 for feICIC (non-MBSFN ABS) .....	1410
8.5.2	TDD.....	1416
8.5.2.1	TDD PHICH Single-antenna Port Performance.....	1416
8.5.2.1.1	Test purpose .....	1416
8.5.2.1.2	Test applicability .....	1416
8.5.2.1.3	Minimum conformance requirements.....	1416
8.5.2.1.4	Test description .....	1417
8.5.2.1.5	Test requirement .....	1419
8.5.2.2	TDD PHICH Transmit Diversity Performance .....	1419
8.5.2.2.1	TDD PHICH Transmit Diversity 2x2.....	1419
8.5.2.2.1_1	TDD PHICH Transmit Diversity 2x2 (Release 9 and forward).....	1422
8.5.2.2.2	TDD PHICH Transmit Diversity 4x2.....	1425
8.5.2.2.2_1	TDD PHICH Transmit Diversity 4x2 (Release 9 and forward).....	1427
8.5.2.2.3	.....	1430
8.5.2.2.3_A	.....	1430
8.5.2.2.3_B	.....	1430
8.5.2.2.3_C	TDD PHICH Transmit Diversity 2x2 for eICIC .....	1430
8.5.2.2.3_C.1	TDD PHICH Transmit Diversity 2x2 for eICIC (non-MBSFN ABS) .....	1430
8.5.2.2.3_D	.....	1436
8.5.2.2.3_E	TDD PHICH Transmit Diversity 2x2 for feICIC .....	1436
8.5.2.2.3_E.1	TDD PHICH Transmit Diversity 2x2 for feICIC (non-MBSFN ABS) .....	1436
8.6	Demodulation of PBCH .....	1442
8.7	Sustained downlink data rate provided by lower layers .....	1442
8.7.1	FDD .....	1442
8.7.1.1	FDD sustained data rate performance .....	1443
8.7.1.1.1	Test purpose .....	1443
8.7.1.1.2	Test applicability .....	1444
8.7.1.1.3	Minimum requirements .....	1444
8.7.1.1.4	Test description .....	1445
8.7.1.1.5	Test requirement .....	1447
8.7.1.1_1	FDD sustained data rate performance (Rel-10 and forward) .....	1448
8.7.1.1_1.1	Test purpose .....	1448
8.7.1.1_1.2	Test applicability .....	1448
8.7.1.1_1.3	Minimum requirements .....	1448
8.7.1.1_1.4	Test description .....	1449
8.7.1.1_1.5	Test requirement .....	1449
8.7.1.1_A	FDD sustained data rate performance for CA .....	1450
8.7.1.1_A.1	FDD Sustained data rate performance for CA (2DL CA) .....	1450
8.7.1.1_A.2	FDD Sustained data rate performance for CA (3DL CA) .....	1457
8.7.1.1_A.3	Void.....	1465
8.7.2	TDD.....	1465
8.7.2.1	TDD sustained data rate performance .....	1466
8.7.2.1.1	Test purpose .....	1466
8.7.2.1.2	Test applicability .....	1467
8.7.2.1.3	Minimum requirements .....	1467
8.7.2.1.4	Test description .....	1468
8.7.2.1.5	Test requirement .....	1471
8.7.2.1_1	TDD sustained data rate performance (Rel-10 and forward) .....	1471
8.7.2.1_1.1	Test purpose .....	1471
8.7.2.1_1.2	Test applicability .....	1471
8.7.2.1_1.3	Minimum requirements .....	1471
8.7.2.1_1.4	Test description .....	1472
8.7.2.1_1.5	Test requirement .....	1472

8.7.2.1_A	TDD sustained data rate performance for CA .....	1473
8.7.2.1_A.1	TDD sustained data rate performance for CA (2DL CA) .....	1473
8.7.2.1_A.2	Void .....	1478
8.7.2.1_A.3	Void .....	1478
8.7.2.1_A.4	TDD Sustained data rate performance for CA (3DL CA) .....	1478
8.7.3	FDD (EPDCCH scheduling) .....	1484
8.7.3.1	FDD sustained data rate performance for EPDCCH scheduling .....	1485
8.7.3.1.1	Test purpose .....	1485
8.7.3.1.2	Test applicability .....	1485
8.7.3.1.3	Minimum requirements .....	1486
8.7.3.1.4	Test description .....	1487
8.7.3.1.5	Test requirement .....	1490
8.7.4	TDD (EPDCCH scheduling) .....	1491
8.7.4.1	TDD sustained data rate performance for EPDCCH scheduling .....	1492
8.7.4.1.1	Test purpose .....	1492
8.7.4.1.2	Test applicability .....	1492
8.7.4.1.3	Minimum requirements .....	1493
8.7.4.1.4	Test description .....	1494
8.7.4.1.5	Test requirement .....	1497
8.7.5	TDD FDD CA Sustained data rate performance .....	1497
8.7.5.1	TDD FDD CA Sustained data rate performance for FDD PCell .....	1498
8.7.5.1.1	TDD FDD CA Sustained data rate performance for FDD PCell (2DL CA) .....	1498
8.7.5.1.1.1	Test purpose .....	1498
8.7.5.1.1.2	Test applicability .....	1499
8.7.5.1.1.3	Minimum requirements .....	1499
8.7.5.1.1.4	Test description .....	1500
8.7.5.1.1.5	Test requirement .....	1503
8.7.5.1.2	TDD FDD CA Sustained data rate performance for FDD PCell (3DL CA) .....	1504
8.7.5.1.2.1	Test purpose .....	1504
8.7.5.1.2.2	Test applicability .....	1504
8.7.5.1.2.3	Minimum requirements .....	1504
8.7.5.1.2.4	Test description .....	1506
8.7.5.1.2.5	Test requirement .....	1509
8.7.5.2	TDD FDD CA Sustained data rate performance for TDD PCell .....	1510
8.7.5.2.1	TDD FDD CA Sustained data rate performance for TDD PCell (2DL CA) .....	1510
8.7.5.2.1.1	Test purpose .....	1510
8.7.5.2.1.2	Test applicability .....	1510
8.7.5.2.1.3	Minimum requirements .....	1510
8.7.5.2.1.4	Test description .....	1512
8.7.5.2.1.5	Test requirement .....	1515
8.7.5.2.2	TDD FDD CA Sustained data rate performance for TDD PCell (3DL CA) .....	1516
8.7.5.2.2.1	Test purpose .....	1516
8.7.5.2.2.2	Test applicability .....	1516
8.7.5.2.2.3	Minimum requirements .....	1516
8.7.5.2.2.4	Test description .....	1518
8.7.5.2.2.5	Test requirement .....	1521
8.8	Demodulation of EPDCCH .....	1522
8.8.1	Distributed Transmission .....	1522
8.8.1.1	FDD distributed EPDCCH performance .....	1522
8.8.1.1.1	Test purpose .....	1522
8.8.1.1.2	Test applicability .....	1522
8.8.1.1.3	Minimum conformance requirements .....	1522
8.8.1.1.4	Test description .....	1523
8.8.1.1.5	Test requirement .....	1524
8.8.1.2	TDD distributed EPDCCH performance .....	1525
8.8.1.2.1	Test purpose .....	1525
8.8.1.2.2	Test applicability .....	1525
8.8.1.2.3	Minimum conformance requirements .....	1525
8.8.1.2.4	Test description .....	1526
8.8.1.2.5	Test requirement .....	1527
8.8.2	Localized Transmission with TM9 .....	1527
8.8.2.1	FDD localized EPDCCH performance with TM9 .....	1527

8.8.2.1.1	Test purpose .....	1527
8.8.2.1.2	Test applicability .....	1527
8.8.2.1.3	Minimum conformance requirements .....	1527
8.8.2.1.4	Test description .....	1529
8.8.2.1.5	Test requirement .....	1530
8.8.2.2	TDD localized EPDCCH performance with TM9 .....	1530
8.8.2.2.1	Test purpose .....	1530
8.8.2.2.2	Test applicability .....	1530
8.8.2.2.3	Minimum conformance requirements .....	1530
8.8.2.2.4	Test description .....	1532
8.8.2.2.5	Test requirement .....	1533
8.8.3	Localized transmission with TM10 Type B quasi co-location type .....	1533
8.8.3.1	FDD localized EPDCCH transmission with TM10 Type B quasi co-location type .....	1533
8.8.3.1.1	Test purpose .....	1533
8.8.3.1.2	Test applicability .....	1533
8.8.3.1.3	Minimum conformance requirements .....	1533
8.8.3.1.4	Test description .....	1535
8.8.3.1.5	Test requirement .....	1538
8.8.3.2	TDD localized EPDCCH transmission with TM10 Type B quasi co-location type .....	1538
8.8.3.2.1	Test purpose .....	1538
8.8.3.2.2	Test applicability .....	1538
8.8.3.2.3	Minimum conformance requirements .....	1538
8.8.3.2.4	Test description .....	1540
8.8.3.2.5	Test requirement .....	1543
8.9	Demodulation (Single receiver antenna) .....	1543
8.9.1	PDSCH .....	1543
8.9.1.1	FDD and half-duplex FDD (Fixed Reference Channel) .....	1543
8.9.1.1.1	Transmit diversity performance (Cell-Specific Reference Symbols) .....	1543
9	Reporting of Channel State Information .....	1546
9.1	General .....	1546
9.1.1	Applicability of requirements .....	1546
9.1.1.1	Applicability of requirements for different channel bandwidths .....	1546
9.1.1.2	Applicability and test rules for different CA configurations and bandwidth combination sets .....	1546
9.1.1.2A	Applicability and test rules for different TDD-FDD CA configurations and bandwidth combination sets .....	1547
9.1.1.3	Test coverage for different number of component carriers .....	1548
9.2	CQI Reporting under AWGN conditions .....	1548
9.2.1	CQI Reporting under AWGN conditions - PUCCH 1-0 (Cell-Specific Reference Symbols) .....	1548
9.2.1.1	FDD CQI Reporting under AWGN conditions – PUCCH 1-0 .....	1548
9.2.1.1.1	Test purpose .....	1548
9.2.1.1.2	Test applicability .....	1548
9.2.1.1.3	Minimum conformance requirements .....	1549
9.2.1.1.4	Test description .....	1550
9.2.1.1.5	Test requirement .....	1552
9.2.1.2	TDD CQI Reporting under AWGN conditions – PUCCH 1-0 .....	1552
9.2.1.2.1	Test purpose .....	1552
9.2.1.2.2	Test applicability .....	1552
9.2.1.2.3	Minimum conformance requirements .....	1552
9.2.1.2.4	Test description .....	1553
9.2.1.2.5	Test requirement .....	1555
9.2.1.3	.....	1555
9.2.1.3_C	FDD CQI Reporting under AWGN conditions – PUCCH 1-0 for eICIC .....	1555
9.2.1.3_C.1	FDD CQI Reporting under AWGN conditions – PUCCH 1-0 for eICIC (non-MBSFN ABS) ..	1555
9.2.1.4	.....	1561
9.2.1.4_C	TDD CQI Reporting under AWGN conditions – PUCCH 1-0 for eICIC .....	1561
9.2.1.4_C.1	TDD CQI Reporting under AWGN conditions – PUCCH 1-0 for eICIC (non-MBSFN ABS) ..	1561
9.2.1.5	.....	1568
9.2.1.5_E	FDD CQI Reporting under AWGN conditions – PUCCH 1-0 for feICIC .....	1568
9.2.1.5_E.1	FDD CQI Reporting under AWGN conditions – PUCCH 1-0 for feICIC (non-MBSFN ABS) ..	1568
9.2.1.5_E.1.1	Test purpose .....	1568
9.2.1.5_E.1.2	Test applicability .....	1568

9.2.1.5_E.1.3	Minimum conformance requirements.....	1568
9.2.1.5_E.1.4	Test description .....	1570
9.2.1.5_E.1.5	Test requirement .....	1575
9.2.1.6	.....	1575
9.2.1.6_E	TDD CQI Reporting under AWGN conditions – PUCCH 1-0 for feICIC.....	1575
9.2.1.6_E.1	TDD CQI Reporting under AWGN conditions – PUCCH 1-0 for feICIC (non-MBSFN ABS).....	1575
9.2.1.6_E.1.1	Test purpose .....	1575
9.2.1.6_E.1.2	Test applicability .....	1576
9.2.1.6_E.1.3	Minimum conformance requirements.....	1576
9.2.1.6_E.1.4	Test description .....	1578
9.2.1.6_E.1.5	Test requirement.....	1582
9.2.2	CQI Reporting under AWGN conditions - PUCCH 1-1 (Cell-Specific Reference Symbols) .....	1582
9.2.2.1	FDD CQI Reporting under AWGN conditions – PUCCH 1-1 .....	1582
9.2.2.1.1	Test purpose .....	1582
9.2.2.1.2	Test applicability .....	1582
9.2.2.1.3	Minimum conformance requirements.....	1582
9.2.2.1.4	Test description .....	1583
9.2.2.1.5	Test requirement .....	1585
9.2.2.1_D.5	Test requirement .....	1585
9.2.2.2	TDD CQI Reporting under AWGN conditions – PUCCH 1-1 .....	1586
9.2.2.2.1	Test purpose .....	1586
9.2.2.2.2	Test applicability .....	1586
9.2.2.2.3	Minimum conformance requirements.....	1586
9.2.2.2.4	Test description .....	1587
9.2.2.2.5	Test requirement .....	1590
9.2.3	CQI Reporting under AWGN conditions - PUCCH 1-1 (CSI Reference Symbols).....	1590
9.2.3.1_D	FDD CQI Reporting under AWGN conditions – PUCCH 1-1 for eDL-MIMO .....	1590
9.2.3.1_D.1	Test purpose .....	1590
9.2.3.1_D.2	Test applicability .....	1590
9.2.3.1_D.3	Minimum conformance requirements.....	1590
9.2.3.1_D.4	Test description .....	1591
9.2.3.1_D.5	Test requirement .....	1595
9.2.3.2_D	TDD CQI Reporting under AWGN conditions – PUCCH 1-1 for eDL-MIMO .....	1595
9.2.3.2_D.1	Test purpose .....	1595
9.2.3.2_D.2	Test applicability .....	1595
9.2.3.2_D.3	Minimum conformance requirements.....	1595
9.2.3.2_D.4	Test description .....	1597
9.2.3.2_D.5	Test requirement .....	1601
9.2.4	CQI Reporting under AWGN conditions - Single CSI Process .....	1602
9.2.4.1_F	FDD CQI Reporting under AWGN conditions - Single CSI Process for CoMP .....	1602
9.2.4.1_F.1	Test purpose .....	1602
9.2.4.1_F.2	Test applicability .....	1602
9.2.4.1_F.3	Minimum conformance requirements.....	1602
9.2.4.1_F.4	Test description .....	1604
9.2.4.1_F.5	Test requirement .....	1607
9.2.4.2_F	TDD CQI Reporting under AWGN conditions - Single CSI Process for CoMP .....	1608
9.2.4.2_F.1	Test purpose .....	1608
9.2.4.2_F.2	Test applicability .....	1608
9.2.4.2_F.3	Minimum conformance requirements.....	1608
9.2.4.2_F.4	Test description .....	1610
9.2.4.2_F.5	Test requirement .....	1614
9.3	CQI Reporting under fading conditions .....	1614
9.3.1	Frequency-selective scheduling mode .....	1614
9.3.1.1	CQI Reporting under fading conditions – PUSCH 3-0 (Cell-Specific Reference Symbols).....	1615
9.3.1.1.1	FDD CQI Reporting under fading conditions – PUSCH 3-0.....	1615
9.3.1.1.2	TDD CQI Reporting under fading conditions – PUSCH 3-0 .....	1618
9.3.1.2	CQI Reporting under fading conditions – PUSCH 3-1 (CSI Reference Symbols) .....	1622
9.3.1.2.1_D	FDD CQI Reporting under fading conditions – PUSCH 3-1 for eDL MIMO.....	1622
9.3.1.2.2_D	TDD CQI Reporting under fading conditions – PUSCH 3-1 for eDL MIMO .....	1626
9.3.1.3	CQI Reporting under fading conditions – PUSCH 3-0 (Cell-Specific Reference Symbols).....	1632
9.3.1.3.1	.....	1632
9.3.1.3.1_E	FDD CQI Reporting under fading conditions – PUSCH 3-0 for feICIC.....	1632

9.3.1.3.1_E.1	FDD CQI Reporting under fading conditions – PUSCH 3-0 for feICIC (non-MBSFN ABS)....	1632
9.3.1.3.2	.....	1637
9.3.1.3.2_E	TDD CQI Reporting under fading conditions – PUSCH 3-0 for feICIC.....	1637
9.3.1.3.2_E.1	TDD CQI Reporting under fading conditions – PUSCH 3-0 for feICIC (non-MBSFN ABS)....	1637
9.3.2	Frequency non-selective scheduling mode .....	1643
9.3.2.1	CQI Reporting under fading conditions – PUCCH 1-0 (Cell-Specific Reference Symbols).....	1643
9.3.2.1.1	FDD CQI Reporting under fading conditions – PUCCH 1-0 .....	1643
9.3.2.1.1_1	FDD CQI Reporting under fading conditions - PUCCH 1-0 (Release 9 and forward).....	1648
9.3.2.1.2	TDD CQI Reporting under fading conditions – PUCCH 1-0.....	1648
9.3.2.2	CQI Reporting under fading conditions – PUCCH 1-1 (CSI Reference Symbols).....	1654
9.3.2.2.1_D	FDD CQI Reporting under fading conditions – PUCCH 1-1 for eDL-MIMO.....	1654
9.3.2.2.1_D.1	Test purpose.....	1654
9.3.2.2.1_D.2	Test applicability.....	1654
9.3.2.2.1_D.3	Minimum conformance requirements .....	1654
9.3.2.2.1_D.4	Test description.....	1655
9.3.2.2.1_D.4.2	Test procedure.....	1656
9.3.2.2.1_D.4.3	Message contents.....	1657
9.3.2.2.1_D.5	Test requirement.....	1659
9.3.2.2.2_D	TDD CQI Reporting under fading conditions – PUCCH 1-1 for eDL-MIMO.....	1659
9.3.2.2.2_D.1	Test purpose.....	1659
9.3.2.2.2_D.2	Test applicability.....	1659
9.3.2.2.2_D.3	Minimum conformance requirements .....	1659
9.3.2.2.2_D.4	Test description.....	1661
9.3.2.2.2_D.4.2	Test procedure .....	1661
9.3.2.2.2_D.4.3	Message contents.....	1662
9.3.3	Frequency-selective interference .....	1664
9.3.3.1	CQI Reporting under fading conditions and frequency-selective interference – PUSCH 3-0 (Cell-Specific Reference Symbols) .....	1665
9.3.3.1.1	FDD CQI Reporting under fading conditions and frequency-selective interference – PUSCH 3-0.....	1665
9.3.3.1.2	TDD CQI Reporting under fading conditions and frequency-selective interference – PUSCH 3-0.....	1668
9.3.4	UE-selected subband CQI.....	1671
9.3.4.1	CQI Reporting under fading conditions – PUSCH 2-0 (Cell-Specific Reference Symbols).....	1672
9.3.4.1.1	FDD CQI Reporting under fading conditions – PUSCH 2-0.....	1672
9.3.4.1.2	TDD CQI Reporting under fading conditions – PUSCH 2-0 .....	1674
9.3.4.2	CQI Reporting under fading conditions – PUCCH 2-0 (Cell-Specific Reference Symbols).....	1677
9.3.4.2.1	FDD CQI Reporting under fading conditions – PUCCH 2-0 .....	1677
9.3.4.2.2	TDD CQI Reporting under fading conditions – PUCCH 2-0.....	1681
9.3.5	Additional requirements for enhanced receiver Type A .....	1686
9.3.5.1	PUCCH 1-0 (Cell-Specific Reference Symbol).....	1686
9.3.5.1.1	FDD CQI Reporting under fading conditions - PUCCH 1-0 - Enhanced Performance Requirement Type A .....	1686
9.3.5.1.2	TDD CQI Reporting under fading conditions - PUCCH 1-0 - Enhanced Performance Requirement Type A .....	1691
9.3.5.2	PUCCH 1-1 (CSI Reference Symbol).....	1696
9.3.5.2.1	FDD CQI Reporting under fading conditions - PUCCH 1-1 - Enhanced Performance Requirement Type A .....	1696
9.3.5.2.2	TDD CQI Reporting under fading conditions - PUCCH 1-1 - Enhanced Performance Requirement Type A .....	1702
9.3.6	CQI Reporting under fading conditions (With multiple CSI processes).....	1707
9.3.6.1_F	FDD CQI Reporting under fading conditions with CSI processes for CoMP.....	1707
9.3.6.1_F.1	FDD CQI Reporting under fading conditions with Single CSI process for CoMP .....	1707
9.3.6.1_F.1.1	Test purpose.....	1707
9.3.6.1_F.1.2	Test applicability.....	1707
9.3.6.1_F.1.3	Minimum conformance requirements .....	1707
9.3.6.1_F.1.4	Test description.....	1711
9.3.6.1_F.1.4.1	Initial conditions.....	1711
9.3.6.1_F.1.4.2	Test procedure.....	1711
9.3.6.1_F.1.4.3	Message contents.....	1712
9.3.6.1_F.1.5	Test requirement .....	1714
9.3.6.1_F.2	FDD CQI Reporting under fading conditions with Three CSI processes for CoMP.....	1714



9.3.6.1_F.2.1	Test purpose .....	1714
9.3.6.1_F.2.2	Test applicability .....	1714
9.3.6.1_F.2.3	Minimum conformance requirements .....	1714
9.3.6.1_F.2.4	Test description .....	1715
9.3.6.1_F.2.4.1	Initial conditions .....	1715
9.3.6.1_F.2.4.2	Test procedure .....	1715
9.3.6.1_F.2.4.3	Message contents .....	1716
9.3.6.1_F.2.5	Test requirement .....	1719
9.3.6.1_F.3	FDD CQI Reporting under fading conditions with Four CSI processes for CoMP .....	1720
9.3.6.1_F.3.1	Test purpose .....	1720
9.3.6.1_F.3.2	Test applicability .....	1720
9.3.6.1_F.3.3	Minimum conformance requirements .....	1720
9.3.6.1_F.3.4	Test description .....	1720
9.3.6.1_F.3.4.1	Initial conditions .....	1720
9.3.6.1_F.3.4.2	Test procedure .....	1720
9.3.6.1_F.3.4.3	Message contents .....	1721
9.3.6.1_F.3.5	Test requirement .....	1724
9.3.6.2_F	TDD CQI Reporting under fading conditions with CSI processes for CoMP .....	1725
9.3.6.2_F.1	TDD CQI Reporting under fading conditions with Single CSI process for CoMP .....	1725
9.3.6.2_F.1.1	Test purpose .....	1725
9.3.6.2_F.1.2	Test applicability .....	1725
9.3.6.2_F.1.3	Minimum conformance requirements .....	1725
9.3.6.2_F.1.4	Test description .....	1728
9.3.6.2_F.1.4.1	Initial conditions .....	1728
9.3.6.2_F.1.4.2	Test procedure .....	1728
9.3.6.2_F.1.4.3	Message contents .....	1729
9.3.6.2_F.1.5	Test requirement .....	1731
9.3.6.2_F.2	TDD CQI Reporting under fading conditions with Three CSI processes for CoMP .....	1731
9.3.6.2_F.2.1	Test purpose .....	1731
9.3.6.2_F.2.2	Test applicability .....	1731
9.3.6.2_F.2.3	Minimum conformance requirements .....	1731
9.3.6.2_F.2.4	Test description .....	1732
9.3.6.2_F.2.4.1	Initial conditions .....	1732
9.3.6.2_F.2.4.2	Test procedure .....	1732
9.3.6.2_F.2.4.3	Message contents .....	1733
9.3.6.2_F.2.5	Test requirement .....	1736
9.3.6.2_F.3	TDD CQI Reporting under fading conditions with Four CSI processes for CoMP .....	1737
9.3.6.2_F.3.1	Test purpose .....	1737
9.3.6.2_F.3.2	Test applicability .....	1737
9.3.6.2_F.3.3	Minimum conformance requirements .....	1737
9.3.6.2_F.3.4	Test description .....	1737
9.3.6.2_F.3.4.1	Initial conditions .....	1737
9.3.6.2_F.3.4.2	Test procedure .....	1737
9.3.6.2_F.3.4.3	Message contents .....	1738
9.3.6.2_F.3.5	Test requirement .....	1741
9.3.7	PUSCH 3-2 for eDL MIMO Enhancement .....	1742
9.3.7.1_G	FDD CQI Reporting under fading conditions - PUSCH 3-2 for eDL MIMO Enhancement .....	1742
9.3.7.1_G.1	Test purpose .....	1742
9.3.7.1_G.2	Test applicability .....	1742
9.3.7.1_G.3	Minimum conformance requirements .....	1742
9.3.7.1_G.4	Test description .....	1743
9.3.7.1_G.5	Test requirement .....	1747
9.3.7.2_G	TDD CQI Reporting under fading conditions - PUSCH 3-2 for eDL MIMO Enhancement .....	1748
9.3.7.2_G.1	Test purpose .....	1748
9.3.7.2_G.2	Test applicability .....	1748
9.3.7.2_G.3	Minimum conformance requirements .....	1748
9.3.7.2_G.4	Test description .....	1749
9.3.7.2_G.5	Test requirement .....	1754
9.4	Reporting of Precoding Matrix Indicator (PMI) .....	1754
9.4.1	Single PMI .....	1755
9.4.1.1	PMI Reporting – PUSCH 3-1 (Single PMI) (Cell-Specific Reference Symbols) .....	1755
9.4.1.1.1	FDD PMI Reporting – PUSCH 3-1 (Single PMI) .....	1755

9.4.1.1.2	TDD PMI Reporting – PUSCH 3-1 (Single PMI).....	1757
9.4.1.2	PMI Reporting – PUCCH 2-1 (Single PMI) (Cell-Specific Reference Symbols).....	1760
9.4.1.2.1	FDD PMI Reporting – PUCCH 2-1 (Single PMI).....	1760
9.4.1.2.2	TDD PMI Reporting – PUCCH 2-1 (Single PMI) .....	1764
9.4.1.3	PMI Reporting – PUSCH 3-1 (Single PMI) (CSI Reference Symbols).....	1768
9.4.1.3.1	.....	1768
9.4.1.3.1_D	FDD Reporting of PMI – PUSCH 3-1 (Single PMI) for eDL MIMO.....	1768
9.4.1.3.2_D	TDD Reporting of PMI – PUSCH 3-1 (Single PMI) for eDL-MIMO .....	1772
9.4.1.4	PMI Reporting – PUCCH 1-1 (Single PMI) (CSI Reference Symbol).....	1777
9.4.1.4.1_G	FDD PMI Reporting with 4Tx enhanced codebook – PUCCH 1-1 (Single PMI) for eDL MIMO Enhancement .....	1777
9.4.1.4.2_G	TDD PMI Reporting with 4Tx enhanced codebook – PUCCH 1-1 (Single PMI) for eDL MIMO Enhancement .....	1782
9.4.2	Multiple PMI .....	1787
9.4.2.1	PMI Reporting – PUSCH 1-2 (Multiple PMI) (Cell-Specific Reference Symbols).....	1787
9.4.2.1.1	FDD PMI Reporting – PUSCH 1-2 (Multiple PMI).....	1787
9.4.2.1.1_1	FDD PMI Reporting – PUSCH 1-2 (Multiple PMI) (Release 9 and forward) .....	1790
9.4.2.1.2	TDD PMI Reporting – PUSCH 1-2 (Multiple PMI) .....	1793
9.4.2.1.2_1	TDD PMI Reporting – PUSCH 1-2 (Multiple PMI) (Release 9 and forward) .....	1796
9.4.2.2	PMI Reporting – PUSCH 2-2 (Multiple PMI) (Cell-Specific Reference Symbols).....	1799
9.4.2.2.1	FDD PMI Reporting – PUSCH 2-2 (Multiple PMI).....	1799
9.4.2.2.2	TDD PMI Reporting – PUSCH 2-2 (Multiple PMI) .....	1802
9.4.2.3	PMI Reporting – PUSCH 1-2 (Multiple PMI) (CSI Reference Symbols) .....	1805
9.4.2.3.1	.....	1805
9.4.2.3.1_D	FDD PMI Reporting - PUSCH 1-2 (Multiple PMI) for eDL-MIMO .....	1805
9.4.2.3.2_D	TDD PMI Reporting - PUSCH 1-2 (Multiple PMI) for eDL-MIMO .....	1809
9.4.2.3.3_G	FDD PMI Reporting with 4Tx enhanced codebook - PUSCH 1-2 (Multiple PMI) for eDL- MIMO Enhancement .....	1814
9.4.2.3.4_G	TDD PMI Reporting with 4Tx enhanced codebook - PUSCH 1-2 (Multiple PMI) for eDL- MIMO Enhancement .....	1818
9.4.2.3.4_G.1	Test purpose .....	1818
9.4.2.3.4_G.2	Test applicability .....	1818
9.4.2.3.4_G.3	Minimum conformance requirements.....	1819
9.4.2.3.4_G.4.2	Test procedure .....	1821
9.5	Reporting of Rank Indicator (RI) .....	1824
9.5.1	RI Reporting (Cell-Specific Reference Symbols).....	1824
9.5.1.1	FDD RI Reporting– PUCCH 1-1 .....	1824
9.5.1.1.1	Test purpose .....	1824
9.5.1.1.2	Test applicability .....	1824
9.5.1.1.3	Minimum conformance requirements.....	1824
9.5.1.1.4	Test description .....	1826
9.5.1.1.5	Test requirement .....	1828
9.5.1.1_1	FDD RI Reporting– PUCCH 1-1 (Release 10) .....	1828
9.5.1.1_1.1	Test purpose .....	1828
9.5.1.1_1.2	Test applicability .....	1828
9.5.1.1_1.3	Minimum conformance requirements.....	1828
9.5.1.1_1.4	Test description .....	1829
9.5.1.1_1.5	Test requirement .....	1830
9.5.1.1_2	FDD RI Reporting– PUCCH 1-1 (Release 11) .....	1831
9.5.1.1_2.1	Test purpose .....	1831
9.5.1.1_2.2	Test applicability .....	1831
9.5.1.1_2.3	Minimum conformance requirements.....	1831
9.5.1.1_2.4	Test description .....	1832
9.5.1.1_2.5	Test requirement .....	1833
9.5.1.2	TDD RI Reporting – PUSCH 3-1 .....	1833
9.5.1.2.1	Test purpose .....	1833
9.5.1.2.2	Test applicability .....	1833
9.5.1.2.3	Minimum conformance requirements.....	1833
9.5.1.2.4	Test description .....	1834
9.5.1.2.5	Test requirement .....	1837
9.5.1.2_1	TDD RI Reporting – PUSCH 3-1 (Release 10).....	1837
9.5.1.2_1.1	Test purpose .....	1837

9.5.1.2_1.2	Test applicability .....	1837
9.5.1.2_1.3	Minimum conformance requirements.....	1837
9.5.1.2_1.4	Test description .....	1838
9.5.1.2_1.5	Test requirement.....	1839
9.5.1.2_2	TDD RI Reporting – PUSCH 3-1 (Release 11).....	1839
9.5.1.2_2.1	Test purpose .....	1839
9.5.1.2_2.2	Test applicability .....	1840
9.5.1.2_2.3	Minimum conformance requirements.....	1840
9.5.1.2_2.4	Test description .....	1840
9.5.1.2_2.5	Test requirement.....	1841
9.5.2	RI Reporting (CSI Reference Symbols).....	1841
9.5.2.1	.....	1841
9.5.2.1_D	FDD RI Reporting- PUCCH 1-1 for eDL-MIMO.....	1841
9.5.2.1_D.1	Test purpose .....	1841
9.5.2.1_D.2	Test applicability .....	1841
9.5.2.1_D.3	Minimum conformance requirements.....	1841
9.5.2.1_D.4	Test description .....	1843
9.5.2.1_D.5	Test requirement.....	1846
9.5.2.2_D	TDD RI Reporting- PUCCH 1-1 for eDL-MIMO .....	1846
9.5.2.2_D.1	Test purpose .....	1846
9.5.2.2_D.2	Test applicability .....	1846
9.5.2.2_D.3	Minimum conformance requirements.....	1846
9.5.2.2_D.4	Test description .....	1848
9.5.2.2_D.5	Test requirement.....	1851
9.5.3	RI Reporting (two CSI subframe sets are configured).....	1851
9.5.3.1_C	FDD RI Reporting – PUCCH 1-0 for eICIC.....	1851
9.5.3.1_C.1	FDD RI Reporting – PUCCH 1-0 for eICIC (non-MBSFN ABS) .....	1851
9.5.3.1_C.1.1	Test purpose.....	1851
9.5.3.1_C.1.2	Test applicability.....	1851
9.5.3.1_C.1.3	Minimum conformance requirements .....	1852
9.5.3.1_C.1.4	Test description.....	1854
9.5.3.1_C.1.4.1	Initial conditions.....	1854
9.5.3.1_C.1.4.2	Test procedure.....	1855
9.5.3.1_C.1.4.3	Message contents.....	1855
9.5.3.1_C.1.5	Test requirement .....	1857
9.5.3.2_C	TDD RI Reporting – PUCCH 1-0 for eICIC.....	1857
9.5.3.2_C.1	TDD RI Reporting – PUCCH 1-0 for eICIC (non-MBSFN ABS) .....	1857
9.5.3.2_C.1.1	Test purpose.....	1857
9.5.3.2_C.1.2	Test applicability.....	1858
9.5.3.2_C.1.3	Minimum conformance requirements .....	1858
9.5.3.2_C.1.4	Test description.....	1860
9.5.3.2_C.1.4.1	Initial conditions.....	1860
9.5.3.2_C.1.4.2	Test procedure.....	1861
9.5.3.2_C.1.4.3	Message contents.....	1861
9.5.3.2_C.1.5	Test requirement .....	1863
9.5.4	RI Reporting (two CSI subframe sets and CRS assistance information are configured).....	1864
9.5.4.1_E	FDD RI Reporting – PUCCH 1-0 for feICIC.....	1864
9.5.4.1_E.1	FDD RI Reporting – PUCCH 1-0 for feICIC (non-MBSFN ABS) .....	1864
9.5.4.1_E.1.1	Test purpose.....	1864
9.5.4.1_E.1.2	Test applicability.....	1864
9.5.4.1_E.1.3	Minimum conformance requirements .....	1864
9.5.4.1_E.1.4	Test description.....	1866
9.5.4.1_E.1.4.1	Initial conditions.....	1866
9.5.4.1_E.1.4.2	Test procedure.....	1867
9.5.4.1_E.1.4.3	Message contents.....	1867
9.5.4.1_E.1.5	Test requirement .....	1871
9.5.4.2_E	TDD RI Reporting – PUCCH 1-0 for feICIC .....	1871
9.5.4.2_E.1	TDD RI Reporting – PUCCH 1-0 for feICIC (non-MBSFN ABS).....	1871
9.5.4.2_E.1.1	Test purpose.....	1871
9.5.4.2_E.1.2	Test applicability.....	1871
9.5.4.2_E.1.3	Minimum conformance requirements .....	1871
9.5.4.2_E.1.4	Test description.....	1874

9.5.4.2_E.1.4.1	Initial conditions.....	1874
9.5.4.2_E.1.4.2	Test procedure.....	1875
9.5.4.2_E.1.4.3	Message contents.....	1875
9.5.4.2_E.1.5	Test requirement .....	1879
9.5.5	RI Reporting (with CSI processes) .....	1879
9.5.5.1_F	FDD RI Reporting with CSI processes for CoMP .....	1879
9.5.5.1_F.1	FDD RI Reporting with Single CSI process for CoMP .....	1879
9.5.5.1_F.1.1	Test purpose.....	1879
9.5.5.1_F.1.2	Test applicability.....	1879
9.5.5.1_F.1.3	Minimum conformance requirements .....	1879
9.5.5.1_F.1.4	Test description.....	1881
9.5.5.1_F.1.4.1	Initial conditions.....	1881
9.5.5.1_F.1.4.2	Test procedure.....	1882
9.5.5.1_F.1.4.3	Message contents.....	1882
9.5.5.1_F.1.5	Test requirement .....	1884
9.5.5.1_F.2	FDD RI Reporting with Multiple CSI processes for CoMP .....	1885
9.5.5.1_F.2.1	Test purpose.....	1885
9.5.5.1_F.2.2	Test applicability.....	1885
9.5.5.1_F.2.3	Minimum conformance requirements .....	1885
9.5.5.1_F.2.4	Test description.....	1885
9.5.5.1_F.2.4.1	Initial conditions.....	1885
9.5.5.1_F.2.4.2	Test procedure.....	1885
9.5.5.1_F.2.4.3	Message contents.....	1886
9.5.5.1_F.2.5	Test requirement .....	1889
9.5.5.2_F	TDD RI Reporting with CSI processes for CoMP .....	1889
9.5.5.2_F.1	TDD RI Reporting with Single CSI process for CoMP .....	1889
9.5.5.2_F.1.1	Test purpose.....	1889
9.5.5.2_F.1.2	Test applicability.....	1889
9.5.5.2_F.1.3	Minimum conformance requirements .....	1889
9.5.5.2_F.1.4	Test description.....	1891
9.5.5.2_F.1.4.1	Initial conditions.....	1891
9.5.5.2_F.1.4.2	Test procedure.....	1891
9.5.5.2_F.1.4.3	Message contents.....	1892
9.5.5.2_F.1.5	Test requirement .....	1894
9.5.5.2_F.2	TDD RI Reporting with Multiple CSI processes for CoMP .....	1894
9.5.5.2_F.2.1	Test purpose.....	1894
9.5.5.2_F.2.2	Test applicability.....	1894
9.5.5.2_F.2.3	Minimum conformance requirements .....	1894
9.5.5.2_F.2.4	Test description.....	1894
9.5.5.2_F.2.4.1	Initial conditions.....	1894
9.5.5.2_F.2.4.2	Test procedure.....	1894
9.5.5.2_F.2.4.3	Message contents.....	1895
9.5.5.2_F.2.5	Test requirement .....	1898
9.6	Additional requirements for carrier aggregation .....	1898
9.6.1	Periodic reporting on multiple cells (Cell-Specific Reference Symbols) .....	1898
9.6.1.1_A	FDD CQI Reporting under AWGN conditions – PUCCH 1-0 for CA .....	1898
9.6.1.1_A.1	FDD CQI Reporting under AWGN conditions – PUCCH 1-0 for CA(2DL CA) .....	1898
9.6.1.1_A.1.1	Test purpose.....	1898
9.6.1.1_A.1.2	Test applicability.....	1898
9.6.1.1_A.1.3	Minimum conformance requirements .....	1898
9.6.1.1_A.1.4	Test description.....	1899
9.6.1.1_A.1.4.1	Initial conditions.....	1899
9.6.1.1_A.1.4.2	Test procedure.....	1900
9.6.1.1_A.1.4.3	Message contents.....	1900
9.6.1.1_A.1.5	Test requirement .....	1902
9.6.1.1_A.2	FDD CQI Reporting under AWGN conditions – PUCCH 1-0 for CA (3DL CA) .....	1902
9.6.1.1_A.2.1	Test purpose.....	1902
9.6.1.1_A.2.2	Test applicability.....	1902
9.6.1.1_A.2.3	Minimum conformance requirements .....	1902
9.6.1.1_A.2.4	Test description.....	1903
9.6.1.1_A.2.4.1	Initial conditions.....	1903
9.6.1.1_A.2.4.2	Test procedure.....	1904

9.6.1.1_A.2.4.3	Message contents.....	1905
9.6.1.1_A.2.5	Test requirement .....	1906
9.6.1.2_A	TDD CQI Reporting under AWGN conditions – PUCCH 1-0 for CA .....	1907
9.6.1.2_A.1	TDD CQI Reporting under AWGN conditions – PUCCH 1-0 for CA (2DL CA) .....	1907
9.6.1.2_A.1.1	Test purpose.....	1907
9.6.1.2_A.1.2	Test applicability.....	1907
9.6.1.2_A.1.3	Minimum conformance requirements .....	1907
9.6.1.2_A.1.4	Test description.....	1908
9.6.1.2_A.1.4.1	Initial conditions.....	1908
9.6.1.2_A.1.4.2	Test procedure.....	1908
9.6.1.2_A.1.4.3	Message contents.....	1909
9.6.1.2_A.1.5	Test requirement .....	1910
9.6.1.2_A.2	TDD CQI Reporting under AWGN conditions – PUCCH 1-0 for CA (3DL CA) .....	1910
9.6.1.2_A.2.1	Test purpose.....	1910
9.6.1.2_A.2.2	Test applicability.....	1911
9.6.1.2_A.2.3	Minimum conformance requirements .....	1911
9.6.1.2_A.2.4	Test description.....	1912
9.6.1.2_A.2.4.1	Initial conditions.....	1912
9.6.1.2_A.2.4.2	Test procedure.....	1912
9.6.1.2_A.2.5	Test requirement .....	1914
9.6.1.3	TDD-FDD CA for FDD PCell .....	1915
9.6.1.3.1	TDD FDD CA CQI Reporting under AWGN conditions – PUCCH 1-0 for FDD PCell (2DL CA).....	1915
9.6.1.3.1.1	Test purpose.....	1915
9.6.1.3.1.2	Test applicability.....	1915
9.6.1.3.1.3	Minimum conformance requirements .....	1915
9.6.1.3.1.4	Test description.....	1916
9.6.1.3.1.4.1	Initial conditions.....	1916
9.6.1.3.1.4.2	Test procedure.....	1917
9.6.1.3.1.4.3	Message contents.....	1917
9.6.1.3.1.5	Test requirement .....	1919
9.6.1.3.2	TDD FDD CQI Reporting under AWGN conditions – PUCCH 1-0 for FDD PCell (3DL CA).....	1919
9.6.1.3.2.1	Test purpose.....	1919
9.6.1.3.2.2	Test applicability.....	1919
9.6.1.3.2.3	Minimum conformance requirements .....	1919
9.6.1.3.2.4	Test description.....	1920
9.6.1.3.2.4.1	Initial conditions.....	1920
9.6.1.3.2.4.2	Test procedure.....	1921
9.6.1.3.2.5	Test requirement .....	1922
9.6.1.4	TDD-FDD CA for TDD PCell.....	1922
9.6.1.4.1	TDD FDD CA CQI Reporting under AWGN conditions – PUCCH 1-0 for TDD PCell (2DL CA).....	1922
9.6.1.4.1.1	Test purpose.....	1922
9.6.1.4.1.2	Test applicability.....	1922
9.6.1.4.1.3	Minimum conformance requirements .....	1922
9.6.1.4.1.4	Test description.....	1923
9.6.1.4.1.4.1	Initial conditions.....	1923
9.6.1.4.1.4.2	Test procedure.....	1924
9.6.1.4.1.4.3	Message contents.....	1924
9.6.1.4.1.5	Test requirement .....	1926
9.6.1.4.2	TDD FDD CQI Reporting under AWGN conditions – PUCCH 1-0 for TDD PCell (3DL CA).....	1926
9.6.1.4.2.1	Test purpose.....	1926
9.6.1.4.2.2	Test applicability.....	1926
9.6.1.4.2.3	Minimum conformance requirements .....	1926
9.6.1.4.2.4	Test description.....	1927
9.6.1.4.2.4.1	Initial conditions.....	1927
9.6.1.4.2.4.2	Test procedure.....	1928
9.6.1.4.2.5	Test requirement .....	1929
9.7	CSI reporting for UE DL category 0 .....	1929
9.7.1	CQI reporting definition under AWGN conditions .....	1929
9.7.1.1	FDD and Half duplex FDD CQI reporting definition under AWGN conditions for UE category 0.....	1929
9.7.1.1.1	Test purpose .....	1929

9.7.1.1.2	Test applicability .....	1929
9.7.1.1.3	Minimum conformance requirements.....	1929
9.7.1.1.4	Test description .....	1930
9.7.1.1.5	Test requirement.....	1931
9.7.1.2	TDD CQI reporting definition under AWGN conditions for UE category 0.....	1931
9.7.1.2.1	Test purpose .....	1931
9.7.1.2.2	Test applicability .....	1932
9.7.1.2.3	Minimum conformance requirements.....	1932
9.7.1.2.4	Test description .....	1932
9.7.1.2.5	Test requirement.....	1933
10	MBMS Performance.....	1934
10.1	FDD MBMS performance (Fixed Reference Channel).....	1934
10.1.1	Test purpose.....	1934
10.1.2	Test applicability .....	1934
10.1.3	Minimum conformance requirements.....	1934
10.1.4	Test description.....	1935
10.1.4.1	Initial conditions .....	1935
10.1.4.2	Test procedure.....	1935
10.1.4.3	Message contents .....	1936
10.1.5	Test requirement .....	1937
10.2	TDD MBMS performance (Fixed Reference Channel).....	1938
10.2.1	Test purpose.....	1938
10.2.2	Test applicability .....	1938
10.2.3	Minimum conformance requirements.....	1938
10.2.4	Test description.....	1939
10.2.4.1	Initial conditions .....	1939
10.2.4.2	Test procedure.....	1939
10.2.4.3	Message contents .....	1940
10.2.5	Test requirement .....	1941
<b>Annex A (normative):</b>	<b>Measurement Channels.....</b>	<b>1943</b>
A.1	General .....	1943
A.2	UL reference measurement channels .....	1944
A.2.1	General .....	1944
A.2.1.1	Applicability and common parameters .....	1944
A.2.1.2	Determination of payload size .....	1944
A.2.1.3	Overview of UL reference measurement channels .....	1945
A.2.2	Reference measurement channels for FDD .....	1952
A.2.2.1	Full RB allocation.....	1952
A.2.2.1.1	QPSK .....	1952
A.2.2.1.2	16-QAM.....	1953
A.2.2.1.3	64-QAM.....	1953
A.2.2.2	Partial RB allocation.....	1953
A.2.2.2.1	QPSK .....	1954
A.2.2.2.2	16-QAM.....	1956
A.2.2.2.3	64-QAM.....	1957
A.2.2.3	Reference measurement channels for sustained downlink data rate provided by lower layers.....	1958
A.2.3	Reference measurement channels for TDD.....	1958
A.2.3.1	Full RB allocation.....	1958
A.2.3.1.1	QPSK .....	1958
A.2.3.1.2	16-QAM.....	1959
A.2.3.1.3	64-QAM.....	1960
A.2.3.2	Partial RB allocation.....	1960
A.2.3.2.1	QPSK .....	1961
A.2.3.2.2	16-QAM.....	1963
A.2.3.2.3	64-QAM.....	1964
A.2.3.3	Reference measurement channels for sustained downlink data rate provided by lower layers.....	1965
A.3	DL reference measurement channels .....	1965
A.3.1	General .....	1965

A.3.1.1	Overview of DL reference measurement channels .....	1966
A.3.2	Reference measurement channel for receiver characteristics .....	1975
A.3.2A	Downlink Reference measurement channel for TX characteristics .....	1987
A.3.3	Reference measurement channel for PDSCH performance requirements (FDD) .....	1990
A.3.3.1	Single-antenna transmission (Common Reference Symbols) .....	1990
A.3.3.2	Multi-antenna transmission (Common Reference Symbols) .....	1995
A.3.3.2.1	Two antenna ports .....	1995
A.3.3.2.2	Four antenna ports .....	1998
A.3.3.3	Reference Measurement Channel for UE-Specific Reference Symbols .....	1998
A.3.3.3.1	Two antenna port (CSI-RS) .....	1998
A.3.3.3.2	Four antenna ports (CSI-RS) .....	2000
A.3.4	Reference measurement channel for PDSCH performance requirements (TDD) .....	2004
A.3.4.1	Single-antenna transmission (Common Reference Symbols) .....	2004
A.3.4.2	Multi-antenna transmission (Common Reference Symbols) .....	2011
A.3.4.2.1	Two antenna ports .....	2011
A.3.4.2.2	Four antenna ports .....	2014
A.3.4.3	Reference Measurement Channels for UE-Specific Reference Symbols .....	2015
A.3.4.3.3	Two antenna ports (CSI-RS) .....	2016
A.3.4.3.4	Four antenna ports (CSI-RS) .....	2018
A.3.4.3.5	Eight antenna ports (CSI-RS) .....	2021
A.3.5	Reference measurement channels for PDCCH/PCFICH performance requirements .....	2024
A.3.5.1	FDD .....	2024
A.3.5.2	TDD .....	2025
A.3.6	Reference measurement channels for PHICH performance requirements .....	2027
A.3.7	[FFS] .....	2028
A.3.8	Reference measurement channels for MBMS performance requirements .....	2028
A.3.8.1	FDD .....	2028
A.3.8.2	TDD .....	2029
A.3.9	Reference measurement channels for sustained downlink data rate provided by lower layers .....	2031
A.3.9.1	FDD .....	2031
A.3.9.2	TDD .....	2033
A.3.9.3	FDD (EPDCCH scheduling) .....	2034
A.3.9.4	TDD (EPDCCH scheduling) .....	2035
A.3.10	Reference Measurement Channels for EPDCCH performance requirements .....	2036
A.3.10.1	FDD .....	2036
A.3.10.2	TDD .....	2036
A.4	CQI reference measurement channels .....	2036
A.4.1	Additional CSI reference measurement channels .....	2040
A.5	OFDMA Channel Noise Generator (OCNG) .....	2041
A.5.1	OCNG Patterns for FDD .....	2041
A.5.1.1	OCNG FDD pattern 1: One sided dynamic OCNG FDD pattern .....	2041
A.5.1.2	OCNG FDD pattern 2: Two sided dynamic OCNG FDD pattern .....	2042
A.5.1.3	OCNG FDD pattern 3: 49 RB OCNG allocation with MBSFN in 10 MHz .....	2042
A.5.1.4	OCNG FDD pattern 4: One sided dynamic OCNG FDD pattern for MBMS transmission .....	2043
A.5.1.5	OCNG FDD pattern 5: One sided dynamic 16QAM modulated OCNG FDD pattern .....	2044
A.5.1.6	OCNG FDD pattern 6: dynamic OCNG FDD pattern when user data is in 2 non-contiguous blocks ...	2044
A.5.1.8	OCNG FDD pattern 8: One sided dynamic OCNG FDD pattern for TM10 transmission .....	2046
A.5.2	OCNG Patterns for TDD .....	2046
A.5.2.1	OCNG TDD pattern 1: One sided dynamic OCNG TDD pattern .....	2046
A.5.2.2	OCNG TDD pattern 2: Two sided dynamic OCNG TDD pattern .....	2047
A.5.2.3	OCNG TDD pattern 3: 49 RB OCNG allocation with MBSFN in 10 MHz .....	2048
A.5.2.4	OCNG TDD pattern 4: One sided dynamic OCNG TDD pattern for MBMS transmission .....	2049
A.5.2.5	OCNG TDD pattern 5: One sided dynamic 16QAM modulated OCNG TDD pattern .....	2049
A.5.2.6	OCNG TDD pattern 6: dynamic OCNG TDD pattern when user data is in 2 non-contiguous blocks ...	2050
A.5.2.8	OCNG TDD pattern 8: One sided dynamic OCNG TDD pattern for TM10 transmission .....	2051
<b>Annex B (normative):</b>	<b>Propagation Conditions .....</b>	<b>2053</b>
B.0	No interference .....	2053
B.1	Static propagation condition .....	2053

B.1.1	Definition of Additive White Gaussian Noise (AWGN) Interferer.....	2053
B.2	Multi-path fading Propagation Conditions.....	2053
B.2.1	Delay profiles.....	2054
B.2.2	Combinations of channel model parameters.....	2055
B.2.3	MIMO Channel Correlation Matrices.....	2055
B.2.3.1	Definition of MIMO Correlation Matrices.....	2055
B.2.3.2	MIMO Correlation Matrices at High, Medium and Low Level.....	2056
B.2.3A	MIMO Channel Correlation Matrices using cross polarized antennas.....	2058
B.2.3A.1	Definition of MIMO Correlation Matrices using cross polarized antennas.....	2059
B.2.3A.2	Spatial Correlation Matrices using cross polarized antennas at eNB and UE sides.....	2059
B.2.3A.2.1	Spatial Correlation Matrices at eNB side.....	2059
B.2.3A.2.2	Spatial Correlation Matrices at UE side.....	2059
B.2.3A.3	MIMO Correlation Matrices using cross polarized antennas.....	2060
B.2.3A.4	Beam steering approach.....	2060
B.2.4	Propagation conditions for CQI tests.....	2061
B.2.5	FFS.....	2061
B.2.6	MBSFN Propagation Channel Profile.....	2061
B.3	High speed train scenario.....	2062
B.4	Beamforming Model.....	2063
B.4.1	Single-layer random beamforming (Antenna port 5, 7 or 8).....	2063
B.4.2	Dual-layer random beamforming (antenna ports 7 and 8).....	2064
B.4.3	Generic beamforming model (antenna ports 7-14).....	2064
B.4.4	Random beamforming for EPDCCH distributed transmission (Antenna port 107 and 109).....	2065
B.4.5	Random beamforming for EPDCCH localized transmission (Antenna port 107, 108, 109 or 110).....	2065
B.5	Interference models for enhanced performance requirements Type-A.....	2066
B.5.1	Dominant interferer proportion.....	2066
B.5.2	Transmission mode 3 interference model.....	2066
B.5.3	Transmission mode 4 interference model.....	2067
B.5.4	Transmission mode 9 interference model.....	2067
<b>Annex C (normative): Downlink Physical Channels.....</b>		<b>2068</b>
C.0	Downlink signal levels.....	2068
C.1	General.....	2068
C.2	Set-up.....	2071
C.3	Connection.....	2072
C.3.0	Measurement of Transmitter Characteristics.....	2072
C.3.1	Measurement of Receiver Characteristics.....	2073
C.3.2	Measurement of Performance requirements.....	2074
C.3.3	Aggressor cell power allocation for Measurement of Performance Requirements when ABS is Configured.....	2076
C.3.4	Power Allocation for Measurement of Performance Requirements when Quasi Co-location Type B: same Cell ID.....	2077
<b>Annex D (normative): Characteristics of the Interfering Signal.....</b>		<b>2078</b>
D.1	General.....	2078
D.2	Interference signals.....	2078
<b>Annex E (normative): Global In-Channel TX-Test.....</b>		<b>2079</b>
E.1	General.....	2079
E.2	Signals and results.....	2079
E.2.1	Basic principle.....	2079
E.2.2	Output signal of the TX under test.....	2079
E.2.3	Reference signal.....	2080
E.2.4	Measurement results.....	2080
E.2.5	Measurement points.....	2080



E.3	Signal processing.....	2081
E.3.1	Pre FFT minimization process.....	2081
E.3.2	Timing of the FFT window .....	2081
E.3.3	Post FFT equalisation.....	2082
E.4	Derivation of the results .....	2083
E.4.1	EVM.....	2083
E.4.2	Averaged EVM .....	2084
E.4.3	In-band emissions measurement.....	2084
E.4.4	EVM equalizer spectrum flatness.....	2086
E.4.5	Frequency error and Carrier leakage .....	2086
E.4.6	EVM of Demodulation reference symbols (EVM <sub>DMRS</sub> ) .....	2087
E.4.6.1	1 <sup>st</sup> average for EVM <sub>DMRS</sub> .....	2087
E.4.6.2	Final average for EVM <sub>DMRS</sub> .....	2088
E.5	EVM and inband emissions for PUCCH.....	2088
E.5.1	Basic principle.....	2088
E.5.2	Output signal of the TX under test .....	2088
E.5.3	Reference signal .....	2088
E.5.4	Measurement results.....	2088
E.5.5	Measurement points .....	2088
E.5.6	Pre FFT minimization process.....	2089
E.5.7	Timing of the FFT window .....	2089
E.5.8	Post FFT equalisation.....	2089
E.5.9	Derivation of the results .....	2090
E.5.9.1	EVM <sub>PUCCH</sub> .....	2090
E.5.9.2	Averaged EVM <sub>PUCCH</sub> .....	2090
E.5.9.3	In-band emissions measurement .....	2091
E.6	EVM for PRACH .....	2092
E.6.1	Basic principle.....	2092
E.6.2	Output signal of the TX under test .....	2092
E.6.3	Reference signal .....	2092
E.6.4	Measurement results.....	2092
E.6.5	Measurement points .....	2093
E.6.6	Pre FFT minimization process.....	2093
E.6.7	Timing of the FFT window .....	2093
E.6.8	Post FFT equalisation.....	2094
E.6.9	Derivation of the results .....	2094
E.6.9.1	EVM <sub>PRACH</sub> .....	2094
E.6.9.2	Averaged EVM <sub>PRACH</sub> .....	2095
E.7	EVM with exclusion period .....	2095
E.7.1	General .....	2095
E.7.2	The model.....	2095
E.7.3	Illustration .....	2096
E.7.4	Formula .....	2099
<b>Annex F (normative): Measurement uncertainties and Test Tolerances .....</b>		<b>2101</b>
F.1	Acceptable uncertainty of Test System (normative) .....	2101
F.1.1	Measurement of test environments.....	2101
F.1.2	Measurement of transmitter.....	2102
F.1.3	Measurement of receiver .....	2109
F.1.4	Measurement of performance requirements .....	2115
F.1.5	Measurement of Channel State Information reporting .....	2142
F.2	Interpretation of measurement results (normative) .....	2150
F.3	Test Tolerance and Derivation of Test Requirements (informative).....	2150
F.3.1	Measurement of test environments.....	2151
F.3.2	Measurement of transmitter.....	2152
F.3.3	Measurement of receiver .....	2167
F.3.4	Measurement of performance requirements .....	2176

F.3.5	Measurement of Channel State Information reporting .....	2188
<b>Annex G (normative): Statistical Testing.....</b>		<b>2194</b>
G.1	General .....	2194
G.2	Statistical testing of receiver characteristics.....	2194
G.2.1	General .....	2194
G.2.2	Mapping throughput to error ratio .....	2194
G.2.3	Design of the test.....	2195
G.2.4	Numerical definition of the pass fail limits .....	2195
G.2.5	Pass fail decision rules .....	2196
G.2.6	Test conditions for receiver tests .....	2197
G.2A	Statistical testing of receiver characteristics with CA .....	2198
G.2A.1	General .....	2198
G.2A.2	Mapping throughput to error ratio .....	2198
G.2A.4	Pass fail limits .....	2198
G.2A.5	void.....	2198
G.2A.6	Test conditions for receiver tests with CA .....	2199
G.3	Statistical testing of Performance Requirements with throughput .....	2199
G.3.1	General .....	2199
G.3.2	Mapping throughput to error ratio .....	2200
G.3.3	Design of the test.....	2200
G.3.4	Pass Fail limit .....	2200
G.3.5	Minimum Test time .....	2201
G.3.6	Test conditions for receiver performance tests .....	2214
G.3A	Statistical testing of Performance Requirements with throughput for CA .....	2221
G.3A.1	General .....	2221
G.3A.2	Mapping throughput to error ratio .....	2221
G.3A.3	Design of the test.....	2221
G.3A.4	Pass Fail limit .....	2222
G.3A.5	Minimum test time .....	2222
G.3A.6	Test conditions.....	2233
G.4	Statistical testing of Performance Requirements with probability of misdetection .....	2234
G.4.1	General .....	2234
G.4.2	Mapping the UE reaction to error ratio .....	2234
G.4.3	Design of the test.....	2234
G.4.4	Numerical definition of the pass fail limits .....	2235
G.4.5	Pass fail decision rules .....	2236
G.4.6	Minimum Test time .....	2237
G.4.7	Test conditions for receiver performance tests .....	2240
G.5	Measuring throughput ratio .....	2241
G.5.1	General .....	2241
G.5.2	Establishing $t_{rnd}$ .....	2241
G.5.3	Measuring T-put .....	2241
G.5.4	Number of samples for throughput ratios .....	2241
G.6	Statistical testing of MBMS Performance .....	2245
G.6.1	General .....	2245
G.6.2	Mapping of MBMS Packet ratio to BLER .....	2245
G.6.3	Design of the test.....	2246
G.6.4	Test time for MBMS performance tests .....	2246
G.X	Theory to derive the numbers in Table G.2.4-1 (Informative) .....	2246
G.X.1	Error Ratio (ER) .....	2247
G.X.2	Test Design.....	2247
G.X.3	Confidence level.....	2247
G.X.4	Introduction: Supplier Risk versus Customer Risk .....	2247
G.X.5	Supplier Risk versus Customer Risk .....	2247
G.X.6	Introduction: Standard test versus early decision concept.....	2248

G.X.7	Standard test versus early decision concept .....	2249
G.X.8	Selectivity .....	2249
G.X.9	Design of the test .....	2250
G.X.10	Simulation to derive the pass fail limits in Table G.2.4-1 .....	2250
<b>Annex H (normative): Uplink Physical Channels .....</b>		<b>2252</b>
H.0	Uplink Signal Levels .....	2252
H.1	General .....	2252
H.2	Set-up .....	2253
H.3	Connection .....	2253
H.3.0	Measurement of Transmitter Characteristics .....	2253
H.3.1	Measurement of Receiver Characteristics .....	2254
H.3.2	Measurement of Performance Requirements .....	2254
<b>Annex I (informative): Handling requirements and tests for different releases and UE capabilities .....</b>		<b>2255</b>
I.1	General Considerations .....	2255
I.2	Concrete scenarios .....	2256
I.2.1	Tests for minimum requirements varying between releases, without introduction of new features .....	2256
I.2.2	Tests for CA (Carrier aggregation) .....	2257
I.2.2.1	CA Tx tests (Chapter 6) .....	2257
I.2.2.2	CA Rx tests (Chapter 7) .....	2258
I.2.2.3	CA Performance tests (Chapter 8) .....	2258
I.2.3	Tests for UL-MIMO (Uplink Multiple Antenna Transmission) .....	2259
I.2.3.1	UL-MIMO Tx tests (Chapter 6) .....	2259
I.2.3.2	UL-MIMO Rx tests (Chapter 7) .....	2259
I.2.4	Tests for eDL-MIMO (Enhanced Downlink Multiple Antenna Transmission) .....	2260
I.2.4.1	eDL MIMO Performance tests (Chapter 8) .....	2260
I.2.4.2	eDL MIMO CSI tests (Chapter 9) .....	2260
I.2.5	Tests for eICIC (Enhanced Inter-carrier Interference Cancellation / Coordination) .....	2261
I.2.5.1	eICIC Performance tests (Chapter 8) .....	2261
I.2.5.2	eICIC CSI tests (Chapter 9) .....	2261
I.2.6	Tests for feICIC (Further Enhanced Non CA-based ICIC for LTE) .....	2262
I.2.6.1	feICIC Performance tests (Chapter 8) .....	2262
I.2.6.2	feICIC CSI tests (Chapter 9) .....	2262
I.2.7	Tests for DL CoMP (Downlink Coordinated Multipoint Transmission) .....	2262
I.2.7.1	CoMP Performance tests (Chapter 8) .....	2262
I.2.7.2	CoMP CSI tests (Chapter 9) .....	2263
I.2.8	Tests for Further eDL-MIMO (Enhanced Downlink Multiple Antenna Transmission) Enhancement for LTE-A .....	2263
I.2.8.1	eDL MIMO Enhancement CSI tests (Chapter 9) .....	2263
I.2.9	Tests for UE category 0 .....	2264
I.2.9.1	UE category 0 Tx tests (Chapter 6) .....	2264
I.2.9.2	UE category 0 Rx tests (Chapter 7) .....	2264
I.2.9.3	UE category 0 Performance tests (Chapter 8) .....	2264
I.2.9.4	UE category 0 CSI tests (Chapter 9) .....	2265
I.2.10	Tests for SCE-L1 (Small Cell Enhancements-Physical layer) .....	2265
I.2.10.1	SCE-L1 Receiver tests (Chapter 7) .....	2265
I.2.10.2	SCE-L1 Performance tests (Chapter 8) .....	2266
I.2.10.3	SCE-L1 CSI tests (Chapter 9) .....	2266
<b>Annex J (informative): Change history .....</b>		<b>2268</b>
History .....		2333

---

# Foreword

This Technical Specification has been produced by the 3<sup>rd</sup> Generation Partnership Project (3GPP).

The contents of the present document are subject to continuing work within the TSG and may change following formal TSG approval. Should the TSG modify the contents of the present document, it will be re-released by the TSG with an identifying change of release date and an increase in version number as follows:

Version x.y.z

where:

- x the first digit:
  - 1 presented to TSG for information;
  - 2 presented to TSG for approval;
  - 3 or greater indicates TSG approved document under change control.
- y the second digit is incremented for all changes of substance, i.e. technical enhancements, corrections, updates, etc.
- z the third digit is incremented when editorial only changes have been incorporated in the document.

---

# Introduction

The present document is part 1 of a multi-parts TS:

3GPP TS 36.521-1: Evolved Universal Terrestrial Radio Access (E-UTRA); User Equipment (UE) conformance specification Radio transmission and reception; Part 1: Conformance Testing.

3GPP TS 36.521-2 [11]: Evolved Universal Terrestrial Radio Access (E-UTRA); User Equipment (UE) conformance specification Radio transmission and reception; Part 2: Implementation Conformance Statement (ICS).

3GPP TS 36.521-3 [12]: Evolved Universal Terrestrial Radio Access (E-UTRA); User Equipment (UE) conformance specification Radio transmission and reception; Part 3: Radio Resource Management (RRM) conformance testing.

---

# 1 Scope

The present document specifies the measurement procedures for the conformance test of the user equipment (UE) that contain transmitting characteristics, receiving characteristics and performance requirements as part of the 3G Long Term Evolution (3G LTE). Conformance test for the support of RRM (Radio Resource Management) are specified in TS 36.521-3 [12].

The requirements are listed in different clauses only if the corresponding parameters deviate. More generally, tests are only applicable to those mobiles that are intended to support the appropriate functionality. To indicate the circumstances in which tests apply, this is noted in the "*definition and applicability*" part of the test.

For example only Release 8 and later UE declared to support LTE shall be tested for this functionality. In the event that for some tests different conditions apply for different releases, this is indicated within the text of the test itself.

---

## 2 References

The following documents contain provisions which, through reference in this text, constitute provisions of the present document.

- References are either specific (identified by date of publication, edition number, version number, etc.) or non-specific.
- For a specific reference, subsequent revisions do not apply.
- For a non-specific reference, the latest version applies. In the case of a reference to a 3GPP document (including a GSM document), a non-specific reference implicitly refers to the latest version of that document in the same Release as the present document unless the context in which the reference is made suggests a different Release is relevant (information on the applicable release in a particular context can be found in e.g. test case title, description or applicability, message description or content).

- [1] 3GPP TR 21.905: "Vocabulary for 3GPP Specifications".
- [2] 3GPP TS 36.101: "E-UTRA UE radio transmission and reception".
- [3] ITU-R Recommendation SM.329-10, "Unwanted emissions in the spurious domain"
- [4] 3GPP TS 36.133: "E-UTRA requirements for support of radio resource management".
- [5] 3GPP TS 36.331: "E-UTRA Radio Resource Control (RRC): protocol specification".
- [6] 3GPP TS 36.304: "E-UTRA UE procedures in idle mode".
- [7] 3GPP TS 36.508: "Common test environments for User Equipment (UE)".
- [8] 3GPP TS 36.211: "Physical Channels and Modulation".
- [9] 3GPP TS 36.212: "E-UTRA Multiplexing and channel coding".
- [10] 3GPP TS 36.213: "E-UTRA Physical layer procedures".
- [11] 3GPP TS 36.521-2: "Evolved Universal Terrestrial Radio Access (E-UTRA); User Equipment (UE) conformance specification; Radio transmission and reception; Part 2: Implementation Conformance Statement (ICS)".
- [12] 3GPP TS 36.521-3: "Evolved Universal Terrestrial Radio Access (E-UTRA); User Equipment (UE) conformance specification; Radio transmission and reception; Part 3: Radio Resource Management (RRM) conformance testing".
- [13] 3GPP TS 36.321: "Evolved Universal Terrestrial Radio Access (E-UTRA); Medium Access Control (MAC) protocol specification".
- [14] 3GPP TS 36.423: "X2 application protocol (X2AP) ".
- [15] 3GPP TS 36.306: "E-UTRA User Equipment (UE) radio access capabilities".
- [16] 3GPP TS 36.307: "Requirements on User Equipments (UEs) Supporting a release-independent frequency band".
- [17] 3GPP TR 36.904: "Derivation of test tolerances for User Equipment (UE) radio reception conformance tests".

## 3 Definitions, symbols and abbreviations

### 3.1 Definitions

For the purposes of the present document, the terms and definitions given in TR 21.905 [1] and the following apply. A term defined in the present document takes precedence over the definition of the same term, if any, in TR 21.905 [1].

**Aggregated Channel Bandwidth:** The RF bandwidth in which a UE transmits and receives multiple contiguously aggregated carriers.

**Aggregated Transmission Bandwidth Configuration:** The number of resource block allocated within the aggregated channel bandwidth.

**Carrier aggregation:** Aggregation of two or more component carriers in order to support wider transmission bandwidths.

**Carrier aggregation band:** A set of one or more operating bands across which multiple carriers are aggregated with a specific set of technical requirements.

**Carrier aggregation bandwidth class:** A class defined by the aggregated transmission bandwidth configuration and maximum number of component carriers supported by a UE.

**Carrier aggregation configuration:** A combination of CA operating band(s) and CA bandwidth class(es) supported by a UE.

**Channel edge:** The lowest and highest frequency of the carrier, separated by the channel bandwidth.

**Channel bandwidth:** The RF bandwidth supporting a single E-UTRA RF carrier with the transmission bandwidth configured in the uplink or downlink of a cell. The channel bandwidth is measured in MHz and is used as a reference for transmitter and receiver RF requirements.

**Contiguous carriers:** A set of two or more carriers configured in a spectrum block where there are no RF requirements based on co-existence for un-coordinated operation within the spectrum block.

**Contiguous resource allocation:** A resource allocation of consecutive resource blocks within one carrier or across contiguously aggregated carriers. The gap between contiguously aggregated carriers due to the nominal channel spacing is allowed.

**Contiguous spectrum:** Spectrum consisting of a contiguous block of spectrum with no sub-block gaps.

**Enhanced performance requirements type A:** This defines performance requirements assuming as baseline receiver reference symbol based linear minimum mean square error interference rejection combining.

**Enhanced performance requirements type C:** This defines performance requirements assuming as baseline receiver inter-stream interference cancellation.

**Inter-band carrier aggregation:** Carrier aggregation of component carriers in different operating bands.

NOTE: Carriers aggregated in each band can be contiguous or non-contiguous.

**Intra-band contiguous carrier aggregation:** Contiguous carriers aggregated in the same operating band.

**Intra-band non-contiguous carrier aggregation:** Non-contiguous carriers aggregated in the same operating band.

**Lower sub-block edge:** The frequency at the lower edge of one sub-block. It is used as a frequency reference point for both transmitter and receiver requirements.

**Non-contiguous spectrum:** Spectrum consisting of two or more sub-blocks separated by sub-block gap(s). **Sub-block:** This is one contiguous allocated block of spectrum for transmission and reception by the same UE. There may be multiple instances of sub-blocks within an RF bandwidth.

**Maximum Output Power:** The mean power level per carrier of UE measured at the antenna connector in a specified reference condition.

**Mean power:** When applied to E-UTRA transmission this is the power measured in the operating system bandwidth of the carrier. The period of measurement shall be at least one subframe (1ms) unless otherwise stated.

**Occupied bandwidth:** The width of a frequency band such that, below the lower and above the upper frequency limits, the mean powers emitted are each equal to a specified percentage  $\beta/2$  of the total mean power of a given emission.

**Output power:** The mean power of one carrier of the UE, delivered to a load with resistance equal to the nominal load impedance of the transmitter.

**PMI delay:** The rate in basic time unit at which PMI is updated.

**Reference bandwidth:** The bandwidth in which an emission level is specified.

**Sub-block:** This is one contiguous allocated block of spectrum for transmission and reception by the same UE. There may be multiple instances of sub-blocks within an RF bandwidth.

**Sub-block bandwidth:** The bandwidth of one sub-block.

**Sub-block gap:** A frequency gap between two consecutive sub-blocks within an RF bandwidth, where the RF requirements in the gap are based on co-existence for un-coordinated operation.

**Synchronized operation:** Operation of TDD in two different systems, where no simultaneous uplink and downlink occur.

**Transmission bandwidth:** Bandwidth of an instantaneous transmission from a UE or BS, measured in Resource Block units.

**Transmission bandwidth configuration:** The highest transmission bandwidth allowed for uplink or downlink in a given channel bandwidth, measured in Resource Block units.

**Transmit Diversity:** Transmit diversity is based on space-frequency block coding techniques complemented with frequency-shift time diversity when four transmit antennas is used.

**Unsynchronized operation:** Operation of TDD in two different systems, where the conditions for synchronized operation

**Upper sub-block edge:** The frequency at the upper edge of one sub-block. It is used as a frequency reference point for both transmitter and receiver requirements.

## 3.2 Symbols

For the purposes of the present document, the following symbols apply:

$BW_{\text{Channel}}$	Channel bandwidth
$BW_{\text{Channel,block}}$	Sub-block bandwidth, expressed in MHz. $BW_{\text{Channel,block}} = F_{\text{edge,block,high}} - F_{\text{edge,block,low}}$ .
$BW_{\text{Channel\_CA}}$	Aggregated channel bandwidth, expressed in MHz.
$BW_{\text{GB}}$	Virtual guard band to facilitate transmitter (receiver) filtering above / below edge CCs.
$E_{RS}$	Transmitted energy per RE for reference symbols during the useful part of the symbol, i.e. excluding the cyclic prefix, (average power normalized to the subcarrier spacing) at the eNode B transmit antenna connector
$\hat{E}_s$	The averaged received energy per RE of the wanted signal during the useful part of the symbol, i.e. excluding the cyclic prefix, at the UE antenna connector; average power is computed within a set of REs used for the transmission of physical channels (including user specific RSs when present), divided by the number of REs within the set, and normalized to the subcarrier spacing
F	Frequency
$F_{\text{agg\_alloc\_low}}$	Aggregated Transmission Bandwidth Configuration. The lowest frequency of the simultaneously transmitted resource blocks.
$F_{\text{agg\_alloc\_high}}$	Aggregated Transmission Bandwidth Configuration. The highest frequency of the simultaneously transmitted resource blocks.
$F_{\text{Interferer (offset)}}$	Frequency offset of the interferer
$F_{\text{Interferer}}$	Frequency of the interferer
$F_C$	Frequency of the carrier centre frequency



$F_{C\_agg}$	Aggregated Transmission Bandwidth Configuration. Center frequency of the aggregated carriers.
$F_{C\_block, high}$	Center frequency of the highest transmitted/received carrier in a sub-block.
$F_{C\_block, low}$	Center frequency of the lowest transmitted/received carrier in a sub-block.
$F_{CA\_low}$	The centre frequency of the <i>lowest carrier</i> , expressed in MHz.
$F_{CA\_high}$	The centre frequency of the <i>highest carrier</i> , expressed in MHz.
$F_{DL\_low}$	The lowest frequency of the downlink operating band
$F_{DL\_high}$	The highest frequency of the downlink operating band
$F_{UL\_low}$	The lowest frequency of the uplink operating band
$F_{UL\_high}$	The highest frequency of the uplink operating band
$F_{edge, block, low}$	The lower sub-block edge, where $F_{edge, block, low} = F_{C, block, low} - F_{offset}$ .
$F_{edge, block, high}$	The upper sub-block edge, where $F_{edge, block, high} = F_{C, block, high} + F_{offset}$ .
$F_{edge\_low}$	The <i>lower edge</i> of aggregated channel bandwidth, expressed in MHz.
$F_{edge\_high}$	The <i>higher edge</i> of aggregated channel bandwidth, expressed in MHz.
$F_{offset}$	Frequency offset from $F_{C\_high}$ to the <i>higher edge</i> or $F_{C\_low}$ to the <i>lower edge</i> .
$F_{offset, block, low}$	Separation between lower edge of a sub-block and the center of the lowest component carrier within the sub-block
$F_{offset, block, high}$	Separation between higher edge of a sub-block and the center of the highest component carrier within the sub-block
$I_o$	The power spectral density of the total input signal (power averaged over the useful part of the symbols within the transmission bandwidth configuration, divided by the total number of RE for this configuration and normalised to the subcarrier spacing) at the UE antenna connector, including the own-cell downlink signal
$I_{or}$	The total transmitted power spectral density of the own-cell downlink signal (power averaged over the useful part of the symbols within the transmission bandwidth configuration, divided by the total number of RE for this configuration and normalised to the subcarrier spacing) at the eNode B transmit antenna connector
$\hat{I}_{or}$	The total received power spectral density of the own-cell downlink signal (power averaged over the useful part of the symbols within the transmission bandwidth configuration, divided by the total number of RE for this configuration and normalised to the subcarrier spacing) at the UE antenna connector
$I_{ot}$	The received power spectral density of the total noise and interference for a certain RE (average power obtained within the RE and normalized to the subcarrier spacing) as measured at the UE antenna connector
$L_{CRB}$	Transmission bandwidth which represents the length of a contiguous resource block allocation expressed in units of resource blocks
$N_{cp}$	Cyclic prefix length
$N_{DL}$	Downlink EARFCN
$N_{oc}$	The power spectral density of a white noise source (average power per RE normalised to the subcarrier spacing), simulating interference from cells that are not defined in a test procedure, as measured at the UE antenna connector.
$N_{oc1}$	The power spectral density of a white noise source (average power per RE normalized to the subcarrier spacing), simulating interference in non-CRS symbols in ABS subframe from cells that are not defined in a test procedure, as measured at the UE antenna connector.
$N_{oc2}$	The power spectral density of a white noise source (average power per RE normalized to the subcarrier spacing), simulating interference in CRS symbols in ABS subframe from all cells that are not defined in a test procedure, as measured at the UE antenna connector.
$N_{oc3}$	The power spectral density of a white noise source (average power per RE normalised to the subcarrier spacing), simulating interference in non-ABS subframe from cells that are not defined in a test procedure, as measured at the UE antenna connector.
$N_{oc}'$	The power spectral density (average power per RE normalised to the subcarrier spacing) of the summation of the received power spectral densities of the strongest interfering cells explicitly defined in a test procedure plus $N_{oc}$ , as measured at the UE antenna connector. The respective power spectral density of each interfering cell relative to $N_{oc}'$ is defined by its associated DIP value.
$N_{Offs-DL}$	Offset used for calculating downlink EARFCN
$N_{Offs-UL}$	Offset used for calculating uplink EARFCN

$N_{otx}$	The power spectral density of a white noise source (average power per RE normalised to the subcarrier spacing) simulating eNode B transmitter impairments as at the eNode B transmit antenna connector
$N_{RB}$	Transmission bandwidth configuration, expressed in units of resource blocks
Highest $N_{RB}$	Highest $N_{RB}$ defined for the band
$N_{RB\_agg}$	The number of the aggregated RBs within the fully allocated Aggregated Channel bandwidth.
Highest $N_{RB\_agg}$	The highest $N_{RB\_agg}$ across Bandwidth Combination Sets supported by the UE as part of the CA Configuration.
Lowest $N_{RB\_agg}$	The lowest $N_{RB\_agg}$ across Bandwidth Combination Sets supported by the UE as part of the CA Configuration.
$N_{RB\_alloc}$	Total number of simultaneously transmitted resource blocks in Aggregated Channel Bandwidth configuration.
$N_{RB,c}$	The transmission bandwidth configuration of component carrier $c$ , expressed in units of resource blocks
$N_{RB,largest\ BW}$	The largest transmission bandwidth configuration of the component carriers in the bandwidth combination, expressed in units of resource blocks
$N_{RX}$	Number of receiver antennas
$N_{UL}$	Uplink EARFCN
$P$	Number of cell-specific antenna ports
$p$	Antenna port number
$P_{CMAX}$	The measured configured maximum UE output power.
$P_{CMAX,c}$	The configured maximum UE output power for serving cell $c$ .
$P_{EMAX}$	Maximum allowed UE output power signalled by higher layers. Same as IE $P-Max$ , defined in [5].
$P_{EMAX,c}$	Maximum allowed UE output power signalled by higher layers for serving cell $c$ . Same as IE $P-Max$ , defined in [7].
$P_{Interferer}$	Modulated mean power of the interferer
$P_{PowerClass}$	$P_{PowerClass}$ is the nominal UE power (i.e., no tolerance).
$P_{UMAX}$	The measured configured maximum UE output power. Maximum UE Power with possible power reduction due to modulation type, network signalling values and location near the edge of the band; it equals $P_{CMAX}$ when the IE $P-Max$ , defined in [5], is not signalled.
$P_{uw}$	Power of an unwanted DL signal
$P_w$	Power of a wanted DL signal
$P\_L_{CRB}$	Number of transmitted resource blocks on the Primary Component Carrier
$R_{av}$	Minimum average throughput per RB
RB #	Position of the RB in the channel bandwidth.
RB <sub>start</sub>	Indicates the lowest RB index of transmitted resource blocks.
RB <sub>end</sub>	Indicates the highest RB index of transmitted resource blocks.
$S\_L_{CRB}$	Number of transmitted resource blocks on the Secondary Component Carrier
$\Delta F_{OOB}$	$\Delta$ Frequency of Out Of Band emission
$\Delta R_{IB,c}$	Allowed reference sensitivity relaxation due to support for inter-band CA operation, for serving cell $c$ .
$\Delta T_{IB,c}$	Allowed maximum configured output power relaxation due to support for inter-band CA operation, for serving cell $c$ .
$\Delta T_C$	Allowed operating band edge transmission power relaxation.
$\Delta T_{C,c}$	Allowed operating band edge transmission power relaxation for serving cell $c$ .
$\sigma$	Test specific auxiliary variable used for the purpose of downlink power allocation, defined in Annex C.3.2.
$W_{gap}$	Sub-block gap size

### 3.3 Abbreviations

For the purposes of the present document, the abbreviations given in TR 21.905 [1] and the following apply. An abbreviation defined in the present document takes precedence over the definition of the same abbreviation, if any, in TR 21.905 [1].

ABS	Almost Blank Subframe
ACLR	Adjacent Channel Leakage Ratio
ACS	Adjacent Channel Selectivity
A-MPR	Additional Maximum Power Reduction
AWGN	Additive White Gaussian Noise

BCCH	Broadcast Control Channel
BCH	Broadcast Channel
BS	Base Station
CA	Carrier Aggregation
CA_X	Intra-band contiguous CA of component carriers in one sub-block within Band X where X is the applicable E-UTRA operating band
CA_X-X	Intra-band non-contiguous intra band CA of component carriers in two sub-blocks within Band X is the applicable E-UTRA operating band
CA_X-Y	Inter-band CA of component carrier(s) in one sub-block within Band X and component carrier(s) in one sub-block within Band Y where X and Y are the applicable E-UTRA operating band
CA_X-X-Y	CA of component carriers in two sub-blocks within Band X and component carrier(s) in one sub-block within Band Y where X and Y are the applicable E-UTRA operating bands
CC	Component Carriers
CP	Cyclic Prefix
CoMP	Coordinated Multi-Point
CPE	Customer Premise Equipment
CPE_X	Customer Premise Equipment for E-UTRA operating band X
CQI	Channel Quality Indicator
CW	Continuous Wave
DCI	Downlink Control Information
DIP	Dominant Interferer Proportion
DPS	Dynamic Point Switch
eDL-MIMO	Down Link Multiple Antenna transmission
DL	Downlink
DTX	Discontinuous Transmission
DwPTS	Downlink Pilot Time-Slot
EARFCN	E-UTRA Absolute Radio Frequency Channel Number
EPRE	Energy Per Resource Element
E-UTRA	Evolved UMTS Terrestrial Radio Access
EUTRAN	Evolved UMTS Terrestrial Radio Access Network
EVM	Error Vector Magnitude
FDD	Frequency Division Duplex
FRC	Fixed Reference Channel
FSTD	Frequency-Shift Time Diversity
HARQ	Hybrid ARQ
HD-FDD	Half- Duplex FDD
MAC	Medium Access Control
MBMS	Multimedia Broadcast Multicast Service
MCS	Modulation and Coding Scheme
MOP	Maximum Output Power
MPR	Maximum Power Reduction
MSR	Maximum Sensitivity Reduction
OCNG	OFDMA Channel Noise Generator
OFDMA	Orthogonal Frequency Division Multiple Access
OOB	Out-of-band
P-MPR	Power Management Maximum Power Reduction
PA	Power Amplifier
PBCH	Physical Broadcast Channel
PCC	Primary Component Carrier
PCCH	Paging Control Channel
PCFICH	Physical Control Format Indicator Channel
PDCCH	Physical Downlink Control Channel
PDSCH	Physical Downlink Shared Channel
PDU	Packet Data Unit
PHICH	Physical Hybrid ARQ Indicator Channel
Pm-dsg	Probability of miss-detection of the Downlink Scheduling Grant
PMI	Precoding Matrix Indicator
PRACH	Physical Random Access Channel
PRB	Physical Resource Block
PSS	Primary Synchronization Signal
PSS_RA	PSS-to-EPRE ratio for the channel PSS
PUCCH	Physical Uplink Control Channel

PUSCH	Physical Uplink Shared Channel	RE	Resource Element
RE	Resource Element		
REFSENS	Reference Sensitivity power level		
RI	Rank Indicator		
RLC	Radio Link Control		
RMC	Reference Measurement Channel		
r.m.s	Root Mean Square		
RNTI	Radio Network Temporary Identifier		
RRC	Radio Resource Control		
RS	Reference Signal		
RSRP	Reference Signal Received Power		
SCC	Secondary Component Carrier		
SCH	Synchronization Channel		
SDU	Service Data Unit		
SFBC	Space-Frequency Block Coding		
SINR	Signal-to-Interference-and-Noise Ratio		
SNR	Signal-to-Noise Ratio		
SRS	Sounding Reference Signal		
SSS	Secondary Synchronization Signal		
SSS_RA	SSS-to-RS EPRE ratio for the channel SSS		
TDD	Time Division Duplex		
TP	Transmission Point		
TPC	Transmit Power Control		
TPMI	Transmitted Precoding Matrix Indicator		
TTI	Transmission Time Interval		
UE	User Equipment		
UL	Uplink		
UL-MIMO	Up Link Multiple Antenna transmission		
UMTS	Universal Mobile Telecommunications System		
UpPTS	Uplink Pilot Time-Slot		
UTRA	UMTS Terrestrial Radio Access		
UTRAN	UMTS Terrestrial Radio Access Network		
xCH_RA	xCH-to-RS EPRE ratio for the channel xCH in all transmitted OFDM symbols not containing RS		
xCH_RB	xCH-to-RS EPRE ratio for the channel xCH in all transmitted OFDM symbols containing RS		

## 4 General

Unless otherwise stated, the following reference conditions used by all test cases in this document are specified in TS 36.508 [7]:

- Connection Diagrams,
- Test Frequencies,
- Cell Settings,
- Reference Environments,
- Environmental Conditions,
- Generic Connection Setup Procedures,
- System Information (SI),
- Message Contents.

Where a test requires one of the above reference conditions that are different, this will be specified within the test itself.

The Minimum Requirements defined in each test make no allowance for Measurement Uncertainty. Therefore, Test Tolerances are used to relax the Minimum Requirements. If the Test Requirement differs from the Minimum Requirement then the Test Tolerance applied for that test is non-zero. For each test the Test Tolerances are individually calculated to create the Test Requirements. The Test Tolerance for each test and the explanation of how the Minimum Requirement has been relaxed by the Test Tolerance is given in Annex F.3.

Downlink and Uplink transmissions are organized into radio frames with  $T_f = 307200 \times T_s = 10$  ms duration. Two radio frame structures are supported in this document:

- Type 1, applicable to FDD,
- Type 2, applicable to TDD.

In clauses 6 and 7 TX and RX test cases for FDD/TDD test cases are defined. FDD and TDD test scenarios/requirements are included within the same test case. For test cases with any difference between the FDD and TDD branches the test description part of the test case has been separated in two sections to cover the two technologies. The applicability for the FDD and TDD branches are specified in TS 36.521-2.

In clause 8 the performance requirement test cases are defined. FDD and TDD performance requirement test cases are defined in different clauses accordingly to the requirements specified in TS 36.101.

Unless otherwise stated, each test case is tested for every operating band supported by the UE and repeated with the applicable test configurations (i.e. test environment, test frequencies, test channel bandwidths, channel bandwidth parameters) indicated in each test case. For test cases in clauses 6, 7, 8 the initial conditions of the downlink physical channels signal levels and downlink physical channels required are specified in Annex C.0, Annex C.1 and Annex C.2.

For test cases in clauses 6 and 7 that require measurements with maximum output power, the UE shall transmit at its maximum output power state with output power level of  $P_{UMAX}$  level. This range of maximum output power shall not be modified for any further additional relaxation.

For UL-MIMO cases, the UE output power is the sum of mean powers as measured at each antenna connector unless otherwise stated.

For test cases in clauses 6 and 7, the partial RB allocations refer to any RB allocation less than full RB allocation except 1 RB allocation.

### 4.1 Categorization of test requirements in CA, UL-MIMO, eDL-MIMO and UE category 0

The test requirements for Clauses 6 (Tx Characteristics) and 7 (Rx Characteristics), which are specific to CA, UL-MIMO, eDL-MIMO and UE category 0 are specified as suffix A, B, C, D and E where;

- a) Suffix A additional requirements need to support CA
- b) Suffix B additional requirements need to support UL-MIMO
- c) Suffix C additional requirements need to support TBD
- d) Suffix D additional requirements need to support eDL-MIMO
- e) Suffix E additional requirements need to support UE category 0

A terminal which supports the above features needs to meet both the general requirements and the additional requirement applicable to the additional sub-clause (suffix A, B, C, D and E).

Where there is a difference in requirement between the general requirements and the additional subclause requirements (suffix A, B, C, D, and E) in clauses 5, 6 and 7, the tighter requirements are applicable unless stated otherwise in the additional subclause.

A terminal which supports more than one feature (CA, UL-MIMO, and eDL-MIMO and UE category 0) shall meet all of the separate corresponding requirements.

For a terminal supporting CA, compliance with minimum requirements for non-contiguous intra-band carrier aggregation in any given operating band does not imply compliance with minimum requirements for contiguous intra-band carrier aggregation in the same operating band.

For a terminal supporting CA, compliance with minimum requirements for contiguous intra-band carrier aggregation in any given operating band does not imply compliance with minimum requirements for non- contiguous intra-band carrier aggregation in the same operating band.

A terminal which supports a DL CA configuration shall support all the lower order fallback DL CA combinations and it shall support at least one bandwidth combination set for each of the constituent lower order DL combinations containing all the bandwidths specified within each specific combination set of the upper order DL combination.

NOTE 1: Test Case 6.5.2.1A, PUSCH-EVM with exclusion period, is a Release 8 non-CA test case and does not indicate a requirement to support CA.

NOTE 2: This categorization of test requirements reflects only the categorization of minimum requirements as done by RAN4 in 3GPP TS 36.101. For the categorization of the tests requirements done on behalf of RAN5 follow the information given in Annex I.

The frequency bands and channel arrangement for CA, UL-MIMO, and eDL-MIMO are specified in Clause 5, where;

- a) The clauses with suffix A specify the operating bands and channel arrangement related information for CA
- b) The clauses with suffix B specify the operating bands and channel arrangement related information for UL-MIMO
- c) The clauses with suffix C specify the operating bands and channel arrangement related information for [TBD]
- d) The clauses with suffix D specify the operating bands and channel arrangement related information for eDL-MIMO

## 4.2 RF requirements in later releases

The standardisation of new frequency bands may be independent of a release. However, in order to implement a UE that conforms to a particular release but supports a band of operation that is specified in a later release, it is necessary to specify some extra requirements. TS 36.307 [16] specifies requirements on UEs supporting a frequency band that is independent of release.

NOTE: For UEs conforming to the 3GPP release of the present document, some RF requirements of later releases may be mandatory independent of whether the UE supports the bands specified in later releases or not. The set of RF requirements of later releases that is also mandatory for UEs conforming to the 3GPP release of the present document is determined by regional regulation.

## 5 Frequency bands and channel arrangement

### 5.1 General

The channel arrangements presented in this clause are based on the frequency bands and channel bandwidths defined in the present release of specifications.

NOTE: Other operating bands and channel bandwidths may be considered in future releases.

### 5.2 Operating bands

E-UTRA is designed to operate in the operating bands defined in Table 5.2-1.

**Table 5.2-1: E-UTRA operating bands**

E-UTRA Operating Band	Uplink (UL) eNode B receive UE transmit	Downlink (DL) eNode B transmit UE receive	Duplex Mode
	$F_{UL\_low} - F_{UL\_high}$	$F_{DL\_low} - F_{DL\_high}$	

1	1920 MHz – 1980 MHz	2110 MHz – 2170 MHz	FDD
2	1850 MHz – 1910 MHz	1930 MHz – 1990 MHz	FDD
3	1710 MHz – 1785 MHz	1805 MHz – 1880 MHz	FDD
4	1710 MHz – 1755 MHz	2110 MHz – 2155 MHz	FDD
5	824 MHz – 849 MHz	869 MHz – 894MHz	FDD
6 <sup>1</sup>	830 MHz – 840 MHz	875 MHz – 885 MHz	FDD
7	2500 MHz – 2570 MHz	2620 MHz – 2690 MHz	FDD
8	880 MHz – 915 MHz	925 MHz – 960 MHz	FDD
9	1749.9 MHz – 1784.9 MHz	1844.9 MHz – 1879.9 MHz	FDD
10	1710 MHz – 1770 MHz	2110 MHz – 2170 MHz	FDD
11	1427.9 MHz – 1447.9 MHz	1475.9 MHz – 1495.9 MHz	FDD
12	699 MHz – 716 MHz	729 MHz – 746 MHz	FDD
13	777 MHz – 787 MHz	746 MHz – 756 MHz	FDD
14	788 MHz – 798 MHz	758 MHz – 768 MHz	FDD
15	Reserved	Reserved	FDD
16	Reserved	Reserved	FDD
17	704 MHz – 716 MHz	734 MHz – 746 MHz	FDD
18	815 MHz – 830 MHz	860 MHz – 875 MHz	FDD
19	830 MHz – 845 MHz	875 MHz – 890 MHz	FDD
20	832 MHz – 862 MHz	791 MHz – 821 MHz	FDD
21	1447.9 MHz – 1462.9 MHz	1495.9 MHz – 1510.9 MHz	FDD
22	3410 MHz – 3490 MHz	3510 MHz – 3590 MHz	FDD
23	2000 MHz – 2020 MHz	2180 MHz – 2200 MHz	FDD
24	1626.5 MHz – 1660.5 MHz	1525 MHz – 1559 MHz	FDD
25	1850 MHz – 1915 MHz	1930 MHz – 1995 MHz	FDD
26	814 MHz – 849 MHz	859 MHz – 894 MHz	FDD
27	807 MHz – 824 MHz	852 MHz – 869 MHz	FDD
28	703 MHz – 748 MHz	758 MHz – 803 MHz	FDD
29	NA	717 MHz – 728 MHz	FDD <sup>2</sup>
30	2305 MHz – 2315 MHz	2350 MHz – 2360 MHz	FDD
31	452.5 MHz – 457.5 MHz	462.5 MHz – 467.5 MHz	FDD
32	N/A	1452 MHz – 1496 MHz	FDD <sup>2</sup>
33	1900 MHz – 1920 MHz	1900 MHz – 1920 MHz	TDD
34	2010 MHz – 2025 MHz	2010 MHz – 2025 MHz	TDD
35	1850 MHz – 1910 MHz	1850 MHz – 1910 MHz	TDD
36	1930 MHz – 1990 MHz	1930 MHz – 1990 MHz	TDD
37	1910 MHz – 1930 MHz	1910 MHz – 1930 MHz	TDD
38	2570 MHz – 2620 MHz	2570 MHz – 2620 MHz	TDD
39	1880 MHz – 1920 MHz	1880 MHz – 1920 MHz	TDD
40	2300 MHz – 2400 MHz	2300 MHz – 2400 MHz	TDD
41	2496 MHz – 2690 MHz	2496 MHz – 2690 MHz	TDD
42	3400 MHz – 3600 MHz	3400 MHz – 3600 MHz	TDD
43	3600 MHz – 3800 MHz	3600 MHz – 3800 MHz	TDD
44	703 MHz – 803 MHz	703 MHz – 803 MHz	TDD

Note 1: Band 6 is not applicable.  
Note 2: Restricted to E-UTRA operation when carrier aggregation is configured. The downlink operating band is paired with the uplink operating band (external) of the carrier aggregation configuration that is supporting the configured Pcell.

## 5.2A Operating bands for CA

E-UTRA carrier aggregation is designed to operate in the operating bands defined in Tables 5.2A-1 and 5.2A-2.

**Table 5.2A-1: Intra-band contiguous CA operating bands**

E-UTRA CA Band	E-UTRA Band	Uplink (UL) operating band	Downlink (DL) operating band	Duplex Mode
		BS receive / UE transmit	BS transmit / UE receive	
		$F_{UL\_low} - F_{UL\_high}$	$F_{DL\_low} - F_{DL\_high}$	



CA_1	1	1920 MHz	–	1980 MHz	2110 MHz	–	2170 MHz	FDD
CA_2	2	1850 MHz	–	1910 MHz	1930 MHz	–	1990 MHz	FDD
CA_3	3	1710MHz	–	1785MHz	1805MHz	–	1880MHz	FDD
CA_7	7	2500 MHz	–	2570 MHz	2620 MHz	–	2690 MHz	FDD
CA_12	12	699 MHz	–	716 MHz	729 MHz	–	746 MHz	FDD
CA_23	23	2000 MHz	–	2020 MHz	2180 MHz	–	2200 MHz	FDD
CA_27	27	807 MHz	–	824 MHz	852 MHz	–	869 MHz	FDD
CA_38	38	2570 MHz	–	2620 MHz	2570MHz	–	2620 MHz	TDD
CA_39	39	1880 MHz	–	1920 MHz	1880 MHz	–	1920 MHz	TDD
CA_40	40	2300 MHz	–	2400 MHz	2300 MHz	–	2400 MHz	TDD
CA_41	41	2496 MHz	–	2690 MHz	2496 MHz	–	2690 MHz	TDD
CA_42	42	3400 MHz	–	3600 MHz	3400 MHz	–	3600 MHz	TDD

Table 5.2A-2: Inter-band CA operating bands (two bands)

E-UTRA CA Band	E-UTRA Band	Uplink (UL) operating band	Downlink (DL) operating band	Duplex Mode
		BS receive / UE transmit	BS transmit / UE receive	
		F <sub>UL_low</sub> – F <sub>UL_high</sub>	F <sub>DL_low</sub> – F <sub>DL_high</sub>	

CA_1-3	1	1920 MHz	–	1980 MHz	2110 MHz	–	2170 MHz	FDD
	3	1710 MHz	–	1785 MHz	1805 MHz	–	1880 MHz	
CA_1-5	1	1920 MHz	–	1980 MHz	2110 MHz	–	2170 MHz	FDD
	5	824 MHz	–	849 MHz	869 MHz	–	894 MHz	
CA_1-7	1	1920 MHz	–	1980 MHz	2110 MHz	–	2170 MHz	FDD
	7	2500 MHz	–	2570 MHz	2620 MHz	–	2690 MHz	
CA_1-8	1	1920 MHz	–	1980 MHz	2110 MHz	–	2170 MHz	FDD
	8	880 MHz	–	915 MHz	925 MHz	–	960 MHz	
CA_1-11	1	1920 MHz	–	1980 MHz	2110 MHz	–	2170 MHz	FDD
	11	1427.9 MHz	–	1447.9 MHz	1475.9 MHz	–	1495.9 MHz	
CA_1-18	1	1920 MHz	–	1980 MHz	2110 MHz	–	2170 MHz	FDD
	18	815 MHz	–	830 MHz	860 MHz	–	875 MHz	
CA_1-19	1	1920 MHz	–	1980 MHz	2110 MHz	–	2170 MHz	FDD
	19	830 MHz	–	845 MHz	875 MHz	–	890 MHz	
CA_1-20	1	1920 MHz	–	1980 MHz	2110 MHz	–	2170 MHz	FDD
	20	832 MHz	–	862 MHz	791 MHz	–	821 MHz	
CA_1-21	1	1920 MHz	–	1980 MHz	2110 MHz	–	2170 MHz	FDD
	21	1447.9 MHz	–	1462.9 MHz	1495.9 MHz	–	1510.9 MHz	
CA_1-26	1	1920 MHz	–	1980 MHz	2110 MHz	–	2170 MHz	FDD
	26	814 MHz	–	849 MHz	859 MHz	–	894 MHz	
CA_1-28	1	1920 MHz	–	1980 MHz	2110 MHz	–	2170 MHz	FDD
	28	703 MHz	–	748 MHz	758 MHz	–	803 MHz	
CA_1-41	1	1920 MHz	–	1980 MHz	2110 MHz	–	2170 MHz	FDD
	41	2496 MHz	–	2690 MHz	2496 MHz	–	2690 MHz	
CA_1-42	1	1920 MHz	–	1980 MHz	2110 MHz	–	2170 MHz	FDD
	42	3400 MHz	–	3600 MHz	3400 MHz	–	3600 MHz	
CA_2-2-5	2	1850 MHz	–	1910 MHz	1930 MHz	–	1990 MHz	FDD
	5	824 MHz	–	849 MHz	869 MHz	–	894 MHz	
CA_2-2-13	2	1850 MHz	–	1910 MHz	1930 MHz	–	1990 MHz	FDD
	13	777 MHz	–	787 MHz	746 MHz	–	756 MHz	
CA_2-4	2	1850 MHz	–	1910 MHz	1930 MHz	–	1990 MHz	FDD
	4	1710 MHz	–	1755 MHz	2110 MHz	–	2155 MHz	
CA_2-4-4	2	1850 MHz	–	1910 MHz	1930 MHz	–	1990 MHz	FDD
	4	1710 MHz	–	1755 MHz	2110 MHz	–	2155 MHz	
CA_2-5	2	1850 MHz	–	1910 MHz	1930 MHz	–	1990 MHz	FDD
	5	824 MHz	–	849 MHz	869 MHz	–	894 MHz	
CA_2-12	2	1850 MHz	–	1910 MHz	1930 MHz	–	1990 MHz	FDD
	12	699 MHz	–	716 MHz	729 MHz	–	746 MHz	
CA_2-13	2	1850 MHz	–	1910 MHz	1930 MHz	–	1990 MHz	FDD
	13	777 MHz	–	787 MHz	746 MHz	–	756 MHz	
CA_2-17	2	1850 MHz	–	1910 MHz	1930 MHz	–	1990 MHz	FDD
	17	704 MHz	–	716 MHz	734 MHz	–	746 MHz	
CA_2-29	2	1850 MHz	–	1910 MHz	1930 MHz	–	1990 MHz	FDD
	29			N/A	717 MHz	–	728 MHz	
CA_2-30	2	1850 MHz	–	1910 MHz	1930 MHz	–	1990 MHz	FDD
	30	2305 MHz	–	2315 MHz	2350 MHz	–	2360 MHz	

CA_3-5	3	1710 MHz	–	1785 MHz	1805 MHz	–	1880 MHz	FDD
	5	824 MHz	–	849 MHz	869 MHz	–	894 MHz	
CA_3-7	3	1710 MHz	–	1785 MHz	1805 MHz	–	1880 MHz	FDD
	7	2500 MHz	–	2570 MHz	2620 MHz	–	2690 MHz	
CA_3-8	3	1710 MHz	–	1785 MHz	1805 MHz	–	1880 MHz	FDD
	8	880 MHz	–	915 MHz	925 MHz	–	960 MHz	
CA_3-19	3	1710 MHz	–	1785 MHz	1805 MHz	–	1880 MHz	FDD
	19	830 MHz	–	845 MHz	875 MHz	–	890 MHz	
CA_3-20	3	1710 MHz	–	1785 MHz	1805 MHz	–	1880 MHz	FDD
	20	832 MHz	–	862 MHz	791 MHz	–	821 MHz	
CA_3-26	3	1710 MHz	–	1785 MHz	1805 MHz	–	1880 MHz	FDD
	26	814 MHz	–	849 MHz	859 MHz	–	894 MHz	
CA_3-27	3	1710 MHz	–	1785 MHz	1805 MHz	–	1880 MHz	FDD
	27	807 MHz	–	824 MHz	852 MHz	–	869 MHz	
CA_3-28	3	1710 MHz	–	1785 MHz	1805 MHz	–	1880 MHz	FDD
	28	703 MHz	–	748 MHz	758 MHz	–	803 MHz	
CA_3-42	3	1710 MHz	–	1785 MHz	1805 MHz	–	1880 MHz	FDD
	42	3400 MHz	–	3600 MHz	3400 MHz	–	3600 MHz	TDD
CA_4-4-5	4	1710 MHz	–	1755 MHz	2110 MHz	–	2155 MHz	FDD
	5	824 MHz	–	849 MHz	869 MHz	–	894 MHz	
CA_4-4-7	4	1710 MHz	–	1755 MHz	2110 MHz	–	2155 MHz	FDD
	7	2500 MHz	–	2570 MHz	2620 MHz	–	2690 MHz	
CA_4-4-12	4	1710 MHz	–	1755 MHz	2110 MHz	–	2155 MHz	FDD
	12	699 MHz	–	716 MHz	729 MHz	–	746 MHz	
CA_4-4-13	4	1710 MHz	–	1755 MHz	2110 MHz	–	2155 MHz	FDD
	13	777 MHz	–	787 MHz	746 MHz	–	756 MHz	
CA_4-5	4	1710 MHz	–	1755 MHz	2110 MHz	–	2155 MHz	FDD
	5	824 MHz	–	849 MHz	869 MHz	–	894 MHz	
CA_4-7	4	1710 MHz	–	1755 MHz	2110 MHz	–	2155 MHz	FDD
	7	2500 MHz	–	2570 MHz	2620 MHz	–	2690 MHz	
CA_4-12	4	1710 MHz	–	1755 MHz	2110 MHz	–	2155 MHz	FDD
	12	699 MHz	–	716 MHz	729 MHz	–	746 MHz	
CA_4-13	4	1710 MHz	–	1755 MHz	2110 MHz	–	2155 MHz	FDD
	13	777 MHz	–	787 MHz	746 MHz	–	756 MHz	
CA_4-17	4	1710 MHz	–	1755 MHz	2110 MHz	–	2155 MHz	FDD
	17	704 MHz	–	716 MHz	734 MHz	–	746 MHz	
CA_4-27	4	1710 MHz	–	1755 MHz	2110 MHz	–	2155 MHz	FDD
	27	807 MHz	–	824 MHz	852 MHz	–	869 MHz	
CA_4-29	4	1710 MHz	–	1755 MHz	2110 MHz	–	2155 MHz	FDD
	29			N/A	717 MHz	–	728 MHz	
CA_4-30	4	1710 MHz	–	1755 MHz	2110 MHz	–	2155 MHz	FDD
	30	2305 MHz	–	2315 MHz	2350 MHz	–	2360 MHz	
CA_5-7	5	824 MHz	–	849 MHz	869 MHz	–	894 MHz	FDD
	7	2500 MHz	–	2570 MHz	2620 MHz	–	2690 MHz	
CA_5-12	5	824 MHz	–	849 MHz	869 MHz	–	894 MHz	FDD
	12	699 MHz	–	716 MHz	729 MHz	–	746 MHz	
CA_5-13	5	824 MHz	–	849 MHz	869 MHz	–	894 MHz	FDD
	13	777 MHz	–	787 MHz	746 MHz	–	756 MHz	
CA_5-17	5	824 MHz	–	849 MHz	869 MHz	–	894 MHz	FDD
	17	704 MHz	–	716 MHz	734 MHz	–	746 MHz	
CA_5-25	5	824 MHz	–	849 MHz	869 MHz	–	894 MHz	FDD
	25	1850 MHz	–	1915 MHz	1930 MHz	–	1995 MHz	
CA_5-30	5	824 MHz	–	849 MHz	869 MHz	–	894 MHz	FDD
	30	2305 MHz	–	2315 MHz	2350 MHz	–	2360 MHz	

CA_7-8	7	2500 MHz	–	2570 MHz	2620 MHz	–	2690 MHz	FDD
	8	880 MHz	–	915 MHz	925 MHz	–	960 MHz	
CA_7-20	7	2500 MHz	–	2570 MHz	2620 MHz	–	2690 MHz	FDD
	20	832 MHz	–	862 MHz	791 MHz	–	821 MHz	
CA_7-28	7	2500 MHz	–	2570 MHz	2620 MHz	–	2690 MHz	FDD
	28	703 MHz	–	748 MHz	758 MHz	–	803 MHz	
CA_8-11	8	880 MHz	–	915 MHz	925 MHz	–	960 MHz	FDD
	11	1427.9 MHz	–	1447.9 MHz	1475.9 MHz	–	1495.9 MHz	
CA_8-20	8	880 MHz	–	915 MHz	925 MHz	–	960 MHz	FDD
	20	832 MHz	–	862 MHz	791 MHz	–	821 MHz	
CA_11-18	11	1427.9 MHz	–	1447.9 MHz	1475.9 MHz	–	1495.9 MHz	FDD
	18	815 MHz	–	830 MHz	860 MHz	–	875 MHz	
CA_12-25	12	699 MHz	–	716 MHz	729 MHz	–	746 MHz	FDD
	25	1850 MHz	–	1915 MHz	1930 MHz	–	1995 MHz	
CA_12-30	12	699 MHz	–	716 MHz	729 MHz	–	746 MHz	FDD
	30	2305 MHz	–	2315 MHz	2350 MHz	–	2360 MHz	
CA_18-28	18	815 MHz	–	830 MHz	860 MHz	–	875 MHz	FDD
	28	703 MHz	–	733 MHz	758 MHz	–	788 MHz	
CA_19-21	19	830 MHz	–	845 MHz	875 MHz	–	890 MHz	FDD
	21	1447.9 MHz	–	1462.9 MHz	1495.9 MHz	–	1510.9 MHz	
CA_19-42	19	830 MHz	–	845 MHz	875 MHz	–	890 MHz	FDD
	42	3400 MHz	–	3600 MHz	3400 MHz	–	3600 MHz	TDD
CA_20-32	20	832 MHz	–	862 MHz	791 MHz	–	821 MHz	FDD
	32	N/A			1452 MHz	–	1496 MHz	
CA_23-29	23	2000 MHz	–	2020 MHz	2180 MHz	–	2200 MHz	FDD
	29	N/A			717 MHz	–	728 MHz	
CA_26-41	26	814 MHz	–	849 MHz	859 MHz	–	894 MHz	FDD
	41	2496 MHz	–	2690 MHz	2496 MHz	–	2690 MHz	TDD
CA_29-30	29	N/A			717 MHz	–	728 MHz	FDD
	30	2305 MHz	–	2315 MHz	2350 MHz	–	2360 MHz	
CA_39-41	39	1880 MHz	–	1920 MHz	1880 MHz	–	1920 MHz	TDD
	41	2496 MHz	–	2690 MHz	2496 MHz	–	2690 MHz	
CA_41-42	41	2496 MHz	–	2690 MHz	2496 MHz	–	2690 MHz	TDD
	42	3400 MHz	–	3600 MHz	3400 MHz	–	3600 MHz	

**Table 5.2A-2a: Inter-band CA operating bands (three bands)**

E-UTRA CA Band	E-UTRA Band	Uplink (UL) operating band			Downlink (DL) operating band			Duplex Mode
		BS receive / UE transmit			BS transmit / UE receive			
		F <sub>UL_low</sub> – F <sub>UL_high</sub>			F <sub>DL_low</sub> – F <sub>DL_high</sub>			
CA_1-3-5	1	1920 MHz	–	1980 MHz	2110 MHz	–	2170 MHz	FDD
	3	1710 MHz	–	1785 MHz	1805 MHz	–	1880 MHz	
	5	824 MHz	–	849 MHz	869 MHz	–	894 MHz	
CA_1-3-8	1	1920 MHz	–	1980 MHz	2110 MHz	–	2170 MHz	FDD
	3	1710 MHz	–	1785 MHz	1805 MHz	–	1880 MHz	
	8	880 MHz	–	915 MHz	925 MHz	–	960 MHz	
CA_1-3-19	1	1920 MHz	–	1980 MHz	2110 MHz	–	2170 MHz	FDD
	3	1710 MHz	–	1785 MHz	1805 MHz	–	1880 MHz	
	19	830 MHz	–	845 MHz	875 MHz	–	890 MHz	
CA_1-3-20	1	1920 MHz	–	1980 MHz	2110 MHz	–	2170 MHz	FDD
	3	1710 MHz	–	1785 MHz	1805 MHz	–	1880 MHz	
	20	832 MHz	–	862 MHz	791 MHz	–	821 MHz	
CA_1-3-26	1	1920 MHz	–	1980 MHz	2110 MHz	–	2170 MHz	FDD
	3	1710 MHz	–	1785 MHz	1805 MHz	–	1880 MHz	
	26	814 MHz	–	849 MHz	859 MHz	–	894 MHz	
CA_1-5-7	1	1920 MHz	–	1980 MHz	2110 MHz	–	2170 MHz	FDD
	5	824 MHz	–	849 MHz	869 MHz	–	894 MHz	
	7	2500 MHz	–	2570 MHz	2620 MHz	–	2690 MHz	
CA_1-7-20	1	1920 MHz	–	1980 MHz	2110 MHz	–	2170 MHz	FDD
	7	2500 MHz	–	2570 MHz	2620 MHz	–	2690 MHz	
	20	832 MHz	–	862 MHz	791 MHz	–	821 MHz	
CA_1-18-28	1	1920 MHz	–	1980 MHz	2110 MHz	–	2170 MHz	FDD
	18	815 MHz	–	830 MHz	860 MHz	–	875 MHz	
	28	703 MHz	–	733 MHz	758 MHz	–	788 MHz	
CA_1-19-21	1	1920 MHz	–	1980 MHz	2110 MHz	–	2170 MHz	FDD
	19	830 MHz	–	845 MHz	875 MHz	–	890 MHz	
	21	1447.9 MHz	–	1462.9 MHz	1495.9 MHz	–	1510.9 MHz	
CA_2-4-5	2	1850 MHz	–	1910 MHz	1930 MHz	–	1990 MHz	FDD
	4	1710 MHz	–	1755 MHz	2110 MHz	–	2155 MHz	
	5	824 MHz	–	849 MHz	869 MHz	–	894 MHz	
CA_2-4-12	2	1850 MHz	–	1910 MHz	1930 MHz	–	1990 MHz	FDD
	4	1710 MHz	–	1755 MHz	2110 MHz	–	2155 MHz	
	12	699 MHz	–	716 MHz	729 MHz	–	746 MHz	
CA_2-4-13	2	1850 MHz	–	1910 MHz	1930 MHz	–	1990 MHz	FDD
	4	1710 MHz	–	1755 MHz	2110 MHz	–	2155 MHz	
	13	777 MHz	–	787 MHz	746 MHz	–	756 MHz	
CA_2-4-29	2	1850 MHz	–	1910 MHz	1930 MHz	–	1990 MHz	FDD
	4	1710 MHz	–	1755 MHz	2110 MHz	–	2155 MHz	
	29	N/A			717 MHz	–	728 MHz	
CA_2-5-12	2	1850 MHz	–	1910 MHz	1930 MHz	–	1990 MHz	FDD
	5	824 MHz	–	849 MHz	869 MHz	–	894 MHz	
	12	699 MHz	–	716 MHz	729 MHz	–	746 MHz	
CA_2-5-13	2	1850 MHz	–	1910 MHz	1930 MHz	–	1990 MHz	FDD
	5	824 MHz	–	849 MHz	869 MHz	–	894 MHz	
	13	777 MHz	–	787 MHz	746 MHz	–	756 MHz	
CA_2-5-30	2	1850 MHz	–	1910 MHz	1930 MHz	–	1990 MHz	FDD
	5	824 MHz	–	849 MHz	869 MHz	–	894 MHz	
	30	2305 MHz	–	2315 MHz	2350 MHz	–	2360 MHz	
CA_2-12-30	2	1850 MHz	–	1910 MHz	1930 MHz	–	1990 MHz	FDD
	12	699 MHz	–	716 MHz	729 MHz	–	746 MHz	
	30	2305 MHz	–	2315 MHz	2350 MHz	–	2360 MHz	
CA_2-29-30	2	1850 MHz	–	1910 MHz	1930 MHz	–	1990 MHz	FDD
	29	N/A			717 MHz	–	728 MHz	
	30	2305 MHz	–	2315 MHz	2350 MHz	–	2360 MHz	
CA_3-7-20	3	1710 MHz	–	1785 MHz	1805 MHz	–	1880 MHz	FDD
	7	2500 MHz	–	2570 MHz	2620 MHz	–	2690 MHz	
	20	832 MHz	–	862 MHz	791 MHz	–	821 MHz	

CA_4-5-12	4	1710 MHz	–	1755 MHz	2110 MHz	–	2155 MHz	FDD
	5	824 MHz	–	849 MHz	869 MHz	–	894 MHz	
	12	699 MHz	–	716 MHz	729 MHz	–	746 MHz	
CA_4-5-13	4	1710 MHz	–	1755 MHz	2110 MHz	–	2155 MHz	FDD
	5	824 MHz	–	849 MHz	869 MHz	–	894 MHz	
	13	777 MHz	–	787 MHz	746 MHz	–	756 MHz	
CA_4-5-30	4	1710 MHz	–	1755 MHz	2110 MHz	–	2155 MHz	FDD
	5	824 MHz	–	849 MHz	869 MHz	–	894 MHz	
	30	2305 MHz	–	2315 MHz	2350 MHz	–	2360 MHz	
CA_4-7-12	4	1710 MHz	–	1755 MHz	2110 MHz	–	2155 MHz	FDD
	7	2500 MHz	–	2570 MHz	2620 MHz	–	2690 MHz	
	12	699 MHz	–	716 MHz	729 MHz	–	746 MHz	
CA_4-12-30	4	1710 MHz	–	1755 MHz	2110 MHz	–	2155 MHz	FDD
	12	699 MHz	–	716 MHz	729 MHz	–	746 MHz	
	30	2305 MHz	–	2315 MHz	2350 MHz	–	2360 MHz	
CA_4-29-30	4	1710 MHz	–	1755 MHz	2110 MHz	–	2155 MHz	FDD
	29	N/A			717 MHz	–	728 MHz	
	30	2305 MHz	–	2315 MHz	2350 MHz	–	2360 MHz	
CA_7-8-20	7	2500 MHz	–	2570 MHz	2620 MHz	–	2690 MHz	FDD
	8	880 MHz	–	915 MHz	925 MHz	–	960 MHz	
	20	832 MHz	–	862 MHz	791 MHz	–	821 MHz	

Table 5.2A-3: Intra-band non-contiguous CA operating bands

E-UTRA CA Band	E-UTRA Band	Uplink (UL) operating band			Downlink (DL) operating band			Duplex Mode
		BS receive / UE transmit			BS transmit / UE receive			
		F <sub>UL_low</sub> – F <sub>UL_high</sub>			F <sub>DL_low</sub> – F <sub>DL_high</sub>			
CA_2-2	2	1850 MHz	–	1910 MHz	1930 MHz	–	1990 MHz	FDD
CA_3-3	3	1710 MHz	–	1785 MHz	1805 MHz	–	1880 MHz	FDD
CA_4-4	4	1710 MHz	–	1755 MHz	2110 MHz	–	2155 MHz	FDD
CA_7-7	7	2500 MHz	–	2570 MHz	2620 MHz	–	2690 MHz	FDD
CA_23-23	23	2000 MHz	–	2020 MHz	2180 MHz	–	2200 MHz	FDD
CA_25-25	25	1850 MHz	–	1915 MHz	1930 MHz	–	1995 MHz	FDD
CA_41-41	41	2496 MHz	–	2690 MHz	2496 MHz	–	2690 MHz	TDD
CA_42-42	42	3400 MHz	–	3600 MHz	3400 MHz	–	3600 MHz	TDD

## 5.2B Operating bands for UL-MIMO

E-UTRA UL-MIMO in Rel-10 is designed to operate in the operating bands defined in Table 5.2-1.

## 5.3 TX–RX frequency separation

- a) The default EUTRA TX channel (carrier centre frequency) to RX channel (carrier centre frequency) separation is specified in Table 5.3-1 for the TX and RX channel bandwidths defined in Table 5.4.2.1-1

**Table 5.3-1: Default UE TX-RX frequency separation**

E-UTRA Operating Band	TX - RX carrier centre frequency separation
1	190 MHz
2	80 MHz
3	95 MHz
4	400 MHz
5	45 MHz
6	45 MHz
7	120 MHz
8	45 MHz
9	95 MHz
10	400 MHz
11	48 MHz
12	30 MHz
13	-31 MHz
14	-30 MHz
17	30 MHz
18	45 MHz
19	45 MHz
20	-41 MHz
21	48 MHz
22	100 MHz
23	180 MHz
24	-101.5 MHz
25	80 MHz
26	45 MHz
27	45 MHz
28	55 MHz
30	45 MHz
31	10 MHz

- b) The use of other TX channel to RX channel carrier centre frequency separation is not precluded and is intended to form part of a later release.

### 5.3A TX–RX frequency separation for CA

For intra-band contiguous carrier aggregation, the same TX-RX frequency separation as specified in Table 5.3-1 is applied to PCC and SCC, respectively.

## 5.4 Channel arrangement

### 5.4.1 Channel spacing

The spacing between carriers will depend on the deployment scenario, the size of the frequency block available and the channel bandwidths. The nominal channel spacing between two adjacent E-UTRA carriers is defined as following:

$$\text{Nominal Channel spacing} = (BW_{\text{Channel}(1)} + BW_{\text{Channel}(2)})/2$$

where  $BW_{\text{Channel}(1)}$  and  $BW_{\text{Channel}(2)}$  are the channel bandwidths of the two respective E-UTRA carriers. The channel spacing can be adjusted to optimize performance in a particular deployment scenario.

#### 5.4.1A Channel spacing for CA

For intra-band contiguous carrier aggregation with two or more component carriers, the nominal channel spacing between two adjacent E-UTRA component carriers is defined as the following:

$$\text{Nominal channel spacing} = \left\lfloor \frac{BW_{\text{Channel}(1)} + BW_{\text{Channel}(2)} - 0.1|BW_{\text{Channel}(1)} - BW_{\text{Channel}(2)}|}{0.6} \right\rfloor 0.3 \text{ [MHz]}$$



where  $BW_{Channel(1)}$  and  $BW_{Channel(2)}$  are the channel bandwidths of the two respective E-UTRA component carriers according to Table 5.4.2-1 with values in MHz. The channel spacing for intra-band contiguous carrier aggregation can be adjusted to any multiple of 300 kHz less than the nominal channel spacing to optimize performance in a particular deployment scenario.

For intra-band non-contiguous carrier aggregation the channel spacing between two E-UTRA component carriers in different sub-blocks shall be larger than the nominal channel spacing defined in this subclause.

### 5.4.2 Channel bandwidth

Requirements in present document are specified for the channel bandwidths listed in Table 5.4.2-1

**Table 5.4.2-1: Transmission bandwidth configuration  $N_{RB}$  in E-UTRA channel bandwidths**

Channel bandwidth $BW_{Channel}$ [MHz]	1.4	3	5	10	15	20
Transmission bandwidth configuration $N_{RB}$	6	15	25	50	75	100

Figure 5.4.2-1 shows the relation between the Channel bandwidth ( $BW_{Channel}$ ) and the Transmission bandwidth configuration ( $N_{RB}$ ). The channel edges are defined as the lowest and highest frequencies of the carrier separated by the channel bandwidth, i.e. at  $F_C \pm BW_{Channel} / 2$ .

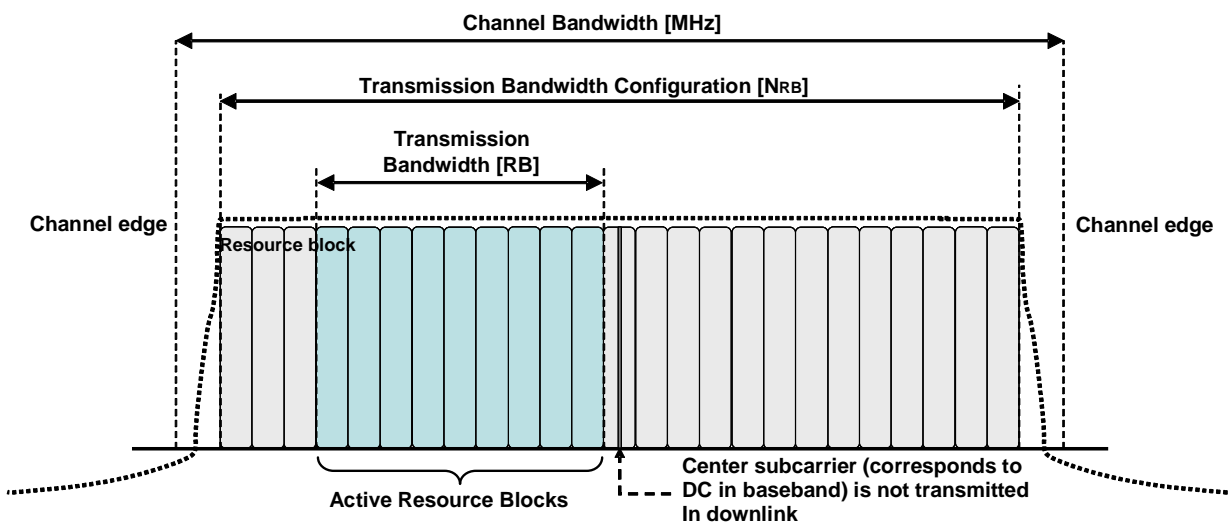

**Figure 5.4.2-1: Definition of channel bandwidth and transmission bandwidth configuration for one E-UTRA carrier**

#### 5.4.2.1 Channel bandwidths per operating band

- a) The requirements in this specification apply to the combination of channel bandwidths and operating bands shown in Table 5.4.2.1-1. The transmission bandwidth configuration in Table 5.4.2-1 shall be supported for each of the specified supported channel bandwidths. The same (symmetrical) channel bandwidth is specified for both the TX and RX path.

Table 5.4.2.1-1: E-UTRA channel bandwidth

E-UTRA Band	E-UTRA band / channel bandwidth					
	1.4 MHz	3 MHz	5 MHz	10 MHz	15 MHz	20 MHz
1			Yes	Yes	Yes	Yes
2	Yes	Yes	Yes	Yes	Yes <sup>1</sup>	Yes <sup>1</sup>
3	Yes	Yes	Yes	Yes	Yes <sup>1</sup>	Yes <sup>1</sup>
4	Yes	Yes	Yes	Yes	Yes	Yes
5	Yes	Yes	Yes	Yes <sup>1</sup>		
6			Yes	Yes <sup>1</sup>		
7			Yes	Yes	Yes <sup>3</sup>	Yes <sup>1, 3</sup>
8	Yes	Yes	Yes	Yes <sup>1</sup>		
9			Yes	Yes	Yes <sup>1</sup>	Yes <sup>1</sup>
10			Yes	Yes	Yes	Yes
11			Yes	Yes <sup>1</sup>		
12	Yes	Yes	Yes <sup>1</sup>	Yes <sup>1</sup>		
13			Yes <sup>1</sup>	Yes <sup>1</sup>		
14			Yes <sup>1</sup>	Yes <sup>1</sup>		
...						
17			Yes <sup>1</sup>	Yes <sup>1</sup>		
18			Yes	Yes <sup>1</sup>	Yes <sup>1</sup>	
19			Yes	Yes <sup>1</sup>	Yes <sup>1</sup>	
20			Yes	Yes <sup>1</sup>	Yes <sup>1</sup>	Yes <sup>1</sup>
21			Yes	Yes <sup>1</sup>	Yes <sup>1</sup>	
22			Yes	Yes	Yes <sup>1</sup>	Yes <sup>1</sup>
23	Yes	Yes	Yes	Yes	Yes <sup>1</sup>	Yes <sup>1</sup>
24			Yes	Yes		
25	Yes	Yes	Yes	Yes	Yes <sup>1</sup>	Yes <sup>1</sup>
26	Yes	Yes	Yes	Yes <sup>1</sup>	Yes <sup>1</sup>	
27	Yes	Yes	Yes	Yes <sup>1</sup>		
28		Yes	Yes	Yes <sup>1</sup>	Yes <sup>1</sup>	Yes <sup>1, 2</sup>
30			Yes	Yes <sup>1</sup>		
31	Yes	Yes <sup>1</sup>	Yes <sup>1</sup>			
...						
33			Yes	Yes	Yes	Yes
34			Yes	Yes	Yes	
35	Yes	Yes	Yes	Yes	Yes	Yes
36	Yes	Yes	Yes	Yes	Yes	Yes
37			Yes	Yes	Yes	Yes
38			Yes	Yes	Yes <sup>3</sup>	Yes <sup>3</sup>
39			Yes	Yes	Yes <sup>3</sup>	Yes <sup>3</sup>
40			Yes	Yes	Yes	Yes
41			Yes	Yes	Yes	Yes
42			Yes	Yes	Yes	Yes
43			Yes	Yes	Yes	Yes
44		Yes	Yes	Yes	Yes	Yes
Note 1:	refers to the bandwidth for which a relaxation of the specified UE receiver sensitivity requirement (Clause 7.3) is allowed.					
Note 2:	For the 20 MHz bandwidth, the minimum requirements are specified for E-UTRA UL carrier frequencies confined to either 713-723 MHz or 728-738 MHz					
Note 3:	refers to bandwidth for which the uplink transmission bandwidth can be restricted by the network for some channel assignments in FDD/TDD co-existence scenarios in order to meet unwanted emissions requirements (Clause 6.6.3.2).					

- b) The use of different (asymmetrical) channel bandwidth for the TX and RX is not precluded and is intended to form part of a later release.

## 5.4.2A Channel bandwidth for CA

For intra-band contiguous carrier aggregation *Aggregated Channel Bandwidth*, *Aggregated Transmission Bandwidth Configuration* and *Guard Bands* are defined as follows, see Figure 5.4.2A-1.

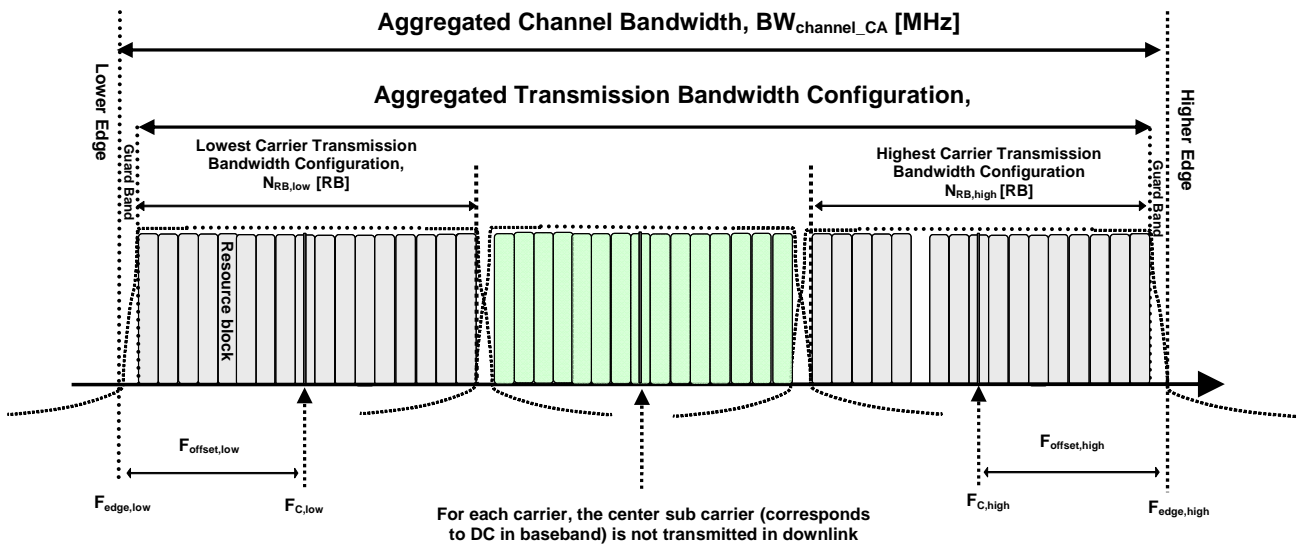

**Figure 5.4.2A-1: Definition of Aggregated channel bandwidth and aggregated carrier channel bandwidth edges**

The *aggregated channel bandwidth*,  $BW_{Channel\_CA}$ , is defined as

$$BW_{Channel\_CA} = F_{edge,high} - F_{edge,low} \text{ [MHz]}.$$

The lower bandwidth edge  $F_{edge,low}$  and the upper bandwidth edge  $F_{edge,high}$  of the aggregated channel bandwidth are used as frequency reference points for transmitter and receiver requirements and are defined by

$$F_{edge,low} = F_{C,low} - F_{offset,low}$$

$$F_{edge,high} = F_{C,high} + F_{offset,high}$$

The lower and upper frequency offsets depend on the transmission bandwidth configurations of the lowest and highest assigned edge component carrier and are defined as

$$F_{offset,low} = (0.18N_{RB,low} + \Delta f_1)/2 + BW_{GB} \text{ [MHz]}$$

$$F_{offset,high} = (0.18N_{RB,high} + \Delta f_1)/2 + BW_{GB} \text{ [MHz]}$$

where  $\Delta f_1 = \Delta f$  for the downlink with  $\Delta f$  the subcarrier spacing and  $\Delta f_1 = 0$  for the uplink, while  $N_{RB,low}$  and  $N_{RB,high}$  are the transmission bandwidth configurations according to Table 5.4.2-1 for the lowest and highest assigned component carrier, respectively.  $BW_{GB}$  denotes the *Nominal Guard Band* and is defined in Table 5.4.2A-1, and the factor 0.18 is the PRB bandwidth in MHz.

**NOTE:** The values of  $BW_{Channel\_CA}$  for UE and BS are the same if the lowest and the highest component carriers are identical.

Aggregated Transmission Bandwidth Configuration is the number of the aggregated RBs within the fully allocated Aggregated Channel bandwidth and is defined per CA Bandwidth Class (Table 5.4.2A-1).

For intra-band non-contiguous carrier aggregation *Sub-block Bandwidth* and *Sub-block edges* are defined as follows, see Figure 5.4.2A-2.

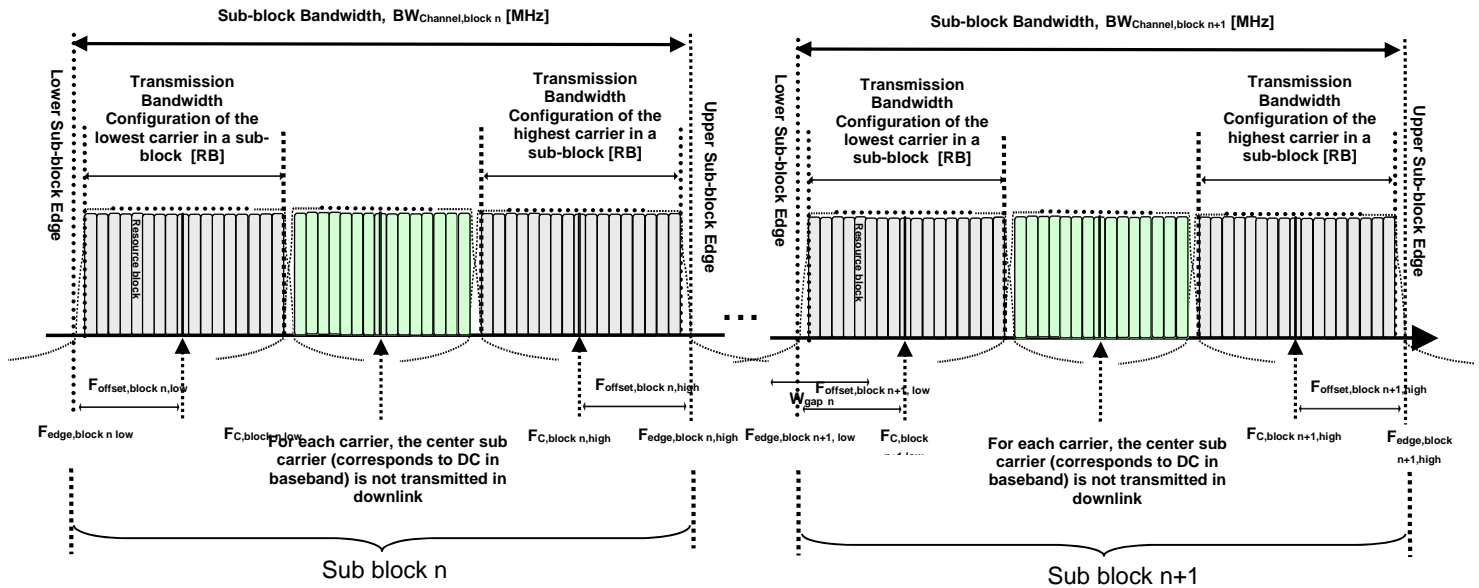

**Figure 5.4.2A-2: Non-contiguous intraband CA terms and definitions**

The lower sub-block edge of the Sub-block Bandwidth ( $BW_{Channel,block}$ ) is defined as:

$$F_{edge,block,low} = F_{C,block,low} - F_{offset,block,low}$$

The upper sub-block edge of the Sub-block Bandwidth is defined as:

$$F_{edge,block,high} = F_{C,block,high} + F_{offset,block,high}$$

The Sub-block Bandwidth,  $BW_{Channel,block}$ , is defined as follows:

$$BW_{Channel,block} = F_{edge,block,high} - F_{edge,block,low} \text{ [MHz]}$$

The lower and upper frequency offsets  $F_{offset,block,low}$  and  $F_{offset,block,high}$  depend on the transmission bandwidth configurations of the lowest and highest assigned edge component carriers within a sub-block and are defined as:

$$F_{offset,block,low} = (0.18N_{RB,low} + \Delta f_1)/2 + BW_{GB} \text{ [MHz]}$$

$$F_{offset,block,high} = (0.18N_{RB,high} + \Delta f_1)/2 + BW_{GB} \text{ [MHz]}$$

where  $\Delta f_1 = \Delta f$  for the downlink with  $\Delta f$  the subcarrier spacing and  $\Delta f_1 = 0$  for the uplink, while  $N_{RB,low}$  and  $N_{RB,high}$  are the transmission bandwidth configurations according to Table 5.6-1 for the lowest and highest assigned component carrier within a sub-block, respectively.  $BW_{GB}$  denotes the *Nominal Guard Band* and is defined in Table 5.4.2A-1, and the factor 0.18 is the PRB bandwidth in MHz.

The sub-block gap size between two consecutive sub-blocks  $W_{gap}$  is defined as:

$$W_{gap} = F_{edge,block\ n+1,low} - F_{edge,block\ n,high} \text{ [MHz]}$$

**Table 5.4.2A-1: CA bandwidth classes and corresponding nominal guard bands**

CA Bandwidth Class	Aggregated Transmission Bandwidth Configuration	Number of contiguous CC	Nominal Guard Band $BW_{GB}$
A	$N_{RB,agg} \leq 100$	1	$a_1 BW_{Channel(1)} - 0.5\Delta f_1$ (NOTE 2)
B	$N_{RB,agg} \leq 100$	2	$0.05 \max(BW_{Channel(1)}, BW_{Channel(2)}) - 0.5\Delta f_1$
C	$100 < N_{RB,agg} \leq 200$	2	$0.05 \max(BW_{Channel(1)}, BW_{Channel(2)}) - 0.5\Delta f_1$
D	$200 < N_{RB,agg} \leq 300$	3	$0.05 \max(BW_{Channel(1)}, BW_{Channel(2)}, BW_{Channel(3)}) - 0.5\Delta f_1$
E	$[300] < N_{RB,agg} \leq [400]$	FFS	FFS
F	$[400] < N_{RB,agg} \leq [500]$	FFS	FFS
NOTE 1: $BW_{Channel(j)}$ , $j = 1, 2, 3$ , is the channel bandwidth of an E-UTRA component carrier according to Table 5.4.2-1 and $\Delta f_1 = \Delta f$ for the downlink with $\Delta f$ the subcarrier spacing while $\Delta f_1 = 0$ for the uplink.			
NOTE 2: $a_1 = 0.16/1.4$ for $BW_{Channel(1)} = 1.4$ MHz whereas $a_1 = 0.05$ for all other channel bandwidths.			

The channel spacing between centre frequencies of contiguously aggregated component carriers is defined in subclause 5.4.1A.

#### 5.4.2A.1 Channel bandwidths per operating band for CA

The requirements for carrier aggregation in this specification are defined for carrier aggregation configurations with associated bandwidth combination sets. For inter-band carrier aggregation, a *carrier aggregation configuration* is a combination of operating bands, each supporting a carrier aggregation bandwidth class. For intra-band contiguous carrier aggregation, a carrier aggregation configuration is a single operating band supporting a carrier aggregation bandwidth class.

For each carrier aggregation configuration, requirements are specified for all bandwidth combinations contained in a *bandwidth combination set*, which is indicated per supported band combination in the UE radio access capability. A UE can indicate support of several bandwidth combination sets per band combination.

Requirements for intra-band contiguous carrier aggregation are defined for the carrier aggregation configurations and bandwidth combination sets specified in Table 5.4.2A.1-1. Requirements for inter-band carrier aggregation are defined for the carrier aggregation configurations and bandwidth combination sets specified in Table 5.4.2A.1-2 and 5.4.2A.1-2a. Requirements for intra-band non-contiguous carrier aggregation are defined for the carrier aggregation configurations and bandwidth combination sets specified in Table 5.4.2A.1-3.

DL component carrier combinations for a given CA configuration shall be symmetrical in relation to channel centre unless stated otherwise in table 5.4.2A.1-1, 5.4.2A.1-2 and 5.4.2A.1-2a.

**Table 5.4.2A.1-1: E-UTRA CA configurations and bandwidth combination sets defined for intra-band contiguous CA**

E-UTRA CA configuration / Bandwidth combination set						
E-UTRA CA configuration	Uplink CA configurations (NOTE 3)	Component carriers in order of increasing carrier frequency			Maximum aggregated bandwidth [MHz]	Bandwidth combination set
		Channel bandwidths for carrier [MHz]	Channel bandwidths for carrier [MHz]	Channel bandwidths for carrier [MHz]		
CA_1C	CA_1C	15	15		40	0
		20	20			
CA_2C		5	20		40	0
		10	15, 20			
		15	10, 15, 20			
		20	5, 10, 15, 20			
CA_3C	CA_3C	5, 10, 15	20		40	0
		20	5, 10, 15, 20			
CA_7C	CA_7C	15	15		40	0
		20	20			
		10	20		40	1
		15	15, 20			
		20	10, 15, 20			
CA_12B	-	5	5, 10		15	0
CA_23B	-	10	10		20	0
		5	15			
CA_27B	-	1.4, 3, 5	5		13	0
		1.4, 3	10			
CA_38C	CA_38C	15	15		40	0
		20	20			
CA_39C	CA_39C	5,10,15	20		35	0
		20	5, 10, 15			
CA_40C	CA_40C	10	20		40	0
		15	15			
		20	10, 20			
		10, 15	20		40	1
		15	15			
		20	10, 15, 20			
CA_40D	CA_40C	10, 15, 20	20	20	60	0
		20	10, 15	20		
		20	20	10, 15		
CA_41C	CA_41C	10	20		40	0
		15	15, 20			
		20	10, 15, 20			
		5, 10	20		40	1
		15	15, 20			
		20	5, 10, 15, 20			
CA_41D	CA_41C	10	20	15	60	0
		10	15, 20	20		
		15	20	10, 15		

		15	10, 15, 20	20		
		20	15, 20	10		
		20	10, 15, 20	15, 20		
CA_42C	CA_42C	5, 10, 15, 20	20		40	0
		20	5, 10, 15			
<p>NOTE 1: The CA configuration refers to an operating band and a CA bandwidth class specified in Table 5.6A-1 (the indexing letter). Absence of a CA bandwidth class for an operating band implies support of all classes.</p> <p>NOTE 2: For the supported CC bandwidth combinations, the CC downlink and uplink bandwidths are equal.</p> <p>NOTE 3: Uplink CA configurations are the configurations supported by the present release of specifications.</p>						



**Table 5.4.2A.1-2: E-UTRA CA configurations and bandwidth combination sets defined for inter-band CA (two bands)**

E-UTRA CA configuration / Bandwidth combination set									
E-UTRA CA Configuration	E-UTRA Bands	1.4 MHz	3 MHz	5 MHz	10 MHz	15 MHz	20 MHz	Maximum aggregated bandwidth [MHz]	Bandwidth combination set
CA_1A-3A	1			Yes	Yes	Yes	Yes	40	0
	3			Yes	Yes	Yes	Yes		
CA_1A-5A	1				Yes			20	0
	5				Yes				
	1			Yes	Yes	Yes	Yes	30	1
	5			Yes	Yes				
CA_1A-7A	1			Yes	Yes	Yes	Yes	40	0
	7				Yes	Yes	Yes		
CA_1A-8A	1			Yes	Yes	Yes	Yes	30	0
	8			Yes	Yes				
	1			Yes	Yes			20	1
	8			Yes	Yes				
	1			Yes	Yes	Yes	Yes	30	2
8		Yes	Yes	Yes					
CA_1A-11A	1			Yes	Yes	Yes	Yes	30	0
	11			Yes	Yes				
CA_1A-18A	1			Yes	Yes	Yes	Yes	35	0
	18			Yes	Yes	Yes			
	1			Yes	Yes			20	1
	18			Yes	Yes				
CA_1A-19A	1			Yes	Yes	Yes	Yes	35	0
	19			Yes	Yes	Yes			
CA_1A-20A	1			Yes	Yes	Yes	Yes	40	0
	20			Yes	Yes	Yes	Yes		
CA_1A-21A	1			Yes	Yes	Yes	Yes	35	0
	21			Yes	Yes	Yes			
CA_1A-26A	1			Yes	Yes	Yes	Yes	35	0
	26			Yes	Yes	Yes			
	1			Yes	Yes			20	1
	26			Yes	Yes				
CA_1A-28A	1			Yes	Yes	Yes	Yes	40	0
	28			Yes	Yes	Yes	Yes		
	1			Yes	Yes			20	1
	28			Yes	Yes				
CA_1A-41A	1			Yes	Yes	Yes	Yes	40	0
	41			Yes	Yes	Yes	Yes		
CA_1A-41C	1			Yes	Yes	Yes	Yes	60	0
	41	See CA_41C Bandwidth Combination Set 1 in Table 5.4.2A.1-1							
CA_1A-42A	1			Yes	Yes	Yes	Yes	40	0
	42			Yes	Yes	Yes	Yes		
CA_1A-42C	1			Yes	Yes	Yes	Yes	60	0
	42	See CA_42C Bandwidth Combination Set 0 in Table 5.4.2A.1-1							
CA_2A-4A	2	Yes	Yes	Yes	Yes	Yes	Yes	40	0
	4			Yes	Yes	Yes	Yes		
	2			Yes	Yes			20	1
	4			Yes	Yes				
	2			Yes	Yes	Yes	Yes	40	2
	4			Yes	Yes	Yes	Yes		
CA_2A-5A	2			Yes	Yes	Yes	Yes	30	0
	5			Yes	Yes				
CA_2A-2A-5A	2	See CA_2A-2A in Table 5.4.2A.1-3						50	0
	5			Yes	Yes				
CA_2A-2A-13A	2	See CA_2A-2A Bandwidth Combination Set 0 in Table 5.4.2A.1-3						50	0
	13				Yes				

CA_2A-4A-4A	2			Yes	Yes	Yes	Yes	60	0
	4	See CA_4A-4A Bandwidth Combination Set 0 in Table 5.4.2A.1-3							
CA_2A-12A	2			Yes	Yes	Yes	Yes	30	0
	12			Yes	Yes				
	2			Yes	Yes	Yes	Yes	30	1
	12		Yes	Yes	Yes				
CA_2A-12B	2			Yes	Yes	Yes	Yes	35	0
	12	See CA_12B Bandwidth Combination Set 0 in table 5.4.2A.1-1							
CA_2A-13A	2			Yes	Yes	Yes	Yes	30	0
	13				Yes				
	2			Yes	Yes			20	1
	13				Yes				
CA_2A-17A	2			Yes	Yes			20	0
	17			Yes	Yes				
CA_2A-29A	2			Yes	Yes			20	0
	29		Yes	Yes	Yes			20	0
	2			Yes	Yes			20	1
	29			Yes	Yes				
	2			Yes	Yes	Yes	Yes	30	2
	29			Yes	Yes				
CA_2C-29A	2	See CA_2C Bandwidth Combination Set 0 in table 5.4.2A.1-1						50	0
	29			Yes	Yes				
CA_2A-30A	2			Yes	Yes	Yes	Yes	30	0
	30			Yes	Yes				

CA_3A-5A	3				Yes	Yes	Yes	30	0
	5			Yes	Yes				
	3				Yes			20	1
	5			Yes	Yes				
	3			Yes	Yes	Yes	Yes	30	2
5			Yes	Yes					
CA_3A-7A	3			Yes	Yes	Yes	Yes	40	0
	7				Yes	Yes	Yes		
CA_3A-7C	3			Yes	Yes	Yes	Yes	60	0
	7	See CA_7C Bandwidth Combination Set 0 in table 5.4.2A.1-1							
CA_3A-8A	3				Yes	Yes	Yes	30	0
	8			Yes	Yes				
	3				Yes			20	1
	8			Yes	Yes				
	3			Yes	Yes	Yes	Yes	30	2
	8	Yes		Yes	Yes				
CA_3A-19A	3			Yes	Yes	Yes	Yes	35	0
	19			Yes	Yes	Yes			
CA_3A-20A	3			Yes	Yes	Yes	Yes	30	0
	20			Yes	Yes				
	3			Yes	Yes	Yes	Yes	40	1
	20			Yes	Yes	Yes	Yes		
CA_3A-26A	3			Yes	Yes	Yes	Yes	35	0
	26			Yes	Yes	Yes			
	3			Yes	Yes			20	1
	26			Yes	Yes				
CA_3A-27A	3			Yes	Yes	Yes	Yes	30	0
	27			Yes	Yes				
CA_3A-28A	3			Yes	Yes	Yes	Yes	40	0
	28			Yes	Yes	Yes	Yes		
CA_3A-42A	3			Yes	Yes	Yes	Yes	40	0
	42			Yes	Yes	Yes	Yes		
CA_3A-42C	3			Yes	Yes	Yes	Yes	60	0
	42	See CA_42C Bandwidth Combination Set 0 in Table 5.4.2A.1-1							
CA_3C-7A	3	See CA_3C Bandwidth Combination Set 0 in table 5.4.2A.1-1						60	0
	7			Yes	Yes	Yes	Yes		
CA_4A-4A-5A	4	See CA_4A-4A Bandwidth Combination Set 0 in Table 5.4.2A.1-3						50	0
	5			Yes	Yes				
CA_4A-4A-7A	4			Yes	Yes			40	0
	4			Yes	Yes				
	7			Yes	Yes	Yes	Yes		
CA_4A-4A-12A	4	See CA_4A-4A Bandwidth Combination Set 0 in Table 5.4.2A.1-3						50	0
	12			Yes	Yes				
CA_4A-4A-13A	4	See CA_4A-4A Bandwidth Combination Set 0 in Table 5.4.2A.1-3						50	0
	13				Yes				
CA_4A-5A	4			Yes	Yes			20	0
	5			Yes	Yes				
	4			Yes	Yes	Yes	Yes	30	1
	5			Yes	Yes				
CA_4A-7A	4			Yes	Yes			30	0
	7			Yes	Yes	Yes	Yes		
CA_4A-12A	4	Yes	Yes	Yes	Yes			20	0
	12			Yes	Yes				
	4	Yes	Yes	Yes	Yes	Yes	Yes	30	1
	12			Yes	Yes				
	4			Yes	Yes	Yes	Yes	30	2
	12		Yes	Yes	Yes				
4			Yes	Yes			20	3	

	12			Yes	Yes				
	4			Yes	Yes	Yes	Yes		
	12			Yes	Yes			30	4
CA_4A-12B	4			Yes	Yes	Yes	Yes		
	12	See CA_12B Bandwidth Combination Set 0 in Table 5.4.2A.1-1						35	0
CA_4A-13A	4			Yes	Yes	Yes	Yes	30	0
	13				Yes				
	4			Yes	Yes			20	1
CA_4A-17A	13				Yes				
	4			Yes	Yes			20	0
CA_4A-17A	17			Yes	Yes				
	4			Yes	Yes	Yes	Yes	30	0
CA_4A-27A	27		Yes	Yes	Yes				
	4			Yes	Yes			20	0
CA_4A-29A	29		Yes	Yes	Yes				
	4			Yes	Yes			20	1
	29			Yes	Yes				
	4			Yes	Yes	Yes	Yes	30	2
	29			Yes	Yes				
CA_4A-30A	4			Yes	Yes	Yes	Yes	30	0
	30			Yes	Yes				
CA_5A-7A	5	Yes	Yes	Yes	Yes			30	0
	7				Yes	Yes	Yes		
CA_5A-12A	5			Yes	Yes			20	0
	12			Yes	Yes				
CA_5A-13A	5			Yes	Yes			20	0
	13				Yes				
CA_5A-17A	5			Yes	Yes			20	0
	17			Yes	Yes				
CA_5A-25A	5			Yes	Yes			30	0
	25			Yes	Yes	Yes	Yes		
CA_5A-30A	5			Yes	Yes			20	0
	30			Yes	Yes				
CA_7A-8A	7				Yes	Yes	Yes	30	0
	8		Yes	Yes	Yes				
CA_7A-12A	7			Yes	Yes	Yes	Yes	30	0
	12			Yes	Yes				

CA_7A-20A	7				Yes	Yes	Yes	30	0
	20			Yes	Yes				
CA_7A-28A	7				Yes	Yes	Yes	40	1
	20			Yes	Yes	Yes	Yes		
CA_7A-28A	7			Yes	Yes	Yes	Yes	35	0
	28			Yes	Yes	Yes			
CA_8A-11A	8			Yes	Yes			20	0
	11			Yes	Yes				
CA_8A-20A	8			Yes	Yes			20	0
	20			Yes	Yes				
	8		Yes	Yes	Yes				
CA_11A-18A	11			Yes	Yes			25	0
	18			Yes	Yes	Yes			
CA_12A-25A	12			Yes	Yes			30	0
	25			Yes	Yes	Yes	Yes		
CA_12A-30A	12			Yes	Yes			20	0
	30			Yes	Yes				
CA_18A-28A	18			Yes	Yes	Yes		25	0
	28			Yes	Yes				
CA_19A-21A	19			Yes	Yes	Yes		30	0
	21			Yes	Yes	Yes			
CA_19A-42A	19			Yes	Yes	Yes		35	0
	42			Yes	Yes	Yes	Yes		
CA_19A-42C	19			Yes	Yes	Yes		55	0
	42	See CA_42C Bandwidth Combination Set 0 in Table 5.4.2A.1-1							
CA_20A-32A	20			Yes	Yes			30	0
	32			Yes	Yes	Yes	Yes		
CA_23A-29A	23			Yes	Yes	Yes	Yes	30	0
	29		Yes	Yes	Yes				
	23			Yes	Yes				
CA_25A-41A	25			Yes	Yes	Yes	Yes	40	0
	41			Yes	Yes	Yes	Yes		
CA_25A-41C	25			Yes	Yes	Yes	Yes	60	0
	41	See CA_41C Bandwidth Combination Set 1 in Table 5.4.2A.1-1							
CA_26A-41A	26			Yes	Yes	Yes		40	0
	41			Yes	Yes	Yes	Yes		
CA_26A-41C	26			Yes	Yes	Yes		55	0
	41	See CA_41C Bandwidth Combination Set 1 in Table 5.4.2A.1-1							
CA_29A-30A	29			Yes	Yes			20	0
	30			Yes	Yes				
CA_39A-41A	39				Yes	Yes	Yes	40	0
	41						Yes		
CA_39A-41C	39				Yes	Yes	Yes	60	0
	41						Yes		
	41						Yes		
CA_39C-41A	39	See CA_39C Bandwidth Combination Set 0 in Table 5.4.2A.1-1						55	0
	41					Yes			
CA_41A-42A	41				Yes	Yes	Yes	40	0
	42				Yes	Yes	Yes		

NOTE 1: The CA Configuration refers to a combination of an operating band and a CA bandwidth class specified in Table 5.4.2A-1 (the indexing letter). Absence of a CA bandwidth class for an operating band implies support of all classes.

NOTE 2: For each band combination, all combinations of indicated bandwidths belong to the set

NOTE 3: For the supported CC bandwidth combinations, the CC downlink and uplink bandwidths are equal

**Table 5.4.2A.1-2a: E-UTRA CA configurations and bandwidth combination sets defined for inter-band CA (three bands)**

E-UTRA CA configuration / Bandwidth combination set										
E-UTRA CA Configuration	E-UTRA Bands	1.4 MHz	3 MHz	5 MHz	10 MHz	15 MHz	20 MHz	Maximum aggregated bandwidth [MHz]	Bandwidth combination set	
CA_1A-3A-5A	1			Yes	Yes	Yes	Yes	50	0	
	3			Yes	Yes	Yes	Yes			
	5			Yes	Yes					
	CA_1A-3A-5A	1			Yes	Yes			40	1
		3			Yes	Yes	Yes	Yes		
		5			Yes	Yes				
CA_1A-3A-8A	1			Yes	Yes	Yes	Yes	50	0	
	3			Yes	Yes	Yes	Yes			
	8		Yes	Yes	Yes					
	CA_1A-3A-8A	1			Yes	Yes			40	1
		3			Yes	Yes	Yes	Yes		
		8		Yes	Yes	Yes				
CA_1A-3A-8A	1			Yes	Yes	Yes		40	2	
	3			Yes	Yes	Yes				
	8		Yes	Yes	Yes					
CA_1A-3A-19A	1			Yes	Yes	Yes	Yes	55	0	
	3			Yes	Yes	Yes	Yes			
	19			Yes	Yes	Yes				
CA_1A-3A-20A (NOTE 4)	1			Yes	Yes	Yes	Yes	60	0	
	3			Yes	Yes	Yes	Yes			
	20			Yes	Yes	Yes	Yes			
CA_1A-3A-26A	1			Yes	Yes	Yes	Yes	50	0	
	3			Yes	Yes	Yes	Yes			
	26			Yes	Yes					
CA_1A-5A-7A	1			Yes	Yes			40	0	
	5			Yes	Yes					
	7				Yes	Yes	Yes			
	CA_1A-5A-7A	1			Yes	Yes	Yes	Yes	50	1
		5			Yes	Yes				
CA_1A-7A-20A (NOTE 4)	1			Yes	Yes	Yes	Yes	50	0	
	7				Yes	Yes	Yes			
	20			Yes	Yes					
CA_1A-18A-28A	1			Yes	Yes	Yes	Yes	45	0	
	18			Yes	Yes	Yes				
	28			Yes	Yes					
	CA_1A-18A-28A	1			Yes	Yes	Yes	Yes	40	1
		18			Yes	Yes				
CA_1A-18A-28A	28			Yes	Yes			40	1	
	1			Yes	Yes	Yes	Yes			
	18			Yes	Yes					
CA_1A-19A-21A	1			Yes	Yes	Yes	Yes	50	0	
	19			Yes	Yes	Yes	Yes			
	21			Yes	Yes	Yes				
CA_2A-4A-5A	2			Yes	Yes	Yes	Yes	50	0	
	4			Yes	Yes	Yes	Yes			
	5			Yes	Yes					
CA_2A-4A-12A	2			Yes	Yes	Yes	Yes	50	0	
	4			Yes	Yes	Yes	Yes			
	12			Yes	Yes					
CA_2A-4A-13A	2			Yes	Yes	Yes	Yes	50	0	
	4			Yes	Yes	Yes	Yes			
	13				Yes					
CA_2A-4A-29A	2			Yes	Yes	Yes	Yes	50	0	
	4			Yes	Yes	Yes	Yes			
	29			Yes	Yes					
CA_2A-5A-12A	2			Yes	Yes	Yes	Yes	40	0	
	5			Yes	Yes					
	12			Yes	Yes					
CA_2A-5A-13A	2			Yes	Yes	Yes	Yes	40	0	
	5			Yes	Yes					



	13				Yes				
CA_2A-5A-30A	2			Yes	Yes	Yes	Yes	40	0
	5			Yes	Yes				
	30			Yes	Yes				
CA_2A-12A-30A	2			Yes	Yes	Yes	Yes	40	0
	12			Yes	Yes				
	30			Yes	Yes				
CA_2A-29A-30A	2			Yes	Yes	Yes	Yes	40	0
	29			Yes	Yes				
	30			Yes	Yes				
CA_3A-7A-20A	3			Yes	Yes	Yes	Yes	60	0
	7				Yes	Yes	Yes		
	20			Yes	Yes	Yes	Yes		
CA_4A-5A-12A	4			Yes	Yes	Yes	Yes	40	0
	5			Yes	Yes				
	12			Yes	Yes				
CA_4A-5A-13A	4			Yes	Yes	Yes	Yes	40	0
	5			Yes	Yes				
	13				Yes				
CA_4A-5A-30A	4			Yes	Yes	Yes	Yes	40	0
	5			Yes	Yes				
	30			Yes	Yes				
CA_4A-7A-12A	4			Yes	Yes			40	0
	7			Yes	Yes	Yes	Yes		
	12			Yes	Yes				
CA_4A-12A-30A	4			Yes	Yes	Yes	Yes	40	0
	12			Yes	Yes				
	30			Yes	Yes				
CA_4A-29A-30A	4			Yes	Yes	Yes	Yes	40	0
	29			Yes	Yes				
	30			Yes	Yes				
CA_7A-8A-20A	7				Yes	Yes	Yes	40	0
	8		Yes	Yes	Yes				
	20			Yes	Yes				

NOTE 1: The CA Configuration refers to a combination of an operating band and a CA bandwidth class specified in Table 5.4.2A-1 (the indexing letter). Absence of a CA bandwidth class for an operating band implies support of all classes.

NOTE 2: For each band combination, all combinations of indicated bandwidths belong to the set.

NOTE 3: For the supported CC bandwidth combinations, the CC downlink and uplink bandwidths are equal.

NOTE 4: A terminal which supports a DL CA configuration shall support all the lower order fallback DL CA combinations and it shall support at least one bandwidth combination set for each of the constituent lower order DL combinations containing all the bandwidths specified within each specific combination set of the upper order DL combination.

**Table 5.4.2A.1-3: E-UTRA CA configurations and bandwidth combination sets defined for non-contiguous intra-band CA**

E-UTRA CA configuration / Bandwidth combination set							
E-UTRA CA configuration	Uplink CA configurations (NOTE 1)	Component carriers in order of increasing carrier frequency			Maximum aggregated bandwidth [MHz]	Bandwidth combination set	uplink CA capability
		Channel bandwidths for carrier [MHz]	Channel bandwidths for carrier [MHz]	Channel bandwidths for carrier [MHz]			
CA_2A-2A	-	5, 10, 15, 20	5, 10, 15, 20		40	0	No
CA_3A-3A	-	5, 10, 15, 20	5, 10, 15, 20		40	0	No
CA_4A-4A	TBD	5, 10, 15, 20	5, 10, 15, 20		40	0	TBD
CA_7A-7A	-	5	15		40	0	No
		10	10, 15				
		15	15, 20				
		20	20				
CA_23A-23A	-	5	10		15	0	No
CA_25A-25A	-	5, 10	5, 10		20	0	No
		5, 10, 15, 20	5, 10, 15, 20		40	1	No
CA_41A-41A	-	10, 15, 20	10, 15, 20		40	0	No
		5, 10, 15, 20	5, 10, 15, 20		40	1	No
CA_41A-41C	-	5, 10, 15, 20	See CA_41C Bandwidth Combination Set 1 in Table 5.4.2A.1-1		60	0	No
CA_41C-41A	-	See CA_41C Bandwidth Combination Set 1 in Table 5.4.2A.1-1		5, 10, 15, 20	60	0	No
CA_42A-42A	-	5, 10, 15, 20	5, 10, 15, 20		40	0	No

NOTE 1: Uplink CA configurations are the configurations supported by the present release of specifications.

## 5.4.2B Channel bandwidth for UL-MIMO

### 5.4.2B.1 Channel bandwidths per operating band for UL- MIMO

For UL-MIMO, the channel bandwidths specified in Table 5.4.2.1-1 in present document apply for the UL-MIMO operating bands.

## 5.4.3 Channel raster

The channel raster is 100 kHz for all bands, which means that the carrier centre frequency must be an integer multiple of 100 kHz.

### 5.4.3A Channel raster for CA

For carrier aggregation the channel raster is 100 kHz for all bands, which means that the carrier centre frequency must be an integer multiple of 100 kHz.

## 5.4.4 Carrier frequency and EARFCN

The carrier frequency in the uplink and downlink is designated by the E-UTRA Absolute Radio Frequency Channel Number (EARFCN) in the range 0 - 65535. The relation between EARFCN and the carrier frequency in MHz for the downlink is given by the following equation, where  $F_{DL\_low}$  and  $N_{offs-DL}$  are given in Table 5.4.4-1 and  $N_{DL}$  is the downlink EARFCN.

$$F_{DL} = F_{DL\_low} + 0.1(N_{DL} - N_{Offs-DL})$$

The relation between EARFCN and the carrier frequency in MHz for the uplink is given by the following equation where  $F_{UL\_low}$  and  $N_{Offs-UL}$  are given in Table 5.4.4-1 and  $N_{UL}$  is the uplink EARFCN.

$$F_{UL} = F_{UL\_low} + 0.1(N_{UL} - N_{Offs-UL})$$

**Table 5.4.4-1: E-UTRA channel numbers**

Band	Downlink			Uplink		
	$F_{DL\_low}$ (MHz)	$N_{Offs-DL}$	Range of $N_{DL}$	$F_{UL\_low}$ (MHz)	$N_{Offs-UL}$	Range of $N_{UL}$
1	2110	0	0 – 599	1920	18000	18000 – 18599
2	1930	600	600 – 1199	1850	18600	18600 – 19199
3	1805	1200	1200 – 1949	1710	19200	19200 – 19949
4	2110	1950	1950 – 2399	1710	19950	19950 – 20399
5	869	2400	2400 – 2649	824	20400	20400 – 20649
6	875	2650	2650 – 2749	830	20650	20650 – 20749
7	2620	2750	2750 – 3449	2500	20750	20750 – 21449
8	925	3450	3450 – 3799	880	21450	21450 – 21799
9	1844.9	3800	3800 – 4149	1749.9	21800	21800 – 22149
10	2110	4150	4150 – 4749	1710	22150	22150 – 22749
11	1475.9	4750	4750 – 4949	1427.9	22750	22750 – 22949
12	729	5010	5010 – 5179	699	23010	23010 – 23179
13	746	5180	5180 – 5279	777	23180	23180 – 23279
14	758	5280	5280 – 5379	788	23280	23280 – 23379
...						
17	734	5730	5730 – 5849	704	23730	23730 – 23849
18	860	5850	5850 – 5999	815	23850	23850 – 23999
19	875	6000	6000 – 6149	830	24000	24000 – 24149
20	791	6150	6150 – 6449	832	24150	24150 – 24449
21	1495.9	6450	6450 – 6599	1447.9	24450	24450 – 24599
22	3510	6600	6600 – 7399	3410	24600	24600 – 25399
23	2180	7500	7500 – 7699	2000	25500	25500 – 25699
24	1525	7700	7700 - 8039	1626.5	25700	25700 – 26039
25	1930	8040	8040 - 8689	1850	26040	26040 - 26689
26	859	8690	8690 - 9039	814	26690	26690 - 27039
27	852	9040	9040 – 9209	807	27040	27040 – 27209
28	758	9210	9210 – 9659	703	27210	27210 – 27659
29 <sup>2</sup>	717	9660	9660 – 9769		N/A	
30	2350	9770	9770 – 9869	2305	27660	27660 – 27759
31	462.5	9870	9870 – 9919	452.5	27760	27760 – 27809
32 <sup>2</sup>	1452	9920	9920 – 10359		N/A	
33	1900	36000	36000 – 36199	1900	36000	36000 – 36199
34	2010	36200	36200 – 36349	2010	36200	36200 – 36349
35	1850	36350	36350 – 36949	1850	36350	36350 – 36949
36	1930	36950	36950 – 37549	1930	36950	36950 – 37549
37	1910	37550	37550 – 37749	1910	37550	37550 – 37749
38	2570	37750	37750 – 38249	2570	37750	37750 – 38249
39	1880	38250	38250 – 38649	1880	38250	38250 – 38649
40	2300	38650	38650 – 39649	2300	38650	38650 – 39649
41	2496	39650	39650 - 41589	2496	39650	39650 - 41589
42	3400	41590	41590 – 43589	3400	41590	41590 – 43589
43	3600	43590	43590 – 45589	3600	43590	43590 – 45589
44	703	45590	45590 – 46589	703	45590	45590 – 46589

Note 1: The channel numbers that designate carrier frequencies so close to the operating band edges that the carrier extends beyond the operating band edge shall not be used. This implies that the first 7, 15, 25, 50, 75 and 100 channel numbers at the lower operating band edge and the last 6, 14, 24, 49, 74 and 99 channel numbers at the upper operating band edge shall not be used for channel bandwidths of 1.4, 3, 5, 10, 15 and 20 MHz respectively.

Note 2: Restricted to E-UTRA operation when carrier aggregation is configured.

## 6 Transmitter Characteristics

### 6.1 General

Unless otherwise stated, the transmitter characteristics are specified at the antenna connector of the UE with a single transmit antenna. For UE with integral antenna only, a reference antenna with a gain of 0 dBi is assumed.

The transient periods due to power steps, OFF/ON and ON/OFF transitions could occur at slot or symbol boundary with transients, on one or both sides of the boundary. The measurement period and whether to exclude the transient periods are specified in the respective sections below.

Unless otherwise stated, the Test Equipment shall be synchronised to the Uplink signal for measurement of TDD transmitter characteristics.

For CA tests, Cell ID = 0 applies to P-Cell, and Cell ID = 1 is used for S-Cell.

Parameters given in table 6.1-1 are used throughout this section for CA, unless otherwise stated by the test case.

**Table 6.1-1: Common Test Parameters**

Parameter	Value	Comments
Cross carrier scheduling	Not configured	

For CA testing, unless otherwise stated, the logical carriers PCC / SCCs are mapped to physical frequencies as defined in Table 6.1-2.

**Table 6.1-2: PCC/SCCs frequency mapping**

CA Configuration	PCC-SCC mapping	Notes
Intra-band contiguous CA	CC1-CC2 (Note 4) or CC2-CC1 (Note 5)	1
Inter-band CA (CA_x-y)	Bx-By and By-Bx	2, 3
Intra-band non-contiguous CA	CC2-CC1 (Note 4) or CC1-CC2 (Note 5)	1
Note 1:	Notation CCI-CCj means PCC on component carrier CCI and SCC on component carrier CCj, with CCI/j frequencies defined in the corresponding intra-band contiguous CA band in TS36.508 [7].	
Note 2:	Notation Bi-Bj means PCC on component Band i and SCC on component Band j, with single Band i/j frequencies defined in TS36.508 [7].	
Note 3:	Applicable for UE declared capability of UL support (within CA operation) in the individual bands. If UE does not support both PCC-SCC mappings, only the supported mapping is applicable.	
Note 4:	Applicable for TDD CA and FDD CA bands with UL frequency < DL frequency.	
Note 5:	Applicable for FDD CA bands with UL frequency > DL frequency.	

For testing of category 0 HD-FDD UE in FDD operating bands, the SS shall ensure downlink transmission is only configured in downlink subframes and that UL grants are given to ensure UE is transmitting only in uplink subframes throughout the test. The subframes reserved for uplink and downlink respectively are specified in the RMC definition in Annex A.2 for uplink and Annex A.3 for downlink.

### 6.2 Transmit power

#### 6.2.1 Void

Editor's note: This "void" section was introduced because TS 36.101 v8.1.0 also contains a "void" sub-clause within the transmit power clause 6.2, and there is a strong desire in RAN5 to keep the test cases clauses numbering matching their specific core requirements as much as possible.

## 6.2.2 UE Maximum Output Power

### 6.2.2.1 Test purpose

To verify that the error of the UE maximum output power does not exceed the range prescribed by the specified nominal maximum output power and tolerance.

An excess maximum output power has the possibility to interfere to other channels or other systems. A small maximum output power decreases the coverage area.

### 6.2.2.2 Test applicability

This test case applies to all types of E-UTRA UE release 8 and forward.

### 6.2.2.3 Minimum conformance requirements

The following UE Power Classes defines the maximum output power for any transmission bandwidth within the channel bandwidth. The period of measurement shall be at least one sub frame (1ms).

Table 6.2.2.3-1: UE Power Class

EUTRA band	Class 1 (dBm)	Tolerance (dB)	Class 2 (dBm)	Tolerance (dB)	Class 3 (dBm)	Tolerance (dB)	Class 4 (dBm)	Tolerance (dB)
1					23	$\pm 2$		
2					23	$\pm 2^2$		
3					23	$\pm 2^2$		
4					23	$\pm 2$		
5					23	$\pm 2$		
6					23	$\pm 2$		
7					23	$\pm 2^2$		
8					23	$\pm 2^2$		
9					23	$\pm 2$		
10					23	$\pm 2$		
11					23	$\pm 2$		
12					23	$\pm 2^2$		
13					23	$\pm 2$		
14					23	$\pm 2$		
...								
17					23	$\pm 2$		
18					23	$\pm 2^6$		
19					23	$\pm 2$		
20					23	$\pm 2^2$		
21					23	$\pm 2$		
22					23	$+2/-3.5^2$		
23					$23^5$	$\pm 2^5$		
24					23	$\pm 2$		
25					23	$\pm 2^2$		
26					23	$\pm 2^2$		
27					23	$\pm 2$		
28					23	$+2/-2.5$		
30					23	$\pm 2$		
31					23	$\pm 2$		
...								
33					23	$\pm 2$		
34					23	$\pm 2$		
35					23	$\pm 2$		
36					23	$\pm 2$		
37					23	$\pm 2$		
38					23	$\pm 2$		
39					23	$\pm 2$		
40					23	$\pm 2$		
41					23	$\pm 2^2$		
42					23	$+2/-3$		
43					23	$+2/-3$		
44					23	$+2/[-3]$		
...								
Note 1:	The above tolerances are applicable for UE(s) that support up to 4 E-UTRA operating bands. For UE(s) that support 5 or more E-UTRA bands the maximum output power is expected to decrease with each additional band and is FFS							
Note 2:	For transmission bandwidths (Figure 5.4.2-1) confined within $F_{UL\_low}$ and $F_{UL\_low} + 4$ MHz or $F_{UL\_high} - 4$ MHz and $F_{UL\_high}$ , the maximum output power requirement is relaxed by reducing the lower tolerance limit by 1.5 dB							
Note 3:	$P_{PowerClass}$ is the maximum UE power specified without taking into account the tolerance							
Note 4:	For the UE which supports both Band 11 and Band 21 operating frequencies, the tolerance is FFS.							
Note 5:	When NS_20 is signalled, the total output power within 2000-2005 MHz shall be limited to 7 dBm.							
Note 6:	For a UE that supports both Band 18 and Band 26, the maximum output power requirement is relaxed by reducing the lower tolerance limit by 1.5dB for transmission bandwidths confined within 815 MHz and 818 MHz							

The normative reference for this requirement is TS 36.101 clause 6.2.2.

## 6.2.2.4 Test description

### 6.2.2.4.1 Initial condition

Initial conditions are a set of test configurations the UE needs to be tested in and the steps for the SS to take with the UE to reach the correct measurement state.

The initial test configurations consist of environmental conditions, test frequencies, and channel bandwidths based on E-UTRA operating bands specified in table 5.4.2.1-1. All of these configurations shall be tested with applicable test parameters for each channel bandwidth, and are shown in table 6.2.2.4.1-1. The details of the uplink reference measurement channels (RMCs) are specified in Annex A.2. Configurations of PDSCH and PDCCH before measurement are specified in Annex C.2.

**Table 6.2.2.4.1-1: Test Configuration Table**

Initial Conditions				
Test Environment as specified in TS 36.508[7] subclause 4.1		Normal, TL/VL, TL/VH, TH/VL, TH/VH		
Test Frequencies as specified in TS 36.508 [7] subclause 4.3.1		Low range, Mid range, High range		
Test Channel Bandwidths as specified in TS 36.508 [7] subclause 4.3.1		Lowest, 5MHz, Highest		
Test Parameters for Channel Bandwidths				
Ch BW	Downlink Configuration	Uplink Configuration		
		Mod'n	RB allocation	
	N/A for Max UE output power testing		FDD	TDD
1.4MHz		QPSK	1	1
1.4MHz		QPSK	5	5
3MHz		QPSK	1	1
3MHz		QPSK	4	4
5MHz		QPSK	1	1
5MHz		QPSK	8	8
10MHz		QPSK	1	1
10MHz		QPSK	12	12
15MHz		QPSK	1	1
15MHz		QPSK	16	16
20MHz		QPSK	1	1
20MHz		QPSK	18	18
<p>Note 1: Test Channel Bandwidths are checked separately for each E-UTRA band, the applicable channel bandwidths are specified in Table 5.4.2.1-1.</p> <p>Note 2: For E-UTRA bands not applied with Note 2 in Table 6.2.2.3-1:</p> <ul style="list-style-type: none"> <li>- The 1 RB allocation shall be tested at RB#0 for low and mid range, RB #max for high range test frequency.</li> <li>- The RBstart of non-1RB allocation shall be RB #0 for low and mid range, RB# (max +1 - RB allocation) for high range test frequency.</li> </ul> <p>Note 3: For E-UTRA bands applied with Note 2 in Table 6.2.2.3-1:</p> <ul style="list-style-type: none"> <li>- If the test channel bandwidth is larger than 4MHz, then the 1 RB allocation shall be tested at both RB #0 and RB #max.</li> <li>- If the test channel bandwidth is smaller or equal to 4MHz, then the 1 RB allocation shall be tested at RB #0.</li> <li>- If the test channel bandwidth = (FUL_high - FUL_low) specified by the operating band, then only one frequency range shall be tested and the 1 RB allocation shall be tested at RB #0, RB # <math>\lceil N_{RB}^{UL} / 2 \rceil</math> and RB #max.</li> <li>- For non-1RB allocation, test frequency is middle range, and the RBstart shall be RB #0.</li> </ul>				

1. Connect the SS to the UE antenna connectors as shown in TS 36.508[7] Annex A Figure A.3.
2. The parameter settings for the cell are set up according to TS 36.508 [7] subclause 4.4.3.
3. Downlink signals are initially set up according to Annex C.0, C.1, and C.3.0, and uplink signals according to Annex H.1 and H.3.0.
4. The UL Reference Measurement channel is set according to Table 6.2.2.4.1-1.

5. Propagation conditions are set according to Annex B.0.
6. Ensure the UE is in State 3A-RF according to TS 36.508 [7] clause 5.2A.2. Message contents are defined in clause 6.2.2.4.3.

#### 6.2.2.4.2 Test procedure

1. SS sends uplink scheduling information for each UL HARQ process via PDCCH DCI format 0 for C\_RNTI to schedule the UL RMC according to Table 6.2.2.4.1-1. Since the UE has no payload and no loopback data to send the UE sends uplink MAC padding bits on the UL RMC.
2. Send continuously uplink power control "up" commands in every uplink scheduling information to the UE; allow at least 200ms for the UE to reach  $P_{UMAX}$  level.
3. Measure the mean power of the UE in the channel bandwidth of the radio access mode. The period of measurement shall be at least the continuous duration of one sub-frame (1ms). For TDD slots with transient periods are not under test.

#### 6.2.2.4.3 Message contents

Message contents are according to TS 36.508 [7] subclause 4.6.

#### 6.2.2.5 Test requirements

The maximum output power, derived in step 3 shall be within the range prescribed by the nominal maximum output power and tolerance in Table 6.2.2.5-1.



Table 6.2.2.5-1: UE Power Class test requirements

EUTRA band	Class 1 (dBm)	Tolerance (dB)	Class 2 (dBm)	Tolerance (dB)	Class 3 (dBm)	Tolerance (dB)	Class 4 (dBm)	Tolerance (dB)
1					23	±2.7		
2					23	±2.7 <sup>2</sup>		
3					23	±2.7 <sup>2</sup>		
4					23	±2.7		
5					23	±2.7		
6					23	±2.7		
7					23	±2.7 <sup>2</sup>		
8					23	±2.7 <sup>2</sup>		
9					23	±2.7		
10					23	±2.7		
11					23	±2.7		
12					23	±2.7 <sup>2</sup>		
13					23	±2.7		
14					23	±2.7		
...								
17					23	±2.7		
18					23	±2.7 <sup>6</sup>		
19					23	±2.7		
20					23	±2.7 <sup>2</sup>		
21					23	±2.7		
22					23	+3.0/-4.5		
23					23 <sup>5</sup>	±2.7 <sup>5</sup>		
24					23	±2.7		
25					23	±2.7 <sup>2</sup>		
26					23	±2.7 <sup>2</sup>		
27					23	±2.7		
28					23	+2.7/-3.2		
30					23	±2.7		
31					23	±2.7		
...								
33					23	±2.7		
34					23	±2.7		
35					23	±2.7		
36					23	±2.7		
37					23	±2.7		
38					23	±2.7		
39					23	±2.7		
40					23	±2.7		
41					23	±2.7 <sup>2</sup>		
42					23	+3.0/-4.0		
43					23	+3.0/-4.0		
44					23	+2.7/[-3.7]		
...								
Note 1:	The above tolerances are applicable for UE(s) that support up to 4 E-UTRA operating bands. For UE(s) that support 5 or more E-UTRA bands the maximum output power is expected to decrease with each additional band and is FFS							
Note 2:	For transmission bandwidths (Figure 5.4.2-1, Table 5.4.4-1) confined within $F_{UL\_low}$ and $F_{UL\_low} + 4$ MHz or $F_{UL\_high} - 4$ MHz and $F_{UL\_high}$ , the maximum output power requirement is relaxed by reducing the lower tolerance limit by 1.5 dB							
Note 3:	$P_{PowerClass}$ is the maximum UE power specified without taking into account the tolerance.							
Note 4:	For the UE which supports both Band 11 and Band 21 operating frequencies, the tolerance is FFS.							
Note 5:	When NS_20 is signalled, the total output power within 2000-2005 MHz shall be limited to 7 dBm.							
Note 6:	For a UE that supports both Band 18 and Band 26, the maximum output power requirement is relaxed by reducing the lower tolerance limit by 1.5dB for transmission bandwidths confined within 815 MHz and 818 MHz.							

For the UE which supports inter-band carrier aggregation configurations with uplink assigned to one E-UTRA band the  $\Delta T_{IB,c}$  in Table 6.2.5.3-2 shall be applied for applicable bands.

In case the UE supports more than one of the above inter-band carrier aggregation configurations and a E-UTRA operating band belongs to more than one inter-band carrier aggregation configurations then:

- When the E-UTRA operating band frequency range is  $\leq 1$ GHz, the applicable additional tolerance shall be the average of the tolerances in Table 6.2.5.3-2, truncated to one decimal place for that operating band among the supported CA configurations. In case there is a harmonic relation between low band UL and high band DL, then the maximum tolerance among the different supported carrier aggregation configurations involving such band shall be applied
- When the E-UTRA operating band frequency range is  $>1$ GHz, the applicable additional tolerance shall be the maximum tolerance in Table 6.2.5.3-2 that applies for that operating band among the supported CA configurations.

## 6.2.2\_1 Maximum Output Power for HPUE

### 6.2.2\_1.1 Test purpose

Same test purpose as in clause 6.2.2.1.

### 6.2.2\_1.2 Test applicability

This test case applies to all types of E-UTRA UE Power Class 1 release 10 and forward.

### 6.2.2\_1.3 Minimum conformance requirements

The following defines the maximum output power for any transmission bandwidth within the channel bandwidth for Power Class 1 UE. The period of measurement shall be at least one sub frame (1ms).

**Table 6.2.2\_1.3-1: HPUE Power Class**

EUTRA band	Class 1 (dBm)	Tolerance (dB)	Class 2 (dBm)	Tolerance (dB)	Class 3 (dBm)	Tolerance (dB)	Class 4 (dBm)	Tolerance (dB)
14	31	+2/-3	N/A	N/A	N/A	N/A	N/A	N/A
Note 1: The above tolerances are applicable for UE(s) that support up to 4 E-UTRA operating bands. For UE(s) that support 5 or more E-UTRA bands the maximum output power is expected to decrease with each additional band and is FFS Note 2-3: N/A Note 4: $P_{\text{PowerClass}}$ is the maximum UE power specified without taking into account the tolerance Note 5-6: N/A								

The normative reference for this requirement is TS 36.101 clause 6.2.2.

### 6.2.2\_1.4 Test description

Same test description as in clause 6.2.2.4 with the following exception:

- Instead of Table 6.2.2.4.1-1 → use Table 6.2.2\_1.4-1

Table 6.2.2\_1.4-1: Test Configuration Table

Initial Conditions				
Test Environment as specified in TS 36.508[7] subclause 4.1	Normal, TL/VL, TL/VH, TH/VL, TH/VH			
Test Frequencies as specified in TS 36.508 [7] subclause 4.3.1	Low range, Mid range, High range			
Test Channel Bandwidths as specified in TS 36.508 [7] subclause 4.3.1	Lowest, 5MHz, Highest			
Test Parameters for Channel Bandwidths				
Ch BW	Downlink Configuration		Uplink Configuration	
	N/A for Max UE output power testing		Mod'n	RB allocation
			FDD	TDD
1.4MHz			QPSK 1	1
1.4MHz			QPSK 5	5
3MHz			QPSK 1	1
3MHz			QPSK 4	4
5MHz			QPSK 1	1
5MHz			QPSK 8	8
10MHz			QPSK 1	1
10MHz			QPSK 12	12
15MHz			QPSK 1	1
15MHz			QPSK 16	16
20MHz			QPSK 1	1
20MHz			QPSK 18	18
Note 1: Test Channel Bandwidths are checked separately for each E-UTRA band, the applicable channel bandwidths are specified in Table 5.4.2.1-1.				
Note 2: The 1 RB allocation shall be tested at RB#0 for low and mid range, RB #max for high range test frequency. The RBstart of non-1RB allocation shall be RB #0 for low and mid range, RB# (max +1 - RB allocation) for high range test frequency.				

### 6.2.2\_1.5 Test requirements

The maximum output power, derived in step 3 shall be within the range prescribed by the nominal maximum output power and tolerance in Table 6.2.2\_1.5-1

Table 6.2.2\_1.5-1: HPUE Power Class test requirements

EUTRA band	Class 1 (dBm)	Tolerance (dB)	Class 2 (dBm)	Tolerance (dB)	Class 3 (dBm)	Tolerance (dB)	Class 4 (dBm)	Tolerance (dB)
14	31	+2.7/-3.7	N/A	N/A	N/A	N/A	N/A	N/A
Note 1: The above tolerances are applicable for UE(s) that support up to 4 E-UTRA operating bands. For UE(s) that support 5 or more E-UTRA bands the maximum output power is expected to decrease with each additional band and is FFS								

## 6.2.2A UE Maximum Output Power for CA

### 6.2.2A.1 UE Maximum Output Power for CA (intra-band contiguous DL CA and UL CA)

#### 6.2.2A.1.1 Test purpose

To verify that the error of UE maximum output power in intra-band contiguous carrier aggregation does not exceed the range prescribed by the specified CA Power Class and tolerance.

An excess maximum output power has the possibility to interfere to other channels or other systems. A small maximum output power decreases the coverage area.

### 6.2.2A.1.2 Test applicability

This test case applies to all types of E-UTRA UE release 10 and forward that support intra-band contiguous DL CA and UL CA.

### 6.2.2A.1.3 Minimum conformance requirements

The following UE Power Classes define the maximum output power for any transmission bandwidth within the aggregated channel bandwidth.

- For inter-band carrier aggregation with uplink assigned to one E-UTRA band the requirements in subclause 6.2.2 apply.
- For intra-band contiguous carrier aggregation the maximum output power is specified in Table 6.2.2A.1.3-1.

The maximum output power is measured as the sum of the maximum output power at each UE antenna connector. The period of measurement shall be at least one sub frame (1ms).

**Table 6.2.2A.1.3-1: CA UE Power Class**

E-UTRA CA Configuration	Class 1 (dBm)	Tolerance (dB)	Class 2 (dBm)	Tolerance (dB)	Class 3 (dBm)	Tolerance (dB)	Class 4 (dBm)	Tolerance (dB)
CA_1C					23	+2/-2		
CA_3C					23	+2/-2 <sup>2</sup>		
CA_7C					23	+2/-2 <sup>2</sup>		
CA_38C					23	+2/-2		
CA_39C					23	+2/-2		
CA_40C					23	+2/-2		
CA_41C					23	+2/-2 <sup>2</sup>		
CA_42C					23	+2/-3		
Note 1:	Void							
Note 2:	For transmission bandwidths (Figure 5.4.2-1) confined within $F_{UL\_low}$ and $F_{UL\_low} + 4$ MHz or $F_{UL\_high} - 4$ MHz and $F_{UL\_high}$ , the maximum output power requirement is relaxed by reducing the lower tolerance limit by 1.5 dB							
Note 3:	$P_{PowerClass}$ is the maximum UE power specified without taking into account the tolerance							
Note 4:	For intra-band contiguous carrier aggregation the maximum power requirement should apply to the total transmitted power over all component carriers (per UE).							

For intra-band non-contiguous carrier aggregation with one uplink carrier on the PCC, the requirements in subclause 6.2.2 apply.

The normative reference for this requirement is in TS 36.101 [2] clause 6.2.2A.

### 6.2.2A.1.4 Test description

#### 6.2.2A.1.4.1 Initial conditions

Initial conditions are a set of test configurations the UE needs to be tested in and the steps for the SS to take with the UE to reach the correct measurement state.

The initial test configurations consist of environmental conditions, test frequencies, and CC combinations based on E-UTRA CA configurations specified in table 5.4.2A.1-1. All of these configurations shall be tested with applicable test parameters for each CA Configuration, and are shown in table 6.2.2A.1.4.1-1. The details of the uplink reference measurement channels (RMCs) are specified in Annex A.2. Configurations of PDSCH and PDCCH before measurement are specified in Annex C.2.

**Table 6.2.2A.1.4.1-1: Test Configuration Table**

Initial Conditions								
Test Environment as specified in TS 36.508[7] subclause 4.1				NC, TL/VL, TL/VH, TH/VL, TH/VH				
Test Frequencies as specified in TS 36.508 [7] subclause 4.3.1 for different CA bandwidth classes, and PCC and SCCs are mapped onto physical frequencies according to Table 6.1-2.				C: Low and High range				
Test CC Combination setting ( $N_{RB\_agg}$ ) as specified in subclause 5.4.2A.1 for the CA Configuration across bandwidth combination sets supported by the UE.				Lowest $N_{RB\_agg}$ Highest $N_{RB\_agg}$ (Note 2)				
Test Parameters for CA Configurations								
CA Configuration / $N_{RB\_agg}$		DL Allocation	CC MOD	UL Allocation				
PCC $N_{RB}$	SCCs $N_{RB}$	PCC & SCC RB allocation		$N_{RB\_alloc}$	PCC & SCC RB allocations ( $L_{CRB}$ @ $RB_{start}$ )			
100	25	N/Afor this test	QPSK	1	P_1@0	S_0@0		
100	25		QPSK	8	P_8@0	S_0@0		
75	75	N/Afor this test	QPSK	1	P_1@0	S_0@0	-	-
75	75		QPSK	16	P_16@0	S_0@0	-	-
100	50		QPSK	1	P_1@0	S_0@0	-	-
100	50		QPSK	12	P_12@0	S_0@0	-	-
100	75		QPSK	1	P_1@0	S_0@0		
100	75		QPSK	16	P_16@0	S_0@0		
100	100		QPSK	1	P_1@0	S_0@0	-	-
100	100		QPSK	18	P_18@0	S_0@0	-	-

Note 1: CA Configuration Test CC Combination settings are checked separately for each CA Configuration, which applicable aggregated channel bandwidths are specified in Table 5.4.2A.1-1

Note 2: If in the CA Configuration UE supports multiple CC Combinations with the same  $N_{RB\_agg}$ , only the first of those is tested, according to the order on the Test Configuration Table list.

1. Connect the SS to the UE antenna connectors as shown in TS 36.508[7] Annex A Figure group A.32 as appropriate.
2. The parameter settings for the cell are set up according to TS 36.508 [7] subclause 4.4.3.
3. Downlink signals for PCC are initially set up according to Annex C.0, C.1, and C.3.0, and uplink signals according to Annex H.1 and H.3.0.
4. The UL Reference Measurement channel is set according to Table 6.2.2A.1.4.1-1.
5. Propagation conditions are set according to Annex B.0.
6. Ensure the UE is in State 3A-RF according to TS 36.508 [7] clause 5.2A.2. Message contents are defined in clause 6.2.2A.1.4.3.

**6.2.2A.1.4.2 Test procedure**

1. Configure SCC according to Annex C.0, C.1 and Annex C.3.0 for all downlink physical channels.
2. The SS shall configure SCC as per TS 36.508 [7] clause 5.2A.4. Message contents are defined in clause 6.2.2A.1.4.3.
3. SS activates SCC by sending the activation MAC-CE (Refer TS 36.321 [13], clauses 5.13, 6.1.3.8). Wait for at least 2 seconds (Refer TS 36.133, clauses 8.3.3.2).

4. SS sends uplink scheduling information for each UL HARQ process via PDCCH DCI format 0 for C\_RNTI to schedule the UL RMC according to Table 6.2.2A.1.4.1-1 on both PCC and SCC. Since the UE has no payload and no loopback data to send the UE sends uplink MAC padding bits on the UL RMC.
5. Send continuously uplink power control "up" commands in every uplink scheduling information to the UE; allow at least 200ms for the UE to reach  $P_{UMAX}$  level.
6. Measure the mean transmitted power over all component carriers in the CA configuration of the radio access mode. The period of measurement shall be at least the continuous duration of one sub-frame (1ms). For TDD slots with transient periods are not under test.

#### 6.2.2A.1.4.3 Message contents

Message contents are according to TS 36.508 [7] subclause 4.6. In test procedure step 2, for SCC configuration there are no additional message contents.

#### 6.2.2A.1.5 Test Requirements

The maximum output power for the CA configuration, derived in step 3 shall be within the range prescribed by the CA UE Power Class and tolerance in Table 6.2.2A.1.5-1.

**Table 6.2.2A.1.5-1: CA UE Power Class test requirements**

CA Conf	Class 1 (dBm)	Tolerance (dB)	Class 2 (dBm)	Tolerance (dB)	Class 3 (dBm)	Tolerance (dB)	Class 4 (dBm)	Tolerance (dB)
CA_1C					23	$\pm 2.7$		
CA_3C					23	$\pm 2.7^2$		
CA_7C					23	$\pm 2.7^2$		
CA_38C					23	$\pm 2.7$		
CA_39C					23	$\pm 2.7$		
CA_40C					23	$\pm 2.7$		
CA_41C					23	$\pm 2.7^2$		
CA_42C					23	+3.0/-4.0		
Note 1:	Void							
Note 2:	For transmission bandwidths (Figure 5.4.2-1) confined within $F_{UL\_low}$ and $F_{UL\_low} + 4$ MHz or $F_{UL\_high} - 4$ MHz and $F_{UL\_high}$ , the maximum output power requirement is relaxed by reducing the lower tolerance limit by 1.5 dB							
Note 3:	$P_{PowerClass}$ is the maximum UE power specified without taking into account the tolerance							
Note 4:	For intra-band contiguous carrier aggregation the maximum power requirement should apply to the total transmitted power over all component carriers (per UE).							

For the UE which supports inter-band carrier aggregation configurations with uplink assigned to one E-UTRA band the  $\Delta T_{IB,c}$  in Table 6.2.5.3-2 shall be applied for applicable bands.

In case the UE supports more than one of the above inter-band carrier aggregation configurations and a E-UTRA operating band belongs to more than one inter-band carrier aggregation configurations then:

- When the E-UTRA operating band frequency range is  $\leq 1$ GHz, the applicable additional tolerance shall be the average of the tolerances in Table 6.2.5.3-2, truncated to one decimal place for that operating band among the supported CA configurations. In case there is a harmonic relation between low band UL and high band DL, then the maximum tolerance among the different supported carrier aggregation configurations involving such band shall be applied
- When the E-UTRA operating band frequency range is  $>1$ GHz, the applicable additional tolerance shall be the maximum tolerance in Table 6.2.5.3-2 that applies for that operating band among the supported CA configurations.

#### 6.2.2A.2 UE Maximum Output Power for CA (inter-band DL CA and UL CA)

##### 6.2.2A.2.1 Test purpose

Same as in clause 6.2.2A.1.1, but for the inter-band carrier aggregation case.

### 6.2.2A.2.2 Test applicability

This test case applies to all types of E-UTRA UE release 11 and forward that support inter-band DL CA and UL CA.

### 6.2.2A.2.3 Minimum conformance requirements

The following UE Power Classes define the maximum output power for any transmission bandwidth within the aggregated channel bandwidth.

- For inter-band carrier aggregation with uplink assigned to one E-UTRA band the requirements in subclause 6.2.2 apply.
- For intra-band contiguous carrier aggregation the maximum output power is specified in Table 6.2.2A.2.3-1.

The maximum output power is measured as the sum of the maximum output power at each UE antenna connector. The period of measurement shall be at least one sub frame (1ms).

**Table 6.2.2A.2.3-1: UE Power Class for dual uplink interband CA**

E-UTRA CA Configuration	Class 1 (dBm)	Tolerance (dB)	Class 2 (dBm)	Tolerance (dB)	Class 3 (dBm)	Tolerance (dB)	Class 4 (dBm)	Tolerance (dB)
CA_1A-3A					23	+2/-3 <sup>2</sup>		
CA_1A-5A					23	+2/-3		
CA_1A-7A					23	+2/-3 <sup>2</sup>		
CA_1A-8A					23	+2/-3 <sup>2</sup>		
CA_1A-19A					23	+2/-3		
CA_1A-21A					23	+2/-3		
CA_2A-4A					23	+2/-3 <sup>2</sup>		
CA_2A-13A					23	+2/-3 <sup>2</sup>		
CA_3A-5A					23	+2/-3 <sup>2</sup>		
CA_3A-7A					23	+2/-3 <sup>2</sup>		
CA_3A-8A					23	+2/-3 <sup>2</sup>		
CA_3A-19A					23	+2/-3 <sup>2</sup>		
CA_3A-20A					23	+2/-3 <sup>2</sup>		
CA_3A-26A					23	+2/-3 <sup>2</sup>		
CA_4A-7A					23	+2/-3 <sup>2</sup>		
CA_4A-12A					23	+2/-3 <sup>2</sup>		
CA_4A-13A					23	+2/-3		
CA_4A-17A					23	+2/-3		
CA_5A-7A					23	+2/-3 <sup>2</sup>		
CA_5A-12A					23	+2/-3 <sup>2</sup>		
CA_5A-17A					23	+2/-3		
CA_7A-20A					23	+2/-3 <sup>2</sup>		
CA_7A-28A					23	+2/-3 <sup>2</sup>		
CA_19A-21A					23	+2/-3		
CA_39A-41A					23	+2/-3 <sup>2</sup>		

NOTE 1: Void.  
 NOTE 2: <sup>2</sup> refers to the transmission bandwidths (Figure 5.6-1) confined within  $F_{UL\_low}$  and  $F_{UL\_low} + 4$  MHz or  $F_{UL\_high} - 4$  MHz and  $F_{UL\_high}$ , the maximum output power requirement is relaxed by reducing the lower tolerance limit by 1.5 dB.  
 NOTE 3:  $P_{PowerClass}$  is the maximum UE power specified without taking into account the tolerance.  
 NOTE 4: For inter-band carrier aggregation the maximum power requirement should apply to the total transmitted power over all component carriers (per UE).

The normative reference for this requirement is in TS 36.101 [2] clause 6.2.2A.

### 6.2.2A.2.4 Test description

#### 6.2.2A.2.4.1 Initial conditions

Same as in clause 6.2.2A.1.4.1 with the following exceptions:

- Instead of Table 5.4.2A.1-1 → use Table 5.4.2A.1-2 for CA configurations with two bands or Table 5.4.2A.1-2a for CA configurations with three bands.

- Instead of Table 6.2.2A.1.4.1-1 → use Table 6.2.2A.2.4.1-1.
- Instead of clause 6.2.2A.1.4.3 use clause 6.2.2A.2.4.3.



Table 6.2.2A.2.4.1-1: Test Configuration Table

Initial Conditions									
Test Environment as specified in TS 36.508[7] subclause 4.1				NC, TL/VL, TL/VH, TH/VL, TH/VH					
Test Frequencies as specified in TS 36.508 [7] subclause 4.3.1 for different CA bandwidth classes.				Low range for PCC and SCC High range for PCC and SCC (Note 3)					
Test CC Combination setting ( $N_{RB\_agg}$ ) as specified in subclause 5.4.2A.1 for the CA Configuration across bandwidth combination sets supported by the UE.				Lowest $N_{RB\_agg}$ Highest $N_{RB\_agg}$ (Note 2)					
Test Parameters for CA Configurations									
CA Configuration / $N_{RB\_agg}$		DL Allocation		CC MOD	UL Allocation				
PCC $N_{RB}$	SCCs $N_{RB}$	PCC & SCC RB allocation			$N_{RB\_alloc}$	PCC & SCC RB allocations ( $L_{CRB}$ @ $RB_{start}$ )			
6	25	N/Afor this test		QPSK	2	P_1@0	S_1@0	-	-
6	25			QPSK	2	P_1@5	S_1@24	-	-
6	25			QPSK	13	P_5@0	S_8@0	-	-
6	25			QPSK	13	P_5@1	S_8@17	-	-
6	50			QPSK	2	P_1@0	S_1@0	-	-
6	50			QPSK	2	P_1@5	S_1@49	-	-
6	50			QPSK	17	P_5@0	S_12@0	-	-
6	50			QPSK	17	P_5@1	S_12@38	-	-
25	15			QPSK	2	P_1@0	S_1@0	-	-
25	15			QPSK	2	P_1@24	S_1@14	-	-
25	15			QPSK	12	P_8@0	S_5@0	-	-
25	15			QPSK	12	P_8@17	S_5@10	-	-
25	25			QPSK	2	P_1@0	S_1@0	-	-
25	25			QPSK	2	P_1@24	S_1@24	-	-
25	25			QPSK	16	P_8@0	S_8@0	-	-
25	25			QPSK	16	P_8@17	S_8@17	-	-
25	50			QPSK	2	P_1@0	S_1@0	-	-
25	50			QPSK	2	P_1@24	S_1@49	-	-
25	50			QPSK	20	P_8@0	S_12@0	-	-
25	50			QPSK	20	P_8@17	S_12@38	-	-
50	25	QPSK	2	P_1@0	S_1@0	-	-		
50	25	QPSK	2	P_1@49	S_1@24	-	-		
50	25	QPSK	8	P_12@0	S_8@0	-	-		
50	25	QPSK	8	P_12@38	S_8@17	-	-		
50	50	QPSK	2	P_1@0	S_1@0	-	-		
50	50	QPSK	2	P_1@49	S_1@49	-	-		
50	50	QPSK	24	P_12@0	S_12@0	-	-		
50	50	QPSK	24	P_12@38	S_12@38	-	-		
50	100	QPSK	2	P_1@0	S_1@0	-	-		
50	100	QPSK	2	P_1@49	S_1@99	-	-		
50	100	QPSK	30	P_12@0	S_18@0	-	-		

50	100	QPSK	30	P_12@38	S_18@82	-	-
75	75	QPSK	2	P_1@0	S_1@0	-	-
75	75	QPSK	2	P_1@74	S_1@74	-	-
75	75	QPSK	32	P_16@0	S_16@0	-	-
75	75	QPSK	32	P_16@59	S_16@59	-	-
100	50	QPSK	2	P_1@0	S_1@0	-	-
100	50	QPSK	2	P_1@99	S_1@49	-	-
100	50	QPSK	30	P_18@0	S_12@0	-	-
100	50	QPSK	30	P_18@82	S_12@38	-	-
100	75	QPSK	2	P_1@0	S_1@0	-	-
100	75	QPSK	2	P_1@99	S_1@74	-	-
100	75	QPSK	34	P_18@0	S_16@0	-	-
100	75	QPSK	34	P_18@82	S_16@59	-	-
100	100	QPSK	2	P_1@0	S_1@0	-	-
100	100	QPSK	2	P_1@99	S_1@99	-	-
100	100	QPSK	36	P_18@0	S_18@0	-	-
100	100	QPSK	36	P_18@82	S_18@82	-	-

Note 1: CA Configuration Test CC Combination settings are checked separately for each CA Configuration, which applicable aggregated channel bandwidths are specified in Table 5.4.2A.1-1

Note 2: If in the CA Configuration UE supports multiple CC Combinations with the same  $N_{RB\_agg}$ , only the first of those is tested, according to the order on the Test Configuration Table list.

Note 3: For Low range use only test points with RBstart=0. For High range use only test points with RBstart=RBmax-LCRB+1.

#### 6.2.2A.2.4.2 Test procedure

Same as in clause 6.2.2A.1.4.2 with the following exceptions:

- Instead of Table 6.2.2A.1.4.1-1 → use Table 6.2.2A.2.4.1-1.
- Instead of clause 6.2.2A.1.4.3 use clause 6.2.2A.2.4.3.

#### 6.2.2A.2.4.3 Message contents

Message contents are according to TS 36.508 [7] subclause 4.6. In test procedure step 2, for SCC configuration there are no additional message contents.

#### 6.2.2A.2.5 Test Requirements

The maximum output power for the CA configuration, derived in step 3 shall be within the range prescribed by the CA UE Power Class and tolerance in Table 6.2.2A.2.5-1.

Table 6.2.2A.2.5-1: UE Power Class for dual uplink interband CA test requirements

E-UTRA CA Configuration	Class 1 (dBm)	Tolerance (dB)	Class 2 (dBm)	Tolerance (dB)	Class 3 (dBm)	Tolerance (dB)	Class 4 (dBm)	Tolerance (dB)
CA_1A-3A					23	+2.7/-3.7 <sup>2</sup>		
CA_1A-5A					23	+2.7/-3.7		
CA_1A-7A					23	+2.7/-3.7 <sup>2</sup>		
CA_1A-8A					23	+2.7/-3.7 <sup>2</sup>		
CA_1A-19A					23	+2.7/-3.7		
CA_1A-21A					23	+2.7/-3.7		
CA_2A-4A					23	+2.7/-3.7 <sup>2</sup>		
CA_2A-13A					23	+2.7/-3.7 <sup>2</sup>		
CA_3A-5A					23	+2.7/-3.7 <sup>2</sup>		
CA_3A-7A					23	+2.7/-3.7 <sup>2</sup>		
CA_3A-8A					23	+2.7/-3.7 <sup>2</sup>		
CA_3A-19A					23	+2.7/-3.7 <sup>2</sup>		
CA_3A-20A					23	+2.7/-3.7 <sup>2</sup>		
CA_3A-26A					23	+2.7/-3.7 <sup>2</sup>		
CA_4A-7A					23	+2.7/-3.7 <sup>2</sup>		
CA_4A-12A					23	+2.7/-3.7 <sup>2</sup>		
CA_4A-13A					23	+2.7/-3.7		
CA_4A-17A					23	+2.7/-3.7		
CA_5A-7A					23	+2.7/-3.7 <sup>2</sup>		
CA_5A-12A					23	+2.7/-3.7 <sup>2</sup>		
CA_5A-17A					23	+2.7/-3.7		
CA_7A-20A					23	+2.7/-3.7 <sup>2</sup>		
CA_7A-28A					23	+2.7/-3.7 <sup>2</sup>		
CA_19A-21A					23	+2.7/-3.7		
CA_39A-41A					23	+2.7/-3.7 <sup>2</sup>		
NOTE 1: Void.								
NOTE 2: <sup>2</sup> refers to the transmission bandwidths (Figure 5.6-1) confined within $F_{UL\_low}$ and $F_{UL\_low} + 4$ MHz or $F_{UL\_high} - 4$ MHz and $F_{UL\_high}$ , the maximum output power requirement is relaxed by reducing the lower tolerance limit by 1.5 dB.								
NOTE 3: $P_{PowerClass}$ is the maximum UE power specified without taking into account the tolerance.								
NOTE 4: For inter-band carrier aggregation the maximum power requirement should apply to the total transmitted power over all component carriers (per UE).								

For the UE which supports inter-band carrier aggregation configurations with uplink assigned to one E-UTRA band the  $\Delta T_{IB,c}$  in Table 6.2.5.3-2 shall be applied for applicable bands.

In case the UE supports more than one of the above inter-band carrier aggregation configurations and an E-UTRA operating band belongs to more than one inter-band carrier aggregation configurations then:

- When the E-UTRA operating band frequency range is  $\leq 1$ GHz, the applicable additional tolerance shall be the average of the tolerances in Table 6.2.5.3-2, truncated to one decimal place for that operating band among the supported CA configurations. In case there is a harmonic relation between low band UL and high band DL, then the maximum tolerance among the different supported carrier aggregation configurations involving such band shall be applied
- When the E-UTRA operating band frequency range is  $>1$ GHz, the applicable additional tolerance shall be the maximum tolerance in Table 6.2.5.3-2 that applies for that operating band among the supported CA configurations.

### 6.2.2A.3 UE Maximum Output Power for CA (intra-band non-contiguous DL CA and UL CA)

NOTE No test case details specified as the UE power class requirements (MPR=0dB) cannot be verified for the intra-band non-contiguous UL CA case due to the MPR is always bigger than 0 dB in current non-contiguous Uplink CA configurations according to Table 5.4.2A.1-3.

## 6.2.2B UE Maximum Output Power for UL-MIMO

### 6.2.2B.1 Test purpose

To verify that the error of UE maximum output power in UL MIMO does not exceed the range prescribed by the specified UL MIMO Power Class and tolerance.

An excess maximum output power has the possibility to interfere to other channels or other systems. A small maximum output power decreases the coverage area.

### 6.2.2B.2 Test applicability

This test case applies to all types of E-UTRA UE release 10 and forward that support UL MIMO.

### 6.2.2B.3 Minimum conformance requirements

For UE with two transmit antenna connectors in closed-loop spatial multiplexing scheme, the maximum output power for any transmission bandwidth within the channel bandwidth is specified in Table 6.2.2B.3-1 with the UL-MIMO configurations specified in Table 6.2.2B.3-2. The maximum output power is measured as the sum of the maximum output power at each UE antenna connector. The period of measurement shall be at least one sub frame (1ms).

**Table 6.2.2B.3-1: UE Power Class for UL-MIMO in closed loop spatial multiplexing scheme**

EUTRA band	Class 1 (dBm)	Tolerance (dB)	Class 2 (dBm)	Tolerance (dB)	Class 3 (dBm)	Tolerance (dB)	Class 4 (dBm)	Tolerance (dB)
1					23	+2/-3		
2					23	+2/-3 <sup>2</sup>		
3					23	+2/-3 <sup>2</sup>		
4					23	+2/-3		
5					23	+2/-3		
6					23	+2/-3		
7					23	+2/-3 <sup>2</sup>		
8					23	+2/-3 <sup>2</sup>		
9					23	+2/-3		
10					23	+2/-3		
11					23	+2/-3		
12					23	+2/-3 <sup>2</sup>		
13					23	+2/-3		
14					23	+2/-3		
...								
17					23	+2/-3		
18					23	+2/-3		
19					23	+2/-3		
20					23	+2/-3 <sup>2</sup>		
21					23	+2/-3		
22					23	+2/-4.5 <sup>2</sup>		
23					23	+2/-3		
24					23	+2/-3		
25					23	+2/-3 <sup>2</sup>		
26					23	+2/-3 <sup>2</sup>		
27					23	+2/-3		
28					23	+2/[-3]		
30					23	+2/-3		
31					23	+2/-3		
...								
33					23	+2/-3		
34					23	+2/-3		
35					23	+2/-3		
36					23	+2/-3		
37					23	+2/-3		
38					23	+2/-3		
39					23	+2/-3		
40					23	+2/-3		
41					23	+2/-3 <sup>2</sup>		
42					23	+2/-4		
43					23	+2/-4		
44					23	+2/[-3]		
Note 1:	Void							
Note 2:	For transmission bandwidths (Figure 5.4.2-1) confined within $F_{UL\_low}$ and $F_{UL\_low} + 4$ MHz or $F_{UL\_high} - 4$ MHz and $F_{UL\_high}$ , the maximum output power requirement is relaxed by reducing the lower tolerance limit by 1.5 dB							
Note 3:	For the UE which supports both Band 11 and Band 21 operating frequencies, the tolerance is FFS.							
Note 4:	$P_{PowerClass}$ is the maximum UE power specified without taking into account the tolerance							

**Table 6.2.2B.3-2: UL-MIMO configuration in closed-loop spatial multiplexing scheme**

Transmission mode	DCI format	Codebook Index
Mode 2	DCI format 4	Codebook index 0

The normative reference for this requirement is TS 36.101 clause 6.2.2B.

## 6.2.2B.4 Test description

### 6.2.2B.4.1 Initial condition

Initial conditions are a set of test configurations the UE needs to be tested in and the steps for the SS to take with the UE to reach the correct measurement state.

The initial test configurations consist of environmental conditions, test frequencies, and channel bandwidths based on E-UTRA operating bands specified in table 5.4.2.1-1. All of these configurations shall be tested with applicable test parameters for each channel bandwidth, and are shown in table 6.2.2B.4.1-1. The details of the uplink reference measurement channels (RMCs) are specified in Annex A.2. Configurations of PDSCH and PDCCH before measurement are specified in Annex C.2.

**Table 6.2.2B.4.1-1: Test Configuration Table**

Initial Conditions				
Test Environment as specified in TS 36.508[7] subclause 4.1		Normal, TL/VL, TL/VH, TH/VL, TH/VH		
Test Frequencies as specified in TS 36.508 [7] subclause 4.3.1		Low range, Mid range, High range		
Test Channel Bandwidths as specified in TS 36.508 [7] subclause 4.3.1		Lowest, 5MHz, Highest		
Test Parameters for Channel Bandwidths				
Ch BW	Downlink Configuration		Uplink Configuration	
	N/A for Max UE output power testing		Mod'n	RB allocation
			FDD	TDD
1.4MHz			QPSK	1
1.4MHz			QPSK	5
3MHz			QPSK	1
3MHz			QPSK	4
5MHz			QPSK	1
5MHz			QPSK	8
10MHz			QPSK	1
10MHz			QPSK	12
15MHz			QPSK	1
15MHz			QPSK	16
20MHz			QPSK	1
20MHz			QPSK	18
<p>Note 1: Test Channel Bandwidths are checked separately for each E-UTRA band, the applicable channel bandwidths are specified in Table 5.4.2.1-1.</p> <p>Note 2: For E-UTRA bands not applied with Note 2 in Table 6.2.2B.3-1:</p> <ul style="list-style-type: none"> <li>- The 1 RB allocation shall be tested at RB#0 for low and mid range, RB #max for high range test frequency.</li> <li>- The starting resource block of non-1RB allocation shall be RB #0 for low and mid range, RB# (max +1 - RB allocation) for high range test frequency.</li> </ul> <p>Note 3: For E-UTRA bands applied with Note 2 in Table 6.2.2B.3-1:</p> <ul style="list-style-type: none"> <li>- If the test channel bandwidth is larger than 4MHz, then the 1 RB allocation shall be tested at both RB #0 and RB #max.</li> <li>- If the test channel bandwidth is smaller or equal to 4MHz, then the 1 RB allocation shall be tested at RB #0.</li> <li>- If the test channel bandwidth = <math>(F_{UL\_high} - F_{UL\_low})</math> specified by the operating band, then only one frequency range shall be tested and the 1 RB allocation shall be tested at RB #0, RB # <math>\lceil N_{RB}^{UL} / 2 \rceil</math> and RB #max.</li> <li>- For non-1RB allocation, test frequency is middle range, and the starting resource block shall be RB #0.</li> </ul>				

1. Connect the SS to the UE antenna connectors as shown in TS 36.508[7] Annex A Figure A.28.
2. The parameter settings for the cell are set up according to TS 36.508 [7] subclause 4.4.3.
3. Downlink signals are initially set up according to Annex C.0, C.1, and C.3.0, and uplink signals according to Annex H.1 and H.3.0.
4. The UL Reference Measurement channel is set according to Table 6.2.2B.4.1-1.

5. Propagation conditions are set according to Annex B.0.
6. Ensure the UE is in State 3A-RF according to TS 36.508 [7] clause 5.2A.2. Message contents are defined in clause 6.2.2B.4.3.

#### 6.2.2B.4.2 Test procedure

1. SS sends uplink scheduling information for each UL HARQ process via PDCCH DCI format 4 for C\_RNTI to schedule the UL RMC according to Table 6.2.2B.4.1-1. Since the UE has no payload and no loopback data to send the UE sends uplink MAC padding bits on the UL RMC.
2. Send continuously uplink power control "up" commands in every uplink scheduling information to the UE; allow at least 200ms for the UE to reach  $P_{UMAX}$  level.
3. Measure the mean sum power of the UE in the channel bandwidth of the radio access mode. The period of measurement shall be at least the continuous duration of one sub-frame (1ms). For TDD slots with transient periods are not under test.

#### 6.2.2B.4.3 Message contents

Message contents are according to TS 36.508 [7] clause 4.6.

#### 6.2.2B.5 Test requirements

The maximum output power, derived in step 3 shall be within the range prescribed by the nominal maximum output power and tolerance in Table 6.2.2B.5-1.

Table 6.2.2B.5-1: UE Power Class for UL-MIMO in closed loop spatial multiplexing scheme

EUTRA band	Class 1 (dBm)	Tolerance (dB)	Class 2 (dBm)	Tolerance (dB)	Class 3 (dBm)	Tolerance (dB)	Class 4 (dBm)	Tolerance (dB)
1					23	+2.7/-3.7		
2					23	+2.7/-3.7 <sup>2</sup>		
3					23	+2.7/-3.7 <sup>2</sup>		
4					23	+2.7/-3.7		
5					23	+2.7/-3.7		
6					23	+2.7/-3.7		
7					23	+2.7/-3.7 <sup>2</sup>		
8					23	+2.7/-3.7 <sup>2</sup>		
9					23	+2.7/-3.7		
10					23	+2.7/-3.7		
11					23	+2.7/-3.7		
12					23	+2.7/-3.7 <sup>2</sup>		
13					23	+2.7/-3.7		
14					23	+2.7/-3.7		
...								
17					23	+2.7/-3.7		
18					23	+2.7/-3.7		
19					23	+2.7/-3.7		
20					23	+2.7/-3.7 <sup>2</sup>		
21					23	+2.7/-3.7		
22					23	+3/-5.5 <sup>2</sup>		
23					23	+2.7/-3.7		
24					23	+2.7/-3.7		
25					23	+2.7/-3.7 <sup>2</sup>		
26					23	+2.7/-3.7		
27					23	+2.7/-3.7		
28					23	+2.7/[-3.7]		
30					23	+2.7/-3.7		
31					23	+2.7/-3.7		
...								
33					23	+2.7/-3.7		
34					23	+2.7/-3.7		
35					23	+2.7/-3.7		
36					23	+2.7/-3.7		
37					23	+2.7/-3.7		
38					23	+2.7/-3.7		
39					23	+2.7/-3.7		
40					23	+2.7/-3.7		
41					23	+2.7/-3.7 <sup>2</sup>		
42					23	+3/-5		
43					23	+3/-5		
44					23	+2.7/[-3.7]		
Note 1:	Void							
Note 2:	For transmission bandwidths (Figure 5.4.2-1) confined within $F_{UL\_low}$ and $F_{UL\_low} + 4$ MHz or $F_{UL\_high} - 4$ MHz and $F_{UL\_high}$ , the maximum output power requirement is relaxed by reducing the lower tolerance limit by 1.5 dB							
Note 3:	For the UE which supports both Band 11 and Band 21 operating frequencies, the tolerance is FFS.							
Note 4:	$P_{PowerClass}$ is the maximum UE power specified without taking into account the tolerance							

For the UE which supports inter-band carrier aggregation configurations with uplink assigned to one E-UTRA band the  $\Delta T_{IB,c}$  in Table 6.2.5.3-2 shall be applied for applicable bands.

In case the UE supports more than one of the above inter-band carrier aggregation configurations and a E-UTRA operating band belongs to more than one inter-band carrier aggregation configurations then:

- When the E-UTRA operating band frequency range is  $\leq 1$ GHz, the applicable additional tolerance shall be the average of the tolerances in Table 6.2.5.3-2, truncated to one decimal place for that operating band among the supported CA configurations. In case there is a harmonic relation between low band UL and high band DL, then the maximum tolerance among the different supported carrier aggregation configurations involving such band shall be applied



- When the E-UTRA operating band frequency range is >1GHz, the applicable additional tolerance shall be the maximum tolerance in Table 6.2.5.3-2 that applies for that operating band among the supported CA configurations.

## 6.2.2E UE Maximum Output Power for UE category 0

### 6.2.2E.1 Test purpose

Same test purpose as in clause 6.2.2.1.

### 6.2.2E.2 Test applicability

This test case applies to all types of E-UTRA UE release 12 and forward of UE category 0.

### 6.2.2E.3 Minimum conformance requirements

Same minimum conformance requirements as in clause 6.2.2.3

### 6.2.2E.4 Test description

#### 6.2.2E.4.1 Initial condition

Same initial conditions as in clause 6.2.2.4.1 with the following exceptions:

- Instead of Table 6.2.2.4.1-1 → use Table 6.2.2E.4.1-1.
- Connect the SS to the UE antenna connectors as shown in TS 36.508[7] Annex A Figure A.3 using only main UE Tx/Rx antenna.

Table 6.2.2E.4.1-1: Test Configuration Table

Initial Conditions				
Test Environment as specified in TS 36.508[7] subclause 4.1	Normal, TL/VL, TL/VH, TH/VL, TH/VH			
Test Frequencies as specified in TS 36.508 [7] subclause 4.3.1	Low range, Mid range, High range			
Test Channel Bandwidths as specified in TS 36.508 [7] subclause 4.3.1	Lowest, 5MHz, Highest			
Test Parameters for Channel Bandwidths				
Ch BW	Downlink Configuration	Uplink Configuration		
	N/A for Max UE output power testing	Mod'n	RB allocation	
			FDD and HD-FDD	TDD
1.4MHz		QPSK	1	1
1.4MHz		QPSK	5	5
3MHz		QPSK	1	1
3MHz		QPSK	4	4
5MHz		QPSK	1	1
5MHz		QPSK	8	8
10MHz		QPSK	1	1
10MHz		QPSK	12	12
15MHz		QPSK	1	1
15MHz		QPSK	16	16
20MHz		QPSK	1	1
20MHz		QPSK	18	18
Note 1:	Test Channel Bandwidths are checked separately for each E-UTRA band, the applicable channel bandwidths are specified in Table 5.4.2.1-1.			
Note 2:	For E-UTRA bands not applied with Note 2 in Table 6.2.2.3-1:			
	- The 1 RB allocation shall be tested at RB#0 for low and mid range, RB #max for high range test frequency.			
	- The RBstart of non-1RB allocation shall be RB #0 for low and mid range, RB# (max +1 - RB allocation) for high range test frequency.			
Note 3:	For E-UTRA bands applied with Note 2 in Table 6.2.2.3-1:			
	- If the test channel bandwidth is larger than 4MHz, then the 1 RB allocation shall be tested at both RB #0 and RB #max.			
	- If the test channel bandwidth is smaller or equal to 4MHz, then the 1 RB allocation shall be tested at RB #0.			
	- If the test channel bandwidth = (FUL_high - FUL_low) specified by the operating band, then only one frequency range shall be tested and the 1 RB allocation shall be tested at RB #0, RB # $\lceil N_{RB}^{UL} / 2 \rceil$ and RB #max.			
	- For non-1RB allocation, test frequency is middle range, and the RBstart shall be RB #0.			

#### 6.2.2E.4.2 Test procedure

Same test procedure as in clause 6.2.2.4.2 with the following exception for HD-FDD:

- In step 3, slots with transient periods are not under test. Half-duplex guard subframes are not under test.

#### 6.2.2E.4.3 Message contents

Message contents are according to TS 36.508 [7] subclause 4.6.

#### 6.2.2E.5 Test requirements

The maximum output power, derived in step 3 shall be within the range prescribed by the nominal maximum output power and tolerance in Table 6.2.2E.5-1.

Table 6.2.2E.5-1: UE Power Class test requirements

EUTRA band	Class 1 (dBm)	Tolerance (dB)	Class 2 (dBm)	Tolerance (dB)	Class 3 (dBm)	Tolerance (dB)	Class 4 (dBm)	Tolerance (dB)
1					23	±2.7		
2					23	±2.7 <sup>2</sup>		
3					23	±2.7 <sup>2</sup>		
4					23	±2.7		
5					23	±2.7		
6					23	±2.7		
7					23	±2.7 <sup>2</sup>		
8					23	±2.7 <sup>2</sup>		
9					23	±2.7		
10					23	±2.7		
11					23	±2.7		
12					23	±2.7 <sup>2</sup>		
13					23	±2.7		
14					23	±2.7		
...								
17					23	±2.7		
18					23	±2.7 <sup>6</sup>		
19					23	±2.7		
20					23	±2.7 <sup>2</sup>		
21					23	±2.7		
22					23	+3.0/-4.5		
23					23 <sup>5</sup>	±2.7 <sup>5</sup>		
24					23	±2.7		
25					23	±2.7 <sup>2</sup>		
26					23	±2.7 <sup>2</sup>		
27					23	±2.7		
28					23	+2.7/-3.2		
30					23	±2.7		
31					23	±2.7		
...								
33					23	±2.7		
34					23	±2.7		
35					23	±2.7		
36					23	±2.7		
37					23	±2.7		
38					23	±2.7		
39					23	±2.7		
40					23	±2.7		
41					23	±2.7 <sup>2</sup>		
42					23	+3.0/-4.0		
43					23	+3.0/-4.0		
44					23	+2.7/[-3.7]		
...								
Note 1:	The above tolerances are applicable for UE(s) that support up to 4 E-UTRA operating bands. For UE(s) that support 5 or more E-UTRA bands the maximum output power is expected to decrease with each additional band and is FFS							
Note 2:	For transmission bandwidths (Figure 5.4.2-1, Table 5.4.4-1) confined within $F_{UL\_low}$ and $F_{UL\_low} + 4$ MHz or $F_{UL\_high} - 4$ MHz and $F_{UL\_high}$ , the maximum output power requirement is relaxed by reducing the lower tolerance limit by 1.5 dB							
Note 3:	$P_{PowerClass}$ is the maximum UE power specified without taking into account the tolerance.							
Note 4:	For the UE which supports both Band 11 and Band 21 operating frequencies, the tolerance is FFS.							
Note 5:	When NS_20 is signalled, the total output power within 2000-2005 MHz shall be limited to 7 dBm.							
Note 6:	For a UE that supports both Band 18 and Band 26, the maximum output power requirement is relaxed by reducing the lower tolerance limit by 1.5dB for transmission bandwidths confined within 815 MHz and 818 MHz.							

### 6.2.3 Maximum Power Reduction (MPR)

Editor's note:

- Requirement for Band 44 is not yet finalised due to square brackets in core specification TS 36.101 Table 6.2.2-1.
- Test requirements values in this section need to be reviewed in order to take into account notes in Table 6.2.5.3-2:  $\Delta T_{IB,c}$  regarding  $\Delta T_{IB,c}$  and asymmetric lower tolerances in table 6.2.2.3-1.

### 6.2.3.1 Test purpose

The number of RB identified in Table 6.2.3.3-1 is based on meeting the requirements for adjacent channel leakage ratio and the maximum power reduction (MPR) due to Cubic Metric (CM).

Simple scaling can be used to derive the requirement for other bandwidth based on the previously agreed value for 5MHz channel bandwidth.

### 6.2.3.2 Test applicability

The requirements of this test apply in test cases 6.6.2.3 Adjacent Channel Leakage power Ratio to all types of E-UTRA UE release 8 and forward

NOTE: As a result TC 6.2.3 has not been included in the test case applicability table 4.1-1, TS 36.521-2. This does not preclude the test from being used for R&D or other purposes if deemed useful..

### 6.2.3.3 Minimum conformance requirements

For UE Power Class 3, the allowed Maximum Power Reduction (MPR) for the maximum output power in Table 6.2.2.3-1 due to higher order modulation and transmit bandwidth configuration (resource blocks) is specified in Table 6.2.3.3-1.

**Table 6.2.3.3-1: Maximum Power Reduction (MPR) for Power Class 3**

Modulation	Channel bandwidth / Transmission bandwidth configuration [RB]						MPR (dB)
	1.4 MHz	3.0 MHz	5 MHz	10 MHz	15 MHz	20 MHz	
QPSK	> 5	> 4	> 8	> 12	> 16	> 18	≤ 1
16 QAM	≤ 5	≤ 4	≤ 8	≤ 12	≤ 16	≤ 18	≤ 1
16 QAM	> 5	> 4	> 8	> 12	> 16	> 18	≤ 2

For PRACH, PUCCH and SRS transmission, the allowed MPR is according to that specified for PUSCH QPSK modulation for the corresponding transmission bandwidth.

For each subframe, the MPR is evaluated per slot and given by the maximum value taken over the transmission(s) within the slot, the maximum MPR over the two slots is then applied for the entire subframe.

For the UE maximum output power modified by MPR, the power limits specified in subclause 6.2.5.3 apply.

The normative reference for this requirement is TS 36.101 clause 6.2.3.

### 6.2.3.4 Test description

#### 6.2.3.4.1 Initial condition

Initial conditions are a set of test configurations the UE needs to be tested in and the steps for the SS to take with the UE to reach the correct measurement state.

The initial test configurations consist of environmental conditions, test frequencies, and channel bandwidths based on E-UTRA operating bands specified in table 5.4.2.1-1. All of these configurations shall be tested with applicable test parameters for each channel bandwidth, and are shown in table 6.2.3.4.1-1. The details of the uplink reference measurement channels (RMCs) are specified in Annexes A.2. Configurations of PDSCH and PDCCH before measurement are specified in Annex C.2.

Table 6.2.3.4.1-1: Test Configuration Table

Initial Conditions				
Test Environment as specified in TS 36.508[7] subclause 4.1	Normal, TL/VL, TL/VH, TH/VL, TH/VH			
Test Frequencies as specified in TS 36.508 [7] subclause 4.3.1	Low range, Mid range, High range			
Test Channel Bandwidths as specified in TS 36.508 [7] subclause 4.3.1	Lowest, 5MHz, 10MHz, Highest			
Test Parameters for Channel Bandwidths				
Ch BW	Downlink Configuration	Uplink Configuration		
		Mod'n	RB allocation	
	N/A for Maximum Power Reduction (MPR) test case		FDD	TDD
1.4MHz		QPSK	5	5
1.4MHz		QPSK	6	6
1.4MHz		16QAM	5	5
1.4MHz		16QAM	6	6
3.0MHz		QPSK	4	4
3.0MHz		QPSK	15	15
3.0MHz		16QAM	4	4
3.0MHz		16QAM	15	15
5MHz		QPSK	8	8
5MHz		QPSK	25	25
5MHz		16QAM	8	8
5MHz		16QAM	25	25
10MHz		QPSK	12	12
10MHz		QPSK	50	50
10MHz		16QAM	12	12
10MHz		16QAM	50 (Note 3)	50 (Note 3)
15MHz		QPSK	16	16
15MHz		QPSK	75	75
15MHz		16QAM	16	16
15MHz		16QAM	75 (Note 3)	75 (Note 3)
20MHz		QPSK	18	18
20MHz		QPSK	100	100
20MHz	16QAM	18	18	
20MHz	16QAM	100 (Note 3)	100 (Note 3)	
Note 1: Test Channel Bandwidths are checked separately for each E-UTRA band, the applicable channel bandwidths are specified in Table 5.4.2.1-1.				
Note 2: The RB <sub>start</sub> of partial RB allocation shall be RB#0 and RB# (max + 1 - RB allocation) of the channel bandwidth.				
Note 3: Applies only for UE-Categories ≥2.				

1. Connect the SS and interfering sources to the UE antenna connectors as shown in TS 36.508[7] Annex A Figure A.3.
2. The parameter settings for the cell are set up according to TS 36.508 [7] subclause 4.4.3.
3. Downlink signals are initially set up according to Annex C.0, C.1, and C.3.0, and uplink signals according to Annex H.1 and H.3.0.
4. The UL Reference Measurement channels are set according to Table 6.2.3.4.1-1.
5. Ensure the UE is in State 3A-RF according to TS 36.508 [7] clause 5.2A.2. Message contents are defined in clause 6.2.2.4.3.

#### 6.2.3.4.2 Test procedure

1. SS sends uplink scheduling information for each UL HARQ process via PDCCH DCI format 0 for C\_RNTI to schedule the UL RMC according to Table 6.2.3.4.1-1. Since the UE has no payload and no loopback data to send the UE sends uplink MAC padding bits on the UL RMC
2. Send continuously uplink power control "up" commands in the uplink scheduling information to the UE to ensure that the UE transmits at  $P_{UMAX}$  level.
3. Measure the mean power of the UE in the channel bandwidth of the radio access mode. The period of measurement shall be at least the continuous duration one sub-frame (1ms). For TDD slots with transient periods are not under test.

#### 6.2.3.4.3 Message contents

Message contents are according to TS 36.508 [7] subclause 4.6.

#### 6.2.3.5 Test requirements

The maximum output power, derived in step 2 shall be within the range prescribed by the nominal maximum output power and tolerance in Table 6.2.3.5-1.

Table 6.2.3.5-1: UE Power Class test requirements

E-UTRA Band	Class 1 (dBm)	Tol. (Db)	Class 2 (dBm)	Tol. (dB)	Class 3 (dBm)	QPSK partial RB allocation Tol. (dB)	QPSK full RB allocation Tol. (dB)	16QAM partial RB allocation Tol. (dB)	16QAM full RB allocation Tol. (dB)
1					23	±2.7	+2.7 / -3.7	+2.7 / -3.7	+2.7 / -4.7
2					23	±2.7 <sup>1</sup>	+2.7 / -3.7 <sup>1,2</sup>	+2.7 / -3.7 <sup>1,2</sup>	+2.7 / -4.7 <sup>1,2</sup>
3					23	±2.7 <sup>1</sup>	+2.7 / -3.7 <sup>1,2</sup>	+2.7 / -3.7 <sup>1,2</sup>	+2.7 / -4.7 <sup>1,2</sup>
4					23	±2.7	+2.7 / -3.7	+2.7 / -3.7	+2.7 / -4.7
5					23	±2.7	+2.7 / -3.7	+2.7 / -3.7	+2.7 / -4.7
6					23	±2.7	+2.7 / -3.7	+2.7 / -3.7	+2.7 / -4.7
7					23	±2.7 <sup>1</sup>	+2.7 / -3.7 <sup>1,2</sup>	+2.7 / -3.7 <sup>1,2</sup>	+2.7 / -4.7 <sup>1,2</sup>
8					23	±2.7 <sup>1</sup>	+2.7 / -3.7 <sup>1,2</sup>	+2.7 / -3.7 <sup>1,2</sup>	+2.7 / -4.7 <sup>1,2</sup>
9					23	±2.7	+2.7 / -3.7	+2.7 / -3.7	+2.7 / -4.7
10					23	±2.7	+2.7 / -3.7	+2.7 / -3.7	+2.7 / -4.7
11					23	±2.7	+2.7 / -3.7	+2.7 / -3.7	+2.7 / -4.7
12					23	±2.7 <sup>1</sup>	+2.7 / -3.7 <sup>1,2</sup>	+2.7 / -3.7 <sup>1,2</sup>	+2.7 / -4.7 <sup>1,2</sup>
13					23	±2.7	+2.7 / -3.7	+2.7 / -3.7	+2.7 / -4.7
14					23	±2.7	+2.7 / -3.7	+2.7 / -3.7	+2.7 / -4.7
...									
17					23	±2.7	+2.7 / -3.7	+2.7 / -3.7	+2.7 / -4.7
18					23	±2.7 <sup>3</sup>	+2.7 / -3.7 <sup>3</sup>	+2.7 / -3.7 <sup>3</sup>	+2.7 / -4.7 <sup>3</sup>
19					23	±2.7	+2.7 / -3.7	+2.7 / -3.7	+2.7 / -4.7
20					23	±2.7 <sup>1</sup>	+2.7 / -3.7 <sup>1,2</sup>	+2.7 / -3.7 <sup>1,2</sup>	+2.7 / -4.7 <sup>1,2</sup>
21					23	±2.7	+2.7 / -3.7	+2.7 / -3.7	+2.7 / -4.7
22					23	+3.0/-4.5	+3.0/-5.5	+3.0/-5.5	+3.0/-6.5
23					23	±2.7	+2.7 / -3.7	+2.7 / -3.7	+2.7 / -4.7
24					23	±2.7	+2.7 / -3.7	+2.7 / -3.7	+2.7 / -4.7
25					23	±2.7 <sup>1</sup>	+2.7 / -3.7 <sup>1,2</sup>	+2.7 / -3.7 <sup>1,2</sup>	+2.7 / -4.7 <sup>1,2</sup>
26					23	±2.7 <sup>1</sup>	+2.7 / -3.7 <sup>1,2</sup>	+2.7 / -3.7 <sup>1,2</sup>	+2.7 / -4.7 <sup>1,2</sup>
27					23	±2.7	+2.7 / -3.7	+2.7 / -3.7	+2.7 / -4.7
28					23	+2.7/-3.2	+2.7/-4.2	+2.7/-4.2	+2.7/-5.2
30					23	±2.7	+2.7 / -3.7	+2.7 / -3.7	+2.7 / -4.7
31					23	±2.7	+2.7 / -3.7	+2.7 / -3.7	+2.7 / -4.7
...									
33					23	±2.7	+2.7 / -3.7	+2.7 / -3.7	+2.7 / -4.7
34					23	±2.7	+2.7 / -3.7	+2.7 / -3.7	+2.7 / -4.7

35				23	$\pm 2.7$	+2.7 / -3.7	+2.7 / -3.7	+2.7 / -4.7	
36				23	$\pm 2.7$	+2.7 / -3.7	+2.7 / -3.7	+2.7 / -4.7	
37				23	$\pm 2.7$	+2.7 / -3.7	+2.7 / -3.7	+2.7 / -4.7	
38				23	$\pm 2.7$	+2.7 / -3.7	+2.7 / -3.7	+2.7 / -4.7	
39				23	$\pm 2.7$	+2.7 / -3.7	+2.7 / -3.7	+2.7 / -4.7	
40				23	$\pm 2.7$	+2.7 / -3.7	+2.7 / -3.7	+2.7 / -4.7	
41				23	$\pm 2.7^1$	+2.7 / <sup>1,2</sup> -3.7	+2.7 / <sup>1,2</sup> -3.7	+2.7 / <sup>1,2</sup> -4.7	
42				23	+3.0 / -4.0	+3.0 / -5.0	+3.0 / -5.0	+3.0 / -6.0	
43				23	+3.0 / -4.0	+3.0 / -5.0	+3.0 / -5.0	+3.0 / -6.0	
44				23	+2.7 / [-3.7]	+2.7 / [-4.7]	+2.7 / [-4.7]	+2.7 / [-5.7]	
Note 1:	For transmission bandwidths (Figure 5.4.2-1) confined within FUL_low and FUL_low + 4 MHz or FUL_high – 4 MHz and FUL_high, the maximum output power requirement is relaxed by reducing the lower tolerance limit by 1.5 dB.								
Note 2:	For the UE maximum output power modified by MPR, the power limits specified in Table 6.2.5.3-1 apply								
Note 3:	For a UE that supports both Band 18 and Band 26, the maximum output power requirement is relaxed by reducing the lower tolerance limit by 1.5dB for transmission bandwidths confined within 815 MHz and 818 MHz								

## 6.2.3\_1 Maximum Power Reduction (MPR) for HPUE

### 6.2.3\_1.1 Test purpose

Same test purpose as in clause 6.2.3.1 with the following exception:

- Instead of Table 6.2.3.3-1 → use Table 6.2.3\_1.3-1

### 6.2.3\_1.2 Test applicability

The requirements of this test apply in test cases 6.6.2.3\_1 Adjacent Channel Leakage power Ratio for HPUE to all types of E-UTRA Power Class 1 UE release 10 and forward.

NOTE: As a result TC 6.2.3\_1 has not been included in the test case applicability table 4.1-1, TS 36.521-2. This does not preclude the test from being used for R&D or other purposes if deemed useful.

### 6.2.3\_1.3 Minimum conformance requirements

For UE Power Class 1, the allowed Maximum Power Reduction (MPR) for the maximum output power in Table 6.2.2\_1.3-1 due to higher order modulation and transmit bandwidth configuration (resource blocks) is specified in Table 6.2.3\_1.3-1.

**Table 6.2.3\_1.3-1: Maximum Power Reduction (MPR) for Power Class 1**

Modulation	Channel bandwidth / Transmission bandwidth configuration [RB]						MPR (dB)
	1.4 MHz	3.0 MHz	5 MHz	10 MHz	15 MHz	20 MHz	
QPSK	> 5	> 4	> 8	> 12	> 16	> 18	≤ 1
16 QAM	≤ 5	≤ 4	≤ 8	≤ 12	≤ 16	≤ 18	≤ 1
16 QAM	> 5	> 4	> 8	> 12	> 16	> 18	≤ 2

For the UE maximum output power modified by MPR, the power limits specified in subclause 6.2.5\_1.3 apply.



The normative reference for this requirement is TS 36.101 clause 6.2.3.

### 6.2.3\_1.4 Test description

Same test description as in clause 6.2.3.4.

### 6.2.3\_1.5 Test requirements

Same test requirements as in clause 6.2.3.5 with the following exceptions:

- Instead of Table 6.2.3.5-1 → use Table 6.2.3\_1.5-1

**Table 6.2.3\_1.5-1: UE Power Class 1 test requirements**

E-UTRA Band	Class 1 (dBm)	QPSK partial RB allocation Tol. (dB)	QPSK full RB allocation Tol. (dB)	16QAM partial RB allocation Tol. (dB)	16QAM full RB allocation Tol. (dB)
14	31	+2.7 / -3.7	+2.7 / -4.7	+2.7 / -4.7	+2.7 / -5.7
Note 1: For transmission bandwidths (Figure 5.4.2-1) confined within FUL_low and FUL_low + 4 MHz or FUL_high – 4 MHz and FUL_high, the maximum output power requirement is relaxed by reducing the lower tolerance limit by 1.5 dB. Note 2: For the UE maximum output power modified by MPR, the power limits specified in Table 6.2.5_1.3-1 apply					

## 6.2.3\_2 Maximum Power Reduction (MPR) for Multi-Cluster PUSCH

### 6.2.3\_2.1 Test purpose

To verify that the error of the UE maximum output power does not exceed the range prescribed by the specified maximum output power with MPR and tolerance when operating in multi-cluster PUSCH scenarios.

An excess maximum output power has the possibility to interfere to other channels or other systems. A small maximum output power decreases the coverage area.

### 6.2.3\_2.2 Test applicability

The requirements of this test apply in test cases 6.6.2.3\_2 Adjacent Channel Leakage power Ratio to all types of E-UTRA UE release 10 and forward that support multi cluster PUSCH within a component carrier for the tested band.

NOTE: As a result TC 6.2.3\_2 has not been included in the test case applicability table 4.1-1, TS 36.521-2. This does not preclude the test from being used for R&D or other purposes if deemed useful.

### 6.2.3\_2.3 Minimum conformance requirements

For UE Power Class 3, the allowed Maximum Power Reduction (MPR) for the maximum output power in table 6.2.2-1 due to multi-cluster PUSCH, is specified as follows:

$$\text{MPR} = \text{CEIL} \{M_A, 0.5\}$$

Where  $M_A$  is defined as follows

$$M_A = 8.00 - 10.12A; 0.00 < A \leq 0.33$$

$$5.67 - 3.07A; 0.33 < A \leq 0.77$$

$$3.31; 0.77 < A \leq 1.00$$

Where

$$A = N_{RB\_alloc} / N_{RB}$$

$CEIL\{M_A, 0.5\}$  means rounding upwards to closest 0.5dB, i.e.  $MPR \in [3.0, 3.5, 4.0, 4.5, 5.0, 5.5, 6.0, 6.5, 7.0, 7.5, 8.0]$

For the UE maximum output power modified by MPR, the power limits specified in clause 6.2.5.3 apply.

The normative reference for this requirement is TS 36.101 clause 6.2.3.

## 6.2.3\_2.4 Test description

### 6.2.3\_2.4.1 Initial condition

Initial conditions are a set of test configurations the UE needs to be tested in and the steps for the SS to take with the UE to reach the correct measurement state.

The initial test configurations consist of environmental conditions, test frequencies, and channel bandwidths based on E-UTRA operating bands specified in clause 5.4.2.1. All of these configurations shall be tested with applicable test parameters for each channel bandwidth, and are shown in table 6.2.3\_2.4.1-1. The details of the uplink reference measurement channels (RMCs) are specified in Annexes A.2. Configurations of PDSCH and PDCCH before measurement are specified in Annex C.2.

**Table 6.2.3\_2.4.1-1: Test Configuration Table**

Initial Conditions					
Test Environment as specified in TS 36.508[7] subclause 4.1			Normal, TL/VL, TL/VH, TH/VL, TH/VH		
Test Frequencies as specified in TS36.508 [7] subclause 4.3.1			Low range, Mid range, High range		
Test Channel Bandwidths as specified in TS 36.508 [7] subclause 4.3.1			Highest		
Test Parameters for Channel Bandwidths					
Configuration ID	Downlink Configuration		Uplink Configuration		
	Ch BW	N/A for Maximum Power Reduction (MPR) test case	Mod'n	Cluster1 RB allocations (LCRB @ RB <sub>start</sub> )	Cluster2 RB allocations (LCRB @ RB <sub>start</sub> )
1	5MHz		16QAM	2@0	1@24
2	5MHz		16QAM	18@0	2@22
3	5MHz		16QAM	2@0	18@6
4	10MHz		16QAM	3@0	2@48
5	10MHz		16QAM	42@0	3@45
6	10MHz		16QAM	3@0	42@6
7	15MHz		16QAM	8@0	7@68
8	15MHz		16QAM	60@0	4@68
9	15MHz		16QAM	4@0	60@12
10	20MHz		16QAM	4@0	4@96
11	20MHz		16QAM	92@0	4@96
12	20MHz		16QAM	4@0	92@8
Note 1: Test Channel Bandwidths are checked separately for each E-UTRA band, the applicable channel bandwidths are specified in Table 5.4.2.1-1.					

1. Connect the SS and interfering sources to the UE antenna connectors as shown in TS 36.508[7] Annex A Figure A.3.
2. The parameter settings for the cell are set up according to TS 36.508 [7] clause 4.4.3.
3. Downlink signals are initially set up according to Annex C.0, C.1, and C.3.0, and uplink signals according to Annex H.1 and H.3.0.
4. The UL Reference Measurement channels are set according to Table 6.2.3\_2.4.1-1.

5. Ensure the UE is in State 3A-RF according to TS 36.508 [7] clause 5.2A.2. Message contents are defined in clause 6.2.3\_2.4.3.

#### 6.2.3\_2.4.2 Test procedure

1. SS sends uplink scheduling information for each UL HARQ process via PDCCH DCI format 0 for C\_RNTI to schedule the UL RMC according to Table 6.2.3\_2.4.1-1. Since the UE has no payload and no loopback data to send the UE sends uplink MAC padding bits on the UL RMC
2. Send continuously uplink power control "up" commands in the uplink scheduling information to the UE to ensure that the UE transmits at  $P_{UMAX}$  level.
3. Measure the mean power of the UE in the channel bandwidth of the radio access mode. The period of measurement shall be at least the continuous duration one sub-frame (1ms). For TDD slots with transient periods are not under test.

#### 6.2.3\_2.4.3 Message contents

Message contents are according to TS 36.508 [7] subclause 4.6.

#### 6.2.3\_2.5 Test requirements

The maximum output power, derived in step 2 shall be within the range prescribed by the nominal maximum output power and tolerance in Table 6.2.3\_2.5-1.

Table 6.2.3\_2.5-1: UE Power Class test requirements for Multi-Cluster PUSCH

Configuration ID	EUTRA band	Class 1 (dBm)	Tol. (dB)	Class 2 (dBm)	Tol. (dB)	Class 3 (dBm)	Tol. (dB)
1	31					23	+2.7 / -12.7
2	31					23	+2.7 / -7.7
3	31					23	+2.7 / -7.7
4	5, 6, 8, 11, 12, 13, 14, 17, 24, 27, 30					23	+2.7 / -12.7
5	5, 6, 8, 11, 12, 13, 14, 17, 24, 27, 30					23	+2.7 / -7.7
6	5, 6, 8, 11, 12, 13, 14, 17, 24, 27, 30					23	+2.7 / -7.7
7	18, 19, 21, 26, 34					23	+2.7 / -11.7
8	18, 19, 21, 26, 34					23	+2.7 / -7.7
9	18, 19, 21, 26, 34					23	+2.7 / -7.7
10	1, 2, 3, 4, 7, 9, 10, 20, 23, 25, 28, 33, 35, 36, 37, 38, 39, 40, 41, 44					23	+2.7 / -13.2
	22, 42, 43					23	+3.0 / -13.5
11	1, 2, 3, 4, 7, 9, 10, 20, 23, 25, 28, 33, 35, 36, 37, 38, 39, 40, 41, 44,					23	+2.7 / -7.7
	22, 42, 43					23	+3.0 / -8.0
12	1, 2, 3, 4, 7, 9, 10, 20, 23, 25, 28, 33, 35, 36, 37, 38, 39, 40, 41, 44,					23	+2.7 / -7.7
	22, 42, 43					23	+3.0 / -8.0

## 6.2.3A Maximum Power Reduction (MPR) for CA

### 6.2.3A.1 Maximum Power Reduction (MPR) for CA (intra-band contiguous DL CA and UL CA)

#### 6.2.3A.1.1 Test purpose

The number of RB identified in Table 6.2.3A.1.3-1 is based on meeting the requirements for Adjacent Channel Leakage power Ratio (ACLR) for CA and the maximum power reduction (MPR) for intra-band contiguous CA Bandwidth Class C due to Cubic Metric (CM).

#### 6.2.3A.1.2 Test applicability

The requirements of this test apply in test case 6.6.2.3A.1 Adjacent Channel Leakage power Ratio (ACLR) for CA to all types of E-UTRA UE release 10 and forward that support intra-band contiguous DL CA and UL CA.

NOTE: As a result TC 6.2.3A.1 has not been included in the test case applicability table 4.1-1, TS 36.521-2. This does not preclude the test from being used for R&D or other purposes if deemed useful.

#### 6.2.3A.1.3 Minimum conformance requirements

The following is specified for maximum power reduction (MPR) for CA.

- For inter-band carrier aggregation with uplink assigned to one E-UTRA band (Table 5.4.2A-1) the requirements in clause 6.2.3 apply.
- For intra-band contiguous carrier aggregation the allowed Maximum Power Reduction (MPR) for the maximum output power in Table 6.2.2A.1.3-1 due to higher order modulation and contiguously allocated transmissions (resource blocks) is specified in Table 6.2.3A.1.3-1. In case the modulation format is different on different component carriers then the MPR is determined by the rules applied to higher order of those modulations.

**Table 6.2.3A.1.3-1: Maximum Power Reduction (MPR) for Power Class 3**

Modulation	CA bandwidth Class C					MPR (dB)
	25 RB + 100 RB	50 RB + 100 RB	75 RB + 75 RB	75 RB + 100 RB	100 RB + 100 RB	
QPSK	> 8 and ≤ 25	> 12 and ≤ 50	> 16 and ≤ 75	> 16 and ≤ 75	> 18 and ≤ 100	≤ 1
QPSK	> 25	> 50	> 75	> 75	> 100	≤ 2
16 QAM	≤ 8	≤ 12	≤ 16	≤ 16	≤ 18	≤ 1
16 QAM	> 8 and ≤ 25	> 12 and ≤ 50	> 16 and ≤ 75	> 16 and ≤ 75	> 18 and ≤ 100	≤ 2
16 QAM	> 25	> 50	> 75	> 75	> 100	≤ 3

For PUCCH and SRS transmission, the allowed MPR is according to that specified for PUSCH QPSK modulation for the corresponding transmission bandwidth.

For intra-band contiguous CA Bandwidth Class C with non-contiguous resource allocation the allowed Maximum Power Reduction (MPR) for the maximum output power in Table 6.2.2A.1.3-1 is specified as follows:

$$\text{MPR} = \text{CEIL} \{M_A, 0.5\}$$

Where  $M_A$  is defined as follows:

$$M_A = 8.2; 0 \leq A < 0.025,$$

$$9.2 - 40A; 0.025 \leq A < 0.05,$$

$$8 - 16A; 0.05 \leq A < 0.25,$$

$$4.83 - 3.33A; 0.25 \leq A \leq 0.4,$$

$$3.83 - 0.83A; 0.4 \leq A \leq 1$$

Where

$$A = N_{RB\_alloc} / N_{RB\_agg}$$

CEIL $\{M_A, 0.5\}$  means rounding upwards to closest 0.5dB, i.e. MPR  $\in [3.0, 3.5, 4.0, 4.5, 5.0, 5.5, 6.0, 6.5, 7.0, 7.5, 8.0, 8.5]$

For intra-band carrier aggregation, the MPR is evaluated per slot and given by the maximum value taken over the transmission(s) on all component carriers within the slot, the maximum MPR over the two slots is then applied for the entire subframe.

For the UE maximum output power modified by MPR, the power limits specified in sub-clause 6.2.5A.1 apply.

For intra-band non-contiguous carrier aggregation with uplink carrier on the PCC, the requirements in subclause 6.2.3 apply.

The normative reference for this requirement is in TS 36.101 [2] clause 6.2.3A.

#### 6.2.3A.1.4 Test description

##### 6.2.3A.1.4.1 Initial condition

Initial conditions are a set of test configurations the UE needs to be tested in and the steps for the SS to take with the UE to reach the correct measurement state.

The initial test configurations consist of environmental conditions, test frequencies, and channel bandwidths based on E-UTRA CA configurations specified in table 5.4.2A.1-1. All of these configurations shall be tested with applicable test parameters for each channel bandwidth, and are shown in table 6.2.3A.1.4.1-1. The details of the uplink reference measurement channels (RMCs) are specified in Annexes A.2. Configurations of PDSCH and PDCCH before measurement are specified in Annex C.2.

**Table 6.2.3A.1.4.1-1: Test Configuration Table**

Initial Conditions								
Test Environment as specified in TS 36.508[7] subclause 4.1					NC, TL/VL, TL/VH, TH/VL, TH/VH			
Test Frequencies as specified in TS 36.508 [7] subclause 4.3.1 for different CA bandwidth classes, and PCC and SCCs are mapped onto physical frequencies according to Table 6.1-2.					C: Low and High range			
Test CC Combination setting ( $N_{RB\_agg}$ ) as specified in subclause 5.4.2A.1 for the CA Configuration across bandwidth combination sets supported by the UE.					Lowest $N_{RB\_agg}$ Highest $N_{RB\_agg}$ (Note 2)			
Test Parameters for CA Configurations								
CA Configuration / $N_{RB\_agg}$			DL Allocation	CC MOD	UL Allocation			
ID	PCC $N_{RB}$	SCCs $N_{RB}$	PCC & SCC RB allocation		$N_{RB\_alloc}$	PCC & SCC RB allocations (LCRB @ $RB_{start}$ )		
1	100	25		QPSK	8	P_8@0	S_0@0	
2	100	25		QPSK	25	P_25@0	S_0@0	
3	100	25		QPSK	125	P_100@0	S_25@0	
4	100	25		16QAM	8	P_8@0	S_0@0	
5	100	25		16QAM	25	P_25@0	S_0@0	
6	100	25		16QAM	125	P_100@0	S_25@0	
7	100	25		QPSK	2	P_1@0	S_1@24	
8	75	75		QPSK	16	P_16@0	S_0@0	
9	75	75		QPSK	75	P_75@0	S_0@0	
10	75	75		QPSK	150	P_75@0	S_75@0	
11	75	75		16QAM	16	P_16@0	S_0@0	
12	75	75		16QAM	75	P_75@0	S_0@0	
13	75	75		16QAM	150	P_75@0	S_75@0	
14	75	75		QPSK	2	P_1@0	S_1@74	
15	100	50		QPSK	12	P_12@0	S_0@0	
16	100	50		QPSK	50	P_50@0	S_0@0	
17	100	50		QPSK	150	P_100@0	S_50@0	
18	100	50		16QAM	12	P_12@0	S_0@0	
19	100	50		16QAM	50	P_50@0	S_0@0	
20	100	50		16QAM	150	P_100@0	S_50@0	
21	100	50		QPSK	2	P_1@0	S_1@49	
22	100	75		QPSK	16	P_16@0	S_0@0	
23	100	75		QPSK	75	P_75@0	S_0@0	
24	100	75		QPSK	175	P_100@0	S_75@0	
25	100	75		16QAM	16	P_16@0	S_0@0	
26	100	75		16QAM	75	P_75@0	S_0@0	
27	100	75		16QAM	175	P_100@0	S_75@0	
28	100	75		QPSK	2	P_1@0	S_1@74	
29	100	100		QPSK	18	P_18@0	S_0@0	
30	100	100		QPSK	100	P_100@0	S_0@0	
31	100	100		QPSK	200	P_100@0	S_100@0	

32	100	100	16QAM	18	P_18@0	S_0@0		
33	100	100	16QAM	100	P_100@0	S_0@0		
34	100	100	16QAM	200	P_100@0	S_100@0		
35	100	100	QPSK	2	P_1@0	S_1@99		
NOTE 1: CA Configuration Test CC Combination settings are checked separately for each CA Configuration, which applicable aggregated channel bandwidths are specified in Table 5.4.2A.1-1.								
NOTE 2: If in the CA Configuration UE supports multiple CC Combinations with the same $N_{RB\_agg}$ , only the first of those is tested, according to the order on the Test Configuration Table list.								

1. Connect the SS and interfering sources to the UE antenna connectors as shown in TS 36.508[7] Annex A, Figure group A.32 as appropriate.
2. The parameter settings for the cell are set up according to TS 36.508 [7] subclause 4.4.3.
3. Downlink signals for PCC are initially set up according to Annex C.0, C.1, and C.3.0, and uplink signals according to Annex H.1 and H.3.0.
4. The UL Reference Measurement channel is set according to Table 6.2.3A.1.4.1-1.
5. Propagation conditions are set according to Annex B.0.
6. Ensure the UE is in State 3A-RF according to TS 36.508 [7] clause 5.2A.2. Message contents are defined in clause 6.2.3A.1.4.3.

#### 6.2.3A.1.4.2 Test procedure

1. Configure SCC according to Annex C.0, C.1, and Annex C.3.0 for all downlink physical channels.
2. The SS shall configure SCC as per TS 36.508 [7] clause 5.2A.4. Message contents are defined in clause 6.2.3A.1.4.3.
3. SS activates SCC by sending the MAC-CE according to TS 36.321 [13] clauses 5.13 and 6.1.3.8. Wait for at least 2 seconds as per TS 36.133 [4] clause 8.3.3.2.
4. SS sends uplink scheduling information for each UL HARQ process via PDCCH DCI format 0 for C\_RNTI to schedule the UL RMC according to Table 6.2.3A.1.4.1-1 on both PCC and SCC. Since the UE has no payload and no loopback data to send the UE sends uplink MAC padding bits on the UL RMC.
5. Send continuously uplink power control “up” commands in the uplink scheduling information to the UE to ensure that the UE transmits at  $P_{UMAX}$  level.
6. Measure the mean power over all component carriers in the CA configuration of the radio access mode. The period of measurement shall be at least the continuous duration one sub-frame (1ms). For TDD slots with transient periods are not under test.

#### 6.2.3A.1.4.3 Message contents

Message contents are according to TS 36.508 [7] subclause 4.6. In test procedure step 2, for SCC configuration there are no additional message contents.

#### 6.2.3A.1.5 Test Requirements

The maximum output power, derived in step 2 shall be within the range prescribed by the nominal maximum output power and tolerance in Table 6.2.3A.1.5-1 or Table.6.2.3A.1.5-2, as applicable.



Table 6.2.3A.1.5-1: CA UE Power Class test requirements, E UTRA bands ≤ 3GHz

Configuration ID	Class 1 (dBm)	Tol. (dB)	Class 2 (dBm)	Tol. (dB)	Class 3 (dBm)	Tol. (dB)
1					23	+2.7/-2.7
2					23	+2.7/-3.7
3					23	+2.7/-4.7
4					23	+2.7/-3.7
5					23	+2.7/-4.7
6					23	+2.7/-6.2
7					23	+2.7/-14.2
8					23	+2.7/-2.7
9					23	+2.7/-3.7
10					23	+2.7/-4.7
11					23	+2.7/-3.7
12					23	+2.7/-4.7
13					23	+2.7/-6.2
14					23	+2.7/-14.2
15					23	+2.7/-2.7
16					23	+2.7/-3.7
17					23	+2.7/-4.7
18					23	+2.7/-3.7
19					23	+2.7/-4.7
20					23	+2.7/-6.2
21					23	+2.7/-14.2
22					23	+2.7/-2.7
23					23	+2.7/-3.7
24					23	+2.7/-4.7
25					23	+2.7/-3.7
26					23	+2.7/-4.7
27					23	+2.7/-6.2
28					23	+2.7/-14.2
29					23	+2.7/-2.7
30					23	+2.7/-3.7
31					23	+2.7/-4.7
32					23	+2.7/-3.7
33					23	+2.7/-4.7
34					23	+2.7/-6.2
35					23	+2.7/-14.2

**Table 6.2.3A.1.5-2: CA UE Power Class test requirements, 3GHz < E UTRA bands ≤ 4.2GHz**

Configuration ID	Class 1 (dBm)	Tol. (dB)	Class 2 (dBm)	Tol. (dB)	Class 3 (dBm)	Tol. (dB)
1					23	+3.0/-4.0
2					23	+3.0/-4.0
3					23	+3.0/-5.0
4					23	+3.0/-4.0
5					23	+3.0/-5.0
6					23	+3.0/-6.5
7					23	+3.0/-14.5
8					23	+3.0/-4.0
9					23	+3.0/-4.0
10					23	+3.0/-5.0
11					23	+3.0/-4.0
12					23	+3.0/-5.0
13					23	+3.0/-6.5
14					23	+3.0/-14.5
15					23	+3.0/-4.0
16					23	+3.0/-4.0
17					23	+3.0/-5.0
18					23	+3.0/-4.0
19					23	+3.0/-5.0
20					23	+3.0/-6.5
21					23	+3.0/-14.5
22					23	+3.0/-4.0
23					23	+3.0/-4.0
24					23	+3.0/-5.0
25					23	+3.0/-4.0
26					23	+3.0/-5.0
27					23	+3.0/-6.5
28					23	+3.0/-14.5
29					23	+3.0/-4.0
30					23	+3.0/-4.0
31					23	+3.0/-5.0
32					23	+3.0/-4.0
33					23	+3.0/-5.0
34					23	+3.0/-6.5
35					23	+3.0/-14.5

## 6.2.3A.2 Maximum Power Reduction (MPR) for CA (inter-band DL CA and UL CA)

### 6.2.3A.2.1 Test purpose

The number of RB identified in Table 6.2.3A.2.3-1 is based on meeting the requirements for Adjacent Channel Leakage power Ratio (ACLR) for CA and the maximum power reduction (MPR) for inter-band CA Bandwidth Class A due to Cubic Metric (CM).

### 6.2.3A.2.2 Test applicability

The requirements of this test apply in test case 6.6.2.3A.2 Adjacent Channel Leakage power Ratio (ACLR) for CA to all types of E-UTRA UE release 11 and forward that support inter-band DL CA and UL CA.

NOTE: As a result TC 6.2.3A.2 has not been included in the test case applicability table 4.1-1, TS 36.521-2. This does not preclude the test from being used for R&D or other purposes if deemed useful.

### 6.2.3A.2.3 Minimum conformance requirements

For inter-band carrier aggregation with uplink assigned to one E-UTRA band (Table 5.4.2A-1), the requirements in subclause 6.2.3 apply.

For inter-band carrier aggregation with one component carrier per operating band and the uplink active in two E-UTRA bands, the requirements in subclause 6.2.3 apply [for each uplink carrier].

For UE Power Class 1 and 3, the allowed Maximum Power Reduction (MPR) for the maximum output power in Table 6.2.2A.2.3-1 due to higher order modulation and transmit bandwidth configuration (resource blocks) is specified in Table 6.2.3A.2.3-1.

**Table 6.2.3A.2.3-1: Maximum Power Reduction (MPR) for Power Class 1 and 3**

Modulation	Channel bandwidth / Transmission bandwidth ( $N_{RB}$ )						MPR (dB)
	1.4 MHz	3.0 MHz	5 MHz	10 MHz	15 MHz	20 MHz	
QPSK	> 5	> 4	> 8	> 12	> 16	> 18	$\leq 1$
16 QAM	$\leq 5$	$\leq 4$	$\leq 8$	$\leq 12$	$\leq 16$	$\leq 18$	$\leq 1$
16 QAM	> 5	> 4	> 8	> 12	> 16	> 18	$\leq 2$

For PRACH, PUCCH and SRS transmissions, the allowed MPR is according to that specified for PUSCH QPSK modulation for the corresponding transmission bandwidth.

For each subframe, the MPR is evaluated per slot and given by the maximum value taken over the transmission(s) within the slot; the maximum MPR over the two slots is then applied for the entire subframe.

For the UE maximum output power modified by MPR, the power limits specified in subclause 6.2.5 apply.

The normative reference for this requirement is in TS 36.101 [2] clause 6.2.3A and 6.2.3.

#### 6.2.3A.2.4 Test description

##### 6.2.3A.2.4.1 Initial condition

Initial conditions are a set of test configurations the UE needs to be tested in and the steps for the SS to take with the UE to reach the correct measurement state.

The initial test configurations consist of environmental conditions, test frequencies, and channel bandwidths based on E-UTRA CA configurations specified in table 5.4.2A.1-1. All of these configurations shall be tested with applicable test parameters for each channel bandwidth, and are shown in table 6.2.3A.2.4.1-1. The details of the uplink reference measurement channels (RMCs) are specified in Annexes A.2. Configurations of PDSCH and PDCCH before measurement are specified in Annex C.2.

Table 6.2.3A.2.4.1-1: Test Configuration Table

Initial Conditions								
Test Environment as specified in TS 36.508[7] subclause 4.1						NC, TL/VL, TL/VH, TH/VL, TH/VH		
Test Frequencies as specified in TS 36.508 [7] subclause 4.3.1 for different CA bandwidth classes						Low and High range for both PCC and SCC (Note 3)		
Test CC Combination setting (NRB_agg) as specified in subclause 5.4.2A.1 for the CA Configuration across bandwidth combination sets supported by the UE.						Lowest N <sub>RB_agg</sub> Highest N <sub>RB_agg</sub> (Note 2)		
Test Parameters for CA Configurations								
Config ID	CA Configuration / NRB_agg		DL Allocation	CC MOD		UL Allocation		
	PCC	SCC	PCC & SCC RB allocation	PCC	SCC	NRB_alloc	PCC & SCC RB allocations	
	NRB	NRB						
1	6	25	N/A for this test	QPSK	QPSK	13	<u>5</u>	<u>8</u>
2	6	25		QPSK	QPSK	31	<u>6</u>	25
3	6	25		16QAM	16QAM	13	5	8
4	6	25		16QAM	16QAM	31	6	25
5	6	25		QPSK	16QAM	30	5	25
6	6	50		QPSK	QPSK	17	<u>5</u>	12
7	6	50		QPSK	QPSK	56	<u>6</u>	50
8	6	50		16QAM	16QAM	17	5	12
9	6	50		16QAM	16QAM	56	6	50
10	6	50		QPSK	16QAM	55	5	50
11	25	15		QPSK	QPSK	12	8	4
12	25	15		QPSK	QPSK	40	25	15
13	25	15		16QAM	16QAM	12	8	4
14	25	15		16QAM	16QAM	40	25	15
15	25	15		QPSK	16QAM	23	8	15
16	25	25		QPSK	QPSK	16	8	<u>8</u>
17	25	25		QPSK	QPSK	50	25	25
18	25	25		16QAM	16QAM	16	8	8
19	25	25		16QAM	16QAM	50	25	25
20	25	25		QPSK	16QAM	33	8	25
21	25	50		QPSK	QPSK	16	4	12
22	25	50		QPSK	QPSK	65	15	50
23	25	50		16QAM	16QAM	16	4	12
24	25	50		16QAM	16QAM	65	15	50
25	25	50		QPSK	16QAM	54	4	50
26	50	25		QPSK	QPSK	20	12	<u>8</u>
27	50	25		QPSK	QPSK	75	50	25
28	50	25		16QAM	16QAM	20	12	8
29	50	25		16QAM	16QAM	75	50	25

30	50	25		QPSK	16QAM	37	12	25
31	50	50		QPSK	QPSK	24	12	12
32	50	50		QPSK	QPSK	100	50	50
33	50	50		16QAM	16QAM	24	12	12
34	50	50		16QAM	16QAM	100	50	50
35	50	50		QPSK	16QAM	62	12	50
36	50	100		QPSK	QPSK	30	12	18
37	50	100		QPSK	QPSK	150	50	100
38	50	100		16QAM	16QAM	30	12	18
39	50	100		16QAM	16QAM	150	50	100
40	50	100		QPSK	16QAM	112	12	100
41	75	75		QPSK	QPSK	32	16	16
42	75	75		QPSK	QPSK	150	75	75
43	75	75		16QAM	16QAM	32	16	16
44	75	75		16QAM	16QAM	150	75	75
45	75	75		QPSK	16QAM	91	16	75
46	100	50		QPSK	QPSK	30	18	12
47	100	50		QPSK	QPSK	150	100	50
48	100	50		16QAM	16QAM	30	18	12
49	100	50		16QAM	16QAM	150	100	50
50	100	50		QPSK	16QAM	68	18	50
51	100	75		QPSK	QPSK	34	18	16
52	100	75		QPSK	QPSK	175	100	75
53	100	75		16QAM	16QAM	34	18	16
54	100	75		16QAM	16QAM	175	100	75
55	100	75		QPSK	16QAM	93	18	75
56	100	100		QPSK	QPSK	36	18	18
57	100	100		QPSK	QPSK	200	100	100
58	100	100		16QAM	16QAM	36	18	18
59	100	100		16QAM	16QAM	200	100	100
60	100	100		QPSK	16QAM	118	18	100
Note 1: CA Configuration Test CC Combination settings are checked separately for each CA Configuration, which applicable aggregated channel bandwidths are specified in Table 5.4.2A.1-1.								
Note 2: If in the CA Configuration UE supports multiple CC Combinations with the same NRB_agg, only the first of those is tested, according to the order on the Test Configuration Table list.								
Note 3: For Low range place test point with RB_start=0. For High range place test point with RB_start=RB_max-L_CRB+1.								

1. Connect the SS and interfering sources to the UE antenna connectors as shown in TS 36.508[7] Annex A, Figure group A.32 as appropriate.
2. The parameter settings for the cell are set up according to TS 36.508 [7] subclause 4.4.3.
3. Downlink signals for PCC are initially set up according to Annex C.0, C.1, and C.3.0, and uplink signals according to Annex H.1 and H.3.0.
4. The UL Reference Measurement channel is set according to Table 6.2.3A.2.4.1-1.
5. Propagation conditions are set according to Annex B.0.

6. Ensure the UE is in State 3A-RF according to TS 36.508 [7] clause 5.2A.2. Message contents are defined in clause 6.2.3A.2.4.3.

#### 6.2.3A.2.4.2 Test procedure

1. Configure SCC according to Annex C.0, C.1, and Annex C.3.0 for all downlink physical channels.
2. The SS shall configure SCC as per TS 36.508 [7] clause 5.2A.4. Message contents are defined in clause 6.2.3A.2.4.3.
3. SS activates SCC by sending the MAC-CE according to TS 36.321 [13] clauses 5.13 and 6.1.3.8. Wait for at least 2 seconds as per TS 36.133 [4] clause 8.3.3.2.
4. SS sends uplink scheduling information for each UL HARQ process via PDCCH DCI format 0 for C\_RNTI to schedule the UL RMC according to Table 6.2.3A.2.4.1-1 on both PCC and SCC. Since the UE has no payload and no loopback data to send the UE sends uplink MAC padding bits on the UL RMC.
5. Send continuously uplink power control "up" commands in the uplink scheduling information to the UE to ensure that the UE transmits at  $P_{UMAX}$  level.
6. Measure the mean power over all component carriers in the CA configuration of the radio access mode. The period of measurement shall be at least the continuous duration one sub-frame (1ms). For TDD slots with transient periods are not under test.

#### 6.2.3A.2.4.3 Message contents

Message contents are according to TS 36.508 [7] subclause 4.6. In test procedure step 2, for SCC configuration there are no additional message contents.

#### 6.2.3A.2.5 Test Requirements

The maximum output power, derived in step 6 shall be within the range prescribed by the nominal maximum output power and tolerance in Table 6.2.3A.2.5-1, as applicable.

Table 6.2.3A.2.5-1: CA UE Output Power test requirements

Config ID	MPR (dB)		$\Delta T_{C,c}$ (dB)		$P_{C_{MAX,c}}$ (dBm)		$P_{C_{MAX}}$ (dBm)	$T(P_{C_{MAX\_L,c}})$ (dB)	Upper limit (dBm)	Lower limit (dBm)
	PCC	SCC	PCC	SCC	PCC	SCC				
1	0	0	1.5	1.5	21.5	21.5	23	3	25.7	19.3
2	1	1	1.5	0	20.5	22	23	3	25.7	19.3
3	1	1	1.5	1.5	20.5	20.5	23	3	25.7	19.3
4	2	2	1.5	0	19.5	21	23	3	25.7	19.3
5	0	2	1.5	0	21.5	21	23	3	25.7	19.3
6	0	0	1.5	1.5	21.5	21.5	23	3	25.7	19.3
7	1	1	1.5	0	20.5	22	23	3	25.7	19.3
8	1	1	1.5	1.5	20.5	20.5	23	3	25.7	19.3
9	2	2	1.5	0	19.5	21	23	3	25.7	19.3
10	0	2	1.5	0	21.5	21	23	3	25.7	19.3
11	0	0	1.5	1.5	21.5	21.5	23	3	25.7	19.3
12	1	1	1.5	1.5	20.5	20.5	23	3	25.7	19.3
13	1	1	1.5	1.5	20.5	20.5	23	3	25.7	19.3
14	2	2	1.5	1.5	19.5	19.5	22.5	5	25.7	17.3
15	0	2	1.5	1.5	21.5	19.5	23	3	25.7	19.3
16	0	0	1.5	1.5	21.5	21.5	23	3	25.7	19.3
17	1	1	1.5	0	20.5	22	23	3	25.7	19.3
18	1	1	1.5	1.5	20.5	20.5	23	3	25.7	19.3
19	2	2	1.5	0	19.5	21	23	3	25.7	19.3
20	0	2	1.5	0	21.5	21	23	3	25.7	19.3
21	0	0	1.5	1.5	21.5	21.5	23	3	25.7	19.3
22	1	1	1.5	0	20.5	22	23	3	25.7	19.3
23	1	1	1.5	1.5	20.5	20.5	23	3	25.7	19.3
24	2	2	1.5	0	19.5	21	23	3	25.7	19.3
25	0	2	1.5	0	21.5	21	23	3	25.7	19.3
26	0	0	1.5	1.5	21.5	21.5	23	3	25.7	19.3
27	1	1	0	0	22	22	23	3	25.7	19.3
28	1	1	1.5	1.5	20.5	20.5	23	3	25.7	19.3
29	2	2	0	0	21	21	23	3	25.7	19.3
30	0	2	1.5	0	21.5	21	23	3	25.7	19.3
31	0	0	1.5	1.5	21.5	21.5	23	3	25.7	19.3
32	1	1	0	0	22	22	23	3	25.7	19.3
33	1	1	1.5	1.5	20.5	20.5	23	3	25.7	19.3
34	2	2	0	0	21	21	23	3	25.7	19.3
35	0	2	1.5	0	21.5	21	23	3	25.7	19.3
36	0	0	1.5	0	21.5	23	23	3	25.7	19.3
37	1	1	0	0	22	22	23	3	25.7	19.3
38	1	1	1.5	0	20.5	22	23	3	25.7	19.3
39	2	2	0	0	21	21	23	3	25.7	19.3
40	0	2	1.5	0	21.5	21	23	3	25.7	19.3

41	0	0	1.5	1.5	21.5	21.5	23	3	25.7	19.3
42	1	1	0	0	22	22	23	3	25.7	19.3
43	1	1	1.5	1.5	20.5	20.5	23	3	25.7	19.3
44	2	2	0	0	21	21	23	3	25.7	19.3
45	0	2	1.5	0	21.5	21	23	3	25.7	19.3
46	0	0	0	1.5	23	21.5	23	3	25.7	19.3
47	1	1	0	0	22	22	23	3	25.7	19.3
48	1	1	0	1.5	22	20.5	23	3	25.7	19.3
49	2	2	0	0	21	21	23	3	25.7	19.3
50	0	2	0	0	23	21	23	3	25.7	19.3
51	0	0	0	1.5	23	21.5	23	3	25.7	19.3
52	1	1	0	0	22	22	23	3	25.7	19.3
53	1	1	0	1.5	22	20.5	23	3	25.7	19.3
54	2	2	0	0	21	21	23	3	25.7	19.3
55	0	2	0	0	23	21	23	3	25.7	19.3
56	0	0	0	0	23	23	23	3	25.7	19.3
57	1	1	0	0	22	22	23	3	25.7	19.3
58	1	1	0	0	22	22	23	3	25.7	19.3
59	2	2	0	0	21	21	23	3	25.7	19.3
60	0	2	0	0	23	21	23	3	25.7	19.3
<p>Note 1: Lower limit is assuming <math>\Delta T_{IB,c}</math> is zero. If non-zero, <math>P_{CMAX,c}</math> will decrease and <math>T(P_{CMAX,L,c})</math> may be higher resulting in different test requirements according to Table 6.2.5.3-1.</p> <p>Note 2: <math>\Delta T_{C,c}</math> does not apply in all bands. For bands without this lower limit is 19.3 dBm in all test points</p>										

### 6.2.3A.3 Maximum Power Reduction (MPR) for CA (intra-band non-contiguous DL CA and UL CA)

Editor's note: Following aspects missing or not yet determined:

- Test frequency definition in 36.508 needs to be updated to include mid frequency and lowest  $N_{RBagg}$

#### 6.2.3A.3.1 Test purpose

The number of RB identified in Table 6.2.3A.2.3-1 is based on meeting the requirements for Adjacent Channel Leakage power Ratio (ACLR) for CA and the maximum power reduction (MPR) for inter-band CA Bandwidth Class A due to Cubic Metric (CM).

#### 6.2.3A.3.2 Test applicability

The requirements of this test apply in test case 6.6.2.3A.3 Adjacent Channel Leakage power Ratio (ACLR) for CA to all types of E-UTRA UE release 11 and forward that support intra-band non-contiguous DL CA and UL CA.

NOTE: As a result TC 6.2.3A.3 has not been included in the test case applicability table 4.1-1, TS 36.521-2. This does not preclude the test from being used for R&D or other purposes if deemed useful.

#### 6.2.3A.3.3 Minimum conformance requirements

For intra-band non-contiguous carrier aggregation with one uplink carrier, the requirements in subclause 6.2.3 apply.



For intra-band non-contiguous carrier aggregation with two uplink carriers MPR is specified for E-UTRA CA configurations with a maximum possible  $W_{\text{GAP}} \leq 35$  MHz; the allowed MPR is

$$\text{MPR} = \text{CEIL} \{M_N, 0.5\}$$

where  $M_N$  is defined as follows

$$M_N = -0.125 N + 18.25; 2 \leq N \leq 50$$

$$-0.0333 N + 13.67; 50 < N \leq 200$$

where  $N = N_{\text{RB\_alloc}}$  is the number of allocated resource blocks. E-UTRA CA configurations with a maximum possible  $W_{\text{gap}} > 35$  MHz and their corresponding MPR are intended to form part of a later release.

For intra-band carrier aggregation, the MPR is evaluated per slot and given by the maximum value taken over the transmission(s) on all component carriers within the slot; the maximum MPR over the two slots is then applied for the entire subframe.

The normative reference for this requirement is in TS 36.101 [2] clause 6.2.3A.

#### 6.2.3A.3.4 Test description

##### 6.2.3A.3.4.1 Initial condition

Initial conditions are a set of test configurations the UE needs to be tested in and the steps for the SS to take with the UE to reach the correct measurement state.

The initial test configurations consist of environmental conditions, test frequencies, and channel bandwidths based on E-UTRA CA configurations specified in table 5.4.2A.1-1. All of these configurations shall be tested with applicable test parameters for each channel bandwidth, and are shown in table 6.2.3A.3.4.1-1. The details of the uplink reference measurement channels (RMCs) are specified in Annexes A.2. Configurations of PDSCH and PDCCH before measurement are specified in Annex C.2.

**Table 6.2.3A.3.4.1-1: Test Configuration Table**

Initial Conditions									
Test Environment as specified in TS 36.508[7] subclause 4.1				NC, TL/VL, TL/VH, TH/VL, TH/VH					
Test Frequencies as specified in TS36.508 [7] subclause 4.3.1 for different CA bandwidth classes, and PCC and SCCs are mapped onto physical frequencies according to Table 6.1-2.				Refer to test points A: Mid frequency, Maximum Wgap(low + high frequency)					
Test CC Combination setting (N <sub>RB</sub> ) as specified in subclause 5.4.2A.1 for the CA Configuration across bandwidth combination sets supported by the UE.				Refer to test point Test only test points with Lowest N <sub>RB</sub> for PCC and SCC Highest N <sub>RB</sub> for PCC and SCC					
Test Parameters for CA Configurations									
ID	CA Configuration / N <sub>RB_agg</sub>		W <sub>gap</sub> [MHz]	DL Allocation		UL Allocation			
	PCC N <sub>RB</sub>	SCCs N <sub>RB</sub>		CC MOD	PCC & SCC RB allocation	CC MOD	PCC N <sub>RB_alloc</sub> (L <sub>CRB</sub> @ RB <sub>start</sub> )	CC MOD	SCC N <sub>RB_alloc</sub> (L <sub>CRB</sub> @ RB <sub>start</sub> )
Test Parameters for CA_4A-4A Configurations									
1	25	25	35	N/A	N/A	16QAM	P_1@0	16QAM	S_1@24
2	25	25	35	N/A	N/A	16QAM	P_25@0	16QAM	S_25@0
3	25	25	5	N/A	N/A	16QAM	P_1@0	16QAM	S_1@24
4	25	25	5	N/A	N/A	16QAM	P_25@0	16QAM	S_25@0
5	100	100	5	N/A	N/A	16QAM	P_1@0	16QAM	S_1@99
6	100	100	5	N/A	N/A	16QAM	P_25@0	16QAM	S_25@75
7	100	100	5	N/A	N/A	16QAM	P_100@0	16QAM	S_100@0

1. Connect the SS and interfering sources to the UE antenna connectors as shown in TS 36.508[7] Annex A, Figure group A.32 as appropriate.
2. The parameter settings for the cell are set up according to TS 36.508 [7] subclause 4.4.3.
3. Downlink signals for PCC are initially set up according to Annex C.0, C.1, and C.3.0, and uplink signals according to Annex H.1 and H.3.0.
4. The UL Reference Measurement channel is set according to Table 6.2.3A.3.4.1-1.
5. Propagation conditions are set according to Annex B.0.
6. Ensure the UE is in State 3A-RF according to TS 36.508 [7] clause 5.2A.2. Message contents are defined in clause 6.2.3A.3.4.3.

**6.2.3A.3.4.2 Test procedure**

1. Configure SCC according to Annex C.0, C.1, and Annex C.3.0 for all downlink physical channels
2. The SS shall configure SCC as per TS 36.508 [7] clause 5.2A.4. Message contents are defined in clause 6.2.3A.2.4.3.
3. SS activates SCC by sending the MAC-CE according to TS 36.321 [13] clauses 5.13 and 6.1.3.8. Wait for at least 2 seconds as per TS 36.133 [4] clause 8.3.3.2.
4. SS sends uplink scheduling information for each UL HARQ process via PDCCH DCI format 0 for C\_RNTI to schedule the UL RMC according to Table 6.2.3A.3.4.1-1on both PCC and SCC. Since the UE has no payload and no loopback data to send the UE sends uplink MAC padding bits on the UL RMC.

5. Send continuously uplink power control “up” commands in the uplink scheduling information to the UE to ensure that the UE transmits at  $P_{UMAX}$  level.
6. Measure the mean power over all component carriers in the CA configuration of the radio access mode. The period of measurement shall be at least the continuous duration one sub-frame (1ms). For TDD slots with transient periods are not under test.

#### 6.2.3A.3.4.3 Message contents

Message contents are according to TS 36.508 [7] subclause 4.6. In test procedure step 2, for SCC configuration there are no additional message contents.

#### 6.2.3A.3.5 Test Requirements

The maximum output power, derived in step 2 shall be within the range prescribed by the nominal maximum output power and tolerance in Table 6.2.3A.3.5-1, as applicable.

**Table 6.2.3A.3.5-1: CA UE Output Power test requirements**

Configuration ID	MPR (dB)	$\Delta T_c$ (dB)	$P_{CMAX}$ (dBm)	$T(P_{CMAX\_L})$ (dB)	Upper limit (dBm)	Lower limit (dBm)
Test Requirements for CA_4A-4A Configurations						
1	18	0	5	7	25.7	-2,7
2	12	0	11	6	25.7	4.3
3	18	0	5	7	25.7	-2,7
4	12	0	11	6	25.7	4.3
5	18	0	5	7	25.7	-2,7
6	12	0	11	6	25.7	4.3
7	7	0	16	5	25.7	10.3

Note 1: Lower limit is assuming  $\Delta T_{IB,c}$  is zero. If non-zero,  $P_{CMAX,c}$  will decrease and  $T(P_{CMAX\_L,c})$  may be higher resulting in different test requirements according to Table 6.2.5.3-1.

### 6.2.3B Maximum Power Reduction (MPR) for UL-MIMO

#### 6.2.3B.1 Test purpose

The number of RB identified in Table 6.2.3B.3-1 is based on meeting the requirements for adjacent channel leakage ratio for UL-MIMO and the maximum power reduction (MPR) for UL-MIMO due to Cubic Metric (CM).

#### 6.2.3B.2 Test applicability

The requirements of this test apply in test cases 6.6.2.3B Adjacent Channel Leakage power Ratio to all types of E-UTRA UE release 10 and forward that support UL-MIMO.

NOTE: As a result TC 6.2.3B has not been included in the test case applicability table 4.1-1, TS 36.521-2. This does not preclude the test from being used for R&D or other purposes if deemed useful.

#### 6.2.3B.3 Minimum conformance requirements

For UE with two transmit antenna connectors in closed-loop spatial multiplexing scheme, the maximum output power is measured as the sum of the maximum output power at each UE antenna connector. For UE Power Class 3, the allowed Maximum Power Reduction (MPR) for the maximum output power in Table 6.2.2B.3-1 due to higher order modulation and transmit bandwidth configuration (resource blocks) is specified in Table 6.2.3B.3-1 with UL-MIMO configurations defined in Table 6.2.2B.3-2.

**Table 6.2.3B.3-1: Maximum Power Reduction (MPR) for Power Class 3**

Modulation	Channel bandwidth / Transmission bandwidth configuration [RB]						MPR (dB)
	1.4 MHz	3.0 MHz	5 MHz	10 MHz	15 MHz	20 MHz	
QPSK	> 5	> 4	> 8	> 12	> 16	> 18	≤ 1
16 QAM	≤ 5	≤ 4	≤ 8	≤ 12	≤ 16	≤ 18	≤ 1
16 QAM	> 5	> 4	> 8	> 12	> 16	> 18	≤ 2

For the UE maximum output power modified by MPR, the power limits specified in clause 6.2.5B.3 apply.

The normative reference for this requirement is TS 36.101 clause 6.2.3B.

## 6.2.3B.4 Test description

### 6.2.3B.4.1 Initial condition

Initial conditions are a set of test configurations the UE needs to be tested in and the steps for the SS to take with the UE to reach the correct measurement state.

The initial test configurations consist of environmental conditions, test frequencies, and channel bandwidths based on E-UTRA operating bands specified in clause 5.4.2B.1. All of these configurations shall be tested with applicable test parameters for each channel bandwidth, and are shown in table 6.2.3B.4.1-1. The details of the uplink reference measurement channels (RMCs) are specified in Annexes A.2. Configurations of PDSCH and PDCCH before measurement are specified in Annex C.2.

**Table 6.2.3B.4.1-1: Test Configuration Table**

Initial Conditions				
Test Environment as specified in TS 36.508[7] clause 4.1	Normal, TL/VL, TL/VH, TH/VL, TH/VH			
Test Frequencies as specified in TS 36.508 [7] clause 4.3.1	Low range, Mid range, High range			
Test Channel Bandwidths as specified in TS 36.508 [7] clause 4.3.1	Lowest, 5MHz, 10MHz, Highest			
Test Parameters for Channel Bandwidths				
Ch BW	Downlink Configuration	Uplink Configuration		
	N/A for Maximum Power Reduction (MPR) test case	Mod'n	RB allocation	
		FDD	TDD	
1.4MHz		QPSK	5	5
1.4MHz		QPSK	6	6
1.4MHz		16QAM	5	5
1.4MHz		16QAM	6	6
3.0MHz		QPSK	4	4
3.0MHz		QPSK	15	15
3.0MHz		16QAM	4	4
3.0MHz		16QAM	15	15
5MHz		QPSK	8	8
5MHz		QPSK	25	25
5MHz		16QAM	8	8
5MHz		16QAM	25	25
10MHz		QPSK	12	12
10MHz		QPSK	50	50
10MHz		16QAM	12	12
10MHz		16QAM	50 (Note 3)	50 (Note 3)
15MHz		QPSK	16	16
15MHz		QPSK	75	75
15MHz	16QAM	16	16	
15MHz	16QAM	75 (Note 3)	75 (Note 3)	
20MHz	QPSK	18	18	
20MHz	QPSK	100	100	
20MHz	16QAM	18	18	
20MHz	16QAM	100 (Note 3)	100 (Note 3)	
Note 1: Test Channel Bandwidths are checked separately for each E-UTRA band, the applicable channel bandwidths are specified in Table 5.4.2.1-1. Note 2: The RB <sub>start</sub> of partial RB allocation shall be RB#0 and RB# (max + 1 - RB allocation) of the channel bandwidth. Note 3: Applies only for UE-Categories ≥2.				

1. Connect the SS and interfering sources to the UE antenna connectors as shown in TS 36.508[7] Annex A Figure A.28.
2. The parameter settings for the cell are set up according to TS 36.508 [7] clause 4.4.3.
3. Downlink signals are initially set up according to Annex C.0, C.1, and C.3.0, and uplink signals according to Annex H.1 and H.3.0.
4. The UL Reference Measurement channels are set according to Table 6.2.3B.4.1-1.
5. Ensure the UE is in State 3A-RF according to TS 36.508 [7] clause 5.2A.2. Message contents are defined in clause 6.2.3B.4.3.

**6.2.3B.4.2 Test procedure**

1. SS sends uplink scheduling information for each UL HARQ process via PDCCH DCI format 4 for C\_RNTI to schedule the UL RMC according to Table 6.2.3B.4.1-1. Since the UE has no payload and no loopback data to send the UE sends uplink MAC padding bits on the UL RMC.

2. Send continuously uplink power control "up" commands in the uplink scheduling information to the UE to ensure that the UE transmits at PUMAX level.
3. Measure the sum of mean power of the UE at each transmit antenna connector in the channel bandwidth of the radio access mode. The period of measurement shall be at least the continuous duration one sub-frame (1ms). For TDD slots with transient periods are not under test.

#### 6.2.3B.4.3 Message contents

Message contents are according to TS 36.508 [7] subclause 4.6.

#### 6.2.3B.5 Test requirements

The maximum output power, derived in step 2 shall be within the range prescribed by the nominal maximum output power and tolerance in Table 6.2.3B.5-1.

Table 6.2.3B.5-1: UE Power Class test requirements

E-UTRA Band	Class 1 (dBm)	Tol. (Db)	Class 2 (dBm)	Tol. (dB)	Class 3 (dBm)	QPSK partial RB allocation Tol. (dB)	QPSK full RB allocation Tol. (dB)	16QAM partial RB allocation Tol. (dB)	16QAM full RB allocation Tol. (dB)
1					23	+2.7/-3.7	+2.7/-4.7	+2.7/-4.7	+2.7/-5.7
2					23	+2.7/-3.7 <sup>1</sup>	+2.7/-4.7 <sup>1,2</sup>	+2.7/-4.7 <sup>1,2</sup>	+2.7/-5.7 <sup>1,2</sup>
3					23	+2.7/-3.7 <sup>1</sup>	+2.7/-4.7 <sup>1,2</sup>	+2.7/-4.7 <sup>1,2</sup>	+2.7/-5.7 <sup>1,2</sup>
4					23	+2.7/-3.7	+2.7/-4.7	+2.7/-4.7	+2.7/-5.7
5					23	+2.7/-3.7	+2.7/-4.7	+2.7/-4.7	+2.7/-5.7
6					23	+2.7/-3.7	+2.7/-4.7	+2.7/-4.7	+2.7/-5.7
7					23	+2.7/-3.7 <sup>1</sup>	+2.7/-4.7 <sup>1,2</sup>	+2.7/-4.7 <sup>1,2</sup>	+2.7/-5.7 <sup>1,2</sup>
8					23	+2.7/-3.7 <sup>1</sup>	+2.7/-4.7 <sup>1,2</sup>	+2.7/-4.7 <sup>1,2</sup>	+2.7/-5.7 <sup>1,2</sup>
9					23	+2.7/-3.7	+2.7/-4.7	+2.7/-4.7	+2.7/-5.7
10					23	+2.7/-3.7	+2.7/-4.7	+2.7/-4.7	+2.7/-5.7
11					23	+2.7/-3.7	+2.7/-4.7	+2.7/-4.7	+2.7/-5.7
12					23	+2.7/-3.7 <sup>1</sup>	+2.7/-4.7 <sup>1,2</sup>	+2.7/-4.7 <sup>1,2</sup>	+2.7/-5.7 <sup>1,2</sup>
13					23	+2.7/-3.7	+2.7/-4.7	+2.7/-4.7	+2.7/-5.7
14					23	+2.7/-3.7	+2.7/-4.7	+2.7/-4.7	+2.7/-5.7
...									
17					23	+2.7/-3.7	+2.7/-4.7	+2.7/-4.7	+2.7/-5.7
18					23	+2.7/-3.7	+2.7/-4.7	+2.7/-4.7	+2.7/-5.7
19					23	+2.7/-3.7	+2.7/-4.7	+2.7/-4.7	+2.7/-5.7
20					23	+2.7/-3.7 <sup>1</sup>	+2.7/-4.7 <sup>1,2</sup>	+2.7/-4.7 <sup>1,2</sup>	+2.7/-5.7 <sup>1,2</sup>
21					23	+2.7/-3.7	+2.7/-4.7	+2.7/-4.7	+2.7/-5.7
22					23	+3.0/-5.5	+3.0/-6.5	+3.0/-6.5	+3.0/-7.5
...									
23					23	+2.7/-3.7	+2.7/-4.7	+2.7/-4.7	+2.7/-5.7
24					23	+2.7/-3.7	+2.7/-4.7	+2.7/-4.7	+2.7/-5.7
25					23	+2.7/-3.7 <sup>1</sup>	+2.7/-[4.7] <sup>1,2</sup>	+2.7/-[4.7] <sup>1,2</sup>	+2.7/-[5.7] <sup>1,2</sup>
26					23	+2.7/-3.7	+2.7/-4.7	+2.7/-4.7	+2.7/-5.7
27					23	+2.7/-3.7	+2.7/-4.7	+2.7/-4.7	+2.7/-5.7

28					23	+2.7/[-3.7]	+2.7/[-4.7]	+2.7/[-4.7]	+2.7/[-5.7]
30					23	+2.7/-3.7	+2.7/-4.7	+2.7/-4.7	+2.7/-5.7
31					23	+2.7/-3.7	+2.7/-4.7	+2.7/-4.7	+2.7/-5.7
...									
33					23	+2.7/-3.7	+2.7/-4.7	+2.7/-4.7	+2.7/-5.7
34					23	+2.7/-3.7	+2.7/-4.7	+2.7/-4.7	+2.7/-5.7
35					23	+2.7/-3.7	+2.7/-4.7	+2.7/-4.7	+2.7/-5.7
36					23	+2.7/-3.7	+2.7/-4.7	+2.7/-4.7	+2.7/-5.7
37					23	+2.7/-3.7	+2.7/-4.7	+2.7/-4.7	+2.7/-5.7
38					23	+2.7/-3.7	+2.7/-4.7	+2.7/-4.7	+2.7/-5.7
39					23	+2.7/-3.7	+2.7/-4.7	+2.7/-4.7	+2.7/-5.7
40					23	+2.7/-3.7	+2.7/-4.7	+2.7/-4.7	+2.7/-5.7
41					23	+2.7/-3.7 <sup>1</sup>	+2.7/-4.7	+2.7/-4.7	+2.7/-5.7
42					23	+3.0/-5.0	+3.0/-6.0 <sup>1,2</sup>	+3.0/-6.0 <sup>1,2</sup>	+3.0/-7.0 <sup>1,2</sup>
43					23	+3.0/-5.0	+3.0/-6.0	+3.0/-6.0	+3.0/-7.0 <sup>1,2</sup>
44					23	+2.7/[-3.7]	+2.7/[-4.7]	+2.7/[-4.7]	+2.7/[-5.7]
Note 1:	For transmission configurations (Figure 5.4.2-1) confined within FUL_low and FUL_low + 4 MHz or FUL_high – 4 MHz and FUL_high, the maximum output power requirement is relaxed by reducing the lower tolerance limit by 1.5 dB.								
Note 2:	For the UE maximum output power modified by MPR, the power limits specified in Table 6.2.5B.3-1 apply								

## 6.2.3C

## 6.2.3D

## 6.2.3E Maximum Power Reduction (MPR) for UE category 0

**Editor's note:** This clause is incomplete. The following aspects are either missing or not yet determined:

**TBD:** -6.2.3E.5 Test Requirements, Tables in Annex F.

### 6.2.3E.1 Test purpose

Same test purpose as in clause 6.2.3.1.

### 6.2.3E.2 Test applicability

This test case applies to all types of E-UTRA UE release 12 and forward of UE category 0.



### 6.2.3E.3 Minimum conformance requirements

Same minimum conformance requirements as in clause 6.2.3.3

### 6.2.3E.4 Test description

#### 6.2.3E.4.1 Initial condition

Same initial conditions as in clause 6.2.3.4.1 with following exceptions for HD-FDD:

- Instead of Table 6.2.3.4.1-1 → use Table 6.2.3E.4.1-1.
- Connect SS to the UE antenna connectors as shown in TS 36.508[7] Annex A Figure A.3 using only main UE Tx/Rx antenna.

**Table 6.2.3E.4.1-1: Test Configuration Table**

Initial Conditions				
Test Environment as specified in TS 36.508[7] subclause 4.1	Normal, TL/VL, TL/VH, TH/VL, TH/VH			
Test Frequencies as specified in TS 36.508 [7] subclause 4.3.1	Low range, Mid range, High range			
Test Channel Bandwidths as specified in TS 36.508 [7] subclause 4.3.1	Lowest, 5MHz, 10MHz, Highest			
Test Parameters for Channel Bandwidths				
Ch BW	Downlink Configuration	Uplink Configuration		
		Mod'n	RB allocation	
	N/A for Maximum Power Reduction (MPR) test case		FDD and HD-FDD	TDD
1.4MHz		QPSK	5	5
1.4MHz		QPSK	6	6
1.4MHz		16QAM	5	5
3.0MHz		QPSK	4	4
3.0MHz		QPSK	15	15
3.0MHz		16QAM	4	4
3.0MHz		16QAM	5	5
5MHz		QPSK	8	8
5MHz		QPSK	25	25
5MHz		16QAM	5	5
10MHz		QPSK	12	12
10MHz		QPSK	36	36
10MHz		16QAM	5	5
15MHz		QPSK	16	16
15MHz		QPSK	36	36
15MHz		16QAM	5	5
20MHz		QPSK	18	18
20MHz		QPSK	36	36
20MHz		16QAM	5	5
Note 1: Test Channel Bandwidths are checked separately for each E-UTRA band, the applicable channel bandwidths are specified in Table 5.4.2.1-1.				
Note 2: The RB <sub>start</sub> of partial RB allocation shall be RB#0 and RB# (max + 1 - RB allocation) of the channel bandwidth.				

#### 6.2.3E.4.2 Test procedure

Same test procedure as in clause 6.2.3.4.2 with following exception for HD-FDD:

- In step 3, slots with transient periods are not under test. Half-duplex guard subframe are not under test.

#### 6.2.3E.4.3 Message contents

Message contents are according to TS 36.508 [7] subclause 4.6.

### 6.2.3E.5 Test requirements

TBD

## 6.2.4 Additional Maximum Power Reduction (A-MPR)

**Editor's note: Test requirements values in this section need to be reviewed in order to take into account notes in Table 6.2.5.3-2:  $\Delta T_{IB,c}$  regarding  $\Delta T_{IB,c}$  and asymmetric lower tolerances in table 6.2.2.3-1.**

### 6.2.4.1 Test purpose

Additional ACLR and spectrum emission requirements can be signalled by the network to indicate that the UE shall also meet additional requirements in a specific deployment scenario. To meet these additional requirements, Additional Maximum Power Reduction A-MPR is allowed for the output power as specified in Table 6.2.2.3-1. Unless stated otherwise, an A-MPR of 0 dB shall be used.

### 6.2.4.2 Test applicability

The requirements of this test apply in test case 6.6.2.2 Additional Spectrum Emission Mask for network signalled values NS\_03, NS\_04, NS\_06, NS\_07, NS\_11, NS\_20 and NS\_21 to all types of E-UTRA UE release 8 and forward.

The requirements of this test apply in test case 6.6.3.3 Additional Spurious Emissions for network signalled values NS\_05, NS\_07, NS\_08, NS\_09, NS\_11, NS\_12, NS\_13, NS\_14, NS\_15, NS\_16, NS\_17, NS\_18, NS\_19, NS\_20 and NS\_21 to all types of E-UTRA UE release 8 and forward.

**NOTE:** As a result TC 6.2.4 has not been included in the test case applicability table 4.1-1, TS 36.521-2. This does not preclude the test from being used for R&D or other purposes if deemed useful.

### 6.2.4.3 Minimum conformance requirements

For UE Power Class 3 the specific requirements and identified sub-clauses are specified in Table 6.2.4.3-1 along with the allowed A-MPR values that may be used to meet these requirements. The allowed A-MPR values specified below in Table 6.2.4.3.-1 to 6.2.4.3-16 are in addition to the allowed MPR requirements specified in clause 6.2.3. For the UE maximum output power modified by A-MPR, the power limits specified in clause 6.2.5 apply.

**Table 6.2.4.3-1: Additional Maximum Power Reduction (A-MPR) / Spectrum Emission requirements**

Network Signalling value	Requirements (sub-clause)	E-UTRA Band	Channel bandwidth (MHz)	Resources Blocks ( $N_{RB}$ )	A-MPR (dB)
NS_01	6.6.2.1.1	Table 5.2-1	1.4,3,5,10,15,20	Table 5.4.2-1	N/A
NS_03	6.6.2.2.3.1	2,4,10, 23, 25,35,36	3	>5	$\leq 1$
			5	>6	$\leq 1$
			10	>6	$\leq 1$
			15	>8	$\leq 1$
			20	>10	$\leq 1$
NS_04	6.6.2.2.3.2	41	5	>6	$\leq 1$
			10, 15, 20	Table 6.2.4.3-4	
NS_05	6.6.3.3.3.1	1	10,15,20	$\geq 50$	$\leq 1$
NS_06	6.6.2.2.3.3	12, 13, 14, 17	1.4, 3, 5, 10	Table 5.4.2-1	N/A
NS_07	6.6.2.2.3.3 6.6.3.3.3.2	13	10	Table 6.2.4.3-2	Table 6.2.4.3-2
NS_08	6.6.3.3.3.3	19	10, 15	> 44	$\leq 3$
NS_09	6.6.3.3.3.4	21	10, 15	> 40	$\leq 1$
				> 55	$\leq 2$
NS_10		20	15, 20	Table 6.2.4.3-3	Table 6.2.4.3-3
NS_11	6.6.2.2.1 6.6.3.3.13	23 <sup>1</sup>	1.4, 3, 5, 10,15,20	Table 6.2.4.3-5	Table 6.2.4.3-5
NS_12	6.6.3.3.5	26	1.4, 3, 5, 10, 15	Table 6.2.4.3-6, Table 6.2.4.3-6a	Table 6.2.4.3-6, Table 6.2.4.3-6a
NS_13	6.6.3.3.6	26	1.4, 3, 5	Table 6.2.4.3-7	Table 6.2.4.3-7
NS_14	6.6.3.3.7	26	10, 15	Table 6.2.4.3-8	Table 6.2.4.3-8
NS_15	6.6.3.3.8	26	1.4, 3, 5, 10, 15	Table 6.2.4.3-9 Table 6.2.4.3-10	Table 6.2.4.3-9, Table 6.2.4.3-10
NS_16	6.6.3.3.9	27	3, 5, 10	Table 6.2.4.3-11, Table 6.2.4.3-12, Table 6.2.4.3-13	
NS_17	6.6.3.3.10	28	5, 10	Table 5.4.2-1	N/A
NS_18	6.6.3.3.11	28	5	$\geq 2$	$\leq 1$
			10, 15, 20	$\geq 1$	$\leq 4$
NS_19	6.6.3.3.12	44	10, 15, 20	Table 6.2.4.3-15	Table 6.2.4.3-15
NS_20	6.2.2 6.6.2.2.1 6.6.3.3.14	23	5, 10, 15, 20	Table 6.2.4.3-14	Table 6.2.4.3-14
NS_21	6.6.2.2.3.1 6.6.3.3.3.15	30	5, 10	Table 6.2.4.3-16	Table 6.2.4.3-16
...					
NS_32	-	-	-	-	-

**Table 6.2.4.3-2: A-MPR for "NS\_07"**

Parameters	Region A		Region B		Region C			
$RB_{start}$ <sup>1</sup>	0 – 12		13 – 18	19 – 42	43 – 49			
$L_{CRB}$ <sup>2</sup> [RBs]	6 – 8	1 to 5 and 9-50	<8	$\geq 8$	<18	$\geq 18$	$\leq 2$	>2
A-MPR [dB]	$\leq 8$	$\leq 12$	0	$\leq 12$	0	$\leq 6$	$\leq 3$	0
Note 1: $RB_{start}$ indicates the lowest RB index of transmitted resource blocks Note 2: $L_{CRB}$ is the length of a contiguous resource block allocation Note 3: For intra-subframe frequency hopping between two regions, notes 1 and 2 apply on a per slot basis. Note 4: For intra-subframe frequency hopping between two regions, the larger A-MPR value of the two regions may be applied for both slots in the subframe.								

**Table 6.2.4.3-3: A-MPR for "NS\_10"**

Channel bandwidth [MHz]	Parameters	Region A
15	$RB_{start}^1$	0 – 10
	$L_{CRB}$ [RBs]	1 -20
	A-MPR [dB]	$\leq 2$
20	$RB_{start}^1$	0 – 15
	$L_{CRB}$ [RBs]	1 -20
	A-MPR [dB]	$\leq 5$
Note 1: $RB_{start}$ indicates the lowest RB index of transmitted resource blocks. Note 2: $L_{CRB}$ is the length of a contiguous resource block allocation. Note 3: For intra-subframe frequency hopping which intersects Region A, notes 1 and 2 apply on a per slot basis. Note 4: For intra-subframe frequency hopping which intersect Region A, the larger A-MPR value may be applied for both slots in the subframe.		

**Table 6.2.4.3-4: A-MPR for NS\_04 for bandwidths > 5MHz**

Channel bandwidth [MHz]	Parameters	Region A	Region B	Region C	
10	$RB_{start}^1$	0 – 12	13 – 36		37 – 49
	$RB_{start}^1 + L_{CRB}^2$ [RBs]	N/A (Note 3)	14 - 37	>37	N/A (Note 3)
	A-MPR [dB]	$\leq 3$ dB	0	$\leq 2$ dB	$\leq 3$ dB
15	$RB_{start}^1$	0 – 18	19 – 55		56 – 74
	$RB_{start}^1 + L_{CRB}^2$ [RBs]	N/A (Note 3)	20 - 56	>56	N/A (Note 3)
	A-MPR [dB]	$\leq 3$ dB	0	$\leq 2$ dB	$\leq 3$ dB
20	$RB_{start}^1$	0 – 24	25 – 74		75 – 99
	$RB_{start}^1 + L_{CRB}^2$ [RBs]	N/A (Note 3)	26 - 75	>75	N/A (Note 3)
	A-MPR [dB]	$\leq 3$ dB	0	$\leq 2$ dB	$\leq 3$ dB
Note 1: $RB_{start}$ indicates the lowest RB index of transmitted resource blocks. Note 2: $L_{CRB}$ is the length of a contiguous resource block allocation. Note 3: Any RB allocation that starts in Region A or C is allowed the specified A-MPR. Note 4: For intra-subframe frequency hopping which intersects regions, notes 1 and 2 apply on a per slot basis. Note 5: For intra-subframe frequency hopping which intersects regions, the larger A-MPR value may be applied for both slots in the subframe.					

Table 6.2.4.3-5: A-MPR for NS\_11

Channel Bandwidth [MHz]	Parameters						
	3	F <sub>c</sub> [MHz]	<2004		≥2004		
L <sub>CRB</sub> [RBs]		1-15		>5			
A-MPR [dB]		≤5		≤1			
5	F <sub>c</sub> [MHz]	<2004		2004 ≤ F <sub>c</sub> <2007		≥2007	
	L <sub>CRB</sub> [RBs]	1-25		1-6 & 15-25	8-12	>6	
	A-MPR [dB]	≤7		≤4	0	≤1	
10	F <sub>c</sub> [MHz]	2005 ≤ F <sub>c</sub> <2015			2015		
	RB <sub>start</sub>	0-49			0-49		
	L <sub>CRB</sub> [RBs]	1-50			1-50		
	A-MPR [dB]	≤12			0		
15	F <sub>c</sub> [MHz]	<2012.5					
	RB <sub>start</sub>	0-4	5-21		22-56		57-74
	L <sub>CRB</sub> [RBs]	≥1	7-50	0-6 & ≥50	≤25	>25	>0
	A-MPR [dB]	≤15	≤7	≤10	0	≤6	≤15
	F <sub>c</sub> [MHz]	2012.5					
	RB <sub>start</sub>	0-12	13-39		40-65		66-74
	L <sub>CRB</sub> [RBs]	≥1	≥30	<30	≥ (69 – RB <sub>start</sub> )		≥1
	A-MPR [dB]	≤10	≤6	0	≤2		≤6.5
20	F <sub>c</sub> [MHz]	2010					
	RB <sub>start</sub>	0-12	13-29		30-68		69-99
	L <sub>CRB</sub> [RBs]	≥1	10-60	1-9 & >60	1-24	≥25	≥1
	A-MPR [dB]	≤15	≤7	≤10	0	≤7	≤15

Table 6.2.4.3-6: A-MPR for "NS\_12" (Rel-11 and earlier)

Channel bandwidth [MHz]	Parameters	Region A		Region B
1.4	RB <sub>start</sub>	0		1-2
	L <sub>CRB</sub> [RBs]	≤3	≥4	≥4
	A-MPR [dB]	≤3	≤6	≤3
3	RB <sub>start</sub>	0-3		4-5
	L <sub>CRB</sub> [RBs]	4-9	1-3 and 10-15	≥9
	A-MPR [dB]	≤4	≤3	≤3
5	RB <sub>start</sub>	0-6		7-9
	L <sub>CRB</sub> [RBs]	≤8	≥9	≥15
	A-MPR [dB]	≤5	≤3	≤3

Table 6.2.4.3-6a: A-MPR for "NS\_12" (Rel-12 and later)

Channel bandwidth [MHz]	Parameters	Region A		Region B
1.4	RB <sub>start</sub>	0		1-2
	L <sub>CRB</sub> [RBs]	≤3	≥4	≥4
	A-MPR [dB]	≤3	≤6	≤3
3	RB <sub>start</sub>	0-3		4-5
	L <sub>CRB</sub> [RBs]	1-15		≥9
	A-MPR [dB]	≤4		≤3
5	RB <sub>start</sub>	0-6		0-9
	L <sub>CRB</sub> [RBs]	≤8		≥9
	A-MPR [dB]	≤5		≤3
10	RB <sub>start</sub>	0-15		0-22
	L <sub>CRB</sub> [RBs]	≤18		≥20
	A-MPR [dB]	≤4		≤2
15	RB <sub>start</sub>	0-30		0-30
	L <sub>CRB</sub> [RBs]	≤30		≥32
	A-MPR [dB]	≤4		≤3

Table 6.2.4.3-7: A-MPR for "NS\_13"

Channel bandwidth [MHz]	Parameters	Region A	
5	RB <sub>start</sub>	0-2	
	L <sub>CRB</sub> [RBs]	≤5	≥18
	A-MPR [dB]	≤3	≤2

Table 6.2.4.3-8: A-MPR for "NS\_14"

Channel bandwidth [MHz]	Parameters	Region A	
10	RB <sub>start</sub>	0	
	L <sub>CRB</sub> [RBs]	≤5	≥50
	A-MPR [dB]	≤3	≤1
15	RB <sub>start</sub>	≤8	
	L <sub>CRB</sub> [RBs]	≤16	≥50
	A-MPR [dB]	≤3	≤1

Table 6.2.4.3-9: A-MPR for "NS\_15" for E-UTRA highest channel edge &gt; 845 MHz and ≤ 849 MHz

Channel bandwidth [MHz]	Parameters	Region A	Region B	Region C
1.4	RB <sub>end</sub> [RB]			4-5
	A-MPR [dB]			≤3
3	RB <sub>end</sub> [RB]	0-1	8-12	13-14
	L <sub>CRB</sub> [RB]	≤2	≥8	>0
	A-MPR [dB]	≤4	≤4	≤9
5	RB <sub>end</sub> [RB]	0-4	12-19	20-24
	L <sub>CRB</sub> [RB]	≤2	≥8	>0
	A-MPR [dB]	≤4	≤5	≤9
10	RB <sub>end</sub> [RB]	0-12	23-36	37-49
	L <sub>CRB</sub> [RB]	≤2	≥15	>0
	A-MPR [dB]	≤4	≤6	≤9
15	RB <sub>end</sub> [RB]	0-20	26-53	54-74
	L <sub>CRB</sub> [RB]	≤2	≥20	>0
	A-MPR [dB]	≤4	≤5	≤9

Table 6.2.4.3-10: A-MPR for "NS\_15" for E-UTRA highest channel edge  $\leq$  845 MHz

Channel bandwidth [MHz]	Parameters	Region A	Region B	Region C
5	RB <sub>end</sub> [RB]			19-24
	L <sub>CRB</sub> [RB]			$\geq$ 18
	A-MPR [dB]			$\leq$ 2
10	RB <sub>end</sub> [RB]	0-4	29-44	45-49
	L <sub>CRB</sub> [RB]	$\leq$ 2	$\geq$ 24	$>$ 0
	A-MPR [dB]	$\leq$ 4	$\leq$ 4	$\leq$ 9
15	RB <sub>end</sub> [RB]	0-12	44-61	62-74
	L <sub>CRB</sub> [RB]	$\leq$ 2	$\geq$ 20	$>$ 0
	A-MPR [dB]	$\leq$ 4	$\leq$ 5	$\leq$ 9

Table 6.2.4.3-11: A-MPR for "NS\_16" with channel lower edge at  $\geq$ 807 MHz and  $<$ 808.5 MHz

Channel bandwidth [MHz]	Parameter	Region A	Region B	Region C	Region D	Region E
3 MHz	RB <sub>start</sub>	0	1-2			
	L <sub>CRB</sub> [RBs]	$\geq$ 12	12			
	A-MPR [dB]	$\leq$ 2	$\leq$ 1			
5 MHz	RB <sub>start</sub>	0-1	2	2-9	2-5	
	L <sub>CRB</sub> [RBs]	1 - 25	12	15-18	20	
	A-MPR [dB]	$\leq$ 5	$\leq$ 1	$\leq$ 2	$\leq$ 3	
10 MHz	RB <sub>start</sub>	0 - 8	0-14		15-20	15-24
	L <sub>CRB</sub> [RBs]	1 - 12	15-20	$\geq$ 24	$\geq$ 30	24-27
	A-MPR [dB]	$\leq$ 5	$\leq$ 3	$\leq$ 7	$\leq$ 3	$\leq$ 1

Table 6.2.4.3-12: A-MPR for "NS\_16" with channel lower edge at  $\geq$ 808.5 MHz and  $<$ 812 MHz

Channel bandwidth [MHz]	Parameter	Region A	Region B	Region C	Region D	Region E
5 MHz	RB <sub>start</sub>	0	0-1	1-5		
	L <sub>CRB</sub> [RBs]	16-20	$\geq$ 24	16-20		
	A-MPR [dB]	$\leq$ 2	$\leq$ 3	$\leq$ 1		
10 MHz	RB <sub>start</sub>	0-6		0-10	0-14	11-20
	L <sub>CRB</sub> [RBs]	1-12	15-20	24-32	$\geq$ 36	24-32
	A-MPR [dB]	$\leq$ 5	$\leq$ 2	$\leq$ 4	$\leq$ 5	$\leq$ 1

Table 6.2.4.3-13: A-MPR for "NS\_16" with channel lower edge at  $\geq$ 812 MHz

Channel bandwidth [MHz]	Parameter	Region A	Region B	Region C	Region D
10 MHz	RB <sub>start</sub>	0 - 9	0	1-14	0-5
	L <sub>CRB</sub> [RBs]	27-32	36-40	36-40	$\geq$ 45
	A-MPR [dB]	$\leq$ 1	$\leq$ 2	$\leq$ 1	$\leq$ 3

Table 6.2.4.3-14: A-MPR for “NS\_20”

Channel bandwidth [MHz]	Parameters							
5	F <sub>c</sub> (MHz)	< 2007.5		2007.5 ≤ F <sub>c</sub> < 2012.5		2012.5 ≤ F <sub>c</sub> ≤ 2017.5		
	RB <sub>start</sub>	≤24		0-3	4-6	≤24		
	L <sub>CRB</sub> (RBs)	>0		15-19	≥20	≥18	1-25	
	A-MPR [dB]	≤17		≤1	≤4	≤2	≤0	
10	F <sub>c</sub> (MHz)	2005						
	RB <sub>start</sub>	0-25		26-34		35-49		
	L <sub>CRB</sub> (RBs)	>0		8-15	>15	>0		
	A-MPR [dB]	≤16		≤2	≤5	≤6		
	F <sub>c</sub> (MHz)	2015						
	RB <sub>start</sub>	0-5			6-10			
	L <sub>CRB</sub> (RBs)	≥32			≥40			
	A-MPR [dB]	≤4			≤2			
15	F <sub>c</sub> (MHz)	2012.5						
	RB <sub>start</sub>	0-14		15-24		25-39	61-74	
	L <sub>CRB</sub> (RBs)	1-9 & 40-75	10-39	24-29	≥30	≥36	≤6	
	A-MPR [dB]	≤11	≤6	≤1	≤7	≤5	≤6	
20	F <sub>c</sub> (MHz)	2010						
	RB <sub>start</sub>	0-21	22-31		32-38	39-49	50-69	70-99
	L <sub>CRB</sub> (RBs)	>0	1-9 & 31-75	10-30	≥15	≥24	≥25	>0
	A-MPR [dB]	≤17	≤12	≤6	≤9	≤7	≤5	≤16

NOTE 1: When NS\_20 is signalled the minimum requirements for the 10 MHz bandwidth are specified for E-UTRA UL carrier centre frequencies of 2005 MHz or 2015 MHz.

NOTE 2: When NS\_20 is signalled the minimum requirements for the 15 MHz channel bandwidth are specified for E-UTRA UL carrier centre frequency of 2012.5 MHz.

Table 6.2.4.3-15: A-MPR for “NS\_19”

Channel bandwidth [MHz]	Parameters	Region A		Region B
10	RB <sub>start</sub>			0-6
	L <sub>CRB</sub> [RBs]			≥40
	A-MPR [dB]			≤1
15	RB <sub>start</sub>	0-6		7-20
	L <sub>CRB</sub> [RBs]	≤18	≥36	≥42
	A-MPR [dB]	≤2	≤3	≤2
20	RB <sub>start</sub>	0-14		15-30
	L <sub>CRB</sub> [RBs]	≤40	≥45	≥50
	A-MPR [dB]	≤2	≤3	≤2



Table 6.2.4.3-16: A-MPR for "NS\_21"

Channel Bandwidth [MHz]	Parameters	Region A		Region B	
10	RB <sub>start</sub>	0 – 6	0 – 6	N/A	N/A
	RB <sub>end</sub>	N/A	N/A	43 – 49	43 – 49
	L <sub>CRB</sub> [RBs]	1 – 2	3 – 12, 32 - 50	1 – 2	3 – 12, 32 - 50
	A-MPR [dB]	≤ 4	≤ 3	≤ 4	≤ 3

For PRACH, PUCCH and SRS transmissions, the allowed A-MPR is according to that specified for PUSCH QPSK modulation for the corresponding transmission bandwidth.

For each subframe, the A-MPR is evaluated per slot and given by the maximum value taken over the transmission(s) within the slot; the maximum A-MPR over the two slots is then applied for the entire subframe.

The normative reference for this requirement is TS 36.101 clause 6.2.4.

## 6.2.4.4 Test description

### 6.2.4.4.1 Initial condition

Initial conditions are a set of test configurations the UE needs to be tested in and the steps for the SS to take with the UE to reach the correct measurement state.

The initial test configurations consist of environmental conditions, test frequencies, and channel bandwidths based on E-UTRA operating bands specified in table 5.4.2.1-1. All of these configurations shall be tested with applicable test parameters for each channel bandwidth, and are shown in table 6.2.4.4.1-1 through table 6.2.4.4.1-19. The details of the uplink reference measurement channels (RMCs) are specified in Annex A.2. Configurations of PDSCH and PDCCH before measurement are specified in Annex C.2.

**Table 6.2.4.4.1-1: Test Configuration Table (network signalled value "NS\_03")**

Initial Conditions							
Test Environment (as specified in TS 36.508 [7] subclause 4.1)					NC		
Test Frequencies (as specified in TS 36.508 [7] subclause 4.3.1)					Low range, Mid range, High range		
Test Channel Bandwidths (as specified in TS 36.508 [7] subclause 4.3.1)					Lowest, 5MHz, 10MHz, Highest		
Test Parameters for NS_03 A-MPR							
Configura- tion ID	Ch BW	Downlink Configuration			Uplink Configuration		
		Mod'n	RB allocation		Mod'n	RB allocation	
			FDD	TDD		FDD	TDD
1	1.4MHz	N/A for A-MPR testing.			QPSK	6	6
2	1.4MHz				QPSK	5	5
3	1.4MHz				16QAM	5	5
4	3MHz				QPSK	15	15
5	3MHz				QPSK	4	4
6	3MHz				16QAM	15	15
7	3MHz				16QAM	4	4
8	5MHz				QPSK	25	25
9	5MHz				QPSK	8	8
10	5MHz				QPSK	6	6
11	5MHz				16QAM	25	25
12	5MHz				16QAM	8	8
13	10MHz				QPSK	50	50
14	10MHz				QPSK	12	12
15	10MHz				QPSK	6	6
16	10MHz				16QAM	50 (Note 4)	50 (Note 4)
17	10MHz				16QAM	12	12
18	15MHz				QPSK	75	75
19	15MHz				QPSK	16	16
20	15MHz				QPSK	8	8
21	15MHz				16QAM	75 (Note 4)	75 (Note 4)
22	15MHz				16QAM	16	16
23	20MHz				QPSK	100	100
24	20MHz				QPSK	18	18
25	20MHz				QPSK	10	10
26	20MHz				16QAM	100 (Note 4)	100 (Note 4)
27	20MHz				16QAM	18	18

Note 1: Test Channel Bandwidths are checked separately for each E-UTRA band, the applicable channel bandwidths are specified in Table 5.4.2.1-1.

Note 2: The Configuration ID will be used to map the applicable Test Configuration to the corresponding Test Requirement in subclause 6.2.4.5 as not all combinations are necessarily required based on the applicability of the UE.

Note 3: The RB<sub>start</sub> of partial RB allocation shall be RB# 0 and RB# (max +1 - RB allocation) of the channel bandwidth.

Note 4: Applies only for UE-Categories ≥2.

Note 5: For band 23, above table only applies to mid and high range test frequencies. Low range test frequencies will be covered by NS\_11 test configuration table.

**Table 6.2.4.4.1-2: Test Configuration Table (network signalled value "NS\_04")**

Initial Conditions						
Test Environment (as specified in TS 36.508 [7] subclause 4.1)				NC		
Test Frequencies (as specified in TS 36.508 [7] subclause 4.3.1)				Low range, Mid range, High range		
Test Channel Bandwidths (as specified in TS 36.508 [7] subclause 4.3.1)				5MHz, 10 MHz, 15 MHz, 20MHz		
Test Parameters for NS_04 A-MPR						
Configura- tion ID	Ch BW	Downlink Configuration		Uplink Configuration		
		Mod'n	RB allocation TDD	Mod'n	RB allocation TDD	RB <sub>start</sub> TDD
1	5MHz	N/A for A-MPR testing		QPSK	25	Note 3
2	5MHz			QPSK	8	Note 3
3	5MHz			QPSK	6	Note 3
4	5MHz			16QAM	25	Note 3
5	5MHz			16QAM	8	Note 3
6	10MHz			QPSK	1	0
7	10MHz			QPSK	12	0
8	10MHz			QPSK	50	0
9	10MHz			16QAM	50 (Note 4)	0
10	10MHz			QPSK	24	13
11	10MHz			16QAM	24	13
12	10MHz			QPSK	36	13
13	10MHz			QPSK	12	37
14	10MHz			QPSK	1	49
15	15MHz			QPSK	1	0
16	15MHz			QPSK	16	0
17	15MHz			QPSK	75	0
18	15MHz			16QAM	75 (Note 4)	0
19	15MHz			QPSK	36	19
20	15MHz			16QAM	36 (Note 4)	19
21	15MHz			QPSK	50	19
22	15MHz			QPSK	18	56
23	15MHz			QPSK	1	74
24	20MHz			QPSK	1	0
25	20MHz			QPSK	18	0
26	20MHz			QPSK	100	0
27	20MHz			16QAM	100 (Note 4)	0
28	20MHz			QPSK	50	25
29	20MHz			16QAM	50 (Note 4)	25
30	20MHz			QPSK	75	25
31	20MHz			QPSK	25	75
32	20MHz			QPSK	1	99

Note 1: Test Channel Bandwidths are checked separately for E-UTRA band, the applicable channel bandwidths are specified in Table 5.4.2.1-1.

Note 2: The configuration ID will be used to map the applicable Test Configuration to be corresponding Test Requirement in subclause 6.2.4 as not all combinations are necessarily required based on the applicability of the UE.

Note 3: The RB<sub>start</sub> of partial RB allocation shall be RB# 0 and RB# (max +1 - RB allocation) of the channel bandwidth.

Note 4: Applies only for UE-Categories ≥2.

**Table 6.2.4.4.1-3: Test Configuration Table (network signalled value "NS\_05")**

Initial Conditions					
Test Environment (as specified in TS 36.508 [7] subclause 4.1)			Normal		
Test Frequencies (as specified in TS 36.508 [7] subclause 4.3.1)			Low range, Mid range  In case of Low range: - For 5MHz Channel Bandwidth: 1927.2MHz (NUL = 18072) - For 10 MHz Channel Bandwidth: 1934.7 MHz (NUL = 18147) - For 15 MHz Channel Bandwidth: 1932.5 MHz (NUL = 18125) - For 20 MHz Channel Bandwidth: 1930 MHz (NUL = 18100)		
Test Channel Bandwidths (as specified in TS 36.508 [7] subclause 4.3.1)			5MHz, 10MHz, 15MHz, 20MHz		
Test Parameters for NS_05 A-MPR					
Configuratio n ID	Ch BW	Downlink Configuration		Uplink Configuration	
		Mod'n	RB allocation FDD	Mod'n	RB allocation FDD
1	5MHz	N/A for A-MPR testing		QPSK	1
2	5MHz			QPSK	25
3	10MHz			QPSK	1
4	10MHz			QPSK	12
5	10MHz			QPSK	48
6	10MHz			QPSK	50
7	10MHz			16QAM	50 (Note 4)
8	15MHz			QPSK	1
9	15MHz			QPSK	16
10	15MHz			QPSK	30 (Note 5)
11	15MHz			QPSK	48 (Note 6)
12	15MHz			QPSK	75 (Note 6)
13	15MHz			16QAM	75 (Note 4, 6)
14	20MHz			QPSK	1
15	20MHz			QPSK	18
16	20MHz			QPSK	24 (Note 5)
17	20MHz			QPSK	48 (Note 6)
18	20MHz			QPSK	100 (Note 6)
19	20MHz			16QAM	100 (Note 4, 6)
Note 1: The 1 RB allocation shall be tested at both RB #0 and RB #max except for 15MHz and 20MHz of Low Range. For 15MHz of Low Range, the 1 RB allocation shall be tested at both RB#8 and RB#66. For 20MHz of Low Range, the 1 RB allocation shall be tested at both RB#24 and RB#75.  Note 2: The RB <sub>start</sub> of partial RB allocation shall be RB# 0 and RB# (max +1 - RB allocation) of the channel bandwidth except for 15MHz and 20MHz of Low Range. For 15MHz of Low Range, the RB <sub>start</sub> shall be RB#8 and RB# (67 - RB allocation). For 20MHz of Low Range, the RB <sub>start</sub> shall be RB#24 and RB# (76 - RB					

	allocation)..
Note 3:	The Configuration ID will be used to map the applicable Test Configuration to the corresponding Test Requirement in subclause 6.2.4.5 as not all combinations are necessarily required based on the applicability of the UE.
Note 4:	Applies only for UE-Categories ≥2.
Note 5:	Required for Low Range only.
Note 6:	Not available for Low Range.

**Table 6.2.4.4.1-4: Test Configuration Table (network signalled value "NS\_06")**

Initial Conditions					
Test Environment (as specified in TS 36.508 [7] subclause 4.1)			Normal		
Test Frequencies (as specified in TS 36.508 [7] subclause 4.3.1)			Low range, Mid range, High range		
Test Channel Bandwidths (as specified in TS 36.508 [7] subclause 4.3.1)			Lowest, 5MHz, 10MHz, Highest		
Test Parameters for NS_06 A-MPR					
Configura- tion ID	Ch BW	Downlink Configuration		Uplink Configuration	
		Mod'n	RB allocation FDD	Mod'n	RB allocation FDD
1	1.4MHz	N/A for A-MPR testing		QPSK	6
2	1.4MHz			QPSK	5
3	1.4MHz			16QAM	5
4	3MHz			QPSK	15
5	3MHz			QPSK	4
6	3MHz			16QAM	4
7	5MHz			QPSK	25
8	5MHz			QPSK	8
9	5MHz			16QAM	8
10	10MHz			QPSK	50
11	10MHz			QPSK	12
12	10MHz			16QAM	12
13	15MHz			QPSK	75
14	15MHz			QPSK	16
15	15MHz			16QAM	16
16	20MHz			QPSK	100
17	20MHz			QPSK	18
18	20MHz			16QAM	18
Note 1:	Test Channel Bandwidths are checked separately for each E-UTRA band, the applicable channel bandwidths are specified in Table 5.4.2.1-1.				
Note 2:	The Configuration ID will be used to map the applicable Test Configuration to the corresponding Test Requirement in subclause 6.2.4.5 as not all combinations are necessarily required based on the applicability of the UE.				
Note 3:	The RB <sub>start</sub> of partial RB allocation shall be RB# 0 and RB# (max +1 - RB allocation) of the channel bandwidth.				

**Table 6.2.4.4.1-5: Test Configuration Table (network signalled value "NS\_07")**

Initial Conditions						
Test Environment (as specified in TS 36.508 [7] subclause 4.1)				NC		
Test Frequencies (as specified in TS 36.508 [7] subclause 4.3.1)				Mid range		
Test Channel Bandwidths (as specified in TS 36.508 [7] subclause 4.3.1)				10MHz		
Test Parameters for NS_07 A-MPR						
Configura- tion ID	Ch BW	Downlink Configuration		Uplink Configuration		
		Mod'n	RB allocation FDD	Mod'n	RB allocation FDD	RB <sub>start</sub> FDD
1	10MHz	N/A for A-MPR testing		QPSK	1	0
2	10MHz			QPSK	8	0
3	10MHz			QPSK	6	13
4	10MHz			QPSK	20	13
5	10MHz			QPSK	12	13
6	10MHz			16QAM	36 (Note 2)	13
7	10MHz			QPSK	16	19
8	10MHz			QPSK	12	19
9	10MHz			16QAM	16	19
10	10MHz			QPSK	30	19
11	10MHz			16QAM	30 (Note 2)	19
12	10MHz			QPSK	6	43
13	10MHz			QPSK	2	48
14	10MHz			QPSK	50	0
15	10MHz			QPSK	12	0
16	10MHz			16QAM	50 (Note 2)	0
Note 1: The Configuration ID will be used to map the applicable Test Configuration to the corresponding Test Requirement in subclause 6.2.4.5 as not all combinations are necessarily required based on the applicability of the UE.						
Note 2: Applies only for UE-Categories $\geq 2$ .						

**Table 6.2.4.4.1-6: Test Configuration Table (network signalled value "NS\_08")**

Initial Conditions					
Test Environment (as specified in TS 36.508 [7] subclause 4.1)			Normal		
Test Frequencies (as specified in TS 36.508 [7] subclause 4.3.1)			High range		
Test Channel Bandwidths (as specified in TS 36.508 [7] subclause 4.3.1)			5MHz, 10MHz, 15MHz		
Test Parameters for NS_08 A-MPR					
Configura- tion ID	Ch BW	Downlink Configuration		Uplink Configuration	
		Mod'n	RB allocation FDD	Mod'n	RB allocation FDD
1	5MHz	N/A for A-MPR testing		QPSK	1
2	5MHz			QPSK	8
3	5MHz			QPSK	25
4	10MHz			QPSK	1
5	10MHz			QPSK	12
6	10MHz			QPSK	40
7	10MHz			QPSK	50
8	10MHz			16QAM	50 (Note 4)
9	15MHz			QPSK	1
10	15MHz			QPSK	16
11	15MHz			QPSK	40
12	15MHz			QPSK	75
13	15MHz			16QAM	75 (Note 4)
Note 1:	The Configuration ID will be used to map the applicable Test Configuration to the corresponding Test Requirement in subclause 6.2.4.5 as not all combinations are necessarily required based on the applicability of the UE.				
Note 2:	The 1 RB allocation shall be tested at both RB #0 and RB #max.				
Note 3:	The RB <sub>start</sub> of partial RB allocation shall be RB# 0 and RB# (max + 1 - RB allocation) of the channel bandwidth				
Note 4:	Applies only for UE-Categories ≥2.				

**Table 6.2.4.4.1-7: Test Configuration Table (network signalled value "NS\_09")**

Initial Conditions					
Test Environment (as specified in TS 36.508 [7] subclause 4.1)			Normal		
Test Frequencies (as specified in TS 36.508 [7] subclause 4.3.1)			High range		
Test Channel Bandwidths (as specified in TS 36.508 [7] subclause 4.3.1)			5MHz, 10MHz, 15MHz		
Test Parameters for Channel Bandwidths					
Configura- tion ID	Ch BW	Downlink Configuration		Uplink Configuration	
		Mod'n	RB allocation FDD	Mod'n	RB allocation FDD
1	5MHz	N/A for A-MPR testing		QPSK	1
2	5MHz			QPSK	8
3	5MHz			QPSK	25
4	10MHz			QPSK	1
5	10MHz			QPSK	12
6	10MHz			QPSK	40
7	10MHz			QPSK	50
8	10MHz			16QAM	50 (Note 4)
9	15MHz			QPSK	1
10	15MHz			QPSK	16
11	15MHz			QPSK	40
12	15MHz			QPSK	54
13	15MHz			QPSK	75
14	15MHz			16QAM	75 (Note 4)
<p>Note 1: The Configuration ID will be used to map the applicable Test Configuration to the corresponding Test Requirement in subclause 6.2.4.5 as not all combinations are necessarily required based on the applicability of the UE.</p> <p>Note 2: The 1 RB allocation shall be tested at both RB #0 and RB #max.</p> <p>Note 3: The RB<sub>start</sub> of partial RB allocation shall be RB# 0 and RB# (max + 1 - RB allocation) of the channel bandwidth</p> <p>Note 4: Applies only for UE-Categories ≥2.</p>					

**Table 6.2.4.4.1-8: Test Configuration Table (network signalled value "NS\_10")**

Void, not tested
------------------



**Table 6.2.4.4.1-9: Test Configuration Table (network signalled value "NS\_11")**

Initial Conditions					
Test Environment (as specified in TS 36.508 [7] subclause 4.1)			Normal		
Test Frequencies (as specified in TS 36.508 [7] subclause 4.3.1)			For 3 MHz Channel Bandwidth: a. 2001.5 MHz ( $N_{UL} = 25515$ ) b. 2004.5 MHz ( $N_{UL} = 25545$ )  For 5 MHz Channel Bandwidth a. 2002.5 MHz ( $N_{UL} = 25525$ ) b. 2004.5 MHz ( $N_{UL} = 25545$ ) c. 2007.5 MHz ( $N_{UL} = 25575$ )  For 10 MHz Channel Bandwidth a. 2005 MHz ( $N_{UL} = 25550$ ) b. 2005.5 MHz ( $N_{UL} = 25555$ ) c. 2015 MHz ( $N_{UL} = 25650$ )  For 15 MHz Channel Bandwidth a. 2007.5 MHz ( $N_{UL} = 25575$ ) b. 2012.5 MHz ( $N_{UL} = 25625$ )  For 20 MHz Channel Bandwidth a. 2010 MHz ( $N_{UL} = 25600$ )		
Test Channel Bandwidths (as specified in TS 36.508 [7] subclause 4.3.1)			3MHz, 5MHz, 10MHz, 15MHz, 20MHz		
Test Parameters for NS_11 A-MPR					
Configuration ID	Ch BW	Downlink Configuration		Uplink Configuration	
		Mod'n	RB allocation FDD	Mod'n	RB allocation FDD
1	3MHz	N/A for A-MPR testing		QPSK	6
2	3MHz			QPSK	15
3	3MHz			16QAM	6
4	3MHz			16QAM	15
5	5MHz			QPSK	1
6	5MHz			QPSK	8
7	5MHz			QPSK	25
8	5MHz			16QAM	8
9	5MHz			16QAM	25
10	10MHz			QPSK	1
11	10MHz			QPSK	12
12	10MHz			QPSK	50
13	10MHz			16QAM	12
14	10MHz			16QAM	50 (Note 3)
15	15MHz			QPSK	1
16	15MHz			QPSK	8
17	15MHz			QPSK	25
18	15MHz			QPSK	30

19	15MHz	QPSK	75
20	15MHz	16QAM	8
21	15MHz	16QAM	25
22	15MHz	16QAM	30
23	15MHz	16QAM	75
24	20MHz	QPSK	1
25	20MHz	QPSK	10
26	20MHz	QPSK	25
27	20MHz	QPSK	100
28	20MHz	16QAM	10
29	20MHz	16QAM	25
30	20MHz	16QAM	100
<p>Note 1: The Configuration ID will be used to map the applicable Test Configuration to the corresponding Test Requirement in subclause 6.2.4.5 as not all combinations are necessarily required based on the applicability of the UE.</p> <p>Note 2: The RB<sub>start</sub> of partial RB allocation shall be RB# 0 and RB# (max +1 - RB allocation) of the channel bandwidth.</p> <p>Note 3: Applies only for UE-Categories ≥2.</p>			

Table 6.2.4.4.1-10: Test Configuration Table (network signalled value "NS\_12")

Initial Conditions						
Test Environment (as specified in TS 36.508 [7] subclause 4.1)		NC				
Test Frequencies (as specified in TS 36.508 [7] subclause 4.3.1)		For 1.4 MHz Channel Bandwidth: UL 814.9 MHz ( $N_{UL} = 26699$ )  For 3 MHz Channel Bandwidth: UL 815.7 MHz ( $N_{UL} = 26707$ )  For 5 MHz Channel Bandwidth: UL 816.7 MHz ( $N_{UL} = 26717$ )  For 10 MHz Channel Bandwidth: UL 819.2 MHz ( $N_{UL} = 26742$ )  For 15 MHz Channel Bandwidth: UL 821.7 MHz ( $N_{UL} = 26767$ )				
Test Channel Bandwidths (as specified in TS 36.508 [7] subclause 4.3.1)		1.4 MHz, 3 MHz, 5 MHz, 10 MHz and 15 MHz				
Test Parameters for Channel Bandwidths						
Configuration ID	Ch BW	Downlink Configuration		Uplink Configuration		
		Mod'n	RB allocation	Mod'n	RB allocation FDD	RBstart FDD
1	1.4 MHz	N/A for A-MPR testing.		QPSK	1	0
2	1.4 MHz			QPSK	6	0
3	1.4 MHz			QPSK	1	1
4	1.4 MHz			QPSK	5	1
5	1.4 MHz			16QAM	6	0
6 (Note 1)	3 MHz			QPSK	4	0
7 (Note 1)	3 MHz			QPSK	10	0
8	3 MHz			QPSK	4	4
9	3 MHz			QPSK	10	4
10 (Note 1)	3 MHz			16QAM	15	0
11	5 MHz			QPSK	8	0
12	5 MHz			QPSK	15	0
13	5 MHz			QPSK	8	7
14 (Note 1)	5 MHz			QPSK	15	7
15	5 MHz			16QAM	25	0
16 (Note 2)	10 MHz	QPSK	18	0		
17 (Note 2)	10 MHz	QPSK	18	16		
18 (Note 2)	10 MHz	16QAM	50	0		
19 (Note 2)	15 MHz	QPSK	30	0		
20 (Note 2)	15 MHz	QPSK	30	31		
21 (Note 2)	15 MHz	16QAM	75	0		
Note 1: Only for UEs of Rel-11 and earlier						
Note 2: Only for UEs of Rel-12 and later						

Table 6.2.4.4.1-11: Test Configuration Table (network signalled value "NS\_13")

Initial Conditions						
Test Environment (as specified in TS 36.508 [7] subclause 4.1)			NC			
Test Frequencies (as specified in TS 36.508 [7] subclause 4.3.1)			For 1.4 MHz Channel Bandwidth: UL 819.7 MHz ( $N_{UL} = 26747$ )  For 3 MHz Channel Bandwidth: UL 820.5 MHz ( $N_{UL} = 26755$ )  For 5 MHz Channel Bandwidth: UL 821.5 MHz ( $N_{UL} = 26765$ )			
Test Channel Bandwidths (as specified in TS 36.508 [7] subclause 4.3.1)			1.4 MHz, 3MHz and 5 MHz			
Test Parameters for Channel Bandwidths						
Configuration ID	Ch BW	Downlink Configuration		Uplink Configuration		
		Mod'n	RB allocation	Mod'n	RB allocation FDD	RBstart FDD
1 (Note 1)	1.4 MHz	N/A for A-MPR testing.		QPSK	6	0
2 (Note 1)	3 MHz			QPSK	15	0
3	5 MHz			QPSK	1	0
4	5 MHz			QPSK	25	0
5	5 MHz			QPSK	15	0
6	5 MHz			QPSK	15	7
7	5 MHz			16QAM	25	0
Note 1: Only for UEs of Rel-12 and later						

**Table 6.2.4.4.1-12: Test Configuration Table (network signalled value "NS\_14")**

<b>Initial Conditions</b>						
Test Environment (as specified in TS 36.508 [7] subclause 4.1)			NC			
Test Frequencies (as specified in TS 36.508 [7] subclause 4.3.1)			For 10 MHz Channel Bandwidth: UL 829 MHz ( $N_{UL} = 26840$ )  For 15 MHz Channel Bandwidth: Mid range			
Test Channel Bandwidths (as specified in TS 36.508 [7] subclause 4.3.1)			10 MHz, 15 MHz			
<b>Test Parameters for Channel Bandwidths</b>						
Configuration ID	Ch BW	Downlink Configuration		Uplink Configuration		
		Mod'n	RB allocation	Mod'n	RB allocation FDD	RBstart FDD
1	10 MHz	N/A for A-MPR testing.		QPSK	1	0
2	10 MHz			QPSK	25	0
3	10 MHz			QPSK	50	0
4	10 MHz			QPSK	25	1
5 (Note 1)	10 MHz			16QAM	50	0
6	15 MHz			QPSK	8	0
7	15 MHz			QPSK	25	0
8	15 MHz			QPSK	75	0
9	15 MHz			QPSK	50	15
10 (Note 1)	15 MHz			16QAM	75	0
Note 1: Applies only for UE-Categories $\geq 2$ .						

**Table 6.2.4.4.1-13: Test Configuration Table (network signalled value "NS\_15")**

Initial Conditions						
Test Environment (as specified in TS 36.508 [7] subclause 4.1)		NC				
Test Frequencies (as specified in TS 36.508 [7] subclause 4.3.1)		For 1.4 MHz Channel Bandwidth: High range  For 3 MHz Channel Bandwidth: UL 843.5 MHz ( $N_{UL} = 26985$ ) or High range  For 5 MHz Channel Bandwidth: UL 842.5 MHz ( $N_{UL} = 26975$ ) or High range  For 10 MHz Channel Bandwidth: UL 840 MHz ( $N_{UL} = 26950$ ) or High range  For 15 MHz Channel Bandwidth: UL 837.5 MHz ( $N_{UL} = 26925$ ) or High range				
Test Channel Bandwidths (as specified in TS 36.508 [7] subclause 4.3.1)		1.4 MHz, 3 MHz, 5 MHz, 10 MHz, 15 MHz				
Test Parameters for Channel Bandwidths						
Configuration ID	Ch BW	Downlink Configuration		Uplink Configuration		
		Mod'n	RB allocation	Mod'n	RB allocation FDD	RBstart FDD
1 (note 3)	1.4 MHz	N/A for A-MPR testing.		QPSK	4	0
2 (note 3)	1.4 MHz			16QAM	6	0
3 (note 3)	3 MHz			QPSK	6	7
4 (note 3)	3 MHz			QPSK	12	1
5 (note 3)	3 MHz			16QAM	15	0
6 (note 2)	3 MHz			QPSK	15	0
7 (note 3)	5 MHz			QPSK	6	14
8 (note 3)	5 MHz			QPSK	20	0
9 (note 3)	5 MHz			16QAM	25	0
10 (note 2)	5 MHz			QPSK	16	9
11 (note 2)	5 MHz			QPSK	25	0
12 (note 3)	10 MHz			QPSK	1	39
13 (note 3)	10 MHz			QPSK	1	10
14 (note 3)	10 MHz			QPSK	3	0
15 (note 3)	10 MHz			QPSK	20	3
16 (note 3)	10 MHz			QPSK	36	1
17 (note 3)	10 MHz			QPSK	50	0
18 (note 1, 3)	10 MHz			16QAM	50	0
19 (note 2)	10 MHz			QPSK	20	25
20 (note 2)	10 MHz			QPSK	45	0
21 (note 3)	15 MHz			QPSK	18	36
22 (note 3)	15 MHz			QPSK	25	1
23 (note 3)	15 MHz			QPSK	54	0
24 (note 1, 3)	15 MHz			16QAM	75	0

25 (note 2)	15 MHz		QPSK	18	44
26 (note 2)	15 MHz		QPSK	60	2
Note 1: Applies only for UE-Categories $\geq 2$ .					
Note 2: Applicable only test frequency < high range.					
Note 3: Applicable only to high range frequency testing.					

**Table 6.2.4.4.1-14: Test Configuration Table (network signalled value "NS\_16")**

Initial Conditions						
Test Environment (as specified in TS 36.508 [7] subclause 4.1)			NC			
Test Frequencies (as specified in TS 36.508 [7] subclause 4.3.1)			For 1.4 MHz Channel Bandwidth: Low range  For 3 MHz Channel Bandwidth: Low range, 810 MHz (N <sub>UL</sub> = 27070)  For 5 MHz Channel Bandwidth: Low range, 811 MHz (N <sub>UL</sub> = 27080), 814.5 MHz (N <sub>UL</sub> = 27115)  For 10 MHz Channel Bandwidth: Low range, 813.5 MHz (N <sub>UL</sub> = 27105), 817 MHz (N <sub>UL</sub> = 27140)			
Test Channel Bandwidths (as specified in TS 36.508 [7] subclause 4.3.1)			1.4 MHz, 3 MHz, 5 MHz, 10 MHz			
Test Parameters for Channel Bandwidths						
Configuration ID	Ch BW	Downlink Configuration		Uplink Configuration		
		Mod'n	RB allocation	Mod'n	RB allocation FDD	RBstart FDD
1	1.4 MHz	N/A for A-MPR testing.		QPSK	1	0
2	1.4 MHz			QPSK	6	0
3	1.4 MHz			16QAM	6	0
4	3 MHz			QPSK	1	0
5	3 MHz			QPSK	12	1
6	3 MHz			QPSK	15	0
7	3 MHz			16QAM	15	0
8	5 MHz			QPSK	1	0
9	5 MHz			QPSK	12	2
10	5 MHz			QPSK	18	2
11	5 MHz			QPSK	20	0
12	5 MHz			QPSK	20	2
13	5 MHz			QPSK	25	0
14	5 MHz			16QAM	25	0
15	10 MHz			QPSK	1	0
16 (Note 2)	10 MHz			QPSK	1	10



17 (Note 2)	10 MHz	QPSK	20	0
18 (Note 2)	10 MHz	QPSK	27	15
19 (Note 2)	10 MHz	QPSK	32	15
20	10 MHz	QPSK	32	0
21	10 MHz	QPSK	50	0
22 (Note 1)	10 MHz	16QAM	50	0
23 (Note 3)	10 MHz	QPSK	40	0
24 (Note 3)	10 MHz	QPSK	40	1

Note 1: Applies only for UE-Categories  $\geq 2$ .  
 Note 2: Applies only for 10 MHz channel for Low Range, and 813.5 MHz  
 Note 3: Applies only for 10 MHz channel for 817 MHz range

**Table 6.2.4.4.1-15: Test Configuration Table (network signalled value "NS\_17")**

Initial Conditions					
Test Environment (as specified in TS 36.508[7] subclause 4.1)			Normal		
Test Frequencies (as specified in TS 36.508 [7] subclause 4.3.1)			Mid range		
Test Channel Bandwidths (as specified in TS 36.508 [7] subclause 4.3.1)			5MHz, 10MHz		
Test Parameters for Channel Bandwidths					
Configuration ID	Ch BW	Downlink Configuration		Uplink Configuration	
		Mod'n	RB allocation FDD	Mod'n	RB allocation FDD
1	5MHz	N/A for A-MPR testing		QPSK	1
2	5MHz			QPSK	8
3	5MHz			QPSK	25
4	5MHz			16QAM	25 (Note 3)
5	10MHz			QPSK	1
6	10MHz			QPSK	12
7	10MHz			QPSK	50
8	10MHz			16QAM	50 (Note 3)

Note 1: The 1 RB allocation shall be tested at both RB #0 and RB #max.  
 Note 2: The RBstart of partial RB allocation shall be RB# 0 and RB# (max +1 - RB allocation) of the channel bandwidth.  
 Note 3: Applies only for UE-Categories  $\geq 2$ .

**Table 6.2.4.4.1-16: Test Configuration Table (network signalled value "NS\_18")**

Initial Conditions
--------------------

Test Environment (as specified in TS 36.508[7] subclause 4.1)				Normal	
Test Frequencies (as specified in TS 36.508 [7] subclause 4.3.1)				Low range	
Test Channel Bandwidths (as specified in TS 36.508 [7] subclause 4.3.1)				5MHz, 10MHz, 15MHz, 20MHz	
Test Parameters for Channel Bandwidths					
Configuration ID	Ch BW	Downlink Configuration		Uplink Configuration	
		Mod'n	RB allocation FDD	Mod'n	RB allocation FDD
1	5MHz	N/A for A-MPR testing		QPSK	1
2	5MHz			QPSK	8
3	5MHz			QPSK	25
4	5MHz			16QAM	25 (Note 3)
5	10MHz			QPSK	1
6	10MHz			QPSK	12
7	10MHz			QPSK	50
8	10MHz			16QAM	50 (Note 3)
9	15MHz			QPSK	1
10	15MHz			QPSK	16
11	15MHz			QPSK	75
12	15MHz			16QAM	75 (Note 3)
13	20MHz			QPSK	1
14	20MHz			QPSK	18
15	20MHz			QPSK	100
16	20MHz			16QAM	100 (Note 3)
<p>Note 1: The 1 RB allocation shall be tested at both RB #0 and RB #max.</p> <p>Note 2: The RBstart of partial RB allocation shall be RB# 0 and RB# (max +1 - RB allocation) of the channel bandwidth.</p> <p>Note 3: Applies only for UE-Categories <math>\geq 2</math>.</p>					

**Table 6.2.4.4.1-17: Test Configuration Table (network signalled value "NS\_20")**

Initial Conditions					
Test Environment (as specified in TS 36.508 [7] subclause 4.1)			Normal		
Test Frequencies (as specified in TS 36.508 [7] subclause 4.3.1)			For 5 MHz Channel Bandwidth a. 2002.5 MHz ( $N_{UL} = 25525$ ) b. 2007.5 MHz ( $N_{UL} = 25575$ ) c. 2012.5 MHz ( $N_{UL} = 25625$ ) d. 2017.5 MHz ( $N_{UL} = 25675$ )  For 10 MHz Channel Bandwidth a. 2005 MHz ( $N_{UL} = 25550$ ) b. 2015 MHz ( $N_{UL} = 25650$ )  For 15 MHz Channel Bandwidth a. 2012.5 MHz ( $N_{UL} = 25625$ )  For 20 MHz Channel Bandwidth a. 2010 MHz ( $N_{UL} = 25600$ )		
Test Channel Bandwidths (as specified in TS 36.508 [7] subclause 4.3.1)			5MHz, 10MHz, 15MHz, 20MHz		
Test Parameters for NS_20 A-MPR					
		Downlink Configuration		Uplink Configuration	
Configuration ID	Ch BW	Mod'n	RB allocation FDD	Mod'n	RB allocation FDD
1	5MHz	N/A for A-MPR testing		QPSK	8
2	5MHz			QPSK	15
3	5MHz			QPSK	25
4	5MHz			16QAM	15
5	5MHz			16QAM	25
6	10MHz			QPSK	8
7	10MHz			QPSK	12
8	10MHz			QPSK	50
9	10MHz			16QAM	12
10	10MHz			16QAM	50 (Note 3)
11	15MHz			QPSK	6
12	15MHz			QPSK	25
13	15MHz			QPSK	36
14	15MHz			QPSK	75
15	15MHz			16QAM	25
16	15MHz			16QAM	36
17	15MHz			16QAM	75
18	20MHz			QPSK	8
19	20MHz			QPSK	18
20	20MHz			QPSK	25
21	20MHz			QPSK	75
22	20MHz			QPSK	100

23	20MHz	16QAM	18
24	20MHz	16QAM	25
25	20MHz	16QAM	75
26	20MHz	16QAM	100

Note 1: The Configuration ID will be used to map the applicable Test Configuration to the corresponding Test Requirement in subclause 6.2.4.5 as not all combinations are necessarily required based on the applicability of the UE.

Note 2: The RB<sub>start</sub> of partial RB allocation shall be RB# 0 and RB# (max +1 - RB allocation) of the channel bandwidth.

Note 3: Applies only for UE-Categories ≥2.

**Table 6.2.4.4.1-18: Test Configuration Table (network signalled value "NS\_19")**

Initial Conditions					
Test Environment (as specified in TS 36.508[7] subclause 4.1)				Normal	
Test Frequencies (as specified in TS 36.508 [7] subclause 4.3.1)				Low range	
Test Channel Bandwidths (as specified in TS 36.508 [7] subclause 4.3.1)				10MHz, 15MHz, 20MHz	
Test Parameters for Channel Bandwidths					
Configuration ID	Ch BW	Downlink Configuration		Uplink Configuration	
		Mod'n	RB allocation FDD	Mod'n	RB allocation FDD
1	10MHz	N/A		QPSK	40
2	10MHz			16QAM	40 (Note 3)
3	15MHz			QPSK	1
4	15MHz			QPSK	18
5	15MHz			QPSK	36
6	15MHz			QPSK	45
7	15MHz			16QAM	45 (Note 3)
8	20MHz			QPSK	1
9	20MHz			QPSK	40
10	20MHz			QPSK	45
11	20MHz			QPSK	50
12	20MHz			16QAM	50 (Note 3)

Note 1: The 1 RB allocation shall be tested at both RB #0 and RB #max.

Note 2: The RB<sub>start</sub> of partial RB allocation shall be RB# 0 and RB# (max +1 - RB allocation) of the channel bandwidth.

Note 3: Applies only for UE-Categories ≥2.

**Table 6.2.4.4.1-19: Test Configuration Table (network signalled value "NS\_21")**

Initial Conditions						
Test Environment (as specified in TS 36.508 [7] subclause 4.1)				NC		
Test Frequencies (as specified in TS 36.508 [7] subclause 4.3.1)				Low range or High range		
Test Channel Bandwidths (as specified in TS 36.508 [7] subclause 4.3.1)				5 MHz, 10 MHz		
Test Parameters for Channel Bandwidths						
Configuration ID	Ch BW	Downlink Configuration		Uplink Configuration		
		Mod'n	RB allocation	Mod'n	RB allocation FDD	RBstart FDD
1 (note 2)	5 MHz			QPSK	1	0
2 (note 2)	5 MHz			QPSK	25	0
3 (note 2)	10 MHz			QPSK	1	0
4 (note 3)	10 MHz			QPSK	1	49
5 (note 2)	10 MHz			QPSK	15	0
6 (note 3)	10 MHz			QPSK	3	47
7 (note 3)	10 MHz			QPSK	50	0
8 (note 1, 3)	10 MHz			16QAM	50	0
Note 1: Applies only for UE-Categories ≥2. Note 2: Applicable only to low range frequency testing. Note 3: Applicable only to high range frequency testing.						

**Editor’s note:** The following lines belong at the end of section 6.2.4.4.1. As new tables are added to this section, these lines should always follow the tables.

1. Connect the SS to the UE antenna connectors as shown in Figure TS 36.508 [7] Annex A, Figure A.3.
2. The parameter settings for the cell are set up according to TS 36.508 [7] clause 4.4.3.
3. Downlink signals are initially set up according to Annex C.0, C.1, and C.3.0, and uplink signals according to Annex H.1 and H.3.0.
4. The UL Reference Measurement channels are set according to the applicable table from Table 6.2.4.4.1-1 to Table 6.2.4.4.1-19.
5. Propagation conditions are set according to Annex B.0.
6. Ensure the UE is in State 3A-RF according to TS 36.508 [7] clause 5.2A.2. Message contents are defined in clause 6.2.4.4.3.

**6.2.4.4.2 Test procedure**

1. SS sends uplink scheduling information for each UL HARQ process via PDCCH DCI format 0 for C\_RNTI to schedule the UL RMC according to the applicable table from Table 6.2.4.4.1-1 to Table 6.2.4.4.1-19. Since the UE has no payload data to send, the UE transmits uplink MAC padding bits on the UL RMC.
2. Send continuously uplink power control "up" commands in the uplink scheduling information to the UE until the UE transmits at P<sub>UMAX</sub> level.
3. Measure the mean power of the UE in the channel bandwidth of the radio access mode. The period of measurement shall be at least the continuous duration one sub-frame (1ms). For TDD slots with transient periods are not under test.

### 6.2.4.4.3 Message contents

Message contents are according to TS 36.508 [7] subclause 4.6, with the following exceptions for each network signalled value.

#### 6.2.4.4.3.1 Message contents exceptions (network signalled value "NS\_03")

1. Information element `additionalSpectrumEmission` is set to NS\_03. This can be set in the *SystemInformationBlockType2* as part of the cell broadcast message. This exception indicates that the UE shall meet the additional spurious emission requirement for a specific deployment scenario.

**Table 6.2.4.4.3.1-1: SystemInformationBlockType2: Additional spurious emissions test requirement for "NS\_03"**

Derivation Path: TS 36.508 [7] clause 4.4.3.3, Table 4.4.3.3-1			
Information Element	Value/remark	Comment	Condition
<code>additionalSpectrumEmission</code>	3 (NS_03)		

#### 6.2.4.4.3.2 Message contents exceptions (network signalled value "NS\_04")

1. Information element `additionalSpectrumEmission` is set to NS\_04. This can be set in the *SystemInformationBlockType2* as part of the cell broadcast message. This exception indicates that the UE shall meet the additional spurious emission requirement for a specific deployment scenario.

**Table 6.2.4.4.3.2-1: SystemInformationBlockType2: Additional spurious emissions test requirement for "NS\_04"**

Derivation Path: TS 36.508 [7] clause 4.4.3.3, Table 4.4.3.3-1			
Information Element	Value/remark	Comment	Condition
<code>additionalSpectrumEmission</code>	4 (NS_04)		

#### 6.2.4.4.3.3 Message contents exceptions (network signalled value "NS\_05")

1. Information element `additionalSpectrumEmission` is set to NS\_05. This can be set in the *SystemInformationBlockType2* as part of the cell broadcast message. This exception indicates that the UE shall meet the additional spurious emission requirement for a specific deployment scenario.

**Table 6.2.4.4.3.3-1: SystemInformationBlockType2: Additional spurious emissions test requirement for "NS\_05"**

Derivation Path: TS 36.508 [7] clause 4.4.3.3, Table 4.4.3.3-1			
Information Element	Value/remark	Comment	Condition
<code>additionalSpectrumEmission</code>	5 (NS_05)		

#### 6.2.4.4.3.4 Message contents exceptions (network signalled value "NS\_06")

1. Information element `additionalSpectrumEmission` is set to NS\_06. This can be set in the *SystemInformationBlockType2* as part of the cell broadcast message. This exception indicates that the UE shall meet the additional spurious emission requirement for a specific deployment scenario.

**Table 6.2.4.4.3.4-1: SystemInformationBlockType2: Additional spurious emissions test requirement for "NS\_06"**

Derivation Path: TS 36.508 [7] clause 4.4.3.3, Table 4.4.3.3-1			
Information Element	Value/remark	Comment	Condition
<code>additionalSpectrumEmission</code>	6 (NS_06)		

## 6.2.4.4.3.5 Message contents exceptions (network signalled value "NS\_07")

1. Information element `additionalSpectrumEmission` is set to NS\_07. This can be set in the *SystemInformationBlockType2* as part of the cell broadcast message. This exception indicates that the UE shall meet the additional spurious emission requirement for a specific deployment scenario.

**Table 6.2.4.4.3.5-1: SystemInformationBlockType2: Additional spurious emissions test requirement for "NS\_07"**

Derivation Path: TS 36.508 [7] clause 4.4.3.3, Table 4.4.3.3-1			
Information Element	Value/remark	Comment	Condition
<code>additionalSpectrumEmission</code>	7 (NS_07)		

## 6.2.4.4.3.6 Message contents exceptions (network signalled value "NS\_08")

1. Information element `additionalSpectrumEmission` is set to NS\_08. This can be set in the *SystemInformationBlockType2* as part of the cell broadcast message. This exception indicates that the UE shall meet the additional spurious emission requirement for a specific deployment scenario.

**Table 6.2.4.4.3.6-1: SystemInformationBlockType2: Additional spurious emissions test requirement for "NS\_08"**

Derivation Path: TS 36.508 [7] clause 4.4.3.3, Table 4.4.3.3-1			
Information Element	Value/remark	Comment	Condition
<code>additionalSpectrumEmission</code>	8 (NS_08)		

## 6.2.4.4.3.7 Message contents exceptions (network signalled value "NS\_09")

1. Information element `additionalSpectrumEmission` is set to NS\_09. This can be set in the *SystemInformationBlockType2* as part of the cell broadcast message. This exception indicates that the UE shall meet the additional spurious emission requirement for a specific deployment scenario.

**Table 6.2.4.4.3.7-1: SystemInformationBlockType2: Additional spurious emissions test requirement for "NS\_09"**

Derivation Path: TS 36.508 [7] clause 4.4.3.3, Table 4.4.3.3-1			
Information Element	Value/remark	Comment	Condition
<code>additionalSpectrumEmission</code>	9 (NS_09)		

## 6.2.4.4.3.8 Message contents exceptions (network signalled value "NS\_10")

Void

## 6.2.4.4.3.9 Message contents exceptions (network signalled value "NS\_11")

1. Information element `additionalSpectrumEmission` is set to NS\_11. This can be set in the *SystemInformationBlockType2* as part of the cell broadcast message. This exception indicates that the UE shall meet the additional spurious emission requirement for a specific deployment scenario.

**Table 6.2.4.4.3.9-1: SystemInformationBlockType2: Additional spurious emissions test requirement for "NS\_11"**

Derivation Path: TS 36.508 [7] clause 4.4.3.3, Table 4.4.3.3-1			
Information Element	Value/remark	Comment	Condition
<code>additionalSpectrumEmission</code>	11 (NS_11)		

## 6.2.4.4.3.10 Message contents exceptions (network signalled value "NS\_12")

1. Information element `additionalSpectrumEmission` is set to NS\_12. This can be set in the *SystemInformationBlockType2* as part of the cell broadcast message. This exception indicates that the UE shall meet the additional spurious emission requirement for a specific deployment scenario.

**Table 6.2.4.4.3.10-1: SystemInformationBlockType2: Additional spurious emissions test requirement for "NS\_12"**

Derivation Path: TS 36.508 [7] clause 4.4.3.3, Table 4.4.3.3-1			
Information Element	Value/remark	Comment	Condition
<code>additionalSpectrumEmission</code>	12 (NS_12)		

## 6.2.4.4.3.11 Message contents exceptions (network signalled value "NS\_13")

1. Information element `additionalSpectrumEmission` is set to NS\_13. This can be set in the *SystemInformationBlockType2* as part of the cell broadcast message. This exception indicates that the UE shall meet the additional spurious emission requirement for a specific deployment scenario.

**Table 6.2.4.4.3.11-1: SystemInformationBlockType2: Additional spurious emissions test requirement for "NS\_13"**

Derivation Path: TS 36.508 [7] clause 4.4.3.3, Table 4.4.3.3-1			
Information Element	Value/remark	Comment	Condition
<code>additionalSpectrumEmission</code>	13 (NS_13)		

## 6.2.4.4.3.12 Message contents exceptions (network signalled value "NS\_14")

1. Information element `additionalSpectrumEmission` is set to NS\_14. This can be set in the *SystemInformationBlockType2* as part of the cell broadcast message. This exception indicates that the UE shall meet the additional spurious emission requirement for a specific deployment scenario.

**Table 6.2.4.4.3.12-1: SystemInformationBlockType2: Additional spurious emissions test requirement for "NS\_14"**

Derivation Path: TS 36.508 [7] clause 4.4.3.3, Table 4.4.3.3-1			
Information Element	Value/remark	Comment	Condition
<code>additionalSpectrumEmission</code>	14 (NS_14)		

## 6.2.4.4.3.13 Message contents exceptions (network signalled value "NS\_15")

1. Information element `additionalSpectrumEmission` is set to NS\_15. This can be set in the *SystemInformationBlockType2* as part of the cell broadcast message. This exception indicates that the UE shall meet the additional spurious emission requirement for a specific deployment scenario.

**Table 6.2.4.4.3.13-1: SystemInformationBlockType2: Additional spurious emissions test requirement for "NS\_15"**

Derivation Path: TS 36.508 [7] clause 4.4.3.3, Table 4.4.3.3-1			
Information Element	Value/remark	Comment	Condition
<code>additionalSpectrumEmission</code>	15 (NS_15)		

## 6.2.4.4.3.14 Message contents exceptions (network signalled value "NS\_16")

1. Information element `additionalSpectrumEmission` is set to NS\_16. This can be set in the *SystemInformationBlockType2* as part of the cell broadcast message. This exception indicates that the UE shall meet the additional spurious emission requirement for a specific deployment scenario.



**Table 6.2.4.4.3.14-1: SystemInformationBlockType2: Additional spurious emissions test requirement for "NS\_16"**

Derivation Path: TS 36.508 [7] clause 4.4.3.3, Table 4.4.3.3-1			
Information Element	Value/remark	Comment	Condition
additionalSpectrumEmission	16 (NS_16)		

## 6.2.4.4.3.15 Message contents exceptions (network signalled value "NS\_17")

1. Information element additionalSpectrumEmission is set to NS\_17. This can be set in the *SystemInformationblockType2* as part of the cell broadcast message. This exception indicates that the UE shall meet the additional spurious emission requirement for a specific deployment scenario.

**Table 6.2.4.4.3.15-1: SystemInformationBlockType2: Additional spurious emissions test requirement for "NS\_17"**

Derivation Path: TS 36.508 [7] clause 4.4.3.3, Table 4.4.3.3-1			
Information Element	Value/remark	Comment	Condition
additionalSpectrumEmission	17 (NS_17)		

## 6.2.4.4.3.16 Message contents exceptions (network signalled value "NS\_18")

1. Information element additionalSpectrumEmission is set to NS\_18. This can be set in the *SystemInformationblockType2* as part of the cell broadcast message. This exception indicates that the UE shall meet the additional spurious emission requirement for a specific deployment scenario.

**Table 6.2.4.4.3.16-1: SystemInformationBlockType2: Additional spurious emissions test requirement for "NS\_18"**

Derivation Path: TS 36.508 [7] clause 4.4.3.3, Table 4.4.3.3-1			
Information Element	Value/remark	Comment	Condition
additionalSpectrumEmission	18 (NS_18)		

## 6.2.4.4.3.17 Message contents exceptions (network signalled value "NS\_19")

1. Information element additionalSpectrumEmission is set to NS\_19. This can be set in the *SystemInformationblockType2* as part of the cell broadcast message. This exception indicates that the UE shall meet the additional spurious emission requirement for a specific deployment scenario.

**Table 6.2.4.4.3.17-1: SystemInformationBlockType2: Additional spurious emissions test requirement for "NS\_19"**

Derivation Path: TS 36.508 [7] clause 4.4.3.3, Table 4.4.3.3-1			
Information Element	Value/remark	Comment	Condition
additionalSpectrumEmission	19 (NS_19)		

## 6.2.4.4.3.18 Message contents exceptions (network signalled value "NS\_20")

1. Information element additionalSpectrumEmission is set to NS\_20. This can be set in the *SystemInformationblockType2* as part of the cell broadcast message. This exception indicates that the UE shall meet the additional spurious emission requirement for a specific deployment scenario.

**Table 6.2.4.4.3.18-1: SystemInformationBlockType2: Additional spurious emissions test requirement for "NS\_20"**

Derivation Path: TS 36.508 [7] clause 4.4.3.3, Table 4.4.3.3-1			
Information Element	Value/remark	Comment	Condition
additionalSpectrumEmission	20 (NS_20)		

## 6.2.4.4.3.19 Message contents exceptions (network signalled value "NS\_21")

1. Information element `additionalSpectrumEmission` is set to NS\_21. This can be set in the *SystemInformationBlockType2* as part of the cell broadcast message. This exception indicates that the UE shall meet the additional spurious emission requirement for a specific deployment scenario.

**Table 6.2.4.4.3.19-1: SystemInformationBlockType2: Additional spurious emissions test requirement for "NS\_21"**

Derivation Path: TS 36.508 [7] clause 4.4.3.3, Table 4.4.3.3-1			
Information Element	Value/remark	Comment	Condition
<code>additionalSpectrumEmission</code>	21 (NS_21)		

## 6.2.4.5 Test requirements

The maximum output power, derived in step 3 shall be within the range prescribed by the nominal maximum output power and tolerance in the applicable table from Table 6.2.4.5-1 to Table 6.2.4.5-21. The allowed A-MPR values specified in Table 6.2.4.3-1 are in addition to the allowed MPR requirements specified in clause 6.2.3. For the UE maximum output power modified by MPR and/or A-MPR, the power limits specified in Table 6.2.5.3-1 apply.

**Table 6.2.4.5-1: UE Power Class test requirements (network signalled value "NS\_03")  
(for Bands 4, 10, 23, 35, and 36)**

Configuration ID	EUTRA band	Class 1 (dBm)	Tol. (dB)	Class 2 (dBm)	Tol. (dB)	Class 3 (dBm)	Tol. (dB)
1	4,10,23,35,36					23	+2.7 / -3.7
2	4,10,23,35,36					23	+2.7 / -2.7
3	4,10,23,35,36					23	+2.7 / -3.7
4	4,10,23,35,36					23	+2.7 / -4.7
5	4,10,23,35,36					23	+2.7 / -2.7
6	4,10,23,35,36					23	+2.7 / -6.2
7	4,10,23,35,36					23	+2.7 / -3.7
8	4,10,23,35,36					23	+2.7 / -4.7
9	4,10,23,35,36					23	+2.7 / -3.7
10	4,10,23,35,36					23	+2.7 / -2.7
11	4,10,23,35,36					23	+2.7 / -6.2
12	4,10,23,35,36					23	+2.7 / -4.7
13	4,10,23,35,36					23	+2.7 / -4.7
14	4,10,23,35,36					23	+2.7 / -3.7
15	4,10,23,35,36					23	+2.7 / -2.7
16	4,10,23,35,36					23	+2.7 / -6.2
17	4,10,23,35,36					23	+2.7 / -4.7
18	4,10,35,36					23	+2.7 / -4.7
19	4,10,35,36					23	+2.7 / -3.7
20	4,10,35,36					23	+2.7 / -2.7
21	4,10,35,36					23	+2.7 / -6.2
22	4,10,35,36					23	+2.7 / -4.7
23	4,10,35,36					23	+2.7 / -4.7
24	4,10,35,36					23	+2.7 / -3.7
25	4,10,35,36					23	+2.7 / -2.7
26	4,10,35,36					23	+2.7 / -6.2
27	4,10,35,36					23	+2.7 / -4.7

**Table 6.2.4.5-2: UE Power Class test requirements (network signalled value "NS\_03")  
(for Bands 2 and 25)**

Configuration ID	EUTRA band	Test Freq.	Class 1 (dBm)	Tol. (dB)	Class 2 (dBm)	Tol. (dB)	Class 3 (dBm)	Tol. (dB)
1	2, 25	Mid					23	+2.7 / -3.7
1	2, 25	Low, High					23	+2.7 / -5.7
2	2, 25	Mid					23	+2.7 / -2.7
2	2, 25	Low, High					23	+2.7 / -4.2
3	2, 25	Mid					23	+2.7 / -3.7
3	2, 25	Low, High					23	+2.7 / -5.7
4	2, 25	Mid					23	+2.7 / -4.7
4	2, 25	Low, High					23	+2.7 / -7.7
5	2, 25	Mid					23	+2.7 / -2.7
5	2, 25	Low, High					23	+2.7 / -4.2
6	2, 25	Mid					23	+2.7 / -6.2
6	2, 25	Low, High					23	+2.7 / -9.2
7	2, 25	Mid					23	+2.7 / -3.7
7	2, 25	Low, High					23	+2.7 / -5.7
8	2, 25	All					23	+2.7 / -4.7
9	2, 25	Low @ RB#(max+1-RB allocation), Mid, High @ RB#0					23	+2.7 / -3.7
9	2, 25	Low @ RB#0, High @ RB#(max+1-RB allocation)					23	+2.7 / -5.7
10	2, 25	Low @ RB#(max+1-RB allocation), Mid, High @ RB#0					23	+2.7 / -2.7
10	2, 25	Low @ RB#0, High @ RB#(max+1-RB allocation)					23	+2.7 / -4.2
11	2, 25	All					23	+2.7 / -6.2
12	2, 25	Low @ RB#(max+1-RB allocation), Mid, High @ RB#0					23	+2.7 / -4.7
12	2, 25	Low @ RB#0, High @ RB#(max+1-RB allocation)					23	+2.7 / -7.7
13	2, 25	All					23	+2.7 / -4.7
14	2, 25	Low @ RB#(max+1-RB allocation), Mid, High @ RB#0					23	+2.7 / -3.7
14	2, 25	Low @ RB#0, High @ RB#(max+1-RB					23	+2.7 / -5.7

		allocation)						
15	2, 25	Low @ RB#(max+1-RB allocation), Mid, High @ RB#0					23	+2.7 / -2.7
15	2, 25	Low @ RB#0, High @ RB#(max+1-RB allocation)					23	+2.7 / -4.2
16	2, 25	All					23	+2.7 / -6.2
17	2, 25	Low @ RB#(max+1-RB allocation), Mid, High @ RB#0					23	+2.7 / -4.7
17	2, 25	Low @ RB#0, High @ RB#(max+1-RB allocation)					23	+2.7 / -7.7
18	2, 25	All					23	+2.7 / -4.7
19	2, 25	Low @ RB#(max+1-RB allocation), Mid, High @ RB#0					23	+2.7 / -3.7
19	2, 25	Low @ RB#0, High @ RB#(max+1-RB allocation)					23	+2.7 / -5.7
20	2, 25	Low @ RB#(max+1-RB allocation), Mid, High @ RB#0					23	+2.7 / -2.7
20	2, 25	Low @ RB#0, High @ RB#(max+1-RB allocation)					23	+2.7 / -4.2
21	2, 25	All					23	+2.7 / -6.2
22	2, 25	Low @ RB#(max+1-RB allocation), Mid, High @ RB#0					23	+2.7 / -4.7
22	2, 25	Low @ RB#0, High @ RB#(max+1-RB allocation)					23	+2.7 / -7.7
23	2, 25	All					23	+2.7 / -4.7
24	2, 25	All					23	+2.7 / -3.7
25	2, 25	Low @ RB#(max+1-RB allocation), Mid, High @ RB#0					23	+2.7 / -2.7
25	2, 25	Low @ RB#0, High @ RB#(max+1-RB allocation)					23	+2.7 / -4.2
26	2, 25	All					23	+2.7 / -6.2
27	2, 25	All					23	+2.7 / -4.7

Table 6.2.4.5-3: UE Power Class test requirements (network signalled value "NS\_04")

Configuration ID	EUTRA band	Bandwidth (MHz)	Class 3 (dBm)	Tol. (dB)
1	41	5 MHz	23	+2.7 / -4.7
2	41	5 MHz	23	+2.7 / -3.7
3	41	5 MHz	23	+2.7 / -2.7
4	41	5 MHz	23	+2.7 / -6.2
5	41	5 MHz	23	+2.7 / -4.7
6	41	10MHz	23	+2.7 / -6.2
7	41	10MHz	23	+2.7 / -6.2
8	41	10MHz	23	+2.7 / -8.2
9	41	10MHz	23	+2.7 / -9.7
10	41	10MHz	23	+2.7 / -3.7
11	41	10MHz	23	+2.7 / -4.7
12	41	10MHz	23	+2.7 / -6.2
13	41	10MHz	23	+2.7 / -6.2
14	41	10MHz	23	+2.7 / -6.2
15	41	15MHz	23	+2.7 / -6.2
16	41	15MHz	23	+2.7 / -6.2
17	41	15MHz	23	+2.7 / -8.2
18	41	15MHz	23	+2.7 / -9.7
19	41	15MHz	23	+2.7 / -3.7
20	41	15MHz	23	+2.7 / -4.7
21	41	15MHz	23	+2.7 / -6.2
22	41	15MHz	23	+2.7 / -8.2
23	41	15MHz	23	+2.7 / -6.2
24	41	20MHz	23	+2.7 / -6.2
25	41	20MHz	23	+2.7 / -6.2
26	41	20MHz	23	+2.7 / -8.2
27	41	20MHz	23	+2.7 / -9.7
28	41	20MHz	23	+2.7 / -3.7
29	41	20MHz	23	+2.7 / -4.7
30	41	20MHz	23	+2.7 / -6.2
31	41	20MHz	23	+2.7 / -8.2
32	41	20MHz	23	+2.7 /

				-6.2
--	--	--	--	------

**Table 6.2.4.5-4: UE Power Class test requirements (network signalled value "NS\_05")**

Configuration ID	EUTRA band	Class 1 (dBm)	Tol. (dB)	Class 2 (dBm)	Tol. (dB)	Class 3 (dBm)	Tol. (dB)
1	1					23	+2.7 / -2.7
2	1					23	+2.7 / -3.7
3	1					23	+2.7 / -2.7
4	1					23	+2.7 / -2.7
5	1					23	+2.7 / -3.7
6	1					23	+2.7 / -4.7
7	1					23	+2.7 / -6.2
8	1					23	+2.7 / -2.7
9	1					23	+2.7 / -2.7
10	1					23	+2.7 / -3.7
11	1					23	+2.7 / -3.7
12	1					23	+2.7 / -4.7
13	1					23	+2.7 / -6.2
14	1					23	+2.7 / -2.7
15	1					23	+2.7 / -2.7
16	1					23	+2.7 / -3.7
17	1					23	+2.7 / -3.7
18	1					23	+2.7 / -4.7
19	1					23	+2.7 / -6.2

**Table 6.2.4.5-5: UE Power Class test requirements (network signalled value "NS\_06")  
(for Bands 13, 14, and 17)**

Configuration ID	EUTRA band	Class 1 (dBm)	Tol. (dB)	Class 2 (dBm)	Tol. (dB)	Class 3 (dBm)	Tol. (dB)
1	13,14,17					23	+2.7 / -3.7
2	13,14,17					23	+2.7 / -2.7
3	13,14,17					23	+2.7 / -2.7
4	13,14,17					23	+2.7 / -3.7
5	13,14,17					23	+2.7 / -2.7
6	13,14,17					23	+2.7 / -3.7
7	13,14,17					23	+2.7 / -3.7
8	13,14,17					23	+2.7 / -2.7
9	13,14,17					23	+2.7 / -3.7
10	13,14,17					23	+2.7 / -3.7
11	13,14,17					23	+2.7 / -2.7
12	13,14,17					23	+2.7 / -3.7
13	13,14,17					23	+2.7 / -3.7
14	13,14,17					23	+2.7 / -2.7
15	13,14,17					23	+2.7 / -3.7
16	13,14,17					23	+2.7 / -3.7
17	13,14,17					23	+2.7 / -2.7
18	13,14,17					23	+2.7 / -3.7



**Table 6.2.4.5-6: UE Power Class test requirements (network signalled value "NS\_06")  
(for Band 12)**

Configuration ID	EUTRA band	Test Freq.	Class 1 (dBm)	Tol. (dB)	Class 2 (dBm)	Tol. (dB)	Class 3 (dBm)	Tol. (dB)
1	12	Mid					23	+2.7 / -3.7
1	12	Low, High					23	+2.7 / -5.7
2	12	Mid					23	+2.7 / -2.7
2	12	Low, High					23	+2.7 / -4.2
3	12	Mid					23	+2.7 / -2.7
3	12	Low, High					23	+2.7 / -4.2
4	12	Mid					23	+2.7 / -3.7
4	12	Low, High					23	+2.7 / -5.7
5	12	Mid					23	+2.7 / -2.7
5	12	Low, High					23	+2.7 / -4.2
6	12	Mid					23	+2.7 / -3.7
6	12	Low, High					23	+2.7 / -5.7
7	12	All					23	+2.7 / -3.7
8	12	Low @ RB#(max+1-RB allocation), Mid, High @ RB#0					23	+2.7 / -2.7
8	12	Low @ RB#0, High @ RB#(max+1-RB allocation)					23	+2.7 / -4.2
9	12	Low @ RB#(max+1-RB allocation), Mid, High @ RB#0					23	+2.7 / -3.7
9	12	Low @ RB#0, High @ RB#(max+1-RB allocation)					23	+2.7 / -5.7
10	12	All					23	+2.7 / -3.7
11	12	Low @ RB#(max+1-RB allocation), Mid, High @ RB#0					23	+2.7 / -2.7
11	12	Low @ RB#0, High @ RB#(max+1-RB allocation)					23	+2.7 / -4.2
12	12	Low @ RB#(max+1-RB allocation), Mid, High @ RB#0					23	+2.7 / -3.7
12	12	Low @ RB#0, High @ RB#(max+1-RB allocation)					23	+2.7 / -5.7

Table 6.2.4.5-7: UE Power Class test requirements (network signalled value "NS\_07")

Configuration ID	EUTRA band	Class 1 (dBm)	Tol. (dB)	Class 2 (dBm)	Tol. (dB)	Class 3 (dBm)	Tol. (dB)
1	13					23	+2.7 / -18.7
2	13					23	+2.7 / -13.7
3	13					23	+2.7 / -2.7
4	13					23	+2.7 / -19.7
5	13					23	+2.7 / -18.7
6	13					23	+2.7 / -20.7
7	13					23	+2.7 / -3.7
8	13					23	+2.7 / -2.7
9	13					23	+2.7 / -4.7
10	13					23	+2.7 / -12.7
11	13					23	+2.7 / -13.7
12	13					23	+2.7 / -2.7
13	13					23	+2.7 / -6.2
14	13					23	+2.7 / -19.7
15	13					23	+2.7 / -18.7
16	13					23	+2.7 / -20.7

Table 6.2.4.5-8: UE Power Class test requirements (network signalled value "NS\_08")

Configuration ID	EUTRA band	Class 1 (dBm)	Tol. (dB)	Class 2 (dBm)	Tol. (dB)	Class 3 (dBm)	Tol. (dB)
1	19					23	+2.7 / -2.7
2	19					23	+2.7 / -2.7
3	19					23	+2.7 / -3.7
4	19					23	+2.7 / -2.7
5	19					23	+2.7 / -2.7
6	19					23	+2.7 / -3.7
7	19					23	+2.7 / -8.2
8	19					23	+2.7 / -9.7
9	19					23	+2.7 / -2.7
10	19					23	+2.7 / -2.7
11	19					23	+2.7 / -3.7
12	19					23	+2.7 / -8.2
13	19					23	+2.7 / -9.7

Table 6.2.4.5-9: UE Power Class test requirements (network signalled value "NS\_09")

Configuration ID	EUTRA band	Class 1 (dBm)	Tol. (dB)	Class 2 (dBm)	Tol. (dB)	Class 3 (dBm)	Tol. (dB)
1	21					23	+2.7 / -2.7
2	21					23	+2.7 / -2.7
3	21					23	+2.7 / -3.7
4	21					23	+2.7 / -2.7
5	21					23	+2.7 / -2.7
6	21					23	+2.7 / -3.7
7	21					23	+2.7 / -4.7
8	21					23	+2.7 / -6.2
9	21					23	+2.7 / -2.7
19	21					23	+2.7 / -2.7
11	21					23	+2.7 / -3.7
12	21					23	+2.7 / -4.7
13	21					23	+2.7 / -6.2
14	21					23	+2.7 / -8.2

**Table 6.2.4.5-10: UE Power Class test requirements (network signalled value "NS\_10")**

Void, not tested
------------------

Table 6.2.4.5-11: UE Power Class test requirements (network signalled value "NS\_11 for Band 23")

Configuration ID	EUTRA Band	Centre Frequency	Class 1 (dBm)	Tol. (dB)	Class 2 (dBm)	Tol. (dB)	Class 3 (dBm)	Tol. (dB)
1a	23	2001.5 MHz					23	+ 2.7 / -11.7
1b	23	2004.5 MHz					23	+ 2.7 / -4.7
2a	23	2001.5 MHz					23	+ 2.7 / -11.7
2b	23	2004.5 MHz					23	+ 2.7 / -4.7
3a	23	2001.5 MHz					23	+ 2.7 / -12.7
3b	23	2004.5 MHz					23	+ 2.7 / -6.2
4a	23	2001.5 MHz					23	+ 2.7 / -12.7
4b	23	2004.5 MHz					23	+ 2.7 / -6.2
5a	23	2002.5 MHz					23	+ 2.7 / -12.7
5b	23	2004.5 MHz					23	+ 2.7 / -8.2
5c	23	2007.5 MHz					23	+ 2.7 / -2.7
6a	23	2002.5 MHz					23	+ 2.7 / -12.7
6b	23	2004.5 MHz					23	+ 2.7 / -2.7
6c	23	2007.5 MHz					23	+ 2.7 / -3.7
7a	23	2002.5 MHz					23	+ 2.7 / -13.7
7b	23	2004.5 MHz					23	+ 2.7 / -9.7
7c	23	2007.5 MHz					23	+ 2.7 / -4.7
8a	23	2002.5 MHz					23	+ 2.7 / -13.7
8b	23	2004.5 MHz					23	+ 2.7 / -3.7
8c	23	2007.5 MHz					23	+ 2.7 / -4.7
9a	23	2002.5 MHz					23	+ 2.7 / -14.7
9b	23	2004.5 MHz					23	+ 2.7 / -11.7
9c	23	2007.5 MHz					23	+ 2.7 / -6.2
10a	23	2005 MHz					23	+ 2.7 /

Configuration ID	EUTRA Band	Centre Frequency	Class 1 (dBm)	Tol. (dB)	Class 2 (dBm)	Tol. (dB)	Class 3 (dBm)	Tol. (dB)
								-17.7
10b	23	2005.5 MHz					23	+ 2.7 / -17.7
10c	23	2015 MHz					23	+ 2.7 / -2.7
11a	23	2005 MHz					23	+ 2.7 / -17.7
11b	23	2005.5 MHz					23	+ 2.7 / -17.7
11c	23	2015 MHz					23	+ 2.7 / -2.7
12a	23	2005 MHz					23	+ 2.7 / -18.7
12b	23	2005.5 MHz					23	+ 2.7 / -18.7
12c	23	2015 MHz					23	+ 2.7 / -3.7
13a	23	2005 MHz					23	+ 2.7 / -18.7
13b	23	2005.5 MHz					23	+ 2.7 / -18.7
13c	23	2015 MHz					23	+ 2.7 / -3.7
14a	23	2005 MHz					23	+ 2.7 / -20.7
14b	23	2005.5 MHz					23	+ 2.7 / -20.7
14c	23	2015 MHz					23	+ 2.7 / -4.7
15a	23	2007.5 MHz					23	+ 2.7 / -21.7
15b	23	2012.5 MHz					23	+ 2.7 / -16.7
16a	23	2007.5 MHz					23	+ 2.7 / -13.7
16b (Note 1)	23	2012.5 MHz					23	+ 2.7 / -13.2
16b (Note 2)	23	2012.5 MHz					23	+ 2.7 / -12.2
17a	23	2007.5 MHz					23	+ 2.7 / -3.7
17b	23	2012.5 MHz					23	+ 2.7 / -3.7
18a	23	2007.5 MHz					23	+ 2.7 / -12.7
18b	23	2012.5 MHz					23	+ 2.7 / -12.7
19a	23	2007.5 MHz					23	+ 2.7 / -16.7
19b	23	2012.5 MHz					23	+ 2.7 / -8.7
20a	23	2007.5 MHz					23	+ 2.7 / -13.7
20b (Note 1)	23	2012.5 MHz					23	+ 2.7 / -13.2
20b (Note 2)	23	2012.5 MHz					23	+ 2.7 / -13.2
21a	23	2007.5 MHz					23	+ 2.7 / -4.7

Configuration ID	EUTRA Band	Centre Frequency	Class 1 (dBm)	Tol. (dB)	Class 2 (dBm)	Tol. (dB)	Class 3 (dBm)	Tol. (dB)
21b	23	2012.5 MHz					23	+ 2.7 / -3.7
22a	23	2007.5 MHz					23	+ 2.7 / -13.7
22b	23	2012.5 MHz					23	+ 2.7 / -13.7
23a	23	2007.5 MHz					23	+ 2.7 / -17.7
23b	23	2012.5 MHz					23	+ 2.7 / -9.7
24	23	2010 MHz					23	+ 2.7 / -20.7
25	23	2010 MHz					23	+ 2.7 / -2.7
26	23	2010 MHz					23	+ 2.7 / -13.7
27	23	2010 MHz					23	+ 2.7 / -16.7
28	23	2010 MHz					23	+ 2.7 / -3.7
29	23	2010 MHz					23	+ 2.7 / -14.7
30	23	2010 MHz					23	+ 2.7 / -17.7
Note 1: RB <sub>start</sub> = RB# 0								
Note 2: RB <sub>start</sub> = RB# (max +1 - RB allocation)								

Table 6.2.4.5-12: UE Power Class 3 test requirements (network signalled value "NS\_12")

Configuration ID	MPR (dB)	A-MPR (dB)	$\Delta T_{c,c}$ (dB)	$P_{\text{CMAX},c}$ (dBm)	$T(P_{\text{CMAX},L,c})$ (dB)	Upper limit (dBm)	Lower limit (dBm)
1	0	3	1.5	18.5	4	25.7	13.8
2	1	4	1.5	16.5	5	25.7	10.8
3	0	0	1.5	21.5	2	25.7	18.8
4	0	3	1.5	18.5	4	25.7	13.8
5	2	4	1.5	15.5	5	25.7	9.8
6	0	4	1.5	17.5	5	25.7	11.8
7	1	3	1.5	17.5	5	25.7	11.8
8	0	0	1.5	21.5	2	25.7	18.8
9	1	3	1.5	17.5	5	25.7	11.8
10	2	4	1.5	15.5	5	25.7	9.8
11	0	4	1.5	17.5	5	25.7	11.8
12	1	3	1.5	17.5	5	25.7	11.8
13	0	0	1.5	21.5	2	25.7	18.8
14	1	3	0	19	3,5	25.7	14.8
15	2	3	0	18	4	25.7	13.3
16	1	4	1.5	16.5	5	25.7	10.8
17	1	0	0	22	2	25.7	19.3
18	2	2	0	19	2	25.7	16.3
19	1	4	0	18	4	25.7	13.3
20	1	0	0	22	2	25.7	19.3
21	2	3	0	18	4	25.7	13.3

Note 1: Lower limit is assuming  $\Delta T_{IB,c}$  is zero. If non-zero,  $P_{\text{CMAX},c}$  will decrease and  $T(P_{\text{CMAX},L,c})$  may be higher resulting in different test requirements according to Table 6.2.5.3-1.

Table 6.2.4.5-13: UE Power Class 3 test requirements (network signalled value "NS\_13")

Configuration ID	MPR (dB)	A-MPR (dB)	$\Delta T_{c,c}$ (dB)	$P_{\text{CMAX},c}$ (dBm)	$T(P_{\text{CMAX},L,c})$ (dB)	Upper limit (dBm)	Lower limit (dBm)
1	1	0	0	22	2	25.7	19.3
2	1	0	0	22	2	25.7	19.3
3	0	3	0	20	2.5	25.7	16.8
4	1	2	0	20	2.5	25.7	16.8
5	1	0	0	22	2	25.7	19.3
6	1	0	0	22	2	25.7	19.3
7	2	2	0	19	3.5	25.7	14.8

Note 1: Lower limit is assuming  $\Delta T_{IB,c}$  is zero. If non-zero,  $P_{\text{CMAX},c}$  will decrease and  $T(P_{\text{CMAX},L,c})$  may be higher resulting in different test requirements according to Table 6.2.5.3-1.



Table 6.2.4.5-14: UE Power Class 3 test requirements (network signalled value "NS\_14")

Configuration ID	MPR (dB)	A-MPR (dB)	$\Delta T_{C,c}$ (dB)	$P_{C_{MAX,c}}$ (dBm)	$T(P_{C_{MAX,L,c}})$ (dB)	Upper limit (dBm)	Lower limit (dBm)
1	0	3	0	20	2.5	25.7	16.8
2	1	0	0	22	2	25.7	19.3
3	1	1	0	21	2	25.7	18.3
4	1	0	0	22	2	25.7	19.3
5	2	1	0	20	2,5	25.7	16.8
6	0	3	0	20	2.5	25.7	16.8
7	1	0	0	22	2	25.7	19.3
8	1	1	0	21	2	25.7	18.3
9	1	0	0	22	2	25.7	19.3
10	2	1	0	20	2,5	25.7	16.8

Note 1: Lower limit is assuming  $\Delta T_{IB,c}$  is zero. If non-zero,  $P_{C_{MAX,c}}$  will decrease and  $T(P_{C_{MAX,L,c}})$  may be higher resulting in different test requirements according to Table 6.2.5.3-1.

Table 6.2.4.5-15: UE Power Class test requirements (network signalled value "NS\_15")

Configuration ID	EUTRA band	Class 1 (dBm)	Tol. (dB)	Class 2 (dBm)	Tol. (dB)	Class 3 (dBm)	Tol. (dB)
1	26					23	+2.7 / -4.2
2	26					23	+2.7 / -12.2
3	26					23	+2.7 / -5.7
4	26					23	+2.7 / -12.2
5	26					23	+2.7 / -19.2
6	26					23	+2.7 / -3.7
7	26					23	+2.7 / -4.2
8	26					23	+2.7 / -11.7
9	26					23	+2.7 / -17.7
10	26					23	+2.7 / -3.7
11	26					23	+2.7 / -6.2
12	26					23	+2.7 / -17.2
13	26					23	+2.7 / -8.2
14	26					23	+2.7 / -2.7
15	26					23	+2.7 / -3.7
16	26					23	+2.7 / -12.7
17	26					23	+2.7 / -15.7
18	26					23	+2.7 / -17.7
19	26					23	+2.7 / 3.7-
20	26					23	+2.7 / -9.7
21	26					23	+2.7 / -3.7
22	26					23	+2.7 / -3.7
23	26					23	+2.7 / -11.7
24	26					23	+2.7 / -17.7
25	26					23	+2.7 / -3.7
26	26					23	+2.7 / -11.7

**Table 6.2.4.5-16A: UE Power Class test requirements (network signalled value "NS\_16") when lower channel edge is at 807 MHz**

Configuration ID	EUTRA band	Class 1 (dBm)	Tol. (dB)	Class 2 (dBm)	Tol. (dB)	Class 3 (dBm)	Tol. (dB)
1	27					23	+2.7/-2.7
2	27					23	+2.7/-3.7
3	27					23	+2.7-4.7
4	27					23	+2.7/-2.7
5	27					23	+2.7 / -4.7
6	27					23	+2.7 / -6.2
7	27					23	+2.7 / -8.2
8	27					23	+2.7 / -9.7
9	27					23	+2.7 / -4.7
10	27					23	+2.7 / -6.2
11	27					23	+2.7 / -11.7
12	27					23	+2.7 / -8.2
13	27					23	+2.7 / -11.7
14	27					23	+2.7 / -12.7
15	27					23	+2.7 / -9.7
16	27					23	+2.7/-2.7
17	27					23	+2.7 / -8.2
18	27					23	+2.7 / -4.7
19	27					23	+2.7 / -8.2
20	27					23	+2.7 / -13.7
21	27					23	+2.7 / -13.7
22	27					23	+2.7 / -14.7
23	27					23	+2.7 / -13.7
24	27					23	+2.7 / -13.7

**Table 6.2.4.5-16B: UE Power Class test requirements (network signalled value "NS\_16") when lower channel edge is at 808.5 MHz**

Configuration ID	EUTRA band	Class 1 (dBm)	Tol. (dB)	Class 2 (dBm)	Tol. (dB)	Class 3 (dBm)	Tol. (dB)
1	27					23	+2.7/-2.7
2	27					23	+2.7/-3.7
3	27					23	+2.7/-5.2
4	27					23	+2.7/-2.7
5	27					23	+2.7 / -3.7
6	27					23	+2.7 / -3.7
7	27					23	+2.7 / -4.7
8	27					23	+2.7 / -2.7
9	27					23	+2.7 / -3.7
10	27					23	+2.7 / -4.7
11	27					23	+2.7 / -6.2
12	27					23	+2.7 / -6.2
13	27					23	+2.7 / -8.2
14	27					23	+2.7 / -9.7
15	27					23	+2.7 / -9.7
16	27					23	+2.7/-2.7
17	27					23	+2.7 / -6.2
18	27					23	+2.7 / -4.7
19	27					23	+2.7 / -4.7
20	27					23	+2.7 / -9.7
21	27					23	+2.7 / -11.7
22	27					23	+2.7 / -12.7
23	27					23	+2.7 / -11.7
24	27					23	+2.7 / -11.7

**Table 6.2.4.5-16C: UE Power Class test requirements (network signalled value "NS\_16") when lower channel edge is at 812 MHz**

Configuration ID	EUTRA band	Class 1 (dBm)	Tol. (dB)	Class 2 (dBm)	Tol. (dB)	Class 3 (dBm)	Tol. (dB)
1	27					23	+2.7/-2.7
2	27					23	+2.7/-3.7
3	27					23	+2.7/-4.7
4	27					23	+2.7/-2.7
5	27					23	+2.7 / -3.7
6	27					23	+2.7 / -3.7
7	27					23	+2.7 / -4.7
8	27					23	+2.7 / -2.7
9	27					23	+2.7 / -3.7
10	27					23	+2.7 / -3.7
11	27					23	+2.7 / -3.7
12	27					23	+2.7 / -3.7
13	27					23	+2.7 / -3.7
14	27					23	+2.7 / -4.7
15	27					23	+2.7 / -2.7
16						23	+2.7/-2.7
17	27					23	+2.7 / -3.7
18	27					23	+2.7 / -3.7
19	27					23	+2.7 / -3.7
20	27					23	+2.7 / -4.7
21	27					23	+2.7 / -8.2
22	27					23	+2.7 / -9.7
23	27					23	+2.7 / -6.2
24	27					23	+2.7 / -4.7

**Table 6.2.4.5-17: UE Power Class test requirements (network signalled value "NS\_17")**

Configuration ID	EUTRA band	Class 1 (dBm)	Tol. (dB)	Class 2 (dBm)	Tol. (dB)	Class 3 (dBm)	Tol. (dB)
1	28					23	+2.7 / -3.2
2	28					23	+2.7 / -3.2
3	28					23	+2.7 / -4.2
4	28					23	+2.7 / -5.2
5	28					23	+2.7 / -3.2
6	28					23	+2.7 / -3.2
7	28					23	+2.7 / -4.2
8	28					23	+2.7 / -5.2

**Table 6.2.4.5-18: UE Power Class test requirements (network signalled value "NS\_18")**

Configuration ID	EUTRA band	Class 1 (dBm)	Tol. (dB)	Class 2 (dBm)	Tol. (dB)	Class 3 (dBm)	Tol. (dB)
------------------	------------	---------------	-----------	---------------	-----------	---------------	-----------

1	28					23	+2.7 / -3.2
2	28					23	+2.7 / -4.2
3	28					23	+2.7 / -5.2
4	28					23	+2.7 / -6.2
5	28					23	+2.7 / -7.2
6	28					23	+2.7 / -7.2
7	28					23	+ 2.7 / -8.7
8	28					23	+2.7 / -9.2
9	28					23	+2.7 / -7.2
10	28					23	+2.7 / -7.2
11	28					23	+2.7 / -8.7
12	28					23	+2.7 / -9.2
13	28					23	+2.7 / -7.2
14	28					23	+2.7 / -7.2
15	28					23	+2.7 / -8.7
16	28					23	+2.7 / -9.2

Table 6.2.4.5-19: UE Power Class test requirements (network signalled value "NS\_19")

Configuration ID	EUTRA band	Class 1 (dBm)	Tol. (dB)	Class 2 (dBm)	Tol. (dB)	Class 3 (dBm)	Tol. (dB)
1	44					23	+2.7 / FFS
2	44					23	+2.7 / FFS
3	44					23	+2.7 / FFS
4	44					23	+2.7 / FFS
5	44					23	+2.7 / FFS
6	44					23	+2.7 / FFS
7	44					23	+ 2.7 / FFS
8	44					23	+2.7 / FFS
9	44					23	+2.7 / FFS
10	44					23	+2.7 / FFS
11	44					23	+2.7 / FFS
12	44					23	+2.7 / FFS

Table 6.2.4.5-20: UE Power Class test requirements (network signalled value "NS\_20 for Band 23")

Configuration ID	EUTRA Band	Centre Frequency	Class 1 (dBm)	Tol. (dB)	Class 2 (dBm)	Tol. (dB)	Class 3 (dBm)	Tol. (dB)
1a	23	2002.5 MHz					23	+ 2.7 / -24.7 (Note 1)
1b	23	2007.5 MHz					23	+ 2.7 / -2.7
1c	23	2012.5 MHz					23	+ 2.7 / -2.7
1d	23	2017.5 MHz					23	+ 2.7 / -2.7
2a	23	2002.5 MHz					23	+ 2.7 / -23.7 (Note 1)
2b	23	2007.5 MHz					23	+ 2.7 / -7.7
2c	23	2012.5 MHz					23	+ 2.7 / -7.7
2d	23	2017.5 MHz					23	+ 2.7 / -3.7
3a	23	2002.5 MHz					23	+ 2.7 / -23.7 (Note 1)
3b	23	2007.5 MHz					23	+ 2.7 / -11.7
3c	23	2012.5 MHz					23	+ 2.7 / -11.7
3d	23	2017.5 MHz					23	+ 2.7 / -3.7
4a	23	2002.5 MHz					23	+ 2.7 / -23.7 (Note 1)
4b	23	2007.5 MHz					23	+ 2.7 / -7.7
4c	23	2012.5 MHz					23	+ 2.7 / -7.7
4d	23	2017.5 MHz					23	+ 2.7 / -3.7
5a	23	2002.5 MHz					23	+ 2.7 / -23.7 (Note 1)
5b	23	2007.5 MHz					23	+ 2.7 / -11.7
5c	23	2012.5 MHz					23	+ 2.7 / -11.7
5d	23	2017.5 MHz					23	+ 2.7 / -3.7
6a	23	2005 MHz					23	+ 2.7 / -21.7 (Note 1)
6b	23	2015 MHz					23	+ 2.7 / -2.7
7a	23	2005 MHz					23	+ 2.7 /

Configuration ID	EUTRA Band	Centre Frequency	Class 1 (dBm)	Tol. (dB)	Class 2 (dBm)	Tol. (dB)	Class 3 (dBm)	Tol. (dB)
								-7.7 (Note 1)
7b	23	2015 MHz					23	+ 2.7 / -2.7
8a	23	2005 MHz					23	+ 2.7 / -11.7 (Note 1)
8b	23	2015 MHz					23	+ 2.7 / -8.7
9a	23	2005 MHz					23	+ 2.7 / -8.7 (Note 1)
9b	23	2015 MHz					23	+ 2.7 / -3.7
10a	23	2005 MHz					23	+ 2.7 / -11.7 (Note 1)
10b	23	2005 MHz					23	+ 2.7 / -8.7
11	23	2012.5 MHz					23	+ 2.7 / -11.7
12	23	2012.5 MHz					23	+ 2.7 / -7.7
13	23	2012.5 MHz					23	+ 2.7 / -11.7
14	23	2012.5 MHz					23	+ 2.7 / -17.7
15	23	2012.5 MHz					23	+ 2.7 / -8.7
16	23	2012.5 MHz					23	+ 2.7 / -12.7
17	23	2012.5 MHz					23	+ 2.7 / -18.7
18	23	2010 MHz					23	+ 2.7 / -22.7
19	23	2010 MHz					23	+ 2.7 / -14.7
20	23	2010 MHz					23	+ 2.7 / -13.7 (Note 1)
21	23	2010 MHz					23	+ 2.7 / -8.7 (Note 1)
22	23	2010 MHz					23	+ 2.7 / -11.7 (Note 1)
23	23	2010 MHz					23	+ 2.7 / -15.7 (Note 1)
24	23	2010 MHz					23	+ 2.7 / -14.7 (Note 1)
25	23	2010 MHz					23	+ 2.7 / -19.7 (Note 1)
26	23	2010 MHz					23	+ 2.7 / -12.7 (Note 1)

Note 1: The output power within 2000-2005 MHz shall not be higher than 7.7 dBm

**Table 6.2.4.5-21: UE Power Class 3 test requirements (network signalled value "NS\_21 for Band 30")**

Configuration ID	MPR (dB)	A-MPR (dB)	$\Delta T_{c,c}$ (dB)	$P_{\text{CMAX},c}$ (dBm)	$T(P_{\text{CMAX},L,c})$ (dB)	Upper limit (dBm)	Lower limit (dBm)
1	0	0	0	23	2.0	25.7	20.3
2	1	0	0	22	2.0	25.7	19.3
3	0	4	0	19	3.5	25.7	14.8
4	0	4	0	19	3.5	25.7	14.8
5	1	0	0	22	2.0	25.7	19.3
6	0	3	0	20	2.5	25.7	16.8
7	1	3	0	19	3.5	25.7	14.8
8	2	3	0	18	4.0	25.7	13.3

Note 1: Lower limit is assuming  $\Delta T_{\text{TIB},c}$  is zero. If non-zero,  $P_{\text{CMAX},c}$  will decrease and  $T(P_{\text{CMAX},L,c})$  may be higher resulting in different test requirements according to Table 6.2.5.3-1.

## 6.2.4\_1 Additional Maximum Power Reduction (A-MPR) for HPUE

### 6.2.4\_1.1 Test purpose

Same test purpose as in clause 6.2.4.1 with the follow exception:

- Instead of Table 6.2.2.3-1 → use Table 6.2.2\_1.3-1

### 6.2.4\_1.2 Test applicability

The requirements of this test apply in test case 6.6.2.2 Additional Spectrum Emission Mask for network signalled values NS\_06, to all types of E-UTRA Power Class 1 UE release 10 and forward.

NOTE: As a result TC 6.2.4\_1 has not been included in the test case applicability table 4.1-1, TS 36.521-2. This does not preclude the test from being used for R&D or other purposes if deemed useful.

### 6.2.4\_1.3 Minimum conformance requirements

For UE Power Class 1 the specific requirements and identified sub-clauses are specified in Table 6.2.4.3-1 along with the allowed A-MPR values that may be used to meet these requirements. The allowed A-MPR values specified in Table 6.2.4.3-1 are in addition to the allowed MPR requirements specified in clause 6.2.3\_1. For the UE maximum output power modified by A-MPR, the power limits specified in clause 6.2.5\_1 apply.

The normative reference for this requirement is TS 36.101 clause 6.2.4.

### 6.2.4\_1.4 Test description

Same test description as in clause 6.2.4.4 with the following exceptions:

- Instead of Table 6.2.4.4.1-4 → use Table 6.2.4\_1.4.1-1



**Table 6.2.4\_1.4.1-1: Test Configuration Table (network signalled value "NS\_06")**

Initial Conditions					
Test Environment (as specified in TS 36.508 [7] subclause 4.1)			Normal		
Test Frequencies (as specified in TS 36.508 [7] subclause 4.3.1)			Low range, Mid range, High range		
Test Channel Bandwidths (as specified in TS 36.508 [7] subclause 4.3.1)			Lowest, 5MHz, 10MHz, Highest		
Test Parameters for NS_06 A-MPR					
Configuration ID	Ch BW	Downlink Configuration		Uplink Configuration	
		Mod'n	RB allocation FDD	Mod'n	RB allocation FDD
1	5MHz	N/A for A-MPR testing		QPSK	25
2	5MHz			QPSK	8
3	5MHz			16QAM	8
4	10MHz			QPSK	50
5	10MHz			QPSK	12
6	10MHz			16QAM	12
Note 1: Test Channel Bandwidths are checked separately for each E-UTRA band, the applicable channel bandwidths are specified in Table 5.4.2.1-1.					
Note 2: The Configuration ID will be used to map the applicable Test Configuration to the corresponding Test Requirement in subclause 6.2.4.5 as not all combinations are necessarily required based on the applicability of the UE.					
Note 3: The RB <sub>start</sub> of partial RB allocation shall be RB# 0 and RB# (max +1 - RB allocation) of the channel bandwidth.					

### 6.2.4\_1.5 Test requirements

The maximum output power, derived in step 2 of clause 6.2.4\_1.4.2 shall be within the range prescribed by the nominal maximum output power and tolerance in Table 6.2.4\_1.5-1. The allowed A-MPR values specified in Table 6.2.4.3-1 are in addition to the allowed MPR requirements specified in clause 6.2.3\_1. For the UE maximum output power modified by MPR and/or A-MPR, the power limits specified in Table 6.2.5\_1.3-1 apply.

**Table 6.2.4\_1.5-1: HPUE Power Class test requirements (network signalled value "NS\_06")**

Configuration ID	EUTRA band	Class 1 (dBm)	Tol. (dB)
1	14	31	+2.7 / -4.7
2	14	31	+2.7 / -3.7
3	14	31	+2.7 / -4.7
4	14	31	+2.7 / -4.7
5	14	31	+2.7 / -3.7
6	14	31	+2.7 / -4.7

### 6.2.4A Additional Maximum Power Reduction (A-MPR) for CA

#### 6.2.4A.1 Additional Maximum Power Reduction (A-MPR) for CA (intra-band contiguous DL CA and UL CA)

### 6.2.4A.1.1 Test purpose

Additional ACLR, spectrum emission and spurious emission requirements for carrier aggregation can be signalled by the network to indicate that the UE shall also meet additional requirements in a specific deployment scenario. To meet these additional requirements, Additional Maximum Power Reduction (A-MPR) is allowed for the CA Power Class as specified in Table 6.2.2A-1.

### 6.2.4A.1.2 Test applicability

The requirements of this test apply in test case 6.6.2.2A.1 Additional Spectrum Emission Mask for CA (intra-band contiguous DL CA and UL CA) for network signalled value NS\_04 to all types of E-UTRA UE release 8 and forward.

The requirements of this test apply in test case 6.6.3.3A.1 Additional spurious emissions for CA (intra-band contiguous DL CA and UL CA) for network signalled values CA\_NS\_01, CA\_NS\_02 and CA\_NS\_03, CA\_NS\_05, CA\_NS\_06, CA\_NS\_07 to all types of E-UTRA UE release 10 and forward that support intra-band contiguous DL CA and UL CA.

NOTE: As a result TC 6.2.4A.1 has not been included in the test case applicability table 4.1-1, TS 36.521-2. This does not preclude the test from being used for R&D or other purposes if deemed useful.

6.2.4A.1.3 Minimum conformance requirements Additional ACLR, spectrum emission and spurious emission requirements for carrier aggregation can be signalled by the network to indicate that the UE shall also meet additional requirements in a specific deployment scenario. To meet these additional requirements, Additional Maximum Power Reduction (A-MPR) is allowed for the CA Power Class as specified in Table 6.2.2A-1.

If for intra-band carrier aggregation the UE is configured for transmissions on a single serving cell, then subclasses 6.2.3 and 6.2.4 apply with the Network Signalling value indicated by the field *additionalSpectrumEmission*.

For intra-band contiguous aggregation with the UE configured for transmissions on two serving cells, the maximum output power reduction specified in Table 6.2.4A.1.3-1 is allowed for all serving cells of the applicable uplink CA configurations according to the CA network signalling value indicated by the field *additionalSpectrumEmissionSCell-r10*. Then clause 6.2.3A.1.3 does not apply, i.e. the carrier aggregation MPR = 0 dB, unless the value indicated is CA\_NS\_31.

For the UE maximum output power modified by A-MPR specified in table 6.2.4A.1.3-1, the power limits specified in subclause 6.2.5A.1.3 apply.

**Table 6.2.4A.1.3-1: Additional Maximum Power Reduction (A-MPR) for intra-band contiguous CA**

CA Network Signalling value	Requirements (subclause)	Uplink CA Configuration	A-MPR [dB] (subclause)
CA_NS_01	6.6.3.3A.1.3.1	CA_1C	6.2.4A.1.3.1
CA_NS_02	6.6.3.3A.1.3.2	CA_1C	6.2.4A.1.3.2
CA_NS_03	6.6.3.3A.1.3.3	CA_1C	6.2.4A.1.3.3
CA_NS_04	6.6.2.2A.1.3.1	CA_41C	6.2.4A.1.3.4
CA_NS_05	6.6.3.3A.1.3.4	CA_38C	6.2.4A.1.3.5
CA_NS_06	6.6.3.3A.1.3.5	CA_7C	6.2.4A.1.3.6
CA_NS_07	6.6.3.3A.1.3.6	CA_39C	6.2.4A.1.3.7
...			
CA_NS_31	NOTE 1	Table 5.4.2A.1-1 (NOTE 1)	N/A
CA_NS_32	Reserved		
NOTE 1: Applicable for uplink CA configurations listed in Table 5.4.2A-1 for which none of the additional requirements in subclauses 6.6.3.3A apply.			
NOTE 2: The index of the sequence CA_NS corresponds to the value of <i>additionalSpectrumEmissionSCell-r10</i> .			

For PUCCH and SRS transmissions, the allowed A-MPR is according to that specified for PUSCH QPSK modulation for the corresponding transmission bandwidth.

For intra-band carrier aggregation, the A-MPR is evaluated per slot and given by the maximum value taken over the transmission(s) on all component carriers within the slot; the maximum A-MPR over the two slots is then applied for the entire subframe.

## 6.2.4A.1.3.1 A-MPR for CA\_NS\_01 for CA\_1C

If the UE is configured to CA\_1C and it receives IE CA\_NS\_01 the allowed maximum output power reduction applied to transmissions on the PCC and the SCC for contiguously aggregated signals is specified in table 6.2.4A.1.3.1-1.

**Table 6.2.4A.1.3.1-1: Contiguous allocation A-MPR for CA\_NS\_01**

CA_1C: CA_NS_01	RB <sub>start</sub>	L <sub>CRB</sub> [RBs]	RB <sub>start</sub> + L <sub>CRB</sub> [RBs]	A-MPR for QPSK and 16-QAM [dB]
100 RB / 100 RB	0 – 23 and 176 - 199	> 0	N/A	≤ 12.0
	24 – 105	> 64	N/A	≤ 6.0
	106 – 175	N/A	> 175	≤ 5.0
75 RB / 75 RB	0 – 6 and 143 – 149	0 < L <sub>CRB</sub> ≤ 10	N/A	≤ 11.0
		> 10	N/A	≤ 6.0
	7 – 90	> 44	N/A	≤ 5.0
	91 – 142	N/A	> 142	≤ 2.0

NOTE 1: RB<sub>start</sub> indicates the lowest RB index of transmitted resource blocks  
NOTE 2: L<sub>CRB</sub> is the length of a contiguous resource block allocation  
NOTE 3: For intra-subframe frequency hopping which intersects regions, notes 1 and 2 apply on a per slot basis  
NOTE 4: For intra-subframe frequency hopping which intersects regions, the larger A-MPR value may be applied for both slots in the subframe

If the UE is configured to CA\_1C and it receives IE CA\_NS\_01 the allowed maximum output power reduction applied to transmissions on the PCell and the SCell with non-contiguous resource allocation is defined as follows

$$A\text{-MPR} = \text{CEIL} \{M_A, 0.5\}$$

Where  $M_A$  is defined as follows,

$$\begin{aligned} M_A &= -22.5 A + 17 && ; 0 \leq A < 0.20 \\ &= -11.0 A + 14.7 && ; 0.20 \leq A < 0.70 \\ &= -1.7 A + 8.2 && ; 0.70 \leq A \leq 1 \end{aligned}$$

Where  $A = N_{\text{RB\_alloc}} / N_{\text{RB\_agg}}$

The normative reference for requirement is in TS 36.101 [2] clause 6.2.4A

## 6.2.4A.1.3.2 A-MPR for CA\_NS\_02 for CA\_1C

If the UE is configured to CA\_1C and it receives IE CA\_NS\_02 the allowed maximum output power reduction applied to transmission on the PCC and the SCC for contiguously aggregated signals is specified in Table 6.2.4A.1.3.2-1.

**Table 6.2.4A.1.3.2-1: Contiguous allocation A-MPR for CA\_NS\_02**

CA_1C: CA_NS_02	RB <sub>end</sub>	L <sub>CRB</sub> [RBs]	A-MPR for QPSK and 16-QAM [dB]
100 RB / 100 RB	0 – 20	> 0	≤ 4 dB
	21 – 46	> 0	≤ 3 dB
	47 – 99	> RB <sub>end</sub> – 20	≤ 3 dB
	100 – 184	> 75	≤ 6 dB
	185 – 199	> 0	≤ 10 dB
75 RB / 75 RB	0 – 48	> 0	≤ 2 dB
	49 – 80	> RB <sub>end</sub> – 20	≤ 3 dB
	81 – 129	> 60	≤ 5 dB
	130 – 149	> 85	≤ 6 dB
	130 – 149	1 – 84	≤ 2 dB

If the UE is configured to CA\_1C and it receives IE CA\_NS\_02 the allowed maximum output power reduction applied to transmissions on the PCell and the SCell with non-contiguous resource allocation is defined as follows:

$$\text{A-MPR} = \text{CEIL} \{M_A, 0.5\}$$

Where  $M_A$  is defined as follows

$$\begin{aligned} [M_A &= -22.5 A + 17 && ; 0 \leq A < 0.20 \\ &-11.0 A + 14.7 && ; 0.20 \leq A < 0.70 \\ &-1.7 A + 8.2 && ; 0.70 \leq A \leq 1] \end{aligned}$$

Where  $A = N_{\text{RB\_alloc}} / N_{\text{RB\_agg}}$ .

#### 6.2.4A.1.3.3 A-MPR for CA\_NS\_03 for CA\_1C

If the UE is configured to CA\_1C and it receives IE CA\_NS\_03 the allowed maximum output power reduction applied to transmission on the PCC and the SCC for contiguously aggregated signals is specified in Table 6.2.4A.1.3.3-1.

**Table 6.2.4A.1.3.3-1: Contiguous allocation A-MPR for CA\_NS\_03**

CA_1C: CA_NS_03	RB <sub>end</sub>	L <sub>CRB</sub> [RBs]	A-MPR for QPSK and 16-QAM [dB]
100 RB / 100 RB	0 – 26	> 0	≤ 10 dB
	27 – 63	≥ RB <sub>end</sub> – 27	≤ 6 dB
	27 – 63	< RB <sub>end</sub> – 27	≤ 1 dB
	64 – 100	> RB <sub>end</sub> – 20	≤ 4 dB
	101 – 171	> 68	≤ 7 dB
	172 – 199	> 0	≤ 10 dB
75 RB / 75 RB	0 – 20	> 0	≤ 10 dB
	21 – 45	> 0	≤ 4 dB
	46 – 75	> RB <sub>end</sub> – 13	≤ 2 dB
	76 – 95	> 45	≤ 5 dB
	96 – 149	> 43	≤ 8 dB
	120 – 149	1 – 43	≤ 6 dB

If the UE is configured to CA\_1C and it receives IE CA\_NS\_03 the allowed maximum output power reduction applied to transmissions on the PCell and the SCell with non-contiguous resource allocation is defined as follows:

$$A\text{-MPR} = \text{CEIL} \{M_A, 0.5\}$$

Where  $M_A$  is defined as follows

$$[M_A = -23.33A + 17.5 \quad ; 0 \leq A < 0.15 \\ -7.65A + 15.15 \quad ; 0.15 \leq A \leq 1]$$

Where  $A = N_{\text{RB\_alloc}} / N_{\text{RB\_agg}}$ .

#### 6.2.4A.1.3.4 A-MPR for CA\_NS\_04 for CA\_41C

If the UE is configured to CA\_41C and it receives IE CA\_NS\_04 the allowed maximum output power reduction applied to transmission on the PCC and the SCC for contiguously aggregated signals is specified in Table 6.2.4A.1.3.4-1.

**Table 6.2.4A.1.3.4-1: Contiguous Allocation A-MPR for CA\_NS\_04**

CA Bandwidth Class C	RB <sub>Start</sub>	L <sub>CRB</sub> [RBs]	RB <sub>start</sub> + L <sub>CRB</sub> [RBs]	A-MPR for QPSK [dB]	A-MPR for 16QAM [dB]
50RB / 100 RB	0 – 44 and 105 – 149	>0	N/A	≤4dB	≤4dB
	45 – 104	N/A	>105	≤3dB	≤4dB
75 RB / 75 RB	0 – 44 and 105 – 149	>0	N/A	≤4dB	≤4dB
	45 – 104	N/A	>105	≤4dB	≤4dB
100 RB / 75 RB	0 – 49 and 125 – 174	>0	N/A	≤4dB	≤4dB
	50 - 124	N/A	>125	≤3dB	≤4dB
100 RB / 100 RB	0 – 59 and 140 – 199	>0	N/A	≤3dB	≤4dB
	60– 139	N/A	>140	≤3dB	≤4dB

NOTE 1: RB<sub>start</sub> indicates the lowest RB index of transmitted resource blocks  
NOTE 2: L<sub>CRB</sub> is the length of a contiguous resource block allocation  
NOTE 3: For intra-subframe frequency hopping which intersects regions, notes 1 and 2 apply on a per slot basis  
NOTE 4: For intra-subframe frequency hopping which intersects regions, the larger A-MPR value may be applied for both slots in the subframe

If the UE is configured to CA\_41C and it receives IE CA\_NS\_04 the allowed maximum output power reduction applied to transmissions on the PCell and the SCell with non-contiguous resource allocation is defined as follows

$$A\text{-MPR} = \text{CEIL} \{M_A, 0.5\}$$

Where  $M_A$  is defined as follows

$$M_A = 10.5, \quad 0 \leq A < 0.05 \\ = -50.0A + 13.00, \quad 0.05 \leq A < 0.15 \\ = -4.0A + 6.10, \quad 0.15 \leq A < 0.40 \\ = -0.83A + 4.83, \quad 0.40 \leq A \leq 1$$

Where  $A = N_{\text{RB\_alloc}} / N_{\text{RB\_agg}}$ .

#### 6.2.4A.1.3.5 A-MPR for CA\_NS\_05 for CA\_38C

If the UE is configured to CA\_38C and it receives IE CA\_NS\_05 the allowed maximum output power reduction applied to transmission on the PCC and the SCC for contiguously aggregated signals is specified in Table 6.2.4A.1.3.5-1.

**Table 6.2.4A.1.3.5-1: Contiguous Allocation A-MPR for CA\_NS\_05**

CA_38C	RB <sub>end</sub>	L <sub>CRB</sub> [RBs]	A-MPR for QPSK and 16-QAM [dB]
100RB/100RB	0 – 12	>0	≤ 5 dB
	13 – 79	> RB <sub>end</sub> – 13	≤ 2 dB
	80 – 180	>60	≤ 6 dB
	181 – 199	> 0	≤ 11 dB
75RB/75RB	0 – 70	> max(0, RB <sub>end</sub> -10)	≤ 2 dB
	71- 108	> 60	≤ 5 dB
	109 – 140	>0	≤ 5 dB
	140 – 149	≤ 70	≤ 2 dB
	140 – 149	>70	≤ 6 dB
NOTE 1: RB <sub>end</sub> indicates the highest RB index of transmitted resource blocks			
NOTE 2: L <sub>CRB</sub> is the length of a contiguous resource block allocation			
NOTE 3: For intra-subframe frequency hopping which intersects regions, notes 1 and 2 apply on a per slot basis			
NOTE 4: For intra-subframe frequency hopping which intersects regions, the larger A-MPR value may be applied for both slots in the subframe			

If the UE is configured to CA\_38C and it receives IE CA\_NS\_05 the allowed maximum output power reduction applied to transmissions on the PCell and the SCell with non-contiguous resource allocation is defined as follows

$$\text{A-MPR} = \text{CEIL} \{M_A, 0.5\}$$

Where MA is defined as follows

$$M_A = -14.17 A + 16.50 \quad ; 0 \leq A < 0.60$$

$$-2.50 A + 9.50 \quad ; 0.60 \leq A \leq 1$$

Where  $A = N_{\text{RB\_alloc}} / N_{\text{RB\_agg}}$ .

#### 6.2.4A.1.3.6 A-MPR for CA\_NS\_06 for CA\_7C

If the UE is configured to CA\_7C and it receives IE CA\_NS\_06 the allowed maximum output power reduction applied to transmission on the PCC and the SCC for contiguously aggregated signals is specified in Table 6.2.4A.1.3.6-1.

**Table 6.2.4A.1.3.6-1: Contiguous Allocation A-MPR for CA\_NS\_06**

CA Bandwidth Class C	RB <sub>end</sub>	L <sub>CRB</sub> [RBs]	A-MPR for QPSK and 16-QAM [dB]
100RB/100RB	[0 – 22]	>[0]	≤ [4] dB
	[23 – 33]	> [RB <sub>end</sub> – 10]	≤ [2] dB
	[106 – 142]	> [75]	≤ [3] dB
	[143 – 178]	>[70]	≤ [5] dB
	[179 – 199]	> [0]	≤ [10] dB
75RB/75RB	[0 – 7]	>[0]	≤ [5] dB
	[20- 75]	> [RB <sub>end</sub> – 10]	≤ [2] dB
	[75 – 110]	>[64]	≤ [2] dB
	[110 – 144]	>[35]	≤ [6] dB
	[145 – 149]	>[0]	≤ [10] dB

If the UE is configured to CA\_7C and it receives IE CA\_NS\_06 the allowed maximum output power reduction applied to transmissions on the PCell and the SCell with non-contiguous resource allocation is defined as follows:

$$A\text{-MPR} = \text{CEIL} \{M_A, 0.5\}$$

Where  $M_A$  is defined as follows

$$M_A = [-23.33A + 17.5; 0 \leq A < 0.15$$

$$-7.65A + 15.15; 0.15 \leq A \leq 1]$$

Where  $A = N_{\text{RB\_alloc}} / N_{\text{RB\_agg}}$ .

#### 6.2.4A.1.3.7 A-MPR for CA\_NS\_07 for CA\_39C

If the UE is configured to CA\_39C and it receives IE CA\_NS\_07 the allowed maximum output power reduction applied to transmission on the PCC and the SCC for contiguously aggregated signals is specified in Table 6.2.4A.1.3.7-1.

**Table 6.2.4A.1.3.7-1: Contiguous Allocation A-MPR for CA\_NS\_07**

CA_39C: CA_NS_07	RB <sub>Start</sub>	L <sub>CRB</sub> [RBs]	A-MPR for QPSK and 16-QAM[dB]
75 RB / 100 RB and 100 RB / 75 RB	0 – 13	> 0	≤ 11
	14 – 50	≤ 60	≤ 3
	14 – 100	> 60	≤ 7
	101 – 155	> max(155 - RB <sub>start</sub> , 0)	≤ 2
	156 – 174	> 0	≤ 5
50 RB / 100 RB and 100 RB / 50 RB	0 – 5	> 0	≤ 11
	6 – 42	≤ 25	≤ 3
		> 25	≤ 6
	43 – 80	> 50	≤ 5
	81 – 138	> 20	≤ 2
139 – 149	> 0	≤ 5	
25 RB / 100 RB and 100 RB / 25 RB	0 – 32	≥ 84	≤ 6
		< 84	≤ 4
	33 – 60	> 50	≤ 3
	61 – 124	> 20	≤ 3

If the UE is configured to CA\_39C and it receives IE CA\_NS\_07 the allowed maximum output power reduction applied to transmissions on the PCell and the SCell with non-contiguous resource allocation is defined as follows

$$A\text{-MPR} = \text{CEIL} \{M_A, 0.5\}$$

Where  $M_A$  is defined as follows

$$M_A = -16.67A + 17.50; 0 \leq A < 0.30$$

$$-9.00 A + 15.20; 0.30 \leq A < 0.80$$

$$-2.50 A + 10.00; 0.80 \leq A \leq 1$$

Where  $A = N_{\text{RB\_alloc}} / N_{\text{RB\_agg}}$

#### 6.2.4A.1.4 Test description

##### 6.2.4A.1.4.1 Initial conditions

Initial conditions are a set of test configurations the UE needs to be tested in and the steps for the SS to take with the UE to reach the correct measurement state.

The initial test configurations consist of environmental conditions, test frequencies, and CC combinations based on E-UTRA CA configurations specified in table 5.4.2A.1-1. All of these configurations shall be tested with applicable test parameters for each CA Configuration, and are shown in table 6.2.4A.1.4.1-1 to 6.2.4A.1.4.1-7. The details of the

uplink reference measurement channels (RMCs) are specified in Annexe A.2. Configurations of PDSCH and PDCCH before measurement are specified in Annex C.2.

**Table 6.2.4A.1.4.1-1: Test Configuration Table (network signalled value "CA\_NS\_01")**

Initial Conditions								
Test Environment as specified in TS 36.508[7] subclause 4.1					NC			
Test Frequencies as specified in TS 36.508 [7] subclause 4.3.1 for different CA bandwidth classes, and PCC and SCCs are mapped onto physical frequencies according to Table 6.1-2.					C: Low and High range			
Test CC Combination setting ( $N_{RB\_agg}$ ) as specified in subclause 5.4.2A.1 for the CA Configuration across bandwidth combination sets supported by the UE.					As in Table 6.2.4A.1.3.1-1			
Test Parameters for CA Configurations								
ID	CA Configuration / $N_{RB\_agg}$		DL Allocation (PDCCH on PCC)	CC MOD	UL Allocation			
	PCC $N_{RB}$	SCCs $N_{RB}$			PCC & SCC RB allocation	$N_{RB\_allo\ c}$	PCC & SCC RB allocations ( $L_{CRB}$ @ $RB_{start}$ )	
1	75	75	N/A	QPSK			1	P_1@0
2	75	75		QPSK	150	P_75@0	S_75@0	
3	75	75		QPSK	45	P_45@7	S_0@0	
4	75	75		QPSK	8	P_0@0	S_8@67	
5	75	75		QPSK	129	P_75@0	S_54@0	
6	75	75		QPSK	2	P_1@0	S_1@74	
7	100	100		QPSK	200	P_100@0	S_100@0	
8	100	100		QPSK	1	P_1@0	S_0@0	
9	100	100		QPSK	175	P_75@25	S_100@0	
10	100	100		QPSK	25	P_0@0	S_25@75	
11	100	100		QPSK	64	P_64@24	S_0@0	
12	100	100		QPSK	2	P_1@0	S_1@99	
Note 1: CA Configuration Test CC Combination settings are checked separately for each CA Configuration which applicable aggregated channel bandwidths are specified in Table 5.4.2A.1-1.								

**Table 6.2.4A.1.4.1-2: Test Configuration Table (network signalled value "CA\_NS\_02")**

Initial Conditions								
Test Environment as specified in TS 36.508[7] subclause 4.1					NC			
Test Frequencies as specified in TS 36.508 [7] subclause 4.3.1 for different CA bandwidth classes, and PCC and SCCs are mapped onto physical frequencies according to Table 6.1-2.					C: Low and High range			
Test CC Combination setting ( $N_{RB\_agg}$ ) as specified in subclause 5.4.2A.1 for the CA Configuration across bandwidth combination sets supported by the UE.					As in Table 6.2.4A.1.3.2-1			
Test Parameters for CA Configurations								
ID	CA Configuration / $N_{RB\_agg}$		DL Allocation (PDCCH on PCC)	CC MOD	UL Allocation			
	PCC $N_{RB}$	SCCs $N_{RB}$			PCC & SCC RB allocation	$N_{RB\_allo\ c}$	PCC & SCC RB allocations ( $L_{CRB}$ @ $RB_{start}$ )	
1	75	75	N/A	QPSK			1	P_1@0
2	75	75		QPSK	75	P_75@0	S_0@0	
3	75	75		QPSK	129	P_75@0	S_54@0	
4	75	75		QPSK	129	P_54@21	S_75@0	
5	75	75		QPSK	1	P_0@0	S_1@74	
6	75	75		QPSK	1	P_0@0	S_1@54	
7	75	75		QPSK	2	P_1@0	S_1@74	
8	100	100		QPSK	1	P_1@0	S_0@0	
9	100	100		QPSK	1	P_1@21	S_0@0	
10	100	100		QPSK	90	P_90@0	S_0@0	
11	100	100		QPSK	180	P_100@0	S_80@0	



12	100	100		QPSK	1	P_0@0	S_1@99		
13	100	100		QPSK	1	P_0@0	S_1@83		
14	100	100		QPSK	2	P_1@0	S_1@99		
Note 1: CA Configuration Test CC Combination settings are checked separately for each CA Configuration which applicable aggregated channel bandwidths are specified in Table 5.4.2A.1-1.									

**Table 6.2.4A.1.4.1-3: Test Configuration Table (network signalled value "CA\_NS\_03")**

Initial Conditions									
Test Environment as specified in TS 36.508[7] subclause 4.1					NC				
Test Frequencies as specified in TS 36.508 [7] subclause 4.3.1 for different CA bandwidth classes, and PCC and SCCs are mapped onto physical frequencies according to Table 6.1-2.					C: Low and High range				
Test CC Combination setting ( $N_{RB\_agg}$ ) as specified in subclause 5.4.2A.1 for the CA Configuration across bandwidth combination sets supported by the UE.					As in Table 6.2.4A.1.3.3-1				
Test Parameters for CA Configurations									
ID	CA Configuration / $N_{RB\_agg}$		DL Allocation (PDCCH on PCC)	CC MOD	UL Allocation				
	PCC $N_{RB}$	SCCs $N_{RB}$			PCC & SCC RB allocation	$N_{RB\_allo\ c}$	PCC & SCC RB allocations ( $L_{CRB}$ @ $RB_{start}$ )		
1	75	75	N/A	QPSK			1	P_1@0	S_0@0
2	75	75		QPSK	1	P_1@21	S_0@0		
3	75	75		QPSK	75	P_75@0	S_0@0		
4	75	75		QPSK	90	P_75@0	S_15@0		
5	75	75		QPSK	150	P_75@0	S_75@0		
6	75	75		QPSK	1	P_0@0	S_1@74		
7	75	75		QPSK	1	P_0@0	S_1@44		
8	75	75		QPSK	2	P_1@0	S_1@74		
9	100	100		QPSK	1	P_1@0	S_0@0		
10	100	100		QPSK	60	P_60@0	S_0@0		
11	100	100		QPSK	1	P_1@63	S_0@0		
12	100	100		QPSK	90	P_90@0	S_0@0		
13	100	100		QPSK	164	P_100@0	S_64@0		
14	100	100		QPSK	1	P_0@0	S_1@99		
15	100	100		QPSK	1	P_0@0	S_1@70		
16	100	100		QPSK	2	P_1@0	S_1@99		
Note 1: CA Configuration Test CC Combination settings are checked separately for each CA Configuration which applicable aggregated channel bandwidths are specified in Table 5.4.2A.1-1.									

**Table 6.2.4A.1.4.1-4: Test Configuration Table (network signalled value "CA\_NS\_04")**

Initial Conditions									
Test Environment as specified in TS 36.508[7] subclause 4.1					NC				
Test Frequencies as specified in TS 36.508 [7] subclause 4.3.1 for different CA bandwidth classes, and PCC and SCCs are mapped onto physical frequencies according to Table 6.1-2.					C: Low and High range				
Test CC Combination setting ( $N_{RB\_agg}$ ) as specified in subclause 5.4.2A.1 for the CA Configuration across bandwidth combination sets supported by the UE.					As in Table 6.2.4A.1.3.4-1				
Test Parameters for CA Configurations									
ID	CA Configuration / $N_{RB\_agg}$		DL Allocation (PDCCH on PCC)	CC MOD	UL Allocation				
	PCC $N_{RB}$	SCCs $N_{RB}$			PCC & SCC RB allocation	$N_{RB\_allo\ c}$	PCC & SCC RB allocations ( $L_{CRB}$ @ $RB_{start}$ )		

1	100	50	N/A	QPSK	10	P_10@20	S_0@0		
2	100	50		QPSK	60	P_50@50	S_10@0		
3	100	50		16QAM	15	P_0@0	S_15@0		
4	100	50		QPSK	2	P_1@0	S_1@49		
5	75	75		QPSK	10	P_10@20	S_0@0		
6	75	75		QPSK	75	P_30@45	S_45@0		
7	75	75		QPSK	2	P_1@0	S_1@74		
8	100	75		QPSK	10	P_10@20	S_0@0		
9	100	75		QPSK	80	P_50@50	S_30@0		
10	100	75		16QAM	20	P_0@0	S_20@15		
11	100	75		QPSK	2	P_1@0	S_1@74		
12	100	100		QPSK	10	P_10@25	S_0@0		
13	100	100		QPSK	90	P_40@60	S_50@0		
14	100	100		16QAM	15	P_0@0	S_15@40		
15	100	100		16QAM	20	P_0@0	S_20@30		
16	100	100		QPSK	2	P_1@0	S_1@99		

Note 1: CA Configuration Test CC Combination settings are checked separately for each CA Configuration which applicable aggregated channel bandwidths are specified in Table 5.4.2A.1-1.

**Table 6.2.4A.1.4.1-5: Test Configuration Table (network signalled value "CA\_NS\_05")**

Initial Conditions								
Test Environment as specified in TS 36.508[7] subclause 4.1					NC			
Test Frequencies as specified in TS 36.508 [7] subclause 4.3.1 for different CA bandwidth classes, and PCC and SCCs are mapped onto physical frequencies according to Table 6.1-2.					C: Low and High range			
Test CC Combination setting ( $N_{RB\_agg}$ ) as specified in subclause 5.4.2A.1 for the CA Configuration across bandwidth combination sets supported by the UE.					As in Table 6.2.4A.1.3.5-1			
Test Parameters for CA Configurations								
ID	CA Configuration / $N_{RB\_agg}$		DL Allocation (PDCCH on PCC)	CC MOD	UL Allocation			
	PCC $N_{RB}$	SCCs $N_{RB}$	PCC & SCC RB allocation		$N_{RB\_alloc}$	PCC & SCC RB allocations ( $L_{CRB}$ @ $RB_{start}$ )		
1	75	75	N/A	QPSK	40	P_40@0	S_0@0	
2	75	75		QPSK	80	P_50@25	S_30@0	
3	75	75		QPSK	60	P_10@65	S_50@0	
4	75	75		QPSK	64	P_1@74	S_63@0	
5	75	75		QPSK	90	P_20@55	S_70@0	
6	75	75		QPSK	2	P_1@0	S_1@74	
7	100	100		QPSK	8	P_8@0	S_0@0	
8	100	100		QPSK	40	P_40@0	S_0@0	
9	100	100		QPSK	80	P_50@50	S_30@0	
10	100	100		QPSK	150	P_60@40	S_90@0	
11	100	100		QPSK	2	P_1@0	S_1@99	

Note 1: CA Configuration Test CC Combination settings are checked separately for each CA Configuration which applicable aggregated channel bandwidths are specified in Table 5.4.2A.1-1.

**Table 6.2.4A.1.4.1-6: Test Configuration Table (network signalled value "CA\_NS\_06")**

Initial Conditions								
Test Environment as specified in TS 36.508[7] subclause 4.1					NC			
Test Frequencies as specified in TS 36.508 [7] subclause 4.3.1 for different CA bandwidth classes, and PCC and SCCs are mapped onto physical frequencies according to Table 6.1-2.					C: Low and High range			
Test CC Combination setting ( $N_{RB\_agg}$ ) as specified in subclause 5.4.2A.1 for the CA Configuration					As in Table 6.2.4A.1.3.6-1			
Test Parameters for CA Configurations								
ID	CA Configuration / $N_{RB\_agg}$		DL Allocation (PDCCH on PCC)	CC MOD	UL Allocation			
	PCC $N_{RB}$	SCCs $N_{RB}$	PCC & SCC RB allocation		$N_{RB\_alloc}$	PCC & SCC RB allocations ( $L_{CRB}$ @ $RB_{start}$ )		
1	75	75	N/A	QPSK	5	P_5@0	S_0@0	
2	75	75		QPSK	45	P_45@0	S_0@0	
3	75	75		QPSK	75	P_60@15	S_15@0	
4	75	75		QPSK	60	P_10@65	S_50@0	
5	75	75		QPSK	90	P_18@57	S_72@0	
6	75	75		QPSK	2	P_1@0	S_1@74	
7	100	100		QPSK	10	P_10@0	S_0@0	
8	100	100		QPSK	30	P_30@0	S_0@0	
9	100	100		QPSK	100	P_75@25	S_25@0	
10	100	100		QPSK	90	P_40@60	S_50@0	
11	100	100		QPSK	100	P_15@85	S_85@0	
12	100	100		QPSK	2	P_1@0	S_1@99	

Note 1: CA Configuration Test CC Combination settings are checked separately for each CA Configuration which applicable aggregated channel bandwidths are specified in Table 5.4.2A.1-1.

**Table 6.2.4A.1.4.1-7: Test Configuration Table (network signalled value "CA\_NS\_07")**

Initial Conditions								
Test Environment as specified in TS 36.508[7] subclause 4.1					NC			
Test Frequencies as specified in TS 36.508 [7] subclause 4.3.1 for different CA bandwidth classes, and PCC and SCCs are mapped onto physical frequencies according to Table 6.1-2.					C: Low and High range			
Test CC Combination setting ( $N_{RB\_agg}$ ) as specified in subclause 5.4.2A.1 for the CA Configuration					As in Table 6.2.4A.1.3.7-1			
Test Parameters for CA Configurations								
ID	CA Configuration / $N_{RB\_agg}$		DL Allocation (PDCCH on PCC)	CC MOD	UL Allocation			
	PCC $N_{RB}$	SCCs $N_{RB}$	PCC & SCC RB allocation		$N_{RB\_alloc}$	PCC & SCC RB allocations ( $L_{CRB}$ @ $RB_{start}$ )		

1	100	25	N/A	QPSK	1	P_1@0	S_0@0		
2	100	25		QPSK	85	P_80@20	S_5@0		
3	100	25		QPSK	65	P_60@40	S_5@0		
4	100	25		QPSK	35	P_30@70	S_5@0		
5	100	25		QPSK	2	P_1@0	S_1@24		
6	100	50		QPSK	1	P_1@1	S_0@0		
7	100	50		QPSK	10	P_10@30	S_0@0		
8	100	50		QPSK	30	P_30@30	S_0@0		
9	100	50		QPSK	60	P_40@60	S_20@0		
10	100	50		QPSK	30	P_10@90	S_20@0		
11	100	50		QPSK	5	P_0@0	S_5@45		
12	100	50		QPSK	2	P_1@0	S_1@49		
13	100	75		QPSK	1	P_1@1	S_0@0		
14	100	75		QPSK	40	P_40@20	S_0@0		
15	100	75		QPSK	85	P_80@20	S_5@0		
16	100	75		QPSK	40	P_0@0	S_40@20		
17	100	75		QPSK	15	P_0@0	S_15@60		
18	100	75		QPSK	2	P_1@0	S_1@74		
Note 1: CA Configuration Test CC Combination settings are checked separately for each CA Configuration which applicable aggregated channel bandwidths are specified in Table 5.4.2A.1-1									

1. Connect the SS to the UE antenna connectors as shown in TS 36.508[7] Annex A Figure group A.32 as appropriate.
2. The parameter settings for the cell are set up according to TS 36.508 [7] subclause 4.4.3.
3. Downlink signals for PCC are initially set up according to Annex C.0, C.1, and C.3.0, and uplink signals according to Annex H.1 and H.3.0.
4. The UL Reference Measurement channel is set according to the applicable table from Table 6.2.4A.1.4.1-1 to 6.2.4A.1.4.1-6.
5. Propagation conditions are set according to Annex B.0.
6. Ensure the UE is in State 3A-RF according to TS 36.508 [7] clause 5.2A.2. Message contents are defined in clause 6.2.4A.1.4.3.

#### 6.2.4A.1.4.2 Test procedure

1. Configure SCC according to Annex C.0, C.1 and Annex C.3.0 for all downlink physical channels.
2. The SS shall configure SCC as per TS 36.508 [7] clause 5.2A.4. Message contents are defined in clause 6.2.4A.1.4.3.
3. SS activates SCC by sending the activation MAC-CE (Refer TS 36.321 [13], clauses 5.13, 6.1.3.8). Wait for at least 2 seconds (Refer TS 36.133, clauses 8.3.3.2).
4. SS sends uplink scheduling information for each UL HARQ process via PDCCH DCI format 0 for C\_RNTI to schedule the UL RMC according to the applicable from Table 6.2.4A.1.4.1-1 to Table 6.2.4A.1.4.1-6 on both PCC and SCC. Since the UE has no payload and no loopback data to send the UE sends uplink MAC padding bits on the UL RMC.
5. Send continuously uplink power control "up" commands in every uplink scheduling information to the UE; allow at least 200ms for the UE to reach  $P_{UMAX}$  level.
6. Measure the mean transmitted power over all component carriers in the CA configuration of the radio access mode. The period of measurement shall be at least the continuous duration of one sub-frame (1ms). For TDD slots with transient periods are not under test.

#### 6.2.4A.1.4.3 Message contents

Message contents are according to TS 36.508 [7] subclause 4.6. The following exceptions apply for each network signalled value.

## 6.2.4A.1.4.3.1 Message contents exceptions (network signalled value "CA\_NS\_01")

1. Information element `additionalSpectrumEmissionSCell-r10` is set to `CA_NS_01`. This can be set in the *RadioResourceConfigCommonSCell-r10-DEFAULT* as part of the common RRC messages. This exception indicates that the UE shall meet the additional spectrum emission requirement for a specific deployment scenario.

**Table 6.2.4A.1.4.3.1-1: *RadioResourceConfigCommonSCell-r10-DEFAULT*: Additional spectrum emission test requirement for "CA\_NS\_01"**

Derivation Path: TS 36.508 [7] clause 4.6.3, Table 4.6.3-13A			
Information Element	Value/remark	Comment	Condition
<code>additionalSpectrumEmissionSCell-r10</code>	1 (CA_NS_01)		

## 6.2.4A.1.4.3.2 Message contents exceptions (network signalled value "CA\_NS\_02")

1. Information element `additionalSpectrumEmissionSCell-r10` is set to `CA_NS_02`. This can be set in the *RadioResourceConfigCommonSCell-r10-DEFAULT* as part of the common RRC messages. This exception indicates that the UE shall meet the additional spectrum emission requirement for a specific deployment scenario.

**Table 6.2.4A.1.4.3.2-1: *RadioResourceConfigCommonSCell-r10-DEFAULT*: Additional spectrum emission test requirement for "CA\_NS\_02"**

Derivation Path: TS 36.508 [7] clause 4.6.3, Table 4.6.3-13A			
Information Element	Value/remark	Comment	Condition
<code>additionalSpectrumEmissionSCell-r10</code>	2 (CA_NS_02)		

## 6.2.4A.1.4.3.3 Message contents exceptions (network signalled value "CA\_NS\_03")

1. Information element `additionalSpectrumEmissionSCell-r10` is set to `CA_NS_03`. This can be set in the *RadioResourceConfigCommonSCell-r10-DEFAULT* as part of the common RRC messages. This exception indicates that the UE shall meet the additional spectrum emission requirement for a specific deployment scenario.

**Table 6.2.4A.1.4.3.3-1: *RadioResourceConfigCommonSCell-r10-DEFAULT*: Additional spectrum emission test requirement for "CA\_NS\_03"**

Derivation Path: TS 36.508 [7] clause 4.6.3, Table 4.6.3-13A			
Information Element	Value/remark	Comment	Condition
<code>additionalSpectrumEmissionSCell-r10</code>	3 (CA_NS_03)		

## 6.2.4A.1.4.3.4 Message contents exceptions (network signalled value "CA\_NS\_04")

1. Information element `additionalSpectrumEmissionSCell-r10` is set to `CA_NS_04`. This can be set in the *RadioResourceConfigCommonSCell-r10-DEFAULT* as part of the common RRC messages. This exception indicates that the UE shall meet the additional spectrum emission requirement for a specific deployment scenario.

**Table 6.2.4A.1.4.3.4-1: *RadioResourceConfigCommonSCell-r10-DEFAULT*: Additional spectrum emission test requirement for "CA\_NS\_04"**

Derivation Path: TS 36.508 [7] clause 4.6.3, Table 4.6.3-13A			
Information Element	Value/remark	Comment	Condition
<code>additionalSpectrumEmissionSCell-r10</code>	4 (CA_NS_04)		

## 6.2.4A.1.4.3.5 Message contents exceptions (network signalled value "CA\_NS\_05")

1. Information element `additionalSpectrumEmissionSCell-r10` is set to `CA_NS_05`. This can be set in the *RadioResourceConfigCommonSCell-r10-DEFAULT* as part of the common RRC messages. This exception indicates that the UE shall meet the additional spectrum emission requirement for a specific deployment scenario.

**Table 6.2.4A.1.4.3.5-1: *RadioResourceConfigCommonSCell-r10-DEFAULT*: Additional spectrum emission test requirement for "CA\_NS\_05"**

Derivation Path: TS 36.508 [7] clause 4.6.3, Table 4.6.3-13A			
Information Element	Value/remark	Comment	Condition
<code>additionalSpectrumEmissionSCell-r10</code>	5 (CA_NS_05)		

## 6.2.4A.1.4.3.6 Message contents exceptions (network signalled value "CA\_NS\_06")

1. Information element `additionalSpectrumEmissionSCell-r10` is set to `CA_NS_06`. This can be set in the *RadioResourceConfigCommonSCell-r10-DEFAULT* as part of the common RRC messages. This exception indicates that the UE shall meet the additional spectrum emission requirement for a specific deployment scenario.

**Table 6.2.4A.1.4.3.6-1: *RadioResourceConfigCommonSCell-r10-DEFAULT*: Additional spectrum emission test requirement for "CA\_NS\_06"**

Derivation Path: TS 36.508 [7] clause 4.6.3, Table 4.6.3-13A			
Information Element	Value/remark	Comment	Condition
<code>additionalSpectrumEmissionSCell-r10</code>	6 (CA_NS_06)		

## 6.2.4A.1.4.3.7 Message contents exceptions (network signalled value "CA\_NS\_07")

1. Information element `additionalSpectrumEmissionSCell-r10` is set to `CA_NS_07`. This can be set in the *RadioResourceConfigCommonSCell-r10-DEFAULT* as part of the common RRC messages. This exception indicates that the UE shall meet the additional spectrum emission requirement for a specific deployment scenario.

**Table 6.2.4A.1.4.3.7-1: *RadioResourceConfigCommonSCell-r10-DEFAULT*: Additional spectrum emission test requirement for "CA\_NS\_07"**

Derivation Path: TS 36.508 [7] clause 4.6.3, Table 4.6.3-13A			
Information Element	Value/remark	Comment	Condition
<code>additionalSpectrumEmissionSCell-r10</code>	7 (CA_NS_07)		

## 6.2.4A.1.5 Test requirements

The maximum output power, derived in step 3 shall be within the range prescribed by the nominal maximum output power and tolerance in the applicable table from Table 6.2.4A.1.5-1 to Table 6.2.4A.1.5-7. The allowed maximum output power reduction is specified in Table 6.2.4A.1.3-1 and clause 6.2.3A.1 does not apply, i.e. carrier aggregation MPR = 0. For the UE maximum output power modified by A-MPR specified in table 6.2.4A.1.3-1, the power limits specified in Table 6.2.5A.1.3-1 apply.

Table 6.2.4A.1.5-1: Test requirement (network signalled value "CA\_NS\_01")

Configuration ID	Class 1 (dBm)	Tol. (dB)	Class 2 (dBm)	Tol. (dB)	Class 3 (dBm)	Tol. (dB)
1					23	+2.7 / -17.7
2					23	+2.7 / -11.7
3					23	+2.7 / -9.7
4					23	+2.7 / -4.7
5					23	+2.7 / -11.7
6					23	+2.7 / -24.7
7					23	+2.7 / -18.7
8					23	+2.7 / -18.7
9					23	+2.7 / -11.7
10					23	+2.7 / -9.7
11					23	+2.7 / -2.7
12					23	+2.7 / -23.7

Table 6.2.4A.1.5-2: Test requirement (network signalled value "CA\_NS\_02")

Configuration ID	Class 1 (dBm)	Tol. (dB)	Class 2 (dBm)	Tol. (dB)	Class 3 (dBm)	Tol. (dB)
1					23	+2.7 / -4.7
2					23	+2.7 / -6.2
3					23	+2.7 / -9.7
4					23	+2.7 / -11.7
5					23	+2.7 / -4.7
6					23	+2.7 / -2.7
7					23	+2.7/-24.7
8					23	+2.7 / -8.2
9					23	+2.7 / -6.2
10					23	+2.7 / -6.2
11					23	+2.7 / -11.7
12					23	+2.7 / -15.7
13					23	+2.7 / -2.7
14					23	+2.7/-24.7

Table 6.2.4A.1.5-3: Test requirement (network signalled value "CA\_NS\_03")

Configuration ID	Class 1 (dBm)	Tol. (dB)	Class 2 (dBm)	Tol. (dB)	Class 3 (dBm)	Tol. (dB)
1					23	+2.7 / -15.7
2					23	+2.7 / -8.2
3					23	+2.7 / -4.7
4					23	+2.7 / -9.7
5					23	+2.7 / -13.7
6					23	+2.7 / -11.7
7					23	+2.7 / -2.7
8					23	+2.7/-25.2
9					23	+2.7 / -15.7
10					23	+2.7 / -11.7
11					23	+2.7 / -3.7
12					23	+2.7 / -8.2
13					23	+2.7 / -12.7
14					23	+2.7 / -15.7
15					23	+2.7 / -2.7
16					23	+2.7/-25.2



Table 6.2.4A.1.5-4: Test requirement (network signalled value "CA\_NS\_04")

Configuration ID	Class 1 (dBm)	Tol. (dB)	Class 2 (dBm)	Tol. (dB)	Class 3 (dBm)	Tol. (dB)
1					23	+2.7 / -8.2
2					23	+2.7 / -6.2
3					23	+2.7 / -8.2
4					23	+2.7 / -18.7
5					23	+2.7 / -8.2
6					23	+2.7 / -8.2
7					23	+2.7 / -18.7
8					23	+2.7 / -8.2
9					23	+2.7 / -6.2
10					23	+2.7 / -8.2
11					23	+2.7 / -18.7
12					23	+2.7 / -6.2
13					23	+2.7 / -6.2
14					23	+2.7 / -8.2
15					23	+2.7 / -8.2
16					23	+2.7 / -18.7

Table 6.2.4A.1.5-5: Test requirement (network signalled value "CA\_NS\_05")

Configuration ID	Test Freq.	Class 1 (dBm)	Tol. (dB)	Class 2 (dBm)	Tol. (dB)	Class 3 (dBm)	Tol. (dB)
1	Low, High					23	+2.7 / -7.7
2	Low, High					23	+2.7 / -9.7
3	Low, High					23	+2.7 / -9.7
4	Low, High					23	+2.7 / -9.7
5	Low, High					23	+2.7 / -11.7
6	Low, High					23	+2.7 / -24.2
7	Low					23	+2.7 / -12.2
7	High					23	+2.7 / -9.7
8	Low, High					23	+2.7 / -4.7
9	Low, High					23	+2.7 / -11.7
10	Low, High					23	+2.7 / -17.7
11	Low, High					23	+2.7 / -24.2

Table 6.2.4A.1.5-6: Test requirement (network signalled value "CA\_NS\_06")

Configuration ID	Class 1 (dBm)	Tol. (dB)	Class 2 (dBm)	Tol. (dB)	Class 3 (dBm)	Tol. (dB)
1					23	+2.7 / -12.2
2					23	+2.7 / -4.7
3					23	+2.7 / -4.7
4					23	+2.7 / -11.7
5					23	+2.7 / -15.7
6					23	+2.7 / -26.7
7					23	+2.7 / -11.2
8					23	+2.7 / -4.7
9					23	+2.7 / -6.2
10					23	+2.7 / -9.7
11					23	+2.7 / -15.7
12					23	+2.7 / -26.7

Table 6.2.4A.1.5-7: Test requirement (network signalled value "CA\_NS\_07")

Configuration ID	Class 1 (dBm)	Tol. (dB)	Class 2 (dBm)	Tol. (dB)	Class 3 (dBm)	Tol. (dB)
1					23	+2.7 / -8.2
2					23	+2.7 / -11.7
3					23	+2.7 / -6.2
4					23	+2.7 / -6.2
5					23	+2.7 / -25.2
6					23	+2.7 / -17.7
7					23	+2.7 / -6.2
8					23	+2.7 / -11.7
9					23	+2.7 / -9.7
10					23	+2.7 / -4.7
11					23	+2.7 / -9.7
12					23	+2.7 / -25.2
13					23	+2.7 / -17.7
14					23	+2.7 / -6.2
15					23	+2.7 / -12.7
16					23	+2.7 / -4.7
17					23	+2.7 / -9.7
18					23	+2.7 / -25.2

## 6.2.4A.2

### 6.2.4A.3 Additional Maximum Power Reduction (A-MPR) for CA (intra-band non-contiguous DL CA and UL CA)

NOTE: No test case details specified because the additional maximum power reduction cannot be verified for the intra-band non-contiguous UL CA case due to A-MPR is N/A in current non-contiguous Uplink CA configuration CA\_4A-4A according to Table 6.2.4A-2 in TS 36.101.

## 6.2.4B Additional Maximum Power Reduction (A-MPR) for UL-MIMO

### 6.2.4B.1 Test purpose

Additional ACLR and spectrum emission requirements can be signalled by the network to indicate that the UE shall also meet additional requirements in a specific deployment scenario. To meet these additional requirements, Additional Maximum Power Reduction A-MPR is allowed for the sum output power at each antenna connector as specified in Table 6.2.2B.3-1. Unless stated otherwise, an A-MPR of 0 dB shall be used.

## 6.2.4B.2 Test applicability

The requirements of this test apply in test case 6.6.2.2 B Additional Spectrum Emission Mask for network signalled values NS\_03, NS\_04, NS\_06, NS\_07, NS\_11, NS\_20 and NS\_21 to all types of E-UTRA UE release 10 and forward that support UL MIMO.

The requirements of this test apply in test case 6.6.3.3 B Additional Spurious Emissions for network signalled values NS\_05, NS\_07, NS\_08, NS\_09, NS\_12, NS\_13, NS\_14, NS\_15, NS\_16, NS\_17, NS\_18, NS\_19 and NS\_21 to all types of E-UTRA UE release 10 and forward that support UL MIMO.

NOTE: As a result TC 6.2.4B has not been included in the test case applicability table 4.1-1, TS 36.521-2. This does not preclude the test from being used for R&D or other purposes if deemed useful.

## 6.2.4B.3 Minimum conformance requirements

For UE Power Class 3 the specific requirements and identified clauses are specified in Table 6.2.4B.3-1 along with the allowed A-MPR values that may be used to meet these requirements. The allowed A-MPR values specified below in Table 6.2.4B.4.3-1 to 6.2.4B.4.3-15 are in addition to the allowed MPR requirements specified in clause 6.2.3B. For the UE maximum output power modified by A-MPR, the power limits specified in clause 6.2.5B apply.

**Table 6.2.4B.3-1: Additional Maximum Power Reduction (A-MPR) / Spectrum Emission requirements**

Network Signalling value	Requirements (sub-clause)	E-UTRA Band	Channel bandwidth (MHz)	Resources Blocks ( $N_{RB}$ )	A-MPR (dB)
NS_01	6.6.2.1.1	Table 5.2-1	1.4,3,5,10,15,20	Table 5.4.2-1	NA
NS_03	6.6.2.2.3.1	2,4,10, 23, 25,35,36	3	>5	$\leq 1$
			5	>6	$\leq 1$
			10	>6	$\leq 1$
			15	>8	$\leq 1$
			20	>10	$\leq 1$
NS_04	6.6.2.2.3.2	41	5	>6	$\leq 1$
			10, 15, 20	See Table 6.2.4B.3-4	
NS_05	6.6.3.3.3.1	1	10,15,20	$\geq 50$	$\leq 1$
NS_06	6.6.2.2.3.3	12, 13, 14, 17	1.4, 3, 5, 10	Table 5.4.2-1	n/a
NS_07	6.6.2.2.3.3	13	10	Table 6.2.4B.3-2	Table 6.2.4B.3-2
	6.6.3.3.3.2				
NS_08	6.6.3.3.3.3	19	10, 15	> 44	$\leq 3$
NS_09	6.6.3.3.3.4	21	10, 15	> 40	$\leq 1$
				> 55	$\leq 2$
				Table 6.2.4B.3-3	
NS_10		20	15, 20	Table 6.2.4B.3-3	Table 6.2.4B.3-3
NS_11	6.6.2.2.1	23	1.4, 3, 5, 10, 15, 20	Table 6.2.4B.3-5	Table 6.2.4B.3-5
NS_12	6.6.3.3.5	26	1.4, 3, 5, 10, 15	Table 6.2.4B.3-6, Table 6.2.4B.3-6a	Table 6.2.4B.3-6, Table 6.2.4B.3-6a
NS_13	6.6.3.3.6	26	1.4, 3, 5	Table 6.2.4B.3-7	Table 6.2.4B.3-7
NS_14	6.6.3.3.7	26	10, 15	Table 6.2.4B.3-8	Table 6.2.4B.3-8
NS_15	6.6.3.3.9	26	1.4, 3, 5, 10, 15	Table 6.2.4B.3-9 Table 6.2.4B.3-10	Table 6.2.4B.3-9, Table 6.2.4B.3-10
NS_16	6.6.3.3.9	27	3, 5, 10	Table 6.2.4B.3-11, Table 6.2.4B.3-12, Table 6.2.4B.3-13	
..					
NS_20	6.2.2, 6.2.2.1, 6.6.3.2	23	5, 10, 15, 20	Table 6.2.4B.3-14	Table 6.2.4B.3-14
NS_21	6.6.2.2B.3.1, 6.6.3B.2.3	30	5, 10	Table 6.2.4B.3-15	Table 6.2.4B.3-15
NS_32	-	-	-	-	-

Note 1: Applies to the lower block of Band 23, i.e. a carrier placed in the 2000-2010 MHz region.

**Table 6.2.4B.3-2: A-MPR for "NS\_07"**

Parameters	Region A		Region B				Region C	
$RB_{start}^1$	0 – 12		13 – 18		19 – 42		43 – 49	
$L\_CRB^2$ [RBs]	6 – 8	1 to 5 and 9-50	<8	≥8	<18	≥18	≤2	>2
A-MPR [dB]	≤8	≤12	0	≤12	0	≤6	≤3	0
Note 1: $RB_{start}$ indicates the lowest RB index of transmitted resource blocks Note 2: $L\_CRB$ is the length of a contiguous resource block allocation Note 3: For intra-subframe frequency hopping between two regions, notes 1 and 2 apply on a per slot basis. Note 4: For intra-subframe frequency hopping between two regions, the larger A-MPR value of the two regions may be applied for both slots in the subframe.								

**Table 6.2.4B.3-3: A-MPR for "NS\_10"**

Channel BW	Parameters	Region A
15	$RB_{start}^1$	0 – 10
	$L\_CRB$ [RBs]	1 -20
	A-MPR [dB]	≤ 2
20	$RB_{start}^1$	0 – 15
	$L\_CRB$ [RBs]	1 -20
	A-MPR [dB]	≤ 5
Note 1: $RB_{start}$ indicates the lowest RB index of transmitted resource blocks. Note 2: $L\_CRB$ is the length of a contiguous resource block allocation. Note 3: For intra-subframe frequency hopping which intersects Region A, notes 1 and 2 apply on a per slot basis. Note 4: For intra-subframe frequency hopping which intersect Region A, the larger A-MPR value may be applied for both slots in the subframe.		

**Table 6.2.4B.3-4: A-MPR for NS\_04 for bandwidths > 5MHz**

Channel BW	Parameters	Region A	Region B		Region C
10	$RB_{start}^1$	0 – 12	13 – 36		37 – 49
	$RB_{start}^1 + L_{CRB}^2$ [RBs]	NA (Note 3)	14 - 37	>37	NA (Note 3)
	A-MPR [dB]	≤3dB	0	≤2dB	≤3dB
15	$RB_{start}^1$	0 – 18	19 – 55		56 – 74
	$RB_{start}^1 + L_{CRB}^2$ [RBs]	NA (Note 3)	20 - 56	>56	NA (Note 3)
	A-MPR [dB]	≤3dB	0	≤2dB	≤3dB
20	$RB_{start}^1$	0 – 24	25 – 74		75 – 99
	$RB_{start}^1 + L_{CRB}^2$ [RBs]	NA (Note 3)	26 - 75	>75	NA (Note 3)
	A-MPR [dB]	≤3dB	0	≤2dB	≤3dB
Note 1: $RB_{start}$ indicates the lowest RB index of transmitted resource blocks. Note 2: $L_{CRB}$ is the length of a contiguous resource block allocation. Note 3: Any RB allocation that starts in Region A or C is allowed the specified A-MPR. Note 4: For intra-subframe frequency hopping which intersects regions, notes 1 and 2 apply on a per slot basis. Note 5: For intra-subframe frequency hopping which intersects regions, the larger A-MPR value may be applied for both slots in the subframe.					

**Table 6.2.4B.3-5: A-MPR for "NS\_11"**

Channel Bandwidth	Parameters						
3	F <sub>c</sub> (MHz)	<2004		≥2004			
	L <sub>CRB</sub> (RBs)	1-15		>5			
	A-MPR	≤5		≤1			
5	F <sub>c</sub> (MHz)	<2004		2004 ≤ F <sub>c</sub> <2007		≥2007	
	L <sub>CRB</sub> (RBs)	1-25		1-6 & 15-25	8-12	>6	
	A-MPR	≤7		≤4	0	≤1	
10	F <sub>c</sub> (MHz)	2005					
	RB <sub>start</sub> (RBs)	0-49					
	L <sub>CRB</sub> (RBs)	1-50					
	A-MPR	≤12					
15	F <sub>c</sub> (MHz)	[<2012.5]					
	RB <sub>start</sub> (RBs)	[0-4]	[5-21]		[22-56]	[57-74]	
	L <sub>CRB</sub> (RBs)	≥1	[7-50]	[0-6 & ≥50]	≤25	>25	>0
	A-MPR	≤15	≤7	≤10	[0]	≤6	≤15
	F <sub>c</sub> (MHz)	[2012.5]					
	RB <sub>start</sub> (RBs)	[0-12]	[13-39]		[40-65]	[66-74]	
	L <sub>CRB</sub> (RBs)	≥1	≥30	<30	≥ (69 – RB <sub>start</sub> )	≥1	
	A-MPR	≤10	≤6	[0]	≤2	≤6.5	
20	F <sub>c</sub> (MHz)	2010					
	RB <sub>start</sub> (RBs)	[0-12]	[13-29]		[30-68]	[69-99]	
	L <sub>CRB</sub> (RBs)	≥1	[10-60]	[1-9 & >60]	[1-24]	≥25	≥1
	A-MPR	≤15	≤7	≤10	[0]	≤7	≤15

**Table 6.2.4B.3-6: A-MPR for "NS\_12" (Rel-11 and earlier)**

Channel BW	Parameters	Region A		Region B
1.4	RB <sub>start</sub>	0		1-2
	L <sub>CRB</sub> [RBs]	≤3	≥4	≥4
	A-MPR [dB]	≤3	≤6	≤3
3	RB <sub>start</sub>	0-3		4-5
	L <sub>CRB</sub> [RBs]	4-9	1-3 and 10-15	≥9
	A-MPR [dB]	≤4	≤3	≤3
5	RB <sub>start</sub>	0-6		7-9
	L <sub>CRB</sub> [RBs]	≤8	≥9	≥15
	A-MPR [dB]	≤5	≥3	≤3

Table 6.2.4B.3-6a: A-MPR for "NS\_12" (Rel-12 and later)

Channel bandwidth [MHz]	Parameters	Region A		Region B
1.4	$RB_{start}$	0		1-2
	$L_{CRB}$ [RBs]	$\leq 3$	$\geq 4$	$\geq 4$
	A-MPR [dB]	$\leq 3$	$\leq 6$	$\leq 3$
3	$RB_{start}$	0-3		4-5
	$L_{CRB}$ [RBs]	1-15		$\geq 9$
	A-MPR [dB]	$\leq 4$		$\leq 3$
5	$RB_{start}$	0-6		0-9
	$L_{CRB}$ [RBs]	$\leq 8$		$\geq 9$
	A-MPR [dB]	$\leq 5$		$\leq 3$
10	$RB_{start}$	0-15		0-22
	$L_{CRB}$ [RBs]	$\leq 18$		$\geq 20$
	A-MPR [dB]	$\leq 4$		$\leq 2$
15	$RB_{start}$	0-30		0-30
	$L_{CRB}$ [RBs]	$\leq 30$		$\geq 32$
	A-MPR [dB]	$\leq 4$		$\leq 3$

Table 6.2.4B.3-7: A-MPR for "NS\_13"

Channel BW	Parameters	Region A	
5	$RB_{start}$	0-2	
	$L_{CRB}$ [RBs]	$\leq 5$	$\geq 18$
	A-MPR [dB]	$\leq 3$	$\leq 2$

Table 6.2.4B.3-8: A-MPR for "NS\_14"

Channel BW	Parameters	Region A	
10	$RB_{start}$	0	
	$L_{CRB}$ [RBs]	$\leq 5$	$\geq 50$
	A-MPR [dB]	$\leq 3$	$\leq 1$
15	$RB_{start}$	$\leq 8$	
	$L_{CRB}$ [RBs]	$\leq 16$	$\geq 50$
	A-MPR [dB]	$\leq 3$	$\leq 1$

Table 6.2.4B.3-9: A-MPR for "NS\_15" for E-UTRA highest channel edge > 845 MHz and  $\leq$  849 MHz

E-UTRA Channel bandwidth [MHz]	Parameters	Region A	Region B	Region C
1.4	$RB_{end}$ [RB]			4-5
	A-MPR [dB]			$\leq 3$
3	$RB_{end}$ [RB]	0-1	8-12	13-14
	$L_{CRB}$ [RB]	$\leq 2$	$\geq 8$	$> 0$
	A-MPR [dB]	$\leq 4$	$\leq 4$	$\leq 9$
5	$RB_{end}$ [RB]	0-4	12-19	20-24
	$L_{CRB}$ [RB]	$\leq 2$	$\geq 8$	$> 0$
	A-MPR [dB]	$\leq 4$	$\leq 5$	$\leq 9$
10	$RB_{end}$ [RB]	0-12	23-36	37-49
	$L_{CRB}$ [RB]	$\leq 2$	$\geq 15$	$> 0$
	A-MPR [dB]	$\leq 4$	$\leq 6$	$\leq 9$
15	$RB_{end}$ [RB]	0-20	26-53	54-74
	$L_{CRB}$ [RB]	$\leq 2$	$\geq 20$	$> 0$
	A-MPR [dB]	$\leq 4$	$\leq 5$	$\leq 9$

Table 6.2.4B.3-10: A-MPR for "NS\_15" for E-UTRA highest channel edge  $\leq$  845 MHz

E-UTRA Channel bandwidth [MHz]	Parameters	Region A	Region B	Region C
5	RB <sub>end</sub> [RB]			19-24
	L <sub>CRB</sub> [RB]			$\geq$ 18
	A-MPR [dB]			$\leq$ 2
10	RB <sub>end</sub> [RB]	0-4	29-44	45-49
	L <sub>CRB</sub> [RB]	$\leq$ 2	$\geq$ 24	$>$ 0
	A-MPR [dB]	$\leq$ 4	$\leq$ 4	$\leq$ 9
15	RB <sub>end</sub> [RB]	0-12	44-61	62-74
	L <sub>CRB</sub> [RB]	$\leq$ 2	$\geq$ 20	$>$ 0
	A-MPR [dB]	$\leq$ 4	$\leq$ 5	$\leq$ 9

Table 6.2.4B.3-11: A-MPR for "NS\_16" with channel lower edge at  $\geq$ 807 MHz and  $<$ 808.5 MHz

CBW	Parameter	Region A	Region B	Region C	Region D	Region E
3 MHz	RB <sub>start</sub>	0	1-2			
	L <sub>CRB</sub> [RBs]	$\geq$ 12	12			
	A-MPR [dB]	$\leq$ 2	$\leq$ 1			
5 MHz	RB <sub>start</sub>	0-1	2	2-9	2-5	
	L <sub>CRB</sub> [RBs]	1 - 25	12	15-18	20	
	A-MPR [dB]	$\leq$ 5	$\leq$ 1	$\leq$ 2	$\leq$ 3	
10 MHz	RB <sub>start</sub>	0 - 8	0-14		15-20	15-24
	L <sub>CRB</sub> [RBs]	1 - 12	15-20	$\geq$ 24	$\geq$ 30	24-27
	A-MPR [dB]	$\leq$ 5	$\leq$ 3	$\leq$ 7	$\leq$ 3	$\leq$ 1

Table 6.2.4B.3-12: A-MPR for "NS\_16" with channel lower edge at  $\geq$ 808.5 MHz and  $<$ 812 MHz

CBW	Parameter	Region A	Region B	Region C	Region D	Region E
5 MHz	RB <sub>start</sub>	0	0-1	1-5		
	L <sub>CRB</sub> [RBs]	16-20	$\geq$ 24	16-20		
	A-MPR [dB]	$\leq$ 2	$\leq$ 3	$\leq$ 1		
10 MHz	RB <sub>start</sub>	0-6		0-10	0-14	11-20
	L <sub>CRB</sub> [RBs]	1-12	15-20	24-32	$\geq$ 36	24-32
	A-MPR [dB]	$\leq$ 5	$\leq$ 2	$\leq$ 4	$\leq$ 5	$\leq$ 1

Table 6.2.4B.3-13: A-MPR for "NS\_16" with channel lower edge at  $\geq$ 812 MHz

CBW	Parameter	Region A	Region B	Region C	Region D
10 MHz	RB <sub>start</sub>	0 - 9	0	1-14	0-5
	L <sub>CRB</sub> [RBs]	27-32	36-40	36-40	$\geq$ 45
	A-MPR [dB]	$\leq$ 1	$\leq$ 2	$\leq$ 1	$\leq$ 3



Table 6.2.4B.3-14: A-MPR for “NS\_20”

Channel Bandwidth	Parameters							
5	F <sub>C</sub> (MHz)	< 2007.5		2007.5 ≤ F <sub>C</sub> < 2012.5		2012.5 ≤ F <sub>C</sub> ≤ 2017.5		
	RB <sub>start</sub> (RBs)	≤24		0-3	4-6	≤24		
	L <sub>CRB</sub> (RBs)	>0		15-19	≥20	≥18	1-25	
	A-MPR	≤17		≤1	≤4	≤2	≤ 0	
10	F <sub>C</sub> (MHz)	2005						
	RB <sub>start</sub> (RBs)	0-25		26-34		35-49		
	L <sub>CRB</sub> (RBs)	>0		8-15	>15	>0		
	A-MPR	≤16		≤2	≤5	≤ 6		
	F <sub>C</sub> (MHz)	2015						
	RB <sub>start</sub> (RBs)	0-5			6-10			
	L <sub>CRB</sub> (RBs)	≥32			≥40			
	A-MPR	≤4			≤2			
15	F <sub>C</sub> (MHz)	2012.5						
	RB <sub>start</sub> (RBs)	0-14		15-24		25-39	61-74	
	L <sub>CRB</sub> (RBs)	1-9 & 40-75	10-39	24-29	≥30	≥36	≤6	
	A-MPR	≤11	≤6	≤1	≤7	≤5	≤6	
20	F <sub>C</sub> (MHz)	2010						
	RB <sub>start</sub> (RBs)	0-21	22-31		32-38	39-49	50-69	70-99
	L <sub>CRB</sub> (RBs)	>0	1-9 & 31-75	10-30	≥15	≥24	≥25	>0
	A-MPR	≤17	≤12	≤6	≤9	≤7	≤5	≤16
NOTE 1: When NS_20 is signalled the minimum requirements for the 10 MHz bandwidth are specified for E-UTRA UL carrier centre frequencies of 2005 MHz or 2015 MHz.								
NOTE 2: When NS_20 is signalled the minimum requirements for the 15 MHz channel bandwidth are specified for E-UTRA UL carrier centre frequency of 2012.5 MHz.								

Table 6.2.4B.3-15: A-MPR for “NS\_21”

TBD

## 6.2.4B.4 Test description

### 6.2.4B.4.1 Initial condition

Initial conditions are a set of test configurations the UE needs to be tested in and the steps for the SS to take with the UE to reach the correct measurement state.

The initial test configurations consist of environmental conditions, test frequencies, and channel bandwidths based on E-UTRA operating bands specified in table 5.4.2.1-1. All of these configurations shall be tested with applicable test parameters for each channel bandwidth, and are shown in table 6.2.4B.4.1-1 through table 6.2.4B.4.1-15. The details of the uplink reference measurement channels (RMCs) are specified in Annex A.2. Configurations of PDSCH and PDCCH before measurement are specified in Annex C.2.

**Table 6.2.4B.4.1-1: Test Configuration Table (network signalled value "NS\_03")**

Initial Conditions							
Test Environment (as specified in TS 36.508 [7] clause 4.1)					NC		
Test Frequencies (as specified in TS 36.508 [7] clause 4.3.1)					Low range, Mid range, High range		
Test Channel Bandwidths (as specified in TS 36.508 [7] clause 4.3.1)					Lowest, 5MHz, 10MHz, Highest		
Test Parameters for NS_03 A-MPR							
Configuration ID	Ch BW	Downlink Configuration			Uplink Configuration		
		Mod'n	RB allocation		Mod'n	RB allocation	
			FDD	TDD		FDD	TDD
1	1.4MHz	N/A for A-MPR testing.			QPSK	6	6
2	1.4MHz				QPSK	5	5
3	1.4MHz				16QAM	5	5
4	3MHz				QPSK	15	15
5	3MHz				QPSK	4	4
6	3MHz				16QAM	15	15
7	3MHz				16QAM	4	4
8	5MHz				QPSK	25	25
9	5MHz				QPSK	8	8
10	5MHz				QPSK	6	6
11	5MHz				16QAM	25	25
12	5MHz				16QAM	8	8
13	10MHz				QPSK	50	50
14	10MHz				QPSK	12	12
15	10MHz				QPSK	6	6
16	10MHz				16QAM	50	50
17	10MHz				16QAM	12	12
18	15MHz				QPSK	75	75
19	15MHz				QPSK	16	16
20	15MHz				QPSK	8	8
21	15MHz				16QAM	75	75
22	15MHz				16QAM	16	16
23	20MHz				QPSK	100	100
24	20MHz				QPSK	18	18
25	20MHz				QPSK	10	10
26	20MHz				16QAM	100	100
27	20MHz				16QAM	18	18

Note 1: Test Channel Bandwidths are checked separately for each E-UTRA band, the applicable channel bandwidths are specified in Table 5.4.2.1-1.

Note 2: The Configuration ID will be used to map the applicable Test Configuration to the corresponding Test Requirement in clause 6.2.4B.5 as not all combinations are necessarily required based on the applicability of the UE.

Note 3: The RB<sub>start</sub> of partial RB allocation shall be RB# 0 and RB# (max +1 - RB allocation) of the channel bandwidth.

Note 4: For band 23, above table only applies to mid and high range test frequencies. Low range test frequencies will be covered by NS\_11 test configuration table.

**Table 6.2.4B.4.1-2: Test Configuration Table (network signalled value "NS\_04")**

Initial Conditions						
Test Environment (as specified in TS 36.508 [7] clause 4.1)		NC				
Test Frequencies (as specified in TS 36.508 [7] clause 4.3.1)		Low range, Mid range, High range				
Test Channel Bandwidths (as specified in TS 36.508 [7] clause 4.3.1)		Lowest, 5MHz, 10MHz, Highest				
Test Parameters for NS_03 A-MPR						
Configuration ID	Ch BW	Downlink Configuration		Uplink Configuration		
		Mod'n	RB allocation TDD	Mod'n	RB allocation TDD	RB <sub>start</sub> TDD
1	5MHz	N/A for A-MPR testing.		QPSK	25	Note 3
2	5MHz			QPSK	8	Note 3
3	5MHz			QPSK	6	Note 3
4	5MHz			16QAM	25	Note 3
5	5MHz			16QAM	8	Note 3
6	10MHz			QPSK	1	0
7	10MHz			QPSK	12	0
8	10MHz			QPSK	50	0
9	10MHz			16QAM	50	0
10	10MHz			QPSK	24	13
11	10MHz			16QAM	24	13
12	10MHz			QPSK	36	13
13	10MHz			QPSK	12	37
14	10MHz			QPSK	1	49
15	15MHz			QPSK	1	0
16	15MHz			QPSK	16	0
17	15MHz			QPSK	75	0
18	15MHz			16QAM	75	0
19	15MHz			QPSK	36	19
20	15MHz			16QAM	36	19
21	15MHz			QPSK	50	19
22	15MHz			QPSK	18	56
23	15MHz			QPSK	1	74
24	20MHz			QPSK	1	0
25	20MHz			QPSK	18	0
26	20MHz			QPSK	100	0
27	20MHz			16QAM	100	0
28	20MHz			QPSK	50	25
29	20MHz			16QAM	50	25
30	20MHz			QPSK	75	25
31	20MHz			QPSK	25	75
32	20MHz			QPSK	1	99

Note 1: Test Channel Bandwidths are checked separately for E-UTRA band, the applicable channel bandwidths are specified in Table 5.4.2.1-1.

Note 2: The configuration ID will be used to map the applicable Test Configuration to be corresponding Test Requirement in clause 6.2.4B as not all combinations are necessarily required based on the applicability of the UE.

Note 3: The RB<sub>start</sub> of partial RB allocation shall be RB# 0 and RB# (max +1 - RB allocation) of the channel bandwidth.

**Table 6.2.4B.4.1-3: Test Configuration Table (network signalled value "NS\_05")**

Initial Conditions					
Test Environment (as specified in TS 36.508 [7] clause 4.1)			Normal		
Test Frequencies (as specified in TS 36.508 [7] clause 4.3.1)			Low range, Mid range  In case of Low range: - For 5MHz Channel Bandwidth: 1927.2MHz (NUL = 18072) - For 10MHz Channel Bandwidth: 1934.7MHz (NUL = 18147) - For 15 MHz Channel Bandwidth: 1932.5 MHz (NUL = 18125) - For 20MHz Channel Bandwidth: 1930 MHz (NUL = 18100)		
Test Channel Bandwidths (as specified in TS 36.508 [7] clause 4.3.1)			5MHz, 10MHz, 15MHz, 20MHz		
Test Parameters for NS_05 A-MPR					
Configuration ID	Ch BW	Downlink Configuration		Uplink Configuration	
		Mod'n	RB allocation FDD	Mod'n	RB allocation FDD
1	5MHz	N/A for A-MPR testing		QPSK	1
2	5MHz			QPSK	25
3	10MHz			QPSK	1
4	10MHz			QPSK	12
5	10MHz			QPSK	48
6	10MHz			QPSK	50
7	10MHz			16QAM	50
8	15MHz			QPSK	1
9	15MHz			QPSK	16
10	15MHz			QPSK	48
11	15MHz			QPSK	75
12	15MHz			16QAM	75
13	20MHz			QPSK	1
14	20MHz			QPSK	18
15	20MHz			QPSK	48
16	20MHz			QPSK	100
17	20MHz			16QAM	100
Note 1: The 1 RB allocation shall be tested at both RB #0 and RB #max. Note 2: The RB <sub>start</sub> of partial RB allocation shall be RB# 0 and RB# (max +1 - RB allocation) of the channel bandwidth. Note 3: The Configuration ID will be used to map the applicable Test Configuration to the corresponding Test Requirement in clause 6.2.4B.5 as not all combinations are necessarily required based on the applicability of the UE.					

**Table 6.2.4B.4.1-4: Test Configuration Table (network signalled value "NS\_06")**

Initial Conditions					
Test Environment (as specified in TS 36.508 [7] clause 4.1)			Normal		
Test Frequencies (as specified in TS 36.508 [7] clause 4.3.1)			Low range, Mid range, High range		
Test Channel Bandwidths (as specified in TS 36.508 [7] clause 4.3.1)			Lowest, 5MHz, 10MHz, Highest		
Test Parameters for NS_05 A-MPR					
Configuration ID	Ch BW	Downlink Configuration		Uplink Configuration	
		Mod'n	RB allocation FDD	Mod'n	RB allocation FDD
1	1.4MHz	N/A for A-MPR testing		QPSK	6
2	1.4MHz			QPSK	5
3	1.4MHz			16QAM	5
4	3MHz			QPSK	15
5	3MHz			QPSK	4
6	3MHz			16QAM	4
7	5MHz			QPSK	25
8	5MHz			QPSK	8
9	5MHz			16QAM	8
10	10MHz			QPSK	50
11	10MHz			QPSK	12
12	10MHz			16QAM	12
13	15MHz			QPSK	75
14	15MHz			QPSK	16
15	15MHz			16QAM	16
16	20MHz			QPSK	100
17	20MHz			QPSK	18
18	20MHz			16QAM	18
Note 1:	Test Channel Bandwidths are checked separately for each E-UTRA band, the applicable channel bandwidths are specified in Table 5.4.2.1-1.				
Note 2:	The Configuration ID will be used to map the applicable Test Configuration to the corresponding Test Requirement in clause 6.2.4B.5 as not all combinations are necessarily required based on the applicability of the UE.				
Note 3:	The RBstart of partial RB allocation shall be RB# 0 and RB# (max +1 - RB allocation) of the channel bandwidth.				

**Table 6.2.4B.4.1-5: Test Configuration Table (network signalled value "NS\_07")**

Initial Conditions						
Test Environment (as specified in TS 36.508 [7] clause 4.1)				NC		
Test Frequencies (as specified in TS 36.508 [7] clause 4.3.1)				Mid range		
Test Channel Bandwidths (as specified in TS 36.508 [7] clause 4.3.1)				10MHz		
Test Parameters for NS_07 A-MPR						
Configuration ID	Ch BW	Downlink Configuration		Uplink Configuration		
		Mod'n	RB allocation FDD	Mod'n	RB allocation FDD	RB <sub>start</sub> FDD
1	10MHz	N/A for A-MPR testing		QPSK	1	0
2	10MHz			QPSK	8	0
3	10MHz			QPSK	6	13
4	10MHz			QPSK	20	13
5	10MHz			QPSK	12	13
6	10MHz			16QAM	36	13
7	10MHz			QPSK	16	19
8	10MHz			QPSK	12	19
9	10MHz			16QAM	16	19
10	10MHz			QPSK	30	19
11	10MHz			16QAM	30	19
12	10MHz			QPSK	6	43
13	10MHz			QPSK	2	48
14	10MHz			QPSK	50	0
15	10MHz			QPSK	12	0
16	10MHz			16QAM	50	0
Note 1: The Configuration ID will be used to map the applicable Test Configuration to the corresponding Test Requirement in clause 6.2.4B.5 as not all combinations are necessarily required based on the applicability of the UE.						

**Table 6.2.4B.4.1-6: Test Configuration Table (network signalled value "NS\_08")**

Initial Conditions					
Test Environment (as specified in TS 36.508 [7] clause 4.1)			Normal		
Test Frequencies (as specified in TS 36.508 [7] clause 4.3.1)			High range		
Test Channel Bandwidths (as specified in TS 36.508 [7] clause 4.3.1)			5MHz, 10MHz, 15MHz		
Test Parameters for NS_08 A-MPR					
Configuration ID	Ch BW	Downlink Configuration		Uplink Configuration	
		Mod'n	RB allocation FDD	Mod'n	RB allocation FDD
1	5MHz	N/A for A-MPR testing		QPSK	1
2	5MHz			QPSK	8
3	5MHz			QPSK	25
4	10MHz			QPSK	1
5	10MHz			QPSK	12
6	10MHz			QPSK	40
7	10MHz			QPSK	50
8	10MHz			16QAM	50
9	15MHz			QPSK	1
10	15MHz			QPSK	16
11	15MHz			QPSK	40
12	15MHz			QPSK	75
13	15MHz			16QAM	75
Note 1:	The Configuration ID will be used to map the applicable Test Configuration to the corresponding Test Requirement in clause 6.2.4B.5 as not all combinations are necessarily required based on the applicability of the UE.				
Note 2:	The 1 RB allocation shall be tested at both RB #0 and RB #max.				
Note 3:	The RB <sub>start</sub> of partial RB allocation shall be RB# 0 and RB# (max + 1 - RB allocation) of the channel bandwidth.				

**Table 6.2.4B.4.1-7: Test Configuration Table (network signalled value “NS\_09”)**

Initial Conditions					
Test Environment (as specified in TS 36.508 [7] clause 4.1)			Normal		
Test Frequencies (as specified in TS 36.508 [7] clause 4.3.1)			High range		
Test Channel Bandwidths (as specified in TS 36.508 [7] clause 4.3.1)			5MHz, 10MHz, 15MHz		
Test Parameters for Channel Bandwidths					
Configuration ID	Ch BW	Downlink Configuration		Uplink Configuration	
		Mod'n	RB allocation FDD	Mod'n	RB allocation FDD
1	5MHz	N/A for A-MPR testing		QPSK	1
2	5MHz			QPSK	8
3	5MHz			QPSK	25
4	10MHz			QPSK	1
5	10MHz			QPSK	12
6	10MHz			QPSK	40
7	10MHz			QPSK	50
8	10MHz			16QAM	50
9	15MHz			QPSK	1
10	15MHz			QPSK	16
11	15MHz			QPSK	40
12	15MHz			QPSK	54
13	15MHz			QPSK	75
14	15MHz			16QAM	75
<p>Note 1: The Configuration ID will be used to map the applicable Test Configuration to the corresponding Test Requirement in clause 6.2.4B.5 as not all combinations are necessarily required based on the applicability of the UE.</p> <p>Note 2: The 1 RB allocation shall be tested at both RB #0 and RB #max.</p> <p>Note 3: The RB<sub>start</sub> of partial RB allocation shall be RB# 0 and RB# (max + 1 - RB allocation) of the channel bandwidth.</p>					



Table 6.2.4B.4.1-8: Test Configuration Table (network signalled value "NS\_11")

Initial Conditions					
Test Environment (as specified in TS 36.508 [7] clause 4.1)			Normal		
Test Frequencies (as specified in TS 36.508 [7] clause 4.3.1)			Low range For 3 MHz Channel Bandwidth: a. UL 2001.5 MHz (N_UL=25515), DL 2181.5 MHz(N_DL=7515) b. UL 2004.5 MHz (N_UL=25545), DL 2184.5 (N_DL=7545)  For 5 MHz Channel Bandwidth: a. UL 2002.5 MHz (N_UL=25525), DL 2182.5 MHz(N_DL=7525) b. UL 2004.5 MHz (N_UL=25545), DL 2184.5 MHz(N_DL=7545) c. UL 2007.5 MHz (N_UL=25575), DL 2187.5 MHz(N_DL=7575)  For 10 MHz Channel Bandwidth: UL 2005 MHz (N_UL=25550), DL 2185 MHz (N_DL=7550)		
Test Channel Bandwidths (as specified in TS 36.508 [7] clause 4.3.1)			1.4MHz, 3MHz, 5MHz, 10MHz		
Test Parameters for NS_11 A-MPR					
Configuration ID	Ch BW	Downlink Configuration		Uplink Configuration	
		Mod'n	RB allocation FDD	Mod'n	RB allocation FDD
1	3MHz	N/A for A-MPR testing		QPSK	6
2	3MHz			QPSK	15
3	3MHz			16QAM	6
4	3MHz			16QAM	15
5	5MHz			QPSK	1
6	5MHz			QPSK	8
7	5MHz			QPSK	25
8	5MHz			16QAM	8
9	5MHz			16QAM	25
10	10MHz			QPSK	1
11	10MHz			QPSK	12
12	10MHz			QPSK	50
13	10MHz			16QAM	12
14	10MHz			16QAM	50
Note 1: The Configuration ID will be used to map the applicable Test Configuration to the corresponding Test Requirement in clause 6.2.4B.5 as not all combinations are necessarily required based on the applicability of the UE. Note 2: The RB <sub>start</sub> of partial RB allocation shall be RB# 0 and RB# (max +1 - RB allocation) of the channel bandwidth.					

**Table 6.2.4B.4.1-9: Test Configuration Table (network signalled value "NS\_12")**

Initial Conditions						
Test Environment (as specified in TS 36.508 [7] clause 4.1)		NC				
Test Frequencies (as specified in TS 36.508 [7] clause 4.3.1)		For 1.4 MHz Channel Bandwidth: UL 814.9 MHz (NUL = 26699)  For 3 MHz Channel Bandwidth: UL 815.7 MHz (NUL = 26707)  For 5 MHz Channel Bandwidth: UL 816.7 MHz (NUL = 26717)  For 10 MHz Channel Bandwidth: UL 819.2 MHz (NUL = 26742)  For 15 MHz Channel Bandwidth: UL 821.7 MHz (NUL = 26767)				
Test Channel Bandwidths (as specified in TS 36.508 [7] clause 4.3.1)		1.4 MHz, 3 MHz, 5 MHz, 10 MHz and 15 MHz				
Test Parameters for Channel Bandwidths						
Test Number	Ch BW	Downlink Configuration		Uplink Configuration		
		Mod'n	RB allocation	Mod'n	RB allocation FDD	RBstart FDD
1	1.4 MHz	N/A for A-MPR testing.		QPSK	1	0
2	1.4 MHz			QPSK	6	0
3	1.4 MHz			QPSK	1	1
4	1.4 MHz			QPSK	5	1
5	1.4 MHz			16QAM	6	0
6 (Note 1)	3 MHz			QPSK	4	0
7 (Note 1)	3 MHz			QPSK	6	0
8	3 MHz			QPSK	4	4
9	3 MHz			QPSK	6	4
10 (Note 1)	3 MHz			16QAM	15	0
11	5 MHz			QPSK	8	0
12	5 MHz			QPSK	15	0
13	5 MHz			QPSK	8	7
14 (Note 1)	5 MHz			QPSK	15	7
15	5 MHz			16QAM	25	0
16 (Note 2)	10 MHz	QPSK	18	0		
17 (Note 2)	10 MHz	QPSK	18	16		
18 (Note 2)	10 MHz	16QAM	50	0		
19 (Note 2)	15 MHz	QPSK	30	0		
20 (Note 2)	15 MHz	QPSK	30	31		
21 (Note 2)	15 MHz	16QAM	75	0		
Note 1: Only for UEs of Rel-11 and earlier						
Note 2: Only for UEs of Rel-12 and later						

**Table 6.2.4B.4.1-10: Test Configuration Table (network signalled value "NS\_13")**

Initial Conditions						
Test Environment (as specified in TS 36.508 [7] clause 4.1)				NC		
Test Frequencies (as specified in TS 36.508 [7] clause 4.3.1)				For 1.4 MHz Channel Bandwidth: UL 819.7 MHz (NUL = 26747)  For 3 MHz Channel Bandwidth: UL 820.5 MHz (NUL = 26755)  For 5 MHz Channel Bandwidth: UL 821.5 MHz (NUL = 26765)		
Test Channel Bandwidths (as specified in TS 36.508 [7] clause 4.3.1)				1.4 MHz, 3MHz and 5 MHz		
Test Parameters for Channel Bandwidths						
Test Number	Ch BW	Downlink Configuration		Uplink Configuration		
		Mod'n	RB allocation	Mod'n	RB allocation FDD	RBstart FDD
1 (Note 1)	1.4 MHz	N/A for A-MPR testing.		QPSK	6	0
2 (Note 1)	3 MHz			QPSK	15	0
3	5 MHz			QPSK	1	0
4	5 MHz			QPSK	25	0
5	5 MHz			QPSK	15	0
6	5 MHz			QPSK	15	7
7	5 MHz			16QAM	25	0
Note 1: Only for UEs of Rel-12 and later						

**Table 6.2.4B.4.1-11: Test Configuration Table (network signalled value "NS\_14")**

Initial Conditions						
Test Environment (as specified in TS 36.508 [7] clause 4.1)				NC		
Test Frequencies (as specified in TS 36.508 [7] clause 4.3.1)				For 10 MHz Channel Bandwidth: UL 829 MHz (NUL = 26840)		
Test Channel Bandwidths (as specified in TS 36.508 [7] clause 4.3.1)				For 15 MHz Channel Bandwidth: Mid range		
				10 MHz, 15 MHz		
Test Parameters for Channel Bandwidths						
Test Number	Ch BW	Downlink Configuration		Uplink Configuration		
		Mod'n	RB allocation	Mod'n	RB allocation FDD	RBstart FDD
1	10 MHz	N/A for A-MPR testing.		QPSK	1	0
2	10 MHz			QPSK	25	0
3	10 MHz			QPSK	50	0
4	10 MHz			QPSK	25	1
5	10 MHz			16QAM	50	0
6	15 MHz			QPSK	8	0
7	15 MHz			QPSK	25	0
8	15 MHz			QPSK	75	0
9	15 MHz			QPSK	50	15
10	15 MHz			16QAM	75	0

**Table 6.2.4B.4.1-12: Test Configuration Table (network signalled value "NS\_15")**

Initial Conditions						
Test Environment (as specified in TS 36.508 [7] subclause 4.1)		NC				
Test Frequencies (as specified in TS 36.508 [7] subclause 4.3.1)		For 1.4 MHz Channel Bandwidth: High range For 3 MHz Channel Bandwidth: UL 843.5 MHz ( $N_{UL} = 26985$ ) or High range  For 5 MHz Channel Bandwidth: UL 842.5 MHz ( $N_{UL} = 26975$ ) or High range For 10 MHz Channel Bandwidth: UL 840 MHz ( $N_{UL} = 26950$ ) or High range For 15 MHz Channel Bandwidth: UL 837.5 MHz ( $N_{UL} = 26925$ ) or High range				
Test Channel Bandwidths (as specified in TS 36.508 [7] subclause 4.3.1)		1.4 MHz, 3 MHz, 5 MHz, 10 MHz, 15 MHz				
Test Parameters for Channel Bandwidths						
Configuration ID	Ch BW	Downlink Configuration		Uplink Configuration		
		Mod'n	RB allocation	Mod'n	RB allocation FDD	RBstart FDD
1 (note 3)	1.4 MHz	N/A for A-MPR testing.		QPSK	4	0
2 (note 3)	1.4 MHz			16QAM	6	0
3 (note 3)	3 MHz			QPSK	6	7
4 (note 3)	3 MHz			QPSK	12	1
5 (note 3)	3 MHz			16QAM	15	0
6 (note 2)	3 MHz			QPSK	15	0
7 (note 3)	5 MHz			QPSK	6	14
8 (note 3)	5 MHz			QPSK	20	0
9 (note 3)	5 MHz			16QAM	25	0
10 (note 2)	5 MHz			QPSK	16	9
11 (note 2)	5 MHz			QPSK	25	0
12 (note 3)	10 MHz			QPSK	1	39
13 (note 3)	10 MHz			QPSK	1	10
14 (note 3)	10 MHz			QPSK	3	0
15 (note 3)	10 MHz			QPSK	20	3
16 (note 3)	10 MHz			QPSK	36	1
17 (note 3)	10 MHz			QPSK	50	0
18 (note 1, 3)	10 MHz			16QAM	50	0
19 (note 2)	10 MHz			QPSK	20	25
20 (note 2)	10 MHz			QPSK	45	0
21 (note 3)	15 MHz			QPSK	18	36
22 (note 3)	15 MHz			QPSK	25	1
23 (note 3)	15 MHz			QPSK	54	0
24 (note 1, 3)	15 MHz			16QAM	75	0
25 (note 2)	15 MHz			QPSK	18	44

26 (note 2)	15 MHz		QPSK	60	2
Note 1: Applies only for UE-Categories $\geq 2$ .					
Note 2: Applicable only test frequency < high range					
Note 3: Applicable only to high range frequency testing					

**Table 6.2.4B.4.1-13: Test Configuration Table (network signalled value "NS\_16")**

Initial Conditions						
Test Environment (as specified in TS 36.508 [7] subclause 4.1)			NC			
Test Frequencies (as specified in TS 36.508 [7] subclause 4.3.1)			For 1.4 MHz Channel Bandwidth: Low range  For 3 MHz Channel Bandwidth: Low range, 810 MHz (N <sub>UL</sub> = 27070)  For 5 MHz Channel Bandwidth: Low range, 811 MHz (N <sub>UL</sub> = 27080), 814.5 MHz (N <sub>UL</sub> = 27115)  For 10 MHz Channel Bandwidth: Low range, 813.5 MHz (N <sub>UL</sub> = 27105), 817 MHz (N <sub>UL</sub> = 27140)			
Test Channel Bandwidths (as specified in TS 36.508 [7] subclause 4.3.1)			1.4 MHz, 3 MHz, 5 MHz, 10 MHz			
Test Parameters for Channel Bandwidths						
Configuration ID	Ch BW	Downlink Configuration		Uplink Configuration		
		Mod'n	RB allocation	Mod'n	RB allocation FDD	RBstart FDD
1	1.4 MHz	N/A for A-MPR testing.		QPSK	1	0
2	1.4 MHz			QPSK	6	0
3	1.4 MHz			16QAM	6	0
4	3 MHz			QPSK	1	0
5	3 MHz			QPSK	12	1
62	3 MHz			QPSK	15	0
7	3 MHz			16QAM	15	0
8	5 MHz			QPSK	1	0
95	5 MHz			QPSK	12	2
10	5 MHz			QPSK	18	2
11	5 MHz			QPSK	20	0
12	5 MHz			QPSK	20	2
13	5 MHz			QPSK	25	0
14	5 MHz			16QAM	25	0
15	10 MHz			QPSK	1	0
16 (Note 2)	10 MHz			QPSK	1	10

17 (Note 2)	10 MHz	QPSK	20	0
18 (Note 2)	10 MHz	QPSK	27	15
19 (Note 2)	10 MHz	QPSK	32	15
20	10 MHz	QPSK	32	0
21	10 MHz	QPSK	50	0
22 (Note 1)	10 MHz	16QAM	50	0
23 (Note 3)	10 MHz	QPSK	40	0
24 (Note 3)	10 MHz	QPSK	40	1
Note 1: Applies only for UE-Categories $\geq 2$ . Note 2: Applies only for 10 MHz channel for Low Range, and 813.5 MHz Note 3: Applies only for 10 MHz channel for 817 MHz range				

**Table 6.2.4B.4.1-14: Test Configuration Table (network signalled value "NS\_20")**

TBD

**Table 6.2.4B.4.1-15: Test Configuration Table (network signalled value "NS\_21")**

Initial Conditions						
Test Environment (as specified in TS 36.508 [7] subclause 4.1)			NC			
Test Frequencies (as specified in TS 36.508 [7] subclause 4.3.1)			Low range or High range			
Test Channel Bandwidths (as specified in TS 36.508 [7] subclause 4.3.1)			5 MHz, 10 MHz			
Test Parameters for Channel Bandwidths						
Configuration ID	Ch BW	Downlink Configuration		Uplink Configuration		
		Mod'n	RB allocation	Mod'n	RB allocation FDD	RBstart FDD
1 (note 2)	5 MHz			QPSK	1	0
2 (note 2)	5 MHz			QPSK	25	0
3 (note 2)	10 MHz			QPSK	1	0
4 (note 3)	10 MHz			QPSK	1	49
5 (note 2)	10 MHz			QPSK	15	0
6 (note 3)	10 MHz			QPSK	3	47
7 (note 3)	10 MHz			QPSK	50	0
8 (note 1, 3)	10 MHz			16QAM	50	0
Note 1: Applies only for UE-Categories $\geq 2$ . Note 2: Applicable only to low range frequency testing. Note 3: Applicable only to high range frequency testing.						

Editor's note: The following lines belong at the end of section 6.2.4B.4.1. As new tables are added to this section, these lines should always follow the tables.



1. Connect the SS to the UE antenna connectors as shown in Figure TS 36.508 [7] Annex A, Figure A.3.
2. The parameter settings for the cell are set up according to TS 36.508 [7] clause 4.4.3.
3. Downlink signals are initially set up according to Annex C.0, C.1, and C.3.0, and uplink signals according to Annex H.1 and H.3.0.
4. The UL Reference Measurement channels are set according to the applicable table from Table 6.2.4B.4.1-1 to 6.2.4B.4.1-15.
5. Propagation conditions are set according to Annex B.0.
6. Ensure the UE is in State 3A-RF according to TS 36.508 [7] clause 5.2A.2. Message contents are defined in clause 6.2.4B.4.3.

#### 6.2.4B.4.2 Test procedure

1. SS sends uplink scheduling information for each UL HARQ process via PDCCH DCI format 0 for C\_RNTI to schedule the UL RMC according to the applicable table from Table 6.2.4B.4.1-1 to Table 6.2.4B.4.1-15. Since the UE has no payload data to send, the UE transmits uplink MAC padding bits on the UL RMC.
2. Send continuously uplink power control "up" commands in the uplink scheduling information to the UE until the UE transmits at  $P_{UMAX}$  level.
3. Measure the output power for UE in the channel bandwidth of the radio access mode. The period of measurement shall be at least the continuous duration one sub-frame (1ms). For TDD slots with transient periods are not under test.

#### 6.2.4B.4.3 Message contents

Message contents are according to TS 36.508 [7] clause 4.6, with the following exceptions for each network signalled value.

##### 6.2.4B.4.3.1 Message contents exceptions (network signalled value "NS\_03")

1. Information element `additionalSpectrumEmission` is set to NS\_03. This can be set in the *SystemInformationBlockType2* as part of the cell broadcast message. This exception indicates that the UE shall meet the additional spurious emission requirement for a specific deployment scenario.

**Table 6.2.4B.4.3.1-1: SystemInformationBlockType2: Additional spurious emissions test requirement for "NS\_03"**

Derivation Path: TS 36.508 [7] clause 4.4.3.3, Table 4.4.3.3-1			
Information Element	Value/remark	Comment	Condition
<code>additionalSpectrumEmission</code>	3 (NS_03)		

##### 6.2.4B.4.3.2 Message contents exceptions (network signalled value "NS\_04")

1. Information element `additionalSpectrumEmission` is set to NS\_04. This can be set in the *SystemInformationBlockType2* as part of the cell broadcast message. This exception indicates that the UE shall meet the additional spurious emission requirement for a specific deployment scenario.

**Table 6.2.4B.4.3.2-1: SystemInformationBlockType2: Additional spurious emissions test requirement for "NS\_04"**

Derivation Path: TS 36.508 [7] clause 4.4.3.3, Table 4.4.3.3-1			
Information Element	Value/remark	Comment	Condition
<code>additionalSpectrumEmission</code>	4 (NS_04)		

## 6.2.4B.4.3.3 Message contents exceptions (network signalled value "NS\_05")

1. Information element `additionalSpectrumEmission` is set to NS\_05. This can be set in the *SystemInformationBlockType2* as part of the cell broadcast message. This exception indicates that the UE shall meet the additional spurious emission requirement for a specific deployment scenario.

**Table 6.2.4B.4.3.3-1: SystemInformationBlockType2: Additional spurious emissions test requirement for "NS\_05"**

Derivation Path: TS 36.508 [7] clause 4.4.3.3, Table 4.4.3.3-1			
Information Element	Value/remark	Comment	Condition
<code>additionalSpectrumEmission</code>	5 (NS_05)		

## 6.2.4B.4.3.4 Message contents exceptions (network signalled value "NS\_06")

1. Information element `additionalSpectrumEmission` is set to NS\_06. This can be set in the *SystemInformationBlockType2* as part of the cell broadcast message. This exception indicates that the UE shall meet the additional spurious emission requirement for a specific deployment scenario.

**Table 6.2.4B.4.3.4-1: SystemInformationBlockType2: Additional spurious emissions test requirement for "NS\_06"**

Derivation Path: TS 36.508 [7] clause 4.4.3.3, Table 4.4.3.3-1			
Information Element	Value/remark	Comment	Condition
<code>additionalSpectrumEmission</code>	6 (NS_06)		

## 6.2.4B.4.3.5 Message contents exceptions (network signalled value "NS\_07")

1. Information element `additionalSpectrumEmission` is set to NS\_07. This can be set in the *SystemInformationBlockType2* as part of the cell broadcast message. This exception indicates that the UE shall meet the additional spurious emission requirement for a specific deployment scenario.

**Table 6.2.4B.4.3.5-1: SystemInformationBlockType2: Additional spurious emissions test requirement for "NS\_07"**

Derivation Path: TS 36.508 [7] clause 4.4.3.3, Table 4.4.3.3-1			
Information Element	Value/remark	Comment	Condition
<code>additionalSpectrumEmission</code>	7 (NS_07)		

## 6.2.4B.4.3.6 Message contents exceptions (network signalled value "NS\_08")

1. Information element `additionalSpectrumEmission` is set to NS\_08. This can be set in the *SystemInformationBlockType2* as part of the cell broadcast message. This exception indicates that the UE shall meet the additional spurious emission requirement for a specific deployment scenario.

**Table 6.2.4B.4.3.6-1: SystemInformationBlockType2: Additional spurious emissions test requirement for "NS\_08"**

Derivation Path: TS 36.508 [7] clause 4.4.3.3, Table 4.4.3.3-1			
Information Element	Value/remark	Comment	Condition
<code>additionalSpectrumEmission</code>	8 (NS_08)		

## 6.2.4B.4.3.7 Message contents exceptions (network signalled value "NS\_09")

1. Information element `additionalSpectrumEmission` is set to NS\_09. This can be set in the *SystemInformationBlockType2* as part of the cell broadcast message. This exception indicates that the UE shall meet the additional spurious emission requirement for a specific deployment scenario.

**Table 6.2.4B.4.3.7-1: SystemInformationBlockType2: Additional spurious emissions test requirement for "NS\_09"**

Derivation Path: TS 36.508 [7] clause 4.4.3.3, Table 4.4.3.3-1			
Information Element	Value/remark	Comment	Condition
additionalSpectrumEmission	9 (NS_09)		

## 6.2.4B.4.3.8 Message contents exceptions (network signalled value "NS\_11")

- Information element additionalSpectrumEmission is set to NS\_11. This can be set in the *SystemInformationblockType2* as part of the cell broadcast message. This exception indicates that the UE shall meet the additional spurious emission requirement for a specific deployment scenario.

**Table 6.2.4B.4.3.8-1: SystemInformationBlockType2: Additional spurious emissions test requirement for "NS\_11"**

Derivation Path: TS 36.508 [7] clause 4.4.3.3, Table 4.4.3.3-1			
Information Element	Value/remark	Comment	Condition
additionalSpectrumEmission	11 (NS_11)		

## 6.2.4B.4.3.9 Message contents exceptions (network signalled value "NS\_12")

- Information element additionalSpectrumEmission is set to NS\_12. This can be set in the *SystemInformationblockType2* as part of the cell broadcast message. This exception indicates that the UE shall meet the additional spurious emission requirement for a specific deployment scenario.

**Table 6.2.4B.4.3.9-1: SystemInformationBlockType2: Additional spurious emissions test requirement for "NS\_12"**

Derivation Path: TS 36.508 [7] clause 4.4.3.3, Table 4.4.3.3-1			
Information Element	Value/remark	Comment	Condition
additionalSpectrumEmission	12 (NS_12)		

## 6.2.4B.4.3.10 Message contents exceptions (network signalled value "NS\_13")

- Information element additionalSpectrumEmission is set to NS\_13. This can be set in the *SystemInformationblockType2* as part of the cell broadcast message. This exception indicates that the UE shall meet the additional spurious emission requirement for a specific deployment scenario.

**Table 6.2.4B.4.3.10-1: SystemInformationBlockType2: Additional spurious emissions test requirement for "NS\_13"**

Derivation Path: TS 36.508 [7] clause 4.4.3.3, Table 4.4.3.3-1			
Information Element	Value/remark	Comment	Condition
additionalSpectrumEmission	13 (NS_13)		

## 6.2.4B.4.3.11 Message contents exceptions (network signalled value "NS\_14")

- Information element additionalSpectrumEmission is set to NS\_14. This can be set in the *SystemInformationblockType2* as part of the cell broadcast message. This exception indicates that the UE shall meet the additional spurious emission requirement for a specific deployment scenario.

**Table 6.2.4B.4.3.11-1: SystemInformationBlockType2: Additional spurious emissions test requirement for "NS\_14"**

Derivation Path: TS 36.508 [7] clause 4.4.3.3, Table 4.4.3.3-1			
Information Element	Value/remark	Comment	Condition
additionalSpectrumEmission	14 (NS_14)		

## 6.2.4B.4.3.12 Message contents exceptions (network signalled value "NS\_15")

1. Information element `additionalSpectrumEmission` is set to NS\_15. This can be set in the *SystemInformationBlockType2* as part of the cell broadcast message. This exception indicates that the UE shall meet the additional spurious emission requirement for a specific deployment scenario.

**Table 6.2.4B.4.3.12-1: SystemInformationBlockType2: Additional spurious emissions test requirement for "NS\_15"**

Derivation Path: TS 36.508 [7] clause 4.4.3.3, Table 4.4.3.3-1			
Information Element	Value/remark	Comment	Condition
<code>additionalSpectrumEmission</code>	15 (NS_15)		

## 6.2.4B.4.3.13 Message contents exceptions (network signalled value "NS\_16")

1. Information element `additionalSpectrumEmission` is set to NS\_16. This can be set in the *SystemInformationBlockType2* as part of the cell broadcast message. This exception indicates that the UE shall meet the additional spurious emission requirement for a specific deployment scenario.

**Table 6.2.4B.4.3.13-1: SystemInformationBlockType2: Additional spurious emissions test requirement for "NS\_16"**

Derivation Path: TS 36.508 [7] clause 4.4.3.3, Table 4.4.3.3-1			
Information Element	Value/remark	Comment	Condition
<code>additionalSpectrumEmission</code>	16 (NS_16)		

## 6.2.4B.4.3.14 Message contents exceptions (network signalled value "NS\_20")

1. Information element `additionalSpectrumEmission` is set to NS\_20. This can be set in the *SystemInformationBlockType2* as part of the cell broadcast message. This exception indicates that the UE shall meet the additional spurious emission requirement for a specific deployment scenario.

**Table 6.2.4B.4.3.14-1: SystemInformationBlockType2: Additional spurious emissions test requirement for "NS\_20"**

Derivation Path: TS 36.508 [7] clause 4.4.3.3, Table 4.4.3.3-1			
Information Element	Value/remark	Comment	Condition
<code>additionalSpectrumEmission</code>	20 (NS_20)		

## 6.2.4B.4.3.15 Message contents exceptions (network signalled value "NS\_21")

1. Information element `additionalSpectrumEmission` is set to NS\_21. This can be set in the *SystemInformationBlockType2* as part of the cell broadcast message. This exception indicates that the UE shall meet the additional spurious emission requirement for a specific deployment scenario.

**Table 6.2.4B.4.3.15-1: SystemInformationBlockType2: Additional spurious emissions test requirement for "NS\_21"**

Derivation Path: TS 36.508 [7] clause 4.4.3.3, Table 4.4.3.3-1			
Information Element	Value/remark	Comment	Condition
<code>additionalSpectrumEmission</code>	21 (NS_21)		

## 6.2.4B.5 Test requirements

The maximum output power, derived in step 2 shall be within the range prescribed by the nominal maximum output power and tolerance in the applicable table from Table 6.2.4B.5-1 to Table 6.2.4B.5-17. The allowed A-MPR values specified in Table 6.2.4B.3-1 are in addition to the allowed MPR requirements specified in clause 6.2.3B. For the UE maximum output power modified by MPR and/or A-MPR, the power limits specified in Table 6.2.5B.3-1 apply.

**Table 6.2.4B.5-1: UE Power Class test requirements (network signalled value "NS\_03")  
(for Bands 4, 10, 23, 35, and 36)**

Configuration ID	EUTRA band	Class 1 (dBm)	Tol. (dB)	Class 2 (dBm)	Tol. (dB)	Class 3 (dBm)	Tol. (dB)
1	4,10,23,35,36					23	+2.7 / -3.7
2	4,10,23,35,36					23	+2.7 / -2.7
3	4,10,23,35,36					23	+2.7 / -3.7
4	4,10,23,35,36					23	2.7 / -4.7
5	4,10,23,35,36					23	+2.7 / -2.7
6	4,10,23,35,36					23	+2.7 / -6.2
7	4,10,23,35,36					23	+2.7 / -3.7
8	4,10,23,35,36					23	2.7 / -4.7
9	4,10,23,35,36					23	+2.7 / -3.7
10	4,10,23,35,36					23	+2.7 / -2.7
11	4,10,23,35,36					23	+2.7 / -6.2
12	4,10,23,35,36					23	2.7 / -4.7
13	4,10,23,35,36					23	2.7 / -4.7
14	4,10,23,35,36					23	+2.7 / -3.7
15	4,10,23,35,36					23	+2.7 / -2.7
16	4,10,23,35,36					23	+2.7 / -6.2
17	4,10,23,35,36					23	2.7 / -4.7
18	4,10,35,36					23	2.7 / -4.7
19	4,10,35,36					23	+2.7 / -3.7
20	4,10,35,36					23	+2.7 / -2.7
21	4,10,35,36					23	+2.7 / -6.2
22	4,10,35,36					23	2.7 / -4.7
23	4,10,35,36					23	2.7 / -4.7
24	4,10,35,36					23	+2.7 / -3.7
25	4,10,35,36					23	+2.7 / -2.7
26	4,10,35,36					23	+2.7 / -6.2
27	4,10,35,36					23	2.7 / -4.7

**Table 6.2.4B.5-2: UE Power Class test requirements (network signalled value "NS\_03")  
(for Bands 2 and 25)**

Configuration ID	EUTRA band	Test Freq.	Class 1 (dBm)	Tol. (dB)	Class 2 (dBm)	Tol. (dB)	Class 3 (dBm)	Tol. (dB)
1	2, 25	Mid					23	+2.7 / -3.7
1	2, 25	Low, High					23	+2.7 / -5.7
2	2, 25	Mid					23	+2.7 / -2.7
2	2, 25	Low, High					23	+2.7 / -4.2
3	2, 25	Mid					23	+2.7 / -3.7
3	2, 25	Low, High					23	+2.7 / -5.7
4	2, 25	Mid					23	+2.7 / -4.7
4	2, 25	Low, High					23	+2.7 / -7.7
5	2, 25	Mid					23	+2.7 / -2.7
5	2, 25	Low, High					23	+2.7 / -4.2
6	2, 25	Mid					23	+2.7 / -6.2
6	2, 25	Low, High					23	+2.7 / -9.2
7	2, 25	Mid					23	+2.7 / -3.7
7	2, 25	Low, High					23	+2.7 / -5.7
8	2, 25	All					23	+2.7 / -4.7
9	2, 25	Low @ RB#(max+1-RB allocation), Mid, High @ RB#0					23	+2.7 / -3.7
9	2, 25	Low @ RB#0, High @ RB#(max+1-RB allocation)					23	+2.7 / -5.7
10	2, 25	Low @ RB#(max+1-RB allocation), Mid, High @ RB#0					23	+2.7 / -2.7
10	2, 25	Low @ RB#0, High @ RB#(max+1-RB allocation)					23	+2.7 / -4.2
11	2, 25	All					23	+2.7 / -6.2
12	2, 25	Low @ RB#(max+1-RB allocation), Mid, High @ RB#0					23	+2.7 / -4.7
12	2, 25	Low @ RB#0, High @ RB#(max+1-RB allocation)					23	+2.7 / -7.7
13	2, 25	All					23	+2.7 / -4.7
14	2, 25	Low @ RB#(max+1-RB allocation), Mid, High @ RB#0					23	+2.7 / -3.7
14	2, 25	Low @ RB#0, High @ RB#(max+1-RB					23	+2.7 / -5.7

		allocation)						
15	2, 25	Low @ RB#(max+1-RB allocation), Mid, High @ RB#0					23	+2.7 / -2.7
15	2, 25	Low @ RB#0, High @ RB#(max+1-RB allocation)					23	+2.7 / -4.2
16	2, 25	All					23	+2.7 / -6.2
17	2, 25	Low @ RB#(max+1-RB allocation), Mid, High @ RB#0					23	+2.7 / -4.7
17	2, 25	Low @ RB#0, High @ RB#(max+1-RB allocation)					23	+2.7 / -7.7
18	2, 25	All					23	+2.7 / -4.7
19	2, 25	Low @ RB#(max+1-RB allocation), Mid, High @ RB#0					23	+2.7 / -3.7
19	2, 25	Low @ RB#0, High @ RB#(max+1-RB allocation)					23	+2.7 / -5.7
20	2, 25	Low @ RB#(max+1-RB allocation), Mid, High @ RB#0					23	+2.7 / -2.7
20	2, 25	Low @ RB#0, High @ RB#(max+1-RB allocation)					23	+2.7 / -4.2
21	2, 25	All					23	+2.7 / -6.2
22	2, 25	Low @ RB#(max+1-RB allocation), Mid, High @ RB#0					23	+2.7 / -4.7
22	2, 25	Low @ RB#0, High @ RB#(max+1-RB allocation)					23	+2.7 / -7.7
23	2, 25	All					23	+2.7 / -4.7
24	2, 25	All					23	+2.7 / -3.7
25	2, 25	Low @ RB#(max+1-RB allocation), Mid, High @ RB#0					23	+2.7 / -2.7
25	2, 25	Low @ RB#0, High @ RB#(max+1-RB allocation)					23	+2.7 / -4.2
26	2, 25	All					23	+2.7 / -6.2
27	2, 25	All					23	+2.7 / -4.7

Table 6.2.4B.5-3: UE Power Class test requirements (network signalled value "NS\_04")

Configuration ID	EUTRA band	Bandwidth (MHz)	Class 3 (dBm)	Tol. (dB)
1	41	5 MHz	23	+2.7 / -4.7
2	41	5 MHz	23	+2.7 / -3.7
3	41	5 MHz	23	+2.7 / -2.7
4	41	5 MHz	23	+2.7 / -6.2
5	41	5 MHz	23	+2.7 / -4.7
6	41	10MHz	23	+2.7 / -6.2
7	41	10MHz	23	+2.7 / -6.2
8	41	10MHz	23	+2.7 / -8.2
9	41	10MHz	23	+2.7 / -9.7
10	41	10MHz	23	+2.7 / -3.7
11	41	10MHz	23	+2.7 / -4.7
12	41	10MHz	23	+2.7 / -6.2
13	41	10MHz	23	+2.7 / -6.2
14	41	10MHz	23	+2.7 / -6.2
15	41	15MHz	23	+2.7 / -6.2
16	41	15MHz	23	+2.7 / -6.2
17	41	15MHz	23	+2.7 / -8.2
18	41	15MHz	23	+2.7 / -9.7
19	41	15MHz	23	+2.7 / -3.7
20	41	15MHz	23	+2.7 / -4.7
21	41	15MHz	23	+2.7 / -6.2
22	41	15MHz	23	+2.7 / -8.2
23	41	15MHz	23	+2.7 / -6.2
24	41	20MHz	23	+2.7 / -6.2
25	41	20MHz	23	+2.7 / -6.2
26	41	20MHz	23	+2.7 / -8.2
27	41	20MHz	23	+2.7 / -9.7
28	41	20MHz	23	+2.7 / -3.7
29	41	20MHz	23	+2.7 / -4.7
30	41	20MHz	23	+2.7 / -6.2
31	41	20MHz	23	+2.7 / -8.2
32	41	20MHz	23	+2.7 /



				-6.2
--	--	--	--	------

**Table 6.2.4B.5-4: UE Power Class test requirements (network signalled value "NS\_05")**

Configuration ID	EUTRA band	Class 1 (dBm)	Tol. (dB)	Class 2 (dBm)	Tol. (dB)	Class 3 (dBm)	Tol. (dB)
1	1					23	+2.7 / -2.7
2	1					23	+2.7 / -3.7
3	1					23	+2.7 / -2.7
4	1					23	+2.7 / -2.7
5	1					23	+2.7 / -3.7
6	1					23	+2.7 / -4.7
7	1					23	+2.7 / -6.2
8	1					23	+2.7 / -2.7
9	1					23	+2.7 / -2.7
10	1					23	+2.7 / -3.7
11	1					23	+2.7 / -4.7
12	1					23	+2.7 / -6.2
13	1					23	+2.7 / -2.7
14	1					23	+2.7 / -2.7
15	1					23	+2.7 / -3.7
16	1					23	+2.7 / -4.7
17	1					23	+2.7 / -6.2

**Table 6.2.4B.5-5: UE Power Class test requirements (network signalled value "NS\_06")  
(for Bands 13, 14, and 17)**

Configuration ID	EUTRA band	Class 1 (dBm)	Tol. (dB)	Class 2 (dBm)	Tol. (dB)	Class 3 (dBm)	Tol. (dB)
1	13,14,17					23	+2.7 / -3.7
2	13,14,17					23	+2.7 / -2.7
3	13,14,17					23	+2.7 / -2.7
4	13,14,17					23	+2.7 / -3.7
5	13,14,17					23	+2.7 / -2.7
6	13,14,17					23	+2.7 / -3.7
7	13,14,17					23	+2.7 / -3.7
8	13,14,17					23	+2.7 / -2.7
9	13,14,17					23	+2.7 / -3.7
10	13,14,17					23	+2.7 / -3.7
11	13,14,17					23	+2.7 / -2.7
12	13,14,17					23	+2.7 / -3.7
13	13,14,17					23	+2.7 / -3.7
14	13,14,17					23	+2.7 / -2.7
15	13,14,17					23	+2.7 / -3.7
16	13,14,17					23	+2.7 / -3.7
17	13,14,17					23	+2.7 / -2.7
18	13,14,17					23	+2.7 / -3.7

**Table 6.2.4B.5-6: UE Power Class test requirements (network signalled value "NS\_06")  
(for Band 12)**

Configuration ID	EUTRA band	Test Freq.	Class 1 (dBm)	Tol. (dB)	Class 2 (dBm)	Tol. (dB)	Class 3 (dBm)	Tol. (dB)
1	12	Mid					23	+2.7 / -3.7
1	12	Low, High					23	+2.7 / -5.7
2	12	Mid					23	+2.7 / -2.7
2	12	Low, High					23	+2.7 / -4.2
3	12	Mid					23	+2.7 / -2.7
3	12	Low, High					23	+2.7 / -4.2
4	12	Mid					23	+2.7 / -3.7
4	12	Low, High					23	+2.7 / -5.7
5	12	Mid					23	+2.7 / -2.7
5	12	Low, High					23	+2.7 / -4.2
6	12	Mid					23	+2.7 / -3.7
6	12	Low, High					23	+2.7 / -5.7
7	12	All					23	+2.7 / -3.7
8	12	Low @ RB#(max+1-RB allocation), Mid, High @ RB#0					23	+2.7 / -2.7
8	12	Low @ RB#0, High @ RB#(max+1-RB allocation)					23	+2.7 / -4.2
9	12	Low @ RB#(max+1-RB allocation), Mid, High @ RB#0					23	+2.7 / -3.7
9	12	Low @ RB#0, High @ RB#(max+1-RB allocation)					23	+2.7 / -5.7
10	12	All					23	+2.7 / -3.7
11	12	Low @ RB#(max+1-RB allocation), Mid, High @ RB#0					23	+2.7 / -2.7
11	12	Low @ RB#0, High @ RB#(max+1-RB allocation)					23	+2.7 / -4.2
12	12	Low @ RB#(max+1-RB allocation), Mid, High @ RB#0					23	+2.7 / -3.7
12	12	Low @ RB#0, High @ RB#(max+1-RB allocation)					23	+2.7 / -5.7

Table 6.2.4B.5-7: UE Power Class test requirements (network signalled value "NS\_07")

Configuration ID	EUTRA band	Class 1 (dBm)	Tol. (dB)	Class 2 (dBm)	Tol. (dB)	Class 3 (dBm)	Tol. (dB)
1	13					23	+2.7 / -18.7
2	13					23	+2.7 / -13.7
3	13					23	+2.7 / -2.7
4	13					23	+2.7 / -19.7
5	13					23	+2.7 / -18.7
6	13					23	+2.7 / -20.7
7	13					23	+2.7 / -3.7
8	13					23	+2.7 / -2.7
9	13					23	+2.7 / -4.7
10	13					23	+2.7 / -12.7
11	13					23	+2.7 / -13.7
12	13					23	+2.7 / -2.7
13	13					23	+2.0 / -5.5±TT
14	13					23	+2.7 / -19.7
15	13					23	+2.7 / -18.7
16	13					23	+2.7 / -20.7

Table 6.2.4B.5-8: UE Power Class test requirements (network signalled value "NS\_08")

Configuration ID	EUTRA band	Class 1 (dBm)	Tol. (dB)	Class 2 (dBm)	Tol. (dB)	Class 3 (dBm)	Tol. (dB)
1	19					23	+2.7 / -2.7
2	19					23	+2.7 / -2.7
3	19					23	+2.7 / -3.7
4	19					23	+2.7 / -2.7
5	19					23	+2.7 / -2.7
6	19					23	+2.7 / -3.7
7	19					23	+2.7 / -8.2
8	19					23	+2.7 / -9.7
9	19					23	+2.7 / -2.7
10	19					23	+2.7 / -2.7
11	19					23	+2.7 / -3.7
12	19					23	+2.7 / -8.2
13	19					23	+2.7 / -9.7

Table 6.2.4B.5-9: UE Power Class test requirements (network signalled value "NS\_09")

Configuration ID	EUTRA band	Class 1 (dBm)	Tol. (dB)	Class 2 (dBm)	Tol. (dB)	Class 3 (dBm)	Tol. (dB)
1	21					23	+2.7 / -2.7
2	21					23	+2.7 / -2.7
3	21					23	+2.7 / -3.7
4	21					23	+2.7 / -2.7
5	21					23	+2.7 / -2.7
6	21					23	+2.7 / -3.7
7	21					23	+2.7 / -4.7
8	21					23	+2.7 / -6.2
9	21					23	+2.7 / -2.7
19	21					23	+2.7 / -2.7
11	21					23	+2.7 / -3.7
12	21					23	+2.7 / -4.7
13	21					23	+2.7 / -6.2
14	21					23	+2.7 / -8.2

Table 6.2.4B.5-10: UE Power Class test requirements (network signalled value "NS\_11 for Band 23")

Configuration ID	EUTRA band	Centre Frequency	Class 1 (dBm)	Tol. (dB)	Class 2 (dBm)	Tol. (dB)	Class 3 (dBm)	Tol. (dB)
1a	23	UL 2001.5 MHz DL 2181.5 MHz						+2.7 / -11.7
1b	23	UL 2004.5 MHz DL 2184.5 MHz						+2.7 / -4.7
2a	23	UL 2001.5 MHz DL 2181.5 MHz						+2.7 / -11.7
2b	23	UL 2004.5 MHz DL 2184.5 MHz						+2.7 / -4.7
3a	23	UL 2001.5 MHz DL 2181.5 MHz						+2.7 / -12.7
3b	23	UL 2004.5 MHz DL 2184.5 MHz						+2.7 / -6.2
4a	23	UL 2001.5 MHz DL 2181.5 MHz						+2.7 / -12.7
4b	23	UL 2004.5 MHz DL 2184.5 MHz						+2.7 / -6.2
5a	23	UL 2002.5 MHz DL 2182.5 MHz						+2.7 / -12.7
5b	23	UL 2004.5 MHz DL 2184.5 MHz						+2.7 / -8.2
5c	23	UL 2007.5 MHz DL 2187.5 MHz						+2.7 / -2.7
6a	23	UL 2002.5 MHz DL 2182.5 MHz						+2.7 / -12.7
6b	23	UL 2004.5 MHz DL 2184.5 MHz						+2.7 / -2.7
6c	23	UL 2007.5 MHz DL 2187.5 MHz						+2.7 / -3.7
7a	23	UL 2002.5 MHz DL 2182.5 MHz						+2.7 / -13.7
7b	23	UL 2004.5 MHz DL 2184.5 MHz						+2.7 / -9.7
7c	23	UL 2007.5 MHz DL 2187.5 MHz						+2.7 / -4.7
8a	23	UL 2002.5 MHz DL 2182.5 MHz						+2.7 / -13.7
8b	23	UL 2004.5 MHz DL 2184.5 MHz						+2.7 / -3.7
8c	23	UL 2007.5 MHz DL 2187.5 MHz						+2.7 / -4.7
9a	23	UL 2002.5 MHz DL 2182.5 MHz						+2.7 / -14.7
9b	23	UL 2004.5 MHz DL 2184.5 MHz						+2.7 / -11.7
9c	23	UL 2007.5 MHz DL 2187.5 MHz						+2.7 / -6.2
10	23	UL 2005 MHz DL 2185 MHz						+2.7 / -18.7
11	23	UL 2005 MHz DL 2185 MHz						+2.7 / -18.7
12	23	UL 2005 MHz DL 2185 MHz						+2.7 / -19.7
13	23	UL 2005 MHz DL 2185 MHz						+2.7 / -19.7
14	23	UL 2005 MHz DL 2185 MHz						+2.7 / -20.7

Table 6.2.4B.5-11: UE Power Class test requirements (network signalled value "NS\_12")

Configuration ID	MPR (dB)	A-MPR (dB)	$\Delta T_{C,c}$ (dB)	$P_{CMAX,c}$ (dBm)	$T(P_{CMAX,L,c})$ (dB)	Upper limit (dBm)	Lower limit (dBm)
1	0	3	1.5	18.5	4	25.7	13.8
2	1	4	1.5	16.5	5	25.7	10.8
3	0	0	1.5	21.5	3	25.7	17.8
4	0	3	1.5	18.5	4	25.7	13.8
5	2	4	1.5	15.5	5	25.7	9.8
6	0	4	1.5	17.5	5	25.7	11.8
7	1	3	1.5	17.5	5	25.7	11.8
8	0	0	1.5	21.5	3	25.7	17.8
9	1	3	1.5	17.5	5	25.7	11.8
10	2	4	1.5	15.5	5	25.7	9.8
11	0	4	1.5	17.5	5	25.7	11.8
12	1	3	1.5	17.5	5	25.7	11.8
13	0	0	1.5	21.5	3	25.7	17.8
14	1	3	0	19	3,5	25.7	14.8
15	2	3	0	18	4	25.7	13.3
16	1	4	1.5	16.5	5	25.7	10.8
17	1	0	0	22	3	25.7	18.3
18	2	2	0	19	3	25.7	15.3
19	1	4	0	18	4	25.7	13.3
20	1	0	0	22	3	25.7	18.3
21	2	3	0	18	4	25.7	13.3

Note 1: Lower limit is assuming  $\Delta T_{IB,c}$  is zero. If non-zero,  $P_{CMAX,c}$  will decrease and  $T(P_{CMAX,L,c})$  may be higher resulting in different test requirements according to Table 6.2.5.3-1.

Table 6.2.4B.5-12: UE Power Class test requirements (network signalled value "NS\_13")

Configuration ID	MPR (dB)	A-MPR (dB)	$\Delta T_{C,c}$ (dB)	$P_{CMAX,c}$ (dBm)	$T(P_{CMAX,L,c})$ (dB)	Upper limit (dBm)	Lower limit (dBm)
1	1	0	0	22	3	25.7	18,3
2	1	0	0	22	3	25.7	18,3
3	0	3	0	20	3	25.7	16,3
4	1	2	0	20	3	25.7	16,3
5	1	0	0	22	3	25.7	18,3
6	1	0	0	22	3	25.7	18,3
7	2	2	0	19	3,5	25.7	14,8

Note 1: Lower limit is assuming  $\Delta T_{IB,c}$  is zero. If non-zero,  $P_{CMAX,c}$  will decrease and  $T(P_{CMAX,L,c})$  may be higher resulting in different test requirements according to Table 6.2.5.3-1.

Table 6.2.4B.5-13: UE Power Class 3 test requirements (network signalled value "NS\_14")

Configuration ID	MPR (dB)	A-MPR (dB)	$\Delta T_{C,c}$ (dB)	$P_{CMAX,c}$ (dBm)	$T(P_{CMAX,L,c})$ (dB)	Upper limit (dBm)	Lower limit (dBm)
1	0	3	0	20	3	25.7	16.3
2	1	0	0	22	3	25.7	18.3
3	1	1	0	21	3	25.7	18.3
4	1	0	0	22	3	25.7	18.3
5	2	1	0	20	3	25.7	16.3
6	0	3	0	20	3	25.7	16.3
7	1	0	0	22	3	25.7	18.3
8	1	1	0	21	3	25.7	17.3
9	1	0	0	22	3	25.7	18.3
10	2	1	0	20	3	25.7	16.3

Note 1: Lower limit is assuming  $\Delta T_{IB,c}$  is zero. If non-zero,  $P_{CMAX,c}$  will decrease and  $T(P_{CMAX,L,c})$  may be higher resulting in different test requirements according to Table 6.2.5.3-1.

Table 6.2.4B.5-14: UE Power Class test requirements (network signalled value "NS\_15")

Configuration ID	EUTRA band	Class 1 (dBm)	Tol. (dB)	Class 2 (dBm)	Tol. (dB)	Class 3 (dBm)	Tol. (dB)
1	26					23	+2.7 / -3.2
2	26					23	+2.7 / -8.2
3	26					23	+2.7 / -4.2
4	26					23	+2.7 / -8.2
5	26					23	+2.7 / -14.2
6	26					23	+2.7 / -4.2
7	26					23	+2.7 / -3.2
8	26					23	+2.7 / -9.2
9	26					23	+2.7 / -14.2
10	26					23	+2.7 / -4.2
11	26					23	+2.7 / -6.2
12	26					23	+2.7 / -12.2
13	26					23	+2.7 / -7.2
14	26					23	+2.7 / -3.2
15	26					23	+2.7 / -4.2
16	26					23	+2.7 / -8.2
17	26					23	+2.7 / -3.2
18	26					23	+2.7 / -12.2
19	26					23	+2.7 / -4.2
20	26					23	+2.7 / -8.2
21	26					23	+2.7 / -3.2
22	26					23	+2.7 / -4.2
23	26					23	+2.7 / -9.2
24	26					23	+2.7 / -14.2
25	26					23	+2.7 / -3.2
26	26					23	+2.7 / -9.2



**Table 6.2.4B.5-15A: UE Power Class test requirements (network signalled value "NS\_16") when lower channel edge is at 807 MHz**

Configuration ID	EUTRA band	Class 1 (dBm)	Tol. (dB)	Class 2 (dBm)	Tol. (dB)	Class 3 (dBm)	Tol. (dB)
1	27					23	+2.7 / -2.7
2	27					23	+2.7 / -3.7
3	27					23	+2.7 / -4.7
4	27					23	+2.7 / -2.7
5	27					23	+2.7 / -4.7
6	27					23	+2.7 / -6.2
7	27					23	+2.7 / -8.2
8	27					23	+2.7 / -9.7
9	27					23	+2.7 / -4.7
10	27					23	+2.7 / -6.2
11	27					23	+2.7 / -11.7
12	27					23	+2.7 / -8.2
13	27					23	+2.7 / -11.7
14	27					23	+2.7 / -12.7
15	27					23	+2.7 / -9.7
16	27					23	+2.7 / -2.7
17	27					23	+2.7 / -8.2
18	27					23	+2.7 / -4.7
19	27					23	+2.7 / -8.2
20	27					23	+2.7 / -13.7
21	27					23	+2.7 / -13.7
22	27					23	+2.7 / -14.7
23	27					23	+2.7 / -13.7
24	27					23	+2.7 / -13.7

**Table 6.2.4B.5-15B: UE Power Class test requirements (network signalled value "NS\_16") when lower channel edge is at 808.5 MHz**

Configuration ID	EUTRA band	Class 1 (dBm)	Tol. (dB)	Class 2 (dBm)	Tol. (dB)	Class 3 (dBm)	Tol. (dB)
1	27					23	+2.7 / -2.7
2	27					23	+2.7 / -3.7
3	27					23	+2.7 / -5.2
4	27					23	+2.7 / -2.7
5	27					23	+2.7 / -3.7
6	27					23	+2.7 / -3.7
7	27					23	+2.7 / -4.7
8	27					23	+2.7 / -2.7
9	27					23	+2.7 / -3.7
10	27					23	+2.7 / -4.7
11	27					23	+2.7 / -6.2
12	27					23	+2.7 / -6.2
13	27					23	+2.7 / -8.2
14	27					23	+2.7 / -9.7
15	27					23	+2.7 / -9.7
16	27					23	+2.7 / -2.7
17	27					23	+2.7 / -6.2
18	27					23	+2.7 / -4.7
19	27					23	+2.7 / -4.7
20	27					23	+2.7 / -9.7
21	27					23	+2.7 / -11.7
22	27					23	+2.7 / -12.7
23	27					23	+2.7 / -11.7
24	27					23	+2.7 / -11.7

**Table 6.2.4B.5-15C: UE Power Class test requirements (network signalled value "NS\_16") when lower channel edge is at 812 MHz**

Configuration ID	EUTRA band	Class 1 (dBm)	Tol. (dB)	Class 2 (dBm)	Tol. (dB)	Class 3 (dBm)	Tol. (dB)
1	27					23	+2.7 / - 2.7
2	27					23	+2.7 / - 3.7
3	27					23	+2.7 / - 4.7
4	27					23	+2.7 / - 2.7
5	27					23	+2.7 / - 3.7
6	27					23	+2.7 / - 3.7
7	27					23	+2.7 / - 4.7
8	27					23	+2.7 / - 2.7
9	27					23	+2.7 / - 3.7
10	27					23	+2.7 / - 3.7
11	27					23	+2.7 / - 3.7
12	27					23	+2.7 / - 3.7
13	27					23	+2.7 / - 3.7
14	27					23	+2.7 / - 4.7
15	27					23	+2.7 / - 2.7
16	27					23	+2.7 / - 2.7
17	27					23	+2.7 / - 3.7
18	27					23	+2.7 / - 3.7
19	27					23	+2.7 / - 3.7
20	27					23	+2.7 / - 4.7
21	27					23	+2.7 / - 8.2
22	27					23	+2.7 / - 9.7
23	27					23	+2.7 / - 6.2
24	27					23	+2.7 / - 4.7

**Table 6.2.4B.5-16: UE Power Class test requirements (network signalled value "NS\_20 for Band 23")**

TBD

**Table 6.2.4B.5-17: UE Power Class 3 test requirements (network signalled value "NS\_21 for Band 30")**

Configuration ID	MPR (dB)	A-MPR (dB)	$\Delta T_{C,c}$ (dB)	$P_{C_{MAX,c}}$ (dBm)	$T(P_{C_{MAX,L,c}})$ (dB)	Upper limit (dBm)	Lower limit (dBm)
1	0	0	0	23	3.0	25.7	19.3
2	1	0	0	22	3.0	25.7	18.3
3	0	4	0	19	3.5	25.7	14.8
4	0	4	0	19	3.5	25.7	14.8
5	1	0	0	22	3.0	25.7	18.3
6	0	3	0	20	3.0	25.7	16.3
7	1	3	0	19	3.5	25.7	14.8
8	2	3	0	18	4.0	25.7	13.3

Note 1: Lower limit is assuming  $\Delta T_{TIB,c}$  is zero. If non-zero,  $P_{C_{MAX,c}}$  will decrease and  $T(P_{C_{MAX,L,c}})$  may be higher resulting in different test requirements according to Table 6.2.5.3-1.

6.2.4C

6.2.4D

6.2.4E Additional Maximum Power Reduction (A-MPR) for UE category 0

Editor's note: This clause is incomplete. The following aspects are either missing or not yet determined:

TBD -6.2.4E.4.1 Initial condition

TBD -6.2.4E.4.2 Test procedure

TBD -6.2.4E.4.3 Message contents

TBD -6.2.4E.5 Test requirements

TBD-Tables in Annex F

#### 6.2.4E.1 Test purpose

Same test purpose in clause 6.2.4.1.

#### 6.2.4E.2 Test applicability

The requirements of this test apply in test case 6.6.2.2E Additional Spectrum Emission Mask for network signalled values NS\_03, NS\_04, NS\_06 and NS\_07 to all types of E-UTRA UE release 12 and forward of UE category 0.

The requirements of this test apply in test case 6.6.3E.3 Additional Spurious Emissions for network signalled values NS\_07 and NS\_09 to all types of E-UTRA UE release 12 and forward of UE category 0.

NOTE: As a result TC 6.2.4E has not been included in the test case applicability table 4.1-1, TS 36.521-2. This does not preclude the test from being used for R&D or other purposes if deemed useful.

#### 6.2.4E.3 Minimum conformance requirements

Same minimum conformance requirements as in clause 6.2.4.3

#### 6.2.4E.4 Test description

##### 6.2.4E.4.1 Initial condition

-TBD

##### 6.2.4E.4.2 Test procedure

-TBD

##### 6.2.4E.4.3 Message contents

-TBD

##### 6.2.4E.5 Test requirements

-TBD

### 6.2.5 Configured UE transmitted Output Power

Editor's notes: This clause is incomplete for B2+B4 CA tests and awaiting for RAN4 decision

- CA\_2A-4A  $\Delta T_{IB,c}$  in Table 6.2.5.3-2 is still in square brackets

#### 6.2.5.1 Test purpose

To verify the UE does not exceed the minimum between the  $P_{EMAX}$  maximum allowed UL TX Power signalled by the E-UTRAN and the  $P_{UMAX}$  maximum UE power for the UE power class.

### 6.2.5.2 Test applicability

This test applies to all types of E-UTRA UE release 8 and forward.

### 6.2.5.3 Minimum conformance requirements

The UE is allowed to set its configured maximum output power  $P_{\text{CMAX},c}$  for serving cell  $c$ . The configured maximum output power  $P_{\text{CMAX}}$  is set within the following bounds:

$$P_{\text{CMAX}_L,c} \leq P_{\text{CMAX},c} \leq P_{\text{CMAX}_H,c}$$

With

$$P_{\text{CMAX}_L,c} = \text{MIN} \{ P_{\text{EMAX},c} - \Delta T_{C,c}, P_{\text{PowerClass}} - \text{MAX}(M\text{PR}_c + A\text{-M}\text{PR}_c + \Delta T_{\text{IB},c}, P\text{-M}\text{PR}_c) - \Delta T_{C,c} \}$$

$$P_{\text{CMAX}_H,c} = \text{MIN} \{ P_{\text{EMAX},c}, P_{\text{PowerClass}} \}$$

Where

- $P_{\text{EMAX},c}$  is the value given by IE *P-Max* for serving cell  $c$ , defined in [5];
- $P_{\text{PowerClass}}$  is the maximum UE power specified in Table 6.2.2.3-1 without taking into account the tolerance specified in the Table 6.2.2.3-1;
- $M\text{PR}_c$  and  $A\text{-M}\text{PR}_c$  for serving cell  $c$  are specified in Section 6.2.3 and Section 6.2.4, respectively;
- $\Delta T_{\text{IB},c}$  is the additional tolerance for serving cell  $c$  as specified in Table 6.2.5.3-2;  $\Delta T_{\text{IB},c} = 0$  dB otherwise;
- $\Delta T_C = 1.5$  dB when Note 2 in Table 6.2.2.3-1 applies;
- $\Delta T_C = 0$  dB when Note 2 in Table 6.2.2.3-1 does not apply.

$P\text{-M}\text{PR}_c$  is the allowed maximum output power reduction for

- a) ensuring compliance with applicable electromagnetic energy absorption requirements and addressing unwanted emissions / self defence requirements in case of simultaneous transmissions on multiple RAT(s) for scenarios not in scope of 3GPP RAN specifications;
- b) ensuring compliance with applicable electromagnetic energy absorption requirements in case of proximity detection is used to address such requirements that require a lower maximum output power.

The UE shall apply  $P\text{-M}\text{PR}_c$  only for the above cases. For UE conducted conformance testing  $P\text{-M}\text{PR}_c$  shall be 0 dB

NOTE 1:  $P\text{-M}\text{PR}_c$  was introduced in the  $P_{\text{CMAX},c}$  equation such that the UE can report to the eNB the available maximum output transmit power. This information can be used by the eNB for scheduling decisions.

NOTE 2:  $P\text{-M}\text{PR}_c$  may impact the maximum uplink performance for the selected UL transmission path.

For each subframe, the  $P_{\text{CMAX}_L,c}$  for serving cell  $c$  is evaluated per slot and given by the minimum value taken over the transmission(s) within the slot; the minimum  $P_{\text{CMAX}_L,c}$  over the two slots is then applied for the entire subframe.  $P_{\text{PowerClass}}$  shall not be exceeded by the UE during any period of time.

The measured maximum output power  $P_{\text{UMAX},c}$  shall be within the following bounds:

$$P_{\text{CMAX}_L,c} - \text{MAX}\{T_L, T(P_{\text{CMAX}_L,c})\} \leq P_{\text{UMAX},c} \leq P_{\text{CMAX}_H,c} + T(P_{\text{CMAX}_H,c})$$

Where  $T(P_{\text{CMAX},c})$  is defined by the tolerance table below and applies to  $P_{\text{CMAX}_L,c}$  and  $P_{\text{CMAX}_H,c}$  separately, while  $T_L$  is the absolute value of the lower tolerance in Table 6.2.2.3-1 for the applicable operating band.

**Table 6.2.5.3-1:  $P_{\text{CMAX},c}$  tolerance**

$P_{\text{CMAX},c}$ (dBm)	Tolerance $T(P_{\text{CMAX},c})$ (dB)
$21 \leq P_{\text{CMAX},c} \leq 23$	2.0
$20 \leq P_{\text{CMAX},c} < 21$	2.5
$19 \leq P_{\text{CMAX},c} < 20$	3.5
$18 \leq P_{\text{CMAX},c} < 19$	4.0
$13 \leq P_{\text{CMAX},c} < 18$	5.0
$8 \leq P_{\text{CMAX},c} < 13$	6.0
$-40 \leq P_{\text{CMAX},c} < 8$	7.0

For the UE which supports inter-band carrier aggregation configurations with the uplink assigned to one or two E-UTRA bands the  $\Delta T_{\text{IB},c}$  is defined for applicable bands in Table 6.2.5.3-2 and Table 6.2.5.3-3.

Table 6.2.5.3-2:  $\Delta T_{IB,c}$  (two bands)

Inter-band CA Configuration	E-UTRA Band	$\Delta T_{IB,c}$ [dB]
CA_1A-3A	1	0.3
	3	0.3
CA_1A-5A	1	0.3
	5	0.3
CA_1A-7A	1	0.5
	7	0.6
CA_1A-8A	1	0.3
	8	0.3
CA_1A-11A	1	0.3
	11	0.3
CA_1A-18A	1	0.3
	18	0.3
CA_1A-19A	1	0.3
	19	0.3
CA_1A-20A	1	0.3
	20	0.3
CA_1A-21A	1	0.3
	21	0.3
CA_1A-26A	1	0.3
	26	0.3
CA_1A-28A	1	0.3
	28	0.6
CA_1A-41A <sup>8</sup>	1	0.5
	41	0.5
CA_1A-41C <sup>8</sup>	1	0.5
	41	0.5
CA_1A-42A	1	0.3
	42	0.8
CA_1A-42C	1	0.3
	42	0.8
CA_2A-4A	2	0.5
	4	0.5
CA_2A-4A-4A	2	0.5
	4	0.5
CA_2A-5A	2	0.3
	5	0.3
CA_2A-2A-5A	2	0.3
	5	0.3
CA_2A-12A	2	0.3
	12	0.3
CA_2A-12B	2	0.3
	12	0.3
CA_2A-13A	2	0.3
	13	0.3
CA_2A-2A-13A	2	0.3
	13	0.3
CA_2A-17A	2	0.3
	17	0.8
CA_2A-29A	2	0.3
CA_2A-30A	2	0.5
	30	0.3
CA_3A-5A	3	0.3
	5	0.3
CA_3A-7A	3	0.5
	7	0.5
CA_3A-7C	3	0.5
	7	0.5
CA_3C-7A	3	0.5
	7	0.5
CA_3A-8A	3	0.3
	8	0.3

CA_3A-19A	3	0.3
	19	0.3
CA_3A-20A	3	0.3
	20	0.3
CA_3A-26A	3	0.3
	26	0.3
CA_3A-27A	3	0.3
	27	0.3
CA_3A-28A	3	0.3
	28	0.3
CA_3A-42A	3	0.6
	42	0.8
CA_3A-42C	3	0.6
	42	0.8
CA_4A-5A	4	0.3
	5	0.3
CA_4A-4A-5A	4	0.3
	5	0.3
CA_4A-7A	4	0.5
	7	0.5
CA_4A-4A-7A	4	0.5
	7	0.5
CA_4A-12A	4	0.3
	12	0.8
CA_4A-4A-12A	4	0.3
	12	0.8
CA_4A-12B	4	0.3
	12	0.8
CA_4A-13A	4	0.3
	13	0.3
CA_4A-4A-13A	4	0.3
	13	0.3
CA_4A-17A	4	0.3
	17	0.8
CA_4A-27A	4	0.3
	27	0.3
CA_4A-29A	4	0.3
CA_4A-30A	4	0.5
	30	0.3
CA_5A-7A	5	0.3
	7	0.3
CA_5A-12A	5	0.8
	12	0.4
CA_5A-13A	5	0.5
	13	0.5
CA_5A-17A	5	0.8
	17	0.4
CA_5A-25A	5	0.3
	25	0.3
CA_5A-30A	5	0.3
	30	0.3
CA_7A-8A	7	0.3
	8	0.6
CA_7A-12A	7	0.3
	12	0.3
CA_7A-20A	7	0.3
	20	0.3
CA_7A-28A	7	0.3
	28	0.3
CA_8A-11A	8	0.3
	11	0.4
CA_8A-20A	8	0.4
	20	0.4
CA_8A-40A	8	0.3
	40	0.3

CA_11A-18A	11	0.3
	18	0.3
CA_12A-25A	12	0.3
	25	0.3
CA_12A-30A	12	0.3
	30	0.3
CA_18A-28A <sup>9</sup>	18	0.5
	28	0.5
CA_19A-21A	19	0.3
	21	0.4
CA_19A-42A	19	0.3
	42	0.8
CA_19A-42C	19	0.3
	42	0.8
CA_20A-32A	20	0.3
CA_23A-29A	23	0.3
CA_25A-41A <sup>8</sup>	25	0.5
	41	0.5
CA_25A-41C <sup>8</sup>	25	0.5
	41	0.5
CA_26A-41A	26	0.3
	41	0.3
CA_26A-41C	26	0.3
	41	0.3
CA_29A-30A	30	0.3
CA_39A-41A	39	0 <sup>4</sup>
	41	0 <sup>4</sup>
CA_39A-41A	39	0.5 <sup>7</sup>
	41	0.5 <sup>7</sup>
CA_39A-41C	39	0 <sup>4</sup>
	41	0 <sup>4</sup>
CA_39C-41A	39	0 <sup>4</sup>
	41	0 <sup>4</sup>
CA_41A-42A	41	0 <sup>4</sup>
	42	[0.5] <sup>4</sup>



NOTE 1:	The above additional tolerances are only applicable for the E-UTRA operating bands that belong to the supported inter-band carrier aggregation configurations
NOTE 2:	The above additional tolerances also apply in non-aggregated operation for the supported E-UTRA operating bands that belong to the supported inter-band carrier aggregation configurations
NOTE 3:	In case the UE supports more than one of the above inter-band carrier aggregation configurations and a E-UTRA operating band belongs to more than one 2DL inter-band carrier aggregation configurations then: <ul style="list-style-type: none"> <li>- When the E-UTRA operating band frequency range is <math>\leq 1</math>GHz, the applicable additional tolerance shall be the average of the 2DL tolerances in Table 6.2.5.3-2, truncated to one decimal place for that operating band among the supported 2DL CA configurations. In case there is a harmonic relation between low band UL and high band DL, then the maximum tolerance among the different supported 2DL carrier aggregation configurations involving such band shall be applied</li> <li>- When the E-UTRA operating band frequency range is <math>&gt;1</math>GHz, the applicable additional 2DL tolerance shall be the maximum tolerance in Table 6.2.5.3-2 that applies for that operating band among the supported 2DL CA configurations</li> </ul>
NOTE 4:	Only applicable for UE supporting inter-band carrier aggregation with uplink in one E-UTRA band and without simultaneous Rx/Tx.
NOTE 5:	Tolerances for a UE supporting multiple 3DL inter-band CA configurations are FFS.
NOTE 6:	The above additional tolerances applicable for the E-UTRA operating bands that belong to the supported highest order inter-band carrier aggregation configuration, also applies to the same E-UTRA operating bands that belong to a supported lower order CA configuration.
NOTE 7:	Applicable for UE supporting inter-band carrier aggregation with two uplinks and without simultaneous Rx/Tx.
NOTE 8:	Only applicable for UE supporting inter-band carrier aggregation with the uplink active in the FDD band.
NOTE 9:	For Band 28, the requirements only apply for the restricted frequency range specified for this CA configuration (Table 5.2A-2).

NOTE 3: The above additional tolerances do not apply to supported UTRA operating bands with frequency range below 1 GHz that correspond to the E-UTRA operating bands that belong to the supported inter-band carrier aggregation configurations when such bands are belonging only to band combination(s) where one band is  $<1$ GHz and another band is  $>1.7$ GHz and there is no harmonic relationship between the low band UL and high band DL. Otherwise the above additional tolerances also apply to supported UTRA operating bands that correspond to the E-UTRA operating bands that belong to the supported inter-band carrier aggregation configurations.

NOTE 4: To meet the  $\Delta T_{IB,c}$  requirements for CA\_3A-7A with state-of-the-art technology, an increase in power consumption of the UE may be required. It is also expected that as the state-of-the-art technology evolves in the future, this possible power consumption increase can be reduced or eliminated.

Table 6.2.5.3-3:  $\Delta T_{IB,c}$  (three bands)

Inter-band CA Configuration	E-UTRA Band	$\Delta T_{IB,c}$ [dB]
CA_1A-3A-8A	1	0.3
	3	0.3
	8	0.3
CA_1A-3A-5A	1	0.3
	3	0.3
	5	0.3
CA_1A-3A-19A	1	0.3
	3	0.3
	19	0.3
CA_1A-3A-20A	1	0.3
	3	0.3
	20	0.3
CA_1A-3A-26A	1	0.3
	3	0.3
	26	0.3
CA_1A-5A-7A	1	0.5
	5	0.3
	7	0.6
CA_1A-7A-20A	1	0.5
	7	0.6
	20	0.3
CA_1A-18A-28A	1	0.3
	18	0.5
	28	0.5
CA_1A-19A-21A	1	0.3
	19	0.3
	21	0.4
CA_2A-4A-5A	2	0.5
	4	0.5
	5	0.3
CA_2A-4A-12A	2	0.5
	4	0.5
	12	0.8
CA_2A-4A-13A	2	0.5
	4	0.5
	13	0.3
CA_2A-4A-29A	2	[0.5]
	4	0.5
CA_2A-5A-12A	2	0.3
	5	0.8
	12	0.4
CA_2A-5A-13A	2	0.3
	5	0.5
	13	0.5
CA_2A-5A-30A	2	0.5
	5	0.3
	30	0.3
CA_2A-12A-30A	2	0.5
	12	0.3
	30	0.3
CA_2A-29A-30A	2	0.5
	30	0.3
CA_3A-7A-20A	3	0.5
	7	0.5
	20	0.3
CA_4A-5A-12A	4	0.3
	5	0.8
	12	0.8
CA_4A-5A-13A	4	0.3
	5	0.5
	13	0.5

CA_4A-5A-30A	4	0.5
	5	0.3
	30	0.3
CA_4A-7A-12A	4	0.5
	7	0.5
	12	0.8
CA_4A-12A-30A	4	0.5
	12	0.8
	30	0.3
CA_4A-29A-30A	4	0.5
	30	0.3
CA_7A-8A-20A	7	0.3
	8	0.6
	20	[0.6]
NOTE 1: The above additional tolerances are only applicable for the E-UTRA operating bands that belong to the supported inter-band carrier aggregation configurations		
NOTE 2: The above additional tolerances also apply in non-aggregated operation for the supported E-UTRA operating bands that belong to the supported inter-band carrier aggregation configurations		
NOTE 3: Tolerances for a UE supporting multiple 3DL inter-band CA configurations are FFS		
NOTE 4: The above additional tolerances applicable for the E-UTRA operating bands that belong to the supported highest order inter-band carrier aggregation configuration, also applies to the same E-UTRA operating bands that belong to a supported lower order CA configuration.		

NOTE: The above additional tolerances do not apply to supported UTRA operating bands with frequency range below 1 GHz that correspond to the E-UTRA operating bands that belong to the supported inter-band carrier aggregation configurations when such bands are belonging only to band combination(s) where one band is <1GHz and other bands are >1.7GHz and there is no harmonic relationship between the low band UL and high band DL. Otherwise the above additional tolerances also apply to supported UTRA operating bands that correspond to the E-UTRA operating bands that belong to the supported inter-band carrier aggregation configurations.

The normative reference for this requirement is TS 36.101 [2] clause 6.2.5.

## 6.2.5.4 Test description

### 6.2.5.4.1 Initial conditions

Initial conditions are a set of test configurations the UE needs to be tested in and the steps for the SS to take with the UE to reach the correct measurement state.

The initial test configurations consist of environmental conditions, test frequencies, and channel bandwidths based on E-UTRA operating bands specified in table 5.4.2.1-1. All of these configurations shall be tested with applicable test parameters for each channel bandwidth, and are shown in table 6.2.5.4.1-1. The details of the uplink reference measurement channels (RMCs) are specified in Annex A.2. Configurations of PDSCH and PDCCH before measurement are specified in Annex C.2.

**Table 6.2.5.4.1-1: Test Configuration Table**

Initial Conditions				
Test Environment as specified in TS 36.508[7] subclause 4.1		Normal, TL/VL, TL/VH, TH/VL, TH/VH		
Test Frequencies as specified in TS 36.508 [7] subclause 4.3.1		Mid range		
Test Channel Bandwidths as specified in TS 36.508 [7] subclause 4.3.1		Lowest, 5MHz, Highest		
Test Parameters for Channel Bandwidths				
Ch BW	Downlink Configuration	Uplink Configuration		
	N/A for Configured UE transmitted Output Power test case	Mod'n	RB allocation	
		FDD	TDD	
1.4MHz		QPSK	5	5
3MHz		QPSK	4	4
5MHz		QPSK	8	8
10MHz		QPSK	12	12
15MHz		QPSK	16	16
20MHz		QPSK	18	18
Note 1: Test Channel Bandwidths are checked separately for each E-UTRA band, the applicable channel bandwidths are specified in Table 5.4.2.1-1.				
Note 2: For the uplink RB allocation the RB <sub>start</sub> shall be RB #0.				

1. Connect the SS to the UE antenna connectors as shown in TS 36.508 [7] Annex A, in Figure A.3.
2. The parameter settings for the cell are set up according to TS 36.508 [7] subclause 4.4.3.
3. Downlink signals are initially set up according to Annex C.0, C.1, and C.3.0, and uplink signals according to Annex H.1 and H.3.0.
4. The UL Reference Measurement channel is set according to Table 6.2.5.4.1-1
5. Propagation conditions are set according to Annex B.0.
6. Ensure the UE is in State 3A-RF according to TS 36.508 [7] clause 5.2A.2. Message contents are defined in clause 6.2.5.4.3.

#### 6.2.5.4.2 Test procedure

1. SS sends uplink scheduling information for each UL HARQ process via PDCCH DCI format 0 for C<sub>RNTI</sub> to schedule the UL RMC according to Table 6.2.5.4.1-1. Since the UE has no payload and no loopback data to send the UE sends uplink MAC padding bits on the UL RMC.
2. Send transmit uplink power control "up" commands in every uplink scheduling information to the UE; allow at least 200ms for the UE to reach the P<sub>max</sub> level of the test point.
3. Measure the mean power of the UE in the channel bandwidth for each test point in table 6.2.5.5-1 according to the test configuration from Table 6.2.5.4.1-1. The period of measurement shall be at least continuous duration of one sub-frame (1ms). For TDD slots with transient periods are not under test.

#### 6.2.5.4.3 Message contents

Message contents are according to TS 36.508 [7] subclause 4.6 with the following exceptions:

**Table 6.2.5.4.3-1: SystemInformationBlockType1: Test point 1**

Derivation Path: TS 36.508 [7] clause 4.4.3.2, Table 4.4.3.2-3 SystemInformationBlockType1			
Information Element	Value/remark	Comment	Condition
p-Max	-10		

**Table 6.2.5.4.3-2: SystemInformationBlockType1: Test point 2**

Derivation Path: TS 36.508 [7] clause 4.4.3.2, Table 4.4.3.2-3 SystemInformationBlockType1			
Information Element	Value/remark	Comment	Condition
p-Max	10		

**Table 6.2.5.4.3-3: SystemInformationBlockType1: Test point 3**

Derivation Path: TS 36.508 [7] clause 4.4.3.2, Table 4.4.3.2-3 SystemInformationBlockType1			
Information Element	Value/remark	Comment	Condition
p-Max	15		

### 6.2.5.5 Test requirement

The maximum output power measured shall not exceed the values specified in Table 6.2.5.5-1.

**Table 6.2.5.5-1: P<sub>C<sub>MAX</sub></sub> configured UE output power**

	Channel bandwidth / maximum output power					
	1.4 MHz	3.0 MHz	5 MHz	10 MHz	15 MHz	20 MHz
Measured UE output power test point 1	For carrier frequency $f \leq 3.0\text{GHz}$ : $-10 \text{ dBm} \pm 7.7$ For carrier frequency $3.0\text{GHz} < f \leq 4.2\text{GHz}$ : $-10 \text{ dBm} \pm 8.0$					
Measured UE output power test point 2	For carrier frequency $f \leq 3.0\text{GHz}$ : $10 \text{ dBm} \pm 6.7$ For carrier frequency $3.0\text{GHz} < f \leq 4.2\text{GHz}$ : $10 \text{ dBm} \pm 7.0$					
Measured UE output power test point 3	For carrier frequency $f \leq 3.0\text{GHz}$ : $15 \text{ dBm} \pm 5.7$ For carrier frequency $3.0\text{GHz} < f \leq 4.2\text{GHz}$ : $15 \text{ dBm} \pm 6.0$					
Note:	In addition note 2 in Table 6.2.2.3-1 shall apply to the tolerances.					

For the UE which supports inter-band carrier aggregation configurations with uplink assigned to one E-UTRA band the  $\Delta T_{IB,c}$  in Table 6.2.5.3-2 shall be applied for applicable bands.

In case the UE supports more than one of the above inter-band carrier aggregation configurations and an E-UTRA operating band belongs to more than one inter-band carrier aggregation configurations then:

- When the E-UTRA operating band frequency range is  $\leq 1\text{GHz}$ , the applicable additional tolerance shall be the average of the tolerances in Table 6.2.5.3-2, truncated to one decimal place for that operating band among the supported CA configurations. In case there is a harmonic relation between low band UL and high band DL, then the maximum tolerance among the different supported carrier aggregation configurations involving such band shall be applied
- When the E-UTRA operating band frequency range is  $>1\text{GHz}$ , the applicable additional tolerance shall be the maximum tolerance in Table 6.2.5.3-2 that applies for that operating band among the supported CA configurations.

## 6.2.5\_1 Configured UE transmitted Output Power for HPUE

### 6.2.5\_1.1 Test purpose

Same test purpose as in clause 6.2.5.1

### 6.2.5\_1.2 Test applicability

This test applies to all types of E-UTRA power Class 1 UE release 10 and forward.

### 6.2.5\_1.3 Minimum conformance requirements

Same minimum conformance requirements as in clause 6.2.5.3 with the following exceptions:

- stead of Table 6.2.2.3-1 → use Table 6.2.2\_1.3-1
- stead of Section 6.2.3 → use Section 6.2.3\_1
- stead of Section 6.2.4 → use Section 6.2.4\_1
- stead of Table 6.2.5.3-1 → use Table 6.2.5\_1.3-1

**Table 6.2.5\_1.3-1: P<sub>C<sub>MAX</sub></sub> tolerance**

P <sub>C<sub>MAX</sub></sub> (dBm)	Tolerance T(P <sub>C<sub>MAX</sub></sub> ) (dB)
23 < P <sub>C<sub>MAX</sub></sub> ≤ 33	2.0
21 ≤ P <sub>C<sub>MAX</sub></sub> ≤ 23	2.0
20 ≤ P <sub>C<sub>MAX</sub></sub> < 21	2.5
19 ≤ P <sub>C<sub>MAX</sub></sub> < 20	3.5
18 ≤ P <sub>C<sub>MAX</sub></sub> < 19	4.0
13 ≤ P <sub>C<sub>MAX</sub></sub> < 18	5.0
8 ≤ P <sub>C<sub>MAX</sub></sub> < 13	6.0
-40 ≤ P <sub>C<sub>MAX</sub></sub> < 8	7.0

The normative reference for this requirement is TS 36.101 [2] clause 6.2.5.

### 6.2.5\_1.4 Test description

#### 6.2.5\_1.4.1 Initial conditions

Same initial conditions as in clause 6.2.5.4.1 with the following exceptions

- stead of clause 6.2.5.4.3 → use clause 6.2.5\_1.4.3

#### 6.2.5\_1.4.2 Test procedure

Same test procedure as in clause 6.2.5.4.2 with the following exceptions:

- stead of Table 6.2.5.5-1 → use Table 6.2.5\_1.5-1

#### 6.2.5\_1.4.3 Message contents

Same message contents as in clause 6.2.5.4.3 with the following additional test point:

**Table 6.2.5\_1.4.3-1: SystemInformationBlockType1: Test point 4**

Derivation Path: TS 36.508 [7] clause 4.4.3.2, Table 4.4.3.2-3 SystemInformationBlockType1			
Information Element	Value/remark	Comment	Condition
p-Max	20		

### 6.2.5\_1.5 Test requirement

The maximum output power measured shall not exceed the values specified in Table 6.2.5\_1.5-1.

**Table 6.2.5\_1.5-1: P<sub>C<sub>MAX</sub></sub> configured HPUE output power**

	Channel bandwidth / maximum output power	
	5MHz	10MHz

Measured UE output power test point 1	-10 dBm ± 7.7
Measured UE output power test point 2	10 dBm ± 6.7
Measured UE output power test point 3	15 dBm ± 5.7
Measured UE output power test point 4	20dBm ± 5.7
Note:	In addition note 2 in Table 6.2.2_1.3-1 shall apply to the tolerances.

## 6.2.5A Configured transmitted power for CA

### 6.2.5A.1 Configured UE transmitted Output Power for CA (intra-band contiguous DL CA and UL CA)

#### 6.2.5A.1.1 Test purpose

To verify the UE does not exceed the minimum between the  $P_{EMAX,c}$  maximum allowed UL TX Power signalled by the E-UTRAN and the  $P_{UMAX}$  maximum UE power for the UE power class.

#### 6.2.5A.1.2 Test applicability

This test applies to all types of E-UTRA UE release 10 and forward that support intra-band contiguous DL CA and UL CA.

#### 6.2.5A.1.3 Minimum conformance requirements

For uplink carrier aggregation the UE is allowed to set its configured maximum output power  $P_{CMAX,c}$  for serving cell  $c$  and its total configured maximum output power  $P_{CMAX}$ .

The configured maximum output power  $P_{CMAX,c}$  on serving cell  $c$  shall be set as specified in subclause 6.2.5.

For uplink inter-band carrier aggregation,  $MPR_c$  and  $A-MPR_c$  apply per serving cell  $c$  and are specified in clause 6.2.3 and clause 6.2.4, respectively.  $P-MPR_c$  accounts for power management for serving cell  $c$ .  $P_{CMAX,c}$  is calculated under the assumption that the transmit power is increased independently on all component carriers.

For uplink intra-band contiguous carrier aggregation,  $MPR_c = MPR$  and  $A-MPR_c = A-MPR$  with  $MPR$  and  $A-MPR$  specified in clause 6.2.3A and clause 6.2.4A respectively. There is one power management term for the UE, denoted  $P-MPR_c$ , and  $P-MPR_c = P-MPR$ .  $P_{CMAX,c}$  is calculated under the assumption that the transmit power is increased by the same amount in dB on all component carriers.

The total configured maximum output power  $P_{CMAX}$  shall be set within the following bounds:

$$P_{CMAX\_L} \leq P_{CMAX} \leq P_{CMAX\_H}$$

For uplink inter-band carrier aggregation with one serving cell  $c$  per operating band,

$$P_{CMAX\_L} = \text{MIN} \left\{ 10 \log_{10} \sum \text{MIN} \left[ p_{EMAX,c} / (\Delta t_{C,c}), p_{PowerClass} / (mpr_c \cdot a-mpr_c \cdot \Delta t_{C,c} \cdot \Delta t_{IB,c}), p_{PowerClass} / (pmpr_c \cdot \Delta t_{C,c}) \right], P_{PowerClass} \right\}$$

$$P_{CMAX\_H} = \text{MIN} \{ 10 \log_{10} \sum p_{EMAX,c}, P_{PowerClass} \}$$

where

- $p_{EMAX,c}$  is the linear value of  $P_{EMAX,c}$  which is given by IE *P-Max* for serving cell  $c$  in [5];
- $P_{PowerClass}$  is the maximum UE power specified in Table 6.2.2A.1.3-1 without taking into account the tolerance specified in the Table 6.2.2A.1.3-1;  $p_{PowerClass}$  is the linear value of  $P_{PowerClass}$ ;
- $mpr_c$  and  $a-mpr_c$  are the linear values of  $MPR_c$  and  $A-MPR_c$  as specified in subclause 6.2.3 and subclause 6.2.4, respectively;

- $p_{mpr_c}$  is the linear value of P-MPR<sub>c</sub>;
- $\Delta t_{C,c}$  is the linear value of  $\Delta T_{C,c}$ .  $\Delta t_{C,c} = 1.41$  when Note 2 in Table 6.2.2A.1.3-1 applies for a serving cell  $c$ , otherwise  $\Delta t_{C,c} = 1$ ;
- $\Delta t_{IB,c}$  is the linear value of the inter-band relaxation term  $\Delta T_{IB,c}$  of the serving cell  $c$  as specified in Table 6.2.5.3-2; otherwise  $\Delta t_{IB,c} = 1$ .

For uplink intra-band contiguous carrier aggregation,

$$P_{CMAX\_L} = \text{MIN}\{10 \log_{10} \sum P_{EMAX,c} - \Delta T_C, P_{PowerClass} - \text{MAX}(MPR + A-MPR + \Delta T_{IB,c}, P-MPR) - \Delta T_C\}$$

$$P_{CMAX\_H} = \text{MIN}\{10 \log_{10} \sum P_{EMAX,c}, P_{PowerClass}\}$$

where

- $P_{EMAX,c}$  is the linear value of  $P_{EMAX,c}$  which is given by IE *P-Max* for serving cell  $c$  in [5] ;
- $P_{PowerClass}$  is the maximum UE power specified in Table 6.2.2A.1.3-1 without taking into account the tolerance specified in the Table 6.2.2A.1.3-1;
- MPR and A-MPR are specified in clause 6.2.3A and clause 6.2.4A respectively ;
- $\Delta T_{IB,c}$  is the additional tolerance for serving cell  $c$  as specified in Table 6.2.5.3-2 ;
- P-MPR is the power management term for the UE ;
- $\Delta T_C$  is the highest value  $\Delta T_{C,c}$  among all serving cells  $c$  in the subframe over both timeslots.  $\Delta T_{C,c} = 1.5$  dB when Note 2 in Table 6.2.2A.1.3-1 applies to the serving cell  $c$ ; otherwise  $\Delta T_{C,c} = 0$  dB.

For each subframe, the  $P_{CMAX\_L}$  is evaluated per slot and given by the minimum value taken over the transmission(s) within the slot; the minimum  $P_{CMAX\_L}$  over the two slots is then applied for the entire subframe.  $P_{PowerClass}$  shall not be exceeded by the UE during any period of time.

The measured maximum output power  $P_{UMAX}$  over all serving cells shall be within the following range:

$$P_{CMAX\_L} - T(P_{CMAX\_L}) \leq P_{UMAX} \leq P_{CMAX\_H} + T(P_{CMAX\_H})$$

$$P_{UMAX} = 10 \log_{10} \sum P_{UMAX,c}$$

where

- $P_{UMAX,c}$  denotes the measured maximum output power for serving cell  $c$  expressed in linear scale.

The tolerance  $T(P_{CMAX})$  is defined by the table below and applies to  $P_{CMAX\_L}$  and  $P_{CMAX\_H}$  separately.

**Table 6.2.5A.1.3-1:  $P_{CMAX}$  tolerance**

$P_{CMAX}$ (dBm)	Tolerance $T(P_{CMAX})$ Intra-band with two active UL serving cells (dB)	Tolerance $T(P_{CMAX})$ Inter-band with two active UL serving cells (dB)
$21 \leq P_{CMAX} \leq 23$	2.0	2.0
$20 \leq P_{CMAX} < 21$	[2.5]	TBD
$19 \leq P_{CMAX} < 20$	[3.5]	TBD
$18 \leq P_{CMAX} < 19$	[4.0]	TBD
$13 \leq P_{CMAX} < 18$	[5.0]	TBD
$8 \leq P_{CMAX} < 13$	[6.0]	TBD
$-40 \leq P_{CMAX} < 8$	[7.0]	TBD

The normative reference for this requirement is TS 36.101 [2] clause 6.2.5A.



6.2.5A.1.4 Test description

6.2.5A.1.4.1 Initial conditions

Initial conditions are a set of test configurations the UE needs to be tested in and the steps for the SS to take with the UE to reach the correct measurement state.

The initial test configurations consist of environmental conditions, test frequencies, and channel bandwidths based on E-UTRA CA configurations specified in table 5.4.2A.1-1. All of these configurations shall be tested with applicable test parameters for each channel bandwidth, and are shown in table 6.2.5A.1.4.1-1. The details of the uplink reference measurement channels (RMCs) are specified in Annex A.2. Configurations of PDSCH and PDCCH before measurement are specified in Annex C.2.

**Table 6.2.5A.1.4.1-1: Test Configuration Table**

Initial Conditions									
Test Environment as specified in TS 36.508[7] subclause 4.1				NC, TL/VL, TL/VH, TH/VL, TH/VH					
Test Frequencies as specified in TS 36.508 [7] subclause 4.3.1 for different CA bandwidth classes, and PCC and SCCs are mapped onto physical frequencies according to Table 6.1-2.				C: Mid range					
Test CC Combination setting ( $N_{RB\_agg}$ ) as specified in subclause 5.4.2A.1 for the CA Configuration across bandwidth combination sets supported by the UE.				Lowest $N_{RB\_agg}$ Highest $N_{RB\_agg}$ (Note 2)					
Test Parameters for CA Configurations									
CA Configuration / $N_{RB\_agg}$		DL Allocation		CC MOD	UL Allocation				
PCC $N_{RB}$	SCCs $N_{RB}$	PCC & SCC RB allocation			$N_{RB\_alloc}$	PCC & SCC RB allocations (L <sub>CRB</sub> @ RB <sub>start</sub> )			
75	75	N/A for this test		QPSK	16	P_16@0	S_0@0	-	-
100	50			QPSK	12	P_12@0	S_0@0	-	-
100	100			QPSK	18	P_18@0	S_0@0	-	-
Note 1: CA Configuration Test CC Combination settings are checked separately for each CA Configuration, which applicable aggregated channel bandwidths are specified in Table 5.4.2A.1-1									
Note 2: If in the CA Configuration UE supports multiple CC Combinations with the same $N_{RB\_agg}$ , only the first of those is tested, according to the order on the Test Configuration Table list.									

1. Connect the SS to the UE antenna connectors as shown in TS 36.508 [7] Annex A, Figure group A.32 as appropriate.
2. The parameter settings for the cell are set up according to TS 36.508 [7] subclause 4.4.3.
3. Downlink signals for PCC are initially set up according to Annex C.0, C.1, and C.3.0, and uplink signals according to Annex H.1 and H.3.0.
4. The UL Reference Measurement channel is set according to Table 6.2.5A.1.4.1-1
5. Propagation conditions are set according to Annex B.0.
6. Ensure the UE is in State 3A-RF according to TS 36.508 [7] clause 5.2A.2. Message contents are defined in clause 6.2.5A.1.4.3.

6.2.5A.1.4.2 Test procedure

1. Configure SCC according to Annex C.0, C.1, and Annex C.3.0 for all downlink physical channels.

2. The SS shall configure SCC as per TS 36.508 [7] clause 5.2A.4. Message contents are defined in clause 6.2.5A.1.4.3.
3. SS activates SCC by sending the MAC-CE according to TS 36.321 [13] clauses 5.13 and 6.1.3.8. Wait for at least 2 seconds as per TS 36.133 [4] clause 8.3.3.2.
4. SS sends uplink scheduling information for each UL HARQ process via PDCCH DCI format 0 for C\_RNTI to schedule the UL RMC according to Table 6.2.5A.1.4.1-1 on both PCC and SCC. Since the UE has no payload and no loopback data to send the UE sends uplink MAC padding bits on the UL RMC.
5. Send transmit uplink power control "up" commands in every uplink scheduling information to the UE; allow at least 200ms for the UE to reach the  $P_{UMAX}$  level of the test point.
6. Measure the mean power over all component carriers in the CA configuration for each test point in table 6.2.5A.1.5-1 according to the test configuration from Table 6.2.5A.1.4.1-1. The period of measurement shall be at least continuous duration of one sub-frame (1ms). For TDD slots with transient periods are not under test.

#### 6.2.5A.1.4.3 Message contents

Message contents are according to TS 36.508 [7] subclause 4.6 with the following exceptions. In test procedure step 2, for SCC configuration there are no additional message contents.

**Table 6.2.5A.1.4.3-1: SystemInformationBlockType1: Test point 1**

Derivation Path: TS 36.508 [7] clause 4.4.3.2, Table 4.4.3.2-3 SystemInformationBlockType1			
Information Element	Value/remark	Comment	Condition
p-Max	-10		

**Table 6.2.5A.1.4.3-2: SystemInformationBlockType1: Test point 2**

Derivation Path: TS 36.508 [7] clause 4.4.3.2, Table 4.4.3.2-3 SystemInformationBlockType1			
Information Element	Value/remark	Comment	Condition
p-Max	10		

**Table 6.2.5A.1.4.3-3: SystemInformationBlockType1: Test point 3**

Derivation Path: TS 36.508 [7] clause 4.4.3.2, Table 4.4.3.2-3 SystemInformationBlockType1			
Information Element	Value/remark	Comment	Condition
p-Max	15		

#### 6.2.5A.1.5 Test requirement

The maximum output power measured shall not exceed the values specified in Table 6.2.5A.1.5-1.

Table 6.2.5A.1.5-1:  $P_{\text{CMAX}}$  configured UE output power

	Channel bandwidth / maximum output power		
	50RB+100RB (10 MHz + 20 MHz)	75RB + 75RB (15 MHz + 15 MHz)	100RB + 100RB (20 MHz + 20 MHz)
Measured UE output power test point 1	For carrier frequency $f \leq 3.0\text{GHz}$ : $-10 \text{ dBm} \pm 7.7$ For carrier frequency $3.0\text{GHz} < f \leq 4.2\text{GHz}$ : $-10 \text{ dBm} \pm 8.0$		
Measured UE output power test point 2	For carrier frequency $f \leq 3.0\text{GHz}$ : $10 \text{ dBm} \pm 6.7$ For carrier frequency $3.0\text{GHz} < f \leq 4.2\text{GHz}$ : $10 \text{ dBm} \pm 7.0$		
Measured UE output power test point 3	For carrier frequency $f \leq 3.0\text{GHz}$ : $15 \text{ dBm} \pm 5.7$ For carrier frequency $3.0\text{GHz} < f \leq 4.2\text{GHz}$ : $15 \text{ dBm} \pm 6.0$		
Note:	In addition Note 2 in Table 6.2.2A.1.3-1 shall apply to the tolerances.		

For the UE which supports inter-band carrier aggregation configurations with uplink assigned to one E-UTRA band the  $\Delta T_{\text{IB},c}$  in Table 6.2.5.3-2 shall be applied for applicable bands.

In case the UE supports more than one of the above inter-band carrier aggregation configurations and an E-UTRA operating band belongs to more than one inter-band carrier aggregation configurations then:

- When the E-UTRA operating band frequency range is  $\leq 1\text{GHz}$ , the applicable additional tolerance shall be the average of the tolerances in Table 6.2.5.3-2, truncated to one decimal place for that operating band among the supported CA configurations. In case there is a harmonic relation between low band UL and high band DL, then the maximum tolerance among the different supported carrier aggregation configurations involving such band shall be applied
- When the E-UTRA operating band frequency range is  $>1\text{GHz}$ , the applicable additional tolerance shall be the maximum tolerance in Table 6.2.5.3-2 that applies for that operating band among the supported CA configurations.

#### 6.2.5A.2 Void

#### 6.2.5A.3 Configured UE transmitted Output Power for CA (inter-band DL CA and UL CA)

**Editor's notes:** Test points still under investigation.

##### 6.2.5A.3.1 Test purpose

To verify the UE does not exceed the minimum between the  $P_{\text{EMAX},c}$  maximum allowed UL TX Power signalled by the E-UTRAN and the  $P_{\text{UMAX}}$  maximum UE power for the UE power class.

##### 6.2.5A.3.2 Test applicability

This test applies to all types of E-UTRA UE release 11 and forward that support inter-band DL CA and UL CA.

##### 6.2.5A.3.3 Minimum conformance requirements

For uplink carrier aggregation the UE is allowed to set its configured maximum output power  $P_{\text{CMAX},c}$  for serving cell  $c$  and its total configured maximum output power  $P_{\text{CMAX}}$ .

The configured maximum output power  $P_{\text{CMAX},c}$  on serving cell  $c$  shall be set as specified in subclause 6.2.5.

For uplink inter-band carrier aggregation,  $\text{MPR}_c$  and  $\text{A-MPR}_c$  apply per serving cell  $c$  and are specified in subclause 6.2.3 and subclause 6.2.4, respectively.  $\text{P-MPR}_c$  accounts for power management for serving cell  $c$ .  $P_{\text{CMAX},c}$  is calculated under the assumption that the transmit power is increased independently on all component carriers.

For uplink intra-band contiguous and non-contiguous carrier aggregation,  $\text{MPR}_c = \text{MPR}$  and  $\text{A-MPR}_c = \text{A-MPR}$  with  $\text{MPR}$  and  $\text{A-MPR}$  specified in subclause 6.2.3A and subclause 6.2.4A respectively. There is one power management

term for the UE, denoted P-MPR, and  $P\text{-MPR}_c = P\text{-MPR}$ .  $P_{\text{CMAX},c}$  is calculated under the assumption that the transmit power is increased by the same amount in dB on all component carriers.

The total configured maximum output power  $P_{\text{CMAX}}$  shall be set within the following bounds:

$$P_{\text{CMAX},L} \leq P_{\text{CMAX}} \leq P_{\text{CMAX},H}$$

For uplink inter-band carrier aggregation with one serving cell  $c$  per operating band,

$$P_{\text{CMAX},L} = \text{MIN} \{ 10 \log_{10} \sum \text{MIN} [ p_{\text{EMAX},c} / (\Delta t_{C,c}), p_{\text{PowerClass}} / (\text{mpr}_c \cdot a\text{-mpr}_c \cdot \Delta t_{C,c} \cdot \Delta t_{\text{IB},c}), p_{\text{PowerClass}} / \text{pmpr}_c ], P_{\text{PowerClass}} \}$$

$$P_{\text{CMAX},H} = \text{MIN} \{ 10 \log_{10} \sum p_{\text{EMAX},c}, P_{\text{PowerClass}} \}$$

where

- $p_{\text{EMAX},c}$  is the linear value of  $P_{\text{EMAX},c}$  which is given by IE *P-Max* for serving cell  $c$  in [5];
- $P_{\text{PowerClass}}$  is the maximum UE power specified in Table 6.2.2A.2.3-1 without taking into account the tolerance specified in the Table 6.2.2A-1;  $p_{\text{PowerClass}}$  is the linear value of  $P_{\text{PowerClass}}$ ;
- $\text{mpr}_c$  and  $a\text{-mpr}_c$  are the linear values of  $\text{MPR}_c$  and  $A\text{-MPR}_c$  as specified in subclause 6.2.3 and subclause 6.2.4, respectively;
- $\text{pmpr}_c$  is the linear value of  $P\text{-MPR}_c$ ;
- $\Delta t_{C,c}$  is the linear value of  $\Delta T_{C,c}$ .  $\Delta t_{C,c} = 1.41$  when Note 2 in Table 6.2.2.3-1 applies for a serving cell  $c$ , otherwise  $\Delta t_{C,c} = 1$ ;
- $\Delta t_{\text{IB},c}$  is the linear value of the inter-band relaxation term  $\Delta T_{\text{IB},c}$  of the serving cell  $c$  as specified in Table 6.2.5.3-2; otherwise  $\Delta t_{\text{IB},c} = 1$ .

For each subframe, the  $P_{\text{CMAX},L}$  is evaluated per slot and given by the minimum value taken over the transmission(s) within the slot; the minimum  $P_{\text{CMAX},L}$  over the two slots is then applied for the entire subframe.  $P_{\text{PowerClass}}$  shall not be exceeded by the UE during any period of time.

If the UE is configured with multiple TAGs and transmissions of the UE on subframe  $i$  for any serving cell in one TAG overlap some portion of the first symbol of the transmission on subframe  $i+1$  for a different serving cell in another TAG, the UE minimum of  $P_{\text{CMAX},L}$  for subframes  $i$  and  $i+1$  applies for any overlapping portion of subframes  $i$  and  $i+1$ .  $P_{\text{PowerClass}}$  shall not be exceeded by the UE during any period of time.

The measured maximum output power  $P_{\text{UMAX}}$  over all serving cells shall be within the following range:

$$P_{\text{CMAX},L} - \text{MAX} \{ T_L, T_{\text{LOW}}(P_{\text{CMAX},L}) \} \leq P_{\text{UMAX}} \leq P_{\text{CMAX},H} + T_{\text{HIGH}}(P_{\text{CMAX},H})$$

$$P_{\text{UMAX}} = 10 \log_{10} \sum p_{\text{UMAX},c}$$

where  $p_{\text{UMAX},c}$  denotes the measured maximum output power for serving cell  $c$  expressed in linear scale. The tolerances  $T_{\text{LOW}}(P_{\text{CMAX}})$  and  $T_{\text{HIGH}}(P_{\text{CMAX}})$  for applicable values of  $P_{\text{CMAX}}$  are specified in Table 6.2.5A.3.3-1 for inter-band carrier aggregation. The tolerance  $T_L$  is the absolute value of the lower tolerance for applicable E-UTRA CA configuration as specified in Table 6.2.2A.2.3-1 for inter-band carrier aggregation.

**Table 6.2.5A.3.3-1:  $P_{\text{CMAX}}$  tolerance for dual-uplink inter-band CA**

$P_{\text{CMAX}}$ (dBm)	Tolerance $T_{\text{LOW}}(P_{\text{CMAX}})$ (dB)	Tolerance $T_{\text{HIGH}}(P_{\text{CMAX}})$ (dB)
$P_{\text{CMAX}} = 23$	3.0	2.0
$22 \leq P_{\text{CMAX}} < 23$	5.0	2.0
$21 \leq P_{\text{CMAX}} < 22$	5.0	3.0
$20 \leq P_{\text{CMAX}} < 21$	6.0	4.0
$16 \leq P_{\text{CMAX}} < 20$	5.0	
$11 \leq P_{\text{CMAX}} < 16$	6.0	
$-40 \leq P_{\text{CMAX}} < 11$	7.0	

The normative reference for this requirement is TS 36.101 [2] clause 6.2.5A.

6.2.5A.3.4 Test description

6.2.5A.3.4.1 Initial conditions

Initial conditions are a set of test configurations the UE needs to be tested in and the steps for the SS to take with the UE to reach the correct measurement state.

The initial test configurations consist of environmental conditions, test frequencies, and channel bandwidths based on E-UTRA CA configurations specified in table 5.4.2A.1-2. All of these configurations shall be tested with applicable test parameters for each channel bandwidth, and are shown in table 6.2.5A.3.4.1-1. The details of the uplink reference measurement channels (RMCs) are specified in Annex A.2. Configurations of PDSCH and PDCCH before measurement are specified in Annex C.2.

Table 6.2.5A.3.4.1-1: Test Configuration Table

Initial Conditions								
Test Environment as specified in TS 36.508[7] subclause 4.1				NC, TL/VL, TL/VH, TH/VL, TH/VH				
Test Frequencies as specified in TS 36.508 [7] subclause 4.3.1 for different CA bandwidth classes.				A: Mid range PCC-SCC: CC1-CC2				
Test CC Combination setting ( $N_{RB\_agg}$ ) as specified in subclause 5.4.2A.1-2 for the CA Configuration across bandwidth combination sets supported by the UE.				Lowest $N_{RB\_agg}$ Highest $N_{RB\_agg}$ (Note 2)				
Test Parameters for CA Configurations								
CA Configuration / $N_{RB\_agg}$		DL Allocation	CC MOD	UL Allocation				
PCC $N_{RB}$	SCCs $N_{RB}$	PCC & SCC RB allocation		$N_{RB\_alloc}$	PCC & SCC RB allocations ( $L_{CRB}$ @ $RB_{start}$ )			
6	25	N/A for this test	QPSK	13	P_5@0	S_8@0	-	-
6	50		QPSK	17	P_5@0	S_12@0	-	-
25	15		QPSK	12	P_8@0	S_5@0	-	-
25	25		QPSK	16	P_8@0	S_8@0	-	-
25	50		QPSK	20	P_8@0	S_12@0	-	-
50	25		QPSK	20	P_12@0	S_8@0	-	-
50	50		QPSK	24	P_12@0	S_12@0	-	-
50	100		QPSK	30	P_12@0	S_18@0	-	-
75	75		QPSK	32	P_16@0	S_16@0	-	-
100	50		QPSK	30	P_18@0	S_12@0	-	-
100	75		QPSK	34	P_18@0	S_16@0	-	-
100	100		QPSK	36	P_18@0	S_18@0	-	-
Note 1: CA Configuration Test CC Combination settings are checked separately for each CA Configuration, which applicable aggregated channel bandwidths are specified in Table 5.4.2A.1-2. Note 2: If in the CA Configuration UE supports multiple CC Combinations with the same $N_{RB\_agg}$ , only the first of those is tested, according to the order on the Test Configuration Table list.								

1. Connect the SS to the UE antenna connectors as shown in TS 36.508 [7] Annex A, Figure group A.32 as appropriate.
2. The parameter settings for the cell are set up according to TS 36.508 [7] subclause 4.4.3.

3. Downlink signals for PCC are initially set up according to Annex C.0, C.1, and C.3.0, and uplink signals according to Annex H.1 and H.3.0.
4. The UL Reference Measurement channel is set according to Table 6.2.5A.3.4.1-1
5. Propagation conditions are set according to Annex B.0.
6. Ensure the UE is in State 3A-RF according to TS 36.508 [7] clause 5.2A.2. Message contents are defined in clause 6.2.5A.3.4.3.

#### 6.2.5A.3.4.2 Test procedure

1. Configure SCC according to Annex C.0, C.1, and Annex C.3.0 for all downlink physical channels.
2. The SS shall configure SCC as per TS 36.508 [7] clause 5.2A.4. Message contents are defined in clause 6.2.5A.3.4.3.
3. SS activates SCC by sending the MAC-CE according to TS 36.321 [13] clauses 5.13 and 6.1.3.8. Wait for at least 2 seconds as per TS 36.133 [4] clause 8.3.3.2.
4. SS sends uplink scheduling information for each UL HARQ process via PDCCH DCI format 0 for C\_RNTI to schedule the UL RMC according to Table 6.2.5A.3.4.1-1 on both PCC and SCC. Since the UE has no payload and no loopback data to send the UE sends uplink MAC padding bits on the UL RMC.
5. Send transmit uplink power control "up" commands in every uplink scheduling information to the UE; allow at least 200ms for the UE to reach the  $P_{UMAX}$  level of the test point.
6. Measure the mean power over all component carriers in the CA configuration for each test point in table 6.2.5A.3.5-1 according to the test configuration from Table 6.2.5A.3.4.1-1. The period of measurement shall be at least continuous duration of one sub-frame (1ms). For TDD slots with transient periods are not under test.

#### 6.2.5A.3.4.3 Message contents

Message contents are according to TS 36.508 [7] subclause 4.6 with the following exceptions. In test procedure step 2, for SCC configuration there are no additional message contents.

**Table 6.2.5A.3.4.3-1: SystemInformationBlockType1: Test point 1**

Derivation Path: TS 36.508 [7] clause 4.4.3.2, Table 4.4.3.2-3 SystemInformationBlockType1			
Information Element	Value/remark	Comment	Condition
p-Max	-13		

**Table 6.2.5A.3.4.3-2: SystemInformationBlockType1: Test point 2**

Derivation Path: TS 36.508 [7] clause 4.4.3.2, Table 4.4.3.2-3 SystemInformationBlockType1			
Information Element	Value/remark	Comment	Condition
p-Max	10		

**Table 6.2.5A.3.4.3-3: SystemInformationBlockType1: Test point 3**

Derivation Path: TS 36.508 [7] clause 4.4.3.2, Table 4.4.3.2-3 SystemInformationBlockType1			
Information Element	Value/remark	Comment	Condition
p-Max	15		

#### 6.2.5A.3.5 Test requirement

The maximum output power measured shall not exceed the values specified in Table 6.2.5A.3.5-1.

**Table 6.2.5A.3.5-1: P<sub>CMAX</sub> configured UE output power**

Test point	maximum output power		
Measured UE output power test point 1	For carrier frequency $f \leq 3.0\text{GHz}$ : $-10 \text{ dBm} \pm 7.7$	For carrier frequency $f \leq 3.0\text{GHz}$ : $13 \text{ dBm} \pm 6.7$	For carrier frequency $f \leq 3.0\text{GHz}$ : $18 \text{ dBm} \pm 5.7$
Measured UE output power test point 2			
Measured UE output power test point 3			

For the UE which supports inter-band carrier aggregation configurations with uplink assigned to one E-UTRA band the  $\Delta T_{IB,c}$  in Table 6.2.5.3-2 shall be applied for applicable bands.

In case the UE supports more than one of the above inter-band carrier aggregation configurations and an E-UTRA operating band belongs to more than one inter-band carrier aggregation configurations then:

- When the E-UTRA operating band frequency range is  $\leq 1\text{GHz}$ , the applicable additional tolerance shall be the average of the tolerances in Table 6.2.5.3-2, truncated to one decimal place for that operating band among the supported CA configurations. In case there is a harmonic relation between low band UL and high band DL, then the maximum tolerance among the different supported carrier aggregation configurations involving such band shall be applied.
- When the E-UTRA operating band frequency range is  $>1\text{GHz}$ , the applicable additional tolerance shall be the maximum tolerance in Table 6.2.5.3-2 that applies for that operating band among the supported CA configurations.

## 6.2.5A.4 Configured UE transmitted Output Power for CA (intra-band non-contiguous DL CA and UL CA)

### 6.2.5A.4.1 Test purpose

To verify the UE does not exceed the minimum between the  $P_{EMAX,c}$  maximum allowed UL TX Power signalled by the E-UTRAN and the  $P_{UMAX}$  maximum UE power for the UE power class.

### 6.2.5A.4.2 Test applicability

This test applies to all types of E-UTRA UE release 11 and forward that support intra-band non-contiguous DL CA and UL CA.

### 6.2.5A.4.3 Minimum conformance requirements

For uplink carrier aggregation the UE is allowed to set its configured maximum output power  $P_{CMAX,c}$  for serving cell  $c$  and its total configured maximum output power  $P_{CMAX}$ .

The configured maximum output power  $P_{CMAX,c}$  on serving cell  $c$  shall be set as specified in subclause 6.2.5.

For uplink intra-band contiguous and non-contiguous carrier aggregation,  $MPR_c = MPR$  and  $A-MPR_c = A-MPR$  with  $MPR$  and  $A-MPR$  specified in clause 6.2.3A and clause 6.2.4A respectively. There is one power management term for the UE, denoted  $P-MPR_c$ , and  $P-MPR_c = P-MPR$ .  $P_{CMAX,c}$  is calculated under the assumption that the transmit power is increased by the same amount in dB on all component carriers.

The total configured maximum output power  $P_{CMAX}$  shall be set within the following bounds:

$$P_{CMAX,L} \leq P_{CMAX} \leq P_{CMAX,H}$$

For uplink intra-band contiguous and non-contiguous carrier aggregation,

$$P_{CMAX,L} = \text{MIN}\{10 \log_{10} \sum P_{EMAX,c} - \Delta T_C, P_{PowerClass} - \text{MAX}(MPR + A-MPR + \Delta T_{IB,c} + \Delta T_C, P-MPR)\}$$

$$P_{CMAX,H} = \text{MIN}\{10 \log_{10} \sum P_{EMAX,c}, P_{PowerClass}\}$$

where

- $p_{EMAX,c}$  is the linear value of  $P_{EMAX,c}$  which is given by IE *P-Max* for serving cell  $c$  in [5];
- $P_{PowerClass}$  is the maximum UE power specified in Table 6.2.2A.1.3-1 without taking into account the tolerance specified in the Table 6.2.2A.1.3-1;
- MPR and A-MPR are specified in subclause 6.2.3A and subclause 6.2.4A respectively;
- $\Delta T_{IB,c}$  is the additional tolerance for serving cell  $c$  as specified in Table 6.2.5.3-2;
- P-MPR is the power management term for the UE;
- $\Delta T_C$  is the highest value  $\Delta T_{C,c}$  among all serving cells  $c$  in the subframe over both timeslots.  $\Delta T_{C,c} = 1.5$  dB when Note 2 in Table 6.2.2A.1.3-1 applies to the serving cell  $c$ , otherwise  $\Delta T_{C,c} = 0$  dB.

For each subframe, the  $P_{CMAX\_L}$  is evaluated per slot and given by the minimum value taken over the transmission(s) within the slot; the minimum  $P_{CMAX\_L}$  over the two slots is then applied for the entire subframe.  $P_{PowerClass}$  shall not be exceeded by the UE during any period of time.

If the UE is configured with multiple TAGs and transmissions of the UE on subframe  $i$  for any serving cell in one TAG overlap some portion of the first symbol of the transmission on subframe  $i + 1$  for a different serving cell in another TAG, the UE minimum of  $P_{CMAX\_L}$  for subframes  $i$  and  $i + 1$  applies for any overlapping portion of subframes  $i$  and  $i + 1$ .  $P_{PowerClass}$  shall not be exceeded by the UE during any period of time.

The measured maximum output power  $P_{UMAX}$  over all serving cells shall be within the following range:

$$P_{CMAX\_L} - \text{MAX}\{T_L, T_{LOW}(P_{CMAX\_L})\} \leq P_{UMAX} \leq P_{CMAX\_H} + T_{HIGH}(P_{CMAX\_H})$$

$$P_{UMAX} = 10 \log_{10} \sum p_{UMAX,c}$$

where  $p_{UMAX,c}$  denotes the measured maximum output power for serving cell  $c$  expressed in linear scale. The tolerances  $T_{LOW}(P_{CMAX})$  and  $T_{HIGH}(P_{CMAX})$  for applicable values of  $P_{CMAX}$  are specified in Table 6.2.5A.4.3-1 for intra-band carrier aggregation. The tolerance  $T_L$  is the absolute value of the lower tolerance for applicable E-UTRA CA configuration as specified in Table 6.2.2A-2 of TS 36.101 for intra-band non-contiguous carrier aggregation.

**Table 6.2.5A.4.3-1:  $P_{CMAX}$  tolerance**

$P_{CMAX}$ (dBm)	Tolerance $T_{LOW}(P_{CMAX})$ (dB)	Tolerance $T_{HIGH}(P_{CMAX})$ (dB)
$21 \leq P_{CMAX} \leq 23$		2.0
$20 \leq P_{CMAX} < 21$		2.5
$19 \leq P_{CMAX} < 20$		3.5
$18 \leq P_{CMAX} < 19$		4.0
$13 \leq P_{CMAX} < 18$		5.0
$8 \leq P_{CMAX} < 13$		6.0
$-40 \leq P_{CMAX} < 8$		7.0

The normative reference for this requirement is TS 36.101 [2] clause 6.2.5A.

#### 6.2.5A.4.4 Test description

##### 6.2.5A.4.4.1 Initial conditions

Initial conditions are a set of test configurations the UE needs to be tested in and the steps for the SS to take with the UE to reach the correct measurement state.

The initial test configurations consist of environmental conditions, test frequencies, and channel bandwidths based on E-UTRA CA configurations specified in table 5.4.2A.1-3. All of these configurations shall be tested with applicable test parameters for each channel bandwidth, and are shown in table 6.2.5A.4.4.1-1. The details of the uplink reference measurement channels (RMCs) are specified in Annex A.2. Configurations of PDSCH and PDCCH before measurement are specified in Annex C.2.



Table 6.2.5A.4.4.1-1: Test Configuration Table

Initial Conditions									
Test Environment as specified in TS 36.508[7] subclause 4.1				NC, TL/VL, TL/VH, TH/VL, TH/VH					
Test Frequencies as specified in TS36.508 [7] subclause 4.3.1 for different CA bandwidth classes, and PCC and SCCs are mapped onto physical frequencies according to Table 6.1-2.				Refer to test points A: Mid frequency, Maximum W <sub>gap</sub> (low + high frequency)					
Test CC Combination setting (N <sub>RB</sub> ) as specified in subclause 5.4.2A.1 for the CA Configuration across bandwidth combination sets supported by the UE.				Refer to test point Test only test points with Lowest N <sub>RB</sub> for PCC and SCC Highest N <sub>RB</sub> for PCC and SCC					
Test Parameters for CA Configurations									
ID	CA Configuration / N <sub>RB_agg</sub>		W <sub>gap</sub> [MHz]	DL Allocation		UL Allocation			
	PCC N <sub>RB</sub>	SCCs N <sub>RB</sub>		CC MOD	PCC & SCC RB allocation	CC MOD	PCC N <sub>RB_alloc</sub> (L <sub>CRB</sub> @ RB <sub>start</sub> )	CC MOD	SCC N <sub>RB_alloc</sub> (L <sub>CRB</sub> @ RB <sub>start</sub> )
Test Parameters for CA_4A-4A Configurations									
1	25	25	35	N/A for this test		QPSK	P_1@0	QPSK	S_1@24
2	25	25	35			QPSK	P_25@0	QPSK	S_25@0
3	100	100	5			QPSK	P_1@0	QPSK	S_1@99
4	100	100	5			QPSK	P_100@0	QPSK	S_100@0

1. Connect the SS to the UE antenna connectors as shown in TS 36.508 [7] Annex A, Figure group A.32 as appropriate.
2. The parameter settings for the cell are set up according to TS 36.508 [7] subclause 4.4.3.
3. Downlink signals for PCC are initially set up according to Annex C.0, C.1, and C.3.0, and uplink signals according to Annex H.1 and H.3.0.
4. The UL Reference Measurement channel is set according to Table 6.2.5A.4.4.1-1
5. Propagation conditions are set according to Annex B.0.
6. Ensure the UE is in State 3A-RF according to TS 36.508 [7] clause 5.2A.2. Message contents are defined in clause 6.2.5A.4.4.3.

#### 6.2.5A.4.4.2 Test procedure

1. Configure SCC according to Annex C.0, C.1, and Annex C.3.0 for all downlink physical channels.
2. The SS shall configure SCC as per TS 36.508 [7] clause 5.2A.4. Message contents are defined in clause 6.2.5A.4.4.3.
3. SS activates SCC by sending the MAC-CE according to TS 36.321 [13] clauses 5.13 and 6.1.3.8. Wait for at least 2 seconds as per TS 36.133 [4] clause 8.3.3.2.
4. SS sends uplink scheduling information for each UL HARQ process via PDCCH DCI format 0 for C\_RNTI to schedule the UL RMC according to Table 6.2.5A.4.4.1-1 on both PCC and SCC. Since the UE has no payload and no loopback data to send the UE sends uplink MAC padding bits on the UL RMC.
5. Send transmit uplink power control "up" commands in every uplink scheduling information to the UE; allow at least 200ms for the UE to reach the P<sub>UMAX</sub> level of the test point.

6. Measure the mean power over all component carriers in the CA configuration for each test point in table 6.2.5A.4.5-1 according to the test configuration from Table 6.2.5A.4.4.1-1. The period of measurement shall be at least continuous duration of one sub-frame (1ms).

#### 6.2.5A.4.4.3 Message contents

Message contents are according to TS 36.508 [7] subclause 4.6 with the following exceptions. In test procedure step 2, for SCC configuration there are no additional message contents.

**Table 6.2.5A.4.4.3-1: SystemInformationBlockType1: Test point 1**

Derivation Path: TS 36.508 [7] clause 4.4.3.2, Table 4.4.3.2-3 SystemInformationBlockType1			
Information Element	Value/remark	Comment	Condition
p-Max	-13		

**Table 6.2.5A.4.4.3-2: SystemInformationBlockType1: Test point 2**

Derivation Path: TS 36.508 [7] clause 4.4.3.2, Table 4.4.3.2-3 SystemInformationBlockType1			
Information Element	Value/remark	Comment	Condition
p-Max	7		

**Table 6.2.5A.4.4.3-3: SystemInformationBlockType1: Test point 3**

Derivation Path: TS 36.508 [7] clause 4.4.3.2, Table 4.4.3.2-3 SystemInformationBlockType1			
Information Element	Value/remark	Comment	Condition
p-Max	12		

#### 6.2.5A.4.5 Test requirement

The maximum output power measured shall not exceed the values specified in Table 6.2.5A.4.5-1.

**Table 6.2.5A.4.5-1: P<sub>CMAX</sub> configured UE output power**

Configuration ID	MPR (dB)	P <sub>CMAX</sub> (dBm)	T(P <sub>CMAX,L</sub> ) (dB)	maximum output power					
				Measured UE output power test point 1		Measured UE output power test point 2		Measured UE output power test point 3	
				Upper limit (dBm)	Lower limit (dBm)	Upper limit (dBm)	Lower limit (dBm)	Upper limit (dBm)	Lower limit (dBm)
1	18	5	7	-2.3	-17.7	16.7	-2.7	20.7	-2.7
2	12	11	6				3.3		4.3
3	18	5	7				-2.7		-2.7
4	7	16	5				3.3		9.3

For the UE which supports inter-band carrier aggregation configurations with uplink assigned to one E-UTRA band the  $\Delta T_{IB,c}$  in Table 6.2.5.3-2 shall be applied for applicable bands.

In case the UE supports more than one of the above inter-band carrier aggregation configurations and an E-UTRA operating band belongs to more than one inter-band carrier aggregation configurations then:

- When the E-UTRA operating band frequency range is  $\leq 1$ GHz, the applicable additional tolerance shall be the average of the tolerances in Table 6.2.5.3-2, truncated to one decimal place for that operating band among the supported CA configurations. In case there is a harmonic relation between low band UL and high band DL, then the maximum tolerance among the different supported carrier aggregation configurations involving such band shall be applied

- When the E-UTRA operating band frequency range is >1GHz, the applicable additional tolerance shall be the maximum tolerance in Table 6.2.5.3-2 that applies for that operating band among the supported CA configurations.

## 6.2.5B Configured UE transmitted Output Power for UL-MIMO

**Editor's notes:** The following items are missing or incomplete:

- **Test Tolerance**

### 6.2.5B.1 Test purpose

To verify the UE does not exceed the minimum between the  $P_{EMAX}$  maximum allowed UL TX Power for UL-MIMO signalled by the E-UTRAN and the  $P_{UMAX}$  maximum UE power for the UE power class.

### 6.2.5B.2 Test applicability

This test applies to all types of E-UTRA UE release 10 and forward that support UL- MIMO.

### 6.2.5B.3 Minimum conformance requirements

For UE with multiple transmit antenna connectors, the transmitted power is configured per each UE.

The definitions of configured maximum output power  $P_{CMAX,c}$ , the lower bound  $P_{CMAX\_L,c}$ , and the higher bound  $P_{CMAX\_H,c}$  specified in Section 6.2.5 shall apply to UE with multiple transmit antenna connectors, where

- $P_{PowerClass}$  and  $\Delta T_{C,c}$  are specified in Section 6.2.2B;
- $MPR_c$  is specified in Section 6.2.3B;
- A- $MPR_c$  is specified in Section 6.2.4B.

The measured configured maximum output power  $P_{UMAX,c}$  for serving cell  $c$  shall be within the following bounds:

$$P_{CMAX\_L,c} - \text{MAX}\{T_L, T_{LOW}(P_{CMAX\_L,c})\} \leq P_{UMAX,c} \leq P_{CMAX\_H,c} + T_{HIGH}(P_{CMAX\_H,c})$$

where  $T_{LOW}(P_{CMAX\_L,c})$  and  $T_{HIGH}(P_{CMAX\_H,c})$  are defined as the tolerance and applies to  $P_{CMAX\_L,c}$  and  $P_{CMAX\_H,c}$  separately, while  $T_L$  is the absolute value of the lower tolerance in Table 6.2.2B.3-1 for the applicable operating band.

For UE with two transmit antenna connectors, the tolerance is specified in Table 6.2.5B.3-1 with UL-MIMO configurations specified in Table 6.2.2B.3-2.

**Table 6.2.5B.3-1:  $P_{CMAX,c}$  tolerance in closed-loop spatial multiplexing scheme**

$P_{CMAX,c}$ (dBm)	Tolerance $T_{LOW}(P_{CMAX\_L,c})$ (dB)	Tolerance $T_{HIGH}(P_{CMAX\_H,c})$ (dB)
$P_{CMAX,c} = 23$	3.0	2.0
$[22] \leq P_{CMAX,c} < [23]$	[5.0]	[2.0]
$[21] \leq P_{CMAX,c} < [22]$	[5.0]	[3.0]
$[20] \leq P_{CMAX,c} < [21]$	[6.0]	[4.0]
$[16] \leq P_{CMAX,c} < [20]$		[5.0]
$[11] \leq P_{CMAX,c} < [16]$		[6.0]
$[-40] \leq P_{CMAX,c} < [11]$		[7.0]

The normative reference for this requirement is TS 36.101 [2] clause 6.2.5B.

## 6.2.5B.4 Test description

### 6.2.5B.4.1 Initial conditions

Initial conditions are a set of test configurations the UE needs to be tested in and the steps for the SS to take with the UE to reach the correct measurement state.

The initial test configurations consist of environmental conditions, test frequencies, and channel bandwidths based on E-UTRA operating bands specified in table 5.4.2.1-1. All of these configurations shall be tested with applicable test parameters for each channel bandwidth, and are shown in table 6.2.5B.4.1-1. The details of the uplink reference measurement channels (RMCs) are specified in Annex A.2. Configurations of PDSCH and PDCCH before measurement are specified in Annex C.2.

**Table 6.2.5B.4.1-1: Test Configuration Table**

Initial Conditions				
Test Environment as specified in TS 36.508 [7] subclause 4.1		Normal, TL/VL, TL/VH, TH/VL, TH/VH		
Test Frequencies as specified in TS 36.508 [7] subclause 4.3.1		Mid range		
Test Channel Bandwidths as specified in TS 36.508 [7] subclause 4.3.1		Lowest, 5MHz, Highest		
Test Parameters for Channel Bandwidths				
Ch BW	Downlink Configuration		Uplink Configuration	
	N/A for Configured UE transmitted Output Power test case		Mod'n	RB allocation
			FDD	TDD
1.4MHz			QPSK	5
3MHz			QPSK	4
5MHz			QPSK	8
10MHz			QPSK	12
15MHz			QPSK	16
20MHz			QPSK	18
Note 1: Test Channel Bandwidths are checked separately for each E-UTRA band, the applicable channel bandwidths are specified in Table 5.4.2.1-1.				
Note 2: For the uplink RB allocation the RB <sub>start</sub> shall be RB #0.				

1. Connect the SS to the UE antenna connectors as shown in TS 36.508 [7] Annex A, in Figure A.28.
2. The parameter settings for the cell are set up according to TS 36.508 [7] subclause 4.4.3.
3. Downlink signals are initially set up according to Annex C.0, C.1, and C.3.0, and uplink signals according to Annex H.1 and H.3.0.
4. The UL Reference Measurement channel is set according to Table 6.2.5B.4.1-1
5. Propagation conditions are set according to Annex B.0.
6. Ensure the UE is in State 3A-RF according to TS 36.508 [7] clause 5.2A.2. Message contents are defined in clause 6.2.5B.4.3.

### 6.2.5B.4.2 Test procedure

1. SS sends uplink scheduling information for each UL HARQ process via PDCCH DCI format 4 for C\_RNTI to schedule the UL RMC according to Table 6.2.5B.4.1-1. Since the UE has no payload and no loopback data to send the UE sends uplink MAC padding bits on the UL RMC.
2. Send transmit uplink power control "up" commands in every uplink scheduling information to the UE; allow at least 200ms for the UE to reach the  $P_{\text{umax}}$  level of the test point.
3. Measure the sum mean power of the UE at each UE antenna connector in the associated measurement bandwidth for each test point in table 6.2.5B.5-1 according to the test configuration from Table 6.2.5B.4.1-1. The period of measurement shall be at least continuous duration of one sub-frame (1ms). For TDD slots with transient periods are not under test.

## 6.2.5B.4.3 Message contents

Message contents are according to TS 36.508 [7] clause 4.6 with the following exceptions:

**Table 6.2.5B.4.3-1: SystemInformationBlockType1: Test point 1**

Derivation Path: TS 36.508 [7] clause 4.4.3.2, Table 4.4.3.2-3 SystemInformationBlockType1			
Information Element	Value/remark	Comment	Condition
p-Max	-10		

**Table 6.2.5B.4.3-2: SystemInformationBlockType1: Test point 2**

Derivation Path: TS 36.508 [7] clause 4.4.3.2, Table 4.4.3.2-3 SystemInformationBlockType1			
Information Element	Value/remark	Comment	Condition
p-Max	13		

**Table 6.2.5B.4.3-3: SystemInformationBlockType1: Test point 3**

Derivation Path: TS 36.508 [7] clause 4.4.3.2, Table 4.4.3.2-3 SystemInformationBlockType1			
Information Element	Value/remark	Comment	Condition
p-Max	18		

## 6.2.5B.5 Test requirement

The maximum output power measured shall not exceed the values specified in Table 6.2.5B.5-1.

**Table 6.2.5B.5-1: P<sub>CMAX</sub> configured UE output power**

	Channel bandwidth / maximum output power					
	1.4 MHz	3.0 MHz	5 MHz	10 MHz	15 MHz	20 MHz
Measured UE output power test point 1	For carrier frequency $f \leq 3.0\text{GHz}$ : $-10 \text{ dBm} \pm [7.7]$ For carrier frequency $3.0\text{GHz} < f \leq 4.2\text{GHz}$ : $-10 \text{ dBm} \pm [8]$					
Measured UE output power test point 2	For carrier frequency $f \leq 3.0\text{GHz}$ : $13 \text{ dBm} \pm [6.7]$ For carrier frequency $3.0\text{GHz} < f \leq 4.2\text{GHz}$ : $13 \text{ dBm} \pm [7]$					
Measured UE output power test point 3	For carrier frequency $f \leq 3.0\text{GHz}$ : $18 \text{ dBm} \pm [5.7]$ For carrier frequency $3.0\text{GHz} < f \leq 4.2\text{GHz}$ : $18 \text{ dBm} \pm [6]$					
Note:	In addition note 2 in Table 6.2.2B.3-1 shall apply to the tolerances.					

For the UE which supports inter-band carrier aggregation configurations with uplink assigned to one E-UTRA band the  $\Delta T_{IB,c}$  in Table 6.2.5.3-2 shall be applied for applicable bands.

In case the UE supports more than one of the above inter-band carrier aggregation configurations and an E-UTRA operating band belongs to more than one inter-band carrier aggregation configurations then:

- When the E-UTRA operating band frequency range is  $\leq 1\text{GHz}$ , the applicable additional tolerance shall be the average of the tolerances in Table 6.2.5.3-2, truncated to one decimal place for that operating band among the supported CA configurations. In case there is a harmonic relation between low band UL and high band DL, then the maximum tolerance among the different supported carrier aggregation configurations involving such band shall be applied
- When the E-UTRA operating band frequency range is  $>1\text{GHz}$ , the applicable additional tolerance shall be the maximum tolerance in Table 6.2.5.3-2 that applies for that operating band among the supported CA configurations.

## 6.3 Output Power Dynamics

### 6.3.1 Void

### 6.3.2 Minimum Output Power

#### 6.3.2.1 Test purpose

To verify the UE's ability to transmit with a broadband output power below the value specified in the test requirement when the power is set to a minimum value.

#### 6.3.2.2 Test applicability

This test applies to all types of E-UTRA UE release 8 and forward.

#### 6.3.2.3 Minimum conformance requirements

The minimum output power is defined as the mean power in one sub-frame (1ms). The minimum output power shall not exceed the values specified in Table 6.3.2.3-1.

**Table 6.3.2.3-1: Minimum output power**

	Channel bandwidth / minimum output power / measurement bandwidth					
	1.4 MHz	3.0 MHz	5 MHz	10 MHz	15 MHz	20 MHz
Minimum output power	-40 dBm					
Measurement bandwidth	1.08 MHz	2.7 MHz	4.5 MHz	9.0 MHz	13.5 MHz	18 MHz

The normative reference for this requirement is TS 36.101 [2] clause 6.3.2.1.

Minimum output power test verifies the UE's ability to transmit with a broadband output power below the specified limit when the power is set to a minimum value. The broadband output power is defined as the power in the channel bandwidth, for all transmit bandwidth configurations (resource blocks).

An excess minimum output power potentially increases the Rise Over Thermal (RoT) and therefore reduces the cell coverage area for other UEs.

#### 6.3.2.4 Test description

##### 6.3.2.4.1 Initial conditions

Initial conditions are a set of test configurations the UE needs to be tested in and the steps for the SS to take with the UE to reach the correct measurement state.

The initial test configurations consist of environmental conditions, test frequencies, and channel bandwidths based on E-UTRA operating bands specified in table 5.4.2.1-1. All of these configurations shall be tested with applicable test parameters for each channel bandwidth, and are shown in table 6.3.2.4.1-1. The details of the uplink reference measurement channels (RMCs) are specified in Annexes A.2. Configurations of PDSCH and PDCCH before measurement are specified in Annex C.2.

**Table 6.3.2.4.1-1: Test Configuration Table**

Initial Conditions					
Test Environment as specified in TS 36.508[7] subclause 4.1	Normal, TL/VL, TL/VH, TH/VL, TH/VH				
Test Frequencies as specified in TS 36.508 [7] subclause 4.3.1	Low range, Mid range, High range				
Test Channel Bandwidths as specified in TS 36.508 [7] subclause 4.3.1	Lowest, 5MHz, Highest				
Test Parameters for Channel Bandwidths					
Ch BW	Downlink Configuration		Uplink Configuration		
	N/A for min output power test		Mod'n	RB allocation	
			FDD	TDD	
1.4MHz			QPSK	6	6
3MHz			QPSK	15	15
5MHz			QPSK	25	25
10MHz			QPSK	50	50
15MHz			QPSK	75	75
20MHz			QPSK	100	100
Note 1: Test Channel Bandwidths are checked separately for each E-UTRA band, the applicable channel bandwidths are specified in Table 5.4.2.1-1.					

1. Connect the SS to the UE antenna connectors as shown in TS 36.508 [7] Annex A, in Figure A.3.
2. The parameter settings for the cell are set up according to TS 36.508 [7] subclause 4.4.3.
3. Downlink signals are initially set up according to Annex C.0, C.1, and C.3.0, and uplink signals according to Annex H.1 and H.3.0.
4. The UL Reference Measurement channel is set according to Table 6.3.2.4.1-1.
5. Propagation conditions are set according to Annex B.0.
6. Ensure the UE is in State 3A-RF according to TS 36.508 [7] clause 5.2A.2. Message contents are defined in clause 6.3.2.4.3.

#### 6.3.2.4.2 Test procedure

SS sends uplink scheduling information for each UL HARQ process via PDCCH DCI format 0 for C\_RNTI to schedule the UL RMC according to Table 6.3.2.1.4.1-1. Since the UE has no payload and no loopback data to send the UE sends uplink MAC padding bits on the UL RMC

2. Send continuous uplink power control "down" commands in the uplink scheduling information to the UE to ensure that the UE transmits at its minimum output power.
3. Measure the mean power of the UE in the associated measurement bandwidth specified in Table 6.3.2.5-1 for the specific channel bandwidth under test. The period of measurement shall be the continuous duration of one sub-frame (1ms). For TDD slots with transient periods are not under test.

#### 6.3.2.4.3 Message contents

Message contents are according to TS 36.508 [7] subclause 4.6.

#### 6.3.2.5 Test requirement

The minimum output power measured shall not exceed the values specified in Table 6.3.2.5-1.

**Table 6.3.2.5-1: Minimum output power**

	Channel bandwidth / minimum output power / measurement bandwidth					
	1.4 MHz	3.0 MHz	5 MHz	10 MHz	15 MHz	20 MHz

Minimum output power	For carrier frequency $f \leq 3.0\text{GHz}$ : $\leq -39\text{ dBm}$ For carrier frequency $3.0\text{GHz} < f \leq 4.2\text{GHz}$ : $\leq -38.7\text{ dBm}$					
Measurement bandwidth (Note 1)	1.08 MHz	2.7 MHz	4.5 MHz	9.0 MHz	13.5 MHz	18 MHz
Note 1:	Different implementations such as FFT or spectrum analyzer approach are allowed. For spectrum analyzer approach the measurement bandwidth is defined as an equivalent noise bandwidth.					

## 6.3.2A Minimum Output Power for CA

### 6.3.2A.1 Minimum Output Power for CA (intra-band contiguous DL CA and UL CA)

#### 6.3.2A.1.1 Test purpose

To verify the UE's ability to transmit with a broadband output power below the value specified in the test requirement when the power on each component carrier is set to a minimum value.

#### 6.3.2A.1.2 Test applicability

This test case applies to all types of E-UTRA UE release 10 and forward that support intra-band contiguous DL CA and UL CA.

#### 6.3.2A.1.3 Minimum conformance requirements

For intra-band contiguous carrier aggregation, the minimum controlled output power of the UE is defined as the transmit power of the UE per component carrier, i.e., the power in the channel bandwidth of each component carrier for all transmit bandwidth configurations (resource blocks), when the power on both component carriers are set to a minimum value.

For intra-band contiguous carrier aggregation the minimum output power is defined as the mean power in one sub-frame (1ms). The minimum output power shall not exceed the values specified in Table 6.3.2A.1.3-1.

**Table 6.3.2A.1.3-1: Minimum output power for intra-band contiguous CA UE**

	CC Channel bandwidth / Minimum output power / Measurement bandwidth					
	1.4 MHz	3.0 MHz	5 MHz	10 MHz	15 MHz	20 MHz
Minimum output power	-40 dBm					
Measurement bandwidth			4.5 MHz	9.0 MHz	13.5 MHz	18 MHz

The normative reference for this requirement is TS 36.101 [2] clause 6.3.2A.

#### 6.3.2A.1.4 Test description

##### 6.3.2A.1.4.1 Initial conditions

Initial conditions are a set of test configurations the UE needs to be tested in and the steps for the SS to take with the UE to reach the correct measurement state.

The initial test configurations consist of environmental conditions, test frequencies, and CC combinations based on E-UTRA CA configurations specified in table 5.4.2A.1-1. All of these configurations shall be tested with applicable test parameters for each CA Configuration, and are shown in table 6.3.2A.1.4.1-1. The details of the uplink reference measurement channels (RMCs) are specified in Annex A.2. Configurations of PDSCH and PDCCH before measurement are specified in Annex C.2.



**Table 6.3.2A.1.4.1-1: Test Configuration Table**

Initial Conditions									
Test Environment as specified in TS 36.508[7] subclause 4.1					NC, TL/VL, TL/VH, TH/VL, TH/VH				
Test Frequencies as specified in TS 36.508 [7] subclause 4.3.1 for different CA bandwidth classes, and PCC and SCCs are mapped onto physical frequencies according to Table 6.1-2.					C: Low and High range				
Test CC Combination setting ( $N_{RB\_agg}$ ) as specified in subclause 5.4.2A.1 for the CA Configuration across bandwidth combination sets supported by the UE.					Lowest $N_{RB\_agg}$ Highest $N_{RB\_agg}$ (Note 2)				
Test Parameters for CA Configurations									
CA Configuration / $N_{RB\_agg}$		DL Allocation		CC MOD	UL Allocation				
PCC $N_{RB}$	SCCs $N_{RB}$	PCC & SCC RB allocation			$N_{RB\_alloc}$	PCC & SCC RB allocations (LCRB @ $RB_{start}$ )			
75	75			QPSK	150	P_75@0	S_75@0	-	-
100	25			QPSK	125	P_100@0	S_25@0	-	-
100	50			QPSK	150	P_100@0	S_50@0	-	-
100	75			QPSK	175	P_100@0	S_75@0		
100	100			QPSK	200	P_100@0	S_100@0	-	-
Note 1: CA Configuration Test CC Combination settings are checked separately for each CA Configuration, which applicable aggregated channel bandwidths are specified in Table 5.4.2A.1-1									
Note 2: If in the CA Configuration UE supports multiple CC Combinations with the same $N_{RB\_agg}$ , only the first of those is tested, according to the order on the Test Configuration Table list.									

1. Connect the SS to the UE antenna connectors as shown in TS 36.508[7] Annex A Figure group A.32 as appropriate.
2. The parameter settings for the cell are set up according to TS 36.508 [7] subclause 4.4.3.
3. Downlink signals for PCC are initially set up according to Annex C.0, C.1, and C.3.0, and uplink signals according to Annex H.1 and H.3.0.
4. The UL Reference Measurement channel is set according to Table 6.3.2A.1.4.1-1.
5. Propagation conditions are set according to Annex B.0.
6. Ensure the UE is in State 3A-RF according to TS 36.508 [7] clause 5.2A.2. Message contents are defined in clause 6.3.2A.1.4.3.

#### 6.3.2A.1.4.2 Test procedure

1. Configure SCC according to Annex C0, C.1 and Annex C.3.2 for all downlink physical channels.
2. The SS shall configure SCC as per TS 36.508 [7] clause 5.2A.4. Message contents are defined in clause 6.3.2A.1.4.3.
3. SS activates SCC by sending the activation MAC-CE (Refer TS 36.321 [13], clauses 5.13, 6.1.3.8). Wait for at least 2 seconds (Refer TS 36.133, clauses 8.3.3.2).
4. SS sends uplink scheduling information for each UL HARQ process via PDCCH DCI format 0 for C\_RNTI to schedule the UL RMC according to Table 6.3.2A.1.4.1-1 on both PCC and SCC. Since the UE has no payload and no loopback data to send the UE sends uplink MAC padding bits on the UL RMC.
5. Send continuously uplink power control "down" commands in every uplink scheduling information to the UE to ensure that the UE transmits at its minimum output power.

6. Measure the mean transmitted power of each component carrier in the CA configuration of the radio access mode. The period of measurement shall be at least the continuous duration of one sub-frame (1ms). For TDD slots with transient periods are not under test.

#### 6.3.2A.1.4.3 Message contents

Message contents are according to TS 36.508 [7] subclause 4.6. In test procedure step 2, for SCC configuration there are no additional message contents.

#### 6.3.2A.1.5 Test requirements

For each component carrier, the minimum output power measured shall not exceed the values specified in Table 6.3.2A.1.5-1.

**Table 6.3.2A.1.5-1: Minimum output power for intra-band contiguous CA UE**

	CC Channel bandwidth / Minimum output power / Measurement bandwidth					
	1.4 MHz	3.0 MHz	5 MHz	10 MHz	15 MHz	20 MHz
Minimum output power	For carrier frequency $f \leq 3.0\text{GHz}$ : $\leq -39\text{ dBm}$ For carrier frequency $3.0\text{GHz} < f \leq 4.2\text{GHz}$ : $\leq -38.7\text{ dBm}$					
Measurement bandwidth			4.5 MHz	9.0 MHz	13.5 MHz	18 MHz
Note 1:	Different implementations such as FFT or spectrum analyzer approach are allowed. For spectrum analyzer approach the measurement bandwidth is defined as an equivalent noise bandwidth.					

### 6.3.2B Minimum Output Power for UL-MIMO

#### 6.3.2B.1 Test purpose

To verify the UE's ability to transmit with a UL-MIMO broadband output power below the value specified in the test requirement when the power is set to a minimum value.

#### 6.3.2B.2 Test applicability

This test applies to all types of E-UTRA UE release 10 and forward that support UL-MIMO

#### 6.3.2B.3 Minimum conformance requirements

For UE with two transmit antenna connectors in closed-loop spatial multiplexing scheme, the minimum output power is defined as the sum of the mean power at each UE antenna connector in one sub-frame (1ms). The minimum output power shall not exceed the values specified in Table 6.3.2B.3-1.

**Table 6.3.2B.3-1: Minimum output power**

	Channel bandwidth / Minimum output power / Measurement bandwidth					
	1.4 MHz	3.0 MHz	5 MHz	10 MHz	15 MHz	20 MHz
Minimum output power	-40 dBm					
Measurement bandwidth	1.08 MHz	2.7 MHz	4.5 MHz	9.0 MHz	13.5 MHz	18 MHz

The normative reference for this requirement is TS 36.101 [2] clause 6.3.2B.1.

## 6.3.2B.4 Test description

### 6.3.2B.4.1 Initial conditions

Initial conditions are a set of test configurations the UE needs to be tested in and the steps for the SS to take with the UE to reach the correct measurement state.

The initial test configurations consist of environmental conditions, test frequencies, and channel bandwidths based on E-UTRA operating bands specified in table 5.4.2.1-1. All of these configurations shall be tested with applicable test parameters for each channel bandwidth, and are shown in table 6.3.2B.4.1-1. The details of the uplink reference measurement channels (RMCs) are specified in Annexes A.2. Configurations of PDSCH and PDCCH before measurement are specified in Annex C.2.

**Table 6.3.2B.4.1-1: Test Configuration Table**

Initial Conditions				
Test Environment as specified in TS 36.508[7] subclause 4.1	Normal, TL/VL, TL/VH, TH/VL, TH/VH			
Test Frequencies as specified in TS 36.508 [7] subclause 4.3.1	Low range, Mid range, High range			
Test Channel Bandwidths as specified in TS 36.508 [7] subclause 4.3.1	Lowest, 5MHz, Highest			
Test Parameters for Channel Bandwidths				
Ch BW	Downlink Configuration	Uplink Configuration		
	N/A for min output power test	Mod'n	RB allocation	
		FDD	TDD	
1.4MHz		QPSK	6	6
3MHz		QPSK	15	15
5MHz		QPSK	25	25
10MHz		QPSK	50	50
15MHz		QPSK	75	75
20MHz		QPSK	100	100
Note 1: Test Channel Bandwidths are checked separately for each E-UTRA band, the applicable channel bandwidths are specified in Table 5.4.2.1-1.				

1. Connect the SS to the UE antenna connectors as shown in TS 36.508 [7] Annex A, in Figure A.28.
2. The parameter settings for the cell are set up according to TS 36.508 [7] subclause 4.4.3.
3. Downlink signals are initially set up according to Annex C.0, C.1, and C.3.0, and uplink signals according to Annex H.1 and H.3.0.
4. The UL Reference Measurement channel is set according to Table 6.3.2B.4.1-1.
5. Propagation conditions are set according to Annex B.0.
6. Ensure the UE is in State 3A-RF according to TS 36.508 [7] clause 5.2A.2. Message contents are defined in clause 6.3.2B.4.3.

### 6.3.2B.4.2 Test procedure

1. SS sends uplink scheduling information for each UL HARQ process via PDCCH DCI format 4 for C\_RNTI to schedule the UL RMC according to Table 6.3.2B.4.1-1. Since the UE has no payload and no loopback data to send the UE sends uplink MAC padding bits on the UL RMC.
2. Send continuous uplink power control "down" commands in the uplink scheduling information to the UE to ensure that the UE transmits at its minimum output power.
3. Measure the sum of mean power of the UE at each UE antenna connector in the associated measurement bandwidth specified in Table 6.3.2B.5-1 for the specific channel bandwidth under test. The period of measurement shall be the continuous duration of one sub-frame (1ms). For TDD slots with transient periods are not under test.

### 6.3.2B.4.3 Message contents

Message contents are according to TS 36.508 [7] clause 4.6.6.3.2B.5 Test requirement

The minimum sum of mean output power of the UE at each antenna connector measured shall not exceed the values specified in Table 6.3.2B.5-1.

**Table 6.3.2B.5-1: Minimum output power**

	Channel bandwidth / minimum output power / measurement bandwidth					
	1.4 MHz	3.0 MHz	5 MHz	10 MHz	15 MHz	20 MHz
Minimum output power	For carrier frequency $f \leq 3.0\text{GHz}$ : $\leq -40 + \text{TT dBm}$ For carrier frequency $3.0\text{GHz} < f \leq 4.2\text{GHz}$ : $\leq -40 + \text{TT dBm}$					
Measurement bandwidth (Note 1)	1.08 MHz	2.7 MHz	4.5 MHz	9.0 MHz	13.5 MHz	18 MHz
Note 1:	Different implementations such as FFT or spectrum analyzer approach are allowed. For spectrum analyzer approach the measurement bandwidth is defined as an equivalent noise bandwidth.					

## 6.3.3 Transmit OFF power

### 6.3.3.1 Test purpose

To verify that the UE transmit OFF power is lower than the value specified in the test requirement.

### 6.3.3.2 Test applicability

The requirements of this test apply in test cases 6.3.4.1 General ON/OFF time mask and 6.3.4.2 PRACH and SRS time mask to all types of E-UTRA UE release 8 and forward.

### 6.3.3.3 Minimum conformance requirement

The transmit OFF power is defined as the mean power in a duration of at least one sub-frame (1ms) excluding any transient periods. The requirement for the transmit OFF power shall not exceed the values specified in Table 6.3.3.3-1.

**Table 6.3.3.3-1: Transmit OFF power**

	Channel bandwidth / Transmit OFF power / measurement bandwidth					
	1.4 MHz	3.0 MHz	5 MHz	10 MHz	15 MHz	20 MHz
Transmit OFF power	-50 dBm					
Measurement bandwidth	1.08 MHz	2.7 MHz	4.5 MHz	9.0 MHz	13.5 MHz	18 MHz

The normative reference for this requirement is TS 36.101 [2] clause 6.3.3.

Transmit OFF power is defined as the mean power when the transmitter is OFF. The transmitter is considered to be OFF when the UE is not allowed to transmit or during periods when the UE is not transmitting a sub-frame. During DTX and measurements gaps, the UE is not considered to be OFF.

An excess transmit OFF power potentially increases the Rise Over Thermal (RoT) and therefore reduces the cell coverage area for other UEs

### 6.3.3.4 Test description

This test is covered by clause 6.3.4.1 General ON/OFF time mask and 6.3.4.2 PRACH and SRS time mask.

### 6.3.3.5 Test requirement

The requirement for the transmit OFF power shall not exceed the values specified in Table 6.3.3.5-1.

**Table 6.3.3.5-1: Transmit OFF power**

	Channel bandwidth / Transmit OFF power / measurement bandwidth					
	1.4 MHz	3.0 MHz	5 MHz	10 MHz	15 MHz	20 MHz
Transmit OFF power	For carrier frequency $f \leq 3.0\text{GHz}$ : $\leq -48.5$ dBm For carrier frequency $3.0\text{GHz} < f \leq 4.2\text{GHz}$ : $\leq -48.2$ dBm					
Measurement bandwidth	1.08 MHz	2.7 MHz	4.5 MHz	9.0 MHz	13.5 MHz	18 MHz

## 6.3.3A UE Transmit OFF power for CA

### 6.3.3A.0 Minimum conformance requirements

For inter-band carrier aggregation with uplink assigned to two E-UTRA bands, transmit OFF power requirement is defined per carrier and the requirement is specified in subclause 6.3.3.3.

For intra-band contiguous and non-contiguous carrier aggregation the transmit OFF power is defined as the mean power in a duration of at least one sub-frame (1ms) excluding any transient periods. The transmit OFF power shall not exceed the values specified in Table 6.3.3A.0-1.

**Table 6.3.3A.0-1: Transmit OFF power for intra-band contiguous and non-contiguous CA UE**

	CC Channel bandwidth / Transmit OFF power / Measurement bandwidth					
	1.4 MHz	3.0 MHz	5 MHz	10 MHz	15 MHz	20 MHz
Transmit OFF power	-50 dBm					
Measurement bandwidth			4.5 MHz	9.0 MHz	13.5 MHz	18 MHz

For inter-band carrier aggregation with uplink assigned to two E-UTRA bands and intra-band contiguous and non-contiguous carrier aggregation, transmit OFF power is defined as the mean power per component carrier when the transmitter is OFF on all component carriers. The transmitter is considered to be OFF when the UE is not allowed to transmit or during periods when the UE is not transmitting a sub-frame. During measurements gaps, the UE is not considered to be OFF.

The normative reference for this requirement is TS 36.101 [2] clause 6.3.3A.

### 6.3.3A.1 UE Transmit OFF power for CA (intra-band contiguous DL CA and UL CA)

#### 6.3.3A.1.1 Test purpose

For intra-band contiguous carrier aggregation the transmit OFF power is defined as the mean power per component carrier when the transmitter is OFF on both component carriers. The transmitter is considered to be OFF when the UE is not allowed to transmit or during periods when the UE is not transmitting a sub-frame. During measurements gaps, the UE is not considered to be OFF.

To verify that the UE transmit OFF power for CA is lower than the value specified in the test requirement.

#### 6.3.3A.1.2 Test applicability

The requirements of this test case apply in test cases 6.3.4A.1 General ON/OFF time mask for CA and 6.3.4.2 PRACH and SRS time mask to all types of E-UTRA UE release 10 and forward that support intra-band contiguous DL CA and UL CA.

### 6.3.3A.1.3 Minimum conformance requirements

The minimum conformance requirements are defined in clause 6.3.3A.0.

### 6.3.3A.1.4 Test description

This test is covered by clause 6.3.4A.1.1 General ON/OFF time mask for CA and 6.3.4.2 PRACH and SRS time mask.

### 6.3.3A.1.5 Test Requirements

**Table 6.3.3A.1.5-1: Transmit OFF power for intra-band contiguous CA UE**

	Channel bandwidth / Minimum output power / Measurement bandwidth					
	1.4 MHz	3.0 MHz	5 MHz	10 MHz	15 MHz	20 MHz
Transmit OFF power	For carrier frequency $f \leq 3.0\text{GHz}$ : -48.5 dBm For carrier frequency $3.0\text{GHz} < f \leq 4.2\text{GHz}$ : -48.2 dBm					
Measurement bandwidth			4.5 MHz	9.0 MHz	13.5 MHz	18 MHz

### 6.3.3A.2 UE Transmit OFF power for CA (inter-band DL CA and UL CA)

#### 6.3.3A.2.1 Test purpose

For inter-band carrier aggregation with uplink assigned to two non-contiguous carriers within one E-UTRA band the transmit OFF power is defined as the mean power per component carrier when the transmitter is OFF. The transmitter is considered to be OFF when the UE is not allowed to transmit or during periods when the UE is not transmitting a sub-frame. During measurements gaps, the UE is not considered to be OFF.

To verify that the UE transmit OFF power for CA is lower than the value specified in the test requirement.

#### 6.3.3A.2.2 Test applicability

The requirements of this test case apply in test cases 6.3.4A.2 General ON/OFF time mask for CA and 6.3.4.2 PRACH and SRS time mask to all types of E-UTRA UE release 11 and forward that support inter-band DL CA and UL CA.

#### 6.3.3A.2.3 Minimum conformance requirements

The minimum conformance requirements are defined in clause 6.3.3A.0.

#### 6.3.3A.2.4 Test description

This test is covered by clause 6.3.4A.1.2 General ON/OFF time mask for CA (inter-band DL CA and UL CA) and 6.3.4.2 PRACH and SRS time mask.

#### 6.3.3A.2.5 Test Requirements

The requirement for the transmit OFF power per each component carrier shall not exceed the values specified in Table 6.3.3A.2.5-1.

**Table 6.3.3A.2.5-1: Transmit OFF power**

	Channel bandwidth / Transmit OFF power / measurement bandwidth					
	1.4 MHz	3.0 MHz	5 MHz	10 MHz	15 MHz	20 MHz

Transmit OFF power	For carrier frequency $f \leq 3.0\text{GHz}$ : $\leq -48.5$ dBm For carrier frequency $3.0\text{GHz} < f \leq 4.2\text{GHz}$ : $\leq -48.2$ dBm					
Measurement bandwidth	1.08 MHz	2.7 MHz	4.5 MHz	9.0 MHz	13.5 MHz	18 MHz

### 6.3.3A.3 UE Transmit OFF power for CA (intra-band non-contiguous DL CA and UL CA)

Editor's notes: This test is incomplete. The following aspects are either missing or not yet determined:

- Clause reference in test description is TBD.

#### 6.3.3A.3.1 Test purpose

For intra-band non-contiguous carrier aggregation with uplink assigned to two non-contiguous carriers within one E-UTRA band the transmit OFF power is defined as the mean power per component carrier when the transmitter is OFF. The transmitter is considered to be OFF when the UE is not allowed to transmit or during periods when the UE is not transmitting a sub-frame. During measurements gaps, the UE is not considered to be OFF.

To verify that the UE transmit OFF power for CA is lower than the value specified in the test requirement.

#### 6.3.3A.3.2 Test applicability

The requirements of this test case apply in test cases 6.3.4A.1 General ON/OFF time mask for CA and 6.3.4.2 PRACH and SRS time mask to all types of E-UTRA UE release 11 and forward that support intra-band non-contiguous DL CA and UL CA.

#### 6.3.3A.3.3 Minimum conformance requirements

The minimum conformance requirements are defined in clause 6.3.3A.0.

#### 6.3.3A.3.4 Test description

This test is covered by clause TBD and 6.3.4.2 PRACH and SRS time mask.

#### 6.3.3A.3.5 Test Requirements

**Table 6.3.3A.3.5-1: Transmit OFF power for intra-band contiguous and non-contiguous CA UE**

	CC Channel bandwidth / Transmit OFF power / Measurement bandwidth					
	1.4 MHz	3.0 MHz	5 MHz	10 MHz	15 MHz	20 MHz
Transmit OFF power	For carrier frequency $f \leq 3.0\text{GHz}$ : $\leq -48.5$ dBm For carrier frequency $3.0\text{GHz} < f \leq 4.2\text{GHz}$ : $\leq -48.2$ dBm					
Measurement bandwidth			4.5 MHz	9.0 MHz	13.5 MHz	18 MHz

### 6.3.3B UE Transmit OFF power for UL-MIMO

#### 6.3.3B.1 Test purpose

To verify that the UE transmit OFF power for UL-MIMO is lower than the value specified in the test requirement.

Transmission of the wrong power increases interference to other channels, or increases transmission errors in the uplink channel.

### 6.3.3B.2 Test applicability

The requirements of this test apply in test cases 6.3.4B.1 General ON/OFF time mask to all types of E-UTRA UE release 10 and forward that support UL-MIMO

### 6.3.3B.3 Minimum conformance requirement

The transmit OFF power is defined as the mean power at each transmit connector in a duration of at least one sub-frame (1ms) excluding any transient periods. The transmit OFF power at each transmit connector shall not exceed the values specified in Table 6.3.3B.3-1.

**Table 6.3.3B.3-1: Transmit OFF power per antenna port**

	Channel bandwidth / Minimum output power / Measurement bandwidth					
	1.4 MHz	3.0 MHz	5 MHz	10 MHz	15 MHz	20 MHz
Transmit OFF power	-50 dBm					
Measurement bandwidth	1.08 MHz	2.7 MHz	4.5 MHz	9.0 MHz	13.5 MHz	18 MHz

The normative reference for this requirement is TS 36.101 [2] clause 6.3.3B.1.

### 6.3.3B.4 Test description

This test is covered by clause 6.3.4B.1 General ON/OFF time mask.

### 6.3.3B.5 Test requirement

The requirement for the transmit OFF power at each transmit antenna connector shall not exceed the values specified in Table 6.3.3B.5-1.

**Table 6.3.3B.5-1: Transmit OFF power**

	Channel bandwidth / Transmit OFF power / measurement bandwidth					
	1.4 MHz	3.0 MHz	5 MHz	10 MHz	15 MHz	20 MHz
Transmit OFF power	For carrier frequency $f \leq 3.0\text{GHz}$ : $\leq -48.5$ dBm For carrier frequency $3.0\text{GHz} < f \leq 4.2\text{GHz}$ : $\leq -48.2$ dBm					
Measurement bandwidth	1.08 MHz	2.7 MHz	4.5 MHz	9.0 MHz	13.5 MHz	18 MHz

## 6.3.4 ON/OFF time mask

### 6.3.4.1 General ON/OFF time mask

**Editor's note:** The measurement period in the minimum requirement is defined to be 1 subframe (14 symbols). Due to practical reasons the TDD measurement period for off power prior the PUSCH is 10 symbols. It is FFS, if this deviation is acceptable.

#### 6.3.4.1.1 Test purpose

To verify that the general ON/OFF time mask meets the requirements given in 6.3.4.1.5.

The time mask for transmit ON/OFF defines the ramping time allowed for the UE between transmit OFF power and transmit ON power.

Transmission of the wrong power increases interference to other channels, or increases transmission errors in the uplink channel.



### 6.3.4.1.2 Test applicability

This test applies to all types of E-UTRA UE release 8 and forward.

### 6.3.4.1.3 Minimum conformance requirement

The General ON/OFF time mask defines the observation period between Transmit OFF and ON power and between Transmit ON and OFF power. ON/OFF scenarios include; the beginning or end of DTX, measurement gap, contiguous, and non contiguous transmission

The OFF power measurement period is defined in a duration of at least one sub-frame excluding any transient periods. The ON power is defined as the mean power over one sub-frame excluding any transient period.

There are no additional requirements on UE transmit power beyond that which is required in clause 6.2.2 and clause 6.6.2.3.

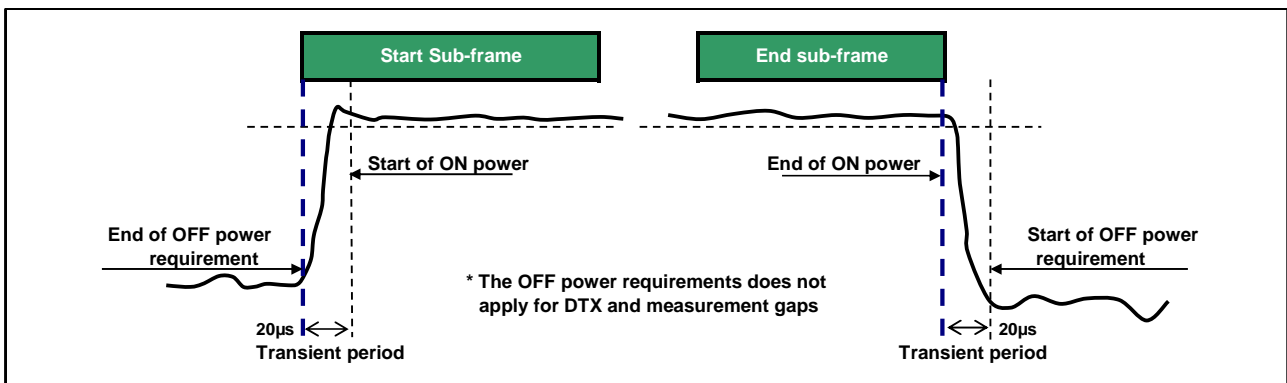

**Figure 6.3.4.1.3-1: General ON/OFF time mask**

The normative reference for this requirement is TS 36.101 [2] clause 6.3.4.1.

### 6.3.4.1.4 Test description

#### 6.3.4.1.4.1 Initial conditions

Initial conditions are a set of test configurations the UE needs to be tested in and the steps for the SS to take with the UE to reach the correct measurement state.

The initial test configurations consist of environmental conditions, test frequencies, and channel bandwidths based on E-UTRA operating bands specified in table 5.4.2.1-1. All of these configurations shall be tested with applicable test parameters for each channel bandwidth, and are shown in table 6.3.4.1.4.1-1. The details of the uplink reference measurement channels (RMCs) are specified in Annexes A.2. Configurations of PDSCH and PDCCH before measurement are specified in Annex C.2

**Table 6.3.4.1.4.1-1: Test Configuration Table**

Initial Conditions				
Test Environment as specified in TS 36.508[7] subclause 4.1		Normal, TL/VL, TL/VH, TH/VL, TH/VH		
Test Frequencies as specified in <b>TS 36.508 [7] subclause 4.3.1</b>		Low range, Mid range, High range		
Test Channel Bandwidths as specified in <b>TS 36.508 [7] subclause 4.3.1</b>		Lowest, 5MHz, Highest		
Test Parameters for Channel Bandwidths				
Ch BW	Downlink Configuration	Uplink Configuration		
	N/A for General On/Off Time Mask test case	Mod'n	RB allocation	
		FDD	TDD	
1.4MHz		QPSK	6	6
3MHz		QPSK	15	15
5MHz		QPSK	25	25
10MHz		QPSK	50	50
15MHz		QPSK	75	75
20MHz		QPSK	100	100
Note 1: Test Channel Bandwidths are checked separately for each E-UTRA band, the applicable channel bandwidths are specified in Table 5.4.2.1-1.				

1. Connect the SS to the UE antenna connectors as shown in TS 36.508 [7] Annex A, Figure A.3.
2. The parameter settings for the cell are set up according to TS 36.508 [7] subclause 4.4.3.
3. Downlink signals are initially set up according to Annex C.0, C.1 and C.3.0, and uplink signals according to Annex H.1 and H.3.0.
4. The UL and DL Reference Measurement channels are set according to Table 6.3.4.1.4.1-1.
5. Propagation conditions are set according to Annex B.0.
6. Ensure the UE is in State 3A-RF according to TS 36.508 [7] clause 5.2A.2. Message contents are defined in clause 6.3.4.1.4.3. Note that PDCCH DCI format 0 sent after resetting uplink power with RRC Connection Reconfiguration, should have TPC command 0dB.

#### 6.3.4.1.4.2 Test procedure

1. SS sends uplink scheduling information via PDCCH DCI format 0 with TPC command 0dB for C\_RNTI to schedule the UL RMC according to Table 6.3.4.1.4.1-1. Since the UE has no payload and no loopback data to send the UE sends uplink MAC padding bits on the UL RMC. The UL assignment is such that the UE transmits on UL sub-frame 2 of every radio frame.
2. For FDD: Measure the UE transmission OFF power during the sub-frame prior to the PUSCH subframe. For TDD: Measure the UE transmission OFF power during the 10 SCFDMA symbols prior to the PUSCH subframe.
3. Measure the output power of the UE PUSCH transmission during one sub-frame, excluding a transient period of 20  $\mu$ s at the beginning of the subframe.
4. Measure the UE transmission OFF power during one sub-frame following the PUSCH subframe, excluding a transient period of 20  $\mu$ s at the beginning of the subframe.

#### 6.3.4.1.4.3 Message contents

Message contents are according to TS 36.508 [7] subclause 4.6 with the following exceptions:

**Table 6.3.4.1.4.3-1: UplinkPowerControlCommon: Test point 1**

Derivation Path: TS 36.508 [7] clause 4.6.3, Table 4.6.3-25 UplinkPowerControlCommon-DEFAULT			
Information Element	Value/remark	Comment	Condition
UplinkPowerControlCommon-DEFAULT ::= SEQUENCE { p0-NominalPUSCH	-105	Test point 1 to verify a UE relative low initial power transmission	

**Table 6.3.4.1.4.3-2: PhysicalConfigDedicated**

Derivation Path: TS 36.508 [7] clause 5.5.1.2, Table 5.5.1.2.1 PhysicalConfigDedicated-DEFAULT			
Information Element	Value/remark	Comment	Condition
PhysicalConfigDedicated-DEFAULT ::= SEQUENCE {			
UplinkPowerControlDedicated	UplinkPowerControlDedicated-DEFAULT	See subclause 4.6.3	SRB1
	UplinkPowerControlDedicated-DEFAULT	See subclause 4.6.3	RBC

**Table 6.3.4.1.4.3-3: UplinkPowerControlDedicated**

Derivation Path: TS 36.508 [7] clause 4.6.3, Table 4.6.3-26 UplinkPowerControlDedicated-DEFAULT			
Information Element	Value/remark	Comment	Condition
UplinkPowerControlDedicated-DEFAULT ::= SEQUENCE {			
p0-UE-PUSCH	1		SRB1
	0		RBC
}			

**Table 6.3.4.1.4.3-4: TDD-Config-DEFAULT: On/OFF time mask measurement**

Derivation Path: 36.508 clause 5.3.1 Table 5.3.1-1 ( <i>SystemInformationBlockType1</i> )			
Information Element	Value/remark	Comment	Condition
TDD-Config-DEFAULT ::= SEQUENCE {			
subframeAssignment	sa1		
specialSubframePatterns	ssp5	To enable two symbol UpPTS, and to have 9 symbols GP.	
}			

6.3.4.1.5 Test requirement

The requirement for the power measured in steps (2), (3) and (4) of the test procedure shall not exceed the values specified in Table 6.3.4.1.5-1.

**Table 6.3.4.1.5-1: General ON/OFF time mask**

	Channel bandwidth / minimum output power / measurement bandwidth					
	1.4 MHz	3.0 MHz	5 MHz	10 MHz	15 MHz	20 MHz

Transmit OFF power	For carrier frequency $f \leq 3.0\text{GHz}$ : $\leq -48.5$ dBm For carrier frequency $3.0\text{GHz} < f \leq 4.2\text{GHz}$ : $\leq -48.2$ dBm					
Transmission OFF Measurement bandwidth	1.08 MHz	2.7 MHz	4.5 MHz	9.0 MHz	13.5 MHz	18 MHz
Expected Transmission ON Measured power	-14.8 dBm	-10.8 dBm	-8.6 dBm	-5.6 dBm	-3.9 dBm	-2.6 dBm
ON power tolerance $f \leq 3.0\text{GHz}$ $3.0\text{GHz} < f \leq 4.2\text{GHz}$	$\pm 7.5\text{dB}$ $\pm 7.8\text{dB}$	$\pm 7.5\text{dB}$ $\pm 7.8\text{dB}$	$\pm 7.5\text{dB}$ $\pm 7.8\text{dB}$	$\pm 7.5\text{dB}$ $\pm 7.8\text{dB}$	$\pm 7.5\text{dB}$ $\pm 7.8\text{dB}$	$\pm 7.5\text{dB}$ $\pm 7.8\text{dB}$

## 6.3.4.2 PRACH and SRS time mask

### 6.3.4.2.1 PRACH time mask

#### 6.3.4.2.1.1 Test purpose

To verify that the PRACH time mask meets the requirements given in 6.3.4.2.1.5.

The time mask for PRACH time mask defines the ramping time allowed for the UE between transmit OFF power and transmit ON power when transmitting the PRACH.

Transmission of the wrong power increases interference to other channels, or increases transmission errors in the uplink channel.

#### 6.3.4.2.1.2 Test applicability

This test applies to all types of E-UTRA UE release 8 and forward.

#### 6.3.4.2.1.3 Minimum conformance requirement

For the PRACH Power / Time mask defines the observation period for PRACH transmissions. The PRACH ON power is specified as the mean power over the PRACH measurement period excluding any transient periods. The measurement period for different PRACH preamble format is specified in Table 6.3.4.2.1.3-1.

There are no additional requirements on UE transmit power beyond that which is required in clause 6.2.2 and clause 6.6.2.3

**Table 6.3.4.2.1.3-1: PRACH ON power measurement period**

PRACH preamble format	Measurement period (ms)
0	0.9031
1	1.4844
2	1.8031
3	2.2844
4	0.1479

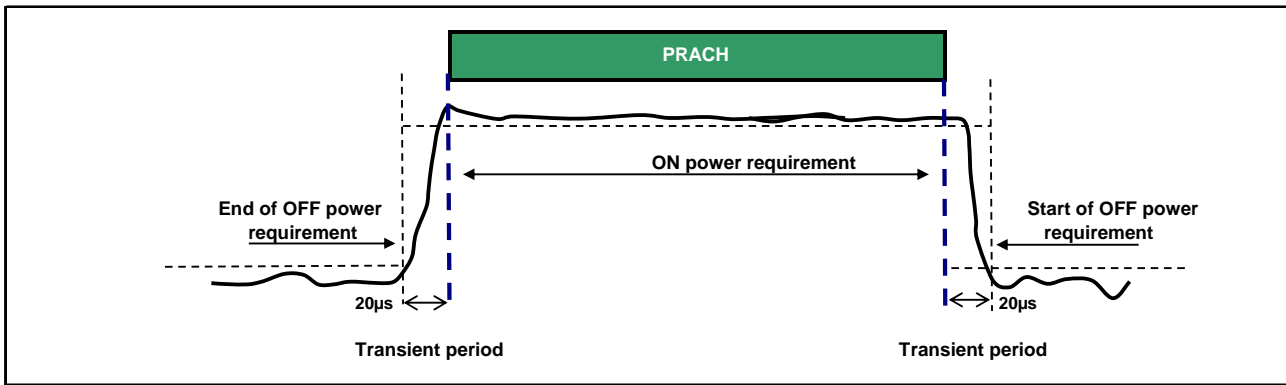

Figure 6.3.4.2.1.3-1: PRACH ON/OFF time mask

The normative reference for this requirement is TS 36.101 [2] clause 6.3.4.2.1.

6.3.4.2.1.4 Test description

6.3.4.2.1.4.1 Initial conditions

Initial conditions are a set of test configurations the UE needs to be tested in and the steps for the SS to take with the UE to reach the correct measurement state.

The initial test configurations consist of environmental conditions, test frequencies, and channel bandwidths based on E-UTRA operating bands specified in table 5.4.2.1-1. All of these configurations shall be tested with applicable test parameters for each channel bandwidth, and are shown in table 6.3.4.2.1.4.1-1. The details of the uplink and downlink reference measurement channels (RMCs) are specified in Annexes A.2 and A.3.

Table 6.3.4.2.1.4.1-1: Test Configuration Table

Initial Conditions		
Test Environment (as specified in TS 36.508 [7] subclause 4.1)	Normal, TL/VL, TL/VH, TH/VL, TH/VH	
Test Frequencies (as specified in TS 36.508 [7] subclause 4.3.1)	Mid range	
Test Channel Bandwidths (as specified in TS 36.508 [7] subclause 4.3.1)	Lowest, 5MHz, Highest	
PRACH preamble format		
	FDD	TDD
PRACH Configuration Index	3	51

1. Connect the SS to the UE antenna connectors as shown in TS 36.508 [7] Annex A, Figure A3.
2. The parameter settings for the cell are set up according to TS 36.508 [7] subclause 4.4.3.
3. Downlink signals are initially set up according to Annex C.0, C.1 and C.3.0, and uplink signals according to Annex H.1 and H.3.0.
4. Propagation conditions are set according to Annex B.0.
5. Ensure the UE is in State 3A-RF according to TS 36.508 [7] clause 5.2A.2. Message contents are defined in clause 6.3.4.2.1.4.3.

6.3.4.2.1.4.2 Test procedure

1. The SS shall signal a Random Access Preamble ID via a PDCCH order to the UE and initiate a Non-contention based Random Access procedure.
2. The UE shall send the signalled preamble to the SS.

3. For FDD UE, the SS measure the UE transmission OFF power during the sub-frame preceding the PRACH preamble excluding a transient period of 20 μs according to Figure 6.3.4.2.1.3-1. For TDD UE, the SS measure the UE transmission OFF power starting (20us+the duration of 8 OFDM symbols) before the PRACH starts, and ending 20us before PRACH starts. Note, the nominal PRACH timing for TDD is not aligned with the sub frame and symbol raster.
4. Measure the output power of the transmitted PRACH preamble according to Figure 6.3.4.2.1.3-1.
5. Measure the UE transmission OFF power, starting 20 μs after the PRACH preamble ends for a measurement period of 980 μs..

6.3.4.2.1.4.3 Message contents

Message contents are according to TS 36.508 [7] subclause 4.6 with the following exceptions:

**Table 6.3.4.2.1.4.3-1: RACH-ConfigCommon-DEFAULT: PRACH measurement**

Derivation Path: TS 36.508 [7] clause 4.6.3, Table 4.6.3-12 RACH-ConfigCommon-DEFAULT			
Information Element	Value/remark	Comment	Condition
RACH-ConfigCommon-DEFAULT ::= SEQUENCE {			
powerRampingParameters SEQUENCE {			
powerRampingStep	dB0		
preambleInitialReceivedTargetPower	dBm-104		PRACH Format 0
	dBm-112		PRACH Format 4
}			
}			

**Table 6.3.4.2.1.4.3-2: PRACH-Config-DEFAULT: PRACH measurement for TDD**

Derivation Path: TS 36.508 [7] clause 5.3.1, Table 5.3.1-3: PRACH-Config-DEFAULT			
Information Element	Value/remark	Comment	Condition
PRACH-Config-DEFAULT ::= SEQUENCE {			
prach-ConfigIndex	51		TDD
}			

**Table 6.3.4.2.1.4.3-3: TDD-Config-DEFAULT: PRACH measurement for TDD**

Derivation Path: TS 36.508 [7] clause 5.3.1, Table 5.3.1-1: TDD-Config-DEFAULT			
Information Element	Value/remark	Comment	Condition
TDD-Config-DEFAULT ::= SEQUENCE {			
subframeAssignment	sa1		
specialSubframePatterns	ssp5	To enable two symbol UpPTS, and to have 9 symbols GP.	
}			

6.3.4.2.1.5 Test requirement

The requirement for the power measured in steps (3), (4) and (5) of the test procedure shall not exceed the values specified in Table 6.3.4.2.1.5-1.

**Table 6.3.4.2.1.5-1: PRACH time mask**

	Channel bandwidth / Output Power [dBm] / measurement bandwidth					
	1.4 MHz	3.0 MHz	5 MHz	10 MHz	15 MHz	20 MHz

Transmit OFF power	For carrier frequency $f \leq 3.0\text{GHz}$ : $\leq -48.5\text{ dBm}$ For carrier frequency $3.0\text{GHz} < f \leq 4.2\text{GHz}$ : $\leq -48.2\text{ dBm}$					
Transmission OFF Measurement bandwidth	1.08 MHz	2.7 MHz	4.5 MHz	9.0 MHz	13.5 MHz	18 MHz
Expected PRACH Transmission ON Measured power	-1 dBm	-1 dBm	-1 dBm	-1 dBm	-1 dBm	-1 dBm
ON power tolerance $f \leq 3.0\text{GHz}$ $3.0\text{GHz} < f \leq 4.2\text{GHz}$	$\pm 7.5\text{dB}$ $\pm 7.8\text{dB}$	$\pm 7.5\text{dB}$ $\pm 7.8\text{dB}$	$\pm 7.5\text{dB}$ $\pm 7.8\text{dB}$	$\pm 7.5\text{dB}$ $\pm 7.8\text{dB}$	$\pm 7.5\text{dB}$ $\pm 7.8\text{dB}$	$\pm 7.5\text{dB}$ $\pm 7.8\text{dB}$

6.3.4.2.2 SRS time mask

6.3.4.2.2.1 Test purpose

To verify that the SRS time mask meets the requirements given in 6.3.4.2.2.5.

The time mask for SRS time mask defines the ramping time allowed for the UE between transmit OFF power and transmit ON power when transmitting the SRS.

Transmission of the wrong power increases interference to other channels, or increases transmission errors in the uplink channel.

6.3.4.2.2.2 Test applicability

This test applies to all types of E-UTRA UE release 8 and forward.

6.3.4.2.2.3 Minimum conformance requirement

In the case a single SRS transmission, the ON power is defined as the mean power for each symbol duration excluding any transient period. Figure 6.3.4.2.2.3-1.

In the case a dual SRS transmission, the ON power is defined as the mean power for each symbol duration excluding any transient period. Figure 6.3.4.2.2.3-2.

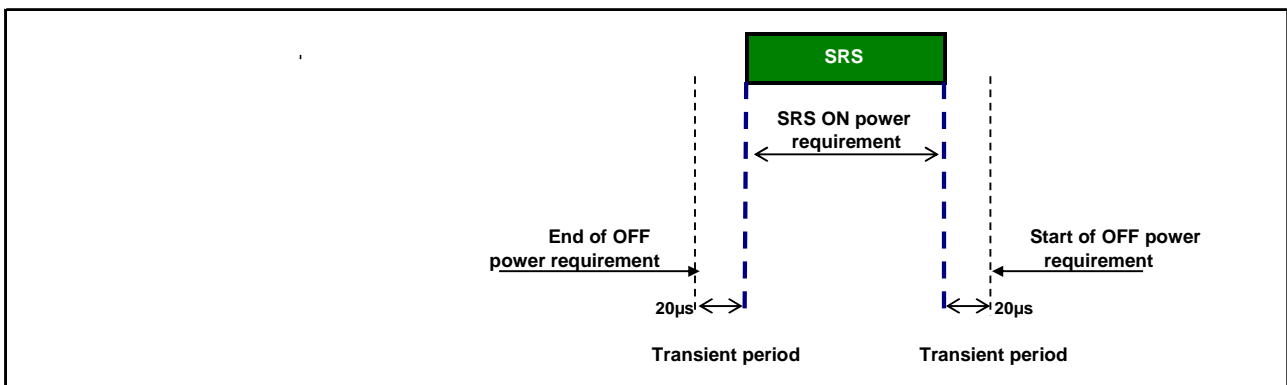
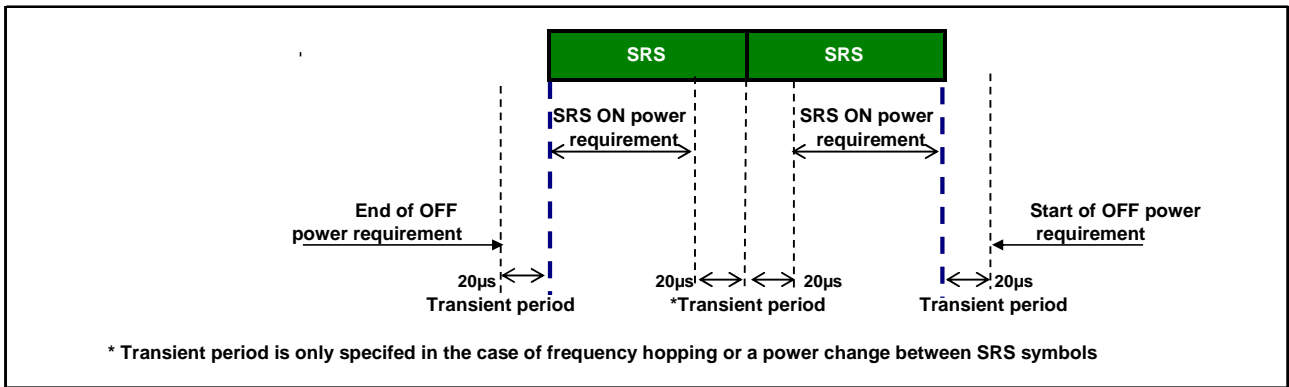

Figure 6.3.4.2.2.3-1: Single SRS time mask



**Figure 6.3.4.2.2.3-2: Dual SRS time mask for the case of UpPTS transmissions**

6.3.4.2.2.4 Test description

6.3.4.2.2.4.1 Initial conditions

Initial conditions are a set of test configurations the UE needs to be tested in and the steps for the SS to take with the UE to reach the correct measurement state.

The initial test configurations consist of environmental conditions, test frequencies, and channel bandwidths based on E-UTRA operating bands specified in table 5.4.2.1-1. All of these configurations shall be tested with applicable test parameters for each channel bandwidth, and are shown in table 6.3.4.2.2.4.1-1. The details of the uplink and downlink reference measurement channels (RMCs) are specified in Annexes A.2 and A.3.

**Table 6.3.4.2.2.4.1-1: Test Configuration Table**

Initial Conditions		
Test Environment (as specified in TS 36.508 [7] subclause 4.1)	Normal, TL/VL, TL/VH, TH/VL, TH/VH	
Test Frequencies (as specified in TS 36.508 [7] subclause 4.3.1)	Mid range	
Test Channel Bandwidths (as specified in TS 36.508 [7] subclause 4.3.1)	Lowest, 5MHz, Highest	
SRS configuration		
	FDD	TDD
srs-BandwidthConfig	bw7	bw7 (for BW 1.4 MHz) bw5 (for BW 3 MHz) bw2 (for BW 5 MHz) bw0 (for BW 10, 15, 20 MHz)
srs-SubframeConfig	sc3	sc0
ackNackSRS-SimultaneousTransmission	FALSE	FALSE
srsMaxUpPts	N/A	N/A
srs-Bandwidth	bw3	bw3
srs-HoppingBandwidth	hbw3	hbw0
freqDomainPosition	0	0
Duration	TRUE	TRUE
srs-ConfigIndex	7	0
transmissionComb	0	0
cyclicShift	cs0	cs0

1. Connect the SS to the UE antenna connectors as shown in TS 36.508 [7] Annex A, Figure A.3.
2. The parameter settings for the cell are set up according to TS 36.508 [7] subclause 4.4.3.
3. Downlink signals are initially set up according to Annex C.0, C.1 and C.3.0, and uplink signals according to Annex H.1 and H.3.0.



4. Propagation conditions are set according to Annex B.0.
5. Ensure the UE is in State 3A-RF according to TS 36.508 [7] clause 5.2A.2. Message contents are defined in clause 6.3.4.2.2.4.3. Note that PDCCH DCI format 0 sent after resetting uplink power with RRC Connection Reconfiguration, should have TPC command 0dB.

#### 6.3.4.2.2.4.2 Test procedure

1. For FDD UE, the SS measure the UE transmission OFF power during the 13 symbols preceding the SRS symbol excluding a transient period of 20  $\mu$ s according to Figure 6.3.4.2.2.3-1. For TDD UE, the SS measure the UE transmission OFF power during the 8 symbols preceding the two SRS symbols excluding a transient period of 20 $\mu$ s according to Figure 6.3.4.2.2.3-2.
2. Measure the output power of the transmitted SRS according to Figure 6.3.4.2.2.3-1 for FDD UE and according to Figure 6.3.4.2.2.3-2 for TDD UE, The transient periods are excluded from measurement accordingly.
3. Measure the UE transmission OFF power during the sub-frame following the SRS under test, excluding a transient period of 20  $\mu$ s according to Figure 6.3.4.2.2.3-1 for FDD UE and according to Figure 6.3.4.2.2.3-2 for TDD UE.

#### 6.3.4.2.2.4.3 Message contents

Message contents are according to TS 36.508 [7] subclause 4.6 with the following exceptions:

**Table 6.3.4.2.2.4.3-1: RadioResourceConfigCommonSIB-DEFAULT: SRS measurement**

Derivation Path: 36.508 clause 5.3.1 Table 5.3.1-2 RadioResourceConfigCommonSIB-DEFAULT			
Information Element	Value/remark	Comment	Condition
RadioResourceConfigCommon-DEFAULT ::= SEQUENCE {			
rach-ConfigCommon	RACH-ConfigCommon-DEFAULT		
bcch-Config	BCCH-Config-DEFAULT		
pcch-Config	PCCH-Config-DEFAULT		
prach-Config	PRACH-ConfigSIB-DEFAULT		
pdsch-ConfigCommon	PDSCH-ConfigCommon-DEFAULT		
pusch-ConfigCommon	PUSCH-ConfigCommon-DEFAULT		
pucch-ConfigCommon	PUCCH-ConfigCommon-DEFAULT		
soundingRSUL-ConfigCommon	<i>SoundingRS-UL-ConfigCommon-DEFAULT</i>		
uplinkPowerControlCommon	UplinkPowerControlCommon-DEFAULT		
ul-CyclicPrefixLength	len1		
}			

**Table 6.3.4.2.2.4.3-2: SoundingRS-UL-ConfigCommon-DEFAULT: SRS time mask measurement**

Derivation Path: TS 36.508 [7] clause 4.6.3, Table 4.6.3-21 SoundingRS-UL-ConfigCommon-DEFAULT			
Information Element	Value/remark	Comment	Condition
SoundingRS-UL-ConfigCommon-DEFAULT ::= SEQUENCE {			
setup SEQUENCE {			
srs-BandwidthConfig	bw7		FDD
	bw7		TDD (BW 1.4 MHz)
	bw5		TDD (BW 3 MHz)
	bw2		TDD (BW 5 MHz)
	bw0		TDD (BW 10, 15, 20 MHz)
srs-SubframeConfig	sc3	Periodicity of 5ms, with offset of 0.	FDD
	sc0	Periodicity of 5ms, with offset of 1.	TDD
ackNackSRS-SimultaneousTransmission	FALSE		
srsMaxUpPts	Not present		
}			
}			

**Table 6.3.4.2.2.4.3-3: PhysicalConfigDedicated-DEFAULT: SRS time mask measurement**

Derivation Path: 36.508 clause 5.5.1 Table 5.5.1.2-1: PhysicalConfigDedicated-DEFAULT			
Information Element	Value/remark	Comment	Condition
PhysicalConfigDedicated-DEFAULT ::= SEQUENCE {			
cqi-ReportConfig	Not present		
soundingRS-UL-ConfigDedicated	<i>SoundingRSUL-ConfigDedicated-DEFAULT</i>		
}			

**Table 6.3.4.2.2.4.3-4: SoundingRSUL-ConfigDedicated-DEFAULT: SRS time mask measurement**

Derivation Path: TS 36.508 [7] clause 4.6.3, Table 4.6.3-22 SoundingRS-UL-ConfigDedicated-DEFAULT			
Information Element	Value/remark	Comment	Condition
SoundingRS-UL-ConfigDedicated-DEFAULT ::= CHOICE {			
setup SEQUENCE {			
srs-Bandwidth	bw3	bw3 used to ensure that the bandwidth is constantly 4 RBs irrespective of channel bandwidth.	
srs-HoppingBandwidth	hbw3	This is selected so that hopping is disabled	FDD
	hbw0	This is selected so that hopping is enabled	TDD
freqDomainPosition	0		
Duration	TRUE	Indefinite duration	
srs-ConfigIndex	7	SRS periodicity of 10ms, Toffset=0.	FDD
	0	SRS periodicity of 2ms, Ksrs=0,1, this is two symbols UpPTS in first half subframe.	TDD
transmissionComb	0		
cyclicShift	cs0	No cyclic shift	
}			
}			

**Table 6.3.4.2.2.4.3-5: TDD-Config-DEFAULT: SRS time mask measurement**

Derivation Path: 36.508 331 clause 65.3.21 Table 5.3.1-1 ( <i>SystemInformationBlockType1</i> )			
Information Element	Value/remark	Comment	Condition
TDD-Config-DEFAULT ::= SEQUENCE {			
subframeAssignment	sa1		
specialSubframePatterns	ssp5	To enable two symbol UpPTS, and to have 9 symbols GP.	
}			

**Table 6.3.4.2.2.4.3-6: PhysicalConfigDedicated**

Derivation Path: TS 36.508 [7] clause 5.5.1.2, Table 5.5.1.2.1 PhysicalConfigDedicated-DEFAULT			
Information Element	Value/remark	Comment	Condition
PhysicalConfigDedicated-DEFAULT ::= SEQUENCE {			
uplinkPowerControlDedicated	UplinkPowerControlDedicated-DEFAULT	See subclause 4.6.3	SRB1
	UplinkPowerControlDedicated-DEFAULT	See subclause 4.6.3	RBC

**Table 6.3.4.2.2.4.3-7: UplinkPowerControlDedicated**

Derivation Path: TS 36.508 [7] clause 4.6.3, Table 4.6.3-26 UplinkPowerControlDedicated-DEFAULT			
Information Element	Value/remark	Comment	Condition
UplinkPowerControlDedicated-DEFAULT ::= SEQUENCE {			
p0-UE-PUSCH	1		SRB1
	0		RBC
}			

Condition	Explanation
FDD	FDD cell environment
TDD	TDD cell environment

#### 6.3.4.2.2.5 Test requirement

The requirement for the power measured in steps (1), (2) and (3) of the test procedure shall not exceed the values specified in Table 6.3.4.2.2.5-1.

**Table 6.3.4.2.2.5-1: SRS time mask**

	Channel bandwidth / Output Power [dBm] / measurement bandwidth					
	1.4 MHz	3.0 MHz	5 MHz	10 MHz	15 MHz	20 MHz
Transmit OFF power	For carrier frequency $f \leq 3.0\text{GHz}$ : $\leq -48.5\text{ dBm}$ For carrier frequency $3.0\text{GHz} < f \leq 4.2\text{GHz}$ : $\leq -48.2\text{ dBm}$					
Transmission OFF Measurement bandwidth	1.08 MHz	2.7 MHz	4.5 MHz	9.0 MHz	13.5 MHz	18 MHz
Expected SRS Transmission ON Measured power	-2.6 dBm	-2.6 dBm	-2.6 dBm	-2.6 dBm	-2.6 dBm	-2.6 dBm
ON power tolerance $f \leq 3.0\text{GHz}$ $3.0\text{GHz} < f \leq 4.2\text{GHz}$	$\pm 7.5\text{dB}$ $\pm 7.8\text{dB}$	$\pm 7.5\text{dB}$ $\pm 7.8\text{dB}$	$\pm 7.5\text{dB}$ $\pm 7.8\text{dB}$	$\pm 7.5\text{dB}$ $\pm 7.8\text{dB}$	$\pm 7.5\text{dB}$ $\pm 7.8\text{dB}$	$\pm 7.5\text{dB}$ $\pm 7.8\text{dB}$

### 6.3.4A ON/OFF time mask for CA

#### 6.3.4A.0 Minimum conformance requirements

For inter-band carrier aggregation with uplink assigned to two E-UTRA bands and intra-band contiguous and non-contiguous carrier aggregation, the general output power ON/OFF time mask specified in subclause 6.3.4.1.3 is applicable for each component carrier during the ON power period and the transient periods. The OFF period as specified in subclause 6.3.4.1.3 shall only be applicable for each component carrier when all the component carriers are OFF.

The normative references for this requirement are TS 36.101 [2] clauses 6.3.4A and 6.3.4.

#### 6.3.4A.1 General ON/OFF time mask for CA

##### 6.3.4A.1.1 General ON/OFF time mask for CA (intra-band contiguous DL CA and UL CA)

###### 6.3.4A.1.1.1 Test purpose

To verify that the general ON/OFF time mask for CA meets the requirements given in 6.3.4A.1.1.5.

The time mask for transmit ON/OFF for CA defines the ramping time allowed for the UE between transmit OFF power and transmit ON power for CA.

Transmission of the wrong power increases interference to other channels, or increases transmission errors in the uplink channel.

6.3.4A.1.1.2 Test applicability

This test case applies to all types of E-UTRA UE release 10 and forward that support intra-band contiguous DL CA and UL CA.

6.3.4A.1.1.3 Minimum conformance requirements

The minimum conformance requirements are defined in clause 6.3.4A.0.

6.3.4A.1.1.4 Test description

6.3.4A.1.1.4.1 Initial conditions

Initial conditions are a set of test configurations the UE needs to be tested in and the steps for the SS to take with the UE to reach the correct measurement state.

The initial test configurations consist of environmental conditions, test frequencies, and CC combinations based on E UTRA CA configurations specified in table 5.4.2A.1-1. All of these configurations shall be tested with applicable test parameters for each CA Configuration, and are shown in table 6.3.4A.1.1.4.1-1. The details of the uplink and downlink reference measurement channels (RMCs) are specified in Annex A.2 and A3. Configurations of PDSCH and PDCCH before measurement are specified in Annex C.2.

**Table 6.3.4A.1.1.4.1-1: Test Configuration Table**

Initial Conditions									
Test Environment as specified in TS 36.508 [7] clause 4.1			NC, TL/VL, TL/VH, TH/VL, TH/VH						
Test Frequencies as specified in TS 36.508 [7] clause 4.3.1 for different CA bandwidth classes, and PCC and SCCs are mapped onto physical frequencies according to Table 6.1-2.			C: Low range, High range						
Test CC Combination setting ( $N_{RB\_agg}$ ) as specified in clause 5.4.2A.1 for the CA Configuration across bandwidth combination sets supported by the UE.			Lowest $N_{RB\_agg}$ Highest $N_{RB\_agg}$ (Note 2)						
Test Parameters for CA Configurations									
CA Configuration / $N_{RB\_agg}$		DL Allocation		UL Allocation					
PCC $N_{RB}$	SCCs $N_{RB}$	PCC & SCC RB allocation		CC MOD	$N_{RB\_alloc}$	PCC & SCC RB allocations ( $L_{CRB}$ @ $RB_{start}$ )			
75	75	N/A for this test		QPSK	150	P_75@0	S_75@0	-	-
100	50			QPSK	150	P_100@0	S_50@0	-	-
100	100			QPSK	200	P_100@0	S_100@0	-	-
Note 1: CA Configuration Test CC Combination settings are checked separately for each CA Configuration, which applicable aggregated channel bandwidths are specified in Table 5.4.2A.1-1									
Note 2: If in the CA Configuration UE supports multiple CC Combinations with the same $N_{RB\_agg}$ , only the first of those is tested, according to the order on the Test Configuration Table list.									

1. Connect the SS to the UE antenna connectors as shown in TS 36.508[7] Annex A Figure group A.32 as appropriate.
2. The parameter settings for the cell are set up according to TS 36.508 [7] clause 4.4.3.

3. Downlink signals for PCC are initially set up according to Annex C.0, C.1, and C.3.0, and uplink signals according to Annex H.1 and H.3.0.
4. The UL Reference Measurement channel is set according to Table 6.3.4A.1.1.4.1-1.
5. Propagation conditions are set according to Annex B.0.
6. Ensure the UE is in State 3A-RF according to TS 36.508 [7] clause 5.2A.2. Message contents are defined in clause 6.3.4A.1.1.4.3.

#### 6.3.4A.1.1.4.2 Test procedure

1. Configure SCC according to Annex C.0, C.1 and Annex C.3.0 for all downlink physical channels.
2. The SS shall configure SCC as per TS 36.508 [7] clause 5.2A.4. Message contents are defined in clause 6.5.1A 3.4A.1.1.4.3
3. SS activates SCC by sending the activation MAC-CE (Refer TS 36.321 [13], clauses 5.13, 6.1.3.8). Wait for at least 2 seconds (Refer TS 36.133, clauses 8.3.3.2).
4. SS sends uplink scheduling information via PDCCH DCI format 0 for C\_RNTI to schedule the UL RMC according to Table 6.2.2A.4.1-1 on both PCC and SCC. Since the UE has no payload and no loopback data to send the UE sends uplink MAC padding bits on the UL RMC. The each UL assignment is such that the UE transmits on UL sub-frame 2 of every radio frame.
5. For FDD: Measure the UE transmission OFF power for each component carrier during the sub-frame prior to the PUSCH subframe. For TDD: Measure the UE transmission OFF power during the 10 SCFDMA symbols prior to the PUSCH subframe.
6. Measure the output power of the UE PUSCH transmission for each component carrier during one sub-frame, excluding a transient period of 20  $\mu$ s at the beginning of the subframe.
7. Measure the UE transmission OFF power for each component carrier during one sub-frame following the PUSCH subframe, excluding a transient period of 20  $\mu$ s at the beginning of the subframe.

#### 6.3.4A.1.1.4.3 Message contents

Message contents are according to TS 36.508 [7] clause 4.6 with the following exceptions:

**Table 6.3.4A.1.1.4.3-1: UplinkPowerControlCommon: Test point 1**

Derivation Path: TS 36.508 [7] clause 4.6.3, Table 4.6.3-25 UplinkPowerControlCommon-DEFAULT			
Information Element	Value/remark	Comment	Condition
UplinkPowerControlCommon-DEFAULT ::= SEQUENCE { p0-NominalPUSCH	-105	Test point 1 to verify a UE relative low initial power transmission for PCC	

**Table 6.3.4A.1.1.4.3-2: PhysicalConfigDedicated**

Derivation Path: TS 36.508 [7] clause 5.5.1.2, Table 5.5.1.2.1 PhysicalConfigDedicated-DEFAULT			
Information Element	Value/remark	Comment	Condition
PhysicalConfigDedicated-DEFAULT ::= SEQUENCE { UplinkPowerControlDedicated	UplinkPowerControlDedicated-DEFAULT	See subclause 4.6.3	RBC
	UplinkPowerControlDedicated-DEFAULT	See subclause 4.6.3	UL CA

**Table 6.3.4A.1.1.4.3-3: UplinkPowerControlDedicated**

Derivation Path: TS 36.508 [7] clause 4.6.3, Table 4.6.3-26 UplinkPowerControlDedicated-DEFAULT			
Information Element	Value/remark	Comment	Condition
UplinkPowerControlDedicated-DEFAULT ::= SEQUENCE {			
p0-UE-PUSCH	1		RBC
	0		UL CA
}			

**Table 6.3.4A.1.1.4.3-4: UplinkPowerControlCommonSCell-r10: Test point 1**

Derivation Path: TS 36.508 [7] clause 4.6.3, Table 4.6.3-25A UplinkPowerControlCommonSCell-r10-DEFAULT			
Information Element	Value/remark	Comment	Condition
UplinkPowerControlCommonSCell-r10 ::= SEQUENCE {			
p0-NominalPUSCH-r10	-105	Test point 1 to verify a UE relative low initial power transmission for SCC	

**Table 6.3.4A.1.1.4.3-5: TDD-Config-DEFAULT: On/OFF time mask measurement**

Derivation Path: 36.508 [7] clause 5.3.1, Table 5.3.1-1 ( <i>SystemInformationBlockType1</i> )			
Information Element	Value/remark	Comment	Condition
TDD-Config-DEFAULT ::= SEQUENCE {			
subframeAssignment	sa1		
specialSubframePatterns	ssp5	To enable two symbol UpPTS, and to have 9 symbols GP.	
}			

#### 6.3.4A.1.1.5 Test requirement

The requirement for the power measured in steps 5, 6 and 7 of the test procedure shall not exceed the values specified in Table 6.3.4.1.5-1.

#### 6.3.4A.1.2 General ON/OFF time mask for CA (inter-band DL CA and UL CA)

**Editor's notes: This test is incomplete. The following aspects are either missing or not yet determined:**

- Message contents are FFS.

##### 6.3.4A.1.2.1 Test purpose

To verify that the general ON/OFF time mask for CA meets the requirements given in 6.3.4A.1.2.5.

The time mask for transmit ON/OFF for CA defines the ramping time allowed for the UE between transmit OFF power and transmit ON power for CA.

Transmission of the wrong power increases interference to other channels, or increases transmission errors in the uplink channel.

##### 6.3.4A.1.2.2 Test applicability

This test case applies to all types of E-UTRA UE release 11 and forward that support inter-band DL CA and UL CA.

6.3.4A.1.2.3 Minimum conformance requirements

The minimum conformance requirements are defined in clause 6.3.4A.0.

6.3.4A.1.2.4 Test description

6.3.4A.1.2.4.1 Initial conditions

Same as in clause 6.3.4A.1.1.4.1 with the following exceptions:

- Instead of Table 5.4.2A.1-1 → use Table 5.4.2A.1-2 for CA configurations with two bands or Table 5.4.2A.1-2a for CA configurations with three bands.
- Instead of Table 6.3.4A.1.1.4.1-1 → use Table 6.3.4A.1.2.4.1-1.
- Instead of clause 6.3.4A.1.1.4.3 use clause 6.3.4A.1.2.4.3.

**Table 6.3.4A.1.2.4.1-1: Test Configuration Table**

Initial Conditions								
Test Environment as specified in TS 36.508[7] subclause 4.1				NC, TL/VL, TL/VH, TH/VL, TH/VH				
Test Frequencies as specified in TS 36.508 [7] subclause 4.3.1 for different CA bandwidth classes.				Low range for PCC and SCC High range for PCC and SCC				
Test CC Combination setting ( $N_{RB\_agg}$ ) as specified in subclause 5.4.2A.1 for the CA Configuration across bandwidth combination sets supported by the UE.				Lowest $N_{RB\_agg}$ Highest $N_{RB\_agg}$ (Note 2)				
Test Parameters for CA Configurations								
CA Configuration / $N_{RB\_agg}$		DL Allocation	CC MOD	UL Allocation				
PCC $N_{RB}$	SCCs $N_{RB}$	PCC & SCC RB allocation		$N_{RB\_alloc}$	PCC & SCC RB allocations ( $L_{CRB}$ @ $RB_{start}$ )			
6	25	N/A for this test	QPSK	31	P_6@0	S_25@0	-	-
6	50		QPSK	56	P_6@0	S_50@0	-	-
25	15		QPSK	40	P_25@0	S_15@0	-	-
25	25		QPSK	50	P_25@0	S_25@0	-	-
25	50		QPSK	75	P_25@0	S_50@0	-	-
50	50		QPSK	100	P_50@0	S_50@0	-	-
50	100		QPSK	150	P_50@0	S_100@0	-	-
75	75		QPSK	150	P_75@0	S_75@0	-	-
100	75		QPSK	175	P_100@0	S_75@0	-	-
100	100		QPSK	200	P_100@0	S_100@0	-	-
Note 1: CA Configuration Test CC Combination settings are checked separately for each CA Configuration, which applicable aggregated channel bandwidths are specified in Table 5.4.2A.1-1. Note 2: If in the CA Configuration UE supports multiple CC Combinations with the same $N_{RB\_agg}$ , only the first of those is tested, according to the order on the Test Configuration Table list.								

6.3.4A.1.2.4.2 Test procedure

Same test procedure as in clause 6.3.4A.1.1.4.2.

- Instead of Table 6.3.4A.1.1.4.1-1 → use Table 6.3.4A.1.2.4.1-1.



- Instead of clause 6.3.4A.1.1.4.3 use clause 6.3.4A.1.2.4.3.

#### 6.3.4A.1.2.4.3 Message contents

FFS

#### 6.3.4A.1.2.5 Test requirement

The requirement for the power measured in steps 5, 6 and 7 of the test procedure shall not exceed the values specified in Table 6.3.4A.1.2.5-1.

**Table 6.3.4A.1.2.5-1: General ON/OFF time mask**

	Channel bandwidth / minimum output power / measurement bandwidth					
	1.4 MHz	3.0 MHz	5 MHz	10 MHz	15 MHz	20 MHz
Transmit OFF power	For carrier frequency $f \leq 3.0\text{GHz}$ : $\leq -48.5\text{ dBm}$ For carrier frequency $3.0\text{GHz} < f \leq 4.2\text{GHz}$ : $\leq -48.2\text{ dBm}$					
Transmission OFF Measurement bandwidth	1.08 MHz	2.7 MHz	4.5 MHz	9.0 MHz	13.5 MHz	18 MHz
Expected Transmission ON Measured power	-14.8 dBm	-10.8 dBm	-8.6 dBm	-5.6 dBm	-3.9 dBm	-2.6 dBm
ON power tolerance $f \leq 3.0\text{GHz}$ $3.0\text{GHz} < f \leq 4.2\text{GHz}$	$\pm 7.5\text{dB}$ $\pm 7.8\text{dB}$	$\pm 7.5\text{dB}$ $\pm 7.8\text{dB}$	$\pm 7.5\text{dB}$ $\pm 7.8\text{dB}$	$\pm 7.5\text{dB}$ $\pm 7.8\text{dB}$	$\pm 7.5\text{dB}$ $\pm 7.8\text{dB}$	$\pm 7.5\text{dB}$ $\pm 7.8\text{dB}$

#### 6.3.4A.1.3 General ON/OFF time mask for CA (intra-band non-contiguous DL CA and UL CA)

##### 6.3.4A.1.3.1 Test purpose

To verify that the general ON/OFF time mask for CA meets the requirements given in 6.3.4A.1.3.5.

The time mask for transmit ON/OFF for CA defines the ramping time allowed for the UE between transmit OFF power and transmit ON power for CA.

Transmission of the wrong power increases interference to other channels, or increases transmission errors in the uplink channel.

##### 6.3.4A.1.3.2 Test applicability

This test case applies to all types of E-UTRA UE release 11 and forward that support intra-band non-contiguous DL CA and UL CA.

##### 6.3.4A.1.3.3 Minimum conformance requirements

The minimum conformance requirements are defined in clause 6.3.4A.0.

##### 6.3.4A.1.3.4 Test description

###### 6.3.4A.1.3.4.1 Initial conditions

Initial conditions are a set of test configurations the UE needs to be tested in and the steps for the SS to take with the UE to reach the correct measurement state.

The initial test configurations consist of environmental conditions, test frequencies, and CC combinations based on E-UTRA CA configurations specified in table 5.4.2A.1-3. All of these configurations shall be tested with applicable test

parameters for each CA Configuration, and are shown in table 6.3.4A.1.3.4.1-1. The details of the uplink and downlink reference measurement channels (RMCs) are specified in Annex A.2 and A3. Configurations of PDSCH and PDCCH before measurement are specified in Annex C.2.

**Table 6.3.4A.1.3.4.1-1: Test Configuration Table**

Initial Conditions									
Test Environment as specified in TS 36.508[7] subclause 4.1				NC, TL/VL, TL/VH, TH/VL, TH/VH					
Test Frequencies as specified in TS36.508 [7] subclause 4.3.1 for different CA bandwidth classes, and PCC and SCCs are mapped onto physical frequencies according to Table 6.1-2.				Refer to test points A: Mid frequency, Maximum W <sub>gap</sub> (low + high frequency)					
Test CC Combination setting (N <sub>RB_agg</sub> ) as specified in subclause 5.4.2A.1 for the CA Configuration across bandwidth combination sets supported by the UE.				Refer to test point Test only test points with Lowest N <sub>RB</sub> for PCC and SCC Highest N <sub>RB</sub> for PCC and SCC					
Test Parameters for CA Configurations									
ID	CA Configuration / N <sub>RB_agg</sub>		W <sub>gap</sub> [MHz]	DL Allocation		UL Allocation			
	PCC N <sub>RB</sub>	SCCs N <sub>RB</sub>		CC MOD	PCC & SCC RB allocation	CC MOD	PCC N <sub>RB_alloc</sub> (L <sub>CRB</sub> @ RB <sub>start</sub> )	CC MOD	SCC N <sub>RB_alloc</sub> (L <sub>CRB</sub> @ RB <sub>start</sub> )
Test Parameters for CA_4A-4A Configurations									
1	25	25	35	N/A	N/A	QPSK	P_25@0	QPSK	S_25@0
2	25	25	5	N/A	N/A	QPSK	P_25@0	QPSK	S_25@0
3	100	100	5	N/A	N/A	QPSK	P_100@0	QPSK	S_100@0
Note 1: CA Configuration Test CC Combination settings are checked separately for each CA Configuration, which applicable aggregated channel bandwidths are specified in Table 5.4.2A.1-3.									
Note 2: The carrier centre frequency of PCC in the UL operating band is configured closer to the DL operating band.									

1. Connect the SS to the UE antenna connectors as shown in TS 36.508[7] Annex A Figure group A.32 as appropriate.
2. The parameter settings for the cell are set up according to TS 36.508 [7] clause 4.4.3.
3. Downlink signals for PCC are initially set up according to Annex C.0, C.1, and C.3.0, and uplink signals according to Annex H.1 and H.3.0.
4. The UL Reference Measurement channel is set according to Table 6.3.4A.1.3.4.1-1.
5. Propagation conditions are set according to Annex B.0.
6. Ensure the UE is in State 3A-RF according to TS 36.508 [7] clause 5.2A.2. Message contents are defined in clause 6.3.4A.1.3.4.3.

#### 6.3.4A.1.3.4.2 Test procedure

Same test procedure as in clause 6.3.4A.1.1.4.2.

#### 6.3.4A.1.3.4.3 Message contents

Message contents are according to TS 36.508 [7] clause 4.6 with exceptions as in clause 6.3.4A.1.1.4.3.

#### 6.3.4A.1.3.5 Test requirement

The requirement for the power measured in steps 5, 6 and 7 of the test procedure shall not exceed the values specified in Table 6.3.4.1.5-1.

### 6.3.4B ON/OFF time mask for UL-MIMO

#### 6.3.4B.1 General ON/OFF time mask for UL-MIMO

**Editor's note:** The measurement period in the minimum requirement is defined to be 1 subframe (14 symbols). Due to practical reasons the TDD measurement period for off power prior the PUSCH is 10 symbols. It is FFS, if this deviation is acceptable.

**Editor's notes:** The following items are missing or incomplete:

- The initial conditions and test procedure are subject to further investigation

##### 6.3.4B.1.1 Test purpose

To verify that the general ON/OFF time mask for UL-MIMO meets the requirements given in 6.3.4B.1.5.

The time mask for transmit ON/OFF defines the ramping time allowed for each transmit antenna of UE between transmit OFF power and transmit ON power.

Transmission of the wrong power increases interference to other channels, or increases transmission errors in the uplink channel.

##### 6.3.4B.1.2 Test applicability

This test applies to all types of E-UTRA UE release 10 and forward that support UL-MIMO

##### 6.3.4B.1.3 Minimum conformance requirement

For UE with multiple transmit antenna connectors, the ON/OFF time mask requirements in subclause 6.3.4.1.3 apply to each transmit antenna connector.

For UE with two transmit antenna connectors in closed-loop spatial multiplexing scheme, the general ON/OFF time mask requirements specified in subclause 6.3.4.1.3 apply to each transmit antenna connector with the UL-MIMO configurations specified in Table 6.2.2B.3-2.

The normative reference for this requirement is TS 36.101 [2] clause 6.3.4B

##### 6.3.4B.1.4 Test description

###### 6.3.4B.1.4.1 Initial conditions

Initial conditions are a set of test configurations the UE needs to be tested in and the steps for the SS to take with the UE to reach the correct measurement state.

The initial test configurations consist of environmental conditions, test frequencies, and channel bandwidths based on E-UTRA operating bands specified in table 5.4.2.1-1. All of these configurations shall be tested with applicable test parameters for each channel bandwidth, and are shown in table 6.3.4B.1.4.1-1. The details of the uplink reference measurement channels (RMCs) are specified in Annexes A.2. Configurations of PDSCH and PDCCH before measurement are specified in Annex C.2

**Table 6.3.4B.1.4.1-1: Test Configuration Table**

Initial Conditions					
Test Environment as specified in TS 36.508[7] subclause 4.1		Normal, TL/VL, TL/VH, TH/VL, TH/VH			
Test Frequencies as specified in <b>TS 36.508 [7] subclause 4.3.1</b>		Low range, Mid range, High range			
Test Channel Bandwidths as specified in <b>TS 36.508 [7] subclause 4.3.1</b>		Lowest, 5MHz, Highest			
Test Parameters for Channel Bandwidths					
		Downlink Configuration		Uplink Configuration	
Ch BW	N/A for General On/Off Time Mask test case	Mod'n	RB allocation		
			FDD	TDD	
1.4MHz		QPSK	6	6	
3MHz		QPSK	15	15	
5MHz		QPSK	25	25	
10MHz		QPSK	50	50	
15MHz		QPSK	75	75	
20MHz		QPSK	100	100	
Note 1: Test Channel Bandwidths are checked separately for each E-UTRA band, the applicable channel bandwidths are specified in Table 5.4.2.1-1.					

1. Connect the SS to the UE antenna connectors as shown in TS 36.508 [7] Annex A, Figure A.28.
2. The parameter settings for the cell are set up according to TS 36.508 [7] subclause 4.4.3.
3. Downlink signals are initially set up according to Annex C.0, C.1 and C.3.0, and uplink signals according to Annex H.1 and H.3.0.
4. The UL and DL Reference Measurement channels are set according to Table 6.3.4B.1.4.1-1.
5. Propagation conditions are set according to Annex B.0.
6. Ensure the UE is in State 3A-RF according to TS 36.508 [7] clause 5.2A.2. Message contents are defined in clause 6.3.4B.1.4.3. Note that PDCCH DCI format 4 sent after resetting uplink power with RRC Connection Reconfiguration, should have TPC command 0dB.

#### 6.3.4B.1.4.2 Test procedure

1. SS sends uplink scheduling information via PDCCH with DCI format 4 and TPC command 0dB for C\_RNTI to schedule the UL RMC according to Table 6.3.4B.1.4.1-1. Since the UE has no payload and no loopback data to send the UE sends uplink MAC padding bits on the UL RMC. The UL assignment is such that the UE transmits on UL sub-frame 2 of every radio frame.
2. For FDD: Measure the UE transmission OFF power during the sub-frame prior to the PUSCH subframe. For TDD: Measure the UE transmission OFF power during the 10 SCFDMA symbols prior to the PUSCH subframe.
3. Measure the output power of the UE PUSCH transmission during one sub-frame, excluding a transient period of 20  $\mu$ s at the beginning of the subframe.
4. Measure the UE transmission OFF power during one sub-frame following the PUSCH subframe, excluding a transient period of 20  $\mu$ s at the beginning of the subframe.
5. Repeat step 2) until 4) for each of transmit antenna of the UE.

#### 6.3.4B.1.4.3 Message contents

Message contents are according to TS 36.508 [7] clause 4.6 with the following exceptions:

**Table 6.3.4B.1.4.3-1: UplinkPowerControlCommon: Test point 1**

Derivation Path: TS 36.508 [7] clause 4.6.3, Table 4.6.3-25 UplinkPowerControlCommon-DEFAULT			
Information Element	Value/remark	Comment	Condition
UplinkPowerControlCommon-DEFAULT ::= SEQUENCE { p0-NominalPUSCH	-105	Test point 1 to verify a UE relative low initial power transmission	

**Table 6.3.4B.1.4.3-2: PhysicalConfigDedicated**

Derivation Path: TS 36.508 [7] clause 5.5.1.2, Table 5.5.1.2.1 PhysicalConfigDedicated-DEFAULT			
Information Element	Value/remark	Comment	Condition
PhysicalConfigDedicated-DEFAULT ::= SEQUENCE {			
UplinkPowerControlDedicated	UplinkPowerControlDedicated-DEFAULT	See clause 4.6.3	SRB1
	UplinkPowerControlDedicated-DEFAULT	See clause 4.6.3	RBC

**Table 6.3.4B.1.4.3-3: UplinkPowerControlDedicated**

Derivation Path: TS 36.508 [7] clause 4.6.3, Table 4.6.3-26 UplinkPowerControlDedicated-DEFAULT			
Information Element	Value/remark	Comment	Condition
UplinkPowerControlDedicated-DEFAULT ::= SEQUENCE {			
p0-UE-PUSCH	1		SRB1
	0		RBC
}			

**Table 6.3.4B.1.3-4: TDD-Config-DEFAULT: On/OFF time mask measurement**

Derivation Path: 36.508 clause 5.3.1 Table 5.3.1-1 ( <i>SystemInformationBlockType1</i> )			
Information Element	Value/remark	Comment	Condition
TDD-Config-DEFAULT ::= SEQUENCE {			
subframeAssignment	sa1		
specialSubframePatterns	ssp5	To enable two symbol UpPTS, and to have 9 symbols GP.	
}			

### 6.3.4B.1.5 Test requirement

The requirement for the power measured in steps (2), (3) and (4) of the test procedure shall not exceed the values specified in Table 6.3.4B.1.5-1.

Table 6.3.4B.1.5-1: General ON/OFF time mask

	Channel bandwidth / minimum output power / measurement bandwidth					
	1.4 MHz	3.0 MHz	5 MHz	10 MHz	15 MHz	20 MHz
Transmit OFF power	For carrier frequency $f \leq 3.0\text{GHz}$ : $\leq -48.5$ dBm For carrier frequency $3.0\text{GHz} < f \leq 4.2\text{GHz}$ : $\leq -48.2$ dBm					
Transmission OFF Measurement bandwidth	1.08 MHz	2.7 MHz	4.5 MHz	9.0 MHz	13.5 MHz	18 MHz
Expected Transmission ON Measured power	-14.8 dBm	-10.8 dBm	-8.6 dBm	-5.6 dBm	-3.9 dBm	-2.6 dBm
ON power tolerance $f \leq 3.0\text{GHz}$ $3.0\text{GHz} < f \leq 4.2\text{GHz}$	7.5 dB $\pm 7.8\text{dB}$	7.5 dB $\pm 7.8\text{dB}$	7.5dB $\pm 7.8\text{dB}$	7.5dB $\pm 7.8\text{dB}$	7.5dB $\pm 7.8\text{dB}$	7.5dB $\pm 7.8\text{dB}$

## 6.3.5 Power Control

Power control is used to limit the interference level and compensate the channel fading. The UE power is defined as the mean power in a subframe or ON power duration, whichever is available.

The UE transmission can be in two contiguity modes, i.e. contiguous transmission and non-contiguous transmission. The former has a transmission gap of 0 and the later has a transmission gap larger than 0. The transmission gap is the time interval between the end of the last UE transmission subframe and the beginning of the next UE transmission subframe or the UpPTS (for TDD).

### 6.3.5.1 Power Control Absolute power tolerance

#### 6.3.5.1.1 Test purpose

To verify the ability of the UE transmitter to set its initial output power to a specific value at the start of a contiguous transmission or non-contiguous transmission with a long transmission gap, i.e. transmission gap is larger than 20 ms.

#### 6.3.5.1.2 Minimum conformance requirement

Absolute power tolerance is the ability of the UE transmitter to set its initial output power to a specific value for the first sub-frame at the start of a contiguous transmission or non-contiguous transmission with a transmission gap larger than 20ms.

The minimum requirement on absolute power tolerance is given in Table 6.3.5.1.2-1 over the power range bounded by the Maximum output power as defined in sub-clause 6.2.2 and the Minimum output power as defined in sub clause 6.3.2.

For operating bands under Note 2 in Table 6.2.2.3-1, the absolute power tolerance as specified in Table 6.3.5.1.2-1 is relaxed by reducing the lower limit by 1.5 dB when the transmission bandwidth is confined within  $F_{UL\_low}$  and  $F_{UL\_low} + 4$  MHz or  $F_{UL\_high} - 4$  MHz and  $F_{UL\_high}$ .

Table 6.3.5.1.2-1: Absolute power tolerance

Conditions	Tolerance
Normal conditions	$\pm 9.0$ dB
Extreme conditions	$\pm 12.0$ dB

The normative reference for this requirement is TS 36.101 [2] clause 6.3.5.1.1.

#### 6.3.5.1.3 Test applicability

This test applies to all types of E-UTRA UE release 8 and forward.

### 6.3.5.1.4 Test description

#### 6.3.5.1.4.1 Initial conditions

Initial conditions are a set of test configurations the UE needs to be tested in and the steps for the SS to take with the UE to reach the correct measurement state.

The initial test configurations consist of environmental conditions, test frequencies, and channel bandwidths based on E-UTRA operating bands specified in table 5.4.2.1-1. All of these configurations shall be tested with applicable test parameters for each channel bandwidth, and are shown in table 6.3.5.1.4.1-1. The details of the uplink reference measurement channel (RMCs) are specified in Annexes A.2. Configurations of PDSCH and PDCCH before measurement are specified in Annex C.2.

**Table 6.3.5.1.4.1-1: Test Configuration Table**

Initial Conditions				
Test Environment as specified in TS 36.508[7] subclause 4.1		Normal, TL/VL, TL/VH, TH/VL, TH/VH		
Test Frequencies as specified in TS 36.508 [7] subclause 4.3.1		Mid range		
Test Channel Bandwidths as specified in TS 36.508 [7] subclause 4.3.1		Lowest, 5MHz, Highest		
Test Parameters for Channel Bandwidths				
Ch BW	Downlink Configuration		Uplink Configuration	
	N/A for Power Control Absolute power tolerance test case		Mod'n	RB allocation
			FDD	TDD
1.4MHz		QPSK	6	6
3MHz		QPSK	15	15
5MHz		QPSK	25	25
10MHz		QPSK	50	50
15MHz		QPSK	75	75
20MHz		QPSK	100	100
Note 1: Test Channel Bandwidths are checked separately for each E-UTRA band, the applicable channel bandwidths are specified in Table 5.4.2.1-1.				

1. Connect the SS to the UE antenna connectors as shown in TS 36.508 [7] Annex A, Figure A.3.
2. The parameter settings for the cell are set up according to TS 36.508 [7] subclause 4.4.3.
3. Downlink signals are initially set up according to Annex C.0, C.1 and C.3.0, and uplink signals according to Annex H.1 and H.3.0.
4. The UL Reference Measurement channel is set according to Table 6.3.5.1.4.1-1.
5. Ensure the UE is in State 3A-RF according to TS 36.508 [7] clause 5.2A.2. Message contents are defined in clause 6.3.5.1.4.3. Note that PDCCH DCI format 0 sent after resetting uplink power with RRC Connection Reconfiguration, should have TPC command 0dB.

#### 6.3.5.1.4.2 Test procedure

1. SS sends uplink scheduling information via PDCCH DCI format 0 with TPC command 0dB for C\_RNTI to schedule the UL RMC according to Table 6.3.5.1.4.1-1. Since the UE has no payload and no loopback data to send the UE sends uplink MAC padding bits on the UL RMC.
2. Measure the initial output power of the first subframe of UE PUSCH first transmission. The transient periods of 20us are excluded.
3. Repeat for the two test points as indicated in section 6.3.5.1.4.3. The timing of the execution between the two test points shall be larger than 20ms.

#### 6.3.5.1.4.3 Message contents

Message contents are according to TS 36.508 [7] subclause 4.6 with the following exceptions:

**Table 6.3.5.1.4.3-1: UplinkPowerControlCommon: Test point 1**

Derivation Path: TS 36.508 [7] clause 4.6.3, Table 4.6.3-25 UplinkPowerControlCommon-DEFAULT			
Information Element	Value/remark	Comment	Condition
UplinkPowerControlCommon-DEFAULT ::= SEQUENCE { p0-NominalPUSCH	-105	Test point 1 to verify a UE relative low initial power transmission	

**Table 6.3.5.1.4.3-2: UplinkPowerControlCommon: Test point 2**

Derivation Path: TS 36.508 [7] clause 4.6.3, Table 4.6.3-25 UplinkPowerControlCommon-DEFAULT			
Information Element	Value/remark	Comment	Condition
UplinkPowerControlCommon-DEFAULT ::= SEQUENCE { p0-NominalPUSCH	-93	Test point 2 to verify a UE relative high initial power transmission	

**Table 6.3.5.1.4.3-3: PhysicalConfigDedicated**

Derivation Path: TS 36.508 [7] clause 5.5.1.2, Table 5.5.1.2.1 PhysicalConfigDedicated-DEFAULT			
Information Element	Value/remark	Comment	Condition
PhysicalConfigDedicated-DEFAULT ::= SEQUENCE {			
uplinkPowerControlDedicated	UplinkPowerControlDedicated-DEFAULT	See subclause 4.6.3	SRB1
	UplinkPowerControlDedicated-DEFAULT	See subclause 4.6.3	RBC

**Table 6.3.5.1.4.3-4: UplinkPowerControlDedicated**

Derivation Path: TS 36.508 [7] clause 4.6.3, Table 4.6.3-26 UplinkPowerControlDedicated-DEFAULT			
Information Element	Value/remark	Comment	Condition
UplinkPowerControlDedicated-DEFAULT ::= SEQUENCE {			
p0-UE-PUSCH	1		SRB1
	0		RBC
}			

### 6.3.5.1.5 Test requirement

The requirement for the power measured in step (2) of the test procedure is not to exceed the values specified in Table 6.3.5.1.5-1 and 6.3.5.1.5-2.

**Table 6.3.5.1.5-1: Absolute power tolerance: test point 1**

	Channel bandwidth / expected output power (dBm)					
	1.4 MHz	3.0 MHz	5 MHz	10 MHz	15 MHz	20 MHz



Expected Measured power Normal conditions	-14.8 dBm	-10.8 dBm	-8.6 dBm	-5.6 dBm	-3.9 dBm	-2.6 dBm
Power tolerance $f \leq 3.0\text{GHz}$ $3.0\text{GHz} < f \leq 4.2\text{GHz}$	$\pm 10.0\text{dB}$ $\pm 10.4\text{dB}$	$\pm 10.0\text{dB}$ $\pm 10.4\text{dB}$	$\pm 10.0\text{dB}$ $\pm 10.4\text{dB}$	$\pm 10.0\text{dB}$ $\pm 10.4\text{dB}$	$\pm 10.0\text{dB}$ $\pm 10.4\text{dB}$	$\pm 10.0\text{dB}$ $\pm 10.4\text{dB}$
Expected Measured power Extreme conditions	-14.8 dBm	-10.8 dBm	-8.6 dBm	-5.6 dBm	-3.9 dBm	-2.6 dBm
Power tolerance $f \leq 3.0\text{GHz}$ $3.0\text{GHz} < f \leq 4.2\text{GHz}$	$\pm 13.0\text{dB}$ $\pm 13.4\text{dB}$	$\pm 13.0\text{dB}$ $\pm 13.4\text{dB}$	$\pm 13.0\text{dB}$ $\pm 13.4\text{dB}$	$\pm 13.0\text{dB}$ $\pm 13.4\text{dB}$	$\pm 13.0\text{dB}$ $\pm 13.4\text{dB}$	$\pm 13.0\text{dB}$ $\pm 13.4\text{dB}$
Note 1: The lower power limit shall not exceed the minimum output power requirements defined in sub-clause 6.3.2.3						

Table 6.3.5.1.5-2: Absolute power tolerance: test point 2

	Channel bandwidth / expected output power (dBm)					
	1.4 MHz	3.0 MHz	5 MHz	10 MHz	15 MHz	20 MHz
Expected Measured power Normal conditions	-2.8 dBm	1.2 dBm	3.4 dBm	6.4 dBm	8.2 dBm	9.4 dBm
Power tolerance $f \leq 3.0\text{GHz}$ $3.0\text{GHz} < f \leq 4.2\text{GHz}$	$\pm 10.0\text{dB}$ $\pm 10.4\text{dB}$	$\pm 10.0\text{dB}$ $\pm 10.4\text{dB}$	$\pm 10.0\text{dB}$ $\pm 10.4\text{dB}$	$\pm 10.0\text{dB}$ $\pm 10.4\text{dB}$	$\pm 10.0\text{dB}$ $\pm 10.4\text{dB}$	$\pm 10.0\text{dB}$ $\pm 10.4\text{dB}$
Expected Measured power Extreme conditions	-2.8 dBm	1.2 dBm	3.4 dBm	6.4 dBm	8.2 dBm	9.4 dBm
Power tolerance $f \leq 3.0\text{GHz}$ $3.0\text{GHz} < f \leq 4.2\text{GHz}$	$\pm 13.0\text{dB}$ $\pm 13.4\text{dB}$	$\pm 13.0\text{dB}$ $\pm 13.4\text{dB}$	$\pm 13.0\text{dB}$ $\pm 13.4\text{dB}$	$\pm 13.0\text{dB}$ $\pm 13.4\text{dB}$	$\pm 13.0\text{dB}$ $\pm 13.4\text{dB}$	$\pm 13.0\text{dB}$ $\pm 13.4\text{dB}$
Note 1: The lower power limit shall not exceed the minimum output power requirements defined in sub-clause 6.3.2.3						

## 6.3.5.2 Power Control Relative power tolerance

### 6.3.5.2.1 Test purpose

To verify the ability of the UE transmitter to set its output power relatively to the power in a target sub-frame relatively to the power of the most recently transmitted reference sub-frame if the transmission gap between these sub-frames is  $\leq 20$  ms.

### 6.3.5.2.2 Test applicability

This test applies to all types of E-UTRA UE release 8 and forward.

### 6.3.5.2.3 Minimum conformance requirement

The UE shall meet the requirements specified in Table 6.3.5.2.3-1.

To account for RF Power amplifier mode changes 2 exceptions are allowed for each of two test patterns. The test patterns are a monotonically increasing power sweep and a monotonically decreasing power sweep over a range bounded by the requirements of minimum power and maximum power specified in clauses 6.3.2.3 and 6.2.2.3. For these exceptions the power tolerance limit is a maximum of  $\pm 6.0$  dB in Table 6.3.5.2.3-1.

**Table 6.3.5.2.3-1 Relative Power Tolerance for Transmission (normal conditions)**

Power step $\Delta P$ (Up or down) [dB]	All combinations of PUSCH and PUCCH transitions [dB]	All combinations of PUSCH/PUCCH and SRS transitions between sub- frames [dB]	PRACH [dB]
$\Delta P < 2$	$\pm 2.5$ (Note 3)	$\pm 3.0$	$\pm 2.5$
$2 \leq \Delta P < 3$	$\pm 3.0$	$\pm 4.0$	$\pm 3.0$
$3 \leq \Delta P < 4$	$\pm 3.5$	$\pm 5.0$	$\pm 3.5$
$4 \leq \Delta P \leq 10$	$\pm 4.0$	$\pm 6.0$	$\pm 4.0$
$10 \leq \Delta P < 15$	$\pm 5.0$	$\pm 8.0$	$\pm 5.0$
$15 \leq \Delta P$	$\pm 6.0$	$\pm 9.0$	$\pm 6.0$
<p>Note 1: For extreme conditions an additional <math>\pm 2.0</math> dB relaxation is allowed</p> <p>Note 2: For operating bands under Note 2 in Table 6.2.2.3-1, the relative power tolerance is relaxed by increasing the upper limit by 1.5 dB if the transmission bandwidth of the reference sub-frames is confined within <math>F_{UL\_low}</math> and <math>F_{UL\_low} + 4</math> MHz or <math>F_{UL\_high} - 4</math> MHz and <math>F_{UL\_high}</math> and the target sub-frame is not confined within any one of these frequency ranges; if the transmission bandwidth of the target sub-frame is confined within <math>F_{UL\_low}</math> and <math>F_{UL\_low} + 4</math> MHz or <math>F_{UL\_high} - 4</math> MHz and <math>F_{UL\_high}</math> and the reference sub-frame is not confined within any one of these frequency ranges, then the tolerance is relaxed by reducing the lower limit by 1.5 dB.</p> <p>Note 3: For PUSCH to PUSCH transitions with the allocated resource blocks fixed in frequency and no transmission gaps other than those generated by downlink subframes, DwPTS fields or Guard Periods for TDD: for a power step <math>\Delta P \leq 1</math> dB, the relative power tolerance for transmission is <math>\pm 1.0</math> dB.</p>			

The power step ( $\Delta P$ ) is defined as the difference in the calculated setting of the UE Transmit power between the target and reference sub-frames with the power setting according to Clause 5.1 of TS 36.213. The error is the difference between  $\Delta P$  and the power change measured at the UE antenna port with the power of the cell-specific reference signals kept constant. The error shall be less than the relative power tolerance specified in Table 6.3.5.2.3-1.

The normative reference for this requirement is TS 36.101 clause 6.3.5.2.

#### 6.3.5.2.4 Test description

##### 6.3.5.2.4.1 Initial conditions

Initial conditions are a set of test configurations the UE needs to be tested in and the steps for the SS to take with the UE to reach the correct measurement state.

The initial test configurations consist of environmental conditions, test frequencies, and channel bandwidths based on E-UTRA operating bands specified in table 5.4.2.1-1. All of these configurations shall be tested with applicable test parameters for each channel bandwidth, and are shown in table 6.3.5.2.4.1-1. The details of the uplink reference measurement channels (RMCs) are specified in Annexes A.2. Configurations of PDSCH and PDCCH before measurement are specified in Annex C.2.

**Table 6.3.5.2.4.1-1: Test Configuration Table**

Initial Conditions	
Test Environment as specified in TS 36.508[7] subclause 4.1	Normal, TL/VL, TL/VH, TH/VL, TH/VH
Test Frequencies as specified in TS 36.508 [7] subclause 4.3.1	Low range
Test Channel Bandwidths as specified in TS 36.508 [7] subclause 4.3.1	Lowest, 5MHz, Highest
Test Parameters for Channel Bandwidths	
	Downlink Configuration                      Uplink Configuration

Ch BW	N/A for Power Control Relative power tolerance test case	Mod'n	RB allocation	
			FDD	TDD
1.4MHz		QPSK	See table 6.3.5.2.5-1 6.3.5.2.5-2 6.3.5.2.5-13	See table 6.3.5.2.5-1 6.3.5.2.5-2 6.3.5.2.5-13
3MHz		QPSK	See table 6.3.5.2.5-3 6.3.5.2.5-4 6.3.5.2.5-13	See table 6.3.5.2.5-3 6.3.5.2.5-4 6.3.5.2.5-13
5MHz		QPSK	See table 6.3.5.2.5-5 6.3.5.2.5-6 6.3.5.2.5-13	See table 6.3.5.2.5-5 6.3.5.2.5-6 6.3.5.2.5-13
10MHz		QPSK	See table 6.3.5.2.5-7 6.3.5.2.5-8 6.3.5.2.5-13	See table 6.3.5.2.5-7 6.3.5.2.5-8 6.3.5.2.5-13
15MHz		QPSK	See table 6.3.5.2.5-9 6.3.5.2.5-10 6.3.5.2.5-13	See table 6.3.5.2.5-9 6.3.5.2.5-10 6.3.5.2.5-13
20MHz		QPSK	See table 6.3.5.2.5-11 6.3.5.2.5-12 6.3.5.2.5-13	See table 6.3.5.2.5-11 6.3.5.2.5-12 6.3.5.2.5-13
Note 1: Test Channel Bandwidths are checked separately for each E-UTRA band, the applicable channel bandwidths are specified in Table 5.4.2.1-1 Note 2: The starting resource block shall be RB# 0.				

1. Connect the SS to the UE antenna connectors as shown in TS 36.508 [7] Annex A, Figure A.3.
2. The parameter settings for the cell are set up according to TS 36.508 [7] subclause 4.4.3.
3. Downlink signals are initially set up according to Annex C.0, C.1 and C.3.0, and uplink signals according to Annex H.1 and H.3.0.
4. The UL Reference Measurement channel is set according to table 6.3.5.2.4.1-1
5. Propagation conditions are set according to Annex B.0.
6. Ensure the UE is in State 3A-RF according to TS 36.508 [7] clause 5.2A.2. Message contents are defined in clause 6.3.5.2.4.3.

#### 6.3.5.2.4.2 Test procedure

The procedure is separated in various subtests to verify different aspects of relative power control. The power patterns of the subtests are described in figure 6.3.5.2.4.2-1.

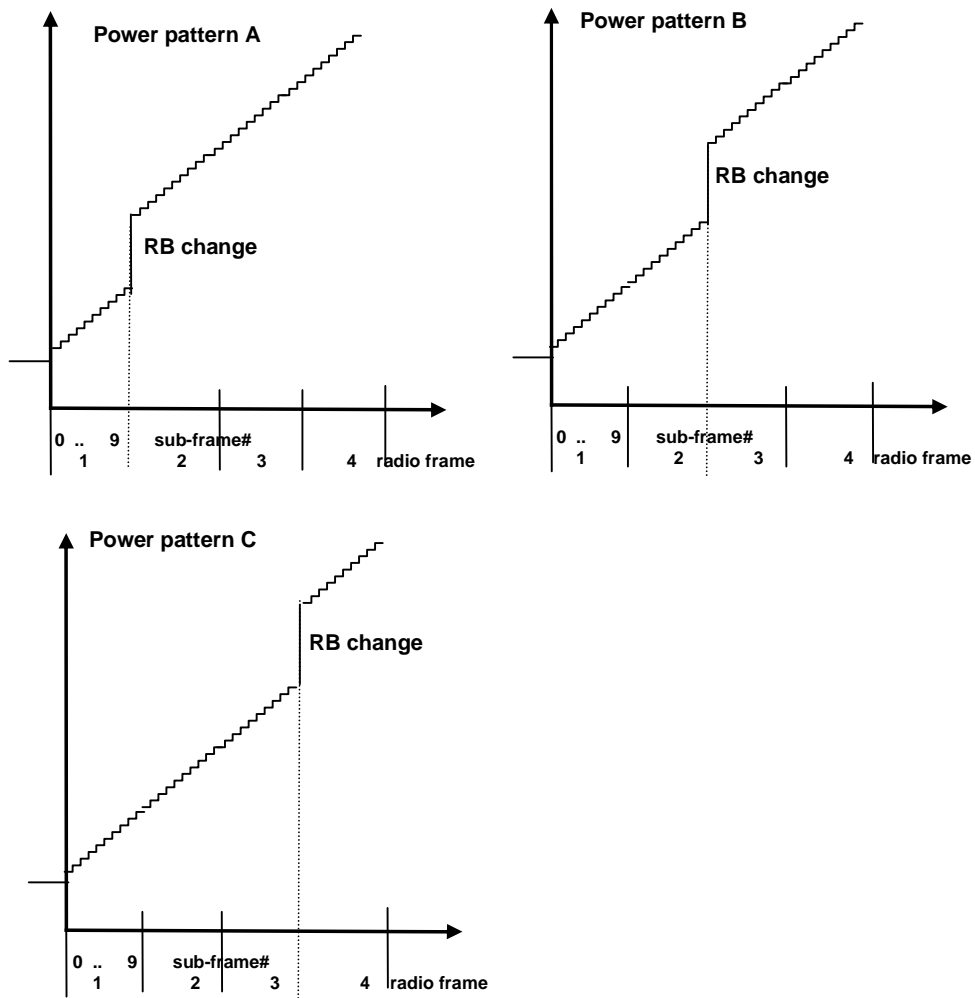

Figure 6.3.5.2.4.2-1: FDD ramping up test power patterns

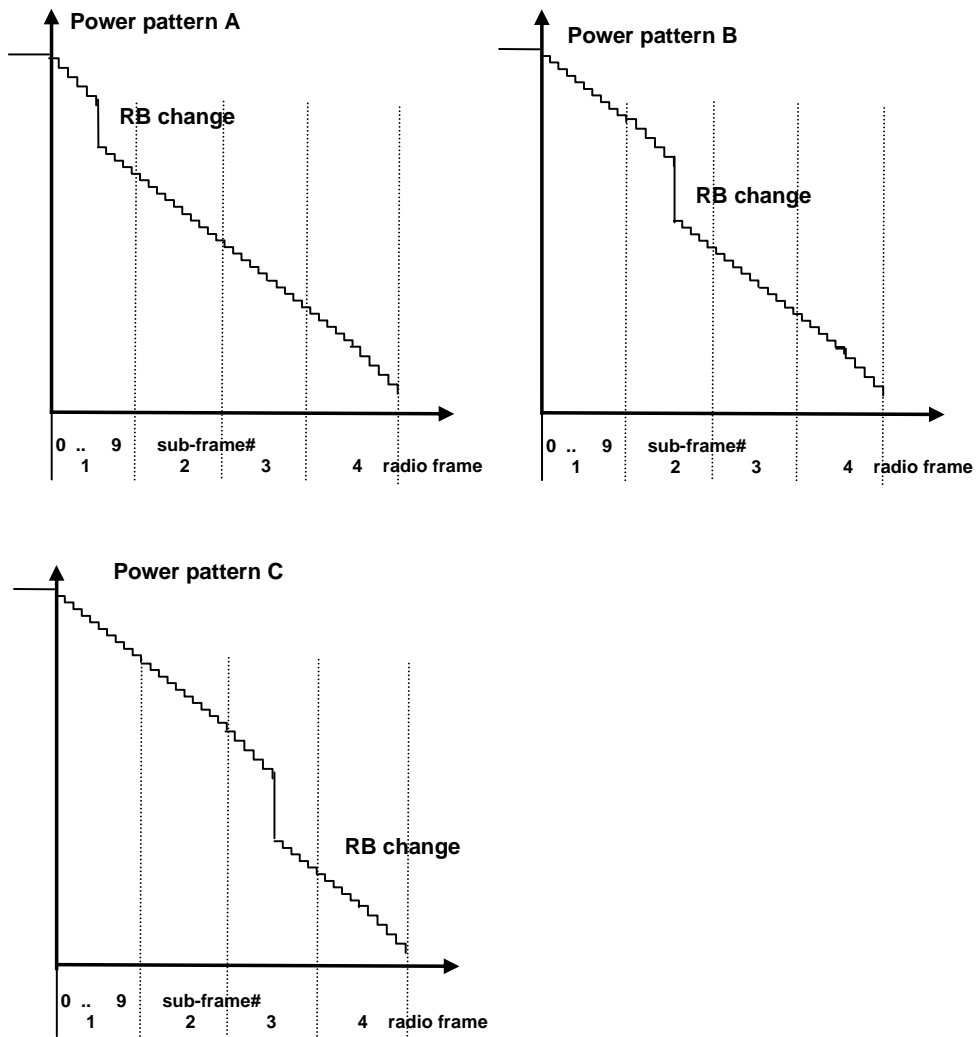

Figure 6.3.5.2.4.2-2: FDD ramping down test power patterns

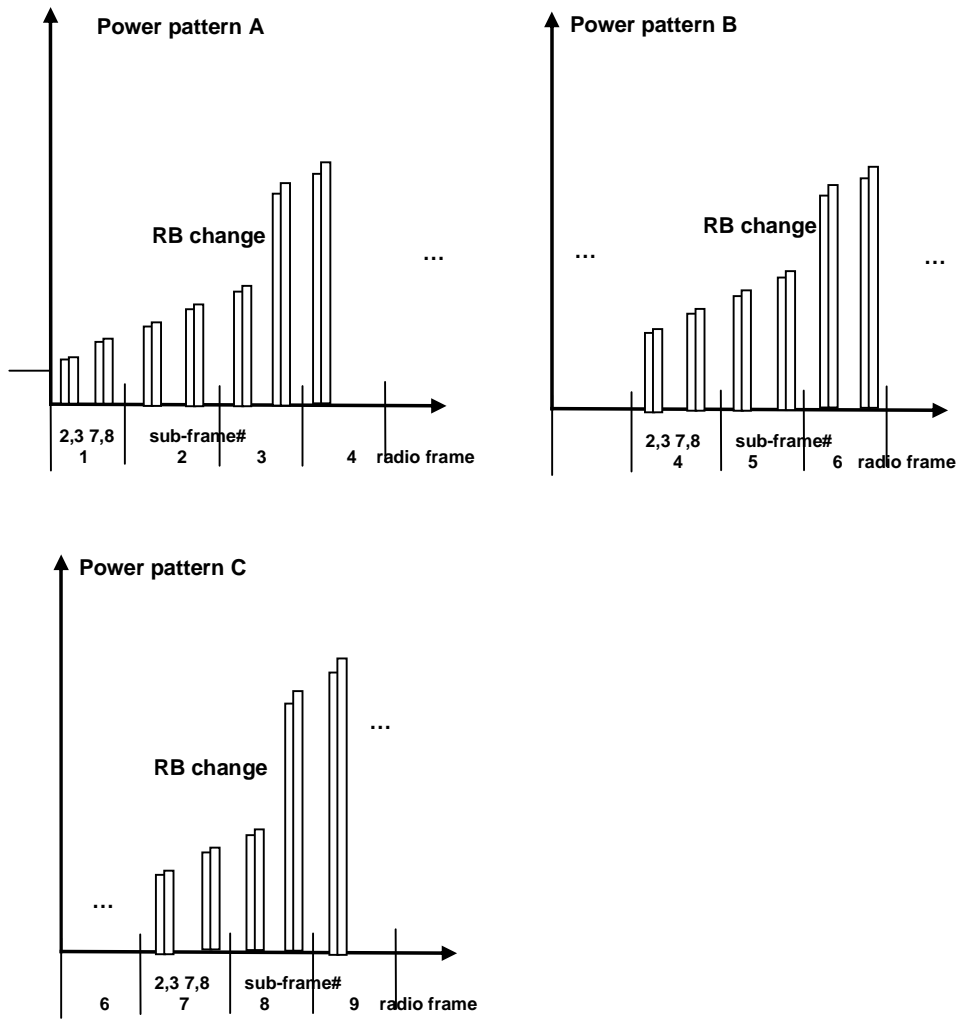

Figure 6.3.5.2.4.2-3: TDD ramping up test power patterns

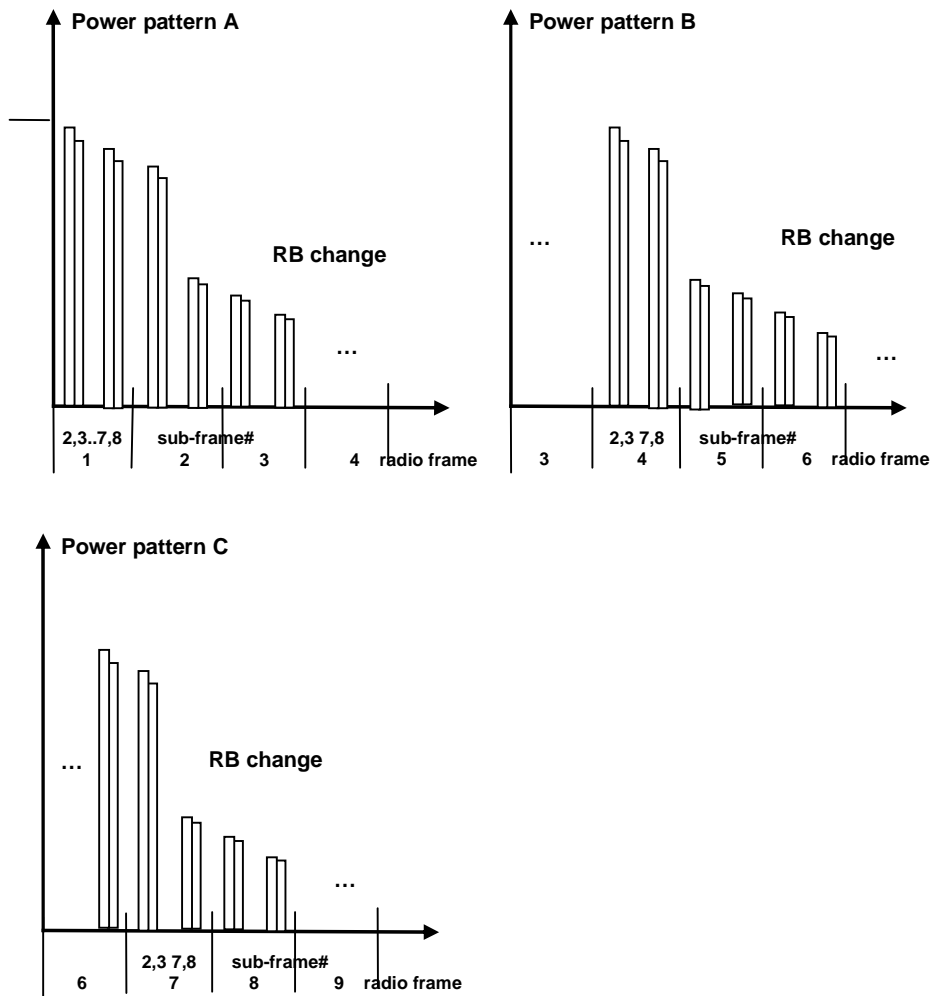

Figure 6.3.5.2.4.2-4: TDD ramping down test power patterns

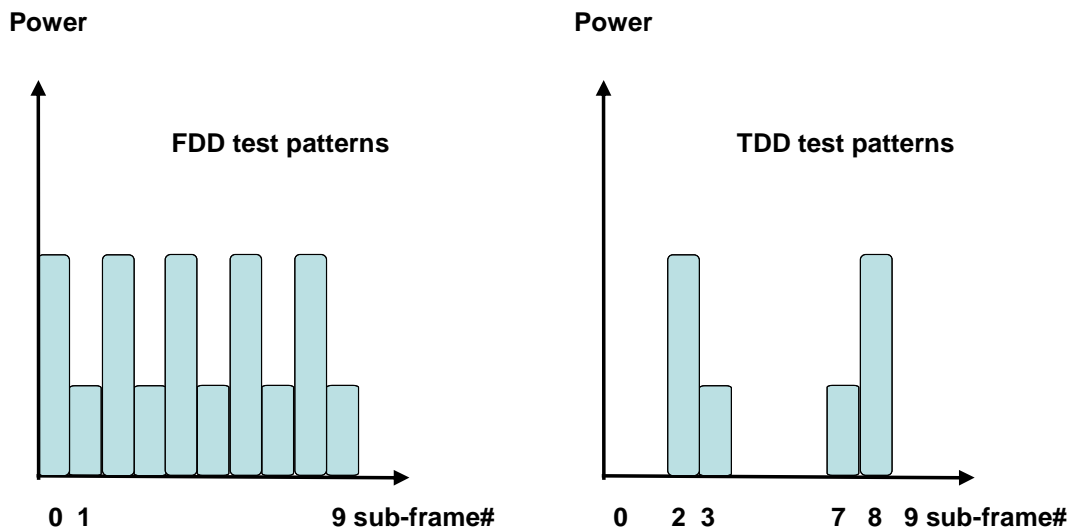

Figure 6.3.5.2.4.2-5: Alternating Test Power patterns

1. Sub test: ramping up pattern

- 1.1. SS sends uplink scheduling information for each UL HARQ process via PDCCH DCI format 0 for C\_RNTI to schedule the PUSCH. Since the UE has no payload and no loopback data to send the UE sends uplink MAC padding bits on the UL RMC. Send the appropriate TPC commands for PUSCH to the UE to ensure that the UE transmits PUSCH at  $-36.8\text{dBm} \pm 3.2\text{ dB}$  for carrier frequency  $f \leq 3.0\text{GHz}$  or at  $-36.5\text{dBm} \pm 3.5\text{ dB}$  for carrier frequency  $3.0\text{GHz} < f \leq 4.2\text{GHz}$ .
- 1.2. Schedule the UE's PUSCH data transmission as described in Figure 6.3.5.2.4.2-1 (FDD pattern A: sub-test is divided in 4 arbitrary radio frames with 10 active uplink sub-frames per radio frame) and Figure 6.3.5.2.4.2-3 (TDD pattern A: sub-test is divided in 10 arbitrary radio frames with 4 active uplink sub-frames per radio frame) with an uplink RB allocation as defined in tables 6.3.5.2.5-1 thru 6.3.5.2.5-12 depending on channel bandwidth. On the PDCCH format 0 for the scheduling of the PUSCH the SS will transmit a +1dB TPC command. Note that the measurement need not be done continuously, provided that interruptions are whole numbers of frames, and TPC commands of 0dB are sent during the interruption.
- 1.3. Measure the power of PUSCH transmissions to verify the UE relative power control meet test requirements 6.3.5.2.5. For power transients between subframes, transient periods of 40us between subframes are excluded. For ON/OFF or OFF/OFF transients, transient periods of 20 us at the beginning of the subframe are excluded.
- 1.4. Repeat the subtest different pattern B, C to move the RB allocation change at different points in the pattern as described in Table 6.3.5.2.5-1 thru Table 6.3.5.2.5-12 to force bigger UE power steps at various points in the power range.

2. Sub test: ramping down pattern

- 2.1. SS sends uplink scheduling information for each UL HARQ process via PDCCH DCI format 0 for C\_RNTI to schedule the PUSCH. Since the UE has no payload and no loopback data to send the UE sends uplink MAC padding bits on the UL RMC. Send the appropriate TPC commands for PUSCH to the UE to ensure that the UE transmits PUSCH at  $+18.0\text{dBm} \pm 3.2\text{ dB}$  for carrier frequency  $f \leq 3.0\text{GHz}$  or at  $+17.7\text{dBm} \pm 3.5\text{ dB}$  for carrier frequency  $3.0\text{GHz} < f \leq 4.2\text{GHz}$ .
- 2.2. Schedule the UE's PUSCH data transmission as described in Figure 6.3.5.2.4.2-2 (FDD pattern A: sub-test is divided in 4 arbitrary radio frames with 10 active uplink sub-frames per radio frame) and Figure 6.3.5.2.4.2-4 (TDD pattern A: sub-test is divided in 10 arbitrary radio frames with 4 active uplink sub-frames per radio frame) with an uplink RB allocation as defined in tables 6.3.5.2.5-1 thru 6.3.5.2.5-12 depending on channel bandwidth. On the PDCCH format 0 for the scheduling of the PUSCH the SS will transmit a -1dB



TPC command. Note that the measurement need not be done continuously, provided that interruptions are whole numbers of frames, and TPC commands of 0dB are sent during the interruption.

- 2.3. Measure the power of PUSCH transmissions to verify the UE relative power control meet test requirements 6.3.5.2.5. For power transients between subframes, transient periods of 40us between subframes are excluded. For ON/OFF or OFF/ON transients, transient periods of 20 us at the beginning of the subframe are excluded.
  - 2.4. Repeat the subtest different pattern B, C to move the RB allocation change at different points in the pattern as described in Table 6.3.5.2.5-1 thru Table 6.3.5.2.5-12 to force bigger UE power steps at various points in the power range.
3. Sub test: alternating pattern
- 3.1 SS sends uplink scheduling information for each UL HARQ process via PDCCH DCI format 0 for C\_RNTI to schedule the PUSCH. Since the UE has no payload and no loopback data to send the UE sends uplink MAC padding bits on the UL RMC. Send the appropriate TPC commands for PUSCH to the UE to ensure that the UE transmits PUSCH at -10dBm +/- 3.2 dB for carrier frequency  $f \leq 3.0\text{GHz}$  or at -10dBm +/- 3.5 dB for carrier frequency  $3.0\text{GHz} < f \leq 4.2\text{GHz}$ . The initial uplink RB allocation is defined as the smaller uplink RB allocation value specified in tables 6.3.5.2.5-13. The power level and RB allocation are reset for each sub-test.
  - 3.2. Schedule the UE's PUSCH data transmission as described in Figure 6.3.5.2.4.2-5 for 10 sub-frames with an uplink RB allocation alternating pattern as defined in table 6.3.5.2.5-13 while transmitting 0dB TPC command for PUSCH via the PDCCH.
  - 3.3. Measure the power of PUSCH transmissions to verify the UE relative power control meet test requirements specified in clause 6.3.5.2.5. For power transients between subframes, transient periods of 40us between subframes are excluded. For ON/OFF or OFF/ON transients, transient periods of 20 us at the beginning of the subframe are excluded.

#### 6.3.5.2.4.3 Message contents

Message contents are according to TS 36.508 [7] subclause 4.6.

#### 6.3.5.2.5 Test requirement

Each UE power step measured in the test procedure 6.3.5.2.4.2 should satisfy the test requirements specified in Table 6.3.5.2.5-1, thru 6.3.5.2.5-13 for normal conditions; for extreme conditions an additional  $\pm 2.0$  dB relaxation is allowed.

To account for RF Power amplifier mode changes 2 exceptions are allowed for each of ramping up and ramping down test patterns. For these exceptions the power tolerance limit is a maximum of  $\pm 6.7$  dB. If there is an exception in the power step caused by the RB change for all test patterns (A, B, C) then fail the UE.

**Table 6.3.5.2.5-1: Test Requirements Relative Power Tolerance for Transmission (normal conditions – Note 5) channel bandwidth 1.4MHz (ramping up)**

Sub-test (ramp up)	Uplink RB allocation	TPC command	Expected power step size (Up) $\Delta P$ [dB]	Power step size range (Up) $\Delta P$ [dB]	PUSCH [dB]
Subframes before RB change	Fixed = 1	TPC=+1dB	1	$\Delta P < 2$	$1 \pm (1.7)$
RB change	Change from 1 to 6 RBs	TPC=+1dB	8.78	$4 \leq \Delta P < 10$	$8.78 \pm (4.7)$ Note 2 $8.78 +6.2/-4.7$ Note 3
Subframes after RB change	Fixed = 6	TPC=+1dB	1	$\Delta P < 2$	$1 \pm (1.7)$
<p>Note 1: Position of RB change:            Pattern A the position of RB uplink allocation change is after 10 active uplink subframes            Pattern B the position of RB uplink allocation change is after 20 active uplink subframes            Pattern C the position of RB uplink allocation change is after 30 active uplink subframes</p> <p>Note 2: When Note 3 does not apply.</p> <p>Note 3: For operating bands under Note 2 in Table 6.2.2.3-1, if the transmission bandwidth of the reference sub-frames is confined within <math>F_{UL\_low}</math> and <math>F_{UL\_low} + 4</math> MHz or <math>F_{UL\_high} - 4</math> MHz and <math>F_{UL\_high}</math> and the target sub-frame is not confined within any one of these frequency ranges.</p> <p>Note 4: N/A</p> <p>Note 5: For extreme conditions an additional <math>\pm 2.0</math> dB relaxation is allowed.</p> <p>Note 6: The starting resource block shall be RB# 0.</p>					

**Table 6.3.5.2.5-2: Test Requirements Relative Power Tolerance for Transmission (normal conditions – Note 5) channel bandwidth 1.4MHz (ramping down)**

Sub-test (ramp down)	Uplink RB allocation	TPC command	Expected power step size (down) $\Delta P$ [dB]	Power step size range (down) $\Delta P$ [dB]	PUSCH [dB]
Subframes before RB change	Fixed = 5	TPC=-1dB	1	$\Delta P < 2$	$1 \pm (1.7)$
RB change	Change from 5 to 1 RBs	TPC=-1dB	7.99	$4 \leq \Delta P < 10$	$7.99 \pm (4.7)$ Note 2 $7.99 +4.7/-6.2$ Note 4
Subframes after RB change	Fixed = 1	TPC=-1dB	1	$\Delta P < 2$	$1 \pm (1.7)$
<p>Note 1: Position of RB change:            Pattern A the position of RB uplink allocation change is after 6 active uplink subframes            Pattern B the position of RB uplink allocation change is after 16 active uplink subframes            Pattern C the position of RB uplink allocation change is after 26 active uplink subframes</p> <p>Note 2: When Note 4 does not apply.</p> <p>Note 3: N/A</p> <p>Note 4: For operating bands under Note 2 in Table 6.2.2.3-1, if the transmission bandwidth of the target sub-frame is confined within <math>F_{UL\_low}</math> and <math>F_{UL\_low} + 4</math> MHz or <math>F_{UL\_high} - 4</math> MHz and <math>F_{UL\_high}</math> and the reference sub-frame is not confined within any one of these frequency ranges.</p> <p>Note 5: For extreme conditions an additional <math>\pm 2.0</math> dB relaxation is allowed.</p> <p>Note 6: The starting resource block shall be RB# 0.</p>					

**Table 6.3.5.2.5-3: Test Requirements Relative Power Tolerance for Transmission (normal conditions – Note 5) channel bandwidth 3MHz (ramping up)**

Sub-test (ramp up)	Uplink RB allocation	TPC command	Expected power step size (Up) $\Delta P$ [dB]	Power step size range (Up) $\Delta P$ [dB]	PUSCH [dB]
Subframes before RB change	Fixed = 1	TPC=+1dB	1	$\Delta P < 2$	$1 \pm (1.7)$
RB change	Change from 1 to 4 RBs	TPC=+1dB	7.02	$4 \leq \Delta P < 10$	$7.02 \pm (4.7)$ Note 2 $7.02 +6.2/-4.7$ Note 3
Subframes after RB change	Fixed =4	TPC=+1dB	1	$\Delta P < 2$	$1 \pm (1.7)$
<p>Note 1: Position of RB change:            Pattern A the position of RB uplink allocation change is after 10 active uplink subframes            Pattern B the position of RB uplink allocation change is after 20 active uplink subframes            Pattern C the position of RB uplink allocation change is after 30 active uplink subframes</p> <p>Note 2: When Note 3 does not apply.</p> <p>Note 3: For operating bands under Note 2 in Table 6.2.2.3-1, if the transmission bandwidth of the reference sub-frames is confined within <math>F_{UL\_low}</math> and <math>F_{UL\_low} + 4</math> MHz or <math>F_{UL\_high} - 4</math> MHz and <math>F_{UL\_high}</math> and the target sub-frame is not confined within any one of these frequency ranges.</p> <p>Note 4: N/A</p> <p>Note 5: For extreme conditions an additional <math>\pm 2.0</math> dB relaxation is allowed.</p> <p>Note 6: The starting resource block shall be RB# 0.</p>					

**Table 6.3.5.2.5-4: Test Requirements Relative Power Tolerance for Transmission (normal conditions – Note 5) channel bandwidth 3MHz (ramping down)**

Sub-test (ramp down)	Uplink RB allocation	TPC command	Expected power step size (down) $\Delta P$ [dB]	Power step size range (down) $\Delta P$ [dB]	PUSCH [dB]
Subframes before RB change	Fixed = 15	TPC=-1dB	1	$\Delta P < 2$	$1 \pm (1.7)$
RB change	Change from 15 to 1 RBs	TPC=-1dB	12.76	$10 \leq \Delta P < 15$	$12.76 \pm (5.7)$ Note 2 $12.76 +5.7/-7.2$ Note 4
Subframes after RB change	Fixed =1	TPC=-1dB	1	$\Delta P < 2$	$1 \pm (1.7)$
<p>Note 1: Position of RB change:            Pattern A the position of RB uplink allocation change is after 6 active uplink subframes            Pattern <b>A</b> the position of RB uplink allocation change is after 16 active uplink subframes            Pattern C the position of RB uplink allocation change is after 26 active uplink subframes</p> <p>Note 2: When Note 4 does not apply.</p> <p>Note 3: N/A</p> <p>Note 4: For operating bands under Note 2 in Table 6.2.2.3-1, if the transmission bandwidth of the target sub-frame is confined within <math>F_{UL\_low}</math> and <math>F_{UL\_low} + 4</math> MHz or <math>F_{UL\_high} - 4</math> MHz and <math>F_{UL\_high}</math> and the reference sub-frame is not confined within any one of these frequency ranges.</p> <p>Note 5: For extreme conditions an additional <math>\pm 2.0</math> dB relaxation is allowed.</p> <p>Note 6: The starting resource block shall be RB# 0.</p>					

**Table 6.3.5.2.5-5: Test Requirements Relative Power Tolerance for Transmission (normal conditions – Note 5) channel bandwidth 5MHz (ramping up)**

Sub-test (ramp up)	Uplink RB allocation	TPC command	Expected power step size (Up) $\Delta P$ [dB]	Power step size range (Up) $\Delta P$ [dB]	PUSCH [dB]
Subframes before RB change	Fixed = 1	TPC=+1dB	1	$\Delta P < 2$	$1 \pm (1.7)$
RB change	Change from 1 to 20	TPC=+1dB	14.01	$10 \leq \Delta P < 15$	$14.01 \pm (5.7)$ Note 2 $14.01 +7.2/-5.7$ Note 3
Subframes after RB change	Fixed = 20	TPC=+1dB	1	$\Delta P < 2$	$1 \pm (1.7)$
<p>Note 1: Position of RB change:            Pattern A the position of RB uplink allocation change is after 10 active uplink subframes            Pattern B the position of RB uplink allocation change is after 20 active uplink subframes            Pattern C the position of RB uplink allocation change is after 30 active uplink subframes</p> <p>Note 2: When Note 3 does not apply.</p> <p>Note 3: For operating bands under Note 2 in Table 6.2.2.3-1, if the transmission bandwidth of the reference sub-frames is confined within <math>F_{UL\_low}</math> and <math>F_{UL\_low} + 4</math> MHz or <math>F_{UL\_high} - 4</math> MHz and <math>F_{UL\_high}</math> and the target sub-frame is not confined within any one of these frequency ranges.</p> <p>Note 4: N/A</p> <p>Note 5: For extreme conditions an additional <math>\pm 2.0</math> dB relaxation is allowed.</p> <p>Note 6: The starting resource block shall be RB# 0.</p>					

**Table 6.3.5.2.5-6: Test Requirements Relative Power Tolerance for Transmission (normal conditions – Note 5) channel bandwidth 5MHz (ramping down)**

Sub-test (ramp down)	Uplink RB allocation	TPC command	Expected power step size (down) $\Delta P$ [dB]	Power step size range (down) $\Delta P$ [dB]	PUSCH [dB]
Subframes before RB change	Fixed = 25	TPC=-1dB	1	$\Delta P < 2$	$1 \pm (1.7)$
RB change	Change from 25 to 1	TPC=-1dB	14.98	$10 \leq \Delta P < 15$	$14.98 \pm (5.7)$ Note 2 $14.98 +5.7/-7.2$ Note 4
Subframes after RB change	Fixed = 1	TPC=-1dB	1	$\Delta P < 2$	$1 \pm (1.7)$
<p>Note 1: Position of RB change:            Pattern A the position of RB uplink allocation change is after 6 active uplink subframes            Pattern B the position of RB uplink allocation change is after 16 active uplink subframes            Pattern C the position of RB uplink allocation change is after 26 active uplink subframes</p> <p>Note 2: When Note 4 does not apply.</p> <p>Note 3: N/A</p> <p>Note 4: For operating bands under Note 2 in Table 6.2.2.3-1, if the transmission bandwidth of the target sub-frame is confined within <math>F_{UL\_low}</math> and <math>F_{UL\_low} + 4</math> MHz or <math>F_{UL\_high} - 4</math> MHz and <math>F_{UL\_high}</math> and the reference sub-frame is not confined within any one of these frequency ranges.</p> <p>Note 5: For extreme conditions an additional <math>\pm 2.0</math> dB relaxation is allowed.</p> <p>Note 6: The starting resource block shall be RB# 0.</p>					

**Table 6.3.5.2.5-7: Test Requirements Relative Power Tolerance for Transmission (normal conditions – Note 5) channel bandwidth 10MHz (ramping up)**

Sub-test (ramp up)	Uplink RB allocation	TPC command	Expected power step size (Up) $\Delta P$ [dB]	Power step size range (Up) $\Delta P$ [dB]	PUSCH [dB]
Subframes before RB change	Fixed = 1	TPC=+1dB	1	$\Delta P < 2$	$1 \pm (1.7)$
RB change	Change from 1 to 25	TPC=+1dB	14.98	$10 \leq \Delta P < 15$	$14.98 \pm (5.7)$ Note 2 $14.98 +7.2/-5.7$ Note 3
Subframes after RB change	Fixed = 25	TPC=+1dB	1	$\Delta P < 2$	$1 \pm (1.7)$
<p>Note 1: Position of RB change:            Pattern A the position of RB uplink allocation change is after 10 active uplink subframes            Pattern B the position of RB uplink allocation change is after 20 active uplink subframes            Pattern C the position of RB uplink allocation change is after 30 active uplink subframes</p> <p>Note 2: When Note 3 does not apply.</p> <p>Note 3: For operating bands under Note 2 in Table 6.2.2.3-1, if the transmission bandwidth of the reference sub-frames is confined within <math>F_{UL\_low}</math> and <math>F_{UL\_low} + 4</math> MHz or <math>F_{UL\_high} - 4</math> MHz and <math>F_{UL\_high}</math> and the target sub-frame is not confined within any one of these frequency ranges.</p> <p>Note 4: N/A</p> <p>Note 5: For extreme conditions an additional <math>\pm 2.0</math> dB relaxation is allowed.</p> <p>Note 6: The starting resource block shall be RB# 0.</p>					

**Table 6.3.5.2.5-8: Test Requirements Relative Power Tolerance for Transmission (normal conditions – Note 5) channel bandwidth 10MHz (ramping down)**

Sub-test (ramp down)	Uplink RB allocation	TPC command	Expected power step size (down) $\Delta P$ [dB]	Power step size range (down) $\Delta P$ [dB]	PUSCH [dB]
Subframes before RB change	Fixed = 50 ( UE- Categories $\geq 2$ )  Fixed = 48 (UE Cat 1)	TPC=-1dB	1	$\Delta P < 2$	$1 \pm (1.7)$
RB change	Change from 50 to 1 ( UE- Categories $\geq 2$ )  Change from 48 to 1 (UE cat 1)	TPC=-1dB	17.99  17.81	$15 \leq \Delta$	$17.99 \pm (6.7)$ Note 2 $17.99 +6.7/-8.2$ Note 4  $17.81 \pm (6.7)$ Note 2 $17.81 +6.7/-8.2$ Note 4
Subframes after RB change	Fixed = 1	TPC=-1dB	1	$\Delta P < 2$	$1 \pm (1.7)$
<p>Note 1: Position of RB change:            Pattern A the position of RB uplink allocation change is after 6 active uplink subframes            Pattern B the position of RB uplink allocation change is after 16 active uplink subframes            Pattern C the position of RB uplink allocation change is after 26 active uplink subframes</p> <p>Note 2: When Note 4 does not apply.</p> <p>Note 3: N/A</p> <p>Note 4: For operating bands under Note 2 in Table 6.2.2.3-1, if the transmission bandwidth of the target sub-frame is confined within <math>F_{UL\_low}</math> and <math>F_{UL\_low} + 4</math> MHz or <math>F_{UL\_high} - 4</math> MHz and <math>F_{UL\_high}</math> and the reference sub-frame is not confined within any one of these frequency ranges.</p> <p>Note 5: For extreme conditions an additional <math>\pm 2.0</math> dB relaxation is allowed.</p> <p>Note 6: The starting resource block shall be RB# 0.</p>					

**Table 6.3.5.2.5-9: Test Requirements Relative Power Tolerance for Transmission (normal conditions – Note 5) channel bandwidth 15MHz (ramping up)**

Sub-test (ramp up)	Uplink RB allocation	TPC command	Expected power step size (Up) $\Delta P$ [dB]	Power step size range (Up) $\Delta P$ [dB]	PUSCH [dB]
Subframes before RB change	Fixed = 1	TPC=+1dB	1	$\Delta P < 2$	$1 \pm (1.7)$
RB change	Change from 1 to 50	TPC=+1dB	17.99	$15 \leq \Delta P$	$17.99 \pm (6.7)$ Note 2 $17.99 + 8.2 / - 6.7$ Note 3
Subframes after RB change	Fixed = 50	TPC=+1dB	1	$\Delta P < 2$	$1 \pm (1.7)$
<p>Note 1: Position of RB change:            Pattern A the position of RB uplink allocation change is after 10 active uplink subframes            Pattern B the position of RB uplink allocation change is after 20 active uplink subframes            Pattern C the position of RB uplink allocation change is after 30 active uplink subframes</p> <p>Note 2: When Note 3 does not apply.</p> <p>Note 3: For operating bands under Note 2 in Table 6.2.2.3-1, if the transmission bandwidth of the reference sub-frames is confined within <math>F_{UL\_low}</math> and <math>F_{UL\_low} + 4</math> MHz or <math>F_{UL\_high} - 4</math> MHz and <math>F_{UL\_high}</math> and the target sub-frame is not confined within any one of these frequency ranges.</p> <p>Note 4: N/A</p> <p>Note 5: For extreme conditions an additional <math>\pm 2.0</math> dB relaxation is allowed.</p> <p>Note 6: The starting resource block shall be RB# 0.</p>					

**Table 6.3.5.2.5-10: Test Requirements Relative Power Tolerance for Transmission (normal conditions – Note 5) channel bandwidth 15MHz (ramping down)**

Sub-test (ramp down)	Uplink RB allocation	TPC command	Expected power step size (down) $\Delta P$ [dB]	Power step size range (down) $\Delta P$ [dB]	PUSCH [dB]
Subframes before RB change	Fixed = 75 (UE-Categories $\geq 2$ )  Fixed = 50 (UE Cat 1)	TPC=-1dB	1	$\Delta P < 2$	$1 \pm (1.7)$
RB change	Change from 75 to 1 (UE-Categories $\geq 2$ )  Change from 50 to 1 (UE Cat 1)	TPC=-1dB	19.75  17.99	$15 \leq \Delta P$	$19.75 \pm (6.7)$ Note 2 $19.75 +6.7/-8.2$ Note 4  $17.99 \pm (6.7)$ Note 2 $17.99 +6.7/-8.2$ Note 4
Subframes after RB change	Fixed = 1	TPC=-1dB	1	$\Delta P < 2$	$1 \pm (1.7)$
<p>Note 1: Position of RB change:            Pattern A the position of RB uplink allocation change is after 6 active uplink subframes            Pattern B the position of RB uplink allocation change is after 16 active uplink subframes            Pattern C the position of RB uplink allocation change is after 26 active uplink subframes</p> <p>Note 2: When Note 4 does not apply.</p> <p>Note 3: N/A</p> <p>Note 4: For operating bands under Note 2 in Table 6.2.2.3-1, if the transmission bandwidth of the target sub-frame is confined within <math>F_{UL\_low}</math> and <math>F_{UL\_low} + 4</math> MHz or <math>F_{UL\_high} - 4</math> MHz and <math>F_{UL\_high}</math> and the reference sub-frame is not confined within any one of these frequency ranges.</p> <p>Note 5: For extreme conditions an additional <math>\pm 2.0</math> dB relaxation is allowed.</p> <p>Note 6: The starting resource block shall be RB# 0.</p>					



**Table 6.3.5.2.5-11: Test Requirements Relative Power Tolerance for Transmission (normal conditions – Note 5) channel bandwidth 20MHz (ramping up)**

Sub-test (ramp up)	Uplink RB allocation	TPC command	Expected power step size (Up) $\Delta P$ [dB]	Power step size range (Up) $\Delta P$ [dB]	PUSCH [dB]
Subframes before RB change	Fixed = 1	TPC=+1dB	1	$\Delta P < 2$	$1 \pm (1.7)$
RB change	Change from 1 to 75	TPC=+1dB	19.75	$15 \leq \Delta P$	$19.75 \pm (6.7)$ Note 2 $19.75 +8.2/-6.7$ Note 3
Subframes after RB change	Fixed = 75	TPC=+1dB	1	$\Delta P < 2$	$1 \pm (1.7)$
<p>Note 1: Position of RB change:            Pattern A the position of RB uplink allocation change is after 10 active uplink subframes            Pattern B the position of RB uplink allocation change is after 20 active uplink subframes            Pattern C the position of RB uplink allocation change is after 30 active uplink subframes</p> <p>Note 2: When Note 3 does not apply.</p> <p>Note 3: For operating bands under Note 2 in Table 6.2.2.3-1, if the transmission bandwidth of the reference sub-frames is confined within <math>F_{UL\_low}</math> and <math>F_{UL\_low} + 4</math> MHz or <math>F_{UL\_high} - 4</math> MHz and <math>F_{UL\_high}</math> and the target sub-frame is not confined within any one of these frequency ranges.</p> <p>Note 4: N/A</p> <p>Note 5: For extreme conditions an additional <math>\pm 2.0</math> dB relaxation is allowed.</p> <p>Note 6: The starting resource block shall be RB# 0.</p>					

**Table 6.3.5.2.5-12: Test Requirements Relative Power Tolerance for Transmission (normal conditions – Note 5) channel bandwidth 20MHz (ramping down)**

Sub-test (ramp down)	Uplink RB allocation	TPC command	Expected power step size (down) $\Delta P$ [dB]	Power step size range (down) $\Delta P$ [dB]	PUSCH [dB]
Subframes before RB change	Fixed = 100 ( UE- Categories $\geq 2$ ) Fixed = 75 (UE Cat 1)	TPC=-1dB	1	$\Delta P < 2$	$1 \pm (1.7)$
RB change	Change from 100 to 1 ( UE- Categories $\geq 2$ ) Change from 75 to 1 (UE Cat 1)	TPC=-1dB	21.0  19.75	$15 \leq \Delta P$	$21.0 \pm (6.7)$ Note 2 $21.0 +6.7/-8.2$ Note 4  $19.75 \pm (6.7)$ Note 2 $19.75 +6.7/-8.2$ Note 4
Subframes after RB change	Fixed = 1	TPC=-1dB	1	$\Delta P < 2$	$1 \pm (1.7)$
<p>Note 1: Position of RB change:            Pattern A the position of RB uplink allocation change is after 6 active uplink subframes            Pattern B the position of RB uplink allocation change is after 16 active uplink subframes            Pattern C the position of RB uplink allocation change is after 26 active uplink subframes</p> <p>Note 2: When Note 4 does not apply.</p> <p>Note 3: N/A</p> <p>Note 4: For operating bands under Note 2 in Table 6.2.2.3-1, if the transmission bandwidth of the target sub-frame is confined within <math>F_{UL\_low}</math> and <math>F_{UL\_low} + 4</math> MHz or <math>F_{UL\_high} - 4</math> MHz and <math>F_{UL\_high}</math> and the reference sub-frame is not confined within any one of these frequency ranges.</p> <p>Note 5: For extreme conditions an additional <math>\pm 2.0</math> dB relaxation is allowed.</p> <p>Note 6: The starting resource block shall be RB# 0.</p>					

**Table 6.3.5.2.5-13: Test Requirements Relative Power Tolerance for Transmission (normal conditions – Note 5) (Alternating pattern)**

Sub-test	Uplink RB allocation	TPC command	Expected power step size (Up or down) $\Delta P$ [dB]	Power step size range (Up or down) $\Delta P$ [dB]	PUSCH [dB]
1.4 MHz	Alternating 1 and 6	TPC=0dB	7.78	$4 \leq \Delta P < 10$	7.78 $\pm$ (6.7) Note 1,2 7.78 +8.2/-6.7 Note 3 7.78 +6.7/-8.2 Note 4
3 MHz	Alternating 1 and 15	TPC=0dB	11.76	$10 \leq \Delta P < 15$	11.76 $\pm$ (6.7) Note 1,2 11.76 +8.2/-6.7 Note 3 11.76 +6.7/-8.2 Note 4
5 MHz	Alternating 1 and 25	TPC=0dB	13.98	$10 \leq \Delta P < 15$	13.98 $\pm$ (6.7) Note 1,2 13.98 +8.2/-6.7 Note 3 13.98 +6.7/-8.2 Note 4
10 MHz	Alternating 1 and 50 ( UE-Categories $\geq 2$ )	TPC=0dB	16.99	$15 \leq \Delta P$	16.99 $\pm$ (6.7) Note 1,2 16.99 +8.2/-6.7 Note 3 16.99 +6.7/-8.2 Note 4
	Alternating 1 and 48 (UE Cat 1)		16,81		16.81 $\pm$ (6.7) Note 1,2 16.81 +8.2/-6.7 Note 3 16.81 +6.7/-8.2 Note 4
15 MHz	Alternating 1 and 75 ( UE-Categories $\geq 2$ )	TPC=0dB	18.75	$15 \leq \Delta P$	18.75 $\pm$ (6.7) Note 1,2 18.75 +8.2/-6.7 Note 3 18.75 +6.7/-8.2 Note 4
	Alternating 1 and 50 (UE Cat 1)		16.99		16.99 $\pm$ (6.7) Note 1,2 16.99 +8.2/-6.7 Note 3 16.99 +6.7/-8.2 Note 4
20 MHz	Alternating 1 and 100 ( UE-Categories $\geq 2$ )	TPC=0dB	20.00	$15 \leq \Delta P$	20.00 $\pm$ (6.7) Note 1,2 20.00 +8.2/-6.7 Note 3 20.00 +6.7/-8.2 Note 4
	Alternating 1 and 75 (UE Cat 1)		18.75		18.75 $\pm$ (6.7) Note 1,2 18.75 +8.2/-6.7 Note 3 18.75 +6.7/-8.2 Note 4
<p>Note 1: Test tolerance +/- 6.7 dB was selected to allow PA switch possible exceptions to occur.</p> <p>Note 2: When neither Note 3 nor Note 4 applies.</p> <p>Note 3: For operating bands under Note 2 in Table 6.2.2.3-1, if the transmission bandwidth of the reference sub-frames is confined within <math>F_{UL\_low}</math> and <math>F_{UL\_low} + 4</math> MHz or <math>F_{UL\_high} - 4</math> MHz and <math>F_{UL\_high}</math> and the target sub-frame is not confined within any one of these frequency ranges.</p> <p>Note 4: For operating bands under Note 2 in Table 6.2.2.3-1, if the transmission bandwidth of the target sub-frame is confined within <math>F_{UL\_low}</math> and <math>F_{UL\_low} + 4</math> MHz or <math>F_{UL\_high} - 4</math> MHz and <math>F_{UL\_high}</math> and the reference sub-frame is not confined within any one of these frequency ranges.</p> <p>Note 5: For extreme conditions an additional <math>\pm 2.0</math> dB relaxation is allowed.</p> <p>Note 6: The starting resource block shall be RB# 0.</p>					

### 6.3.5.3 Aggregate power control tolerance

#### 6.3.5.3.1 Test purpose

To verify the ability of the UE to maintain its power level in non-contiguous transmission within 21 ms in response to 0 dB TPC commands with respect to the first UE transmission, when the power control parameters specified in TS 36.213 are constant.

### 6.3.5.3.2 Test applicability

This test applies to all types of E-UTRA UE release 8 and forward.

### 6.3.5.3.3 Minimum conformance requirement

The UE shall meet the requirements specified in Table 6.3.5.3.3-1 for relative power control over the power range bounded by the minimum output power as defined in sub clause 6.3.2 and the maximum output power in subclause 6.2.2.

**Table 6.3.5.3.3-1: Power control tolerance**

TPC command	UL channel	Aggregate power tolerance within 21 ms
0 dB	PUCCH	$\pm 2.5$ dB
0 dB	PUSCH	$\pm 3.5$ dB
Note 1: The UE transmission gap is 4 ms. TPC command is transmitted via PDCCH 4 subframes preceding each PUCCH/PUSCH transmission.		

The normative reference for this requirement is TS 36.101 [2] clause 6.3.5.3.1.

### 6.3.5.3.4 Test description

#### 6.3.5.3.4.1 Initial conditions

Initial conditions are a set of test configurations the UE needs to be tested in and the steps for the SS to take with the UE to reach the correct measurement state.

The initial test configurations consist of environmental conditions, test frequencies, and channel bandwidths based on E-UTRA operating bands specified in table 5.4.2.1-1. All of these configurations shall be tested with applicable test parameters for each channel bandwidth, and are shown in table 6.3.5.3.4.1-1. The details of the uplink and downlink reference measurement channels (RMCs) are specified in Annexes A.2 and A.3. Configurations of PDSCH and PDCCH before measurement are specified in Annex C.2.

**Table 6.3.5.3.4.1-1: Test Configuration Table: PUCCH sub-test**

Initial Conditions				
Test Environment as specified in TS 36.508[7] subclause 4.1			Normal	
Test Frequencies as specified in <b>TS 36.508 [7] subclause 4.3.1</b>			Mid range	
Test Channel Bandwidths as specified in <b>TS 36.508 [7] subclause 4.3.1</b>			Lowest, 5MHz, Highest	
Test Parameters for Channel Bandwidths				
		Downlink Configuration		Uplink Configuration
Ch BW	Mod'n	RB allocation		FDD: PUCCH format = Format 1a TDD: PUCCH format = Format 1a/1b
		FDD	TDD	
1.4MHz	QPSK	3	3	
3MHz	QPSK	4	4	
5MHz	QPSK	8	8	
10MHz	QPSK	16	16	
15MHz	QPSK	25	25	
20MHz	QPSK	30	30	
Note 1: Test Channel Bandwidths are checked separately for each E-UTRA band, the applicable channel bandwidths are specified in Table 5.4.2.1-1.				

**Table 6.3.5.3.4.1-2: Test Configuration Table: PUSCH sub-test**

Initial Conditions				
Test Environment as specified in TS 36.508[7] subclause 4.1		Normal		
Test Frequencies as specified in <b>TS 36.508 [7] subclause 4.3.1</b>		Mid range		
Test Channel Bandwidths as specified in <b>TS 36.508 [7] subclause 4.3.1</b>		Lowest, 5MHz, Highest		
Test Parameters for Channel Bandwidths				
Ch BW	Downlink Configuration		Uplink Configuration	
	N/A for PUSCH sub-test		Mod'n	RB allocation
			FDD	TDD
1.4MHz		QPSK	1	1
3MHz		QPSK	4	4
5MHz		QPSK	8	8
10MHz		QPSK	12	12
15MHz		QPSK	16	16
20MHz		QPSK	18	18
Note 1: Test Channel Bandwidths are checked separately for each E-UTRA band, the applicable channel bandwidths are specified in Table 5.4.2.1-1.				

1. Connect the SS to the UE antenna connectors as shown in TS 36.508 [7] Annex A, Figure A.3.
2. The parameter settings for the cell are set up according to TS 36.508 [7] subclause 4.4.3.
3. Downlink signals are initially set up according to Annex C0, C.1 and C.3.0, and uplink signals according to Annex H.1 and H.3.0.
4. The UL and DL Reference Measurement channels are set according to Table 6.3.5.3.4.1-1 (PUCCH sub-test) and Table 6.3.5.3.4.1-2 (PUSCH sub-test).
5. Ensure the UE is in State 3A-RF according to TS 36.508 [7] clause 5.2A.2. Message contents are defined in clause 6.3.5.3.4.3.

**6.3.5.3.4.2 Test procedure**

The procedure is separated in two subtests to verify PUCCH and PUSCH aggregate power control tolerance respectively. The uplink transmission patterns are described in figure 6.3.5.3.4.2-1.

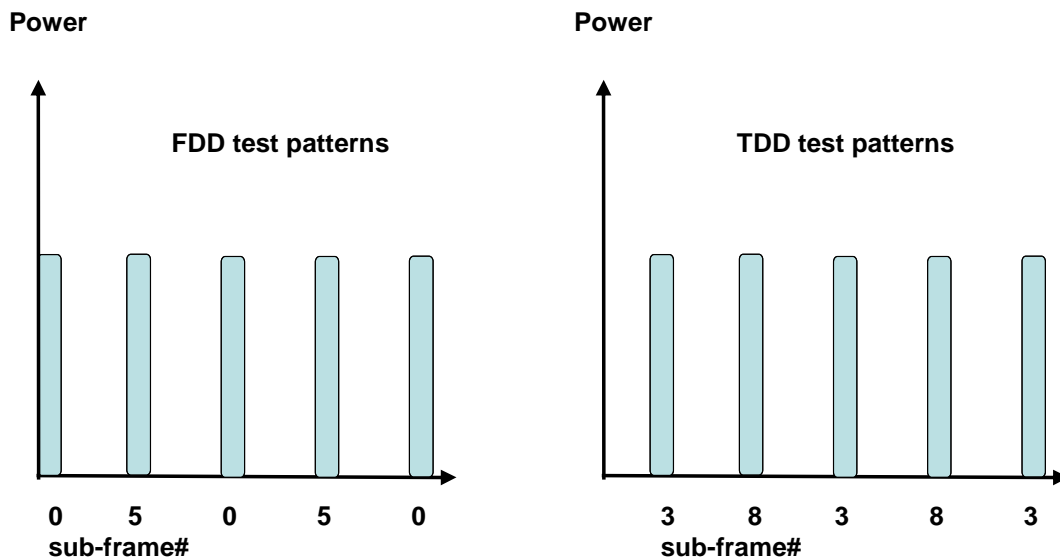

**Figure 6.3.5.3.4.2-1 Test uplink transmission**

### 1. PUCCH sub test:

- 1.1 The SS transmits PDSCH via PDCCH DCI format 1A for C\_RNTI to transmit the DL RMC according to Table 6.3.5.3.4.1-1. The SS sends downlink MAC padding bits on the DL RMC. The transmission of PDSCH will make the UE send uplink ACK/NACK using PUCCH. Send the appropriate TPC commands for PUCCH to the UE to ensure that the UE transmits PUCCH at 0dBm +/- 3.2 dB for carrier frequency  $f \leq 3.0\text{GHz}$  or at 0dBm +/- 3.5 dB for carrier frequency  $3.0\text{GHz} < f \leq 4.2\text{GHz}$ .
- 1.2. Every 5 subframes transmit to the UE downlink PDSCH MAC padding bits as well as 0 dB TPC command for PUCCH via the PDCCH to make the UE transmit ACK/NACK on the PUCCH with transmission gap of 4 subframes. The downlink transmission is scheduled in the appropriate sub-frames to make the UE transmit PUCCH as described in figure 6.3.5.3.4.2-1.
- 1.3. Measure the power of 5 consecutive PUCCH transmissions to verify the UE transmitted PUCCH power is maintained within 21 ms. The transient periods of 20us are excluded from the power measurement.

### 2. PUSCH sub test:

- 2.1. The SS sends uplink scheduling information via PDCCH DCI format 0 for C\_RNTI to schedule the PUSCH. Since the UE has no payload and no loopback data to send the UE sends uplink MAC padding bits on the UL RMC. Send the appropriate TPC commands for PUSCH to the UE to ensure that the UE transmits PUSCH at 0dBm +/- 3.2.dB for carrier frequency  $f \leq 3.0\text{GHz}$  or at 0dBm +/- 3.5 dB for carrier frequency  $3.0\text{GHz} < f \leq 4.2\text{GHz}$ .
- 2.2. Every 5 subframes schedule the UE's PUSCH data transmission and transmit 0 dB TPC command for PUSCH via the PDCCH to make the UE transmit PUSCH with 4 subframes gap. The uplink transmission patterns are described in figure 6.3.5.3.4.2-1.
- 2.3. Measure the power of 5 consecutive PUSCH transmissions to verify the UE transmitted PUSCH power is maintained within 21 ms. The transient periods of 20us are excluded from the power measurement.

#### 6.3.5.3.4.3 Message contents

Message contents are according to TS 36.508 [7] subclause 4.6.

#### 6.3.5.3.5 Test requirement

The requirement for the power measurements made in step (1.3) and (2.3) of the test procedure shall not exceed the values specified in Table 6.3.5.3.5-1. The power measurement period shall be 1 sub-frame excluding transient periods.

**Table 6.3.5.3.5-1: Power control tolerance**

TPC command	UL channel	Test requirement measured power
0 dB	PUCCH	Given 5 power measurements in the pattern, the 2 <sup>nd</sup> , 3 <sup>rd</sup> , 4 <sup>th</sup> , and 5 <sup>th</sup> measurements shall be within $\pm 3.2$ dB of the 1 <sup>st</sup> measurement.
0 dB	PUSCH	Given 5 power measurements in the pattern, the 2 <sup>nd</sup> , 3 <sup>rd</sup> , 4 <sup>th</sup> , and 5 <sup>th</sup> measurements shall be within $\pm 4.2$ dB of the 1 <sup>st</sup> measurement.
Note 1: The UE transmission gap is 4 ms. TPC command is transmitted via PDCCH 4 subframes preceding each PUCCH/PUSCH transmission.		

### 6.3.5\_1 Power Control for HPUE

Same text as in clause 6.3.5.

6.3.5\_1.1 Power Control Absolute power tolerance for HPUE

6.3.5\_1.1.1 Test purpose

Same test purpose as in clause 6.3.5.1.1.

6.3.5\_1.1.2 Test applicability

This test applies to all types of E-UTRA Power Class 1 UE release 10 and forward.

6.3.5\_1.1.3 Minimum conformance requirement

Same minimum conformance requirement as in clause 6.3.5.1.2 with the following exceptions:

- of sub-clause 6.2.2 → use sub-clause 6.2.2\_1

The normative reference for this requirement is TS 36.101 [2] clause 6.3.5.1.1.

6.3.5\_1.1.4 Test description

Same test description as in clause 6.3.5.1.4 with the following exceptions:

- For test point 2, instead of Table 6.3.5.1.4.3-2 → use Table 6.3.5\_1.1.4.3-1

**Table 6.3.5\_1.1.4.3-1: UplinkPowerControlCommon: Test point 2**

Derivation Path: TS 36.508 [7] clause 4.6.3, Table 4.6.3-25 UplinkPowerControlCommon-DEFAULT			
Information Element	Value/remark	Comment	Condition
UplinkPowerControlCommon-DEFAULT ::= SEQUENCE { p0-NominalPUSCH	-85	Test point 2 to verify a UE relative high initial power transmission	

6.3.5\_1.1.5 Test requirement

The requirement for the power measured in step (2) of the test procedure is not to exceed the values specified in Table 6.3.5\_1.1.5-1 and 6.3.5\_1.1.5-2.

**Table 6.3.5\_1.1.5-1: Absolute power tolerance: test point 1**

	Channel bandwidth / expected output power (dBm)	
	5 MHz	10 MHz
Expected Measured power Normal conditions	-8.6 dBm	-5.6 dBm
Power tolerance	± 10.0dB	± 10.0dB
Expected Measured power Extreme conditions	-8.6 dBm	-5.6 dBm
Power tolerance	± 13.0dB	± 13.0dB
Note 1: The lower power limit shall not exceed the minimum output power requirements defined in sub-clause 6.3.2.3		

**Table 6.3.5\_1.1.5-2: Absolute power tolerance: test point 2**

	Channel bandwidth / expected output power (dBm)	
	5 MHz	10 MHz

Expected Measured power Normal conditions	11.4 dBm	14.4 dBm
Power tolerance	$\pm 10.0$ dB	$\pm 10.0$ dB
Expected Measured power Extreme conditions	11.4 dBm	14.4 dBm
Power tolerance	$\pm 13.0$ dB	$\pm 13.0$ dB
Note 1: The lower power limit shall not exceed the minimum output power requirements defined in sub-clause 6.3.2.3		

### 6.3.5\_1.2 Power Control Relative power tolerance for HPUE

#### 6.3.5\_1.2.1 Test purpose

Same test purpose as in clause 6.3.5.2.1.

#### 6.3.5\_1.2.2 Test applicability

This test applies to all types of E-UTRA Power Class 1 UE release 10 and forward.

#### 6.3.5\_1.2.3 Minimum conformance requirement

Same minimum conformance requirement as in clause 6.3.5.2.3 with the following exceptions

- instead of clause 6.2.2.3 → use sub-clause 6.2.2\_1.3

The normative reference for this requirement is TS 36.101 [2] clause 6.3.5.2.

#### 6.3.5\_1.2.4 Test description

Same test description as in clause 6.3.5.2.4 with the following exceptions:

- clause 6.3.5.2.4.2, test step 2.1, setting the UE PUSCH power at +26dBm +/-3.2dB instead of +18.0dBm +/-3.2dB

#### 6.3.5\_1.2.5 Test requirement

Same test requirement as in clause 6.3.5.2.5.

### 6.3.5\_1.3 Aggregate power control tolerance for HPUE

#### 6.3.5\_1.3.1 Test purpose

Same test purpose as in clause 6.3.5.3.1.

#### 6.3.5\_1.3.2 Test applicability

This test applies to all types of E-UTRA Power Class 1 UE release 10 and forward.

#### 6.3.5\_1.3.3 Minimum conformance requirement

Same minimum conformance requirement as in clause 6.3.5.3.3 with the following exception:

- Instead of sub-clause 6.2.2 → use sub-clause 6.2.2\_1

The normative reference for this requirement is TS 36.101 [2] clause 6.3.5.3.1.

#### 6.3.5\_1.3.4 Test description

Same test description as in clause 6.3.5.3.4.



### 6.3.5\_1.3.5 Test requirement

Same test requirement as in clause 6.3.5.3.5.

## 6.3.5A Power Control for CA

### 6.3.5A.1 Power Control Absolute power tolerance for CA

#### 6.3.5A.1.1 Power Control Absolute power tolerance for CA (intra-band contiguous DL CA and UL CA)

##### 6.3.5A.1.1.1 Test purpose

To verify the ability of the UE transmitter to set its initial output power to a specific value for the first sub-frame at the start of a contiguous transmission or non-contiguous transmission with a transmission gap on each active component carriers larger than 20ms.

##### 6.3.5A.1.1.2 Test applicability

This test applies to all types of E-UTRA UE release 10 and forward that support intra-band contiguous DL CA and UL CA.

##### 6.3.5A.1.1.3 Minimum conformance requirements

The absolute power tolerance is the ability of the UE transmitter to set its initial output power to a specific value for the first sub-frame at the start of a contiguous transmission or non-contiguous transmission with a transmission gap on each active component carriers larger than 20ms. The requirement can be tested by time aligning any transmission gaps on the component carriers.

For intra-band contiguous carrier aggregation bandwidth class C the absolute power control tolerance per component carrier is given in Table 6.3.5A.1.1.3-1.

The requirements apply for one single PUCCH, PUSCH or SRS transmission of contiguous PRB allocation per component carrier.

**Table 6.3.5A.1.1.3-1: Absolute power tolerance for intra-band contiguous CA**

Conditions	Tolerance
Normal conditions	$\pm 9.0$ dB
Extreme conditions	$\pm 12.0$ dB

The normative reference for this requirement is TS 36.101 [2] clause 6.3.5A.1.1.

##### 6.3.5A.1.1.4 Test description

##### 6.3.5A.1.1.4.1 Initial conditions

Initial conditions are a set of test configurations the UE needs to be tested in and the steps for the SS to take with the UE to reach the correct measurement state.

The initial test configurations consist of environmental conditions, test frequencies, and CC combinations based on E-UTRA CA configurations specified in table 5.4.2A.1-1. All of these configurations shall be tested with applicable test parameters for each CA Configuration, and are shown in table 6.3.5A.1.1.4.1-1. The details of the uplink reference measurement channel (RMCs) are specified in Annexes A.2. Configurations of PDSCH and PDCCH before measurement are specified in Annex C.2.

**Table 6.3.5A.1.1.4.1-1: Test Configuration Table**

<b>Initial Conditions</b>							
Test Environment as specified in TS 36.508[7] clause 4.1				Normal, TL/VL, TL/VH, TH/VL, TH/VH			
Test Frequencies as specified in TS 36.508 [7] clause [4.3.1] for different CA bandwidth classes, and PCC and SCCs are mapped onto physical frequencies according to Table 6.1-2.				C: Mid range			
Test CC Combination setting (NRB_agg) as specified in clause 5.4.2A.1 for the CA Configuration across bandwidth combination sets supported by the UE.				Lowest N <sub>RB_agg</sub> Highest N <sub>RB_agg</sub> (Note 2)			
Test Parameters for CA Configurations							
CA Configuration / N <sub>RB_agg</sub>		DL Allocation	CC MOD	UL Allocation			
PCC N <sub>RB</sub>	SCCs N <sub>RB</sub>	PCC & SCC RB allocation		N <sub>RB_alloc</sub>	PCC & SCC RB allocations (L <sub>CRB</sub> @ RB <sub>start</sub> )		
75	75	N/A for this test	QPSK	150	P_75@0	S_75@0	
100	50		QPSK	150	P_100@0	S_50@0	
100	100		QPSK	200	P_100@0	S_100@0	
Note 1: CA Configuration Test CC Combination settings are checked separately for each CA Configuration, which applicable aggregated channel bandwidths are specified in Table 5.4.2A.1-1.							
Note 2: If in the CA Configuration UE supports multiple CC Combinations with the same N <sub>RB_agg</sub> , only the first of those is tested, according to the order on the Test Configuration Table list.							

1. Connect the SS to the UE antenna connectors as shown in TS 36.508 [7] Annex A, Figure group A.32 as appropriate group A.32 as appropriate.
2. The parameter settings for the cell are set up according to TS 36.508 [7] clause 4.4.3.
3. Downlink signals for PCC are initially set up according to Annex C.0, C.1 and C.3.0, and uplink signals according to Annex H.1 and H.3.0.
4. The UL Reference Measurement channel is set according to Table 6.3.5A.1.1.4.1-1.
5. Propagation conditions are set according to Annex B.0.
6. Ensure the UE is in State 3A-RF according to TS 36.508 [7] clause 5.2A.2. Message contents are defined in clause 6.3.5A.1.1.4.3. Any PDCCH DCI format 0 sent to the UE during the configuration should have TPC command 0dB.

#### 6.3.5A.1.1.4.2 Test procedure

1. Configure SCC according to Annex C.0, C.1 and Annex C.3.0 for all downlink physical channels.
2. The SS shall configure SCC as per TS 36.508 [7] clause 5.2A.4. Message contents for UplinkPowerControlCommonSCell-r10 are defined in tables 6.3.5A.1.1.4.3-2, 6.3.5A.1.1.4.3-4 and 6.3.5A.1.1.4.3-7. Any PDCCH DCI format 0 sent to the UE during the configuration should have TPC command 0dB.
3. SS activates SCC by sending the activation MAC-CE (Refer TS 36.321 [13], clauses 5.13, 6.1.3.8). Wait for at least 2 seconds (Refer TS 36.133, clauses 8.3.3.2).
4. SS sends uplink scheduling information for each UL HARQ process via PDCCH DCI format 0 with TPC command 0dB for C\_RNTI to schedule the UL RMC according to Table 6.3.5A.1.1.4.1-1 on both PCC and SCC. Since the UE has no payload and no loopback data to send the UE sends uplink MAC padding bits on the UL RMC.
5. Measure the initial output power of the first subframe of the UE PUSH first transmission for each component carrier. The transient periods of 20us are excluded.
6. Repeat for the two test points as indicated in section 6.3.5A.1.1.4.3. The timing of the execution between the two test points shall be larger than 20ms.

## 6.3.5A.1.1.4.3 Message contents

Message contents are according to TS 36.508 [7] subclause 4.6 with the following exceptions.

**Table 6.3.5A.1.1.4.3-1: UplinkPowerControlCommon: Test point 1**

Derivation Path: TS 36.508 [7] clause 4.6.3, Table 4.6.3-25 UplinkPowerControlCommon-DEFAULT			
Information Element	Value/remark	Comment	Condition
UplinkPowerControlCommon-DEFAULT ::= SEQUENCE { p0-NominalPUSCH	-105	Test point 1 to verify a UE relative low initial power transmission	

**Table 6.3.5A.1.1.4.3-2: UplinkPowerControlCommonSCell-r10: Test point 1**

Derivation Path: TS 36.508 [7] clause 4.6.3, Table 4.6.3-25A UplinkPowerControlCommonSCell-r10-DEFAULT			
Information Element	Value/remark	Comment	Condition
UplinkPowerControlCommonSCell-r10 ::= SEQUENCE { p0-NominalPUSCH-r10	-105	Test point 1 to verify a UE relative low initial power transmission	

**Table 6.3.5A.1.1.4.3-3: UplinkPowerControlCommon: Test point 2**

Derivation Path: TS 36.508 [7] clause 4.6.3, Table 4.6.3-25 UplinkPowerControlCommon-DEFAULT			
Information Element	Value/remark	Comment	Condition
UplinkPowerControlCommon-DEFAULT ::= SEQUENCE { p0-NominalPUSCH	-93	Test point 2 to verify a UE relative high initial power transmission	

**Table 6.3.5A.1.1.4.3-4: UplinkPowerControlCommonSCell-r10: Test point 2**

Derivation Path: TS 36.508 [7] clause 4.6.3, Table 4.6.3-25A UplinkPowerControlCommonSCell-r10-DEFAULT			
Information Element	Value/remark	Comment	Condition
UplinkPowerControlCommonSCell-r10 ::= SEQUENCE { p0-NominalPUSCH-r10	-93	Test point 2 to verify a UE relative high initial power transmission	

**Table 6.3.5A.1.1.4.3-5: PhysicalConfigDedicated**

Derivation Path: TS 36.508 [7] clause 5.5.1.2, Table 5.5.1.2.1 PhysicalConfigDedicated-DEFAULT			
Information Element	Value/remark	Comment	Condition
PhysicalConfigDedicated-DEFAULT ::= SEQUENCE { uplinkPowerControlDedicated	UplinkPowerControlDedicated-DEFAULT	See subclause 4.6.3	RBC
	UplinkPowerControlDedicated-DEFAULT	See subclause 4.6.3	UL CA

**Table 6.3.5A.1.1.4.3-6: UplinkPowerControlDedicated**

Derivation Path: TS 36.508 [7] clause 4.6.3, Table 4.6.3-26 UplinkPowerControlDedicated-DEFAULT			
Information Element	Value/remark	Comment	Condition
UplinkPowerControlDedicated-DEFAULT ::= SEQUENCE {			
p0-UE-PUSCH	1		RBC
	0		UL CA
}			

## 6.3.5A.1.1.5 Test requirement

For intra-band contiguous carrier aggregation bandwidth class C, the absolute power control tolerance per component carrier measured in step (5) of the test procedure is not to exceed the values specified in Table 6.3.5A.1.1.5-1 and 6.3.5A.1.1.5-2. The test requirement tables are originated from tables 6.3.5.1.5-1 and 6.3.5.1.5-2.

**Table 6.3.5A.1.1.5-1: Absolute power tolerance for intra-band contiguous CA: test point 1**

	Channel bandwidth / expected output power (dBm)					
	1.4 MHz	3.0 MHz	5 MHz	10 MHz	15 MHz	20 MHz
Expected Measured power Normal conditions	-14.8 dBm	-10.8 dBm	-8.6 dBm	-5.6 dBm	-3.9 dBm	-2.6 dBm
Power tolerance f ≤ 3.0GHz 3.0GHz < f ≤ 4.2GHz	± 10.0dB ± 10.4dB	± 10.0dB ± 10.4dB	± 10.0dB ± 10.4dB	± 10.0dB ± 10.4dB	± 10.0dB ± 10.4dB	± 10.0dB ± 10.4dB
Expected Measured power Extreme conditions	-14.8 dBm	-10.8 dBm	-8.6 dBm	-5.6 dBm	-3.9 dBm	-2.6 dBm
Power tolerance f ≤ 3.0GHz 3.0GHz < f ≤ 4.2GHz	± 13.0dB ± 13.4dB	± 13.0dB ± 13.4dB	± 13.0dB ± 13.4dB	± 13.0dB ± 13.4dB	± 13.0dB ± 13.4dB	± 13.0dB ± 13.4dB
Note 1: The lower power limit shall not exceed the minimum output power requirements defined in sub-clause 6.3.2.3						

**Table 6.3.5A.1.1.5-2: Absolute power tolerance for intra-band contiguous CA: test point 2**

	Channel bandwidth / expected output power (dBm)					
	1.4 MHz	3.0 MHz	5 MHz	10 MHz	15 MHz	20 MHz
Expected Measured power Normal conditions	-2.8 dBm	1.2 dBm	3.4 dBm	6.4 dBm	8.2 dBm	9.4 dBm
Power tolerance f ≤ 3.0GHz 3.0GHz < f ≤ 4.2GHz	± 10.0dB ± 10.4dB	± 10.0dB ± 10.4dB	± 10.0dB ± 10.4dB	± 10.0dB ± 10.4dB	± 10.0dB ± 10.4dB	± 10.0dB ± 10.4dB
Expected Measured power Extreme conditions	-2.8 dBm	1.2 dBm	3.4 dBm	6.4 dBm	8.2 dBm	9.4 dBm
Power tolerance f ≤ 3.0GHz 3.0GHz < f ≤ 4.2GHz	± 13.0dB ± 13.4dB	± 13.0dB ± 13.4dB	± 13.0dB ± 13.4dB	± 13.0dB ± 13.4dB	± 13.0dB ± 13.4dB	± 13.0dB ± 13.4dB
Note 1: The lower power limit shall not exceed the minimum output power requirements defined in sub-clause 6.3.2.3						

### 6.3.5A.1.2 Power Control Absolute power tolerance for CA (inter-band DL CA and UL CA)

Editor's notes: This test is incomplete. The following aspects are either missing or not yet determined:

- The initial conditions are not yet defined
- The test description is not yet defined
- The test procedure is not yet defined
- The message contents are not yet defined
- The test requirements are not yet defined

#### 6.3.5A.1.2.1 Test purpose

To verify the ability of the UE transmitter to set its initial output power to a specific value for the first sub-frame at the start of a contiguous transmission or non-contiguous transmission with a transmission gap on each active component carriers larger than 20ms.

#### 6.3.5A.1.2.2 Test applicability

This test applies to all types of E-UTRA UE release 11 and forward that support inter-band DL CA and UL CA.

#### 6.3.5A.1.2.3 Minimum conformance requirements

The absolute power tolerance is the ability of the UE transmitter to set its initial output power to a specific value for the first sub-frame at the start of a contiguous transmission or non-contiguous transmission with a transmission gap on each active component carriers larger than 20ms. The requirement can be tested by time aligning any transmission gaps on the component carriers.

For inter-band carrier aggregation with uplink assigned to two E-UTRA bands, the absolute power control tolerance is specified on each component carrier exceed the minimum output power as defined in subclause 6.3.2A and the total power is limited by maximum output as defined in subclause 6.2.2A. The requirements defined in Table 6.3.5A.1.2.3-1 shall apply on each component carrier with both component carriers active. The requirements can be tested by time aligning any transmission gaps on both the component carriers.

The requirements apply for one single PUCCH, PUSCH or SRS transmission of contiguous PRB allocation per component carrier.

**Table 6.3.5A.1.2.3-1: Absolute power tolerance for inter-band DL CA and UL CA**

Conditions	Tolerance
Normal conditions	$\pm 9.0$ dB
Extreme conditions	$\pm 12.0$ dB

The normative reference for this requirement is TS 36.101 [2] clause 6.3.5A.1.

#### 6.3.5A.1.2.4 Test description

##### 6.3.5A.1.2.4.1 Initial conditions

TBD

##### 6.3.5A.1.2.4.2 Test procedure

TBD

##### 6.3.5A.1.2.4.3 Message contents

TBD

## 6.3.5A.1.2.5 Test requirement

TBD

## 6.3.5A.1.3 Power Control Absolute power tolerance for CA (intra-band non-contiguous DL CA and UL CA)

Editor's notes: This test is incomplete. The following aspects are either missing or not yet determined:

- The test description is not yet defined
- The initial conditions are not yet defined
- The test procedure is not yet defined
- The message contents are not yet defined
- The test requirements are not yet defined

## 6.3.5A.1.3.1 Test purpose

To verify the ability of the UE transmitter to set its initial output power to a specific value for the first sub-frame at the start of a contiguous transmission or non-contiguous transmission with a transmission gap on each active component carriers larger than 20ms.

## 6.3.5A.1.3.2 Test applicability

This test applies to all types of E-UTRA UE release 11 and forward that support intra-band non-contiguous DL CA and UL CA.

## 6.3.5A.1.3.3 Minimum conformance requirements

The absolute power tolerance is the ability of the UE transmitter to set its initial output power to a specific value for the first sub-frame at the start of a contiguous transmission or non-contiguous transmission with a transmission gap on each active component carriers larger than 20ms. The requirement can be tested by time aligning any transmission gaps on the component carriers.

For intra-band non-contiguous carrier aggregation the absolute power control tolerance per component carrier is given in Table 6.3.5A.1.3.3-1.

The requirements apply for one single PUCCH, PUSCH or SRS transmission of contiguous PRB allocation per component carrier.

**Table 6.3.5A.1.3.3-1: Absolute power tolerance for intra-band non-contiguous DL CA and UL CA**

Conditions	Tolerance
Normal conditions	$\pm 9.0$ dB
Extreme conditions	$\pm 12.0$ dB

The normative reference for this requirement is TS 36.101 [2] clause 6.3.5A.1.

## 6.3.5A.1.3.4 Test description

## 6.3.5A.1.3.4.1 Initial conditions

TBD

## 6.3.5A.1.3.4.2 Test procedure

TBD

6.3.5A.1.3.4.3 Message contents

TBD

6.3.5A.1.3.5 Test requirement

TBD

## 6.3.5A.2 Power Control Relative power tolerance for CA

6.3.5A.2.1 Power Control Relative power tolerance for CA (intra-band contiguous DL CA and UL CA)

*Editor's notes: This test is incomplete. The following aspects are either missing or not yet determined:*

- *The uncertainties, Test Tolerances and setting margins shown as [FFS]dB in the Test Procedure are undefined.*
- *The way to test the scenario when both carriers change power simultaneously*
- *The Test coverage defined by the Test Configuration Table is to be reviewed.*

6.3.5A.2.1.1 Test purpose

To verify the ability of the UE transmitter to change the output power in both assigned component carrier in the uplink with a defined power step sizes between sub-frames on the two respective component carrier.

6.3.5A.2.1.2 Test applicability

This test applies to all types of E-UTRA UE release 10 and forward that support intra-band contiguous DL CA and UL CA.

6.3.5A.2.1.3 Minimum conformance requirement

The requirements apply when the power of the target and reference sub-frames on each component carrier exceed -20 dBm and the total power is limited by  $P_{UMAX}$  as defined in TS 36.101 [2] subclause 6.2.5A. For the purpose of these requirements, the power in each component carrier is specified over only the transmitted resource blocks .

For intra-band contiguous carrier aggregation bandwidth class C, the UE shall meet the following requirements for transmission on both assigned component carriers when the average transmit power per PRB is aligned across both assigned carriers in the reference sub-frame:

- a) for all possible combinations of PUSCH and PUCCH transitions per component carrier, the corresponding requirements given in Table 6.3.5A.2.1.3-1
- b) For SRS transitions on each component carrier, the requirements for combinations of PUSCH/PUCCH and SRS transitions given in Table 6.3.5A.2.1.3-1 with simultaneous SRS of constant SRS bandwidth allocated in the target and reference subframes
- c) For RACH on the primary component carrier, the requirements given in Table 6.3.5A.2.1.3-1 for PRACH

For a) and b) above, the power step  $\Delta P$  between the reference and target subframes shall be set by a TPC command and/or an uplink scheduling grant transmitted by means of an appropriate DCI Format.

For a), b) and c) above, two exceptions are allowed for each component carrier for a power per carrier ranging from -20 dBm to  $P_{UMAX,c}$  as defined in TS 36.101 [2] subclause 6.2.5. For these exceptions the power tolerance limit is  $\pm 6.0$  dB in Table 6.3.5A.2.1.3-1.

**Table 6.3.5A.2.1.3-1: Relative Power Tolerance for Transmission (normal conditions)**

Power step $\Delta P$ (Up or down) [dB]	All combinations of PUSCH and PUCCH transitions [dB]	All combinations of PUSCH/PUCCH and SRS transitions between sub- frames [dB]	PRACH [dB]
$\Delta P < 2$	$\pm 2.5$ (Note 3)	$\pm 3.0$	$\pm 2.5$
$2 \leq \Delta P < 3$	$\pm 3.0$	$\pm 4.0$	$\pm 3.0$
$3 \leq \Delta P < 4$	$\pm 3.5$	$\pm 5.0$	$\pm 3.5$
$4 \leq \Delta P \leq 10$	$\pm 4.0$	$\pm 6.0$	$\pm 4.0$
$10 \leq \Delta P < 15$	$\pm 5.0$	$\pm 8.0$	$\pm 5.0$
$15 \leq \Delta P$	$\pm 6.0$	$\pm 9.0$	$\pm 6.0$
<p>Note 1: For extreme conditions an additional <math>\pm 2.0</math> dB relaxation is allowed</p> <p>Note 2: For operating bands under Note 2 in Table 6.2.2.3-1, the relative power tolerance is relaxed by increasing the upper limit by 1.5 dB if the transmission bandwidth of the reference sub-frames is confined within <math>F_{UL\_low}</math> and <math>F_{UL\_low} + 4</math> MHz or <math>F_{UL\_high} - 4</math> MHz and <math>F_{UL\_high}</math> and the target sub-frame is not confined within any one of these frequency ranges; if the transmission bandwidth of the target sub-frame is confined within <math>F_{UL\_low}</math> and <math>F_{UL\_low} + 4</math> MHz or <math>F_{UL\_high} - 4</math> MHz and <math>F_{UL\_high}</math> and the reference sub-frame is not confined within any one of these frequency ranges, then the tolerance is relaxed by reducing the lower limit by 1.5 dB.</p> <p>Note 3: For PUSCH to PUSCH transitions with the allocated resource blocks fixed in frequency and no transmission gaps other than those generated by downlink subframes, DwPTS fields or Guard Periods for TDD: for a power step <math>\Delta P \leq 1</math> dB, the relative power tolerance for transmission is <math>\pm 1.0</math> dB.</p>			

The power step ( $\Delta P$ ) is defined as the difference in the calculated setting of the UE Transmit power between the target and reference sub-frames with the power setting according to Clause 5.1 of TS 36.213 [10]. The error is the difference between  $\Delta P$  and the power change measured at the UE antenna port with the power of the cell-specific reference signals kept constant. The error shall be less than the relative power tolerance specified in Table 6.3.5A.2.1.3-1.

For sub-frames not containing an SRS symbol, the power change is defined as the relative power difference between the mean power of the original reference sub-frame and the mean power of the target subframe not including transient durations. The mean power of successive sub-frames shall be calculated according to TS 36.101 [2] Figure 6.3.4.3-1 and TS 36.101 [2] Figure 6.3.4.1-1 if there is a transmission gap between the reference and target sub-frames.

The normative reference for this requirement is TS 36.101 [2] clause 6.3.5A.2.

#### 6.3.5A.2.1.4 Test description

##### 6.3.5A.2.1.4.1 Initial conditions

Initial conditions are a set of test configurations the UE needs to be tested in and the steps for the SS to take with the UE to reach the correct measurement state.

The initial test configurations consist of environmental conditions, test frequencies, and CC combinations based on E-UTRA CA configurations specified in table 5.4.2A.1-1. All of these configurations shall be tested with applicable test parameters for each CA Configuration, and are shown in table 6.3.5A.2.1.4.1-1. The details of the uplink reference measurement channels (RMCs) are specified in Annex A.2. Configurations of PDSCH and PDCCH before measurement are specified in Annex C.2.



Table 6.3.5A.2.1.4.1-1: Test Configuration Table

Initial Conditions									
Test Environment as specified in TS 36.508[7] clause 4.1					Normal				
Test Frequencies as specified in TS 36.508 [7] clause [4.3.1] for different CA bandwidth classes, and PCC and SCCs are mapped onto physical frequencies according to Table 6.1-2.					C: Mid range				
Test CC Combination setting (NRB_agg) as specified in clause 5.4.2A.1 for the CA Configuration across bandwidth combination sets supported by the UE.					[FFS]				
Test Parameters for CA Configurations									
CA Configuration / N <sub>RB_agg</sub>		DL Allocation		CC MOD	UL Allocation				
PCC N <sub>RB</sub>	SCCs N <sub>RB</sub>	PCC & SCC RB allocation			N <sub>RB_alloc</sub>	PCC & SCC RB allocations (L <sub>CRB</sub> @ RB <sub>start</sub> )			
75	75	N/A for this test		QPSK	[FFS]	[FFS]	[FFS]	-	-
100	50			QPSK	[FFS]	[FFS]	[FFS]	-	-
100	100			QPSK	[FFS]	[FFS]	[FFS]	-	-
Note 1: CA Configuration Test CC Combination settings are checked separately for each CA Configuration, which applicable aggregated channel bandwidths are specified in Table 5.4.2A.1-1									

1. Connect the SS to the UE antenna connectors as shown in TS 36.508 [7] Annex A, Figure group A.32 as appropriate.
2. The parameter settings for the cell are set up according to TS 36.508 [7] clause 4.4.3.
3. Downlink signals for PCC are initially set up according to Annex C.0, C.1 and C.3.0, and uplink signals according to Annex H.1 and H.3.0.
4. The UL Reference Measurement channel is set according to table 6.3.5A.2.1.4.1-1
5. Propagation conditions are set according to Annex B.0.
6. Ensure the UE is in State 3A-RF according to TS 36.508 [7] clause 5.2A.2. Message contents are defined in clause 6.3.5A.2.1.4.3.

#### 6.3.5A.2.1.4.2 Test procedure

1. Configure SCC according to Annex C.0, C.1 and Annex C.3.0 for all downlink physical channels.
2. The SS shall configure SCC as per TS 36.508 [7] clause 5.2A.4.
3. SS activates SCC by sending the activation MAC-CE (Refer TS 36.321 [13], clauses 5.13, 6.1.3.8). Wait for at least 2 seconds (Refer TS 36.133, clause 8.3.3.2).
4. The procedure is separated in various subtests to verify different aspects of relative power control. The power changes of the subtests are shown by diagrams in the Test Procedure.
5. Sub test: SCC power increase
  - 5.1. SS sends uplink scheduling information for each UL HARQ process via PDCCH DCI format 0 for C<sub>RNTI</sub> to schedule the UL RMC according to A.2.2.2.1-1 (FDD) or Table A.2.3.2.1-1 (TDD) on both PCC and SCC. Since the UE has no payload and no loopback data to send the UE sends uplink MAC padding bits on the UL RMC. Send the appropriate TPC commands for PUSCH on each component carrier to the UE to ensure that the UE transmits PUSCH on the PCC and on the SCC with powers nearest to PCC<sub>RefSet, 0</sub> and SCC<sub>RefSet, 0</sub> respectively, as defined in Table 6.3.5A.2.1.4.2-1. The powers and allocations are chosen so the average transmit power per PRB is aligned across both assigned carriers in the reference sub-frame. In the target subframe the SCC allocation is increased, and the corresponding power increase is measured.

**Table 6.3.5A.2.1.4.2-1: Power settings and RB allocations for SCC power increase, step n=0**

PCC		SCC	
Parameter	Value	Parameter	Value
<b>Reference subframe</b>			
$PCC_{RefSet, 0}$ , dBm/ $N_{RB\ alloc}$	$(SCC_{RefSet, 0}) + 7$	$SCC_{RefSet, 0}$ , dBm/ $N_{RB\ alloc}$	-17
PCC allocation, $N_{RB\ alloc}$	5	SCC allocation, $N_{RB\ alloc}$	1
Measured power, dBm/ $N_{RB\ alloc}$	$PCC_{RefMeas, 0}$	Measured power, dBm/ $N_{RB\ alloc}$	$SCC_{RefMeas, 0}$
<b>Target subframe</b>			
$PCC_{TargetSet, 0}$ , dBm/ $N_{RB\ alloc}$	$(SCC_{RefSet, 0}) + 7$	$SCC_{TargetSet, 0}$ , dBm/ $N_{RB\ alloc}$	$(SCC_{RefSet, 0}) + 9$
PCC allocation, $N_{RB\ alloc}$	5	SCC allocation, $N_{RB\ alloc}$	8
Measured power, dBm/ $N_{RB\ alloc}$	$PCC_{TargetMeas, 0}$	Measured power, dBm/ $N_{RB\ alloc}$	$SCC_{TargetMeas, 0}$

- 5.2. For the PCC, calculate the change in power as  $(PCC_{TargetMeas, n} - PCC_{RefMeas, n})$  and compare to the PCC Test requirement specified in Table 6.3.5A.2.1.5-1. If the result meets the normal Test requirement, continue to step 5.3. If the result does not meet the normal Test requirement but meets the exception Test requirement, increment the PCC exception counter by 1 and continue to step 5.3. Otherwise, fail the UE for this subtest.
- 5.3. For the SCC, calculate the change in power as  $(SCC_{TargetMeas, n} - SCC_{RefMeas, n})$  and compare to the SCC Test requirement specified in Table 6.3.5A.2.1.5-1. If the result meets the normal Test requirement, continue to step 5.4. If the result does not meet the normal Test requirement but meets the exception Test requirement, increment the SCC exception counter by 1 and continue to step 5.4. Otherwise, fail the UE for this subtest.
- 5.4. Calculate the Total uplink power across both CCs in dBm as  $10\log_{10}((PCC_{TargetMeas, n} \text{ in mW}) + (SCC_{TargetMeas, n} \text{ in mW}))$ . If  $(P_{UMAX} - \text{Total uplink power}) > [FFS]dB$ , continue to step 5.5. Otherwise, go to step 5.6.
- 5.5. Send the appropriate TPC commands for PUSCH on each component carrier to the UE to ensure that the UE transmits PUSCH on the PCC and on the SCC with powers nearest to  $PCC_{RefSet, n+1}$  and  $SCC_{RefSet, n+1}$  respectively, as defined in Table 6.3.5A.2.1.4.2-2, Repeat steps 5.2 to 5.4.

**Table 6.3.5A.2.1.4.2-2: Power settings and RB allocations for SCC power increase, step n+1**

PCC		SCC	
Parameter	Value	Parameter	Value
<b>Reference subframe</b>			
$PCC_{RefSet, n+1}$ , dBm/ $N_{RB\ alloc}$	$(SCC_{RefSet, n+1}) + 7$	$SCC_{RefSet, n+1}$ , dBm/ $N_{RB\ alloc}$	$(SCC_{RefSet, n} + (SCC_{TargetMeas, n} - SCC_{RefMeas, n}) + [FFS]dB)$
PCC allocation, $N_{RB\ alloc}$	5	SCC allocation, $N_{RB\ alloc}$	1
Measured power, dBm/ $N_{RB\ alloc}$	$PCC_{RefMeas, n+1}$	Measured power, dBm/ $N_{RB\ alloc}$	$SCC_{RefMeas, n+1}$
<b>Target subframe</b>			
$PCC_{TargetSet, n+1}$ , dBm/ $N_{RB\ alloc}$	$(SCC_{RefSet, n+1}) + 7$	$SCC_{TargetSet, n+1}$ , dBm/ $N_{RB\ alloc}$	$(SCC_{RefSet, n+1}) + 9$
PCC allocation, $N_{RB\ alloc}$	5	SCC allocation, $N_{RB\ alloc}$	8
Measured power, dBm/ $N_{RB\ alloc}$	$PCC_{TargetMeas, n+1}$	Measured power, dBm/ $N_{RB\ alloc}$	$SCC_{TargetMeas, n+1}$

- 5.6. If the PCC exception counter is  $\leq 2$  and the SCC exception counter is  $\leq 2$ , and the requirements specified in Table 6.3.5A.2.1.5-1 are all met, pass the UE for this subtest.

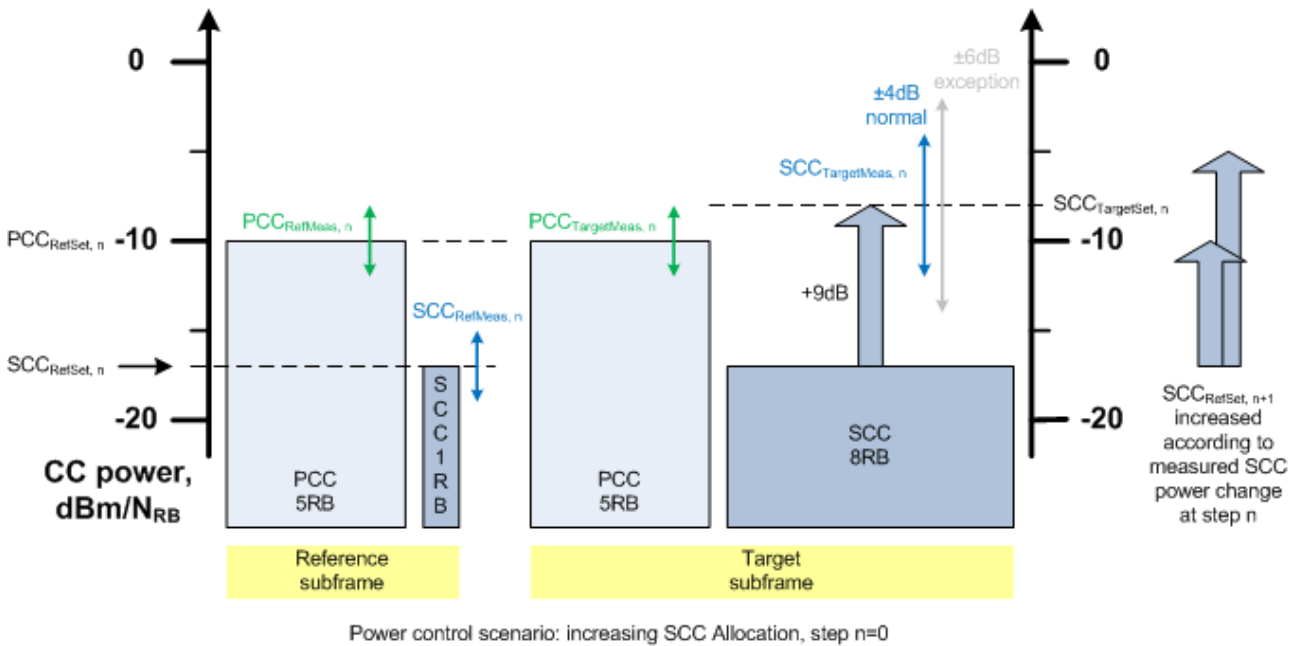

**Figure 6.3.5A.2.1.4.2-1: SCC power increase**

6. Sub test: SCC power decrease

6.1. SS sends uplink scheduling information for each UL HARQ process via PDCCH DCI format 0 for C\_RNTI to schedule the UL RMC according to Table A.2.2.2.1-1 (FDD) or Table A.2.3.2.1-1 (TDD) on both PCC and SCC. Since the UE has no payload and no loopback data to send the UE sends uplink MAC padding bits on the UL RMC. Send the appropriate TPC commands for PUSCH on each component carrier to the UE to ensure that the UE transmits PUSCH on the PCC and on the SCC with powers nearest to  $PCC_{RefSet,0}$  and  $SCC_{RefSet,0}$  respectively, as defined in Table 6.3.5A.2.1.4.2-3. The powers and allocations are chosen so the average transmit power per PRB is aligned across both assigned carriers in the reference sub-frame. In the target subframe the SCC allocation is decreased, and the corresponding power decrease is measured.

**Table 6.3.5A.2.1.4.2-3: Power settings and RB allocations for SCC power decrease, step n=0**

PCC		SCC	
Parameter	Value	Parameter	Value
<b>Reference subframe</b>			
$PCC_{RefSet,0}$ , dBm/ $N_{RB}$ alloc	$(SCC_{RefSet,0}) - 2$	$SCC_{RefSet,0}$ , dBm/ $N_{RB}$ alloc	$P_{UMAX} - 5$
PCC allocation, $N_{RB}$ alloc	5	SCC allocation, $N_{RB}$ alloc	8
Measured power, dBm/ $N_{RB}$ alloc	$PCC_{RefMeas,0}$	Measured power, dBm/ $N_{RB}$ alloc	$SCC_{RefMeas,0}$
<b>Target subframe</b>			
$PCC_{TargetSet,0}$ , dBm/ $N_{RB}$ alloc	$(SCC_{RefSet,0}) - 2$	$SCC_{TargetSet,0}$ , dBm/ $N_{RB}$ alloc	$(SCC_{RefSet,0}) - 9$
PCC allocation, $N_{RB}$ alloc	5	SCC allocation, $N_{RB}$ alloc	1
Measured power, dBm/ $N_{RB}$ alloc	$PCC_{TargetMeas,0}$	Measured power, dBm/ $N_{RB}$ alloc	$SCC_{TargetMeas,0}$

6.2. For the PCC, calculate the change in power as  $(PCC_{TargetMeas,n} - PCC_{RefMeas,n})$  and compare to the PCC Test requirement specified in Table 6.3.5A.2.1.5-2. If the result meets the normal Test requirement, continue to step 6.3. If the result does not meet the normal Test requirement but meets the exception Test requirement, increment the PCC exception counter by 1 and continue to step 6.3, Otherwise, fail the UE for this subtest.

- 6.3. For the SCC, calculate the change in power as  $(SCC_{TargetMeas, n} - SCC_{RefMeas, n})$  and compare to the SCC Test requirement specified in Table 6.3.5A.2.1.5-2. If the result meets the normal Test requirement, continue to step 6.4. If the result does not meet the normal Test requirement but meets the exception Test requirement, increment the SCC exception counter by 1 and continue to step 6.4, Otherwise, fail the UE for this subtest.
- 6.4. If the uplink (power for each CC – (-20dBm)) is  $> [FFS]dB$ , continue to step 6.5. Otherwise, go to step 6.6.
- 6.5. Send the appropriate TPC commands for PUSCH on each component carrier to the UE to ensure that the UE transmits PUSCH on the PCC and on the SCC with powers nearest to  $PCC_{RefSet, n+1}$  and  $SCC_{RefSet, n+1}$  respectively, as defined in Table 6.3.5A.2.1.4.2-4, Repeat steps 6.2 to 6.4.

**Table 6.3.5A.2.1.4.2-4: Power settings and RB allocations for SCC power decrease, step n+1**

PCC		SCC	
Parameter	Value	Parameter	Value
<b>Reference subframe</b>			
$PCC_{RefSet, n+1}$ , dBm/ $N_{RB alloc}$	$(SCC_{RefSet, n+1}) - 2$	$SCC_{RefSet, n+1}$ , dBm/ $N_{RB alloc}$	$(SCC_{RefSet, n} + (SCC_{TargetMeas, n} - SCC_{RefMeas, n}) - [FFS]dB)$
PCC allocation, $N_{RB alloc}$	5	SCC allocation, $N_{RB alloc}$	8
Measured power, dBm/ $N_{RB alloc}$	$PCC_{RefMeas, n+1}$	Measured power, dBm/ $N_{RB alloc}$	$SCC_{RefMeas, n+1}$
<b>Target subframe</b>			
$PCC_{TargetSet, n+1}$ , dBm/ $N_{RB alloc}$	$(SCC_{RefSet, n+1}) - 2$	$SCC_{TargetSet, n+1}$ , dBm/ $N_{RB alloc}$	$(SCC_{RefSet, n+1}) - 9$
PCC allocation, $N_{RB alloc}$	5	SCC allocation, $N_{RB alloc}$	1
Measured power, dBm/ $N_{RB alloc}$	$PCC_{TargetMeas, n+1}$	Measured power, dBm/ $N_{RB alloc}$	$SCC_{TargetMeas, n+1}$

- 6.6. If the PCC exception counter is  $\leq 2$  and the SCC exception counter is  $\leq 2$ , and the requirements specified in Table 6.3.5A.2.1.5-2 are all met, pass the UE for this subtest.

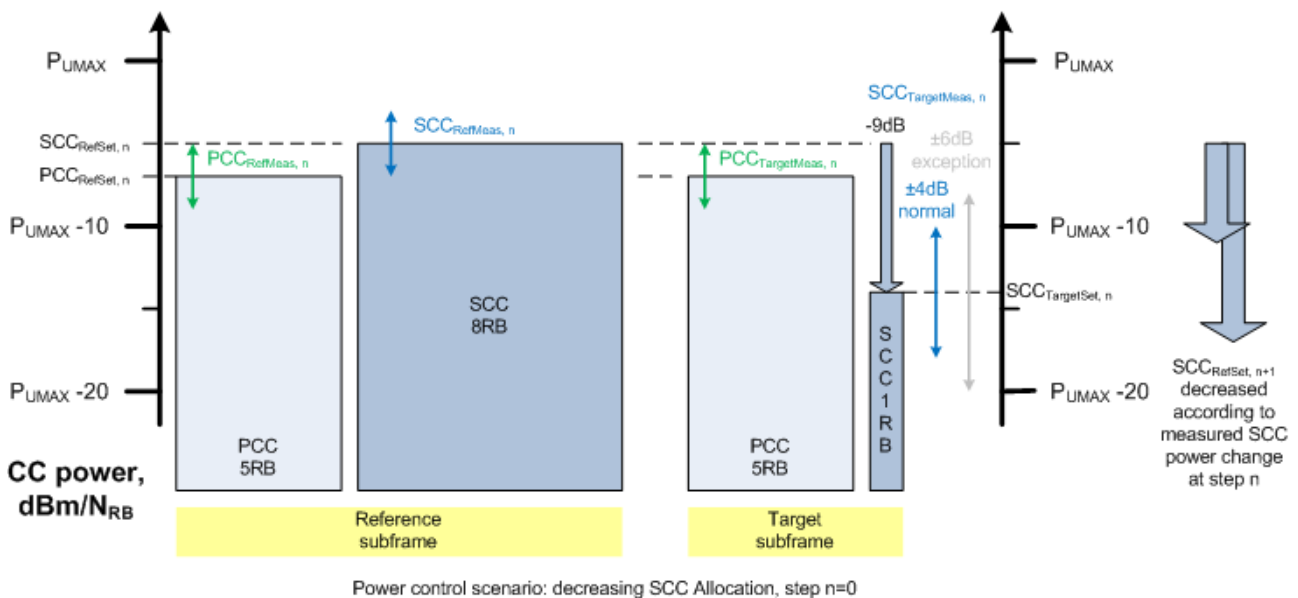

**Figure 6.3.5A.2.1.4.2-2: SCC power decrease**

- 7. Sub test: PCC and SCC power increase together
- 7.1. [Placeholder for Test Procedure steps]

## 6.3.5A.2.1.4.3 Message contents

Message contents are according to TS 36.508 [7] subclause 4.6.

## 6.3.5A.2.1.5 Test requirement

For intra-band contiguous carrier aggregation bandwidth class C, the relative power control tolerance per component carrier measured in steps 5, 6, 7 and 8 of the test procedure should satisfy the applicable test requirements specified in Tables 6.3.5A.2.1.5-1 to 6.3.5A.2.1.5-[FFS] for normal conditions.

To account for RF Power amplifier mode changes 2 exceptions are allowed for each subtest, and are counted during the Test Procedure.

**Table 6.3.5A.2.1.5-1: Test requirements for SCC power increase**

Parameter	Condition	Unit	Minimum	Maximum
$(PCC_{TargetMeas, n} - PCC_{RefMeas, n})$	Normal	dB	-1dB -TT	+1dB +TT
	Exception	dB	-6dB -TT	+6dB +TT
$(SCC_{TargetMeas, n} - SCC_{RefMeas, n})$	Normal	dB	+5dB -TT	+13dB +TT
	Exception	dB	+3dB -TT	+15dB +TT

**Table 6.3.5A.2.1.5-2: Test requirements for SCC power decrease**

Parameter	Condition	Unit	Minimum	Maximum
$(PCC_{TargetMeas, n} - PCC_{RefMeas, n})$	Normal	dB	-1dB -TT	+1dB +TT
	Exception	dB	-6dB -TT	+6dB +TT
$(SCC_{TargetMeas, n} - SCC_{RefMeas, n})$	Normal	dB	-13dB -TT	-5dB +TT
	Exception	dB	-15dB -TT	-3dB +TT

**Table 6.3.5A.2.1.5-3: Test requirements for PCC and SCC power increase together**  
[FFS]

## 6.3.5A.2.2 Power Control Relative power tolerance for CA (inter-band DL CA and UL CA)

Editor's notes: This test is incomplete. The following aspects are either missing or not yet determined:

- The test description is not yet defined
- The initial conditions are not yet defined
- The test procedure is not yet defined
- The message contents are not yet defined
- The test requirements are not yet defined
- For the nature and the value of the PRB power dB in the minimum conformance paragraph the alignment ( $\pm$  [2]) between the two UL component carriers need to be further clarified and confirmed by RAN4.

## 6.3.5A.2.2.1 Test purpose

To verify the ability of the UE transmitter to change the output power in both assigned component carrier in the uplink with a defined power step sizes between sub-frames on the two respective component carrier.

## 6.3.5A.2.2.2 Test applicability

This test applies to all types of E-UTRA UE release 11 and forward that support inter-band DL CA and UL CA.

## 6.3.5A.2.2.3 Minimum conformance requirement

The requirements apply when the power of the target and reference sub-frames on each component carrier exceed the minimum output power as defined in subclause 6.3.2A and the total power is limited by  $P_{UMAX}$  as defined in subclause 6.2.5A.

For inter-band carrier aggregation, the UE transmitter shall have the capability of changing the output power in both assigned component carrier in the uplink with a step sizes of  $\Delta P$  between subframes on the two respective component carrier as follows:

- a) The requirements for all combinations of PUSCH and PUCCH transitions per component carrier is given in Table 6.3.5A.2.2.3-1, when the average transmit power per PRB for the transmission on the assigned carriers are aligned to within  $\pm[2]$  dB in the reference sub-frame and the target subframe after the transition;
- b) For SRS the requirements for combinations of PUSCH/PUCCH and SRS transitions between sub-frames given in Table 6.3.5A.2.2.3-1 apply per component carrier when the target and reference subframes are configured for either simultaneous SRS or simultaneous PUSCH and with the average transmit power per PRB for the transmissions on the assigned carrier aligned to within  $\pm[2]$  dB in the reference sub-frame and the target subframe after the transition;
- c) For RACH the requirements apply for the primary cell and are given in Table 6.3.5A.2.2.3-1.

**Table 6.3.5A.2.2.3-1: Relative Power Tolerance for Transmission (normal conditions)**

Power step $\Delta P$ (Up or down) [dB]	All combinations of PUSCH and PUCCH transitions [dB]	All combinations of PUSCH/PUCCH and SRS transitions between sub- frames [dB]	PRACH [dB]
$\Delta P < 2$	$\pm 2.5$ (Note 3)	$\pm 3.0$	$\pm 2.5$
$2 \leq \Delta P < 3$	$\pm 3.0$	$\pm 4.0$	$\pm 3.0$
$3 \leq \Delta P < 4$	$\pm 3.5$	$\pm 5.0$	$\pm 3.5$
$4 \leq \Delta P \leq 10$	$\pm 4.0$	$\pm 6.0$	$\pm 4.0$
$10 \leq \Delta P < 15$	$\pm 5.0$	$\pm 8.0$	$\pm 5.0$
$15 \leq \Delta P$	$\pm 6.0$	$\pm 9.0$	$\pm 6.0$
Note 1: For extreme conditions an additional $\pm 2.0$ dB relaxation is allowed. Note 2: For operating bands under Note 2 in Table 6.2.2.3-1, the relative power tolerance is relaxed by increasing the upper limit by 1.5 dB if the transmission bandwidth of the reference sub-frames is confined within $F_{UL\_low}$ and $F_{UL\_low} + 4$ MHz or $F_{UL\_high} - 4$ MHz and $F_{UL\_high}$ and the target sub-frame is not confined within any one of these frequency ranges; if the transmission bandwidth of the target sub-frame is confined within $F_{UL\_low}$ and $F_{UL\_low} + 4$ MHz or $F_{UL\_high} - 4$ MHz and $F_{UL\_high}$ and the reference sub-frame is not confined within any one of these frequency ranges, then the tolerance is relaxed by reducing the lower limit by 1.5 dB. Note 3: For PUSCH to PUSCH transitions with the allocated resource blocks fixed in frequency and no transmission gaps other than those generated by downlink subframes, DwPTS fields or Guard Periods for TDD: for a power step $\Delta P \leq 1$ dB, the relative power tolerance for transmission is $\pm 1.0$ dB.			

The power step ( $\Delta P$ ) is defined as the difference in the calculated setting of the UE Transmit power between the target and reference sub-frames with the power setting according to Clause 5.1 of TS 36.213. The error is the difference between  $\Delta P$  and the power change measured at the UE antenna port with the power of the cell-specific reference signals kept constant. The error shall be less than the relative power tolerance specified in Table 6.3.5A.2.2.3-1.

The normative reference for this requirement is TS 36.101 clause 6.3.5A.2.

6.3.5A.2.2.4	Test description
6.3.5A.2.2.4.1	Initial conditions
TBD	
6.3.5A.2.2.4.2	Test procedure
TBD	
6.3.5A.2.2.4.3	Message contents
TBD	
6.3.5A.2.2.5	Test requirement
TBD	
6.3.5A.2.3	Power Control Relative power tolerance for CA (intra-band non-contiguous DL CA and UL CA)

Editor's notes: This test is incomplete. The following aspects are either missing or not yet determined:

- The test description is not yet defined
- The initial conditions are not yet defined
- The test procedure is not yet defined
- The message contents are not yet defined
- The test requirements are not yet defined
- For the nature and the value of the PRB power dB in the minimum conformance paragraph the alignment ( $\pm [2]$ ) between the two UL component carriers need to be further clarified and confirmed by RAN4.

#### 6.3.5A.2.3.1 Test purpose

To verify the ability of the UE transmitter to change the output power in both assigned component carrier in the uplink with a defined power step sizes between sub-frames on the two respective component carrier.

#### 6.3.5A.2.3.2 Test applicability

This test applies to all types of E-UTRA UE release 11 and forward that support intra-band non-contiguous DL CA and UL CA.

#### 6.3.5A.2.3.3 Minimum conformance requirement

The requirements apply when the power of the target and reference sub-frames on each component carrier exceed the minimum output power as defined in subclause 6.3.2A and the total power is limited by  $P_{UMAX}$  as defined in subclause 6.2.5A.

For intra-band non-contiguous carrier aggregation, the UE transmitter shall have the capability of changing the output power in both assigned component carrier in the uplink with a step sizes of  $\Delta P$  between the reference and target subframes as follows:

- a) The requirements for all combinations of PUSCH and PUCCH transitions per component carrier is given in Table 6.3.5A.2.3.3-1, when the average transmit power per PRB for the transmission on the assigned carriers are aligned to within  $\pm[2]$  dB in the reference sub-frame and the target subframe after the transition;
- b) For SRS the requirements for combinations of PUSCH/PUCCH and SRS transitions given in Table 6.3.5A.2.3.3-1 with simultaneous SRS of constant SRS bandwidth allocated in the target and reference subframes and with the

average transmit power per PRB for the transmissions on the assigned carrier aligned to within  $\pm[2]$  dB in the reference sub-frame and the target subframe after the transition;

- c) For RACH the requirements apply for the primary cell and are given in Table 6.3.5A.2.3.3-1.

**Table 6.3.5A.2.3.3-1: Relative Power Tolerance for Transmission (normal conditions)**

Power step $\Delta P$ (Up or down) [dB]	All combinations of PUSCH and PUCCH transitions [dB]	All combinations of PUSCH/PUCCH and SRS transitions between sub- frames [dB]	PRACH [dB]
$\Delta P < 2$	$\pm 2.5$ (Note 3)	$\pm 3.0$	$\pm 2.5$
$2 \leq \Delta P < 3$	$\pm 3.0$	$\pm 4.0$	$\pm 3.0$
$3 \leq \Delta P < 4$	$\pm 3.5$	$\pm 5.0$	$\pm 3.5$
$4 \leq \Delta P \leq 10$	$\pm 4.0$	$\pm 6.0$	$\pm 4.0$
$10 \leq \Delta P < 15$	$\pm 5.0$	$\pm 8.0$	$\pm 5.0$
$15 \leq \Delta P$	$\pm 6.0$	$\pm 9.0$	$\pm 6.0$
Note 1:	For extreme conditions an additional $\pm 2.0$ dB relaxation is allowed		
Note 2:	For operating bands under Note 2 in Table 6.2.2.3-1, the relative power tolerance is relaxed by increasing the upper limit by 1.5 dB if the transmission bandwidth of the reference sub-frames is confined within $F_{UL\_low}$ and $F_{UL\_low} + 4$ MHz or $F_{UL\_high} - 4$ MHz and $F_{UL\_high}$ and the target sub-frame is not confined within any one of these frequency ranges; if the transmission bandwidth of the target sub-frame is confined within $F_{UL\_low}$ and $F_{UL\_low} + 4$ MHz or $F_{UL\_high} - 4$ MHz and $F_{UL\_high}$ and the reference sub-frame is not confined within any one of these frequency ranges, then the tolerance is relaxed by reducing the lower limit by 1.5 dB.		
Note 3:	For PUSCH to PUSCH transitions with the allocated resource blocks fixed in frequency and no transmission gaps other than those generated by downlink subframes, DwPTS fields or Guard Periods for TDD: for a power step $\Delta P \leq 1$ dB, the relative power tolerance for transmission is $\pm 1.0$ dB.		

The power step ( $\Delta P$ ) is defined as the difference in the calculated setting of the UE Transmit power between the target and reference sub-frames with the power setting according to Clause 5.1 of TS 36.213. The error is the difference between  $\Delta P$  and the power change measured at the UE antenna port with the power of the cell-specific reference signals kept constant. The error shall be less than the relative power tolerance specified in Table 6.3.5A.2.3.3-1.

The normative reference for this requirement is TS 36.101 clause 6.3.5A.2.

6.3.5A.2.3.4 Test description

6.3.5A.2.3.4.1 Initial conditions

TBD

6.3.5A.2.3.4.2 Test procedure

TBD

6.3.5A.2.3.4.3 Message contents

TBD

6.3.5A.2.3.5 Test requirement

TBD



### 6.3.5A.3 Aggregate power control tolerance for CA

#### 6.3.5A.3.1 Aggregate power control tolerance for CA (intra-band contiguous DL CA and UL CA)

##### 6.3.5A.3.1.1 Test purpose

To verify the ability of a UE to maintain its power in non-contiguous transmission within 21 ms in response to 0 dB TPC commands with respect to the first UE transmission, when the power control parameters specified in [TS 36.213] are constant on all active component carriers.

##### 6.3.5A.3.1.2 Test applicability

This test applies to all types of E-UTRA UE release 10 and forward that support intra-band contiguous DL CA and UL CA.

##### 6.3.5A.3.1.3 Minimum conformance requirements

For intra-band contiguous carrier aggregation bandwidth class C, the aggregate power tolerance per component carrier is given in Table 6.3.5A.3.1.3-1 with simultaneous PUCCH and PUSCH configured if supported. The requirement can be tested with the transmission gaps time aligned between component carriers.

**Table 6.3.5A.3.1.3-1: Aggregate power control tolerance for intra-band contiguous CA**

TPC command	UL channel	Aggregate power tolerance within 21 ms
0 dB	PUCCH	$\pm 2.5$ dB
0 dB	PUSCH	$\pm 3.5$ dB
NOTE: The UE transmission gap is 4 ms. TPC command is transmitted via PDCCH 4 subframes preceding each PUCCH/PUSCH transmission.		

The normative reference for this requirement is TS 36.101 [2] clause 6.3.5A.3.1.

##### 6.3.5A.3.1.4 Test description

###### 6.3.5A.3.1.4.1 Initial conditions

Initial conditions are a set of test configurations the UE needs to be tested in and the steps for the SS to take with the UE to reach the correct measurement state.

The initial test configurations consist of environmental conditions, test frequencies, and CC combinations based on E-UTRA CA configurations specified in table 5.4.2A.1-1. All of these configurations shall be tested with applicable test parameters for each CA Configuration, and are shown in table 6.3.5A.3.1.4.1-1 and table 6.3.5A.3.1.4.1-2. The details of the uplink reference measurement channel (RMCs) are specified in Annexes A.2. Configurations of PDSCH and PDCCH before measurement are specified in Annex C.2.

**Table 6.3.5A.3.1.4.1-1: Test Configuration Table: PUCCH sub-test**

Initial Conditions				
Test Environment as specified in TS 36.508[7] subclause 4.1			Normal	
Test Frequencies as specified in TS 36.508 [7] subclause 4.3.1 for different CA bandwidth classes, and PCC and SCCs are mapped onto physical frequencies according to Table 6.1-2.			C: Mid range	
Test CC Combination setting ( $N_{RB\_agg}$ ) as specified in subclause 5.4.2A.1 for the CA Configuration across bandwidth combination sets supported by the UE.			Lowest $N_{RB\_agg}$ Highest $N_{RB\_agg}$	
Test Parameters for CA Configurations				
CA Configuration / $N_{RB\_agg}$		DL Allocation		Uplink Configuration
PCC $N_{RB}$	SCCs $N_{RB}$	CC Mod	PCC & SCC RB allocation	
75	75	QPSK	75+75	FDD: PUCCH format = Format 1b with channel selection/Format 3 TDD: PUCCH format = Format 1b with channel selection/Format 3
100	50	QPSK	100+50	
100	100	QPSK	100+100	
Note 1 :CA Configuration Test CC Combination settings are checked separately for each CA Configuration, which applicable aggregated channel bandwidths are specified in Table 5.4.2A.1-1				

**Table 6.3.5A.3.1.4.1-2: Test Configuration Table: PUSCH sub-test**

Initial Conditions							
Test Environment as specified in TS 36.508[7] clause 4.1				Normal			
Test Frequencies as specified in TS 36.508 [7] clause 4.3.1 for different CA bandwidth classes, and PCC and SCCs are mapped onto physical frequencies according to Table 6.1-2.				C: Mid range			
Test CC Combination setting ( $N_{RB\_agg}$ ) as specified in clause 5.4.2A.1 for the CA Configuration				Lowest $N_{RB\_agg}$ Highest $N_{RB\_agg}$			
Test Parameters for CA Configurations							
CA Configuration / $N_{RB\_agg}$		DL Allocation		CC MOD	UL Allocation		
PCC $N_{RB}$	SCCs $N_{RB}$	PCC & SCC RB allocation			$N_{RB\_alloc}$	PCC & SCC RB allocations ( $L_{CRB} @ RB_{start}$ )	
75	75	N/A		QPSK	150	P_75@0	S_75@0
100	50			QPSK	150	P_100@0	S_50@0
100	100			QPSK	200	P_100@0	S_100@0
Note 1: CA Configuration Test CC Combination settings are checked separately for each CA Configuration, which applicable aggregated channel bandwidths are specified in Table 5.4.2A.1-1							

1. Connect the SS to the UE antenna connectors as shown in TS 36.508 [7] Annex A, Figure group A.32 as appropriate.
2. The parameter settings for the cell are set up according to TS 36.508 [7] clause 4.4.3.
3. Downlink signals for PCC are initially set up according to Annex C.0, C.1 and Annex C.3.0, and uplink signals according to Annex H.1 and H.3.0.
4. The UL and DL Reference Measurement channel is set according to Table 6.3.5A.3.1.4.1-1 (PUCCH sub-test) and Table 6.3.5A.3.1.4.1-2 (PUSCH sub-test).
5. Propagation conditions are set according to Annex B.0.
6. Ensure the UE is in State 3A-RF according to TS 36.508 [7] clause 5.2A.2. Message contents are defined in clause 6.3.5A.3.1.4.3.

## 6.3.5A.3.1.4.2 Test procedure

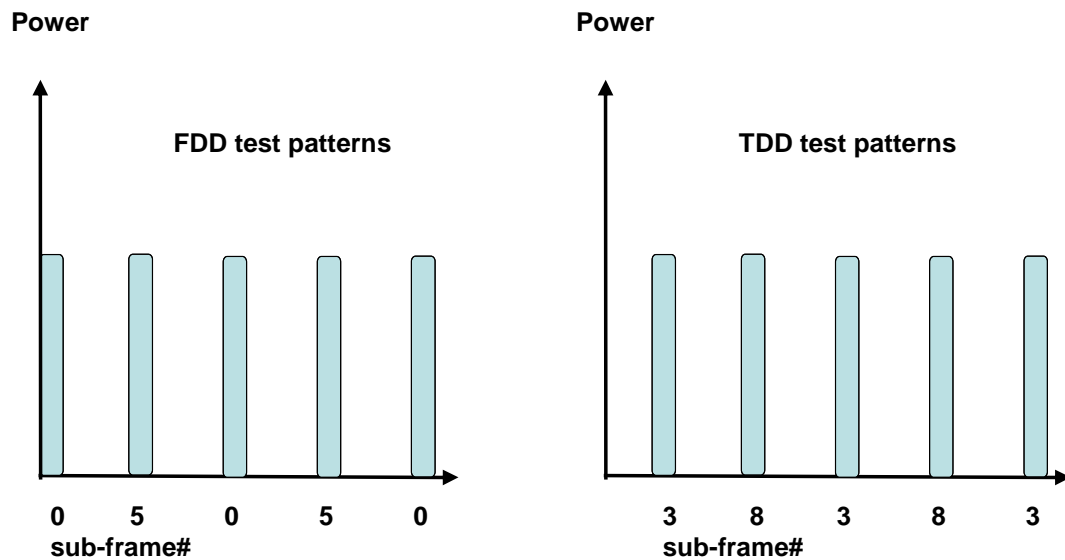

Figure 6.3.5A.3.1.4.2-1: Test uplink transmission

1. Configure SCC according to Annex C.0, C.1 and Annex C.3.0 for all downlink physical channels.
2. The SS shall configure SCC as per TS 36.508 [7] clause 5.2A.4.
3. SS activates SCC by sending the activation MAC-CE (Refer TS 36.321 [13], clauses 5.13, 6.1.3.8). Wait for at least 2 seconds (Refer TS 36.133, clauses 8.3.3.2).
4. The procedure is separated in two subtests to verify PUCCH and PUSCH aggregate power control tolerance respectively. The uplink transmission patterns are described in figure 6.3.5A.3.1.4.2-1.
5. PUCCH sub test:
  - 5.1 The SS transmits PDSCH via PDCCH DCI format 1A for C\_RNTI to transmit the DL RMC according to Table 6.3.5A.3.1.4.1-1 on both PCC and SCC. The SS sends downlink MAC padding bits on the DL RMC. The transmission of PDSCH will make the UE send uplink ACK/NACK using PUCCH on PCC. Send the appropriate TPC commands for PUCCH to the UE to ensure that the UE transmits PUCCH at 0dBm +/- 3.2 dB for carrier frequency  $f \leq 3.0\text{GHz}$  or at 0dBm +/- 3.5 dB for carrier frequency  $3.0\text{GHz} < f \leq 4.2\text{GHz}$ .
  - 5.2 Every 5 subframes transmit to the UE downlink PDSCH MAC padding bits as well as 0 dB TPC command for PUCCH via the PDCCH to make the UE transmit ACK/NACK on the PUCCH with transmission gap of 4 subframes. The downlink transmission is scheduled in the appropriate sub-frames to make the UE transmit PUCCH as described in figure 6.3.5A.3.1.4.2-1.
  - 5.3 Measure the power of 5 consecutive PUCCH transmissions on PCC to verify the UE transmitted PUCCH power is maintained within 21 ms. The transient periods of 20us are excluded from the power measurement.
6. PUSCH sub test:
  - 6.1 The SS sends uplink scheduling information for each UL HARQ process via PDCCH DCI format 0 for C\_RNTI to schedule the UL RMC according to Table 6.3.5A.3.1.4.1-2 on both PCC and SCC. Since the UE has no payload and no loopback data to send the UE sends uplink MAC padding bits on the UL RMC. Send the appropriate TPC commands for PUSCH to the UE to ensure that the UE transmits PUSCH at 0dBm +/- 3.2dB for carrier frequency  $f \leq 3.0\text{GHz}$  or at 0dBm +/- 3.5 dB for carrier frequency  $3.0\text{GHz} < f \leq 4.2\text{GHz}$ .
  - 6.2 Every 5 subframes schedule the UE's PUSCH data transmission and transmit 0 dB TPC command for PUSCH via the PDCCH to make the UE transmit PUSCH with 4 subframes gap. The uplink transmission patterns are described in figure 6.3.5A.3.1.4.2-1.

6.3 Measure the power on both PCC and SCC of 5 consecutive PUSCH transmissions to verify the UE transmitted PUSCH power is maintained within 21 ms on each component carrier. The transient periods of 20 $\mu$ s are excluded from the power measurement.

#### 6.3.5A.3.1.4.3 Message contents

Message contents are according to TS 36.508 [7] subclause 4.6.

#### 6.3.5A.3.1.5 Test requirement

For intra-band contiguous carrier aggregation bandwidth class C, the aggregate power control tolerance per component carrier measured in step (2) of the test procedure is not to exceed the values specified in Table 6.3.5A.3.1.5-1.

**Table 6.3.5A.3.1.5-1: Aggregate power control tolerance for intra-band contiguous CA**

TPC command	UL channel	Aggregate power tolerance within 21 ms
0 dB	PUCCH	$\pm 3.2$ dB
0 dB	PUSCH	$\pm 4.2$ dB
NOTE: The UE transmission gap is 4 ms. TPC command is transmitted via PDCCH 4 subframes preceding each PUCCH/PUSCH transmission.		

## 6.3.5B Power Control for UL- MIMO

### 6.3.5B.1 Power Control Absolute Power Tolerance for UL- MIMO

#### 6.3.5B.1.1 Test purpose

To verify the ability of the UE transmitter for UL-MIMO to set its initial output power to a specific value at the start of a contiguous transmission or non-contiguous transmission with a long transmission gap, i.e. transmission gap is larger than 20 ms.

#### 6.3.5B.1.2 Minimum conformance requirement

For UE with multiple transmit antenna connectors, the power control tolerance applies to the sum of output power at each transmit antenna connector.

The power control requirements specified in subclause 6.3.5 apply to UE with two transmit antenna connectors with UL-MIMO configurations specified in Table 6.2.2B.3-2 for closed-loop spatial multiplexing scheme, wherein

- The Maximum output power requirements for UL-MIMO are specified in subclause 6.2.2B
- The Minimum output power requirements for UL-MIMO are specified in subclause 6.3.2B

The normative reference for this requirement is TS 36.101 [2] clause 6.3.5B.

#### 6.3.5B.1.3 Test applicability

This test applies to all types of E-UTRA UE release 10 and forward that support UL- MIMO.

#### 6.3.5B.1.4 Test description

##### 6.3.5B.1.4.1 Initial conditions

Initial conditions are a set of test configurations the UE needs to be tested in and the steps for the SS to take with the UE to reach the correct measurement state.

The initial test configurations consist of environmental conditions, test frequencies, and channel bandwidths based on E-UTRA operating bands specified in table 5.4.2.1-1. All of these configurations shall be tested with applicable test parameters for each channel bandwidth, and are shown in table 6.3.5B.1.4.1-1. The details of the uplink reference

measurement channel (RMCs) are specified in Annexes A.2. Configurations of PDSCH and PDCCH before measurement are specified in Annex C.2.

**Table 6.3.5B.1.4.1-1: Test Configuration Table**

Initial Conditions			
Test Environment as specified in TS 36.508[7] subclause 4.1	Normal, TL/VL, TL/VH, TH/VL, TH/VH		
Test Frequencies as specified in TS 36.508 [7] subclause 4.3.1	Mid range		
Test Channel Bandwidths as specified in TS 36.508 [7] subclause 4.3.1	Lowest, 5MHz, Highest		
Test Parameters for Channel Bandwidths			
Ch BW	Downlink Configuration	Uplink Configuration	
	N/A for Power Control Absolute power tolerance test case	Mod'n	RB allocation
		FDD	TDD
1.4MHz		QPSK	6
3MHz		QPSK	15
5MHz		QPSK	25
10MHz		QPSK	50
15MHz		QPSK	75
20MHz		QPSK	100
Note 1: Test Channel Bandwidths are checked separately for each E-UTRA band, the applicable channel bandwidths are specified in Table 5.4.2.1-1.			

1. Connect the SS to the UE antenna connectors as shown in TS 36.508 [7] Annex A, Figure A.28.
2. The parameter settings for the cell are set up according to TS 36.508 [7] subclause 4.4.3.
3. Downlink signals are initially set up according to Annex C.0, C.1 and C.3.0, and uplink signals according to Annex H.1 and H.3.0.
4. The UL Reference Measurement channel is set according to Table 6.3.5B.1.4.1-1.
5. Ensure the UE is in State 3A-RF according to TS 36.508 [7] clause 5.2A.2. Message contents are defined in clause 6.3.5B.1.4.3. Note that PDCCH DCI format 4 sent after resetting uplink power with RRC Connection Reconfiguration, should have TPC command 0dB.

**6.3.5B.1.4.2 Test procedure**

1. SS sends uplink scheduling information via PDCCH DCI format 4 with TPC command 0dB for C\_RNTI to schedule the UL RMC according to Table 6.3.5B.1.4.1-1. Since the UE has no payload and no loopback data to send the UE sends uplink MAC padding bits on the UL RMC.
2. Measure the initial sum power of the first subframe of UE PUSCH first transmission at each UE antenna connector. The transient periods of 20us are excluded.
3. Repeat for the two test points as indicated in section 6.3.5B.1.4.3. The timing of the execution between the two test points shall be larger than 20ms.

**6.3.5B.1.4.3 Message contents**

Message contents are according to TS 36.508 [7] clause 4.6 with the following exceptions:

**Table 6.3.5B.1.4.3-1: UplinkPowerControlCommon: Test point 1**

Derivation Path: TS 36.508 [7] clause 4.6.3, Table 4.6.3-25 UplinkPowerControlCommon-DEFAULT			
Information Element	Value/remark	Comment	Condition
UplinkPowerControlCommon-DEFAULT ::= SEQUENCE { p0-NominalPUSCH	-105	Test point 1 to verify a UE relative low initial power transmission	

**Table 6.3.5B.1.4.3-2: UplinkPowerControlCommon: Test point 2**

Derivation Path: TS 36.508 [7] clause 4.6.3, Table 4.6.3-25 UplinkPowerControlCommon-DEFAULT			
Information Element	Value/remark	Comment	Condition
PhysicalConfigDedicated-DEFAULT ::= SEQUENCE {	-93	Test point 2 to verify a UE relative high initial power transmission	
p0-NominalPUSCH			

**Table 6.3.5B.1.4.3-3: PhysicalConfigDedicated**

Derivation Path: TS 36.508 [7] clause 5.5.1.2, Table 5.5.1.2.1 PhysicalConfigDedicated-DEFAULT			
Information Element	Value/remark	Comment	Condition
UplinkPowerControlCommon-DEFAULT ::= SEQUENCE {			
p0-NominalPUSCH			
uplinkPowerControlDedicated	UplinkPowerControlDedicated-DEFAULT	See clause 4.6.3	SRB1
	UplinkPowerControlDedicated-DEFAULT	See clause 4.6.3	RBC

**Table 6.3.5B.1.4.3-4: UplinkPowerControlDedicated**

Derivation Path: TS 36.508 [7] clause 4.6.3, Table 4.6.3-26 UplinkPowerControlDedicated-DEFAULT			
Information Element	Value/remark	Comment	Condition
UplinkPowerControlDedicated-DEFAULT ::= SEQUENCE {			
p0-UE-PUSCH	1		SRB1
	0		RBC
}			

**6.3.5B.1.5 Test requirement**

The requirement for the power measured in step (2) of the test procedure is not to exceed the values specified in Table 6.3.5B.1.5-1 and 6.3.5B.1.5-2.

**Table 6.3.5B.1.5-1: Absolute power tolerance: test point 1**

	Channel bandwidth / expected output power (dBm)					
	1.4 MHz	3.0 MHz	5 MHz	10 MHz	15 MHz	20 MHz
Expected Measured power Normal conditions	-14.8 dBm	-10.8 dBm	-8.6 dBm	-5.6 dBm	-3.9 dBm	-2.6 dBm
Power tolerance f ≤ 3.0GHz	± 10.0dB	± 10.0dB	± 10.0dB	± 10.0dB	± 10.0dB	± 10.0dB
3.0GHz < f ≤ 4.2GHz	± 10.4dB	± 10.4dB	± 10.4dB	± 10.4dB	± 10.4dB	± 10.4dB
Expected Measured power Extreme conditions	-14.8 dBm	-10.8 dBm	-8.6 dBm	-5.6 dBm	-3.9 dBm	-2.6 dBm
Power tolerance f ≤ 3.0GHz	± 13.0dB	± 13.0dB	± 13.0dB	± 13.0dB	± 13.0dB	± 13.0dB
3.0GHz < f ≤ 4.2GHz	± 13.4dB	± 13.4dB	± 13.4dB	± 13.4dB	± 13.4dB	± 13.4dB
Note 1: The lower power limit shall not exceed the minimum output power requirements defined in sub-clause 6.3.2.3						

**Table 6.3.5B.1.5-2: Absolute power tolerance: test point 2**

	Channel bandwidth / expected output power (dBm)					
	1.4 MHz	3.0 MHz	5 MHz	10 MHz	15 MHz	20 MHz

Expected Measured power Normal conditions	-2.8 dBm	1.2 dBm	3.4 dBm	6.4 dBm	8.2 dBm	9.4 dBm
Power tolerance $f \leq 3.0\text{GHz}$ $3.0\text{GHz} < f \leq 4.2\text{GHz}$	$\pm 10.0\text{dB}$ $\pm 10.4\text{dB}$	$\pm 10.0\text{dB}$ $\pm 10.4\text{dB}$	$\pm 10.0\text{dB}$ $\pm 10.4\text{dB}$	$\pm 10.0\text{dB}$ $\pm 10.4\text{dB}$	$\pm 10.0\text{dB}$ $\pm 10.4\text{dB}$	$\pm 10.0\text{dB}$ $\pm 10.4\text{dB}$
Expected Measured power Extreme conditions	-2.8 dBm	1.2 dBm	3.4 dBm	6.4 dBm	8.2 dBm	9.4 dBm
Power tolerance $f \leq 3.0\text{GHz}$ $3.0\text{GHz} < f \leq 4.2\text{GHz}$	$\pm 13.0\text{dB}$ $\pm 13.4\text{dB}$	$\pm 13.0\text{dB}$ $\pm 13.4\text{dB}$	$\pm 13.0\text{dB}$ $\pm 13.4\text{dB}$	$\pm 13.0\text{dB}$ $\pm 13.4\text{dB}$	$\pm 13.0\text{dB}$ $\pm 13.4\text{dB}$	$\pm 13.0\text{dB}$ $\pm 13.4\text{dB}$
Note 1: The lower power limit shall not exceed the minimum output power requirements defined in sub-clause 6.3.2.3						

## 6.3.5B.2 Power Control Relative power tolerance for UL-MIMO

### 6.3.5B.2.1 Test purpose

To verify the ability of the UE transmitter to set its output power relatively to the power in a target sub-frame relatively to the power of the most recently transmitted reference sub-frame if the transmission gap between these sub-frames is  $\leq 20$  ms.

### 6.3.5B.2.2 Test applicability

This test case applies to all types of E-UTRA UE release 10 and forward that support UL MIMO.

### 6.3.5B.2.3 Minimum conformance requirement

For UE with multiple transmit antenna connectors, the power control tolerance applies to the sum of output power at each transmit antenna connector.

The power control requirements specified in clause 6.3.5 apply to UE with two transmit antenna connectors with UL-MIMO configurations specified in Table 6.2.2B.3-2 for closed-loop spatial multiplexing scheme, wherein:

- The Maximum output power requirements for UL-MIMO are specified in clause 6.2.2B
- The Minimum output power requirements for UL-MIMO are specified in clause 6.3.2B

The normative reference for this requirement is TS 36.101 [2] clause 6.3.5B.

### 6.3.5B.2.4 Test description

#### 6.3.5B.2.4.1 Initial conditions

Initial conditions are a set of test configurations the UE needs to be tested in and the steps for the SS to take with the UE to reach the correct measurement state.

The initial test configurations consist of environmental conditions, test frequencies, and channel bandwidths based on E-UTRA operating bands specified in table 5.4.2.1-1. All of these configurations shall be tested with applicable test parameters for each channel bandwidth, and are shown in table 6.3.5B.2.4.1-1. The details of the uplink reference measurement channels (RMCs) are specified in Annexes A.2. Configurations of PDSCH and PDCCH before measurement are specified in Annex C.2.

**Table 6.3.5B.2.4.1-1: Test Configuration Table**

Initial Conditions				
Test Environment as specified in TS 36.508 [7] clause 4.1		Normal, TL/VL, TL/VH, TH/VL, TH/VH		
Test Frequencies as specified in TS 36.508 [7] clause 4.3.1		Low range		
Test Channel Bandwidths as specified in TS 36.508 [7] clause 4.3.1		Lowest, 5MHz, Highest		
Test Parameters for Channel Bandwidths				
Ch BW	Downlink Configuration	Mod'n	Uplink Configuration	
	N/A for Power Control Relative power tolerance test case		RB allocation	
			FDD	TDD
1.4MHz		QPSK	See table 6.3.5B.2.5-1 6.3.5B.2.5-2 6.3.5B.2.5-13	See table 6.3.5B.2.5-1 6.3.5B.2.5-2 6.3.5B.2.5-13
3MHz		QPSK	See table 6.3.5B.2.5-3 6.3.5B.2.5-4 6.3.5B.2.5-13	See table 6.3.5B.2.5-3 6.3.5B.2.5-4 6.3.5B.2.5-13
5MHz		QPSK	See table 6.3.5B.2.5-5 6.3.5B.2.5-6 6.3.5B.2.5-13	See table 6.3.5B.2.5-5 6.3.5B.2.5-6 6.3.5B.2.5-13
10MHz		QPSK	See table 6.3.5B.2.5-7 6.3.5B.2.5-8 6.3.5B.2.5-13	See table 6.3.5B.2.5-7 6.3.5B.2.5-8 6.3.5B.2.5-13
15MHz		QPSK	See table 6.3.5B.2.5-9 6.3.5B.2.5-10 6.3.5B.2.5-13	See table 6.3.5B.2.5-9 6.3.5B.2.5-10 6.3.5B.2.5-13
20MHz		QPSK	See table 6.3.5B.2.5-11 6.3.5B.2.5-12 6.3.5B.2.5-13	See table 6.3.5B.2.5-11 6.3.5B.2.5-12 6.3.5B.2.5-13
Note 1: Test Channel Bandwidths are checked separately for each E-UTRA band, the applicable channel bandwidths are specified in Table 5.4.2.1-1				
Note 2: The starting resource block shall be RB# 0.				

1. Connect the SS to the UE antenna connectors as shown in TS 36.508 [7] Annex A, Figure A.28.
2. The parameter settings for the cell are set up according to TS 36.508 [7] clause 4.4.3.
3. Downlink signals are initially set up according to Annex C.0, C.1 and C.3.0, and uplink signals according to Annex H.1 and H.3.0.
4. The UL Reference Measurement channel is set according to table 6.3.5B.2.4.1-1.
5. Propagation conditions are set according to Annex B.0.
6. Ensure the UE is in State 3A-RF according to TS 36.508 [7] clause 5.2A.2. Message contents are defined in clause 6.3.5B.2.4.3.

#### 6.3.5B.2.4.2 Test procedure

The procedure is separated in various subtests to verify different aspects of relative power control. The power patterns of the subtests are described in figure 6.3.5B.2.4.2-1.



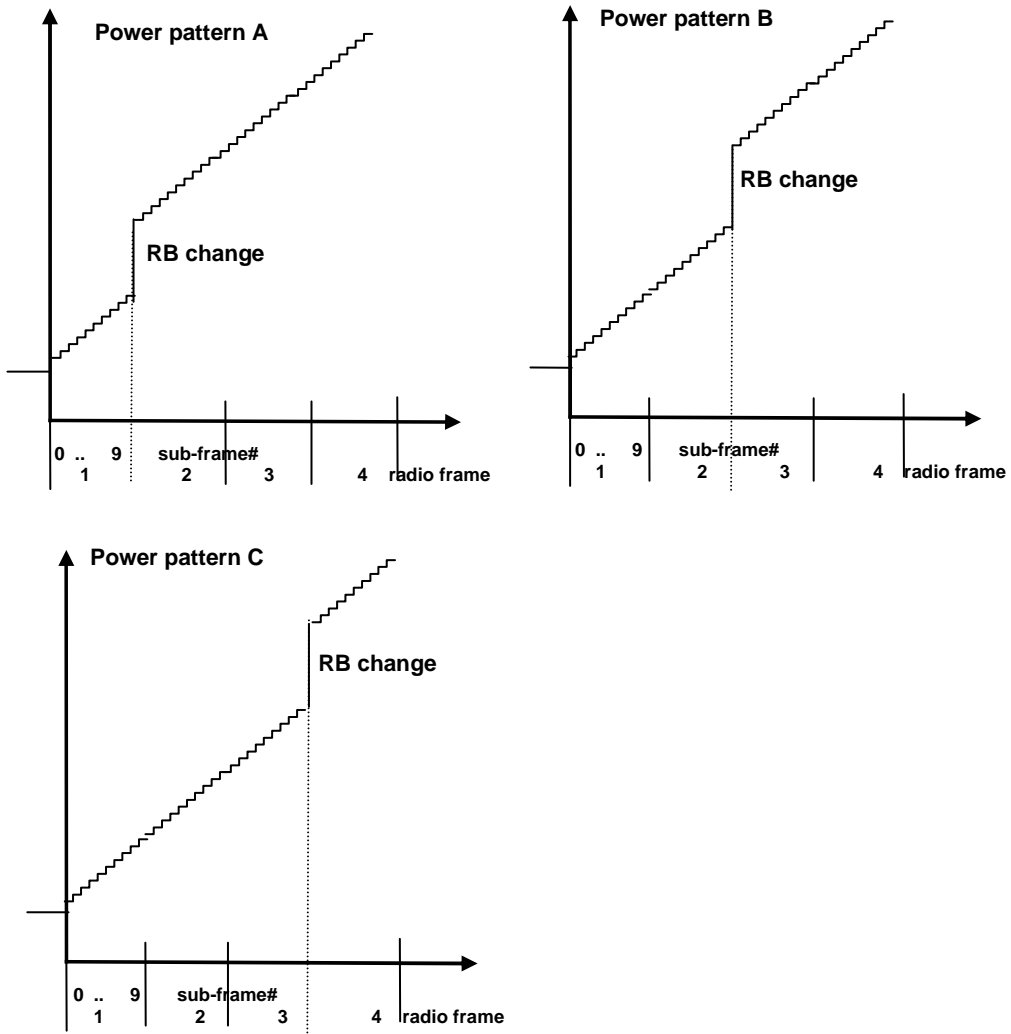

Figure 6.3.5B.2.4.2-1: FDD ramping up test power patterns

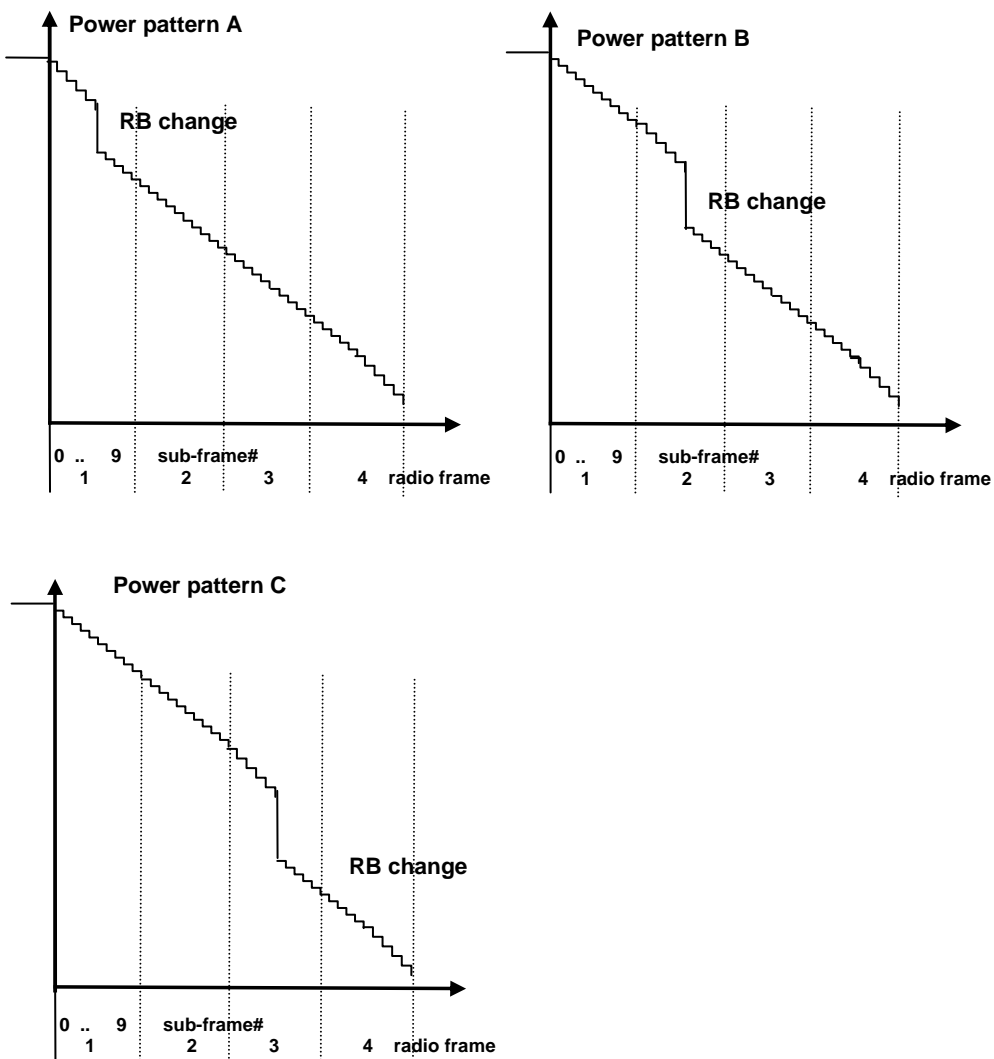

Figure 6.3.5B.2.4.2-2: FDD ramping down test power patterns

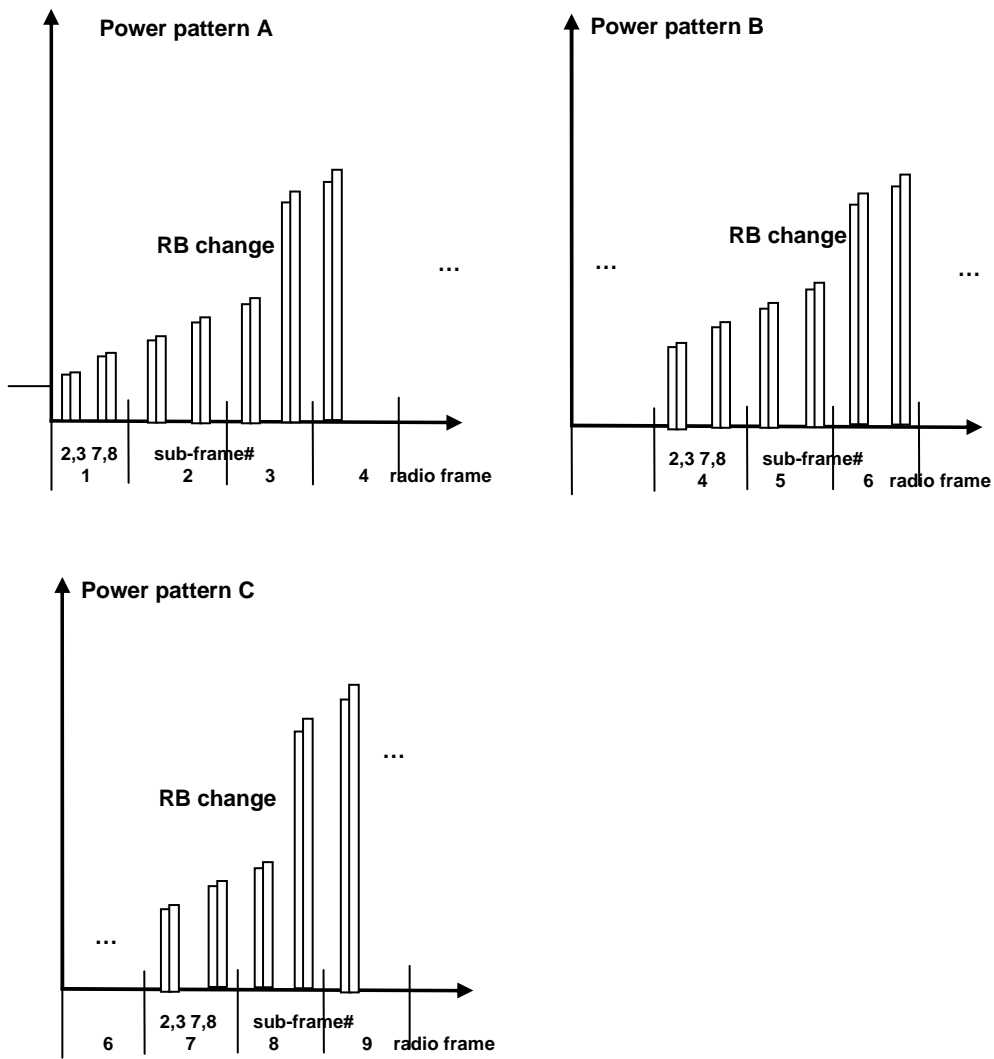

Figure 6.3.5B.2.4.2-3: TDD ramping up test power patterns

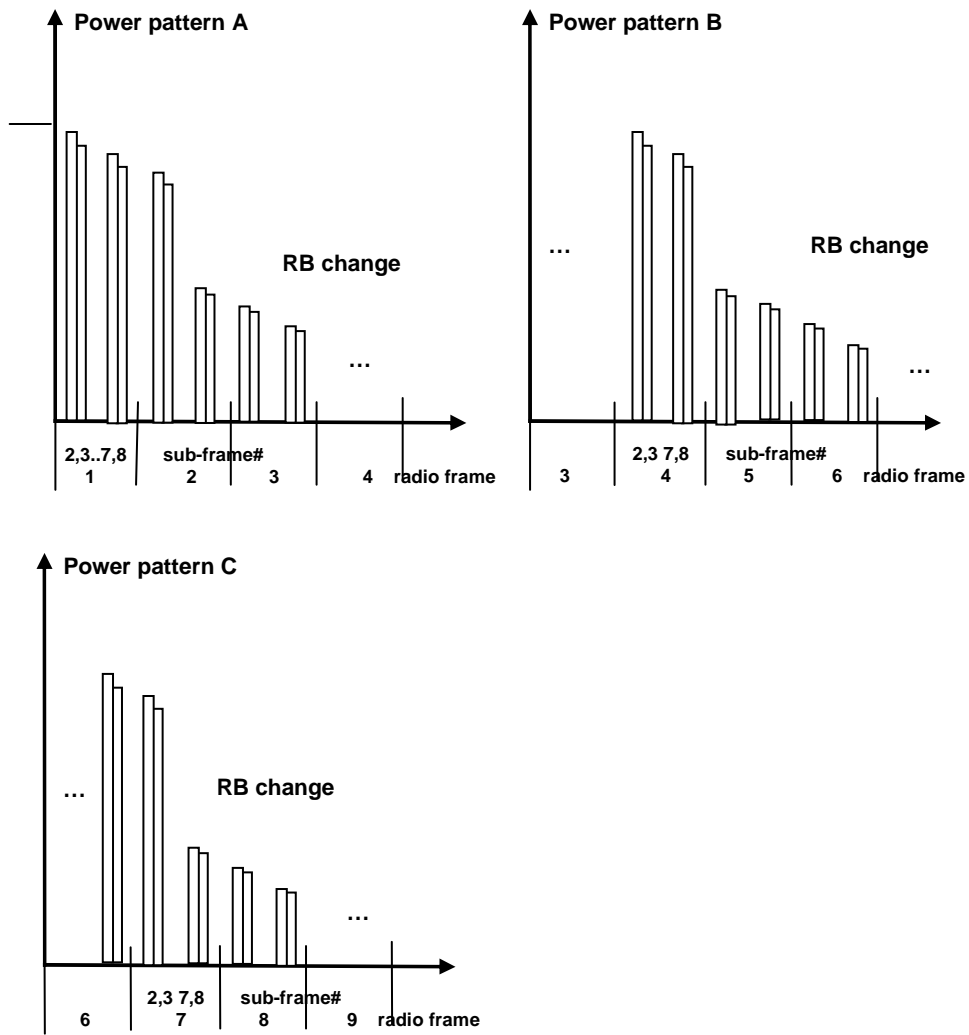

Figure 6.3.5B.2.4.2-4: TDD ramping down test power patterns

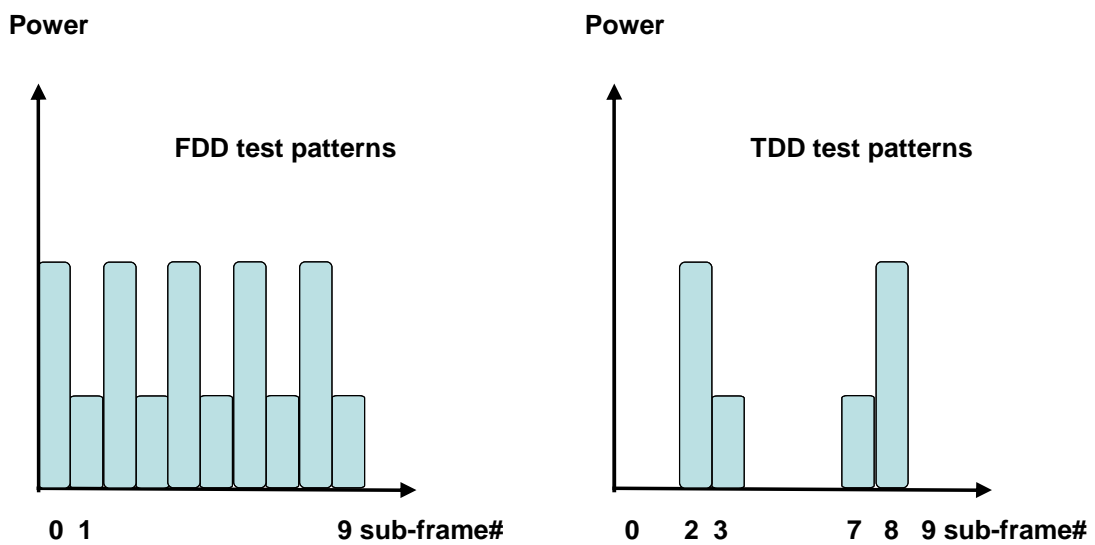

Figure 6.3.5B.2.4.2-5: Alternating Test Power patterns

### 1. Sub test: ramping up pattern

- 1.1. SS sends uplink scheduling information for each UL HARQ process via PDCCH DCI format 4 for C\_RNTI to schedule the UL RMC according to Table 6.3.5B.2.4.1-1. Since the UE has no payload and no loopback data to send the UE sends uplink MAC padding bits on the UL RMC. Send the appropriate TPC commands for PUSCH to the UE to ensure that the UE transmits PUSCH at -36.8dBm +/- 3.2 dB for carrier frequency  $f \leq 3.0\text{GHz}$  or at -36.5dBm +/- 3.5 dB for carrier frequency  $3.0\text{GHz} < f \leq 4.2\text{GHz}$ .
- 1.2. Schedule the UE's PUSCH data transmission as described in Figure 6.3.5B.2.4.2-1 (FDD pattern A: sub-test is divided in 4 arbitrary radio frames with 10 active uplink sub-frames per radio frame) and Figure 6.3.5B.2.4.2-3 (TDD pattern A: sub-test is divided in 10 arbitrary radio frames with 4 active uplink sub-frames per radio frame) with an uplink RB allocation as defined in tables 6.3.5B.2.5-1 thru 6.3.5B.2.5-12 depending on channel bandwidth. On the PDCCH format 4 for the scheduling of the PUSCH the SS will transmit a +1dB TPC command. Note that the measurement need not be done continuously, provided that interruptions are whole numbers of frames, and TPC commands of 0dB are sent during the interruption.
- 1.3. Measure the mean sum power at each antenna connector for PUSCH transmissions to verify the UE relative power control meet test requirements 6.3.5B.2.5. For power transients between subframes, transient periods of 40us between subframes are excluded. For ON/OFF or OFF/ON transients, transient periods of 20 us at the beginning of the subframe are excluded.
- 1.4. Repeat the subtest different pattern B, C to move the RB allocation change at different points in the pattern as described in Table 6.3.5B.2.5-1 thru Table 6.3.5B.2.5-12 to force bigger UE power steps at various points in the power range.

### 2. Sub test: ramping down pattern

- 2.1. SS sends uplink scheduling information for each UL HARQ process via PDCCH DCI format 4 for C\_RNTI to schedule the UL RMC according to Table 6.3.5B.2.4.1-1. Since the UE has no payload and no loopback data to send the UE sends uplink MAC padding bits on the UL RMC. Send the appropriate TPC commands for PUSCH to the UE to ensure that the UE transmits PUSCH at +18.0dBm +/- 3.2 dB for carrier frequency  $f \leq 3.0\text{GHz}$  or at +17.7dBm +/- 3.5 dB for carrier frequency  $3.0\text{GHz} < f \leq 4.2\text{GHz}$ .
- 2.2. Schedule the UE's PUSCH data transmission as described in Figure 6.3.5B.2.4.2-2 (FDD pattern A: sub-test is divided in 4 arbitrary radio frames with 10 active uplink sub-frames per radio frame) and Figure 6.3.5B.2.4.2-4 (TDD pattern A: sub-test is divided in 10 arbitrary radio frames with 4 active uplink sub-frames per radio frame) with an uplink RB allocation as defined in tables 6.3.5B.2.5-1 thru 6.3.5B.2.5-12 depending on channel bandwidth. On the PDCCH format 4 for the scheduling of the PUSCH the SS will transmit a -1dB TPC command. Note that the measurement need not be done continuously, provided that interruptions are whole numbers of frames, and TPC commands of 0dB are sent during the interruption.
- 2.3. Measure the mean sum power at each antenna connector for PUSCH transmissions to verify the UE relative power control meet test requirements 6.3.5B.2.5. For power transients between subframes, transient periods of 40us between subframes are excluded. For ON/OFF or OFF/ON transients, transient periods of 20 us at the beginning of the subframe are excluded.
- 2.4. Repeat the subtest different pattern B, C to move the RB allocation change at different points in the pattern as described in Table 6.3.5B.2.5-1 thru Table 6.3.5B.2.5-12 to force bigger UE power steps at various points in the power range.

### 3. Sub test: alternating pattern

- 3.1. SS sends uplink scheduling information for each UL HARQ process via PDCCH DCI format 4 for C\_RNTI to schedule the UL RMC according to Table 6.3.5B.2.4.1-1. Since the UE has no payload and no loopback data to send the UE sends uplink MAC padding bits on the UL RMC. Send the appropriate TPC commands for PUSCH to the UE to ensure that the UE transmits PUSCH at -10dBm +/- 3.2 dB for carrier frequency  $f \leq 3.0\text{GHz}$  or at -10dBm +/- 3.5 dB for carrier frequency  $3.0\text{GHz} < f \leq 4.2\text{GHz}$ . The initial uplink RB allocation is defined as the smaller uplink RB allocation value specified in tables 6.3.5B.2.5-13. The power level and RB allocation are reset for each sub-test.
- 3.2. Schedule the UE's PUSCH data transmission as described in Figure 6.3.5B.2.4.2-5 for 10 sub-frames with an uplink RB allocation alternating pattern as defined in table 6.3.5B.2.5-13 while transmitting 0dB TPC command for PUSCH via the PDCCH.

- 3.3. Measure the mean sum power of each antenna connector for PUSCH transmissions to verify the UE relative power control meet test requirements specified in clause 6.3.5B.2.5. For power transients between subframes, transient periods of 40us between subframes are excluded. For ON/OFF or OFF/ON transients, transient periods of 20 us at the beginning of the subframe are excluded.

#### 6.3.5B.2.4.3 Message contents

Message contents are according to TS 36.508 [7] clause 4.6.

#### 6.3.5B.2.5 Test requirement

Each UE power step measured in the test procedure 6.3.5B.2.4.2 should satisfy the test requirements specified in Table 6.3.5B.2.5-1, thru 6.3.5B.2.5-13 for normal conditions; for extreme conditions an additional  $\pm 2.0$  dB relaxation is allowed.

To account for RF Power amplifier mode changes 2 exceptions are allowed for each of ramping up and ramping down test patterns. For these exceptions the power tolerance limit is a maximum of  $\pm 6.7$  dB. If there is an exception in the power step caused by the RB change for all test patterns (A, B, C) then fail the UE.

**Table 6.3.5B.2.5-1: Test Requirements Relative Power Tolerance for Transmission (normal conditions - Note 5) channel bandwidth 1.4MHz (ramping up)**

Sub-test (ramp up)	Uplink RB allocation	TPC command	Expected power step size (Up) $\Delta P$ [dB]	Power step size range (Up) $\Delta P$ [dB]	PUSCH [dB]
Subframes before RB change	Fixed = 1	TPC=+1dB	1	$\Delta P < 2$	$1 \pm 1.7$
RB change	Change from 1 to 6 RBs	TPC=+1dB	8.78	$4 \leq \Delta P < 10$	$8.78 \pm 4.7$ Note 2 $8.78 + 6.2 / - 4.7$ Note 3
Subframes after RB change	Fixed = 6	TPC=+1dB	1	$\Delta P < 2$	$1 \pm 1.7$
<p>Note 1: Position of RB change:            Pattern A the position of RB uplink allocation change is after 10 active uplink subframes.            Pattern B the position of RB uplink allocation change is after 20 active uplink subframes.            Pattern C the position of RB uplink allocation change is after 30 active uplink subframes.</p> <p>Note 2: When Note 3 does not apply.</p> <p>Note 3: For operating bands under Note 2 in Table 6.2.2.3-1, if the transmission bandwidth of the reference sub-frames is confined within <math>F_{UL\_low}</math> and <math>F_{UL\_low} + 4</math> MHz or <math>F_{UL\_high} - 4</math> MHz and <math>F_{UL\_high}</math> and the target sub-frame is not confined within any one of these frequency ranges.</p> <p>Note 4: N/A.</p> <p>Note 5: For extreme conditions an additional <math>\pm 2.0</math> dB relaxation is allowed.</p> <p>Note 6: The starting resource block shall be RB# 0.</p>					

**Table 6.3.5B.2.5-2: Test Requirements Relative Power Tolerance for Transmission (normal conditions - Note 5) channel bandwidth 1.4MHz (ramping down)**

Sub-test (ramp down)	Uplink RB allocation	TPC command	Expected power step size (down) $\Delta P$ [dB]	Power step size range (down) $\Delta P$ [dB]	PUSCH [dB]
Subframes before RB change	Fixed = 5	TPC=-1dB	1	$\Delta P < 2$	$1 \pm 1.7$
RB change	Change from 5 to 1 RBs	TPC=-1dB	7.99	$4 \leq \Delta P < 1$	$7.99 \pm 4.7$ Note 2 $7.99 + 4.7/-6.2$ Note 4
Subframes after RB change	Fixed = 1	TPC=-1dB	1	$\Delta P < 2$	$1 \pm 1.7$
<p>Note 1: Position of RB change:            Pattern A the position of RB uplink allocation change is after 6 active uplink subframes.            Pattern B the position of RB uplink allocation change is after 16 active uplink subframes.            Pattern C the position of RB uplink allocation change is after 26 active uplink subframes.</p> <p>Note 2: When Note 4 does not apply.</p> <p>Note 3: N/A.</p> <p>Note 4: For operating bands under Note 2 in Table 6.2.2.3-1, if the transmission bandwidth of the target sub-frame is confined within <math>F_{UL\_low}</math> and <math>F_{UL\_low} + 4</math> MHz or <math>F_{UL\_high} - 4</math> MHz and <math>F_{UL\_high}</math> and the reference sub-frame is not confined within any one of these frequency ranges.</p> <p>Note 5: For extreme conditions an additional <math>\pm 2.0</math> dB relaxation is allowed.</p> <p>Note 6: The starting resource block shall be RB# 0.</p>					

**Table 6.3.5B.2.5-3: Test Requirements Relative Power Tolerance for Transmission (normal conditions - Note 5) channel bandwidth 3MHz (ramping up)**

Sub-test (ramp up)	Uplink RB allocation	TPC command	Expected power step size (Up) $\Delta P$ [dB]	Power step size range (Up) $\Delta P$ [dB]	PUSCH [dB]
Subframes before RB change	Fixed = 1	TPC=+1dB	1	$\Delta P < 2$	$1 \pm 1.7$
RB change	Change from 1 to 4 RBs	TPC=+1dB	7.02	$4 \leq \Delta P < 10$	$7.02 \pm 4.7$ Note 2 $7.02 + 6.2/-4.7$ Note 3
Subframes after RB change	Fixed = 4	TPC=+1dB	1	$\Delta P < 2$	$1 \pm 1.7$
<p>Note 1: Position of RB change:            Pattern A the position of RB uplink allocation change is after 10 active uplink subframes.            Pattern B the position of RB uplink allocation change is after 20 active uplink subframes.            Pattern C the position of RB uplink allocation change is after 30 active uplink subframes.</p> <p>Note 2: When Note 3 does not apply.</p> <p>Note 3: For operating bands under Note 2 in Table 6.2.2.3-1, if the transmission bandwidth of the reference sub-frames is confined within <math>F_{UL\_low}</math> and <math>F_{UL\_low} + 4</math> MHz or <math>F_{UL\_high} - 4</math> MHz and <math>F_{UL\_high}</math> and the target sub-frame is not confined within any one of these frequency ranges.</p> <p>Note 4: N/A.</p> <p>Note 5: For extreme conditions an additional <math>\pm 2.0</math> dB relaxation is allowed.</p> <p>Note 6: The starting resource block shall be RB# 0.</p>					

**Table 6.3.5B.2.5-4: Test Requirements Relative Power Tolerance for Transmission (normal conditions - Note 5) channel bandwidth 3MHz (ramping down)**

Sub-test (ramp down)	Uplink RB allocation	TPC command	Expected power step size (down) $\Delta P$ [dB]	Power step size range (down) $\Delta P$ [dB]	PUSCH [dB]
Subframes before RB change	Fixed = 15	TPC=-1dB	1	$\Delta P < 2$	$1 \pm 1.7$
RB change	Change from 15 to 1 RBs	TPC=-1dB	12.76	$10 \leq \Delta P < 15$	$12.76 \pm 5.7$ Note 2 $12.76 + 5.7/-7.2$ Note 4
Subframes after RB change	Fixed =1	TPC=-1dB	1	$\Delta P < 2$	$1 \pm 1.7$
<p>Note 1: Position of RB change:            Pattern A the position of RB uplink allocation change is after 6 active uplink subframes.            Pattern B the position of RB uplink allocation change is after 16 active uplink subframes.            Pattern C the position of RB uplink allocation change is after 26 active uplink subframes.</p> <p>Note 2: When Note 4 does not apply.</p> <p>Note 3: N/A.</p> <p>Note 4: For operating bands under Note 2 in Table 6.2.2.3-1, if the transmission bandwidth of the target sub-frame is confined within <math>F_{UL\_low}</math> and <math>F_{UL\_low} + 4</math> MHz or <math>F_{UL\_high} - 4</math> MHz and <math>F_{UL\_high}</math> and the reference sub-frame is not confined within any one of these frequency ranges.</p> <p>Note 5: For extreme conditions an additional <math>\pm 2.0</math> dB relaxation is allowed.</p> <p>Note 6: The starting resource block shall be RB# 0.</p>					

**Table 6.3.5B.2.5-5: Test Requirements Relative Power Tolerance for Transmission (normal conditions - Note 5) channel bandwidth 5MHz (ramping up)**

Sub-test (ramp up)	Uplink RB allocation	TPC command	Expected power step size (Up) $\Delta P$ [dB]	Power step size range (Up) $\Delta P$ [dB]	PUSCH [dB]
Subframes before RB change	Fixed = 1	TPC=+1dB	1	$\Delta P < 2$	$1 \pm 1.7$
RB change	Change from 1 to 20	TPC=+1dB	14.01	$10 \leq \Delta P < 15$	$14.01 \pm 5.7$ Note 2 $14.01 + 7.2/-5.7$ Note 3
Subframes after RB change	Fixed = 20	TPC=+1dB	1	$\Delta P < 2$	$1 \pm 1.7$
<p>Note 1: Position of RB change:            Pattern A the position of RB uplink allocation change is after 10 active uplink subframes.            Pattern B the position of RB uplink allocation change is after 20 active uplink subframes.            Pattern C the position of RB uplink allocation change is after 30 active uplink subframes.</p> <p>Note 2: When Note 3 does not apply.</p> <p>Note 3: For operating bands under Note 2 in Table 6.2.2.3-1, if the transmission bandwidth of the reference sub-frames is confined within <math>F_{UL\_low}</math> and <math>F_{UL\_low} + 4</math> MHz or <math>F_{UL\_high} - 4</math> MHz and <math>F_{UL\_high}</math> and the target sub-frame is not confined within any one of these frequency ranges.</p> <p>Note 4: N/A.</p> <p>Note 5: For extreme conditions an additional <math>\pm 2.0</math> dB relaxation is allowed.</p> <p>Note 6: The starting resource block shall be RB# 0.</p>					



**Table 6.3.5B.2.5-6: Test Requirements Relative Power Tolerance for Transmission (normal conditions - Note 5) channel bandwidth 5MHz (ramping down)**

Sub-test (ramp down)	Uplink RB allocation	TPC command	Expected power step size (down) $\Delta P$ [dB]	Power step size range (down) $\Delta P$ [dB]	PUSCH [dB]
Subframes before RB change	Fixed = 25	TPC=-1dB	1	$\Delta P < 2$	$1 \pm 1.7$
RB change	Change from 25 to 1	TPC=-1dB	14.98	$10 \leq \Delta P < 15$	$14.98 \pm 5.7$ Note 2 $14.98 + 5.7/-7.2$ Note 4
Subframes after RB change	Fixed = 1	TPC=-1dB	1	$\Delta P < 2$	$1 \pm 1.7$
<p>Note 1: Position of RB change:            Pattern A the position of RB uplink allocation change is after 6 active uplink subframes.            Pattern B the position of RB uplink allocation change is after 16 active uplink subframes.            Pattern C the position of RB uplink allocation change is after 26 active uplink subframes.</p> <p>Note 2: When Note 4 does not apply.</p> <p>Note 3: N/A.</p> <p>Note 4: For operating bands under Note 2 in Table 6.2.2.3-1, if the transmission bandwidth of the target sub-frame is confined within <math>F_{UL\_low}</math> and <math>F_{UL\_low} + 4</math> MHz or <math>F_{UL\_high} - 4</math> MHz and <math>F_{UL\_high}</math> and the reference sub-frame is not confined within any one of these frequency ranges.</p> <p>Note 5: For extreme conditions an additional <math>\pm 2.0</math> dB relaxation is allowed.</p> <p>Note 6: The starting resource block shall be RB# 0.</p>					

**Table 6.3.5B.2.5-7: Test Requirements Relative Power Tolerance for Transmission (normal conditions - Note 5) channel bandwidth 10MHz (ramping up)**

Sub-test (ramp up)	Uplink RB allocation	TPC command	Expected power step size (Up) $\Delta P$ [dB]	Power step size range (Up) $\Delta P$ [dB]	PUSCH [dB]
Subframes before RB change	Fixed = 1	TPC=+1dB	1	$\Delta P < 2$	$1 \pm 1.7$
RB change	Change from 1 to 25	TPC=+1dB	14.98	$10 \leq \Delta P < 15$	$14.98 \pm 5.7$ Note 2 $14.98 + 7.2/-5.7$ Note 3
Subframes after RB change	Fixed = 25	TPC=+1dB	1	$\Delta P < 2$	$1 \pm 1.7$
<p>Note 1: Position of RB change:            Pattern A the position of RB uplink allocation change is after 10 active uplink subframes.            Pattern B the position of RB uplink allocation change is after 20 active uplink subframes.            Pattern C the position of RB uplink allocation change is after 30 active uplink subframes.</p> <p>Note 2: When Note 3 does not apply.</p> <p>Note 3: For operating bands under Note 2 in Table 6.2.2.3-1, if the transmission bandwidth of the reference sub-frames is confined within <math>F_{UL\_low}</math> and <math>F_{UL\_low} + 4</math> MHz or <math>F_{UL\_high} - 4</math> MHz and <math>F_{UL\_high}</math> and the target sub-frame is not confined within any one of these frequency ranges.</p> <p>Note 4: N/A.</p> <p>Note 5: For extreme conditions an additional <math>\pm 2.0</math> dB relaxation is allowed.</p> <p>Note 6: The starting resource block shall be RB# 0.</p>					

**Table 6.3.5B.2.5-8: Test Requirements Relative Power Tolerance for Transmission (normal conditions – Note 5) channel bandwidth 10MHz (ramping down)**

Sub-test (ramp down)	Uplink RB allocation	TPC command	Expected power step size (down) ΔP [dB]	Power step size range (down) ΔP [dB]	PUSCH [dB]
Subframes before RB change	Fixed = 50 ( UE-Categories ≥2)  Fixed = 48 (UE Cat 1)	TPC=-1dB	1	ΔP < 2	1 ± 1.7
RB change	Change from 50 to 1 ( UE-Categories ≥2)  Change from 48 to 1 (UE cat 1)	TPC=-1dB	17.99  17.81	15 ≤ Δ	17.99 ± 6.7 Note 2 17.99 +6.7/-8.2 Note 4  17.81 ± 6.7 Note 2 17.81 +6.7/-8.2 Note 4
Subframes after RB change	Fixed = 1	TPC=-1dB	1	ΔP < 2	1 ± 1.7
<p>Note 1: Position of RB change:                      Pattern A the position of RB uplink allocation change is after 6 active uplink subframes.                      Pattern B the position of RB uplink allocation change is after 16 active uplink subframes.                      Pattern C the position of RB uplink allocation change is after 26 active uplink subframes.</p> <p>Note 2: When Note 3 does not apply.</p> <p>Note 3: N/A.</p> <p>Note 4: For operating bands under Note 2 in Table 6.2.2.3-1, if the transmission bandwidth of the target sub-frame is confined within <math>F_{UL\_low}</math> and <math>F_{UL\_low} + 4</math> MHz or <math>F_{UL\_high} - 4</math> MHz and <math>F_{UL\_high}</math> and the reference sub-frame is not confined within any one of these frequency ranges.</p> <p>Note 5: For extreme conditions an additional ± 2.0 dB relaxation is allowed.</p> <p>Note 6: The starting resource block shall be RB# 0.</p>					

**Table 6.3.5B.2.5-9: Test Requirements Relative Power Tolerance for Transmission (normal conditions – Note 5) channel bandwidth 15MHz (ramping up)**

Sub-test (ramp up)	Uplink RB allocation	TPC command	Expected power step size (Up) $\Delta P$ [dB]	Power step size range (Up) $\Delta P$ [dB]	PUSCH [dB]
Subframes before RB change	Fixed = 1	TPC=+1dB	1	$\Delta P < 2$	$1 \pm 1.7$
RB change	Change from 1 to 50	TPC=+1dB	17.99	$15 \leq \Delta P$	17.99 $\pm$ 6.7 Note 2 17.99 +8.2/-6.7 Note 3
Subframes after RB change	Fixed = 50	TPC=+1dB	1	$\Delta P < 2$	$1 \pm 1.7$
<p>Note 1: Position of RB change:            Pattern A the position of RB uplink allocation change is after 10 active uplink subframes.            Pattern B the position of RB uplink allocation change is after 20 active uplink subframes.            Pattern C the position of RB uplink allocation change is after 30 active uplink subframes.</p> <p>Note 2: When Note 3 does not apply.</p> <p>Note 3: For operating bands under Note 2 in Table 6.2.2.3-1, if the transmission bandwidth of the reference sub-frames is confined within <math>F_{UL\_low}</math> and <math>F_{UL\_low} + 4</math> MHz or <math>F_{UL\_high} - 4</math> MHz and <math>F_{UL\_high}</math> and the target sub-frame is not confined within any one of these frequency ranges.</p> <p>Note 4: N/A.</p> <p>Note 5: For extreme conditions an additional <math>\pm 2.0</math> dB relaxation is allowed.</p> <p>Note 6: The starting resource block shall be RB# 0.</p>					

**Table 6.3.5B.2.5-10: Test Requirements Relative Power Tolerance for Transmission (normal conditions – Note 5) channel bandwidth 15MHz (ramping down)**

Sub-test (ramp down)	Uplink RB allocation	TPC command	Expected power step size (down) $\Delta P$ [dB]	Power step size range (down) $\Delta P$ [dB]	PUSCH [dB]
Subframes before RB change	Fixed = 75 ( UE- Categories $\geq 2$ )  Fixed = 50 (UE Cat 1)	TPC=-1dB	1	$\Delta P < 2$	$1 \pm 1.7$
RB change	Change from 75 to 1 ( UE- Categories $\geq 2$ )  Change from 50 to 1 (UE Cat 1)	TPC=-1dB	19.75  17.99	$15 \leq \Delta P$	$19.75 \pm 6.7$ Note 2 $19.75 + 6.7/8.2 \pm TT$ Note 4  $17.99 \pm 6.7$ Note 2 $17.99 + 6.7/-8.2$ Note 4
Subframes after RB change	Fixed = 1	TPC=-1dB	1	$\Delta P < 2$	$1 \pm 1.7$
<p>Note 1: Position of RB change:            Pattern A the position of RB uplink allocation change is after 6 active uplink subframes.            Pattern B the position of RB uplink allocation change is after 16 active uplink subframes.            Pattern C the position of RB uplink allocation change is after 26 active uplink subframes.</p> <p>Note 2: When Note 4 does not apply.</p> <p>Note 3: N/A.</p> <p>Note 4: For operating bands under Note 2 in Table 6.2.2.3-1, if the transmission bandwidth of the target sub-frame is confined within <math>F_{UL\_low}</math> and <math>F_{UL\_low} + 4</math> MHz or <math>F_{UL\_high} - 4</math> MHz and <math>F_{UL\_high}</math> and the reference sub-frame is not confined within any one of these frequency ranges.</p> <p>Note 5: For extreme conditions an additional <math>\pm 2.0</math> dB relaxation is allowed.</p> <p>Note 6: The starting resource block shall be RB# 0.</p>					

**Table 6.3.5B.2.5-11: Test Requirements Relative Power Tolerance for Transmission (normal conditions – Note 5) channel bandwidth 20MHz (ramping up)**

Sub-test (ramp up)	Uplink RB allocation	TPC command	Expected power step size (Up) $\Delta P$ [dB]	Power step size range (Up) $\Delta P$ [dB]	PUSCH [dB]
Subframes before RB change	Fixed = 1	TPC=+1dB	1	$\Delta P < 2$	$1 \pm 1.7$
RB change	Change from 1 to 75	TPC=+1dB	19.75	$15 \leq \Delta P$	$19.75 \pm 6.7$ Note 2 $19.75 + 8.2 / - 6.7$ Note 3
Subframes after RB change	Fixed = 75	TPC=+1dB	1	$\Delta P < 2$	$1 \pm 1.7$
<p>Note 1: Position of RB change:            Pattern A the position of RB uplink allocation change is after 10 active uplink subframes.            Pattern B the position of RB uplink allocation change is after 20 active uplink subframes.            Pattern C the position of RB uplink allocation change is after 30 active uplink subframes.</p> <p>Note 2: When Note 3 does not apply.</p> <p>Note 3: For operating bands under Note 2 in Table 6.2.2.3-1, if the transmission bandwidth of the reference sub-frames is confined within <math>F_{UL\_low}</math> and <math>F_{UL\_low} + 4</math> MHz or <math>F_{UL\_high} - 4</math> MHz and <math>F_{UL\_high}</math> and the target sub-frame is not confined within any one of these frequency ranges.</p> <p>Note 4: N/A.</p> <p>Note 5: For extreme conditions an additional <math>\pm 2.0</math> dB relaxation is allowed.</p> <p>Note 6: The starting resource block shall be RB# 0.</p>					

**Table 6.3.5B.2.5-12: Test Requirements Relative Power Tolerance for Transmission (normal conditions – Note 5) channel bandwidth 20MHz (ramping down)**

Sub-test (ramp down)	Uplink RB allocation	TPC command	Expected power step size (down) $\Delta P$ [dB]	Power step size range (down) $\Delta P$ [dB]	PUSCH [dB]
Subframes before RB change	Fixed = 100 ( UE- Categories $\geq 2$ ) Fixed = 75 (UE Cat 1)	TPC=-1dB	1	$\Delta P < 2$	$1 \pm 1.7$
RB change	Change from 100 to 1 ( UE- Categories $\geq 2$ ) Change from 75 to 1 (UE Cat 1)	TPC=-1dB	21.0  19.75	$15 \leq \Delta P$	$21.0 \pm 6.7$ Note 2 $21.0 +6.7/-8.2$ Note 4  $19.75 \pm 6.7$ Note 2 $19.75 +6.7/-8.2$ Note 4
Subframes after RB change	Fixed = 1	TPC=-1dB	1	$\Delta P < 2$	$1 \pm 1.7$
<p>Note 1: Position of RB change:            Pattern A the position of RB uplink allocation change is after 6 active uplink subframes.            Pattern B the position of RB uplink allocation change is after 16 active uplink subframes.            Pattern C the position of RB uplink allocation change is after 26 active uplink subframes.</p> <p>Note 2: When Note 4 does not apply.</p> <p>Note 3: N/A.</p> <p>Note 4: For operating bands under Note 2 in Table 6.2.2.3-1, if the transmission bandwidth of the target sub-frame is confined within <math>F_{UL\_low}</math> and <math>F_{UL\_low} + 4</math> MHz or <math>F_{UL\_high} - 4</math> MHz and <math>F_{UL\_high}</math> and the reference sub-frame is not confined within any one of these frequency ranges.</p> <p>Note 5: For extreme conditions an additional <math>\pm 2.0</math> dB relaxation is allowed.</p> <p>Note 6: The starting resource block shall be RB# 0.</p>					

**Table 6.3.5B.2.5-13: Test Requirements Relative Power Tolerance for Transmission (normal conditions – Note 5) (Alternating pattern)**

Sub-test	Uplink RB allocation	TPC command	Expected power step size (Up or down) $\Delta P$ [dB]	Power step size range (Up or down) $\Delta P$ [dB]	PUSCH [dB]
1.4 MHz	Alternating 1 and 6	TPC=0dB	7.78	$4 \leq \Delta P < 10$	7.78 $\pm$ 6.7 Note 1,2 7.78 +8.2/-6.7 Note 3 7.78 +6.7/-8.2 Note 4
3 MHz	Alternating 1 and 15	TPC=0dB	11.76	$10 \leq \Delta P < 15$	11.76 $\pm$ 6.7 Note 1,2 11.76 +8.2/-6.7 Note 3 11.76 +6.7/-8.2 Note 4
5 MHz	Alternating 1 and 25	TPC=0dB	13.98	$10 \leq \Delta P < 15$	13.98 $\pm$ 6.7 Note 1 13.98 +8.2/-6.7 Note 2 13.98 +6.7/-8.2 Note 3
10 MHz	Alternating 1 and 50 ( UE- Categories $\geq 2$ )	TPC=0dB	16.99	$15 \leq \Delta P$	16.99 $\pm$ 6.7 Note 1,2 16.99 +8.2/-6.7 Note 3 16.99 +6.7/-8.2 Note 4
	Alternating 1 and 48 (UE Cat 1)		16,81		16.81 $\pm$ 6.7 Note 1,2 16.81 +8.2/-6.7 Note 3 16.81 +6.7/-8.2 Note 4
15 MHz	Alternating 1 and 75 ( UE- Categories $\geq 2$ )	TPC=0dB	18.75	$15 \leq \Delta P$	18.75 $\pm$ 6.7 Note 1,2 18.75 +8.2/-6.7 Note 3 18.75 +6.7/-8.2 Note 4
	Alternating 1 and 50 (UE Cat 1)		16.99		16.99 $\pm$ 6.7 Note 1,2 16.99 +8.2/-6.7 Note 3 16.99 +6.7/-8.2 Note 4
20 MHz	Alternating 1 and 100 ( UE- Categories $\geq 2$ )	TPC=0dB	20.00	$15 \leq \Delta P$	20.00 $\pm$ 6.7 Note 1,2 20.00 +8.2/-6.7 Note 3 20.00 +6.7/-8.2 Note 4
	Alternating 1 and 75 (UE Cat 1)		18.75		18.75 $\pm$ 6.7 Note 1,2 18.75 +8.2/-6.7 Note 3 18.75 +6.7/-8.2 Note 4
<p>Note 1: Test tolerance +/- 6.7 dB was selected to allow PA switch possible exceptions to occur.</p> <p>Note 2: When neither Note 3 nor Note 4 applies.</p> <p>Note 3: For operating bands under Note 2 in Table 6.2.2.3-1, if the transmission bandwidth of the reference sub-frames is confined within <math>F_{UL\_low}</math> and <math>F_{UL\_low} + 4</math> MHz or <math>F_{UL\_high} - 4</math> MHz and <math>F_{UL\_high}</math> and the target sub-frame is not confined within any one of these frequency ranges.</p> <p>Note 4: For operating bands under Note 2 in Table 6.2.2.3-1, if the transmission bandwidth of the target sub-frame is confined within <math>F_{UL\_low}</math> and <math>F_{UL\_low} + 4</math> MHz or <math>F_{UL\_high} - 4</math> MHz and <math>F_{UL\_high}</math> and the reference sub-frame is not confined within any one of these frequency ranges.</p> <p>Note 5: For extreme conditions an additional <math>\pm 2.0</math> dB relaxation is allowed.</p> <p>Note 6: The starting resource block shall be RB# 0.</p>					

### 6.3.5B.3 Aggregate power control tolerance for UL-MIMO

#### 6.3.5B.3.1 Test purpose

To verify the ability of the UE with UL-MIMO to maintain its power level in non-contiguous transmission within 21 ms in response to 0 dB TPC commands with respect to the first UE transmission, when the power control parameters specified in TS 36.213 are constant.

#### 6.3.5B.3.2 Test applicability

This test case applies to all types of E-UTRA UE release 10 and forward that support UL MIMO.

#### 6.3.5B.3.3 Minimum conformance requirement

For UE with multiple transmit antenna connectors, the power control tolerance applies to the sum of output power at each transmit antenna connector.

The power control requirements specified in clause 6.3.5 apply to UE with two transmit antenna connectors with UL-MIMO configurations specified in Table 6.2.2B.3-2 for closed-loop spatial multiplexing scheme, wherein:

- The Maximum output power requirements for UL-MIMO are specified in clause 6.2.2B.
- The Minimum output power requirements for UL-MIMO are specified in clause 6.3.2B.

The normative reference for this requirement is TS 36.101 [2] clause 6.3.5B.

#### 6.3.5B.3.4 Test description

##### 6.3.5B.3.4.1 Initial conditions

Initial conditions are a set of test configurations the UE needs to be tested in and the steps for the SS to take with the UE to reach the correct measurement state.

The initial test configurations consist of environmental conditions, test frequencies, and channel bandwidths based on E-UTRA operating bands specified in table 5.4.2.1-1. All of these configurations shall be tested with applicable test parameters for each channel bandwidth, and are shown in table 6.3.5B.3.4.1-1. The details of the uplink and downlink reference measurement channels (RMCs) are specified in Annexes A.2 and A.3. Configurations of PDSCH and PDCCH before measurement are specified in Annex C.2.

**Table 6.3.5B.3.4.1-1: Test Configuration Table: PUCCH sub-test**

Initial Conditions				
Test Environment as specified in TS 36.508[7] subclause 4.1		Normal		
Test Frequencies as specified in <b>TS 36.508 [7] subclause 4.3.1</b>		Mid range		
Test Channel Bandwidths as specified in <b>TS 36.508 [7] subclause 4.3.1</b>		Lowest, 5MHz, Highest		
Test Parameters for Channel Bandwidths				
Ch BW	Downlink Configuration			Uplink Configuration
	Mod'n	RB allocation		
		FDD	TDD	FDD: PUCCH format = Format 1a TDD: PUCCH format = Format 1a/1b
1.4MHz	QPSK	3	3	
3MHz	QPSK	4	4	
5MHz	QPSK	8	8	
10MHz	QPSK	16	16	
15MHz	QPSK	25	25	
20MHz	QPSK	30	30	
Note 1: Test Channel Bandwidths are checked separately for each E-UTRA band, the applicable channel bandwidths are specified in Table 5.4.2.1-1.				



**Table 6.3.5B.3.4.1-2: Test Configuration Table: PUSCH sub-test**

Initial Conditions				
Test Environment as specified in TS 36.508[7] subclause 4.1		Normal		
Test Frequencies as specified in <b>TS 36.508 [7] subclause 4.3.1</b>		Mid range		
Test Channel Bandwidths as specified in <b>TS 36.508 [7] subclause 4.3.1</b>		Lowest, 5MHz, Highest		
Test Parameters for Channel Bandwidths				
Ch BW	Downlink Configuration	Uplink Configuration		
	N/A for PUSCH sub-test	Mod'n	RB allocation	
			FDD	TDD
1.4MHz		QPSK	1	1
3MHz		QPSK	4	4
5MHz		QPSK	8	8
10MHz		QPSK	12	12
15MHz		QPSK	16	16
20MHz		QPSK	18	18
Note 1: Test Channel Bandwidths are checked separately for each E-UTRA band, the applicable channel bandwidths are specified in Table 5.4.2.1-1.				

1. Connect the SS to the UE antenna connectors as shown in TS 36.508 [7] Annex A, Figure A.28.
2. The parameter settings for the cell are set up according to TS 36.508 [7] clause 4.4.3.
3. Downlink signals are initially set up according to Annex C0, C.1 and C.3.0, and uplink signals according to Annex H.1 and H.3.0.
4. The UL and DL Reference Measurement channels are set according to Table 6.3.5B.3.4.1-1 (PUCCH sub-test) and Table 6.3.5B.3.4.1-2 (PUSCH sub-test).
5. Ensure the UE is in State 3A-RF according to TS 36.508 [7] clause 5.2A.2. Message contents are defined in clause 6.3.5B.3.4.3.

**6.3.5B.3.4.2 Test procedure**

The procedure is separated in two subtests to verify PUCCH and PUSCH aggregate power control tolerance respectively. The uplink transmission patterns are described in figure 6.3.5B.3.4.2-1.

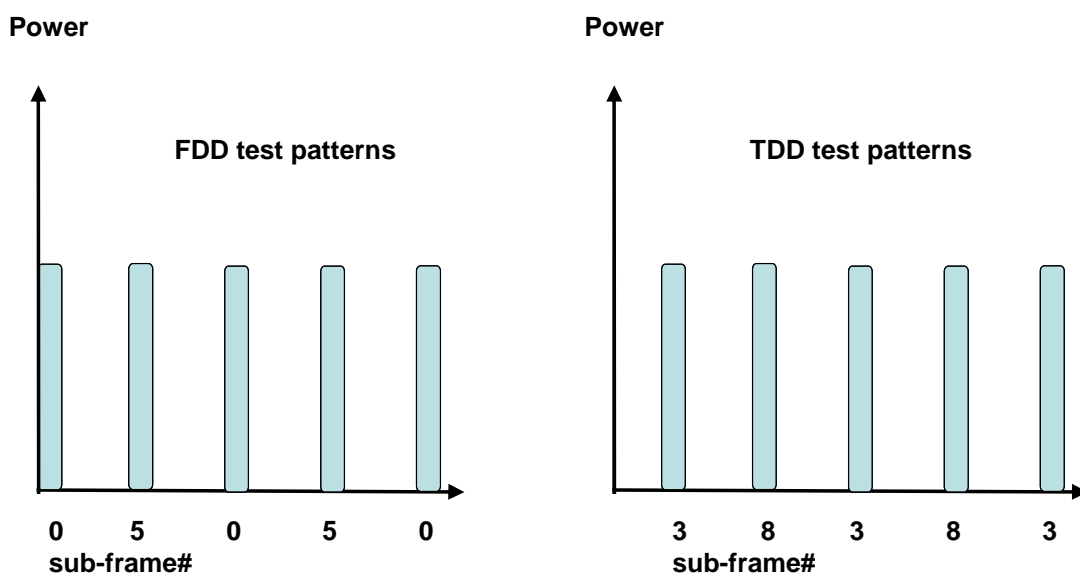

**Figure 6.3.5B.3.4.2-1 Test uplink transmission**

## 1. PUCCH sub test:

- 1.1 The SS transmits PDSCH via PDCCH DCI format 1A for C\_RNTI to transmit the DL RMC according to Table 6.3.5B.3.4.1-1. The SS sends downlink MAC padding bits on the DL RMC. The transmission of PDSCH will make the UE send uplink ACK/NACK using PUCCH. Send the appropriate TPC commands for PUCCH to the UE to ensure that the UE transmits PUCCH at 0dBm +/- 3.2 dB for carrier frequency  $f \leq 3.0\text{GHz}$  or at 0dBm +/- 3.5 dB for carrier frequency  $3.0\text{GHz} < f \leq 4.2\text{GHz}$ .
- 1.2. Every 5 subframes transmit to the UE downlink PDSCH MAC padding bits as well as 0 dB TPC command for PUCCH via the PDCCH to make the UE transmit ACK/NACK on the PUCCH with transmission gap of 4 subframes. The downlink transmission is scheduled in the appropriate sub-frames to make the UE transmit PUCCH as described in figure 6.3.5B.3.4.2-1.
- 1.3. Measure the mean sum power at each antenna connector for UE of 5 consecutive PUCCH transmissions to verify the UE transmitted PUCCH power is maintained within 21 ms. The transient periods of 20us are excluded from the power measurement.

## 2. PUSCH sub test:

- 2.1. The SS sends uplink scheduling information via PDCCH DCI format 4 for C\_RNTI to schedule the UL RMC according to Table 6.3.5B.3.4.1-2. Since the UE has no payload and no loopback data to send the UE sends uplink MAC padding bits on the UL RMC. Send the appropriate TPC commands for PUSCH to the UE to ensure that the UE transmits PUSCH at 0dBm +/- 3.2dB for carrier frequency  $f \leq 3.0\text{GHz}$  or at 0dBm +/- 3.5 dB for carrier frequency  $3.0\text{GHz} < f \leq 4.2\text{GHz}$ .
- 2.2. Every 5 subframes schedule the UE's PUSCH data transmission and transmit 0 dB TPC command for PUSCH via the PDCCH to make the UE transmit PUSCH with 4 subframes gap. The uplink transmission patterns are described in figure 6.3.5B.3.4.2-1.
- 2.3. Measure the mean sum power at each antenna connector for UE of 5 consecutive PUSCH transmissions to verify the UE transmitted PUSCH power is maintained within 21 ms. The transient periods of 20us are excluded from the power measurement.

## 6.3.5B.3.4.3 Message contents

Message contents are according to TS 36.508 [7] clause 4.6 with the following exceptions:

**Table 6.3.5B.3.4.3-1: PUCCH-ConfigDedicated-v1020-DEFAULT**

Derivation Path: TS 36.508 [7] clause 4.6.3, Table 4.6.3-9A: PUCCH-ConfigDedicated-v1020-DEFAULT			
Information Element	Value/remark	Comment	Condition
PUCCH-ConfigDedicated-v1020 ::= SEQUENCE {			
twoAntennaPortActivatedPUCCH-Format1a1b-r10	true		
}			

## 6.3.5B.3.5 Test requirement

The requirement for the power measurements made in step (1.3) and (2.3) of the test procedure shall not exceed the values specified in Table 6.3.5B.3.5-1. The power measurement period shall be 1 sub-frame excluding transient periods.

**Table 6.3.5B.3.5-1: Power control tolerance**

TPC command	UL channel	Test requirement measured power
0 dB	PUCCH	Given 5 power measurements in the pattern, the 2 <sup>nd</sup> , 3 <sup>rd</sup> , 4 <sup>th</sup> , and 5 <sup>th</sup> measurements shall be within $\pm 3.2$ dB of the 1 <sup>st</sup> measurement.
0 dB	PUSCH	Given 5 power measurements in the pattern, the 2 <sup>nd</sup> , 3 <sup>rd</sup> , 4 <sup>th</sup> , and 5 <sup>th</sup> measurements shall be within $\pm 4.2$ dB of the 1 <sup>st</sup> measurement.
Note 1: The UE transmission gap is 4 ms. TPC command is transmitted via PDCCH 4 subframes preceding each PUCCH/PUSCH transmission.		

## 6.4 Void

## 6.5 Transmit signal quality

**Editor's note:** The test cases for transmit signal quality: frequency error, EVM, carrier leakage, IBE, EVM equalizer spectrum flatness are complete, except the following aspect is not determined:

- Reference signal EVM and PRACH EVM minimum requirements from the core specification are still in brackets

In this clause a multitude of results are derived, all using one common algorithm returning these results: Global In-Channels TX-Test (Annex E). Each sub clause of this clause contains a procedure and test requirements described for a specific measurement. If all relevant test parameters in different sub clauses are the same, then the results, returned by the Global In-Channel TX-Test, may be used across the applicable sub clauses.

### 6.5.1 Frequency Error

#### 6.5.1.1 Test purpose

This test verifies the ability of both, the receiver and the transmitter, to process frequency correctly.

Receiver: to extract the correct frequency from the stimulus signal, offered by the System simulator, under ideal propagation conditions and low level.

Transmitter: to derive the correct modulated carrier frequency from the results, gained by the receiver.

#### 6.5.1.2 Test applicability

This test case applies to all types of E-UTRA UE release 8 and forward.

#### 6.5.1.3 Minimum conformance requirements

The UE modulated carrier frequency shall be accurate to within  $\pm 0.1$  PPM observed over a period of one time slot (0.5ms) compared to the carrier frequency received from the E-UTRA Node B.

The normative reference for this requirement is TS 36.101 clause 6.5.1

#### 6.5.1.4 Test description

##### 6.5.1.4.1 Initial condition

Initial conditions are a set of test configurations the UE needs to be tested in and the steps for the SS to take with the UE to reach the correct measurement state.

The initial test configurations consist of environmental conditions, test frequencies, and channel bandwidths based on E-UTRA bands specified in table 5.4.2.1-1. All of these configurations shall be tested with applicable test parameters for each channel bandwidth, and are shown in table 6.5.1.4.1-1. The details of the uplink and downlink reference measurement channels (RMCs) are specified in Annexes A.2 and A.3. Configurations of PDSCH and PDCCH before measurement are specified in Annex C.2.

Table 6.5.1.4.1-1: Test Configuration Table

Initial Conditions						
Test Environment as specified in TS 36.508[7] subclause 4.1			NC, TL/VL, TL/VH, TH/VL, TH/VH			
Test Frequencies as specified in TS36.508 [7] subclause 4.3.1			Low range, Mid range, High range			
Test Channel Bandwidths as specified in TS 36.508 [7] subclause 4.3.1			Lowest, 5MHz, Highest			
Test Parameters for Channel Bandwidths						
Ch BW	Downlink Configuration			Uplink Configuration		
	Mod'n	RB allocation		Mod'n	RB allocation	
		FDD	TDD		FDD	TDD
1.4MHz	QPSK	6	6	QPSK	6	6
3MHz	QPSK	15	15	QPSK	15	15
5MHz	QPSK	25	25	QPSK	25	25
5MHz	QPSK	25	N/A	QPSK	20	N/A
5MHz	QPSK	25	N/A	QPSK	15	N/A
5MHz	QPSK	25	N/A	QPSK	5 <sup>3</sup>	N/A
10MHz	QPSK	50	50	QPSK	50	50
10MHz	QPSK	50	N/A	QPSK	25	N/A
10MHz	QPSK	50	N/A	QPSK	20	N/A
10MHz	QPSK	50	N/A	QPSK	15	N/A
15MHz	QPSK	75	75	QPSK	75	75
15MHz	QPSK	75	N/A	QPSK	50	N/A
15MHz	QPSK	75	N/A	QPSK	25	N/A
15MHz	QPSK	75	N/A	QPSK	20	N/A
20MHz	QPSK	100	100	QPSK	100	100
20MHz	QPSK	100	N/A	QPSK	75	N/A
20MHz	QPSK	100	N/A	QPSK	50	N/A
20MHz	QPSK	100	N/A	QPSK	25	N/A
20MHz	QPSK	100	N/A	QPSK	20	N/A
Note 1: Test Channel Bandwidths are checked separately for each E-UTRA band, which applicable channel bandwidths are specified in Table 5.4.2.1-1. Note 2: Depending on E-UTRA band, only the appropriate Uplink RB allocation value according to table 7.3.3-2 is tested per Test Channel Bandwidth. Note 3: Applicable only to E-UTRA FDD Band 31. The UL resource blocks shall be located at RBstart 10 (according to Table 7.3.3-2).						

1. Connect the SS to the UE to the UE antenna connectors as shown in TS 36.508 [7] Annex A, Figure A.3.
2. The parameter settings for the cell are set up according to TS 36.508[7] subclause 4.4.3.
3. Downlink signals are initially set up according to Annex C0, C.1 and C.3.0, and uplink signals according to Annex H.1 and H.3.0.
4. The UL and DL Reference Measurement channels are set according to Table 6.5.1.4.1-1.
5. Propagation conditions are set according to Annex B.0
6. Ensure the UE is in State 3A-RF according to TS 36.508 [7] clause 5.2A.2. Message contents are defined in clause 6.5.1.4.3.

#### 6.5.1.4.2 Test procedure

1. SS transmits PDSCH via PDCCH DCI format 1A for C\_RNTI to transmit the DL RMC according to Table 6.5.1.4.1-1. The SS sends downlink MAC padding bits on the DL RMC.
2. SS sends uplink scheduling information for each UL HARQ process via PDCCH DCI format 0 for C\_RNTI to schedule the UL RMC according to Table 6.5.1.4.1-1, since the UE has no payload data to send, the UE transmit uplink MAC padding bits on the UL RMC
3. Set the Downlink signal level to the appropriate REFSSENS value defined in Table 7.3.5-1. Send continuously uplink power control "up" commands to the UE in every uplink scheduling information to the UE so that the UE transmits at  $P_{UMAX}$  level for the duration of the test.

4. Measure the Frequency Error using Global In-Channel Tx-Test (Annex E). For TDD slots with transient periods are not under test.

#### 6.5.1.4.3 Message contents

Message contents are according to TS 36.508 [7] subclause 4.6 with the exceptions in subclause 7.3.4.3 and Table 7.3.3-3.

#### 6.5.1.5 Test requirement

The 20 frequency error  $\Delta f$  results must fulfil the test requirement:

$$|\Delta f| \leq (0.1 \text{ PPM} + 15 \text{ Hz})$$

### 6.5.1A Frequency error for CA

#### 6.5.1A.0 Minimum conformance requirements

For inter-band carrier aggregation with uplink assigned to two E-UTRA bands, the frequency error requirements defined in subclause 6.5.1 shall apply on each component carrier with both component carriers active.

For intra-band contiguous carrier aggregation the UE modulated carrier frequencies per band shall be accurate to within  $\pm 0.1$  PPM observed over a period of one timeslot compared to the carrier frequency of primary component carrier received from the E-UTRA in the corresponding band.

For intra-band non-contiguous carrier aggregation the requirements in Section 6.5.1 applies per component carrier.

The normative reference for this requirement is TS 36.101[2] clause 6.5.1A.

#### 6.5.1A.1 Frequency error for CA (intra-band contiguous DL CA and UL CA)

##### 6.5.1A.1.1 Test purpose

This test verifies the ability of both, receiver and the transmitter, to process frequency for intra-band CA correctly.

Receiver: to extract the correct frequency from the stimulus signal, offered by the System simulator, under ideal propagation conditions and low level.

Transmitter: to derive the correct modulated carrier frequency from the results, gained by the receiver.

##### 6.5.1A.1.2 Test applicability

This test case applies to all types of E-UTRA UE release 10 and forward that support intra-band contiguous DL CA and UL CA.

##### 6.5.1A.1.3 Minimum conformance requirements

The minimum conformance requirements are defined in clause 6.5.1A.0.

##### 6.5.1A.1.4 Test description

###### 6.5.1A.1.4.1 Initial condition

Initial conditions are a set of test configurations the UE needs to be tested in and the steps for the SS to take with the UE to reach the correct measurement state.

The initial test configurations consist of environmental conditions, test frequencies, and CC combinations based on E-UTRA CA configurations specified in table 5.4.2A.1-1. All of these configurations shall be tested with applicable test parameters for each CA Configuration, and are shown in table 6.5.1A.1.4.1-1. The details of the uplink and downlink

reference measurement channels (RMCs) are specified in Annex A.2 and A3. Configurations of PDSCH and PDCCH before measurement are specified in Annex C.2.

**Table 6.5.1A.1.4.1-1: Test Configuration Table**

Initial Conditions									
Test Environment as specified in TS 36.508[7] subclause 4.1					NC, TL/VL, TL/VH, TH/VL, TH/VH				
Test Frequencies as specified in TS36.508 [7] subclause 4.3.1 for different CA bandwidth classes and PCC and SCCs are mapped onto physical frequencies according to Table 6.1-2.					C: Low range, High range				
Test CC Combination setting ( $N_{RB\_agg}$ ) as specified in subclause 5.4.2A.1 for the CA Configuration					Lowest $N_{RB\_agg}$ Highest $N_{RB\_agg}$ (Note 3)				
Test Parameters for CA Configurations									
CA Configuration / $N_{RB\_agg}$		DL Allocation		UL Allocation					
PCC $N_{RB}$	SCCs $N_{RB}$	CC Mod	PCC & SCC RB allocation	CC MOD	$N_{RB\_alloc}$	PCC & SCC RB allocations (L <sub>CRB</sub> @ RB <sub>start</sub> )			
75	75	QPSK	75+75	QPSK	129	P_75@0	S_54@0	-	-
75	75	QPSK	75+75	QPSK	150	P_75@0	S_75@0	-	-
100	50	QPSK	100+50	QPSK	150	P_100@0	S_50@0	-	-
100	75	QPSK	100+75	QPSK	175	P_100@0	S_75@0	-	-
100	100	QPSK	100+100	QPSK	130	P_100@0	S_30@0	-	-
100	100	QPSK	100+100	QPSK	75	P_75@0	S_0@0	-	-
<p>Note 1: CA Configuration Test CC Combination settings are checked separately for each CA Configuration, which applicable aggregated channel bandwidths are specified in Table 5.4.2A.1-1.</p> <p>Note 2: Depending on CA configurations, only the appropriate Uplink RB allocation value according to table 7.3A.1.3-1 for UE supporting two uplink carriers is tested per Test CA configuration.</p> <p>Note 3: If in the CA Configuration UE supports multiple CC Combinations with the same <math>N_{RB\_agg}</math>, only the first of those is tested, according to the order on the Test Configuration Table list.</p>									

1. Connect the SS to the UE antenna connectors as shown in TS 36.508[7] Annex A Figure group A.32 as appropriate.
2. The parameter settings for the cell are set up according to TS 36.508 [7] subclause 4.4.3.
3. Downlink signals for PCC are initially set up according to Annex C.0, C.1, and C.3.0, and uplink signals according to Annex H.1 and H.3.0.
4. The UL and DL Reference Measurement channel is set according to Table 6.5.1A.1.4.1-1.
5. Propagation conditions are set according to Annex B.0.
6. Ensure the UE is in State 3A-RF according to TS 36.508 [7] clause 5.2A.2. Message contents are defined in clause 6.5.1A.1.4.3.

#### 6.5.1A.1.4.2 Test procedure

1. Configure SCC according to Annex C0, C.1 and Annex C.3.0 for all downlink physical channels.
2. The SS shall configure SCC as per TS 36.508 [7] clause 5.2A.4. Message contents are defined in clause 6.5.1A.1.4.3
3. SS activates SCC by sending the activation MAC-CE (Refer TS 36.321 [13], clauses 5.13, 6.1.3.8). Wait for at least 2 seconds (Refer TS 36.133, clauses 8.3.3.2).
4. SS transmits PDSCH via PDCCH DCI format 1A for C\_RNTI to transmit the DL RMC according to Tables 6.5.1A.1.4.1-1 on both PCC and SCC. The SS sends downlink MAC padding bits on the DL RMC.

5. SS sends uplink scheduling information for each UL HARQ process via PDCCH DCI format 0 for C\_RNTI to schedule the UL RMC according to Table 6.5.1A.1.4.1-1 on both PCC and SCC. Since the UE has no payload and no loopback data to send the UE sends uplink MAC padding bits on the UL RMC.
6. Set the Downlink signal level for PCC and SCC to the appropriate REFSSENS value defined in Table 7.3A.2.5-1. Send continuously uplink power control "up" commands in every uplink scheduling information to the UE to ensure the UE transmits  $P_{UMAX}$  level for at least the duration of the test.
7. Measure the Frequency Error on PCC and SCC using Global In-Channel Tx-Test (Annex E) respectively. For TDD slots with transient periods are not under test.

#### 6.5.1A.1.4.3 Message contents

Message contents are according to TS 36.508 [7] subclause 4.6. In test procedure step 2, for SCC configuration there are no additional message contents.

#### 6.5.1A.1.5 Test Requirements

The 20 frequency error  $\Delta f$  results per test point must fulfil the test requirement:

$$|\Delta f| \leq (0.1 \text{ PPM} + 15 \text{ Hz}) \text{ for each test point.}$$

#### 6.5.1A.2 Frequency error for CA (inter-band DL CA and UL CA)

**Editor's note: This clause is incomplete. The following aspects are either missing or not yet determined:**

- Initial conditions are FFS

##### 6.5.1A.2.1 Test purpose

This test verifies the ability of both, receiver and the transmitter, to process frequency for inter-band CA correctly.

Receiver: to extract the correct frequency from the stimulus signal, offered by the System simulator, under ideal propagation conditions and low level.

Transmitter: to derive the correct modulated carrier frequency from the results, gained by the receiver.

##### 6.5.1A.2.2 Test applicability

This test case applies to all types of E-UTRA UE release 11 and forward that support inter-band DL CA and UL CA.

##### 6.5.1A.2.3 Minimum conformance requirements

The minimum conformance requirements are defined in clause 6.5.1A.0.

##### 6.5.1A.2.4 Test description

###### 6.5.1A.2.4.1 Initial condition

Same as in clause 6.5.1A.1.4.1 with the following exceptions:

- Instead of Table 5.4.2A.1-1 → use Table 5.4.2A.1-2 for CA configurations with two bands or Table 5.4.2A.1-2a for CA configurations with three bands.
- Instead of Table 6.5.1A.1.4.1-1 → use Table 6.5.1A.2.4.1-1.
- Instead of clause 6.3.4A.1.1.4.3 use clause 6.3.4A.1.2.4.3.

**Table 6.5.1A.2.4.1-1: Test Configuration Table**

FFS



#### 6.5.1A.2.4.2 Test procedure

Same test procedure as in clause 6.5.1A.1.4.2.

- Instead of Table 6.5.1A.1.4.1-1 → use Table 6.5.1A.2.4.1-1.
- Instead of Table 7.3A.2.5-1 use Table 7.3A.6.5-1.
- Instead of clause 6.3.4A.1.1.4.3 use clause 6.3.4A.1.2.4.3.

#### 6.5.1A.2.4.3 Message contents

Message contents are according to TS 36.508 [7] subclause 4.6. In test procedure step 2, for SCC configuration there are no additional message contents.

#### 6.5.1A.2.5 Test requirement

The 20 frequency error  $\Delta f$  results per test point must fulfil the test requirement:

$$|\Delta f| \leq (0.1 \text{ PPM} + 15 \text{ Hz}) \text{ for each test point.}$$

### 6.5.1B Frequency Error for UL-MIMO

#### 6.5.1B.1 Test purpose

This test verifies the ability of both, the receiver and the transmitter for UL-MIMO, to process frequency correctly.

Receiver: to extract the correct frequency from the stimulus signal, offered by the System simulator, under ideal propagation conditions and low level.

Transmitter: to derive the correct modulated carrier frequency for each transmitter connector from the results, gained by the receiver.

#### 6.5.1B.2 Test applicability

This test applies to all types of E-UTRA UE release 10 and forward that support UL-MIMO.

#### 6.5.1B.3 Minimum conformance requirements

The UE modulated carrier frequency for each transmit antenna shall be accurate to within  $\pm 0.1$  PPM observed over a period of one time slot (0.5ms) compared to the carrier frequency received from the E-UTRA Node B.

The normative reference for this requirement is TS 36.101 clause 6.5.1B

#### 6.5.1B.4 Test description

##### 6.5.1B.4.1 Initial condition

Initial conditions are a set of test configurations the UE needs to be tested in and the steps for the SS to take with the UE to reach the correct measurement state.

The initial test configurations consist of environmental conditions, test frequencies, and channel bandwidths based on E-UTRA bands specified in table 5.4.2.1-1. All of these configurations shall be tested with applicable test parameters for each channel bandwidth, and are shown in table 6.5.1B.4.1-1. The details of the uplink and downlink reference measurement channels (RMCs) are specified in Annexes A.2 and A.3. Configurations of PDSCH and PDCCH before measurement are specified in Annex C.2.

Table 6.5.1B.4.1-1: Test Configuration Table

Initial Conditions						
Test Environment as specified in TS 36.508[7] subclause 4.1			NC, TL/VL, TL/VH, TH/VL, TH/VH			
Test Frequencies as specified in TS36.508 [7] subclause 4.3.1			Low range, Mid range, High range			
Test Channel Bandwidths as specified in TS 36.508 [7] subclause 4.3.1			Lowest, 5MHz, Highest			
Test Parameters for Channel Bandwidths						
Ch BW	Downlink Configuration			Uplink Configuration		
	Mod'n	RB allocation		Mod'n	RB allocation	
		FDD	TDD		FDD	TDD
1.4MHz	QPSK	6	6	QPSK	6	6
3MHz	QPSK	15	15	QPSK	15	15
5MHz	QPSK	25	25	QPSK	25	25
5MHz	QPSK	25	N/A	QPSK	20	N/A
5MHz	QPSK	25	N/A	QPSK	15	N/A
5MHz	QPSK	25	N/A	QPSK	5 <sup>3</sup>	N/A
10MHz	QPSK	50	50	QPSK	50	50
10MHz	QPSK	50	N/A	QPSK	25	N/A
10MHz	QPSK	50	N/A	QPSK	20	N/A
10MHz	QPSK	50	N/A	QPSK	15	N/A
15MHz	QPSK	75	75	QPSK	75	75
15MHz	QPSK	75	N/A	QPSK	50	N/A
15MHz	QPSK	75	N/A	QPSK	25	N/A
15MHz	QPSK	75	N/A	QPSK	20	N/A
20MHz	QPSK	100	100	QPSK	100	100
20MHz	QPSK	100	N/A	QPSK	75	N/A
20MHz	QPSK	100	N/A	QPSK	50	N/A
20MHz	QPSK	100	N/A	QPSK	25	N/A
20MHz	QPSK	100	N/A	QPSK	20	N/A
Note 1:	Test Channel Bandwidths are checked separately for each E-UTRA band, which applicable channel bandwidths are specified in Table 5.4.2.1-1.					
Note 2:	Depending on E-UTRA band, only the appropriate Uplink RB allocation value according to table 7.3.3-2 is tested per Test Channel Bandwidth.					
Note 3:	Applicable only to E-UTRA FDD Band 31. The UL resource blocks shall be located at RBstart 10 (according to Table 7.3.3-2).					

1. Connect the SS to the UE to the UE antenna connectors as shown in TS 36.508 [7] Annex A, Figure A.28.
2. The parameter settings for the cell are set up according to TS 36.508[7] subclause 4.4.3.
3. Downlink signals are initially set up according to Annex C0, C.1 and C.3.0, and uplink signals according to Annex H.1 and H.3.0.
4. The UL and DL Reference Measurement channels are set according to Table 6.5.1B.4.1-1.
5. Propagation conditions are set according to Annex B.0
6. Ensure the UE is in State 3A-RF according to TS 36.508 [7] clause 5.2A.2. Message contents are defined in clause 6.5.1B.4.3.

#### 6.5.1B.4.2 Test procedure

1. SS transmits PDSCH via PDCCH DCI format 1A for C\_RNTI to transmit the DL RMC according to Table 6.5.1B.4.1-1. The SS sends downlink MAC padding bits on the DL RMC.
2. SS sends uplink scheduling information for each UL HARQ process via PDCCH DCI format 4 for C\_RNTI to schedule the UL RMC according to Table 6.5.1B.4.1-1, since the UE has no payload data to send, the UE transmit uplink MAC padding bits on the UL RMC.
3. Set the Downlink signal level to the appropriate REFSENS value defined in Table 7.3B.5-1. Send continuously uplink power control "up" commands to the UE in every uplink scheduling information to the UE so that the UE transmits at PUMAX level for the duration of the test.

4. Measure the Frequency Error using Global In-Channel Tx-Test (Annex E) for each of transmit antenna of the UE. For TDD slots with transient periods are not under test.

#### 6.5.1B.4.3 Message contents

Message contents are according to TS 36.508 [7] clause 4.6 with the exceptions in clause 7.3.4.3 and Table 7.3.3-3.

#### 6.5.1B.5 Test requirement

The requirements apply to each transmit antenna connector.

The 20 frequency error  $\Delta f$  results must fulfil the test requirement:

$$|\Delta f| \leq (0.1\text{PPM} + 15 \text{ Hz})$$

### 6.5.2 Transmit modulation

Transmit modulation defines the modulation quality for expected in-channel RF transmissions from the UE. This transmit modulation limit is specified in terms of:

- Error Vector Magnitude (EVM) for the allocated resources blocks (RB),
- EVM equalizer spectrum flatness derived from the equalizer coefficients generated by the EVM measurement process
- Carrier leakage

In-band emissions for the non-allocated RB

#### 6.5.2.1 Error Vector Magnitude (EVM)

##### 6.5.2.1.1 Test Purpose

The Error Vector Magnitude is a measure of the difference between the reference waveform and the measured waveform. This difference is called the error vector. Before calculating the EVM the measured waveform is corrected by the sample timing offset and RF frequency offset. Then the carrier leakage shall be removed from the measured waveform before calculating the EVM.

The measured waveform is further modified by selecting the absolute phase and absolute amplitude of the Tx chain. The EVM result is defined after the front-end IDFT as the square root of the ratio of the mean error vector power to the mean reference power expressed as a %.

The basic EVM measurement interval in the time domain is one preamble sequence for the PRACH and is one slot for the PUCCH and PUSCH in the time domain. When the PUSCH or PUCCH transmission slot is shortened due to multiplexing with SRS, the EVM measurement interval is reduced by one symbol, accordingly. The PUSCH or PUCCH EVM measurement interval is also reduced when the mean power, modulation or allocation between slots is expected to change. In the case of PUSCH transmission, the measurement interval is reduced by a time interval equal to the sum of 5  $\mu\text{s}$  and the applicable exclusion period defined in subclause 6.3.4, adjacent to the boundary where the power change is expected to occur. The PUSCH exclusion period is applied to the signal obtained after the front-end IDFT. In the case of PUCCH transmission, the PUCCH EVM measurement interval is reduced by one symbol adjacent to the slot boundary.

##### 6.5.2.1.2 Test applicability

This test case applies to all types of E-UTRA UE release 8 and forward.

##### 6.5.2.1.3 Minimum conformance requirements

EVM measurements are evaluated for 10 uplink sub-frames excluding any transient period for the average EVM case, and 60 subframes excluding any transient period for the reference signal EVM case, the different modulations schemes shall not exceed the values specified in Table 6.5.2.1.3-1 for the parameters defined in Table 6.5.2.1.3-2. For EVM

evaluation purposes, [all PRACH preamble formats 0-4 and] all PUCCH formats 1, 1a, 1b, 2, 2a and 2b are considered to have the same EVM requirement as QPSK modulated.

**Table 6.5.2.1.3-1: Minimum requirements for Error Vector Magnitude**

Parameter	Unit	Average EVM Level	Reference Signal EVM Level
QPSK or BPSK	%	17.5	17.5
16QAM	%	12.5	12.5

**Table 6.5.2.1.3-2: Parameters for Error Vector Magnitude**

Parameter	Unit	Level
UE Output Power	dBm	≥ -40
Operating conditions		Normal conditions

The normative reference for this requirement is TS 36.101 [2] clause 6.5.2.1.1.

#### 6.5.2.1.4 Test description

##### 6.5.2.1.4.1 Initial conditions

Initial conditions are a set of test configurations the UE needs to be tested in and the steps for the SS to take with the UE to reach the correct measurement state.

The initial test configurations consist of environmental conditions, test frequencies, and channel bandwidths based on E-UTRA bands specified in table 5.4.2.1-1. All of these configurations shall be tested with applicable test parameters for each channel bandwidth, and are shown in table 6.5.2.1.4.1-1. The details of the uplink reference measurement channels (RMCs) are specified in Annex A.2. Configurations of PDSCH and PDCCH before measurement are specified in Annex C.2.

**Table 6.5.2.1.4.1-1: Test Configuration Table for PUSCH**

Initial Conditions			
Test Environment (as specified in TS 36.508 [7] subclause 4.1)		NC	
Test Frequencies (as specified in TS36.508 [7] subclause 4.3.1)		See Table 6.5.1.4.1-1	
Test Channel Bandwidths (as specified in TS 36.508 [7] subclause 4.3.1)		See Table 6.5.1.4.1-1	
Test Parameters for Channel Bandwidths			
	Downlink Configuration	Uplink Configuration	
Ch BW	N/A for PUSCH EVM testing	Mod'n	RB allocation
			FDD      TDD

1.4MHz		QPSK	6	6
1.4MHz		QPSK	1	1
1.4MHz		16QAM	6	6
1.4MHz		16QAM	1	1
3MHz		QPSK	15	15
3MHz		QPSK	4	4
3MHz		16QAM	15	15
3MHz		16QAM	4	4
5MHz		QPSK	25	25
5MHz		QPSK	8	8
5MHz		16QAM	25	25
5MHz		16QAM	8	8
10MHz		QPSK	50	50
10MHz		QPSK	12	12
10MHz		16QAM	50	50
			(Note 3)	(Note 3)
10MHz		16QAM	12	12
15MHz		QPSK	75	75
15MHz		QPSK	16	16
15MHz		16QAM	75	75
			(Note 3)	(Note 3)
15MHz		16QAM	16	16
20MHz		QPSK	100	100
20MHz		QPSK	18	18
20MHz		16QAM	100	100
			(Note 3)	(Note 3)
20MHz		16QAM	18	18
Note 1: Test Channel Bandwidths are checked separately for each E-UTRA band, which applicable channel bandwidths are specified in Table 5.4.2.1-1.				
Note 2: For partial RB allocation, the RB <sub>start</sub> shall be RB #0 and RB# (max+1 - RB allocation) of the channel bandwidth.				
Note 3: Applies only for UE-Categories ≥2				

**Table 6.5.2.1.4.1-2: Test Configuration Table for PUCCH**

Initial Conditions				
Test Environment as specified in TS 36.508[7] subclause 4.1		NC		
Test Frequencies as specified in <b>TS36.508 [7] subclause 4.3.1</b>		See Table 6.5.1.4.1-1		
Test Channel Bandwidths as specified in <b>TS 36.508 [7] subclause 4.3.1</b>		See Table 6.5.1.4.1-1		
Test Parameters for Channel Bandwidths				
Ch BW	Downlink Configuration			Uplink Configuration
	Mod'n	RB allocation		
		FDD	TDD	FDD: PUCCH format = Format 1a TDD: PUCCH format = Format 1a / 1b
1.4MHz	QPSK	3	3	
3MHz	QPSK	4	4	
5MHz	QPSK	8	8	
10MHz	QPSK	16	16	
15MHz	QPSK	25	25	
20MHz	QPSK	30	30	
Note 1: Test Channel Bandwidths are checked separately for each E-UTRA band, the applicable channel bandwidths are specified in Table 5.4.2.1-1.				

**Table 6.5.2.1.4.1-3: Test Configuration for PRACH**

Initial Conditions		
Test Environment (as specified in TS 36.508 [7] subclause 4.1)	NC	
Test Frequencies (as specified in TS36.508 [7] subclause 4.3.1)	See Table 6.5.1.4.1-1	
Test Channel Bandwidths (as specified in TS 36.508 [7] subclause 4.3.1)	See Table 6.5.1.4.1-1	
PRACH preamble format		
	FDD	TDD
PRACH Configuration Index	4	53
RS EPRE setting for test point 1 (dBm/15kHz)	-71	-63
RS EPRE setting for test point 2 (dBm/15kHz)	-86	-78

1. Connect the SS to the UE to the UE antenna connectors as shown in TS 36.508 [7] Annex A, Figure A.3.
2. The parameter settings for the cell are set up according to TS 36.508[7] subclause 4.4.3.
3. Downlink signals are initially set up according to Annex C0, C.1 and C.3.0, and uplink signals according to Annex H.1 and H.3.0.
4. The UL Reference Measurement channels are set according to in Table 6.5.2.1.4.1-1.
5. Propagation conditions are set according to Annex B.0
6. Ensure the UE is in State 3A-RF according to TS 36.508 [7] clause 5.2A.2. Message contents are defined in clause 6.5.2.1.4.3.

#### 6.5.2.1.4.2 Test procedure

Test procedure for PUSCH:

- 1.1. SS sends uplink scheduling information for each UL HARQ process via PDCCH DCI format 0 for C\_RNTI to schedule the UL RMC according to Table 6.5.2.1.4.1-1. Since the UE has no payload data to send, the UE transmits uplink MAC padding bits on the UL RMC.
- 1.2 Send continuously uplink power control "up" commands in the uplink scheduling information to the UE until the UE transmits at  $P_{UMAX}$  level.
- 1.3 Measure the EVM and  $\overline{EVM}_{DMRS}$  using Global In-Channel Tx-Test (Annex E).
- 1.4 Send the appropriate TPC commands in the uplink scheduling information to the UE until UE output power is  $-36.8\text{dBm} \pm 3.2\text{dB}$  for carrier frequency  $f \leq 3.0\text{GHz}$  or  $-36.5\text{dBm} \pm 3.5\text{dB}$  for carrier frequency  $3.0\text{GHz} < f \leq 4.2\text{GHz}$ .
- 1.5 Measure the EVM and  $\overline{EVM}_{DMRS}$  using Global In-Channel Tx-Test (Annex E).

Test procedure for PUCCH:

- 2.1 PUCCH are set according to Table 6.5.2.1.4.1-2.
- 2.2 SS transmits PDSCH via PDCCH DCI format 1A for C\_RNTI to transmit the DL RMC according to Table 6.5.2.1.4.1-2. The SS sends downlink MAC padding bits on the DL RMC. The transmission of PDSCH will make the UE send uplink ACK/NACK using PUCCH. There is no PUSCH transmission.
- 2.3 SS send appropriate TPC commands for PUCCH to the UE until the UE transmit PUCCH at  $P_{UMAX}$  level.
- 2.4 Measure PUCCH EVM using Global In-Channel Tx-Test (Annex E).
- 2.5 Send the appropriate TPC commands for PUCCH to the UE until the UE transmits PUCCH at  $-36.8\text{dBm} \pm 3.2\text{dB}$  for carrier frequency  $f \leq 3.0\text{GHz}$  or  $-36.5\text{dBm} \pm 3.5\text{dB}$  for carrier frequency  $3.0\text{GHz} < f \leq 4.2\text{GHz}$ .
- 2.6 Measure PUCCH EVM using Global In-Channel Tx-Test (Annex E).

Test procedure for PRACH:

3.1 The SS shall set RS EPRE according to Table 6.5.2.1.4.1-3.

3.2 PRACH is set according to Table 6.5.2.1.4.1-3.

3.3 The SS shall signal a Random Access Preamble ID via a PDCCH order to the UE and initiate a Non-contention based Random Access procedure

3.4 The UE shall send the signalled preamble to the SS.

3.5 In response to the preamble, the SS shall transmit a random access response not corresponding to the transmitted random access preamble, or send no response.

3.6 The UE shall consider the random access response reception not successful then re-transmit the preamble with the calculated PRACH transmission power.

3.7 Repeat step 5 and 6 until the SS collect enough PRACH preambles (2 preambles for format 0 and 10 preambles for format 4). Measure the EVM in PRACH channel using Global In-Channel Tx-Test (Annex E).

#### 6.5.2.1.4.3 Message contents

Message contents are according to TS 36.508 [7] subclause 4.6 with the following exceptions:

**Table 6.5.2.1.4.3-1: PRACH-ConfCommonDEFAULT: PRACH EVM measurement for FDD**

Derivation Path: TS 36.508 [7] clause 4.6.3, Table 4.6.3-7 PRACH-ConfCommonDEFAULT			
Information Element	Value/remark	Comment	Condition
PRACH-ConfigInfo SEQUENCE {			
prach-ConfigIndex	4		

**Table 6.5.2.1.4.3-2: PRACH-ConfCommonDEFAULT: PRACH EVM measurement for TDD**

Derivation Path: TS 36.508 [7] clause 5.3.1, Table 5.3.1-1 PRACH-ConfCommonDEFAULT			
Information Element	Value/remark	Comment	Condition
PRACH-ConfigInfo SEQUENCE {			
prach-ConfigIndex	53		

**Table 6.5.2.1.4.3-4: RACH-ConfigCommon-DEFAULT: PRACH EVM measurement**

Derivation Path: TS 36.508 [7] clause 4.6.3, Table 4.6.3-12 RACH-ConfigCommon-DEFAULT			
Information Element	Value/remark	Comment	Condition
RACH-ConfigCommon-DEFAULT ::= SEQUENCE {			
preambleInfo SEQUENCE {			
numberOfRA-Preambles	n52		
preamblesGroupAConfig SEQUENCE {	Not present		
}			
powerRampingParameters SEQUENCE {			
powerRampingStep	dB0		
preambleInitialReceivedTargetPower	dBm-120 Test point 1 dBm-90 Test point 2		
}			
ra-SupervisionInfo SEQUENCE {			
preambleTransMax	n10 n20		FDD TDD
ra-ResponseWindowSize	Sf10		
mac-ContentionResolutionTimer	sf48		
}			
ra-SupervisionInfo SEQUENCE {			

**Table 6.5.2.1.4.3-5: TDD-Config-DEFAULT: PRACH EVM measurement for TDD**

Derivation Path: TS 36.508 [7] clause 5.3.1, Table 5.3.1-1: TDD-Config-DEFAULT			
Information Element	Value/remark	Comment	Condition
TDD-Config-DEFAULT ::= SEQUENCE {			
subframeAssignment	sa1		
specialSubframePatterns	ssp5	To enable two symbol UpPTS, and to have 9 symbols GP.	
}			

### 6.5.2.1.5 Test requirement

The PUSCH EVM derived in E.4.2 shall not exceed 17,5 % for QPSK and BPSK, 12,5% for 16 QAM.

The PUSCH  $\overline{EVM}_{DMRS}$  derived in E.4.6.2 shall not exceed [17,5 %] when embedded with data symbols of QPSK and BPSK, [12,5%] for 16 QAM.

The PUCCH EVM and derived in E.5.9.2 shall not exceed 17,5 %.

The PRACH EVM derived in FFS shall not exceed 17.5%.

### 6.5.2.1A PUSCH-EVM with exclusion period

#### 6.5.2.1A.1 Test purpose

To verify the ability of the UE transmitter to keep the EVM minimum requirements, even in the presence of transients according to subclause 6.5.2.1.1 third paragraph:

In the case of PUSCH transmission, the measurement interval is reduced by a time interval equal to the sum of 5  $\mu$ s and the applicable exclusion period defined in subclause 6.3.4, adjacent to the boundary where the power change is expected to occur. The PUSCH exclusion period is applied to the signal obtained after the front-end IDFT.

#### 6.5.2.1A.2 Test applicability

This test applies to all types of E-UTRA UE release 8 and forward.

#### 6.5.2.1A.3 Minimum conformance requirement

EVM measurements are evaluated for 10 uplink sub-frames in a reduced time interval due to exclusion periods for the average EVM. The different modulations schemes shall not exceed the values specified in Table 6.5.2.1.3-1 for the parameters defined in Table 6.5.2.1.3-2.

#### 6.5.2.1A.4 Test description

##### 6.5.2.1A.4.1 Initial conditions

Initial conditions are a set of test configurations the UE needs to be tested in and the steps for the SS to take with the UE to reach the correct measurement state.

The initial test configurations consist of environmental conditions, test frequencies, and channel bandwidths based on E-UTRA operating bands specified in table 5.4.2.1-1. All of these configurations shall be tested with applicable test parameters for each channel bandwidth, and are shown in table 6.5.2.1A.4.1-1. The details of the uplink reference measurement channels (RMCs) are specified in Annexes A.2. Configurations of PDSCH and PDCCH before measurement are specified in Annex C.2.



**Table 6.5.2.1A.4.1-1: Test Configuration Table**

<b>Initial Conditions</b>				
Test Environment as specified in TS 36.508[7] subclause 4.1		Normal Conditions		
Test Frequencies as specified in TS36.508 [7] subclause 4.3.1		Low range		
Test Channel Bandwidths as specified in TS 36.508 [7] subclause 4.3.1		10 MHz		
<b>Test Parameters for Channel Bandwidths</b>				
Ch BW	<b>Downlink Configuration</b>		<b>Uplink Configuration</b>	
	N/A		Mod'n	RB allocation
10MHz				
			FDD	TDD
10MHz			QPSK	Alternating 12 and 1 (as shown in Figure 6.5.2.1A.4.2-1)
10MHz			16 QAM	Alternating 12 and 1 (as shown in Figure 6.5.2.1A.4.2-1)
				Alternating 12 and 1 (as shown in Figure 6.5.2.1A.4.2-1)

1. Connect the SS to the UE antenna connectors as shown in TS 36.508 [7] Annex A, Figure A.3.
2. The parameter settings for the cell are set up according to TS 36.508 [7] subclause 4.4.3.
3. Downlink signals are initially set up according to Annex C.0, C.1 and C.3.0, and uplink signals according to Annex H.1 and H.3.0.
4. The UL Reference Measurement channel is set according to table 6.5.2.1A.4.1-1
5. Propagation conditions are set according to Annex B.0.
6. Ensure the UE is in State 3A-RF according to TS 36.508 [7] clause 5.2A.2. Message contents are defined in clause 6.3.5.2.4.3.

#### 6.5.2.1A.4.2 Test procedure

The test pattern is illustrated in figure 6.5.2.1A.4.2-1.

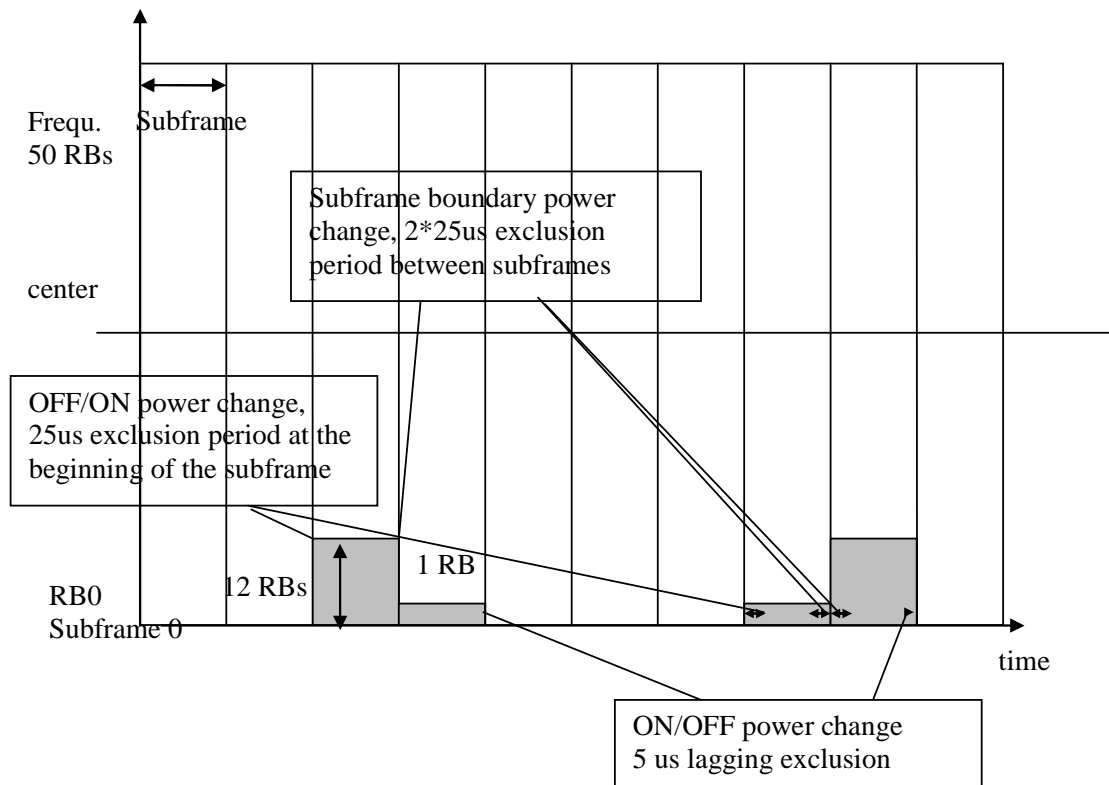

**Figure 6.5.2.1A.4.2-1: Test pattern**

NOTE 1: In TDD the free subframes are special subframes or DL, in FDD the free subframes are OFF.

1. SS sends uplink scheduling information for each UL HARQ process via PDCCH DCI format 0 for C\_RNTI to schedule the PUSCH... Since the UE has no payload data to send, the UE transmits uplink MAC padding bits on the UL RMC. The initial uplink RB allocation is 12. Send appropriate TPC commands for PUSCH to the UE to ensure the UE transmits PUSCH at 0dBm ±3.2dB for carrier frequency  $f \leq 3.0\text{GHz}$  or 0dBm ±3.5 dB for carrier frequency  $3.0\text{GHz} < f \leq 4.2\text{GHz}$ .
2. Schedule the UE's PUSCH data transmission as described in Figure 6.5.2.1A.4.2-1 for 16<sup>1)</sup> active time slots with an uplink RB allocation alternating pattern as described in table 6.5.2.1A.4.1-1 while transmitting 0dB TPC command for PUSCH via the PDCCH.
3. Measure the EVM using Global In-Channel Tx-Test. The averaging across 16<sup>1)</sup> timeslots is done across mixed RB allocations, as illustrated in Figure 6.5.2.1A.4.2-1

NOTE 2: Averaging across 16 timeslots is used to represent each type of transition equally in the average.

### 6.5.2.1A.5 Test requirement

The PUSCH EVM derived in Annex E.4.2 taking into account Annex E.7 shall not exceed 17,5 % for QPSK and 12,5% for 16 QAM. The test requirements shall be fulfilled for early and late EVM window.

## 6.5.2.2 Carrier leakage

### 6.5.2.2.1 Test Purpose

Carrier leakage expresses itself as unmodulated sine wave with the carrier frequency or centre frequency of aggregated transmission bandwidth configuration. It is an interference of approximately constant amplitude and independent of the amplitude of the wanted signal. Carrier leakage interferes with the centre sub carriers of the UE under test (if allocated), especially, when their amplitude is small. The measurement interval is defined over one slot in the time domain.

The purpose of this test is to exercise the UE transmitter to verify its modulation quality in terms of carrier leakage.

### 6.5.2.2.2 Test applicability

This test case applies to all types of E-UTRA UE release 8 and forward.

### 6.5.2.2.3 Minimum conformance requirements

The relative carrier leakage power is a power ratio of the additive sinusoid waveform and the modulated waveform. The relative carrier leakage power shall not exceed the values specified in Table 6.5.2.2.3-1.

**Table 6.5.2.2.3-1: Minimum requirements for Relative Carrier Leakage Power**

LO Leakage	Parameters	Relative Limit (dBc)
	Output power >0 dBm	-25
	-30 dBm ≤ Output power ≤ 0 dBm	-20
	-40 dBm ≤ Output power < -30 dBm	-10

The normative reference for this requirement is TS 36.101 clause 6.5.2.2.1

### 6.5.2.2.4 Test description

#### 6.5.2.2.4.1 Initial conditions

Initial conditions are a set of test configurations the UE needs to be tested in and the steps for the SS to take with the UE to reach the correct measurement state.

The initial test configurations consist of environmental conditions, test frequencies, and channel bandwidths based on E-UTRA bands specified in table 5.4.2.1-1. All of these configurations shall be tested with applicable test parameters for each channel bandwidth, and are shown in table 6.5.2.2.4.1-1. The details of the uplink reference measurement channels (RMCs) are specified in Annexes A.2. Configurations of PDSCH and PDCCH before measurement are specified in Annex C.2.

**Table 6.5.2.2.4.1-1: Test Configuration Table**

Initial Conditions				
Test Environment (as specified in TS 36.508 [7] subclause 4.1)		See Table 6.5.1.4.1-1		
Test Frequencies (as specified in TS36.508 [7] subclause 4.3.1)		See Table 6.5.1.4.1-1		
Test Channel Bandwidths (as specified in TS 36.508 [7] subclause 4.3.1)		See Table 6.5.1.4.1-1		
Test Parameters for Channel Bandwidths				
Ch BW	Downlink Configuration	Uplink Configuration		
	N/A for carrier leakage testing	Mod'n	RB allocation	
		FDD	TDD	
1.4MHz		QPSK	1	1
3MHz		QPSK	4	4
5MHz		QPSK	8	8
10MHz		QPSK	12	12
15MHz		QPSK	16	16
20MHz		QPSK	18	18
Note 1: Test Channel Bandwidths are checked separately for each E-UTRA band, which applicable channel bandwidths are specified in Table 5.4.2.1-1.				
Note 2: For partial RB allocation, the RB <sub>start</sub> shall be RB #0 and RB# (max +1- RB allocation) of the channel bandwidth.				

1. Connect the SS to the UE to the UE antenna connectors as shown in TS 36.508 [7] Annex A, Figure A.3.
2. The parameter settings for the cell are set up according to TS 36.508[7] subclause 4.4.3.
3. Downlink signals are initially set up according to Annex C0, C.1 and C.3.0, and uplink signals according to Annex H.1 and H.3.0.
4. The UL Reference Measurement channels are set according to in Table 6.5.2.2.4.1-1.
5. Propagation conditions are set according to Annex B.0
6. Ensure the UE is in State 3A-RF according to TS 36.508 [7] clause 5.2A.2. Message contents are defined in clause 6.5.2.2.4.3.

#### 6.5.2.2.4.2 Test procedure

SS sends uplink scheduling information for each UL HARQ process via PDCCH DCI format 0 for C\_RNTI to schedule the UL RMC according to Table 6.5.2.2.4.1-1. Since the UE has no payload and no loopback data to send the UE sends uplink MAC padding bits on the UL RMC

Send the appropriate TPC commands in the uplink scheduling information to the UE until UE output power is 3.2 dBm  $\pm 3.2$ dB for carrier frequency  $f \leq 3.0$ GHz or 3.5dBm  $\pm 3.5$  dB for carrier frequency  $3.0$ GHz  $< f \leq 4.2$ GHz.

Measure carrier leakage using Global In-Channel Tx-Test (Annex E). For TDD slots with transient periods are not under test.

4. Send the appropriate TPC commands in the uplink scheduling information to the UE until UE output power is -26.8 dBm  $\pm 3.2$ dB for carrier frequency  $f \leq 3.0$ GHz or -26.5dBm  $\pm 3.5$  dB for carrier frequency  $3.0$ GHz  $< f \leq 4.2$ GHz.
5. Measure carrier leakage using Global In-Channel Tx-Test (Annex E). For TDD slots with transient periods are not under test
6. Send the appropriate TPC commands in the uplink scheduling information to the UE until UE output power is -36.8dBm  $\pm 3.2$ dB for carrier frequency  $f \leq 3.0$ GHz or -36.5dBm  $\pm 3.5$  dB for carrier frequency  $3.0$ GHz  $< f \leq 4.2$ GHz.
7. Measure carrier leakage using Global In-Channel Tx-Test (Annex E). For TDD slots with transient periods are not under test

#### 6.5.2.2.4.3 Message contents

Message contents are according to TS 36.508 [7] subclause 4.6.

### 6.5.2.2.5 Test requirement

Each of the 20 carrier leakage results, derived in Annex E.3.1, shall not exceed the values in table 6.5.2.2.5-1

**Table 6.5.2.2.5-1: Test requirements for Relative Carrier Leakage Power**

LO Leakage	Parameters	Relative Limit (dBc)
	f ≤ 3.0GHz: 3.2 dBm ±3.2dB 3.0GHz < f ≤ 4.2GHz: 3.5 dBm ±3.5dB	-24.2
	f ≤ 3.0GHz: -26.8 dBm ±3.2dB 3.0GHz < f ≤ 4.2GHz: -26.5 dBm ±3.5dB	-19.2
	f ≤ 3.0GHz: -36.8dBm±3.2dB 3.0GHz < f ≤ 4.2GHz: -36.5 dBm ±3.5dB	-9.2

### 6.5.2.3 In-band emissions for non allocated RB

#### 6.5.2.3.1 Test Purpose

The in-band emissions are a measure of the interference falling into the non-allocated resources blocks

The in-band emission is defined as the average across 12 sub-carrier and as a function of the RB offset from the edge of the allocated UL transmission bandwidth. The in-band emission is measured as the ratio of the UE output power in a non-allocated RB to the UE output power in an allocated RB. The basic in-band emissions measurement interval is defined over one slot in the time domain. When the PUSCH or PUCCH transmission slot is shortened due to multiplexing with SRS, the in-band emissions measurement interval is reduced by one SC-FDMA symbol, accordingly.

#### 6.5.2.3.2 Test applicability

This test case applies to all types of E-UTRA UE release 8 and forward.

#### 6.5.2.3.3 Minimum conformance requirements

The relative in-band emission shall not exceed the values specified in Table 6.5.2.3.3-1.

Table 6.5.2.3.3-1: Minimum requirements for in-band emissions

Parameter Description	Unit	Limit (Note 1)		Applicable Frequencies
General	dB	$\max \left\{ -25 - 10 \cdot \log_{10} (N_{RB} / L_{CRB}), \right.$ $20 \cdot \log_{10} EVM - 3 - 5 \cdot ( \Delta_{RB}  - 1) / L_{CRB},$ $\left. -57 \text{ dBm} / 180 \text{ kHz} - P_{RB} \right\}$		Any non-allocated (Note 2)
IQ Image	dB	-25		Image frequencies (Notes 2, 3)
Carrier leakage	dBc	-25	Output power > 0 dBm	LO frequency (Notes 4, 5)
		-20	-30 dBm ≤ Output power ≤ 0 dBm	
		-10	-40 dBm ≤ Output power < -30 dBm	
<p>Note 1: An in-band emissions combined limit is evaluated in each non-allocated RB. For each such RB, the minimum requirement is calculated as the higher of <math>P_{RB} - 30</math> dB and the power sum of all limit values (General, IQ Image or Carrier leakage) that apply. <math>P_{RB}</math> is defined in Note 10.</p> <p>Note 2: The measurement bandwidth is 1 RB and the limit is expressed as a ratio of measured power in one non-allocated RB to the measured average power per allocated RB, where the averaging is done across all allocated RBs.</p> <p>Note 3: The applicable frequencies for this limit are those that are enclosed in the reflection of the allocated bandwidth, based on symmetry with respect to the centre carrier frequency, but excluding any allocated RBs.</p> <p>Note 4: The measurement bandwidth is 1 RB and the limit is expressed as a ratio of measured power in one non-allocated RB to the measured total power in all allocated RBs.</p> <p>Note 5: The applicable frequencies for this limit are those that are enclosed in the RBs containing the DC frequency if <math>N_{RB}</math> is odd, or in the two RBs immediately adjacent to the DC frequency if <math>N_{RB}</math> is even, but excluding any allocated RB.</p> <p>Note 6: <math>L_{CRB}</math> is the Transmission Bandwidth (see Figure 5.4.2-1).</p> <p>Note 7: <math>N_{RB}</math> is the Transmission Bandwidth Configuration (see Figure 5.4.2-1).</p> <p>Note 8: <math>EVM</math> is the limit specified in Table 6.5.2.1.1-1 for the modulation format used in the allocated RBs.</p> <p>Note 9: <math>\Delta_{RB}</math> is the starting frequency offset between the allocated RB and the measured non-allocated RB (e.g. <math>\Delta_{RB} = 1</math> or <math>\Delta_{RB} = -1</math> for the first adjacent RB outside of the allocated bandwidth).</p> <p>Note 10: <math>P_{RB}</math> is the transmitted power per 180 kHz in allocated RBs, measured in dBm.</p>				

The normative reference for this requirement is TS 36.101 [2] clause 6.5.2.3.1.

The in-band emission is defined as the average across 12 sub-carrier and as a function of the RB offset from the edge of the allocated UL transmission bandwidth. The in-band emission is measured as the ratio of the UE output power in a non-allocated RB to the UE output power in an allocated RB. The basic in-band emissions measurement interval is defined over one slot in the time domain.

### 6.5.2.3.4 Test description

#### 6.5.2.3.4.1 Initial conditions

Initial conditions are a set of test configurations the UE needs to be tested in and the steps for the SS to take with the UE to reach the correct measurement state.

The initial test configurations consist of environmental conditions, test frequencies, and channel bandwidths based on E-UTRA bands specified in table 5.4.2.1-1. All of these configurations shall be tested with applicable test parameters for each channel bandwidth, and are shown in table 6.5.2.3.4.1-1. The details of the uplink reference measurement channels (RMCs) are specified in Annexes A.2. Configurations of PDSCH and PDCCH before measurement are specified in Annex C.2.

**Table 6.5.2.3.4.1-1: Test Configuration Table for PUSCH**

Initial Conditions				
Test Environment (as specified in TS 36.508 [7] subclause 4.1)		See Table 6.5.1.4.1-1		
Test Frequencies (as specified in TS36.508 [7] subclause 4.3.1)		See Table 6.5.1.4.1-1		
Test Channel Bandwidths (as specified in TS 36.508 [7] subclause 4.3.1)		See Table 6.5.1.4.1-1		
Test Parameters for Channel Bandwidths				
Ch BW	Downlink Configuration		Uplink Configuration	
	N/A for in-band emissions testing		Mod'n	RB allocation
1.4MHz			FDD	TDD
3MHz			QPSK	1
5MHz			QPSK	4
10MHz			QPSK	8
15MHz			QPSK	12
20MHz			QPSK	16
			QPSK	18
Note 1: Test Channel Bandwidths are checked separately for each E-UTRA band, which applicable channel bandwidths are specified in Table 5.4.2.1-1.				
Note 2: For partial RB allocation, the starting resource block shall be RB #0 and RB# (max+1 - RB allocation) of the channel bandwidth.				

**Table 6.5.2.3.4.1-2: Test Configuration Table for PUCCH**

Initial Conditions			
Test Environment as specified in TS 36.508[7] subclause 4.1		See Table 6.5.1.4.1-1	
Test Frequencies as specified in <b>TS36.508 [7] subclause 4.3.1</b>		See Table 6.5.1.4.1-1	
Test Channel Bandwidths as specified in <b>TS 36.508 [7] subclause 4.3.1</b>		See Table 6.5.1.4.1-1	
Test Parameters for Channel Bandwidths			
Ch BW	Downlink Configuration		Uplink Configuration
	Mod'n	RB allocation	
		FDD	TDD
1.4MHz	QPSK	3	3
3MHz	QPSK	4	4
5MHz	QPSK	8	8
10MHz	QPSK	16	16
15MHz	QPSK	25	25
20MHz	QPSK	30	30
Note 1: Test Channel Bandwidths are checked separately for each E-UTRA band, the applicable channel bandwidths are specified in Table 5.4.2.1-1.			

1. Connect the SS to the UE antenna connectors as shown in TS 36.508 [7] Figure A.3.
2. The parameter settings for the cell are set up according to TS 36.508 [7] subclause 4.4.3.
3. Downlink signals are initially set up according to Annex C.0, C.1, and C.3.0, and uplink signals according to Annex H.1 and H.3.0.
4. The UL Reference Measurement channels are set according to in Table 6.5.2.3.4.1-1.
5. Propagation conditions are set according to Annex B.0
6. Ensure the UE is in State 3A-RF according to TS 36.508 [7] clause 5.2A.2. Message contents are defined in clause 6.5.2.3.4.3.

6.5.2.3.4.2 Test procedure

Test procedure for PUSCH:

1.1 SS sends uplink scheduling information for each UL HARQ process via PDCCH DCI format 0 for C\_RNTI to schedule the UL RMC according to Table 6.5.2.3.4.1-1. Since the UE has no payload and no loopback data to send the UE sends uplink MAC padding bits on the UL RMC

1.2 Send the appropriate TPC commands in the uplink scheduling information to the UE until UE output power is 3.2 dBm  $\pm$ 3.2dB for carrier frequency  $f \leq 3.0$ GHz or 3.5dBm  $\pm$ 3.5 dB for carrier frequency  $3.0$ GHz  $< f \leq 4.2$ GHz.

1.3 Measure In-band emission using Global In-Channel Tx-Test (Annex E)

1.4 Send the appropriate TPC commands in the uplink scheduling information to the UE until UE output power is -26.8 dBm  $\pm$ 3.2dB for carrier frequency  $f \leq 3.0$ GHz or -36.5dBm  $\pm$ 3.5 dB for carrier frequency  $3.0$ GHz  $< f \leq 4.2$ GHz.

1.5 Measure In-band emission using Global In-Channel Tx-Test (Annex E). For TDD slots with transient periods are not under test

1.6 Send the appropriate TPC commands in the uplink scheduling information to the UE until UE output power is to -36.8 dBm  $\pm$ 3.2dB for carrier frequency  $f \leq 3.0$ GHz or -36.5dBm  $\pm$ 3.5 dB for carrier frequency  $3.0$ GHz  $< f \leq 4.2$ GHz.

1,7 Measure In-band emission using Global In-Channel Tx-Test (Annex E). For TDD slots with transient periods are not under test

Test procedure for PUCCH:

2.1 PUCCH is set according to Table 6.5.2.3.4.1-2. SS transmits PDSCH via PDCCH DCI format 1A for C\_RNTI to transmit the DL RMC according to Table 6.5.2.3.4.1-2. The SS sends downlink MAC padding bits on the DL RMC. The transmission of PDSCH will make the UE send uplink ACK/NACK using PUCCH.

2.2 Send the appropriate TPC commands in the uplink scheduling information for PUCCH to the UE until UE output power is 3.2 dBm  $\pm$ 3.2dB for carrier frequency  $f \leq 3.0$ GHz or 3.5dBm  $\pm$ 3.5 dB for carrier frequency  $3.0$ GHz  $< f \leq 4.2$ GHz.

2.3 Measure In-band emission using Global In-Channel Tx-Test (Annex E)

2.4 Send the appropriate TPC commands for PUCCH in the uplink scheduling information to the UE until UE output power is -26.8 dBm  $\pm$ 3.2dB for carrier frequency  $f \leq 3.0$ GHz or -26.5dBm  $\pm$ 3.5 dB for carrier frequency  $3.0$ GHz  $< f \leq 4.2$ GHz.

2.5 Measure In-band emission using Global In-Channel Tx-Test (Annex E)

2.6 Send the appropriate TPC commands for PUCCH in the uplink scheduling information to the UE until UE output power is to -36.8 dBm  $\pm$ 3.2dB for carrier frequency  $f \leq 3.0$ GHz or -36.5dBm  $\pm$ 3.5 dB for carrier frequency  $3.0$ GHz  $< f \leq 4.2$ GHz.

2.7 Measure In-band emission using Global In-Channel Tx-Test (Annex E)

#### 6.5.2.3.4.3 Message contents

Message contents are according to TS 36.508 [7] subclause 4.6 with the following exceptions:

**Table 4.6.3-8: PUCCH-ConfigCommon: PUCCH in-band emissions measurement**

Derivation Path: 36.331 clause 6.3.2, Table 4.6.3-8: PUCCH-ConfigCommon-DEFAULT			
Information Element	Value/remark	Comment	Condition
PUCCH-ConfigCommon-DEFAULT ::= SEQUENCE {			
nRB-CQI	0		
}			

#### 6.5.2.3.5 Test requirement

Each of the 20 In-band emissions results, derived in Annex E.4.3 shall not exceed the corresponding values in Table 6.5.2.3.5-1



Table 6.5.2.3.5-1: Test requirements for in-band emissions

Parameter Description	Unit	Limit (Note 1)		Applicable Frequencies
General	dB	$\max \left\{ -25 - 10 \cdot \log_{10} (N_{RB} / L_{CRBs}), \right.$ $20 \cdot \log_{10} EVM - 3 - 5 \cdot ( \Delta_{RB}  - 1) / L_{CRBs}, \quad +0.8$ $\left. - 57 \text{ dBm} / 180 \text{ kHz} - P_{RB} \right\}$		Any non-allocated (Note 2)
IQ Image	dB	-24.2		Image frequencies (Notes 2, 3)
DC	dBc	-24.2	Output power $f \leq 3.0\text{GHz}$ : 3.2dBm $\pm 3.2\text{dB}$ $3.0\text{GHz} < f \leq 4.2\text{GHz}$ : 3.5 dBm $\pm 3.5\text{dB}$	LO frequency (Notes 4, 5)
		-19.2	Output power $f \leq 3.0\text{GHz}$ : -26.8 dBm $\pm 3.2\text{dB}$ $3.0\text{GHz} < f \leq 4.2\text{GHz}$ : -26.5 dBm $\pm 3.5\text{dB}$	
		-9.2	Output power $f \leq 3.0\text{GHz}$ : -36.8 dBm $\pm 3.2\text{dB}$ $3.0\text{GHz} < f \leq 4.2\text{GHz}$ : -36.5 dBm $\pm 3.5\text{dB}$	
<p>Note 1: An in-band emissions combined limit is evaluated in each non-allocated RB. For each such RB, the test requirement is calculated as the higher of <math>P_{RB} - 29.2</math> dB and the power sum of all limit values (General, IQ Image or Carrier leakage) that apply. <math>P_{RB}</math> is defined in Note 10.</p> <p>Note 2: The measurement bandwidth is 1 RB and the limit is expressed as a ratio of measured power in one non-allocated RB to the measured average power per allocated RB, where the averaging is done across all allocated RBs.</p> <p>Note 3: The applicable frequencies for this limit are those that are enclosed in the reflection of the allocated bandwidth, based on symmetry with respect to the centre carrier frequency, but excluding any allocated RBs.</p> <p>Note 4: The measurement bandwidth is 1 RB and the limit is expressed as a ratio of measured power in one non-allocated RB to the measured total power in all allocated RBs.</p> <p>Note 5: The applicable frequencies for this limit are those that are enclosed in the RBs containing the DC frequency if <math>N_{RB}</math> is odd, or in the two RBs immediately adjacent to the DC frequency if <math>N_{RB}</math> is even, but excluding any allocated RB.</p> <p>Note 6: <math>L_{CRBs}</math> is the Transmission Bandwidth (see Figure 5.4.2-1).</p> <p>Note 7: <math>N_{RB}</math> is the Transmission Bandwidth Configuration (see Figure 5.4.2-1).</p> <p>Note 8: <math>EVM</math> is the limit specified in Table 6.5.2.1.1-1 for the modulation format used in the allocated RBs.</p> <p>Note 9: <math>\Delta_{RB}</math> is the starting frequency offset between the allocated RB and the measured non-allocated RB (e.g. <math>\Delta_{RB} = 1</math> or <math>\Delta_{RB} = -1</math> for the first adjacent RB outside of the allocated bandwidth).</p> <p>Note 10: <math>P_{RB}</math> is the transmitted power per 180 kHz in allocated RBs, measured in dBm.</p>				

## 6.5.2.4 EVM equalizer spectrum flatness

### 6.5.2.4.1 Test Purpose

The zero-forcing equalizer correction applied in the EVM measurement process (as described in Annex E) must meet a spectrum flatness requirement for the EVM measurement to be valid. The EVM equalizer spectrum flatness is defined in terms of the maximum peak-to-peak ripple of the equalizer coefficients (dB) across the allocated uplink block variation in dB of the equalizer coefficients generated by the EVM measurement process. The EVM equalizer spectrum flatness requirement does not limit the correction applied to the signal in the EVM measurement process but for the EVM result to be valid, the equalizer correction that was applied must meet the EVM equalizer spectrum flatness minimum requirements. The basic measurement interval is the same as for EVM.

### 6.5.2.4.2 Test applicability

This test case applies to all types of E-UTRA UE release 8 and forward.

6.5.2.4.3 Minimum conformance requirements

The peak-to-peak variation of the EVM equalizer coefficients contained within the frequency range of the uplink allocation shall not exceed the maximum ripple. The EVM equalizer spectrum flatness shall not exceed the values specified in Table 6.5.2.4.3-1 for normal conditions. For uplink allocations contained within both Range 1 and Range 2, the coefficients evaluated within each of these frequency ranges shall meet the corresponding ripple requirement and the following additional requirement: the relative difference between the maximum coefficient in Range 1 and the minimum coefficient in Range 2 must not be larger than 5 dB, and the relative difference between the maximum coefficient in Range 2 and the minimum coefficient in Range 1 must not be larger than 7 dB (see Figure 6.5.2.4.3-1).

The EVM equalizer spectrum flatness shall not exceed the values specified in Table 6.5.2.4.3-2 for extreme conditions. For uplink allocations contained within both Range 1 and Range 2, the coefficients evaluated within each of these frequency ranges shall meet the corresponding ripple requirement and the following additional requirement: the relative difference between the maximum coefficient in Range 1 and the minimum coefficient in Range 2 must not be larger than 6 dB, and the relative difference between the maximum coefficient in Range 2 and the minimum coefficient in Range 1 must not be larger than 10 dB (see Figure 6.5.2.4.3-1).

**Table 6.5.2.4.3-1: Minimum requirements for EVM equalizer spectrum flatness (normal conditions)**

Frequency Range	Maximum Ripple [dB]
$F_{UL\_Meas} - F_{UL\_Low} \geq 3 \text{ MHz}$ and $F_{UL\_High} - F_{UL\_Meas} \geq 3 \text{ MHz}$ (Range 1)	4 (p-p)
$F_{UL\_Meas} - F_{UL\_Low} < 3 \text{ MHz}$ or $F_{UL\_High} - F_{UL\_Meas} < 3 \text{ MHz}$ (Range 2)	8 (p-p)
Note 1: $F_{UL\_Meas}$ refers to the sub-carrier frequency for which the equalizer coefficient is evaluated	
Note 2: $F_{UL\_Low}$ and $F_{UL\_High}$ refer to each E-UTRA frequency band specified in Table 5.2-1	

**Table 6.5.2.4.3-2: Minimum requirements for EVM equalizer spectrum flatness (extreme conditions)**

$F_{UL\_Meas} - F_{UL\_Low} \geq 5 \text{ MHz}$ and $F_{UL\_High} - F_{UL\_Meas} \geq 5 \text{ MHz}$ (Range 1)	4 (p-p)
$F_{UL\_Meas} - F_{UL\_Low} < 5 \text{ MHz}$ or $F_{UL\_High} - F_{UL\_Meas} < 5 \text{ MHz}$ (Range 2)	12 (p-p)
Note 1: $F_{UL\_Meas}$ refers to the sub-carrier frequency for which the equalizer coefficient is evaluated	
Note 2: $F_{UL\_Low}$ and $F_{UL\_High}$ refer to each E-UTRA frequency band specified in Table 5.2-1	

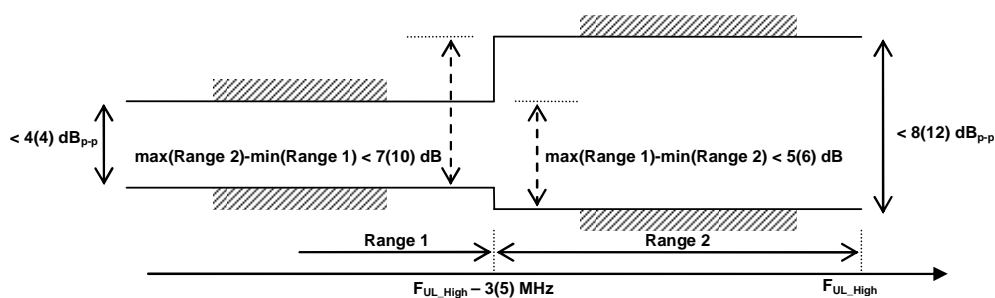

**Figure 6.5.2.4.3-1: The limits for EVM equalizer spectrum flatness with the maximum allowed variation of the coefficients indicated (the ETC minimum requirement within brackets)**

The normative reference for this requirement is TS 36.101 clause 6.5.2.4.1.

#### 6.5.2.4.4 Test description

##### 6.5.2.4.4.1 Initial conditions

Initial conditions are a set of test configurations the UE needs to be tested in and the steps for the SS to take with the UE to reach the correct measurement state.

The initial test configurations consist of environmental conditions, test frequencies, and channel bandwidths based on E-UTRA bands specified in table 5.4.2.1-1. All of these configurations shall be tested with applicable test parameters for each channel bandwidth, and are shown in table 6.4.2.4.4.1-1. The details of the uplink reference measurement channels (RMCs) are specified in A.2. Configurations of PDSCH and PDCCH before measurement are specified in Annex C.2.

**Table 6.5.2.4.4.1-1: Test Configuration Table**

Initial Conditions				
Test Environment (as specified in TS 36.508 [7] subclause 4.1)		See Table 6.5.1.4.1-1		
Test Frequencies (as specified in TS36.508 [7] subclause 4.3.1)		See Table 6.5.1.4.1-1		
Test Channel Bandwidths (as specified in TS 36.508 [7] subclause 4.3.1)		See Table 6.5.1.4.1-1		
Test Parameters for Channel Bandwidths				
Ch BW	Downlink Configuration	Uplink Configuration		
		Mod'n	RB allocation	
	N/A for EVM equalizer spectrum flatness testing		FDD	TDD
1.4MHz		QPSK	6	6
3MHz		QPSK	15	15
5MHz		QPSK	25	25
10MHz		QPSK	50	50
15MHz		QPSK	75	75
20MHz		QPSK	100	100
Note 1: Test Channel Bandwidths are checked separately for each E-UTRA band, which applicable channel bandwidths are specified in Table 5.4.2.1-1.				

1. Connect the SS to the UE antenna connectors as shown in TS 36.508 [7] Figure A.3.
2. The parameter settings for the cell are set up according to TS 36.508 [7] subclause 4.4.3.
3. Downlink signals are initially set up according to Annex C0, C.1 and C.3.0, and uplink signals according to Annex H.1 and H.3.0.
4. The UL Reference Measurement channels are set according to in Table 6.5.2.4.4.1-1.
5. Propagation conditions are set according to Annex B.0
6. Ensure the UE is in State 3A-RF according to TS 36.508 [7] clause 5.2A.2. Message contents are defined in clause 6.5.2.4.4.3.

##### 6.5.2.4.4.2 Test procedure

1. SS sends uplink scheduling information for each UL HARQ process via PDCCH DCI format 0 for C\_RNTI to schedule the UL RMC according to Table 6.5.2.4.4.1-1. Since the UE has no payload and no loopback data to send the UE sends uplink MAC padding bits on the UL RMC
2. Send continuously uplink power control "up" commands in the uplink scheduling information to the UE until the UE transmits at  $P_{UMAX}$  level.
3. Measure spectrum flatness using Global In-Channel Tx-Test (Annex E). For TDD slots with transient periods are not under test.

##### 6.5.2.4.4.3 Message contents

Message contents are according to TS 36.508 [7] subclause 4.6.

6.5.2.4.5 Test requirement

Each of the 20 spectrum flatness functions, shall derive four ripple results in Annex E.4.4, The derived results shall not exceed the values in Figure 6.5.2.4.5-1:

For normal conditions, the maximum ripple in Range 1 and Range 2 shall not exceed the values specified in Table 6.5.2.4.5-1 and the following additional requirement: the relative difference between the maximum coefficient in Range 1 and the minimum coefficient in Range 2 must not be larger than 6.4 dB, and the relative difference between the maximum coefficient in Range 2 and the minimum coefficient in Range 1 must not be larger than 8.4 dB (see Figure 6.5.2.4.5-1).

For extreme conditions, the maximum ripple in Range 1 and Range 2 shall not exceed the values specified in Table 6.5.2.4.5-2 and the following additional requirement: the relative difference between the maximum coefficient in Range 1 and the minimum coefficient in Range 2 must not be larger than 7.4 dB, and the relative difference between the maximum coefficient in Range 2 and the minimum coefficient in Range 1 must not be larger than 11.4 dB (see Figure 6.5.2.4.5-1).

**Table 6.5.2.4.5-1: Test requirements for EVM equalizer spectrum flatness (normal conditions)**

Frequency Range	Maximum Ripple [dB]
$F_{UL\_Meas} - F_{UL\_Low} \geq 3 \text{ MHz}$ and $F_{UL\_High} - F_{UL\_Meas} \geq 3 \text{ MHz}$ (Range 1)	5.4 (p-p)
$F_{UL\_Meas} - F_{UL\_Low} < 3 \text{ MHz}$ or $F_{UL\_High} - F_{UL\_Meas} < 3 \text{ MHz}$ (Range 2)	9.4 (p-p)
Note 1: $F_{UL\_Meas}$ refers to the sub-carrier frequency for which the equalizer coefficient is evaluated	
Note 2: $F_{UL\_Low}$ and $F_{UL\_High}$ refer to each E-UTRA frequency band specified in Table 5.2-1	

**Table 6.5.2.4.5-2: Test requirements for spectrum flatness (extreme conditions)**

Frequency Range	Maximum Ripple [dB]
$F_{UL\_Meas} - F_{UL\_Low} \geq 5 \text{ MHz}$ and $F_{UL\_High} - F_{UL\_Meas} \geq 5 \text{ MHz}$ (Range 1)	5.4 (p-p)
$F_{UL\_Meas} - F_{UL\_Low} < 5 \text{ MHz}$ or $F_{UL\_High} - F_{UL\_Meas} < 5 \text{ MHz}$ (Range 2)	13.4 (p-p)
Note 1: $F_{UL\_Meas}$ refers to the sub-carrier frequency for which the equalizer coefficient is evaluated	
Note 2: $F_{UL\_Low}$ and $F_{UL\_High}$ refer to each E-UTRA frequency band specified in Table 5.2-1	

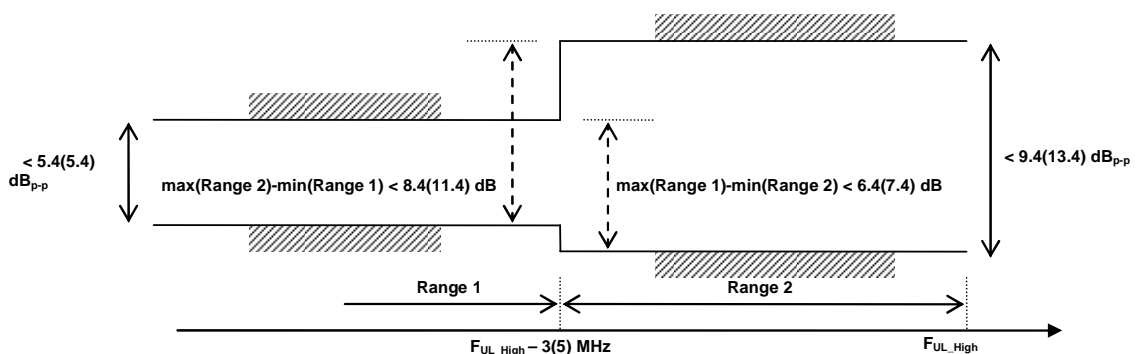

**Figure 6.5.2.4.5-1: The limits for EVM equalizer spectrum flatness with the maximum allowed variation of the coefficients indicated (the ETC minimum requirement within brackets)**

## 6.5.2A Transmit modulation for CA

The requirements in this clause apply with PCC and SCC in the UL configured and activated: PCC with PRB allocation and SCC without PRB allocation and without CSI reporting and SRS configured.

### 6.5.2A.1 Error Vector Magnitude (EVM) for CA

#### 6.5.2A.1.1 Error Vector Magnitude (EVM) for CA (intra-band contiguous DL CA and UL CA)

**Editor's notes:** The following items are missing or incomplete:

- Initial conditions (test setup for SCC is FFS, references need update, and test state for CA RF testing is FFS)
- Test procedure (incomplete, references need update)
- Message Contents

##### 6.5.2A.1.1.1 Test Purpose

For the intra-band contiguous carrier aggregation, the Error Vector Magnitude requirement should be defined for each component carrier. Requirement applies for the allocated component carrier, when all other component carriers are activated, but not allocated.

Similar transmitter impairment removal procedures are applied for CA waveform before EVM calculation as is specified for non-CA waveform in sub-section 6.5.2.1.

##### 6.5.2A.1.1.2 Test applicability

This test case applies to all types of E-UTRA UE release 10 and forward that support intra-band contiguous DL CA and UL CA.

##### 6.5.2A.1.1.3 Minimum conformance requirements

When a single component carrier is configured Table 6.5.2.1.4.1-1 apply.

The EVM requirements are according to Table 6.5.2A.1.1.3-1 if CA is configured in uplink.

**Table 6.5.2A.1.1.3-1: Minimum requirements for Error Vector Magnitude**

Parameter	Unit	Average EVM Level per CC	Reference Signal EVM Level
QPSK or BPSK	%	17.5	17.5
16QAM	%	12.5	12.5

##### 6.5.2A.1.1.4 Test description

###### 6.5.2A.1.1.4.1 Initial conditions

Initial conditions are a set of test configurations the UE needs to be tested in and the steps for the SS to take with the UE to reach the correct measurement state.

The initial test configurations consist of environmental conditions, test frequencies, and CC combinations based on E-UTRA CA configurations specified in table 5.4.2A.1-1. All of these configurations shall be tested with applicable test parameters for each CA Configuration, and are shown in table 6.5.2A.1.1.4.1-1. The details of the uplink reference measurement channels (RMCs) are specified in Annex A.2. Configurations of PDSCH and PDCCH before measurement are specified in Annex C.2.

**Table 6.5.2A.1.1.4.1-1: Test Configuration Table**

Initial Conditions									
Test Environment as specified in TS 36.508[7] subclause 4.1					NC				
Test Frequencies as specified in TS36.508 [7] subclause 4.3.1 for different CA bandwidth classes. PCC and SCC mapped onto component carriers CC according to the notation: PCC-SCC: C <i>i</i> -C <i>j</i> , which means PCC on C <i>i</i> and SCC on C <i>j</i> , with C <i>i</i> / <i>j</i> frequencies defined in the corresponding intra-band contiguous CA band in TS36.508 [7] as above.					See Table 6.5.1A.1.4.1-1: PCC-SCC: CC1-CC2 and CC2-CC1				
Test CC Combination setting ( <i>N<sub>RB,agg</sub></i> ) as specified in subclause 5.4.2A.1 for the CA Configuration					See Table 6.5.1A.1.4.1-1:				
Test Parameters for CA Configurations									
Config ID	CA Configuration / <i>N<sub>RB,agg</sub></i>		DL Allocation (PDCCH on PCC)	CC MOD	UL Allocation				
	PCC <i>N<sub>RB</sub></i> Note 1	SCCs <i>N<sub>RB</sub></i> Note 1	PCC & SCC RB allocation		<i>N<sub>RB,alloc</sub></i>	PCC & SCC RB allocations (L <sub>CRB</sub> @ RB <sub>start</sub> )			
1	75	75	N.A.	QPSK	75	P_75@0	S_0@0	-	-
2	75	75		QPSK	16	P_16@0	S_0@0	-	-
3	75	75		QPSK	16	P_16@59	S_0@0	-	-
4	75	75		16QAM	75	P_75@0	S_0@0	-	-
5	75	75		16QAM	16	P_16@0	S_0@0	-	-
6	75	75		16QAM	16	P_16@59	S_0@0	-	-
7	100	50		QPSK	100	P_100@0	S_0@0	-	-
8	100	50		QPSK	50	P_50@0	S_0@0	-	-
9	100	50		QPSK	50	P_50@50	S_0@0	-	-
10	100	50		QPSK	12	P_12@0	S_0@0	-	-
11	100	50		QPSK	12	P_12@88	S_0@0	-	-
12	100	50		16QAM	100	P_100@0	S_0@0	-	-
13	100	50		16QAM	50	P_50@0	S_0@0	-	-
14	100	50		16QAM	50	P_50@50	S_0@0	-	-
15	100	50		16QAM	12	P_12@0	S_0@0	-	-
16	100	50		16QAM	12	P_12@88	S_0@0	-	-
17	50	100		QPSK	50	P_50@0	S_0@0	-	-
18	50	100		QPSK	12	P_12@0	S_0@0	-	-
19	50	100		QPSK	12	P_12@38	S_0@0	-	-
20	50	100		16QAM	50	P_50@0	S_0@0	-	-
21	50	100		16QAM	12	P_12@0	S_0@0	-	-
22	50	100		16QAM	12	P_12@38	S_0@0	-	-
23	100	100		QPSK	100	P_100@0	S_0@0	-	-
24	100	100		QPSK	18	P_18@0	S_0@0	-	-
25	100	100		QPSK	18	P_18@82	S_0@0	-	-
26	100	100		16QAM	100	P_100@0	S_0@0	-	-
27	100	100		16QAM	18	P_18@0	S_0@0	-	-
28	100	100		16QAM	18	P_18@82	S_0@0	-	-
Note 1: CA Configuration Test CC Combination settings are checked separately for each CA Configuration which applicable aggregated channel bandwidths are specified in Table 5.4.2A.1-1.									

1. Connect the SS to the UE antenna connectors as shown in TS 36.508[7] Annex A, Figure group A.32 as appropriate.
2. The parameter settings for the cell are set up according to TS 36.508 [7] subclause 4.4.3.
3. Downlink signals are initially set up according to Annex C.0, C.1, and C.3.0, and uplink signals according to Annex H.1 and H.3.0.
4. The UL Reference Measurement channel is set according to Table 6.5.2A.1.1.4.1-1.
5. Propagation conditions are set according to Annex B.0.
6. Ensure the UE is in State 3A-RF according to TS 36.508 [7] clause [5.2A.2]. Message contents are defined in clause 6.5.2A.1.1.4.3.

#### 6.5.2A.1.1.4.2 Test procedure

1. SS sends uplink scheduling information for each UL HARQ process via PDCCH DCI format 0 for C\_RNTI to schedule the UL RMC according to Table 6.5.2A.1.1.4.1-1. Since the UE has no payload data to send, the UE transmits uplink MAC padding bits on the UL RMC.
2. Send continuously uplink power control "up" commands in the uplink scheduling information to the UE until the UE transmits at  $P_{UMAX}$  level.
3. Measure the EVM and  $\overline{EVM}_{DMRS}$  on PCC using Global In-Channel Tx-Test (Annex E).
4. Send the appropriate TPC commands in the uplink scheduling information to the UE until UE output power is  $-36.8\text{dBm} \pm 3.2\text{dB}$  for carrier frequency  $f \leq 3.0\text{GHz}$  or  $-36.5\text{dBm} \pm 3.5\text{dB}$  for carrier frequency  $3.0\text{GHz} < f \leq 4.2\text{GHz}$ .
5. Measure the EVM and  $\overline{EVM}_{DMRS}$  on PCC using Global In-Channel Tx-Test (Annex E).

#### 6.5.2A.1.1.4.3 Message contents

FFS.

#### 6.5.2A.1.1.5 Test requirement

The PUSCH EVM derived in E.4.2 shall not exceed 17,5 % for QPSK and BPSK, 12,5% for 16 QAM.

The PUSCH  $\overline{EVM}_{DMRS}$  derived in E.4.6.2 shall not exceed [17,5 %] when embedded with data symbols of QPSK and BPSK, [12,5%] for 16 QAM.

### 6.5.2A.2 Carrier leakage for CA

#### 6.5.2A.2.1 Carrier leakage for CA (intra-band contiguous DL CA and UL CA)

Editor's notes: The following items are missing or incomplete:

- Initial conditions (test setup for SCC is FFS, references need update, and test state for CA RF testing is FFS)
- Test procedure (incomplete, references need update)
- Message Contents
- Test tolerances not yet in the annex

##### 6.5.2A.2.1.1 Test Purpose

Carrier leakage is an additive sinusoid waveform that is confined within the aggregated transmission bandwidth configuration. The carrier leakage requirement is defined for each component carrier and is measured on the component carrier with PRBs allocated. The measurement interval is one slot in the time domain.

##### 6.5.2A.2.1.2 Test applicability

This test case applies to all types of E-UTRA UE release 10 and forward that support intra-band contiguous DL CA and UL CA.

##### 6.5.2A.2.1.3 Minimum conformance requirements

The relative carrier leakage power is a power ratio of the additive sinusoid waveform and the modulated waveform. The relative carrier leakage power shall not exceed the values specified in Table 6.5.2A.2.1.3-1.

**Table 6.5.2A.2.1.3-1: Minimum requirements for Relative Carrier Leakage Power**

	Parameters	Relative Limit (dBc)
	Output power >0 dBm	-25
	-30 dBm ≤ Output power ≤ 0 dBm	-20
	-40 dBm ≤ Output power < -30 dBm	-10

6.5.2A.2.1.4 Test description

6.5.2A.2.1.4.1 Initial conditions

Initial conditions are a set of test configurations the UE needs to be tested in and the steps for the SS to take with the UE to reach the correct measurement state.

The initial test configurations consist of environmental conditions, test frequencies, and CC combinations based on E-UTRA CA configurations specified in table 5.4.2A.1-1. All of these configurations shall be tested with applicable test parameters for each CA Configuration, and are shown in table 6.5.2A.2.1.4.1-1. The details of the uplink reference measurement channels (RMCs) are specified in Annex A.2. Configurations of PDSCH and PDCCH before measurement are specified in Annex C.2.

**Table 6.5.2A.2.1.4.1-1: Test Configuration Table**

Initial Conditions									
Test Environment as specified in TS 36.508[7] subclause 4.1					NC				
Test Frequencies as specified in TS36.508 [7] subclause [4.3.1] for different CA bandwidth classes. PCC and SCC mapped onto component carriers CC according to the notation: PCC-SCC: CCi-CCj, which means PCC on CCi and SCC on CCj, with CCi/j frequencies defined in the corresponding intra-band contiguous CA band in TS36.508 [7] as above.					See Table 6.5.1A.1.4.1-1: PCC-SCC: CC1-CC2 and CC2-CC1				
Test CC Combination setting ( $N_{RB\_agg}$ ) as specified in subclause 5.4.2A.1 for the CA Configuration					See Table 6.5.1A.1.4.1-1:				
Test Parameters for CA Configurations									
Config ID	CA Configuration / $N_{RB\_agg}$		DL Allocation (PDCCH on PCC)	CC MOD	UL Allocation				
	PCC $N_{RB}$ Note 1	SCCs $N_{RB}$ Note 1	PCC & SCC RB allocation		$N_{RB\_alloc}$	PCC & SCC RB allocations ( $L_{CRB}$ @ $RB_{start}$ )			
1	75	75	NA	QPSK	16	P_16@0	S_0@0	-	-
2	75	75		QPSK	16	P_16@59	S_0@0	-	-
3	100	50		QPSK	12	P_12@0	S_0@0	-	-
4	100	50		QPSK	12	P_12@88	S_0@0	-	-
5	50	100		QPSK	12	P_12@0	S_0@0	-	-
6	50	100		QPSK	12	P_12@38	S_0@0	-	-
7	100	100		QPSK	18	P_18@0	S_0@0	-	-
8	100	100		QPSK	18	P_18@82	S_0@0	-	-
Note 1: CA Configuration Test CC Combination settings are checked separately for each CA Configuration, which applicable aggregated channel bandwidths are specified in Table 5.4.2A.1-1.									

1. Connect the SS to the UE to the UE antenna connectors as shown in TS 36.508 [7] Annex A, Figure group A.32 as appropriate.
2. The parameter settings for the cell are set up according to TS 36.508[7] subclause 4.4.3.
3. Downlink signals are initially set up according to Annex C0, C.1 and C.3.0, and uplink signals according to Annex H.1 and H.3.0.
4. The UL Reference Measurement channels are set according to in Table 6.5.2A.2.1.4.1-1.
5. Propagation conditions are set according to Annex B.0



6. Ensure the UE is in State 3A-RF according to TS 36.508 [7] clause 5.2A.2. Message contents are defined in clause 6.5.2A.2.1.4.3.

#### 6.5.2A.2.1.4.2 Test procedure

1. SS sends uplink scheduling information for each UL HARQ process via PDCCH DCI format 0 for C\_RNTI to schedule the UL RMC according to Table 6.5.2A.2.1.4.1-1. Since the UE has no payload and no loopback data to send the UE sends uplink MAC padding bits on the UL RMC.
2. Send the appropriate TPC commands in the uplink scheduling information to the UE until UE output power is 3.2 dBm  $\pm$ 3.2dB for carrier frequency  $f \leq 3.0$ GHz or 3.5dBm  $\pm$ 3.5 dB for carrier frequency  $3.0$ GHz  $< f \leq 4.2$ GHz.
3. Measure carrier leakage on PCC using Global In-Channel Tx-Test (Annex E). For TDD slots with transient periods are not under test.
4. Send the appropriate TPC commands in the uplink scheduling information to the UE until UE output power is -26.8 dBm  $\pm$ 3.2dB for carrier frequency  $f \leq 3.0$ GHz or -26.5dBm  $\pm$ 3.5 dB for carrier frequency  $3.0$ GHz  $< f \leq 4.2$ GHz.
5. Measure carrier leakage on PCC using Global In-Channel Tx-Test (Annex E). For TDD slots with transient periods are not under test.
6. Send the appropriate TPC commands in the uplink scheduling information to the UE until UE output power is -36.8dBm  $\pm$ 3.2dB for carrier frequency  $f \leq 3.0$ GHz or -36.5dBm  $\pm$ 3.5 dB for carrier frequency  $3.0$ GHz  $< f \leq 4.2$ GHz.
7. Measure carrier leakage on PCC using Global In-Channel Tx-Test (Annex E). For TDD slots with transient periods are not under test.

#### 6.5.2A.2.1.4.3 Message contents

FFS.

#### 6.5.2A.2.1.5 Test requirement

Each of the 20 carrier leakage results, derived in Annex E.3.1, shall not exceed the values in table 6.5.2A.2.1.5-1.

**Table 6.5.2A.2.1.5-1: Test requirements for Relative Carrier Leakage Power**

Carrier Leakage	Parameters	Relative Limit (dBc)
	$f \leq 3.0$ GHz: 3.2 dBm $\pm$ 3.2dB $3.0$ GHz $< f \leq 4.2$ GHz: 3.5 dBm $\pm$ 3.5dB	-24.2
	$f \leq 3.0$ GHz: -26.8 dBm $\pm$ 3.2dB $3.0$ GHz $< f \leq 4.2$ GHz: -26.5 dBm $\pm$ 3.5dB	-19.2
	$f \leq 3.0$ GHz: -36.8dBm $\pm$ 3.2dB $3.0$ GHz $< f \leq 4.2$ GHz: -36.5 dBm $\pm$ 3.5dB	-9.2

### 6.5.2A.3 In-band emissions for non allocated RB for CA

#### 6.5.2A.3.1 In-band emissions for non allocated RB for CA (intra-band contiguous DL CA and UL CA)

**Editor's notes:** The following items are missing or incomplete:

- Test procedure(incomplete, references need update)
- Test tolerances not yet in the annex

##### 6.5.2A.3.1.1 Test Purpose

The in-band emissions are a measure of the interference falling into the non-allocated resources blocks.

For an allocated component carrier, the in-band emission is defined as the average across 12 sub-carrier and as a function of the RB offset from the edge of the allocated UL transmission bandwidth. The in-band emission is measured as the ratio of the UE output power in a non-allocated RB to the UE output power in an allocated RB. The basic in-band emissions measurement interval is defined over one slot in the time domain. When the PUSCH or PUCCH transmission slot is shortened due to multiplexing with SRS, the in-band emissions measurement interval is reduced by one SC-FDMA symbol, accordingly.

For a non allocated component carrier a spectral measurement is specified.

#### 6.5.2A.3.1.2 Test applicability

This test case applies to all types of E-UTRA UE release 10 and forward that support intra-band contiguous DL CA and UL CA.

#### 6.5.2A.3.1.3 Minimum conformance requirements

For intra-band contiguous carrier aggregation, the requirements in Table 6.5.2A.3.1.3-1 and 6.5.2A.3.1.3-2 apply within the aggregated transmission bandwidth configuration with both component carrier (s) active and one single contiguous PRB allocation of bandwidth  $L_{CRB}$  at the edge of the aggregated transmission bandwidth configuration.

The in-band emission is defined as the interference falling into the non allocated resource blocks for all component carriers. The measurement method for the in band emissions in the component carrier with PRB allocation is specified in Annex E Global In-Channel Tx-Test. For a non allocated component carrier a spectral measurement is specified.

**Table 6.5.2A.3.1.3-1: Minimum requirements for in-band emissions (allocated component carrier)**

Parameter	Unit	Limit		Applicable Frequencies
General	dB	$\max \left\{ -25 - 10 \cdot \log_{10} (N_{RB} / L_{CRB}), \right.$ $20 \cdot \log_{10} EVM - 3 - 5 \cdot ( \Delta_{RB}  - 1) / L_{CRB},$ $\left. -57 \text{ dBm} / 180 \text{ kHz} - P_{RB} \right\}$		Any non-allocated (Note 2)
IQ Image	dB	-25		Exception for IQ image (Note 3)
Carrier leakage	dBc	-25	Output power > 0 dBm	Exception for Carrier frequency (Note 4)
		-20	-30 dBm ≤ Output power ≤ 0 dBm	
		-10	-40 dBm ≤ Output power < -30 dBm	
Note 1:	An in-band emissions combined limit is evaluated in each non-allocated RB. For each such RB, the minimum requirement is calculated as the higher of $P_{RB} - 30$ dB and the power sum of all limit values (General, IQ Image or Carrier leakage) that apply. $P_{RB}$ is defined in Note 9. The limit is evaluated in each non-allocated RB.			
Note 2:	The measurement bandwidth is 1 RB and the limit is expressed as a ratio of measured power in one non-allocated RB to the measured average power per allocated RB, where the averaging is done across all allocated RBs			
Note 3:	Exceptions to the general limit are allowed for up to $L_{CRB} + 1$ RBs within a contiguous width of $L_{CRB} + 1$ non-allocated RBs. The measurement bandwidth is 1 RB.			
Note 4:	Exceptions to the general limit are allowed for up to two contiguous non-allocated RBs. The measurement bandwidth is 1 RB and the limit is expressed as a ratio of measured power in the non-allocated RB to the measured total power in all allocated RBs.			
Note 5:	$L_{CRB}$ is the Transmission Bandwidth (see Figure 5.4.2-1) not exceeding $\lfloor N_{RB} / 2 - 1 \rfloor$			
Note 6:	$N_{RB}$ is the Transmission Bandwidth Configuration (see Figure 5.4.2-1) of the component carrier with RBs allocated.			
Note 7:	$EVM$ is the limit specified in Table 6.5.2.1.3-1 for the modulation format used in the allocated RBs.			
Note 8:	$\Delta_{RB}$ is the starting frequency offset between the allocated RB and the measured non-allocated RB (e.g. $\Delta_{RB} = 1$ or $\Delta_{RB} = -1$ for the first adjacent RB outside of the allocated bandwidth).			
Note 9:	$P_{RB}$ is the transmitted power per 180 kHz in allocated RBs, measured in dBm.			

**Table 6.5.2A.3.1.3-2: Minimum requirements for in-band emissions (not allocated component carrier)**

Parameter	Unit	Meas BW Note 1	Limit	remark	Applicable Frequencies	
General	dB	BW of 1 RB (180KHz rectangular)	$\max \{ -25 - 10 \cdot \log_{10}(N_{RB} / L_{CRB}), 20 \cdot \log_{10} EVM - 3 - 5 \cdot ( \Delta_{RB}  - 1) / L_{CRB} - 57 \text{ dBm} / 180 \text{ kHz} - P_{RB} \}$	The reference value is the average power per allocated RB in the allocated component carrier	Any RB in the non allocated component carrier. The frequency raster of the RBs is derived when this component carrier is allocated with RBs	
IQ Image	dB	BW of 1 RB (180KHz rectangular)	-25 Note 2	The reference value is the average power per allocated RB in the allocated component carrier	The frequencies of the $L_{CRB}$ contiguous non-allocated RBs are unknown. The frequency raster of the RBs is derived when this component carrier is allocated with RBs	
Carrier leakage	dBc	BW of 1 RB (180KHz rectangular)	Note 3		The reference value is the total power of the allocated RBs in the allocated component carrier	The frequencies of the up to 2 non-allocated RBs are unknown. The frequency raster of the RBs is derived when this component carrier is allocated with RBs
			-25	Output power > 0 dBm		
			-20	-30 dBm ≤ Output power ≤ 0 dBm		
			-10	-40 dBm ≤ Output power < -30 dBm		
<p>Note 1: Resolution BWs smaller than the measurement BW may be integrated to achieve the measurement bandwidth.</p> <p>Note 2: Exceptions to the general limit are allowed for up to <math>L_{CRB} + 1</math> RBs within a contiguous width of <math>L_{CRB} + 1</math> non-allocated RBs.</p> <p>Note 3: Exceptions to the general limit are allowed for up to two contiguous non-allocated RBs</p> <p>Note 4: Notes 1, 5, 6, 7, 8, 9 from Table 6.5.2A.3.3-1 apply for Table 6.5.2A.3.1-2 as well.</p> <p>Note 5: <math>\Delta_{RB}</math> for measured non-allocated RB in the non allocated component carrier may take non-integer values when the carrier spacing between the CCs is not a multiple of RB.</p>						

6.5.2A.3.1.4 Test description

6.5.2A.3.1.4.1 Initial conditions

Initial conditions are a set of test configurations the UE needs to be tested in and the steps for the SS to take with the UE to reach the correct measurement state.

The initial test configurations consist of environmental conditions, test frequencies, and CC combinations based on E-UTRA CA configurations specified in table 5.4.2A.1-1. All of these configurations shall be tested with applicable test parameters for each CA Configuration, and are shown in table 6.5.2A.3.4.1-1. The details of the uplink reference

measurement channels (RMCs) are specified in Annex A.2. Configurations of PDSCH and PDCCH before measurement are specified in Annex C.2.

**Table 6.5.2A.3.1.4.1-1: Test Configuration Table**

Initial Conditions									
Test Environment as specified in TS 36.508[7] subclause 4.1					NC				
Test Frequencies as specified in TS36.508 [7] subclause 4.3.1 for different CA bandwidth classes. PCC and SCC mapped onto component carriers CC according to the notation: PCC-SCC: CCi-CCj, which means PCC on CCi and SCC on CCj, with CCi/j frequencies defined in the corresponding intra-band contiguous CA band in TS36.508 [7] as above.					See Table 6.5.1A.1.4.1-1: PCC-SCC: CC1-CC2, CC2-CC1				
Test CC Combination setting (N <sub>RB_agg</sub> ) as specified in subclause 5.4.2A.1 for the CA Configuration					See Table 6.5.1A.1.4.1-1:				
Test Parameters for CA Configurations									
Config ID	CA Configuration / N <sub>RB_agg</sub>		DL Allocation (PDCCH on PCC)	CC MOD	UL Allocation				
	PCC	SCC	PCC & SCC RB allocation		N <sub>RB_alloc</sub>	PCC & SCC RB allocations (L <sub>CRB</sub> @ RB <sub>start</sub> )			
1 Note 2	75	75	N.A.	QPSK	16	P_16@0	S_0@0	-	-
2 Note 3	75	75		QPSK	16	P_16@59	S_0@0	-	-
3 Note 2	100	50		QPSK	12	P_12@0	S_0@0	-	-
4 Note 3	100	50		QPSK	12	P_12@88	S_0@0	-	-
5 Note 2	50	100		QPSK	12	P_12@0	S_0@0	-	-
6 Note 3	50	100		QPSK	12	P_12@38	S_0@0	-	-
7 Note 2	100	100		QPSK	18	P_18@0	S_0@0	-	-
8 Note 3	100	100		QPSK	18	P_18@82	S_0@0	-	-
Note 1: CA Configuration Test CC Combination settings are checked separately for each CA Configuration, which applicable aggregated channel bandwidths are specified in Table 5.4.2A.1-1. Note 2: Applicable only for PCC-SCC: CC1-CC2. Note 3: Applicable only for PCC-SCC: CC2-CC1.									

1. Connect the SS to the UE to the UE antenna connectors as shown in TS 36.508 [7] Annex A, Figure group A.32 as appropriate.
2. The parameter settings for the cell are set up according to TS 36.508[7] subclause 4.4.3.
3. Downlink signals for PCC are initially set up according to Annex C0, C.1 and C.3.0, and uplink signals according to Annex H.1 and H.3.0.
4. The UL Reference Measurement channels are set according to in Table 6.5.2A.3.1.4.1-1.
5. Propagation conditions are set according to Annex B.0.
6. Ensure the UE is in State 3A-RF according to TS 36.508 [7] clause 5.2A.2. Message contents are defined in clause 6.5.2A.3.1.4.3.

**6.5.2A.3.1.4.2 Test procedure**

1. Configure SCC according to Annex C.0, C.1 and Annex C.3.0 for all downlink physical channels.
2. The SS shall configure SCC as per TS 36.508 [7] clause 5.2A.4. Message contents are defined in clause 6.5.2A.3.1.4.3.
3. SS activates SCC by sending the activation MAC-CE (Refer TS 36.321 [13], clauses 5.13, 6.1.3.8). Wait for at least 2 seconds (Refer TS 36.133, clauses 8.3.3.2).

4. SS sends uplink scheduling information for each UL HARQ process via PDCCH DCI format 0 for C\_RNTI to schedule the UL RMC according to Table 6.5.2A.3.1.4.1-1. Since the UE has no payload and no loopback data to send the UE sends uplink MAC padding bits on the UL RMC.
5. Send the appropriate TPC commands in the uplink scheduling information to the UE until UE output power is  $3.2 \text{ dBm} \pm 3.2 \text{ dB}$  for carrier frequency  $f \leq 3.0 \text{ GHz}$  or  $3.5 \text{ dBm} \pm 3.5 \text{ dB}$  for carrier frequency  $3.0 \text{ GHz} < f \leq 4.2 \text{ GHz}$ .
6. Measure In-band emission on PCC using Global In-Channel Tx-Test (Annex E). Measure power spectral density on the SCC. For TDD slots with transient periods are not under test.
7. Send the appropriate TPC commands in the uplink scheduling information to the UE until UE output power is  $-26.8 \text{ dBm} \pm 3.2 \text{ dB}$  for carrier frequency  $f \leq 3.0 \text{ GHz}$  or  $-36.5 \text{ dBm} \pm 3.5 \text{ dB}$  for carrier frequency  $3.0 \text{ GHz} < f \leq 4.2 \text{ GHz}$ .
8. Measure In-band emission on PCC using Global In-Channel Tx-Test (Annex E). Measure power spectral density on the SCC. For TDD slots with transient periods are not under test.
9. Send the appropriate TPC commands in the uplink scheduling information to the UE until UE output power is to  $-36.8 \text{ dBm} \pm 3.2 \text{ dB}$  for carrier frequency  $f \leq 3.0 \text{ GHz}$  or  $-36.5 \text{ dBm} \pm 3.5 \text{ dB}$  for carrier frequency  $3.0 \text{ GHz} < f \leq 4.2 \text{ GHz}$ .
10. Measure In-band emission on PCC using Global In-Channel Tx-Test (Annex E). Measure power spectral density on the SCC. For TDD slots with transient periods are not under test.

#### 6.5.2A.3.1.4.3 Message contents

Message contents are according to TS 36.508 [7] clause 4.6. In test procedure step 2, for SCC configuration there are no additional message contents.

#### 6.5.2A.3.1.5 Test requirement

Each of the 20 In-band emissions results, derived in Annex E.4.3 shall not exceed the corresponding values in Table 6.5.2A.3.1.5-1.

Table 6.5.2A.3.1.5-1: Test requirements for in-band emissions (allocated component carrier)

Parameter Description	Unit	Limit (Note 1)		Applicable Frequencies
General	dB	$\max \left\{ -25 - 10 \cdot \log_{10} (N_{RB} / L_{CRBs}), \right.$ $20 \cdot \log_{10} EVM - 3 - 5 \cdot ( \Delta_{RB}  - 1) / L_{CRBs}, \quad +0.8$ $\left. - 57 \text{ dBm} / 180 \text{ kHz} - P_{RB} \right\}$		Any non-allocated (Note 2)
IQ Image	dB	-24.2		Image frequencies (Notes 2, 3)
Carrier leakage	dBc	-24.2	Output power $f \leq 3.0\text{GHz}$ : 3.2dBm $\pm 3.2\text{dB}$ $3.0\text{GHz} < f \leq 4.2\text{GHz}$ : 3.5 dBm $\pm 3.5\text{dB}$	LO frequency (Notes 4, 5)
		-19.2	Output power $f \leq 3.0\text{GHz}$ : -26.8 dBm $\pm 3.2\text{dB}$ $3.0\text{GHz} < f \leq 4.2\text{GHz}$ : -26.5 dBm $\pm 3.5\text{dB}$	
		-9.2	Output power $f \leq 3.0\text{GHz}$ : -36.8 dBm $\pm 3.2\text{dB}$ $3.0\text{GHz} < f \leq 4.2\text{GHz}$ : -36.5 dBm $\pm 3.5\text{dB}$	
<p>Note 1: An in-band emissions combined limit is evaluated in each non-allocated RB. For each such RB, the test requirement is calculated as the higher of <math>P_{RB} - 29.2</math> dB and the power sum of all limit values (General, IQ Image or Carrier leakage) that apply. <math>P_{RB}</math> is defined in Note 10.</p> <p>Note 2: The measurement bandwidth is 1 RB and the limit is expressed as a ratio of measured power in one non-allocated RB to the measured average power per allocated RB, where the averaging is done across all allocated RBs.</p> <p>Note 3: The applicable frequencies for this limit are not known due to unknown LO frequency. See Note 3 in Table 6.5.2A.3.1.3-1.</p> <p>Note 4: The measurement bandwidth is 1 RB and the limit is expressed as a ratio of measured power in one non-allocated RB to the measured total power in all allocated RBs.</p> <p>Note 5: The applicable frequencies for this limit are not known due to unknown LO frequency. See Note 4 in Table 6.5.2A.3.1.3-1.</p> <p>Note 6: <math>L_{CRB}</math> is the Transmission Bandwidth (see Figure 5.4.2-1).</p> <p>Note 7: <math>N_{RB}</math> is the Transmission Bandwidth Configuration (see Figure 5.4.2-1) of the component carrier with RBs allocated.</p> <p>Note 8: <math>EVM</math> is the limit specified in Table 6.5.2.1.1-1 for the modulation format used in the allocated RBs.</p> <p>Note 9: <math>\Delta_{RB}</math> is the starting frequency offset between the allocated RB and the measured non-allocated RB (e.g. <math>\Delta_{RB} = 1</math> or <math>\Delta_{RB} = -1</math> for the first adjacent RB outside of the allocated bandwidth).</p> <p>Note 10: <math>P_{RB}</math> is the transmitted power per 180 kHz in allocated RBs, measured in dBm.</p>				

The in-band emissions results, measured with the spectral test shall not exceed the corresponding values in Table 6.5.2A.3.5-2

Table 6.5.2A.3.1.5-2: Test requirements for in-band emissions (not allocated component carrier)

Parameter	Unit	Meas BW Note 1	Limit	remark	Applicable Frequencies	
General	dB	BW of 1 RB (180KHz rectangular)	$\max \left\{ -25 - 10 \cdot \log_{10} (N_{RB} / L_{CRBs}), \right.$ $20 \cdot \log_{10} EVM - 3 - 5 \cdot ( \Delta_{RB}  - 1) / L_{CRBs}$ $\left. - 57 \text{ dBm} / 180 \text{ kHz} - P_{RB} \right\}$	The reference value is the average power per allocated RB in the allocated component carrier	Any RB in the non allocated component carrier. The frequency raster of the RBs is derived when this component carrier is allocated with RBs	
IQ Image	dB	BW of 1 RB (180KHz rectangular)	-24.2 Note 2	The reference value is the average power per allocated RB in the allocated component carrier	The frequencies of the $L_{CRB}$ contiguous non-allocated RBs are unknown. The frequency raster of the RBs is derived when this component carrier is allocated with RBs	
Carrier leakage	dBc	BW of 1 RB (180KHz rectangular)	Note 3		The reference value is the total power of the allocated RBs in the allocated component carrier	The frequencies of the up to 2 non-allocated RBs are unknown. The frequency raster of the RBs is derived when this component carrier is allocated with RBs
			-24.2	Output power > 0 dBm		
			-19.2	-30 dBm ≤ Output power ≤ 0 dBm		
			-9.2	-40 dBm ≤ Output power < -30 dBm		
Note1:	Resolution BWs smaller than the measurement BW may be integrated to achieve the measurement bandwidth.					
Note 2:	Exceptions to the general limit are allowed for up to $L_{CRB} + 1$ RBs within a contiguous width of $L_{CRB} + 1$ non-allocated RBs.					
Note 3:	Exceptions to the general limit are allowed for up to two contiguous non-allocated RBs.					
Note 4:	Notes 1, 6, 7, 8, 9, 10 from Table 6.5.2A.3.3-1 apply for Table 6.5.2A.3.1-2 as well.					
Note 5:	$\Delta_{RB}$ for measured non-allocated RB in the non allocated component carrier may take non-integer values when the carrier spacing between the CCs is not a multiple of RB.					

## 6.5.2B Transmit modulation for UL- MIMO

### 6.5.2B.1 Error Vector Magnitude (EVM) for UL- MIMO

#### 6.5.2B.1.1 Test Purpose

The Error Vector Magnitude is a measure of the difference between the reference waveform and the measured waveform. This difference is called the error vector. Before calculating the EVM the measured waveform is corrected by the sample timing offset and RF frequency offset. Then the carrier leakage shall be removed from the measured waveform before calculating the EVM.

The measured waveform is further modified by selecting the absolute phase and absolute amplitude of the Tx chain. The EVM result is defined after the front-end IDFT as the square root of the ratio of the mean error vector power to the mean reference power expressed as a %.

When the PUSCH or PUCCH transmission slot is shortened due to multiplexing with SRS, the EVM measurement interval is reduced by one symbol, accordingly. The PUSCH or PUCCH EVM measurement interval is also reduced when the mean power, modulation or allocation between slots is expected to change. In the case of PUSCH transmission, the measurement interval is reduced by a time interval equal to the sum of 5  $\mu$ s and the applicable exclusion period defined in subclause 6.3.4, adjacent to the boundary where the power change is expected to occur. The PUSCH exclusion period is applied to the signal obtained after the front-end IDFT. In the case of PUCCH transmission, the PUCCH EVM measurement interval is reduced by one symbol adjacent to the slot boundary.

### 6.5.2B.1.2 Test applicability

This test case applies to all types of E-UTRA UE release 10 and forward that support UL-MIMO.

### 6.5.2B.1.3 Minimum conformance requirements

For UE with two transmit antenna connectors in closed-loop spatial multiplexing scheme, the Error Vector Magnitude requirements specified in Table 6.5.2.1.1-1 which is defined in sub-clause 6.5.2.1 apply to each transmit antenna connector with the UL-MIMO configurations specified in Table 6.2.2B-2.

The normative reference for this requirement is TS 36.101 [2] clause 6.5.2B.1.1.

### 6.5.2B.1.4 Test description

#### 6.5.2B.1.4.1 Initial conditions

Initial conditions are a set of test configurations the UE needs to be tested in and the steps for the SS to take with the UE to reach the correct measurement state.

The initial test configurations consist of environmental conditions, test frequencies, and channel bandwidths based on E-UTRA bands specified in table 5.4.2.1-1. All of these configurations shall be tested with applicable test parameters for each channel bandwidth, and are shown in table 6.5.2B.1.4.1-1. The details of the uplink reference measurement channels (RMCs) are specified in Annex A.2. Configurations of PDSCH and PDCCH before measurement are specified in Annex C.2.

**Table 6.5.2B.1.4.1-1: Test Configuration Table for PUSCH**

Initial Conditions			
Test Environment (as specified in TS 36.508 [7] subclause 4.1)		NC	
Test Frequencies (as specified in TS36.508 [7] subclause 4.3.1)		See Table 6.5.1.4.1-1	
Test Channel Bandwidths (as specified in TS 36.508 [7] subclause 4.3.1)		See Table 6.5.1.4.1-1	
Test Parameters for Channel Bandwidths			
	Downlink Configuration	Uplink Configuration	
Ch BW	N/A for PUSCH EVM testing	Mod'n	RB allocation
			FDD      TDD



1.4MHz		QPSK	6	6
1.4MHz		QPSK	1	1
1.4MHz		16QAM	6	6
1.4MHz		16QAM	1	1
3MHz		QPSK	15	15
3MHz		QPSK	4	4
3MHz		16QAM	15	15
3MHz		16QAM	4	4
5MHz		QPSK	25	25
5MHz		QPSK	8	8
5MHz		16QAM	25	25
5MHz		16QAM	8	8
10MHz		QPSK	50	50
10MHz		QPSK	12	12
10MHz		16QAM	50	50
			(Note 3)	(Note 3)
10MHz		16QAM	12	12
15MHz		QPSK	75	75
15MHz		QPSK	16	16
15MHz		16QAM	75	75
			(Note 3)	(Note 3)
15MHz		16QAM	16	16
20MHz		QPSK	100	100
20MHz		QPSK	18	18
20MHz		16QAM	100	100
			(Note 3)	(Note 3)
20MHz		16QAM	18	18

Note 1: Test Channel Bandwidths are checked separately for each E-UTRA band, which applicable channel bandwidths are specified in Table 5.4.2.1-1.

Note 2: For partial RB allocation, the RB<sub>start</sub> shall be RB #0 and RB# (max+1 - RB allocation) of the channel bandwidth.

Note 3: Applies only for UE-Categories [FFS].

**Table 6.5.2B.1.4.1-2: Test Configuration Table for PUCCH**

Initial Conditions				
Test Environment as specified in TS 36.508[7] subclause 4.1		NC		
Test Frequencies as specified in <b>TS36.508 [7] subclause 4.3.1</b>		See Table 6.5.1.4.1-1		
Test Channel Bandwidths as specified in <b>TS 36.508 [7] subclause 4.3.1</b>		See Table 6.5.1.4.1-1		
Test Parameters for Channel Bandwidths				
Downlink Configuration			Uplink Configuration	
Ch BW	Mod'n	RB allocation		FDD: PUCCH format = Format 1a TDD: PUCCH format = Format 1a / 1b
		FDD	TDD	
1.4MHz	QPSK	3	3	
3MHz	QPSK	4	4	
5MHz	QPSK	8	8	
10MHz	QPSK	16	16	
15MHz	QPSK	25	25	
20MHz	QPSK	30	30	

Note 1: Test Channel Bandwidths are checked separately for each E-UTRA band, the applicable channel bandwidths are specified in Table 5.4.2.1-1.

1. Connect the SS to the UE to the UE antenna connectors as shown in TS 36.508 [7] Annex A, Figure A.28.
2. The parameter settings for the cell are set up according to TS 36.508[7] subclause 4.4.3.
3. Downlink signals are initially set up according to Annex C0, C.1 and C.3.0, and uplink signals according to Annex H.1 and H.3.0.
4. The UL Reference Measurement channels are set according to in Table 6.5.2B.1.4.1-1.

5. Propagation conditions are set according to Annex B.0
6. Ensure the UE is in State 3A-RF according to TS 36.508 [7] clause 5.2A.2. Message contents are defined in clause 6.5.2B.1.4.3.

#### 6.5.2B.1.4.2 Test procedure

Test procedure for PUSCH:

- 1.1. SS sends uplink scheduling information for each UL HARQ process via PDCCH DCI format 4 for C\_RNTI to schedule the UL RMC according to Table 6.5.2B.1.4.1-1. Since the UE has no payload data to send, the UE transmits uplink MAC padding bits on the UL RMC.
- 1.2 Send continuously uplink power control "up" commands in the uplink scheduling information to the UE until the UE transmits at  $P_{UMAX}$  level.
- 1.3 Measure the EVM and  $\overline{EVM}_{DMRS}$  using Global In-Channel Tx-Test (Annex E) for each of transmit antenna of the UE.
- 1.4 Send the appropriate TPC commands in the uplink scheduling information to the UE until UE output power is  $-36.8\text{dBm} \pm 3.2\text{dB}$  for carrier frequency  $f \leq 3.0\text{GHz}$  or  $-36.5\text{dBm} \pm 3.5\text{ dB}$  for carrier frequency  $3.0\text{GHz} < f \leq 4.2\text{GHz}$ .
- 1.5 Measure the EVM and  $\overline{EVM}_{DMRS}$  using Global In-Channel Tx-Test (Annex E) for each of transmit antenna of the UE.

Test procedure for PUCCH:

- 2.1 PUCCH are set according to Table 6.5.2B.1.4.1-2.
- 2.2 SS transmits PDSCH via PDCCH DCI format 1A for C\_RNTI to transmit the DL RMC according to Table 6.5.2B.1.4.1-2. The SS sends downlink MAC padding bits on the DL RMC. The transmission of PDSCH will make the UE send uplink ACK/NACK using PUCCH. There is no PUSCH transmission.
- 2.3 SS send appropriate TPC commands for PUCCH to the UE until the UE transmit PUCCH at  $P_{UMAX}$  level.
- 2.4 Measure PUCCH EVM using Global In-Channel Tx-Test (Annex E) for each of transmit antenna of the UE.
- 2.5 Send the appropriate TPC commands for PUCCH to the UE until the UE transmits PUCCH at  $-36.8\text{dBm} \pm 3.2\text{dB}$  for carrier frequency  $f \leq 3.0\text{GHz}$  or  $-36.5\text{dBm} \pm 3.5\text{ dB}$  for carrier frequency  $3.0\text{GHz} < f \leq 4.2\text{GHz}$ .
- 2.6 Measure PUCCH EVM using Global In-Channel Tx-Test (Annex E) for each of transmit antenna of the UE.

#### 6.5.2B.1.4.3 Message contents

Message contents are according to TS 36.508 [7] clause 4.6 with the following exceptions:

**Table 6.5.2B.1.4.3-1: PUCCH-ConfigDedicated-v1020-DEFAULT**

Derivation Path: TS 36.508 [7] clause 4.6.3, Table 4.6.3-9A: PUCCH-ConfigDedicated-v1020-DEFAULT			
Information Element	Value/remark	Comment	Condition
PUCCH-ConfigDedicated-v1020 ::= SEQUENCE {			
twoAntennaPortActivatedPUCCH-Format1a1b-r10	true		
}			

#### 6.5.2B.1.5 Test requirement

The requirements apply to each transmit antenna connector.

The PUSCH EVM derived in E.4.2 shall not exceed 17.5 % for QPSK and BPSK, 12.5% for 16 QAM.

The PUSCH  $\overline{EVM}_{DMRS}$  derived in E.4.6.2 shall not exceed [17.5 %] when embedded with data symbols of QPSK and BPSK, [12.5%] for 16 QAM.

The PUCCH EVM and derived in E.5.9.2 shall not exceed 17.5 %.

## 6.5.2B.2 Carrier leakage for UL-MIMO

### 6.5.2B.2.1 Test Purpose

The purpose of this test is to exercise the transmitter of UE that support UL-MIMO to verify its modulation quality in terms of carrier leakage for UL-MIMO.

### 6.5.2B.2.2 Test applicability

This test case applies to all types of E-UTRA UE release 10 and forward that support UL-MIMO.

### 6.5.2B.2.3 Minimum conformance requirements

For UE with two transmit antenna connectors in closed-loop spatial multiplexing scheme, the Relative Carrier Leakage Power requirements specified in Table 6.5.2.2.3-1 which is defined in subclause 6.5.2.2 apply to each transmit antenna connector with the UL-MIMO configurations specified in Table 6.2.2B.3-2.

The normative reference for this requirement is TS 36.101 clause 6.5.2B.2

### 6.5.2B.2.4 Test description

#### 6.5.2B.2.4.1 Initial conditions

Initial conditions are a set of test configurations the UE needs to be tested in and the steps for the SS to take with the UE to reach the correct measurement state.

The initial test configurations consist of environmental conditions, test frequencies, and channel bandwidths based on E-UTRA bands specified in table 5.4.2.1-1. All of these configurations shall be tested with applicable test parameters for each channel bandwidth, and are shown in table 6.5.2.2B.4.1-1. The details of the uplink reference measurement channels (RMCs) are specified in Annexes A.2. Configurations of PDSCH and PDCCH before measurement are specified in Annex C.2.

**Table 6.5.2.2B.4.1-1: Test Configuration Table**

Initial Conditions				
Test Environment (as specified in TS 36.508 [7] subclause 4.1)		See Table 6.5.1.4.1-1		
Test Frequencies (as specified in TS36.508 [7] subclause 4.3.1)		See Table 6.5.1.4.1-1		
Test Channel Bandwidths (as specified in TS 36.508 [7] subclause 4.3.1)		See Table 6.5.1.4.1-1		
Test Parameters for Channel Bandwidths				
Ch BW	Downlink Configuration	Uplink Configuration		
		Mod'n	RB allocation	
	N/A for carrier leakage testing		FDD	TDD
1.4MHz		QPSK	1	1
3MHz		QPSK	4	4
5MHz		QPSK	8	8
10MHz		QPSK	12	12
15MHz		QPSK	16	16
20MHz		QPSK	18	18
Note 1: Test Channel Bandwidths are checked separately for each E-UTRA band, which applicable channel bandwidths are specified in Table 5.4.2.1-1.				
Note 2: For partial RB allocation, the RB <sub>start</sub> shall be RB #0 and RB# (max +1- RB allocation) of the channel bandwidth.				

1. Connect the SS to the UE to the UE antenna connectors as shown in TS 36.508 [7] Annex A, Figure A.28.
2. The parameter settings for the cell are set up according to TS 36.508[7] subclause 4.4.3.

3. Downlink signals are initially set up according to Annex C0, C.1 and C.3.0, and uplink signals according to Annex H.1 and H.3.0.
4. The UL Reference Measurement channels are set according to in Table 6.5.2B.2.4.1-1.
5. Propagation conditions are set according to Annex B.0
6. Ensure the UE is in State 3A-RF according to TS 36.508 [7] clause 5.2A.2. Message contents are defined in clause 6.5.2B.2.4.3.

#### 6.5.2B.2.4.2 Test procedure

1. SS sends uplink scheduling information for each UL HARQ process via PDCCH DCI format 4 for C\_RNTI to schedule the UL RMC according to Table 6.5.2B.2.4.1-1. Since the UE has no payload and no loopback data to send the UE sends uplink MAC padding bits on the UL RMC
2. Send the appropriate TPC commands in the uplink scheduling information to the UE until UE output power is 3.2 dBm  $\pm$ 3.2dB for carrier frequency  $f \leq 3.0$ GHz or 3.5dBm  $\pm$ 3.5 dB for carrier frequency  $3.0$ GHz  $< f \leq 4.2$ GHz.
3. Measure carrier leakage using Global In-Channel Tx-Test (Annex E) for each of transmit antenna of the UE. For TDD slots with transient periods are not under test.
4. Send the appropriate TPC commands in the uplink scheduling information to the UE until UE output power is -26.8 dBm  $\pm$ 3.2dB for carrier frequency  $f \leq 3.0$ GHz or -26.5dBm  $\pm$ 3.5 dB for carrier frequency  $3.0$ GHz  $< f \leq 4.2$ GHz.
5. Measure carrier leakage using Global In-Channel Tx-Test (Annex E) for each of transmit antenna of the UE. For TDD slots with transient periods are not under test.
6. Send the appropriate TPC commands in the uplink scheduling information to the UE until UE output power is -36.8dBm  $\pm$ 3.2dB for carrier frequency  $f \leq 3.0$ GHz or -36.5dBm  $\pm$ 3.5 dB for carrier frequency  $3.0$ GHz  $< f \leq 4.2$ GHz.
7. Measure carrier leakage using Global In-Channel Tx-Test (Annex E) for each of transmit antenna of the UE. For TDD slots with transient periods are not under test

#### 6.5.2B.2.4.3 Message contents

Message contents are according to TS 36.508 [7] clause 4.6.

#### 6.5.2B.2.5 Test requirement

The requirements apply to each transmit antenna connector.

Each of the 20 carrier leakage results, derived in Annex E.3.1, shall not exceed the values in table 6.5.2B.2.5-1

**Table 6.5.2B.2.5-1: Test requirements for Relative Carrier Leakage Power**

LO Leakage	Parameters	Relative Limit (dBc)
	$f \leq 3.0$ GHz: 3.2 dBm $\pm$ 3.2dB $3.0$ GHz $< f \leq 4.2$ GHz: 3.5 dBm $\pm$ 3.5dB	24.2
	$f \leq 3.0$ GHz: -26.8 dBm $\pm$ 3.2dB $3.0$ GHz $< f \leq 4.2$ GHz: -26.5 dBm $\pm$ 3.5dB	19.2
	$f \leq 3.0$ GHz: -36.8dBm $\pm$ 3.2dB $3.0$ GHz $< f \leq 4.2$ GHz: -36.5 dBm $\pm$ 3.5dB	9.2

### 6.5.2B.3 In-band emissions for non allocated RB for UL-MIMO

#### 6.5.2B.3.1 Test Purpose

The in-band emissions are a measure of the interference falling into the non-allocated resources blocks.

The in-band emission is defined as the average across 12 sub-carrier and as a function of the RB offset from the edge of the allocated UL transmission bandwidth. The in-band emission for UL-MIMO is measured as the ratio of the output power of UE that support UL-MIMO in a non-allocated RB to the output power of UE that support UL-MIMO in an allocated RB. The basic in-band emissions measurement interval is defined over one slot in the time domain. When the PUSCH or PUCCH transmission slot is shortened due to multiplexing with SRS, the in-band emissions measurement interval is reduced by one SC-FDMA symbol, accordingly.

### 6.5.2B.3.2 Test applicability

This test case applies to all types of E-UTRA UE release 10 and forward that support UL-MIMO.

### 6.5.2B.3.3 Minimum conformance requirements

The relative in-band emission shall not exceed the values specified in Table 6.5.2B.3.3-1.

**Table 6.5.2B.3.3-1: Minimum requirements for in-band emissions**

Parameter Description	Unit	Limit (Note 1)		Applicable Frequencies
General	dB	$\max \left\{ -25 - 10 \cdot \log_{10} (N_{RB} / L_{CRBs}), \right.$ $20 \cdot \log_{10} EVM - 3 - 5 \cdot ( \Delta_{RB}  - 1) / L_{CRBs},$ $\left. -57 \text{ dBm} / 180 \text{ kHz} - P_{RB} \right\}$		Any non-allocated (Note 2)
IQ Image	dB	-25		Image frequencies (Notes 2, 3)
Carrier leakage	dBc	-25	Output power > 0 dBm	LO frequency (Notes 4, 5)
		-20	-30 dBm ≤ Output power ≤ 0 dBm	
		-10	-40 dBm ≤ Output power < -30 dBm	
<p>Note 1: An in-band emissions combined limit is evaluated in each non-allocated RB. For each such RB, the minimum requirement is calculated as the higher of <math>P_{RB} - 30</math> dB and the power sum of all limit values (General, IQ Image or Carrier leakage) that apply. <math>P_{RB}</math> is defined in Note 10.</p> <p>Note 2: The measurement bandwidth is 1 RB and the limit is expressed as a ratio of measured power in one non-allocated RB to the measured average power per allocated RB, where the averaging is done across all allocated RBs.</p> <p>Note 3: The applicable frequencies for this limit are those that are enclosed in the reflection of the allocated bandwidth, based on symmetry with respect to the centre carrier frequency, but excluding any allocated RBs.</p> <p>Note 4: The measurement bandwidth is 1 RB and the limit is expressed as a ratio of measured power in one non-allocated RB to the measured total power in all allocated RBs.</p> <p>Note 5: The applicable frequencies for this limit are those that are enclosed in the RBs containing the DC frequency if <math>N_{RB}</math> is odd, or in the two RBs immediately adjacent to the DC frequency if <math>N_{RB}</math> is even, but excluding any allocated RB.</p> <p>Note 6: <math>L_{CRBs}</math> is the Transmission Bandwidth (see Figure 5.4.2-1).</p> <p>Note 7: <math>N_{RB}</math> is the Transmission Bandwidth Configuration (see Figure 5.4.2-1).</p> <p>Note 8: <math>EVM</math> is the limit specified in Table 6.5.2.1.1-1 for the modulation format used in the allocated RBs.</p> <p>Note 9: <math>\Delta_{RB}</math> is the starting frequency offset between the allocated RB and the measured non-allocated RB (e.g. <math>\Delta_{RB} = 1</math> or <math>\Delta_{RB} = -1</math> for the first adjacent RB outside of the allocated bandwidth).</p> <p>Note 10: <math>P_{RB}</math> is the transmitted power per 180 kHz in allocated RBs, measured in dBm.</p>				

The normative reference for this requirement is TS 36.101 [2] clause 6.5.2B.3.

The in-band emission is defined as the average across 12 sub-carrier and as a function of the RB offset from the edge of the allocated UL transmission bandwidth. The in-band emission is measured as the ratio of the UE output power in a non-allocated RB to the UE output power in an allocated RB. The basic in-band emissions measurement interval is defined over one slot in the time domain.

## 6.5.2B.3.4 Test description

## 6.5.2B.3.4.1 Initial conditions

Initial conditions are a set of test configurations the UE needs to be tested in and the steps for the SS to take with the UE to reach the correct measurement state.

The initial test configurations consist of environmental conditions, test frequencies, and channel bandwidths based on E-UTRA bands specified in table 5.4.2.1-1. All of these configurations shall be tested with applicable test parameters for each channel bandwidth, and are shown in table 6.5.2B.3.4.1-1. The details of the uplink reference measurement channels (RMCs) are specified in Annexes A.2. Configurations of PDSCH and PDCCH before measurement are specified in Annex C.2.

Table 6.5.2B.3.4.1-1: Test Configuration Table for PUSCH

Initial Conditions				
Test Environment (as specified in TS 36.508 [7] subclause 4.1)		See Table 6.5.1.4.1-1		
Test Frequencies (as specified in TS36.508 [7] subclause 4.3.1)		See Table 6.5.1.4.1-1		
Test Channel Bandwidths (as specified in TS 36.508 [7] subclause 4.3.1)		See Table 6.5.1.4.1-1		
Test Parameters for Channel Bandwidths				
Ch BW	Downlink Configuration		Uplink Configuration	
	N/A for in-band emissions testing		Mod'n	RB allocation
			FDD	TDD
1.4MHz			QPSK	1
3MHz			QPSK	4
5MHz			QPSK	8
10MHz			QPSK	12
15MHz			QPSK	16
20MHz			QPSK	18
Note 1: Test Channel Bandwidths are checked separately for each E-UTRA band, which applicable channel bandwidths are specified in Table 5.4.2.1-1.				
Note 2: For partial RB allocation, the starting resource block shall be RB #0 and RB# (max+1 - RB allocation) of the channel bandwidth.				

Table 6.5.2B.3.4.1-2: Test Configuration Table for PUCCH

Initial Conditions				
Test Environment as specified in TS 36.508[7] subclause 4.1		See Table 6.5.1.4.1-1		
Test Frequencies as specified in <b>TS36.508 [7] subclause 4.3.1</b>		See Table 6.5.1.4.1-1		
Test Channel Bandwidths as specified in <b>TS 36.508 [7] subclause 4.3.1</b>		See Table 6.5.1.4.1-1		
Test Parameters for Channel Bandwidths				
Ch BW	Downlink Configuration		Uplink Configuration	
	Mod'n	RB allocation	FDD: PUCCH format = Format 1a TDD: PUCCH format = Format 1a / 1b	
		FDD	TDD	
1.4MHz	QPSK	3	3	
3MHz	QPSK	4	4	
5MHz	QPSK	8	8	
10MHz	QPSK	16	16	
15MHz	QPSK	25	25	
20MHz	QPSK	30	30	
Note 1: Test Channel Bandwidths are checked separately for each E-UTRA band, the applicable channel bandwidths are specified in Table 5.4.2.1-1.				

1. Connect the SS to the UE antenna connectors as shown in TS 36.508 [7] Figure A.28.
2. The parameter settings for the cell are set up according to TS 36.508 [7] subclause 4.4.3.
3. Downlink signals are initially set up according to Annex C.0, C.1, and C.3.0, and uplink signals according to Annex H.1 and H.3.0.

4. The UL Reference Measurement channels are set according to in Table 6.5.2B.3.4.1-1.
5. Propagation conditions are set according to Annex B.0
6. Ensure the UE is in State 3A-RF according to TS 36.508 [7] clause 5.2A.2. Message contents are defined in clause 6.5.2B.3.4.3.

#### 6.5.2B.3.4.2 Test procedure

Test procedure for PUSCH:

- 1.1 SS sends uplink scheduling information for each UL HARQ process via PDCCH DCI format 4 for C\_RNTI to schedule the UL RMC according to Table 6.5.2B.3.4.1-1. Since the UE has no payload and no loopback data to send the UE sends uplink MAC padding bits on the UL RMC.
- 1.2 Send the appropriate TPC commands in the uplink scheduling information to the UE until UE output power is 3.2 dBm  $\pm$ 3.2dB for carrier frequency  $f \leq 3.0$ GHz or 3.5dBm  $\pm$ 3.5 dB for carrier frequency  $3.0$ GHz  $< f \leq 4.2$ GHz.
- 1.3 Measure In-band emission using Global In-Channel Tx-Test (Annex E) for each of transmit antennas of the UE.
- 1.4 Send the appropriate TPC commands in the uplink scheduling information to the UE until UE output power is -26.8 dBm  $\pm$ 3.2dB for carrier frequency  $f \leq 3.0$ GHz or -36.5dBm  $\pm$ 3.5 dB for carrier frequency  $3.0$ GHz  $< f \leq 4.2$ GHz.
- 1.5 Measure In-band emission using Global In-Channel Tx-Test (Annex E) for each of transmit antennas of the UE. For TDD slots with transient periods are not under test.
- 1.6 Send the appropriate TPC commands in the uplink scheduling information to the UE until UE output power is to -36.8 dBm  $\pm$ 3.2dB for carrier frequency  $f \leq 3.0$ GHz or -36.5dBm  $\pm$ 3.5 dB for carrier frequency  $3.0$ GHz  $< f \leq 4.2$ GHz.
- 1.7 Measure In-band emission using Global In-Channel Tx-Test (Annex E) for each of transmit antennas of the UE. For TDD slots with transient periods are not under test.

Test procedure for PUCCH:

- 2.1 PUCCH is set according to Table 6.5.2B.3.4.1-2. SS transmits PDSCH via PDCCH DCI format 1A for C\_RNTI to transmit the DL RMC according to Table 6.5.2B.3.4.1-2. The SS sends downlink MAC padding bits on the DL RMC. The transmission of PDSCH will make the UE send uplink ACK/NACK using PUCCH.
- 2.2 Send the appropriate TPC commands in the uplink scheduling information for PUCCH to the UE until UE output power is 3.2 dBm  $\pm$ 3.2dB for carrier frequency  $f \leq 3.0$ GHz or 3.5dBm  $\pm$ 3.5 dB for carrier frequency  $3.0$ GHz  $< f \leq 4.2$ GHz.
- 2.3 Measure In-band emission using Global In-Channel Tx-Test (Annex E) for each of transmit antennas of the UE.
- 2.4 Send the appropriate TPC commands for PUCCH in the uplink scheduling information to the UE until UE output power is -26.8 dBm  $\pm$ 3.2dB for carrier frequency  $f \leq 3.0$ GHz or -26.5dBm  $\pm$ 3.5 dB for carrier frequency  $3.0$ GHz  $< f \leq 4.2$ GHz.
- 2.5 Measure In-band emission using Global In-Channel Tx-Test (Annex E) for each of transmit antennas of the UE.
- 2.6 Send the appropriate TPC commands for PUCCH in the uplink scheduling information to the UE until UE output power is to -36.8 dBm  $\pm$ 3.2dB for carrier frequency  $f \leq 3.0$ GHz or -36.5dBm  $\pm$ 3.5 dB for carrier frequency  $3.0$ GHz  $< f \leq 4.2$ GHz.
- 2.7 Measure In-band emission using Global In-Channel Tx-Test (Annex E) for each of transmit antennas of the UE.

#### 6.5.2B.3.4.3 Message contents

Message contents are according to TS 36.508 [7] clause 4.6 with the following exceptions:

**Table 6.5.2B.3.4.3-1: PUCCH-ConfigDedicated-v1020-DEFAULT**

Derivation Path: TS 36.508 [7] clause 4.6.3, Table 4.6.3-9A: PUCCH-ConfigDedicated-v1020-DEFAULT			
Information Element	Value/remark	Comment	Condition
PUCCH-ConfigDedicated-v1020 ::= SEQUENCE {			
twoAntennaPortActivatedPUCCH-Format1a1b-r10	true		
}			

### 6.5.2B.3.5 Test requirement

The requirements apply to each transmit antenna connector.

Each of the 20 In-band emissions results, derived in Annex E.4.3 shall not exceed the corresponding values in Table 6.5.2B.3.5-1.

**Table 6.5.2B.3.5-1: Test requirements for in-band emissions**

Parameter Description	Unit	Limit (Note 1)		Applicable Frequencies
General	dB	$\max \left\{ -25 - 10 \cdot \log_{10} (N_{RB} / L_{CRBs}), \right.$ $20 \cdot \log_{10} EVM - 3 - 5 \cdot ( \Delta_{RB}  - 1) / L_{CRBs}, \quad +0.8$ $\left. -57 \text{ dBm} / 180 \text{ kHz} - P_{RB} \right\}$		Any non-allocated (Note 2)
IQ Image	dB	-24.2		Image frequencies (Notes 2, 3)
Carrier leakage	dBc	-24.2	Output power > 0 dBm	LO frequency (Notes 4, 5)
		-19.2	-30 dBm ≤ Output power ≤ 0 dBm	
		-9.2	-40 dBm ≤ Output power < -30 dBm	
<p>Note 1: An in-band emissions combined limit is evaluated in each non-allocated RB. For each such RB, the minimum requirement is calculated as the higher of <math>P_{RB} - 30</math> dB and the power sum of all limit values (General, IQ Image or Carrier leakage) that apply. <math>P_{RB}</math> is defined in Note 10.</p> <p>Note 2: The measurement bandwidth is 1 RB and the limit is expressed as a ratio of measured power in one non-allocated RB to the measured average power per allocated RB, where the averaging is done across all allocated RBs.</p> <p>Note 3: The applicable frequencies for this limit are those that are enclosed in the reflection of the allocated bandwidth, based on symmetry with respect to the centre carrier frequency, but excluding any allocated RBs.</p> <p>Note 4: The measurement bandwidth is 1 RB and the limit is expressed as a ratio of measured power in one non-allocated RB to the measured total power in all allocated RBs.</p> <p>Note 5: The applicable frequencies for this limit are those that are enclosed in the RBs containing the DC frequency if <math>N_{RB}</math> is odd, or in the two RBs immediately adjacent to the DC frequency if <math>N_{RB}</math> is even, but excluding any allocated RB.</p> <p>Note 6: <math>L_{CRBs}</math> is the Transmission Bandwidth (see Figure 5.4.2-1).</p> <p>Note 7: <math>N_{RB}</math> is the Transmission Bandwidth Configuration (see Figure 5.4.2-1).</p> <p>Note 8: <math>EVM</math> is the limit specified in Table 6.5.2.1.1-1 for the modulation format used in the allocated RBs.</p> <p>Note 9: <math>\Delta_{RB}</math> is the starting frequency offset between the allocated RB and the measured non-allocated RB (e.g. <math>\Delta_{RB} = 1</math> or <math>\Delta_{RB} = -1</math> for the first adjacent RB outside of the allocated bandwidth).</p> <p>Note 10: <math>P_{RB}</math> is the transmitted power per 180 kHz in allocated RBs, measured in dBm.</p>				

## 6.5.2B.4 EVM equalizer spectrum flatness for UL-MIMO

### 6.5.2B.4.1 Test Purpose

The zero-forcing equalizer correction applied in the EVM measurement process (as described in Annex E) must meet a spectrum flatness requirement for the EVM measurement to be valid. The EVM equalizer spectrum flatness is defined in terms of the maximum peak-to-peak ripple of the equalizer coefficients (dB) across the allocated uplink block variation in dB of the equalizer coefficients generated by the EVM measurement process. The EVM equalizer spectrum flatness requirement does not limit the correction applied to the signal in the EVM measurement process but for the



EVM result to be valid, the equalizer correction that was applied must meet the EVM equalizer spectrum flatness minimum requirements. The basic measurement interval is the same as for EVM.

#### 6.5.2B.4.2 Test applicability

This test case applies to all types of E-UTRA UE release 10 and forward that support UL-MIMO.

#### 6.5.2B.4.3 Minimum conformance requirements

For UE with two transmit antenna connectors in closed-loop spatial multiplexing scheme, the EVM Equalizer Spectrum Flatness requirements specified in Table 6.5.2B.4.3-1 and Table 6.5.2B.4.3-2 which are defined in sub-clause 6.5.2B.4 apply to each transmit antenna connector with the UL-MIMO configurations specified in Table 6.2.2B.3-2.

The normative reference for this requirement is TS 36.101 clause 6.5.2B.4.

#### 6.5.2B.4.4 Test description

##### 6.5.2B.4.4.1 Initial conditions

Initial conditions are a set of test configurations the UE needs to be tested in and the steps for the SS to take with the UE to reach the correct measurement state.

The initial test configurations consist of environmental conditions, test frequencies, and channel bandwidths based on E-UTRA bands specified in table 5.4.2.1-1. All of these configurations shall be tested with applicable test parameters for each channel bandwidth, and are shown in table 6.5.2B.4.4.1-1. The details of the uplink reference measurement channels (RMCs) are specified in A.2. Configurations of PDSCH and PDCCH before measurement are specified in Annex C.2.

**Table 6.5.2B.4.4.1-1: Test Configuration Table**

Initial Conditions				
Test Environment (as specified in TS 36.508 [7] subclause 4.1)		See Table 6.5.1.4.1-1		
Test Frequencies (as specified in TS36.508 [7] subclause 4.3.1)		See Table 6.5.1.4.1-1		
Test Channel Bandwidths (as specified in TS 36.508 [7] subclause 4.3.1)		See Table 6.5.1.4.1-1		
Test Parameters for Channel Bandwidths				
Ch BW	Downlink Configuration	Uplink Configuration		
		Mod'n	RB allocation	
	N/A for EVM equalizer spectrum flatness testing		FDD	TDD
1.4MHz		QPSK	6	6
3MHz		QPSK	15	15
5MHz		QPSK	25	25
10MHz		QPSK	50	50
15MHz		QPSK	75	75
20MHz		QPSK	100	100
Note 1: Test Channel Bandwidths are checked separately for each E-UTRA band, which applicable channel bandwidths are specified in Table 5.4.2.1-1.				

1. Connect the SS to the UE antenna connectors as shown in TS 36.508 [7] Figure A.28.
2. The parameter settings for the cell are set up according to TS 36.508 [7] subclause 4.4.3.
3. Downlink signals are initially set up according to Annex C0, C.1 and C.3.0, and uplink signals according to Annex H.1 and H.3.0.
4. The UL Reference Measurement channels are set according to in Table 6.5.2B.4.4.1-1.
5. Propagation conditions are set according to Annex B.0.
6. Ensure the UE is in State 3A-RF according to TS 36.508 [7] clause 5.2A.2. Message contents are defined in clause 6.5.2B.4.4.3.

#### 6.5.2B.4.4.2 Test procedure

1. SS sends uplink scheduling information for each UL HARQ process via PDCCH DCI format 4 for C\_RNTI to schedule the UL RMC according to Table 6.5.2B.4.4.1-1. Since the UE has no payload and no loopback data to send the UE sends uplink MAC padding bits on the UL RMC.
2. Send continuously uplink power control "up" commands in the uplink scheduling information to the UE until the UE transmits at  $P_{UMAX}$  level.
3. Measure spectrum flatness using Global In-Channel Tx-Test (Annex E) for each of transmit antennas of the UE. For TDD slots with transient periods are not under test.

#### 6.5.2B.4.4.3 Message contents

Message contents are according to TS 36.508 [7] clause 4.6.

#### 6.5.2B.4.5 Test requirement

The requirements apply to each transmit antenna connector.

Each of the 20 spectrum flatness functions, shall derive four ripple results in Annex E.4.4, The derived results shall not exceed the values in Figure 6.5.2B.4.5-1:

For normal conditions, the maximum ripple in Range 1 and Range 2 shall not exceed the values specified in Table 6.5.2B.4.5-1 and the following additional requirement: the relative difference between the maximum coefficient in Range 1 and the minimum coefficient in Range 2 must not be larger than 6.4 dB, and the relative difference between the maximum coefficient in Range 2 and the minimum coefficient in Range 1 must not be larger than 8.4 dB (see Figure 6.5.2B.4.5-1).

For extreme conditions, the maximum ripple in Range 1 and Range 2 shall not exceed the values specified in Table 6.5.2B.4.5-2 and the following additional requirement: the relative difference between the maximum coefficient in Range 1 and the minimum coefficient in Range 2 must not be larger than 7.4 dB, and the relative difference between the maximum coefficient in Range 2 and the minimum coefficient in Range 1 must not be larger than 11.4 dB (see Figure 6.5.2B.4.5-1).

**Table 6.5.2B.4.5-1: Test requirements for EVM equalizer spectrum flatness (normal conditions)**

Frequency Range	Maximum Ripple [dB]
$F_{UL\_Meas} - F_{UL\_Low} \geq 3 \text{ MHz}$ and $F_{UL\_High} - F_{UL\_Meas} \geq 3 \text{ MHz}$ (Range 1)	5.4 (p-p)
$F_{UL\_Meas} - F_{UL\_Low} < 3 \text{ MHz}$ or $F_{UL\_High} - F_{UL\_Meas} < 3 \text{ MHz}$ (Range 2)	9.4 (p-p)
Note 1: $F_{UL\_Meas}$ refers to the sub-carrier frequency for which the equalizer coefficient is evaluated	
Note 2: $F_{UL\_Low}$ and $F_{UL\_High}$ refer to each E-UTRA frequency band specified in Table 5.2-1	

**Table 6.5.2B.4.5-2: Test requirements for spectrum flatness (extreme conditions)**

$F_{UL\_Meas} - F_{UL\_Low} \geq 5 \text{ MHz}$ and $F_{UL\_High} - F_{UL\_Meas} \geq 5 \text{ MHz}$ (Range 1)	5.4 (p-p)
$F_{UL\_Meas} - F_{UL\_Low} < 5 \text{ MHz}$ or $F_{UL\_High} - F_{UL\_Meas} < 5 \text{ MHz}$ (Range 2)	13.4 (p-p)
Note 1: $F_{UL\_Meas}$ refers to the sub-carrier frequency for which the equalizer coefficient is evaluated	
Note 2: $F_{UL\_Low}$ and $F_{UL\_High}$ refer to each E-UTRA frequency band specified in Table 5.2-1	

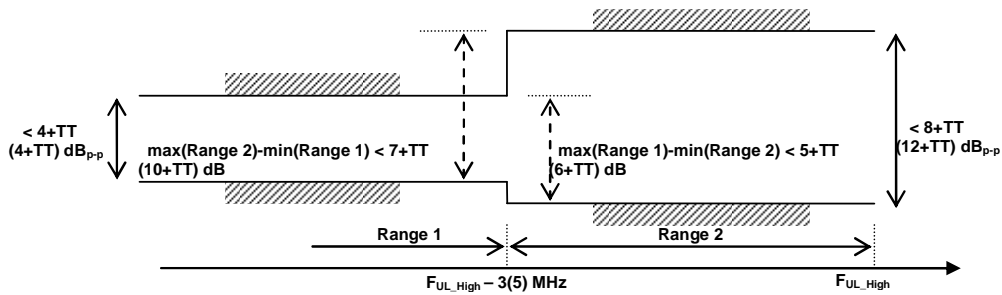

**Figure 6.5.2B.4.5-1: The limits for EVM equalizer spectrum flatness with the maximum allowed variation of the coefficients indicated (the ETC minimum requirement within brackets)**

## 6.6 Output RF spectrum emissions

Unwanted emissions are divided into "Out-of-band emission" and "Spurious emissions" in 3GPP RF specifications. This notation is in line with ITU-R recommendations such as SM.329 [2] and the Radio Regulations [3].

ITU defines:

Out-of-band emission = Emission on a frequency or frequencies immediately outside the necessary bandwidth which results from the modulation process, but excluding spurious emissions.

Spurious emission = Emission on a frequency, or frequencies, which are outside the necessary bandwidth and the level of which may be reduced without affecting the corresponding transmission of information. Spurious emissions include harmonic emissions, parasitic emissions, intermodulation products and frequency conversion products but exclude out-of-band emissions.

Unwanted emissions = Consist of spurious emissions and out-of-band emissions.

The UE transmitter spectrum emission consists of the three components; the occupied bandwidth (channel bandwidth), the Out Of Band (OOB) emissions and the far out spurious emission domain.

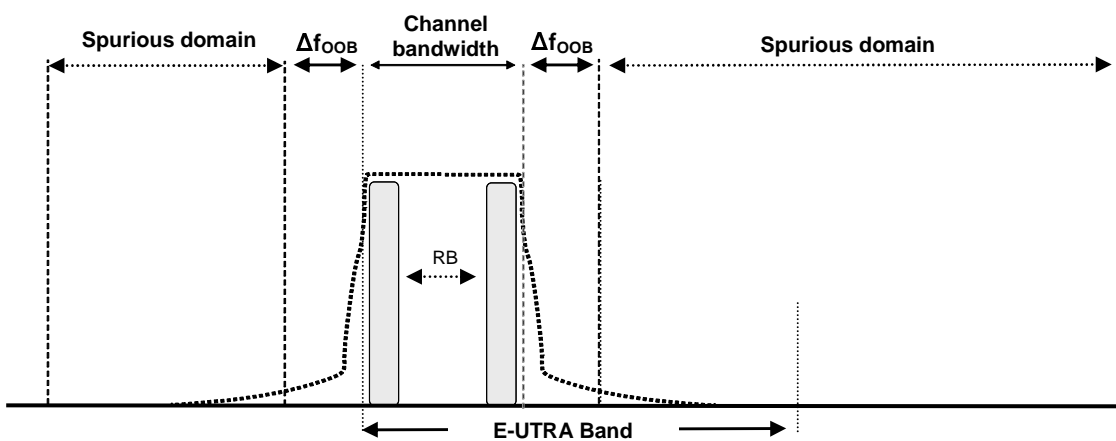

**Figure 6.6-1: Transmitter RF spectrum**

## 6.6.1 Occupied bandwidth

### 6.6.1.1 Test purpose

To verify that the UE occupied bandwidth for all transmission bandwidth configurations supported by the UE are less than their specific limits

### 6.6.1.2 Test applicability

This test applies to all types of E-UTRA UE release 8 and forward.

### 6.6.1.2 Minimum conformance requirements

Occupied bandwidth is a measure of the bandwidth containing 99 % of the total integrated mean power of the transmitted spectrum on the assigned channel. The occupied channel bandwidth for all transmission bandwidth configurations (Resources Blocks) should be less than the channel bandwidth specified in Table 6.6.1.2-1

**Table 6.6.1.2-1: Occupied channel bandwidth**

	Occupied channel bandwidth / channel bandwidth					
	1.4 MHz	3.0 MHz	5 MHz	10 MHz	15 MHz	20 MHz
<b>Channel bandwidth [MHz]</b>	1.4	3	5	10	15	20

The normative reference for this requirement is TS 36.101 [2] clause 6.6.1.

### 6.6.1.4 Test description

#### 6.6.1.4.1 Initial conditions

Initial conditions are a set of test configurations the UE needs to be tested in and the steps for the SS to take with the UE to reach the correct measurement state.

The initial test configurations consist of environmental conditions, test frequencies, and channel bandwidths based on E-UTRA operating bands specified in table 5.4.2.1-1. All of these configurations shall be tested with applicable test parameters for each channel bandwidth, and are shown in table 6.6.1.4.1-1. The details of the uplink reference measurement channels (RMCs) are specified in Annexes A.2. Configurations of PDSCH and PDCCH before measurement are specified in Annex C.2.

**Table 6.6.1.4.1-1: Test Configuration Table**

Initial Conditions			
Test Environment as specified in TS 36.508[7] subclause 4.1	Normal		
Test Frequencies as specified in TS36.508 [7] subclause 4.3.1	Mid range		
Test Channel Bandwidths as specified in TS 36.508 [7] subclause 4.3.1	All		
Test Parameters for Channel Bandwidths			
Ch BW	Downlink Configuration	Uplink Configuration	
	N/A for Occupied bandwidth	Mod'n	RB allocation
			FDD TDD
1.4MHz		QPSK	6 6
3MHz		QPSK	15 15
5MHz		QPSK	25 25
10MHz		QPSK	50 50
15MHz		QPSK	75 75
20MHz		QPSK	100 100
Note 1: Test Channel Bandwidths are checked separately for each E-UTRA band, the applicable channel bandwidths are specified in Table 5.4.2.1-1.			

1. Connect the SS to the UE antenna connectors as shown in TS 36.508 [7] Annex A, Figure A.3.
2. The parameter settings for the cell are set up according to TS 36.508 [7] subclause 4.4.3.
3. Downlink signals are initially set up according to Annex C0, C.1 and C.3.0, and uplink signals according to Annex H.1 and H.3.0.
4. The UL Reference Measurement channels are set according to Table 6.6.1.4.1-1.
5. Propagation conditions are set according to Annex B.0
6. Ensure the UE is in State 3A-RF according to TS 36.508 [7] clause 5.2A.2. Message contents are defined in clause 6.6.1.4.3

#### 6.6.1.4.2 Test procedure

1. SS sends uplink scheduling information for each UL HARQ process via PDCCH DCI format 0 for C\_RNTI to schedule the UL RMC according to Table 6.6.1.4.1-1. Since the UE has no payload and no loopback data to send the UE sends uplink MAC padding bits on the UL RMC.
2. Send continuously power control "up" commands to the UE until the UE transmits at  $P_{UMAX}$  level.
3. Measure the power spectrum distribution within two times or more range over the requirement for Occupied Bandwidth specification centring on the current carrier frequency. The characteristic of the filter shall be approximately Gaussian (typical spectrum analyzer filter). Other methods to measure the power spectrum distribution are allowed. The measuring duration is one active uplink subframe. For TDD slots with transient periods are not under test.
4. Calculate the total power within the range of all frequencies measured in '3)' and save this value as "Total Power".
5. Sum up the power upward from the lower boundary of the measured frequency range in '3)' and seek the limit frequency point by which this sum becomes 0,5 % of "Total Power" and save this point as "Lower Frequency".
6. Sum up the power downward from the upper boundary of the measured frequency range in '3)' and seek the limit frequency point by which this sum becomes 0,5 % of "Total Power" and save this point as "Upper Frequency".
7. Calculate the difference ("Upper Frequency" – "Lower Frequency" = "Occupied Bandwidth") between two limit frequencies obtained in '5)' and '6)'.

#### 6.6.1.4.3 Message contents

Message contents are according to TS 36.508 [7] subclause 4.6

#### 6.6.1.5 Test requirement

The measured Occupied Bandwidth shall not exceed values in Table 6.6.1.5-1.

**Table 6.6.1.5-1: Occupied channel bandwidth**

	Occupied channel bandwidth / channel bandwidth					
	1.4 MHz	3.0 MHz	5 MHz	10 MHz	15 MHz	20 MHz
<b>Channel bandwidth [MHz]</b>	1.4	3	5	10	15	20

### 6.6.1A Occupied bandwidth for CA

#### 6.6.1A.0 Minimum conformance requirements

For inter-band carrier aggregation with uplink assigned to two E-UTRA bands the occupied bandwidth is defined per component carrier. Occupied bandwidth is the bandwidth containing 99 % of the total integrated mean power of the transmitted spectrum on assigned channel bandwidth on the component carrier. The occupied bandwidth shall be less than the channel bandwidth specified in Table 6.6.1.2-1.

For intra-band contiguous carrier aggregation the occupied bandwidth is a measure of the bandwidth containing 99 % of the total integrated power of the transmitted spectrum. The OBW shall be less than the aggregated channel bandwidth defined in subclause 5.4.2A.

For intra-band non-contiguous carrier aggregation sub-block occupied bandwidth is defined as the bandwidth containing 99 % of the total integrated mean power of the transmitted spectrum on the sub-block. In case the sub-block consist of one component carrier the occupied bandwidth of the sub-block shall be less than the channel bandwidth specified in Table 6.6.1.2-1.

The normative reference for this requirement is TS 36.101[2] clause 6.6.1A.

## 6.6.1A.1 Occupied bandwidth for CA (intra-band contiguous DL CA and UL CA)

### 6.6.1A.1.1 Test purpose

To verify that the UE occupied bandwidth for intra-band contiguous CA for all transmission bandwidth configurations supported by the UE are less than their specific limits

### 6.6.1A.1.2 Test applicability

This test case applies to all types of E-UTRA UE release 10 and forward that support intra-band contiguous DL CA and UL CA.

### 6.6.1A.1.3 Minimum conformance requirements

The minimum conformance requirements are defined in clause 6.6.1A.0.

### 6.6.1A.1.4 Test description

#### 6.6.1A.1.4.1 Initial condition

Initial conditions are a set of test configurations the UE needs to be tested in and the steps for the SS to take with the UE to reach the correct measurement state.

The initial test configurations consist of environmental conditions, test frequencies, and CC combinations based on E-UTRA CA configurations specified in table 5.4.2A.1-1. All of these configurations shall be tested with applicable test parameters for each CA configuration, and are shown in table 6.6.1A.1.4.1-1. The details of the uplink reference measurement channels (RMCs) are specified in Annexes A.2. Configurations of PDSCH and PDCCH before measurement are specified in Annex C.2.

Table 6.6.1A.1.4.1-1: Test Configuration Table

Initial Conditions									
Test Environment as specified in TS 36.508[7] subclause 4.1					NC				
Test Frequencies as specified in TS36.508 [7] subclause 4.3.1 for different CA bandwidth classes, and PCC and SCCs are mapped onto physical frequencies according to Table 6.1-2.					C: Mid range				
Test CC Combination setting ( $N_{RB\_agg}$ ) as specified in subclause 5.4.2A.1 for the CA Configuration					C: All				
Test Parameters for CA Configurations									
CA Configuration / $N_{RB\_agg}$		DL Allocation		CC MOD	UL Allocation				
PCC $N_{RB}$	SCCs $N_{RB}$	PCC & SCC RB allocation			$N_{RB\_alloc}$	PCC & SCC RB allocations (LCRB @ $RB_{start}$ )			
75	75	N/A for this test		QPSK	150	P_75@0	S_75@0	-	-
100	25			QPSK	125	P_100@0	S_25@0	-	-
100	50			QPSK	150	P_100@0	S_50@0	-	-
100	75			QPSK	175	P_100@0	S_75@0	-	-
100	100			QPSK	200	P_100@0	S_100@0	-	-
Note 1: CA Configuration Test CC Combination settings are checked separately for each CA Configuration, which applicable aggregated channel bandwidths are specified in Table 5.4.2A.1-1.									

1. Connect the SS to the UE antenna connectors as shown in TS 36.508[7] Annex A Figure group A.32 as appropriate .
2. The parameter settings for the cell are set up according to TS 36.508 [7] subclause 4.4.3.
3. Downlink signals for PCC are initially set up according to Annex C.0, C.1, and C.3.0, and uplink signals according to Annex H.1 and H.3.0.
4. The UL Reference Measurement channel is set according to Table 6.6.1A.1.4.1-1.
5. Propagation conditions are set according to Annex B.0.
6. Ensure the UE is in State 3A-RF according to TS 36.508 [7] clause 5.2A.2. Message contents are defined in clause 6.6.1A.1.4.3.

#### 6.6.1A.1.4.2 Test procedure

1. Configure SCC according to Annex C.0, C.1 and Annex C.3.0 for all downlink physical channels.
2. The SS shall configure SCC as per TS 36.508 [7] clause 5.2A.4. Message contents are defined in clause 6.6.1A.1.4.3
3. SS activates SCC by sending the activation MAC-CE (Refer TS 36.321 [13], clauses 5.13, 6.1.3.8). Wait for at least 2 seconds (Refer TS 36.133, clauses 8.3.3.2).
4. SS sends uplink scheduling information for each UL HARQ process via PDCCH DCI format 0 for  $C\_RNTI$  to schedule the UL RMC according to Table 6.6.1A.1.4.1-1 on both PCC and SCC. Since the UE has no payload and no loopback data to send the UE sends uplink MAC padding bits on the UL RMC.
5. Send continuously uplink power control "up" commands to the UE until the UE transmits at  $P_{UMAX}$  level.
6. Measure the power spectrum distribution over all component carriers within two times or more range over the requirement for Occupied Bandwidth for CA specification centring on the current carrier frequency in CA configuration. The characteristic of the filter shall be approximately Gaussian (typical spectrum analyzer filter). Other

methods to measure the power spectrum distribution are allowed. The measuring duration is one active uplink subframe. For TDD slots with transient periods are not under test.

7. Calculate the total power for the total integrated power of the transmitted spectrum within the range of all frequencies measured in '6)' and save this values as "Total Power".
8. Sum up the power upward from the lower boundary of the measured frequency range in '6)' and seek the limit frequency point by which this sum becomes 0,5 % of "Total Power" and save this point as "Lower Frequency".
9. Sum up the power downward from the upper boundary of the measured frequency range in '6)' and seek the limit frequency point by which this sum becomes 0,5 % of "Total Power" and save this point as "Upper Frequency".
10. Calculate the difference ("Upper Frequency" – "Lower Frequency" = "Occupied Bandwidth") between two limit frequencies obtained in '8)' and '9)'.

#### 6.6.1A.1.4.3 Message contents

Message contents are according to TS 36.508 [7] subclause 4.6. In test procedure step 2, for SCC configuration there are no additional message contents.

#### 6.6.1A.1.5 Test Requirements

The measured Occupied Bandwidth shall not exceed values of aggregated channel bandwidth as defined in section 5.4.2A for intra-band contiguous carrier aggregation.

#### 6.6.1A.2 Occupied bandwidth for CA (inter-band DL CA and UL CA)

**Editor's note: This clause is incomplete. The following aspects are either missing or not yet determined:**

**- Test condition has square brackets**

##### 6.6.1A.2.1 Test purpose

To verify that the UE occupied bandwidth for inter-band CA for all transmission bandwidth configurations supported by the UE are less than their specific limits

##### 6.6.1A.2.2 Test applicability

This test case applies to all types of E-UTRA UE release 11 and forward that support inter-band CA and UL CA.

##### 6.6.1A.2.3 Minimum conformance requirements

The minimum conformance requirements are defined in clause 6.6.1A.0.

##### 6.6.1A.2.4 Test description

###### 6.6.1A.2.4.1 Initial condition

Same as in clause 6.6.1A.1.4.1 with the following exceptions:

- Instead of Table 5.4.2A.1-1 → use Table 5.4.2A.1-2 for CA configurations with two bands or Table 5.4.2A.1-2a for CA configurations with three bands.
- Instead of Table 6.6.1A.1.4.1-1 → use Table 6.6.1A.2.4.1-1.
- Instead of clause 6.6.1A.1.4.3 use clause 6.6.1A.2.4.3.



**Table 6.6.1A.2.4.1-1: Test Configuration Table**

Initial Conditions									
Test Environment as specified in TS 36.508[7] subclause 4.1					NC				
Test Frequencies as specified in TS 36.508 [7] subclause 4.3.1 for different CA bandwidth classes.					Mid range for PCC and SCC				
Test CC Combination setting ( $N_{RB\_agg}$ ) as specified in subclause 5.4.2A.1 for the CA Configuration across bandwidth combination sets supported by the UE.					[All]				
Test Parameters for CA Configurations									
CA Configuration / $N_{RB\_agg}$		DL Allocation	CC MOD	UL Allocation					
PCC $N_{RB}$	SCCs $N_{RB}$	PCC & SCC RB allocation		$N_{RB\_alloc}$	PCC & SCC RB allocations ( $L_{CRB}$ @ $RB_{start}$ )				
6	25	N/Afor this test	QPSK	31	P_6@0	S_25@0	-	-	
6	50		QPSK	56	P_6@0	S_50@0	-	-	
6	75		QPSK	81	P_6@0	S_75@0	-	-	
6	100		QPSK	106	P_6@0	S_100@0	-	-	
15	25		QPSK	40	P_15@0	S_25@0	-	-	
15	50		QPSK	65	P_15@0	S_50@0	-	-	
15	75		QPSK	90	P_15@0	S_75@0	-	-	
15	100		QPSK	115	P_15@0	S_100@0	-	-	
25	25		QPSK	50	P_25@0	S_25@0	-	-	
25	50		QPSK	75	P_25@0	S_50@0	-	-	
25	75		QPSK	100	P_25@0	S_75@0	-	-	
25	100		QPSK	125	P_25@0	S_100@0	-	-	
50	50		QPSK	100	P_50@0	S_50@0	-	-	
50	75		QPSK	125	P_50@0	S_75@0	-	-	
50	100		QPSK	150	P_50@0	S_100@0	-	-	
75	75		QPSK	150	P_75@0	S_75@0	-	-	
75	100		QPSK	175	P_75@0	S_100@0	-	-	
100	100		QPSK	200	P_100@0	S_100@0	-	-	
Note 1: CA Configuration Test CC Combination settings are checked separately for each CA Configuration, which applicable aggregated channel bandwidths are specified in Table 5.4.2A.1-1.									

6.6.1A.2.4.2 Test procedure

1. Configure SCC according to Annex C.0, C.1 and Annex C.3.0 for all downlink physical channels.
2. The SS shall configure SCC as per TS 36.508 [7] clause 5.2A.4. Message contents are defined in clause 6.6.1A.2.4.3
3. SS activates SCC by sending the activation MAC-CE (Refer TS 36.321 [13], clauses 5.13, 6.1.3.8). Wait for at least 2 seconds (Refer TS 36.133, clauses 8.3.3.2).
4. SS sends uplink scheduling information for each UL HARQ process via PDCCH DCI format 0 for  $C\_RNTI$  to schedule the UL RMC according to Table 6.6.1A.2.4.1-1 on both PCC and SCC. Since the UE has no payload and no loopback data to send the UE sends uplink MAC padding bits on the UL RMC.
5. Send continuously uplink power control "up" commands to the UE until the UE transmits at  $P_{UMAX}$  level.

6. Measure the power spectrum distribution of both PCC and SCC within two times or more range over the requirement for Occupied Bandwidth specification centring on the current carrier frequencies respectively. The characteristic of the filter shall be approximately Gaussian (typical spectrum analyzer filter). Other methods to measure the power spectrum distribution are allowed. The measuring duration is one active uplink subframe. For TDD slots with transient periods are not under test.
7. Calculate the total power for the total integrated power of the transmitted spectrum within the range of all frequencies measured in '6)' and save this values as "Total Power" for both PCC and SCC.
8. Sum up the power upward from the lower boundary of the measured frequency range in '6)' and seek the limit frequency point by which this sum becomes 0,5 % of "Total Power" and save this point as "Lower Frequency" for both PCC and SCC.
9. Sum up the power downward from the upper boundary of the measured frequency range in '3)' and seek the limit frequency point by which this sum becomes 0,5 % of "Total Power" and save this point as "Upper Frequency" for both PCC and SCC.
10. Calculate the difference ("Upper Frequency" – "Lower Frequency" = "Occupied Bandwidth") between two limit frequencies obtained in '8)' and '9)' for both PCC and SCC.

#### 6.6.1A.2.4.3 Message contents

Message contents are according to TS 36.508 [7] subclause 4.6. In test procedure step 2, for SCC configuration there are no additional message contents.

#### 6.6.1A.2.5 Test Requirements

The measured Occupied Bandwidth for each component carrier shall not exceed values in Table 6.6.1A.2.5-1.

**Table 6.6.1A.2.5-1: Occupied channel bandwidth**

	Occupied channel bandwidth / channel bandwidth					
	1.4 MHz	3.0 MHz	5 MHz	10 MHz	15 MHz	20 MHz
Channel bandwidth [MHz]	1.4	3	5	10	15	20

#### 6.6.1A.3 Occupied bandwidth for CA (intra-band non-contiguous DL CA and UL CA)

##### 6.6.1A.3.1 Test purpose

To verify that the UE occupied bandwidth for intra-band non-contiguous CA for all transmission bandwidth configurations supported by the UE are less than their specific limits

##### 6.6.1A.3.2 Test applicability

This test case applies to all types of E-UTRA UE release 11 and forward that support intra-band non-contiguous DL CA and UL CA.

##### 6.6.1A.3.3 Minimum conformance requirements

The minimum conformance requirements are defined in clause 6.6.1A.0.

##### 6.6.1A.3.4 Test description

###### 6.6.1A.3.4.1 Initial condition

Initial conditions are a set of test configurations the UE needs to be tested in and the steps for the SS to take with the UE to reach the correct measurement state.

The initial test configurations consist of environmental conditions, test frequencies, and CC combinations based on E-UTRA CA configurations specified in table 5.4.2A.1-3. All of these configurations shall be tested with applicable test

parameters for each CA configuration, and are shown in table 6.6.1A.3.4.1-1. The details of the uplink reference measurement channels (RMCs) are specified in Annexes A.2. Configurations of PDSCH and PDCCH before measurement are specified in Annex C.2.

**Table 6.6.1A.3.4.1-1: Test Configuration Table**

Initial Conditions									
Test Environment as specified in TS 36.508[7] subclause 4.1				NC					
Test Frequencies as specified in TS36.508 [7] subclause 4.3.1 for different CA bandwidth classes, and PCC and SCCs are mapped onto physical frequencies according to Table 6.1-2.				Refer to test points A: Mid frequency					
Test CC Combination setting ( $N_{RB\_agg}$ ) as specified in subclause 5.4.2A.1 for the CA Configuration across bandwidth combination sets supported by the UE.				Refer to test points All PCC $N_{RB}$ = SCC $N_{RB}$ test points					
Test Parameters for CA Configurations									
ID	CA Configuration / $N_{RB\_agg}$		$W_{gap}$ [MHz]	DL Allocation		UL Allocation			
	PCC $N_{RB}$	SCCs $N_{RB}$		CC MOD	PCC & SCC RB allocation	CC MOD	PCC $N_{RB\_alloc}$ ( $L_{CRB}$ @ $RB_{start}$ )	CC MOD	SCC $N_{RB\_alloc}$ ( $L_{CRB}$ @ $RB_{start}$ )
Test Parameters for CA_4A-4A Configurations									
1	25	25	5	QPSK	25+25	QPSK	P_25@0	QPSK	S_25@0
2	50	50	5	QPSK	50+50	QPSK	P_50@0	QPSK	S_50@0
3	75	75	5	QPSK	75+75	QPSK	P_75@0	QPSK	S_100@0
4	100	100	5	QPSK	100+100	QPSK	P_100@0	QPSK	S_100@0
Note 1: CA Configuration Test CC Combination settings are checked separately for each CA Configuration, which applicable aggregated channel bandwidths are specified in Table 5.4.2A.1-3.									
Note 2: The carrier centre frequency of PCC in the UL operating band is configured closer to the DL operating band.									

1. Connect the SS to the UE antenna connectors as shown in TS 36.508[7] Annex A Figure group A.32 as appropriate .
2. The parameter settings for the cell are set up according to TS 36.508 [7] subclause 4.4.3.
3. Downlink signals for PCC are initially set up according to Annex C.0, C.1, and C.3.0, and uplink signals according to Annex H.1 and H.3.0.
4. The UL Reference Measurement channel is set according to Table 6.6.1A.3.4.1-1.
5. Propagation conditions are set according to Annex B.0.
6. Ensure the UE is in State 3A-RF according to TS 36.508 [7] clause 5.2A.2. Message contents are defined in clause 6.6.1A.3.4.3.

**6.6.1A.3.4.2 Test procedure**

1. Configure SCC according to Annex C.0, C.1 and Annex C.3.0 for all downlink physical channels except PHICH.
2. The SS shall configure SCC as per TS 36.508 [7] clause 5.2A.4. Message contents are defined in clause 6.6.1A.3.4.3
3. SS activates SCC by sending the activation MAC-CE (Refer TS 36.321 [13], clauses 5.13, 6.1.3.8). Wait for at least 2 seconds (Refer TS 36.133, clauses 8.3.3.2).

4. SS sends uplink scheduling information for each UL HARQ process via PDCCH DCI format 0 for C\_RNTI to schedule the UL RMC according to Table 6.2.2A.4.1-1 on both PCC and SCC. Since the UE has no payload and no loopback data to send the UE sends uplink MAC padding bits on the UL RMC.
5. Send continuously uplink power control "up" commands to the UE until the UE transmits at  $P_{UMAX}$  level.
6. Measure the power spectrum distribution of each sub-block over all component carriers within the requirement for Occupied Bandwidth for CA specification + 5MHz, centring on the carrier frequency of each sub-block in CA configuration. The characteristic of the filter shall be approximately Gaussian (typical spectrum analyzer filter). Other methods to measure the power spectrum distribution are allowed. The measuring duration is one active uplink subframe. For TDD slots with transient periods are not under test.
7. Calculate the total power for the total integrated power of the transmitted spectrum within the range of all frequencies measured for each sub-block in '6)' and save this values as "Total Power".
8. Sum up the power upward from the lower boundary of the measured frequency range in '3)' and seek the limit frequency point by which this sum becomes 0,5 % of "Total Power" and save this point as "Lower Frequency".
9. Sum up the power downward from the upper boundary of the measured frequency range in '3)' and seek the limit frequency point by which this sum becomes 0,5 % of "Total Power" and save this point as "Upper Frequency".
10. Calculate the difference ("Upper Frequency" – "Lower Frequency" = "Occupied Bandwidth") between two limit frequencies obtained in '8)' and '9)' for each sub-block.

#### 6.6.1A.3.4.3 Message contents

Message contents are according to TS 36.508 [7] subclause 4.6. In test procedure step 2, for SCC configuration there are no additional message contents.

#### 6.6.1A.3.5 Test Requirements

The measured Occupied Bandwidth shall not exceed values of channel bandwidth as defined in section 5.4.2A for intra-band non-contiguous carrier aggregation.

### 6.6.1B Occupied bandwidth for UL-MIMO

#### 6.6.1B.1 Test purpose

To verify that the UE occupied bandwidth for all transmission bandwidth configurations supported by each of transmit antenna of the UE are less than their specific limits.

#### 6.6.1B.2 Test applicability

This test applies to all types of E-UTRA UE release 10 and forward that support UL-MIMO.

#### 6.6.1B.3 Minimum conformance requirements

For UE with multiple transmit antenna connectors, the requirements for occupied bandwidth is specified at each transmit antenna connector. The occupied bandwidth is defined as the bandwidth containing 99 % of the total integrated mean power of the transmitted spectrum on the assigned channel at each transmit antenna connector.

For UE with two transmit antenna connectors in closed-loop spatial multiplexing scheme, the occupied bandwidth at each transmitter antenna shall be less than the channel bandwidth specified in Table 6.6.1B.3-1 with the UL-MIMO configurations specified in Table 6.2.2B.3-2.

**Table 6.6.1B.3-1: Occupied channel bandwidth**

	Occupied channel bandwidth / Channel bandwidth					
	1.4 MHz	3.0 MHz	5 MHz	10 MHz	15 MHz	20 MHz
<b>Channel bandwidth (MHz)</b>	1.4	3	5	10	15	20

The normative reference for this requirement is TS 36.101 [2] clause 6.6.1B.

## 6.6.1B.4 Test description

### 6.6.1B.4.1 Initial conditions

Initial conditions are a set of test configurations the UE needs to be tested in and the steps for the SS to take with the UE to reach the correct measurement state.

The initial test configurations consist of environmental conditions, test frequencies, and channel bandwidths based on E-UTRA operating bands specified in table 5.4.2.1-1. All of these configurations shall be tested with applicable test parameters for each channel bandwidth, and are shown in table 6.6.1B.4.1-1. The details of the uplink reference measurement channels (RMCs) are specified in Annexes A.2. Configurations of PDSCH and PDCCH before measurement are specified in Annex C.2.

**Table 6.6.1B.4.1-1: Test Configuration Table**

Initial Conditions				
Test Environment as specified in TS 36.508[7] subclause 4.1	Normal			
Test Frequencies as specified in TS36.508 [7] subclause 4.3.1	Mid range			
Test Channel Bandwidths as specified in TS 36.508 [7] subclause 4.3.1	All			
Test Parameters for Channel Bandwidths				
Ch BW	Downlink Configuration		Uplink Configuration	
	N/A for Occupied bandwidth		Mod'n	RB allocation
			FDD	TDD
1.4MHz		QPSK	6	6
3MHz		QPSK	15	15
5MHz		QPSK	25	25
10MHz		QPSK	50	50
15MHz		QPSK	75	75
20MHz		QPSK	100	100
Note 1: Test Channel Bandwidths are checked separately for each E-UTRA band, the applicable channel bandwidths are specified in Table 5.4.2.1-1.				

1. Connect the SS to the UE antenna connectors as shown in TS 36.508 [7] Annex A, Figure A.28.
2. The parameter settings for the cell are set up according to TS 36.508 [7] subclause 4.4.3.
3. Downlink signals are initially set up according to Annex C0, C.1 and C.3.0, and uplink signals according to Annex H.1 and H.3.0.
4. The UL Reference Measurement channels are set according to Table 6.6.1B.4.1-1.
5. Propagation conditions are set according to Annex B.0.
6. Ensure the UE is in State 3A-RF according to TS 36.508 [7] clause 5.2A.2. Message contents are defined in clause 6.6.1B.4.3.

### 6.6.1B.4.2 Test procedure

1. SS sends uplink scheduling information for each UL HARQ process via PDCCH DCI format 4 for C\_RNTI to schedule the UL RMC according to Table 6.6.1B.4.1-1. Since the UE has no payload and no loopback data to send the UE sends uplink MAC padding bits on the UL RMC.
2. Send continuously power control "up" commands to the UE until the UE transmits at  $P_{UMAX}$  level.
3. Measure the power spectrum distribution within two times or more range over the requirement for Occupied Bandwidth specification centring on the current carrier frequency. The characteristic of the filter shall be approximately Gaussian (typical spectrum analyzer filter). Other methods to measure the power spectrum distribution are allowed. The measuring duration is one active uplink subframe. For TDD slots with transient periods are not under test.
4. Calculate the total power within the range of all frequencies measured in '3)' and save this value as "Total Power".
5. Sum up the power upward from the lower boundary of the measured frequency range in '3)' and seek the limit frequency point by which this sum becomes 0,5 % of "Total Power" and save this point as "Lower Frequency".
6. Sum up the power downward from the upper boundary of the measured frequency range in '3)' and seek the limit frequency point by which this sum becomes 0,5 % of "Total Power" and save this point as "Upper Frequency".
7. Calculate the difference ("Upper Frequency" – "Lower Frequency" = "Occupied Bandwidth") between two limit frequencies obtained in '5)' and '6)'.
8. Repeat step 3) until 7) for each of transmit antenna of the UE.

### 6.6.1B.4.3 Message contents

Message contents are according to TS 36.508 [7] clause 4.6.6.6.1B.5 Test requirement

The measured Occupied Bandwidth at each transmit antenna of UE shall not exceed values in Table 6.6.1B.5-1.

**Table 6.6.1B.5-1: Occupied channel bandwidth**

	Occupied channel bandwidth / channel bandwidth					
	1.4 MHz	3.0 MHz	5 MHz	10 MHz	15 MHz	20 MHz
Channel bandwidth [MHz]	1.4	3	5	10	15	20

## 6.6.2 Out of band emission

Out of band emissions are unwanted emissions immediately outside the nominal channel resulting from the modulation process and non-linearity in the transmitter but excluding spurious emissions. This out of band emission limit is specified in terms of a Spectrum Emission Mask and Adjacent Channel Leakage power Ratio.

### 6.6.2.1 Spectrum Emission Mask

#### 6.6.2.1.1 Test purpose

To verify that the power of any UE emission shall not exceed specified lever for the specified channel bandwidth.

#### 6.6.2.1.2 Test applicability

This test case applies to all types of E-UTRA UE release 8 and forward.

#### 6.6.2.1.3 Minimum conformance requirements

The spectrum emission mask of the UE applies to frequencies ( $\Delta f_{OoB}$ ) starting from the edge of the assigned E-UTRA channel bandwidth. For frequencies greater than ( $\Delta f_{OoB}$ ) as specified in Table 6.6.2.1.3-1 the spurious requirements in clause 6.6.3 are applicable.

The power of any UE emission shall not exceed the levels specified in Table 6.6.2.1.3-1 for the specified channel bandwidth.

**Table 6.6.2.1.3-1: General E-UTRA spectrum emission mask**

Spectrum emission limit (dBm)/ Channel bandwidth							
$\Delta f_{\text{OoB}}$ (MHz)	1.4 MHz	3.0 MHz	5 MHz	10 MHz	15 MHz	20 MHz	Measurement bandwidth
$\pm 0-1$	-10	-13	-15	-18	-20	-21	30 kHz
$\pm 1-2.5$	-10	-10	-10	-10	-10	-10	1 MHz
$\pm 2.5-2.8$	-25	-10	-10	-10	-10	-10	1 MHz
$\pm 2.8-5$		-10	-10	-10	-10	-10	1 MHz
$\pm 5-6$		-25	-13	-13	-13	-13	1 MHz
$\pm 6-10$			-25	-13	-13	-13	1 MHz
$\pm 10-15$				-25	-13	-13	1 MHz
$\pm 15-20$					-25	-13	1 MHz
$\pm 20-25$						-25	1 MHz

NOTE: As a general rule, the resolution bandwidth of the measuring equipment should be equal to the measurement bandwidth. However, to improve measurement accuracy, sensitivity and efficiency, the resolution bandwidth may be smaller than the measurement bandwidth. When the resolution bandwidth is smaller than the measurement bandwidth, the result should be integrated over the measurement bandwidth in order to obtain the equivalent noise bandwidth of the measurement bandwidth.

The normative reference for this requirement is TS 36.101 [2] clause 6.6.2.1.

#### 6.6.2.1.4 Test description

##### 6.6.2.1.4.1 Initial conditions

Initial conditions are a set of test configurations the UE needs to be tested in and the steps for the SS to take with the UE to reach the correct measurement state.

The initial test configurations consist of environmental conditions, test frequencies, and channel bandwidths based on E-UTRA bands specified in table 5.4.2.1-1. All of these configurations shall be tested with applicable test parameters for each channel bandwidth, and are shown in table 6.6.2.1.4.1-1. The details of the uplink reference measurement channels (RMCs) are specified in Annexes A.2 respectively. Configurations of PDSCH and PDCCCH before measurement are specified in Annex C.2.

**Table 6.6.2.1.4.1-1: Test Configuration Table**

Initial Conditions				
Test Environment (as specified in TS 36.508 [7] subclause 4.1)		NC		
Test Frequencies (as specified in TS36.508 [7] subclause 4.3.1)		Low range, Mid range, High range		
Test Channel Bandwidths (as specified in TS 36.508 [7] subclause 4.3.1)		Lowest, 5MHz, 10MHz, Highest		
Test Parameters for Channel Bandwidths				
Ch BW	Downlink Configuration	Uplink Configuration		
	N/A for SEM testing	Mod'n	RB allocation	
			FDD	TDD
1.4MHz		QPSK	6	6
1.4MHz		QPSK	5	5
1.4MHz		16QAM	5	5
1.4MHz		16QAM	6	6
3MHz		QPSK	15	15
3MHz		QPSK	4	4
3MHz		16QAM	4	4
3MHz		16QAM	15	15
5MHz		QPSK	25	25
5MHz		QPSK	8	8
5MHz		16QAM	8	8
5MHz		16QAM	25	25
10MHz		QPSK	50	50
10MHz		QPSK	12	12
10MHz		16QAM	12	12
10MHz		16QAM	50 (Note 4)	50 (Note 4)
15MHz		QPSK	75	75
15MHz		QPSK	16	16
15MHz		16QAM	16	16
15MHz		16QAM	75 (Note 4)	75 (Note 4)
20MHz		QPSK	100	100
20MHz		QPSK	18	18
20MHz		16QAM	18	18
20MHz		16QAM	100 (Note 4)	100 (Note 4)
Note 1: Test Channel Bandwidths are checked separately for each E-UTRA band, which applicable channel bandwidths are specified in Table 5.4.2.1-1. Note 2: The allowed MPR for maximum output power UE might apply is described in clause 6.2.3.3. Note 3: The RB <sub>start</sub> of partial RB allocation shall be RB#0 and RB# (max+1 - RB allocation) of the channel bandwidth. Note 4: Applies only for UE-Categories ≥2				

1. Connect the SS to the UE antenna connectors as shown in Figure TS 36.508 [7] Annex A, Figure A.3.
2. The parameter settings for the cell are set up according to TS 36.508 [7] subclause 4.4.3.
3. Downlink signals are initially set up according to Annex C0, C.1 and C.3.0, and uplink signals according to Annex H.1 and H.3.0.
4. The UL Reference Measurement channels are set according to Table 6.6.2.1.4.1-1.
5. Propagation conditions are set according to Annex B.0.
6. Ensure the UE is in State 3A-RF according to TS 36.508 [7] clause 5.2A.2. Message contents are defined in clause 6.6.2.1.4.3.



6.6.2.1.4.2 Test procedure

SS sends uplink scheduling information via PDCCH DCI format 0 for C\_RNTI to schedule the UL RMC according to Table 6.6.2.1.4.1-1. Since the UE has no payload data to send, the UE transmits uplink MAC padding bits on the UL RMC.

2. Send continuously uplink power control "up" commands in the uplink scheduling information to the UE until the UE transmits at P<sub>UMAX</sub> level.
3. Measure the mean power of the UE in the channel bandwidth of the radio access mode according to the test configuration, which shall meet the requirements described in Table 6.2.3.5-1. The period of the measurement shall be at least the continuous duration of one sub-frame (1ms). For TDD slots with transient periods are not under test.
4. Measure the power of the transmitted signal with a measurement filter of bandwidths according to table 6.6.2.1.5-1 or 6.6.2.1.5-2, as applicable. The centre frequency of the filter shall be stepped in continuous steps according to the same table. The measured power shall be recorded for each step. The measurement period shall capture the active TSs.

6.6.2.1.4.3 Message contents

Message contents are according to TS 36.508 [7] subclause 4.6.

6.6.2.1.5 Test requirements

The measured UE mean power in the channel bandwidth, derived in step 3, shall fulfil requirements in Table 6.2.3.5-1 as appropriate, and the power of any UE emission shall fulfil requirements in Table.6.6.2.1.5-1 or Table.6.6.2.1.5-2, as applicable.

**Table 6.6.2.1.5-1: General E-UTRA spectrum emission mask, E-UTRA bands ≤ 3GHz**

$\Delta f_{OOB}$ (MHz)	Spectrum emission limit (dBm)/ Channel bandwidth						Measurement bandwidth
	1.4 MHz	3.0 MHz	5 MHz	10 MHz	15 MHz	20 MHz	
0-1	-8.5	-11.5	-13.5	-16.5	-18.5	-19.5	30 kHz
1-2.5	-8.5	-8.5	-8.5	-8.5	-8.5	-8.5	1 MHz
2.5-2.8	-23.5						1 MHz
2.8-5							1 MHz
5-6		-23.5	-11.5	-11.5	-11.5	-11.5	1 MHz
6-10			-23.5				1 MHz
10-15				-23.5			1 MHz
15-20					-23.5		1 MHz
20-25						-23.5	1 MHz
Note 1:	The first and last measurement position with a 30 kHz filter is at $\Delta f_{OOB}$ equals to 0.015 MHz and 0.985 MHz.						
Note 2:	At the boundary of spectrum emission limit, the first and last measurement position with a 1 MHz filter is the inside of +0.5MHz and -0.5MHz, respectively.						
Note 3:	The measurements are to be performed above the upper edge of the channel and below the lower edge of the channel						
Note 4:	For the 2.5-2.8 MHz offset range with 1.4 MHz channel bandwidth, the measurement position is at $\Delta f_{OOB}$ equals to 3 MHz.						

**Table 6.6.2.1.5-2: General E-UTRA spectrum emission mask, 3GHz < E-UTRA bands ≤ 4.2GHz**

	Spectrum emission limit (dBm)/ Channel bandwidth
--	--------------------------------------------------

$\Delta f_{\text{OoB}}$ (MHz)	1.4 MHz	3.0 MHz	5 MHz	10 MHz	15 MHz	20 MHz	Measurement bandwidth
0-1	-8.2	-11.2	-13.2	-16.2	-18.2	-19.2	30 kHz
1-2.5	-8.2	-8.2	-8.2	-8.2	-8.2	-8.2	1 MHz
2.5-2.8	-23.2						1 MHz
2.8-5							1 MHz
5-6		-23.2	-11.2	-11.2	-11.2	-11.2	1 MHz
6-10			-23.2				1 MHz
10-15				-23.2			1 MHz
15-20					-23.2		1 MHz
20-25						-23.2	1 MHz
Note 1:	The first and last measurement position with a 30 kHz filter is at $\Delta f_{\text{OoB}}$ equals to 0.015 MHz and 0.985 MHz.						
Note 2:	At the boundary of spectrum emission limit, the first and last measurement position with a 1 MHz filter is the inside of +0.5MHz and -0.5MHz, respectively.						
Note 3:	The measurements are to be performed above the upper edge of the channel and below the lower edge of the channel						
Note 4:	For the 2.5-2.8 MHz offset range with 1.4 MHz channel bandwidth, the measurement position is at $\Delta f_{\text{OoB}}$ equals to 3 MHz.						

NOTE: As a general rule, the resolution bandwidth of the measuring equipment should be equal to the measurement bandwidth. However, to improve measurement accuracy, sensitivity and efficiency, the resolution bandwidth may be smaller than the measurement bandwidth. When the resolution bandwidth is smaller than the measurement bandwidth, the result should be integrated over the measurement bandwidth in order to obtain the equivalent noise bandwidth of the measurement bandwidth.

## 6.6.2.1\_1 Spectrum Emission Mask for Multi-Cluster PUSCH

### 6.6.2.1\_1.1 Test purpose

To verify that the power of any UE emission shall not exceed specified level for the specified channel bandwidth for Multi-Cluster PUSCH transmission.

### 6.6.2.1\_1.2 Test applicability

This test cases applies to all types of E-UTRA UE release 10 and forward that support multi cluster PUSCH within a component carrier for the tested band.

### 6.6.2.1\_1.3 Minimum conformance requirements

The spectrum emission mask of the UE applies to frequencies ( $\Delta f_{\text{OoB}}$ ) starting from the edge of the assigned E-UTRA channel bandwidth. For frequencies greater than ( $\Delta f_{\text{OoB}}$ ) as specified in Table 6.6.2.1\_1.3-1 the spurious requirements in clause 6.6.3 are applicable.

The power of any UE emission shall not exceed the levels specified in Table 6.6.2.1\_1.3-1 for the specified channel bandwidth.

**Table 6.6.2.1\_1.3-1: General E-UTRA spectrum emission mask**

Spectrum emission limit (dBm)/ Channel bandwidth							
$\Delta f_{\text{OoB}}$ (MHz)	1.4 MHz	3.0 MHz	5 MHz	10 MHz	15 MHz	20 MHz	Measurement bandwidth
$\pm$ 0-1	-10	-13	-15	-18	-20	-21	30 kHz
$\pm$ 1-2.5	-10	-10	-10	-10	-10	-10	1 MHz
$\pm$ 2.5-2.8	-25	-10	-10	-10	-10	-10	1 MHz
$\pm$ 2.8-5		-10	-10	-10	-10	-10	1 MHz
$\pm$ 5-6		-25	-13	-13	-13	-13	1 MHz
$\pm$ 6-10			-25	-13	-13	-13	1 MHz
$\pm$ 10-15				-25	-13	-13	1 MHz
$\pm$ 15-20					-25	-13	1 MHz
$\pm$ 20-25						-25	1 MHz

NOTE: As a general rule, the resolution bandwidth of the measuring equipment should be equal to the measurement bandwidth. However, to improve measurement accuracy, sensitivity and efficiency, the resolution bandwidth may be smaller than the measurement bandwidth. When the resolution bandwidth is smaller than the measurement bandwidth, the result should be integrated over the measurement bandwidth in order to obtain the equivalent noise bandwidth of the measurement bandwidth.

The normative reference for this requirement is TS 36.101 [2] clause 6.6.2.1.

## 6.6.2.1\_1.4 Test description

### 6.6.2.1\_1.4.1 Initial conditions

Initial conditions are a set of test configurations the UE needs to be tested in and the steps for the SS to take with the UE to reach the correct measurement state.

The initial test configurations consist of environmental conditions, test frequencies, and channel bandwidths based on E-UTRA bands specified in table 5.4.2.1-1. All of these configurations shall be tested with applicable test parameters for each channel bandwidth, and are shown in table 6.6.2.1\_1.4.1-1. The details of the uplink reference measurement channels (RMCs) are specified in Annexes A.2 respectively. Configurations of PDSCH and PDCCH before measurement are specified in Annex C.2.

**Table 6.6.2.1\_1.4.1-1: Test Configuration Table**

Initial Conditions					
Test Environment as specified in TS 36.508[7] subclause 4.1		Normal			
Test Frequencies as specified in TS36.508 [7] subclause 4.3.1		Low range, Mid range, High range			
Test Channel Bandwidths as specified in TS 36.508 [7] subclause 4.3.1		Highest			
Test Parameters for Channel Bandwidths					
Configuration ID	Downlink Configuration		Uplink Configuration		
	Ch BW	N/A for SEM testing	Mod'n	Cluster1 RB allocations (L <sub>CRB</sub> @ RB <sub>start</sub> )	Cluster2 RB allocations (L <sub>CRB</sub> @ RB <sub>start</sub> )
1	5MHz		16QAM	2@0	1@24
2	5MHz		16QAM	18@0	2@22
3	5MHz		16QAM	2@0	18@6
4	10MHz		16QAM	3@0	2@48
5	10MHz		16QAM	42@0	3@45
6	10MHz		16QAM	3@0	42@6
7	15MHz		16QAM	8@0	7@68
8	15MHz		16QAM	60@0	4@68
9	15MHz		16QAM	4@0	60@12
10	20MHz		16QAM	4@0	4@96
11	20MHz		16QAM	92@0	4@96
12	20MHz		16QAM	4@0	92@8
Note 1: Test Channel Bandwidths are checked separately for each E-UTRA band, the applicable channel bandwidths are specified in Table 5.4.2.1-1.					

1. Connect the SS to the UE antenna connectors as shown in Figure TS 36.508 [7] Annex A, Figure A.3.
2. The parameter settings for the cell are set up according to TS 36.508 [7] subclause 4.4.3.

3. Downlink signals are initially set up according to Annex C0, C.1 and C.3.0, and uplink signals according to Annex H.1 and H.3.0.
4. The UL Reference Measurement channels are set according to Table 6.6.2.1\_1.4.1-1.
5. Propagation conditions are set according to Annex B.0.
6. Ensure the UE is in State 3A-RF according to TS 36.508 [7] clause 5.2A.2. Message contents are defined in clause 6.6.2.1.4.3.

6.6.2.1\_1.4.2 Test procedure

1. SS sends uplink scheduling information via PDCCH DCI format 0 for C\_RNTI to schedule the UL RMC according to Table 6.6.2.1\_1.4.1-1. Since the UE has no payload data to send, the UE transmits uplink MAC padding bits on the UL RMC.
2. Send continuously uplink power control "up" commands in the uplink scheduling information to the UE until the UE transmits at P<sub>UMAX</sub> level.
3. Measure the mean power of the UE in the channel bandwidth of the radio access mode according to the test configuration, which shall meet the requirements described in Table 6.2.3\_1.5-1. The period of the measurement shall be at least the continuous duration of one sub-frame (1ms). For TDD slots with transient periods are not under test.
4. Measure the power of the transmitted signal with a measurement filter of bandwidths according to table 6.6.2.1\_1.5-1 or 6.6.2.1\_1.5-2, as applicable. The centre frequency of the filter shall be stepped in continuous steps according to the same table. The measured power shall be recorded for each step. The measurement period shall capture the active TSs.

6.6.2.1\_1.4.3 Message contents

Message contents are according to TS 36.508 [7] subclause 4.6.

6.6.2.1\_1.5 Test requirements

The measured UE mean power in the channel bandwidth, derived in step 3, shall fulfil requirements in Table 6.2.3\_1.5-1 as appropriate, and the power of any UE emission shall fulfil requirements in Table.6.6.2.1\_1.5-1 or Table.6.6.2.1\_1.5-2, as applicable.

**Table 6.6.2.1\_1.5-1: General E-UTRA spectrum emission mask, E-UTRA bands ≤ 3GHz**

$\Delta f_{OOB}$ (MHz)	Spectrum emission limit (dBm)/ Channel bandwidth						Measurement bandwidth
	1.4 MHz	3.0 MHz	5 MHz	10 MHz	15 MHz	20 MHz	
0-1	-8.5	-11.5	-13.5	-16.5	-18.5	-19.5	30 kHz
1-2.5	-8.5	-8.5	-8.5	-8.5	-8.5	-8.5	1 MHz
2.5-2.8	-23.5						1 MHz
2.8-5							1 MHz
5-6		-23.5	-11.5	-11.5	-11.5	-11.5	1 MHz
6-10			-23.5				1 MHz
10-15				-23.5			1 MHz
15-20					-23.5		1 MHz
20-25						-23.5	1 MHz
Note 1:	The first and last measurement position with a 30 kHz filter is at $\Delta f_{OOB}$ equals to 0.015 MHz and 0.985 MHz.						
Note 2:	At the boundary of spectrum emission limit, the first and last measurement position with a 1 MHz filter is the inside of +0.5MHz and -0.5MHz, respectively.						
Note 3:	The measurements are to be performed above the upper edge of the channel and below the lower edge of the channel						
Note 4:	For the 2.5-2.8 MHz offset range with 1.4 MHz channel bandwidth, the measurement position is at $\Delta f_{OOB}$ equals to 3 MHz.						

**Table 6.6.2.1\_1.5-2: General E-UTRA spectrum emission mask, 3GHz < E-UTRA bands ≤ 4.2GHz**

	Spectrum emission limit (dBm)/ Channel bandwidth
--	--------------------------------------------------

$\Delta f_{\text{OOB}}$ (MHz)	1.4 MHz	3.0 MHz	5 MHz	10 MHz	15 MHz	20 MHz	Measurement bandwidth
0-1	-8.2	-11.2	-13.2	-16.2	-18.2	-19.2	30 kHz
1-2.5	-8.2	-8.2	-8.2	-8.2	-8.2	-8.2	1 MHz
2.5-2.8	-23.2						1 MHz
2.8-5							1 MHz
5-6		-23.2	-11.2	-11.2	-11.2	-11.2	1 MHz
6-10			-23.2				1 MHz
10-15				-23.2			1 MHz
15-20					-23.2		1 MHz
20-25						-23.2	1 MHz
Note 1:	The first and last measurement position with a 30 kHz filter is at $\Delta f_{\text{OOB}}$ equals to 0.015 MHz and 0.985 MHz.						
Note 2:	At the boundary of spectrum emission limit, the first and last measurement position with a 1 MHz filter is the inside of +0.5MHz and -0.5MHz, respectively.						
Note 3:	The measurements are to be performed above the upper edge of the channel and below the lower edge of the channel						
Note 4:	For the 2.5-2.8 MHz offset range with 1.4 MHz channel bandwidth, the measurement position is at $\Delta f_{\text{OOB}}$ equals to 3 MHz.						

NOTE: As a general rule, the resolution bandwidth of the measuring equipment should be equal to the measurement bandwidth. However, to improve measurement accuracy, sensitivity and efficiency, the resolution bandwidth may be smaller than the measurement bandwidth. When the resolution bandwidth is smaller than the measurement bandwidth, the result should be integrated over the measurement bandwidth in order to obtain the equivalent noise bandwidth of the measurement bandwidth.

### 6.6.2.1A Spectrum emission mask for CA

#### 6.6.2.1A.0 Minimum conformance requirements

For inter-band carrier aggregation with uplink assigned to two E-UTRA bands, the spectrum emission mask of the UE is defined per component carrier while both component carriers are active and the requirements are specified in subclauses 6.6.2.1.3 and 6.6.2.2.3. If for some frequency spectrum emission masks of component carriers overlap then spectrum emission mask allowing higher power spectral density applies for that frequency. If for some frequency a component carrier spectrum emission mask overlaps with the channel bandwidth of another component carrier, then the emission mask does not apply for that frequency.

For intra-band contiguous carrier aggregation the spectrum emission mask of the UE applies to frequencies ( $\Delta f_{\text{OOB}}$ ) starting from the  $\pm$  edge of the aggregated channel bandwidth (Table 5.4.2A-1) For intra-band contiguous carrier aggregation the bandwidth class C, the power of any UE emission shall not exceed the levels specified in Table 6.6.2.1A.0-1 for the specified channel bandwidth.

**Table 6.6.2.1A.0-1: General E-UTRA CA spectrum emission mask for Bandwidth Class C**

$\Delta f_{\text{OOB}}$ (MHz)	Spectrum emission limit [dBm]/BW <sub>Channel_CA</sub>					Measurement bandwidth
	25RB+100RB (24.95MHz)	50RB+100RB (29.9 MHz)	75RB+75RB (30 MHz)	75RB+100RB (34.85 MHz)	100RB+100RB (39.8 MHz)	
$\pm$ 0-1	-22	-22.5	-22.5	-23.5	-24	30 kHz
$\pm$ 1-5	-10	-10	-10	-10	-10	1 MHz
$\pm$ 5-24.95	-13	-13	-13	-13	-13	1 MHz
$\pm$ 24.95-29.9	-25	-13	-13	-13	-13	1 MHz
$\pm$ 29.9-29.95	-25	-25	-13	-13	-13	1 MHz
$\pm$ 29.95-30		-25	-13	-13	-13	1 MHz
$\pm$ 30-34.85		-25	-25	-13	-13	1 MHz
$\pm$ 34.85-34.9		-25	-25	-25	-13	1 MHz
$\pm$ 34.9-35			-25	-25	-13	1 MHz
$\pm$ 35-39.8				-25	-13	1 MHz
$\pm$ 39.8-39.85				-25	-25	1 MHz
$\pm$ 39.85-44.8					-25	1 MHz

For intra-band non-contiguous carrier aggregation transmission the spectrum emission mask requirement is defined as a composite spectrum emissions mask. Composite spectrum emission mask applies to frequencies up to  $\pm \Delta f_{\text{OOB}}$  starting from the edges of the sub-blocks. Composite spectrum emission mask is defined as follows

- a) Composite spectrum emission mask is a combination of individual sub-block spectrum emissions masks
- b) In case the sub-block consist of one component carrier the sub-block general spectrum emission mask is defined in subclause 6.6.2.1.3
- c) If for some frequency sub-block spectrum emission masks overlap then spectrum emission mask allowing higher power spectral density applies for that frequency
- d) If for some frequency a sub-block spectrum emission mask overlaps with the sub-block bandwidth of another sub-block, then the emission mask does not apply for that frequency.

The normative reference for this requirement is TS 36.101 [2] subclause 6.6.2.1A.

### 6.6.2.1A.1 Spectrum emission mask for CA (intra-band contiguous DL CA and UL CA)

#### 6.6.2.1A.1.1 Test purpose

To verify that the power of any UE emission shall not exceed specified level for the specified channel bandwidth for CA.

#### 6.6.2.1A.1.2 Test applicability

This test case applies to all types of E-UTRA UE release 10 and forward that support intra-band contiguous DL CA and UL CA.

#### 6.6.2.1A.1.3 Minimum conformance requirements

The minimum conformance requirements are defined in clause 6.6.2.1A.0.

#### 6.6.2.1A.1.4 Test description

##### 6.6.2.1A.1.4.1 Initial condition

Initial conditions are a set of test configurations the UE needs to be tested in and the steps for the SS to take with the UE to reach the correct measurement state.

The initial test configurations consist of environmental conditions, test frequencies, and channel bandwidths based on E-UTRA CA configurations specified in table 5.4.2A.1-1. All of these configurations shall be tested with applicable test parameters for each channel bandwidth, and are shown in table 6.6.2.1A.1.4.1-1. The details of the uplink reference measurement channels (RMCs) are specified in Annex A.2. Configurations of PDSCH and PDCCH before measurement are specified in Annex C.2.

Table 6.6.2.1A.1.4.1-1: Test Configuration Table

Initial Conditions								
Test Environment as specified in TS 36.508[7] subclause 4.1					NC			
Test Frequencies as specified in TS36.508 [7] subclause 4.3.1 for different CA bandwidth classes, and PCC and SCCs are mapped onto physical frequencies according to Table 6.1-2.					C: Low and High range			
Test CC Combination setting ( $N_{RB\_agg}$ ) as specified in subclause 5.4.2A.1 for the CA Configuration across bandwidth combination sets supported by the UE.					Lowest $N_{RB\_agg}$ Highest $N_{RB\_agg}$ (Note 2)			
Test Parameters for CA Configurations								
CA Configuration / $N_{RB\_agg}$			DL Allocation	CC MOD	UL Allocation			
ID	PCC $N_{RB}$	SCCs $N_{RB}$	PCC & SCC RB allocation		$N_{RB\_alloc}$	PCC & SCC RB allocations (LCRB @ $RB_{start}$ )		
1	100	25		QPSK	8	P_8@0	S_0@0	
2	100	25		QPSK	25	P_25@0	S_0@0	
3	100	25		QPSK	125	P_100@0	S_25@0	
4	100	25		16QAM	8	P_8@0	S_0@0	
5	100	25		16QAM	25	P_25@0	S_0@0	
6	100	25		16QAM	125	P_100@0	S_25@0	
7	100	25		QPSK	2	P_1@0	S_1@24	
8	75	75		QPSK	16	P_16@0	S_0@0	
9	75	75		QPSK	75	P_75@0	S_0@0	
10	75	75		QPSK	150	P_75@0	S_75@0	
11	75	75		16QAM	16	P_16@0	S_0@0	
12	75	75		16QAM	75	P_75@0	S_0@0	
13	75	75		16QAM	150	P_75@0	S_75@0	
14	75	75		QPSK	2	P_1@0	S_1@74	
15	100	50		QPSK	12	P_12@0	S_0@0	
16	100	50		QPSK	50	P_50@0	S_0@0	
17	100	50		QPSK	150	P_100@0	S_50@0	
18	100	50		16QAM	12	P_12@0	S_0@0	
19	100	50		16QAM	50	P_50@0	S_0@0	
20	100	50		16QAM	150	P_100@0	S_50@0	
21	100	50		QPSK	2	P_1@0	S_1@49	
22	100	75		QPSK	16	P_16@0	S_0@0	
23	100	75		QPSK	75	P_75@0	S_0@0	
24	100	75		QPSK	175	P_100@0	S_75@0	
25	100	75		16QAM	16	P_16@0	S_0@0	
26	100	75		16QAM	75	P_75@0	S_0@0	
27	100	75		16QAM	175	P_100@0	S_75@0	
28	100	75		QPSK	2	P_1@0	S_1@74	
29	100	100		QPSK	18	P_18@0	S_0@0	
30	100	100		QPSK	100	P_100@0	S_0@0	
31	100	100		QPSK	200	P_100@0	S_100@0	

32	100	100	16QAM	18	P_18@0	S_0@0		
33	100	100	16QAM	100	P_100@0	S_0@0		
34	100	100	16QAM	200	P_100@0	S_100@0		
35	100	100	QPSK	2	P_1@0	S_1@99		
Note 1: CA Configuration Test CC Combination settings are checked separately for each CA Configuration, which applicable aggregated channel bandwidths are specified in Table 5.4.2A.1-1.								
Note 2: If in the CA Configuration UE supports multiple CC Combinations with the same $N_{RB\_agg}$ , only the first of those is tested, according to the order on the Test Configuration Table list.								

1. Connect the SS to the UE antenna connectors as shown in Figure TS 36.508 [7] Annex A, Figure group A.32 as appropriate.
2. The parameter settings for the cell are set up according to TS 36.508 [7] clause 4.4.3.
3. Downlink signals for PCC are initially set up according to Annex C0, C.1 and C.3.0, and uplink signals according to Annex H.1 and H.3.0.
4. The UL Reference Measurement channels are set according to Table 6.6.2.1A.1.4.1-1.
5. Propagation conditions are set according to Annex B.0.
6. Ensure the UE is in State 3A-RF according to TS 36.508 [7] clause 5.2A.2. Message contents are defined in clause 6.6.2.1A.1.4.3.

#### 6.6.2.1A.1.4.2 Test procedure

1. Configure SCC according to Annex C.0, C.1 and Annex C.3.0 for all downlink physical channels.
2. The SS shall configure SCC as per TS 36.508 [7] clause 5.2A.4. Message contents are defined in clause 6.6.2.1A.1.4.3.
3. SS activates SCC by sending the activation MAC-CE (Refer TS 36.321 [13], clauses 5.13, 6.1.3.8). Wait for at least 2 seconds (Refer TS 36.133, clauses 8.3.3.2).
4. SS sends uplink scheduling information via PDCCH DCI format 0 for  $C\_RNTI$  to schedule the UL RMC according to Table 6.6.2.1A.1.4.1-1 on both PCC and SCC. Since the UE has no payload data to send, the UE transmits uplink MAC padding bits on the UL RMC.
5. Send continuously uplink power control "up" commands in the uplink scheduling information to the UE until the UE transmits at  $P_{UMAX}$  level.
6. Measure the mean power over all component carriers in the CA configuration of the radio access mode, which shall meet the requirements described in Table 6.2.3A.1.5-1. The period of the measurement shall be at least the continuous duration of one sub-frame (1ms). For TDD slots with transient periods are not under test.
7. Measure the power of the transmitted signal with a measurement filter of bandwidths according to table 6.6.2.1A.1.5-1 or 6.6.2.1A.1.5-2, as applicable. The centre frequency of the filter shall be stepped in continuous steps according to the same table. The measured power shall be recorded for each step. The measurement period shall capture the active TSs.

#### 6.6.2.1A.1.4.3 Message contents

Message contents are according to TS 36.508 [7] clause 4.6. In test procedure step 2, for SCC configuration there are no additional message contents.

#### 6.6.2.1A.1.5 Test Requirements

The measured UE mean power with the aggregated channel bandwidth as specified in clause 5.4.2A, derived in step [FFS], shall fulfil requirements in Table 6.2.3A.1.5-1 as appropriate,

and



the power of any UE emission shall fulfil requirements in Table.6.6.2.1A.1.5-1 or Table.6.6.2.1A.1.5-2, as applicable.

**Table 6.6.2.1A.1.5-1: General E-UTRA spectrum emission mask for CA, E UTRA bands  $\leq$  3GHz**

Spectrum emission limit [dBm]/BWChannel_CA						
$\Delta f_{\text{OoB}}$ (MHz)	25RB+100RB (24.95 MHz)	50RB+100RB (29.9 MHz)	75RB+75RB (30 MHz)	75RB+100RB (34.85 MHz)	100RB+100R B (39.8 MHz)	Measurement bandwidth
± 0-1	-20.5	-21	-21	-22	-22.5	30 kHz
± 1-5	-8.5	-8.5	-8.5	-8.5	-8.5	1 MHz
± 5-24.95	-11.5	-11.5	-11.5	-11.5	-11.5	1 MHz
± 24.95-29.9	-23.5					-23.5
± 29.9-29.95		-23.5	-23.5	-23.5	-23.5	
± 29.95-30	-23.5					-23.5
± 30-34.85		-23.5	-23.5	-23.5	-23.5	
± 34.85-34.9	-23.5					-23.5
± 34.9-35		-23.5	-23.5	-23.5	-23.5	
± 35-39.8	-23.5					-23.5
± 39.8-39.85		-23.5	-23.5	-23.5	-23.5	
± 39.85-44.8	-23.5					-23.5
Note 1: The first and last measurement position with a 30 kHz filter is at $\Delta f_{\text{OoB}}$ equals to 0.015 MHz and 0.985 MHz. Note 2: At the boundary of spectrum emission limit, the first and last measurement position with a 1 MHz filter is the inside of +0.5MHz and -0.5MHz, respectively. Note 3: The measurements are to be performed above the upper edge of the aggregated channel bandwidth and below the lower edge of the aggregated channel bandwidth.						

**Table 6.6.2.1A.1.5-2: General E-UTRA spectrum emission mask for CA, 3GHz < E UTRA bands ≤ 4.2GHz**

Spectrum emission limit [dBm]/BWChannel_CA						
$\Delta f_{\text{OoB}}$ (MHz)	25RB+100RB (24.95 MHz)	50RB+100RB (29.9 MHz)	75RB+75RB (30 MHz)	75RB+100RB (34.85 MHz)	100RB+100R B (39.8 MHz)	Measurement bandwidth
± 0-1	-20.2	-20.7	-20.7	-21.7	-22.2	30 kHz
± 1-5	-8.2	-8.2	-8.2	-8.2	-8.2	1 MHz
± 5-24.95	-11.2	-11.2	-11.2	-11.2	-11.2	1 MHz
± 24.95-29.9	-23.2					-23.2
± 29.9-29.95		-23.2	-23.2	-23.2	-23.2	
± 29.95-30	-23.2					-23.2
± 30-34.85		-23.2	-23.2	-23.2	-23.2	
± 34.85-34.9	-23.2					-23.2
± 34.9-35		-23.2	-23.2	-23.2	-23.2	
± 35-39.8	-23.2					-23.2
± 39.8-39.85		-23.2	-23.2	-23.2	-23.2	
± 39.85-44.8	-23.2					-23.2
Note 1: The first and last measurement position with a 30 kHz filter is at $\Delta f_{\text{OoB}}$ equals to 0.015 MHz and 0.985 MHz. Note 2: At the boundary of spectrum emission limit, the first and last measurement position with a 1 MHz filter is the inside of +0.5MHz and -0.5MHz, respectively. Note 3: The measurements are to be performed above the upper edge of the aggregated channel bandwidth and below the lower edge of the aggregated channel bandwidth.						

NOTE: As a general rule, the resolution bandwidth of the measuring equipment should be equal to the measurement bandwidth. However, to improve measurement accuracy, sensitivity and efficiency, the resolution bandwidth may be smaller than the measurement bandwidth. When the resolution bandwidth is smaller than the measurement bandwidth, the result should be integrated over the measurement bandwidth in order to obtain the equivalent noise bandwidth of the measurement bandwidth.

#### 6.6.2.1A.2 Spectrum emission mask for CA (inter-band DL CA and UL CA)

Editor's note: This clause is incomplete. The following aspects are either missing or not yet determined:

- Need further investigation for test requirements in case some frequency spectrum emission masks of component carriers overlap

##### 6.6.2.1A.2.1 Test purpose

To verify that the power of any UE emission shall not exceed specified level for the specified channel bandwidth for CA.

##### 6.6.2.1A.2.2 Test applicability

This test case applies to all types of E-UTRA UE release 11 and forward that support inter-band DL CA and UL CA.

##### 6.6.2.1A.2.3 Minimum conformance requirements

The minimum conformance requirements are defined in clause 6.6.2.1A.0.

##### 6.6.2.1A.2.4 Test description

###### 6.6.2.1A.2.4.1 Initial condition

Same as in clause 6.6.2.1A.1.4.1 with the following exceptions:

- Instead of Table 5.4.2A.1-1 → use Table 5.4.2A.1-2 for CA configurations with two bands or Table 5.4.2A.1-2a for CA configurations with three bands.
- Instead of Table 6.6.2.1A.1.4.1-1 → use Table 6.6.2.1A.2.4.1-1.
- Instead of clause 6.6.2.1A.1.4.3 use clause 6.6.2.1A.2.4.3.

**Table 6.6.2.1A.2.4.1-1: Test Configuration Table**

Initial Conditions									
Test Environment as specified in TS 36.508[7] subclause 4.1					NC				
Test Frequencies as specified in TS 36.508 [7] subclause 4.3.1 for different CA bandwidth classes.					Low range for PCC and SCC High range for PCC and SCC				
Test CC Combination setting ( $N_{RB\_agg}$ ) as specified in subclause 5.4.2A.1 for the CA Configuration across bandwidth combination sets supported by the UE.					Lowest $N_{RB\_agg}$ Highest $N_{RB\_agg}$ (Note 2)				
Test Parameters for CA Configurations									
CA Configuration / $N_{RB\_agg}$		DL Allocation		CC MOD	UL Allocation				
PCC $N_{RB}$	SCCs $N_{RB}$	PCC & SCC RB allocation			$N_{RB\_alloc}$	PCC & SCC RB allocations ( $L_{CRB}$ @ $RB_{start}$ )			
6	25	N/Afor this test		QPSK	2	P_1@0	S_1@0	-	-
6	25			QPSK	2	P_1@5	S_1@24	-	-
6	25			QPSK	13	P_5@0	S_8@0	-	-
6	25			QPSK	13	P_5@1	S_8@17	-	-
6	25			16QAM	2	P_1@0	S_1@0		
6	25			16QAM	2	P_1@5	S_1@24		
6	25			16QAM	13	P_5@0	S_8@0		
6	25			16QAM	13	P_5@1	S_8@17		
6	50			QPSK	2	P_1@0	S_1@0	-	-
6	50			QPSK	2	P_1@5	S_1@49	-	-
6	50			QPSK	17	P_5@0	S_12@0	-	-
6	50			QPSK	17	P_5@1	S_12@38	-	-
6	50			16QAM	2	P_1@0	S_1@0	-	-
6	50			16QAM	2	P_1@5	S_1@49	-	-
6	50			16QAM	17	P_5@0	S_12@0	-	-
6	50			16QAM	17	P_5@1	S_12@38	-	-
25	15			QPSK	2	P_1@0	S_1@0	-	-
25	15			QPSK	2	P_1@24	S_1@14	-	-
25	15			QPSK	12	P_8@0	S_5@0	-	-
25	15			QPSK	12	P_8@17	S_5@10	-	-
25	15	16QAM	2	P_1@0	S_1@0	-	-		
25	15	16QAM	2	P_1@24	S_1@14	-	-		
25	15	16QAM	12	P_8@0	S_5@0	-	-		
25	15	16QAM	12	P_8@17	S_5@10	-	-		
25	25	QPSK	2	P_1@0	S_1@0	-	-		
25	25	QPSK	2	P_1@24	S_1@24	-	-		
25	25	QPSK	16	P_8@0	S_8@0	-	-		
25	25	QPSK	16	P_8@17	S_8@17	-	-		
25	25	16QAM	2	P_1@0	S_1@0	-	-		
25	25	16QAM	2	P_1@24	S_1@24	-	-		
25	25	16QAM	16	P_8@0	S_8@0	-	-		

25	25
25	50
25	50
25	50
25	50
25	50
25	50
25	50
25	50
50	50
50	50
50	50
50	50
50	50
50	50
50	50
50	50
50	50
50	100
50	100
50	100
50	100
50	100
50	100
50	100
50	100
75	75
75	75
75	75
75	75
75	75
75	75
75	75
75	75
75	75
100	75
100	75
100	75
100	75
100	75
100	75
100	75
100	100
100	100
100	100
100	100
100	100

16QAM	16	P_8@17	S_8@17	-	-
QPSK	2	P_1@0	S_1@0	-	-
QPSK	2	P_1@24	S_1@49	-	-
QPSK	20	P_8@0	S_12@0	-	-
QPSK	20	P_8@17	S_12@38	-	-
16QAM	2	P_1@0	S_1@0	-	-
16QAM	2	P_1@24	S_1@49	-	-
16QAM	20	P_8@0	S_12@0	-	-
16QAM	20	P_8@17	S_12@38	-	-
QPSK	2	P_1@0	S_1@0	-	-
QPSK	2	P_1@49	S_1@49	-	-
QPSK	24	P_12@0	S_12@0	-	-
QPSK	24	P_12@38	S_12@38	-	-
16QAM	2	P_1@0	S_1@0	-	-
16QAM	2	P_1@49	S_1@49	-	-
16QAM	24	P_12@0	S_12@0	-	-
16QAM	24	P_12@38	S_12@38	-	-
QPSK	2	P_1@0	S_1@0	-	-
QPSK	2	P_1@49	S_1@99	-	-
QPSK	30	P_12@0	S_18@0	-	-
QPSK	30	P_12@38	S_18@82	-	-
16QAM	2	P_1@0	S_1@0	-	-
16QAM	2	P_1@49	S_1@99	-	-
16QAM	30	P_12@0	S_18@0	-	-
16QAM	30	P_12@38	S_18@82	-	-
QPSK	2	P_1@0	S_1@0	-	-
QPSK	2	P_1@74	S_1@74	-	-
QPSK	32	P_16@0	S_16@0	-	-
QPSK	32	P_16@59	S_16@59	-	-
16QAM	2	P_1@0	S_1@0	-	-
16QAM	2	P_1@74	S_1@74	-	-
16QAM	32	P_16@0	S_16@0	-	-
16QAM	32	P_16@59	S_16@59	-	-
QPSK	2	P_1@0	S_1@0	-	-
QPSK	2	P_1@99	S_1@74	-	-
QPSK	34	P_18@0	S_16@0	-	-
QPSK	34	P_18@82	S_16@59	-	-
16QAM	2	P_1@0	S_1@0	-	-
16QAM	2	P_1@99	S_1@74	-	-
16QAM	34	P_18@0	S_16@0	-	-
16QAM	34	P_18@82	S_16@59	-	-
QPSK	2	P_1@0	S_1@0	-	-
QPSK	2	P_1@99	S_1@99	-	-
QPSK	36	P_18@0	S_18@0	-	-
QPSK	36	P_18@82	S_18@82	-	-
16QAM	2	P_1@0	S_1@0	-	-

100	100	16QAM	2	P_1@99	S_1@99	-	-
100	100	16QAM	36	P_18@0	S_18@0	-	-
100	100	16QAM	36	P_18@82	S_18@82	-	-
<p>Note 1: CA Configuration Test CC Combination settings are checked separately for each CA Configuration, which applicable aggregated channel bandwidths are specified in Table 5.4.2A.1-1</p> <p>Note 2: If in the CA Configuration UE supports multiple CC Combinations with the same <math>N_{RB\_agg}</math>, only the first of those is tested, according to the order on the Test Configuration Table list.</p>							

#### 6.6.2.1A.2.4.2 Test procedure

1. Configure SCC according to Annex C.0, C.1 and Annex C.3.0 for all downlink physical channels.
2. The SS shall configure SCC as per TS 36.508 [7] clause 5.2A.4. Message contents are defined in clause 6.6.2.1A.1.4.3.
3. SS activates SCC by sending the activation MAC-CE (Refer TS 36.321 [13], clauses 5.13, 6.1.3.8). Wait for at least 2 seconds (Refer TS 36.133, clauses 8.3.3.2).
4. SS sends uplink scheduling information via PDCCH DCI format 0 for C\_RNTI to schedule the UL RMC according to Table 6.6.2.1.4.1-1 on both PCC and SCC. Since the UE has no payload data to send, the UE transmits uplink MAC padding bits on the UL RMC.
5. Send continuously uplink power control "up" commands in the uplink scheduling information to the UE until the UE transmits at  $P_{UMAX}$  level.
6. Measure the mean power for each CC, which shall meet the requirements described in Table 6.2.3A.2.5-1. The period of the measurement shall be at least the continuous duration of one sub-frame (1ms). For TDD slots with transient periods are not under test.
7. Measure the power of the transmitted signal with a measurement filter of bandwidths according to table 6.6.2.1A.2.5-1 or 6.6.2.1A.2.5-2, as applicable. The centre frequency of the filter shall be stepped in continuous steps according to the same table. The measured power shall be recorded for each step. The measurement period shall capture the active TSs.

#### 6.6.2.1A.2.4.3 Message contents

Message contents are according to TS 36.508 [7] clause 4.6. The following exceptions apply for each network signalled value.

##### 6.6.2.1A.2.4.3.1 Message contents exceptions (network signalled value "CA\_NS\_03")

1. Information element `additionalSpectrumEmission` is set to NS\_03. This can be set in the `SystemInformationBlockType2` as part of the cell broadcast message. This exception indicates that the UE shall meet the additional spurious emission requirement for a specific deployment scenario.

**Table 6.6.2.1A.2.4.3.1-1: SystemInformationBlockType2 :Additional spurious emissions requirement**

Derivation Path: TS 36.508 [7] clause 4.4.3.3, Table 4.4.3.3-1			
Information Element	Value/remark	Comment	Condition
<code>additionalSpectrumEmission</code>	3 (NS_03)		

##### 6.6.2.1A.2.4.3.2 Message contents exceptions (network signalled value "NS\_06")

1. Information element `additionalSpectrumEmission` is set to NS\_06. This can be set in the `SystemInformationBlockType2` as part of the cell broadcast message. This exception indicates that the UE shall meet the additional spurious emission requirement for a specific deployment scenario.

**Table 6.6.2.1A.2.4.3.2-1: SystemInformationBlockType2 :Additional spurious emissions requirement**

Derivation Path: TS 36.508 [7] clause 4.4.3.3, Table 4.4.3.3-1			
Information Element	Value/remark	Comment	Condition
additionalSpectrumEmission	6 (NS_06)		

6.6.2.1A.2.4.3.3 Message contents exceptions (network signalled value "NS\_07")

1. Information element additionalSpectrumEmission is set to NS\_07. This can be set in the SystemInformationblockType2 as part of the cell broadcast message. This exception indicates that the UE shall meet the additional spurious emission requirement for a specific deployment scenario.

**Table 6.6.2.1A.2.4.3.3-1: SystemInformationBlockType2 :Additional spurious emissions requirement**

Derivation Path: TS 36.508 [7] clause 4.4.3.3, Table 4.4.3.3-1			
Information Element	Value/remark	Comment	Condition
additionalSpectrumEmission	7 (NS_07)		

6.6.2.1A.2.5 Test Requirements

The measured UE mean power in the channel bandwidth for each CC, derived in step 6, shall fulfil requirements in Table 6.2.3A.2.5-1 as appropriate, and the power of any UE emission shall fulfil requirements in Table.6.6.2.1A.2.5-1 or Table.6.6.2.1A.2.5-2, as applicable. The following exceptions defined in from clause 6.6.2.1A.2.5.1 to 6.6.2.1A.2.5.2 apply for each network signalled value.

**Table 6.6.2.1A.2.5-1: General E-UTRA spectrum emission mask, E-UTRA bands ≤ 3GHz**

$\Delta f_{\text{OoB}}$ (MHz)	Spectrum emission limit (dBm)/ Channel bandwidth						Measurement bandwidth
	1.4 MHz	3.0 MHz	5 MHz	10 MHz	15 MHz	20 MHz	
0-1	-8.5	-11.5	-13.5	-16.5	-18.5	-19.5	30 kHz
1-2.5	-8.5	-8.5	-8.5	-8.5	-8.5	-8.5	1 MHz
2.5-2.8	-23.5						1 MHz
2.8-5							1 MHz
5-6		-23.5	-11.5	-11.5	-11.5	-11.5	1 MHz
6-10			-23.5				1 MHz
10-15				-23.5			1 MHz
15-20					-23.5		1 MHz
20-25						-23.5	1 MHz
Note 1:	The first and last measurement position with a 30 kHz filter is at $\Delta f_{\text{OoB}}$ equals to 0.015 MHz and 0.985 MHz.						
Note 2:	At the boundary of spectrum emission limit, the first and last measurement position with a 1 MHz filter is the inside of +0.5MHz and -0.5MHz, respectively.						
Note 3:	The measurements are to be performed above the upper edge of the channel and below the lower edge of the channel						
Note 4:	For the 2.5-2.8 MHz offset range with 1.4 MHz channel bandwidth, the measurement position is at $\Delta f_{\text{OoB}}$ equals to 3 MHz.						

**Table 6.6.2.1A.2.5-2: General E-UTRA spectrum emission mask, 3GHz < E-UTRA bands ≤ 4.2GHz**

Spectrum emission limit (dBm)/ Channel bandwidth	
--------------------------------------------------	--

$\Delta f_{OOB}$ (MHz)	1.4 MHz	3.0 MHz	5 MHz	10 MHz	15 MHz	20 MHz	Measurement bandwidth
0-1	-8.2	-11.2	-13.2	-16.2	-18.2	-19.2	30 kHz
1-2.5	-8.2	-8.2	-8.2	-8.2	-8.2	-8.2	1 MHz
2.5-2.8	-23.2						1 MHz
2.8-5							1 MHz
5-6		-23.2	-11.2	-11.2	-11.2	-11.2	1 MHz
6-10			-23.2				1 MHz
10-15				-23.2			1 MHz
15-20					-23.2		1 MHz
20-25						-23.2	1 MHz
Note 1:	The first and last measurement position with a 30 kHz filter is at $\Delta f_{OOB}$ equals to 0.015 MHz and 0.985 MHz.						
Note 2:	At the boundary of spectrum emission limit, the first and last measurement position with a 1 MHz filter is the inside of +0.5MHz and -0.5MHz, respectively.						
Note 3:	The measurements are to be performed above the upper edge of the channel and below the lower edge of the channel						
Note 4:	For the 2.5-2.8 MHz offset range with 1.4 MHz channel bandwidth, the measurement position is at $\Delta f_{OOB}$ equals to 3 MHz.						

NOTE: As a general rule, the resolution bandwidth of the measuring equipment should be equal to the measurement bandwidth. However, to improve measurement accuracy, sensitivity and efficiency, the resolution bandwidth may be smaller than the measurement bandwidth. When the resolution bandwidth is smaller than the measurement bandwidth, the result should be integrated over the measurement bandwidth in order to obtain the equivalent noise bandwidth of the measurement bandwidth.

6.6.2.1A.2.5.1 Test requirements (network signalled value "NS\_03")

When "NS\_03" is indicated in the cell:

- the measured UE mean power in the channel bandwidth, derived in step 3, shall fulfil requirements in Table 6.2.4.5-1 and 6.2.4.5-2 as appropriate,

and

- the power of any UE emission shall fulfil requirements in Table 6.6.2.1A.2.5.1-1 or 6.6.2.1A.2.5.1-2, as applicable.

**Table 6.6.2.1A.2.5.1-1: Additional requirements (network signalled value "NS\_03"), E-UTRA bands ≤ 3GHz**

$\Delta f_{OOB}$ (MHz)	Spectrum emission limit (dBm)/ Channel bandwidth						Measurement bandwidth
	1.4 MHz	3.0 MHz	5 MHz	10 MHz	15 MHz	20 MHz	
0-1	-8.5	-11.5	-13.5	-16.5	-18.5	-19.5	30 kHz
1-2.5	-11.5	-11.5	-11.5	-11.5	-11.5	-11.5	1 MHz
2.5-2.8	-23.5						1 MHz
2.8-5							1 MHz
5-6		-23.5					1 MHz
6-10			-23.5				1 MHz
10-15				-23.5			1 MHz
15-20					-23.5		1 MHz
20-25						-23.5	1 MHz
Note 1:	The first and last measurement position with a 30 kHz filter is at $\Delta f_{OOB}$ equals to 0.015 MHz and 0.985 MHz.						
Note 2:	At the boundary of spectrum emission limit, the first and last measurement position with a 1 MHz filter is the inside of +0.5MHz and -0.5MHz, respectively.						
Note 3:	The measurements are to be performed above the upper edge of the channel and below the lower edge of the channel						
Note 4:	Above SEM requirement applies to bands corresponding to network signalling value NS_03 as defined in TS 36.101 [2] subclause 6.2.4 Table 6.2.4-1.						
Note 5:	For the 2.5-2.8 MHz offset range with 1.4 MHz channel bandwidth, the measurement position is at $\Delta f_{OOB}$ equals to 3 MHz.						



**Table 6.6.2.1A.2.5.1-2: Additional requirements (network signalled value "NS\_03"), 3GHz < E-UTRA bands ≤ 4.2GHz**

$\Delta f_{\text{OOB}}$ (MHz)	Spectrum emission limit (dBm)/ Channel bandwidth						Measurement bandwidth
	1.4 MHz	3.0 MHz	5 MHz	10 MHz	15 MHz	20 MHz	
0-1	-8.2	-11.2	-13.2	-16.2	-18.2	-19.2	30 kHz
1-2.5	-11.2	-11.2	-11.2	-11.2	-11.2	-11.2	1 MHz
2.5-2.8	-23.2						1 MHz
2.8-5							1 MHz
5-6		-23.2					1 MHz
6-10			-23.2				1 MHz
10-15				-23.2			1 MHz
15-20					-23.2		1 MHz
20-25						-23.2	1 MHz
Note 1:	The first and last measurement position with a 30 kHz filter is at $\Delta f_{\text{OOB}}$ equals to 0.015 MHz and 0.985 MHz.						
Note 2:	At the boundary of spectrum emission limit, the first and last measurement position with a 1 MHz filter is the inside of +0.5MHz and -0.5MHz, respectively.						
Note 3:	The measurements are to be performed above the upper edge of the channel and below the lower edge of the channel						
Note 4:	Above SEM requirement applies to bands corresponding to network signalling value NS_03 as defined in TS 36.101 [2] subclause 6.2.4 Table 6.2.4-1.						
Note 5:	For the 2.5-2.8 MHz offset range with 1.4 MHz channel bandwidth, the measurement position is at $\Delta f_{\text{OOB}}$ equals to 3 MHz.						

**NOTE:** (only for emission measurement) As a general rule, the resolution bandwidth of the measuring equipment should be equal to the measurement bandwidth. However, to improve measurement accuracy, sensitivity and efficiency, the resolution bandwidth may be smaller than the measurement bandwidth. When the resolution bandwidth is smaller than the measurement bandwidth, the result should be integrated over the measurement bandwidth in order to obtain the equivalent noise bandwidth of the measurement bandwidth.

#### 6.6.2.1A.2.5.2 Test requirements (network signalled value "NS\_06" or "NS\_07")

When "NS\_06" or "NS\_07" is indicated in the cell:

- the measured UE mean power in the channel bandwidth, derived in step 3, shall fulfil requirements in Tables 6.2.4.5-5, 6.2.4.5-6 and 6.2.4.5-7 as appropriate,

and

- the power of any UE emission shall fulfil requirements in Table 6.6.2.1A.2.5.2-1 or Table 6.6.2.1A.2.5.2-2, as applicable.

**Table 6.6.2.1A.2.5.2-1: Additional requirements (network signalled value "NS\_06" or "NS\_07"), E-UTRA bands ≤ 3GHz**

$\Delta f_{\text{OOB}}$ (MHz)	Spectrum emission limit (dBm)/ Channel bandwidth				
	1.4 MHz	3.0 MHz	5 MHz	10 MHz	Measurement bandwidth
0-0.1	-11.5	-11.5	-13.5	-16.5	30 kHz
0.1-1	-11.5	-11.5	-11.5	-11.5	100 kHz
1-2.5	-11.5	-11.5	-11.5	-11.5	1 MHz
2.5-2.8	-23.5				1 MHz
2.8-5		-23.5	-23.5	-11.5	1 MHz
5-6					1 MHz
6-10			-23.5		1 MHz
10-15				-23.5	1 MHz
Note 1:	The first and last measurement position with a 30 kHz filter is at $\Delta f_{\text{OOB}}$ equals to 0.015 MHz and 0.085 MHz. The first and last measurement position with a 100 kHz filter is at $\Delta f_{\text{OOB}}$ equals to 0.15 MHz and 0.95 MHz.				
Note 2:	At the boundary of spectrum emission limit, the first and last measurement position with a 1 MHz filter is the inside of +0.5MHz and -0.5MHz, respectively.				
Note 3:	The measurements are to be performed above the upper edge of the channel and below the lower edge of the channel				
Note 4:	Above SEM requirement applies to bands corresponding to network signalling value NS_06 and NS_07 as defined in TS 36.101 [2] subclause 6.2.4 Table 6.2.4-1.				
Note 5:	For the 2.5-2.8 MHz offset range with 1.4 MHz channel bandwidth, the measurement position is at $\Delta f_{\text{OOB}}$ equals to 3 MHz.				

**Table 6.6.2.1A.2.5.2-2: Additional requirements (network signalled value "NS\_06" or "NS\_07"), 3GHz < E-UTRA bands ≤ 4.2GHz**

$\Delta f_{\text{OOB}}$ (MHz)	Spectrum emission limit (dBm)/ Channel bandwidth				
	1.4 MHz	3.0 MHz	5 MHz	10 MHz	Measurement bandwidth
0-0.1	-11.2	-11.2	-13.2	-16.2	30 kHz
0.1-1	-11.2	-11.2	-11.2	-11.2	100 kHz
1-2.5	-11.2	-11.2	-11.2	-11.2	1 MHz
2.5-2.8	-23.2				1 MHz
2.8-5		-23.2	-23.2	-11.2	1 MHz
5-6					1 MHz
6-10			-23.2		1 MHz
10-15				-23.2	1 MHz
Note 1:	The first and last measurement position with a 30 kHz filter is at $\Delta f_{\text{OOB}}$ equals to 0.015 MHz and 0.085 MHz. The first and last measurement position with a 100 kHz filter is at $\Delta f_{\text{OOB}}$ equals to 0.15 MHz and 0.95 MHz.				
Note 2:	At the boundary of spectrum emission limit, the first and last measurement position with a 1 MHz filter is the inside of +0.5MHz and -0.5MHz, respectively.				
Note 3:	The measurements are to be performed above the upper edge of the channel and below the lower edge of the channel				
Note 4:	Above SEM requirement applies to bands corresponding to network signalling value NS_06 and NS_07 as defined in TS 36.101 [2] subclause 6.2.4 Table 6.2.4-1.				
Note 5:	For the 2.5-2.8 MHz offset range with 1.4 MHz channel bandwidth, the measurement position is at $\Delta f_{\text{OOB}}$ equals to 3 MHz.				

NOTE: (only for emission measurement) As a general rule, the resolution bandwidth of the measuring equipment should be equal to the measurement bandwidth. However, to improve measurement accuracy, sensitivity and efficiency, the resolution bandwidth may be smaller than the measurement bandwidth. When the resolution bandwidth is smaller than the measurement bandwidth, the result should be integrated over the measurement bandwidth in order to obtain the equivalent noise bandwidth of the measurement bandwidth.

### 6.6.2.1A.3 Spectrum emission mask for CA (intra-band non-contiguous DL CA and UL CA)

#### 6.6.2.1A.3.1 Test purpose

To verify that the power of any UE emission shall not exceed specified level for the specified channel bandwidth for CA.

#### 6.6.2.1A.3.2 Test applicability

This test case applies to all types of E-UTRA UE release 11 and forward that support intra-band non-contiguous DL CA and UL CA.

#### 6.6.2.1A.3.3 Minimum conformance requirements

The minimum conformance requirements are defined in clause 6.6.2.1A.0.

#### 6.6.2.1A.3.4 Test description

##### 6.6.2.1A.3.4.1 Initial condition

Initial conditions are a set of test configurations the UE needs to be tested in and the steps for the SS to take with the UE to reach the correct measurement state.

The initial test configurations consist of environmental conditions, test frequencies, and channel bandwidths based on E-UTRA CA configurations specified in table 5.4.2A.1-3. All of these configurations shall be tested with applicable test parameters for each channel bandwidth, and are shown in table 6.6.2.1A.3.4.1-1. The details of the uplink reference measurement channels (RMCs) are specified in Annex A.2. Configurations of PDSCH and PDCCH before measurement are specified in Annex C.2.

Table 6.6.2.1A.3.4.1-1: Test Configuration Table

Initial Conditions									
Test Environment as specified in TS 36.508[7] subclause 4.1				NC					
Test Frequencies as specified in TS36.508 [7] subclause 4.3.1 for different CA bandwidth classes, and PCC and SCCs are mapped onto physical frequencies according to Table 6.1-2.				Refer to test points A: Mid frequency, Maximum Wgap(low + high frequency)					
Test CC Combination setting ( $N_{RB\_agg}$ ) as specified in subclause 5.4.2A.1 for the CA Configuration across bandwidth combination sets supported by the UE.				Refer to test point Test only test points with Lowest $N_{RB}$ for PCC and SCC Highest $N_{RB}$ for PCC and SCC					
Test Parameters for CA Configurations									
ID	CA Configuration / $N_{RB\_agg}$		$W_{gap}$ [MHz]	DL Allocation		UL Allocation			
	PCC $N_{RB}$	SCCs $N_{RB}$		CC MOD	PCC & SCC RB allocation	CC MOD	PCC $N_{RB\_alloc}$ ( $L_{CRB}$ @ $RB_{start}$ )	CC MOD	SCC $N_{RB\_alloc}$ ( $L_{CRB}$ @ $RB_{start}$ )
Test Parameters for CA_4A-4A Configurations									
1	25	25	35	N/A	N/A	16QAM	P_1@0	16QAM	S_1@24
2	25	25	35	N/A	N/A	16QAM	P_25@0	16QAM	S_25@0
3	25	25	5	N/A	N/A	16QAM	P_1@0	16QAM	S_1@24
4	25	25	5	N/A	N/A	16QAM	P_25@0	16QAM	S_25@0
5	100	100	5	N/A	N/A	16QAM	P_1@0	16QAM	S_1@99
6	100	100	5	N/A	N/A	16QAM	P_25@0	16QAM	S_25@75
7	100	100	5	N/A	N/A	16QAM	P_100@0	16QAM	S_100@0

1. Connect the SS to the UE antenna connectors as shown in Figure TS 36.508 [7] Annex A, Figure group A.32 as appropriate.
2. The parameter settings for the cell are set up according to TS 36.508 [7] clause 4.4.3.
3. Downlink signals for PCC are initially set up according to Annex C0, C.1 and C.3.0, and uplink signals according to Annex H.1 and H.3.0.
4. The UL Reference Measurement channels are set according to Table 6.6.2.1A.3.4.1-1.
5. Propagation conditions are set according to Annex B.0.
6. Ensure the UE is in State 3A-RF according to TS 36.508 [7] clause 5.2A.2. Message contents are defined in clause 6.6.2.1A.3.4.3.

#### 6.6.2.1A.3.4.2 Test procedure

1. Configure SCC according to Annex C.0, C.1 and Annex C.3.0 for all downlink physical channels except PHICH.
2. The SS shall configure SCC as per TS 36.508 [7] clause 5.2A.4. Message contents are defined in clause 6.6.2.1A.3.4.3.
3. SS activates SCC by sending the activation MAC-CE (Refer TS 36.321 [13], clauses 5.13, 6.1.3.8). Wait for at least 2 seconds (Refer TS 36.133, clauses 8.3.3.2).
4. SS sends uplink scheduling information via PDCCH DCI format 0 for C\_RNTI to schedule the UL RMC according to Table 6.6.2.1.4.1-1 on both PCC and SCC. Since the UE has no payload data to send, the UE transmits uplink MAC padding bits on the UL RMC.

5. Send continuously uplink power control "up" commands in the uplink scheduling information to the UE until the UE transmits at  $P_{UMAX}$  level.
6. Measure the mean power over all component carriers in the CA configuration of the radio access mode, which shall meet the requirements described in Table 6.2.3A.1.5-1. The period of the measurement shall be at least the continuous duration of one sub-frame (1ms). For TDD slots with transient periods are not under test.
7. Measure the power of the transmitted signal with a measurement filter of bandwidths according to table 6.6.2.1A.3.5-1 or 6.6.2.1A.3.5-2, as applicable. The centre frequency of the filter shall be stepped in continuous steps according to the same table. The measured power shall be recorded for each step. The measurement period shall capture the active TSs.

#### 6.6.2.1A.3.4.3 Message contents

Message contents are according to TS 36.508 [7] clause 4.6. In test procedure step 2, for SCC configuration there are no additional message contents.

#### 6.6.2.1A.3.5 Test Requirements

The measured UE mean power with the aggregated channel bandwidth as specified in clause 5.4.2A, derived in step 6, shall fulfil requirements in Table 6.2.3A.1.5-1 as appropriate,

and

the power of any UE emission shall fulfil requirements in Table.6.6.2.1A.3.5-1.

**Table 6.6.2.1A.3.5-1: E-UTRA spectrum emission mask for CA\_4A-4A**

Spectrum emission limit [dBm]/BWChannel_CA								
25RB+25RB (Max Gap)			25RB+25RB (Mid range)			100RB+100RB		
Frequency ranges[MHz]	Limit [dBm]	MBW [MHz]	Frequency ranges[MHz]	Limit [dBm]	MBW	Frequency ranges[MHz]	Limit [dBm]	MBW [MHz]
1700-1704	-23.5	1	1715-1719	-23.5	1	1685-1690	-23.5	1
1704-1705	-11.5	1	1719-1720	-11.5	1	1690-1705	-11.5	1
1705-1709	-8.5	1	1720-1724	-8.5	1	1705-1709	-8.5	1
1709-1710	-13.5	0.03	1724-1725	-13.5	0.03	1709-1710	-19.5	0.03
-	-	-	-	-	-	-	-	-
1715-1716	-13.5	0.03	1730-1731	-13.5	0.03	1730-1731	-19.5	0.03
1716-1720	-8.5	1	1732-1734	-8.5	1	1731-1734	-8.5	1
1720-1721	-11.5	1	1734-1735	-13.5	0.03	1734-1735	-19.5	0.03
1721-1725	-23.5	1	-	-	-	-	-	-
1740-1744	-23.5	1	1741-1745	-8.5	1	1756-1760	-8.5	1
1744-1745	-11.5	1	1745-1746	-11.5	1	1760-1775	-11.5	1
1745-1749	-8.5	1	1746-1750	-23.5	1	1775-1780	-23.5	1
1749-1750	-13.5	0.03						
-	-	-						
1755-1756	-13.5	0.03						
1756-1760	-8.5	1						
1760-1761	-11.5	1						
1761-1765	-23.5	1						
Note 1: At the boundary of spectrum emission limit, the first and last measurement position with a 30kHz filter is the inside of +0.015MHz and -0.015MHz, respectively.								
Note 2: At the boundary of spectrum emission limit, the first and last measurement position with a 1 MHz filter is the inside of +0.5MHz and -0.5MHz, respectively.								
Note 3: MBW denotes Measurement Bandwidth with which the requirement has to be met.								

NOTE: As a general rule, the resolution bandwidth of the measuring equipment should be equal to the measurement bandwidth. However, to improve measurement accuracy, sensitivity and efficiency, the resolution bandwidth may be smaller than the measurement bandwidth. When the resolution bandwidth is smaller than the measurement bandwidth, the result should be integrated over the measurement bandwidth in order to obtain the equivalent noise bandwidth of the measurement bandwidth.

## 6.6.2.1B Spectrum Emission Mask for UL-MIMO

### 6.6.2.1B.1 Test purpose

To verify that the power of any UE emission at each transmit antenna shall not exceed specified level for the specified channel bandwidth.

### 6.6.2.1B.2 Test applicability

This test case applies to all types of E-UTRA UE release 10 and forward that support UL-MIMO.

### 6.6.2.1B.3 Minimum conformance requirements

For UE with multiple transmit antenna connectors, the requirements for the spectrum emission mask are specified at each transmit antenna connector. The spectrum emission mask of the UE applies to frequencies ( $\Delta f_{\text{OoB}}$ ) starting from the edge of the assigned E-UTRA channel bandwidth. For frequencies greater than ( $\Delta f_{\text{OoB}}$ ) as specified in Table 6.6.2.1B.3-1.

For UEs with two transmit antenna connectors in closed-loop spatial multiplexing scheme, the requirements in Table 6.6.2.1B.3-1 apply to each transmit antenna connector with the UL-MIMO configurations specified in Table 6.2.2B.3-2.

**Table 6.6.2.1B.3-1: General E-UTRA spectrum emission mask**

Spectrum emission limit (dBm)/ Channel bandwidth							
$\Delta f_{\text{OoB}}$ (MHz)	1.4 MHz	3.0 MHz	5 MHz	10 MHz	15 MHz	20 MHz	Measurement bandwidth
$\pm 0-1$	-10	-13	-15	-18	-20	-21	30 kHz
$\pm 1-2.5$	-10	-10	-10	-10	-10	-10	1 MHz
$\pm 2.5-2.8$	-25	-10	-10	-10	-10	-10	1 MHz
$\pm 2.8-5$		-10	-10	-10	-10	-10	1 MHz
$\pm 5-6$		-25	-13	-13	-13	-13	1 MHz
$\pm 6-10$			-25	-13	-13	-13	1 MHz
$\pm 10-15$				-25	-13	-13	1 MHz
$\pm 15-20$					-25	-13	1 MHz
$\pm 20-25$						-25	1 MHz

NOTE: As a general rule, the resolution bandwidth of the measuring equipment should be equal to the measurement bandwidth. However, to improve measurement accuracy, sensitivity and efficiency, the resolution bandwidth may be smaller than the measurement bandwidth. When the resolution bandwidth is smaller than the measurement bandwidth, the result should be integrated over the measurement bandwidth in order to obtain the equivalent noise bandwidth of the measurement bandwidth.

The normative reference for this requirement is TS 36.101 clause 6.6.2B.

### 6.6.2.1B.4 Test description

#### 6.6.2.1B.4.1 Initial conditions

Initial conditions are a set of test configurations the UE needs to be tested in and the steps for the SS to take with the UE to reach the correct measurement state.

The initial test configurations consist of environmental conditions, test frequencies, and channel bandwidths based on E-UTRA bands specified in table 5.4.2.1-1. All of these configurations shall be tested with applicable test parameters for each channel bandwidth, and are shown in table 6.6.2.1B.4.1-1. The details of the uplink reference measurement channels (RMCs) are specified in Annexes A.2 respectively. Configurations of PDSCH and PDCCH before measurement are specified in Annex C.2.

**Table 6.6.2.1B.4.1-1: Test Configuration Table**

Initial Conditions				
Test Environment (as specified in TS 36.508 [7] clause 4.1)		NC		
Test Frequencies (as specified in TS 36.508 [7] clause 4.3.1)		Low range, Mid range, High range		
Test Channel Bandwidths (as specified in TS 36.508 [7] clause 4.3.1)		Lowest, 5MHz, 10MHz, Highest		
Test Parameters for Channel Bandwidths				
Downlink Configuration		Uplink Configuration		
Ch BW	N/A for SEM testing	Mod'n	RB allocation	
		FDD	TDD	
1.4MHz		QPSK	6	6
1.4MHz		QPSK	5	5
1.4MHz		16QAM	5	5
1.4MHz		16QAM	6	6
3MHz		QPSK	15	15
3MHz		QPSK	4	4
3MHz		16QAM	4	4
3MHz		16QAM	15	15
5MHz		QPSK	25	25
5MHz		QPSK	8	8
5MHz		16QAM	8	8
5MHz		16QAM	25	25
10MHz		QPSK	50	50
10MHz		QPSK	12	12
10MHz		16QAM	12	12
10MHz		16QAM	50 (Note 4)	50 (Note 4)
15MHz		QPSK	75	75
15MHz		QPSK	16	16
15MHz	16QAM	16	16	
15MHz	16QAM	75 (Note 4)	75 (Note 4)	
20MHz	QPSK	100	100	
20MHz	QPSK	18	18	
20MHz	16QAM	18	18	
20MHz	16QAM	100 (Note 4)	100 (Note 4)	
Note 1: Test Channel Bandwidths are checked separately for each E-UTRA band, which applicable channel bandwidths are specified in Table 5.4.2.1-1. Note 2: The allowed MPR for maximum output power UE might apply is described in clause 6.2.3B.3. Note 3: The RB <sub>start</sub> of partial RB allocation shall be RB#0 and RB# (max+1 - RB allocation) of the channel bandwidth. Note 4: Applies only for UE-Categories [FFS].				

1. Connect the SS to the UE antenna connectors as shown in Figure TS 36.508 [7] Annex A, Figure A.28.
2. The parameter settings for the cell are set up according to TS 36.508 [7] clause 4.4.3.
3. Downlink signals are initially set up according to Annex C0, C.1 and C.3.0, and uplink signals according to Annex H.1 and H.3.0.
4. The UL Reference Measurement channels are set according to Table 6.6.2.1B.4.1-1.
5. Propagation conditions are set according to Annex B.0.
6. Ensure the UE is in State 3A-RF according to TS 36.508 [7] clause 5.2A.2. Message contents are defined in clause 6.6.2.1B.4.3.

### 6.6.2.1B.4.2 Test procedure

1. SS sends uplink scheduling information via PDCCH DCI format 4 for C\_RNTI to schedule the UL RMC according to Table 6.6.2.1B.4.1-1. Since the UE has no payload data to send, the UE transmits uplink MAC padding bits on the UL RMC.
2. Send continuously uplink power control "up" commands in the uplink scheduling information to the UE until the UE transmits at PUMAX level.
3. Measure the sum of the mean power at each antenna connector of UE in the channel bandwidth of the radio access mode according to the test configuration, which shall meet the requirements described in clause 6.2.3B.5. The period of the measurement shall be at least the continuous duration of one sub-frame (1ms). For TDD slots with transient periods are not under test.
4. Measure the power of the transmitted signal at each antenna connector of UE with a measurement filter of bandwidths according to table 6.6.2.1B.5-1 or 6.6.2.1B.5-2 as applicable. The centre frequency of the filter shall be stepped in continuous steps according to the same table. The measured power shall be recorded for each step. The measurement period shall capture the active TSs.

### 6.6.2.1B.4.3 Message contents

Message contents are according to TS 36.508 [7] subclause 4.6.

### 6.6.2.1B.5 Test requirements

The measured sum of mean power at each antenna connector of UE in the channel bandwidth, derived in step 3, shall fulfil requirements in clause 6.2.3B.5 as appropriate,

And the power of any UE emission at each transmit antenna connector shall fulfil requirements in Table.6.6.2.1B.5-1 or Table.6.6.2.1B.5-2 as applicable.

**Table 6.6.2.1B.5-1: General E-UTRA spectrum emission mask, E UTRA bands  $\leq$  3GHz**

Spectrum emission limit (dBm)/ Channel bandwidth							
$\Delta f_{\text{OoB}}$ (MHz)	1.4 MHz	3.0 MHz	5 MHz	10 MHz	15 MHz	20 MHz	Measurement bandwidth
0-1	-8.5	-11.5	-13.5	-16.5	-18.5	-19.5	30 kHz
1-2.5	-8.5	-8.5	-8.5	-8.5	-8.5	-8.5	1 MHz
2.5-2.8	-23.5						1 MHz
2.8-5							1 MHz
5-6		-23.5	-11.5	-11.5	-11.5	-11.5	1 MHz
6-10							-23.5
10-15				-23.5			1 MHz
15-20					-23.5		1 MHz
20-25						-23.5	1 MHz
Note 1: The first and last measurement position with a 30 kHz filter is at $\Delta f_{\text{OoB}}$ equals to 0.015 MHz and 0.985 MHz. Note 2: At the boundary of spectrum emission limit, the first and last measurement position with a 1 MHz filter is the inside of +0.5MHz and -0.5MHz, respectively. Note 3: The measurements are to be performed above the upper edge of the channel and below the lower edge of the channel Note 4: For the 2.5-2.8 MHz offset range with 1.4 MHz channel bandwidth, the measurement position is at $\Delta f_{\text{OoB}}$ equals to 3 MHz.							



**Table 6.6.2.1B.5-2: General E-UTRA spectrum emission mask, 3GHz < E UTRA bands ≤ 4.2GHz**

Spectrum emission limit (dBm)/ Channel bandwidth							
$\Delta f_{\text{OoB}}$ (MHz)	1.4 MHz	3.0 MHz	5 MHz	10 MHz	15 MHz	20 MHz	Measurement bandwidth
0-1	-8.2	-11.2	-13.2	-16.2	-18.2	-19.2	30 kHz
1-2.5	-8.2	-8.2	-8.2	-8.2	-8.2	-8.2	1 MHz
2.5-2.8	-23.2						1 MHz
2.8-5							1 MHz
5-6		-23.2	-11.2	-11.2	-11.2	-11.2	1 MHz
6-10			-23.2				1 MHz
10-15				-23.2			1 MHz
15-20					-23.2		1 MHz
20-25						-23.2	1 MHz
Note 1:	The first and last measurement position with a 30 kHz filter is at $\Delta f_{\text{OoB}}$ equals to 0.015 MHz and 0.985 MHz.						
Note 2:	At the boundary of spectrum emission limit, the first and last measurement position with a 1 MHz filter is the inside of +0.5MHz and -0.5MHz, respectively.						
Note 3:	The measurements are to be performed above the upper edge of the channel and below the lower edge of the channel						
Note 4:	For the 2.5-2.8 MHz offset range with 1.4 MHz channel bandwidth, the measurement position is at $\Delta f_{\text{OoB}}$ equals to 3 MHz.						

NOTE: As a general rule, the resolution bandwidth of the measuring equipment should be equal to the measurement bandwidth. However, to improve measurement accuracy, sensitivity and efficiency, the resolution bandwidth may be smaller than the measurement bandwidth. When the resolution bandwidth is smaller than the measurement bandwidth, the result should be integrated over the measurement bandwidth in order to obtain the equivalent noise bandwidth of the measurement bandwidth.

## 6.6.2.2 Additional Spectrum Emission Mask

### 6.6.2.2.1 Test purpose

To verify that the power of any UE emission shall not exceed specified level for the specified channel bandwidth under the deployment scenarios where additional requirements are specified.

### 6.6.2.2.2 Test applicability

This test case applies to all types of E-UTRA UE release 8 and forward.

### 6.6.2.2.3 Minimum conformance requirements

#### 6.6.2.2.3.1 Minimum requirement (network signalled value "NS\_03", "NS\_11", "NS\_20" and "NS\_21")

When "NS\_03", "NS\_11", "NS\_20" or "NS\_21" is indicated in the cell, the power of any UE emission shall not exceed the levels specified in Table 6.6.2.2.3.1-1.

**Table 6.6.2.2.3.1-1: Additional requirements (network signalled value "NS\_03", "NS\_11", "NS\_20" and "NS\_21")**

$\Delta f_{\text{OoB}}$ (MHz)	Spectrum emission limit (dBm)/ Channel bandwidth						
	1.4 MHz	3.0 MHz	5 MHz	10 MHz	15 MHz	20 MHz	Measurement bandwidth
$\pm 0-1$	-10	-13	-15	-18	-20	-21	30 kHz
$\pm 1-2.5$	-13	-13	-13	-13	-13	-13	1 MHz
$\pm 2.5-2.8$	-25	-13	-13	-13	-13	-13	1 MHz
$\pm 2.8-5$		-13	-13	-13	-13	-13	1 MHz
$\pm 5-6$		-25	-13	-13	-13	-13	1 MHz
$\pm 6-10$			-25	-13	-13	-13	1 MHz
$\pm 10-15$				-25	-13	-13	1 MHz
$\pm 15-20$					-25	-13	1 MHz
$\pm 20-25$						-25	1 MHz

NOTE: As a general rule, the resolution bandwidth of the measuring equipment should be equal to the measurement bandwidth. However, to improve measurement accuracy, sensitivity and efficiency, the resolution bandwidth may be smaller than the measurement bandwidth. When the resolution bandwidth is smaller than the measurement bandwidth, the result should be integrated over the measurement bandwidth in order to obtain the equivalent noise bandwidth of the measurement bandwidth.

The normative reference for this requirement is TS 36.101 [2] clause 6.6.2.2.1.

#### 6.6.2.2.3.2 Minimum requirement (network signalled value "NS\_04")

When "NS\_04" is indicated in the cell, the power of any UE emission shall not exceed the levels specified in Table 6.6.2.2.3.2-1.

**Table 6.6.2.2.3.2-1: Additional requirements (network signalled value "NS\_04")**

$\Delta f_{\text{OoB}}$ (MHz)	Spectrum emission limit (dBm)/ Channel bandwidth						
	1.4 MHz	3.0 MHz	5 MHz	10 MHz	15 MHz	20 MHz	Measurement bandwidth
$\pm 0-1$	-10	-13	-15	-18	-20	-21	30 kHz
$\pm 1-2.5$	-13	-13	-13	-13	-13	-13	1 MHz
$\pm 2.5-2.8$	-25	-13	-13	-13	-13	-13	1 MHz
$\pm 2.8-5$		-13	-13	-13	-13	-13	1 MHz
$\pm 5-6$		-25	-25	-25	-25	-25	1 MHz
$\pm 6-10$			-25	-25	-25	-25	1 MHz
$\pm 10-15$				-25	-25	-25	1 MHz
$\pm 15-20$					-25	-25	1 MHz
$\pm 20-25$						-25	1 MHz

NOTE: As a general rule, the resolution bandwidth of the measuring equipment should be equal to the measurement bandwidth. However, to improve measurement accuracy, sensitivity and efficiency, the resolution bandwidth may be smaller than the measurement bandwidth. When the resolution bandwidth is smaller than the measurement bandwidth, the result should be integrated over the measurement bandwidth in order to obtain the equivalent noise bandwidth of the measurement bandwidth.

The normative reference for this requirement is TS 36.101 [2] clause 6.6.2.2.2.

#### 6.6.2.2.3.3 Minimum requirement (network signalled value "NS\_06" or NS\_07)

When "NS\_06" or "NS\_07" is indicated in the cell, the power of any UE emission shall not exceed the levels specified in Table 6.6.2.2.3.3-1.

**Table 6.6.2.2.3.3-1: Additional requirements (network signalled value "NS\_06" or "NS\_07")**

$\Delta f_{\text{OoB}}$ (MHz)	Spectrum emission limit (dBm)/ Channel bandwidth				
	1.4 MHz	3.0 MHz	5 MHz	10 MHz	Measurement bandwidth
$\pm 0-0.1$	-13	-13	-15	-18	30 kHz
$\pm 0.1-1$	-13	-13	-13	-13	100 kHz
$\pm 1-2.5$	-13	-13	-13	-13	1 MHz
$\pm 2.5-2.8$	-25	-13	-13	-13	1 MHz
$\pm 2.8-5$		-13	-13	-13	1 MHz
$\pm 5-6$		-25	-13	-13	1 MHz
$\pm 6-10$			-25	-13	1 MHz
$\pm 10-15$				-25	1 MHz

NOTE: As a general rule, the resolution bandwidth of the measuring equipment should be equal to the measurement bandwidth. However, to improve measurement accuracy, sensitivity and efficiency, the resolution bandwidth may be smaller than the measurement bandwidth. When the resolution bandwidth is smaller than the measurement bandwidth, the result should be integrated over the measurement bandwidth in order to obtain the equivalent noise bandwidth of the measurement bandwidth.

The normative reference for this requirement is TS 36.101 [2] clause 6.6.2.2.3.

#### 6.6.2.2.4 Test description

##### 6.6.2.2.4.1 Initial conditions

Initial conditions are a set of test configurations the UE needs to be tested in and the steps for the SS to take with the UE to reach the correct measurement state.

The initial test configurations consist of environmental conditions, test frequencies, and channel bandwidths based on E-UTRA bands specified in table 5.4.2.1-1. All of these configurations shall be tested with applicable test parameters for each channel bandwidth, and are shown in Tables 6.6.2.2.4.1-1 through 6.6.2.2.4.1-7. The details of the uplink reference measurement channels (RMCs) are specified in Annex A.2 respectively. Configurations of PDSCH and PDCCH before measurement are specified in Annex C.2.

**Table 6.6.2.2.4.1-1: Test Configuration Table (network signalled value "NS\_03")**

Initial Conditions						
Test Environment (as specified in TS 36.508 [7] subclause 4.1)				NC		
Test Frequencies (as specified in TS36.508 [7] subclause 4.3.1)				Low range, Mid range, High range		
Test Channel Bandwidths (as specified in TS 36.508 [7] subclause 4.3.1)				Lowest, 5MHz, 10MHz, Highest		
Test Parameters for Channel Bandwidths						
Ch BW	Downlink Configuration			Uplink Configuration		
	Mod'n	RB allocation		Mod'n	RB allocation	
		FDD	TDD		FDD	TDD
1.4MHz	N/A for Additional Spectrum Emission Mask testing.			QPSK	6	6
1.4MHz				QPSK	5	5
1.4MHz				16QAM	5	5
3MHz				QPSK	15	15
3MHz				QPSK	4	4
3MHz				16QAM	15	15
3MHz				16QAM	4	4
5MHz				QPSK	25	25
5MHz				QPSK	8	8
5MHz				QPSK	6	6
5MHz				16QAM	25	25
5MHz				16QAM	8	8
10MHz				QPSK	50	50
10MHz				QPSK	12	12
10MHz				QPSK	6	6
10MHz				16QAM	50 (Note 3)	50 (Note 3)
10MHz				16QAM	12	12
15MHz				QPSK	75	75
15MHz				QPSK	16	16
15MHz				QPSK	8	8
15MHz			16QAM	75 (Note 3)	75 (Note 3)	
15MHz			16QAM	16	16	
20MHz			QPSK	100	100	
20MHz			QPSK	18	18	
20MHz			QPSK	10	10	
20MHz			16QAM	100 (Note 3)	100 (Note 3)	
20MHz			16QAM	18	18	

Note 1: Test Channel Bandwidths are checked separately for each E-UTRA band, the applicable channel bandwidths are specified in Table 5.4.2.1-1.

Note 2: The RB<sub>start</sub> of partial RB allocation shall be RB# 0 and RB# (max +1 - RB allocation) of the channel bandwidth.

Note 3: Applies only for UE-Categories ≥2

**Table 6.6.2.2.4.1-2: Test Configuration Table (network signalled value "NS\_06")**

Initial Conditions						
Test Environment (as specified in TS 36.508 [7] subclause 4.1)				NC		
Test Frequencies (as specified in TS36.508 [7] subclause 4.3.1)				Low range, Mid range, High range		
Test Channel Bandwidths (as specified in TS 36.508 [7] subclause 4.3.1)				Lowest, 5MHz, 10MHz, Highest		
Test Parameters for Channel Bandwidths						
Ch BW	Downlink Configuration			Uplink Configuration		
	Mod'n	RB allocation		Mod'n	RB allocation	
		FDD	TDD		FDD	TDD
1.4MHz	N/A for Additional Spectrum Emission Mask testing.			QPSK	6	NA
1.4MHz				QPSK	5	
1.4MHz				16QAM	5	
3MHz				QPSK	15	
3MHz				QPSK	4	
3MHz				16QAM	4	
5MHz				QPSK	25	
5MHz				QPSK	8	
5MHz				16QAM	8	
10MHz				QPSK	50	
10MHz				QPSK	12	
10MHz				16QAM	12	
15MHz				QPSK	75	
15MHz				QPSK	16	
15MHz				16QAM	16	
20MHz				QPSK	100	
20MHz				QPSK	18	
20MHz			16QAM	18		
<p>Note 1: Test Channel Bandwidths are checked separately for each E-UTRA band, the applicable channel bandwidths are specified in Table 5.4.2.1-1.</p> <p>Note 2: The RB<sub>start</sub> of partial RB allocation shall be RB# 0 and RB# (max +1 - RB allocation) of the channel bandwidth.</p>						

**Table 6.6.2.2.4.1-3: Test Configuration Table (network signalled value "NS\_07")**

Initial Conditions						
Test Environment (as specified in TS 36.508 [7] subclause 4.1)				NC		
Test Frequencies (as specified in TS36.508 [7] subclause 4.3.1)				Mid range		
Test Channel Bandwidths (as specified in TS 36.508 [7] subclause 4.3.1)				10MHz		
Test Parameters for Channel Bandwidths						
Test Number	Ch BW	Downlink Configuration		Uplink Configuration		
		Mod'n	RB allocation FDD	Mod'n	RB allocation FDD	RB <sub>start</sub>
1	10MHz	N/A for Additional Spectrum Emission Mask testing.		QPSK	1	0
2	10MHz			QPSK	8	0
3	10MHz			QPSK	6	13
4	10MHz			QPSK	20	13
5	10MHz			QPSK	12	13
6	10MHz			16QAM	36 (Note 1)	13
7	10MHz			QPSK	16	19
8	10MHz			QPSK	12	19
9	10MHz			16QAM	16	19
10	10MHz			QPSK	30	19
11	10MHz			16QAM	30 (Note 1)	19
12	10MHz			QPSK	6	43
13	10MHz			QPSK	2	48
14	10MHz			QPSK	50	0
15	10MHz			QPSK	12	0
16	10MHz			16QAM	50 (Note 1)	0
Note 1: Applies only for UE-Categories 2-5						

**Table 6.6.2.2.4.1-4: Test Configuration Table (network signalled value "NS\_04")**

Initial Conditions						
Test Environment (as specified in TS 36.508 [7] subclause 4.1)				NC		
Test Frequencies (as specified in TS36.508 [7] subclause 4.3.1)				Low range, Mid range, High range		
Test Channel Bandwidths (as specified in TS 36.508 [7] subclause 4.3.1)				5MHz, 10 MHz, 15 MHz, 20MHz		
Test Parameters for NS_04 A-MPR						
Configuration ID	Ch BW	Downlink Configuration		Uplink Configuration		
		Mod'n	RB allocation TDD	Mod'n	RB allocation TDD	RB <sub>start</sub> TDD
1	5MHz	N/A for Additional Spectrum Emission Mask testing.		QPSK	25	Note 2
2	5MHz			QPSK	8	Note 2
3	5MHz			QPSK	6	Note 2
4	5MHz			16QAM	25	Note 2
5	5MHz			16QAM	8	Note 2
6	10MHz			QPSK	1	0
7	10MHz			QPSK	12	0
8	10MHz			QPSK	50	0
9	10MHz			16QAM	50 (Note 3)	0
10	10MHz			QPSK	24	13
11	10MHz			16QAM	24	13
12	10MHz			QPSK	36	13
13	10MHz			QPSK	12	37
14	10MHz			QPSK	1	49
15	15MHz			QPSK	1	0
16	15MHz			QPSK	16	0
17	15MHz			QPSK	75	0
18	15MHz			16QAM	75 (Note 3)	0
19	15MHz			QPSK	36	19
20	15MHz			16QAM	36 (Note 3)	19
21	15MHz			QPSK	50	19
22	15MHz			QPSK	18	56
23	15MHz			QPSK	1	74
24	20MHz			QPSK	1	0
25	20MHz			QPSK	18	0
26	20MHz			QPSK	100	0
27	20MHz			16QAM	100 (Note 3)	0
28	20MHz			QPSK	50	25
29	20MHz			16QAM	50 (Note 3)	25
30	20MHz			QPSK	75	25
31	20MHz			QPSK	25	75
32	20MHz			QPSK	1	99
Note 1: Test Channel Bandwidths are checked separately for E-UTRA band, the applicable channel bandwidths are specified in Table 5.4.2.1-1. Note 2: The RB <sub>start</sub> of partial RB allocation shall be RB# 0 and RB# (max +1 - RB allocation) of the channel bandwidth. Note 3: Applies only for UE-Categories 2-5						

**Table 6.6.2.2.4.1-5: Test Configuration Table (network signalled value "NS\_11")**

Initial Conditions	
Test Environment (as specified in TS 36.508 [7] subclause 4.1)	Normal

<p>Test Frequencies (as specified in TS36.508 [7] subclause 4.3.1)</p>	<p>Low range, Mid range, High range</p> <p>For 3 MHz Channel Bandwidth:                      a. 2001.5 MHz (<math>N_{UL} = 25515</math>)                      b. 2004.5 MHz (<math>N_{UL} = 25545</math>)</p> <p>For 5 MHz Channel Bandwidth                      a. 2002.5 MHz (<math>N_{UL} = 25525</math>)                      b. 2004.5 MHz (<math>N_{UL} = 25545</math>)                      c. 2007.5 MHz (<math>N_{UL} = 25575</math>)</p> <p>For 10 MHz Channel Bandwidth                      a. 2005 MHz (<math>N_{UL} = 25550</math>)                      b. 2005.5 MHz (<math>N_{UL} = 25555</math>)                      c. 2015 MHz (<math>N_{UL} = 25650</math>)</p> <p>For 15 MHz Channel Bandwidth                      a. 2007.5 MHz (<math>N_{UL} = 25575</math>)                      b. 2012.5 MHz (<math>N_{UL} = 25625</math>)</p> <p>For 20 MHz Channel Bandwidth                      a. 2010 MHz (<math>N_{UL} = 25600</math>)</p>
<p>Test Channel Bandwidths (as specified in TS 36.508 [7] subclause 4.3.1)</p>	<p>3MHz, 5MHz, 10MHz, 15MHz, 20MHz</p>



Test Parameters for NS_11 A-MPR					
Configuration ID	Ch BW	Downlink Configuration		Uplink Configuration	
		Mod'n	RB allocation FDD	Mod'n	RB allocation FDD
1	3MHz	N/A for A-MPR testing		QPSK	6
2	3MHz			QPSK	15
3	3MHz			16QAM	6
4	3MHz			16QAM	15
5	5MHz			QPSK	1
6	5MHz			QPSK	8
7	5MHz			QPSK	25
8	5MHz			16QAM	8
9	5MHz			16QAM	25
10	10MHz			QPSK	1
11	10MHz			QPSK	12
12	10MHz			QPSK	50
13	10MHz			16QAM	12
14	10MHz			16QAM	50 (Note 3)
15	15MHz			QPSK	1
16	15MHz			QPSK	8
17	15MHz			QPSK	25
18	15MHz			QPSK	30
19	15MHz			QPSK	75
20	15MHz			16QAM	8
21	15MHz			16QAM	25
22	15MHz			16QAM	30
23	15MHz			16QAM	75
24	20MHz			QPSK	1
25	20MHz			QPSK	10
26	20MHz			QPSK	25
27	20MHz			QPSK	100
28	20MHz			16QAM	10
29	20MHz			16QAM	25
30	20MHz			16QAM	100

Note 1: The Configuration ID will be used to map the applicable Test Configuration to the corresponding Test Requirement in subclause 6.2.4.5 as not all combinations are necessarily required based on the applicability of the UE.

Note 2: The RB<sub>start</sub> of partial RB allocation shall be RB# 0 and RB# (max +1 - RB allocation) of the channel bandwidth.

Note 3: Applies only for UE-Categories ≥2.

**Table 6.6.2.4.1-6: Test Configuration Table (network signalled value "NS\_20")**

<b>Initial Conditions</b>	
Test Environment (as specified in TS 36.508 [7] subclause 4.1)	Normal
Test Frequencies (as specified in TS36.508 [7] subclause 4.3.1)	<p>Low range, Mid range, High range</p> <p>For 5 MHz Channel Bandwidth</p> <ul style="list-style-type: none"> <li>a. 2002.5 MHz (<math>N_{UL} = 25525</math>)</li> <li>b. 2007.5 MHz (<math>N_{UL} = 25575</math>)</li> <li>c. 2012.5 MHz (<math>N_{UL} = 25625</math>)</li> <li>d. 2017.5 MHz (<math>N_{UL} = 25675</math>)</li> </ul> <p>For 10 MHz Channel Bandwidth</p> <ul style="list-style-type: none"> <li>a. 2005 MHz (<math>N_{UL} = 25550</math>)</li> <li>b. 2015 MHz (<math>N_{UL} = 25650</math>)</li> </ul> <p>For 15 MHz Channel Bandwidth</p> <ul style="list-style-type: none"> <li>a. 2012.5 MHz (<math>N_{UL} = 25625</math>)</li> </ul> <p>For 20 MHz Channel Bandwidth</p> <ul style="list-style-type: none"> <li>a. 2010 MHz (<math>N_{UL} = 25600</math>)</li> </ul>
Test Channel Bandwidths (as specified in TS 36.508 [7] subclause 4.3.1)	5MHz, 10MHz, 15MHz, 20MHz

Test Parameters for NS_20 A-MPR					
Configuration ID	Ch BW	Downlink Configuration		Uplink Configuration	
		Mod'n	RB allocation FDD	Mod'n	RB allocation FDD
1	5MHz	N/A for A-MPR testing		QPSK	8
2	5MHz			QPSK	15
3	5MHz			QPSK	25
4	5MHz			16QAM	15
5	5MHz			16QAM	25
6	10MHz			QPSK	8
7	10MHz			QPSK	12
8	10MHz			QPSK	50
9	10MHz			16QAM	12
10	10MHz			16QAM	50 (Note 3)
11	15MHz			QPSK	6
12	15MHz			QPSK	25
13	15MHz			QPSK	36
14	15MHz			QPSK	75
15	15MHz			16QAM	25
16	15MHz			16QAM	36
17	15MHz			16QAM	75
18	20MHz			QPSK	8
19	20MHz			QPSK	18
20	20MHz			QPSK	25
21	20MHz			QPSK	75
22	20MHz			QPSK	100
23	20MHz			16QAM	18
24	20MHz			16QAM	25
25	20MHz			16QAM	75
26	20MHz			16QAM	100

Note 1: The Configuration ID will be used to map the applicable Test Configuration to the corresponding Test Requirement in subclause 6.2.4.5 as not all combinations are necessarily required based on the applicability of the UE.

Note 2: The RB<sub>start</sub> of partial RB allocation shall be RB# 0 and RB# (max +1 - RB allocation) of the channel bandwidth.

Note 3: Applies only for UE-Categories ≥2.

**Table 6.6.2.2.4.1-7: Test Configuration Table (network signalled value "NS\_21")**

Initial Conditions						
Test Environment (as specified in TS 36.508 [7] subclause 4.1)				NC		
Test Frequencies (as specified in TS36.508 [7] subclause 4.3.1)				Low range or High range		
Test Channel Bandwidths (as specified in TS 36.508 [7] subclause 4.3.1)				5 MHz, 10 MHz		
Test Parameters for Channel Bandwidths						
Configuration ID	Ch BW	Downlink Configuration		Uplink Configuration		
		Mod'n	RB allocation	Mod'n	RB allocation FDD	RBstart FDD
1 (note 2)	5 MHz			QPSK	1	0
2 (note 2)	5 MHz			QPSK	25	0
3 (note 2)	10 MHz			QPSK	1	0
4 (note 3)	10 MHz			QPSK	1	49
5 (note 2)	10 MHz			QPSK	15	0
6 (note 3)	10 MHz			QPSK	3	47
7 (note 3)	10 MHz			QPSK	50	0
8 (note 1, 3)	10 MHz			16QAM	50	0
Note 1: Applies only for UE-Categories $\geq 2$ .						
Note 2: Applicable only to low range frequency testing.						
Note 3: Applicable only to high range frequency testing.						

1. Connect the SS to the UE antenna connectors as shown in TS 36.508 [7] Annex A, Figure A.3.
2. The parameter settings for the cell are set up according to TS 36.508 [7] subclause 4.4.3.
3. Downlink signals are initially set up according to Annex C0, C.1 and C.3.0, and uplink signals according to Annex H.1 and H.3.0.
4. The DL Reference Measurement channels are set according to Tables 6.6.2.2.4.1-1 to 6.6.2.2.4.1-7.
5. Propagation conditions are set according to Annex B.0.
6. Ensure the UE is in State 3A-RF according to TS 36.508 [7] clause 5.2A.2. Message contents are defined in clause 6.6.2.2.4.3.

#### 6.6.2.2.4.2 Test procedure

1. SS sends uplink scheduling information for each UL HARQ process via PDCCH DCI format 0 for C\_RNTI to schedule the UL RMC according to applicable table from Table 6.6.2.2.4.1-1 to 6.6.2.2.4.1-7. Since the UE has no payload data to send, the UE transmits uplink MAC padding bits on the UL RMC.
2. Send continuously uplink power control "up" commands in the uplink scheduling information to the UE until the UE transmits at  $P_{UMAX}$  level.
3. Measure the mean power of the UE in the channel bandwidth of the radio access mode according to the test configuration, which shall meet the requirements described in Table 6.2.4.5-1 to 6.2.4.5-9 as appropriate. The period of the measurement shall be at least one sub-frame (1ms).
4. Measure the power of the transmitted signal with a measurement filter of bandwidths according to Table 6.6.2.2.5.1-1, 6.6.2.2.5.2-1, 6.6.2.2.5.3-1 or Table 6.6.2.2.5.1-2, 6.6.2.2.5.2-2, 6.6.2.2.5.3-2, as applicable. The centre frequency of the filter shall be stepped in continuous steps according to the same table. The measured power shall be recorded for each step. The measurement period shall capture the active TSs.

## 6.6.2.2.4.3 Message contents

Message contents are according to TS 36.508 [7] subclause 4.6, with the following exceptions for each network signalled value.

## 6.6.2.2.4.3.1 Message contents exceptions (network signalled value "NS\_03")

1. Information element `additionalSpectrumEmission` is set to NS\_03. This can be set in the *SystemInformationBlockType2* as part of the cell broadcast message. This exception indicates that the UE shall meet the additional spurious emission requirement for a specific deployment scenario.

**Table 6.6.2.2.4.3.1-1: SystemInformationBlockType2 :Additional spurious emissions requirement**

Derivation Path: TS 36.508 [7] clause 4.4.3.3, Table 4.4.3.3-1			
Information Element	Value/remark	Comment	Condition
<code>additionalSpectrumEmission</code>	3 (NS_03)		

## 6.6.2.2.4.3.2 Message contents exceptions (network signalled value "NS\_04")

1. Information element `additionalSpectrumEmission` is set to NS\_04. This can be set in the *SystemInformationBlockType2* as part of the cell broadcast message. This exception indicates that the UE shall meet the additional spurious emission requirement for a specific deployment scenario.

**Table 6.6.2.2.4.3.2-1: SystemInformationBlockType2 :Additional spurious emissions requirement**

Derivation Path: TS 36.508 [7] clause 4.4.3.3, Table 4.4.3.3-1			
Information Element	Value/remark	Comment	Condition
<code>additionalSpectrumEmission</code>	4 (NS_04)		

## 6.6.2.2.4.3.3 Message contents exceptions (network signalled value "NS\_06")

1. Information element `additionalSpectrumEmission` is set to NS\_06. This can be set in the *SystemInformationBlockType2* as part of the cell broadcast message. This exception indicates that the UE shall meet the additional spurious emission requirement for a specific deployment scenario.

**Table 6.6.2.2.4.3.3-1: SystemInformationBlockType2 :Additional spurious emissions requirement**

Derivation Path: TS 36.508 [7] clause 4.4.3.3, Table 4.4.3.3-1			
Information Element	Value/remark	Comment	Condition
<code>additionalSpectrumEmission</code>	6 (NS_06)		

## 6.6.2.2.4.3.4 Message contents exceptions (network signalled value "NS\_07")

1. Information element `additionalSpectrumEmission` is set to NS\_07. This can be set in the *SystemInformationBlockType2* as part of the cell broadcast message. This exception indicates that the UE shall meet the additional spurious emission requirement for a specific deployment scenario.

**Table 6.6.2.2.4.3.4-1: SystemInformationBlockType2 :Additional spurious emissions requirement**

Derivation Path: TS 36.508 [7] clause 4.4.3.3, Table 4.4.3.3-1			
Information Element	Value/remark	Comment	Condition
<code>additionalSpectrumEmission</code>	7 (NS_07)		

## 6.6.2.2.4.3.5 Message contents exceptions (network signalled value "NS\_11")

1. Information element `additionalSpectrumEmission` is set to NS\_11. This can be set in the *SystemInformationBlockType2* as part of the cell broadcast message. This exception indicates that the UE shall meet the additional spurious emission requirement for a specific deployment scenario.

**Table 6.6.2.2.4.3.5-1: SystemInformationBlockType2 :Additional spurious emissions requirement**

Derivation Path: TS 36.508 [7] clause 4.4.3.3, Table 4.4.3.3-1			
Information Element	Value/remark	Comment	Condition
additionalSpectrumEmission	11 (NS_11)		

6.6.2.2.4.3.6 Message contents exceptions (network signalled value "NS\_20")

1. Information element additionalSpectrumEmission is set to NS\_20. This can be set in the SystemInformationblockType2 as part of the cell broadcast message. This exception indicates that the UE shall meet the additional spurious emission requirement for a specific deployment scenario.

**Table 6.6.2.2.4.3.6-1: SystemInformationBlockType2 :Additional spurious emissions requirement**

Derivation Path: TS 36.508 [7] clause 4.4.3.3, Table 4.4.3.3-1			
Information Element	Value/remark	Comment	Condition
additionalSpectrumEmission	20 (NS_20)		

6.6.2.2.4.3.7 Message contents exceptions (network signalled value "NS\_21")

1. Information element additionalSpectrumEmission is set to NS\_21. This can be set in the SystemInformationblockType2 as part of the cell broadcast message. This exception indicates that the UE shall meet the additional spurious emission requirement for a specific deployment scenario.

**Table 6.6.2.2.4.3.7-1: SystemInformationBlockType2 :Additional spurious emissions requirement**

Derivation Path: TS 36.508 [7] clause 4.4.3.3, Table 4.4.3.3-1			
Information Element	Value/remark	Comment	Condition
additionalSpectrumEmission	21 (NS_21)		

6.6.2.2.5 Test requirements

6.6.2.2.5.1 Test requirements (network signalled value "NS\_03", "NS\_11", "NS\_20" and "NS\_21")

When "NS\_03" or "NS\_11" or "NS\_20" or "NS\_21" is indicated in the cell:

- the measured UE mean power in the channel bandwidth, derived in step 3, shall fulfil requirements in Table 6.2.4.5-1 and 6.2.4.5-2 as appropriate,

and

- the power of any UE emission shall fulfil requirements in Table 6.6.2.2.5.1-1 or 6.6.2.2.5.1-2, as applicable.

**Table 6.6.2.2.5.1-1: Additional requirements (network signalled value "NS\_03", "NS\_11", "NS\_20" and "NS\_21"), E-UTRA bands ≤ 3GHz**

	Spectrum emission limit (dBm)/ Channel bandwidth
--	--------------------------------------------------

$\Delta f_{OOB}$ (MHz)	1.4 MHz	3.0 MHz	5 MHz	10 MHz	15 MHz	20 MHz	Measurement bandwidth
0-1	-8.5	-11.5	-13.5	-16.5	-18.5	-19.5	30 kHz
1-2.5	-11.5	-11.5	-11.5	-11.5	-11.5	-11.5	1 MHz
2.5-2.8	-23.5						1 MHz
2.8-5		-23.5	-23.5	-23.5	-23.5	-23.5	1 MHz
5-6							1 MHz
6-10			-23.5				1 MHz
10-15				-23.5			1 MHz
15-20					-23.5		1 MHz
20-25						-23.5	1 MHz

Note 1: The first and last measurement position with a 30 kHz filter is at  $\Delta f_{OOB}$  equals to 0.015 MHz and 0.985 MHz.  
 Note 2: At the boundary of spectrum emission limit, the first and last measurement position with a 1 MHz filter is the inside of +0.5MHz and -0.5MHz, respectively.  
 Note 3: The measurements are to be performed above the upper edge of the channel and below the lower edge of the channel  
 Note 4: Above SEM requirement applies to bands corresponding to network signalling value NS\_03 as defined in TS 36.101 [2] subclause 6.2.4 Table 6.2.4-1.  
 Note 5: For the 2.5-2.8 MHz offset range with 1.4 MHz channel bandwidth, the measurement position is at  $\Delta f_{OOB}$  equals to 3 MHz.

**Table 6.6.2.2.5.1-2: Additional requirements (network signalled value "NS\_03", "NS\_11", "NS\_20" and "NS\_21"), 3GHz < E-UTRA bands ≤ 4.2GHz**

Spectrum emission limit (dBm)/ Channel bandwidth							
$\Delta f_{OOB}$ (MHz)	1.4 MHz	3.0 MHz	5 MHz	10 MHz	15 MHz	20 MHz	Measurement bandwidth
0-1	-8.2	-11.2	-13.2	-16.2	-18.2	-19.2	30 kHz
1-2.5	-11.2	-11.2	-11.2	-11.2	-11.2	-11.2	1 MHz
2.5-2.8	-23.2						1 MHz
2.8-5		-23.2	-23.2	-23.2	-23.2	-23.2	1 MHz
5-6							1 MHz
6-10			-23.2				1 MHz
10-15				-23.2			1 MHz
15-20					-23.2		1 MHz
20-25						-23.2	1 MHz

Note 1: The first and last measurement position with a 30 kHz filter is at  $\Delta f_{OOB}$  equals to 0.015 MHz and 0.985 MHz.  
 Note 2: At the boundary of spectrum emission limit, the first and last measurement position with a 1 MHz filter is the inside of +0.5MHz and -0.5MHz, respectively.  
 Note 3: The measurements are to be performed above the upper edge of the channel and below the lower edge of the channel  
 Note 4: Above SEM requirement applies to bands corresponding to network signalling value NS\_03 as defined in TS 36.101 [2] subclause 6.2.4 Table 6.2.4-1.  
 Note 5: For the 2.5-2.8 MHz offset range with 1.4 MHz channel bandwidth, the measurement position is at  $\Delta f_{OOB}$  equals to 3 MHz.

NOTE: (only for emission measurement) As a general rule, the resolution bandwidth of the measuring equipment should be equal to the measurement bandwidth. However, to improve measurement accuracy, sensitivity and efficiency, the resolution bandwidth may be smaller than the measurement bandwidth. When the resolution bandwidth is smaller than the measurement bandwidth, the result should be integrated over the measurement bandwidth in order to obtain the equivalent noise bandwidth of the measurement bandwidth.

6.6.2.2.5.2 Test requirements (network signalled value "NS\_04")

When "NS\_04" is indicated in the cell:

- the measured UE mean power in the channel bandwidth, derived in step 3, shall fulfil requirements in Table 6.2.4.5-3 as appropriate,

and

- the power of any UE emission shall fulfil requirements in Table 6.6.2.2.5.2-1 or Table.6.6.2.2.5.2-2, as applicable.

**Table 6.6.2.2.5.2-1: Additional requirements (network signalled value "NS\_04"), E-UTRA bands ≤ 3GHz**

Spectrum emission limit (dBm)/ Channel bandwidth							
$\Delta f_{OOB}$ (MHz)	1.4 MHz	3.0 MHz	5 MHz	10 MHz	15 MHz	20 MHz	Measurement bandwidth
0-1	-8.5	-11.5	-13.5	-16.5	-18.5	-19.5	30 kHz
1-2.5	-11.5	-11.5	-11.5	-11.5	-11.5	-11.5	1 MHz
2.5-2.8	-23.5						1 MHz
2.8-5							1 MHz
5-6		-23.5	-23.5	-23.5	-23.5	-23.5	1 MHz
6-10							1 MHz
10-15							1 MHz
15-20							1 MHz
20-25							1 MHz
Note 1:	The first and last measurement position with a 30 kHz filter is at $\Delta f_{OOB}$ equals to 0.015 MHz and 0.985 MHz.						
Note 2:	At the boundary of spectrum emission limit, the first and last measurement position with a 1 MHz filter is the inside of +0.5MHz and -0.5MHz, respectively.						
Note 3:	The measurements are to be performed above the upper edge of the channel and below the lower edge of the channel						
Note 4:	Above SEM requirement applies to bands corresponding to network signalling value NS_04 as defined in TS 36.101 [2] subclause 6.2.4 Table 6.2.4-1.						
Note 5:	For the 2.5-2.8 MHz offset range with 1.4 MHz channel bandwidth, the measurement position is at $\Delta f_{OOB}$ equals to 3 MHz.						

**Table 6.6.2.2.5.2-2: Additional requirements (network signalled value "NS\_04"), 3GHz < E-UTRA bands ≤ 4.2GHz**

Spectrum emission limit (dBm)/ Channel bandwidth							
$\Delta f_{OOB}$ (MHz)	1.4 MHz	3.0 MHz	5 MHz	10 MHz	15 MHz	20 MHz	Measurement bandwidth
0-1	-8.2	-11.2	-13.2	-16.2	-18.2	-19.2	30 kHz
1-2.5	-11.2	-11.2	-11.2	-11.2	-11.2	-11.2	1 MHz
2.5-2.8	-23.2						1 MHz
2.8-5							1 MHz
5-6		-23.2	-23.2	-23.2	-23.2	-23.2	1 MHz
6-10							1 MHz
10-15							1 MHz
15-20							1 MHz
20-25							1 MHz
Note 1:	The first and last measurement position with a 30 kHz filter is at $\Delta f_{OOB}$ equals to 0.015 MHz and 0.985 MHz.						
Note 2:	At the boundary of spectrum emission limit, the first and last measurement position with a 1 MHz filter is the inside of +0.5MHz and -0.5MHz, respectively.						
Note 3:	The measurements are to be performed above the upper edge of the channel and below the lower edge of the channel						
Note 4:	Above SEM requirement applies to bands corresponding to network signalling value NS_04 as defined in TS 36.101 [2] subclause 6.2.4 Table 6.2.4-1.						
Note 5:	For the 2.5-2.8 MHz offset range with 1.4 MHz channel bandwidth, the measurement position is at $\Delta f_{OOB}$ equals to 3 MHz.						

NOTE: (only for emission measurement) As a general rule, the resolution bandwidth of the measuring equipment should be equal to the measurement bandwidth. However, to improve measurement accuracy, sensitivity and efficiency, the resolution bandwidth may be smaller than the measurement bandwidth. When the resolution bandwidth is smaller than the measurement bandwidth, the result should be integrated over the measurement bandwidth in order to obtain the equivalent noise bandwidth of the measurement bandwidth.



Test requirements (network signalled value "NS\_06" or "NS\_07")

When "NS\_06" or "NS\_07" is indicated in the cell:

- the measured UE mean power in the channel bandwidth, derived in step 3, shall fulfil requirements in Table 6.2.4.5-5, 6.2.4.5-6 and 6.2.4.5-7 as appropriate 1,

and

- the power of any UE emission shall fulfil requirements in Table 6.6.2.2.5.3-1 or Table.6.6.2.2.5.3-2, as applicable.

**Table 6.6.2.2.5.3-1: Additional requirements (network signalled value "NS\_06" or "NS\_07"), E-UTRA bands ≤ 3GHz**

$\Delta f_{OOB}$ (MHz)	Spectrum emission limit (dBm)/ Channel bandwidth				
	1.4 MHz	3.0 MHz	5 MHz	10 MHz	Measurement bandwidth
0-0.1	-11.5	-11.5	-13.5	-16.5	30 kHz
0.1-1	-11.5	-11.5	-11.5	-11.5	100 kHz
1-2.5	-11.5	-11.5	-11.5	-11.5	1 MHz
2.5-2.8	-23.5				1 MHz
2.8-5					1 MHz
5-6		-23.5			1 MHz
6-10			-23.5		1 MHz
10-15				-23.5	1 MHz
Note 1:	The first and last measurement position with a 30 kHz filter is at $\Delta f_{OOB}$ equals to 0.015 MHz and 0.085 MHz. The first and last measurement position with a 100 kHz filter is at $\Delta f_{OOB}$ equals to 0.15 MHz and 0.95 MHz.				
Note 2:	At the boundary of spectrum emission limit, the first and last measurement position with a 1 MHz filter is the inside of +0.5MHz and -0.5MHz, respectively.				
Note 3:	The measurements are to be performed above the upper edge of the channel and below the lower edge of the channel				
Note 4:	Above SEM requirement applies to bands corresponding to network signalling value NS_06 and NS_07 as defined in TS 36.101 [2] subclause 6.2.4 Table 6.2.4-1.				
Note 5:	For the 2.5-2.8 MHz offset range with 1.4 MHz channel bandwidth, the measurement position is at $\Delta f_{OOB}$ equals to 3 MHz.				

**Table 6.6.2.2.5.3-2: Additional requirements (network signalled value "NS\_06" or "NS\_07"), 3GHz < E-UTRA bands ≤ 4.2GHz**

	Spectrum emission limit (dBm)/ Channel bandwidth

$\Delta f_{\text{OOB}}$ (MHz)	1.4 MHz	3.0 MHz	5 MHz	10 MHz	Measurement bandwidth
0-0.1	-11.2	-11.2	-13.2	-16.2	30 kHz
0.1-1	-11.2	-11.2	-11.2	-11.2	100 kHz
1-2.5	-11.2	-11.2	-11.2	-11.2	1 MHz
2.5-2.8	-23.2				1 MHz
2.8-5					1 MHz
5-6		-23.2			1 MHz
6-10			-23.2		1 MHz
10-15				-23.2	1 MHz
Note 1:	The first and last measurement position with a 30 kHz filter is at $\Delta f_{\text{OOB}}$ equals to 0.015 MHz and 0.085 MHz. The first and last measurement position with a 100 kHz filter is at $\Delta f_{\text{OOB}}$ equals to 0.15 MHz and 0.95 MHz.				
Note 2:	At the boundary of spectrum emission limit, the first and last measurement position with a 1 MHz filter is the inside of +0.5MHz and -0.5MHz, respectively.				
Note 3:	The measurements are to be performed above the upper edge of the channel and below the lower edge of the channel				
Note 4:	Above SEM requirement applies to bands corresponding to network signalling value NS_06 and NS_07 as defined in TS 36.101 [2] subclause 6.2.4 Table 6.2.4-1.				
Note 5:	For the 2.5-2.8 MHz offset range with 1.4 MHz channel bandwidth, the measurement position is at $\Delta f_{\text{OOB}}$ equals to 3 MHz.				

NOTE: (only for emission measurement) As a general rule, the resolution bandwidth of the measuring equipment should be equal to the measurement bandwidth. However, to improve measurement accuracy, sensitivity and efficiency, the resolution bandwidth may be smaller than the measurement bandwidth. When the resolution bandwidth is smaller than the measurement bandwidth, the result should be integrated over the measurement bandwidth in order to obtain the equivalent noise bandwidth of the measurement bandwidth.

## 6.6.2.2A Additional Spectrum Emission Mask for CA

### 6.6.2.2A.1 Additional Spectrum Emission Mask for CA (intra-band contiguous DL CA and UL CA)

Editor's notes: The following items are missing or incomplete:

- Need to update 36.521-2 with this new test case.

#### 6.6.2.2A.1.1 Test purpose

To verify that the power of any UE emission shall not exceed specified lever for the specified channel bandwidth for CA under the deployment scenarios where additional requirements are specified.

#### 6.6.2.2A.1.2 Test applicability

This test case applies to all types of E-UTRA UE release 10 and forward that support intra-band contiguous DL CA and UL CA.

#### 6.6.2.2A.1.3 Minimum conformance requirements

##### 6.6.2.2A.1.3.1 Minimum requirements (network signalled value "CA\_NS\_04")

Additional spectrum emission requirements are signalled by the network to indicate that the UE shall meet an additional requirement for a specific deployment scenario as part of the cell handover/broadcast message.

When "CA\_NS\_04" is indicated in the cell, the power of any UE emission shall not exceed the levels specified in Table 6.6.2.2A.1.3.1-1.

**Table 6.6.2.2A.1.3.1-1: Additional requirements**

Spectrum emission limit [dBm]/BW <sub>Channel_CA</sub>					
$\Delta f_{\text{OOB}}$ (MHz)	50+100RB (29.9 MHz)	75+75B (30 MHz)	75+100RB (34.85 MHz)	100+100RB (39.8 MHz)	Measurement bandwidth
± 0-1	-22.5	-22.5	-23.5	-24	30 kHz
± 1-5.5	-13	-13	-13	-13	1 MHz
± 5.5-34.9	-25	-25	-25	-25	1 MHz
± 34.9-35		-25	-25	-25	1 MHz
± 35-39.85			-25	-25	1 MHz
± 39.85-44.8				-25	1 MHz

NOTE: As a general rule, the resolution bandwidth of the measuring equipment should be equal to the measurement bandwidth. However, to improve measurement accuracy, sensitivity and efficiency, the resolution bandwidth may be smaller than the measurement bandwidth. When the resolution bandwidth is smaller than the measurement bandwidth, the result should be integrated over the measurement bandwidth in order to obtain the equivalent noise bandwidth of the measurement bandwidth.

The normative reference for this requirement is TS 36.101[2] subclause 6.6.2.2A.

6.6.2.2A.1.4 Test description

6.6.2.2A.1.4.1 Initial condition

Initial conditions are a set of test configurations the UE needs to be tested in and the steps for the SS to take with the UE to reach the correct measurement state.

The initial test configurations consist of environmental conditions, test frequencies, and channel bandwidths based on E-UTRA CA configurations specified in table 5.4.2A.1-1. All of these configurations shall be tested with applicable test parameters for each channel bandwidth, and are shown in table 6.6.2.2A.1.4.1-1. The details of the uplink reference measurement channels (RMCs) are specified in Annex A.2. Configurations of PDSCH and PDCCH before measurement are specified in Annex C.2.

**Table 6.6.2.2A.1.4.1-1: Test Configuration Table**

Initial Conditions						
Test Environment as specified in TS 36.508[7] subclause 4.1				NC		
Test Frequencies as specified in TS36.508 [7] subclause 4.3.1 for different CA bandwidth classes, and PCC and SCCs are mapped onto physical frequencies according to Table 6.1-2.				C: Low and High range		
Test CC Combination setting ( $N_{RB\_agg}$ ) as specified in subclause 5.4.2A.1 for the CA Configuration				As in Table 6.6.2.2A.1.3.1-1		
Test Parameters for CA Configurations						
ID	CA Configuration / $N_{RB\_agg}$		DL Allocation (PDCCH on PCC)	CC MOD	UL Allocation	
	PCC $N_{RB}$	SCCs $N_{RB}$	PCC & SCC RB allocation		$N_{RB\_allo\ c}$	PCC & SCC RB allocations ( $L_{CRB}$ @ $RB_{start}$ )

1	100	50	N/A	QPSK	10	P_10@20	S_0@0		
2	100	50		QPSK	60	P_50@50	S_10@0		
3	100	50		16QAM	15	P_0@0	S_15@0		
4	100	50		QPSK	2	P_1@0	S_1@49		
5	75	75		QPSK	10	P_10@20	S_0@0		
6	75	75		QPSK	75	P_30@45	S_45@0		
7	75	75		QPSK	2	P_1@0	S_1@74		
8	100	75		QPSK	10	P_10@20	S_0@0		
9	100	75		QPSK	80	P_50@50	S_30@0		
10	100	75		16QAM	20	P_0@0	S_20@15		
11	100	75		QPSK	2	P_1@0	S_1@74		
12	100	100		QPSK	10	P_10@25	S_0@0		
13	100	100		QPSK	90	P_40@60	S_50@0		
14	100	100		16QAM	15	P_0@0	S_15@40		
15	100	100		16QAM	20	P_0@0	S_20@30		
16	100	100		QPSK	2	P_1@0	S_1@99		

Note 1: CA Configuration Test CC Combination settings are checked separately for each CA Configuration which applicable aggregated channel bandwidths are specified in Table 5.4.2A.1-1

1. Connect the SS to the UE antenna connectors as shown in Figure TS 36.508 [7] Annex A, Figure group A.32 as appropriate.
2. The parameter settings for the cell are set up according to TS 36.508 [7] clause 4.4.3.
3. Downlink signals for PCC are initially set up according to Annex C0, C.1 and C.3.0, and uplink signals according to Annex H.1 and H.3.0.
4. The UL Reference Measurement channels are set according to Table 6.6.2.2A.1.4.1-1.
5. Propagation conditions are set according to Annex B.0.
6. Ensure the UE is in State 3A-RF according to TS 36.508 [7] clause 5.2A.2. Message contents are defined in clause 6.6.2.2A.1.4.3.

#### 6.6.2.2A.1.4.2 Test procedure

1. Configure SCC according to Annex C.0, C.1 and Annex C.3.0 for all downlink physical channels.
2. The SS shall configure SCC as per TS 36.508 [7] clause 5.2A.4. Message contents are defined in clause 6.6.2.2A.1.4.3.
3. SS activates SCC by sending the activation MAC-CE (Refer TS 36.321 [13], clauses 5.13, 6.1.3.8). Wait for at least 2 seconds (Refer TS 36.133, clauses 8.3.3.2).
4. SS sends uplink scheduling information via PDCCH DCI format 0 for C\_RNTI to schedule the UL RMC according to Table 6.6.2.2A.1.4.1-1 on both PCC and SCC. Since the UE has no payload data to send, the UE transmits uplink MAC padding bits on the UL RMC.
5. Send continuously uplink power control "up" commands in the uplink scheduling information to the UE until the UE transmits at  $P_{UMAX}$  level.
6. Measure the mean power over all component carriers in the CA configuration of the radio access mode, which shall meet the requirements described in Table 6.2.4A.1.5-4. The period of the measurement shall be at least the continuous duration of one sub-frame (1ms). For TDD slots with transient periods are not under test.
7. Measure the power of the transmitted signal with a measurement filter of bandwidths according to table 6.6.2.2A.1.5.1-1. The centre frequency of the filter shall be stepped in continuous steps according to the same table. The measured power shall be recorded for each step. The measurement period shall capture the active TSs.

#### 6.6.2.2A.1.4.3 Message contents

Message contents are according to TS 36.508 [7] clause 4.6. The following exceptions apply for each network signalled value.

## 6.6.2.2A.1.4.3.1 Message contents exceptions (network signalled value "CA\_NS\_04")

1. Information element `additionalSpectrumEmissionSCell-r10` is set to `CA_NS_04`. This can be set in the *RadioResourceConfigCommonSCell-r10-DEFAULT* as part of the common RRC messages. This exception indicates that the UE shall meet the additional spectrum emission requirement for a specific deployment scenario.

**Table 6.6.2.2A.1.4.3.1-1: *RadioResourceConfigCommonSCell-r10-DEFAULT*: Additional spectrum emission test requirement for "CA\_NS\_04"**

Derivation Path: TS 36.508 [7] clause 4.6.3, Table 4.6.3-13A			
Information Element	Value/remark	Comment	Condition
<code>additionalSpectrumEmissionSCell-r10</code>	4 (CA_NS_04)		

## 6.6.2.2A.1.5 Test Requirements

## 6.6.2.2A.1.5.1 Test requirement for CA (network signalled value "CA\_NS\_04")

When "CA\_NS\_04" is indicated in the cell

- the measured UE mean power with the aggregated channel bandwidth as specified in clause 5.4.2A, derived in step 6, shall fulfil requirements in Table 6.2.4A.1.5-4 as appropriate,

and

- the power of any UE emission shall not exceed the levels specified in Table 6.6.2.2A.1.5.1-1.

**Table 6.6.2.2A.1.5.1-1: Additional requirements**

$\Delta f_{\text{OOB}}$ (MHz)	Spectrum emission limit [dBm]/ $BW_{\text{Channel\_CA}}$				Measurement bandwidth
	50+100RB (29.9 MHz)	75+75B (30 MHz)	75+100RB (34.85 MHz)	100+100RB (39.8 MHz)	
± 0-1	-21	-21	-22	-22.5	30 kHz
± 1-5.5	-11.5	-11.5	-11.5	-11.5	1 MHz
± 5.5-34.9	-23.5	-23.5	-23.5	-23.5	1 MHz
± 34.9-35		-23.5	-23.5	-23.5	1 MHz
± 35-39.85			-23.5	-23.5	1 MHz
± 39.85-44.8				-23.5	1 MHz
Note 1:	The first and last measurement position with a 30 kHz filter is at $\Delta f_{\text{OOB}}$ equals to 0.015 MHz and 0.985 MHz.				
Note 2:	At the boundary of spectrum emission limit, the first and last measurement position with a 1 MHz filter is the inside of +0.5MHz and -0.5MHz, respectively.				
Note 3:	The measurements are to be performed above the upper edge of the channel and below the lower edge of the channel				
Note 4:	Above SEM requirement applies to bands corresponding to network signalling value CA_NS_04 as defined in TS 36.101 [2] subclause 6.6.2.2A Table 6.2.2A-1.				

NOTE: As a general rule, the resolution bandwidth of the measuring equipment should be equal to the measurement bandwidth. However, to improve measurement accuracy, sensitivity and efficiency, the resolution bandwidth may be smaller than the measurement bandwidth. When the resolution bandwidth is smaller than the measurement bandwidth, the result should be integrated over the measurement bandwidth in order to obtain the equivalent noise bandwidth of the measurement bandwidth.

## 6.6.2.2B Additional Spectrum Emission Mask for UL-MIMO

## 6.6.2.2B.1 Test purpose

To verify that the power of any UE emission at each transmit antenna shall not exceed specified level for the specified channel bandwidth under the deployment scenarios where additional requirements are specified.

### 6.6.2.2B.2 Test applicability

This test case applies to all types of E-UTRA UE release 10 and forward that support UL-MIMO

### 6.6.2.2B.3 Minimum conformance requirements

#### 6.6.2.2B.3.1 Minimum requirement (network signalled value "NS\_03", "NS\_11", "NS\_20" and "NS\_21")

For UEs with two transmit antenna connectors in closed-loop spatial multiplexing scheme, the requirements in Table 6.6.2.2B.3.1-1 apply to each transmit antenna connector with the UL-MIMO configurations specified in Table 6.2.2B.3-2.

When "NS\_03", "NS\_11", "NS\_20" or "NS\_21" is indicated in the cell, the power of any UE emission shall not exceed the levels specified in Table 6.6.2.2B.3.1-1.

**Table 6.6.2.2B.3.1-1: Additional requirements (network signalled value "NS\_03", "NS\_11", "NS\_20" and "NS\_21")**

Spectrum emission limit (dBm)/ Channel bandwidth							
$\Delta f_{\text{OoB}}$ (MHz)	1.4 MHz	3.0 MHz	5 MHz	10 MHz	15 MHz	20 MHz	Measurement bandwidth
± 0-1	-10	-13	-15	-18	-20	-21	30 kHz
± 1-2.5	-13	-13	-13	-13	-13	-13	1 MHz
± 2.5-2.8	-25	-13	-13	-13	-13	-13	1 MHz
± 2.8-5		-13	-13	-13	-13	-13	1 MHz
± 5-6		-25	-13	-13	-13	-13	1 MHz
± 6-10			-25	-13	-13	-13	1 MHz
± 10-15				-25	-13	-13	1 MHz
± 15-20					-25	-13	1 MHz
± 20-25						-25	1 MHz

NOTE: As a general rule, the resolution bandwidth of the measuring equipment should be equal to the measurement bandwidth. However, to improve measurement accuracy, sensitivity and efficiency, the resolution bandwidth may be smaller than the measurement bandwidth. When the resolution bandwidth is smaller than the measurement bandwidth, the result should be integrated over the measurement bandwidth in order to obtain the equivalent noise bandwidth of the measurement bandwidth.

The normative reference for this requirement is TS 36.101 clause 6.6.2B.

#### 6.6.2.2B.3.2 Minimum requirement (network signalled value "NS\_04")

For UEs with two transmit antenna connectors in closed-loop spatial multiplexing scheme, the requirements in Table 6.6.2.2B.3.2-1 apply to each transmit antenna connector with the UL-MIMO configurations specified in Table 6.2.2B.3-2.

When "NS\_04" is indicated in the cell, the power of any UE emission shall not exceed the levels specified in Table 6.6.2.2B.3.2-1.

**Table 6.6.2B.3.2-1: Additional requirements (network signalled value "NS\_04")**

Spectrum emission limit (dBm)/ Channel bandwidth							
$\Delta f_{\text{OoB}}$ (MHz)	1.4 MHz	3.0 MHz	5 MHz	10 MHz	15 MHz	20 MHz	Measurement bandwidth
$\pm 0-1$	-10	-13	-15	-18	-20	-21	30 kHz
$\pm 1-2.5$	-13	-13	-13	-13	-13	-13	1 MHz
$\pm 2.5-2.8$	-25	-13	-13	-13	-13	-13	1 MHz
$\pm 2.8-5$		-13	-13	-13	-13	-13	1 MHz
$\pm 5-6$		-25	-25	-25	-25	-25	1 MHz
$\pm 6-10$			-25	-25	-25	-25	1 MHz
$\pm 10-15$				-25	-25	-25	1 MHz
$\pm 15-20$					-25	-25	1 MHz
$\pm 20-25$						-25	1 MHz

NOTE: As a general rule, the resolution bandwidth of the measuring equipment should be equal to the measurement bandwidth. However, to improve measurement accuracy, sensitivity and efficiency, the resolution bandwidth may be smaller than the measurement bandwidth. When the resolution bandwidth is smaller than the measurement bandwidth, the result should be integrated over the measurement bandwidth in order to obtain the equivalent noise bandwidth of the measurement bandwidth.

The normative reference for this requirement is TS 36.101 clause 6.6.2B.

#### 6.6.2B.3.3 Minimum requirement (network signalled value "NS\_06" or "NS\_07")

For UEs with two transmit antenna connectors in closed-loop spatial multiplexing scheme, the requirements in Table 6.6.2B.3.3-1 apply to each transmit antenna connector with the UL-MIMO configurations specified in Table 6.2.2B.3-2.

When "NS\_06" or "NS\_07" is indicated in the cell, the power of any UE emission shall not exceed the levels specified in Table 6.6.2B.3.3-1.

**Table 6.6.2B.3.3-1: Additional requirements (network signalled value "NS\_06" or "NS\_07")**

Spectrum emission limit (dBm)/ Channel bandwidth					
$\Delta f_{\text{OoB}}$ (MHz)	1.4 MHz	3.0 MHz	5 MHz	10 MHz	Measurement bandwidth
$\pm 0-0.1$	-13	-13	-15	-18	30 kHz
$\pm 0.1-1$	-13	-13	-13	-13	100 kHz
$\pm 1-2.5$	-13	-13	-13	-13	1 MHz
$\pm 2.5-2.8$	-25	-13	-13	-13	1 MHz
$\pm 2.8-5$		-13	-13	-13	1 MHz
$\pm 5-6$		-25	-13	-13	1 MHz
$\pm 6-10$			-25	-13	1 MHz
$\pm 10-15$				-25	1 MHz

NOTE: As a general rule, the resolution bandwidth of the measuring equipment should be equal to the measurement bandwidth. However, to improve measurement accuracy, sensitivity and efficiency, the resolution bandwidth may be smaller than the measurement bandwidth. When the resolution bandwidth is smaller than the measurement bandwidth, the result should be integrated over the measurement bandwidth in order to obtain the equivalent noise bandwidth of the measurement bandwidth.

The normative reference for this requirement is TS 36.101 clause 6.6.2B.

#### 6.6.2B.4 Test description

##### 6.6.2B.4.1 Initial conditions

Initial conditions are a set of test configurations the UE needs to be tested in and the steps for the SS to take with the UE to reach the correct measurement state.

The initial test configurations consist of environmental conditions, test frequencies, and channel bandwidths based on E-UTRA bands specified in table 5.4.2.1-1. All of these configurations shall be tested with applicable test parameters for each channel bandwidth, and are shown in tables 6.6.2.2B.4.1-1 through 6.6.2.2B.4.1-5. The details of the uplink reference measurement channels (RMCs) are specified in Annexes A.2 respectively. Configurations of PDSCH and PDCCH before measurement are specified in Annex C.2.

**Table 6.6.2.2B.4.1-1: Test Configuration Table (network signalled value "NS\_03", "NS\_11", and "NS\_20")**

Initial Conditions						
Test Environment (as specified in TS 36.508 [7] clause 4.1)				NC		
Test Frequencies (as specified in TS 36.508 [7] clause 4.3.1)				Low range, Mid range, High range		
Test Channel Bandwidths (as specified in TS 36.508 [7] clause 4.3.1)				Lowest, 5MHz, 10MHz, Highest		
Test Parameters for Channel Bandwidths						
Ch BW	Downlink Configuration			Uplink Configuration		
	Mod'n	RB allocation		Mod'n	RB allocation	
		FDD	TDD		FDD	TDD
1.4MHz	N/A for Additional Spectrum Emission Mask testing.			QPSK	6	6
1.4MHz				QPSK	5	5
1.4MHz				16QAM	5	5
3MHz				QPSK	15	15
3MHz				QPSK	4	4
3MHz				16QAM	15	15
3MHz				16QAM	4	4
5MHz				QPSK	25	25
5MHz				QPSK	8	8
5MHz				QPSK	6	6
5MHz				16QAM	25	25
5MHz				16QAM	8	8
10MHz				QPSK	50	50
10MHz				QPSK	12	12
10MHz				QPSK	6	6
10MHz				16QAM	50 (Note 3)	50 (Note 3)
10MHz				16QAM	12	12
15MHz				QPSK	75	75
15MHz				QPSK	16	16
15MHz				QPSK	8	8
15MHz			16QAM	75 (Note 3)	75 (Note 3)	
15MHz			16QAM	16	16	
20MHz			QPSK	100	100	
20MHz			QPSK	18	18	
20MHz			QPSK	10	10	
20MHz			16QAM	100 (Note 3)	100 (Note 3)	
20MHz			16QAM	18	18	
Note 1: Test Channel Bandwidths are checked separately for each E-UTRA band, the applicable channel bandwidths are specified in Table 5.4.2.1-1. Note 2: The RB <sub>start</sub> of partial RB allocation shall be RB# 0 and RB# (max +1 - RB allocation) of the channel bandwidth. Note 3: Applies only for UE-Categories [FFS].						



**Table 6.6.2B.4.1-2: Test Configuration Table (network signalled value "NS\_06")**

Initial Conditions						
Test Environment (as specified in TS 36.508 [7] clause 4.1)				NC		
Test Frequencies (as specified in TS 36.508 [7] clause 4.3.1)				Low range, Mid range, High range		
Test Channel Bandwidths (as specified in TS 36.508 [7] clause 4.3.1)				Lowest, 5MHz, 10MHz, Highest		
Test Parameters for Channel Bandwidths						
Ch BW	Downlink Configuration			Uplink Configuration		
	Mod'n	RB allocation		Mod'n	RB allocation	
		FDD	TDD		FDD	TDD
1.4MHz	N/A for Additional Spectrum Emission Mask testing.			QPSK	6	NA
1.4MHz				QPSK	5	
1.4MHz				16QAM	5	
3MHz				QPSK	15	
3MHz				QPSK	4	
3MHz				16QAM	4	
5MHz				QPSK	25	
5MHz				QPSK	8	
5MHz				16QAM	8	
10MHz				QPSK	50	
10MHz				QPSK	12	
10MHz				16QAM	12	
15MHz				QPSK	75	
15MHz				QPSK	16	
15MHz				16QAM	16	
20MHz				QPSK	100	
20MHz				QPSK	18	
20MHz			16QAM	18		
<p>Note 1: Test Channel Bandwidths are checked separately for each E-UTRA band, the applicable channel bandwidths are specified in Table 5.4.2.1-1.</p> <p>Note 2: The RB<sub>start</sub> of partial RB allocation shall be RB# 0 and RB# (max +1 - RB allocation) of the channel bandwidth.</p>						

**Table 6.6.2B.4.1-3: Test Configuration Table (network signalled value "NS\_07")**

Initial Conditions						
Test Environment (as specified in TS 36.508 [7] clause 4.1)				NC		
Test Frequencies (as specified in TS 36.508 [7] clause 4.3.1)				Mid range		
Test Channel Bandwidths (as specified in TS 36.508 [7] clause 4.3.1)				10MHz		
Test Parameters for Channel Bandwidths						
Test Number	Ch BW	Downlink Configuration		Uplink Configuration		
		Mod'n	RB allocation	Mod'n	RB allocation	RB <sub>start</sub>
1	10MHz	N/A for Additional Spectrum Emission Mask testing.		QPSK	1	0
2	10MHz			QPSK	8	0
3	10MHz			QPSK	6	13
4	10MHz			QPSK	20	13
5	10MHz			QPSK	12	13
6	10MHz			16QAM	36 (Note 1)	13
7	10MHz			QPSK	16	19
8	10MHz			QPSK	12	19
9	10MHz			16QAM	16	19
10	10MHz			QPSK	30	19
11	10MHz			16QAM	30 (Note 1)	19
12	10MHz			QPSK	6	43
13	10MHz			QPSK	2	48
14	10MHz			QPSK	50	0
15	10MHz			QPSK	12	0
16	10MHz			16QAM	50 (Note 1)	0
Note 1: Applies only for UE-Categories[FFS].						

**Table 6.6.2B.4.1-4: Test Configuration Table (network signalled value "NS\_04")**

Initial Conditions						
Test Environment (as specified in TS 36.508 [7] clause 4.1)			NC			
Test Frequencies (as specified in TS 36.508 [7] clause 4.3.1)			Low range, Mid range, High range			
Test Channel Bandwidths (as specified in TS 36.508 [7] clause 4.3.1)			5MHz, 10 MHz, 15 MHz, 20MHz			
Test Parameters for NS_04 A-MPR						
Configuration ID	Ch BW	Downlink Configuration		Uplink Configuration		
		Mod'n	RB allocation TDD	Mod'n	RB allocation TDD	RB <sub>start</sub> TDD
1	5MHz	N/A for Additional Spectrum Emission Mask testing.		QPSK	25	Note 2
2	5MHz			QPSK	8	Note 2
3	5MHz			QPSK	6	Note 2
4	5MHz			16QAM	25	Note 2
5	5MHz			16QAM	8	Note 2
6	10MHz			QPSK	1	0
7	10MHz			QPSK	12	0
8	10MHz			QPSK	50	0
9	10MHz			16QAM	50 (Note 3)	0
10	10MHz			QPSK	24	13
11	10MHz			16QAM	24	13
12	10MHz			QPSK	36	13
13	10MHz			QPSK	12	37
14	10MHz			QPSK	1	49
15	15MHz			QPSK	1	0
16	15MHz			QPSK	16	0
17	15MHz			QPSK	75	0
18	15MHz			16QAM	75 (Note 3)	0
19	15MHz			QPSK	36	19
20	15MHz			16QAM	36 (Note 3)	19
21	15MHz			QPSK	50	19
22	15MHz			QPSK	18	56
23	15MHz			QPSK	1	74
24	20MHz			QPSK	1	0
25	20MHz			QPSK	18	0
26	20MHz			QPSK	100	0
27	20MHz			16QAM	100 (Note 3)	0
28	20MHz			QPSK	50	25
29	20MHz			16QAM	50 (Note 3)	25
30	20MHz			QPSK	75	25
31	20MHz			QPSK	25	75
32	20MHz			QPSK	1	99

Note 1: Test Channel Bandwidths are checked separately for E-UTRA band, the applicable channel bandwidths are specified in Table 5.4.2.1-1.

Note 2: The RB<sub>start</sub> of partial RB allocation shall be RB# 0 and RB# (max +1 - RB allocation) of the channel bandwidth.

Note 3: Applies only for UE-Categories [FFS]

**Table 6.6.2B.4.1-5: Test Configuration Table (network signalled value "NS\_21")**

Initial Conditions						
Test Environment (as specified in TS 36.508 [7] subclause 4.1)				NC		
Test Frequencies (as specified in TS36.508 [7] subclause 4.3.1)				Low range or High range		
Test Channel Bandwidths (as specified in TS 36.508 [7] subclause 4.3.1)				5 MHz, 10 MHz		
Test Parameters for Channel Bandwidths						
Configuration ID	Ch BW	Downlink Configuration		Uplink Configuration		
		Mod'n	RB allocation	Mod'n	RB allocation FDD	RBstart FDD
1 (note 2)	5 MHz			QPSK	1	0
2 (note 2)	5 MHz			QPSK	25	0
3 (note 2)	10 MHz			QPSK	1	0
4 (note 3)	10 MHz			QPSK	1	49
5 (note 2)	10 MHz			QPSK	15	0
6 (note 3)	10 MHz			QPSK	3	47
7 (note 3)	10 MHz			QPSK	50	0
8 (note 1, 3)	10 MHz			16QAM	50	0
Note 1: Applies only for UE-Categories $\geq 2$ .						
Note 2: Applicable only to low range frequency testing.						
Note 3: Applicable only to high range frequency testing.						

1. Connect the SS to the UE antenna connectors as shown in Figure TS 36.508 [7] Annex A, Figure A.28.
2. The parameter settings for the cell are set up according to TS 36.508 [7] clause 4.4.3.
3. Downlink signals are initially set up according to Annex C0, C.1 and C.3.0, and uplink signals according to Annex H.1 and H.3.0.
4. The UL Reference Measurement channels are set according to Table 6.6.2B.4.1-1, 6.6.2B.4.1-2, 6.6.2B.4.1-3 and 6.6.2B.4.1-4.
5. Propagation conditions are set according to Annex B.0.
6. Ensure the UE is in State 3A-RF according to TS 36.508 [7] clause 5.2A.2. Message contents are defined in clause 6.6.2B.4.3.

#### 6.6.2B.4.2 Test procedure

1. SS sends uplink scheduling information via PDCCH DCI format 4 for C\_RNTI to schedule the UL RMC according to Table 6.6.2B.4.1-1, 6.6.2B.4.1-2, 6.6.2B.4.1-3 or 6.6.2B.4.1-4. Since the UE has no payload data to send, the UE transmits uplink MAC padding bits on the UL RMC.
2. Send continuously uplink power control "up" commands in the uplink scheduling information to the UE until the UE transmits at PUMAX level.
3. Measure the sum of the mean power at each antenna connector of UE in the channel bandwidth of the radio access mode according to the test configuration, which shall meet the requirements described in Table 6.2.3B.5-1. The period of the measurement shall be at least the continuous duration of one sub-frame (1ms). For TDD slots with transient periods are not under test.
4. Measure the power of the transmitted signal at each antenna connector of UE with a measurement filter of bandwidths according to table 6.6.2B.5.1-1, 6.6.2B.5.2-1, 6.6.2B.5.3-1 or Table 6.6.2B.5.1-2, 6.6.2B.5.2-2, and

6.6.2.2B.5.3-2 as applicable. The centre frequency of the filter shall be stepped in continuous steps according to the same table. The measured power shall be recorded for each step. The measurement period shall capture the active TSs.

#### 6.6.2.2B.4.3 Message contents

Message contents are according to TS 36.508 [7] subclause 4.6, with the following exceptions for each network signalled value.

##### 6.6.2.2B.4.3.1 Message contents exceptions (network signalled value "NS\_03")

1. Information element `additionalSpectrumEmission` is set to NS\_03. This can be set in the *SystemInformationBlockType2* as part of the cell broadcast message. This exception indicates that the UE shall meet the additional spurious emission requirement for a specific deployment scenario.

**Table 6.6.2.2B.4.3.1-1: SystemInformationBlockType2 :Additional spurious emissions requirement**

Derivation Path: TS 36.508 [7] clause 4.4.3.3, Table 4.4.3.3-1			
Information Element	Value/remark	Comment	Condition
<code>additionalSpectrumEmission</code>	3 (NS_03)		

##### 6.6.2.2B.4.3.2 Message contents exceptions (network signalled value "NS\_04")

1. Information element `additionalSpectrumEmission` is set to NS\_04. This can be set in the *SystemInformationBlockType2* as part of the cell broadcast message. This exception indicates that the UE shall meet the additional spurious emission requirement for a specific deployment scenario.

**Table 6.6.2.2B.4.3.2-1: SystemInformationBlockType2 :Additional spurious emissions requirement**

Derivation Path: TS 36.508 [7] clause 4.4.3.3, Table 4.4.3.3-1			
Information Element	Value/remark	Comment	Condition
<code>additionalSpectrumEmission</code>	4 (NS_04)		

##### 6.6.2.2B.4.3.3 Message contents exceptions (network signalled value "NS\_06")

1. Information element `additionalSpectrumEmission` is set to NS\_06. This can be set in the *SystemInformationBlockType2* as part of the cell broadcast message. This exception indicates that the UE shall meet the additional spurious emission requirement for a specific deployment scenario.

**Table 6.6.2.2B.4.3.3-1: SystemInformationBlockType2 :Additional spurious emissions requirement**

Derivation Path: TS 36.508 [7] clause 4.4.3.3, Table 4.4.3.3-1			
Information Element	Value/remark	Comment	Condition
<code>additionalSpectrumEmission</code>	6 (NS_06)		

##### 6.6.2.2B.4.3.4 Message contents exceptions (network signalled value "NS\_07")

1. Information element `additionalSpectrumEmission` is set to NS\_07. This can be set in the *SystemInformationBlockType2* as part of the cell broadcast message. This exception indicates that the UE shall meet the additional spurious emission requirement for a specific deployment scenario.

**Table 6.6.2.2B.4.3.4-1: SystemInformationBlockType2 :Additional spurious emissions requirement**

Derivation Path: TS 36.508 [7] clause 4.4.3.3, Table 4.4.3.3-1			
Information Element	Value/remark	Comment	Condition
<code>additionalSpectrumEmission</code>	7 (NS_07)		

#### 6.6.2.2B.4.3.5 Message contents exceptions (network signalled value "NS\_11")

1. Information element `additionalSpectrumEmission` is set to NS\_11. This can be set in the *SystemInformationBlockType2* as part of the cell broadcast message. This exception indicates that the UE shall meet the additional spurious emission requirement for a specific deployment scenario.

**Table 6.6.2.2B.4.3.5-1: *SystemInformationBlockType2* :Additional spurious emissions requirement**

Derivation Path: TS 36.508 [7] clause 4.4.3.3, Table 4.4.3.3-1			
Information Element	Value/remark	Comment	Condition
<code>additionalSpectrumEmission</code>	11(NS_11)		

#### 6.6.2.2B.4.3.6 Message contents exceptions (network signalled value "NS\_20")

1. Information element `additionalSpectrumEmission` is set to NS\_20. This can be set in the *SystemInformationBlockType2* as part of the cell broadcast message. This exception indicates that the UE shall meet the additional spurious emission requirement for a specific deployment scenario.

**Table 6.6.2.2B.4.3.6-1: *SystemInformationBlockType2* :Additional spurious emissions requirement**

Derivation Path: TS 36.508 [7] clause 4.4.3.3, Table 4.4.3.3-1			
Information Element	Value/remark	Comment	Condition
<code>additionalSpectrumEmission</code>	20 (NS_20)		

#### 6.6.2.2B.4.3.7 Message contents exceptions (network signalled value "NS\_21")

1. Information element `additionalSpectrumEmission` is set to NS\_21. This can be set in the *SystemInformationBlockType2* as part of the cell broadcast message. This exception indicates that the UE shall meet the additional spurious emission requirement for a specific deployment scenario.

**Table 6.6.2.2B.4.3.7-1: *SystemInformationBlockType2* :Additional spurious emissions requirement**

Derivation Path: TS 36.508 [7] clause 4.4.3.3, Table 4.4.3.3-1			
Information Element	Value/remark	Comment	Condition
<code>additionalSpectrumEmission</code>	21 (NS_21)		

#### 6.6.2.2B.5 Test requirements

##### 6.6.2.2B.5.1 Test requirements (network signalled value "NS\_03", "NS\_11", "NS\_20" and "NS\_21")

When "NS\_03" or "NS\_11" or "NS\_20" or "NS\_21" is indicated in the cell:

- the measured sum of mean power at each antenna connector of UE in the channel bandwidth, derived in step 3, shall fulfil requirements in clause 6.2.4B Table [TBD] as appropriate,

and

- the power of any UE emission at each transmit antenna connector shall fulfil requirements in Table 6.6.2.2B.5.1-1 or 6.6.2.2B.5.1-2, as applicable.

**Table 6.6.2.B.5.1-1: Additional requirements (network signalled value "NS\_03", "NS\_11", "NS\_20" and "NS\_21"), E UTRA bands ≤ 3GHz**

Spectrum emission limit (dBm)/ Channel bandwidth								
$\Delta f_{\text{OoB}}$ (MHz)	1.4 MHz	3.0 MHz	5 MHz	10 MHz	15 MHz	20 MHz	Measurement bandwidth	
0-1	-8.5	-11.5	-13.5	-16.5	-18.5	-19.5	30 kHz	
1-2.5	-11.5	-11.5	-11.5	-11.5	-11.5	-11.5	1 MHz	
2.5-2.8	-23.5						1 MHz	
2.8-5							1 MHz	
5-6							-23.5	1 MHz
6-10								-23.5
10-15				-23.5			1 MHz	
15-20					-23.5		1 MHz	
20-25						-23.5	1 MHz	
Note 1:	The first and last measurement position with a 30 kHz filter is at $\Delta f_{\text{OoB}}$ equals to 0.015 MHz and 0.985 MHz.							
Note 2:	At the boundary of spectrum emission limit, the first and last measurement position with a 1 MHz filter is the inside of +0.5MHz and -0.5MHz, respectively.							
Note 3:	The measurements are to be performed above the upper edge of the channel and below the lower edge of the channel							
Note 4:	Above SEM requirement applies to bands corresponding to network signalling value NS_03 as defined in TS 36.101 [2] clause 6.2.4B							
Note 5:	For the 2.5-2.8 MHz offset range with 1.4 MHz channel bandwidth, the measurement position is at $\Delta f_{\text{OoB}}$ equals to 3 MHz.							

**Table 6.6.2.B.5.1-2: Additional requirements (network signalled value "NS\_03", "NS\_11", "NS\_20" and "NS\_21"), 3GHz < E UTRA bands ≤ 4.2GHz**

Spectrum emission limit (dBm)/ Channel bandwidth								
$\Delta f_{\text{OoB}}$ (MHz)	1.4 MHz	3.0 MHz	5 MHz	10 MHz	15 MHz	20 MHz	Measurement bandwidth	
0-1	-8.2	-11.2	-13.2	-16.2	-18.2	-19.2	30 kHz	
1-2.5	-11.2	-11.2	-11.2	-11.2	-11.2	-11.2	1 MHz	
2.5-2.8	-23.2						1 MHz	
2.8-5							1 MHz	
5-6							-23.2	1 MHz
6-10								-23.2
10-15				-23.2			1 MHz	
15-20					-23.2		1 MHz	
20-25						-23.2	1 MHz	
Note 1:	The first and last measurement position with a 30 kHz filter is at $\Delta f_{\text{OoB}}$ equals to 0.015 MHz and 0.985 MHz.							
Note 2:	At the boundary of spectrum emission limit, the first and last measurement position with a 1 MHz filter is the inside of +0.5MHz and -0.5MHz, respectively.							
Note 3:	The measurements are to be performed above the upper edge of the channel and below the lower edge of the channel							
Note 4:	Above SEM requirement applies to bands corresponding to network signalling value NS_03 as defined in TS 36.101 [2] clause 6.2.4B							
Note 5:	For the 2.5-2.8 MHz offset range with 1.4 MHz channel bandwidth, the measurement position is at $\Delta f_{\text{OoB}}$ equals to 3 MHz.							

NOTE: (only for emission measurement) As a general rule, the resolution bandwidth of the measuring equipment should be equal to the measurement bandwidth. However, to improve measurement accuracy, sensitivity and efficiency, the resolution bandwidth may be smaller than the measurement bandwidth. When the resolution bandwidth is smaller than the measurement bandwidth, the result should be integrated over the measurement bandwidth in order to obtain the equivalent noise bandwidth of the measurement bandwidth.

#### 6.6.2.B.5.2 Test requirements (network signalled value "NS\_04")

When "NS\_04" is indicated in the cell:

- the measured sum of mean power at each antenna connector of UE in the channel bandwidth, derived in step 3, shall fulfil requirements in clause 6.2.4B Table [TBD] as appropriate,

and

- the power of any UE emission at each antenna connector shall fulfil requirements in Table 6.6.2.2B.5.2-1 or Table.6.6.2.2B.5.2-2, as applicable.

**Table 6.6.2.2B.5.2-1: Additional requirements (network signalled value "NS\_04"), E UTRA bands ≤ 3GHz**

Spectrum emission limit (dBm)/ Channel bandwidth							
$\Delta f_{\text{OoB}}$ (MHz)	1.4 MHz	3.0 MHz	5 MHz	10 MHz	15 MHz	20 MHz	Measurement bandwidth
0-1	-8.5	-11.5	-13.5	-16.5	-18.5	-19.5	30 kHz
1-2.5	-11.5	-11.5		-11.5	-11.5	-11.5	1 MHz
2.5-2.8	-23.5						1 MHz
2.8-5							1 MHz
5-6		-23.5	-23.5	-23.5	-23.5	-23.5	1 MHz
6-10							1 MHz
10-15							1 MHz
15-20							1 MHz
20-25							1 MHz
Note 1:	The first and last measurement position with a 30 kHz filter is at $\Delta f_{\text{OoB}}$ equals to 0.015 MHz and 0.985 MHz.						
Note 2:	At the boundary of spectrum emission limit, the first and last measurement position with a 1 MHz filter is the inside of +0.5MHz and -0.5MHz, respectively.						
Note 3:	The measurements are to be performed above the upper edge of the channel and below the lower edge of the channel.						
Note 4:	Above SEM requirement applies to bands corresponding to network signalling value NS_04 as defined in TS 36.101 [2] clause 6.2.4B.						
Note 5:	For the 2.5-2.8 MHz offset range with 1.4 MHz channel bandwidth, the measurement position is at $\Delta f_{\text{OoB}}$ equals to 3 MHz.						

**Table 6.6.2.2B.5.2-2: Additional requirements (network signalled value "NS\_04"), 3GHz < E UTRA bands ≤ 4.2GHz**

Spectrum emission limit (dBm)/ Channel bandwidth							
$\Delta f_{\text{OoB}}$ (MHz)	1.4 MHz	3.0 MHz	5 MHz	10 MHz	15 MHz	20 MHz	Measurement bandwidth
0-1	-8.2	-11.2	-13.2	-16.2	-18.2	-19.2	30 kHz
1-2.5	-11.2	-11.2	-11.2	-11.2	-11.2	-11.2	1 MHz
2.5-2.8	-23.2						1 MHz
2.8-5							1 MHz
5-6		-23.2	-23.2	-23.2	-23.2	-23.2	1 MHz
6-10							1 MHz
10-15							1 MHz
15-20							1 MHz
20-25							1 MHz
Note 1:	The first and last measurement position with a 30 kHz filter is at $\Delta f_{\text{OoB}}$ equals to 0.015 MHz and 0.985 MHz.						
Note 2:	At the boundary of spectrum emission limit, the first and last measurement position with a 1 MHz filter is the inside of +0.5MHz and -0.5MHz, respectively.						
Note 3:	The measurements are to be performed above the upper edge of the channel and below the lower edge of the channel.						
Note 4:	Above SEM requirement applies to bands corresponding to network signalling value NS_04 as defined in TS 36.101 [2] clause 6.2.4 Table 6.2.4-1.						
Note 5:	For the 2.5-2.8 MHz offset range with 1.4 MHz channel bandwidth, the measurement position is at $\Delta f_{\text{OoB}}$ equals to 3 MHz.						

**NOTE:** (only for emission measurement) As a general rule, the resolution bandwidth of the measuring equipment should be equal to the measurement bandwidth. However, to improve measurement accuracy, sensitivity and efficiency, the resolution bandwidth may be smaller than the measurement bandwidth. When the resolution bandwidth is smaller than the measurement bandwidth, the result should be integrated over the measurement bandwidth in order to obtain the equivalent noise bandwidth of the measurement bandwidth.



6.6.2.2B.5.3 Test requirements (network signalled value "NS\_06" or "NS\_07")

When "NS\_06" or "NS\_07" is indicated in the cell:

- the measured sum of mean power at each antenna connector of UE in the channel bandwidth, derived in step 3, shall fulfil requirements in clause 6.2.4B Table [TBD] as appropriate 1,

and

- the power of any UE emission at each antenna connector shall fulfil requirements in Table 6.6.2.2B.5.3-1 or Table.6.6.2.2B.5.3-2, as applicable.

**Table 6.6.2.2B.5.3-1: Additional requirements (network signalled value "NS\_06" or "NS\_07") , E UTRA bands ≤ 3GHz**

$\Delta f_{\text{OOB}}$ (MHz)	Spectrum emission limit (dBm)/ Channel bandwidth				Measurement bandwidth
	1.4 MHz	3.0 MHz	5 MHz	10 MHz	
0-0.1	-11.5	-11.5	-13.5	-16.5	30 kHz
0.1-1	-11.5	-11.5	-11.5	-11.5	100 kHz
1-2.5	-11.5	-11.5	-11.5	-11.5	1 MHz
2.5-2.8	-23.5				1 MHz
2.8-5					1 MHz
5-6	-23.5				1 MHz
6-10			-23.5		1 MHz
10-15				-23.5	1 MHz
<p>Note 1: The first and last measurement position with a 30 kHz filter is at <math>\Delta f_{\text{OOB}}</math> equals to 0.015 MHz and 0.085 MHz. The first and last measurement position with a 100 kHz filter is at <math>\Delta f_{\text{OOB}}</math> equals to 0.15 MHz and 0.95 MHz.</p> <p>Note 2: At the boundary of spectrum emission limit, the first and last measurement position with a 1 MHz filter is the inside of +0.5MHz and -0.5MHz, respectively.</p> <p>Note 3: The measurements are to be performed above the upper edge of the channel and below the lower edge of the channel.</p> <p>Note 4: Above SEM requirement applies to bands corresponding to network signalling value NS_06 and NS_07 as defined in TS 36.101 [2] clause 6.2.4B.</p> <p>Note 5: For the 2.5-2.8 MHz offset range with 1.4 MHz channel bandwidth, the measurement position is at <math>\Delta f_{\text{OOB}}</math> equals to 3 MHz.</p>					

**Table 6.6.2B.5.3-2: Additional requirements (network signalled value "NS\_06" or "NS\_07") , 3GHz < E UTRA bands ≤ 4.2GHz**

$\Delta f_{\text{OoB}}$ (MHz)	Spectrum emission limit (dBm)/ Channel bandwidth				
	1.4 MHz	3.0 MHz	5 MHz	10 MHz	Measurement bandwidth
0-0.1	-11.2	-11.2	-13.2	-16.2	30 kHz
0.1-1	-11.2	-11.2	-11.2	-11.2	100 kHz
1-2.5	-11.2	-11.2	-11.2	-11.2	1 MHz
2.5-2.8	-23.2				1 MHz
2.8-5					1 MHz
5-6	-23.2				1 MHz
6-10			-23.2		1 MHz
10-15				-23.2	1 MHz
<p>Note 1: The first and last measurement position with a 30 kHz filter is at <math>\Delta f_{\text{OoB}}</math> equals to 0.015 MHz and 0.085 MHz. The first and last measurement position with a 100 kHz filter is at <math>\Delta f_{\text{OoB}}</math> equals to 0.15 MHz and 0.95 MHz.</p> <p>Note 2: At the boundary of spectrum emission limit, the first and last measurement position with a 1 MHz filter is the inside of +0.5MHz and -0.5MHz, respectively.</p> <p>Note 3: The measurements are to be performed above the upper edge of the channel and below the lower edge of the channel.</p> <p>Note 4: Above SEM requirement applies to bands corresponding to network signalling value NS_06 and NS_07 as defined in TS 36.101 [2] clause 6.2.4B.</p> <p>Note 5: For the 2.5-2.8 MHz offset range with 1.4 MHz channel bandwidth, the measurement position is at <math>\Delta f_{\text{OoB}}</math> equals to 3 MHz.</p>					

NOTE: (only for emission measurement) As a general rule, the resolution bandwidth of the measuring equipment should be equal to the measurement bandwidth. However, to improve measurement accuracy, sensitivity and efficiency, the resolution bandwidth may be smaller than the measurement bandwidth. When the resolution bandwidth is smaller than the measurement bandwidth, the result should be integrated over the measurement bandwidth in order to obtain the equivalent noise bandwidth of the measurement bandwidth.

### 6.6.2.3 Adjacent Channel Leakage power Ratio

#### 6.6.2.3.1 Test purpose

To verify that UE transmitter does not cause unacceptable interference to adjacent channels in terms of Adjacent Channel Leakage power Ratio (ACLR).

#### 6.6.2.3.2 Test applicability

This test case applies to all types of E-UTRA UE release 8 and forward.

#### 6.6.2.3.3 Minimum conformance requirements

ACLR requirements are specified for two scenarios for an adjacent E -UTRA<sub>ACLR</sub> and UTRA<sub>ACLR1/2</sub> as shown in Figure 6.6.2.3.3-1.

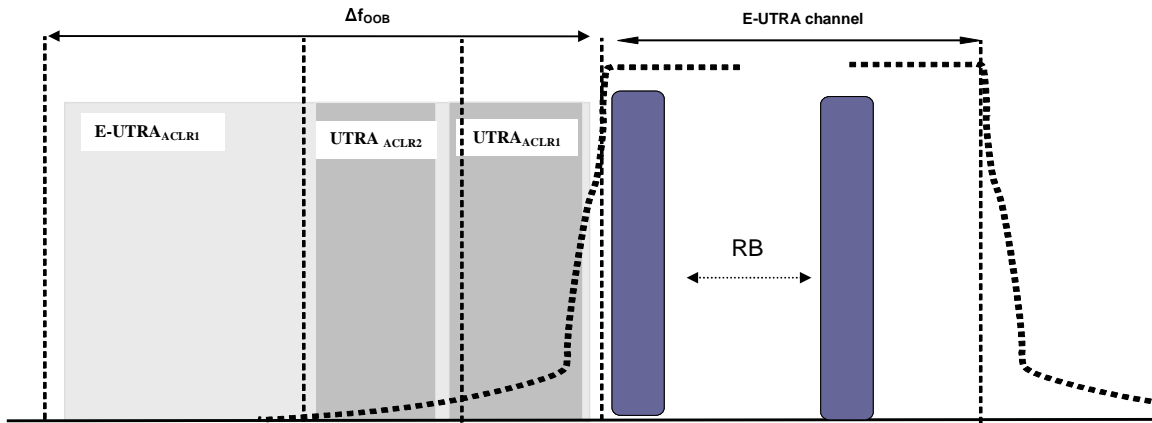

Figure 6.6.2.3.3-1: Adjacent Channel Leakage Power Ratio requirements

6.6.2.3.3.1 Minimum conformance requirements for E-UTRA

E-UTRA ACLR ( $E-UTRA_{ACLR}$ ) is the ratio of the filtered mean power centred on the assigned channel frequency to the filtered mean power centred on an adjacent channel frequency at nominal channel spacing. The assigned E-UTRA channel power and adjacent E-UTRA channel power are measured with rectangular filters with measurement bandwidth specified in Table 6.6.2.3.3.1-1.

If the measured adjacent channel power is greater than  $-50\text{dBm}$  then the  $E-UTRA_{ACLR}$  shall be higher than the valued specified in Table 6.6.2.3.3.1-1.

Table 6.6.2.3.3.1-1: General requirements for  $E-UTRA_{ACLR}$

	Channel bandwidth / $E-UTRA_{ACLR1}$ / measurement bandwidth					
	1.4 MHz	3.0 MHz	5 MHz	10 MHz	15 MHz	20 MHz
$E-UTRA_{ACLR1}$	30 dB	30 dB	30 dB	30 dB	30 dB	30 dB
<b>E-UTRA channel Measurement bandwidth</b>	1.08 MHz	2.7 MHz	4.5 MHz	9.0 MHz	13.5 MHz	18 MHz

The normative reference for this requirement is TS 36.101 [2] subclause 6.6.2.3.1.

6.6.2.3.3.2 Minimum conformance requirements for UTRA

UTRA ACLR ( $UTRA_{ACLR}$ ) is the ratio of the filtered mean power centred on the assigned E-UTRA channel frequency to the filtered mean power centred on an adjacent UTRA channel frequency.

UTRA ACLR is specified for both the first UTRA adjacent channel ( $UTRA_{ACLR1}$ ) and the 2<sup>nd</sup> UTRA adjacent channel ( $UTRA_{ACLR2}$ ). The UTRA channel power is measured with a RRC bandwidth filter with roll-off factor  $\alpha = 0.22$ . The assigned E-UTRA channel power is measured with a rectangular filter with measurement bandwidth specified in Table 6.6.2.3.3.2-1.

If the measured UTRA channel power is greater than  $-50\text{dBm}$  then the  $UTRA_{ACLR1}$ , and  $UTRA_{ACLR2}$  shall be higher than the valued specified in Table 6.6.2.3.3.2-1.

Table 6.6.2.3.3.2-1: General requirements for  $UTRA_{ACLR1/2}$

	Channel bandwidth / $UTRA_{ACLR1/2}$ / measurement bandwidth					
	1.4 MHz	3.0 MHz	5 MHz	10 MHz	15 MHz	20 MHz

<b>UTRA<sub>ACL</sub>R1</b>	33 dB	33 dB	33 dB	33 dB	33 dB	33 dB
<b>Adjacent channel centre frequency offset (in MHz)</b>	0.7+BW <sub>U</sub> TRA/2 /	1.5+BW <sub>U</sub> TRA/2 /	2.5+BW <sub>U</sub> TRA/2 /	5+BW <sub>UTR</sub> A/2 /	7.5+BW <sub>U</sub> TRA/2 /	10+BW <sub>UT</sub> RA/2 /
	-0.7- BW <sub>UTRA</sub> /2	-1.5- BW <sub>UTRA</sub> /2	-2.5- BW <sub>UTRA</sub> /2	-5- BW <sub>UTRA</sub> /2	-7.5- BW <sub>UTRA</sub> /2	-10- BW <sub>UTRA</sub> /2
<b>UTRA<sub>ACL</sub>R2</b>	-	-	36 dB	36 dB	36 dB	36 dB
<b>Adjacent channel centre frequency offset (in MHz)</b>	-	-	2.5+3*B W <sub>UTRA</sub> /2 /	5+3*BW <sub>U</sub> TRA/2 /	7.5+3*B W <sub>UTRA</sub> /2 /	10+3*BW UTRA/2 /
			-2.5- 3*BW <sub>UTR</sub> A/2	-5- 3*BW <sub>UTR</sub> A/2	-7.5- 3*BW <sub>UTR</sub> A/2	-10- 3*BW <sub>UTR</sub> A/2
<b>E-UTRA channel Measurement bandwidth</b>	1.08 MHz	2.7 MHz	4.5 MHz	9.0 MHz	13.5 MHz	18 MHz
<b>UTRA 5MHz channel Measurement bandwidth<sup>1</sup></b>	3.84 MHz	3.84 MHz	3.84 MHz	3.84 MHz	3.84 MHz	3.84 MHz
<b>UTRA 1.6MHz channel measurement bandwidth<sup>2</sup></b>	1.28 MHz	1.28 MHz	1.28 MHz	1.28 MHz	1.28 MHz	1.28 MHz
Note 1: Applicable for E-UTRA FDD co-existence with UTRA FDD in paired spectrum. Note 2: Applicable for E-UTRA TDD co-existence with UTRA TDD in unpaired spectrum.						

The normative reference for this requirement is TS 36.101 subclause 6.6.2.3.2.

#### 6.6.2.3.4 Test description

##### 6.6.2.3.4.1 Initial conditions

Initial conditions are a set of test configurations the UE needs to be tested in and the steps for the SS to take with the UE to reach the correct measurement state.

The initial test configurations consist of environmental conditions, test frequencies, and channel bandwidths based on E-UTRA bands specified in table 5.4.2.1-1. All of these configurations shall be tested with applicable test parameters for each channel bandwidth, and are shown in table 6.6.2.3.4.1-1. The details of the uplink reference measurement channels (RMCs) are specified in Annex A.2. Configurations of PDSCH and PDCCH before measurement are specified in Annex C.2.

**Table 6.6.2.3.4.1-1: Test Configuration Table**

Initial Conditions						
Test Environment (as specified in TS 36.508 [7] subclause 4.1)			NC, TL/VL, TL/VH, TH/VL, TH/VH			
Test Frequencies (as specified in TS36.508 [7] subclause 4.3.1)			Low range, Mid range, High range			
Test Channel Bandwidths (as specified in TS 36.508 [7] subclause 4.3.1)			Lowest, 5MHz, 10MHz, Highest			
Test Parameters for Channel Bandwidths						
Downlink Configuration			Uplink Configuration			
Ch BW	Mod'n	RB allocation		Mod'n	RB allocation	
		FDD	TDD		FDD	TDD

1.4MHz	N/A for ACLR testing	QPSK	6	6
1.4MHz		QPSK	5	5
1.4MHz		16QAM	6	6
1.4MHz		16QAM	5	5
3MHz		QPSK	15	15
3MHz		QPSK	4	4
3MHz		16QAM	15	15
3MHz		16QAM	4	4
5MHz		QPSK	25	25
5MHz		QPSK	8	8
5MHz		16QAM	25	25
5MHz		16QAM	8	8
10MHz		QPSK	50	50
10MHz		QPSK	12	12
10MHz		16QAM	50 (Note 3)	50 (Note 3)
10MHz		16QAM	12	12
15MHz		QPSK	75	75
15MHz		QPSK	16	16
15MHz		16QAM	75 (Note 3)	75 (Note 3)
15MHz		16QAM	16	16
20MHz	QPSK	100	100	
20MHz	QPSK	18	18	
20MHz	16QAM	100 (Note 3)	100 (Note 3)	
20MHz	16QAM	18	18	
<p>Note 1: Test Channel Bandwidths are checked separately for each E-UTRA band, which applicable channel bandwidths are specified in Table 5.4.2.1-1.</p> <p>Note 2: The RB<sub>start</sub> of partial RB allocation shall be RB#0 and RB# (max + 1 – RB allocation) of the channel bandwidth.</p> <p>Note 3: Applies only for UE-Categories 2-5</p>				

1. Connect the SS to the UE antenna connectors as shown in Figure TS 36.508 [7] Annex A, Figure A.3.
2. The parameter settings for the cell are set up according to TS 36.508 [7] subclause 4.4.3.
3. Downlink signals are initially set up according to Annex C0, C.1 and C.3.0, and uplink signals according to Annex H.1 and H.3.0.
4. The UL Reference Measurement channels are set according to Table 6.6.2.3.4.1-1.
5. Propagation conditions are set according to Annex B.0.
6. Ensure the UE is in State 3A-RF according to TS 36.508 [7] clause 5.2A.2. Message contents are defined in clause 6.6.2.3.4.3.

#### 6.6.2.3.4.2 Test procedure

1. SS sends uplink scheduling information for each UL HARQ process via PDCCH DCI format 0 for C\_RNTI to schedule the UL RMC according to Table 6.6.2.3.4.1-1. Since the UE has no payload data to send, the UE transmits uplink MAC padding bits on the UL RMC.
2. Send continuously uplink power control "up" commands in the uplink scheduling information to the UE until the UE transmits at P<sub>UMAX</sub> level.
3. Measure the mean power of the UE in the channel bandwidth of the radio access mode according to the test configuration, which shall meet the requirements described in Table 6.2.3.5-1. The period of the measurement shall be at least the continuous duration of one sub-frame (1ms). For TDD slots with transient periods are not under test.
4. Measure the rectangular filtered mean power for E-UTRA.
5. Measure the rectangular filtered mean power of the first E-UTRA adjacent channel on both lower and upper side of the E-UTRA channel, respectively.

6. Measure the RRC filtered mean power of the first and the second UTRA adjacent channel on both lower and upper side of the E-UTRA channel, respectively.

7. Calculate the ratios of the power between the values measured in step 4 over step 5 for lower and upper E-UTRA<sub>ACLR</sub>, respectively.

8. Calculated the ratios of the power between the values measured in step 4 over step 6 for lower and upper UTRA<sub>ACLR1</sub>, UTRA<sub>ACLR2</sub>, respectively.

#### 6.6.2.3.4.3 Message contents

Message contents are according to TS 36.508 [7] subclause 4.6.

#### 6.6.2.3.5 Test requirement

##### 6.6.2.3.5.1 Test requirements E-UTRA

- The measured UE mean power in the channel bandwidth, derived in step 3, shall fulfil requirements in Table 6.2.3.5-1 as appropriate,

and

- if the measured adjacent channel power is greater than  $-50$  dBm then the measured E-UTRA<sub>ACLR</sub>, derived in step 7, shall be higher than the limits in table 6.6.2.3.5.1-1.

**Table 6.6.2.3.5.1-1: E-UTRA UE ACLR**

	Channel bandwidth / E-UTRA <sub>ACLR1</sub> / measurement bandwidth					
	1.4 MHz	3.0 MHz	5 MHz	10 MHz	15 MHz	20 MHz
<b>E-UTRA<sub>ACLR1</sub></b>	29.2 dB	29.2 dB	29.2 dB	29.2 dB	29.2 dB	29.2 dB
<b>E-UTRA channel Measurement bandwidth</b>	1.08 MHz	2.7 MHz	4.5 MHz	9.0 MHz	13.5 MHz	18 MHz
<b>UE channel</b>	+1.4 MHz or -1.4 MHz	+3 MHz or -3 MHz	+5MHz or -5MHz	+10MHz or -10MHz	+15MHz or -15MHz	+20MHz or -20MHz

#### Test requirements UTRA

If the measured UTRA channel power is greater than  $-50$ dBm then the measured UTRA<sub>ACLR1</sub>, UTRA<sub>ACLR2</sub>, derived in step 8, shall be higher than the limits in table 6.6.2.3.5.2-1.

**Table 6.6.2.3.5.2-1: UTRA UE ACLR**

	Channel bandwidth / UTRA <sub>ACLR1/2</sub> / measurement bandwidth					
	1.4 MHz	3.0 MHz	5 MHz	10 MHz	15 MHz	20 MHz

<b>UTRA<sub>ACLR1</sub></b>	32.2 dB	32.2 dB	32.2 dB	32.2 dB	32.2 dB	32.2 dB
<b>Adjacent channel centre frequency offset (in MHz)</b>	$0.7+BW_{UTR}/2$ / -0.7- $BW_{UTR}/2$	$1.5+BW_{UTR}/2$ / -1.5- $BW_{UTR}/2$	$2.5+BW_{UTR}/2$ / -2.5- $BW_{UTR}/2$	$5+BW_{UTR}/2$ / -5- $BW_{UTR}/2$	$7.5+BW_{UTR}/2$ / -7.5- $BW_{UTR}/2$	$10+BW_{UTR}/2$ / -10- $BW_{UTR}/2$
<b>UTRA<sub>ACLR2</sub></b>	-	-	35.2 dB	35.2 dB	35.2 dB	35.2 dB
<b>Adjacent channel centre frequency offset (in MHz)</b>	-	-	$2.5+3*BW_{UTR}/2$ / -2.5- $3*BW_{UTR}/2$	$5+3*BW_{UTR}/2$ / -5- $3*BW_{UTR}/2$	$7.5+3*BW_{UTR}/2$ / -7.5- $3*BW_{UTR}/2$	$10+3*BW_{UTR}/2$ / -10- $3*BW_{UTR}/2$
<b>E-UTRA channel Measurement bandwidth</b>	1.08 MHz	2.7 MHz	4.5 MHz	9.0 MHz	13.5 MHz	18 MHz
<b>UTRA 5MHz channel Measurement bandwidth<sup>1</sup></b>	3.84 MHz	3.84 MHz	3.84 MHz	3.84 MHz	3.84 MHz	3.84 MHz
<b>UTRA 1.6MHz channel measurement bandwidth<sup>2</sup></b>	1.28 MHz	1.28 MHz	1.28 MHz	1.28 MHz	1.28 MHz	1.28 MHz
Note 1: Applicable for E-UTRA FDD co-existence with UTRA FDD in paired spectrum. Note 2: Applicable for E-UTRA TDD co-existence with UTRA TDD in unpaired spectrum. Note 3: $BW_{UTR}$ for UTRA FDD is 5MHz and for UTRA TDD is 1.6MHz.						

### 6.6.2.3\_1 Adjacent Channel Leakage power Ratio for HPUE

#### 6.6.2.3\_1.1 Test purpose

To verify that HPUE transmitter does not cause unacceptable interference to adjacent channels in terms of Adjacent Channel Leakage power Ratio (ACLR).

#### 6.6.2.3\_1.2 Test applicability

This test case applies to all types of E-UTRA Power Class 1 UE release 10 and forward.

#### 6.6.2.3\_1.3 Minimum conformance requirements

ACLR requirements are specified for an adjacent E -UTRA<sub>ACLR</sub> as shown in Figure 6.6.2.3\_1.3-1.

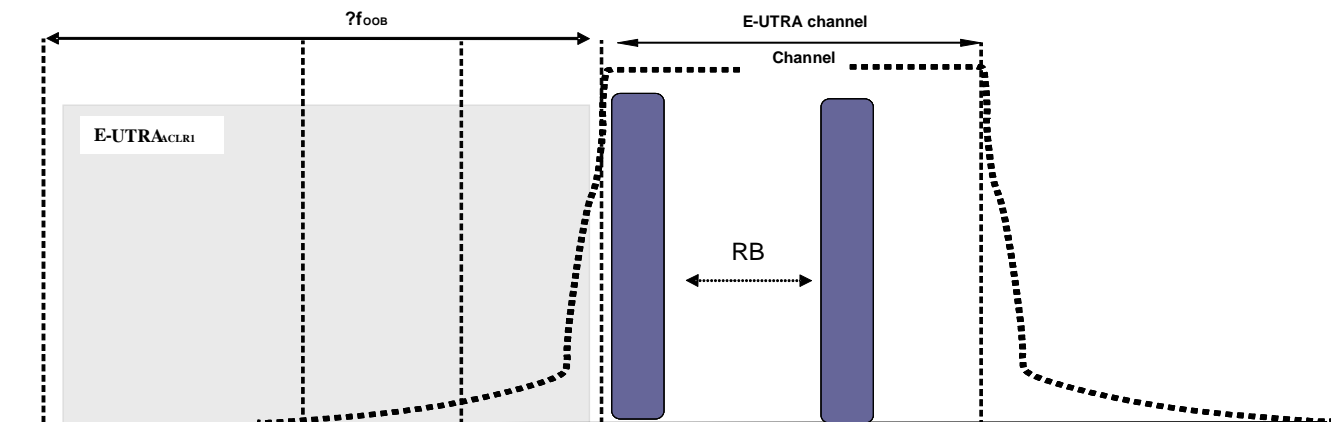

Figure 6.6.2.3\_1.3-1: Adjacent Channel Leakage Power Ratio requirements

### 6.6.2.3\_1.3.1 Minimum conformance requirements for E-UTRA for HPUE

Same minimum conformance requirements as in clause 6.6.2.3.3.1 with for following exceptions:

- Instead of Table 6.6.2.3.3.1-1 → use Table 6.6.2.3\_1.3.1-1

**Table 6.6.2.3\_1.3.1-1: Additional E-UTRA<sub>ACLR</sub> requirements for Power Class 1**

	Channel bandwidth / E-UTRA <sub>ACLR1</sub> / Measurement bandwidth					
	1.4 MHz	3.0 MHz	5 MHz	10 MHz	15 MHz	20 MHz
E-UTRA <sub>ACLR1</sub>	N/A	N/A	37 dB	37 dB	N/A	N/A
E-UTRA channel Measurement bandwidth	N/A	N/A	4.5 MHz	9.0 MHz	N/A	N/A
Adjacent channel centre frequency offset [MHz]	N/A	N/A	+5 / -5	+10 / -10	N/A	N/A
Note 1: E-UTRA <sub>ACLR1</sub> shall be applicable for >23dBm						

The normative reference for this requirement is TS 36.101 [2] clause 6.6.2.1.

### 6.6.2.3\_1.4 Test description

#### 6.6.2.3\_1.4.1 Initial conditions

Same initial conditions as in clause 6.6.2.3.4.1.

#### 6.6.2.3\_1.4.2 Test procedure

1. SS sends uplink scheduling information for each UL HARQ process via PDCCH DCI format 0 for C\_RNTI to schedule the UL RMC according to Table 6.6.2.3.4.1-1. Since the UE has no payload data to send, the UE transmits uplink MAC padding bits on the UL RMC.
2. Send continuously uplink power control "up" commands in the uplink scheduling information to the UE until the UE transmits at  $P_{UMAX}$  level.
3. Measure the mean power of the UE in the channel bandwidth of the radio access mode according to the test configuration, which shall meet the requirements described in Table 6.2.3\_1.5-1. The period of the measurement shall be at least the continuous duration of one sub-frame (1ms). For TDD slots with transient periods are not under test.
4. Measure the rectangular filtered mean power for E-UTRA.
5. Measure the rectangular filtered mean power of the first E-UTRA adjacent channel on both lower and upper side of the E-UTRA channel, respectively.
6. Calculate the ratios of the power between the values measured in step 4 over step 5 for lower and upper E-UTRA<sub>ACLR</sub>, respectively.

#### 6.6.2.3\_1.4.3 Message contents

Same message contents as in clause 6.6.2.3.4.3

### 6.6.2.3\_1.5 Test requirement

#### 6.6.2.3\_1.5.1 Test requirements E-UTRA

- The measured UE mean power in the channel bandwidth, derived in step 3, shall fulfil requirements in Table 6.2.3\_1.5-1 as appropriate,



and

- if the measured adjacent channel power is greater than  $-50$  dBm then the measured  $E-UTRA_{ACLR}$ , derived in step 7, shall be higher than the limits in table 6.6.2.3\_1.4.1-1.

**Table 6.6.2.3\_1.4.1-1: E-UTRA UE ACLR**

	Channel bandwidth / E-UTRA <sub>ACLR1</sub> / measurement bandwidth					
	1.4 MHz	3.0 MHz	5 MHz	10 MHz	15 MHz	20 MHz
E-UTRA <sub>ACLR1</sub>	N/A	N/A	36.2 dB	36.2 dB	N/A	N/A
E-UTRA channel Measurement bandwidth	N/A	N/A	4.5 MHz	9.0 MHz	N/A	N/A
UE channel	N/A	N/A	+5MHz or -5MHz	+10MHz or -10MHz	N/A	N/A

### 6.6.2.3\_2 Adjacent Channel Leakage power Ratio for Multi-Cluster PUSCH

#### 6.6.2.3\_2.1 Test purpose

To verify that UE transmitter does not cause unacceptable interference to adjacent channels in terms of Adjacent Channel Leakage power Ratio (ACLR) for Multi-Cluster PUSCH transmission.

#### 6.6.2.3\_2.2 Test applicability

This test case applies to all types of E-UTRA UE release 10 and forward that support multi cluster PUSCH within a component carrier for the tested band.

#### 6.6.2.3\_2.3 Minimum conformance requirements

ACLR requirements are specified for two scenarios for an adjacent E-UTRA<sub>ACLR</sub> and UTRA<sub>ACLR1/2</sub> as shown in Figure 6.6.2.3\_2.3-1.

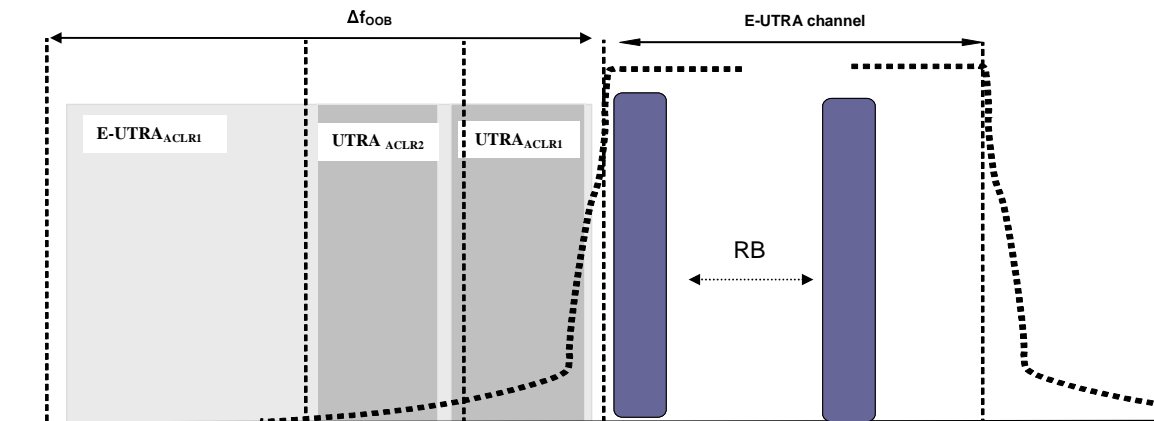

**Figure 6.6.2.3\_2.3-1: Adjacent Channel Leakage Power Ratio requirements**

#### 6.6.2.3\_2.3.1 Minimum conformance requirements for E-UTRA

E-UTRA ACLR ( $E-UTRA_{ACLR}$ ) is the ratio of the filtered mean power centred on the assigned channel frequency to the filtered mean power centred on an adjacent channel frequency at nominal channel spacing. The assigned E-UTRA channel power and adjacent E-UTRA channel power are measured with rectangular filters with measurement bandwidth specified in Table 6.6.2.3\_2.3.1-1.

If the measured adjacent channel power is greater than  $-50\text{dBm}$  then the  $\text{E-UTRA}_{\text{ACLR}}$  shall be higher than the valued specified in Table 6.6.2.3\_2.3.1-1.

**Table 6.6.2.3\_2.3.1-1: General requirements for  $\text{E-UTRA}_{\text{ACLR}}$**

	Channel bandwidth / $\text{E-UTRA}_{\text{ACLR1}}$ / measurement bandwidth					
	1.4 MHz	3.0 MHz	5 MHz	10 MHz	15 MHz	20 MHz
$\text{E-UTRA}_{\text{ACLR1}}$	30 dB	30 dB	30 dB	30 dB	30 dB	30 dB
<b>E-UTRA channel Measurement bandwidth</b>	1.08 MHz	2.7 MHz	4.5 MHz	9.0 MHz	13.5 MHz	18 MHz

The normative reference for this requirement is TS 36.101 [2] subclause 6.6.2.3.1.

#### 6.6.2.3\_2.3.2 Minimum conformance requirements for UTRA

UTRA ACLR ( $\text{UTRA}_{\text{ACLR}}$ ) is the ratio of the filtered mean power centred on the assigned E-UTRA channel frequency to the filtered mean power centred on an adjacent UTRA channel frequency.

UTRA ACLR is specified for both the first UTRA adjacent channel ( $\text{UTRA}_{\text{ACLR1}}$ ) and the 2<sup>nd</sup> UTRA adjacent channel ( $\text{UTRA}_{\text{ACLR2}}$ ). The UTRA channel power is measured with a RRC bandwidth filter with roll-off factor  $\alpha = 0.22$ . The assigned E-UTRA channel power is measured with a rectangular filter with measurement bandwidth specified in Table 6.6.2.3\_2.3.2-1.

If the measured UTRA channel power is greater than  $-50\text{dBm}$  then the  $\text{UTRA}_{\text{ACLR1}}$ , and  $\text{UTRA}_{\text{ACLR2}}$  shall be higher than the valued specified in Table 6.6.2.3\_2.3.2-1.

**Table 6.6.2.3\_2.3.2-1: General requirements for  $\text{UTRA}_{\text{ACLR1/2}}$**

	Channel bandwidth / $\text{UTRA}_{\text{ACLR1/2}}$ / measurement bandwidth					
	1.4 MHz	3.0 MHz	5 MHz	10 MHz	15 MHz	20 MHz
$\text{UTRA}_{\text{ACLR1}}$	33 dB	33 dB	33 dB	33 dB	33 dB	33 dB
<b>Adjacent channel centre frequency offset (in MHz)</b>	$0.7+BW_U$ $TR_A/2$ / $-0.7-$ $BW_{UTRA}/2$	$1.5+BW_U$ $TR_A/2$ / $-1.5-$ $BW_{UTRA}/2$	$2.5+BW_U$ $TR_A/2$ / $-2.5-$ $BW_{UTRA}/2$	$5+BW_{UTR}$ $A/2$ / $-5-$ $BW_{UTRA}/2$	$7.5+BW_U$ $TR_A/2$ / $-7.5-$ $BW_{UTRA}/2$	$10+BW_{UT}$ $RA/2$ / $-10-$ $BW_{UTRA}/2$
$\text{UTRA}_{\text{ACLR2}}$	-	-	36 dB	36 dB	36 dB	36 dB
<b>Adjacent channel centre frequency offset (in MHz)</b>	-	-	$2.5+3*B$ $W_{UTRA}/2$ / $-2.5-$ $3*BW_{UTR}$ $A/2$	$5+3*BW_U$ $TR_A/2$ / $-5-$ $3*BW_{UTR}$ $A/2$	$7.5+3*B$ $W_{UTRA}/2$ / $-7.5-$ $3*BW_{UTR}$ $A/2$	$10+3*BW$ $UTRA/2$ / $-10-$ $3*BW_{UTR}$ $A/2$
<b>E-UTRA channel Measurement bandwidth</b>	1.08 MHz	2.7 MHz	4.5 MHz	9.0 MHz	13.5 MHz	18 MHz
<b>UTRA 5MHz channel Measurement bandwidth<sup>1</sup></b>	3.84 MHz	3.84 MHz	3.84 MHz	3.84 MHz	3.84 MHz	3.84 MHz
<b>UTRA 1.6MHz channel measurement bandwidth<sup>2</sup></b>	1.28 MHz	1.28 MHz	1.28 MHz	1.28 MHz	1.28 MHz	1.28 MHz
Note 1:	Applicable for E-UTRA FDD co-existence with UTRA FDD in paired spectrum.					
Note 2:	Applicable for E-UTRA TDD co-existence with UTRA TDD in unpaired spectrum.					

The normative reference for this requirement is TS 36.101 subclause 6.6.2.3.2.

### 6.6.2.3\_2.4 Test description

#### 6.6.2.3\_2.4.1 Initial conditions

Initial conditions are a set of test configurations the UE needs to be tested in and the steps for the SS to take with the UE to reach the correct measurement state.

The initial test configurations consist of environmental conditions, test frequencies, and channel bandwidths based on E-UTRA bands specified in table 5.4.2.1-1. All of these configurations shall be tested with applicable test parameters for each channel bandwidth, and are shown in table 6.6.2.3\_2.4.1-1. The details of the uplink reference measurement channels (RMCs) are specified in Annex A.2. Configurations of PDSCH and PDCCH before measurement are specified in Annex C.2.

**Table 6.6.2.3\_2.4.1-1: Test Configuration Table**

Initial Conditions					
Test Environment as specified in TS 36.508[7] subclause 4.1			Normal, TL/VL, TL/VH, TH/VL, TH/VH		
Test Frequencies as specified in TS36.508 [7] subclause 4.3.1			Low range, Mid range, High range		
Test Channel Bandwidths as specified in TS 36.508 [7] subclause 4.3.1			Highest		
Test Parameters for Channel Bandwidths					
Configuration ID	Downlink Configuration		Uplink Configuration		
	Ch BW	N/A for SEM testing	Mod'n	Cluster1 RB allocations (LCRB @ RB <sub>start</sub> )	Cluster2 RB allocations (LCRB @ RB <sub>start</sub> )
1	5MHz		16QAM	2@0	1@24
2	5MHz		16QAM	18@0	2@22
3	5MHz		16QAM	2@0	18@6
4	10MHz		16QAM	3@0	2@48
5	10MHz		16QAM	42@0	3@45
6	10MHz		16QAM	3@0	42@6
7	15MHz		16QAM	8@0	7@68
8	15MHz		16QAM	60@0	4@68
9	15MHz		16QAM	4@0	60@12
10	20MHz		16QAM	4@0	4@96
11	20MHz		16QAM	92@0	4@96
12	20MHz		16QAM	4@0	92@8
Note 1: Test Channel Bandwidths are checked separately for each E-UTRA band, the applicable channel bandwidths are specified in Table 5.4.2.1-1.					

1. Connect the SS to the UE antenna connectors as shown in Figure TS 36.508 [7] Annex A, Figure A.3.
2. The parameter settings for the cell are set up according to TS 36.508 [7] subclause 4.4.3.
3. Downlink signals are initially set up according to Annex C0, C.1 and C.3.0, and uplink signals according to Annex H.1 and H.3.0.
4. The UL Reference Measurement channels are set according to Table 6.6.2.3\_2.4.1-1.
5. Propagation conditions are set according to Annex B.0.
6. Ensure the UE is in State 3A-RF according to TS 36.508 [7] clause 5.2A.2. Message contents are defined in clause 6.6.2.3\_2.4.3.

#### 6.6.2.3\_2.4.2 Test procedure

1. SS sends uplink scheduling information for each UL HARQ process via PDCCH DCI format 0 for C\_RNTI to schedule the UL RMC according to Table 6.6.2.3\_2.4.1-1. Since the UE has no payload data to send, the UE transmits uplink MAC padding bits on the UL RMC.

2. Send continuously uplink power control "up" commands in the uplink scheduling information to the UE until the UE transmits at  $P_{UMAX}$  level.
3. Measure the mean power of the UE in the channel bandwidth of the radio access mode according to the test configuration, which shall meet the requirements described in Table 6.2.3\_2.5-1. The period of the measurement shall be at least the continuous duration of one sub-frame (1ms). For TDD slots with transient periods are not under test.
4. Measure the rectangular filtered mean power for E-UTRA.
5. Measure the rectangular filtered mean power of the first E-UTRA adjacent channel on both lower and upper side of the E-UTRA channel, respectively.
6. Measure the RRC filtered mean power of the first and the second UTRA adjacent channel on both lower and upper side of the E-UTRA channel, respectively.
7. Calculate the ratios of the power between the values measured in step 4 over step 5 for lower and upper E-UTRA<sub>ACLR</sub>, respectively.
8. Calculated the ratios of the power between the values measured in step 4 over step 6 for lower and upper UTRA<sub>ACLR1</sub>, UTRA<sub>ACLR2</sub>, respectively.

#### 6.6.2.3\_2.4.3 Message contents

Message contents are according to TS 36.508 [7] subclause 4.6.

#### 6.6.2.3\_2.5 Test requirement

##### 6.6.2.3\_2.5.1 Test requirements E-UTRA

- The measured UE mean power in the channel bandwidth, derived in step 3, shall fulfil requirements in Table 6.2.3\_2.5-1 as appropriate,

and

- if the measured adjacent channel power is greater than  $-50$  dBm then the measured E-UTRA<sub>ACLR</sub>, derived in step 7, shall be higher than the limits in table 6.6.2.3\_2.5.1-1.

**Table 6.6.2.3\_2.5.1-1: E-UTRA UE ACLR**

	Channel bandwidth / E-UTRA <sub>ACLR1</sub> / measurement bandwidth					
	1.4 MHz	3.0 MHz	5 MHz	10 MHz	15 MHz	20 MHz
<b>E-UTRA<sub>ACLR1</sub></b>	29.2 dB	29.2 dB	29.2 dB	29.2 dB	29.2 dB	29.2 dB
<b>E-UTRA channel Measurement bandwidth</b>	1.08 MHz	2.7 MHz	4.5 MHz	9.0 MHz	13.5 MHz	18 MHz
<b>UE channel</b>	+1.4 MHz or -1.4 MHz	+3 MHz or -3 MHz	+5MHz or -5MHz	+10MHz or -10MHz	+15MHz or -15MHz	+20MHz or -20MHz

##### 6.6.2.3\_2.5.2 Test requirements UTRA

If the measured UTRA channel power is greater than  $-50$ dBm then the measured UTRA<sub>ACLR1</sub>, UTRA<sub>ACLR2</sub>, derived in step 8, shall be higher than the limits in table 6.6.2.3\_2.5.2-1.

**Table 6.6.2.3\_2.5.2-1: UTRA UE ACLR**

	Channel bandwidth / UTRA <sub>ACLR1/2</sub> / measurement bandwidth					
	1.4 MHz	3.0 MHz	5 MHz	10 MHz	15 MHz	20 MHz

<b>UTRA<sub>ACLR1</sub></b>	32.2 dB	32.2 dB	32.2 dB	32.2 dB	32.2 dB	32.2 dB
<b>Adjacent channel centre frequency offset (in MHz)</b>	$0.7+BW_{UTR}$ $A/2$ / -0.7- $BW_{UTR}/2$	$1.5+BW_{UTR}$ $A/2$ / -1.5- $BW_{UTR}/2$	$2.5+BW_{UTR}$ $A/2$ / -2.5- $BW_{UTR}/2$	$5+BW_{UTR}/2$ / -5- $BW_{UTR}/2$	$7.5+BW_{UTR}$ $A/2$ / -7.5- $BW_{UTR}/2$	$10+BW_{UTR}$ $A/2$ / -10- $BW_{UTR}/2$
<b>UTRA<sub>ACLR2</sub></b>	-	-	35.2 dB	35.2 dB	35.2 dB	35.2 dB
<b>Adjacent channel centre frequency offset (in MHz)</b>	-	-	$2.5+3*BW_U$ $TR/2$ / -2.5- $3*BW_{UTR}/2$	$5+3*BW_{UTR}$ $A/2$ / -5- $3*BW_{UTR}/2$	$7.5+3*BW_U$ $TR/2$ / -7.5- $3*BW_{UTR}/2$	$10+3*BW_{UT}$ $RA/2$ / -10- $3*BW_{UTR}/2$
<b>E-UTRA channel Measurement bandwidth</b>	1.08 MHz	2.7 MHz	4.5 MHz	9.0 MHz	13.5 MHz	18 MHz
<b>UTRA 5MHz channel Measurement bandwidth<sup>1</sup></b>	3.84 MHz	3.84 MHz	3.84 MHz	3.84 MHz	3.84 MHz	3.84 MHz
<b>UTRA 1.6MHz channel measurement bandwidth<sup>2</sup></b>	1.28 MHz	1.28 MHz	1.28 MHz	1.28 MHz	1.28 MHz	1.28 MHz
Note 1:	Applicable for E-UTRA FDD co-existence with UTRA FDD in paired spectrum.					
Note 2:	Applicable for E-UTRA TDD co-existence with UTRA TDD in unpaired spectrum.					
Note 3:	$BW_{UTR}$ for UTRA FDD is 5MHz and for UTRA TDD is 1.6MHz.					

### 6.6.2.3A Adjacent Channel Leakage power Ratio for CA

#### 6.6.2.3A.1 Adjacent Channel Leakage power Ratio for CA (intra-band contiguous DL CA and UL CA)

##### 6.6.2.3A.1.1 Test purpose

To verify that UE transmitter does not cause unacceptable interference to adjacent channels in terms of Adjacent Channel Leakage power Ratio (ACLR) for CA.

##### 6.6.2.3A.1.2 Test applicability

This test case applies to all types of E-UTRA UE release 10 and forward that support intra band contiguous DL CA and UL CA.

##### 6.6.2.3A.1.3 Minimum conformance requirements

ACLR for CA requirements are specified for two scenarios for an adjacent E-UTRA<sub>ACLR</sub> and UTRA<sub>ACLR1/2</sub> as shown in Figure 6.6.2.3A.1.3-1.

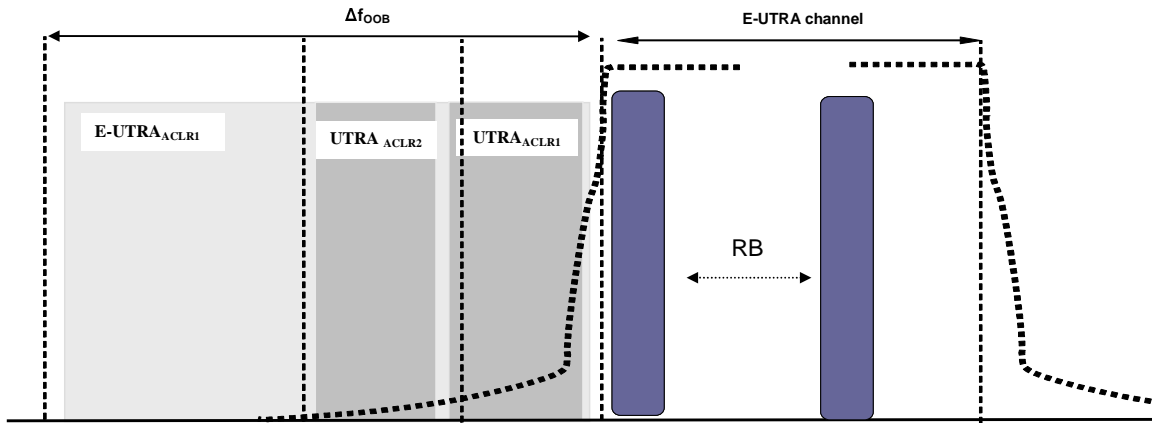

Figure 6.6.2.3A.1.3-1: Adjacent Channel Leakage Power Ratio for CA requirements

6.6.2.3A.1.3.1 Minimum conformance requirements of UTRA for CA

For intra-band contiguous carrier aggregation the UTRA Adjacent Channel Leakage power Ratio ( $UTRA_{ACLR}$ ) is the ratio of the filtered mean power centred on the assigned carrier aggregated channel bandwidth to the filtered mean power centred on an adjacent(s) UTRA channel frequency.

UTRA Adjacent Channel Leakage power Ratio is specified for both the first UTRA adjacent channel ( $UTRA_{ACLR1}$ ) and the 2<sup>nd</sup> UTRA adjacent channel ( $UTRA_{ACLR2}$ ). The UTRA channel power is measured with a RRC bandwidth filter with roll-off factor  $\alpha = 0.22$ . The assigned aggregated channel bandwidth power is measured with a rectangular filter with measurement bandwidth specified in Table 6.6.2.3A.1.3.1-1. If the measured UTRA channel power is greater than  $-50\text{dBm}$  then the  $UTRA_{ACLR1}$  shall be higher than the valued specified in Table 6.6.2.3A.1.3.1-1.

Table 6.6.2.3A.1.3.1-1: General requirements of  $UTRA_{ACLR1/2}$  for CA

	CA bandwidth class / $UTRA_{ACLR1/2}$ / measurement bandwidth
	<b>CA bandwidth class C</b>
$UTRA_{ACLR1}$	33 dB
Adjacent channel centre frequency offset (in MHz)	$+ BW_{Channel\_CA} / 2 + BW_{UTRA} / 2$ / $- BW_{Channel\_CA} / 2 - BW_{UTRA} / 2$
$UTRA_{ACLR2}$	36 dB
Adjacent channel centre frequency offset (in MHz)	$+ BW_{Channel\_CA} / 2 + 3 * BW_{UTRA} / 2$ / $- BW_{Channel\_CA} / 2 - 3 * BW_{UTRA} / 2$
CA E-UTRA channel Measurement bandwidth	$BW_{Channel\_CA} - 2 * BW_{GB}$
UTRA 5MHz channel Measurement bandwidth*	3.84 MHz
UTRA 1.6MHz channel measurement bandwidth**	1.28 MHz
* Note: Applicable for E-UTRA FDD co-existence with UTRA FDD in paired spectrum.	
** Note: Applicable for E-UTRA TDD co-existence with UTRA TDD in unpaired spectrum.	

The normative reference for this requirement is TS 36.101 [2] subclause 6.6.2.3.2A.

6.6.2.3A.1.3.2 Minimum conformance requirements of CA E-UTRA

For intra-band contiguous carrier aggregation the carrier aggregation E-UTRA Adjacent Channel Leakage power Ratio (CA E- $UTRA_{ACLR}$ ) is the ratio of the filtered mean power centred on the aggregated channel bandwidth to the filtered mean power centred on an adjacent aggregated channel bandwidth at nominal channel spacing. The assigned aggregated channel bandwidth power and adjacent aggregated channel bandwidth power are measured with rectangular filters with measurement bandwidth specified in Table 6.6.2.3A.1.3.2-1.

If the measured adjacent channel power is greater than  $-50\text{dBm}$  then the  $E\text{-UTRA}_{\text{ACLR}}$  shall be higher than the value specified in Table 6.6.2.3A.1.3.2-1.

**Table 6.6.2.3A.1.3.2-1: General requirements of  $E\text{-UTRA}_{\text{ACLR}}$  for CA**

	CA bandwidth class / CA $E\text{-UTRA}_{\text{ACLR}}$ / measurement bandwidth
	CA bandwidth class C
CA $E\text{-UTRA}_{\text{ACLR}}$	30 dB
CA $E\text{-UTRA}$ channel Measurement bandwidth	$BW_{\text{Channel\_CA}} - 2 * BW_{\text{GB}}$
Adjacent channel centre frequency offset (in MHz)	$+ BW_{\text{Channel\_CA}}$ / $- BW_{\text{Channel\_CA}}$

The normative reference for this requirement is TS 36.101 [2] subclause 6.6.2.3.3A.

#### 6.6.2.3A.1.4 Test description

##### 6.6.2.3A.1.4.1 Initial condition

Initial conditions are a set of test configurations the UE needs to be tested in and the steps for the SS to take with the UE to reach the correct measurement state.

The initial test configurations consist of environmental conditions, test frequencies, and channel bandwidths based on  $E\text{-UTRA}$  CA configurations specified in table 5.4.2A.1-1. All of these configurations shall be tested with applicable test parameters for each channel bandwidth, and are shown in table 6.6.2.3A.1.4.1-1. The details of the uplink reference measurement channels (RMCs) are specified in Annex A.2. Configurations of PDSCH and PDCCH before measurement are specified in Annex C.2.

**Table 6.6.2.3A.1.4.1-1: Test Configuration Table**

Initial Conditions									
Test Environment as specified in TS 36.508[7] subclause 4.1					NC, TL/VL, TL/VH, TH/VL, TH/VH				
Test Frequencies as specified in TS36.508 [7] subclause 4.3.1 for different CA bandwidth classes, and PCC and SCCs are mapped onto physical frequencies according to Table 6.1-2.					C: Low range, High range				
Test CC Combination setting (N <sub>RB_agg</sub> ) as specified in subclause 5.4.2A.1 for the CA Configuration					Lowest N <sub>RB_agg</sub> , Highest N <sub>RB_agg</sub> (Note 2)				
Test Parameters for CA Configurations									
CA Configuration / N <sub>RB_agg</sub>			DL Allocation		CC MOD	UL Allocation			
ID	PCC N <sub>RB</sub>	SCCs N <sub>RB</sub>	PCC & SCC RB allocation			N <sub>RB_alloc</sub>	PCC & SCC RB allocations(L <sub>CRB</sub> @ RB <sub>start</sub> )		
1	100	25	N/A for this test	QPSK	8	P_8@0	S_0@0		
2	100	25		QPSK	25	P_25@0	S_0@0		
3	100	25		QPSK	125	P_100@0	S_25@0		
4	100	25		16QAM	8	P_8@0	S_0@0		
5	100	25		16QAM	25	P_25@0	S_0@0		
6	100	25		16QAM	125	P_100@0	S_25@0		
7	100	25		QPSK	2	P_1@0	S_1@24		
8	75	75		QPSK	75	P_75@0	S_0@0	-	-
9	75	75		QPSK	16	P_16@0	S_0@0	-	-
10	75	75		QPSK	129	P_75@0	S_54@0	-	-
11	75	75		QPSK	150	P_75@0	S_75@0	-	-
12	75	75		16QAM	75	P_75@0	S_0@0	-	-
13	75	75		16QAM	16	P_16@0	S_0@0	-	-
14	75	75		16QAM	129	P_75@0	S_54@0	-	-
15	75	75		16QAM	150	P_75@0	S_75@0	-	-
16	75	75	N/A for this test	QPSK	2	P_1@0	S_1@74	-	-
17	100	50		QPSK	100	P_100@0	S_0@0	-	-
18	100	50		QPSK	12	P_12@0	S_0@0	-	-
19	100	50		QPSK	150	P_100@0	S_50@0	-	-
20	100	50		16QAM	100	P_100@0	S_0@0	-	-
21	100	50		16QAM	12	P_12@0	S_0@0	-	-
22	100	50		16QAM	150	P_100@0	S_50@0	-	-
23	100	50		QPSK	2	P_1@0	S_1@49	-	-
24	100	75		QPSK	16	P_16@0	S_0@0		
25	100	75		QPSK	75	P_75@0	S_0@0		
26	100	75		QPSK	175	P_100@0	S_75@0		
27	100	75		16QAM	16	P_16@0	S_0@0		
28	100	75		16QAM	75	P_75@0	S_0@0		
29	100	75		16QAM	175	P_100@0	S_75@0		
30	100	75		QPSK	2	P_1@0	S_1@74		
31	100	100	QPSK	100	P_100@0	S_0@0	-	-	
32	100	100	QPSK	18	P_18@0	S_0@0	-	-	
33	100	100	QPSK	130	P_100@0	S_30@0	-	-	



34	100	100	QPSK	200	P_100@0	S_100@0	-	-
35	100	100	16QAM	100	P_100@0	S_0@0	-	-
36	100	100	16QAM	18	P_18@0	S_0@0	-	-
37	100	100	16QAM	130	P_100@0	S_30@0	-	-
38	100	100	16QAM	200	P_100@0	S_100@0	-	-
39	100	100	QPSK	2	P_1@0	S_1@99	-	-
Note 1: CA Configuration Test CC Combination settings are checked separately for each CA Configuration, which applicable aggregated channel bandwidths are specified in Table 5.4.2A.1-1.								
Note 2: If in the CA Configuration UE supports multiple CC Combinations with the same $N_{RB\_agg}$ , only the first of those is tested, according to the order on the Test Configuration Table list.								

1. Connect the SS to the UE antenna connectors as shown in Figure TS 36.508 [7] Annex A, Figure group A.32 as appropriate.
2. The parameter settings for the cell are set up according to TS 36.508 [7] subclause 4.4.3.
3. Downlink signals for PCC are initially set up according to Annex C.0, C.1 and C.3.0, and uplink signals according to Annex H.1 and H.3.0.
4. The UL Reference Measurement channels are set according to Table 6.6.2.3A.1.4.1-1.
5. Propagation conditions are set according to Annex B.0.
6. Ensure the UE is in State 3A-RF according to TS 36.508 [7] clause 5.2A.2. Message contents are defined in clause 6.6.2.3A.1.4.3.

#### 6.6.2.3A.1.4.2 Test procedure

1. Configure SCC according to Annex C.0, C.1 and Annex C.3.0 for all downlink physical channels.
2. The SS shall configure SCC as per TS 36.508 [7] clause 5.2A.4. Message contents are defined in clause 6.6.2.3A.1.4.3
3. SS activates SCC by sending the activation MAC-CE (Refer TS 36.321 [13], clauses 5.13, 6.1.3.8). Wait for at least 2 seconds (Refer TS 36.133, clauses 8.3.3.2).
4. SS sends uplink scheduling information for each UL HARQ process via PDCCH DCI format 0 for C\_RNTI to schedule the UL RMC according to Table 6.6.2.3A.1.4.1-1 on both PCC and SCC. Since the UE has no payload and no loopback data to send the UE sends uplink MAC padding bits on the UL RMC.
5. Send continuously uplink power control “up” commands in every uplink scheduling information to the UE until the UE transmits at  $P_{UMAX}$  level.
6. Measure the mean power over all component carriers of the UE in the CA configuration of the radio access mode according to the test configuration, which shall meet the requirements described in Table 6.2.3A.1.5-1. The period of the measurement shall be at least the continuous duration of one sub-frame (1ms). For TDD slots with transient periods are not under test.
7. Measure the rectangular filtered mean power for CA E-UTRA.
8. Measure the rectangular filtered mean power of the first CA E-UTRA adjacent channel on both lower and upper side of the CA E-UTRA channel, respectively.
9. Measure the RRC filtered mean power of the first and the second UTRA adjacent channel on both lower and upper side of the CA E-UTRA channel, respectively.
10. Calculate the ratio of the power between the values measured in step 7 over step 8 for CA E-UTRA<sub>ACLR</sub>.
11. Calculate the ratio of the power between the values measured in step 7 over step 9 for UTRA<sub>ACLR1</sub>, UTRA<sub>ACLR2</sub>.

## 6.6.2.3A.1.4.3 Message contents

Message contents are according to TS 36.508 [7] subclause 4.6. In test procedure step 2, for SCC configuration there are no additional message contents.

## 6.6.2.3A.1.5 Test Requirements

## 6.6.2.3A.1.5.1 Test requirements of UTRA for CA

If the measured UTRA channel power is greater than  $-50$  dBm then the measured  $UTRA_{ACLR1}$  and  $UTRA_{ACLR2}$ , derived in step 11, shall be higher than the limits in table 6.6.2.3A.1.5.1-1.

Table 6.6.2.3A.1.5.1-1: UTRA UE ACLR for CA

	CA bandwidth class / $UTRA_{ACLR1/2}$ / measurement bandwidth
	CA bandwidth class C
$UTRA_{ACLR1}$	32.2 dB
Adjacent channel centre frequency offset (in MHz)	$\frac{+ BW_{Channel\_CA} / 2 + BW_{UTRA} / 2}{- BW_{Channel\_CA} / 2 - BW_{UTRA} / 2}$
$UTRA_{ACLR2}$	35.2 dB
Adjacent channel centre frequency offset (in MHz)	$\frac{+ BW_{Channel\_CA} / 2 + 3 * BW_{UTRA} / 2}{- BW_{Channel\_CA} / 2 - 3 * BW_{UTRA} / 2}$
CA E-UTRA channel Measurement bandwidth	$BW_{Channel\_CA} - 2 * BW_{GB}$
UTRA 5MHz channel Measurement bandwidth (Note 1)	3.84 MHz
UTRA 1.6MHz channel measurement bandwidth (Note 2)	1.28 MHz
Note 1:	Applicable for E-UTRA FDD co-existence with UTRA FDD in paired spectrum.
Note 2:	Applicable for E-UTRA TDD co-existence with UTRA TDD in unpaired spectrum.

## 6.6.2.3A.1.5.2 Test requirements of CA E-UTRA

- The measured UE mean power in the channel bandwidth as specified in clause 5.4.2A, derived in step 6, shall fulfil requirements in Table 6.2.3A.1.5-1 as appropriate,

and

- if the measured adjacent channel power is greater than  $-50$  dBm then the measured CA E- $UTRA_{ACLR}$ , derived in step 10, shall be higher than the limits in table 6.6.2.3A.1.5.2-1.

Table 6.6.2.3A.1.5.2-1: CA E-UTRA ACLR

	CA bandwidth class / CA E- $UTRA_{ACLR}$ / Measurement bandwidth
	CA bandwidth class C
CA E- $UTRA_{ACLR}$	29.2 dB
CA E-UTRA channel Measurement bandwidth	$BW_{Channel\_CA} - 2 * BW_{GB}$
Adjacent channel centre frequency offset (in MHz)	$\frac{+ BW_{Channel\_CA}}{- BW_{Channel\_CA}}$

## 6.6.2.3A.2 Adjacent Channel Leakage power Ratio for CA (inter-band DL CA and UL CA)

### 6.6.2.3A.2.1 Test purpose

To verify that UE transmitter does not cause unacceptable interference to adjacent channels in terms of Adjacent Channel Leakage power Ratio (ACLR) for CA.

### 6.6.2.3A.2.2 Test applicability

This test case applies to all types of E-UTRA UE release 10 and forward that support inter band DL CA and UL CA.

### 6.6.2.3A.2.3 Minimum conformance requirements

ACLR for CA requirements are specified for two scenarios for an adjacent E-UTRA<sub>ACLR</sub> and UTRA<sub>ACLR1/2</sub> as shown in Figure 6.6.2.3A.2.3-1.

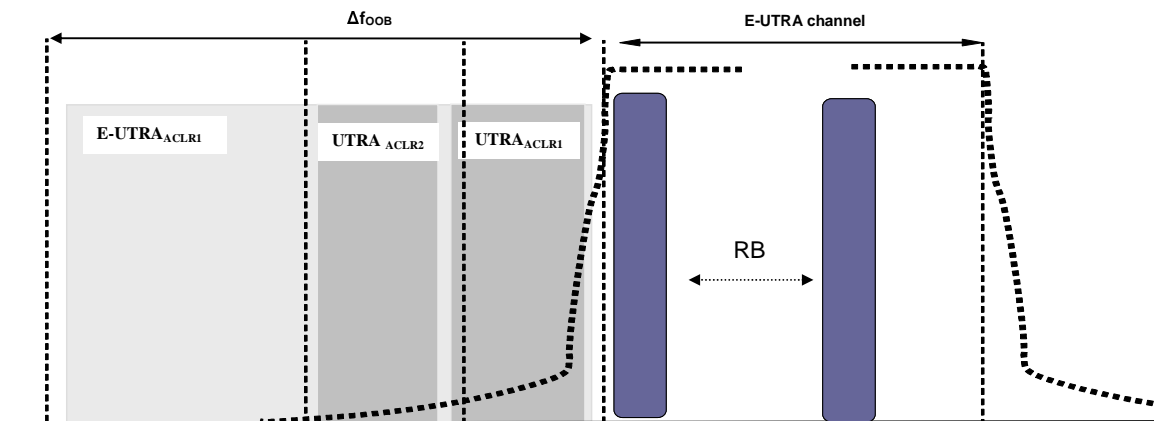

**Figure 6.6.2.3A.1.3-1: Adjacent Channel Leakage Power Ratio for CA requirements**

#### 6.6.2.3A.2.3.1 Minimum conformance requirements of UTRA for CA

For inter-band carrier aggregation with uplink assigned to two E-UTRA bands, the UTRA Adjacent Channel Leakage power Ratio (UTRA<sub>ACLR</sub>) is the ratio of the filtered mean power centred on the assigned channel bandwidth on the component carrier to the filtered mean power centred on an adjacent channel frequency. The UTRA Adjacent Channel Leakage power Ratio is defined per carrier and the requirement is specified in subclause 6.6.2.3.3.2.

The normative reference for this requirement is TS 36.101 [2] subclause 6.6.2.3.2A and 6.6.2.3.2.

#### 6.6.2.3A.2.3.2 Minimum conformance requirements of CA E-UTRA

For inter-band carrier aggregation with uplink assigned to two E-UTRA bands, E-UTRA Adjacent Channel Leakage power Ratio (E-UTRA<sub>ACLR</sub>) is the ratio of the filtered mean power centred on the assigned channel bandwidth on a component carrier to the filtered mean power centred on an adjacent channel frequency. The E-UTRA Adjacent Channel Leakage power Ratio is defined per carrier and the requirement is specified in subclause 6.6.2.3.3.1.

The normative reference for this requirement is TS 36.101 [2] subclause 6.6.2.3.3A and 6.6.2.3.1.

### 6.6.2.3A.2.4 Test description

#### 6.6.2.3A.2.4.1 Initial condition

Initial conditions are a set of test configurations the UE needs to be tested in and the steps for the SS to take with the UE to reach the correct measurement state.

The initial test configurations consist of environmental conditions, test frequencies, and channel bandwidths based on E-UTRA CA configurations specified in table 5.4.2A.1-1. All of these configurations shall be tested with applicable test

parameters for each channel bandwidth, and are shown in table 6.6.2.3A.2.4.1-1. The details of the uplink reference measurement channels (RMCs) are specified in Annex A.2. Configurations of PDSCH and PDCCH before measurement are specified in Annex C.2.

Table 6.6.2.3A.2.4.1-1: Test Configuration Table

Initial Conditions								
Test Environment as specified in TS 36.508[7] subclause 4.1						NC, TL/VL, TL/VH, TH/VL, TH/VH		
Test Frequencies as specified in TS 36.508 [7] subclause 4.3.1 for different CA bandwidth classes						Low and High range for both PCC and SCC (Note 3)		
Test CC Combination setting (NRB_agg) as specified in subclause 5.4.2A.1 for the CA Configuration across bandwidth combination sets supported by the UE.						Lowest N <sub>RB_agg</sub> Highest N <sub>RB_agg</sub> (Note 2)		
Test Parameters for CA Configurations								
Config ID	CA Configuration / NRB_agg		DL Allocation	CC MOD		UL Allocation		
	PCC	SCC	PCC & SCC RB allocation	PCC	SCC	NRB_alloc	PCC & SCC RB allocations	
	NRB	NRB						
1	6	25	N/A for this test	QPSK	QPSK	13	<u>5</u>	<u>8</u>
2	6	25		QPSK	QPSK	31	<u>6</u>	25
3	6	25		16QAM	16QAM	13	5	8
4	6	25		16QAM	16QAM	31	6	25
5	6	25		QPSK	16QAM	30	5	25
6	6	50		QPSK	QPSK	17	<u>5</u>	12
7	6	50		QPSK	QPSK	56	<u>6</u>	50
8	6	50		16QAM	16QAM	17	5	12
9	6	50		16QAM	16QAM	56	6	50
10	6	50		QPSK	16QAM	55	5	50
11	25	15		QPSK	QPSK	12	8	4
12	25	15		QPSK	QPSK	40	25	15
13	25	15		16QAM	16QAM	12	8	4
14	25	15		16QAM	16QAM	40	25	15
15	25	15		QPSK	16QAM	23	8	15
16	25	25		QPSK	QPSK	16	8	<u>8</u>
17	25	25		QPSK	QPSK	50	25	25
18	25	25		16QAM	16QAM	16	8	8
19	25	25		16QAM	16QAM	50	25	25
20	25	25		QPSK	16QAM	33	8	25
21	25	50		QPSK	QPSK	16	4	12
22	25	50		QPSK	QPSK	65	15	50
23	25	50		16QAM	16QAM	16	4	12
24	25	50		16QAM	16QAM	65	15	50
25	25	50		QPSK	16QAM	54	4	50
26	50	25		QPSK	QPSK	20	12	<u>8</u>
27	50	25		QPSK	QPSK	75	50	25
28	50	25		16QAM	16QAM	20	12	8
29	50	25		16QAM	16QAM	75	50	25

30	50	25		QPSK	16QAM	37	12	25
31	50	50		QPSK	QPSK	24	12	12
32	50	50		QPSK	QPSK	100	50	50
33	50	50		16QAM	16QAM	24	12	12
34	50	50		16QAM	16QAM	100	50	50
35	50	50		QPSK	16QAM	62	12	50
36	50	100		QPSK	QPSK	30	12	18
37	50	100		QPSK	QPSK	150	50	100
38	50	100		16QAM	16QAM	30	12	18
39	50	100		16QAM	16QAM	150	50	100
40	50	100		QPSK	16QAM	112	12	100
41	75	75		QPSK	QPSK	32	16	16
42	75	75		QPSK	QPSK	150	75	75
43	75	75		16QAM	16QAM	32	16	16
44	75	75		16QAM	16QAM	150	75	75
45	75	75		QPSK	16QAM	91	16	75
46	100	50		QPSK	QPSK	30	18	12
47	100	50		QPSK	QPSK	150	100	50
48	100	50		16QAM	16QAM	30	18	12
49	100	50		16QAM	16QAM	150	100	50
50	100	50		QPSK	16QAM	68	18	50
51	100	75		QPSK	QPSK	34	18	16
52	100	75		QPSK	QPSK	175	100	75
53	100	75		16QAM	16QAM	34	18	16
54	100	75		16QAM	16QAM	175	100	75
55	100	75		QPSK	16QAM	93	18	75
56	100	100		QPSK	QPSK	36	18	18
57	100	100		QPSK	QPSK	200	100	100
58	100	100		16QAM	16QAM	36	18	18
59	100	100		16QAM	16QAM	200	100	100
60	100	100		QPSK	16QAM	118	18	100
Note 1: CA Configuration Test CC Combination settings are checked separately for each CA Configuration, which applicable aggregated channel bandwidths are specified in Table 5.4.2A.1-1.								
Note 2: If in the CA Configuration UE supports multiple CC Combinations with the same NRB_agg, only the first of those is tested, according to the order on the Test Configuration Table list.								
Note 3: For Low range place test point with RB_start=0. For High range place test point with RB_start=RB_max-L_CRB+1.								

1. Connect the SS to the UE antenna connectors as shown in Figure TS 36.508 [7] Annex A, Figure group A.32 as appropriate.
2. The parameter settings for the cell are set up according to TS 36.508 [7] subclause 4.4.3.
3. Downlink signals for PCC are initially set up according to Annex C.0, C.1 and C.3.0, and uplink signals according to Annex H.1 and H.3.0.
4. The UL Reference Measurement channels are set according to Table 6.6.2.3A.2.4.1-1.
5. Propagation conditions are set according to Annex B.0.

6. Ensure the UE is in State 3A-RF according to TS 36.508 [7] clause 5.2A.2. Message contents are defined in clause 6.6.2.3A.1.4.3.

#### 6.6.2.3A.1.4.2 Test procedure

1. Configure SCC according to Annex C.0, C.1 and Annex C.3.0 for all downlink physical channels.
2. The SS shall configure SCC as per TS 36.508 [7] clause 5.2A.4. Message contents are defined in clause 6.6.2.3A.1.4.3
3. SS activates SCC by sending the activation MAC-CE (Refer TS 36.321 [13], clauses 5.13, 6.1.3.8). Wait for at least 2 seconds (Refer TS 36.133, clauses 8.3.3.2).
4. SS sends uplink scheduling information for each UL HARQ process via PDCCH DCI format 0 for C\_RNTI to schedule the UL RMC according to Table 6.6.2.3A.2.4.1-1 on both PCC and SCC. Since the UE has no payload and no loopback data to send the UE sends uplink MAC padding bits on the UL RMC.
5. Send continuously uplink power control “up” commands in every uplink scheduling information to the UE until the UE transmits at  $P_{UMAX}$  level.
6. Measure the mean power of the component carrier of the UE in the first band of the CA configuration of the radio access mode according to the test configuration, which shall meet the requirements described in Table 6.2.3A.2.5-1. The period of the measurement shall be at least the continuous duration of one sub-frame (1ms). For TDD slots with transient periods are not under test.
7. Measure the rectangular filtered mean power for CA E-UTRA in the first band of the CA configuration.
8. Measure the rectangular filtered mean power of the first CA E-UTRA adjacent channel on both lower and upper side of the CA E-UTRA channel in the first band of the CA configuration, respectively.
9. Measure the RRC filtered mean power of the first and the second UTRA adjacent channel on both lower and upper side of the CA E-UTRA channel in the first band of the CA configuration, respectively.
10. Calculate the ratio of the power between the values measured in step 7 over step 8 for CA E-UTRA<sub>ACLR</sub>.
11. Calculate the ratio of the power between the values measured in step 7 over step 9 for UTRA<sub>ACLR1</sub>, UTRA<sub>ACLR2</sub>.
12. Repeat steps 6 to 11 for the second band of the CA configuration.

#### 6.6.2.3A.1.4.3 Message contents

Message contents are according to TS 36.508 [7] subclause 4.6. In test procedure step 2, for SCC configuration there are no additional message contents.

#### 6.6.2.3A.1.5 Test Requirements

##### 6.6.2.3A.1.5.1 Test requirements of UTRA for CA

If the measured UTRA channel power is greater than  $-50\text{dBm}$  then the measured UTRA<sub>ACLR1</sub> and UTRA<sub>ACLR2</sub>, derived in step 11, shall be higher than the limits in table 6.6.2.3A.2.5.1-1.

**Table 6.6.2.3A.2.5.1-1: UTRA UE ACLR for CA**

	Channel bandwidth / E-UTRA <sub>ACLR1</sub> / measurement bandwidth					
	1.4 MHz	3.0 MHz	5 MHz	10 MHz	15 MHz	20 MHz
E-UTRA <sub>ACLR1</sub>	29.2 dB	29.2 dB	29.2 dB	29.2 dB	29.2 dB	29.2 dB
E-UTRA channel Measurement bandwidth	1.08 MHz	2.7 MHz	4.5 MHz	9.0 MHz	13.5 MHz	18 MHz
UE channel	+1.4 MHz or -1.4 MHz	+3 MHz or -3 MHz	+5MHz or -5MHz	+10MHz or -10MHz	+15MHz or -15MHz	+20MHz or -20MHz

## 6.6.2.3A.1.5.2 Test requirements of CA E-UTRA

- The measured UE mean power in the channel bandwidth as specified in clause 5.4.2A, derived in step 6, shall fulfil requirements in Table 6.2.3A.2.5-1 as appropriate,

and

- if the measured adjacent channel power is greater than  $-50$  dBm then the measured CA E-UTRA<sub>ACLR</sub>, derived in step 10, shall be higher than the limits in table 6.6.2.3A.2.5.2-1.

Table 6.6.2.3A.2.5.2-1: CA E-UTRA ACLR

	Channel bandwidth / UTRA <sub>ACLR1/2</sub> / measurement bandwidth					
	1.4 MHz	3.0 MHz	5 MHz	10 MHz	15 MHz	20 MHz
UTRA <sub>ACLR1</sub>	32.2 dB	32.2 dB	32.2 dB	32.2 dB	32.2 dB	32.2 dB
Adjacent channel centre frequency offset (in MHz)	0.7+BW <sub>UTR</sub> A/2 / -0.7- BW <sub>UTR</sub> /2	1.5+BW <sub>UTR</sub> A/2 / -1.5- BW <sub>UTR</sub> /2	2.5+BW <sub>UTR</sub> A/2 / -2.5- BW <sub>UTR</sub> /2	5+BW <sub>UTR</sub> 2 / -5- BW <sub>UTR</sub> /2	7.5+BW <sub>UTR</sub> A/2 / -7.5- BW <sub>UTR</sub> /2	10+BW <sub>UTR</sub> /2 / -10- BW <sub>UTR</sub> /2
UTRA <sub>ACLR2</sub>	-	-	35.2 dB	35.2 dB	35.2 dB	35.2 dB
Adjacent channel centre frequency offset (in MHz)	-	-	2.5+3*BW <sub>U</sub> TRA/2 / -2.5- 3*BW <sub>UTR</sub> /2	5+3*BW <sub>UTR</sub> A/2 / -5- 3*BW <sub>UTR</sub> /2	7.5+3*BW <sub>U</sub> TRA/2 / -7.5- 3*BW <sub>UTR</sub> /2	10+3*BW <sub>UT</sub> RA/2 / -10- 3*BW <sub>UTR</sub> /2
E-UTRA channel Measurement bandwidth	1.08 MHz	2.7 MHz	4.5 MHz	9.0 MHz	13.5 MHz	18 MHz
UTRA 5MHz channel Measurement bandwidth <sup>1</sup>	3.84 MHz	3.84 MHz	3.84 MHz	3.84 MHz	3.84 MHz	3.84 MHz
UTRA 1.6MHz channel measurement bandwidth <sup>2</sup>	1.28 MHz	1.28 MHz	1.28 MHz	1.28 MHz	1.28 MHz	1.28 MHz
Note 1:	Applicable for E-UTRA FDD co-existence with UTRA FDD in paired spectrum.					
Note 2:	Applicable for E-UTRA TDD co-existence with UTRA TDD in unpaired spectrum.					
Note 3:	BW <sub>UTR</sub> for UTRA FDD is 5MHz and for UTRA TDD is 1.6MHz.					

## 6.6.2.3B Adjacent Channel Leakage power Ratio for UL-MIMO

## 6.6.2.3B.1 Test purpose

To verify that UE transmitter does not cause unacceptable interference to adjacent channels in terms of Adjacent Channel Leakage power Ratio (ACLR) for UL-MIMO.

## 6.6.2.3B.2 Test applicability

This test case applies to all types of E-UTRA UE release 10 and forward that support UL-MIMO.

## 6.6.2.3B.3 Minimum conformance requirements

For UE with multiple transmit antenna connectors, the requirements for ACLR are specified at each transmit antenna connector. ACLR requirements are specified for two scenarios for an adjacent E-UTRA<sub>ACLR</sub> and UTRA<sub>ACLR1/2</sub> as shown in Figure 6.6.2.3B.3-1.



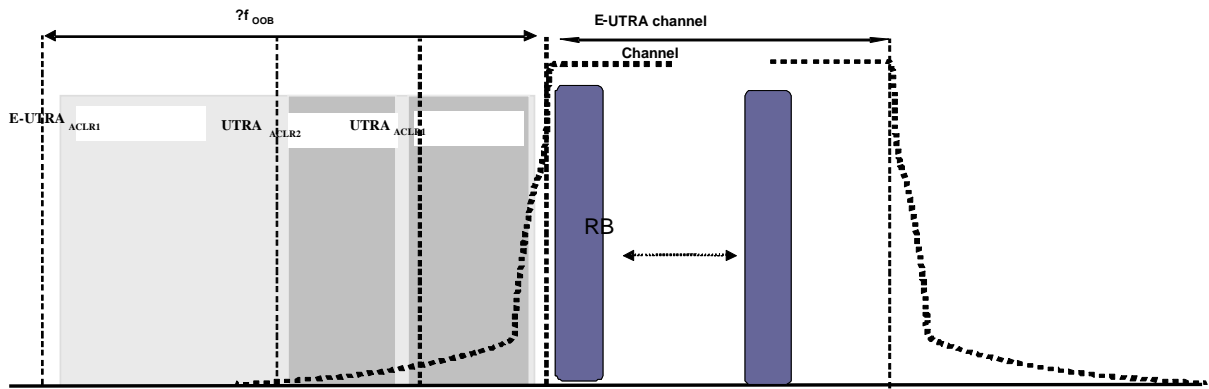

Figure 6.6.2.3B.3-1: Adjacent Channel Leakage Power Ratio requirements

6.6.2.3B.3.1 Minimum conformance requirements for E-UTRA

E-UTRA ACLR (E-UTRAACLR) is the ratio of the filtered mean power centred on the assigned channel frequency to the filtered mean power centred on an adjacent channel frequency at nominal channel spacing. The assigned E-UTRA channel power and adjacent E-UTRA channel power are measured with rectangular filters with measurement bandwidth specified in Table 6.6.2.3B.3.1-1.

For UEs with two transmit antenna connectors in closed-loop spatial multiplexing scheme, the requirements in Table 6.6.2.3B.3.1-1 apply to each transmit antenna connector with the UL-MIMO configurations specified in Table 6.2.2B.3-2.

If the measured adjacent channel power is greater than -50dBm then the E-UTRAACLR shall be higher than the valued specified in Table 6.6.2.3B.3.1-1.

Table 6.6.2.3B.3.1-1: General requirements for E-UTRA<sub>ACLR</sub>

	Channel bandwidth / E-UTRA <sub>ACLR1</sub> / measurement bandwidth					
	1.4 MHz	3.0 MHz	5 MHz	10 MHz	15 MHz	20 MHz
<b>E-UTRA<sub>ACLR1</sub></b>	30 dB	30 dB	30 dB	30 dB	30 dB	30 dB
<b>E-UTRA channel Measurement bandwidth</b>	1.08 MHz	2.7 MHz	4.5 MHz	9.0 MHz	13.5 MHz	18 MHz

The normative reference for this requirement is TS 36.101 clause 6.6.2B.

6.6.2.3B.3.2 Minimum conformance requirements for UTRA

UTRA ACLR (UTRA<sub>ACLR</sub>) is the ratio of the filtered mean power centred on the assigned E-UTRA channel frequency to the filtered mean power centred on an adjacent UTRA channel frequency.

UTRA ACLR is specified for both the first UTRA adjacent channel (UTRA<sub>ACLR1</sub>) and the 2nd UTRA adjacent channel (UTRA<sub>ACLR2</sub>). The UTRA channel power is measured with a RRC bandwidth filter with roll-off factor  $\alpha = 0.22$ . The assigned E-UTRA channel power is measured with a rectangular filter with measurement bandwidth specified in Table 6.6.2.3B.3.2-1.

For UEs with two transmit antenna connectors in closed-loop spatial multiplexing scheme, the requirements in Table 6.6.2.3B.3.2-1 apply to each transmit antenna connector with the UL-MIMO configurations specified in Table 6.2.2B.3-2.

If the measured UTRA channel power is greater than -50dBm then the UTRA<sub>ACLR1</sub>, and UTRA<sub>ACLR2</sub> shall be higher than the valued specified in Table 6.6.2.3B.3.2-1.

Table 6.6.2.3B.3.2-1: General requirements for UTRA<sub>ACLR1/2</sub>

	Channel bandwidth / E-UTRA <sub>ACLR1/2</sub> / measurement bandwidth					
	1.4 MHz	3.0 MHz	5 MHz	10 MHz	15 MHz	20 MHz
<b>E-UTRA<sub>ACLR1</sub></b>	33 dB	33 dB	33 dB	33 dB	33 dB	33 dB
<b>Adjacent channel centre frequency offset (in MHz)</b>	$0.7+BW_{UTRA}/2$ / $-0.7-BW_{UTRA}/2$	$1.5+BW_{UTRA}/2$ / $-1.5-BW_{UTRA}/2$	$2.5+BW_{UTRA}/2$ / $-2.5-BW_{UTRA}/2$	$5+BW_{UTRA}/2$ / $-5-BW_{UTRA}/2$	$7.5+BW_{UTRA}/2$ / $-7.5-BW_{UTRA}/2$	$10+BW_{UTRA}/2$ / $-10-BW_{UTRA}/2$
<b>UTRA<sub>ACLR2</sub></b>	-	-	36 dB	36 dB	36 dB	36 dB
<b>Adjacent channel centre frequency offset (in MHz)</b>	-	-	$2.5+3*BW_{UTRA}/2$ / $-2.5-3*BW_{UTRA}/2$	$5+3*BW_{UTRA}/2$ / $-5-3*BW_{UTRA}/2$	$7.5+3*BW_{UTRA}/2$ / $-7.5-3*BW_{UTRA}/2$	$10+3*BW_{UTRA}/2$ / $-10-3*BW_{UTRA}/2$
<b>E-UTRA channel Measurement bandwidth</b>	1.08 MHz	2.7 MHz	4.5 MHz	9.0 MHz	13.5 MHz	18 MHz
<b>UTRA 5MHz channel Measurement bandwidth<sup>1</sup></b>	3.84 MHz	3.84 MHz	3.84 MHz	3.84 MHz	3.84 MHz	3.84 MHz
<b>UTRA 1.6MHz channel measurement bandwidth<sup>2</sup></b>	1.28 MHz	1.28 MHz	1.28 MHz	1.28 MHz	1.28 MHz	1.28 MHz
Note 1: Applicable for E-UTRA FDD co-existence with UTRA FDD in paired spectrum.						
Note 2: Applicable for E-UTRA TDD co-existence with UTRA TDD in unpaired spectrum.						

The normative reference for this requirement is TS 36.101 clause 6.6.2B.

#### 6.6.2.3B.4 Test description

##### 6.6.2.3B.4.1 Initial conditions

Initial conditions are a set of test configurations the UE needs to be tested in and the steps for the SS to take with the UE to reach the correct measurement state.

The initial test configurations consist of environmental conditions, test frequencies, and channel bandwidths based on E-UTRA bands specified in table 5.4.2.1-1. All of these configurations shall be tested with applicable test parameters for each channel bandwidth, and are shown in table 6.6.2.3B.4.1-1. The details of the uplink reference measurement channels (RMCs) are specified in Annex A.2. Configurations of PDSCH and PDCCH before measurement are specified in Annex C.2.

**Table 6.6.2.3B.4.1-1: Test Configuration Table**

Initial Conditions						
Test Environment (as specified in TS 36.508 [7] clause 4.1)				NC, TL/VL, TL/VH, TH/VL, TH/VH		
Test Frequencies (as specified in TS 36.508 [7] clause 4.3.1)				Low range, Mid range, High range		
Test Channel Bandwidths (as specified in TS 36.508 [7] clause 4.3.1)				Lowest, 5MHz, 10MHz, Highest		
Test Parameters for Channel Bandwidths						
Ch BW	Downlink Configuration			Uplink Configuration		
	Mod'n	RB allocation		Mod'n	RB allocation	
		FDD	TDD		FDD	TDD
1.4MHz	N/A for ACLR testing			QPSK	6	6
1.4MHz				QPSK	5	5
1.4MHz				16QAM	6	6
1.4MHz				16QAM	5	5
3MHz				QPSK	15	15
3MHz				QPSK	4	4
3MHz				16QAM	15	15
3MHz				16QAM	4	4
5MHz				QPSK	25	25
5MHz				QPSK	8	8
5MHz				16QAM	25	25
5MHz				16QAM	8	8
10MHz				QPSK	50	50
10MHz				QPSK	12	12
10MHz				16QAM	50 (Note 3)	50 (Note 3)
10MHz				16QAM	12	12
15MHz				QPSK	75	75
15MHz				QPSK	16	16
15MHz				16QAM	75 (Note 3)	75 (Note 3)
15MHz				16QAM	16	16
20MHz				QPSK	100	100
20MHz				QPSK	18	18
20MHz				16QAM	100 (Note 3)	100 (Note 3)
20MHz				16QAM	18	18
Note 1: Test Channel Bandwidths are checked separately for each E-UTRA band, which applicable channel bandwidths are specified in Table 5.4.2.1-1. Note 2: The RBstart of partial RB allocation shall be RB#0 and RB# (max + 1 - RB allocation) of the channel bandwidth. Note 3: Applies only for UE-Categories [FFS].						

1. Connect the SS to the UE antenna connectors as shown in Figure TS 36.508 [7] Annex A, Figure A.28.
2. The parameter settings for the cell are set up according to TS 36.508 [7] clause 4.4.3.
3. Downlink signals are initially set up according to Annex C0, C.1 and C.3.0, and uplink signals according to Annex H.1 and H.3.0.
4. The UL Reference Measurement channels are set according to Table 6.6.2.3B.4.1-1.
5. Propagation conditions are set according to Annex B.0.
6. Ensure the UE is in State 3A-RF according to TS 36.508 [7] clause 5.2A.2. Message contents are defined in clause 6.6.2.3B.4.3.

**6.6.2.3B.4.2 Test procedure**

1. SS sends uplink scheduling information for each UL HARQ process via PDCCH DCI format 4 for C\_RNTI to schedule the UL RMC according to Table 6.6.2.3B.4.1-1. Since the UE has no payload data to send, the UE transmits uplink MAC padding bits on the UL RMC.

2. Send continuously uplink power control "up" commands in the uplink scheduling information to the UE until the UE transmits at  $P_{UMAX}$  level.
3. Measure the sum of the mean power at each antenna connector of UE in the channel bandwidth of the radio access mode according to the test configuration, which shall meet the requirements described in clause 6.2.3B.5. The period of the measurement shall be at least the continuous duration of one sub-frame (1ms). For TDD slots with transient periods are not under test.
4. Measure the rectangular filtered mean power for E-UTRA at each antenna connector of UE.
5. Measure the rectangular filtered mean power of the first E-UTRA adjacent channel at each antenna connector of UE.
6. Measure the RRC filtered mean power of the first and the second UTRA adjacent channel at each antenna connector of UE.
7. Calculate the ratio of the power between the values measured in step 4 over step 5 for E-UTRA<sub>ACLR</sub>.
8. Calculated the ratio of the power between the values measured in step 4 over step 6 for UTRA<sub>ACLR1</sub>, UTRA<sub>ACLR2</sub>.

#### 6.6.2.3B.4.3 Message contents

Message contents are according to TS 36.508 [7] subclause 4.6.

#### 6.6.2.3B.5 Test requirement

##### 6.6.2.3B.5.1 Test requirements E-UTRA

- The measured sum of mean power at each transmit antenna connector for UE in the channel bandwidth, derived in step 3, shall fulfil requirements in clause 6.2.3B.5 as appropriate,
- and
- The requirements apply to each transmit antenna connector.
  - if the measured adjacent channel power is greater than -50 dBm then the measured E-UTRA<sub>ACLR</sub>, derived in step 7, shall be higher than the limits in table 6.6.2.3B.5.1-1.

**Table 6.6.2.3B.5.1-1: E-UTRA UE ACLR**

	Channel bandwidth / E-UTRA <sub>ACLR1</sub> / measurement bandwidth					
	1.4 MHz	3.0 MHz	5 MHz	10 MHz	15 MHz	20 MHz
<b>E-UTRA<sub>ACLR1</sub></b>	29.2 dB	29.2 dB	29.2 dB	29.2 dB	29.2 dB	29.2 dB
<b>E-UTRA channel Measurement bandwidth</b>	1.08 MHz	2.7 MHz	4.5 MHz	9.0 MHz	13.5 MHz	18 MHz
<b>UE channel</b>	+1.4 MHz or -1.4 MHz	+3 MHz or -3 MHz	+5MHz or -5MHz	+10MHz or -10MHz	+15MHz or -15MHz	+20MHz or -20MHz

##### 6.6.2.3B.5.2 Test requirements UTRA

The requirements apply to each transmit antenna connector.

If the measured UTRA channel power is greater than -50dBm then the measured UTRA<sub>ACLR1</sub>, UTRA<sub>ACLR2</sub>, derived in step 8, shall be higher than the limits in table 6.6.2.3B.5.2-1.

Table 6.6.2.3B.5.2-1: UTRA UE ACLR

	Channel bandwidth / E-UTRA <sub>ACLR1/2</sub> / measurement bandwidth					
	1.4 MHz	3.0 MHz	5 MHz	10 MHz	15 MHz	20 MHz
UTRA <sub>ACLR1</sub>	32.2 dB	32.2 dB	32.2 dB	32.2 dB	32.2 dB	32.2 dB
Adjacent channel centre frequency offset (in MHz)	0.7+BW <sub>UTRA</sub> / 2 / -0.7- BW <sub>UTRA</sub> /2	1.5+BW <sub>UTR</sub> A/2 / -1.5- BW <sub>UTRA</sub> /2	2.5+BW <sub>UTR</sub> A/2 / -2.5- BW <sub>UTRA</sub> /2	5+BW <sub>UTRA</sub> / 2 / -5- BW <sub>UTRA</sub> /2	7.5+BW <sub>UTRA</sub> / 2 / -7.5- BW <sub>UTRA</sub> /2	10+BW <sub>UTRA</sub> / 2 / -10- BW <sub>UTRA</sub> /2
UTRA <sub>ACLR2</sub>	-	-	35.2 dB	35.2 dB	35.2 dB	35.2 dB
Adjacent channel centre frequency offset (in MHz)	-	-	2.5+3*BW <sub>U</sub> TRA/2 / -2.5- 3*BW <sub>UTRA</sub> / 2	5+3*BW <sub>UTR</sub> A/2 / -5- 3*BW <sub>UTRA</sub> / 2	7.5+3*BW <sub>UT</sub> RA/2 / -7.5- 3*BW <sub>UTRA</sub> /2	10+3*BW <sub>UT</sub> RA/2 / -10- 3*BW <sub>UTRA</sub> /2
E-UTRA channel Measurement bandwidth	1.08 MHz	2.7 MHz	4.5 MHz	9.0 MHz	13.5 MHz	18 MHz
UTRA 5MHz channel Measurement bandwidth <sup>1</sup>	3.84 MHz	3.84 MHz	3.84 MHz	3.84 MHz	3.84 MHz	3.84 MHz
UTRA 1.6MHz channel measurement bandwidth <sup>2</sup>	1.28 MHz	1.28 MHz	1.28 MHz	1.28 MHz	1.28 MHz	1.28 MHz
Note 1:	Applicable for E-UTRA FDD co-existence with UTRA FDD in paired spectrum.					
Note 2:	Applicable for E-UTRA TDD co-existence with UTRA TDD in unpaired spectrum.					
Note 3:	BW <sub>UTRA</sub> for UTRA FDD is 5MHz and for UTRA TDD is 1.6MHz.					

#### 6.6.2.4 Void

### 6.6.3 Spurious emissions

Spurious emissions are emissions which are caused by unwanted transmitter effects such as harmonics emission, parasitic emissions, intermodulation products and frequency conversion products, but exclude out of band emissions. The spurious emission limits are specified in terms of general requirements inline with SM.329 [3] and E-UTRA operating band requirement to address UE co-existence.

Unless otherwise stated, the spurious emission limits apply for the frequency ranges that are more than  $\Delta f_{OOB}$  (MHz) in Table 6.6.3.1.3-1 from the edge of the channel bandwidth. To improve measurement accuracy, sensitivity and efficiency, the resolution bandwidth may be smaller than the measurement bandwidth. When the resolution bandwidth is smaller than the measurement bandwidth, the result should be integrated over the measurement bandwidth in order to obtain the equivalent noise bandwidth of the measurement bandwidth.

#### 6.6.3.1 Transmitter Spurious emissions

##### 6.6.3.1.1 Test purpose

To verify that UE transmitter does not cause unacceptable interference to other channels or other systems in terms of transmitter spurious emissions.

##### 6.6.3.1.2 Test applicability

This test case applies to all types of E-UTRA UE release 8 and forward.

### 6.6.3.1.3 Minimum conformance requirements

This clause specifies the requirements for the specified E-UTRA band for Transmitter Spurious emissions requirement with frequency range as indicated in table 6.6.3.1.3-2.

The spurious emission limits apply for the frequency ranges that are more than  $\Delta f_{\text{OOB}}$  (MHz) from the edge of the channel bandwidth.

NOTE: For measurement conditions at the edge of each frequency range, the lowest frequency of the measurement position in each frequency range should be set at the lowest boundary of the frequency range plus MBW/2. The highest frequency of the measurement position in each frequency range should be set at the highest boundary of the frequency range minus MBW/2. MBW denotes the measurement bandwidth defined for the protected band.

**Table 6.6.3.1.3-1:  $\Delta f_{\text{OOB}}$  boundary between E-UTRA channel and spurious emission domain**

Channel bandwidth	1.4 MHz	3.0 MHz	5 MHz	10 MHz	15 MHz	20 MHz
$\Delta f_{\text{OOB}}$ (MHz)	2.8	6	10	15	20	25

The spurious emission limits in Table 6.6.3.1.3-2 apply for all transmitter band configurations (RB) and channel bandwidths.

**Table 6.6.3.1.3-2: Spurious emissions limits**

Frequency Range	Maximum Level	Measurement Bandwidth	Notes
$9 \text{ kHz} \leq f < 150 \text{ kHz}$	-36 dBm	1 kHz	
$150 \text{ kHz} \leq f < 30 \text{ MHz}$	-36 dBm	10 kHz	
$30 \text{ MHz} \leq f < 1000 \text{ MHz}$	-36 dBm	100 kHz	
$1 \text{ GHz} \leq f < 12.75 \text{ GHz}$	-30 dBm	1 MHz	
$12.75 \text{ GHz} \leq f < 5^{\text{th}}$ harmonic of the upper frequency edge of the UL operating band in GHz	-30 dBm	1 MHz	Note 1
Note 1: Applies for Band 22, Band 42 and Band 43			

The normative reference for this requirement is TS 36.101 [2] subclause 6.6.3.1.

### 6.6.3.1.4 Test description

#### 6.6.3.1.4.1 Initial conditions

Initial conditions are a set of test configurations the UE needs to be tested in and the steps for the SS to take with the UE to reach the correct measurement state.

The initial test configurations consist of environmental conditions, test frequencies, and channel bandwidths based on E-UTRA bands specified in Table 5.4.2.1-1. All of these configurations shall be tested with applicable test parameters for each channel bandwidth, and are shown in Table 6.6.3.1.4.1-1. The details of the uplink reference measurement channels (RMCs) are specified in Annex A.2. Configurations of PDSCH and PDCCH before measurement are specified in Annex C.2.

Table 6.6.3.1.4.1-1: Test Configuration Table

Initial Conditions						
Test Environment (as specified in TS 36.508 [7] subclause 4.1)				NC		
Test Frequencies (as specified in TS36.508 [7] subclause 4.3.1)				Low range, Mid range, High range		
Test Channel Bandwidths (as specified in TS 36.508 [7] subclause 4.3.1)				Lowest, 5MHz, Highest		
Test Parameters for Channel Bandwidths						
Ch BW	Downlink Configuration			Uplink Configuration		
	Mod'n	RB allocation		Mod'n	RB allocation	
		FDD	TDD		FDD	TDD
1.4MHz	N/A for Spurious Emissions testing			QPSK	6	6
1.4MHz				QPSK	1	1
3MHz				QPSK	15	15
3MHz				QPSK	1	1
5MHz				QPSK	25	25
5MHz				QPSK	1	1
10MHz				QPSK	50	50
10MHz				QPSK	1	1
15MHz				QPSK	75	75
15MHz				QPSK	1	1
20MHz				QPSK	100	100
20MHz				QPSK	1	1
Note 1: Test Channel Bandwidths are checked separately for each E-UTRA band, which applicable channel bandwidths are specified in Table 5.4.2.1-1.						
Note 2: The 1 RB allocation shall be tested at both RB #0 and RB #max.						

1. Connect the SS to the UE antenna connectors as shown in Figure TS 36.508 [7] Annex A, Figure A.7.
2. The parameter settings for the cell are set up according to TS 36.508 [7] subclause 4.4.3.
3. Downlink signals are initially set up according to Annex C0, C.1 and C.3.0, and uplink signals according to Annex H.1 and H.3.0.
4. The UL Reference Measurement channels are set according to Table 6.6.3.1.4.1-1.
5. Propagation conditions are set according to Annex B.0.
6. Ensure the UE is in State 3A-RF according to TS 36.508 [7] clause 5.2A.2. Message contents are defined in clause 6.6.3.1.4.3.

#### 6.6.3.1.4.2 Test procedure

1. SS sends uplink scheduling information for each UL HARQ process via PDCCH DCI format 0 for C\_RNTI to schedule the UL RMC according to Table 6.6.3.1.4.1-1. Since the UE has no payload data to send, the UE transmits uplink MAC padding bits on the UL RMC.
  2. Send continuously uplink power control "up" commands in the uplink scheduling information to the UE until the UE transmits at  $P_{UMAX}$  level.
3. Measure the power of the transmitted signal with a measurement filter of bandwidths according to table 6.6.3.1.5-1. The centre frequency of the filter shall be stepped in contiguous steps according to table 6.6.3.1.5-1. The measured power shall be verified for each step. The measurement period shall capture the active time slots.

#### 6.6.3.1.4.3 Message contents

Message contents are according to TS 36.508 [7] subclause 4.6.

#### 6.6.3.1.5 Test requirement

This clause specifies the requirements for the specified E-UTRA band for Transmitter Spurious emissions requirement with frequency range as indicated in table. 6.6.3.1.5-1.

The measured average power of spurious emission, derived in step 3, shall not exceed the described value in Table 6.6.3.1.5-1.

The spurious emission limits apply for the frequency ranges that are more than  $\Delta f_{\text{OOB}}$  (MHz) from the edge of the channel bandwidth shown in Table 6.6.3.1.3-1.

NOTE: For measurement conditions at the edge of each frequency range, the lowest frequency of the measurement position in each frequency range should be set at the lowest boundary of the frequency range plus MBW/2. The highest frequency of the measurement position in each frequency range should be set at the highest boundary of the frequency range minus MBW/2. MBW denotes the measurement bandwidth defined for the protected band.

**Table 6.6.3.1.5-1: General spurious emissions test requirements**

Frequency Range	Maximum Level	Measurement Bandwidth	Notes
$9 \text{ kHz} \leq f < 150 \text{ kHz}$	-36 dBm	1 kHz	
$150 \text{ kHz} \leq f < 30 \text{ MHz}$	-36 dBm	10 kHz	
$30 \text{ MHz} \leq f < 1000 \text{ MHz}$	-36 dBm	100 kHz	
$1 \text{ GHz} \leq f < 12.75 \text{ GHz}$	-30 dBm	1 MHz	
$12.75 \text{ GHz} \leq f < 5^{\text{th}}$ harmonic of the upper frequency edge of the UL operating band in GHz	-30 dBm	1 MHz	Note 1
Note 1: Applies for Band 22, Band 42 and Band 43			

### 6.6.3.1\_1 Transmitter Spurious emissions for Multi-Cluster PUSCH

#### 6.6.3.1\_1.1 Test purpose

To verify that UE transmitter does not cause unacceptable interference to other channels or other systems in terms of transmitter spurious emissions for Multi-Cluster PUSCH transmission.

#### 6.6.3.1\_1.2 Test applicability

This test case applies to all types of E-UTRA UE release 10 and forward that support multi cluster PUSCH within a component carrier for the tested band.

#### 6.6.3.1\_1.3 Minimum conformance requirements

This clause specifies the requirements for the specified E-UTRA band for Transmitter Spurious emissions requirement with frequency range as indicated in table 6.6.3.1\_1.3-2.

The spurious emission limits apply for the frequency ranges that are more than  $\Delta f_{\text{OOB}}$  (MHz) from the edge of the channel bandwidth.

NOTE: For measurement conditions at the edge of each frequency range, the lowest frequency of the measurement position in each frequency range should be set at the lowest boundary of the frequency range plus MBW/2. The highest frequency of the measurement position in each frequency range should be set at the highest boundary of the frequency range minus MBW/2. MBW denotes the measurement bandwidth defined for the protected band.

**Table 6.6.3.1\_1.3-1:  $\Delta f_{\text{OOB}}$  boundary between E-UTRA channel and spurious emission domain**

Channel bandwidth	1.4 MHz	3.0 MHz	5 MHz	10 MHz	15 MHz	20 MHz
$\Delta f_{\text{OOB}}$ (MHz)	2.8	6	10	15	20	25

The spurious emission limits in Table 6.6.3.1\_1.3-2 apply for all transmitter band configurations (RB) and channel bandwidths.



**Table 6.6.3.1\_1.3-2: Spurious emissions limits**

Frequency Range	Maximum Level	Measurement Bandwidth	Notes
$9 \text{ kHz} \leq f < 150 \text{ kHz}$	-36 dBm	1 kHz	
$150 \text{ kHz} \leq f < 30 \text{ MHz}$	-36 dBm	10 kHz	
$30 \text{ MHz} \leq f < 1000 \text{ MHz}$	-36 dBm	100 kHz	
$1 \text{ GHz} \leq f < 12.75 \text{ GHz}$	-30 dBm	1 MHz	
$12.75 \text{ GHz} \leq f < 5^{\text{th}}$ harmonic of the upper frequency edge of the UL operating band in GHz	-30 dBm	1 MHz	Note 1
Note 1: Applies for Band 22, Band 42 and Band 43			

The normative reference for this requirement is TS 36.101 [2] subclause 6.6.3.1.

### 6.6.3.1\_1.4 Test description

#### 6.6.3.1\_1.4.1 Initial conditions

Initial conditions are a set of test configurations the UE needs to be tested in and the steps for the SS to take with the UE to reach the correct measurement state.

The initial test configurations consist of environmental conditions, test frequencies, and channel bandwidths based on E-UTRA bands specified in Table 5.4.2.1-1. All of these configurations shall be tested with applicable test parameters for each channel bandwidth, and are shown in Table 6.6.3.1\_1.4.1-1. The details of the uplink reference measurement channels (RMCs) are specified in Annex A.2. Configurations of PDSCH and PDCCH before measurement are specified in Annex C.2.

**Table 6.6.3.1\_1.4.1-1: Test Configuration Table**

Initial Conditions					
Test Environment as specified in TS 36.508[7] subclause 4.1			Normal		
Test Frequencies as specified in TS36.508 [7] subclause 4.3.1			Low range, Mid range, High range		
Test Channel Bandwidths as specified in TS 36.508 [7] subclause 4.3.1			Highest		
Test Parameters for Channel Bandwidths					
Configuration ID	Downlink Configuration		Uplink Configuration		
	Ch BW	N/A for SEM testing	Mod'n	Cluster1 RB allocations (LCRB @ RB <sub>start</sub> )	Cluster2 RB allocations (LCRB @ RB <sub>start</sub> )
1	5MHz		16QAM	2@0	1@24
2	5MHz		16QAM	18@0	2@22
3	5MHz		16QAM	2@0	18@6
4	10MHz		16QAM	3@0	2@48
5	10MHz		16QAM	42@0	3@45
6	10MHz		16QAM	3@0	42@6
7	15MHz		16QAM	8@0	7@68
8	15MHz		16QAM	60@0	4@68
9	15MHz		16QAM	4@0	60@12
10	20MHz		16QAM	4@0	4@96
11	20MHz		16QAM	92@0	4@96
12	20MHz		16QAM	4@0	92@8
Note 1: Test Channel Bandwidths are checked separately for each E-UTRA band, the applicable channel bandwidths are specified in Table 5.4.2.1-1.					

1. Connect the SS to the UE antenna connectors as shown in Figure TS 36.508 [7] Annex A, Figure A.7.
2. The parameter settings for the cell are set up according to TS 36.508 [7] subclause 4.4.3.

3. Downlink signals are initially set up according to Annex C0, C.1 and C.3.0, and uplink signals according to Annex H.1 and H.3.0.
4. The UL Reference Measurement channels are set according to Table 6.6.3.1\_1.4.1-1.
5. Propagation conditions are set according to Annex B.0.
6. Ensure the UE is in State 3A-RF according to TS 36.508 [7] clause 5.2A.2. Message contents are defined in clause 6.6.3.1\_1.4.3.

#### 6.6.3.1\_1.4.2 Test procedure

1. SS sends uplink scheduling information for each UL HARQ process via PDCCH DCI format 0 for C\_RNTI to schedule the UL RMC according to Table 6.6.3.1\_1.4.1-1. Since the UE has no payload data to send, the UE transmits uplink MAC padding bits on the UL RMC.
  2. Send continuously uplink power control "up" commands in the uplink scheduling information to the UE until the UE transmits at  $P_{UMAX}$  level.
3. Measure the power of the transmitted signal with a measurement filter of bandwidths according to table 6.6.3.1\_1.5-1. The centre frequency of the filter shall be stepped in contiguous steps according to table 6.6.3.1\_1.5-1. The measured power shall be verified for each step. The measurement period shall capture the active time slots.

#### 6.6.3.1\_1.4.3 Message contents

Message contents are according to TS 36.508 [7] subclause 4.6.

#### 6.6.3.1\_1.5 Test requirement

This clause specifies the requirements for the specified E-UTRA band for Transmitter Spurious emissions requirement with frequency range as indicated in table 6.6.3.1\_1.5-1.

The measured average power of spurious emission, derived in step 3, shall not exceed the described value in Table 6.6.3.1\_1.5-1.

The spurious emission limits apply for the frequency ranges that are more than  $\Delta f_{OEB}$  (MHz) from the edge of the channel bandwidth shown in Table 6.6.3.1\_1. 5-1.

**NOTE:** For measurement conditions at the edge of each frequency range, the lowest frequency of the measurement position in each frequency range should be set at the lowest boundary of the frequency range plus MBW/2. The highest frequency of the measurement position in each frequency range should be set at the highest boundary of the frequency range minus MBW/2. MBW denotes the measurement bandwidth defined for the protected band.

**Table 6.6.3.1\_1.5-1: General spurious emissions test requirements**

Frequency Range	Maximum Level	Measurement Bandwidth	Notes
$9 \text{ kHz} \leq f < 150 \text{ kHz}$	-36 dBm	1 kHz	
$150 \text{ kHz} \leq f < 30 \text{ MHz}$	-36 dBm	10 kHz	
$30 \text{ MHz} \leq f < 1000 \text{ MHz}$	-36 dBm	100 kHz	
$1 \text{ GHz} \leq f < 12.75 \text{ GHz}$	-30 dBm	1 MHz	
$12.75 \text{ GHz} \leq f < 5^{\text{th}}$ harmonic of the upper frequency edge of the UL operating band in GHz	-30 dBm	1 MHz	Note 1
Note 1: Applies for Band 22, Band 42 and Band 43			

## 6.6.3.1A Transmitter Spurious emissions for CA

### 6.6.3.1A.0 Minimum conformance requirements

This clause specifies the spurious emission requirements for carrier aggregation.

NOTE 1: For measurement conditions at the edge of each frequency range, the lowest frequency of the measurement position in each frequency range should be set at the lowest boundary of the frequency range plus  $MBW/2$ . The highest frequency of the measurement position in each frequency range should be set at the highest boundary of the frequency range minus  $MBW/2$ . MBW denotes the measurement bandwidth defined for the protected band.

For inter-band carrier aggregation with uplink assigned to two E-UTRA bands, the spurious emission requirement Table 6.6.3.1.3-2 apply for the frequency ranges that are more than  $F_{OOB}$  as defined in Table 6.6.3.1.3-1 away from edges of the assigned channel bandwidth on a component carrier. If for some frequency a spurious emission requirement of individual component carrier overlaps with the spectrum emission mask or channel bandwidth of another component carrier then it does not apply.

NOTE 2: For inter-band carrier aggregation with uplink assigned to two E-UTRA bands the requirements in Table 6.6.3.1.3-2 could be verified by measuring spurious emissions at the specific frequencies where second and third order intermodulation products generated by the two transmitted carriers can occur; in that case, the requirements for remaining applicable frequencies in Table 6.6.3.1.3-2 would be considered to be verified by the measurements verifying the one uplink inter-band CA spurious emission requirement.

For intra-band contiguous carrier aggregation the spurious emission limits apply for the frequency ranges that are more than  $F_{OOB}$  (MHz) in Table 6.6.3.1A.0-1 from the edge of the aggregated channel bandwidth (Table 5.4.2A-1). For frequencies  $\Delta f_{OOB}$  greater than  $F_{OOB}$  as specified in Table 6.6.3.1A.0-1 the spurious emission requirements in Table 6.6.3.1.3-2 are applicable.

**Table 6.6.3.1A.0-1: Boundary between E-UTRA out of band and spurious emission domain for intra-band contiguous carrier aggregation**

CA Bandwidth Class	OOB boundary $F_{OOB}$ (MHz)
A	Table 6.6.3.1.3-1
B	FFS
C	$BW_{Channel\_CA} + 5$

For intra-band non-contiguous carrier aggregation transmission the spurious emission requirement is defined as a composite spurious emission requirement. Composite spurious emission requirement applies to frequency ranges that are more than  $F_{OOB}$  away from the edges of the sub-blocks. Composite spurious emission requirement is defined as follows

- Composite spurious emission requirement is a combination of individual sub-block spurious emission requirements
- In case the sub-block consist of one component carrier the sub-block spurious emission requirement and  $F_{OOB}$  are defined in subclause 6.6.3.1.3
- If for some frequency an individual sub-block spurious emission requirement overlaps with the general spectrum emission mask or the sub-block bandwidth of another sub-block then it does not apply

The normative reference for this requirement is TS 36.101[2] clause 6.6.3.1A

### 6.6.3.1A.1 Transmitter Spurious emissions for CA (intra-band contiguous DL CA and UL CA)

#### 6.6.3.1A.1.1 Test purpose

To verify that transmitter of UE that support CA does not cause unacceptable interference to other channels or other systems in terms of transmitter spurious emissions.

#### 6.6.3.1A.1.2 Test applicability

This test case applies to all types of E-UTRA UE release 10 and forward that support intra-band contiguous DL CA and UL CA.

#### 6.6.3.1A.1.3 Minimum conformance requirements

The minimum conformance requirements are defined in clause 6.6.3.1A.0.

#### 6.6.3.1A.1.4 Test description

##### 6.6.3.1A.1.4.1 Initial condition

Initial conditions are a set of test configurations the UE needs to be tested in and the steps for the SS to take with the UE to reach the correct measurement state.

The initial test configurations consist of environmental conditions, test frequencies, and CC combinations based on E-UTRA CA bands specified in table 5.4.2A.1-1. All of these configurations shall be tested with applicable test parameters for each CA configuration, and are shown in table 6.6.3.1A.1.4.1-1. The details of the uplink and downlink reference measurement channels (RMCs) are specified in Annexes A.2 and A.3. Configurations of PDSCH and PDCCH before measurement are specified in Annex C.2.

**Table 6.6.3.1A.1.4.1-1: Test Configuration Table**

Initial Conditions								
Test Environment as specified in TS 36.508[7] subclause 4.1					NC			
Test Frequencies as specified in TS36.508 [7] subclause 4.3.1 for different CA bandwidth classes, and PCC and SCCs are mapped onto physical frequencies according to Table 6.1-2.					C: Low range, High range			
Test CC Combination setting ( $N_{RB\_agg}$ ) as specified in subclause 5.4.2A.1 for the CA Configuration					Lowest $N_{RB\_agg}$ , Highest $N_{RB\_agg}$ (Note 2)			
Test Parameters for CA Configurations								
CA Configuration / $N_{RB\_agg}$		DL Allocation	CC MOD	UL Allocation				
PCC $N_{RB}$	SCCs $N_{RB}$	PCC & SCC RB allocation		$N_{RB\_alloc}$	PCC & SCC RB allocations (L <sub>CRB</sub> @ RB <sub>start</sub> )			
75	75	N/A for Spurious Emissions testing	QPSK	75	P_75@0	S_0@0	-	-
75	75		QPSK	1	P_1@0	S_0@0	-	-
75	75		QPSK	1	P_1@74	S_0@0	-	-
75	75		QPSK	2	P_1@0	S_1@74	-	-
75	75		QPSK	150	P_75@0	S_75@0	-	-
100	50		QPSK	50	P_50@0	S_0@0	-	-
100	50		QPSK	1	P_1@0	S_0@0	-	-
100	50		QPSK	1	P_1@99	S_0@0	-	-
100	50		QPSK	2	P_1@0	S_1@49	-	-
100	50		QPSK	150	P_100@0	S_50@0	-	-
100	100		QPSK	100	P_100@0	S_0@0	-	-
100	100		QPSK	1	P_1@0	S_0@0	-	-
100	100		QPSK	1	P_1@99	S_0@0	-	-
100	100		QPSK	2	P_1@0	S_1@99	-	-
100	100		QPSK	200	P_100@0	S_100@0	-	-
Note 1: CA Configuration Test CC Combination settings are checked separately for each CA Configuration, which applicable aggregated channel bandwidths are specified in Table 5.4.2A.1-1								
Note 2: If in the CA Configuration UE supports multiple CC Combinations with the same $N_{RB\_agg}$ , only the first of those is tested, according to the order on the Test Configuration Table list.								

1. Connect the SS to the UE antenna connectors as shown in TS 36.508[7] Annex A Figure group A.33 as appropriate.
2. The parameter settings for the cell are set up according to TS 36.508 [7] subclause 4.4.3.
3. Downlink signals for PCC are initially set up according to Annex C.0, C.1, and C.3.0, and uplink signals according to Annex H.1 and H.3.0.
4. The UL Reference Measurement channel is set according to Table 6.6.3.1A.1.4.1-1.
5. Propagation conditions are set according to Annex B.0.
6. Ensure the UE is in State 3A-RF according to TS 36.508 [7] clause 5.2A.2. Message contents are defined in clause 6.6.3.1A.1.4.3.

**6.6.3.1A.1.4.2 Test procedure**

1. Configure SCC according to Annex C.0, C.1 and Annex C.3.0 for all downlink physical channels.
2. The SS shall configure SCC as per TS 36.508 [7] clause 5.2A.4. Message contents are defined in clause 6.6.3.1A.1.4.3

3. SS activates SCC by sending the activation MAC-CE (Refer TS 36.321 [13], clauses 5.13, 6.1.3.8). Wait for at least 2 seconds (Refer TS 36.133, clauses 8.3.3.2).
4. SS sends uplink scheduling information for each UL HARQ process via PDCCH DCI format 0 for C\_RNTI to schedule the UL RMC according to Table 6.6.3.1A.1.4.1-1 on both PCC and SCC. Since the UE has no payload and no loopback data to send the UE sends uplink MAC padding bits on the UL RMC.
5. Send continuously uplink power control “up” commands in every uplink scheduling information to the UE until the UE transmits at  $P_{UMAX}$  level.
6. Measure the power of the transmitted signal with a measurement filter of bandwidths according to Table 6.6.3.1A.1.5-1 for each component carrier. The centre frequency of the filter shall be stepped in contiguous steps according to Table 6.6.3.1A.1.5-1. The measured power shall be verified for each step. The measurement period shall capture the active time slots.

#### 6.6.3.1A.1.4.3 Message contents

Message contents are according to TS 36.508 [7] subclause 4.6. In test procedure step 2, for SCC configuration there are no additional message contents.

#### 6.6.3.1A.1.5 Test Requirements

This clause specifies the requirements for the specified E-UTRA band for Transmitter Spurious emissions requirement with frequency range as indicated in table 6.6.3.1A.1.5-1.

For frequencies  $\Delta f_{OOB}$  greater than  $F_{OOB}$  as specified in Table 6.6.3.1A.0-1 the measured average power of spurious emission, derived in step 6, shall not exceed the described value in Table 6.6.3.1A.1.5-1.

NOTE: For measurement conditions at the edge of each frequency range, the lowest frequency of the measurement position in each frequency range should be set at the lowest boundary of the frequency range plus MBW/2. The highest frequency of the measurement position in each frequency range should be set at the highest boundary of the frequency range minus MBW/2. MBW denotes the measurement bandwidth defined for the protected band.

**Table 6.6.3.1A.1.5-1: Spurious emissions limits**

Frequency Range	Maximum Level	Measurement Bandwidth	Notes
$9 \text{ kHz} \leq f < 150 \text{ kHz}$	-36 dBm	1 kHz	
$150 \text{ kHz} \leq f < 30 \text{ MHz}$	-36 dBm	10 kHz	
$30 \text{ MHz} \leq f < 1000 \text{ MHz}$	-36 dBm	100 kHz	
$1 \text{ GHz} \leq f < 12.75 \text{ GHz}$	-30 dBm	1 MHz	
$12.75 \text{ GHz} \leq f < 5^{\text{th}}$ harmonic of the upper frequency edge of the UL operating band in GHz	-30 dBm	1 MHz	Note 1
Note1: Applicability of this test requirement is FFS.			

#### 6.6.3.1A.2 Transmitter Spurious emissions for CA (inter-band DL CA and UL CA)

Editor's note: This clause is incomplete. The following aspects are either missing or not yet determined:

- Test requirement is FFS

##### 6.6.3.1A.2.1 Test purpose

To verify that transmitter of UE that support CA does not cause unacceptable interference to other channels or other systems in terms of transmitter spurious emissions.

#### 6.6.3.1A.2.2 Test applicability

This test case applies to all types of E-UTRA UE release 11 and forward that support inter-band DL CA and UL CA.

#### 6.6.3.1A.2.3 Minimum conformance requirements

The minimum conformance requirements are defined in clause 6.6.3.1A.0.

#### 6.6.3.1A.2.4 Test description

##### 6.6.3.1A.2.4.1 Initial condition

Same as in clause 6.6.3.1A.1.4.1 with the following exceptions:

- Instead of Table 5.4.2A.1-1 → use Table 5.4.2A.1-2 for CA configurations with two bands or Table 5.4.2A.1-2a for CA configurations with three bands.
- Instead of Table 6.6.3.1A.1.4.1-1 → use Table 6.6.3.1A.2.4.1-1.
- Instead of clause 6.6.3.1A.1.4.3 use clause 6.6.3.1A.2.4.3.

**Table 6.6.3.1A.2.4.1-1: Test Configuration Table**

Initial Conditions									
Test Environment as specified in TS 36.508[7] subclause 4.1					NC				
Test Frequencies as specified in TS 36.508 [7] subclause 4.3.1 for different CA bandwidth classes.					Low range for PCC and SCC High range for PCC and SCC				
Test CC Combination setting ( $N_{RB\_agg}$ ) as specified in subclause 5.4.2A.1 for the CA Configuration across bandwidth combination sets supported by the UE.					Lowest $N_{RB\_agg}$ Highest $N_{RB\_agg}$ (Note 2)				
Test Parameters for CA Configurations									
CA Configuration / $N_{RB\_agg}$		DL Allocation		CC MOD	UL Allocation				
PCC $N_{RB}$	SCCs $N_{RB}$	PCC & SCC RB allocation			$N_{RB\_alloc}$	PCC & SCC RB allocations ( $L_{CRB}$ @ $RB_{start}$ )			
6	25	N/Afor this test		QPSK	2	P_1@0	S_1@0	-	-
6	25			QPSK	2	P_1@5	S_1@24	-	-
6	25			QPSK	31	P_6@0	S_25@0	-	-
6	50			QPSK	2	P_1@0	S_1@0	-	-
6	50			QPSK	2	P_1@5	S_1@49	-	-
6	50			QPSK	56	P_6@0	S_50@0	-	-
25	15			QPSK	2	P_1@0	S_1@0	-	-
25	15			QPSK	2	P_1@24	S_1@14	-	-
25	15			QPSK	40	P_25@0	S_15@0	-	-
25	25			QPSK	2	P_1@0	S_1@0	-	-
25	25			QPSK	2	P_1@24	S_1@24	-	-
25	25			QPSK	50	P_25@0	S_25@0	-	-
25	50			QPSK	2	P_1@0	S_1@0	-	-
25	50			QPSK	2	P_1@24	S_1@49	-	-
25	50			QPSK	75	P_25@0	S_50@0	-	-
50	50			QPSK	2	P_1@0	S_1@0	-	-
50	50			QPSK	2	P_1@49	S_1@49	-	-
50	50			QPSK	100	P_50@0	S_50@0	-	-
50	100			QPSK	2	P_1@0	S_1@0	-	-
50	100			QPSK	2	P_1@49	S_1@99	-	-
50	100	QPSK	150	P_50@0	S_100@0	-	-		
75	75	QPSK	2	P_1@0	S_1@0	-	-		
75	75	QPSK	2	P_1@74	S_1@74	-	-		
75	75	QPSK	150	P_75@0	S_75@0	-	-		
100	75	QPSK	2	P_1@0	S_1@0	-	-		
100	75	QPSK	2	P_1@99	S_1@74	-	-		
100	75	QPSK	175	P_100@0	S_75@0	-	-		
100	100	QPSK	2	P_1@0	S_1@0	-	-		
100	100	QPSK	2	P_1@99	S_1@99	-	-		
100	100	QPSK	200	P_100@0	S_100@0	-	-		



Note 1: CA Configuration Test CC Combination settings are checked separately for each CA Configuration, which applicable aggregated channel bandwidths are specified in Table 5.4.2A.1-1

Note 2: If in the CA Configuration UE supports multiple CC Combinations with the same  $N_{RB\_agg}$ , only the first of those is tested, according to the order on the Test Configuration Table list.

#### 6.6.3.1A.2.4.2 Test procedure

Same test procedure as in clause 6.6.3.1A.1.4.2.

- Instead of Table 6.6.3.1A.1.4.1-1 → use Table 6.6.3.1A.2.4.1-1.
- Instead of Table 6.6.3.1A.1.5-1 → use Table 6.6.3.1A.2.5-1.
- Instead of clause 6.6.3.1A.1.4.3 use clause 6.6.3.1A.2.4.3.

#### 6.6.3.1A.2.4.3 Message contents

Message contents are according to TS 36.508 [7] clause 4.6 with exceptions as in clause 6.6.3.1A.1.4.3.

#### 6.6.3.1A.2.5 Test requirement

FFS

### 6.6.3.2 Spurious emission band UE co-existence

**Editor's note: This test case contains different requirements for different UE releases**

#### 6.6.3.2.1 Test purpose

To verify that UE transmitter does not cause unacceptable interference to co-existing systems for the specified bands which has specific requirements in terms of transmitter spurious emissions.

#### 6.6.3.2.2 Test applicability

This test case applies to all types of E-UTRA UE release 8 and forward.

#### 6.6.3.2.3 Minimum conformance requirements

This clause specifies the requirements for the specified E-UTRA band for coexistence with protected bands as indicated in Table 6.6.3.2.3-1.

**NOTE:** For measurement conditions at the edge of each frequency range, the lowest frequency of the measurement position in each frequency range should be set at the lowest boundary of the frequency range plus  $MBW/2$ . The highest frequency of the measurement position in each frequency range should be set at the highest boundary of the frequency range minus  $MBW/2$ .  $MBW$  denotes the measurement bandwidth defined for the protected band.

Table 6.6.3.2.3-1: Spurious emission band UE co-existence limits Rel-8

E-UTRA Band	Spurious emission						
	Protected band	Frequency range (MHz)			Maximum Level (dBm)	MBW (MHz)	Comment
1	E-UTRA Band 1, 3, 7, 8, 9, 11, 34, 38, 40	FDL_low	-	FDL_high	-50	1	
	Frequency range	860	-	895	-50	1	
	Frequency range	1475.9	-	1510.9	-50	1	
	Frequency range	1895	-	1915	-15.5	5	Note <sup>14</sup> , Note <sup>17</sup>
	Frequency range	1915	-	1920	+1.6	5	Note <sup>14</sup> , Note <sup>17</sup>
2	E-UTRA Band 4, 5, 10, 12, 13, 14, 17	FDL_low	-	FDL_high	-50	1	
	E-UTRA Band 2	FDL_low	-	FDL_high	-50		Note <sup>14</sup>
3	E-UTRA Band 1, 7, 8, 33, 34, 38	FDL_low	-	FDL_high	-50	1	
	E-UTRA Band 3	FDL_low	-	FDL_high	-50		Note <sup>14</sup>
	Frequency range	860	-	895	-50	1	Note <sup>13</sup>
	Frequency range	1475.9	-	1510.9	-50	1	Note <sup>13</sup>
	Frequency range	1884.5	-	1915.7	-41	0.3	Note <sup>13</sup>
4	E-UTRA Band 2, 4, 5, 10, 12, 13, 14, 17	FDL_low	-	FDL_high	-50	1	
5	E-UTRA Band 2, 4, 5, 10, 12, 13, 14, 17	FDL_low	-	FDL_high	-50	1	
6	E-UTRA Band 1, 9, 11, 34	FDL_low	-	FDL_high	-50	1	
	Frequency range	860	-	875	-37	1	
	Frequency range	875	-	895	-50	1	
	Frequency range	1884.5	-	1919.6	-41	0.3	Note <sup>7</sup>
		1884.5	-	1915.7			Note <sup>8</sup>
7	E-UTRA Band 1, 3, 7, 8, 33, 34	FDL_low	-	FDL_high	-50	1	
	Frequency range	2570	-	2575	+1.6	5	Note <sup>14</sup> , Note <sup>15</sup> , Note <sup>18</sup>
	Frequency range	2575	-	2595	-15.5	5	Note <sup>14</sup> , Note <sup>15</sup> , Note <sup>18</sup>
8	E-UTRA Band 1, 33, 34, 38, 39, 40	FDL_low	-	FDL_high	-50	1	
	E-UTRA band 3	FDL_low	-	FDL_high	-50	1	Note <sup>2</sup>
	E-UTRA band 7	FDL_low	-	FDL_high	-50	1	Note <sup>2</sup>
	E-UTRA Band 8	FDL_low	-	FDL_high	-50	1	Note <sup>14</sup>
9	E-UTRA Band 1, 9, 11, 34	FDL_low	-	FDL_high	-50	1	
	Frequency range	860	-	895	-50	1	
	Frequency range	1475.9	-	1510.9	-50	1	
	Frequency range	1884.5	-	1915.7	-41	0.3	Note <sup>8</sup>
10	E-UTRA Band 2, 4, 5, 10, 12, 13, 14, 17	FDL_low	-	FDL_high	-50	1	
11	E-UTRA Band 1, 9, 11, 34	FDL_low	-	FDL_high	-50	1	
	Frequency range	1457.9	-	1510.9	-50	1	
	Frequency range	860	-	895	-50	1	
	Frequency range	1884.5	-	1915.7	-41	0.3	Note <sup>8</sup>
12	E-UTRA Band 2, 5, 13, 14, 17	FDL_low	-	FDL_high	-50	1	
	E-UTRA Band 4, 10	FDL_low	-	FDL_high	-50	1	Note <sup>2</sup>
	E-UTRA Band 12	FDL_low	-	FDL_high	-50	1	Note <sup>14</sup>
13	E-UTRA Band 2, 4, 5, 10, 12, 13, 17	FDL_low	-	FDL_high	-50	1	
	E-UTRA Band 14	FDL_low	-	FDL_high	-50	1	Note <sup>14</sup>

	Frequency range	769	-	775	-35	0.00625	Note <sup>14</sup>
	Frequency range	799	-	805	-35	0.00625	Note <sup>11</sup> Note <sup>14</sup>
14	E-UTRA Band 2, 4, 5, 10, 12, 13, 14, 17	FDL_low	-	FDL_high	-50	1	
	Frequency range	769	-	775	-35	0.00625	Note <sup>12</sup> Note <sup>14</sup>
	Frequency range	799	-	805	-35	0.00625	Note <sup>11</sup> Note <sup>12</sup> Note <sup>14</sup>
17	E-UTRA Band 2, 5, 13, 14, 17	FDL_low	-	FDL_high	-50	1	
	E-UTRA Band 4, 10	FDL_low	-	FDL_high	-50	1	Note <sup>2</sup>
	E-UTRA Band 12	FDL_low	-	FDL_high	-50	1	Note <sup>14</sup>
...							
33	E-UTRA Band 1, 7, 8, 34, 38, 40	FDL_low	-	FDL_high	-50	1	Note <sup>5</sup>
	E-UTRA Band 3	FDL_low	-	FDL_high	-50	1	Note <sup>14</sup>
34	E-UTRA Band 1, 3, 7, 8, 9, 11, 33, 38, 39, 40	FDL_low	-	FDL_high	-50	1	Note <sup>5</sup>
	Frequency range	860	-	895	-50	1	
	Frequency range	1475.9	-	1510.9	-50	1	
	Frequency range	1884.5	-	1915.7	-41	0.3	Note <sup>8</sup>
35							
36							
37			-				
38	E-UTRA Band 1, 3, 8, 33, 34	FDL_low	-	FDL_high	-50	1	
	Frequency range	2620	-	2645	-15.5	5	Note <sup>14</sup> Note <sup>16</sup> Note <sup>18</sup>
39	E-UTRA Band 34, 40	FDL_low	-	FDL_high	-50	1	
40	E-UTRA Band 1, 3, 33, 34, 39	FDL_low	-	FDL_high	-50	1	

Note 1: FDL\_low and FDL\_high refer to each E-UTRA frequency band specified in Table 5.2-1

Note 2: As exceptions, measurements with a level up to the applicable requirements defined in Table 6.6.3.1.3-2 are permitted for each assigned E-UTRA carrier used in the measurement due to 2nd or 3rd harmonic spurious emissions. An exception is allowed if there is at least one individual RE within the transmission bandwidth (see Figure 5.4.2-1) for which the 2nd or 3rd harmonic, i.e. the frequency equal to two or three times the frequency of that RE, is within the measurement bandwidth (MBW).

Note 3: To meet these requirements some restriction will be needed for either the operating band or protected band

Note 4: N/A

Note 5: For non synchronised TDD operation to meet these requirements some restriction will be needed for either the operating band or protected band

Note 6: N/A.

Note 7: Applicable when co-existence with PHS system operating in 1884.5-1919.6MHz.

Note 8: Applicable when co-existence with PHS system operating in 1884.5-1915.7MHz.

Note 9: N/A

Note 10: N/A

Note 11: Whether the applicable frequency range should be 793-805MHz instead of 799-805MHz is TBD

Note 12: The emissions measurement shall be sufficiently power averaged to ensure a standard deviation < 0.5 dB

Note 13: Applicable when UE transmits anywhere within 1749.9 – 1784.9MHz. Applicable when the assigned E-UTRA UL operating channel is  $\geq 1749.9$  MHz and  $\leq 1784.9$  MHz.

Note 14: These requirements also apply for the frequency ranges that are less than  $\Delta f_{\text{OOB}}$  (MHz) in Table 6.6.3.1.3-1 from the edge of the channel bandwidth.

Note 15: This requirement is applicable for an uplink transmission bandwidth less than or equal to 54 RB for carriers of 15 MHz bandwidth when carrier centre frequency is within the range 2560.5 - 2562.5 MHz and for carriers of 20 MHz bandwidth when carrier centre frequency is within the range 2552 - 2560 MHz. This requirement is applicable without any other uplink transmission bandwidth restriction for channel bandwidths within the range 2500 - 2570 MHz.

Note 16: This requirement is applicable for an uplink transmission bandwidth less than or equal to 54 RB for carriers of 15 MHz bandwidth when carrier centre frequency is within the range 2605.5 - 2607.5 MHz and for carriers of 20 MHz bandwidth when carrier centre frequency is within the range 2597 – 2605 MHz. This requirement is applicable without any other uplink transmission bandwidth restriction for channel bandwidths within the range 2570 – 2615 MHz. For assigned carriers with bandwidths overlapping the frequency range 2615-2620 MHz the requirements apply with the maximum output power configured to +19 dBm in the IE *P-Max*.

Note 17: This requirement is applicable for an uplink transmission bandwidth less than or equal to 54 RB for carriers of

15 MHz bandwidth when carrier centre frequency is within the range 1927.5 - 1929.5 MHz and for carriers of 20 MHz bandwidth when carrier centre frequency is within the range 1930 - 1938 MHz. This requirement is applicable without any other uplink transmission bandwidth restriction for channel bandwidths within the range 1920 - 1980 MHz.

Note 18: For these adjacent bands, the emission limit could imply risk of harmful interference to UE(s) operating in the protected operating band.

NOTE: The restriction on the maximum uplink transmission to 54 RB in Notes 15, 16, and 17 of Table 6.6.3.2.3-1 is intended for conformance testing and may be applied to network operation to facilitate coexistence when the aggressor and victim bands are deployed in the same geographical area. The applicable spurious emission requirement of -15.5 dBm/5MHz is a least restrictive technical condition for FDD/TDD coexistence and may have to be revised in the future.

Table 6.6.3.2.3-1A: Spurious emission band UE co-existence limits Rel-9

E-UTRA Band	Spurious emission						
	Protected band	Frequency range (MHz)			Maximum level (dBm)	MBW (MHz)	NOTE
1	E-UTRA Band 1, 3, 7, 8, 11, 20, 21, 34, 38, 40	F <sub>DL_low</sub>	-	F <sub>DL_high</sub>	-50	1	
	Frequency range	860	-	895	-50	1	
	Frequency range	1880	-	1895	-40	1	14,18
	Frequency range	1839.9	-	1879.9	-50	1	
	Frequency range	1895	-	1915	-15.5	5	14,18,19
	Frequency range	1915	-	1920	+1.6	5	14,18,19
2	E-UTRA Band 4, 5, 10, 12, 13, 14, 17	F <sub>DL_low</sub>	-	F <sub>DL_high</sub>	-50	1	
	E-UTRA Band 2	F <sub>DL_low</sub>	-	F <sub>DL_high</sub>	-50	1	14
3	E-UTRA Band 1, 7, 8, 20, 33, 34, 38	F <sub>DL_low</sub>	-	F <sub>DL_high</sub>	-50	1	
	E-UTRA Band 3	F <sub>DL_low</sub>	-	F <sub>DL_high</sub>	-50	1	14
	E-UTRA Band 11, 21	F <sub>DL_low</sub>	-	F <sub>DL_high</sub>	-50	1	13
	Frequency range	860	-	895	-50	1	13
	Frequency range	1884.5	-	1915.7	-41	0.3	13
4	E-UTRA Band 2, 4, 5, 10, 12, 13, 14, 17	F <sub>DL_low</sub>	-	F <sub>DL_high</sub>	-50	1	
5	E-UTRA Band 2, 4, 5, 10, 12, 13, 14, 17	F <sub>DL_low</sub>	-	F <sub>DL_high</sub>	-50	1	
6	E-UTRA Band 1, 9, 11, 34	F <sub>DL_low</sub>	-	F <sub>DL_high</sub>	-50	1	
	Frequency range	860	-	875	-37	1	
	Frequency range	875	-	895	-50	1	
	Frequency range	1884.5	-	1919.6	-41	0.3	7
	Frequency range	1884.5	-	1915.7			8
7	E-UTRA Band 1, 3, 7, 8, 20, 33, 34	F <sub>DL_low</sub>	-	F <sub>DL_high</sub>	-50	1	
	Frequency range	2570	-	2575	+1.6	5	14, 15, 19
	Frequency range	2575	-	2595	-15.5	5	14, 15, 19
	Frequency range	2595	-	2620	-40	1	14, 15
8	E-UTRA Band 1, 20, 33, 34, 38, 39, 40	F <sub>DL_low</sub>	-	F <sub>DL_high</sub>	-50	1	
	E-UTRA band 3	F <sub>DL_low</sub>	-	F <sub>DL_high</sub>	-50	1	2
	E-UTRA band 7	F <sub>DL_low</sub>	-	F <sub>DL_high</sub>	-50	1	2
	E-UTRA Band 8	F <sub>DL_low</sub>	-	F <sub>DL_high</sub>	-50	1	14
	E-UTRA Band 11, 21	F <sub>DL_low</sub>	-	F <sub>DL_high</sub>	-50	1	17
	Frequency range	860	-	890	-40	1	14, 17
	Frequency range	1884.5	-	1915.7	-41	0.3	8, 17
9	E-UTRA Band 1, 11, 21, 34	F <sub>DL_low</sub>	-	F <sub>DL_high</sub>	-50	1	
	Frequency range	860	-	895	-50	1	
	Frequency range	1884.5	-	1915.7	-41	0.3	8
	Frequency range	945	-	960	-50	1	
	Frequency range	1839.9	-	1879.9	-50	1	
10	E-UTRA Band 2, 4, 5, 10, 12, 13, 14, 17	F <sub>DL_low</sub>	-	F <sub>DL_high</sub>	-50	1	
11	E-UTRA Band 1, 9, 11, 21, 34	F <sub>DL_low</sub>	-	F <sub>DL_high</sub>	-50	1	
	Frequency range	860	-	895	-50	1	
	Frequency range	1884.5	-	1915.7	-41	0.3	8
	Frequency range	945	-	960	-50	1	
12	E-UTRA Band 2, 5, 13, 14, 17	F <sub>DL_low</sub>	-	F <sub>DL_high</sub>	-50	1	
	E-UTRA Band 4, 10	F <sub>DL_low</sub>	-	F <sub>DL_high</sub>	-50	1	2
	E-UTRA Band 12	F <sub>DL_low</sub>	-	F <sub>DL_high</sub>	-50	1	14
13	E-UTRA Band 2, 4, 5, 10, 12, 13, 17	F <sub>DL_low</sub>	-	F <sub>DL_high</sub>	-50	1	
	E-UTRA Band 14	F <sub>DL_low</sub>	-	F <sub>DL_high</sub>	-50	1	14
	Frequency range	769	-	775	-35	0.00625	14
	Frequency range	799	-	805	-35	0.00625	11, 14
14	E-UTRA Band 2, 4, 5, 10, 12, 13, 14, 17	F <sub>DL_low</sub>	-	F <sub>DL_high</sub>	-50	1	
	Frequency range	769	-	775	-35	0.00625	12, 14
	Frequency range	799	-	805	-35	0.00625	11, 12, 14
17	E-UTRA Band 2, 5, 13, 14, 17	F <sub>DL_low</sub>	-	F <sub>DL_high</sub>	-50	1	

	E-UTRA Band 4, 10	F <sub>DL_low</sub>	-	F <sub>DL_high</sub>	-50	1	2
	E-UTRA Band 12	F <sub>DL_low</sub>	-	F <sub>DL_high</sub>	-50	1	14
18	E-UTRA Band 1, 11, 21, 34	F <sub>DL_low</sub>	-	F <sub>DL_high</sub>	-50	1	
	Frequency range	860	-	895	-40	1	
	Frequency range	1884.5	-	1915.7	-41	0.3	8
	Frequency range	945	-	960	-50	1	
	Frequency range	1839.9	-	1879.9	-50	1	
19	E-UTRA Band 1, 11, 21, 34	F <sub>DL_low</sub>	-	F <sub>DL_high</sub>	-50	1	
	Frequency range	1884.5	-	1915.7	-41	0.3	8
	Frequency range	945	-	960	-50	1	
	Frequency range	1839.9	-	1879.9	-50	1	
20	E-UTRA Band 1, 3, 7, 8, 33, 34,	F <sub>DL_low</sub>	-	F <sub>DL_high</sub>	-50	1	
	E-UTRA Band 20	F <sub>DL_low</sub>	-	F <sub>DL_high</sub>	-50	1	14
	E-UTRA Band 38	F <sub>DL_low</sub>	-	F <sub>DL_high</sub>	-50	1	2
21	E-UTRA Band 1, 34	F <sub>DL_low</sub>	-	F <sub>DL_high</sub>	-50	1	
	Frequency range	860	-	895	-50	1	
	Frequency range	1884.5	-	1915.7	-41	0.3	8
	Frequency range	945	-	960	-50	1	
	Frequency range	1839.9	-	1879.9	-50	1	
33	E-UTRA Band 1, 7, 8, 20, 34, 38, 40	F <sub>DL_low</sub>	-	F <sub>DL_high</sub>	-50	1	5
	E-UTRA Band 3	F <sub>DL_low</sub>	-	F <sub>DL_high</sub>	-50	1	14
34	E-UTRA Band 1, 3, 7, 8, 11, 20, 21, 33, 38,39, 40	F <sub>DL_low</sub>	-	F <sub>DL_high</sub>	-50	1	5
	Frequency range	860	-	895	-50	1	
	Frequency range	1884.5	-	1915.7	-41	0.3	8
	Frequency range	1839.9	-	1879.9	-50	1	
35			-				
36			-				
37			-				
38	E-UTRA Band 1,3, 8, 20, 33, 34	F <sub>DL_low</sub>	-	F <sub>DL_high</sub>	-50	1	
	Frequency range	2620	-	2645	-15.5	5	14, 16, 19
	Frequency range	2645	-	2690	-40	1	14, 16
39	E-UTRA Band 34, 40	F <sub>DL_low</sub>	-	F <sub>DL_high</sub>	-50	1	
40	E-UTRA Band 1, 3, 33, 34, 39	F <sub>DL_low</sub>	-	F <sub>DL_high</sub>	-50	1	
Note 1:	FDL_low and FDL_high refer to each E-UTRA frequency band specified in Table 5.2-1						
Note 2:	As exceptions, measurements with a level up to the applicable requirements defined in Table 6.6.3.1.3-2 are permitted for each assigned E-UTRA carrier used in the measurement due to 2nd or 3rd harmonic spurious emissions. An exception is allowed if there is at least one individual RE within the transmission bandwidth (see Figure 5.4.2-1) for which the 2nd or 3rd harmonic, i.e. the frequency equal to two or three times the frequency of that RE, is within the measurement bandwidth (MBW).						
Note 3:	To meet these requirements some restriction will be needed for either the operating band or protected band						
Note 4:	N/A						
Note 5:	For non synchronised TDD operation to meet these requirements some restriction will be needed for either the operating band or protected band						
Note 6:	N/A						
Note 7:	Applicable when co-existence with PHS system operating in 1884.5-1919.6MHz.						
Note 8:	Applicable when co-existence with PHS system operating in 1884.5 -1915.7MHz.						
Note 9:	N/A						
Note 10:	N/A						
Note 11:	Whether the applicable frequency range should be 793-805MHz instead of 799-805MHz is TBD						
Note 12:	The emissions measurement shall be sufficiently power averaged to ensure a standard deviation < 0.5 dB						
Note 13:	Applicable when the assigned E-UTRA UL operating channel is ≥1744.9MHz and ≤ 1784.9MHz.						
Note 14:	These requirements also apply for the frequency ranges that are less than Δf <sub>oob</sub> (MHz) in Table 6.6.3.1-1 from the edge of the channel bandwidth.						
Note 15:	This requirement is applicable for an uplink transmission bandwidth less than or equal to 54 RB for carriers of 15 MHz bandwidth when carrier centre frequency is within the range 2560.5 - 2562.5 MHz and for carriers of 20 MHz bandwidth when carrier centre frequency is within the range 2552 - 2560 MHz. This requirement is applicable without any other uplink transmission bandwidth restriction for channel bandwidths within the range 2500 - 2570 MHz.						
Note 16:	This requirement is applicable for an uplink transmission bandwidth less than or equal to 54 RB for carriers of 15 MHz bandwidth when carrier centre frequency is within the range 2605.5 - 2607.5 MHz and for carriers of 20 MHz bandwidth when carrier centre frequency is within the range 2597 – 2605 MHz. This requirement is						

	applicable without any other uplink transmission bandwidth restriction for channel bandwidths within the range 2570 – 2615 MHz. For assigned carriers with bandwidths overlapping the frequency range 2615-2620 MHz the requirements apply with the maximum output power configured to +19 dBm in the IE <i>P-Max</i> .
Note 17:	For carriers of 5 MHz channel bandwidth with carrier centre frequencies ( $F_c$ ) in the range $902.5\text{MHz} \leq F_c < 907.5\text{ MHz}$ , the requirement applies for uplink transmission bandwidths less than or equal to 20 RB. No restrictions apply in the range $907.5\text{ MHz} \leq F_c \leq 912.5\text{ MHz}$ . For carriers of 10 MHz channel bandwidth, the requirement only applies for $F_c = 910\text{ MHz}$ and uplink transmission bandwidths less than or equal to 32 RB with $\text{RB}_{\text{start}} > 3$ .
Note 18:	This requirement is applicable for an uplink transmission bandwidth less than or equal to 54 RB for carriers of 15 MHz bandwidth when carrier centre frequency is within the range 1927.5 - 1929.5 MHz and for carriers of 20 MHz bandwidth when carrier centre frequency is within the range 1930 - 1938 MHz. This requirement is applicable without any other uplink transmission bandwidth restriction for channel bandwidths within the range 1920 - 1980 MHz.
Note 19:	For these adjacent bands, the emission limit could imply risk of harmful interference to UE(s) operating in the protected operating band.

NOTE: The restriction on the maximum uplink transmission to 54 RB in Notes 15, 16 and 18 of Table 6.6.3.2.3-1A is intended for conformance testing and may be applied to network operation to facilitate coexistence when the aggressor and victim bands are deployed in the same geographical area. The applicable spurious emission requirement of -15.5 dBm/5MHz is a least restrictive technical condition for FDD/TDD coexistence and may have to be revised in the future.

Table 6.6.3.2.3-1B: Spurious emission band UE co-existence limits Rel-10

E-UTRA Band	Spurious emission						
	Protected band	Frequency range (MHz)		Maximum Level (dBm)	MBW (MHz)	Note	
1	E-UTRA Band 1, 7, 8, 11, 18, 19, 20, 21, 22, 38, 40, 42, 43	F <sub>DL_low</sub>	-	F <sub>DL_high</sub>	-50	1	
	E-UTRA Band 3, 34	F <sub>DL_low</sub>	-	F <sub>DL_high</sub>	-50	1	15
	Frequency range	1880	-	1895	-40	1	15,19
	Frequency range	1895	-	1915	-15.5	5	15,19,20
	Frequency range	1915	-	1920	+1.6	5	15,19,20
	Frequency range	1839.9	-	1879.9	-50	1	15
2	E-UTRA Band 4, 5, 10, 12, 13, 14, 17, 23, 24, 41, 42	F <sub>DL_low</sub>	-	F <sub>DL_high</sub>	-50	1	
	E-UTRA Band 2, 25	F <sub>DL_low</sub>	-	F <sub>DL_high</sub>	-50	1	15
	E-UTRA Band 43	F <sub>DL_low</sub>	-	F <sub>DL_high</sub>	-50	1	2
3	E-UTRA Band 1, 7, 8, 20, 33, 34, 38, 43	F <sub>DL_low</sub>	-	F <sub>DL_high</sub>	-50	1	
	E-UTRA Band 3	F <sub>DL_low</sub>	-	F <sub>DL_high</sub>	-50	1	15
	E-UTRA Band 11, 18, 19, 21	F <sub>DL_low</sub>	-	F <sub>DL_high</sub>	-50	1	13
	E-UTRA Band 22, 42	F <sub>DL_low</sub>	-	F <sub>DL_high</sub>	-50	1	2
	Frequency range	1884.5	-	1915.7	-41	0.3	13
4	E-UTRA Band 2, 4, 5, 10, 12, 13, 14, 17, 22, 23, 24, 25, 41, 43	F <sub>DL_low</sub>	-	F <sub>DL_high</sub>	-50	1	
	E-UTRA Band 42	F <sub>DL_low</sub>	-	F <sub>DL_high</sub>	-50	1	2
5	E-UTRA Band 2, 4, 5, 10, 12, 13, 14, 17, 22, 23, 24, 25, 42, 43	F <sub>DL_low</sub>	-	F <sub>DL_high</sub>	-50	1	
	E-UTRA Band 41	F <sub>DL_low</sub>	-	F <sub>DL_high</sub>	-50	1	2
6	E-UTRA Band 1, 9, 11, 34	F <sub>DL_low</sub>	-	F <sub>DL_high</sub>	-50	1	
	Frequency range	860	-	875	-37	1	
	Frequency range	875	-	895	-50	1	
	Frequency range	1884.5	-	1919.6	-41	0.3	7
	Frequency range	1884.5	-	1915.7	-41	0.3	8
7	E-UTRA Band 1, 3, 7, 8, 20, 22, 33, 34, 40, 42, 43	F <sub>DL_low</sub>	-	F <sub>DL_high</sub>	-50	1	
	Frequency range	2570	-	2575	+1.6	5	15, 16, 20
	Frequency range	2575	-	2595	-15.5	5	15, 16, 20
	Frequency range	2595	-	2620	-40	1	15, 16
8	E-UTRA Band 1, 20, 33, 34, 38, 39, 40	F <sub>DL_low</sub>	-	F <sub>DL_high</sub>	-50	1	
	E-UTRA band 3	F <sub>DL_low</sub>	-	F <sub>DL_high</sub>	-50	1	2
	E-UTRA band 7	F <sub>DL_low</sub>	-	F <sub>DL_high</sub>	-50	1	2
	E-UTRA Band 8	F <sub>DL_low</sub>	-	F <sub>DL_high</sub>	-50	1	15
	E-UTRA Band 22, 42, 43	F <sub>DL_low</sub>	-	F <sub>DL_high</sub>	-50	1	2
	E-UTRA Band 11, 21	F <sub>DL_low</sub>	-	F <sub>DL_high</sub>	-50	1	18
	Frequency range	860	-	890	-40	1	15, 18
	Frequency range	1884.5	-	1915.7	-41	0.3	8, 18
9	E-UTRA Band 1, 11, 18, 19, 21, 34	F <sub>DL_low</sub>	-	F <sub>DL_high</sub>	-50	1	
	E-UTRA Band 42	F <sub>DL_low</sub>	-	F <sub>DL_high</sub>	-50	1	2
	Frequency range	1884.5	-	1915.7	-41	0.3	8
	Frequency range	945	-	960	-50	1	
	Frequency range	1839.9	-	1879.9	-50	1	
10	E-UTRA Band 2, 4, 5, 10, 12, 13, 14, 17, 23, 24, 25, 41, 43	F <sub>DL_low</sub>	-	F <sub>DL_high</sub>	-50	1	
	E-UTRA Band 22, 42	F <sub>DL_low</sub>	-	F <sub>DL_high</sub>	-50	1	2
11	E-UTRA Band 1, 11, 18, 19, 21, 34, 42	F <sub>DL_low</sub>	-	F <sub>DL_high</sub>	-50	1	
	Frequency range	1884.5	-	1915.7	-41	0.3	8
	Frequency range	945	-	960	-50	1	
	Frequency range	1839.9	-	1879.9	-50	1	
12	E-UTRA Band 2, 5, 13, 14, 17, 23, 24, 25, 41	F <sub>DL_low</sub>	-	F <sub>DL_high</sub>	-50	1	
	E-UTRA Band 4, 10	F <sub>DL_low</sub>	-	F <sub>DL_high</sub>	-50	1	2
	E-UTRA Band 12	F <sub>DL_low</sub>	-	F <sub>DL_high</sub>	-50	1	15
13	E-UTRA Band 2, 4, 5, 10, 12, 13, 17, 23, 25, 41	F <sub>DL_low</sub>	-	F <sub>DL_high</sub>	-50	1	



	Frequency range	769	-	775	-35	0.00625	15
	Frequency range	799	-	805	-35	0.00625	11, 15
	E-UTRA Band 14	F <sub>DL_low</sub>	-	F <sub>DL_high</sub>	-50	1	15
	E-UTRA Band 24	F <sub>DL_low</sub>	-	F <sub>DL_high</sub>	-50	1	2
14	E-UTRA Band 2, 4, 5, 10, 12, 13, 14, 17, 23, 24, 25, 41	F <sub>DL_low</sub>	-	F <sub>DL_high</sub>	-50	1	
	Frequency range	769	-	775	-35	0.00625	12, 15
	Frequency range	799	-	805	-35	0.00625	11, 12, 15
17	E-UTRA Band 2, 5, 13, 14, 17, 23, 24, 25, 41	F <sub>DL_low</sub>	-	F <sub>DL_high</sub>	-50	1	
	E-UTRA Band 4, 10	F <sub>DL_low</sub>	-	F <sub>DL_high</sub>	-50	1	2
	E-UTRA Band 12	F <sub>DL_low</sub>	-	F <sub>DL_high</sub>	-50	1	15
18	E-UTRA Band 1, 11, 21, 34, 42	F <sub>DL_low</sub>	-	F <sub>DL_high</sub>	-50	1	
	Frequency range	860	-	890	-40	1	
	Frequency range	1884.5	-	1915.7	-41	0.3	8
	Frequency range	945	-	960	-50	1	
	Frequency range	1839.9	-	1879.9	-50	1	
19	E-UTRA Band 1, 11, 21, 34, 42	F <sub>DL_low</sub>	-	F <sub>DL_high</sub>	-50	1	
	Frequency range	1884.5	-	1915.7	-41	0.3	8
	Frequency range	945	-	960	-50	1	
	Frequency range	1839.9	-	1879.9	-50	1	
20	E-UTRA Band 1, 3, 7, 8, 20, 22, 33, 34, 40, 43	F <sub>DL_low</sub>	-	F <sub>DL_high</sub>	-50	1	
	E-UTRA Band 20	F <sub>DL_low</sub>	-	F <sub>DL_high</sub>	-50	1	15
	E-UTRA Band 38, 42	F <sub>DL_low</sub>	-	F <sub>DL_high</sub>	-50	1	2
21							
	E-UTRA Band 1, 18, 19, 34, 42	F <sub>DL_low</sub>	-	F <sub>DL_high</sub>	-50	1	
	Frequency range	1884.5	-	1915.7	-41	0.3	8
	Frequency range	945	-	960	-50	1	
	Frequency range	1839.9	-	1879.9	-50	1	
22	E-UTRA Band 1, 3, 7, 8, 20, 33, 34, 38, 39, 40, 43	F <sub>DL_low</sub>	-	F <sub>DL_high</sub>	-50	1	
	Frequency range	3510	-	3525	-40	1	15
	Frequency range	3525	-	3590	-50	1	
23	E-UTRA Band 4, 5, 10, 12, 13, 14, 17, 23, 24, 41	F <sub>DL_low</sub>	-	F <sub>DL_high</sub>	-50	1	
24	E-UTRA Band 2, 4, 5, 10, 12, 13, 14, 17, 23, 24, 25, 41	F <sub>DL_low</sub>	-	F <sub>DL_high</sub>	-50	1	
25	E-UTRA Band 4, 5, 10, 12, 13, 14, 17, 23, 24, 41, 42	F <sub>DL_low</sub>	-	F <sub>DL_high</sub>	-50	1	
	E-UTRA Band 2	F <sub>DL_low</sub>	-	F <sub>DL_high</sub>	-50	1	15
	E-UTRA Band 25	F <sub>DL_low</sub>	-	F <sub>DL_high</sub>	-50	1	15
	E-UTRA Band 43	F <sub>DL_low</sub>	-	F <sub>DL_high</sub>	-50	1	2
...							
33	E-UTRA Band 1, 7, 8, 20, 22, 34, 38, 40, 42, 43	F <sub>DL_low</sub>	-	F <sub>DL_high</sub>	-50	1	5
	E-UTRA Band 3	F <sub>DL_low</sub>	-	F <sub>DL_high</sub>	-50	1	15
34	E-UTRA Band 1, 3, 7, 8, 11, 18, 19, 20, 21, 22, 33, 38, 39, 40, 42, 43	F <sub>DL_low</sub>	-	F <sub>DL_high</sub>	-50	1	5
	Frequency range	1884.5	-	1915.7	-41	0.3	8
	Frequency range	1839.9	-	1879.9	-50	1	
35							
36							
37			-				
38	E-UTRA Band 1, 3, 8, 20, 22, 33, 34, 40, 42, 43	F <sub>DL_low</sub>	-	F <sub>DL_high</sub>	-50	1	
	Frequency range	2620	-	2645	-15.5	5	15, 17, 20
	Frequency range	2645	-	2690	-40	1	15, 17
39	E-UTRA Band 22, 34, 40, 42	F <sub>DL_low</sub>	-	F <sub>DL_high</sub>	-50	1	
	E-UTRA Band 43	F <sub>DL_low</sub>	-	F <sub>DL_high</sub>	-50	1	2
40	E-UTRA Band 1, 3, 7, 8, 20, 22, 33, 34, 38, 39, 42, 43	F <sub>DL_low</sub>	-	F <sub>DL_high</sub>	-50	1	

41	E-UTRA Band 2, 4, 5, 10, 12, 13, 14, 17, 23, 24, 25	$F_{DL\_low}$	-	$F_{DL\_high}$	-50	1	
42	E-UTRA Band 1, 2, 3, 4, 5, 7, 8, 10, 11, 18, 19, 20, 21, 25, 33, 34, 38, 40	$F_{DL\_low}$	-	$F_{DL\_high}$	-50	1	
	Frequency range	1884.5	-	1915.7	-41	0.3	8
43	E-UTRA Band 1, 2, 3, 4, 5, 7, 8, 10, 20, 25, 33, 34, 38, 40	$F_{DL\_low}$	-	$F_{DL\_high}$	-50	1	
	E-UTRA Band 42	$F_{DL\_low}$	-	$F_{DL\_high}$	-50	1	3
	E-UTRA Band 22	$F_{DL\_low}$	-	$F_{DL\_high}$	[-50]	[1]	3
Note 1:	$F_{DL\_low}$ and $F_{DL\_high}$ refer to each E-UTRA frequency band specified in Table 5.2-1						
Note 2:	As exceptions, measurements with a level up to the applicable requirements defined in Table 6.6.3.1.3-2 are permitted for each assigned E-UTRA carrier used in the measurement due to 2 <sup>nd</sup> , 3 <sup>rd</sup> , 4 <sup>th</sup> [or 5 <sup>th</sup> ] harmonic spurious emissions. Due to spreading of the harmonic emission the exception is also allowed for the first 1 MHz frequency range immediately outside the harmonic emission on both sides of the harmonic emission. This results in an overall exception interval centred at the harmonic emission of (2MHz + N x $L_{CRB}$ x 180kHz), where N is 2, 3, 4, [5] for the 2 <sup>nd</sup> , 3 <sup>rd</sup> , 4 <sup>th</sup> [or 5 <sup>th</sup> ] harmonic respectively. The exception is allowed if the measurement bandwidth (MBW) totally or partially overlaps the overall exception interval.						
Note 3:	To meet these requirements some restriction will be needed for either the operating band or protected band						
Note 4:	N/A						
Note 5:	For non synchronised TDD operation to meet these requirements some restriction will be needed for either the operating band or protected band						
Note 6:	N/A						
Note 7:	Applicable when co-existence with PHS system operating in 1884.5-1919.6MHz.						
Note 8:	Applicable when co-existence with PHS system operating in 1884.5 -1915.7MHz.						
Note 9:	N/A						
Note 10:	N/A						
Note 11:	Whether the applicable frequency range should be 793-805MHz instead of 799-805MHz is TBD						
Note 12:	The emissions measurement shall be sufficiently power averaged to ensure a standard deviation < 0.5 dB						
Note 13:	This requirement applies for 5, 10, 15 and 20 MHz E-UTRA channel bandwidth allocated within 1744.9MHz and 1784.9MHz.						
Note 14:	N/A						
Note 15:	These requirements also apply for the frequency ranges that are less than $F_{OoB}$ (MHz) in Table 6.6.3.1.3-1 and Table 6.6.3.1A.1.3-1 from the edge of the channel bandwidth.						
NOTE 16:	This requirement is applicable for any channel bandwidths within the range 2500 - 2570 MHz with the following restriction: for carriers of 15 MHz bandwidth when carrier centre frequency is within the range 2560.5 - 2562.5 MHz and for carriers of 20 MHz bandwidth when carrier centre frequency is within the range 2552 - 2560 MHz the requirement is applicable only for an uplink transmission bandwidth less than or equal to 54 RB.						
NOTE 17:	This requirement is applicable for any channel bandwidths within the range 2570 - 2615 MHz with the following restriction: for carriers of 15 MHz bandwidth when carrier centre frequency is within the range 2605.5 - 2607.5 MHz and for carriers of 20 MHz bandwidth when carrier centre frequency is within the range 2597 - 2605 MHz the requirement is applicable only for an uplink transmission bandwidth less than or equal to 54 RB. For carriers with channel bandwidth overlapping the frequency range 2615 - 2620 MHz the requirement applies with the maximum output power configured to +19 dBm in the IE <i>P-Max</i> .						
NOTE 18:	This requirement is applicable only for the following cases: - for carriers of 5 MHz channel bandwidth when carrier centre frequency ( $F_c$ ) is within the range $902.5 \text{ MHz} \leq F_c < 907.5 \text{ MHz}$ with an uplink transmission bandwidth less than or equal to 20 RB - for carriers of 5 MHz channel bandwidth when carrier centre frequency ( $F_c$ ) is within the range $907.5 \text{ MHz} \leq F_c \leq 912.5 \text{ MHz}$ without any restriction on uplink transmission bandwidth - for carriers of 10 MHz channel bandwidth when carrier centre frequency ( $F_c$ ) is $F_c = 910 \text{ MHz}$ with an uplink transmission bandwidth less than or equal to 32 RB with $RB_{start} > 3$ .						
NOTE 19:	This requirement is applicable for any channel bandwidths within the range 1920 - 1980 MHz with the following restriction: for carriers of 15 MHz bandwidth when carrier centre frequency is within the range 1927.5 - 1929.5 MHz and for carriers of 20 MHz bandwidth when carrier centre frequency is within the range 1930 - 1938 MHz the requirement is applicable only for an uplink transmission bandwidth less than or equal to 54 RB.						
Note 20:	For these adjacent bands, the emission limit could imply risk of harmful interference to UE(s) operating in the protected operating band.						
Note 21:	N/A						
Note 22:	N/A						

NOTE: The restriction on the maximum uplink transmission to 54 RB in Notes 16, 17, and 19 of Table 6.6.3.2.3-1B is intended for conformance testing and may be applied to network operation to facilitate coexistence when the aggressor and victim bands are deployed in the same geographical area. The applicable spurious emission requirement of -15.5 dBm/5MHz is a least restrictive technical condition for FDD/TDD coexistence and may have to be revised in the future.

Table 6.6.3.2.3-1C: Spurious emission band UE co-existence limits Rel-11

E-UTRA Band	Spurious emission						
	Protected band	Frequency range (MHz)			Maximum Level (dBm)	MBW (MHz)	Note
1	E-UTRA Band 1, 7, 8, 11, 18, 19, 20, 21, 22, 26, 27, 28, 38, 40, 41, 42, 43, 44	F <sub>DL_low</sub>	-	F <sub>DL_high</sub>	-50	1	
	E-UTRA Band 3, 34	F <sub>DL_low</sub>	-	F <sub>DL_high</sub>	-50	1	15
	Frequency range	1880		1895	-40	1	15,27
	Frequency range	1895		1915	-15.5	5	15, 26, 27
	Frequency range	1915		1920	+1.6	5	15, 26, 27
	Frequency range	1839.9	-	1879.9	-50	1	15
2	E-UTRA Band 4, 5, 10, 12, 13, 14, 17, 22, 23, 24, 26, 27, 28, 29, 41, 42	F <sub>DL_low</sub>	-	F <sub>DL_high</sub>	-50	1	
	E-UTRA Band 2, 25	F <sub>DL_low</sub>	-	F <sub>DL_high</sub>	-50	1	15
	E-UTRA Band 43	F <sub>DL_low</sub>	-	F <sub>DL_high</sub>	-50	1	2
3	E-UTRA Band 1, 7, 8, 20, 26, 27, 28, 33, 34, 38, 41, 43, 44	F <sub>DL_low</sub>	-	F <sub>DL_high</sub>	-50	1	
	E-UTRA Band 3	F <sub>DL_low</sub>	-	F <sub>DL_high</sub>	-50	1	15
	E-UTRA Band 11, 18, 19, 21	F <sub>DL_low</sub>	-	F <sub>DL_high</sub>	-50	1	13
	E-UTRA Band 22, 42	F <sub>DL_low</sub>	-	F <sub>DL_high</sub>	-50	1	2
	Frequency range	1884.5	-	1915.7	-41	0.3	13
4	E-UTRA Band 2, 4, 5, 10, 12, 13, 14, 17, 22, 23, 24, 25, 26, 27, 28, 29, 41, 43	F <sub>DL_low</sub>	-	F <sub>DL_high</sub>	-50	1	
	E-UTRA Band 42	F <sub>DL_low</sub>	-	F <sub>DL_high</sub>	-50	1	2
5	E-UTRA Band 2, 4, 5, 10, 12, 13, 14, 17, 22, 23, 24, 25, 28, 29,42, 43	F <sub>DL_low</sub>	-	F <sub>DL_high</sub>	-50	1	
	E-UTRA Band 41	F <sub>DL_low</sub>	-	F <sub>DL_high</sub>	-50	1	2
	E-UTRA Band 26	859	-	869	-27	1	
6	E-UTRA Band 1, 9, 11, 34	F <sub>DL_low</sub>	-	F <sub>DL_high</sub>	-50	1	
	Frequency range	860	-	875	-37	1	
	Frequency range	875	-	895	-50	1	
	Frequency range	1884.5	-	1919.6	-41	0.3	7
	Frequency range	1884.5	-	1915.7			8
7	E-UTRA Band 1, 3, 7, 8, 20, 22, 27, 28, 29, 33, 34, 40, 42, 43	F <sub>DL_low</sub>	-	F <sub>DL_high</sub>	-50	1	
	Frequency range	2570	-	2575	+1.6	5	15, 21, 26
	Frequency range	2575	-	2595	-15.5	5	15, 21, 26
	Frequency range	2595	-	2620	-40	1	15, 21
8	E-UTRA Band 1, 20, 28, 33, 34, 38, 39, 40	F <sub>DL_low</sub>	-	F <sub>DL_high</sub>	-50	1	
	E-UTRA band 3	F <sub>DL_low</sub>	-	F <sub>DL_high</sub>	-50	1	2
	E-UTRA band 7	F <sub>DL_low</sub>	-	F <sub>DL_high</sub>	-50	1	2
	E-UTRA Band 8	F <sub>DL_low</sub>	-	F <sub>DL_high</sub>	-50	1	15
	E-UTRA Band 22, 41, 42, 43	F <sub>DL_low</sub>	-	F <sub>DL_high</sub>	-50	1	2
	E-UTRA Band 11, 21	F <sub>DL_low</sub>	-	F <sub>DL_high</sub>	-50	1	23
	Frequency range	860	-	890	-40	1	15, 23
	Frequency range	1884.5	-	1915.7	-41	0.3	8, 23
9	E-UTRA Band 1, 11, 18, 19, 21, 26, 28, 34	F <sub>DL_low</sub>	-	F <sub>DL_high</sub>	-50	1	
	E-UTRA Band 42	F <sub>DL_low</sub>	-	F <sub>DL_high</sub>	-50	1	2
	Frequency range	1884.5	-	1915.7	-41	0.3	8
	Frequency range	945	-	960	-50	1	
	Frequency range	1839.9	-	1879.9	-50	1	
	Frequency range	2545	-	2575	-50	1	
10	E-UTRA Band 2, 4, 5, 10, 12, 13, 14, 17, 23, 24, 25, 26, 27, 28, 29, 41, 43	F <sub>DL_low</sub>	-	F <sub>DL_high</sub>	-50	1	
	E-UTRA Band 22, 42	F <sub>DL_low</sub>	-	F <sub>DL_high</sub>	-50	1	2
11	E-UTRA Band 1, 11, 18, 19, 21, 28, 34, 42	F <sub>DL_low</sub>	-	F <sub>DL_high</sub>	-50	1	
	Frequency range	1884.5	-	1915.7	-41	0.3	8

	Frequency range	945	-	960	-50	1	
	Frequency range	1839.9	-	1879.9	-50	1	
	Frequency range	2545	-	2575	-50	1	
12	E-UTRA Band 2, 5, 13, 14, 17, 23, 24, 25, 26, 27, 41	$F_{DL\_low}$	-	$F_{DL\_high}$	-50	1	
	E-UTRA Band 4, 10	$F_{DL\_low}$	-	$F_{DL\_high}$	-50	1	2
	E-UTRA Band 12	$F_{DL\_low}$	-	$F_{DL\_high}$	-50	1	15
13	E-UTRA Band 2, 4, 5, 10, 12, 13, 17, 23, 25, 26, 27, 29, 41	$F_{DL\_low}$	-	$F_{DL\_high}$	-50	1	
	Frequency range	769	-	775	-35	0.00625	15
	Frequency range	799	-	805	-35	0.00625	11, 15
	E-UTRA Band 14	$F_{DL\_low}$	-	$F_{DL\_high}$	-50	1	15
	E-UTRA Band 24	$F_{DL\_low}$	-	$F_{DL\_high}$	-50	1	2
14	E-UTRA Band 2, 4, 5, 10, 12, 13, 14, 17, 23, 24, 25, 26, 27, 29, 41	$F_{DL\_low}$	-	$F_{DL\_high}$	-50	1	
	Frequency range	769	-	775	-35	0.00625	12, 15
	Frequency range	799	-	805	-35	0.00625	11, 12, 15
17	E-UTRA Band 2, 5, 13, 14, 17, 23, 24, 25, 26, 27, 41	$F_{DL\_low}$	-	$F_{DL\_high}$	-50	1	
	E-UTRA Band 4, 10	$F_{DL\_low}$	-	$F_{DL\_high}$	-50	1	2
	E-UTRA Band 12	$F_{DL\_low}$	-	$F_{DL\_high}$	-50	1	15
18	E-UTRA Band 1, 11, 21, 34, 42	$F_{DL\_low}$	-	$F_{DL\_high}$	-50	1	
	Frequency range	860	-	890	-40	1	
	Frequency range	1884.5	-	1915.7	-41	0.3	8
	Frequency range	758	-	799	-50	1	
	Frequency range	799	-	803	-40	1	15
	Frequency range	945	-	960	-50	1	
	Frequency range	1839.9	-	1879.9	-50	1	
	Frequency range	2545	-	2575	-50	1	
19	E-UTRA Band 1, 11, 21, 28, 34, 42	$F_{DL\_low}$	-	$F_{DL\_high}$	-50	1	
	Frequency range	1884.5	-	1915.7	-41	0.3	8
	Frequency range	945	-	960	-50	1	
	Frequency range	1839.9	-	1879.9	-50	1	
	Frequency range	2545	-	2575	-50	1	
20	E-UTRA Band 1, 3, 7, 8, 20, 22, 33, 34, 40, 43	$F_{DL\_low}$	-	$F_{DL\_high}$	-50	1	
	E-UTRA Band 20	$F_{DL\_low}$	-	$F_{DL\_high}$	-50	1	15
	E-UTRA Band 38, 42	$F_{DL\_low}$	-	$F_{DL\_high}$	-50	1	2
	Frequency range	758	-	788	-50	1	
21							
	E-UTRA Band 1, 18, 19, 28, 34, 42	$F_{DL\_low}$	-	$F_{DL\_high}$	-50	1	
	Frequency range	1884.5	-	1915.7	-41	0.3	8
	Frequency range	945	-	960	-50	1	
	Frequency range	1839.9	-	1879.9	-50	1	
	Frequency range	2545	-	2575	-50	1	
22	E-UTRA Band 1, 3, 7, 8, 20, 26, 27, 28, 33, 34, 38, 39, 40, 43	$F_{DL\_low}$	-	$F_{DL\_high}$	-50	1	
	Frequency range	3510	-	3525	-40	1	15
	Frequency range	3525	-	3590	-50	1	
23	E-UTRA Band 4, 5, 10, 12, 13, 14, 17, 23, 24, 26, 27, 29, 41	$F_{DL\_low}$	-	$F_{DL\_high}$	-50	1	
24	E-UTRA Band 2, 4, 5, 10, 12, 13, 14, 17, 23, 24, 25, 26, 29, 41	$F_{DL\_low}$	-	$F_{DL\_high}$	-50	1	
25	E-UTRA Band 4, 5, 10, 12, 13, 14, 17, 23, 24, 26, 27, 28, 29, 41, 42	$F_{DL\_low}$	-	$F_{DL\_high}$	-50	1	
	E-UTRA Band 2	$F_{DL\_low}$	-	$F_{DL\_high}$	-50	1	15
	E-UTRA Band 25	$F_{DL\_low}$	-	$F_{DL\_high}$	-50	1	15
	E-UTRA Band 43	$F_{DL\_low}$	-	$F_{DL\_high}$	-50	1	2
26	E-UTRA Band 1, 2, 3, 4, 5, 10, 11, 12, 13, 14, 17, 18, 19, 21, 23, 24, 25, 26, 29, 34, 40, 42, 43	$F_{DL\_low}$	-	$F_{DL\_high}$	-50	1	
	E-UTRA Band 41	$F_{DL\_low}$	-	$F_{DL\_high}$	-50	1	2
	Frequency range	1884.5	-	1915.7	-41	0.3	8
	Frequency range	703	-	799	-50	1	
	Frequency range	799	-	803	-40	1	15

	Frequency range	945	-	960	-50	1		
	Frequency range	1839.9	-	1879.9	-50	1		
27	E-UTRA Band 1, 2, 3, 4, 5, 7, 10, 12, 13, 14, 17, 23, 25, 26, 27, 29, 38, 41, 42, 43	$F_{DL\_low}$	-	$F_{DL\_high}$	-50	1		
	Frequency range	799	-	805	-35	0.00625		
	E-UTRA Band 28	$F_{DL\_low}$	-	790	-50	1		
28	E-UTRA Band 2, 3, 5, 7, 8, 18, 19, 25, 26, 27, 34, 38, 41	$F_{DL\_low}$	-	$F_{DL\_high}$	-50	1		
	E-UTRA Band 1, 4, 10, 22, 42, 43	$F_{DL\_low}$	-	$F_{DL\_high}$	-50	1	2	
	E-UTRA Band 11, 21	$F_{DL\_low}$	-	$F_{DL\_high}$	-50	1	19, 24	
	E-UTRA Band 1	$F_{DL\_low}$	-	$F_{DL\_high}$	-50	1	19, 25	
	Frequency range	470	-	694	-42	8	15, 32	
	Frequency range	470	-	710	-26.2	6	31	
	Frequency range	758	-	773	-32	1	15	
	Frequency range	773	-	803	-50	1		
	Frequency range	662	-	694	-26.2	6	15	
	Frequency range	1884.5	-	1915.7	-41	0.3	8, 19	
	Frequency range	1839.9	-	1879.9	-50	1		
	...							
	33	E-UTRA Band 1, 7, 8, 20, 22, 28, 34, 38, 40, 42, 43	$F_{DL\_low}$	-	$F_{DL\_high}$	-50	1	5
E-UTRA Band 3		$F_{DL\_low}$	-	$F_{DL\_high}$	-50	1	15	
34	E-UTRA Band 1, 3, 7, 8, 11, 18, 19, 20, 21, 22, 26, 28, 33, 38, 39, 40, 41, 42, 43, 44	$F_{DL\_low}$	-	$F_{DL\_high}$	-50	1	5	
	Frequency range	1884.5	-	1915.7	-41	0.3	8	
	Frequency range	1839.9	-	1879.9	-50	1		
35								
36								
37			-					
38	E-UTRA Band 1,3, 8, 20, 22, 27, 28, 29, 33, 34, 40, 42, 43	$F_{DL\_low}$	-	$F_{DL\_high}$	-50	1		
	Frequency range	2620	-	2645	-15.5	5	15, 22, 26	
	Frequency range	2645	-	2690	-40	1	15, 22	
39	E-UTRA Band 22, 34, 40, 41, 42, 44	$F_{DL\_low}$	-	$F_{DL\_high}$	-50	1		
40	E-UTRA Band 1, 3, 7, 8, 20, 22, 26, 27, 28, 33, 34, 38, 39, 41, 42, 43, 44	$F_{DL\_low}$	-	$F_{DL\_high}$	-50	1		
41	E-UTRA Band 1, 2, 3, 4, 5, 8, 10, 12, 13, 14, 17, 23, 24, 25, 26, 27, 28, 29, 34, 39, 40, 42, 44	$F_{DL\_low}$	-	$F_{DL\_high}$	-50	1		
	E-UTRA Band 9, 11, 18, 19, 21	$F_{DL\_low}$	-	$F_{DL\_high}$	-50	1	30	
	Frequency range	1839.9		1879.9	-50	1	30	
	Frequency range	1884.5		1915.7	-41	0.3	8, 30	
42	E-UTRA Band 1, 2, 3, 4, 5, 7, 8, 10, 11, 18, 19, 20, 21, 25, 26, 27, 28, 33, 34, 38, 40, 41, 44	$F_{DL\_low}$	-	$F_{DL\_high}$	-50	1		
	Frequency range	1884.5	-	1915.7	-41	0.3	8	
43	E-UTRA Band 1, 2, 3, 4, 5, 7, 8, 10, 20, 25, 26, 27, 28, 33, 34, 38, 40	$F_{DL\_low}$	-	$F_{DL\_high}$	-50	1		
	E-UTRA Band 42	$F_{DL\_low}$	-	$F_{DL\_high}$	-50	1	3	
	E-UTRA Band 22	$F_{DL\_low}$	-	$F_{DL\_high}$	[-50]	[1]	3	
44	E-UTRA Band 3, 5, 8, 34, 39, 41	$F_{DL\_low}$	-	$F_{DL\_high}$	-50	1		
	E-UTRA Band 1, 40, 42	$F_{DL\_low}$	-	$F_{DL\_high}$	-50	1	2	

- Note 1:  $F_{DL\_low}$  and  $F_{DL\_high}$  refer to each E-UTRA frequency band specified in Table 5.2-1
- Note 2: As exceptions, measurements with a level up to the applicable requirements defined in Table 6.6.3.1.3-2 are permitted for each assigned E-UTRA carrier used in the measurement due to 2<sup>nd</sup>, 3<sup>rd</sup>, 4<sup>th</sup> [or 5<sup>th</sup>] harmonic spurious emissions. Due to spreading of the harmonic emission the exception is also allowed for the first 1 MHz frequency range immediately outside the harmonic emission on both sides of the harmonic emission. This results in an overall exception interval centred at the harmonic emission of  $(2\text{MHz} + N \times L_{CRB} \times 180\text{kHz})$ , where N is 2, 3, 4, [5] for the 2<sup>nd</sup>, 3<sup>rd</sup>, 4<sup>th</sup> [or 5<sup>th</sup>] harmonic respectively. The exception is allowed if the measurement bandwidth (MBW) totally or partially overlaps the overall exception interval.
- Note 3: To meet these requirements some restriction will be needed for either the operating band or protected band
- Note 4: N/A
- Note 5: For non synchronised TDD operation to meet these requirements some restriction will be needed for either the operating band or protected band
- Note 6: N/A
- Note 7: Applicable when co-existence with PHS system operating in 1884.5-1919.6MHz.
- Note 8: Applicable when co-existence with PHS system operating in 1884.5 -1915.7MHz.
- Note 9: N/A
- Note 10: N/A
- Note 11: Whether the applicable frequency range should be 793-805MHz instead of 799-805MHz is TBD
- Note 12: The emissions measurement shall be sufficiently power averaged to ensure a standard deviation < 0.5 dB
- Note 13: This requirement applies for 5, 10, 15 and 20 MHz E-UTRA channel bandwidth allocated within 1744.9MHz and 1784.9MHz.
- Note 14: N/A
- Note 15: These requirements also apply for the frequency ranges that are less than  $F_{OOB}$  (MHz) in Table 6.6.3.1.3-1 and Table 6.6.3.1A.1.3-1 from the edge of the channel bandwidth.
- Note 16: N/A
- Note 17: N/A
- Note 18: N/A
- Note 19: Applicable when the assigned E-UTRA carrier is confined within 718 MHz and 748 MHz and when the channel bandwidth used is 5 or 10 MHz.
- Note 20: N/A
- Note 21: This requirement is applicable for any channel bandwidths within the range 2500 - 2570 MHz with the following restriction: for carriers of 15 MHz bandwidth when carrier centre frequency is within the range 2560.5 - 2562.5 MHz and for carriers of 20 MHz bandwidth when carrier centre frequency is within the range 2552 - 2560 MHz the requirement is applicable only for an uplink transmission bandwidth less than or equal to 54 RB.
- Note 22: This requirement is applicable for any channel bandwidths within the range 2570 - 2615 MHz with the following restriction: for carriers of 15 MHz bandwidth when carrier centre frequency is within the range 2605.5 - 2607.5 MHz and for carriers of 20 MHz bandwidth when carrier centre frequency is within the range 2597 - 2605 MHz the requirement is applicable only for an uplink transmission bandwidth less than or equal to 54 RB.  
For carriers with channel bandwidth overlapping the frequency range 2615 - 2620 MHz the requirement applies with the maximum output power configured to +19 dBm in the IE *P-Max*.
- Note 23: This requirement is applicable only for the following cases:  
- for carriers of 5 MHz channel bandwidth when carrier centre frequency ( $F_c$ ) is within the range  $902.5 \text{ MHz} \leq F_c < 907.5 \text{ MHz}$  with an uplink transmission bandwidth less than or equal to 20 RB  
- for carriers of 5 MHz channel bandwidth when carrier centre frequency ( $F_c$ ) is within the range  $907.5 \text{ MHz} \leq F_c \leq 912.5 \text{ MHz}$  without any restriction on uplink transmission bandwidth  
- for carriers of 10 MHz channel bandwidth when carrier centre frequency ( $F_c$ ) is  $F_c = 910 \text{ MHz}$  with an uplink transmission bandwidth less than or equal to 32 RB with  $RB_{start} > 3$ .
- Note 24: As exceptions, measurements with a level up to the applicable requirement of -38 dBm/MHz is permitted for each assigned E-UTRA carrier used in the measurement due to 2<sup>nd</sup> harmonic spurious emissions. An exception is allowed if there is at least one individual RB within the transmission bandwidth (see Figure 5.6-1) for which the 2<sup>nd</sup> harmonic totally or partially overlaps the measurement bandwidth (MBW).
- Note 25: As exceptions, measurements with a level up to the applicable requirement of -36 dBm/MHz is permitted for each assigned E-UTRA carrier used in the measurement due to 3<sup>rd</sup> harmonic spurious emissions. An exception is allowed if there is at least one individual RB within the transmission bandwidth (see Figure 5.6-1) for which the 3<sup>rd</sup> harmonic totally or partially overlaps the measurement bandwidth (MBW).
- Note 26: For these adjacent bands, the emission limit could imply risk of harmful interference to UE(s) operating in the protected operating band.
- Note 27: This requirement is applicable for any channel bandwidths within the range 1920 - 1980 MHz with the following restriction: for carriers of 15 MHz bandwidth when carrier centre frequency is within the range 1927.5 - 1929.5 MHz and for carriers of 20 MHz bandwidth when carrier centre frequency is within the range 1930 - 1938 MHz the requirement is applicable only for an uplink

- transmission bandwidth less than or equal to 54 RB.
- Note 28: N/A
- Note 29: N/A
- Note 30: This requirement applies when the E-UTRA carrier is confined within 2545-2575 MHz and the channel bandwidth is 10 or 20 MHz
- Note 31: This requirement is applicable for 5 and 10 MHz E-UTRA channel bandwidth allocated within 718-728MHz. For carriers of 10 MHz bandwidth, this requirement applies for an uplink transmission bandwidth less than or equal to 30 RB with RBstart > 1 and RBstart<48.
- Note 32: This requirement is applicable in the case of a 10 MHz E-UTRA carrier confined within 703 MHz and 733 MHz, otherwise the requirement of -25 dBm with a measurement bandwidth of 8 MHz applies.

Table 6.6.3.2.3-1D: Spurious emission band UE co-existence limits Rel-12

E-UTRA Band	Spurious emission						
	Protected band	Frequency range (MHz)		Maximum Level (dBm)	MBW (MHz)	Note	
1	E-UTRA Band 1, 5, 7, 8, 11, 18, 19, 20, 21, 22, 26, 27, 28, 31, 32, 38, 40, 41, 42, 43, 44	F <sub>DL_low</sub>	-	F <sub>DL_high</sub>	-50	1	
	E-UTRA Band 3, 34	F <sub>DL_low</sub>	-	F <sub>DL_high</sub>	-50	1	15
	Frequency range	1880	-	1895	-40	1	15,27
	Frequency range	1895	-	1915	-15.5	5	15, 26, 27
	Frequency range	1915	-	1920	+1.6	5	15, 26, 27
	Frequency range	1839.9	-	1879.9	-50	1	15
2	E-UTRA Band 4, 5, 10, 12, 13, 14, 17, 22, 23, 24, 26, 27, 28, 29, 30, 41, 42	F <sub>DL_low</sub>	-	F <sub>DL_high</sub>	-50	1	
	E-UTRA Band 2, 25	F <sub>DL_low</sub>	-	F <sub>DL_high</sub>	-50	1	15
	E-UTRA Band 43	F <sub>DL_low</sub>	-	F <sub>DL_high</sub>	-50	1	2
3	E-UTRA Band 1, 5, 7, 8, 20, 26, 27, 28, 31, 32, 33, 34, 38, 41, 43, 44	F <sub>DL_low</sub>	-	F <sub>DL_high</sub>	-50	1	
	E-UTRA Band 3	F <sub>DL_low</sub>	-	F <sub>DL_high</sub>	-50	1	15
	E-UTRA Band 11, 18, 19, 21	F <sub>DL_low</sub>	-	F <sub>DL_high</sub>	-50	1	13
	E-UTRA Band 22, 42	F <sub>DL_low</sub>	-	F <sub>DL_high</sub>	-50	1	2
	Frequency range	1884.5	-	1915.7	-41	0.3	13
4	E-UTRA Band 2, 4, 5, 10, 12, 13, 14, 17, 22, 23, 24, 25, 26, 27, 28, 29, 30, 41, 43	F <sub>DL_low</sub>	-	F <sub>DL_high</sub>	-50	1	
	E-UTRA Band 42	F <sub>DL_low</sub>	-	F <sub>DL_high</sub>	-50	1	2
5	E-UTRA Band 1, 2, 3, 4, 5, 7, 8, 10, 12, 13, 14, 17, 23, 24, 25, 28, 29, 30, 31, 38, 40, 42, 43	F <sub>DL_low</sub>	-	F <sub>DL_high</sub>	-50	1	
	E-UTRA Band 41	F <sub>DL_low</sub>	-	F <sub>DL_high</sub>	-50	1	2
	E-UTRA Band 26	859	-	869	-27	1	
6	E-UTRA Band 1, 9, 11, 34	F <sub>DL_low</sub>	-	F <sub>DL_high</sub>	-50	1	
	Frequency range	860	-	875	-37	1	
	Frequency range	875	-	895	-50	1	
	Frequency range	1884.5	-	1919.6	-41	0.3	7
Frequency range	1884.5	-	1915.7	8			
7	E-UTRA Band 1, 2, 3, 4, 5, 7, 8, 10, 12, 13, 14, 17, 20, 22, 27, 28, 29, 30, 31, 32, 33, 34, 40, 42, 43	F <sub>DL_low</sub>	-	F <sub>DL_high</sub>	-50	1	
	Frequency range	2570	-	2575	+1.6	5	15, 21, 26
	Frequency range	2575	-	2595	-15.5	5	15, 21, 26
	Frequency range	2595	-	2620	-40	1	15, 21
8	E-UTRA Band 1, 20, 28, 31, 32, 33, 34, 38, 39, 40	F <sub>DL_low</sub>	-	F <sub>DL_high</sub>	-50	1	
	E-UTRA band 3	F <sub>DL_low</sub>	-	F <sub>DL_high</sub>	-50	1	2
	E-UTRA band 7	F <sub>DL_low</sub>	-	F <sub>DL_high</sub>	-50	1	2
	E-UTRA Band 8	F <sub>DL_low</sub>	-	F <sub>DL_high</sub>	-50	1	15
	E-UTRA Band 22, 41, 42, 43	F <sub>DL_low</sub>	-	F <sub>DL_high</sub>	-50	1	2
	E-UTRA Band 11, 21	F <sub>DL_low</sub>	-	F <sub>DL_high</sub>	-50	1	23
	Frequency range	860	-	890	-40	1	15, 23
	Frequency range	1884.5	-	1915.7	-41	0.3	8, 23
9	E-UTRA Band 1, 11, 18, 19, 21, 26, 28, 34	F <sub>DL_low</sub>	-	F <sub>DL_high</sub>	-50	1	
	E-UTRA Band 42	F <sub>DL_low</sub>	-	F <sub>DL_high</sub>	-50	1	2
	Frequency range	1884.5	-	1915.7	-41	0.3	8
	Frequency range	945	-	960	-50	1	
	Frequency range	1839.9	-	1879.9	-50	1	
	Frequency range	2545	-	2575	-50	1	
	Frequency range	2595	-	2645	-50	1	
10	E-UTRA Band 2, 4, 5, 10, 12, 13, 14, 17, 23, 24, 25, 26, 27, 28, 29, 30, 41, 43	F <sub>DL_low</sub>	-	F <sub>DL_high</sub>	-50	1	



	E-UTRA Band 22, 42	$F_{DL\_low}$	-	$F_{DL\_high}$	-50	1	2
11	E-UTRA Band 1, 11, 18, 19, 21, 28, 34, 42	$F_{DL\_low}$	-	$F_{DL\_high}$	-50	1	
	Frequency range	1884.5	-	1915.7	-41	0.3	8
	Frequency range	945	-	960	-50	1	
	Frequency range	1839.9	-	1879.9	-50	1	
	Frequency range	2545	-	2575	-50	1	
	Frequency range	2595	-	2645	-50	1	
12	E-UTRA Band 2, 5, 13, 14, 17, 23, 24, 25, 26, 27, 30, 41	$F_{DL\_low}$	-	$F_{DL\_high}$	-50	1	
	E-UTRA Band 4, 10	$F_{DL\_low}$	-	$F_{DL\_high}$	-50	1	2
	E-UTRA Band 12	$F_{DL\_low}$	-	$F_{DL\_high}$	-50	1	15
13	E-UTRA Band 2, 4, 5, 10, 12, 13, 17, 23, 25, 26, 27, 29, 41	$F_{DL\_low}$	-	$F_{DL\_high}$	-50	1	
	Frequency range	769	-	775	-35	0.00625	15
	Frequency range	799	-	805	-35	0.00625	11, 15
	E-UTRA Band 14	$F_{DL\_low}$	-	$F_{DL\_high}$	-50	1	15
	E-UTRA Band 24, 30	$F_{DL\_low}$	-	$F_{DL\_high}$	-50	1	2
14	E-UTRA Band 2, 4, 5, 10, 12, 13, 14, 17, 23, 24, 25, 26, 27, 29, 30, 41	$F_{DL\_low}$	-	$F_{DL\_high}$	-50	1	
	Frequency range	769	-	775	-35	0.00625	12, 15
	Frequency range	799	-	805	-35	0.00625	11, 12, 15
17	E-UTRA Band 2, 5, 13, 14, 17, 23, 24, 25, 26, 27, 30, 41	$F_{DL\_low}$	-	$F_{DL\_high}$	-50	1	
	E-UTRA Band 4, 10	$F_{DL\_low}$	-	$F_{DL\_high}$	-50	1	2
	E-UTRA Band 12	$F_{DL\_low}$	-	$F_{DL\_high}$	-50	1	15
18	E-UTRA Band 1, 11, 21, 34, 42	$F_{DL\_low}$	-	$F_{DL\_high}$	-50	1	
	Frequency range	860	-	890	-40	1	
	Frequency range	1884.5	-	1915.7	-41	0.3	8
	Frequency range	758	-	799	-50	1	
	Frequency range	799	-	803	-40	1	15
	Frequency range	945	-	960	-50	1	
	Frequency range	1839.9	-	1879.9	-50	1	
	Frequency range	2545	-	2575	-50	1	
	Frequency range	2595	-	2645	-50	1	

19	E-UTRA Band 1, 11, 21, 28, 34, 42	$F_{DL\_low}$	-	$F_{DL\_high}$	-50	1	
	Frequency range	1884.5	-	1915.7	-41	0.3	8
	Frequency range	945	-	960	-50	1	
	Frequency range	1839.9	-	1879.9	-50	1	
	Frequency range	2545	-	2575	-50	1	
	Frequency range	2595	-	2645	-50	1	
20	E-UTRA Band 1, 3, 7, 8, 20, 22, 31, 32, 33, 34, 40, 43	$F_{DL\_low}$	-	$F_{DL\_high}$	-50	1	
	E-UTRA Band 20	$F_{DL\_low}$	-	$F_{DL\_high}$	-50	1	15
	E-UTRA Band 38, 42	$F_{DL\_low}$	-	$F_{DL\_high}$	-50	1	2
	Frequency range	758	-	788	-50	1	
21	E-UTRA Band 1, 18, 19, 28, 34, 42	$F_{DL\_low}$	-	$F_{DL\_high}$	-50	1	
	Frequency range	1884.5	-	1915.7	-41	0.3	8
	Frequency range	945	-	960	-50	1	
	Frequency range	1839.9	-	1879.9	-50	1	
	Frequency range	2545	-	2575	-50	1	
	Frequency range	2595	-	2645	-50	1	
22	E-UTRA Band 1, 3, 7, 8, 20, 26, 27, 28, 31, 32, 33, 34, 38, 39, 40, 43	$F_{DL\_low}$	-	$F_{DL\_high}$	-50	1	
	Frequency range	3510	-	3525	-40	1	15
	Frequency range	3525	-	3590	-50	1	
23	E-UTRA Band 4, 5, 10, 12, 13, 14, 17, 23, 24, 26, 27, 29, 30, 41	$F_{DL\_low}$	-	$F_{DL\_high}$	-50	1	
24	E-UTRA Band 2, 4, 5, 10, 12, 13, 14, 17, 23, 24, 25, 26, 29, 30, 41	$F_{DL\_low}$	-	$F_{DL\_high}$	-50	1	
25	E-UTRA Band 4, 5, 10, 12, 13, 14, 17, 23, 24, 26, 27, 28, 29, 30, 41, 42	$F_{DL\_low}$	-	$F_{DL\_high}$	-50	1	
	E-UTRA Band 2	$F_{DL\_low}$	-	$F_{DL\_high}$	-50	1	15
	E-UTRA Band 25	$F_{DL\_low}$	-	$F_{DL\_high}$	-50	1	15
	E-UTRA Band 43	$F_{DL\_low}$	-	$F_{DL\_high}$	-50	1	2
26	E-UTRA Band 1, 2, 3, 4, 5, 10, 11, 12, 13, 14, 17, 18, 19, 21, 23, 24, 25, 26, 29, 30, 31, 34, 40, 42, 43	$F_{DL\_low}$	-	$F_{DL\_high}$	-50	1	
	E-UTRA Band 41	$F_{DL\_low}$	-	$F_{DL\_high}$	-50	1	2
	Frequency range	1884.5	-	1915.7	-41	0.3	8
	Frequency range	703	-	799	-50	1	
	Frequency range	799	-	803	-40	1	15
	Frequency range	945	-	960	-50	1	
27	E-UTRA Band 1, 2, 3, 4, 5, 7, 10, 12, 13, 14, 17, 23, 25, 26, 27, 29, 30, 31, 38, 41, 42, 43	$F_{DL\_low}$	-	$F_{DL\_high}$	-50	1	
	Frequency range	799	-	805	-35	0.0062 5	
	E-UTRA Band 28	$F_{DL\_low}$	-	790	-50	1	
28	E-UTRA Band 2, 3, 5, 7, 8, 18, 19, 20, 25, 26, 27, 31, 34, 38, 41	$F_{DL\_low}$	-	$F_{DL\_high}$	-50	1	
	E-UTRA Band 1, 4, 10, 22, 42, 43	$F_{DL\_low}$	-	$F_{DL\_high}$	-50	1	2
	E-UTRA Band 11, 21	$F_{DL\_low}$	-	$F_{DL\_high}$	-50	1	19, 24
	E-UTRA Band 1	$F_{DL\_low}$	-	$F_{DL\_high}$	-50	1	19, 25
	Frequency range	470	-	694	-42	8	15, 35
	Frequency range	470	-	710	-26.2	6	34
	Frequency range	758	-	773	-32	1	15
	Frequency range	773	-	803	-50	1	
	Frequency range	662	-	694	-26.2	6	15
	Frequency range	1884.5	-	1915.7	-41	0.3	8, 19
30	E-UTRA Band 2, 4, 5, 7, 10, 12, 13, 14, 17, 23, 24, 25, 26, 27, 29, 30, 38, 41	$F_{DL\_low}$	-	$F_{DL\_high}$	-50	1	
	Frequency range	1839.9	-	1879.9	-50	1	
31	E-UTRA Band 1, 5, 7, 8, 20, 22, 26, 27, 28, 31, 32, 33, 34, 38, 40, 42, 43	$F_{DL\_low}$	-	$F_{DL\_high}$	-50	1	
	E-UTRA Band 3	$F_{DL\_low}$	-	$F_{DL\_high}$	-50	1	2
...							
33	E-UTRA Band 1, 7, 8, 20, 22, 28, 31, 32,	$F_{DL\_low}$	-	$F_{DL\_high}$	-50	1	5

	34, 38, 40, 42, 43						
	E-UTRA Band 3	$F_{DL\_low}$	-	$F_{DL\_high}$	-50	1	15
34	E-UTRA Band 1, 3, 7, 8, 11, 18, 19, 20, 21, 22, 26, 28, 31, 32, 33, 38, 39, 40, 41, 42, 43, 44	$F_{DL\_low}$	-	$F_{DL\_high}$	-50	1	5
	Frequency range	1884.5	-	1915.7	-41	0.3	8
	Frequency range	1839.9	-	1879.9	-50	1	
35							
36							
37			-				
38	E-UTRA Band 1, 2, 3, 4, 5, 8, 10, 12, 13, 14, 17, 20, 22, 27, 28, 29, 30, 31, 32, 33, 34, 40, 42, 43	$F_{DL\_low}$	-	$F_{DL\_high}$	-50	1	
	Frequency range	2620	-	2645	-15.5	5	15, 22, 26
	Frequency range	2645	-	2690	-40	1	15, 22
39	E-UTRA Band 22, 34, 40, 41, 42, 44	$F_{DL\_low}$	-	$F_{DL\_high}$	-50	1	
	Frequency range	1805		1855	-40	1	32
	Frequency range	1855		1875	-15.5	5	15,26,32
	Frequency range	1875		1880	-15.5	5	15,26,33
40	E-UTRA Band 1, 3, 5, 7, 8, 20, 22, 26, 27, 28, 31, 32, 33, 34, 38, 39, 41, 42, 43, 44	$F_{DL\_low}$	-	$F_{DL\_high}$	-50	1	
41	E-UTRA Band 1, 2, 3, 4, 5, 8, 10, 12, 13, 14, 17, 23, 24, 25, 26, 27, 28, 29, 30, 34, 39, 40, 42, 44	$F_{DL\_low}$	-	$F_{DL\_high}$	-50	1	
	E-UTRA Band 9, 11, 18, 19, 21	$F_{DL\_low}$	-	$F_{DL\_high}$	-50	1	30
	Frequency range	1839.9		1879.9	-50	1	30
	Frequency range	1884.5		1915.7	-41	0.3	8, 30
42	E-UTRA Band 1, 2, 3, 4, 5, 7, 8, 10, 11, 18, 19, 20, 21, 25, 26, 27, 28, 31, 32, 33, 34, 38, 40, 41, 44	$F_{DL\_low}$	-	$F_{DL\_high}$	-50	1	
	Frequency range	1884.5	-	1915.7	-41	0.3	8
43	E-UTRA Band 1, 2, 3, 4, 5, 7, 8, 10, 20, 25, 26, 27, 28, 31, 32, 33, 34, 38, 40	$F_{DL\_low}$	-	$F_{DL\_high}$	-50	1	
	E-UTRA Band 42	$F_{DL\_low}$	-	$F_{DL\_high}$	-50	1	3
	E-UTRA Band 22	$F_{DL\_low}$	-	$F_{DL\_high}$	[-50]	[1]	3
44	E-UTRA Band 3, 5, 8, 34, 39, 41	$F_{DL\_low}$	-	$F_{DL\_high}$	-50	1	
	E-UTRA Band 1, 40, 42	$F_{DL\_low}$	-	$F_{DL\_high}$	-50	1	2

- Note 1:  $F_{DL\_low}$  and  $F_{DL\_high}$  refer to each E-UTRA frequency band specified in Table 5.5-1
- Note 2: As exceptions, measurements with a level up to the applicable requirements defined in Table 6.6.3.1.3-2 are permitted for each assigned E-UTRA carrier used in the measurement due to 2<sup>nd</sup>, 3<sup>rd</sup>, 4<sup>th</sup> [or 5<sup>th</sup>] harmonic spurious emissions. Due to spreading of the harmonic emission the exception is also allowed for the first 1 MHz frequency range immediately outside the harmonic emission on both sides of the harmonic emission. This results in an overall exception interval centred at the harmonic emission of  $(2\text{MHz} + N \times L_{CRB} \times 180\text{kHz})$ , where N is 2, 3, 4, [5] for the 2<sup>nd</sup>, 3<sup>rd</sup>, 4<sup>th</sup> [or 5<sup>th</sup>] harmonic respectively. The exception is allowed if the measurement bandwidth (MBW) totally or partially overlaps the overall exception interval.
- Note 3: To meet these requirements some restriction will be needed for either the operating band or protected band
- Note 4: N/A
- Note 5: For non synchronised TDD operation to meet these requirements some restriction will be needed for either the operating band or protected band
- Note 6: N/A
- Note 7: Applicable when co-existence with PHS system operating in 1884.5-1919.6MHz.
- Note 8: Applicable when co-existence with PHS system operating in 1884.5 -1915.7MHz.
- Note 9: N/A
- Note 10: N/A
- Note 11: Whether the applicable frequency range should be 793-805MHz instead of 799-805MHz is TBD
- Note 12: The emissions measurement shall be sufficiently power averaged to ensure a standard deviation < 0.5 dB
- Note 13: This requirement applies for 5, 10, 15 and 20 MHz E-UTRA channel bandwidth allocated within 1744.9MHz and 1784.9MHz.
- Note 14: N/A
- Note 15: These requirements also apply for the frequency ranges that are less than  $F_{OOB}$  (MHz) in Table 6.6.3.1.3-1 and Table 6.6.3.1A.1.3-1 from the edge of the channel bandwidth.
- Note 16: N/A
- Note 17: N/A
- Note 18: N/A
- Note 19: Applicable when the assigned E-UTRA carrier is confined within 718 MHz and 748 MHz and when the channel bandwidth used is 5 or 10 MHz.
- Note 20: N/A
- Note 21: This requirement is applicable for any channel bandwidths within the range 2500 - 2570 MHz with the following restriction: for carriers of 15 MHz bandwidth when carrier centre frequency is within the range 2560.5 - 2562.5 MHz and for carriers of 20 MHz bandwidth when carrier centre frequency is within the range 2552 - 2560 MHz the requirement is applicable only for an uplink transmission bandwidth less than or equal to 54 RB.
- Note 22: This requirement is applicable for any channel bandwidths within the range 2570 - 2615 MHz with the following restriction: for carriers of 15 MHz bandwidth when carrier centre frequency is within the range 2605.5 - 2607.5 MHz and for carriers of 20 MHz bandwidth when carrier centre frequency is within the range 2597 - 2605 MHz the requirement is applicable only for an uplink transmission bandwidth less than or equal to 54 RB.  
For carriers with channel bandwidth overlapping the frequency range 2615 - 2620 MHz the requirement applies with the maximum output power configured to +19 dBm in the IE *P-Max*.
- Note 23: This requirement is applicable only for the following cases:  
- for carriers of 5 MHz channel bandwidth when carrier centre frequency ( $F_c$ ) is within the range  $902.5 \text{ MHz} \leq F_c < 907.5 \text{ MHz}$  with an uplink transmission bandwidth less than or equal to 20 RB  
- for carriers of 5 MHz channel bandwidth when carrier centre frequency ( $F_c$ ) is within the range  $907.5 \text{ MHz} \leq F_c \leq 912.5 \text{ MHz}$  without any restriction on uplink transmission bandwidth  
- for carriers of 10 MHz channel bandwidth when carrier centre frequency ( $F_c$ ) is  $F_c = 910 \text{ MHz}$  with an uplink transmission bandwidth less than or equal to 32 RB with  $RB_{start} > 3$ .
- Note 24: As exceptions, measurements with a level up to the applicable requirement of -38 dBm/MHz is permitted for each assigned E-UTRA carrier used in the measurement due to 2<sup>nd</sup> harmonic spurious emissions. An exception is allowed if there is at least one individual RB within the transmission bandwidth (see Figure 5.6-1) for which the 2<sup>nd</sup> harmonic totally or partially overlaps the measurement bandwidth (MBW).
- Note 25: As exceptions, measurements with a level up to the applicable requirement of -36 dBm/MHz is permitted for each assigned E-UTRA carrier used in the measurement due to 3<sup>rd</sup> harmonic spurious emissions. An exception is allowed if there is at least one individual RB within the transmission bandwidth (see Figure 5.6-1) for which the 3<sup>rd</sup> harmonic totally or partially overlaps the measurement bandwidth (MBW).
- Note 26: For these adjacent bands, the emission limit could imply risk of harmful interference to UE(s) operating in the protected operating band.
- Note 27: This requirement is applicable for any channel bandwidths within the range 1920 - 1980 MHz with the following restriction: for carriers of 15 MHz bandwidth when carrier centre frequency is within the range 1927.5 - 1929.5 MHz and for carriers of 20 MHz bandwidth when carrier centre frequency is within the range 1930 - 1938 MHz the requirement is applicable only for an uplink

	transmission bandwidth less than or equal to 54 RB.
Note 28:	N/A
Note 29:	N/A
Note 30:	This requirement applies when the E-UTRA carrier is confined within 2545-2575MHz or 2595-2645MHz and the channel bandwidth is 10 or 20 MHz
Note 31:	N/A
Note 32:	This requirement is applicable for an uplink transmission bandwidth less than or equal to [54 RB] for carriers of 15 MHz bandwidth when carrier centre frequency is within the range 1887.5 - 1889.5 MHz and for carriers of 20 MHz bandwidth when carrier centre frequency is within the range 1890 - 1898 MHz.
Note 33:	This requirement is only applicable for carriers with bandwidth confined within 1885-1920 MHz (requirement for carriers with at least 1RB confined within 1880 - 1885 MHz is not specified). This requirement applies for an uplink transmission bandwidth less than or equal to [54 RB] for carriers of 15 MHz bandwidth when carrier centre frequency is within the range 1892.5 - 1894.5 MHz and for carriers of 20 MHz bandwidth when carrier centre frequency is within the range 1895 - 1903 MHz.
Note 34:	This requirement is applicable for 5 and 10 MHz E-UTRA channel bandwidth allocated within 718-728MHz. For carriers of 10 MHz bandwidth, this requirement applies for an uplink transmission bandwidth less than or equal to 30 RB with RBstart > 1 and RBstart<48.
Note 35:	This requirement is applicable in the case of a 10 MHz E-UTRA carrier confined within 703 MHz and 733 MHz, otherwise the requirement of -25 dBm with a measurement bandwidth of 8 MHz applies.

The normative reference for this requirement is TS 36.101 [2] subclause 6.6.3.2.

This test use minimum requirements from many releases of TS 36.101 [2] due to release independence defined in TS 36.307 [16]

#### 6.6.3.2.4 Test description

##### 6.6.3.2.4.1 Initial conditions

Initial conditions are a set of test configurations the UE needs to be tested in and the steps for the SS to take with the UE to reach the correct measurement state.

The initial test configurations consist of environmental conditions, test frequencies, and channel bandwidths based on E-UTRA bands specified in Table 5.4.2.1-1. All of these configurations shall be tested with applicable test parameters for each channel bandwidth, and are shown in Table 6.6.3.2.4.1-1. The details of the uplink reference measurement channels (RMCs) are specified in Annexe A.2. Configurations of PDSCH and PDCCH before measurement are specified in Annex C.2.

Table 6.6.3.2.4.1-1: Test Configuration Table

Initial Conditions						
Test Environment (as specified in TS 36.508 [7] subclause 4.1)			NC			
Test Frequencies (as specified in TS36.508 [7] subclause 4.3.1) (Note 6, Note 7)			Low range, Mid range, High range (Note 6, 13, 16)			
Test Channel Bandwidths (as specified in TS 36.508 [7] subclause 4.3.1)			Lowest, 5MHz, Highest (Note 13, 16)			
Test Parameters for Channel Bandwidths						
Ch BW	Downlink Configuration			Uplink Configuration		
	Mod'n	RB allocation		Mod'n	RB allocation	
		FDD	TDD		FDD	TDD
1.4MHz	N/A for Spurious Emissions testing			QPSK	6	6
1.4MHz				QPSK	1	1
3MHz				QPSK	15	15
3MHz				QPSK	1	1
5MHz				QPSK	25	25 <sup>12</sup>
5MHz				QPSK	1	1 <sup>12</sup>
5MHz				QPSK	20 <sup>8</sup>	-
10MHz				QPSK	50	50
10MHz				QPSK	1	1
10MHz				QPSK	30 <sup>15</sup>	
10MHz				QPSK	32 <sup>9</sup>	-
10MHz				QPSK	1 <sup>10,14</sup>	-
15MHz				QPSK	75	75
15MHz				QPSK	54 <sup>3,11</sup>	54 <sup>4,17,18</sup>
15MHz				QPSK	1	1 <sup>5</sup>
20MHz				QPSK	100	100
20MHz			QPSK	54 <sup>3,11</sup>	54 <sup>4,17,18</sup>	
20MHz			QPSK	1	1 <sup>5</sup>	

Note 1:	Test Channel Bandwidths are checked separately for each E-UTRA band, which applicable channel bandwidths are specified in Table 5.4.2.1-1.
Note 2:	The 1 RB allocation shall be tested at both RB #0 and RB #max.
Note 3:	To be used for requirements under note 15 in table 6.6.3.2.3-1 and table 6.6.3.2.3-1A, note 16 in table 6.6.3.2.3-1B, note 21 in table 6.6.3.2.3-1C in high range at RB#(full allocation – 54), instead of full allocation.
Note 4:	To be used for requirements under note 16 in table 6.6.3.2.3-1 and table 6.6.3.2.3-1A, note 17 in table 6.6.3.2.3-1B, note 22 in table 6.6.3.2.3-1C in high range - 5MHz at RB#(full allocation – 54), instead of full allocation.
Note 5:	For requirements under note 16 in table 6.6.3.2.-1 and table 6.6.3.2.3-1A, note 17 in table 6.6.3.2.3-1B, note 22 in table 6.6.3.2.3-1C (high range – 5MHz) is tested instead of high channel.
Note 6:	Do not apply for requirements under Note 13 in Tables 6.6.3.2.3-1 to 6.6.3.2.3-1C. Test frequencies for these requirements are defined in Table 6.6.3.2.4.1-2.
Note 7:	Void
Note 8:	For requirements under note 17 in table 6.6.3.2.3-1A, note 18 in table 6.6.3.2.3-1B, note 23 in table 6.6.3.2.3-1C (high range – 10MHz) is tested with RB #0 to RB #19 used.
Note 9:	For requirements under note 17 in table 6.6.3.2.3-1A, note 18 in table 6.6.3.2.3-1B, note 23 in table 6.6.3.2.3-1C high range is tested with RB #4 to RB #35 used.
Note 10:	For requirements under note 17 in table 6.6.3.2.3-1A, note 18 in table 6.6.3.2.3-1B, note 23 in table 6.6.3.2.3-1C high range is tested with RB #4 and (RB#max -4) used.
Note 11:	To be used for requirements under note 17 in table 6.6.3.2.3-1, note 18 in table 6.6.3.2.3-1A, note 19 in table 6.6.3.2.3-1B and note 27 in table 6.6.3.2.3-1C in low range at RB#0, instead of full allocation.
Note 12:	For requirements under note 16 in table 6.6.3.2.3-1 and table 6.6.3.2.3-1A, note 17 in table 6.6.3.2.3-1B, note 22 in table 6.6.3.2.3-1C, the message exception in Table 6.6.3.2.4.3-1 is used to test with the high range.
Note 13:	For requirements under note 31 in table 6.6.3.2.3-1C and note 34 in table 6.6.3.2.3-1D only 720.5 MHz is tested with 5 MHz and only 723 MHz is tested with 10 MHz.
Note 14:	For requirements under note 31 in table 6.6.3.2.3-1C and note 34 in table 6.6.3.2.3-1D RB #2 and RB #47 used.
Note 15:	To be used for requirements under note 31 in table 6.6.3.2.3-1C and note 34 in table 6.6.3.2.3-1D at RB#2, instead of full allocation.
Note 16:	For requirements under note 32 in table 6.6.3.2.3-1C and note 35 in table 6.6.3.2.3-1D only low range and 728 MHz with 10 MHz is tested.
Note 17:	To be used for requirements under note 32 in table 6.6.3.2.3-1D in low range, instead of full allocation.
Note 18:	To be used for requirements under note 33 in table 6.6.3.2.3-1D (high range-7 MHz), instead of full allocation and high range.

**Table 6.6.3.2.4.1-2: Test frequencies for E-UTRA channel bandwidth for operating band 3 with Note 13 (in Tables 6.6.3.2.3-1 to 6.6.3.2.3-1D)**

Bandwidth [MHz]	N <sub>UL</sub>	Frequency of Uplink [MHz]	N <sub>DL</sub>	Frequency of Downlink [MHz]
1.4	19942	1784.2	1942	1879.2
3	19934	1783.4	1934	1878.4
5	19924	1782.4	1924	1877.4
10	19899	1779.9	1899	1874.9
15	19874	1777.4	1874	1872.4
20	19849	1774.9	1849	1869.9
Note: 1.4 and 3 MHz only tested for Rel8 and Rel9.				

1. Connect the SS to the UE to the UE antenna connectors as shown in Figure TS 36.508 [7] Annex A, Figure A.7.
2. The parameter settings for the cell are set up according to TS 36.508 [7] subclause 4.4.3.
3. Downlink signals are initially set up according to Annex C0, C.1 and C.3.0, and uplink signals according to Annex H.1 and H.3.0.
4. The UL Reference Measurement channels are set according to Table 6.6.3.2.4.1-1.
5. Propagation conditions are set according to Annex B.0.

6. Ensure the UE is in State 3A-RF according to TS 36.508 [7] clause 5.2A.2. Message contents are defined in clause 6.6.3.2.4.3.

#### 6.6.3.2.4.2 Test procedure

1. SS sends uplink scheduling information for each UL HARQ process via PDCCH DCI format 0 for C\_RNTI to schedule the UL RMC according to Table 6.6.3.2.4.1-1. Since the UE has no payload data to send, the UE transmits uplink MAC padding bits on the UL RMC.
2. Send continuously uplink power control "up" commands in the uplink scheduling information to the UE until the UE transmits at  $P_{UMAX}$  level.
3. Measure the power of the transmitted signal with a measurement filter of bandwidths according to table 6.6.3.2.3-1 to 6.6.3.2.3-1D. For band 14 measurements made in a bandwidth of 6.25kHz, measurement parameter settings defined in table 6.6.3.2.4.2-1 shall be used. The centre frequency of the filter shall be stepped in contiguous steps according to table 6.6.3.2.5-1. The measured power shall be verified for each step. The measurement period shall capture the active time slots.

**Table 6.6.3.2.4.2-1: Measurement setup for band 14**

	<b>Option 1: Measurement with No RMS VBW available</b>	<b>Option2 Measurement with VBW Filtering on Power scale</b>
VBW	$\geq 62.5$ kHz  (10 times or more the RBW)	$\leq 43$ Hz
RBW	$\leq 6.25$ kHz	$\leq 6.25$ kHz
Detector type	Averages signal envelope during each measurement point, such as "RMS detector"	Peak
Averaging mode (Trace averaging)	Power (RMS voltage)	Power (RMS voltage), as controlled by "Average Type"
Average Type (applies to detector)	Power (RMS voltage) (automatically occurs with "RMS detector")	Not applicable
Average Type (applies to VBW filter)	Not applicable	Power (RMS voltage)
Number of averages	30, to reduce variance as required, or use an even longer sweep time	1 or use an even narrower VBW filter, thus a longer sweep time
Sweep time	[Don't specify]	Sweep rate (span divided by sweep time) $\leq 0.8$ * RBW*VBW

#### 6.6.3.2.4.3 Message contents

Message contents are according to TS 36.508 [7] subclause 4.6 with the following exceptions:

**Table 6.6.3.2.4.3-1: SystemInformationBlockType1  
for Note 16 in table 6.6.3.2.3-1 and table 6.6.3.2.3-1A,  
Note 17 in table 6.6.3.2.3-1B, Note 22 in table 6.6.3.2.3-1C**

Derivation Path: TS 36.508 [7] clause 4.4.3.2, Table 4.4.3.2-3 SystemInformationBlockType1			
<b>Information Element</b>	<b>Value/remark</b>	<b>Comment</b>	<b>Condition</b>
p-Max	19		



### 6.6.3.2.5 Test requirement

Test requirements for Spurious Emissions UE Co-existence are the same as the minimum requirements and are not repeated in this section.

The measured average power of spurious emission, derived in step 3, shall not exceed the described value in tables 6.6.3.2.3-1 to 6.6.3.2.3-1D according to the following rule:

The requirements for the UE are release specific and can be found in Tables 6.6.3.2.3-1 to 6.6.3.2.3-1D. If the UE support a band, which is not defined in the table corresponding UE's release, the requirements for this band are taken from the table of earliest release where requirements for this band are defined. This has been described in following Table 6.6.3.2.5-1.

Table 6.6.3.2.5-1: UE Requirements according to UE E-UTRA release and supported E-UTRA band

Band	UE Requirements per release				
	Rel-8	Rel-9	Rel-10	Rel-11	Rel-12
1	Table 6.6.3.2.3-1	Table 6.6.3.2.3-1A	Table 6.6.3.2.3-1B	Table 6.6.3.2.3-1C	Table 6.6.3.2.3-1D
2	Table 6.6.3.2.3-1	Table 6.6.3.2.3-1A	Table 6.6.3.2.3-1B	Table 6.6.3.2.3-1C	Table 6.6.3.2.3-1D
3	Table 6.6.3.2.3-1	Table 6.6.3.2.3-1A	Table 6.6.3.2.3-1B	Table 6.6.3.2.3-1C	Table 6.6.3.2.3-1D
4	Table 6.6.3.2.3-1	Table 6.6.3.2.3-1A	Table 6.6.3.2.3-1B	Table 6.6.3.2.3-1C	Table 6.6.3.2.3-1D
5	Table 6.6.3.2.3-1	Table 6.6.3.2.3-1A	Table 6.6.3.2.3-1B	Table 6.6.3.2.3-1C	Table 6.6.3.2.3-1D
6	Table 6.6.3.2.3-1	Table 6.6.3.2.3-1A	Table 6.6.3.2.3-1B	Table 6.6.3.2.3-1C	Table 6.6.3.2.3-1D
7	Table 6.6.3.2.3-1	Table 6.6.3.2.3-1A	Table 6.6.3.2.3-1B	Table 6.6.3.2.3-1C	Table 6.6.3.2.3-1D
8	Table 6.6.3.2.3-1	Table 6.6.3.2.3-1A	Table 6.6.3.2.3-1B	Table 6.6.3.2.3-1C	Table 6.6.3.2.3-1D
9	Table 6.6.3.2.3-1	Table 6.6.3.2.3-1A	Table 6.6.3.2.3-1B	Table 6.6.3.2.3-1C	Table 6.6.3.2.3-1D
10	Table 6.6.3.2.3-1	Table 6.6.3.2.3-1A	Table 6.6.3.2.3-1B	Table 6.6.3.2.3-1C	Table 6.6.3.2.3-1D
11	Table 6.6.3.2.3-1	Table 6.6.3.2.3-1A	Table 6.6.3.2.3-1B	Table 6.6.3.2.3-1C	Table 6.6.3.2.3-1D
12	Table 6.6.3.2.3-1	Table 6.6.3.2.3-1A	Table 6.6.3.2.3-1B	Table 6.6.3.2.3-1C	Table 6.6.3.2.3-1D
13	Table 6.6.3.2.3-1	Table 6.6.3.2.3-1A	Table 6.6.3.2.3-1B	Table 6.6.3.2.3-1C	Table 6.6.3.2.3-1D
14	Table 6.6.3.2.3-1	Table 6.6.3.2.3-1A	Table 6.6.3.2.3-1B	Table 6.6.3.2.3-1C	Table 6.6.3.2.3-1D
...					
17	Table 6.6.3.2.3-1	Table 6.6.3.2.3-1A	Table 6.6.3.2.3-1B	Table 6.6.3.2.3-1C	Table 6.6.3.2.3-1D
18	Table 6.6.3.2.3-1A	Table 6.6.3.2.3-1A	Table 6.6.3.2.3-1B	Table 6.6.3.2.3-1C	Table 6.6.3.2.3-1D
19	Table 6.6.3.2.3-1A	Table 6.6.3.2.3-1A	Table 6.6.3.2.3-1B	Table 6.6.3.2.3-1C	Table 6.6.3.2.3-1D
20	Table 6.6.3.2.3-1A	Table 6.6.3.2.3-1A	Table 6.6.3.2.3-1B	Table 6.6.3.2.3-1C	Table 6.6.3.2.3-1D
21	Table 6.6.3.2.3-1A	Table 6.6.3.2.3-1A	Table 6.6.3.2.3-1B	Table 6.6.3.2.3-1C	Table 6.6.3.2.3-1D
22	Table 6.6.3.2.3-1B	Table 6.6.3.2.3-1B	Table 6.6.3.2.3-1B	Table 6.6.3.2.3-1C	Table 6.6.3.2.3-1D

23	Table 6.6.3.2.3-1B	Table 6.6.3.2.3-1B	Table 6.6.3.2.3-1B	Table 6.6.3.2.3-1C	Table 6.6.3.2.3-1D
24	Table 6.6.3.2.3-1B	Table 6.6.3.2.3-1B	Table 6.6.3.2.3-1B	Table 6.6.3.2.3-1C	Table 6.6.3.2.3-1D
25	Table 6.6.3.2.3-1B	Table 6.6.3.2.3-1B	Table 6.6.3.2.3-1B	Table 6.6.3.2.3-1C	Table 6.6.3.2.3-1D
26	Table 6.6.3.2.3-1C	Table 6.6.3.2.3-1C	Table 6.6.3.2.3-1C	Table 6.6.3.2.3-1C	Table 6.6.3.2.3-1D
27	Table 6.6.3.2.3-1C	Table 6.6.3.2.3-1C	Table 6.6.3.2.3-1C	Table 6.6.3.2.3-1C	Table 6.6.3.2.3-1D
28	Table 6.6.3.2.3-1C	Table 6.6.3.2.3-1C	Table 6.6.3.2.3-1C	Table 6.6.3.2.3-1C	Table 6.6.3.2.3-1D
30	Table 6.6.3.2.3-1D	Table 6.6.3.2.3-1D	Table 6.6.3.2.3-1D	Table 6.6.3.2.3-1D	Table 6.6.3.2.3-1D
31	Table 6.6.3.2.3-1D	Table 6.6.3.2.3-1D	Table 6.6.3.2.3-1D	Table 6.6.3.2.3-1D	Table 6.6.3.2.3-1D
...					
33	Table 6.6.3.2.3-1	Table 6.6.3.2.3-1A	Table 6.6.3.2.3-1B	Table 6.6.3.2.3-1C	Table 6.6.3.2.3-1D
34	Table 6.6.3.2.3-1	Table 6.6.3.2.3-1A	Table 6.6.3.2.3-1B	Table 6.6.3.2.3-1C	Table 6.6.3.2.3-1D
35					
36					
37					
38	Table 6.6.3.2.3-1	Table 6.6.3.2.3-1A	Table 6.6.3.2.3-1B	Table 6.6.3.2.3-1C	Table 6.6.3.2.3-1D
39	Table 6.6.3.2.3-1	Table 6.6.3.2.3-1A	Table 6.6.3.2.3-1B	Table 6.6.3.2.3-1C	Table 6.6.3.2.3-1D
40	Table 6.6.3.2.3-1	Table 6.6.3.2.3-1A	Table 6.6.3.2.3-1B	Table 6.6.3.2.3-1C	Table 6.6.3.2.3-1D
41	Table 6.6.3.2.3-1B	Table 6.6.3.2.3-1B	Table 6.6.3.2.3-1B	Table 6.6.3.2.3-1C	Table 6.6.3.2.3-1D
42	Table 6.6.3.2.3-1B	Table 6.6.3.2.3-1B	Table 6.6.3.2.3-1B	Table 6.6.3.2.3-1C	Table 6.6.3.2.3-1D
43	Table 6.6.3.2.3-1B	Table 6.6.3.2.3-1B	Table 6.6.3.2.3-1B	Table 6.6.3.2.3-1C	Table 6.6.3.2.3-1D
44	Table 6.6.3.2.3-1C	Table 6.6.3.2.3-1C	Table 6.6.3.2.3-1C	Table 6.6.3.2.3-1C	Table 6.6.3.2.3-1D

NOTE 1: The frequency range applicable with network signalled values of NS\_05, NS\_08, NS\_09, NS\_15 and NS\_16 are covered in 6.6.3.3 Additional Spurious Emissions.

NOTE 2: The following is applied to Note2 in Table 6.6.3.2.3-1, Table 6.6.3.2.3-1A, Table 6.6.3.2.3-1B, Table 6.6.3.2.3-1C and Table 6.6.3.2.3-1D. For frequency with 2nd, 3rd or 4th harmonic spurious emissions, the measurements are covered in 6.6.3.1.

NOTE 2: The restriction on the maximum uplink transmission to 54 RB in Notes 14 and 15 of Table 6.6.3.2.5-1 is intended for conformance testing and may be applied to network operation to facilitate coexistence when the aggressor and victim bands are deployed in the same geographical area. The applicable spurious emission requirement of -15.5 dBm/5MHz is a least restrictive technical condition for FDD/TDD coexistence and may have to be revised in the future.

### 6.6.3.2\_1 Void

### 6.6.3.2A Spurious emission band UE co-existence for CA

**Editor's note: This test case contains different requirements for different UE releases**

#### 6.6.3.2A.0 Minimum conformance requirements

This clause specifies the requirements for the specified carrier aggregation configurations for coexistence with protected bands.

NOTE 1: For measurement conditions at the edge of each frequency range, the lowest frequency of the measurement position in each frequency range should be set at the lowest boundary of the frequency range plus MBW/2. The highest frequency of the measurement position in each frequency range should be set at the highest boundary of the frequency range minus MBW/2. MBW denotes the measurement bandwidth defined for the protected band.

For inter-band carrier aggregation with the uplink assigned to two E-UTRA bands, the requirements in Table 6.6.3.2A.0-1a apply on each component carrier with both component carriers are active.

NOTE 2: For inter-band carrier aggregation with uplink assigned to two E-UTRA bands the requirements in Table 6.6.3.2A.0-1a could be verified by measuring spurious emissions at the specific frequencies where second and third order intermodulation products generated by the two transmitted carriers can occur; in that case, the requirements for remaining applicable frequencies in Table 6.6.3.2A.0-1a would be considered to be verified by the measurements verifying the one uplink inter-band CA UE to UE co-existence requirements.

**Table 6.6.3.2A.0-1a: Requirements for dual-uplink inter-band carrier aggregation limits for Rel-11 and Rel-12**

E-UTRA CA Configuration	Spurious emission						
	Protected band	Frequency range (MHz)		Maximum Level (dBm)	MBW (MHz)	Note	
CA_1A-3A	E-UTRA Band 1, 5, 7, 8, 20, 26, 27, 28, 31, 32, 38, 40, 41, 43, 44	F <sub>DL_low</sub>	-	F <sub>DL_high</sub>	-50	1	
	E-UTRA band 3, 34	F <sub>DL_low</sub>	-	F <sub>DL_high</sub>	-50	1	3
	E-UTRA band 11,18,19, 21	F <sub>DL_low</sub>	-	F <sub>DL_high</sub>	-50	1	10
	E-UTRA band 22, 42	F <sub>DL_low</sub>	-	F <sub>DL_high</sub>	-50	1	2
	Frequency range	1884.5	-	1915.7	-41	0.3	10
	Frequency range	1880		1895	-40	1	3,12
	Frequency range	1895		1915	-15.5	5	3, 12, 13
	Frequency range	1915		1920	+1.6	5	3, 12, 13
CA_1A-5A	E-UTRA Band 1, 5, 7, 8, 22, 28, 31, 38, 40, 42, 43	F <sub>DL_low</sub>	-	F <sub>DL_high</sub>	-50	1	
	E-UTRA band 3,34	F <sub>DL_low</sub>	-	F <sub>DL_high</sub>	-50	1	3
	E-UTRA band 26	859	-	869	-27	1	
CA_1A-7A	E-UTRA Band 1, 2, 4, 5, 7, 8, 10, 12, 13, 14, 17, 20, 22, 26, 27, 28, 29, 30, 31,32, 40, 42, 43	F <sub>DL_low</sub>	-	F <sub>DL_high</sub>	-50	1	
	E-UTRA band 3, 34	F <sub>DL_low</sub>	-	F <sub>DL_high</sub>	-50	1	3
	Frequency range	1880		1895	-40	1	3,12
	Frequency range	1895		1915	-15.5	5	3, 12, 13
	Frequency range	1915		1920	+1.6	5	3, 12, 13
	Frequency range	2570	-	2575	+1.6	5	3, 13, 14
	Frequency range	2575	-	2595	-15.5	5	3, 13, 14
	Frequency range	2595	-	2620	-40	1	3, 14
CA_1A-8A	E-UTRA Band 1, 5, 20, 26, 28, 31, 32, 38, 40	F <sub>DL_low</sub>	-	F <sub>DL_high</sub>	-50	1	
	E-UTRA band 3, 34	F <sub>DL_low</sub>	-	F <sub>DL_high</sub>	-50	1	2,3
	E-UTRA band 7	F <sub>DL_low</sub>	-	F <sub>DL_high</sub>	-50	1	2
	E-UTRA Band 8	F <sub>DL_low</sub>	-	F <sub>DL_high</sub>	-50	1	3
	E-UTRA band 11, 21	F <sub>DL_low</sub>	-	F <sub>DL_high</sub>	-50	1	11
	E-UTRA band 22, 41, 42, 43	F <sub>DL_low</sub>	-	F <sub>DL_high</sub>	-50	1	2
	Frequency range	860	-	890	-40	1	3, 11
	Frequency range	1884.5	-	1915.7	-41	0.3	4, 11
	Frequency range	1880		1895	-40	1	3,12
	Frequency range	1895		1915	-15.5	5	3, 12, 13
	Frequency range	1915		1920	+1.6	5	3, 12, 13
CA_1A-19A	E-UTRA Band 1, 11, 21, 28, 42	F <sub>DL_low</sub>	-	F <sub>DL_high</sub>	-50	1	
	E-UTRA Band 34	F <sub>DL_low</sub>	-	F <sub>DL_high</sub>	-50	1	3
	Frequency range	860	-	890	-40	1	3, 8
	Frequency range	945	-	960	-50	1	3
	Frequency range	1884.5	-	1915.7	-41	0.3	3, 4, 7
	Frequency range	1839.9	-	1879.9	-50	1	3
	Frequency range	2545	-	2575	-50	1	
	Frequency range	2595	-	2645	-50	1	
CA_1A-21A	E-UTRA Band 11	F <sub>DL_low</sub>	-	F <sub>DL_high</sub>	-35	1	3, 16
	E-UTRA Band 1, 18, 19, 28, 34, 42	F <sub>DL_low</sub>	-	F <sub>DL_high</sub>	-50	1	
	E-UTRA Band 21	F <sub>DL_low</sub>	-	F <sub>DL_high</sub>	-50	1	16
	Frequency range	1884.5	-	1915.7	-41	0.3	4
	Frequency range	945	-	960	-50	1	
	Frequency range	1839.9	-	1879.9	-50	1	
	Frequency range	2545	-	2575	-50	1	
	Frequency range	2595	-	2645	-50	1	
CA_2A-4A	E-UTRA Band 4, 5, 10, 12, 13, 14, 17, 22, 23, 24, 26, 27, 28, 29, 30, 41	F <sub>DL_low</sub>	-	F <sub>DL_high</sub>	-50	1	
	E-UTRA Band 2, 25	F <sub>DL_low</sub>	-	F <sub>DL_high</sub>	-50	1	3

	E-UTRA Band 42, 43	F <sub>DL_low</sub>	-	F <sub>DL_high</sub>	-50	1	2
CA_2A-13A	E-UTRA Band 4, 5, 10, 12, 13, 17, 22, 23, 26, 27, 29, 41, 42	F <sub>DL_low</sub>	-	F <sub>DL_high</sub>	-50	1	
	E-UTRA Band 2, 14, 25	F <sub>DL_low</sub>	-	F <sub>DL_high</sub>	-50	1	3
	E-UTRA Band 24, 30, 43	F <sub>DL_low</sub>	-	F <sub>DL_high</sub>	-50	1	2
	Frequency range	769	-	775	-35	0.00625	3
	Frequency range	799	-	805	-35	0.00625	3, 9
CA_3A-5A	E-UTRA Band 1, 5, 7, 8, 22, 28, 31, 38, 40, 42, 43	F <sub>DL_low</sub>	-	F <sub>DL_high</sub>	-50	1	
	E-UTRA band 3, 34	F <sub>DL_low</sub>	-	F <sub>DL_high</sub>	-50	1	3
	E-UTRA band 26	859	-	869	-27	1	
CA_3A-7A	E-UTRA Band 1, 7, 8, 20, 26, 27, 28, 29, 34, 40, 41, 43, 44	F <sub>DL_low</sub>	-	F <sub>DL_high</sub>	-50	1	
	E-UTRA band 3	F <sub>DL_low</sub>	-	F <sub>DL_high</sub>	-50	1	3
	E-UTRA band 11, 18, 19, 21	F <sub>DL_low</sub>	-	F <sub>DL_high</sub>	-50	1	10
	E-UTRA band 22, 42	F <sub>DL_low</sub>	-	F <sub>DL_high</sub>	-50	1	2
	Frequency range	1884.5	-	1915.7	-41	0.3	10
	Frequency range	2570	-	2575	+1.6	5	3, 13, 14
	Frequency range	2575	-	2595	-15.5	5	3, 13, 14
	Frequency range	2595	-	2620	-40	1	3, 14
CA_3A-8A	E-UTRA Band 1, 20, , 27, 28, 31, 33, 34, 38, 39, 40, 44	F <sub>DL_low</sub>	-	F <sub>DL_high</sub>	-50	1	
	E-UTRA band 3, 8	F <sub>DL_low</sub>	-	F <sub>DL_high</sub>	-50	1	2, 3
	E-UTRA band 11, , , 21,	F <sub>DL_low</sub>	-	F <sub>DL_high</sub>	-50	1	10, 11
	E-UTRA band 7, 22, 41, 42, 43	F <sub>DL_low</sub>	-	F <sub>DL_high</sub>	-50	1	2
	Frequency range	1884.5	-	1915.7	-41	0.3	4, 10, 11
	Frequency range	860	-	890	-40	1	3, 11, 17
CA_3A-19A	E-UTRA Band 1, 11, 21, 28	F <sub>DL_low</sub>	-	F <sub>DL_high</sub>	-50	1	
	E-UTRA Band 34	F <sub>DL_low</sub>	-	F <sub>DL_high</sub>	-50	1	3
	E-UTRA Band 42	F <sub>DL_low</sub>	-	F <sub>DL_high</sub>	-50	1	2
	Frequency range	860	-	890	-40	1	3, 8
	Frequency range	945	-	960	-50	1	3
	Frequency range	1884.5	-	1915.7	-41	0.3	3, 4, 7
	Frequency range	1839.9	-	1879.9	-50	1	3
	Frequency range	2545	-	2575	-50	1	
	Frequency range	2595	-	2645	-50	1	
CA_3A-20A	E-UTRA Band 1, 7, 8, 33, 34, 43	F <sub>DL_low</sub>	-	F <sub>DL_high</sub>	-50	1	
	E-UTRA Band 3, 20	F <sub>DL_low</sub>	-	F <sub>DL_high</sub>	-50	1	3
	E-UTRA Band 22, 38, 42	F <sub>DL_low</sub>	-	F <sub>DL_high</sub>	-50	1	2
CA_3A-26A	E-UTRA Band 1, 2, 4, 5, 7, 8, 10, 12, 13, 14, 17, 23, 24, 25, 26, 28, 29, 30, 31, 34, 40, 43	F <sub>DL_low</sub>	-	F <sub>DL_high</sub>	-50	1	
	E-UTRA band 3	F <sub>DL_low</sub>	-	F <sub>DL_high</sub>	-50	1	3
	E-UTRA band 11, 18, 19, 21	F <sub>DL_low</sub>	-	F <sub>DL_high</sub>	-50	1	10
	E-UTRA band 22, 41, 42	F <sub>DL_low</sub>	-	F <sub>DL_high</sub>	-50	1	2
	Frequency range	1884.5	-	1915.7	-41	0.3	4, 10
	Frequency range	703	-	799	-50	1	
		799	-	803	-40	1	3
	Frequency range	851	-	859	-53	0.00625	15
	E-UTRA Band 27	F <sub>DL_low</sub>	-	859	-32	1	15
	Frequency range	945	-	960	-50	1	
Frequency range	1839.9	-	1879.9	-50	1		
CA_4A-7A	E-UTRA Band 2, 4, 5, 7, 10, 12, 13, 14, 17, 27, 28, 29	F <sub>DL_low</sub>	-	F <sub>DL_high</sub>	-50	1	
	E-UTRA band 42	F <sub>DL_low</sub>	-	F <sub>DL_high</sub>	-50	1	2
	Frequency range	2570	-	2575	+1.6	5	3, 13, 14
	Frequency range	2575	-	2595	-15.5	5	3, 13, 14
	Frequency range	2595	-	2620	-40	1	3, 14
CA_4A-12A	E-UTRA Band 2, 5, 7, 13, 14, 17, 22, 23, 24, 25, 26, 27, 28, 29, 30, 41, 43	F <sub>DL_low</sub>	-	F <sub>DL_high</sub>	-50	1	
	E-UTRA Band 4, 10, 42	F <sub>DL_low</sub>	-	F <sub>DL_high</sub>	-50	1	2
	E-UTRA Band 12	F <sub>DL_low</sub>	-	F <sub>DL_high</sub>	-50	1	3

CA_4A-13A	E-UTRA Band 2,4, 5, 7, 10,12,13,17, 22, 23,25, 26, 27, 29, 41, 43	$F_{DL\_low}$	-	$F_{DL\_high}$	-50	1	
	E-UTRA Band 14	$F_{DL\_low}$	-	$F_{DL\_high}$	-50	1	3
	E-UTRA Band 24, 30, 42	$F_{DL\_low}$	-	$F_{DL\_high}$	-50	1	2
	Frequency range	769	-	775	-35	0.00625	3
	Frequency range	799	-	805	-35	0.00625	3, 9
CA_4A-17A	E-UTRA Band 2, 5, 7,13, 14, 17, 22, 23, 24, 25, 26, 27,28, 29, 30, 41, 43	$F_{DL\_low}$	-	$F_{DL\_high}$	-50	1	
	E-UTRA Band 4, 10, 42	$F_{DL\_low}$	-	$F_{DL\_high}$	-50	1	2
	E-UTRA Band 12	$F_{DL\_low}$	-	$F_{DL\_high}$	-50	1	3
CA_5A-7A	E-UTRA Band 1, 2, 3, 4, 5, 7, 8, 10, 12, 13, 14, 17, 22, 28, 29, 30, 31, 40, 42, 43	$F_{DL\_low}$	-	$F_{DL\_high}$	-50	1	
	E-UTRA band 26	859	-	869	-27	1	
	Frequency range	2570	-	2575	+1.6	5	3, 13, 14
	Frequency range	2575	-	2595	-15.5	5	3, 13, 14
CA_5A-12A	E-UTRA Band 2, 5, 13, 14, 17, 22, 23, 24, 25, 28, 29, 30, 31, 42, 43	$F_{DL\_low}$	-	$F_{DL\_high}$	-50	1	
	E-UTRA band 4, 10, 41	$F_{DL\_low}$	-	$F_{DL\_high}$	-50	1	2
	E-UTRA band 26	859	-	869	-27	1	
	E-UTRA band 12	$F_{DL\_low}$	-	$F_{DL\_high}$	-50	1	3
CA_5A-17A	E-UTRA Band 2, 5, 13, 14, 17, 22, 23, 24, 25, 28, 29, 30, 31, 42, 43	$F_{DL\_low}$	-	$F_{DL\_high}$	-50	1	
	E-UTRA band 4, 10, 41	$F_{DL\_low}$	-	$F_{DL\_high}$	-50	1	2
	E-UTRA band 26	859	-	869	-27	1	
	E-UTRA band 12	$F_{DL\_low}$	-	$F_{DL\_high}$	-50	1	3
CA_7A-20A	E-UTRA Band 1,3, 7, 8, 22, 28, 29, 33, 34, 40, 43	$F_{DL\_low}$	-	$F_{DL\_high}$	-50	1	
	E-UTRA Band 20	$F_{DL\_low}$	-	$F_{DL\_high}$	-50	1	3
	E-UTRA Band 38, 42	$F_{DL\_low}$	-	$F_{DL\_high}$	-50	1	2
	Frequency range	2570	-	2575	+1.6	5	3, 13, 14
	Frequency range	2575	-	2595	-15.5	5	3, 13, 14
CA_7A-28A	E-UTRA Band 3,7,8, 20,27,31,34	$F_{DL\_low}$	-	$F_{DL\_high}$	-50	1	
	E-UTRA Band 1, 22, 42, 43	$F_{DL\_low}$	-	$F_{DL\_high}$	-50	1	2
	E-UTRA Band 1	$F_{DL\_low}$	-	$F_{DL\_high}$	-50	1	5, 6
	Frequency range	758	-	773	-32	1	3
	Frequency range	773	-	803	-50	1	
CA_19A-21A	E-UTRA Band 1, 18, 19, 28, 34, 42	$F_{DL\_low}$	-	$F_{DL\_high}$	-50	1	
	E-UTRA Band 11	$F_{DL\_low}$	-	$F_{DL\_high}$	-50	1	3, 16
	E-UTRA Band 21	$F_{DL\_low}$	-	$F_{DL\_high}$	-50	1	16
	Frequency range	860	-	890	-40	1	3, 8
	Frequency range	945	-	960	-50	1	
	Frequency range	1884.5	-	1915.7	-41	0.3	4
	Frequency range	1839.9	-	1879.9	-50	1	
	Frequency range	2545	-	2575	-50	1	
CA_39A-41A	E-UTRA Band 34, 40, 42, 44	$F_{DL\_low}$	-	$F_{DL\_high}$	-50	1	
	Frequency range	1805	-	1855	[-40]	1	19
	Frequency range	1855	-	1875	[-15.5]	5	3, 13,19
	Frequency range	1875	-	1880	[-15.5]	5	3, 13, 20
Frequency range	1884.5	-	1915.7	-41	0.3	4, 18	

NOTE 1:  $F_{DL\_low}$  and  $F_{DL\_high}$  refer to each E-UTRA frequency band specified in Table 5.2-1

NOTE 2: As exceptions, measurements with a level up to the applicable requirements defined in Table 6.6.3.1.3-2 are permitted for each assigned E-UTRA carrier used in the measurement due to 2<sup>nd</sup>, 3<sup>rd</sup>, 4<sup>th</sup> [or 5<sup>th</sup>] harmonic spurious emissions. An exception is allowed if there is at least one individual RB within the transmission bandwidth (see Figure 5.4.2-1) for which the 2<sup>nd</sup>, 3<sup>rd</sup> or 4<sup>th</sup> harmonic totally or partially overlaps the measurement bandwidth (MBW).

NOTE 3: These requirements also apply for the frequency ranges that are less than  $F_{OoB}$  (MHz) in Table

- 6.6.3.1.3-1 and Table 6.6.3.1A.0-1 from the edge of the aggregated channel bandwidth.
- NOTE 4: Applicable when co-existence with PHS system operating in 1884.5 -1915.7MHz.
- NOTE 5: Applicable when the assigned E-UTRA carrier is confined within 718 MHz and 748 MHz and when the channel bandwidth used is 5 or 10 MHz.
- NOTE 6: As exceptions, measurements with a level up to the applicable requirement of -36 dBm/MHz is permitted for each assigned E-UTRA carrier used in the measurement due to 3<sup>rd</sup> harmonic spurious emissions. An exception is allowed if there is at least one individual RB within the transmission bandwidth (see Figure 5.6-1) for which the 3<sup>rd</sup> harmonic totally or partially overlaps the measurement bandwidth (MBW).
- NOTE 7: Applicable when NS\_05 in section 6.6.3.3.3.1 is signalled by the network.
- NOTE 8: Applicable when NS\_08 in subclause 6.6.3.3.3.3 is signalled by the network
- NOTE 9: Whether the applicable frequency range should be 793-805MHz instead of 799-805MHz is TBD.
- NOTE10: This requirement applies for 5, 10, 15 and 20 MHz E-UTRA channel bandwidth allocated within 1744.9MHz and 1784.9MHz.
- NOTE 11: This requirement is applicable only for the following cases:
- for carriers of 5 MHz channel bandwidth when carrier centre frequency ( $F_c$ ) is within the range  $902.5 \text{ MHz} \leq F_c < 907.5 \text{ MHz}$  with an uplink transmission bandwidth less than or equal to 20 RB
  - for carriers of 5 MHz channel bandwidth when carrier centre frequency ( $F_c$ ) is within the range  $907.5 \text{ MHz} \leq F_c \leq 912.5 \text{ MHz}$  without any restriction on uplink transmission bandwidth.
  - for carriers of 10 MHz channel bandwidth when carrier centre frequency ( $F_c$ ) is  $F_c = 910 \text{ MHz}$  with an uplink transmission bandwidth less than or equal to 32 RB with  $RB_{\text{start}} > 3$ .
- NOTE 12: This requirement is applicable for any channel bandwidths within the range 1920 - 1980 MHz with the following restriction: for carriers of 15 MHz bandwidth when carrier centre frequency is within the range 1927.5 - 1929.5 MHz and for carriers of 20 MHz bandwidth when carrier centre frequency is within the range 1930 - 1938 MHz the requirement is applicable only for an uplink transmission bandwidth less than or equal to 54 RB.
- NOTE13: For these adjacent bands, the emission limit could imply risk of harmful interference to UE(s) operating in the protected operating band.
- NOTE 14: This requirement is applicable for any channel bandwidths within the range 2500 - 2570 MHz with the following restriction: for carriers of 15 MHz bandwidth when carrier centre frequency is within the range 2560.5 - 2562.5 MHz and for carriers of 20 MHz bandwidth when carrier centre frequency is within the range 2552 - 2560 MHz the requirement is applicable only for an uplink transmission bandwidth less than or equal to 54 RB.
- NOTE 15: Applicable when NS\_15 in subclause 6.6.3.3.3.8 is signalled by the network.
- NOTE 16: Applicable when NS\_09 in subclause 6.6.3.3.3.4 is signalled by the network
- NOTE 17: This requirement is applicable only when Band 3 transmission frequency is less than or equal to 1765 MHz.
- NOTE 18: This requirement applies when the E-UTRA carrier is confined within 2545-2575MHz or 2595-2645MHz and the channel bandwidth is 10 or 20 MHz
- NOTE 19: This requirement is applicable for an uplink transmission bandwidth less than or equal to [54 RB] for carriers of 15 MHz bandwidth when carrier centre frequency is within the range 1887.5 - 1889.5 MHz and for carriers of 20 MHz bandwidth when carrier centre frequency is within the range 1890 - 1898 MHz.
- NOTE 20: This requirement is only applicable for carriers with bandwidth confined within 1885-1920 MHz (requirement for carriers with at least 1RB confined within 1880 - 1885 MHz is not specified). This requirement applies for an uplink transmission bandwidth less than or equal to [54 RB] for carriers of 15 MHz bandwidth when carrier centre frequency is within the range 1892.5 - 1894.5 MHz and for carriers of 20 MHz bandwidth when carrier centre frequency is within the range 1895 - 1903 MHz.



**Table 6.6.3.2A.0-2a: Spurious emission band UE co-existence for intraband carrier aggregation limits for Rel10**

E-UTRA CA Configuration	Spurious emission						
	Protected band	Frequency range (MHz)			Maximum Level (dBm)	MBW (MHz)	Note
CA_1C	E-UTRA Band 1, 3, 7, 8, 11, 18, 19, 20, 21, 22, 38, 40, 42, 43	F <sub>DL_low</sub>	-	F <sub>DL_high</sub>	-50	1	
	E-UTRA band 34	F <sub>DL_low</sub>	-	F <sub>DL_high</sub>	-50	1	4, 6, 7, 8
	Frequency range	1880	-	1895	-40	1	7,8
	Frequency range	1895	-	1915	-15.5	5	7,8
	Frequency range	1900	-	1915	-15.5	5	6,8,9
	Frequency range	1915	-	1920	+1.6	5	6,7,8,9
	Frequency range	1884.5	-	1915.7	-41	0.3	4, 5
	Frequency range	1839.9	-	1879.9	-50	1	
CA_40C	E-UTRA Band 1, 3, 7, 8, 20, 22, 33, 34, 38, 39, 42, 43	F <sub>DL_low</sub>	-	F <sub>DL_high</sub>	-50	1	
NOTE 1:	F <sub>DL_low</sub> and F <sub>DL_high</sub> refer to each E-UTRA frequency band specified in Table 5.2-1						
NOTE 2:	As exceptions, measurements with a level up to the applicable requirements defined in Table 6.6.3.1.3-2 are permitted for each assigned E-UTRA carrier used in the measurement due to 2 <sup>nd</sup> , 3 <sup>rd</sup> , 4 <sup>th</sup> , [or 5 <sup>th</sup> ] harmonic spurious emissions. Due to spreading of the harmonic emission the exception is also allowed for the first 1 MHz frequency range immediately outside the harmonic emission on both sides of the harmonic emission. This results in an overall exception interval centred at the harmonic emission of (2MHz + N x L <sub>CRB</sub> x 180kHz), where N is 2, 3, 4, [5] for the 2 <sup>nd</sup> , 3 <sup>rd</sup> , 4 <sup>th</sup> [or 5 <sup>th</sup> ] harmonic respectively. The exception is allowed if the measurement bandwidth (MBW) totally or partially overlaps the overall exception interval.						
NOTE 3:	To meet these requirements some restriction will be needed for either the operating band or protected band						
NOTE 4:	Applicable when CA_NS_01 in section 6.6.3.3A.1.3.1 is signalled by the network.						
NOTE 5:	Applicable when co-existence with PHS system operating in 1884.5 -1915.7MHz.						
NOTE 6:	Applicable when CA_NS_02 in section 6.6.3.3A.1.3.2 is signalled by the network.						
NOTE 7:	Applicable when CA_NS_03 in section 6.6.3.3A.1.3.3 is signalled by the network.						
NOTE 8:	The requirement also applies for the frequency ranges that are less than F <sub>OOB</sub> (MHz) in Table 6.6.3.1.3-1 and Table 6.6.3.1A.1.3-1 from the edge of the channel bandwidth.						
NOTE 9:	For these adjacent bands, the emission limit could imply risk of harmful interference to UE(s) operating in the protected operating band.						

**Table 6.6.3.2A.0-2b: Spurious emission band UE co-existence for intraband carrier aggregation limits for Rel11**

E-UTRA CA Configuration	Spurious emission						
	Protected band	Frequency range (MHz)		Maximum Level (dBm)	MBW (MHz)	Note	
CA_1C	E-UTRA Band 1, 3, 7, 8, 11, 18, 19, 20, 21, 22, 26, 27, 28, 38, 40, 41, 42, 43, 44	$F_{DL\_low}$	-	$F_{DL\_high}$	-50	1	
	E-UTRA band 34	$F_{DL\_low}$	-	$F_{DL\_high}$	-50	1	4, 6, 7
	Frequency range	1880	-	1895	-40	1	7, 10
	Frequency range	1895	-	1915	-15.5	5	7, 10, 12
	Frequency range	1900	-	1915	-15.5	5	6, 7, 10, 12
	Frequency range	1915	-	1920	+1.6	5	6, 7, 10, 12
	Frequency range	1884.5	-	1915.7	-41	0.3	4, 5
	Frequency range	1839.9	-	1879.9	-50	1	
CA_7C	E-UTRA Band 1, 3, 7, 8, 20, 22, 27, 28, 29, 33, 34, 40, 42, 43	$F_{DL\_low}$	-	$F_{DL\_high}$	-50	1	
	Frequency range	2570	-	2575	+1.6	5	8, 12
	Frequency range	2575	-	2595	-15.5	5	8, 12
	Frequency range	2595	-	2620	-40	1	8
CA_38C	E-UTRA Band 1,3, 8, 20, 22, 27, 28, 29, 33, 34, 42, 43	$F_{DL\_low}$	-	$F_{DL\_high}$	-50	1	
	Frequency range	2620	-	2645	-15.5	5	9, 10, 11, 12
	Frequency range	2645	-	2690	-40	1	9, 10, 11
CA_40C	E-UTRA Band 1, 3, 7, 8, 20, 22, 26, 27, 33, 34, 38, 39, 41, 42, 43, 44	$F_{DL\_low}$	-	$F_{DL\_high}$	-50	1	
CA_41C	E-UTRA Band 1, 2, 3, 4, 5, 8, 10, 12, 13, 14, 17, 23, 24, 25, 26, 27, 28, 29, 34, 39, 40, 42, 44	$F_{DL\_low}$	-	$F_{DL\_high}$	-50	1	
<p>NOTE 1: <math>F_{DL\_low}</math> and <math>F_{DL\_high}</math> refer to each E-UTRA frequency band specified in Table 5.2-1</p> <p>NOTE 2: As exceptions, measurements with a level up to the applicable requirements defined in Table 6.6.3.1.3-2 are permitted for each assigned E-UTRA carrier used in the measurement due to 2<sup>nd</sup>, 3<sup>rd</sup>, 4<sup>th</sup> [or 5<sup>th</sup>] harmonic spurious emissions. Due to spreading of the harmonic emission the exception is also allowed for the first 1 MHz frequency range immediately outside the harmonic emission on both sides of the harmonic emission. This results in an overall exception interval centred at the harmonic emission of (2MHz + N x <math>L_{CRB}</math> x 180kHz), where N is 2, 3, 4, [5] for the 2<sup>nd</sup>, 3<sup>rd</sup>, 4<sup>th</sup> or [5<sup>th</sup>] harmonic respectively. The exception is allowed if the measurement bandwidth (MBW) totally or partially overlaps the overall exception interval.</p> <p>NOTE 3: To meet these requirements some restriction will be needed for either the operating band or protected band</p> <p>NOTE 4: Applicable when CA_NS_01 in subclause 6.6.3.3A.1.3.1 is signalled by the network.</p> <p>NOTE 5: Applicable when co-existence with PHS system operating in 1884.5 -1915.7MHz.</p> <p>NOTE 6: Applicable when CA_NS_02 in subclause 6.6.3.3A.1.3.2 is signalled by the network.</p> <p>NOTE 7: Applicable when CA_NS_03 in subclause 6.6.3.3A.1.3.3 is signalled by the network.</p> <p>NOTE 8: Applicable when CA_NS_06 in subclause 6.6.3.3A.1.3.5 is signalled by the network.</p> <p>NOTE 9: Applicable when CA_NS_05 in subclause 6.6.3.3A.1.3.4 is signalled by the network.</p> <p>NOTE 10: The requirement also applies for the frequency ranges that are less than <math>F_{OOB}</math> (MHz) in Table 6.6.3.1.3-1 and Table 6.6.3.1A.1.3-1 from the edge of the channel bandwidth.</p> <p>NOTE 11: This requirement is applicable for carriers with bandwidths confined in 2570-2615 MHz. For assigned carriers with bandwidths overlapping the frequency range 2615-2620 MHz the requirements apply with the maximum output power configured to +20 dBm in the IE <i>P-Max</i>.</p> <p>NOTE 12: For these adjacent bands, the emission limit could imply risk of harmful interference to UE(s) operating in the protected operating band.</p>							

**Table 6.6.3.2A.0-2c: Spurious emission band UE co-existence for intraband carrier aggregation limits for Rel12**

E-UTRA CA Configuration	Spurious emission						
	Protected band	Frequency range (MHz)		Maximum Level (dBm)	MBW (MHz)	Note	
CA_1C	E-UTRA Band 1, 3, 7, 8, 11, 18, 19, 20, 21, 22, 26, 27, 28, 31, 38, 40, 41, 42, 43, 44	F <sub>DL_low</sub>	-	F <sub>DL_high</sub>	-50	1	
	Frequency range	1839.9	-	1879.9	-50	1	
CA_3C	E-UTRA Band 1, 7, 8, 20, 26, 27, 28, 31, 33, 34, 38, 41, 43, 44	F <sub>DL_low</sub>	-	F <sub>DL_high</sub>	-50	1	
	E-UTRA Band 3	F <sub>DL_low</sub>	-	F <sub>DL_high</sub>	-50	1	10
	E-UTRA Band 22, 42	F <sub>DL_low</sub>	-	F <sub>DL_high</sub>	-50	1	2
CA_7C	E-UTRA Band 1, 3, 7, 8, 20, 22, 27, 28, 29, 30, 31, 33, 34, 40, 42, 43	F <sub>DL_low</sub>	-	F <sub>DL_high</sub>	-50	1	
CA_38C	E-UTRA Band 1,3, 8, 20, 22, 27, 28, 29, 30, 31, 33, 34, 40, 42, 43	F <sub>DL_low</sub>	-	F <sub>DL_high</sub>	-50	1	
CA_39C	E-UTRA Band 22, 34, 40, 41, 42, 44	F <sub>DL_low</sub>	-	F <sub>DL_high</sub>	-50	1	
CA_40C	E-UTRA Band 1, 3, 7, 8, 20, 22, 26, 27, 33, 34, 38, 39, 41, 42, 43, 44	F <sub>DL_low</sub>	-	F <sub>DL_high</sub>	-50	1	
CA_41C	E-UTRA Band 1, 2, 3, 4, 5, 8, 10, 12, 13, 14, 17, 23, 24, 25, 26, 27, 28, 29, 30, 34, 39, 40, 42, 44	F <sub>DL_low</sub>	-	F <sub>DL_high</sub>	-50	1	
CA_42C	E-UTRA Band 1, 2, 3, 4, 5, 7, 8, 10, 11, 18, 19, 20, 21, 25, 26, 27, 28, 31, 33, 34, 38, 40, 41, 44	F <sub>DL_low</sub>	-	F <sub>DL_high</sub>	-50	1	
	Frequency range	1884.5	-	1915.7	-41	0.3	
<p>NOTE 1: FDL_low and FDL_high refer to each E-UTRA frequency band specified in Table 5.2-1</p> <p>NOTE 2: As exceptions, measurements with a level up to the applicable requirements defined in Table 6.6.3.1.3-2 are permitted for each assigned E-UTRA carrier used in the measurement due to 2<sup>nd</sup>, 3<sup>rd</sup>, 4<sup>th</sup> [or 5<sup>th</sup>] harmonic spurious emissions. Due to spreading of the harmonic emission the exception is also allowed for the first 1 MHz frequency range immediately outside the harmonic emission on both sides of the harmonic emission. This results in an overall exception interval centred at the harmonic emission of (2MHz + N x L<sub>CRB</sub> x 180kHz), where N is 2, 3, 4, [5] for the 2<sup>nd</sup>, 3<sup>rd</sup>, 4<sup>th</sup> [or 5<sup>th</sup>] harmonic respectively. The exception is allowed if the measurement bandwidth (MBW) totally or partially overlaps the overall exception interval</p> <p>NOTE 3: To meet these requirements some restriction will be needed for either the operating band or protected band</p> <p>NOTE 4: N/A</p> <p>NOTE 5: N/A</p> <p>NOTE 6: N/A</p> <p>NOTE 7: N/A</p> <p>NOTE 8: N/A</p> <p>NOTE 9: N/A</p> <p>NOTE 10: The requirement also applies for the frequency ranges that are less than F<sub>OOB</sub> (MHz) in Table 6.6.3.1.3-1 and Table 6.6.3.1A.0-1 from the edge of the aggregated channel bandwidth.</p> <p>NOTE 11: N/A</p> <p>NOTE 12: For these adjacent bands, the emission limit could imply risk of harmful interference to UE(s) operating in the protected operating band.</p> <p>NOTE 13: N/A</p> <p>NOTE 14: N/A</p>							

Table 6.6.3.2A-3a: Requirements for intraband non-contiguous CA

E-UTRA CA Configuration	Spurious emission						
	Protected band	Frequency range (MHz)		Maximum Level (dBm)	MBW (MHz)	Note	
CA_4A-4A	E-UTRA Band 2, 4, 5, 7, 10, 12, 13, 14, 17, 22, 23, 24, 25, 26, 27, 28, 29, 30, 41, 43	F <sub>DL_low</sub>	-	F <sub>DL_high</sub>	-50	1	
	E-UTRA Band 42	F <sub>DL_low</sub>	-	F <sub>DL_high</sub>	-50	1	2
NOTE 1: F <sub>DL_low</sub> and F <sub>DL_high</sub> refer to each E-UTRA frequency band specified in Table 5.2-1							
NOTE 2: As exceptions, measurements with a level up to the applicable requirements defined in Table 6.6.3.1.3-2 are permitted for each assigned E-UTRA carrier used in the measurement due to 2nd or 3rd harmonic spurious emissions. An exception is allowed if there is at least one individual RE within the transmission bandwidth (see Figure 5.4.2-1) for which the 2nd or 3rd harmonic, i.e. the frequency equal to two or three times the frequency of that RE, is within the measurement bandwidth (MBW).							

The normative reference for this requirement is TS 36.101 [2] subclause 6.6.3.2A.

This test use minimum requirements from many releases of TS 36.101 [2] due to release independence defined in TS 36.307 [16].

#### 6.6.3.2A.1 Spurious emission band UE co-existence for CA (intra-band contiguous DL CA and UL CA)

**Editor's note: This clause is incomplete. The following aspects are either missing or not yet determined:**

**-The minimum conformance requirements for CA\_39C are still FFS in core spec.**

##### 6.6.3.2A.1.1 Test purpose

To verify that UE transmitter does not cause unacceptable interference to co-existing systems for the specified bands which has specific requirements in terms of transmitter spurious emissions for intra-band contiguous DL CA and UL CA.

##### 6.6.3.2A.1.2 Test applicability

This test case applies to all types of E-UTRA UE release 10 and forward that support intra-band contiguous DL CA and UL CA.

##### 6.6.3.2A.1.3 Minimum conformance requirements

The minimum conformance requirements are defined in clause 6.6.3.2A.0.

##### 6.6.3.2A.1.4 Test description

###### 6.6.3.2A.1.4.1 Initial conditions

Initial conditions are a set of test configurations the UE needs to be tested in and the steps for the SS to take with the UE to reach the correct measurement state.

The initial test configurations consist of environmental conditions, test frequencies, and channel bandwidths based on E-UTRA bands specified in Table 5.4.2.1-1. All of these configurations shall be tested with applicable test parameters for each channel bandwidth, and are shown in Table 6.6.3.2A.1.4.1-1. The details of the uplink reference measurement channels (RMCs) are specified in Annex A.2. Configurations of PDSCH and PDCCH before measurement are specified in Annex C.2.

Table 6.6.3.2A.1.4.1-1: Test Configuration Table

Initial Conditions									
Test Environment as specified in TS 36.508[7] clause 4.1				NC					
Test Frequencies as specified in TS36.508 [7] clause 4.3.1 for different CA bandwidth classes, and PCC and SCCs are mapped onto physical frequencies according to Table 6.1-2.				C: Low range, High range					
Test CC Combination setting (NRB_agg) as specified in clause 5.4.2A.1 for the CA Configuration				Lowest N <sub>RB_agg</sub> Highest N <sub>RB_agg</sub> (Note 2)					
Test Parameters for CA Configurations									
CA Configuration / N <sub>RB_agg</sub>		DL Allocation		CC MOD	UL Allocation				
PCC N <sub>RB</sub>	SCCs N <sub>RB</sub>	PCC & SCC RB allocation			N <sub>RB_alloc</sub>	PCC & SCC RB allocations (L <sub>CRB</sub> @ RB <sub>start</sub> )			
75	75			QPSK	2	P_1@0	S_1@74		
75	75			QPSK	150	P_75@0	S_75@0		
100	25			QPSK	2	P_1@0	S_1@24		
100	25			QPSK	125	P_100@0	S_25@0		
100	50			QPSK	2	P_1@0	S_1@49		
100	50			QPSK	150	P_100@0	S_50@0		
100	75			QPSK	2	P_1@0	S_1@74		
100	75			QPSK	175	P_100@0	S_75@0		
100	100			QPSK	2	P_1@0	S_1@99		
100	100			QPSK	200	P_100@0	S_100@0		
Note 1: CA Configuration Test CC Combination settings are checked separately for each CA Configuration, which applicable aggregated channel bandwidths are specified in Table 5.4.2A.1-1.									
Note 2: If in the CA Configuration UE supports multiple CC Combinations with the same N <sub>RB_agg</sub> , only the first of those is tested, according to the order on the Test Configuration Table list.									

1. Connect the SS to the UE antenna connectors as shown in Figure TS 36.508 [7] Annex A, Figure group A.33 as appropriate.
2. The parameter settings for the cell are set up according to TS 36.508 [7] subclause 4.4.3.
3. Downlink signals for PCC are initially set up according to Annex C.0, C.1 and Annex C.3.0, and uplink signals according to Annex H.1 and H.3.0.
4. The UL Reference Measurement channels are set according to Table 6.6.3.2A.1.4.1-1.
5. Propagation conditions are set according to Annex B.0.
6. Ensure the UE is in State 3A-RF according to TS 36.508 [7] clause 5.2A.2. Message contents are defined in clause 6.6.3.2A.1.4.3.

#### 6.6.3.2A.1.4.2 Test procedure

1. Configure SCC according to Annex C.0, C.1 and Annex C.3.0 for all downlink physical channels.
2. The SS shall configure SCC as per TS 36.508 [7] clause 5.2A.4. Message contents are defined in clause 6.6.3.2A.1.4.3
3. SS activates SCC by sending the activation MAC-CE (Refer TS 36.321 [13], clauses 5.13, 6.1.3.8). Wait for at least 2 seconds (Refer TS 36.133, clauses 8.3.3.2).
4. SS sends uplink scheduling information for each UL HARQ process via PDCCH DCI format 0 for C\_RNTI to schedule the UL RMC according to Table 6.6.3.2A.1.4.1-1 on both PCC and SCC. Since the UE has no payload and no loopback data to send the UE sends uplink MAC padding bits on the UL RMC.
5. Send continuously uplink power control “up” commands in every uplink scheduling information to the UE until the UE transmits at P<sub>UMAX</sub> level.

6. Measure the power of the transmitted signal with a measurement filter of bandwidths according to Table 6.6.3.2A.1.3-1 to 6.6.3.2A.1.3-3. The centre frequency of the filter shall be stepped in contiguous steps according to Table 6.6.3.2A.1.3-1 to 6.6.3.2A.1.3-3. The measured power shall be verified for each step. The measurement period shall capture the active time slots.

#### 6.6.3.2A.1.4.3 Message contents

Message contents are according to TS 36.508 [7] subclause subclause 4.6 with the following exceptions:

**Table 6.6.3.2A.1.4.3-1: SystemInformationBlockType1 with Note 11 in table 6.6.3.2A.1.3-1**

Derivation Path: TS 36.508 [7] clause 4.4.3.2, Table 4.4.3.2-3 SystemInformationBlockType1			
Information Element	Value/remark	Comment	Condition
p-Max	20		

#### 6.6.3.2A.1.5 Test requirement

Test requirements for Spurious Emissions UE Co-existence are the same as the minimum requirements and are not repeated in this section.

The measured average power of spurious emission, derived in step 6, shall not exceed the described value in Tables 6.6.3.2A.1.5-1.

The requirements for the UE are release specific and can be found in Tables 6.6.3.2A.0-2a to 6.6.3.2A.0-2c . If the UE support a band, which is not defined in the table corresponding UE's release, the requirements for this band are taken from the table of earliest release where requirements for this band are defined. This has been described in following Table 6.6.3.2A.1.5-1.

**Table 6.6.3.2A.1.5-1: UE Requirements according to UE E-UTRA release and supported E-UTRA CA configuration**

E-UTRA CA Configuration	UE Requirements per release		
	Rel-10	Rel-11	Rel-12
CA_1C	Table 6.6.3.2A.0-2a	Table 6.6.3.2A.0-2b	Table 6.6.3.2A.0-2c
CA_3C	Table 6.6.3.2A.0-2c	Table 6.6.3.2A.0-2c	Table 6.6.3.2A.0-2c
CA_7C	Table 6.6.3.2A.0-2b	Table 6.6.3.2A.0-2b	Table 6.6.3.2A.0-2c
CA_38C	Table 6.6.3.2A.0-2b	Table 6.6.3.2A.0-2b	Table 6.6.3.2A.0-2c
CA_39C	Table 6.6.3.2A.0-2c	Table 6.6.3.2A.0-2c	Table 6.6.3.2A.0-2c
CA_40C	Table 6.6.3.2A.0-2a	Table 6.6.3.2A.0-2b	Table 6.6.3.2A.0-2c
CA_41C	Table 6.6.3.2A.0-2b	Table 6.6.3.2A.0-2b	Table 6.6.3.2A.0-2c
CA_42C	Table 6.6.3.2A.0-2c	Table 6.6.3.2A.0-2c	Table 6.6.3.2A.0-2c

#### 6.6.3.2A.2 Spurious emission band UE co-existence for CA (inter-band DL CA and UL CA)

**Editor's note: This clause is incomplete. The following aspects are either missing or not yet determined:**

- Initial conditions are FFS

- Test requirements for CA\_4A-7A, CA\_5A-12A and CA\_5A-17A are undefined due to no explanation in TR 36.860

#### 6.6.3.2A.2.1 Test purpose

To verify that UE transmitter does not cause unacceptable interference to co-existing systems for the specified bands which has specific requirements in terms of transmitter spurious emissions for inter-band DL CA and UL CA.

#### 6.6.3.2A.2.2 Test applicability

This test case applies to all types of E-UTRA UE release 11 and forward that support inter-band DL CA and UL CA.

#### 6.6.3.2A.2.3 Minimum conformance requirements

The minimum conformance requirements are defined in clause 6.6.3.2A.0.

#### 6.6.3.2A.2.4 Test description

##### 6.6.3.2A.2.4.1 Initial conditions

Same as in clause 6.6.3.2A.1.4.1 with the following exceptions:

- Instead of Table 5.4.2A.1-1 → use Table 5.4.2A.1-2 for CA configurations with two bands or Table 5.4.2A.1-2a for CA configurations with three bands.
- Instead of Table 6.6.3.2A.1.4.1-1 → use Table 6.6.3.2A.2.4.1-1.
- Instead of clause 6.6.3.2A.1.4.3 use clause 6.6.3.2A.2.4.3.

**Table 6.6.3.2A.2.4.1-1: Test Configuration Table**

FFS

##### 6.6.3.2A.2.4.2 Test procedure

FFS

##### 6.6.3.2A.2.4.3 Message contents

Message contents are according to TS 36.508 [7] clause 4.6. In test procedure step 2, for SCC configuration there are no additional message contents.

##### 6.6.3.2A.2.5 Test requirement

The measured average power of spurious emission, derived in step 6, shall not exceed the described value in table 6.6.3.2A.5-1.

Table 6.6.3.2A.5-1: Requirements for dual-uplink inter-band carrier aggregation for Rel-11 and Rel-12

E-UTRA CA Configuration	Spurious emission						
	Protected band	Frequency range (MHz)		Maximum Level (dBm)	MBW (MHz)	Note	
CA_1A-3A	E-UTRA Band 1, 32, 43	F <sub>DL_low</sub>	-	F <sub>DL_high</sub>	-50	1	
	E-UTRA band 11, 21	F <sub>DL_low</sub>	-	F <sub>DL_high</sub>	-50	1	10
CA_1A-5A	E-UTRA Band 42, 43	F <sub>DL_low</sub>	-	F <sub>DL_high</sub>	-50	1	
CA_1A-7A	E-UTRA Band 32	F <sub>DL_low</sub>	-	F <sub>DL_high</sub>	-50	1	
CA_1A-8A	E-UTRA band43	F <sub>DL_low</sub>	-	F <sub>DL_high</sub>	-50	1	2
CA_1A-19A	E-UTRA Band 42	F <sub>DL_low</sub>	-	F <sub>DL_high</sub>	-50	1	
CA_1A-21A	E-UTRA Band 42	F <sub>DL_low</sub>	-	F <sub>DL_high</sub>	-50	1	
	Frequency range	945	-	960	-50	1	
CA_2A-4A	E-UTRA Band 4	F <sub>DL_low</sub>	-	F <sub>DL_high</sub>	-50	1	
	E-UTRA Band 25	F <sub>DL_low</sub>	-	F <sub>DL_high</sub>	-50	1	3
	E-UTRA Band 42, 43	F <sub>DL_low</sub>	-	F <sub>DL_high</sub>	-50	1	2
CA_2A-13A	E-UTRA Band 41, 42	F <sub>DL_low</sub>	-	F <sub>DL_high</sub>	-50	1	
	E-UTRA Band 2,14, 25	F <sub>DL_low</sub>	-	F <sub>DL_high</sub>	-50	1	3
CA_3A-5A	E-UTRA Band 5, 7, 8, 42	F <sub>DL_low</sub>	-	F <sub>DL_high</sub>	-50	1	
	E-UTRA band 26	859	-	869	-27	1	
CA_3A-7A	E-UTRA Band 8, 20, 26, 27, 28, 29, 44	F <sub>DL_low</sub>	-	F <sub>DL_high</sub>	-50	1	
	E-UTRA band 18, 19	F <sub>DL_low</sub>	-	F <sub>DL_high</sub>	-50	1	10
	E-UTRA band 42	F <sub>DL_low</sub>	-	F <sub>DL_high</sub>	-50	1	2
CA_3A-8A	E-UTRA Band 20, 27, 28, 38, 44	F <sub>DL_low</sub>	-	F <sub>DL_high</sub>	-50	1	
	E-UTRA band 7, 22, 41, 42, 43	F <sub>DL_low</sub>	-	F <sub>DL_high</sub>	-50	1	2
	Frequency range	860	-	890	-40	1	3,11,17
CA_3A-19A	E-UTRA Band 42	F <sub>DL_low</sub>	-	F <sub>DL_high</sub>	-50	1	2
	Frequency range	860	-	890	-40	1	3, 8
	Frequency range	945	-	960	-50	1	3
	Frequency range	2595	-	2645	-50	1	
CA_3A-20A	E-UTRA Band 7, 8	F <sub>DL_low</sub>	-	F <sub>DL_high</sub>	-50	1	
	E-UTRA Band 38, 42	F <sub>DL_low</sub>	-	F <sub>DL_high</sub>	-50	1	2
CA_3A-26A	E-UTRA Band 5, 8, 26	F <sub>DL_low</sub>	-	F <sub>DL_high</sub>	-50	1	
	E-UTRA band 18, 19	F <sub>DL_low</sub>	-	F <sub>DL_high</sub>	-50	1	10
	E-UTRA band 41, 42	F <sub>DL_low</sub>	-	F <sub>DL_high</sub>	-50	1	2
	Frequency range	945	-	960	-50	1	
CA_4A-7A	E-UTRA Band 2, 4, 5, 7, 10, 12, 13, 14, 17, 27, 28, 29	F <sub>DL_low</sub>	-	F <sub>DL_high</sub>	-50	1	
	E-UTRA band 42	F <sub>DL_low</sub>	-	F <sub>DL_high</sub>	-50	1	2
	Frequency range	2570	-	2575	+1.6	5	3, 13, 14
	Frequency range	2575	-	2595	-15.5	5	3, 13, 14
	Frequency range	2595	-	2620	-40	1	3, 14
CA_4A-12A	No requirement						
CA_4A-13A	E-UTRA Band 7, 41	F <sub>DL_low</sub>	-	F <sub>DL_high</sub>	-50	1	
CA_4A-17A	No requirement						
CA_5A-7A	E-UTRA Band 5, 28, 42	F <sub>DL_low</sub>	-	F <sub>DL_high</sub>	-50	1	
	E-UTRA band 26	859	-	869	-27	1	
CA_5A-12A	E-UTRA Band 2, 5, 13, 14, 17, 22, 23, 24, 25, 28, 29, 30, 31, 42, 43	F <sub>DL_low</sub>	-	F <sub>DL_high</sub>	-50	1	
	E-UTRA band 4, 10, 41	F <sub>DL_low</sub>	-	F <sub>DL_high</sub>	-50	1	2
	E-UTRA band 26	859	-	869	-27	1	
	E-UTRA band 12	F <sub>DL_low</sub>	-	F <sub>DL_high</sub>	-50	1	3
CA_5A-17A	E-UTRA Band 2, 5, 13, 14, 17, 22, 23, 24, 25, 28, 29, 30, 31, 42, 43	F <sub>DL_low</sub>	-	F <sub>DL_high</sub>	-50	1	
	E-UTRA band 4, 10, 41	F <sub>DL_low</sub>	-	F <sub>DL_high</sub>	-50	1	2
	E-UTRA band 26	859	-	869	-27	1	
	E-UTRA band 12	F <sub>DL_low</sub>	-	F <sub>DL_high</sub>	-50	1	3
CA_7A-20A	E-UTRA Band 28	F <sub>DL_low</sub>	-	F <sub>DL_high</sub>	-50	1	
CA_7A-28A	E-UTRA Band 3	F <sub>DL_low</sub>	-	F <sub>DL_high</sub>	-50	1	



CA_19A-21A	No requirement						
CA 39A-41A	E-UTRA Band 42, 44	$F_{DL\_low}$	-	$F_{DL\_high}$	-50	1	
NOTE 1: $F_{DL\_low}$ and $F_{DL\_high}$ refer to each E-UTRA frequency band specified in Table 5.2-1							
NOTE 2: As exceptions, measurements with a level up to the applicable requirements defined in Table 6.6.3.1.3-2 are permitted for each assigned E-UTRA carrier used in the measurement due to 2 <sup>nd</sup> , 3 <sup>rd</sup> , 4 <sup>th</sup> [or 5 <sup>th</sup> ] harmonic spurious emissions. An exception is allowed if there is at least one individual RB within the transmission bandwidth (see Figure 5.4.2-1) for which the 2 <sup>nd</sup> , 3 <sup>rd</sup> or 4 <sup>th</sup> harmonic totally or partially overlaps the measurement bandwidth (MBW).							
NOTE 3: These requirements also apply for the frequency ranges that are less than $F_{OOB}$ (MHz) in Table 6.6.3.1.3-1 and Table 6.6.3.1A.0-1 from the edge of the aggregated channel bandwidth.							
NOTE 4: Void.							
NOTE 5: Void.							
NOTE 6: Void.							
NOTE 7: Void.							
NOTE 8: Applicable when NS_08 in subclause 6.6.3.3.3.3 is signalled by the network.							
NOTE 9: Void.							
NOTE10: This requirement applies for 5, 10, 15 and 20 MHz E-UTRA channel bandwidth allocated within 1744.9MHz and 1784.9MHz.							
NOTE 11: This requirement is applicable only for the following cases: - for carriers of 5 MHz channel bandwidth when carrier centre frequency ( $F_c$ ) is within the range $902.5 \text{ MHz} \leq F_c < 907.5 \text{ MHz}$ with an uplink transmission bandwidth less than or equal to 20 RB - for carriers of 5 MHz channel bandwidth when carrier centre frequency ( $F_c$ ) is within the range $907.5 \text{ MHz} \leq F_c \leq 912.5 \text{ MHz}$ without any restriction on uplink transmission bandwidth. - for carriers of 10 MHz channel bandwidth when carrier centre frequency ( $F_c$ ) is $F_c = 910 \text{ MHz}$ with an uplink transmission bandwidth less than or equal to 32 RB with $RB_{start} > 3$ .							
NOTE 12: Void.							
NOTE13: For these adjacent bands, the emission limit could imply risk of harmful interference to UE(s) operating in the protected operating band.							
NOTE 14: This requirement is applicable for any channel bandwidths within the range 2500 - 2570 MHz with the following restriction: for carriers of 15 MHz bandwidth when carrier centre frequency is within the range 2560.5 - 2562.5 MHz and for carriers of 20 MHz bandwidth when carrier centre frequency is within the range 2552 - 2560 MHz the requirement is applicable only for an uplink transmission bandwidth less than or equal to 54 RB.							
NOTE 15: Void.							
NOTE 16: Void.							
NOTE 17: This requirement is applicable only when Band 3 transmission frequency is less than or equal to 1765 MHz.							
NOTE 18: Void.							
NOTE 19: Void.							
NOTE 20: Void.							

### 6.6.3.3 Additional spurious emissions

#### 6.6.3.3.1 Test purpose

To verify that UE transmitter does not cause unacceptable interference to other channels or other systems in terms of transmitter spurious emissions under the deployment scenarios where additional requirements are specified.

#### 6.6.3.3.2 Test applicability

This test case applies to all types of E-UTRA UE release 8 and forward.

#### 6.6.3.3.3 Minimum conformance requirements

These requirements are specified in terms of an additional spectrum emission requirement. Additional spurious emission requirements are signalled by the network to indicate that the UE shall meet an additional requirement for a specific deployment scenario as part of the cell handover/broadcast message.

NOTE: For measurement conditions at the edge of each frequency range, the lowest frequency of the measurement position in each frequency range should be set at the lowest boundary of the frequency range plus  $MBW/2$ . The highest frequency of the measurement position in each frequency range should be set at the highest boundary of the frequency range minus  $MBW/2$ .  $MBW$  denotes the measurement bandwidth defined for the protected band.

### 6.6.3.3.3.1 Minimum conformance requirements (network signalled value "NS\_05")

When "NS\_05" is indicated in the cell, the power of any UE emission shall not exceed the levels specified in Table 6.6.3.3.3.1-1. This requirement also applies for the frequency ranges that are less than  $\Delta f_{\text{OOB}}$  (MHz) in Table 6.6.3.1.3-1 from the edge of the channel bandwidth.

**Table 6.6.3.3.3.1-1: Additional requirements (PHS)**

Frequency band (MHz)	Channel bandwidth / Spectrum emission limit (dBm)				Measurement bandwidth
	5 MHz	10 MHz	15 MHz	20 MHz	
$1884.5 \leq f \leq 1915.7^{*1}$	-41	-41	-41	-41	300 KHz
Note 1: Applicable when the lower edge of the assigned E-UTRA UL channel bandwidth frequency is larger than or equal to the upper edge of PHS band (1915.7 MHz) + 4 MHz + the Channel BW assigned, where Channel BW is as defined in sub-clause 5.4.2. Additional restrictions apply for operations below this point.					

The requirements in Table 6.6.3.3.3.1-1 apply with the additional restrictions specified in Table 6.6.3.3.3.1-2 when the lower edge of the assigned E-UTRA UL channel bandwidth frequency is less than the upper edge of PHS band (1915.7 MHz) + 4 MHz + the channel BW assigned.

**Table 6.6.3.3.3.1-2: RB restrictions for additional requirement (PHS)**

15 MHz channel bandwidth with $f_c = 1932.5$ MHz			
RB <sub>start</sub>	0-7	8-66	67-74
LCRB	N/A	$\leq \text{MIN}(30, 67 - \text{RB}_{\text{start}})$	N/A
20 MHz channel bandwidth with $f_c = 1930$ MHz			
RB <sub>start</sub>	0-23	24-75	76-99
LCRB	N/A	$\leq \text{MIN}(24, 76 - \text{RB}_{\text{start}})$	N/A

The normative reference for this requirement is TS 36.101[2] subclause 6.6.3.3.1.

### 6.6.3.3.3.2 Minimum conformance requirements (network signalled value "NS\_07")

When "NS\_07" is indicated in the cell, the power of any UE emission shall not exceed the levels specified in Table 6.6.3.3.3.2-1. These requirements also apply for the frequency ranges that are less than  $\Delta f_{\text{OOB}}$  (MHz) in Table 6.6.3.1.3-1 from the edge of the channel bandwidth.

**Table 6.6.3.3.3.2-1: Additional requirements**

Frequency band (MHz)	Channel bandwidth / Spectrum emission limit (dBm)	Measurement bandwidth
	10 MHz	
$769 \leq f \leq 775$	-57	6.25 kHz
Note: The emissions measurement shall be sufficiently power averaged to ensure a standard deviation < 0.5 dB.		

The normative reference for this requirement is TS 36.101[2] subclause 6.6.3.3.2.

### 6.6.3.3.3.3 Minimum requirement (network signalled value "NS\_08")

When "NS\_08" is indicated in the cell, the power of any UE emission shall not exceed the levels specified in Table 6.6.3.3.3-1. This requirement also applies for the frequency ranges that are less than  $\Delta f_{\text{OOB}}$  (MHz) in Table 6.6.3.1.3-1 from the edge of the channel bandwidth.

**Table 6.6.3.3.3-1: Additional requirement**

Frequency band (MHz)	Channel bandwidth / Spectrum emission limit (dBm)			Measurement bandwidth
	5MHz	10MHz	15MHz	
$860 \leq f \leq 895$	-40	-40	-40	1 MHz

#### 6.6.3.3.3.4 Minimum requirement (network signalled value "NS\_09")

When "NS 09" is indicated in the cell, the power of any UE emission shall not exceed the levels specified in Table 6.6.3.3.3.4-1. This requirement also applies for the frequency ranges that are less than  $\Delta f_{\text{OOB}}$  (MHz) in Table 6.6.3.1.3-1 from the edge of the channel bandwidth.

**Table 6.6.3.3.3.4-1: Additional requirement**

Frequency band (MHz)	Channel bandwidth / Spectrum emission limit (dBm)			Measurement bandwidth
	5MHz	10MHz	15MHz	
$1475.9 \leq f \leq 1510.9$	-35	-35	-35	1 MHz

NOTE 1: To improve measurement accuracy, A-MPR values for NS\_09 specified in Table 6.2.4.3-1 in sub-clause 6.2.4 are derived based on 100 kHz RBW.

#### 6.6.3.3.3.5 Minimum requirement (network signalled value "NS\_12")

When "NS 12" is indicated in the cell, the power of any UE emission shall not exceed the levels specified in Table 6.6.3.3.5-1. This requirement also applies for the frequency ranges that are less than  $\Delta f_{\text{OOB}}$  (MHz) in Table 6.6.3.1.3-1 from the edge of the channel bandwidth.

**Table 6.6.3.3.3.5-1: Additional requirements**

Frequency band (MHz)	Channel bandwidth/ Spectrum emission limit (dBm)	Measurement bandwidth
	1.4 MHz, 3 MHz, 5 MHz, 10 MHz, 15 MHz	
$806 \leq f \leq 813.5$	-42	6.25 kHz
NOTE 1: The requirement applies for E-UTRA carriers with lower channel edge at or above 814.2 MHz.		
NOTE 2: The emissions measurement shall be sufficiently power averaged to ensure a standard deviation < 0.5 dB.		

#### 6.6.3.3.3.6 Minimum requirement (network signalled value "NS\_13")

When "NS 13" is indicated in the cell, the power of any UE emission shall not exceed the levels specified in Table 6.6.3.3.6-1. This requirement also applies for the frequency ranges that are less than  $\Delta f_{\text{OOB}}$  (MHz) in Table 6.6.3.1.3-1 from the edge of the channel bandwidth.

**Table 6.6.3.3.3.6-1: Additional requirements**

Frequency band (MHz)	Channel bandwidth/ Spectrum emission limit (dBm)	Measurement bandwidth
	1.4, 3, 5 MHz	
$806 \leq f \leq 816$	-42	6.25 kHz
NOTE 1: The requirement applies for E-UTRA carriers with lower channel edge at or above 819 MHz.		
NOTE 2: The emissions measurement shall be sufficiently power averaged to ensure a standard deviation < 0.5 dB.		

## 6.6.3.3.3.7 Minimum requirement (network signalled value "NS\_14")

When "NS 14" is indicated in the cell, the power of any UE emission shall not exceed the levels specified in Table 6.6.3.3.7-1. This requirement also applies for the frequency ranges that are less than  $\Delta f_{\text{OOB}}$  (MHz) in Table 6.6.3.1.3-1 from the edge of the channel bandwidth.

**Table 6.6.3.3.3.7-1: Additional requirements**

Frequency band (MHz)	Channel bandwidth / Spectrum emission limit (dBm)	Measurement bandwidth
	10 MHz, 15 MHz	
$806 \leq f \leq 816$	-42	6.25 kHz
NOTE 1: The requirement applies for E-UTRA carriers with lower channel edge at or above 824 MHz.		
NOTE 2: The emissions measurement shall be sufficiently power averaged to ensure a standard deviation < 0.5 dB.		

## 6.6.3.3.3.8 Minimum requirement (network signalled value "NS\_15")

When "NS 15" is indicated in the cell, the power of any UE emission shall not exceed the levels specified in Table 6.6.3.3.8-1. This requirement also applies for the frequency ranges that are less than  $\Delta f_{\text{OOB}}$  (MHz) in Table 6.6.3.1.3-1 from the edge of the channel bandwidth.

**Table 6.6.3.3.3.8-1: Additional requirements**

Frequency band (MHz)	Channel bandwidth / Spectrum emission limit (dBm)	Measurement bandwidth	Note
	1.4, 3, 5, 10, 15 MHz		
$851 \leq f \leq 859$	-53	6.25 kHz	1
Note 1: The emissions measurement shall be sufficiently power averaged to ensure standard deviation < 0.5 dB.			

## 6.6.3.3.3.9 Minimum requirement (network signalled value "NS\_16")

When "NS\_16" is indicated in the cell, the power of any UE emission shall not exceed the levels specified in Table 6.6.3.3.9-1. This requirement also applies for the frequency ranges that are less than  $\Delta f_{\text{OOB}}$  (MHz) in Table 6.6.3.1-1 from the edge of the channel bandwidth.

**Table 6.6.3.3.3.9-1: Additional requirements**

Frequency band (MHz)	Channel bandwidth / Spectrum emission limit (dBm)	Measurement bandwidth	Note
	1.4, 3, 5, 10 MHz		
$790 \leq f \leq 803$	-32	1 MHz	

## 6.6.3.3.3.10 Minimum requirement (network signalled value "NS\_17")

When "NS\_17" is indicated in the cell, the power of any UE emission shall not exceed the levels specified in Table 6.6.3.3.3.10-1. This requirement also applies for the frequency ranges that are less than  $\Delta f_{\text{OOB}}$  (MHz) in Table 6.6.3.3.3.10-1 from the edge of the channel bandwidth.

**Table 6.6.3.3.3.10-1: Additional requirements**

Frequency band (MHz)	Channel bandwidth / Spectrum emission limit (dBm)	Measurement bandwidth	Note
	5, 10 MHz		

$470 \leq f \leq 710$	-26.2	6 MHz	1
Note 1: Applicable when the assigned E-UTRA carrier is confined within 718 MHz and 748 MHz and when the channel bandwidth used is 5 or 10 MHz.			

#### 6.6.3.3.3.11 Minimum requirement (network signalled value "NS\_18")

When "NS\_18" is indicated in the cell, the power of any UE emission shall not exceed the levels specified in Table 6.6.3.3.3.11-1. This requirement also applies for the frequency ranges that are less than  $\Delta f_{\text{OOB}}$  (MHz) in Table 6.6.3.1.3-1 from the edge of the channel bandwidth.

**Table 6.6.3.3.3.11-1: Additional requirements**

Frequency band (MHz)	Channel bandwidth / Spectrum emission limit (dBm)	Measurement bandwidth	Note
	5, 10, 15, 20 MHz		
$692 \leq f \leq 698$	-26.2	6 MHz	

#### 6.6.3.3.3.12 Minimum requirement (network signalled value "NS\_19")

When "NS\_19" is indicated in the cell, the power of any UE emission shall not exceed the levels specified in Table 6.6.3.3.3.12-1. This requirement also applies for the frequency ranges that are less than  $\Delta f_{\text{OOB}}$  (MHz) in Table 6.6.3.1.3-1 from the edge of the channel bandwidth.

**Table 6.6.3.3.3.12-1: Additional requirements**

Frequency band (MHz)	Channel bandwidth / Spectrum emission limit (dBm)	Measurement bandwidth	Note
	3, 5, 10, 15, 20 MHz		
$662 \leq f \leq 694$	-25	8 MHz	

#### 6.6.3.3.3.13 Minimum requirement (network signalled value "NS\_11")

When "NS\_11" is indicated in the cell, the power of any UE emission shall not exceed the levels specified in Table 6.6.3.3.3.13-1. These requirements also apply for the frequency ranges that are less than  $F_{\text{OOB}}$  (MHz) in Table 6.6.3.1.3-1 from the edge of the channel bandwidth.

**Table 6.6.3.3.3.13-1: Additional requirements**

Frequency band (MHz)	Channel bandwidth / Spectrum emission limit (dBm)	Measurement bandwidth	Note
	1.4, 3, 5, 10, 15, 20 MHz		
E-UTRA Band 2	-50	1 MHz	
$1998 \leq f \leq 1999$	-21	1 MHz	
$1997 \leq f < 1998$	-27	1 MHz	
$1996 \leq f < 1997$	-32	1 MHz	
$1995 \leq f < 1996$	-37	1 MHz	
$1990 \leq f < 1995$	-40	1 MHz	

#### 6.6.3.3.3.14 Minimum requirement (network signalled value "NS\_20")

When "NS\_20" is indicated in the cell, the power of any UE emission shall not exceed the levels specified in Table 6.6.3.3.3.14-1. These requirements also apply for the frequency ranges that are less than  $F_{\text{OOB}}$  (MHz) in Table 6.6.3.1.3-1 from the edge of the channel bandwidth.

**Table 6.6.3.3.14-1: Additional requirements**

Frequency band (MHz)	Channel bandwidth / Spectrum emission limit (dBm)	Measurement bandwidth	Note
	5, 10, 15, 20 MHz		
$1990 \leq f < 1999$	-40	1 MHz	
$1999 \leq f \leq 2000$	-40	Note 1	
Note 1: The measurement bandwidth is 1% of the applicable E-UTRA channel bandwidth (5.4.2.1-1).			

#### 6.6.3.3.3.15 Minimum requirement (network signalled value "NS\_21")

When "NS\_21" is indicated in the cell, the power of any UE emission shall not exceed the levels specified in Table 6.6.3.3.15-1. These requirements also apply for the frequency ranges that are less than  $F_{\text{OoB}}$  (MHz) in Table 6.6.3.1.3-1 and Table 6.6.3.1A-1 from the edge of the channel bandwidth.

**Table 6.6.3.3.15-1: Additional requirements**

Frequency band (MHz)	Channel bandwidth / Spectrum emission limit (dBm)	Measurement bandwidth
	5, 10 MHz	
$2200 \leq f < 2288$	-40	1 MHz
$2288 \leq f < 2292$	-37	1 MHz
$2292 \leq f < 2296$	-31	1 MHz
$2296 \leq f < 2300$	-25	1 MHz
$2320 \leq f < 2324$	-25	1 MHz
$2324 \leq f < 2328$	-31	1 MHz
$2328 \leq f < 2332$	-37	1 MHz
$2332 \leq f \leq 2395$	-40	1 MHz

#### 6.6.3.3.4 Test description

##### 6.6.3.3.4.1 Initial conditions

Initial conditions are a set of test configurations the UE needs to be tested in and the steps for the SS to take with the UE to reach the correct measurement state.

The initial test configurations consist of environmental conditions, test frequencies, and channel bandwidths based on E-UTRA operating bands specified in table 5.4.2.1-1. All of these configurations shall be tested with applicable test parameters for each channel bandwidth, and are shown in tables 6.6.3.3.4.1-1 through table 6.6.3.3.4.1-15. The details of the uplink reference measurement channels (RMCs) are specified in Annexes A.2. Configurations of PDSCH and PDCCH before measurement are specified in Annex C.2.

**Table 6.6.3.3.4.1-1: Test Configuration Table (network signalled value "NS\_05")**

Initial Conditions						
Test Environment as specified in TS 36.508[7] subclause 4.1			Normal			
Test Frequencies as specified in TS36.508 [7] subclause 4.3.1			Low range, Mid range  In case of Low range: <ul style="list-style-type: none"> <li>- For 5MHz Channel Bandwidth: 1927.2MHz (<math>N_{UL} = 18072</math>)</li> <li>- For 10MHz Channel Bandwidth: 1934.7MHz (<math>N_{UL} = 18147</math>)</li> <li>- For 15MHz Channel Bandwidth: 1932.5MHz (<math>N_{UL} = 18125</math>)</li> <li>- For 20MHz Channel Bandwidth: 1930MHz (<math>N_{UL} = 18100</math>)</li> </ul>			
Test Channel Bandwidths as specified in TS 36.508 [7] subclause 4.3.1			5MHz, 10MHz, 15MHz, 20MHz			
Test Parameters for Channel Bandwidths						
Ch BW	Downlink Configuration			Uplink Configuration		
	Mod'n	RB allocation		Mod'n	RB allocation	
		FDD	TDD		FDD	TDD
5MHz	N/A for Additional Spurious Emissions testing			QPSK	1	N/A
5MHz				QPSK	25	
10MHz				QPSK	1	
10MHz				QPSK	12	
10MHz				QPSK	48	
10MHz				QPSK	50	
10MHz				16QAM	50 (Note 3)	
15MHz				QPSK	1	
15MHz				QPSK	16	
15MHz				QPSK	30 (Note 4)	
15MHz				QPSK	48 (Note 5)	
15MHz				QPSK	75 (Note 5)	
15MHz				16QAM	75 (Note 3, 5)	
20MHz				QPSK	1	
20MHz				QPSK	18	
20MHz				QPSK	24 (Note 4)	
20MHz				QPSK	48 (Note 5)	
20MHz				QPSK	100 (Note 5)	
20MHz				16QAM	100 (Note 3, 5)	
Note 1: The 1 RB allocation shall be tested at both RB #0 and RB #max except for 15MHz and 20MHz of Low Range. For 15MHz of Low Range, the 1 RB allocation shall be tested at both RB#8 and RB#66. For 20MHz of Low Range, the 1 RB allocation shall be tested at both RB#24 and RB#75.  Note 2: The RB <sub>start</sub> of partial RB allocation shall be RB# 0 and RB# (max +1 - RB allocation) of the channel bandwidth except for 15MHz and 20MHz of Low Range. For 15MHz of Low Range, the RB <sub>start</sub> shall be RB#8 and RB# (67 - RB allocation). For 20MHz of Low Range, the RB <sub>start</sub> shall be RB#24 and RB# (76 - RB allocation).  Note 3: Applies only for UE-Categories ≥2. Note 4: Required for Low Range only. Note 5: Not available for Low Range.						

**Table 6.6.3.3.4.1-2: Test Configuration Table (network signalled value "NS\_07")**

Initial Conditions						
Test Environment (as specified in TS 36.508 [7] subclause 4.1)				NC		
Test Frequencies (as specified in TS36.508 [7] subclause 4.3.1)				Mid range		
Test Channel Bandwidths (as specified in TS 36.508 [7] subclause 4.3.1)				10MHz		
Test Parameters for Channel Bandwidths						
Test Number	Ch BW	Downlink Configuration		Uplink Configuration		
		Mod'n	RB allocation	Mod'n	RB allocation	RB <sub>start</sub>
1	10MHz	N/A for Additional Spurious Emissions testing.		QPSK	1	0
2	10MHz			QPSK	8	0
3	10MHz			QPSK	6	13
4	10MHz			QPSK	20	13
5	10MHz			QPSK	12	13
6	10MHz			16QAM	36 (Note 1)	13
7	10MHz			QPSK	16	19
8	10MHz			QPSK	12	19
9	10MHz			16QAM	16	19
10	10MHz			QPSK	30	19
11	10MHz			16QAM	30 (Note 1)	19
12	10MHz			QPSK	6	43
13	10MHz			QPSK	2	48
14	10MHz			QPSK	50	0
15	10MHz			QPSK	12	0
16	10MHz			16QAM	50 (Note 1)	0
Note 1: Applies only for UE-Categories $\geq 2$ .						



**Table 6.6.3.3.4.1-3: Test Configuration Table (network signalled value "NS\_08")**

Initial Conditions						
Test Environment as specified in <b>TS 36.508[7] subclause 4.1</b>			Normal			
Test Frequencies as specified in <b>TS36.508 [7] subclause 4.3.1</b>			High range			
Test Channel Bandwidths as specified in <b>TS 36.508 [7] subclause 4.3.1</b>			5MHz, 10MHz, 15MHz			
Test Parameters for Channel Bandwidths						
Ch BW	Downlink Configuration			Uplink Configuration		
	Mod'n	RB allocation		Mod'n	RB allocation	
		FDD	TDD		FDD	TDD
5MHz	N/A for Additional Spurious Emissions testing			QPSK	1	N/A
5MHz				QPSK	8	
5MHz				QPSK	25	
10MHz				QPSK	1	
10MHz				QPSK	12	
10MHz				QPSK	40	
10MHz				QPSK	50	
10MHz				16QAM	50 (Note 3)	
15MHz				QPSK	1	
15MHz				QPSK	16	
15MHz				QPSK	40	
15MHz				QPSK	75	
15MHz				16QAM	75 (Note 3)	
Note 1: The 1 RB allocation shall be tested at both RB #0 and RB #max. Note 2: The RB <sub>start</sub> of partial RB allocation shall be RB#0 and RB# (max + 1 - RB allocation) of the channel bandwidth Note 3: Applies only for UE-Categories ≥2.						

**Table 6.6.3.3.4.1-4: Test Configuration Table (network signalled value "NS\_09")**

Initial Conditions						
Test Environment as specified in TS 36.508[7] subclause 4.1			Normal			
Test Frequencies as specified in TS36.508 [7] subclause 4.3.1			High range			
Test Channel Bandwidths as specified in TS 36.508 [7] subclause 4.3.1			5MHz, 10MHz, 15MHz			
Test Parameters for Channel Bandwidths						
Ch BW	Downlink Configuration			Uplink Configuration		
	Mod'n	RB allocation		Mod'n	RB allocation	
		FDD	TDD		FDD	TDD
5MHz	N/A for Additional Spurious Emissions testing			QPSK	1	N/A
5MHz				QPSK	8	
5MHz				QPSK	25	
10MHz				QPSK	1	
10MHz				QPSK	12	
10MHz				QPSK	40	
10MHz				QPSK	50	
10MHz				16QAM	50 (Note 3)	
15MHz				QPSK	1	
15MHz				QPSK	16	
15MHz				QPSK	40	
15MHz				QPSK	54	
15MHz				QPSK	75	
15MHz				16QAM	75 (Note 3)	
Note 1: The 1 RB allocation shall be tested at both RB #0 and RB #max. Note 2: The RB <sub>start</sub> of partial RB allocation shall be RB#0 and RB# (max + 1 - RB allocation) of the channel bandwidth Note 3: Applies only for UE-Categories ≥2.						

**Table 6.6.3.3.4.1-5: Test Configuration Table (network signalled value "NS\_12")**

Initial Conditions									
Test Environment (as specified in TS 36.508 [7] subclause 4.1)	NC								
Test Frequencies (as specified in TS36.508 [7] subclause 4.3.1)	For 1.4 MHz Channel Bandwidth: UL 814.9 MHz (NUL = 26699)  For 3 MHz Channel Bandwidth: UL 815.7 MHz (NUL = 26707)  For 5 MHz Channel Bandwidth: UL 816.7 MHz (NUL = 26717)  For 10 MHz Channel Bandwidth: UL 819.2 MHz (NUL = 26742)  For 15 MHz Channel Bandwidth: UL 821.7 MHz (NUL = 26767)								
Test Channel Bandwidths (as specified in TS 36.508 [7] subclause 4.3.1)	1.4 MHz, 3 MHz, 5 MHz, 10 MHz and 15 MHz								
Test Parameters for Channel Bandwidths									
	<table border="1" style="width:100%; border-collapse: collapse;"> <thead> <tr> <th style="width:50%;"></th> <th style="width:50%; text-align: center;">Downlink Configuration</th> <th style="width:50%;"></th> <th style="width:50%; text-align: center;">Uplink Configuration</th> </tr> </thead> <tbody> <tr> <td> </td> <td> </td> <td> </td> <td> </td> </tr> </tbody> </table>		Downlink Configuration		Uplink Configuration				
	Downlink Configuration		Uplink Configuration						

Test Number	Ch BW	Mod'n	RB allocation	Mod'n	RB allocation FDD	RBstart FDD
1	1.4 MHz	N/A for Additional Spurious Emissions testing		QPSK	1	0
2	1.4 MHz			QPSK	6	0
3	1.4 MHz			QPSK	1	1
4	1.4 MHz			QPSK	5	1
5	1.4 MHz			16QAM	6	0
6 (Note 1)	3 MHz			QPSK	4	0
7 (Note 1)	3 MHz			QPSK	10	0
8	3 MHz			QPSK	4	4
9	3 MHz			QPSK	10	4
10 (Note 1)	3 MHz			16QAM	15	0
11	5 MHz			QPSK	8	0
12	5 MHz			QPSK	15	0
13	5 MHz			QPSK	8	7
14 (Note 1)	5 MHz			QPSK	15	7
15	5 MHz			16QAM	25	0
16 (Note 2)	10 MHz			QPSK	18	0
17 (Note 2)	10 MHz			QPSK	18	16
18 (Note 2)	10 MHz			16QAM	50	0
19 (Note 2)	15 MHz			QPSK	30	0
20 (Note 2)	15 MHz			QPSK	30	31
21 (Note 2)	15 MHz			16QAM	75	0
Note 1: Only for UEs of Rel-11 and earlier						
Note 2: Only for UEs of Rel-12 and later						

**Table 6.3.3.4.1-6: Test Configuration Table (network signalled value "NS\_13")**

Initial Conditions						
Test Environment (as specified in TS 36.508 [7] subclause 4.1)				NC		
Test Frequencies (as specified in TS36.508 [7] subclause 4.3.1)				For 1.4 MHz Channel Bandwidth: UL 819.7 MHz (NUL = 26747)  For 3 MHz Channel Bandwidth: UL 820.5 MHz (NUL = 26755)  For 5 MHz Channel Bandwidth: UL 821.5 MHz (NUL = 26765)		
Test Channel Bandwidths (as specified in TS 36.508 [7] subclause 4.3.1)				1.4 MHz, 3MHz and 5 MHz		
Test Parameters for Channel Bandwidths						
		Downlink Configuration		Uplink Configuration		
Test Number	Ch BW	Mod'n	RB allocation	Mod'n	RB allocation FDD	RBstart FDD

1 (Note 1)	1.4 MHz	N/A for Additional Spurious Emissions testing	QPSK	6	0
2 (Note 1)	3 MHz		QPSK	15	0
3	5 MHz		QPSK	1	0
4	5 MHz		QPSK	25	0
5	5 MHz		QPSK	15	0
6	5 MHz		QPSK	15	7
7	5 MHz		16QAM	25	0
Note 1: Only for UEs of Rel-12 and later					

**Table 6.6.3.4.1-7: Test Configuration Table (network signalled value "NS\_14")**

Initial Conditions						
Test Environment (as specified in TS 36.508 [7] subclause 4.1)			NC			
Test Frequencies (as specified in TS36.508 [7] subclause 4.3.1)			For 10 MHz Channel Bandwidth: UL 829 MHz (N <sub>UL</sub> = 26840)  For 15 MHz Channel Bandwidth: Mid range			
Test Channel Bandwidths (as specified in TS 36.508 [7] subclause 4.3.1)			10 MHz, 15 MHz			
Test Parameters for Channel Bandwidths						
Test Number	Ch BW	Downlink Configuration		Uplink Configuration		
		Mod'n	RB allocation	Mod'n	RB allocation FDD	RBstart FDD
1	10 MHz	N/A for Additional Spurious Emissions testing		QPSK	1	0
2	10 MHz			QPSK	25	0
3	10 MHz			QPSK	50	0
4	10 MHz			QPSK	25	1
5 (Note 1)	10 MHz			16QAM	50	0
6	15 MHz			QPSK	8	0
7	15 MHz			QPSK	25	0
8	15 MHz			QPSK	75	0
9	15 MHz			QPSK	50	15
10 (Note 1)	15 MHz			16QAM	75	0
Note 1: Applies only for UE-Categories ≥2.						

**Table 6.6.3.3.4.1-8: Test Configuration Table (network signalled value "NS\_15")**

Initial Conditions						
Test Environment (as specified in TS 36.508 [7] subclause 4.1)		NC				
Test Frequencies (as specified in TS36.508 [7] subclause 4.3.1)		For 1.4 MHz Channel Bandwidth: High range  For 3 MHz Channel Bandwidth: UL 843.5 MHz ( $N_{UL} = 26985$ ) or High range  For 5 MHz Channel Bandwidth: UL 842.5 MHz ( $N_{UL} = 26975$ ) or High range  For 10 MHz Channel Bandwidth: UL 840 MHz ( $N_{UL} = 26950$ ) or High range  For 15 MHz Channel Bandwidth: UL 837.5 MHz ( $N_{UL} = 26925$ ) or High range				
Test Channel Bandwidths (as specified in TS 36.508 [7] subclause 4.3.1)		1.4 MHz, 3 MHz, 5 MHz, 10 MHz, 15 MHz				
Test Parameters for Channel Bandwidths						
Configuration ID	Ch BW	Downlink Configuration		Uplink Configuration		
		Mod'n	RB allocation	Mod'n	RB allocation FDD	RBstart FDD
1 (note 3)	1.4 MHz	N/A for Additional Spurious Emissions testing		QPSK	4	0
2 (note 3)	1.4 MHz			16QAM	6	0
3 (note 3)	3 MHz			QPSK	6	7
4 (note 3)	3 MHz			QPSK	12	1
5 (note 3)	3 MHz			16QAM	15	0
6 (note 2)	3 MHz			QPSK	15	0
7 (note 3)	5 MHz			QPSK	6	14
8 (note 3)	5 MHz			QPSK	20	0
9 (note 3)	5 MHz			16QAM	25	0
10 (note 2)	5 MHz			QPSK	16	9
11 (note 2)	5 MHz			QPSK	25	0
12 (note 3)	10 MHz			QPSK	1	39
13 (note 3)	10 MHz			QPSK	1	10
14 (note 3)	10 MHz			QPSK	3	0
15 (note 3)	10 MHz			QPSK	20	3
16 (note 3)	10 MHz			QPSK	36	1
17 (note 3)	10 MHz			QPSK	50	0
18 (note 1, 3)	10 MHz			16QAM	50	0
19 (note 2)	10 MHz			QPSK	20	25
20 (note 2)	10 MHz			QPSK	45	0
21 (note 3)	15 MHz			QPSK	18	36
22 (note 3)	15 MHz			QPSK	25	1
23 (note 3)	15 MHz			QPSK	54	0
24 (note 1, 3)	15 MHz			16QAM	75	0

25 (note 2)	15 MHz		QPSK	18	44
26 (note 2)	15 MHz		QPSK	60	2
Note 1: Applies only for UE-Categories $\geq 2$ . Note 2: Applicable only test frequency < high range Note 3: Applicable only to high range frequency testing					

**Table 6.6.3.3.4.1-9: Test Configuration Table (network signalled value "NS\_16")**

Initial Conditions						
Test Environment (as specified in TS 36.508 [7] subclause 4.1)				NC		
Test Frequencies (as specified in TS36.508 [7] subclause 4.3.1)				For 1.4 MHz Channel Bandwidth: Low range  For 3 MHz Channel Bandwidth: Low range, 810 MHz ( $N_{UL}= 27070$ )  For 5 MHz Channel Bandwidth: Low range, 811 MHz ( $N_{UL}= 27080$ ) , 814.5 MHz ( $N_{UL}= 27115$ )  For 10 MHz Channel Bandwidth: Low range, 813.5 MHz ( $N_{UL}= 27105$ ), 817 MHz ( $N_{UL}= 27140$ )		
Test Channel Bandwidths (as specified in TS 36.508 [7] subclause 4.3.1)				1.4 MHz, 3 MHz, 5 MHz, 10 MHz		
Test Parameters for Channel Bandwidths						
Configuration ID	Ch BW	Downlink Configuration		Uplink Configuration		
		Mod'n	RB allocation	Mod'n	RB allocation FDD	RBstart FDD
1	1.4 MHz	N/A for Additional Spurious Emissions testing.		QPSK	1	0
2	1.4 MHz			QPSK	6	0
3 (Note 1)	1.4 MHz			16QAM	6	0
4	3 MHz			QPSK	1	0
5	3 MHz			QPSK	12	1
6	3 MHz			QPSK	15	0
7 (Note 1)	3 MHz			16QAM	15	0
8	5 MHz			QPSK	1	0
9	5 MHz			QPSK	12	2
10	5 MHz			QPSK	18	2
11	5 MHz			QPSK	20	0
12	5 MHz			QPSK	20	2
13	5 MHz			QPSK	25	0
14 (Note 1)	5 MHz			16QAM	25	0
15	10 MHz			QPSK	1	0
16 (Note 2)	10 MHz			QPSK	1	10

17 (Note 2)	10 MHz	QPSK	20	0
18 (Note 2)	10 MHz	QPSK	27	15
19 (Note 2)	10 MHz	QPSK	32	15
20	10 MHz	QPSK	32	0
21	10 MHz	QPSK	50	0
22 (Note 1)	10 MHz	16QAM	50	0
23 (Note 3)	10 MHz	QPSK	40	0
24 (Note 3)	10 MHz	QPSK	40	1
Note 1: Applies only for UE-Categories $\geq 2$ . Note 2: Applies only for 10 MHz channel for Low Range, and 813.5 MHz Note 3: Applies only for 10 MHz channel for 817 MHz range				

**Table 6.6.3.3.4.1-10: Test Configuration Table (network signalled value "NS\_17")**

Initial Conditions					
Test Environment (as specified in TS 36.508[7] subclause 4.1)				Normal	
Test Frequencies (as specified in TS 36.508 [7] subclause 4.3.1)				Mid range	
Test Channel Bandwidths (as specified in TS 36.508 [7] subclause 4.3.1)				5MHz, 10MHz	
Test Parameters for Channel Bandwidths					
Configuration ID	Ch BW	Downlink Configuration		Uplink Configuration	
		Mod'n	RB allocation FDD	Mod'n	RB allocation FDD
1	5MHz	N/A for Additional Spurious Emissions testing		QPSK	1
2	5MHz			QPSK	8
3	5MHz			QPSK	25
4	5MHz			16QAM	25 (Note 3)
5	10MHz			QPSK	1
6	10MHz			QPSK	12
7	10MHz			QPSK	50
8	10MHz			16QAM	50 (Note 3)
Note 1: The 1 RB allocation shall be tested at both RB #0 and RB #max. Note 2: The RBstart of partial RB allocation shall be RB# 0 and RB# (max +1 - RB allocation) of the channel bandwidth. Note 3: Applies only for UE-Categories $\geq 2$ .					



**Table 6.6.3.4.1-11: Test Configuration Table (network signalled value "NS\_18")**

Initial Conditions					
Test Environment (as specified in TS 36.508[7] subclause 4.1)				Normal	
Test Frequencies (as specified in TS36.508 [7] subclause 4.3.1)				Low range	
Test Channel Bandwidths (as specified in TS 36.508 [7] subclause 4.3.1)				5MHz, 10MHz, 15MHz, 20MHz	
Test Parameters for Channel Bandwidths					
Configuration ID	Ch BW	Downlink Configuration		Uplink Configuration	
		Mod'n	RB allocation FDD	Mod'n	RB allocation FDD
1	5MHz	N/A for Additional Spurious Emissions testing		QPSK	1
2	5MHz			QPSK	8
3	5MHz			QPSK	25
4	5MHz			16QAM	25 (Note 3)
5	10MHz			QPSK	1
6	10MHz			QPSK	12
7	10MHz			QPSK	50
8	10MHz			16QAM	50 (Note 3)
9	15MHz			QPSK	1
10	15MHz			QPSK	16
11	15MHz			QPSK	75
12	15MHz			16QAM	75 (Note 3)
13	20MHz			QPSK	1
14	20MHz			QPSK	18
15	20MHz			QPSK	100
16	20MHz			16QAM	100 (Note 3)

Note 1: The 1 RB allocation shall be tested at both RB #0 and RB #max.  
 Note 2: The RBstart of partial RB allocation shall be RB# 0 and RB# (max +1 - RB allocation) of the channel bandwidth.  
 Note 3: Applies only for UE-Categories ≥2.

Table 6.6.3.3.4.1-12: Test Configuration Table (network signalled value "NS\_19")

Initial Conditions					
Test Environment (as specified in TS 36.508[7] subclause 4.1)				Normal	
Test Frequencies (as specified in TS36.508 [7] subclause 4.3.1)				Low range	
Test Channel Bandwidths (as specified in TS 36.508 [7] subclause 4.3.1)				10MHz, 15MHz, 20MHz	
Test Parameters for Channel Bandwidths					
Configuration ID	Ch BW	Downlink Configuration		Uplink Configuration	
		Mod'n	RB allocation FDD	Mod'n	RB allocation TDD
1	10MHz	N/A		QPSK	40
2	10MHz			16QAM	40 (Note 3)
3	15MHz			QPSK	1
4	15MHz			QPSK	18
5	15MHz			QPSK	36
6	15MHz			QPSK	45
7	15MHz			16QAM	45 (Note 3)
8	20MHz			QPSK	1
9	20MHz			QPSK	40
10	20MHz			QPSK	45
11	20MHz			QPSK	50
12	20MHz			16QAM	50 (Note 3)

Note 1: The 1 RB allocation shall be tested at both RB #0 and RB #max.  
Note 2: The RBstart of partial RB allocation shall be RB# 0 and RB# (max +1 - RB allocation) of the channel bandwidth.  
Note 3: Applies only for UE-Categories  $\geq 2$ .

**Table 6.2.4.4.1-13: Test Configuration Table (network signalled value "NS\_11")**

Initial Conditions					
Test Environment (as specified in TS 36.508 [7] subclause 4.1)			Normal		
Test Frequencies (as specified in TS36.508 [7] subclause 4.3.1)			For 3 MHz Channel Bandwidth: a. 2001.5 MHz ( $N_{UL} = 25515$ ) b. 2004.5 MHz ( $N_{UL} = 25545$ )  For 5 MHz Channel Bandwidth a. 2002.5 MHz ( $N_{UL} = 25525$ ) b. 2004.5 MHz ( $N_{UL} = 25545$ ) c. 2007.5 MHz ( $N_{UL} = 25575$ )  For 10 MHz Channel Bandwidth a. 2005 MHz ( $N_{UL} = 25550$ ) b. 2005.5 MHz ( $N_{UL} = 25555$ ) c. 2015 MHz ( $N_{UL} = 25650$ )  For 15 MHz Channel Bandwidth a. 2007.5 MHz ( $N_{UL} = 25575$ ) b. 2012.5 MHz ( $N_{UL} = 25625$ )  For 20 MHz Channel Bandwidth a. 2010 MHz ( $N_{UL} = 25600$ )		
Test Channel Bandwidths (as specified in TS 36.508 [7] subclause 4.3.1)			3MHz, 5MHz, 10MHz, 15MHz, 20MHz		
Test Parameters for NS_11 A-MPR					
		Downlink Configuration		Uplink Configuration	
Configuration ID	Ch BW	Mod'n	RB allocation FDD	Mod'n	RB allocation FDD
1	3MHz	N/A for A-MPR testing		QPSK	6
2	3MHz			QPSK	15
3	3MHz			16QAM	6
4	3MHz			16QAM	15
5	5MHz			QPSK	1
6	5MHz			QPSK	8
7	5MHz			QPSK	25
8	5MHz			16QAM	8
9	5MHz			16QAM	25
10	10MHz			QPSK	1
11	10MHz			QPSK	12
12	10MHz			QPSK	50
13	10MHz			16QAM	12
14	10MHz			16QAM	50 (Note 3)
15	15MHz			QPSK	1
16	15MHz			QPSK	8
17	15MHz			QPSK	25
18	15MHz			QPSK	30

19	15MHz	QPSK	75
20	15MHz	16QAM	8
21	15MHz	16QAM	25
22	15MHz	16QAM	30
23	15MHz	16QAM	75
24	20MHz	QPSK	1
25	20MHz	QPSK	10
26	20MHz	QPSK	25
27	20MHz	QPSK	100
28	20MHz	16QAM	10
29	20MHz	16QAM	25
30	20MHz	16QAM	100
<p>Note 1: The Configuration ID will be used to map the applicable Test Configuration to the corresponding Test Requirement in subclause 6.2.4.5 as not all combinations are necessarily required based on the applicability of the UE.</p> <p>Note 2: The RB<sub>start</sub> of partial RB allocation shall be RB# 0 and RB# (max +1 - RB allocation) of the channel bandwidth.</p> <p>Note 3: Applies only for UE-Categories ≥2.</p>			

**Table 6.2.4.4.1-14: Test Configuration Table (network signalled value "NS\_20")**

Initial Conditions					
Test Environment (as specified in TS 36.508 [7] subclause 4.1)			Normal		
Test Frequencies (as specified in TS36.508 [7] subclause 4.3.1)			For 5 MHz Channel Bandwidth a. 2002.5 MHz ( $N_{UL} = 25525$ ) b. 2007.5 MHz ( $N_{UL} = 25575$ ) c. 2012.5 MHz ( $N_{UL} = 25625$ ) d. 2017.5 MHz ( $N_{UL} = 25675$ )  For 10 MHz Channel Bandwidth a. 2005 MHz ( $N_{UL} = 25550$ ) b. 2015 MHz ( $N_{UL} = 25650$ )  For 15 MHz Channel Bandwidth a. 2012.5 MHz ( $N_{UL} = 25625$ )  For 20 MHz Channel Bandwidth a. 2010 MHz ( $N_{UL} = 25600$ )		
Test Channel Bandwidths (as specified in TS 36.508 [7] subclause 4.3.1)			5MHz, 10MHz, 15MHz, 20MHz		
Test Parameters for NS_20 A-MPR					
		Downlink Configuration		Uplink Configuration	
Configuration ID	Ch BW	Mod'n	RB allocation FDD	Mod'n	RB allocation FDD
1	5MHz	N/A for A-MPR testing		QPSK	8
2	5MHz			QPSK	15
3	5MHz			QPSK	25
4	5MHz			16QAM	15
5	5MHz			16QAM	25
6	10MHz			QPSK	8
7	10MHz			QPSK	12
8	10MHz			QPSK	50
9	10MHz			16QAM	12
10	10MHz			16QAM	50 (Note 3)
11	15MHz			QPSK	6
12	15MHz			QPSK	25
13	15MHz			QPSK	36
14	15MHz			QPSK	75
15	15MHz			16QAM	25
16	15MHz			16QAM	36
17	15MHz			16QAM	75
18	20MHz			QPSK	8
19	20MHz			QPSK	18
20	20MHz			QPSK	25
21	20MHz			QPSK	75
22	20MHz			QPSK	100

23	20MHz	16QAM	18
24	20MHz	16QAM	25
25	20MHz	16QAM	75
26	20MHz	16QAM	100
<p>Note 1: The Configuration ID will be used to map the applicable Test Configuration to the corresponding Test Requirement in subclause 6.2.4.5 as not all combinations are necessarily required based on the applicability of the UE.</p> <p>Note 2: The RB<sub>start</sub> of partial RB allocation shall be RB# 0 and RB# (max +1 - RB allocation) of the channel bandwidth.</p> <p>Note 3: Applies only for UE-Categories ≥2.</p>			

**Table 6.2.4.4.1-15: Test Configuration Table (network signalled value "NS\_21")**

Initial Conditions						
Test Environment (as specified in TS 36.508 [7] subclause 4.1)				NC		
Test Frequencies (as specified in TS36.508 [7] subclause 4.3.1)				Low range or High range		
Test Channel Bandwidths (as specified in TS 36.508 [7] subclause 4.3.1)				5 MHz, 10 MHz		
Test Parameters for Channel Bandwidths						
Configuration ID	Ch BW	Downlink Configuration		Uplink Configuration		
		Mod'n	RB allocation	Mod'n	RB allocation FDD	RBstart FDD
1 (note 2)	5 MHz			QPSK	1	0
2 (note 2)	5 MHz			QPSK	25	0
3 (note 2)	10 MHz			QPSK	1	0
4 (note 3)	10 MHz			QPSK	1	49
5 (note 2)	10 MHz			QPSK	15	0
6 (note 3)	10 MHz			QPSK	3	47
7 (note 3)	10 MHz			QPSK	50	0
8 (note 1, 3)	10 MHz			16QAM	50	0
<p>Note 1: Applies only for UE-Categories ≥2.</p> <p>Note 2: Applicable only to low range frequency testing.</p> <p>Note 3: Applicable only to high range frequency testing.</p>						

**Editor’s note:** The following lines belong at the end of section 6.2.4.4.1. As new tables are added to this section, these lines should always follow the tables.

1. Connect the SS to the UE to the UE antenna connectors as shown in Figure TS 36.508 [7] Annex A, Figure A.7.
2. The parameter settings for the cell are set up according to TS 36.508 [7] subclause 4.4.3.
3. Downlink signals are initially set up according to Annex C0, C.1 and C.3.0, and uplink signals according to Annex H.1 and H.3.0.
4. The UL Reference Measurement channels are set according to Table 6.6.3.3.4.1-1to Table 6.6.3.3.4.1-12 depending on network signal value.
5. Propagation conditions are set according to Annex B.0.
6. Ensure the UE is in State 3A-RF according to TS 36.508 [7] clause 5.2A.2. Message contents are defined in clause 6.6.3.3.4.3.

#### 6.6.3.3.4.2 Test procedure

1. SS sends uplink scheduling information for each UL HARQ process via PDCCH DCI format 0 for C\_RNTI to schedule the UL RMC according to Table 6.6.3.3.4.1-1 to 6.6.3.3.4.1-14. Since the UE has no payload and no loopback data to send the UE sends uplink MAC padding bits on the UL RMC.
2. Send continuously uplink power control "up" commands in the uplink scheduling information to the UE until the UE transmits at  $P_{UMAX}$  level.
3. Measure the mean power of the UE in the channel bandwidth of the radio access mode according to the test configuration, which shall meet the requirements described in Tables 6.2.4.5-1 to 6.2.4.5-20 as appropriate. The period of the measurement shall be at least one sub-frame (1 ms).
4. Measure the power of the transmitted signal with a measurement filter of bandwidths according to Table 6.6.3.3.5.1-1, 6.6.3.3.5.2-1, 6.6.3.3.5.3-1, 6.6.3.3.5.4-1, 6.6.3.3.5.5-1, 6.6.3.3.5.6-1, 6.6.3.3.5.7-1, 6.6.3.3.5.8-1, 6.6.3.3.5.9-1, 6.6.3.3.5.10-1, 6.6.3.3.5.11-1, 6.6.3.3.5.12-1, 6.6.3.3.5.13-1 and 6.6.3.3.5.14-1 as appropriate. The centre frequency of the filter shall be stepped in contiguous steps according to the same table. For NS\_07 measurements made in a bandwidth of 6.25kHz, measurement parameter settings defined in table 6.6.3.3.4.2-1 shall be used. The measured power shall be verified for each step. The measurement period shall capture the active time slots.

**Table 6.6.3.3.4.2-1: Measurement setup for NS\_07**

	<b>Option 1: Measurement with No RMS VBW available</b>	<b>Option2 Measurement with VBW Filtering on Power scale</b>
VBW	$\geq 62.5$ kHz (10 times or more the RBW)	$\leq 43$ Hz
RBW	$\leq 6.25$ kHz	$\leq 6.25$ kHz
Detector type	Averages signal envelope during each measurement point, such as "RMS detector"	Peak
Averaging mode (Trace averaging)	Power (RMS voltage)	Power (RMS voltage), as controlled by "Average Type"
Average Type (applies to detector)	Power (RMS voltage) (automatically occurs with "RMS detector")	Not applicable
Average Type (applies to VBW filter)	Not applicable	Power (RMS voltage)
Number of averages	30, to reduce variance as required, or use an even longer sweep time	1 or use an even narrower VBW filter, thus a longer sweep time
Sweep time	[Don't specify]	Sweep rate (span divided by sweep time) $\leq 0.8 *RBW * VBW$

#### 6.6.3.3.4.3 Message contents

##### 6.6.3.3.4.3.1 Message contents (network signalled value "NS\_05")

Message contents are according to TS 36.508 [7] subclause 4.6, with the following exceptions:

1. Information element additionalSpectrumEmission is set to NS\_05. This can be set in the *SystemInformationBlockType2* as part of the cell broadcast message. This exception indicates that the UE shall meet the additional spurious emission requirement for a specific deployment scenario.

**Table 6.6.3.3.4.3.1-1: SystemInformationBlockType2 :Additional spurious emissions requirement**

Derivation Path: TS 36.508 [7] clause 4.4.3.3, Table 4.4.3.3-1			
Information Element	Value/remark	Comment	Condition
additionalSpectrumEmission	5 (NS_05)		

#### 6.6.3.3.4.3.2 Message contents (network signalled value "NS\_07")

Message contents are according to TS 36.508 [7] subclause 4.6, with the following exceptions:

1. Information element additionalSpectrumEmission is set to NS\_07. This can be set in the *SystemInformationblockType2* as part of the cell broadcast message. This exception indicates that the UE shall meet the additional spurious emission requirement for a specific deployment scenario.

**Table 6.6.3.3.4.3.2-1: SystemInformationBlockType2 :Additional spurious emissions requirement**

Derivation Path: TS 36.508 [7] clause 4.4.3.3, Table 4.4.3.3-1			
Information Element	Value/remark	Comment	Condition
additionalSpectrumEmission	7 (NS_07)		

#### 6.6.3.3.4.3.3 Message contents (network signalled value "NS\_08")

Message contents are according to TS 36.508 [7] subclause 4.6, with the following exceptions:

1. Information element additionalSpectrumEmission is set to NS\_08. This can be set in the *SystemInformationblockType2* as part of the cell broadcast message. This exception indicates that the UE shall meet the additional spurious emission requirement for a specific deployment scenario.

**Table 6.6.3.3.4.3.3-1: SystemInformationBlockType2 :Additional spurious emissions requirement**

Derivation Path: TS 36.508 [7] clause 4.4.3.3, Table 4.4.3.3-1			
Information Element	Value/remark	Comment	Condition
additionalSpectrumEmission	8 (NS_08)		

#### 6.6.3.3.4.3.4 Message contents (network signalled value "NS\_09")

Message contents are according to TS 36.508 [7] subclause 4.6, with the following exceptions:

1. Information element additionalSpectrumEmission is set to NS\_09. This can be set in the *SystemInformationblockType2* as part of the cell broadcast message. This exception indicates that the UE shall meet the additional spurious emission requirement for a specific deployment scenario.

**Table 6.6.3.3.4.3.4-1: SystemInformationBlockType2 :Additional spurious emissions requirement**

Derivation Path: TS 36.508 [7] clause 4.4.3.3, Table 4.4.3.3-1			
Information Element	Value/remark	Comment	Condition
additionalSpectrumEmission	9 (NS_09)		

#### 6.6.3.3.4.3.5 Message contents exceptions (network signalled value "NS\_12")

1. Information element additionalSpectrumEmission is set to NS\_12. This can be set in the *SystemInformationblockType2* as part of the cell broadcast message. This exception indicates that the UE shall meet the additional spurious emission requirement for a specific deployment scenario.



**Table 6.6.3.3.4.3.5-1: SystemInformationBlockType2 :Additional spurious emissions test requirement for "NS\_12"**

Derivation Path: TS 36.508 [7] clause 4.4.3.3, Table 4.4.3.3-1			
Information Element	Value/remark	Comment	Condition
additionalSpectrumEmission	12 (NS_12)		

6.6.3.3.4.3.6 Message contents exceptions (network signalled value "NS\_13")

1. Information element additionalSpectrumEmission is set to NS\_13. This can be set in the *SystemInformationblockType2* as part of the cell broadcast message. This exception indicates that the UE shall meet the additional spurious emission requirement for a specific deployment scenario.

**Table 6.6.3.3.4.3.6-1: SystemInformationBlockType2 :Additional spurious emissions test requirement for "NS\_13"**

Derivation Path: TS 36.508 [7] clause 4.4.3.3, Table 4.4.3.3-1			
Information Element	Value/remark	Comment	Condition
additionalSpectrumEmission	13 (NS_13)		

6.6.3.3.4.3.7 Message contents exceptions (network signalled value "NS\_14")

1. Information element additionalSpectrumEmission is set to NS\_14. This can be set in the *SystemInformationblockType2* as part of the cell broadcast message. This exception indicates that the UE shall meet the additional spurious emission requirement for a specific deployment scenario.

**Table 6.6.3.3.4.3.7-1: SystemInformationBlockType2 :Additional spurious emissions test requirement for "NS\_14"**

Derivation Path: TS 36.508 [7] clause 4.4.3.3, Table 4.4.3.3-1			
Information Element	Value/remark	Comment	Condition
additionalSpectrumEmission	14 (NS_14)		

6.6.3.3.4.3.8 Message contents exceptions (network signalled value "NS\_15")

1. Information element additionalSpectrumEmission is set to NS\_15. This can be set in the *SystemInformationblockType2* as part of the cell broadcast message. This exception indicates that the UE shall meet the additional spurious emission requirement for a specific deployment scenario.

**Table 6.6.3.3.4.3.8-1: SystemInformationBlockType2 :Additional spurious emissions test requirement for "NS\_15"**

Derivation Path: TS 36.508 [7] clause 4.4.3.3, Table 4.4.3.3-1			
Information Element	Value/remark	Comment	Condition
additionalSpectrumEmission	15 (NS_15)		

6.6.3.3.4.3.9 Message contents exceptions (network signalled value "NS\_16")

1. Information element additionalSpectrumEmission is set to NS\_16. This can be set in the *SystemInformationblockType2* as part of the cell broadcast message. This exception indicates that the UE shall meet the additional spurious emission requirement for a specific deployment scenario.

**Table 6.6.3.3.4.3.9-1: SystemInformationBlockType2 :Additional spurious emissions test requirement for "NS\_16"**

Derivation Path: TS 36.508 [7] clause 4.4.3.3, Table 4.4.3.3-1			
Information Element	Value/remark	Comment	Condition
additionalSpectrumEmission	16 (NS_16)		

## 6.6.3.3.4.3.10 Message contents exceptions (network signalled value "NS\_17")

1. Information element `additionalSpectrumEmission` is set to NS\_17. This can be set in the *SystemInformationBlockType2* as part of the cell broadcast message. This exception indicates that the UE shall meet the additional spurious emission requirement for a specific deployment scenario.

**Table 6.6.3.3.4.3.10-1: SystemInformationBlockType2 :Additional spurious emissions test requirement for "NS\_17"**

Derivation Path: TS 36.508 [7] clause 4.4.3.3, Table 4.4.3.3-1			
Information Element	Value/remark	Comment	Condition
<code>additionalSpectrumEmission</code>	17 (NS_17)		

## 6.6.3.3.4.3.11 Message contents exceptions (network signalled value "NS\_18")

1. Information element `additionalSpectrumEmission` is set to NS\_18. This can be set in the *SystemInformationBlockType2* as part of the cell broadcast message. This exception indicates that the UE shall meet the additional spurious emission requirement for a specific deployment scenario.

**Table 6.6.3.3.4.3.11-1: SystemInformationBlockType2 :Additional spurious emissions test requirement for "NS\_18"**

Derivation Path: TS 36.508 [7] clause 4.4.3.3, Table 4.4.3.3-1			
Information Element	Value/remark	Comment	Condition
<code>additionalSpectrumEmission</code>	18 (NS_18)		

## 6.6.3.3.4.3.12 Message contents exceptions (network signalled value "NS\_19")

1. Information element `additionalSpectrumEmission` is set to NS\_19. This can be set in the *SystemInformationBlockType2* as part of the cell broadcast message. This exception indicates that the UE shall meet the additional spurious emission requirement for a specific deployment scenario.

**Table 6.6.3.3.4.3.12-1: SystemInformationBlockType2 :Additional spurious emissions test requirement for "NS\_19"**

Derivation Path: TS 36.508 [7] clause 4.4.3.3, Table 4.4.3.3-1			
Information Element	Value/remark	Comment	Condition
<code>additionalSpectrumEmission</code>	19 (NS_19)		

## 6.6.3.3.4.3.13 Message contents exceptions (network signalled value "NS\_11")

1. Information element `additionalSpectrumEmission` is set to NS\_11. This can be set in the *SystemInformationBlockType2* as part of the cell broadcast message. This exception indicates that the UE shall meet the additional spurious emission requirement for a specific deployment scenario.

**Table 6.6.3.3.4.3.13-1: SystemInformationBlockType2 :Additional spurious emissions test requirement for "NS\_11"**

Derivation Path: TS 36.508 [7] clause 4.4.3.3, Table 4.4.3.3-1			
Information Element	Value/remark	Comment	Condition
<code>additionalSpectrumEmission</code>	11 (NS_11)		

## 6.6.3.3.4.3.14 Message contents exceptions (network signalled value "NS\_20")

1. Information element `additionalSpectrumEmission` is set to NS\_20. This can be set in the *SystemInformationBlockType2* as part of the cell broadcast message. This exception indicates that the UE shall meet the additional spurious emission requirement for a specific deployment scenario.

**Table 6.6.3.4.3.14-1: SystemInformationBlockType2 :Additional spurious emissions test requirement for "NS\_20"**

Derivation Path: TS 36.508 [7] clause 4.4.3.3, Table 4.4.3.3-1			
Information Element	Value/remark	Comment	Condition
additionalSpectrumEmission	20 (NS_20)		

#### 6.6.3.4.3.15 Message contents exceptions (network signalled value "NS\_21")

1. Information element additionalSpectrumEmission is set to NS\_21. This can be set in the SystemInformationblockType2 as part of the cell broadcast message. This exception indicates that the UE shall meet the additional spurious emission requirement for a specific deployment scenario.

**Table 6.6.3.4.3.15-1: SystemInformationBlockType2 :Additional spurious emissions test requirement for "NS\_21"**

Derivation Path: TS 36.508 [7] clause 4.4.3.3, Table 4.4.3.3-1			
Information Element	Value/remark	Comment	Condition
additionalSpectrumEmission	21 (NS_21)		

#### 6.6.3.3.5 Test requirement

This clause specifies the requirements for the specified E-UTRA band for an additional spectrum emission requirement with protected bands as indicated from table 6.6.3.3.5.1-1 to table 6.6.3.3.5.15-1.

NOTE: For measurement conditions at the edge of each frequency range, the lowest frequency of the measurement position in each frequency range should be set at the lowest boundary of the frequency range plus MBW/2. The highest frequency of the measurement position in each frequency range should be set at the highest boundary of the frequency range minus MBW/2. MBW denotes the measurement bandwidth defined for the protected band.

#### 6.6.3.3.5.1 Test requirement (network signalled value "NS\_05")

When "NS\_05" is indicated in the cell:

- the measured UE mean power in the channel bandwidth, derived in step 3, shall fulfil requirements in Table 6.2.4.5-4 as appropriate,

and

the measured average power of spurious emission, derived in step 2, shall not exceed the described value in Table 6.6.3.3.5.1-1. This requirement also applies for the frequency ranges that are less than  $\Delta f_{\text{OoB}}$  (MHz) in Table 6.6.3.1.3-1 from the edge of the channel bandwidth.

**Table 6.6.3.3.5.1-1: Additional requirements (PHS) test requirements**

Frequency band (MHz)	Channel bandwidth / Spectrum emission limit (dBm)				Measurement bandwidth
	5 MHz	10 MHz	15 MHz	20 MHz	
$1884.5 \leq f \leq 1915.7^{*1}$	-41	-41	-41	-41	300 KHz
Note 1: Applicable when the lower edge of the assigned E-UTRA UL channel bandwidth frequency is larger than or equal to the upper edge of PHS band (1915.7 MHz) + 4 MHz + the Channel BW assigned, where Channel BW is as defined in sub-clause 5.4.2. Additional restrictions apply for operations below this point.					

The requirements in Table 6.6.3.3.5.1-1 apply with the additional restrictions specified in Table 6.6.3.3.5.1-2 when the lower edge of the assigned E-UTRA UL channel bandwidth frequency is less than the upper edge of PHS band (1915.7 MHz) + 4 MHz + the channel BW assigned.

**Table 6.6.3.3.5.1-2: RB restrictions for additional requirement (PHS)**

15 MHz channel bandwidth with $f_c = 1932.5$ MHz			
RB <sub>start</sub>	0-7	8-66	67-74
LCRB	N/A	$\leq \text{MIN}(30, 67 - \text{RB}_{\text{start}})$	N/A
20 MHz channel bandwidth with $f_c = 1930$ MHz			
RB <sub>start</sub>	0-23	24-75	76-99
LCRB	N/A	$\leq \text{MIN}(24, 76 - \text{RB}_{\text{start}})$	N/A

**6.6.3.3.5.2 Test requirement (network signalled value "NS\_07")**

When "NS\_07" is indicated in the cell:

- the measured UE mean power in the channel bandwidth, derived in step 3, shall fulfil requirements in Table 6.2.4.5-7 as appropriate,

and

- the measured average power of spurious emission, derived in step 4, shall not exceed the described value in Table 6.6.3.3.5.2-1. These requirements also apply for the frequency ranges that are less than  $\Delta f_{\text{OoB}}$  (MHz) in Table 6.6.3.1.3-1 from the edge of the channel bandwidth.

**Table 6.6.3.3.5.2-1: Additional requirements (network signalled value "NS\_07")**

Frequency band (MHz)	Channel bandwidth / Spectrum emission limit (dBm)		Measurement bandwidth
	10 MHz		
$769 \leq f \leq 775$	-55.5		6.25 kHz
Note: The emissions measurement shall be sufficiently power averaged to ensure a standard deviation < 0.5 dB			

**6.6.3.3.5.3 Test requirement (network signalled value "NS\_08")**

When "NS\_08" is indicated in the cell:

- the measured UE mean power in the channel bandwidth, derived in step 3, shall fulfil requirements in Table 6.2.4.5-8 as appropriate,

and

the measured average power of spurious emission, derived in step 4, shall not exceed the described value in Table 6.6.3.3.5.3-1. This requirement also applies for the frequency ranges that are less than  $\Delta f_{\text{OoB}}$  (MHz) in Table 6.6.3.1.3-1 from the edge of the channel bandwidth.

**Table 6.6.3.3.5.3-1: Additional requirements (network signalled value "NS\_08")**

Frequency band (MHz)	Channel bandwidth / Spectrum emission limit (dBm)			Measurement bandwidth
	5MHz	10MHz	15MHz	
$860 \leq f \leq 895$	-40	-40	-40	1 MHz

**6.6.3.3.5.4 Test requirement (network signalled value "NS\_09")**

When "NS\_09" is indicated in the cell:

- the measured UE mean power in the channel bandwidth, derived in step 3, shall fulfil requirements in Table 6.2.4.5-9 as appropriate,

and

- the measured average power of spurious emission, derived in step 4, shall not exceed the described value in table 6.6.3.3.5.4-1. This requirement also applies for the frequency ranges that are less than  $\Delta f_{\text{OOB}}$  (MHz) in Table 6.6.3.1.3-1 from the edge of the channel bandwidth.

**Table 6.6.3.3.5.4-1: Additional requirements (network signalled value "NS\_09")**

Frequency band (MHz)	Channel bandwidth / Spectrum emission limit (dBm)			Measurement bandwidth
	5MHz	10MHz	15MHz	
$1475.9 \leq f \leq 1510.9$	-35	-35	-35	1 MHz

NOTE 1: To improve measurement accuracy, A-MPR values for NS\_09 specified in Table 6.2.4.3-1 in sub-clause 6.2.4 are derived based on 100 kHz RBW.

#### 6.6.3.3.5.5 Test requirement (network signalled value "NS\_12")

When "NS 12" is indicated in the cell:

- the measured UE mean power in the channel bandwidth, derived in step 3, shall fulfil requirements in Table 6.2.4.5-12 as appropriate,

and

- the power of any UE emission shall not exceed the levels specified in Table 6.6.3.3.5-1. This requirement also applies for the frequency ranges that are less than  $\Delta f_{\text{OOB}}$  (MHz) in Table 6.6.3.1.3-1 from the edge of the channel bandwidth.

**Table 6.6.3.3.5.5-1: Additional requirements**

Frequency band (MHz)	Channel bandwidth/ Spectrum emission limit (dBm)	Measurement bandwidth
	1.4 MHz, 3 MHz, 5 MHz, 10 MHz, 15 MHz	
$806 \leq f \leq 813.5$	-42	6.25 kHz
NOTE 1: The requirement applies for E-UTRA carriers with lower channel edge at or above 814.2 MHz.		
NOTE 2: The emissions measurement shall be sufficiently power averaged to ensure a standard deviation < 0.5 dB.		

#### 6.6.3.3.5.6 Test requirement (network signalled value "NS\_13")

When "NS 13" is indicated in the cell:

- the measured UE mean power in the channel bandwidth, derived in step 3, shall fulfil requirements in Table 6.2.4.5-13 as appropriate,

and

- the power of any UE emission shall not exceed the levels specified in Table 6.6.3.3.5.6-1. This requirement also applies for the frequency ranges that are less than  $\Delta f_{\text{OOB}}$  (MHz) in Table 6.6.3.1.3-1 from the edge of the channel bandwidth.

**Table 6.6.3.3.5.6-1: Additional requirements**

Frequency band (MHz)	Channel bandwidth/ Spectrum emission limit (dBm)	Measurement bandwidth
	1.4, 3, 5 MHz	
$806 \leq f \leq 816$	-42	6.25 kHz
NOTE 1: The requirement applies for E-UTRA carriers with lower channel edge at or above 819 MHz.		
NOTE 2: The emissions measurement shall be sufficiently power averaged to ensure a standard deviation < 0.5 dB.		

**6.6.3.3.5.7 Test requirement (network signalled value "NS\_14")**

When "NS 14" is indicated in the cell:

- the measured UE mean power in the channel bandwidth, derived in step 3, shall fulfil requirements in Table 6.2.4.5-14 as appropriate,

and

- the power of any UE emission shall not exceed the levels specified in Table 6.6.3.3.5.7-1. This requirement also applies for the frequency ranges that are less than  $\Delta f_{\text{OOB}}$  (MHz) in Table 6.6.3.1.3-1 from the edge of the channel bandwidth.

**Table 6.6.3.3.5.7-1: Additional requirements**

Frequency band (MHz)	Channel bandwidth/ Spectrum emission limit (dBm)	Measurement bandwidth
	10 MHz, 15 MHz	
$806 \leq f \leq 816$	-42	6.25 kHz
NOTE 1: The requirement applies for E-UTRA carriers with lower channel edge at or above 824 MHz.		
NOTE 2: The emissions measurement shall be sufficiently power averaged to ensure a standard deviation < 0.5 dB.		

**6.6.3.3.5.8 Test requirement (network signalled value "NS\_15")**

When "NS 15" is indicated in the cell:

the measured UE mean power in the channel bandwidth, derived in step 3, shall fulfil requirements in Table 6.2.4.5-15 as appropriate,

and

- the power of any UE emission shall not exceed the levels specified in Table 6.6.3.3.5.8-1. This requirement also applies for the frequency ranges that are less than  $\Delta f_{\text{OOB}}$  (MHz) in Table 6.6.3.1.3-1 from the edge of the channel bandwidth.

**Table 6.6.3.3.5.8-1: Additional requirements**

Frequency band (MHz)	Channel bandwidth / Spectrum emission limit (dBm)	Measurement bandwidth	Note
	1.4, 3, 5, 10, 15 MHz		
$851 \leq f \leq 859$	-53	6.25 kHz	

**6.6.3.3.5.9 Test requirement (network signalled value "NS\_16")**

When "NS 16" is indicated in the cell:

the measured UE mean power in the channel bandwidth, derived in step 3, shall fulfil requirements in Table 6.2.4.5-16 as appropriate,

and

- the power of any UE emission shall not exceed the levels specified in Table 6.6.3.3.5.9-1. This requirement also applies for the frequency ranges that are less than  $\Delta f_{\text{OOB}}$  (MHz) in Table 6.6.3.1.3-1 from the edge of the channel bandwidth.

**Table 6.6.3.3.5.9-1: Additional requirements**

Frequency band (MHz)	Channel bandwidth / Spectrum emission limit (dBm)	Measurement bandwidth	Note
	1.4, 3, 5, 10 MHz		
$790 \leq f \leq 803$	-32	1 MHz	

#### 6.6.3.3.5.10 Test requirement (network signalled value "NS\_17")

When "NS 17" is indicated in the cell:

the measured UE mean power in the channel bandwidth, derived in step 3, shall fulfil requirements in Table 6.2.4.5-17 as appropriate,

and

- the power of any UE emission shall not exceed the levels specified in Table 6.6.3.3.5.10-1. This requirement also applies for the frequency ranges that are less than  $\Delta f_{\text{OOB}}$  (MHz) in Table 6.6.3.1.3-1 from the edge of the channel bandwidth.

**Table 6.6.3.3.5.10-1: Additional requirements**

Frequency band (MHz)	Channel bandwidth / Spectrum emission limit (dBm)	Measurement bandwidth	Note
	5, 10 MHz		
$470 \leq f \leq 710$	-26.2	6 MHz	1
Note 1: Applicable when the assigned E-UTRA carrier is confined within 718 MHz and 748 MHz and when the channel bandwidth used is 5 or 10 MHz.			

#### 6.6.3.3.5.11 Test requirement (network signalled value "NS\_18")

When "NS 18" is indicated in the cell:

the measured UE mean power in the channel bandwidth, derived in step 3, shall fulfil requirements in Table 6.2.4.5-18 as appropriate,

and

- the power of any UE emission shall not exceed the levels specified in Table 6.6.3.3.5.11-1. This requirement also applies for the frequency ranges that are less than  $\Delta f_{\text{OOB}}$  (MHz) in Table 6.6.3.1.3-1 from the edge of the channel bandwidth.

**Table 6.6.3.3.5.11-1: Additional requirements**

Frequency band (MHz)	Channel bandwidth / Spectrum emission limit (dBm)	Measurement bandwidth	Note
	5, 10, 15, 20 MHz		
$692 \leq f \leq 698$	-26.2	6 MHz	

## 6.6.3.3.5.12 Test requirement (network signalled value "NS\_19")

When "NS 19" is indicated in the cell:

the measured UE mean power in the channel bandwidth, derived in step 3, shall fulfil requirements in Table 6.2.4.5-19 as appropriate,

and

- the power of any UE emission shall not exceed the levels specified in Table 6.6.3.3.5.12-1. This requirement also applies for the frequency ranges that are less than  $\Delta f_{\text{OOB}}$  (MHz) in Table 6.6.3.1.3-1 from the edge of the channel bandwidth.

**Table 6.6.3.3.5.12-1: Additional requirements**

Frequency band (MHz)	Channel bandwidth / Spectrum emission limit (dBm)	Measurement bandwidth	Note
	3, 5, 10, 15, 20 MHz		
$662 \leq f \leq 694$	-25	8 MHz	

## 6.6.3.3.5.13 Test requirement (network signalled value "NS\_11")

When "NS 11" is indicated in the cell:

the measured UE mean power in the channel bandwidth, derived in step 3, shall fulfil requirements in Table 6.2.4.5-11 as appropriate,

and

- the power of any UE emission shall not exceed the levels specified in Table 6.6.3.3.5.13-1. This requirement also applies for the frequency ranges that are less than  $\Delta f_{\text{OOB}}$  (MHz) in Table 6.6.3.1.3-1 from the edge of the channel bandwidth.

**Table 6.6.3.3.5.13-1: Additional requirements**

Frequency band (MHz)	Channel bandwidth / Spectrum emission limit (dBm)	Measurement bandwidth	Note
	1.4, 3, 5, 10, 15, 20 MHz		
E-UTRA Band 2	-50	1 MHz	
$1998 \leq f \leq 1999$	-21	1 MHz	
$1997 \leq f < 1998$	-27	1 MHz	
$1996 \leq f < 1997$	-32	1 MHz	
$1995 \leq f < 1996$	-37	1 MHz	
$1990 \leq f < 1995$	-40	1 MHz	

## 6.6.3.3.5.14 Test requirement (network signalled value "NS\_20")

When "NS 20" is indicated in the cell:

the measured UE mean power in the channel bandwidth, derived in step 3, shall fulfil requirements in Table 6.2.4.5-20 as appropriate,

and

- the power of any UE emission shall not exceed the levels specified in Table 6.6.3.3.5.14-1. This requirement also applies for the frequency ranges that are less than  $\Delta f_{\text{OOB}}$  (MHz) in Table 6.6.3.1.3-1 from the edge of the channel bandwidth.



Table 6.6.3.3.5.14-1: Additional requirements

Frequency band (MHz)	Channel bandwidth / Spectrum emission limit (dBm)	Measurement bandwidth	Note
	5, 10, 15, 20 MHz		
$1990 \leq f < 1999$	-40	1 MHz	
$1999 \leq f \leq 2000$	-40	Note 1	
Note 1: The measurement bandwidth is 1% of the applicable E-UTRA channel bandwidth (5.4.2.1-1).			

## 6.6.3.3.5.15 Test requirement (network signalled value "NS\_21")

When "NS\_21" is indicated in the cell, the power of any UE emission shall not exceed the levels specified in Table 6.6.3.3.5.15-1. These requirements also apply for the frequency ranges that are less than  $F_{OOB}$  (MHz) in Table 6.6.3.1.3-1 and Table 6.6.3.1A-1 from the edge of the channel bandwidth.

Table 6.6.3.3.5.15-1: Additional requirements

Frequency band (MHz)	Channel bandwidth / Spectrum emission limit (dBm)	Measurement bandwidth
	5, 10 MHz	
$2200 \leq f < 2288$	-40	1 MHz
$2288 \leq f < 2292$	-37	1 MHz
$2292 \leq f < 2296$	-31	1 MHz
$2296 \leq f < 2300$	-25	1 MHz
$2320 \leq f < 2324$	-25	1 MHz
$2324 \leq f < 2328$	-31	1 MHz
$2328 \leq f < 2332$	-37	1 MHz
$2332 \leq f \leq 2395$	-40	1 MHz

## 6.6.3.3A Additional spurious emissions for CA

-

## 6.6.3.3A.1 Additional spurious emissions for CA (intra-band contiguous DL CA and UL CA)

**Editor's note: This clause is incomplete. The following aspects are either missing or not yet determined:**

- **The minimum conformance requirements for CA\_39C are still FFS in core spec.**
- **The test requirements for CA\_39C are still FFS.**

## 6.6.3.3A.1.1 Test purpose

To verify that UE transmitter does not cause unacceptable interference to other channels or other systems in terms of transmitter spurious emissions in intra-band contiguous carrier aggregation under the deployment scenarios where additional requirements are specified.

## 6.6.3.3A.1.2 Test applicability

This test case applies to all types of E-UTRA UE release 10 and forward that support intra-band contiguous DL CA and UL CA.

## 6.6.3.3A.1.3 Minimum conformance requirements

This clause specifies the requirements for the specified E-UTRA band for an additional spectrum emission for CA requirement with protected bands as indicated from Table 6.6.3.3A.1.3.1-1 to Table 6.6.3.3A.1.3.6-1.

NOTE: For measurement conditions at the edge of each frequency range, the lowest frequency of the measurement position in each frequency range should be set at the lowest boundary of the frequency range plus MBW/2. The highest frequency of the measurement position in each frequency range should be set at the highest boundary of the frequency range minus MBW/2. MBW denotes the measurement bandwidth defined for the protected band.

#### 6.6.3.3A.1.3.1 Minimum conformance requirements for CA\_1C (network signalled value "CA\_NS\_01")

When "CA\_NS\_01" is indicated in the cell, the power of any UE emission shall not exceed the levels specified in Table 6.6.3.3A.1.3.1-1. This requirement also applies for the frequency ranges that are less than  $\Delta f_{\text{OOB}}$  (MHz) in Table 6.6.3.1A.3-1 from the edge of the channel bandwidth.

**Table 6.6.3.3A.1.3.1-1: Additional requirements (PHS) for CA**

Protected band	Frequency range (MHz)			Maximum Level (dBm)	MBW (MHz)	Note
E-UTRA band 34	$F_{\text{DL\_low}}$	-	$F_{\text{DL\_high}}$	-50	1	
Frequency range	1884.5	-	1915.7	-41	0.3	1
Note 1: Applicable when the aggregated channel bandwidth is confined within frequency range 1940 – 1980 MHz						

The normative reference for this requirement is TS 36.101[2] subclause 6.6.3.3A.1.

#### 6.6.3.3A.1.3.2 Minimum conformance requirements for CA\_1C (network signalled value "CA\_NS\_02")

When "CA\_NS\_02" is indicated in the cell, the power of any UE emission shall not exceed the levels specified in Table 6.6.3.3A.1.3.2-1. These requirements also apply for the frequency ranges that are less than  $\Delta f_{\text{OOB}}$  (MHz) in Table 6.6.3.1A.3-1 from the edge of the channel bandwidth.

**Table 6.6.3.3A.1.3.2-1: Additional requirements for CA**

Protected band	Frequency range (MHz)			Maximum Level (dBm)	MBW (MHz)
E-UTRA band 34	$F_{\text{DL\_low}}$	-	$F_{\text{DL\_high}}$	-50	1
Frequency range	1900	-	1915	-15.5	5
Frequency range	1915	-	1920	+1.6	5

The normative reference for this requirement is TS 36.101[2] subclause 6.6.3.3A.2.

#### 6.6.3.3A.1.3.3 Minimum requirement for CA\_1C (network signalled value "CA\_NS\_03")

When "CA\_NS\_03" is indicated in the cell, the power of any UE emission shall not exceed the levels specified in Table 6.6.3.3A.1.3.3-1. This requirement also applies for the frequency ranges that are less than  $\Delta f_{\text{OOB}}$  (MHz) in Table 6.6.3.1A.3-1 from the edge of the channel bandwidth.

**Table 6.6.3.3A.1.3.3-1: Additional requirement for CA**

Protected band	Frequency range (MHz)			Maximum Level (dBm)	MBW (MHz)
E-UTRA band 34	$F_{\text{DL\_low}}$	-	$F_{\text{DL\_high}}$	-50	1
Frequency range	1880	-	1895	-40	1
Frequency range	1895	-	1915	-15.5	5
Frequency range	1915	-	1920	+1.6	5

#### 6.6.3.3A.1.3.4 Minimum requirement for CA\_38C (network signalled value "CA\_NS\_05")

When "CA\_NS\_05" is indicated in the cell, the power of any UE emission shall not exceed the levels specified in Table 6.6.3.3A.1.3.4-1. This requirement also applies for the frequency ranges that are less than  $F_{OOB}$  (MHz) in Table 6.6.3.1A.1.3-1 from the edge of the aggregated channel bandwidth.

**Table 6.6.3.3A.1.3.4-1: Additional requirements**

Protected band	Frequency range (MHz)			Maximum Level (dBm)	MBW (MHz)
Frequency range	2620	-	2645	-15.5	5
Frequency range	2645	-	2690	-40	1

#### 6.6.3.3A.1.3.5 Minimum requirement for CA\_7C (network signalled value "CA\_NS\_06")

When "CA\_NS\_06" is indicated in the cell, the power of any UE emission shall not exceed the levels specified in Table 6.6.3.3A.1.3.5-1. This requirement also applies for the frequency ranges that are less than  $F_{OOB}$  (MHz) in Table 6.6.3.1A.3-1 from the edge of the aggregated channel bandwidth.

**Table 6.6.3.3A.1.3.5-1: Additional requirements**

Protected band	Frequency range (MHz)			Maximum Level (dBm)	MBW (MHz)
Frequency range	2570	-	2575	+1.6	5
Frequency range	2575	-	2595	-15.5	5
Frequency range	2595	-	2620	-40	1

#### 6.6.3.3A.1.3.6 Minimum requirement for CA\_39C (network signalled value "CA\_NS\_07")

When "CA\_NS\_07" is indicated in the cell, the power of any UE emission shall not exceed the levels specified in Table 6.6.3.3A.1.3.6-1. This requirement also applies for the frequency ranges that are less than  $F_{OOB}$  (MHz) in Table 6.6.3.1A.1.3-1 from the edge of the aggregated channel bandwidth.

**Table 6.6.3.3A.1.3.6-1: Additional requirements**

Protected band	Frequency range (MHz)			Maximum Level (dBm)	MBW (MHz)
Frequency range	1805	-	1855	[-40]	1
Frequency range	1855	-	1875	[-15.5]	5
Frequency range	1875	-	1880	[-15.5] <sup>1</sup>	5
NOTE 1: This requirement is applicable for carriers with aggregated channel bandwidths confined in 1885-1920 MHz.					

The normative reference for this requirement is TS 36.101[2] subclause 6.6.3.3A.3.

#### 6.6.3.3A.1.4 Test description

##### 6.6.3.3A.1.4.1 Initial conditions

Initial conditions are a set of test configurations the UE needs to be tested in and the steps for the SS to take with the UE to reach the correct measurement state.

The initial test configurations consist of environmental conditions, test frequencies, and CC combinations based on E-UTRA CA configurations specified in table 5.4.2A.1-1. All of these configurations shall be tested with applicable test parameters for each CA Configuration, and are shown in tables' 6.6.3.3A.1.4.1-1 to 6.6.3.3A.1.4.1-3. The details of the uplink reference measurement channels (RMCs) are specified in Annexes A.2. Configurations of PDSCH and PDCCH before measurement are specified in Annex C.2.

**Table 6.6.3.3A.1.4.1-1: Test Configuration Table for CA (network signalled value “CA\_NS\_01”)**

Initial Conditions								
Test Environment as specified in TS 36.508[7] subclause 4.1					NC			
Test Frequencies as specified in TS36.508 [7] subclause 4.3.1 for different CA bandwidth classes, and PCC and SCCs are mapped onto physical frequencies according to Table 6.1-2.					C: Low and High range			
Test CC Combination setting ( $N_{RB\_agg}$ ) as specified in subclause 5.4.2A.1 for the CA Configuration					Lowest $N_{RB\_agg}$ Highest $N_{RB\_agg}$			
Test Parameters for CA Configurations								
ID	CA Configuration / $N_{RB\_agg}$		DL Allocation (PDCCH on PCC)	CC MOD	UL Allocation			
	PCC $N_{RB}$	SCCs $N_{RB}$	PCC & SCC RB allocation		$N_{RB\_alloc}$	PCC & SCC RB allocations ( $L_{CRB}$ @ $RB_{start}$ )		
1	75	75	N/A	QPSK	1	P_1@0	S_0@0	
2	75	75		QPSK	150	P_75@0	S_75@0	
3	75	75		QPSK	45	P_45@7	S_0@0	
4	75	75		QPSK	8	P_0@0	S_8@67	
5	75	75		QPSK	129	P_75@0	S_54@0	
6	75	75		QPSK	2	P_1@0	S_1@74	
7	100	100		QPSK	200	P_100@0	S_100@0	
8	100	100		QPSK	1	P_1@0	S_0@0	
9	100	100		QPSK	175	P_75@25	S_100@0	
10	100	100		QPSK	25	P_0@0	S_25@75	
11	100	100		QPSK	64	P_64@24	S_0@0	
12	100	100		QPSK	2	P_1@0	S_1@99	
Note 1: CA Configuration Test CC Combination settings are checked separately for each CA Configuration which applicable aggregated channel bandwidths are specified in Table 5.4.2A.1-1								

**Table 6.6.3.3A.1.4.1-2: Test Configuration Table for CA (network signalled value "CA\_NS\_02")**

Initial Conditions								
Test Environment as specified in TS 36.508[7] subclause 4.1					NC			
Test Frequencies as specified in TS36.508 [7] subclause 4.3.1 for different CA bandwidth classes, and PCC and SCCs are mapped onto physical frequencies according to Table 6.1-2.					C: Low and High range			
Test CC Combination setting (N <sub>RB_agg</sub> ) as specified in subclause 5.4.2A.1 for the CA Configuration					Lowest N <sub>RB_agg</sub> Highest N <sub>RB_agg</sub>			
Test Parameters for CA Configurations								
ID	CA Configuration / N <sub>RB_agg</sub>		DL Allocation (PDCCH on PCC)	CC MOD	UL Allocation			
	PCC N <sub>RB</sub>	SCCs N <sub>RB</sub>			PCC & SCC RB allocation	N <sub>RB_alloc</sub>	PCC & SCC RB allocations (L <sub>CRB</sub> @ RB <sub>start</sub> )	
1	75	75	N/A	QPSK			1	P_1@0
2	75	75		QPSK	75	P_75@0	S_0@0	
3	75	75		QPSK	129	P_75@0	S_54@0	
4	75	75		QPSK	129	P_54@21	S_75@0	
5	75	75		QPSK	1	P_0@0	S_1@74	
6	75	75		QPSK	1	P_0@0	S_1@54	
7	75	75		QPSK	2	P_1@0	S_1@74	
8	100	100		QPSK	1	P_1@0	S_0@0	
9	100	100		QPSK	1	P_1@21	S_0@0	
10	100	100		QPSK	90	P_90@0	S_0@0	
11	100	100		QPSK	180	P_100@0	S_80@0	
12	100	100		QPSK	1	P_0@0	S_1@99	
13	100	100		QPSK	1	P_0@0	S_1@83	
14	100	100		QPSK	2	P_1@0	S_1@99	

Note 1: CA Configuration Test CC Combination settings are checked separately for each CA Configuration which applicable aggregated channel bandwidths are specified in Table 5.4.2A.1-1

**Table 6.6.3.3A.1.4.1-3: Test Configuration Table for CA (network signalled value "CA\_NS\_03")**

Initial Conditions								
Test Environment as specified in TS 36.508[7] subclause 4.1					NC			
Test Frequencies as specified in TS36.508 [7] subclause 4.3.1 for different CA bandwidth classes, and PCC and SCCs are mapped onto physical frequencies according to Table 6.1-2.					C: Low and High range			
Test CC Combination setting (N <sub>RB_agg</sub> ) as specified in subclause 5.4.2A.1 for the CA Configuration					Lowest N <sub>RB_agg</sub> Highest N <sub>RB_agg</sub>			
Test Parameters for CA Configurations								
ID	CA Configuration / N <sub>RB_agg</sub>		DL Allocation (PDCCH on PCC)	CC MOD	UL Allocation			
	PCC N <sub>RB</sub>	SCCs N <sub>RB</sub>			PCC & SCC RB allocation	N <sub>RB_alloc</sub>	PCC & SCC RB allocations (L <sub>CRB</sub> @ RB <sub>start</sub> )	
1	75	75	N/A	QPSK			1	P_1@0
2	75	75		QPSK	1	P_1@21	S_0@0	
3	75	75		QPSK	75	P_75@0	S_0@0	
4	75	75		QPSK	90	P_75@0	S_15@0	
5	75	75		QPSK	150	P_75@0	S_75@0	
6	75	75		QPSK	1	P_0@0	S_1@74	
7	75	75		QPSK	1	P_0@0	S_1@44	
8	75	75		QPSK	2	P_1@0	S_1@74	
9	100	100		QPSK	1	P_1@0	S_0@0	
10	100	100		QPSK	60	P_60@0	S_0@0	
11	100	100		QPSK	1	P_1@63	S_0@0	
12	100	100		QPSK	90	P_90@0	S_0@0	
13	100	100		QPSK	164	P_100@0	S_64@0	
14	100	100		QPSK	1	P_0@0	S_1@99	

15	100	100		QPSK	1	P_0@0	S_1@70		
16	100	100		QPSK	2	P_1@0	S_1@99		
Note 1: CA Configuration Test CC Combination settings are checked separately for each CA Configuration which applicable aggregated channel bandwidths are specified in Table 5.4.2A.1-1									

**Table 6.6.3.3A.1.4.1-4: Test Configuration Table for CA (network signalled value "CA\_NS\_05")**

Initial Conditions									
Test Environment as specified in TS 36.508[7] subclause 4.1					NC				
Test Frequencies as specified in TS36.508 [7] subclause 4.3.1 for different CA bandwidth classes, and PCC and SCCs are mapped onto physical frequencies according to Table 6.1-2.					C: High range				
Test CC Combination setting ( $N_{RB\_agg}$ ) as specified in subclause 5.4.2A.1 for the CA Configuration					Lowest $N_{RB\_agg}$ Highest $N_{RB\_agg}$				
Test Parameters for CA Configurations									
ID	CA Configuration / $N_{RB\_agg}$		DL Allocation (PDCCH on PCC)	CC MOD	UL Allocation				
	PCC $N_{RB}$	SCCs $N_{RB}$	PCC & SCC RB allocation		$N_{RB\_alloc}$	PCC & SCC RB allocations ( $L_{CRB}$ @ $RB_{start}$ )			
1	75	75	N/A	QPSK	40	P_40@0	S_0@0		
2	75	75		QPSK	80	P_50@25	S_30@0		
3	75	75		QPSK	60	P_10@65	S_50@0		
4	75	75		QPSK	64	P_1@74	S_63@0		
5	75	75		QPSK	90	P_20@55	S_70@0		
6	75	75		QPSK	2	P_1@0	S_1@74		
7	100	100		QPSK	8	P_8@0	S_0@0		
8	100	100		QPSK	40	P_40@0	S_0@0		
9	100	100		QPSK	80	P_50@50	S_30@0		
10	100	100		QPSK	150	P_60@40	S_90@0		
11	100	100		QPSK	2	P_1@0	S_1@99		
Note 1: CA Configuration Test CC Combination settings are checked separately for each CA Configuration which applicable aggregated channel bandwidths are specified in Table 5.4.2A.1-1									

**Table 6.6.3.3A.1.4.1-5: Test Configuration Table (network signalled value "CA\_NS\_06")**

Initial Conditions									
Test Environment as specified in TS 36.508[7] subclause 4.1					NC				
Test Frequencies as specified in TS36.508 [7] subclause 4.3.1 for different CA bandwidth classes, and PCC and SCCs are mapped onto physical frequencies according to Table 6.1-2.					C: Low and High range				
Test CC Combination setting ( $N_{RB\_agg}$ ) as specified in subclause 5.4.2A.1 for the CA Configuration					As in Table 6.2.4A.1.3.6-1				
Test Parameters for CA Configurations									
ID	CA Configuration / $N_{RB\_agg}$		DL Allocation (PDCCH on PCC)	CC MOD	UL Allocation				
	PCC $N_{RB}$	SCCs $N_{RB}$	PCC & SCC RB allocation		$N_{RB\_alloc}$	PCC & SCC RB allocations ( $L_{CRB}$ @ $RB_{start}$ )			

1	75	75	N/A	QPSK	5	P_5@0	S_0@0		
2	75	75		QPSK	45	P_45@0	S_0@0		
3	75	75		QPSK	75	P_60@15	S_15@0		
4	75	75		QPSK	60	P_10@65	S_50@0		
5	75	75		QPSK	90	P_18@57	S_72@0		
6	75	75		QPSK	2	P_1@0	S_1@74		
7	100	100		QPSK	10	P_10@0	S_0@0		
8	100	100		QPSK	30	P_30@0	S_0@0		
9	100	100		QPSK	100	P_75@25	S_25@0		
10	100	100		QPSK	90	P_40@60	S_50@0		
11	100	100		QPSK	100	P_15@85	S_85@0		
12	100	100		QPSK	2	P_1@0	S_1@99		

Note 1: CA Configuration Test CC Combination settings are checked separately for each CA Configuration which applicable aggregated channel bandwidths are specified in Table 5.4.2A.1-1.

**Table 6.6.3.3A.1.4.1-6: Test Configuration Table for CA (network signalled value “CA\_NS\_07”)**

Initial Conditions								
Test Environment as specified in TS 36.508[7] subclause 4.1					NC			
Test Frequencies as specified in TS36.508 [7] subclause 4.3.1 for different CA bandwidth classes, and PCC and SCCs are mapped onto physical frequencies according to Table 6.1-2.					C: Low and High range			
Test CC Combination setting (N <sub>RB_agg</sub> ) as specified in subclause 5.4.2A.1 for the CA Configuration					As in Table 6.2.4A.1.3.7-1			
Test Parameters for CA Configurations								
ID	CA Configuration / N <sub>RB_agg</sub>		DL Allocation (PDCCH on PCC)	CC MOD	UL Allocation			
	PCC N <sub>RB</sub>	SCCs N <sub>RB</sub>	PCC & SCC RB allocation		N <sub>RB_alloc</sub>	PCC & SCC RB allocations (L <sub>CRB</sub> @ RB <sub>start</sub> )		
1	100	25	N/A	QPSK	1	P_1@0	S_0@0	
2	100	25		QPSK	85	P_80@20	S_5@0	
3	100	25		QPSK	65	P_60@40	S_5@0	
4	100	25		QPSK	35	P_30@70	S_5@0	
5	100	25		QPSK	2	P_1@0	S_1@24	
6	100	50		QPSK	1	P_1@1	S_0@0	
7	100	50		QPSK	10	P_10@30	S_0@0	
8	100	50		QPSK	30	P_30@30	S_0@0	
9	100	50		QPSK	60	P_40@60	S_20@0	
10	100	50		QPSK	30	P_10@90	S_20@0	
11	100	50		QPSK	5	P_0@0	S_5@45	
12	100	50		QPSK	2	P_1@0	S_1@49	
13	100	75		QPSK	1	P_1@1	S_0@0	
14	100	75		QPSK	40	P_40@20	S_0@0	
15	100	75		QPSK	85	P_80@20	S_5@0	
16	100	75		QPSK	40	P_0@0	S_40@20	
17	100	75		QPSK	15	P_0@0	S_15@60	
18	100	75		QPSK	2	P_1@0	S_1@74	

Note 1: CA Configuration Test CC Combination settings are checked separately for each CA Configuration which applicable aggregated channel bandwidths are specified in Table 5.4.2A.1-1

1. Connect the SS to the UE to the UE antenna connectors as shown in Figure TS 36.508 [7] Annex A, Figure group A.33 as appropriate.
2. The parameter settings for the cell are set up according to TS 36.508 [7] subclause 4.4.3.
3. Downlink signals for PCC are initially set up according to Annex C.0, C.1 and C.3.0, and uplink signals according to Annex H.1 and H.3.0.
4. The UL Reference Measurement channels are set according to Table 6.6.3.3A.1.4.1-1, Table 6.6.3.3A.1.4.1-2, Table 6.6.3.3A.1.4.1-3, Table 6.6.3.3A.1.4.1-4, Table 6.6.3.3A.1.4.1-5 or Table 6.6.3.3A.1.4.1-6 depending on network signal value.

- 5. Propagation conditions are set according to Annex B.0.
- 6. Ensure the UE is in State 3A-RF according to TS 36.508 [7] clause 5.2A.2. Message contents are defined in clause 6.6.3.3A.1.4.3.

6.6.3.3A.1.4.2 Test procedure

- 1. Configure SCC according to Annex C.0, C.1 and Annex C.3.0 for all downlink physical channels.
- 2. The SS shall configure SCC as per TS 36.508 [7] clause 5.2A.4. Message contents are defined in clause 6.6.2.3A.1.4.3
- 3. SS activates SCC by sending the activation MAC-CE (Refer TS 36.321 [13], clauses 5.13, 6.1.3.8). Wait for at least 2 seconds (Refer TS 36.133, clauses 8.3.3.2).
- 4. SS sends uplink scheduling information for each UL HARQ process via PDCCH DCI format 0 for C\_RNTI to schedule the UL RMC according to Table 6.6.3.3A.1.4.1-1 on both PCC and SCC. Since the UE has no payload and no loopback data to send the UE sends uplink MAC padding bits on the UL RMC.
- 5. Send continuously uplink power control “up” commands in every uplink scheduling information to the UE until the UE transmits at P<sub>UMAX</sub> level.
- 3. Measure the mean power of the UE in the channel bandwidth of the radio access mode according to the test configuration, which shall meet the requirements described in Tables 6.2.4A.1.5-1 to 6.2.4A.1.5-5 as appropriate. The period of the measurement shall be at least one sub-frame (1ms).
- 4. Measure the power of the transmitted signal with a measurement filter of bandwidths according to Table 6.6.3.3A.1.5.1-1, 6.6.3.3A.1.5.2-1, 6.6.3.3A.1.5.3-1, 6.6.3.3A.1.5.4-1, 6.6.3.3A.1.5.5-1 and 6.6.3.3A.1.5.6-1 as appropriate. The centre frequency of the filter shall be stepped in contiguous steps according to the same table. The measured power shall be verified for each step. The measurement period shall capture the active time slots.

6.6.3.3A.1.4.3 Message contents

Message contents are according to TS 36.508 [7] subclause 4.6, with the following exceptions for each network signalled value.

6.6.3.3A.1.4.3.1 Message contents (network signalled value "CA\_NS\_01")

- 1. Information element additionalSpectrumEmissionSCell-r10 is set to CA\_NS\_01. This can be set in the *RadioResourceConfigCommonSCell-r10-DEFAULT* as part of the common RRC messages. This exception indicates that the UE shall meet the additional spurious emission requirement for a specific deployment scenario.

**Table 6.6.3.3A.1.4.3.1-1: RadioResourceConfigCommonSCell-r10-DEFAULT: Additional spectrum emission test requirement for “CA\_NS\_01”**

Derivation Path: TS 36.508 [7] clause 4.6.3, Table 4.6.3-13A			
Information Element	Value/remark	Comment	Condition
additionalSpectrumEmissionSCell-r10	1 (CA_NS_01)		

6.6.3.3A.1.4.3.2 Message contents exceptions (network signalled value "CA\_NS\_02")

- 1. Information element additionalSpectrumEmissionSCell-r10 is set to CA\_NS\_02. This can be set in the *RadioResourceConfigCommonSCell-r10-DEFAULT* as part of the common RRC messages. This exception indicates that the UE shall meet the additional spurious emission requirement for a specific deployment scenario.

**Table 6.6.3.3A.1.4.3.2-1: RadioResourceConfigCommonSCell-r10-DEFAULT: Additional spectrum emission test requirement for “CA\_NS\_02”**

Derivation Path: TS 36.508 [7] clause 4.6.3, Table 4.6.3-13A			
Information Element	Value/remark	Comment	Condition
additionalSpectrumEmissionSCell-r10	2 (CA_NS_02)		



## 6.6.3.3A.1.4.3.3 Message contents exceptions (network signalled value "CA\_NS\_03")

1. Information element `additionalSpectrumEmission` is set to NS\_08. This can be set in the *RadioResourceConfigCommonSCell-r10-DEFAULT* as part of the common RRC messages. This exception indicates that the UE shall meet the additional spurious emission requirement for a specific deployment scenario.

**Table 6.6.3.3A.1.4.3.3-1: *RadioResourceConfigCommonSCell-r10-DEFAULT*: Additional spectrum emission test requirement for "CA\_NS\_03"**

Derivation Path: TS 36.508 [7] clause 4.6.3, Table 4.6.3-13A			
Information Element	Value/remark	Comment	Condition
<code>additionalSpectrumEmissionSCell-r10</code>	3 (CA_NS_03)		

## 6.6.3.3A.1.4.3.4 Message contents exceptions (network signalled value "CA\_NS\_05")

1. Information element `additionalSpectrumEmission` is set to CA\_NS\_05. This can be set in the *RadioResourceConfigCommonSCell-r10-DEFAULT* as part of the common RRC messages. This exception indicates that the UE shall meet the additional spurious emission requirement for a specific deployment scenario.

**Table 6.6.3.3A.1.4.3.4-1: *RadioResourceConfigCommonSCell-r10-DEFAULT*: Additional spectrum emission test requirement for "CA\_NS\_05"**

Derivation Path: TS 36.508 [7] clause 4.6.3, Table 4.6.3-13A			
Information Element	Value/remark	Comment	Condition
<code>additionalSpectrumEmissionSCell-r10</code>	5 (CA_NS_05)		

## 6.6.3.3A.1.4.3.5 Message contents exceptions (network signalled value "CA\_NS\_06")

1. Information element `additionalSpectrumEmission` is set to CA\_NS\_06. This can be set in the *RadioResourceConfigCommonSCell-r10-DEFAULT* as part of the common RRC messages. This exception indicates that the UE shall meet the additional spurious emission requirement for a specific deployment scenario.

**Table 6.6.3.3A.1.4.3.5-1: *RadioResourceConfigCommonSCell-r10-DEFAULT*: Additional spectrum emission test requirement for "CA\_NS\_06"**

Derivation Path: TS 36.508 [7] clause 4.6.3, Table 4.6.3-13A			
Information Element	Value/remark	Comment	Condition
<code>additionalSpectrumEmissionSCell-r10</code>	6 (CA_NS_06)		

## 6.6.3.3A.1.4.3.6 Message contents exceptions (network signalled value "CA\_NS\_07")

1. Information element `additionalSpectrumEmission` is set to CA\_NS\_07. This can be set in the *RadioResourceConfigCommonSCell-r10-DEFAULT* as part of the common RRC messages. This exception indicates that the UE shall meet the additional spurious emission requirement for a specific deployment scenario.

**Table 6.6.3.3A.1.4.3.6-1: *RadioResourceConfigCommonSCell-r10-DEFAULT*: Additional spectrum emission test requirement for "CA\_NS\_07"**

Derivation Path: TS 36.508 [7] clause 4.6.3, Table 4.6.3-13A			
Information Element	Value/remark	Comment	Condition
<code>additionalSpectrumEmissionSCell-r10</code>	7 (CA_NS_07)		

## 6.6.3.3A.1.5 Test requirement

This clause specifies the requirements for the specified E-UTRA band for an additional spectrum emission for CA requirement with protected bands as indicated from table 6.6.3.3A.1.5.1-1 to table 6.6.3.3A.1.5.6-1.

NOTE: For measurement conditions at the edge of each frequency range, the lowest frequency of the measurement position in each frequency range should be set at the lowest boundary of the frequency range plus MBW/2. The highest frequency of the measurement position in each frequency range should be set at the highest boundary of the frequency range minus MBW/2. MBW denotes the measurement bandwidth defined for the protected band.

#### 6.6.3.3A.1.5.1 Test requirement for CA (network signalled value "CA\_NS\_01")

When "CA\_NS\_01" is indicated in the cell:

- the measured UE mean power in the channel bandwidth, derived in step 3, shall fulfil requirements in Table 6.2.4A.1.5-1 as appropriate,

and

the measured average power of spurious emission, derived in step 2, shall not exceed the described value in Table 6.6.3.3A.1.5.1-1. This requirement also applies for the frequency ranges that are less than  $\Delta f_{\text{OOB}}$  (MHz) in Table 6.6.3.1A.1.3-1 from the edge of the channel bandwidth.

**Table 6.6.3.3A.1.5.1-1: Additional requirements (PHS) for CA**

Protected band	Frequency range (MHz)			Maximum Level (dBm)	MBW (MHz)	Note
E-UTRA band 34	$F_{\text{DL\_low}}$	-	$F_{\text{DL\_high}}$	-50	1	
Frequency range	1884.5	-	1915.7	-41	0.3	1
Note 1: Applicable when the aggregated channel bandwidth is confined within frequency range 1940 – 1980 MHz.						

#### 6.6.3.3A.1.5.2 Test requirement for CA (network signalled value "CA\_NS\_02")

When "CA\_NS\_02" is indicated in the cell:

- the measured UE mean power in the channel bandwidth, derived in step 3, shall fulfil requirements in Table 6.2.4A.1.5-2 as appropriate,

and

the measured average power of spurious emission, derived in step 2, shall not exceed the described value in Table 6.6.3.3A.1.5.2-1. This requirement also applies for the frequency ranges that are less than  $\Delta f_{\text{OOB}}$  (MHz) in Table 6.6.3.1A.1.3-1 from the edge of the channel bandwidth.

**Table 6.6.3.3A.1.5.2-1: Additional requirements for CA**

Protected band	Frequency range (MHz)			Maximum Level (dBm)	MBW (MHz)
E-UTRA band 34	$F_{\text{DL\_low}}$	-	$F_{\text{DL\_high}}$	-50	1
Frequency range	1900	-	1915	-15.5	5
Frequency range	1915	-	1920	+1.6	5

#### 6.6.3.3A.1.5.3 Test requirement for CA (network signalled value "CA\_NS\_03")

When "CA\_NS\_03" is indicated in the cell:

- the measured UE mean power in the channel bandwidth, derived in step 3, shall fulfil requirements in Table 6.2.4A.1.5-3 as appropriate,

and

the measured average power of spurious emission, derived in step 2, shall not exceed the described value in Table 6.6.3.3A.1.5.3-1. This requirement also applies for the frequency ranges that are less than  $\Delta f_{\text{OOB}}$  (MHz) in Table 6.6.3.1A.1.3-1 from the edge of the channel bandwidth.

**Table 6.6.3.3A.1.5.3-1: Additional requirement for CA**

Protected band	Frequency range (MHz)			Maximum Level (dBm)	MBW (MHz)
E-UTRA band 34	F <sub>DL_low</sub>	-	F <sub>DL_high</sub>	-50	1
Frequency range	1880	-	1895	-40	1
Frequency range	1895	-	1915	-15.5	5
Frequency range	1915	-	1920	+1.6	5

#### 6.6.3.3A.1.5.4 Test requirement for CA (network signalled value "CA\_NS\_05")

When "CA\_NS\_05" is indicated in the cell:

- the measured UE mean power in the channel bandwidth, derived in step 3, shall fulfil requirements in Table 6.2.4A.1.5-5 as appropriate,

and

the measured average power of spurious emission, derived in step 2, shall not exceed the described value in Table 6.6.3.3A.1.5.4-1. This requirement also applies for the frequency ranges that are less than  $\Delta f_{\text{OoB}}$  (MHz) in Table 6.6.3.1A.1.3-1 from the edge of the channel bandwidth.

**Table 6.6.3.3A.1.5.4-1: Additional requirement for CA**

Protected band	Frequency range (MHz)			Maximum Level (dBm)	MBW (MHz)
Frequency range	2620	-	2645	-15.5	5
Frequency range	2645	-	2690	-40	1

#### 6.6.3.3A.1.5.5 Test requirement for CA (network signalled value "CA\_NS\_06")

When "CA\_NS\_06" is indicated in the cell:

- the measured UE mean power in the channel bandwidth, derived in step 3, shall fulfil requirements in Table 6.2.4A.1.5-6 as appropriate,

and

the measured average power of spurious emission, derived in step 2, shall not exceed the described value in Table 6.6.3.3A.1.5.5-1. This requirement also applies for the frequency ranges that are less than  $\Delta f_{\text{OoB}}$  (MHz) in Table 6.6.3.1A.1.3-1 from the edge of the channel bandwidth.

**Table 6.6.3.3A.1.5.5-1: Additional requirements**

Protected band	Frequency range (MHz)			Maximum Level (dBm)	MBW (MHz)
Frequency range	2570	-	2575	+1.6	5
Frequency range	2575	-	2595	-15.5	5
Frequency range	2595	-	2620	-40	1

#### 6.6.3.3A.1.5.6 Test requirement for CA (network signalled value "CA\_NS\_07")

When "CA\_NS\_07" is indicated in the cell:

- the measured UE mean power in the channel bandwidth, derived in step 3, shall fulfil requirements in Table 6.2.4A.1.5-7 as appropriate,

and

the measured average power of spurious emission, derived in step 2, shall not exceed the described value in Table 6.6.3.3A.1.5.6-1. This requirement also applies for the frequency ranges that are less than  $\Delta f_{\text{OOB}}$  (MHz) in Table 6.6.3.1A.1.3-1 from the edge of the channel bandwidth.

**Table 6.6.3.3A.1.5.6-1: Additional requirement for CA**

Protected band	Frequency range (MHz)			Maximum Level (dBm)	MBW (MHz)
Frequency range	1805	-	1855	[-40]	1
Frequency range	1855	-	1875	[-15.5]	5
Frequency range	1875	-	1880	[-15.5] <sup>1</sup>	5
NOTE 1: This requirement is applicable for carriers with aggregated channel bandwidths confined in 1885-1920 MHz					

## 6.6.3B Spurious emission for UL-MIMO

For UE supporting UL-MIMO, the requirements for Spurious emissions which are caused by unwanted transmitter effects such as harmonics emission, parasitic emissions, intermodulation products and frequency conversion products are specified at each transmit antenna connector.

For UEs with two transmit antenna connectors in closed-loop spatial multiplexing scheme, the requirements in subclause 6.6.3 apply to each transmit antenna connector. The requirements shall be met with the UL-MIMO configurations specified in Table 6.2.2B-1.

For single-antenna port scheme, the general requirements in subclause 6.6.2 apply.

### 6.6.3B.1 Transmitter Spurious emissions for UL-MIMO

#### 6.6.3B.1.1 Test purpose

To verify that UE transmitter with a UL-MIMO does not cause unacceptable interference to other channels or other systems in terms of transmitter spurious emissions.

#### 6.6.3B.1.2 Test applicability

This test case applies to all types of E-UTRA UE release 10 and forward that support UL-MIMO.

#### 6.6.3B.1.3 Minimum conformance requirements

For UE with multiple transmit antenna connectors, the requirements for Spurious emissions which are caused by unwanted transmitter effects such as harmonics emission, parasitic emissions, intermodulation products and frequency conversion products are specified at each transmit antenna connector.

For UEs with two transmit antenna connectors, the requirements in clause 6.6.3 apply to each transmit antenna with the UL-MIMO configurations specified in Table 6.2.2B-1 for closed-loop spatial multiplexing scheme.

The normative reference for this requirement is TS 36.101 [2] clause 6.6.3B.

#### 6.6.3B.1.4 Test description

##### 6.6.3B.1.4.1 Initial conditions

Initial conditions are a set of test configurations the UE needs to be tested in and the steps for the SS to take with the UE to reach the correct measurement state.

The initial test configurations consist of environmental conditions, test frequencies, and channel bandwidths based on E-UTRA bands specified in Table 5.4.2.1-1. All of these configurations shall be tested with applicable test parameters for each channel bandwidth, and are shown in Table 6.6.3B.1.4.1-1. The details of the uplink reference measurement

channels (RMCs) are specified in Annex A.2. Configurations of PDSCH and PDCCH before measurement are specified in Annex C.2.

**Table 6.6.3B.1.4.1-1: Test Configuration Table**

Initial Conditions								
Test Environment (as specified in TS 36.508 [7] clause 4.1)		NC						
Test Frequencies (as specified in TS 36.508 [7] clause 4.3.1)		Low range, Mid range, High range						
Test Channel Bandwidths (as specified in TS 36.508 [7] clause 4.3.1)		Lowest, 5MHz, Highest						
Test Parameters for Channel Bandwidths								
Ch BW	Downlink Configuration			Uplink Configuration				
	Mod'n	RB allocation		Mod'n	RB allocation			
		FDD	TDD		FDD	TDD		
1.4MHz	N/A for Spurious Emissions testing			QPSK	6	6		
1.4MHz				QPSK	1	1		
3MHz				QPSK	15	15		
3MHz				QPSK	1	1		
5MHz				QPSK	25	25		
5MHz				QPSK	1	1		
10MHz				QPSK	50	50		
10MHz				QPSK	1	1		
15MHz				QPSK	75	75		
15MHz				QPSK	1	1		
20MHz				QPSK	100	100		
20MHz				QPSK	1	1		
Note 1: Test Channel Bandwidths are checked separately for each E-UTRA band, which applicable channel bandwidths are specified in Table 5.4.2.1-1.								
Note 2: The 1 RB allocation shall be tested at both RB #0 and RB #max.								

1. Connect the SS to the UE antenna connectors as shown in Figure TS 36.508 [7] Annex A, Figure A.38.
2. The parameter settings for the cell are set up according to TS 36.508 [7] clause 4.4.3.
3. Downlink signals are initially set up according to Annex C0, C.1 and C.3.0, and uplink signals according to Annex H.1 and H.3.0.
4. The UL Reference Measurement channels are set according to Table 6.6.3B.1.4.1-1.
5. Propagation conditions are set according to Annex B.0.
6. Ensure the UE is in State 3A-RF according to TS 36.508 [7] clause 5.2A.2. Message contents are defined in clause 6.6.3B.1.4.3.

#### 6.6.3B.1.4.2 Test procedure

1. SS sends uplink scheduling information for each UL HARQ process via PDCCH DCI format 4 for C\_RNTI to schedule the UL RMC according to Table 6.6.3B.1.4.1-1. Since the UE has no payload data to send, the UE transmits uplink MAC padding bits on the UL RMC.
2. Send continuously uplink power control "up" commands in the uplink scheduling information to the UE until the UE transmits at PUMAX level.
3. Measure the power of the transmitted signal at each UE antenna connector with a measurement filter of bandwidths according to table 6.6.3B.1.5-1. The centre frequency of the filter shall be stepped in contiguous steps according to table 6.6.3B.1.5-1. The measured power shall be verified for each step. The measurement period shall capture the active time slots.

### 6.6.3B.1.4.3 Message contents

Message contents are according to TS 36.508 [7] subclause 4.6.

### 6.6.3B.1.5 Test requirement

The measured average power of spurious emission, derived in step 3, shall not exceed the described value in table 6.6.3B.1.5-1.

The spurious emission limits apply for the frequency ranges that are more than  $\Delta f_{OOB}$  (MHz) from the edge of the channel bandwidth shown in Table 6.6.3.1.3-1.

**Table 6.6.3B.1.5-1: General spurious emissions test requirements**

Frequency Range	Maximum Level	Measurement Bandwidth	Notes
$9 \text{ kHz} \leq f < 150 \text{ kHz}$	-36 dBm	1 kHz	
$150 \text{ kHz} \leq f < 30 \text{ MHz}$	-36 dBm	10 kHz	
$30 \text{ MHz} \leq f < 1000 \text{ MHz}$	-36 dBm	100 kHz	
$1 \text{ GHz} \leq f < 12.75 \text{ GHz}$	-30 dBm	1 MHz	
$12.75 \text{ GHz} \leq f < 5\text{th}$ harmonic of the upper frequency edge of the UL operating band in GHz	-30 dBm	1 MHz	Note 1
Note 1: Applies for Band 22, Band 42 and Band 43.			

NOTE: In order that the measurement of spurious emissions falls within the frequency ranges that are more than  $\Delta f_{OOB}$  (MHz) from the edge of the channel bandwidth, the minimum offset of the measurement frequency from each edge of the channel should be  $\Delta f_{OOB} + MBW/2$ . MBW denotes the measurement bandwidth defined in Table 6.6.3B.1.5-1.

## 6.6.3B.2 Spurious emission band UE co-existence for UL-MIMO

*Editor's note: This test case contains different requirements for different UE releases*

### 6.6.3B.2.1 Test purpose

To verify that UE transmitter with a UL-MIMO does not cause unacceptable interference to co-existing systems for the specified bands which has specific requirements in terms of transmitter spurious emissions.

### 6.6.3B.2.2 Test applicability

This test case applies to all types of E-UTRA UE release 10 and forward that support UL-MIMO.

### 6.6.3B.2.3 Minimum conformance requirements

For UE with multiple transmit antenna connectors, the requirements for Spurious emissions which are caused by unwanted transmitter effects such as harmonics emission, parasitic emissions, intermodulation products and frequency conversion products are specified at each transmit antenna connector.

For UEs with two transmit antenna connectors, the requirements in clause 6.6.3 apply to each transmit antenna with the UL-MIMO configurations specified in Table 6.2.2B-1 for closed-loop spatial multiplexing scheme.

The normative reference for this requirement is TS 36.101 [2] clause 6.6.3B.

This test use minimum requirements from many releases of TS 36.101 [2] due to release independence defined in TS 36.307 [16].

6.6.3B.2.4 Test description

6.6.3B.2.4.1 Initial conditions

Initial conditions are a set of test configurations the UE needs to be tested in and the steps for the SS to take with the UE to reach the correct measurement state.

The initial test configurations consist of environmental conditions, test frequencies, and channel bandwidths based on E-UTRA bands specified in Table 5.4.2.1-1. All of these configurations shall be tested with applicable test parameters for each channel bandwidth, and are shown in Table 6.6.3B.2.4.1-1. The details of the uplink reference measurement channels (RMCs) are specified in Annex A.2. Configurations of PDSCH and PDCCH before measurement are specified in Annex C.2.

**Table 6.6.3B.2.4.1-1: Test Configuration Table**

Initial Conditions								
Test Environment (as specified in TS 36.508 [7] clause 4.1)			NC					
Test Frequencies (as specified in TS 36.508 [7] clause 4.3.1) (Note 3)			Low range, Mid range, High range (Note 3)					
Test Channel Bandwidths (as specified in TS 36.508 [7] clause 4.3.1)			Lowest, 5MHz, Highest					
Test Parameters for Channel Bandwidths								
Ch BW	Downlink Configuration			Uplink Configuration				
	Mod'n	RB allocation		Mod'n	RB allocation			
		FDD	TDD		FDD	TDD		
1.4MHz	N/A for Spurious Emissions testing			QPSK	6	6		
1.4MHz				QPSK	1	1		
3MHz				QPSK	15	15		
3MHz				QPSK	1	1		
5MHz				QPSK	25	25 <sup>b</sup>		
5MHz				QPSK	1	1 <sup>b</sup>		
10MHz				QPSK	50	50		
10MHz				QPSK	1	1		
15MHz				QPSK	75	75		
15MHz				QPSK	1	1		
20MHz				QPSK	100	100		
20MHz				QPSK	1	1		
Note 1: Test Channel Bandwidths are checked separately for each E-UTRA band, which applicable channel bandwidths are specified in Table 5.4.2.1-1. Note 2: The 1 RB allocation shall be tested at both RB #0 and RB #max. Note 3: Do not apply for requirements under Note 13 in Tables 6.6.3.2.3-1B to 6.6.3.2.3-1D . Test frequencies for these requirements are defined in Table 6.6.3B.2.4.1-2. Note 4: Void Note 5: For requirements under note 22 in Table 6.6.3B.2.5-1, the message exception in Table 6.6.3B.2.4.3-1 is used to test with the high channel.								

**Table 6.6.3B.2.4.1-2: Test frequencies for E-UTRA channel bandwidth for operating band 3 with Note 13 (in Tables 6.6.3.2.3-1B to 6.6.3.2.3-1D )**

Bandwidth [MHz]	N <sub>UL</sub>	Frequency of Uplink [MHz]	N <sub>DL</sub>	Frequency of Downlink [MHz]
5	19924	1782.4	1924	1877.4
10	19899	1779.9	1899	1874.9
15	19874	1777.4	1874	1872.4
20	19849	1774.9	1849	1869.9

1. Connect the SS to the UE antenna connectors as shown in Figure TS 36.508 [7] Annex A, Figure A.38.
2. The parameter settings for the cell are set up according to TS 36.508 [7] clause 4.4.3.

3. Downlink signals are initially set up according to Annex C0, C.1 and C.3.0, and uplink signals according to Annex H.1 and H.3.0.
4. The UL Reference Measurement channels are set according to Table 6.6.3B.2.4.1-1.
5. Propagation conditions are set according to Annex B.0.
6. Ensure the UE is in State 3A-RF according to TS 36.508 [7] clause 5.2A.2. Message contents are defined in clause 6.6.3B.2.4.3.

#### 6.6.3B.2.4.2 Test procedure

1. SS sends uplink scheduling information for each UL HARQ process via PDCCH DCI format 4 for C\_RNTI to schedule the UL RMC according to Table 6.6.3B.2.4.1-1. Since the UE has no payload data to send, the UE transmits uplink MAC padding bits on the UL RMC.
2. Send continuously uplink power control "up" commands in the uplink scheduling information to the UE until the UE transmits at  $P_{UMAX}$  level.
3. Measure the power of the transmitted signal at each UE antenna connector with a measurement filter of bandwidths according to table 6.6.3B.2.5-1. For band 14 measurements made in a bandwidth of 6.25kHz, measurement parameter settings defined in table 6.6.3B.2.4.2-1 shall be used. The centre frequency of the filter shall be stepped in contiguous steps according to table 6.6.3B.2.5-1. The measured power shall be verified for each step. The measurement period shall capture the active time slots.

**Table 6.6.3B.2.4.2-1: Measurement setup for band 14**

	<b>Option 1: Measurement with No RMS VBW available</b>	<b>Option2 Measurement with VBW Filtering on Power scale</b>
VBW	$\geq 62.5$ kHz  (10 times or more the RBW)	$\leq 43$ Hz
RBW	$\leq 6.25$ kHz	$\leq 6.25$ kHz
Detector type	Averages signal envelope during each measurement point, such as "RMS detector"	Peak
Averaging mode (Trace averaging)	Power (RMS voltage)	Power (RMS voltage), as controlled by "Average Type"
Average Type (applies to detector)	Power (RMS voltage) (automatically occurs with "RMS detector")	Not applicable
Average Type (applies to VBW filter)	Not applicable	Power (RMS voltage)
Number of averages	30, to reduce variance as required, or use an even longer sweep time	1 or use an even narrower VBW filter, thus a longer sweep time
Sweep time	[Don't specify]	Sweep rate (span divided by sweep time) $\leq 0.8 * RBW * VBW$

#### 6.6.3B.2.4.3 Message contents

Message contents are according to TS 36.508 [7] subclause 4.6 with the following exceptions:

**Table 6.6.3B.2.4.3-1: SystemInformationBlockType1 with Note 22 in table 6.6.3B.2.5-1**

Derivation Path: TS 36.508 [7] clause 4.4.3.2, Table 4.4.3.2-3 SystemInformationBlockType1			
Information Element	Value/remark	Comment	Condition
p-Max	20		



### 6.6.3B.2.5 Test requirement

Test requirements for Spurious Emissions UE Co-existence for UL-MIMO are the same as the minimum requirements and are not repeated in this section.

The measured average power of spurious emission, derived in step 3, shall not exceed the described value in tables 6.6.3.2.3-1B to 6.6.3.2.3-1D according to the following rule:

The requirements for the UE are release specific and can be found in Tables 6.6.3.2.3-1B to 6.6.3.2.3-1D. If the UE support a band, which is not defined in the table corresponding UE's release, the requirements for this band are taken from the table of earliest release where requirements for this band are defined. This has been described in following Table 6.6.3B.2.5-1.

The spurious emission limits apply for the frequency ranges that are more than  $\Delta f_{OOB}$  (MHz) from the edge of the channel bandwidth shown in Table 6.6.3.1.3-1.

**Table 6.6.3B.2.5-1: UE Requirements according to UE E-UTRA release and supported E-UTRA band**

Band	UE Requirements per release				
	Rel-10	Rel-11	Rel-12		
1	Table 6.6.3.2.3-1B	Table 6.6.3.2.3-1C	Table 6.6.3.2.3-1D		
2	Table 6.6.3.2.3-1B	Table 6.6.3.2.3-1C	Table 6.6.3.2.3-1D		
3	Table 6.6.3.2.3-1B	Table 6.6.3.2.3-1C	Table 6.6.3.2.3-1D		
4	Table 6.6.3.2.3-1B	Table 6.6.3.2.3-1C	Table 6.6.3.2.3-1D		
5	Table 6.6.3.2.3-1B	Table 6.6.3.2.3-1C	Table 6.6.3.2.3-1D		
6	Table 6.6.3.2.3-1B	Table 6.6.3.2.3-1C	Table 6.6.3.2.3-1D		
7	Table 6.6.3.2.3-1B	Table 6.6.3.2.3-1C	Table 6.6.3.2.3-1D		
8	Table 6.6.3.2.3-1B	Table 6.6.3.2.3-1C	Table 6.6.3.2.3-1D		
9	Table 6.6.3.2.3-1B	Table 6.6.3.2.3-1C	Table 6.6.3.2.3-1D		
10	Table 6.6.3.2.3-1B	Table 6.6.3.2.3-1C	Table 6.6.3.2.3-1D		
11	Table 6.6.3.2.3-1B	Table 6.6.3.2.3-1C	Table 6.6.3.2.3-1D		
12	Table 6.6.3.2.3-1B	Table 6.6.3.2.3-1C	Table 6.6.3.2.3-1D		
13	Table 6.6.3.2.3-1B	Table 6.6.3.2.3-1C	Table 6.6.3.2.3-1D		
14	Table 6.6.3.2.3-1B	Table 6.6.3.2.3-1C	Table 6.6.3.2.3-1D		
...					
17	Table 6.6.3.2.3-1B	Table 6.6.3.2.3-1C	Table 6.6.3.2.3-1D		
18	Table 6.6.3.2.3-1B	Table 6.6.3.2.3-1C	Table 6.6.3.2.3-1D		
19	Table 6.6.3.2.3-1B	Table 6.6.3.2.3-1C	Table 6.6.3.2.3-1D		
20	Table 6.6.3.2.3-1B	Table 6.6.3.2.3-1C	Table 6.6.3.2.3-1D		
21	Table 6.6.3.2.3-1B	Table 6.6.3.2.3-1C	Table 6.6.3.2.3-1D		
22	Table 6.6.3.2.3-1B	Table 6.6.3.2.3-1C	Table 6.6.3.2.3-1D		

23	Table 6.6.3.2.3- 1B	Table 6.6.3.2.3- 1C	Table 6.6.3.2.3- 1D		
24	Table 6.6.3.2.3- 1B	Table 6.6.3.2.3- 1C	Table 6.6.3.2.3- 1D		
25	Table 6.6.3.2.3- 1B	Table 6.6.3.2.3- 1C	Table 6.6.3.2.3- 1D		
26	Table 6.6.3.2.3- 1C	Table 6.6.3.2.3- 1C	Table 6.6.3.2.3- 1D		
27	Table 6.6.3.2.3- 1C	Table 6.6.3.2.3- 1C	Table 6.6.3.2.3- 1D		
28	Table 6.6.3.2.3- 1C	Table 6.6.3.2.3- 1C	Table 6.6.3.2.3- 1D		
30	Table 6.6.3.2.3- 1D	Table 6.6.3.2.3- 1D	Table 6.6.3.2.3- 1D		
31	Table 6.6.3.2.3- 1D	Table 6.6.3.2.3- 1D	Table 6.6.3.2.3- 1D		
...					
33	Table 6.6.3.2.3- 1B	Table 6.6.3.2.3- 1C	Table 6.6.3.2.3- 1D		
34	Table 6.6.3.2.3- 1B	Table 6.6.3.2.3- 1C	Table 6.6.3.2.3- 1D		
35					
36					
37					
38	Table 6.6.3.2.3- 1B	Table 6.6.3.2.3- 1C	Table 6.6.3.2.3- 1D		
39	Table 6.6.3.2.3- 1B	Table 6.6.3.2.3- 1C	Table 6.6.3.2.3- 1D		
40	Table 6.6.3.2.3- 1B	Table 6.6.3.2.3- 1C	Table 6.6.3.2.3- 1D		
41	Table 6.6.3.2.3- 1B	Table 6.6.3.2.3- 1C	Table 6.6.3.2.3- 1D		
42	Table 6.6.3.2.3- 1B	Table 6.6.3.2.3- 1C	Table 6.6.3.2.3- 1D		
43	Table 6.6.3.2.3- 1B	Table 6.6.3.2.3- 1C	Table 6.6.3.2.3- 1D		
44	Table 6.6.3.2.3- 1C	Table 6.6.3.2.3- 1C	Table 6.6.3.2.3- 1D		

NOTE: The frequency range applicable with network signalled values of NS\_05, NS\_08, and NS\_09 are covered in 6.6.3B.3 Additional Spurious Emissions for UL-MIMO.

### 6.6.3B.3 Additional spurious emissions for UL-MIMO

Editor's note: This clause is incomplete. for Rel-10 as it is also testing Rel-11 minimum requirements.

### 6.6.3B.3.1 Test purpose

To verify that UE transmitter with a UL-MIMO does not cause unacceptable interference to other channels or other systems in terms of transmitter spurious emissions under the deployment scenarios where additional requirements are specified.

### 6.6.3B.3.2 Test applicability

This test case applies to all types of E-UTRA UE release 10 and forward that support UL-MIMO.

### 6.6.3B.3.3 Minimum conformance requirements

For UE with multiple transmit antenna connectors, the requirements for Spurious emissions which are caused by unwanted transmitter effects such as harmonics emission, parasitic emissions, intermodulation products and frequency conversion products are specified at each transmit antenna connector.

For UEs with two transmit antenna connectors, the requirements in clause 6.6.3 apply to each transmit antenna with the UL-MIMO configurations specified in Table 6.2.2B-1 for closed-loop spatial multiplexing scheme.

The normative reference for this requirement is TS 36.101 [2] clause 6.6.3B.

### 6.6.3B.3.4 Test description

#### 6.6.3B.3.4.1 Initial conditions

Initial conditions are a set of test configurations the UE needs to be tested in and the steps for the SS to take with the UE to reach the correct measurement state.

The initial test configurations consist of environmental conditions, test frequencies, and channel bandwidths based on E-UTRA operating bands specified in table 5.4.2.1-1. All of these configurations shall be tested with applicable test parameters for each channel bandwidth, and are shown in tables 6.6.3B.3.4.1-1 through table, 6.6.3B.3.4.1-13. The details of the uplink reference measurement channels (RMCs) are specified in Annexes A.2. Configurations of PDSCH and PDCCH before measurement are specified in Annex C.2.

**Table 6.6.3B.3.4.1-1: Test Configuration Table (network signalled value "NS\_05")**

Initial Conditions						
Test Environment as specified in TS 36.508 [7] clause 4.1			Normal			
Test Frequencies as specified in TS 36.508 [7] clause 4.3.1			Low range, Mid range  In case of Low range: <ul style="list-style-type: none"> <li>- For 5MHz Channel Bandwidth: 1927.2MHz (N<sub>UL</sub> = 18072)</li> <li>- For 10MHz Channel Bandwidth: 1934.7MHz (N<sub>UL</sub> = 18147)</li> <li>- For 15MHz Channel Bandwidth: 1932.5MHz (N<sub>UL</sub> = 18125)</li> <li>- For 20MHz Channel Bandwidth: 1930MHz (N<sub>UL</sub> = 18100)</li> </ul>			
Test Channel Bandwidths as specified in TS 36.508 [7] clause 4.3.1			5MHz, 10MHz, 15MHz, 20MHz			
Test Parameters for Channel Bandwidths						
Ch BW	Downlink Configuration			Uplink Configuration		
	Mod'n	RB allocation		Mod'n	RB allocation	
		FDD	TDD		FDD	TDD
5MHz	N/A for Additional Spurious Emissions testing			QPSK	1	N/A
5MHz				QPSK	25	
10MHz				QPSK	1	
10MHz				QPSK	12	
10MHz				QPSK	48	
10MHz				QPSK	50	
10MHz				16QAM	50 (Note 3)	
15MHz				QPSK	1	
15MHz				QPSK	16	
15MHz				QPSK	30 (Note 4)	
15MHz			QPSK	48 (Note 5)		
15MHz			QPSK	75 (Note 5)		
15MHz			16QAM	75 (Note 3, 5)		
20MHz			QPSK	1		
20MHz			QPSK	18		
20MHz			QPSK	24 (Note 4)		
20MHz			QPSK	48 (Note 5)		
20MHz			QPSK	100 (Note 5)		
20MHz			16QAM	100 (Note 3, 5)		
Note 1: The 1 RB allocation shall be tested at both RB #0 and RB #max except for 15MHz and 20MHz of Low Range. For 15MHz of Low Range, the 1 RB allocation shall be tested at both RB#8 and RB#66. For 20MHz of Low Range, the 1 RB allocation shall be tested at both RB#24 and RB#75. Note 2: The RB <sub>start</sub> of partial RB allocation shall be RB# 0 and RB# (max +1 - RB allocation) of the channel bandwidth except for 15MHz and 20MHz of Low Range. For 15MHz of Low Range, the RB <sub>start</sub> shall be RB#8 and RB# (67 - RB allocation). For 20MHz of Low Range, the RB <sub>start</sub> shall be RB#24 and RB# (76 - RB allocation). Note 3: Applies only for UE-Categories ≥2. Note 4: Required for Low Range only. Note 5: Not available for Low Range.						

**Table 6.6.3B.3.4.1-2: Test Configuration Table (network signalled value "NS\_07")**

Initial Conditions						
Test Environment as specified in TS 36.508 [7] clause 4.1				NC		
Test Frequencies as specified in TS 36.508 [7] clause 4.3.1				Mid range		
Test Channel Bandwidths as specified in TS 36.508 [7] clause 4.3.1				10MHz		
Test Parameters for Channel Bandwidths						
Test Number	Ch BW	Downlink Configuration		Uplink Configuration		
		Mod'n	RB allocation	Mod'n	RB allocation	TDD
1	10MHz	N/A for Additional Spurious Emissions testing.		QPSK	1	0
2	10MHz			QPSK	8	0
3	10MHz			QPSK	6	13
4	10MHz			QPSK	20	13
5	10MHz			QPSK	12	13
6	10MHz			16QAM	36 (Note 1)	13
7	10MHz			QPSK	16	19
8	10MHz			QPSK	12	19
9	10MHz			16QAM	16	19
10	10MHz			QPSK	30	19
11	10MHz			16QAM	30 (Note 1)	19
12	10MHz			QPSK	6	43
13	10MHz			QPSK	2	48
14	10MHz			QPSK	50	0
15	10MHz			QPSK	12	0
16	10MHz			16QAM	50 (Note 1)	0

Note 1: Applies only for UE-Categories  $\geq 2$ .

**Table 6.6.3B.3.4.1-3: Test Configuration Table (network signalled value "NS\_08")**

Initial Conditions						
Test Environment as specified in TS 36.508 [7] clause 4.1				Normal		
Test Frequencies as specified in TS 36.508 [7] clause 4.3.1				High range		
Test Channel Bandwidths as specified in TS 36.508 [7] clause 4.3.1				5MHz, 10MHz, 15MHz		
Test Parameters for Channel Bandwidths						
Ch BW	Downlink Configuration			Uplink Configuration		
	Mod'n	RB allocation		Mod'n	RB allocation	
		FDD	TDD		FDD	TDD
5MHz	N/A for Additional Spurious Emissions testing			QPSK	1	N/A
5MHz				QPSK	8	
5MHz				QPSK	25	
10MHz				QPSK	1	
10MHz				QPSK	12	
10MHz				QPSK	40	
10MHz				QPSK	50	
10MHz				16QAM	50 (Note 3)	
15MHz				QPSK	1	
15MHz				QPSK	16	
15MHz				QPSK	40	
15MHz				QPSK	75	
15MHz				16QAM	75 (Note 3)	
Note 1: The 1 RB allocation shall be tested at both RB #0 and RB #max. Note 2: The RBstart of partial RB allocation shall be RB#0 and RB# (max + 1 - RB allocation) of the channel bandwidth. Note 3: Applies only for UE-Categories $\geq 2$ .						

**Table 6.6.3B.3.4.1-4: Test Configuration Table (network signalled value "NS\_09")**

Initial Conditions						
Test Environment as specified in TS 36.508 [7] clause 4.1				Normal		
Test Frequencies as specified in TS 36.508 [7] clause 4.3.1				High range		
Test Channel Bandwidths as specified in TS 36.508 [7] clause 4.3.1				5MHz, 10MHz, 15MHz		
Test Parameters for Channel Bandwidths						
Ch BW	Downlink Configuration			Uplink Configuration		
	Mod'n	RB allocation		Mod'n	RB allocation	
		FDD	TDD		FDD	TDD
5MHz	N/A for Additional Spurious Emissions testing			QPSK	1	N/A
5MHz				QPSK	8	
5MHz				QPSK	25	
10MHz				QPSK	1	
10MHz				QPSK	12	
10MHz				QPSK	40	
10MHz				QPSK	50	
10MHz				16QAM	50 (Note 3)	
15MHz				QPSK	1	
15MHz				QPSK	16	
15MHz				QPSK	40	
15MHz				QPSK	54	
15MHz				QPSK	75	
15MHz				16QAM	75 (Note 3)	
<p>Note 1: The 1 RB allocation shall be tested at both RB #0 and RB #max.</p> <p>Note 2: The RBstart of partial RB allocation shall be RB#0 and RB# (max + 1 - RB allocation) of the channel bandwidth.</p> <p>Note 3: Applies only for UE-Categories <math>\geq 2</math>.</p>						



**Table 6.6.3B.3.4.1-5: Test Configuration Table (network signalled value "NS\_12")**

Initial Conditions						
Test Environment (as specified in TS 36.508 [7] clause 4.1)			NC			
Test Frequencies (as specified in TS 36.508 [7] clause 4.3.1)			For 1.4 MHz Channel Bandwidth: UL 814.9 MHz (NUL = 26699)  For 3 MHz Channel Bandwidth: UL 815.7 MHz (NUL = 26707)  For 5 MHz Channel Bandwidth: UL 816.7 MHz (NUL = 26717)  For 10 MHz Channel Bandwidth: UL 819.2 MHz (NUL = 26742)  For 15 MHz Channel Bandwidth: UL 821.7 MHz (NUL = 26767)			
Test Channel Bandwidths (as specified in TS 36.508 [7] clause 4.3.1)			1.4 MHz, 3 MHz, 5 MHz, 10 MHz and 15 MHz			
Test Parameters for Channel Bandwidths						
Test Number	Ch BW	Downlink Configuration		Uplink Configuration		
		Mod'n	RB allocation	Mod'n	RB allocation FDD	RB <sub>start</sub> FDD
1	1.4 MHz	N/A for Additional Spurious Emissions testing		QPSK	1	0
2	1.4 MHz			QPSK	6	0
3	1.4 MHz			QPSK	1	1
4	1.4 MHz			QPSK	5	1
5	1.4 MHz			16QAM	6	0
6 (Note 1)	3 MHz			QPSK	4	0
7 (Note 1)	3 MHz			QPSK	10	0
8	3 MHz			QPSK	4	4
9	3 MHz			QPSK	10	4
10 (Note 1)	3 MHz			16QAM	15	0
11	5 MHz			QPSK	8	0
12	5 MHz			QPSK	15	0
13	5 MHz			QPSK	8	7
14 (Note 1)	5 MHz			QPSK	15	7
15	5 MHz			16QAM	25	0
16 (Note 2)	10 MHz	QPSK	18	0		
17 (Note 2)	10 MHz	QPSK	18	16		
18 (Note 2)	10 MHz	16QAM	50	0		
19 (Note 2)	15 MHz	QPSK	30	0		
20 (Note 2)	15 MHz	QPSK	30	31		
21 (Note 2)	15 MHz	16QAM	75	0		
Note 1: Only for UEs of Rel-11 and earlier						
Note 2: Only for UEs of Rel-12 and later						

**Table 6.6.3B.3.4.1-6: Test Configuration Table (network signalled value "NS\_13")**

Initial Conditions						
Test Environment (as specified in TS 36.508 [7] clause 4.1)			NC			
Test Frequencies (as specified in TS 36.508 [7] clause 4.3.1)			For 1.4 MHz Channel Bandwidth: UL 819.7 MHz (NUL = 26747)  For 3 MHz Channel Bandwidth: UL 820.5 MHz (NUL = 26755)  For 5 MHz Channel Bandwidth: UL 821.5 MHz (NUL = 26765)			
Test Channel Bandwidths (as specified in TS 36.508 [7] clause 4.3.1)			1.4 MHz, 3MHz and 5 MHz			
Test Parameters for Channel Bandwidths						
Test Number	Ch BW	Downlink Configuration		Uplink Configuration		
		Mod'n	RB allocation	Mod'n	RB allocation FDD	RB <sub>start</sub> FDD
1 (Note 1)	1.4 MHz	N/A for Additional Spurious Emissions testing		QPSK	6	0
2 (Note 1)	3 MHz			QPSK	15	0
1	5 MHz			QPSK	1	0
2	5 MHz			QPSK	25	0
3	5 MHz			QPSK	15	0
4	5 MHz			QPSK	15	7
5	5 MHz			16QAM	25	0
Note 1: Only for UEs of Rel-12 and later						

**Table 6.6.3B.3.4.1-7: Test Configuration Table (network signalled value "NS\_14")**

Initial Conditions						
Test Environment (as specified in TS 36.508 [7] clause 4.1)			NC			
Test Frequencies (as specified in TS 36.508 [7] clause 4.3.1)			For 10 MHz Channel Bandwidth: UL 829 MHz (NUL = 26840)  For 15 MHz Channel Bandwidth: Mid range			
Test Channel Bandwidths (as specified in TS 36.508 [7] clause 4.3.1)			10 MHz, 15 MHz			
Test Parameters for Channel Bandwidths						
Test Number	Ch BW	Downlink Configuration		Uplink Configuration		
		Mod'n	RB allocation	Mod'n	RB allocation FDD	RB <sub>start</sub> FDD
1	10 MHz	N/A for Additional Spurious Emissions testing		QPSK	1	0
2	10 MHz			QPSK	25	0
3	10 MHz			QPSK	50	0
4	10 MHz			QPSK	25	1
5 (Note 1)	10 MHz			16QAM	50	0
6	15 MHz			QPSK	8	0
7	15 MHz			QPSK	25	0
8	15 MHz			QPSK	75	0
9	15 MHz			QPSK	50	15
10 (Note 1)	15 MHz			16QAM	75	0
Note 1: Applies only for UE-Categories ≥2.						

**Table 6.6.3B.3.4.1-8: Test Configuration Table (network signalled value "NS\_15")**

Initial Conditions						
Test Environment (as specified in TS 36.508 [7] subclause 4.1)		NC				
Test Frequencies (as specified in TS36.508 [7] subclause 4.3.1)		For 1.4 MHz Channel Bandwidth: High range For 3 MHz Channel Bandwidth: 843.5 MHz (N <sub>UL</sub> = 26985) or High range For 5 MHz Channel Bandwidth: 842.5 MHz (N <sub>UL</sub> = 26975) or High range  For 10 MHz Channel Bandwidth: 840 MHz (NUL = 26950) or High range  For 15 MHz Channel Bandwidth: 837.5 MHz (NUL = 26925) or High range				
Test Channel Bandwidths (as specified in TS 36.508 [7] subclause 4.3.1)		1.4 MHz, 3 MHz, 5 MHz, 10 MHz, 15 MHz				
Test Parameters for Channel Bandwidths						
Configuration ID	Ch BW	Downlink Configuration		Uplink Configuration		
		Mod'n	RB allocation	Mod'n	RB allocation FDD	RBstart FDD
1 (note 3)	1.4 MHz	N/A for A-MPR testing.		QPSK	4	0
2 (note 3)	1.4 MHz			16QAM	6	0
3 (note 3)	3 MHz			QPSK	6	7
4 (note 3)	3 MHz			QPSK	12	1
5 (note 3)	3 MHz			16QAM	15	0
6 (note 2)	3 MHz			QPSK	15	0
7 (note 3)	5 MHz			QPSK	6	14
8 (note 3)	5 MHz			QPSK	20	0
9 (note 3)	5 MHz			16QAM	25	0
10 (note 2)	5 MHz			QPSK	16	9
11 (note 2)	5 MHz			QPSK	25	0
12 (note 3)	10 MHz			QPSK	1	49
13 (note 3)	10 MHz			QPSK	1	0
14 (note 3)	10 MHz			QPSK	3	0
15 (note 3)	10 MHz			QPSK	20	3
16 (note 3)	10 MHz			QPSK	36	1
17 (note 3)	10 MHz			QPSK	50	0
18 (note 3)	10 MHz			16QAM	50	0
19 (note 2)	10 MHz			QPSK	20	25
20 (note 2)	10 MHz			QPSK	45	0
21 (note 3)	15 MHz			QPSK	18	36
22 (note 3)	15 MHz			QPSK	25	1
23 (note 3)	15 MHz			QPSK	54	0
24 (note 3)	15 MHz			16QAM	75	0
25 (note 2)	15 MHz			QPSK	18	44

26 (note 2)	15 MHz		QPSK	60	2
Note 1: Applies only for UE-Categories $\geq 2$ .					
Note 2: Applicable only test frequency < high range					
Note 3: Applicable only to high range frequency testing					

**Table 6.6.3B.3.4.1-9: Test Configuration Table (network signalled value "NS\_16")**

Initial Conditions						
Test Environment (as specified in TS 36.508 [7] subclause 4.1)				NC		
Test Frequencies (as specified in TS36.508 [7] subclause 4.3.1)				For 1.4 MHz Channel Bandwidth: Low range  For 3 MHz Channel Bandwidth: Low range, 810 MHz (N <sub>UL</sub> = 27070)  For 5 MHz Channel Bandwidth: Low range, 811 MHz (N <sub>UL</sub> = 27080) , 814.5 MHz (N <sub>UL</sub> = 27115)  For 10 MHz Channel Bandwidth: Low range, 813.5 MHz (N <sub>UL</sub> = 27105), 817 MHz (N <sub>UL</sub> = 27140)		
Test Channel Bandwidths (as specified in TS 36.508 [7] subclause 4.3.1)				1.4 MHz, 3 MHz, 5 MHz, 10 MHz		
Test Parameters for Channel Bandwidths						
Configuration ID	Ch BW	Downlink Configuration		Uplink Configuration		
		Mod'n	RB allocation	Mod'n	RB allocation FDD	RBstart FDD
1	1.4 MHz	N/A for Additional Spurious Emissions A-MPR testing.		QPSK	1	0
2	1.4 MHz			QPSK	6	0
3 (Note 1)	1.4 MHz			16QAM	6	0
4	3 MHz			QPSK	1	0
5	3 MHz			QPSK	12	1
6	3 MHz			QPSK	15	0
7 (Note 1)	3 MHz			16QAM	15	0
8	5 MHz			QPSK	1	0
9	5 MHz			QPSK	12	2
10	5 MHz			QPSK	18	2
11	5 MHz			QPSK	20	0
12	5 MHz			QPSK	20	2
13	5 MHz			QPSK	25	0
14 (Note 1)	5 MHz			16QAM	25	0
15	10 MHz			QPSK	1	0
16 (Note 2)	10 MHz			QPSK	1	10

17 (Note 2)	10 MHz	QPSK	20	0
18 (Note 2)	10 MHz	QPSK	27	15
19 (Note 2)	10 MHz	QPSK	32	15
20	10 MHz	QPSK	32	0
21	10 MHz	QPSK	50	0
22 (Note 1)	10 MHz	16QAM	50	0
23 (Note 3)	10 MHz	QPSK	40	0
24 Note 3)	10 MHz	QPSK	40	1
Note 1: Applies only for UE-Categories $\geq 2$ . Note 2: Applies only for 10 MHz channel for Low Range, and 813.5 MHz Note 3: Applies only for 10 MHz channel for 817 MHz range				

**Table 6.6.3B.3.4.1-10: Test Configuration Table (network signalled value "NS\_17")**

Initial Conditions					
Test Environment (as specified in TS 36.508[7] subclause 4.1)			Normal		
Test Frequencies (as specified in TS 36.508 [7] subclause 4.3.1)			For 5 MHz Channel Bandwidth: 720.5 MHz ( $N_{UL} = 27385$ )  For 10 MHz Channel Bandwidth: 723 MHz ( $N_{UL} = 27410$ )		
Test Channel Bandwidths (as specified in TS 36.508 [7] subclause 4.3.1)			5MHz, 10MHz		
Test Parameters for Channel Bandwidths					
Configuration ID	Ch BW	Downlink Configuration		Uplink Configuration	
		Mod'n	RB allocation FDD	Mod'n	RB allocation FDD
1	5MHz	N/A for Additional Spurious Emissions testing		QPSK	1
2	5MHz			QPSK	8
3	5MHz			QPSK	25
4	5MHz			16QAM	25 (Note 3)
5	10MHz			QPSK	1
6	10MHz			QPSK	12
7	10MHz			QPSK	50
8	10MHz			16QAM	50 (Note 3)
Note 1: The 1 RB allocation shall be tested at both RB #0 and RB #max. Note 2: The RBstart of partial RB allocation shall be RB# 0 and RB# (max +1 - RB allocation) of the channel bandwidth. Note 3: Applies only for UE-Categories $\geq 2$ .					

**Table 6.6.3B.3.4.1-11: Test Configuration Table (network signalled value "NS\_18")**

Initial Conditions					
Test Environment (as specified in TS 36.508[7] subclause 4.1)				Normal	
Test Frequencies (as specified in TS36.508 [7] subclause 4.3.1)				Low range	
Test Channel Bandwidths (as specified in TS 36.508 [7] subclause 4.3.1)				5MHz, 10MHz, 15MHz, 20MHz	
Test Parameters for Channel Bandwidths					
Configuration ID	Ch BW	Downlink Configuration		Uplink Configuration	
		Mod'n	RB allocation FDD	Mod'n	RB allocation FDD
1	5MHz	N/A for Additional Spurious Emissions testing		QPSK	1
2	5MHz			QPSK	8
3	5MHz			QPSK	25
4	5MHz			16QAM	25 (Note 3)
5	10MHz			QPSK	1
6	10MHz			QPSK	12
7	10MHz			QPSK	50
8	10MHz			16QAM	50 (Note 3)
9	15MHz			QPSK	1
10	15MHz			QPSK	16
11	15MHz			QPSK	75
12	15MHz			16QAM	75 (Note 3)
13	20MHz			QPSK	1
14	20MHz			QPSK	18
15	20MHz			QPSK	100
16	20MHz			16QAM	100 (Note 3)

Note 1: The 1 RB allocation shall be tested at both RB #0 and RB #max.  
 Note 2: The RBstart of partial RB allocation shall be RB# 0 and RB# (max +1 - RB allocation) of the channel bandwidth.  
 Note 3: Applies only for UE-Categories ≥2.

**Table 6.6.3B.3.4.1-12: Test Configuration Table (network signalled value "NS\_19")**

FFS

**Table 6.6.3B.3.4.1-13: Test Configuration Table (network signalled value "NS\_21")**

Initial Conditions						
Test Environment (as specified in TS 36.508 [7] subclause 4.1)				NC		
Test Frequencies (as specified in TS36.508 [7] subclause 4.3.1)				Low range or High range		
Test Channel Bandwidths (as specified in TS 36.508 [7] subclause 4.3.1)				5 MHz, 10 MHz		
Test Parameters for Channel Bandwidths						
Configuration ID	Ch BW	Downlink Configuration		Uplink Configuration		
		Mod'n	RB allocation	Mod'n	RB allocation FDD	RBstart FDD
1 (note 2)	5 MHz			QPSK	1	0
2 (note 2)	5 MHz			QPSK	25	0
3 (note 2)	10 MHz			QPSK	1	0
4 (note 3)	10 MHz			QPSK	1	49
5 (note 2)	10 MHz			QPSK	15	0
6 (note 3)	10 MHz			QPSK	3	47
7 (note 3)	10 MHz			QPSK	50	0
8 (note 1, 3)	10 MHz			16QAM	50	0
Note 1: Applies only for UE-Categories ≥2. Note 2: Applicable only to low range frequency testing. Note 3: Applicable only to high range frequency testing.						

**Editor's note:** The following lines belong at the end of section 6.2.4.4.1. As new tables are added to this section, these lines should always follow the tables.

1. Connect the SS to the UE antenna connectors as shown in Figure TS 36.508 [7] Annex A, Figure A.38.
2. The parameter settings for the cell are set up according to TS 36.508 [7] clause 4.4.3.
3. Downlink signals are initially set up according to Annex C0, C.1 and C.3.0, and uplink signals according to Annex H.1 and H.3.0.
4. The UL Reference Measurement channels are set according to Tables 6.6.3B.3.4.1-1 through Table, 6.6.3B.3.4.1-13 depending on network signal value.
5. Propagation conditions are set according to Annex B.0.
6. Ensure the UE is in State 3A-RF according to TS 36.508 [7] clause 5.2A.2. Message contents are defined in clause 6.6.3B.3.4.3.

**6.6.3B.3.4.2 Test procedure**

1. SS sends uplink scheduling information for each UL HARQ process via PDCCH DCI format 4 for C\_RNTI to schedule the UL RMC according to Tables 6.6.3B.3.4.1-1 through table, 6.6.3B.3.4.1-13. Since the UE has no payload and no loopback data to send the UE sends uplink MAC padding bits on the UL RMC.
2. Send continuously uplink power control "up" commands in the uplink scheduling information to the UE until the UE transmits at P<sub>UMAX</sub> level.



3. Measure the mean power of the UE in the channel bandwidth of the radio access mode according to the test configuration, which shall meet the requirements described in Tables 6.2.4B.5-1 to 6.2.4B.5 9 as appropriate. The period of the measurement shall be at least one sub-frame (1ms).

4. Measure the power of the transmitted signal at each UE antenna connector with a measurement filter of bandwidths according to Tables 6.6.3B.3.5.1-1 through table, 6.6.3B.3.5.1-8 as appropriate. The centre frequency of the filter shall be stepped in contiguous steps according to the same table. For NS\_07 measurements made in a bandwidth of 6.25kHz, measurement parameter settings defined in table 6.6.3B.3.4.2-1 shall be used. The measured power shall be verified for each step. The measurement period shall capture the active time slots.

**Table 6.6.3B.3.4.2-1: Measurement setup for NS\_07**

	<b>Option 1: Measurement with No RMS VBW available</b>	<b>Option 2: Measurement with VBW Filtering on Power scale</b>
VBW	>=62.5 kHz  (10 times or more the RBW)	<=43Hz
RBW	<=6.25kHz	<=6.25kHz
Detector type	Averages signal envelope during each measurement point, such as "RMS detector"	Peak
Averaging mode (Trace averaging)	Power (RMS voltage)	Power (RMS voltage), as controlled by "Average Type"
Average Type (applies to detector)	Power (RMS voltage) (automatically occurs with "RMS detector")	Not applicable
Average Type (applies to VBW filter)	Not applicable	Power (RMS voltage)
Number of averages	30, to reduce variance as required, or use an even longer sweep time	1 or use an even narrower VBW filter, thus a longer sweep time
Sweep time	[Don't specify]	Sweep rate (span divided by sweep time) <= 0.8 * RBW*VBW

6.6.3B.3.4.3 Message contents

6.6.3B.3.4.3.1 Message contents (network signalled value "NS\_05")

Message contents are according to TS 36.508 [7] subclause 4.6, with the following exceptions:

1. Information element `additionalSpectrumEmission` is set to NS\_05. This can be set in the `SystemInformationBlockType2` as part of the cell broadcast message. This exception indicates that the UE shall meet the additional spurious emission requirement for a specific deployment scenario.

**Table 6.6.3B.3.4.3.1-1: SystemInformationBlockType2 :Additional spurious emissions requirement**

Derivation Path: TS 36.508 [7] clause 4.4.3.3, Table 4.4.3.3-1			
Information Element	Value/remark	Comment	Condition
<code>additionalSpectrumEmission</code>	5 (NS_05)		

6.6.3B.3.4.3.2 Message contents (network signalled value "NS\_07")

Message contents are according to TS 36.508 [7] subclause 4.6, with the following exceptions:

1. Information element `additionalSpectrumEmission` is set to NS\_07. This can be set in the `SystemInformationBlockType2` as part of the cell broadcast message. This exception indicates that the UE shall meet the additional spurious emission requirement for a specific deployment scenario.

**Table 6.6.3B.3.4.3.2-1: SystemInformationBlockType2 :Additional spurious emissions requirement**

Derivation Path: TS 36.508 [7] clause 4.4.3.3, Table 4.4.3.3-1			
Information Element	Value/remark	Comment	Condition
additionalSpectrumEmission	7 (NS_07)		

#### 6.6.3B.3.4.3.3 Message contents (network signalled value "NS\_08")

Message contents are according to TS 36.508 [7] subclause 4.6, with the following exceptions:

1. Information element additionalSpectrumEmission is set to NS\_08. This can be set in the *SystemInformationblockType2* as part of the cell broadcast message. This exception indicates that the UE shall meet the additional spurious emission requirement for a specific deployment scenario.

**Table 6.6.3B.3.4.3.3-1: SystemInformationBlockType2 :Additional spurious emissions requirement**

Derivation Path: TS 36.508 [7] clause 4.4.3.3, Table 4.4.3.3-1			
Information Element	Value/remark	Comment	Condition
additionalSpectrumEmission	8 (NS_08)		

#### 6.6.3B.3.4.3.4 Message contents (network signalled value "NS\_09")

Message contents are according to TS 36.508 [7] subclause 4.6, with the following exceptions:

1. Information element additionalSpectrumEmission is set to NS\_09. This can be set in the *SystemInformationblockType2* as part of the cell broadcast message. This exception indicates that the UE shall meet the additional spurious emission requirement for a specific deployment scenario.

**Table 6.6.3B.3.4.3.4-1: SystemInformationBlockType2 :Additional spurious emissions requirement**

Derivation Path: TS 36.508 [7] clause 4.4.3.3, Table 4.4.3.3-1			
Information Element	Value/remark	Comment	Condition
additionalSpectrumEmission	9 (NS_09)		

#### 6.6.3B.3.4.3.5 Message contents exceptions (network signalled value "NS\_12")

1. Information element additionalSpectrumEmission is set to NS\_12. This can be set in the *SystemInformationblockType2* as part of the cell broadcast message. This exception indicates that the UE shall meet the additional spurious emission requirement for a specific deployment scenario.

**Table 6.6.3B.3.4.3.5-1: SystemInformationBlockType2 :Additional spurious emissions test requirement for "NS\_12"**

Derivation Path: TS 36.508 [7] clause 4.4.3.3, Table 4.4.3.3-1			
Information Element	Value/remark	Comment	Condition
additionalSpectrumEmission	12 (NS_12)		

#### 6.6.3B.3.4.3.6 Message contents exceptions (network signalled value "NS\_13")

1. Information element additionalSpectrumEmission is set to NS\_13. This can be set in the *SystemInformationblockType2* as part of the cell broadcast message. This exception indicates that the UE shall meet the additional spurious emission requirement for a specific deployment scenario.

**Table 6.6.3B.3.4.3.6-1: SystemInformationBlockType2 :Additional spurious emissions test requirement for "NS\_13"**

Derivation Path: TS 36.508 [7] clause 4.4.3.3, Table 4.4.3.3-1			
Information Element	Value/remark	Comment	Condition
additionalSpectrumEmission	13 (NS_13)		

#### 6.6.3B.3.4.3.7 Message contents exceptions (network signalled value "NS\_14")

1. Information element additionalSpectrumEmission is set to NS\_14. This can be set in the *SystemInformationblockType2* as part of the cell broadcast message. This exception indicates that the UE shall meet the additional spurious emission requirement for a specific deployment scenario.

**Table 6.6.3B.3.4.3.7-1: SystemInformationBlockType2 :Additional spurious emissions test requirement for "NS\_14"**

Derivation Path: TS 36.508 [7] clause 4.4.3.3, Table 4.4.3.3-1			
Information Element	Value/remark	Comment	Condition
additionalSpectrumEmission	14 (NS_14)		

#### 6.6.3B.3.4.3.8 Message contents exceptions (network signalled value "NS\_15")

1. Information element additionalSpectrumEmission is set to NS\_15. This can be set in the *SystemInformationblockType2* as part of the cell broadcast message. This exception indicates that the UE shall meet the additional spurious emission requirement for a specific deployment scenario.

**Table 6.6.3B.3.4.3.8-1: SystemInformationBlockType2 :Additional spurious emissions test requirement for "NS\_15"**

Derivation Path: TS 36.508 [7] clause 4.4.3.3, Table 4.4.3.3-1			
Information Element	Value/remark	Comment	Condition
additionalSpectrumEmission	15 (NS_15)		

#### 6.6.3B.3.4.3.9 Message contents exceptions (network signalled value "NS\_16")

1. Information element additionalSpectrumEmission is set to NS\_16. This can be set in the *SystemInformationblockType2* as part of the cell broadcast message. This exception indicates that the UE shall meet the additional spurious emission requirement for a specific deployment scenario.

**Table 6.6.3B.3.4.3.9-1: SystemInformationBlockType2 :Additional spurious emissions test requirement for "NS\_16"**

Derivation Path: TS 36.508 [7] clause 4.4.3.3, Table 4.4.3.3-1			
Information Element	Value/remark	Comment	Condition
additionalSpectrumEmission	16 (NS_16)		

#### 6.6.3B.3.4.3.10 Message contents exceptions (network signalled value "NS\_17")

1. Information element additionalSpectrumEmission is set to NS\_17. This can be set in the *SystemInformationblockType2* as part of the cell broadcast message. This exception indicates that the UE shall meet the additional spurious emission requirement for a specific deployment scenario.

**Table 6.6.3B.3.4.3.10-1: SystemInformationBlockType2 :Additional spurious emissions test requirement for "NS\_17"**

Derivation Path: TS 36.508 [7] clause 4.4.3.3, Table 4.4.3.3-1			
Information Element	Value/remark	Comment	Condition
additionalSpectrumEmission	17 (NS_17)		

## 6.6.3B.3.4.3.11 Message contents exceptions (network signalled value "NS\_18")

1. Information element `additionalSpectrumEmission` is set to NS\_18. This can be set in the *SystemInformationBlockType2* as part of the cell broadcast message. This exception indicates that the UE shall meet the additional spurious emission requirement for a specific deployment scenario.

**Table 6.6.3B.3.4.3.11-1: SystemInformationBlockType2: Additional spurious emissions test requirement for "NS\_18"**

Derivation Path: TS 36.508 [7] clause 4.4.3.3, Table 4.4.3.3-1			
Information Element	Value/remark	Comment	Condition
<code>additionalSpectrumEmission</code>	18 (NS_18)		

## 6.6.3B.3.4.3.12 Message contents exceptions (network signalled value "NS\_19")

1. Information element `additionalSpectrumEmission` is set to NS\_19. This can be set in the *SystemInformationBlockType2* as part of the cell broadcast message. This exception indicates that the UE shall meet the additional spurious emission requirement for a specific deployment scenario.

**Table 6.6.3B.3.4.3.12-1: SystemInformationBlockType2: Additional spurious emissions test requirement for "NS\_19"**

Derivation Path: TS 36.508 [7] clause 4.4.3.3, Table 4.4.3.3-1			
Information Element	Value/remark	Comment	Condition
<code>additionalSpectrumEmission</code>	19 (NS_19)		

## 6.6.3B.3.4.3.13 Message contents exceptions (network signalled value "NS\_21")

1. Information element `additionalSpectrumEmission` is set to NS\_21. This can be set in the *SystemInformationBlockType2* as part of the cell broadcast message. This exception indicates that the UE shall meet the additional spurious emission requirement for a specific deployment scenario.

**Table 6.6.3B.3.4.3.13-1: SystemInformationBlockType2: Additional spurious emissions test requirement for "NS\_21"**

Derivation Path: TS 36.508 [7] clause 4.4.3.3, Table 4.4.3.3-1			
Information Element	Value/remark	Comment	Condition
<code>additionalSpectrumEmission</code>	21 (NS_21)		

## 6.6.3B.3.5 Test requirement

## 6.6.3B.3.5.1 Test requirement (network signalled value "NS\_05")

When "NS\_05" is indicated in the cell:

- the measured UE mean power in the channel bandwidth, derived in step 3, shall fulfil requirements in Table 6.2.4B.5-4 as appropriate,

and

- the measured average power of spurious emission, derived in step 2, shall not exceed the described value in Table 6.6.3B.3.5.1-1. This requirement also applies for the frequency ranges that are less than  $\Delta f_{OOB}$  (MHz) in Table 6.6.3.1.3-1 from the edge of the channel bandwidth.

**Table 6.6.3B.3.5.1-1: Additional requirements (PHS) test requirements**

Frequency band (MHz)	Channel bandwidth / Spectrum emission limit (dBm)				Measurement bandwidth
	5 MHz	10 MHz	15 MHz	20 MHz	
$1884.5 \leq f \leq 1915.7^*1$	-41	-41	-41	-41	300 KHz
Note 1: Applicable when the lower edge of the assigned E-UTRA UL channel bandwidth frequency is larger than or equal to the upper edge of PHS band (1915.7 MHz) + 4 MHz + the Channel BW assigned, where Channel BW is as defined in clause 5.4.2. <b>Additional restrictions apply for operations below this point.</b>					

The requirements in Table 6.6.3B.3.5.1-1 apply with the additional restrictions specified in Table 6.6.3B.3.5.1-2 when the lower edge of the assigned E-UTRA UL channel bandwidth frequency is less than the upper edge of PHS band (1915.7 MHz) + 4 MHz + the channel BW assigned.

**Table 6.6.3B.3.5.1-2: RB restrictions for additional requirement (PHS)**

15 MHz channel bandwidth with $f_c = 1932.5$ MHz			
RB <sub>start</sub>	0-7	8-66	67-74
LCRB	N/A	$\leq \text{MIN}(30, 67 - \text{RB}_{\text{start}})$	N/A
20 MHz channel bandwidth with $f_c = 1930$ MHz			
RB <sub>start</sub>	0-23	24-75	76-99
LCRB	N/A	$\leq \text{MIN}(24, 76 - \text{RB}_{\text{start}})$	N/A

NOTE: (only for testing requirements in Table 6.6.3B.3.5.1-1):  
 For measurement conditions at the edge of each frequency range, the lowest frequency of the measurement position in each frequency range should be set at the lowest boundary of the frequency range plus MBW/2. The highest frequency of the measurement position in each frequency range should be set at the highest boundary of the frequency range minus MBW/2. MBW denotes the measurement bandwidth (300 kHz).

#### 6.6.3B.3.5.2 Test requirement (network signalled value "NS\_07")

When "NS\_07" is indicated in the cell:

- the measured UE mean power in the channel bandwidth, derived in step 3, shall fulfil requirements in Table 6.2.4B.5-7 as appropriate,

and

- the measured average power of spurious emission, derived in step 4, shall not exceed the described value in Table 6.6.3B.3.5.2-1. These requirements also apply for the frequency ranges that are less than  $\Delta f_{\text{OOB}}$  (MHz) in Table 6.6.3.1.3-1 from the edge of the channel bandwidth.

**Table 6.6.3B.3.5.2-1: Additional requirements (network signalled value "NS\_07")**

Frequency band (MHz)	Channel bandwidth / Spectrum emission limit (dBm)	Measurement bandwidth
	10 MHz	
$769 \leq f \leq 775$	-55.5	6.25 kHz
Note: The emissions measurement shall be sufficiently power averaged to ensure a standard deviation < 0.5 dB.		

NOTE: (only for testing requirements in Table 6.6.3B.3.5.2-1):  
 For measurement conditions at the edge of each frequency range, the lowest frequency of the measurement position in each frequency range should be set at the lowest boundary of the frequency range plus MBW/2. The highest frequency of the measurement position in each frequency range should be set at the highest boundary of the frequency range minus MBW/2. MBW denotes the measurement bandwidth (6.25 kHz).

## 6.6.3B.3.5.3 Test requirement (network signalled value "NS\_08")

When "NS\_08" is indicated in the cell:

- the measured UE mean power in the channel bandwidth, derived in step 3, shall fulfil requirements in Table 6.2.4B.5-8 as appropriate,

and

- the measured average power of spurious emission, derived in step 4, shall not exceed the described value in Table 6.6.3B.3.5.3-1. This requirement also applies for the frequency ranges that are less than  $\Delta f_{OOB}$  (MHz) in Table 6.6.3.1.3-1 from the edge of the channel bandwidth.

**Table 6.6.3B.3.5.3-1: Additional requirements (network signalled value "NS\_08")**

Frequency band (MHz)	Channel bandwidth / Spectrum emission limit (dBm)			Measurement bandwidth
	5MHz	10MHz	15MHz	
$860 \leq f \leq 890$	-40	-40	-40	1 MHz

NOTE: (only for testing requirements in Table 6.6.3B.3.5.3-1):

For measurement conditions at the edge of each frequency range, the lowest frequency of the measurement position in each frequency range should be set at the lowest boundary of the frequency range plus MBW/2. The highest frequency of the measurement position in each frequency range should be set at the highest boundary of the frequency range minus MBW/2. MBW denotes the measurement bandwidth (1 MHz).

## 6.6.3B.3.5.4 Test requirement (network signalled value "NS\_09")

When "NS\_09" is indicated in the cell:

- the measured UE mean power in the channel bandwidth, derived in step 3, shall fulfil requirements in Table 6.2.4B.5-9 as appropriate,

and

- the measured average power of spurious emission, derived in step 4, shall not exceed the described value in table 6.6.3B.3.5.4-1. This requirement also applies for the frequency ranges that are less than  $\Delta f_{OOB}$  (MHz) in Table 6.6.3.1.3-1 from the edge of the channel bandwidth.

**Table 6.6.3B.3.5.4-1: Additional requirements (network signalled value "NS\_09")**

Frequency band (MHz)	Channel bandwidth / Spectrum emission limit (dBm)			Measurement bandwidth
	5MHz	10MHz	15MHz	
$1475.9 \leq f \leq 1510.9$	-35	-35	-35	1 MHz

NOTE 1: (only for testing requirements in Table 6.6.3B.3.5.4-1):

For measurement conditions at the edge of each frequency range, the lowest frequency of the measurement position in each frequency range should be set at the lowest boundary of the frequency range plus MBW/2. The highest frequency of the measurement position in each frequency range should be set at the highest boundary of the frequency range minus MBW/2. MBW denotes the measurement bandwidth (1 MHz).

NOTE 2: To improve measurement accuracy, A-MPR values for NS\_09 specified in Table 6.2.4B.3-1 in clause 6.2.4B are derived based on both the above NOTE 1 and 100 kHz RBW.

## 6.6.3B.3.5.5 Test requirement (network signalled value "NS\_12")

When "NS 12" is indicated in the cell:

- the measured UE mean power in the channel bandwidth, derived in step 3, shall fulfil requirements in Table 6.2.4B.5-12 as appropriate,

and

- the power of any UE emission shall not exceed the levels specified in Table 6.6.3B.3.5-1. This requirement also applies for the frequency ranges that are less than  $\Delta f_{OOB}$  (MHz) in Table 6.6.3.1.3-1 from the edge of the channel bandwidth.

**Table 6.6.3B.3.5-1: Additional requirements**

Frequency band (MHz)	Channel bandwidth/ Spectrum emission limit (dBm)	Measurement bandwidth
	1.4 MHz, 3 MHz, 5 MHz, 10 MHz, 15 MHz	
$806 \leq f \leq 813.5$	-42	6.25 kHz
NOTE 1: The requirement applies for E-UTRA carriers with lower channel edge at or above 814.2 MHz.		
NOTE 2: The emissions measurement shall be sufficiently power averaged to ensure a standard deviation < 0.5 dB.		

#### 6.6.3B.3.5.6 Test requirement (network signalled value "NS\_13")

When "NS 13" is indicated in the cell:

- the measured UE mean power in the channel bandwidth, derived in step 3, shall fulfil requirements in Table 6.2.4B.5-13 as appropriate,

and

- the power of any UE emission shall not exceed the levels specified in Table 6.6.3B.3.5.6-1. This requirement also applies for the frequency ranges that are less than  $\Delta f_{OOB}$  (MHz) in Table 6.6.3.1.3-1 from the edge of the channel bandwidth.

**Table 6.6.3B.3.5.6-1: Additional requirements**

Frequency band (MHz)	Channel bandwidth/ Spectrum emission limit (dBm)	Measurement bandwidth
	1.4, 3, 5 MHz	
$806 \leq f \leq 816$	-42	6.25 kHz
NOTE 1: The requirement applies for E-UTRA carriers with lower channel edge at or above 819 MHz.		
NOTE 2: The emissions measurement shall be sufficiently power averaged to ensure a standard deviation < 0.5 dB.		

#### 6.6.3B.3.5.7 Test requirement (network signalled value "NS\_14")

When "NS 14" is indicated in the cell:

- the measured UE mean power in the channel bandwidth, derived in step 3, shall fulfil requirements in Table 6.2.4B.5-14 as appropriate,

and

- the power of any UE emission shall not exceed the levels specified in Table 6.6.3B.3.5.7-1. This requirement also applies for the frequency ranges that are less than  $\Delta f_{OOB}$  (MHz) in Table 6.6.3.1.3-1 from the edge of the channel bandwidth.

**Table 6.6.3B.3.5.7-1: Additional requirements**

Frequency band (MHz)	Channel bandwidth/ Spectrum emission limit (dBm)	Measurement bandwidth
	10 MHz, 15 MHz	
$806 \leq f \leq 816$	-42	6.25 kHz
NOTE 1: The requirement applies for E-UTRA carriers with lower channel edge at or above 824 MHz.		
NOTE 2: The emissions measurement shall be sufficiently power averaged to ensure a standard deviation < 0.5 dB.		

## 6.6.3B.3.5.8 Test requirement (network signalled value "NS\_15")

When "NS 15" is indicated in the cell:

- the measured UE mean power in the channel bandwidth, derived in step 3, shall fulfil requirements in Table 6.2.4B.5-15 as appropriate,

and

- the power of any UE emission shall not exceed the levels specified in Table 6.6.3B.3.5.8-1. This requirement also applies for the frequency ranges that are less than  $\Delta f_{\text{OOB}}$  (MHz) in Table 6.6.3.1.3-1 from the edge of the channel bandwidth.

**Table 6.6.3B.3.5.8-1: Additional requirements**

Frequency band (MHz)	Channel bandwidth / Spectrum emission limit (dBm)	Measurement bandwidth	Note
	1.4, 3, 5, 10, 15 MHz		
$851 \leq f \leq 859$	-53	6.25 kHz	
Note: The emissions measurement shall be sufficiently power averaged to ensure standard deviation < 0.5 dB.			

## 6.6.3B.3.5.9 Test requirement (network signalled value "NS\_16")

When "NS 16" is indicated in the cell:

- the measured UE mean power in the channel bandwidth, derived in step 3, shall fulfil requirements in Table 6.2.4B.5-16 as appropriate,

and

- the power of any UE emission shall not exceed the levels specified in Table 6.6.3B.3.5.9-1. This requirement also applies for the frequency ranges that are less than  $\Delta f_{\text{OOB}}$  (MHz) in Table 6.6.3.1.3-1 from the edge of the channel bandwidth.

**Table 6.6.3B.3.5.9-1: Additional requirements**

Frequency band (MHz)	Channel bandwidth / Spectrum emission limit (dBm)	Measurement bandwidth	Note
	1.4, 3, 5, 10 MHz		
$790 \leq f \leq 803$	-32	1 MHz	

## 6.6.3B.3.5.10 Test requirement (network signalled value "NS\_17")

When "NS 17" is indicated in the cell:

the measured UE mean power in the channel bandwidth, derived in step 3, shall fulfil requirements in Table 6.2.4B.5-17 as appropriate,

and

- the power of any UE emission shall not exceed the levels specified in Table 6.6.3B.3.5.10-1. This requirement also applies for the frequency ranges that are less than  $\Delta f_{\text{OOB}}$  (MHz) in Table 6.6.3.1.3-1 from the edge of the channel bandwidth.

**Table 6.6.3B.3.5.10-1: Additional requirements**

Frequency band (MHz)	Channel bandwidth / Spectrum emission limit (dBm)	Measurement bandwidth	Note
	5, 10 MHz		



$470 \leq f \leq 710$	-26.2	6 MHz	1
Note 1: Applicable when the assigned E-UTRA carrier is confined within 718 MHz and 748 MHz and when the channel bandwidth used is 5 or 10 MHz.			

#### 6.6.3B.3.5.11 Test requirement (network signalled value "NS\_18")

When "NS 18" is indicated in the cell:

the measured UE mean power in the channel bandwidth, derived in step 3, shall fulfil requirements in Table 6.2.4B.5-18 as appropriate,

and

- the power of any UE emission shall not exceed the levels specified in Table 6.6.3B.3.5.11-1. This requirement also applies for the frequency ranges that are less than  $\Delta f_{\text{OOB}}$  (MHz) in Table 6.6.3.1.3-1 from the edge of the channel bandwidth.

**Table 6.6.3B.3.5.11-1: Additional requirements**

Frequency band (MHz)	Channel bandwidth / Spectrum emission limit (dBm)	Measurement bandwidth	Note
	5, 10, 15, 20 MHz		
692-698	-26.2	6 MHz	

#### 6.6.3B.3.5.12 Test requirement (network signalled value "NS\_19")

When "NS\_19" is indicated in the cell:

- the measured UE mean power in the channel bandwidth, derived in step 3, shall fulfil requirements in Table 6.2.4B.5-18 as appropriate,

and

- the power of any UE emission shall not exceed the levels specified in Table 6.6.3B.3.5.12-1. This requirement also applies for the frequency ranges that are less than  $F_{\text{OOB}}$  (MHz) in Table 6.6.3.1.3-1 from the edge of the channel bandwidth.

**Table 6.6.3B.3.5.12-1: Additional requirements**

Frequency band (MHz)	Channel bandwidth / Spectrum emission limit (dBm)	Measurement bandwidth	Note
	3, 5, 10, 15, 20 MHz		
$662 \leq f \leq 694$	-25	8 MHz	

#### 6.6.3B.3.5.13 Test requirement (network signalled value "NS\_21")

When "NS\_21" is indicated in the cell, the power of any UE emission shall not exceed the levels specified in Table 6.6.3B.3.5.13-1. These requirements also apply for the frequency ranges that are less than  $F_{\text{OOB}}$  (MHz) in Table 6.6.3.1.3-1 and Table 6.6.3.1A-1 from the edge of the channel bandwidth.

**Table 6.6.3B.3.5.13-1: Additional requirements**

Frequency band (MHz)	Channel bandwidth / Spectrum emission limit (dBm)	Measurement bandwidth
	5, 10 MHz	
$2200 \leq f < 2288$	-40	1 MHz
$2288 \leq f < 2292$	-37	1 MHz
$2292 \leq f < 2296$	-31	1 MHz
$2296 \leq f < 2300$	-25	1 MHz
$2320 \leq f < 2324$	-25	1 MHz
$2324 \leq f < 2328$	-31	1 MHz
$2328 \leq f < 2332$	-37	1 MHz
$2332 \leq f \leq 2395$	-40	1 MHz

## 6.7 Transmit intermodulation

### 6.7.1 Test purpose

To verify that the UE transmit intermodulation does not exceed the described value in the test requirement.

The transmit intermodulation performance is a measure of the capability of the transmitter to inhibit the generation of signals in its non linear elements caused by presence of the wanted signal and an interfering signal reaching the transmitter via the antenna.

### 6.7.2 Test applicability

This test applies to all types of E-UTRA UE release 8 and forward.

### 6.7.3 Minimum conformance requirements

User Equipment(s) transmitting in close vicinity of each other can produce intermodulation products, which can fall into the UE, or eNode B receive band as an unwanted interfering signal. The UE intermodulation attenuation is defined by the ratio of the mean power of the wanted signal to the mean power of the intermodulation product when an interfering CW signal is added at a level below the wanted signal at each of the transmitter antenna port with the other antenna port(s) if any is terminated. Both the wanted signal power and the intermodulation product power are measured through E-UTRA rectangular filter with measurement bandwidth shown in Table 6.7.3-1.

The requirement of transmitting intermodulation is prescribed in Table 6.7.3-1.

**Table 6.7.3-1: Transmit Intermodulation**

BWChannel (UL)	5MHz		10MHz		15MHz		20MHz	
Interference Signal Frequency Offset	5MHz	10MHz	10MHz	20MHz	15MHz	30MHz	20MHz	40MHz
Interference CW Signal Level	-40dBc							
Intermodulation Product	-29dBc	-35dBc	-29dBc	-35dBc	-29dBc	-35dBc	-29dBc	-35dBc
Measurement bandwidth	4.5MHz	4.5MHz	9.0MHz	9.0MHz	13.5MHz	13.5MHz	18MHz	18MHz

The normative reference for this requirement is TS 36.101 [2] clause 6.7.1.

## 6.7.4 Test description

### 6.7.4.1 Initial conditions

Initial conditions are a set of test configurations the UE needs to be tested in and the steps for the SS to take with the UE to reach the correct measurement state.

The initial test configurations consist of environmental conditions, test frequencies, and channel bandwidths based on E-UTRA operating bands specified in table 5.4.2.1-1. All of these configurations shall be tested with applicable test parameters for each channel bandwidth, and are shown in table 6.7.4.1-1. The details of the uplink reference measurement channels (RMCs) are specified in Annexes A.2. Configurations of PDSCH and PDCCH before measurement are specified in Annex C.2.

**Table 6.7.4.1-1: Test Configuration Table**

Initial Conditions						
Test Environment as specified in TS 36.508[7] subclause 4.1		Normal				
Test Frequencies as specified in TS36.508 [7] subclause 4.3.1		Mid range				
Test Channel Bandwidths as specified in TS 36.508 [7] subclause 4.3.1		5MHz and Highest				
Test Parameters for Channel Bandwidths						
	Downlink Configuration		Uplink Configuration			
Ch BW	N/A for Transmit Intermodulation		Mod'n	RB allocation		
			FDD	TDD		
5MHz			QPSK	8	8	
10MHz			QPSK	12	12	
15MHz			QPSK	16	16	
20MHz			QPSK	18	18	
Note 1: Test Channel Bandwidths are checked separately for each E-UTRA band, the applicable channel bandwidths are specified in Table 5.4.2.1-1.						

1. Connect the SS to the UE antenna connectors as shown in TS 36.508 [7] Annex A, Figure A.2.
2. The parameter settings for the cell are set up according to TS 36.508 [7] subclause 4.4.3.
3. Downlink signals are initially set up according to Annex C.0, C.1, and C.3.0, and uplink signals according to Annex H.1 and H.3.0.
4. The UL Reference Measurement channels are set according to Table 6.7.4.1-1.
5. Propagation conditions are set according to Annex B.0.
6. Ensure the UE is in State 3A-RF according to TS 36.508 [7] clause 5.2A.2. Message contents are defined in clause 6.7.4.3.

### 6.7.4.3 Test procedure

1. SS sends uplink scheduling information for each UL HARQ process via PDCCH DCI format 0 for C\_RNTI to schedule the UL RMC according to Table 6.7.4.1-1. Since the UE has no payload and no loopback data to send the UE sends uplink MAC padding bits on the UL RMC.
2. Send continuously uplink power control "up" commands to the UE until the UE transmits at its  $P_{UMAX}$  level.
3. Measure the rectangular filtered mean power of the UE. For TDD slots with transient periods are not under test for the wanted signal and for the intermodulation product.
4. Set the interference signal frequency below the UL carrier frequency using the first offset in table 6.7.5-1.
5. Set the interference CW signal level according to table 6.7.5-1.

6. Search the intermodulation product signals below and above the UL carrier frequency, then measure the rectangular filtered mean power of transmitting intermodulation for both signals, and calculate the ratios with the power measured in step 3.

7. Set the interference signal frequency above the UL carrier frequency using the first offset in table 6.7.5-1.

8. Search the intermodulation product signals below and above the UL carrier frequency, then measure the rectangular filtered mean power of transmitting intermodulation for both signals, and calculate the ratios with the power measured in step 3.

Repeat the measurement using the second offset in table 6.7.5-1.

### 6.7.4.3 Message contents

Message contents are according to TS 36.508 [7] subclause 4.6.

## 6.7.5 Test requirement

The ratio derived in step 5 and 7, shall not exceed the described value in table 6.7.5-1

**Table 6.7.5-1: Transmit Intermodulation**

BWChannel (UL)	5MHz		10MHz		15MHz		20MHz	
Interference Signal Frequency Offset	5MHz	10MHz	10MHz	20MHz	15MHz	30MHz	20MHz	40MHz (Note 1)
Interference CW Signal Level	-40dBc							
Intermodulation Product	-29dBc	-35dBc	-29dBc	-35dBc	-29dBc	-35dBc	-29dBc	-35dBc
Measurement bandwidth	4.5MHz	4.5MHz	9.0MHz	9.0MHz	13.5MHz	13.5MHz	18MHz	18MHz
Note 1: For Band 20, only applicable for interference signal frequency above the UL carrier frequency.								

## 6.7A Transmit intermodulation for CA

### 6.7A.1 Transmit intermodulation for CA (intra-band contiguous DL CA and UL CA)

#### 6.7A.1.1 Test purpose

To verify that the UE transmit intermodulation does not exceed the described value in the test requirement.

The transmit intermodulation performance is a measure of the capability of the transmitter to inhibit the generation of signals in its non linear elements caused by presence of the wanted signal and an interfering signal reaching the transmitter via the antenna.

#### 6.7A.1.2 Test applicability

This test applies to all types of E-UTRA UE release 10 and forward that supports intra-band contiguous DL CA and UL CA.

#### 6.7A.1.3 Minimum conformance requirements

User Equipment(s) transmitting in close vicinity of each other can produce intermodulation products, which can fall into the UE, or eNode B receive band as an unwanted interfering signal. The UE intermodulation attenuation is defined by the ratio of the mean power of the wanted signal to the mean power of the intermodulation product on both component carriers when an interfering CW signal is added at a level below the wanted signal at each of the transmitter antenna

port with the other antenna port(s) if any is terminated. Both the wanted signal power and the intermodulation product power are measured through rectangular filter with measurement bandwidth shown in Table 6.7A.1-1.

For intra-band contiguous carrier aggregation the requirement of transmitting intermodulation is specified in Table 6.7.1A-1.

**Table 6.7A.1-1: Transmit Intermodulation**

CA bandwidth class(UL)	C	
Interference Signal Frequency Offset	$BW_{\text{Channel\_CA}}$	$2 * BW_{\text{Channel\_CA}}$
Interference CW Signal Level	-40dBc	
Intermodulation Product	-29dBc	-35dBc
Measurement bandwidth	$BW_{\text{Channel\_CA}} - 2 * BW_{\text{GB}}$	

The normative reference for this requirement is TS 36.101 [2] clause 6.7.1A.

#### 6.7A.1.4 Test description

##### 6.7A.1.4.1 Initial conditions

Initial conditions are a set of test configurations the UE needs to be tested in and the steps for the SS to take with the UE to reach the correct measurement state.

The initial test configurations consist of environmental conditions, test frequencies, and channel bandwidths based on E-UTRA operating bands specified in table 5.4.2.1-1. All of these configurations shall be tested with applicable test parameters for each channel bandwidth, and are shown in table 6.7A.1.4.1-1. The details of the uplink reference measurement channels (RMCs) are specified in Annexes A.2. Configurations of PDSCH and PDCCH before measurement are specified in Annex C.2.

Table 6.7A.1.4.1-1: Test Configuration Table

Initial Conditions								
Test Environment as specified in TS 36.508[7] subclause 4.1					Normal			
Test Frequencies as specified in TS36.508 [7] subclause 4.3.1 for different CA bandwidth classes, and PCC and SCCs are mapped onto physical frequencies according to Table 6.1-2.					C: Mid range			
Test CC Combination setting ( $N_{RB\_agg}$ ) as specified in subclause 5.4.2A.1 for the CA Configuration					Lowest $N_{RB\_agg}$ Highest $N_{RB\_agg}$ (Note 2)			
Test Parameters for CA Configurations								
CA Configuration / $N_{RB\_agg}$		DL Allocation	CC MOD	UL Allocation				
PCC $N_{RB}$	SCCs $N_{RB}$	PCC & SCC RB allocation		$N_{RB\_alloc}$	PCC & SCC RB allocations (L <sub>CRB</sub> @ RB <sub>start</sub> )			
75	75	N/A	QPSK	16	P_16@0	S_0@0	-	-
100	25		QPSK	8	P_8@0	S_0@0	-	-
100	50		QPSK	12	P_12@0	S_0@0	-	-
100	100		QPSK	18	P_18@0	S_0@0	-	-
Note 1: CA Configuration Test CC Combination settings are checked separately for each CA Configuration, which applicable aggregated channel bandwidths are specified in Table 5.4.2A.1-1								
Note 2: If in the CA Configuration UE supports multiple CC Combinations with the same $N_{RB\_agg}$ , only the first of those is tested, according to the order on the Test Configuration Table list.								

1. Connect the SS to the UE antenna connectors as shown in TS 36.508 [7] Annex A, Figure group A.37 as appropriate.
2. The parameter settings for the cell are set up according to TS 36.508 [7] subclause 4.4.3.
3. Downlink signals for PCC are initially set up according to Annex C.0, C.1, and C.3.0, and uplink signals according to Annex H.1 and H.3.0.
4. Propagation conditions are set according to Annex B.0.
5. Ensure the UE is in State 3A-RF according to TS 36.508 [7] clause 5.2A.2. Message contents are defined in clause 6.7A.1.4.3.

#### 6.7A.1.4.2 Test procedure

1. Configure SCC according to Annex C.0, C.1 and Annex C.3.0 for all downlink physical channels.
2. The SS shall configure SCC as per TS 36.508 [7] clause 5.2A.4. Message contents are defined in clause 6.7A.1.4.3
3. SS activates SCC by sending the activation MAC-CE (Refer TS 36.321 [13], clauses 5.13, 6.1.3.8). Wait for at least 2 seconds (Refer TS 36.133, clauses 8.3.3.2).
4. SS sends uplink scheduling information for each UL HARQ process via PDCCH DCI format 0 for C\_RNTI to schedule the UL RMC according to Table 6.7A.1.4.1-1. Since the UE has no payload and no loopback data to send the UE sends uplink MAC padding bits on the UL RMC.
5. Send continuously uplink power control "up" commands on PCC and SCC to the UE until the UE transmits at its  $P_{UMAX}$  level; allow at least 200ms for the UE to reach PUMAX level.
6. Measure the rectangular filtered mean power of the UE. For TDD slots with transient periods are not under test for the wanted signal and for the intermodulation product.
7. Set the interference signal frequency below  $F_{CA\_low}$  using the first offset in table 6.7A.1-1.

8. Set the interference CW signal level according to table 6.7A.1-1.
9. Search the intermodulation product signals below and above the aggregated UL carrier, then measure the rectangular filtered mean power of transmitting intermodulation for both signals, and calculate the ratios with the power measured in step 6.
10. Set the interference signal frequency above  $F_{CA\_high}$  using the first offset in table 6.7A.1-1.
11. Search the intermodulation product signals below and above the aggregated UL carrier, then measure the rectangular filtered mean power of transmitting intermodulation for both signals, and calculate the ratios with the power measured in step 6.
12. Repeat the measurement using the second offset in table 6.7A.1-1.

#### 6.7A.1.4.3 Message contents

Message contents are according to TS 36.508 [7] subclause 4.6. In test procedure step 2, for SCC configuration there are no additional message contents.

#### 6.7A.1.5 Test requirement

The ratio derived in step 9 and 11, shall not exceed the described value in table 6.7A.1.5-1

**Table 6.7A.1.5-1: Transmit Intermodulation**

CA bandwidth class(UL)	C	
Interference Signal Frequency Offset	$BW_{Channel\_CA}$	$2 * BW_{Channel\_CA}$
Interference CW Signal Level	-40dBc	
Intermodulation Product	-29dBc	-35dBc
Measurement bandwidth	$BW_{Channel\_CA} - 2 * BW_{GB}$	

### 6.7A.2 Transmit intermodulation for CA (inter-band DL CA and UL CA)

Editor's notes: This test is incomplete. The following aspects are either missing or not yet determined:

- The initial conditions are not yet defined
- The test description is not yet defined
- The test procedure is not yet defined
- The message contents are not yet defined
- The test requirements are not yet defined

#### 6.7A.2.1 Test purpose

To verify that the UE transmit intermodulation does not exceed the described value in the test requirement.

The transmit intermodulation performance is a measure of the capability of the transmitter to inhibit the generation of signals in its non linear elements caused by presence of the wanted signal and an interfering signal reaching the transmitter via the antenna.

#### 6.7A.2.2 Test applicability

This test applies to all types of E-UTRA UE release 11 and forward that supports inter-band DL CA and UL CA.

### 6.7A.2.3 Minimum conformance requirements

User Equipment(s) transmitting in close vicinity of each other can produce intermodulation products, which can fall into the UE, or eNode B receive band as an unwanted interfering signal. The UE intermodulation attenuation is defined by the ratio of the mean power of the wanted signal to the mean power of the intermodulation product on both component carriers when an interfering CW signal is added at a level below the wanted signal at each of the transmitter antenna port with the other antenna port(s) if any is terminated. Both the wanted signal power and the intermodulation product power are measured through rectangular filter with measurement bandwidth shown in Table 6.7A.2-1.

For inter-band carrier aggregation with uplink assigned to two E-UTRA bands, the requirement is specified in Table 6.7A.2-1, which shall apply on each component carrier with both component carriers active.

**Table 6.7A.2-1: Transmit Intermodulation**

BW Channel (UL)	5MHz		10MHz		15MHz		20MHz	
Interference Signal Frequency Offset	5MHz	10MHz	10MHz	20MHz	15MHz	30MHz	20MHz	40MHz
Interference CW Signal Level	-40dBc							
Intermodulation Product	-29dBc	-35dBc	-29dBc	-35dBc	-29dBc	-35dBc	-29dBc	-35dBc
Measurement bandwidth	4.5MHz	4.5MHz	9.0MHz	9.0MHz	13.5MHz	13.5MHz	18MHz	18MHz

The normative reference for this requirement is TS 36.101 [2] clause 6.7.1A.

### 6.7A.2.4 Test description

#### 6.7A.2.4.1 Initial conditions

TBD

#### 6.7A.2.4.2 Test procedure

TBD

#### 6.7A.2.4.3 Message contents

TBD

### 6.7A.2.5 Test requirement

TBD

## 6.7B Transmit intermodulation for UL-MIMO

### 6.7B.1 Test purpose

To verify that the UE transmit intermodulation at each transmit antenna does not exceed the described value in the test requirement.

The transmit intermodulation performance is a measure of the capability of the transmitter to inhibit the generation of signals in its non linear elements caused by presence of the wanted signal and an interfering signal reaching the transmitter via the antenna.

### 6.7B.2 Test applicability

This test applies to all types of E-UTRA UE release 10 and forward that support UL-MIMO.



## 6.7B.3 Minimum conformance requirements

For UE with multiple antenna transmit connectors, the transmit intermodulation requirements are specified at each transmit antenna connector and the wanted signal is defined as the sum of output power at each transmit antenna connector.

For UEs with two transmit antenna connectors supporting dual-layer transmission, the requirements in subclause 6.7.3-1 apply to each transmit antenna connector with the UL-MIMO configurations specified in Table 6.2.2B.3-2.

The normative reference for this requirement is TS 36.101 [2] clause 6.7.1B.

## 6.7B.4 Test description

### 6.7B.4.1 Initial conditions

Initial conditions are a set of test configurations the UE needs to be tested in and the steps for the SS to take with the UE to reach the correct measurement state.

The initial test configurations consist of environmental conditions, test frequencies, and channel bandwidths based on E-UTRA operating bands specified in table 5.4.2.1-1. All of these configurations shall be tested with applicable test parameters for each channel bandwidth, and are shown in table 6.7B.4.1-1. The details of the uplink reference measurement channels (RMCs) are specified in Annexes A.2. Configurations of PDSCH and PDCCH before measurement are specified in Annex C.2.

**Table 6.7B.4.1-1: Test Configuration Table**

Initial Conditions				
Test Environment as specified in TS 36.508[7] subclause 4.1	Normal			
Test Frequencies as specified in <b>TS36.508 [7] subclause 4.3.1</b>	Mid range			
Test Channel Bandwidths as specified in <b>TS 36.508 [7] subclause 4.3.1</b>	5MHz and Highest			
Test Parameters for Channel Bandwidths				
Ch BW	Downlink Configuration	Uplink Configuration		
	N/A for Transmit Intermodulation	Mod'n	RB allocation	
		FDD	TDD	
5MHz		QPSK	8	8
10MHz		QPSK	12	12
15MHz		QPSK	16	16
20MHz		QPSK	18	18
Note 1: Test Channel Bandwidths are checked separately for each E-UTRA band, the applicable channel bandwidths are specified in Table 5.4.2.1-1.				

1. Connect the SS to the UE antenna connectors as shown in TS 36.508 [7] Annex A, Figure A.39.
2. The parameter settings for the cell are set up according to TS 36.508 [7] subclause 4.4.3.
3. Downlink signals are initially set up according to Annex C.0, C.1, and C.3.0, and uplink signals according to Annex H.1 and H.3.0.
4. The UL Reference Measurement channels are set according to Table 6.7B.4.1-1.
5. Propagation conditions are set according to Annex B.0.
6. Ensure the UE is in State 3A-RF according to TS 36.508 [7] clause 5.2A.2. Message contents are defined in clause 6.7B.4.3.

### 6.7B.4.2 Test procedure

1. SS sends uplink scheduling information for each UL HARQ process via PDCCH DCI format 4 for C\_RNTI to schedule the UL RMC according to Table 6.7B.4.1-1. Since the UE has no payload and no loopback data to send the UE sends uplink MAC padding bits on the UL RMC.
2. Send continuously uplink power control "up" commands to the UE until the UE transmits at its  $P_{UMAX}$  level.
3. Measure the rectangular filtered mean power of the UE. For TDD slots with transient periods are not under test for the wanted signal and for the intermodulation product.
4. Set the interference signal frequency below the UL carrier frequency using the first offset in table 6.7B.5-1.
5. Set the interference CW signal level according to table 6.7B.5-1.
6. Search the intermodulation product signals below and above the UL carrier frequency, then measure the rectangular filtered mean power of transmitting intermodulation for both signals, and calculate the ratios with the power measured in step 3.
7. Set the interference signal frequency above the UL carrier frequency using the first offset in table 6.7B.5-1.
8. Search the intermodulation product signals below and above the UL carrier frequency, then measure the rectangular filtered mean power of transmitting intermodulation for both signals, and calculate the ratios with the power measured in step 3.
9. Repeat the measurement using the second offset in table 6.7B.5-1.
10. Repeat step 3) until 9) for each of transmit antenna of the UE.

### 6.7B.4.3 Message contents

Message contents are according to TS 36.508 [7] clause 4.6.6.7B.5 Test requirement

The ratio derived in step 5 and 7 at each transmit antenna of UE shall not exceed the described value in table 6.7B.5-1.

**Table 6.7B.5-1: Transmit Intermodulation**

BWChannel (UL)	5MHz		10MHz		15MHz		20MHz	
Interference Signal Frequency Offset	5MHz	10MHz	10MHz	20MHz	15MHz	30MHz	20MHz	40MHz (Note 1)
Interference CW Signal Level	-40dBc							
Intermodulation Product	-29dBc	-35dBc	-29dBc	-35dBc	-29dBc	-35dBc	-29dBc	-35dBc
Measurement bandwidth	4.5MHz	4.5MHz	9.0MHz	9.0MHz	13.5MHz	13.5MHz	18MHz	18MHz
Note 1: For Band 20, only applicable for interference signal frequency above the UL carrier frequency.								

## 6.8 Time alignment

FFS.

## 6.8.1 Void

## 6.8A Void

## 6.8B Time alignment error for UL-MIMO

### 6.8B.1 Test purpose

To verify that the error of time alignment in UL MIMO does not exceed the range prescribed by the specified UL MIMO Time Alignment Error (TAE) and tolerance.

An excess time alignment error has the possibility to interfere to other channels or other systems and decrease UL MIMO performance because of the timing unsynchronization.

### 6.8B.2 Test applicability

This test case applies to all types of E-UTRA UE release 10 and forward that support UL MIMO.

### 6.8B.3 Minimum conformance requirements

For UE(s) with multiple transmit antenna connectors, the Time Alignment Error (TAE) shall not exceed 130 ns.

**Table 6.8B.3-1: UL-MIMO configuration in closed-loop spatial multiplexing scheme**

Transmission mode	DCI format	Codebook Index
Mode 2	DCI format 4	Codebook index 0

The normative reference for this requirement is TS 36.101 [2] clause 6.8B.

### 6.8B.4 Test description

#### 6.8B.4.1 Initial condition

Initial conditions are a set of test configurations the UE needs to be tested in and the steps for the SS to take with the UE to reach the correct measurement state.

The initial test configurations consist of environmental conditions, test frequencies, and channel bandwidths based on E-UTRA operating bands specified in table 5.4.2.1-1. All of these configurations shall be tested with applicable test parameters for each channel bandwidth, and are shown in table 6.8B.4.1-1. The details of the uplink reference measurement channels (RMCs) are specified in Annex A.2. Configurations of PDSCH and PDCCH before measurement are specified in Annex C.2.

**Table 6.8B.4.1-1: Test Configuration Table**

Initial Conditions				
Test Environment as specified in TS 36.508[7] clause 4.1	Normal			
Test Frequencies as specified in TS36.508 [7] clause 4.3.1	Mid range			
Test Channel Bandwidths as specified in TS 36.508 [7] clause 4.3.1	Lowest, 5MHz, Highest			
Test Parameters for Channel Bandwidths				
Ch BW	Downlink Configuration	Uplink Configuration		
		Mod'n	RB allocation	
	N/A		FDD	TDD
1.4MHz		QPSK	6	6
3MHz		QPSK	15	15
5MHz		QPSK	25	25
10MHz		QPSK	50	50
15MHz		QPSK	75	75
20MHz		QPSK	100	100
Note 1: Test Channel Bandwidths are checked separately for each E-UTRA band, the applicable channel bandwidths are specified in Table 5.4.2.1-1.				

1. Connect the SS to the UE antenna connectors as shown in TS 36.508[7] Annex A Figure A.28.
2. The parameter settings for the cell are set up according to TS 36.508 [7] clause 4.4.3.
3. Downlink signals are initially set up according to Annex C.0, C.1, and C.3.0, and uplink signals according to Annex H.1 and H.3.0.
4. The UL Reference Measurement channel is set according to Table 6.8B.4.1-1.
5. Propagation conditions are set according to Annex B.0.
6. Ensure the UE is in State 3A-RF according to TS 36.508 [7] clause 5.2A.2. Message contents are defined in clause 6.8B.4.3.

### 6.8B.4.2 Test procedure

1. SS sends uplink scheduling information for each UL HARQ process via PDCCH DCI format 4 for C\_RNTI to schedule the UL RMC according to Table 6.8B.4.1-1. Since the UE has no payload and no loopback data to send the UE sends uplink MAC padding bits on the UL RMC.
2. Send continuously uplink power control "up" commands in every uplink scheduling information to the UE; allow at least 200ms for the UE to reach PUMAX level for UE.
3. Measure the timing of one sub-frame at each antenna connector.

### 6.8B.4.3 Message contents

Message contents are according to TS 36.508 [7] clause 4.6.

### 6.8B.5 Test requirements

For UE(s) with multiple transmit antenna connectors, the Time Alignment Error (TAE) shall not exceed 155 ns.

## 7 Receiver Characteristics

### 7.1 General

Unless otherwise stated the receiver characteristics are specified at the antenna connector(s) of the UE. For UE(s) with an integral antenna only, a reference antenna(s) with a gain of 0 dBi is assumed for each antenna port(s). UE with an integral antenna(s) may be taken into account by converting these power levels into field strength requirements, assuming a 0 dBi gain antenna. For UEs with more than one receiver antenna connector, identical interfering signals shall be applied to each receiver antenna port if more than one of these is used (diversity).

Unless otherwise stated, the test signal levels are defined at each antenna port, and specified in the respective sections below. Any specific test conditions are defined in the paragraph for each test. Unless stated otherwise, power control of the Downlink is OFF.

In general, the UE is set into the correct state in the "Initial conditions" part of the test, using normal SS signalling procedures over the air interface under easy radio conditions to ensure reliable message exchange. In the "Test procedure" part of the test, specific radio conditions are applied according to the test requirement and the desired measurement is made or the desired response is tested.

The ACS, blocking, spurious emissions and intermodulation requirements in sections 7.5, 7.6, 7.7 and 7.8 are defined for full band width signals i.e. for signals where all resource blocks are allocated for a specific user.

With the exception of Clause 7.3, the requirements shall be verified with the network signalling value NS\_01 configured (Table 6.2.4.3-1).

All the parameters in clause 7 are defined using the UL reference measurement channels specified in Annexes A.2.2 and A.2.3, the DL reference measurement channels specified in Annex A.3.2 and using the set-up specified in Annex C.3.1.

For the additional requirements for intra-band non-contiguous carrier aggregation of two component carriers (one component carrier per sub-block), an in-gap test refers to the case when the interfering signal is located at a negative offset with respect to the assigned channel frequency of the highest carrier frequency and located at a positive offset with respect to the assigned channel frequency of the lowest carrier frequency.

For the additional requirements for intra-band non-contiguous carrier aggregation of two component carriers (one component carrier per sub-block), an out-of-gap test refers to the case when the interfering signal(s) is (are) located at a positive offset with respect to the assigned channel frequency of the highest carrier frequency, or located at a negative offset with respect to the assigned channel frequency of the lowest carrier frequency.

For the additional requirements for intra-band non-contiguous carrier aggregation of two component carriers with channel bandwidth larger than or equal to 5 MHz (one component carrier per sub-block), the existing adjacent channel selectivity requirements, in-band blocking requirements (for each case), and narrow band blocking requirements apply for in-gap tests only if the corresponding interferer frequency offsets with respect to the two measured carriers satisfy the following condition in relation to the sub-block gap size  $W_{\text{gap}}$  for at least one of these carriers  $j, j = 1, 2$ , so that the interferer frequency position does not change the nature of the core requirement tested:

$$W_{\text{gap}} \geq 2 \cdot |F_{\text{Interferer (offset)}_j} - BW_{\text{Channel}(j)}|$$

where  $F_{\text{Interferer (offset)}_j}$  is the interferer frequency offset with respect to carrier  $j$  as specified in subclause 7.5.1A, subclause 7.6.1A and subclause 7.6.3A for the respective requirement and  $BW_{\text{Channel}(j)}$  the channel bandwidth of carrier  $j$ . The interferer frequency offsets for adjacent channel selectivity, each in-band blocking case and narrow-band blocking shall be tested separately with a single in-gap interferer at a time.

For CA tests, Cell ID = 0 applies to P-Cell, and Cell ID = n (where n is 1,2,3..) applies to S-Celln (where n is 1,2,3..), respectively..

Parameters given in table 7.1-1 are used throughout this section for CA, unless otherwise stated by the test case.

**Table 7.1-1: Common Test Parameters**

Parameter	Value	Comments
Cross carrier scheduling	Not configured	

For CA testing, unless otherwise stated, the logical carriers PCC / SCCs are mapped to physical frequencies as defined in Table 7.1-2.

**Table 7.1-2: PCC/SCCs frequency mapping**

CA Configuration	PCC-SCC mapping	Notes
Intra-band contiguous CA	CC1-CC2 (Note 4) or CC2-CC1 (Note 5)	1
Inter-band CA (CA_x-y)	Bx-By and By-Bx	2, 3
Intra-band non-contiguous CA	CC2-CC1 (Note 4) or CC1-CC2 (Note 5)	1
Note 1:	Notation C <i>i</i> -C <i>j</i> means PCC on component carrier C <i>i</i> and SCC on component carrier C <i>j</i> , with C <i>i</i> / <i>j</i> frequencies defined in the corresponding intra-band contiguous / non-contiguous CA band in TS36.508 [7].	
Note 2:	Notation B <i>i</i> -B <i>j</i> means PCC on component Band <i>i</i> and SCC on component Band <i>j</i> , with single Band <i>i</i> / <i>j</i> frequencies defined in TS36.508 [7].	
Note 3:	Applicable for UE declared capability of UL support (within CA operation) in the individual bands. If UE does not support both PCC-SCC mappings, only the supported mapping is applicable.	
Note 4:	Applicable for TDD CA and FDD CA bands with UL frequency < DL frequency.	
Note 5:	Applicable for FDD CA bands with UL frequency > DL frequency.	

For testing of category 0 HD-FDD UE in FDD operating bands, the SS shall ensure downlink transmission is only configured in downlink subframes and that UL grants are given to ensure UE is transmitting only in uplink subframes throughout the test. The subframes reserved for uplink and downlink respectively are specified in the RMC definition in Annex A.2 for uplink and Annex A.3 for downlink.

## 7.2 Diversity characteristics

The requirements in Section 7 assume that the receiver is equipped with two Rx port as a baseline. Requirements for 4 ports are FFS. With the exception of clause 7.9, All requirements shall be verified by using both (all) antenna ports simultaneously.

For a category 0 UE the requirements in Section 7 assume that the receiver is equipped with single Rx port.

## 7.3 Reference sensitivity level

**Editor's note: FDD/TDD aspects missing or not yet determined:**

- **The Maximum Sensitivity Degradation figures for large transmission configurations are not finalised in the core specification.**

### 7.3.1 Test purpose

To verify the UE's ability to receive data with a given average throughput for a specified reference measurement channel, under conditions of low signal level, ideal propagation and no added noise.

A UE unable to meet the throughput requirement under these conditions will decrease the effective coverage area of an e-NodeB.

### 7.3.2 Test applicability

This test applies to all types of E-UTRA UE release 8 and forward.

### 7.3.3 Minimum conformance requirements

The throughput shall be  $\geq 95\%$  of the maximum throughput of the reference measurement channels as specified in Annexes A.2.2, A.2.3 and A.3.2 (with one sided dynamic OCNG Pattern OP.1 FDD/TDD for the DL-signal as described in Annex A.5.1.1/A.5.2.1) with parameters specified in Table 7.3.3-1, Table 7.3.3-2 and Table 7.3.3-3.

Table 7.3.3-1: Reference sensitivity QPSK  $P_{REFSENS}$

Channel bandwidth							
E-UTRA Band	1.4 MHz (dBm)	3 MHz (dBm)	5 MHz (dBm)	10 MHz (dBm)	15 MHz (dBm)	20 MHz (dBm)	Duplex Mode
1	-	-	-100	-97	-95.2	-94	FDD
2	-102.7	-99.7	-98	-95	-93.2	-92	FDD
3	-101.7	-98.7	-97	-94	-92.2	-91	FDD
4	-104.7	-101.7	-100	-97	-95.2	-94	FDD
5	-103.2	-100.2	-98	-95			FDD
6	-	-	-100	-97			FDD
7	-	-	-98	-95	-93.2	-92	FDD
8	-102.2	-99.2	-97	-94			FDD
9	-	-	-99	-96	-94.2	-93	FDD
10	-	-	-100	-97	-95.2	-94	FDD
11	-	-	-100	-97			FDD
12	-101.7	-98.7	-97	-94			FDD
13			-97	-94			FDD
14		-	-97	-94			FDD
...							
17	-	-	-97	-94			FDD
18	-	-	-100 <sup>7</sup>	-97 <sup>7</sup>	-95.2 <sup>7</sup>	-	FDD
19	-	-	-100	-97	-95.2	-	FDD
20			-97	-94	-91.2	-90	FDD
21			-100	-97	-95.2		FDD
22			-97	-94	-92.2	-91	FDD
23	-104.7	-101.7	-100	-97	-95.2	-94	FDD
24			-100	-97			FDD
25	-101.2	-98.2	-96.5	-93.5	-91.7	-90.5	FDD
26	-102.7	-99.7	-97.5 <sup>6</sup>	-94.5 <sup>6</sup>	-92.7 <sup>6</sup>		FDD
27	-103.2	-100.2	-98	-95			FDD
28		-100.2	-98.5	-95.5	-93.7	-91	FDD
30	-	-	-99	-96	-	-	FDD
31	-99.0	-95.7	-93.5				FDD
...							
33	-	-	-100	-97	-95.2	-94	TDD
34	-	-	-100	-97	-95.2	-	TDD
35	-106.2	-102.2	-100	-97	-95.2	-94	TDD
36	-106.2	-102.2	-100	-97	-95.2	-94	TDD
37	-	-	-100	-97	-95.2	-94	TDD
38	-	-	-100	-97	-95.2	-94	TDD
39	-	-	-100	-97	-95.2	-94	TDD
40	-	-	-100	-97	-95.2	-94	TDD
41	-	-	-98	-95	-93.2	-92	TDD
42	-	-	-99	-96	-94.2	-93	TDD
43	-	-	-99	-96	-94.2	-93	TDD
44		[-100.2]	[-98]	[-95]	[-93.2]	[-92]	TDD
Note 1:	The transmitter shall be set to $P_{UMAX}$ as defined in clause 6.2.5						
Note 2:	The reference measurement channel is specified in A.3.2 with one sided dynamic OCNG Pattern OP.1 FDD/TDD as described in Annex A.5.1.1/A.5.2.1						
Note 3:	The signal power is specified per port						
Note 4:	For the UE which supports both Band 3 and Band 9 the reference sensitivity level is FFS.						
Note 5:	For the UE which supports both Band 11 and Band 21 the reference sensitivity level is FFS.						
Note 6:	<sup>6</sup> indicates that the requirement is modified by -0.5 dB when the carrier						



Note 7:	frequency of the assigned E-UTRA channel bandwidth is within 865-894 MHz. For a UE that support both Band 18 and Band 26, the reference sensitivity level for Band 26 applies for the applicable channel bandwidths.
---------	-------------------------------------------------------------------------------------------------------------------------------------------------------------------------------------------------------------------------

The reference receive sensitivity (REFSENS) requirement specified in Table 7.3.3-1 shall be met for an uplink transmission bandwidth less than or equal to that specified in Table 7.3.3-2.

NOTE: Table 7.3.3-2 does not necessarily reflect the operational conditions of the network, where the number of uplink and downlink allocated resource blocks will be practically constrained by other factors.

For the UE which supports inter-band carrier aggregation configuration in Table 7.3.3-1A with uplink in one or two E-UTRA bands, the minimum requirement for reference sensitivity in Table 7.3.3-1 shall be increased by the amount given in  $\Delta R_{B,c}$  in Table 7.3.3-1A and Table 7.3.3-1B for the applicable E-UTRA bands.

Table 7.3.3-1A:  $\Delta R_{IB,c}$  (two bands)

Inter-band CA Configuration	E-UTRA Band	$\Delta R_{IB,c}$ [dB]
CA_1A-3A	1	0
	3	0
CA_1A-5A	1	0
	5	0
CA_1A-7A	1	0
	7	0
CA_1A-8A	1	0
	8	0
CA_1A-11A	1	0
	11	0
CA_1A-18A	1	0
	18	0
CA_1A-19A	1	0
	19	0
CA_1A-20A	1	0
	20	0
CA_1A-21A	1	0
	21	0
CA_1A-26A	1	0
	26	0
CA_1A-28A	1	0
	28	0.2
CA_1A-41A <sup>8</sup>	1	0
	41	0
CA_1A-41C <sup>8</sup>	1	0
	41	0
CA_1A-42A	1	0
	42	0.5
CA_1A-42C	1	0
	42	0.5
CA_2A-4A	2	0.3
	4	0.3
CA_2A-4A-4A	2	0.3
	4	0.3
CA_2A-5A	2	0
	5	0
CA_2A-2A-5A	2	0
	5	0
CA_2A-12A	2	0
	12	0
CA_2A-13A	2	0
	13	0
CA_2A-2A-13A	2	0
	13	0
CA_2A-17A	2	0
	17	0.5
CA_2A-30A	2	0.4
	30	0.5
CA_3A-5A	3	0
	5	0
CA_3A-7A	3	0
	7	0
CA_3A-8A	3	0
	8	0
CA_3A-19A	3	0
	19	0
CA_3A-20A	3	0
	20	0
CA_3A-26A	3	0
	26	0
CA_3A-27A	3	0

	27	0
CA_3A-28A	3	0
	28	0
CA_3A-42A	3	0.2
	42	0.5
CA_3A-42C	3	0.2
	42	0.5
CA_4A-5A	4	0
	5	0
CA_4A-4A-5A	4	0
	5	0
CA_4A-7A	4	0.5
	7	0.5
CA_4A-12A	4	0
	12	0.5
CA_4A-4A-12A	4	0
	12	0.5
CA_4A-13A	4	0
	13	0
CA_4A-17A	4	0
	17	0.5
CA_4A-27A	4	0
	27	0
CA_4A-30A	4	0.4
	30	0.5
CA_5A-7A	5	0
	7	0
CA_5A-12A	5	0.5
	12	0.3
CA_5A-13A	5	0
	13	0
CA_5A-17A	5	0.5
	17	0.3
CA_5A-25A	5	0
	25	0
CA_5A-30A	5	0
	30	0
CA_7A-20A	7	0
	20	0
CA_7A-28A	7	0
	28	0
CA_8A-11A	8	0
	11	0
CA_8A-20A	8	0
	20	0
CA_11A-18A	11	0
	18	0
CA_12A-25A	12	0
	25	0
CA_12A-30A	12	0
	30	0
CA_18A-28A <sup>9</sup>	18	0
	28	0
CA_19A-21A	19	0
	21	0
CA_19A-42A	1	0
	42	0.5
CA_19A-42C	1	0
	42	0.5
CA_26A-41A	26	0
	41	0
CA_26A-41C	26	0
	41	0
CA_39A-41A	39	0.2 <sup>4</sup>
	41	0.2 <sup>4</sup>

CA_41A-42A	41	[0.4] <sup>4</sup>
	42	[0.5] <sup>4</sup>
NOTE 1: The above additional tolerances are only applicable for the E-UTRA operating bands that belong to the supported inter-band carrier aggregation configurations		
NOTE 2: The above additional tolerances also apply in intra-band CA and non-aggregated operation for the supported E-UTRA operating bands that belong to the supported inter-band carrier aggregation configurations		
NOTE 3: In case the UE supports more than one of the above 2DL inter-band carrier aggregation configurations and a E-UTRA operating band belongs to more than one 2DL inter-band carrier aggregation configurations then: <ul style="list-style-type: none"> <li>- When the E-UTRA operating band frequency range is <math>\leq 1</math>GHz, the applicable additional tolerance shall be the average of the 2DL tolerances in Table 7.3.3-1A, truncated to one decimal place that would apply for that operating band among the supported 2DL CA configurations. In case there is a harmonic relation between low band UL and high band DL, then the maximum tolerance among the different supported 2DL carrier aggregation configurations involving such band shall be applied</li> <li>- When the E-UTRA operating band frequency range is <math>&gt;1</math>GHz, the applicable additional tolerance shall be the maximum 2DL tolerance in Table 7.3.3-1A that would apply for that operating band among the supported 2DL CA configurations</li> </ul>		
NOTE 4: Only applicable for UE supporting inter-band carrier aggregation with uplink in one E-UTRA band and without simultaneous Rx/Tx.		
NOTE 5: Tolerances for a UE supporting multiple 3DL inter-band CA configurations are FFS		
NOTE 6: The above additional tolerances applicable for the E-UTRA operating bands that belong to the supported highest order inter-band carrier aggregation configuration, also apply to the same E-UTRA operating bands that belong to a supported lower order CA configuration.		
NOTE 7: Tolerances for a UE supporting multiple 3DL inter-band CA configurations are FFS		
NOTE 8: The above additional tolerances applicable for the E-UTRA operating bands that belong to the supported highest order inter-band carrier aggregation configuration, also apply to the same E-UTRA operating bands that belong to a supported lower order CA configuration.		
NOTE 9: For Band 28, the requirements only apply for the restricted frequency range specified for this CA configuration (Table 5.2A-2).		
NOTE 10: Only applicable for UE supporting inter-band carrier aggregation with the uplink active in the FDD band.		

Table 7.3.3-1B:  $\Delta R_{IB,c}$  (three bands)

Inter-band CA Configuration	E-UTRA Band	$\Delta R_{IB,c}$ [dB]
CA_1A-3A-5A	1	0
	3	0
	5	0
CA_1A-3A-19A	1	0
	3	0
	19	0
CA_1A-5A-7A	1	0
	5	0
	7	0
CA_1A-7A-20A	1	0
	7	0
	20	0
CA_1A-18A-28A	1	0
	18	0
	28	0
CA_1A-19A-21A	1	0
	19	0
	21	0
CA_2A-4A-12A	2	0.3
	4	0.3
	12	0.5
CA_2A-4A-13A	2	0.3
	4	0.3
	13	0
CA_2A-5A-30A	2	0.4
	5	0
	30	0.5
CA_2A-12A-30A	2	0.4
	12	0
	30	0.5
CA_4A-5A-13A	4	0
	5	0
	13	0
CA_4A-5A-30A	4	0.4
	5	0
	30	0.5
CA_4A-12A-30A	4	0.4
	12	0.5
	30	0.5
NOTE 1: The above additional tolerances are only applicable for the E-UTRA operating bands that belong to the supported inter-band carrier aggregation configurations.		
NOTE 2: The above additional tolerances also apply in intra-band and non-aggregated operation for the supported E-UTRA operating bands that belong to the supported inter-band carrier aggregation configurations.		
NOTE 3: Tolerances for a UE supporting multiple 3DL inter-band CA configurations are FFS.		
NOTE 4: The above additional tolerances applicable for the E-UTRA operating bands that belong to the supported highest order inter-band carrier aggregation configuration, also apply to the same E-UTRA operating bands that belong to a supported lower order CA configuration.		

NOTE: The above additional tolerances do not apply to supported UTRA operating bands with frequency range below 1 GHz that correspond to the E-UTRA operating bands that belong to the supported inter-band carrier aggregation configurations when such bands are belonging only to band combination(s) where one band is <1GHz and another band is >1.7GHz and there is no harmonic relationship between the low band UL and high band DL. Otherwise the above additional tolerances also apply to supported UTRA operating bands that correspond to the E-UTRA operating bands that belong to the supported inter-band carrier aggregation configurations.

Table 7.3.3-2: Uplink configuration for reference sensitivity

E-UTRA Band / Channel bandwidth / $N_{RB}$ / Duplex mode							
E-UTRA Band	1.4 MHz	3 MHz	5 MHz	10 MHz	15 MHz	20 MHz	Duplex Mode
1	-	-	25	50	75	100	FDD
2	6	15	25	50	50 <sup>1</sup>	50 <sup>1</sup>	FDD
3	6	15	25	50	50 <sup>1</sup>	50 <sup>1</sup>	FDD
4	6	15	25	50	75	100	FDD
5	6	15	25	25 <sup>1</sup>	-	-	FDD
6	-	-	25	25 <sup>1</sup>	-	-	FDD
7	-	-	25	50	75	75 <sup>1</sup>	FDD
8	6	15	25	25 <sup>1</sup>	-	-	FDD
9	-	-	25	50	50 <sup>1</sup>	50 <sup>1</sup>	FDD
10	-	-	25	50	75	100	FDD
11	-	-	25	25 <sup>1</sup>			FDD
12	6	15	20 <sup>1</sup>	20 <sup>1</sup>			FDD
13			20 <sup>1</sup>	20 <sup>1</sup>			FDD
14		-	15 <sup>1</sup>	15 <sup>1</sup>			FDD
...							
17	-	-	20 <sup>1</sup>	20 <sup>1</sup>			FDD
18	-	-	25	25 <sup>1</sup>	25 <sup>1</sup>	-	FDD
19	-	-	25	25 <sup>1</sup>	25 <sup>1</sup>	-	FDD
20			25	20 <sup>1</sup>	20 <sup>3</sup>	20 <sup>3</sup>	FDD
21			25	25 <sup>1</sup>	25 <sup>1</sup>		FDD
22			25	50	50 <sup>1</sup>	50 <sup>1</sup>	FDD
23	6	15	25	50	75	100	FDD
24			25	50			FDD
25	6	15	25	50	50 <sup>1</sup>	50 <sup>1</sup>	FDD
26	6	15	25	25 <sup>1</sup>	25 <sup>1</sup>		FDD
27	6	15	25	25 <sup>1</sup>			FDD
28		15	25	25 <sup>1</sup>	25 <sup>1</sup>	25 <sup>1</sup>	FDD
30	-	-	25	25 <sup>1</sup>	-	-	FDD
31	6	5 <sup>4</sup>	5 <sup>4</sup>				FDD
...							
33	-	-	25	50	75	100	TDD
34	-	-	25	50	75	-	TDD
35	6	15	25	50	75	100	TDD
36	6	15	25	50	75	100	TDD
37	-	-	25	50	75	100	TDD
38	-	-	25	50	75	100	TDD
39			25	50	75	100	TDD
40			25	50	75	100	TDD
41			25	50	75	100	TDD
42			25	50	75	100	TDD
43			25	50	75	100	TDD
44		15	25	50	75	100	TDD
Note 1:	The UL resource blocks shall be located as close as possible to the downlink operating band but confined within the transmission bandwidth configuration for the channel bandwidth (Table 5.4.2-1).						
Note 2:	For the UE which supports both Band 11 and Band 21 the uplink configuration for reference sensitivity is FFS.						
Note 3:	For Band 20; in the case of 15MHz channel bandwidth, the UL resource blocks shall be located at $RB_{start}=11$ and in the case of 20MHz channel bandwidth, the UL resource blocks shall be located at $RB_{start}=16$ .						

Note 4: <sup>4</sup> refers to Band 31; in the case of 3 MHz channel bandwidth, the UL resource blocks shall be located at RB<sub>start</sub> 9 and in the case of 5 MHz channel bandwidth, the UL resource blocks shall be located at RB<sub>start</sub> 10.

Unless given by Table 7.3.3-3, the minimum requirements specified in Tables 7.3.3-1 and 7.3.3-2 shall be verified with the network signalling value NS\_01 (Table 6.2.4.3-1) configured.

**Table 7.3.3-3: Network Signalling Value for reference sensitivity**

E-UTRA Band	Network Signalling value
2	NS_03
4	NS_03
10	NS_03
12	NS_06
13	NS_06
14	NS_06
17	NS_06
19	NS_08
21	NS_09
23	NS_03
30	NS_21

The normative reference for this requirement is TS 36.101 [2] clause 7.3.1.

## 7.3.4 Test description

### 7.3.4.1 Initial conditions

Initial conditions are a set of test configurations the UE needs to be tested in and the steps for the SS to take with the UE to reach the correct measurement state.

The initial test configurations consist of environmental conditions, test frequencies, and channel bandwidths based on E-UTRA bands specified in table 5.4.2.1-1. All of these configurations shall be tested with applicable test parameters for each channel bandwidth, and are shown in table 7.3.4.1-1. The details of the downlink and uplink reference measurement channels (RMCs) are specified in Annexes A.2 and A.3. The details of the OCN patterns used are specified in Annex A.5. Configurations of PDSCH and PDCCH before measurement are specified in Annex C.2.

**Table 7.3.4.1-1: Test Configuration Table**

Initial Conditions						
Test Environment as specified in TS 36.508[7] subclause 4.1			NC, TL/VL, TL/VH, TH/VL, TH/VH			
Test Frequencies as specified in TS36.508 [7] subclause 4.3.1			Low range, Mid range, High range			
Test Channel Bandwidths as specified in TS 36.508 [7] subclause 4.3.1			Lowest, 5MHz, Highest			
Test Parameters for Channel Bandwidths						
Ch BW	Downlink Configuration			Uplink Configuration		
	Mod'n	RB allocation		Mod'n	RB allocation	
		FDD	TDD		FDD	TDD
1.4MHz	QPSK	6	6	QPSK	6	6
3MHz	QPSK	15	15	QPSK	15	15
5MHz	QPSK	25	25	QPSK	25	25
5MHz	QPSK	25	N/A	QPSK	20	N/A
5MHz	QPSK	25	N/A	QPSK	15	N/A
5MHz	QPSK	25	N/A	QPSK	5 <sup>+</sup>	N/A
10MHz	QPSK	50	50	QPSK	50	50
10MHz	QPSK	50	N/A	QPSK	25	N/A
10MHz	QPSK	50	N/A	QPSK	20	N/A
10MHz	QPSK	50	N/A	QPSK	15	N/A
15MHz	QPSK	75	75	QPSK	75	75
15MHz	QPSK	75	N/A	QPSK	50	N/A
15MHz	QPSK	75	N/A	QPSK	25	N/A
15MHz	QPSK	75	N/A	QPSK	20	N/A
20MHz	QPSK	100	100	QPSK	100	100
20MHz	QPSK	100	N/A	QPSK	75	N/A
20MHz	QPSK	100	N/A	QPSK	50	N/A
20MHz	QPSK	100	N/A	QPSK	25	N/A
20MHz	QPSK	100	N/A	QPSK	20	N/A
Note 1:	Test Channel Bandwidths are checked separately for each E-UTRA band, which applicable channel bandwidths are specified in Table 5.4.2.1-1.					
Note 2:	Depending on E-UTRA band, only the appropriate Uplink RB allocation value according to table 7.3.3-2 is tested per Test Channel Bandwidth. The allocation shall be located as close as possible to the downlink operating band but confined within the transmission bandwidth configuration for the channel bandwidth (Table 5.4.2-1).					
Note 3:	For the DL signal one sided dynamic OCNG Pattern OP.1 FDD/TDD is used.					
Note 4:	Applicable only to E-UTRA FDD Band 31. The UL resource blocks shall be located at RBstart 10 (according to Table 7.3.3-2).					

1. Connect the SS to the UE antenna connectors as shown in TS 36.508 [7] Annex A, Figure A.3.
2. The parameter settings for the cell are set up according to TS 36.508 [7] subclause 4.4.3.
3. Downlink signals are initially set up according to Annex C0, C.1 and C.3.1, and uplink signals according to Annex H.1 and H.3.1.
4. The UL and DL Reference Measurement channels are set according to Table 7.3.4.1-1.
5. Propagation conditions are set according to Annex B.0.
6. Ensure the UE is in State 3A-RF according to TS 36.508 [7] clause 5.2A.2. Message contents are defined in clause 7.3.4.3.

### 7.3.4.2 Test procedure

1. SS transmits PDSCH via PDCCH DCI format 1A for C\_RNTI to transmit the DL RMC according to Table 7.3.4.1-1. The SS sends downlink MAC padding bits on the DL RMC.
2. SS sends uplink scheduling information for each UL HARQ process via PDCCH DCI format 0 for C\_RNTI to schedule the UL RMC according to Table 7.3.4.1-1. Since the UE has no payload data to send, the UE transmits uplink MAC padding bits on the UL RMC.



3. Set the Downlink signal level to the appropriate REFSENS value defined in Table 7.3.5-1. Send continuously uplink power control "up" commands in the uplink scheduling information to the UE to ensure the UE transmits  $P_{UMAX}$  level for at least the duration of the Throughput measurement.
4. Measure the average throughput for a duration sufficient to achieve statistical significance according to Annex G.2.

### 7.3.4.3 Message contents

Message contents are according to TS 36.508 [7] subclause 4.6 with the following exceptions.

#### 7.3.4.3.1 Message contents exceptions (network signalled value "NS\_01")

Message contents according to TS 36.508 [7] subclause 4.6 can be used without exceptions.

#### 7.3.4.3.2 Message contents exceptions (network signalled value "NS\_03")

1. Information element `additionalSpectrumEmission` is set to NS\_03. This can be set in the *SystemInformationBlockType2* as part of the cell broadcast message. This exception indicates that the UE shall meet the additional spurious emission requirement for a specific deployment scenario.

**Table 7.3.4.3.2-1: SystemInformationBlockType2: Additional spurious emissions test requirement for "NS\_03"**

Derivation Path: TS 36.508 [7] clause 4.4.3.3, Table 4.4.3.3-1			
Information Element	Value/remark	Comment	Condition
<code>additionalSpectrumEmission</code>	3 (NS_03)		

#### 7.3.4.3.3 Message contents exceptions (network signalled value "NS\_06")

1. Information element `additionalSpectrumEmission` is set to NS\_06. This can be set in the *SystemInformationBlockType2* as part of the cell broadcast message. This exception indicates that the UE shall meet the additional spurious emission requirement for a specific deployment scenario.

**Table 7.3.4.3.3-1: SystemInformationBlockType2: Additional spurious emissions test requirement for "NS\_06"**

Derivation Path: TS 36.508 [7] clause 4.4.3.3, Table 4.4.3.3-1			
Information Element	Value/remark	Comment	Condition
<code>additionalSpectrumEmission</code>	6 (NS_06)		

#### 7.3.4.3.4 Message contents exceptions (network signalled value "NS\_09")

1. Information element `additionalSpectrumEmission` is set to NS\_09. This can be set in the *SystemInformationBlockType2* as part of the cell broadcast message. This exception indicates that the UE shall meet the additional spurious emission requirement for a specific deployment scenario.

**Table 7.3.4.3.4-1: SystemInformationBlockType2: Additional spurious emissions test requirement for "NS\_09"**

Derivation Path: TS 36.508 [7] clause 4.4.3.3, Table 4.4.3.3-1			
Information Element	Value/remark	Comment	Condition
<code>additionalSpectrumEmission</code>	9 (NS_09)		

#### 7.3.4.3.5 Message contents exceptions (network signalled value "NS\_08")

1. Information element `additionalSpectrumEmission` is set to NS\_08. This can be set in the *SystemInformationBlockType2* as part of the cell broadcast message. This exception indicates that the UE shall meet the additional spurious emission requirement for a specific deployment scenario.

**Table 7.3.4.3.5-1: SystemInformationBlockType2: Additional spurious emissions test requirement for "NS\_08"**

Derivation Path: TS 36.508 [7] clause 4.4.3.3, Table 4.4.3.3-1			
Information Element	Value/remark	Comment	Condition
additionalSpectrumEmission	8 (NS_08)		

#### 7.3.4.3.6 Message contents exceptions (network signalled value "NS\_21")

1. Information element additionalSpectrumEmission is set to NS\_21. This can be set in the *SystemInformationblockType2* as part of the cell broadcast message. This exception indicates that the UE shall meet the additional spurious emission requirement for a specific deployment scenario.

**Table 7.3.4.3.6-1: SystemInformationBlockType2: Additional spurious emissions test requirement for "NS\_21"**

Derivation Path: TS 36.508 [7] clause 4.4.3.3, Table 4.4.3.3-1			
Information Element	Value/remark	Comment	Condition
additionalSpectrumEmission	21 (NS_21)		

### 7.3.5 Test requirement

The throughput shall be  $\geq 95\%$  of the maximum throughput of the reference measurement channels as specified in Annex A.3.2 with parameters specified in Tables 7.3.5-1 and Table 7.3.5-2.

Table 7.3.5-1: Reference sensitivity QPSK P<sub>REFSENS</sub>

Channel bandwidth							
E-UTRA Band	1.4 MHz (dBm)	3 MHz (dBm)	5 MHz (dBm)	10 MHz (dBm)	15 MHz (dBm)	20 MHz (dBm)	Duplex Mode
1	-	-	-99.3	-96.3	-94.5	-93.3	FDD
2	-102.0	-99.0	-97.3	-94.3	-92.5	-91.3	FDD
3	-101.0	-98.0	-96.3	-93.3	-91.5	-90.3	FDD
4	-104.0	-101	-99.3	-96.3	-94.5	-93.3	FDD
5	-102.5	-99.5	-97.3	-94.3			FDD
6	-	-	-99.3	-96.3			FDD
7	-	-	-97.3	-94.3	-92.5	-91.3	FDD
8	-101.5	-98.5	-96.3	-93.3			FDD
9	-	-	-98.3	-95.3	-93.5	-92.3	FDD
10	-	-	-99.3	-96.3	-94.5	-93.3	FDD
11	-	-	-99.3	-96.3			FDD
12	-101.0	-98.0	-96.3	-93.3			FDD
13			-96.3	-93.3			FDD
14		-	-96.3	-93.3			FDD
...							
17	-	-	-96.3	-93.3			FDD
18	-	-	-99.3 <sup>7</sup>	-96.3 <sup>7</sup>	-94.5 <sup>7</sup>	-	FDD
19	-	-	-99.3	-96.3	-94.5	-	FDD
20			-96.3	-93.3	-90.5	-89.3	FDD
21			-99.3	-96.3	-94.5		FDD
22			-96.0	-93.0	-91.2	-90.0	FDD
23	-104.0	-101	-99.3	-96.3	-94.5	-93.3	FDD
24			-99.3	-96.3			FDD
25	-100.5	-97.5	-95.8	-92.8	-91.0	-89.8	FDD
26	-102	-99	-96.8 <sup>6</sup>	-93.8 <sup>6</sup>	-92 <sup>6</sup>		FDD
27	-102.5	-99.5	-97.3	-94.3			FDD
28		-99.5	-97.8	-94.8	-93.0	-90.3	FDD
30	-	-	-98.3	-95.3	-	-	FDD
31	-98.3	-95.0	-92.8				FDD
...							
33	-	-	-99.3	-96.3	-94.5	-93.3	TDD
34	-	-	-99.3	-96.3	-94.5	-	TDD
35	-105.5	-101.5	-99.3	-96.3	-94.5	-93.3	TDD
36	-105.5	-101.5	-99.3	-96.3	-94.5	-93.3	TDD
37	-	-	-99.3	-96.3	-94.5	-93.3	TDD
38	-	-	-99.3	-96.3	-94.5	-93.3	TDD
39	-	-	-99.3	-96.3	-94.5	-93.3	TDD
40	-	-	-99.3	-96.3	-94.5	-93.3	TDD
41	-	-	-97.3	-94.3	-92.5	-91.3	TDD
42	-	-	-98.0	-95.0	-93.2	-92.0	TDD
43	-	-	-98.0	-95.0	-93.2	-92.0	TDD
44		[-99.5]	[-97.3]	[-94.3]	[-92.5]	[-91.3]	TDD
Note 1:	The transmitter shall be set to maximum output power level (Table 7.3.5-2)						
Note 2:	The reference measurement channel is specified in A.3.2 with one sided dynamic OCNG Pattern OP.1 FDD/TDD as described in Annex A.5.1.1/A.5.2.1						
Note 3:	The signal power is specified per port						
Note 4:	For the UE which supports both Band 3 and Band 9 the reference sensitivity level is FFS.						
Note 5:	For the UE which supports both Band 11 and Band 21 the reference sensitivity level is FFS.						
Note 6:	<sup>6</sup> indicates that the requirement is modified by -0.5 dB when the carrier						

Note 7: frequency of the assigned E-UTRA channel bandwidth is within 865-894 MHz.  
 For a UE that support both Band 18 and Band 26, the reference sensitivity level for Band 26 applies for the applicable channel bandwidths.

For the UE which supports inter-band carrier aggregation configurations the  $\Delta R_{IB,c}$  in Table 7.3.3-1A shall be applied for applicable bands.

In case the UE supports more than one of the inter-band carrier aggregation configurations and a E-UTRA operating band belongs to more than one inter-band carrier aggregation configurations then:

- When the E-UTRA operating band frequency range is  $\leq 1$ GHz, the applicable additional tolerance shall be the average of the tolerances in Table 7.3.3-1A, truncated to one decimal place that would apply for that operating band among the supported CA configurations. In case there is a harmonic relation between low band UL and high band DL (i.e. bands listed in Table 7.3A.0-1), then the maximum tolerance among the different supported carrier aggregation configurations involving such band shall be applied
- When the E-UTRA operating band frequency range is  $>1$ GHz, the applicable additional tolerance shall be the maximum tolerance in Table 7.3.3-1A that would apply for that operating band among the supported CA configurations

NOTE 1: The relation to the received PSD is  $\langle \text{REF} \hat{I}_{or} \rangle = P_{\text{REFSENS}} (N_{sc}^{RB} N_{RB} \Delta f)^{-1}$  with  $N_{RB}$  is the transmission bandwidth configuration according to Table 5.4.2-1.

The reference receive sensitivity (REFSENS) requirement specified in Table 7.3.5-1 shall be met for an uplink transmission bandwidth less than or equal to that specified in Table 7.3.5-2.

NOTE 2: Table 7.3.5-2 does not necessarily reflect the operational conditions of the network, where the number of uplink and downlink allocated resource blocks will be practically constrained by other factors.

Table 7.3.5-2: Uplink configuration for reference sensitivity,  $L_{CRB}$  @  $RB_{start}$  format

E-UTRA Band	E-UTRA Band / Channel bandwidth / $N_{RB}$ / Duplex mode						Duplex Mode
	1.4 MHz / 6	3 MHz / 15	5 MHz / 25	10 MHz / 50	15 MHz / 75	20 MHz / 100	
1	-	-	25@0	50@0	75@0	100@0	FDD
2	6@0	15@0	25@0	50@0	50@25	50@50	FDD
3	6@0	15@0	25@0	50@0	50@25	50@50	FDD
4	6@0	15@0	25@0	50@0	75@0	100@0	FDD
5	6@0	15@0	25@0	25@25	-	-	FDD
6	-	-	25@0	25@25	-	-	FDD
7	-	-	25@0	50@0	75@0	75@25	FDD
8	6@0	15@0	25@0	25@25	-	-	FDD
9	-	-	25@0	50@0	50@25	50@50	FDD
10	-	-	25@0	50@0	75@0	100@0	FDD
11	-	-	25@0	25@25	-	-	FDD
12	6@0	15@0	20@5	20@30	-	-	FDD
13	-	-	20@0	20@0	-	-	FDD
14	-	-	15@0	15@0	-	-	FDD
...							
17	-	-	20@5	20@30	-	-	FDD
18	-	-	25@0	25@25	25@50	-	FDD
19	-	-	25@0	25@25	25@50	-	FDD
20	-	-	25@0	20@0	20@11	20@16	FDD
21	-	-	25@0	25@25	25@50	-	FDD
22	-	-	25@0	50@0	50@25	50@50	FDD
23	6@0	15@0	25@0	50@0	75@0	100@0	FDD
24	-	-	25@0	50@0	-	-	FDD
25	6@0	15@0	25@0	50@0	50@25	50@50	FDD
26	6@0	15@0	25@0	25@25	25@50	-	FDD
27	6@0	15@0	25@0	25@25	-	-	FDD
28		15@0	25@0	25@25	25@50	25@75	FDD
30	-	-	25@0	25@25	-	-	FDD
31	6@0	5@9	5@10	-	-	-	FDD
...							
33	-	-	25@0	50@0	75@0	100@0	TDD
34	-	-	25@0	50@0	75@0	-	TDD
35	6@0	15@0	25@0	50@0	75@0	100@0	TDD
36	6@0	15@0	25@0	50@0	75@0	100@0	TDD
37	-	-	25@0	50@0	75@0	100@0	TDD
38	-	-	25@0	50@0	75@0	100@0	TDD
39	-	-	25@0	50@0	75@0	100@0	TDD
40	-	-	25@0	50@0	75@0	100@0	TDD
41	-	-	25@0	50@0	75@0	100@0	TDD
42	-	-	25@0	50@0	75@0	100@0	TDD
43	-	-	25@0	50@0	75@0	100@0	TDD
44	-	15@0	25@0	50@0	75@0	100@0	TDD

## 7.3A Reference sensitivity level for CA

Editor's note: The Test Requirements for CA\_2A-30A are missing.

## 7.3A.0 Minimum conformance requirements

For inter-band carrier aggregation with uplink assigned to one E-UTRA band the throughput shall be  $\geq 95\%$  of the maximum throughput of the reference measurement channels as specified in Annexes A.2.2, A.2.3 and A.3.2 (with one sided dynamic OCNG Pattern OP.1 FDD/TDD for the DL-signal as described in Annex A.5.1.1/A.5.2.1) with parameters specified in Table 7.3.3-1 and Table 7.3.3-2. The reference sensitivity is defined to be met with both downlink component carriers active and either of the uplink component carriers active and one of the uplink carriers active. The uplink resource blocks shall be located as close as possible to the primary downlink operating band but confined within the transmission bandwidth configuration for the channel bandwidth (Table 5.4.2-1). The primary downlink operating band is the downlink band of the active uplink operating band. The UE shall meet the requirements specified in subclause 7.3.3 with the following exceptions.

For the UE that supports any of the E-UTRA CA configurations given in Table 7.3A.0-1, exceptions to the aforementioned requirements are allowed when the uplink active in a lower-frequency band and is within a specified frequency range such that transmitter harmonics fall within the downlink transmission bandwidth assigned in a higher band as noted in Table 7.3A.0-1. For these exceptions, the UE shall meet the requirements specified in Table 7.3A.0-1 and Table 7.3A.0-1a.

**Table 7.3A.0-1: Reference sensitivity for carrier aggregation QPSK  $P_{REFSENS, CA}$  (exceptions)**

Channel bandwidth								
EUTRA CA Configuration	EUTRA band	1.4 MHz (dBm)	3 MHz (dBm)	5 MHz (dBm)	10 MHz (dBm)	15 MHz (dBm)	20 MHz (dBm)	Duplex mode
CA_1A-28A <sup>5,6</sup>	1			-89.8	-89.4	-89	-88.7	FDD
	28			-98.3	-95.3	-93.5	-90.8	
CA_3A-8A <sup>4</sup>	3				N/A	N/A	N/A	FDD
	8			N/A	N/A			
CA_3A-42A <sup>9,10</sup>	3			-96.8	-93.8	-92	-90.8	FDD
	42			-71.7	-71.7	-71.7	-71.7	TDD
CA_3A-42A <sup>11</sup>	3			-96.8	-93.8	-92	-90.8	FDD
	42			-97.1	-94.7	-93.2	-92.5	TDD
CA_3A-42C <sup>9,10</sup>	3			-96.8	-93.8	-92	-90.8	FDD
	42			-71.7	-71.7	-71.7	-71.7	TDD
CA_3A-42C <sup>11</sup>	3			-96.8	-93.8	-92	-90.8	FDD
	42			-97.1	-94.7	-93.2	-92.5	TDD
CA_4A-12A <sup>5,6</sup>	4	-89.2	-89.2	-90	-89.5	-89	-88.5	FDD
	12			-96.5	-93.5			
CA_4A-17A <sup>5,6</sup>	4			[-90]	[-89.5]			FDD
	17			-96.5	-93.5			
CA_2A-4A-12A <sup>5,6</sup>	2			-97.7	-94.7	-92.9	-91.7	FDD
	4			-90	-89.5	-89	-88.5	
	12			-96.5	-93.5			
CA_26A-41A <sup>8</sup>	26			N/A	N/A	N/A	N/A	FDD
	41			N/A	N/A	N/A	N/A	TDD
CA_26A-41C <sup>8</sup>	26			N/A	N/A	N/A	N/A	FDD
	41			N/A	N/A	N/A	N/A	TDD

- Note 1: The transmitter shall be set to  $P_{UMAX}$  as defined in subclause 6.2.5A.
- Note 2: Reference measurement channel is A.3.2 with one sided dynamic OCNG Pattern OP.1 FDD/TDD as described in Annex A.5.1.1/A.5.2.1
- Note 3: The signal power is specified per port
- Note 4: No requirements apply when there is at least one individual RE within the transmission bandwidth of the low band for which the 2nd harmonic is within the transmission bandwidth of the high band. The reference sensitivity is only verified when this is not the case (the requirements specified in clause 7.3.3 apply).
- Note 5: These requirements apply when there is at least one individual RE within the transmission bandwidth of the low band for which the 3rd harmonic is within transmission bandwidth of the high band.
- Note 6: The requirements should be verified for UL EARFCN of the low band (superscript LB) such that  $f_{UL}^{LB} = \lfloor f_{DL}^{HB} / 0.3 \rfloor 0.1$  in MHz and  $F_{UL\_low}^{LB} + BW_{Channel}^{LB} / 2 < f_{UL}^{LB} < F_{UL\_high}^{LB} - BW_{Channel}^{LB} / 2$  with  $f_{DL}^{HB}$  the carrier frequency of the high band in MHz and  $BW_{Channel}^{LB}$  the channel bandwidth configured in the low band.
- NOTE 7: Void.
- NOTE 8: No requirements apply when there is at least one individual RE within the uplink transmission bandwidth of the low band for which the 3rd transmitter harmonic is within the downlink transmission bandwidth of the high band. The reference sensitivity is only verified when this is not the case (the requirements specified in clause 7.3.3 apply).
- NOTE 9: These requirements apply when there is at least one individual RE within the uplink transmission bandwidth of the aggressor (lower) band for which the 2nd transmitter harmonic is within the downlink transmission bandwidth of a victim (higher) band and a range  $\Delta F_{HD}$  above and below the edge of this downlink transmission bandwidth. The value  $\Delta F_{HD}$  depends on the E-UTRA configuration:  $\Delta F_{HD} = 10$  MHz for CA\_3A-42A, CA\_3A-42C, CA\_1A-3A-42A and CA\_3A-19A-42A.
- NOTE 10: The requirements should be verified for UL EARFCN of the aggressor (lower) band (superscript LB) such that  $f_{UL}^{LB} = \lfloor f_{DL}^{HB} / 0.2 \rfloor 0.1$  in MHz and  $F_{UL\_low}^{LB} + BW_{Channel}^{LB} / 2 < f_{UL}^{LB} < F_{UL\_high}^{LB} - BW_{Channel}^{LB} / 2$  with  $f_{DL}^{HB}$  carrier frequency in the victim (higher) band in MHz and  $BW_{Channel}^{LB}$  the channel bandwidth configured in the lower band.
- NOTE 11: The requirements are only applicable to channel bandwidths with a carrier frequency at  $\pm (20 + BW_{Channel}^{HB} / 2)$  MHz offset from  $2f_{UL}^{LB}$  in the victim (higher band) with

$$F_{UL\_low}^{LB} + BW_{Channel}^{LB}/2 < f_{UL}^{LB} < F_{UL\_high}^{LB} - BW_{Channel}^{LB}/2$$
, where  $BW_{Channel}^{LB}$  and  $BW_{Channel}^{HB}$  are the channel bandwidths configured in the aggressor (lower) and victim (higher) bands in MHz, respectively.
**Table 7.3A.0-1a: Uplink configuration for the low band (exceptions)**

E-UTRA Band / Channel bandwidth of the high band / NRB / Duplex mode								
EUTRA CA Configuration	UL band	1.4 MHz (dBm)	3 MHz (dBm)	5 MHz (dBm)	10 MHz (dBm)	15 MHz (dBm)	20 MHz (dBm)	Duplex mode
CA_1A-28A	28			8	16	25	25	FDD
CA_4A-12A	12	2	5	8	16			FDD
CA_4A-17A	17			8	16			FDD
CA_2A-4A-12A	12			8	16	20	20	FDD
CA_3A-42A	3			12	25	36	50	FDD
CA_3A-42C	3			12	25	36	50	FDD
CA_4A-4A-12A	12			8	16	20	20	FDD
CA_4A-5A-12A	12			8	16	20	20	FDD
CA_4A-7A-12A	12			8	16	20	20	FDD
CA_4A-12B	12			8	16	20	20	FDD
CA_7A-8A	8				16	25	25	FDD
CA_7A-8A-20A	8				16	25	25	FDD
Note 1: refers to the UL resource blocks, which shall be centred within the transmission bandwidth configuration for the channel bandwidth								
Note 2: the UL configuration applies regardless of the channel bandwidth of the low band unless the UL resource blocks exceed that specified in Table 7.3.3-2 for the uplink bandwidth in which case the allocation according to Table 7.3.3-2 applies								

For the UE that supports any of the E-UTRA CA configurations given in Table 7.3A.0-1b, exceptions are allowed when the uplink is active within a specified frequency range as noted in Table 7.3A.0-1b. For these exceptions, the UE shall meet the requirements specified in Table 7.3A.0-1b and Table 7.3A.0-1c.



**Table 7.3A.0-1b: Reference sensitivity for carrier aggregation QPSK  $P_{\text{REFSENS, CA}}$  (exceptions for two bands)**

Channel bandwidth								
EUTRA CA Configuration	EUTRA band	1.4 MHz (dBm)	3 MHz (dBm)	5 MHz (dBm)	10 MHz (dBm)	15 MHz (dBm)	20 MHz (dBm)	Duplex mode
CA_1A-3A <sup>4</sup>	1			-100	-97	-95.2	-94	FDD
	3			-94	-91.5	-90	-89	
CA_1A-3A <sup>5</sup>	1			-100	-97	-95.2	-94	FDD
	3			-97	-94	-92.2	-91	
CA_18A-28A <sup>6</sup>	18			-100	-97	-95.2		FDD
	28			-94	-92.5			

NOTE 1: The transmitter shall be set to  $P_{\text{UMAX}}$  as defined in subclause 6.2.5A.  
NOTE 2: Reference measurement channel is A.3.2 with one sided dynamic OCNG Pattern OP.1 FDD/TDD as described in Annex A.5.1.1/A.5.2.1  
NOTE 3: The signal power is specified per port  
NOTE 4: These requirements apply when the uplink is active in Band 1 and the separation between the lower edge of the uplink channel in Band 1 and the upper edge of the downlink channel in Band 3 is < 60 MHz. For each channel bandwidth in Band 3, the requirement applies regardless of channel bandwidth in Band 1.  
NOTE 5: These requirements apply when the uplink is active in Band 1 and the separation between the lower edge of the uplink channel in Band 1 and the upper edge of the downlink channel in Band 3 is  $\geq$  60 MHz. For each channel bandwidth in Band 3, the requirement applies regardless of channel bandwidth in Band 1.  
NOTE 6: These requirements apply when the uplink is active in Band 18 and the downlink channels in Band 28 are confined within the restricted frequency range specified for this CA configuration (Table 5.2A-2). For each channel bandwidth in Band 28, the requirement applies regardless of channel bandwidth in Band 18.

**Table 7.3A.0-1c: Uplink configuration for the low band (exceptions for two bands)**

E-UTRA Band / Channel bandwidth / $N_{\text{RB}}$ / Duplex mode								
EUTRA CA Configuration	UL band	1.4 MHz	3 MHz	5 MHz	10 MHz	15 MHz	20 MHz	Duplex mode
CA_1A-3A <sup>1,2</sup>	1			25	25	25	25	FDD
CA_1A-3A <sup>1,3</sup>	1			25	45	45	45	FDD
CA_18A-28A <sup>4</sup>	18			25	25	25		FDD

NOTE 1: refers to the UL resource blocks shall be located as close as possible to the downlink channel in Band 3 but confined within the transmission bandwidth configuration for the channel bandwidth (Table 5.6-1) in the uplink channel in Band 1.  
NOTE 2: UL allocation when the separation between the lower edge of the uplink channel in Band 1 and the upper edge of the downlink channel in Band 3 is < 60 MHz  
NOTE 3: UL allocation when the separation between the lower edge of the uplink channel in Band 1 and the upper edge of the downlink channel in Band 3 is  $\geq$  60 MHz.  
NOTE 4: refers to the UL resource blocks shall be located as close as possible to the downlink channel in Band 18 but confined within the transmission bandwidth configuration for the channel bandwidth (Table 5.4.2-1).

For the UE that supports any of the E-UTRA CA configurations given in Table 7.3A.0-1cA, exceptions are allowed when the uplink is active within a specified frequency range as noted in Table 7.3A.0-1cA. For these exceptions, the UE shall meet the requirements specified in Table 7.3A.0-1cA and Table 7.3A.0-1cB.

**Table 7.3A.0-1cA: Reference sensitivity for carrier aggregation QPSK  $P_{\text{REFSENS, CA}}$  (exceptions for three bands)**

Channel bandwidth								
EUTRA CA Configuration	EUTRA band	1.4 MHz (dBm)	3 MHz (dBm)	5 MHz (dBm)	10 MHz (dBm)	15 MHz (dBm)	20 MHz (dBm)	Duplex mode
CA_1A-3A-5A <sup>4</sup>	1			-100	-97	-95.2	-94	FDD
	3			[-94]	[-91.5]	[-90]	[-89]	
	5			-98	-95			
CA_1A-3A-5A <sup>5</sup>	1			-100	-97	-95.2	-94	FDD
	3			[-94]	[-91.5]	[-90]	[-89]	
	5			-98	-95			
CA_1A-3A-8A <sup>4</sup>	1			-100	-97	-95.2	-94	FDD
	3			-94	-91.5	-90	-89	
	8		-99.2	-97	-94			
CA_1A-3A-8A <sup>5</sup>	1			-100	-97	-95.2	-94	FDD
	3			-97	-94	-92.2	-91	
	8		-99.2	-97	-94			
CA_1A-3A-19A <sup>4</sup>	1			-100	-97	-95.2	-94	FDD
	3			-94	-91.5	-90	-89	
	19			-100	-97	-95.2		
CA_1A-3A-19A <sup>5</sup>	1			-100	-97	-95.2	-94	FDD
	3			-97	-94	-92.2	-91	
	19			-100	-97	-95.2		
CA_1A-3A-20A <sup>4</sup>	1			-100	-97	-95.2	-94	FDD
	3			-94	-91.5	-90	-89	
	20			-97	-94	-91.2	-90	
CA_1A-3A-20A <sup>5</sup>	1			-100	-97	-95.2	-94	FDD
	3			-97	-94	-92.2	-91	
	20			-97	-94	-91.2	-90	
CA_1A-3A-26A <sup>4</sup>	1			-100	-97	-95.2	-94	FDD
	3			-94	-91.5	-90	-89	
	26			-97.5 <sup>7</sup>	-94.5 <sup>7</sup>			
CA_1A-3A-26A <sup>5</sup>	1			-100	-97	-95.2	-94	FDD
	3			-97	-94	-92.2	-91	
	26			-97.5 <sup>7</sup>	-94.5 <sup>7</sup>			
CA_1A-18A-28A <sup>6</sup>	1			-100	-97	-95.2	-94	FDD
	18			-100	-97	-95.2		

	28			-94	-92.5			
<p>NOTE 1: The transmitter shall be set to <math>P_{UMAX}</math> as defined in subclause 6.2.5.3.</p> <p>NOTE 2: Reference measurement channel is A.3.2 with one sided dynamic OCNG Pattern OP.1 FDD/TDD as described in Annex A.5.1.1/A.5.2.1</p> <p>NOTE 3: The signal power is specified per port</p> <p>NOTE 4: These requirements apply when the uplink is active in Band 1 and the separation between the lower edge of the uplink channel in Band 1 and the upper edge of the downlink channel in Band 3 is &lt; 60 MHz. For each channel bandwidth in Band 3 and Band 19, the requirement applies regardless of channel bandwidth in Band 1.</p> <p>NOTE 5: These requirements apply when the uplink is active in Band 1 and the separation between the lower edge of the uplink channel in Band 1 and the upper edge of the downlink channel in Band 3 is <math>\geq</math> 60 MHz. For each channel bandwidth in Band 3 and Band 19, the requirement applies regardless of channel bandwidth in Band 1.</p> <p>NOTE 6: These requirements apply when the uplink is active in Band 18 and the downlink channels in Band 28 are confined within the restricted frequency range specified for this CA configuration (Table 5.2A-2). For each channel bandwidth in Band 28, the requirement applies regardless of channel bandwidth in Band 18.</p> <p>NOTE 7: <sup>7</sup> indicates that the requirement is modified by -0.5 dB when the carrier frequency of the assigned E-UTRA channel bandwidth is within 865-894 MHz.</p>								

**Table 7.3A.0-1cB: Uplink configuration for the low band (exceptions for three bands)**

E-UTRA Band / Channel bandwidth / $N_{RB}$ / Duplex mode								
EUTRA CA Configuration	UL band	1.4 MHz	3 MHz	5 MHz	10 MHz	15 MHz	20 MHz	Duplex mode
CA_1A-3A-5A <sup>1,2</sup>	1			25	25	25	25	FDD
CA_1A-3A-5A <sup>1,3</sup>	1			[25]	[45]	[45]	[45]	FDD
CA_1A-3A-8A <sup>1,2</sup>	1			25	25	25	25	FDD
CA_1A-3A-8A <sup>1,3</sup>	1			25	45	45	45	FDD
CA_1A-3A-19A <sup>1,2</sup>	1			25	25	25	25	FDD
CA_1A-3A-19A <sup>1,3</sup>	1			25	45	45	45	FDD
CA_1A-3A-20A <sup>1,2</sup>	1			25	25	25	25	FDD
CA_1A-3A-20A <sup>1,3</sup>	1			25	45	45	45	FDD
CA_1A-3A-26A <sup>1,2</sup>	1			25	25	25	25	FDD
CA_1A-3A-26A <sup>1,3</sup>	1			25	45	45	45	FDD
CA_1A-18A-28A <sup>4</sup>	18			25	25	25		FDD
<p>NOTE 1: refers to the UL resource blocks shall be located as close as possible to the downlink channel in Band 3 but confined within the transmission bandwidth configuration for the channel bandwidth (Table 5.4.2-1) in the uplink channel in Band 1.</p> <p>NOTE 2: UL allocation when the separation between the lower edge of the uplink channel in Band 1 and the upper edge of the downlink channel in Band 3 is &lt; 60 MHz.</p> <p>NOTE 3: UL allocation when the separation between the lower edge of the uplink channel in Band 1 and the upper edge of the downlink channel in Band 3 is <math>\geq</math> 60 MHz.</p> <p>NOTE 4: refers to the UL resource blocks shall be located as close as possible to the downlink channel in Band 18 but confined within the transmission bandwidth configuration for the channel bandwidth (Table 5.4.2-1).</p>								

For band combinations including operating bands without uplink band (as noted in Table 5.2-1), the requirements are specified in Table 7.3A.0-1d and Table 7.3A.0-1e.

Table 7.3A.0-1d: Reference sensitivity QPSK  $P_{\text{REFSENS}}$ 

Channel bandwidth								
EUTRA CA Configuration	EUTRA band	1.4 MHz (dBm)	3 MHz (dBm)	5 MHz (dBm)	10 MHz (dBm)	15 MHz (dBm)	20 MHz (dBm)	Duplex mode
CA_2A-29A	2			-98	-95	-93.2	-92	FDD
	29		-98.7	-97	-94			
CA_2C-29A	2			-98	-95	-93.2	-92	FDD
	29		-98.7	-97	-94			
CA_4A-29A	4			-100	-97	-95.2	-94	FDD
	29		-98.7	-97	-94			
CA_20A-32A	20			-97	-94	-91.2	-90	FDD
	32			-100	-97	-95.2	-94	
CA_23A-29A	23			-100	-97	-95.2	-94	FDD
	29		-98.7	-97	-94			
CA_29A-30A	29			-97	-94			FDD
	30			-99	-96			
CA_2A-4A-29A	2			-97.7	-94.7	-92.9	-91.7	FDD
	4			-99.7	-96.7	-94.9	-93.7	
	29			-97	-94			
CA_2A-29A-30A	2			-97.6	-94.6	-92.8	-91.6	FDD
	29			-97	-94			
	30			-98.5	-95.5			
CA_4A-29A-30A	4			-99.6	-96.6	-94.8	-93.6	FDD
	29			-97	-94			
	30			-98.5	-95.5			
Note 1:	The transmitter shall be set to $P_{\text{UMAX}}$ as defined in subclause 6.2.5A.							
Note 2:	Reference measurement channel is A.3.2 with one sided dynamic OCNG Pattern OP.1 FDD/TDD as described in Annex A.5.1.1/A.5.2.1							
Note 3:	The signal power is specified per port							

Table 7.3A.0-1e: Uplink configuration for reference sensitivity

E-UTRA Band / Channel bandwidth / NRB / Duplex mode								
E-UTRA CA Configuration	EUTRA band	1.4 MHz (dBm)	3 MHz (dBm)	5 MHz (dBm)	10 MHz (dBm)	15 MHz (dBm)	20 MHz (dBm)	Duplex mode
CA_2A-29A	2			25	50	50 <sup>1</sup>	50 <sup>1</sup>	FDD
	29		N/A	N/A	N/A			
CA_2C-29A	2			25	50	50 <sup>1</sup>	50 <sup>1</sup>	FDD
	29		N/A	N/A	N/A			
CA_4A-29A	4			25	50	75	100	FDD
	29		N/A	N/A	N/A			
CA_20A-32A	20			25	20 <sup>1</sup>	20 <sup>2</sup>	20 <sup>2</sup>	FDD
	32			N/A	N/A	N/A	N/A	
CA_23A-29A	23			25	50	75	100	FDD
	29		N/A	N/A	N/A			
CA_29A-30A	29			N/A	N/A			FDD
	30			25	25			
CA_2A-4A-29A	2			25	50	50 <sup>1</sup>	50 <sup>1</sup>	FDD
	4			25	50	75	100	
	29			N/A	N/A			
CA_2A-29A-30A	2			25	50	50 <sup>1</sup>	50 <sup>1</sup>	FDD
	29			N/A	N/A			
	30			25	25 <sup>1</sup>			
CA_4A-29A-30A	4			25	50	75	100	FDD
	29			N/A	N/A			
	30			25	25 <sup>1</sup>			
NOTE 1: <sup>1</sup> refers to the UL resource blocks shall be located as close as possible to the downlink operating band but confined within the transmission bandwidth configuration for the channel bandwidth (Table 5.4.2-1).								
NOTE 2: <sup>2</sup> refers to Band 20; in the case of 15MHz channel bandwidth, the UL resource blocks shall be located at RB <sub>start</sub> 11 and in the case of 20MHz channel bandwidth, the UL resource blocks shall be located at RB <sub>start</sub> 16								

In all cases for single uplink inter-band CA, unless given by Table 7.3.3-3 for the band with the active uplink carrier, the applicable reference sensitivity requirements shall be verified with the network signalling value NS\_01 (Table 6.2.4.3-1) configured.

For inter-band carrier aggregation with uplink assigned to two E-UTRA bands the throughput shall be  $\geq 95\%$  of the maximum throughput of the reference measurement channels as specified in Annexes A.2.2, A.2.3 and A.3.2 (with one sided dynamic OCNG Pattern OP.1 FDD/TDD for the DL-signal as described in Annex A.5.1.1/A.5.2.1) with parameters specified in Table 7.3.3-1 and Table 7.3.3-2. The reference sensitivity is defined to be met with all downlink component carriers active and both of the uplink carriers active.

For E-UTRA CA configurations given in Table 7.3A.0-1f the reference sensitivity is defined only for the specific uplink and downlink test points which are specified in Table 7.3A.0-1f. For these test points the reference sensitivity requirement specified in Table 7.3.3-1 is relaxed by the amount of parameter MSD given in Table 7.3A.0-1f.

The allowed exceptions defined in Table 7.3A.0-1 and Table 7.3A.0-1a for inter-band carrier aggregation with a single active uplink are also applicable for dual uplink operation.

Table 7.3A.0-1f: dual uplink interband Reference sensitivity QPSK  $P_{REFSENS}$  and uplink/downlink configurations

E-UTRA Band / Channel bandwidth / N <sub>RB</sub> / Duplex mode							
EUTRA CA Configuration	EUTRA band	UL F <sub>c</sub> (MHz)	UL/DL BW (MHz)	UL C <sub>LRB</sub>	DL F <sub>c</sub> (MHz)	MSD (dB)	Duplex mode

CA_1A_3A	1	1950	5	25	2140	TBD	FDD
	3	1760	5	25	1855	N/A	
CA_1A_8A	1	1965	5	25	2155	6	FDD
	8	887.5	5	25	932.5	N/A	
CA_2A-4A	2	1860	20	50 <sup>1</sup>	1940	[5]	FDD
	4	1752.5	5	25	2152.5	N/A	
CA_2A-4A	2	1868.3	5	25	1948.3	N/A	FDD
	4	1735	5	25	2135	5	
CA_3A-5A	3	1771	10	50	1866	4	FDD
	5	838	5	25	883	N/A	
CA_3A-5A	3	1721	10	50	1816	N/A	FDD
	5	838	5	25	883	24	
CA_3A-7A	3	1730	5	25	1825	N/A	FDD
	7	2535	10	50	2655	13	
CA_3A-8A	3	1755	10	50	1850	N/A	FDD
	8	900	5	25	945	8	
CA_3A-19A	3	1771	5	25	1866	4	FDD
	19	838	5	25	883	N/A	
CA_3A-19A	3	1721	5	25	1816	N/A	FDD
	19	838	5	25	883	27	
CA-3A-20A	3	1775	5	25	1870	4	FDD
	20	840	5	25	799	N/A	
CA-3A-20A	3	1735	5	25	1830	N/A	FDD
	20	847	5	25	806	9	
CA_3A-26A	3	1771	5	25	1866	4	FDD
	26	838	5	25	883	N/A	
CA_3A-26A	3	1721	5	25	1816	N/A	FDD
	26	838	5	25	883	26	
CA_4A-7A	4	1730	5	25	1825	N/A	FDD
	7	2535	5	25	2655	15	
CA_5A-7A	5	834	5	25	879	12	FDD
	7	2547	10	50	2667	N/A	
CA_7A-20A	7	2512	10	50	2632	N/A	FDD
	20	851	5	25	810	12	
NOTE 1: Both of the transmitters shall be set min(+20 dBm, P <sub>C<sub>MAX</sub>L<sub>C</sub></sub> ) as defined in subclause 6.2.5A							
NOTE 2: RB <sub>START</sub> = 0							

For intra-band contiguous carrier aggregation the throughput of each component carrier shall be  $\geq 95\%$  of the maximum throughput of the reference measurement channels as specified in Annexes A.2.2, A.2.3 and A.3.2 (with one sided dynamic OCNG Pattern OP.1 FDD/TDD for the DL-signal as described in Annex A.5.1.1/A.5.2.1) with parameters specified in Table 7.3.3-1 and table 7.3A.0-2. Table 7.3A.0-2 specifies the maximum number of allocated uplink resource blocks for which the intra-band contiguous carrier aggregation reference sensitivity requirement shall be met. The PCC and SCC allocations follow Table 7.3.3-2 and form a contiguous allocation where TX–RX frequency separations are as defined in Table 5.3-1. In case downlink CA configuration has additional SCC(s) compared to uplink CA configuration those are configured furthers away from uplink band. For UE(s) supporting one uplink carrier, the uplink configuration of the PCC shall be in accordance with Table 7.3.3-2 and the downlink PCC carrier centre frequency shall be configured closer to uplink operating band than the downlink SCC centre frequency. Unless given by Table 7.3.3-3, the reference sensitivity requirements shall be verified with the network signalling value NS\_01 (Table 6.2.4.3-1) configured.

Table 7.3A.0-2: Intra-band contiguous CA uplink configuration for reference sensitivity

CA configuration / CC combination / $N_{RB\_agg}$ / Duplex mode											
CA configuration	100RB+25RB		100RB+50RB		75RB+75RB		100RB+75RB		100RB+100RB		Duplex Mode
	PCC	SCC	PCC	SCC	PCC	SCC	PCC	SCC	PCC	SCC	
CA_1C	N/A	N/A	N/A	N/A	75	54	N/A	N/A	100	30	FDD
CA_3C	50	0	50	0	N/A	N/A	50	0	50	0	FDD
CA_7C	N/A	N/A	75	0	75	0	75	0	75	0	FDD
CA_38C	N/A	N/A	N/A	N/A	75	75	N/A	N/A	100	100	TDD
CA_39C	100	25	100	50	N/A	N/A	100	75	N/A	N/A	TDD
CA_40C	N/A	N/A	100	50	75	75	100	75	100	100	TDD
CA_41C	N/A	N/A	100	50	75	75	100	75	100	100	TDD
CA_42C	100	25	100	50	N/A	N/A	100	75	100	100	TDD
Note 1:	The carrier centre frequency of SCC in the UL operating band is configured closer to the DL operating band.										
Note 2:	The transmitted power over both PCC and SCC shall be set to $P_{UMAX}$ as defined in subclause 6.2.5A.										
Note 3:	The UL resource blocks in both PCC and SCC shall be confined within the transmission bandwidth configuration for the channel bandwidth (Table 5.4.2-1).										
Note 4:	The UL resource blocks in PCC shall be located as close as possible to the downlink operating band, while the UL resource blocks in SCC shall be located as far as possible from the downlink operating band.										
Note 5:	In case a CA configuration consists of CC channel bandwidths which are unequal in bandwidth the PCC channel bandwidth shall be the larger one for reference sensitivity test.										
Note 6:	Void.										

For intra-band non-contiguous carrier aggregation with one uplink carrier and two downlink sub-blocks, the throughput of each downlink component carrier shall be  $\geq 95\%$  of the maximum throughput of the reference measurement channels as specified in Annexes A.2.2, A.2.3 and A.3.2 (with one sided dynamic OCNG Pattern OP.1 FDD/TDD for the DL-signal as described in Annex A.5.1.1/A.5.2.1) and parameters specified in Table 7.3.3-1 and Table 7.3A.0-3 with the power level in Table 7.3.1-1 increased by  $\Delta R_{IBNC}$  given in Table 7.3A.0-3 for the SCC(s). The requirements apply with all downlink carriers active. Unless given by Table 7.3.3-3, the reference sensitivity requirements shall be verified with the network signalling value NS\_01 (Table 6.2.4.3-1) configured.

Table 7.3A.0-3: Intra-band non-contiguous CA with one uplink configuration for reference sensitivity

CA configuration	Aggregated channel bandwidth (PCC+SCC)	$W_{\text{gap}}$ / [MHz]	UL PCC allocation	$\Delta R_{\text{IBNC}}$ (dB)	Duplex mode
CA_2A-2A	25RB+25RB	$30.0 < W_{\text{gap}} \leq 50.0$	$12^1$	5.3	FDD
		$0.0 < W_{\text{gap}} \leq 30.0$	$25^1$	0	
	25RB+50RB	$25.0 < W_{\text{gap}} \leq 45.0$	$12^1$	4.4	
		$0.0 < W_{\text{gap}} \leq 25.0$	$25^1$	0	
	25RB+75RB	$20.0 < W_{\text{gap}} \leq 40.0$	$12^1$	4.2	
		$0.0 < W_{\text{gap}} \leq 20.0$	$25^1$	0	
	25RB+100RB	$15.0 < W_{\text{gap}} \leq 35.0$	$12^1$	3.8	
		$0.0 < W_{\text{gap}} \leq 15.0$	$25^1$	0	
	50RB+25RB	$15.0 < W_{\text{gap}} \leq 45.0$	$12^1$	5.9	
		$0.0 < W_{\text{gap}} \leq 15.0$	$32^1$	0	
	50RB+50RB	$10.0 < W_{\text{gap}} \leq 40.0$	$12^1$	4.6	
		$0.0 < W_{\text{gap}} \leq 10.0$	$32^1$	0	
	50RB+75RB	$5.0 < W_{\text{gap}} \leq 35.0$	$12^1$	4.1	
		$0.0 < W_{\text{gap}} \leq 5.0$	$32^1$	0	
	50RB+100RB	$0.0 < W_{\text{gap}} \leq 30.0$	$12^1$	4.0	
	75RB+25RB	$10.0 < W_{\text{gap}} \leq 40.0$	$12^{12}$	6.7	
		$0.0 < W_{\text{gap}} \leq 10.0$	$36^1$	0	
	75RB+50RB	$5.0 < W_{\text{gap}} \leq 35.0$	$12^{12}$	5.4	
		$0.0 < W_{\text{gap}} \leq 5.0$	$36^1$	0	
	75RB+75RB	$0.0 < W_{\text{gap}} \leq 30.0$	$12^{12}$	4.6	
75RB+100RB	$0.0 < W_{\text{gap}} \leq 25.0$	$12^{12}$	4.2		
100RB+25RB	$0.0 < W_{\text{gap}} \leq 35.0$	$16^{13}$	7.2		
100RB+50RB	$0.0 < W_{\text{gap}} \leq 30.0$	$16^{13}$	5.8		
100RB+75RB	$0.0 < W_{\text{gap}} \leq 25.0$	$16^{13}$	5.0		
100RB+100RB	$0.0 < W_{\text{gap}} \leq 20.0$	$16^{13}$	4.6		
CA_3A-3A	25RB+25RB	$45.0 < W_{\text{gap}} \leq 65.0$	$12^1$	4.7	FDD
		$0.0 < W_{\text{gap}} \leq 45.0$	$25^1$	0	
	25RB+50RB	$40.0 < W_{\text{gap}} \leq 60.0$	$12^1$	3.8	
		$0.0 < W_{\text{gap}} \leq 40.0$	$25^1$	0	
	25RB+75RB	$35.0 < W_{\text{gap}} \leq 55.0$	$12^1$	3.6	
		$0.0 < W_{\text{gap}} \leq 35.0$	$25^1$	0	
	25RB+100RB	$30.0 < W_{\text{gap}} \leq 50.0$	$12^1$	3.4	
		$0.0 < W_{\text{gap}} \leq 30.0$	$25^1$	0	
	50RB+25RB	$30.0 < W_{\text{gap}} \leq 60.0$	$12^9$	5.1	
		$0.0 < W_{\text{gap}} \leq 30.0$	$32^1$	0	
	50RB+50RB	$25.0 < W_{\text{gap}} \leq 55.0$	$12^9$	4.3	
		$0.0 < W_{\text{gap}} \leq 25.0$	$32^1$	0	
	50RB+75RB	$20.0 < W_{\text{gap}} \leq 50.0$	$12^9$	3.8	
		$0.0 < W_{\text{gap}} \leq 20.0$	$32^1$	0	
	50RB+100RB	$15.0 < W_{\text{gap}} \leq 45.0$	$12^9$	3.4	
		$0.0 < W_{\text{gap}} \leq 15.0$	$32^1$	0	
	75RB+25RB	$25.0 < W_{\text{gap}} \leq 55.0$	$12^{10}$	6.0	
		$0.0 < W_{\text{gap}} \leq 25.0$	$32^1$	0	
	75RB+50RB	$20.0 < W_{\text{gap}} \leq 50.0$	$12^{10}$	4.7	
		$0.0 < W_{\text{gap}} \leq 20.0$	$32^1$	0	



	75RB+75RB	$15.0 < W_{gap} \leq 45.0$	$12^{10}$	4.2	
		$0.0 < W_{gap} \leq 15.0$	$32^1$	0	
	75RB+100RB	$10.0 < W_{gap} \leq 40.0$	$12^{10}$	3.8	
		$0.0 < W_{gap} \leq 10.0$	$32^1$	0	
	100RB+25RB	$15.0 < W_{gap} \leq 50.0$	$16^{11}$	6.5	
		$0.0 < W_{gap} \leq 15.0$	$32^1$	0	
	100RB+50RB	$10.0 < W_{gap} \leq 45.0$	$16^{11}$	5.1	
		$0.0 < W_{gap} \leq 10.0$	$32^1$	0	
100RB+75RB	$5.0 < W_{gap} \leq 40.0$	$16^{11}$	4.5		
	$0.0 < W_{gap} \leq 5.0$	$32^1$	0		
100RB+100RB	$0.0 < W_{gap} \leq 35.0$	$16^{11}$	4.1		
CA_4A-4A	Note 6	Note 7	Note 8	0.0	FDD
CA_7A_7A	50RB+50RB	$25.0 < W_{gap} \leq 50.0$	$32^1$	0.0	FDD
		$0.0 < W_{gap} \leq 25.0$	$50^1$	0.0	
	75RB+25RB	$20.0 < W_{gap} \leq 50.0$	$32^1$	0.0	
		$0.0 < W_{gap} \leq 20.0$	$50^1$	0.0	
	75RB+50RB	$20.0 < W_{gap} \leq 45.0$	$32^1$	0.0	
		$0.0 < W_{gap} \leq 20.0$	$50^1$	0.0	
	75RB+75RB	$15.0 < W_{gap} \leq 40.0$	$32^1$	0.0	
		$0.0 < W_{gap} \leq 15.0$	$50^1$	0.0	
100RB+75RB	$15.0 < W_{gap} \leq 35.0$	$36^1$	0.0		
	$0.0 < W_{gap} \leq 15.0$	$50^1$	0.0		
100RB+100RB	$15.0 < W_{gap} \leq 30.0$	$32^1$	0.0		
	$0.0 < W_{gap} \leq 15.0$	$45^1$	0.0		
CA_23A-23A	Note 6	Note 7	Note 8	0.0	FDD
CA_25A-25A	25RB+25RB	$30.0 < W_{gap} \leq 55.0$	$10^1$	5.0	FDD
		$0.0 < W_{gap} \leq 30.0$	$25^1$	0.0	
	25RB+50RB	$25.0 < W_{gap} \leq 50.0$	$10^1$	4.5	
		$0.0 < W_{gap} \leq 25.0$	$25^1$	0.0	
	25RB+75RB	$20 < W_{gap} \leq 45$	$10^1$	4.3	
		$0 < W_{gap} \leq 20$	$25^1$	0	
	25RB+100RB	$15 < W_{gap} \leq 40$	$10^1$	4.1	
		$0 < W_{gap} \leq 15$	$25^1$	0	
	50RB+25RB	$15.0 < W_{gap} \leq 50.0$	$10^4$	5.5	
		$0.0 < W_{gap} \leq 15.0$	$32^1$	0.0	
	50RB+50RB	$10.0 < W_{gap} \leq 45.0$	$10^4$	5.0	
		$0.0 < W_{gap} \leq 10.0$	$32^1$	0.0	
	50RB+75RB	$5 < W_{gap} \leq 40$	$10^4$	4.5	
		$0 < W_{gap} \leq 5$	$32^1$	0	
	50RB+100RB	$0 < W_{gap} \leq 35$	$10^4$	4.2	
	75RB+25RB	$10 < W_{gap} \leq 45$	$10^{14}$	7.6	
		$0 < W_{gap} \leq 10$	$32^1$	0	
	75RB+50RB	$5 < W_{gap} \leq 40$	$10^{14}$	6.7	
		$0 < W_{gap} \leq 5$	$32^1$	0	
	75RB+75RB	$0 < W_{gap} \leq 35$	$10^{14}$	5.6	
75RB+100RB	$0 < W_{gap} \leq 30$	$10^{14}$	4.8		
100RB+25RB	$0 < W_{gap} \leq 40$	$12^{15}$	8		
100RB+50RB	$0 < W_{gap} \leq 35$	$12^{15}$	6.7		
100RB+75RB	$0 < W_{gap} \leq 30$	$12^{15}$	6.1		
100RB+100RB	$0 < W_{gap} \leq 25$	$12^{15}$	5.7		
CA_41A-41A	Note 6	Note 7	Note 8	0.0	TDD
CA_41A-41C	NOTE 6	NOTE 7	NOTE 8	0.0	TDD
CA_41C-41A	NOTE 6	NOTE 7	NOTE 8	0.0	TDD

CA_42A-42A	Note 6	Note 7	Note 8	0.0	TDD
Note 1:	refers to the UL resource blocks shall be located as close as possible to the downlink operating band but confined within the transmission.				
Note 2:	$W_{\text{gap}}$ is the sub-block gap between the two sub-blocks.				
Note 3:	The carrier centre frequency of PCC in the UL operating band is configured closer to the DL operating band.				
Note 4:	refers to the UL resource blocks shall be located at $RB_{\text{start}}=33$ .				
Note 5:	For the TDD intra-band non-contiguous CA configurations, the minimum requirements apply only in synchronized operation between all component carriers.				
Note 6:	All combinations of channel bandwidths defined in Table 5.4.2A.1-3 .				
Note 7:	All applicable sub-block gap sizes.				
Note 8:	The PCC allocation is same as Transmission bandwidth configuration $N_{\text{RB}}$ as defined in Table 5.4.2-1.				
Note 9:	refers to the UL resource blocks shall be located at $RB_{\text{start}}=25$ .				
Note 10:	refers to the UL resource blocks shall be located at $RB_{\text{start}}=35$ .				
Note 11:	refers to the UL resource blocks shall be located at $RB_{\text{start}}=50$ .				
Note 12:	refers to the UL resource blocks shall be located at $RB_{\text{start}}=39$ .				
Note 13:	refers to the UL resource blocks shall be located at $RB_{\text{start}}=57$ .				
Note 14:	refers to the UL resource blocks shall be located at $RB_{\text{start}}=44$ .				
Note 15:	refers to the UL resource blocks shall be located at $RB_{\text{start}}=62$ .				

For intra-band non-contiguous carrier aggregation with two uplink and downlink carriers the reference sensitivity is defined to be met with both downlink and uplink carriers activated. The downlink PCC and SCC minimum requirements for reference sensitivity as specified in Table 7.3.3-1 are increased by amount of  $\Delta R_{2\text{UL\_PCC}}$  and  $\Delta R_{2\text{UL\_SCC}}$  which are defined in Table 7.3A.0-4 when uplink PCC and SCC allocations are according to the Table 7.3A.0-4.

**Table 7.3A.0-4: Intra-band non-contiguous CA with two uplinks configuration for reference sensitivity**

CA configuration	Aggregated channel bandwidth (PCC+SCC)	$W_{\text{gap}}$ / [MHz]	UL PCC allocation	UL SCC allocation	$\Delta R_{2\text{UL\_PCC}}$ (dB)	$\Delta R_{2\text{UL\_SCC}}$ (dB)	Duplex mode
CA_4A-4A	NOTE 2	NOTE 3	NOTE 4	NOTE 5	0.0	0.0	FDD
NOTE 1: The transmitter shall be set to $P_{\text{UMAX}}$ as defined in subclause 6.2.5A.							
NOTE 2: All combinations of channel bandwidths defined in Table 5.4.2A.1-3.							
NOTE 3: All applicable sub-block gap sizes.							
NOTE 4: The PCC allocation is same as Transmission bandwidth configuration $N_{\text{RB}}$ as defined in Table 5.4.2-1.							
NOTE 5: The SCC allocation is same as Transmission bandwidth configuration $N_{\text{RB}}$ as defined in Table 5.4.2-1.							

For combinations of intra-band contiguous and inter-band carrier aggregation with three downlink carriers and one uplink carrier assigned to one E-UTRA band, the requirement is defined with an uplink configuration in accordance with Table 7.3.3-2 for each band capable of uplink operation. The downlink PCC carrier centre frequency shall be configured closer to the uplink operating band than the downlink SCC centre frequency when the uplink is active in the band supporting two component carriers. For these uplink configurations, the UE shall meet the reference sensitivity requirements for intra-band contiguous carrier aggregation of two downlink carriers and for the remaining component carrier the requirements specified in subclause 7.3.3. The three downlink carriers shall be active throughout the tests. Unless given by Table 7.3.3-3, the reference sensitivity requirements shall be verified with the network signalling value  $NS\_01$  (Table 6.2.4.3-1) configured.

For combinations of intra-band non-contiguous and inter-band carrier aggregation with three downlink carriers and one uplink carrier assigned to one E-UTRA band, the requirement is defined with an uplink configuration in accordance with Table 7.3A.0-3 when the uplink is active in the band supporting two component carriers and in accordance with Table 7.3.3-2 when the uplink is active in the other band. For these uplink configurations, the UE shall meet the reference sensitivity requirements for intra-band non-contiguous carrier aggregation of two downlink carriers and for the remaining component carrier the requirements specified in subclause 7.3.3. For the two component carriers within the same band,  $\Delta R_{\text{IBNC}} = 0$  dB for all sub-block gaps (Table 7.3A.0-3) when the uplink is active in the band supporting the single component carrier. The three downlink carriers shall be active throughout the tests. Unless given by Table 7.3.3-3, the reference sensitivity requirements shall be verified with the network signalling value  $NS\_01$  (Table 6.2.4.3-1) configured.

For the UE that supports any of the E-UTRA CA configurations of three downlink carriers given in Table 7.3A.0-1, exceptions to the aforementioned requirements are allowed when the uplink is active in a lower-frequency band and within a specified frequency range such that transmitter harmonics fall within the downlink transmission bandwidth

assigned in a higher band as noted in Table 7.3A.0-1. For these exceptions, the UE shall meet the requirements specified in Table 7.3A.0-1 and Table 7.3A.0-1a.

The normative reference for this requirement is TS 36.101[2] clause 7.3.1 and 7.3.1A.

## 7.3A.1 Reference sensitivity level for CA (intra-band contiguous DL CA and UL CA)

### 7.3A.1.1 Test purpose

To verify the ability of UE that support CA to receive data with a given average throughput for a specified reference measurement channel, under conditions of low signal level, ideal propagation and no added noise.

A UE unable to meet the throughput requirement under these conditions will decrease the effective coverage area of an e-NodeB.

### 7.3A.1.2 Test applicability

This test case applies to all types of E-UTRA UE release 10 and forward that support intra-band contiguous DL CA and UL CA.

### 7.3A.1.3 Minimum conformance requirements

The minimum conformance requirements are defined in clause 7.3A.0.

### 7.3A.1.4 Test description

#### 7.3A.1.4.1 Initial conditions

Initial conditions are a set of test configurations the UE needs to be tested in and the steps for the SS to take with the UE to reach the correct measurement state.

The initial test configurations consist of environmental conditions, test frequencies, and channel bandwidths based on E-UTRA CA configurations specified in table 5.4.2A.1-1. All of these configurations shall be tested with applicable test parameters for each channel bandwidth, and are shown in table 7.3A.1.4.1-1. The details of the uplink reference measurement channels (RMCs) are specified in Annex A.2. Configurations of PDSCH and PDCCH before measurement are specified in Annex C.2.

**Table 7.3A.1.4.1-1: Test Configuration Table**

Initial Conditions									
Test Environment as specified in 36.508[7] subclause 4.1			NC, TL/VL, TL/VH, TH/VL, TH/VH						
Test Frequencies as specified in 36.508 [7] subclause 4.3.1 for different CA bandwidth classes, and PCC and SCCs are mapped to physical frequencies according to Table 7.1-2			C: Low range, High range						
Test CC Combination setting ( $N_{RB\_agg}$ ) as specified in clause 5.4.2A.1 for the CA Configuration across bandwidth combination sets supported by the UE.			Lowest $N_{RB\_agg}$ , Highest $N_{RB\_agg}$ (Note 3)						
Test Parameters for CA Configurations									
CA Configuration / $N_{RB\_agg}$		DL Allocation		UL Allocation					
PCC $N_{RB}$	SCC $N_{RB}$	CC MOD	PCC & SCC RB allocation	CC MOD	$N_{RB\_alloc}$	PCC & SCC RB allocations ( $L_{CRB}$ @ $RB_{start}$ )			
75	75	QPSK	75+75	QPSK	75	P_75@0	S_0@0	-	-
75	75	QPSK	75+75	QPSK	129	P_75@0	S_54@0	-	-
75	75	QPSK	75+75	QPSK	150	P_75@0	S_75@0	-	-
100	25	QPSK	100+25	QPSK	50	P_50@50	S_0@0	-	-
100	25	QPSK	100+25	QPSK	125	P_100@0	S_25@0	-	-
100	50	QPSK	100+50	QPSK	50	P_50@50	S_0@0	-	-
100	50	QPSK	100+50	QPSK	75	P_75@25	S_0@0	-	-
100	50	QPSK	100+50	QPSK	150	P_100@0	S_50@0	-	-
100	75	QPSK	100+75	QPSK	175	P_100@0	S_75@0	-	-
100	100	QPSK	100+100	QPSK	50	P_50@50	S_0@0	-	-
100	100	QPSK	100+100	QPSK	75	P_75@50	S_0@0	-	-
100	100	QPSK	100+100	QPSK	130	P_100@0	S_30@0	-	-
100	100	QPSK	100+100	QPSK	200	P_100@0	S_100@0	-	-
Note 1: CA Configuration Test CC Combination settings are checked separately for each CA Configuration, which applicable aggregated channel bandwidths are specified in Table 5.4.2A.1-1. Note 2: Depending on CA configurations, only the appropriate Uplink RB allocation value according to table 7.3A.0-2 for UE supporting two uplink carriers is tested per Test CA configuration. Note 3: If in the CA Configuration UE supports multiple CC Combinations with the same $N_{RB\_agg}$ , only the first those is tested, according to the order on the Test Configuration Table list.									

1. Connect the SS to the UE antenna connectors as shown in TS 36.508[7] Annex A Figure group A.32 as appropriate.
2. The parameter settings for the cell are set up according to TS 36.508 [7] subclause 4.4.3.
3. Downlink signals for PCC are initially set up according to Annex C.0, C.1, and C.3.1, and uplink signals according to Annex H.1 and H.3.0.
4. The UL and DL Reference Measurement channels are set according to Table 7.3A.1.4.1-1.
5. Propagation conditions are set according to Annex B.0.
6. Ensure the UE is in State 3A-RF according to TS 36.508 [7] clause 5.2A.2. Message contents are defined in clause 7.3A.1.4.3.

**7.3A.1.4.2 Test procedure**

1. Configure SCC according to Annex C.0, C.1 and Annex C.3.1 for all downlink physical channels.
2. The SS shall configure SCC as per TS 36.508 [7] clause 5.2A.4. Message contents are defined in clause 7.3A.1.4.3
3. SS activates SCC by sending the activation MAC-CE (Refer TS 36.321 [13], clauses 5.13, 6.1.3.8). Wait for at least 2 seconds (Refer TS 36.133, clauses 8.3.3.2).
4. SS transmits PDSCH via PDCCH DCI format 1A for C\_RNTI to transmit the DL RMC according to Tables 7.3A.1.4.1-1 on both PCC and SCC. The SS sends downlink MAC padding bits on the DL RMC.

5. SS sends uplink scheduling information for each UL HARQ process via PDCCH DCI format 0 for C\_RNTI to schedule the UL RMC according to Table 7.3A.1.4.1-1 on both PCC and SCC. Since the UE has no payload and no loopback data to send the UE sends uplink MAC padding bits on the UL RMC.
6. Set the Downlink signal level for PCC and SCC to the appropriate REFSENS value defined in Table 7.3A.1.5-1. Send continuously uplink power control "up" commands in every uplink scheduling information to the UE to ensure the UE transmits  $P_{UMAX}$  level for at least the duration of the Throughput measurement.
7. Measure the average throughput for each component carrier for a duration sufficient to achieve statistical significance according to Annex G.2A.

### 7.3A.1.4.3 Message contents

Message contents are according to TS 36.508 [7] subclause 4.6. In test procedure step 2, for SCC configuration there are no additional message contents.

### 7.3A.1.5 Test requirement

For intra-band contiguous carrier aggregation the throughput of each component carrier shall be  $\geq 95\%$  of the maximum throughput of the reference measurement channels as specified in Annexes A.2.2, A.2.3 and A.3.2 (with one sided dynamic OCNG Pattern OP.1 FDD/TDD for the DL-signal as described in Annex A.5.1.1/A.5.2.1) with parameters specified in Table 7.3A.1.5-1 and table 7.3A.1.5-2.

**Table 7.3A.1.5-1: Reference sensitivity QPSK  $P_{REFSENS}$  for intra-band**

CA Configuration	100RB+25RB		100RB+50RB		75RB+75RB		100RB+75RB		100RB+100RB		Duplex Mode
	100RB	25RB	100RB	50RB	75RB	75RB	100RB	75RB	100RB	100RB	
CA_1C	-	-	-	-	-94.5	-94.5	-	-	-93.3	-93.3	FDD
CA_3C	-90.3	-96.3	-90.3	-93.3	-	-	-90.3	-91.5	-90.3	-90.3	FDD
CA_7C	-	-	-	-	-92.5	-92.5	-	-	-91.3	-91.3	FDD
CA_38C	-	-	-	-	-94.5	-94.5	-	-	-93.3	-93.3	TDD
CA_39C	-93.3	-99.3	-93.3	-96.3	-	-	-93.3	-94.5	-	-	TDD
CA_40C	-	-	-93.3	-96.3	-94.5	-94.5	-	-	-93.3	-93.3	TDD
CA_41C	-	-	-91.3	-94.3	-92.5	-92.5	-91.3	-92.5	-91.3	-91.3	TDD
CA_42C	-92	-98	-92	-95	-	-	-92	-93.2	-92	-92	TDD

Note 1: The transmitter shall be set to  $P_{UMAX}$  as defined in subclause 6.2.5 for one uplink carrier and in subclause 6.2.5A for two uplink carriers.

Note 2: The reference measurement channel is specified in A.3.2 with one sided dynamic OCNG Pattern OP.1 FDD/TDD as described in Annex A.5.1.1/A.5.2.1

Note 3: The signal power is specified per port

For the UE which supports inter-band carrier aggregation configurations the  $\Delta R_{IB,c}$  in Table 7.3.3-1A shall be applied for applicable bands.

In case the UE supports more than one of the inter-band carrier aggregation configurations and a E-UTRA operating band belongs to more than one inter-band carrier aggregation configurations then:

- When the E-UTRA operating band frequency range is  $\leq 1$ GHz, the applicable additional tolerance shall be the average of the tolerances in Table 7.3.3-1A, truncated to one decimal place that would apply for that operating band among the supported CA configurations. In case there is a harmonic relation between low band UL and high band DL (i.e. bands listed in Table 7.3A.0-1), then the maximum tolerance among the different supported carrier aggregation configurations involving such band shall be applied
- When the E-UTRA operating band frequency range is  $>1$ GHz, the applicable additional tolerance shall be the maximum tolerance in Table 7.3.3-1A that would apply for that operating band among the supported CA configurations

The reference receive sensitivity (REFSENS) requirement for intra-band specified in Table 7.3A.1.5-1 shall be met for each uplink CA configurations less than or equal to that specified in Table 7.3A.1.5-2.

NOTE: Table 7.3A.1.5-2 does not necessarily reflect the operational conditions of the network, where the number of uplink and downlink allocated resource blocks will be practically constrained by other factors.

**Table 7.3A.1.5-2: Intra-band CA uplink configuration for reference sensitivity**

CA configuration / CC combination / NRB_agg / Duplex mode											
CA configuration	100RB+25RB		100RB+50RB		75RB+75RB		100RB+75RB		100RB+100RB		Duplex Mode
	PCC	SCC	PCC	SCC	PCC	SCC	PCC	SCC	PCC	SCC	
CA_1C			N/A	N/A	75	54	N/A	N/A	100	30	FDD
CA_3C	50	0	50	0	N/A	N/A	50	0	50	0	FDD
CA_7C			N/A	N/A	75	0	N/A	N/A	75	0	FDD
CA_38C					75	75			100	100	TDD
CA_39C	100	25	100	50	N/A	N/A	100	75	N/A	N/A	TDD
CA_40C			100	50	75	75	N/A	N/A	100	100	TDD
CA_41C			100	50	75	75	100	75	100	100	TDD
CA_42C	100	25	100	50	N/A	N/A	100	75	100	100	TDD

Note 1: The carrier centre frequency of SCC in the UL operating band is configured closer to the DL operating band.  
Note 2: The transmitted power over both PCC and SCC shall be set to  $P_{UMAX}$  as defined in subclause 6.2.5 for one uplink carrier and in subclause 6.2.5A for two uplink carriers.  
Note 3: The UL resource blocks in both PCC and SCC shall be confined within the transmission bandwidth configuration for the channel bandwidth (Table 5.4.2A-1).  
Note 4: The UL resource blocks in PCC shall be located as close as possible to the downlink operating band, while the UL resource blocks in SCC shall be located as far as possible from the downlink operating band.

## 7.3A.2 Reference sensitivity level for CA (intra-band contiguous DL CA without UL CA)

### 7.3A.2.1 Test purpose

Same as in clause 7.3A.1.1.

### 7.3A.2.2 Test applicability

This test case applies to all types of E-UTRA UE release 10 and forward that support intra-band contiguous DL CA. This test case applies only for CA Configurations that do not support UL CA.

### 7.3A.2.3 Minimum conformance requirements

The minimum conformance requirements are defined in clause 7.3A.0.

### 7.3A.2.4 Test description

#### 7.3A.2.4.1 Initial conditions

Same as in clause 7.3A.1.4.1 with the following exceptions:

- Instead of Table 7.3A.1.4.1-1 → use Table 7.3A.2.4.1-1.

Table 7.3A.2.4.1-1: Test Configuration Table

Initial Conditions									
Test Environment as specified in TS 36.508[7] subclause 4.1					NC, TL/VL, TL/VH, TH/VL, TH/VH				
Test Frequencies as specified in TS36.508 [7] subclause 4.3.1 for different CA bandwidth classes, and PCC and SCCs are mapped onto physical frequencies according to Table 7.1-2					B: Low range, High range C: Low range, High range				
Test CC Combination setting ( $N_{RB\_agg}$ ) as specified in subclause 5.4.2A.1 for the CA Configuration across bandwidth combination sets supported by the UE.					Lowest $N_{RB\_agg}$ , Highest $N_{RB\_agg}$ (Note 3)				
Test Parameters for CA Configurations									
CA Configuration / $N_{RB\_agg}$		DL Allocation			UL Allocation				
PCC $N_{RB}$	SCCs $N_{RB}$	CC MOD	PCC & SCC RB allocation	CC MOD	$N_{RB\_alloc}$	PCC & SCC RB allocations ( $L_{CRB}$ @ $RB_{start}$ )			
6	25	QPSK	6+25	QPSK	6	P_6@0	-	-	-
15	50	QPSK	15+50	QPSK	15	P_15@0	-	-	-
25	25	QPSK	25+25	QPSK	20	P_20@0	-	-	-
25	50	QPSK	25+50	QPSK	20	P_20@0	-	-	-
50	50	QPSK	50+50	QPSK	50	P_50@0	-	-	-
75	75	QPSK	75+75	QPSK	75	P_75@0	-	-	-
100	25	QPSK	100+25	QPSK	100	P_100@0	-	-	-
100	25	QPSK	100+25	QPSK	50	P_50@50	-	-	-
100	50	QPSK	100+50	QPSK	100	P_100@0	-	-	-
100	50	QPSK	100+50	QPSK	75	P_75@25	-	-	-
100	50	QPSK	100+50	QPSK	50	P_50@50	-	-	-
100	75	QPSK	100+75	QPSK	100	P_100@0	-	-	-
100	100	QPSK	100+100	QPSK	100	P_100@0	-	-	-
100	100	QPSK	100+100	QPSK	75	P_75@25	-	-	-
100	100	QPSK	100+100	QPSK	50	P_50@50	-	-	-
<p>Note 1: CA Configuration Test CC Combination settings are checked separately for each CA Configuration, which applicable aggregated channel bandwidths are specified in Table 5.4.2A.1-1.</p> <p>Note 2: Depending on CA configurations, only the appropriate Uplink RB allocation value according to table 7.3.3-2 for UE supporting one uplink carrier is tested per Test CA configuration.</p> <p>Note 3: If in the CA Configuration UE supports multiple CC Combinations with the same <math>N_{RB\_agg}</math>, only the first of those is tested, according to the order on the Test Configuration Table list.</p>									

### 7.3A.2.4.2 Test procedure

1. Configure SCC according to Annex C.0, C.1 and Annex C.3.1 for all downlink physical channels.
2. The SS shall configure SCC as per TS 36.508 [7] clause 5.2A.4. Message contents are defined in clause 7.3A.1.4.3
3. SS activates SCC by sending the activation MAC-CE (Refer TS 36.321 [13], clauses 5.13, 6.1.3.8). Wait for at least 2 seconds (Refer TS 36.133, clauses 8.3.3.2).
4. SS transmits PDSCH via PDCCH DCI format 1A for  $C\_RNTI$  to transmit the DL RMC according to Tables 7.3A.2.4.1-1 on both PCC and SCC. The SS sends downlink MAC padding bits on the DL RMC.
5. SS sends uplink scheduling information for each UL HARQ process via PDCCH DCI format 0 for  $C\_RNTI$  to schedule the UL RMC according to Table 7.3A.2.4.1-1 on PCC. Since the UE has no payload and no loopback data to send the UE sends uplink MAC padding bits on the UL RMC.
6. Set the Downlink signal level for PCC and SCC to the appropriate REFSENS value defined in Table 7.3A.1.5-1. Send continuously uplink power control "up" commands in every uplink scheduling information to the UE to ensure the UE transmits  $P_{UMAX}$  level for at least the duration of the Throughput measurement.
7. Measure the average throughput for each component carrier for a duration sufficient to achieve statistical significance according to Annex G.2A.

### 7.3A.2.4.3 Message contents

Same as in clause 7.3A.1.4.3.

### 7.3A.2.5 Test requirement

Same as in clause 7.3A.1.5 with the following test requirement defined in Table 7.3A.2.5-1 additions.

**Table 7.3A.2.5-1: Reference sensitivity QPSK  $P_{\text{REFSENS}}$  for intra-band contiguous DL CA without UL CA**

CA Configuration	25RB+6RB		25RB+15RB		25RB+25RB		50RB+6RB		50RB+15RB		Duplex Mode
	25RB	6RB	25RB	15RB	25RB	25RB	50RB	6RB	50RB	15RB	
CA_27B	-97.3	-102.5	-97.3	-99.5	-97.3	-97.3	-94.3	-	-94.3	-99.5	FDD
Note 1: The transmitter shall be set to $P_{\text{UMAX}}$ as defined in clause 6.2.5 Note 2: The reference measurement channel is specified in A.3.2 with one sided dynamic OCNG Pattern OP.1 FDD/TDD as described in Annex A.5.1.1/A.5.2.1 Note 3: The signal power is specified per port											

**Table 7.3A.2.5-2: Reference sensitivity QPSK  $P_{\text{REFSENS}}$  for intra-band contiguous DL CA without UL CA (table 2)**

CA Configuration	50RB+50RB		25RB+75RB								Duplex Mode
	50RB	50RB	25RB	75RB							
CA_23B	-96.3	-96.3	-99.3	-94.5							FDD
Note 1: The transmitter shall be set to $P_{\text{UMAX}}$ as defined in clause 6.2.5 Note 2: The reference measurement channel is specified in A.3.2 with one sided dynamic OCNG Pattern OP.1 FDD/TDD as described in Annex A.5.1.1/A.5.2.1 Note 3: The signal power is specified per port											

## 7.3A.3 Reference sensitivity level for CA (inter-band DL CA without UL CA)

### 7.3A.3.1 Test purpose

Same as in clause 7.3A.1.1.

### 7.3A.3.2 Test applicability

This test case applies to all types of E-UTRA UE release 10 and forward that support inter-band DL CA but no UL CA.

### 7.3A.3.3 Minimum conformance requirements

The minimum conformance requirements are defined in clause 7.3A.0.

### 7.3A.3.4 Test description

#### 7.3A.3.4.1 Initial conditions

Same as in clause 7.3A.1.4.1 with the following exceptions:

- Instead of Table 7.3A.1.4.1-1 → use Table 7.3A.3.4.1-1.
- Instead of clause 7.3A.1.4.3 use clause 7.3A.3.4.3.



Table 7.3A.3.4.1-1: Test Configuration Table

Initial Conditions						
Test Environment as specified in TS 36.508[7] subclause 4.1				NC, TL/VL, TL/VH, TH/VL, TH/VH		
Test Frequencies as specified in TS36.508 [7] subclause 4.3.1 for different CA bandwidth classes, and PCC and SCCs are mapped onto physical frequencies according to Table 7.1-2.				A: Mid range for PCC and SCC, unless otherwise specified in the Tables 7.3A.3.4.1-2 to 7.3A.3.4.1-21		
Test CC Combination setting ( $N_{RB\_agg}$ ) as specified in subclause 5.4.2A.1 for the CA Configuration across bandwidth combination sets supported by the UE.				Highest $N_{RB\_agg}$ , unless otherwise specified in the Tables 7.3A.3.4.1-2 to 7.3A.3.4.1-21		
Network signalling value				NS_01  Unless given by Table 7.3.3.-3 for the band with active uplink carrier		
Test Parameters for CA Configurations						
CA Configuration / $N_{RB\_agg}$		DL Allocation			UL Allocation	
PCC NRB	SCCs $N_{RB}$	CC MOD	PCC & SCC RB allocation		CC MOD	PCC $N_{RB\_alloc}$
50	50	QPSK	50	50	QPSK	50
50	50	QPSK	50	50	QPSK	25
50	50	QPSK	50	50	QPSK	20
50	50	QPSK	50	50	QPSK	16
50	75	QPSK	50	75	QPSK	50
50	75	QPSK	50	75	QPSK	25
50	75	QPSK	50	75	QPSK	20
50	100	QPSK	50	100	QPSK	50
50	100	QPSK	50	100	QPSK	25
50	100	QPSK	50	100	QPSK	20
75	50	QPSK	75	50	QPSK	75
75	50	QPSK	75	50	QPSK	50
75	50	QPSK	75	50	QPSK	25
75	50	QPSK	75	50	QPSK	20
75	75	QPSK	75	75	QPSK	75
75	75	QPSK	75	75	QPSK	50
75	75	QPSK	75	75	QPSK	25
75	75	QPSK	75	75	QPSK	20
75	100	QPSK	75	100	QPSK	75
75	100	QPSK	75	100	QPSK	50
75	100	QPSK	75	100	QPSK	25
75	100	QPSK	75	100	QPSK	20
100	25	QPSK	100	25	QPSK	25
100	50	QPSK	100	50	QPSK	100
100	50	QPSK	100	50	QPSK	75

100	50	QPSK	100	50	QPSK	50
100	50	QPSK	100	50	QPSK	25
100	50	QPSK	100	50	QPSK	20
100	75	QPSK	100	75	QPSK	100
100	75	QPSK	100	75	QPSK	75
100	75	QPSK	100	75	QPSK	50
100	75	QPSK	100	75	QPSK	25
100	75	QPSK	100	75	QPSK	25
100	75	QPSK	100	75	QPSK	20
100	100	QPSK	100	100	QPSK	25
100	100	QPSK	100	100	QPSK	45
100	100	QPSK	100	100	QPSK	50
Note 1:	CA Configuration Test CC Combination settings are checked separately for each CA Configuration, which applicable aggregated channel bandwidths are specified in Table 5.4.2A.1-2.					
Note 2:	Depending on CA configurations, only the appropriate Uplink RB allocation value according to table 7.3A.3.5-2 for UE supporting one uplink carrier is tested per Test CA configuration.					
Note 3:	The UL resource blocks shall be located as close as possible to the downlink PCC but confined within the transmission bandwidth configuration for the channel bandwidth (Table 5.4.2-1).					
Note 4:	The frequencies of PCC and SCC shall be switched and tested in each configuration, according to the UE declared capability for UL support (within CA operation) in the individual bands.					

Table 7.3A.3.4.1-1a: Void

Table 7.3A.3.4.1-2: Test frequencies and Test CC combinations for CA\_1A-3A

CBW			Band 3		
			5MHz	15MHz	20MHz
			High range		
Band 1 as PCC (Note 1)	20MHz	Low range	X <sup>2</sup>	X <sup>2</sup>	X <sup>2</sup>
		Mid range	-	-	X <sup>3</sup>
Band 1 as SCC	20MHz	Low range	-	-	X
Note 1:	For Band 1 as PCC, the exceptions described in Table 7.3A.0-1b are tested.				
Note 2:	This is the case that the uplink is active in Band 1 and the separation between the lower edge of the uplink channel in Band 1 and the upper edge of the downlink channel in Band 3 is < 60 MHz. The appropriate Uplink RB allocation value according to Table 7.3A.0-1c should be applied.				
Note 3:	This is the case that the uplink is active in Band 1 and the separation between the lower edge of the uplink channel in Band 1 and the upper edge of the downlink channel in Band 3 is ≥ 60 MHz. The appropriate Uplink RB allocation value according to Table 7.3A.0-1c should be applied.				

Table 7.3A.3.4.1-2a: Test frequencies and Test CC combinations for CA\_1A-11A

CBW			Band 11	
			10MHz	10MHz
			Low range	High range
Band 1	20MHz	Low range		X
	20MHz	High range	X	

Table 7.3A.3.4.1-3: Test frequencies and Test CC combinations for CA\_1A-18A

CBW			Band 18	
			10MHz	15MHz
			Low range	Mid range
Band 1	10MHz	Low range	X	
	15MHz		X	
	20MHz		X	X

Table 7.3A.3.4.1-4: Test frequencies and Test CC combinations for CA\_1A-19A

CBW			Band 19	
			10MHz	15MHz
			High range	Mid range
Band 1	10MHz	Mid range		X
	15MHz		X	
	20MHz			X

Table 7.3A.3.4.1-5: Test frequencies and Test CC combinations for CA\_1A-21A

CBW			Band 21	
			10MHz	15MHz
			High range	Mid range
Band 1	15MHz	Mid range	X	X
	20MHz		-	X

Table 7.3A.3.4.1-6: Test frequencies and Test CC combinations for CA\_1A-26A

CBW			Band 26	
			10MHz	15MHz
			Low range	Low range
Band 1	10MHz	Low range	X	
	15MHz		X	
	20MHz		X	X

Table 7.3A.3.4.1-6a: Test frequencies and Test CC combinations for CA\_1A-28A

CBW			Band 28		
			5MHz	20MHz	
			Mid range	Low range	High range
Band 1 as PCC	20MHz	Low range	-	X	-
		High range	-	-	X

<b>Band 1 as SCC</b>	<b>5MHz</b>	High range	X <sup>1,2</sup>	-	-
	<b>20MHz</b>	Low range	-	X	-
		High range	-	-	-
<p>Note 1: For Band 1 as SCC the exceptions described in Table 7.3A.0-1 are tested. For this purpose the test frequencies are selected to fulfil the equation in Table 7.3A.0-1 Note 5.</p> <p>Note 2: Band 28: <math>f_{UL} = 722.5</math> MHz (<math>N_{UL} = 27405</math>), <math>f_{DL} = 777.5</math> MHz (<math>N_{DL} = 9405</math>)                  Band 1: <math>f_{DL} = 2167.5</math> MHz (<math>N_{DL} = 575</math>)</p>					

**Table 7.3A.3.4.1-7: Test frequencies and Test CC combinations for CA\_1A-41A**

<b>CBW</b>			<b>Band 41 as SCC</b>
			<b>20MHz</b>
			<b>Mid range</b>
<b>Band 1 as PCC</b>	<b>20MHz</b>	Low range	X
	<b>20MHz</b>	High range	X

**Table 7.3A.3.4.1-8: Test frequencies and Test CC combinations for CA\_2A-13A**

<b>CBW</b>			<b>Band 13</b>
			<b>10MHz</b>
			<b>Mid range</b>
<b>Band 2</b>	<b>10MHz</b>	Low range	X
	<b>15 MHz</b>	Mid range	X
	<b>20 MHz</b>	High range	X

**Table 7.3A.3.4.1-9: Test frequencies and Test CC combinations for CA\_3A-8A**

<b>CBW</b>			<b>Band 8</b>	
			<b>5 MHz</b>	<b>10 MHz</b>
			High range	
<b>Band 3</b>	<b>10MHz</b>	Mid range	-	X
	<b>15MHz</b>		X	-
	<b>20MHz</b>		X	X

**Table 7.3A.3.4.1-10: Test frequencies and Test CC combinations for CA\_3A-19A**

<b>CBW</b>		<b>Band 19</b>	
		<b>10MHz</b>	<b>15MHz</b>
		<b>High range</b>	<b>Mid range</b>

Band 3	15MHz	High range	X	X
	20MHz		X	X

Table 7.3A.3.4.1-11: Test frequencies and Test CC combinations for CA\_3A-26A

CBW			Band 26	
			10MHz	15MHz
			Low range	
Band 3	10MHz	Mid range	X	-
	15MHz		X	-
	20MHz		X	X

Table 7.3A.3.4.1-12: Test frequencies and Test CC combinations for CA\_3A-27A

CBW			Band 27
			10MHz
			High range
Band 3	10MHz	Mid range	X
	15MHz		X
	20MHz		X

Table 7.3A.3.4.1-12a: Test frequencies and Test CC combinations for CA\_3A-28A

CBW			Band 28	
			20MHz	
			Low range	High range
Band 3	20MHz	Low range	X	-
		High range	-	X

Table 7.3A.3.4.1-13: Test frequencies and Test CC combinations for CA\_4A-5A

CBW			Band 5		
			10 MHz		
			Low range	Mid range	High range
Band 4	10MHz	Mid range	X	X	X

**Table 7.3A.3.4.1-14: Test frequencies and Test CC combinations for CA\_4A-13A**

CBW			Band 13
			10MHz
			Mid range
Band 4	10MHz	Low range	X
	15 MHz	Mid range	X
	20 MHz	High range	X

**Table 7.3A.3.4.1-15: Test frequencies and Test CC combinations for CA\_4A-17A**

CBW			Band 17		
			10MHz		
			Low range	Mid range	High range
Band 4 as PCC	10 MHz	Mid range	X	-	X
Band 4 as SCC (Note 1)	10MHz	Low range	X <sup>2</sup>	-	-
		Mid range	-	X <sup>3</sup>	-
		High range	-	-	X <sup>4</sup>
Note 1: For Band 4 as SCC the exceptions described in Table 7.3A.0-1 are tested. For this purpose the test frequencies are selected to fulfil the equation in Table 7.3A.0-1 Note 5. Note 2: Band 17: $f_{UL} = 709.1 \text{ MHz}$ ( $N_{UL} = 23781$ ), $f_{DL} = 739.1 \text{ MHz}$ ( $N_{DL} = 5781$ ) Band 4: $f_{DL} = 2127.3 \text{ MHz}$ ( $N_{DL} = 2123$ ) Note 3: Band 17: $f_{UL} = 710 \text{ MHz}$ ( $N_{UL} = 23790$ ), $f_{DL} = 740 \text{ MHz}$ ( $N_{DL} = 5790$ ) Band 4: $f_{DL} = 2130 \text{ MHz}$ ( $N_{DL} = 2150$ ) Note 4: Band 17: $f_{UL} = 710.9 \text{ MHz}$ ( $N_{UL} = 23799$ ), $f_{DL} = 740.9 \text{ MHz}$ ( $N_{DL} = 5799$ ) Band 4: $f_{DL} = 2132.7 \text{ MHz}$ ( $N_{DL} = 2177$ )					

**Table 7.3A.3.4.1-15a: Test frequencies and Test CC combinations for CA\_8A-11A**

CBW			Band 11
			10MHz
			Low range
Band 8	10MHz	High range	X

**Table 7.3A.3.4.1-16: Test frequencies and Test CC combinations for CA\_11A-18A**

CBW			Band 18	
			10MHz	15MHz
			Low range	Mid range
Band 11	10MHz	High range	X	X

**Table 7.3A.3.4.1-17: Test frequencies and Test CC combinations for CA\_18A-28A**

CBW			Band 28		
			5MHz	10MHz	
			High range	Mid range	High range
Band 18	10MHz	Low range		X	
	15MHz	Middle range	X		X

**Table 7.3A.3.4.1-18: Test frequencies and Test CC combinations for CA\_19A-21A**

CBW			Band 21	
			10MHz	15MHz
			High range	Mid range
Band 19	10MHz	High range		X
	15MHz	Mid range	X	X

**Table 7.3A.3.4.1-19: Test frequencies and Test CC combinations for CA\_26A-41A**

CBW			Band 41
			20MHz
			Mid range
Band 26	10MHz	Low range	X
	15MHz		X

**Table 7.3A.3.4.1-20: Test frequencies and Test CC combinations for CA\_39A-41A**

CBW			Band 41
			20MHz
			Mid range
Band 39	20 MHz	Low range	X
		Mid range	X
		High range	X

**Table 7.3A.3.4.1-21: Test frequencies and Test CC combinations for CA\_7A-28A**

CBW			Band 28	
			10MHz	15MHz
			High range	Mid range
Band 7	15MHz	High range		X
	20MHz	Mid range	X	X

### 7.3A.3.4.2 Test procedure

1. Configure SCC according to Annex C.0, C.1 and Annex C.3.1 for all downlink physical channels.
2. The SS shall configure SCC as per TS 36.508 [7] clause 5.2A.4. Message contents are defined in clause 7.3A3.4.3
3. SS activates SCC by sending the activation MAC-CE (Refer TS 36.321 [13], clauses 5.13, 6.1.3.8). Wait for at least 2 seconds (Refer TS 36.133, clauses 8.3.3.2).
4. SS transmits PDSCH via PDCCH DCI format 1A for C\_RNTI to transmit the DL RMC according to Tables 7.3A.3.4.1-1 on both PCC and SCC. The SS sends downlink MAC padding bits on the DL RMC.
5. SS sends uplink scheduling information for each UL HARQ process via PDCCH DCI format 0 for C\_RNTI to schedule the UL RMC according to Table 7.3A.3.4.1-1 on PCC. Since the UE has no payload and no loopback data to send the UE sends uplink MAC padding bits on the UL RMC.
6. Set the Downlink signal level for PCC and SCC to the appropriate REFSSENS value defined in Table 7.3A.3.5-1. Send continuously uplink power control "up" commands in the uplink scheduling information to the UE to ensure the UE transmits  $P_{UMAX}$  level for at least the duration of the Throughput measurement.
7. Measure the average throughput for each component carrier for a duration sufficient to achieve statistical significance according to Annex G.2A.

### 7.3A.3.4.3 Message contents

Message contents are according to TS 36.508 [7] subclause 4.6 with the following exceptions.

#### 7.3A.3.4.3.1 Message contents exceptions (network signalled value "NS\_01")

Message contents according to TS 36.508 [7] subclause 4.6 can be used without exceptions.

#### 7.3A.3.4.3.2 Message contents exceptions (network signalled value "NS\_06")

1. Information element `additionalSpectrumEmission` is set to NS\_06. This can be set in the `SystemInformationBlockType2` as part of the cell broadcast message. This exception indicates that the UE shall meet the additional spurious emission requirement for a specific deployment scenario.

**Table 7.3A.3.4.3.2-1: SystemInformationBlockType2: Additional spurious emissions test requirement for "NS\_06"**

Derivation Path: TS 36.508 [7] clause 4.4.3.3, Table 4.4.3.3-1			
Information Element	Value/remark	Comment	Condition
<code>additionalSpectrumEmission</code>	6 (NS_06)		

### 7.3A.3.5 Test requirement

For inter-band carrier aggregation with uplink assigned to one E-UTRA band the throughput shall be  $\geq 95\%$  of the maximum throughput of the reference measurement channels as specified in Annex A.3.2 with parameters specified in Tables 7.3A.3.5-1 and Table 7.3A.3.5-2 (originated from single carrier Tables 7.3.5-1 and 7.3.5-2). The reference sensitivity is defined to be met with both downlink component carriers active and either of the uplink component carriers active.



Table 7.3A.3.5-1: Reference sensitivity QPSK  $P_{\text{REFSENS}}$  for inter-band

CA Configuration	Channel bandwidth							Duplex Mode
	E-UTRA Band	1.4 MHz (dBm)	3 MHz (dBm)	5 MHz (dBm)	10 MHz (dBm)	15 MHz (dBm)	20 MHz (dBm)	
CA_1A-3A	1			-99.3	-96.3	-94.5	-93.3	FDD
	3			-96.3	-93.3	-91.5	-90.3	
	3 (Note 6)			-93.3	-90.8	-89.3	-88.3	FDD
CA_1A-5A	1	-	-	-	-96.3	-	-	FDD
	5	-	-	-	-94.3	-	-	
CA_1A-7A	1	-	-	-99.3	-96.3	-94.5	-93.3	FDD
	7	-	-	-	-94.3	-92.5	-91.3	
CA_1A-8A	1	-	-	-99.3	-96.3	-94.5	-93.3	FDD
	8	-	-	-96.3	-93.3	-	-	
CA_1A-11A	1			-99.3	-96.3	-94.5	-93.3	FDD
	11			-99.3	-96.3			
CA_1A-18A	1	-	-	-99.3	-96.3	-94.5	-93.3	FDD
	18	-	-	-99.3	-96.3	-94.5	-	
CA_1A-19A	1	-	-	-99.3	-96.3	-94.5	-93.3	FDD
	19	-	-	-99.3	-96.3	-94.5	-	
CA_1A-20A	1	-	-	-99.3	-96.3	-94.5	-93.3	FDD
	20	-	-	-96.3	-93.3	-90.5	-89.3	
CA_1A-21A	1	-	-	-99.3	-96.3	-94.5	-93.3	FDD
	21	-	-	-99.3	-96.3	-94.5	-	
CA_1A-26A	1	-	-	-99.3	-96.3	-94.5	-93.3	FDD
	26	-	-	-96.8 <sup>o</sup>	-93.8 <sup>o</sup>	-92 <sup>o</sup>	-	
CA_1A-28A	1	-	-	-99.3	-96.3	-94.5	-93.3	FDD
	1 (Note 4)	-	-	-89.1	-88.7	-88.3	-88.0	
	28	-	-	-97.6	-94.6	-92.8	-90.1	
CA_1A-41A	1	-	-	-99.3	-96.3	-94.5	-93.3	FDD
	41	-	-	-97.3	-94.3	-92.5	-91.3	TDD
CA_2A-4A	2	-101.7	-98.7	-97	-94	-92.2	-91	FDD
	4	-	-	-99	-96	-94.2	-93	
CA_2A-5A	2	-	-	-97.3	-94.3	-92.5	-91.3	FDD
	5	-	-	-97.3	-94.3	-	-	
CA_2A-12A	2	-	-	-97.3	-94.3	-92.5	-91.3	FDD
	12	-	-98	-96.3	-93.3	-	-	
CA_2A-13A	2	-	-	-	-94.3	-92.5	-91.3	FDD
	13	-	-	-	-93.3	-	-	
CA_2A-17A	2	-	-	-97.3	-94.3	-	-	FDD
	17	-	-	-96.3	-93.3	-	-	
CA_3A-5A	3	-	-	-	-93.3	-91.5	-90.3	FDD
	5	-	-	-97.3	-94.3	-	-	
CA_3A-7A	3	-	-	-96.3	-93.3	-91.5	-90.3	FDD
	7	-	-	-	-94.3	-92.5	-91.3	
CA_3A-8A	3	-	-	-	-93.3	-91.5	-90.3	FDD
	8	-	-	-96.3	-93.3	-	-	
CA_3A-19A	3	-	-	-96.3	-93.3	-91.5	-90.3	FDD
	19	-	-	-99.3	-96.3	-94.5	-	

CA_3A-20A	3	-	-	-96.3	-93.3	-91.5	-90.3	FDD
	20	-	-	-96.3	-93.3	-	-	
CA_3A-26A	3	-	-	-96.3	-93.3	-91.5	-90.3	FDD
	26	-	-	-96.8 <sup>b</sup>	-93.8 <sup>b</sup>	-92 <sup>b</sup>	-	
CA_3A-27A	3	-	-	-96.3	-93.3	-91.5	-90.3	FDD
	27	-	-	-97.3	-94.3	-	-	
CA_3A-28A	3	-	-	-96.3	-93.3	-91.5	-90.3	FDD
	28	-	-	-97.8	-94.8	-93	-90.3	
CA_4A-5A	4	-	-	-99.3	-96.3	-	-	FDD
	5	-	-	-97.3	-94.3	-	-	
CA_4A-7A	4	-	-	-99.3	-96.3	-	-	FDD
	7	-	-	-97.3	-94.3	-92.5	-91.3	
CA_4A-12A	4	-104	-101	-99.3	-96.3	-94.5	-93.3	FDD
	4 (Note 4)	-88.5	-88.5	-89.3	-88.8	-88.3	-87.8	
	12	-	-	-96.3	-93.3	-	-	
CA_4A-13A	4	-	-	-99.3	-96.3	-94.5	-93.3	FDD
	13	-	-	-	-93.3	-	-	
CA_4A-17A	4	-	-	-99.3	-96.3	-	-	FDD
	4 (Note 4)	-	-	[-89.3]	[-88.8]	-	-	
	17	-	-	-96.3	-93.3	-	-	
CA_4A-27A	4	-	-	-99.3	-96.3	-94.5	-93.3	FDD
	27	-	-99.5	-97.3	-94.3	-	-	
CA_4A-29A	4	-	-	-99.3	-96.3	-	-	FDD
	29	-	-98	-96.3	-93.3	-	-	
CA_5A-7A	5	-102.5	-99.5	-97.3	-94.3	-	-	FDD
	7	-	-	-	-94.3	-92.5	-91.3	
CA_5A-12A	5	-	-	-97.3	-94.3	-	-	FDD
	12	-	-	-96.3	-93.3	-	-	
CA_5A-13A	5	-	-	-97.3	-94.3	-	-	FDD
	13	-	-	-	-93.3	-	-	
CA_5A-25A	5	-	-	-97.3	-94.3	-	-	FDD
	25	-	-	-95.8	-92.8	-91	-89.8	
CA_7A-20A	7	-	-	-	-94.3	-92.5	-91.3	FDD
	20	-	-	-96.3	-93.3	-	-	
CA_7A-28A	7	-	-	-97.3	-94.3	-92.5	-91.3	FDD
	28	-	-	-98.5	-95.5	-93.7	-	
CA_8A-11A	8	-	-	-96.3	-93.3	-	-	FDD
	11	-	-	-99.3	-96.3	-	-	
CA_11A-18A	11	-	-	-99.3	-96.3	-	-	FDD
	18	-	-	-99.3	-96.3	-94.5	-	
CA_12A-25A	12	-	-	-96.3	-93.3	-	-	FDD
	25	-	-	-95.8	-92.8	-91	-89.8	
CA_18A-28A	18	-	-	-99.3	-96.3	-94.5	-	FDD
	28	-	-	-97.8	-94.8	-	-	
CA_19A-21A	19	-	-	-99.3	-96.3	-94.5	-	FDD
	21	-	-	-99.3	-96.3	-94.5	-	
CA_20A-32A	20	-	-	-96.3	-93.3	-90.5	-89.3	FDD
	32	-	-	-99.3	-96.3	-94.5	-93.3	
CA_2A-29A	2	-	-	-97.3	-94.3	-	-	FDD
	29	-	-98	-96.3	-93.3	-	-	
CA_23A-29A	23	-	-	-99.3	-96.3	-94.5	-93.3	FDD
	29	-	-98	-96.3	-93.3	-	-	
CA_26A-41A	26	-	-	-96.8 <sup>b</sup>	-93.8 <sup>b</sup>	-92 <sup>b</sup>	-	FDD
	41	-	-	-97.3	-94.3	-92.5	-91.3	
CA_39A-41A	39	-	-	-99.3	-96.3	-94.5	-93.3	TDD
	41	-	-	-97.3	-94.3	-92.5	-91.3	
CA_41A-42A	41	-	-	-	-93.9	-92.1	-90.9	TDD
	42	-	-	-	-94.8	-93.0	-91.8	

Note 1:	The transmitter shall be set to maximum output power level (Table 7.3A.3.5-2)
Note 2:	The reference measurement channel is specified in A.3.2 with one sided dynamic OCNG Pattern OP.1 FDD/TDD as described in Annex A.5.1.1/A.5.2.1
Note 3:	The signal power is specified per port
Note 4:	Reference sensitivity for the high band for which the 3rd harmonic of the low band is within transmission bandwidth, as specified Note 6 in Table 7.3A.0-1.
Note 5:	<sup>5</sup> indicates that the requirement is modified by -0.5 dB when the carrier frequency of the assigned E-UTRA channel bandwidth is within 865-894 MHz.
Note 6:	Reference sensitivity for the case that the uplink is active in Band 1 and the separation between the lower edge of the uplink channel in Band 1 and the upper edge of the downlink channel in Band 3 is < 60 MHz

For the UE which supports inter-band carrier aggregation configurations the  $\Delta R_{IB,c}$  in Table 7.3.3-1A shall be applied for applicable bands.

In case the UE supports more than one of the inter-band carrier aggregation configurations and a E-UTRA operating band belongs to more than one inter-band carrier aggregation configurations then:

- When the E-UTRA operating band frequency range is  $\leq 1$ GHz, the applicable additional tolerance shall be the average of the tolerances in Table 7.3.3-1A, truncated to one decimal place that would apply for that operating band among the supported CA configurations. In case there is a harmonic relation between low band UL and high band DL (i.e. bands listed in Table 7.3A.0-1), then the maximum tolerance among the different supported carrier aggregation configurations involving such band shall be applied
- When the E-UTRA operating band frequency range is  $> 1$ GHz, the applicable additional tolerance shall be the maximum tolerance in Table 7.3.3-1A that would apply for that operating band among the supported CA configurations

The reference receive sensitivity (REFSENS) requirement for inter-band specified in Table 7.3A.3.5-1 shall be met for an uplink CA configurations than or equal to that specified in Table 7.3A.3.5-2.

NOTE: Table 7.3A.3.5-2 does not necessarily reflect the operational conditions of the network, where the number of uplink and downlink allocated resource blocks will be practically constrained by other factors.

**Table 7.3A.3.5-2: Inter-band CA uplink configuration for reference sensitivity,  $L_{CRB}$  @  $RB_{start}$  format**

CA Configuration	Channel bandwidth							Duplex Mode
	E-UTRA Band	1.4 MHz	3 MHz	5 MHz	10 MHz	15 MHz	20 MHz	
CA_1A-3A	1	-	-	25@0 <sup>5</sup>	25@0 <sup>5</sup>	25@0 <sup>5</sup>	25@0 <sup>5</sup>	FDD
	1	-	-	25@0 <sup>6</sup>	45@0 <sup>6</sup>	45@0 <sup>6</sup>	45@0 <sup>6</sup>	
	3	-	-	25@0	50@0	50@25	50@50	
CA_1A-5A	1	-	-	-	50@0	-	-	FDD
	5	-	-	-	25@25	-	-	
CA_1A-7A	1	-	-	25@0	50@0	75@0	100@0	FDD
	7	-	-	-	50@0	75@0	75@25	
CA_1A-8A	1	-	-	25@0	50@0	75@0	100@0	FDD
	8	-	-	25@0	25@25	-	-	
CA_1A-11A	1	-	-	25@0	50@0	75@0	100@0	FDD
	11	-	-	25@0	25@25	-	-	
CA_1A-18A	1	-	-	25@0	50@0	75@0	100@0	FDD
	18	-	-	25@0	25@25	25@50	-	
CA_1A-19A	1	-	-	25@0	50@0	75@0	100@0	FDD
	19	-	-	25@0	25@25	25@50	-	
CA_1A-20A	1	-	-	25@0	50@0	75@0	100@0	FDD
	20	-	-	25@0	20@30	20@11	20@16	
CA_1A-21A	1	-	-	25@0	50@0	75@0	100@0	FDD
	21	-	-	25@0	25@25	25@50	-	
CA_1A-26A	1	-	-	25@0	50@0	75@0	100@0	FDD
	26	-	-	25@0	25@25	25@50	-	
CA_1A-28A	1	-	-	25@0	50@0	75@0	100@0	FDD
	28	-	-	25@0	25@25	25@50	25@75	

	28			8@9 <sup>2</sup>	16@17 <sup>2</sup>	25@24 <sup>2</sup>	25@38 <sup>2</sup>	
CA_1A-41A	1	-	-	25@0	50@0	75@0	100@0	FDD
	41	-	-	-	-	-	-	TDD
CA_2A-4A	2	6@0	15@0	25@0	50@0	50@25	50@50	FDD
	4	-	-	25@0	50@0	75@0	100@0	
CA_2A-5A	2	-	-	25@0	50@0	50@25	50@50	FDD
	5	-	-	25@0	25@25	-	-	
CA_2A-12A	2	-	-	25@0	50@0	50@25	50@50	FDD
	12	-	15@0	20@5	20@30	-	-	
CA_2A-13A	2	-	-	-	50@0	50@25	50@50	FDD
	13	-	-	-	20@0	-	-	
CA_2A-17A	2	-	-	25@0	50@0	-	-	FDD
	17	-	-	20@5	20@30	-	-	
CA_2A-29A	2	-	-	25@0	50@0	50@25	50@50	FDD
	29	-	-	-	-	-	-	
CA_3A-5A	3	-	-	-	50@0	50@25	50@50	FDD
	5	-	-	25@0	25@25	-	-	
CA_3A-7A	3	-	-	25@0	50@0	50@25	50@50	FDD
	7	-	-	-	50@0	75@0	75@25	
CA_3A-8A	3	-	-	25@0	50@0	50@25	50@50	FDD
	8	-	-	25@0	25@25	-	-	
CA_3A-19A	3	-	-	25@0	50@0	50@25	50@50	FDD
	19	-	-	25@0	25@25	25@50	-	
CA_3A-20A	3	-	-	25@0	50@0	50@25	50@50	FDD
	20	-	-	25@0	20@0	-	-	
CA_3A-26A	3	-	-	25@0	50@0	50@25	50@50	FDD
	26	-	-	25@0	25@25	25@50	-	
CA_3A-27A	3	-	-	25@0	50@0	50@25	50@50	FDD
	27	-	-	25@0	25@25	-	-	
CA_3A-28A	3	-	-	25@0	50@0	50@25	50@50	FDD
	28	-	-	25@0	25@25	25@50	25@75	
CA_4A-5A	4	-	-	25@0	50@0	-	-	FDD
	5	-	-	25@0	25@25	-	-	
CA_4A-7A	4	-	-	25@0	50@0	-	-	FDD
	7	-	-	25@0	50@0	75@0	75@25	
CA_4A-12A	4	6@0	15@0	25@0	50@0	75@0	100@0	FDD
	12	-	-	20@5	20@30	-	-	
CA_4A-13A	4	-	-	25@0	50@0	75@0	100@0	FDD
	13	-	-	-	20@0	-	-	
CA_4A-17A	4	-	-	25@0	50@0	-	-	FDD
	17	-	-	20@5	20@30	-	-	
CA_4A-27A	4	-	-	25@0	50@0	75@0	100@0	FDD
	27	-	15@0	25@0	25@25	-	-	
CA_4A-29A	4	-	-	25@0	50@0	-	-	FDD
	29	-	-	-	-	-	-	
CA_5A-7A	5	6@0	15@0	25@0	25@25	-	-	FDD
	7	-	-	-	50@0	75@0	75@25	
CA_5A-12A	5	-	-	25@0	25@25	-	*	FDD
	12	-	-	20@5	20@30	-	-	
CA_5A-13A	5	-	-	25@0	25@25	-	-	FDD
	13	-	-	-	20@30	-	-	
CA_5A-25A	5	-	-	25@0	25@25	-	-	FDD
	25	-	-	25@0	50@0	50@25	50@50	
CA_7A-20A	7	-	-	-	50@0	75@0	75@25	FDD
	20	-	-	25@0	20@30	-	-	
CA_7A-28A	7	-	-	25@0	50@0	75@0	75@25	FDD
	28	-	-	25@0	25@25	25@50	-	
CA_8A-11A	8	-	-	25@0	25@25	-	-	FDD
	11	-	-	25@0	25@25	-	-	
CA_11A-18A	11	-	-	25@0	25@25	-	-	FDD
	18	-	-	25@0	25@25	25@50	-	

CA_12A-25A	12	-	-	20@5	20@30	-	-	FDD
	25	-	-	25@0	50@0	50@25	50@50	
CA_18A-28A	18	-	-	25@0	25@25	25@50	-	FDD
	28	-	-	25@0	25@25	-	-	
CA_19A-21A	19	-	-	25@0	25@25	25@50	-	FDD
	21	-	-	25@0	25@25	25@50	-	
CA_20A-32A	20	-	-	25@0	20@0	20@11	20@16	FDD
	32	-	-	N/A	N/A	N/A	N/A	
CA_23A-29A	23	-	-	25@0	50@0	75@0	100@0	FDD
	29	-	-	-	-	-	-	
CA_26A-41A	26	-	-	25@0	25@25	25@50	-	FDD
	41	-	-	25@0	50@0	75@0	100@0	TDD
CA_39A-41A	39	-	-	25@0	50@0	75@0	100@0	TDD
	41	-	-	25@0	50@0	75@0	100@0	
CA_41A-42A	41	-	-	-	50@0	75@0	100@0	TDD
	42	-	-	-	50@0	75@0	100@0	
<p>Note 1: Void</p> <p>Note 2: Configuration for the low band for which the 3rd harmonic is within transmission bandwidth of the high band, as specified in Table 7.3A.0-1a.</p> <p>Note 3: Void</p> <p>Note 4: Void</p> <p>Note 5: UL allocation when the separation between the lower edge of the uplink channel in Band 1 and the upper edge of the downlink channel in Band 3 is &lt; 60 MHz.</p> <p>Note 6: UL allocation when the separation between the lower edge of the uplink channel in Band 1 and the upper edge of the downlink channel in Band 3 is ≥ 60 MHz.</p> <p>Note 7: Void</p> <p>Note 8: Void</p>								

## 7.3A.4 Reference sensitivity level for CA (intra-band non-contiguous DL CA without UL CA)

### 7.3A.4.1 Test purpose

Same as in clause 7.3A.1.1.

### 7.3A.4.2 Test applicability

This test case applies to all types of E-UTRA UE release 11 and forward that support intra-band non-contiguous DL CA but no UL CA.

### 7.3A.4.3 Minimum conformance requirements

The minimum conformance requirements are defined in clause 7.3A.0.

### 7.3A.4.4 Test description

#### 7.3A.4.4.1 Initial conditions

Same as in clause 7.3A.1.4.1 with the following exceptions:

- Instead of Table 7.3A.1.4.1-1 → use Table 7.3A.4.4.1-1.
- Instead of clause 7.3A.1.4.3 use clause 7.3A.3.4.3.

**Table 7.3A.4.4.1-1: Test Configuration Table**

Initial Conditions									
Test Environment as specified in TS 36.508[7] subclause 4.1				NC, TL/VL, TL/VH, TH/VL, TH/VH					
Test Frequencies as specified in TS36.508 [7] subclause 4.3.1 for different CA bandwidth classes, and PCC and SCCs are mapped onto physical frequencies according to Table 7.1-2.				A: N/A (Range is not relevant)					
Test CC Combination setting ( $N_{RB\_agg}$ ) as specified in subclause 5.4.2A.1 for the CA Configuration.				Refer to test point					
Test Parameters for CA Configurations									
ID	CA Configuration / $N_{RB\_agg}$		$W_{gap}$ [MHz]	DL Allocation		UL Allocation			
	PCC $N_{RB}$	SCCs $N_{RB}$		CC MOD	PCC & SCC RB allocation	CC MOD	PCC $N_{RB\_alloc}$ for PCC measurement ( $L_{CRB}$ @ $RB_{start}$ )	CC MOD	PCC $N_{RB\_alloc}$ for SCC measurement ( $L_{CRB}$ @ $RB_{start}$ )
Test Parameters for CA_2A-2A Configurations									
1	100	25	35	QPSK	100+25	QPSK	P_50@50	QPSK	P_16@57
2	100	100	20	QPSK	100+100	QPSK	P_50@50	QPSK	P_16@57
Test Parameters for CA_3A-3A Configurations									
3	100	25	50	QPSK	100+25	QPSK	P_50@50	QPSK	P_16@50
4	100	25	15	QPSK	100+25	QPSK	P_50@50	QPSK	P_32@68
5	100	100	35	QPSK	100+100	QPSK	P_50@50	QPSK	P_16@50
Test Parameters for CA_4A-4A Configurations									
6	100	25	20	QPSK	100+25	QPSK	P_100@0	QPSK	P_100@0
7	100	100	5	QPSK	100+100	QPSK	P_100@0	QPSK	P_100@0
Test Parameters for CA_7A-7A Configurations									
8	100	75	35	QPSK	100+75	QPSK	P_75@25	QPSK	P_36@64
9	100	75	15	QPSK	100+75	QPSK	P_75@25	QPSK	P_50@50
10	100	100	30	QPSK	100+100	QPSK	P_75@25	QPSK	P_32@68
11	100	100	15	QPSK	100+100	QPSK	P_75@25	QPSK	P_45@55
Test Parameters for CA_23A-23A Configurations									
12	50	25	5	QPSK	50+25	QPSK	P_50@0	QPSK	P_50@0
Test Parameters for CA_25A-25A Configurations									
13	50	25	50	QPSK	50+25	QPSK	P_50@0	QPSK	P_10@33
14	50	25	15	QPSK	50+25	QPSK	P_50@0	QPSK	P_32@18
15 <sup>3</sup>	50	50	45	QPSK	50+50	QPSK	P_50@0	QPSK	P_10@33
16 <sup>3</sup>	50	50	10	QPSK	50+50	QPSK	P_50@0	QPSK	P_32@18
17 <sup>4</sup>	100	25	40	QPSK	100+25	QPSK	P_50@50	QPSK	P_12@62
18 <sup>4</sup>	100	100	25	QPSK	100+100	QPSK	P_50@50	QPSK	P_12@62
Test Parameters for CA_41A-41A Configurations									
19 <sup>4</sup>	100	25	169	QPSK	100+25	QPSK	P_100@0	QPSK	P_100@0
20 <sup>3</sup>	100	50	164	QPSK	100+50	QPSK	P_100@0	QPSK	P_100@0
21	100	100	154	QPSK	100+100	QPSK	P_100@0	QPSK	P_100@0
Test Parameters for CA_42A-42A Configurations									
22	100	25	175	QPSK	100+25	QPSK	P_100@0	QPSK	P_100@0

23	100	100	160	QPSK	100+100	QPSK	P_100@0	QPSK	P_100@0
<p>Note 1: CA Configuration Test CC Combination settings are checked separately for each CA Configuration, which applicable aggregated channel bandwidths are specified in Table 5.4.2A.1-3.</p> <p>Note 2: The carrier centre frequency of PCC in the UL operating band is configured closer to the DL operating band.</p> <p>Note 3: Applicable if only Bandwidth Combination Set 0 is supported by the UE for the CA Configuration</p> <p>Note 4: Not applicable if only Bandwidth Combination Set 0 is supported by the UE for the CA Configuration</p>									

7.3A.4.4.2 Test procedure

1. Configure SCC according to Annex C.0, C.1 and Annex C.3.1 for all downlink physical channels.
2. The SS shall configure SCC as per TS 36.508 [7] clause 5.2A.4. Message contents are defined in clause 7.3A.4.4.3
3. SS activates SCC by sending the activation MAC-CE (Refer TS 36.321 [13], clauses 5.13, 6.1.3.8). Wait for at least 2 seconds (Refer TS 36.133, clauses 8.3.3.2).
4. SS transmits PDSCH via PDCCH DCI format 1A for C\_RNTI to transmit the DL RMC according to Tables 7.3A.4.4.1-1 on both PCC and SCC. The SS sends downlink MAC padding bits on the DL RMC.
5. SS sends uplink scheduling information for each UL HARQ process via PDCCH DCI format 0 for C\_RNTI to schedule the UL RMC according to Table 7.3A.4.4.1-1 on PCC for PCC measurement. Since the UE has no payload and no loopback data to send the UE sends uplink MAC padding bits on the UL RMC.
6. Set the Downlink signal level for PCC and SCC to the appropriate REFSENS value defined in Table 7.3A.4.5-1. Send continuously uplink power control "up" commands in the uplink scheduling information to the UE to ensure the UE transmits P<sub>UMAX</sub> level for at least the duration of the Throughput measurement.
7. Measure the average throughput for PCC for a duration sufficient to achieve statistical significance according to Annex G.2A.
8. SS sends uplink scheduling information for each UL HARQ process via PDCCH DCI format 0 for C\_RNTI to schedule the UL RMC according to Table 7.3A.4.4.1-1 on PCC for SCC measurement. Since the UE has no payload and no loopback data to send the UE sends uplink MAC padding bits on the UL RMC.
9. Set the Downlink signal level for PCC and SCC to the appropriate REFSENS value defined in Table 7.3A.4.5-1. Send continuously uplink power control "up" commands in the uplink scheduling information to the UE to ensure the UE transmits P<sub>UMAX</sub> level for at least the duration of the Throughput measurement.
10. Measure the average throughput for SCC for a duration sufficient to achieve statistical significance according to Annex G.2A.

7.3A.4.4.3 Message contents

Message contents are according to TS 36.508 [7] subclause 4.6 with the following exceptions.

7.3A.4.4.3.1 Message contents exceptions (network signalled value "NS\_01")

Message contents according to TS 36.508 [7] subclause 4.6 can be used without exceptions.

7.3A.4.4.3.2 Message contents exceptions (network signalled value "NS\_03")

1. Information element additionalSpectrumEmission is set to NS\_03. This can be set in the *SystemInformationBlockType2* as part of the cell broadcast message. This exception indicates that the UE shall meet the additional spurious emission requirement for a specific deployment scenario.

**Table 7.3A.4.4.3.2-1: SystemInformationBlockType2: Additional spurious emissions test requirement for "NS\_03"**

Derivation Path: TS 36.508 [7] clause 4.4.3.3, Table 4.4.3.3-1			
Information Element	Value/remark	Comment	Condition
additionalSpectrumEmission	3 (NS_03)		

### 7.3A.4.5 Test requirement

For intra-band non-contiguous carrier aggregation with one uplink carrier on the PCC, the throughput of each downlink component carrier shall be  $\geq 95\%$  of the maximum throughput of the reference measurement channels as specified in Annexes A.3.2 with parameters specified in Table 7.3A.4.5-1 and Table 7.3A.4.5-2.

**Table 7.3A.4.5-1: Reference sensitivity QPSK  $P_{\text{REFSENS}}$  for intra-band Non-contiguous**

ID/ CA configuration / $P_{\text{REFSENS}}$			
ID	CA configuration	PCC measurement (dBm)	SCC measurement (dBm)
1	CA_2A-2A	-91.3	-90.1
2		-91.3	-86.7
3	CA_3A-3A	-90.3	-89.8
4		-90.3	-96.3
5		-90.3	-86.2
6	CA_4A-4A	-93.3	-99.3
7		-93.3	-93.3
8	CA_7A-7A	-91.3	-92.5
9		-91.3	-92.5
10		-91.3	-91.3
11		-91.3	-91.3
12	CA_23A-23A	-96.3	-99.3
13	CA_25A-25A	-92.8	-90.3
14		-92.8	-95.8
15		-92.8	-87.8
16		-92.8	-92.8
17		-89.8	-87.8
18		-89.8	-84.1
19	CA_41A-41A	-91.3	-97.3
20		-91.3	-94.3
21		-91.3	-91.3
22	CA_42A-42A	-92	-98
23		-92	-92
Note 1: The transmitter shall be set to maximum output power level (Table 7.3A.4.5-2)			
Note 2: The reference measurement channel is specified in A.3.2 with one sided dynamic OCNG Pattern OP.1 FDD/TDD as described in Annex A.5.1.1/A.5.2.1			
Note 3: The signal power is specified per port			

For the UE which supports inter-band carrier aggregation configurations the  $\Delta R_{\text{IB,c}}$  in Table 7.3.3-1A shall be applied for applicable bands.

In case the UE supports more than one of the inter-band carrier aggregation configurations and a E-UTRA operating band belongs to more than one inter-band carrier aggregation configurations then:

- When the E-UTRA operating band frequency range is  $\leq 1\text{GHz}$ , the applicable additional tolerance shall be the average of the tolerances in Table 7.3.3-1A, truncated to one decimal place that would apply for that operating band among the supported CA configurations. In case there is a harmonic relation between low band UL and high band DL (i.e. bands listed in Table 7.3A.0-1), then the maximum tolerance among the different supported carrier aggregation configurations involving such band shall be applied



- When the E-UTRA operating band frequency range is >1GHz, the applicable additional tolerance shall be the maximum tolerance in Table 7.3.3-1A that would apply for that operating band among the supported CA configurations

The reference receive sensitivity (REFSENS) requirement for inter-band specified in Table 7.3A.4.5-1 shall be met for an uplink CA configurations than or equal to that specified in Table 7.3A.4.5-2.

NOTE: Table 7.3A.4.5-2 does not necessarily reflect the operational conditions of the network, where the number of uplink and downlink allocated resource blocks will be practically constrained by other factors.

**Table 7.3A.4.5-2: Intra-band Non-contiguous CA uplink configuration for reference sensitivity**

ID / CA configuration / PCC $N_{RB\_alloc}$			
ID	CA configuration	PCC measurement	SCC measurement
1	CA_2A-2A	50	16 <sup>6</sup>
2		50	16 <sup>6</sup>
3	CA_3A-3A	50	16 <sup>5</sup>
4		50	32 <sup>1</sup>
5		50	16 <sup>5</sup>
6	CA_4A-4A	100	100 <sup>7</sup>
7		100	100 <sup>7</sup>
8	CA_7A-7A	75	36
9		75	50
10		75	32
11		75	45
12	CA_23A-23A	50	50 <sup>7</sup>
13	CA_25A-25A	50	10 <sup>3</sup>
14		50	32
15		50	10 <sup>3</sup>
16		50	32
17		50	12 <sup>8</sup>
18		50	12 <sup>8</sup>
19	CA_41A-41A	100	100 <sup>7</sup>
20		100	100 <sup>7</sup>
21		100	100 <sup>7</sup>
22	CA_42A-42A	100	100 <sup>7</sup>
23		100	100 <sup>7</sup>
Note 1: <sup>1</sup> refers to the UL resource blocks shall be located as close as possible to the downlink operating band but confined within the transmission. Note 2: The carrier centre frequency of PCC in the UL operating band is configured closer to the DL operating band. Note 3: <sup>3</sup> refers to the UL resource blocks shall be located at $RB_{start}=33$ . Note 4: All combinations of channel bandwidths defined in Table 5.4.2A.1-3. Note 5: <sup>5</sup> refers to the UL resource blocks shall be located at $RB_{start}=50$ . Note 6: <sup>6</sup> refers to the UL resource blocks shall be located at $RB_{start}=57$ . Note 7: The PCC allocation is same as Transmission bandwidth configuration $N_{RB}$ as defined in Table 5.4.2-1. Note 8: <sup>8</sup> refers to the UL resource blocks shall be located at $RB_{start}=62$ .			

### 7.3A.5 Reference sensitivity level for CA (3DL CA without UL CA)

*Editor's note: This test case is incomplete for some types of CA only:*

- *Inter-band + Intra-band non-contiguous*

- *Intra-band non-contiguous + Intra-band contiguous*

### 7.3A.5.1 Test purpose

Same as in clause 7.3A.1.1.

### 7.3A.5.2 Test applicability

This test case applies to all types of E-UTRA UE release 10 and forward that support 3DL with Intra-band contiguous CA, or 3DL with Inter-band CA, or 3DL with Intra-band contiguous and Inter-band CA.

This test case also applies to all types of E-UTRA UE release 11 and forward that support 3DL with Intra-band non-contiguous and Inter-band CA, or 3DL with Intra-band non-contiguous and Intra-band contiguous CA.

This test case also applies to all types of E-UTRA UE release 12 and forward that support 3DL CA with FDD-TDD CA.

### 7.3A.5.3 Minimum conformance requirements

The minimum conformance requirements are defined in clause 7.3A.0.

### 7.3A.5.4 Test description

#### 7.3A.5.4.1 Initial conditions

Initial conditions are a set of test configurations the UE needs to be tested in and the steps for the SS to take with the UE to reach the correct measurement state.

The initial test configurations consist of environmental conditions, test frequencies, and channel bandwidths based on E-UTRA CA configurations specified in table 5.4.2A.1-1 through table 5.4.2A.1-2a. All of these configurations shall be tested with applicable test parameters for each channel bandwidth, and are shown in table 7.3A.5.4.1-1 through table 7.3A.5.4.1-5 as appropriate. The details of the uplink reference measurement channels (RMCs) are specified in Annex A.2 and A.3. Configurations of PDSCH and PDCCH before measurement are specified in Annex C.2.

**Table 7.3A.5.4.1-1: Test Configuration Table (Intra-band contiguous)**

Initial Conditions											
Test Environment as specified in TS 36.508[7] subclause 4.1							NC, TL/VL, TL/VH, TH/VL, TH/VH				
Test Frequencies as specified in TS36.508 [7] subclause 4.3.1 for different CA bandwidth classes.							For test frequencies refer to “Range” columns. For mapping within Band refer to “CC” columns				
Test CC Combination setting ( $N_{RB\_agg}$ ) as specified in subclause 5.4.2A.1 for the CA Configuration across bandwidth combination sets supported by the UE.							Refer to “PCC $N_{RB}$ ” and “SCCs $N_{RB}$ ” columns				
Network signalling value							NS_01 by default, exceptions listed in Table 7.3.3-3, dependent on PCC Band				
Test Parameters for CA Configurations											
ID	CA Configuration / $N_{RB\_agg}$						DL Allocation			UL Allocation (Note 2,3)	
	CA Configuration					PCC $N_{RB}$	SCCs $N_{RB}$		PCC & SCCs RB allocation	CC MOD	PCC $L_{CRB} @ RB_{start}$
	Band	Range	PCC CC	SCC1 CC	SCC2 CC		SCC1	SCC2			
Default Test Settings for a CA_XD Configuration											
1	X	Low	CC1	CC2	CC3	Highest $N_{RB\_agg}$	QPSK	All RBs	QPSK	REFSENS	
2	X	Low	CC1	CC2	CC3	Lowest $N_{RB\_agg}$	QPSK	All RBs	QPSK	REFSENS	
3	X	High	CC1	CC2	CC3	Highest $N_{RB\_agg}$	QPSK	All RBs	QPSK	REFSENS	
4	X	High	CC1	CC2	CC3	Lowest $N_{RB\_agg}$	QPSK	All RBs	QPSK	REFSENS	
Note 1:	CA Configuration Test CC Combination test settings are checked separately for each CA Configuration.										
Note 2:	Use CA Configuration – specific test points if present in the table, otherwise use Default Test Settings test points.										
Note 3:	X corresponds to the band of the CA Configuration. Eg. for CA_41D ,X=41										
Note 4:	REFSENS refers to the PCC band’s and PCC $N_{RB}$ ‘s single carrier Uplink RB allocation for reference sensitivity according to table 7.3.5-2.										
Note 5:	If in the CA Configuration UE supports multiple CC Combinations with the same $N_{RB\_agg}$ , choose for testing the Combination with maximum $N_{RB\_PCC}$ and then select maximum $N_{RB\_SCC1}$ for the chosen $N_{RB\_PCC}$										

**Table 7.3A.5.4.1-2: Test Configuration Table (Inter-band)**

Initial Conditions															
Test Environment as specified in TS 36.508[7] subclause 4.1											NC, TL/VL, TL/VH, TH/VL, TH/VH				
Test Frequencies as specified in TS36.508 [7] subclause 4.3.1 for different CA bandwidth classes.											For test frequencies refer to "Range" columns. For mapping within Band refer to "CC" columns				
Test CC Combination setting (N <sub>RB_agg</sub> ) as specified in subclause 5.4.2A.1 for the CA Configuration across bandwidth combination sets supported by the UE.											Refer to "PCC N <sub>RB</sub> " and "SCCs N <sub>RB</sub> " columns				
Network signalling value											NS_01 by default, exceptions listed in Table 7.3.3-3, dependent on PCC Band				
Test Parameters for CA Configurations															
ID	CA Configuration / N <sub>RB_agg</sub>							DL Allocation			UL Allocation (Note 2,3)				
	CA Configuration						PCC N <sub>RB</sub>	SCCs N <sub>RB</sub>		CC MOD	PCC & SCCs RB allocation			CC MOD	PCC L <sub>CRB</sub> @ RB <sub>start</sub>
	PCC		SCC1		SCC2			SCC1	SCC2		PCC	SCC1	SCC2		
	Band	Range	Band	Range	Band	Range									
Default Test Settings for a CA_XA-YA-ZA Configuration															
1	X	Mid	Y	Mid	Z	Mid	Highest N <sub>RB</sub>	Highest N <sub>RB</sub>	Highest N <sub>RB</sub>	QPSK	All RBs	QPSK	REFSENS		
2	Y	Mid	X	Mid	Z	Mid	Highest N <sub>RB</sub>	Highest N <sub>RB</sub>	Highest N <sub>RB</sub>	QPSK	All RBs	QPSK	REFSENS		
3	Z	Mid	X	Mid	Y	Mid	Highest N <sub>RB</sub>	Highest N <sub>RB</sub>	Highest N <sub>RB</sub>	QPSK	All RBs	QPSK	REFSENS		
Test Settings for CA_1A-3A-5A Configuration															
1 <sup>9</sup>	1	Low	3	High	5	Mid	100	25	50	QPSK	All RBs	QPSK	25@0		
2 <sup>9</sup>	1	Low	3	High	5	Mid	100	100	50	QPSK	All RBs	QPSK	25@0		
3	1	Mid	3	High	5	Mid	100	100	50	QPSK	All RBs	QPSK	45@0		
4	3	High	1	Low	5	Mid	100	100	50	QPSK	All RBs	QPSK	50@50		
5	5	Mid	1	Mid	3	Mid	50	100	100	QPSK	All RBs	QPSK	25@25		
Test Settings for CA_1A-3A-19A Configuration															
1	1	Mid	3	High	19	High	75	100	50	QPSK	All RBs	QPSK	45@0		
2	1	Mid	3	High	19	Mid	75	100	75	QPSK	All RBs	QPSK	45@0		
3 <sup>9</sup>	1	Low	3	High	19	Mid	100	25	75	QPSK	All RBs	QPSK	25@0		
4	1	Mid	3	High	19	High	100	100	50	QPSK	All RBs	QPSK	45@0		
5	1	Mid	3	High	19	Mid	100	100	75	QPSK	All RBs	QPSK	45@0		
6	3	High	1	Mid	19	High	100	75	50	QPSK	All RBs	QPSK	50@50		
7	3	High	1	Mid	19	Mid	100	75	75	QPSK	All RBs	QPSK	50@50		
8	3	High	1	Mid	19	High	100	100	50	QPSK	All RBs	QPSK	50@50		
9	3	High	1	Mid	19	Mid	100	100	75	QPSK	All RBs	QPSK	50@50		
10	19	High	1	Mid	3	High	50	75	100	QPSK	All RBs	QPSK	25@25		
11	19	High	1	Mid	3	High	50	100	100	QPSK	All RBs	QPSK	25@25		
12	19	Mid	1	Mid	3	High	75	75	100	QPSK	All RBs	QPSK	25@50		
13	19	Mid	1	Mid	3	High	75	100	100	QPSK	All RBs	QPSK	25@50		
Test Settings for CA_1A-5A-7A Configuration															
1	1	Low	5	High	7	Mid	50	50	100	QPSK	All RBs	QPSK	50@0		
2	1	Low	5	High	7	Mid	100	50	100	QPSK	All RBs	QPSK	100@0		
3	5	High	1	Low	7	Mid	50	50	100	QPSK	All RBs	QPSK	25@25		
4	5	High	1	Low	7	Mid	50	100	100	QPSK	All RBs	QPSK	25@25		
5	7	Mid	1	Low	5	High	100	50	50	QPSK	All RBs	QPSK	75@25		
6	7	Mid	1	Low	5	High	100	100	50	QPSK	All RBs	QPSK	75@25		
Test Settings for CA_1A-18A-28A Configuration (Note 8)															
1	1	Low	18	Low	28	Mid	50	50	50	QPSK	All RBs	QPSK	50@0		
2	1	Low	18	Low	28	Mid	75	50	50	QPSK	All RBs	QPSK	75@0		
3	1	Low	18	Low	28	Mid	100	50	50	QPSK	All RBs	QPSK	100@0		
4	1	Low	18	Mid	28	High	100	75	50	QPSK	All RBs	QPSK	100@0		

5	18	Low	1	Low	28	Mid	50	50	50	QPSK	All RBs	QPSK	25@25
6	18	Low	1	Low	28	Mid	50	75	50	QPSK	All RBs	QPSK	25@25
7	18	Low	1	Low	28	Mid	50	100	50	QPSK	All RBs	QPSK	25@25
8	18	Mid	1	Low	28	High	75	100	25	QPSK	All RBs	QPSK	25@50
9	18	Mid	1	Low	28	High	75	100	50	QPSK	All RBs	QPSK	25@50
10	28	High	1	Low	18	Mid	25	100	75	QPSK	All RBs	QPSK	25@0
11	28	Mid	1	Low	18	Low	50	100	50	QPSK	All RBs	QPSK	25@25
12	28	High	1	High	18	Mid	50	100	75	QPSK	All RBs	QPSK	25@25
<b>Test Settings for CA_1A-19A-21A Configuration</b>													
1	1	Mid	19	High	21	Mid	75	50	75	QPSK	All RBs	QPSK	75@0
2	1	Mid	19	Mid	21	Mid	75	75	75	QPSK	All RBs	QPSK	75@0
3	1	Mid	19	High	21	Mid	100	50	75	QPSK	All RBs	QPSK	100@0
4	1	Mid	19	Mid	21	Mid	100	75	75	QPSK	All RBs	QPSK	100@0
5	19	High	1	Mid	21	Mid	50	75	75	QPSK	All RBs	QPSK	25@25
6	19	High	1	Mid	21	Mid	50	100	75	QPSK	All RBs	QPSK	25@25
7	19	Mid	1	Mid	21	Mid	75	75	75	QPSK	All RBs	QPSK	25@50
8	19	Mid	1	Mid	21	Mid	75	100	75	QPSK	All RBs	QPSK	25@50
9	21	Mid	1	Mid	19	High	75	75	50	QPSK	All RBs	QPSK	25@50
10	21	Mid	1	Mid	19	Mid	75	75	75	QPSK	All RBs	QPSK	25@50
11	21	Mid	1	Mid	19	High	75	100	50	QPSK	All RBs	QPSK	25@50
12	21	Mid	1	Mid	19	Mid	75	100	75	QPSK	All RBs	QPSK	25@50
<b>Test Settings for CA_2A-4A-12A Configuration</b>													
1	2	Mid	4	Mid	12	Mid	100	100	50	QPSK	All RBs	QPSK	50@50
2	4	Mid	2	Mid	12	Low	100	100	50	QPSK	All RBs	QPSK	100@0
3	4	Mid	2	Mid	12	High	100	100	50	QPSK	All RBs	QPSK	100@0
5	12	Low <sup>6</sup>	4	Low <sup>6</sup>	2	Mid	50	50	100	QPSK	All RBs	QPSK	16@17
6	12	High <sup>7</sup>	4	High <sup>7</sup>	2	Mid	50	50	100	QPSK	All RBs	QPSK	16@17
<b>Test Settings for CA_2A-4A-13A Configuration</b>													
1	2	Mid	4	Mid	13	Mid	100	100	50	QPSK	All RBs	QPSK	50@50
2	4	Mid	2	Mid	13	Mid	100	100	50	QPSK	All RBs	QPSK	100@0
3	13	Mid	2	Low	4	Low	50	50	50	QPSK	All RBs	QPSK	20@0
4	13	Mid	2	Mid	4	Mid	50	75	75	QPSK	All RBs	QPSK	20@0
5	13	Mid	2	High	4	High	50	100	100	QPSK	All RBs	QPSK	20@0
<b>Test Settings for CA_2A-5A-13A Configuration</b>													
1	2	Mid	5	Mid	13	Mid	100	50	50	QPSK	All RBs	QPSK	50@50
2	5	Mid	2	Mid	13	Mid	50	100	50	QPSK	All RBs	QPSK	25@25
3	13	Mid	2	Low	5	Low	50	50	50	QPSK	All RBs	QPSK	20@0
4	13	Mid	2	Mid	5	Mid	50	75	50	QPSK	All RBs	QPSK	20@0
5	13	Mid	2	High	5	High	50	100	50	QPSK	All RBs	QPSK	20@0
<b>Test Settings for CA_4A-5A-13A Configuration</b>													
1	4	Mid	5	Mid	13	Mid	50	50	50	QPSK	All RBs	QPSK	50@0
2	5	Low	4	Mid	13	Mid	50	50	50	QPSK	All RBs	QPSK	25@25
3	5	Mid	4	Mid	13	Mid	50	50	50	QPSK	All RBs	QPSK	25@25
4	5	High	4	Mid	13	Mid	50	50	50	QPSK	All RBs	QPSK	25@25
5	13	Mid	4	Low	5	Low	50	50	50	QPSK	All RBs	QPSK	20@0
6	13	Mid	4	Mid	5	Mid	50	75	50	QPSK	All RBs	QPSK	20@0
7	13	Mid	4	High	5	High	50	100	50	QPSK	All RBs	QPSK	20@0
Note 1:	CA Configuration Test CC Combination test settings are checked separately for each CA Configuration.												
Note 2:	Use CA Configuration – specific test points if present in the table, Otherwise use test points from matching Group Test Settings, if present in the table. Otherwise use the Default Test Settings test points.												
Note 3:	If, according to the UE declared capability, UE does not support UL in an individual band within the CA Configuration, test points with that individual band as PCC are not applicable.												
Note 4:	X,Y,Z correspond to the different bands in the CA Configuration. Eg. for CA_1A-3A-19A,X=1,Y=3,Z=19												
Note 5:	REFSENS refers to the PCC band's and PCC N <sub>RB</sub> 's single carrier Uplink RB allocation for reference sensitivity according to table 7.3.5-2.												
Note 6:	Band 12: f <sub>UL</sub> = 706.7 MHz (N <sub>UL</sub> = 23087), f <sub>DL</sub> = 736.7 MHz (N <sub>DL</sub> = 5087) Band 4: f <sub>DL</sub> = 2120.1 MHz (N <sub>DL</sub> = 2051)												
Note 7:	Band 12: f <sub>UL</sub> = 710.9 MHz (N <sub>UL</sub> = 23129), f <sub>DL</sub> = 740.9 MHz (N <sub>DL</sub> = 5129) Band 4: f <sub>DL</sub> = 2132.7 MHz (N <sub>DL</sub> = 2177)												
Note 8:	CA_1A-28A test shall not be skipped due to CA_1A_18A_28A test being conducted.												
Note 9:	Test points that fulfill criteria of Note 4 in Table 7.3A.5.5-3												



**Table 7.3A.5.4.1-3: Test Configuration Table (Intra-band contiguous + Inter-band)**

Initial Conditions													
Implementation as specified in [7] subclause 4.1								NC, TL/VL, TL/VH, TH/VL, TH/VH					
Frequencies as specified in TS36.508 [7] subclause 4.3.1 for different CA bandwidth classes.								For test frequencies refer to "Range" columns; for RB mapping within Band refer to "CC" columns					
Combination setting (N <sub>RB_agg</sub> ) as specified in subclause 5.4.2A.1 for the CA Configuration across combination sets supported by the UE.								Refer to "PCC N <sub>RB</sub> " and "SCCs N <sub>RB</sub> " columns					
Scaling value								NS_01 by default, exceptions listed in Table 7.3A.5.4.1-3 dependent on PCC Band					
Test Parameters for CA Configurations													
CA Configuration / N <sub>RB_agg</sub>								DL Allocation			UL Allocation		
CA Configuration						PCC N <sub>RB</sub>	SCCs N <sub>RB</sub>		CC MOD	PCC & SCCs RB allocation			CC MOD
PCC		SCC1		SCC2			SCC1	SCC2		PCC	SCC1	SCC2	
Band	Range /CC	Band	Range /CC	Band	Range /CC								
<b>Default Test Settings for a CA_XC-Y and A CA_XB- YA Configurations</b>													
	X	Low /CC1	X	Low /CC2	Y	Mid	Highest N <sub>RB_agg</sub>	Highest N <sub>RB</sub>	QPSK	All RBs	QPSK		
	X	Low /CC1	X	Low /CC2	Y	Mid	Lowest N <sub>RB_agg</sub>	Highest N <sub>RB</sub>	QPSK	All RBs	QPSK		
	X	High /CC1	X	High /CC2	Y	Mid	Highest N <sub>RB_agg</sub>	Highest N <sub>RB</sub>	QPSK	All RBs	QPSK		
	X	High /CC1	X	High /CC2	Y	Mid	Lowest N <sub>RB_agg</sub>	Highest N <sub>RB</sub>	QPSK	All RBs	QPSK		
	Y	Mid	X	Mid /CC1	X	Mid /CC2	Highest N <sub>RB</sub>	Highest N <sub>RB_agg</sub>	QPSK	All RBs	QPSK		
<b>Default Test Settings for CA_XA-YC and CA_XA-YB Configurations</b>													
	Y	Low /CC1	Y	Low /CC2	X	Mid	Highest N <sub>RB_agg</sub>	Highest N <sub>RB</sub>	QPSK	All RBs	QPSK		
	Y	Low /CC1	Y	Low /CC2	X	Mid	Lowest N <sub>RB_agg</sub>	Highest N <sub>RB</sub>	QPSK	All RBs	QPSK		
	Y	High /CC1	Y	High /CC2	X	Mid	Highest N <sub>RB_agg</sub>	Highest N <sub>RB</sub>	QPSK	All RBs	QPSK		
	Y	High /CC1	Y	High /CC2	X	Mid	Lowest N <sub>RB_agg</sub>	Highest N <sub>RB</sub>	QPSK	All RBs	QPSK		
	X	Mid	Y	Mid /CC1	Y	Mid /CC2	Highest N <sub>RB</sub>	Highest N <sub>RB_agg</sub>	QPSK	All RBs	QPSK		
<b>Test Settings for a CA_1A-41C Configuration (Note 7, Note 8)</b>													
	1	Low	41	Mid /CC1	41	Mid /CC2	Highest N <sub>RB</sub>	Highest N <sub>RB_agg</sub>	QPSK	All RBs	QPSK		
	1	High	41	Mid /CC1	41	Mid /CC2	Highest N <sub>RB</sub>	Highest N <sub>RB_agg</sub>	QPSK	All RBs	QPSK		
<b>Test Settings for CA_3A-42C configuration</b>													
	3	Low	42	Low <sup>7</sup>	42	Low <sup>7</sup>	Highest N <sub>RB</sub>	Highest N <sub>RB_agg</sub>	QPSK	All RBs	QPSK		
	3	High	42	Mid <sup>8</sup>	42	Mid <sup>8</sup>	Highest N <sub>RB</sub>	Highest N <sub>RB_agg</sub>	QPSK	All RBs	QPSK		
	42	Low /CC1	42	Low /CC2	3	Mid	Highest N <sub>RB_agg</sub>	Highest N <sub>RB</sub>	QPSK	All RBs	QPSK		
	42	High /CC1	42	High /CC2	3	Mid	Highest N <sub>RB_agg</sub>	Highest N <sub>RB</sub>	QPSK	All RBs	QPSK		
<b>Test Settings for a CA_26A-41C Configuration</b>													
	26	Low	41	Mid /CC1	41	Mid /CC2	Highest N <sub>RB</sub>	Highest N <sub>RB_agg</sub>	QPSK	All RBs	QPSK		
	41	Low /CC1	41	Low /CC2	26	Low	Lowest N <sub>RB_agg</sub>	Highest N <sub>RB</sub>	QPSK	All RBs	QPSK		

	41	Low /CC1	41	Low /CC2	26	Low	Highest N <sub>RB_agg</sub>	Highest N <sub>RB</sub>	QPSK	All RBs	QPSK
	41	High /CC1	41	High /CC2	26	Low	Lowest N <sub>RB_agg</sub>	Highest N <sub>RB</sub>	QPSK	All RBs	QPSK
	41	High /CC1	41	High /CC2	26	Low	Highest N <sub>RB_agg</sub>	Highest N <sub>RB</sub>	QPSK	All RBs	QPSK

**Test Settings for CA\_39C-41A Configuration**

	39	Low /CC1	39	Low /CC2	41	Mid	100	50	100	QPSK	All RBs	QPSK
	39	Low /CC1	39	Low /CC2	41	Mid	25	50	100	QPSK	All RBs	QPSK
	39	High /CC1	39	High /CC2	41	Mid	100	50	100	QPSK	All RBs	QPSK
	39	High /CC1	39	High /CC2	41	Mid	25	50	100	QPSK	All RBs	QPSK
	39	Mid /CC1	39	Mid /CC2	41	Mid	25	50	100	QPSK	All RBs	QPSK
	41	Mid	39	Low /CC1	39	Low /CC2	100	100	50	QPSK	All RBs	QPSK
	41	Mid	39	High /CC1	39	High /CC2	100	100	50	QPSK	All RBs	QPSK

**Test Settings for CA\_39A-41C Configuration**

	39	Low	41	Mid /CC1	41	Mid /CC2	100	100	100	QPSK	All RBs	QPSK
	39	High	41	Mid /CC1	41	Mid /CC2	25	100	100	QPSK	All RBs	QPSK
	41	Mid /CC1	41	Mid /CC2	39	Low	100	100	100	QPSK	All RBs	QPSK
	41	Mid /CC1	41	Mid /CC2	39	Low	25	100	100	QPSK	All RBs	QPSK
	41	Mid /CC1	41	Mid /CC2	39	High	100	100	100	QPSK	All RBs	QPSK
	41	Mid /CC1	41	Mid /CC2	39	High	25	100	100	QPSK	All RBs	QPSK

A Configuration Test CC Combination test settings are checked separately for each CA Configuration.

Use CA Configuration – specific test points if present in the table. Otherwise use the Default Test Settings test points.

According to the UE declared capability, UE does not support UL in an individual band within the CA Configuration, test points with that individual CC are not applicable.

X, Y correspond to the different bands in the CA Configuration. Eg. for CA\_1C-3A, X=1, Y=3, for CA\_1A\_42C, X=1, Y=42 or Y=3, X=1

EFSENS refers to the PCC band's and PCC N<sub>RB</sub>'s single carrier Uplink RB allocation for reference sensitivity according to table 7.3.5-2.

In the CA Configuration UE supports multiple CC Combinations with the same N<sub>RB\_agg</sub>, choose the Combination with N<sub>RB\_PCC</sub> = N<sub>RB\_SCC1</sub> for testing. If each combination is supported, choose Combination with maximum N<sub>RB\_PCC</sub> for testing.

and 42: f<sub>UL/DL</sub> for SCC1 = 3430.2MHz (N<sub>UL/DL</sub> = 41892), f<sub>UL/DL</sub> for SCC2 = 3450MHz (N<sub>UL/DL</sub> = 42090)

and 42: f<sub>UL/DL</sub> for SCC1 = 3500.2MHz (N<sub>UL/DL</sub> = 42592), f<sub>UL/DL</sub> for SCC2 = 3520MHz (N<sub>UL/DL</sub> = 42790)



**Table 7.3A.5.4.1-4: Test Configuration Table (Intra-band non-contiguous + Inter-band)**

Initial Conditions																
Test Environment as specified in TS 36.508[7] subclause 4.1												NC, TL/VL, TL/VH, TH/VL, TH/VH				
Test Frequencies as specified in TS36.508 [7] subclause 4.3.1 for different CA bandwidth classes.												For test frequencies refer to “Range” columns. For mapping within Band refer to “CC” columns				
Test CC Combination setting ( $N_{RB\_agg}$ ) as specified in subclause 5.4.2A.1 for the CA Configuration across bandwidth combination sets supported by the UE.												Refer to “PCC $N_{RB}$ ” and “SCCs $N_{RB}$ ” columns				
Network signalling value												NS_01 by default, exceptions listed in Table 7.3.3-3, dependent on PCC Band				
Test Parameters for CA Configurations																
ID	CA Configuration / $N_{RB\_agg}$										DL Allocation			UL Allocation (Note 2,3)		
	CA Configuration										CC MOD	PCC & SCCs RB allocation			CC MOD	PCC $L_{CRB}$ @ $RB_{start}$
	PCC		$W_{gap}$ [MHz]	SCC1		$W_{gap}$ [MHz]	SCC2		PC $C_{NR}$ B	SCCs $N_{RB}$						
	Band	Range /CC		Band	Range /CC		Band	Range /CC		SCC 1		SCC 2	PCC	SCC1		
Group Test Settings for CA_2A-2A-XA Configurations																
1	2	CC2	35	2	CC1	-	5	Mid	100	25	50	QPSK	All RBs	QPSK	16@57	
2	2	CC2	20	2	CC1	-	5	Mid	100	100	50	QPSK	All RBs	QPSK	16@57	
3	5	Mid	-	2	CC2	20	2	CC1	50	100	100	QPSK	All RBs	QPSK	REFSENS	
Group Test Settings for CA_4A-4A-XA Configurations																
1	4	CC2	20	4	CC1	-	5	Mid	100	25	50	QPSK	All RBs	QPSK	100@0	
2	4	CC2	5	4	CC1	-	5	Mid	100	100	50	QPSK	All RBs	QPSK	100@0	
3	5	Mid	-	4	CC2	5	4	CC1	100	100	50	QPSK	All RBs	QPSK	REFSENS	
Note 1: CA Configuration Test CC Combination test settings are checked separately for each CA Configuration. Note 2: Use CA Configuration – specific test points if present in the table. Otherwise use test points from matching Group Test Settings, if present in the table. Otherwise use Default Test Settings test points. Note 3: If, according to the UE declared capability, UE does not support UL in an individual band within the CA Configuration, test points with that individual band as PCC are not applicable. Note 4: X and Y correspond to the different bands in the CA Configuration. Eg. for CA_2A-2A-5A, X=2, Y=5 or Y=5, X=2 Note 5: REFSSENS refers to the PCC band's and PCC $N_{RB}$ 's single carrier Uplink RB allocation for reference sensitivity according to table 7.3.5-2.																

**Table 7.3A.5.4.1-5: Test Configuration Table (Intra-band non-contiguous + Intra-band contiguous)**

Initial Conditions															
Test Environment as specified in TS 36.508[7] subclause 4.1										NC, TL/VL, TL/VH, TH/VL, TH/VH					
Test Frequencies as specified in TS36.508 [7] subclause 4.3.1 for different CA bandwidth classes.										For test frequencies refer to “Range” columns. For mapping within band refer to “CC” columns					
Test CC Combination setting ( $N_{RB\_agg}$ ) as specified in subclause 5.4.2A.1 for the CA Configuration across bandwidth combination sets supported by the UE.										Refer to “PCC $N_{RB}$ ” and “SCCs $N_{RB}$ ” columns					
Network signalling value										NS_01 by default, exceptions listed in Table 7.3.3-3, dependent on PCC Band					
Test Parameters for CA Configurations															
ID	CA Configuration / $N_{RB\_agg}$								DL Allocation			UL Allocation (Note 2,3)			
	CA Configuration						PCC $N_{RB}$	SCCs $N_{RB}$		CC MOD	PCC & SCCs RB allocation			CC MOD	PCC $L_{CRB}$ @ $RB_{start}$
	Band	PC C	$W_{gap}$ [MHz]	SCC 1	$W_{gap}$ [MHz]	SCC 2		SCC 1	SCC 2		PCC	SCC1	SCC2		
		CC		CC		CC									
Test Settings for a 41A-41C Configuration															
1	41	CC3	149	CC2	-	CC1	100	100	25	QPS K	All RBs	QPS K	100@0		
2	41	CC3	134.2	CC2	-	CC1	100	100	100	QPS K	All RBs	QPS K	100@0		
Test Settings for a CA_41C-41A Configuration															
1	41	CC3	-	CC2	149.2	CC1	100	100	25	QPS K	All RBs	QPS K	100@0		
2	41	CC3	-	CC2	134.2	CC1	100	100	100	QPS K	All RBs	QPS K	100@0		
Note 1: CA Configuration Test CC Combination test settings are checked separately for each CA Configuration. Note 2: Use CA Configuration – specific test points if present in the table, otherwise use Default Test Settings test points. Note 3: If, according to the UE declared capability, UE does not support UL in an individual band within the CA Configuration, test points with that individual band as PCC are not applicable. Note 4: X corresponds to the band of the CA Configuration. Eg. for CA_41C-41A, X=41. Note 5: REFSENS refers to the PCC band’s and PCC $N_{RB}$ ‘s single carrier Uplink RB allocation for reference sensitivity according to table 7.3.5-2. Note 6: If in the CA Configuration UE supports multiple CC Combinations with the same $N_{RB\_agg}$ , choose the Combination with $N_{RB\_CC1} = N_{RB\_CC2}$ for testing. If no such combination is supported, choose Combination with maximum $N_{RB\_CC1}$ for testing.															

1. Connect the SS to the UE antenna connectors as shown in TS 36.508[7] Annex A Figure A.55.
2. The parameter settings for the cell are set up according to TS 36.508 [7] subclause 4.4.3.
3. Downlink signals for PCC are initially set up according to Annex C.0, C.1, and C.3.1, and uplink signals according to Annex H.1 and H.3.0.
4. The UL and DL Reference Measurement channels are set according to Table 7.3A.5.4.1-1 through Table 7.3A.5.4.1-5 as appropriate.
5. Propagation conditions are set according to Annex B.0.
6. Ensure the UE is in State 3A-RF according to TS 36.508 [7] clause 5.2A.2. Message contents are defined in clause 7.3A.5.4.3.

### 7.3A.5.4.2 Test procedure

1. Configure SCCs according to Annex C.0, C.1 and Annex C.3.1 for all downlink physical channels.
2. The SS shall configure SCCs as per TS 36.508 [7] clause 5.2A.4. Message contents are defined in clause 7.3A.5.4.3
3. SS activates SCCs by sending the activation MAC-CE (Refer TS 36.321 [13], clauses 5.13, 6.1.3.8). Wait for at least 2 seconds (Refer TS 36.133, clauses 8.3.3.2).
4. SS transmits PDSCH via PDCCH DCI format 1A for C\_RNTI to transmit the DL RMC according to Table 7.3A.5.4.1-1 through Table 7.3A.5.4.1-5 as appropriate on PCC and SCCs. The SS sends downlink MAC padding bits on the DL RMC.
5. SS sends uplink scheduling information for each UL HARQ process via PDCCH DCI format 0 for C\_RNTI to schedule the UL RMC according to Table 7.3A.5.4.1-1 through Table 7.3A.5.4.1-5 as appropriate on PCC and SCCs. Since the UE has no payload and no loopback data to send the UE sends uplink MAC padding bits on the UL RMC.
6. Set the Downlink signal level for PCC and SCCs to the appropriate REFSENS value defined in Table 7.3A.5.4.5-1 through Table 7.3A.5.4.5-5. Send continuously uplink power control "up" commands in every uplink scheduling information to the UE to ensure the UE transmits  $P_{UMAX}$  level for at least the duration of the Throughput measurement.
7. Measure the average throughput for each component carrier for a duration sufficient to achieve statistical significance according to Annex G.2A.

### 7.3A.5.4.3 Message contents

Message contents are according to TS 36.508 [7] subclause 4.6. In test procedure step 2, for SCCs configuration there are no additional message contents.

### 7.3A.5.5 Test requirement

For intra-band contiguous carrier aggregation the throughput of each component carrier shall be  $\geq 95\%$  of the maximum throughput of the reference measurement channels as specified in Annexes A.2.2, A.2.3 and A.3.2 (with one sided dynamic OCNG Pattern OP.1 FDD/TDD for the DL-signal as described in Annex A.5.1.1/A.5.2.1) with parameters specified in Table 7.3A.5.5-1. The reference sensitivity is defined to be met with all downlink component carriers active and one of the uplink carriers active.

**Table 7.3A.5.5-1: Reference sensitivity QPSK  $P_{REFSENS}$  for Intra-band contiguous**

CA Configuration	E-UTRA Band	Channel bandwidth						Duplex Mode
		1.4 MHz (dBm)	3 MHz (dBm)	5 MHz (dBm)	10 MHz (dBm)	15 MHz (dBm)	20 MHz (dBm)	
CA_40D	40	-	-	-	-96.3	-94.5	-93.3	TDD
CA_41D	41	-	-	-	-94.3	-92.5	-91.3	TDD
Note 1:	The transmitter shall be set to maximum output power level (Table 7.3A.5.5-2)							
Note 2:	The reference measurement channel is specified in A.3.2 with one sided dynamic OCNG Pattern OP.1 FDD/TDD as described in Annex A.5.1.1/A.5.2.1							
Note 3:	The signal power is specified per port							

**Table 7.3A.5.5-2: Void**

For inter-band carrier aggregation with one component carrier per operating band and the uplink assigned to one E-UTRA band the throughput shall be  $\geq 95\%$  of the maximum throughput of the reference measurement channels as specified in Annexes A.2.2, A.2.3 and A.3.2 (with one sided dynamic OCNG Pattern OP.1 FDD/TDD for the DL-signal as described in Annex A.5.1.1/A.5.2.1) with parameters specified in Table 7.3A.5.5-3 (originated from single carrier Tables 7.3.5-3). The reference sensitivity is defined to be met with all downlink component carriers active and one of the uplink carriers active.

Table 7.3A.5.5-3: Reference sensitivity QPSK  $P_{\text{REFSENS}}$  for inter-band

CA Configuration	Channel bandwidth							Duplex Mode
	E-UTRA Band	1.4 MHz (dBm)	3 MHz (dBm)	5 MHz (dBm)	10 MHz (dBm)	15 MHz (dBm)	20 MHz (dBm)	
CA_1A-3A-5A	1	-	-	-99.3	-96.3	-94.5	-93.3	FDD
	3	-	-	-96.3	-93.3	-91.5	-90.3	
	3 (Note 4)	-	-	-93.3	-90.8	-89.3	-88.3	
	5	-	-	-97.3	-94.3	-	-	
CA_1A-3A-19A	1	-	-	-99.3	-96.3	-94.5	-93.3	FDD
	3	-	-	-96.3	-93.3	-91.5	-90.3	
	3 (Note 4)	-	-	-93.3	-90.8	-89.3	-88.3	
	19	-	-	-99.3	-96.3	-94.5	-	
CA_1A-5A-7A	1	-	-	-99.3	-96.3	-94.5	-93.3	FDD
	5	-	-	-97.3	-94.3	-	-	
	7	-	-	-97.3	-94.3	-92.5	-91.3	
CA_1A-18A-28A	1	-	-	-99.3	-96.3	-94.5	-93.3	FDD
	18	-	-	-99.3	-96.3	-94.5	-	
	28	-	-	-93.3	-91.8	-	-	
CA_1A-19A-21A	1	-	-	-99.3	-96.3	-94.5	-93.3	FDD
	19	-	-	-99.3	-96.3	-94.5	-	
	21	-	-	-99.3	-96.3	-94.5	-	
CA_2A-4A-12A	2	-	-	-97	-94	-92.2	-91	FDD
	4	-	-	-89.3	-88.8	-88.3	-87.8	
	12	-	-	-95.8	-92.8	-	-	
CA_2A-4A-13A	2	-	-	-97	-94	-92.2	-91	FDD
	4	-	-	-99	-96	-94.2	-93	
	13	-	-	-	-93.3	-	-	
CA_2A-5A-13A	2	-	-	-97.3	-94.3	-92.5	-91.3	FDD
	5	-	-	-97.3	-94.3	-	-	
	13	-	-	-	-93.3	-	-	
CA_2A-12A-30A	2	-	-	-97.3	-94.3	-92.5	-91.3	FDD
	12	-	-	-96.3	-93.3	-	-	
	30	-	-	-98.3	-95.3	-	-	
CA_4A-5A-13A	4	-	-	-99.3	-96.3	-94.5	-93.3	FDD
	5	-	-	-97.3	-94.3	-	-	
	13	-	-	-	-93.3	-	-	

Note 1: The transmitter shall be set to maximum output power level (Table 7.3A.5.5-4)

Note 2: The reference measurement channel is specified in A.3.2 with one sided dynamic OCNG Pattern OP.1 FDD/TDD as described in Annex A.5.1.1/A.5.2.1

Note 3: The signal power is specified per port

Note 4: Reference sensitivity for the case that the uplink is active in Band 1 and the separation between the lower edge of the uplink channel in Band 1 and the upper edge of the downlink channel in Band 3 is < 60 MHz

For the UE which supports inter-band carrier aggregation configurations the  $\Delta R_{\text{IB,c}}$  in Tables 7.3.3-1A and 7.3.3-1B shall be applied for applicable bands.

Tolerances for a UE supporting multiple 3DL inter-band CA configurations are FFS.

The reference receive sensitivity (REFSENS) requirement for inter-band specified in Table 7.3A.5.5-3 shall be met for an uplink CA configurations than or equal to that specified in Table 7.3.5-2.

NOTE: Table 7.3A.5.5-4 does not necessarily reflect the operational conditions of the network, where the number of uplink and downlink allocated resource blocks will be practically constrained by other factors.

#### Table 7.3A.5.5-4: Void

For combinations of intra-band contiguous and inter-band carrier aggregation with three downlink carriers and one uplink carrier assigned to one E-UTRA band the throughput of each component carrier shall be  $\geq 95\%$  of the maximum throughput of the reference measurement channels as specified in Annexes A.2.2, A.2.3 and A.3.2 (with one sided dynamic OCNG Pattern OP.1 FDD/TDD for the DL-signal as described in Annex A.5.1.1/A.5.2.1) with parameters

specified in Table 7.3A.5.5-5. The reference sensitivity is defined to be met with all downlink component carriers active and one of the uplink carriers active.

**Table 7.3A.5.5-5: Reference sensitivity QPSK  $P_{\text{REFSENS}}$  for intra-band contiguous + inter-band**

CA Configuration	E-UTRA Band	Channel bandwidth						Duplex Mode
		1.4 MHz (dBm)	3 MHz (dBm)	5 MHz (dBm)	10 MHz (dBm)	15 MHz (dBm)	20 MHz (dBm)	
CA_1A-41C	1	-	-	-99.3	-96.3	-94.5	-93.3	FDD
	41	-	-	-97.3	-94.3	-92.5	-91.3	TDD
CA_1A-42C	1	-	-	-99.3	-96.3	-94.5	-93.3	FDD
	42	-	-	-98.0	-95.0	-93.2	-92.0	TDD
CA_3A-42C	3	-	-	-96.1	-93.1	-91.3	-90.1	FDD
	42 (Note 4)	-	-	-71.2	-71.2	-71.2	-71.2	TDD
	42 (Note 5)	-	-	-96.6	-94.2	-92.7	-92.0	TDD
CA_19A-42C	19	-	-	-99.3	-96.3	-94.5	-	FDD
	42	-	-	-98.0	-95.0	-93.2	-92.0	TDD
CA_26A-41C	26	-	-	-96.8 <sup>6</sup>	-93.8 <sup>6</sup>	-92 <sup>6</sup>	-	FDD
	41	-	-	-97.3	-94.3	-92.5	-91.3	TDD

Note 1: The transmitter shall be set to maximum output power level (Table 7.3A.5.5-4)

Note 2: The reference measurement channel is specified in A.3.2 with one sided dynamic OCNG Pattern OP.1 FDD/TDD as described in Annex A.5.1.1/A.5.2.1

Note 3: The signal power is specified per port

Note 4: Reference sensitivity for the high band for which the 3rd harmonic of the low band is within transmission bandwidth, as specified Note 10 in Table 7.3A.0-1.

Note 5: Reference sensitivity for the high band for which the 3rd harmonic of the low band is within transmission bandwidth, as specified Note 11 in Table 7.3A.0-1.

Note 6: <sup>6</sup>indicates that the requirement is modified by -0.5 dB when the carrier frequency of the assigned E-UTRA channel bandwidth is within 865-894 MHz.

For combinations of intra-band non-contiguous and inter-band carrier aggregation with three downlink carriers and one uplink carrier assigned to one E-UTRA band the throughput of each component carrier shall be  $\geq 95\%$  of the maximum throughput of the reference measurement channels as specified in Annexes A.2.2, A.2.3 and A.3.2 (with one sided dynamic OCNG Pattern OP.1 FDD/TDD for the DL-signal as described in Annex A.5.1.1/A.5.2.1) with parameters specified in Table 7.3A.5.5-6. The reference sensitivity is defined to be met with all downlink component carriers active and one of the uplink carriers active.

**Table 7.3A.5.5-6: Reference sensitivity QPSK  $P_{\text{REFSENS}}$  for intra-band non-contiguous + inter-band**

FFS

For combinations of intra-band non-contiguous and intra-band contiguous carrier aggregation with three downlink carriers and one uplink carrier assigned to one E-UTRA band the throughput of each component carrier shall be  $\geq 95\%$  of the maximum throughput of the reference measurement channels as specified in Annexes A.2.2, A.2.3 and A.3.2 (with one sided dynamic OCNG Pattern OP.1 FDD/TDD for the DL-signal as described in Annex A.5.1.1/A.5.2.1) with parameters specified in Table 7.3A.5.5-7. The reference sensitivity is defined to be met with all downlink component carriers active and one of the uplink carriers active.

**Table 7.3A.5.5-7: Reference sensitivity QPSK  $P_{\text{REFSENS}}$  for intra-band non-contiguous + intra-band contiguous**

FFS

## 7.3A.6 Reference sensitivity level for CA (inter-band DL CA and UL CA)

*Editor's note: This test case is incomplete. The following general aspects are either missing or not yet determined:*

- *Initial conditions*
- *Test requirement*

### 7.3A.6.1 Test purpose

Same as in clause 7.3A.1.1.

### 7.3A.6.2 Test applicability

This test case applies to all types of E-UTRA UE release 11 and forward that support inter-band DL CA and UL CA.

### 7.3A.6.3 Minimum conformance requirements

The minimum conformance requirements are defined in clause 7.3A.0.

### 7.3A.6.4 Test description

#### 7.3A.6.4.1 Initial conditions

Same as in clause 7.3A.1.4.1 with the following exceptions:

- Instead of Table 7.3A.1.4.1-1 → use Table 7.3A.6.4.1-1.
- Instead of clause 7.3A.1.4.3 use clause 7.3A.6.4.3.

**Table 7.3A.6.4.1-1: Test Configuration Table**

FFS

#### 7.3A.6.4.2 Test procedure

1. Configure SCC according to Annex C.0, C.1 and Annex C.3.1 for all downlink physical channels.
2. The SS shall configure SCC as per TS 36.508 [7] clause 5.2A.4. Message contents are defined in clause 7.3A.1.4.3
3. SS activates SCC by sending the activation MAC-CE (Refer TS 36.321 [13], clauses 5.13, 6.1.3.8). Wait for at least 2 seconds (Refer TS 36.133, clauses 8.3.3.2).
4. SS transmits PDSCH via PDCCH DCI format 1A for C\_RNTI to transmit the DL RMC according to Tables 7.3A.6.4.1-1 on both PCC and SCC. The SS sends downlink MAC padding bits on the DL RMC.
5. SS sends uplink scheduling information for each UL HARQ process via PDCCH DCI format 0 for C\_RNTI to schedule the UL RMC according to Table 7.3A.6.4.1-1 on both PCC and SCC. Since the UE has no payload and no loopback data to send the UE sends uplink MAC padding bits on the UL RMC.
6. Set the Downlink signal level for PCC and SCC to the appropriate REFSENS value defined in Table 7.3A.6.5-1. Send continuously uplink power control "up" commands in every uplink scheduling information to the UE to ensure the UE transmits  $P_{UMAX}$  level for at least the duration of the Throughput measurement.
7. Measure the average throughput for each component carrier for a duration sufficient to achieve statistical significance according to Annex G.2A.

#### 7.3A.6.4.3 Message contents

Message contents are according to TS 36.508 [7] subclause 4.6. In test procedure step 2, for SCC configuration there are no additional message contents.

### 7.3A.6.5 Test requirement

FFS

## 7.3B Reference sensitivity level for UL-MIMO

### 7.3B.1 Test purpose

To verify the ability of UE that support UL-MIMO to receive data with a given average throughput for a specified reference measurement channel, under conditions of low signal level, ideal propagation and no added noise.

A UE unable to meet the throughput requirement under these conditions will decrease the effective coverage area of an e-NodeB.

## 7.3B.2 Test applicability

This test applies to all types of E-UTRA UE release 10 and forward that support UL-MIMO.

## 7.3B.3 Minimum conformance requirements

For UE with two transmitter antenna connectors in closed-loop spatial multiplexing scheme, the minimum requirements in Clause 7.3.3 shall be met with the UL-MIMO configurations specified in Table 6.2.2B.3-2. For UL-MIMO, the parameter  $P_{UMAX}$  is the total transmitter power over the two transmit antenna connectors.

The normative reference for this requirement is TS 36.101 [2] clause 7.3.1B.

## 7.3B.4 Test description

### 7.3B.4.1 Initial conditions

Initial conditions are a set of test configurations the UE needs to be tested in and the steps for the SS to take with the UE to reach the correct measurement state.

The initial test configurations consist of environmental conditions, test frequencies, and channel bandwidths based on E-UTRA bands specified in table 5.4.2.1-1. All of these configurations shall be tested with applicable test parameters for each channel bandwidth, and are shown in table 7.3B.4.1-1. The details of the downlink and uplink reference measurement channels (RMCs) are specified in Annexes A.2 and A.3. The details of the OCNG patterns used are specified in Annex A.5. Configurations of PDSCH and PDCCH before measurement are specified in Annex C.2.

**Table 7.3B.4.1-1: Test Configuration Table**

Initial Conditions		
Test Environment as specified in TS 36.508[7] subclause 4.1	NC, TL/VL, TL/VH, TH/VL, TH/VH	
Test Frequencies as specified in TS36.508 [7] subclause 4.3.1	Low range, Mid range, High range	
Test Channel Bandwidths as specified in TS 36.508 [7] subclause 4.3.1	Lowest, 5MHz, Highest	
Test Parameters for Channel Bandwidths		
	Downlink Configuration	Uplink Configuration

Ch BW	Mod'n	RB allocation		Mod'n	RB allocation	
		FDD	TDD		FDD	TDD
1.4MHz	QPSK	6	6	QPSK	6	6
3MHz	QPSK	15	15	QPSK	15	15
5MHz	QPSK	25	25	QPSK	25	25
5MHz	QPSK	25	N/A	QPSK	20	N/A
5MHz	QPSK	25	N/A	QPSK	15	N/A
5MHz	QPSK	25	N/A	QPSK	5 <sup>4</sup>	N/A
10MHz	QPSK	50	50	QPSK	50	50
10MHz	QPSK	50	N/A	QPSK	25	N/A
10MHz	QPSK	50	N/A	QPSK	20	N/A
10MHz	QPSK	50	N/A	QPSK	15	N/A
15MHz	QPSK	75	75	QPSK	75	75
15MHz	QPSK	75	N/A	QPSK	50	N/A
15MHz	QPSK	75	N/A	QPSK	25	N/A
15MHz	QPSK	75	N/A	QPSK	20	N/A
20MHz	QPSK	100	100	QPSK	100	100
20MHz	QPSK	100	N/A	QPSK	75	N/A
20MHz	QPSK	100	N/A	QPSK	50	N/A
20MHz	QPSK	100	N/A	QPSK	25	N/A
20MHz	QPSK	100	N/A	QPSK	20	N/A

Note 1: Test Channel Bandwidths are checked separately for each E-UTRA band, which applicable channel bandwidths are specified in Table 5.4.2.1-1.

Note 2: Depending on E-UTRA band, only the appropriate Uplink RB allocation value according to table 7.3.3-2 is tested per Test Channel Bandwidth.

Note 3: For the DL signal one sided dynamic OCNG Pattern OP.1 FDD/TDD is used.

Note 4: Applicable only to E-UTRA FDD Band 31. The UL resource blocks shall be located at RBstart 10 (according to Table 7.3.3-2).

1. Connect the SS to the UE antenna connectors as shown in TS 36.508 [7] Annex A, Figure A.28.
2. The parameter settings for the cell are set up according to TS 36.508 [7] subclause 4.4.3.
3. Downlink signals are initially set up according to Annex C0, C.1 and C.3.1, and uplink signals according to Annex H.1 and H.3.1.
4. The UL and DL Reference Measurement channels are set according to Table 7.3B.4.1-1.
5. Propagation conditions are set according to Annex B.0.
6. Ensure the UE is in State 3A-RF according to TS 36.508 [7] clause 5.2A.2. Message contents are defined in clause 7.3B.4.3.

### 7.3B.4.2 Test procedure

1. SS transmits PDSCH via PDCCH DCI format 1A for C\_RNTI to transmit the DL RMC according to Table 7.3B.4.1-1. The SS sends downlink MAC padding bits on the DL RMC.
2. SS sends uplink scheduling information for each UL HARQ process via PDCCH DCI format 4 for C\_RNTI to schedule the UL RMC according to Table 7.3B.4.1-1. Since the UE has no payload data to send, the UE transmits uplink MAC padding bits on the UL RMC.
3. Set the Downlink signal level to the appropriate REFSSENS value defined in Table 7.3B.5-1. Send continuously uplink power control "up" commands in the uplink scheduling information to the UE to ensure the UE transmits  $P_{UMAX}$  level for at least the duration of the throughput measurement.
4. Measure the average throughput for a duration sufficient to achieve statistical significance according to Annex G.2.

### 7.3B.4.3 Message contents

Message contents are according to TS 36.508 [7] clause 4.6 with the following exceptions.



### 7.3B.4.3.1 Message contents exceptions (network signalled value "NS\_01")

Message contents according to TS 36.508 [7] clause 4.6 can be used without exceptions.

### 7.3B.4.3.2 Message contents exceptions (network signalled value "NS\_03")

1. Information element additionalSpectrumEmission is set to NS\_03. This can be set in the SystemInformationblockType2 as part of the cell broadcast message. This exception indicates that the UE shall meet the additional spurious emission requirement for a specific deployment scenario.

**Table 7.3B.4.3.2-1: SystemInformationBlockType2: Additional spurious emissions test requirement for "NS\_03"**

Derivation Path: TS 36.508 [7] clause 4.4.3.3, Table 4.4.3.3-1			
Information Element	Value/remark	Comment	Condition
additionalSpectrumEmission	3 (NS_03)		

### 7.3B.4.3.3 Message contents exceptions (network signalled value "NS\_06")

1. Information element additionalSpectrumEmission is set to NS\_06. This can be set in the SystemInformationblockType2 as part of the cell broadcast message. This exception indicates that the UE shall meet the additional spurious emission requirement for a specific deployment scenario.

**Table 7.3B.4.3.3-1: SystemInformationBlockType2: Additional spurious emissions test requirement for "NS\_06"**

Derivation Path: TS 36.508 [7] clause 4.4.3.3, Table 4.4.3.3-1			
Information Element	Value/remark	Comment	Condition
additionalSpectrumEmission	6 (NS_06)		

### 7.3B.4.3.4 Message contents exceptions (network signalled value "NS\_[09]")

1. Information element additionalSpectrumEmission is set to NS\_[09]. This can be set in the SystemInformationblockType2 as part of the cell broadcast message. This exception indicates that the UE shall meet the additional spurious emission requirement for a specific deployment scenario.

**Table 7.3B.4.3.4-1: SystemInformationBlockType2: Additional spurious emissions test requirement for "NS\_[09]"**

Derivation Path: TS 36.508 [7] clause 4.4.3.3, Table 4.4.3.3-1			
Information Element	Value/remark	Comment	Condition
additionalSpectrumEmission	TBD		

## 7.3B.5 Test requirement

The throughput shall be  $\geq 95\%$  of the maximum throughput of the reference measurement channels as specified in Annex A.3.2 with parameters specified in Tables 7.3B.5-1 and Table 7.3B.5-2.

Table 7.3B.5-1: Reference sensitivity QPSK  $P_{REFSENS}$

E-UTRA Band	Channel bandwidth						Duplex Mode
	1.4 MHz (dBm)	3 MHz (dBm)	5 MHz (dBm)	10 MHz (dBm)	15 MHz (dBm)	20 MHz (dBm)	
1	-	-	-99.3	-96.3	-94.5	-93.3	FDD
2	-102.0	-99.0	-97.3	-94.3	-92.5	-91.3	FDD
3	-101.0	-98.0	-96.3	-93.3	-91.5	-90.3	FDD
4	-104.0	-101.0	-99.3	-96.3	-94.5	-93.3	FDD
5	-102.5	-99.5	-97.3	-94.3			FDD
6	-	-	-99.3	-96.3			FDD
7	-	-	-97.3	-94.3	-92.5	-91.3	FDD
8	-101.5	-98.5	-96.3	-93.3			FDD
9	-	-	-98.3	-95.3	-93.5	-92.3	FDD
10	-	-	-99.3	-96.3	-94.5	-93.3	FDD
11	-	-	-99.3	-96.3			FDD
12	-101.0	-98.0	-96.3	-93.3			FDD
13			-96.3	-93.3			FDD
14		-	-96.3	-93.3			FDD
...							
17	-	-	-96.3	-93.3			FDD
18	-	-	-99.3	-96.3	-94.5	-	FDD
19	-	-	-99.3	-96.3	-94.5	-	FDD
20			-96.3	-93.3	-90.5	-89.3	FDD
21			-99.3	-96.3	-94.5		FDD
22			-96.0	-93.0	-91.2	-90.0	FDD
23	-104.0	-101.0	-99.3	-96.3	-94.5	-93.3	FDD
24			-99.3	-96.3			FDD
25	-100.5	-97.5	-95.8	-92.8	-91.0	-89.8	FDD
26	-102	-99	-96.8 <sup>6</sup>	-93.8 <sup>6</sup>	-92 <sup>6</sup>		FDD
27	-102.5	-99.5	-97.3	-94.3			FDD
28		-99.5	-97.8	-94.8	-93.0	-90.3	FDD
30	-	-	-98.3	-95.3	-	-	FDD
31	-98.3	-95.0	-92.8				FDD
...							
33	-	-	-99.3	-96.3	-94.5	-93.3	TDD
34	-	-	-99.3	-96.3	-94.5	-	TDD
35	-105.5	-101.5	-99.3	-96.3	-94.5	-93.3	TDD
36	-105.5	-101.5	-99.3	-96.3	-94.5	-93.3	TDD
37	-	-	-99.3	-96.3	-94.5	-93.3	TDD
38	-	-	-99.3	-96.3	-94.5	-93.3	TDD
39	-	-	-99.3	-96.3	-94.5	-93.3	TDD
40	-	-	-99.3	-96.3	-94.5	-93.3	TDD
41	-	-	-97.3	-94.3	-92.5	-91.3	TDD
42	-	-	-98.0	-95.0	-93.2	-92.0	TDD
43	-	-	-98.0	-95.0	-93.2	-92.0	TDD
Note 1:	The transmitter shall be set to $P_{UMAX}$ as defined in clause 6.2.5						
Note 2:	The reference measurement channel is specified in A.3.2 with one sided dynamic OCNG Pattern OP.1 FDD/TDD as described in Annex A.5.1.1/A.5.2.1						
Note 3:	The signal power is specified per port						
Note 4:	For the UE which supports both Band 3 and Band 9 the reference sensitivity level is FFS.						
Note 5:	For the UE which supports both Band 11 and Band 21 the reference sensitivity level is FFS.						
Note 6:	<sup>6</sup> indicates that the requirement is modified by -0.5 dB when the carrier frequency of the assigned E-UTRA channel bandwidth is within 865-894 MHz.						

For the UE which supports inter-band carrier aggregation configurations the  $\Delta R_{IB,c}$  in Table 7.3.3-1A shall be applied for applicable bands.

In case the UE supports more than one of the inter-band carrier aggregation configurations and a E-UTRA operating band belongs to more than one inter-band carrier aggregation configurations then:

- When the E-UTRA operating band frequency range is  $\leq 1$ GHz, the applicable additional tolerance shall be the average of the tolerances in Table 7.3.3-1A, truncated to one decimal place that would apply for that operating band among the supported CA configurations. In case there is a harmonic relation between low band UL and high band DL (i.e. bands listed in Table 7.3A.0-1), then the maximum tolerance among the different supported carrier aggregation configurations involving such band shall be applied
- When the E-UTRA operating band frequency range is  $>1$ GHz, the applicable additional tolerance shall be the maximum tolerance in Table 7.3.3-1A that would apply for that operating band among the supported CA configurations

NOTE 1: The relation to the received PSD is  $\langle \text{REF } \hat{I}_{or} \rangle = P_{REFSENS} (N_{sc}^{RB} N_{RB} \Delta f)^{-1}$  with  $N_{RB}$  is the transmission bandwidth configuration according to Table 5.4.2-1.

The reference receive sensitivity (REFSENS) requirement specified in Table 7.3B.5-1 shall be met for an uplink transmission bandwidth less than or equal to that specified in Table 7.3B.5-2.

NOTE 2: Table 7.3B.5-2 does not necessarily reflect the operational conditions of the network, where the number of uplink and downlink allocated resource blocks will be practically constrained by other factors.

Table 7.3B.5-2: Uplink configuration for reference sensitivity

E-UTRA Band	E-UTRA Band / Channel bandwidth / $N_{RB}$ / Duplex mode						Duplex Mode
	1.4 MHz	3 MHz	5 MHz	10 MHz	15 MHz	20 MHz	
1	-	-	25	50	75	100	FDD
2	6	15	25	50	50 <sup>1</sup>	50 <sup>1</sup>	FDD
3	6	15	25	50	50 <sup>1</sup>	50 <sup>1</sup>	FDD
4	6	15	25	50	75	100	FDD
5	6	15	25	25 <sup>1</sup>	-	-	FDD
6	-	-	25	25 <sup>1</sup>	-	-	FDD
7	-	-	25	50	75 <sup>1</sup>	75 <sup>1</sup>	FDD
8	6	15	25	25 <sup>1</sup>	-	-	FDD
9	-	-	25	50	50 <sup>1</sup>	50 <sup>1</sup>	FDD
10	-	-	25	50	75	100	FDD
11	-	-	25	25 <sup>1</sup>			FDD
12	6	15	20 <sup>1</sup>	20 <sup>1</sup>			FDD
13			20 <sup>1</sup>	20 <sup>1</sup>			FDD
14		-	15 <sup>1</sup>	15 <sup>1</sup>			FDD
...							
17	-	-	20 <sup>1</sup>	20 <sup>1</sup>			FDD
18	-	-	25	25 <sup>1</sup>	25 <sup>1</sup>	-	FDD
19	-	-	25	25 <sup>1</sup>	25 <sup>1</sup>	-	FDD
20			25	20 <sup>1</sup>	20 <sup>3</sup>	20 <sup>3</sup>	FDD
21			25	25 <sup>1</sup>	25 <sup>1</sup>		FDD
22			25	50	50 <sup>1</sup>	50 <sup>1</sup>	FDD
23	6	15	25	50	75 <sup>1</sup>	100 <sup>1</sup>	FDD
24			25	50			FDD
25	6	15	25	50	50 <sup>1</sup>	50 <sup>1</sup>	FDD
26	6	15	25	25 <sup>1</sup>	25 <sup>1</sup>		FDD
27	6	15	25	25 <sup>1</sup>	-	-	FDD
28		15	25	25 <sup>1</sup>	25 <sup>1</sup>	25 <sup>1</sup>	FDD
30	-	-	25	25 <sup>1</sup>	-	-	FDD
31	6	5 <sup>4</sup>	5 <sup>4</sup>				FDD
...							
33	-	-	25	50	75	100	TDD
34	-	-	25	50	75	-	TDD
35	6	15	25	50	75	100	TDD
36	6	15	25	50	75	100	TDD
37	-	-	25	50	75	100	TDD
38	-	-	25	50	75	100	TDD
39			25	50	75	100	TDD
40			25	50	75	100	TDD
41			25	50	75	100	TDD
42			25	50	75	100	TDD
43			25	50	75	100	TDD
Note 1:	The UL resource blocks shall be located as close as possible to the downlink operating band but confined within the transmission bandwidth configuration for the channel bandwidth (Table 5.4.2-1).						
Note 2:	For the UE which supports both Band 11 and Band 21 the uplink configuration for reference sensitivity is FFS.						
Note 3:	For Band 20; in the case of 15MHz channel bandwidth, the UL resource blocks shall be located at $RB_{start}=11$ and in the case of 20MHz channel bandwidth, the UL resource blocks shall be located at $RB_{start}=16$ .						
Note 4:	<sup>4</sup> refers to Band 31; in the case of 3 MHz channel bandwidth, the UL resource blocks shall be located at $RB_{start}$ 9 and in the case of 5 MHz						

channel bandwidth, the UL resource blocks shall be located at RB<sub>start</sub> 10.

## 7.3C

## 7.3D

## 7.3E Reference sensitivity level for UE category 0

Editor's note: Following aspects missing or not yet determined:

- RB allocation within brackets

### 7.3E.1 Test purpose

Same test purpose as in clause 7.3.1

### 7.3E.2 Test applicability

This test applies to all types of E-UTRA UE release 12 and forward of UE category 0.

### 7.3E.3 Minimum conformance requirements

The throughput shall be  $\geq 95\%$  of the maximum throughput of the reference measurement channels as specified in Annexes A.2.2, A.2.3 and A.3.2 (with one sided dynamic OCNG Pattern OP.1 FDD/TDD for the DL-signal as described in Annex A.5.1.1/A.5.2.1) with parameters specified in Table 7.3E.3-1/Table 7.3E.3-2 and Table 7.3E.3-3.

**Table 7.3E.3-1: Reference sensitivity for FDD and TDD UE category 0 QPSK  $P_{\text{REFSENS}}$**

E-UTRA Band	Channel bandwidth						Duplex Mode
	1.4 MHz (dBm)	3 MHz (dBm)	5 MHz (dBm)	10 MHz (dBm)	15 MHz (dBm)	20 MHz (dBm)	
2	-100.2	-97.2	-95.5	-92.5	-90.7	-89.5	FDD
3	-99.2	-96.2	-94.5	-91.5	-89.7	-88.5	FDD
4	-102.2	-99.2	-97.5	-94.5	-92.7	-91.5	FDD
5	-100.7	-97.7	-95.5	-92.5			FDD
8	-99.7	-96.7	-94.5	-91.5			FDD
13			-94	-91			FDD
20			-94.5	-91.5	-88.2	-87	FDD
39			-97.5	-94.5	-92.7	-91.5	TDD
41			-95.5	-92.5	-90.7	-89.5	TDD

NOTE 1: The transmitter shall be set to  $P_{\text{UMAX}}$  as defined in subclause 6.2.5  
 NOTE 2: Reference measurement channel is A.3.2 with one sided dynamic OCNG Pattern OP.1 FDD/TDD as described in Annex A.5.1.1/A.5.2.1

**Table 7.3E.3-2: Reference sensitivity for HD-FDD UE category 0 QPSK  $P_{\text{REFSENS}}$**

E-UTRA Band	Channel bandwidth						Duplex Mode
	1.4 MHz (dBm)	3 MHz (dBm)	5 MHz (dBm)	10 MHz (dBm)	15 MHz (dBm)	20 MHz (dBm)	
2	-101	-98	-96.3	-93.3	-91.5	-90.3	HD-FDD
3	-100	-97	-95.3	-92.3	-90.5	-89.3	HD-FDD
4	-103	-100	-98.3	-95.3	-93.5	-92.3	HD-FDD
5	-101.5	-98.5	-96.3	-93.3			HD-FDD
8	-100.5	-97.5	-95.3	-92.3			HD-FDD
13			-95.3	-92.3			HD-FDD
20			-95.3	-92.3	-89.5	-88.3	HD-FDD

NOTE 1: The transmitter shall be set to  $P_{\text{UMAX}}$  as defined in subclause 6.2.5  
 NOTE 2: Reference measurement channel is A.3.2 with one sided dynamic OCNG Pattern OP.1 FDD/TDD as described in Annex A.5.1.1/A.5.2.1

The reference receive sensitivity (REFSENS) requirement specified in Table 7.3E.3-1/Table 7.3E.3-2 shall be met for an uplink transmission bandwidth less than or equal to that specified in Table 7.3E.3-3.

NOTE: Table 7.3E.3-3 is intended for conformance tests and does not necessarily reflect the operational conditions of the network, where the number of uplink and downlink allocated resource blocks will be practically constrained by other factors.

**Table 7.3E.3-3: FDD and TDD UE category 0 Uplink configuration for reference sensitivity**

E-UTRA Band / Channel bandwidth / $N_{RB}$ / Duplex mode							
E-UTRA Band	1.4 MHz	3 MHz	5 MHz	10 MHz	15 MHz	20 MHz	Duplex Mode
2	6	15	25	[36 <sup>1</sup> ]	[36 <sup>1</sup> ]	[36 <sup>1</sup> ]	FDD and HD-FDD
3	6	15	25	[36 <sup>1</sup> ]	[36 <sup>1</sup> ]	[36 <sup>1</sup> ]	FDD and HD-FDD
4	6	15	25	[36 <sup>1</sup> ]	[36 <sup>1</sup> ]	[36 <sup>1</sup> ]	FDD and HD-FDD
5	6	15	25	[25 <sup>1</sup> ]			FDD and HD-FDD
8	6	15	25	25 <sup>1</sup>			FDD and HD-FDD
13			20 <sup>1</sup>	[20 <sup>1</sup> ]			FDD and HD-FDD
20			25	20 <sup>1</sup>	20 <sup>2</sup>	20 <sup>2</sup>	FDD and HD-FDD
39			25	[36 <sup>1</sup> ]	[36 <sup>1</sup> ]	[36 <sup>1</sup> ]	TDD
41			25	[36 <sup>1</sup> ]	[36 <sup>1</sup> ]	[36 <sup>1</sup> ]	TDD
NOTE 1: <sup>1</sup> refers to the UL resource blocks shall be located as close as possible to the downlink operating band but confined within the transmission bandwidth configuration for the channel bandwidth (Table 5.6-1).							
NOTE 2: <sup>2</sup> refers to Band 20; in the case of 15MHz channel bandwidth, the UL resource blocks shall be located at $RB_{start}$ 11 and in the case of 20MHz channel bandwidth, the UL resource blocks shall be located at $RB_{start}$ 16.							

The normative reference for this requirement is TS 36.101 [2] clause 7.3.1E.

## 7.3E.4 Test description

### 7.3E.4.1 Initial conditions

Same initial conditions as in clause 7.3.4.1 with the following exceptions:

- Instead of Table 7.3.4.1-1 → use Table 7.3E.4.1-1.
- Connect the SS to the UE antenna connectors as shown in TS 36.508[7] Annex A Figure A.3 using only main UE Tx/Rx antenna.

Table 7.3E.4.1-1: Test Configuration Table

Initial Conditions						
Test Environment as specified in TS 36.508[7] subclause 4.1		NC, TL/VL, TL/VH, TH/VL, TH/VH				
Test Frequencies as specified in TS36.508 [7] subclause 4.3.1		Low range, Mid range, High range				
Test Channel Bandwidths as specified in TS 36.508 [7] subclause 4.3.1		Lowest, 5MHz, Highest				
Test Parameters for Channel Bandwidths						
Ch BW	Downlink Configuration			Uplink Configuration		
	Mod'n	RB allocation		Mod'n	RB allocation	
		FDD	TDD		FDD and HD-FDD	TDD
1.4MHz	QPSK	6	6	QPSK	6	6
3MHz	QPSK	14	14	QPSK	15	15
5MHz	QPSK	14	14	QPSK	25	25
5MHz	QPSK	14	N/A	QPSK	20	N/A
10MHz	QPSK	14	14	QPSK	[36]	[36]
10MHz	QPSK	14	N/A	QPSK	25	N/A
10MHz	QPSK	14	N/A	QPSK	20	N/A
15MHz	QPSK	14	14	QPSK	[36]	[36]
15MHz	QPSK	14	N/A	QPSK	20	N/A
20MHz	QPSK	14	14	QPSK	[36]	[36]
20MHz	QPSK	14	N/A	QPSK	20	N/A
Note 1: Test Channel Bandwidths are checked separately for each E-UTRA band, which applicable channel bandwidths are specified in Table 5.4.2.1-1.						
Note 2: Depending on E-UTRA band, only the appropriate Uplink RB allocation value according to table 7.3E.3-3 is tested per Test Channel Bandwidth. The allocation shall be located as close as possible to the downlink operating band but confined within the transmission bandwidth configuration for the channel bandwidth (Table 5.4.2-1).						
Note 3: For the DL signal one sided dynamic OCNG Pattern OP.1 FDD/TDD is used.						
Note 4: Downlink RB position shall be $RB_{start} = 0$						

### 7.3E.4.2 Test procedure

Same test procedure as in clause 7.3.4.2.

### 7.3E.4.3 Message contents

Same message contents as in clause 7.3.4.3

### 7.3E.5 Test requirement

The throughput shall be  $\geq 95\%$  of the maximum throughput of the reference measurement channels as specified in Annexes A.2.2, A.2.3 and A.3.2 (with one sided dynamic OCNG Pattern OP.1 FDD/TDD for the DL-signal as described in Annex A.5.1.1/A.5.2.1) with parameters specified in Table 7.3E.5-1 and Table 7.3E.5-2.

**Table 7.3E.5-1: Reference sensitivity for FDD and TDD UE category 0 QPSK  $P_{\text{REFSENS}}$** 

Channel bandwidth							
E-UTRA Band	1.4 MHz (dBm)	3 MHz (dBm)	5 MHz (dBm)	10 MHz (dBm)	15 MHz (dBm)	20 MHz (dBm)	Duplex Mode
2	-99.5	-96.5	-94.8	-91.8	-90	-88.8	FDD
3	-98.5	-95.5	-93.8	-90.8	-89	-87.8	FDD
4	-101.5	-98.5	-96.8	-93.8	-92	-90.8	FDD
5	-100	-97	-94.8	-91.8			FDD
8	-99	-96	-93.8	-90.8			FDD
13			-93.3	-90.3			FDD
20			-93.8	-90.8	-87.5	-86.3	FDD
39			-96.8	-93.8	-92	-90.8	TDD
41			-94.8	-91.8	-90	-88.8	TDD

NOTE 1: The transmitter shall be set to  $P_{\text{UMAX}}$  as defined in subclause 6.2.5  
NOTE 2: Reference measurement channel is A.3.2 with one sided dynamic OCNG Pattern OP.1 FDD/TDD as described in Annex A.5.1.1/A.5.2.1

**Table 7.3E.5-2: Reference sensitivity for HD-FDD UE category 0 QPSK  $P_{\text{REFSENS}}$** 

Channel bandwidth							
E-UTRA Band	1.4 MHz (dBm)	3 MHz (dBm)	5 MHz (dBm)	10 MHz (dBm)	15 MHz (dBm)	20 MHz (dBm)	Duplex Mode
2	-100.3	-97.3	-95.6	-92.6	-90.8	-89.6	HD-FDD
3	-99.3	-96.3	-94.6	-91.6	-89.8	-88.6	HD-FDD
4	-102.3	-99.3	-97.6	-94.6	-92.8	-91.6	HD-FDD
5	-100.8	-97.8	-95.6	-92.6			HD-FDD
8	-99.8	-96.8	-94.6	-91.6			HD-FDD
13			-94.6	-91.6			HD-FDD
20			-94.6	-91.6	-88.8	-87.6	HD-FDD

NOTE 1: The transmitter shall be set to  $P_{\text{UMAX}}$  as defined in subclause 6.2.5  
NOTE 2: Reference measurement channel is A.3.2 with one sided dynamic OCNG Pattern OP.1 FDD/TDD as described in Annex A.5.1.1/A.5.2.1

## 7.4 Maximum input level

### 7.4.1 Test purpose

Maximum input level tests the UE's ability to receive data with a given average throughput for a specified reference measurement channel, under conditions of high signal level, ideal propagation and no added noise.

A UE unable to meet the throughput requirement under these conditions will decrease the coverage area near to an e-NodeB.

### 7.4.2 Test applicability

This test applies to all types of E-UTRA UE release 8 and forward.

### 7.4.3 Minimum conformance requirements

Maximum input level is defined as the maximum mean power received at the UE antenna port, at which the specified relative throughput shall meet or exceed the minimum requirements for the specified reference measurement channel.

The throughput shall be  $\geq 95\%$  of the maximum throughput of the reference measurement channels as specified in Annexes A.2.2, A.2.3 and A.3.2 (with one sided dynamic OCNG Pattern OP.1 FDD/TDD as described in Annex A.5.1.1/A.5.2.1) with parameters specified in Table 7.4.3-1.

**Table 7.4.3-1: Maximum input level**

Rx Parameter	Units	Channel bandwidth					
		1.4 MHz	3 MHz	5 MHz	10 MHz	15 MHz	20 MHz



Power in Transmission Bandwidth Configuration	dBm	-25
Note 1:	The transmitter shall be set to 4dB below $P_{\text{CMAX}_L}$ at the minimum uplink configuration specified in Table 7.3.3-2 with $P_{\text{CMAX}_L}$ as defined in clause 6.2.5.	
Note 2:	Reference measurement channel is Annex A.3.2 64QAM R=3/4 variant with one sided dynamic OCNG Pattern OP.1 FDD/TDD as described in Annex A.5.1.1/A.5.2.1.	

The normative reference for this requirement is TS 36.101 [2] clause 7.4.1.

## 7.4.4 Test description

### 7.4.4.1 Initial conditions

Initial conditions are a set of test configurations the UE needs to be tested in and the steps for the SS to take with the UE to reach the correct measurement state.

The initial test configurations consist of environmental conditions, test frequencies, and channel bandwidths based on E-UTRA bands specified in table 5.4.2.1-1. All of these configurations shall be tested with applicable test parameters for each channel bandwidth, and are shown in table 7.4.4.1-1. The details of the uplink and downlink reference measurement channels (RMCs) are specified in Annexes A.2 and A.3 respectively. The details of the OCNG patterns used are specified in Annex A.5. Configurations of PDSCH and PDCCH before measurement are specified in Annex C.2.

**Table 7.4.4.1-1: Test Configuration Table**

Initial Conditions							
Test Environment as specified in TS 36.508[7] clause 4.1				NC			
Test Frequencies as specified in TS36.508 [7] clause 4.3.1				Mid range			
Test Channel Bandwidths as specified in TS 36.508 [7] clause 4.3.1				Lowest, 5MHz, Highest			
Test Parameters for Channel Bandwidths							
Ch BW	Downlink Configuration			Uplink Configuration			UE Category
	Mod'n	RB allocation		Mod'n	RB allocation		
		FDD	TDD		FDD	TDD	
1.4MHz	64-QAM	6	6	QPSK	6	6	1-5
3MHz	64-QAM	15	15	QPSK	15	15	1-5
5MHz	64-QAM	25	25	QPSK	25	25	2-5
5MHz	64-QAM	25	N/A	QPSK	20	N/A	2-5
5MHz	64-QAM	25	N/A	QPSK	15	N/A	2-5
5MHz	64-QAM	25	N/A	QPSK	5 <sup>4</sup>	N/A	2-5
5MHz	64-QAM	18	18	QPSK	25	25	1
5MHz	64-QAM	18	18	QPSK	20	20	1
5MHz	64-QAM	18	18	QPSK	15	15	1
5MHz	64-QAM	18	N/A	QPSK	5 <sup>4</sup>	N/A	1
10MHz	64-QAM	50	50	QPSK	50	50	2-5
10MHz	64-QAM	50	N/A	QPSK	25	N/A	2-5
10MHz	64-QAM	50	N/A	QPSK	20	N/A	2-5
10MHz	64-QAM	50	N/A	QPSK	15	N/A	2-5
10MHz	64-QAM	17	17	QPSK	50	50	1
10MHz	64-QAM	17	N/A	QPSK	25	N/A	1
10MHz	64-QAM	17	N/A	QPSK	20	N/A	1
10MHz	64-QAM	17	N/A	QPSK	15	N/A	1
15MHz	64-QAM	75	75	QPSK	75	75	2-5
15MHz	64-QAM	75	N/A	QPSK	50	N/A	2-5
15MHz	64-QAM	75	N/A	QPSK	25	N/A	2-5
15MHz	64-QAM	75	N/A	QPSK	20	N/A	2-5
15MHz	64-QAM	17	17	QPSK	75	75	1
15MHz	64-QAM	17	N/A	QPSK	50	N/A	1
15MHz	64-QAM	17	N/A	QPSK	25	N/A	1
15MHz	64-QAM	17	N/A	QPSK	20	N/A	1
20MHz	64-QAM	100	100	QPSK	100	100	3-5
20MHz	64-QAM	100	N/A	QPSK	75	N/A	3-5
20MHz	64-QAM	100	N/A	QPSK	50	N/A	3-5
20MHz	64-QAM	100	N/A	QPSK	25	N/A	3-5
20MHz	64-QAM	100	N/A	QPSK	20	N/A	3-5
20MHz	64-QAM	83	83	QPSK	100	100	2
20MHz	64-QAM	83	N/A	QPSK	75	N/A	2
20MHz	64-QAM	83	N/A	QPSK	50	N/A	2
20MHz	64-QAM	83	N/A	QPSK	25	N/A	2
20MHz	64-QAM	83	N/A	QPSK	20	N/A	2
20MHz	64-QAM	17	17	QPSK	100	100	1
20MHz	64-QAM	17	N/A	QPSK	75	N/A	1
20MHz	64-QAM	17	N/A	QPSK	50	N/A	1
20MHz	64-QAM	17	N/A	QPSK	25	N/A	1
20MHz	64-QAM	17	N/A	QPSK	20	N/A	1

Note 1: Test Channel Bandwidths are checked separately for each E-UTRA band. The applicable channel bandwidths are specified in Table 5.4.2.1-1.

Note 2: Depending on E-UTRA band, only the appropriate Uplink RB allocation value according to table 7.3.3-2 is tested per Test Channel Bandwidth. The allocation shall be located as close as possible to the downlink operating band but confined within the transmission bandwidth configuration for the channel bandwidth (Table 5.4.2-1).

Note 3: For the DL signal one sided dynamic OCNG Pattern OP.1 FDD/TDD is used.

Note 4: Applicable only to E-UTRA FDD Band 31. The UL resource blocks shall be located at RBstart 10 (according to Table 7.3.3-2).

1. Connect the SS to the UE antenna connectors as shown in TS 36.508 [7] Figure A.3.

2. The parameter settings for the cell are set up according to TS 36.508 [7] subclause 4.4.3.
3. Downlink signals are initially set up according to Annex C0, C.1 and C.3.1, and uplink signals according to Annex H.1 and H.3.1.
4. The UL and DL Reference Measurement channels are set according to Table 7.4.4.1-1.
5. Propagation conditions are set according to Annex B.0.
6. Ensure the UE is in State 3A-RF according to TS 36.508 [7] clause 5.2A.2. Message contents are defined in clause 7.4.4.3.

#### 7.4.4.2 Test procedure

SS transmits PDSCH via PDCCH DCI format 1A for C\_RNTI to transmit the DL RMC according to Table 7.4.4.1-1. The SS sends downlink MAC padding bits on the DL RMC.

SS sends uplink scheduling information for each UL HARQ process via PDCCH DCI format 0 for C\_RNTI to schedule the UL RMC according to Table 7.4.4.1-1. Since the UE has no payload data to send, the UE transmits uplink MAC padding bits on the UL RMC.

Set the Downlink signal level to the value defined in Table 7.4.5-1. Send Uplink power control commands to the UE (less or equal to 1dB step size should be used), to ensure that the UE output power is within +0, - 3.4 dB of the target level in Table 7.4.5-1 for carrier frequency  $f \leq 3.0\text{GHz}$  or within +0, -4.0 dB of the target level for carrier frequency  $3.0\text{GHz} < f \leq 4.2\text{GHz}$ , for at least the duration of the Throughput measurement.

Measure the average throughput for a duration sufficient to achieve statistical significance according to Annex G.2.

#### 7.4.4.3 Message contents

Message contents are according to TS 36.508 [7] subclause 4.6 with the following exception.

**Table 7.4.4.3-1: UplinkPowerControlDedicated**

Derivation Path: 36.331 clause 6.3.2			
Information Element	Value/remark	Comment	Condition
UplinkPowerControlDedicated-DEFAULT ::= SEQUENCE {			
p0-UePUSCH	0		
deltaMCS-Enabled	en0		
accumulationEnabled	TRUE		
p0-uePUCCH	0		
pSRS-Offset	3 (-6 dB)		
filterCoefficient	fc8	larger filter length is used to reduce the RSRP measurement variation	
}			

#### 7.4.5 Test requirement

The throughput shall be  $\geq 95\%$  of the maximum throughput of the reference measurement channels as specified in Annex A.3.2 with parameters specified in Table 7.4.5-1.

**Table 7.4.5-1: Maximum input level**

Rx Parameter	Units	Channel bandwidth					
		1.4 MHz	3 MHz	5 MHz	10 MHz	15 MHz	20 MHz

Power in Transmission Bandwidth Configuration	dBm	For carrier frequency $f \leq 3.0\text{GHz}$ : -25.7 For carrier frequency $3.0\text{GHz} < f \leq 4.2\text{GHz}$ : -26.0
Note 1:	The transmitter shall be set to 4dB below $P_{\text{CMAX\_L}}$ with $P_{\text{CMAX\_L}}$ as defined in clause 6.2.5.	
Note 2:	Reference measurement channel is Annex A.3.2 64QAM R=3/4 variant with one sided dynamic OCNG Pattern OP.1 FDD/TDD as described in Annex A.5.1.1/A.5.2.1.	

## 7.4A Maximum input level for CA

### 7.4A.0 Minimum conformance requirements

For inter-band carrier aggregation with one component carrier per operating band and the uplink assigned to one E-UTRA band the maximum input level is defined with the uplink active on the band(s) other than the band whose downlink is being tested. For E-UTRA CA configurations including an operating band without uplink band, the requirements for all downlinks shall be met with the single uplink carrier active in each band capable of UL operation. The UE shall meet the requirements specified in subclause 7.4.3 for each component carrier while all downlink carriers are active.

For intra-band contiguous carrier aggregation UE maximum input level is defined as the powers received at the UE antenna port over the Transmission bandwidth configuration of each CC, at which the specified relative throughput shall meet or exceed the minimum requirements for the specified reference measurement channel over each component carrier.

The downlink SCC shall be configured at nominal channel spacing to the PCC. For FDD the PCC shall be configured closest to the uplink band. All downlink carriers shall be active throughout the test. The uplink output power shall be set as specified in Table 7.4A.0-1 with the uplink configuration set according to Table 7.3A.0-2 for the applicable carrier aggregation configuration. For UE(s) supporting one uplink carrier, the uplink configuration of the PCC shall be in accordance with Table 7.3A.0-3.

The throughput shall be  $\geq 95\%$  of the maximum throughput of the reference measurement channels over each component carrier as specified in Annexes A.2.2, A.2.3 and A.3.2 (with one sided dynamic OCNG Pattern OP.1 FDD/TDD as described in Annex A.5.1.1/A.5.2.1) with parameters specified in Table 7.4A.0-1.

For intra-band non-contiguous carrier aggregation any single non-contiguous downlink carrier shall meet the requirements specified in Table 7.4.3-1 while all downlink carriers are active, any contiguous downlink carriers belonging to non-contiguous carrier aggregation configuration shall meet the requirements specified in Table 7.4A.0-1 while all downlink carriers are active.

The throughput shall be  $\geq 95\%$  of the maximum throughput of the specified reference measurement channel as specified in Annexes A.2.2, A.2.3 and A.3.2 (with one sided dynamic OCNG Pattern OP.1 FDD/TDD as described in Annex A.5.1.1/A.5.2.1) over each carrier. For UE(s) supporting one uplink carrier, the uplink configuration of the PCC shall be in accordance with Table 7.3A.0-3.

**Table 7.4A.0-1: Maximum input level for intra-band contiguous CA**

Rx Parameter	Units	CA Bandwidth Class					
		A	B	C	D	E	F
Power in largest Transmission Bandwidth Configuration CC	dBm		-28	-25	-25		
Power in each other CC	dBm		$-28 + 10\log(N_{\text{RB,c}} / N_{\text{RB,largest BW}})$	$-25 + 10\log(N_{\text{RB,c}} / N_{\text{RB,largest BW}})$	$-25 + 10\log(N_{\text{RB,c}} / N_{\text{RB,largest BW}})$		
Note 1:	The transmitter shall be set to 4dB below $P_{\text{CMAX\_L}}$ or $P_{\text{CMAX\_L\_CA}}$ as defined in clause 6.2.5A.						
Note 2:	Reference measurement channel is Annex A.3.2: 64QAM, R=3/4 variant with one sided dynamic OCNG Pattern OP.1 FDD/TDD as described in Annex A.5.1.1/A.5.2.1.						

For combinations of intra-band contiguous and inter-band carrier aggregation with three downlink carriers and one uplink assigned to one E-UTRA band, the requirement is defined with the uplink active in the band other than that supporting the downlink(s) under test and a configuration in accordance with Table 7.3.3-2. The downlink PCC carrier centre frequency shall be configured closer to the uplink operating band than the downlink SCC centre frequency when the uplink is active in the band supporting two component carriers. For E-UTRA CA configurations including an operating band without uplink band, the requirements for all downlinks shall be met with the single uplink carrier active in each band capable of UL operation. For these uplink configurations, the UE shall meet the maximum input-level requirements for intra-band contiguous carrier aggregation of two downlink carriers and for the remaining component carrier the requirements specified in subclause 7.4.3. The three downlink carriers shall be active throughout the tests.

For combinations of intra-band non-contiguous and inter-band carrier aggregation with three downlink carriers and one uplink assigned to one E-UTRA band, the requirement is defined with the uplink active in the band other than that supporting the downlink(s) under test. The uplink configuration shall be in accordance with Table 7.3A.0-3 when the uplink is active in the band supporting two component carriers and in accordance with Table 7.3.3-2 when the uplink is active in the other band. For E-UTRA CA configurations including an operating band without uplink band, the requirements for all downlinks shall be met with the single uplink carrier active in each band capable of UL operation. For these uplink configurations, the UE shall meet the maximum input-level requirements for intra-band non-contiguous carrier aggregation of two downlink carriers and for the remaining component carrier the requirements specified in subclause 7.4.3. The three downlink carriers shall be active throughout the tests.

The normative references for this requirement are TS 36.101 [2] clauses 7.4.1A and 7.4.1.

## 7.4A.1 Maximum input level for CA (intra-band contiguous DL CA and UL CA)

- Editor's note:

- Any restriction of the applicability of test points due to the supported UE category is under investigation

### 7.4A.1.1 Test purpose

Maximum input level for CA test verifies the UE's ability to receive data with a given average throughput for a specified reference measurement channel, under conditions of high signal level, ideal propagation and no added noise.

A UE unable to meet the throughput requirement under these conditions will decrease the coverage area near to an e-NodeB.

### 7.4A.1.2 Test applicability

This test applies to all types of E-UTRA UE release 10 and forward that support intra-band contiguous DL CA and UL CA.

### 7.4A.1.3 Minimum conformance requirements

The minimum conformance requirements are defined in clause 7.4A.0.

### 7.4A.1.4 Test description

#### 7.4A.1.4.1 Initial conditions

Initial conditions are a set of test configurations the UE needs to be tested in and the steps for the SS to take with the UE to reach the correct measurement state.

The initial test configurations consist of environmental conditions, test frequencies, and channel bandwidths based on E-UTRA CA configurations specified in table 5.4.2A.1-1. All of these configurations shall be tested with applicable test parameters for each CA Configuration, and are shown in table 7.4A.1.4.1-1. The details of the uplink and downlink reference measurement channels (RMCs) are specified in Annexes A.2 and A.3 respectively. The details of the OCNG patterns used are specified in Annex A.5. Configurations of PDSCH and PDCCH before measurement are specified in Annex C.2.

Table 7.4A.1.4.1-1: Test Configuration Table

Initial Conditions							
Test Environment as specified in TS 36.508[7] clause 4.1					NC		
Test Frequencies as specified in TS36.508 [7] clause 4.3.1 for different CA bandwidth classes, and PCC and SCCs are mapped onto physical frequencies according to Table 7.1-2					C: Mid range		
Test CC Combination setting ( $N_{RB\_agg}$ ) as specified in clause 5.4.2A.1 for the CA Configuration across bandwidth combination sets supported by the UE.					Lowest $N_{RB\_agg}$ Highest $N_{RB\_agg}$ (Note 3)		
Test Parameters for CA Configurations							
CA Configuration / $N_{RB\_agg}$		DL Allocation		UL Allocation			
PCC $N_{RB}$	SCC $N_{RB}$	CC MOD	PCC & SCC RB allocation	CC MOD	$N_{RB\_alloc}$	PCC & SCC RB allocations ( $L_{CRB}$ @ $RB_{start}$ )	
75	75	64-QAM	75+75	QPSK	75	P_75@0	S_0@0
75	75	64-QAM	75+75	QPSK	129	P_75@0	S_54@0
75	75	64-QAM	75+75	QPSK	150	P_75@0	S_75@0
100	25	64QAM	100+25	QPSK	50	P_50@0	S_0@0
100	25	64-QAM	100+25	QPSK	125	P_100@0	S_25@0
100	50	64-QAM	100+50	QPSK	50	P_50@50	S_0@0
100	50	64-QAM	100+50	QPSK	75	P_75@25	S_0@0
100	50	64-QAM	100+50	QPSK	150	P_100@0	S_50@0
100	75	64-QAM	100+75	QPSK	175	P_100@0	S_75@0
100	100	64-QAM	100+100	QPSK	50	P_50@50	S_0@0
100	100	64-QAM	100+100	QPSK	75	P_75@25	S_0@0
100	100	64-QAM	100+100	QPSK	130	P_100@0	S_30@0
100	100	64-QAM	100+100	QPSK	200	P_100@0	S_100@0
Note 1: CA Configuration Test CC Combination settings are checked separately for each CA Configuration, which applicable aggregated channel bandwidths are specified in Table 5.4.2A.1-1.							
Note 2: Depending on CA Configuration only the appropriate Uplink RB allocation value according to table 7.3A.0-2 is tested per CA Configuration Test CC combination.							
Note 3: If in the CA Configuration UE supports multiple CC Combinations with the same $N_{RB\_agg}$ , only the first of those is tested, according to the order on the Test Configuration Table list.							

- 1 Connect the SS to the UE antenna connectors as shown in TS 36.508 [7] Annex A, Figure group A.32 as appropriate
- 2 The parameter settings for the cell are set up according to TS 36.508 [7] clause 4.4.3.
- 3 Downlink signals for PCC are initially set up according to Annex C.0, C.1 and C.3.1, and uplink signals according to Annex H.1 and H.3.1
- 4 The UL and DL Reference Measurement channels are set according to Table 7.4A.1.4.1-1.
- 5 Propagation conditions are set according to Annex B.0.
- 6 Ensure the UE is in State 3A-RF according to TS 36.508 [7] clause 5.2A.2. Message contents are defined in clause 7.4A.1.4.3.

#### 7.4A.1.4.2 Test procedure

1. Configure SCC according to Annex C.0, C.1 and Annex C.3.1 for all downlink physical channels.
2. The SS shall configure SCC as per TS 36.508 [7] clause 5.2A.4. Message contents are defined in clause 7.4A.1.4.3
3. SS activates SCC by sending the activation MAC-CE (Refer TS 36.321 [13], clauses 5.13, 6.1.3.8). Wait for at least 2 seconds (Refer TS 36.133, clauses 8.3.3.2).
4. SS transmits PDSCH via PDCCH DCI format 1A for C\_RNTI to transmit the DL RMC according to Table 7.4A.1.4.1-1 on both PCC and SCC. The SS sends downlink MAC padding bits on the DL RMC.
5. SS sends uplink scheduling information for each UL HARQ process via PDCCH DCI format 0 for C\_RNTI to schedule the UL RMC according to Table 7.4A.1.4.1-1 on both PCC and SCC. Since the UE has no payload data to send, the UE sends uplink MAC padding bits on the UL RMC.
6. Set the Downlink signal level for PCC and SCC to the value defined in Table 7.4A.1.5-1. Send Uplink power control commands to the UE (less or equal to 1dB step size should be used), to ensure that for at least the duration of the Throughput measurement:  
The PCC output power is within (+0dB, -3.4 dB) of (target level in Table 7.4A.1.5-1 +  $10\log(P_{L_{CRB}}/N_{RB\_alloc})$ ), for carrier frequency  $f \leq 3.0\text{GHz}$ ,  
or within (+0dB, -4 dB) of (target level in Table 7.4A.1.5-1 +  $10\log(P_{L_{CRB}}/N_{RB\_alloc})$ ) for carrier frequency  $3.0\text{GHz} < f \leq 4.2\text{GHz}$ .  
The SCC output power is within (+0dB, -3.4 dB) of (target level in Table 7.4A.1.5-1 +  $10\log(S_{L_{CRB}}/N_{RB\_alloc})$ ), for carrier frequency  $f \leq 3.0\text{GHz}$ ,  
or within (+0dB, -4 dB) of (target level in Table 7.4A.1.5-1 +  $10\log(S_{L_{CRB}}/N_{RB\_alloc})$ ) for carrier frequency  $3.0\text{GHz} < f \leq 4.2\text{GHz}$ .
7. Measure the average throughput for each component carrier for duration sufficient to achieve statistical significance according to Annex G.2A.

#### 7.4A.1.4.3 Message contents

Message contents are according to TS 36.508 [7] subclause 4.6 with the following exception.

Table 7.4A.1.4.3-1: UplinkPowerControlDedicatedSCell-r10

Derivation Path: 36.508 clause 4.6.3			
Information Element	Value/remark	Comment	Condition
UplinkPowerControlDedicated-DEFAULT ::= SEQUENCE {			
p0-UE-PUSCH-r10	0		
deltaMCS-Enabled-r10	en0		
accumulationEnabled-r10	TRUE		
pSRS-Offset-r10	7 (0 dB)	The actual parameter value is $-10.5 + 1.5 \cdot \text{pSRS-Offset}$ value; 0 is the actual value in dB ( $-10.5 + 1.5 \cdot 7$ dB).	
pSRS-OffsetAp-r10	7 (0 dB)	The actual parameter value is $-10.5 + 1.5 \cdot \text{pSRS-Offset}$ value; 0 is the actual value in dB ( $-10.5 + 1.5 \cdot 7$ dB).	
filterCoefficient-r10	fc8	larger filter length is used to reduce the RSRP measurement variation	
pathlossReferenceLinking-r10	sCell		
}			

### 7.4A.1.5 Test requirement

The throughput measurement of each carrier derived in test procedure shall be  $\geq 95\%$  of the maximum throughput of the reference measurement channels as specified in Annex A.3.2 with parameters specified in Table 7.4A.1.5-1.

Table 7.4A.1.5-1: Maximum input level for intra-band contiguous CA

Rx Parameter	Units	CA Bandwidth Class					
		A	B	C	D	E	F
Power in largest Transmission Bandwidth Configuration CC	dBm			For carrier frequency $f \leq 3.0\text{GHz}$ : -25.7 For carrier frequency $3.0\text{GHz} < f \leq 4.2\text{GHz}$ : -26.0			
Power in each other CC	dBm			For carrier frequency $f \leq 3.0\text{GHz}$ : $-25.7 + 10\log(N_{\text{RB},c} / N_{\text{RB},\text{largest BW}})$ For carrier frequency $3.0\text{GHz} < f \leq 4.2\text{GHz}$ : $-26.0 + 10\log(N_{\text{RB},c} / N_{\text{RB},\text{largest BW}})$			
Note 1:	The transmitter shall be set to 4dB below $P_{\text{CMAX}_L}$ or $P_{\text{CMAX}_L, \text{CA}}$ as defined in subclause 6.2.5 for one uplink carrier and in subclause 6.2.5A for two uplink carriers.						
Note 2:	Reference measurement channel is Annex A.3.2: 64QAM, R=3/4 variant with one sided dynamic OCNG Pattern OP.1 FDD/TDD as described in Annex A.5.1.1/A.5.2.1.						

### 7.4A.2 Maximum input level for CA (intra-band contiguous DL CA without UL CA)

- Editor's note:
- Any restriction of the applicability of test points due to the supported UE category is under investigation



### 7.4A.2.1 Test purpose

Same test purpose as in clause 7.4A.1.1.

### 7.4A.2.2 Test applicability

This test applies to all types of E-UTRA UE release 10 and forward that support intra-band contiguous DL CA. This test case applies only for CA Configurations that do not support UL CA.

### 7.4A.2.3 Minimum conformance requirements

The minimum conformance requirements are defined in clause 7.4A.0.

### 7.4A.2.4 Test description

#### 7.4A.2.4.1 Initial conditions

Same initial conditions as in clause 7.4A.1.4.1 with the following exceptions:

- Instead of Table 7.4A.1.4.1-1 → use Table 7.4A.2.4.1-1.
- Instead of clause 7.4A.1.4.3 → use clause 7.4A.2.4.3.

Table 7.4A.2.4.1-1: Test Configuration Table

Initial Conditions							
Test Environment as specified in TS 36.508[7] clause 4.1					NC		
Test Frequencies as specified in TS36.508 [7] clause 4.3.1 for different CA bandwidth classes, and PCC and SCCs are mapped onto physical frequencies according to Table 7.1-2					B: Mid range C: Mid range		
Test CC Combination setting ( $N_{RB\_agg}$ ) as specified in clause 5.4.2A.1 for the CA Configuration across bandwidth combination sets supported by the UE.					Lowest $N_{RB\_agg}$ Highest $N_{RB\_agg}$ (Note 3)		
Test Parameters for CA Configurations							
CA Configuration / $N_{RB\_agg}$		DL Allocation			UL Allocation		
PCC $N_{RB}$	SCC $N_{RB}$	CC MOD	PCC & SCC RB allocation	CC MOD	$N_{RB\_alloc}$	PCC & SCC RB allocations ( $L_{CRB}$ @ $RB_{start}$ )	
6	25	64-QAM	6+25	QPSK	6	P_6@0	NA
15	50	64-QAM	15+50	QPSK	15	P_15@0	NA
25	25	64-QAM	25+25	QPSK	20	P_20@0	NA
25	50	64-QAM	25+50	QPSK	20	P_20@0	NA
50	50	64-QAM	50+50	QPSK	50	P_50@0	NA
75	75	64-QAM	75+75	QPSK	75	P_75@0	NA
100	25	64-QAM	100+25	QPSK	100	P_100@0	NA
100	25	64-QAM	100+25	QPSK	50	P_50@50	NA
100	50	64-QAM	100+50	QPSK	100	P_100@0	NA
100	50	64-QAM	100+50	QPSK	75	P_75@25	NA
100	50	64-QAM	100+50	QPSK	50	P_50@50	NA
100	75	64-QAM	100+75	QPSK	100	P_100@0	NA
100	100	64-QAM	100+100	QPSK	100	P_100@0	NA
100	100	64-QAM	100+100	QPSK	75	P_75@25	NA
100	100	64-QAM	100+100	QPSK	50	P_50@50	NA
Note 1: CA Configuration Test CC Combination settings are checked separately for each CA Configuration, which applicable aggregated channel bandwidths are specified in Table 5.4.2A.1-1.							
Note 2: Depending on CA Configuration only the appropriate Uplink RB allocation value according to table 7.3.3-2 is tested per CA Configuration Test CC combination.							
Note 3: If in the CA Configuration UE supports multiple CC Combinations with the same $N_{RB\_agg}$ , only the first of those is tested, according to the order on the Test Configuration Table list.							

#### 7.4A.2.4.2 Test procedure

1. Configure SCC according to Annex C.0, C.1 and Annex C.3.1 for all downlink physical channels.
2. The SS shall configure SCC as per TS 36.508 [7] clause 5.2A.4.
3. SS activates SCC by sending the activation MAC-CE (Refer TS 36.321 [13], clauses 5.13, 6.1.3.8). Wait for at least 2 seconds (Refer TS 36.133, clauses 8.3.3.2).

4. SS transmits PDSCH via PDCCH DCI format 1A for C\_RNTI to transmit the DL RMC according to Table 7.4A.2.4.1-1 on both PCC and SCC. The SS sends downlink MAC padding bits on the DL RMC.
5. SS sends uplink scheduling information for each UL HARQ process via PDCCH DCI format 0 for C\_RNTI to schedule the UL RMC according to Table 7.4A.2.4.1-1 on PCC. Since the UE has no payload data to send, the UE sends uplink MAC padding bits on the UL RMC.
6. Set the Downlink signal level for PCC and SCC to the value defined in Table 7.4A.1.5-1. Send Uplink power control commands to the UE (less or equal to 1dB step size should be used), to ensure that the UE output power is within +0, - 3.4 dB of the target level in Table 7.4A.1.5-1 for carrier frequency  $f \leq 3.0\text{GHz}$  or within +0, -4.0 dB of the target level for carrier frequency  $3.0\text{GHz} < f \leq 4.2\text{GHz}$ , for at least the duration of the Throughput measurement.
7. Measure the average throughput for each component carrier for duration sufficient to achieve statistical significance according to Annex G.2A.

#### 7.4A.2.4.3 Message contents

Same message contents as in clause 7.4.4.3.

#### 7.4A.2.5 Test requirement

Same test requirements as in clause 7.4A.1.5 with the following exceptions:

- Instead of Table 7.4A.1.5-1 → use Table 7.4A.2.5-1.

**Table 7.4A.2.5-1: Maximum input level for intra-band contiguous CA**

Rx Parameter	Units	CA Bandwidth Class					
		A	B	C	D	E	F
Power in largest Transmission Bandwidth Configuration CC	dBm		For carrier frequency $f \leq 3.0\text{GHz}$ : -28.7 For carrier frequency $3.0\text{GHz} < f \leq 4.2\text{GHz}$ : -29.0	For carrier frequency $f \leq 3.0\text{GHz}$ : -25.7 For carrier frequency $3.0\text{GHz} < f \leq 4.2\text{GHz}$ : -26.0			
Power in each other CC	dBm		For carrier frequency $f \leq 3.0\text{GHz}$ : $-28.7 + 10\log(N_{RB,c} / N_{RB,largest\ BW})$ For carrier frequency $3.0\text{GHz} < f \leq 4.2\text{GHz}$ : $-29.0 + 10\log(N_{RB,c} / N_{RB,largest\ BW})$	For carrier frequency $f \leq 3.0\text{GHz}$ : $-25.7 + 10\log(N_{RB,c} / N_{RB,largest\ BW})$ For carrier frequency $3.0\text{GHz} < f \leq 4.2\text{GHz}$ : $-26.0 + 10\log(N_{RB,c} / N_{RB,largest\ BW})$			
Note 1: The transmitter shall be set to 4dB below $PC_{MAX\_L}$ as defined in clause 6.2.5. Note 2: Reference measurement channel is Annex A.3.2: 64QAM, R=3/4 variant with one sided dynamic OCNG Pattern OP.1 FDD/TDD as described in Annex A.5.1.1/A.5.2.1.							

#### 7.4A.3 Maximum input level for CA (inter-band DL CA without UL CA)

- **Editor's note:**
- - Any restriction of the applicability of test points due to the supported UE category is under investigation

##### 7.4A.3.1 Test purpose

Same test purpose as in clause 7.4A.1.1

##### 7.4A.3.2 Test applicability

This test applies to all types of E-UTRA UE release 10 and forward that support inter-band DL CA but no UL CA.

### 7.4A.3.3 Minimum conformance requirements

The minimum conformance requirements are defined in clause 7.4A.0.

### 7.4A.3.4 Test description

#### 7.4A.3.4.1 Initial conditions

Same initial conditions as in clause 7.4A.1.4.1 with the following exceptions:

- Instead of Table 7.4A.1.4.1-1 → use Table 7.4A.3.4.1-1.
- Instead of clause 7.4A.1.4.3 → use clause 7.4A.3.4.3.

Table 7.4A.3.4.1-1: Test Configuration Table

Initial Conditions						
Test Environment as specified in TS 36.508[7] subclause 4.1			NC			
Test Frequencies as specified in TS36.508 [7] subclause 4.3.1 for different CA bandwidth classes, and PCC and SCCs are mapped onto physical frequencies according to Table 7.1-2			A: Mid range for PCC and SCC			
Test CC Combination setting ( $N_{RB\_agg}$ ) as specified in subclause 5.4.2A.1 for the CA Configuration across bandwidth combination sets supported by the UE			Highest $N_{RB\_agg}$ for PCC and SCC			
Test Parameters for CA Configurations						
CA Configuration / $N_{RB\_agg}$		DL Allocation			UL Allocation	
PCC $N_{RB}$	SCCs $N_{RB}$	CC MOD	PCC & SCC RB allocation		CC MOD	PCC $N_{RB\_alloc}$
50	50	64-QAM	50	50	QPSK	50
50	50	64-QAM	50	50	QPSK	25
50	50	64-QAM	50	50	QPSK	20
50	50	64-QAM	50	50	QPSK	16
50	75	64-QAM	50	75	QPSK	25
50	100	64-QAM	50	100	QPSK	50
50	100	64-QAM	50	100	QPSK	25
50	100	64-QAM	50	100	QPSK	20
75	50	64-QAM	75	50	QPSK	25
75	100	64-QAM	75	100	QPSK	25
100	50	64-QAM	100	50	QPSK	100
100	50	64-QAM	100	50	QPSK	75
100	50	64-QAM	100	50	QPSK	50
100	75	64-QAM	100	75	QPSK	100
100	100	64-QAM	100	100	QPSK	75
100	100	64-QAM	100	100	QPSK	50
<p>Note 1: CA Configuration Test CC Combination settings are checked separately for each CA Configuration, which applicable aggregated channel bandwidths are specified in Table 5.4.2A.1-2.</p> <p>Note 2: Depending on CA configurations, only the appropriate Uplink RB allocation value according to table 7.3A.3.5-2 for UE supporting one uplink carrier is tested per Test CA configuration.</p> <p>Note 3: The UL resource blocks shall be located as close as possible to the downlink PCC but confined within the transmission bandwidth configuration for the channel bandwidth (Table 5.4.2-1).</p> <p>Note 4: The frequencies of PCC and SCC shall be switched and tested in each configuration, according to the UE declared capability for UL support (within CA operation) in the individual bands.</p>						

#### 7.4A.3.4.2 Test procedure

1. Configure SCC according to Annex C.0, C.1 and Annex C.3.1 for all downlink physical channels.
2. The SS shall configure SCC as per TS 36.508 [7] clause 5.2A.4.
3. SS activates SCC by sending the activation MAC-CE (Refer TS 36.321 [13], clauses 5.13, 6.1.3.8). Wait for at least 2 seconds (Refer TS 36.133, clauses 8.3.3.2).
4. SS transmits PDSCH via PDCCH DCI format 1A for C\_RNTI to transmit the DL RMC according to Tables 7.4A.3.4.1-1 on both PCC and SCC. The SS sends downlink MAC padding bits on the DL RMC.

5. SS sends uplink scheduling information for each UL HARQ process via PDCCH DCI format 0 for C\_RNTI to schedule the UL RMC according to Table 7.4A.3.4.1-1 on PCC. Since the UE has no payload and no loopback data to send the UE sends uplink MAC padding bits on the UL RMC.
6. Set the Downlink signal level to the value as defined in Table 7.4A.3.5-1. Send Uplink power control commands to the UE (less or equal to 1dB step size should be used), to ensure that the UE output power is within +0, - 3.4 dB of the target level in Table 7.4A.3.5-1 for carrier frequency  $f \leq 3.0\text{GHz}$  or within +0, -4.0 dB of the target level for carrier frequency  $3.0\text{GHz} < f \leq 4.2\text{GHz}$ , for at least the duration of the Throughput measurement.
7. Measure the average throughput of SCC for a duration sufficient to achieve statistical significance according to Annex G.2.

#### 7.4A.3.4.3 Message contents

Same message contents as in clause 7.4.4.3.

#### 7.4A.3.5 Test requirement

For inter-band carrier aggregation with uplink assigned to one E-UTRA band the maximum input level is defined with the uplink active on the band other than the band whose downlink is being tested, i.e. the requirements are tested only for the SCell downlink. The UE shall meet the requirement for each component carrier, when operated as SCell, while both downlink carriers are active.

The throughput measured during the test procedure for each component carrier, when operated as SCell, shall be  $\geq 95\%$  of the maximum throughput of the reference measurement channels as specified in Annex A.3.2 with parameters specified in Table 7.4A.3.5-1 (originated from the single carrier Table 7.4.5-1).

**Table 7.4A.3.5-1: Maximum input level for inter-band DL CA without UL CA**

Rx Parameter	Units	Channel bandwidth					
		1.4 MHz	3 MHz	5 MHz	10 MHz	15 MHz	20 MHz
Power in Transmission Bandwidth Configuration for each CC	dBm	For carrier frequency $f \leq 3.0\text{GHz}$ : -25.7 For carrier frequency $3.0\text{GHz} < f \leq 4.2\text{GHz}$ : -26.0					
Note 1:	The transmitter shall be set to 4dB below $P_{\text{CMAX,L}}$ with $P_{\text{CMAX,L}}$ as defined in clause 6.2.5.						
Note 2:	Reference measurement channel is Annex A.3.2 64QAM R=3/4 variant with one sided dynamic OCNG Pattern OP.1 FDD/TDD as described in Annex A.5.1.1/A.5.2.1.						

#### 7.4A.4 Maximum input level for CA (intra band non-contiguous DL CA without UL CA)

##### 7.4A.4.1 Test purpose

Same as in clause 7.4A.1.1.

##### 7.4A.4.2 Test applicability

This test case applies to all types of E-UTRA UE release 11 and forward that support intra-band non-contiguous DL CA but no UL CA.

##### 7.4A.4.3 Minimum conformance requirements

The minimum conformance requirements are defined in clause 7.4A.0.

##### 7.4A.4.4 Test description

###### 7.4A.4.4.1 Initial conditions

Same initial conditions as in clause 7.4A.1.4.1 with the following exceptions:

- Instead of Table 7.4A.1.4.1-1 → use Tables 7.4A.4.4.1-1.

- Instead of clause 7.4A.1.4.3 → use clause 7.4A.3.4.3.

**Table 7.4A.4.4.1-1: Test Configuration Table**

Initial Conditions							
Test Environment as specified in TS 36.508[7] subclause 4.1				NC			
Test Frequencies as specified in TS36.508 [7] subclause 4.3.1 for different CA bandwidth classes, and PCC and SCCs are mapped onto physical frequencies according to Table 7.1-2				A: N/A (Range is not relevant)			
Test CC Combination setting ( $N_{RB\_agg}$ ) as specified in subclause 5.4.2A.1 for the CA Configuration .				Refer to test point			
Test Parameters for CA Configurations							
ID	CA Configuration / $N_{RB\_agg}$		$W_{gap}$ [MHz]	DL Allocation		UL Allocation	
	PCC $N_{RB}$	SCCs $N_{RB}$		CC MOD	PCC & SCC RB allocation	CC MOD	PCC RB allocations ( $L_{CRB}$ @ $RB_{start}$ )

Test Parameters for CA_2A-2A Configurations							
1	100	25	35	64QAM	100+25	QPSK	P_16@57
2	100	100	20	64QAM	100+100	QPSK	P_16@57
Test Parameters for CA_3A-3A Configurations							
3	100	25	50	64QAM	100+25	QPSK	P_16@50
4	100	25	15	64QAM	100+25	QPSK	P_32@68
5	100	100	35	64QAM	100+100	QPSK	P_16@50
Test Parameters for CA_4A-4A Configurations							
6	100	25	20	64QAM	100+25	QPSK	P_100@0
7	100	100	5	64QAM	100+100	QPSK	P_100@0
Test Parameters for CA_7A-7A Configurations							
8	100	75	35	64QAM	100+75	QPSK	P_36@64
9	100	75	15	64QAM	100+75	QPSK	P_50@50
10	100	100	30	64QAM	100+100	QPSK	P_32@68
11	100	100	15	64QAM	100+100	QPSK	P_45@55
Test Parameters for CA_23A-23A Configurations							
12	50	25	5	64QAM	50+25	QPSK	P_50@0
Test Parameters for CA_25A-25A Configurations							
13	50	25	50	64QAM	50+25	QPSK	P_10@33
14	50	25	15	64QAM	50+25	QPSK	P_32@18
15 <sup>3</sup>	50	50	45	64QAM	50+50	QPSK	P_10@33
16 <sup>3</sup>	50	50	10	64QAM	50+50	QPSK	P_32@18
17 <sup>4</sup>	100	25	40	64QAM	100+25	QPSK	P_12@62
18 <sup>4</sup>	100	100	25	64QAM	100+100	QPSK	P_12@62
Test Parameters for CA_41A-41A Configurations							
19 <sup>4</sup>	100	25	169	64QAM	100+25	QPSK	P_100@0
20 <sup>3</sup>	100	50	164	64QAM	100+50	QPSK	P_100@0
21	100	100	154	64QAM	100+100	QPSK	P_100@0
Test Parameters for CA_42A-42A Configurations							
22	100	25	175	64QAM	100+25	QPSK	P_100@0
23	100	100	160	64QAM	100+100	QPSK	P_100@0
Note 1:	CA Configuration Test CC Combination settings are checked separately for each CA Configuration, which applicable aggregated channel bandwidths are specified in Table 5.4.2A.1-3.						
Note 2:	The carrier centre frequency of PCC in the UL operating band is configured closer to the DL operating band.						
Note 3:	Applicable if only Bandwidth Combination Set 0 is supported by the UE for the CA Configuration						
Note 4:	Not applicable if only Bandwidth Combination Set 0 is supported by the UE for the CA Configuration						

#### 7.4A.4.4.2 Test procedure

1. Configure SCC according to Annex C.0, C.1 and Annex C.3.1 for all downlink physical channels.
2. The SS shall configure SCC as per TS 36.508 [7] clause 5.2A.4. Message contents are defined in clause 7.4A.4.4.3
3. SS activates SCC by sending the activation MAC-CE (Refer TS 36.321 [13], clauses 5.13, 6.1.3.8). Wait for at least 2 seconds (Refer TS 36.133, clauses 8.3.3.2).



4. SS transmits PDSCH via PDCCH DCI format 1A for C\_RNTI to transmit the DL RMC according to Table 7.4A.4.4.1-1 on both PCC and SCC. The SS sends downlink MAC padding bits on the DL RMC.
5. SS sends uplink scheduling information for each UL HARQ process via PDCCH DCI format 0 for C\_RNTI to schedule the UL RMC according to Table 7.4A.4.4.1-1 on PCC. Since the UE has no payload data to send, the UE sends uplink MAC padding bits on the UL RMC.
6. Set the Downlink signal level for PCC and SCC to the value defined in Table 7.4A.4.5-1. Send Uplink power control commands to the UE (less or equal to 1dB step size should be used), to ensure that for at least the duration of the Throughput measurement:  
The PCC output power is within (+0dB, -3.4 dB) of (target level in Table 7.4A.4.5-1), for carrier frequency  $f \leq 3.0\text{GHz}$ ,  
or within (+0dB, -4 dB) of (target level in Table 7.4A.4.5-1) for carrier frequency  $3.0\text{GHz} < f \leq 4.2\text{GHz}$ .
7. Measure the average throughput for each component carrier for duration sufficient to achieve statistical significance according to Annex G.2A.

#### 7.4A.4.4.3 Message contents

Message contents are according to TS 36.508 [7] subclause 4.6.

#### 7.4A.4.5 Test requirement

The throughput measurement of each carrier derived in test procedure shall be  $\geq 95\%$  of the maximum throughput of the reference measurement channels as specified in Annex A.3.2 with parameters specified in Table 7.4A.4.5-1 (originated from the single carrier Table 7.4.5-1).

**Table 7.4A.4.5-1: Maximum input level for intra band non-contiguous DL CA without UL CA**

Rx Parameter	Units	Channel bandwidth					
		1.4 MHz	3 MHz	5 MHz	10 MHz	15 MHz	20 MHz
Power in Transmission Bandwidth Configuration for each CC	dBm	For carrier frequency $f \leq 3.0\text{GHz}$ : -25.7 For carrier frequency $3.0\text{GHz} < f \leq 4.2\text{GHz}$ : -26.0					
Note 1:	The transmitter shall be set to 4dB below $P_{\text{CMAX}_L}$ with $P_{\text{CMAX}_L}$ as defined in clause 6.2.5.						
Note 2:	Reference measurement channel is Annex A.3.2 64QAM R=3/4 variant with one sided dynamic OCNG Pattern OP.1 FDD/TDD as described in Annex A.5.1.1/A.5.2.1.						

### 7.4A.5 Maximum input level for CA (3DL CA without UL CA)

#### 7.4A.5.1 Test purpose

Maximum input level for CA test verifies the UE's ability to receive data with a given average throughput for a specified reference measurement channel, under conditions of high signal level, ideal propagation and no added noise.

A UE unable to meet the throughput requirement under these conditions will decrease the coverage area near to an e-NodeB.

#### 7.4A.5.2 Test applicability

This test case applies to all types of E-UTRA UE release 10 and forward that support 3DL with Intra-band contiguous CA or 3DL with Inter-band CA or 3DL with Intra-band contiguous and Inter-band CA.

This test case also applies to all types of E-UTRA UE release 11 and forward that support 3DL with Intra-band non-contiguous and Inter-band CA or 3DL with Intra-band non-contiguous and Intra-band contiguous CA.

This test case also applies to all types of E-UTRA UE release 12 and forward that support 3DL CA with FDD-TDD CA.

#### 7.4A.5.3 Minimum conformance requirements

The Minimum conformance requirements are defined in clause 7.4A.0.

7.4A.5.4 Test description

7.4A.5.4.1 Initial conditions

Initial conditions are a set of test configurations the UE needs to be tested in and the steps for the SS to take with the UE to reach the correct measurement state.

The initial test configurations consist of environmental conditions, test frequencies, and channel bandwidths based on E-UTRA CA configurations specified in tables of 5.4.2A.1 as applicable. All of these configurations shall be tested with applicable test parameters for each CA Configuration, and are shown in table 7.4A.5.4.1-1 to 7.4A.5.4.1-5. The details of the uplink and downlink reference measurement channels (RMCs) are specified in Annexes A.2 and A.3 respectively. The details of the OCN patterns used are specified in Annex A.5. Configurations of PDSCH and PDCCH before measurement are specified in Annex C.2.

**Table 7.4A.5.4.1-1: Test Configuration Table (Intra-band contiguous)**

Initial Conditions													
Test Environment as specified in TS 36.508 [7] subclause 4.1							NC						
Test Frequencies as specified in TS36.508 [7] subclause 4.3.1 for different CA bandwidth classes.							For test frequencies refer to “Range” columns. For mapping within Band refer to “CC” columns						
Test CC Combination setting ( $N_{RB\_agg}$ ) as specified in subclause 5.4.2A.1 for the CA Configuration across bandwidth combination sets supported by the UE.							Refer to “PCC $N_{RB}$ ” and “SCCs $N_{RB}$ ” columns						
Network signalling value							NS_01 by default, exceptions listed in Table 7.3.3-3, dependent on PCC Band						
Test Parameters for CA Configurations													
ID	CA Configuration / $N_{RB\_agg}$					DL Allocation			UL Allocation (Note 4)				
	CA Configuration					PCC $N_{RB}$	SCCs $N_{RB}$		CC MOD	PCC & SCCs RB allocation		CC MOD	PCC $L_{CRB}$ @ $RB_{start}$
	Band	Range	PCC CC	SCC1 CC	SCC2 CC		SCC1	SCC2		PCC	SCC1		
Default Test Settings for a CA_XD Configuration													
1	X	Mid	CC1	CC2	CC3	Lowest $N_{RB\_agg}$	64-QAM	All RBs	QPSK	REFSENS			
2	X	Mid	CC1	CC2	CC3	Highest $N_{RB\_agg}$	64-QAM	All RBs	QPSK	REFSENS			
Note 1:	CA Configuration Test CC Combination test settings are checked separately for each CA Configuration, The applicable aggregated channel bandwidths are specified in Table 5.4.2A.1-1.												
Note 2:	Use CA Configuration – specific test points if present in the table, otherwise use Default Test Settings test points.												
Note 3:	X corresponds to the band in the CA Configuration. E.g. for CA_41D, X=41												
Note 4:	REFSENS refers to the PCC band’s and PCC $N_{RB}$ ‘s single carrier Uplink RB allocation for reference sensitivity according to table 7.3.5-2.												
Note 5:	If in the CA Configuration UE supports multiple CC Combinations with the same $N_{RB\_agg}$ , choose for testing the Combination with maximum $N_{RB\_PCC}$ and then select maximum $N_{RB\_SCC1}$ for the chosen $N_{RB\_PCC}$ .												

**Table 7.4A.5.4.1-2: Test Configuration Table (Inter-band)**

Initial Conditions															
Test Environment as specified in TS 36.508 [7] subclause 4.1											NC				
Test Frequencies as specified in TS36.508 [7] subclause 4.3.1 for different CA bandwidth classes.											For test frequencies refer to "Range" columns. For mapping within Band refer to "CC" columns				
Test CC Combination setting ( $N_{RB\_agg}$ ) as specified in subclause 5.4.2A.1 for the CA Configuration across bandwidth combination sets supported by the UE.											Refer to "PCC $N_{RB}$ " and "SCCs $N_{RB}$ " columns				
Network signalling value											NS_01 by default, exceptions listed in Table 7.3.3-3, dependent on PCC Band				
Test Parameters for CA Configurations															
ID	CA Configuration / $N_{RB\_agg}$							DL Allocation			UL Allocation (Note 5)				
	CA Configuration						PCC $N_{RB}$	SCCs $N_{RB}$		CC MOD	PCC & SCCs RB allocation			CC MOD	PCC $L_{CRB}$ @ $RB_{start}$
	PCC		SCC1		SCC2			SCC1	SCC2		PCC	SCC1	SCC2		
	Band	Range	Band	Range	Band	Range									
Default Test Settings for a CA_XA-YA-ZA Configuration															
1	X	Mid	Y	Mid	Z	Mid	Highest $N_{RB}$	Highest $N_{RB}$	Highest $N_{RB}$	64-QAM	All RBs	QPSK	REFSENS		
2	Y	Mid	X	Mid	Z	Mid	Highest $N_{RB}$	Highest $N_{RB}$	Highest $N_{RB}$	64-QAM	All RBs	QPSK	REFSENS		
3	Z	Mid	X	Mid	Y	Mid	Highest $N_{RB}$	Highest $N_{RB}$	Highest $N_{RB}$	64-QAM	All RBs	QPSK	REFSENS		
<p>Note 1: CA Configuration Test CC Combination test settings are checked separately for each CA Configuration. The applicable aggregated channel bandwidths are specified in Table 5.4.2A.1-2a.</p> <p>Note 2: Use CA Configuration – specific test points if present in the table, otherwise use Default Test Settings test points.</p> <p>Note 3: If, according to the UE declared capability, UE does not support UL in an individual band within the CA Configuration, test points with that individual band as PCC are not applicable.</p> <p>Note 4: X,Y,Z correspond to the 1<sup>st</sup>, 2<sup>nd</sup> and 3<sup>rd</sup> band in the CA Configuration. E.g. for CA_1A-3A-19A, X=1, Y=3, Z=19</p> <p>Note 5: REFSSENS refers to the PCC band's and PCC <math>N_{RB}</math> 's single carrier Uplink RB allocation for reference sensitivity according to table 7.3.5-2.</p>															

**Table 7.4A.5.4.1-3: Test Configuration Table (Intra-band contiguous + Inter-band)**

Initial Conditions															
Test Environment as specified in TS 36.508 [7] subclause 4.1										NC					
Test Frequencies as specified in TS36.508 [7] subclause 4.3.1 for different CA bandwidth classes.										For test frequencies refer to “Range” columns. For mapping within Band refer to “CC” columns					
Test CC Combination setting ( $N_{RB\_agg}$ ) as specified in subclause 5.4.2A.1 for the CA Configuration across bandwidth combination sets supported by the UE.										Refer to “PCC $N_{RB}$ ” and “SCCs $N_{RB}$ ” columns					
Network signalling value										NS_01 by default, exceptions listed in Table 7.3.3-3, dependent on PCC Band					
Test Parameters for CA Configurations															
ID	CA Configuration / $N_{RB\_agg}$							DL Allocation			UL Allocation (Note 2,3)				
	CA Configuration						PCC $N_{RB}$	SCCs $N_{RB}$		CC MOD	PCC & SCCs RB allocation			CC MOD	PCC $L_{CRB}$ @ $RB_{start}$
	PCC		SCC1		SCC2			SCC1	SCC2		PCC	SCC1	SCC2		
	Band	Range /CC	Band	Range /CC	Band	Range /CC									
Default Test Settings for CA_XB-YA and CA_XC-YA Configuration															
1	X	Mid /CC1	X	Mid /CC2	Y	Mid	Lowest $N_{RB\_agg}$		Highest $N_{RB}$	64-QAM	All RBs	QPSK	REFSENS		
2	X	Mid /CC1	X	Mid /CC2	Y	Mid	Highest $N_{RB\_agg}$		Highest $N_{RB}$	64-QAM	All RBs	QPSK	REFSENS		
3	Y	Mid	X	Mid /CC1	X	Mid /CC2	Highest $N_{RB}$	Lowest $N_{RB\_agg}$		64-QAM	All RBs	QPSK	REFSENS		
4	Y	Mid	X	Mid /CC1	X	Mid /CC2	Highest $N_{RB}$	Highest $N_{RB\_agg}$		64-QAM	All RBs	QPSK	REFSENS		
Default Test Settings for CA_XA-YB and CA_XA-YC Configuration															
1	Y	Mid /CC1	Y	Mid /CC2	X	Mid	Highest $N_{RB\_agg}$		Highest $N_{RB}$	64-QAM	All RBs	QPSK	REFSENS		
2	Y	Mid /CC1	Y	Mid /CC2	X	Mid	Lowest $N_{RB\_agg}$		Highest $N_{RB}$	64-QAM	All RBs	QPSK	REFSENS		
3	X	Mid	Y	Mid /CC1	Y	Mid /CC2	Highest $N_{RB}$	Highest $N_{RB\_agg}$		64-QAM	All RBs	QPSK	REFSENS		
4	X	Mid	Y	Mid /CC1	Y	Mid /CC2	Highest $N_{RB}$	Lowest $N_{RB\_agg}$		64-QAM	All RBs	QPSK	REFSENS		
Note 1: CA Configuration Test CC Combination test settings are checked separately for each CA Configuration. Note 2: Use CA Configuration – specific test points if present in the table. Otherwise use the Default Test Settings test points. Note 3: If, according to the UE declared capability, UE does not support UL in an individual band within the CA Configuration, test points with that individual band as PCC are not applicable. Note 4: X,Y correspond to the different bands in the CA Configuration. Eg. for CA_1C-3A, X=1 and Y=3 Note 5: REFSENS refers to the PCC band's and PCC $N_{RB}$ 's single carrier Uplink RB allocation for reference sensitivity according to table 7.3.5-2. Note 6: If in the CA Configuration UE supports multiple CC Combinations with the same $N_{RB\_agg}$ , choose the Combination with $N_{RB\_PCC} = N_{RB\_SCC1}$ for testing. If no such combination is supported, choose Combination with maximum $N_{RB\_PCC}$ for testing.															

**Table 7.4A.5.4.1-4: Test Configuration Table (Intra-band non-contiguous + Inter-band)**

Initial Conditions	
Test Environment as specified in TS 36.508 [7] subclause 4.1	NC
Test Frequencies as specified in TS36.508 [7] subclause 4.3.1 for different CA bandwidth classes.	For test frequencies refer to “Range” columns. For mapping within Band refer to “CC” columns
Test CC Combination setting ( $N_{RB\_agg}$ ) as specified in subclause 5.4.2A.1 for the CA Configuration across bandwidth combination sets supported by the UE.	Highest $N_{RB}$

Network signalling value									NS_01 by default, exceptions listed in Table 7.3.3-3, dependent on PCC Band					
Test Parameters for CA Configurations														
ID	CA Configuration / N <sub>RB_agg</sub>								DL Allocation			UL Allocation (Note 2,3)		
	CA Configuration								CC MOD	PCC & SCCs			CC MOD	PCC L <sub>CRB</sub> @ RB <sub>sta</sub>
	PCC		W <sub>gap</sub> [MHz]	SCC1		W <sub>gap</sub> [MHz]	SCC2			RB allocation				
	Band	Range /CC		Band	Range /CC		Band	Range /CC		PCC	SCC1	SCC2		
<b>Default Test Settings for CA_XA-XA-YA Configurations</b>														
1	X	CC2	Max	X	CC1	-	Y	Mid	64-QAM	All RBs			QPSK	REFSENS_CA
2	Y	Mid	-	X	CC2	Max	X	CC1	64-QAM	All RBs			QPSK	REFSENS
<b>Default Test Settings for CA_XA-YA-YA Configurations</b>														
1	Y	CC2	Max	Y	CC1	-	X	Mid	64-QAM	All RBs			QPSK	REFSENS_CA
2	X	Mid	-	Y	CC2	Max	Y	CC1	64-QAM	All RBs			QPSK	REFSENS
<p>Note 1: CA Configuration Test CC Combination test settings are checked separately for each CA Configuration.</p> <p>Note 2: Use CA Configuration – specific test points if present in the table. Otherwise use test points from matching Group Test Settings, if present in the table. Otherwise use Default Test Settings test points.</p> <p>Note 3: If, according to the UE declared capability, UE does not support UL in an individual band within the CA Configuration, test points with that individual band as PCC are not applicable.</p> <p>Note 4: X and Y correspond to the different bands in the CA Configuration. Eg. for CA_2A-2A-5A,X=2,Y=5</p> <p>Note 5: REFSENS refers to the PCC band's and PCC N<sub>RB</sub> 's single carrier Uplink RB allocation for reference sensitivity according to table 7.3.5-2. REFSENS_CA refers to the PCC band's and PCC N<sub>RB</sub> 's single carrier Uplink RB allocation for reference sensitivity according to table 7.3.4.5-2 (selecting RB allocation for SCC measurement).</p>														

**Table 7.4A.5.4.1-5: Test Configuration Table (Intra-band non-contiguous + Intra-band contiguous)**

Initial Conditions																
Test Environment as specified in TS 36.508 [7] subclause 4.1									NC							
Test Frequencies as specified in TS36.508 [7] subclause 4.3.1 for different CA bandwidth classes.									For test frequencies refer to "Range" columns. For mapping within band refer to "CC" columns							
Test CC Combination setting (N <sub>RB_agg</sub> ) as specified in subclause 5.4.2A.1 for the CA Configuration across bandwidth combination sets supported by the UE.									Refer to "PCC N <sub>RB</sub> " and "SCCs N <sub>RB</sub> " columns							
Network signalling value									NS_01 by default, exceptions listed in Table 7.3.3-3, dependent on PCC Band							
Test Parameters for CA Configurations																
ID	CA Configuration / N <sub>RB_agg</sub>								DL Allocation			UL Allocation (Note 2,3)				
	CA Configuration								PCC N <sub>RB</sub>	SCCs N <sub>RB</sub>	CC MOD	PCC & SCCs RB allocation			CC MOD	PCC L <sub>CRB</sub> @ RB <sub>start</sub>
	Band	PCC	W <sub>gap</sub> [MHz]	SCC1	W <sub>gap</sub> [MHz]	SCC2	PCC	SCC1				SCC2				
		CC		CC		CC										
<b>Test Settings for a 41A-41C Configuration</b>																
1	41	CC3	134.2	CC2	-	CC1	100	100	100	64-QAM	All RBs			QPSK	100@0	

Test Settings for a CA_41C-41A Configuration													
2	41	CC3	-	CC2	134.2	CC1	100	100	100	64-QAM	All RBs	QPSK	100@0
<p>Note 1: CA Configuration Test CC Combination test settings are checked separately for each CA Configuration.</p> <p>Note 2: Use CA Configuration – specific test points if present in the table, otherwise use Default Test Settings test points.</p> <p>Note 3: If, according to the UE declared capability, UE does not support UL in an individual band within the CA Configuration, test points with that individual band as PCC are not applicable.</p> <p>Note 4: X corresponds to the band of the CA Configuration. Eg. for CA_41C-41A, X=41.</p> <p>Note 5: REFSSENS refers to the PCC band's and PCC <math>N_{RB}</math> 's single carrier Uplink RB allocation for reference sensitivity according to table 7.3.5-2.</p> <p>Note 6: If in the CA Configuration UE supports multiple CC Combinations with the same <math>N_{RB\_agg}</math>, choose the Combination with <math>N_{RB\_CC1} = N_{RB\_CC2}</math> for testing. If no such combination is supported, choose Combination with maximum <math>N_{RB\_CC1}</math> for testing.</p>													

1. Connect the SS to the UE antenna connectors as shown in TS 36.508 [7] Annex A, Figure A.55.
2. The parameter settings for the cell are set up according to TS 36.508 [7] clause 4.4.3.
3. Downlink signals for PCC are initially set up according to Annex C.0, C.1 and C.3.1, and uplink signals according to Annex H.1 and H.3.1
4. The UL and DL Reference Measurement channels are set according to Tables 7.4A.5.4.1-1 to 7.4A.5.4.1-5.
5. Propagation conditions are set according to Annex B.0.
6. Ensure the UE is in State 3A-RF according to TS 36.508 [7] clause 5.2A.2. Message contents are defined in clause 7.4A.5.4.3.

#### 7.4A.5.4.2 Test procedure

1. Configure SCCs according to Annex C.0, C.1 and Annex C.3.1 for all downlink physical channels.
2. The SS shall configure SCCs as per TS 36.508 [7] clause 5.2A.4. Message contents are defined in clause 7.4A.5.4.3
3. SS activates SCCs by sending the activation MAC-CE (Refer to TS 36.321 [13] clauses 5.13 and 6.1.3.8). Wait for at least 2 seconds (Refer TS 36.133 [4], clause 8.3.3.2).
4. SS transmits PDSCH via PDCCH DCI format 1A for  $C\_RNTI$  to transmit the DL RMC according to Tables 7.4A.5.4.1-1 to 7.4A.5.4.1-5 as appropriate on PCC and SCCs. The SS sends downlink MAC padding bits on the DL RMC.
5. SS sends uplink scheduling information for each UL HARQ process via PDCCH DCI format 0 for  $C\_RNTI$  to schedule the UL RMC according to Tables 7.4A.5.4.1-1 to 7.4A.5.4.1-5 as appropriate on PCC. Since the UE has no payload and no loopback data to send, the UE sends uplink MAC padding bits on the UL RMC.
6. Set the Downlink signal level for PCC and SCCs to the value defined in Table 7.4A.5.5-2 or 7.4A.5.5-3 according to the type of CA. Send Uplink power control commands to the UE (less or equal to 1dB step size should be used), to ensure that the PCC output power is within +0dB, -3.4 dB of the target level for carrier frequency  $f \leq 3.0\text{GHz}$  or within +0dB, -4 dB of the target level for carrier frequency  $3.0\text{GHz} < f \leq 4.2\text{GHz}$ , for at least the duration of the Throughput measurement.
7. Measure the average throughput for the carrier(s) indicated in table 7.4A.5.4.2-1 for duration sufficient to achieve statistical significance according to Annex G.2A.
8. Repeat steps 6 to 7 for all component carriers indicated in Table 7.4A.5.4.2-1.

**Table 7.4A.5.4.2-1: Test repetition and measurement configuration**

CA configuration	ID (Note 1)	Throughput measured on (Note 3)	Table with test parameters to select (Note 2)
Intra-band contiguous	1	PCC, SCC1, SCC2	7.4A.5.5-1
	2		
Inter-band	1	SCC1	7.4A.5.5-2
		SCC2	
	2	SCC1	
		SCC2	
	3	SCC1	
		SCC2	
Intra-band contiguous + Inter-band	1	SCC2	7.4A.5.5-2
	2		
	3	SCC1, SCC2	7.4A.5.5-1
	4		
Intra-band non-contiguous + Inter-band	1	SCC2	7.4A.5.5-2
	2	SCC1	
		SCC2	
Intra-band non-contiguous + Intra-band contiguous	1	PCC	7.4A.5.5-2
		SCC1, SCC2	7.4A.5.5-1
	2	PCC, SCC1	7.4A.5.5-1
		SCC2	7.4A.5.5-2
Note 1: Test point ID for the particular CA configuration as defined in section 7.4A.5.4.1. Note 2: The reference for the placement of the interferer signals is the centre frequency of the carrier closest to the interferer among the carriers throughput is measured on. Note 3: Where there are multiple rows for a single Test point ID, the test is repeated for each row.			

**7.4A.5.4.3 Message contents**

Message contents are according to TS 36.508 [7] subclause 4.6

**7.4A.5.5 Test requirement**

The throughput measurement of each carrier derived in test procedure shall be  $\geq 95\%$  of the maximum throughput of the reference measurement channels as specified in Annex A.3.2 with parameters specified in Tables 7.4A.5.5-1 to 7.4A.5.5-5, as applicable.

**Table 7.4A.5.5-1: Maximum input level for 3DL CA (Intra-band contiguous)**

Rx Parameter	Units	CA Bandwidth Class					
		A	B	C	D	E	F

Power in largest Transmission Bandwidth Configuration CC	dBm		For carrier frequency $f \leq 3.0\text{GHz}$ : -28.7	For carrier frequency $f \leq 3.0\text{GHz}$ : -25.7	For carrier frequency $f \leq 3.0\text{GHz}$ : -25.7		
			For carrier frequency $3.0\text{GHz} < f \leq 4.2\text{GHz}$ : -29.0	For carrier frequency $3.0\text{GHz} < f \leq 4.2\text{GHz}$ : -26.0	For carrier frequency $3.0\text{GHz} < f \leq 4.2\text{GHz}$ : -26.0		
Power in each other CC	dBm		For carrier frequency $f \leq 3.0\text{GHz}$ : -28.7 + $10\log(N_{RB,c} / N_{RB,largest\ BW})$	For carrier frequency $f \leq 3.0\text{GHz}$ : -25.7 + $10\log(N_{RB,c} / N_{RB,largest\ BW})$	For carrier frequency $f \leq 3.0\text{GHz}$ : -25.7 + $10\log(N_{RB,c} / N_{RB,largest\ BW})$		
			For carrier frequency $3.0\text{GHz} < f \leq 4.2\text{GHz}$ : -29.0 + $10\log(N_{RB,c} / N_{RB,largest\ BW})$	For carrier frequency $3.0\text{GHz} < f \leq 4.2\text{GHz}$ : -26.0 + $10\log(N_{RB,c} / N_{RB,largest\ BW})$	For carrier frequency $3.0\text{GHz} < f \leq 4.2\text{GHz}$ : -26.0 + $10\log(N_{RB,c} / N_{RB,largest\ BW})$		
<p>Note 1: The transmitter shall be set to 4dB below <math>P_{CMAX,L}</math> or <math>P_{CMAX,L,CA}</math> as defined in subclause 6.2.5 for one uplink carrier.</p> <p>Note 2: Reference measurement channel is Annex A.3.2: 64QAM, R=3/4 variant with one sided dynamic OCNG Pattern OP.1 FDD/TDD as described in Annex A.5.1.1/A.5.2.1.</p>							

**Table 7.4A.5.5-2: Maximum input level for 3DL CA (Inter-band), per CC**

Rx Parameter	Units	Channel bandwidth					
		1.4 MHz	3 MHz	5 MHz	10 MHz	15 MHz	20 MHz
Power in Transmission Bandwidth Configuration	dBm	For carrier frequency $f \leq 3.0\text{GHz}$ : -25.7 For carrier frequency $3.0\text{GHz} < f \leq 4.2\text{GHz}$ : -26.0					
<p>Note 1: The transmitter shall be set to 4dB below <math>P_{CMAX,L}</math> with <math>P_{CMAX,L}</math> as defined in clause 6.2.5.</p> <p>Note 2: Reference measurement channel is Annex A.3.2 64QAM R=3/4variant with one sided dynamic OCNG Pattern OP.1 FDD/TDD as described in Annex A.5.1.1/A.5.2.1.</p>							

## 7.4B Maximum input level for UL-MIMO

### 7.4B.1 Test purpose

Maximum input level tests the ability of UE that support UL- MIMO to receive data with a given average throughput for a specified reference measurement channel, under conditions of high signal level, ideal propagation and no added noise.

A UE unable to meet the throughput requirement under these conditions will decrease the coverage area near to an e-NodeB.

### 7.4B.2 Test applicability

This test applies to all types of E-UTRA UE release 10 and forward that support UL- MIMO.

### 7.4B.3 Minimum conformance requirements

For UE with two transmitter antenna connectors in closed-loop spatial multiplexing, the minimum requirements in Clause 7.4.3 shall be met with the UL-MIMO configurations specified in Table 6.2.2B.3-2. For UL-MIMO, the parameter  $P_{CMAX,L}$  is defined as the total transmitter power over the two transmit antenna connectors.

The normative reference for this requirement is TS 36.101 [2] clause 7.4.1B.



## 7.4B.4 Test description

### 7.4B.4.1 Initial conditions

Initial conditions are a set of test configurations the UE needs to be tested in and the steps for the SS to take with the UE to reach the correct measurement state.

The initial test configurations consist of environmental conditions, test frequencies, and channel bandwidths based on E-UTRA bands specified in table 5.4.2.1-1. All of these configurations shall be tested with applicable test parameters for each channel bandwidth, and are shown in table 7.4B.4.1-1. The details of the uplink and downlink reference measurement channels (RMCs) are specified in Annexes A.2 and A.3 respectively. The details of the OCNG patterns used are specified in Annex A.5. Configurations of PDSCH and PDCCH before measurement are specified in Annex C.2.

**Table 7.4B.4.1-1: Test Configuration Table**

Initial Conditions							
Test Environment as specified in TS 36.508[7] subclause 4.1				NC			
Test Frequencies as specified in TS36.508 [7] subclause 4.3.1				Mid range			
Test Channel Bandwidths as specified in TS 36.508 [7] subclause 4.3.1				Lowest, 5MHz, Highest			
Test Parameters for Channel Bandwidths							
Ch BW	Downlink Configuration			Uplink Configuration			UE Category
	Mod'n	RB allocation		Mod'n	RB allocation		
		FDD	TDD		FDD	TDD	
1.4MHz	64-QAM	6	6	QPSK	5	5	1-5
3MHz	64-QAM	15	15	QPSK	4	4	1-5
5MHz	64-QAM	25	25	QPSK	8	8	2-5
5MHz	64-QAM	25	N/A	QPSK	5 <sup>3</sup>	N/A	2-5
5MHz	64-QAM	18	18	QPSK	8	8	1
5MHz	64-QAM	18	N/A	QPSK	5 <sup>3</sup>	N/A	1
10MHz	64-QAM	50	50	QPSK	12	12	2-5
10MHz	64-QAM	17	17	QPSK	12	12	1
15MHz	64-QAM	75	75	QPSK	16	16	2-5
15MHz	64-QAM	17	17	QPSK	16	16	1
20MHz	64-QAM	100	100	QPSK	18	18	3-5
20MHz	64-QAM	83	83	QPSK	18	18	2
20MHz	64-QAM	17	17	QPSK	18	18	1
Note 1: Test Channel Bandwidths are checked separately for each E-UTRA band. The applicable channel bandwidths are specified in Table 7.3.3-2.							
Note 2: For the DL signal one sided dynamic OCNG Pattern OP.1 FDD/TDD is used.							
Note 3: Applicable only to E-UTRA FDD Band 31. The UL resource blocks shall be located at RBstart 10 (according to Table 7.3.3-2).							

1. Connect the SS to the UE antenna connectors as shown in TS 36.508 [7] Figure A.28.
2. The parameter settings for the cell are set up according to TS 36.508 [7] subclause 4.4.3.
3. Downlink signals are initially set up according to Annex C0, C.1 and C.3.1, and uplink signals according to Annex H.1 and H.3.1.
4. The UL and DL Reference Measurement channels are set according to Table 7.4B.4.1-1.
5. Propagation conditions are set according to Annex B.0.
6. Ensure the UE is in State 3A-RF according to TS 36.508 [7] clause 5.2A.2. Message contents are defined in clause 7.4B.4.3.

### 7.4B.4.2 Test procedure

1. SS transmits PDSCH via PDCCH DCI format 1A for C\_RNTI to transmit the DL RMC according to Table 7.4B.4.1-1. The SS sends downlink MAC padding bits on the DL RMC.

2. SS sends uplink scheduling information for each UL HARQ process via PDCCH DCI format 4 for C\_RNTI to schedule the UL RMC according to Table 7.4B.4.1-1. Since the UE has no payload data to send, the UE transmits uplink MAC padding bits on the UL RMC.
3. Set the Downlink signal level to the value defined in Table 7.4B.5-1. Send Uplink power control commands to the UE (less or equal to 1dB step size should be used), to ensure that the UE output power is within +0, - 3.4 dB of the target level in Table 7.4B.5-1 for carrier frequency  $f \leq 3.0\text{GHz}$  or within +0, -4.0 dB of the target level for carrier frequency  $3.0\text{GHz} < f \leq 4.2\text{GHz}$ , for at least the duration of the throughput measurement.
4. Measure the average throughput for a duration sufficient to achieve statistical significance according to Annex G.2.

### 7.4B.4.3 Message contents

Message contents are according to TS 36.508 [7] clause 4.6 with the following exception.

**Table 7.4B.4.3-1: UplinkPowerControlDedicated**

Derivation Path: 36.331 clause 6.3.2			
Information Element	Value/remark	Comment	Condition
UplinkPowerControlDedicated-DEFAULT ::= SEQUENCE {			
p0-UePUSCH	0		
deltaMCS-Enabled	en0		
accumulationEnabled	TRUE		
p0-uePUCCH	0		
pSRS-Offset	3 (-6 dB)		
filterCoefficient	fc8	larger filter length is used to reduce the RSRP measurement variation	
}			

### 7.4B.5 Test requirement

The throughput shall be  $\geq 95\%$  of the maximum throughput of the reference measurement channels as specified in Annex A.3.2 with parameters specified in Table 7.4B.5-1.

**Table 7.4B.5-1: Maximum input level**

Rx Parameter	Units	Channel bandwidth					
		1.4 MHz	3MHz	5MHz	10 MHz	15 MHz	20 MHz
Power in Transmission Bandwidth Configuration	dBm	For carrier frequency $f \leq 3.0\text{GHz}$ : -25.7 For carrier frequency $3.0\text{GHz} < f \leq 4.2\text{GHz}$ : -26.0					
Note 1:	The transmitter shall be set to 4dB below $P_{\text{CMAX,L}}$ at the minimum uplink configuration specified in Table 7.3.1-2 with $P_{\text{CMAX,L}}$ as defined in clause 6.2.5.						
Note 2:	Reference measurement channel is Annex A.3.2: 64QAM, R=3/4 variant with one sided dynamic OCNG Pattern OP.1 FDD/TDD as described in Annex A.5.1.1/A.5.2.1.						

## 7.4E Maximum input level for UE category 0

**Editor's note: Following aspects missing or not yet determined:**

- RB allocation within brackets
- Test tolerance for this case in Annex F is not completed

### 7.4E.1 Test purpose

Same test purpose as in clause 7.4.1.

## 7.4E.2 Test applicability

This test applies to all types of E-UTRA UE release 12 and forward of UE category 0.

## 7.4E.3 Minimum conformance requirements

Same minimum conformance requirements as in clause 7.4.3.

## 7.4E.4 Test description

### 7.4E.4.1 Initial conditions

Same initial conditions as in clause 7.4.4.1 with the following exceptions:

- Instead of Table 7.4.4.1-1 → use Table 7.4E.4.1-1.
- Connect the SS to the UE antenna connectors as shown in TS 36.508[7] Annex A Figure A.3 using only main UE Tx/Rx antenna.

**Table 7.4E.4.1-1: Test Configuration Table**

Initial Conditions							
Test Environment as specified in TS 36.508[7] clause 4.1				NC			
Test Frequencies as specified in TS36.508 [7] clause 4.3.1				Mid range			
Test Channel Bandwidths as specified in TS 36.508 [7] clause 4.3.1				Lowest, 5MHz, Highest			
Test Parameters for Channel Bandwidths							
Ch BW	Downlink Configuration			Uplink Configuration			UE Category
	Mod'n	RB allocation		Mod'n	RB allocation		
		FDD and HD-FDD	TDD		FDD and HD-FDD	TDD	
1.4MHz	64QAM	2	2	QPSK	6	6	0
3MHz	64QAM	2	2	QPSK	15	15	0
5MHz	64QAM	2	2	QPSK	25	25	0
5MHz	64QAM	2	N/A	QPSK	20	N/A	0
10MHz	64QAM	2	2	QPSK	[36]	[36]	0
10MHz	64QAM	2	N/A	QPSK	[25]	N/A	0
10MHz	64QAM	2	N/A	QPSK	[20]	N/A	0
15MHz	64QAM	2	2	QPSK	[36]	[36]	0
20MHz	64QAM	2	2	QPSK	[36]	[36]	0
Note 1:	Test Channel Bandwidths are checked separately for each E-UTRA band. The applicable channel bandwidths are specified in Table 5.4.2.1-1.						
Note 2:	Depending on E-UTRA band, only the appropriate Uplink RB allocation value according to table 7.3E.3-3 is tested per Test Channel Bandwidth. The allocation shall be located as close as possible to the downlink operating band but confined within the transmission bandwidth configuration for the channel bandwidth (Table 5.4.2-1).						
Note 3:	For the DL signal one sided dynamic OCNG Pattern OP.1 FDD/TDD is used.						
Note 4:	Downlink RB position shall be $RB_{start} = 0$						

### 7.4E.4.2 Test procedure

Same test procedure as in clause 7.4.4.2.

### 7.4E.4.3 Message contents

Same message contents as in clause 7.4.4.3

## 7.4E.5 Test requirement

# 7.5 Adjacent Channel Selectivity (ACS)

## 7.5.1 Test purpose

Adjacent channel selectivity tests the UE's ability to receive data with a given average throughput for a specified reference measurement channel, in the presence of an adjacent channel signal at a given frequency offset from the centre frequency of the assigned channel, under conditions of ideal propagation and no added noise.

A UE unable to meet the throughput requirement under these conditions will decrease the coverage area when other e-NodeB transmitters exist in the adjacent channel.

## 7.5.2 Test applicability

This test applies to all types of E-UTRA UE release 8 and forward.

## 7.5.3 Minimum conformance requirements

Adjacent Channel Selectivity (ACS) is a measure of a receiver's ability to receive an E-UTRA signal at its assigned channel frequency in the presence of an adjacent channel signal at a given frequency offset from the centre frequency of the assigned channel. ACS is the ratio of the receive filter attenuation on the assigned channel frequency to the receive filter attenuation on the adjacent channel(s).

The UE shall fulfil the minimum requirement specified in Table 7.5.3-1 for all values of an adjacent channel interferer up to  $-25$  dBm. However it is not possible to directly measure the ACS, instead the lower and upper range of test parameters are chosen in Table 7.5.3-2 and Table 7.5.3-3 where the throughput  $R_{av}$  shall be  $\geq 95\%$  of the maximum throughput of the reference measurement channels as specified in Annexes A.2.2, A.2.3 and A.3.2 (with one sided dynamic OCNG Pattern OP.1 FDD/TDD for the DL-signal as described in Annex A.5.1.1/A.5.2.1).

**Table 7.5.3-1: Adjacent channel selectivity**

Rx Parameter	Units	Channel bandwidth					
		1.4 MHz	3 MHz	5 MHz	10 MHz	15 MHz	20 MHz
ACS	dB	33.0	33.0	33.0	33.0	30	27

**Table 7.5.3-2: Test parameters for Adjacent channel selectivity, Case 1**

Rx Parameter	Units	Channel bandwidth					
		1.4 MHz	3 MHz	5 MHz	10 MHz	15 MHz	20 MHz
Power in Transmission Bandwidth Configuration	dBm	REFSENS + 14 dB					
$P_{\text{Interferer}}$	dBm	REFSENS +45.5dB	REFSENS +45.5dB	REFSENS +45.5dB	REFSENS +45.5dB	REFSENS +42.5dB	REFSENS +39.5dB
$BW_{\text{Interferer}}$	MHz	1.4	3	5	5	5	5
$F_{\text{Interferer}}$ (offset)	MHz	1.4+0.0025 / -1.4-0.0025	3+0.0075 / -3-0.0075	5+0.0025 / -5-0.0025	7.5+0.0075 / -7.5-0.0075	10+0.0125 / -10-0.0125	12.5+0.0025 5 / -12.5-0.0025
Note 1:	The transmitter shall be set to 4dB below $P_{\text{CMAX\_L}}$ at the minimum uplink configuration specified in Table 7.3.3-2 with $P_{\text{CMAX\_L}}$ as defined in clause 6.2.5.						
Note 2:	The interferer consists of the Reference measurement channel specified in Annex A.3.2 with one sided dynamic OCNG Pattern OP.1 FDD/TDD as described in Annex A.5.1.1/A.5.2.1 and set-up according to Annex C.3.1.						

**Table 7.5.3-3: Test parameters for Adjacent channel selectivity, Case 2**

Rx Parameter	Units	Channel bandwidth					
		1.4 MHz	3 MHz	5 MHz	10 MHz	15 MHz	20 MHz
Power in Transmission Bandwidth Configuration	dBm	-56.5	-56.5	-56.5	-56.5	-53.5	-50.5
$P_{\text{Interferer}}$	dBm	-25					
$BW_{\text{Interferer}}$	MHz	1.4	3	5	5	5	5
$F_{\text{Interferer}}$ (offset)	MHz	$1.4+0.0025$ / -1.4- 0.0025	$3+0.0075$ / -3-0.0075	$5+0.0025$ / -5-0.0025	$7.5+0.0075$ / -7.5- 0.0075	$10+0.0125$ / -10-0.0125	$12.5+0.0025$ / 5 / -12.5- 0.0025
Note 1:	The transmitter shall be set to 24dB below $P_{\text{CMAX\_L}}$ at the minimum uplink configuration specified in Table 7.3.3-2 with $P_{\text{CMAX\_L}}$ as defined in clause 6.2.5.						
Note 2:	The interferer consists of the Reference measurement channel specified in Annex A.3.2 with one sided dynamic OCNG Pattern OP.1 FDD/TDD as described in Annex A.5.1.1/A.5.2.1 and set-up according to Annex C.3.1.						

The normative reference for this requirement is TS 36.101 [2] clause 7.5.1.

## 7.5.4 Test description

### 7.5.4.1 Initial conditions

Initial conditions are a set of test configurations the UE needs to be tested in and the steps for the SS to take with the UE to reach the correct measurement state.

The initial test configurations consist of environmental conditions, test frequencies, and channel bandwidths based on E-UTRA bands specified in table 5.4.2.1-1. All of these configurations shall be tested with applicable test parameters for each channel bandwidth, and are shown in table 7.5.4.1-1. The details of the uplink and downlink reference measurement channels (RMCs) are specified in Annexes A.2 and A.3 respectively. The details of the OCNG patterns used are specified in Annex A.5. Configurations of PDSCH and PDCCH before measurement are specified in Annex C.2.

Table 7.5.4.1-1: Test Configuration Table

Initial Conditions						
Test Environment as specified in TS 36.508[7] clause 4.1			NC			
Test Frequencies as specified in TS36.508 [7] clause 4.3.1			Mid range			
Test Channel Bandwidths as specified in TS 36.508 [7] clause 4.3.			Lowest, 5MHz, Highest			
Test Parameters for Channel Bandwidths						
Ch BW	Downlink Configuration			Uplink Configuration		
	Mod'n	RB allocation		Mod'n	RB allocation	
		FDD	TDD		FDD	TDD
1.4MHz	QPSK	6	6	QPSK	6	6
3MHz	QPSK	15	15	QPSK	15	15
5MHz	QPSK	25	25	QPSK	25	25
5MHz	QPSK	25	N/A	QPSK	20	N/A
5MHz	QPSK	25	N/A	QPSK	15	N/A
5MHz	QPSK	25	N/A	QPSK	5 <sup>+</sup>	N/A
10MHz	QPSK	50	50	QPSK	50	50
10MHz	QPSK	50	N/A	QPSK	25	N/A
10MHz	QPSK	50	N/A	QPSK	20	N/A
10MHz	QPSK	50	N/A	QPSK	15	N/A
15MHz	QPSK	75	75	QPSK	75	75
15MHz	QPSK	75	N/A	QPSK	50	N/A
15MHz	QPSK	75	N/A	QPSK	25	N/A
15MHz	QPSK	75	N/A	QPSK	20	N/A
20MHz	QPSK	100	100	QPSK	100	100
20MHz	QPSK	100	N/A	QPSK	75	N/A
20MHz	QPSK	100	N/A	QPSK	50	N/A
20MHz	QPSK	100	N/A	QPSK	25	N/A
20MHz	QPSK	100	N/A	QPSK	20	N/A
Note 1:	Test Channel Bandwidths are checked separately for each E-UTRA band, which applicable channel bandwidths are specified in Table 5.4.2.1-1.					
Note 2:	Depending on E-UTRA band, only the appropriate Uplink RB allocation value according to table 7.3.3-2 is tested per Test Channel Bandwidth. The allocation shall be located as close as possible to the downlink operating band but confined within the transmission bandwidth configuration for the channel bandwidth (Table 5.4.2-1).					
Note 3:	For the DL signal one sided dynamic OCNB Pattern OP.1 FDD/TDD is used.					
Note 4:	Applicable only to E-UTRA FDD Band 31. The UL resource blocks shall be located at RBstart 10 (according to Table 7.3.3-2).					

1. Connect the SS and interfering source to the UE antenna connectors as shown in TS 36.508 [7] Figure A.4.
2. The parameter settings for the cell are set up according to TS 36.508 [7] subclause 4.4.3.
3. Downlink signals are initially set up according to Annex C0, C.1 and C.3.1, and uplink signals according to Annex H.1 and H.3.1.
4. The UL and DL Reference Measurement channels are set according to Table 7.5.4.1-1.
5. Propagation conditions are set according to Annex B.0.
6. Ensure the UE is in State 3A-RF according to TS 36.508 [7] clause 5.2A.2. Message contents are defined in clause 7.5.4.3.

### 7.5.4.2 Test procedure

1. SS transmits PDSCH via PDCCH DCI format 1A for C\_RNTI to transmit the DL RMC according to Table 7.5.4.1-1. The SS sends downlink MAC padding bits on the DL RMC.
2. SS sends uplink scheduling information for each UL HARQ process via PDCCH DCI format 0 for C\_RNTI to schedule the UL RMC according to Table 7.5.4.1-1. Since the UE has no payload data to send, the UE transmits uplink MAC padding bits on the UL RMC.

3. Set the Downlink signal level to the value as defined in Table 7.5.5-2 (Case 1). Send Uplink power control commands to the UE (less or equal to 1dB step size should be used), to ensure that the UE output power is within +0, - 3.4 dB of the target level in Table 7.5.5-2 (Case 1) for carrier frequency  $f \leq 3.0\text{GHz}$  or within +0, -4.0 dB of the target level for carrier frequency  $3.0\text{GHz} < f \leq 4.2\text{GHz}$ , for at least the duration of the Throughput measurement.
4. Set the Interferer signal level to the value as defined in Table 7.5.5-2 (Case 1) and frequency below the wanted signal, using a modulated interferer bandwidth as defined in Annex D of the present document.
5. Measure the average throughput for a duration sufficient to achieve statistical significance according to Annex G.2.
6. Repeat steps from 3 to 5, using an interfering signal above the wanted signal in Case 1 at step 4.
7. Set the Downlink signal level to the value as defined in Table 7.5.5-3 (Case 2). Send Uplink power control commands to the UE (less or equal to 1dB step size should be used), to ensure that the UE output power is within +0, - 3.4 dB of the target level in Table 7.5.5-3 (Case 2) for carrier frequency  $f \leq 3.0\text{GHz}$  or within +0, -4.0 dB of the target level for carrier frequency  $3.0\text{GHz} < f \leq 4.2\text{GHz}$ , for at least the duration of the Throughput measurement.
8. Set the Interferer signal level to the value as defined in Table 7.5.5-3 (Case 2) and frequency below the wanted signal, using a modulated interferer bandwidth as defined in Annex D of the present document.
9. Measure the average throughput for a duration sufficient to achieve statistical significance according to Annex G.2.
10. Repeat steps from 7 to 9, using an interfering signal above the wanted signal in Case 2 at step 8.
11. Repeat for applicable channel bandwidths and operating band combinations in both Case 1 and Case 2.

### 7.5.4.3 Message contents

Message contents are according to TS 36.508 [7] subclause 4.6 with the following exception

**Table 7.5.4.3-1: UplinkPowerControlDedicated**

Derivation Path: 36.331 clause 6.3.2			
Information Element	Value/remark	Comment	Condition
UplinkPowerControlDedicated-DEFAULT ::= SEQUENCE {			
p0-UePUSCH	0		
deltaMCS-Enabled	en0		
accumulationEnabled	TRUE		
p0-uePUCCH	0		
pSRS-Offset	3 (-6 dB)		
filterCoefficient	fc8	larger filter length is used to reduce the RSRP measurement variation	
}			

## 7.5.5 Test requirement

The throughput  $R_{av}$  shall be  $\geq 95\%$  of the maximum throughput of the reference measurement channels as specified in Annex A.3.2 under the conditions specified in table 7.5.5-2, and also under the conditions specified in table 7.5.5-3.

**Table 7.5.5-1: Adjacent channel selectivity**

Rx Parameter	Units	Channel bandwidth					
		1.4 MHz	3 MHz	5 MHz	10 MHz	15 MHz	20 MHz
ACS	dB	33.0	33.0	33.0	33.0	30	27

Table 7.5.5-2: Test parameters for Adjacent channel selectivity, Case 1

Rx Parameter	Units	Channel bandwidth					
		1.4MHz	3 MHz	5 MHz	10 MHz	15 MHz	20 MHz
Power in Transmission Bandwidth Configuration	dBm	REFSENS + 14 dB					
$P_{\text{Interferer}}$	dBm	REFSENS +45.5dB	REFSENS +45.5dB	REFSENS +45.5dB	REFSENS +45.5dB	REFSENS +42.5dB	REFSENS +39.5dB
$BW_{\text{Interferer}}$	MHz	1.4	3	5	5	5	5
$F_{\text{Interferer}}$ (offset)	MHz	1.4+0.0025/ -1.4-0.0025	3+0.0075 / -3-0.0075	5+0.0025 / -5-0.0025	7.5+0.0075 / -7.5-0.0075	10+0.0125 / -10-0.0125	12.5+0.0025 5 / -12.5-0.0025
Note 1: The transmitter shall be set to 4dB below $P_{\text{CMAX\_L}}$ with $P_{\text{CMAX\_L}}$ as defined in clause 6.2.5.							
Note 2: The interferer consists of the Reference measurement channel specified in Annex A.3.2 with one sided dynamic OCNG Pattern OP.1 FDD/TDD as described in Annex A.5.1.1/A.5.2.1 and set-up according to Annex C.3.1.							

Table 7.5.5-3: Test parameters for Adjacent channel selectivity, Case 2

Rx Parameter	Units	Channel bandwidth					
		1.4 MHz	3 MHz	5 MHz	10 MHz	15 MHz	20 MHz
Power in Transmission Bandwidth Configuration	dBm	-56.5	-56.5	-56.5	-56.5	-53.5	-50.5
$P_{\text{Interferer}}$	dBm	-25					
$BW_{\text{Interferer}}$	MHz	1.4	3	5	5	5	5
$F_{\text{Interferer}}$ (offset)	MHz	1.4+0.0025 / -1.4-0.0025	3+0.0075 / -3-0.0075	5+0.0025 / -5-0.0025	7.5+0.0075 / -7.5-0.0075	10+0.0125 / -10-0.0125	12.5+0.0025 5 / -12.5-0.0025
Note 1: The transmitter shall be set to 24dB below $P_{\text{CMAX\_L}}$ with $P_{\text{CMAX\_L}}$ as defined in clause 6.2.5.							
Note 2: The interferer consists of the Reference measurement channel specified in Annex A.3.2 with one sided dynamic OCNG Pattern OP.1 FDD/TDD as described in Annex A.5.1.1/A.5.2.1 and set-up according to Annex C.3.1.							

## 7.5A Adjacent Channel Selectivity (ACS) for CA

### 7.5A.0 Minimum conformance requirements

For inter-band carrier aggregation with one component carrier per operating band and the uplink assigned to one E-UTRA band, the adjacent channel requirements are defined with the uplink active on the band(s) other than the band whose downlink is being tested. The UE shall meet the requirements specified in subclause 7.5.3 for each component carrier while all downlink carriers are active. For E-UTRA CA configurations including an operating band without uplink band (as noted in Table 5.2-1), the requirements for all downlinks shall be met with the single uplink carrier active in each band capable of UL operation. For E-UTRA CA configurations listed in Table 7.3A.0-1 under conditions for which reference sensitivity for the operating band being tested is N/A, the adjacent channel requirements of subclause 7.5A.0 do not apply.

For intra-band contiguous carrier aggregation the downlink SCC(s) shall be configured at nominal channel spacing to the PCC. For FDD, the PCC shall be configured closest to the uplink band. All downlink carriers shall be active throughout the test. The uplink output power shall be set as specified in Table 7.5A.0-2 or Table 7.5A.0-3 with the uplink configuration set according to Table 7.3A.0-2 for the applicable carrier aggregation configuration. For UE(s) supporting one uplink carrier, the uplink configuration of the PCC shall be in accordance with Table 7.3.3-2. The UE shall fulfil the minimum requirement specified in Table 7.5A.0-1 for an adjacent channel interferer on either side of the aggregated downlink signal at a specified frequency offset and for an interferer power up to -25 dBm. The throughput of each carrier shall be  $\geq 95\%$  of the maximum throughput of the reference measurement channels as specified in Annexes A.2.2, A.2.3 and A.3.2 (with one sided dynamic OCNG Pattern OP.1 FDD/TDD for the DL-signal as described in Annex A.5.1.1/A.5.2.1) with parameters specified in Tables 7.5A.0-2 and 7.5A.0-3.



For intra-band non-contiguous carrier aggregation with one uplink carrier and two downlink sub-blocks, each larger than or equal to 5 MHz, the adjacent channel selectivity requirements are defined with the uplink configuration in accordance with Table 7.3A.0-3. For this uplink configuration, the UE shall meet the requirements for each sub-block as specified in subclauses 7.5.3 and 7.5A.0 for a single component carrier and intra-band contiguous component carriers per sub-block, respectively. The requirements apply for in-gap and out-of-gap interferers while all downlink carriers are active. The interferer power  $P_{interferer}$  for Case 1 in Table 7.5.3-2 and Table 7.5A.0-2 shall be set to the maximum of the levels given by the carriers of the respective sub-blocks. For both Case 1 and Case 2 (Table 7.5.3-3 and Table 7.5A.0-3), the wanted signal power level for the carriers of each sub-block shall be set in accordance with the ACS requirement (Table 7.5.3-1 and Table 7.5A.0-1) relative to the interferer power  $P_{interferer}$ .

**Table 7.5A.0-1: Adjacent channel selectivity**

Rx Parameter	Units	CA Bandwidth Class				
		B	C	D	E	F
ACS	dB	27	24	22.2		

**Table 7.5A.0-2: Test parameters for Adjacent channel selectivity, Case 1**

Rx Parameter	Units	CA Bandwidth Class				
		B	C	D	E	F
Pw in Transmission Bandwidth Configuration, per CC		REFSENS + 14 dB	REFSENS + 14 dB	REFSENS + 14 dB		
$P_{interferer}$	dBm	Aggregated power + 25.5 dB	Aggregated power + 22.5 dB	Aggregated power + 20.7 dB		
$BW_{interferer}$	MHz	5	5	5		
$F_{interferer}$ (offset)	MHz	$2.5 + F_{offset}$ / $-2.5 - F_{offset}$	$2.5 + F_{offset}$ / $-2.5 - F_{offset}$	$2.5 + F_{offset}$ / $-2.5 - F_{offset}$		
<p>NOTE 1: The transmitter shall be set to 4dB below <math>P_{C_{MAX\_L}}</math> or <math>P_{C_{MAX\_L\_CA}}</math> as defined in subclause 6.2.5A.</p> <p>NOTE 2: The interferer consists of the Reference measurement channel specified in Annex A.3.2 with one sided dynamic OCNG Pattern OP.1 FDD/TDD as described in Annex A.5.1.1/A.5.2.1 and set-up according to Annex C.3.1.</p> <p>NOTE 3: The <math>F_{interferer}</math> (offset) is relative to the centre frequency of the adjacent CC being tested and shall be further adjusted to <math>\lfloor F_{interferer} / 0.015 + 0.5 \rfloor 0.015 + 0.0075</math> MHz to be offset from the sub-carrier raster for interferer signal above the wanted signal and adjusted to <math>\lfloor F_{interferer} / 0.015 + 0.5 \rfloor 0.015 - 0.0075</math> MHz to be offset from the sub-carrier raster for interferer signal below the wanted signal.</p>						

Table 7.5A.0-3: Test parameters for Adjacent channel selectivity, Case 2

Rx Parameter	Units	CA Bandwidth Class				
		B	C	D	E	F
Pw in Transmission Bandwidth Configuration, per CC	dBm	-50.5 $+10\log_{10}(N_{RB,c}/N_{RB,agg})$	-47.5 $+10\log_{10}(N_{RB,c}/N_{RB,agg})$	-43.9 $+10\log_{10}(N_{RB,c}/N_{RB,agg})$		
$P_{Interferer}$	dBm	-25				
$BW_{Interferer}$	MHz	5	5	5		
$F_{Interferer}$ (offset)	MHz	$2.5+ F_{offset}$ / $-2.5- F_{offset}$	$2.5+ F_{offset}$ / $-2.5- F_{offset}$	$2.5+ F_{offset}$ / $-2.5- F_{offset}$		
NOTE 1: The transmitter shall be set to 24dB below $P_{CMAX\_L}$ or $P_{CMAX\_L\_CA}$ as defined in subclause 6.2.5A.						
NOTE 2: The interferer consists of the Reference measurement channel specified in Annex 3.2 with one sided dynamic OCNG Pattern OP.1 FDD/TDD as described in Annex A.5.1.1/A.5.2.1 and set-up according to Annex C.3.1						
NOTE 3: The $F_{Interferer}$ (offset) is relative to the centre frequency of the adjacent CC being tested and shall be further adjusted to $\lfloor F_{interferer} / 0.015 + 0.5 \rfloor 0.015 + 0.0075$ MHz to be offset from the sub-carrier raster for interferer signal above the wanted signal and adjusted to $\lfloor F_{interferer} / 0.015 + 0.5 \rfloor 0.015 - 0.0075$ MHz to be offset from the sub-carrier raster for interferer signal below the wanted signal.						

For combinations of intra-band contiguous and inter-band carrier aggregation with three downlink carriers and one uplink carrier assigned to one E-UTRA band, the requirement is defined with the uplink active in the band other than that supporting the downlink(s) under test and a configuration in accordance with Table 7.3.3-2. The downlink PCC carrier centre frequency shall be configured closer to the uplink operating band than the downlink SCC centre frequency when the uplink is active in the band supporting two component carriers. For E-UTRA CA configurations including an operating band without uplink band, the requirements for all downlinks shall be met with the single uplink carrier active in each band capable of UL operation. For these uplink configurations, the UE shall meet the adjacent channel selectivity requirements for intra-band contiguous carrier aggregation of two downlink carriers and for the remaining component carrier the requirements specified in subclause 7.5.3. The three downlink carriers shall be active throughout the tests.

For combinations of intra-band non-contiguous and inter-band carrier aggregation with three downlink carriers and one uplink carrier assigned to one E-UTRA band, the requirement is defined with the uplink active in the band other than that supporting the downlink(s) under test. The uplink configuration shall be in accordance with Table 7.3A.0-3 when the uplink is active in the band supporting two component carriers and in accordance with Table 7.3.3-2 when the uplink is active in the other band. For E-UTRA CA configurations including an operating band without uplink band, the requirements for all downlinks shall be met with the single uplink carrier active in each band capable of UL operation. For these uplink configurations, the UE shall meet the adjacent channel selectivity requirements for intra-band non-contiguous carrier aggregation of two downlink carriers with  $\Delta R_{IBNC} = 0$  dB for all sub-block gaps (Table 7.3A.0-3) and for the remaining component carrier the requirements specified in subclause 7.5.3. The three downlink carriers shall be active throughout the tests.

The normative references for this requirement are TS 36.101 [2] clauses 7.5.1A and 7.5.1.

## 7.5A.1 Adjacent Channel Selectivity (ACS) for CA (intra-band contiguous DL CA and UL CA)

### 7.5A.1.1 Test purpose

Adjacent channel selectivity for CA test verifies the UE's ability to receive data with a given average throughput for a specified reference measurement channel, in the presence of an adjacent channel signal at a given frequency offset from the centre frequency of the assigned channel, under conditions of ideal propagation and no added noise.

A UE unable to meet the throughput requirement under these conditions will decrease the coverage area when other e-NodeB transmitters exist in the adjacent channel.

### 7.5A.1.2 Test applicability

This test applies to all types of E-UTRA UE release 10 and forward that support intra-band contiguous DL CA and UL CA.

### 7.5A.1.3 Minimum conformance requirements

The minimum conformance requirements are defined in clause 7.5A.0.

### 7.5A.1.4 Test description

#### 7.5A.1.4.1 Initial conditions

Initial conditions are a set of test configurations the UE needs to be tested in and the steps for the SS to take with the UE to reach the correct measurement state.

The initial test configurations consist of environmental conditions, test frequencies, and channel bandwidths based on E-UTRA CA configurations specified in table 5.4.2A.1-1. All of these configurations shall be tested with applicable test parameters for each channel bandwidth, and are shown in table 7.5A.1.4.1-1. The details of the uplink and downlink reference measurement channels (RMCs) are specified in Annexes A.2 and A.3 respectively. The details of the OCNG patterns used are specified in Annex A.5. Configurations of PDSCH and PDCCH before measurement are specified in Annex C.2.

**Table 7.5A.1.4.1-1: Test Configuration Table**

Initial Conditions									
Test Environment as specified in TS 36.508[7] clause 4.1					NC				
Test Frequencies as specified in TS36.508 [7] clause 4.3.1 for different CA bandwidth classes, and PCC and SCCs are mapped onto physical frequencies according to Table 7.1-2					C: Mid range				
Test CC Combination setting ( $N_{RB\_agg}$ ) as specified in clause 5.4.2A.1 for the CA Configuration across bandwidth combination sets supported by the UE					Lowest $N_{RB\_agg}$ Highest $N_{RB\_agg}$ (Note 3)				
Test Parameters for CA Configurations									
CA Configuration / $N_{RB\_agg}$		DL Allocation			UL Allocation				
PCC $N_{RB}$	SCC $N_{RB}$	CC MOD	PCC & SCC RB allocation	CC MOD	$N_{RB\_allo\ c}$	PCC & SCC RB allocations (LCRB @ RB <sub>start</sub> )			
75	75	QPSK	75+75	QPSK	75	P_75@0	S_0@0	-	-
75	75	QPSK	75+75	QPSK	129	P_75@0	S_54@0	-	-
75	75	QPSK	75+75	QPSK	150	P_75@0	S_75@0	-	-
100	25	QPSK	100+25	QPSK	50	P_50@50	S_0@0	-	-
100	25	QPSK	100+25	QPSK	125	P_100@0	S_25@0	-	-
100	50	QPSK	100+50	QPSK	50	P_50@50	S_0@0	-	-
100	50	QPSK	100+50	QPSK	75	P_75@25	S_0@0	-	-
100	50	QPSK	100+50	QPSK	150	P_100@0	S_50@0	-	-
100	75	QPSK	100+75	QPSK	175	P_100@0	S_75@0	-	-
100	100	QPSK	100+100	QPSK	50	P_50@50	S_0@0	-	-
100	100	QPSK	100+100	QPSK	75	P_75@25	S_0@0	-	-
100	100	QPSK	100+100	QPSK	130	P_100@0	S_30@0	-	-
100	100	QPSK	100+100	QPSK	200	P_100@0	S_100@0	-	-
Note 1: CA Configuration Test CC Combination settings are checked separately for each CA Configuration, which applicable aggregated channel bandwidths are specified in Table 5.4.2A.1-1. Note 2: Depending on CA configurations, only the appropriate Uplink RB allocation value according to table 7.3.3-2 for UE supporting one uplink carrier and to table 7.3A.0-2 for UE supporting two uplink carriers are tested per Test CA configuration. Note 3: If in the CA Configuration UE supports multiple CC Combinations with the same $N_{RB\_agg}$ , only the first of those is tested, according to the order on the Test Configuration Table list.									

1. Connect the SS and interfering source to the UE antenna connectors as shown in TS 36.508 [7] Annex A, Figure group A.34 as appropriate.
2. The parameter settings for the cell are set up according to TS 36.508 [7] clause 4.4.3.
3. Downlink signals for PCC are initially set up according to Annex C.0, C.1 and C.3.0, and uplink signals according to Annex H.1 and H.3.0.
4. The UL and DL Reference Measurement channels are set according to Table 7.5A.1.4.1-1.
5. Propagation conditions are set according to Annex B.0.
6. Ensure the UE is in State 3A-RF according to TS 36.508 [7] clause 5.2A.2. Message contents are defined in clause 7.5A.1.4.3.

#### 7.5A.1.4.2 Test procedure

1. Configure SCC according to Annex C.0, C.1 and Annex C.3.1 for all downlink physical channels.
2. The SS shall configure SCC as per TS 36.508 [7] clause 5.2A.4. Message contents are defined in clause 7.5A.1.4.3.
3. SS activates SCC by sending the activation MAC-CE (Refer TS 36.321 [13], clauses 5.13, 6.1.3.8). Wait for at least 2 seconds (Refer TS 36.133, clauses 8.3.3.2).
4. SS transmits PDSCH via PDCCH DCI format 1A for C\_RNTI to transmit the DL RMC according to Tables 7.5A.1.4.1-1 on both PCC and SCC. The SS sends downlink MAC padding bits on the DL RMC.
5. SS sends uplink scheduling information for each UL HARQ process via PDCCH DCI format 0 for C\_RNTI to schedule the UL RMC according to Table 7.5A.1.4.1-1 on both PCC and SCC. Since the UE has no payload and no loopback data to send the UE sends uplink MAC padding bits on the UL RMC.
6. Set the Downlink signal level for PCC and SCC to the value as defined in Table 7.5A.1.5-2 (Case 1). Send Uplink power control commands to the UE (less or equal to 1dB step size should be used), to ensure that for at least the duration of the Throughput measurement:  
The PCC output power is within (+0dB, -3.4 dB) of (target level in Table 7.5A.1.5-2 (Case 1) +  $10\log(P_{L_{CRB}}/N_{RB\_alloc})$ ), for carrier frequency  $f \leq 3.0\text{GHz}$ ,  
or within (+0dB, -4 dB) of (target level in Table 7.5A.1.5-2 (Case 1) +  $10\log(P_{L_{CRB}}/N_{RB\_alloc})$ ) for carrier frequency  $3.0\text{GHz} < f \leq 4.2\text{GHz}$ .  
The SCC output power is within (+0dB, -3.4 dB) of (target level in Table 7.5A.1.5-2 (Case 1) +  $10\log(S_{L_{CRB}}/N_{RB\_alloc})$ ), for carrier frequency  $f \leq 3.0\text{GHz}$ ,  
or within (+0dB, -4 dB) of (target level in Table 7.5A.1.5-2 (Case 1) +  $10\log(S_{L_{CRB}}/N_{RB\_alloc})$ ) for carrier frequency  $3.0\text{GHz} < f \leq 4.2\text{GHz}$ .  
7. Set the Interferer signal level to the value as defined in Table 7.5A.1.5-2 (Case 1) and frequency below the wanted signal, using a modulated interferer bandwidth as defined in Annex D of the present document.
8. Measure the average throughput for each component carrier for a duration sufficient to achieve statistical significance according to Annex G.2A.
9. Repeat steps from 6 to 8, using an interfering signal above the wanted signal in Case 1 at step 7.
10. Set the Downlink signal level for PCC and SCC to the value as defined in Table 7.5A.1.5-3 (Case 2). Send Uplink power control commands to the UE (less or equal to 1dB step size should be used), to ensure that for at least the duration of the Throughput measurement:  
The PCC output power is within (+0dB, -3.4 dB) of (target level in Table 7.5A.1.5-3 (Case 2) +  $10\log(P_{L_{CRB}}/N_{RB\_alloc})$ ), for carrier frequency  $f \leq 3.0\text{GHz}$ ,  
or within (+0dB, -4 dB) of (target level in Table 7.5A.1.5-3 (Case 2) +  $10\log(P_{L_{CRB}}/N_{RB\_alloc})$ ) for carrier frequency  $3.0\text{GHz} < f \leq 4.2\text{GHz}$ .  
The SCC output power is within (+0dB, -3.4 dB) of (target level in Table 7.5A.1.5-3 (Case 2) +  $10\log(S_{L_{CRB}}/N_{RB\_alloc})$ ), for carrier frequency  $f \leq 3.0\text{GHz}$ ,  
or within (+0dB, -4 dB) of (target level in Table 7.5A.1.5-3 (Case 2) +  $10\log(S_{L_{CRB}}/N_{RB\_alloc})$ ) for carrier frequency  $3.0\text{GHz} < f \leq 4.2\text{GHz}$ .  
11. Set the Interferer signal level to the value as defined in Table 7.5A.1.5-3 (Case 2) and frequency below the wanted signal, using a modulated interferer bandwidth as defined in Annex D of the present document.

12. Measure the average throughput for each component carrier for a duration sufficient to achieve statistical significance according to Annex G.2A.

13. Repeat steps from 10 to 12, using an interfering signal above the wanted signal in Case 2 at step 11.

### 7.5A.1.4.3 Message contents

Message contents are according to TS 36.508 [7] subclause 4.6 with the following exception.

**Table 7.5A.1.4.3-1: UplinkPowerControlDedicatedSCell-r10**

Derivation Path: 36.508 clause 4.6.3			
Information Element	Value/remark	Comment	Condition
UplinkPowerControlDedicated-DEFAULT ::= SEQUENCE {			
p0-UE-PUSCH-r10	0		
deltaMCS-Enabled-r10	en0		
accumulationEnabled-r10	TRUE		
pSRS-Offset-r10	7 (0 dB)	The actual parameter value is $-10.5 + 1.5 \cdot \text{pSRS-Offset value}$ ; 0 is the actual value in dB ( $-10.5 + 1.5 \cdot 7$ dB).	
pSRS-OffsetAp-r10	7 (0 dB)	The actual parameter value is $-10.5 + 1.5 \cdot \text{pSRS-Offset value}$ ; 0 is the actual value in dB ( $-10.5 + 1.5 \cdot 7$ dB).	
filterCoefficient-r10	fc8	larger filter length is used to reduce the RSRP measurement variation	
pathlossReferenceLinking-r10	sCell		
}			

### 7.5A.1.5 Test Requirements

The throughput of each carrier shall be  $\geq 95\%$  of the maximum throughput of the reference measurement channels as specified in Annex A.3.2 under the conditions specified in table 7.5A.1.5-2, and also under the conditions specified in table 7.5A.1.5-3.

**Table 7.5A.1.5-1: Adjacent channel selectivity**

Rx Parameter	Units	CA Bandwidth Class				
		B	C	D	E	F
ACS	dB		24			

**Table 7.5A.1.5-2: Test parameters for Adjacent channel selectivity, Case 1**

Rx Parameter	Units	CA Bandwidth Class				
		B	C	D	E	F
Pw in Transmission Bandwidth Configuration, per CC			REFSENS + 14 dB			
$P_{\text{Interferer}}$	dBm		Aggregated power + 22.5 dB			
$BW_{\text{Interferer}}$	MHz		5			
$F_{\text{Interferer}}$ (offset)	MHz		$2.5 + F_{\text{offset}}$ / $-2.5 - F_{\text{offset}}$			
<p>Note 1: The transmitter shall be set to 4dB below <math>P_{\text{CMAX\_L}}</math> or <math>P_{\text{CMAX\_L\_CA}}</math> as defined in subclause 6.2.5 for one uplink carrier and in subclause 6.2.5A for two uplink carriers.</p> <p>Note 2: The interferer consists of the Reference measurement channel specified in Annex A.3.2 with one sided dynamic OCNG Pattern OP.1 FDD/TDD as described in Annex A.5.1.1/A.5.2.1 and set-up according to Annex C.3.1</p> <p>Note 3: The <math>F_{\text{interferer}}</math> (offset) is relative to the centre frequency of the adjacent CC being tested and shall be further adjusted to <math>\lfloor F_{\text{interferer}} / 0.015 + 0.5 \rfloor 0.015 + 0.0075</math> MHz to be offset from the sub-carrier raster for interferer signal above the wanted signal and adjusted to <math>\lfloor F_{\text{interferer}} / 0.015 + 0.5 \rfloor 0.015 - 0.0075</math> MHz to be offset from the sub-carrier raster for interferer signal below the wanted signal.</p>						

**Table 7.5A.1.5-3: Test parameters for Adjacent channel selectivity, Case 2**

Rx Parameter	Units	CA Bandwidth Class				
		B	C	D	E	F
Pw in Transmission Bandwidth Configuration, per CC	dBm		$-47.5 + 10\log(N_{\text{RB}} / N_{\text{RB\_agg}})$			
$P_{\text{Interferer}}$	dBm			-25		
$BW_{\text{Interferer}}$	MHz		5			
$F_{\text{Interferer}}$ (offset)	MHz		$2.5 + F_{\text{offset}}$ / $-2.5 - F_{\text{offset}}$			
<p>Note 1: The transmitter shall be set to 24dB below <math>P_{\text{CMAX\_L}}</math> or <math>P_{\text{CMAX\_L\_CA}}</math> as defined in subclause 6.2.5 for one uplink carrier and in subclause 6.2.5A for two uplink carriers.</p> <p>Note 2: The interferer consists of the Reference measurement channel specified in Annex 3.2 with one sided dynamic OCNG Pattern OP.1 FDD/TDD as described in Annex A.5.1.1/A.5.2.1 and set-up according to Annex C.3.1</p> <p>Note 3: The <math>F_{\text{interferer}}</math> (offset) is relative to the centre frequency of the adjacent CC being tested and shall be further adjusted to <math>\lfloor F_{\text{interferer}} / 0.015 + 0.5 \rfloor 0.015 + 0.0075</math> MHz to be offset from the sub-carrier raster for interferer signal above the wanted signal and adjusted to <math>\lfloor F_{\text{interferer}} / 0.015 + 0.5 \rfloor 0.015 - 0.0075</math> MHz to be offset from the sub-carrier raster for interferer signal below the wanted signal.</p>						

## 7.5A.2 Adjacent Channel Selectivity (ACS) for CA (intra-band contiguous DL CA without UL CA)

### 7.5A.2.1 Test purpose

The test purpose is the same as in clause 7.5A.1.1.

### 7.5A.2.2 Test applicability

This test applies to all types of E-UTRA UE release 10 and forward that support intra-band contiguous DL CA. This test case applies only for CA Configurations that do not support UL CA.

### 7.5A.2.3 Minimum conformance requirements

The minimum conformance requirements are defined in clause 7.5A.0.

## 7.5A.2.4 Test description

### 7.5A.2.4.1 Initial conditions

Same as in clause 7.5A.1.4.1 with the following exceptions:

- Instead of Table 7.5A.1.4.1-1 → use Table 7.5A.2.4.1-1.
- Instead of clause 7.5A.1.4.3 → use clause 7.5A.2.4.3.

**Table 7.5A.2.4.1-1: Test Configuration Table**

Initial Conditions									
Test Environment as specified in TS 36.508[7] clause 4.1					NC				
Test Frequencies as specified in TS36.508 [7] clause 4.3.1 for different CA bandwidth classes, and PCC and SCCs are mapped onto physical frequencies according to Table 7.1-2					B: Mid range C: Mid range				
Test CC Combination setting ( $N_{RB\_agg}$ ) as specified in clause 5.4.2A.1 for the CA Configuration across bandwidth combination sets supported by the UE.					Lowest $N_{RB\_agg}$ Highest $N_{RB\_agg}$ (Note 3)				
Test Parameters for CA Configurations									
CA Configuration / $N_{RB\_agg}$		DL Allocation			UL Allocation				
PCC $N_{RB}$	SCC $N_{RB}$	CC MOD	PCC & SCC RB allocation	CC MOD	$N_{RB\_alloc}$	PCC & SCC RB allocations (LCRB @ RB <sub>start</sub> )			
6	25	QPSK	6+25	QPSK	6	P_6@0	-	-	-
15	50	QPSK	15+50	QPSK	15	P_15@0	-	-	-
25	25	QPSK	25+25	QPSK	20	P_20@0	-	-	-
25	50	QPSK	25+50	QPSK	20	P_20@0	-	-	-
50	50	QPSK	50+50	QPSK	50	P_50@0	-	-	-
75	75	QPSK	75+75	QPSK	75	P_75@0	-	-	-
100	25	QPSK	100+25	QPSK	100	P_100@0	-	-	-
100	25	QPSK	100+25	QPSK	50	P_50@50	-	-	-
100	50	QPSK	100+50	QPSK	100	P_100@0	-	-	-
100	50	QPSK	100+50	QPSK	75	P_75@25	-	-	-
100	50	QPSK	100+50	QPSK	50	P_50@50	-	-	-
100	75	QPSK	100+75	QPSK	100	P_100@0	-	-	-
100	100	QPSK	100+100	QPSK	100	P_100@0	-	-	-
100	100	QPSK	100+100	QPSK	75	P_75@25	-	-	-
100	100	QPSK	100+100	QPSK	50	P_50@50	-	-	-
Note 1: CA Configuration Test CC Combination settings are checked separately for each CA Configuration, which applicable aggregated channel bandwidths are specified in Table 5.4.2A.1-1. Note 2: Depending on CA configurations, only the appropriate Uplink RB allocation value according to table 7.3.3-2 for UE supporting one uplink carrier. Note 3: If in the CA Configuration UE supports multiple CC Combinations with the same $N_{RB\_agg}$ , only the first of those is tested, according to the order on the Test Configuration Table list.									

### 7.5A.2.4.2 Test procedure

1. Configure SCC according to Annex C.0, C.1 and Annex C.3.1 for all downlink physical channels.

2. The SS shall configure SCC as per TS 36.508 [7] clause 5.2A.4.
3. SS activates SCC by sending the activation MAC-CE (Refer TS 36.321 [13], clauses 5.13, 6.1.3.8). Wait for at least 2 seconds (Refer TS 36.133, clauses 8.3.3.2).
4. SS transmits PDSCH via PDCCH DCI format 1A for C\_RNTI to transmit the DL RMC according to Tables 7.5A.2.4.1-1 on both PCC and SCC. The SS sends downlink MAC padding bits on the DL RMC.
5. SS sends uplink scheduling information for each UL HARQ process via PDCCH DCI format 0 for C\_RNTI to schedule the UL RMC according to Table 7.5A.2.4.1-1 on PCC. Since the UE has no payload and no loopback data to send the UE sends uplink MAC padding bits on the UL RMC.
6. Set the Downlink signal level for PCC and SCC to the value as defined in Table 7.5A.1.5-2 (Case 1). Send Uplink power control commands to the UE (less or equal to 1dB step size should be used), to ensure that the UE output power is within +0, - 3.4 dB of the target level in Table 7.5A.1.5-2 (Case 1) for carrier frequency  $f \leq 3.0\text{GHz}$  or within +0, -4.0 dB of the target level for carrier frequency  $3.0\text{GHz} < f \leq 4.2\text{GHz}$ , for at least the duration of the Throughput measurement.
7. Set the Interferer signal level to the value as defined in Table 7.5A.1.5-2 (Case 1) and frequency below the aggregated component carriers, using a modulated interferer bandwidth as defined in Annex D of the present document.
8. Measure the average throughput for each component carrier for a duration sufficient to achieve statistical significance according to Annex G.2A.
9. Repeat steps from 6 to 8, using an interfering signal above the aggregated component carriers in Case 1 at step 7.
10. Set the Downlink signal level for PCC and SCC to the value as defined in Table 7.5A.1.5-3 (Case 2). Send Uplink power control commands to the UE (less or equal to 1dB step size should be used), to ensure that the UE output power is within +0, - 3.4 dB of the target level in Table 7.5A.1.5-3 (Case 2) for carrier frequency  $f \leq 3.0\text{GHz}$  or within +0, -4.0 dB of the target level for carrier frequency  $3.0\text{GHz} < f \leq 4.2\text{GHz}$ , for at least the duration of the Throughput measurement.
11. Set the Interferer signal level to the value as defined in Table 7.5A.1.5-3 (Case 2) and frequency below the aggregated component carriers, using a modulated interferer bandwidth as defined in Annex D of the present document.
12. Measure the average throughput for each component carrier for a duration sufficient to achieve statistical significance according to Annex G.2A.
13. Repeat steps from 10 to 12, using an interfering signal above the aggregated component carriers in Case 2 at step 11.

#### 7.5A.2.4.3 Message contents

The message contents are the same as in clause 7.5.4.3.

#### 7.5A.2.5 Test Requirements

The test requirements are the same as in clause 7.5A.1.5 with the following exceptions:

- Instead of Table 7.5A.1.5-1 → use Table 7.5A.2.5-1.
- Instead of Table 7.5A.1.5-2 → use Table 7.5A.2.5-2.
- Instead of Table 7.5A.1.5-3 → use Table 7.5A.2.5-3.

**Table 7.5A.2.5-1: Adjacent channel selectivity**

Rx Parameter	Units	CA Bandwidth Class				
		B	C	D	E	F
ACS	dB	27	24			



**Table 7.5A.2.5-2: Test parameters for Adjacent channel selectivity, Case 1**

Rx Parameter	Units	CA Bandwidth Class				
		B	C	D	E	F
Pw in Transmission Bandwidth Configuration, per CC		REFSENS + 14 dB	REFSENS + 14 dB			
$P_{Interferer}$	dBm	Aggregated power + 25.5 dB	Aggregated power + 22.5 dB			
$BW_{Interferer}$	MHz	5	5			
$F_{Interferer}$ (offset)	MHz	$2.5 + F_{offset}$ / $-2.5 - F_{offset}$	$2.5 + F_{offset}$ / $-2.5 - F_{offset}$			
Note 1: The transmitter shall be set to 4dB below $P_{CMAX\_L}$ as defined in subclause 6.2.5. Note 2: The interferer consists of the Reference measurement channel specified in Annex A.3.2 with one sided dynamic OCNG Pattern OP.1 FDD/TDD as described in Annex A.5.1.1/A.5.2.1 and set-up according to Annex C.3.1 Note 3: The $F_{interferer}$ (offset) is relative to the centre frequency of the adjacent CC being tested and shall be further adjusted to $\lfloor F_{interferer} / 0.015 + 0.5 \rfloor 0.015 + 0.0075$ MHz to be offset from the sub-carrier raster.						

**Table 7.5A.2.5-3: Test parameters for Adjacent channel selectivity, Case 2**

Rx Parameter	Units	CA Bandwidth Class				
		B	C	D	E	F
Pw in Transmission Bandwidth Configuration, per CC	dBm	-50.5 $+10\log(N_{RB,c} / N_{RB,agg})$	-47.5 $+10\log(N_{RB,c} / N_{RB,agg})$			
$P_{Interferer}$	dBm	-25				
$BW_{Interferer}$	MHz	5	5			
$F_{Interferer}$ (offset)	MHz	$2.5 + F_{offset}$ / $-2.5 - F_{offset}$	$2.5 + F_{offset}$ / $-2.5 - F_{offset}$			
Note 1: The transmitter shall be set to 24dB below $P_{CMAX\_L}$ as defined in subclause 6.2.5. Note 2: The interferer consists of the Reference measurement channel specified in Annex 3.2 with one sided dynamic OCNG Pattern OP.1 FDD/TDD as described in Annex A.5.1.1/A.5.2.1 and set-up according to Annex C.3.1 Note 3: The $F_{interferer}$ (offset) is relative to the centre frequency of the adjacent CC being tested and shall be further adjusted to $\lfloor F_{interferer} / 0.015 + 0.5 \rfloor 0.015 + 0.0075$ MHz to be offset from the sub-carrier raster.						

### 7.5A.3 Adjacent Channel Selectivity (ACS) for CA (inter-band DL CA without UL CA)

#### 7.5A.3.1 Test purpose

The test purpose is the same as in clause 7.5A.1.1.

#### 7.5A.3.2 Test applicability

This test applies to all types of E-UTRA UE release 10 and forward that support inter-band DL CA without UL CA.

#### 7.5A.3.3 Minimum conformance requirements

The minimum conformance requirements are defined in clause 7.5A.0.

#### 7.5A.3.4 Test description

##### 7.5A.3.4.1 Initial conditions

Same as in clause 7.5A.1.4.1 with the following exceptions:

- Instead of Table 7.5A.1.4.1-1 → use Table 7.5A.3.4.1-1.
- Instead of clause 7.5A.1.4.3 → use clause 7.5A.3.4.3.

**Table 7.5A.3.4.1-1: Test Configuration Table**

Initial Conditions						
Test Environment as specified in TS 36.508[7] subclause 4.1			NC			
Test Frequencies as specified in TS36.508 [7] subclause 4.3.1 for different CA bandwidth classes, and PCC and SCCs are mapped onto physical frequencies according to Table 7.1-2			A: Mid range for PCC and SCC			
Test CC Combination setting ( $N_{RB\_agg}$ ) as specified in subclause 5.4.2A.1 for the CA Configuration across bandwidth combination sets supported by the UE			Highest $N_{RB\_agg}$ for PCC and SCC			
Test Parameters for CA Configurations						
CA Configuration / $N_{RB\_agg}$		DL Allocation			UL Allocation	
PCC $N_{RB}$	SCCs $N_{RB}$	CC MOD	PCC & SCC RB allocation		CC MOD	PCC $N_{RB\_alloc}$
50	50	QPSK	50	50	QPSK	50
50	50	QPSK	50	50	QPSK	25
50	50	QPSK	50	50	QPSK	20
50	50	QPSK	50	50	QPSK	16
50	75	QPSK	50	75	QPSK	25
50	100	QPSK	50	100	QPSK	50
50	100	QPSK	50	100	QPSK	25
50	100	QPSK	50	100	QPSK	20
75	50	QPSK	75	50	QPSK	25
75	100	QPSK	75	100	QPSK	25
100	50	QPSK	100	50	QPSK	100
100	50	QPSK	100	50	QPSK	75
100	50	QPSK	100	50	QPSK	50
100	75	QPSK	100	75	QPSK	100
100	100	QPSK	100	100	QPSK	75
100	100	QPSK	100	100	QPSK	50
Note 1: CA Configuration Test CC Combination settings are checked separately for each CA Configuration, which applicable aggregated channel bandwidths are specified in Table 5.4.2A.1-2. Note 2: Depending on CA configurations, only the appropriate Uplink RB allocation value according to table 7.3A.3.5-2 for UE supporting one uplink carrier is tested per Test CA configuration. Note 3: The UL resource blocks shall be located as close as possible to the downlink PCC but confined within the transmission bandwidth configuration for the channel bandwidth (Table 5.4.2-1). Note 4: The frequencies of PCC and SCC shall be switched and tested in each configuration, according to the UE declared capability for UL support (within CA operation) in the individual bands.						

#### 7.5A.3.4.2 Test procedure

1. Configure SCC according to Annex C.0, C.1 and Annex C.3.1 for all downlink physical channels.
2. The SS shall configure SCC as per TS 36.508 [7] clause 5.2A.4.
3. SS activates SCC by sending the activation MAC-CE (Refer TS 36.321 [13], clauses 5.13, 6.1.3.8). Wait for at least 2 seconds (Refer TS 36.133, clauses 8.3.3.2).
4. SS transmits PDSCH via PDCCH DCI format 1A for C\_RNTI to transmit the DL RMC according to Tables 7.5A.3.4.1-1 on both PCC and SCC. The SS sends downlink MAC padding bits on the DL RMC.

5. SS sends uplink scheduling information for each UL HARQ process via PDCCH DCI format 0 for C\_RNTI to schedule the UL RMC according to Table 7.5A.3.4.1-1 on PCC. Since the UE has no payload and no loopback data to send the UE sends uplink MAC padding bits on the UL RMC.
6. Set the Downlink signal level for PCC and SCC to the value as defined in Table 7.5A.3.5-2 (Case 1). Send Uplink power control commands to the UE (less or equal to 1dB step size should be used), to ensure that the UE output power is within +0, - 3.4 dB of the target level in Table 7.5A.3.5-2 (Case 1) for carrier frequency  $f \leq 3.0\text{GHz}$  or within +0, -4.0 dB of the target level for carrier frequency  $3.0\text{GHz} < f \leq 4.2\text{GHz}$ , for at least the duration of the Throughput measurement.
7. Set the Interferer signal level to the value as defined in Table 7.5A.3.5-2 (Case 1) and frequency below the wanted signal, using a modulated interferer bandwidth as defined in Annex D of the present document.
8. Measure the average throughput of SCC for a duration sufficient to achieve statistical significance according to Annex G.2.
9. Repeat steps from 6 to 8, using an interfering signal above the wanted signal in Case 1 at step 7.
10. Set the Downlink signal level for PCC and SCC to the value as defined in Table 7.5A.3.5-3 (Case 2). Send Uplink power control commands to the UE (less or equal to 1dB step size should be used), to ensure that the UE output power is within +0, - 3.4 dB of the target level in Table 7.5A.3.5-3 (Case 2) for carrier frequency  $f \leq 3.0\text{GHz}$  or within +0, -4.0 dB of the target level for carrier frequency  $3.0\text{GHz} < f \leq 4.2\text{GHz}$ , for at least the duration of the Throughput measurement.
11. Set the Interferer signal level to the value as defined in Table 7.5A.3.5-3 (Case 2) and frequency below the wanted signal, using a modulated interferer bandwidth as defined in Annex D of the present document.
12. Measure the average throughput of SCC for a duration sufficient to achieve statistical significance according to Annex G.2.
13. Repeat steps from 10 to 12, using an interfering signal above the wanted signal in Case 2 at step 11.

#### 7.5A.3.4.3 Message contents

The message contents are the same as in clause 7.5.4.3.

#### 7.5A.3.5 Test Requirements

For inter-band carrier aggregation with uplink assigned to one E-UTRA band, the adjacent channel requirements are defined with the uplink active on the band other than the band whose downlink is being tested i.e. the requirements are tested only for the SCell downlink. The UE shall meet the requirement specified in Table 7.5A.3.5-1 (originated from the single carrier Table 7.5.3.5-1) with the test parameters specified in Tables 7.5A.3.5-2 and 7.5A.3.5-3 (originated from the single carrier Tables 7.5.5-2 and 7.5.5-3) for each component carrier, when operated as SCell, while both downlink carriers are active.

**Table 7.5A.3.5-1: Adjacent channel selectivity**

Rx Parameter	Units	Channel bandwidth					
		1.4 MHz	3 MHz	5 MHz	10 MHz	15 MHz	20 MHz
ACS	dB	33.0	33.0	33.0	33.0	30	27

**Table 7.5A.3.5-2: Test parameters for Adjacent channel selectivity, Case 1**

Rx Parameter	Units	Channel bandwidth					
		1.4 MHz	3 MHz	5 MHz	10 MHz	15 MHz	20 MHz

Pw in Transmission Bandwidth Configuration, per CC	dBm	REFSENS + 14 dB					
$P_{\text{Interferer}}$	dBm	REFSENS for SCC +45.5dB	REFSENS for SCC+45.5 dB	REFSENS +45.5dB	REFSENS for SCC+45.5 dB	REFSENS for SCC+42.5 dB	REFSENSf or SCC +39.5dB
$BW_{\text{Interferer}}$	MHz	1.4	3	5	5	5	5
$F_{\text{Interferer}}$ (offset from SCC)	MHz	1.4+0.0025 / -1.4-0.0025	3+0.0075 / -3-0.0075	5+0.0025 / -5-0.0025	7.5+0.0075 / -7.5-0.0075	10+0.0125 / -10-0.0125	12.5+0.0025 / -12.5-0.0025
<p>Note 1: The transmitter shall be set to 4dB below <math>P_{\text{CMAX\_L}}</math> at the minimum uplink configuration specified in Table 7.3.3-2 with <math>P_{\text{CMAX\_L}}</math> as defined in clause 6.2.5.</p> <p>Note 2: The interferer consists of the Reference measurement channel specified in Annex A.3.2 with one sided dynamic OCNG Pattern OP.1 FDD/TDD as described in Annex A.5.1.1/A.5.2.1 and set-up according to Annex C.3.1.</p>							

Table 7.5A.3.5-3: Test parameters for Adjacent channel selectivity, Case 2

Rx Parameter	Units	Channel bandwidth					
		1.4 MHz	3 MHz	5 MHz	10 MHz	15 MHz	20 MHz
Pw in Transmission Bandwidth Configuration, per CC	dBm	-56.5	-56.5	-56.5	-56.5	-53.5	-50.5
$P_{\text{Interferer}}$	dBm	-25					
$BW_{\text{Interferer}}$	MHz	1.4	3	5	5	5	5
$F_{\text{Interferer}}$ (offset from SCC)	MHz	1.4+0.0025 / -1.4-0.0025	3+0.0075 / -3-0.0075	5+0.0025 / -5-0.0025	7.5+0.0075 / -7.5-0.0075	10+0.0125 / -10-0.0125	12.5+0.0025 / -12.5-0.0025
<p>Note 1: The transmitter shall be set to 24dB below <math>P_{\text{CMAX\_L}}</math> at the minimum uplink configuration specified in Table 7.3.3-2 with <math>P_{\text{CMAX\_L}}</math> as defined in clause 6.2.5.</p> <p>Note 2: The interferer consists of the Reference measurement channel specified in Annex A.3.2 with one sided dynamic OCNG Pattern OP.1 FDD/TDD as described in Annex A.5.1.1/A.5.2.1 and set-up according to Annex C.3.1.</p>							

## 7.5A.4 Adjacent Channel Selectivity (ACS) for CA (intra-band non-contiguous DL CA without UL CA)

### 7.5A.4.1 Test purpose

Same as in clause 7.5A.1.1.

### 7.5A.4.2 Test applicability

This test case applies to all types of E-UTRA UE release 11 and forward that support intra-band non-contiguous DL CA but no UL CA.

### 7.5A.4.3 Minimum conformance requirements

The minimum conformance requirements are defined in clause 7.5A.0.

### 7.5A.4.4 Test description

#### 7.5A.4.4.1 Initial conditions

Same as in clause 7.5A.1.4.1 with the following exceptions:

- Instead of Table 7.5A.1.4.1-1 → use Tables 7.5A.4.4.1-1.
- Instead of clause 7.5A.1.4.3 → use clause 7.5A.4.4.3.

**Table 7.5A.4.4.1-1: Test Configuration Table**

Initial Conditions							
Test Environment as specified in TS 36.508[7] subclause 4.1				NC			
Test Frequencies as specified in TS36.508 [7] subclause 4.3.1 for different CA bandwidth classes , and PCC and SCCs are mapped onto physical frequencies according to Table 7.1-2				A: N/A (Range is not relevant)			
Test CC Combination setting ( $N_{RB\_agg}$ ) as specified in subclause 5.4.2A.1 for the CA Configuration .				Refer to test point			
Test Parameters for CA Configurations							
ID	CA Configuration / $N_{RB\_agg}$		$W_{gap}$ [MHz]	DL Allocation		UL Allocation	
	PCC $N_{RB}$	SCCs $N_{RB}$		CC MOD	PCC & SCC RB allocation	CC MOD	PCC RB allocations ( $L_{CRB}$ @ $RB_{start}$ )

Test Parameters for CA_2A-2A Configurations							
1	100	25	35	QPSK	100+25	QPSK	P_16@57
2	100	100	20	QPSK	100+100	QPSK	P_16@57
Test Parameters for CA_3A-3A Configurations							
3	100	25	50	QPSK	100+25	QPSK	P_16@50
4	100	25	15	QPSK	100+25	QPSK	P_32@68
5	100	100	35	QPSK	100+100	QPSK	P_16@50
Test Parameters for CA_4A-4A Configurations							
6	100	25	20	QPSK	100+25	QPSK	P_100@0
7	100	100	5	QPSK	100+100	QPSK	P_100@0
Test Parameters for CA_7A-7A Configurations							
8	100	75	35	QPSK	100+75	QPSK	P_36@64
9	100	75	15	QPSK	100+75	QPSK	P_50@50
10	100	100	30	QPSK	100+100	QPSK	P_32@68
11	100	100	15	QPSK	100+100	QPSK	P_45@55
Test Parameters for CA_23A-23A Configurations							
12	50	25	5	QPSK	50+25	QPSK	P_50@0
Test Parameters for CA_25A-25A Configurations							
13	50	25	50	QPSK	50+25	QPSK	P_10@33
14	50	25	15	QPSK	50+25	QPSK	P_32@18
15 <sup>3</sup>	50	50	45	QPSK	50+50	QPSK	P_10@33
16 <sup>3</sup>	50	50	10	QPSK	50+50	QPSK	P_32@18
17 <sup>4</sup>	100	25	40	QPSK	100+25	QPSK	P_12@62
18 <sup>4</sup>	100	100	25	QPSK	100+100	QPSK	P_12@62
Test Parameters for CA_41A-41A Configurations							
19 <sup>4</sup>	100	25	169	QPSK	100+25	QPSK	P_100@0
20 <sup>3</sup>	100	50	164	QPSK	100+50	QPSK	P_100@0
21	100	100	154	QPSK	100+100	QPSK	P_100@0
Test Parameters for CA_42A-42A Configurations							
22	100	25	175	QPSK	100+25	QPSK	P_100@0
23	100	100	160	QPSK	100+100	QPSK	P_100@0
Note 1:	CA Configuration Test CC Combination settings are checked separately for each CA Configuration, which applicable aggregated channel bandwidths are specified in Table 5.4.2A.1-3.						
Note 2:	The carrier centre frequency of PCC in the UL operating band is configured closer to the DL operating band.						
Note 3:	Applicable if only Bandwidth Combination Set 0 is supported by the UE for the CA Configuration						
Note 4:	Not applicable if only Bandwidth Combination Set 0 is supported by the UE for the CA Configuration						

#### 7.5A.4.4.2 Test procedure

1. Configure SCC according to Annex C.0, C.1 and Annex C.3.1 for all downlink physical channels.
2. The SS shall configure SCC as per TS 36.508 [7] clause 5.2A.4. Message contents are defined in clause 7.5A.4.4.3.
3. SS activates SCC by sending the activation MAC-CE (Refer TS 36.321 [13], clauses 5.13, 6.1.3.8). Wait for at least 2 seconds (Refer TS 36.133, clauses 8.3.3.2).

4. SS transmits PDSCH via PDCCH DCI format 1A for C\_RNTI to transmit the DL RMC according to Tables 7.5A.4.4.1-1 on both PCC and SCC. The SS sends downlink MAC padding bits on the DL RMC.
5. SS sends uplink scheduling information for each UL HARQ process via PDCCH DCI format 0 for C\_RNTI to schedule the UL RMC according to Tables 7.5A.4.4.1-1 on PCC. Since the UE has no payload and no loopback data to send the UE sends uplink MAC padding bits on the UL RMC.
6. Set the Downlink signal level for PCC and SCC to the value as defined in Table 7.5A.4.5-2 (Case 1). Send Uplink power control commands to the UE (less or equal to 1dB step size should be used), to ensure that the UE output power is within +0, - 3.4 dB of the target level in Table 7.5A.1.5-2 (Case 1) for carrier frequency  $f \leq 3.0\text{GHz}$  or within +0, -4.0 dB of the target level for carrier frequency  $3.0\text{GHz} < f \leq 4.2\text{GHz}$ , for at least the duration of the Throughput measurement.
7. Set the Interferer signal level to the value as defined in Table 7.5A.4.5-2 (Case 1) and frequency below the wanted signal, using a modulated interferer bandwidth as defined in Annex D of the present document.
8. Measure the average throughput for each component carrier for a duration sufficient to achieve statistical significance according to Annex G.2A.
9. Repeat steps from 6 to 8, using an interfering signal above the wanted signal in Case 1 at step 7.
10. Set the Downlink signal level for PCC and SCC to the value as defined in Table 7.5A.4.5-3 (Case 2). Send Uplink power control commands to the UE (less or equal to 1dB step size should be used), to ensure that the UE output power is within +0, - 3.4 dB of the target level in Table 7.5A.4.5-3 (Case 2) for carrier frequency  $f \leq 3.0\text{GHz}$  or within +0, -4.0 dB of the target level for carrier frequency  $3.0\text{GHz} < f \leq 4.2\text{GHz}$ , for at least the duration of the Throughput measurement.
11. Set the Interferer signal level to the value as defined in Table 7.5A.4.5-3 (Case 2) and frequency below the wanted signal, using a modulated interferer bandwidth as defined in Annex D of the present document.
12. Measure the average throughput for each component carrier for a duration sufficient to achieve statistical significance according to Annex G.2A.
13. Repeat steps from 10 to 12, using an interfering signal above the wanted signal in Case 2 at step 11.

#### 7.5A.4.4.3 Message contents

Message contents are according to TS 36.508 [7] subclause 4.6.

#### 7.5A.4.5 Test requirement

The throughput of each carrier shall be  $\geq 95\%$  of the maximum throughput of the reference measurement channels as specified in Annex A.3.2 under the conditions specified in table 7.5A.4.5-2, and also under the conditions specified in table 7.5A.4.5-3.

**Table 7.5A.4.5-1: Adjacent channel selectivity**

Rx Parameter	Units	Channel bandwidth					
		1.4 MHz	3 MHz	5 MHz	10 MHz	15 MHz	20 MHz
ACS	dB	33.0	33.0	33.0	33.0	30	27

**Table 7.5A.4.5-2: Test parameters for Adjacent channel selectivity, Case 1**

Rx Parameter	Units	Channel bandwidth					
		1.4MHz	3 MHz	5 MHz	10 MHz	15 MHz	20 MHz

Pw in Transmission Bandwidth Configuration, per CC	dBm	REFSENS + 14 dB					
$P_{\text{Interferer}}$	dBm	REFSENS +45.5dB	REFSENS +45.5dB	REFSENS +45.5dB	REFSENS +45.5dB	REFSENS +42.5dB	REFSENS +39.5dB
$BW_{\text{Interferer}}$	MHz	1.4	3	5	5	5	5
$F_{\text{Interferer}}$ (offset)	MHz	1.4+0.0025/ -1.4-0.0025	3+0.0075 / -3-0.0075	5+0.0025 / -5-0.0025	7.5+0.0075 / -7.5- 0.0075	10+0.0125 / -10-0.0125	12.5+0.0025 / 5 / -12.5- 0.0025
Note 1: The transmitter shall be set to 4dB below $P_{\text{CMAX\_L}}$ with $P_{\text{CMAX\_L}}$ as defined in clause 6.2.5.							
Note 2: The interferer consists of the Reference measurement channel specified in Annex A.3.2 with one sided dynamic OCNG Pattern OP.1 FDD/TDD as described in Annex A.5.1.1/A.5.2.1 and set-up according to Annex C.3.1.							

Table 7.5A.4.5-3: Test parameters for Adjacent channel selectivity, Case 2

Rx Parameter	Units	Channel bandwidth					
		1.4 MHz	3 MHz	5 MHz	10 MHz	15 MHz	20 MHz
Pw in Transmission Bandwidth Configuration, per CC	dBm	-56.5	-56.5	-56.5	-56.5	-53.5	-50.5
$P_{\text{Interferer}}$	dBm	-25					
$BW_{\text{Interferer}}$	MHz	1.4	3	5	5	5	5
$F_{\text{Interferer}}$ (offset)	MHz	1.4+0.0025 / -1.4- 0.0025	3+0.0075 / -3-0.0075	5+0.0025 / -5-0.0025	7.5+0.0075 / -7.5- 0.0075	10+0.0125 / -10-0.0125	12.5+0.0025 / 5 / -12.5- 0.0025
Note 1: The transmitter shall be set to 24dB below $P_{\text{CMAX\_L}}$ with $P_{\text{CMAX\_L}}$ as defined in clause 6.2.5.							
Note 2: The interferer consists of the Reference measurement channel specified in Annex A.3.2 with one sided dynamic OCNG Pattern OP.1 FDD/TDD as described in Annex A.5.1.1/A.5.2.1 and set-up according to Annex C.3.1							

## 7.5A.5 Adjacent Channel Selectivity (ACS) for 3DL CA without UL CA

### 7.5A.5.1 Test purpose

Adjacent channel selectivity for CA test verifies the UE's ability to receive data with a given average throughput for a specified reference measurement channel, in the presence of an adjacent channel signal at a given frequency offset from the centre frequency of the assigned channel, under conditions of ideal propagation and no added noise.

A UE unable to meet the throughput requirement under these conditions will decrease the coverage area when other e-NodeB transmitters exist in the adjacent channel.

### 7.5A.5.2 Test applicability

This test case applies to all types of E-UTRA UE release 10 and forward that support 3DL Intra-band contiguous CA with or 3DL Inter-band CA with or 3DL Intra-band contiguous and Inter-band CA.

This test case also applies to all types of E-UTRA UE release 11 and forward that support 3DL with Intra-band non-contiguous CA and Inter-band CA, or 3DL with Intra-band non-contiguous and Intra-band contiguous CA.

This test case also applies to all types of E-UTRA UE release 12 and forward that support 3DL CA with FDD-TDD CA.

### 7.5A.5.3 Minimum conformance requirements

The Minimum conformance requirements are defined in clause 7.5A.0.



7.5A.5.4 Test description

7.5A.5.4.1 Initial conditions

Initial conditions are a set of test configurations the UE needs to be tested in and the steps for the SS to take with the UE to reach the correct measurement state.

The initial test configurations consist of environmental conditions, test frequencies, and channel bandwidths based on E-UTRA CA configurations specified in tables of 5.4.2A.1 as applicable. All of these configurations shall be tested with applicable test parameters for each CA Configuration, and are shown in tables 7.5A.5.4.1-1 to 7.5A.5.4.1-5. The details of the uplink and downlink reference measurement channels (RMCs) are specified in Annexes A.2 and A.3 respectively. The details of the OCNG patterns used are specified in Annex A.5. Configurations of PDSCH and PDCCH before measurement are specified in Annex C.2.

**Table 7.5A.5.4.1-1: Test Configuration Table (Intra-band contiguous)**

Initial Conditions														
Test Environment as specified in TS 36.508 [7] subclause 4.1								NC						
Test Frequencies as specified in TS36.508 [7] subclause 4.3.1 for different CA bandwidth classes.								For test frequencies refer to “Range” columns. For mapping within Band refer to “CC” columns						
Test CC Combination setting ( $N_{RB\_agg}$ ) as specified in subclause 5.4.2A.1 for the CA Configuration across bandwidth combination sets supported by the UE.								Refer to “PCC $N_{RB}$ ” and “SCCs $N_{RB}$ ” columns						
Network signalling value								NS_01 by default, exceptions listed in Table 7.3.3-3, dependent on PCC Band						
Test Parameters for CA Configurations														
ID	CA Configuration / $N_{RB\_agg}$						DL Allocation			UL Allocation (Note 2,3)				
	CA Configuration						PCC $N_{RB}$	SCCs $N_{RB}$		CC MOD	PCC & SCCs RB allocation		CC MOD	PCC $L_{CRB}$ @ $RB_{start}$
	Band		Range		PCC	SCC1		SCC2	SCC1		SCC2	PCC		
				CC	CC	CC								
Default Test Settings for a CA_XD Configuration														
1	X	Mid	CC1	CC2	CC3	Lowest $N_{RB\_agg}$		QPSK	All RBs	QPSK	REFSENS			
2	X	Mid	CC1	CC2	CC3	Highest $N_{RB\_agg}$		QPSK	All RBs	QPSK	REFSENS			
Note 1: CA Configuration Test CC Combination test settings are checked separately for each CA Configuration. Note 2: Use CA Configuration – specific test points if present in the table, otherwise use Default Test Settings test points. Note 3: X corresponds to the band of the CA Configuration. Eg. for CA_41D ,X=41 Note 4: REFSENS refers to the PCC band's and PCC $N_{RB}$ 's single carrier Uplink RB allocation for reference sensitivity according to table 7.3.5-2. Note 5: If in the CA Configuration UE supports multiple CC Combinations with the same $N_{RB\_agg}$ , choose for testing the Combination with maximum $N_{RB\_PCC}$ and then select maximum $N_{RB\_SCC1}$ for the chosen $N_{RB\_PCC}$														

**Table 7.5A.5.4.1-2: Test Configuration Table (Inter-band)**

Initial Conditions																
Test Environment as specified in TS 36.508 [7] subclause 4.1										NC						
Test Frequencies as specified in TS36.508 [7] subclause 4.3.1 for different CA bandwidth classes.										For test frequencies refer to “Range” columns. For mapping within Band refer to “CC” columns						
Test CC Combination setting ( $N_{RB\_agg}$ ) as specified in subclause 5.4.2A.1 for the CA Configuration across bandwidth combination sets supported by the UE.										Refer to “PCC $N_{RB}$ ” and “SCCs $N_{RB}$ ” columns						
Network signalling value										NS_01 by default, exceptions listed in Table 7.3.3-3, dependent on PCC Band						
Test Parameters for CA Configurations																
ID	CA Configuration / $N_{RB\_agg}$								DL Allocation			UL Allocation (Note 2,3)				
	CA Configuration								PCC $N_{RB}$	SCCs $N_{RB}$		CC MOD	PCC & SCCs RB allocation		CC MOD	PCC $L_{CRB}$ @ $RB_{start}$
	PCC		SCC1		SCC2		SCC1	SCC2		PCC	SCC1		SCC2			
	Band	Range	Band	Range	Band	Range										
Default Test Settings for a CA_XA-YA-ZA Configuration																
1	X	Mid	Y	Mid	Z	Mid	Highest $N_{RB}$	Highest $N_{RB}$	Highest $N_{RB}$	QPSK	All RBs	QPSK	REFSENS			
2	Y	Mid	X	Mid	Z	Mid	Highest $N_{RB}$	Highest $N_{RB}$	Highest $N_{RB}$	QPSK	All RBs	QPSK	REFSENS			
3	Z	Mid	X	Mid	Y	Mid	Highest $N_{RB}$	Highest $N_{RB}$	Highest $N_{RB}$	QPSK	All RBs	QPSK	REFSENS			

- Note 1: CA Configuration Test CC Combination test settings are checked separately for each CA Configuration.
- Note 2: Use CA Configuration – specific test points if present in the table, Otherwise use test points from matching Group Test Settings, if present in the table. Otherwise use the Default Test Settings test points.
- Note 3: If, according to the UE declared capability, UE does not support UL in an individual band within the CA Configuration, test points with that individual band as PCC are not applicable.
- Note 4: X,Y,Z correspond to the different bands in the CA Configuration. Eg. for CA\_1A-3A-19A,X=1,Y=3,Z=19
- Note 5: REFSSENS refers to the PCC band's and PCC N<sub>RB</sub> 's single carrier Uplink RB allocation for reference sensitivity according to table 7.3.5-2.

**Table 7.5A.5.4.1-3: Test Configuration Table (Intra-band contiguous + Inter-band)**

Initial Conditions														
Test Environment as specified in TS 36.508 [7] subclause 4.1										NC				
Test Frequencies as specified in TS36.508 [7] subclause 4.3.1 for different CA bandwidth classes.										For test frequencies refer to “Range” columns. For mapping within Band refer to “CC” columns				
Test CC Combination setting (N <sub>RB_agg</sub> ) as specified in subclause 5.4.2A.1 for the CA Configuration across bandwidth combination sets supported by the UE.										Refer to “PCC N <sub>RB</sub> ” and “SCCs N <sub>RB</sub> ” columns				
Network signalling value										NS_01 by default, exceptions listed in Table 7.3.3-3, dependent on PCC Band				
Test Parameters for CA Configurations														
ID	CA Configuration / N <sub>RB_agg</sub>							DL Allocation			UL Allocation (Note 2,3)			
	CA Configuration						PCC N <sub>RB</sub>	SCCs N <sub>RB</sub>		CC MOD	PCC & SCCs RB allocation		CC MOD	PCC L <sub>CRB</sub> @ RB <sub>start</sub>
	PCC		SCC1		SCC2			SCC1	SCC2		PCC	SCC1		
	Band	Range /CC	Band	Range /CC	Band	Range /CC								
Default Test Settings for CA_XB-YA and CA_XC-YA Configurations														
1	X	Mid /CC1	X	Mid /CC2	Y	Mid	Lowest N <sub>RB_agg</sub>	Highest N <sub>RB</sub>	QPSK	All RBs	QPSK	REFSENS		
2	X	Mid /CC1	X	Mid /CC2	Y	Mid	Highest N <sub>RB_agg</sub>	Highest N <sub>RB</sub>	QPSK	All RBs	QPSK	REFSENS		
3	Y	Mid	X	Mid /CC1	X	Mid /CC2	Highest N <sub>RB</sub>	Lowest N <sub>RB_agg</sub>	QPSK	All RBs	QPSK	REFSENS		
4	Y	Mid	X	Mid /CC1	X	Mid /CC2	Highest N <sub>RB</sub>	Highest N <sub>RB_agg</sub>	QPSK	All RBs	QPSK	REFSENS		
Default Test Settings for CA_XA-YB and CA_XA-YC Configurations														
1	Y	Mid /CC1	Y	Mid /CC2	X	Mid	Lowest N <sub>RB_agg</sub>	Highest N <sub>RB</sub>	QPSK	All RBs	QPSK	REFSENS		
2	Y	Mid /CC1	Y	Mid /CC2	X	Mid	Highest N <sub>RB_agg</sub>	Highest N <sub>RB</sub>	QPSK	All RBs	QPSK	REFSENS		
3	X	Mid	Y	Mid /CC1	Y	Mid /CC2	Highest N <sub>RB</sub>	Lowest N <sub>RB_agg</sub>	QPSK	All RBs	QPSK	REFSENS		
4	X	Mid	Y	Mid /CC1	Y	Mid /CC2	Highest N <sub>RB</sub>	Highest N <sub>RB_agg</sub>	QPSK	All RBs	QPSK	REFSENS		
<p>Note 1: CA Configuration Test CC Combination test settings are checked separately for each CA Configuration.</p> <p>Note 2: Use CA Configuration – specific test points if present in the table. Otherwise use the Default Test Settings test points.</p> <p>Note 3: If, according to the UE declared capability, UE does not support UL in an individual band within the CA Configuration, test points with that individual band as PCC are not applicable.</p> <p>Note 4: X,Y correspond to the different bands in the CA Configuration. Eg. for CA_1C-3A, X=1 and Y=3</p> <p>Note 5: REFSSENS refers to the PCC band's and PCC N<sub>RB</sub> 's single carrier Uplink RB allocation for reference sensitivity according to table 7.3.5-2.</p> <p>Note 6: If in the CA Configuration UE supports multiple CC Combinations with the same N<sub>RB_agg</sub>, choose the Combination with N<sub>RB_PCC</sub> = N<sub>RB_SCC1</sub> for testing. If no such combination is supported, choose Combination with maximum N<sub>RB_PCC</sub> for testing.</p>														

**Table 7.5A.5.4.1-4: Test Configuration Table (Intra-band non-contiguous + Inter-band)**

Initial Conditions														
Test Environment as specified in TS 36.508 [7] subclause 4.1										NC				
Test Frequencies as specified in TS36.508 [7] subclause 4.3.1 for different CA bandwidth classes.										For test frequencies refer to “Range” columns. For mapping within Band refer to “CC” columns				
Test CC Combination setting ( $N_{RB\_agg}$ ) as specified in subclause 5.4.2A.1 for the CA Configuration across bandwidth combination sets supported by the UE.										Highest $N_{RB}$				
Network signalling value										NS_01 by default, exceptions listed in Table 7.3.3-3, dependent on PCC Band				
Test Parameters for CA Configurations														
ID	CA Configuration / $N_{RB\_agg}$								DL Allocation			UL Allocation (Note 2,3)		
	CA Configuration								CC MOD	PCC & SCCs			CC MOD	PCC $L_{CRB} @ RB_{sta}$
	PCC		$W_{gap}$ [MHz]	SCC1		$W_{gap}$ [MHz]	SCC2			RB allocation				
	Band	Range /CC		Band	Range /CC		Band	Range /CC		PCC	SCC1	SCC2		
Default Test Settings for CA_XA-XA-YA Configurations														
1	X	CC2	Max	X	CC1	-	Y	Mid	QPSK	All RBs			QPSK	REFSENS_CA
2	Y	Mid	-	X	CC2	Max	X	CC1	QPSK	All RBs			QPSK	REFSENS
Default Test Settings for CA_XA-YA-YA Configurations														
1	Y	CC2	Max	Y	CC1	-	X	Mid	QPSK	All RBs			QPSK	REFSENS_CA
2	X	Mid	-	Y	CC2	Max	Y	CC1	QPSK	All RBs			QPSK	REFSENS
Note 1: CA Configuration Test CC Combination test settings are checked separately for each CA Configuration. Note 2: Use CA Configuration – specific test points if present in the table. Otherwise use test points from matching Group Test Settings, if present in the table. Otherwise use Default Test Settings test points. Note 3: If, according to the UE declared capability, UE does not support UL in an individual band within the CA Configuration, test points with that individual band as PCC are not applicable. Note 4: X and Y correspond to the different bands in the CA Configuration. Eg. for CA_2A-2A-5A,X=2,Y=5 Note 5: REFSENS refers to the PCC band's and PCC $N_{RB}$ 's single carrier Uplink RB allocation for reference sensitivity according to table 7.3.5-2. REFSENS_CA refers to the PCC band's and PCC $N_{RB}$ 's single carrier Uplink RB allocation for reference sensitivity according to table 7.3.4.5-2 (selecting RB allocation for SCC measurement).														

**Table 7.5A.5.4.1-5: Test Configuration Table (Intra-band non-contiguous + Intra-band contiguous)**

Initial Conditions															
Test Environment as specified in TS 36.508 [7] subclause 4.1										NC					
Test Frequencies as specified in TS36.508 [7] subclause 4.3.1 for different CA bandwidth classes.										For test frequencies refer to “Range” columns. For mapping within band refer to “CC” columns					
Test CC Combination setting ( $N_{RB\_agg}$ ) as specified in subclause 5.4.2A.1 for the CA Configuration across bandwidth combination sets supported by the UE.										Refer to “PCC $N_{RB}$ ” and “SCCs $N_{RB}$ ” columns					
Network signalling value										NS_01 by default, exceptions listed in Table 7.3.3-3, dependent on PCC Band					
Test Parameters for CA Configurations															
ID	CA Configuration / $N_{RB\_agg}$							DL Allocation			UL Allocation (Note 2,3)				
	CA Configuration						PCC $N_{RB}$	SCCs $N_{RB}$		CC MOD	PCC & SCCs RB allocation			CC MOD	PCC $L_{CRB}$ @ $RB_{start}$
	Band	PCC	$W_{gap}$ [MHz]	SCC1	$W_{gap}$ [MHz]	SCC2		SCC1	SCC2		PCC	SCC1	SCC2		
		CC		CC		CC									
Test Settings for a 41A-41C Configuration															
1	41	CC3	134.2	CC2	-	CC1	100	100	100	QPSK	All RBs	QPSK	100@0		
Test Settings for a CA_41C-41A Configuration															
2	41	CC3	-	CC2	134.2	CC1	100	100	100	QPSK	All RBs	QPSK	100@0		
Note 1: CA Configuration Test CC Combination test settings are checked separately for each CA Configuration. Note 2: Use CA Configuration – specific test points if present in the table, otherwise use Default Test Settings test points. Note 3: If, according to the UE declared capability, UE does not support UL in an individual band within the CA Configuration, test points with that individual band as PCC are not applicable. Note 4: X corresponds to the band of the CA Configuration. Eg. for CA_41C-41A, X=41. Note 5: REFSENS refers to the PCC band’s and PCC $N_{RB}$ ‘s single carrier Uplink RB allocation for reference sensitivity according to table 7.3.5-2. Note 6: If in the CA Configuration UE supports multiple CC Combinations with the same $N_{RB\_agg}$ , choose the Combination with $N_{RB\_CC1} = N_{RB\_CC2}$ for testing. If no such combination is supported, choose Combination with maximum $N_{RB\_CC1}$ for testing.															

1. Connect the SS to the UE antenna connectors as shown in TS 36.508 [7] Annex A, Figure A.58.
2. The parameter settings for the cell are set up according to TS 36.508 [7] clause 4.4.3.
3. Downlink signals for PCC are initially set up according to Annex C.0, C.1 and C.3.1, and uplink signals according to Annex H.1 and H.3.1
4. The UL and DL Reference Measurement channels are set according to Tables 7.5A.5.4.1-1 to 7.5A.5.4.1-5.
5. Propagation conditions are set according to Annex B.0.
6. Ensure the UE is in State 3A-RF according to TS 36.508 [7] clause 5.2A.2. Message contents are defined in clause 7.5A.5.4.3.

**7.5A.5.4.2 Test procedure**

1. Configure SCCs according to Annex C.0, C.1 and Annex C.3.1 for all downlink physical channels.
2. The SS shall configure SCCs as per TS 36.508 [7] clause 5.2A.4. Message contents are defined in clause 7.5A.5.4.3

3. SS activates SCCs by sending the activation MAC-CE (Refer to TS 36.321 [13] clauses 5.13 and 6.1.3.8). Wait for at least 2 seconds (Refer to TS 36.133 [4], clause 8.3.3.2).
4. SS transmits PDSCH via PDCCH DCI format 1A for C\_RNTI to transmit the DL RMC according to Tables 7.5A.5.4.1-1 to 7.5A.5.4.1-5 as appropriate on PCC and SCCs. The SS sends downlink MAC padding bits on the DL RMC.
5. SS sends uplink scheduling information for each UL HARQ process via PDCCH DCI format 0 for C\_RNTI to schedule the UL RMC according to Tables 7.5A.5.4.1-1 to 7.5A.5.4.1-5 as appropriate on PCC. Since the UE has no payload and no loopback data to send, the UE sends uplink MAC padding bits on the UL RMC.
6. Set the Downlink signal level for PCC and SCCs to the value defined for Case 1 in Table 7.5A.5.5-2 or 7.5A.5.5-5, according to the type of CA. Send Uplink power control commands to the UE (less or equal to 1dB step size should be used), to ensure that the PCC output power is within +0dB, -3.4 dB of the target level for carrier frequency  $f \leq 3.0\text{GHz}$  or within +0dB, -4 dB of the target level for carrier frequency  $3.0\text{GHz} < f \leq 4.2\text{GHz}$ , for at least the duration of the Throughput measurement.
7. Set the Interferer signal level to the value defined for Case 1 in Table 7.5A.5.5-2 or 7.5A.5.5-5, according to the type of CA, with frequency below the measured carrier(s) according to table 7.5A.5.4.2-1, using a modulated interferer bandwidth as defined in Annex D of the present document.
8. Measure the average throughput for the carrier(s) indicated in table 7.5A.5.4.2-1 for a duration sufficient to achieve statistical significance according to Annex G.2A.
9. Repeat steps from 6 to 8, using an interfering signal above the measured carrier(s) according to table 7.5A.5.4.2-1.
10. Set the Downlink signal level for PCC and SCCs to the value defined for Case 2 in Table 7.5A.5.5-3 or 7.5A.5.5-6, according to the type of CA. Send Uplink power control commands to the UE (less or equal to 1dB step size should be used), to ensure that the PCC output power is within +0dB, -3.4 dB of the target level for carrier frequency  $f \leq 3.0\text{GHz}$ , or within +0dB, -4 dB of the target level for carrier frequency  $3.0\text{GHz} < f \leq 4.2\text{GHz}$ , for at least the duration of the Throughput measurement.
11. Set the Interferer signal level to the value defined for Case 2 in Table 7.5A.5.5-3 or 7.5A.5.5-6, according to the type of CA, with frequency below the measured carrier(s) according to table 7.5A.5.4.2-1, using a modulated interferer bandwidth as defined in Annex D of the present document.
12. Measure the average throughput for the carrier(s) indicated in table 7.5A.5.4.2-1 for a duration sufficient to achieve statistical significance according to Annex G.2A.
13. Repeat steps from 10 to 12, using an interfering signal above the measured carrier(s) according to table 7.5A.5.4.2-1.
14. Repeat steps 6 to 13 for component carriers listed in Table 7.5A.5.4.2-1.

**Table 7.5A.5.4.2-1: Test repetition and measurement configuration**

CA configuration	ID (Note 1)	Throughput measured on (Note 3)	Table with test parameters to select (Note 2)
Intra-band contiguous	1	PCC, SCC1, SCC2	7.5A.5.5-2 7.5A.5.5-3
	2		
Inter-band	1	SCC1	7.5A.5.5-5 7.5A.5.5-6
		SCC2	
	2	SCC1	
		SCC2	
	3	SCC1	
		SCC2	
Intra-band contiguous + Inter-band	1	SCC2	7.5A.5.5-5
	2		7.5A.5.5-6
	3	SCC1, SCC2	7.5A.5.5-2
	4		7.5A.5.5-3
Intra-band non-contiguous + Inter-band	1	SCC2	7.5A.5.5-5
		SCC1	7.5A.5.5-6
	2	SCC2	7.5A.5.5-6
Intra-band non-contiguous + Intra-band contiguous	1	PCC	7.5A.5.5-5 7.5A.5.5-6
		SCC1, SCC2	7.5A.5.5-2
			7.5A.5.5-3
	2	PCC, SCC1	7.5A.5.5-2
			7.5A.5.5-3
		SCC2	7.5A.5.5-5 7.5A.5.5-6
Note 1: Test point ID for the particular CA configuration as defined in section 7.5A.5.4.1. Note 2: The reference for the placement of the interferer signals is the centre frequency of the carrier closest to the interferer among the carriers throughput is measured on. Note 3: Where there are multiple rows for a single Test point ID, the test is repeated for each row.			

7.5A.5.4.3 Message contents

Message contents are according to TS 36.508 [7] subclause 4.6

7.5A.5.5 Test requirement

The throughput measurement of each carrier derived in test procedure shall be  $\geq 95\%$  of the maximum throughput of the reference measurement channels as specified in Annex A.3.2 with parameters specified in Tables below, according to the type of CA.

**Table 7.5A.5.5-1: Adjacent channel selectivity for 3DL CA (Intra-band contiguous)**

Rx Parameter	Units	CA Bandwidth Class				
		B	C	D	E	F
ACS	dB	27	24	22.2		

**Table 7.5A.5.5-2: Test parameters for Adjacent channel selectivity, Case 1, 3DL CA (Intra-band contiguous)**

Rx Parameter	Units	CA Bandwidth Class				
		B	C	D	E	F
Pw in Transmission Bandwidth Configuration, per CC		REFSENS + 14 dB	REFSENS + 14 dB	REFSENS + 14 dB		
$P_{\text{Interferer}}$	dBm	Aggregated power + 22.5 dB	Aggregated power + 22.5 dB	Aggregated power + 20.7 dB		
$BW_{\text{Interferer}}$	MHz	5	5	5		
$F_{\text{Interferer}}$ (offset)	MHz	$2.5 + F_{\text{offset}}$ / $-2.5 - F_{\text{offset}}$	$2.5 + F_{\text{offset}}$ / $-2.5 - F_{\text{offset}}$	$2.5 + F_{\text{offset}}$ / $-2.5 - F_{\text{offset}}$		
<p>NOTE 1: The transmitter shall be set to 4dB below <math>P_{\text{CMAX\_L}}</math> or <math>P_{\text{CMAX\_L\_CA}}</math> as defined in subclause 6.2.5 for one uplink carrier.</p> <p>NOTE 2: The interferer consists of the Reference measurement channel specified in Annex A.3.2 with one sided dynamic OCNG Pattern OP.1 FDD/TDD as described in Annex A.5.1.1/A.5.2.1 and set-up according to Annex C.3.1</p> <p>NOTE 3: The <math>F_{\text{Interferer}}</math> (offset) is relative to the centre frequency of the adjacent CC being tested and shall be further adjusted to <math>\lfloor F_{\text{Interferer}} / 0.015 + 0.5 \rfloor 0.015 + 0.0075</math> MHz to be offset from the sub-carrier raster for interferer signal above the wanted signal and adjusted to <math>\lfloor F_{\text{Interferer}} / 0.015 + 0.5 \rfloor 0.015 - 0.0075</math> MHz to be offset from the sub-carrier raster for interferer signal below the wanted signal.</p>						

**Table 7.5A.5.5-3: Test parameters for Adjacent channel selectivity, Case 2, 3DL CA (Intra-band contiguous)**

Rx Parameter	Units	CA Bandwidth Class				
		B	C	D	E	F
Pw in Transmission Bandwidth Configuration, per CC	dBm	$-50.5 + 10\log_{10}(N_{\text{RB},c} / N_{\text{RB agg}})$	$-47.5 + 10\log_{10}(N_{\text{RB},c} / N_{\text{RB agg}})$	$-43.9 + 10\log_{10}(N_{\text{RB},c} / N_{\text{RB agg}})$		
$P_{\text{Interferer}}$	dBm	-25				
$BW_{\text{Interferer}}$	MHz	5	5	5		
$F_{\text{Interferer}}$ (offset)	MHz	$2.5 + F_{\text{offset}}$ / $-2.5 - F_{\text{offset}}$	$2.5 + F_{\text{offset}}$ / $-2.5 - F_{\text{offset}}$	$2.5 + F_{\text{offset}}$ / $-2.5 - F_{\text{offset}}$		
<p>NOTE 1: The transmitter shall be set to 24dB below <math>P_{\text{CMAX\_L}}</math> or <math>P_{\text{CMAX\_L\_CA}}</math> as defined in subclause 6.2.5 for one uplink carrier.</p> <p>NOTE 2: The interferer consists of the Reference measurement channel specified in Annex 3.2 with one sided dynamic OCNG Pattern OP.1 FDD/TDD as described in Annex A.5.1.1/A.5.2.1 and set-up according to Annex C.3.1</p> <p>NOTE 3: The <math>F_{\text{Interferer}}</math> (offset) is relative to the centre frequency of the adjacent CC being tested and shall be further adjusted to <math>\lfloor F_{\text{Interferer}} / 0.015 + 0.5 \rfloor 0.015 + 0.0075</math> MHz to be offset from the sub-carrier raster for interferer signal above the wanted signal and adjusted to <math>\lfloor F_{\text{Interferer}} / 0.015 + 0.5 \rfloor 0.015 - 0.0075</math> MHz to be offset from the sub-carrier raster for interferer signal below the wanted signal.</p>						

**Table 7.5A.5.5-4: Adjacent channel selectivity for 3DL CA (Inter-band), per CC**

Rx Parameter	Units	Channel bandwidth					
		1.4 MHz	3 MHz	5 MHz	10 MHz	15 MHz	20 MHz
ACS	dB	33.0	33.0	33.0	33.0	30	27



**Table 7.5A.5.5-5: Test parameters for Adjacent channel selectivity for 3DL CA (Inter-band), Case 1**

Rx Parameter	Units	Channel bandwidth					
		1.4 MHz	3 MHz	5 MHz	10 MHz	15 MHz	20 MHz
Power in Transmission Bandwidth Configuration for each CC	dBm	REFSENS + 14 dB					
$P_{\text{Interferer}}$	dBm	REFSENS for SCC +45.5dB	REFSENS for SCC +45.5dB	REFSENS for SCC +45.5dB	REFSENS for SCC +45.5dB	REFSENS for SCC +42.5dB	REFSENS for SCC +39.5dB
$BW_{\text{Interferer}}$	MHz	1.4	3	5	5	5	5
$F_{\text{Interferer}}$ (offset)	MHz	1.4+0.0025 / -1.4-0.0025	3+0.0075 / -3-0.0075	5+0.0025 / -5-0.0025	7.5+0.0075 / -7.5-0.0075	10+0.0125 / -10-0.0125	12.5+0.0025 / -12.5-0.0025
NOTE 1: The transmitter shall be set to 4dB below $P_{\text{CMAX\_L}}$ at the minimum uplink configuration specified in Table 7.3.3-2 with $P_{\text{CMAX\_L}}$ as defined in subclause 6.2.5.							
NOTE 2: The interferer consists of the Reference measurement channel specified in Annex A.3.2 with one sided dynamic OCNG Pattern OP.1 FDD/TDD as described in Annex A.5.1.1/A.5.2.1 and set-up according to Annex C.3.1							

**Table 7.5A.5.5-6: Test parameters for Adjacent channel selectivity for 3DL CA (Inter-band), Case 2**

Rx Parameter	Units	Channel bandwidth					
		1.4 MHz	3 MHz	5 MHz	10 MHz	15 MHz	20 MHz
Power in Transmission Bandwidth Configuration for each CC	dBm	-56.5	-56.5	-56.5	-56.5	-53.5	-50.5
$P_{\text{Interferer}}$	dBm	-25					
$BW_{\text{Interferer}}$	MHz	1.4	3	5	5	5	5
$F_{\text{Interferer}}$ (offset)	MHz	1.4+0.0025 / -1.4-0.0025	3+0.0075 / -3-0.0075	5+0.0025 / -5-0.0025	7.5+0.0075 / -7.5-0.0075	10+0.0125 / -10-0.0125	12.5+0.0025 / -12.5-0.0025
NOTE 1: The transmitter shall be set to 24dB below $P_{\text{CMAX\_L}}$ at the minimum uplink configuration specified in Table 7.3.3-2 with $P_{\text{CMAX\_L}}$ as defined in subclause 6.2.5.							
NOTE 2: The interferer consists of the Reference measurement channel specified in Annex 3.2 with one sided dynamic OCNG Pattern OP.1 FDD/TDD as described in Annex A.5.1.1/A.5.2.1 and set-up according to Annex C.3.1.							

## 7.5B Adjacent Channel Selectivity (ACS) for UL-MIMO

### 7.5B.1 Test purpose

Adjacent channel selectivity tests the ability of UE that support UL-MIMO to receive data with a given average throughput for a specified reference measurement channel, in the presence of an adjacent channel signal at a given frequency offset from the centre frequency of the assigned channel, under conditions of ideal propagation and no added noise.

A UE unable to meet the throughput requirement under these conditions will decrease the coverage area when other e-NodeB transmitters exist in the adjacent channel.

### 7.5B.2 Test applicability

This test applies to all types of E-UTRA UE release 10 and forward that support UL-MIMO.

## 7.5B.3 Minimum conformance requirements

For UE(s) with two transmitter antenna connectors in closed-loop spatial multiplexing scheme, the minimum requirements in Clause 7.5.3 shall be met with the UL-MIMO configurations specified in Table 6.2.2B.3-2. For UL-MIMO, the parameter  $P_{\text{CMAX,L}}$  is defined as the total transmitter power over the two transmit antenna connectors.

The normative reference for this requirement is TS 36.101 [2] clause 7.5.1B.

## 7.5B.4 Test description

### 7.5B.4.1 Initial conditions

Initial conditions are a set of test configurations the UE needs to be tested in and the steps for the SS to take with the UE to reach the correct measurement state.

The initial test configurations consist of environmental conditions, test frequencies, and channel bandwidths based on E-UTRA bands specified in table 5.4.2.1-1. All of these configurations shall be tested with applicable test parameters for each channel bandwidth, and are shown in table 7.5B.4.1-1. The details of the uplink and downlink reference measurement channels (RMCs) are specified in Annexes A.2 and A.3 respectively. The details of the OCNG patterns used are specified in Annex A.5. Configurations of PDSCH and PDCCH before measurement are specified in Annex C.2.

**Table 7.5B.4.1-1: Test Configuration Table**

Initial Conditions						
Test Environment as specified in TS 36.508[7] subclause 4.1			NC			
Test Frequencies as specified in TS36.508 [7] subclause 4.3.1			Mid range			
Test Channel Bandwidths as specified in TS 36.508 [7] subclause 4.3.1			Lowest, 5MHz, Highest			
Test Parameters for Channel Bandwidths						
Ch BW	Downlink Configuration			Uplink Configuration		
	Mod'n	RB allocation		Mod'n	RB allocation	
		FDD	TDD		FDD	TDD
1.4MHz	QPSK	Full	Full	QPSK	5	5
3MHz	QPSK	Full	Full	QPSK	4	4
5MHz	QPSK	Full	Full	QPSK	8	8
5MHz	QPSK	Full	N/A	QPSK	5 <sup>3</sup>	N/A
10MHz	QPSK	Full	Full	QPSK	12	12
15MHz	QPSK	Full	Full	QPSK	16	16
20MHz	QPSK	Full	Full	QPSK	18	18
Note 1: Test Channel Bandwidths are checked separately for each E-UTRA band. The applicable channel bandwidths are specified in Table 7.3.3-2.						
Note 2: For the DL signal one sided dynamic OCNG Pattern OP.1 FDD/TDD is used.						
Note 3: Applicable only to E-UTRA FDD Band 31. The UL resource blocks shall be located at RBstart 10 (according to Table 7.3.3-2).						

1. Connect the SS and interfering source to the UE antenna connectors as shown in TS 36.508 [7] Figure A.29.
2. The parameter settings for the cell are set up according to TS 36.508 [7] subclause 4.4.3.
3. Downlink signals are initially set up according to Annex C0, C.1 and C.3.1, and uplink signals according to Annex H.1 and H.3.1.
4. The UL and DL Reference Measurement channels are set according to Table 7.5B.4.1-1.
5. Propagation conditions are set according to Annex B.0.
6. Ensure the UE is in State 3A-RF according to TS 36.508 [7] clause 5.2A.2. Message contents are defined in clause 7.5B.4.3.

### 7.5B.4.2 Test procedure

1. SS transmits PDSCH via PDCCH DCI format 1A for C\_RNTI to transmit the DL RMC according to Table 7.5B.4.1-1. The SS sends downlink MAC padding bits on the DL RMC.
2. SS sends uplink scheduling information for each UL HARQ process via PDCCH DCI format 4 for C\_RNTI to schedule the UL RMC according to Table 7.5B.4.1-1. Since the UE has no payload data to send, the UE transmits uplink MAC padding bits on the UL RMC.
3. Set the Downlink signal level to the value as defined in Table 7.5B.5-2 (Case 1). Send Uplink power control commands to the UE (less or equal to 1dB step size should be used), to ensure that the UE output power is within +0, - 3.4 dB of the target level in Table 7.5B.5-2 (Case 1) for carrier frequency  $f \leq 3.0\text{GHz}$  or within +0, -4.0 dB of the target level for carrier frequency  $3.0\text{GHz} < f \leq 4.2\text{GHz}$ , for at least the duration of the Throughput measurement.
4. Set the Interferer signal level to the value as defined in Table 7.5B.5-2 (Case 1) and frequency below the wanted signal, using a modulated interferer bandwidth as defined in Annex D of the present document.
5. Measure the average throughput for a duration sufficient to achieve statistical significance according to Annex G.2.
6. Repeat steps from 3 to 5, using an interfering signal above the wanted signal in Case 1 at step 4.
7. Set the Downlink signal level to the value as defined in Table 7.5B.5-3 (Case 2). Send Uplink power control commands to the UE (less or equal to 1dB step size should be used), to ensure that the UE output power is within +0, - 3.4 dB of the target level in Table 7.5B.5-3 (Case 2) for carrier frequency  $f \leq 3.0\text{GHz}$  or within +0, -4.0 dB of the target level for carrier frequency  $3.0\text{GHz} < f \leq 4.2\text{GHz}$ , for at least the duration of the throughput measurement.
8. Set the Interferer signal level to the value as defined in Table 7.5B.5-3 (Case 2) and frequency below the wanted signal, using a modulated interferer bandwidth as defined in Annex D of the present document.
9. Measure the average throughput for a duration sufficient to achieve statistical significance according to Annex G.2.
10. Repeat steps from 7 to 9, using an interfering signal above the wanted signal in Case 2 at step 8.
11. Repeat for applicable channel bandwidths and operating band combinations in both Case 1 and Case 2.

### 7.5B.4.3 Message contents

Message contents are according to TS 36.508 [7] clause 4.6 with the following exception

**Table 7.5B.4.3-1: UplinkPowerControlDedicated**

Derivation Path: 36.331 clause 6.3.2			
Information Element	Value/remark	Comment	Condition
UplinkPowerControlDedicated-DEFAULT ::= SEQUENCE {			
p0-UePUSCH	0		
deltaMCS-Enabled	en0		
accumulationEnabled	TRUE		
p0-uePUCCH	0		
pSRS-Offset	3 (-6 dB)		
filterCoefficient	fc8	larger filter length is used to reduce the RSRP measurement variation	
}			

### 7.5B.5 Test requirement

The throughput  $R_{av}$  shall be  $\geq 95\%$  of the maximum throughput of the reference measurement channels as specified in Annex A.3.2 under the conditions specified in table 7.5B.5-2, and also under the conditions specified in table 7.5B.5-3.

Table 7.5B.5-1: Adjacent channel selectivity

Rx Parameter	Units	Channel bandwidth					
		1.4 MHz	3 MHz	5 MHz	10 MHz	15 MHz	20 MHz
ACS	dB	33.0	33.0	33.0	33.0	30	27

Table 7.5B.5-2: Test parameters for Adjacent channel selectivity, Case 1

Rx Parameter	Units	Channel bandwidth					
		1.4 MHz	3 MHz	5 MHz	10 MHz	15 MHz	20 MHz
Power in Transmission Bandwidth Configuration	dBm	REFSENS + 14 dB					
$P_{\text{Interferer}}$	dBm	REFSENS +45.5dB	REFSENS +45.5dB	REFSENS +45.5dB*	REFSENS +45.5dB	REFSENS +42.5dB	REFSENS +39.5dB
$BW_{\text{Interferer}}$	MHz	1.4	3	5	5	5	5
$F_{\text{Interferer}}$ (offset)	MHz	1.4+0.0025	3+0.0075	5+0.0025	7.5+0.0075	10+0.0125	12.5+0.0025
Note 1:	The transmitter shall be set to 4dB below $P_{\text{CMAX,L}}$ at the minimum uplink configuration specified in Table 7.3.3-2 with $P_{\text{CMAX,L}}$ as defined in clause 6.2.5.						
Note 2:	The interferer consists of the Reference measurement channel specified in Annex A.3.2 with one sided dynamic OCNG Pattern OP.1 FDD/TDD as described in Annex A.5.1.1/A.5.2.1 and set-up according to Annex C.3.1.						

Table 7.5B.5-3: Test parameters for Adjacent channel selectivity, Case 2

Rx Parameter	Units	Channel bandwidth					
		1.4 MHz	3 MHz	5 MHz	10 MHz	15 MHz	20 MHz
Power in Transmission Bandwidth Configuration	dBm	-56.5	-56.5	-56.5	-56.5	-53.5	-50.5
$P_{\text{Interferer}}$	dBm	-25					
$BW_{\text{Interferer}}$	MHz	1.4	3	5	5	5	5
$F_{\text{Interferer}}$ (offset)	MHz	1.4+0.0025	3+0.0075	5+0.0025	7.5+0.0075	10+0.0125	12.5+0.0025
Note 1:	The transmitter shall be set to 24dB below $P_{\text{CMAX,L}}$ at the minimum uplink configuration specified in Table 7.3.3-2 with $P_{\text{CMAX,L}}$ as defined in clause 6.2.5.						
Note 2:	The interferer consists of the Reference measurement channel specified in Annex A.3.2 with one sided dynamic OCNG Pattern OP.1 FDD/TDD as described in Annex A.5.1.1/A.5.2.1 and set-up according to Annex C.3.1.						

## 7.5E Adjacent Channel Selectivity (ACS) for category 0

Editor's note: Following aspects missing or not yet determined:

- RB allocation within brackets
- Test tolerance for this case in Annex F is not completed

### 7.5E.1 Test purpose

Same test purpose as in clause 7.5.1.

### 7.5E.2 Test applicability

This test applies to all types of E-UTRA UE release 12 and forward of category 0.

### 7.5E.3 Minimum conformance requirements

Same minimum conformance requirements as in clause 7.5.3

## 7.5E.4 Test description

### 7.5E.4.1 Initial conditions

Same initial conditions as in clause 7.5.4.1 with the following exceptions:

- Instead of Table 7.5.4.1-1 → use Table 7.5E.4.1-1.
- Connect the SS to the UE antenna connectors as shown in TS 36.508[7] Annex A Figure A.4 using only main UE Tx/Rx antenna.

**Table 7.5E.4.1-1: Test Configuration Table**

Initial Conditions						
Test Environment as specified in TS 36.508[7] clause 4.1			NC			
Test Frequencies as specified in TS36.508 [7] clause 4.3.1			Mid range			
Test Channel Bandwidths as specified in TS 36.508 [7] clause 4.3.			Lowest, 5MHz, Highest			
Test Parameters for Channel Bandwidths						
Ch BW	Downlink Configuration			Uplink Configuration		
	Mod'n	RB allocation		Mod'n	RB allocation	
		FDD and HD-FDD	TDD		FDD and HD-FDD	TDD
1.4MHz	QPSK	6	6	QPSK	6	6
3MHz	QPSK	14	14	QPSK	15	15
5MHz	QPSK	14	14	QPSK	25	25
5MHz	QPSK	14	N/A	QPSK	20	N/A
10MHz	QPSK	14	14	QPSK	[36]	[36]
10MHz	QPSK	14	N/A	QPSK	25	N/A
10MHz	QPSK	14	N/A	QPSK	20	N/A
15MHz	QPSK	14	14	QPSK	[36]	[36]
15MHz	QPSK	14	N/A	QPSK	20	N/A
20MHz	QPSK	14	14	QPSK	[36]	[36]
20MHz	QPSK	14	N/A	QPSK	20	N/A
Note 1: Test Channel Bandwidths are checked separately for each E-UTRA band, which applicable channel bandwidths are specified in Table 5.4.2.1-1. Note 2: Depending on E-UTRA band, only the appropriate Uplink RB allocation value according to table 7.3E.3-3 is tested per Test Channel Bandwidth. The allocation shall be located as close as possible to the downlink operating band but confined within the transmission bandwidth configuration for the channel bandwidth (Table 5.4.2-1). Note 3: For the DL signal one sided dynamic OCNG Pattern OP.1 FDD/TDD is used. Note 4: Downlink RB position shall be $RB_{start} = 0$ .						

### 7.5E.4.2 Test procedure

Same test procedure as in clause 7.5.4.2

### 7.5E.4.3 Message contents

Same message contents as in clause 7.5.4.3

## 7.5E.5 Test requirement

## 7.6 Blocking characteristics

The blocking characteristic is a measure of the receiver's ability to receive a wanted signal at its assigned channel frequency in the presence of an unwanted interferer on frequencies other than those of the spurious response or the adjacent channels, without this unwanted input signal causing a degradation of the performance of the receiver beyond a specified limit. The blocking performance shall apply at all frequencies except those at which a spurious response occur.

## 7.6.1 In-band blocking

### 7.6.1.1 Test Purpose

In-band blocking is defined for an unwanted interfering signal falling into the range from 15MHz below to 15MHz above the UE receive band, at which the relative throughput shall meet or exceed the requirement for the specified measurement channels.

The lack of in-band blocking ability will decrease the coverage area when other e-NodeB transmitters exist (except in the adjacent channels and spurious response).

### 7.6.1.2 Test Applicability

This test applies to all types of E-UTRA UE release 8 and forward..

### 7.6.1.3 Minimum Conformance Requirements

The throughput shall be  $\geq 95\%$  of the maximum throughput of the reference measurement channels as specified in Annexes A.2.2, A.2.3 and A.3.2 (with one sided dynamic OCNG Pattern OP.1 FDD/TDD for the DL-signal as described in Annex A.5.1.1/A.5.2.1) with parameters specified in Tables 7.6.1.3-1 and 7.6.1.3-2.

**Table 7.6.1.3-1: In band blocking parameters**

Rx Parameter	Units	Channel bandwidth					
		1.4 MHz	3 MHz	5 MHz	10 MHz	15 MHz	20 MHz
Power in Transmission Bandwidth Configuration	dBm	REFSENS + channel bandwidth specific value below					
		6	6	6	6	7	9
$BW_{\text{Interferer}}$	MHz	1.4	3	5	5	5	5
$F_{\text{offset, case 1}}$	MHz	2.1+0.0125	4.5+0.0075	7.5+0.0125	7.5+0.0025	7.5+0.0075	7.5+0.0125
$F_{\text{offset, case 2}}$	MHz	3.5+0.0075	7.5+0.0075	12.5+0.0075	12.5+0.012	12.5+0.002	12.5+0.007
Note 1:		The transmitter shall be set to 4dB below $P_{\text{CMAX,L}}$ at the minimum uplink configuration specified in Table 7.3.3-2 with $P_{\text{CMAX,L}}$ as defined in clause 6.2.5.					
Note 2:		The interferer consists of the Reference measurement channel specified in Annex A.3.2 with one sided dynamic OCNG Pattern OP.1 FDD/TDD as described in Annex A.5.1.1/A.5.2.1 and set-up according to Annex C.3.1.					

Table 7.6.1.3-2: In-band blocking

E-UTRA band	Parameter	Unit	Case 1	Case 2	Case 3	Case 4	Case 5
	$P_{\text{Interferer}}$	dBm	-56	-44			-38
	$F_{\text{Interferer}}$ (offset)	MHz	$= -BW/2 - F_{\text{offset, case 1}}$ & $= +BW/2 + F_{\text{offset, case 1}}$	$\leq -BW/2 - F_{\text{offset, case 2}}$ & $\geq +BW/2 + F_{\text{offset, case 2}}$			$-BW/2 - 11$
1, 2, 3, 4, 5, 6, 7, 8, 9, 10, 11, 12, 13, 14, 17, 18, 19, 20, 21, 22, 23, 25, 26, 27, 28, 31, 33, 34, 35, 36, 37, 38, 39, 40, 41, 42, 43, 44	$F_{\text{Interferer}}$	MHz	(Note 2)	$F_{\text{DL\_low}} - 15$ to $F_{\text{DL\_high}} + 15$	Void	Void	
30	$F_{\text{Interferer}}$	MHz	(Note 2)	$F_{\text{DL\_low}} - 15$ to $F_{\text{DL\_high}} + 15$			$F_{\text{DL\_low}} - 11$
NOTE 1: For certain bands, the unwanted modulated interfering signal may not fall inside the UE receive band, but within the first 15 MHz below or above the UE receive band							
NOTE 2: For each carrier frequency the requirement is valid for two frequencies: a. the carrier frequency $-BW/2 - F_{\text{offset, case 1}}$ and b. the carrier frequency $+BW/2 + F_{\text{offset, case 1}}$							
NOTE 3: $F_{\text{Interferer}}$ range values for unwanted modulated interfering signal are interferer centre frequencies							

For the UE which supports inter band CA configuration in Table 7.3.3-1A,  $P_{\text{Interferer}}$  power defined in Table 7.6.1.3-2 is increased by the amount given by  $\Delta R_{\text{IB,c}}$  in Table 7.3.3-1A.

The normative reference for this requirement is TS 36.101 [2] clause 7.6.1.

## 7.6.1.4 Test Description

### 7.6.1.4.1 Initial Conditions

Initial conditions are a set of test configurations the UE needs to be tested in and the steps for the SS to take with the UE to reach the correct measurement state.

The initial test configurations consist of environmental conditions, test frequencies, and channel bandwidths based on E-UTRA bands specified in table 5.4.2.1-1. All of these configurations shall be tested with applicable test parameters for each channel bandwidth, and are shown in table 7.6.1.4.1-1. The details of the uplink and downlink reference measurement channels (RMCs) are specified in Annexes A.2 and A.3 respectively. The details of the OCNG patterns used are specified in Annex A.5. Configurations of PDSCH and PDCCH before measurement are specified in Annex C.2.

Table 7.6.1.4.1-1: Test Configuration Table

Initial Conditions						
Test Environment as specified in TS 36.508[7] subclause 4.1				NC		
Test Frequencies as specified in TS36.508 [7] subclause 4.3.1				Mid range		
Test Channel Bandwidths as specified in TS 36.508 [7] subclause 4.3.1				Lowest, 5MHz, Highest		
Test Parameters for Channel Bandwidths						
Ch BW	Downlink Configuration			Uplink Configuration		
	Mod'n	RB allocation		Mod'n	RB allocation	
		FDD	TDD		FDD	TDD
1.4MHz	QPSK	6	6	QPSK	6	6
3MHz	QPSK	15	15	QPSK	15	15
5MHz	QPSK	25	25	QPSK	25	25
5MHz	QPSK	25	N/A	QPSK	20	N/A
5MHz	QPSK	25	N/A	QPSK	15	N/A
5MHz	QPSK	25	N/A	QPSK	5 <sup>+</sup>	N/A
10MHz	QPSK	50	50	QPSK	50	50
10MHz	QPSK	50	N/A	QPSK	25	N/A
10MHz	QPSK	50	N/A	QPSK	20	N/A
10MHz	QPSK	50	N/A	QPSK	15	N/A
15MHz	QPSK	75	75	QPSK	75	75
15MHz	QPSK	75	N/A	QPSK	50	N/A
15MHz	QPSK	75	N/A	QPSK	25	N/A
15MHz	QPSK	75	N/A	QPSK	20	N/A
20MHz	QPSK	100	100	QPSK	100	100
20MHz	QPSK	100	N/A	QPSK	75	N/A
20MHz	QPSK	100	N/A	QPSK	50	N/A
20MHz	QPSK	100	N/A	QPSK	25	N/A
20MHz	QPSK	100	N/A	QPSK	20	N/A
Note 1:	Test Channel Bandwidths are checked separately for each E-UTRA band, which applicable channel bandwidths are specified in Table 5.4.2.1-1.					
Note 2:	Depending on E-UTRA band, only the appropriate Uplink RB allocation value according to table 7.3.3-2 is tested per Test Channel Bandwidth. The allocation shall be located as close as possible to the downlink operating band but confined within the transmission bandwidth configuration for the channel bandwidth (Table 5.4.2-1).					
Note 3:	For the DL signal one sided dynamic OCNG Pattern OP.1 FDD/TDD is used.					
Note 4:	Applicable only to E-UTRA FDD Band 31. The UL resource blocks shall be located at RBstart 10 (according to Table 7.3.3-2).					

1. Connect the SS to the UE antenna connectors as shown in TS 36.508 [7] Annex A, in Figure A.4.
2. The parameter settings for the cell are set up according to TS 36.508 [7] subclause 4.4.3.
3. Downlink signals are initially set up according to Annex C0, C.1 and C.3.1, and uplink signals according to Annex H.1 and H.3.1.
4. The UL and DL Reference Measurement channels are set according to in Table 7.6.1.4.1-1.
5. Propagation conditions are set according to Annex B.0.
6. Ensure the UE is in State 3A-RF according to TS 36.508 [7] clause 5.2A.2. Message contents are defined in clause 7.6.1.4.3.

#### 7.6.1.4.2 Test Procedure

1. SS transmits PDSCH via PDCCH DCI format 1A for C\_RNTI to transmit the DL RMC according to Table 7.6.1.4.1-1. The SS sends downlink MAC padding bits on the DL RMC.
2. SS sends uplink scheduling information for each UL HARQ process via PDCCH DCI format 0 for C\_RNTI to schedule the UL RMC according to Table 7.6.1.4.1-1. Since the UE has no payload data to send, the UE transmits uplink MAC padding bits on the UL RMC.



3. Set the parameters of the signal generator for an interfering signal below the wanted signal in Case 1 according to Tables 7.6.1.5-1 and 7.6.1.5-2.
4. Set the downlink signal level according to the table 7.6.1.5-1. Send uplink power control commands to the UE (less or equal to 1dB step size should be used), to ensure that the UE output power is within +0, - 3.4 dB of the target level in table 7.6.1.5-1 for carrier frequency  $f \leq 3.0\text{GHz}$  or within +0, -4.0 dB of the target level for carrier frequency  $3.0\text{GHz} < f \leq 4.2\text{GHz}$ , for at least the duration of the throughput measurement.
5. Measure the average throughput for a duration sufficient to achieve statistical significance according to Annex G.2.
6. Repeat steps from 3 to 5, using an interfering signal above the wanted signal in Case 1 at step 3.
7. Repeat steps from 3 to 6, using interfering signals in Case 2 at step 3 and 6. The ranges of case 2 are covered in steps equal to the interferer bandwidth. The test frequencies are chosen in analogy to table 7.6.1.4.2-1.

**Table 7.6.1.4.2-1: Example for interferer frequencies**

	Lower frequency	Upper frequency
Band 1 DL	2110 MHz	2170 MHz
Band 1 Midrange	2140 MHz	
Receive band wanted signal (BW 5MHz)	2137.5 MHz	2142.5 MHz
Interferer case 1	2129.9875 MHz	2150.0125 MHz
Interferer case 2 (inner frequency)	2124.9925 MHz	2155.0075 MHz
Interferer case 2 (outer frequency)	2099.9925 MHz	2180.0075 MHz
Outer limit for in band blocking	2095MHz	2185MHz
Number of test frequencies case 2	6	6
Number of test frequencies for Band 17(asymmetric!), BW 5MHz, case 2	0	2

### 7.6.1.4.3 Message Contents

Message contents are according to TS 36.508 [7] subclause 4.6 with the following exception

**Table 7.6.1.4.3-1: UplinkPowerControlDedicated**

Derivation Path: 36.331 clause 6.3.2			
Information Element	Value/remark	Comment	Condition
UplinkPowerControlDedicated-DEFAULT ::= SEQUENCE {			
p0-UePUSCH	0		
deltaMCS-Enabled	en0		
accumulationEnabled	TRUE		
p0-uePUCCH	0		
pSRS-Offset	3 (-6 dB)		
filterCoefficient	fc8	larger filter length is used to reduce the RSRP measurement variation	
}			

### 7.6.1.5 Test Requirement

The throughput measurement derived in test procedure shall be  $\geq 95\%$  of the maximum throughput of the reference measurement channels as specified in Annex A.3.2 with parameters specified in Tables 7.6.1.5-1 and 7.6.1.5-2.

**Table 7.6.1.5-1: In band blocking parameters**

Rx Parameter	Units	Channel bandwidth					
		1.4 MHz	3 MHz	5 MHz	10 MHz	15 MHz	20 MHz
Power in Transmission	dBm	REFSENS + channel bandwidth specific value below					
		6	6	6	6	7	9

Bandwidth Configuration							
BW <sub>Interferer</sub>	MHz	1.4	3	5	5	5	5
F <sub>offset, case 1</sub>	MHz	2.1+0.0125	4.5+0.0075	7.5+0.0125	7.5+0.0025	7.5+0.0075	7.5+0.0125
F <sub>offset, case 2</sub>	MHz	3.5+0.0075	7.5+0.0075	12.5+0.0075	12.5+0.012	12.5+0.002	12.5+0.007
Note 1:		The transmitter shall be set to 4dB below P <sub>CMAX,L</sub> with P <sub>CMAX,L</sub> as defined in clause 6.2.5.					
Note 2:		The interferer consists of the Reference measurement channel specified in Annex A.3.2 with one sided dynamic OCNG Pattern OP.1 FDD/TDD as described in Annex A.5.1.1/A.5.2.1 and set-up according to Annex C.3.1.					

**Table 7.6.1.5-2: In-band blocking**

E-UTRA band	Parameter	Unit	Case 1	Case 2	Case 3	Case 4	Case 5
	P <sub>Interferer</sub>	dBm	-56	-44			-38
	F <sub>Interferer (offset)</sub>	MHz	$= -BW/2 - F_{offset, case 1}$ & $= +BW/2 + F_{offset, case 1}$	$\leq -BW/2 - F_{offset, case 2}$ & $\geq +BW/2 + F_{offset, case 2}$			$-BW/2 - 11$
1, 2, 3, 4, 5, 6, 7, 8, 9, 10, 11, 12, 13, 14, 17, 18, 19, 20, 21, 22, 23, 25, 26, 27, 28, 31, 33, 34, 35, 36, 37, 38, 39, 40, 41, 42, 43, 44	F <sub>Interferer</sub>	MHz	(Note 2)	F <sub>DL_low</sub> - 15 to F <sub>DL_high</sub> + 15	Void	Void	
30	F <sub>Interferer</sub>	MHz	(Note 2)	F <sub>DL_low</sub> - 15 to F <sub>DL_high</sub> + 15			F <sub>DL_low</sub> - 11
NOTE 1: For certain bands, the unwanted modulated interfering signal may not fall inside the UE receive band, but within the first 15 MHz below or above the UE receive band							
NOTE 2: For each carrier frequency the requirement is valid for two frequencies: a. the carrier frequency $-BW/2 - F_{offset, case 1}$ and b. the carrier frequency $+BW/2 + F_{offset, case 1}$							
NOTE 3: F <sub>Interferer</sub> range values for unwanted modulated interfering signal are interferer centre frequencies							

For the UE which supports inter band CA configuration in Table 7.3.3-1A, P<sub>Interferer</sub> power defined in Table 7.6.1.5-2 is increased by the amount given by ΔR<sub>IB,c</sub> in Table 7.3.3-1A.

## 7.6.1A In-band blocking for CA

### 7.6.1A.0 Minimum conformance requirements

For inter-band carrier aggregation with one component carrier per operating band and the uplink assigned to one E-UTRA band the in-band blocking requirements are defined with the uplink active on the band(s) other than the band whose downlink is being tested. The UE shall meet the requirements specified in subclause 7.6.1 for each component carrier while all downlink carriers are active. For the UE which supports inter band CA configuration in Table 7.3.3-1A, P<sub>Interferer</sub> power defined in Table 7.6.1.3-2 is increased by the amount given by ΔR<sub>IB,c</sub> in Table 7.3.3-1A. For E-UTRA CA configurations including an operating band without uplink band (as noted in Table 5.2-1), the requirements for all downlinks shall be met with the uplink in the band(s) capable of UL operation. The requirements for the component carrier configured in the operating band without uplink band are specified in Table 7.6.1.3-1 and Table 7.6.1A.0-0.

**Table 7.6.1A.0-0: In-band blocking for additional operating bands for carrier aggregation**

E-UTRA band	Parameter	Unit	Case 1	Case 2
		$P_{\text{Interferer}}$	dBm	-56
	$F_{\text{Interferer}}$ (offset)	MHz	$=-BW/2 - F_{\text{offset,case 1}}$ & $=+BW/2 + F_{\text{offset,case 1}}$	$\leq -BW/2 - F_{\text{offset,case 2}}$ & $\geq +BW/2 + F_{\text{offset,case 2}}$
29, 32	$F_{\text{Interferer}}$	MHz	(Note 2)	$F_{\text{DL\_low}} - 15$ to $F_{\text{DL\_high}} + 15$
<p>Note 1: For certain bands, the unwanted modulated interfering signal may not fall inside the UE receive band, but within the first 15 MHz below or above the UE receive band.</p> <p>Note 2: For each carrier frequency the requirement is valid for two frequencies:                      a. the carrier frequency <math>-BW/2 - F_{\text{offset, case 1}}</math> and                      b. the carrier frequency <math>+BW/2 + F_{\text{offset, case 1}}</math></p> <p>Note 3: <math>F_{\text{Interferer}}</math> range values for unwanted modulated interfering signal are interferer centre frequencies.</p>				

For E-UTRA CA configurations listed in Table 7.3A.0-1 under conditions for which reference sensitivity for the operating band being tested is N/A, the in-band blocking requirements of subclause 7.6.1A.0 do not apply.

For intra-band contiguous carrier aggregation the downlink SCC(s) shall be configured at nominal channel spacing to the PCC. For FDD, the PCC shall be configured closest to the uplink band. All downlink carriers shall be active throughout the test. The uplink output power shall be set as specified in Table 7.6.1A.0-1 with the uplink configuration set according to Table 7.3A.0-2 for the applicable carrier aggregation configuration. For UE(s) supporting one uplink carrier, the uplink configuration of the PCC shall be in accordance with Table 7.3.3-2. The UE shall fulfil the minimum requirement in presence of an interfering signal specified in Tables 7.6.1A.0-1 and Tables 7.6.1A.0-2 being on either side of the aggregated signal. The throughput of each carrier shall be  $\geq 95\%$  of the maximum throughput of the reference measurement channels as specified in Annexes A.2.2, A.2.3 and A.3.2 (with one sided dynamic OCNB Pattern OP.1 FDD/TDD for the DL-signal as described in Annex A.5.1.1/A.5.2.1) with parameters specified in Tables 7.6.1A.0-1 and 7.6.1A.0-2.

For intra-band non-contiguous carrier aggregation with one uplink carrier and more than or equal to two downlink carriers, each larger than or equal to 5 MHz, the in-band blocking requirements are defined with the uplink configuration in accordance with Table 7.3A.0-3. For this uplink configuration, the UE shall meet the requirements specified in subclause 7.6.1.3 and in this subclause for single component carrier and two component carriers separately, subject to in-gap and out-of-gap interferers while all downlink carriers are active.

**Table 7.6.1A.0-1: In band blocking parameters**

Rx Parameter	Units	CA Bandwidth Class				
		B	C	D	E	F
Pw in Transmission Bandwidth Configuration, per CC	dBm	REFSENS + CA Bandwidth Class specific value below				
		9	12	13.8		
$BW_{\text{Interferer}}$	MHz	5	5	5		
$F_{\text{offset, case 1}}$	MHz	7.5	7.5	7.5		
$F_{\text{offset, case 2}}$	MHz	12.5	12.5	12.5		
<p>Note 1: The transmitter shall be set to 4dB below <math>P_{\text{CMAX\_L}}</math> or <math>P_{\text{CMAX\_L\_CA}}</math> as defined in subclause 6.2.5A</p> <p>Note 2: The interferer consists of the Reference measurement channel specified in Annex A.3.2 with one sided dynamic OCNB Pattern OP.1 FDD/TDD as described in Annex A.5.1.1/A.5.2.1 and set-up according to Annex C.3.1</p>						

**Table 7.6.1A.0-2: In-band blocking**

CA configuration	Parameter	Unit	Case 1	Case 2
		$P_{\text{Interferer}}$	dBm	-56
	$F_{\text{Interferer}}$	MHz	$=-F_{\text{offset}} - F_{\text{offset,case 1}}$ & $=+F_{\text{offset}} + F_{\text{offset,case 1}}$	$\leq -F_{\text{offset}} - F_{\text{offset,case 2}}$ & $\geq +F_{\text{offset}} + F_{\text{offset,case 2}}$

CA_1C, CA_2C, CA_3C, CA_7C, CA_12B, CA_23B, CA_27B, CA_38C, CA_39C, CA_40C, CA_40D, CA_41C, CA_41D, CA_42C	$F_{\text{Interferer}}$ (Range)	MHz	(Note 2)	$F_{\text{DL\_low}} - 15$ to $F_{\text{DL\_high}} + 15$
note 1:	For certain bands, the unwanted modulated interfering signal may not fall inside the UE receive band, but within the first 15 MHz below or above the UE receive band			
note 2:	For each carrier frequency the requirement is valid for two frequencies: a) the carrier frequency $-F_{\text{offset}} - F_{\text{offset, case 1}}$ and b) the carrier frequency $+F_{\text{offset}} + F_{\text{offset, case 1}}$			
note 3:	$F_{\text{offset}}$ is the frequency offset from the centre frequency of the adjacent CC being tested to the edge of aggregated channel bandwidth.			
note 4:	The $F_{\text{interferer}}$ (offset) is relative to the centre frequency of the adjacent CC being tested and shall be further adjusted to $\lfloor F_{\text{interferer}} / 0.015 + 0.5 \rfloor 0.015 + 0.0075$ MHz to be offset from the sub-carrier raster for interferer signal above the wanted signal and adjusted to $\lfloor F_{\text{interferer}} / 0.015 + 0.5 \rfloor 0.015 - 0.0075$ MHz to be offset from the sub-carrier raster for interferer signal below the wanted signal.			

For combinations of intra-band contiguous and inter-band carrier aggregation with three downlink carriers and one uplink carrier assigned to one E-UTRA band, the requirement is defined with the uplink active in the band other than that supporting the downlink(s) under test and a configuration in accordance with Table 7.3.3-2. The downlink PCC carrier centre frequency shall be configured closer to the uplink operating band than the downlink SCC centre frequency when the uplink is active in the band supporting two component carriers. For these uplink configurations, the UE shall meet the in-band blocking requirements for intra-band contiguous carrier aggregation of two downlink carriers and for the remaining component carrier the requirements specified in subclause 7.6.1. The three downlink carriers shall be active throughout the tests.

For combinations of intra-band non-contiguous and inter-band carrier aggregation with three downlink carriers and one uplink carrier assigned to one E-UTRA band, the requirement is defined with the uplink active in the band other than that supporting the downlink(s) under test. The uplink configuration shall be in accordance with Table 7.3A.0-3 when the uplink is active in the band supporting two component carriers and in accordance with Table 7.3.3-2 when the uplink is active in the other band. For these uplink configurations, the UE shall meet the in-band blocking requirements for intra-band non-contiguous carrier aggregation of two downlink carriers with  $\Delta R_{\text{IBNC}} = 0$  dB for all sub-block gaps (Table 7.3A.0-3) and for the remaining component carrier the requirements specified in subclause 7.6.1. The three downlink carriers shall be active throughout the tests.

The normative reference for this requirement is TS 36.101 [2] clause 7.6.1.1A.

## 7.6.1A.1 In-band blocking for CA (intra-band contiguous DL CA and UL CA)

### 7.6.1A.1.1 Test Purpose

In-band blocking is defined for an unwanted interfering signal falling into the range from 15MHz below to 15MHz above the UE receive band, at which the relative throughput shall meet or exceed the requirement for the specified measurement channels.

The lack of in-band blocking ability will decrease the coverage area when other e-NodeB transmitters exist (except in the adjacent channels and spurious response).

### 7.6.1A.1.2 Test Applicability

This test applies to all types of E-UTRA UE release 10 and forward that support intra-band contiguous DL CA and UL CA.

### 7.6.1A.1.3 Minimum Conformance Requirements

The minimum conformance requirements are defined in clause 7.6.1A.0.

### 7.6.1A.1.4 Test Description

#### 7.6.1A.1.4.1 Initial Conditions

Initial conditions are a set of test configurations the UE needs to be tested in and the steps for the SS to take with the UE to reach the correct measurement state.

The initial test configurations consist of environmental conditions, test frequencies, and CC combinations based on E-UTRA CA configurations specified in table 5.4.2A.1-1. All of these configurations shall be tested with applicable test

parameters for each CA Configuration, and are shown in table 7.6.1A.1.4.1-1. The details of the OCNG patterns used are specified in Annex A.5. Configurations of PDSCH and PDCCH before measurement are specified in Annex C.2.

**Table 7.6.1A.1.4.1-1: Test Configuration Table**

Initial Conditions							
Test Environment as specified in TS 36.508[7] subclause 4.1				NC			
Test Frequencies as specified in TS36.508 [7] subclause 4.3.1 for different CA bandwidth classes, and PCC and SCCs are mapped onto physical frequencies according to Table 7.1-2				C: Mid range			
Test CC Combination setting ( $N_{RB\_agg}$ ) as specified in subclause 5.4.2A.1 for the CA Configuration across bandwidth combination sets supported by the UE.				Lowest $N_{RB\_agg}$ Highest $N_{RB\_agg}$ (Note 3)			
Test Parameters for CA Configurations							
CA Configuration / $N_{RB\_agg}$		DL Allocation		UL Allocation			
PCC $N_{RB}$	SCC $N_{RB}$	CC MOD	PCC & SCC RB allocation	CC MOD	$N_{RB\_alloc}$	PCC & SCC RB allocations ( $L_{CRB}$ @ $RB_{start}$ )	
75	75	QPSK	75+75	QPSK	75	P_75@0	S_0@0
75	75	QPSK	75+75	QPSK	129	P_75@0	S_54@0
75	75	QPSK	75+75	QPSK	150	P_75@0	S_75@0
100	25	QPSK	100+25	QPSK	50	P_50@50	S_0@0
100	25	QPSK	100+25	QPSK	125	P_100@0	S_25@0
100	50	QPSK	100+50	QPSK	50	P_50@50	S_0@0
100	50	QPSK	100+50	QPSK	75	P_75@25	S_0@0
100	50	QPSK	100+50	QPSK	150	P_100@0	S_50@0
100	75	QPSK	100+75	QPSK	175	P_100@0	S_75@0
100	100	QPSK	100+100	QPSK	50	P_50@50	S_0@0
100	100	QPSK	100+100	QPSK	75	P_75@25	S_0@0
100	100	QPSK	100+100	QPSK	130	P_100@0	S_30@0
100	100	QPSK	100+100	QPSK	200	P_100@0	S_100@0
Note 1: CA Configuration Test CC Combination settings are checked separately for each CA Configuration, which applicable aggregated channel bandwidths are specified in Table 5.4.2A.1-1.							
Note 2: Depending on CA Configuration only the appropriate Uplink RB allocation value according to table 7.3A.0-2 is tested per CA Configuration Test CC combination.							
Note 3: If in the CA Configuration UE supports multiple CC Combinations with the same $N_{RB\_agg}$ , only the first of those is tested, according to the order on the Test Configuration Table list.							

1. Connect the SS to the UE antenna connectors as shown in TS 36.508 [7] Annex A, Figure group A.34 as appropriate.
2. The parameter settings for the cell are set up according to TS 36.508 [7] subclause 4.4.3.
3. Downlink signals are for PCC initially set up according to Annex C.0, C.1 and C.3.1, and uplink signals according to Annex H.1 and H.3.1.
4. The UL and DL Reference Measurement channels are set according to Table 7.6.1A.1.4.1-1.
5. Propagation conditions are set according to Annex B.0.
6. Ensure the UE is in State 3A-RF according to TS 36.508 [7] clause 5.2A.2. Message contents are defined in clause 7.6.1A.1.4.3.

#### 7.6.1A.1.4.2 Test Procedure

1. Configure SCC according to Annex C.0, C.1 and Annex C.3.1 for all downlink physical channels.

2. The SS shall configure SCC as per TS 36.508 [7] clause 5.2A.4. Message contents are defined in clause 7.6.1A.1.4.3.
3. SS activates SCC by sending the activation MAC-CE (Refer TS 36.321 [13], clauses 5.13, 6.1.3.8). Wait for at least 2 seconds (Refer TS 36.133, clauses 8.3.3.2).
4. SS transmits PDSCH via PDCCH DCI format 1A for C\_RNTI to transmit the DL RMC according to Table 7.6.1A.1.4.1-1 on both PCC and SCC. The SS sends downlink MAC padding bits on the DL RMC.
5. SS sends uplink scheduling information for each UL HARQ process via PDCCH DCI format 0 for C\_RNTI to schedule the UL RMC according to Table 7.6.1A.1.4.1-1 on both PCC and SCC. Since the UE has no payload data to send, the UE sends uplink MAC padding bits on the UL RMC.
6. Set the parameters of the signal generator for an interfering signal below the aggregated component carriers in Case 1 according to Tables 7.6.1A.1.5-1 and 7.6.1A.1.5-2.
7. Set the downlink signal level according to the table 7.6.1A.1.5-1. Send uplink power control commands to the UE (less or equal to 1dB step size should be used), to ensure that for at least the duration of the throughput measurement:  
The PCC output power is within (+0dB, -3.4 dB) of (target level in Table 7.6.1A.1.5-1 +  $10\log(P_{L\_CRB}/N_{RB\_alloc})$ ), for carrier frequency  $f \leq 3.0\text{GHz}$ ,  
or within (+0dB, -4 dB) of (target level in Table 7.6.1A.1.5-1 +  $10\log(P_{L\_CRB}/N_{RB\_alloc})$ ) for carrier frequency  $3.0\text{GHz} < f \leq 4.2\text{GHz}$ .  
The SCC output power is within (+0dB, -3.4 dB) of (target level in Table 7.6.1A.1.5-1 +  $10\log(S_{L\_CRB}/N_{RB\_alloc})$ ), for carrier frequency  $f \leq 3.0\text{GHz}$ ,  
or within (+0dB, -4 dB) of (target level in Table 7.6.1A.1.5-1 +  $10\log(S_{L\_CRB}/N_{RB\_alloc})$ ) for carrier frequency  $3.0\text{GHz} < f \leq 4.2\text{GHz}$ .
8. Measure the average throughput for each component carrier for duration sufficient to achieve statistical significance according to Annex G.2A.
9. Repeat steps from 6 to 8, using an interfering signal above the aggregated component carriers in Case 1 at step 6.
10. Repeat steps from 6 to 9, using interfering signals in Case 2 at step 6 and 9. The ranges of case 2 are covered in steps equal to the interferer bandwidth. The test frequencies are chosen in analogy to table 7.6.1A.1.4.2-1.

**Table 7.6.1A.1.4.2-1: Example for interferer frequencies**

	Lower frequency	Upper frequency
Band 1 DL	2110 MHz	2170 MHz
Band 1 Midrange	PCC: 2132.5 MHz SCC: 2147.5 MHz	
Receive band wanted signal (CC Configuration / $N_{RB\_agg} 75 + 75$ )	PCC: 2125 MHz SCC: 2140 MHz	2140 MHz 2155 MHz
Interferer case 1	2117.5125 MHz	2162.5125 MHz
Interferer case 2 (inner frequency)	2112.5025 MHz	2167.5075 MHz
Interferer case 2 (outer frequency)	2097.5025 MHz	2177.5075 MHz
Outer limit for in band blocking	2095MHz	2185MHz
Number of test frequencies case 2	4	3

#### 7.6.1A.1.4.3 Message Contents

Message contents are according to TS 36.508 [7] subclause 4.6 with the following exception.

**Table 7.6.1A.1.4.3-1: UplinkPowerControlDedicatedSCell-r10**

Derivation Path: 36.508 clause 4.6.3			
Information Element	Value/remark	Comment	Condition
UplinkPowerControlDedicated-DEFAULT::= SEQUENCE {			
p0-UE-PUSCH-r10	0		
deltaMCS-Enabled-r10	en0		
accumulationEnabled-r10	TRUE		
pSRS-Offset-r10	7 (0 dB)	The actual parameter value is $-10.5 + 1.5 \cdot \text{pSRS-Offset}$ value; 0 is the actual value in dB ( $-10.5 + 1.5 \cdot 7$ dB).	
pSRS-OffsetAp-r10	7 (0 dB)	The actual parameter value is $-10.5 + 1.5 \cdot \text{pSRS-Offset}$ value; 0 is the actual value in dB ( $-10.5 + 1.5 \cdot 7$ dB).	
filterCoefficient-r10	fc8	larger filter length is used to reduce the RSRP measurement variation	
pathlossReferenceLinking-r10	sCell		
}			

**7.6.1A.1.5 Test Requirement**

The throughput measurement of each carrier derived in test procedure shall be  $\geq 95\%$  of the maximum throughput of the reference measurement channels as specified in Annex A.3.2 with parameters specified in Table 7.6.1A.1.5-1 and 7.6.1A.1.5-2.

**Table 7.6.1A.1.5-1: In band blocking parameters**

Rx Parameter	Units	CA Bandwidth Class				
		B	C	D	E	F
Pw in Transmission Bandwidth Configuration, per CC	dBm	REFSENS + CA Bandwidth Class specific value below				
BW <sub>Interferer</sub>			12			
F <sub>offset, case 1</sub>	MHz		5			
F <sub>offset, case 2</sub>	MHz		7.5			
			12.5			
Note 1: The transmitter shall be set to 4dB below P <sub>CMAX,L</sub> or P <sub>CMAX,L,CA</sub> as defined in subclause 6.2.5 for one uplink carrier and in subclause 6.2.5A for two uplink carriers. Note 2: The interferer consists of the Reference measurement channel specified in Annex A.3.2 with one sided dynamic OCNG Pattern OP.1 FDD/TDD as described in Annex A.5.1.1/A.5.2.1 and set-up according to Annex C.3.1						

**Table 7.6.1A.1.5-2: In-band blocking**

CA configuration	Parameter	Unit	Case 1	Case 2
	P <sub>Interferer</sub>	dBm	-56	-44
	F <sub>Interferer</sub>	MHz	$= -F_{\text{offset}} - F_{\text{offset,case 1}}$ & $= +F_{\text{offset}} + F_{\text{offset,case 1}}$	$\leq -F_{\text{offset}} - F_{\text{offset,case 2}}$ & $\geq +F_{\text{offset}} + F_{\text{offset,case 2}}$

CA_1C, CA_2C, CA_3C, CA_7C, CA_12B, CA_23B, CA_27B, CA_38C, CA_39C, CA_40C, CA_41C, CA_42C	$F_{\text{Interferer}}$ (Range)	MHz	(Note 2)	$F_{\text{DL\_low}} - 15$ to $F_{\text{DL\_high}} + 15$
Note 1:	For certain bands, the unwanted modulated interfering signal may not fall inside the UE receive band, but within the first 15 MHz below or above the UE receive band			
Note 2:	For each carrier frequency the requirement is valid for two frequencies: a) the carrier frequency $-F_{\text{offset}} - F_{\text{offset, case 1}}$ and b) the carrier frequency $+F_{\text{offset}} + F_{\text{offset, case 1}}$			
Note 3:	$F_{\text{offset}}$ is the frequency offset from the centre frequency of the adjacent CC being tested to the edge of aggregated channel bandwidth.			
Note 4:	The $F_{\text{interferer}}$ (offset) is relative to the centre frequency of the adjacent CC being tested and shall be further adjusted to $\lfloor F_{\text{interferer}} / 0.015 + 0.5 \rfloor 0.015 + 0.0075$ MHz to be offset from the sub-carrier raster for interferer signal above the wanted signal and adjusted to $\lfloor F_{\text{interferer}} / 0.015 + 0.5 \rfloor 0.015 - 0.0075$ MHz to be offset from the sub-carrier raster for interferer signal below the wanted signal.			

For the UE which supports inter band CA configuration in Table 7.3.3-1A,  $P_{\text{Interferer}}$  power defined in Table 7.6.1A.1.5-2 is increased by the amount given by  $\Delta R_{\text{IB,c}}$  in Table 7.3.3-1A.

## 7.6.1A.2 In-band blocking for CA (intra-band contiguous DL CA without UL CA)

### 7.6.1A.2.1 Test Purpose

Same test purpose as in clause 7.6.1A.1.

### 7.6.1A.2.2 Test Applicability

This test applies to all types of E-UTRA UE release 10 and forward that support intra-band contiguous DL CA. This test case applies only for CA Configurations that do not support UL CA.

### 7.6.1A.2.3 Minimum Conformance Requirements

The minimum conformance requirements are defined in clause 7.6.1A.0.

### 7.6.1A.2.4 Test Description

#### 7.6.1A.2.4.1 Initial Conditions

Same initial conditions as in clause 7.6.1A.1.4.1 with the following exceptions:

- Instead of Table 7.6.1A.1.4.1-1 → use Table 7.6.1A.2.4.1-1.
- Instead of clause 7.6.1A.1.4.3 → use clause 7.6.1A.2.4.3.



Table 7.6.1A.2.4.1-1: Test Configuration Table

Initial Conditions							
Test Environment as specified in TS 36.508[7] subclause 4.1					NC		
Test Frequencies as specified in TS36.508 [7] subclause 4.3.1 for different CA bandwidth classes, and PCC and SCCs are mapped onto physical frequencies according to Table 7.1-2					B: Mid range C: Mid range		
Test CC Combination setting ( $N_{RB\_agg}$ ) as specified in subclause 5.4.2A.1 for the CA Configuration across bandwidth combination sets supported by the UE.					Lowest $N_{RB\_agg}$ Highest $N_{RB\_agg}$ (Note 3)		
Test Parameters for CA Configurations							
CA Configuration / $N_{RB\_agg}$		DL Allocation		UL Allocation			
PCC $N_{RB}$	SCC $N_{RB}$	CC MOD	PCC & SCC RB allocation	CC MOD	$N_{RB\_alloc}$	PCC & SCC RB allocations ( $L_{CRB}$ @ $RB_{start}$ )	
6	25	QPSK	6+25	QPSK	6	P_6@0	-
15	50	QPSK	15+50	QPSK	15	P_15@0	-
25	25	QPSK	25+25	QPSK	20	P_20@0	-
25	50	QPSK	25+50	QPSK	20	P_20@0	-
50	50	QPSK	50+50	QPSK	50	P_50@0	-
75	75	QPSK	75+75	QPSK	75	P_75@0	-
100	25	QPSK	100+25	QPSK	100	P_100@0	-
100	25	QPSK	100+25	QPSK	50	P_50@50	-
100	50	QPSK	100+50	QPSK	100	P_100@0	-
100	50	QPSK	100+50	QPSK	75	P_75@25	-
100	50	QPSK	100+50	QPSK	50	P_50@50	-
100	75	QPSK	100+75	QPSK	100	P_100@0	-
100	100	QPSK	100+100	QPSK	100	P_100@0	-
100	100	QPSK	100+100	QPSK	75	P_75@25	-
100	100	QPSK	100+100	QPSK	50	P_50@50	-
Note 1: CA Configuration Test CC Combination settings are checked separately for each CA Configuration, which applicable aggregated channel bandwidths are specified in Table 5.4.2A.1-1.							
Note 2: Depending on CA Configuration only the appropriate Uplink RB allocation value according to table 7.3.3-2 is tested per CA Configuration Test CC combination.							
Note 3: If in the CA Configuration UE supports multiple CC Combinations with the same $N_{RB\_agg}$ , only the first of those is tested, according to the order on the Test Configuration Table list.							

## 7.6.1A.2.4.2 Test Procedure

1. Configure SCC according to Annex C.0, C.1 and Annex C.3.1 for all downlink physical channels.
2. The SS shall configure SCC as per TS 36.508 [7] clause 5.2A.4.
3. SS activates SCC by sending the activation MAC-CE (Refer TS 36.321 [13], clauses 5.13, 6.1.3.8). Wait for at least 2 seconds (Refer TS 36.133, clauses 8.3.3.2).
4. SS transmits PDSCH via PDCCH DCI format 1A for  $C\_RNTI$  to transmit the DL RMC according to Table 7.6.1A.2.4.1-1 on both PCC and SCC. The SS sends downlink MAC padding bits on the DL RMC.
5. SS sends uplink scheduling information for each UL HARQ process via PDCCH DCI format 0 for  $C\_RNTI$  to schedule the UL RMC according to Table 7.6.1A.2.4.1-1 on PCC. Since the UE has no payload data to send, the UE sends uplink MAC padding bits on the UL RMC.
6. Set the parameters of the signal generator for an interfering signal below the aggregated component carriers in Case 1 according to Tables 7.6.1A.1.5-1 and 7.6.1A.1.5-2.

7. Set the downlink signal level according to the table 7.6.1A.1.5-1. Send uplink power control commands to the UE (less or equal to 1dB step size should be used), to ensure that the UE output power is within +0, - 3.4 dB of the target level in table 7.6.1A.1.5-1 for carrier frequency  $f \leq 3.0\text{GHz}$  or within +0, -4.0 dB of the target level for carrier frequency  $3.0\text{GHz} < f \leq 4.2\text{GHz}$ , for at least the duration of the throughput measurement.
8. Measure the average throughput for each component carrier for duration sufficient to achieve statistical significance according to Annex G.2A.
9. Repeat steps from 6 to 8, using an interfering signal above the aggregated component carriers in Case 1 at step 6.
10. Repeat steps from 6 to 9, using interfering signals in Case 2 at step 6 and 9. The ranges of case 2 are covered in steps equal to the interferer bandwidth. The test frequencies are chosen in analogy to table 7.6.1A.1.4.2-1.

7.6.1A.2.4.3 Message Contents

Same message contents as in clause 7.6.1.4.3.

7.6.1A.2.5 Test Requirement

Same test requirement as in clause 7.6.1A.1.5 with the following exceptions:

- Instead of Table 7.6.1A.1.5-1 → use Table 7.6.1A.2.5-1.
- Instead of Table 7.6.1A.1.5-2 → use Table 7.6.1A.2.5-2.

**Table 7.6.1A.2.5-1: In band blocking parameter**

Rx Parameter	Units	CA Bandwidth Class				
		B	C	D	E	F
Pw in Transmission Bandwidth Configuration, per CC	dBm	REFSENS + CA Bandwidth Class specific value below				
		9	12			
BW <sub>Interferer</sub>	MHz	5	5			
F <sub>offset, case 1</sub>	MHz	7.5	7.5			
F <sub>offset, case 2</sub>	MHz	12.5	12.5			
Note 1: The transmitter shall be set to 4dB below P <sub>C<sub>MAX,L</sub></sub> or P <sub>C<sub>MAX,L,CA</sub></sub> as defined in subclause 6.2.5						
Note 2: The interferer consists of the Reference measurement channel specified in Annex A.3.2 with one sided dynamic OCNG Pattern OP.1 FDD/TDD as described in Annex A.5.1.1/A.5.2.1 and set-up according to Annex C.3.1						

**Table 7.6.1A.2.5-2: In-band blocking**

CA configuration	Parameter	Unit	Case 1	Case 2
		P <sub>Interferer</sub>	dBm	-56
	F <sub>Interferer</sub>	MHz	$= -F_{\text{offset}} - F_{\text{offset, case 1}}$ & $= +F_{\text{offset}} + F_{\text{offset, case 1}}$	$\leq -F_{\text{offset}} - F_{\text{offset, case 2}}$ & $\geq +F_{\text{offset}} + F_{\text{offset, case 2}}$
CA_1C, CA_2C, CA_3C, CA_7C, CA_12B, CA_23B, CA_27B, CA_38C, CA_39C, CA_40C, CA_41C, CA_42C	F <sub>Interferer</sub> (Range)	MHz	(Note 2)	F <sub>DL_low</sub> - 15 to F <sub>DL_high</sub> + 15
Note 1: For certain bands, the unwanted modulated interfering signal may not fall inside the UE receive band, but within the first 15 MHz below or above the UE receive band				
Note 2: For each carrier frequency the requirement is valid for two frequencies: a) the carrier frequency $-F_{\text{offset}} - F_{\text{offset, case 1}}$ and b) the carrier frequency $+F_{\text{offset}} + F_{\text{offset, case 1}}$				
Note 3: F <sub>offset</sub> is the frequency offset from the centre frequency of the adjacent CC being tested to the edge of aggregated channel bandwidth.				
Note 4: The F <sub>interferer</sub> (offset) is relative to the centre frequency of the adjacent CC being tested and shall be further adjusted to $\lfloor F_{\text{interferer}} / 0.015 + 0.5 \rfloor 0.015 + 0.0075$ MHz to be offset from the sub-carrier raster for interferer signal above the wanted signal and adjusted to $\lfloor F_{\text{interferer}} / 0.015 + 0.5 \rfloor 0.015 - 0.0075$ MHz to be offset from the sub-carrier raster for interferer signal below the wanted signal.				

For the UE which supports inter band CA configuration in Table 7.3.3-1A, P<sub>Interferer</sub> power defined in Table 7.6.1A.2.5-2 is increased by the amount given by ΔR<sub>IB,c</sub> in Table 7.3.3-1A.

### 7.6.1A.3 In-band blocking for CA (inter-band DL CA without UL CA)

#### 7.6.1A.3.1 Test Purpose

Same test purpose as in clause 7.6.1A.1.

#### 7.6.1A.3.2 Test Applicability

This test applies to all types of E-UTRA UE release 10 and forward that support inter-band DL CA without UL CA.

#### 7.6.1A.3.3 Minimum Conformance Requirements

The minimum conformance requirements are defined in clause 7.6.1A.0.

#### 7.6.1A.3.4 Test Description

##### 7.6.1A.3.4.1 Initial Conditions

Same initial conditions as in clause 7.6.1A.1.4.1 with the following exceptions:

- Instead of Table 7.6.1A.1.4.1-1 → use Table 7.6.1A.3.4.1-1.
- Instead of clause 7.6.1A.1.4.3 → use clause 7.6.1A.3.4.3.

Table 7.6.1A.3.4.1-1: Test Configuration Table

Initial Conditions						
Test Environment as specified in TS 36.508[7] subclause 4.1			NC			
Test Frequencies as specified in TS36.508 [7] subclause 4.3.1 for different CA bandwidth classes, and PCC and SCCs are mapped onto physical frequencies according to Table 7.1-2			A: Mid range for PCC and SCC			
Test CC Combination setting ( $N_{RB\_agg}$ ) as specified in subclause 5.4.2A.1 for the CA Configuration across bandwidth combination sets supported by the UE			Highest $N_{RB\_agg}$ for PCC and SCC			
Test Parameters for CA Configurations						
CA Configuration / $N_{RB\_agg}$		DL Allocation			UL Allocation	
PCC $N_{RB}$	SCCs $N_{RB}$	CC MOD	PCC & SCC RB allocation		CC MOD	PCC $N_{RB\_alloc}$
50	50	QPSK	50	50	QPSK	50
50	50	QPSK	50	50	QPSK	25
50	50	QPSK	50	50	QPSK	20
50	50	QPSK	50	50	QPSK	16
50	75	QPSK	50	75	QPSK	25
50	100	QPSK	50	100	QPSK	50
50	100	QPSK	50	100	QPSK	25
50	100	QPSK	50	100	QPSK	20
75	50	QPSK	75	50	QPSK	25
75	100	QPSK	75	100	QPSK	25
100	50	QPSK	100	50	QPSK	100
100	50	QPSK	100	50	QPSK	75
100	50	QPSK	100	50	QPSK	50
100	75	QPSK	100	75	QPSK	100
100	100	QPSK	100	100	QPSK	75
100	100	QPSK	100	100	QPSK	50
Note 1: CA Configuration Test CC Combination settings are checked separately for each CA Configuration, which applicable aggregated channel bandwidths are specified in Table 5.4.2A.1-2. Note 2: Depending on CA configurations, only the appropriate Uplink RB allocation value according to table 7.3A.3.5-2 for UE supporting one uplink carrier is tested per Test CA configuration. Note 3: The UL resource blocks shall be located as close as possible to the downlink PCC but confined within the transmission bandwidth configuration for the channel bandwidth (Table 5.4.2-1). Note 4: The frequencies of PCC and SCC shall be switched and tested in each configuration, according to the UE declared capability for UL support (within CA operation) in the individual bands.						

#### 7.6.1A.3.4.2 Test Procedure

1. Configure SCC according to Annex C0, C.1 and Annex C.3.2 for all downlink physical channels.
2. The SS shall configure SCC as per TS 36.508 [7] clause 5.2A.4.
3. SS activates SCC by sending the activation MAC-CE (Refer TS 36.321 [13], clauses 5.13, 6.1.3.8). Wait for at least 2 seconds (Refer TS 36.133, clauses 8.3.3.2).
4. SS transmits PDSCH via PDCCH DCI format 1A for  $C\_RNTI$  to transmit the DL RMC according to Table 7.6.1A.3.4.1-1 on both PCC and SCC. The SS sends downlink MAC padding bits on the DL RMC.
5. SS sends uplink scheduling information for each UL HARQ process via PDCCH DCI format 0 for  $C\_RNTI$  to schedule the UL RMC according to Table 7.6.1A.3.4.1-1 on PCC. Since the UE has no payload data to send, the UE transmits uplink MAC padding bits on the UL RMC.

6. Set the parameters of the signal generator for an interfering signal below the SCC in Case 1 according to Tables 7.6.1.5-1 and 7.6.1.5-2, or 7.6.1.5-1 and 7.6.1A.3.5-0 for operating bands without uplink band (as noted in Table 5.2-1).
7. Set the downlink signal level according to the table 7.6.1A.3.5-1. Send uplink power control commands to the UE (less or equal to 1dB step size should be used), to ensure that the UE output power is within +0, - 3.4 dB of the target level in table 7.6.1A.3.5-1 for carrier frequency  $f \leq 3.0\text{GHz}$  or within +0, -4.0 dB of the target level for carrier frequency  $3.0\text{GHz} < f \leq 4.2\text{GHz}$ , for at least the duration of the throughput measurement.
8. Measure the average throughput of SCC for duration sufficient to achieve statistical significance according to Annex G.2.
9. Repeat steps from 6 to 8, using an interfering signal above the SCC in Case 1 at step 6.
10. Repeat steps from 6 to 9, using interfering signals in Case 2 at step 6 and 9. The ranges of case 2 are covered in steps equal to the interferer bandwidth. The test frequencies are chosen in analogy to table 7.6.1.4.2-1.

7.6.1A.3.4.3 Message Contents

Same message contents as in clause 7.6.1.4.3.

7.6.1A.3.5 Test Requirement

For inter-band carrier aggregation with uplink assigned to one E-UTRA band the in-band blocking requirements are defined with the uplink active on the band other than the band whose downlink is being tested i.e. the requirements are tested only for the SCell downlink. The UE shall meet the requirement for each component carrier, when operated as SCell, while both downlink carriers are active.

For band combinations including an operating band without uplink band (as noted in Table 5.2-1), the requirements for both downlinks shall be met with the uplink in the band capable of UL operation.

The throughput measured during the test procedure for each component carrier, when operated as SCell, shall be  $\geq 95\%$  of the maximum throughput of the reference measurement channels as specified in Annex A.3.2 with parameters specified in Tables 7.6.1A.3.5-1 and 7.6.1A.3.5-2 (originated from the single carrier Tables 7.6.1.5-1 and 7.6.1.5-2) and also Table 7.6.1A.3.5-0 for band combinations including an operating band without uplink band.

**Table 7.6.1A.3.5-0: In-band blocking for additional operating bands for carrier aggregation**

E-UTRA band	Parameter	Unit	Case 1	Case 2
		$P_{\text{Interferer}}$	dBm	-56
	$F_{\text{Interferer}}$ (offset from SCC)	MHz	$=-BW/2 - F_{\text{offset, case 1}}$ & $=+BW/2 + F_{\text{offset, case 1}}$	$\leq -BW/2 - F_{\text{offset, case 2}}$ & $\geq +BW/2 + F_{\text{offset, case 2}}$
29, 32	$F_{\text{Interferer}}$	MHz	(Note 2)	$F_{\text{DL\_low}} - 15$ to $F_{\text{DL\_high}} + 15$
Note 1: For certain bands, the unwanted modulated interfering signal may not fall inside the UE receive band, but within the first 15 MHz below or above the UE receive band. Note 2: For each carrier frequency the requirement is valid for two frequencies: a. the carrier frequency $-BW/2 - F_{\text{offset, case 1}}$ and b. the carrier frequency $+BW/2 + F_{\text{offset, case 1}}$ Note 3: $F_{\text{Interferer}}$ range values for unwanted modulated interfering signal are interferer centre frequencies.				

**Table 7.6.1A.3.5-1: In band blocking parameters**

Rx Parameter	Units	Channel bandwidth					
		1.4 MHz	3 MHz	5 MHz	10 MHz	15 MHz	20 MHz
Pw in Transmission Bandwidth Configuration, per CC	dBm	REFSENS + channel bandwidth specific value below					
		6	6	6	6	7	9

$BW_{\text{Interferer}}$	MHz	1.4	3	5	5	5	5
$F_{\text{offset, case 1}}$	MHz	2.1+0.0125	4.5+0.0075	7.5+0.0125	7.5+0.0025	7.5+0.0075	7.5+0.0125
$F_{\text{offset, case 2}}$	MHz	3.5+0.0075	7.5+0.0075	12.5+0.0075	12.5+0.0125	12.5+0.0025	12.5+0.0075

Note 1: The transmitter shall be set to 4dB below  $P_{\text{CMAX}_L}$  with  $P_{\text{CMAX}_L}$  as defined in clause 6.2.5.  
 Note 2: The interferer consists of the Reference measurement channel specified in Annex A.3.2 with one sided dynamic OCNG Pattern OP.1 FDD/TDD as described in Annex A.5.1.1/A.5.2.1 and set-up according to Annex C.3.1.

**Table 7.6.1A.3.5-2: In-band blocking**

E-UTRA band	Parameter	Unit	Case 1	Case 2	Case 3	Case 4	Case 5
	$P_{\text{Interferer}}$	dBm	-56	-44			-38
	$F_{\text{Interferer}}$ (offset from SCC)	MHz	$=-BW/2 - F_{\text{offset, case 1}}$ & $=+BW/2 + F_{\text{offset, case 1}}$	$\leq -BW/2 - F_{\text{offset, case 2}}$ & $\geq +BW/2 + F_{\text{offset, case 2}}$			$-BW/2 - 11$
1, 2, 3, 4, 5, 6, 7, 8, 9, 10, 11, 12, 13, 14, 17, 18, 19, 20, 21, 22, 23, 25, 26, 27, 28, 31, 33, 34, 35, 36, 37, 38, 39, 40, 41, 42, 43, 44	$F_{\text{Interferer}}$	MHz	(Note 2)	$F_{\text{DL\_low}} - 15$ to $F_{\text{DL\_high}} + 15$	Void	Void	
30	$F_{\text{Interferer}}$	MHz	(Note 2)	$F_{\text{DL\_low}} - 15$ to $F_{\text{DL\_high}} + 15$			$F_{\text{DL\_low}} - 11$

Note 1: For certain bands, the unwanted modulated interfering signal may not fall inside the UE receive band, but within the first 15 MHz below or above the UE receive band  
 Note 2: For each carrier frequency the requirement is valid for two frequencies:  
 a. the carrier frequency  $-BW/2 - F_{\text{offset, case 1}}$  and  
 b. the carrier frequency  $+BW/2 + F_{\text{offset, case 1}}$   
 Note 3:  $F_{\text{Interferer}}$  range values for unwanted modulated interfering signal are interferer centre frequencies

For the UE which supports inter band CA configuration in Table 7.3.3-1A,  $P_{\text{Interferer}}$  power defined in Table 7.6.1A.3.5-2 is increased by the amount given by  $\Delta R_{\text{IB,c}}$  in Table 7.3.3-1A.

**7.6.1A.4 In-band blocking for CA (intra-band non-contiguous DL CA without UL CA)**

**7.6.1A.4.1 Test Purpose**

Same as in clause 7.6.1A.1.1.

**7.6.1A.4.2 Test Applicability**

This test case applies to all types of E-UTRA UE release 11 and forward that support intra-band non-contiguous DL CA but no UL CA.

**7.6.1A.4.3 Minimum Conformance Requirements**

The minimum conformance requirements are defined in clause 7.6.1A.0.

**7.6.1A.4.4 Test description**

**7.6.1A.4.4.1 Initial Conditions**

Same as in clause 7.6.1A.1.4.1 with the following exceptions:

- Instead of Table 7.6.1A.1.4.1-1 → use Table 7.6.1A.4.4.1-1.

**Table 7.6.1A.4.4.1-1: Test Configuration Table**

Initial Conditions							
Test Environment as specified in TS 36.508[7] subclause 4.1				NC			
Test Frequencies as specified in TS36.508 [7] subclause 4.3.1 for different CA bandwidth classes, and PCC and SCCs are mapped onto physical frequencies according to Table 7.1-2				A: N/A (Range is not relevant)			
Test CC Combination setting ( $N_{RB\_agg}$ ) as specified in subclause 5.4.2A.1 for the CA Configuration .				Refer to test point			
Test Parameters for CA Configurations							
ID	CA Configuration / $N_{RB\_agg}$		$W_{gap}$ [MHz]	DL Allocation		UL Allocation	
	PCC $N_{RB}$	SCCs $N_{RB}$		CC MOD	PCC & SCC RB allocation	CC MOD	PCC RB allocations ( $L_{CRB}$ @ $RB_{start}$ )

Test Parameters for CA_2A-2A Configurations							
1	100	25	35	QPSK	100+25	QPSK	P_16@57
2	100	100	20	QPSK	100+100	QPSK	P_16@57
Test Parameters for CA_3A-3A Configurations							
3	100	25	50	QPSK	100+25	QPSK	P_16@50
4	100	25	15	QPSK	100+25	QPSK	P_32@68
5	100	100	35	QPSK	100+100	QPSK	P_16@50
Test Parameters for CA_4A-4A Configurations							
6	100	25	20	QPSK	100+25	QPSK	P_100@0
7	100	100	5	QPSK	100+100	QPSK	P_100@0
Test Parameters for CA_7A-7A Configurations							
8	100	75	35	QPSK	100+75	QPSK	P_36@64
9	100	75	15	QPSK	100+75	QPSK	P_50@50
10	100	100	30	QPSK	100+100	QPSK	P_32@68
11	100	100	15	QPSK	100+100	QPSK	P_45@55
Test Parameters for CA_23A-23A Configurations							
12	50	25	5	QPSK	50+25	QPSK	P_50@0
Test Parameters for CA_25A-25A Configurations							
13	50	25	50	QPSK	50+25	QPSK	P_10@33
14	50	25	15	QPSK	50+25	QPSK	P_32@18
15 <sup>3</sup>	50	50	45	QPSK	50+50	QPSK	P_10@33
16 <sup>3</sup>	50	50	10	QPSK	50+50	QPSK	P_32@18
17 <sup>4</sup>	100	25	40	QPSK	100+25	QPSK	P_12@62
18 <sup>4</sup>	100	100	25	QPSK	100+100	QPSK	P_12@62
Test Parameters for CA_41A-41A Configurations							
19 <sup>4</sup>	100	25	169	QPSK	100+25	QPSK	P_100@0
20 <sup>3</sup>	100	50	164	QPSK	100+50	QPSK	P_100@0
21	100	100	154	QPSK	100+100	QPSK	P_100@0
Test Parameters for CA_42A-42A Configurations							
22	100	25	175	QPSK	100+25	QPSK	P_100@0
23	100	100	160	QPSK	100+100	QPSK	P_100@0
Note 1:	CA Configuration Test CC Combination settings are checked separately for each CA Configuration, which applicable aggregated channel bandwidths are specified in Table 5.4.2A.1-3.						
Note 2:	The carrier centre frequency of PCC in the UL operating band is configured closer to the DL operating band.						
Note 3:	Applicable if only Bandwidth Combination Set 0 is supported by the UE for the CA Configuration						
Note 4:	Not applicable if only Bandwidth Combination Set 0 is supported by the UE for the CA Configuration						

#### 7.6.1A.4.4.2 Test Procedure

1. Configure SCC according to Annex C0, C.1 and Annex C.3.2 for all downlink physical channels.
2. The SS shall configure SCC as per TS 36.508 [7] clause 5.2A.4. Message contents are defined in clause 7.6.1A.4.4.3.
3. SS activates SCC by sending the activation MAC-CE (Refer TS 36.321 [13], clauses 5.13, 6.1.3.8). Wait for at least 2 seconds (Refer TS 36.133, clauses 8.3.3.2).



4. SS transmits PDSCH via PDCCH DCI format 1A for C\_RNTI to transmit the DL RMC according to Table 7.6.1A.3.4.1-1 on both PCC and SCC. The SS sends downlink MAC padding bits on the DL RMC.
5. SS sends uplink scheduling information for each UL HARQ process via PDCCH DCI format 0 for C\_RNTI to schedule the UL RMC according to Table 7.6.1A.4.4.1-1 on PCC. Since the UE has no payload data to send, the UE transmits uplink MAC padding bits on the UL RMC.
6. Set the parameters of the signal generator for an interfering signal below the PCC in Case 1 according to Tables 7.6.1.5-1 and 7.6.1.5-2, excluding frequencies where the interferer centre frequency falls within SCC carrier  $\pm(BW/2 + F_{\text{offset,case 1}})$ , where BW & offset refer to SCC.
7. Set the downlink signal level for PCC and SCC according to the table 7.6.1.5-1. Send uplink power control commands to the UE (less or equal to 1dB step size should be used), to ensure that the UE output power is within +0, - 3.4 dB of the target level in table 7.6.1.5-1 for carrier frequency  $f \leq 3.0\text{GHz}$  or within +0, -4.0 dB of the target level for carrier frequency  $3.0\text{GHz} < f \leq 4.2\text{GHz}$ , for at least the duration of the throughput measurement.
8. Measure the average throughput of the PCC for duration sufficient to achieve statistical significance according to Annex G.2A.
9. Repeat steps from 6 to 8, using an interfering signal above the PCC in Case 1 at step 6.
10. Repeat steps from 6 to 9, using an interfering signal below and above the SCC in Case 1 and measuring SCC instead of PCC in step 8, excluding the frequencies where the interferer centre frequency falls within PCC carrier  $\pm(BW/2 + F_{\text{offset,case 1}})$ , where BW & offset refer to PCC.
11. Repeat steps from 6 to 10, replacing references to Case 1 with references to Case 2. The ranges of case 2 are covered in steps equal to the interferer bandwidth. The test frequencies are chosen in analogy to table 7.6.1.4.2-1.

#### 7.6.1A.4.4.3 Message Contents

Message contents are according to TS 36.508 [7] subclause 4.6. In test procedure step 2, for SCC configuration there are no additional message contents.

#### 7.6.1A.4.5 Test Requirement

For intra-band non-contiguous carrier aggregation with one uplink carrier and two downlink carriers, each larger than or equal to 5 MHz, the in-band blocking requirements are defined with the uplink configuration of the PCC being in accordance with Table 7.3A.0-3. The UE shall meet the requirements specified in tables 7.6.1A.4.5-1 and 7.6.1A.4.5-2 for each component carrier while both downlink carriers are active. The requirements for each component carrier are the same as single carrier requirements in Tables 7.6.1.5-1 and 7.6.1.5-2.

The throughput measurement derived in test procedure shall be  $\geq 95\%$  of the maximum throughput of the reference measurement channels as specified in Annex A.3.2 with parameters specified in Tables 7.6.1A.4.5-1 and 7.6.1A.4.5-2.

**Table 7.6.1A.4.5-1: In band blocking parameters**

Rx Parameter	Units	Channel bandwidth					
		1.4 MHz	3 MHz	5 MHz	10 MHz	15 MHz	20 MHz
Pw in Transmission Bandwidth Configuration, per CC	dBm	REFSENS + channel bandwidth specific value below					
		6	6	6	6	7	9
BW <sub>Interferer</sub>	MHz	1.4	3	5	5	5	5
F <sub>offset, case 1</sub>	MHz	2.1+0.0125	4.5+0.0075	7.5+0.0125	7.5+0.0025	7.5+0.0075	7.5+0.0125
F <sub>offset, case 2</sub>	MHz	3.5+0.0075	7.5+0.0075	12.5+0.0075	12.5+0.012	12.5+0.002	12.5+0.007
					5	5	5
Note 1:	The transmitter shall be set to 4dB below P <sub>CMAX_L</sub> with P <sub>CMAX_L</sub> as defined in clause 6.2.5.						
Note 2:	The interferer consists of the Reference measurement channel specified in Annex A.3.2 with one sided dynamic OCN Pattern OP.1 FDD/TDD as described in Annex A.5.1.1/A.5.2.1 and set-up according to Annex C.3.1.						

**Table 7.6.1A.4.5-2: In-band blocking**

CA Configuration	Parameter	Unit	Case 1	Case 2
		$P_{\text{Interferer}}$	dBm	-56
	$F_{\text{Interferer}}$ (offset)	MHz	$= -BW/2 - F_{\text{offset, case 1}}$ & $= +BW/2 + F_{\text{offset, case 1}}$	$\leq -BW/2 - F_{\text{offset, case 2}}$ & $\geq +BW/2 + F_{\text{offset, case 2}}$
CA_2A-2A, CA_3A-3A, CA_4A-4A, CA_7A-7A, CA_23A-23A, CA_25A-25A, CA_41A-41A, CA_42A-42A	$F_{\text{Interferer}}$	MHz	(Note 2)	$F_{\text{DL\_low}} - 15$ to $F_{\text{DL\_high}} + 15$
<p>Note 1: For certain bands, the unwanted modulated interfering signal may not fall inside the UE receive band, but within the first 15 MHz below or above the UE receive band</p> <p>Note 2: For each carrier frequency the requirement is valid for two frequencies:  a. the carrier frequency <math>-BW/2 - F_{\text{offset, case 1}}</math> and  b. the carrier frequency <math>+BW/2 + F_{\text{offset, case 1}}</math></p> <p>Note 3: <math>F_{\text{Interferer}}</math> range values for unwanted modulated interfering signal are interferer centre frequencies</p>				

For the UE which supports inter band CA configuration in Table 7.3.3-1A,  $P_{\text{Interferer}}$  power defined in Table 7.6.1A.4.5-2 is increased by the amount given by  $\Delta R_{\text{IB,c}}$  in Table 7.3.3-1A.

### 7.6.1A.5 In-band blocking for CA (3DL CA without UL CA)

#### 7.6.1A.5.1 Test Purpose

Same test purpose as in clause 7.6.1A.1.

#### 7.6.1A.5.2 Test Applicability

This test case applies to all types of E-UTRA UE release 10 and forward that support 3DL Intra-band contiguous CA or 3DL Inter-band CA or 3DL Intra-band contiguous + Inter-band CA.

This test case also applies to all types of E-UTRA UE release 11 and forward that support 3DL Intra-band non-contiguous CA + Inter-band CA or 3DL Intra-band non-contiguous + Intra-band contiguous CA.

This test case also applies to all types of E-UTRA UE release 12 and forward that support 3DL CA with FDD-TDD CA.7.6.1A.5.3 Minimum Conformance Requirements

The minimum conformance requirements are defined in clause 7.6.1A.0.

#### 7.6.1A.5.4 Test Description

##### 7.6.1A.5.4.1 Initial Conditions

Initial conditions are a set of test configurations the UE needs to be tested in and the steps for the SS to take with the UE to reach the correct measurement state.

The initial test configurations consist of environmental conditions, test frequencies, and channel bandwidths based on E-UTRA CA configurations specified in table 5.4.2A.1-1 through table 5.4.2A.1-2a. All of these configurations shall be tested with applicable test parameters for each channel bandwidth, and are shown in table 7.6.1A.5.4.1-1 through table 7.6.1A.5.4.1-5 as appropriate. The details of the uplink reference measurement channels (RMCs) are specified in Annex A.2 and A.3. Configurations of PDSCH and PDCCH before measurement are specified in Annex C.2.

**Table 7.6.1A.5.4.1-1: Test Configuration Table (Intra-band contiguous)**

Initial Conditions												
Test Environment as specified in TS 36.508 [7] subclause 4.1						NC						
Test Frequencies as specified in TS36.508 [7] subclause 4.3.1 for different CA bandwidth classes.						For test frequencies refer to “Range” columns. For mapping within Band refer to “CC” columns						
Test CC Combination setting ( $N_{RB\_agg}$ ) as specified in subclause 5.4.2A.1 for the CA Configuration across bandwidth combination sets supported by the UE.						Refer to “PCC $N_{RB}$ ” and “SCCs $N_{RB}$ ” columns						
Network signalling value						NS_01 by default, exceptions listed in Table 7.3.3-3, dependent on PCC Band						
Test Parameters for CA Configurations												
ID	CA Configuration / $N_{RB\_agg}$						DL Allocation			UL Allocation (Note 2,3)		
	CA Configuration			PCC $N_{RB}$	SCCs $N_{RB}$		CC MOD	PCC & SCCs RB allocation			CC MOD	PCC $L_{CRB} @ RB_{start}$
	Band	Range	PCC CC		SCC1 CC	SCC2 CC		PCC	SCC1	SCC2		
Default Test Settings for a CA_XD Configuration												
1	X	Mid	CC1	CC2	CC3	Lowest $N_{RB\_agg}$	QPSK	All RBs			QPSK	REFSENS
2	X	Mid	CC1	CC2	CC3	Highest $N_{RB\_agg}$	QPSK	All RBs			QPSK	REFSENS
<p>Note 1: CA Configuration Test CC Combination test settings are checked separately for each CA Configuration.</p> <p>Note 2: Use CA Configuration – specific test points if present in the table, otherwise use Default Test Settings test points.</p> <p>Note 3: X corresponds to the band of the CA Configuration. Eg. for CA_41D ,X=41</p> <p>Note 4: REFSENS refers to the PCC band's and PCC <math>N_{RB}</math> 's single carrier Uplink RB allocation for reference sensitivity according to table 7.3.5-2.</p> <p>Note 5: If in the CA Configuration UE supports multiple CC Combinations with the same <math>N_{RB\_agg}</math> , choose for testing the Combination with maximum <math>N_{RB\_PCC}</math> and then select maximum <math>N_{RB\_SCC1}</math> for the chosen <math>N_{RB\_PCC}</math></p>												

**Table 7.6.1A.5.4.1-2: Test Configuration Table (Inter-band)**

Initial Conditions															
Test Environment as specified in TS 36.508[7] subclause 4.1											NC				
Test Frequencies as specified in TS36.508 [7] subclause 4.3.1 for different CA bandwidth classes.											For test frequencies refer to "Range" columns. For mapping within Band refer to "CC" columns				
Test CC Combination setting ( $N_{RB\_agg}$ ) as specified in subclause 5.4.2A.1 for the CA Configuration across bandwidth combination sets supported by the UE.											Refer to "PCC $N_{RB}$ " and "SCCs $N_{RB}$ " columns				
Network signalling value											NS_01 by default, exceptions listed in Table 7.3.3-3, dependent on PCC Band				
Test Parameters for CA Configurations															
ID	CA Configuration / $N_{RB\_agg}$							DL Allocation			UL Allocation (Note 2,3)				
	CA Configuration						PCC $N_{RB}$	SCCs $N_{RB}$		CC MOD	PCC & SCCs RB allocation			CC MOD	PCC $L_{CRB}$ @ $RB_{start}$
	PCC		SCC1		SCC2			SCC1	SCC2		PCC	SCC1	SCC2		
	Band	Range	Band	Range	Band	Range									
Default Test Settings for a CA_XA-YA-ZA Configuration															
1	X	Mid	Y	Mid	Z	Mid	Highest $N_{RB}$	Highest $N_{RB}$	Highest $N_{RB}$	QPSK	All RBs	QPSK	REFSENS		
2	Y	Mid	X	Mid	Z	Mid	Highest $N_{RB}$	Highest $N_{RB}$	Highest $N_{RB}$	QPSK	All RBs	QPSK	REFSENS		
3	Z	Mid	X	Mid	Y	Mid	Highest $N_{RB}$	Highest $N_{RB}$	Highest $N_{RB}$	QPSK	All RBs	QPSK	REFSENS		
Note 1:	CA Configuration Test CC Combination test settings are checked separately for each CA Configuration.														
Note 2:	Use CA Configuration – specific test points if present in the table, Otherwise use test points from matching Group Test Settings, if present in the table. Otherwise use the Default Test Settings test points.														
Note 3:	If, according to the UE declared capability, UE does not support UL in an individual band within the CA Configuration, test points with that individual band as PCC are not applicable.														
Note 4:	X,Y,Z correspond to the different bands in the CA Configuration. Eg. for CA_1A-3A-19A,X=1,Y=3,Z=19														
Note 5:	REFSENS refers to the PCC band's and PCC $N_{RB}$ 's single carrier Uplink RB allocation for reference sensitivity according to table 7.3.5-2.														

**Table 7.6.1A.5.4.1-3: Test Configuration Table (Intra-band contiguous + Inter-band)**

Initial Conditions															
Test Environment as specified in TS 36.508[7] subclause 4.1										NC					
Test Frequencies as specified in TS36.508 [7] subclause 4.3.1 for different CA bandwidth classes.										For test frequencies refer to “Range” columns. For mapping within Band refer to “CC” columns					
Test CC Combination setting ( $N_{RB\_agg}$ ) as specified in subclause 5.4.2A.1 for the CA Configuration across bandwidth combination sets supported by the UE.										Refer to “PCC $N_{RB}$ ” and “SCCs $N_{RB}$ ” columns					
Network signalling value										NS_01 by default, exceptions listed in Table 7.3.3-3, dependent on PCC Band					
Test Parameters for CA Configurations															
ID	CA Configuration / $N_{RB\_agg}$							DL Allocation			UL Allocation (Note 2,3)				
	CA Configuration						PCC $N_{RB}$	SCCs $N_{RB}$		CC MOD	PCC & SCCs RB allocation			CC MOD	PCC $L_{CRB}$ @ $RB_{start}$
	PCC		SCC1		SCC2			SCC1	SCC2		PCC	SCC1	SCC2		
	Band	Range /CC	Band	Range /CC	Band	Range /CC									
Default Test Settings for CA_XB-YA and CA_XC-YA Configuration															
1	X	Mid /CC1	X	Mid /CC2	Y	Mid	Highest $N_{RB\_agg}$	Highest $N_{RB}$	QPSK	All RBs	QPSK	REFSENS			
2	X	Mid /CC1	X	Mid /CC2	Y	Mid	Lowest $N_{RB\_agg}$	Highest $N_{RB}$	QPSK	All RBs	QPSK	REFSENS			
3	Y	Mid	X	Mid /CC1	X	Mid /CC2	Highest $N_{RB}$	Highest $N_{RB\_agg}$	QPSK	All RBs	QPSK	REFSENS			
4	Y	Mid	X	Mid /CC1	X	Mid /CC2	Highest $N_{RB}$	Lowest $N_{RB\_agg}$	QPSK	All RBs	QPSK	REFSENS			
Default Test Settings for CA_XA-YB and CA_XA-YC Configuration															
1	Y	Mid /CC1	Y	Mid /CC2	X	Mid	Highest $N_{RB\_agg}$	Highest $N_{RB}$	QPSK	All RBs	QPSK	REFSENS			
2	Y	Mid /CC1	Y	Mid /CC2	X	Mid	Lowest $N_{RB\_agg}$	Highest $N_{RB}$	QPSK	All RBs	QPSK	REFSENS			
3	X	Mid	Y	Mid /CC1	Y	Mid /CC2	Highest $N_{RB}$	Highest $N_{RB\_agg}$	QPSK	All RBs	QPSK	REFSENS			
4	X	Mid	Y	Mid /CC1	Y	Mid /CC2	Highest $N_{RB}$	Lowest $N_{RB\_agg}$	QPSK	All RBs	QPSK	REFSENS			
<p>Note 1: CA Configuration Test CC Combination test settings are checked separately for each CA Configuration.</p> <p>Note 2: Use CA Configuration – specific test points if present in the table. Otherwise use the Default Test Settings test points.</p> <p>Note 3: If, according to the UE declared capability, UE does not support UL in an individual band within the CA Configuration, test points with that individual band as PCC are not applicable.</p> <p>Note 4: X,Y correspond to the different bands in the CA Configuration. Eg. for CA_1C-3A, X=1 and Y=3</p> <p>Note 5: REFSSENS refers to the PCC band's and PCC <math>N_{RB}</math> 's single carrier Uplink RB allocation for reference sensitivity according to table 7.3.5-2.</p> <p>Note 6: If in the CA Configuration UE supports multiple CC Combinations with the same <math>N_{RB\_agg}</math>, choose the Combination with <math>N_{RB\_PCC} = N_{RB\_SCC1}</math> for testing. If no such combination is supported, choose Combination with maximum <math>N_{RB\_PCC}</math> for testing.</p>															

**Table 7.6.1A.5.4.1-4: Test Configuration Table (Intra-band non-contiguous + Inter-band)**

Initial Conditions														
Test Environment as specified in TS 36.508[7] subclause 4.1										NC				
Test Frequencies as specified in TS36.508 [7] subclause 4.3.1 for different CA bandwidth classes.										For test frequencies refer to "Range" columns. For mapping within Band refer to "CC" columns				
Test CC Combination setting ( $N_{RB\_agg}$ ) as specified in subclause 5.4.2A.1 for the CA Configuration across bandwidth combination sets supported by the UE.										Highest $N_{RB}$				
Network signalling value										NS_01 by default, exceptions listed in Table 7.3.3-3, dependent on PCC Band				
Test Parameters for CA Configurations														
ID	CA Configuration / $N_{RB\_agg}$							DL Allocation			UL Allocation (Note 2,3)			
	CA Configuration							CC MOD	PCC & SCCs			CC MOD	PCC	
	PCC		$W_{gap}$ [MHz]	SCC1		$W_{gap}$ [MHz]	SCC2		RB allocation				$L_{CRB}$ @ $RB_{sta}$	
	Band	Range		Band	Range		Band		Range	PCC	SCC1			SCC2
Default Test Settings for CA_XA-XA-YA Configurations														
1	X	CC2	Max	X	CC1	-	Y	Mid	QPSK	All RBs	QPSK	REFSENS_C		
2	Y	Mid	-	X	CC2	Max	X	CC1	QPSK	All RBs	QPSK	REFSENS		
Default Test Settings for CA_XA-YA-YA Configurations														
1	Y	CC2	Max	Y	CC1	-	X	Mid	QPSK	All RBs	QPSK	REFSENS_C		
2	X	Mid	-	Y	CC2	Max	Y	CC1	QPSK	All RBs	QPSK	REFSENS		
Note 1:	CA Configuration Test CC Combination test settings are checked separately for each CA Configuration.													
Note 2:	Use CA Configuration – specific test points if present in the table. Otherwise use test points from matching Group Test Settings, present in the table. Otherwise use Default Test Settings test points.													
Note 3:	If, according to the UE declared capability, UE does not support UL in an individual band within the CA Configuration, test points with that individual band as PCC are not applicable.													
Note 4:	X and Y correspond to the different bands in the CA Configuration. Eg. for CA_2A-2A-5A,X=2,Y=5													
Note 5:	REFSENS refers to the PCC band's and PCC $N_{RB}$ 's single carrier Uplink RB allocation for reference sensitivity according to tab 7.3.5-2. REFSENS_CA refers to the PCC band's and PCC $N_{RB}$ 's single carrier Uplink RB allocation for reference sensitivity according to table 7.3.4.5-2 (selecting RB allocation for SCC measurement).													

**Table 7.6.1A.5.4.1-5: Test Configuration Table (Intra-band non-contiguous + Intra-band contiguous)**

Initial Conditions															
Test Environment as specified in TS 36.508[7] subclause 4.1										NC					
Test Frequencies as specified in TS36.508 [7] subclause 4.3.1 for different CA bandwidth classes.										For test frequencies refer to “Range” columns. For mapping within band refer to “CC” columns					
Test CC Combination setting ( $N_{RB\_agg}$ ) as specified in subclause 5.4.2A.1 for the CA Configuration across bandwidth combination sets supported by the UE.										Refer to “PCC $N_{RB}$ ” and “SCCs $N_{RB}$ ” columns					
Network signalling value										NS_01 by default, exceptions listed in Table 7.3.3-3, dependent on PCC Band					
Test Parameters for CA Configurations															
ID	CA Configuration / $N_{RB\_agg}$							DL Allocation			UL Allocation (Note 2,3)				
	CA Configuration						PCC $N_{RB}$	SCCs $N_{RB}$		CC MOD	PCC & SCCs RB allocation			CC MOD	PCC $L_{CRB}$ @ $RB_{start}$
	Band	PCC	$W_{gap}$ [MHz]	SCC1	$W_{gap}$ [MHz]	SCC2		SCC1	SCC2		PCC	SCC1	SCC2		
		CC		CC		CC									
Test Settings for a 41A-41C Configuration															
1	41	CC3	134.2	CC2	-	CC1	100	100	100	QPSK	All RBs	QPSK	100@0		
Test Settings for a CA_41C-41A Configuration															
2	41	CC3	-	CC2	134.2	CC1	100	100	100	QPSK	All RBs	QPSK	100@0		
Note 1: CA Configuration Test CC Combination test settings are checked separately for each CA Configuration. Note 2: Use CA Configuration – specific test points if present in the table, otherwise use Default Test Settings test points. Note 3: If, according to the UE declared capability, UE does not support UL in an individual band within the CA Configuration, test points with that individual band as PCC are not applicable. Note 4: X corresponds to the band of the CA Configuration. Eg. for CA_41C-41A,X=41. Note 5: REFSSENS refers to the PCC band's and PCC $N_{RB}$ 's single carrier Uplink RB allocation for reference sensitivity according to table 7.3.5-2. Note 6: If in the CA Configuration UE supports multiple CC Combinations with the same $N_{RB\_agg}$ , choose the Combination with $N_{RB\_CC1} = N_{RB\_CC2}$ for testing. If no such combination is supported, choose Combination with maximum $N_{RB\_CC1}$ for testing.															

1. Connect the SS to the UE antenna connectors as shown in TS 36.508[7] Annex A Figure A.58 as appropriate.
2. The parameter settings for the cell are set up according to TS 36.508 [7] subclause 4.4.3.
3. Downlink signals for PCC are initially set up according to Annex C.0, C.1, and C.3.1, and uplink signals according to Annex H.1 and H.3.0.
4. The UL and DL Reference Measurement channels are set according to Table 7.6.1A.5.4.1-1 through Table 7.6.1A.5.4.1-5 as appropriate.
5. Propagation conditions are set according to Annex B.0.
6. Ensure the UE is in State 3A-RF according to TS 36.508 [7] clause 5.2A.2. Message contents are defined in clause 7.6.1A.5.4.3.

**7.6.1A.5.4.2 Test Procedure**

1. Configure SCCs according to Annex C.0, C.1 and Annex C.3.1 for all downlink physical channels except PHICH.
2. The SS shall configure SCCs as per TS 36.508 [7] clause 5.2A.4. Message contents are defined in clause 7.6.1A.5.4.3

3. SS activates SCCs by sending the activation MAC-CE (Refer TS 36.321 [13], clauses 5.13, 6.1.3.8). Wait for at least 2 seconds (Refer TS 36.133, clauses 8.3.3.2).
4. SS transmits PDSCH via PDCCH DCI format 1A for C\_RNTI to transmit the DL RMC according to Table 7.6.1A.5.4.1-1 through Table 7.6.1A.5.4.1-5 as appropriate on PCC and SCCs. The SS sends downlink MAC padding bits on the DL RMC.
5. SS sends uplink scheduling information for each UL HARQ process via PDCCH DCI format 0 for C\_RNTI to schedule the UL RMC according to Table 7.6.1A.5.4.1-1 through Table 7.6.1A.5.4.1-5 on PCC. Since the UE has no payload data to send, the UE sends uplink MAC padding bits on the UL RMC.
6. Set the parameters of the signal generator for an interfering signal below the aggregated component carriers in Case 1 according to Table 7.6.1A.5.4.2-1.
7. Set the downlink signal level according to the Table 7.6.1A.5.4.2-1. Send uplink power control commands to the UE (less or equal to 1dB step size should be used), to ensure that the UE output power is within +0, - 3.4 dB of the target level in table 7.6.1A.5.5-1 for carrier frequency  $f \leq 3.0\text{GHz}$  or within +0, -4.0 dB of the target level for carrier frequency  $3.0\text{GHz} < f \leq 4.2\text{GHz}$ , for at least the duration of the throughput measurement.
8. Measure the average throughput for the carrier(s) indicated in Table 7.6.1A.5.4.2-1 for duration sufficient to achieve statistical significance according to Annex G.2A.
9. Repeat steps from 6 to 8, using an interfering signal above the measured carrier(s) according to Table 7.6.1A.5.5-1 in Case 1 at step 6.
10. Repeat steps from 6 to 9, using interfering signals in Case 2 at step 6 and 9. The ranges of case 2 are covered in steps equal to the interferer bandwidth. The test frequencies are chosen in analogy to table 7.6.1A.1.4.2-1.
11. Repeat steps 1 to 10 for all component carriers listed in Table 7.6.1A.5.4.2-1.

**Table 7.6.1A.5.4.2-1: Test repetition and measurement configuration**



CA configuration	ID (Note 1)	Throughput measured on (Note 3)	Table with test parameters to select (Note 2)
Intra-band contiguous	1	PCC, SCC1, SCC2	7.6.1A.5.5-2
	2		7.6.1A.5.5-3
Inter-band	1	SCC1	7.6.1A.5.5-1 7.6.1A.5.5-4 7.6.1A.5.5-5
		SCC2	
	2	SCC1	
		SCC2	
	3	SCC1	
		SCC2	
Intra-band contiguous + Inter-band	1	SCC2	7.6.1A.5.5-1
	2		7.6.1A.5.5-4
	3	SCC1,	7.6.1A.5.5-2
	4	SCC2	7.6.1A.5.5-3
Intra-band non-contiguous + Inter-band	1	SCC2	7.6.1A.5.5-1 7.6.1A.5.5-4 7.6.1A.5.5-5
	2	SCC1,	7.6.1A.5.5-4
SCC2		7.6.1A.5.5-5	
Intra-band non-contiguous + Intra-band contiguous	1	PCC	7.6.1A.5.5-4
		SCC1, SCC2	7.6.1A.5.5-2 7.6.1A.5.5-3
	2	SCC2	7.6.1A.5.5-4 7.6.1A.5.5-5
		PCC, SCC1	7.6.1A.5.5-2 7.6.1A.5.5-3
<p>Note 1: Test point ID for the particular CA configuration as defined in section 7.6.1A.5.4.1.</p> <p>Note 2: The reference for the placement of the interferer signals is the centre frequency of the carrier closest to the interferer among the carriers throughput is measured on.</p> <p>Note 3: Where there are multiple rows for a single Test point ID, the test is repeated for each row.</p>			

### 7.6.1A.5.4.3 Message Contents

Same message contents as in clause 7.6.1.4.3.

### 7.6.1A.5.5 Test Requirement

The throughput measurement of each carrier derived in test procedure shall be  $\geq 95\%$  of the maximum throughput of the reference measurement channels as specified in Annex A.3.2 with parameters specified in Tables below, according to the type of CA.

**Table 7.6.1A.5.5-1: In-band blocking for additional operating bands for carrier aggregation (inter-band)**

E-UTRA band	Parameter	Unit	Case 1	Case 2
		$P_{\text{Interferer}}$	dBm	-56
	$F_{\text{Interferer}}$ (offset from SCC)	MHz	$=-BW/2 - F_{\text{offset, case 1}}$ & $=+BW/2 + F_{\text{offset, case 1}}$	$\leq -BW/2 - F_{\text{offset, case 2}}$ & $\geq +BW/2 + F_{\text{offset, case 2}}$
29	$F_{\text{Interferer}}$	MHz	(Note 2)	$F_{\text{DL, low}} - 15$ to $F_{\text{DL, high}} + 15$
<p>Note 1: For certain bands, the unwanted modulated interfering signal may not fall inside the UE receive band, but within the first 15 MHz below or above the UE receive band.</p> <p>Note 2: For each carrier frequency the requirement is valid for two frequencies:                      a. the carrier frequency <math>-BW/2 - F_{\text{offset, case 1}}</math> and                      b. the carrier frequency <math>+BW/2 + F_{\text{offset, case 1}}</math></p> <p>Note 3: <math>F_{\text{Interferer}}</math> range values for unwanted modulated interfering signal are interferer centre frequencies.</p>				

**Table 7.6.1A.5.5-2: In band blocking parameter (intra-band contiguous)**

Rx Parameter	Units	CA Bandwidth Class				
		B	C	D	E	F
Power per CC in Aggregated Transmission Bandwidth Configuration	dBm	REFSENS + CA Bandwidth Class specific value below				
		9	12	13.8		
$BW_{\text{Interferer}}$	MHz	5	5	5		
$F_{\text{offset, case 1}}$	MHz	7.5	7.5	7.5		
$F_{\text{offset, case 2}}$	MHz	12.5	12.5	12.5		
<p>Note 1: The transmitter shall be set to 4dB below <math>P_{\text{CMAX, L}}</math> or <math>P_{\text{CMAX, L, CA}}</math> as defined in subclause 6.2.5</p> <p>Note 2: The interferer consists of the Reference measurement channel specified in Annex A.3.2 with one sided dynamic OCNG Pattern OP.1 FDD/TDD as described in Annex A.5.1.1/A.5.2.1 and set-up according to Annex C.3.1</p>						

**Table 7.6.1A.5.5-3: In-band blocking (intra-band contiguous)**

CA configuration	Parameter	Unit	Case 1	Case 2
		$P_{\text{Interferer}}$	dBm	-56
	$F_{\text{Interferer}}$	MHz	$=-F_{\text{offset}} - F_{\text{offset, case 1}}$ & $=+F_{\text{offset}} + F_{\text{offset, case 1}}$	$\leq -F_{\text{offset}} - F_{\text{offset, case 2}}$ & $\geq +F_{\text{offset}} + F_{\text{offset, case 2}}$
CA_1C, CA_2C, CA_3C, CA_7C, CA_12B, CA_23B, CA_27B, CA_38C, CA_39C, CA_40C, CA_41C, CA_40D, CA_41D, CA_42C	$F_{\text{Interferer}}$ (Range)	MHz	(Note 2)	$F_{\text{DL, low}} - 15$ to $F_{\text{DL, high}} + 15$
<p>Note 1: For certain bands, the unwanted modulated interfering signal may not fall inside the UE receive band, but within the first 15 MHz below or above the UE receive band</p> <p>Note 2: For each carrier frequency the requirement is valid for two frequencies:                      a. the carrier frequency <math>-F_{\text{offset}} - F_{\text{offset, case 1}}</math> and                      b. the carrier frequency <math>+F_{\text{offset}} + F_{\text{offset, case 1}}</math></p> <p>Note 3: <math>F_{\text{offset}}</math> is the frequency offset from the centre frequency of the adjacent CC being tested to the edge of aggregated channel bandwidth.</p> <p>Note 4: The <math>F_{\text{Interferer}}</math> (offset) is relative to the centre frequency of the adjacent CC being tested and shall be further adjusted to <math>\lfloor F_{\text{interferer}} / 0.015 + 0.5 \rfloor 0.015 + 0.0075</math> MHz to be offset from the sub-carrier raster.</p>				

**Table 7.6.1A.5.5-4: In-band blocking parameters (inter-band, intra-band non-contiguous)**

Rx Parameter	Units	Channel bandwidth					
		1.4 MHz	3 MHz	5 MHz	10 MHz	15 MHz	20 MHz

Power in Transmission Bandwidth Configuration for each CC	dBm	REFSENS + channel bandwidth specific value below					
		6	6	6	6	7	9
$BW_{\text{Interferer}}$	MHz	1.4	3	5	5	5	5
$F_{\text{offset, case 1}}$	MHz	$2.1+0.0125$	$4.5+0.0075$	$7.5+0.0125$	$7.5+0.0025$	$7.5+0.0075$	$7.5+0.0125$
$F_{\text{offset, case 2}}$	MHz	$3.5+0.0075$	$7.5+0.0075$	$12.5+0.0075$	$12.5+0.012$	$12.5+0.002$	$12.5+0.007$
					5	5	5

Note 1: The transmitter shall be set to 4dB below  $P_{\text{CMAX,L}}$  with  $P_{\text{CMAX,L}}$  as defined in clause 6.2.5.  
Note 2: The interferer consists of the Reference measurement channel specified in Annex A.3.2 with one sided dynamic OCN Pattern OP.1 FDD/TDD as described in Annex A.5.1.1/A.5.2.1 and set-up according to Annex C.3.1.

Table 7.6.1A.5.5-5: In-band blocking (inter-band, intra-band non-contiguous)

E-UTRA band	Parameter	Unit	Case 1	Case 2	Case 3	Case 4	Case 5
		$P_{\text{Interferer}}$	dBm	-56	-44		
	$F_{\text{Interferer}}$ (offset from SCC)	MHz	$=-BW/2 - F_{\text{offset, case 1}}$ & $=+BW/2 + F_{\text{offset, case 1}}$	$\leq -BW/2 - F_{\text{offset, case 2}}$ & $\geq +BW/2 + F_{\text{offset, case 2}}$			$-BW/2 - 11$
1, 2, 3, 4, 5, 6, 7, 8, 9, 10, 11, 12, 13, 14, 17, 18, 19, 20, 21, 22, 23, 25, 26, 27, 28, 31, 33, 34, 35, 36, 37, 38, 39, 40, 41, 42, 43, 44	$F_{\text{Interferer}}$	MHz	(Note 2)	$F_{\text{DL\_low}} - 15$ to $F_{\text{DL\_high}} + 15$	Void	Void	
30	$F_{\text{Interferer}}$	MHz	(Note 2)	$F_{\text{DL\_low}} - 15$ to $F_{\text{DL\_high}} + 15$			$F_{\text{DL\_low}} - 11$

Note 1: For certain bands, the unwanted modulated interfering signal may not fall inside the UE receive band, but within the first 15 MHz below or above the UE receive band  
Note 2: For each carrier frequency the requirement is valid for two frequencies:  
a. the carrier frequency  $-BW/2 - F_{\text{offset, case 1}}$  and  
b. the carrier frequency  $+BW/2 + F_{\text{offset, case 1}}$   
Note 3:  $F_{\text{Interferer}}$  range values for unwanted modulated interfering signal are interferer centre frequencies  
Note 4: For intra-band non-contiguous + inter-band CA,  $\Delta R_{\text{IB,C}} = 0$  dB for all sub-block gaps.

For a UE, which supports CA configuration in Table 7.3.3-1A or 7.3.3-1B,  $P_{\text{Interferer}}$  power defined in Tables 7.6.1A.5.5-1 and 7.6.1A.5.5-5 is increased by the amount given by  $\Delta R_{\text{IB,C}}$  in Table 7.3.3-1A or 7.3.3-1B accordingly.

## 7.6.1B In-band blocking for UL-MIMO

### 7.6.1B.1 Test Purpose

In-band blocking for UL- MIMO is defined for an unwanted interfering signal falling into the range from 15MHz below to 15MHz above the UE that support UL-MIMO receive band, at which the relative throughput shall meet or exceed the requirement for the specified measurement channels.

The lack of in-band blocking ability will decrease the coverage area when other e-NodeB transmitters exist (except in the adjacent channels and spurious response).

### 7.6.1B.2 Test Applicability

This test applies to all types of E-UTRA UE release 10 and forward that support UL-MIMO.

### 7.6.1B.3 Minimum Conformance Requirements

For UE with two transmitter antenna connectors in closed-loop spatial multiplexing scheme, the minimum requirements in subclause 7.6 shall be met with the UL-MIMO configurations specified in Table 6.2.2B.3-2. For UL-MIMO, the parameter  $P_{\text{CMAX,L}}$  is defined as the total transmitter power over the two transmit antenna connectors.

The normative reference for this requirement is TS 36.101 [2] clause 7.6B.

### 7.6.1B.4 Test Description

#### 7.6.1B.4.1 Initial Conditions

Initial conditions are a set of test configurations the UE needs to be tested in and the steps for the SS to take with the UE to reach the correct measurement state.

The initial test configurations consist of environmental conditions, test frequencies, and channel bandwidths based on E-UTRA bands specified in table 5.4.2.1-1. All of these configurations shall be tested with applicable test parameters for each channel bandwidth, and are shown in table 7.6.1B.4.1-1. The details of the uplink and downlink reference measurement channels (RMCs) are specified in Annexes A.2 and A.3 respectively. The details of the OCNG patterns used are specified in Annex A.5. Configurations of PDSCH and PDCCH before measurement are specified in Annex C.2.

**Table 7.6.1B.4.1-1: Test Configuration Table**

Initial Conditions						
Test Environment as specified in TS 36.508[7] subclause 4.1			NC			
Test Frequencies as specified in TS36.508 [7] subclause 4.3.1			Mid range			
Test Channel Bandwidths as specified in TS 36.508 [7] subclause 4.3.1			Lowest, 5MHz, Highest			
Test Parameters for Channel Bandwidths						
Ch BW	Downlink Configuration			Uplink Configuration		
	Mod'n	RB allocation		Mod'n	RB allocation	
		FDD	TDD		FDD	TDD
1.4MHz	QPSK	6	6	QPSK	6	6
3MHz	QPSK	15	15	QPSK	15	15
5MHz	QPSK	25	25	QPSK	25	25
5MHz	QPSK	25	N/A	QPSK	20	N/A
5MHz	QPSK	25	N/A	QPSK	15	N/A
5MHz	QPSK	25	N/A	QPSK	5 <sup>4</sup>	N/A
10MHz	QPSK	50	50	QPSK	50	50
10MHz	QPSK	50	N/A	QPSK	25	N/A
10MHz	QPSK	50	N/A	QPSK	20	N/A
10MHz	QPSK	50	N/A	QPSK	15	N/A
15MHz	QPSK	75	75	QPSK	75	75
15MHz	QPSK	75	N/A	QPSK	50	N/A
15MHz	QPSK	75	N/A	QPSK	25	N/A
15MHz	QPSK	75	N/A	QPSK	20	N/A
20MHz	QPSK	100	100	QPSK	100	100
20MHz	QPSK	100	N/A	QPSK	75	N/A
20MHz	QPSK	100	N/A	QPSK	50	N/A
20MHz	QPSK	100	N/A	QPSK	25	N/A
20MHz	QPSK	100	N/A	QPSK	20	N/A
Note 1:	Test Channel Bandwidths are checked separately for each E-UTRA band, which applicable channel bandwidths are specified in Table 5.4.2.1-1.					
Note 2:	Depending on E-UTRA band, only the appropriate Uplink RB allocation value according to table 7.3.3-2 is tested per Test Channel Bandwidth.					
Note 3:	For the DL signal one sided dynamic OCNG Pattern OP.1 FDD/TDD is used.					
Note 4:	Applicable only to E-UTRA FDD Band 31. The UL resource blocks shall be located at RBstart 10 (according to Table 7.3.3-2).					

1. Connect the SS to the UE antenna connectors as shown in TS 36.508 [7] Annex A, in Figure A.29.
2. The parameter settings for the cell are set up according to TS 36.508 [7] subclause 4.4.3.

3. Downlink signals are initially set up according to Annex C0, C.1 and C.3.1, and uplink signals according to Annex H.1 and H.3.1.
4. The UL and DL Reference Measurement channels are set according to in Table 7.6.1B.4.1-1.
5. Propagation conditions are set according to Annex B.0.
6. Ensure the UE is in State 3A-RF according to TS 36.508 [7] clause 5.2A.2. Message contents are defined in clause 7.6.1B.4.3.

#### 7.6.1B.4.2 Test Procedure

1. SS transmits PDSCH via PDCCH DCI format 1A for C\_RNTI to transmit the DL RMC according to Table 7.6.1B.4.1-1. The SS sends downlink MAC padding bits on the DL RMC.
2. SS sends uplink scheduling information for each UL HARQ process via PDCCH DCI format 4 for C\_RNTI to schedule the UL RMC according to Table 7.6.1B.4.1-1. Since the UE has no payload data to send, the UE transmits uplink MAC padding bits on the UL RMC.
3. Set the parameters of the signal generator for an interfering signal below the wanted signal in Case 1 according to Tables 7.6.1B.5-1 and 7.6.1B.5-2.
4. Set the downlink signal level according to the table 7.6.1B.5-1. Send uplink power control commands to the UE (less or equal to 1dB step size should be used), to ensure that the UE output power is within +0, - 3.4 dB of the target level in table 7.6.1B.5-1 for carrier frequency  $f \leq 3.0\text{GHz}$  or within +0, -4.0 dB of the target level for carrier frequency  $3.0\text{GHz} < f \leq 4.2\text{GHz}$ , for at least the duration of the throughput measurement.
5. Measure the average throughput for a duration sufficient to achieve statistical significance according to Annex G.2.
6. Repeat steps from 3 to 5, using an interfering signal above the wanted signal in Case 1 at step 3.
7. Repeat steps from 3 to 6, using interfering signals in Case 2 at step 3 and 6. The ranges of case 2 are covered in steps equal to the interferer bandwidth. The test frequencies are chosen in analogy to table 7.6.1B.4.2-1.
8. Repeat steps from 3 to 5, using successively all interfering signals in Case 3 and Case 4 at step 3.

**Table 7.6.1B.4.2-1: Example for interferer frequencies**

	Lower frequency	Upper frequency
Band 1 DL	2110 MHz	2170 MHz
Band 1 Midrange	2140 MHz	
Receive band wanted signal (BW 5MHz)	2137.5 MHz	2142.5 MHz
Interferer case 1	2129.9875 MHz	2150.0125 MHz
Interferer case 2 (inner frequency)	2124.9925 MHz	2155.0075 MHz
Interferer case 2 (outer frequency)	2099.9925 MHz	2180.0075 MHz
Outer limit for in band blocking	2095MHz	2185MHz
Number of test frequencies case 2	6	6
Number of test frequencies for Band 17(asymmetric!), BW 5MHz, case 2	0	2

#### 7.6.1B.4.3 Message Contents

Message contents are according to TS 36.508 [7] clause 4.6 with the following exception:

Table 7.6.1B.4.3-1: UplinkPowerControlDedicated

Derivation Path: 36.331 clause 6.3.2			
Information Element	Value/remark	Comment	Condition
UplinkPowerControlDedicated-DEFAULT ::= SEQUENCE {			
p0-UePUSCH	0		
deltaMCS-Enabled	en0		
accumulationEnabled	TRUE		
p0-uePUCCH	0		
pSRS-Offset	3 (-6 dB)		
filterCoefficient	fc8	larger filter length is used to reduce the RSRP measurement variation	
}			

### 7.6.1B.5 Test Requirement

The throughput measurement derived in test procedure shall be  $\geq 95\%$  of the maximum throughput of the reference measurement channels as specified in Annex A.3.2 with parameters specified in Tables 7.6.1B.5-1 and 7.6.1B.5-2.

Table 7.6.1B.5-1: In band blocking parameters

Rx Parameter	Units	Channel bandwidth					
		1.4 MHz	3 MHz	5 MHz	10 MHz	15 MHz	20 MHz
Power in Transmission Bandwidth Configuration	dBm	REFSENS + channel bandwidth specific value below					
		6	6	6	6	7	9
BW <sub>Interferer</sub>	MHz	1.4	3	5	5	5	5
F <sub>offset, case 1</sub>	MHz	2.1+0.0125	4.5+0.0075	7.5+0.0125	7.5+0.0025	7.5+0.0075	7.5+0.0125
F <sub>offset, case 2</sub>	MHz	3.5+0.0075	7.5+0.0075	12.5+0.0075	12.5+0.012	12.5+0.002	12.5+0.007
Note 1:		The transmitter shall be set to 4dB below P <sub>CMAX,L</sub> with P <sub>CMAX,L</sub> as defined in clause 6.2.5.					
Note 2:		The interferer consists of the Reference measurement channel specified in Annex A.3.2 with one sided dynamic OCNG Pattern OP.1 FDD/TDD as described in Annex A.5.1.1/A.5.2.1 and set-up according to Annex C.3.1.					

Table 7.6.1B.5-2: In-band blocking

E-UTRA band	Parameter	Unit	Case 1	Case 2	Case 3	Case 4	Case 5
	$P_{\text{Interferer}}$	dBm	-56	-44			-38
	$F_{\text{Interferer}}$ (offset)	MHz	$= -BW/2 - F_{\text{offset, case 1}}$ & $= +BW/2 + F_{\text{offset, case 1}}$	$\leq -BW/2 - F_{\text{offset, case 2}}$ & $\geq +BW/2 + F_{\text{offset, case 2}}$			$-BW/2 - 11$
1, 2, 3, 4, 5, 6, 7, 8, 9, 10, 11, 12, 13, 14, 17, 18, 19, 20, 21, 22, 23, 25, 26, 27, 28, 31, 33, 34, 35, 36, 37, 38, 39, 40, 41, 42, 43, 44	$F_{\text{Interferer}}$	MHz	(Note 2)	$F_{\text{DL\_low}} - 15$ to $F_{\text{DL\_high}} + 15$	Void	Void	
30	$F_{\text{Interferer}}$	MHz	(Note 2)	$F_{\text{DL\_low}} - 15$ to $F_{\text{DL\_high}} + 15$			$F_{\text{DL\_low}} - 11$
NOTE 1: For certain bands, the unwanted modulated interfering signal may not fall inside the UE receive band, but within the first 15 MHz below or above the UE receive band							
NOTE 2: For each carrier frequency the requirement is valid for two frequencies: a. the carrier frequency $-BW/2 - F_{\text{offset, case 1}}$ b. the carrier frequency $+BW/2 + F_{\text{offset, case 1}}$							
NOTE 3: $F_{\text{Interferer}}$ range values for unwanted modulated interfering signal are interferer centre frequencies							

For the UE which supports inter band CA configuration in Table 7.3.3-1A,  $P_{\text{Interferer}}$  power defined in Table 7.6.1B.5-2 is increased by the amount given by  $\Delta R_{\text{IB,c}}$  in Table 7.3.3-1A.

## 7.6.1E In-band blocking for UE category 0

Editor's note: Following aspects missing or not yet determined:

- RB allocation within brackets
- Test tolerance for this case in Annex F is not completed
- Test requirement TBD

### 7.6.1E.1 Test Purpose

The same test purpose as in clause 7.6.1.

### 7.6.1E.2 Test Applicability

This test applies to all types of E-UTRA UE release 12 and forward of UE category 0.

### 7.6.1E.3 Minimum Conformance Requirements

Same minimum conformance requirements as in clause 7.6.1.3.

### 7.6.1E.4 Test Description

#### 7.6.1E.4.1 Initial Conditions

Same initial conditions as in clause 7.6.1.4.1 with the following exceptions:

- Instead of Table 7.6.1.4.1-1 → use Table 7.6.1E.4.1-1.
- Connect the SS to the UE antenna connectors as shown in TS 36.508[7] Annex A Figure A.4 using only main UE Tx/Rx antenna.

Table 7.6.1E.4.1-1: Test Configuration Table

Initial Conditions						
Test Environment as specified in TS 36.508[7] subclause 4.1				NC		
Test Frequencies as specified in TS36.508 [7] subclause 4.3.1				Mid range		
Test Channel Bandwidths as specified in TS 36.508 [7] subclause 4.3.1				Lowest, 5MHz, Highest		
Test Parameters for Channel Bandwidths						
Ch BW	Downlink Configuration			Uplink Configuration		
	Mod'n	RB allocation		Mod'n	RB allocation	
		FDD and HD-FDD	TDD		FDD and HD-FDD	TDD
1.4MHz	QPSK	6	6	QPSK	6	6
3MHz	QPSK	14	14	QPSK	15	15
5MHz	QPSK	14	14	QPSK	25	25
5MHz	QPSK	14	N/A	QPSK	20	N/A
10MHz	QPSK	14	14	QPSK	[36]	[36]
10MHz	QPSK	14	N/A	QPSK	25	N/A
10MHz	QPSK	14	N/A	QPSK	20	N/A
15MHz	QPSK	14	14	QPSK	[36]	[36]
15MHz	QPSK	14	N/A	QPSK	20	N/A
20MHz	QPSK	14	14	QPSK	[36]	[36]
20MHz	QPSK	14	N/A	QPSK	20	N/A
Note 1: Test Channel Bandwidths are checked separately for each E-UTRA band, which applicable channel bandwidths are specified in Table 5.4.2.1-1.						
Note 2: Depending on E-UTRA band, only the appropriate Uplink RB allocation value according to table 7.3E.3-3 is tested per Test Channel Bandwidth. The allocation shall be located as close as possible to the downlink operating band but confined within the transmission bandwidth configuration for the channel bandwidth (Table 5.4.2-1).						
Note 3: For the DL signal one sided dynamic OCNG Pattern OP.1 FDD/TDD is used.						
Note 4: Downlink RB position shall be RBstart = 0.						

#### 7.6.1E.4.2 Test Procedure

Same test procedure as in clause 7.6.1.4.2

#### 7.6.1E.4.3 Message Contents

Same message contents as in clause 7.6.1.4.3

#### 7.6.1E.5 Test Requirement

TBD

### 7.6.2 Out-of-band blocking

#### 7.6.2.1 Test Purpose

Out-of-band band blocking is defined for an unwanted CW interfering signal falling more than 15 MHz below or above the UE receive band, at which a given average throughput shall meet or exceed the requirement for the specified measurement channels.

For the first 15 MHz below or above the UE receive band the appropriate in-band blocking or adjacent channel selectivity in sub-clause 7.5.1 and sub-clause 7.6.1 shall be applied.

The lack of out-of-band blocking ability will decrease the coverage area when other e-NodeB transmitters exist (except in the adjacent channels and spurious response).

#### 7.6.2.2 Test Applicability

This test applies to all types of E-UTRA UE release 8 and forward.



### 7.6.2.3 Minimum Conformance Requirements

The throughput shall be  $\geq 95\%$  of the maximum throughput of the reference measurement channels as specified in Annexes A.2.2, A.2.3 and A.3.2 (with one sided dynamic OCNG Pattern OP.1 FDD/TDD for the DL-signal as described in Annex A.5.1.1/A.5.2.1) with parameters specified in Tables 7.6.2.3-1 and 7.6.2.3-2.

For Table 7.6.2.3-2 in frequency range 1, 2 and 3, up to  $\max(24, 6 \cdot \lceil N_{RB} / 6 \rceil)$  exceptions are allowed for spurious response frequencies in each assigned frequency channel when measured using a 1MHz step size, where  $N_{RB}$  is the number of resource blocks in the downlink transmission bandwidth configuration (see Figure 5.4.2-1). For these exceptions the requirements of clause 7.7 Spurious Response are applicable.

For Table 7.6.2.3-2 in frequency range 4, up to  $\max(8, \lceil (N_{RB} + 2 \cdot L_{CRBS}) / 8 \rceil)$  exceptions are allowed for spurious response frequencies in each assigned frequency channel when measured using a 1MHz step size, where  $N_{RB}$  is the number of resource blocks in the downlink transmission bandwidth configurations (see Figure 5.4.2-1) and  $L_{CRBS}$  is the number of resource blocks allocated in the uplink. For these exceptions the requirements of clause 7.7 Spurious Response are applicable.

**Table 7.6.2.3-1: Out-of-band blocking parameters**

Rx Parameter	Units	Channel bandwidth					
		1.4 MHz	3 MHz	5 MHz	10 MHz	15 MHz	20 MHz
Power in Transmission Bandwidth Configuration	dBm	REFSENS + channel bandwidth specific value below					
		6	6	6	6	7	9
Note 1: The transmitter shall be set to 4dB below $P_{CMAX\_L}$ at the minimum uplink configuration specified in Table 7.3.3-2 with $P_{CMAX\_L}$ as defined in clause 6.2.5. Note 2: The reference measurement channel is specified in Annex A.3.2 with one sided dynamic OCNG Pattern OP.1 FDD/TDD as described in Annex A.5.1.1/A.5.2.1.							

**Table 7.6.2.3-2: Out of band blocking**

E-UTRA band	Parameter	Units	Frequency			
			range 1	range 2	range 3	range 4
	$P_{Interferer}$	dBm	-44	-30	-15	-15
1, 2, 3, 4, 5, 6, 7, 8, 9, 10, 11, 12, 13, 14, 17, 18, 19, 20, 21, 22, 23, 24, 25, 26, 27, 28, 30, 31, 33, 34, 35, 36, 37, 38, 39, 40, 41, 42, 43, 44	$F_{Interferer}$ (CW)	MHz	$F_{DL\_low} -15$ to $F_{DL\_low} -60$	$F_{DL\_low} -60$ to $F_{DL\_low} -85$	$F_{DL\_low} -85$ to 1 MHz	-
			$F_{DL\_high} +15$ to $F_{DL\_high} +60$	$F_{DL\_high} +60$ to $F_{DL\_high} +85$	$F_{DL\_high} +85$ to +12750 MHz	-
2, 5, 12, 17	$F_{Interferer}$	MHz	-	-	-	$F_{UL\_low} - F_{UL\_high}$
Note: For the UE which supports both Band 11 and Band 21 the out of blocking is FFS.						

The normative reference for this requirement is TS 36.101 [2] clause 7.6.2.

### 7.6.2.4 Test Description

#### 7.6.2.4.1 Initial Conditions

Initial conditions are a set of test configurations the UE needs to be tested in and the steps for the SS to take with the UE to reach the correct measurement state.

The initial test configurations consist of environmental conditions, test frequencies, and channel bandwidths based on E-UTRA bands specified in table 5.4.2.1-1. All of these configurations shall be tested with applicable test parameters

for each channel bandwidth, and are shown in table 7.6.2.4.1-1. The details of the uplink and downlink reference measurement channels (RMCs) are specified in Annexes A.2 and A.3 respectively. The details of the OCNG patterns used are specified in Annex A.5. Configurations of PDSCH and PDCCH before measurement are specified in Annex C.2.

**Table 7.6.2.4.1-1: Test Configuration Table**

Initial Conditions						
Test Environment as specified in TS 36.508[7] subclause 4.1			NC			
Test Frequencies as specified in TS36.508 [7] subclause 4.3.1			One frequency chosen arbitrarily from low or high range			
Test Channel Bandwidths as specified in TS 36.508 [7] subclause 4.3.1			Lowest, 5MHz, Highest			
Test Parameters for Channel Bandwidths						
Ch BW	Downlink Configuration			Uplink Configuration		
	Mod'n	RB allocation		Mod'n	RB allocation	
		FDD	TDD		FDD	TDD
1.4MHz	QPSK	6	6	QPSK	6	6
3MHz	QPSK	15	15	QPSK	15	15
5MHz	QPSK	25	25	QPSK	25	25
5MHz	QPSK	25	N/A	QPSK	20	N/A
5MHz	QPSK	25	N/A	QPSK	15	N/A
5MHz	QPSK	25	N/A	QPSK	5 <sup>4</sup>	N/A
10MHz	QPSK	50	50	QPSK	50	50
10MHz	QPSK	50	N/A	QPSK	25	N/A
10MHz	QPSK	50	N/A	QPSK	20	N/A
10MHz	QPSK	50	N/A	QPSK	15	N/A
15MHz	QPSK	75	75	QPSK	75	75
15MHz	QPSK	75	N/A	QPSK	50	N/A
15MHz	QPSK	75	N/A	QPSK	25	N/A
15MHz	QPSK	75	N/A	QPSK	20	N/A
20MHz	QPSK	100	100	QPSK	100	100
20MHz	QPSK	100	N/A	QPSK	75	N/A
20MHz	QPSK	100	N/A	QPSK	50	N/A
20MHz	QPSK	100	N/A	QPSK	25	N/A
20MHz	QPSK	100	N/A	QPSK	20	N/A
Note 1: Test Channel Bandwidths are checked separately for each E-UTRA band, which applicable channel bandwidths are specified in Table 5.4.2.1-1. Note 2: Depending on E-UTRA band, only the appropriate Uplink RB allocation value according to table 7.3.3-2 is tested per Test Channel Bandwidth. The allocation shall be located as close as possible to the downlink operating band but confined within the transmission bandwidth configuration for the channel bandwidth (Table 5.4.2-1). Note 3: For the DL signal one sided dynamic OCNG Pattern OP.1 FDD/TDD is used. Note 4: Applicable only to E-UTRA FDD Band 31. The UL resource blocks shall be located at RBstart 10 (according to Table 7.3.3-2).						

1. Connect the SS to the UE antenna connectors as shown in TS 36.508 [7] Annex A, in Figure A.5.
2. The parameter settings for the cell are set up according to TS 36.508 [7] subclause 4.4.3.
3. Downlink signals are initially set up according to Annex C0, C.1 and C.3.1, and uplink signals according to Annex H.1 and H.3.1.
4. The UL and DL Reference Measurement channels are set according to Table 7.6.2.4.1-1.
5. Propagation conditions are set according to Annex B.0.
6. Ensure the UE is in State 3A-RF according to TS 36.508 [7] clause 5.2A.2. Message contents are defined in clause 7.6.2.4.3.

#### 7.6.2.4.2 Test Procedure

1. SS transmits PDSCH via PDCCH DCI format 1A for C\_RNTI to transmit the DL RMC according to Table 7.6.2.4.1-1. The SS sends downlink MAC padding bits on the DL RMC.

2. SS sends uplink scheduling information for each UL HARQ process via PDCCH DCI format 0 for C\_RNTI to schedule the UL RMC according to Table 7.6.2.4.1-1. Since the UE has no payload data to send, the UE transmits uplink MAC padding bits on the UL RMC.
3. Set the parameters of the CW signal generator for an interfering signal below the wanted signal according to Table 7.6.2.5-2. The frequency step size is 1MHz.
4. Set the downlink signal level according to the table 7.6.2.5-1. Send uplink power control commands to the UE (less or equal to 1dB step size should be used), to ensure that the UE output power is within +0, - 3.4 dB of the target level in table 7.6.2.5-1 for carrier frequency  $f \leq 3.0\text{GHz}$  or within +0, -4.0 dB of the target level for carrier frequency  $3.0\text{GHz} < f \leq 4.2\text{GHz}$ , for at least the duration of the throughput measurement.
5. Measure the average throughput for a duration sufficient to achieve statistical significance according to Annex G.2.
6. Record the frequencies for which the throughput doesn't meet the requirements.
7. Repeat steps from 3 to 6, using an interfering signal above the wanted signal at step 3.

### 7.6.2.4.3 Message Contents

Message contents are according to TS 36.508 [7] subclause 4.6 with the following exception.

**Table 7.6.2.4.3-1: UplinkPowerControlDedicated**

Derivation Path: 36.331 clause 6.3.2			
Information Element	Value/remark	Comment	Condition
UplinkPowerControlDedicated-DEFAULT ::= SEQUENCE {			
p0-UePUSCH	0		
deltaMCS-Enabled	en0		
accumulationEnabled	TRUE		
p0-uePUCCH	0		
pSRS-Offset	3 (-6 dB)		
filterCoefficient	fc8	larger filter length is used to reduce the RSRP measurement variation	
}			

### 7.6.2.5 Test Requirement

Except for the spurious response frequencies recorded at the final step of test procedure, the throughput measurement derived in test procedure shall be  $\geq 95\%$  of the maximum throughput of the reference measurement channels as specified in Annex A.3.2 with parameters specified in Tables 7.6.2.5-1 and 7.6.2.5-2.

For frequency range 1, 2, and 3, the number of spurious response frequencies recorded in the final step of test procedure shall not exceed  $\max(24, 6 \cdot \lceil N_{RB} / 6 \rceil)$  in each assigned frequency channel when measured using a 1MHz step size. For these exceptions the requirements of clause 7.7 Spurious Response are applicable.

For frequency range 4, the number of spurious response frequencies recorded in the final step of test procedure shall not exceed  $\max(8, \lceil (N_{RB} + 2 \cdot L_{CRBS}) / 8 \rceil)$  in each assigned frequency channel when measured using a 1MHz step size. For these exceptions the requirements of clause 7.7 Spurious Response are applicable.

**Table 7.6.2.5-1: Out-of-band blocking parameters**

Rx Parameter	Units	Channel bandwidth					
		1.4 MHz	3 MHz	5 MHz	10 MHz	15 MHz	20 MHz
Power in Transmission Bandwidth Configuration	dBm	REFSENS + channel bandwidth specific value below					
		6	6	6	6	7	9

Note 1:	The transmitter shall be set to 4dB below $P_{\text{CMAX}_L}$ with $P_{\text{CMAX}_L}$ as defined in clause 6.2.5.
Note 2:	The reference measurement channel is specified in Annex A.3.2 with one sided dynamic OCNG Pattern OP.1 FDD/TDD as described in Annex A.5.1.1/A.5.2.1.

**Table 7.6.2.5-2: Out of band blocking**

E-UTRA band	Parameter	Units	Frequency			
			range 1	range 2	range 3	range 4
	$P_{\text{Interferer}}$	dBm	-44	-30	-15	-15
1, 2, 3, 4, 5, 6, 7, 8, 9, 10, 11, 12, 13, 14, 17, 18, 19, 20, 21, 22, 23, 24, 25, 26, 27, 28, 30, 31, 33, 34, 35, 36, 37, 38, 39, 40, 41, 42, 43, 44	$F_{\text{Interferer}}$ (CW)	MHz	$F_{\text{DL\_low}} -15$ to $F_{\text{DL\_low}} -60$	$F_{\text{DL\_low}} -60$ to $F_{\text{DL\_low}} -85$	$F_{\text{DL\_low}} -85$ to 1 MHz	-
			$F_{\text{DL\_high}} +15$ to $F_{\text{DL\_high}} +60$	$F_{\text{DL\_high}} +60$ to $F_{\text{DL\_high}} +85$	$F_{\text{DL\_high}} +85$ to +12750 MHz	-
2, 5, 12, 17	$F_{\text{Interferer}}$	MHz	-	-	-	$F_{\text{UL\_low}} - F_{\text{UL\_high}}$
Note 1: Range 3 shall be tested only with the highest channel bandwidth.						
Note 2: For the UE which supports both Band 11 and Band 21 the out of blocking is FFS.						

For the UE which supports inter band CA configuration in Table 7.3.3-1A,  $P_{\text{Interferer}}$  power defined in Table 7.6.2.5-2 is increased by the amount given by  $\Delta R_{\text{IB,c}}$  in Table 7.3.3-1A.

## 7.6.2A Out-of-band blocking for CA

### 7.6.2A.0 Minimum conformance requirements

For inter-band carrier aggregation with one component carrier per operating band and the uplink assigned to one E-UTRA band, the out-of-band blocking requirements are defined with the uplink active on the band(s) other than the band whose downlink is being tested. The throughput in the downlink measured shall be  $\geq 95\%$  of the maximum throughput of the reference measurement channels as specified in Annexes A.2.2, A.2.3 and A.3.2 (with one sided dynamic OCNG Pattern OP.1 FDD/TDD for the DL-signal as described in Annex A.5.1.1/A.5.2.1) with parameters specified in Tables 7.6.2.3-1 and 7.6.2A.0-0. The UE shall meet these requirements for each component carrier while all downlink carriers are active. For E-UTRA CA configurations including an operating band without uplink band (as noted in Table 5.5-1), the requirements for all downlinks shall be met with the uplink active in the band(s) capable of UL operation.

For E-UTRA CA configurations listed in Table 7.3A.0-1 under conditions for which reference sensitivity for the operating band being tested is N/A, the out-of-band blocking requirements of subclause 7.6.2A.0 do not apply.

For Table 7.6.2A.0-0 in frequency ranges 1, 2 and 3, up to  $\max(24,6 \cdot \lceil N_{\text{RB}} / 6 \rceil)$  exceptions per downlink are allowed for spurious response frequencies when measured using a step size of 1 MHz. For these exceptions the requirements in clause 7.7A.3.3 apply.

For intra-band contiguous carrier aggregations the downlink SCC(s) shall be configured at nominal channel spacing to the PCC. For FDD, the PCC shall be configured closest to the uplink band. All downlink carriers shall be active throughout the test. The uplink output power shall be set as specified in Table 7.6.2A.0-1 with the uplink configuration set according to Table 7.3A.0-2 for the applicable carrier aggregation configuration. For UE(s) supporting one uplink carrier, the uplink configuration of the PCC shall be in accordance with Table 7.3.3-2.

The UE shall fulfil the minimum requirement in presence of an interfering signal specified in Tables 7.6.2A.0-1 and Tables 7.6.2A.0-2 being on either side of the aggregated signal. The throughput of each carrier shall be  $\geq 95\%$  of the maximum throughput of the reference measurement channels as specified in Annexes A.2.2, A.2.3 and A.3.2 (with one sided dynamic OCNG Pattern OP.1 FDD/TDD for the DL-signal as described in Annex A.5.1.1/A.5.2.1) with parameters specified in Tables 7.6.2A.0-1 and 7.6.2A.0-2.

For Table 7.6.2A.0-2 in frequency range 1, 2 and 3, up to  $\max(24,6 \cdot \lceil N_{\text{RB}} / 6 \rceil)$  exceptions are allowed for spurious response frequencies in each assigned frequency channel when measured using a 1MHz step size. For these exceptions the requirements of subclause 7.7A.1.3 Spurious response for CA are applicable.

**Table 7.6.2A.0-0: Out-of-band blocking for inter-band carrier aggregation with one active uplink**

Parameter	Unit	Range 1	Range 2	Range 3
$P_{\text{wanted}}$	dBm	Table 7.6.2.3-1 for all component carriers		
$P_{\text{interferer}}$	dBm	$-44 + \Delta R_{\text{IB,c}}$	$-30 + \Delta R_{\text{IB,c}}$	$-15 + \Delta R_{\text{IB,c}}$
$F_{\text{interferer (CW)}}$	MHz	$-60 < f - F_{\text{DL\_Low}(j)} < -15$ or $15 < f - F_{\text{DL\_High}(j)} < 60$	$-85 < f - F_{\text{DL\_Low}(j)} \leq -60$ or $60 \leq f - F_{\text{DL\_High}(j)} < 85$	$1 \leq f \leq F_{\text{DL\_Low}(1)} - 85$ or $F_{\text{DL\_High}(j)} + 85 \leq f \leq F_{\text{DL\_Low}(j+1)} - 85$ or $F_{\text{DL\_High}(X)} + 85 \leq f \leq 12750$
Note 1:	$F_{\text{DL\_Low}(j)}$ and $F_{\text{DL\_High}(j)}$ denote the respective lower and upper frequency limits of the operating band containing carrier $j$ , $j = 1, \dots, X$ , with carriers numbered in increasing order of carrier frequency and $X$ the number of component carriers in the band combination ( $X = 2$ or $X = 3$ for the present version of this specification).			
Note 2:	For $F_{\text{DL\_Low}(j+1)} - F_{\text{DL\_High}(j)} < 145$ MHz and $F_{\text{interferer}}$ in $F_{\text{DL\_High}(j)} < f < F_{\text{DL\_Low}(j+1)}$ , $F_{\text{interferer}}$ can be in both Range 1 and Range 2. Then the lower of the $P_{\text{interferer}}$ applies.			
Note 3:	For $F_{\text{DL\_Low}(j)} - 15$ MHz $\leq f \leq F_{\text{DL\_High}(j)} + 15$ MHz the appropriate adjacent channel selectivity and in-band blocking requirements in the respective subclauses 7.5.1A and 7.6.1.1A shall be applied for carrier $j$ .			
Note 4:	$\Delta R_{\text{IB,c}}$ according to Table 7.3.3-1A applies when serving cell $c$ is measured.			
Note 5:	For inter-band CA combinations containing Bands 42 or 43, the interferer with respect to Band 42 or Band 43 shall have power level ( $P_{\text{interferer}}$ ) for Range 3 modified to $-20 + \Delta R_{\text{IB,c}}$ dBm for $F_{\text{interferer}} > 2800$ MHz and $F_{\text{interferer}} < 4400$ MHz.			

**Table 7.6.2A.0-1: Out-of-band blocking parameters**

Rx Parameter	Units	CA Bandwidth Class				
		B	C	D	E	F
$P_w$ in Transmission Bandwidth Configuration, per CC	dBm	REFSENS + CA Bandwidth Class specific value below				
		9	9	9		
Note 1:	The transmitter shall be set to 4dB below $P_{\text{CMAX,L}}$ or $P_{\text{CMAX,L,CA}}$ as defined in subclause 6.2.5A.					
Note 2:	Reference measurement channel is specified in Annex A.3.2 with one sided dynamic OCN Pattern OP.1 FDD/TDD as described in Annex A.5.1.1/A.5.2.					

**Table 7.6.2A.0-2: Out of band blocking**

CA configuration	Parameter	Units	Frequency		
			Range 1	Range 2	Range 3
	$P_{\text{interferer}}$	dBm	-44	-30	-15
CA_1C, CA_2C, CA_3C, CA_7C, CA_12B, CA_23B, CA_27B, CA_38C, CA_39C, CA_40C, CA_40D, CA_41C, CA_41D, CA_42C (Note)	$F_{\text{interferer (CW)}}$	MHz	$F_{\text{DL\_low}} - 15$ to $F_{\text{DL\_low}} - 60$	$F_{\text{DL\_low}} - 60$ to $F_{\text{DL\_low}} - 85$	$F_{\text{DL\_low}} - 85$ to 1 MHz
			$F_{\text{DL\_high}} + 15$ to $F_{\text{DL\_high}} + 60$	$F_{\text{DL\_high}} + 60$ to $F_{\text{DL\_high}} + 85$	$F_{\text{DL\_high}} + 85$ to +12750 MHz
Note:	For CA_42C, the power level of the interferer ( $P_{\text{interferer}}$ ) for Range 3 shall be modified to -20 dBm for $F_{\text{interferer}} > 2800$ MHz and $F_{\text{interferer}} < 4400$ MHz.				

For intra-band non-contiguous carrier aggregation with one uplink carrier and more than or equal to two downlink carriers, the out-of-band blocking requirements are defined with the uplink configuration in accordance with table 7.3A.0-3. For this uplink configuration, the UE shall meet the requirements specified in subclauses 7.6.2.3 and 7.6.2A.0 for single component carrier and intra-band contiguous component carriers separately while all downlink carriers are active.

For Table 7.6.2.3-2 in frequency range 1, 2 and 3, up to  $\max(24, 6 \cdot \lceil N_{\text{RB}} / 6 \rceil)$  exceptions per assigned E-UTRA channel per sub-block of the E-UTRA CA configuration are allowed for spurious response frequencies when measured using a 1MHz step size. For these exceptions the requirements of subclause 7.7A.4.3 spurious response are applicable.

For Table 7.6.2.3-2 in frequency range 4, up to  $\max(8, \lceil (N_{RB} + 2 \cdot L_{CRBs}) / 8 \rceil)$  exceptions per assigned E-UTRA channel per sub-block of the E-UTRA CA configuration are allowed for spurious response frequencies when measured using a 1MHz step size. For these exceptions the requirements of clause 7.7A.4.3 spurious response are applicable.

For combinations of intra-band contiguous and inter-band carrier aggregation with three downlink carriers and the uplink assigned to one E-UTRA band, the requirement is defined with the uplink active in the band other than that supporting the downlink(s) under test and a configuration in accordance with Table 7.3.3-2. The downlink PCC carrier centre frequency shall be configured closer to the uplink operating band than the downlink SCC centre frequency when the uplink is active in the band supporting two component carriers. For E-UTRA CA configurations including an operating band without uplink band, the requirements for all downlinks shall be met with the single uplink carrier active in each band capable of UL operation, but with a sub-block of up to two component carriers assigned to the same operating band. For the sub-block of two component carriers the out-of-band blocking parameters in Table 7.6.2.3-1 are replaced by those specified in Table 7.6.2A.0-1. The three downlink carriers shall be active throughout the tests.

For combinations of intra-band non-contiguous and inter-band carrier aggregation with three downlink carriers and the uplink assigned to one E-UTRA band, the requirement is defined with the uplink active in the band other than that supporting the downlink(s) under test and a configuration in accordance with Table 7.3.3-2. The uplink configuration shall be in accordance with Table 7.3A.0-3 when the uplink is active in the band supporting two component carriers and in accordance with Table 7.3.3-2 when the uplink is active in the other band. For E-UTRA CA configurations including an operating band without uplink band, the requirements for all downlinks shall be met with the single uplink carrier active in each band capable of UL operation. For the two component carriers within the same band,  $P_{\text{wanted}}$  in Table 7.6.2A.0-0 is set using  $\Delta R_{\text{IBNC}} = 0$  dB for all sub-block gaps (Table 7.3A.0-3). For each downlink the UE shall meet the out-of-band blocking requirements applicable for inter-band carrier aggregation with one component carrier per operating band, but with up to two component carriers assigned to the same band. The three downlink carriers shall be active throughout the tests.

The normative reference for this requirement is TS 36.101 [2] clause 7.6.2.1A.

## 7.6.2A.1 Out-of-band blocking for CA (intra-band contiguous DL CA and UL CA)

### 7.6.2A.1.1 Test Purpose

Out-of-band blocking for CA is defined for an unwanted CW interfering signal falling more than 15 MHz below or above the UE receive band, at which a given average throughput shall meet or exceed the requirement for the specified measurement channels in aggregated signals.

For the first 15 MHz below or above the UE receive band the appropriate in-band blocking or adjacent channel selectivity in sub-clause 7.5A and sub-clause 7.6.1A shall be applied.

The lack of out-of-band blocking ability will decrease the coverage area when other e-NodeB transmitters exist (except in the adjacent channels and spurious response).

### 7.6.2A.1.2 Test Applicability

This test applies to all types of E-UTRA UE release 10 and forward that support intra-band contiguous DL CA and UL CA.

### 7.6.2A.1.3 Minimum Conformance Requirements

The minimum conformance requirements are defined in clause 7.6.2A.0.

### 7.6.2A.1.4 Test Description

#### 7.6.2A.1.4.1 Initial Conditions

Initial conditions are a set of test configurations the UE needs to be tested in and the steps for the SS to take with the UE to reach the correct measurement state.

The initial test configurations consist of environmental conditions, test frequencies, and CC combinations based on E-UTRA CA configurations specified in table 5.4.2A.1-1. All of these configurations shall be tested with applicable test parameters for each CA Configuration, and are shown in table 7.6.2A.1.4.1-1. The details of the OCN patterns used are specified in Annex A.5. Configurations of PDSCH and PDCCH before measurement are specified in Annex C.2.

Table 7.6.2A.1.4.1-1: Test Configuration Table

Initial Conditions							
Test Environment as specified in TS 36.508[7] subclause 4.1					NC		
Test Frequencies as specified in TS36.508 [7] subclause 4.3.1 for different CA bandwidth classes, and PCC and SCCs are mapped onto physical frequencies according to Table 7.1-2					C: Mid range		
Test CC Combination setting ( $N_{RB\_agg}$ ) as specified in subclause 5.4.2A.1 for the CA Configuration across bandwidth combination sets supported by the UE					Highest $N_{RB\_agg}$ (Note 3)		
Test Parameters for CA Configurations							
CA Configuration / $N_{RB\_agg}$		DL Allocation		UL Allocation			
PCC $N_{RB}$	SCC $N_{RB}$	CC MOD	PCC & SCC RB allocation	CC MOD	$N_{RB\_alloc}$	PCC & SCC RB allocations ( $L_{CRB}$ @ $RB_{start}$ )	
100	75	QPSK	100+75	QPSK	175	P_100@0	S_75@0
100	100	QPSK	100+100	QPSK	50	P_50@50	S_0@0
100	100	QPSK	100+100	QPSK	75	P_75@25	S_0@0
100	100	QPSK	100+100	QPSK	130	P_100@0	S_30@0
100	100	QPSK	100+100	QPSK	200	P_100@0	S_100@0
Note 1: CA Configuration Test CC Combination settings are checked separately for each CA Configuration, which applicable aggregated channel bandwidths are specified in Table 5.4.2A.1-1.							
Note 2: Depending on CA Configuration only the appropriate Uplink RB allocation value according to table 7.3A.0-2 is tested per CA Configuration Test CC combination.							
Note 3: If in the CA Configuration UE supports multiple CC Combinations with the same $N_{RB\_agg}$ , only the first of those is tested, according to the order on the Test Configuration Table list.							

1. Connect the SS to the UE antenna connectors as shown in TS 36.508 [7] Annex A, Figure group A.34 as appropriate.
2. The parameter settings for the cell are set up according to TS 36.508 [7] subclause 4.4.3.
3. Downlink signals for PCC are initially set up according to Annex C.0, C.1 and C.3.1, and uplink signals according to Annex H.1 and H.3.1
4. The UL and DL Reference Measurement channels are set according to Table 7.6.2A.1.4.1-1.
5. Propagation conditions are set according to Annex B.0.
6. Ensure the UE is in State 3A-RF according to TS 36.508 [7] clause 5.2A.2. Message contents are defined in clause 7.6.2A.1.4.3.

#### 7.6.2A.1.4.2 Test Procedure

1. Configure SCC according to Annex C.0, C.1 and Annex C.3.1 for all downlink physical channels.
2. The SS shall configure SCC as per TS 36.508 [7] clause 5.2A.4. Message contents are defined in clause 7.6.2A.1.4.3.
3. SS activates SCC by sending the activation MAC-CE (Refer TS 36.321 [13], clauses 5.13, 6.1.3.8). Wait for at least 2 seconds (Refer TS 36.133, clauses 8.3.3.2).
4. SS transmits PDSCH via PDCCH DCI format 1A for  $C\_RNTI$  to transmit the DL RMC according to Table 7.6.2A.1.4.1-1 on both PCC and SCC. The SS sends downlink MAC padding bits on the DL RMC.
5. SS sends uplink scheduling information for each UL HARQ process via PDCCH DCI format 0 for  $C\_RNTI$  to schedule the UL RMC according to Table 7.6.2A.1.4.1-1 on both PCC and SCC. Since the UE has no payload data to send, the UE sends uplink MAC padding bits on the UL RMC.

6. Set the parameters of the CW signal generator for an interfering signal below the CA Band according to Table 7.6.2A.1.5-2. The frequency step size is 1MHz.
7. Set the downlink signal level according to the table 7.6.2A.1.5-1 for both carriers. Send uplink power control commands to the UE (less or equal to 1dB step size should be used), to ensure that for at least the duration of the throughput measurement:  
The PCC output power is within (+0dB, -3.4 dB) of (target level in Table 7.6.2A.1.5-1 +  $10\log(P_{L\_CRB}/N_{RB\_alloc})$ ), for carrier frequency  $f \leq 3.0\text{GHz}$ ,  
or within (+0dB, -4 dB) of (target level in Table 7.6.2A.1.5-1 +  $10\log(P_{L\_CRB}/N_{RB\_alloc})$ ) for carrier frequency  $3.0\text{GHz} < f \leq 4.2\text{GHz}$ .  
The SCC output power is within (+0dB, -3.4 dB) of (target level in Table 7.6.2A.1.5-1 +  $10\log(S_{L\_CRB}/N_{RB\_alloc})$ ), for carrier frequency  $f \leq 3.0\text{GHz}$ ,  
or within (+0dB, -4 dB) of (target level in Table 7.6.2A.1.5-1 +  $10\log(S_{L\_CRB}/N_{RB\_alloc})$ ) for carrier frequency  $3.0\text{GHz} < f \leq 4.2\text{GHz}$ .
8. Measure the average throughput for each component carrier for duration sufficient to achieve statistical significance according to Annex G.2A.
9. Record the frequencies for which the throughput doesn't meet the requirements.
10. Repeat steps from 6 to 9, using an interfering signal above the CA Band at step 5.

#### 7.6.2A.1.4.3 Message Contents

Message contents are according to TS 36.508 [7] subclause 4.6 with the following exception.

**Table 7.6.2A.1.4.3-1: UplinkPowerControlDedicatedSCell-r10**

Derivation Path: 36.508 clause 4.6.3			
Information Element	Value/remark	Comment	Condition
UplinkPowerControlDedicated-DEFAULT ::= SEQUENCE {			
p0-UE-PUSCH-r10	0		
deltaMCS-Enabled-r10	en0		
accumulationEnabled-r10	TRUE		
pSRS-Offset-r10	7 (0 dB)	The actual parameter value is $-10.5 + 1.5 \cdot \text{pSRS-Offset}$ value; 0 is the actual value in dB ( $-10.5 + 1.5 \cdot 7$ dB).	
pSRS-OffsetAp-r10	7 (0 dB)	The actual parameter value is $-10.5 + 1.5 \cdot \text{pSRS-Offset}$ value; 0 is the actual value in dB ( $-10.5 + 1.5 \cdot 7$ dB).	
filterCoefficient-r10	fc8	larger filter length is used to reduce the RSRP measurement variation	
pathlossReferenceLinking-r10	sCell		
}			

#### 7.6.2A.1.5 Test Requirement

Except for the spurious response frequencies recorded at the final step of test procedure, the throughput measurement of each carrier derived in test procedure shall be  $\geq 95\%$  of the maximum throughput of the reference measurement channels as specified in Annex A.3.2 with parameters specified in Table 7.6.2A.1.5-1 and 7.6.2A.1.5-2.

For Table 7.6.2A.1.5-2 in frequency range 1, 2 and 3, up to  $\max(24,6 \cdot \lceil N_{RB} / 6 \rceil)$  exceptions are allowed for spurious response frequencies in each assigned frequency channel when measured using a 1MHz step size, where  $N_{RB}$  is the



allocated number of resource blocks in the frequency channel. For these exceptions the requirements of subclause 7.7A Spurious response for CA are applicable.

**Table 7.6.2A.1.5-1: Out-of-band blocking parameters**

Rx Parameter	Units	CA Bandwidth Class				
		B	C	D	E	F
Pw in Transmission Bandwidth Configuration, per CC	dBm	REFSENS + CA Bandwidth Class specific value below				
		9				
NOTE 1: The transmitter shall be set to 4dB below P <sub>C<sub>MAX</sub>L</sub> or P <sub>C<sub>MAX</sub>L,CA</sub> as defined in subclause 6.2.5A.						
NOTE 2: Reference measurement channel is specified in Annex A.3.2 with one sided dynamic OCNG Pattern OP.1 FDD/TDD as described in Annex A.5.1.1/A.5.2.						

**Table 7.6.2A.1.5-2: Out of band blocking**

CA configuration	Parameter	Units	Frequency		
			range 1	range 2	range 3
	P <sub>Interferer</sub>	dBm	-44	-30	-15
CA_1C, CA_2C, CA_3C, CA_7C, CA_12B, CA_23B, CA_27B, CA_38C, CA_39C, CA_40C, CA_41C, CA_42C (note)	F <sub>Interferer</sub> (CW)	MHz	F <sub>DL_low</sub> - 15 to F <sub>DL_low</sub> - 60	F <sub>DL_low</sub> - 60 to F <sub>DL_low</sub> - 85	F <sub>DL_low</sub> - 85 to 1 MHz
			F <sub>DL_high</sub> + 15 to F <sub>DL_high</sub> + 60	F <sub>DL_high</sub> + 60 to F <sub>DL_high</sub> + 85	F <sub>DL_high</sub> + 85 to +12750 MHz
Note: For CA_42C, the power level of the interferer (P <sub>Interferer</sub> ) for Range 3 shall be modified to -20 dBm for F <sub>Interferer</sub> > 2800 MHz and F <sub>Interferer</sub> < 4400 MHz.					

For the UE which supports inter band CA configuration in Table 7.3.3-1A, P<sub>Interferer</sub> power defined in Table 7.6.2A.1.5-2 is increased by the amount given by ΔR<sub>IB,c</sub> in Table 7.3.3-1A.

**7.6.2A.2 Out-of-band blocking for CA (intra-band contiguous DL CA without UL CA)**

**7.6.2A.2.1 Test Purpose**

Same test purpose as 7.6.2A.1.

**7.6.2A.2.2 Test Applicability**

This test applies to all types of E-UTRA UE release 10 and forward that support intra-band contiguous DL CA. This test case applies only for CA Configurations that do not support UL CA.

**7.6.2A.2.3 Minimum Conformance Requirements**

The minimum conformance requirements are defined in clause 7.6.2A.0.

**7.6.2A.2.4 Test Description**

**7.6.2A.2.4.1 Initial Conditions**

Same initial conditions as in clause 7.6.2A.1.4.1 with the following exceptions:

- Instead of Table 7.6.2A.1.4.1-1 → use Table 7.6.2A.2.4.1-1.
- Instead of clause 7.6.2A.1.4.3 → use clause 7.6.2A.2.4.3.

Table 7.6.2A.2.4.1-1: Test Configuration Table

Initial Conditions							
Test Environment as specified in TS 36.508[7] subclause 4.1					NC		
Test Frequencies as specified in TS36.508 [7] subclause 4.3.1 for different CA bandwidth classes, and PCC and SCCs are mapped onto physical frequencies according to Table 7.1-2					B: Mid range C: Mid range		
Test CC Combination setting ( $N_{RB\_agg}$ ) as specified in subclause 5.4.2A.1 for the CA Configuration across bandwidth combination sets supported by the UE					Highest $N_{RB\_agg}$ (Note 3)		
Test Parameters for CA Configurations							
CA Configuration / $N_{RB\_agg}$		DL Allocation		UL Allocation			
PCC $N_{RB}$	SCC $N_{RB}$	CC MOD	PCC & SCC RB allocation	CC MOD	$N_{RB\_alloc}$	PCC & SCC RB allocations ( $L_{CRB}$ @ $RB_{start}$ )	
15	50	QPSK	15+50	QPSK	15	P_15@0	-
25	50	QPSK	25+50	QPSK	20	P_20@0	-
50	50	QPSK	50+50	QPSK	50	P_50@0	-
100	75	QPSK	100+75	QPSK	100	P_100@0	-
100	100	QPSK	100+100	QPSK	100	P_100@0	-
100	100	QPSK	100+100	QPSK	75	P_75@0	-
100	100	QPSK	100+100	QPSK	50	P_50@0	-
Note 1: CA Configuration Test CC Combination settings are checked separately for each CA Configuration, which applicable aggregated channel bandwidths are specified in Table 5.4.2A.1-1.							
Note 2: Depending on CA Configuration only the appropriate Uplink RB allocation value according to table 7.3.3-2 is tested per CA Configuration Test CC combination.							
Note 3: If in the CA Configuration UE supports multiple CC Combinations with the same $N_{RB\_agg}$ , only the first of those is tested, according to the order on the Test Configuration Table list.							

## 7.6.2A.2.4.2 Test Procedure

1. Configure SCC according to Annex C.0, C.1 and Annex C.3.1 for all downlink physical channels.
2. The SS shall configure SCC as per TS 36.508 [7] clause 5.2A.4.
3. SS activates SCC by sending the activation MAC-CE (Refer TS 36.321 [13], clauses 5.13, 6.1.3.8). Wait for at least 2 seconds (Refer TS 36.133, clauses 8.3.3.2).
4. SS transmits PDSCH via PDCCH DCI format 1A for C\_RNTI to transmit the DL RMC according to Table 7.6.2A.2.4.1-1 on both PCC and SCC. The SS sends downlink MAC padding bits on the DL RMC.
5. SS sends uplink scheduling information for each UL HARQ process via PDCCH DCI format 0 for C\_RNTI to schedule the UL RMC according to Table 7.6.2A.2.4.1-1 on PCC. Since the UE has no payload data to send, the UE sends uplink MAC padding bits on the UL RMC.
6. Set the parameters of the CW signal generator for an interfering signal below the CA Band according to Table 7.6.2A.1.5-2. The frequency step size is 1MHz.
7. Set the downlink signal level according to the table 7.6.2A.1.5-1 for both carriers. Send uplink power control commands to the UE (less or equal to 1dB step size should be used), to ensure that the UE output power is within +0, - 3.4 dB of the target level in table 7.6.2A.1.5-1 for carrier frequency  $f \leq 3.0\text{GHz}$  or within +0, -4.0 dB of the target level for carrier frequency  $3.0\text{GHz} < f \leq 4.2\text{GHz}$ , for at least the duration of the throughput measurement.
8. Measure the average throughput for each component carrier for duration sufficient to achieve statistical significance according to Annex G.2A.
9. Record the frequencies for which the throughput doesn't meet the requirements.
10. Repeat steps from 6 to 9, using an interfering signal above the CA Band at step 5.

### 7.6.2A.2.4.3 Message Contents

Same message contents as in clause 7.6.2.4.3.

### 7.6.2A.2.5 Test Requirement

Same test requirement as in clause 7.6.2A.1.5 with the following exceptions:

- Instead of Table 7.6.2A.1.5-1 → use Table 7.6.2A.2.5-1.
- Instead of Table 7.6.2A.1.5-2 → use Table 7.6.2A.2.5-2.

**Table 7.6.2A.2.5-1: Out-of-band blocking parameters**

Rx Parameter	Units	CA Bandwidth Class				
		B	C	D	E	F
Pw in Transmission Bandwidth Configuration, per CC	dBm	REFSENS + CA Bandwidth Class specific value below				
		9	9			
Note 1:	The transmitter shall be set to 4dB below $P_{\text{CMAX\_L}}$ or $P_{\text{CMAX\_L\_CA}}$ as defined in subclause 6.2.5.					
Note 2:	Reference measurement channel is specified in Annex A.3.2 with one sided dynamic OCNG Pattern OP.1 FDD/TDD as described in Annex A.5.1.1/A.5.2.					

**Table 7.6.2A.2.5-2: Out of band blocking**

CA configuration	Parameter	Units	Frequency		
			range 1	range 2	range 3
	$P_{\text{Interferer}}$	dBm	-44	-30	-15
CA_1C, CA_2C, CA_3C, CA_7C, CA_12B, CA_23B, CA_27B, CA_38C, CA_39C, CA_40C, CA_41C, CA_42C (note)	$F_{\text{Interferer}}$ (CW)	MHz	$F_{\text{DL\_low}} - 15$ to $F_{\text{DL\_low}} - 60$	$F_{\text{DL\_low}} - 60$ to $F_{\text{DL\_low}} - 85$	$F_{\text{DL\_low}} - 85$ to 1 MHz
			$F_{\text{DL\_high}} + 15$ to $F_{\text{DL\_high}} + 60$	$F_{\text{DL\_high}} + 60$ to $F_{\text{DL\_high}} + 85$	$F_{\text{DL\_high}} + 85$ to +12750 MHz
Note:	For CA_42C, the power level of the interferer ( $P_{\text{Interferer}}$ ) for Range 3 shall be modified to -20 dBm for $F_{\text{Interferer}} > 2800$ MHz and $F_{\text{Interferer}} < 4400$ MHz.				

For the UE which supports inter band CA configuration in Table 7.3.3-1A,  $P_{\text{Interferer}}$  power defined in Table 7.6.2A.2.5-2 is increased by the amount given by  $\Delta R_{\text{IB,c}}$  in Table 7.3.3-1A.

### 7.6.2A.3 Out-of-band blocking for CA (inter-band DL CA without UL CA)

#### 7.6.2A.3.1 Test Purpose

Same test purpose as 7.6.2A.1.

#### 7.6.2A.3.2 Test Applicability

This test applies to all types of E-UTRA UE release 10 and forward that support inter-band DL CA without UL CA.

#### 7.6.2A.3.3 Minimum Conformance Requirements

The minimum conformance requirements are defined in clause 7.6.2A.0.

#### 7.6.2A.3.4 Test Description

##### 7.6.2A.3.4.1 Initial Conditions

Same initial conditions as in clause 7.6.2A.1.4.1 with the following exceptions:

- Instead of Table 7.6.2A.1.4.1-1 → use Table 7.6.2A.3.4.1-1.
- Instead of clause 7.6.2A.1.4.3 → use clause 7.6.2A.3.4.3.

**Table 7.6.2A.3.4.1-1: Test Configuration Table**

Initial Conditions						
Test Environment as specified in TS 36.508[7] subclause 4.1		NC				
Test Frequencies as specified in TS36.508 [7] subclause 4.3.1 for different CA bandwidth classes, and PCC and SCCs are mapped onto physical frequencies according to Table 7.1-2		A: Mid range for PCC and SCC				
Test CC Combination setting $b(N_{RB\_agg})$ as specified in subclause 5.4.2A.1 for the CA Configuration across bandwidth combination sets supported by the UE		Highest $N_{RB\_agg}$ for PCC and SCC				
Test Parameters for CA Configurations						
CA Configuration / $N_{RB\_agg}$		DL Allocation			UL Allocation	
PCC $N_{RB}$	SCCs $N_{RB}$	CC MOD	PCC & SCC RB allocation		CC MOD	PCC $N_{RB\_alloc}$
50	50	QPSK	50	50	QPSK	50
50	50	QPSK	50	50	QPSK	25
50	50	QPSK	50	50	QPSK	20
50	50	QPSK	50	50	QPSK	16
50	75	QPSK	50	75	QPSK	25
50	100	QPSK	50	100	QPSK	50
50	100	QPSK	50	100	QPSK	25
50	100	QPSK	50	100	QPSK	20
75	50	QPSK	75	50	QPSK	25
75	100	QPSK	75	100	QPSK	25
100	50	QPSK	100	50	QPSK	100
100	50	QPSK	100	50	QPSK	75
100	50	QPSK	100	50	QPSK	50
100	75	QPSK	100	75	QPSK	100
100	100	QPSK	100	100	QPSK	75
100	100	QPSK	100	100	QPSK	50
Note 1: CA Configuration Test CC Combination settings are checked separately for each CA Configuration, which applicable aggregated channel bandwidths are specified in Table 5.4.2A.1-2. Note 2: Depending on CA configurations, only the appropriate Uplink RB allocation value according to table 7.3A.3.5-2for UE supporting one uplink carrier is tested per Test CA configuration. Note 3: The UL resource blocks shall be located as close as possible to the downlink PCC but confined within the transmission bandwidth configuration for the channel bandwidth (Table 5.4.2-1). Note 4: The frequencies of PCC and SCC shall be switched and tested in each configuration (given UL is supported in PCC band as per Table 5.2-1).						

**7.6.2A.3.4.2 Test Procedure**

1. Configure SCC according to Annex C0, C.1 and Annex C.3.2 for all downlink physical channels.
2. The SS shall configure SCC as per TS 36.508 [7] clause 5.2A.4.
3. SS activates SCC by sending the activation MAC-CE (Refer TS 36.321 [13], clauses 5.13, 6.1.3.8). Wait for at least 2 seconds (Refer TS 36.133, clauses 8.3.3.2).

4. SS transmits PDSCH via PDCCH DCI format 1A for C\_RNTI to transmit the DL RMC according to Table 7.6.2A.3.4.1-1 on both PCC and SCC. The SS sends downlink MAC padding bits on the DL RMC.
5. SS sends uplink scheduling information for each UL HARQ process via PDCCH DCI format 0 for C\_RNTI to schedule the UL RMC according to Table 7.6.2A.3.4.1-1 on PCC. Since the UE has no payload data to send, the UE transmits uplink MAC padding bits on the UL RMC.
6. Set the parameters of the signal generator for an interfering signal below the SCC's operating band according to Table 7.6.2 A.3.5-2. The frequency step size is 1 MHz.
7. Set the downlink signal level according to the table 7.6.2A.3.5-1 for both carriers. Send uplink power control commands to the UE (less or equal to 1dB step size should be used), to ensure that the UE output power is within +0, - 3.4 dB of the target level in table 7.6.2A.3.5-1 for carrier frequency  $f \leq 3.0\text{GHz}$  or within +0, -4.0 dB of the target level for carrier frequency  $3.0\text{GHz} < f \leq 4.2\text{GHz}$ , for at least the duration of the throughput measurement.
8. Measure the average throughput of SCC for duration sufficient to achieve statistical significance according to Annex G.2.
9. Record the frequencies for which the throughput doesn't meet the requirements.
10. Repeat steps from 6 to 9, using an interfering signal above the SCC's operating band at step 6.
11. Switch the SCell into PCell and repeat steps 1 to 10, except for operating bands without uplink band (as noted in Table 5.2-1).

#### 7.6.2A.3.4.3 Message Contents

Same message contents as in clause 7.6.2.4.3.

#### 7.6.2A.3.5 Test Requirement

For inter-band carrier aggregation with uplink assigned to one E-UTRA band the out-of-band blocking requirements are defined with the uplink active on the band other than the band whose downlink is being tested i.e. the requirements are tested only for the SCell downlink. The UE shall meet the requirement for each component carrier, when operated as SCell, while both downlink carriers are active.

Except for the spurious response frequencies recorded at step 9, the throughput measured during the test procedure for each component carrier, when operated as SCell, shall be  $\geq 95\%$  of the maximum throughput of the reference measurement channels as specified in Annexes A.2.2, A.2.3 and A.3.2 (with one sided dynamic OCNG Pattern OP.1 FDD/TDD for the DL-signal as described in Annex A.5.1.1/A.5.2.1) with parameters specified in Tables 7.6.2A.3.5-1 (originated from the single carrier Table 7.6.2.5-1) and 7.6.2.3.5-2.

For frequency range 1, 2, and 3, the number of spurious response frequencies recorded in the step 9 of the test procedure shall not exceed  $\max(24, 6 \cdot \lceil N_{RB} / 6 \rceil)$  exceptions per downlink in each assigned frequency channel when measured using a 1MHz step size. For these exceptions the requirements of clause 7.7A.3 Spurious Response are applicable.

**Table 7.6.2A.3.5-1: Out-of-band blocking parameters**

Rx Parameter	Units	Channel bandwidth					
		1.4 MHz	3 MHz	5 MHz	10 MHz	15 MHz	20 MHz
Pw in Transmission Bandwidth Configuration, per CC	dBm	REFSENS + channel bandwidth specific value below					
		6	6	6	6	7	9
Note 1: The transmitter shall be set to 4dB below $P_{\text{CMAX\_L}}$ with $P_{\text{CMAX\_L}}$ as defined in clause 6.2.5.							
Note 2: The reference measurement channel is specified in Annex A.3.2 with one sided dynamic OCNG Pattern OP.1 FDD/TDD as described in Annex A.5.1.1/A.5.2.1.							

Table 7.6.2A.3.5-2: Out-of-band blocking for inter-band carrier aggregation with one uplink carrier

Parameter	Unit	Range 1	Range 2	Range 3
$P_w$	dBm	Table 7.6.2A.3.5-1 for both component carriers		
$P_{\text{interferer}}$	dBm	$-44 + \Delta R_{\text{IB},c}$	$-30 + \Delta R_{\text{IB},c}$	$-15 + \Delta R_{\text{IB},c}$
$F_{\text{interferer}}$ (CW)	MHz	$-60 < f - F_{\text{DL\_Low}(1)} < -15$ or $-60 < f - F_{\text{DL\_Low}(2)} < -15$ or $15 < f - F_{\text{DL\_High}(1)} < 60$ or $15 < f - F_{\text{DL\_High}(2)} < 60$	$-85 < f - F_{\text{DL\_Low}(1)} \leq -60$ or $-85 < f - F_{\text{DL\_Low}(2)} \leq -60$ or $60 \leq f - F_{\text{DL\_High}(1)} < 85$ or $60 \leq f - F_{\text{DL\_High}(2)} < 85$	$1 \leq f \leq F_{\text{DL\_Low}(1)} - 85$ or $F_{\text{DL\_High}(1)} + 85 \leq f \leq F_{\text{DL\_Low}(2)} - 85$ or $F_{\text{DL\_High}(2)} + 85 \leq f \leq 12750$
Note 1:	$F_{\text{DL\_Low}(1)}$ and $F_{\text{DL\_High}(1)}$ denote the respective lower and upper frequency limits of the lower operating band, $F_{\text{DL\_Low}(2)}$ and $F_{\text{DL\_High}(2)}$ the respective lower and upper frequency limits of the upper operating band.			
Note 2:	For $F_{\text{DL\_Low}(2)} - F_{\text{DL\_High}(1)} < 145$ MHz and $F_{\text{interferer}}$ in $F_{\text{DL\_High}(1)} < f < F_{\text{DL\_Low}(2)}$ , $F_{\text{interferer}}$ can be in both Range 1 and Range 2. Then the lower of the $P_{\text{interferer}}$ applies.			
Note 3:	For $F_{\text{DL\_Low}(1)} - 15$ MHz $\leq f \leq F_{\text{DL\_High}(1)} + 15$ MHz and $F_{\text{DL\_Low}(2)} - 15$ MHz $\leq f \leq F_{\text{DL\_High}(2)} + 15$ MHz the appropriate adjacent channel selectivity and in-band blocking in the respective subclauses 7.5A.1.5 and 7.6.1A.5 shall be applied.			
Note 4:	$\Delta R_{\text{IB},c}$ according to Table 7.3.3-1A applies when serving cell c is measured.			
Note 5:	For inter-band CA combinations containing Bands 42 or 43, the interferer with respect to Band 42 or Band 43 shall have power level ( $P_{\text{interferer}}$ ) for Range 3 modified to $-20 + \Delta R_{\text{IB},c}$ dBm for $F_{\text{interferer}} > 2800$ MHz and $F_{\text{interferer}} < 4400$ MHz.			

#### 7.6.2A.4 Out-of-band blocking for CA (intra-band non-contiguous DL CA without UL CA)

##### 7.6.2A.4.1 Test Purpose

Same as in clause 7.6.2A.1.1.

##### 7.6.2A.4.2 Test Applicability

This test case applies to all types of E-UTRA UE release 11 and forward that support intra-band non-contiguous DL CA but no UL CA.

##### 7.6.2A.4.3 Minimum Conformance Requirements

The minimum conformance requirements are defined in clause 7.6.2A.0.

##### 7.6.2A.4.4 Test description

###### 7.6.2A.4.4.1 Initial Conditions

Same as in clause 7.6.2A.1.4.1 with the following exceptions:

- Instead of Table 7.6.2A.1.4.1-1 → use Table 7.6.2A.4.4.1-1.

Table 7.6.2A.4.4.1-1: Test Configuration Table

Initial Conditions							
Test Environment as specified in TS 36.508[7] subclause 4.1				NC			
Test Frequencies as specified in TS36.508 [7] subclause 4.3.1 for different CA bandwidth classes, and PCC and SCCs are mapped onto physical frequencies according to Table 7.1-2.				A: N/A (Range is not relevant)			
Test CC Combination setting ( $N_{RB\_agg}$ ) as specified in subclause 5.4.2A.1 for the CA Configuration .				Refer to test point			
Test Parameters for CA Configurations							
ID	CA Configuration / $N_{RB\_agg}$		$W_{gap}$ [MHz]	DL Allocation		UL Allocation	
	PCC $N_{RB}$	SCCs $N_{RB}$		CC MOD	PCC & SCC RB allocation	CC MOD	PCC RB allocations ( $L_{CRB}$ @ $RB_{start}$ )
Test Parameters for CA_2A-2A Configurations							
1	100	100	20	QPSK	100+100	QPSK	P_16@57
Test Parameters for CA_3A-3A Configurations							
2	100	100	35	QPSK	100+100	QPSK	P_16@50
Test Parameters for CA_4A-4A Configurations							
3	100	100	5	QPSK	100+100	QPSK	P_100@0
Test Parameters for CA_7A-7A Configurations							
4	100	100	15	QPSK	100+100	QPSK	P_45@55
Test Parameters for CA_23A-23A Configurations							
5	50	25	5	QPSK	50+25	QPSK	P_50@0
Test Parameters for CA_25A-25A Configurations							
6 <sup>3</sup>	50	50	10	QPSK	50+50	QPSK	P_32@18
7 <sup>4</sup>	100	100	25	QPSK	100+100	QPSK	P_12@62
Test Parameters for CA_41A-41A Configurations							
8	100	100	154	QPSK	100+100	QPSK	P_100@0
Test Parameters for CA_42A-42A Configurations							
9	100	100	160	QPSK	100+100	QPSK	P_100@0
Note 1:	CA Configuration Test CC Combination settings are checked separately for each CA Configuration, which applicable aggregated channel bandwidths are specified in Table 5.4.2A.1-3.						
Note 2:	The carrier centre frequency of PCC in the UL operating band is configured closer to the DL operating band.						
Note 3:	Applicable if only Bandwidth Combination Set 0 is supported by the UE for the CA Configuration						
Note 4:	Not applicable if only Bandwidth Combination Set 0 is supported by the UE for the CA Configuration						

## 7.6.2A.4.4.2 Test Procedure

1. Configure SCC according to Annex C0, C.1 and Annex C.3.2 for all downlink physical channels.
2. The SS shall configure SCC as per TS 36.508 [7] clause 5.2A.4. Message contents are defined in clause 7.6.2A.4.4.3.
3. SS activates SCC by sending the activation MAC-CE (Refer TS 36.321 [13], clauses 5.13, 6.1.3.8). Wait for at least 2 seconds (Refer TS 36.133, clauses 8.3.3.2).
4. SS transmits PDSCH via PDCCH DCI format 1A for C\_RNTI to transmit the DL RMC according to Table 7.6.2A.3.4.1-1 on both PCC and SCC. The SS sends downlink MAC padding bits on the DL RMC.

5. SS sends uplink scheduling information for each UL HARQ process via PDCCH DCI format 0 for C\_RNTI to schedule the UL RMC according to Table 7.6.2A.4.4.1-1 on PCC. Since the UE has no payload data to send, the UE transmits uplink MAC padding bits on the UL RMC.
6. Set the parameters of the signal generator for an interfering signal below the CA band according to Table 7.6.2.5-2. The frequency step size is 1 MHz.
7. Set the downlink signal level according to the table 7.6.2.5-1 for both carriers. Send uplink power control commands to the UE (less or equal to 1dB step size should be used), to ensure that the UE output power is within +0, - 3.4 dB of the target level in table 7.6.2.5-1 for carrier frequency  $f \leq 3.0\text{GHz}$  or within +0, -4.0 dB of the target level for carrier frequency  $3.0\text{GHz} < f \leq 4.2\text{GHz}$ , for at least the duration of the throughput measurement.
8. Measure the average throughput for each component carrier for duration sufficient to achieve statistical significance according to Annex G.2A.
9. Record the frequencies for which the throughput doesn't meet the requirements.
10. Repeat steps from 6 to 9, using an interfering signal above the CA band at step 6.

#### 7.6.2A.4.4.3 Message Contents

Message contents are according to TS 36.508 [7] subclause 4.6. In test procedure step 2, for SCC configuration there are no additional message contents.

#### 7.6.2A.4.5 Test Requirement

For intra-band non-contiguous carrier aggregation with one uplink carrier and two downlink carriers, the out-of-band blocking requirements are defined with the uplink configuration of the PCC being in accordance with table 7.3.1A-3. The UE shall meet the requirements specified in tables 7.6.2A.4.5-1 and 7.6.2A.4.5-2 for each component carrier while both downlink carriers are active.

The out-of-band blocking parameters in tables 7.6.2A.4.5-1 and 7.6.2A.4.5-2 for each component carrier are the same as single carrier requirements in Tables 7.6.2.5-1 and 7.6.2.5-2.

For Table 7.6.2A.4.5-2 in frequency range 1, 2 and 3, the number of spurious response frequencies recorded in the step 9 of the test procedure shall not exceed  $\max(24, 6 \cdot \lceil N_{RB} / 6 \rceil)$  exceptions per assigned E-UTRA channel per sub-block gap of the E-UTRA CA configuration are allowed for spurious response frequencies when measured using a 1MHz step size. For these exceptions the requirements of subclause 7.7A.4 spurious response are applicable.

For Table 7.6.2A.4.5-2 in frequency range 4 the number of spurious response frequencies recorded in the step 9 of the test procedure shall not exceed  $\max(8, \lceil (N_{RB} + 2 \cdot L_{CRBs}) / 8 \rceil)$  exceptions per assigned E-UTRA channel per sub-block gap of the E-UTRA CA configuration are allowed for spurious response frequencies when measured using a 1MHz step size. For these exceptions the requirements of clause 7.7A.4 spurious response are applicable.

**Table 7.6.2A.4.5-1: Out-of-band blocking parameters**

Rx Parameter	Units	Channel bandwidth				
		1.4 MHz	3 MHz	5 MHz	10 MHz	15 MHz
Pw in Transmission Bandwidth Configuration, per CC	dBm	REFSENS + channel bandwidth specific value below				
		6	6	6	6	7
Note 1: The transmitter shall be set to 4dB below P <sub>CMAX_L</sub> with P <sub>CMAX_L</sub> as defined in clause 6.2.5.						
Note 2: The reference measurement channel is specified in Annex A.3.2 with one sided dynamic OCN Pattern OP.1 FDD/TDD as described in Annex A.5.1.1/A.5.2.1.						

**Table 7.6.2A.4.5-2: Out of band blocking**

E-UTRA band	Parameter	Units	Frequency			
			range 1	range 2	range 3	range 4
	P <sub>Interferer</sub>	dBm	-44	-30	-15	-15



1, 2, 3, 4, 5, 6, 7, 8, 9, 10, 11, 12, 13, 14, 17, 18, 19, 20, 21, 22, 23, 24, 25, 26, 27, 28, 30, 31, 33, 34, 35, 36, 37, 38, 39, 40, 41, 42 (Note 4), 43 (Note 4), 44	$F_{\text{Interferer}}$ (CW)	MHz	$F_{\text{DL\_low}} -15$ to $F_{\text{DL\_low}} -60$	$F_{\text{DL\_low}} -60$ to $F_{\text{DL\_low}} -85$	$F_{\text{DL\_low}} -85$ to 1 MHz	-
2, 5, 12, 17	$F_{\text{Interferer}}$	MHz	-	-	-	$F_{\text{UL\_low}} - F_{\text{UL\_high}}$
<p>Note 1: Range 3 shall be tested only with the highest channel bandwidth.</p> <p>Note 2: For the UE which supports both Band 11 and Band 21 the out of band blocking is FFS.</p> <p>Note 3: The power level of the interferer (<math>P_{\text{Interferer}}</math>) for Range 3 shall be modified to -20 dBm for <math>F_{\text{Interferer}} &gt; 2800</math> MHz and <math>F_{\text{Interferer}} &lt; 4400</math> MHz.</p>						

### 7.6.2A.5 Out-of-band blocking for CA (3DL CA without UL CA)

#### 7.6.2A.5.1 Test Purpose

Same test purpose as in clause 7.6.2A.1.

#### 7.6.2A.5.2 Test Applicability

This test case applies to all types of E-UTRA UE release 10 and forward that support 3DL Intra-band contiguous CA or 3DL Inter-band CA or 3DL Intra-band contiguous + Inter-band CA.

This test case also applies to all types of E-UTRA UE release 11 and forward that support 3DL Intra-band non-contiguous CA + Inter-band CA or 3DL Intra-band non-contiguous + Intra-band contiguous CA.

This test case also applies to all types of E-UTRA UE release 12 and forward that support 3DL CA with FDD-TDD CA.

#### 7.6.2A.5.3 Minimum Conformance Requirements

The minimum conformance requirements are defined in clause 7.6.2A.0.

#### 7.6.2A.5.4 Test Description

##### 7.6.2A.5.4.1 Initial Conditions

Initial conditions are a set of test configurations the UE needs to be tested in and the steps for the SS to take with the UE to reach the correct measurement state.

The initial test configurations consist of environmental conditions, test frequencies, and channel bandwidths based on E-UTRA CA configurations specified in table 5.4.2A.1-1 through table 5.4.2A.1-2a. All of these configurations shall be tested with applicable test parameters for each channel bandwidth, and are shown in table 7.6.2A.5.4.1-1 through table 7.6.2A.5.4.1-5 as appropriate. The details of the uplink reference measurement channels (RMCs) are specified in Annex A.2 and A.3. Configurations of PDSCH and PDCCH before measurement are specified in Annex C.2.

**Table 7.6.2A.5.4.1-1: Test Configuration Table (Intra-band contiguous)**

Initial Conditions														
Test Environment as specified in TS 36.508 [7] subclause 4.1							NC							
Test Frequencies as specified in TS36.508 [7] subclause 4.3.1 for different CA bandwidth classes.							For test frequencies refer to “Range” columns. For mapping within Band refer to “CC” columns							
Test CC Combination setting ( $N_{RB\_agg}$ ) as specified in subclause 5.4.2A.1 for the CA Configuration across bandwidth combination sets supported by the UE.							Refer to “PCC $N_{RB}$ ” and “SCCs $N_{RB}$ ” columns							
Network signalling value							NS_01 by default, exceptions listed in Table 7.3.3-3, dependent on PCC Band							
Test Parameters for CA Configurations														
ID	CA Configuration / $N_{RB\_agg}$						DL Allocation			UL Allocation (Note 2,3)				
	CA Configuration					PCC $N_{RB}$	SCCs $N_{RB}$		CC MOD	PCC & SCCs RB allocation			CC MOD	PCC $L_{CRB} @ RB_{start}$
	Band	Range	PCC CC	SCC1 CC	SCC2 CC		SCC1	SCC2		PCC	SCC1	SCC2		
Default Test Settings for a CA_XD Configuration														
1	X	Mid	CC1	CC2	CC3	Highest $N_{RB\_agg}$		QPSK	All RBs			QPSK	REFSENS	
<p>Note 1: CA Configuration Test CC Combination test settings are checked separately for each CA Configuration.</p> <p>Note 2: Use CA Configuration – specific test points if present in the table, otherwise use Default Test Settings test points.</p> <p>Note 3: X corresponds to the band of the CA Configuration. Eg. for CA_41D ,X=41</p> <p>Note 4: REFSENS refers to the PCC band's and PCC <math>N_{RB}</math> 's single carrier Uplink RB allocation for reference sensitivity according to table 7.3.5-2.</p> <p>Note 5: If in the CA Configuration UE supports multiple CC Combinations with the same <math>N_{RB\_agg}</math> , choose for testing the Combination with maximum <math>N_{RB\_PCC}</math> and then select maximum <math>N_{RB\_SCC1}</math> for the chosen <math>N_{RB\_PCC}</math></p>														

**Table 7.6.2A.5.4.1-2: Test Configuration Table (Inter-band)**

Initial Conditions															
Test Environment as specified in TS 36.508[7] subclause 4.1											NC				
Test Frequencies as specified in TS36.508 [7] subclause 4.3.1 for different CA bandwidth classes.											For test frequencies refer to "Range" columns. For mapping within Band refer to "CC" columns				
Test CC Combination setting ( $N_{RB\_agg}$ ) as specified in subclause 5.4.2A.1 for the CA Configuration across bandwidth combination sets supported by the UE.											Refer to "PCC $N_{RB}$ " and "SCCs $N_{RB}$ " columns				
Network signalling value											NS_01 by default, exceptions listed in Table 7.3.3-3, dependent on PCC Band				
Test Parameters for CA Configurations															
ID	CA Configuration / $N_{RB\_agg}$							DL Allocation			UL Allocation (Note 2,3)				
	CA Configuration						PCC $N_{RB}$	SCCs $N_{RB}$		CC MOD	PCC & SCCs RB allocation			CC MOD	PCC $L_{CRB}$ @ $RB_{start}$
	PCC		SCC1		SCC2			SCC1	SCC2		PCC	SCC1	SCC2		
	Band	Range	Band	Range	Band	Range									
Default Test Settings for a CA_XA-YA-ZA Configuration															
1	X	Mid	Y	Mid	Z	Mid	Highest $N_{RB}$	Highest $N_{RB}$	Highest $N_{RB}$	QPSK	All RBs	QPSK	REFSENS		
2	Y	Mid	X	Mid	Z	Mid	Highest $N_{RB}$	Highest $N_{RB}$	Highest $N_{RB}$	QPSK	All RBs	QPSK	REFSENS		
3	Z	Mid	X	Mid	Y	Mid	Highest $N_{RB}$	Highest $N_{RB}$	Highest $N_{RB}$	QPSK	All RBs	QPSK	REFSENS		
Note 1: CA Configuration Test CC Combination test settings are checked separately for each CA Configuration. Note 2: Use CA Configuration – specific test points if present in the table, Otherwise use test points from matching Group Test Settings, if present in the table. Otherwise use the Default Test Settings test points. Note 3: If, according to the UE declared capability, UE does not support UL in an individual band within the CA Configuration, test points with that individual band as PCC are not applicable. Note 4: X,Y,Z correspond to the different bands in the CA Configuration. Eg. for CA_1A-3A-19A,X=1,Y=3,Z=19 Note 5: REFSSENS refers to the PCC band's and PCC $N_{RB}$ 's single carrier Uplink RB allocation for reference sensitivity according to table 7.3.5-2.															

**Table 7.6.2A.5.4.1-3: Test Configuration Table (Intra-band contiguous + Inter-band)**

Initial Conditions															
Test Environment as specified in TS 36.508[7] subclause 4.1										NC					
Test Frequencies as specified in TS36.508 [7] subclause 4.3.1 for different CA bandwidth classes.										For test frequencies refer to “Range” columns. For mapping within Band refer to “CC” columns					
Test CC Combination setting ( $N_{RB\_agg}$ ) as specified in subclause 5.4.2A.1 for the CA Configuration across bandwidth combination sets supported by the UE.										Refer to “PCC $N_{RB}$ ” and “SCCs $N_{RB}$ ” columns					
Network signalling value										NS_01 by default, exceptions listed in Table 7.3.3-3, dependent on PCC Band					
Test Parameters for CA Configurations															
ID	CA Configuration / $N_{RB\_agg}$							DL Allocation			UL Allocation (Note 2,3)				
	CA Configuration						PCC $N_{RB}$	SCCs $N_{RB}$		CC MOD	PCC & SCCs RB allocation			CC MOD	PCC $L_{CRB}$ @ $RB_{start}$
	PCC		SCC1		SCC2			SCC1	SCC2		PCC	SCC1	SCC2		
	Band	Range /CC	Band	Range /CC	Band	Range /CC									
Default Test Settings for CA_XB-YA and CA_XC-YA Configuration															
1	X	Mid /CC1	X	Mid /CC2	Y	Mid	Highest $N_{RB\_agg}$	Highest $N_{RB}$	QPSK	All RBs	QPSK	REFSENS			
2	Y	Mid	X	Mid /CC1	X	Mid /CC2	Highest $N_{RB}$	Highest $N_{RB\_agg}$	QPSK	All RBs	QPSK	REFSENS			
Default Test Settings for CA_XA-YB and CA_XA-YC Configuration															
1	Y	Mid /CC1	Y	Mid /CC2	X	Mid	Highest $N_{RB\_agg}$	Highest $N_{RB}$	QPSK	All RBs	QPSK	REFSENS			
2	X	Mid	Y	Mid /CC1	Y	Mid /CC2	Highest $N_{RB}$	Highest $N_{RB\_agg}$	QPSK	All RBs	QPSK	REFSENS			
<p>Note 1: CA Configuration Test CC Combination test settings are checked separately for each CA Configuration.</p> <p>Note 2: Use CA Configuration – specific test points if present in the table. Otherwise use the Default Test Settings test points.</p> <p>Note 3: If, according to the UE declared capability, UE does not support UL in an individual band within the CA Configuration, test points with that individual band as PCC are not applicable.</p> <p>Note 4: X,Y correspond to the different bands in the CA Configuration. Eg. for CA_1C-3A, X=1 and Y=3</p> <p>Note 5: REFSSENS refers to the PCC band’s and PCC <math>N_{RB}</math> ‘s single carrier Uplink RB allocation for reference sensitivity according to table 7.3.5-2.</p> <p>Note 6: If in the CA Configuration UE supports multiple CC Combinations with the same <math>N_{RB\_agg}</math>, choose the Combination with <math>N_{RB\_PCC} = N_{RB\_SCC1}</math> for testing. If no such combination is supported, choose Combination with maximum <math>N_{RB\_PCC}</math> for testing.</p>															

**Table 7.6.2A.5.4.1-4: Test Configuration Table (Intra-band non-contiguous + Inter-band)**

Initial Conditions														
Test Environment as specified in TS 36.508[7] subclause 4.1									NC					
Test Frequencies as specified in TS36.508 [7] subclause 4.3.1 for different CA bandwidth classes.									For test frequencies refer to “Range” columns. For mapping within Band refer to “CC” columns					
Test CC Combination setting ( $N_{RB\_agg}$ ) as specified in subclause 5.4.2A.1 for the CA Configuration across bandwidth combination sets supported by the UE.									Highest $N_{RB}$					
Network signalling value									NS_01 by default, exceptions listed in Table 7.3.3-3, dependent on PCC Band					
Test Parameters for CA Configurations														
ID	CA Configuration / $N_{RB\_agg}$							DL Allocation			UL Allocation (Note 2,3)			
	CA Configuration							CC MOD	PCC & SCCs			CC MOD	PCC $L_{CRB} @ RB_{sta}$	
	PCC		$W_{gap}$ [MHz]	SCC1		$W_{gap}$ [MHz]	SCC2		RB allocation					
	Band	Range /CC		Band	Range /CC		Band		Range /CC	PCC	SCC1			SCC2
Default Test Settings for CA_XA-XA-YA Configurations														
1	X	CC2	Max	X	CC1	-	Y	Mid	QPSK	All RBs	QPSK	REFSENS_C		
2	Y	Mid	-	X	CC2	Max	X	CC1	QPSK	All RBs	QPSK	REFSENS		
Default Test Settings for CA_XA-YA-YA Configurations														
1	Y	CC2	Max	Y	CC1	-	X	Mid	QPSK	All RBs	QPSK	REFSENS_C		
2	X	Mid	-	Y	CC2	Max	Y	CC1	QPSK	All RBs	QPSK	REFSENS		
Note 1:	CA Configuration Test CC Combination test settings are checked separately for each CA Configuration.													
Note 2:	Use CA Configuration – specific test points if present in the table. Otherwise use test points from matching Group Test Settings, present in the table. Otherwise use Default Test Settings test points.													
Note 3:	If, according to the UE declared capability, UE does not support UL in an individual band within the CA Configuration, test points with that individual band as PCC are not applicable.													
Note 4:	X and Y correspond to the different bands in the CA Configuration. Eg. for CA_2A-2A-5A,X=2,Y=5													
Note 5:	REFSENS refers to the PCC band's and PCC $N_{RB}$ 's single carrier Uplink RB allocation for reference sensitivity according to tab 7.3.5-2. REFSENS_CA refers to the PCC band's and PCC $N_{RB}$ 's single carrier Uplink RB allocation for reference sensitivity according to table 7.3.4.5-2 (selecting RB allocation for SCC measurement).													

**Table 7.6.2A.5.4.1-5: Test Configuration Table (Intra-band non-contiguous + Intra-band contiguous)**

Initial Conditions															
Test Environment as specified in TS 36.508[7] subclause 4.1										NC					
Test Frequencies as specified in TS36.508 [7] subclause 4.3.1 for different CA bandwidth classes.										For test frequencies refer to “Range” columns. For mapping within band refer to “CC” columns					
Test CC Combination setting ( $N_{RB\_agg}$ ) as specified in subclause 5.4.2A.1 for the CA Configuration across bandwidth combination sets supported by the UE.										Refer to “PCC $N_{RB}$ ” and “SCCs $N_{RB}$ ” columns					
Network signalling value										NS_01 by default, exceptions listed in Table 7.3.3-3, dependent on PCC Band					
Test Parameters for CA Configurations															
ID	CA Configuration / $N_{RB\_agg}$							DL Allocation			UL Allocation (Note 2,3)				
	CA Configuration						PCC $N_{RB}$	SCCs $N_{RB}$		CC MOD	PCC & SCCs RB allocation			CC MOD	PCC $L_{CRB}$ @ $RB_{start}$
	Band	PCC	$W_{gap}$ [MHz]	SCC1	$W_{gap}$ [MHz]	SCC2		SCC1	SCC2		PCC	SCC1	SCC2		
		CC		CC		CC									
Test Settings for a 41A-41C Configuration															
1	41	CC3	134.2	CC2	-	CC1	100	100	100	QPSK	All RBs	QPSK	100@0		
Test Settings for a CA_41C-41A Configuration															
2	41	CC3	-	CC2	134.2	CC1	100	100	100	QPSK	All RBs	QPSK	100@0		
Note 1: CA Configuration Test CC Combination test settings are checked separately for each CA Configuration. Note 2: Use CA Configuration – specific test points if present in the table, otherwise use Default Test Settings test points. Note 3: If, according to the UE declared capability, UE does not support UL in an individual band within the CA Configuration, test points with that individual band as PCC are not applicable. Note 4: X corresponds to the band of the CA Configuration. Eg. for CA_41C-41A, X=41. Note 5: REFSENS refers to the PCC band’s and PCC $N_{RB}$ ‘s single carrier Uplink RB allocation for reference sensitivity according to table 7.3.5-2. Note 6: If in the CA Configuration UE supports multiple CC Combinations with the same $N_{RB\_agg}$ , choose the Combination with $N_{RB\_CC1} = N_{RB\_CC2}$ for testing. If no such combination is supported, choose Combination with maximum $N_{RB\_CC1}$ for testing.															

1. Connect the SS to the UE antenna connectors as shown in TS 36.508[7] Annex A Figure group [TBD] as appropriate.
2. The parameter settings for the cell are set up according to TS 36.508 [7] subclause [4.4.3].
3. Downlink signals for PCC are initially set up according to Annex C.0, C.1, and C.3.1, and uplink signals according to Annex H.1 and H.3.0.
4. The UL and DL Reference Measurement channels are set according to Table 7.6.2A.5.4.1-1 through Table 7.6.2A.5.4.1-5 as appropriate.
5. Propagation conditions are set according to Annex B.0.
6. Ensure the UE is in State 3A-RF according to TS 36.508 [7] clause 5.2A.2. Message contents are defined in clause 7.6.2A.5.4.3.

**7.6.2A.5.4.2 Test Procedure**

1. Configure SCCs according to Annex C.0, C.1 and Annex C.3.1 for all downlink physical channels except PHICH.

2. The SS shall configure SCCs as per TS 36.508 [7] clause 5.2A.4. Message contents are defined in clause 7.6.2A.5.4.3
3. SS activates SCCs by sending the activation MAC-CE (Refer TS 36.321 [13], clauses 5.13, 6.1.3.8). Wait for at least 2 seconds (Refer TS 36.133, clauses 8.3.3.2).
4. SS transmits PDSCH via PDCCH DCI format 1A for C\_RNTI to transmit the DL RMC according to Table 7.6.2A.5.4.1-1 through Table 7.6.2A.5.4.1-5 as appropriate on PCC and SCCs. The SS sends downlink MAC padding bits on the DL RMC.
5. SS sends uplink scheduling information for each UL HARQ process via PDCCH DCI format 0 for C\_RNTI to schedule the UL RMC according to Table 7.6.2A.5.4.1-1 through Table 7.6.2A.5.4.1-5 on PCC. Since the UE has no payload data to send, the UE sends uplink MAC padding bits on the UL RMC.
6. Set the parameters of the CW signal generator for an interfering signal below the CA Band according to Table 7.6.2A.5.4.251.1-. The frequency step size is 1MHz.
7. Set the downlink signal level according to the table 7.6.2A.5.5-1. Send uplink power control commands to the UE (less or equal to 1dB step size should be used), to ensure that the UE output power is within +0, - 3.4 dB of the target level in table 7.6.2A.5.5-1 for carrier frequency  $f \leq 3.0\text{GHz}$  or within +0, -4.0 dB of the target level for carrier frequency  $3.0\text{GHz} < f \leq 4.2\text{GHz}$ , for at least the duration of the throughput measurement.
8. Measure the average throughput for the carrier(s) indicated in Table 7.6.2A.5.4.2-1 for duration sufficient to achieve statistical significance according to Annex G.2A.
9. Record the frequencies for which the throughput doesn't meet the requirements.
10. Repeat steps from 6 to 9, using an interfering signal above the measured carrier(s) according to Table 7.6.2A.5.4.2-1 at step 5.
11. Repeat steps 1 to 10 for all component carriers listed in Table 7.6.2A.5.4.2-1.

**Table 7.6.2A.5.4.2-1: Test repetition and measurement configuration**

CA configuration	ID (Note 1)	Throughput measured on (Note 3)	Table with test parameters to select (Note 2)
Intra-band contiguous	1	PCC, SCC1, SCC2	7.6.2A.5.5-1
	2		7.6.2A.5.5-2
Inter-band	1	SCC1	7.6.2A.5.5-3 7.6.2A.5.5-4
		SCC2	
	2	SCC1	
		SCC2	
	3	SCC1	
		SCC2	
Intra-band contiguous + Inter-band	1	SCC2	7.6.2A.5.5-3
	2		7.6.2A.5.5-4
	3	SCC1, SCC2	7.6.2A.5.5-1
	4		7.6.2A.5.5-2
Intra-band non-contiguous + Inter-band	1	SCC2	7.6.2A.5.5-3 7.6.2A.5.5-4
	2	SCC1,	7.6.2A.5.5-3
		SCC2	7.6.2A.5.5-5
Intra-band non-contiguous + Intra-band contiguous	1	PCC	7.6.2A.5.5-3 7.6.2A.5.5-5
		SCC1,	7.6.2A.5.5-1
		SCC2	7.6.2A.5.5-2
	2	SCC2	7.6.2A.5.5-4 7.6.2A.5.5-5
		PCC, SCC1	7.6.2A.5.5-1
			7.6.2A.5.5-2
Note 1: Test point ID for the particular CA configuration as defined in section 7.6.2A.5.4.1. Note 2: The reference for the placement of the interferer signals is the centre frequency of the carrier closest to the interferer among the carriers throughput is measured on. Note 3: Where there are multiple rows for a single Test point ID, the test is repeated for each row.			

7.6.2A.5.4.3 Message Contents

Same message contents as in clause 7.6.2.4.3.

7.6.2A.5.5 Test Requirement

Except for the spurious response frequencies recorded at the final step of test procedure, the throughput measurement of each carrier derived in test procedure shall be ≥ 95% of the maximum throughput of the reference measurement channels as specified in Annex A.3.2 with parameters specified in Tables below, according to the type of CA.

For Table 7.6.2A.5.5-2 in frequency range 1, 2 and 3, up to  $\max(24,6 \cdot \lceil N_{RB} \cdot /6 \rceil)$  exceptions are allowed for spurious response frequencies in each assigned frequency channel when measured using a 1MHz step size, where  $N_{RB}$  is the allocated number of resource blocks in the frequency channel. For these exceptions the requirements of subclause 7.7A.5 Spurious Response for CA are applicable.

**Table 7.6.2A.5.5-1: Out-of-band blocking parameters (intra-band contiguous)**

Rx Parameter	Units	CA Bandwidth Class				
		B	C	D	E	F
Pw in Transmission Bandwidth Configuration, per CC	dBm	REFSENS + CA Bandwidth Class specific value below				
		9	9	9		
Note 1: The transmitter shall be set to 4dB below P <sub>CMAX_L</sub> or P <sub>CMAX_L_CA</sub> as defined in subclause 6.2.5. Note 2: Reference measurement channel is specified in Annex A.3.2 with one sided dynamic OCNB Pattern OP.1 FDD/TDD as described in Annex A.5.1.1/A.5.2.						



**Table 7.6.2A.5.5.1-2: Out of band blocking (intra-band contiguous)**

CA configuration	Parameter	Units	Frequency		
			range 1	range 2	range 3
	$P_{\text{Interferer}}$	dBm	-44	-30	-15
CA_1C, CA_2C, CA_3C, CA_7C, CA_12B, CA_23B, CA_27B, CA_38C, CA_40C, CA_41C, CA_40D, CA_42C (Note)	$F_{\text{Interferer}}$ (CW)	MHz	$F_{\text{DL\_low}} - 15$ to $F_{\text{DL\_low}} - 60$	$F_{\text{DL\_low}} - 60$ to $F_{\text{DL\_low}} - 85$	$F_{\text{DL\_low}} - 85$ to 1 MHz
			$F_{\text{DL\_high}} + 15$ to $F_{\text{DL\_high}} + 60$	$F_{\text{DL\_high}} + 60$ to $F_{\text{DL\_high}} + 85$	$F_{\text{DL\_high}} + 85$ to +12750 MHz
Note:	For CA_42C, the power level of the interferer ( $P_{\text{Interferer}}$ ) for Range 3 shall be modified to -20 dBm for $F_{\text{Interferer}} > 2800$ MHz and $F_{\text{Interferer}} < 4400$ MHz.				

For Table 7.6.2A.5.5-4 frequency range 1, 2, and 3, the number of spurious response frequencies recorded in the step 9 of the test procedure shall not exceed  $\max(24, 6 \cdot \lceil N_{RB} / 6 \rceil)$  exceptions per downlink in each assigned frequency channel when measured using a 1MHz step size. For these exceptions the requirements of clause 7.7A.5 Spurious Response for CA are applicable.

**Table 7.6.2A.5.5-3: Out-of-band blocking parameters (inter-band, intra-band non-contiguous)**

Rx Parameter	Units	Channel bandwidth					
		1.4 MHz	3 MHz	5 MHz	10 MHz	15 MHz	20 MHz
Pw in Transmission Bandwidth Configuration	dBm	REFSENS + channel bandwidth specific value below					
		6	6	6	6	7	9
Note 1: The transmitter shall be set to 4dB below $P_{\text{CMAX\_L}}$ with $P_{\text{CMAX\_L}}$ as defined in clause 6.2.5.							
Note 2: The reference measurement channel is specified in Annex A.3.2 with one sided dynamic OCN Pattern OP.1 FDD/TDD as described in Annex A.5.1.1/A.5.2.1.							

**Table 7.6.2A.5.5-4: Out-of-band blocking for inter-band carrier aggregation with one uplink carrier**

Parameter	Unit	Range 1	Range 2	Range 3
$P_{\text{wanted}}$	dBm	Table 7.6.2A.5.5-4 for all component carriers		
$P_{\text{Interferer}}$	dBm	$-44 + \Delta R_{\text{IB,c}}$	$-30 + \Delta R_{\text{IB,c}}$	$-15 + \Delta R_{\text{IB,c}}$
$F_{\text{interferer}}$ (CW)	MHz	$-60 < f - F_{\text{DL\_Low}(1)} < -15$ or $-60 < f - F_{\text{DL\_Low}(2)} < -15$ or $15 < f - F_{\text{DL\_High}(1)} < 60$ or $15 < f - F_{\text{DL\_High}(2)} < 60$	$-85 < f - F_{\text{DL\_Low}(1)} \leq -60$ or $-85 < f - F_{\text{DL\_Low}(2)} \leq -60$ or $60 \leq f - F_{\text{DL\_High}(1)} < 85$ or $60 \leq f - F_{\text{DL\_High}(2)} < 85$	$1 \leq f \leq F_{\text{DL\_Low}(1)} - 85$ or $F_{\text{DL\_High}(1)} + 85 \leq f \leq F_{\text{DL\_Low}(2)} - 85$ or $F_{\text{DL\_High}(2)} + 85 \leq f \leq 12750$
Note 1:	$F_{\text{DL\_Low}(1)}$ and $F_{\text{DL\_High}(1)}$ denote the respective lower and upper frequency limits of the lower operating band, $F_{\text{DL\_Low}(2)}$ and $F_{\text{DL\_High}(2)}$ the respective lower and upper frequency limits of the upper operating band.			
Note 2:	For $F_{\text{DL\_Low}(2)} - F_{\text{DL\_High}(1)} < 145$ MHz and $F_{\text{interferer}}$ in $F_{\text{DL\_High}(1)} < f < F_{\text{DL\_Low}(2)}$ , $F_{\text{interferer}}$ can be in both Range 1 and Range 2. Then the lower of the $P_{\text{interferer}}$ applies.			
Note 3:	For $F_{\text{DL\_Low}(1)} - 15 \text{ MHz} \leq f \leq F_{\text{DL\_High}(1)} + 15 \text{ MHz}$ and $F_{\text{DL\_Low}(2)} - 15 \text{ MHz} \leq f \leq F_{\text{DL\_High}(2)} + 15 \text{ MHz}$ the appropriate adjacent channel selectivity and in-band blocking in the respective subclauses 7.5A.5.5 and 7.6.1A.5.5 shall be applied.			
Note 4:	$\Delta R_{\text{IB,c}}$ according to Table 1A and 7.3.3-1A and 7.3.3-1B/7.3.3-1B apply when serving cell c is measured.			
Note 5:	For inter-band CA combinations containing Bands 42 or 43, the interferer with respect to Band 42 or Band 43 shall have power level ( $P_{\text{interferer}}$ ) for Range 3 modified to $-20 + \Delta R_{\text{IB,c}}$ dBm for $F_{\text{interferer}} > 2800$ MHz and $F_{\text{interferer}} < 4400$ MHz.			

For Table 7.6.2A.5.5-5 in frequency range 1, 2 and 3, the number of spurious response frequencies recorded in the step 9 of the test procedure shall not exceed  $\max(24, 6 \cdot \lceil N_{RB} / 6 \rceil)$  exceptions per assigned E-UTRA channel per sub-block

gap of the E-UTRA CA configuration are allowed for spurious response frequencies when measured using a 1MHz step size. For these exceptions the requirements of subclause 7.7A.5 spurious response for CA are applicable.

For Table 7.6.2A.5.5-5 in frequency range 4 the number of spurious response frequencies recorded in the step 9 of the test procedure shall not exceed  $\max(8, \lceil (N_{RB} + 2 \cdot L_{CRBs}) / 8 \rceil)$  exceptions per assigned E-UTRA channel per sub-block

gap of the E-UTRA CA configuration are allowed for spurious response frequencies when measured using a 1MHz step size. For these exceptions the requirements of clause 7.7A.5 spurious response for CA are applicable.

**Table 7.6.2A.5.5-5: Out of band blocking (intra-band non-contiguous)**

E-UTRA band	Parameter	Units	Frequency			
			range 1	range 2	range 3	range 4
	$P_{\text{Interferer}}$	dBm	-44	-30	-15	-15
1, 2, 3, 4, 5, 6, 7, 8, 9, 10, 11, 12, 13, 14, 17, 18, 19, 20, 21, 22, 23, 24, 25, 26, 27, 28, 30, 31, 33, 34, 35, 36, 37, 38, 39, 40, 41, 42 (Note 4), 43 (Note 4), 44	$F_{\text{Interferer}}$ (CW)	MHz	$F_{\text{DL\_low}} -15$ to $F_{\text{DL\_low}} -60$	$F_{\text{DL\_low}} -60$ to $F_{\text{DL\_low}} -85$	$F_{\text{DL\_low}} -85$ to 1 MHz	-
			$F_{\text{DL\_high}} +15$ to $F_{\text{DL\_high}} +60$	$F_{\text{DL\_high}} +60$ to $F_{\text{DL\_high}} +85$	$F_{\text{DL\_high}} +85$ to +12750 MHz	-
2, 5, 12, 17	$F_{\text{Interferer}}$	MHz	-	-	-	$F_{\text{UL\_low}} - F_{\text{UL\_high}}$
Note 1: Range 3 shall be tested only with the highest channel bandwidth. Note 2: For the UE which supports both Band 11 and Band 21 the out of band blocking is FFS. Note 3: For intra-band non-contiguous + inter-band CA, $\Delta R_{\text{IB,c}} = 0$ dB for all sub-block gaps. Note 4: The power level of the interferer ( $P_{\text{Interferer}}$ ) for Range 3 shall be modified to -20 dBm for $F_{\text{Interferer}} > 2800$ MHz and $F_{\text{Interferer}} < 4400$ MHz.						

For a UE, which supports CA configuration in Table 7.3.3-1A or 7.3.3-1B,  $P_{\text{Interferer}}$  power defined in Tables 7.6.2A.5.5-4 and 7.6.2A.5.5-5 is increased by the amount given by  $\Delta R_{\text{IB,c}}$  in Table 7.3.3-1A or 7.3.3-1B accordingly.

## 7.6.2B Out-of-band blocking for UL-MIMO

### 7.6.2B.1 Test Purpose

Out-of-band band blocking for UL-MIMO is defined for an unwanted CW interfering signal falling more than 15 MHz below or above the UE that support UL- MIMO receive band, at which a given average throughput shall meet or exceed the requirement for the specified measurement channels.

For the first 15 MHz below or above the UE that support UL-MIMO receive band the appropriate in-band blocking for UL-MIMO or adjacent channel selectivity for UL-MIMO in sub-clause 7.5.3 and sub-clause 7.6.1.3 shall be applied.

The lack of out-of-band blocking ability will decrease the coverage area when other e-NodeB transmitters exist (except in the adjacent channels and spurious response).

### 7.6.2B.2 Test Applicability

This test applies to all types of E-UTRA UE release 10 and forward that support UL-MIMO.

### 7.6.2B.3 Minimum Conformance Requirements

For UE with two transmitter antenna connectors in closed-loop spatial multiplexing scheme, the minimum requirements in subclause 7.6 shall be met with the UL-MIMO configurations specified in Table 6.2.2B.3-2. For UL-MIMO, the parameter  $P_{\text{C}_{\text{MAX,L}}}$  is defined as the total transmitter power over the two transmit antenna connectors.

The normative reference for this requirement is TS 36.101 [2] clause 7.6B.

## 7.6.2B.4 Test Description

### 7.6.2B.4.1 Initial Conditions

Initial conditions are a set of test configurations the UE needs to be tested in and the steps for the SS to take with the UE to reach the correct measurement state.

The initial test configurations consist of environmental conditions, test frequencies, and channel bandwidths based on E-UTRA bands specified in table 5.4.2.1-1. All of these configurations shall be tested with applicable test parameters for each channel bandwidth, and are shown in table 7.6.2B.4.1-1. The details of the uplink and downlink reference measurement channels (RMCs) are specified in Annexes A.2 and A.3 respectively. The details of the OCNG patterns used are specified in Annex A.5. Configurations of PDSCH and PDCCH before measurement are specified in Annex C.2.

**Table 7.6.2B.4.1-1: Test Configuration Table**

Initial Conditions						
Test Environment as specified in TS 36.508[7] subclause 4.1			NC			
Test Frequencies as specified in TS36.508 [7] subclause 4.3.1			One frequency chosen arbitrarily from low or high range			
Test Channel Bandwidths as specified in TS 36.508 [7] subclause 4.3.1			Lowest, 5MHz, Highest			
Test Parameters for Channel Bandwidths						
Ch BW	Downlink Configuration			Uplink Configuration		
	Mod'n	RB allocation		Mod'n	RB allocation	
		FDD	TDD		FDD	TDD
1.4MHz	QPSK	6	6	QPSK	6	6
3MHz	QPSK	15	15	QPSK	15	15
5MHz	QPSK	25	25	QPSK	25	25
5MHz	QPSK	25	N/A	QPSK	20	N/A
5MHz	QPSK	25	N/A	QPSK	15	N/A
5MHz	QPSK	25	N/A	QPSK	5 <sup>4</sup>	N/A
10MHz	QPSK	50	50	QPSK	50	50
10MHz	QPSK	50	N/A	QPSK	25	N/A
10MHz	QPSK	50	N/A	QPSK	20	N/A
10MHz	QPSK	50	N/A	QPSK	15	N/A
15MHz	QPSK	75	75	QPSK	75	75
15MHz	QPSK	75	N/A	QPSK	50	N/A
15MHz	QPSK	75	N/A	QPSK	25	N/A
15MHz	QPSK	75	N/A	QPSK	20	N/A
20MHz	QPSK	100	100	QPSK	100	100
20MHz	QPSK	100	N/A	QPSK	75	N/A
20MHz	QPSK	100	N/A	QPSK	50	N/A
20MHz	QPSK	100	N/A	QPSK	25	N/A
20MHz	QPSK	100	N/A	QPSK	20	N/A

Note 1: Test Channel Bandwidths are checked separately for each E-UTRA band, which applicable channel bandwidths are specified in Table 5.4.2.1-1.

Note 2: Depending on E-UTRA band, only the appropriate Uplink RB allocation value according to table 7.3.3-2 is tested per Test Channel Bandwidth.

Note 3: For the DL signal one sided dynamic OCNG Pattern OP.1 FDD/TDD is used.

Note 4: Applicable only to E-UTRA FDD Band 31. The UL resource blocks shall be located at RBstart 10 (according to Table 7.3.3-2).

1. Connect the SS to the UE antenna connectors as shown in TS 36.508 [7] Annex A, in Figure A.30.
2. The parameter settings for the cell are set up according to TS 36.508 [7] subclause 4.4.3.
3. Downlink signals are initially set up according to Annex C0, C.1 and C.3.1, and uplink signals according to Annex H.1 and H.3.1.
4. The UL and DL Reference Measurement channels are set according to Table 7.6.2B.4.1-1.
5. Propagation conditions are set according to Annex B.0.

6. Ensure the UE is in State 3A-RF according to TS 36.508 [7] clause 5.2A.2. Message contents are defined in clause 7.6.2B.4.3.

#### 7.6.2B.4.2 Test Procedure

1. SS transmits PDSCH via PDCCH DCI format 1A for C\_RNTI to transmit the DL RMC according to Table 7.6.2B.4.1-1. The SS sends downlink MAC padding bits on the DL RMC.
2. SS sends uplink scheduling information for each UL HARQ process via PDCCH DCI format 4 for C\_RNTI to schedule the UL RMC according to Table 7.6.2B.4.1-1. Since the UE has no payload data to send, the UE transmits uplink MAC padding bits on the UL RMC.
3. Set the parameters of the CW signal generator for an interfering signal below the wanted signal according to Table 7.6.2B.5-2. The frequency step size is 1MHz.
4. Set the downlink signal level according to the table 7.6.2B.5-1. Send uplink power control commands to the UE (less or equal to 1dB step size should be used), to ensure that the UE output power is within +0, - 3.4 dB of the target level in table 7.6.2B.5-1 for carrier frequency  $f \leq 3.0\text{GHz}$  or within +0, -4.0 dB of the target level for carrier frequency  $3.0\text{GHz} < f \leq 4.2\text{GHz}$ , for at least the duration of the throughput measurement.
5. Measure the average throughput for a duration sufficient to achieve statistical significance according to Annex G.2.
6. Record the frequencies for which the throughput doesn't meet the requirements.
7. Repeat steps from 3 to 6, using an interfering signal above the wanted signal at step 3.

#### 7.6.2B.4.3 Message Contents

Message contents are according to TS 36.508 [7] clause 4.6 with the following exception.

**Table 7.6.2B.4.3-1: UplinkPowerControlDedicated**

Derivation Path: 36.331 clause 6.3.2			
Information Element	Value/remark	Comment	Condition
UplinkPowerControlDedicated-DEFAULT ::= SEQUENCE {			
p0-UePUSCH	0		
deltaMCS-Enabled	en0		
accumulationEnabled	TRUE		
p0-uePUCCH	0		
pSRS-Offset	3 (-6 dB)		
filterCoefficient	fc8	larger filter length is used to reduce the RSRP measurement variation	
}			

#### 7.6.2B.5 Test Requirement

Except for the spurious response frequencies recorded at the final step of test procedure, the throughput measurement derived in test procedure shall be  $\geq 95\%$  of the maximum throughput of the reference measurement channels as specified in Annex A.3.2 with parameters specified in Tables 7.6.2B.5-1 and 7.6.2B.5-2.

For frequency range 1, 2, and 3, the number of spurious response frequencies recorded in the final step of test procedure shall not exceed  $\max(24, 6 \cdot \lceil N_{RB} / 6 \rceil)$  in each assigned frequency channel when measured using a 1MHz step size. For these exceptions the requirements of clause 7.7 Spurious Response are applicable.

For frequency range 4, the number of spurious response frequencies recorded in the final step of test procedure shall not exceed  $\max(8, \lceil (N_{RB} + 2 \cdot L_{CRBs}) / 8 \rceil)$  in each assigned frequency channel when measured using a 1MHz step size. For these exceptions the requirements of clause 7.7 Spurious Response are applicable.

Table 7.6.2B.5-1: Out-of-band blocking parameters

Rx Parameter	Units	Channel bandwidth					
		1.4 MHz	3 MHz	5 MHz	10 MHz	15 MHz	20 MHz
Power in Transmission Bandwidth Configuration	dBm	REFSENS + channel bandwidth specific value below					
		6	6	6	6	7	9
Note 1: The transmitter shall be set to 4dB below $P_{CMAX\_L}$ with $P_{CMAX\_L}$ as defined in clause 6.2.5.							
Note 2: The reference measurement channel is specified in Annex A.3.2 with one sided dynamic OCN Pattern OP.1 FDD/TDD as described in Annex A.5.1.1/A.5.2.1.							

Table 7.6.2B.5-2: Out of band blocking

E-UTRA band	Parameter	Units	Frequency			
			range 1	range 2	range 3	range 4
	$P_{Interferer}$	dBm	-44	-30	-15	-15
1, 2, 3, 4, 5, 6, 7, 8, 9, 10, 11, 12, 13, 14, 17, 18, 19, 20, 21, 22, 23, 24, 25, 26, 27, 28, 30, 31, 33, 34, 35, 36, 37, 38, 39, 40, 41, 42, 43, 44	$F_{Interferer}$ (CW)	MHz	$F_{DL\_low} -15$ to $F_{DL\_low} -60$	$F_{DL\_low} -60$ to $F_{DL\_low} -85$	$F_{DL\_low} -85$ to 1 MHz	-
			$F_{DL\_high} +15$ to $F_{DL\_high} +60$	$F_{DL\_high} +60$ to $F_{DL\_high} +85$	$F_{DL\_high} +85$ to +12750 MHz	-
2, 5, 12, 17	$F_{Interferer}$	MHz	-	-	-	$F_{UL\_low} - F_{UL\_high}$
Note 1: Range 3 shall be tested only with the highest channel bandwidth.						
Note 2: For the UE which supports both Band 11 and Band 21 the out of blocking is FFS.						

## 7.6.2E Out-of-band blocking for UE category 0

Editor's note: Following aspects missing or not yet determined:

- RB allocation within brackets
- Test tolerance for this case in Annex F is not completed
- Test requirement TBD

### 7.6.2E.1 Test Purpose

Same test purpose as in clause 7.6.2.1.

### 7.6.2E.2 Test Applicability

This test applies to all types of E-UTRA UE release 12 and forward of UE category 0.

### 7.6.2E.3 Minimum Conformance Requirements

Same minimum conformance requirements as in clause 7.6.2.3.

### 7.6.2E.4 Test Description

#### 7.6.2E.4.1 Initial Conditions

Same initial conditions as in clause 7.6.2.4.1 with the following exceptions:

- Instead of Table 7.6.2.4.1-1 → use Table 7.6.2E.4.1-1.
- Connect the SS to the UE antenna connectors as shown in TS 36.508[7] Annex A Figure A.5 using only main UE Tx/Rx antenna.

Table 7.6.2E.4.1-1: Test Configuration Table

Initial Conditions						
Test Environment as specified in TS 36.508[7] subclause 4.1				NC		
Test Frequencies as specified in TS36.508 [7] subclause 4.3.1				One frequency chosen arbitrarily from low or high range		
Test Channel Bandwidths as specified in TS 36.508 [7] subclause 4.3.1				Lowest, 5MHz, Highest		
Test Parameters for Channel Bandwidths						
Ch BW	Downlink Configuration			Uplink Configuration		
	Mod'n	RB allocation		Mod'n	RB allocation	
		FDD and HD-FDD	TDD		FDD and HD-FDD	TDD
1.4MHz	QPSK	6	6	QPSK	6	6
3MHz	QPSK	14	14	QPSK	15	15
5MHz	QPSK	14	14	QPSK	25	25
5MHz	QPSK	14	N/A	QPSK	20	N/A
10MHz	QPSK	14	14	QPSK	[36]	[36]
10MHz	QPSK	14	N/A	QPSK	25	N/A
10MHz	QPSK	14	N/A	QPSK	20	N/A
15MHz	QPSK	14	14	QPSK	[36]	[36]
15MHz	QPSK	14	N/A	QPSK	20	N/A
20MHz	QPSK	14	14	QPSK	[36]	[36]
20MHz	QPSK	14	N/A	QPSK	20	N/A
Note 1: Test Channel Bandwidths are checked separately for each E-UTRA band, which applicable channel bandwidths are specified in Table 5.4.2.1-1.						
Note 2: Depending on E-UTRA band, only the appropriate Uplink RB allocation value according to table 7.3E.3-3 is tested per Test Channel Bandwidth. The allocation shall be located as close as possible to the downlink operating band but confined within the transmission bandwidth configuration for the channel bandwidth (Table 5.4.2-1).						
Note 3: For the DL signal one sided dynamic OCNG Pattern OP.1 FDD/TDD is used.						
Note 4: Downlink RB position shall be $RB_{start} = 0$ .						

#### 7.6.2E.4.2 Test Procedure

Same test procedure as in clause 7.6.2.4.2

#### 7.6.2E.4.3 Message Contents

Same message contents as in clause 7.6.2.4.3

#### 7.6.2E.5 Test Requirement

TBD

### 7.6.3 Narrow band blocking

#### 7.6.3.1 Test Purpose

Verifies a receiver's ability to receive an E-UTRA signal at its assigned channel frequency in the presence of an unwanted narrow band CW interferer at a frequency, which is less than the nominal channel spacing.

The lack of narrow-band blocking ability will decrease the coverage area when other e-NodeB transmitters exist (except in the adjacent channels and spurious response).

#### 7.6.3.2 Test Applicability

This test applies to all types of E-UTRA UE release 8 and forward.

#### 7.6.3.3 Minimum Conformance Requirements

The relative throughput shall be  $\geq 95\%$  of the maximum throughput of the reference measurement channels as specified in Annexes A.2.2, A.2.3 and A.3.2 (with one sided dynamic OCNG Pattern OP.1 FDD/TDD for the DL-signal as described in Annex A.5.1.1/A.5.2.1) with parameters specified in Table 7.6.3.3-1.

Table 7.6.3.3-1: Narrow-band blocking

Parameter	Unit	Channel Bandwidth					
		1.4 MHz	3 MHz	5 MHz	10 MHz	15 MHz	20 MHz
$P_w$	dBm	$P_{\text{REFSENS}}$ + channel-bandwidth specific value below					
		22	18	16	13	14	16
$P_{\text{uw}} \text{ (CW)}$	dBm	-55	-55	-55	-55	-55	-55
$F_{\text{uw}}$ (offset for $\Delta f = 15 \text{ kHz}$ )	MHz	0.9075	1.7025	2.7075	5.2125	7.7025	10.2075
$F_{\text{uw}}$ (offset for $\Delta f = 7.5 \text{ kHz}$ )	MHz						
Note 1: The transmitter shall be set a 4 dB below $P_{\text{CMAX,L}}$ at the minimum uplink configuration specified in Table 7.3.3-2 with $P_{\text{CMAX,L}}$ as defined in clause 6.2.5. Note 2: The reference measurement channel is specified in Annex A.3.2 with one sided dynamic OCNG Pattern OP.1 FDD/TDD as described in Annex A.5.1.1/A.5.2.1.							

For the UE which supports inter band CA configuration in Table 7.3.3-1A,  $P_{\text{uw}}$  power defined in Table 7.6.3.3-1 is increased by the amount given by  $\Delta R_{\text{B,c}}$  in Table 7.3.3-1A.

The normative reference for this requirement is TS 36.101 [2] clause 7.6.3.

## 7.6.3.4 Test Description

### 7.6.3.4.1 Initial Conditions

Initial conditions are a set of test configurations the UE needs to be tested in and the steps for the SS to take with the UE to reach the correct measurement state.

The initial test configurations consist of environmental conditions, test frequencies, and channel bandwidths based on E-UTRA bands specified in table 5.4.2.1-1. All of these configurations shall be tested with applicable test parameters for each channel bandwidth, and are shown in table 7.6.3.4.1-1. The details of the uplink and downlink reference measurement channels (RMCs) are specified in Annexes A.2 and A.3 respectively. The details of the OCNG patterns used are specified in Annex A.5. Configurations of PDSCH and PDCCH before measurement are specified in Annex C.2.

Table 7.6.3.4.1-1: Test Configuration Table

Initial Conditions						
Test Environment as specified in TS 36.508 [7] subclause 4.1				NC		
Test Frequencies as specified in TS 36.508 [7] subclause 4.3.1				Mid range		
Test Channel Bandwidths as specified in TS 36.508 [7] subclause 4.3.1				Lowest, 5MHz, Highest		
Test Parameters for Channel Bandwidths						
Ch BW	Downlink Configuration			Uplink Configuration		
	Mod'n	RB allocation		Mod'n	RB allocation	
		FDD	TDD		FDD	TDD
1.4MHz	QPSK	6	6	QPSK	6	6
3MHz	QPSK	15	15	QPSK	15	15
5MHz	QPSK	25	25	QPSK	25	25
5MHz	QPSK	25	N/A	QPSK	20	N/A
5MHz	QPSK	25	N/A	QPSK	15	N/A
5MHz	QPSK	25	N/A	QPSK	5 <sup>+</sup>	N/A
10MHz	QPSK	50	50	QPSK	50	50
10MHz	QPSK	50	N/A	QPSK	25	N/A
10MHz	QPSK	50	N/A	QPSK	20	N/A
10MHz	QPSK	50	N/A	QPSK	15	N/A
15MHz	QPSK	75	75	QPSK	75	75
15MHz	QPSK	75	N/A	QPSK	50	N/A
15MHz	QPSK	75	N/A	QPSK	25	N/A
15MHz	QPSK	75	N/A	QPSK	20	N/A
20MHz	QPSK	100	100	QPSK	100	100
20MHz	QPSK	100	N/A	QPSK	75	N/A
20MHz	QPSK	100	N/A	QPSK	50	N/A
20MHz	QPSK	100	N/A	QPSK	25	N/A
20MHz	QPSK	100	N/A	QPSK	20	N/A
Note 1: Test Channel Bandwidths are checked separately for each E-UTRA band, which applicable channel bandwidths are specified in Table 5.4.2.1-1. Note 2: Depending on E-UTRA band, only the appropriate Uplink RB allocation value according to table 7.3.3-2 is tested per Test Channel Bandwidth. The allocation shall be located as close as possible to the downlink operating band but confined within the transmission bandwidth configuration for the channel bandwidth (Table 5.4.2-1). Note 3: For the DL signal one sided dynamic OCNG Pattern OP.1 FDD/TDD is used. Note 4: Applicable only to E-UTRA FDD Band 31. The UL resource blocks shall be located at RBstart 10 (according to Table 7.3.3-2).						

1. Connect the SS to the UE antenna connectors as shown in TS 36.508 [7] Annex A, Figure A.5.
2. The parameter settings for the cell are set up according to TS 36.508 [7] subclause 4.4.3.
3. Downlink signals are initially set up according to Annex C0, C.1 and C.3.1, and uplink signals according to Annex H.1 and H.3.1
4. The UL and DL Reference Measurement channels are set according to Table 7.6.3.4.1-1.
5. Propagation conditions are set according to Annex B.0.
6. Ensure the UE is in State 3A-RF according to TS 36.508 [7] clause 5.2A.2. Message contents are defined in clause 7.6.3.4.3.

#### 7.6.3.4.2 Test Procedure

1. SS transmits PDSCH via PDCCH DCI format 1A for C\_RNTI to transmit the DL RMC according to Table 7.6.3.4.1-1. The SS sends downlink MAC padding bits on the DL RMC.
2. SS sends uplink scheduling information for each UL HARQ process via PDCCH DCI format 0 for C\_RNTI to schedule the UL RMC according to Table 7.6.3.4.1-1. Since the UE has no payload data to send, the UE transmits uplink MAC padding bits on the UL RMC.



3. Set the parameters of the CW signal generator for an interfering signal below the wanted signal according to Table 7.6.3.5-1.
4. Set the downlink signal level according to the table 7.6.3.5-1. Send uplink power control commands to the UE (less or equal to 1dB step size should be used), to ensure that the UE output power is within +0, - 3.4 dB of the target level in table 7.6.3.5-1 for carrier frequency  $f \leq 3.0\text{GHz}$  or within +0, -4.0 dB of the target level for carrier frequency  $3.0\text{GHz} < f \leq 4.2\text{GHz}$ , for at least the duration of the throughput measurement.
5. Measure the average throughput for a duration sufficient to achieve statistical significance according to Annex G.2.
6. Repeat steps from 3 to 5, using an interfering signal above the wanted signal at step 3.

### 7.6.3.4.3 Message Contents

Message contents are according to TS 36.508 [7] subclause 4.6 with the following exception.

**Table 7.6.3.4.3-1: UplinkPowerControlDedicated**

Derivation Path: 36.331 clause 6.3.2			
Information Element	Value/remark	Comment	Condition
UplinkPowerControlDedicated-DEFAULT ::= SEQUENCE {			
p0-UePUSCH	0		
deltaMCS-Enabled	en0		
accumulationEnabled	TRUE		
p0-uePUCCH	0		
pSRS-Offset	3 (-6 dB)		
filterCoefficient	fc8	larger filter length is used to reduce the RSRP measurement variation	
}			

### 7.6.3.5 Test Requirement

The throughput measurement derived in test procedure shall be  $\geq 95\%$  of the maximum throughput of the reference measurement channels as specified in Annex A.3.2 with parameters specified in Table 7.6.3.5-1.

**Table 7.6.3.5-1: Narrow-band blocking**

Parameter	Unit	Channel Bandwidth					
		1.4 MHz	3 MHz	5 MHz	10 MHz	15 MHz	20 MHz
$P_w$	dBm	$P_{\text{REFSENS}}$ + channel-bandwidth specific value below					
		22	18	16	13	14	16
$P_{uw}$ (CW)	dBm	-55	-55	-55	-55	-55	-55
$F_{uw}$ (offset for $\Delta f = 15$ kHz)	MHz	0.9075	1.7025	2.7075	5.2125	7.7025	10.2075
$F_{uw}$ (offset for $\Delta f = 7.5$ kHz)	MHz						
Note 1: The transmitter shall be set a 4 dB below $P_{\text{CMAX}_L}$ with $P_{\text{CMAX}_L}$ as defined in clause 6.2.5.							
Note 2: The reference measurement channel is specified in Annex A.3.2 with one sided dynamic OCNB Pattern OP.1 FDD/TDD as described in Annex A.5.1.1/A.5.2.1.							

For the UE which supports inter band CA configuration in Table 7.3.3-1A,  $P_{uw}$  power defined in Table 7.6.3.5-1 is increased by the amount given by  $\Delta R_{\text{IB},c}$  in Table 7.3.3-1A.

## 7.6.3A Narrow band blocking for CA

### 7.6.3A.0 Minimum conformance requirements

For inter-band carrier aggregation with one component carrier per operating band and the uplink assigned to one E-UTRA band the narrow-band blocking requirements are defined with the uplink active on the band(s) other than the

band whose downlink is being tested. The UE shall meet the requirements specified in subclause 7.6.3 for each component carrier while all downlink carriers are active. For E-UTRA CA configurations including an operating band without uplink band (as noted in Table 5.2-1), the requirements for all downlinks shall be met with the uplink active in the band(s) capable of UL operation. For E-UTRA CA configurations listed in Table 7.3A.0-1 under conditions for which reference sensitivity for the operating band being tested is N/A, the narrow-band blocking requirements of subclause 7.6.3A.0 do not apply.

For intra-band contiguous carrier aggregation the downlink SCC(s) shall be configured at nominal channel spacing to the PCC. For FDD, the PCC shall be configured closest to the uplink band. All downlink carriers shall be active throughout the test. The uplink output power shall be set as specified in Table 7.6.3A.0-1 with the uplink configuration set according to Table 7.3A.0-2 for the applicable carrier aggregation configuration. For UE(s) supporting one uplink, the uplink configuration of the PCC shall be in accordance with Table 7.3.3-2.

The UE shall fulfil the minimum requirement in presence of an interfering signal specified in Table 7.6.3A.0-1 being on either side of the aggregated signal. The throughput of each carrier shall be  $\geq 95\%$  of the maximum throughput of the reference measurement channels as specified in Annexes A.2.2, A.2.3 and A.3.2 (with one sided dynamic OCNB Pattern OP.1 FDD/TDD for the DL-signal as described in Annex A.5.1.1/A.5.2.1) with parameters specified in Table 7.6.3A.0-1.

**Table 7.6.3A.0-1: Narrow-band blocking**

Parameter	Unit	CA Bandwidth Class				
		B	C	D	E	F
Pw in Transmission Bandwidth Configuration, per CC	dBm	REFSENS + CA Bandwidth Class specific value below				
		16	16 <sup>4</sup>	16		
P <sub>uw</sub> (CW)	dBm	-55	-55	-55		
F <sub>uw</sub> (offset for $\Delta f = 15$ kHz)	MHz	- F <sub>offset</sub> - 0.2 / + F <sub>offset</sub> + 0.2	- F <sub>offset</sub> - 0.2 / + F <sub>offset</sub> + 0.2	- F <sub>offset</sub> - 0.2 / + F <sub>offset</sub> + 0.2		
F <sub>uw</sub> (offset for $\Delta f = 7.5$ kHz)	MHz					
Note 1: The transmitter shall be set to 4dB below P <sub>C<sub>MAX</sub>L</sub> or P <sub>C<sub>MAX</sub>L,CA</sub> as defined in subclause 6.2.5A.						
Note 2: Reference measurement channel is specified in Annex A.3.2 with one sided dynamic OCNB Pattern OP.1 FDD/TDD as described in Annex A.5.1.1/A.5.2.1.						
Note 3: The F <sub>interferer</sub> (offset) is relative to the centre frequency of the adjacent CC being tested and shall be further adjusted to $\lfloor F_{interferer} / 0.015 + 0.5 \rfloor 0.015 + 0.0075$ MHz to be offset from the sub-carrier raster for interferer signal above the wanted signal and adjusted to $\lfloor F_{interferer} / 0.015 + 0.5 \rfloor 0.015 - 0.0075$ MHz to be offset from the sub-carrier raster for interferer signal below the wanted signal.						
Note 4: The requirement is applied for the band combinations whose component carriers' BW $\geq 5$ MHz.						

For intra-band non-contiguous carrier aggregation with one uplink carrier and more than or equal to two downlink carriers, the narrow band blocking requirements are defined with the uplink configuration in accordance with Table 7.3A.0-3. For this uplink configuration, the UE shall meet the requirements specified in subclauses 7.6.3.3 and 7.6.3A.0 for single component carrier and intra-band contiguous component carriers separately, subject to in-gap and out-of-gap interferers while all downlink carriers are active.

For combinations of intra-band contiguous and inter-band carrier aggregation with three downlink carriers and one uplink carrier assigned to one E-UTRA band, the requirement is defined with the uplink active in the band other than that supporting the downlink(s) under test and a configuration in accordance with Table 7.3.3-2. The downlink PCC carrier centre frequency shall be configured closer to the uplink operating band than the downlink SCC centre frequency when the uplink is active in the band supporting two component carriers. For these uplink configurations, the UE shall meet the narrow-band blocking requirements for intra-band contiguous carrier aggregation of two downlink carriers and for the remaining component carrier the requirements specified in subclause 7.6.3. The three downlink carriers shall be active throughout the tests.

For combinations of intra-band non-contiguous and inter-band carrier aggregation with three downlink carriers and one uplink carrier assigned to one E-UTRA band, the requirement is defined with the uplink active in the band other than that supporting the downlink(s) under test. The uplink configuration shall be in accordance with Table 7.3A.0-3 when the uplink is active in the band supporting two component carriers and in accordance with Table 7.3.3-2 when the uplink is active in the other band. For these uplink configurations, the UE shall meet the narrow-band blocking requirements for intra-band non-contiguous carrier aggregation of two downlink carriers with  $\Delta R_{IBNC} = 0$  dB for all sub-

block gaps (Table 7.3A.0-3) and for the remaining component carrier the requirements specified in subclause 7.6.3. The three downlink carriers shall be active throughout the tests.

The normative reference for this requirement is TS 36.101 [2] clause 7.6.3.1A.

## 7.6.3A.1 Narrow band blocking for CA (intra-band contiguous DL CA and UL CA)

### 7.6.3A.1.1 Test Purpose

Verifies a receiver's ability to receive an E-UTRA signal at its assigned CA channel frequencies in the presence of an unwanted narrow band CW interferer at a frequency, which is less than the nominal channel spacing.

The lack of narrow-band blocking ability will decrease the coverage area when other e-NodeB transmitters exist (except in the adjacent channels and spurious response).

### 7.6.3A.1.2 Test Applicability

This test applies to all types of E-UTRA UE release 10 and forward that support intra-band contiguous DL CA and UL CA.

### 7.6.3A.1.3 Minimum Conformance Requirements

The minimum conformance requirements are defined in clause 7.6.3A.0.

### 7.6.3A.1.4 Test Description

#### 7.6.3A.1.4.1 Initial Conditions

Initial conditions are a set of test configurations the UE needs to be tested in and the steps for the SS to take with the UE to reach the correct measurement state.

The initial test configurations consist of environmental conditions, test frequencies, and CC combinations based on E-UTRA CA configurations specified in table 5.4.2A.1-1. All of these configurations shall be tested with applicable test parameters for each CA Configuration, and are shown in table 7.6.3A.1.4.1-1. The details of the OCN patterns used are specified in Annex A.5. Configurations of PDSCH and PDCCH before measurement are specified in Annex C.2.

Table 7.6.3A.1.4.1-1: Test Configuration Table

Initial Conditions							
Test Environment as specified in TS 36.508[7] subclause 4.1				NC			
Test Frequencies as specified in TS36.508 [7] subclause 4.3.1 for different CA bandwidth classes, and PCC and SCCs are mapped onto physical frequencies according to Table 7.1-2				C: Mid range			
Test CC Combination setting ( $N_{RB\_agg}$ ) as specified in subclause 5.4.2A.1 for the CA Configuration across bandwidth combination sets supported by the UE.				Lowest $N_{RB\_agg}$ Highest $N_{RB\_agg}$ (Note 3)			
Test Parameters for CA Configurations							
CA Configuration / $N_{RB\_agg}$		DL Allocation		UL Allocation			
PCC $N_{RB}$	SCC $N_{RB}$	CC MOD	PCC & SCC RB allocation	CC MOD	$N_{RB\_alloc}$	PCC & SCC RB allocations (L <sub>CRB</sub> @ RB <sub>start</sub> )	
75	75	QPSK	75+75	QPSK	75	P_75@0	S_0@0
75	75	QPSK	75+75	QPSK	129	P_75@0	S_54@0
75	75	QPSK	75+75	QPSK	150	P_75@0	S_75@0
100	25	QPSK	100+25	QPSK	50	P_50@50	S_0@0
100	25	QPSK	100+25	QPSK	125	P_100@0	S_25@0
100	50	QPSK	100+50	QPSK	50	P_50@50	S_0@0
100	50	QPSK	100+50	QPSK	75	P_75@25	S_0@0
100	50	QPSK	100+50	QPSK	150	P_100@0	S_50@0
100	75	QPSK	100+75	QPSK	50	P_50@0	S_0@0
100	100	QPSK	100+100	QPSK	50	P_50@50	S_0@0
100	100	QPSK	100+100	QPSK	75	P_75@25	S_0@0
100	100	QPSK	100+100	QPSK	130	P_100@0	S_30@0
100	100	QPSK	100+100	QPSK	200	P_100@0	S_100@0
Note 1: CA Configuration Test CC Combination settings are checked separately for each CA Configuration, which applicable aggregated channel bandwidths are specified in Table 5.4.2A.1-1.							
Note 2: Depending on CA Configuration only the appropriate Uplink RB allocation value according to table 7.3A.0-2 is tested per CA Configuration Test CC combination.							
Note 3: If in the CA Configuration UE supports multiple CC Combinations with the same $N_{RB\_agg}$ , only the first of those is tested, according to the order on the Test Configuration Table list.							

1. Connect the SS to the UE antenna connectors as shown in TS 36.508 [7] Annex A, Figure group A.34 as appropriate.
2. The parameter settings for the cell are set up according to TS 36.508 [7] subclause 4.4.3.
3. Downlink signals are for PCC initially set up according to Annex C.0, C.1 and C.3.1, and uplink signals according to Annex H.1 and H.3.1.
4. The UL and DL Reference Measurement channels are set according to Table 7.6.3A.1.4.1-1.
5. Propagation conditions are set according to Annex B.0.
6. Ensure the UE is in State 3A-RF according to TS 36.508 [7] clause 5.2A.2. Message contents are defined in clause 7.6.3A.1.4.3.

#### 7.6.3A.1.4.2 Test Procedure

1. Configure SCC according to Annex C.0, C.1 and Annex C.3.1 for all downlink physical channels.
2. The SS shall configure SCC as per TS 36.508 [7] clause 5.2A.4. Message contents are defined in clause 7.6.3A.1.4.3.

3. SS activates SCC by sending the activation MAC-CE (Refer TS 36.321 [13], clauses 5.13, 6.1.3.8). Wait for at least 2 seconds (Refer TS 36.133, clauses 8.3.3.2).
4. SS transmits PDSCH via PDCCH DCI format 1A for C\_RNTI to transmit the DL RMC according to Table 7.6.3A.1.4.1-1 on both PCC and SCC. The SS sends downlink MAC padding bits on the DL RMC.
5. SS sends uplink scheduling information for each UL HARQ process via PDCCH DCI format 0 for C\_RNTI to schedule the UL RMC according to Table 7.6.3A.1.4.1-1 on both PCC and SCC. Since the UE has no payload data to send, the UE sends uplink MAC padding bits on the UL RMC.
6. Set the parameters of the CW signal generator for an interfering signal below the aggregated component carriers according to Table 7.6.3A.1.5-1.
7. Set the downlink signal level according to the table 7.6.3A.1.5-1. Send uplink power control commands to the UE (less or equal to 1dB step size should be used), to ensure that for at least the duration of the throughput measurement:  
 The PCC output power is within (+0dB, -3.4 dB) of (target level in Table 7.6.3A.1.5-1 +  $10\log(P_{L\_CRB}/N_{RB\_alloc})$ ), for carrier frequency  $f \leq 3.0\text{GHz}$ ,  
 or within (+0dB, -4 dB) of (target level in Table 7.6.3A.1.5-1 +  $10\log(P_{L\_CRB}/N_{RB\_alloc})$ ) for carrier frequency  $3.0\text{GHz} < f \leq 4.2\text{GHz}$ .  
 The SCC output power is within (+0dB, -3.4 dB) of (target level in Table 7.6.3A.1.5-1 +  $10\log(S_{L\_CRB}/N_{RB\_alloc})$ ), for carrier frequency  $f \leq 3.0\text{GHz}$ ,  
 or within (+0dB, -4 dB) of (target level in Table 7.6.3A.1.5-1 +  $10\log(S_{L\_CRB}/N_{RB\_alloc})$ ) for carrier frequency  $3.0\text{GHz} < f \leq 4.2\text{GHz}$ .
8. Measure the average throughput for each component carrier for duration sufficient to achieve statistical significance according to Annex G.2A.
9. Repeat steps from 6 to 8, using an interfering signal above the aggregated component carriers at step 6.

#### 7.6.3A.1.4.3 Message Contents

Message contents are according to TS 36.508 [7] subclause 4.6 with the following exception.

**Table 7.6.3A.1.4.3-1: UplinkPowerControlDedicatedSCell-r10**

Derivation Path: 36.508 clause 4.6.3			
Information Element	Value/remark	Comment	Condition
UplinkPowerControlDedicated-DEFAULT ::= SEQUENCE {			
p0-UE-PUSCH-r10	0		
deltaMCS-Enabled-r10	en0		
accumulationEnabled-r10	TRUE		
pSRS-Offset-r10	7 (0 dB)	The actual parameter value is $-10.5 + 1.5 \cdot \text{pSRS-Offset}$ value; 0 is the actual value in dB ( $-10.5 + 1.5 \cdot 7$ dB).	
pSRS-OffsetAp-r10	7 (0 dB)	The actual parameter value is $-10.5 + 1.5 \cdot \text{pSRS-Offset}$ value; 0 is the actual value in dB ( $-10.5 + 1.5 \cdot 7$ dB).	
filterCoefficient-r10	fc8	larger filter length is used to reduce the RSRP measurement variation	
pathlossReferenceLinking-r10	sCell		
}			

### 7.6.3A.1.5 Test Requirement

The throughput measurement of each carrier derived in test procedure shall be  $\geq 95\%$  of the maximum throughput of the reference measurement channels as specified in Annex A.3.2 with parameters specified in Table 7.6.3A.5-1.

**Table 7.6.3A.1.5-1: Narrow-band blocking**

Parameter	Unit	CA Bandwidth Class				
		B	C	D	E	F
P <sub>w</sub> in Transmission Bandwidth Configuration, per CC	dBm	REFSENS + CA Bandwidth Class specific value below				
P <sub>uw</sub> (CW)			16			
F <sub>uw</sub> (offset for $\Delta f = 15$ kHz)	MHz		- F <sub>offset</sub> - 0.2 / + F <sub>offset</sub> + 0.2			
F <sub>uw</sub> (offset for $\Delta f = 7.5$ kHz)						
Note 1:	The transmitter shall be set to 4dB below P <sub>C<sub>MAX</sub>L</sub> or P <sub>C<sub>MAX</sub>L,CA</sub> as defined in subclause 6.2.5 for one uplink carrier and in subclause 6.2.5A for two uplink carriers.					
Note 2:	Reference measurement channel is specified in Annex A.3.2 with one sided dynamic OCNNG Pattern OP.1 FDD/TDD as described in Annex A.5.1.1/A.5.2.1.					
Note 3:	The F <sub>interferer</sub> (offset) is relative to the centre frequency of the adjacent CC being tested and shall be further adjusted to $\lfloor F_{interferer} / 0.015 + 0.5 \rfloor 0.015 + 0.0075$ MHz to be offset from the sub-carrier raster for interferer signal above the wanted signal and adjusted to $\lfloor F_{interferer} / 0.015 + 0.5 \rfloor 0.015 - 0.0075$ MHz to be offset from the sub-carrier raster for interferer signal below the wanted signal.					

For the UE which supports inter band CA configuration in Table 7.3.3-1A, P<sub>uw</sub> power defined in Table 7.6.3A.1.5-1 is increased by the amount given by  $\Delta R_{IB,c}$  in Table 7.3.3-1A.

### 7.6.3A.2 Narrow band blocking for CA (intra-band contiguous DL CA without UL CA)

#### 7.6.3A.2.1 Test Purpose

Same test purpose as 7.6.3A.1.

#### 7.6.3A.2.2 Test Applicability

This test applies to all types of E-UTRA UE release 10 and forward that support intra-band contiguous DL CA. This test case applies only for CA Configurations that do not support UL CA.

#### 7.6.3A.2.3 Minimum Conformance Requirements

The minimum conformance requirements are defined in clause 7.6.3A.0.

#### 7.6.3A.2.4 Test Description

##### 7.6.3A.2.4.1 Initial Conditions

Same initial conditions as in clause 7.6.3A.1.4.1 with the following exceptions:

- instead of Table 7.6.3A.1.4.1-1 → use Table 7.6.3A.2.4.1-1.
- Instead of clause 7.6.3A.1.4.3 → use clause 7.6.3A.2.4.3.

Table 7.6.3A.2.4.1-1: Test Configuration Table

Initial Conditions							
Test Environment as specified in TS 36.508[7] subclause 4.1					NC		
Test Frequencies as specified in TS36.508 [7] subclause 4.3.1 for different CA bandwidth classes, and PCC and SCCs are mapped onto physical frequencies according to Table 7.1-2					B: Mid range C: Mid range		
Test CC Combination setting ( $N_{RB\_agg}$ ) as specified in subclause 5.4.2A.1 for the CA Configuration across bandwidth combination sets supported by the UE.					Lowest $N_{RB\_agg}$ Highest $N_{RB\_agg}$ (Note 3)		
Test Parameters for CA Configurations							
CA Configuration / $N_{RB\_agg}$		DL Allocation		UL Allocation			
PCC $N_{RB}$	SCC $N_{RB}$	CC MOD	PCC & SCC RB allocation	CC MOD	$N_{RB\_alloc}$	PCC & SCC RB allocations ( $L_{CRB}$ @ $RB_{start}$ )	
6	25	QPSK	6+25	QPSK	6	P_6@0	-
15	50	QPSK	15+50	QPSK	15	P_15@0	-
25	25	QPSK	25+25	QPSK	20	P_20@0	-
25	50	QPSK	25+50	QPSK	20	P_20@0	-
50	50	QPSK	50+50	QPSK	50	P_50@50	-
75	75	QPSK	75+75	QPSK	75	P_75@0	-
100	25	QPSK	100+25	QPSK	100	P_100@0	-
100	25	QPSK	100+25	QPSK	50	P_50@50	-
100	50	QPSK	100+50	QPSK	100	P_100@0	-
100	50	QPSK	100+50	QPSK	75	P_75@25	-
100	50	QPSK	100+50	QPSK	50	P_50@50	-
100	75	QPSK	100+75	QPSK	100	P_100@0	-
100	100	QPSK	100+100	QPSK	100	P_100@0	-
100	100	QPSK	100+100	QPSK	75	P_75@25	-
100	100	QPSK	100+100	QPSK	50	P_50@75	-
<p>Note 1: CA Configuration Test CC Combination settings are checked separately for each CA Configuration, which applicable aggregated channel bandwidths are specified in Table 5.4.2A.1-1.</p> <p>Note 2: Depending on CA Configuration only the appropriate Uplink RB allocation value according to table 7.3.3-2 is tested per CA Configuration Test CC combination.</p> <p>Note 3: If in the CA Configuration UE supports multiple CC Combinations with the same <math>N_{RB\_agg}</math>, only the first of those is tested, according to the order on the Test Configuration Table list.</p>							

#### 7.6.3A.2.4.2 Test Procedure

1. Configure SCC according to Annex C.0, C.1 and Annex C.3.1 for all downlink physical channels.
2. The SS shall configure SCC as per TS 36.508 [7] clause 5.2A.4.
3. SS activates SCC by sending the activation MAC-CE (Refer TS 36.321 [13], clauses 5.13, 6.1.3.8). Wait for at least 2 seconds (Refer TS 36.133, clauses 8.3.3.2).
4. SS transmits PDSCH via PDCCH DCI format 1A for  $C\_RNTI$  to transmit the DL RMC according to Table 7.6.3A.2.4.1-1 on both PCC and SCC. The SS sends downlink MAC padding bits on the DL RMC.
5. SS sends uplink scheduling information for each UL HARQ process via PDCCH DCI format 0 for  $C\_RNTI$  to schedule the UL RMC according to Table 7.6.3A.2.4.1-1 on PCC. Since the UE has no payload data to send, the UE sends uplink MAC padding bits on the UL RMC.
6. Set the parameters of the CW signal generator for an interfering signal below the aggregated component carriers according to Table 7.6.3A.1.5-1.

7. Set the downlink signal level according to the table 7.6.3A.1.5-1. Send uplink power control commands to the UE (less or equal to 1dB step size should be used), to ensure that the UE output power is within +0, - 3.4 dB of the target level in table 7.6.3A.1.5-1 for carrier frequency  $f \leq 3.0\text{GHz}$  or within +0, -4.0 dB of the target level for carrier frequency  $3.0\text{GHz} < f \leq 4.2\text{GHz}$ , for at least the duration of the throughput measurement.
8. Measure the average throughput for each component carrier for duration sufficient to achieve statistical significance according to Annex G.2A.
9. Repeat steps from 6 to 8, using an interfering signal above the aggregated component carriers at step 6.

#### 7.6.3A.2.4.3 Message Contents

Same message contents as in clause 7.6.3.4.3.

#### 7.6.3A.2.5 Test Requirement

Same test requirement as in clause 7.6.3A.1.5 with the following exceptions:

- Instead of Table 7.6.3A.1.5-1 → use Table 7.6.3A.2.5-1.

**Table 7.6.3A.2.5-1: Narrow-band blocking**

Parameter	Unit	CA Bandwidth Class				
		B	C	D	E	F
P <sub>w</sub> in Transmission Bandwidth Configuration, per CC	dBm	REFSENS + CA Bandwidth Class specific value below				
		16	16			
P <sub>uw</sub> (CW)	dBm	-55	-55			
F <sub>uw</sub> (offset for $\Delta f = 15$ kHz)	MHz	- F <sub>offset</sub> - 0.2 / + F <sub>offset</sub> + 0.2	- F <sub>offset</sub> - 0.2 / + F <sub>offset</sub> + 0.2			
F <sub>uw</sub> (offset for $\Delta f = 7.5$ kHz)	MHz					
Note 1:	The transmitter shall be set to 4dB below P <sub>C<sub>MAX,L</sub></sub> or P <sub>C<sub>MAX,L,CA</sub></sub> as defined in subclause 6.2.5.					
Note 2:	Reference measurement channel is specified in Annex A.3.2 with one sided dynamic OCNG Pattern OP.1 FDD/TDD as described in Annex A.5.1.1/A.5.2.1.					
Note 3:	The F <sub>interferer</sub> (offset) is relative to the centre frequency of the adjacent CC being tested and shall be further adjusted to $\lfloor \frac{F_{interferer}}{0.015 + 0.5} \rfloor 0.015 + 0.0075$ MHz to be offset from the sub-carrier raster.					

For the UE which supports inter band CA configuration in Table 7.3.3-1A, P<sub>uw</sub> power defined in Table 7.6.3A.2.5-1 is increased by the amount given by  $\Delta R_{IB,c}$  in Table 7.3.3-1A.

### 7.6.3A.3 Narrow band blocking for CA (inter-band DL CA without UL CA)

#### 7.6.3A.3.1 Test Purpose

Same test purpose as 7.6.3A.1.

#### 7.6.3A.3.2 Test Applicability

This test applies to all types of E-UTRA UE release 10 and forward that support inter-band DL CA without UL CA.

#### 7.6.3A.3.3 Minimum Conformance Requirements

The minimum conformance requirements are defined in clause 7.6.3A.0.

#### 7.6.3A.3.4 Test Description

##### 7.6.3A.3.4.1 Initial Conditions

Same initial conditions as in clause 7.6.3A.1.4.1 with the following exceptions:

- instead of Table 7.6.3A.1.4.1-1 → use Table 7.6.3A.3.4.1-1.
- Instead of clause 7.6.3A.1.4.3 → use clause 7.6.3A.3.4.3.



Table 7.6.3A.3.4.1-1: Test Configuration Table

Initial Conditions						
Test Environment as specified in TS 36.508[7] subclause 4.1			NC			
Test Frequencies as specified in TS36.508 [7] subclause 4.3.1 for different CA bandwidth classes, and PCC and SCCs are mapped onto physical frequencies according to Table 7.1-2			A: Mid range for PCC and SCC			
Test CC Combination setting ( $N_{RB\_agg}$ ) as specified in subclause 5.4.2A.1 for the CA Configuration across bandwidth combination sets supported by the UE			Highest $N_{RB\_agg}$ for PCC and SCC			
Test Parameters for CA Configurations						
CA Configuration / $N_{RB\_agg}$		DL Allocation			UL Allocation	
PCC $N_{RB}$	SCCs $N_{RB}$	CC MOD	PCC & SCC RB allocation		CC MOD	PCC $N_{RB\_alloc}$
50	50	QPSK	50	50	QPSK	50
50	50	QPSK	50	50	QPSK	25
50	50	QPSK	50	50	QPSK	20
50	50	QPSK	50	50	QPSK	16
50	75	QPSK	50	75	QPSK	25
50	100	QPSK	50	100	QPSK	50
50	100	QPSK	50	100	QPSK	25
50	100	QPSK	50	100	QPSK	20
75	50	QPSK	75	50	QPSK	25
75	100	QPSK	75	100	QPSK	25
100	50	QPSK	100	50	QPSK	100
100	50	QPSK	100	50	QPSK	75
100	50	QPSK	100	50	QPSK	50
100	75	QPSK	100	75	QPSK	100
100	100	QPSK	100	100	QPSK	75
100	100	QPSK	100	100	QPSK	50
Note 1: CA Configuration Test CC Combination settings are checked separately for each CA Configuration, which applicable aggregated channel bandwidths are specified in Table 5.4.2A.1-2. Note 2: Depending on CA configurations, only the appropriate Uplink RB allocation value according to table 7.3A.3.5-2 for UE supporting one uplink carrier is tested per Test CA configuration. Note 3: The UL resource blocks shall be located as close as possible to the downlink PCC but confined within the transmission bandwidth configuration for the channel bandwidth (Table 5.4.2-1). Note 4: The frequencies of PCC and SCC shall be switched and tested in each configuration, according to the UE declared capability for UL support (within CA operation) in the individual bands. (given UL is supported in PCC band as per Table 5.2-1).						

## 7.6.3A.3.4.2 Test Procedure

1. Configure SCC according to Annex C0, C.1 and Annex C.3.1 for all downlink physical channels.
2. The SS shall configure SCC as per TS 36.508 [7] clause 5.2A.4.
3. SS activates SCC by sending the activation MAC-CE (Refer TS 36.321 [13], clauses 5.13, 6.1.3.8). Wait for at least 2 seconds (Refer TS 36.133, clauses 8.3.3.2).
4. SS transmits PDSCH via PDCCH DCI format 1A for C\_RNTI to transmit the DL RMC according to Table 7.6.3A.3.4.1-1 on both PCC and SCC. The SS sends downlink MAC padding bits on the DL RMC.

5. SS sends uplink scheduling information for each UL HARQ process via PDCCH DCI format 0 for C\_RNTI to schedule the UL RMC according to Table 7.6.3A.3.4.1-1 on PCC. Since the UE has no payload data to send, the UE transmits uplink MAC padding bits on the UL RMC.
6. Set the parameters of the CW signal generator for an interfering signal below the SCC according to Table 7.6.3A.3.5-1.
7. Set the downlink signal level according to the table 7.6.3A.3.5-1. Send uplink power control commands to the UE (less or equal to 1dB step size should be used), to ensure that the UE output power is within +0, - 3.4 dB of the target level in table 7.6.3A.3.5-1 for carrier frequency  $f \leq 3.0\text{GHz}$  or within +0, -4.0 dB of the target level for carrier frequency  $3.0\text{GHz} < f \leq 4.2\text{GHz}$ , for at least the duration of the throughput measurement.
8. Measure the average throughput of SCC for duration sufficient to achieve statistical significance according to Annex G.2.
9. Repeat steps from 6 to 8, using an interfering signal above the SCC at step 6.

#### 7.6.3A.3.4.3 Message Contents

Same message contents as in clause 7.6.3.4.3.

#### 7.6.3A.3.5 Test Requirement

For inter-band carrier aggregation with uplink assigned to one E-UTRA band the narrow-band blocking requirements are defined with the uplink active on the band other than the band whose downlink is being tested, i.e. the requirements are tested only for the SCell downlink. The UE shall meet the requirement for each component carrier, when operated as SCell, while both downlink carriers are active.

The throughput measured during the test procedure for each component carrier, when operated as SCell, shall be  $\geq 95\%$  of the maximum throughput of the reference measurement channels as specified in Annex A.3.2 with parameters specified in Table 7.6.3A.3.5-1 (originated from the single carrier Table 7.6.3.5-1).

**Table 7.6.3A.3.5-1: Narrow-band blocking**

Parameter	Unit	Channel Bandwidth					
		1.4 MHz	3 MHz	5 MHz	10 MHz	15 MHz	20 MHz
P <sub>w</sub> in Transmission Bandwidth Configuration, per CC	dBm	P <sub>REFSENS</sub> + channel-bandwidth specific value below					
		22	18	16	13	14	16
P <sub>uw</sub> (CW)	dBm	-55	-55	-55	-55	-55	-55
F <sub>uw</sub> (offset for $\Delta f = 15$ kHz from SCC)	MHz	0.9075	1.7025	2.7075	5.2125	7.7025	10.2075
F <sub>uw</sub> (offset for $\Delta f = 7.5$ kHz from SCC)	MHz						
Note 1: The transmitter shall be set a 4 dB below P <sub>C<sub>MAX,L</sub></sub> with P <sub>C<sub>MAX,L</sub></sub> as defined in clause 6.2.5.							
Note 2: The reference measurement channel is specified in Annex A.3.2 with one sided dynamic OCNG Pattern OP.1 FDD/TDD as described in Annex A.5.1.1/A.5.2.1.							

For the UE which supports inter band CA configuration in Table 7.3.3-1A, P<sub>uw</sub> power defined in Table 7.6.3A.3.5-1 is increased by the amount given by  $\Delta R_{IB,c}$  in Table 7.3.3-1A.

#### 7.6.3A.4 Narrow band blocking for CA (intra-band non-contiguous DL CA without UL CA)

##### 7.6.3A.4.1 Test Purpose

Same as in clause 7.6.3A.1.1.

7.6.3A.4.2 Test Applicability

This test case applies to all types of E-UTRA UE release 11 and forward that support intra-band non-contiguous DL CA but no UL CA.

7.6.3A.4.3 Minimum Conformance Requirements

The minimum conformance requirements are defined in clause 7.6.3A.0.

7.6.3A.4.4 Test description

7.6.3A.4.4.1 Initial Conditions

Same as in clause 7.6.3A.1.4.1 with the following exceptions:

- Instead of Table 7.6.3A.1.4.1-1 → use Table 7.6.3A.4.4.1-1.

**Table 7.6.3A.4.4.1-1: Test Configuration Table**

Initial Conditions							
Test Environment as specified in TS 36.508[7] subclause 4.1				NC			
Test Frequencies as specified in TS36.508 [7] subclause 4.3.1 for different CA bandwidth classes, and PCC and SCCs are mapped onto physical frequencies according to Table 7.1-2				A: N/A (Range is not relevant)			
Test CC Combination setting ( $N_{RB\_agg}$ ) as specified in subclause 5.4.2A.1 for the CA Configuration .				Refer to test point			
Test Parameters for CA Configurations							
ID	CA Configuration / $N_{RB\_agg}$		$W_{gap}$ [MHz]	DL Allocation		UL Allocation	
	PCC $N_{RB}$	SCCs $N_{RB}$		CC MOD	PCC & SCC RB allocation	CC MOD	PCC RB allocations ( $L_{CRB}$ @ $RB_{start}$ )

Test Parameters for CA_2A-2A Configurations							
1	100	25	35	QPSK	100+25	QPSK	P_16@57
2	100	100	20	QPSK	100+100	QPSK	P_16@57
Test Parameters for CA_3A-3A Configurations							
3	100	25	50	QPSK	100+25	QPSK	P_16@50
4	100	25	15	QPSK	100+25	QPSK	P_32@68
5	100	100	35	QPSK	100+100	QPSK	P_16@50
Test Parameters for CA_4A-4A Configurations							
6	100	25	20	QPSK	100+25	QPSK	P_100@0
7	100	100	5	QPSK	100+100	QPSK	P_100@0
Test Parameters for CA_7A-7A Configurations							
8	100	75	35	QPSK	100+75	QPSK	P_36@64
9	100	75	15	QPSK	100+75	QPSK	P_50@50
10	100	100	30	QPSK	100+100	QPSK	P_32@68
11	100	100	15	QPSK	100+100	QPSK	P_45@55
Test Parameters for CA_23A-23A Configurations							
12	50	25	5	QPSK	50+25	QPSK	P_50@0
Test Parameters for CA_25A-25A Configurations							
13	50	25	50	QPSK	50+25	QPSK	P_10@33
14	50	25	15	QPSK	50+25	QPSK	P_32@18
15 <sup>3</sup>	50	50	45	QPSK	50+50	QPSK	P_10@33
16 <sup>3</sup>	50	50	10	QPSK	50+50	QPSK	P_32@18
17 <sup>4</sup>	100	25	40	QPSK	100+25	QPSK	P_12@62
18 <sup>4</sup>	100	100	25	QPSK	100+100	QPSK	P_12@62
Test Parameters for CA_41A-41A Configurations							
19 <sup>4</sup>	100	25	169	QPSK	100+25	QPSK	P_100@0
20 <sup>3</sup>	100	50	164	QPSK	100+50	QPSK	P_100@0
21	100	100	154	QPSK	100+100	QPSK	P_100@0
Test Parameters for CA_42A-42A Configurations							
22	100	25	175	QPSK	100+25	QPSK	P_100@0
23	100	100	160	QPSK	100+100	QPSK	P_100@0
Note 1:	CA Configuration Test CC Combination settings are checked separately for each CA Configuration, which applicable aggregated channel bandwidths are specified in Table 5.4.2A.1-3.						
Note 2:	The carrier centre frequency of PCC in the UL operating band is configured closer to the DL operating band.						
Note 3:	Applicable if only Bandwidth Combination Set 0 is supported by the UE for the CA Configuration						
Note 4:	Not applicable if only Bandwidth Combination Set 0 is supported by the UE for the CA Configuration						

#### 7.6.3A.4.4.2 Test Procedure

1. Configure SCC according to Annex C0, C.1 and Annex C.3.2 for all downlink physical channels.
2. The SS shall configure SCC as per TS 36.508 [7] clause 5.2A.4. Message contents are defined in clause 7.6.3A.4.4.3.
3. SS activates SCC by sending the activation MAC-CE (Refer TS 36.321 [13], clauses 5.13, 6.1.3.8). Wait for at least 2 seconds (Refer TS 36.133, clauses 8.3.3.2).

4. SS transmits PDSCH via PDCCH DCI format 1A for C\_RNTI to transmit the DL RMC according to Table 7.6.3A.3.4.1-1 on both PCC and SCC. The SS sends downlink MAC padding bits on the DL RMC.
5. SS sends uplink scheduling information for each UL HARQ process via PDCCH DCI format 0 for C\_RNTI to schedule the UL RMC according to Table 7.6.3A.4.4.1-1 on PCC. Since the UE has no payload data to send, the UE transmits uplink MAC padding bits on the UL RMC.
6. Set the parameters of the signal generator for the interfering signal below the PCC according to Tables 7.6.3A.4.5-1.
7. Set the downlink signal level for PCC and SCC according to the table 7.6.3.5-1. Send uplink power control commands to the UE (less or equal to 1dB step size should be used), to ensure that the UE output power is within +0, - 3.4 dB of the target level in table 7.6.3A.4.5-1 for carrier frequency  $f \leq 3.0\text{GHz}$  or within +0, -4.0 dB of the target level for carrier frequency  $3.0\text{GHz} < f \leq 4.2\text{GHz}$ , for at least the duration of the throughput measurement.
8. Measure the average throughput for each component carrier for duration sufficient to achieve statistical significance according to Annex G.2A.
9. Repeat steps from 6 to 8, using the interfering signal above the PCC at step 6.
10. Repeat the steps from 6 to 9, using the interferer signal to the SCC.

#### 7.6.3A.4.4.3 Message Contents

Message contents are according to TS 36.508 [7] subclause 4.6. In test procedure step 2, for SCC configuration there are no additional message contents.

#### 7.6.3A.4.5 Test Requirement

For intra-band non-contiguous carrier aggregation with one uplink carrier and two downlink carriers, the narrow band blocking requirements are defined with the uplink configuration of the PCC being in accordance with Table 7.3A.0-3. The UE shall meet the requirements specified in table 7.6.3A.4.5-1 for each component carrier while both downlink carriers are active. The requirements for each component carrier are the same as single carrier requirements in Table 7.6.3.5-1.

The throughput measurement derived in test procedure shall be  $\geq 95\%$  of the maximum throughput of the reference measurement channels as specified in Annex A.3.2 with parameters specified in Table 7.6.3A.4.5-1.

**Table 7.6.3A.4.5-1: Narrow-band blocking**

Parameter	Unit	Channel Bandwidth					
		1.4 MHz	3 MHz	5 MHz	10 MHz	15 MHz	20 MHz
Pw in Transmission Bandwidth Configuration, per CC	dBm	P <sub>REFSENS</sub> + channel-bandwidth specific value below					
		22	18	16	13	14	16
P <sub>uw</sub> (CW)	dBm	-55	-55	-55	-55	-55	-55
F <sub>uw</sub> (offset for $\Delta f = 15$ kHz)	MHz	0.9075	1.7025	2.7075	5.2125	7.7025	10.2075
F <sub>uw</sub> (offset for $\Delta f = 7.5$ kHz)	MHz						
Note 1: The transmitter shall be set a 4 dB below P <sub>CMAX,L</sub> with P <sub>CMAX,L</sub> as defined in clause 6.2.5.							
Note 2: The reference measurement channel is specified in Annex A.3.2 with one sided dynamic OCNG Pattern OP.1 FDD/TDD as described in Annex A.5.1.1/A.5.2.1.							

For the UE which supports inter band CA configuration in Table 7.3.3-1A, P<sub>uw</sub> power defined in Table 7.6.3A.4.5-1 is increased by the amount given by  $\Delta R_{IB,c}$  in Table 7.3.3-1A.

#### 7.6.3A.5 Narrow band blocking for CA (3DL CA without UL CA)

##### 7.6.3A.5.1 Test Purpose

Same test purpose as 7.6.3A.1.

7.6.3A.5.2 Test Applicability

This test case applies to all types of E-UTRA UE release 10 and forward that support 3DL Intra-band contiguous CA or 3DL Inter-band CA or 3DL Intra-band contiguous + Inter-band CA.

This test case also applies to all types of E-UTRA UE release 11 and forward that support 3DL Intra-band non-contiguous CA + Inter-band CA or 3DL Intra-band non-contiguous + Intra-band contiguous CA.

This test case also applies to all types of E-UTRA UE release 12 and forward that support 3DL CA with FDD-TDD CA.

7.6.3A.5.3 Minimum Conformance Requirements

Same as in clause 7.6.3A.1.

7.6.3A.5.4 Test Description

7.6.3A.5.4.1 Initial Conditions

Initial conditions are a set of test configurations the UE needs to be tested in and the steps for the SS to take with the UE to reach the correct measurement state.

The initial test configurations consist of environmental conditions, test frequencies, and channel bandwidths based on E-UTRA CA configurations specified in table 5.4.2A.1-1 through table 5.4.2A.1-2a. All of these configurations shall be tested with applicable test parameters for each channel bandwidth, and are shown in table 7.6.3A.5.4.1-1 through table 7.6.3A.5.4.1-5 as appropriate. The details of the uplink reference measurement channels (RMCs) are specified in Annex A.2 and A.3. Configurations of PDSCH and PDCCH before measurement are specified in Annex C.2.

**Table 7.6.3A.5.4.1-1: Test Configuration Table (Intra-band contiguous)**

Initial Conditions												
Test Environment as specified in TS 36.508 [7] subclause 4.1						NC						
Test Frequencies as specified in TS36.508 [7] subclause 4.3.1 for different CA bandwidth classes.						For test frequencies refer to "Range" columns. For mapping within Band refer to "CC" columns						
Test CC Combination setting ( $N_{RB\_agg}$ ) as specified in subclause 5.4.2A.1 for the CA Configuration across bandwidth combination sets supported by the UE.						Refer to "PCC $N_{RB}$ " and "SCCs $N_{RB}$ " columns						
Network signalling value						NS_01 by default, exceptions listed in Table 7.3.3-3, dependent on PCC Band						
Test Parameters for CA Configurations												
ID	CA Configuration / $N_{RB\_agg}$						DL Allocation			UL Allocation (Note 2,3)		
	CA Configuration			PCC $N_{RB}$	SCCs $N_{RB}$		CC MOD	PCC & SCCs RB allocation			CC MOD	PCC $L_{CRB}$ @ $RB_{start}$
	Band	Range	PCC CC		SCC1 CC	SCC2 CC		PCC	SCC1	SCC2		
Default Test Settings for a CA_XD Configuration												
1	X	Mid	CC1	CC2	CC3	Lowest $N_{RB\_agg}$	QPSK	All RBs			QPSK	REFSENS
2	X	Mid	CC1	CC2	CC3	Highest $N_{RB\_agg}$	QPSK	All RBs			QPSK	REFSENS
Note 1: CA Configuration Test CC Combination test settings are checked separately for each CA Configuration. Note 2: Use CA Configuration – specific test points if present in the table, otherwise use Default Test Settings test points. Note 3: X corresponds to the band of the CA Configuration. Eg. for CA_41D ,X=41 Note 4: REFSENS refers to the PCC band's and PCC $N_{RB}$ 's single carrier Uplink RB allocation for reference sensitivity according to table 7.3.5-2. Note 5: If in the CA Configuration UE supports multiple CC Combinations with the same $N_{RB\_agg}$ , choose for testing the Combination with maximum $N_{RB\_PCC}$ and then select maximum $N_{RB\_SCC1}$ for the chosen $N_{RB\_PCC}$												

**Table 7.6.3A.5.4.1-2: Test Configuration Table (Inter-band)**

Initial Conditions															
Test Environment as specified in TS 36.508[7] subclause 4.1											NC				
Test Frequencies as specified in TS36.508 [7] subclause 4.3.1 for different CA bandwidth classes.											For test frequencies refer to "Range" columns. For mapping within Band refer to "CC" columns				
Test CC Combination setting ( $N_{RB\_agg}$ ) as specified in subclause 5.4.2A.1 for the CA Configuration across bandwidth combination sets supported by the UE.											Refer to "PCC $N_{RB}$ " and "SCCs $N_{RB}$ " columns				
Network signalling value											NS_01 by default, exceptions listed in Table 7.3.3-3, dependent on PCC Band				
Test Parameters for CA Configurations															
ID	CA Configuration / $N_{RB\_agg}$							DL Allocation			UL Allocation (Note 2,3)				
	CA Configuration						PCC $N_{RB}$	SCCs $N_{RB}$		CC MOD	PCC & SCCs RB allocation			CC MOD	PCC $L_{CRB}$ @ $RB_{start}$
	PCC		SCC1		SCC2			SCC1	SCC2		PCC	SCC1	SCC2		
	Band	Range	Band	Range	Band	Range									
Default Test Settings for a CA_XA-YA-ZA Configuration															
1	X	Mid	Y	Mid	Z	Mid	Highest $N_{RB}$	Highest $N_{RB}$	Highest $N_{RB}$	QPSK	All RBs	QPSK	REFSENS		
2	Y	Mid	X	Mid	Z	Mid	Highest $N_{RB}$	Highest $N_{RB}$	Highest $N_{RB}$	QPSK	All RBs	QPSK	REFSENS		
3	Z	Mid	X	Mid	Y	Mid	Highest $N_{RB}$	Highest $N_{RB}$	Highest $N_{RB}$	QPSK	All RBs	QPSK	REFSENS		
Note 1: CA Configuration Test CC Combination test settings are checked separately for each CA Configuration. Note 2: Use CA Configuration – specific test points if present in the table, Otherwise use test points from matching Group Test Settings, if present in the table. Otherwise use the Default Test Settings test points. Note 3: If, according to the UE declared capability, UE does not support UL in an individual band within the CA Configuration, test points with that individual band as PCC are not applicable. Note 4: X,Y,Z correspond to the different bands in the CA Configuration. Eg. for CA_1A-3A-19A,X=1,Y=3,Z=19 Note 5: REFSSENS refers to the PCC band's and PCC $N_{RB}$ 's single carrier Uplink RB allocation for reference sensitivity according to table 7.3.5-2.															

**Table 7.6.3A.5.4.1-3: Test Configuration Table (Intra-band contiguous + Inter-band)**

Initial Conditions															
Test Environment as specified in TS 36.508[7] subclause 4.1										NC					
Test Frequencies as specified in TS36.508 [7] subclause 4.3.1 for different CA bandwidth classes.										For test frequencies refer to “Range” columns. For mapping within Band refer to “CC” columns					
Test CC Combination setting ( $N_{RB\_agg}$ ) as specified in subclause 5.4.2A.1 for the CA Configuration across bandwidth combination sets supported by the UE.										Refer to “PCC $N_{RB}$ ” and “SCCs $N_{RB}$ ” columns					
Network signalling value										NS_01 by default, exceptions listed in Table 7.3.3-3, dependent on PCC Band					
Test Parameters for CA Configurations															
ID	CA Configuration / $N_{RB\_agg}$							DL Allocation			UL Allocation (Note 2,3)				
	CA Configuration						PCC $N_{RB}$	SCCs $N_{RB}$		CC MOD	PCC & SCCs RB allocation			CC MOD	PCC $L_{CRB}$ @ $RB_{start}$
	PCC		SCC1		SCC2			SCC1	SCC2		PCC	SCC1	SCC2		
	Band	Range /CC	Band	Range /CC	Band	Range /CC									
Default Test Settings for CA_XB-YA and CA_XC-YA Configuration															
1	X	Mid /CC1	X	Mid /CC2	Y	Mid	Highest $N_{RB\_agg}$	Highest $N_{RB}$	QPSK	All RBs	QPSK	REFSENS			
2	X	Mid /CC1	X	Mid /CC2	Y	Mid	Lowest $N_{RB\_agg}$	Highest $N_{RB}$	QPSK	All RBs	QPSK	REFSENS			
3	Y	Mid	X	Mid /CC1	X	Mid /CC2	Highest $N_{RB}$	Highest $N_{RB\_agg}$	QPSK	All RBs	QPSK	REFSENS			
4	Y	Mid	X	Mid /CC1	X	Mid /CC2	Highest $N_{RB}$	Lowest $N_{RB\_agg}$	QPSK	All RBs	QPSK	REFSENS			
Default Test Settings CA_XA-YB and for CA_XA-YC Configuration															
1	Y	Mid /CC1	Y	Mid /CC2	X	Mid	Highest $N_{RB\_agg}$	Highest $N_{RB}$	QPSK	All RBs	QPSK	REFSENS			
2	Y	Mid /CC1	Y	Mid /CC2	X	Mid	Lowest $N_{RB\_agg}$	Highest $N_{RB}$	QPSK	All RBs	QPSK	REFSENS			
3	X	Mid	Y	Mid /CC1	Y	Mid /CC2	Highest $N_{RB}$	Highest $N_{RB\_agg}$	QPSK	All RBs	QPSK	REFSENS			
4	X	Mid	Y	Mid /CC1	Y	Mid /CC2	Highest $N_{RB}$	Lowest $N_{RB\_agg}$	QPSK	All RBs	QPSK	REFSENS			
<p>Note 1: CA Configuration Test CC Combination test settings are checked separately for each CA Configuration.</p> <p>Note 2: Use CA Configuration – specific test points if present in the table. Otherwise use the Default Test Settings test points.</p> <p>Note 3: If, according to the UE declared capability, UE does not support UL in an individual band within the CA Configuration, test points with that individual band as PCC are not applicable.</p> <p>Note 4: X,Y correspond to the different bands in the CA Configuration. Eg. for CA_1C-3A, X=1 and Y=3</p> <p>Note 5: REFSENS refers to the PCC band's and PCC <math>N_{RB}</math> 's single carrier Uplink RB allocation for reference sensitivity according to table 7.3.5-2.</p> <p>Note 6: If in the CA Configuration UE supports multiple CC Combinations with the same <math>N_{RB\_agg}</math>, choose the Combination with <math>N_{RB\_PCC} = N_{RB\_SCC1}</math> for testing. If no such combination is supported, choose Combination with maximum <math>N_{RB\_PCC}</math> for testing.</p>															



**Table 7.6.3A.5.4.1-4: Test Configuration Table (Intra-band non-contiguous + Inter-band)**

Initial Conditions														
Test Environment as specified in TS 36.508[7] subclause 4.1										NC				
Test Frequencies as specified in TS36.508 [7] subclause 4.3.1 for different CA bandwidth classes.										For test frequencies refer to “Range” columns. For mapping within Band refer to “CC” columns				
Test CC Combination setting ( $N_{RB\_agg}$ ) as specified in subclause 5.4.2A.1 for the CA Configuration across bandwidth combination sets supported by the UE.										Highest $N_{RB}$				
Network signalling value										NS_01 by default, exceptions listed in Table 7.3.3-3, dependent on PCC Band				
Test Parameters for CA Configurations														
ID	CA Configuration / $N_{RB\_agg}$								DL Allocation			UL Allocation (Note 2,3)		
	CA Configuration								CC MOD	PCC & SCCs			CC MOD	PCC
	PCC		$W_{gap}$ [MHz]	SCC1		$W_{gap}$ [MHz]	SCC2			RB allocation				$L_{CRB} @ RB_{sta}$
	Band	Range		Band	Range		Band	Range		PCC	SCC1	SCC2		
		/CC		/CC		/CC								
Default Test Settings for CA_XA-XA-YA Configurations														
1	X	CC2	Max	X	CC1	-	Y	Mid	QPSK	All RBs			QPSK	REFSENS_C
2	Y	Mid	-	X	CC2	Max	X	CC1	QPSK	All RBs			QPSK	REFSENS
Default Test Settings for CA_XA-YA-YA Configurations														
1	Y	CC2	Max	Y	CC1	-	X	Mid	QPSK	All RBs			QPSK	REFSENS_C
2	X	Mid	-	Y	CC2	Max	Y	CC1	QPSK	All RBs			QPSK	REFSENS
Note 1:	CA Configuration Test CC Combination test settings are checked separately for each CA Configuration.													
Note 2:	Use CA Configuration – specific test points if present in the table. Otherwise use test points from matching Group Test Settings, present in the table. Otherwise use Default Test Settings test points.													
Note 3:	If, according to the UE declared capability, UE does not support UL in an individual band within the CA Configuration, test points with that individual band as PCC are not applicable.													
Note 4:	X and Y correspond to the different bands in the CA Configuration. Eg. for CA_2A-2A-5A,X=2,Y=5													
Note 5:	REFSENS refers to the PCC band's and PCC $N_{RB}$ 's single carrier Uplink RB allocation for reference sensitivity according to tab 7.3.5-2. REFSENS_CA refers to the PCC band's and PCC $N_{RB}$ 's single carrier Uplink RB allocation for reference sensitivity according to table 7.3.4.5-2 (selecting RB allocation for SCC measurement).													

**Table 7.6.3A.5.4.1-5: Test Configuration Table (Intra-band non-contiguous + Intra-band contiguous)**

Initial Conditions															
Test Environment as specified in TS 36.508[7] subclause 4.1										NC					
Test Frequencies as specified in TS36.508 [7] subclause 4.3.1 for different CA bandwidth classes.										For test frequencies refer to “Range” columns. For mapping within band refer to “CC” columns					
Test CC Combination setting ( $N_{RB\_agg}$ ) as specified in subclause 5.4.2A.1 for the CA Configuration across bandwidth combination sets supported by the UE.										Refer to “PCC $N_{RB}$ ” and “SCCs $N_{RB}$ ” columns					
Network signalling value										NS_01 by default, exceptions listed in Table 7.3.3-3, dependent on PCC Band					
Test Parameters for CA Configurations															
ID	CA Configuration / $N_{RB\_agg}$								DL Allocation			UL Allocation (Note 2,3)			
	CA Configuration						PCC $N_{RB}$	SCCs $N_{RB}$		CC MOD	PCC & SCCs RB allocation			CC MOD	PCC $L_{CRB}$ @ $RB_{start}$
	Band	PCC CC	$W_{gap}$ [MHz]	SCC1 CC	$W_{gap}$ [MHz]	SCC2 CC		SCC1	SCC2		PCC	SCC1	SCC2		
<b>Test Settings for a 41A-41C Configuration</b>															
1	41	CC3	134.2	CC2	-	CC1	100	100	100	QPSK	All RBs	QPSK	100@0		
<b>Test Settings for a CA_41C-41A Configuration</b>															
2	41	CC3	-	CC2	134.2	CC1	100	100	100	QPSK	All RBs	QPSK	100@0		
Note 1: CA Configuration Test CC Combination test settings are checked separately for each CA Configuration. Note 2: Use CA Configuration – specific test points if present in the table, otherwise use Default Test Settings test points. Note 3: If, according to the UE declared capability, UE does not support UL in an individual band within the CA Configuration, test points with that individual band as PCC are not applicable. Note 4: X corresponds to the band of the CA Configuration. Eg. for CA_41C-41A, X=41. Note 5: REFSENS refers to the PCC band's and PCC $N_{RB}$ 's single carrier Uplink RB allocation for reference sensitivity according to table 7.3.5-2. Note 6: If in the CA Configuration UE supports multiple CC Combinations with the same $N_{RB\_agg}$ , choose the Combination with $N_{RB\_CC1} = N_{RB\_CC2}$ for testing. If no such combination is supported, choose Combination with maximum $N_{RB\_CC1}$ for testing.															

1. Connect the SS to the UE antenna connectors as shown in TS 36.508[7] Annex A Figure group [TBD] as appropriate.
2. The parameter settings for the cell are set up according to TS 36.508 [7] subclause [4.4.3].
3. Downlink signals for PCC are initially set up according to Annex C.0, C.1, and C.3.1, and uplink signals according to Annex H.1 and H.3.0.
4. The UL and DL Reference Measurement channels are set according to Table 7.6.3A.5.4.1-1 through Table 7.6.3A.5.4.1-5 as appropriate.
5. Propagation conditions are set according to Annex B.0.
6. Ensure the UE is in State 3A-RF according to TS 36.508 [7] clause 5.2A.2. Message contents are defined in clause 7.6.3A.5.4.3.

**7.6.3A.5.4.2 Test Procedure**

1. Configure SCCs according to Annex C.0, C.1 and Annex C.3.1 for all downlink physical channels except PHICH.
2. The SS shall configure SCCs as per TS 36.508 [7] clause 5.2A.4. Message contents are defined in clause 7.6.3A.5.4.3

3. SS activates SCCs by sending the activation MAC-CE (Refer TS 36.321 [13], clauses 5.13, 6.1.3.8). Wait for at least 2 seconds (Refer TS 36.133, clauses 8.3.3.2).
4. SS transmits PDSCH via PDCCH DCI format 1A for C\_RNTI to transmit the DL RMC according to Table 7.6.3A.5.4.1-1 through Table 7.6.3A.5.4.1-5 as appropriate on PCC and SCCs. The SS sends downlink MAC padding bits on the DL RMC.
5. SS sends uplink scheduling information for each UL HARQ process via PDCCH DCI format 0 for C\_RNTI to schedule the UL RMC according to Table 7.6.3A.5.4.1-1 through Table 7.6.3A.5.4.1-5 on PCC. Since the UE has no payload data to send, the UE sends uplink MAC padding bits on the UL RMC.
6. Set the parameters of the CW signal generator for an interfering signal below the aggregated component carriers according to Table 7.6.3A.5.4.2-1.
7. Set the downlink signal level according to the table 7.6.3A.5.4.2-1. Send uplink power control commands to the UE (less or equal to 1dB step size should be used), to ensure that the UE output power is within +0, - 3.4 dB of the target level in table 7.6.3A.5.4.2-1 for carrier frequency  $f \leq 3.0\text{GHz}$  or within +0, -4.0 dB of the target level for carrier frequency  $3.0\text{GHz} < f \leq 4.2\text{GHz}$ , for at least the duration of the throughput measurement.
8. Measure the average throughput for the carrier(s) indicated in Table 7.6.3A.5.4.2-1 for duration sufficient to achieve statistical significance according to Annex G.2A.
9. Repeat steps from 6 to 8, using an interfering signal above the measured carrier(s) according to Table 7.6.3A.5.4.2-1 at step 6.
10. Repeat steps 1 to 9 for component carriers listed in Table 7.6.3A.5.4.2-1.

**Table 7.6.3A.5.4.2-1: Test repetition and measurement configuration**

CA configuration	ID (Note 1)	Throughput measured on (Note 3)	Table with test parameters to select (Note 2)
Intra-band contiguous	1	PCC, SCC1, SCC2	7.6.3A.5.5-1
	2		
Inter-band	1	SCC1	7.6.3A.5.5-2
		SCC2	
	2	SCC1	
		SCC2	
	3	SCC1	
		SCC2	
Intra-band contiguous + Inter-band	1	SCC2	7.6.3A.5.5-2
	2		
	3	SCC1, SCC2	7.6.3A.5.5-1
	4		
Intra-band non-contiguous + Inter-band	1	SCC2	7.6.3A.5.5-2
	2	SCC1, SCC2	7.6.3A.5.5-2
Intra-band non-contiguous + Intra-band contiguous		1	PCC
	SCC1, SCC2		7.6.3A.5.5-1
	2	SCC2	7.6.3A.5.5-2
		PCC, SCC1	7.6.3A.5.5-1
Note 1: Test point ID for the particular CA configuration as defined in section 7.6.3A.5.4.1. Note 2: The reference for the placement of the interferer signals is the centre frequency of the carrier closest to the interferer among the carriers throughput is measured on. Note 3: Where there are multiple rows for a single Test point ID, the test is repeated for each row.			

## 7.6.3A.5.4.3 Message Contents

Same message contents as in clause 7.6.3.4.3.

## 7.6.3A.5.5 Test Requirement

The throughput measurement of each carrier derived in test procedure shall be  $\geq 95\%$  of the maximum throughput of the reference measurement channels as specified in Annex A.3.2 with parameters specified in Table Tables below, according to the type of CA.

**Table 7.6.3A.5.5-1: Narrow-band blocking (intra-band contiguous)**

Parameter	Unit	CA Bandwidth Class				
		B	C	D	E	F
Power per CC in Aggregated Transmission Bandwidth Configuration	dBm	REFSENS + CA Bandwidth Class specific value below				
		16	16 <sup>4</sup>	16		
$P_{uw}$ (CW)	dBm	-55	-55	-55		
$F_{uw}$ (offset for $\Delta f = 15$ kHz)		MHz	- $F_{offset} - 0.2$ / + $F_{offset} + 0.2$	- $F_{offset} - 0.2$ / + $F_{offset} + 0.2$	- $F_{offset} - 0.2$ / + $F_{offset} + 0.2$	
$F_{uw}$ (offset for $\Delta f = 7.5$ kHz)	MHz					
Note 1:	The transmitter shall be set to 4dB below $P_{CMAX,L}$ or $P_{CMAX,L,CA}$ as defined in subclause 6.2.5.					
Note 2:	Reference measurement channel is specified in Annex A.3.2 with one sided dynamic OCNG Pattern OP.1 FDD/TDD as described in Annex A.5.1.1/A.5.2.1.					
Note 3:	The $F_{interferer}$ (offset) is the frequency separation of the centre frequency of the carrier closest to the interferer and the centre frequency of the interferer and shall be further adjusted to $\lfloor F_{interferer} / 0.015 + 0.5 \rfloor \cdot 0.015 + 0.0075$ MHz to be offset from the sub-carrier raster.					
Note 4:	The requirement is applied for the band combinations whose component carriers' $BW \geq 5$ MHz.					

**Table 7.6.3A.5.5-2: Narrow-band blocking (inter-band, intra-band non-contiguous)**

Parameter	Unit	Channel Bandwidth					
		1.4 MHz	3 MHz	5 MHz	10 MHz	15 MHz	20 MHz
$P_w$ for each CC	dBm	$P_{REFSENS}$ + channel-bandwidth specific value below					
		22	18	16	13	14	16
$P_{uw}$ (CW)	dBm	-55	-55	-55	-55	-55	-55
$F_{uw}$ (offset for $\Delta f = 15$ kHz from SCC)		MHz	0.9075	1.7025	2.7075	5.2125	7.7025
$F_{uw}$ (offset for $\Delta f = 7.5$ kHz from SCC)	MHz						
Note 1:	The transmitter shall be set to 4 dB below $P_{CMAX,L}$ with $P_{CMAX,L}$ as defined in clause 6.2.5.						
Note 2:	The reference measurement channel is specified in Annex A.3.2 with one sided dynamic OCNG Pattern OP.1 FDD/TDD as described in Annex A.5.1.1/A.5.2.1.						
Note 3:	For intra-band non-contiguous + inter-band CA, $\Delta R_{IBNC} = 0$ dB for all sub-block gaps.						

For a UE, which supports CA configuration in Table 7.3.3-1A or 7.3.3-1B,  $P_{uw}$  power defined in Table 7.6.3A.5.5-2 is increased by the amount given by  $\Delta R_{IB,c}$  in Table 7.3.3-1A or 7.3.3-1B accordingly.

## 7.6.3B Narrow band blocking for UL-MIMO

## 7.6.3B.1 Test Purpose

Narrow band blocking for UL-MIMO is defined for an unwanted CW interfering signal falling near the UE that supports UL-MIMO receive band, at which a given average throughput shall meet or exceed the requirement for the specified measurement channels,

The lack of narrow-band blocking ability will decrease the coverage area when other e-NodeB transmitters exist (except in the adjacent channels and spurious response).

## 7.6.3B.2 Test Applicability

This test applies to all types of E-UTRA UE release 10 and forward that support UL-MIMO.

## 7.6.3B.3 Minimum Conformance Requirements

For UE with two transmitter antenna connectors in closed-loop spatial multiplexing scheme, the minimum requirements in clause 7.6 shall be met with the UL-MIMO configurations specified in Table 6.2.2B-2. For UL-MIMO, the parameter  $P_{\text{CMAX,L}}$  is defined as the total transmitter power over the two transmit antenna connectors.

## 7.6.3B.4 Test Description

### 7.6.3B.4.1 Initial Conditions

Initial conditions are a set of test configurations the UE needs to be tested in and the steps for the SS to take with the UE to reach the correct measurement state.

The initial test configurations consist of environmental conditions, test frequencies, and channel bandwidths based on E-UTRA bands specified in table 5.4.2.1-1. All of these configurations shall be tested with applicable test parameters for each channel bandwidth, and are shown in table 7.6.3B.4.1-1. The details of the uplink and downlink reference measurement channels (RMCs) are specified in Annexes A.2 and A.3 respectively. The details of the OCNG patterns used are specified in Annex A.5. Configurations of PDSCH and PDCCH before measurement are specified in Annex C.2.

**Table 7.6.3B.4.1-1: Test Configuration Table**

Initial Conditions						
Test Environment as specified in TS 36.508 [7] clause 4.1			NC			
Test Frequencies as specified in TS 36.508 [7] clause 4.3.1			Mid range			
Test Channel Bandwidths as specified in TS 36.508 [7] clause 4.3.1			Lowest, 5MHz, Highest			
Test Parameters for Channel Bandwidths						
Ch BW	Downlink Configuration			Uplink Configuration		
	Mod'n	RB allocation		Mod'n	RB allocation	
		FDD	TDD		FDD	TDD
1.4MHz	QPSK	6	6	QPSK	6	6
3MHz	QPSK	15	15	QPSK	15	15
5MHz	QPSK	25	25	QPSK	25	25
5MHz	QPSK	25	N/A	QPSK	20	N/A
5MHz	QPSK	25	N/A	QPSK	15	N/A
5MHz	QPSK	25	N/A	QPSK	5 <sup>+</sup>	N/A
10MHz	QPSK	50	50	QPSK	50	50
10MHz	QPSK	50	N/A	QPSK	25	N/A
10MHz	QPSK	50	N/A	QPSK	20	N/A
10MHz	QPSK	50	N/A	QPSK	15	N/A
15MHz	QPSK	75	75	QPSK	75	75
15MHz	QPSK	75	N/A	QPSK	50	N/A
15MHz	QPSK	75	N/A	QPSK	25	N/A
15MHz	QPSK	75	N/A	QPSK	20	N/A
20MHz	QPSK	100	100	QPSK	100	100
20MHz	QPSK	100	N/A	QPSK	75	N/A
20MHz	QPSK	100	N/A	QPSK	50	N/A
20MHz	QPSK	100	N/A	QPSK	25	N/A
20MHz	QPSK	100	N/A	QPSK	20	N/A
Note 1: Test Channel Bandwidths are checked separately for each E-UTRA band, which applicable channel bandwidths are specified in Table 5.4.2.1-1. Note 2: Depending on E-UTRA band, only the appropriate Uplink RB allocation value according to table 7.3.3-2 is tested per Test Channel Bandwidth. Note 3: For the DL signal one sided dynamic OCNG Pattern OP.1 FDD/TDD is used. Note 4: Applicable only to E-UTRA FDD Band 31. The UL resource blocks shall be located at RBstart 10 (according to Table 7.3.3-2).						

1. Connect the SS to the UE antenna connectors as shown in TS 36.508 [7] Annex A, Figure A.30.

2. The parameter settings for the cell are set up according to TS 36.508 [7] clause 4.4.3.
3. Downlink signals are initially set up according to Annex C0, C.1 and C.3.1, and uplink signals according to Annex H.1 and H.3.1
4. The UL and DL Reference Measurement channels are set according to Table 7.6.3B.4.1-1.
5. Propagation conditions are set according to Annex B.0.
6. Ensure the UE is in State 3A-RF according to TS 36.508 [7] clause 5.2A.2. Message contents are defined in clause 7.6.3B.4.3.

#### 7.6.3B.4.2 Test Procedure

1. SS transmits PDSCH via PDCCH DCI format 1A for C\_RNTI to transmit the DL RMC according to Table 7.6.3B.4.1-1. The SS sends downlink MAC padding bits on the DL RMC.
2. SS sends uplink scheduling information for each UL HARQ process via PDCCH DCI format 4 for C\_RNTI to schedule the UL RMC according to Table 7.6.3B.4.1-1. Since the UE has no payload data to send, the UE transmits uplink MAC padding bits on the UL RMC.
3. Set the parameters of the CW signal generator for an interfering signal below the wanted signal according to Table 7.6.3B.5-1.
4. Set the downlink signal level according to the table 7.6.3B.5-1. Send uplink power control commands to the UE (less or equal to 1dB step size should be used), to ensure that the UE output power is within +0, - 3.4 dB of the target level in table 7.6.3B.5-1 for carrier frequency  $f \leq 3.0\text{GHz}$  or within +0, -4.0 dB of the target level for carrier frequency  $3.0\text{GHz} < f \leq 4.2\text{GHz}$ , for at least the duration of the throughput measurement and the UE output power is mean sum power of each antenna connector for UE.
5. Measure the average throughput for a duration sufficient to achieve statistical significance according to Annex G.2.
6. Repeat steps from 3 to 5, using an interfering signal above the wanted signal at step 3.

#### 7.6.3B.4.3 Message Contents

Message contents are according to TS 36.508 [7] clause 4.6 with the following exception.

**Table 7.6.3B.4.3-1: UplinkPowerControlDedicated**

Derivation Path: 36.331 clause 6.3.2			
Information Element	Value/remark	Comment	Condition
UplinkPowerControlDedicated-DEFAULT ::= SEQUENCE {			
p0-UePUSCH	0		
deltaMCS-Enabled	en0		
accumulationEnabled	TRUE		
p0-uePUCCH	0		
pSRS-Offset	3 (-6 dB)		
filterCoefficient	fc8	larger filter length is used to reduce the RSRP measurement variation	
}			

#### 7.6.3B.5 Test Requirement

The throughput measurement derived in test procedure shall be  $\geq 95\%$  of the maximum throughput of the reference measurement channels as specified in Annex A.3.2 with parameters specified in Table 7.6.3B.5-1.

Table 7.6.3B.5-1: Narrow-band blocking

Parameter	Unit	Channel Bandwidth					
		1.4 MHz	3 MHz	5 MHz	10 MHz	15 MHz	20 MHz
$P_w$	dBm	$P_{REFSENS}$ + channel-bandwidth specific value below					
		22	18	16	13	14	16
$P_{uw}$ (CW)	dBm	-55	-55	-55	-55	-55	-55
$F_{uw}$ (offset for $\Delta f = 15$ kHz)	MHz	0.9075	1.7025	2.7075	5.2125	7.7025	10.2075
$F_{uw}$ (offset for $\Delta f = 7.5$ kHz)	MHz						
Note 1: The transmitter shall be set a 4 dB below $P_{CMAX,L}$ with $P_{CMAX,L}$ as defined in clause 6.2.5. Note 2: The reference measurement channel is specified in Annex A.3.2 with one sided dynamic OCNNG Pattern OP.1 FDD/TDD as described in Annex A.5.1.1/A.5.2.1.							

For the UE which supports inter band CA configuration in Table 7.3.3-1A,  $P_{uw}$  power defined in Table 7.6.3B.5-1 is increased by the amount given by  $\Delta R_{IB,c}$  in Table 7.3.3-1A.

### 7.6.3E Narrow band blocking for UE category 0

Editor's note: Following aspects missing or not yet determined:

- RB allocation within brackets
- Test tolerance for this case in Annex F is not completed
- Test requirement TBD

#### 7.6.3E.1 Test Purpose

Same test purpose as in clause 7.6.3.

#### 7.6.3E.2 Test Applicability

This test applies to all types of E-UTRA UE release 12 and forward of UE category 0.

#### 7.6.3E.3 Minimum Conformance Requirements

Same minimum conformance requirements as in clause 7.6.3.3.

#### 7.6.3E.4 Test Description

##### 7.6.3E.4.1 Initial Conditions

Same initial conditions as in clause 7.5.4.1 with the following exceptions:

- Instead of Table 7.6.3.4.1-1 → use Table 7.6.3E.4.1-1.
- Connect the SS to the UE antenna connectors as shown in TS 36.508[7] Annex A Figure A.5 using only main UE Tx/Rx antenna.

Table 7.6.3E.4.1-1: Test Configuration Table

Initial Conditions						
Test Environment as specified in TS 36.508 [7] subclause 4.1			NC			
Test Frequencies as specified in TS 36.508 [7] subclause 4.3.1			Mid range			
Test Channel Bandwidths as specified in TS 36.508 [7] subclause 4.3.1			Lowest, 5MHz, Highest			
Test Parameters for Channel Bandwidths						
Ch BW	Downlink Configuration			Uplink Configuration		
	Mod'n	RB allocation		Mod'n	RB allocation	
		FDD and HD-FDD	TDD		FDD and HD-FDD	TDD
1.4MHz	QPSK	6	6	QPSK	6	6
3MHz	QPSK	14	14	QPSK	15	15
5MHz	QPSK	14	14	QPSK	25	25
5MHz	QPSK	14	N/A	QPSK	20	N/A
10MHz	QPSK	14	14	QPSK	[36]	[36]
10MHz	QPSK	14	N/A	QPSK	25	N/A
10MHz	QPSK	14	N/A	QPSK	20	N/A
15MHz	QPSK	14	14	QPSK	[36]	[36]
15MHz	QPSK	14	N/A	QPSK	20	N/A
20MHz	QPSK	14	14	QPSK	[36]	[36]
20MHz	QPSK	14	N/A	QPSK	20	N/A
Note 1:	Test Channel Bandwidths are checked separately for each E-UTRA band, which applicable channel bandwidths are specified in Table 5.4.2.1-1.					
Note 2:	Depending on E-UTRA band, only the appropriate Uplink RB allocation value according to table 7.3E.3-3 is tested per Test Channel Bandwidth. The allocation shall be located as close as possible to the downlink operating band but confined within the transmission bandwidth configuration for the channel bandwidth (Table 5.4.2-1).					
Note 3:	For the DL signal one sided dynamic OCNG Pattern OP.1 FDD/TDD is used.					
Note 4:	Downlink RB position shall be $RB_{start} = 0$					

### 7.6.3E.4.2 Test Procedure

Same test procedure as in clause 7.6.3.4.2

### 7.6.3E.4.3 Message Contents

Same message contents as in clause 7.6.3.4.3

### 7.6.3E.5 Test Requirement

TBD

## 7.7 Spurious response

### 7.7.1 Test Purpose

Spurious response verifies the receiver's ability to receive a wanted signal on its assigned channel frequency without exceeding a given degradation due to the presence of an unwanted CW interfering signal at any other frequency at which a response is obtained i.e. for which the out of band blocking limit as specified in sub-clause 7.6.2 is not met.

The lack of the spurious response ability decreases the coverage area when other unwanted interfering signal exists at any other frequency.

### 7.7.2 Test Applicability

This test applies to all types of E-UTRA UE release 8 and forward.



## 7.7.3 Minimum Conformance Requirements

The throughput shall be  $\geq 95\%$  of the maximum throughput of the reference measurement channels as specified in Annexes A.2.2, A.2.3 and A.3.2 (with one sided dynamic OCNG Pattern OP.1 FDD/TDD for the DL-signal as described in Annex A.5.1.1/A.5.2.1) with parameters specified in Tables 7.7.3-1 and 7.7.3-2.

**Table 7.7.3-1: Spurious response parameters**

Rx Parameter	Units	Channel bandwidth					
		1.4 MHz	3 MHz	5 MHz	10 MHz	15 MHz	20 MHz
Power in Transmission Bandwidth Configuration	dBm	REFSENS + channel bandwidth specific value below					
		6	6	6	6	7	9
Note 1: The transmitter shall be set to 4dB below $P_{\text{CMAX\_L}}$ at the minimum uplink configuration specified in Table 7.3.3-2 with $P_{\text{CMAX\_L}}$ as defined in clause 6.2.5.							
Note 2: The reference measurement channel is specified in Annex A.3.2 with one sided dynamic OCNG Pattern OP.1 FDD/TDD as described in Annex A.5.1.1/A.5.2.1.							

**Table 7.7.3-2: Spurious Response**

Parameter	Unit	Level
$P_{\text{Interferer}}$ (CW)	dBm	-44
$F_{\text{Interferer}}$	MHz	Spurious response frequencies

For the UE which supports inter band CA configuration in Table 7.3.3-1A,  $P_{\text{uw}}$  power defined in Table 7.7.3-2 is increased by the amount given by  $\Delta R_{\text{IB,c}}$  in Table 7.3.3-1A.

The normative reference for this requirement is TS 36.101 [2] clause 7.7.

## 7.7.4 Test Description

### 7.7.4.1 Initial Conditions

The initial conditions shall be the same as in clause 7.6.2.4.1 in order to test spurious responses obtained in clause 7.6.2 under the same conditions.

### 7.7.4.2 Test Procedure

1. SS transmits PDSCH via PDCCH DCI format 1A for  $C_{\text{RNTI}}$  to transmit the DL RMC according to Table 7.6.2.4.1-1. The SS sends downlink MAC padding bits on the DL RMC.
2. SS sends uplink scheduling information for each UL HARQ process via PDCCH DCI format 0 for  $C_{\text{RNTI}}$  to schedule the UL RMC according to Table 7.6.2.4.1-1. Since the UE has no payload data to send, the UE transmits uplink MAC padding bits on the UL RMC.
3. Set the parameters of the CW signal generator for an interfering signal according to Table 7.7.5-2. The spurious frequencies are taken from records in the final step of test procedures in clause 7.6.2.4.2.
4. Set the downlink signal level according to the table 7.7.5-1. Send uplink power control commands to the UE (less or equal to 1dB step size should be used), to ensure that the UE output power is within +0, - 3.4 dB of the target level in table 7.7.5-1 for carrier frequency  $f \leq 3.0\text{GHz}$  or within +0, -4.0 dB of the target level for carrier frequency  $3.0\text{GHz} < f \leq 4.2\text{GHz}$ , for at least the duration of the throughput measurement.
5. For the spurious frequency, measure the average throughput for a duration sufficient to achieve statistical significance according to Annex G.2.

### 7.7.4.3 Message Contents

Message contents are according to TS 36.508 [7] subclause 4.6 with the following exception.

Table 7.7.4.3-1: UplinkPowerControlDedicated

Derivation Path: 36.331 clause 6.3.2			
Information Element	Value/remark	Comment	Condition
UplinkPowerControlDedicated-DEFAULT ::= SEQUENCE {			
p0-UePUSCH	0		
deltaMCS-Enabled	en0		
accumulationEnabled	TRUE		
p0-uePUCCH	0		
pSRS-Offset	3 (-6 dB)		
filterCoefficient	fc8	larger filter length is used to reduce the RSRP measurement variation	
}			

## 7.7.5 Test Requirement

The throughput measurement derived in test procedure shall be  $\geq 95\%$  of the maximum throughput of the reference measurement channels as specified in Annex A.3.2 with parameters specified in Tables 7.7.5-1 and 7.7.5-2.

Table 7.7.5-1: Spurious response parameters

Rx Parameter	Units	Channel bandwidth					
		1.4 MHz	3 MHz	5 MHz	10 MHz	15 MHz	20 MHz
Power in Transmission Bandwidth Configuration	dBm	REFSENS + channel bandwidth specific value below					
		6	6	6	6	7	9
Note 1: The transmitter shall be set to 4dB below $P_{\text{CMAX}_L}$ with $P_{\text{CMAX}_L}$ as defined in clause 6.2.5.							
Note 2: The reference measurement channel is specified in Annex A.3.2 with one sided dynamic OCNB Pattern OP.1 FDD/TDD as described in Annex A.5.1.1/A.5.2.1.							

Table 7.7.5-2: Spurious Response

Parameter	Unit	Level
$P_{\text{Interferer}}(\text{CW})$	dBm	-44
$F_{\text{Interferer}}$	MHz	Spurious response frequencies

For the UE which supports inter band CA configuration in Table 7.3.3-1A,  $P_{\text{uw}}$  power defined in Table 7.7.5-2 is increased by the amount given by  $\Delta R_{\text{IB,c}}$  in Table 7.3.3-1A.

## 7.7A Spurious response for CA

### 7.7A.0 Minimum conformance requirements

For inter-band carrier aggregation with one component carrier per operating band and the uplink assigned to one E-UTRA band the spurious response requirements are defined with the uplink active on the band(s) other than the band whose downlink is being tested. The throughput measured in each downlink with  $F_{\text{interferer}}$  in Table 7.6.2A.1.3-0 at spurious response frequencies shall be  $\geq 95\%$  of the maximum throughput of the reference measurement channels as specified in Annexes A.2.2, A.2.3 and A.3.2 (with one sided dynamic OCNB Pattern OP.1 FDD/TDD for the DL-signal as described in Annex A.5.1.1/A.5.2.1) with parameters specified in Tables 7.7.3-1 and 7.7.3-2. The UE shall meet these requirements for each component carrier while all downlink carriers are active.

For E-UTRA CA configurations including an operating band without uplink band (as noted in Table 5.2-1), the requirements for all downlinks shall be met with the uplink active in the band(s) capable of UL operation. For E-UTRA CA configurations listed in Table 7.3A.0-1 under conditions for which reference sensitivity for the operating band being tested is N/A, the spurious response requirements of subclause 7.7A.0 do not apply.

For intra-band contiguous carrier aggregation the downlink SCC(s) shall be configured at nominal channel spacing to the PCC. For FDD, the PCC shall configure closest to the uplink band. All downlink carriers shall be active throughout the test. The uplink output power shall be set as specified in Table 7.7A.0-1 with the uplink configuration set according to Table 7.3A.0-2 for the applicable carrier aggregation configuration. For UE(s) supporting one uplink carrier, the uplink configuration of the PCC shall be in accordance with Table 7.3.3-2. The throughput shall be  $\geq 95\%$  of the maximum throughput of the reference measurement channels as specified in Annexes A.2.2, A.2.3 and A.3.2 (with one sided dynamic OCNG Pattern OP.1 FDD/TDD for the DL-signal as described in Annex A.5.1.1/A.5.2.1) with parameters specified in Tables 7.7A.0-1 and 7.7A.0-2.

**Table 7.7A.0-1: Spurious response parameters**

Rx Parameter	Units	CA Bandwidth Class				
		B	C	D	E	F
Pw in Transmission Bandwidth Configuration, per CC	dBm	REFSENS + CA Bandwidth Class specific value below				
		9	9	9		
Note 1: The transmitter shall be set to 4dB below $P_{\text{CMAX\_L}}$ or $P_{\text{CMAX\_L\_CA}}$ as defined in subclause 6.2.5A.						
Note 2: Reference measurement channel is specified in Annex A.3.2 with one sided dynamic OCNG Pattern OP.1 FDD/TDD as described in Annex A.5.1.1/A.5.2.1.						

**Table 7.7A.0-2: Spurious response**

Parameter	Unit	Level
$P_{\text{Interferer (CW)}}$	dBm	-44
$F_{\text{Interferer}}$	MHz	Spurious response frequencies

For intra-band non-contiguous carrier aggregation with one uplink carrier and more than or equal to two downlink carriers, the spurious response requirements are defined with the uplink configuration in accordance with Table 7.3A.0-3. For this uplink configuration, the UE shall meet the requirements specified in clauses 7.7.1.3 and 7.7A.3 for single component carrier and intra-band contiguous component carriers separately while all downlink carriers are active.

For combinations of intra-band contiguous and inter-band carrier aggregation with three downlink carriers and one uplink carrier assigned to one E-UTRA band, the requirement is defined with the uplink active in the band other than that supporting the downlink(s) under test and a configuration in accordance with Table 7.3.3-2. The downlink PCC carrier centre frequency shall be configured closer to the uplink operating band than the downlink SCC centre frequency when the uplink is active in the band supporting two component carriers. For each downlink the UE shall meet the spurious-response requirements applicable for inter-band carrier aggregation with one component carrier per operating band. The three downlink carriers shall be active throughout the tests.

For combinations of intra-band non-contiguous and inter-band carrier aggregation with three downlink carriers and one uplink carrier assigned to one E-UTRA band, the requirement is defined with the uplink active in the band other than that supporting the downlink(s) under test. The uplink configuration shall be in accordance with Table 7.3A.0-3 when the uplink is active in the band supporting two component carriers and in accordance with Table 7.3.3-2 when the uplink is active in the other band. For the two component carriers within the same band,  $P_{\text{wanted}}$  in Table 7.6.2A.1.3-0 is set using  $\Delta R_{\text{IBNC}} = 0$  dB for all sub-block gaps (Table 7.3A.0-3). For each downlink the UE shall meet the spurious-response requirements applicable for inter-band carrier aggregation with one component carrier per operating band. The three downlink carriers shall be active throughout the tests.

The normative reference for this requirement is TS 36.101 [2] clause 7.7.1A.

## 7.7A.1 Spurious response for CA (intra-band contiguous DL CA and UL CA)

### 7.7A.1.1 Test Purpose

Spurious response for CA verifies the receiver's ability to receive a wanted aggregated signal on its assigned channel frequency without exceeding a given degradation due to the presence of an unwanted CW interfering signal at any other frequency at which a response is obtained i.e. for which the out of band blocking limit as specified in sub-clause 7.6.2A is not met.

The lack of the spurious response ability decreases the coverage area when other unwanted interfering signal exists at any other frequency.

### 7.7A.1.2 Test Applicability

This test applies to all types of E-UTRA UE release 10 and forward that support intra-band contiguous DL CA and UL CA.

### 7.7A.1.3 Minimum Conformance Requirements

The minimum conformance requirements are defined in clause 7.7A.0.

### 7.7A.1.4 Test Description

#### 7.7A.1.4.1 Initial Conditions

The initial conditions shall be the same as in clause 7.6.2A.1.4.1 in order to test spurious responses obtained in clause 7.6.2A.1 under the same conditions.

#### 7.7A.1.4.2 Test Procedure

1. Configure SCC according to Annex C.0, C.1 and Annex C.3.1 for all downlink physical channels.
2. The SS shall configure SCC as per TS 36.508 [7] clause 5.2A.4. Message contents are defined in clause 7.7A.1.4.3.
3. SS activates SCC by sending the activation MAC-CE (Refer TS 36.321 [13], clauses 5.13, 6.1.3.8). Wait for at least 2 seconds (Refer TS 36.133, clauses 8.3.3.2).
4. SS transmits PDSCH via PDCCH DCI format 1A for C\_RNTI to transmit the DL RMC according to Table 7.6.2A.1.4.1-1 on both PCC and SCC. The SS sends downlink MAC padding bits on the DL RMC.
5. SS sends uplink scheduling information for each UL HARQ process via PDCCH DCI format 0 for C\_RNTI to schedule the UL RMC according to Table 7.6.2A.1.4.1-1 on both PCC and SCC. Since the UE has no payload data to send, the UE sends uplink MAC padding bits on the UL RMC.
6. Set the parameters of the CW signal generator for an interfering signal according to Table 7.7A.1.5-2. The spurious frequencies are taken from records in the final step of test procedures in clause 7.6.2A.1.4.2.
7. Set the downlink signal level according to the table 7.7A.1.5-1 for both carriers. Send uplink power control commands to the UE (less or equal to 1dB step size should be used), to ensure that for at least the duration of the throughput measurement:  
 The PCC output power is within (+0dB, -3.4 dB) of (target level in Table 7.7A.1.5-1 +  $10\log(P_{L_{CRB}}/N_{RB\_alloc})$ ), for carrier frequency  $f \leq 3.0\text{GHz}$ ,  
 or within (+0dB, -4 dB) of (target level in Table 7.7A.1.5-1 +  $10\log(P_{L_{CRB}}/N_{RB\_alloc})$ ) for carrier frequency  $3.0\text{GHz} < f \leq 4.2\text{GHz}$ .  
 The SCC output power is within (+0dB, -3.4 dB) of (target level in Table 7.7A.1.5-1 +  $10\log(S_{L_{CRB}}/N_{RB\_alloc})$ ), for carrier frequency  $f \leq 3.0\text{GHz}$ ,  
 or within (+0dB, -4 dB) of (target level in Table 7.7A.1.5-1 +  $10\log(S_{L_{CRB}}/N_{RB\_alloc})$ ) for carrier frequency  $3.0\text{GHz} < f \leq 4.2\text{GHz}$ .
8. For each spurious frequency, measure the average throughput for each component carrier for duration sufficient to achieve statistical significance according to Annex G.2A.

7.7A.1.4.3 Message Contents

Message contents are according to TS 36.508 [7] subclause 4.6 with the following exception.

**Table 7.7A.1.4.3-1: UplinkPowerControlDedicatedSCell-r10**

Derivation Path: 36.508 clause 4.6.3			
Information Element	Value/remark	Comment	Condition
UplinkPowerControlDedicated-DEFAULT ::= SEQUENCE {			
p0-UE-PUSCH-r10	0		
deltaMCS-Enabled-r10	en0		
accumulationEnabled-r10	TRUE		
pSRS-Offset-r10	7 (0 dB)	The actual parameter value is $-10.5 + 1.5 \cdot \text{pSRS-Offset}$ value; 0 is the actual value in dB ( $-10.5 + 1.5 \cdot 7$ dB).	
pSRS-OffsetAp-r10	7 (0 dB)	The actual parameter value is $-10.5 + 1.5 \cdot \text{pSRS-Offset}$ value; 0 is the actual value in dB ( $-10.5 + 1.5 \cdot 7$ dB).	
filterCoefficient-r10	fc8	larger filter length is used to reduce the RSRP measurement variation	
pathlossReferenceLinking-r10	sCell		
}			

7.7A.1.5 Test Requirement

The throughput measurement of each carrier derived in test procedure shall be  $\geq 95\%$  of the maximum throughput of the reference measurement channels as specified in Annex A.3.2 with parameters specified in Table 7.7A.1.5-1 and 7.7A.1.5-2.

**Table 7.7A.1.5-1: Spurious response parameters**

Rx Parameter	Units	CA Bandwidth Class				
		B	C	D	E	F
Pw in Transmission Bandwidth Configuration, per CC	dBm	REFSENS + CA Bandwidth Class specific value below				
			9			
Note 1: The transmitter shall be set to 4dB below $P_{\text{CMAX\_L}}$ or $P_{\text{CMAX\_L\_CA}}$ as defined in subclause 6.2.5 for one uplink carrier and in subclause 6.2.5A for two uplink carriers.						
Note 2: Reference measurement channel is specified in Annex A.3.2 with one sided dynamic OCNG Pattern OP.1 FDD/TDD as described in Annex A.5.1.1/A.5.2.1.						

**Table 7.7A.1.5-2: Spurious response**

Parameter	Unit	Level
$P_{\text{Interferer}}$ (CW)	dBm	-44
$F_{\text{Interferer}}$	MHz	Spurious response frequencies

For the UE which supports inter band CA configuration in Table 7.3.3-1A,  $P_{\text{Interferer}}$  power defined in Table 7.7A.1.5-2 is increased by the amount given by  $\Delta R_{\text{IB,c}}$  in Table 7.3.3-1A.

## 7.7A.2 Spurious response for CA (intra-band contiguous DL CA without UL CA)

### 7.7A.2.1 Test Purpose

Same test purpose as in clause 7.7A.1.

### 7.7A.2.2 Test Applicability

This test applies to all types of E-UTRA UE release 10 and forward that support intra-band contiguous DL CA. This test case applies only for CA Configurations that do not support UL CA.

### 7.7A.2.3 Minimum Conformance Requirements

The minimum conformance requirements are defined in clause 7.7A.0.

### 7.7A.2.4 Test Description

#### 7.7A.2.4.1 Initial Conditions

The initial conditions shall be the same as in clause 7.6.2A.2.4.1 in order to test spurious responses obtained in clause 7.6.2A.2 under the same conditions.

#### 7.7A.2.4.2 Test Procedure

1. Configure SCC according to Annex C.0, C.1 and Annex C.3.1 for all downlink physical channels.
2. The SS shall configure SCC as per TS 36.508 [7] clause 5.2A.4.
3. SS activates SCC by sending the activation MAC-CE (Refer TS 36.321 [13], clauses 5.13, 6.1.3.8). Wait for at least 2 seconds (Refer TS 36.133, clauses 8.3.3.2).
4. SS transmits PDSCH via PDCCH DCI format 1A for C\_RNTI to transmit the DL RMC according to Table 7.6.2A.2.4.1-1 on both PCC and SCC. The SS sends downlink MAC padding bits on the DL RMC.
5. SS sends uplink scheduling information for each UL HARQ process via PDCCH DCI format 0 for C\_RNTI to schedule the UL RMC according to Table 7.6.2A.2.4.1-1 on PCC. Since the UE has no payload data to send, the UE sends uplink MAC padding bits on the UL RMC.
6. Set the parameters of the CW signal generator for an interfering signal according to Table 7.7A.1.5-2. The spurious frequencies are taken from records in the final step of test procedures in clause 7.6.2A.2.4.2.
7. Set the downlink signal level according to the table 7.7A.1.5-1 for both carriers. Send uplink power control commands to the UE (less or equal to 1dB step size should be used), to ensure that the UE output power is within +0, - 3.4 dB of the target level in table 7.7A.1.5-1 for carrier frequency  $f \leq 3.0\text{GHz}$  or within +0, -4.0 dB of the target level for carrier frequency  $3.0\text{GHz} < f \leq 4.2\text{GHz}$ , for at least the duration of the throughput measurement.
8. For each spurious frequency, measure the average throughput for each component carrier for duration sufficient to achieve statistical significance according to Annex G.2A.

#### 7.7A.2.4.3 Message Contents

Same message contents as in clause 7.7.4.3.

### 7.7A.2.5 Test Requirement

Same test requirement as in clause 7.7A.1.5 with the following exceptions :

- Instead of Table 7.7A.1.5-1 → use Table 7.7A.2.5-1.

**Table 7.7A.2.5-1: Spurious response parameters**

Rx Parameter	Units	CA Bandwidth Class				
		B	C	D	E	F

Pw in Transmission Bandwidth Configuration, per CC	dBm	REFSENS + CA Bandwidth Class specific value below			
		9	9		
Note 1:	The transmitter shall be set to 4dB below $P_{\text{CMAX\_L}}$ or $P_{\text{CMAX\_L\_CA}}$ as defined in subclause 6.2.5.				
Note 2:	Reference measurement channel is specified in Annex A.3.2 with one sided dynamic OCNG Pattern OP.1 FDD/TDD as described in Annex A.5.1.1/A.5.2.1.				

### 7.7A.3 Spurious response for CA (inter-band DL CA without UL CA)

#### 7.7A.3.1 Test Purpose

Same test purpose as in clause 7.7A.1.

#### 7.7A.3.2 Test Applicability

This test applies to all types of E-UTRA UE release 10 and forward that support inter-band DL CA without UL CA.

#### 7.7A.3.3 Minimum Conformance Requirements

The minimum conformance requirements are defined in clause 7.7A.0.

#### 7.7A.3.4 Test Description

##### 7.7A.3.4.1 Initial Conditions

The initial conditions shall be the same as in clause 7.6.2A.3.4.1 in order to test spurious responses obtained in clause 7.6.2A.3 under the same conditions.

##### 7.7A.3.4.2 Test Procedure

1. Configure SCC according to Annex C0, C.1 and Annex C.3.1 for all downlink physical channels.
2. The SS shall configure SCC as per TS 36.508 [7] clause 5.2A.4.
3. SS activates SCC by sending the activation MAC-CE (Refer TS 36.321 [13], clauses 5.13, 6.1.3.8). Wait for at least 2 seconds (Refer TS 36.133, clauses 8.3.3.2).
4. SS transmits PDSCH via PDCCH DCI format 1A for C\_RNTI to transmit the DL RMC according to Table 7.6.2A.3.4.1-1 on both PCC and SCC. The SS sends downlink MAC padding bits on the DL RMC.
5. SS sends uplink scheduling information for each UL HARQ process via PDCCH DCI format 0 for C\_RNTI to schedule the UL RMC according to Table 7.6.2A.3.4.1-1 on PCC. Since the UE has no payload data to send, the UE transmits uplink MAC padding bits on the UL RMC.
6. Set the parameters of the CW signal generator for an interfering signal according to Table 7.7A.3.5-2. The spurious frequencies are taken from records in the step 9 of test procedures in clause 7.6.2A.3.4.2.
7. Set the downlink signal level according to the table 7.7A.3.5-1 for both carriers. Send uplink power control commands to the UE (less or equal to 1dB step size should be used), to ensure that the UE output power is within +0, - 3.4 dB of the target level in table 7.7A.3.5-1 for carrier frequency  $f \leq 3.0\text{GHz}$  or within +0, -4.0 dB of the target level for carrier frequency  $3.0\text{GHz} < f \leq 4.2\text{GHz}$ , for at least the duration of the throughput measurement.
8. For each spurious frequency, measure the average throughput of SCC for duration sufficient to achieve statistical significance according to Annex G.2.

##### 7.7A.3.4.3 Message Contents

Same message contents as in clause 7.7.4.3.

#### 7.7A.3.5 Test Requirement

For inter-band carrier aggregation with uplink assigned to one E-UTRA band the spurious response requirements are defined with the uplink active on the band other than the band whose downlink is being tested i.e. the requirements are tested only for the SCell downlink. The UE shall meet the requirement for each component carrier, when operated as SCell, while both downlink carriers are active.

The throughput measured during the test procedure for each component carrier, when operated as SCell, shall be  $\geq 95\%$  of the maximum throughput of the reference measurement channels as specified in Annexes A.2.2, A.2.3 and A.3.2 (with one sided dynamic OCNG Pattern OP.1 FDD/TDD for the DL-signal as described in Annex A.5.1.1/A.5.2.1) with parameters specified in Tables 7.7A.3.5-1 (originated from the single carrier Table 7.7.5-1) and 7.7A.3.5-2 (originated from Table 7.6.2A.3.5-2).

**Table 7.7A.3.5-1: Spurious response parameters**

Rx Parameter	Units	Channel bandwidth					
		1.4 MHz	3 MHz	5 MHz	10 MHz	15 MHz	20 MHz
P <sub>w</sub> in Transmission Bandwidth Configuration, per CC	dBm	REFSENS + channel bandwidth specific value below					
		6	6	6	6	7	9
Note 1: The transmitter shall be set to 4dB below P <sub>C<sub>MAX</sub>L</sub> with P <sub>C<sub>MAX</sub>L</sub> as defined in clause 6.2.5.							
Note 2: The reference measurement channel is specified in Annex A.3.2 with one sided dynamic OCNG Pattern OP.1 FDD/TDD as described in Annex A.5.1.1/A.5.2.1.							

**Table 7.7A.3.5-2: Spurious Response**

Parameter	Unit	Level
P <sub>Interferer</sub> (CW)	dBm	-44
F <sub>Interferer</sub>	MHz	Spurious response frequencies

For the UE which supports inter band CA configuration in Table 7.3.3-1A, P<sub>uw</sub> power defined in Table 7.7A.3.5-2 is increased by the amount given by  $\Delta R_{IB,c}$  in Table 7.3.3-1A.

## 7.7A.4 Spurious response for CA (intra-band non-contiguous DL CA without UL CA)

### 7.7A.4.1 Test Purpose

Same test purpose as in clause 7.7A.1.

### 7.7A.4.2 Test Applicability

This test applies to all types of E-UTRA UE release 11 and forward that support intra-band non-contiguous DL CA without UL CA.

### 7.7A.4.3 Minimum Conformance Requirements

The minimum conformance requirements are defined in clause 7.7A.0.

### 7.7A.4.4 Test Description

#### 7.7A.4.4.1 Initial Conditions

The initial conditions shall be the same as in clause 7.6.2A.4.4.1 in order to test spurious responses obtained in clause 7.6.2A.4 under the same conditions.

#### 7.7A.4.4.2 Test Procedure

1. Configure SCC according to Annex C0, C.1 and Annex C.3.1 for all downlink physical channels.
2. The SS shall configure SCC as per TS 36.508 [7] clause 5.2A.4. Message contents are defined in clause 7.7A.4.4.3.
3. SS activates SCC by sending the activation MAC-CE (Refer TS 36.321 [13], clauses 5.13, 6.1.3.8). Wait for at least 2 seconds (Refer TS 36.133, clauses 8.3.3.2).



4. SS transmits PDSCH via PDCCH DCI format 1A for C\_RNTI to transmit the DL RMC according to Table 7.6.2A.4.4.1-1 on both PCC and SCC. The SS sends downlink MAC padding bits on the DL RMC.
5. SS sends uplink scheduling information for each UL HARQ process via PDCCH DCI format 0 for C\_RNTI to schedule the UL RMC according to Table 7.6.2A.4.4.1-1 on PCC. Since the UE has no payload data to send, the UE transmits uplink MAC padding bits on the UL RMC.
6. Set the parameters of the CW signal generator for an interfering signal below or above the wanted aggregated signal according to Table 7.7A.4.5-2. The spurious frequencies are taken from records in the step 9 of test procedures in clause 7.6.2A.4.4.2.
7. Set the downlink signal level according to the table 7.7A.4.5-1 for both carriers. Send uplink power control commands to the UE (less or equal to 1dB step size should be used), to ensure that the UE output power is within +0, - 3.4 dB of the target level in table 7.7A.4.5-1 for carrier frequency  $f \leq 3.0\text{GHz}$  or within +0, -4.0 dB of the target level for carrier frequency  $3.0\text{GHz} < f \leq 4.2\text{GHz}$ , for at least the duration of the throughput measurement.
8. For each spurious frequency, measure the average throughput of each component carrier for duration sufficient to achieve statistical significance according to Annex G.2A.

### 7.7A.4.4.3 Message Contents

Message contents are according to TS 36.508 [7] subclause 4.6.

### 7.7A.4.5 Test Requirement

For intra-band non-contiguous carrier aggregation with one uplink carrier and two downlink carriers, the spurious response requirements are defined with the uplink configuration of the PCC being in accordance with Table 7.3A.0-3. The UE shall meet the requirements specified in tables 7.7A.4.5-1 and 7.7A.4.5-2 for each component carrier while both downlink carriers are active.

The requirements for each component carrier are the same as single carrier requirements in Tables 7.7.5-1 and 7.7.5-2.

**Table 7.7A.4.5-1: Spurious response parameters**

Rx Parameter	Units	Channel bandwidth					
		1.4 MHz	3 MHz	5 MHz	10 MHz	15 MHz	20 MHz
P <sub>w</sub> in Transmission Bandwidth Configuration, per CC	dBm	REFSENS + channel bandwidth specific value below					
		6	6	6	6	7	9
Note 1: The transmitter shall be set to 4dB below P <sub>C<sub>MAX,L</sub></sub> with P <sub>C<sub>MAX,L</sub></sub> as defined in clause 6.2.5.							
Note 2: The reference measurement channel is specified in Annex A.3.2 with one sided dynamic OCNG Pattern OP.1 FDD/TDD as described in Annex A.5.1.1/A.5.2.1.							

**Table 7.7A.4.5-2: Spurious Response**

Parameter	Unit	Level
P <sub>Interferer (CW)</sub>	dBm	-44
F <sub>Interferer</sub>	MHz	Spurious response frequencies

For the UE which supports inter band CA configuration in Table 7.3.3-1A, P<sub>uw</sub> power defined in Table 7.7A.4.5-2 is increased by the amount given by ΔR<sub>IB,c</sub> in Table 7.3.3-1A.

## 7.7A.5 Spurious response for CA (3DL CA without UL CA)

### 7.7A.5.1 Test Purpose

Same test purpose as in clause 7.7A.1.

### 7.7A.5.2 Test Applicability

This test case applies to all types of E-UTRA UE release 10 and forward that support 3DL Intra-band contiguous CA or 3DL Inter-band CA or 3DL Intra-band contiguous + Inter-band CA.

This test case also applies to all types of E-UTRA UE release 11 and forward that support 3DL Intra-band non-contiguous CA + Inter-band CA or 3DL Intra-band non-contiguous + Intra-band contiguous CA.

This test case also applies to all types of E-UTRA UE release 12 and forward that support 3DL CA with FDD-TDD CA.

### 7.7A.5.3 Minimum Conformance Requirements

The minimum conformance requirements are defined in clause 7.7A.0.

### 7.7A.5.4 Test Description

#### 7.7A.5.4.1 Initial Conditions

The initial conditions shall be the same as in clause 7.6.2A.5.4.1 in order to test spurious responses obtained in clause 7.6.2A.5 under the same conditions.

#### 7.7A.5.4.2 Test Procedure

1. Configure SCCs according to Annex C.0, C.1 and Annex C.3.1 for all downlink physical channels except PHICH.
2. The SS shall configure SCCs as per TS 36.508 [7] clause 5.2A.4. Message contents are defined in clause 7.7A.5.4.3
3. SS activates SCCs by sending the activation MAC-CE (Refer TS 36.321 [13], clauses 5.13, 6.1.3.8). Wait for at least 2 seconds (Refer TS 36.133, clauses 8.3.3.2).
4. SS transmits PDSCH via PDCCH DCI format 1A for C\_RNTI to transmit the DL RMC according to Table 7.6.2A.5.4.1-1 through Table 7.6.2A.5.4.1-5 as appropriate on PCC and SCCs. The SS sends downlink MAC padding bits on the DL RMC.
5. SS sends uplink scheduling information for each UL HARQ process via PDCCH DCI format 0 for C\_RNTI to schedule the UL RMC according to Table 7.6.2A.5.4.1-1 through Table 7.6.2A.5.4.1-5 on PCC. Since the UE has no payload data to send, the UE sends uplink MAC padding bits on the UL RMC.
6. Set the parameters of the CW signal generator for an interfering signal according to Table 7.7A. 5.5. 25-. The spurious frequencies are taken from records in the final step of test procedures in clause 7.6.2A.5.4.2.
7. Set the downlink signal level according to the tables 7.7A.5.5-1 and 7.7A.5.5-3 for all carriers accordingly. Send uplink power control commands to the UE (less or equal to 1dB step size should be used), to ensure that the UE output power is within +0, - 3.4 dB of the target level in corresponding tables 7.7A.5. 5-1 and 7.7A.5.5-3 for carrier frequency  $f \leq 3.0\text{GHz}$  or within +0, -4.0 dB of the target level for carrier frequency  $3.0\text{GHz} < f \leq 4.2\text{GHz}$ , for at least the duration of the throughput measurement.
8. For each spurious frequency, measure the average throughput for each component carrier for duration sufficient to achieve statistical significance according to Annex G.2A.

#### 7.7A.5.4.3 Message Contents

Same message contents as in clause 7.7.4.3.

### 7.7A.5.5 Test Requirement

The throughput measurement of each carrier derived in test procedure shall be  $\geq 95\%$  of the maximum throughput of the reference measurement channels as specified in Annex A.3.2 with parameters specified in Tables below, according to the type of CA.

**Table 7.7A.5.5-1: Spurious response parameters (Intra-band contiguous)**

Rx Parameter	Units	CA Bandwidth Class				
		B	C	D	E	F
Power per CC in Aggregated Transmission Bandwidth Configuration	dBm	REFSENS + CA Bandwidth Class specific value below				
		9	9	9		
Note 1: The transmitter shall be set to 4dB below $P_{\text{CMAX\_L}}$ or $P_{\text{CMAX\_L\_CA}}$ as defined in subclause 6.2.5.						
Note 2: Reference measurement channel is specified in Annex A.3.2 with one sided dynamic OCNG Pattern OP.1 FDD/TDD as described in Annex A.5.1.1/A.5.2.1.						

**Table 7.7A.5.52: Spurious response (All types of CA)**

Parameter	Unit	Level
$P_{\text{Interferer (CW)}}$	dBm	-44
$F_{\text{Interferer}}$	MHz	Spurious response frequencies

**Table 7.7A.5.5-3: Spurious response parameters (Inter-band, Intra-band non-contiguous)**

Rx Parameter	Units	Channel bandwidth					
		1.4 MHz	3 MHz	5 MHz	10 MHz	15 MHz	20 MHz
Power in Transmission Bandwidth Configuration for each CC	dBm	REFSENS + channel bandwidth specific value below					
		6	6	6	6	7	9
Note 1: The transmitter shall be set to 4dB below $P_{\text{CMAX\_L}}$ with $P_{\text{CMAX\_L}}$ as defined in clause 6.2.5.							
Note 2: The reference measurement channel is specified in Annex A.3.2 with one sided dynamic OCNG Pattern OP.1 FDD/TDD as described in Annex A.5.1.1/A.5.2.1.							
Note 3: For intra-band non-contiguous + inter-band CA, $\Delta R_{\text{IBNC}} = 0$ dB for all sub-block gaps.							

For a UE, which supports CA configuration in Table 7.3.3-1A or 7.3.3-1B,  $P_{\text{uw}}$  power defined in Table 7.7A.5.5-2 is increased by the amount given by  $\Delta R_{\text{IB,c}}$  in Table 7.3.3-1A or 7.3.3-1B accordingly.

## 7.7B Spurious response for UL-MIMO

### 7.7B.1 Test Purpose

Spurious response verifies the ability of the UE that support UL-MIMO to receive a wanted signal on its assigned channel frequency without exceeding a given degradation due to the presence of an unwanted CW interfering signal at any other frequency at which a response is obtained i.e. for which the out of band blocking limit as specified in sub-clause 7.6B.2 is not met.

The lack of the spurious response ability decreases the coverage area when other unwanted interfering signal exists at any other frequency.

### 7.7B.2 Test Applicability

This test applies to all types of E-UTRA UE release 10 and forward that support UL-MIMO.

### 7.7B.3 Minimum Conformance Requirements

For UE with two transmitter antenna connectors in closed-loop spatial multiplexing scheme, the minimum requirements in Clause 7.7.3 shall be met with the UL-MIMO configurations specified in Table 6.2.2B.3-2. For UL-MIMO, the parameter  $P_{\text{CMAX\_L}}$  is defined as the total transmitter power over the two transmit antenna connectors.

The normative reference for this requirement is TS 36.101 [2] clause 7.7.1B.

## 7.7B.4 Test Description

### 7.7B.4.1 Initial Conditions

The initial conditions shall be the same as in clause 7.6B.2.4.1 in order to test spurious responses obtained in clause 7.6B.2 under the same conditions.

### 7.7B.4.2 Test Procedure

1. SS transmits PDSCH via PDCCH DCI format 1A for C\_RNTI to transmit the DL RMC according to Table 7.6.2B.4.1-1. The SS sends downlink MAC padding bits on the DL RMC.
2. SS sends uplink scheduling information for each UL HARQ process via PDCCH DCI format 4 for C\_RNTI to schedule the UL RMC according to Table 7.6B.2.4.1-1. Since the UE has no payload data to send, the UE transmits uplink MAC padding bits on the UL RMC.
3. Set the parameters of the CW signal generator for an interfering signal according to Table 7.7B.5-2. The spurious frequencies are taken from records in the final step of test procedures in clause 7.6B.2.4.2.
4. Set the downlink signal level according to the table 7.7B.5-1. Send uplink power control commands to the UE (less or equal to 1dB step size should be used), to ensure that the UE output power is within +0, - 3.4 dB of the target level in table 7.7B.5-1 for carrier frequency  $f \leq 3.0\text{GHz}$  or within +0, -4.0 dB of the target level for carrier frequency  $3.0\text{GHz} < f \leq 4.2\text{GHz}$ , for at least the duration of the throughput measurement.
5. For the spurious frequency, measure the average throughput for a duration sufficient to achieve statistical significance according to Annex G.2.

### 7.7B.4.3 Message Contents

Message contents are according to TS 36.508 [7] clause 4.6 with the following exception.

**Table 7.7B.4.3-1: UplinkPowerControlDedicated**

Derivation Path: 36.331 clause 6.3.2			
Information Element	Value/remark	Comment	Condition
UplinkPowerControlDedicated-DEFAULT ::= SEQUENCE {			
p0-UePUSCH	0		
deltaMCS-Enabled	en0		
accumulationEnabled	TRUE		
p0-uePUCCH	0		
pSRS-Offset	3 (-6 dB)		
filterCoefficient	fc8	larger filter length is used to reduce the RSRP measurement variation	
}			

## 7.7B.5 Test Requirement

The throughput measurement derived in test procedure shall be  $\geq 95\%$  of the maximum throughput of the reference measurement channels as specified in Annex A.3.2 with parameters specified in Tables 7.7B.5-1 and 7.7B.5-2.

**Table 7.7B.5-1: Spurious response parameters**

Rx Parameter	Units	Channel bandwidth					
		1.4 MHz	3 MHz	5 MHz	10 MHz	15 MHz	20 MHz
Power in Transmission Bandwidth Configuration	dBm	REFSENS + channel bandwidth specific value below					
		6	6	6	6	7	9

Note 1: The transmitter shall be set to 4dB below  $P_{CMAX\_L}$  with  $P_{CMAX\_L}$  as defined in clause 6.2.5.  
 Note 2: The reference measurement channel is specified in Annex A.3.2 with one sided dynamic OCNB Pattern OP.1 FDD/TDD as described in Annex A.5.1.1/A.5.2.1.

**Table 7.7B.5-2: Spurious Response**

Parameter	Unit	Level
$P_{Interferer}$ (CW)	dBm	-44
$F_{Interferer}$	MHz	Spurious response frequencies

For the UE which supports inter band CA configuration in Table 7.3.3-1A,  $P_{uw}$  power defined in Table 7.7B.5-2 is increased by the amount given by  $\Delta R_{IB,c}$  in Table 7.3.3-1A.

## 7.7E Spurious response for UE category 0

*Editor's note: Following aspects missing or not yet determined:*

- *Test tolerance for this case in Annex F is not completed*

### 7.7E.1 Test Purpose

Same test purpose as in clause 7.7.1.

### 7.7E.2 Test Applicability

This test applies to all types of E-UTRA UE release 12 and forward of UE category 0.

### 7.7E.3 Minimum Conformance Requirements

Same minimum conformance requirements as in clause 7.7.3.

### 7.7E.4 Test Description

#### 7.7E.4.1 Initial Conditions

The initial conditions shall be the same as in clause 7.6.2E.4.1 in order to test spurious responses obtained in clause 7.6.2E under the same conditions.

#### 7.7E.4.2 Test Procedure

Same test procedure as in clause 7.7.4.2

#### 7.7E.4.3 Message Contents

Same message contents as in clause 7.7.4.3

### 7.7E.5 Test Requirement

The throughput measurement derived in test procedure shall be  $\geq 95\%$  of the maximum throughput of the reference measurement channels as specified in Annex A.3.2 with parameters specified in Tables 7.7E.5-1 and 7.7E.5-2.

**Table 7.7E.5-1: Spurious response parameters**

Rx Parameter	Units	Channel bandwidth					
		1.4 MHz	3 MHz	5 MHz	10 MHz	15 MHz	20 MHz
Power in Transmission Bandwidth Configuration	dBm	REFSENS + channel bandwidth specific value below					
		6	6	6	6	7	9

Note 1:	The transmitter shall be set to 4dB below $P_{\text{CMAX\_L}}$ with $P_{\text{CMAX\_L}}$ as defined in clause 6.2.5.
Note 2:	The reference measurement channel is specified in Annex A.3.2 with one sided dynamic OCNG Pattern OP.1 FDD/TDD as described in Annex A.5.1.1/A.5.2.1.

**Table 7.7E.5-2: Spurious Response**

Parameter	Unit	Level
$P_{\text{Interferer}}$ (CW)	dBm	-44
$F_{\text{Interferer}}$	MHz	Spurious response frequencies

## 7.8 Intermodulation characteristics

### 7.8.1 Wide band Intermodulation

#### 7.8.1.1 Test purpose

Intermodulation response tests the UE's ability to receive data with a given average throughput for a specified reference measurement channel, in the presence of two or more interfering signals which have a specific frequency relationship to the wanted signal, under conditions of ideal propagation and no added noise.

A UE unable to meet the throughput requirement under these conditions will decrease the coverage area when two or more interfering signals exist which have a specific frequency relationship to the wanted signal.

#### 7.8.1.2 Test applicability

This test applies to all types of E-UTRA UE release 8 and forward.

#### 7.8.1.3 Minimum conformance requirements

Intermodulation response rejection is a measure of the capability of the receiver to receive a wanted signal on its assigned channel frequency in the presence of two or more interfering signals which have a specific frequency relationship to the wanted signal.

The throughput shall be  $\geq 95\%$  of the maximum throughput of the reference measurement channels as specified in Annexes A.2.2, A.2.3 and A.3.2 (with one sided dynamic OCNG Pattern OP.1 FDD/TDD for the DL-signal as described in Annex A.5.1.1/A.5.2.1) with parameters specified in Table 7.8.1.3-1 for the specified wanted signal mean power in the presence of two interfering signals.

**Table 7.8.1.3-1: Wide band intermodulation**

Rx Parameter	Units	Channel bandwidth					
		1.4 MHz	3 MHz	5 MHz	10 MHz	15 MHz	20 MHz
Power in Transmission Bandwidth Configuration	dBm	REFSENS + channel bandwidth specific value below					
		12	8	6	6	7	9

$P_{\text{Interferer 1}}$ (CW)	dBm	-46		
$P_{\text{Interferer 2}}$ (Modulated)	dBm	-46		
$BW_{\text{Interferer 2}}$		1.4	3	5
$F_{\text{Interferer 1}}$ (Offset)	MHz	$-BW/2 - 2.1$ / $+BW/2 + 2.1$	$-BW/2 - 4.5$ / $+BW/2 + 4.5$	$-BW/2 - 7.5$ / $+BW/2 + 7.5$
$F_{\text{Interferer 2}}$ (Offset)	MHz	$2 * F_{\text{Interferer 1}}$		
Note 1:	The transmitter shall be set to 4dB below $P_{\text{CMAX\_L}}$ at the minimum uplink configuration specified in Table 7.3.3-2 with $P_{\text{CMAX\_L}}$ as defined in clause 6.2.5.			
Note 2:	The reference measurement channel is specified in Annex A.3.2 with one sided dynamic OCNG Pattern OP.1 FDD/TDD as described in Annex A.5.1.1/A.5.2.1.			
Note 3:	The modulated interferer consists of the Reference measurement channel specified in Annex A.3.2 with one sided dynamic OCNG Pattern OP.1 FDD/TDD as described in Annex A.5.1.1/A.5.2.1 with set-up according to Annex C.3.1. The interfering modulated signal is 5MHz E-UTRA signal as described in Annex D for channel bandwidth $\geq 5\text{MHz}$			

For the UE which supports inter band CA configuration in Table 7.3.1A-2,  $P_{\text{interferer1}}$  and  $P_{\text{interferer2}}$  powers defined in Table 7.8.1.1-1 are increased by the amount given by  $\Delta R_{\text{IB}}$  in Table 7.3.1A-2.

The normative reference for this requirement is TS 36.101 [2] clause 7.8.1 and TS 36.101 [2] Annexes A and D.

[FFS: Although it is not explicitly stated in TS 36.101 [2] whether the modulated interferer defined in 36.101 Annex D applies to wanted channel bandwidths of less than 5MHz, this test specification has assumed that the modulated interferer definition applies to all channel bandwidths. The content of TS 36.101 [2] Annex D.2 has been copied into Annex FFS of the present document]

## 7.8.1.4 Test description

### 7.8.1.4.1 Initial condition

Initial conditions are a set of test configurations the UE needs to be tested in and the steps for the SS to take with the UE to reach the correct measurement state.

The initial test configurations consist of environmental conditions, test frequencies, and channel bandwidths based on E-UTRA bands specified in table 5.4.2.1-1. All of these configurations shall be tested with applicable test parameters for each channel bandwidth, and are shown in table 7.8.1.4.1-1. The details of the uplink and downlink reference measurement channels (RMCs) are specified in Annexes A.2 and A.3 respectively. The details of the OCNG patterns used are specified in Annex A.5. Configurations of PDSCH and PDCCH before measurement are specified in Annex C.2.

Table 7.8.1.4.1-1: Test Configuration Table

Initial Conditions						
Test Environment as specified in TS 36.508[7] subclause 4.1				NC		
Test Frequencies as specified in TS36.508 [7] subclause 4.3.1				Mid range		
Test Channel Bandwidths as specified in TS 36.508 [7] subclause 4.3.1				Lowest, 5MHz, Highest		
Test Parameters for Channel Bandwidths						
Ch BW	Downlink Configuration			Uplink Configuration		
	Mod'n	RB allocation		Mod'n	RB allocation	
		FDD	TDD		FDD	TDD
1.4MHz	QPSK	6	6	QPSK	6	6
3MHz	QPSK	15	15	QPSK	15	15
5MHz	QPSK	25	25	QPSK	25	25
5MHz	QPSK	25	N/A	QPSK	20	N/A
5MHz	QPSK	25	N/A	QPSK	15	N/A
5MHz	QPSK	25	N/A	QPSK	5 <sup>+</sup>	N/A
10MHz	QPSK	50	50	QPSK	50	50
10MHz	QPSK	50	N/A	QPSK	25	N/A
10MHz	QPSK	50	N/A	QPSK	20	N/A
10MHz	QPSK	50	N/A	QPSK	15	N/A
15MHz	QPSK	75	75	QPSK	75	75
15MHz	QPSK	75	N/A	QPSK	50	N/A
15MHz	QPSK	75	N/A	QPSK	25	N/A
15MHz	QPSK	75	N/A	QPSK	20	N/A
20MHz	QPSK	100	100	QPSK	100	100
20MHz	QPSK	100	N/A	QPSK	75	N/A
20MHz	QPSK	100	N/A	QPSK	50	N/A
20MHz	QPSK	100	N/A	QPSK	25	N/A
20MHz	QPSK	100	N/A	QPSK	20	N/A
Note 1:	Test Channel Bandwidths are checked separately for each E-UTRA band, which applicable channel bandwidths are specified in Table 5.4.2.1-1.					
Note 2:	Depending on E-UTRA band, only the appropriate Uplink RB allocation value according to table 7.3.3-2 is tested per Test Channel Bandwidth. The allocation shall be located as close as possible to the downlink operating band but confined within the transmission bandwidth configuration for the channel bandwidth (Table 5.4.2-1).					
Note 3:	For the DL signal one sided dynamic OCN Pattern OP.1 FDD/TDD is used.					
Note 4:	Applicable only to E-UTRA FDD Band 31. The UL resource blocks shall be located at RBstart 10 (according to Table 7.3.3-2).					

1. Connect the SS and interfering sources to the UE antenna connectors as shown in TS 36.508 [7] Figure A.6.
2. The parameter settings for the cell are set up according to TS 36.508 [7] subclause 4.4.3.
3. Downlink signals are initially set up according to Annex C.0, C.1 and C.3.1, and uplink signals according to Annex H.1 and H.3.1.
4. The UL and DL Reference Measurement channels are set according to Table 7.8.1.4.1-1.
5. Propagation conditions are set according to Annex B.0.
6. Ensure the UE is in State 3A-RF according to TS 36.508 [7] clause 5.2A.2. Message contents are defined in clause 7.8.1.4.3.

#### 7.8.1.4.2 Test procedure

1. SS transmits PDSCH via PDCCH DCI format 1A for C\_RNTI to transmit the DL RMC according to Table 7.8.1.4.1-1. The SS sends downlink MAC padding bits on the DL RMC.
2. SS sends uplink scheduling information for each UL HARQ process via PDCCH DCI format 0 for C\_RNTI to schedule the UL RMC according to Table 7.8.1.4.1-1. Since the UE has no payload data to send, the UE transmits uplink MAC padding bits on the UL RMC.



3. Set the Downlink signal level to the value as defined in Table 7.8.1.5-1. Send Uplink power control commands to the UE (less or equal to 1dB step size should be used), to ensure that the UE output power is within +0, - 3.4 dB of the target level in Table 7.8.1.5-1 for carrier frequency  $f \leq 3.0\text{GHz}$  or within +0, -4.0 dB of the target level for carrier frequency  $3.0\text{GHz} < f \leq 4.2\text{GHz}$ , for at least the duration of the Throughput measurement.
4. Set the Interfering signal levels to the values as defined in Table 7.8.1.5-1 and frequency below the wanted signal, using a modulated interferer bandwidth as defined in Annex D of the present document.
5. Measure the average throughput for a duration sufficient to achieve statistical significance according to Annex G.2.
6. Repeat steps from 3 to 5, using an interfering signal above the wanted signal at step 4.

7.8.1.4.3 Message contents

Message contents are according to TS 36.508 [7] subclause 4.6 with the following exception.

**Table 7.8.1.4.3-1: UplinkPowerControlDedicated**

Derivation Path: 36.331 clause 6.3.2			
Information Element	Value/remark	Comment	Condition
UplinkPowerControlDedicated-DEFAULT ::= SEQUENCE {			
p0-UePUSCH	0		
deltaMCS-Enabled	en0		
accumulationEnabled	TRUE		
p0-uePUCCH	0		
pSRS-Offset	3 (-6 dB)		
filterCoefficient	fc8	larger filter length is used to reduce the RSRP measurement variation	
}			

7.8.1.5 Test requirements

The throughput shall be  $\geq 95\%$  of the maximum throughput of the reference measurement channels as specified in Annex A.3.2 with parameters specified in Table 7.8.1.5-1 for the specified wanted signal mean power in the presence of two interfering signals.

**Table 7.8.1.5-1: Test parameters for Wide band intermodulation**

Rx Parameter	Units	Channel bandwidth					
		1.4 MHz	3 MHz	5 MHz	10 MHz	15 MHz	20 MHz
Power in Transmission Bandwidth Configuration	dBm	REFSENS + channel bandwidth specific value below					
		12	8	6	6	7	9

$P_{\text{Interferer 1}}$ (CW)	dBm	-46		
$P_{\text{Interferer 2}}$ (Modulated)	dBm	-46		
$BW_{\text{Interferer 2}}$		1.4	3	5
$F_{\text{Interferer 1}}$ (Offset)	MHz	-BW/2 -2.1 / +BW/2+ 2.1	-BW/2 -4.5 / +BW/2 + 4.5	-BW/2 - 7.5 / +BW/2 + 7.5
$F_{\text{Interferer 2}}$ (Offset)	MHz	$2 \cdot F_{\text{Interferer 1}}$		
Note 1:	The transmitter shall be set to 4dB below $P_{\text{C}_{\text{MAX\_L}}}$ with $P_{\text{C}_{\text{MAX\_L}}}$ as defined in clause 6.2.5.			
Note 2:	The reference measurement channel is specified in Annex A.3.2 with one sided dynamic OCNG Pattern OP.1 FDD/TDD as described in Annex A.5.1.1/A.5.2.1.			
Note 3:	The modulated interferer consists of the Reference measurement channel specified in Annex A.3.2 with one sided dynamic OCNG Pattern OP.1 FDD/TDD as described in Annex A.5.1.1/A.5.2.1 and set-up according to Annex C.3.1. The interfering modulated signal is 5MHz E-UTRA signal as described in Annex D for channel bandwidth $\geq 5\text{MHz}$			
Note 4:	For the UE which supports inter band CA configuration in Table 7.3A.3-0, $P_{\text{Interferer1}}$ and $P_{\text{Interferer2}}$ powers are increased by the amount given by $\Delta R_{\text{IB}}$ in Table 7.3A.3-0			

## 7.8.1A Wide band Intermodulation for CA

### 7.8.1A.0 Minimum conformance requirements

For inter-band carrier aggregation with one component carrier per operating band and the uplink assigned to one E-UTRA band the wide band intermodulation requirements are defined with the uplink active on the band(s) other than the band whose downlink is being tested. The UE shall meet the requirements specified in subclause 7.8.1.3 for each component carrier while all downlink carriers are active. For E-UTRA CA configurations including an operating band without uplink band (as noted in Table 5.2-1), the requirements for all downlinks shall be met with the single uplink carrier active in each band capable of UL operation. For E-UTRA CA configurations listed in Table 7.3A.0-1 under conditions for which reference sensitivity for the operating band being tested is N/A, the wideband intermodulation requirements of subclause 7.8.1A.0 do not apply.

For intra-band contiguous carrier aggregation the downlink SCC(s) shall be configured at nominal channel spacing to the PCC. For FDD, the PCC shall be configured closest to the uplink band. All downlink carriers shall be active throughout the test. The uplink output power shall be set as specified in Table 7.8.1A.0-1 with the uplink configuration set according to Table 7.3A.0-1 for the applicable carrier aggregation configuration. For UE(s) supporting one uplink carrier, the uplink configuration of the PCC shall be in accordance with Table 7.3.3-2. The UE shall fulfil the minimum requirement in presence of an interfering signal specified in Table 7.8.1A.0-1 being on either side of the aggregated signal. The throughput of each carrier shall be  $\geq 95\%$  of the maximum throughput of the reference measurement channels as specified in Annexes A.2.2, A.2.3 and A.3.2 (with one sided dynamic OCNG Pattern OP.1 FDD/TDD for the DL-signal as described in Annex A.5.1.1/A.5.2.1) with parameters specified in Table 7.8.1A.0-1

**Table 7.8.1A.0-1: Wide band intermodulation**

Rx parameter	Units	CA Bandwidth Class				
		B	C	D	E	F
Pw in Transmission Bandwidth Configuration, per CC	dBm	REFSENS + CA Bandwidth Class specific value below				
		9	12	13.8		

$P_{\text{Interferer 1}}$ (CW)	dBm	-46				
$P_{\text{Interferer 2}}$ (Modulated)	dBm	-46				
$BW_{\text{Interferer 2}}$	MHz	5	5	5		
$F_{\text{Interferer 1}}$ (Offset)	MHz	$-F_{\text{offset}}-7.5$ / $+ F_{\text{offset}}+7.5$	$-F_{\text{offset}}-7.5$ / $+ F_{\text{offset}}+7.5$	$-F_{\text{offset}}-7.5$ / $+ F_{\text{offset}}+7.5$		
$F_{\text{Interferer 2}}$ (Offset)	MHz	$2 \cdot F_{\text{Interferer 1}}$				
Note 1:	The transmitter shall be set to 4dB below $P_{\text{CMAX\_L}}$ or $P_{\text{CMAX\_L\_CA}}$ as defined in subclause 6.2.5A.					
Note 2:	Reference measurement channel is specified in Annex A.3.2 with one sided dynamic OCNG Pattern OP.1 FDD/TDD as described in Annex A.5.1.1/A.5.2.1.					
Note 3:	The modulated interferer consists of the Reference measurement channel specified in Annex A.3.2 with one sided dynamic OCNG Pattern OP.1 FDD/TDD as described in Annex A.5.1.1/A.5.2.1 with set-up according to Annex C.3.1.					
Note 4:	The interfering modulated signal is 5MHz E-UTRA signal as described in Annex D for channel bandwidth $\geq 5$ MHz					
Note 5:	The $F_{\text{interferer 1}}$ (offset) is the frequency separation of the centre frequency of the carrier closest to the interferer and the centre frequency of the CW interferer and $F_{\text{interferer 2}}$ (offset) is the frequency separation of the centre frequency of the carrier closest to the interferer and the centre frequency of the modulated interferer.					

For intra-band non-contiguous carrier aggregation with one uplink carrier and two downlink sub-blocks, the wide band intermodulation requirements are defined with the uplink configuration in accordance with Table 7.3.1A-3. For this uplink configuration, the UE shall meet the requirements for each sub-block as specified in subclause 7.8.1.1 and 7.8.1A.0 for a component carrier and intra-band contiguous component carriers per sub-block, respectively. The requirements apply for out-of-gap interferers while all downlink carriers are active.

For combinations of intra-band contiguous and inter-band carrier aggregation with three downlink carriers and one uplink carrier assigned to one E-UTRA band, the requirement is defined with the uplink active in the band other than that supporting the downlink(s) under test and a configuration in accordance with Table 7.3.3-2. The downlink PCC carrier centre frequency shall be configured closer to the uplink operating band than the downlink SCC centre frequency when the uplink is active in the band supporting two component carriers. For E-UTRA CA configurations including an operating band without uplink band, the requirements for all downlinks shall be met with the single uplink carrier active in each band capable of UL operation. For these uplink configurations, the UE shall meet the wide-band intermodulation requirements for intra-band contiguous carrier aggregation of two downlink carriers and for the remaining component carrier the requirements specified in subclause 7.8.1. The three downlink carriers shall be active throughout the tests.

For combinations of intra-band non-contiguous and inter-band carrier aggregation with three downlink carriers and one uplink carrier assigned to one E-UTRA band, the requirement is defined with the uplink active in the band other than that supporting the downlink(s) under test. The uplink configuration shall be in accordance with Table 7.3A.0-3 when the uplink is active in the band supporting two component carriers and in accordance with Table 7.3.3-2 when the uplink is active in the other band. For E-UTRA CA configurations including an operating band without uplink band, the requirements for all downlinks shall be met with the single uplink carrier active in each band capable of UL operation. For these uplink configurations, the UE shall meet the wide-band intermodulation requirements for intra-band non-contiguous carrier aggregation of two downlink carriers with  $\Delta R_{\text{IBNC}} = 0$  dB for all sub-block gaps (Table 7.3A.0-3) and for the remaining component carrier the requirements specified in subclause 7.8.1. The three downlink carriers shall be active throughout the tests.

The normative reference for this requirement is TS 36.101 [2] clause 7.8.1A and TS 36.101 [2] Annexes A and D.

## 7.8.1A.1 Wideband intermodulation for CA (intra-band contiguous DL CA and UL CA)

### 7.8.1A.1.1 Test purpose

Intermodulation response tests the UE's ability to receive data with a given average throughput for a specified reference measurement channel, in the presence of two or more interfering signals which have a specific frequency relationship to the wanted signal, under conditions of ideal propagation and no added noise.

A UE unable to meet the throughput requirement under these conditions will decrease the coverage area when two or more interfering signals exist which have a specific frequency relationship to the wanted signal.

### 7.8.1A.1.2 Test applicability

This test applies to all types of E-UTRA UE release 10 and forward that supports intra-band contiguous DL CA and UL CA.

### 7.8.1A.1.3 Minimum conformance requirements

Minimum conformance requirements are specified in clause 7.8.1A.0.

### 7.8.1A.1.4 Test description

#### 7.8.1A.1.4.1 Initial condition

Initial conditions are a set of test configurations the UE needs to be tested in and the steps for the SS to take with the UE to reach the correct measurement state.

The initial test configurations consist of environmental conditions, test frequencies, and channel bandwidths based on E-UTRA bands specified in table 5.4.2.1-1. All of these configurations shall be tested with applicable test parameters for each channel bandwidth, and are shown in table 7.8.1A.1.4.1-1. The details of the uplink and downlink reference measurement channels (RMCs) are specified in Annexes A.2 and A.3 respectively. The details of the OCNG patterns used are specified in Annex A.5. Configurations of PDSCH and PDCCH before measurement are specified in Annex C.2.

**Table 7.8.1A.1.4.1-1: Test Configuration Table**

Initial Conditions									
Test Environment as specified in TS 36.508[7] subclause 4.1					NC				
Test Frequencies as specified in TS36.508 [7] subclause 4.3.1 for different CA bandwidth classes, and PCC and SCCs are mapped onto physical frequencies according to Table 7.1-2					C: Mid range				
Test CC Combination setting ( $N_{RB\_agg}$ ) as specified in subclause 5.4.2A.1 for the CA Configuration across bandwidth combination sets supported by the UE					Lowest $N_{RB\_agg}$ , Highest $N_{RB\_agg}$ (Note 3)				
Test Parameters for CA Configurations									
CA Configuration / $N_{RB\_agg}$		DL Allocation			UL Allocation				
PCC $N_{RB}$	SCC NRB	CC MOD	PCC & SCC RB allocation		CC MOD	$N_{RB\_alloc}$	PCC & SCC RB allocations ( $L_{CRB}$ @ $RB_{start}$ )		
75	75	QPSK	75+75		QPSK	75	P_75@0	S_0@0	
75	75	QPSK	75+75		QPSK	129	P_75@0	S_54@0	
75	75	QPSK	75+75		QPSK	150	P_75@0	S_75@0	
100	25	QPSK	100+25		QPSK	50	P_50@50	S_0@0	
100	25	QPSK	100+25		QPSK	125	P_100@0	S_25@0	
100	50	QPSK	100+50		QPSK	50	P_50@50	S_0@0	
100	50	QPSK	100+50		QPSK	75	P_75@25	S_0@0	
100	50	QPSK	100+50		QPSK	150	P_100@0	S_50@0	
100	75	QPSK	100+75		QPSK	175	P_100@0	S_75@0	
100	100	QPSK	100+100		QPSK	50	P_50@50	S_0@0	
100	100	QPSK	100+100		QPSK	75	P_75@25	S_0@0	
100	100	QPSK	100+100		QPSK	130	P_100@0	S_30@0	
100	100	QPSK	100+100		QPSK	200	P_100@0	S_100@0	
Note 1: CA Configuration Test CC Combination settings are checked separately for each CA Configuration, which applicable channel bandwidths are specified in Table 5.4.2A.1-1.									
Note 2: Depending on CA configurations, only the appropriate Uplink RB allocation value according to table 7.3A.0-2 is tested per configuration.									
Note 3: If in the CA Configuration UE supports multiple CC Combinations with the same $N_{RB\_agg}$ , only the first of those is tested, the order on the Test Configuration Table list.									

1. Connect the SS and interfering sources to the UE antenna connectors as shown in TS 36.508 [7] Figure group A.34 as appropriate.
2. The parameter settings for the cell are set up according to TS 36.508 [7] subclause 4.4.3.

3. Downlink signals for PCC are initially set up according to Annex C.0, C.1 and C.3.1, and uplink signals according to Annex H.1 and H.3.1.
4. The UL and DL Reference Measurement channels are set according to Table 7.8.1A.1.4.1-1.
5. Propagation conditions are set according to Annex B.0.
6. Ensure the UE is in State 3A-RF according to TS 36.508 [7] clause 5.2A.2. Message contents are defined in clause 7.8.1.1A.4.3.

#### 7.8.1A.1.4.2 Test procedure

1. Configure SCC according to Annex C.0, C.1 and Annex C.3.1 for all downlink physical channels.
2. The SS shall configure SCC as per TS 36.508 [7] clause 5.2A.4. Message contents are defined in clause 7.8.1A.1.4.3
3. SS activates SCC by sending the activation MAC-CE (Refer TS 36.321 [13], clauses 5.13, 6.1.3.8). Wait for at least 2 seconds (Refer TS 36.133, clauses 8.3.3.2).
4. SS transmits PDSCH via PDCCH DCI format 1A for C\_RNTI to transmit the DL RMC according to Table 7.8.1A.1.4.1-1 on both PCC and SCC. The SS sends downlink MAC padding bits on the DL RMC.
5. SS sends uplink scheduling information for each UL HARQ process via PDCCH DCI format 0 for C\_RNTI to schedule the UL RMC according to Table 7.8.1A.1.4.1-1 on both PCC and SCC. Since the UE has no payload data to send, the UE sends uplink MAC padding bits on the UL RMC.
6. Set the Downlink signal level for PCC and SCC to the value as defined in Table 7.8.1A.1.5-1. Send Uplink power control commands to the UE (less or equal to 1dB step size should be used), to ensure that for at least the duration of the Throughput measurement:  
The PCC output power is within (+0dB, -3.4 dB) of (target level in Table 7.8.1A.1.5-1 +  $10\log(P_{L\_CRB}/N_{RB\_alloc})$ ), for carrier frequency  $f \leq 3.0\text{GHz}$ ,  
or within (+0dB, -4 dB) of (target level in Table 7.8.1A.1.5-1 +  $10\log(P_{L\_CRB}/N_{RB\_alloc})$ ) for carrier frequency  $3.0\text{GHz} < f \leq 4.2\text{GHz}$ .  
The SCC output power is within (+0dB, -3.4 dB) of (target level in Table 7.8.1A.1.5-1 +  $10\log(S_{L\_CRB}/N_{RB\_alloc})$ ), for carrier frequency  $f \leq 3.0\text{GHz}$ ,  
or within (+0dB, -4 dB) of (target level in Table 7.8.1A.1.5-1 +  $10\log(S_{L\_CRB}/N_{RB\_alloc})$ ) for carrier frequency  $3.0\text{GHz} < f \leq 4.2\text{GHz}$ .
7. Set the Interfering signal levels to the values as defined in Table 7.8.1A.1.5-1 and frequency below the wanted signal, using a modulated interferer bandwidth as defined in Annex D of the present document.
8. Measure the average throughput for each component carrier for a duration sufficient to achieve statistical significance according to Annex G.2A.
9. Repeat steps from 6 to 8, using an interfering signal above the wanted signal at step 7.

#### 7.8.1A.1.4.3 Message contents

Message contents are according to TS 36.508 [7] subclause 4.6 with the following exception.

**Table 7.8.1A.1.4.3-1: UplinkPowerControlDedicatedSCell-r10**

Derivation Path: 36.508 clause 4.6.3			
Information Element	Value/remark	Comment	Condition
UplinkPowerControlDedicated-DEFAULT ::= SEQUENCE {			
p0-UE-PUSCH-r10	0		
deltaMCS-Enabled-r10	en0		
accumulationEnabled-r10	TRUE		
pSRS-Offset-r10	7 (0 dB)	The actual parameter value is $-10.5 + 1.5 \cdot \text{pSRS-Offset}$ value; 0 is the actual value in dB ( $-10.5 + 1.5 \cdot 7$ dB).	
pSRS-OffsetAp-r10	7 (0 dB)	The actual parameter value is $-10.5 + 1.5 \cdot \text{pSRS-Offset}$ value; 0 is the actual value in dB ( $-10.5 + 1.5 \cdot 7$ dB).	
filterCoefficient-r10	fc8	larger filter length is used to reduce the RSRP measurement variation	
pathlossReferenceLinking-r10	sCell		
}			

**7.8.1A.1.5 Test requirements**

The throughput of each carrier shall be  $\geq 95\%$  of the maximum throughput of the reference measurement channels as specified in Annex A.3.2 with parameters specified in Table 7.8.1A.1.5-1 for the specified wanted signal mean power in the presence of two interfering signals.

**Table 7.8.1A.1.5-1: Test parameters for Wide band intermodulation**

Rx parameter	Units	CA Bandwidth Class				
		B	C	D	E	F
Pw in Transmission Bandwidth Configuration, per CC	dBm	REFSENS + CA Bandwidth Class specific value below				
			12			

$P_{\text{Interferer 1}}$ (CW)	dBm	-46				
$P_{\text{Interferer 2}}$ (Modulated)	dBm	-46				
$BW_{\text{Interferer 2}}$	MHz		5			
$F_{\text{Interferer 1}}$ (Offset)	MHz		$-F_{\text{offset}}-7.5$ / $+ F_{\text{offset}}+7.5$			
$F_{\text{Interferer 2}}$ (Offset)	MHz	$2 \cdot F_{\text{Interferer 1}}$				
Note 1:	The transmitter shall be set to 4dB below $P_{\text{CMAX\_L}}$ or $P_{\text{CMAX\_L\_CA}}$ as defined in subclause 6.2.5 for one uplink carrier and in subclause 6.2.5 for two uplink carriers A.					
Note 2:	Reference measurement channel is specified in Annex A.3.2 with one sided dynamic OCNG Pattern OP.1 FDD/TDD as described in Annex A.5.1.1/A.5.2.1.					
Note 3:	The modulated interferer consists of the Reference measurement channel specified in Annex A.3.2 with one sided dynamic OCNG Pattern OP.1 FDD/TDD as described in Annex A.5.1.1/A.5.2.1 with set-up according to Annex C.3.1.					
Note 4:	The interfering modulated signal is 5MHz E-UTRA signal as described in Annex D for channel bandwidth $\geq 5\text{MHz}$					

For the UE which supports inter band CA configuration in Table 7.3.3-1A,  $P_{\text{Interferer 1}}$  and  $P_{\text{Interferer 2}}$  power defined in Table 7.8.1A.1.5-1 is increased by the amount given by  $\Delta R_{\text{IB,c}}$  in Table 7.3.3-1A.

### 7.8.1A.2 Wideband intermodulation for CA (intra-band contiguous DL CA without UL CA)

#### 7.8.1A.2.1 Test purpose

Same as 7.8.1A.1

#### 7.8.1A.2.2 Test applicability

This test applies to all types of E-UTRA UE release 10 and forward that supports intra-band contiguous DL CA. This test case applies only for CA Configurations that do not support UL CA.

#### 7.8.1A.2.3 Minimum conformance requirements

Same as 7.8.1A.1

#### 7.8.1A.2.4 Test description

##### 7.8.1A.2.4.1 Initial condition

Initial conditions are a set of test configurations the UE needs to be tested in and the steps for the SS to take with the UE to reach the correct measurement state.

The initial test configurations consist of environmental conditions, test frequencies, and channel bandwidths based on E-UTRA bands specified in table 5.4.2.1-1. All of these configurations shall be tested with applicable test parameters for each channel bandwidth, and are shown in table 7.8.1A.2.4.1-1. The details of the uplink and downlink reference measurement channels (RMCs) are specified in Annexes A.2 and A.3 respectively. The details of the OCNG patterns used are specified in Annex A.5. Configurations of PDSCH and PDCCH before measurement are specified in Annex C.2.

**Table 7.8.1A.2.4.1-1: Test Configuration Table**

Initial Conditions									
Test Environment as specified in TS 36.508[7] subclause 4.1					Normal				
Test Frequencies as specified in TS36.508 [7] subclause 4.3.1 for different CA bandwidth classes, and PCC and SCCs are mapped onto physical frequencies according to Table 7.1-2					B: Mid range C: Mid range				
Test CC Combination setting ( $N_{RB\_agg}$ ) as specified in subclause 5.4.2A.1 for the CA Configuration across bandwidth combination sets supported by the UE					Lowest $N_{RB\_agg}$ , Highest $N_{RB\_agg}$ (Note 3)				
Test Parameters for CA Configurations									
CA Configuration / $N_{RB\_agg}$		DL Allocation			UL Allocation				
PCC $N_{RB}$	SCCs $N_{RB}$	CC MOD	PCC & SCC RB allocation		CC MOD	$N_{RB\_alloc}$	PCC & SCC RB allocations ( $L_{CRB}$ @ $RB_{start}$ )		
6	25	QPSK	6+25		QPSK	6	P_6@0		
15	50	QPSK	15+50		QPSK	15	P_15@0		
25	25	QPSK	25+25		QPSK	20	P_20@0		
25	50	QPSK	25+50		QPSK	20	P_20@0		
50	50	QPSK	50+50		QPSK	50	P_50@0		
75	75	QPSK	75+75		QPSK	75	P_75@0		
100	25	QPSK	100+25		QPSK	100	P_100@0		
100	25	QPSK	100+25		QPSK	50	P_50@50		
100	50	QPSK	100+50		QPSK	100	P_100@0		
100	50	QPSK	100+50		QPSK	75	P_75@25		
100	50	QPSK	100+50		QPSK	50	P_50@50		
100	75	QPSK	100+75		QPSK	100	P_100@0		
100	100	QPSK	100+100		QPSK	100	P_100@0		
100	100	QPSK	100+100		QPSK	75	P_75@25		
100	100	QPSK	100+100		QPSK	50	P_50@50		
Note 1: CA Configuration Test CC Combination settings are checked separately for each CA Configuration, which applicable aggregated channel bandwidths are specified in Table 5.4.2A.1-1. Note 2: Depending on CA configurations, only the appropriate Uplink RB allocation value according to table 7.3.3-2 is tested per Test CA configuration. Note 3: If in the CA Configuration UE supports multiple CC Combinations with the same $N_{RB\_agg}$ , only the first of those is tested, according to the order on the Test Configuration Table list.									

1. Connect the SS and interfering sources to the UE antenna connectors as shown in TS 36.508 [7] Figure group A.34 as appropriate.
2. The parameter settings for the cell are set up according to TS 36.508 [7] subclause 4.4.3.
3. Downlink signals for PCC are initially set up according to Annex C.0, C.1 and C.3.1, and uplink signals according to Annex H.1 and H.3.1.
4. Propagation conditions are set according to Annex B.0.
5. Ensure the UE is in State 3A-RF according to TS 36.508 [7] clause 5.2A.2. Message contents are defined in clause 7.8.1.2A.4.3.

**7.8.1A.2.4.2 Test procedure**

1. Configure SCC according to Annex C.0, C.1 and Annex C.3.1 for all downlink physical channels.
2. The SS shall configure SCC as per TS 36.508 [7] clause 5.2A.4.
3. SS activates SCC by sending the activation MAC-CE (Refer TS 36.321 [13], clauses 5.13, 6.1.3.8). Wait for at least 2 seconds (Refer TS 36.133, clauses 8.3.3.2).
4. SS transmits PDSCH via PDCCH DCI format 1A for C\_RNTI to transmit the DL RMC according to Table 7.8.1A.2.4.1-1 on both PCC and SCC. The SS sends downlink MAC padding bits on the DL RMC.



5. SS sends uplink scheduling information for each UL HARQ process via PDCCH DCI format 0 for C\_RNTI to schedule the UL RMC according to Table 7.8.1A.2.4.1-1. Since the UE has no payload data to send, the UE transmits uplink MAC padding bits on the UL RMC.
6. Set the Downlink signal level to the value as defined in Table 7.8.1A.1.5-1. Send Uplink power control commands to the UE (less or equal to 1dB step size should be used), to ensure that the UE output power is within +0, - 3.4 dB of the target level in Table 7.8.1A.1.5-1 for carrier frequency  $f \leq 3.0\text{GHz}$  or within +0, -4.0 dB of the target level for carrier frequency  $3.0\text{GHz} < f \leq 4.2\text{GHz}$ , for at least the duration of the Throughput measurement.
7. Set the Interfering signal levels to the values as defined in subclause 7.8.1A.2.5 and frequency below the aggregated component carriers, using a modulated interferer bandwidth as defined in Annex D of the present document.
8. Measure the average throughput for each component carrier for a duration sufficient to achieve statistical significance according to Annex G.2.
9. Repeat steps from 6 to 8, using an interfering signal above the aggregated component carriers at step 7.

#### 7.8.1A.2.4.3 Message contents

Same message contents as in clause 7.8.1.4.3.

#### 7.8.1A.2.5 Test requirements

Same as 7.8.1A.1.5. with the following exceptions:

- Instead of Table 7.8.1A.1.5-1 → use Table 7.8.1A.2.5-1.

**Table 7.8.1A.2.5-1: Test parameters for Wide band intermodulation**

Rx parameter	Units	CA Bandwidth Class				
		B	C	D	E	F
P <sub>w</sub> in Transmission Bandwidth Configuration, per CC	dBm	REFSENS + CA Bandwidth Class specific value below				
		9	12			
P <sub>Interferer 1</sub> (CW)	dBm	-46				
P <sub>Interferer 2</sub> (Modulated)	dBm	-46				
BW <sub>Interferer 2</sub>	MHz	5	5			
F <sub>Interferer 1</sub> (Offset)	MHz	$-F_{\text{offset}}-7.5$ / $+ F_{\text{offset}}+7.5$	$-F_{\text{offset}}-7.5$ / $+ F_{\text{offset}}+7.5$			
F <sub>Interferer 2</sub> (Offset)	MHz	$2 \cdot F_{\text{Interferer 1}}$				
Note 1:	The transmitter shall be set to 4dB below P <sub>CMAX_L</sub> or P <sub>CMAX_L_CA</sub> as defined in subclause 6.2.5.					
Note 2:	Reference measurement channel is specified in Annex A.3.2 with one sided dynamic OCNG Pattern OP.1 FDD/TDD as described in Annex A.5.1.1/A.5.2.1.					
Note 3:	The modulated interferer consists of the Reference measurement channel specified in Annex A.3.2 with one sided dynamic OCNG Pattern OP.1 FDD/TDD as described in Annex A.5.1.1/A.5.2.1 with set-up according to Annex C.3.1.					
Note 4:	The interfering modulated signal is 5MHz E-UTRA signal as described in Annex D for channel bandwidth $\geq 5\text{MHz}$					

For the UE which supports inter band CA configuration in Table 7.3.3-1A, P<sub>Interferer 1</sub> and P<sub>Interferer 2</sub> power defined in Table 7.8.1A.2.5-1 is increased by the amount given by  $\Delta R_{\text{IB,c}}$  in Table 7.3.3-1A.

### 7.8.1A.3 Wideband intermodulation for CA (inter-band DL CA without UL CA)

#### 7.8.1A.3.1 Test purpose

Intermodulation response tests the UE's ability to receive data with a given average throughput for a specified reference measurement channel, in the presence of two or more interfering signals which have a specific frequency relationship to the wanted signal, under conditions of ideal propagation and no added noise.

A UE unable to meet the throughput requirement under these conditions will decrease the coverage area when two or more interfering signals exist which have a specific frequency relationship to the wanted signal.

#### 7.8.1A.3.2 Test applicability

This test applies to all types of E-UTRA UE release 10 and forward that supports inter-band contiguous DL CA but not UL CA.

#### 7.8.1A.3.3 Minimum conformance requirements

Same as 7.8.1A.1

#### 7.8.1A.3.4 Test description

##### 7.8.1A.3.4.1 Initial condition

Initial conditions are a set of test configurations the UE needs to be tested in and the steps for the SS to take with the UE to reach the correct measurement state.

The initial test configurations consist of environmental conditions, test frequencies, and channel bandwidths based on E-UTRA bands specified in table 5.4.2.1-1. All of these configurations shall be tested with applicable test parameters for each channel bandwidth, and are shown in table 7.8.1A.3.4.1-1. The details of the uplink and downlink reference measurement channels (RMCs) are specified in Annexes A.2 and A.3 respectively. The details of the OCNG patterns used are specified in Annex A.5. Configurations of PDSCH and PDCCH before measurement are specified in Annex C.2.

**Table 7.8.1A.3.4.1-1: Test Configuration Table**

Initial Conditions						
Test Environment as specified in TS 36.508[7] subclause 4.1		NC				
Test Frequencies as specified in TS36.508 [7] subclause 4.3.1 for different CA bandwidth classes, and PCC and SCCs are mapped onto physical frequencies according to Table 7.1-2		A: Mid range for PCC and SCC				
Test CC Combination setting ( $N_{RB\_agg}$ ) as specified in subclause 5.4.2A.1 for the CA Configuration across bandwidth combination sets supported by the UE		Highest $N_{RB\_agg}$ for PCC and SCC				
Test Parameters for CA Configurations						
CA Configuration / $N_{RB\_agg}$		DL Allocation			UL Allocation	
PCC $N_{RB}$	SCCs $N_{RB}$	CC MOD	PCC & SCC RB allocation		CC MOD	PCC $N_{RB\_alloc}$
50	50	QPSK	50	50	QPSK	50
50	50	QPSK	50	50	QPSK	25
50	50	QPSK	50	50	QPSK	20
50	50	QPSK	50	50	QPSK	16
50	75	QPSK	50	75	QPSK	25
50	100	QPSK	50	100	QPSK	50
50	100	QPSK	50	100	QPSK	25
50	100	QPSK	50	100	QPSK	20
75	50	QPSK	75	50	QPSK	25
75	100	QPSK	75	100	QPSK	25
100	50	QPSK	100	50	QPSK	100
100	50	QPSK	100	50	QPSK	75
100	50	QPSK	100	50	QPSK	50
100	75	QPSK	100	75	QPSK	100
100	100	QPSK	100	100	QPSK	75
100	100	QPSK	100	100	QPSK	50
Note 1: CA Configuration Test CC Combination settings are checked separately for each CA Configuration, which applicable aggregated channel bandwidths are specified in Table 5.4.2A.1-2. Note 2: Depending on CA configurations, only the appropriate Uplink RB allocation value according to table 7.3A.3.5-2for UE supporting one uplink carrier is tested per Test CA configuration. Note 3: The UL resource blocks shall be located as close as possible to the downlink PCC but confined within the transmission bandwidth configuration for the channel bandwidth (Table 5.4.2-1). Note 4: The frequencies of PCC and SCC shall be switched and tested in each configuration, according to the UE declared capability for UL support (within CA operation) in the individual bands.						

1. Connect the SS and interfering sources to the UE antenna connectors as shown in TS 36.508 [7] Figure group A.34 as appropriate.
2. The parameter settings for the cell are set up according to TS 36.508 [7] subclause 4.4.3.

3. Downlink signals for PCC are initially set up according to Annex C.0, C.1 and C.3.1, and uplink signals according to Annex H.1 and H.3.1.
4. Propagation conditions are set according to Annex B.0.
5. Ensure the UE is in State 3A-RF according to TS 36.508 [7] clause 5.2A.2. Message contents are defined in clause 7.8.1A.3.4.3.

#### 7.8.1A.3.4.2 Test procedure

1. Configure SCC according to Annex C.0, C.1 and Annex C.3.1 for all downlink physical channels.
2. The SS shall configure SCC as per TS 36.508 [7] clause 5.2A.4.
3. SS activates SCC by sending the activation MAC-CE (Refer TS 36.321 [13], clauses 5.13, 6.1.3.8). Wait for at least 2 seconds (Refer TS 36.133, clauses 8.3.3.2).
4. SS transmits PDSCH via PDCCH DCI format 1A for C\_RNTI to transmit the DL RMC according to Table 7.8.1A.3.4.1-1 on both PCC and SCC. The SS sends downlink MAC padding bits on the DL RMC.
5. SS sends uplink scheduling information for each UL HARQ process via PDCCH DCI format 0 for C\_RNTI to schedule the UL RMC according to Table 7.8.1A.3.4.1-1. Since the UE has no payload data to send, the UE transmits uplink MAC padding bits on the UL RMC.
6. Set the Downlink signal level to the value as defined in Table 7.8.1A.3.5-1. Send Uplink power control commands to the UE (less or equal to 1dB step size should be used), to ensure that the UE output power is within +0, - 3.4 dB of the target level in Table 7.8.1A.3.5-1 for carrier frequency  $f \leq 3.0\text{GHz}$  or within +0, -4.0 dB of the target level for carrier frequency  $3.0\text{GHz} < f \leq 4.2\text{GHz}$ , for at least the duration of the Throughput measurement.
7. Set the Interfering signal levels to the values as defined in Table 7.8.1A.3.5-1 and frequency below the wanted signal, using a modulated interferer bandwidth as defined in Annex D of the present document.
8. Measure the average throughput of SCC for a duration sufficient to achieve statistical significance according to Annex G.2.
9. Repeat steps from 6 to 8, using an interfering signal above the wanted signal at step 4.

#### 7.8.1A.3.4.3 Message contents

Same message contents as in clause 7.8.1.4.3.

#### 7.8.1A.3.5 Test requirements

For inter-band carrier aggregation with uplink assigned to one E-UTRA band the in-band blocking requirements are defined with the uplink active on the band other than the band whose downlink is being tested, i.e., the requirements are tested only for the SCell downlink. The UE shall meet the requirement for each component carrier, when operated as SCell, while both downlink carriers are active.

The throughput measured during the test procedure for each component carrier, when operated as SCell, shall be  $\geq 95\%$  of the maximum throughput of the reference measurement channels as specified in Annex A.3.2 with parameters specified in Table 7.8.1A.3.5-1 (originated from the single carrier Table 7.8.1.5-1).

**Table 7.8.1A.3.5-1: Test parameters for Wide band intermodulation**

Rx Parameter	Units	Channel bandwidth					
		1.4 MHz	3 MHz	5 MHz	10 MHz	15 MHz	20 MHz
Pw in Transmission Bandwidth Configuration, per CC	dBm	REFSENS + channel bandwidth specific value below					
		12	8	6	6	7	9

$P_{\text{Interferer 1}}$ (CW)	dBm	-46		
$P_{\text{Interferer 2}}$ (Modulated)	dBm	-46		
$BW_{\text{Interferer 2}}$		1.4	3	5
$F_{\text{Interferer 1}}$ (Offset from SCC)	MHz	-BW/2 -2.1 / +BW/2+ 2.1	-BW/2 -4.5 / +BW/2 + 4.5	-BW/2 - 7.5 / +BW/2 + 7.5
$F_{\text{Interferer 2}}$ (Offset from SCC)	MHz	$2 * F_{\text{Interferer 1}}$		
Note 1:	The transmitter shall be set to 4dB below $P_{\text{C}_{\text{MAX\_L}}}$ with $P_{\text{C}_{\text{MAX\_L}}}$ as defined in clause 6.2.5.			
Note 2:	The reference measurement channel is specified in Annex A.3.2 with one sided dynamic OCNG Pattern OP.1 FDD/TDD as described in Annex A.5.1.1/A.5.2.1.			
Note 3:	The modulated interferer consists of the Reference measurement channel specified in Annex A.3.2 with one sided dynamic OCNG Pattern OP.1 FDD/TDD as described in Annex A.5.1.1/A.5.2.1 and set-up according to Annex C.3.1. The interfering modulated signal is 5MHz E-UTRA signal as described in Annex D for channel bandwidth $\geq 5\text{MHz}$			
Note 4:	For the UE which supports inter band CA configuration in Table 7.3A.3-0, $P_{\text{Interferer1}}$ and $P_{\text{Interferer2}}$ powers are increased by the amount given by $\Delta R_{\text{IB}}$ in Table 7.3A.3-0			

#### 7.8.1A.4 Wideband intermodulation for CA (intra band non-contiguous DL CA without UL CA)

##### 7.8.1A.4.1 Test purpose

Same as 7.8.1A.1

##### 7.8.1A.4.2 Test applicability

This test case applies to all types of E-UTRA UE release 11 and forward that support intra-band non-contiguous DL CA but no UL CA.

##### 7.8.1A.4.3 Minimum conformance requirements

Same as 7.8.1A.1

##### 7.8.1A.4.4 Test description

###### 7.8.1A.4.4.1 Initial condition

Initial conditions are a set of test configurations the UE needs to be tested in and the steps for the SS to take with the UE to reach the correct measurement state.

The initial test configurations consist of environmental conditions, test frequencies, and channel bandwidths based on E-UTRA bands specified in table 5.4.2.1-1. All of these configurations shall be tested with applicable test parameters for each channel bandwidth, and are shown in table 7.8.1A.4.4.1-1. The details of the uplink and downlink reference measurement channels (RMCs) are specified in Annexes A.2 and A.3 respectively. The details of the OCNG patterns used are specified in Annex A.5. Configurations of PDSCH and PDCCH before measurement are specified in Annex C.2.

**Table 7.8.1A.4.4.1-1: Test Configuration Table**

Initial Conditions							
Test Environment as specified in TS 36.508[7] subclause 4.1				NC			
Test Frequencies as specified in TS36.508 [7] subclause 4.3.1 for different CA bandwidth classes, and PCC and SCCs are mapped onto physical frequencies according to Table 7.1-2				A: N/A (Range is not relevant)			
Test CC Combination setting ( $N_{RB\_agg}$ ) as specified in subclause 5.4.2A.1 for the CA Configuration .				Refer to test point			
Test Parameters for CA Configurations							
ID	CA Configuration / $N_{RB\_agg}$		$W_{gap}$ [MHz]	DL Allocation		UL Allocation	
	PCC $N_{RB}$	SCCs $N_{RB}$		CC MOD	PCC & SCC RB allocation	CC MOD	PCC RB allocations ( $L_{CRB}$ @ $RB_{start}$ )

Test Parameters for CA_2A-2A Configuration							
1	100	25	35	QPSK	100+25	QPSK	P_16@57
2	100	100	20	QPSK	100+100	QPSK	P_16@57
Test Parameters for CA_3A-3A Configuration							
3	100	25	50	QPSK	100+25	QPSK	P_16@50
4	100	25	15	QPSK	100+25	QPSK	P_32@68
5	100	100	35	QPSK	100+100	QPSK	P_16@50
Test Parameters for CA_4A-4A Configuration							
6	100	25	20	QPSK	100+25	QPSK	P_100@0
7	100	100	5	QPSK	100+100	QPSK	P_100@0
Test Parameters for CA_7A-7A Configuration							
8	100	75	35	QPSK	100+75	QPSK	P_36@64
9	100	75	15	QPSK	100+75	QPSK	P_50@50
10	100	100	30	QPSK	100+100	QPSK	P_32@68
11	100	100	15	QPSK	100+100	QPSK	P_45@55
Test Parameters for CA_23A-23A Configuration							
12	50	25	5	QPSK	50+25	QPSK	P_50@0
Test Parameters for CA_25A-25A Configuration							
13	50	25	50	QPSK	50+25	QPSK	P_10@33
14	50	25	15	QPSK	50+25	QPSK	P_32@18
15 <sup>3</sup>	50	50	45	QPSK	50+50	QPSK	P_10@33
16 <sup>3</sup>	50	50	10	QPSK	50+50	QPSK	P_32@18
17 <sup>4</sup>	100	25	40	QPSK	100+25	QPSK	P_12@62
18 <sup>4</sup>	100	100	25	QPSK	100+100	QPSK	P_12@62
Test Parameters for CA_41A-41A Configuration							
19 <sup>4</sup>	100	25	169	QPSK	100+25	QPSK	P_100@0
20 <sup>3</sup>	100	50	164	QPSK	100+50	QPSK	P_100@0
21	100	100	154	QPSK	100+100	QPSK	P_100@0
Test Parameters for CA_42A-42A Configuration							
22	100	25	175	QPSK	100+25	QPSK	P_100@0
23	100	100	160	QPSK	100+100	QPSK	P_100@0
Note 1:	CA Configuration Test CC Combination settings are checked separately for each CA Configuration, which applicable aggregated channel bandwidths are specified in Table 5.4.2A.1-3.						
Note 2:	The carrier centre frequency of PCC in the UL operating band is configured closer to the DL operating band.						
Note 3:	Applicable if only Bandwidth Combination Set 0 is supported by the UE for the CA Configuration						
Note 4:	Not applicable if only Bandwidth Combination Set 0 is supported by the UE for the CA Configuration						

1. Connect the SS and interfering sources to the UE antenna connectors as shown in TS 36.508 [7] Figure group A.34 as appropriate.
2. The parameter settings for the cell are set up according to TS 36.508 [7] subclause 4.4.3.
3. Downlink signals for PCC are initially set up according to Annex C.0, C.1 and C.3.1, and uplink signals according to Annex H.1 and H.3.1.
4. Propagation conditions are set according to Annex B.0.

5. Ensure the UE is in State 3A-RF according to TS 36.508 [7] clause 5.2A.2. Message contents are defined in clause 7.8.1A.3.4.3.

#### 7.8.1A.4.4.2 Test procedure

1. Configure SCC according to Annex C.0, C.1 and Annex C.3.1 for all downlink physical channels.
2. The SS shall configure SCC as per TS 36.508 [7] clause 5.2A.4.
3. SS activates SCC by sending the activation MAC-CE (Refer TS 36.321 [13], clauses 5.13, 6.1.3.8). Wait for at least 2 seconds (Refer TS 36.133, clauses 8.3.3.2).
4. SS transmits PDSCH via PDCCH DCI format 1A for C\_RNTI to transmit the DL RMC according to Table 7.8.1A.3.4.1-1 on both PCC and SCC. The SS sends downlink MAC padding bits on the DL RMC.
5. SS sends uplink scheduling information for each UL HARQ process via PDCCH DCI format 0 for C\_RNTI to schedule the UL RMC according to Table 7.8.1A.4.4.1-1. Since the UE has no payload data to send, the UE transmits uplink MAC padding bits on the UL RMC.
6. Set the Downlink signal level to the value as defined in Table 7.8.1A.4.5-1. Send Uplink power control commands to the UE (less or equal to 1dB step size should be used), to ensure that the UE output power is within +0, - 3.4 dB of the target level in Table 7.8.1A.4.5-1 for carrier frequency  $f \leq 3.0\text{GHz}$  or within +0, -4.0 dB of the target level for carrier frequency  $3.0\text{GHz} < f \leq 4.2\text{GHz}$ , for at least the duration of the Throughput measurement.
7. Set the Interfering signal levels to the values as defined in Table 7.8.1A.4.5-1 and frequency below SCC, using a modulated interferer bandwidth as defined in Annex D of the present document.
8. Measure the average throughput for each component carrier for a duration sufficient to achieve statistical significance according to Annex G.2A.
9. Repeat steps from 6 to 8, using an interfering signal above PCC at step 7.

#### 7.8.1A.4.4.3 Message contents

Same message contents as in clause 7.8.1.4.3.

#### 7.8.1A.4.5 Test requirements

The throughput measured during the test procedure for each component carrier, shall be  $\geq 95\%$  of the maximum throughput of the reference measurement channels as specified in Annex A.3.2 with parameters specified in Table 7.8.1A.4.5-1 (originated from the single carrier Table 7.8.1.5-1).

**Table 7.8.1A.4.5-1: Test parameters for Wide band intermodulation**

Rx Parameter	Units	Channel bandwidth					
		1.4 MHz	3 MHz	5 MHz	10 MHz	15 MHz	20 MHz
Pw in Transmission Bandwidth Configuration, per CC	dBm	REFSENS + channel bandwidth specific value below					
		12	8	6	6	7	9



$P_{\text{Interferer 1 (CW)}}$	dBm	-46		
$P_{\text{Interferer 2 (Modulated)}}$	dBm	-46		
$BW_{\text{Interferer 2}}$		1.4	3	5
$F_{\text{Interferer 1 (Offset)}}$	MHz	$-BW/2 - 2.1$ / $+BW/2 + 2.1$	$-BW/2 - 4.5$ / $+BW/2 + 4.5$	$-BW/2 - 7.5$ / $+BW/2 + 7.5$
$F_{\text{Interferer 2 (Offset)}}$	MHz	$2 * F_{\text{Interferer 1}}$		
Note 1:	The transmitter shall be set to 4dB below $P_{\text{CMAX,L}}$ with $P_{\text{CMAX,L}}$ as defined in clause 6.2.5.			
Note 2:	The reference measurement channel is specified in Annex A.3.2 with one sided dynamic OCNG Pattern OP.1 FDD/TDD as described in Annex A.5.1.1/A.5.2.1.			
Note 3:	The modulated interferer consists of the Reference measurement channel specified in Annex A.3.2 with one sided dynamic OCNG Pattern OP.1 FDD/TDD as described in Annex A.5.1.1/A.5.2.1 and set-up according to Annex C.3.1. The interfering modulated signal is 5MHz E-UTRA signal as described in Annex D for channel bandwidth $\geq 5\text{MHz}$			
Note 4:	For the UE which supports inter band CA configuration in Table 7.3A.3-0, $P_{\text{Interferer1}}$ and $P_{\text{Interferer2}}$ powers are increased by the amount given by $\Delta R_{\text{IB}}$ in Table 7.3A.3-0			

### 7.8.1A.5 Wideband intermodulation for CA (3DL CA without UL CA)

#### 7.8.1A.5.1 Test purpose

Same as 7.8.1A.1

#### 7.8.1A.5.2 Test applicability

This test case applies to all types of E-UTRA UE release 10 and forward that support 3DL with Intra-band contiguous CA or 3DL with Inter-band CA, or 3DL with Inter-band and Intra-band contiguous CA.

This test case also applies to all types of E-UTRA UE release 11 and forward that support 3DL with Intra-band non-contiguous CA and Inter-band CA, or 3DL with Intra-band non-contiguous and Intra-band contiguous CA.

This test case also applies to all types of E-UTRA UE release 12 and forward that support 3DL CA with FDD-TDD CA.

#### 7.8.1A.5.3 Minimum conformance requirements

Same as 7.8.1A.1.

#### 7.8.1A.5.4 Test description

##### 7.8.1A.5.4.1 Initial conditions

Initial conditions are a set of test configurations the UE needs to be tested in and the steps for the SS to take with the UE to reach the correct measurement state.

The initial test configurations consist of environmental conditions, test frequencies, and channel bandwidths based on E-UTRA CA configurations specified in table 5.4.2A.1-1 through table 5.4.2A.1-2a. All of these configurations shall be tested with applicable test parameters for each channel bandwidth, and are shown in table 7.8.1A.5.4.1-1 through table 7.8.1A.5.4.1-5 as appropriate. The details of the uplink reference measurement channels (RMCs) are specified in Annex A.2 and A.3. Configurations of PDSCH and PDCCH before measurement are specified in Annex C.2.

**Table 7.8.1A.5.4.1-1: Test Configuration Table (Intra-band contiguous)**

Initial Conditions											
Test Environment as specified in TS 36.508[7] subclause 4.1							NC				
Test Frequencies as specified in TS36.508 [7] subclause 4.3.1 for different CA bandwidth classes.							For test frequencies refer to “Range” columns. For mapping within Band refer to “CC” columns				
Test CC Combination setting ( $N_{RB\_agg}$ ) as specified in subclause 5.4.2A.1 for the CA Configuration across bandwidth combination sets supported by the UE.							Refer to “PCC $N_{RB}$ ” and “SCCs $N_{RB}$ ” columns				
Network signalling value							NS_01 by default, exceptions listed in Table 7.3.3-3, dependent on PCC Band				
Test Parameters for CA Configurations											
ID	CA Configuration / $N_{RB\_agg}$						DL Allocation			UL Allocation (Note 2,3)	
	CA Configuration					PCC $N_{RB}$	SCCs $N_{RB}$		PCC & SCCs RB allocation	CC MOD	PCC $L_{CRB} @ RB_{start}$
	Band	Range	PCC CC	SCC1 CC	SCC2 CC		SCC1	SCC2			
Default Test Settings for a CA_XD Configuration											
1	X	Mid	CC1	CC2	CC3	Highest $N_{RB\_agg}$		QPSK	All RBs	QPSK	REFSENS
2	X	Mid	CC1	CC2	CC3	Lowest $N_{RB\_agg}$		QPSK	All RBs	QPSK	REFSENS
<p>Note 1: CA Configuration Test CC Combination test settings are checked separately for each CA Configuration.</p> <p>Note 2: Use CA Configuration – specific test points if present in the table, otherwise use Default Test Settings test points.</p> <p>Note 3: X corresponds to the band of the CA Configuration. Eg. for CA_41D ,X=41</p> <p>Note 4: REFSENS refers to the PCC band's and PCC <math>N_{RB}</math> 's single carrier Uplink RB allocation for reference sensitivity according to table 7.3.5-2.</p> <p>Note 5: If in the CA Configuration UE supports multiple CC Combinations with the same <math>N_{RB\_agg}</math>, choose for testing the Combination with maximum <math>N_{RB\_PCC}</math> and then select maximum <math>N_{RB\_SCC1}</math> for the chosen <math>N_{RB\_PCC}</math>.</p>											

**Table 7.8.1A.5.4.1-2: Test Configuration Table (Inter-band)**

Initial Conditions															
Test Environment as specified in TS 36.508[7] subclause 4.1											NC				
Test Frequencies as specified in TS36.508 [7] subclause 4.3.1 for different CA bandwidth classes.											For test frequencies refer to “Range” columns. For mapping within Band refer to “CC” columns				
Test CC Combination setting ( $N_{RB\_agg}$ ) as specified in subclause 5.4.2A.1 for the CA Configuration across bandwidth combination sets supported by the UE.											Refer to “PCC $N_{RB}$ ” and “SCCs $N_{RB}$ ” columns				
Network signalling value											NS_01 by default, exceptions listed in Table 7.3.3-3, dependent on PCC Band				
Test Parameters for CA Configurations															
ID	CA Configuration / $N_{RB\_agg}$							DL Allocation			UL Allocation (Note 2,3)				
	CA Configuration						PCC $N_{RB}$	SCCs $N_{RB}$		CC MOD	PCC & SCCs RB allocation			CC MOD	PCC $L_{CRB}$ @ $RB_{start}$
	PCC		SCC1		SCC2			SCC1	SCC2		PCC	SCC1	SCC2		
	Band	Range	Band	Range	Band	Range									
Default Test Settings for a CA_XA-YA-ZA Configuration															
1	X	Mid	Y	Mid	Z	Mid	Highest $N_{RB}$	Highest $N_{RB}$	Highest $N_{RB}$	QPSK	All RBs	QPSK	REFSENS		
2	Y	Mid	X	Mid	Z	Mid	Highest $N_{RB}$	Highest $N_{RB}$	Highest $N_{RB}$	QPSK	All RBs	QPSK	REFSENS		
3	Z	Mid	X	Mid	Y	Mid	Highest $N_{RB}$	Highest $N_{RB}$	Highest $N_{RB}$	QPSK	All RBs	QPSK	REFSENS		
Note 1: CA Configuration Test CC Combination test settings are checked separately for each CA Configuration. Note 2: Use CA Configuration – specific test points if present in the table, Otherwise use test points from matching Group Test Settings, if present in the table. Otherwise use the Default Test Settings test points. Note 3: If, according to the UE declared capability, UE does not support UL in an individual band within the CA Configuration, test points with that individual band as PCC are not applicable. Note 4: X,Y,Z correspond to the different bands in the CA Configuration. Eg. for CA_1A-3A-19A,X=1,Y=3,Z=19 Note 5: REFSSENS refers to the PCC band's and PCC $N_{RB}$ 's single carrier Uplink RB allocation for reference sensitivity according to table 7.3.5-2.															

**Table 7.8.1A.5.4.1-3: Test Configuration Table (Intra-band contiguous + Inter-band)**

Initial Conditions															
Test Environment as specified in TS 36.508[7] subclause 4.1										NC					
Test Frequencies as specified in TS36.508 [7] subclause 4.3.1 for different CA bandwidth classes.										For test frequencies refer to “Range” columns. For mapping within Band refer to “CC” columns					
Test CC Combination setting ( $N_{RB\_agg}$ ) as specified in subclause 5.4.2A.1 for the CA Configuration across bandwidth combination sets supported by the UE.										Refer to “PCC $N_{RB}$ ” and “SCCs $N_{RB}$ ” columns					
Network signalling value										NS_01 by default, exceptions listed in Table 7.3.3-3, dependent on PCC Band					
Test Parameters for CA Configurations															
ID	CA Configuration / $N_{RB\_agg}$							DL Allocation			UL Allocation (Note 2,3)				
	CA Configuration						PCC $N_{RB}$	SCCs $N_{RB}$		CC MOD	PCC & SCCs RB allocation			CC MOD	PCC $L_{CRB}$ @ $RB_{start}$
	PCC		SCC1		SCC2			SCC1	SCC2		PCC	SCC1	SCC2		
	Band	Range /CC	Band	Range /CC	Band	Range /CC									
Default Test Settings for a CA_XB-YA and CA_XC-YA Configuration															
1	X	Mid /CC1	X	Mid /CC2	Y	Mid	Highest $N_{RB\_agg}$	Highest $N_{RB}$	QPSK	All RBs	QPSK	REFSENS			
2	X	Mid /CC1	X	Mid /CC2	Y	Mid	Lowest $N_{RB\_agg}$	Highest $N_{RB}$	QPSK	All RBs	QPSK	REFSENS			
3	Y	Mid	X	Mid /CC1	X	Mid /CC2	Highest $N_{RB}$	Highest $N_{RB\_agg}$	QPSK	All RBs	QPSK	REFSENS			
4	Y	Mid	X	Mid /CC1	X	Mid /CC2	Highest $N_{RB}$	Lowest $N_{RB\_agg}$	QPSK	All RBs	QPSK	REFSENS			
Default Test Settings for a CA_XA-YB and CA_XA-YC Configuration															
1	Y	Mid /CC1	Y	Mid /CC2	X	Mid	Highest $N_{RB\_agg}$	Highest $N_{RB}$	QPSK	All RBs	QPSK	REFSENS			
2	Y	Mid /CC1	Y	Mid /CC2	X	Mid	Lowest $N_{RB\_agg}$	Highest $N_{RB}$	QPSK	All RBs	QPSK	REFSENS			
3	X	Mid	Y	Mid /CC1	Y	Mid /CC2	Highest $N_{RB}$	Highest $N_{RB\_agg}$	QPSK	All RBs	QPSK	REFSENS			
4	X	Mid	Y	Mid /CC1	Y	Mid /CC2	Highest $N_{RB}$	Lowest $N_{RB\_agg}$	QPSK	All RBs	QPSK	REFSENS			
<p>Note 1: CA Configuration Test CC Combination test settings are checked separately for each CA Configuration.</p> <p>Note 2: Use CA Configuration – specific test points if present in the table. Otherwise use the Default Test Settings test points.</p> <p>Note 3: If, according to the UE declared capability, UE does not support UL in an individual band within the CA Configuration, test points with that individual band as PCC are not applicable.</p> <p>Note 4: X,Y correspond to the different bands in the CA Configuration. Eg. for CA_1C-3A, X=1 and Y=3</p> <p>Note 5: REFSENS refers to the PCC band's and PCC <math>N_{RB}</math> 's single carrier Uplink RB allocation for reference sensitivity according to table 7.3.5-2.</p> <p>Note 6: If in the CA Configuration UE supports multiple CC Combinations with the same <math>N_{RB\_agg}</math>, choose the Combination with <math>N_{RB\_PCC} = N_{RB\_SCC1}</math> for testing. If no such combination is supported, choose Combination with maximum <math>N_{RB\_PCC}</math> for testing.</p>															

**Table 7.8.1A.5.4.1-4: Test Configuration Table (Intra-band non-contiguous + Inter-band)**

Initial Conditions														
Test Environment as specified in TS 36.508[7] subclause 4.1										NC				
Test Frequencies as specified in TS36.508 [7] subclause 4.3.1 for different CA bandwidth classes.										For test frequencies refer to “Range” columns. For mapping within Band refer to “CC” columns				
Test CC Combination setting ( $N_{RB\_agg}$ ) as specified in subclause 5.4.2A.1 for the CA Configuration across bandwidth combination sets supported by the UE.										Highest $N_{RB}$				
Network signalling value										NS_01 by default, exceptions listed in Table 7.3.3-3, dependent on PCC Band				
Test Parameters for CA Configurations														
ID	CA Configuration / $N_{RB\_agg}$								DL Allocation			UL Allocation (Note 2,3)		
	CA Configuration								CC MOD	PCC & SCCs			CC MOD	PCC
	PCC		$W_{gap}$ [MHz]	SCC1		$W_{gap}$ [MHz]	SCC2			RB allocation				
	Band	Range /CC		Band	Range /CC		Band	Range /CC		PCC	SCC1	SCC2		
<b>Default Test Settings for CA_XA-XA-YA Configurations</b>														
1	X	CC2	Max	X	CC1	-	Y	Mid	QPSK	All RBs			QPSK	REFSENS_C
2	Y	Mid	-	X	CC2	Max	X	CC1	QPSK	All RBs			QPSK	REFSENS
<b>Default Test Settings for CA_XA-YA-YA Configurations</b>														
1	Y	CC2	Max	Y	CC1	-	X	Mid	QPSK	All RBs			QPSK	REFSENS_C
2	X	Mid	-	Y	CC2	Max	Y	CC1	QPSK	All RBs			QPSK	REFSENS
<p>Note 1: CA Configuration Test CC Combination test settings are checked separately for each CA Configuration.</p> <p>Note 2: Use CA Configuration – specific test points if present in the table. Otherwise use test points from matching Group Test Settings, if present in the table. Otherwise use Default Test Settings test points.</p> <p>Note 3: If, according to the UE declared capability, UE does not support UL in an individual band within the CA Configuration, test points with that individual band as PCC are not applicable.</p> <p>Note 4: X and Y correspond to the different bands in the CA Configuration. Eg. for CA_2A-2A-5A,X=2,Y=5</p> <p>Note 5: REFSENS refers to the PCC band’s and PCC <math>N_{RB}</math> ‘s single carrier Uplink RB allocation for reference sensitivity according to table 7.3.5-2. REFSENS_CA refers to the PCC band’s and PCC <math>N_{RB}</math> ‘s single carrier Uplink RB allocation for reference sensitivity according to table 7.3.4.5-2 (selecting RB allocation for SCC measurement).</p>														

**Table 7.8.1A.5.4.1-5: Test Configuration Table (Intra-band non-contiguous + Intra-band contiguous)**

Initial Conditions															
Test Environment as specified in TS 36.508[7] subclause 4.1										NC					
Test Frequencies as specified in TS36.508 [7] subclause 4.3.1 for different CA bandwidth classes.										For test frequencies refer to “Range” columns. For mapping within band refer to “CC” columns					
Test CC Combination setting ( $N_{RB\_agg}$ ) as specified in subclause 5.4.2A.1 for the CA Configuration across bandwidth combination sets supported by the UE.										Refer to “PCC $N_{RB}$ ” and “SCCs $N_{RB}$ ” columns					
Network signalling value										NS_01 by default, exceptions listed in Table 7.3.3-3, dependent on PCC Band					
Test Parameters for CA Configurations															
ID	CA Configuration / $N_{RB\_agg}$							DL Allocation			UL Allocation (Note 2,3)				
	CA Configuration						PCC $N_{RB}$	SCCs $N_{RB}$		CC MOD	PCC & SCCs RB allocation			CC MOD	PCC $L_{CRB}$ @ $RB_{start}$
	Band	PCC	$W_{gap}$ [MHz]	SCC1	$W_{gap}$ [MHz]	SCC2		SCC1	SCC2		PCC	SCC1	SCC2		
		CC		CC		CC									
Test Settings for a 41A-41C Configuration															
1	41	CC3	134.2	CC2	-	CC1	100	100	100	QPSK	All RBs	QPSK	100@0		
Test Settings for a CA_41C-41A Configuration															
2	41	CC3	-	CC2	134.2	CC1	100	100	100	QPSK	All RBs	QPSK	100@0		
Note 1: CA Configuration Test CC Combination test settings are checked separately for each CA Configuration. Note 2: Use CA Configuration – specific test points if present in the table, otherwise use Default Test Settings test points. Note 3: If, according to the UE declared capability, UE does not support UL in an individual band within the CA Configuration, test points with that individual band as PCC are not applicable. Note 4: X corresponds to the band of the CA Configuration. Eg. for CA_41C-41A, X=41. Note 5: REFSSENS refers to the PCC band's and PCC $N_{RB}$ 's single carrier Uplink RB allocation for reference sensitivity according to table 7.3.5-2. Note 6: If in the CA Configuration UE supports multiple CC Combinations with the same $N_{RB\_agg}$ , choose the Combination with $N_{RB\_CC1} = N_{RB\_CC2}$ for testing. If no such combination is supported, choose Combination with maximum $N_{RB\_CC1}$ for testing.															

1. Connect the SS to the UE antenna connectors as shown in TS 36.508[7] Annex A Figure group [TBD] as appropriate.
2. The parameter settings for the cell are set up according to TS 36.508 [7] subclause [4.4.3].
3. Downlink signals for PCC are initially set up according to Annex C.0, C.1, and C.3.1, and uplink signals according to Annex H.1 and H.3.0.
4. The UL and DL Reference Measurement channels are set according to Table 7.8.1A.5.4.1-1 through Table 7.8.1A.5.4.1-5 as appropriate.
5. Propagation conditions are set according to Annex B.0.
6. Ensure the UE is in State 3A-RF according to TS 36.508 [7] clause 5.2A.2. Message contents are defined in clause 7.3A.5.4.3.

**7.8.1A.5.4.2 Test procedure**

1. Configure SCCs according to Annex C.0, C.1 and Annex C.3.1 for all downlink physical channels.
2. The SS shall configure SCCs as per TS 36.508 [7] clause 5.2A.4. Message contents are defined in clause 7.8.1A.5.4.3

3. SS activates SCCs by sending the activation MAC-CE (Refer TS 36.321 [13], clauses 5.13, 6.1.3.8). Wait for at least 2 seconds (Refer TS 36.133, clauses 8.3.3.2).
4. SS transmits PDSCH via PDCCH DCI format 1A for C\_RNTI to transmit the DL RMC according to Table 7.3A.5.4.1-1 through Table 7.3A.5.4.1-5 as appropriate on PCC and SCCs. The SS sends downlink MAC padding bits on the DL RMC.
5. SS sends uplink scheduling information for each UL HARQ process via PDCCH DCI format 0 for C\_RNTI to schedule the UL RMC according to Table 7.8.1A.5.4.1-1 through Table 7.8.1A.5.4.1-5 as appropriate on PCC and SCCs. Since the UE has no payload and no loopback data to send the UE sends uplink MAC padding bits on the UL RMC.
6. Set the Downlink signal level to the value as defined in Table 7.8.1A.5.5-1 or 7.8.1A.5.5-2. Send Uplink power control commands to the UE (less or equal to 1dB step size should be used), to ensure that the UE output power is within +0, - 3.4 dB of the target level for carrier frequency  $f \leq 3.0\text{GHz}$  or within +0, -4.0 dB of the target level for carrier frequency  $3.0\text{GHz} < f \leq 4.2\text{GHz}$ , for at least the duration of the Throughput measurement.
7. Set the Interfering signal levels to the values as defined in 7.8.1A.5.5-1 or 7.8.1A.5.5-2 and frequency below the measured carrier(s) according to table 7.8.1A.5.4.2-1, using a modulated interferer bandwidth as defined in Annex D of the present document.
8. Measure the average throughput for the carrier(s) indicated in table 7.8.1A.5.4.2-1 for a duration sufficient to achieve statistical significance according to Annex G.2.
9. Repeat steps from 6 to 8, using an interfering signal above the measured carrier(s) according to table 7.8.1A.5.4.2-1.
10. Repeat steps 6 to 9 for component carriers listed in table 7.8.1A.5.4.2-1.

**Table 7.8.1A.5.4.2-1: Test repetition and measurement configuration**

CA configuration	ID (Note 1)	Throughput measured on (Note 3)	Table with test parameters to select (Note 2)
Intra-band contiguous	1	PCC, SCC1, SCC2	7.8.1A.5.5-2
	2		
Inter-band	1	SCC1	7.8.1A.5.5-1
		SCC2	
	2	SCC1	
		SCC2	
	3	SCC1	
		SCC2	
Intra-band contiguous + Inter-band	1	SCC2	7.8.1A.5.5-1
	2		
	3	SCC1, SCC2	7.8.1A.5.5-2
	4		
Intra-band non-contiguous + Inter-band	1	SCC2	7.8.1A.5.5-1
	2	SCC1	
		SCC2	
Intra-band non-contiguous + Intra-band contiguous	1	PCC	7.8.1A.5.5-1
		SCC1, SCC2	7.8.1A.5.5-2
		SCC2	7.8.1A.5.5-1
	2	PCC, SCC1	7.8.1A.5.5-2
<p>Note 1: Test point ID for the particular CA configuration as defined in section 7.8.1A.5.4.1.</p> <p>Note 2: The reference for the placement of the interferer signals is the centre frequency of the carrier closest to the interferer among the carriers throughput is measured on.</p> <p>Note 3: Where there are multiple rows for a single Test point ID, the test is repeated for each row.</p> <p>Note 4: Skip the parts of the test procedure configuring in-gap interferer positions for a non-contiguous component carrier</p>			

#### 7.8.1A.5.4.3 Message contents

[Message contents are according to TS 36.508 [7] subclause 4.6. In test procedure step 2, for SCCs configuration there are no additional message contents.]

#### 7.8.1A.5.5 Test requirement

The throughput of the carrier(s) under test shall be  $\geq 95\%$  of the maximum throughput of the reference measurement channels as specified in Annex A.3.2 with parameters specified in Table 7.8.1A.5.5-1 or Table 7.8.1A.5.5-2 for the specified wanted signal mean power in the presence of two interfering signals.



Table 7.8.1A.5.5-1: Test parameters for Wide band intermodulation

Rx Parameter	Units	Channel bandwidth					
		1.4 MHz	3 MHz	5 MHz	10 MHz	15 MHz	20 MHz
Power in Transmission Bandwidth Configuration for each CC	dBm	REFSENS + channel bandwidth specific value below					
		12	8	6	6	7	9
$P_{\text{Interferer 1 (CW)}}$	dBm	-46					
$P_{\text{Interferer 2 (Modulated)}}$	dBm	-46					
$BW_{\text{Interferer 2}}$		1.4	3	5			
$F_{\text{Interferer 1 (Offset from SCC)}}$	MHz	-BW/2 -2.1 / +BW/2+ 2.1	-BW/2 -4.5 / +BW/2 + 4.5	-BW/2 - 7.5 / +BW/2 + 7.5			
$F_{\text{Interferer 2 (Offset from SCC)}}$	MHz	$2 * F_{\text{Interferer 1}}$					
Note 1:	The transmitter shall be set to 4dB below $P_{\text{CMAX\_L}}$ with $P_{\text{CMAX\_L}}$ as defined in clause 6.2.5.						
Note 2:	The reference measurement channel is specified in Annex A.3.2 with one sided dynamic OCNG Pattern OP.1 FDD/TDD as described in Annex A.5.1.1/A.5.2.1.						
Note 3:	The modulated interferer consists of the Reference measurement channel specified in Annex A.3.2 with one sided dynamic OCNG Pattern OP.1 FDD/TDD as described in Annex A.5.1.1/A.5.2.1 and set-up according to Annex C.3.1. The interfering modulated signal is 5MHz E-UTRA signal as described in Annex D for channel bandwidth $\geq 5$ MHz						
Note 4:	For the UE which supports inter band CA configuration in Table 7.3A.3-0, $P_{\text{Interferer 1}}$ and $P_{\text{Interferer 2}}$ powers are increased by the amount given by $\Delta R_{\text{IB}}$ in Table 7.3A.3-0						
Note 5:	For intra-band non-contiguous + inter-band CA, $\Delta R_{\text{BNC}} = 0$ dB for all sub-block gaps						

Table 7.8.1A.5.5-2: Wide band intermodulation

Rx parameter	Units	CA Bandwidth Class					
		B	C	D	E	F	
Power per CC in Aggregated Transmission Bandwidth Configuration	dBm	REFSENS + CA Bandwidth Class specific value below					
		9	12	13.8			
$P_{\text{Interferer 1 (CW)}}$	dBm	-46					
$P_{\text{Interferer 2 (Modulated)}}$	dBm	-46					
$BW_{\text{Interferer 2}}$	MHz	5	5	5			
$F_{\text{Interferer 1 (Offset)}}$	MHz	$-F_{\text{offset}}-7.5$ / $+ F_{\text{offset}}+7.5$	$-F_{\text{offset}}-7.5$ / $+ F_{\text{offset}}+7.5$	$-F_{\text{offset}}-7.5$ / $+ F_{\text{offset}}+7.5$			
$F_{\text{Interferer 2 (Offset)}}$	MHz	$2 * F_{\text{Interferer 1}}$					
Note 1:	The transmitter shall be set to 4dB below $P_{\text{CMAX\_L}}$ or $P_{\text{CMAX\_L\_CA}}$ as defined in subclause 6.2.5A.						
Note 2:	Reference measurement channel is specified in Annex A.3.2 with one sided dynamic OCNG Pattern OP.1 FDD/TDD as described in Annex A.5.1.1/A.5.2.1.						
Note 3:	The modulated interferer consists of the Reference measurement channel specified in Annex A.3.2 with one sided dynamic OCNG Pattern OP.1 FDD/TDD as described in Annex A.5.1.1/A.5.2.1 with set-up according to Annex C.3.1.						
Note 4:	The interfering modulated signal is 5MHz E-UTRA signal as described in Annex D for channel bandwidth $\geq 5$ MHz						
Note 5:	The $F_{\text{interferer 1 (offset)}}$ is the frequency separation of the centre frequency of the carrier closest to the interferer and the centre frequency of the CW interferer and $F_{\text{interferer 2 (offset)}}$ is the frequency separation of the centre frequency of the carrier closest to the interferer and the centre frequency of the modulated interferer.						

## 7.8.1B Wide band Intermodulation for UL-MIMO

### 7.8.1B.1 Test purpose

Intermodulation response tests the ability of UE that support UL-MIMO to receive data with a given average throughput for a specified reference measurement channel, in the presence of two or more interfering signals which have a specific frequency relationship to the wanted signal, under conditions of ideal propagation and no added noise.

A UE unable to meet the throughput requirement under these conditions will decrease the coverage area when two or more interfering signals exist which have a specific frequency relationship to the wanted signal.

### 7.8.1B.2 Test applicability

This test applies to all types of E-UTRA UE release 10 and forward that support UL-MIMO.

### 7.8.1B.3 Minimum conformance requirements

For UE(s) with two transmitter antenna connectors in closed-loop spatial multiplexing scheme, the minimum requirements in subclause 7.8.1B.3 shall be met with the UL-MIMO configurations specified in Table 6.2.2B.3-2. For UL-MIMO, the parameter  $P_{\text{CMAX}_L}$  is defined as the total transmitter power over the two transmit antenna connectors.

The normative reference for this requirement is TS 36.101 [2] clause 7.8.1B and TS 36.101 [2] Annexes A and D.

### 7.8.1B.4 Test description

#### 7.8.1B.4.1 Initial condition

Initial conditions are a set of test configurations the UE needs to be tested in and the steps for the SS to take with the UE to reach the correct measurement state.

The initial test configurations consist of environmental conditions, test frequencies, and channel bandwidths based on E-UTRA bands specified in table 5.4.2.1-1. All of these configurations shall be tested with applicable test parameters for each channel bandwidth, and are shown in table 7.8.1B.4.1-1. The details of the uplink and downlink reference measurement channels (RMCs) are specified in Annexes A.2 and A.3 respectively. The details of the OCNG patterns used are specified in Annex A.5. Configurations of PDSCH and PDCCH before measurement are specified in Annex C.2.

Table 7.8.1B.4.1-1: Test Configuration Table

Initial Conditions						
Test Environment as specified in TS 36.508[7] subclause 4.1				NC		
Test Frequencies as specified in TS36.508 [7] subclause 4.3.1				Mid range		
Test Channel Bandwidths as specified in TS 36.508 [7] subclause 4.3.1				Lowest, 5MHz, Highest		
Test Parameters for Channel Bandwidths						
Ch BW	Downlink Configuration			Uplink Configuration		
	Mod'n	RB allocation		Mod'n	RB allocation	
		FDD	TDD		FDD	TDD
1.4MHz	QPSK	6	6	QPSK	6	6
3MHz	QPSK	15	15	QPSK	15	15
5MHz	QPSK	25	25	QPSK	25	25
5MHz	QPSK	25	N/A	QPSK	20	N/A
5MHz	QPSK	25	N/A	QPSK	15	N/A
5MHz	QPSK	25	N/A	QPSK	5 <sup>†</sup>	N/A
10MHz	QPSK	50	50	QPSK	50	50
10MHz	QPSK	50	N/A	QPSK	25	N/A
10MHz	QPSK	50	N/A	QPSK	20	N/A
10MHz	QPSK	50	N/A	QPSK	15	N/A
15MHz	QPSK	75	75	QPSK	75	75
15MHz	QPSK	75	N/A	QPSK	50	N/A
15MHz	QPSK	75	N/A	QPSK	25	N/A
15MHz	QPSK	75	N/A	QPSK	20	N/A
20MHz	QPSK	100	100	QPSK	100	100
20MHz	QPSK	100	N/A	QPSK	75	N/A
20MHz	QPSK	100	N/A	QPSK	50	N/A
20MHz	QPSK	100	N/A	QPSK	25	N/A
20MHz	QPSK	100	N/A	QPSK	20	N/A
Note 1: Test Channel Bandwidths are checked separately for each E-UTRA band, which applicable channel bandwidths are specified in Table 5.4.2.1-1. Note 2: Depending on E-UTRA band, only the appropriate Uplink RB allocation value according to table 7.3.3-2 is tested per Test Channel Bandwidth. Note 3: For the DL signal one sided dynamic OCNG Pattern OP.1 FDD/TDD is used. Note 4: Applicable only to E-UTRA FDD Band 31. The UL resource blocks shall be located at RBstart 10 (according to Table 7.3.3-2).						

1. Connect the SS and interfering sources to the UE antenna connectors as shown in TS 36.508 [7] Figure A.31.
2. The parameter settings for the cell are set up according to TS 36.508 [7] subclause 4.4.3.
3. Downlink signals are initially set up according to Annex C0, C.1 and C.3.1, and uplink signals according to Annex H.1 and H.3.1.
4. The UL and DL Reference Measurement channels are set according to Table 7.8.1B.4.1-1.
5. Propagation conditions are set according to Annex B.0.
6. Ensure the UE is in State 3A-RF according to TS 36.508 [7] clause 5.2A.2. Message contents are defined in clause 7.8.1B.4.3.

#### 7.8.1B.4.2 Test procedure

1. SS transmits PDSCH via PDCCH DCI format 1A for C\_RNTI to transmit the DL RMC according to Table 7.8.1B.4.1-1. The SS sends downlink MAC padding bits on the DL RMC.
2. SS sends uplink scheduling information for each UL HARQ process via PDCCH DCI format 4 for C\_RNTI to schedule the UL RMC according to Table 7.8.1B.4.1-1. Since the UE has no payload data to send, the UE transmits uplink MAC padding bits on the UL RMC.
3. Set the Downlink signal level to the value as defined in Table 7.8.1B.5-1. Send Uplink power control commands to the UE (less or equal to 1dB step size should be used), to ensure that the UE output power is within +0, - 3.4

dB of the target level in Table 7.8.1B.5-1 for carrier frequency  $f \leq 3.0\text{GHz}$  or within  $+0, -4.0$  dB of the target level for carrier frequency  $3.0\text{GHz} < f \leq 4.2\text{GHz}$ , for at least the duration of the throughput measurement.

4. Set the Interfering signal levels to the values as defined in Table 7.8.1B.5-1 and frequency below the wanted signal, using a modulated interferer bandwidth as defined in Annex D of the present document.
5. Measure the average throughput for a duration sufficient to achieve statistical significance according to Annex G.2.
6. Repeat steps from 3 to 5, using an interfering signal above the wanted signal at step 4.

#### 7.8.1B.4.3 Message contents

Message contents are according to TS 36.508 [7] clause 4.6 with the following exception.

**Table 7.8.1B.4.3-1: UplinkPowerControlDedicated**

Derivation Path: 36.331 clause 6.3.2			
Information Element	Value/remark	Comment	Condition
UplinkPowerControlDedicated-DEFAULT ::= SEQUENCE {			
p0-UePUSCH	0		
deltaMCS-Enabled	en0		
accumulationEnabled	TRUE		
p0-uePUCCH	0		
pSRS-Offset	3 (-6 dB)		
filterCoefficient	fc8	larger filter length is used to reduce the RSRP measurement variation	
}			

#### 7.8.1B.5 Test requirements

The throughput shall be  $\geq 95\%$  of the maximum throughput of the reference measurement channels as specified in Annex A.3.2 with parameters specified in Table 7.8.1B.5-1 for the specified wanted signal mean power in the presence of two interfering signals.

**Table 7.8.1B.5-1: Test parameters for Wide band intermodulation**

Rx Parameter	Units	Channel bandwidth					
		1.4 MHz	3 MHz	5 MHz	10 MHz	15 MHz	20 MHz
Power in Transmission Bandwidth Configuration	dBm	REFSENS + channel bandwidth specific value below					
		12	8	6	6	7	9
$P_{\text{Interferer 1 (CW)}}$	dBm	-46					
$P_{\text{Interferer 2 (Modulated)}}$	dBm	-46					
$BW_{\text{Interferer 2}}$		1.4	3	5			
$F_{\text{Interferer 1 (Offset)}}$	MHz	-BW/2 -2.1 / +BW/2+ 2.1	-BW/2 -4.5 / +BW/2 + 4.5	-BW/2 - 7.5 / +BW/2 + 7.5			
$F_{\text{Interferer 2 (Offset)}}$	MHz	$2 * F_{\text{Interferer 1}}$					
Note 1:	The transmitter shall be set to 4dB below $P_{\text{CMAX\_L}}$ with $P_{\text{CMAX\_L}}$ as defined in clause 6.2.5.						
Note 2:	The reference measurement channel is specified in Annex A.3.2 with one sided dynamic OCNG Pattern OP.1 FDD/TDD as described in Annex A.5.1.1/A.5.2.1.						
Note 3:	The modulated interferer consists of the Reference measurement channel specified in Annex A.3.2 with one sided dynamic OCNG Pattern OP.1 FDD/TDD as described in Annex A.5.1.1/A.5.2.1 and set-up according to Annex C.3.1. The interfering modulated signal is 5MHz E-UTRA signal as described in Annex D for channel bandwidth $\geq 5\text{MHz}$ .						

## 7.8.1E Wide band Intermodulation for UE category 0

Editor's note: Following aspects missing or not yet determined:

- RB allocation within brackets
- Test tolerance for this case in Annex F is not completed

### 7.8.1E.1 Test purpose

Same test purpose as in clause 7.8.1.1.

### 7.8.1E.2 Test applicability

This test applies to all types of E-UTRA UE release 12 and forward of UE category 0.

### 7.8.1E.3 Minimum conformance requirements

Same minimum conformance requirements as in clause 7.8.1.3.

### 7.8.1E.4 Test description

#### 7.8.1E.4.1 Initial condition

Same initial conditions as in clause 7.8.1.4.1 with the following exceptions:

- Instead of Table 7.8.1.4.1-1 → use Table 7.8.1E.4.1-1.
- Connect the SS to the UE antenna connectors as shown in TS 36.508[7] Annex A Figure A.6 using only main UE Tx/Rx antenna.

**Table 7.8.1E.4.1-1: Test Configuration Table**

Initial Conditions						
Test Environment as specified in TS 36.508[7] subclause 4.1				NC		
Test Frequencies as specified in TS36.508 [7] subclause 4.3.1				Mid range		
Test Channel Bandwidths as specified in TS 36.508 [7] subclause 4.3.1				Lowest, 5MHz, Highest		
Test Parameters for Channel Bandwidths						
Ch BW	Downlink Configuration			Uplink Configuration		
	Mod'n	RB allocation		Mod'n	RB allocation	
		FDD and HD-FDD	TDD		FDD and HD-FDD	TDD
1.4MHz	QPSK	6	6	QPSK	6	6
3MHz	QPSK	14	14	QPSK	15	15
5MHz	QPSK	14	14	QPSK	25	25
5MHz	QPSK	14	N/A	QPSK	20	N/A
10MHz	QPSK	14	14	QPSK	[36]	[36]
10MHz	QPSK	14	N/A	QPSK	25	N/A
10MHz	QPSK	14	N/A	QPSK	20	N/A
15MHz	QPSK	14	14	QPSK	[36]	[36]
15MHz	QPSK	14	N/A	QPSK	20	N/A
20MHz	QPSK	14	14	QPSK	[36]	[36]
20MHz	QPSK	14	N/A	QPSK	20	N/A
Note 1: Test Channel Bandwidths are checked separately for each E-UTRA band, which applicable channel bandwidths are specified in Table 5.4.2.1-1. Note 2: Depending on E-UTRA band, only the appropriate Uplink RB allocation value according to table 7.3E.3-3 is tested per Test Channel Bandwidth. The allocation shall be located as close as possible to the downlink operating band but confined within the transmission bandwidth configuration for the channel bandwidth (Table 5.4.2-1). Note 3: For the DL signal one sided dynamic OCNG Pattern OP.1 FDD/TDD is used. Note 4: Downlink RB position shall be RBstart = 0.						

### 7.8.1E.4.2 Test procedure

Same test procedure as in clause 7.8.1.4.2

### 7.8.1E.4.3 Message contents

Same message contents as in clause 7.8.1.4.3

### 7.8.1E.5 Test requirements

The throughput shall be  $\geq 95\%$  of the maximum throughput of the reference measurement channels as specified in Annex A.3.2 with parameters specified in Table 7.8.1E.5-1 for the specified wanted signal mean power in the presence of two interfering signals.

**Table 7.8.1E.5-1: Test parameters for Wide band intermodulation**

Rx Parameter	Units	Channel bandwidth					
		1.4 MHz	3 MHz	5 MHz	10 MHz	15 MHz	20 MHz
Power in Transmission Bandwidth Configuration	dBm	REFSENS + channel bandwidth specific value below					
		12	8	6	6	7	9
$P_{\text{Interferer 1}}$ (CW)	dBm	-46					
$P_{\text{Interferer 2}}$ (Modulated)	dBm	-46					
$BW_{\text{Interferer 2}}$		1.4	3	5			
$F_{\text{Interferer 1}}$ (Offset)	MHz	-BW/2 -2.1	-BW/2 -4.5	-BW/2 - 7.5			
		/	/	/			
		+BW/2+ 2.1	+BW/2 + 4.5	+BW/2 + 7.5			
$F_{\text{Interferer 2}}$ (Offset)	MHz	$2 \cdot F_{\text{Interferer 1}}$					
Note 1: The transmitter shall be set to 4dB below $P_{\text{CMAX\_L}}$ with $P_{\text{CMAX\_L}}$ as defined in clause 6.2.5.							
Note 2: The reference measurement channel is specified in Annex A.3.2 with one sided dynamic OCNG Pattern OP.1 FDD/TDD as described in Annex A.5.1.1/A.5.2.1.							
Note 3: The modulated interferer consists of the Reference measurement channel specified in Annex A.3.2 with one sided dynamic OCNG Pattern OP.1 FDD/TDD as described in Annex A.5.1.1/A.5.2.1 and set-up according to Annex C.3.1. The interfering modulated signal is 5MHz E-UTRA signal as described in Annex D for channel bandwidth $\geq 5\text{MHz}$							

## 7.8.2 Void

## 7.9 Spurious emissions

The spurious emissions power is the power of emissions generated or amplified in a receiver that appear at the UE antenna connector.

### 7.9.1 Test Purpose

Test verifies the UE's spurious emissions meet the requirements described in clause 7.9.3.

Excess spurious emissions increase the interference to other systems.

### 7.9.2 Test Applicability

This test applies to all types of E-UTRA UE release 8 and forward.

## 7.9.3 Minimum Conformance Requirements

The power of any narrow band CW spurious emission shall not exceed the maximum level specified in Table 7.9.3-1

**Table 7.9.3-1: General receiver spurious emission requirements**

Frequency Band	Measurement Bandwidth	Maximum level	Note
$30\text{MHz} \leq f < 1\text{GHz}$	100 kHz	-57 dBm	
$1\text{GHz} \leq f \leq 12.75\text{ GHz}$	1 MHz	-47 dBm	
$12.75\text{ GHz} \leq f \leq 5^{\text{th}}$ harmonic of the upper frequency edge of the DL operating band in GHz	1 MHz	-47 dBm	Note 1
Note 1: Applies only for Band 22, Band 42 and Band 43.			
Note 2: Unused PDCCH resources are padded with resource element groups with power level given by PDCCH_RA/RB as defined in Annex C.3.1.			

The normative reference for this requirement is TS 36.101 [2] clause 7.9.1.

## 7.9.4 Test Description

### 7.9.4.1 Initial Conditions

Initial conditions are a set of test configurations the UE needs to be tested in and the steps for the SS to take with the UE to reach the correct measurement state.

The initial test configurations consist of environmental conditions, test frequencies, and channel bandwidths based on E-UTRA bands specified in table 5.4.2.1-1. All of these configurations shall be tested with applicable test parameters for each channel bandwidth, and are shown in table 7.9.4.1-1. The details of the downlink and uplink reference measurement channels (RMCs) are specified in Annexes A.3 and A.2 respectively.

**Table 7.9.4.1-1: Test Configuration Table**

Initial Conditions						
Test Environment as specified in TS 36.508[7] subclause 4.1				NC		
Test Frequencies as specified in TS36.508 [7] subclause 4.3.1				Low range, Mid range, High range		
Test Channel Bandwidths as specified in TS 36.508 [7] subclause 4.3.1				Highest		
Test Parameters for Channel Bandwidths						
Ch BW	Downlink Configuration			Uplink Configuration		
	Mod'n	RB allocation		Mod'n	RB allocation	
		FDD	TDD		FDD	TDD
1.4MHz	QPSK	0	0	QPSK	0	0
3MHz	QPSK	0	0	QPSK	0	0
5MHz	QPSK	0	0	QPSK	0	0
10MHz	QPSK	0	0	QPSK	0	0
15MHz	QPSK	0	0	QPSK	0	0
20MHz	QPSK	0	0	QPSK	0	0
Note 1: Test Channel Bandwidths are checked separately for each E-UTRA band. The applicable channel bandwidths are specified in Table 7.3.3-2.						

1. Connect a spectrum analyzer (or other suitable test equipment) to the UE antenna connectors as shown in TS 36.508 [7] Annex A, Figure A.8.
2. The parameter settings for the cell are set up according to TS 36.508 [7] subclause 4.4.3.
3. Downlink signals are initially set up according to Annex C0, C.1 and C.3.1.
4. The DL Reference Measurement channels are set according to Table 7.9.4.1-1.
5. Propagation conditions are set according to Annex B.0.

6. Ensure the UE is in State 3A-RF according to TS 36.508 [7] clause 5.2A.2. Message contents are defined in clause 7.9.4.3.

### 7.9.4.2 Test Procedure

1. Sweep the spectrum analyzer (or equivalent equipment) over a frequency range and measure the average power of spurious emission.
2. Repeat step 1 for all E-UTRA Rx antennas of the UE.

### 7.9.4.3 Message Contents

Message contents are according to TS 36.508 [7] subclause 4.6.

## 7.9.5 Test Requirement

The measured spurious emissions derived in step 1), shall not exceed the maximum level specified in Table 7.9.5-1

**Table 7.9.5-1: General receiver spurious emission requirements**

Frequency Band	Measurement Bandwidth	Maximum level	Note
$30\text{MHz} \leq f < 1\text{GHz}$	100 kHz	-57 dBm	
$1\text{GHz} \leq f \leq 12.75\text{ GHz}$	1 MHz	-47 dBm	
$12.75\text{ GHz} \leq f \leq 5^{\text{th}}$ harmonic of the upper frequency edge of the DL operating band in GHz	1 MHz	-47 dBm	Note 1
Note 1: Applies only for Band 22, Band 42 and Band 43.			
Note 2: Unused PDCCH resources are padded with resource element groups with power level given by PDCCH_RA/RB as defined in Annex C.3.1.			

## 7.9A Spurious emissions for CA

**Editor's note: This clause is incomplete. The following aspects are either missing or not yet determined:**

- Connection diagram for UEs with separate antennas per carrier is not covered.

The spurious emissions power is the power of emissions generated or amplified in a receiver that appear at the UE antenna connector.

### 7.9A.1 Test Purpose

Test verifies the UE's spurious emissions meet the requirements described in clause 7.9A.3.

Excess spurious emissions increase the interference to other systems.

### 7.9A.2 Test Applicability

This test applies to all types of E-UTRA UE release 10 and forward that support inter-band DL CA with a DL-only band.



### 7.9A.3 Minimum Conformance Requirements

For E-UTRA CA configurations including an operating band without uplink band (as noted in Table 5.2-1), the power of any narrow band CW spurious emission shall not exceed the maximum level specified in Table 7.9A.3-1.

**Table 7.9A.3-1: General receiver spurious emission requirements**

Frequency band	Measurement bandwidth	Maximum level	Note
$30\text{MHz} \leq f < 1\text{GHz}$	100 kHz	-57 dBm	
$1\text{GHz} \leq f \leq 12.75\text{ GHz}$	1 MHz	-47 dBm	
NOTE 1: Unused PDCCH resources are padded with resource element groups with power level given by PDCCH_RA/RB as defined in Annex C.3.1.			
NOTE 2: The requirements apply when the UE is configured for carrier aggregation but is not transmitting.			

The normative reference for this requirement is TS 36.101 [2] clause 7.9.1A

### 7.9A.4 Test Description

#### 7.9A.4.1 Initial Conditions

Initial conditions are a set of test configurations the UE needs to be tested in and the steps for the SS to take with the UE to reach the correct measurement state.

The initial test configurations consist of environmental conditions, test frequencies, and channel bandwidths based on E-UTRA bands specified in Table 5.4.2.1-1. All of these configurations shall be tested with applicable test parameters for each channel bandwidth, and are shown in Table 7.9A.4.1-1. The details of the uplink reference measurement channels (RMCs) are specified in Annex A.2. Configurations of PDSCH and PDCCH before measurement are specified in Annex C.2.

Table 7.9A.4.1-1: Test Configuration Table

Initial Conditions						
Test Environment as specified in TS 36.508[7] subclause 4.1			NC			
Test Frequencies as specified in TS36.508 [7] subclause 4.3.1 for different CA bandwidth classes, and PCC and SCCs are mapped onto physical frequencies according to Table 7.1-2			A: Low range, Mid range, High range for PCC and SCC			
Test CC Combination setting ( $N_{RB\_agg}$ ) as specified in subclause 5.4.2A.1 for the CA Configuration across bandwidth combination sets supported by the UE			Highest $N_{RB\_agg}$ for PCC and SCC			
Test Parameters for CA Configurations						
CA Configuration / $N_{RB\_agg}$		DL Allocation			UL Allocation	
PCC $N_{RB}$	SCCs $N_{RB}$	CC MOD	PCC & SCC RB allocation		CC MOD	PCC $N_{RB\_alloc}$
50	50	QPSK	50	50	QPSK	0
50	50	QPSK	50	50	QPSK	0
50	50	QPSK	50	50	QPSK	0
50	50	QPSK	50	50	QPSK	0
50	75	QPSK	50	75	QPSK	0
50	100	QPSK	50	100	QPSK	0
50	100	QPSK	50	100	QPSK	0
50	100	QPSK	50	100	QPSK	0
75	50	QPSK	75	50	QPSK	0
75	100	QPSK	75	100	QPSK	0
100	50	QPSK	100	50	QPSK	0
100	50	QPSK	100	50	QPSK	0
100	50	QPSK	100	50	QPSK	0
100	75	QPSK	100	75	QPSK	0
100	100	QPSK	100	100	QPSK	0
100	100	QPSK	100	100	QPSK	0
Note 1: CA Configuration Test CC Combination settings are checked separately for each CA Configuration, which applicable aggregated channel bandwidths are specified in Table 5.4.2A.1-2.						

1. Connect the SS to the UE antenna connectors as shown in Figure TS 36.508 [7] Annex A, Figure A.8 as appropriate.
2. The parameter settings for the cell are set up according to TS 36.508 [7] subclause 4.4.3.
3. Downlink signals for PCC are initially set up according to Annex C.0, C.1 and Annex C.3.0, and uplink signals according to Annex H.1 and H.3.0.
4. Propagation conditions are set according to Annex B.0.
5. Ensure the UE is in State 3A-RF according to TS 36.508 [7] clause 5.2A.2. Message contents are defined in clause 7.9A.4.3.

#### 7.9A.4.2 Test Procedure

1. Configure SCC according to Annex C.0, C.1 and Annex C.3.1 for all downlink physical channels.

2. The SS shall configure SCC as per TS 36.508 [7] clause 5.2A.4. Message contents are defined in clause 7.9A.4.3.
3. SS activates SCC by sending the activation MAC-CE (Refer TS 36.321 [13], clauses 5.13, 6.1.3.8). Wait for at least 2 seconds (Refer TS 36.133, clauses 8.3.3.2).
4. SS transmits PDSCH via PDCCH DCI format 1A for C\_RNTI to transmit the DL RMC according to Table 7.9A.4.1-1 on both PCC and SCC. The SS sends downlink MAC padding bits on the DL RMC.
5. Sweep the spectrum analyzer (or equivalent equipment) over a frequency range and measure the average power of spurious emission. During measurement SS sends no uplink scheduling information to the UE
6. Repeat step 1 to 5 for all E-UTRA Rx antennas of the UE.

### 7.9A.4.3 Message Contents

Message contents are according to TS 36.508 [7] subclause 4.6.

### 7.9A.5 Test Requirement

The measured spurious emissions derived in step 5), shall not exceed the maximum level specified in Table 7.9A.5-1

**Table 7.9A.5-1: General receiver spurious emission requirements**

Frequency band	Measurement bandwidth	Maximum level	Note
$30\text{MHz} \leq f < 1\text{GHz}$	100 kHz	-57 dBm	
$1\text{GHz} \leq f \leq 12.75\text{GHz}$	1 MHz	-47 dBm	
NOTE 1: Unused PDCCH resources are padded with resource element groups with power level given by PDCCH_RA/RB as defined in Annex C.3.1.			
NOTE 2: The requirements apply when the UE is configured for carrier aggregation but is not transmitting.			

## 7.9E Spurious emissions for UE category 0

**Editor's note: Following aspects missing or not yet determined:**

- **Test tolerance for this case in Annex F is not completed**

The spurious emissions power is the power of emissions generated or amplified in a receiver that appear at the UE antenna connector.

### 7.9E.1 Test Purpose

Same test purpose as in clause 7.9.1.

### 7.9E.2 Test Applicability

This test applies to all types of E-UTRA UE release 12 and forward of UE category 0.

### 7.9E.3 Minimum Conformance Requirements

Same minimum conformance requirements as in clause 7.9.3.

### 7.9E.4 Test Description

#### 7.9E.4.1 Initial Conditions

Same initial conditions as in clause 7.9.4.1 with the following exceptions:

- Instead of Table 7.9.4.1-1 → use Table 7.9E.4.1-1.
- Connect the SS to the UE antenna connectors as shown in TS 36.508[7] Annex A Figure A.8 using only main UE Tx/Rx antenna.

Table 7.9E.4.1-1: Test Configuration Table

Initial Conditions						
Test Environment as specified in TS 36.508[7] subclause 4.1			NC			
Test Frequencies as specified in TS36.508 [7] subclause 4.3.1			Low range, Mid range, High range			
Test Channel Bandwidths as specified in TS 36.508 [7] subclause 4.3.1			Highest			
Test Parameters for Channel Bandwidths						
Ch BW	Downlink Configuration			Uplink Configuration		
	Mod'n	RB allocation		Mod'n	RB allocation	
		FDD and HD-FDD	TDD		FDD and HD-FDD	TDD
1.4MHz	QPSK	0	0	QPSK	0	0
3MHz	QPSK	0	0	QPSK	0	0
5MHz	QPSK	0	0	QPSK	0	0
10MHz	QPSK	0	0	QPSK	0	0
15MHz	QPSK	0	0	QPSK	0	0
20MHz	QPSK	0	0	QPSK	0	0
Note 1: Test Channel Bandwidths are checked separately for each E-UTRA band. The applicable channel bandwidths are specified in Table 7.3E.3-3.						

## 7.9E.4.2 Test Procedure

Same test procedure as in clause 7.9.4.2

## 7.9E.4.3 Message Contents

Message contents are according to TS 36.508 [7] subclause 4.6.

## 7.9E.5 Test Requirement

The measured spurious emissions derived in step 1), shall not exceed the maximum level specified in Table 7.9E.5-1

Table 7.9E.5-1: General receiver spurious emission requirements

Frequency Band	Measurement Bandwidth	Maximum level	Note
$30\text{MHz} \leq f < 1\text{GHz}$	100 kHz	-57 dBm	
$1\text{GHz} \leq f \leq 12.75\text{ GHz}$	1 MHz	-47 dBm	
$12.75\text{ GHz} \leq f \leq 5^{\text{th}}$ harmonic of the upper frequency edge of the DL operating band in GHz	1 MHz	-47 dBm	Note 1
Note 1: Applies only for Band 22, Band 42 and Band 43.			
Note 2: Unused PDCCH resources are padded with resource element groups with power level given by PDCCH_RA/RB as defined in Annex C.3.1.			

## 7.10 Void

### 7.10A Receiver image for CA

TS 36.101 [2] clause 7.10.1A specifies minimum requirements for receiver image for CA but recommends that these requirements do not need to be tested.

## 8 Performance Requirement

### 8.1 General

The performance requirements for the physical channels specified in TS 36.211 [8] clause 6 (for downlink physical channels) shall be as defined in the respective sections below.

The requirements for the UE in this clause are specified for the downlink reference measurement channels specified in Annex A, the propagation conditions specified in Annex B and the downlink physical channels specified in Annex C.

Unless otherwise stated the throughput measurements in clause 8 shall be performed according to the general rules for statistical testing in Annex G clause G.3.

The requirement for a UE that support E-UTRA in downlink shall be tested according to the declared UE PDSCH category and CA capabilities.

The fading of the signals and the AWGN signals applied to each receiver antenna connector shall be uncorrelated. The levels of the test signal applied to each of the antenna connectors shall be as defined in the respective test cases.

The UE performance in this section is considered to be operating band independent. Therefore, the required performance in the respective test cases can be verified in one of the operating bands supported by the UE under test. All the test points supported by the bands of the multiband UE (based on channel bandwidth, DL and UL configuration) need to be tested.

For CA testing, unless otherwise stated, the logical carriers PCC / SCC are mapped on physical frequencies as defined in Table 8.1-1.

**Table 8.1-1: PCC/SCCs frequency mapping**

CA Configuration	PCC-SCC mapping	Notes
Intra-band CA	CC1-CC2	1
Inter-band CA (CA_x-y)	Bx-By (if not supported by the UE, then By-Bx)	2
Note 1:	Notation CCi-CCj means PCC on component carrier CCi and SCC on component carrier CCj, with CCi/j frequencies defined in the corresponding intra-band contiguous / non-contiguous CA band in TS 36.508.	
Note 2:	Notation Bi-Bj means PCC on component Band i and SCC on component Band j, with single Band i/j frequencies defined in TS 36.508.	

#### 8.1.1 Receiver antenna capability

The performance requirements are based on UE(s) that utilize one or more antenna receivers.

For all test cases, the SNR is defined as:

$$SNR = \frac{\sum_{j=1}^{N_{RX}} \hat{E}_s^{(j)}}{\sum_{j=1}^{N_{RX}} N_{oc}^{(j)}}$$

where  $N_{RX}$  denotes the number of receiver antenna connectors and the superscript receiver antenna connector  $j$ . The above SNR definition assumes that the REs are not precoded. The SNR definition does not account for any gain which can be associated to the precoding operation. The relative power of physical channels transmitted is defined in Table C.3.2-1. The SNR requirement applies for the UE categories and CA capabilities given for each test.

For enhanced performance requirements type A, the SINR is defined as

$$SINR = \frac{\sum_{j=1}^{N_{RX}} \hat{E}_s^{(j)}}{\sum_{j=1}^{N_{RX}} N_{oc}^{(j)}}$$

where  $N_{RX}$  denotes the number of receiver antenna connectors and the superscript receiver antenna connector  $j$ . The above SINR definition assumes that the REs are not precoded. The SINR definition does not account for any gain which can be associated to the precoding operation. The relative power of physical channels transmitted is defined in Table C.3.2-1. The SINR requirement applies for the UE categories given for each test.

For the performance requirements specified in this clause, it is assumed that  $N_{RX}=2$  unless otherwise stated.

**Table 8.1.1-1: Void**

8.1.1.1 Simultaneous unicast and MBMS operations

8.1.1.2 Dual-antenna receiver capability in idle mode

8.1.2 Applicability of requirements

8.1.2.1 Applicability of requirements for different channel bandwidths

In Clause 8 the test cases may be defined with different channel bandwidth to verify the same target FRC conditions with the same propagation conditions, correlation matrix and antenna configuration.

Test cases defined for 5MHz channel bandwidth that reference this clause are applicable to UEs that support only Band 31.

8.1.2.2 Definition of CA capability

The definition with respect to CA capabilities for 2CCs is given as in Table 8.1.2.2-1.

**Table 8.1.2.2-1: Definition of CA capability with 2DL CCs**

CA Capability	CA Capability Description
CA2_C	Intra-band contiguous CA
CA2_A2	Inter-band CA (two bands)
CA2_N2	Intra-band non-contiguous CA (with two sub-blocks)
Note 1:	CA2_C corresponds to E-UTRA CA configurations and bandwidth combination sets defined in Table 5.4.2A.1-1 for 2 DL CCs. CA2_A2 corresponds to E-UTRA CA configurations and bandwidth combination sets defined in Table 5.4.2A.1-2 for 2 DL CCs. CA2_N2 corresponds to E-UTRA CA configurations and bandwidth combination sets defined in Table 5.4.2A.1-3 for 2 DL CCs.

The supported testable aggregated CA bandwidth combinations for 2CCs for each CA capability are listed in Table 8.1.2.2-2.

**Table 8.1.2.2-2: Supported testable aggregated CA bandwidth combinations for different CA capability with 2DL CCs**

CA Capability	Bandwidth combination for FDD CA	Bandwidth combination for TDD CA	Bandwidth combination for TDD-FDD CA
CA_C	[5+5MHz, 5+10MHz, 10+10MHz, 20+20MHz]	[20+20MHz, 15+20MHz]	NA
CA_A_2	[10+10MHz, 10+15MHz, 10+20MHz, 15+20MHz, 20+20MHz]	[20+20MHz]	[10(FDD)+20(TDD)MHz, 15(FDD)+20(TDD)MHz, 20(FDD)+20(TDD)MHz]
CA_N	[5+10MHz, 10+10MHz, 20+20MHz]	[20+20MHz]	NA
Note 1: This table is only for information and applicability and test rules of CA performance requirements are specified in 8.1.2.3 and 9.1.1.2.			

**Table 8.1.2.2-3: Definition of CA capability with 3 DL CCs**

CA Capability	CA Capability Description
CA_C	Intra-band contiguous CA
CA_A_2	Inter-band CA (two bands)
CA_A_3	Inter-band CA (three bands)
CA_N	Intra-band non-contiguous CA (with two sub-blocks)
Note 1: CA_C corresponds to E-UTRA CA configurations and bandwidth combination sets defined in Table 5.4.2A.1-1. CA_A_2 corresponds to E-UTRA CA configurations and bandwidth combination sets defined in Table 5.4.2A.1-2. CA_A_3 corresponds to E-UTRA CA configurations and bandwidth combination sets defined in and Table 5.4.2A.1-2a. CA_N corresponds to E-UTRA CA configurations and bandwidth combination sets defined in Table 5.4.2A.1-3.	

The supported largest aggregated CA bandwidth combinations for 3CCs for each CA capability are listed in Table 8.1.2.2-4.

**Table 8.1.2.2-4: Supported largest aggregated CA bandwidth combinations for different CA capability with 3 CCs**

CA capability	Bandwidth combination for FDD CA	Bandwidth combination for TDD CA	Bandwidth combination for TDD-FDD CA
CA_C	NA	[20+20+20MHz]	NA
CA_A_2	[5+10+20MHz, 10+10+20MHz, 10+20+20MHz, 20+20+20MHz]	[15+20+20MHz, 20+20+20MHz]	[15(FDD)+20(TDD)+20(TDD)MHz, 20(FDD)+20(TDD)+20(TDD)MHz]
CA_A_3	[10+10+20MHz, 10+15+15MHz, 10+20+20MHz, 15+15+20MHz, 15+20+20MHz, 20+20+20MHz]	NA	NA
CA_N	NA	[20+20+20MHz]	NA
Note 1: This table is only for information and applicability and test rules of CA performance requirements are specified in 8.1.2.3 and 9.1.1.2.			

For test cases with more than one component carrier, "Fraction of Maximum Throughput" in the performance requirement refers to the ratio of the sum of throughput values of all component carriers to the sum of the nominal maximum throughput values of all component carriers, unless otherwise stated.

### 8.1.2.3 Applicability and test rules for different CA configurations and bandwidth combination sets

The performance requirement for CA UE demodulation tests in Clause 8 are defined independent of CA configurations and bandwidth combination sets specified in Clause 5.4.2A.1. For UEs supporting different CA configurations and bandwidth combination sets, the applicability and test rules are defined for the tests for 2 DL CCs in Table 8.1.2.3-1 and 3DL CCs in Table 8.2.2.3-2. For simplicity, CA configuration below refers to combination of CA configuration and bandwidth combination set.

**Table 8.1.2.3-1: Applicability and test rules for CA UE demodulation tests with 2 DL CCs**

Tests	CA capability where the tests apply	CA configuration from the selected CA capability where the tests apply	CA Bandwidth combination to be tested in priority order	No. of the supported bandwidth combinations to be tested from each selected CA configuration
CA tests with 2CCs in Clause 8.2.1.1.1_A, 8.2.1.4.2_A	Any one of the supported CA capabilities	Any one of the supported FDD CA configurations	10+10 MHz, 20+20 MHz, 5+5 MHz, and 10MHz+5MHz.	1
CA tests with 2CCs in Clause 8.2.1.3.1_A	Each supported CA capability	Any one of the supported FDD CA configurations in each CA capability	10+10 MHz, 20+20 MHz, 5+5 MHz, and 10MHz+5MHz.	1
CA tests with 2CCs in Clause 8.2.1.3.1A, 8.7.1.1_A	Any one of the supported CA capabilities with largest aggregated CA bandwidth combination	Any one of the supported FDD CA configurations with largest aggregated CA bandwidth combination	Largest aggregated CA bandwidth combination	1
CA tests with 2CCs in Clause 8.2.1.7	CA2_C	Supported FDD intra-band contiguous CA configurations covering the lowest and highest operating bands	Largest aggregated CA bandwidth combinations	1
CA tests with 2CCs in Clause 8.2.2.1.1_A, 8.2.2.4.2_A	Any one of the supported CA capabilities with largest aggregated CA bandwidth combination	Any one of the supported TDD CA configurations with largest aggregated CA bandwidth combination	Largest aggregated CA bandwidth combination	1
CA tests with 2CCs in Clause 8.2.2.3.1_A	Each supported CA capability	Any one of the supported TDD CA configurations in each CA capability with largest aggregated CA bandwidth combination	Largest aggregated CA bandwidth combination	1
CA tests with 2CCs in Clause 8.2.2.3.1A, 8.7.2.1_A	Any one of the supported CA capabilities with largest aggregated CA bandwidth	Any one of the supported TDD CA configurations with largest aggregated CA bandwidth combination	Largest aggregated CA bandwidth combination	1
CA tests with 2CCs in 8.2.2.7	CA2_C	Supported TDD intra-band contiguous CA configurations covering the lowest and highest operating bands	Largest aggregated CA bandwidth combinations	1
CA tests with 2CCs in Clause [8.2.1.8.1]	CA2_N2	CA_3A-3A defined in Table 5.4.2A.1-3	10+10 MHz	1

Note 1: The applicability and test rules are specified in this table, unless otherwise stated.



**Table 8.1.2.3-2: Applicability and test rules for CA UE demodulation tests with 3 DL CCs**

Tests	CA capability where the tests apply	CA configuration from the selected CA capability where the tests apply	CA Bandwidth combination to be tested in priority order	No. of the supported bandwidth combinations to be tested from each selected CA configuration
CA tests with 3CCs in Clause 8.2.1.1.1_A, 8.2.1.4.2_A, 8.7.1.1_A	Any one of the supported CA capabilities with largest aggregated CA bandwidth combination	Any one of the supported FDD CA configurations with largest aggregated CA bandwidth combination	Largest aggregated CA bandwidth combination	1
CA tests with 3CCs in Clause 8.2.1.3.1_A	Each supported CA capability	Any one of the supported FDD CA configurations in each CA capability with largest aggregated CA bandwidth combination	Largest aggregated CA bandwidth combination	1
CA tests with 3CCs in Clause 8.2.2.1.1_A, 8.2.2.4.2_A, 8.7.2.1_A	Any one of the supported CA capabilities with largest aggregated CA bandwidth combination	Any one of the supported TDD CA configurations with largest aggregated CA bandwidth combination	Largest aggregated CA bandwidth combination	1
CA tests with 3CCs in Clause 8.2.2.3.1_A	Each supported CA capability	Any one of the supported TDD CA configurations in each CA capability with largest aggregated CA bandwidth combination	Largest aggregated CA bandwidth combination	1
Note 1: The applicability and test rules are specified in this table, unless otherwise stated.				

### 8.1.2.3A

### 8.1.2.3B Applicability and test rules for different TDD-FDD CA configurations and bandwidth combination sets

The performance requirement for TDD-FDD CA UE demodulation tests in Clause 8 are defined independent of CA configurations and bandwidth combination sets specified in Clause 5.6A.1. For UEs supporting different CA configurations and bandwidth combination sets, the applicability and test rules are defined for the tests for 2 DL TDD-FDD CA in Table 8.1.2.3B-1 in Table 8.1.2.3B-2 and for 3 DL TDD-FDD CA. For simplicity, CA configuration below refers to combination of CA configuration and bandwidth combination set.

**Table 8.1.2.3B-1: Applicability and test rules for CA UE demodulation tests for TDD-FDD CA with 2 DL CCs**

Tests	CA capability where the tests apply	CA configuration from the selected CA capability where the tests apply	CA Bandwidth combination to be tested in priority order
CA tests with 2CCs in Clause 8.2.3.1_A.1, 8.2.3.2A_A.1, 8.2.3.3_A.1, 8.7.5_A.1	Any one of the supported CA capabilities with largest aggregated CA bandwidth combination	Any one of the supported TDD-FDD CA configurations with FDD PCell with largest aggregated CA bandwidth combination	Largest aggregated CA bandwidth combination
CA tests with 2CCs in Clause 8.2.3.2_A.1	Each supported CA capability	Any one of the supported TDD-FDD CA configurations with FDD PCell in each CA capability with largest aggregated CA bandwidth combination	Largest aggregated CA bandwidth combination
CA tests with 2CCs in Clause 8.2.3.1_A.2, 8.2.3.2A_A.2, 8.2.3.3_A.2, 8.7.5_A.2	Any one of the supported CA capabilities with largest aggregated CA bandwidth combination	Any one of the supported TDD-FDD CA configurations with TDD PCell with largest aggregated CA bandwidth combination	Largest aggregated CA bandwidth combination
CA tests with 2CCs in Clause 8.2.3.2_A.2	Each supported CA capability	Any one of the supported TDD-FDD CA configurations with TDD PCell in each CA capability with largest aggregated CA bandwidth combination	Largest aggregated CA bandwidth combination

**Table 8.1.2.3B-2: Applicability and test rules for CA UE demodulation tests for TDD-FDD CA with 3 DL CCs**

Tests	CA capability where the tests apply	CA configuration from the selected CA capability where the tests apply	CA Bandwidth combination to be tested in priority order
CA tests with 3CCs in Clause 8.2.3.1_A.3, 8.2.3.2A_A.1, 8.2.3.3_A.1, 8.7.5_A.1	Any one of the supported CA capabilities with largest aggregated CA bandwidth combination	Any one of the supported TDD-FDD CA configurations with FDD PCell with largest aggregated CA bandwidth combination	Largest aggregated CA bandwidth combination
CA tests with 3CCs in Clause 8.2.3.2_A.1	Each supported CA capability	Any one of the supported TDD-FDD CA configurations with FDD PCell in each CA capability with largest aggregated CA bandwidth combination	Largest aggregated CA bandwidth combination
CA tests with 3CCs in Clause 8.2.3.1_A.4, 8.2.3.2A_A.2, 8.2.3.3_A.2, 8.7.5_A.2	Any one of the supported CA capabilities with largest aggregated CA bandwidth combination	Any one of the supported TDD-FDD CA configurations with TDD PCell with largest aggregated CA bandwidth combination	Largest aggregated CA bandwidth combination
CA tests with 3CCs in Clause 8.2.3.2_A.2	Each supported CA capability	Any one of the supported TDD-FDD CA configurations with TDD PCell in each CA capability with largest aggregated CA bandwidth combination	Largest aggregated CA bandwidth combination

#### 8.1.2.4 Test coverage for different number of component carriers

For FDD tests specified in 8.2.1.1.1, 8.2.1.3.1, 8.2.1.4.2, and 8.7.1.1, if corresponding CA tests are tested, the test coverage can be considered fulfilled without executing single carrier tests.

For TDD tests specified in 8.2.2.1.1, 8.2.2.3.1, 8.2.2.4.2, and 8.7.2.1, if corresponding CA tests are tested, the test coverage can be considered fulfilled without executing single carrier tests.

For FDD CA tests specified in 8.2.1.1.1\_A, 8.2.1.4.2\_A, and 8.7.1.1\_A, among all supported CA capabilities, if corresponding CA tests with the largest number of CCs supported by the UE are tested, the test coverage can be considered fulfilled without executing the CA tests with less than the largest number of CCs supported by the UE.

For FDD CA tests specified in 8.2.1.3.1\_A, for each supported CA capability, if corresponding CA tests with the largest number of CCs supported by the UE are tested, the test coverage can be considered fulfilled without executing the CA tests with less than the largest number of CCs supported by the UE.

For TDD CA tests specified in 8.2.2.1.1\_A, 8.2.2.4.2\_A, and 8.7.2.1\_A, among all supported CA capabilities, if corresponding CA tests with the largest number of CCs supported by the UE are tested, the test coverage can be considered fulfilled without executing the CA tests with less than the largest number of CCs supported by the UE.

For TDD CA tests specified in 8.2.2.3.1\_A, for each supported CA capability, if corresponding CA tests with the largest number of CCs supported by the UE are tested, the test coverage can be considered fulfilled without executing the CA tests with less than the largest number of CCs supported by the UE.

## 8.2 Demodulation of PDSCH (Cell-Specific Reference Symbols)

### 8.2.1 FDD (Fixed Reference Channel)

The parameters specified in Table 8.2.1-1 are valid for all FDD tests unless otherwise stated.

Table 8.2.1-1: Common Test Parameters (FDD)

Parameter	Unit	Value	Comments
Inter-TTI Distance		1	
Number of HARQ processes	Processes	8	For FDD, 8 HARQ processes in the DL, as specified in TS 36.213 [10] clause 7. All 8 HARQ processes are used.
Scheduling of retransmissions			1. Retransmissions use the same Transport Block Size (TBS) as the initial transmission. 2. HARQ processes are scheduled consecutively, independent of the fact, whether retransmissions (for negatively acknowledged HARQ processes) or new transmissions (for positively acknowledged HARQ processes) occur.
Maximum number of HARQ transmission		4	It is always 4 for FDD, as specified in TS 36.213 [10] clause 8
Redundancy version coding sequence		{0,1,2,3} for QPSK and 16QAM {0,0,1,2} for 64QAM	
Number of OFDM symbols for PDCCH	OFDM symbols	4 for 1.4 MHz bandwidth, 3 for 3 MHz and 5 MHz bandwidths, 2 for 10 MHz, 15 MHz and 20 MHz bandwidths	The PCFICH carries information about the number of OFDM symbols used for transmission of PDCCHs in a subframe, as specified in TS 36.211 [8] clause 6.7
Cyclic Prefix		Normal	CP consist of the following physical resource blocks (RBs) parameters: 12 consecutive subcarriers at a 15 kHz spacing and 7 OFDM symbols, as specified in TS 36.211 [8] clause 6.2.3
Cell ID		0 (Note 1)	The Cell ID is uniquely defined by a number in the range of 0 to 503, representing the physical-layer cell identity, as specified in TS 36.211 [8] clause 6.11.
Cross carrier scheduling		Not configured	
Note 1: For CA tests, Cell ID = 0 applies to P-Cell. For (n)th S-Cell, Cell ID = n is used.			

The normative reference for this requirement is TS 36.101 [2] clause 8.2.1.

### 8.2.1.1 FDD PDSCH Single Antenna Port Performance (Cell-Specific Reference Symbols)

#### 8.2.1.1.1 FDD PDSCH Single Antenna Port Performance

##### 8.2.1.1.1.1 Test purpose

To verify the UE's ability to receive a predefined test signal, representing a multi-path fading channel that is determined by the SNR with a percentage of the information bit throughput for a specified downlink Reference Measurement Channel (RMC) not falling below a specified value for transmission on a single-antenna port with different channel models and MCS.

##### 8.2.1.1.1.2 Test applicability

This test applies to all types of E-UTRA FDD UE release 8 and forward.

## 8.2.1.1.1.3 Minimum conformance requirements

The requirements are specified in terms of the percentage of information bit throughput for the downlink reference measurement channels specified in Annex A clause A.3.3.1, with the addition of the relevant parameters in Tables 8.2.1-1, 8.2.1.1.1.3-1 and the downlink physical channel setup according to Table C.3.2-1 in Annex C.

Using this configuration the fraction of maximum throughput percentage shall meet or exceed the minimum requirements specified in Table 8.2.1.1.1.3-2 for the specified SNR. For QPSK and 64QAM performance the bandwidths specified in Table 5.4.2.1-1 are verified.

**Table 8.2.1.1.1.3-1: Test Parameters for Testing**

Parameter		Unit	Test 1- 5	Test 6- 8	Test 9- 15	Test 16- 18
Downlink power allocation	$\rho_A$	dB	0	0	0	0
	$\rho_B$	dB	0 (Note 1)	0 (Note 1)	0 (Note 1)	0 (Note 1)
	$\sigma$	dB	0	0	0	0
$N_{oc}$ at antenna port		dBm/15kHz	-98	-98	-98	-98
Symbols for unused PRBs			OCNG (Note 2)	OCNG (Note 2)	OCNG (Note 2)	OCNG (Note 2)
Modulation			QPSK	16QAM	64QAM	16QAM
PDSCH transmission mode			1	1	1	1
Note 1: $P_B = 0$						
Note 2: These physical resource blocks are assigned to an arbitrary number of virtual UE's with one PDSCH per virtual UE; the data transmitted over the OCNG PDSCHs shall be uncorrelated pseudo random data, which is QPSK modulated.						

Table 8.2.1.1.1.3-2: Minimum performance (FRC)

Test number	Bandwidth	Reference Channel	OCNG Pattern	Propagation Condition	Correlation Matrix and Antenna Configuration	Reference value		UE Category
						Fraction of Maximum Throughput (%)	SNR (dB)	
1	10 MHz (Note 1)	R.2 FDD	OP.1 FDD	EVA5	1x2 Low	70	-1.0	1-8
2	10 MHz	R.2 FDD	OP.1 FDD	ETU70	1x2 Low	70	-0.4	1-8
3	10 MHz	R.2 FDD	OP.1 FDD	ETU300	1x2 Low	70	0.0	1-8
4	10 MHz	R.2 FDD	OP.1 FDD	HST	1x2	70	-2.4	1-8
5	1.4 MHz	R.4 FDD	OP.1 FDD	EVA5	1x2 Low	70	0.0	1-8
6	10 MHz	R.3 FDD	OP.1 FDD	EVA5	1x2 Low	70	6.7	2-8
	5 MHz (Note 2)	R.3-1 FDD	OP.1 FDD	EVA5	1x2 Low	70	6.7	2-8
7	10 MHz	R.3 FDD	OP.1 FDD	ETU70	1x2 Low	30	1.4	2-8
	5 MHz (Note 2)	R.3-1 FDD	OP.1 FDD	ETU70	1x2 Low	30	1.4	2-8
8	10 MHz	R.3 FDD	OP.1 FDD	ETU300	1x2 High	70	9.4	2-8
	5 MHz (Note 2)	R.3-1 FDD	OP.1 FDD	ETU300	1x2 High	70	9.4	2-8
9	3 MHz	R.5 FDD	OP.1 FDD	EVA5	1x2 Low	70	17.6	1-8
10	5 MHz	R.6 FDD	OP.1 FDD	EVA5	1x2 Low	70	17.4	2-8
11	10 MHz	R.7 FDD	OP.1 FDD	EVA5	1x2 Low	70	17.7	2-8
12	10 MHz	R.7 FDD	OP.1 FDD	ETU70	1x2 Low	70	19.0	2-8
13	10 MHz	R.7 FDD	OP.1 FDD	EVA5	1x2 High	70	19.1	2-8
14	15 MHz	R.8 FDD	OP.1 FDD	EVA5	1x2 Low	70	17.7	2-8
15	20 MHz	R.9 FDD	OP.1 FDD	EVA5	1x2 Low	70	17.6	3-8
16	3 MHz	R.0 FDD	OP.1 FDD	ETU70	1x2 Low	30	1.9	1-8
17	10 MHz	R.1 FDD	OP.1 FDD	ETU70	1x2 Low	30	1.9	1-8
18	20 MHz	R.1 FDD	OP.1 FDD	ETU70	1x2 Low	30	1.9	1-8

Note 1: Test 1 may not be executed for UE-s for which Test 1 in section 8.2.1.1.1\_A.2 is applicable.  
Note 2: Test case applicability is defined in 8.1.2.1.

The normative reference for this requirement is TS 36.101 [2] clause 8.2.1.1.

#### 8.2.1.1.1.4 Test description

##### 8.2.1.1.1.4.1 Initial conditions

Initial conditions are a set of test configurations the UE needs to be tested in and the steps for the SS to take with the UE to reach the correct measurement state.

Configurations of PDSCH and PDCCH before measurement are specified in Annex C.2.

Test Environment: Normal, as defined in TS 36.508 [7] clause 4.1.

Frequencies to be tested: Mid Range, as defined in TS 36.508 [7] clause 4.3.1.1.

Frequencies to be tested for 1PRB allocation: Low Range, as defined in TS 36.508 [7] clause 4.3.1.1.

Channel Bandwidths to be tested: As specified per test number in Table 8.2.1.1.3-2 as defined in TS 36.508 [7] clause 4.3.1.1

1. Connect the SS, the faders and AWGN noise source to the UE antenna connectors as shown in TS 36.508 [7] Annex A, Figure A.9.
2. The parameter settings for the cell are set up according to Table 8.2.1-1 and 8.2.1.1.3-1 as appropriate.
3. Downlink signals are initially set up according to Annex C0, C.1 and Annex C.3.2 and uplink signals according to Annex H.1 and H.3.2.
4. Propagation conditions are set according to Annex B.0.
5. Ensure the UE is in State 3A-RF according to TS 36.508 [7] clause 5.2A.2. Message contents are defined in clause 8.2.1.1.4.3.

#### 8.2.1.1.4.2 Test procedure

1. SS transmits PDSCH via PDCCH DCI format 1A for C\_RNTI to transmit the DL RMC according to Tables 8.2.1.1.3-1 and 8.2.1.1.3-2. The SS sends downlink MAC padding bits on the DL RMC.
2. Set the parameters of the bandwidth, MCS, reference channel, the propagation condition, the correlation matrix and the SNR according to Tables 8.2.1.1.5-1 as appropriate.
3. Measure the average throughput for a duration sufficient to achieve statistical significance according to Annex G clause G.3. Count the number of NACKs, ACKs and statDTXs on the UL during each subtest and decide pass or fail according to Tables G.3.5 and G.3.6 in Annex G clause G.3.
4. Repeat steps from 1 to 3 for each subtest in Table 8.2.1.1.5-1 as appropriate.

#### 8.2.1.1.4.3 Message contents

Message contents are according to TS 36.508 [7] clause 4.6.

#### 8.2.1.1.5 Test requirement

Table 8.2.1.1.3-1 defines the primary level settings.

The fraction of maximum throughput percentage for the downlink reference measurement channels specified in Annex A clause A.3.3.1 for each throughput test shall meet or exceed the specified value in Table 8.2.1.1.5-1 for the specified SNR including test tolerances for all throughput tests.

Table 8.2.1.1.1.5-1: Test requirement (FRC)

Test number	Bandwidth	Reference Channel	OCNG Pattern	Propagation Condition	Correlation Matrix and Antenna Configuration	Reference value		UE Category
						Fraction of Maximum Throughput (%)	SNR (dB)	
1	10 MHz	R.2 FDD	OP.1 FDD	EVA5	1x2 Low	70	-0.2	1-8
2	10 MHz	R.2 FDD	OP.1 FDD	ETU70	1x2 Low	70	+0.4	1-8
3	10 MHz	R.2 FDD	OP.1 FDD	ETU300	1x2 Low	70	+0.8	1-8
4	10 MHz	R.2 FDD	OP.1 FDD	HST	1x2	70	-1.8	1-8
5	1.4 MHz	R.4 FDD	OP.1 FDD	EVA5	1x2 Low	70	+0.8	1-8
6	10 MHz	R.3 FDD	OP.1 FDD	EVA5	1x2 Low	70	+7.5	2-8
	5 MHz (Note 2)	R.3-1 FDD	OP.1 FDD	EVA5	1x2 Low	70	+7.5	2-8
7	10 MHz	R.3 FDD	OP.1 FDD	ETU70	1x2 Low	30	+2.2	2-8
	5 MHz (Note 2)	R.3-1 FDD	OP.1 FDD	ETU70	1x2 Low	30	+2.2	2-8
8	10 MHz	R.3 FDD	OP.1 FDD	ETU300	1x2 High	70	+10.2	2-8
	5 MHz (Note 2)	R.3-1 FDD	OP.1 FDD	ETU300	1x2 High	70	+10.2	2-8
9	3 MHz	R.5 FDD	OP.1 FDD	EVA5	1x2 Low	70	+18.4	1-8
10	5 MHz	R.6 FDD	OP.1 FDD	EVA5	1x2 Low	70	+18.2	2-8
11	10 MHz	R.7 FDD	OP.1 FDD	EVA5	1x2 Low	70	+18.5	2-8
12	10 MHz	R.7 FDD	OP.1 FDD	ETU70	1x2 Low	70	+19.8	2-8
13	10 MHz	R.7 FDD	OP.1 FDD	EVA5	1x2 High	70	+19.9	2-8
14	15 MHz	R.8 FDD	OP.1 FDD	EVA5	1x2 Low	70	+18.5	2-8
15	20 MHz	R.9 FDD	OP.1 FDD	EVA5	1x2 Low	70	+18.4	3-8
16	3 MHz	R.0 FDD	OP.1 FDD	ETU70	1x2 Low	30	+2.7	1-8
17	10 MHz	R.1 FDD	OP.1 FDD	ETU70	1x2 Low	30	+2.7	1-8
18	20 MHz	R.1 FDD	OP.1 FDD	ETU70	1x2 Low	30	+2.7	1-8

Note 1: N/A.  
Note 2: Test case is applicable (according to sub clause 8.1.2.1) to UE's which, from the E-UTRA operating bands defined in Table 5.2-1, support only E-UTRA band 31.

### 8.2.1.1.1\_1 FDD PDSCH Single Antenna Port Performance (Release 9 and forward)

#### 8.2.1.1.1\_1.1 Test purpose

Same test purpose as in clause 8.2.1.1.1.1.

#### 8.2.1.1.1\_1.2 Test applicability

This test applies to all types of E-UTRA FDD UE release 9 and forward of UE category 1 and 2.



## 8.2.1.1.1\_1.3 Minimum conformance requirements

Same minimum conformance requirements as in clause 8.2.1.1.1.3 with the following exceptions:

- Instead of Table 8.2.1.1.1.3-1 → use Table 8.2.1.1.1\_1.3-1.
- Instead of Table 8.2.1.1.1.3-2 → use Table 8.2.1.1.1\_1.3-2.

**Table 8.2.1.1.1\_1.3-1: Test Parameters for Testing**

Parameter		Unit	Test 1- 5	Test 6- 8	Test 9	Test 10- 15	Test 16- 18
Downlink power allocation	$\rho_A$	dB	N/A	0	N/A	0	N/A
	$\rho_B$	dB		0 (Note 1)		0 (Note 1)	
	$\sigma$	dB		0		0	
$N_{oc}$ at antenna port		dBm/15kHz		-98		-98	
Symbols for unused PRBs				OCNG (Note 2)		OCNG (Note 2)	
Modulation				16QAM		64QAM	
PDSCH transmission mode				1		1	
Note 1: $P_B = 0$ Note 2: These physical resource blocks are assigned to an arbitrary number of virtual UEs with one PDSCH per virtual UE; the data transmitted over the OCNG PDSCHs shall be uncorrelated pseudo random data, which is QPSK modulated.							

**Table 8.2.1.1.1\_1.3-2: Minimum performance (FRC)**

Test number	Bandwidth	Reference Channel	OCNG Pattern	Propagation Condition	Correlation Matrix and Antenna Configuration	Reference value		UE Category
						Fraction of Maximum Throughput (%)	SNR (dB)	
1	N/A							
2	N/A							
3	N/A							
4	N/A							
5	N/A							
6	5 MHz	R.3-1 FDD	OP.1 FDD	EVA5	1x2 Low	70	6.7	1
7	5 MHz	R.3-1 FDD	OP.1 FDD	ETU70	1x2 Low	30	1.4	1
8	5 MHz	R.3-1 FDD	OP.1 FDD	ETU300	1x2 High	70	9.4	1
9	N/A							
10	5 MHz	R.6-1 FDD	OP.1 FDD	EVA5	1x2 Low	70	17.5	1
11	10 MHz	R.7-1 FDD	OP.1 FDD	EVA5	1x2 Low	70	16.7	1
12	10 MHz	R.7-1 FDD	OP.1 FDD	ETU70	1x2 Low	70	18.1	1
13	10 MHz	R.7-1 FDD	OP.1 FDD	EVA5	1x2 High	70	17.8	1
14	15 MHz	R.8-1 FDD	OP.1 FDD	EVA5	1x2 Low	70	16.8	1
15	20 MHz	R.9-2 FDD	OP.1 FDD	EVA5	1x2 Low	70	17.3	2
	20 MHz	R.9-1 FDD	OP.1 FDD	EVA5	1x2 Low	70	16.7	1
16	N/A							
17	N/A							
18	N/A							

The normative reference for this requirement is TS 36.101 [2] clause 8.2.1.1.

## 8.2.1.1.1\_1.4 Test description

Same test description as in clause 8.2.1.1.1.4 with the following exceptions:

- Instead of Table 8.2.1.1.1.3-1 → use Table 8.2.1.1.1\_1.3-1.
- Instead of Table 8.2.1.1.1.3-2 → use Table 8.2.1.1.1\_1.3-2.
- Instead of Table 8.2.1.1.1.5-1 → use Table 8.2.1.1.1\_1.5-1.

## 8.2.1.1.1\_1.5 Test requirement

Same test requirements as in clause 8.2.1.1.1.5 with the following exceptions:

- Instead of Table 8.2.1.1.1.3-1 → use Table 8.2.1.1.1\_1.3-1.
- Instead of Table 8.2.1.1.1.5-1 → use Table 8.2.1.1.1\_1.5-1.

**Table 8.2.1.1.1\_1.5-1: Test requirement (FRC)**

Test number	Bandwidth	Reference Channel	OCNG Pattern	Propagation Condition	Correlation Matrix and Antenna Configuration	Reference value		UE Category
						Fraction of Maximum Throughput (%)	SNR (dB)	
1	N/A							
2	N/A							
3	N/A							
4	N/A							
5	N/A							
6	5 MHz	R.3-1 FDD	OP.1 FDD	EVA5	1x2 Low	70	+7.5	1
7	5 MHz	R.3-1 FDD	OP.1 FDD	ETU70	1x2 Low	30	+2.2	1
8	5 MHz	R.3-1 FDD	OP.1 FDD	ETU300	1x2 High	70	+10.2	1
9	N/A							
10	5 MHz	R.6-1 FDD	OP.1 FDD	EVA5	1x2 Low	70	+18.3	1
11	10 MHz	R.7-1 FDD	OP.1 FDD	EVA5	1x2 Low	70	+17.5	1
12	10 MHz	R.7-1 FDD	OP.1 FDD	ETU70	1x2 Low	70	+18.9	1
13	10 MHz	R.7-1 FDD	OP.1 FDD	EVA5	1x2 High	70	+18.6	1
14	15 MHz	R.8-1 FDD	OP.1 FDD	EVA5	1x2 Low	70	+17.6	1
15	20 MHz	R.9-2 FDD	OP.1 FDD	EVA5	1x2 Low	70	+18.1	2
	20 MHz	R.9-1 FDD	OP.1 FDD	EVA5	1x2 Low	70	+17.5	1
16	N/A							
17	N/A							
18	N/A							

## 8.2.1.1.1\_2 FDD PDSCH Single Antenna Port Performance (Release 10 and forward)

## 8.2.1.1.1\_2.1 Test purpose

Same test purpose as in clause 8.2.1.1.1.1.

## 8.2.1.1.1\_2.2 Test applicability

This test applies to all types of E-UTRA FDD UE release 10 and forward.

## 8.2.1.1.1\_2.3 Minimum conformance requirements

Same minimum conformance requirements as in clause 8.2.1.1.1.3 with the following exceptions:

- Instead of Table 8.2.1.1.1.3-1 → use Table 8.2.1.1.1\_2.3-1.
- Instead of Table 8.2.1.1.1.3-2 → use Table 8.2.1.1.1\_2.3-2.

**Table 8.2.1.1.1\_2.3-1: Test Parameters for Testing**

Parameter	Unit	Test 1
Downlink power allocation	$\rho_A$	dB
	$\rho_B$	dB
	$\sigma$	dB
$N_{oc}$ at antenna port	dBm/15kHz	-98
Symbols for unused PRBs		OCNG (Note 2)
Modulation		QPSK
PDSCH transmission mode		1
Note 1: $P_B = 0$		
Note 2: These physical resource blocks are assigned to an arbitrary number of virtual UEs with one PDSCH per virtual UE; the data transmitted over the OCNG PDSCHs shall be uncorrelated pseudo random data, which is QPSK modulated.		

**Table 8.2.1.1.1\_2.3-2: Minimum performance (FRC)**

Test number	Bandwidth	Reference Channel	OCNG Pattern	Propagation Condition	Correlation Matrix and Antenna Configuration	Reference value		UE Category
						Fraction of Maximum Throughput (%)	SNR (dB)	
1	10 MHz	R.41 FDD	OP.1 FDD	EVA5	1x2 Low	70	-5.4	≥1

The normative reference for this requirement is TS 36.101 [2] clause 8.2.1.1.

## 8.2.1.1.1\_2.4 Test description

Same test description as in clause 8.2.1.1.1.4 with the following exceptions:

- Instead of Table 8.2.1.1.1.3-1 → use Table 8.2.1.1.1\_2.3-1.
- Instead of Table 8.2.1.1.1.3-2 → use Table 8.2.1.1.1\_2.3-2.
- Instead of Table 8.2.1.1.1.5-1 → use Table 8.2.1.1.1\_2.5-1.

## 8.2.1.1.1\_2.5 Test requirement

Same test requirements as in clause 8.2.1.1.1.5 with the following exceptions:

- Instead of Table 8.2.1.1.1.3-1 → use Table 8.2.1.1.1\_2.3-1.
- Instead of Table 8.2.1.1.1.5-1 → use Table 8.2.1.1.1\_2.5-1.

**Table 8.2.1.1.1\_2.5-1: Test requirement (FRC)**

Test number	Bandwidth	Reference Channel	OCNG Pattern	Propagation Condition	Correlation Matrix and Antenna Configuration	Reference value		UE Category
						Fraction of Maximum Throughput (%)	SNR (dB)	

1	10 MHz	R.41 FDD	OP.1 FDD	EVA5	1x2 Low	70	-4.6	$\geq 1$
---	--------	----------	----------	------	---------	----	------	----------

### 8.2.1.1.1\_A FDD PDSCH Single Antenna Port Performance for CA

#### 8.2.1.1.1\_A.1 FDD PDSCH Single Antenna Port Performance for CA (2DL CA)

##### 8.2.1.1.1\_A.1.1 Test purpose

To verify the UE's ability to receive a predefined test signal, representing a multi-path fading channel that is determined by the SNR with a percentage of the information bit throughput for a specified downlink Reference Measurement Channel (RMC) not falling below a specified value for transmission on a single-antenna port with different channel models and MCS.

##### 8.2.1.1.1\_A.1.2 Test applicability

This test applies to E-UTRA FDD release 10 and forward UE of category 3 or higher that supports inter-band OR intra-band contiguous DL CA.

This test also applies to E-UTRA FDD release 11 and forward UE of category 3 or higher that supports intra-band non-contiguous DL CA.

##### 8.2.1.1.1\_A.1.3 Minimum conformance requirements

The requirements are specified in terms of the percentage of information bit throughput for the downlink reference measurement channels specified in Annex A clause A.3.3.1, with the addition of the relevant parameters in Tables 8.2.1-1, 8.2.1.1.1\_A.1.3-1 and the downlink physical channel setup according to Table C.3.2-1 in Annex C.

Using this configuration the fraction of maximum throughput percentage shall meet or exceed the minimum requirements specified in Table 8.2.1.1.1\_A.1.3-2 for the specified SNR. For QPSK and 64QAM performance the bandwidths specified in Table 5.4.2.1-1 are verified.

**Table 8.2.1.1.1\_A.1.3-1: Test Parameters for CA**

Parameter		Unit	Test 1-2
Downlink power allocation	$\rho_A$	dB	0
	$\rho_B$	dB	0 (Note 1)
	$\sigma$	dB	0
$N_{oc}$ at antenna port		dBm/15kHz	-98
Symbols for unused PRBs			OCNG (Note 2)
Modulation			QPSK
PDSCH transmission mode			1
Note 1: $P_B = 0$ .			
Note 2: These physical resource blocks are assigned to an arbitrary number of virtual UEs with one PDSCH per virtual UE; the data transmitted over the OCNG PDSCHs shall be uncorrelated pseudo random data, which is QPSK modulated.			
Note 3: PUCCH format 1b with channel selection is used to feedback ACK/NACK.			
Note 4: The same PDSCH transmission mode is applied to each component carrier.			

**Table 8.2.1.1.1\_A.1.3-2: Minimum performance (FRC) for CA**

Test num.	Band-width	Reference channel	OCNG pattern	Propa-gation condition	Correlation matrix and antenna config.	Reference value		UE category
						Fraction of maximum throughput (%)	SNR (dB)	
1	2x10 MHz	R.2 FDD	OP.1 FDD (Note 1)	EVA5	1x2 Low	70	-1.1	≥3
2	2x20 MHz	R.42 FDD	OP.1 FDD (Note 1)	EVA5	1x2 Low	70	-1.3	≥5
Note 1: The OCNG pattern applies for each CC. Note 2: 30usec timing difference between two CCs is applied in inter-band CA case. Note 3: The applicability of requirements for different CA configurations and bandwidth combination sets is defined in 8.1.2.3.								

The normative reference for this requirement is TS 36.101 [2] clause 8.2.1.1.

#### 8.2.1.1.1\_A.1.4 Test description

##### 8.2.1.1.1\_A.1.4.1 Initial conditions

Initial conditions are a set of test configurations the UE needs to be tested in and the steps for the SS to take with the UE to reach the correct measurement state.

Configurations of PDSCH and PDCCH before measurement are specified in Annex C.2.

Test Environment: Normal, as defined in TS 36.508 [7] clause 4.1.

Frequencies to be tested: Maximum WGap for Intra-band non-contiguous CA, otherwise Mid Range, as defined in TS 36.508 [7] clause 4.3.1.

Channel Bandwidths to be tested: Select one according to Table 8.2.1.1.1\_A.1.4-1.

CA Capability to be tested: Select one according to Table 8.2.1.1.1\_A.1.4-1

**Table 8.2.1.1.1\_A.1.4-1: Test point selection for TM1 CA**

CA Capability	Bandwidth combination	
	10+10	20+20
Inter-band CA (two bands) (CA2_A2)	Test1	Test2
Intra-band contiguous CA (CA2_C)	Test1	Test2
Intra-band non-contiguous CA (with two sub-blocks) (CA2_N2)	Test1	Test2
Note1: Only one test point is tested. Select any one of the UE supported CA capabilities and then moving from left to right select the first CA bandwidth combination supported by the UE within the chosen CA capability.		

1. Connect the SS, the faders and AWGN noise source to the UE antenna connectors as shown in TS 36.508 [7] Annex A, Figure group A.35 as appropriate
2. The parameter settings for the cell are set up according to Table 8.2.1-1 and 8.2.1.1.1\_A.1.3-1 as appropriate.
3. Downlink signals for PCC are initially set up according to Annex C0, C.1 and Annex C.3.2 and uplink signals according to Annex H.1 and H.3.2.
4. Propagation conditions are set according to Annex B.0.
5. Ensure the UE is in State 3A-RF according to TS 36.508 [7] clause 5.2A.2. Message contents are defined in clause 8.2.1.1.1\_A.1.4.3.

## 8.2.1.1.1\_A.1.4.2 Test procedure

1. Configure SCC according to Annex C0, C.1 and Annex C.3.2 for all downlink physical channels.
2. The SS shall configure SCC as per TS 36.508 [7] clause 5.2A.4. Message contents are defined in clause 8.2.1.1.1\_A.1.4.3
3. SS activates SCC by sending the activation MAC-CE (Refer TS 36.321 [13], clauses 5.13, 6.1.3.8). Wait for at least 2 seconds (Refer TS 36.133, clauses 8.3.3.2).
4. SS transmits PDSCH via PDCCH DCI format 1A for C\_RNTI to transmit the DL RMC according to Tables 8.2.1.1.1\_A.1.3-1 and 8.2.1.1.1\_A.1.3-2 on both PCC and SCC. The SS sends downlink MAC padding bits on the DL RMC.
5. Set the parameters of the bandwidth, MCS, reference channel, the propagation condition, the correlation matrix and the SNR on each of the component carriers according to Tables 8.2.1.1.1\_A.1.5-1 as appropriate.
6. Measure the average throughput per component carrier for a duration sufficient to achieve statistical significance according to Annex G clause G.3A.5 on both PCC and SCC. Count the number of NACKs, ACKs and statDTXs on the UL during each subtest on both component carriers.

## 8.2.1.1.1\_A.1.4.3 Message contents

Message contents are according to TS 36.508 [7] subclause 4.6. In test procedure step 2, for SCC configuration there are no additional message contents.

## 8.2.1.1.1\_A.1.5 Test requirement

Table 8.2.1.1.1\_A.1.3-1 defines the primary level settings.

The fraction of maximum throughput percentage for the downlink reference measurement channels specified in Annex A clause A.3.3.1 for the throughput test shall meet or exceed the specified value in Table 8.2.1.1.1\_A.1.5-1 for the specified SNR including test tolerances for all throughput tests.

**Table 8.2.1.1.1\_A.5-1: Test requirement (FRC)**

Test num.	Band-width Combination	Reference channel	OCNG pattern	Propagation condition	Correlation matrix and antenna config.	Reference value		UE category
						Fraction of maximum throughput (%)	SNR (dB)	
1	2x10 MHz	R.2 FDD	OP.1 FDD (Note 1)	EVA5	1x2 Low	70	-0.3	≥3
2	2x20 MHz	R.42 FDD	OP.1 FDD (Note 1)	EVA5	1x2 Low	70	-0.5	≥5

Note 1: The OCNG pattern applies for each CC.  
 Note 2: 30usec or 922\*Ts timing difference between two CCs is applied in inter-band CA case.  
 Note 3: The applicability of requirements for different CA configurations and bandwidth combination sets is defined in 8.1.2.3.

Decide pass or fail for each subtest according to Annex G.3A.4. Decide the entire test pass or fail according to Annex G.3A.6.

## 8.2.1.1.1\_A.2 FDD PDSCH Single Antenna Port Performance for CA (3DL CA)

**Editor's note: The following aspects are either missing or not yet determined:**

- SNR values are still in brackets in core spec.

## 8.2.1.1.1\_A.2.1 Test purpose

To verify the UE's ability to receive a predefined test signal, representing a multi-path fading channel that is determined by the SNR with a percentage of the information bit throughput for a specified downlink Reference Measurement

Channel (RMC) not falling below a specified value for transmission on a single-antenna port with different channel models and MCS.

#### 8.2.1.1.1\_A.2.2 Test applicability

This test case applies to all types of E-UTRA FDD release 10 and forward UE of categories 5 or higher that support 3DL intra-band contiguous CA, or 3DL inter-band CA, or 3DL with intra-band contiguous and inter-band CA (UE categories 5 and onwards).

This test case also applies to all types of E-UTRA FDD release 11 and forward UE of categories 5 or higher that support 3DL with intra-band non-contiguous and inter-band CA, or 3DL with intra-band non-contiguous and intra-band contiguous CA.

#### 8.2.1.1.1\_A.2.3 Minimum conformance requirements

For CA with 3DL CCs, the requirements are specified in Table 8.2.1.1.1\_A.2.3-3, based on single carrier requirement specified in Table 8.2.1.1.1\_A.2.3-2, with the addition of the parameters in Table 8.2.1.1.1\_A.2.3-1 and the downlink physical channel setup according to Table C.3.2-1 in Annex C.

**Table 8.2.1.1.1\_A.2.3-1: Test Parameters for CA (3DL CA)**

Parameter		Unit	Value
Downlink power allocation	$\rho_A$	dB	0
	$\rho_B$	dB	0 (Note 1)
	$\sigma$	dB	0
$N_{oc}$ at antenna port		dBm/15kHz	-98
Symbols for unused PRBs			OCNG (Note 2)
Modulation			QPSK
PDSCH transmission mode			1
Note 1: $P_B = 0$ .			
Note 2: These physical resource blocks are assigned to an arbitrary number of virtual UEs with one PDSCH per virtual UE; the data transmitted over the OCNG PDSCHs shall be uncorrelated pseudo random data, which is QPSK modulated.			
Note 3: PUCCH format 3 is used to feedback ACK/NACK for Tests in Table 8.2.1.1.1_A.2.3-3.			
Note 4: The same PDSCH transmission mode is applied to each component carrier.			

**Table 8.2.1.1.1\_A.2.3-2: Single carrier performance for multiple CA configurations**

Band-width	Reference channel	OCNG pattern	Propagation condition	Correlation matrix and antenna config.	Reference value	
					Fraction of maximum throughput (%)	SNR (dB)
1.4MHz	R.4 FDD	OP.1 FDD	EVA5	1x2 Low	70	[-1.3]
3MHz	R.42-1 FDD	OP.1 FDD	EVA5	1x2 Low	70	[-1.1]
5MHz	R.42-2 FDD	OP.1 FDD	EVA5	1x2 Low	70	[-1.0]
10MHz	R.2 FDD	OP.1 FDD	EVA5	1x2 Low	70	[-1.7]
15MHz	R.42-3 FDD	OP.1 FDD	EVA5	1x2 Low	70	[-1.6]
20MHz	R.42 FDD	OP.1 FDD	EVA5	1x2 Low	70	[-1.7]

**Table 8.2.1.1.1\_A.2.3-3: Minimum performance (FRC) based on single carrier performance for CA with 3DL CCs**

Test num.	CA Band-width combination	Requirement	UE category
1	3x20MHz	As specified in Table 8.2.1.1.1_A.2.3-2 per CC	≥5
2	20MHz+20MHz+15MHz	As specified in Table 8.2.1.1.1_A.2.3-2 per CC	≥5
3	20MHz+20MHz+10MHz	As specified in Table 8.2.1.1.1_A.2.3-2 per CC	≥5
4	20MHz+15MHz+15MHz	As specified in Table 8.2.1.1.1_A.2.3-2 per CC	≥5
5	20MHz+15MHz+10MHz	As specified in Table 8.2.1.1.1_A.2.3-2 per CC	≥5
6	20MHz+10MHz+10MHz	As specified in Table 8.2.1.1.1_A.2.3-2 per CC	≥5
7	15MHz+15MHz+10MHz	As specified in Table 8.2.1.1.1_A.2.3-2 per CC	≥5
8	20MHz+10MHz+5MHz	As specified in Table 8.2.1.1.1_A.2.3-2 per CC	≥5
Note 1:	The applicability of requirements for different CA configurations and bandwidth combination sets is defined in 8.1.2.3		
Note 2:	30usec timing difference between PCell and any SCell is applied in inter-band CA case, where PCell can be assigned on any CC.		

The normative reference for this requirement is TS 36.101 [2] clause 8.2.1.1.

#### 8.2.1.1.1\_A.2.4 Test description

##### 8.2.1.1.1\_A.2.4.1 Initial conditions

Initial conditions are a set of test configurations the UE needs to be tested in and the steps for the SS to take with the UE to reach the correct measurement state.

Configurations of PDSCH and PDCCH before measurement are specified in Annex C.2.

Test Environment: Normal, as defined in TS 36.508 [7] clause 4.1.

Frequencies to be tested: Maximum WGap for Intra-band non-contiguous CA, otherwise Mid Range, as defined in TS 36.508 [7] clause 4.3.1.

Channel Bandwidths to be tested: Select one according to Table 8.2.1.1.1\_A.2.4-1.

CA Capability to be tested: Select one according to Table 8.2.1.1.1\_A.2.4-1

**Table 8.2.1.1.1\_A.2.4-1: Test point selection for TM1 CA**

CA Capability	Bandwidth combination							
	3x20	20+20+15	20+20+10	20+15+15	20+15+10	20+10+10	15+15+10	20+10+5
Intra-band contiguous CA (CA3_C)	Test1	Test2	Test3	Test4	Test5	Test6	Test7	Test8
Inter-band CA (two bands) (CA3_A2)	Test1	Test2	Test3	Test4	Test5	Test6	Test7	Test8
Inter-band CA (three bands) (CA3_A3)	Test1	Test2	Test3	Test4	Test5	Test6	Test7	Test8
Intra-band non-contiguous CA (with two sub-blocks) (CA3_N2)	Test1	Test2	Test3	Test4	Test5	Test6	Test7	Test8



Note1: Only one test point is tested.  
Select the largest aggregated CA bandwidth combination supported by the UE among the UE supported CA capabilities.

1. Connect the SS, the faders and AWGN noise source to the UE antenna connectors as shown in TS 36.508 [7] Annex A, Figure A.59.
2. The parameter settings for the cell are set up according to Table 8.2.1-1 and 8.2.1.1.1\_A.2.3-1 as appropriate.
3. Downlink signals for PCC are initially set up according to Annex C0, C.1 and Annex C.3.2 and uplink signals according to Annex H.1 and H.3.2.
4. Propagation conditions are set according to Annex B.0.
5. Ensure the UE is in State 3A-RF according to TS 36.508 [7] clause 5.2A.2. Message contents are defined in clause 8.2.1.1.1\_A.2.4.3.

#### 8.2.1.1.1\_A.2.4.2 Test procedure

1. Configure SCCs according to Annex C0, C.1 and Annex C.3.2 for all downlink physical channels.
2. The SS shall configure SCCs as per TS 36.508 [7] clause 5.2A.4. Message contents are defined in clause 8.2.1.1.1\_A.2.4.3.
3. SS activates SCCs by sending the activation MAC-CE (Refer TS 36.321 [13], clauses 5.13, 6.1.3.8). Wait for at least 2 seconds (Refer TS 36.133, clauses 8.3.3.2).
4. SS transmits PDSCH via PDCCH DCI format 1A for C\_RNTI to transmit the DL RMC according to Tables 8.2.1.1.1\_A.2.3-1 and 8.2.1.1.1\_A.2.3-2 on both PCC and SCCs. The SS sends downlink MAC padding bits on the DL RMC.
5. Set the parameters of the bandwidth, MCS, reference channel, the propagation condition, the correlation matrix and the SNR on each of the component carriers according to Tables 8.2.1.1.1\_A.2.5-1 as appropriate.
6. Measure the average throughput per component carrier for duration sufficient to achieve statistical significance according to Annex G clause G.3A.5 on each of the component carriers. Count the number of NACKs, ACKs and statDTXs on the UL during each subtest on each of the component carriers.

#### 8.2.1.1.1\_A.2.4.3 Message contents

Message contents are according to TS 36.508 [7] subclause 4.6. In test procedure step 2, for SCCs configuration there are no additional message contents.

#### 8.2.1.1.1\_A.2.5 Test requirement

Table 8.2.1.1.1\_A.1.3-1 defines the primary level settings.

For CA with 3DL CCs, the requirements are specified in Table 8.2.1.1.1\_A.2.5-2, based on single carrier requirement specified in Table 8.2.1.1.1\_A.2.5-1.

The fraction of maximum throughput percentage for the downlink reference measurement channels specified in Annex A clause A.3.3.1 for the throughput test shall meet or exceed the specified value in Table 8.2.1.1.1\_A.2.5-1 for the specified SNR including test tolerances for all throughput tests.

**Table 8.2.1.1.1\_A.2.5-1: Single carrier Test requirement for multiple CA configurations**

Band-width	Reference channel	OCNG pattern	Propagation condition	Correlation matrix and antenna config.	Reference value	
					Fraction of maximum throughput (%)	SNR (dB)
1.4MHz	R.4 FDD	OP.1 FDD	EVA5	1x2 Low	70	[-1.3] +TT
3MHz	R.42-1 FDD	OP.1 FDD	EVA5	1x2 Low	70	[-1.1] +TT
5MHz	R.42-2 FDD	OP.1 FDD	EVA5	1x2 Low	70	[-1.0] +TT
10MHz	R.2 FDD	OP.1 FDD	EVA5	1x2 Low	70	[-1.7] +TT
15MHz	R.42-3 FDD	OP.1 FDD	EVA5	1x2 Low	70	[-1.6] +TT
20MHz	R.42 FDD	OP.1 FDD	EVA5	1x2 Low	70	[-1.7] +TT

**Table 8.2.1.1.1\_A.2.5-2: Test requirement (FRC) based on single carrier performance for CA with 3DL CCs**

Test num.	CA Band-width combination	Requirement	UE category
1	3x20MHz	As specified in Table 8.2.1.1.1_A.2.5-1 per CC	≥5
2	20MHz+20MHz+15MHz	As specified in Table 8.2.1.1.1_A.2.5-1 per CC	≥5
3	20MHz+20MHz+10MHz	As specified in Table 8.2.1.1.1_A.2.5-1 per CC	≥5
4	20MHz+15MHz+15MHz	As specified in Table 8.2.1.1.1_A.2.5-1 per CC	≥5
5	20MHz+15MHz+10MHz	As specified in Table 8.2.1.1.1_A.2.5-1 per CC	≥5
6	20MHz+10MHz+10MHz	As specified in Table 8.2.1.1.1_A.2.5-1 per CC	≥5
7	15MHz+15MHz+10MHz	As specified in Table 8.2.1.1.1_A.2.5-1 per CC	≥5
8	20MHz+10MHz+5MHz	As specified in Table 8.2.1.1.1_A.2.5-1 per CC	≥5
Note 1:	The applicability of requirements for different CA configurations and bandwidth combination sets is defined in 8.1.2.3		
Note 2:	30usec timing difference between PCell and any SCell is applied in inter-band CA case, where PCell can be assigned on any CC.		

Decide pass or fail for each subtest according to Annex G.3A.4. Decide the entire test pass or fail according to Annex G.3A.6.

8.2.1.1.1\_A.3 Void

8.2.1.1.2 FDD PDSCH Single Antenna Port Performance with 1 PRB in presence of MBSFN

8.2.1.1.2.1 Test purpose

To verify the UE's ability to receive a predefined test signal, representing a multi-path fading channel that is determined by the SNR with a percentage of the information bit throughput for a specified downlink Reference Measurement Channel (RMC) not falling below a specified value for transmission on a single-antenna port with different channel models and MCS for 1 PRB allocation in presence of MBSFN.

## 8.2.1.1.2.2 Test applicability

This test applies to all types of E-UTRA FDD UE release 8 and forward.

## 8.2.1.1.2.3 Minimum conformance requirements

The requirements are specified in terms of the percentage of information bit throughput for the downlink reference measurement channels specified in Annex A clause A.3.3.1, with the addition of the relevant parameters in Tables 8.2.1-1, 8.2.1.1.2.3-1, and the downlink physical channel setup according to Table C.3.2-1 in Annex C.

Using this configuration the fraction of maximum throughput percentage shall meet or exceed the minimum requirements specified in Tables 8.2.1.1.2.3-2, for the specified SNR.

**Table 8.2.1.1.2.3-1: Test Parameters for Testing 1 PRB allocation**

Parameter	Unit	Test 1	
Downlink power allocation	$\rho_A$	dB	0
	$\rho_B$	dB	0 (Note 1)
	$\sigma$	dB	0
$N_{oc}$ at antenna port	dBm/15kHz	-98	
Symbols for MBSFN portion of MBSFN subframes (Note 2)		OCNG (Note 3)	
PDSCH transmission mode		1	
Note 1: $P_B = 0$ Note 2: The MBSFN portion of an MBSFN subframe comprises the whole MBSFN subframe except the first two symbols in the first slot. Note 3: The MBSFN portion of the MBSFN subframes shall contain QPSK modulated data. Cell-specific reference signals are not inserted in the MBSFN portion of the MBSFN subframes, QPSK modulated MBSFN data is used instead.			

**Table 8.2.1.1.2.3-2: Minimum performance 1 PRB allocation (FRC)**

Test number	Bandwidth	Reference Channel	OCNG Pattern	Propagation Condition	Correlation Matrix and Antenna Configuration	Reference value		UE Category
						Fraction of Maximum Throughput (%)	SNR (dB)	
1	10 MHz	R.29 FDD	OP.3 FDD	ETU70	1x2 Low	30	2.0	1-8

The normative reference for this requirement is TS 36.101 [2] clause 8.2.1.1.

## 8.2.1.1.2.4 Test description

## 8.2.1.1.2.4.1 Initial conditions

Initial conditions are a set of test configurations the UE needs to be tested in and the steps for the SS to take with the UE to reach the correct measurement state.

Configurations of PDSCH and PDCCH before measurement are specified in Annex C.2.

Test Environment: Normal, as defined in TS 36.508 [7] clause 4.1.

Frequencies to be tested: Low Range, as defined in TS 36.508 [7] clause 4.3.1.1.

Channel Bandwidths to be tested: As specified per test number in Tables 8.2.1.1.2.3-2 as defined in TS 36.508 [7] clause 4.3.1.1

1. Connect the SS, the faders and AWGN noise source to the UE antenna connectors as shown in TS 36.508 [7] Annex A, Figure A.9.
2. The parameter settings for the cell are set up according to Tables 8.2.1-1, 8.2.1.1.2.3-1 as appropriate.
3. Downlink signals are initially set up according to Annex C.1 and Annex C.3.2 and uplink signals according to Annex H.1 and H.3.2.
4. Propagation conditions are set according to Annex B.0.
5. Ensure the UE is in State 3A-RF according to TS 36.508 [7] clause 5.2A.2. Message contents are defined in clause 8.2.1.1.2.4.3.

#### 8.2.1.1.2.4.2 Test procedure

1. SS transmits PDSCH via PDCCH DCI format 1A for C\_RNTI to transmit the DL RMC according to Tables 8.2.1.1.2.3-1 and 8.2.1.1.2.3-2. The SS sends downlink MAC padding bits on the DL RMC.
2. Set the parameters of the bandwidth, MCS, reference channel, the propagation condition, the correlation matrix and the SNR according to Table 8.2.1.1.2.5-1 as appropriate.
3. Measure the average throughput for a duration sufficient to achieve statistical significance according to Annex G clause G.3. Count the number of NACKs, ACKs and statDTXs on the UL during each subtest and decide pass or fail according to Tables G.3.5 and G.3.6 in Annex G clause G.3.

#### 8.2.1.1.2.4.3 Message contents

Message contents are according to TS 36.508 [7] clause 4.6 with the following exceptions:

**Table 8.2.1.1.2.4.3-1: SystemInformationBlockType2: Additional FDD PDSCH Single Antenna Port Performance for 1 PRB allocation with MBSFN subframes test point 1 requirement**

Derivation Path: TS 36.508 [7] clause 4.4.3.3, Table 4.4.3.3-1 SystemInformationBlockType2			
Information Element	Value/remark	Comment	Condition
SystemInformationBlockType2 ::= SEQUENCE {			
mbsfn-SubframeConfig ::= SEQUENCE {			
radioframeAllocationPeriod	n1	Every radio frame is with MBSFN subframe	
radioframeAllocationOffset	0		
subframeAllocation CHOICE {			
oneFrame	111111	Subframe 1, 2, 3, 6, 7, 8 is used for MBSFN	FDD
}			
}			
}			

#### 8.2.1.1.2.5 Test requirement

Table 8.2.1.1.2.3-1 defines the primary level settings.

The fraction of maximum throughput percentage for the downlink reference measurement channels specified in Annex A clause A.3.3.1 for each throughput test shall meet or exceed the specified value in Tables 8.2.1.1.2.5-1 for the specified SNR including test tolerances for all throughput tests.

**Table 8.2.1.1.2.5-1: Test requirement 1 PRB allocation with MBSFN subframes (FRC)**

Test number	Bandwidth	Reference Channel	OCNG Pattern	Propagation Condition	Correlation Matrix and Antenna Configuration	Reference value		UE Category
						Fraction of Maximum Throughput (%)	SNR (dB)	
1	10 MHz	R.29 FDD	OP.3 FDD	ETU70	1x2 Low	30	+2.8	1-8

### 8.2.1.2 FDD PDSCH Transmit Diversity Performance (Cell-Specific Reference Symbols)

#### 8.2.1.2.1 FDD PDSCH Transmit Diversity 2x2

##### 8.2.1.2.1.1 Test purpose

To verify the UE's ability to receive a predefined test signal, representing a multi-path fading channel that is determined by the SNR with a percentage of the information bit throughput for a specified downlink Reference Measurement Channel (RMC) not falling below a specified value for transmission on two antenna ports using transmit diversity (SFBC).

##### 8.2.1.2.1.2 Test applicability

This test applies to all types of E-UTRA FDD UE release 8 and forward.

##### 8.2.1.2.1.3 Minimum conformance requirements

The requirements are specified in terms of the percentage of information bit throughput for the downlink reference measurement channels specified in Annex A clause A.3.3.2, with the addition of the relevant parameters in Tables 8.2.1-1 and 8.2.1.2.1.3-1 and the downlink physical channel setup according to Table C.3.2-1 in Annex C.3.2.

Using this configuration the fraction of maximum throughput percentage shall meet or exceed the minimum requirements specified in Table 8.2.1.2.1.3-2 for the specified SNR. For transmit diversity (SFBC) performance with 2 transmitter antennas as specified.

**Table 8.2.1.2.1.3-1: Test Parameters for Testing Transmit Diversity Performance**

Parameter		Unit	Test 1-2
Downlink power allocation	$\rho_A$	dB	-3
	$\rho_B$	dB	-3 (Note 1)
	$\sigma$	dB	0
$N_{oc}$ at antenna port		dBm/15kHz	-98
PDSCH transmission mode			2
Note 1: $P_b = 1$			

**Table 8.2.1.2.1.3-2: Minimum performance Transmit Diversity (FRC)**

Test number	Bandwidth	Reference Channel	OCNG Pattern	Propagation Condition	Correlation Matrix and Antenna Configuration	Reference value		UE Category
						Fraction of Maximum Throughput (%)	SNR (dB)	
1	10 MHz	R.11 FDD	OP.1 FDD	EVA5	2x2 Medium	70	6.8	2-8
	5 MHz (Note 1)	R.11-2 FDD	OP.1 FDD	EVA5	2x2 Medium	70	5.9	
2	10 MHz	R.10 FDD	OP.1 FDD	HST	2x2	70	-2.3	1-8
Note 1: Test case applicability is defined in 8.1.2.1.								

The normative reference for this requirement is TS 36.101 [2] clause 8.2.1.2.

#### 8.2.1.2.1.4 Test description

##### 8.2.1.2.1.4.1 Initial conditions

Initial conditions are a set of test configurations the UE needs to be tested in and the steps for the SS to take with the UE to reach the correct measurement state.

Configurations of PDSCH and PDCCH before measurement are specified in Annex C.2.

Test Environment: Normal, as defined in TS 36.508 [7] clause 4.1.

Frequencies to be tested: Mid Range, as defined in TS 36.508 [7] clause 4.3.1.1.

Channel Bandwidths to be tested: As specified per test number in Table 8.2.1.2.1.3-2 as defined in TS 36.508 [7] clause 4.3.1.1.

1. Connect the SS, the faders and AWGN noise sources to the UE antenna connectors as shown in TS 36.508 [7] Annex A, Figure A.10 for antenna configuration 2x2.
2. The parameter settings for the cell are set up according to Tables 8.2.1-1 and 8.2.1.2.1.3-1 as appropriate.
3. Downlink signals are initially set up according to Annex C.0, C.1 and Annex C.3.2 and uplink signals according to Annex H.1 and H.3.2.
4. Propagation conditions are set according to Annex B.0.
5. Ensure the UE is in State 3A-RF according to TS 36.508 [7] clause 5.2A.2. Message contents are defined in clause 8.2.1.2.1.4.3.

##### 8.2.1.2.1.4.2 Test procedure

1. SS transmits PDSCH via PDCCH DCI format 1A for C\_RNTI to transmit the DL RMC according to Tables 8.2.1.2.1.3-1 and 8.2.1.2.1.3-2. The SS sends downlink MAC padding bits on the DL RMC.
2. Set the parameters of the bandwidth, MCS, reference channel, the propagation condition, the correlation matrix, antenna configuration and the SNR according to Tables 8.2.1.2.1.5-1 as appropriate.
3. Measure the average throughput for a duration sufficient to achieve statistical significance according to Annex G clause G.3. Count the number of NACKs, ACKs and statDTXs on the UL during the test interval and decide pass or fail according to Tables G.3.5 and G.3.6 in Annex G clause G.3.
4. Repeat steps from 1 to 3 for each test interval in Table 8.2.1.2.1.5-1 as appropriate.

##### 8.2.1.2.1.4.3 Message contents

Message contents are according to TS 36.508 [7] clause 4.6.

##### 8.2.1.2.1.5 Test requirement

Table 8.2.1.2.1.3-1 defines the primary level settings.

The fraction of maximum throughput percentage for the downlink reference measurement channels specified in Annex A clause A.3.3.2 for each throughput test shall meet or exceed the specified value in Table 8.2.1.2.1.5-1 for the specified SNR including test tolerances for all throughput tests.

**Table 8.2.1.2.1.5-1: Test requirement Transmit Diversity (FRC)**

Test number	Band-width	Reference Channel	OCNG Pattern	Propagation Condition	Correlation Matrix and Antenna Configuration	Reference value		UE Category
						Fraction of Maximum Throughput (%)	SNR (dB)	
1	10 MHz	R.11 FDD	OP.1 FDD	EVA5	2x2 Medium	70	7.7	2-8
	5 MHz (Note 1)	R.11-2 FDD	OP.1 FDD	EVA5	2x2 Medium	70	6.8	2-8
2	10 MHz	R.10 FDD	OP.1 FDD	HST	2x2	70	-1.7	1-8
Note 1: Test case is applicable (according to sub clause 8.1.2.1) to UE's which, from the E-UTRA operating bands defined in Table 5.2-1, support only E-UTRA band 31.								

**8.2.1.2.1\_1 FDD PDSCH Transmit Diversity 2x2 (Release 9 and forward)****8.2.1.2.1\_1.1 Test purpose**

Same test purpose as in clause 8.2.1.2.1.1.

**8.2.1.2.1\_1.2 Test applicability**

This test applies to all types of E-UTRA FDD UE release 9 and forward of UE category 1.

**8.2.1.2.1\_1.3 Minimum conformance requirements**

Same minimum conformance requirements as in clause 8.2.1.2.1.3 with the following exceptions:

- Instead of Table 8.2.1.2.1.3-1 → use Table 8.2.1.2.1\_1.3-1.
- Instead of Table 8.2.1.2.1.3-2 → use Table 8.2.1.2.1\_1.3-2.

**Table 8.2.1.2.1\_1.3-1: Test Parameters for Testing Transmit Diversity Performance**

Parameter	Unit	Test 1
Downlink power allocation	$\rho_A$	dB
	$\rho_B$	dB
	$\sigma$	dB
$N_{oc}$ at antenna port	dBm/15kHz	-98
PDSCH transmission mode		2
Note 1: $P_B = 1$		

**Table 8.2.1.2.1\_1.3-2: Minimum performance Transmit Diversity (FRC)**

Test number	Band-width	Reference Channel	OCNG Pattern	Propagation Condition	Correlation Matrix and Antenna Configuration	Reference value		UE Category
						Fraction of Maximum Throughput (%)	SNR (dB)	
1	5 MHz	R.11-2 FDD	OP.1 FDD	EVA5	2x2 Medium	70	5.9	1

The normative reference for this requirement is TS 36.101 [2] clause 8.2.1.2.

**8.2.1.2.1\_1.4 Test description**

Same test description as in clause 8.2.1.2.1.4 with the following exceptions:

- Instead of Table 8.2.1.2.1.3-1 → use Table 8.2.1.2.1\_1.3-1.
- Instead of Table 8.2.1.2.1.3-2 → use Table 8.2.1.2.1\_1.3-2.
- Instead of Table 8.2.1.2.1.5-1 → use Table 8.2.1.2.1\_1.5-1.

#### 8.2.1.2.1\_1.5 Test requirement

Same test requirements as in clause 8.2.1.2.1.5 with the following exceptions:

- Instead of Table 8.2.1.2.1.3-1 → use Table 8.2.1.2.1\_1.3-1.
- Instead of Table 8.2.1.2.1.5-1 → use Table 8.2.1.2.1\_1.5-1.

**Table 8.2.1.2.1\_1.5-1: Test requirement Transmit Diversity (FRC)**

Test number	Band-width	Reference Channel	OCNG Pattern	Propagation Condition	Correlation Matrix and Antenna Configuration	Reference value		UE Category
						Fraction of Maximum Throughput (%)	SNR (dB)	
1	5 MHz	R.11-2 FDD	OP.1 FDD	EVA5	2x2 Medium	70	+6.8	1

#### 8.2.1.2.2 FDD PDSCH Transmit Diversity 4x2

##### 8.2.1.2.2.1 Test purpose

To verify the UE's ability to receive a predefined test signal, representing a multi-path fading channel that is determined by the SNR with a percentage of the information bit throughput for a specified downlink Reference Measurement Channel (RMC) not falling below a specified value for transmission on two antenna ports using transmit diversity (SFBC-FSTD).

##### 8.2.1.2.2.2 Test applicability

This test applies to all types of E-UTRA FDD UE release 8 and forward.

##### 8.2.1.2.2.3 Minimum conformance requirements

The requirements are specified in terms of the percentage of information bit throughput for the downlink reference measurement channels specified in Annex A clause A.3.3.2, with the addition of the relevant parameters in Tables 8.2.1-1 and 8.2.1.2.2.3-1 and the downlink physical channel setup according to Table C.3.2-1 in Annex C.3.2.

Using this configuration the fraction of maximum throughput percentage shall meet or exceed the minimum requirements specified in Table 8.2.1.2.2.3-2 for the specified SNR. For transmit diversity (SFBC) performance with 4 transmitter antennas as specified.

**Table 8.2.1.2.2.3-1: Test Parameters for Testing Transmit Diversity Performance**

Parameter	Unit	Test 1
Downlink power allocation	$\rho_A$	-3
	$\rho_B$	-3 (Note 1)
	$\sigma$	0
$N_{oc}$ at antenna port	dBm/15kHz	-98
PDSCH transmission mode		2
Note 1: $P_B = 1$		



**Table 8.2.1.2.2.3-2: Minimum performance Transmit Diversity (FRC)**

Test number	Band-width	Reference Channel	OCNG Pattern	Propagation Condition	Correlation Matrix and Antenna Configuration	Reference value		UE Category
						Fraction of Maximum Throughput (%)	SNR (dB)	
1	1.4 MHz	R.12 FDD	OP.1 FDD	EPA5	4x2 Medium	70	0.6	1-8

The normative reference for this requirement is TS 36.101 [2] clause 8.2.1.2.

#### 8.2.1.2.2.4 Test description

##### 8.2.1.2.2.4.1 Initial conditions

Initial conditions are a set of test configurations the UE needs to be tested in and the steps for the SS to take with the UE to reach the correct measurement state.

Configurations of PDSCH and PDCCH before measurement are specified in Annex C.2.

Test Environment: Normal, as defined in TS 36.508 [7] clause 4.1.

Frequencies to be tested: Mid Range, as defined in TS 36.508 [7] clause 4.3.1.1.

Channel Bandwidths to be tested: As specified per test number in Table 8.2.1.2.2.3-2 as defined in TS 36.508 [7] clause 4.3.1.1.

1. Connect the SS, the faders and AWGN noise sources to the UE antenna connectors as shown in TS 36.508 [7] Annex A, Figure A.11 for antenna configuration 4x2.
2. The parameter settings for the cell are set up according to Tables 8.2.1-1 and 8.2.1.2.2.3-1 as appropriate.
3. Downlink signals are initially set up according to Annex C.1 and Annex C.3.2 and uplink signals according to Annex H.1 and H.3.2.
4. Propagation conditions are set according to Annex B.0.
5. Ensure the UE is in State 3A-RF according to TS 36.508 [7] clause 5.2A.2. Message contents are defined in clause 8.2.1.2.2.4.3.

##### 8.2.1.2.2.4.2 Test procedure

1. SS transmits PDSCH via PDCCH DCI format 1A for C\_RNTI to transmit the DL RMC according to Tables 8.2.1.2.2.3-1 and 8.2.1.2.2.3-2. The SS sends downlink MAC padding bits on the DL RMC.
2. Set the parameters of the bandwidth, MCS, reference channel, the propagation condition, the correlation matrix, antenna configuration and the SNR according to Tables 8.2.1.2.2.5-1 as appropriate.
3. Measure the average throughput for a duration sufficient to achieve statistical significance according to Annex G clause G.3. Count the number of NACKs, ACKs and statDTXs on the UL during the test interval and decide pass or fail according to Tables G.3.5 and G.3.6 in Annex G clause G.3.

##### 8.2.1.2.2.4.3 Message contents

Message contents are according to TS 36.508 [7] clause 4.6 with the following exceptions:

**Table 8.2.1.2.2.4.3-1: PDSCH-ConfigDedicated-DEFAULT: Additional FDD PDSCH transmit diversity performance downlink power allocation test point 1 requirement**

Derivation Path: 36.331 clause 6.3.2			
Information Element	Value/remark	Comment	Condition
PDSCH-ConfigDedicated-DEFAULT ::= SEQUENCE {			
p-a	dB-3		
}			

## 8.2.1.2.2.5 Test requirement

Table 8.2.1.2.2.3-1 defines the primary level settings.

The fraction of maximum throughput percentage for the downlink reference measurement channels specified in Annex A clause A.3.3.2 for each throughput test shall meet or exceed the specified value in Table 8.2.1.2.2.5-1 for the specified SNR including test tolerances for all throughput tests.

**Table 8.2.1.2.2.5-1: Test requirement Transmit Diversity (FRC)**

Test number	Band-width	Reference Channel	OCNG Pattern	Propagation Condition	Correlation Matrix and Antenna Configuration	Reference value		UE Category
						Fraction of Maximum Throughput (%)	SNR (dB)	
1	1.4 MHz	R.12 FDD	OP.1 FDD	EPA5	4x2 Medium	70	1.5	1-8

## 8.2.1.2.2\_1 FDD PDSCH Transmit Diversity 4x2 (Release 9 and forward)

## 8.2.1.2.2\_1.1 Test purpose

Same test purpose as in clause 8.2.1.2.2.1.

## 8.2.1.2.2\_1.2 Test applicability

This test applies to all types of E-UTRA FDD UE release 9 and forward.

## 8.2.1.2.2\_1.3 Minimum conformance requirements

Same minimum conformance requirements as in clause 8.2.1.2.2.3 with the following exceptions:

- Instead of Table 8.2.1.2.2.3-1 → use Table 8.2.1.2.2\_1.3-1.
- Instead of Table 8.2.1.2.2.3-2 → use Table 8.2.1.2.2\_1.3-2.

**Table 8.2.1.2.2\_1.3-1: Test Parameters for Testing Transmit Diversity Performance**

Parameter		Unit	Test 1
Downlink power allocation	$\rho_A$	dB	-3
	$\rho_B$	dB	-3 (Note 1)
	$\sigma$	dB	0
$N_{oc}$ at antenna port		dBm/15kHz	-98
PDSCH transmission mode			2
Note 1: $P_B = 1$			

**Table 8.2.1.2.2\_1.3-2: Minimum performance Transmit Diversity (FRC)**

Test number	Band-width	Reference Channel	OCNG Pattern	Propagation Condition	Correlation Matrix and Antenna Configuration	Reference value		UE Category
						Fraction of Maximum Throughput (%)	SNR (dB)	
1	10 MHz	R.13 FDD	OP.1 FDD	ETU70	4x2 Low	70	-0.9	1-8

The normative reference for this requirement is TS 36.101 [2] clause 8.2.1.2.

#### 8.2.1.2.2\_1.4 Test description

Same test description as in clause 8.2.1.2.2.4 with the following exceptions:

- Instead of Table 8.2.1.2.2.3-1 → use Table 8.2.1.2.2\_1.3-1.
- Instead of Table 8.2.1.2.2.3-2 → use Table 8.2.1.2.2\_1.3-2.
- Instead of Table 8.2.1.2.2.5-1 → use Table 8.2.1.2.2\_1.5-1.

#### 8.2.1.2.2\_1.5 Test requirement

Same test requirements as in clause 8.2.1.2.2.5 with the following exceptions:

- Instead of Table 8.2.1.2.2.3-1 → use Table 8.2.1.2.2\_1.3-1.
- Instead of Table 8.2.1.2.2.5-1 → use Table 8.2.1.2.2\_1.5-1.

**Table 8.2.1.2.2\_1.5-1: Test requirement Transmit Diversity (FRC)**

Test number	Band-width	Reference Channel	OCNG Pattern	Propagation Condition	Correlation Matrix and Antenna Configuration	Reference value		UE Category
						Fraction of Maximum Throughput (%)	SNR (dB)	
1	10 MHz	R.13 FDD	OP.1 FDD	ETU70	4x2 Low	70	0	1-8

### 8.2.1.2.3

#### 8.2.1.2.3\_C FDD PDSCH Transmit diversity 2x2 for eICIC

##### 8.2.1.2.3\_C.1 FDD PDSCH Transmit diversity 2x2 for eICIC (non-MBSFN ABS)

###### 8.2.1.2.3\_C.1.1 Test purpose

To verify the UE's performance of transmit diversity (SFBC) with 2 transmit antennas if the PDSCH transmission in the serving cell takes place in subframes that overlap with ABS of the aggressor cell.

###### 8.2.1.2.3\_C.1.2 Test applicability

This test applies to all types of E-UTRA FDD UE release 10 and forward. Applicability requires support for FGI bit 115.

###### 8.2.1.2.3\_C.1.3 Minimum conformance requirements

The requirements are specified in terms of the percentage of information bit throughput for the downlink reference measurement channels specified in Annex A clause A.3.3.2, with the addition of the relevant parameters in Tables 8.2.1-1 and 8.2.1.2.3\_C.1.3-1.

In Table 8.2.1.2.3\_C.1.3-1, Cell 1 is the serving cell, and Cell 2 is the aggressor cell. The downlink physical channel setup for Cell 1 is according to Table C.3.2-1 in Annex C.3.2 and for Cell 2 is according to Table C.3.3-1 in Annex C.3.3, respectively.

Using this configuration the fraction of maximum throughput percentage shall meet or exceed the minimum requirements specified in Table 8.2.1.2.3\_C.1.3-2 for the specified SNR.

**Table 8.2.1.2.3\_C.1.3-1: Test Parameters for Transmit diversity Performance (FRC)**

Parameter		Unit	Cell 1	Cell 2
Downlink power allocation	$\rho_A$	dB	-3	-3
	$\rho_B$	dB	-3 (Note 1)	-3
	$\sigma$	dB	0	N/A
$N_{oc}$ at antenna port	$N_{oc1}$	dBm/15kHz	-102 (Note 2)	N/A
	$N_{oc2}$	dBm/15kHz	-98 (Note 3)	N/A
	$N_{oc3}$	dBm/15kHz	-94.8 (Note 4)	N/A
$\hat{E}_s / N_{oc2}$		dB	Reference Value in Table 8.2.1.2.3_C.1.3-2	6
BW <sub>Channel</sub>		MHz	10	10
Subframe Configuration			Non-MBSFN	Non-MBSFN
Time Offset between Cells		$\mu$ s	2.5 (synchronous cells)	
Cell Id			0	1
ABS pattern (Note 5)			N/A	11000100 11000000 11000000 11000000 11000000
RLM/RRM Measurement Subframe Pattern (Note 6)			10000000 10000000 10000000 10000000 10000000	N/A
CSI Subframe Sets (Note7)	$C_{CSI,0}$		11000100 11000000 11000000 11000000 11000000	N/A
	$C_{CSI,1}$		00111011 00111111 00111111 00111111 00111111	N/A
Number of control OFDM symbols			2	2
PDSCH transmission mode			2	N/A
Cyclic prefix			Normal	Normal
<p>Note 1: <math>P_B = 1</math>.</p> <p>Note 2: This noise is applied in OFDM symbols #1, #2, #3, #5, #6, #8, #9, #10, #12, #13 of a subframe overlapping with the aggressor ABS.</p> <p>Note 3: This noise is applied in OFDM symbols #0, #4, #7, #11 of a subframe overlapping with the aggressor ABS.</p> <p>Note 4: This noise is applied in all OFDM symbols of a subframe overlapping with aggressor non-ABS</p> <p>Note 5: ABS pattern as defined in [14].</p> <p>Note 6: Time-domain measurement resource restriction pattern for PCell measurements as defined in [5]</p> <p>Note 7: As configured according to the time-domain measurement resource restriction pattern for CSI measurements defined in [5].</p> <p>Note 8: Cell 1 is the serving cell. Cell 2 is the aggressor cell. The number of the CRS ports in Cell1 and Cell2 is the same.</p> <p>Note 9: SIB-1 will not be transmitted in Cell2 in this test.</p>				

Table 8.2.1.2.3\_C.1.3-2: Minimum Performance Transmit Diversity (FRC)

Test Number	Reference Channel	OCNG Pattern		Propagation Conditions (Note 1)		Correlation Matrix and Antenna Configuration	Reference Value		UE Category
		Cell 1	Cell 2	Cell 1	Cell 2		Fraction of Maximum Throughput (%) Note 5	SNR (dB) (Note 2)	
1	R.11-4 FDD Note 4	OP.1 FDD	OP.1 FDD	EVA5	EVA 5	2x2 Medium	70	3.4	2-8
<p>Note 1: The propagation conditions for Cell 1 and Cell2 are statistically independent.</p> <p>Note 2: SNR corresponds to <math>\hat{E}_s / N_{oc2}</math> of cell 1.</p> <p>Note 3: The correlation matrix and antenna configuration apply for Cell 1 and Cell 2.</p> <p>Note 4: Cell 1 Reference channel is modified: PDSCH other than SIB1/paging and its associated PDCCH/PCFICH are transmitted in the serving cell subframe when the subframe is overlapped with the ABS subframe of aggressor cell and the subframe is available in the definition of the reference channel.</p> <p>Note 5: The maximum Throughput is calculated from the total Payload in 9 subframes, averaged over 40ms.</p>									

The normative reference for this requirement is TS 36.101 [2] clause 8.2.1.2.3.

#### 8.2.1.2.3\_C.1.4 Test description

##### 8.2.1.2.3\_C.1.4.1 Initial conditions

Initial conditions are a set of test configurations the UE needs to be tested in and the steps for the SS to take with the UE to reach the correct measurement state.

Configurations of PDSCH and PDCCH before measurement are specified in Annex C.2.

Test Environment: Normal, as defined in TS 36.508 [7] clause 4.1.

Frequencies to be tested: Mid Range, as defined in TS 36.508 [7] clause 4.3.1.1.

Channel Bandwidths to be tested: As specified per test number in Table 8.2.1.2.3\_C.1.3-2 as defined in TS 36.508 [7] clause 4.3.1.1.

1. Connect the SS, the faders and AWGN noise sources to the UE antenna connectors as shown in TS 36.508 [7] Annex A, Figure A.40 for antenna configuration 2x2.
2. The parameter settings for the cell1 are set up according to Tables 8.2.1-1 and 8.2.1.2.3\_C.1.3-1 as appropriate.
3. Downlink signals are initially set up for Cell1 according to Annex C.0, C.1 and Annex C.3.2 and uplink signals according to Annex H.1 and H.3.2.
4. Propagation conditions are set according to Annex B.0.
5. Ensure the UE is in State 3A-RF according to TS 36.508 [7] clause 5.2A.2. Message contents are defined in clause 8.2.1.2.3\_C.1.4.3.

##### 8.2.1.2.3\_C.1.4.2 Test procedure

1. Set the parameters for Cell1 and Cell2 according to Tables 8.2.1.2.3\_C.1.5-1, 8.2.1.2.3\_C.1.5-2, C.3.3-1 of Annex C.3.3 as appropriate, and SS transmits PDSCH via PDCCH DCI format 1A for C\_RNTI to transmit the DL RMC. The SS sends downlink MAC padding bits on the DL RMC. Propagation conditions are set according to Annex B clause B.2
2. Measure the average throughput for a duration sufficient to achieve statistical significance according to Annex G clause G.3. Count the number of NACKs, ACKs and statDTXs on the UL during the test interval and decide pass or fail according to Tables G.3.5 and G.3.6 in Annex G clause G.3.

## 8.2.1.2.3\_C.1.4.3 Message contents

Message contents are according to TS 36.508 [7] clause 4.6 with the following exceptions:

**Table 8.2.1.2.3\_C.1.4.3-1: RadioResourceConfigDedicated-SRB2-DRB(n, m): Additional FDD PDSCH transmit diversity performance downlink power allocation**

Derivation Path: TS 36.508 [7] clause 4.6.3, Table 4.6.3-16 RadioResourceConfigDedicated-SRB2-DRB(n,m)			
Information Element	Value/remark	Comment	Condition
RadioResourceConfigDedicated-SRB2-DRB(n, m) ::= SEQUENCE {			
MeasSubframePatternPCell-r10 CHOICE {			
setup SEQUENCE {			
subframePatternFDD-r10	'10000000100000001000 00001000000010000000'	BIT STRING (SIZE (40))	
}			
}			
}			

**Table 8.2.1.2.3\_C.1.4.3-2: CQI-ReportConfig-r10-DEFAULT: Additional FDD PDSCH transmit diversity performance downlink power allocation**

Derivation Path: 36.508 [7] clause 4.6.3, Table 4.6.3-2AA CQI-ReportConfig-r10-DEFAULT			
Information Element	Value/remark	Comment	Condition
CQI-ReportConfig-r10-DEFAULT ::= SEQUENCE {			
cqi-ReportAperiodic-r10	Not present		
nomPDSCH-RS-EPRE-Offset	0		
cqi-ReportPeriodic-r10	Not present		
pmi-RI-Report-r9	Not present		
csi-SubframePatternConfig-r10 CHOICE {			
setup SEQUENCE {			
csi-MeasSubframeSet1-r10 CHOICE {			
subframePatternFDD-r10	'11000100110000001100 00001100000011000000'	BIT STRING (SIZE (40))	
}			
csi-MeasSubframeSet2-r10 CHOICE {			
subframePatternFDD-r10	'00111011001111110011 11110011111100111111'	BIT STRING (SIZE (40))	
}			
}			
}			
}			

## 8.2.1.2.3\_C.1.5 Test requirement

Table 8.2.1.2.3\_C.1.5-1 defines the primary level settings.

The fraction of maximum throughput percentage for the downlink reference measurement channels specified in Annex A clause A.3.3.2 for each throughput test shall meet or exceed the specified value in Table 8.2.1.2.3\_C.1.5-2 for the specified SNR including test tolerances for all throughput tests.

**Table 8.2.1.2.3\_C.1.5-1: Test Parameters for Transmit Diversity (FRC)**

Parameter	Unit	Cell 1	Cell 2
Downlink power allocation	$\rho_A$	dB	-3
	$\rho_B$	dB	-3 (Note 1)
	$\sigma$	dB	0
$N_{oc}$ at antenna port	$N_{oc1}$	dBm/15kHz	-102.1 (Note 2)
	$N_{oc2}$	dBm/15kHz	-98 (Note 3)

	$N_{oc3}$	dBm/15kHz	-94.9 (Note 4)	N/A
$\hat{E}_s / N_{oc2}$		dB	Reference Value in Table 8.2.1.2.3_C.1.5-2	5.8
BW <sub>Channel</sub>		MHz	10	10
Subframe Configuration			Non-MBSFN	Non-MBSFN
Time Offset between Cells		μs	2.5 (synchronous cells)	
Cell Id			0	1
ABS pattern (Note 5)			N/A	11000100 11000000 11000000 11000000 11000000
RLM/RRM Measurement Subframe Pattern (Note 6)			10000000 10000000 10000000 10000000 10000000	N/A
CSI Subframe Sets (Note7)	C <sub>CSI,0</sub>		11000100 11000000 11000000 11000000 11000000	N/A
	C <sub>CSI,1</sub>		00111011 00111111 00111111 00111111 00111111	N/A
Number of control OFDM symbols			2	2
PDSCH transmission mode			2	N/A
Cyclic prefix			Normal	Normal
<p>Note 1: <math>P_b = 1</math>.</p> <p>Note 2: This noise is applied in OFDM symbols #1, #2, #3, #5, #6, #8, #9, #10, #12, #13 of a subframe overlapping with the aggressor ABS.</p> <p>Note 3: This noise is applied in OFDM symbols #0, #4, #7, #11 of a subframe overlapping with the aggressor ABS.</p> <p>Note 4: This noise is applied in all OFDM symbols of a subframe overlapping with aggressor non-ABS</p> <p>Note 5: ABS pattern as defined in [14].</p> <p>Note 6: Time-domain measurement resource restriction pattern for PCell measurements as defined in [5]</p> <p>Note 7: As configured according to the time-domain measurement resource restriction pattern for CSI measurements defined in [5].</p> <p>Note 8: Cell 1 is the serving cell. Cell 2 is the aggressor cell. The number of the CRS ports in Cell1 and Cell2 is the same.</p> <p>Note 9: SIB-1 will not be transmitted in Cell2 in this test.</p>				

**Table 8.2.1.2.3\_C.1.5-2: Test requirement Transmit Diversity (FRC)**

Test Number	Reference Channel	OCNG Pattern		Propagation Conditions (Note 1)		Correlation Matrix and Antenna Configuration	Reference Value		UE Category
		Cell 1	Cell 2	Cell 1	Cell 2		Fraction of Maximum Throughput (%) Note 5	SNR (dB) (Note 2)	

1	R.11-4 FDD Note 4	OP.1 FDD	OP.1 FDD	EVA5	EVA 5	2x2 Medium	70	4.3	2-8
<p>Note 1: The propagation conditions for Cell 1 and Cell2 are statistically independent.</p> <p>Note 2: SNR corresponds to <math>\hat{E}_s / N_{oc2}</math> of cell 1.</p> <p>Note 3: The correlation matrix and antenna configuration apply for Cell 1 and Cell 2.</p> <p>Note 4: Cell 1 Reference channel is modified: PDSCH other than SIB1/paging and its associated PDCCH/PCFICH are transmitted in the serving cell subframe when the subframe is overlapped with the ABS subframe of aggressor cell and the subframe is available in the definition of the reference channel.</p> <p>Note 5: The maximum Throughput is calculated from the total Payload in 9 subframes, averaged over 40ms.</p>									

### 8.2.1.2.3\_D

#### 8.2.1.2.3\_E FDD PDSCH Transmit diversity 2x2 for feICIC

#### 8.2.1.2.3\_E.1 FDD PDSCH Transmit diversity 2x2 for feICIC (non-MBSFN ABS)

##### 8.2.1.2.3\_E.1.1 Test purpose

To verify the UE's performance of transmit diversity (SFBC) with 2 transmit antennas if the PDSCH transmission in the serving cell takes place in subframes that overlap with ABS [14] of the aggressor cells with CRS assistance information.

##### 8.2.1.2.3\_E.1.2 Test applicability

This test applies to all types of E-UTRA FDD UE and CRS interference handling – Category 2-8 release 11 and forward. Applicability requires support of FGI bit 115.

##### 8.2.1.2.3\_E.1.3 Minimum conformance requirements

The requirements are specified in terms of the percentage of information bit throughput for the downlink reference measurement channels specified in Annex A clause A.3.3.2, with the addition of the relevant parameters in Tables 8.2.1-1 and 8.2.1.2.3\_E.1.3-1.

In Table 8.2.1.2.3\_E.1-1, Cell 1 is the serving cell, and Cell 2 and Cell 3 are the aggressor cells. The downlink physical channel setup for Cell 1 is according to Annex C.3.2 and for Cell 2 and Cell 3 is according to Annex C.3.3, respectively. The CRS assistance information TS 36.331 [5] includes Cell 2 and Cell 3.

Using this configuration the fraction of maximum throughput percentage shall meet or exceed the minimum requirements specified in Table 8.2.1.2.3\_E.1.3-2 for the specified SNR.



Table 8.2.1.2.3\_E.1.3-1: Test Parameters for Transmit diversity Performance (FRC)

Parameter		Unit	Cell 1	Cell 2	Cell 3
Downlink power allocation	$\rho_A$	dB	-3	-3	-3
	$\rho_B$	dB	-3 (Note 1)	-3 (Note 1)	-3 (Note 1)
	$\sigma$	dB	0	N/A	N/A
$N_{oc}$ at antenna port	$N_{oc1}$	dBm/15kHz	-98 (Note 2)	N/A	N/A
	$N_{oc2}$	dBm/15kHz	-98 (Note 3)	N/A	N/A
	$N_{oc3}$	dBm/15kHz	-93 (Note 4)	N/A	N/A
$\hat{E}_s/N_{oc2}$		dB	Reference Value in Table 8.2.1.2.3_E.1.3-2	12	10
BW <sub>Channel</sub>		MHz	10	10	10
Subframe Configuration			Non-MBSFN	Non-MBSFN	Non-MBSFN
Time Offset between Cells		μs	N/A	3	-1
Frequency shift between Cells		Hz	N/A	300	-100
Cell Id			0	126	1
ABS pattern (Note 5)			N/A	11000000 11000000 11000000 11000000 11000000	11000000 11000000 11000000 11000000 11000000
RLM/RRM Measurement Subframe Pattern (Note 6)			10000000 10000000 10000000 10000000 10000000	N/A	N/A
CSI Subframe Sets (Note7)	$C_{CSI,0}$		11000000 11000000 11000000 11000000 11000000	N/A	N/A
	$C_{CSI,1}$		00111111 00111111 00111111 00111111 00111111	N/A	N/A
Number of control OFDM symbols			2	Note 8	Note 8
PDSCH transmission mode			2	Note 9	Note 9
Cyclic prefix			Normal	Normal	Normal
<p>Note 1: <math>P_B = 1</math>.</p> <p>Note 2: This noise is applied in OFDM symbols #1, #2, #3, #5, #6, #8, #9, #10, #12, #13 of a subframe overlapping with the aggressor ABS.</p> <p>Note 3: This noise is applied in OFDM symbols #0, #4, #7, #11 of a subframe overlapping with the aggressor ABS.</p> <p>Note 4: This noise is applied in all OFDM symbols of a subframe overlapping with aggressor non-ABS</p> <p>Note 5: ABS pattern as defined in [14].</p> <p>Note 6: Time-domain measurement resource restriction pattern for PCell measurements as defined in TS 36.331 [5].</p> <p>Note 7: As configured according to the time-domain measurement resource restriction pattern for CSI measurements defined in TS 36.331 [5].</p> <p>Note 8: The number of control OFDM symbols is not available for ABS and is 2 for the subframe indicated by "0" of ABS pattern.</p> <p>Note 9: Downlink physical channel setup in Cell 2 and Cell 3 in accordance with TS 36.521-1 [10] Annex C.3.3 applying OCNG pattern as defined in TS 36.521-1 [10] Annex A.5.</p> <p>Note 10: The number of the CRS ports in Cell 1, Cell 2 and Cell 3 is the same.</p> <p>Note 11: SIB-1 will not be transmitted in Cell 2 and Cell 3 in this test.</p>					

**Table 8.2.1.2.3\_E.1.3-2: Minimum Performance Transmit Diversity (FRC)**

Test Number	Reference Channel	OCNG Pattern			Propagation Conditions (Note1)			Correlation Matrix and Antenna Configuration (Note 2)	Reference Value		UE Category
		Cell 1	Cell 2	Cell 3	Cell 1	Cell 2	Cell 3		Fraction of Maximum Throughput (%) (Note 5)	SNR (dB) (Note 3)	
1	R.11-4 FDD (Note 4)	OP.1 FDD	OP.1 FDD	OP.1 FDD	EVA5	EVA5	EVA5	2x2 Medium	70	3.4	2-8
Note 1:	The propagation conditions for Cell 1, Cell 2 and Cell 3 are statistically independent.										
Note 2:	The correlation matrix and antenna configuration apply for Cell 1, Cell 2 and Cell 3.										
Note 3:	SNR corresponds to $\hat{E}_s/N_{oc2}$ of Cell 1.										
Note 4:	Cell 1 reference channel is modified: PDSCH other than SIB1/paging and its associated PDCCH/PCFICH are transmitted in the serving cell subframe when the subframe is overlapped with the ABS subframe of aggressor cell and the subframe is available in the definition of the reference channel.										
Note 5:	The maximum throughput is calculated from the total Payload in 9 subframes, averaged over 40ms.										

The normative reference for this requirement is TS 36.101 [2] clause 8.2.1.2.3A.

#### 8.2.1.2.3\_E.1.4 Test description

##### 8.2.1.2.3\_E.1.4.1 Initial conditions

Initial conditions are a set of test configurations the UE needs to be tested in and the steps for the SS to take with the UE to reach the correct measurement state.

Configurations of PDSCH and PDCCH before measurement are specified in Annex C.2.

Test Environment: Normal, as defined in TS 36.508 [7] clause 4.1.

Frequencies to be tested: Mid Range, as defined in TS 36.508 [7] clause 4.3.1.1.

Channel Bandwidths to be tested: As specified per test number in Table 8.2.1.2.3\_E.1.3-2 as defined in TS 36.508 [7] clause 4.3.1.1.

1. Connect the SS, the faders and AWGN noise sources to the UE antenna connectors as shown in TS 36.508 [7] Annex A, Figure A.48 for antenna configuration 2x2.
2. The parameter settings for the cell are set up according to Tables 8.2.1-1 and 8.2.1.2.3\_E.1.3-1 as appropriate.
3. Downlink signals are initially set up for Cell 1 according to Annex C0, C.1 and Annex C.3.2 and uplink signals according to Annex H.1 and H.3.2.
4. Propagation conditions are set according to Annex B.0.
5. Ensure the UE is in State 3A-RF according to TS 36.508 [7] clause 5.2A.2. Message contents are defined in clause 8.2.1.2.3\_E.1.4.3.

##### 8.2.1.2.3\_E.1.4.2 Test procedure

1. Set the parameters for Cell 1, Cell 2 and Cell 3, according to Tables 8.2.1.2.3\_E.1.5-1, 8.2.1.2.3\_E.1.5-2, and C.3.3.2 of Annex C.3.3. SS transmits PDSCH via PDCCH DCI format 1A for C\_RNTI to transmit the DL RMC.
2. The SS sends downlink MAC padding bits on the DL RMC. Propagation conditions are set according to Annex B clause B.2
3. Measure the average throughput for a duration sufficient to achieve statistical significance according to Annex G clause G.3. Count the number of NACKs, ACKs and statDTXs on the UL during the test interval and decide pass or fail according to Tables G.3.5 and G.3.6 in Annex G clause G.3.

8.2.1.2.3\_E.1.4.3 Message contents

Message contents are according to TS 36.508 [7] clause 5.2A.5.1 with the following exceptions:

**Table 8.2.1.2.3\_E.1.4.3-1: RadioResourceConfigDedicated-SRB2-DRB(n, m): Additional FDD PDSCH transmit diversity performance downlink power allocation**

Derivation Path: TS 36.508 [7] clause 5.2A.5, Table 5.2A.5.1.1-2 RadioResourceConfigDedicated-SRB2-DRB(n,m)			
Information Element	Value/remark	Comment	Condition
RadioResourceConfigDedicated-SRB2-DRB(n, m) ::= SEQUENCE {			
MeasSubframePatternPCell-r10 CHOICE {			
setup SEQUENCE {			
subframePatternFDD-r10	'1000000010000000 1000000010000000 10000000'	BIT STRING (SIZE (40))	
}			
}			
neighCellsCRS-Info-r11 ::= CHOICE {			
setup SEQUENCE {			
CRS-AssistancedInfoList-r11 ::= SEQUENCE (SIZE (1..maxCellReport)) OF CRS-AssistancedInfo-r11{		2 entries	
CRS-AssistancedInfo-r11 ::= SEQUENCE {			
physCellId-r11	126		Cell 2
	1		Cell 3
antennaPortsCount-r11	an2		Cell 2, Cell 3
mbsfn-SubframeConfigList-r11 ::= SEQUENCE (SIZE (1..maxMBSFN-Allocations)) OF MBSFN-SubframeConfig{			Cell 2, Cell 3
MBSFN-SubframeConfig:: = SEQUENCE {			
radioframeAllocationPeriod	n1		
radioframeAllocationOffset	0		
subframeAllocation CHOICE{			
oneFrame	'000000' B	non-MBSFN	
}			
}			
}			
}			
}			
}			
}			

**Table 8.2.1.2.3\_E.1.4.3-2: CQI-ReportConfig-r10-DEFAULT: Additional FDD PDSCH transmit diversity performance downlink power allocation**

Derivation Path: 36.508 [7] clause 4.6.3, Table 4.6.3-2AA CQI-ReportConfig-r10-DEFAULT_			
Information Element	Value/remark	Comment	Condition
CQI-ReportConfig-r10-DEFAULT ::= SEQUENCE {			
cqi-ReportAperiodic-r10	Not present		
nomPDSCH-RS-EPRE-Offset	0		
cqi-ReportPeriodic-r10	Not present		
pmi-RI-Report-r9	Not present		
csi-SubframePatternConfig-r10 CHOICE {			
setup SEQUENCE {			
csi-MeasSubframeSet1-r10 CHOICE {			
subframePatternFDD-r10	'11000000 11000000 11000000 11000000 11000000'	BIT STRING (SIZE (40))	
}			
csi-MeasSubframeSet2-r10 CHOICE {			
subframePatternFDD-r10	'00111111 00111111 00111111 00111111 00111111'	BIT STRING (SIZE (40))	
}			
}			
}			
}			

8.2.1.2.3\_E.1.5 Test requirement

Table 8.2.1.2.3\_E.1.5-1 defines the primary level settings.

The fraction of maximum throughput percentage for the downlink reference measurement channels specified in Annex A clause A.3.3.2 for each throughput test shall meet or exceed the specified value in Table 8.2.1.2.3\_E.1.5-2 for the specified SNR including test tolerances for all throughput tests.

**Table 8.2.1.2.3\_E.1.5-1: Test Parameters for Transmit diversity Performance (FRC)**

Parameter		Unit	Cell 1	Cell 2	Cell 3
Downlink power allocation	$\rho_A$	dB	-3	-3	-3
	$\rho_B$	dB	-3 (Note 1)	-3 (Note 1)	-3 (Note 1)
	$\sigma$	dB	0	N/A	N/A
$N_{oc}$ at antenna port	$N_{oc1}$	dBm/15kHz	-98 (Note 2)	N/A	N/A
	$N_{oc2}$	dBm/15kHz	-98 (Note 3)	N/A	N/A
	$N_{oc3}$	dBm/15kHz	-93.1 (Note 4)	N/A	N/A
$\hat{E}_s / N_{oc2}$		dB	Reference Value in Table 8.2.1.2.3_E.1.5-2	11.8	9.8
BW <sub>Channel</sub>		MHz	10	10	10
Subframe Configuration			Non-MBSFN	Non-MBSFN	Non-MBSFN
Time Offset between Cells		μs	N/A	3	-1
Frequency shift between Cells		Hz	N/A	300	-100
Cell Id			0	126	1
ABS pattern (Note 5)			N/A	11000000 11000000 11000000 11000000 11000000	11000000 11000000 11000000 11000000 11000000
RLM/RRM Measurement Subframe Pattern (Note 6)			10000000 10000000 10000000 10000000 10000000	N/A	N/A
CSI Subframe Sets (Note7)	$C_{CSI,0}$		11000000 11000000 11000000 11000000 11000000	N/A	N/A
	$C_{CSI,1}$		00111111 00111111 00111111 00111111 00111111	N/A	N/A
Number of control OFDM symbols			2	Note 8	Note 8
PDSCH transmission mode			2	Note 9	Note 9
Cyclic prefix			Normal	Normal	Normal
<p>Note 1: <math>P_B = 1</math>.</p> <p>Note 2: This noise is applied in OFDM symbols #1, #2, #3, #5, #6, #8, #9, #10, #12, #13 of a subframe overlapping with the aggressor ABS.</p> <p>Note 3: This noise is applied in OFDM symbols #0, #4, #7, #11 of a subframe overlapping with the aggressor ABS.</p> <p>Note 4: This noise is applied in all OFDM symbols of a subframe overlapping with aggressor non-ABS</p> <p>Note 5: ABS pattern as defined in [14].</p> <p>Note 6: Time-domain measurement resource restriction pattern for PCell measurements as defined in TS 36.331 [5].</p> <p>Note 7: As configured according to the time-domain measurement resource restriction pattern for CSI measurements defined in TS 36.331 [5].</p> <p>Note 8: The number of control OFDM symbols is not available for ABS and is 2 for the subframe indicated by "0" of ABS pattern.</p> <p>Note 9: Downlink physical channel setup in Cell 2 and Cell 3 in accordance with TS 36.521-1 [10] Annex C.3.3 applying OCNG pattern as defined in TS 36.521-1 [10] Annex A.5.</p> <p>Note 10: The number of the CRS ports in Cell 1, Cell 2 and Cell 3 is the same.</p> <p>Note 11: SIB-1 will not be transmitted in Cell 2 and Cell 3 in this test.</p>					

**Table 8.2.1.2.3\_E.1.5-2: Test requirement Transmit Diversity (FRC)**

Test Number	Reference Channel	OCNG Pattern			Propagation Conditions (Note1)			Correlation Matrix and Antenna Configuration (Note 2)	Reference Value		UE Category
		Cell 1	Cell 2	Cell 3	Cell 1	Cell 2	Cell 3		Fraction of Maximum Throughput (%) (Note 5)	SNR (dB) (Note 3)	
1	R.11-4 FDD (Note 4)	OP.1 FDD	OP.1 FDD	OP.1 FDD	EVA5	EVA5	EVA5	2x2 Medium	70	4.3	2-8
Note 1:	The propagation conditions for Cell 1, Cell 2 and Cell 3 are statistically independent.										
Note 2:	The correlation matrix and antenna configuration apply for Cell 1, Cell 2 and Cell 3.										
Note 3:	SNR corresponds to $\hat{E}_s/N_{oc2}$ of Cell 1.										
Note 4:	Cell 1 reference channel is modified: PDSCH other than SIB1/paging and its associated PDCCH/PCFICH are transmitted in the serving cell subframe when the subframe is overlapped with the ABS subframe of aggressor cell and the subframe is available in the definition of the reference channel.										
Note 5:	The maximum throughput is calculated from the total Payload in 9 subframes, averaged over 40ms.										

#### 8.2.1.2.4 FDD PDSCH Transmit Diversity 2x2 with TM3 Interference Model – Enhanced Performance Requirement Type A

##### 8.2.1.2.4.1 Test purpose

The purpose is to verify the performance of transmit diversity (SFBC) with 2 transmit antennas when the PDSCH transmission in the serving cell is interfered by PDSCH of two dominant interfering cells applying transmission mode 3 interference model defined in clause B.5.2.

##### 8.2.1.2.4.2 Test applicability

This test applies to all types of E-UTRA FDD UE release 11 and forward that support enhanced receiver Type A.

##### 8.2.1.2.4.3 Minimum conformance requirements

The requirements are specified in Table 8.2.1.2.4.3-2, with the addition of parameters in Table 8.2.1.2.4.3-1 and the downlink physical channel setup according to Annex C.3.2. In Table 8.2.1.2.4.3-1, Cell 1 is the serving cell, and Cell 2, 3 are interfering cells. The downlink physical channel setup is according to Annex C.3.2 for each of Cell 1, Cell 2 and Cell 3, respectively.

**Table 8.2.1.2.4.3-1: Test Parameters for Transmit diversity Performance (FRC) with TM3 interference model**

Parameter	Unit	Cell 1	Cell 2	Cell 3	
Downlink power allocation	$\rho_A$	dB	-3	-3	-3
	$\rho_B$	dB	-3 (Note 1)	-3	-3
	$\sigma$	dB	0	0	0

Cell-specific reference signals			Antenna ports 0,1	Antenna ports 0,1	Antenna ports 0,1
$N_{oc}$ at antenna port		dBm/15kHz	-98	N/A	N/A
DIP (Note 2)		dB	N/A	-2.23	-8.06
$BW_{Channel}$		MHz	10	10	10
Cyclic Prefix			Normal	Normal	Normal
Cell Id			0	1	2
Number of control OFDM symbols			2	2	2
PDSCH transmission mode			2	N/A	N/A
Interference model			N/A	As specified in clause B.5.2	As specified in clause B.5.2
Probability of occurrence of transmission rank in interfering cells	Rank 1	%	N/A	80	80
	Rank 2	%	N/A	20	20
Reporting interval		ms	5	N/A	N/A
Reporting mode			PUCCH 1-0	N/A	N/A
Note 1: $P_B = 1$					
Note 2: The respective received power spectral density of each interfering cell relative to $N_{oc}$ is defined by its associated DIP value as specified in clause B.5.1.					
Note 3: Cell 1 is the serving cell. Cell 2, 3 are the interfering cells.					
Note 4: Cell 2 transmission is delayed with respect to Cell 1 by 0.33 ms and Cell 3 transmission is delayed with respect to Cell 1 by 0.67 ms.					

**Table 8.2.1.2.4.3-2: Enhanced Performance Requirement Type A, Transmit Diversity (FRC) with TM3 interference model**

Test Number	Reference Channel	OCNG Pattern			Propagation Conditions			Correlation Matrix and Antenna Configuration (Note 3)	Reference Value		UE Category
		Cell 1	Cell 2	Cell 3	Cell 1	Cell 2	Cell 3		Fraction of Maximum Throughput (%)	SINR (dB) (Note 2)	
1	R.46 FDD	OP. 1 FD D	N/A	N/A	EV A70	EV A70	EV A70	2x2 Low	70	-1.1	1-8
Note 1: The propagation conditions for Cell 1, Cell 2 and Cell 3 are statistically independent.											
Note 2: SINR corresponds to $\hat{E}_s / N_{oc}$ of Cell 1 as defined in clause 8.1.1.											
Note 3: Correlation matrix and antenna configuration parameters apply for each of Cell 1, Cell 2 and Cell 3.											

The normative reference for this requirement is TS 36.101 [2] clause 8.2.1.2.4.

#### 8.2.1.2.4.4 Test description

##### 8.2.1.2.4.4.1 Initial conditions

Initial conditions are a set of test configurations the UE needs to be tested in and the steps for the SS to take with the UE to reach the correct measurement state.

Configurations of PDSCH and PDCCH before measurement are specified in Annex C.2.

Test Environment: Normal, as defined in TS 36.508 [7] clause 4.1.

Frequencies to be tested: Mid Range, as defined in TS 36.508 [7] clause 4.3.1.1.

Channel Bandwidths to be tested: As specified per test number in Table 8.2.1.2.1.3-2 as defined in TS 36.508 [7] clause 4.3.1.1.

1. Connect the SS, the faders and AWGN noise sources to the UE antenna connectors as shown in TS 36.508 [7] Annex A, Figure A.48.
2. The parameter settings for the cell 1 are set up according to Tables 8.2.1-1 and 8.2.1.2.4.5-1 as appropriate.
3. Downlink signals are initially set up according to Annex C0, C.1 and Annex C.3.2 and uplink signals according to Annex H.1 and H.3.2.
4. Propagation conditions are set according to Annex B.0.
5. Ensure the UE is in State 3A-RF according to TS 36.508 [7] clause 5.2A.2. Message contents are defined in clause 8.2.1.2.4.4.3.

#### 8.2.1.2.4.4.2 Test procedure

1. SS transmits PDSCH via PDCCH DCI format 1A for C\_RNTI to transmit the DL RMC according to Tables 8.2.1.2.4.5-1 and 8.2.1.2.4.5-2. The SS sends downlink MAC padding bits on the DL RMC.
2. SS sets up parameters for cell 2 and cell 3 according to table 8.2.1.2.4.5-1 as appropriate.
3. Set the parameters of the bandwidth, MCS, reference channel, the propagation condition, the correlation matrix, antenna configuration and the SINR according to Tables 8.2.1.2.4.5-1 as appropriate.
4. Measure the average throughput for a duration sufficient to achieve statistical significance according to Annex G clause G.3. Count the number of NACKs, ACKs and statDTXs on the UL during the test interval and decide pass or fail according to Tables G.3.5-15 in Annex G clause G.3.

#### 8.2.1.2.4.4.3 Message contents

Message contents are according to TS 36.508 [7] clause 4.6.

#### 8.2.1.2.4.5 Test requirement

Table 8.2.1.2.4.5-1 defines the primary level settings.

The fraction of maximum throughput percentage for the downlink reference measurement channels specified in Annex A clause A.3.3.2 for throughput test shall meet or exceed the specified value in Table 8.2.1.2.4.5-2 for the specified SINR including test tolerances.

**Table 8.2.1.2.4.5-1: Test Parameters for Transmit diversity Performance (FRC) with TM3 interference model**

Parameter		Unit	Cell 1	Cell 2	Cell 3
Downlink power allocation	$\rho_A$	dB	-3	-3	-3
	$\rho_B$	dB	-3 (Note 1)	-3	-3
	$\sigma$	dB	0	0	0



Cell-specific reference signals			Antenna ports 0,1	Antenna ports 0,1	Antenna ports 0,1
$N_{oc}$ at antenna port		dBm/15kHz	-98	N/A	N/A
DIP (Note 2)		dB	N/A	-1.88	-7.21
$BW_{Channel}$		MHz	10	10	10
Cyclic Prefix			Normal	Normal	Normal
Cell Id			0	1	2
Number of control OFDM symbols			2	2	2
PDSCH transmission mode			2	N/A	N/A
Interference model			N/A	As specified in clause B.5.2	As specified in clause B.5.2
Probability of occurrence of transmission rank in interfering cells	Rank 1	%	N/A	80	80
	Rank 2	%	N/A	20	20
Reporting interval		ms	5	N/A	N/A
Reporting mode			PUCCH 1-0	N/A	N/A
Note 1: $P_B = 1$					
Note 2: The respective received power spectral density of each interfering cell relative to $N_{oc}$ is defined by its associated DIP value as specified in clause B.5.1.					
Note 3: Cell 1 is the serving cell. Cell 2, 3 are the interfering cells.					
Note 4: Cell 2 transmission is delayed with respect to Cell 1 by 0.33 ms and Cell 3 transmission is delayed with respect to Cell 1 by 0.67 ms.					

**Table 8.2.1.2.4.5-2: Test requirement for Enhanced Performance Requirement Type A, Transmit Diversity (FRC) with TM3 interference model**

Test Number	Reference Channel	OCNG Pattern			Propagation Conditions			Correlation Matrix and Antenna Configuration (Note 3)	Reference Value		UE Category
		Cell 1	Cell 2	Cell 3	Cell 1	Cell 2	Cell 3		Fraction of Maximum Throughput (%)	SINR (dB) (Note 2)	
1	R.46 FDD	OP. 1 FD D	N/A	N/A	EV A70	EV A70	EV A70	2x2 Low	70	-0.15	1-8
Note 1: The propagation conditions for Cell 1, Cell 2 and Cell 3 are statistically independent.											
Note 2: SINR corresponds to $\hat{E}_s / N_{oc}$ of Cell 1 as defined in clause 8.1.1.											
Note 3: Correlation matrix and antenna configuration parameters apply for each of Cell 1, Cell 2 and Cell 3.											

**8.2.1.3 FDD PDSCH Open Loop Spatial Multiplexing Performance (Cell-Specific Reference Symbols)**

**8.2.1.3.1 FDD PDSCH Open Loop Spatial Multiplexing 2x2**

**8.2.1.3.1.1 Test purpose**

To verify the UE's ability to receive a predefined test signal, representing a multi-path fading channel that is determined by the SNR with a percentage of the information bit throughput for a specified downlink Reference Measurement Channel (RMC) not falling below a specified value for transmission on two antenna ports using large delay CDD.

**8.2.1.3.1.2 Test applicability**

This test applies to all types of E-UTRA FDD UE release 8 and forward.

### 8.2.1.3.1.3 Minimum conformance requirements

The requirements are specified in terms of the percentage of information bit throughput for the downlink reference measurement channels specified in Annex A clause A.3.3.2, with the addition of the relevant parameters in Tables 8.2.1-1 and 8.2.1.3.1.3-1 and the downlink physical channel setup according to Table C.3.2-1 in Annex C.

Using this configuration the fraction of maximum throughput percentage shall meet or exceed the minimum requirements specified in Table 8.2.1.3.1.3-1 for the specified SNR. For open-loop spatial multiplexing performance with large delay CDD is specified.

**Table 8.2.1.3.1.3-1: Test Parameters for Large Delay CDD (FRC)**

Parameter		Unit	Test 1-2
Downlink power allocation	$\rho_A$	dB	-3
	$\rho_B$	dB	-3 (Note 1)
	$\sigma$	dB	0
$N_{oc}$ at antenna port		dBm/15kHz	-98
PDSCH transmission mode			3
Note 1: $P_B = 1$			

**Table 8.2.1.3.1.3-2: Minimum performance Large Delay CDD (FRC)**

Test number	Band-width	Reference Channel	OCNG Pattern	Propagation Condition	Correlation Matrix and Antenna Configuration	Reference value		UE Category
						Fraction of Maximum Throughput (%)	SNR (dB)	
1 (Note 1)	10 MHz	R.11 FDD	OP.1 FDD	EVA70	2x2 Low	70	13.0	$\geq 2$
2 (Note 2)	5 MHz	R.11-2 FDD	OP.1 FDD	EVA70	2x2 Low	70	12.7	$\geq 2$
Note 1: Test 1 may not be executed for UE-s for which Test 1 in 8.2.1.3.1_A.2 is applicable.								
Note 2: Test case applicability is defined in 8.1.2.1.								

The normative reference for this requirement is TS 36.101 [2] clause 8.2.1.3.

### 8.2.1.3.1.4 Test description

#### 8.2.1.3.1.4.1 Initial conditions

Initial conditions are a set of test configurations the UE needs to be tested in and the steps for the SS to take with the UE to reach the correct measurement state.

Configurations of PDSCH and PDCCH before measurement are specified in Annex C.2.

Test Environment: Normal, as defined in TS 36.508 [7] clause 4.1.

Frequencies to be tested: Mid Range, as defined in TS 36.508 [7] clause 4.3.1.1.

Channel Bandwidths to be tested: As specified per test number in Table 8.2.1.3.1.3-2, as defined in TS 36.508 [7] clause 4.3.1.1

1. Connect the SS, the faders and AWGN noise sources to the UE antenna connectors as shown in TS 36.508 [7] Annex A, Figure A.10 for antenna configuration 2x2.
2. The parameter settings for the cell are set up according to Tables 8.2.1-1 and 8.2.1.3.1.3-1 as appropriate.
3. Downlink signals are initially set up according to Annex C.0, C.1 and Annex C.3.2 and uplink signals according to Annex H.1 and H.3.2.
4. Propagation conditions are set according to Annex B.0.

5. Ensure the UE is in State 3A-RF according to TS 36.508 [7] clause 5.2A.2. Message contents are defined in clause 8.2.1.3.1.4.3.

8.2.1.3.1.4.2 Test procedure

1. SS transmits PDSCH via PDCCH DCI format 2A for C\_RNTI to transmit the DL RMC according to Tables 8.2.1.3.1.3-1 and 8.2.1.3.1.3-2. The SS sends downlink MAC padding bits on the DL RMC.
2. Set the parameters of the reference channel, the propagation condition, the correlation matrix and the SNR according to Table 8.2.1.3.1.5-1 as appropriate.
3. Measure the average throughput for a duration sufficient to achieve statistical significance according to Annex G clause G.3. Count the number of NACKs, ACKs and statDTXs on the UL during the test interval and decide pass or fail according to Tables G.3.5 and G.3.6 in Annex G clause G.3.

8.2.1.3.1.4.3 Message contents

Message contents are according to TS 36.508 [7] clause 4.6 with the following exceptions:

**Table 8.2.1.3.1.4.3-1: PhysicalConfigDedicated-DEFAULT: Additional FDD PDSCH open loop spatial multiplexing performance downlink power allocation**

Derivation Path: 36.331 clause 6.3.2			
Information Element	Value/remark	Comment	Condition
PhysicalConfigDedicated-DEFAULT ::= SEQUENCE {			
antennaInfo CHOICE {			
antennaInfoDedicated ::= SEQUENCE {			
transmissionMode	tm3		
codebookSubsetRestriction CHOICE {			
n2TxAntenna-tm3	11		
}			
ue-TransmitAntennaSelection CHOICE {			
release	NULL		
}			
}			

8.2.1.3.1.5 Test requirement

Table 8.2.1.3.1.3-1 defines the primary level settings.

The fraction of maximum throughput percentage for the downlink reference measurement channels specified in Annex A clause A.3.3.2 for each throughput test shall meet or exceed the specified value in Tables 8.2.1.3.1.5-1 for the specified SNR including test tolerances for all throughput tests.

**Table 8.2.1.3.1.5-1: Test Requirement Large Delay CDD (FRC)**

Test number	Band-width	Reference Channel	OCNG Pattern	Propagation Condition	Correlation Matrix and Antenna Configuration	Reference value		UE Category
						Fraction of Maximum Throughput (%)	SNR (dB)	
1	10 MHz	R.11 FDD	OP.1 FDD	EVA70	2x2 Low	70	13.9	≥2
2 (Note 2)	5 MHz	R.11-2 FDD	OP.1 FDD	EVA70	2x2 Low	70	13.6	≥2
Note 1:	N/A							
Note 2:	Test case is applicable (according to sub clause 8.1.2.1) to UE's which, from the E-UTRA operating bands defined in Table 5.2-1, support only E-UTRA band 31.							

## 8.2.1.3.1\_1 FDD PDSCH Open Loop Spatial Multiplexing 2x2 (Release 11 and forward)

## 8.2.1.3.1\_1.1 Test purpose

Same test purpose as in clause 8.2.1.3.1.1.

## 8.2.1.3.1\_1.2 Test applicability

This test applies to all types of E-UTRA FDD UE release 11 and forward.

## 8.2.1.3.1\_1.3 Minimum conformance requirements

Same minimum conformance requirements as in clause 8.2.1.3.1.3 with the following exceptions:

- Instead of Table 8.2.1.3.1.3-1 → use Table 8.2.1.3.1\_1.3-1.
- Instead of Table 8.2.1.3.1.3-2 → use Table 8.2.1.3.1\_1.3-2.

**Table 8.2.1.3.1\_1.3-1: Test Parameters for Large Delay CDD (FRC)**

Parameter		Unit	Test 1-2
Downlink power allocation	$\rho_A$	dB	-3
	$\rho_B$	dB	-3 (Note 1)
	$\sigma$	dB	0
$N_{oc}$ at antenna port		dBm/15kHz	-98
PDSCH transmission mode			3
Note 1: $P_B = 1$			

**Table 8.2.1.3.1\_1.3-2: Minimum performance Large Delay CDD (FRC)**

Test number	Bandwidth	Reference Channel	OCNG Pattern	Propagation Condition	Correlation Matrix and Antenna Configuration	Reference value		UE Category
						Fraction of Maximum Throughput (%)	SNR (dB)	
1	10 MHz	R.35 FDD	OP.1 FDD	EVA200	2x2 Low	70	20.2	$\geq 2$
2	10 MHz	R.35-4 FDD	OP.1 FDD	ETU300	2x2 Low	70	19.7	$\geq 2$

The normative reference for this requirement is TS 36.101 [2] clause 8.2.1.3.

## 8.2.1.3.1\_1.4 Test description

Same test description as in clause 8.2.1.3.1.4 with the following exceptions:

- Instead of Table 8.2.1.3.1.3-1 → use Table 8.2.1.3.1\_1.3-1.
- Instead of Table 8.2.1.3.1.3-2 → use Table 8.2.1.3.1\_1.3-2.
- Instead of Table 8.2.1.3.1.5-1 → use Table 8.2.1.3.1\_1.5-1.

## 8.2.1.3.1\_1.5 Test requirement

Same test requirements as in clause 8.2.1.3.1.5 with the following exceptions:

- Instead of Table 8.2.1.3.1.3-1 → use Table 8.2.1.3.1\_1.3-1.
- Instead of Table 8.2.1.3.1.5-1 → use Table 8.2.1.3.1\_1.5-1.

**Table 8.2.1.3.1\_1.5-1: Test Requirement Large Delay CDD (FRC)**

Test number	Bandwidth	Reference Channel	OCNG Pattern	Propagation Condition	Correlation Matrix and Antenna Configuration	Reference value		UE Category
						Fraction of Maximum Throughput (%)	SNR (dB)	
1	10 MHz	R.35 FDD	OP.1 FDD	EVA200	2x2 Low	70	[21.1]	≥2
2	10 MHz	R.35-4 FDD	OP.1 FDD	ETU300	2x2 Low	70	20.6	≥2

### 8.2.1.3.1\_A FDD PDSCH Open Loop Spatial Multiplexing 2x2 for CA

#### 8.2.1.3.1\_A.1 FDD PDSCH Open Loop Spatial Multiplexing 2x2 for CA (2DL CA)

##### 8.2.1.3.1\_A.1.1 Test purpose

To verify the UE's ability to receive a predefined test signal, representing a multi-path fading channel that is determined by the SNR with a percentage of the information bit throughput for a specified downlink Reference Measurement Channel (RMC) not falling below a specified value for transmission on two antenna ports using large delay CDD.

##### 8.2.1.3.1\_A.1.2 Test applicability

This test applies to

E-UTRA FDD release 10 and forward UE of category 2 or higher that supports inter-band OR intra-band contiguous DL CA

This test also applies to E-UTRA FDD release 11 and forward UE of category 2 or higher that supports intra-band non-contiguous DL CA.

##### 8.2.1.3.1\_A.1.3 Minimum conformance requirements

The requirements are specified in terms of the percentage of information bit throughput for the downlink reference measurement channels specified in Annex A clause A.3.3.2, with the addition of the relevant parameters in Tables 8.2.1-1 and 8.2.1.3.1\_A.1.3-1 and the downlink physical channel setup according to Table C.3.2-1 in Annex C.

Using this configuration the fraction of maximum throughput percentage shall meet or exceed the minimum requirements specified in Table 8.2.1.3.1\_A.1.3-1 for the specified SNR. For open-loop spatial multiplexing performance with large delay CDD is specified.

**Table 8.2.1.3.1\_A.1.3-1: Test Parameters for Large Delay CDD (FRC) for CA**

Parameter		Unit	Test 1 -4
Downlink power allocation	$\rho_A$	dB	-3
	$\rho_B$	dB	-3 (Note 1)
	$\sigma$	dB	0
dB $N_{oc}$ 0at antenna port		dBm/15kHz	-98
PDSCH Transmission mode			3
Note 1: $P_B = 1$			
Note 2: PUCCH format 1b with channel selection is used to feedback ACK/NACK.			
Note 3: The same PDSCH transmission mode is applied to each component carrier.			

**Table 8.2.1.3.1\_A.1.3-2: Minimum performance Large Delay CDD (FRC) for CA**

Test num	Bandwidth	Reference channel	OCNG pattern	Propagation condition	Correlation matrix and antenna config.	Reference value		UE category
						Fraction of maximum Throughput (%)	SNR (dB)	
1	2x10 MHz	R.11 FDD	OP.1 FDD (Note 1)	EVA70	2x2 Low	70	13.7	≥3
2	2x20 MHz	R.30 FDD	OP.1 FDD (Note 1)	EVA70	2x2 Low	70	13.2	≥5
3	2x5 MHz	R.11-2 FDD	OP.1 FDD	EVA70	2x2 Low	70	12.7	≥2
4	10MHz+5 MHz	R.11 FDD for 10MHz CC,	OP.1 FDD (Note 1)	EVA70	2x2 Low	70	13.0	≥3
		R.11-2 FDD for 5MHz CC	OP.1 FDD (Note 1)			70	12.7	
Note 1: The OCNG pattern applies for each CC.								
Note 2: Void								
Note 3: The applicability of requirements for different CA configurations and bandwidth combination sets is defined in 8.1.2.3.								

The normative reference for this requirement is TS 36.101 [2] clause 8.2.1.3.

#### 8.2.1.3.1\_A.1.4 Test description

##### 8.2.1.3.1\_A.1.4.1 Initial conditions

Initial conditions are a set of test configurations the UE needs to be tested in and the steps for the SS to take with the UE to reach the correct measurement state.

Configurations of PDSCH and PDCCH before measurement are specified in Annex C.2.

Test Environment: Normal, as defined in TS 36.508 [7] clause 4.1.

Frequencies to be tested: Maximum WGap for Intra-band non-contiguous CA, otherwise Mid Range, as defined in TS 36.508 [7] clause 4.3.1.

Channel Bandwidths to be tested: Select one according to Table 8.2.1.3.1\_A.1.4.1-1. CA Capability to be tested: Select one according to Table 8.2.1.3.1\_A.1.4.1-1

**Table 8.2.1.3.1\_A.1.4.1-1: Test point selection for TM3 2DLCA**

CA Capability	Bandwidth Combination			
	10+10	20+20	5+5	10+5
Inter-band CA (two bands) (CA2_A2)	Test 1	Test 2	Test 3	Test4
Intra-band contiguous CA (CA2_C)	Test 1	Test 2	Test 3	Test4
Intra-band non-contiguous CA (with two sub-blocks) (CA2_N2)	Test 1	Test 2	Test 3	Test4
Note 1: One test point per UE supported CA capability is tested. For each UE supported CA capability, select the first bandwidth combination (moving from left to right) supported by the UE within the chosen CA capability.				

1. Connect the SS, the faders and AWGN noise sources to the UE antenna connectors as shown in TS 36.508 [7] Annex A, Figure group A.36 as appropriate.
2. The parameter settings for the cell are set up according to Tables 8.2.1-1 and 8.2.1.3.1\_A.1.3-1 as appropriate.
3. Downlink signals for PCC are initially set up according to Annex C0, C.1 and Annex C.3.2 and uplink signals according to Annex H.1 and H.3.2.
4. Propagation conditions are set according to Annex B.0.

- Ensure the UE is in State 3A-RF according to TS 36.508 [7] clause 5.2A.2. Message contents are defined in clause 8.2.1.3.1\_A.1.4.3.

8.2.1.3.1\_A.1.4.2 Test procedure

- Configure SCC according to Annex C0, C.1 and Annex C.3.2 for all downlink physical channels.
- The SS shall configure SCC as per TS 36.508 [7] clause 5.2A.4. Message contents for PhysicalConfigDedicated-DEFAULT is defined in Table 8.2.1.3.1\_A.1.4.3-1, PhysicalConfigDedicatedSCell-r10-DEFAULT is defined in Table 8.2.1.3.1\_A.1.4.3-1A.
- SS activates SCC by sending the activation MAC-CE (Refer TS 36.321 [13], clauses 5.13, 6.1.3.8). Wait for at least 2 seconds (Refer TS 36.133, clauses 8.3.3.2).
- SS transmits PDSCH via PDCCH DCI format 2A for C\_RNTI to transmit the DL RMC according to Tables 8.2.1.3.1\_A.1.3-1 and 8.2.1.3.1\_A.1.3-2 on both PCC and SCC. The SS sends downlink MAC padding bits on the DL RMC.
- Set the parameters of the reference channel, the propagation condition, the correlation matrix and the SNR on each of the component carrier according to Table 8.2.1.3.1\_A.1.5-1 as appropriate.
- Measure the average throughput per component carrier for a duration sufficient to achieve statistical significance according to Annex G clause G.3A.5. Count the number of NACKs, ACKs and statDTXs on the UL during the test interval on both the component carrier.
- Repeat steps from 1 to 6 for each subtest in Table 8.2.1.3.1\_A.1.5-1 depending on UE CA capability as defined in Table 8.2.1.3.1\_A.1.4.1-1 and as appropriate.

8.2.1.3.1\_A.1.4.3 Message contents

Message contents are according to TS 36.508 [7] clauses 5.5 and 4.6 with the following exceptions

**Table 8.2.1.3.1\_A.1.4.3-1: PhysicalConfigDedicated-DEFAULT: Additional FDD PDSCH open loop spatial multiplexing performance downlink power allocation**

Derivation Path: 36.508 clause 5.5.1, Table 5.5.1.2-1			
Information Element	Value/remark	Comment	Condition
PhysicalConfigDedicated-DEFAULT ::= SEQUENCE {			
antennaInfo CHOICE {			
explicitValue ::= SEQUENCE {			
transmissionMode	tm3		
codebookSubsetRestriction CHOICE {			
n2TxAntenna-tm3	11		
}			
ue-TransmitAntennaSelection CHOICE {			
release	NULL		
}			
}			
}			
}			
}			

**Table 8.2.1.3.1\_A.1.4.3-1A: PhysicalConfigDedicatedSCell-r10-DEFAULT: Additional FDD PDSCH open loop spatial multiplexing performance downlink power allocation**

Derivation Path: 36.508 clause 4.6.3 Table 4.6.3-6A			
Information Element	Value/remark	Comment	Condition
PhysicalConfigDedicated SCell-r10-DEFAULT ::= SEQUENCE {			
nonUL-Configuration-r10 SEQUENCE {			
antennaInfo-r10 SEQUENCE {			
transmissionMode-r10	tm3		
codebookSubsetRestriction-r10	11	BIT STRING	
ue-TransmitAntennaSelection CHOICE {			
release	NULL		
}			
}			
}			

8.2.1.3.1\_A.1.5 Test requirement

Table 8.2.1.3.1\_A.1.3-1 defines the primary level settings.

The fraction of maximum throughput percentage for the downlink reference measurement channels specified in Annex A clause A.3.3.2 for the throughput test shall meet or exceed the specified value in Tables 8.2.1.3.1\_A.1.5-1 for the specified SNR including test tolerances for all throughput tests.

**Table 8.2.1.3.1\_A.1.5-1: Test Requirement Large Delay CDD (FRC) for CA**

Test num	Bandwidth	Reference channel	OCNG pattern	Propagation condition	Correlation matrix and antenna config.	Reference value		UE category
						Fraction of maximum Throughput (%)	SNR (dB)	
1	2x10 MHz	R.11 FDD	OP.1 FDD (Note 1)	EVA70	2x2 Low	70	14.6	≥3
2	2x20 MHz	R.30 FDD	OP.1 FDD (Note 1)	EVA70	2x2 Low	70	14.1	≥5
3	2x5 MHz	R.11-2 FDD	OP.1 FDD	EVA70	2x2 Low	70	13.6	≥2
4	10MHz+5 MHz	R.11 FDD for 10MHz CC,	OP.1 FDD (Note 1)	EVA70	2x2 Low	70	13.9	≥3
		R.11-2 FDD for 5MHz CC	OP.1 FDD (Note 1)			70	12.6	

Note 1: The OCNG pattern applies for each CC.  
 Note 2: Void  
 Note 3: The applicability of requirements for different CA configurations and bandwidth combination sets is defined in 8.1.2.3.

Decide pass or fail for each subtest according to Annex G.3A.4. Decide the entire test pass or fail according to Annex G.3A.6.

8.2.1.3.1\_A.2 FDD PDSCH Open Loop Spatial Multiplexing 2x2 for CA (3DL CA)

**Editor’s notes: This test case is incomplete. The following items are missing or incomplete:**

**- The SNR values for minimum conformance and test requirements are still in brackets.**

8.2.1.3.1\_A.2.1 Test purpose

To verify the UE's ability to receive a predefined test signal, representing a multi-path fading channel that is determined by the SNR with a percentage of the information bit throughput for a specified downlink Reference Measurement Channel (RMC) not falling below a specified value for transmission on two antenna ports using large delay CDD.



## 8.2.1.3.1\_A.2.2 Test applicability

This test case applies to all types of E-UTRA FDD release 10 and forward UE of category 5 or higher that support 3DL Intra-band contiguous CA or 3DL Inter-band CA, or 3DL with Intra-band contiguous and Inter-band CA.

This test case also applies to all types of E-UTRA FDD release 11 and forward UE of category 5 or higher that support 3DL with Intra-band non-contiguous and Inter-band CA, or 3DL with Intra-band non-contiguous and Intra-band contiguous CA.

## 8.2.1.3.1\_A.2.3 Minimum conformance requirements

For CA with 3 DL CCs, the requirements are specified in Table 8.2.1.3.1\_A.2.3-3, based on single carrier requirement specified in Table 8.2.1.3.1\_A.2.3-2, with the addition of the parameters in Table 8.2.1.3.1\_A.2.3-1 and the downlink physical channel setup according to Table C.3.2-1 in Annex C.

Table 8.2.1.3.1\_A.2.3-1: Test Parameters for Large Delay CDD (FRC) for CA

Parameter	Unit	Value
Downlink power allocation	$\rho_A$	dB
	$\rho_B$	dB
	$\sigma$	dB
$N_{oc}$ at antenna port	dBm/15kHz	-98
PDSCH transmission mode		3
Note 1: $P_B = 1$ .		
Note 2: PUCCH format 3 with channel selection is used to feedback ACK/NACK for Tests in Table 8.2.1.3.1_A.2.3-3.		
Note 3: The same PDSCH transmission mode is applied to each component carrier.		

Table 8.2.1.3.1\_A.2.3-2: Single carrier performance for multiple CA configurations

Band-width	Reference channel	OCNG pattern	Propagation condition	Correlation matrix and antenna config.	Reference value	
					Fraction of maximum throughput (%)	SNR (dB)
1.4MHz	R.11-5 FDD	OP.1 FDD	EVA70	2x2 Low	70	[13.6]
3MHz	R.11-6 FDD	OP.1 FDD	EVA70	2x2 Low	70	[12.3]
5MHz	R.11-2 FDD	OP.1 FDD	EVA70	2x2 Low	70	[12.3]
10MHz	R.11 FDD	OP.1 FDD	EVA70	2x2 Low	70	[12.9]
15MHz	R.11-7 FDD	OP.1 FDD	EVA70	2x2 Low	70	[12.8]
20MHz	R.30 FDD	OP.1 FDD	EVA70	2x2 Low	70	[12.9]

Table 8.2.1.3.1\_A.2.3-2: Minimum performance (FRC) based on single carrier performance for CA with 3DL CCs

Test num.	CA Band-width combination	Requirement	UE category
1	3x20MHz	As specified in Table 8.2.1.3.1_A.2.3-2 per CC	$\geq 5$
2	20MHz+20MHz+15MHz	As specified in Table 8.2.1.3.1_A.2.3-2 per CC	$\geq 5$
3	20MHz+20MHz+10MHz	As specified in Table 8.2.1.3.1_A.2.3-2 per CC	$\geq 5$
4	20MHz+15MHz+15MHz	As specified in Table 8.2.1.3.1_A.2.3-2 per CC	$\geq 5$
5	20MHz+15MHz+10MHz	As specified in Table 8.2.1.3.1_A.2.3-2 per CC	$\geq 5$
6	20MHz+10MHz+10MHz	As specified in Table 8.2.1.3.1_A.2.3-2 per CC	$\geq 5$
7	15MHz+15MHz+10MHz	As specified in Table 8.2.1.3.1_A.2.3-2 per CC	$\geq 5$
8	20MHz+10MHz+5MHz	As specified in Table 8.2.1.3.1_A.2.3-2 per CC	$\geq 5$
Note 1: The applicability of requirements for different CA configurations and bandwidth combination sets is defined in 8.1.2.3			

The normative reference for this requirement is TS 36.101 [2] clause 8.2.1.3.

## 8.2.1.3.1\_A.2.4 Test description

## 8.2.1.3.1\_A.2.4.1 Initial conditions

Initial conditions are a set of test configurations the UE needs to be tested in and the steps for the SS to take with the UE to reach the correct measurement state.

Configurations of PDSCH and PDCCH before measurement are specified in Annex C.2.

Test Environment: Normal, as defined in TS 36.508 [7] clause 4.1.

Frequencies to be tested: Maximum WGap for Intra-band non-contiguous CA, otherwise Mid Range, as defined in TS 36.508 [7] clause 4.3.1.

Channel Bandwidths to be tested: Select one according to Table 8.2.1.3.1\_A.2.4.1-1.

CA Capability to be tested: Select one according to Table 8.2.1.3.1\_A.2.4.1-1.

**Table 8.2.1.3.1\_A.2.4.1-1: Test point selection for TM3 3DL CA**

CA Capability	Bandwidth combination							
	3x20	20+20+15	20+20+10	20+15+15	20+15+10	20+10+10	15+15+10	20+10+5
Intra-band contiguous (CA3_C)	Test1	Test2	Test3	Test4	Test5	Test6	Test7	Test8
Inter-band CA (two bands) (CA3_A2)	Test1	Test2	Test3	Test4	Test5	Test6	Test7	Test8
Inter-band CA (three bands) (CA3_A3)	Test1	Test2	Test3	Test4	Test5	Test6	Test7	Test8
Intra-band non-contiguous CA (with two sub-blocks) (CA3_N2)	Test1	Test2	Test3	Test4	Test5	Test6	Test7	Test8
Note1:	One test point per UE supported CA capability is tested. For each UE supported CA capability, select the largest aggregated CA bandwidth combination supported by the UE within the chosen CA capability.							

1. Connect the SS, the faders and AWGN noise source to the UE antenna connectors as shown in TS 36.508 [7] Annex A, Figure A.60.
2. The parameter settings for the cell are set up according to Table 8.2.1-1 and 8.2.1.3.1\_A.2.3-1 as appropriate.
3. Downlink signals for PCC are initially set up according to Annex C.0, C.1 and Annex C.3.2 and uplink signals according to Annex H.1 and H.3.2.
4. Propagation conditions are set according to Annex B.0.
5. Ensure the UE is in State 3A-RF according to TS 36.508 [7] clause 5.2A.2. Message contents are defined in clause 8.2.1.3.1\_A.2.4.3.

## 8.2.1.3.1\_A.2.4.2 Test procedure

1. Configure SCCs according to Annex C.0, C.1 and Annex C.3.2 for all downlink physical channels.
2. The SS shall configure SCCs as per TS 36.508 [7] clause 5.2A.4. Message contents are defined in clause 8.2.1.3.1\_A.2.4.3.
3. The SS activates SCCs by sending the MAC-CE according to TS 36.321 [13] clauses 5.13 and 6.1.3.8. Wait for at least 2 seconds as per TS 36.133 [4] clause 8.3.3.2.

4. The SS transmits PDSCH via PDCCH DCI format 2A for C\_RNTI to transmit the DL RMC according to Tables 8.2.1.3.1\_A.2.3-1 and 8.2.1.3.1\_A.2.3-2 on both PCC and SCCs. The SS sends downlink MAC padding bits on the DL RMC.
5. Set the parameters of the bandwidth, MCS, reference channel, the propagation condition, the correlation matrix and the SNR on each of the component carriers according to Tables 8.2.1.3.1\_A.2.5-1 as appropriate.
6. Measure the average throughput per component carrier for duration sufficient to achieve statistical significance according to Annex G clause G.3A.5 on each of the component carriers. Count the number of NACKs, ACKs and statDTXs on the UL during each subtest on each of the component carriers.

8.2.1.3.1\_A.2.4.3 Message contents

Message contents are according to TS 36.508 [7] subclause 4.6 with the following exceptions

**Table 8.2.1.3.1\_A.2.4.3-1: PhysicalConfigDedicated-DEFAULT: Additional FDD PDSCH open loop spatial multiplexing performance downlink power allocation**

Derivation Path: 36.508 clause 5.5.1, Table 5.5.1.2-1			
Information Element	Value/remark	Comment	Condition
PhysicalConfigDedicated-DEFAULT ::= SEQUENCE {			
antennaInfo CHOICE {			
explicitValue ::= SEQUENCE {			
transmissionMode	tm3		
codebookSubsetRestriction CHOICE {			
n2TxAntenna-tm3	11		
}			
ue-TransmitAntennaSelection CHOICE {			
release	NULL		
}			
}			
}			

**Table 8.2.1.3.1\_A.2.4.3-1A: PhysicalConfigDedicatedSCell-r10-DEFAULT: Additional FDD PDSCH open loop spatial multiplexing performance downlink power allocation**

Derivation Path: 36.508 clause 4.6.3 Table 4.6.3-6A			
Information Element	Value/remark	Comment	Condition
PhysicalConfigDedicated SCell-r10-DEFAULT ::= SEQUENCE {			
nonUL-Configuration-r10 SEQUENCE {			
antennaInfo-r10 SEQUENCE {			
transmissionMode-r10	tm3		
codebookSubsetRestriction-r10	11	BIT STRING	
ue-TransmitAntennaSelection CHOICE {			
release	NULL		
}			
}			
}			
}			

8.2.1.3.1\_A.2.5 Test requirement

Table 8.2.1.3.1\_A.2.3-1 defines the primary level settings.

The fraction of maximum throughput percentage for the downlink reference measurement channels specified in Annex A clause A.3.3.2.1 for the throughput test shall meet or exceed the specified value in Table 8.2.1.3.1\_A.2.5-1 for the specified SNR including test tolerances for all throughput tests.

**Table 8.2.1.3.1\_A.2.5-1: Single carrier performance for multiple CA configurations**

Band-width	Reference channel	OCNG pattern	Propa-gation condition	Correlation matrix and antenna config.	Reference value	
					Fraction of maximum throughput (%)	SNR (dB)
1.4MHz	R.11-5 FDD	OP.1 FDD	EVA70	2x2 Low	70	[14.5]
3MHz	R.11-6 FDD	OP.1 FDD	EVA70	2x2 Low	70	[13.2]
5MHz	R.11-2 FDD	OP.1 FDD	EVA70	2x2 Low	70	[13.2]
10MHz	R.11 FDD	OP.1 FDD	EVA70	2x2 Low	70	[13.8]
15MHz	R.11-7 FDD	OP.1 FDD	EVA70	2x2 Low	70	[13.7]
20MHz	R.30 FDD	OP.1 FDD	EVA70	2x2 Low	70	[13.8]

**Table 8.2.1.3.1\_A.2.5-2: Test requirement (FRC) based on single carrier performance for CA with 3DL CCs**

Test num.	CA Band-width combination	Requirement	UE category
1	3x20MHz	As specified in Table 8.2.1.3.1_A.2.5-1 per CC	≥5
2	20MHz+20MHz+15MHz	As specified in Table 8.2.1.3.1_A.2.5-1 per CC	≥5
3	20MHz+20MHz+10MHz	As specified in Table 8.2.1.3.1_A.2.5-1 per CC	≥5
4	20MHz+15MHz+15MHz	As specified in Table 8.2.1.3.1_A.2.5-1 per CC	≥5
5	20MHz+15MHz+10MHz	As specified in Table 8.2.1.3.1_A.2.5-1 per CC	≥5
6	20MHz+10MHz+10MHz	As specified in Table 8.2.1.3.1_A.2.5-1 per CC	≥5
7	15MHz+15MHz+10MHz	As specified in Table 8.2.1.3.1_A.2.5-1 per CC	≥5
8	20MHz+10MHz+5MHz	As specified in Table 8.2.1.3.1_A.2.5-1 per CC	≥5
Note 1: The applicability of requirements for different CA configurations and bandwidth combination sets is defined in 8.1.2.3			

Decide pass or fail for each subtest according to Annex G.3A.4. Decide the entire test pass or fail according to Annex G.3A.6.

#### 8.2.1.3.1A FDD Soft buffer management test

##### 8.2.1.3.1A\_A.1 FDD PDSCH Soft buffer management test for CA (2 DL CA)

###### 8.2.1.3.1A\_A.1.1 Test purpose

To verify the UE's ability to receive a predefined test signal, representing a multi-path fading channel that is determined by the SNR with a percentage of the information bit throughput for a specified downlink Reference Measurement Channel (RMC) not falling below a specified value for transmission on two antenna ports using large delay CDD.

###### 8.2.1.3.1A\_A.1.2 Test applicability

This test applies to E-UTRA FDD UE category 3 and 4 release 10 and forward that support intra-band contiguous DL CA or inter-band DL CA.

This test applies also to E-UTRA FDD UE category 3 and 4 release 11 and forward that support intra-band non-contiguous DL CA.

###### 8.2.1.3.1A\_A.1.3 Minimum conformance requirements

The requirements are specified in Table 8.2.1.3.1A\_A.1.3-2, with the addition of the parameters in Table 8.2.1.3.1A\_A.1.3-1 and the downlink physical channel setup according to Table C.3.2-1 in Annex C. The purpose is to verify the UE performance with proper instantaneous buffer implementation.

**Table 8.2.1.3.1A\_A.1.3-1: Test Parameters for soft buffer management test (FRC) for CA**

Parameter		Unit	Test 1-7
Downlink power allocation	$\rho_A$	dB	-3
	$\rho_B$	dB	-3 (Note 1)
	$\sigma$	dB	0
$N_{oc}$ at antenna port		dBm/15kHz	-98
PDSCH transmission mode			3
Note 1: $P_B = 1$			
Note 2: For CA test cases, PUCCH format 1b with channel selection is used to feedback ACK/NACK.			
Note 3: For CA test cases, the same PDSCH transmission mode is applied to each component carrier.			

**Table 8.2.1.3.1A\_A.1.3-2: Minimum performance soft buffer management test (FRC) for CA**

Test num	Bandwidth	Reference channel	OCNG pattern	Propagation condition	Correlation matrix and antenna config.	Reference value	
						Fraction of maximum Throughput (%)	SNR (dB)
1	2x20 MHz	R.30 FDD	OP.1 FDD (Note 1)	EVA70	2x2 Low	70	13.2
2	15MHz + 10MHz	R.35-2 FDD for 15MHz CC	OP.1 FDD (Note 1)	EVA5	2x2 Low	70	15.1
		R.35-3 FDD for 10MHz CC	OP.1 FDD (Note 1)			70	15.1
3	20MHz + 10MHz	R.30 FDD for 20MHz CC	OP.1 FDD (Note 1)	EVA70	2x2 Low	70	13.5
		R.11 FDD for 10MHz CC	OP.1 FDD (Note 1)			70	13.5
4	20MHz + 15MHz	R.30 FDD for 20MHz CC	OP.1 FDD (Note 1)	EVA70	2x2 Low	70	13.5
		R.30-1 FDD for 15MHz CC	OP.1 FDD (Note 1)			70	13.5
5	2x20 MHz	R.35-1 FDD	OP.1 FDD (Note 1)	EVA5	2x2 Low	70	15.8
6	20MHz + 10MHz	R.35-1 FDD for 20MHz CC	OP.1 FDD (Note 1)	EVA5	2x2 Low	70	15.9
		R.35-3 FDD for 10MHz CC	OP.1 FDD (Note 1)			70	15.9
7	20MHz + 15MHz	R.35-1 FDD for 20MHz CC	OP.1 FDD (Note 1)	EVA5	2x2 Low	70	15.9
		R.35-2 FDD for 15MHz CC	OP.1 FDD (Note 1)			70	15.9
Note 1: For CA test cases, the OCNG pattern applies for each CC.							
Note 2: For Test 2, 3, 4, 6, 7 the Fraction of maximum Throughput applies to each CC.							
Note 3: The applicability of requirements for different CA configurations and bandwidth combination sets is defined in 8.1.2.3.							

**Table 8.2.1.3.1A\_A.1.3-3: Test points for soft buffer management tests for CA**

UE category	Bandwidth combination with maximum aggregated bandwidth (Note 1)			
	2x20MHz	15MHz+10MHz	20MHz+10MHz	20MHz+15MHz
3	1	2	3	4
4	5	N/A	6	7
Note 1: Maximum over all supported CA configurations and bandwidth combination sets according to Table 5.4.2A.1-1 and Table 5.4.2A.1-2.				

The normative reference for this requirement is TS 36.101 [2] clause 8.2.1.3.1A.

## 8.2.1.3.1A\_A.1.4 Test description

## 8.2.1.3.1A\_A.1.4.1 Initial conditions

Initial conditions are a set of test configurations the UE needs to be tested in and the steps for the SS to take with the UE to reach the correct measurement state.

Configurations of PDSCH and PDCCH before measurement are specified in Annex C.2.

Test Environment: Normal, as defined in TS 36.508 [7] clause 4.1.

Frequencies to be tested: Maximum Wgap for Intra-band non-contiguous CA, otherwise Mid Range, as defined in TS 36.508 [7] clause 4.3.1.

Channel Bandwidths to be tested: Select one according to Table 8.2.1.3.1A\_A.1.4-1.

CA Capability to be tested: Select one according to Table 8.2.1.3.1A\_A.1.4-1.

**Table 8.2.1.3.1A\_A.1.4-1: Test point selection soft buffer management tests for CA**

CA Capability	Bandwidth combination			
	20+20	20+15	20+10	15+10
Inter-band CA (two bands) (CA2_A2)	Test 1 or 5	Test 4 or 7	Test 3 or 6	Test 2
Intra-band contiguous CA (CA2_C)	Test 1 or 5	Test 4 or 7	Test 3 or 6	Test 2
Intra-band non-contiguous CA (with two sub-blocks) (CA2_N2)	Test 1 or 5	Test 4 or 7	Test 3 or 6	Test 2
Note1:	Only one test point is tested. Select the first UE supported CA bandwidth combination (moving from left to right) and choose any one of the UE supported CA capabilities supporting that CA bandwidth combination.			
Note2:	One of the two tests per table position is selected, depending on UE category.			

1. Connect the SS, the faders and AWGN noise sources to the UE antenna connectors as shown in TS 36.508 [7] Annex A, Figure group A.36 as appropriate.
2. The parameter settings for the cell are set up according to Tables 8.2.1-1 and 8.2.1.3.1A\_A.1.3-1 as appropriate.
3. Downlink signals for PCC are initially set up according to Annex C.0, C.1 and Annex C.3.2 and uplink signals according to Annex H.1 and H.3.2.
4. Propagation conditions are set according to Annex B.0.
5. Ensure the UE is in State 3A-RF according to TS 36.508 [7] clause 5.2A.2. Message contents are defined in clause 8.2.1.3.1\_A.1.4.3.

## 8.2.1.3.1A\_A.1.4.2 Test procedure

1. Configure SCC according to Annex C.0, C.1 and Annex C.3.2 for all downlink physical channels.
2. The SS shall configure SCC as per TS 36.508 [7] clause 5.2A.4. Message contents for PhysicalConfigDedicated-DEFAULT is defined in Table 8.2.1.3.1\_A.1.4.3-1, PhysicalConfigDedicatedSCell-r10-DEFAULT is defined in Table 8.2.1.3.1\_A.1.4.3-1A.
3. SS activates SCC by sending the activation MAC-CE (Refer TS 36.321 [13], clauses 5.13, 6.1.3.8). Wait for at least 2 seconds (Refer TS 36.133, clauses 8.3.3.2).
4. SS transmits PDSCH via PDCCH DCI format 2A for C\_RNTI to transmit the DL RMC according to Tables 8.2.1.3.1A\_A.1.3-1 and 8.2.1.3.1A\_A.1.3-2 on both PCC and SCC. The SS sends downlink MAC padding bits on the DL RMC.
5. Set the parameters of the reference channel, the propagation condition, the correlation matrix and the SNR on each of the component carrier according to Table 8.2.1.3.1A\_A.1.5-1 as appropriate.

6. Measure the average throughput per component carrier for a duration sufficient to achieve statistical significance according to Annex G clause G.3A.5. Count the number of NACKs, ACKs and statDTXs on the UL during the test interval on both the component carrier.

#### 8.2.1.3.1A\_A.1.4.3 Message contents

Same Message contents as 8.2.1.3.1\_A.1.4.3

#### 8.2.1.3.1A\_A.1.5 Test requirement

Table 8.2.1.3.1A\_A.1.3-1 defines the primary level settings.

The fraction of maximum throughput percentage for the downlink reference measurement channels specified in Annex A clause A.3.3.2 for the throughput test shall meet or exceed the specified value in Tables 8.2.1.3.1A\_A.1.5-1 for the specified SNR including test tolerances for all throughput tests.

**Table 8.2.1.3.1A\_A.1.5-1: Test Requirement soft buffer management test (FRC) for CA**

Test num	Bandwidth	Reference channel	OCNG pattern	Propagation condition	Correlation matrix and antenna config.	Reference value	
						Fraction of maximum Throughput (%)	SNR (dB)
1	2x20 MHz	R.30 FDD	OP.1 FDD (Note 1)	EVA70	2x2 Low	70	14.1
2	15MHz + 10MHz	R.35-2 FDD for 15MHz CC	OP.1 FDD (Note 1)	EVA5	2x2 Low	70	16.0
		R.35-3 FDD for 10MHz CC	OP.1 FDD (Note 1)			70	16.0
3	20MHz + 10MHz	R.30 FDD for 20MHz CC	OP.1 FDD (Note 1)	EVA70	2x2 Low	70	14.4
		R.11 FDD for 10MHz CC	OP.1 FDD (Note 1)			70	14.4
4	20MHz + 15MHz	R.30 FDD for 20MHz CC	OP.1 FDD (Note 1)	EVA70	2x2 Low	70	14.4
		R.30-1 FDD for 15MHz CC	OP.1 FDD (Note 1)			70	14.4
5	2x20 MHz	R.35-1 FDD	OP.1 FDD (Note 1)	EVA5	2x2 Low	70	16.7
6	20MHz + 10MHz	R.35-1 FDD for 20MHz CC	OP.1 FDD (Note 1)	EVA5	2x2 Low	70	16.8
		R.35-3 FDD for 10MHz CC	OP.1 FDD (Note 1)			70	16.8
7	20MHz + 15MHz	R.35-1 FDD for 20MHz CC	OP.1 FDD (Note 1)	EVA5	2x2 Low	70	16.8
		R.35-2 FDD for 15MHz CC	OP.1 FDD (Note 1)			70	16.8
Note 1: For CA test cases, the OCNG pattern applies for each CC. Note 2: For Test 2, 3, 4, 6, 7 the Fraction of maximum Throughput applies to each CC. Note 3: There is no applicable test point for a UE supporting max 10+10 MHz bandwidth combination. Note 4: The applicability of requirements for different CA configurations and bandwidth combination sets is defined in 8.1.2.3.							

Decide pass or fail for each subtest according to Annex G.3A.4.

#### 8.2.1.3.1A\_A.2 Void

#### 8.2.1.3.1B FDD PDSCH Open Loop Spatial Multiplexing 2x2 – Enhanced Performance Requirement Type C

Editor's notes: This test case is incomplete. The following items are missing or are incomplete:

- Test tolerances are undefined

- The SNR values in minimum and test requirement are still in square brackets

- The minimum testing time in Annex G is still undefined.

#### 8.2.1.3.1B.1 Test purpose

To verify the UE's ability to receive a predefined test signal, representing a multi-path fading channel that is determined by the SNR with a percentage of the information bit throughput for a specified downlink Reference Measurement Channel (RMC) not falling below a specified value for transmission on two antenna ports using large delay CDD.

#### 8.2.1.3.1B.2 Test applicability

This test applies to all types of E-UTRA FDD UE release 12 and forward UE of Category 2 or higher that support enhanced receiver Type C.

#### 8.2.1.3.1B.3 Minimum conformance requirements

The requirements are specified in terms of the percentage of information bit throughput for the downlink reference measurement channels specified in Annex A clause A.3.3.2, with the addition of the relevant parameters in Tables 8.2.1-1 and 8.2.1.3.1B.3-1 and the downlink physical channel setup according to Table C.3.2-1 in Annex C.

Using this configuration the fraction of maximum throughput percentage shall meet or exceed the minimum requirements specified in Table 8.2.1.3.1B.3-2 for the specified SNR. For open-loop spatial multiplexing performance with large delay CDD is specified.

**Table 8.2.1.3.1B.3-1: Test Parameters for Large Delay CDD (FRC)**

Parameter		Unit	Test 1
Downlink power allocation	$\rho_A$	dB	-3
	$\rho_B$	dB	-3 (Note 1)
	$\sigma$	dB	0
$N_{oc}$ at antenna port		dBm/15kHz	-98
PDSCH transmission mode			3
Note 1: $P_B = 1$ .			

**Table 8.2.1.3.1B.3-2: Enhanced Performance Requirement Type C, Large Delay CDD (FRC)**

Test num	Bandwidth	Reference channel	OCNG pattern	Propagation condition	Correlation matrix and antenna config.	Reference value		UE category
						Fraction of maximum Throughput (%)	SNR (dB)	
1	10 MHz	R.11 FDD	OP.1 FDD	EVA70	2x2 Medium	70	[17.8]	$\geq 2$

The normative reference for this requirement is TS 36.101 [2] clause 8.2.1.3.1B.

#### 8.2.1.3.1B.4 Test description

##### 8.2.1.3.1B.4.1 Initial conditions

Initial conditions are a set of test configurations the UE needs to be tested in and the steps for the SS to take with the UE to reach the correct measurement state.

Configurations of PDSCH and PDCCH before measurement are specified in Annex C.2.

Test Environment: Normal, as defined in TS 36.508 [7] clause 4.1.

Frequencies to be tested: Mid Range, as defined in TS 36.508 [7] clause 4.3.1.1.



Channel Bandwidths to be tested: As specified per test number in Table 8.2.1.3.1B.3-2, as defined in TS 36.508 [7] clause 4.3.1.1

1. Connect the SS, the faders and AWGN noise sources to the UE antenna connectors as shown in TS 36.508 [7] Annex A, Figure A.10 for antenna configuration 2x2.
2. The parameter settings for the cell are set up according to Tables 8.2.1-1 and 8.2.1.3.1B.3-1 as appropriate.
3. Downlink signals are initially set up according to Annex C.0, C.1 and Annex C.3.2 and uplink signals according to Annex H.1 and H.3.2.
4. Propagation conditions are set according to Annex B.0.
5. Ensure the UE is in State 3A-RF according to TS 36.508 [7] clause 5.2A.2. Message contents are defined in clause 8.2.1.3.1B.4.3.

#### 8.2.1.3.1B.4.2 Test procedure

1. SS transmits PDSCH via PDCCH DCI format 2A for C\_RNTI to transmit the DL RMC according to Tables 8.2.1.3.1B.3-1 and 8.2.1.3.1B.3-2. The SS sends downlink MAC padding bits on the DL RMC.
2. Set the parameters of the reference channel, the propagation condition, the correlation matrix and the SNR according to Table 8.2.1.3.1B.5-1 as appropriate.
3. Measure the average throughput for a duration sufficient to achieve statistical significance according to Annex G clause G.3. Count the number of NACKs, ACKs and statDTXs on the UL during the test interval and decide pass or fail according to Tables G.3.5 and G.3.6 in Annex G clause G.3.

#### 8.2.1.3.1B.4.3 Message contents

Message contents are according to TS 36.508 [7] clause 4.6 with the following exceptions:

**Table 8.2.1.3.1B.4.3-1: PhysicalConfigDedicated-DEFAULT**

Derivation Path: 36.331 clause 6.3.2			
Information Element	Value/remark	Comment	Condition
PhysicalConfigDedicated-DEFAULT ::= SEQUENCE {			
antennaInfo CHOICE {			
antennaInfoDedicated ::= SEQUENCE {			
transmissionMode	tm3		
codebookSubsetRestriction CHOICE {			
n2TxAntenna-tm3	11		
}			
ue-TransmitAntennaSelection CHOICE {			
release	NULL		
}			
}			
}			

#### 8.2.1.3.1B.5 Test requirement

Table 8.2.1.3.1B.3-1 defines the primary level settings.

The fraction of maximum throughput percentage for the downlink reference measurement channels specified in Annex A clause A.3.3.2 for each throughput test shall meet or exceed the specified value in Tables 8.2.1.3.1B.5-1 for the specified SNR including test tolerances for all throughput tests.

**Table 8.2.1.3.1B.5-1: Test requirement for Enhanced Performance Requirement Type C, Large Delay CDD (FRC)**

Test num	Bandwidth	Reference channel	OCNG pattern	Propagation condition	Correlation matrix and antenna config.	Reference value		UE category
						Fraction of maximum Throughput (%)	SNR (dB)	
1	10 MHz	R.11 FDD	OP.1 FDD	EVA70	2x2 Medium	70	[17.8] +TT	≥2

### 8.2.1.3.1C FDD PDSCH Open Loop Spatial Multiplexing 2x2 with TM1 Interference – Enhanced Performance Requirement Type C

Editor's notes: This test case is incomplete. The following items are missing or are incomplete:

- Test tolerances are undefined
- Connection diagram is TBD
- The SNR values in minimum and test requirement are still in square brackets
- The minimum testing time in Annex G is still undefined.

#### 8.2.1.3.1C.1 Test purpose

The purpose is to verify the performance of open-loop spatial multiplexing performance with 2 transmit antennas when the PDSCH transmission in the serving cell is interfered by PDSCH of one dominant interfering cell with transmission mode 1.

#### 8.2.1.3.1C.2 Test applicability

This test applies to all types of E-UTRA FDD release 12 and forward UE of Category 2 or higher that support enhanced receiver Type C.

#### 8.2.1.3.1C.3 Minimum conformance requirements

The requirements are specified in Table 8.2.1.3.1C.3-2, with the addition of parameters in Table 8.2.1.3.1C.3-1 and the downlink physical channel setup according to Annex C.3.2. In Table 8.2.1.3.1C.3-1, Cell 1 is the serving cell, and Cell 2 is interfering cell. The downlink physical channel setup is according to Annex C.3.2 for each of Cell 1 and Cell 2 respectively.

**Table 8.2.1.3.1C.3-1: Test Parameters for Large Delay CDD (FRC) with TM1 interference**

Parameter		Unit	Cell 1	Cell 2
Bandwidth		MHz	10 MHz	
Downlink power allocation	$\rho_A$	dB	-3	0
	$\rho_B$		-3 (Note 1)	0
	$\sigma$		0	0
Cell-specific reference signals			Antenna ports 0,1	Antenna port 0
Cyclic Prefix			Normal	Normal
Cell ID			0	1
Transmission mode			3	Note 2
$N_{oc}$ at antenna port		dBm/15kHz	-98	N/A
$\hat{E}_s/N_{oc}$ (Note 3)		dB	Reference Value in Table 8.2.1.3.1C.3-2	12.95
Correlation and antenna configuration			Medium (2x2)	Medium(1x2)
Number of OFDM symbols for PDCCH			2	N/A
Max number of HARQ transmissions			4	N/A
Redundancy version coding sequence			{0,1,2,3}	N/A
Note 1: $P_B = 1$				
Note 2: Downlink physical channel setup in Cell 2 in accordance with Annex C.3.2 applying OCNB pattern OP.5 FDD as defined in Annex A.5.1.5.				
Note 3: Cell 1 is the serving cell. Cell 2 is the interfering cell.				
Note 4: All cells are time-synchronous.				
Note 5: SIB-1 will not be transmitted in Cell2 in this test.				

**Table 8.2.1.3.1C.3-2: Enhanced Performance Requirement Type C, Large Delay CDD (FRC) with TM1 interference**

Test Number	Reference Channel	OCNB Pattern		Propagation Conditions (Note 1)		Reference Value		UE Category
		Cell 1	Cell 2	Cell 1	Cell 2	Fraction of Maximum Throughput (%)	SNR (dB) (Note 2)	
1	R.11-8 FDD	OP.1 FDD	OP.5 FDD	EVA70	EVA70	70	[19.9]	$\geq 2$
Note 1: The propagation conditions for Cell 1 and Cell 2 are statistically independent.								
Note 2: SNR corresponds to $\hat{E}_s/N_{oc}$ of Cell 1.								

The normative reference for this requirement is TS 36.101 [2] clause 8.2.1.3.1C.

#### 8.2.1.3.1C.4 Test description

##### 8.2.1.3.1C.4.1 Initial conditions

Initial conditions are a set of test configurations the UE needs to be tested in and the steps for the SS to take with the UE to reach the correct measurement state.

Configurations of PDSCH and PDCCH before measurement are specified in Annex C.2.

Test Environment: Normal, as defined in TS 36.508 [7] clause 4.1.

Frequencies to be tested: Mid Range, as defined in TS 36.508 [7] clause 4.3.1.1.

Channel Bandwidths to be tested: As specified per test number in Table 8.2.1.3.1C.3-2, as defined in TS 36.508 [7] clause 4.3.1.1

1. Connect the SS, the faders and AWGN noise sources to the UE antenna connectors as shown in TS 36.508 [7] Annex A, Figure TBD.
2. The parameter settings for the cell 1 are set up according to Tables 8.2.1-1 and 8.2.1.3.1C.5-1 as appropriate.
3. Downlink signals are initially set up according to Annex C.0, C.1 and Annex C.3.2 and uplink signals according to Annex H.1 and H.3.2.
4. Propagation conditions are set according to Annex B.0.
5. Ensure the UE is in State 3A-RF according to TS 36.508 [7] clause 5.2A.2. Message contents are defined in clause 8.2.1.3.1C.4.3.

8.2.1.3.1C.4.2 Test procedure

1. SS transmits PDSCH via PDCCH DCI format 2A for C\_RNTI to transmit the DL RMC according to Tables 8.2.1.3.1C.5-1 and 8.2.1.3.1C.5-2. The SS sends downlink MAC padding bits on the DL RMC.
2. SS sets up parameters for cell 2 according to Table 8.2.1.3.1C.5-1 as appropriate.
3. Set the parameters of the bandwidth, MCS, reference channel, the propagation condition, the correlation matrix and the SNR according to Table 8.2.1.3.1C.5-1 and Table 8.2.1.3.1C.5-2 as appropriate.
4. Measure the average throughput for a duration sufficient to achieve statistical significance according to Annex G clause G.3. Count the number of NACKs, ACKs and statDTXs on the UL during the test interval and decide pass or fail according to Tables G.3.5 and G.3.6 in Annex G clause G.3.

8.2.1.3.1C.4.3 Message contents

Message contents are according to TS 36.508 [7] clause 4.6 with the following exceptions:

**Table 8.2.1.3.1C.4.3-1: PhysicalConfigDedicated-DEFAULT**

Derivation Path: 36.331 clause 6.3.2			
Information Element	Value/remark	Comment	Condition
PhysicalConfigDedicated-DEFAULT ::= SEQUENCE {			
antennaInfo CHOICE {			
antennaInfoDedicated ::= SEQUENCE {			
transmissionMode	tm3		
codebookSubsetRestriction CHOICE {			
n2TxAntenna-tm3	11		
}			
ue-TransmitAntennaSelection CHOICE {			
release	NULL		
}			
}			
}			

8.2.1.3.1C.5 Test requirement

Table 8.2.1.3.1C.5-1 defines the primary level settings.

The fraction of maximum throughput percentage for the downlink reference measurement channels specified in Annex A clause A.3.3.2 for each throughput test shall meet or exceed the specified value in Tables 8.2.1.3.1C.5-2 for the specified SNR including test tolerances for all throughput tests.

**Table 8.2.1.3.1C.5-1: Test Parameters for Large Delay CDD (FRC) with TM1 interference**

Parameter		Unit	Cell 1	Cell 2
Bandwidth		MHz	10 MHz	
Downlink power allocation	$\rho_A$	dB	-3	0
	$\rho_B$		-3 (Note 1)	0
	$\sigma$		0	0
Cell-specific reference signals			Antenna ports 0,1	Antenna port 0
Cyclic Prefix			Normal	Normal
Cell ID			0	1
Transmission mode			3	Note 2
$N_{oc}$ at antenna port		dBm/15kHz	-98	N/A
$\hat{E}_s/N_{oc}$ (Note 3)		dB	Reference Value in Table 8.2.1.3.1C.5-2	TBD
Correlation and antenna configuration			Medium (2x2)	Medium(1x2)
Number of OFDM symbols for PDCCH			2	N/A
Max number of HARQ transmissions			4	N/A
Redundancy version coding sequence			{0,1,2,3}	N/A
Note 1: $P_B = 1$ Note 2: Downlink physical channel setup in Cell 2 in accordance with Annex C.3.2 applying OCNG pattern OP.5 FDD as defined in Annex A.5.1.5. Note 3: Cell 1 is the serving cell. Cell 2 is the interfering cell. Note 4: All cells are time-synchronous. Note 5: SIB-1 will not be transmitted in Cell2 in this test.				

**Table 8.2.1.3.1C.5-2: Test requirement for Enhanced Performance Requirement Type C, Large Delay CDD (FRC) with TM1 interference**

Test Number	Reference Channel	OCNG Pattern		Propagation Conditions (Note 1)		Reference Value		UE Category
		Cell 1	Cell 2	Cell 1	Cell 2	Fraction of Maximum Throughput (%)	SNR (dB) (Note 2)	
1	R.11-8 FDD	OP.1 FDD	OP.5 FDD	EVA70	EVA70	70	[19.9] + TT	≥2
Note 1: The propagation conditions for Cell 1 and Cell 2 are statistically independent. Note 2: SNR corresponds to $\hat{E}_s/N_{oc}$ of Cell 1.								

### 8.2.1.3.2 FDD PDSCH Open Loop Spatial Multiplexing 4x2

#### 8.2.1.3.2.1 Test purpose

To verify the UE's ability to receive a predefined test signal, representing a multi-path fading channel that is determined by the SNR with a percentage of the information bit throughput for a specified downlink Reference Measurement Channel (RMC) not falling below a specified value for transmission on two antenna ports using large delay CDD.

#### 8.2.1.3.2.2 Test applicability

This test applies to all types of E-UTRA FDD UE release 8 and forward of UE category ≥2.

#### 8.2.1.3.2.3 Minimum conformance requirements

The requirements are specified in terms of the percentage of information bit throughput for the downlink reference measurement channels specified in Annex A clause A.3.3.2, with the addition of the relevant parameters in Tables 8.2.1-1 and 8.2.1.3.2.3-1 and the downlink physical channel setup according to Table C.3.2-1 in Annex C.

Using this configuration the fraction of maximum throughput percentage shall meet or exceed the minimum requirements specified in Table 8.2.1.3.2.3-1 for the specified SNR. For open-loop spatial multiplexing performance with large delay CDD is specified.

**Table 8.2.1.3.2.3-1: Test Parameters for Large Delay CDD (FRC)**

Parameter	Unit	Test 1	
Downlink power allocation	$\rho_A$	dB	-6
	$\rho_B$	dB	-6 (Note 1)
	$\sigma$	dB	3
$N_{oc}$ at antenna port	dBm/15kHz	-98	
PDSCH transmission mode		3	
Note 1: $P_B = 1$			

**Table 8.2.1.3.2.3-2: Minimum performance Large Delay CDD (FRC)**

Test number	Band-width	Reference Channel	OCNG Pattern	Propagation Condition	Correlation Matrix and Antenna Configuration	Reference value		UE Category
						Fraction of Maximum Throughput (%)	SNR (dB)	
1	10 MHz	R.14 FDD	OP.1 FDD	EVA70	4x2 Low	70	14.3	2-8

The normative reference for this requirement is TS 36.101 [2] clause 8.2.1.3.

#### 8.2.1.3.2.4 Test description

##### 8.2.1.3.2.4.1 Initial conditions

Initial conditions are a set of test configurations the UE needs to be tested in and the steps for the SS to take with the UE to reach the correct measurement state.

Configurations of PDSCH and PDCCH before measurement are specified in Annex C.2.

Test Environment: Normal, as defined in TS 36.508 [7] clause 4.1.

Frequencies to be tested: Mid Range, as defined in TS 36.508 [7] clause 4.3.1.1.

Channel Bandwidths to be tested: As specified per test number in Table 8.2.1.3.2.3-2, as defined in TS 36.508 [7] clause 4.3.1.1

1. Connect the SS, the faders and AWGN noise sources to the UE antenna connectors as shown in TS 36.508 [7] Annex A, Figure A.11 for antenna configuration 4x2.
2. The parameter settings for the cell are set up according to Tables 8.2.1-1 and 8.2.1.3.2.3-1 as appropriate.
3. Downlink signals are initially set up according to Annex C.1 and Annex C.3.2 and uplink signals according to Annex H.1 and H.3.2.
4. Propagation conditions are set according to Annex B.0.
5. Ensure the UE is in State 3A-RF according to TS 36.508 [7] clause 5.2A.2. Message contents are defined in clause 8.2.1.3.2.4.3.

##### 8.2.1.3.2.4.2 Test procedure

1. SS transmits PDSCH via PDCCH DCI format 2A for C\_RNTI to transmit the DL RMC according to Tables 8.2.1.3.2.3-1 and 8.2.1.3.2.3-2. The SS sends downlink MAC padding bits on the DL RMC.
2. Set the parameters of the reference channel, the propagation condition, the correlation matrix and the SNR according to Table 8.2.1.3.2.5-1 as appropriate.

3. Measure the average throughput for a duration sufficient to achieve statistical significance according to Annex G clause G.3. Count the number of NACKs, ACKs and statDTXs on the UL during the test interval and decide pass or fail according to Tables G.3.5 and G.3.6 in Annex G clause G.3.

#### 8.2.1.3.2.4.3 Message contents

Message contents are according to TS 36.508 [7] clause 4.6 with the following exceptions:

**Table 8.2.1.3.2.4.3-1: PDSCH-ConfigDedicated-DEFAULT: Additional FDD PDSCH open loop spatial multiplexing performance downlink power allocation for Test number 1**

Derivation Path: 36.331 clause 6.3.2			
Information Element	Value/remark	Comment	Condition
PDSCH-ConfigDedicated-DEFAULT ::= SEQUENCE {			
p-a	dB-6		
}			

**Table 8.2.1.3.2.4.3-2: PhysicalConfigDedicated-DEFAULT: Additional FDD PDSCH open loop spatial multiplexing performance downlink power allocation for Test number 1**

Derivation Path: 36.331 clause 6.3.2			
Information Element	Value/remark	Comment	Condition
PhysicalConfigDedicated-DEFAULT ::= SEQUENCE {			
antennaInfo CHOICE {			
antennaInfoDedicated ::= SEQUENCE {			
transmissionMode	tm3		
codebookSubsetRestriction CHOICE {			
n4TxAntenna-tm3	1111		
}			
ue-TransmitAntennaSelection CHOICE {			
release	NULL		
}			
}			
}			

#### 8.2.1.3.2.5 Test requirement

Table 8.2.1.3.2.3-1 defines the primary level settings.

The fraction of maximum throughput percentage for the downlink reference measurement channels specified in Annex A clause A.3.3.2 for each throughput test shall meet or exceed the specified value in Tables 8.2.1.3.2.5-1 for the specified SNR including test tolerances for all throughput tests.

**Table 8.2.1.3.2.5-1: Test Requirement Large Delay CDD (FRC)**

Test number	Band-width	Reference Channel	OCNG Pattern	Propagation Condition	Correlation Matrix and Antenna Configuration	Reference value		UE Category
						Fraction of Maximum Throughput (%)	SNR (dB)	
1	10 MHz	R.14 FDD	OP.1 FDD	EVA70	4x2 Low	70	15.2	2-8

## 8.2.1.3.3\_C FDD PDSCH Open Loop Spatial Multiplexing 2x2 for eICIC

## 8.2.1.3.3\_C.1 FDD PDSCH Open Loop Spatial Multiplexing 2x2 for eICIC (non-MBSFN ABS)

## 8.2.1.3.3\_C.1.1 Test purpose

To verify the UE's performance of large delay CDD with 2 transmit antennas if the PDSCH transmission in the serving cell takes place in subframes that overlap with ABS of the aggressor cell.

## 8.2.1.3.3\_C.1.2 Test applicability

This test applies to all types of E-UTRA FDD UE release 10 and forward. Applicability requires support for FGI bit 115.

## 8.2.1.3.3\_C.1.3 Minimum conformance requirements

The requirements are specified in terms of the percentage of information bit throughput for the downlink reference measurement channels specified in Annex A clause A.3.3.2, with the addition of the relevant parameters in Tables 8.2.1-1 and 8.2.1.3.3\_C.1.3-1.

In Table 8.2.1.3.3\_C.1.3-1, Cell 1 is the serving cell, and Cell 2 is the aggressor cell. The downlink physical channel setup for Cell 1 is according to Table C.3.2-1 in Annex C.3.2 and for Cell 2 is according to Table C.3.3-1 in Annex C.3.3, respectively.

Using this configuration the fraction of maximum throughput percentage shall meet or exceed the minimum requirements specified in Table 8.2.1.3.3\_C.1.3-1 for the specified SNR. For open-loop spatial multiplexing performance with large delay CDD is specified.

**Table 8.2.1.3.3\_C.1.3-1: Test Parameters for Large Delay CDD (FRC) non-MBSFN ABS**

Parameter	Unit	Cell 1	Cell 2
Downlink power allocation	$\rho_A$	dB	-3
	$\rho_B$	dB	-3 (Note 1)
	$\sigma$	dB	0
$N_{oc}$ at antenna port	$N_{oc1}$	dBm/15kHz	-102 (Note 2)
	$N_{oc2}$	dBm/15kHz	-98 (Note 3)
	$N_{oc3}$	dBm/15kHz	-94.8 (Note 4)



$\hat{E}_s / N_{oc2}$		dB	Reference Value in Table 8.2.1.3.3_C.1.3-2	6
BW <sub>Channel</sub>		MHz	10	10
Subframe Configuration			Non-MBSFN	Non-MBSFN
Cell Id			0	1
Time Offset between Cells		μs	2.5 (synchronous cells)	
ABS pattern (Note 5)			N/A	11000100 11000000 11000000 11000000 11000000
RLM/RRM Measurement Subframe Pattern(Note 6)			10000000 10000000 10000000 10000000 10000000	N/A
CSI Subframe Sets (Note 7)	C <sub>CSI,0</sub>		11000100 11000000 11000000 11000000 11000000	N/A
	C <sub>CSI,1</sub>		00111011 00111111 00111111 00111111 00111111	N/A
Number of control OFDM symbols			2	2
PDSCH transmission mode			3	N/A
Cyclic prefix			Normal	Normal
<p>Note 1: <math>P_B = 1</math></p> <p>Note 2: This noise is applied in OFDM symbols #1, #2, #3, #5, #6, #8, #9, #10, #12, #13 of a subframe overlapping with the aggressor ABS</p> <p>Note 3: This noise is applied in OFDM symbols #0, #4, #7, #11 of a subframe overlapping with the aggressor ABS</p> <p>Note 4: This noise is applied in all OFDM symbols of a subframe overlapping with aggressor non-ABS</p> <p>Note 5: ABS pattern as defined in [14].</p> <p>Note 6: Time-domain measurement resource restriction pattern for PCell measurements as defined in [5]</p> <p>Note 7: As configured according to the time-domain measurement resource restriction pattern for CSI measurements defined in [5]</p> <p>Note 8: Cell 1 is the serving cell. Cell 2 is the aggressor cell. The number of the CRS ports in Cell1 and Cell2 is the same.</p> <p>Note 9: SIB-1 will not be transmitted in Cell2 in this test.</p>				

Table 8.2.1.3.3\_C.1.3-2: Minimum performance Large Delay CDD (FRC) non-MBSFN ABS

Test Number	Reference Channel	OCNG Pattern		Propagation Conditions (Note 1)		Correlation Matrix and Antenna Configuration	Reference Value		UE Category
		Cell 1	Cell 2	Cell 1	Cell 2		Fraction of Maximum Throughput (%) Note 5	SNR (dB) (Note 2)	
1	R.11 FDD Note 4	OP.1 FDD	OP.1 FDD	EVA 5	EVA 5	2x2 Low	70	13.3	2-8
<p>Note 1: The propagation conditions for Cell 1 and Cell2 are statistically independent.</p> <p>Note 2: SNR corresponds to <math>\hat{E}_s / N_{oc2}</math> of cell 1.</p> <p>Note 3: The correlation matrix and antenna configuration apply for Cell 1 and Cell 2.</p> <p>Note 4: Cell 1 Reference channel is modified: PDSCH other than SIB1/paging and its associated PDCCH/PCFICH are transmitted in the serving cell subframe when the subframe is overlapped with the ABS subframe of aggressor cell and the subframe is available in the definition of the reference channel.</p> <p>Note 5: The maximum Throughput is calculated from the total Payload in 9 subframes, averaged over 40ms.</p>									

The normative reference for this requirement is TS 36.101 [2] clause 8.2.1.3.3.

#### 8.2.1.3.3\_C.1.4 Test description

##### 8.2.1.3.3\_C.1.4.1 Initial conditions

Initial conditions are a set of test configurations the UE needs to be tested in and the steps for the SS to take with the UE to reach the correct measurement state.

Configurations of PDSCH and PDCCH before measurement are specified in Annex C.2.

Test Environment: Normal, as defined in TS 36.508 [7] clause 4.1.

Frequencies to be tested: Mid Range, as defined in TS 36.508 [7] clause 4.3.1.1.

Channel Bandwidths to be tested: As specified per test number in Table 8.2.1.3.3\_C.1.3-2, as defined in TS 36.508 [7] clause 4.3.1.1

1. Connect the SS, the faders and AWGN noise sources to the UE antenna connectors as shown in TS 36.508 [7] Annex A, Figure A.40 for antenna configuration 2x2.
2. The parameter settings for the cell 1 are set up according to Tables 8.2.1-1 and 8.2.1.3.3\_C.1.3-1 as appropriate.
3. Downlink signals are initially set up according to Annex C0, C.1 and Annex C.3.2 and uplink signals according to Annex H.1 and H.3.2.
4. Propagation conditions are set according to Annex B.0.
5. Ensure the UE is in State 3A-RF according to TS 36.508 [7] clause 5.2A.2. Message contents are defined in clause 8.2.1.3.3\_C.1.4.3.

##### 8.2.1.3.3\_C.1.4.2 Test procedure

1. Set the parameters for Cell1 and Cell2 according to Tables 8.2.1.3.3\_C.1.5-1, 8.2.1.3.3\_C.1.5-2, C.3.3-1 of Annex C.3.3 as appropriate, and SS transmits PDSCH via PDCCH DCI format 2A for C\_RNTI to transmit the DL RMC. The SS sends downlink MAC padding bits on the DL RMC. Propagation conditions are set according to Annex B clause B.2.
2. Measure the average throughput for a duration sufficient to achieve statistical significance according to Annex G clause G.3. Count the number of NACKs, ACKs and statDTXs on the UL during the test interval and decide pass or fail according to Tables G.3.5 and G.3.6 in Annex G clause G.3.

8.2.1.3.3\_C.1.4.3 Message contents

Message contents are according to TS 36.508 [7] clause 4.6 with the following exceptions:

**Table 8.2.1.3.3\_C.1.4.3-1: PhysicalConfigDedicated-DEFAULT: Additional FDD PDSCH open loop spatial multiplexing performance downlink power allocation**

Derivation Path: 36.331 clause 6.3.2			
Information Element	Value/remark	Comment	Condition
PhysicalConfigDedicated-DEFAULT ::= SEQUENCE {			
antennaInfo CHOICE {			
antennaInfoDedicated ::= SEQUENCE {			
transmissionMode	tm3		
codebookSubsetRestriction CHOICE {			
n2TxAntenna-tm3	11		
}			
ue-TransmitAntennaSelection CHOICE {			
release	NULL		
}			
}			
}			

**Table 8.2.1.3.3\_C.1.4.3-2: RadioResourceConfigDedicated-SRB2-DRB(n, m): Additional FDD PDSCH open loop spatial multiplexing performance downlink power allocation**

Derivation Path: TS 36.508 [7] clause 4.6.3, Table 4.6.3-16 RadioResourceConfigDedicated-SRB2-DRB(n,m)			
Information Element	Value/remark	Comment	Condition
RadioResourceConfigDedicated-SRB2-DRB(n, m) ::= SEQUENCE {			
MeasSubframePatternPCell-r10 CHOICE {			
setup SEQUENCE {			
subframePatternFDD-r10	'1000000010000000100000001000000010000000'	BIT STRING (SIZE (40))	
}			
}			
}			

**Table 8.2.1.3.3\_C.1.4.3-3: CQI-ReportConfig-r10-DEFAULT: Additional FDD PDSCH open loop spatial multiplexing performance downlink power allocation**

Derivation Path: 36.508 [7] clause 4.6.3, Table 4.6.3-2AA CQI-ReportConfig-r10-DEFAULT			
Information Element	Value/remark	Comment	Condition
CQI-ReportConfig-r10-DEFAULT ::= SEQUENCE {			
cqi-ReportAperiodic-r10	Not present		
nomPDSCH-RS-EPRE-Offset	0		
cqi-ReportPeriodic-r10	Not present		
pmi-RI-Report-r9	Not present		
csi-SubframePatternConfig-r10 CHOICE {			
setup SEQUENCE {			
csi-MeasSubframeSet1-r10 CHOICE {			
subframePatternFDD-r10	'1100010011000000110000001100000011000000'	BIT STRING (SIZE (40))	
}			
csi-MeasSubframeSet2-r10 CHOICE {			
subframePatternFDD-r10	'0011101100111111001111100111110011111001111111'	BIT STRING (SIZE (40))	
}			
}			
}			
}			

### 8.2.1.3.3\_C.1.5 Test requirement

Table 8.2.1.3.3\_C.1.5-1 defines the primary level settings.

The fraction of maximum throughput percentage for the downlink reference measurement channels specified in Annex A clause A.3.3.2 for each throughput test shall meet or exceed the specified value in Tables 8.2.1.3.3\_C.1.5-2 for the specified SNR including test tolerances for all throughput tests.

**Table 8.2.1.3.3\_C.1.5-1: Test Parameters for Large Delay CDD (FRC) non-MBSFN ABS**

Parameter		Unit	Cell 1	Cell 2
Downlink power allocation	$\rho_A$	dB	-3	-3
	$\rho_B$	dB	-3 (Note 1)	-3
	$\sigma$	dB	0	N/A
$N_{oc}$ at antenna port	$N_{oc1}$	dBm/15kHz	-102.1 (Note 2)	N/A
	$N_{oc2}$	dBm/15kHz	-98 (Note 3)	N/A
	$N_{oc3}$	dBm/15kHz	-94.9 (Note 4)	N/A
$\hat{E}_s / N_{oc2}$		dB	Reference Value in Table 8.2.1.3.3_C.1.5-2	5.8
BW <sub>Channel</sub>		MHz	10	10
Subframe Configuration			Non-MBSFN	Non-MBSFN
Cell Id			0	1
Time Offset between Cells		$\mu$ s	2.5 (synchronous cells)	
ABS pattern (Note 5)			N/A	11000100 11000000 11000000 11000000 11000000
RLM/RRM Measurement Subframe Pattern(Note 6)			10000000 10000000 10000000 10000000 10000000	N/A
CSI Subframe Sets (Note 7)	C <sub>CSI,0</sub>		11000100 11000000 11000000 11000000 11000000	N/A
	C <sub>CSI,1</sub>		00111011 00111111 00111111 00111111 00111111	N/A
Number of control OFDM symbols			2	2
PDSCH transmission mode			3	N/A
Cyclic prefix			Normal	Normal
<p>Note 1: <math>P_B = 1</math></p> <p>Note 2: This noise is applied in OFDM symbols #1, #2, #3, #5, #6, #8, #9, #10,#12, #13 of a subframe overlapping with the aggressor ABS</p> <p>Note 3: This noise is applied in OFDM symbols #0, #4, #7, #11 of a subframe overlapping with the aggressor ABS</p> <p>Note 4: This noise is applied in all OFDM symbols of a subframe overlapping with aggressor non-ABS</p> <p>Note 5: ABS pattern as defined in [14].</p> <p>Note 6: Time-domain measurement resource restriction pattern for PCell measurements as defined in [5]</p> <p>Note 7: As configured according to the time-domain measurement resource restriction pattern for CSI measurements defined in [5]</p> <p>Note 8: Cell 1 is the serving cell. Cell 2 is the aggressor cell. The number of the CRS ports in Cell1 and Cell2 is the same.</p> <p>Note 9: SIB-1 will not be transmitted in Cell2 in this test.</p>				

**Table 8.2.1.3.3\_C.1.5-2: Test Requirement Large Delay CDD (FRC)**

Test Number	Reference Channel	OCNG Pattern		Propagation Conditions (Note 1)		Correlation Matrix and Antenna Configuration	Reference Value		UE Category
		Cell 1	Cell 2	Cell 1	Cell 2		Fraction of	SNR	

							Maximum Throughput (%) Note 5	(dB) (Note 2)	
1	R.11 FDD Note 4	OP.1 FDD	OP.1 FDD	EVA 5	EVA 5	2x2 Low	70	14.2	2-8
<p>Note 1: The propagation conditions for Cell 1 and Cell2 are statistically independent.</p> <p>Note 2: SNR corresponds to <math>\hat{E}_s / N_{oc2}</math> of cell 1.</p> <p>Note 3: The correlation matrix and antenna configuration apply for Cell 1 and Cell 2.</p> <p>Note 4: Cell 1 Reference channel is modified: PDSCH other than SIB1/paging and its associated PDCCH/PCFICH are transmitted in the serving cell subframe when the subframe is overlapped with the ABS subframe of aggressor cell and the subframe is available in the definition of the reference channel.</p> <p>Note 5: The maximum Throughput is calculated from the total Payload in 9 subframes, averaged over 40ms.</p>									

### 8.2.1.3.3\_C.2 FDD PDSCH Open Loop Spatial Multiplexing 2x2 for eICIC (MBSFN ABS)

#### 8.2.1.3.3\_C.2.1 Test purpose

To verify the UE's performance of large delay CDD with 2 transmit antennas if the PDSCH transmission in the serving cell takes place in subframes that overlap with ABS of the aggressor cell.

#### 8.2.1.3.3\_C.2.2 Test applicability

This test applies to all types of E-UTRA FDD UE release 10 and forward. Applicability requires support for FGI bit 115.

#### 8.2.1.3.3\_C.2.3 Minimum conformance requirements

The requirements are specified in terms of the percentage of information bit throughput for the downlink reference measurement channels specified in Annex A clause A.3.3.2, with the addition of the relevant parameters in Tables 8.2.1-1 and 8.2.1.3.3\_C.2.3-1.

In Table 8.2.1.3.3\_C.2.3-1, Cell 1 is the serving cell, and Cell 2 is the aggressor cell. The downlink physical channel setup for Cell 1 is according to Table C.3.2-1 in Annex C.3.2 and for Cell 2 is according to Table C.3.3-1 in Annex C.3.3, respectively.

Using this configuration the fraction of maximum throughput percentage shall meet or exceed the minimum requirements specified in Table 8.2.1.3.3\_C.2.3-2 for the specified SNR. For open-loop spatial multiplexing performance with large delay CDD is specified.

**Table 8.2.1.3.3\_C.2.3-1: Test Parameters for Large Delay CDD (FRC) MBSFN ABS**

Parameter		Unit	Cell 1	Cell 2
Downlink power allocation	$\rho_A$	dB	-3	-3
	$\rho_B$	dB	-3 (Note 1)	-3
	$\sigma$	dB	0	N/A
$N_{oc}$ at antenna port	$N_{oc1}$	dBm/15kHz	-102 (Note 2)	N/A
	$N_{oc2}$	dBm/15kHz	-98 (Note 3)	N/A
	$N_{oc3}$	dBm/15kHz	-94.8 (Note 4)	N/A
$\widehat{E}_s / N_{oc2}$		dB	Reference Value in Table 8.2.1.3.3_C.2.3-2	6
BW <sub>Channel</sub>		MHz	10	10
Subframe Configuration			Non-MBSFN	MBSFN
Cell Id			0	126
Time Offset between Cells		$\mu$ s	2.5 (synchronous cells)	
ABS pattern (Note 5)			N/A	0001000000 0100000010 0000001000 0000000000
RLM/RRM Measurement Subframe Pattern (Note 6)			0001000000 0100000010 0000001000 0000000000	N/A
CSI Subframe Sets (Note 7)	$C_{CSI,0}$		0001000000 0100000010 0000001000 0000000000	N/A
	$C_{CSI,1}$		1110111111 1011111101 1111110111 1111111111	N/A
MBSFN Subframe Allocation (Note 10)			N/A	001000 100001 000100 000000
Number of control OFDM symbols			2	2
PDSCH transmission mode			3	N/A
Cyclic prefix			Normal	Normal
<p>Note 1: <math>P_B = 1</math>.</p> <p>Note 2: This noise is applied in OFDM symbols #1, #2, #3, #4, #5, #6, #7, #8, #9, #10, #11, #12, #13 of a subframe overlapping with the aggressor ABS.</p> <p>Note 3: This noise is applied in OFDM symbol #0 of a subframe overlapping with the aggressor ABS.</p> <p>Note 4: This noise is applied in all OFDM symbols of a subframe overlapping with aggressor non-ABS.</p> <p>Note 5: ABS pattern as defined in [14]. The 4<sup>th</sup>, 12<sup>th</sup>, 19<sup>th</sup> and 27<sup>th</sup> subframes indicated by ABS pattern are MBSFN ABS subframes.</p> <p>Note 6: Time-domain measurement resource restriction pattern for PCell measurements as defined in [5].</p> <p>Note 7: As configured according to the time-domain measurement resource restriction pattern for CSI measurements defined in [5].</p> <p>Note 8: Cell 1 is the serving cell. Cell 2 is the aggressor cell. The number of the CRS ports in Cell1 and Cell2 is the same.</p> <p>Note 9: SIB-1 will not be transmitted in Cell2 in this test.</p> <p>Note 10: MBSFN Subframe Allocation as defined in [5], four frames with 24 bits is chosen for MBSFN subframe allocation.</p> <p>Note 11: The maximum number of uplink HARQ transmission is <math>\leq 2</math> so that each PHICH channel transmission is in a subframe protected by MBSFN ABS in this test.</p>				

Table 8.2.1.3.3\_C.2.3-2: Minimum performance Large Delay CDD (FRC) MBSFN ABS

Test Number	Reference Channel	OCNG Pattern		Propagation Conditions (Note 1)		Correlation Matrix and Antenna Configuration	Reference Value		UE Category
		Cell 1	Cell 2	Cell 1	Cell 2		Fraction of Maximum Throughput (%) Note 5	SNR (dB) (Note 2)	
1	R.11 FDD Note 4	OP.1 FDD	OP.1 FDD	EVA 5	EVA 5	2x2 Low	70	12.0	2-8
<p>Note 1: The propagation conditions for Cell 1 and Cell2 are statistically independent.</p> <p>Note 2: SNR corresponds to <math>\hat{E}_s/N_{oc2}</math> of cell 1.</p> <p>Note 3: The correlation matrix and antenna configuration apply for Cell 1 and Cell 2.</p> <p>Note 4: Cell 1 Reference channel is modified: PDSCH other than SIB1/paging and its associated PDCCH/PCFICH are transmitted in the serving cell subframe when the subframe is overlapped with the ABS subframe of aggressor cell and the subframe is available in the definition of the reference channel.</p> <p>Note 5: The maximum Throughput is calculated from the total Payload in 4 subframes, averaged over 40ms.</p>									

The normative reference for this requirement is TS 36.101 [2] clause 8.2.1.3.3.

#### 8.2.1.3.3\_C.2.4 Test description

##### 8.2.1.3.3\_C.2.4.1 Initial conditions

Initial conditions are a set of test configurations the UE needs to be tested in and the steps for the SS to take with the UE to reach the correct measurement state.

Configurations of PDSCH and PDCCH before measurement are specified in Annex C.2.

Test Environment: Normal, as defined in TS 36.508 [7] clause 4.1.

Frequencies to be tested: Mid Range, as defined in TS 36.508 [7] clause 4.3.1.1.

Channel Bandwidths to be tested: As specified per test number in Table 8.2.1.3.3\_C.2.3-2, as defined in TS 36.508 [7] clause 4.3.1.1

1. Connect the SS, the faders and AWGN noise sources to the UE antenna connectors as shown in TS 36.508 [7] Annex A, Figure A.40 for antenna configuration 2x2.
2. The parameter settings for the cell 1 are set up according to Tables 8.2.1-1 and 8.2.1.3.3\_C.2.3-1 as appropriate.
3. Downlink signals are initially set up according to Annex C0, C.1 and Annex C.3.2 and uplink signals according to Annex H.1 and H.3.2.
4. Propagation conditions are set according to Annex B.0.
5. Ensure the UE is in State 3A-RF according to TS 36.508 [7] clause 5.2A.2. Message contents are defined in clause 8.2.1.3.3\_C.2.4.3.

##### 8.2.1.3.3\_C.2.4.2 Test procedure

1. Set the parameters for Cell1 and Cell2 according to Tables 8.2.1.3.3\_C.2.5-1, 8.2.1.3.3\_C.2.5-2, C.3.3-1 of Annex C.3.3 as appropriate, and SS transmits PDSCH via PDCCH DCI format 2A for C\_RNTI to transmit the DL RMC. The SS sends downlink MAC padding bits on the DL RMC. Propagation conditions are set according to Annex B clause B.2.
2. Measure the average throughput for a duration sufficient to achieve statistical significance according to Annex G clause G.3. Count the number of NACKs, ACKs and statDTXs on the UL during the test interval and decide pass or fail according to Tables G.3.5 and G.3.6 in Annex G clause G.3.



8.2.1.3.3\_C.2.4.3 Message contents

Message contents are according to TS 36.508 [7] clause 4.6 with the following exceptions:

**Table 8.2.1.3.3\_C.2.4.3-1: PhysicalConfigDedicated-DEFAULT: Additional FDD PDSCH open loop spatial multiplexing performance downlink power allocation**

Derivation Path: 36.331 clause 6.3.2			
Information Element	Value/remark	Comment	Condition
PhysicalConfigDedicated-DEFAULT ::= SEQUENCE {			
antennaInfo CHOICE {			
antennaInfoDedicated ::= SEQUENCE {			
transmissionMode	tm3		
codebookSubsetRestriction CHOICE {			
n2TxAntenna-tm3	11		
}			
ue-TransmitAntennaSelection CHOICE {			
release	NULL		
}			
}			
}			

**Table 8.2.1.3.3\_C.2.4.3-2: RadioResourceConfigDedicated-SRB2-DRB(n, m): Additional FDD PDSCH open loop spatial multiplexing performance downlink power allocation**

Derivation Path: TS 36.508 [7] clause 4.6.3, Table 4.6.3-16 RadioResourceConfigDedicated-SRB2-DRB(n,m)			
Information Element	Value/remark	Comment	Condition
RadioResourceConfigDedicated-SRB2-DRB(n, m) ::= SEQUENCE {			
MeasSubframePatternPCell-r10 CHOICE {			
setup SEQUENCE {			
subframePatternFDD-r10	'00010000000100000010000001000000010000000000000000'	BIT STRING (SIZE (40))	
}			
}			
}			

**Table 8.2.1.3.3\_C.2.4.3-3: CQI-ReportConfig-r10-DEFAULT: Additional FDD PDSCH open loop spatial multiplexing performance downlink power allocation**

Derivation Path: 36.508 [7] clause 4.6.3, Table 4.6.3-2AA CQI-ReportConfig-r10-DEFAULT			
Information Element	Value/remark	Comment	Condition
CQI-ReportConfig-r10-DEFAULT ::= SEQUENCE {			
cqi-ReportAperiodic-r10	Not present		
nomPDSCH-RS-EPRE-Offset	0		
cqi-ReportPeriodic-r10	Not present		
pmi-RI-Report-r9	Not present		
csi-SubframePatternConfig-r10 CHOICE {			
setup SEQUENCE {			
csi-MeasSubframeSet1-r10 CHOICE {			
subframePatternFDD-r10	'00010000000100000010000001000000010000000000000000'	BIT STRING (SIZE (40))	
}			
csi-MeasSubframeSet2-r10 CHOICE {			
subframePatternFDD-r10	'1110111111101111110111111011111101111110111111111111'	BIT STRING (SIZE (40))	
}			
}			
}			
}			

**Table 8.2.1.3.3\_C.2.4.3-4: SystemInformationBlockType3: Additional FDD PDSCH open loop spatial multiplexing performance downlink power allocation**

Derivation Path: TS 36.508 [7] clause 4.4.3.3, Table 4.4.3.3-2 SystemInformationBlockType3			
Information Element	Value/remark	Comment	Condition
SystemInformationBlockType3 ::= SEQUENCE {			
neighCellConfig	'00'B (Not all neighbour cells have the same MBSFN subframe allocation as serving cell)		Cell 1
}			

#### 8.2.1.3.3\_C.2.5 Test requirement

Table 8.2.1.3.3\_C.2.5-1 defines the primary level settings.

The fraction of maximum throughput percentage for the downlink reference measurement channels specified in Annex A clause A.3.3.2 for each throughput test shall meet or exceed the specified value in Tables 8.2.1.3.3\_C.2.5-2 for the specified SNR including test tolerances for all throughput tests.

Table 8.2.1.3.3\_C.2.5-1: Test Parameters for Large Delay CDD (FRC) MBSFN ABS

Parameter		Unit	Cell 1	Cell 2
Downlink power allocation	$\rho_A$	dB	-3	-3
	$\rho_B$	dB	-3 (Note 1)	-3
	$\sigma$	dB	0	N/A
$N_{oc}$ at antenna port	$N_{oc1}$	dBm/15kHz	-102.1 (Note 2)	N/A
	$N_{oc2}$	dBm/15kHz	-98 (Note 3)	N/A
	$N_{oc3}$	dBm/15kHz	-94.9 (Note 4)	N/A
$\widehat{E}_s / N_{oc2}$		dB	Reference Value in Table 8.2.1.3.3_C.2.5-2	5.8
BW <sub>Channel</sub>		MHz	10	10
Subframe Configuration			Non-MBSFN	MBSFN
Cell Id			0	126
Time Offset between Cells		$\mu$ s	2.5 (synchronous cells)	
ABS pattern (Note 5)			N/A	0001000000 0100000010 0000001000 0000000000
RLM/RRM Measurement Subframe Pattern (Note 6)			0001000000 0100000010 0000001000 0000000000	N/A
CSI Subframe Sets (Note 7)	$C_{CSI,0}$		0001000000 0100000010 0000001000 0000000000	N/A
	$C_{CSI,1}$		1110111111 1011111101 1111110111 1111111111	N/A
MBSFN Subframe Allocation (Note 10)			N/A	001000 100001 000100 000000
Number of control OFDM symbols			2	2
PDSCH transmission mode			3	N/A
Cyclic prefix			Normal	Normal
<p>Note 1: <math>P_B = 1</math>.</p> <p>Note 2: This noise is applied in OFDM symbols #1, #2, #3, #4, #5, #6, #7, #8, #9, #10, #11, #12, #13 of a subframe overlapping with the aggressor ABS.</p> <p>Note 3: This noise is applied in OFDM symbol #0 of a subframe overlapping with the aggressor ABS.</p> <p>Note 4: This noise is applied in all OFDM symbols of a subframe overlapping with aggressor non-ABS.</p> <p>Note 5: ABS pattern as defined in [14]. The 4<sup>th</sup>, 12<sup>th</sup>, 19<sup>th</sup> and 27<sup>th</sup> subframes indicated by ABS pattern are MBSFN ABS subframes.</p> <p>Note 6: Time-domain measurement resource restriction pattern for PCell measurements as defined in [5].</p> <p>Note 7: As configured according to the time-domain measurement resource restriction pattern for CSI measurements defined in [5].</p> <p>Note 8: Cell 1 is the serving cell. Cell 2 is the aggressor cell. The number of the CRS ports in Cell1 and Cell2 is the same.</p> <p>Note 9: SIB-1 will not be transmitted in Cell2 in this test.</p> <p>Note 10: MBSFN Subframe Allocation as defined in [5], four frames with 24 bits is chosen for MBSFN subframe allocation.</p> <p>Note 11: The maximum number of uplink HARQ transmission is <math>\leq 2</math> so that each PHICH channel transmission is in a subframe protected by MBSFN ABS in this test.</p>				

Table 8.2.1.3.3\_C.2.5-2: Test Requirement Large Delay CDD (FRC)

Test Number	Reference Channel	OCNG Pattern		Propagation Conditions (Note 1)		Correlation Matrix and Antenna Configuration	Reference Value		UE Category
		Cell 1	Cell 2	Cell 1	Cell 2		Fraction of Maximum Throughput (%) Note 5	SNR (dB) (Note 2)	
1	R.11 FDD Note 4	OP.1 FDD	OP.1 FDD	EVA 5	EVA 5	2x2 Low	70	12.9	2-8
<p>Note 1: The propagation conditions for Cell 1 and Cell2 are statistically independent.</p> <p>Note 2: SNR corresponds to <math>\hat{E}_s/N_{oc2}</math> of cell 1.</p> <p>Note 3: The correlation matrix and antenna configuration apply for Cell 1 and Cell 2.</p> <p>Note 4: Cell 1 Reference channel is modified: PDSCH other than SIB1/paging and its associated PDCCH/PCFICH are transmitted in the serving cell subframe when the subframe is overlapped with the ABS subframe of aggressor cell and the subframe is available in the definition of the reference channel.</p> <p>Note 5: The maximum Throughput is calculated from the total Payload in 4 subframes, averaged over 40ms.</p>									

## 8.2.1.3.3\_D

## 8.2.1.3.3\_E FDD PDSCH Open Loop Spatial Multiplexing 2x2 for feICIC

## 8.2.1.3.3\_E.1 FDD PDSCH Open Loop Spatial Multiplexing 2x2 for feICIC (demodulation subframe overlaps with aggressor cell ABS and CRS assistance information are configured, non-MBSFN ABS)

## 8.2.1.3.3\_E.1.1 Test purpose

To verify the UE's performance of large delay CDD with 2 transmit antennas if the PDSCH transmission in the serving cell takes place in subframes that overlap with ABS [9] of the aggressor cells with CRS assistance information.

## 8.2.1.3.3\_E.1.2 Test applicability

This test applies to all types of E-UTRA FDD UE and CRS interference handling – Category 2-8 release 11 and forward. Applicability requires support of FGI bit 115.

## 8.2.1.3.3\_E.1.3 Minimum conformance requirements

The requirements are specified in terms of the percentage of information bit throughput for the downlink reference measurement channels specified in Annex A clause A.3.3.2, with the addition of the relevant parameters in Tables 8.2.1-1 and 8.2.1.3.3\_E.1.3-1 and the downlink physical channel setup according to Table C.3.2-1 in Annex C.

Using this configuration the fraction of maximum throughput percentage shall meet or exceed the minimum requirements specified in Table 8.2.1.3.3\_E.1.3-2 for the specified SNR. For open-loop spatial multiplexing performance with large delay CDD is specified.

Table 8.2.1.3.3\_E.1.3-1: Test Parameters for Large Delay CDD (FRC) non-MBSFN ABS

Parameter		Unit	Cell 1	Cell 2	Cell 3
Downlink power allocation	$\rho_A$	dB	-3	-3	-3
	$\rho_B$	dB	-3 (Note 1)	-3 (Note 1)	-3 (Note 1)
	$\sigma$	dB	0	N/A	N/A
$N_{oc}$ at antenna port	$N_{oc1}$	dBm/15kHz	-98 (Note 2)	N/A	N/A
	$N_{oc2}$	dBm/15kHz	-98 (Note 3)	N/A	N/A
	$N_{oc3}$	dBm/15kHz	-93 (Note 4)	N/A	N/A
$\hat{E}_s / N_{oc2}$		dB	Reference Value in Table 8.2.1.3.3_E.1.3-2	Reference Value in Table 8.2.1.3.3_E.1.3-2	Reference Value in Table 8.2.1.3.3_E.1.3-2
$BW_{Channel}$		MHz	10	10	10
Subframe Configuration			Non-MBSFN	Non-MBSFN	Non-MBSFN
Time Offset between Cells		$\mu s$	N/A	3	-1
Frequency shift between Cells		Hz	N/A	300	-100
Cell Id			0	1	126
ABS pattern (Note 5)			N/A	11000000 11000000 11000000 11000000 11000000	11000000 11000000 11000000 11000000 11000000
RLM/RRM Measurement Subframe Pattern (Note 6)			10000000 10000000 10000000 10000000 10000000	N/A	N/A
CSI Subframe Sets (Note7)	$C_{CSI,0}$		11000000 11000000 11000000 11000000 11000000	N/A	N/A
	$C_{CSI,1}$		00111111 00111111 00111111 00111111 00111111	N/A	N/A
Number of control OFDM symbols			2	Note 8	Note 8
PDSCH transmission mode			3	Note 9	Note 9
Cyclic prefix			Normal	Normal	Normal
<p>Note 1: <math>P_B = 1</math>.</p> <p>Note 2: This noise is applied in OFDM symbols #1, #2, #3, #5, #6, #8, #9, #10, #12, #13 of a subframe overlapping with the aggressor ABS.</p> <p>Note 3: This noise is applied in OFDM symbols #0, #4, #7, #11 of a subframe overlapping with the aggressor ABS.</p> <p>Note 4: This noise is applied in all OFDM symbols of a subframe overlapping with aggressor non-ABS</p> <p>Note 5: ABS pattern as defined in [14].</p> <p>Note 6: Time-domain measurement resource restriction pattern for PCell measurements as defined in [5]</p> <p>Note 7: As configured according to the time-domain measurement resource restriction pattern for CSI measurements defined in [5].</p> <p>Note 8: The number of control OFDM symbols is not available for ABS and is 2 for the subframe indicated by "0" of ABS pattern.</p> <p>Note 9: Downlink physical channel setup in Cell 2 and Cell 3 in accordance with Annex C.3.3 applying OCNB pattern as defined in Annex A.5.</p> <p>Note 10: The number of the CRS ports in Cell 1, Cell 2 and Cell 3 is the same.</p> <p>Note 11: SIB-1 will not be transmitted in Cell 2 and Cell 3 in this test.</p>					

**Table 8.2.1.3.3\_E.1.3-2: Minimum performance Large Delay CDD (FRC) non-MBSFN ABS**

Test Number	Reference Channel	$\hat{E}_s/N_{oc2}$		OCNG Pattern			Propagation Conditions (Note1)			Correlation Matrix and Antenna Configuration (Note 2)	Reference Value		UE Category
		Cell 2	Cell 3	Cell 1	Cell 2	Cell 3	Cell 1	Cell 2	Cell 3		Fraction of Maximum Throughput (%) (Note 5)	SNR (dB) (Note 3)	
1	R.11 FDD (Note 4)	9	7	OP.1 FDD	OP.1 FDD	OP.1 FDD	EVA5	EVA5	EVA5	2x2 Low	70	13.9	2-8
2	R.35 FDD (Note 4)	9	1	OP.1 FDD	OP.1 FDD	OP.1 FDD	EVA5	EVA5	EVA5	2x2 Low	70	22.6	2-8

Note 1: The propagation conditions for Cell 1, Cell 2 and Cell 3 are statistically independent.  
Note 2: The correlation matrix and antenna configuration apply for Cell 1, Cell 2 and Cell 3.  
Note 3: SNR corresponds to  $\hat{E}_s/N_{oc2}$  of Cell 1.  
Note 4: Cell 1 reference channel is modified: PDSCH other than SIB1/paging and its associated PDCCH/PCFICH are transmitted in the serving cell subframe when the subframe is overlapped with the ABS subframe of aggressor cell and the subframe is available in the definition of the reference channel.  
Note 5: The maximum throughput is calculated from the total Payload in 9 subframes, averaged over 40ms.

The normative reference for this requirement is TS 36.101 [2] clause 8.2.1.3.4.

#### 8.2.1.3.3\_E.1.4 Test description

##### 8.2.1.3.3\_E.1.4.1 Initial conditions

Initial conditions are a set of test configurations the UE needs to be tested in and the steps for the SS to take with the UE to reach the correct measurement state.

Configurations of PDSCH and PDCCH before measurement are specified in Annex C.2.

Test Environment: Normal, as defined in TS 36.508 [7] clause 4.1.

Frequencies to be tested: Mid Range, as defined in TS 36.508 [7] clause 4.3.1.1.

Channel Bandwidths to be tested: As specified per test number in Table 8.2.1.3.3\_E.1.3-2, as defined in TS 36.508 [7] clause 4.3.1.1

1. Connect the SS, the faders and AWGN noise sources to the UE antenna connectors as shown in TS 36.508 [7] Annex A, Figure A.48 for antenna configuration 2x2.
2. The parameter settings for the cell 1 are set up according to Tables 8.2.1-1 and 8.2.1.3.3\_E.1.3-1 as appropriate.
3. Downlink signals are initially set up according to Annex C0, C.1 and Annex C.3.2 and uplink signals according to Annex H.1 and H.3.2.
4. Propagation conditions are set according to Annex B.0.
5. Ensure the UE is in State 3A-RF according to TS 36.508 [7] clause 5.2A.2 with exceptions listed in 5.2A.5. Message contents are defined in clause 8.2.1.3.3\_E.1.4.3.

##### 8.2.1.3.3\_E.1.4.2 Test procedure

1. Set the parameters for Cell 1, Cell 2 and Cell 3 according to Tables 8.2.1.3.3\_E.1.5-1, 8.2.1.3.3\_E.1.5-2 and C.3.3-2 of Annex C.3.3 as appropriate. SS transmits PDSCH via PDCCH DCI format 2A for C\_RNTI to transmit the DL RMC.
2. The SS sends downlink MAC padding bits on the DL RMC. Propagation conditions are set according to Annex B clause B.2.

3. Measure the average throughput for a duration sufficient to achieve statistical significance according to Annex G clause G.3. Count the number of NACKs, ACKs and statDTXs on the UL during the test interval and decide pass or fail according to Tables G.3.5 and G.3.6 in Annex G clause G.3.

#### 8.2.1.3.3\_E.1.4.3 Message contents

Message contents are according to TS 36.508 [7] clause 5.2A.5.1 with the following exceptions:

**Table 8.2.1.3.3\_E.1.4.3-1: *PhysicalConfigDedicated-DEFAULT*: Additional FDD PDSCH open loop spatial multiplexing performance downlink power allocation**

Derivation Path: 36.508 clause 5.5.1.2			
Information Element	Value/remark	Comment	Condition
PhysicalConfigDedicated-DEFAULT ::= SEQUENCE {			
antennaInfo CHOICE {			
antennaInfoDedicated ::= SEQUENCE {			
transmissionMode	tm3		
codebookSubsetRestriction CHOICE {			
n2TxAntenna-tm3	11		
}			
ue-TransmitAntennaSelection CHOICE {			
release	NULL		
}			
}			
}			

**Table 8.2.1.3.3\_E.1.4.3-2: RadioResourceConfigDedicated-SRB2-DRB(n, m): Additional FDD PDSCH open loop spatial multiplexing performance downlink power allocation**

Derivation Path: TS 36.508 [7] clause 5.2A.5, Table 5.2A.5.1.1-2 RadioResourceConfigDedicated-SRB2-DRB(n,m)			
Information Element	Value/remark	Comment	Condition
RadioResourceConfigDedicated-SRB2-DRB(n, m) ::= SEQUENCE {			
MeasSubframePatternPCell-r10 CHOICE {			
setup SEQUENCE {			
subframePatternFDD-r10	'1000000010000000 1000000010000000 10000000'	BIT STRING (SIZE (40))	
}			
}			
neighCellsCRS-Info-r11 ::= CHOICE {			
setup SEQUENCE {			
CRS-AssistancedInfoList-r11 ::= SEQUENCE (SIZE (1..maxCellReport)) OF CRS-AssistancedInfo-r11{		2 entries	
CRS-AssistancedInfo-r11 ::= SEQUENCE {			
physCellId-r11	1		Cell 2
	126		Cell 3
antennaPortsCount-r11	an2		Cell 2, Cell 3
mbsfn-SubframeConfigList-r11 ::= SEQUENCE (SIZE (1..maxMBSFN-Allocations)) OF MBSFN-SubframeConfig{			Cell 2, Cell 3
MBSFN-SubframeConfig ::= SEQUENCE {			
radioframeAllocationPeriod	n1		
radioframeAllocationOffset	0		
subframeAllocation CHOICE{			
oneFrame	'000000' B	non-MBSFN	
}			
}			
}			
}			
}			
}			
}			

**Table 8.2.1.3.3\_E.1.4.3-3: PhysicalConfigDedicated-DEFAULT: Additional FDD PDSCH open loop spatial multiplexing performance downlink power allocation**

Derivation Path: 36.508 clause 5.5.1.2			
Information Element	Value/remark	Comment	Condition
PhysicalConfigDedicated-DEFAULT ::= SEQUENCE {			
cqi-ReportConfig-r10	CQI-ReportConfig-r10-DEFAULT		
}			



**Table 8.2.1.3.3\_E.1.4.3-4: CQI-ReportConfig-r10-DEFAULT: Additional FDD PDSCH open loop spatial multiplexing performance downlink power allocation**

Derivation Path: 36.508 [7] clause 4.6.3, Table 4.6.3-2AA CQI-ReportConfig-r10-DEFAULT_			
Information Element	Value/remark	Comment	Condition
CQI-ReportConfig-r10-DEFAULT ::= SEQUENCE {			
cqi-ReportAperiodic-r10	Not present		
nomPDSCH-RS-EPRE-Offset	0		
cqi-ReportPeriodic-r10	Not present		
pmi-RI-Report-r9	Not present		
csi-SubframePatternConfig-r10 CHOICE {			
setup SEQUENCE {			
csi-MeasSubframeSet1-r10 CHOICE {			
subframePatternFDD-r10	'11000000 11000000 11000000 11000000 11000000'	BIT STRING (SIZE (40))	
}			
csi-MeasSubframeSet2-r10 CHOICE {			
subframePatternFDD-r10	'00111111 00111111 00111111 00111111 00111111'	BIT STRING (SIZE (40))	
}			
}			
}			
}			

**8.2.1.3.3\_E.1.5 Test requirement**

Table 8.2.1.3.3\_E.1.5-1 defines the primary level settings.

The fraction of maximum throughput percentage for the downlink reference measurement channels specified in Annex A clause A.3.3.2 for each throughput test shall meet or exceed the specified value in Tables 8.2.1.3.3\_E.1.5-2 for the specified SNR including test tolerances for all throughput tests.

Table 8.2.1.3.3\_E.1.5-1: Test Parameters for Large Delay CDD (FRC) non-MBSFN ABS

Parameter		Unit	Cell 1	Cell 2	Cell 3
Downlink power allocation	$\rho_A$	dB	-3	-3	-3
	$\rho_B$	dB	-3 (Note 1)	-3 (Note 1)	-3 (Note 1)
	$\sigma$	dB	0	N/A	N/A
$N_{oc}$ at antenna port	$N_{oc1}$	dBm/15kHz	-98 (Note 2)	N/A	N/A
	$N_{oc2}$	dBm/15kHz	-98 (Note 3)	N/A	N/A
	$N_{oc3}$	dBm/15kHz	-93.1 (Note 4)	N/A	N/A
$\hat{E}_s / N_{oc2}$		dB	Reference Value in Table 8.2.1.3.3_E.1.3-2	Reference Value in Table 8.2.1.3.3_E.1.3-2	Reference Value in Table 8.2.1.3.3_E.1.3-2
$BW_{Channel}$		MHz	10	10	10
Subframe Configuration			Non-MBSFN	Non-MBSFN	Non-MBSFN
Time Offset between Cells		$\mu s$	N/A	3	-1
Frequency shift between Cells		Hz	N/A	300	-100
Cell Id			0	1	126
ABS pattern (Note 5)			N/A	11000000 11000000 11000000 11000000 11000000	11000000 11000000 11000000 11000000 11000000
RLM/RRM Measurement Subframe Pattern (Note 6)			10000000 10000000 10000000 10000000 10000000	N/A	N/A
CSI Subframe Sets (Note7)	$C_{CSI,0}$		11000000 11000000 11000000 11000000 11000000	N/A	N/A
	$C_{CSI,1}$		00111111 00111111 00111111 00111111 00111111	N/A	N/A
Number of control OFDM symbols			2	Note 8	Note 8
PDSCH transmission mode			3	Note 9	Note 9
Cyclic prefix			Normal	Normal	Normal
<p>Note 1: <math>P_B = 1</math>.</p> <p>Note 2: This noise is applied in OFDM symbols #1, #2, #3, #5, #6, #8, #9, #10, #12, #13 of a subframe overlapping with the aggressor ABS.</p> <p>Note 3: This noise is applied in OFDM symbols #0, #4, #7, #11 of a subframe overlapping with the aggressor ABS.</p> <p>Note 4: This noise is applied in all OFDM symbols of a subframe overlapping with aggressor non-ABS</p> <p>Note 5: ABS pattern as defined in [14].</p> <p>Note 6: Time-domain measurement resource restriction pattern for PCell measurements as defined in [5]</p> <p>Note 7: As configured according to the time-domain measurement resource restriction pattern for CSI measurements defined in [5].</p> <p>Note 8: The number of control OFDM symbols is not available for ABS and is 2 for the subframe indicated by "0" of ABS pattern.</p> <p>Note 9: Downlink physical channel setup in Cell 2 and Cell 3 in accordance with Annex C.3.3 applying OCNB pattern as defined in Annex A.5.</p> <p>Note 10: The number of the CRS ports in Cell 1, Cell 2 and Cell 3 is the same.</p> <p>Note 11: SIB-1 will not be transmitted in Cell 2 and Cell 3 in this test.</p>					

Table 8.2.1.3.3\_E.1.5-2: Test Requirement Large Delay CDD (FRC)

Test Number	Reference Channel	$\hat{E}_s/N_{oc2}$		OCNG Pattern			Propagation Conditions (Note1)			Correlation Matrix and Antenna Configuration (Note 2)	Reference Value		UE Category
		Cell 2	Cell 3	Cell 1	Cell 2	Cell 3	Cell 1	Cell 2	Cell 3		Fraction of Maximum Throughput (%) (Note 5)	SNR (dB) (Note 3)	
1	R.11 FDD (Note 4)	8.8	6.8	OP.1 FDD	OP.1 FDD	OP.1 FDD	EVA5	EVA5	EVA5	2x2 Low	70	14.8	2-8
2	R.35 FDD (Note 4)	8.8	0.8	OP.1 FDD	OP.1 FDD	OP.1 FDD	EVA5	EVA5	EVA5	2x2 Low	70	23.5	2-8

Note 1: The propagation conditions for Cell 1, Cell 2 and Cell 3 are statistically independent.  
Note 2: The correlation matrix and antenna configuration apply for Cell 1, Cell 2 and Cell 3.  
Note 3: SNR corresponds to  $\hat{E}_s/N_{oc2}$  of Cell 1.  
Note 4: Cell 1 reference channel is modified: PDSCH other than SIB1/paging and its associated PDCCH/PCFICH are transmitted in the serving cell subframe when the subframe is overlapped with the ABS subframe of aggressor cell and the subframe is available in the definition of the reference channel.  
Note 5: The maximum throughput is calculated from the total Payload in 9 subframes, averaged over 40ms.

#### 8.2.1.4 FDD PDSCH Closed Loop Spatial Multiplexing Performance (Cell-Specific Reference Symbols)

##### 8.2.1.4.1 FDD PDSCH Closed Loop Single/Multi Layer Spatial Multiplexing 2x2

###### 8.2.1.4.1.1 Test purpose

To verify the UE's ability to receive a predefined test signal, representing a multi-path fading channel that is determined by the SNR with a percentage of the information bit throughput for a specified downlink Reference Measurement Channel (RMC) not falling below a specified value for transmission on two antenna ports using closed-loop spatial multiplexing.

###### 8.2.1.4.1.2 Test applicability

This test applies to all types of E-UTRA FDD UE release 8.

###### 8.2.1.4.1.3 Minimum conformance requirements

The requirements are specified in terms of the percentage of information bit throughput for the downlink reference measurement channels specified in Annex A clause A.3.3.2, with the addition of the relevant parameters in Tables 8.2.1-1, 8.2.1.4.1.3-1 and 8.2.1.4.1.3-3 and the downlink physical channel setup according to Table C.3.2-1 in Annex C.

Using this configuration the fraction of maximum throughput percentage shall meet or exceed the minimum requirements specified in Tables 8.2.1.4.1.3-2 and 8.2.1.4.1.3-4 for the specified SNR. For single-layer spatial multiplexing closed loop rank-one performance with wideband and frequency selective precoding is specified. For multi-layer spatial multiplexing closed loop rank-two performance with wideband and frequency selective precoding is specified.

**Table 8.2.1.4.1.3-1: Test Parameters for Testing Single-Layer Spatial Multiplexing (FRC)**

Parameter	Unit	Test 1	Test 1A	Test 2
Downlink power allocation	$\rho_A$	dB	-3	-3
	$\rho_B$	dB	-3 (Note 1)	-3 (Note 1)
	$\sigma$	dB	0	0
$N_{oc}$ at antenna port	dBm/15kHz	-98	-98	-98
Precoding granularity	PRB	6	4	50
PMI delay (Note 2)	ms	8	8	8
Reporting interval	ms	1	1	1
Reporting mode		PUSCH 1-2	PUSCH 1-2	PUSCH 3-1
CodeBookSubsetRestriction bitmap		001111	001111	001111
PDSCH transmission mode		4	4	4
Note 1: $P_B = 1$				
Note 2: If the UE reports in an available uplink reporting instance at subframe SF#n based on PMI estimation at a downlink SF not later than SF#(n-4), this reported PMI cannot be applied at the eNB downlink before SF#(n+4).				

**Table 8.2.1.4.1.3-2: Minimum performance Single-Layer Spatial Multiplexing (FRC)**

Test number	Bandwidth	Reference Channel	OCNG Pattern	Propagation Condition	Correlation Matrix and Antenna Configuration	Reference value		UE Category
						Fraction of Maximum Throughput (%)	SNR (dB)	
1	10 MHz	R.10 FDD	OP.1 FDD	EVA5	2x2 Low	70	-2.5	1-5
1A(Note 1)	5 MHz	R.10-2 FDD	OP.1 FDD	EVA5	2x2 Low	70	-2.9	1-5
2	10 MHz	R.10 FDD	OP.1 FDD	EPA5	2x2 High	70	-2.3	1-5
Note 1: Test case applicability is defined in 8.1.2.1.								

**Table 8.2.1.4.1.3-3: Test Parameters for Testing Multi-Layer Spatial Multiplexing**

Parameter	Unit	Test 3	Test 4	Test 4A
Downlink power allocation	$\rho_A$	dB	-3	-3
	$\rho_B$	dB	-3 (Note 1)	-3 (Note 1)
	$\sigma$	dB	0	0
$N_{oc}$ at antenna port	dBm/15kHz	-98	-98	-98
Precoding granularity	PRB	50	50	25
PMI delay (Note 2)	ms	8	8	8
Reporting interval	ms	1	1	1
Reporting mode		PUSCH 3-1	PUSCH 3-1	PUSCH 3-1
CodeBookSubsetRestriction bitmap		110000	110000	110000
PDSCH transmission mode		4	4	4
Note 1: $P_B = 1$				
Note 2: If the UE reports in an available uplink reporting instance at subframe SF#n based on PMI estimation at a downlink SF not later than SF#(n-4), this reported PMI cannot be applied at the eNB downlink before SF#(n+4)				

**Table 8.2.1.4.1.3-4: Minimum performance Multi-Layer Spatial Multiplexing (FRC)**

Test number	Band-width	Reference Channel	OCNG Pattern	Propagation Condition	Correlation Matrix and Antenna Configuration	Reference value		UE Category
						Fraction of Maximum Throughput (%)	SNR (dB)	
3	10 MHz	R.11 FDD	OP.1 FDD	EVA5	2x2 Low	70	12.9	2-5
4	10 MHz	R.11 FDD	OP.1 FDD	ETU70	2x2 Low	70	14.3	2-5
4A (Note 1)	5 MHz	R.11-2 FDD	OP.1 FDD	ETU70	2x2 Low	70	14.0	2-5

Note 1: Test case applicability is defined in 8.1.2.1.

The normative reference for this requirement is TS 36.101 [2] clause 8.2.1.4.

#### 8.2.1.4.1.4 Test description

##### 8.2.1.4.1.4.1 Initial conditions

Initial conditions are a set of test configurations the UE needs to be tested in and the steps for the SS to take with the UE to reach the correct measurement state.

Configurations of PDSCH and PDCCH before measurement are specified in Annex C.2.

Test Environment: Normal, as defined in TS 36.508 [7] clause 4.1.

Frequencies to be tested: Mid Range, as defined in TS 36.508 [7] clause 4.3.1.1.

Channel Bandwidths to be tested: As specified per test number in Tables 8.2.1.4.1.3-2 and 8.2.1.4.1.3-4 as defined in TS 36.508 [7] clause 4.3.1.1.

1. Connect the SS, the faders and AWGN noise sources to the UE antenna connectors as shown in TS 36.508 [7] Annex A, Figure A.10 for antenna configuration 2x2.
2. The parameter settings for the cell are set up according to Tables 8.2.1-1, 8.2.1.4.1.3-1 and 8.2.1.4.1.3-3 as appropriate.
3. Downlink signals are initially set up according to Annex C.0, C.1 and Annex C.3.2 and uplink signals according to Annex H.1 and H.3.2.
4. Propagation conditions are set according to Annex B.0.
5. Ensure the UE is in State 3A-RF according to TS 36.508 [7] clause 5.2A.2. Message contents are defined in clause 8.2.1.4.1.4.3.

##### 8.2.1.4.1.4.2 Test procedure

1. For single-layer spatial multiplexing, SS transmits PDSCH via PDCCH DCI format 2 for C\_RNTI to transmit the DL RMC according to Tables 8.2.1.4.1.3-1 and 8.2.1.4.1.3-2. For multi-layer spatial multiplexing, SS transmits PDSCH via PDCCH DCI format 2 for C\_RNTI to transmit the DL RMC according to Tables 8.2.1.4.1.3-3 and 8.2.1.4.1.3-4. The SS sends downlink MAC padding bits on the DL RMC.
2. SS schedules the UL transmission to carry the PUSCH CQI feedback via PDCCH DCI format 0 with CQI request bit set to 1 and I\_MCS=29 and N\_PRB allocated to be less or equal to 4.
3. Set the parameters of the bandwidth, MCS, reference channel, the propagation condition, the correlation matrix, antenna configuration and the SNR according to Tables 8.2.1.4.1.5-1 and 8.2.1.4.1.5-2 as appropriate.
4. Measure the average throughput for a duration sufficient to achieve statistical significance according to Annex G clause G.3. Count the number of NACKs, ACKs and statDTXs on the UL during the test interval and decide pass or fail according to Tables G.3.5 and G.3.6 in Annex G clause G.3.
5. Repeat steps from 1 to 4 for each test interval in Tables 8.2.1.4.1.5-1 and 8.2.1.4.1.5-2 as appropriate.

## 8.2.1.4.1.4.3 Message contents

Message contents are according to TS 36.508 [7] clause 4.6 with the following exceptions:

**Table 8.2.1.4.1.4.3-1: *PhysicalConfigDedicated-DEFAULT*: Additional FDD PDSCH closed loop single-layer spatial multiplexing performance downlink power allocation for Test number 1, 1A, 2**

Derivation Path: 36.331 clause 6.3.2			
Information Element	Value/remark	Comment	Condition
PhysicalConfigDedicated-DEFAULT ::= SEQUENCE {			
antennaInfo CHOICE {			
antennaInfoDedicated ::= SEQUENCE {			
transmissionMode	tm4		
codebookSubsetRestriction CHOICE {			
n2TxAntenna-tm4	001111		
}			
ue-TransmitAntennaSelection CHOICE {			
release	NULL		
}			
}			
}			

**Table 8.2.1.4.1.4.3-2: *PhysicalConfigDedicated-DEFAULT*: Additional FDD PDSCH closed loop multi-layer spatial multiplexing performance downlink power allocation for Test number 3, 4, 4A**

Derivation Path: 36.331 clause 6.3.2			
Information Element	Value/remark	Comment	Condition
PhysicalConfigDedicated-DEFAULT ::= SEQUENCE {			
antennaInfo CHOICE {			
antennaInfoDedicated ::= SEQUENCE {			
transmissionMode	tm4		
codebookSubsetRestriction CHOICE {			
n2TxAntenna-tm4	110000		
}			
ue-TransmitAntennaSelection CHOICE {			
release	NULL		
}			
}			
}			

**Table 8.2.1.4.1.4.3-3: *CQI-ReportConfig-DEFAULT*: Additional FDD PDSCH closed loop single-layer spatial multiplexing performance downlink power allocation for Test number 1, 1A**

Derivation Path: 36.331 clause 6.3.2			
Information Element	Value/remark	Comment	Condition
CQI-ReportConfig-DEFAULT ::= SEQUENCE {			
cqi-ReportModeAperiodic	rm12		
nomPDSCH-RS-EPRE-Offset	0		
cqi-ReportPeriodic	Not present		
}			

**Table 8.2.1.4.1.4.3-4: CQI-ReportConfig-DEFAULT: Additional FDD PDSCH closed loop single/multi-layer spatial multiplexing performance downlink power allocation for Test number 2, 3, 4, 4A**

Derivation Path: 36.331 clause 6.3.2			
Information Element	Value/remark	Comment	Condition
CQI-ReportConfig-DEFAULT ::= SEQUENCE {			
cqi-ReportModeAperiodic	rm31		
nomPDSCH-RS-EPRE-Offset	0		
cqi-ReportPeriodic	Not present		
}			

#### 8.2.1.4.1.5 Test requirement

Tables 8.2.1.4.1.3-1 and 8.2.1.4.1.3-3 define the primary level settings.

The fraction of maximum throughput percentage for the downlink reference measurement channels specified in Annex A clause A.3.3.2 for each throughput test shall meet or exceed the specified value in Tables 8.2.1.4.1.5-1 and 8.2.1.4.1.5-2 for the specified SNR including test tolerances for all throughput tests.

**Table 8.2.1.4.1.5-1: Test requirement Single-Layer Spatial Multiplexing (FRC)**

Test number	Band-width	Reference Channel	OCNG Pattern	Propagation Condition	Correlation Matrix and Antenna Configuration	Reference value		UE Category
						Fraction of Maximum Throughput (%)	SNR (dB)	
1	10 MHz	R.10 FDD	OP.1 FDD	EVA5	2x2 Low	70	-1.6	1-5
1A(Note 1)	5 MHz	R.10-2 FDD	OP.1 FDD	EVA5	2x2 Low	70	-2.0	1-5
2	10 MHz	R.10 FDD	OP.1 FDD	EPA5	2x2 High	70	-1.4	1-5

Note 1: Test case is applicable (according to sub clause 8.1.2.1) to UE's which, from the E-UTRA operating bands defined in Table 5.2-1, support only E-UTRA band 31.

**Table 8.2.1.4.1.5-2: Test requirement Multi-Layer Spatial Multiplexing (FRC)**

Test number	Band-width	Reference Channel	OCNG Pattern	Propagation Condition	Correlation Matrix and Antenna Configuration	Reference value		UE Category
						Fraction of Maximum Throughput (%)	SNR (dB)	
3	10 MHz	R.11 FDD	OP.1 FDD	EVA5	2x2 Low	70	13.8	2-5
4	10 MHz	R.11 FDD	OP.1 FDD	ETU70	2x2 Low	70	15.2	2-5
4A (Note 1)	5 MHz	R.11-2 FDD	OP.1 FDD	ETU70	2x2 Low	70	14.9	2-5

Note 1: Test case is applicable (according to sub clause 8.1.2.1) to UE's which, from the E-UTRA operating bands defined in Table 5.2-1, support only E-UTRA band 31.

#### 8.2.1.4.1\_1 FDD PDSCH Closed Loop Single/Multi Layer Spatial Multiplexing 2x2 (Release 9 and forward)

##### 8.2.1.4.1\_1.1 Test purpose

Same test purpose as in clause 8.2.1.4.1.1

##### 8.2.1.4.1\_1.2 Test applicability

This test applies to all types of E-UTRA FDD UE release 9 and forward.

##### 8.2.1.4.1\_1.3 Minimum conformance requirements

Same minimum conformance requirements as in clause 8.2.1.4.1.3 with the following exceptions:

- Instead of Table 8.2.1.4.1.3-2 → use Table 8.2.1.4.1\_1.3-1.
- Instead of Table 8.2.1.4.1.3-4 → use Table 8.2.1.4.1\_1.3-2.

**Table 8.2.1.4.1\_1.3-1: Minimum performance Single-Layer Spatial Multiplexing (FRC)**

Test number	Band-width	Reference Channel	OCNG Pattern	Propagation Condition	Correlation Matrix and Antenna Configuration	Reference value		UE Category
						Fraction of Maximum Throughput (%)	SNR (dB)	
1	10 MHz	R.10 FDD	OP.1 FDD	EVA5	2x2 Low	70	-2.5	1-8
1A (Note 1)	5 MHz	R.10-2 FDD	OP.1 FDD	EVA5	2x2 Low	70	-2.9	1-8
2	10 MHz	R.10 FDD	OP.1 FDD	EPA5	2x2 High	70	-2.3	1-8

Note 1: Test case applicability is defined in 8.1.2.1.

**Table 8.2.1.4.1\_1.3-2: Minimum performance Multi-Layer Spatial Multiplexing (FRC)**

Test number	Band-width	Reference Channel	OCNG Pattern	Propagation Condition	Correlation Matrix and Antenna Configuration	Reference value		UE Category
						Fraction of Maximum Throughput (%)	SNR (dB)	
3	10 MHz	R.35 FDD	OP.1 FDD	EPA5	2x2 Low	70	18.9	2-8
4	10 MHz	R.11 FDD	OP.1 FDD	ETU70	2x2 Low	70	14.3	2-8
4A (Note 1)	5 MHz	R.11-2 FDD	OP.1 FDD	ETU70	2x2 Low	70	14.0	2-8

Note 1: Test case applicability is defined in 8.1.2.1.

The normative reference for this requirement is TS 36.101 [2] clause 8.2.1.4.

#### 8.2.1.4.1\_1.4 Test description

Same test description as in clause 8.2.1.4.1.4 with the following exceptions:

- Instead of Table 8.2.1.4.1.3-2 → use Table 8.2.1.4.1\_1.3-1.
- Instead of Table 8.2.1.4.1.3-4 → use Table 8.2.1.4.1\_1.3-2.
- Instead of Table 8.2.1.4.1.5-1 → use Table 8.2.1.4.1\_1.5-1.
- Instead of Table 8.2.1.4.1.5-2 → use Table 8.2.1.4.1\_1.5-2.

#### 8.2.1.4.1\_1.5 Test requirement

Same test requirement as in clause 8.2.1.4.1.5 with the following exceptions:

- Instead of Table 8.2.1.4.1.5-1 → use Table 8.2.1.4.1\_1.5-1.
- Instead of Table 8.2.1.4.1.5-2 → use Table 8.2.1.4.1\_1.5-2.



**Table 8.2.1.4.1\_1.5-1: Test requirement Single-Layer Spatial Multiplexing (FRC)**

Test number	Band-width	Reference Channel	OCNG Pattern	Propagation Condition	Correlation Matrix and Antenna Configuration	Reference value		UE Category
						Fraction of Maximum Throughput (%)	SNR (dB)	
1	10 MHz	R.10 FDD	OP.1 FDD	EVA5	2x2 Low	70	-1.6	1-8
1A (Note 1)	5 MHz	R.10-2 FDD	OP.1 FDD	EVA5	2x2 Low	70	-2.0	1-8
2	10 MHz	R.10 FDD	OP.1 FDD	EPA5	2x2 High	70	-1.4	1-8
Note 1:	Test case is applicable (according to sub clause 8.1.2.1) to UE's which, from the E-UTRA operating bands defined in Table 5.2-1, support only E-UTRA band 31.							

**Table 8.2.1.4.1\_1.5-2: Test requirement Multi-Layer Spatial Multiplexing (FRC)**

Test number	Band-width	Reference Channel	OCNG Pattern	Propagation Condition	Correlation Matrix and Antenna Configuration	Reference value		UE Category
						Fraction of Maximum Throughput (%)	SNR (dB)	
3	10 MHz	R.35 FDD	OP.1 FDD	EPA5	2x2 Low	70	+19.8	2-8
4	10 MHz	R.11 FDD	OP.1 FDD	ETU70	2x2 Low	70	+15.2	2-8
4A (Note 1)	5 MHz	R.11-2 FDD	OP.1 FDD	ETU70	2x2 Low	70	14.9	2-8
Note 1:	Test case is applicable (according to sub clause 8.1.2.1) to UE's which, from the E-UTRA operating bands defined in Table 5.2-1, support only E-UTRA band 31.							

**8.2.1.4.1\_A to D**

**8.2.1.4.1\_E** FDD PDSCH Closed Loop Single/Multi Layer Spatial Multiplexing 2x2 for feICIC

**8.2.1.4.1\_E.1** FDD PDSCH Closed Loop Single/Multi Layer Spatial Multiplexing 2x2 for feICIC (non-MBSFN ABS)

**8.2.1.4.1\_E.1** Test purpose

To verify The purpose is to verify the closed loop rank-one performance with wideband precoding if the PDSCH transmission in the serving cell takes place in subframes that overlap with ABS [14] of the aggressor cell with CRS assistance information.

**8.2.1.4.1\_E.1.2** Test applicability

This test applies to all types of E-UTRA FDD UE and CRS interference handling – UE Category 2-8 release 11 and forward. Applicability requires support of FGI bit 115.

**8.2.1.4.1\_E.1.3** Minimum conformance requirements

The requirements are specified in Table 8.2.1.4.1\_E.1.3-2, with the addition of parameters in Table 8.2.1.4.1\_E.1.3-1. In Table 8.2.1.4.1\_E.1.3-1, Cell 1 is the serving cell, and Cell 2 and Cell 3 are the aggressor cells. The downlink physical channel setup for Cell 1 is according to Annex C.3.2 and for Cell 2 and Cell 3 is according to Annex C.3.3, respectively. The CRS assistance information TS 36.331 [5] includes Cell 2 and Cell 3.

Table 8.2.1.4.1\_E.1.3-1: Test Parameters for Testing Single-Layer Spatial Multiplexing (FRC)

Parameter		Unit	Cell 1	Cell 2	Cell 3
Downlink power allocation	$\rho_A$	dB	-3	-3	-3
	$\rho_B$	dB	-3 (Note 1)	-3 (Note 1)	-3 (Note 1)
	$\sigma$	dB	0	N/A	N/A
$N_{oc}$ at antenna port	$N_{oc1}$	dBm/15kHz	-98 (Note 2)	N/A	N/A
	$N_{oc2}$	dBm/15kHz	-98 (Note 3)	N/A	N/A
	$N_{oc3}$	dBm/15kHz	-93 (Note 4)	N/A	N/A
$\hat{E}_s / N_{oc2}$		dB	Reference Value in Table 8.2.1.4.1_E.1.3-2	12	10
BW <sub>Channel</sub>		MHz	10	10	10
Subframe Configuration			Non-MBSFN	Non-MBSFN	Non-MBSFN
Time Offset between Cells		$\mu$ s	N/A	3	-1
Frequency shift between Cells		Hz	N/A	300	-100
Cell Id			0	126	1
ABS pattern (Note 5)			N/A	11000000 11000000 11000000 11000000 11000000	11000000 11000000 11000000 11000000 11000000
RLM/RRM Measurement Subframe Pattern (Note 6)			10000000 10000000 10000000 10000000 10000000	N/A	N/A
CSI Subframe Sets (Note7)	$C_{CSI,0}$		11000000 11000000 11000000 11000000 11000000	N/A	N/A
	$C_{CSI,1}$		00111111 00111111 00111111 00111111 00111111	N/A	N/A
Number of control OFDM symbols			2	Note 8	Note 8
PDSCH transmission mode			6	Note 9	Note 9
Precoding granularity		PRB	50	N/A	N/A
PMI delay (Note 10)		ms	8	N/A	N/A
Reporting interval		ms	1	N/A	N/A
Reporting mode			PUSCH 3-1	N/A	N/A
CodeBookSubsetRestriction bitmap			1111	N/A	N/A
Cyclic prefix			Normal	Normal	Normal

Note 1:	$P_B = 1$ .
Note 2:	This noise is applied in OFDM symbols #1, #2, #3, #5, #6, #8, #9, #10, #12, #13 of a subframe overlapping with the aggressor ABS.
Note 3:	This noise is applied in OFDM symbols #0, #4, #7, #11 of a subframe overlapping with the aggressor ABS.
Note 4:	This noise is applied in all OFDM symbols of a subframe overlapping with aggressor non-ABS
Note 5:	ABS pattern as defined in [14].
Note 6:	Time-domain measurement resource restriction pattern for PCell measurements as defined in TS 36.331 [5].
Note 7:	As configured according to the time-domain measurement resource restriction pattern for CSI measurements defined in TS 36.331 [5].
Note 8:	The number of control OFDM symbols is not available for ABS and is 2 for the subframe indicated by "0" of ABS pattern.
Note 9:	Downlink physical channel setup in Cell 2 and Cell 3 in accordance with TS 36.521-1 [10] Annex C.3.3 applying OCNG pattern as defined in TS 36.521-1 [10] Annex A.5.
Note 10:	If the UE reports in an available uplink reporting instance at subframe SF#n based on PMI estimation at a downlink SF not later than SF#(n-4), this reported PMI cannot be applied at the eNB downlink before SF#(n+4).
Note 11:	The number of the CRS ports in Cell 1, Cell 2 and Cell 3 is the same.
Note 12:	SIB-1 will not be transmitted in Cell 2 and Cell 3 in this test.

**Table 8.2.1.4.1\_E.1.3-2: Minimum performance Single-Layer Spatial Multiplexing (FRC)**

Test Number	Reference Channel	OCNG Pattern			Propagation Conditions (Note1)			Correlation Matrix and Antenna Configuration (Note 2)	Reference Value		UE Category
		Cell 1	Cell 2	Cell 3	Cell 1	Cell 2	Cell 3		Fraction of Maximum Throughput (%) (Note 5)	SNR (dB) (Note 3)	
1	R.11 FDD (Note 4)	OP.1FD D	OP.1F DD	OP.1FD D	EPA5	EPA5	EPA5	2x2 High	70	6.1	≥2
Note 1: The propagation conditions for Cell 1, Cell 2 and Cell 3 are statistically independent. Note 2: The correlation matrix and antenna configuration apply for Cell 1, Cell 2 and Cell 3. Note 3: SNR corresponds to $\hat{E}_s / N_{oc2}$ of Cell 1. Note 4: Cell 1 reference channel is modified: PDSCH other than SIB1/paging and its associated PDCCH/PCFICH are transmitted in the serving cell subframe when the subframe is overlapped with the ABS subframe of aggressor cell and the subframe is available in the definition of the reference channel. Note 5: The maximum throughput is calculated from the total Payload in 9 subframes, averaged over 40ms.											

The normative reference for this requirement is TS 36.101 [2] clause 8.2.1.4.1C.

8.2.1.4.1\_E.1.4 Test description

8.2.1.4.1\_E.1.4.1 Initial conditions

Initial conditions are a set of test configurations the UE needs to be tested in and the steps for the SS to take with the UE to reach the correct measurement state.

Configurations of PDSCH and PDCCH before measurement are specified in Annex C.2.

Test Environment: Normal, as defined in TS 36.508 [7] clause 4.1.

Frequencies to be tested: Mid Range, as defined in TS 36.508 [7] clause 4.3.1.1.

Channel Bandwidths to be tested: As specified per test number in Table 8.2.1.4.1\_E.1.3-2 as defined in TS 36.508 [7] clause 4.3.1.1.

1. Connect the SS, the faders and AWGN noise sources to the UE antenna connectors as shown in TS 36.508 [7] Annex A, Figure A.48 for antenna configuration 2x2.
2. The parameter settings for the cell are set up according to Tables 8.2.1.4.1\_E.1.3-1 as appropriate.

3. Downlink signals are initially set up according to Annex C0, C.1 and Annex C.3.2 and uplink signals according to Annex H.1 and H.3.2.
4. Propagation conditions are set according to Annex B.0.
5. Ensure the UE is in State 3A-RF according to TS 36.508 [7] clause 5.2A.2 with exceptions listed in 5.2A.5. Message contents are defined in clause 8.2.1.4.1\_E.1.4.3.

#### 8.2.1.4.1\_E.1.4.2 Test procedure

1. Set the parameters for Cell 1, Cell 2 and Cell 3, according to Tables 8.2.1.4.1\_E.1.5-1, 8.2.1.4.1\_E.1.5-2, and C.3.3.2 of Annex C.3.3. SS transmits PDSCH via PDCCH DCI format 1B for C\_RNTI to transmit the DL RMC.
2. The SS sends downlink MAC padding bits on the DL RMC. Propagation conditions are set according to Annex B clause B.2
3. SS schedules the UL transmission to carry the PUSCH CQI feedback via PDCCH DCI format 0 with CQI request bit set to 1 and I\_MCS=29 and N\_PRB allocated to be less or equal to 4.
4. Set the parameters of the bandwidth, MCS, reference channel, the propagation condition, the correlation matrix, antenna configuration and the SNR according to Table 8.2.1.4.1\_E.1.5-2 as appropriate.
5. Measure the average throughput for a duration sufficient to achieve statistical significance according to Annex G clause G.3. Count the number of NACKs, ACKs and statDTXs on the UL during each test interval and decide pass or fail according to Tables G.3.5 and G.3.6 in Annex G clause G.3.

#### 8.2.1.4.1\_E.1.4.3 Message contents

Message contents are according to TS 36.508 [7] clause 5.2A.5.1 with the following exceptions:

**Table 8.2.1.4.1\_E.1.4.3-1: RadioResourceConfigDedicated-SRB2-DRB(n, m): Additional FDD PDSCH closed loop single-layer spatial multiplexing performance downlink power allocation**

Derivation Path: TS 36.508 [7] clause 5.2A.5, Table 5.2A.5.1.1-2 RadioResourceConfigDedicated-SRB2-DRB(n,m)			
Information Element	Value/remark	Comment	Condition
RadioResourceConfigDedicated-SRB2-DRB(n, m) ::= SEQUENCE {			
MeasSubframePatternPCell-r10 CHOICE {			
setup SEQUENCE {			
subframePatternFDD-r10	'1000000010000000 1000000010000000 10000000'	BIT STRING (SIZE (40))	
}			
}			
neighCellsCRS-Info-r11 ::= CHOICE {			
setup SEQUENCE {			
CRS-AssistancedInfoList-r11 ::= SEQUENCE (SIZE (1..maxCellReport)) OF CRS-AssistancedInfo-r11{		2 entries	
CRS-AssistancedInfo-r11 ::= SEQUENCE {			
physCellId-r11	126		Cell 2
	1		Cell 3
antennaPortsCount-r11	an2		Cell 2, Cell 3
mbsfn-SubframeConfigList-r11 ::= SEQUENCE (SIZE (1..maxMBSFN-Allocations)) OF MBSFN-SubframeConfig{			Cell 2, Cell 3
MBSFN-SubframeConfig ::= SEQUENCE {			
radioframeAllocationPeriod	n1		
radioframeAllocationOffset	0		
subframeAllocation CHOICE{			
oneFrame	'000000' B	non-MBSFN	
}			
}			
}			
}			
}			
}			
}			

**Table 8.2.1.4.1\_E.1.4.3-2: PhysicalConfigDedicated-DEFAULT: Additional FDD PDSCH closed loop single-layer spatial multiplexing performance downlink power allocation**

Derivation Path: 36.508 clause 5.5.1.2			
Information Element	Value/remark	Comment	Condition
PhysicalConfigDedicated-DEFAULT ::= SEQUENCE {			
cqi-ReportConfig-r10	CQI-ReportConfig-r10-DEFAULT		
}			

**Table 8.2.1.4.1\_E.1.4.3-3: CQI-ReportConfig-r10-DEFAULT: Additional FDD PDSCH closed loop single-layer spatial multiplexing performance downlink power allocation**

Derivation Path: 36.508 [7] clause 4.6.3, Table 4.6.3-2AA CQI-ReportConfig-r10-DEFAULT_			
Information Element	Value/remark	Comment	Condition
CQI-ReportConfig-r10-DEFAULT ::= SEQUENCE {			
cqi-ReportAperiodic-r10	rm31		
nomPDSCH-RS-EPRE-Offset	0		
cqi-ReportPeriodic-r10	Not present		
pmi-RI-Report-r9	Not present		
csi-SubframePatternConfig-r10 CHOICE {			
setup SEQUENCE {			
csi-MeasSubframeSet1-r10 CHOICE {			
subframePatternFDD-r10	'11000000 11000000 11000000 11000000 11000000'	BIT STRING (SIZE (40))	
}			
csi-MeasSubframeSet2-r10 CHOICE {			
subframePatternFDD-r10	'00111111 00111111 00111111 00111111 00111111'	BIT STRING (SIZE (40))	
}			
}			
}			
}			

**Table 8.2.1.4.1\_E.1.4.3-4: PhysicalConfigDedicated-DEFAULT: Additional FDD PDSCH closed loop single-layer spatial multiplexing performance downlink power allocation**

Derivation Path: 36.508 clause 5.5.1.2			
Information Element	Value/remark	Comment	Condition
PhysicalConfigDedicated-DEFAULT ::= SEQUENCE {			
antennaInfo CHOICE {			
antennaInfoDedicated ::= SEQUENCE {			
transmissionMode	tm6		
codebookSubsetRestriction CHOICE {			
n2TxAntenna-tm6	1111		
}			
ue-TransmitAntennaSelection CHOICE {			
release	NULL		
}			
}			
}			

#### 8.2.1.4.1\_E.1.5 Test requirement

Table 8.2.1.4\_E.1.5-1 defines the primary level settings.

The fraction of maximum throughput percentage for the downlink reference measurement channels specified in Annex A clause A.3.3.2 for each throughput test shall meet or exceed the specified value in Tables 8.2.1.4.1\_E.1.5-2 for the specified SNR including test tolerances for all throughput tests.

Table 8.2.1.4.1\_E.1.5-1: Test Parameters for Testing Single-Layer Spatial Multiplexing (FRC)

Parameter		Unit	Cell 1	Cell 2	Cell 3
Downlink power allocation	$\rho_A$	dB	-3	-3	-3
	$\rho_B$	dB	-3 (Note 1)	-3 (Note 1)	-3 (Note 1)
	$\sigma$	dB	0	N/A	N/A
$N_{oc}$ at antenna port	$N_{oc1}$	dBm/15kHz	-98 (Note 2)	N/A	N/A
	$N_{oc2}$	dBm/15kHz	-98 (Note 3)	N/A	N/A
	$N_{oc3}$	dBm/15kHz	-93.1 (Note 4)	N/A	N/A
$\hat{E}_s / N_{oc2}$		dB	Reference Value in Table 8.2.1.4.1_E.1.5-2	11.8	9.8
BW <sub>Channel</sub>		MHz	10	10	10
Subframe Configuration			Non-MBSFN	Non-MBSFN	Non-MBSFN
Time Offset between Cells		μs	N/A	3	-1
Frequency shift between Cells		Hz	N/A	300	-100
Cell Id			0	126	1
ABS pattern (Note 5)			N/A	11000000 11000000 11000000 11000000 11000000	11000000 11000000 11000000 11000000 11000000
RLM/RRM Measurement Subframe Pattern (Note 6)			10000000 10000000 10000000 10000000 10000000	N/A	N/A
CSI Subframe Sets (Note7)	$C_{CSI,0}$		11000000 11000000 11000000 11000000 11000000	N/A	N/A
	$C_{CSI,1}$		00111111 00111111 00111111 00111111 00111111	N/A	N/A
Number of control OFDM symbols			2	Note 8	Note 8
PDSCH transmission mode			6	Note 9	Note 9
Precoding granularity		PRB	50	N/A	N/A
PMI delay (Note 10)		ms	8	N/A	N/A
Reporting interval		ms	1	N/A	N/A
Reporting mode			PUSCH 3-1	N/A	N/A
CodeBookSubsetRestriction bitmap			1111	N/A	N/A
Cyclic prefix			Normal	Normal	Normal

Note 1:	$P_B = 1$ .
Note 2:	This noise is applied in OFDM symbols #1, #2, #3, #5, #6, #8, #9, #10, #12, #13 of a subframe overlapping with the aggressor ABS.
Note 3:	This noise is applied in OFDM symbols #0, #4, #7, #11 of a subframe overlapping with the aggressor ABS.
Note 4:	This noise is applied in all OFDM symbols of a subframe overlapping with aggressor non-ABS
Note 5:	ABS pattern as defined in [14]. Note 6: Time-domain measurement resource restriction pattern for PCell measurements as defined in TS 36.331 [5].
Note 7:	As configured according to the time-domain measurement resource restriction pattern for CSI measurements defined in TS 36.331 [5].
Note 8:	The number of control OFDM symbols is not available for ABS and is 2 for the subframe indicated by "0" of ABS pattern.
Note 9:	Downlink physical channel setup in Cell 2 and Cell 3 in accordance with TS 36.521-1 [10] Annex C.3.3 applying OCNG pattern as defined in TS 36.521-1 [10] Annex A.5.
Note 10:	If the UE reports in an available uplink reporting instance at subframe SF#n based on PMI estimation at a downlink SF not later than SF#(n-4), this reported PMI cannot be applied at the eNB downlink before SF#(n+4).
Note 11:	The number of the CRS ports in Cell 1, Cell 2 and Cell 3 is the same.
Note 12:	SIB-1 will not be transmitted in Cell 2 and Cell 3 in this test.

**Table 8.2.1.4.1\_E.1.5-2: Test requirement Single-Layer Spatial Multiplexing (FRC)**

Test Number	Reference Channel	OCNG Pattern			Propagation Conditions (Note1)			Correlation Matrix and Antenna Configuration (Note 2)	Reference Value		UE Category
		Cell 1	Cell 2	Cell 3	Cell 1	Cell 2	Cell 3		Fraction of Maximum Throughput (%) (Note 5)	SNR (dB) (Note 3)	
1	R.11 FDD (Note 4)	OP.1 FDD	OP.1 FDD	OP.1 FDD	EPA5	EPA5	EPA5	2x2 High	70	7.0	≥2
Note 1: The propagation conditions for Cell 1, Cell 2 and Cell 3 are statistically independent. Note 2: The correlation matrix and antenna configuration apply for Cell 1, Cell 2 and Cell 3. Note 3: SNR corresponds to $\hat{E}_s / N_{oc2}$ of Cell 1. Note 4: Cell 1 reference channel is modified: PDSCH other than SIB1/paging and its associated PDCCH/PCFICH are transmitted in the serving cell subframe when the subframe is overlapped with the ABS subframe of aggressor cell and the subframe is available in the definition of the reference channel. Note 5: The maximum throughput is calculated from the total Payload in 9 subframes, averaged over 40ms.											

**8.2.1.4.2A FDD PDSCH Closed Loop Multi Layer Spatial Multiplexing 2x2 – Enhanced Performance Requirement Type C**

**Editor’s notes: This test case is incomplete. The following items are missing or are incomplete:**

- Test tolerances are undefined
- The SNR values in minimum and test requirement are still in square brackets
- The minimum testing time in Annex G is still undefined.

**8.2.1.4.2A.1 Test purpose**

To verify the UE's ability to receive a predefined test signal, representing a multi-path fading channel that is determined by the SNR with a percentage of the information bit throughput for a specified downlink Reference Measurement Channel (RMC) not falling below a specified value for transmission on two antenna ports using closed loop rank-two spatial multiplexing with wideband and frequency selective precoding.

**8.2.1.4.2A.2 Test applicability**

This test applies to all types of E-UTRA FDD release 12 and forward UE of Category 2 or higher that support enhanced receiver Type C.



## 8.2.1.4.2A.3 Minimum conformance requirements

The requirements are specified in terms of the percentage of information bit throughput for the downlink reference measurement channels specified in Annex A clause A.3.3.2, with the addition of the relevant parameters in Tables 8.2.1-1 and 8.2.1.4.2A.3-1 and the downlink physical channel setup according to Table C.3.2-1 in Annex C.

Using this configuration the fraction of maximum throughput percentage shall meet or exceed the minimum requirements specified in Table 8.2.1.4.2A.3-2 for the specified SNR.

**Table 8.2.1.4.2A.3-1: Test Parameters for Testing Multi-Layer Spatial Multiplexing**

Parameter	Unit	Test 1	
Downlink power allocation	$\rho_A$	dB	-3
	$\rho_B$	dB	-3 (Note 1)
	$\sigma$	dB	0
$N_{oc}$ at antenna port	dBm/15kHz	-98	
Precoding granularity	PRB	50	
PMI delay (Note 2)	ms	8	
Reporting interval	ms	1	
Reporting mode		PUSCH 3-1	
CodeBookSubsetRestriction bitmap		110000	
PDSCH transmission mode		4	
Note 1: $P_B = 1$ .			
Note 2: If the UE reports in an available uplink reporting instance at subframe SF#n based on PMI estimation at a downlink SF not later than SF#(n-4), this reported PMI cannot be applied at the eNB downlink before SF#(n+4).			

**Table 8.2.1.4.2A.3-2: Enhanced Performance Requirement Type C, Multi-Layer Spatial Multiplexing (FRC)**

Test number	Bandwidth	Reference Channel	OCNG Pattern	Propagation Condition	Correlation Matrix and Antenna Configuration	Reference value		UE Category
						Fraction of Maximum Throughput (%)	SNR (dB)	
1	10 MHz	R.11 FDD	OP.1 FDD	ETU70	2x2 Medium	70	[18.3]	≥2

The normative reference for this requirement is TS 36.101 [2] clause 8.2.1.4.2A.

## 8.2.1.4.2A.4 Test description

## 8.2.1.4.2A.4.1 Initial conditions

Initial conditions are a set of test configurations the UE needs to be tested in and the steps for the SS to take with the UE to reach the correct measurement state.

Configurations of PDSCH and PDCCH before measurement are specified in Annex C.2.

Test Environment: Normal, as defined in TS 36.508 [7] clause 4.1.

Frequencies to be tested: Mid Range, as defined in TS 36.508 [7] clause 4.3.1.1.

Channel Bandwidths to be tested: As specified per test number in Table 8.2.1.4.2A.3-2 as defined in TS 36.508 [7] clause 4.3.1.1.

1. Connect the SS, the faders and AWGN noise sources to the UE antenna connectors as shown in TS 36.508 [7] Annex A, Figure A.10 for antenna configuration 2x2.
2. The parameter settings for the cell are set up according to Tables 8.2.1-1 and 8.2.1.4.2A.3-1 as appropriate.

3. Downlink signals are initially set up according to Annex C.0, C.1 and Annex C.3.2 and uplink signals according to Annex H.1 and H.3.2.
4. Propagation conditions are set according to Annex B.0.
5. Ensure the UE is in State 3A-RF according to TS 36.508 [7] clause 5.2A.2. Message contents are defined in clause 8.2.1.4.2A.4.3.

8.2.1.4.2A.4.2 Test procedure

1. SS transmits PDSCH via PDCCH DCI format 2 for C\_RNTI to transmit the DL RMC according to Tables 8.2.1.4.2A.3-1 and 8.2.1.4.2A.3-2. The SS sends downlink MAC padding bits on the DL RMC.
2. SS schedules the UL transmission to carry the PUSCH CQI feedback via PDCCH DCI format 0 with CQI request bit set to 1 and I\_MCS=29 and N\_PRB allocated to be less or equal to 4.
3. Set the parameters of the bandwidth, MCS, reference channel, the propagation condition, the correlation matrix, antenna configuration and the SNR according to Table 8.2.1.4.2A.5-2 as appropriate.
4. Measure the average throughput for a duration sufficient to achieve statistical significance according to Annex G clause G.3. Count the number of NACKs, ACKs and statDTXs on the UL during the test interval and decide pass or fail according to Tables G.3.5 and G.3.6 in Annex G clause G.3.

8.2.1.4.2A.4.3 Message contents

Message contents are according to TS 36.508 [7] clause 4.6 with the following exceptions:

**Table 8.2.1.4.2A.4.3-1: PhysicalConfigDedicated-DEFAULT**

Derivation Path: 36.331 clause 6.3.2			
Information Element	Value/remark	Comment	Condition
PhysicalConfigDedicated-DEFAULT ::= SEQUENCE {			
antennaInfo CHOICE {			
antennaInfoDedicated ::= SEQUENCE {			
transmissionMode	tm4		
codebookSubsetRestriction CHOICE {			
n2TxAntenna-tm4	110000		
}			
ue-TransmitAntennaSelection CHOICE {			
release	NULL		
}			
}			
}			

**Table 8.2.1.4.2A.4.3-2: CQI-ReportConfig-DEFAULT**

Derivation Path: 36.331 clause 6.3.2			
Information Element	Value/remark	Comment	Condition
CQI-ReportConfig-DEFAULT ::= SEQUENCE {			
cqi-ReportModeAperiodic	rm31		
nomPDSCH-RS-EPRE-Offset	0		
cqi-ReportPeriodic	Not present		
}			

8.2.1.4.2A.5 Test requirement

Table 8.2.1.4.2A.3-1 define the primary level settings.

The fraction of maximum throughput percentage for the downlink reference measurement channels specified in Annex A clause A.3.3.2 for each throughput test shall meet or exceed the specified value in Table 8.2.1.4.2A.5-2 for the specified SNR including test tolerances for all throughput tests.

**Table 8.2.1.4.2A.5-1: Test requirement for Enhanced Performance Requirement Type C, Multi-Layer Spatial Multiplexing (FRC)**

Test number	Band-width	Reference Channel	OCNG Pattern	Propagation Condition	Correlation Matrix and Antenna Configuration	Reference value		UE Category
						Fraction of Maximum Throughput (%)	SNR (dB)	
1	10 MHz	R.11 FDD	OP.1 FDD	ETU70	2x2 Medium	70	[18.3] +TT	≥2

#### 8.2.1.4.2 FDD PDSCH Closed Loop Single/Multi Layer Spatial Multiplexing 4x2

##### 8.2.1.4.2.1 Test purpose

To verify the UE's ability to receive a predefined test signal, representing a multi-path fading channel that is determined by the SNR with a percentage of the information bit throughput for a specified downlink Reference Measurement Channel (RMC) not falling below a specified value for transmission on two antenna ports using closed-loop spatial multiplexing.

##### 8.2.1.4.2.2 Test applicability

This test applies to all types of E-UTRA FDD UE release 8.

##### 8.2.1.4.2.3 Minimum conformance requirements

The requirements are specified in terms of the percentage of information bit throughput for the downlink reference measurement channels specified in Annex A clause A.3.3.2, with the addition of the relevant parameters in Tables 8.2.1-1, 8.2.1.4.2.3-1 and 8.2.1.4.2.3-3 and the downlink physical channel setup according to Table C.3.2-1 in Annex C.

Using this configuration the fraction of maximum throughput percentage shall meet or exceed the minimum requirements specified in Tables 8.2.1.4.2.3-2 and 8.2.1.4.2.3-4 for the specified SNR. For single-layer spatial multiplexing closed loop rank-one performance with wideband and frequency selective precoding is specified. For multi-layer spatial multiplexing closed loop rank-two performance with wideband and frequency selective precoding is specified.

**Table 8.2.1.4.2.3-1: Test Parameters for Testing Single-Layer Spatial Multiplexing**

Parameter	Unit	Test 1
Downlink power allocation	$\rho_A$	-6
	$\rho_B$	-6 (Note 1)
	$\sigma$	3
$N_{oc}$ at antenna port	dBm/15kHz	-98
Precoding granularity	PRB	6
PMI delay (Note 2)	ms	8
Reporting interval	ms	1
Reporting mode		PUSCH 1-2
CodeBookSubsetRestriction bitmap		00000000000000 00000000000000 00000000000000 00000011111111 11111111
PDSCH transmission mode		4
Note 1: $P_B = 1$		
Note 2:		

**Table 8.2.1.4.2.3-2: Minimum performance Single-Layer Spatial Multiplexing (FRC)**

Test number	Band-width	Reference Channel	OCNG Pattern	Propagation Condition	Correlation Matrix and Antenna Configuration	Reference value		UE Category
						Fraction of Maximum Throughput (%)	SNR (dB)	
1	10 MHz	R.13 FDD	OP.1 FDD	EVA5	4x2 Low	70	-3.2	1-5

**Table 8.2.1.4.2.3-3: Test Parameters for Testing Multi-Layer Spatial Multiplexing**

Parameter	Unit	Test 2
Downlink power allocation	$\rho_A$	-6
	$\rho_B$	-6 (Note 1)
	$\sigma$	3
$N_{oc}$ at antenna port	dBm/15kHz	-98
Precoding granularity	PRB	6
PMI delay (Note 2)	ms	8
Reporting interval	ms	1
Reporting mode		PUSCH 1-2
CodeBookSubsetRestriction bitmap		00000000000000 00000000000000 00001111111111 11111100000000 00000000
PDSCH transmission mode		4
Note 1: $P_B = 1$		
Note 2: If the UE reports in an available uplink reporting instance at subframe SF#n based on PMI estimation at a downlink SF not later than SF#(n-4), this reported PMI cannot be applied at the eNB downlink before SF#(n+4)		

**Table 8.2.1.4.2.3-4: Minimum performance Multi-Layer Spatial Multiplexing (FRC)**

Test number	Band-width	Reference Channel	OCNG Pattern	Propagation Condition	Correlation Matrix and Antenna Configuration	Reference value		UE Category
						Fraction of Maximum Throughput (%)	SNR (dB)	
2	10 MHz	R.14 FDD	OP.1 FDD	EVA5	4x2 Low	70	10.5	2-5

The normative reference for this requirement is TS 36.101 [2] clause 8.2.1.4.

#### 8.2.1.4.2.4 Test description

##### 8.2.1.4.2.4.1 Initial conditions

Initial conditions are a set of test configurations the UE needs to be tested in and the steps for the SS to take with the UE to reach the correct measurement state.

Configurations of PDSCH and PDCCH before measurement are specified in Annex C.2.

Test Environment: Normal, as defined in TS 36.508 [7] clause 4.1.

Frequencies to be tested: Mid Range, as defined in TS 36.508 [7] clause 4.3.1.1.

Channel Bandwidths to be tested: As specified per test number in Tables 8.2.1.4.2.3-2 and 8.2.1.4.2.3-4 as defined in TS 36.508 [7] clause 4.3.1.1.

1. Connect the SS, the faders and AWGN noise sources to the UE antenna connectors as shown in TS 36.508 [7] Annex A, Figure A.11 for antenna configuration 4x2.

2. The parameter settings for the cell are set up according to Tables 8.2.1-1, 8.2.1.4.2.3-1 and 8.2.1.4.2.3-3 as appropriate.
3. Downlink signals are initially set up according to Annex C.1 and Annex C.3.2 and uplink signals according to Annex H.1 and H.3.2.
4. Propagation conditions are set according to Annex B.0.
5. Ensure the UE is in State 3A-RF according to TS 36.508 [7] clause 5.2A.2. Message contents are defined in clause 8.2.1.4.2.4.3.

8.2.1.4.2.4.2 Test procedure

1. For single-layer spatial multiplexing, SS transmits PDSCH via PDCCH DCI format 2 for C\_RNTI to transmit the DL RMC according to Tables 8.2.1.4.2.3-1 and 8.2.1.4.2.3-2. For multi-layer spatial multiplexing, SS transmits PDSCH via PDCCH DCI format 2 for C\_RNTI to transmit the DL RMC according to Tables 8.2.1.4.2.3-3 and 8.2.1.4.2.3-4. The SS sends downlink MAC padding bits on the DL RMC.
2. SS schedules the UL transmission to carry the PUSCH CQI feedback via PDCCH DCI format 0 with CQI request bit set to 1 and I\_MCS=29 and N\_PRB allocated to be less or equal to 4.
3. Set the parameters of the bandwidth, MCS, reference channel, the propagation condition, the correlation matrix, antenna configuration and the SNR according to Tables 8.2.1.4.2.5-1 and 8.2.1.4.2.5-2 as appropriate.
4. Measure the average throughput for a duration sufficient to achieve statistical significance according to Annex G clause G.3. Count the number of NACKs, ACKs and statDTXs on the UL during the test interval and decide pass or fail according to Tables G.3.5 and G.3.6 in Annex G clause G.3.
5. Repeat steps from 1 to 4 for each test interval in Tables 8.2.1.4.2.5-1 and 8.2.1.4.2.5-2 as appropriate.

8.2.1.4.2.4.3 Message contents

Message contents are according to TS 36.508 [7] clause 4.6 with the following exceptions:

**Table 8.2.1.4.2.4.3-1: PDSCH-ConfigDedicated-DEFAULT: Additional FDD PDSCH closed loop spatial multiplexing performance downlink power allocation for Test numbers 1, 2**

Derivation Path: TS 36.508 [7] clause 4.6.3, Table 4.6.3-6 PDSCH-ConfigDedicated-DEFAULT			
Information Element	Value/remark	Comment	Condition
PDSCH-ConfigDedicated-DEFAULT ::= SEQUENCE {			
p-a	dB-6		
}			

**Table 8.2.1.4.2.4.3-2: PhysicalConfigDedicated-DEFAULT: Additional FDD PDSCH closed loop single-layer spatial multiplexing performance downlink power for Test number 1**

Derivation Path: 36.331 clause 6.3.2			
Information Element	Value/remark	Comment	Condition
PhysicalConfigDedicated-DEFAULT ::= SEQUENCE {			
antennaInfo CHOICE {			
antennaInfoDedicated ::= SEQUENCE {			
transmissionMode	tm4		
codebookSubsetRestriction CHOICE {			
n4TxAntenna-tm4	00000000000000000000 00000000000000000000 00000000111111111111 1111		
}			
ue-TransmitAntennaSelection CHOICE {			
release	NULL		
}			
}			
}			

**Table 8.2.1.4.2.4.3-3: PhysicalConfigDedicated-DEFAULT: Additional FDD PDSCH closed loop multi-layer spatial multiplexing performance downlink power allocation Test number 2**

Derivation Path: 36.331 clause 6.3.2			
Information Element	Value/remark	Comment	Condition
PhysicalConfigDedicated-DEFAULT ::= SEQUENCE {			
antennaInfo CHOICE {			
antennaInfoDedicated ::= SEQUENCE {			
transmissionMode	tm4		
codebookSubsetRestriction CHOICE {			
n4TxAntenna-tm4	00000000000000000000 00000000000011111111 11111111100000000000 0000		
}			
ue-TransmitAntennaSelection CHOICE {			
release	NULL		
}			
}			
}			

**Table 8.2.1.4.2.4.3-4: CQI-ReportConfig-DEFAULT: Additional FDD PDSCH closed loop single/multi-layer spatial multiplexing performance downlink power allocation Test number 1, 2**

Derivation Path: 36.331 clause 6.3.2			
Information Element	Value/remark	Comment	Condition
CQI-ReportConfig-DEFAULT ::= SEQUENCE {			
cqi-ReportModeAperiodic	rm12		
nomPDSCH-RS-EPRE-Offset	0		
cqi-ReportPeriodic	Not present		
}			

8.2.1.4.2.5 Test requirement

Tables 8.2.1.4.2.3-1 and 8.2.1.4.2.3-3 define the primary level settings.

The fraction of maximum throughput percentage for the downlink reference measurement channels specified in Annex A clause A.3.3.2 for each throughput test shall meet or exceed the specified value in Tables 8.2.1.4.25-1 and 8.2.1.4.2.5-2 for the specified SNR including test tolerances for all throughput tests.

**Table 8.2.1.4.2.5-1: Test requirement Single-Layer Spatial Multiplexing (FRC)**

Test number	Band-width	Reference Channel	OCNG Pattern	Propagation Condition	Correlation Matrix and Antenna Configuration	Reference value		UE Category
						Fraction of Maximum Throughput (%)	SNR (dB)	
1	10 MHz	R.13 FDD	OP.1 FDD	EVA5	4x2 Low	70	-2.3	1-5

**Table 8.2.1.4.2.5-2: Test requirement Multi-Layer Spatial Multiplexing (FRC)**

Test number	Band-width	Reference Channel	OCNG Pattern	Propagation Condition	Correlation Matrix and Antenna Configuration	Reference value		UE Category
						Fraction of Maximum Throughput (%)	SNR (dB)	
2	10 MHz	R.14 FDD	OP.1 FDD	EVA5	4x2 Low	70	11.4	2-5

8.2.1.4.2\_1 FDD PDSCH Closed Loop Single/Multi Layer Spatial Multiplexing 4x2 (Release 9 and forward)

8.2.1.4.2\_1.1 Test purpose

Same test purpose as in clause 8.2.1.4.2.1

8.2.1.4.2\_1.2 Test applicability

This test applies to all types of E-UTRA FDD UE release 9 and forward.

8.2.1.4.2\_1.3 Minimum conformance requirements

Same minimum conformance requirements as in clause 8.2.1.4.2.3 with the following exceptions:

- Instead of Table 8.2.1.4.2.3-2 → use Table 8.2.1.4.2\_1.3-1.
- Instead of Table 8.2.1.4.2.3-4 → use Table 8.2.1.4.2\_1.3-2.

**Table 8.2.1.4.2\_1.3-1: Minimum performance Single-Layer Spatial Multiplexing (FRC)**

Test number	Band-width	Reference Channel	OCNG Pattern	Propagation Condition	Correlation Matrix and Antenna Configuration	Reference value		UE Category
						Fraction of Maximum Throughput (%)	SNR (dB)	
1	10 MHz	R.13 FDD	OP.1 FDD	EVA5	4x2 Low	70	-3.2	1-8

**Table 8.2.1.4.2\_1.3-2: Minimum performance Multi-Layer Spatial Multiplexing (FRC)**

Test number	Band-width	Reference Channel	OCNG Pattern	Propagation Condition	Correlation Matrix and Antenna Configuration	Reference value		UE Category
						Fraction of Maximum Throughput (%)	SNR (dB)	
2	10 MHz	R.36 FDD	OP.1 FDD	EPA5	4x2 Low	70	14.7	2-8

The normative reference for this requirement is TS 36.101 [2] clause 8.2.1.4.

8.2.1.4.2\_1.4 Test description

Same test description as in clause 8.2.1.4.2.4 with the following exceptions:

- Instead of Table 8.2.1.4.2.3-2 → use Table 8.2.1.4.2\_1.3-1.
- Instead of Table 8.2.1.4.2.3-4 → use Table 8.2.1.4.2\_1.3-2.
- Instead of Table 8.2.1.4.2.5-1 → use Table 8.2.1.4.2\_1.5-1.
- Instead of Table 8.2.1.4.2.5-2 → use Table 8.2.1.4.2\_1.5-2.

8.2.1.4.2\_1.5 Test requirement

Same test requirement as in clause 8.2.1.4.2.5 with the following exceptions:

- Instead of Table 8.2.1.4.2.5-1 → use Table 8.2.1.4.2\_1.5-1.
- Instead of Table 8.2.1.4.2.5-2 → use Table 8.2.1.4.2\_1.5-2.

**Table 8.2.1.4.2\_1.5-1: Test requirement Single-Layer Spatial Multiplexing (FRC)**

Test number	Band-width	Reference Channel	OCNG Pattern	Propagation Condition	Correlation Matrix and Antenna Configuration	Reference value		UE Category
						Fraction of Maximum Throughput (%)	SNR (dB)	
1	10 MHz	R.13 FDD	OP.1 FDD	EVA5	4x2 Low	70	-2.3	1-8

**Table 8.2.1.4.2\_1.5-2: Test requirement Multi-Layer Spatial Multiplexing (FRC)**

Test number	Band-width	Reference Channel	OCNG Pattern	Propagation Condition	Correlation Matrix and Antenna Configuration	Reference value		UE Category
						Fraction of Maximum Throughput (%)	SNR (dB)	
2	10 MHz	R.36 FDD	OP.1 FDD	EPA5	4x2 Low	70	+15.6	2-8

8.2.1.4.2\_A FDD PDSCH Closed Loop Multi Layer Spatial Multiplexing 4x2 for CA

8.2.1.4.2\_A.1 FDD PDSCH Closed Loop Multi Layer Spatial Multiplexing 4x2 for CA (2DL CA)

8.2.1.4.2\_A.1.1 Test purpose

To verify the UE's ability to receive a predefined test signal, representing a multi-path fading channel that is determined by the SNR with a percentage of the information bit throughput for a specified downlink Reference Measurement Channel (RMC) not falling below a specified value for transmission on two antenna ports using closed-loop spatial multiplexing.

8.2.1.4.2\_A.1.2 Test applicability

This test applies to

E-UTRA FDD release10 and forward UE of category 3 or higher which supports inter-band OR intra-band contiguous DL CA.

**Editor's note: RAN4 is still in discussion to cover in the future also test points with lower UE categories than 3.**

This test also applies to E-UTRA FDD release 11 and forward UE of category 3 or higher that supports intra-band non-contiguous DL CA.



8.2.1.4.2\_A.1.3 Minimum conformance requirements

The requirements are specified in terms of the percentage of information bit throughput for the downlink reference measurement channels specified in Annex A clause A.3.3.2, with the addition of the relevant parameters in Tables 8.2.1-1, 8.2.1.4.2\_A.1.3-1 and the downlink physical channel setup according to Table C.3.2-1 in Annex C.

Using this configuration the fraction of maximum throughput percentage shall meet or exceed the minimum requirements specified in Tables 8.2.1.4.2\_A.1.3-2 for the specified SNR. For multi-layer spatial multiplexing closed loop rank-two performance with wideband and frequency selective precoding is specified.

**Table 8.2.1.4.2\_A.1.3-1: Test Parameters for Testing Multi-Layer Spatial Multiplexing for CA**

Parameter	Unit	Test 1	Test 2
Downlink power allocation	$\rho_A$	dB	-6
	$\rho_B$	dB	-6 (Note 1)
	$\sigma$	dB	3
$N_{oc}$ at antenna port	dBm/15kHz	-98	-98
Precoding granularity	PRB	6	8
PMI delay (Note 2)	ms	8	8
Reporting interval	ms	1	1
Reporting mode		PUSCH 1-2	PUSCH 1-2
CodeBookSubsetRestriction bitmap		000000000000 000000000000 000000111111 111111110000 000000000000	000000000000 000000000000 000000111111 111111110000 000000000000
CSI request field (Note 3)		'10'	
PDSCH transmission mode		4	
Note 1: $P_B = 1$ . Note 2: If the UE reports in an available uplink reporting instance at subframe SF#n based on PMI estimation at a downlink SF not later than SF#(n-4), this reported PMI cannot be applied at the eNB downlink before SF#(n+4). Note 3: Multiple CC-s under test are configured as the 1 <sup>st</sup> set of serving cells by higher layers. Note 4: ACK/NACK bits are transmitted using PUSCH with PUCCH format 1b with channel selection configured. Note 5: The same PDSCH transmission mode is applied to each component carrier.			

**Table 8.2.1.4.2\_A.1.3-2: Minimum performance Multi-Layer Spatial Multiplexing (FRC) for CA**

Test num.	Band-width	Reference channel	OCNG pattern	Propagation condition	Correlation matrix and antenna config.	Reference value		UE category
						Fraction of maximum throughput (%)	SNR (dB)	
1	2x10 MHz	R.14 FDD	OP.1 FDD (Note 1)	EVA5	4x2 Low	70	10.8	3-8
2	2x20 MHz	R.14-3 FDD	OP.1 FDD (Note 1)	EVA5	4x2 Low	70	10.9	5-8

Note 1: The OCNG pattern applies for each CC.

The normative reference for this requirement is TS 36.101 [2] clause 8.2.1.4.

8.2.1.4.2\_A.1.4 Test description

8.2.1.4.2\_A.1.4.1 Initial conditions

Initial conditions are a set of test configurations the UE needs to be tested in and the steps for the SS to take with the UE to reach the correct measurement state.

Configurations of PDSCH and PDCCH before measurement are specified in Annex C.2.

Test Environment: Normal, as defined in TS 36.508 [7] clause 4.1.

Frequencies to be tested: Maximum Wgap for Intra-band non-contiguous CA, otherwise Mid Range, as defined in TS 36.508 [7] clause 4.3.1.

Channel Bandwidths to be tested: Select one according to Table 8.2.1.4.2\_A.1.4.1-1.

CA Capability to be tested: Select one according to Table 8.2.1.4.2\_A.1.4.1-1.

**Table 8.2.1.4.2\_A.1.4.1-1: Test point selection for TM4 2DL CA**

CA Capability	Bandwidth Combination	
	10+10	20+20
Inter-band CA (two bands) (CA2_A2)	Test1	Test2
Intra-band contiguous CA (CA2_C)	Test1	Test2
Intra-band non-contiguous CA (with two sub-blocks) (CA2_N2)	Test1	Test2
Note1: Only one test point is tested. Select any one of the UE supported CA capabilities and then moving from left to right select the first CA bandwidth combination supported by the UE within the chosen CA capability.		

1. Connect the SS, the faders and AWGN noise sources to the UE antenna connectors as shown in TS 36.508 [7] Annex A, Figure group A.46 as appropriate.
2. The parameter settings for the cell are set up according to Tables 8.2.1-1, 8.2.1.4.2\_A.1.3-1 as appropriate.
3. Downlink signals for PCC are initially set up according to Annex C.1 and Annex C.3.2 and uplink signals according to Annex H.1 and H.3.2.
4. Propagation conditions are set according to Annex B.0.
5. Ensure the UE is in State 3A-RF according to TS 36.508 [7] clause 5.2A.2. Message contents are defined in clause 8.2.1.4.2\_A.1.4.3.

#### 8.2.1.4.2\_A.1.4.2 Test procedure

1. Configure SCC according to Annex C.0, C.1 and Annex C.3.2 for all downlink physical channels.
2. The SS shall configure SCC as per TS 36.508 [7] clause 5.2A.4. Message contents for *PDSCH-ConfigDedicated-DEFAULT* is defined in Table 8.2.1.4.2\_A.1.4.3-1, *PhysicalConfigDedicated-DEFAULT* is defined in Table 8.2.1.4.2\_A.1.4.3-2, *PhysicalConfigDedicatedSCell-r10-DEFAULT* is defined in Table 8.2.1.4.2\_A.1.4.3-2A, *CQI-ReportConfig-r10-DEFAULT* is defined in Table 8.2.1.4.2\_A.1.4.3-4, *CQI-ReportAperiodic-r10-DEFAULT* is defined in Table 8.2.1.4.2\_A.1.4.3-5, *CQI-ReportConfigSCell-r10-DEFAULT* is defined in Table 8.2.1.4.2\_A.1.4.3-6, *PUSCH-ConfigDedicated-DEFAULT* is defined in Table 8.2.1.4.2\_A.1.4.3-7.
3. SS activates SCC by sending the activation MAC-CE (Refer TS 36.321 [13], clauses 5.13, 6.1.3.8). Wait for at least 2 seconds (Refer TS 36.133, clauses 8.3.3.2).
4. For multi-layer spatial multiplexing, SS transmits PDSCH via PDCCH DCI format 2 for C\_RNTI to transmit the DL RMC according to Tables 8.2.1.4.2\_A.1.3-1 and 8.2.1.4.2\_A.1.3-3. The SS sends downlink MAC padding bits on the DL RMC.
5. SS schedules the UL transmission to carry the PUSCH CSI feedback via PDCCH DCI format 0 with CSI request bit set to '10' and I\_MCS=29 and N\_PRB allocated to be less or equal to 20.
6. Set the parameters of the bandwidth, MCS, reference channel, the propagation condition, the correlation matrix, antenna configuration and the SNR according to Tables 8.2.1.4.2\_A.1.5-1 as appropriate.
7. Measure the average throughput for a duration sufficient to achieve statistical significance according to Annex G clause G.3A.5 on each of the component carriers. Count the number of NACKs, ACKs and statDTXs on the UL during the test interval and decide pass or fail according to Tables G.3.5 and G.3.6 in Annex G clause G.3.

8.2.1.4.2\_A.1.4.3 Message contents

Message contents are according to TS 36.508 [7] clauses 5.5 and 4.6 with the following exceptions:

**Table 8.2.1.4.2\_A.1.4.3-1: PDSCH-ConfigDedicated-DEFAULT: Additional FDD PDSCH closed loop spatial multiplexing performance downlink power allocation**

Derivation Path: TS 36.508 [7] clause 4.6.3, Table 4.6.3-6 PDSCH-ConfigDedicated-DEFAULT			
Information Element	Value/remark	Comment	Condition
PDSCH-ConfigDedicated-DEFAULT ::= SEQUENCE {			
p-a	dB-6		
}			

**Table 8.2.1.4.2\_A.1.4.3-2: PhysicalConfigDedicated-DEFAULT: Additional FDD PDSCH closed loop multi-layer spatial multiplexing performance downlink power allocation**

Derivation Path: TS 36.508 [7] clause 5.5.1.2, Table 5.5.1.2-1 PhysicalConfigDedicated-DEFAULT			
Information Element	Value/remark	Comment	Condition
PhysicalConfigDedicated-DEFAULT ::= SEQUENCE {			
antennaInfo CHOICE {			
explicitValue ::= SEQUENCE {			
transmissionMode	tm4		
codebookSubsetRestriction CHOICE {			
n4TxAntenna-tm4	00000000000000000000 00000000000011111111 11111111000000000000 0000		
}			
ue-TransmitAntennaSelection CHOICE {			
release	NULL		
}			
}			
cqi-ReportConfig-r10	CQI-ReportConfig-r10-DEFAULT		
}			

**Table 8.2.1.4.2\_A.1.4.3-2A: PhysicalConfigDedicatedSCell-r10-DEFAULT: Additional FDD PDSCH closed loop multi-layer spatial multiplexing performance downlink power allocation**

Derivation Path: 36.508 clause 4.6.3 Table 4.6.3-6A			
Information Element	Value/remark	Comment	Condition
PhysicalConfigDedicatedSCell-r10-DEFAULT ::= SEQUENCE {			
nonUL-Configuration-r10 SEQUENCE {			
antennaInfo-r10 SEQUENCE {			
transmissionMode-r10	tm4		
codebookSubsetRestriction-r10	00000000000000000000 00000000000011111111 11111111000000000000 0000	BIT STRING	
ue-TransmitAntennaSelection CHOICE {			
release	NULL		
}			
}			
ul-Configuration-r10 SEQUENCE {			
cqi-ReportConfigSCell-r10	CQI-ReportConfigSCell-r10-DEFAULT		
}			
}			

**Table 8.2.1.4.2\_A.1.4.3-3: CQI-ReportConfig-DEFAULT: Additional FDD PDSCH closed loop multi-layer spatial multiplexing performance downlink power allocation**

Derivation Path: 36.508 clause 4.6.3 Table 4.6.3-2			
Information Element	Value/remark	Comment	Condition
CQI-ReportConfig-DEFAULT ::= SEQUENCE {			RBC
cqi-ReportModeAperiodic	rm12		
nomPDSCH-RS-EPRE-Offset	0		
cqi-ReportPeriodic	Not present		
}			

**Table 8.2.1.4.2\_A.1.4.3-4: CQI-ReportConfig-r10-DEFAULT: Additional FDD PDSCH closed loop multi-layer spatial multiplexing performance downlink power allocation**

Derivation Path: 36.508 clause 4.6.3 Table 4.6.3-2AA			
Information Element	Value/remark	Comment	Condition
CQI-ReportConfig-r10 ::= SEQUENCE {			
cqi-ReportAperiodic-r10	CQI-ReportAperiodic-r10-DEFAULT		
nomPDSCH-RS-EPRE-Offset	0		
cqi-ReportPeriodic-r10	Not present		
pmi-RI-Report-r9	Not present		
csi-SubframePatternConfig-r10	Not present		
}			

**Table 8.2.1.4.2\_A.1.4.3-5: CQI-ReportAperiodic-r10-DEFAULT: Additional FDD PDSCH closed loop multi-layer spatial multiplexing performance downlink power allocation**

Derivation Path: 36.508 clause 4.6.3 Table 4.6.3-1A			
Information Element	Value/remark	Comment	Condition
CQI-ReportAperiodic-r10 ::= CHOICE {			
setup SEQUENCE {			
cqi-ReportModeAperiodic-r10	rm12		
aperiodicCSI-Trigger-r10 ::= SEQUENCE {			
trigger1-r10	11000000	P-Cell, S-Cell report	
trigger2-r10	00000000	No report	
}			
}			
}			

**Table 8.2.1.4.2\_A.1.4.3-6: CQI-ReportConfigSCell-r10-DEFAULT: Additional FDD PDSCH closed loop multi-layer spatial multiplexing performance downlink power allocation**

Derivation Path: 36.508 clause 4.6.3 Table 4.6.3-2AB			
Information Element	Value/remark	Comment	Condition
CQI-ReportConfigSCell-r10 ::= SEQUENCE {			
cqi-ReportModeAperiodic-r10	rm12		
nomPDSCH-RS-EPRE-Offset-r10	0		
cqi-ReportPeriodicSCell-r10	Not present		
pmi-RI-Report-r10	Not present		
}			

**Table 8.2.1.4.2\_A.1.4.3-7: PUSCH-ConfigDedicated-DEFAULT**

Derivation Path: 36.331 clause 6.3.2			
Information Element	Value/remark	Comment	Condition
PUSCH-ConfigDedicated-DEFAULT ::= SEQUENCE {			
betaOffset-ACK-Index	5		
betaOffset-RI-Index	6		
betaOffset-CQI-Index	5		
}			

8.2.1.4.2\_A.1.5 Test requirement

Tables 8.2.1.4.2\_A.1.3-1 define the primary level settings.

The fraction of maximum throughput percentage for the downlink reference measurement channels specified in Annex A clause A.3.4.2 for each throughput test shall meet or exceed the specified value in Tables 8.2.1.4.2\_A.1.5-1 for the specified SNR including test tolerances for all throughput tests.

**Table 8.2.1.4.2\_A.1.5-1: Test requirement Multi-Layer Spatial Multiplexing (FRC) for CA**

Test num.	Band-width	Reference channel	OCNG pattern	Propagation condition	Correlation matrix and antenna config.	Reference value		UE category
						Fraction of maximum throughput (%)	SNR (dB)	
1	2x10 MHz	R.14 FDD	OP.1 FDD (Note 1)	EVA5	4x2 Low	70	11.7	3-8
2	2x20 MHz	R.14-3 FDD	OP.1 FDD (Note 1)	EVA5	4x2 Low	70	11.8	5-8

Note 1: The OCNG pattern applies for each CC.

Decide pass or fail for each subtest according to Annex G.3A.4. Decide the entire test pass or fail according to Annex G.3A.6.

#### 8.2.1.4.2\_A.2 FDD PDSCH Closed Loop Multi Layer Spatial Multiplexing 4x2 for CA (3DL CA)

**Editor's notes: This test case is incomplete. The following items are missing or incomplete:**

**- The SNR values for minimum conformance and test requirements are still in brackets.**

##### 8.2.1.4.2\_A.2.1 Test purpose

To verify the UE's ability to receive a predefined test signal, representing a multi-path fading channel that is determined by the SNR with a percentage of the information bit throughput for a specified downlink Reference Measurement Channel (RMC) not falling below a specified value for transmission on two antenna ports using closed-loop spatial multiplexing.

##### 8.2.1.4.2\_A.2.2 Test applicability

This test case applies to all types of E-UTRA FDD release 10 and forward UE of category 5 or higher that support 3DL Intra-band contiguous CA or 3DL Inter-band CA, or 3DL with Intra-band contiguous and Inter-band CA.

This test case also applies to all types of E-UTRA FDD release 11 and forward UE of category 5 or higher that support 3DL with Intra-band non-contiguous and Inter-band CA, or 3DL with Intra-band non-contiguous and Intra-band contiguous CA.

##### 8.2.1.4.2\_A.2.3 Minimum conformance requirements

For CA with 3 DL CCs, the requirements are specified in Table 8.2.1.4.2\_A.2.3-3, based on single carrier requirement specified in Table 8.2.1.4.2\_A.2.3-2, with the addition of the parameters in Table 8.2.1.4.2\_A.2.3-1 and the downlink physical channel setup according to Table C.3.2-1 in Annex C.

**Table 8.2.1.4.2\_A.2.3-1: Test Parameters for Multi-Layer Spatial Multiplexing (FRC) for CA**

Parameter	Unit	Value
Downlink power allocation	$\rho_A$	dB
	$\rho_B$	dB
	$\sigma$	dB
$N_{oc}$ at antenna port	dBm/15kHz	-98
Precoding granularity	PRB	4 for 3MHz and 5MHz CCs, 6 for 10MHz CCs, 8 for 15MHz and 20MHz CCs
PMI delay (Note 2)	ms	8
Reporting interval	ms	1
Reporting mode		PUSCH 1-2
CodeBookSubsetRestriction bitmap		00000000000000000000000000000000 0011111111111111111111000000000000 0000
CSI request field (Note 3)		'10'
PDSCH transmission mode		4
Note 1: $P_B = 1$ . Note 2: If the UE reports in an available uplink reporting instance at subframe SF#n based on PMI estimation at a downlink SF not later than SF#(n-4), this reported PMI cannot be applied at the eNB downlink before SF#(n+4). Note 3: Multiple CC-s under test are configured as the 1 <sup>st</sup> set of serving cells by higher layers. Note 4: ACK/NACK bits are transmitted using PUSCH with PUCCH format 3 with channel selection configured for Tests in Table 8.2.1.4.2_A.2.3-3. Note 5: The same PDSCH transmission mode is applied to each component carrier.		

**Table 8.2.1.4.2\_A.2.3-2: Single carrier performance for multiple CA configurations**

Band-width	Reference channel	OCNG pattern	Propagation condition	Correlation matrix and antenna config.	Reference value	
					Fraction of maximum throughput (%)	SNR (dB)
1.4MHz	R.14-4 FDD	OP.1 FDD	EVA5	4x2 Low	70	[TBD]
3MHz	R.14-5 FDD	OP.1 FDD	EVA5	4x2 Low	70	[9.5]
5MHz	R.14-6 FDD	OP.1 FDD	EVA5	4x2 Low	70	[9.5]
10 MHz	R.14 FDD	OP.1 FDD	EVA5	4x2 Low	70	[10.1]
15MHz	R.14-7 FDD	OP.1 FDD	EVA5	4x2 Low	70	[10.1]
20MHz	R.14-3 FDD	OP.1 FDD	EVA5	4x2 Low	70	[10.3]

**Table 8.2.1.4.2\_A.2.3-3: Minimum performance (FRC) based on single carrier performance SNR for CA with 3DL CCs**

Test num.	CA Band-width combination	Requirement	UE category
1	3x20MHz	As specified in Table 8.2.1.4.2_A.2.3-2 per CC	≥5
2	20MHz+20MHz+15MHz	As specified in Table 8.2.1.4.2_A.2.3-2 per CC	≥5
3	20MHz+20MHz+10MHz	As specified in Table 8.2.1.4.2_A.2.3-2 per CC	≥5
4	20MHz+15MHz+15MHz	As specified in Table 8.2.1.4.2_A.2.3-2 per CC	≥5
5	20MHz+15MHz+10MHz	As specified in Table 8.2.1.4.2_A.2.3-2 per CC	≥5
6	20MHz+10MHz+10MHz	As specified in Table 8.2.1.4.2_A.2.3-2 per CC	≥5
7	15MHz+15MHz+10MHz	As specified in Table 8.2.1.4.2_A.2.3-2 per CC	≥5
8	20MHz+10MHz+5MHz	As specified in Table 8.2.1.4.2_A.2.3-2 per CC	≥5
Note 1: The applicability of requirements for different CA configurations and bandwidth combination sets is defined in 8.1.2.3			

The normative reference for this requirement is TS 36.101 [2] clause 8.2.1.4.

#### 8.2.1.4.2\_A.2.4 Test description

##### 8.2.1.4.2\_A.2.4.1 Initial conditions

Initial conditions are a set of test configurations the UE needs to be tested in and the steps for the SS to take with the UE to reach the correct measurement state.

Configurations of PDSCH and PDCCH before measurement are specified in Annex C.2.

Test Environment: Normal, as defined in TS 36.508 [7] clause 4.1.

Frequencies to be tested: Maximum Wgap for Intra-band non-contiguous CA, otherwise Mid Range, as defined in TS 36.508 [7] clause 4.3.1.

Channel Bandwidths to be tested: Select one according to Table 8.2.1.4.2\_A.2.4.1-1.

CA Capability to be tested: Select one according to Table 8.2.1.4.2\_A.2.4.1-1.

**Table 8.2.1.4.2\_A.2.4.1-1: Test point selection for TM4 3DL CA**

CA Capability	Bandwidth combination							
	3x20	20+20+15	20+20+10	20+15+15	20+15+10	20+10+10	15+15+10	20+10+5
Intra-band contiguous (CA3_C)	Test1	Test2	Test3	Test4	Test5	Test6	Test7	Test8
Inter-band CA (two bands) (CA3_A2)	Test1	Test2	Test3	Test4	Test5	Test6	Test7	Test8
Inter-band CA (three bands) (CA3_A3)	Test1	Test2	Test3	Test4	Test5	Test6	Test7	Test8
Intra-band non-	Test1	Test2	Test3	Test4	Test5	Test6	Test7	Test8

contiguous CA (with two sub-blocks) (CA3_N2)								
Note1: Only one test point is tested. Select the largest aggregated CA bandwidth combination supported by the UE among the UE supported CA capabilities.								

1. Connect the SS, the faders and AWGN noise source to the UE antenna connectors as shown in TS 36.508 [7] Annex A, Figure A.61.
2. The parameter settings for the cell are set up according to Table 8.2.1-1 and 8.2.1.4.2\_A.2.3-1 as appropriate.
3. Downlink signals for PCC are initially set up according to Annex C.0, C.1 and Annex C.3.2 and uplink signals according to Annex H.1 and H.3.2.
4. Propagation conditions are set according to Annex B.0.
5. Ensure the UE is in State 3A-RF according to TS 36.508 [7] clause 5.2A.2. Message contents are defined in clause 8.2.1.4.2\_A.2.4.3.

8.2.1.4.2\_A.2.4.2 Test procedure

1. Configure SCCs according to Annex C.0, C.1 and Annex C.3.2 for all downlink physical channels.
2. The SS shall configure SCCs as per TS 36.508 [7] clause 5.2A.4. Message contents are defined in clause 8.2.1.4.2\_A.2.4.3.
3. The SS activates SCCs by sending the MAC-CE according to TS 36.321 [13] clauses 5.13 and 6.1.3.8. Wait for at least 2 seconds as per TS 36.133 [4] clause 8.3.3.2.
4. The SS transmits PDSCH via PDCCH DCI format 2 for C\_RNTI to transmit the DL RMC according to Tables 8.2.1.3.1\_A.2.3-1 and 8.2.1.3.1\_A.2.3-2 on both PCC and SCCs. The SS sends downlink MAC padding bits on the DL RMC.
5. The SS schedules the UL transmission to carry the PUSCH CQI feedback via PDCCH DCI format 0 with CQI request bit set to '10' and I\_MCS=29 and N\_PRB allocated to be less or equal to 20.
6. Set the parameters of the bandwidth, MCS, reference channel, the propagation condition, the correlation matrix and the SNR on each of the component carriers according to Tables 8.2.1.4.2\_A.2.5-1 as appropriate.
7. Measure the average throughput per component carrier for duration sufficient to achieve statistical significance according to Annex G clause G.3A.5 on each of the component carriers. Count the number of NACKs, ACKs and statDTXs on the UL during each subtest on each of the component carriers.

8.2.1.4.2\_A.2.4.3 Message contents

Message contents are according to TS 36.508 [7] subclause 4.6 with the following exceptions:

**Table 8.2.1.4.2\_A.2.4.3-1: PDSCH-ConfigDedicated-DEFAULT: Additional FDD PDSCH closed loop spatial multiplexing performance downlink power allocation**

Derivation Path: TS 36.508 [7] clause 4.6.3, Table 4.6.3-6 PDSCH-ConfigDedicated-DEFAULT			
Information Element	Value/remark	Comment	Condition
PDSCH-ConfigDedicated-DEFAULT ::= SEQUENCE {			
p-a	dB-6		
}			



**Table 8.2.1.4.2\_A.2.4.3-2: PhysicalConfigDedicated-DEFAULT: Additional FDD PDSCH closed loop multi-layer spatial multiplexing performance downlink power allocation**

Derivation Path: TS 36.508 [7] clause 5.5.1.2, Table 5.5.1.2-1 PhysicalConfigDedicated-DEFAULT			
Information Element	Value/remark	Comment	Condition
PhysicalConfigDedicated-DEFAULT ::= SEQUENCE {			
antennaInfo CHOICE {			
explicitValue ::= SEQUENCE {			
transmissionMode	tm4		
codebookSubsetRestriction CHOICE {			
n4TxAntenna-tm4	00000000000000000000 00000000000011111111 11111111000000000000 0000		
}			
ue-TransmitAntennaSelection CHOICE {			
release	NULL		
}			
}			
cqi-ReportConfig-r10	CQI-ReportConfig-r10-DEFAULT		
}			

**Table 8.2.1.4.2\_A.2.4.3-2A: PhysicalConfigDedicatedSCell-r10-DEFAULT: Additional FDD PDSCH closed loop multi-layer spatial multiplexing performance downlink power allocation**

Derivation Path: 36.508 clause 4.6.3 Table 4.6.3-6A			
Information Element	Value/remark	Comment	Condition
PhysicalConfigDedicatedSCell-r10-DEFAULT ::= SEQUENCE {			
nonUL-Configuration-r10 SEQUENCE {			
antennaInfo-r10 SEQUENCE {			
transmissionMode-r10	tm4		
codebookSubsetRestriction-r10	00000000000000000000 00000000000011111111 11111111000000000000 0000	BIT STRING	
ue-TransmitAntennaSelection CHOICE {			
release	NULL		
}			
}			
ul-Configuration-r10 SEQUENCE {			
cqi-ReportConfigSCell-r10	CQI-ReportConfigSCell-r10-DEFAULT		
}			
}			

**Table 8.2.1.4.2\_A.2.4.3-3: CQI-ReportConfig-DEFAULT: Additional FDD PDSCH closed loop multi-layer spatial multiplexing performance downlink power allocation**

Derivation Path: 36.508 clause 4.6.3 Table 4.6.3-2			
Information Element	Value/remark	Comment	Condition
CQI-ReportConfig-DEFAULT ::= SEQUENCE {			RBC
cqi-ReportModeAperiodic	rm12		
nomPDSCH-RS-EPRE-Offset	0		
cqi-ReportPeriodic	Not present		
}			

**Table 8.2.1.4.2\_A.2.4.3-4: CQI-ReportConfig-r10-DEFAULT: Additional FDD PDSCH closed loop multi-layer spatial multiplexing performance downlink power allocation**

Derivation Path: 36.508 clause 4.6.3 Table 4.6.3-2AA			
Information Element	Value/remark	Comment	Condition
CQI-ReportConfig-r10 ::= SEQUENCE {			
cqi-ReportAperiodic-r10	CQI-ReportAperiodic-r10-DEFAULT		
nomPDSCH-RS-EPRE-Offset	0		
cqi-ReportPeriodic-r10	Not present		
pmi-RI-Report-r9	Not present		
csi-SubframePatternConfig-r10	Not present		
}			

**Table 8.2.1.4.2\_A.2.4.3-5: CQI-ReportAperiodic-r10-DEFAULT: Additional FDD PDSCH closed loop multi-layer spatial multiplexing performance downlink power allocation**

Derivation Path: 36.508 clause 4.6.3 Table 4.6.3-1A			
Information Element	Value/remark	Comment	Condition
CQI-ReportAperiodic-r10 ::= CHOICE {			
setup SEQUENCE {			
cqi-ReportModeAperiodic-r10	rm12		
aperiodicCSI-Trigger-r10 ::= SEQUENCE {			
trigger1-r10	11100000	P-Cell, S-Cells report	
trigger2-r10	00000000	No report	
}			
}			
}			

**Table 8.2.1.4.2\_A.2.4.3-6: CQI-ReportConfigSCell-r10-DEFAULT: Additional FDD PDSCH closed loop multi-layer spatial multiplexing performance downlink power allocation**

Derivation Path: 36.508 clause 4.6.3 Table 4.6.3-2AB			
Information Element	Value/remark	Comment	Condition
CQI-ReportConfigSCell-r10 ::= SEQUENCE {			
cqi-ReportModeAperiodic-r10	rm12		
nomPDSCH-RS-EPRE-Offset-r10	0		
cqi-ReportPeriodicSCell-r10	Not present		
pmi-RI-Report-r10	Not present		
}			

**Table 8.2.1.4.2\_A.2.4.3-7: PUSCH-ConfigDedicated-DEFAULT**

Derivation Path: 36.331 clause 6.3.2			
Information Element	Value/remark	Comment	Condition
PUSCH-ConfigDedicated-DEFAULT ::= SEQUENCE {			
betaOffset-ACK-Index	5		
betaOffset-RI-Index	6		
betaOffset-CQI-Index	5		
}			

#### 8.2.1.4.2\_A.2.5 Test requirement

Table 8.2.1.4.2\_A.2.3-1 defines the primary level settings.

The fraction of maximum throughput percentage for the downlink reference measurement channels specified in Annex A clause A.3.3.2.2 for the throughput test shall meet or exceed the specified value in Table 8.2.1.4.2\_A.2.5-1 for the specified SNR including test tolerances for all throughput tests.

**Table 8.2.1.4.2\_A.2.5-1: Single carrier performance for multiple CA configurations**

Band-width	Reference channel	OCNG pattern	Propagation condition	Correlation matrix and antenna config.	Reference value	
					Fraction of maximum throughput (%)	SNR (dB)
1.4MHz	R.14-4 FDD	OP.1 FDD	EVA5	4x2 Low	70	[11.3]
3MHz	R.14-5 FDD	OP.1 FDD	EVA5	4x2 Low	70	[10.4]
5MHz	R.14-6 FDD	OP.1 FDD	EVA5	4x2 Low	70	[10.4]
10MHz	R.14 FDD	OP.1 FDD	EVA5	4x2 Low	70	[11.0]
15MHz	R.14-7 FDD	OP.1 FDD	EVA5	4x2 Low	70	[11.0]
20MHz	R.14-3 FDD	OP.1 FDD	EVA5	4x2 Low	70	[11.2]

**Table 8.2.1.4.2\_A.2.5-2: Test requirement (FRC) based on single carrier performance for CA with 3DL CCs**

Test num.	CA Band-width combination	Requirement	UE category
1	3x20MHz	As specified in Table 8.2.1.4.2_A.2.5-1 per CC	≥5
2	20MHz+20MHz+15MHz	As specified in Table 8.2.1.4.2_A.2.5-1 per CC	≥5
3	20MHz+20MHz+10MHz	As specified in Table 8.2.1.4.2_A.2.5-1 per CC	≥5
4	20MHz+15MHz+15MHz	As specified in Table 8.2.1.4.2_A.2.5-1 per CC	≥5
5	20MHz+15MHz+10MHz	As specified in Table 8.2.1.4.2_A.2.5-1 per CC	≥5
6	20MHz+10MHz+10MHz	As specified in Table 8.2.1.4.2_A.2.5-1 per CC	≥5
7	15MHz+15MHz+10MHz	As specified in Table 8.2.1.4.2_A.2.5-1 per CC	≥5
8	20MHz+10MHz+5MHz	As specified in Table 8.2.1.4.2_A.2.5-1 per CC	≥5
Note 1: The applicability of requirements for different CA configurations and bandwidth combination sets is defined in 8.1.2.3			

Decide pass or fail for each subtest according to Annex G.3A.4. Decide the entire test pass or fail according to Annex G.3A.6.

#### 8.2.1.4.2\_A.2.5 Test requirement

FFS

#### 8.2.1.4.2\_A.3

#### 8.2.1.4.3 FDD PDSCH Closed Loop Single Layer Spatial Multiplexing 2x2 with TM4 Interference Model – Enhanced Performance Requirement Type A

##### 8.2.1.4.3.1 Test purpose

The purpose of these tests is to verify the closed loop rank one performance with wideband precoding with two transmit antennas when the PDSCH transmission in the serving cell is interfered by PDSCH of two dominant interfering cells applying transmission mode 4 interference model defined in clause B.5.3.

##### 8.2.1.4.3.2 Test applicability

This test applies to all types of E-UTRA FDD UE release 11 and forward that support enhanced receiver Type A.

##### 8.2.1.4.3.3 Minimum conformance requirements

The requirements are specified in Table 8.2.1.4.3-2, with the addition of parameters in Table 8.2.1.4.3.3-1 and the downlink physical channel setup according to Annex C.3.2. In Table 8.2.1.4.3.3-1, Cell 1 is the serving cell, and Cell 2, 3 are interfering cells. The downlink physical channel setup is according to Annex C.3.2 for each of Cell 1, Cell 2 and Cell 3, respectively.

**Table 8.2.1.4.3.3-1: Test Parameters for Single-Layer Spatial Multiplexing (FRC) with TM4 interference model**

Parameter		Unit	Cell 1	Cell 2	Cell 3
Downlink power allocation	$\rho_A$	dB	-3	-3	-3
	$\rho_B$	dB	-3 (Note 1)	-3	-3
	$\sigma$	dB	0	0	0
Cell-specific reference signals			Antenna ports 0,1	Antenna ports 0,1	Antenna ports 0,1
$N_{oc}$ at antenna port		dBm/15kHz	-98	N/A	N/A
DIP (Note 2)		dB	N/A	-1.73	-8.66
BW <sub>Channel</sub>		MHz	10	10	10
Cyclic Prefix			Normal	Normal	Normal
Cell Id			0	1	2
Number of control OFDM symbols			2	2	2
PDSCH transmission mode			6	N/A	N/A
Interference model			N/A	As specified in clause B.5.3	As specified in clause B.5.3
Probability of occurrence of transmission rank in interfering cells	Rank 1	%	N/A	80	80
	Rank 2	%	N/A	20	20
Precoding granularity		PRB	50	6	6
PMI delay (Note 4)		ms	8	N/A	N/A
Reporting interval		ms	5	N/A	N/A
Reporting mode			PUCCH 1-1	N/A	N/A
CodeBookSubsetRestriction bitmap			001111	N/A	N/A
Note 1: $P_B = 1$ Note 2: The respective received power spectral density of each interfering cell relative to $N_{oc}$ is defined by its associated DIP value as specified in clause B.5.1. Note 3: Cell 1 is the serving cell. Cell 2, 3 are the interfering cells. Note 4: If the UE reports in an available uplink reporting instance at subframe SF#n based on PMI estimation at a downlink SF not later than SF#(n-4), this reported PMI cannot be applied at the eNB downlink before SF#(n+4). Note 5: All cells are time-synchronous.					

**Table 8.2.1.4.3.3-2: Enhanced Performance Requirement Type A, Single-Layer Spatial Multiplexing (FRC) with TM4 interference model**

Test Number	Reference Channel	OCNG Pattern			Propagation Conditions			Correlation Matrix and Antenna Configuration (Note 3)	Reference Value		UE Category
		Cell 1	Cell 2	Cell 3	Cell 1	Cell 2	Cell 3		Fraction of Maximum Throughput (%)	SINR (dB) (Note 2)	
1	R.47 FDD	OP. 1 FD D	N/A	N/A	EV A5	EV A5	EV A5	2x2 Low	70	0.8	1-8
Note 1: The propagation conditions for Cell 1, Cell 2 and Cell 3 are statistically independent. Note 2: SINR corresponds to $\hat{E}_s / N_{oc}$ of Cell 1 as defined in clause 8.1.1. Note 3: Correlation matrix and antenna configuration parameters apply for each of Cell 1, Cell 2 and Cell 3.											

The normative reference for this requirement is TS 36.101 [2] clause 8.2.1.4.1B.

#### 8.2.1.4.3.4 Test description

##### 8.2.1.4.3.4.1 Initial conditions

Initial conditions are a set of test configurations the UE needs to be tested in and the steps for the SS to take with the UE to reach the correct measurement state.

Configurations of PDSCH and PDCCH before measurement are specified in Annex C.2.

Test Environment: Normal, as defined in TS 36.508 [7] clause 4.1.

Frequencies to be tested: Mid Range, as defined in TS 36.508 [7] clause 4.3.1.1.

Channel Bandwidths to be tested: As specified per test number in Table 8.2.1.4.3.3-2 as defined in TS 36.508 [7] clause 4.3.1.1.

1. Connect the SS, the faders and AWGN noise sources to the UE antenna connectors as shown in TS 36.508 [7] Annex A, Figure A.48.
2. The parameter settings for the cell 1 are set up according to Tables 8.2.1-1 and 8.2.1.4.3.5-1 as appropriate.
3. Downlink signals are initially set up according to Annex C0, C.1 and Annex C.3.2 and uplink signals according to Annex H.1 and H.3.2.
4. Propagation conditions are set according to Annex B.0.
5. Ensure the UE is in State 3A-RF according to TS 36.508 [7] clause 5.2A.2. Message contents are defined in clause 8.2.1.4.3.4.3.

##### 8.2.1.4.3.4.2 Test procedure

1. SS transmits PDSCH via PDCCH DCI format 1B for C\_RNTI to transmit the DL RMC according to Tables 8.2.1.4.3.5-1 and 8.2.1.4.3.5-2. The SS sends downlink MAC padding bits on the DL RMC.
2. SS sets up parameters for cell 2 and cell 3 according to table 8.2.1.4.3.5-1 as appropriate.
3. Set the parameters of the bandwidth, MCS, reference channel, the propagation condition, the correlation matrix, antenna configuration and the SINR according to Tables 8.2.1.4.3.5-2 as appropriate.
4. Measure the average throughput for duration sufficient to achieve statistical significance according to Annex G clause G.3. Count the number of NACKs, ACKs and statDTXs on the UL during the test interval and decide pass or fail according to Tables G.3.5-15 in Annex G clause G.3.

##### 8.2.1.4.3.4.3 Message contents

Message contents are according to TS 36.508 [7] clause 4.6 with the following exceptions.

**Table 8.2.1.4.3.4.3-1: PhysicalConfigDedicated-DEFAULT: Additional FDD Single-Layer Spatial Multiplexing (FRC) with TM4 interference model downlink power allocation for Test number 1**

Derivation Path: 36.331 clause 6.3.2			
Information Element	Value/remark	Comment	Condition
PhysicalConfigDedicated-DEFAULT ::= SEQUENCE {			
antennaInfo CHOICE {			
antennaInfoDedicated ::= SEQUENCE {			
transmissionMode	tm6		
codebookSubsetRestriction CHOICE {			
n2TxAntenna-tm6	1111		
}			
ue-TransmitAntennaSelection CHOICE {			
Release	NULL		
}			
}			
}			

**Table 8.2.1.4.3.4.3-2: CQI-ReportPeriodic-r10**

Derivation Path: TS 36.508 [7] clause 4.6.3, Table 4.6.3-2AC CQI-ReportPeriodic-r10-DEFAULT			
Information Element	Value/remark	Comment	Condition
CQI-ReportPeriodic-r10 ::= CHOICE {			
setup SEQUENCE {			
cqi-PUCCH-ResourceIndex-r10	0		
cqi-PUCCH-ResourceIndexP1-r10	Not present		
cqi-pmi-ConfigIndex	2	FDD	
cqi-FormatIndicatorPeriodic-r10 CHOICE {			
widebandCQI-r10 SEQUENCE {			
csi-ReportMode-r10	Not present		
}			
}			
ri-ConfigIndex	483	FDD	
simultaneousAckNackAndCQI	FALSE		
cqi-Mask-r9	Not present		
csi-ConfigIndex-r10	Not present		
}			
}			

#### 8.2.1.4.3.5 Test requirement

Table 8.2.1.4.3.5-1 defines the primary level settings.

The fraction of maximum throughput percentage for the downlink reference measurement channels specified in Annex A clause A.3.3.2 for throughput test shall meet or exceed the specified value in Table 8.2.1.4.3.5-2 for the specified SINR including test tolerances.

**Table 8.2.1.4.3.5-1: Test Parameters for Single-Layer Spatial Multiplexing (FRC) with TM4 interference model**

Parameter		Unit	Cell 1	Cell 2	Cell 3
Downlink power allocation	$\rho_A$	dB	-3	-3	-3
	$\rho_B$	dB	-3 (Note 1)	-3	-3
	$\sigma$	dB	0	0	0
Cell-specific reference signals			Antenna ports 0,1	Antenna ports 0,1	Antenna ports 0,1
$N_{oc}$ at antenna port		dBm/15kHz	-98	N/A	N/A
DIP (Note 2)		dB	N/A	-1.44	-7.77
$BW_{Channel}$		MHz	10	10	10
Cyclic Prefix			Normal	Normal	Normal
Cell Id			0	1	2
Number of control OFDM symbols			2	2	2
PDSCH transmission mode			6	N/A	N/A
Interference model			N/A	As specified in clause B.5.3	As specified in clause B.5.3
Probability of occurrence of transmission rank in interfering cells	Rank 1	%	N/A	80	80
	Rank 2	%	N/A	20	20
Precoding granularity		PRB	50	6	6
PMI delay (Note 4)		ms	8	N/A	N/A
Reporting interval		ms	5	N/A	N/A
Reporting mode			PUCCH 1-1	N/A	N/A
CodeBookSubsetRestriction bitmap			001111	N/A	N/A
Note 1: $P_B = 1$					
Note 2: The respective received power spectral density of each interfering cell relative to $N_{oc}$ is defined by its associated DIP value as specified in clause B.5.1.					
Note 3: Cell 1 is the serving cell. Cell 2, 3 are the interfering cells.					
Note 4: If the UE reports in an available uplink reporting instance at subframe SF#n based on PMI estimation at a downlink SF not later than SF#(n-4), this reported PMI cannot be applied at the eNB downlink before SF#(n+4).					
Note 5: All cells are time-synchronous.					

**Table 8.2.1.4.3.5-2: Test requirement for Enhanced Performance Requirement Type A, Single-Layer Spatial Multiplexing (FRC) with TM4 interference model**

Test Number	Reference Channel	OCNG Pattern			Propagation Conditions			Correlation Matrix and Antenna Configuration (Note 3)	Reference Value		UE Category
		Cell 1	Cell 2	Cell 3	Cell 1	Cell 2	Cell 3		Fraction of Maximum Throughput (%)	SINR (dB) (Note 2)	
1	R.47 FDD	OP. 1 FD D	N/A	N/A	EV A5	EV A5	EV A5	2x2 Low	70	1.79	1-8
Note 1: The propagation conditions for Cell 1, Cell 2 and Cell 3 are statistically independent.											
Note 2: SINR corresponds to $\hat{E}_s / N_{oc}$ of Cell 1 as defined in clause 8.1.1.											
Note 3: Correlation matrix and antenna configuration parameters apply for each of Cell 1, Cell 2 and Cell 3.											

## 8.2.1.5

## 8.2.1.6

## 8.2.1.7 Carrier aggregation with power imbalance

Editor's Note: This test case is incomplete. The following items are missing or are incomplete:

- Connection diagram in Annex A of TS 36.508 is TBD
- Test tolerances are undefined
- The minimum test time need to be added to G.3A.5

## 8.2.1.7\_A.1 FDD Carrier aggregation with power imbalance (intra-band contiguous DL CA)

## 8.2.1.7\_A.1.1 Test purpose

To verify the ability of an intraband adjacent carrier aggregation UE to demodulate the signal transmitted by the PCell or SCell in the presence of a stronger SCell signal on an adjacent frequency. Throughput is measured on the PCell or SCell only.

## 8.2.1.7\_A.1.2 Test applicability

This test applies to all types of E-UTRA FDD UE release 10 and forward that support intra-band contiguous DL CA.

## 8.2.1.7\_A.1.3 Minimum conformance requirements

The requirements are specified in Table 8.2.1.7\_A.1.3-2, with the addition of the parameters in Table 8.2.1.7\_A.1.3-1 and the downlink physical channel setup according to table C.3.2-1 in Annex C.



Table 8.2.1.7\_A.1.3-1: Test Parameters for CA

Parameter		Unit	Test 1	Test 2-3
Downlink power allocation	$\rho_A$	dB	0	0
	$\rho_B$	dB	0 (Note 1)	0 (Note 1)
	$\sigma$	dB	0	0
$N_{oc}$ at antenna port		dBm/15kHz	Off (Note 2)	Off (Note 2)
Symbols for unused PRBs			OCNG (Note 3)	OCNG (Note 3)
Modulation			64 QAM	64 QAM
Maximum number of HARQ transmission			1	1
Redundancy version coding sequence			{0}	{0}
PDSCH transmission mode of PCell			1	3
PDSCH transmission mode of SCell			3	1
OCNG Pattern	PCell		OP.1 FDD	OP.5 FDD
	SCell		OP.5 FDD	OP.1 FDD
Propagation Conditions	PCell		Clause B.1	Clause B.1
	SCell		Clause B.1	Clause B.1
Correlation Matrix and Antenna	PCell		1x2	2x2
	SCell		2x2	1x2
Note 1: $P_B = 0$ .				
Note 2: No external noise sources are applied				
Note 3: These physical resource blocks are assigned to an arbitrary number of virtual UEs with one PDSCH per virtual UE; the data transmitted over the OCNG PDSCHs shall be uncorrelated. pseudo random data, which is QPSK modulated.				
Note 4: Void				

Table 8.2.1.7\_A.1.3-2: Minimum performance (FRC) for CA

Test Number	Bandwidth (MHz)		Reference channel		Power at antenna port (dBm/15KHz)		Reference value Fraction of Maximum Throughput (%)		UE Category
	PCell	SCell	PCell	SCell	$\hat{E}_{s\_PCell}$ for PCell	$\hat{E}_{s\_SCell}$ for SCell	PCell	SCell	
1	20	20	R.49 FDD	NA	-85	-79	85	NA	$\geq 5$
2	10	10	NA	R.49-1 FDD	-79	[-85.8]	NA	85	$\geq 5$
3	5	5	NA	R.49-2 FDD	-79	[-85.9]	NA	85	$\geq 5$
Note 1: The OCNG pattern for PCell is used to fill the control channel. The OCNG pattern for SCell is used to fill the control channel and PDSCH.									
Note 2: The applicability of requirements for different CA configurations and bandwidth combination sets is defined in 8.1.2.3.									

The normative reference for this requirement is TS 36.101 [2] clause 8.2.1.7.

#### 8.2.1.7\_A.1.4 Test description

##### 8.2.1.7\_A.1.4.1 Initial conditions

Initial conditions are a set of test configurations the UE needs to be tested in and the steps for the SS to take with the UE to reach the correct measurement state.

Configurations of PDSCH and PDCCH before measurement are specified in Annex C.2.

Test Environment: Normal, as defined in TS 36.508 [7] clause 4.1.

Frequencies to be tested: Mid Range, as defined in TS 36.508 [7] clause 4.3.1.

Channel Bandwidths to be tested: As specified per test number in Table 8.2.1.7\_A.1.3-2 as defined in TS 36.508 [7] clause 4.3.1.

1. Connect the SS, the faders and AWGN noise source to the UE antenna connectors as shown in TS 36.508 [7] Annex A, Figure group TBD
2. The parameter settings for the cell are set up according to Table 8.2.1-1 and 8.2.1.7\_A.1.3-1 as appropriate.
3. Downlink signals for PCC are initially set up according to Annex C0, C.1 and Annex C.3.2 and uplink signals according to Annex H.1 and H.3.2.
4. Propagation conditions are set according to Annex B.0.
5. Ensure the UE is in State 3A-RF according to TS 36.508 [7] clause 5.2A.2. Message contents are defined in clause 8.2.1.7\_A.1.4.3.

#### 8.2.1.7\_A.1.4.2 Test procedure

1. Configure SCC according to Annex C0, C.1 and Annex C.3.2 for all downlink physical channels except control channel and PDSCH.
2. The SS shall configure SCC as per TS 36.508 [7] clause 5.2A.4. Message contents are defined in clause 8.2.1.7\_A.1.4.3
3. SS activates SCC by sending the activation MAC-CE (Refer TS 36.321 [13], clauses 5.13, 6.1.3.8). Wait for at least 2 seconds (Refer TS 36.133, clauses 8.3.3.2).
4. SS transmits PDSCH via PDCCH DCI format 1A for C\_RNTI to transmit the DL RMC according to Tables 8.2.1.7\_A.1.3-1 and 8.2.1.7\_A.1.3-2. The SS sends downlink MAC padding bits on the DL RMC.
5. Set the parameters of the bandwidth, MCS, reference channel, the propagation condition and the correlation matrix on each of the component carriers according to Tables 8.2.1.7\_A.1.5-1 as appropriate.
6. Measure the average throughput on PCC in test number 1 or measure the average throughput on SCC in test number 2 or 3 for a duration sufficient to achieve statistical significance according to Annex G clause G.3A, Table G.3A.5-1. Count the number of NACKs, ACKs and statDTXs on the UL during the test on PCC in test number 1 or on SCC in test number 2 or 3.

#### 8.2.1.7\_A.1.4.3 Message contents

Message contents are according to TS 36.508 [7] subclause 4.6. In test procedure step 3, for SCC configuration there are no additional message contents.

#### 8.2.1.7\_A.1.5 Test requirement

Table 8.2.1.7\_A.1.5-1 defines the primary level settings.

The fraction of maximum throughput percentage for the downlink reference measurement channels specified in Annex A clause A.3.3.1 for the throughput test shall meet or exceed the specified value in Table 8.2.1.7\_A.1.5-1 for the specified cell power levels including test tolerances for all throughput tests.

Table 8.2.1.7\_A.1.5-1: Test Requirement (FRC) for CA

Test Number	Bandwidth (MHz)		Reference channel		Power at antenna port (dBm/15KHz)		Reference value Fraction of Maximum Throughput (%)		UE Category
	PCell	SCell	PCell	SCell	$\hat{E}_{s\_PCell}$ for PCell	$\hat{E}_{s\_SCell}$ for SCell	PCell	SCell	
1	20	20	R.49 FDD	NA	-85	-79	85	NA	$\geq 5$
2	10	10	NA	R.49-1 FDD	-79	[-85.8]	NA	85	$\geq 5$
3	5	5	NA	R.49-2 FDD	-79	[-85.9]	NA	85	$\geq 5$
Note 1:	The OCNG pattern for PCell is used to fill the control channel. The OCNG pattern for SCell is used to fill the control channel and PDSCH.								
Note 2:	The applicability of requirements for different CA configurations and bandwidth combination sets is defined in 8.1.2.3.								

Decide pass or fail for each subtest according to Annex G.3A.4. Decide the entire test pass or fail according to Annex G.3A.6.

## 8.2.2 TDD (Fixed Reference Channel)

The parameters specified in Table 8.2.2-1 are valid for all TDD tests unless otherwise stated.

Table 8.2.2-1: Common Test Parameters (TDD)

Parameter	Unit	Value	Comments
Uplink downlink configuration (Note 1)		1	
Special subframe configuration (Note 2)		4	
Inter-TTI Distance		1	
Number of HARQ processes	Processes	7	For TDD, 7 HARQ processes in the DL, as specified in TS 36.213 [10] clause 7. All 7 HARQ processes are used.
Scheduling of retransmissions			1. Retransmissions use the same Transport Block Size (TBS) as the initial transmission. 2. HARQ processes are scheduled consecutively, independent of the fact, whether retransmissions (for negatively acknowledged HARQ processes) or new transmissions (for positively acknowledged HARQ processes) occur. 3. In case when the initial transmission and the retransmissions are scheduled in subframes with a different $N_{PRB}$ (in terms of TS 36.213 [10] subclause 7.1.7) $29 \leq I_{MCS} \leq 31$ according to TS 36.213 [10] subclause 7.1.7.2 and the appropriate modulation is used.
Maximum number of HARQ transmission		4	It is always 4 for TDD, as specified in TS 36.213 [10] clause 8
Redundancy version coding sequence		{0,1,2,3} for QPSK and 16QAM {0,0,1,2} for 64QAM	
Number of OFDM symbols for PDCCH	OFDM symbols	4 for 1.4 MHz bandwidth, 3 for 3 MHz and 5 MHz bandwidths, 2 for 10 MHz, 15 MHz and 20 MHz bandwidths	The PCFICH carries information about the number of OFDM symbols used for transmission of PDCCHs in a subframe, as specified in TS 36.211 [8] clause 6.7
Cyclic Prefix		Normal	CP consist of the following physical resource blocks (RBs) parameters: 12 consecutive subcarriers at a 15 kHz spacing and 7 OFDM symbols, as specified in TS 36.211 [8] clause 6.2.3
Cell ID		0 (Note 3)	The Cell ID is uniquely defined by a number in the range of 0 to 503, representing the physical-layer cell identity, as specified in TS 36.211 [8] clause 6.11.
Cross carrier scheduling		Not configured	
Note 1: as specified in Table 4.2-2 in TS 36.211 [8] Note 2: as specified in Table 4.2-1 in TS 36.211 [8] Note 3: For CA tests, Cell ID = 0 applies only to P-Cell. For (n)th S-Cell, Cell ID = n is used.			

The normative reference for this requirement is TS 36.101 [2] clause 8.2.2.

## 8.2.2.1 TDD PDSCH Single Antenna Port Performance (Cell-Specific Reference Symbols)

### 8.2.2.1.1 TDD PDSCH Single Antenna Port Performance

#### 8.2.2.1.1.1 Test purpose

To verify the UE's ability to receive a predefined test signal, representing a multi-path fading channel that is determined by the SNR with a percentage of the information bit throughput for a specified downlink Reference Measurement Channel (RMC) not falling below a specified value for transmission on a single-antenna port with different channel models and MCS.

#### 8.2.2.1.1.2 Test applicability

This test applies to all types of E-UTRA TDD UE release 8 and forward.

#### 8.2.2.1.1.3 Minimum conformance requirements

The requirements are specified in terms of the percentage of information bit throughput for the downlink reference measurement channels specified in Annex A clause A.3.4.1, with the addition of the relevant parameters in Tables 8.2.2-1, 8.2.2.1.1.3-1 and the downlink physical channel setup according to table C.3.2-1 in Annex C.

Using this configuration the fraction of maximum throughput percentage shall meet or exceed the minimum requirements specified in Tables 8.2.2.1.1.3-2 for the specified SNR.

**Table 8.2.2.1.1.3-1: Test Parameters**

Parameter	Unit	Test 1- 5	Test 6- 8	Test 9- 15	Test 16- 18	
Downlink power allocation	$\rho_A$	dB	0	0	0	0
	$\rho_B$	dB	0 (Note 1)	0 (Note 1)	0 (Note 1)	0 (Note 1)
	$\sigma$	dB	0	0	0	0
$N_{oc}$ at antenna port	dBm/15kHz	-98	-98	-98	-98	
Symbols for unused PRBs		OCNG (Note 2)	OCNG (Note 2)	OCNG (Note 2)	OCNG (Note 2)	
Modulation		QPSK	16QAM	64QAM	16QAM	
ACK/NACK feedback mode		Multiplexing	Multiplexing	Multiplexing	Multiplexing	
PDSCH transmission mode		1	1	1	1	
Note 1: $P_B = 0$						
Note 2: These physical resource blocks are assigned to an arbitrary number of virtual UEs with one PDSCH per virtual UE; the data transmitted over the OCNG PDSCHs shall be uncorrelated pseudo random data, which is QPSK modulated.						

Table 8.2.2.1.1.3-2: Minimum performance (FRC)

Test number	Bandwidth	Reference Channel	OCNG Pattern	Propagation Condition	Correlation Matrix and Antenna Configuration	Reference value		UE Category
						Fraction of Maximum Throughput (%)	SNR (dB)	
1	10 MHz	R.2 TDD	OP.1 TDD	EVA5	1x2 Low	70	-1.2	≥1
2	10 MHz	R.2 TDD	OP.1 TDD	ETU70	1x2 Low	70	-0.6	≥1
3	10 MHz	R.2 TDD	OP.1 TDD	ETU300	1x2 Low	70	-0.2	≥1
4	10 MHz	R.2 TDD	OP.1 TDD	HST	1x2	70	-2.6	≥1
5	1.4 MHz	R.4 TDD	OP.1 TDD	EVA5	1x2 Low	70	0.0	≥1
6	10 MHz	R.3 TDD	OP.1 TDD	EVA5	1x2 Low	70	6.7	≥2
7	10 MHz	R.3 TDD	OP.1 TDD	ETU70	1x2 Low	30	1.4	≥2
8	10 MHz	R.3 TDD	OP.1 TDD	ETU300	1x2 High	70	9.3	≥2
9	3 MHz	R.5 TDD	OP.1 TDD	EVA5	1x2 Low	70	17.6	≥1
10	5 MHz	R.6 TDD	OP.1 TDD	EVA5	1x2 Low	70	17.6	≥2
11	10 MHz	R.7 TDD	OP.1 TDD	EVA5	1x2 Low	70	17.6	≥2
12	10 MHz	R.7 TDD	OP.1 TDD	ETU70	1x2 Low	70	19.1	≥2
13	10 MHz	R.7 TDD	OP.1 TDD	EVA5	1x2 High	70	19.1	≥2
14	15 MHz	R.8 TDD	OP.1 TDD	EVA5	1x2 Low	70	17.8	≥2
15	20 MHz	R.9 TDD	OP.1 TDD	EVA5	1x2 Low	70	17.7	≥3
16	3 MHz	R.0 TDD	OP.1 TDD	ETU70	1x2 Low	30	2.1	≥1
17	10 MHz	R.1 TDD	OP.1 TDD	ETU70	1x2 Low	30	2.0	≥1
18	20 MHz	R.1 TDD	OP.1 TDD	ETU70	1x2 Low	30	2.1	≥1

The normative reference for this requirement is TS 36.101 [2] clause 8.2.2.

#### 8.2.2.1.1.4 Test description

##### 8.2.2.1.1.4.1 Initial conditions

Initial conditions are a set of test configurations the UE needs to be tested in and the steps for the SS to take with the UE to reach the correct measurement state.

Configurations of PDSCH and PDCCH before measurement are specified in Annex C.2.

Test Environment: Normal, as defined in TS 36.508 [7] clause 4.1.

Frequencies to be tested: Mid Range, as defined in TS 36.508 [7] clause 4.3.1.2.

Frequencies to be tested for 1PRB allocation: Low Range, as defined in TS 36.508 [7] clause 4.3.1.2.

Bandwidths to be tested: As specified per test number in Tables 8.2.2.1.1.3-2 as defined in TS 36.508 [7] clause 4.3.1.2.

1. Connect the SS, the faders and AWGN noise sources to the UE antenna connectors as shown in TS 36.508 [7] Annex A, Figure A.9.

2. The parameter settings for the cell are set up according to Tables 8.2.2-1, 8.2.2.1.1.3-1 as appropriate.
3. Downlink signals are initially set up according to Annex C.0, C.1 and Annex C.3.2 and uplink signals according to Annex H.1 and H.3.2.
4. Propagation conditions are set according to Annex B.0.
5. Ensure the UE is in State 3A-RF according to TS 36.508 [7] clause 5.2A.2. Message contents are defined in clause 8.2.2.1.1.4.3.

#### 8.2.2.1.1.4.2 Test procedure

1. SS transmits PDSCH via PDCCH DCI format 1A for C\_RNTI to transmit the DL RMC according to Tables 8.2.2.1.1.3-1 and 8.2.2.1.1.3-2. The SS sends downlink MAC padding bits on the DL RMC.
2. Set the parameters of the reference channel, MCS, reference channel, the propagation condition, the correlation matrix and the SNR according to Tables 8.2.2.1.1.5-1 as appropriate.
3. Measure the average throughput for a duration sufficient to achieve statistical significance according to Annex G clause G.3. Count the number of NACKs, ACKs and statDTXs on the UL during each subtest interval and decide pass or fail according to Tables G.3.5 and G.3.6 in Annex G clause G.3.
4. Repeat steps from 1 to 3 for each subtest in Tables 8.2.2.1.1.5-1 as appropriate.

#### 8.2.2.1.1.4.3 Message contents

Message contents are according to TS 36.508 [7] clause 4.6.

#### 8.2.2.1.1.5 Test requirement

Table 8.2.2.1.1.3-1 defines the primary level settings including test tolerances for all throughput tests.

The fraction of maximum throughput percentage for the downlink reference measurement channels specified in Annex A for each throughput test shall meet or exceed the specified value in Tables 8.2.2.1.1.5-1 for the specified SNR including test tolerances for all throughput tests.

Table 8.2.2.1.1.5-1: Test Requirement (FRC)

Test number	Bandwidth	Reference Channel	OCNG Pattern	Propagation Condition	Correlation Matrix and Antenna Configuration	Reference value		UE Category
						Fraction of Maximum Throughput (%)	SNR (dB)	
1	10 MHz	R.2 TDD	OP.1 TDD	EVA5	1x2 Low	70	-0.4	≥1
2	10 MHz	R.2 TDD	OP.1 TDD	ETU70	1x2 Low	70	0.2	≥1
3	10 MHz	R.2 TDD	OP.1 TDD	ETU300	1x2 Low	70	0.6	≥1
4	10 MHz	R.2 TDD	OP.1 TDD	HST	1x2	70	-2.0	≥1
5	1.4 MHz	R.4 TDD	OP.1 TDD	EVA5	1x2 Low	70	0.8	≥1
6	10 MHz	R.3 TDD	OP.1 TDD	EVA5	1x2 Low	70	7.5	≥2
7	10 MHz	R.3 TDD	OP.1 TDD	ETU70	1x2 Low	30	2.2	≥2
8	10 MHz	R.3 TDD	OP.1 TDD	ETU300	1x2 High	70	10.1	≥2
9	3 MHz	R.5 TDD	OP.1 TDD	EVA5	1x2 Low	70	18.4	≥1
10	5 MHz	R.6 TDD	OP.1 TDD	EVA5	1x2 Low	70	18.4	≥2
11	10 MHz	R.7 TDD	OP.1 TDD	EVA5	1x2 Low	70	18.4	≥2
12	10 MHz	R.7 TDD	OP.1 TDD	ETU70	1x2 Low	70	19.9	≥2
13	10 MHz	R.7 TDD	OP.1 TDD	EVA5	1x2 High	70	19.9	≥2
14	15 MHz	R.8 TDD	OP.1 TDD	EVA5	1x2 Low	70	18.6	≥2
15	20 MHz	R.9 TDD	OP.1 TDD	EVA5	1x2 Low	70	18.5	≥3
16	3 MHz	R.0 TDD	OP.1 TDD	ETU70	1x2 Low	30	2.9	≥1
17	10 MHz	R.1 TDD	OP.1 TDD	ETU70	1x2 Low	30	2.8	≥1
18	20 MHz	R.1 TDD	OP.1 TDD	ETU70	1x2 Low	30	2.9	≥1

### 8.2.2.1.1\_1 TDD PDSCH Single Antenna Port Performance (Release 9 and forward)

#### 8.2.2.1.1\_1.1 Test purpose

Same test purpose as in clause 8.2.2.1.1.1.

#### 8.2.2.1.1\_1.2 Test applicability

This test applies to all types of E-UTRA TDD UE release 9 and forward of UE category 1 and 2.

#### 8.2.2.1.1\_1.3 Minimum conformance requirements

Same minimum conformance requirements as in clause 8.2.2.1.1.3 with the following exceptions:

- Instead of Table 8.2.2.1.1.3-2 → use Table 8.2.2.1.1\_1.3-2.

#### Table 8.2.2.1.1\_1.3-1: Void



Table 8.2.2.1.1\_1.3-2: Minimum performance (FRC)

Test number	Bandwidth	Reference Channel	OCNG Pattern	Propagation Condition	Correlation Matrix and Antenna Configuration	Reference value		UE Category
						Fraction of Maximum Throughput (%)	SNR (dB)	
1	N/A							
2	N/A							
3	N/A							
4	N/A							
5	N/A							
6	5 MHz	R.3-1 TDD	OP.1 TDD	EVA5	1x2 Low	70	6.7	1
7	5 MHz	R.3-1 TDD	OP.1 TDD	ETU70	1x2 Low	30	1.4	1
8	5 MHz	R.3-1 TDD	OP.1 TDD	ETU300	1x2 High	70	9.3	1
9	N/A							
10	5 MHz	R.6-1 TDD	OP.1 TDD	EVA5	1x2 Low	70	17.6	1
11	10 MHz	R.7-1 TDD	OP.1 TDD	EVA5	1x2 Low	70	17.6	1
12	10 MHz	R.7-1 TDD	OP.1 TDD	ETU70	1x2 Low	70	19.1	1
13	10 MHz	R.7-1 TDD	OP.1 TDD	EVA5	1x2 High	70	19.1	1
14	15 MHz	R.8-1 TDD	OP.1 TDD	EVA5	1x2 Low	70	17.8	1
15	20 MHz	R.9-2 TDD	OP.1 TDD	EVA5	1x2 Low	70	17.7	2
	20 MHz	R.9-1 TDD	OP.1 TDD	EVA5	1x2 Low	70	17.7	1
16	N/A							
17	N/A							
18	N/A							

The normative reference for this requirement is TS 36.101 [2] clause 8.2.2.

#### 8.2.2.1.1\_1.4 Test description

Same test description as in clause 8.2.2.1.1.4 with the following exceptions:

- Instead of Table 8.2.2.1.1.3-1 → use Table 8.2.2.1.1\_1.3-1.
- Instead of Table 8.2.2.1.1.3-2 → use Table 8.2.2.1.1\_1.3-2.
- Instead of Table 8.2.2.1.1.5-1 → use Table 8.2.2.1.1\_1.5-1.

#### 8.2.2.1.1\_1.5 Test requirement

Same test requirements as in clause 8.2.2.1.1.5 with the following exceptions:

- Instead of Table 8.2.2.1.1.3-1 → use Table 8.2.2.1.1\_1.3-1.
- Instead of Table 8.2.2.1.1.5-1 → use Table 8.2.2.1.1\_1.5-1.

Table 8.2.2.1.1\_1.5-1: Test Requirement (FRC)

Test number	Bandwidth	Reference Channel	OCNG Pattern	Propagation Condition	Correlation Matrix and Antenna Configuration	Reference value		UE Category
						Fraction of Maximum Throughput (%)	SNR (dB)	
1	N/A							
2	N/A							
3	N/A							
4	N/A							
5	N/A							
6	5 MHz	R.3-1 TDD	OP.1 TDD	EVA5	1x2 Low	70	7.5	1
7	5 MHz	R.3-1 TDD	OP.1 TDD	ETU70	1x2 Low	30	2.2	1
8	5 MHz	R.3-1 TDD	OP.1 TDD	ETU300	1x2 High	70	10.1	1
9	N/A							
10	5 MHz	R.6-1 TDD	OP.1 TDD	EVA5	1x2 Low	70	+18.4	1
11	10 MHz	R.7-1 TDD	OP.1 TDD	EVA5	1x2 Low	70	+18.4	1
12	10 MHz	R.7-1 TDD	OP.1 TDD	ETU70	1x2 Low	70	+19.9	1
13	10 MHz	R.7-1 TDD	OP.1 TDD	EVA5	1x2 High	70	+19.9	1
14	15 MHz	R.8-1 TDD	OP.1 TDD	EVA5	1x2 Low	70	+18.6	1
15	20 MHz	R.9-2 TDD	OP.1 TDD	EVA5	1x2 Low	70	+18.5	2
	20 MHz	R.9-1 TDD	OP.1 TDD	EVA5	1x2 Low	70	+18.5	1
16	N/A							
17	N/A							
18	N/A							

### 8.2.2.1.1\_2 TDD PDSCH Single Antenna Port Performance (Release 10 and forward)

#### 8.2.2.1.1\_2.1 Test purpose

Same test purpose as in clause 8.2.2.1.1.1.

#### 8.2.2.1.1\_2.2 Test applicability

This test applies to all types of E-UTRA TDD UE release 10 and forward.

#### 8.2.2.1.1\_2.3 Minimum conformance requirements

Same minimum conformance requirements as in clause 8.2.2.1.1.3 with the following exceptions:

- Instead of Table 8.2.2.1.1.3-1 → use Table 8.2.2.1.1\_2.3-1.
- Instead of Table 8.2.2.1.1.3-2 → use Table 8.2.2.1.1\_2.3-2.

Table 8.2.2.1.1\_2.3-1: Test Parameters

Parameter	Unit	Test 1	
Downlink power allocation	$\rho_A$	dB	0
	$\rho_B$	dB	0 (Note 1)
	$\sigma$	dB	0
$N_{oc}$ at antenna port	dBm/15kHz	-98	
Symbols for unused PRBs		OCNG (Note 2)	
Modulation		QPSK	
ACK/NACK feedback mode		Multiplexing	
PDSCH transmission mode		1	
Note 1: $P_B = 0$			
Note 2: These physical resource blocks are assigned to an arbitrary number of virtual UEs with one PDSCH per virtual UE; the data transmitted over the OCNG PDSCHs shall be uncorrelated pseudo random data, which is QPSK modulated.			

Table 8.2.2.1.1\_2.3-2: Minimum performance (FRC)

Test number	Bandwidth	Reference Channel	OCNG Pattern	Propagation Condition	Correlation Matrix and Antenna Configuration	Reference value		UE Category
						Fraction of Maximum Throughput (%)	SNR (dB)	
1	10 MHz	R.41 TDD	OP.1 TDD	EVA5	1x2 Low	70	-5.3	$\geq 1$

The normative reference for this requirement is TS 36.101 [2] clause 8.2.2.1.

#### 8.2.2.1.1\_2.4 Test description

Same test description as in clause 8.2.2.1.1.4 with the following exceptions:

- Instead of Table 8.2.2.1.1.3-1 → use Table 8.2.2.1.1\_2.3-1.
- Instead of Table 8.2.2.1.1.3-2 → use Table 8.2.2.1.1\_2.3-2.
- Instead of Table 8.2.2.1.1.5-1 → use Table 8.2.2.1.1\_2.5-1.

#### 8.2.2.1.1\_2.5 Test requirement

Same test requirements as in clause 8.2.2.1.1.5 with the following exceptions:

- Instead of Table 8.2.2.1.1.3-1 → use Table 8.2.2.1.1\_2.3-1.
- Instead of Table 8.2.2.1.1.5-1 → use Table 8.2.2.1.1\_2.5-1.

Table 8.2.2.1.1\_1.5-1: Test Requirement (FRC)

Test number	Bandwidth	Reference Channel	OCNG Pattern	Propagation Condition	Correlation Matrix and Antenna Configuration	Reference value		UE Category
						Fraction of Maximum Throughput (%)	SNR (dB)	
1	10 MHz	R.41 TDD	OP.1 TDD	EVA5	1x2 Low	70	-4.5	$\geq 1$

## 8.2.2.1.1\_A TDD PDSCH Single Antenna Port Performance for CA

## 8.2.2.1.1\_A.1 TDD PDSCH Single Antenna Port Performance for CA (2DL CA)

Editor's note: The following aspects are either missing or not yet determined:

- SNR values in table 8.2.2.1.1\_A.1.3-2 are still in bracket in core spec.

## 8.2.2.1.1\_A.1.1 Test purpose

Same test purpose as 8.2.2.1.1.1.

## 8.2.2.1.1\_A.1.2 Test applicability

This test applies to E-UTRA TDD release 10 and forward UE of category 5 or higher that supports inter-band OR intra-band contiguous DL CA

This test also applies to E-UTRA TDD release 11 and forward UE of category 5 or higher that supports intra-band non-contiguous DL CA.

## 8.2.2.1.1\_A.1.3 Minimum conformance requirements

The requirements are specified in terms of the percentage of information bit throughput for the downlink reference measurement channels specified in Annex A clause A.3.4.1, with the addition of the relevant parameters in Tables 8.2.2-1, 8.2.2.1.1\_A.1.3-1 and the downlink physical channel setup according to table C.3.2-1 in Annex C.

Using this configuration the fraction of maximum throughput percentage shall meet or exceed the minimum requirements specified in Tables 8.2.2.1.1\_A.1.3-2 for the specified SNR. For QPSK and 64QAM performance the bandwidths specified in Table 5.4.2.1-1 are verified.

**Table 8.2.2.1.1\_A.1.3-1: Test Parameters for CA**

Parameter	Unit	Test 1-2	
Downlink power allocation	$\rho_A$	dB	0
	$\rho_B$	dB	0 (Note 1)
	$\sigma$	dB	0
$N_{oc}$ at antenna port	dBm/15kHz	-98	
Symbols for unused PRBs		OCNG (Note 2)	
Modulation		QPSK	
ACK/NACK feedback mode		PUCCH format 1b with channel selection	
PDSCH transmission mode		1	
Note 1:	$P_B = 0$		
Note 2:	These physical resource blocks are assigned to an arbitrary number of virtual UEs with one PDSCH per virtual UE; the data transmitted over the OCNG PDSCHs shall be uncorrelated pseudo random data, which is QPSK modulated.		
Note 3:	The same PDSCH transmission mode is applied to each component carrier.		

**Table 8.2.2.1.1\_A.1.3-2: Minimum performance (FRC) for CA**

Test number	Bandwidth	Reference Channel	OCNG Pattern	Propagation Condition	Correlation Matrix and Antenna Configuration	Reference value		UE Category
						Fraction of Maximum Throughput (%)	SNR (dB)	
1	2x20 MHz	R.42 TDD	OP.1 TDD (Note1)	EVA5	1x2 Low	70	-1.2	≥5
2	20MHz+15MHz	R.42 TDD for 20MHz CC	OP.1 TDD (Note 1)	EVA5	1x2 Low	70	[-1.4]	≥5
		R.42-3 TDD for 15MHz CC	OP.1 TDD (Note 1)			70	[-1.4]	
Note 1: The OCNG pattern applies for each CC. Note 2: The applicability of requirements for different CA configurations and bandwidth combination sets is defined in 8.1.2.3.								

**Table 8.2.2.1.1\_A.1.3-3: Void**

The normative reference for this requirement is TS 36.101 [2] clause 8.2.2.1.

8.2.2.1.1\_A.1.4 Test description

8.2.2.1.1\_A.1.4.1 Initial conditions

Initial conditions are a set of test configurations the UE needs to be tested in and the steps for the SS to take with the UE to reach the correct measurement state.

Configurations of PDSCH and PDCCH before measurement are specified in Annex C.2.

Test Environment: Normal, as defined in TS 36.508 [7] clause 4.1.

Frequencies to be tested: Maximum WGap for Intra-band non-contiguous CA, otherwise Mid Range, as defined in TS 36.508 [7] clause 4.3.1.2.

Bandwidths to be tested: Select one according to Table 8.2.2.1.1\_A.1.4.1-1.

CA Capability to be tested: Select one according to Table 8.2.2.1.1\_A.1.4.1

**Table 8.2.2.1.1\_A.1.4.1-1: Test point selection for TM3 2DL CA**

CA Capability	Bandwidth Combination	
	20+20	20+15
Inter-band CA (two bands) (CA2_A2)	Test 1	Test 2
Intra-band contiguous CA (CA2_C)	Test 1	Test 2
Intra-band non-contiguous CA (with two sub-blocks) (CA2_N2)	Test 1	Test 2

Note1: Only one test point to be tested. Select the largest aggregated CA bandwidth combination supported by the UE among the UE supported CA capabilities.
-------------------------------------------------------------------------------------------------------------------------------------------------------------

1. Connect the SS, the faders and AWGN noise sources to the UE antenna connectors as shown in TS 36.508 [7] Annex A, Figure group A.35 as appropriate.
2. The parameter settings for the cell are set up according to Tables 8.2.2-1, 8.2.2.1.1\_A.1.3-1 as appropriate.
3. Downlink signals for PCC are initially set up according to Annex C.0, C.1 and Annex C.3.2 and uplink signals according to Annex H.1 and H.3.2.
4. Propagation conditions are set according to Annex B.0.
5. Ensure the UE is in State 3A-RF according to TS 36.508 [7] clause 5.2A.2. Message contents are defined in clause 8.2.2.1.1\_A.1.4.3.

#### 8.2.2.1.1\_A.1.4.2 Test procedure

1. Configure SCC according to Annex C0, C.1 and Annex C.3.2 for all downlink physical channels.
2. The SS shall configure SCC as per TS 36.508 [7] clause 5.2A.4. Message contents are defined in clause 8.2.2.1.1\_A.1.4.3.
3. SS activates SCC by sending the activation MAC-CE (Refer TS 36.321 [13], clauses 5.13, 6.1.3.8). Wait for at least 2 seconds (Refer TS 36.133, clauses 8.3.3.2).
4. SS transmits PDSCH via PDCCH DCI format 1A for C\_RNTI to transmit the DL RMC according to Tables 8.2.2.1.1\_A.1.3-1 and 8.2.2.1.1\_A.1.3-2 on both PCC and SCC. The SS sends downlink MAC padding bits on the DL RMC.
5. Set the parameters of the reference channel, MCS, reference channel, the propagation condition, the correlation matrix and the SNR according to Tables 8.2.2.1.1\_A.1.5-1 as appropriate.
6. Measure the average throughput per component carrier for a duration sufficient to achieve statistical significance according to Annex G clause G.3A, Table G.3A.5-6 on both PCC and SCC. Count the number of NACKs, ACKs and statDTXs on the UL during each subtest on both component carriers.

#### 8.2.2.1.1\_A.1.4.3 Message contents

Message contents are according to TS 36.508 [7] clause 4.6.

In test procedure step 2, for SCC configuration there are no additional message contents.

#### 8.2.2.1.1\_A.1.5 Test requirement

Table 8.2.2.1.1\_A.1.3-1 defines the primary level settings including test tolerances for all throughput tests.

The fraction of maximum throughput percentage for the downlink reference measurement channels specified in Annex A clause 3.3.1 for the throughput test shall meet or exceed the specified value in Table 8.2.2.1.1\_A.1.5-1 for the specified SNR including test tolerances for all throughput tests.

**Table 8.2.2.1.1\_A.1.5-1: Test Requirement (FRC) for CA**

Test number	Bandwidth	Reference Channel	OCNG Pattern	Propagation Condition	Correlation Matrix and Antenna Configuration	Reference value		UE Category
						Fraction of Maximum Throughput (%)	SNR (dB)	
1	2x20 MHz	R.42 TDD	OP.1 TDD (Note1)	EVA5	1x2 Low	70	-0.4	≥5
2	20MHz+15MHz	R.42 TDD for 20MHz CC	OP.1 TDD (Note 1)	EVA5	1x2 Low	70	[-0.6]	≥5
		R.42-3 TDD for 15MHz CC	OP.1 TDD (Note 1)			70	[-0.6]	
Note 1: The OCNG pattern applies for each CC. Note 2: The applicability of requirements for different CA configurations and bandwidth combination sets is defined in 8.1.2.3.								

**Table 8.2.2.1.1\_A.1.5-3: Void**

Decide pass or fail for each subtest according to Annex G.3A.4. Decide the entire test pass or fail according to Annex G.3A.6.

**8.2.2.1.1\_A.2 TDD PDSCH Single Antenna Port Performance for CA (3DL CA)**

**Editor’s notes: This test case is incomplete. The following items are missing or incomplete:**

**- SNR values in minimum requirement and test requirement sections are still with square brackets.**

**8.2.2.1.1\_A.2.1 Test purpose**

To verify the UE's ability to receive a predefined test signal, representing a multi-path fading channel that is determined by the SNR with a percentage of the information bit throughput for a specified downlink Reference Measurement Channel (RMC) not falling below a specified value for transmission on a single-antenna port with different channel models and MCS.

**8.2.2.1.1\_A.2.2 Test applicability**

This test case applies to all types of E-UTRA TDD UE release 10 and forward of UE categories 5 and onwards that support 3DL Intra-band contiguous CA or 3DL Inter-band CA or 3DL with Intra-band contiguous and Inter-band CA.

This test case also applies to all types of E-UTRA TDD UE release 11 and forward of UE categories 5 and onwards that support 3DL with Intra-band non-contiguous and Inter-band CA or 3DL with Intra-band non-contiguous and Intra-band contiguous CA.

**8.2.2.1.1\_A.2.3 Minimum conformance requirements**

For CA with 3 DL CCs, the requirements are specified in Table 8.2.2.1.1\_A.4.3-2, based on single carrier requirement specified in Table 8.2.2.1.1\_A.2.3-1, with the addition of the parameters in Table 8.2.2.1.1.3-1 and the downlink physical channel setup according to Table C.3.2-1 in Annex C.

**Table 8.2.2.1.1\_A.2.3-1: Single carrier performance for multiple CA configurations**

Band-width	Reference channel	OCNG pattern	Propagation condition	Correlation matrix and antenna config.	Reference value	
					Fraction of maximum throughput (%)	SNR (dB)
1.4MHz	R.4 TDD	OP.1 TDD	EVA5	1x2 Low	70	[-0.6]
3MHz	R.42-1 TDD	OP.1 TDD	EVA5	1x2 Low	70	[-0.8]
5MHz	R.42-2 TDD	OP.1 TDD	EVA5	1x2 Low	70	[-1.2]
10MHz	R.2 TDD	OP.1 TDD	EVA5	1x2 Low	70	[-1.6]
15MHz	R.42-3 TDD	OP.1 TDD	EVA5	1x2 Low	70	[-1.4]
20MHz	R.42 TDD	OP.1 TDD	EVA5	1x2 Low	70	[-1.4]

**Table 8.2.2.1.1\_A.2.3-2: Minimum performance (FRC) based on single carrier performance for CA with 3 DL CCs**

Test num.	CA Band-width combination	Requirement	UE category
1	3x20MHz	As specified in Table 8.2.2.1.1_A.2.3-1 per CC	≥5
2	20MHz+20MHz+15MHz	As specified in Table 8.2.2.1.1_A.2.3-1 per CC	≥5

Note 1: The applicability of requirements for different CA configurations and bandwidth combination sets is defined in 8.1.2.3

The normative reference for this requirement is TS 36.101 [2] clause 8.2.1.1.

#### 8.2.2.1.1\_A.2.4 Test description

##### 8.2.2.1.1\_A.2.4.1 Initial conditions

Initial conditions are a set of test configurations the UE needs to be tested in and the steps for the SS to take with the UE to reach the correct measurement state.

Configurations of PDSCH and PDCCH before measurement are specified in Annex C.2.

Test Environment: Normal, as defined in TS 36.508 [7] clause 4.1.

Frequencies to be tested: Maximum WGap for Intra-band non-contiguous CA, otherwise Mid Range, as defined in TS 36.508 [7] clause 4.3.1.

Channel Bandwidths to be tested: Select one according to Table 8.2.2.1.1\_A.2.4.1-1.

CA Capability to be tested: Select one according to Table 8.2.2.1.1\_A.2.4.1-1

**Table 8.2.2.1.1\_A.2.4.1-1: Test point selection for TM1 CA**

CA Capability	Bandwidth combination	
	3x20	20+20+15
Intra-band contiguous (CA3_C)	Test1	NA
Inter-band (CA3_A2)	Test1	Test2
Inter-band CA (three bands) (CA_A3)	NA	NA
Intra-band non-contiguous (with two sub-blocks) (CA3_N2)	Test1	NA

Note1: Only one test point is tested.  
Select the largest aggregated CA bandwidth combination supported by the UE among the UE supported CA capabilities.

1. Connect the SS, the faders and AWGN noise source to the UE antenna connectors as shown in TS 36.508 [7] Annex A, Figure A.59.
2. The parameter settings for the cell are set up according to Table 8.2.2-1 and 8.2.2.1.1\_A.2.3-1 as appropriate.



3. Downlink signals for PCC are initially set up according to Annex C.0, C.1 and Annex C.3.2 and uplink signals according to Annex H.1 and H.3.2.
4. Propagation conditions are set according to Annex B.0.
5. Ensure the UE is in State 3A-RF according to TS 36.508 [7] clause 5.2A.2. Message contents are defined in clause 8.2.2.1.1\_A.2.4.3.

8.2.2.1.1\_A.2.4.2 Test procedure

1. Configure SCCs according to Annex C.0, C.1 and Annex C.3.2 for all downlink physical channels.
2. The SS shall configure SCCs as per TS 36.508 [7] clause 5.2A.4. Message contents are defined in clause 8.2.2.1.1\_A.2.4.3.
3. SS activates SCCs by sending the activation MAC-CE (Refer TS 36.321 [13], clauses 5.13, 6.1.3.8). Wait for at least 2 seconds (Refer TS 36.133, clauses 8.3.3.2).
4. SS transmits PDSCH via PDCCH DCI format 1A for C\_RNTI to transmit the DL RMC according to Tables 8.2.2.1.1\_A.1.3-1 and 8.2.2.1.1\_A.2.3-1 on both PCC and SCCs. The SS sends downlink MAC padding bits on the DL RMC.
5. Set the parameters of the bandwidth, MCS, reference channel, the propagation condition, the correlation matrix and the SNR on each of the component carriers according to Tables 8.2.2.1.1\_A.2.5-1 as appropriate.
6. Measure the average throughput per component carrier for duration sufficient to achieve statistical significance according to Annex G clause G.3A.5 on each of the component carriers. Count the number of NACKs, ACKs and statDTXs on the UL during each subtest on each of the component carriers.

8.2.1.1.1\_A.2.4.3 Message contents

Message contents are according to TS 36.508 [7] subclause 4.6. In test procedure step 2, for SCCs configuration there are no additional message contents.

8.2.2.1.1\_A.2.5 Test requirement

Table 8.2.2.1.1\_A.2.3-1 defines the primary level settings.

The fraction of maximum throughput percentage for the downlink reference measurement channels specified in Annex A clause A.3.3.1 for the throughput test shall meet or exceed the specified value in Table 8.2.2.1.1\_A.2.5-1 for the specified SNR including test tolerances for all throughput tests.

**Table 8.2.2.1.1\_A.2.5-1: Single carrier performance test requirement (FRC) for multiple CA configurations**

Band-width	Reference channel	OCNG pattern	Propa-gation condi-tion	Correlation matrix and antenna config.	Reference value	
					Fraction of maximum throughput (%)	SNR (dB)
1.4MHz	R.4 TDD	OP.1 TDD	EVA5	1x2 Low	70	[0.2]
3MHz	R.42-1 TDD	OP.1 TDD	EVA5	1x2 Low	70	[0]
5MHz	R.42-2 TDD	OP.1 TDD	EVA5	1x2 Low	70	[-0.4]
10MHz	R.2 TDD	OP.1 TDD	EVA5	1x2 Low	70	[-0.8]
15MHz	R.42-3 TDD	OP.1 TDD	EVA5	1x2 Low	70	[-0.6]
20MHz	R.42 TDD	OP.1 TDD	EVA5	1x2 Low	70	[-0.6]

**Table 8.2.2.1.1\_A.2.5-2: Test requirement (FRC) based on single carrier performance for CA with 3DL CCs**

Test num.	CA Band-width combination	Requirement	UE category
-----------	---------------------------	-------------	-------------

1	3x20MHz	As specified in Table 8.2.2.1.1_A.2.5-1 per CC	$\geq 5$
2	20MHz+20MHz+15MHz	As specified in Table 8.2.2.1.1_A.2.5-1 per CC	$\geq 5$
Note 1: The applicability of requirements for different CA configurations and bandwidth combination sets is defined in 8.1.2.3.			

Decide pass or fail for each subtest according to Annex G.3A.4. Decide the entire test pass or fail according to Annex G.3A.6.

### 8.2.2.1.2 TDD PDSCH Single Antenna Port Performance with 1 PRB in the presence of MBSFN

#### 8.2.2.1.2.1 Test purpose

To verify the UE's ability to receive a predefined test signal, representing a multi-path fading channel that is determined by the SNR with a percentage of the information bit throughput for a specified downlink Reference Measurement Channel (RMC) not falling below a specified value for transmission on a single-antenna port with different channel models and MCS and also for the transmission on a single-antenna port with single RB allocation in the presence of MBSFN.

#### 8.2.2.1.2.2 Test applicability

This test applies to all types of E-UTRA TDD UE release 8 and forward.

#### 8.2.2.1.2.3 Minimum conformance requirements

The requirements are specified in terms of the percentage of information bit throughput for the downlink reference measurement channels specified in Annex A clause A.3.4.1, with the addition of the relevant parameters in Tables 8.2.2-1, 8.2.2.1.2.3-1 and the downlink physical channel setup according to table C.3.2-1 in Annex C.

Using this configuration the fraction of maximum throughput percentage shall meet or exceed the minimum requirements specified in Tables 8.2.2.1.2.3-2 for the specified SNR.

**Table 8.2.2.1.2.3-1: Test Parameters for Testing 1 PRB allocation**

Parameter		Unit	Test 1
Downlink power allocation	$\rho_A$	dB	0
	$\rho_B$	dB	0 (Note 1)
$N_{oc}$ at antenna port		dBm/15kHz	-98
Symbols for MBSFN portion of MBSFN subframes (Note 2)			OCNG (Note 3)
ACK/NACK feedback mode			Multiplexing
Note 1: $P_B = 0$ Note 2: The MBSFN portion of an MBSFN subframe comprises the whole MBSFN subframe except the first two symbols in the first slot. Note 3: The MBSFN portion of the MBSFN subframes shall contain QPSK modulated data. Cell-specific reference signals are not inserted in the MBSFN portion of the MBSFN subframes, QPSK modulated MBSFN data is used instead.			

**Table 8.2.2.1.2.3-2: Minimum performance 1 PRB allocation (FRC)**

Test number	Bandwidth	Reference Channel	OCNG Pattern	Propagation Condition	Correlation Matrix and Antenna Configuration	Reference value		UE Category
						Fraction of Maximum Throughput (%)	SNR (dB)	
1	10 MHz	R.29 TDD	OP.3 TDD	ETU70	1x2 Low	30	2.0	1-5

The normative reference for this requirement is TS 36.101 [2] clause 8.2.2.

#### 8.2.2.1.2.4 Test description

##### 8.2.2.1.2.4.1 Initial conditions

Initial conditions are a set of test configurations the UE needs to be tested in and the steps for the SS to take with the UE to reach the correct measurement state.

Configurations of PDSCH and PDCCH before measurement are specified in Annex C.2.

Test Environment: Normal, as defined in TS 36.508 [7] clause 4.1.

Frequencies to be tested: Low Range, as defined in TS 36.508 [7] clause 4.3.1.1.

Bandwidths to be tested: As specified per test number in Tables 8.2.2.1.2.3-2 as defined in TS 36.508 [7] clause 4.3.1.2.

1. Connect the SS, the faders and AWGN noise sources to the UE antenna connectors as shown in TS 36.508 [7] Annex A, Figure A.9.
2. The parameter settings for the cell are set up according to Tables 8.2.2-1, 8.2.2.1.2.3-1 as appropriate.
3. Downlink signals are initially set up according to Annex C.0, C.1 and Annex C.3.2 and uplink signals according to Annex H.1 and H.3.2.
4. Propagation conditions are set according to Annex B.0.
5. Ensure the UE is in State 3A-RF according to TS 36.508 [7] clause 5.2A.2. Message contents are defined in clause 8.2.2.1.2.4.3.

##### 8.2.2.1.2.4.2 Test procedure

1. SS transmits PDSCH via PDCCH DCI format 1A for C\_RNTI to transmit the DL RMC according to Tables 8.2.2.1.2.3-1 and 8.2.2.1.2.3-2. The SS sends downlink MAC padding bits on the DL RMC.
2. Set the parameters of the reference channel, MCS, reference channel, the propagation condition, the correlation matrix and the SNR according to Tables 8.2.2.1.1.2.5-1 as appropriate.
3. Measure the average throughput for a duration sufficient to achieve statistical significance according to Annex G clause G.3. Count the number of NACKs, ACKs and statDTXs on the UL during each subtest interval and decide pass or fail according to Tables G.3.5 and G.3.6 in Annex G clause G.3.

##### 8.2.2.1.2.4.3 Message contents

Message contents are according to TS 36.508 [7] clause 4.6 with the following exceptions.

**Table 8.2.2.1.2.4.3-1: SystemInformationBlockType2: Additional TDD PDSCH Single Antenna Port Performance for 1 PRB allocation with MBSFN subframes test point 1 requirement**

Derivation Path: TS 36.508 [7] clause 4.4.3.3, Table 4.4.3.3-1 SystemInformationBlockType2			
Information Element	Value/remark	Comment	Condition
SystemInformationBlockType2 ::= SEQUENCE {			
mbsfn-SubframeConfig ::= SEQUENCE {			
radioframeAllocationPeriod	n1	Every radio frame is with MBSFN subframe	
radioframeAllocationOffset	0		
subframeAllocation CHOICE {			
oneFrame	01001x	subframe 4 and 9 is used for MBSFN.	TDD
}			
}			
}			

#### 8.2.2.1.2.5 Test requirement

Table 8.2.2.1.2.3-1 defines the primary level settings including test tolerances for all throughput tests.

The fraction of maximum throughput percentage for the downlink reference measurement channels specified in Annex A for each throughput test shall meet or exceed the specified value in Tables 8.2.2.1.2.5-1 for the specified SNR including test tolerances for all throughput tests.

**Table 8.2.2.1.2.5-1: Test Requirement 1PRB with MBSFN subframes (FRC)**

Test number	Bandwidth	Reference Channel	OCNG Pattern	Propagation Condition	Correlation Matrix and Antenna Configuration	Reference value		UE Category
						Fraction of Maximum Throughput (%)	SNR (dB)	
1	10 MHz	R.29 TDD	OP.3 TDD	ETU70	1x2 Low	30	2.8	1-5

#### 8.2.2.2 TDD PDSCH Transmit Diversity Performance (Cell-Specific Reference Symbols)

##### 8.2.2.2.1 TDD PDSCH Transmit Diversity 2x2

###### 8.2.2.2.1.1 Test purpose

To verify the UE's ability to receive a predefined test signal, representing a multi-path fading channel that is determined by the SNR with a percentage of the information bit throughput for a specified downlink Reference Measurement Channel (RMC) not falling below a specified value for transmission on two antenna ports using transmit diversity (SFBC).

###### 8.2.2.2.1.2 Test applicability

This test applies to all types of E-UTRA TDD UE release 8 and forward.

###### 8.2.2.2.1.3 Minimum conformance requirements

The requirements are specified in terms of the percentage of information bit throughput for the downlink reference measurement channels specified in Annex A clause A.3.4.2, with the addition of the relevant parameters in Tables 8.2.2-1 and 8.2.2.2.1.3-1 and the downlink physical channel setup according to Table C.3.2-1 in Annex C.3.2.

Using this configuration the fraction of maximum throughput percentage shall meet or exceed the minimum requirements specified in Table 8.2.2.2.1.3-2 for the specified SNR. For transmit diversity (SFBC) performance with 2 and 4 transmitter antennas as specified.

**Table 8.2.2.2.1.3-1: Test Parameters for Testing Transmit Diversity Performance (FRC)**

Parameter	Unit	Test 1-2	
Downlink power allocation	$\rho_A$	dB	-3
	$\rho_B$	dB	-3 (Note 1)
	$\sigma$	dB	0
$N_{oc}$ at antenna port	dBm/15kHz	-98	
ACK/NACK feedback mode		Multiplexing	
PDSCH transmission mode		2	
Note 1: $P_B = 1$			

**Table 8.2.2.2.1.3-2: Minimum performance Transmit Diversity (FRC)**

Test number	Bandwidth	Reference Channel	OCNG Pattern	Propagation Condition	Correlation Matrix and Antenna Configuration	Reference value		UE Category
						Fraction of Maximum Throughput (%)	SNR (dB)	
1	10 MHz	R.11 TDD	OP.1 TDD	EVA5	2x2 Medium	70	6.8	$\geq 2$
2	10 MHz	R.10 TDD	OP.1 TDD	HST	2x2	70	-2.3	$\geq 1$

The normative reference for this requirement is TS 36.101 [2] clause 8.2.2.2.

#### 8.2.2.2.1.4 Test description

##### 8.2.2.2.1.4.1 Initial conditions

Initial conditions are a set of test configurations the UE needs to be tested in and the steps for the SS to take with the UE to reach the correct measurement state.

Configurations of PDSCH and PDCCH before measurement are specified in Annex C.2.

Test Environment: Normal, as defined in TS 36.508 [7] clause 4.1.

Frequencies to be tested: Mid Range, as defined in TS 36.508 [7] clause 4.3.1.2.

Bandwidths to be tested: As specified per test number in Table 8.2.2.2.1.3-2 as defined in TS 36.508 [7] clause 4.3.1.2

1. Connect the SS, the faders and AWGN noise sources to the UE antenna connectors as shown in TS 36.508 [7] Annex A, Figure A.10 for antenna configuration 2x2.
2. The parameter settings for the cell are set up according to Tables 8.2.2-1 and 8.2.2.2.1.3-1 as appropriate.
3. Downlink signals are initially set up according to Annex C.0, C.1 and Annex C.3.2 and uplink signals according to Annex H.1 and H.3.2.
4. Propagation conditions are set according to Annex B.0.
5. Ensure the UE is in State 3A-RF according to TS 36.508 [7] clause 5.2A.2. Message contents are defined in clause 8.2.2.2.1.4.3.

##### 8.2.2.2.1.4.2 Test procedure

1. SS transmits PDSCH via PDCCH DCI format 1A for C\_RNTI to transmit the DL RMC according to Tables 8.2.2.2.1.3-1 and 8.2.2.2.1.3-2. The SS sends downlink MAC padding bits on the DL RMC.
2. Set the parameters of the bandwidth, MCS, reference channel, the propagation condition, the correlation matrix, antenna configuration and the SNR according to Table 8.2.2.2.1.5-1 as appropriate.

3. Measure the average throughput for a duration sufficient to achieve statistical significance according to Annex G clause G.3. Count the number of NACKs, ACKs and statDTXs on the UL during each test interval and decide pass or fail according to Tables G.3.5 and G.3.6 in Annex G clause G.3.
4. Repeat steps from 1 to 3 for each test interval in Table 8.2.2.2.1.5-1 as appropriate.

#### 8.2.2.2.1.4.3 Message contents

Message contents are according to TS 36.508 [7] clause 4.6.

#### 8.2.2.2.1.5 Test requirement

Table 8.2.2.2.1.3-1 defines the primary level settings.

The fraction of maximum throughput percentage for the downlink reference measurement channels specified in Annex A clause A.3.4.2, for each throughput test shall meet or exceed the specified value in Table 8.2.2.2.1.5-1 for the specified SNR including test tolerances for all throughput tests.

**Table 8.2.2.2.1.5-1: Test requirement Transmit Diversity (FRC)**

Test number	Bandwidth	Reference Channel	OCNG Pattern	Propagation Condition	Correlation Matrix and Antenna Configuration	Reference value		UE Category
						Fraction of Maximum Throughput (%)	SNR (dB)	
1	10 MHz	R.11 TDD	OP.1 TDD	EVA5	2x2 Medium	70	7.7	≥2
2	10 MHz	R.10 TDD	OP.1 TDD	HST	2x2	70	-1.7	≥1

#### 8.2.2.2.1\_1 TDD PDSCH Transmit Diversity 2x2 (Release 9 and forward)

##### 8.2.2.2.1\_1.1 Test purpose

Same test purpose as in clause 8.2.2.2.1.1

##### 8.2.2.2.1\_1.2 Test applicability

This test applies to all types of E-UTRA TDD UE release 9 and forward of UE category 1.

##### 8.2.2.2.1\_1.3 Minimum conformance requirements

Same minimum conformance requirements as in clause 8.2.2.2.1.3 with the following exceptions:

- Instead of Table 8.2.2.2.1.3-2 → use Table 8.2.2.2.1\_1.3-1.

**Table 8.2.2.2.1\_1.3-1: Minimum performance Transmit Diversity (FRC)**

Test number	Bandwidth	Reference Channel	OCNG Pattern	Propagation Condition	Correlation Matrix and Antenna Configuration	Reference value		UE Category
						Fraction of Maximum Throughput (%)	SNR (dB)	
1	5 MHz	R.11-2 TDD	OP.1 TDD	EVA5	2x2 Medium	70	6.8	1

The normative reference for this requirement is TS 36.101 [2] clause 8.2.2.2.

##### 8.2.2.2.1\_1.4 Test description

Same test description as in clause 8.2.2.2.1.4 with the following exceptions:

- Instead of Table 8.2.2.2.1.3-2 → use Table 8.2.2.2.1\_1.3-1.

- Instead of Table 8.2.2.2.1.5-1 → use Table 8.2.2.2.1\_1.5-1.

#### 8.2.2.2.1\_1.5 Test requirement

Same test requirements as in clause 8.2.2.2.1.5 with the following exceptions:

- Instead of Table 8.2.2.2.1.5-1 → use Table 8.2.2.2.1\_1.5-1.

**Table 8.2.2.2.1\_1.5-1: Test requirement Transmit Diversity (FRC)**

Test number	Bandwidth	Reference Channel	OCNG Pattern	Propagation Condition	Correlation Matrix and Antenna Configuration	Reference value		UE Category
						Fraction of Maximum Throughput (%)	SNR (dB)	
1	5 MHz	R.11-2 TDD	OP.1 TDD	EVA5	2x2 Medium	70	+7.7	1

#### 8.2.2.2.2 TDD PDSCH Transmit Diversity 4x2

##### 8.2.2.2.2.1 Test purpose

To verify the UE's ability to receive a predefined test signal, representing a multi-path fading channel that is determined by the SNR with a percentage of the information bit throughput for a specified downlink Reference Measurement Channel (RMC) not falling below a specified value for transmission on four antenna ports using transmit diversity (SFBC-FSTD).

##### 8.2.2.2.2.2 Test applicability

This test applies to all types of E-UTRA TDD UE release 8 and forward.

##### 8.2.2.2.2.3 Minimum conformance requirements

The requirements are specified in terms of the percentage of information bit throughput for the downlink reference measurement channels specified in Annex A clause A.3.4.2, with the addition of the relevant parameters in Tables 8.2.2-1 and 8.2.2.2.2.3-1 and the downlink physical channel setup according to Table C.3.2-1 in Annex C.3.2.

Using this configuration the fraction of maximum throughput percentage shall meet or exceed the minimum requirements specified in Table 8.2.2.2.2.3-2 for the specified SNR. For transmit diversity (SFBC) performance with 2 and 4 transmitter antennas as specified.

**Table 8.2.2.2.2.3-1: Test Parameters for Testing Transmit Diversity Performance (FRC)**

Parameter	Unit	Test 1	
Downlink power allocation	$\rho_A$	dB	-3
	$\rho_B$	dB	-3 (Note 1)
	$\sigma$	dB	0
$N_{oc}$ at antenna port	dBm/15kHz	-98	
ACK/NACK feedback mode		Multiplexing	
PDSCH transmission mode		2	
Note 1: $P_B = 1$			

**Table 8.2.2.2.3-2: Minimum performance Transmit Diversity (FRC)**

Test number	Bandwidth	Reference Channel	OCNG Pattern	Propagation Condition	Correlation Matrix and Antenna Configuration	Reference value		UE Category
						Fraction of Maximum Throughput (%)	SNR (dB)	
1	1.4 MHz	R.12 TDD	OP.1 TDD	EPA5	4x2 Medium	70	0.2	≥1

The normative reference for this requirement is TS 36.101 [2] clause 8.2.2.2.

#### 8.2.2.2.2.4 Test description

##### 8.2.2.2.2.4.1 Initial conditions

Initial conditions are a set of test configurations the UE needs to be tested in and the steps for the SS to take with the UE to reach the correct measurement state.

Configurations of PDSCH and PDCCH before measurement are specified in Annex C.2.

Test Environment: Normal, as defined in TS 36.508 [7] clause 4.1.

Frequencies to be tested: Mid Range, as defined in TS 36.508 [7] clause 4.3.1.2.

Bandwidths to be tested: As specified per test number in Table 8.2.2.2.3-2 as defined in TS 36.508 [7] clause 4.3.1.2

1. Connect the SS, the faders and AWGN noise sources to the UE antenna connectors as shown in TS 36.508 [7] Annex A, Figure A.11 for antenna configuration 4x2.
2. The parameter settings for the cell are set up according to Tables 8.2.2-1 and 8.2.2.2.3-1 as appropriate.
3. Downlink signals are initially set up according to Annex C.0, C.1 and Annex C.3.2 and uplink signals according to Annex H.1 and H.3.2.
4. Propagation conditions are set according to Annex B.0.
5. Ensure the UE is in State 3A-RF according to TS 36.508 [7] clause 5.2A.2. Message contents are defined in clause 8.2.2.2.4.3.

##### 8.2.2.2.2.4.2 Test procedure

1. SS transmits PDSCH via PDCCH DCI format 1A for C\_RNTI to transmit the DL RMC according to Tables 8.2.2.2.3-1 and 8.2.2.2.3-2. The SS sends downlink MAC padding bits on the DL RMC.
2. Set the parameters of the bandwidth, MCS, reference channel, the propagation condition, the correlation matrix, antenna configuration and the SNR according to Table 8.2.2.2.5-1 as appropriate.
3. Measure the average throughput for a duration sufficient to achieve statistical significance according to Annex G clause G.3. Count the number of NACKs, ACKs and statDTXs on the UL during each test interval and decide pass or fail according to Tables G.3.5 and G.3.6 in Annex G clause G.3.

##### 8.2.2.2.2.4.3 Message contents

Message contents are according to TS 36.508 [7] clause 4.6 with the following exceptions.



**Table 8.2.2.2.4.3-1: PDSCH-ConfigDedicated-DEFAULT: Additional TDD PDSCH transmit diversity performance downlink power allocation test point 1 requirement**

Derivation Path: 36.508 clause 4.6.3			
Information Element	Value/remark	Comment	Condition
PDSCH-ConfigDedicated-DEFAULT ::= SEQUENCE {			
p-a	dB-3		
}			

#### 8.2.2.2.2.5 Test requirement

Table 8.2.2.2.3-1 defines the primary level settings.

The fraction of maximum throughput percentage for the downlink reference measurement channels specified in Annex A clause A.3.4.2, for each throughput test shall meet or exceed the specified value in Table 8.2.2.2.5-1 for the specified SNR including test tolerances for all throughput tests.

**Table 8.2.2.2.5-1: Test requirement Transmit Diversity (FRC)**

Test number	Bandwidth	Reference Channel	OCNG Pattern	Propagation Condition	Correlation Matrix and Antenna Configuration	Reference value		UE Category
						Fraction of Maximum Throughput (%)	SNR (dB)	
1	1.4 MHz	R.12 TDD	OP.1 TDD	EPA5	4x2 Medium	70	1.1	≥1

#### 8.2.2.2.2\_1 TDD PDSCH Transmit Diversity 4x2 (Release 9 and forward)

##### 8.2.2.2.2\_1.1 Test purpose

Same test purpose as in clause 8.2.2.2.1.

##### 8.2.2.2.2\_1.2 Test applicability

This test applies to all types of E-UTRA TDD UE release 9 and forward.

##### 8.2.2.2.2\_1.3 Minimum conformance requirements

Same minimum conformance requirements as in clause 8.2.2.2.3 with the following exceptions:

- Instead of Table 8.2.2.2.3-2 → use Table 8.2.2.2\_1.3-1.

**Table 8.2.2.2\_1.3-1: Minimum performance Transmit Diversity (FRC)**

Test number	Bandwidth	Reference Channel	OCNG Pattern	Propagation Condition	Correlation Matrix and Antenna Configuration	Reference value		UE Category
						Fraction of Maximum Throughput (%)	SNR (dB)	
1	10 MHz	R.13 TDD	OP.1 TDD	ETU70	4x2 Low	70	-0.5	≥1

The normative reference for this requirement is TS 36.101 [2] clause 8.2.2.2.

##### 8.2.2.2.2\_1.4 Test description

Same test description as in clause 8.2.2.2.4 with the following exceptions:

- Instead of Table 8.2.2.2.3-2 → use Table 8.2.2.2\_1.3-1.

- Instead of Table 8.2.2.2.2.5-1 → use Table 8.2.2.2.2\_1.5-1.

#### 8.2.2.2.2\_1.5 Test requirement

Same test requirements as in clause 8.2.2.2.2.5 with the following exceptions:

- Instead of Table 8.2.2.2.2.5-1 → use Table 8.2.2.2.2\_1.5-1.

**Table 8.2.2.2.2\_1.5-1: Test requirement Transmit Diversity (FRC)**

Test number	Bandwidth	Reference Channel	OCNG Pattern	Propagation Condition	Correlation Matrix and Antenna Configuration	Reference value		UE Category
						Fraction of Maximum Throughput (%)	SNR (dB)	
1	10 MHz	R.13 TDD	OP.1 TDD	ETU70	4x2 Low	70	+0.4	≥1

#### 8.2.2.2.3\_C TDD PDSCH Transmit diversity 2x2 for eICIC

##### 8.2.2.2.3\_C.1 TDD PDSCH Transmit diversity 2x2 for eICIC (non-MBSFN ABS)

###### 8.2.2.2.3\_C.1.1 Test purpose

To verify the UE's performance of transmit diversity (SFBC) with 2 transmit antennas if the PDSCH transmission in the serving cell takes place in subframes that overlap with ABS of the aggressor cell.

###### 8.2.2.2.3\_C.1.2 Test applicability

This test applies to all types of E-UTRA TDD UE release 10 and forward. Applicability requires support for FGI bit 115.

###### 8.2.2.2.3\_C.1.3 Minimum conformance requirements

The requirements are specified in terms of the percentage of information bit throughput for the downlink reference measurement channels specified in Annex A clause A.3.4.2, with the addition of the relevant parameters in Tables 8.2.2-1 and 8.2.2.2.3\_C.1.3-1.

In Table 8.2.2.2.3\_C.1.3-1, Cell 1 is the serving cell, and Cell 2 is the aggressor cell. The downlink physical channel setup for Cell 1 is according to Table C.3.2-1 in Annex C.3.2 and for Cell 2 is according to Table C.3.3-1 in Annex C.3.3, respectively.

Using this configuration the fraction of maximum throughput percentage shall meet or exceed the minimum requirements specified in Table 8.2.2.2.3\_C.1.3-2 for the specified SNR.

**Table 8.2.2.2.3\_C.1.3-1: Test Parameters for Transmit diversity Performance (FRC)**

Parameter		Unit	Cell 1	Cell 2
Uplink downlink configuration			1	1
Special subframe configuration			4	4
Downlink power allocation	$\rho_A$	dB	-3	-3
	$\rho_B$	dB	-3 (Note 1)	-3 (Note 1)
	$\sigma$	dB	0	N/A
$N_{oc}$ at antenna port	$N_{oc1}$	dBm/15kHz	-102 (Note 2)	N/A
	$N_{oc2}$	dBm/15kHz	-98 (Note 3)	N/A
	$N_{oc3}$	dBm/15kHz	-94.8 (Note 4)	N/A
$\hat{E}_s / N_{oc2}$		dB	Reference Value in Table 8.2.2.2.3_C.1.3-2	6
BW <sub>channel</sub>		MHz	10	10
Subframe Configuration			Non-MBSFN	Non-MBSFN
Time Offset between Cells		$\mu$ s	2.5 (synchronous cells)	
Cell Id			0	1
ABS pattern (Note 5)			N/A	0000010001 0000000001
RLM/RRM Measurement Subframe Pattern (Note 6)			0000000001 0000000001	N/A
CSI Subframe Sets (Note 7)	$C_{CSI,0}$		0000010001 0000000001	N/A
	$C_{CSI,1}$		1100101000 1100111000	N/A
Number of control OFDM symbols			2	2
ACK/NACK feedback mode			Multiplexing	N/A
PDSCH transmission mode			2	N/A
Cyclic prefix			Normal	Normal
<p>Note 1: <math>P_B = 1</math>.</p> <p>Note 2: This noise is applied in OFDM symbols #1, #2, #3, #5, #6, #8, #9, #10, #12, #13 of a subframe overlapping with the aggressor ABS.</p> <p>Note 3: This noise is applied in OFDM symbols #0, #4, #7, #11 of a subframe overlapping with the aggressor ABS.</p> <p>Note 4: This noise is applied in all OFDM symbols of a subframe overlapping with aggressor non-ABS.</p> <p>Note 5: ABS pattern as defined in [14].</p> <p>Note 6: Time-domain measurement resource restriction pattern for PCell measurements as defined in [5].</p> <p>Note 7: As configured according to the time-domain measurement resource restriction pattern for CSI measurements defined in [5].</p> <p>Note 8: Cell 1 is the serving cell. Cell 2 is the aggressor cell. The number of the CRS ports in Cell1 and Cell2 is the same.</p> <p>Note 9: SIB-1 will not be transmitted in Cell2 in this test.</p>				

Table 8.2.2.2.3\_C.1.3-2: Minimum Performance Transmit Diversity (FRC)

Test Number	Reference Channel	OCNG Pattern		Propagation Conditions (Note 1)		Correlation Matrix and Antenna Configuration	Reference Value		UE Category
		Cell 1	Cell 2	Cell 1	Cell 2		Fraction of Maximum Throughput (%) Note 5	SNR (dB) (Note 2)	
1	R.11-4 TDD Note 4	OP.1 TDD	OP.1 TDD	EVA5	EVA5	2x2 Medium	70	3.8	2-8
<p>Note 1: The propagation conditions for Cell 1 and Cell2 are statistically independent.</p> <p>Note 2: SNR corresponds to <math>\widehat{E}_s/N_{oc2}</math> of cell 1.</p> <p>Note 3: The correlation matrix and antenna configuration apply for Cell 1 and Cell 2.</p> <p>Note 4: Cell 1 Reference channel is modified: PDSCH other than SIB1/paging and its associated PDCCH/PCFICH are transmitted in the serving cell subframe when the subframe is overlapped with the ABS subframe of aggressor cell and the subframe is available in the definition of the reference channel.</p> <p>Note 5: The maximum Throughput is calculated from the total Payload in 2 subframes, averaged over 20ms.</p>									

The normative reference for this requirement is TS 36.101 [2] clause 8.2.2.2.3.

#### 8.2.2.2.3\_C.1.4 Test description

##### 8.2.2.2.3\_C.1.4.1 Initial conditions

Initial conditions are a set of test configurations the UE needs to be tested in and the steps for the SS to take with the UE to reach the correct measurement state.

Configurations of PDSCH and PDCCH before measurement are specified in Annex C.2.

Test Environment: Normal, as defined in TS 36.508 [7] clause 4.1.

Frequencies to be tested: Mid Range, as defined in TS 36.508 [7] clause 4.3.1.2.

Channel Bandwidths to be tested: As specified per test number in Table 8.2.2.2.3\_C.1.3-2 as defined in TS 36.508 [7] clause 4.3.1.2.

1. Connect the SS, the faders and AWGN noise sources to the UE antenna connectors as shown in TS 36.508 [7] Annex A, Figure A.40 for antenna configuration 2x2.
2. The parameter settings for the cell1 are set up according to Tables 8.2.2-1 and 8.2.2.2.3\_C.1.3-1 as appropriate.
3. Downlink signals are initially set up for Cell1 according to Annex C.0, C.1 and Annex C.3.2 and uplink signals according to Annex H.1 and H.3.2.
4. Propagation conditions are set according to Annex B.0.
5. Ensure the UE is in State 3A-RF according to TS 36.508 [7] clause 5.2A.2. Message contents are defined in clause 8.2.2.2.3\_C.1.4.3.

##### 8.2.2.2.3\_C.1.4.2 Test procedure

1. Set the parameters for Cell1 and Cell2 according to Tables 8.2.2.2.3\_C.1.5-1, 8.2.2.2.3\_C.1.5-2, C.3.3-1 of Annex C.3.3 as appropriate, and SS transmits PDSCH via PDCCH DCI format 1A for C\_RNTI to transmit the DL RMC. The SS sends downlink MAC padding bits on the DL RMC. Propagation conditions are set according to Annex B clause B.2.
2. Measure the average throughput for a duration sufficient to achieve statistical significance according to Annex G clause G.3. Count the number of NACKs, ACKs and statDTXs on the UL during the test interval and decide pass or fail according to Tables G.3.5 and G.3.6 in Annex G clause G.3.

## 8.2.2.2.3\_C.1.4.3 Message contents

Message contents are according to TS 36.508 [7] clause 4.6 with the following exceptions:

**Table 8.2.2.2.3\_C.1.4.3-1: *RadioResourceConfigDedicated-SRB2-DRB(n, m)*: Additional TDD PDSCH transmit diversity performance downlink power allocation**

Derivation Path: TS 36.508 [7] clause 4.6.3, Table 4.6.3-16 RadioResourceConfigDedicated-SRB2-DRB(n,m)			
Information Element	Value/remark	Comment	Condition
RadioResourceConfigDedicated-SRB2-DRB(n, m) ::= SEQUENCE {			
MeasSubframePatternPCell-r10 CHOICE {			
setup SEQUENCE {			
subframePatternTDD-r10 CHOICE {			
subframeConfig1-5-r10	'00000000010000000001	BIT STRING (SIZE (20))	
}			
}			
}			
}			

**Table 8.2.2.2.3\_C.1.4.3-2: *CQI-ReportConfig-r10-DEFAULT*: Additional TDD PDSCH transmit diversity performance downlink power allocation**

Derivation Path: 36.508 [7] clause 4.6.3, Table 4.6.3-2AA CQI-ReportConfig-r10-DEFAULT_			
Information Element	Value/remark	Comment	Condition
CQI-ReportConfig-r10-DEFAULT ::= SEQUENCE {			
cqi-ReportAperiodic-r10	Not present		
nomPDSCH-RS-EPRE-Offset	0		
cqi-ReportPeriodic-r10	Not present		
pmi-RI-Report-r9	Not present		
csi-SubframePatternConfig-r10 CHOICE {			
setup SEQUENCE {			
csi-MeasSubframeSet1-r10 CHOICE {			
subframePatternTDD-r10 CHOICE {			
subframeConfig1-5-r10	'00000100010000000001	BIT STRING (SIZE (20))	
}			
}			
csi-MeasSubframeSet2-r10 CHOICE {			
subframePatternTDD-r10 CHOICE {			
subframeConfig1-5-r10	'11001010001100111000	BIT STRING (SIZE (20))	
}			
}			
}			
}			

## 8.2.2.2.3\_C.1.5 Test requirement

Table 8.2.2.2.3\_C.1.5-1 defines the primary level settings.

The fraction of maximum throughput percentage for the downlink reference measurement channels specified in Annex A clause A.3.4.2 for each throughput test shall meet or exceed the specified value in Table 8.2.2.2.3\_C.1.5-2 for the specified SNR including test tolerances for all throughput tests.

Table 8.2.2.2.3\_C.1.5-1: Test Parameters for Transmit Diversity (FRC)

Parameter		Unit	Cell 1	Cell 2
Uplink downlink configuration			1	1
Special subframe configuration			4	4
Downlink power allocation	$\rho_A$	dB	-3	-3
	$\rho_B$	dB	-3 (Note 1)	-3 (Note 1)
	$\sigma$	dB	0	N/A
$N_{oc}$ at antenna port	$N_{oc1}$	dBm/15kHz	-102.1 (Note 2)	N/A
	$N_{oc2}$	dBm/15kHz	-98 (Note 3)	N/A
	$N_{oc3}$	dBm/15kHz	-94.9 (Note 4)	N/A
$\hat{E}_s / N_{oc2}$		dB	Reference Value in Table 8.2.2.2.3_C.1.5-2	5.8
$BW_{\text{Channel}}$		MHz	10	10
Subframe Configuration			Non-MBSFN	Non-MBSFN
Time Offset between Cells		$\mu\text{s}$	2.5 (synchronous cells)	
Cell Id			0	1
ABS pattern (Note 5)			N/A	0000010001 0000000001
RLM/RRM Measurement Subframe Pattern (Note 6)			0000000001 0000000001	N/A
CSI Subframe Sets (Note 7)	$C_{\text{CSI},0}$		0000010001 0000000001	N/A
	$C_{\text{CSI},1}$		1100101000 1100111000	N/A
Number of control OFDM symbols			2	2
ACK/NACK feedback mode			Multiplexing	N/A
PDSCH transmission mode			2	N/A
Cyclic prefix			Normal	Normal
<p>Note 1: <math>P_B = 1</math>.</p> <p>Note 2: This noise is applied in OFDM symbols #1, #2, #3, #5, #6, #8, #9, #10, #12, #13 of a subframe overlapping with the aggressor ABS.</p> <p>Note 3: This noise is applied in OFDM symbols #0, #4, #7, #11 of a subframe overlapping with the aggressor ABS.</p> <p>Note 4: This noise is applied in all OFDM symbols of a subframe overlapping with aggressor non-ABS.</p> <p>Note 5: ABS pattern as defined in [14].</p> <p>Note 6: Time-domain measurement resource restriction pattern for PCell measurements as defined in [5].</p> <p>Note 7: As configured according to the time-domain measurement resource restriction pattern for CSI measurements defined in [5].</p> <p>Note 8: Cell 1 is the serving cell. Cell 2 is the aggressor cell. The number of the CRS ports in Cell1 and Cell2 is the same.</p> <p>Note 9: SIB-1 will not be transmitted in Cell2 in this test.</p>				

Table 8.2.2.2.3\_C.1.5-2: Test requirement Transmit Diversity (FRC)

Test Number	Reference Channel	OCNG Pattern		Propagation Conditions (Note 1)		Correlation Matrix and Antenna Configuration	Reference Value		UE Category
		Cell 1	Cell 2	Cell 1	Cell 2		Fraction of Maximum Throughput (%) Note 5	SNR (dB) (Note 2)	
1	R.11-4 TDD Note 4	OP.1 TDD	OP.1 TDD	EVA5	EVA5	2x2 Medium	70	4.7	2-8
<p>Note 1: The propagation conditions for Cell 1 and Cell2 are statistically independent.</p> <p>Note 2: SNR corresponds to <math>\widehat{E}_s/N_{oc2}</math> of cell 1.</p> <p>Note 3: The correlation matrix and antenna configuration apply for Cell 1 and Cell 2.</p> <p>Note 4: Cell 1 Reference channel is modified: PDSCH other than SIB1/paging and its associated PDCCH/PCFICH are transmitted in the serving cell subframe when the subframe is overlapped with the ABS subframe of aggressor cell and the subframe is available in the definition of the reference channel.</p> <p>Note 5: The maximum Throughput is calculated from the total Payload in 2 subframes, averaged over 20ms.</p>									

## 8.2.2.2.3\_D

## 8.2.2.2.3\_E TDD PDSCH Transmit diversity 2x2 for feICIC

## 8.2.2.2.3\_E.1 TDD PDSCH Transmit diversity 2x2 for feICIC (non-MBSFN ABS)

## 8.2.2.2.3\_E.1.1 Test purpose

To verify the UE's performance of transmit diversity (SFBC) with 2 transmit antennas if the PDSCH transmission in the serving cell takes place in subframes that overlap with ABS [14] of the aggressor cells with CRS assistance information.

## 8.2.2.2.3\_E.1.2 Test applicability

This test applies to all types of E-UTRA TDD UE – Category 2-8 release 11 and forward. Applicability requires support of FGI bit 115.

## 8.2.2.2.3\_E.1.3 Minimum conformance requirements

The requirements are specified in terms of the percentage of information bit throughput for the downlink reference measurement channels specified in Annex A clause A.3.3.2, with the addition of the relevant parameters in Tables 8.2.1-1 and 8.2.2.2.3\_E.1.3-1.

In Table 8.2.2.2.3\_E.1-1, Cell 1 is the serving cell, and Cell 2 and Cell 3 are the aggressor cells. The downlink physical channel setup for Cell 1 is according to Annex C.3.2 and for Cell 2 and Cell 3 is according to Annex C.3.3, respectively. The CRS assistance information TS 36.331 [5] includes Cell 2 and Cell 3.

Using this configuration the fraction of maximum throughput percentage shall meet or exceed the minimum requirements specified in Table 8.2.2.2.3\_E.1.3-2 for the specified SNR.

**Table 8.2.2.3\_E.1.3-1: Test Parameters for Transmit diversity Performance (FRC)**

Parameter		Unit	Cell 1	Cell 2	Cell 3
Uplink downlink configuration			1	1	1
Special subframe configuration			4	4	4
Downlink power allocation	$\rho_A$	dB	-3	-3	-3
	$\rho_B$	dB	-3 (Note 1)	-3 (Note 1)	-3 (Note 1)
	$\sigma$	dB	0	N/A	N/A
$N_{oc}$ at antenna port	$N_{oc1}$	dBm/15kHz	-98 (Note 2)	N/A	N/A
	$N_{oc2}$	dBm/15kHz	-98 (Note 3)	N/A	N/A
	$N_{oc3}$	dBm/15kHz	-93 (Note 4)	N/A	N/A
$\hat{E}_s / N_{oc2}$		dB	Reference Value in Table 8.2.2.3_E.1.3-2	12	10
$BW_{Channel}$		MHz	10	10	10
Subframe Configuration			Non-MBSFN	Non-MBSFN	Non-MBSFN
Time Offset between Cells		$\mu s$	N/A	3	-1
Frequency shift between Cells		Hz	N/A	300	-100
Cell Id			0	126	1
ABS pattern (Note 5)			N/A	0000000001 0000000001	0000000001 0000000001
RLM/RRM Measurement Subframe Pattern (Note 6)			0000000001 0000000001	N/A	N/A
CSI Subframe Sets (Note7)	$C_{CSI,0}$		0000000001 0000000001	N/A	N/A
	$C_{CSI,1}$		1100111000 1100111000	N/A	N/A
Number of control OFDM symbols			2	Note 8	Note 8
ACK/NACK feedback mode			Multiplexing	N/A	N/A
PDSCH transmission mode			2	Note 9	Note 9
Cyclic prefix			Normal	Normal	Normal
<p>Note 1: <math>P_B = 1</math>.</p> <p>Note 2: This noise is applied in OFDM symbols #1, #2, #3, #5, #6, #8, #9, #10, #12, #13 of a subframe overlapping with the aggressor ABS.</p> <p>Note 3: This noise is applied in OFDM symbols #0, #4, #7, #11 of a subframe overlapping with the aggressor ABS.</p> <p>Note 4: This noise is applied in all OFDM symbols of a subframe overlapping with aggressor non-ABS</p> <p>Note 5: ABS pattern as defined in [14].</p> <p>Note 6: Time-domain measurement resource restriction pattern for PCell measurements as defined in TS 36.331 [5].</p> <p>Note 7: As configured according to the time-domain measurement resource restriction pattern for CSI measurements defined in TS 36.331 [5].</p> <p>Note 8: The number of control OFDM symbols is not available for ABS and is 2 for the subframe indicated by "0" of ABS pattern.</p> <p>Note 9: Downlink physical channel setup in Cell 2 and Cell 3 in accordance with TS 36.521-1 [10] Annex C.3.3 applying OCNG pattern as defined in TS 36.521-1 [10] Annex A.5.</p> <p>Note 10: The number of the CRS ports in Cell 1, Cell 2 and Cell 3 is the same.</p> <p>Note 11: SIB-1 will not be transmitted in Cell 2 and Cell 3 in this test.</p>					

**Table 8.2.2.3\_E.1.3-2: Minimum Performance Transmit Diversity (FRC)**

Test Number	Reference Channel	OCNG Pattern			Propagation Conditions (Note 1)			Correlation Matrix and Antenna Configuration (Note 2)	Reference Value		UE Category
		Cell 1	Cell 2	Cell 3	Cell 1	Cell 2	Cell 3		Fraction of Maximum Throughput	SNR (dB) (Note 3)	



									ut (%) (Note 5)		
1	R.11-4 TDD (Note 4)	OP.1 TDD	OP.1 TDD	OP.1 TDD	EVA5	EVA5	EVA5	2x2 Medium	70	3.5	2-8
<p>Note 1: The propagation conditions for Cell 1, Cell 2 and Cell 3 are statistically independent.</p> <p>Note 2: The correlation matrix and antenna configuration apply for Cell 1, Cell 2 and Cell 3.</p> <p>Note 3: SNR corresponds to <math>\hat{E}_s/N_{oc2}</math> of Cell 1.</p> <p>Note 4: Cell 1 reference channel is modified: PDSCH other than SIB1/paging and its associated PDCCH/PCFICH are transmitted in the serving cell subframe when the subframe is overlapped with the ABS subframe of aggressor cell and the subframe is available in the definition of the reference channel.</p> <p>Note 5: The maximum throughput is calculated from the total Payload in 2 subframes, averaged over 20ms.</p>											

The normative reference for this requirement is TS 36.101 [2] clause 8.2.2.2.3A.

#### 8.2.2.2.3\_E.1.4 Test description

##### 8.2.2.2.3\_E.1.4.1 Initial conditions

Initial conditions are a set of test configurations the UE needs to be tested in and the steps for the SS to take with the UE to reach the correct measurement state.

Configurations of PDSCH and PDCCH before measurement are specified in Annex C.2.

Test Environment: Normal, as defined in TS 36.508 [7] clause 4.1.

Frequencies to be tested: Mid Range, as defined in TS 36.508 [7] clause 4.3.1.2.

Channel Bandwidths to be tested: As specified per test number in Table 8.2.2.2.3\_E.1.3-2 as defined in TS 36.508 [7] clause 4.3.1.2.

1. Connect the SS, the faders and AWGN noise sources to the UE antenna connectors as shown in TS 36.508 [7] Annex A, Figure A.48 for antenna configuration 2x2.
2. The parameter settings for the cell1 are set up according to Tables 8.2.2-1 and 8.2.2.2.3\_E.1.3-1 as appropriate.
3. Downlink signals are initially set up for Cell1 according to Annex C.0, C.1 and Annex C.3.2 and uplink signals according to Annex H.1 and H.3.2.
4. Propagation conditions are set according to Annex B.0.
5. Ensure the UE is in State 3A-RF according to TS 36.508 [7] clause 5.2A.2. Message contents are defined in clause 8.2.2.2.3\_E.1.4.3.

##### 8.2.2.2.3\_E.1.4.2 Test procedure

1. Set the parameters for Cell 1, Cell 2 and Cell 3, according to Tables 8.2.2.2.3\_E.1.5-1, 8.2.2.2.3\_E.1.5-2, and C.3.3.2 of Annex C.3.3. SS transmits PDSCH via PDCCH DCI format 1A for C\_RNTI to transmit the DL RMC.
2. The SS sends downlink MAC padding bits on the DL RMC. Propagation conditions are set according to Annex B clause B.2
3. Measure the average throughput for a duration sufficient to achieve statistical significance according to Annex G clause G.3. Count the number of NACKs, ACKs and statDTXs on the UL during the test interval and decide pass or fail according to Tables G.3.5 and G.3.6 in Annex G clause G.3.

##### 8.2.2.2.3\_E.1.4.3 Message contents

Message contents are according to TS 36.508 [7] clause 5.2A.5.1 with the following exceptions:

**Table 8.2.2.3\_E.1.4.3-1: RadioResourceConfigDedicated-SRB2-DRB(n, m): Additional TDD PDSCH transmit diversity performance downlink power allocation**

Derivation Path: TS 36.508 [7] clause 5.2A.5, Table 5.2A.5.1.1-2 RadioResourceConfigDedicated-SRB2-DRB(n,m)			
Information Element	Value/remark	Comment	Condition
RadioResourceConfigDedicated-SRB2-DRB(n, m) ::= SEQUENCE {			
MeasSubframePatternPCell-r10 CHOICE {			
setup SEQUENCE {			
subframePatternTDD-r10 CHOICE {			
subframeConfig1-5-r10	'0000000001 0000000001'	BIT STRING (SIZE (20))	
}			
}			
}			
neighCellsCRS-Info-r11 ::= CHOICE {			
setup SEQUENCE {			
CRS-AssistancedInfoList-r11 ::= SEQUENCE (SIZE (1..maxCellReport)) OF CRS-AssistancedInfo-r11{		2 entries	
CRS-AssistancedInfo-r11 ::= SEQUENCE {			
physCellId-r11	126		Cell 2
	1		Cell 3
antennaPortsCount-r11	an2		Cell 2, Cell 3
mbsfn-SubframeConfigList-r11 ::= SEQUENCE (SIZE (1..maxMBSFN-Allocations)) OF MBSFN-SubframeConfig{			Cell 2, Cell 3
MBSFN-SubframeConfig ::= SEQUENCE {			
radioframeAllocationPeriod	n1		
radioframeAllocationOffset	0		
subframeAllocation CHOICE{			
oneFrame	'000000' B	non-MBSFN	
}			
}			
}			
}			
}			
}			
}			

**Table 8.2.2.2.3\_E.1.4.3-2: CQI-ReportConfig-r10-DEFAULT: Additional TDD PDSCH transmit diversity performance downlink power allocation**

Derivation Path: 36.508 [7] clause 4.6.3, Table 4.6.3-2AA CQI-ReportConfig-r10-DEFAULT_			
Information Element	Value/remark	Comment	Condition
CQI-ReportConfig-r10-DEFAULT ::= SEQUENCE {			
cqi-ReportAperiodic-r10	Not present		
nomPDSCH-RS-EPRE-Offset	0		
cqi-ReportPeriodic-r10	Not present		
pmi-RI-Report-r9	Not present		
csi-SubframePatternConfig-r10 CHOICE {			
setup SEQUENCE {			
csi-MeasSubframeSet1-r10 CHOICE {			
subframePatternTDD-r10 CHOICE {			
subframeConfig1-5-r10	'0000000001 0000000001'	BIT STRING (SIZE (20))	
}			
}			
}			
csi-MeasSubframeSet2-r10 CHOICE {			
subframePatternTDD-r10 CHOICE {			
subframeConfig1-5-r10	'1100111000 1100111000'	BIT STRING (SIZE (20))	
}			
}			
}			
}			

#### 8.2.2.2.3\_E.1.5 Test requirement

Table 8.2.2.2.3\_E.1.5-1 defines the primary level settings.

The fraction of maximum throughput percentage for the downlink reference measurement channels specified in Annex A clause A.3.3.2 for each throughput test shall meet or exceed the specified value in Table 8.2.2.2.3\_E.1.5-2 for the specified SNR including test tolerances for all throughput tests.

**Table 8.2.2.3\_E.1.5-1: Test Parameters for Transmit diversity Performance (FRC)**

Parameter		Unit	Cell 1	Cell 2	Cell 3
Uplink downlink configuration			1	1	1
Special subframe configuration			4	4	4
Downlink power allocation	$\rho_A$	dB	-3	-3	-3
	$\rho_B$	dB	-3 (Note 1)	-3 (Note 1)	-3 (Note 1)
	$\sigma$	dB	0	N/A	N/A
$N_{oc}$ at antenna port	$N_{oc1}$	dBm/15kHz	-98 (Note 2)	N/A	N/A
	$N_{oc2}$	dBm/15kHz	-98 (Note 3)	N/A	N/A
	$N_{oc3}$	dBm/15kHz	-93.1 (Note 4)	N/A	N/A
$\hat{E}_s / N_{oc2}$		dB	Reference Value in Table 8.2.2.3_E.1.5-2	11.8	9.8
$BW_{Channel}$		MHz	10	10	10
Subframe Configuration			Non-MBSFN	Non-MBSFN	Non-MBSFN
Time Offset between Cells		$\mu s$	N/A	3	-1
Frequency shift between Cells		Hz	N/A	300	-100
Cell Id			0	126	1
ABS pattern (Note 5)			N/A	0000000001 0000000001	0000000001 0000000001
RLM/RRM Measurement Subframe Pattern (Note 6)			0000000001 0000000001	N/A	N/A
CSI Subframe Sets (Note7)	$C_{CSI,0}$		0000000001 0000000001	N/A	N/A
	$C_{CSI,1}$		1100111000 1100111000	N/A	N/A
Number of control OFDM symbols			2	Note 8	Note 8
ACK/NACK feedback mode			Multiplexing	N/A	N/A
PDSCH transmission mode			2	Note 9	Note 9
Cyclic prefix			Normal	Normal	Normal
<p>Note 1: <math>P_B = 1</math>.</p> <p>Note 2: This noise is applied in OFDM symbols #1, #2, #3, #5, #6, #8, #9, #10, #12, #13 of a subframe overlapping with the aggressor ABS.</p> <p>Note 3: This noise is applied in OFDM symbols #0, #4, #7, #11 of a subframe overlapping with the aggressor ABS.</p> <p>Note 4: This noise is applied in all OFDM symbols of a subframe overlapping with aggressor non-ABS</p> <p>Note 5: ABS pattern as defined in [14].</p> <p>Note 6: Time-domain measurement resource restriction pattern for PCell measurements as defined in TS 36.331 [5].</p> <p>Note 7: As configured according to the time-domain measurement resource restriction pattern for CSI measurements defined in TS 36.331 [5].</p> <p>Note 8: The number of control OFDM symbols is not available for ABS and is 2 for the subframe indicated by "0" of ABS pattern.</p> <p>Note 9: Downlink physical channel setup in Cell 2 and Cell 3 in accordance with TS 36.521-1 [10] Annex C.3.3 applying OCNG pattern as defined in TS 36.521-1 [10] Annex A.5.</p> <p>Note 10: The number of the CRS ports in Cell 1, Cell 2 and Cell 3 is the same.</p> <p>Note 11: SIB-1 will not be transmitted in Cell 2 and Cell 3 in this test.</p>					

**Table 8.2.2.3\_E.1.5-2: Test requirement Transmit Diversity (FRC)**

Test Number	Reference Channel	OCNG Pattern			Propagation Conditions (Note 1)			Correlation Matrix and Antenna Configuration (Note 2)	Reference Value		UE Category
		Cell 1	Cell 2	Cell 3	Cell 1	Cell 2	Cell 3		Fraction of Maximum Throughp	SNR (dB) (Note 3)	

									ut (%) (Note 5)		
1	R.11-4 TDD (Note 4)	OP.1 TDD	OP.1 TDD	OP.1 TDD	EVA5	EVA5	EVA5	2x2 Medium	70	4.4	2-8
<p>Note 1: The propagation conditions for Cell 1, Cell 2 and Cell 3 are statistically independent.</p> <p>Note 2: The correlation matrix and antenna configuration apply for Cell 1, Cell 2 and Cell 3.</p> <p>Note 3: SNR corresponds to <math>\hat{E}_s/N_{oc2}</math> of Cell 1.</p> <p>Note 4: Cell 1 reference channel is modified: PDSCH other than SIB1/paging and its associated PDCCH/PCFICH are transmitted in the serving cell subframe when the subframe is overlapped with the ABS subframe of aggressor cell and the subframe is available in the definition of the reference channel.</p> <p>Note 5: The maximum throughput is calculated from the total Payload in 2 subframes, averaged over 20ms.</p>											

#### 8.2.2.2.4 TDD PDSCH Transmit Diversity 2x2 with TM3 Interference Model – Enhanced Performance Requirement Type A

**Editor's note: This clause is incomplete. The following aspects are either missing or not yet determined:**

##### 8.2.2.2.4.1 Test purpose

To verify the performance of transmit diversity (SFBC) with 2 transmit antennas when the PDSCH transmission in the serving cell is interfered by PDSCH of two dominant interfering cells applying transmission mode 3 interference model.

##### 8.2.2.2.4.2 Test applicability

This test applies to all types of E-UTRA TDD UE release 11 and forward that support enhanced receiver Type A.

##### 8.2.2.2.4.3 Minimum conformance requirements

The requirements are specified in terms of the percentage of information bit throughput for the downlink reference measurement channels specified in Annex A clause A.3.4.2, with the addition of the relevant parameters in Tables 8.2.2-1, 8.2.2.2.4.3-1 and 8.2.2.2.4.3-2 and the downlink physical channel setup according to Table C.3.2-1 in Annex C.

Using this configuration the fraction of maximum throughput percentage shall meet or exceed the minimum requirements specified in Tables 8.2.2.2.4.3-2 for the specified SINR.

**Table 8.2.2.4.3-1: Test Parameters for Transmit diversity Performance (FRC) with TM3 interference model**

Parameter		Unit	Cell 1	Cell 2	Cell 3
Downlink power allocation	$\rho_A$	dB	-3	-3	-3
	$\rho_B$	dB	-3 (Note 1)	-3	-3
	$\sigma$	dB	0	0	0
Cell-specific reference signals			Antenna ports 0,1	Antenna ports 0,1	Antenna ports 0,1
$N_{oc}$ at antenna port		dBm/15kHz	-98	N/A	N/A
DIP (Note 2)		dB	N/A	-1.73	-8.66
$BW_{Channel}$		MHz	10	10	10
Cyclic Prefix			Normal	Normal	Normal
Cell Id			0	1	2
Number of control OFDM symbols			2	2	2
PDSCH transmission mode			2	N/A	N/A
Interference model			N/A	As specified in clause B.5.2	As specified in clause B.5.2
Probability of occurrence of transmission rank in interfering cells	Rank 1	%	N/A	80	80
	Rank 2	%	N/A	20	20
Reporting interval		ms	5	N/A	N/A
Reporting mode			PUCCH 1-0	N/A	N/A
ACK/NACK feedback mode			Multiplexing	N/A	N/A
Note 1: $P_B = 1$					
Note 2: The respective received power spectral density of each interfering cell relative to $N_{oc}$ is defined by its associated DIP value as specified in clause B.5.1.					
Note 3: Cell 1 is the serving cell. Cell 2, 3 are the interfering cells.					
Note 4: All cells are time-synchronous.					

**Table 8.2.2.4.3-2: Enhanced Performance Requirement Type A, Transmit Diversity (FRC) with TM3 interference model**

Test Number	Reference Channel	OCNG Pattern			Propagation Conditions			Correlation Matrix and Antenna Configuration (Note 3)	Reference Value		UE Category
		Cell 1	Cell 2	Cell 3	Cell 1	Cell 2	Cell 3		Fraction of Maximum Throughput (%)	SINR (dB) (Note 2)	
1	R.46 TDD	OP.1 TDD	N/A	N/A	EVA 70	EVA 70	EVA 70	2x2 Low	70	-1.4	1-8
Note 1: The propagation conditions for Cell 1, Cell 2 and Cell 3 are statistically independent.											
Note 2: SINR corresponds to $\hat{E}_s / N_{oc}$ of Cell 1 as defined in clause 8.1.1.											
Note 3: Correlation matrix and antenna configuration parameters apply for each of Cell 1, Cell 2 and Cell 3.											

The normative reference for this requirement is TS 36.101 [2] clause 8.2.2.2.

8.2.2.2.4.4 Test description

8.2.2.2.4.4.1 Initial conditions

Initial conditions are a set of test configurations the UE needs to be tested in and the steps for the SS to take with the UE to reach the correct measurement state.

Configurations of PDSCH and PDCCH before measurement are specified in Annex C.2.

Test Environment: Normal, as defined in TS 36.508 [7] clause 4.1.

Frequencies to be tested: Mid Range, as defined in TS 36.508 [7] clause 4.3.1.2.

Bandwidths to be tested: As specified per test number in Tables 8.2.2.2.4.5-2 as defined in TS 36.508 [7] clause 4.3.1.2.

1. Connect the SS, the faders and AWGN noise sources to the UE antenna connectors as shown in TS 36.508 [7] Annex A, Figure A.48.
2. The parameter settings for the cell1 are set up according to Tables 8.2.2-1, 8.2.2.2.4.5-1 and 8.2.2.2.4.5-2 as appropriate.
3. Downlink signals are initially set up for cell1 according to Annex C.1 and Annex C.3.2 and uplink signals according to Annex H.1 and H.3.2.
4. Propagation conditions are set according to Annex B.0.
5. Ensure the UE is in State 3A-RF according to TS 36.508 [7] clause 5.2A.2. Message contents are defined in clause 8.2.2.2.4.4.3.

#### 8.2.2.2.4.4.2 Test procedure

1. SS transmits PDSCH via PDCCH DCI format 2 for C\_RNTI to transmit the DL RMC according to Table 8.2.2.2.4.3-2. The SS sends downlink MAC padding bits on the DL RMC.
2. Set the parameters for cell1 and cell2 according to Tables 8.2.2.2.4.5-1 and 8.2.2.2.4.5-2 as appropriate.
3. Measure the average throughput for a duration sufficient to achieve statistical significance according to Annex G clause G.3. Count the number of NACKs, ACKs and statDTXs on the UL during each test interval and decide pass or fail according to Tables G.3.5 and G.3.6 in Annex G clause G.3.

#### 8.2.2.2.4.4.3 Message contents

Message contents are according to TS 36.508 [7] clause 4.6.

#### 8.2.2.2.4.5 Test requirement

Table 8.2.2.2.4.5-1 defines the primary level settings.

**Table 8.2.2.4.5-1: Test Parameters for Transmit diversity Performance (FRC) with TM3 interference model**

Parameter		Unit	Cell 1	Cell 2	Cell 3
Downlink power allocation	$\rho_A$	dB	-3	-3	-3
	$\rho_B$	dB	-3 (Note 1)	-3	-3
	$\sigma$	dB	0	0	0
Cell-specific reference signals			Antenna ports 0,1	Antenna ports 0,1	Antenna ports 0,1
$N_{oc}$ at antenna port		dBm/15kHz	-98	N/A	N/A
DIP (Note 2)		dB	N/A	-1.44	-7.77
$BW_{Channel}$		MHz	10	10	10
Cyclic Prefix			Normal	Normal	Normal
Cell Id			0	1	2
Number of control OFDM symbols			2	2	2
PDSCH transmission mode			2	N/A	N/A
Interference model			N/A	As specified in clause B.5.2	As specified in clause B.5.2
Probability of occurrence of transmission rank in interfering cells	Rank 1	%	N/A	80	80
	Rank 2	%	N/A	20	20
Reporting interval		ms	5	N/A	N/A
Reporting mode			PUCCH 1-0	N/A	N/A
ACK/NACK feedback mode			Multiplexing	N/A	N/A
Note 1: $P_B = 1$					
Note 2: The respective received power spectral density of each interfering cell relative to $N_{oc}$ is defined by its associated DIP value as specified in clause B.5.1.					
Note 3: Cell 1 is the serving cell. Cell 2, 3 are the interfering cells.					
Note 4: All cells are time-synchronous.					

The fraction of maximum throughput percentage for the downlink reference measurement channels specified in Annex A clause A.3.4.2, for each throughput test shall meet or exceed the specified value in Table 8.2.2.4.3.5-2 for the specified SINR including test tolerances for all throughput tests.

**Table 8.2.2.4.5-2: Enhanced Performance Requirement Type A, Transmit Diversity (FRC) with TM3 interference model**

Test Number	Reference Channel	OCNG Pattern			Propagation Conditions			Correlation Matrix and Antenna Configuration (Note 3)	Reference Value		UE Category
		Cell 1	Cell 2	Cell 3	Cell 1	Cell 2	Cell 3		Fraction of Maximum Throughput (%)	SINR (dB) (Note 2)	
1	R.46 TDD	OP.1 TDD	N/A	N/A	EVA 70	EVA 70	EVA 70	2x2 Low	70	-0.41	1-8
Note 1: The propagation conditions for Cell 1, Cell 2 and Cell 3 are statistically independent.											
Note 2: SINR corresponds to $\hat{E}_s / N_{oc}$ of Cell 1 as defined in clause 8.1.1.											
Note 3: Correlation matrix and antenna configuration parameters apply for each of Cell 1, Cell 2 and Cell 3.											



### 8.2.2.3 TDD PDSCH Open Loop Spatial Multiplexing Performance (Cell-Specific Reference Symbols)

#### 8.2.2.3.1 TDD PDSCH Open Loop Spatial Multiplexing 2x2

##### 8.2.2.3.1.1 Test purpose

To verify the UE's ability to receive a predefined test signal, representing a multi-path fading channel that is determined by the SNR with a percentage of the information bit throughput for a specified downlink Reference Measurement Channel (RMC) not falling below a specified value for transmission on two antenna ports using large delay CDD.

##### 8.2.2.3.1.2 Test applicability

This test applies to all types of E-UTRA TDD release 8 and forward UE of category 2-8.

##### 8.2.2.3.1.3 Minimum conformance requirements

The requirements are specified in terms of the percentage of information bit throughput for the downlink reference measurement channels specified in Annex A clause A.3.4.2, with the addition of the relevant parameters in Tables 8.2.2-1 and 8.2.2.3.1.3-1 and the downlink physical channel setup according to Table C.3.2-1 in Annex C.

Using this configuration the fraction of maximum throughput percentage shall meet or exceed the minimum requirements specified in Tables 8.2.2.3.1.3-2 for the specified SNR. For open-loop spatial multiplexing performance with large delay CDD is specified.

**Table 8.2.2.3.1.3-1: Test Parameters for Large Delay CDD (FRC)**

Parameter	Unit	Test 1
Downlink power allocation	$\rho_A$	dB
	$\rho_B$	dB
	$\sigma$	dB
$N_{oc}$ at antenna port	dBm/15kHz	-98
ACK/NACK feedback mode		Bundling
PDSCH transmission mode		3
Note 1: $P_B = 1$		

**Table 8.2.2.3.1.3-2: Minimum performance Large Delay CDD (FRC)**

Test number	Bandwidth	Reference Channel	OCNG Pattern	Propagation Condition	Correlation Matrix and Antenna Configuration	Reference value		UE Category
						Fraction of Maximum Throughput (%)	SNR (dB)	
1	10 MHz	R.11-1 TDD	OP.1 TDD	EVA70	2x2 Low	70	13.1	$\geq 2$

The normative reference for this requirement is TS 36.101 [2] clause 8.2.2.3.

##### 8.2.2.3.1.4 Test description

###### 8.2.2.3.1.4.1 Initial conditions

Initial conditions are a set of test configurations the UE needs to be tested in and the steps for the SS to take with the UE to reach the correct measurement state.

Configurations of PDSCH and PDCCH before measurement are specified in Annex C.2.

Test Environment: Normal, as defined in TS 36.508 [7] clause 4.1.

Frequencies to be tested: Mid Range, as defined in TS 36.508 [7] clause 4.3.1.2.

Bandwidths to be tested: As specified per test number in Table 8.2.2.3.1.3-2 as defined in TS 36.508 [7] clause 4.3.1.2.

1. Connect the SS, the faders and AWGN noise sources to the UE antenna connectors as shown in TS 36.508 [7] Annex A, Figure A.10 for antenna configuration 2x2.
2. The parameter settings for the cell are set up according to Tables 8.2.2-1 and 8.2.2.3.1.3-1 as appropriate.
3. Downlink signals are initially set up according to Annex C.0, C.1 and Annex C.3.2 and uplink signals according to Annex H.1 and H.3.2.
4. Propagation conditions are set according to Annex B.0.
5. Ensure the UE is in State 3A-RF according to TS 36.508 [7] clause 5.2A.2. Message contents are defined in clause 8.2.2.3.1.4.3.

#### 8.2.2.3.1.4.2 Test procedure

1. SS transmits PDSCH via PDCCH DCI format 2A for C\_RNTI to transmit the DL RMC according to Tables 8.2.2.3.1.3-1 and 8.2.2.3.1.3-2. The SS sends downlink MAC padding bits on the DL RMC.
2. Set the parameters of the bandwidth, MCS, reference channel, the propagation condition, the correlation matrix, antenna configuration and the SNR according to Table 8.2.2.3.1.5-1 as appropriate.
3. Measure the average throughput for a duration sufficient to achieve statistical significance according to Annex G clause G.3. Count the number of NACKs, ACKs and statDTXs on the UL during each test interval and decide pass or fail according to Tables G.3.5 and G.3.6 in Annex G clause G.3.

#### 8.2.2.3.1.4.3 Message contents

Message contents are according to TS 36.508 [7] clause 4.6 with the following exceptions.

**Table 8.2.2.3.1.4.3-1: *PhysicalConfigDedicated-DEFAULT*: Additional TDD PDSCH open loop spatial multiplexing performance downlink power allocation for Test number 1**

Derivation Path: 36.508 Table 5.5.1.2-1			
Information Element	Value/remark	Comment	Condition
PhysicalConfigDedicated-DEFAULT ::= SEQUENCE {			
antennaInfo CHOICE {			
antennaInfoDedicated ::= SEQUENCE {			
transmissionMode	tm3		
codebookSubsetRestriction CHOICE {			
n2TxAntenna-tm3	11		
}			
ue-TransmitAntennaSelection CHOICE {			
release	NULL		
}			
}			
}			

#### 8.2.2.3.1.5 Test requirement

Table 8.2.2.3.1.3-1 defines the primary level settings.

The fraction of maximum throughput percentage for the downlink reference measurement channels specified in Annex A clause A.3.4.2, for each throughput test shall meet or exceed the specified value in Tables 8.2.2.3.1.5-1 for the specified SNR including test tolerances for all throughput tests.

**Table 8.2.2.3.5-1: Test requirement Large Delay CDD (FRC)**

Test number	Bandwidth	Reference Channel	OCNG Pattern	Propagation Condition	Correlation Matrix and Antenna Configuration	Reference value		UE Category
						Fraction of Maximum Throughput (%)	SNR (dB)	
1	10 MHz	R.11-1 TDD	OP.1 TDD	EVA70	2x2 Low	70	14.0	≥2

8.2.2.3.1\_1 TDD PDSCH Open Loop Spatial Multiplexing 2x2 (Release 11 and forward)

8.2.2.3.1\_1.1 Test purpose

Same test purpose as in clause 8.2.2.3.1.1.

8.2.2.3.1\_1.2 Test applicability

This test applies to all types of E-UTRA TDD release 11 and forward UE of category 2-8.

8.2.2.3.1\_1.3 Minimum conformance requirements

Same minimum conformance requirements as in clause 8.2.2.3.1.3 with the following exceptions:

- Instead of Table 8.2.2.3.1.3-2 → use Table 8.2.2.3.1\_1.3-1.

**Table 8.2.2.3.1\_1.3-1: Minimum performance Large Delay CDD (FRC)**

Test number	Band-width	Reference Channel	OCNG Pattern	Propagation Condition	Correlation Matrix and Antenna Configuration	Reference value		UE Category
						Fraction of Maximum Throughput (%)	SNR (dB)	
1	10 MHz	R.35 TDD	OP.1 TDD	EVA200	2x2 Low	70	20.3	≥2

The normative reference for this requirement is TS 36.101 [2] clause 8.2.2.3.

8.2.2.3.1\_1.4 Test description

Same test description as in clause 8.2.2.3.1.4 with the following exceptions:

- Instead of Table 8.2.2.3.1.3-2 → use Table 8.2.2.3.1\_1.3-1.
- Instead of Table 8.2.2.3.1.5-1 → use Table 8.2.2.3.1\_1.5-1.

8.2.2.3.1\_1.5 Test requirement

Same test requirements as in clause 8.2.2.3.1.5 with the following exceptions:

- Instead of Table 8.2.2.3.1.5-1 → use Table 8.2.2.3.1\_1.5-1.

**Table 8.2.2.3.1\_1.5-1: Test Requirement Large Delay CDD (FRC)**

Test number	Band-width	Reference Channel	OCNG Pattern	Propagation Condition	Correlation Matrix and Antenna Configuration	Reference value		UE Category
						Fraction of Maximum Throughput (%)	SNR (dB)	
1	10 MHz	R.35 TDD	OP.1 TDD	EVA200	2x2 Low	70	21.2	≥2

## 8.2.2.3.1\_A TDD PDSCH Open Loop Spatial Multiplexing 2x2 for CA

## 8.2.2.3.1\_A.1 TDD PDSCH Open Loop Spatial Multiplexing 2x2 for CA (2DL CA)

Editor's note: The following aspects are either missing or not yet determined:

- SNR values in table 8.2.2.3.1\_A.1.3-2 are still in bracket in core spec.

## 8.2.2.3.1\_A.1.1 Test purpose

Same test purpose as 8.2.2.3.1.1.

## 8.2.2.3.1\_A.1.2 Test applicability

This test applies to E-UTRA TDD release 10 and forward UE of category 5 or higher that supports inter-band or intra-band contiguous DL CA

This test also applies to E-UTRA TDD release 11 and forward UE of category 5 or higher that supports intra-band non-contiguous DL CA.

## 8.2.2.3.1\_A.1.3 Minimum conformance requirements

The requirements are specified in terms of the percentage of information bit throughput for the downlink reference measurement channels specified in Annex A clause A.3.4.2, with the addition of the relevant parameters in Tables 8.2.2-1 and 8.2.2.3.1\_A.1.3-1 and the downlink physical channel setup according to Table C.3.2-1 in Annex C.

Using this configuration the fraction of maximum throughput percentage shall meet or exceed the minimum requirements specified in Tables 8.2.2.3.1\_A.1.3-2 for the specified SNR. For open-loop spatial multiplexing performance with large delay CDD is specified.

**Table 8.2.2.3.1\_A.1.3-1: Test Parameters for Large Delay CDD (FRC) for CA**

Parameter	Unit	Test 1-2	
Downlink power allocation	$\rho_A$	dB	-3
	$\rho_B$	dB	-3 (Note 1)
	$\sigma$	dB	0
$N_{oc}$ at antenna port	dBm/15kHz	-98	
ACK/NACK feedback mode		PUCCH format 1b with channel selection	
PDSCH transmission mode		3	
Note 1: $P_B = 1$			
Note 2: The same PDSCH transmission mode is applied to each component carrier.			

**Table 8.2.2.3.1\_A.1.3-2: Minimum performance Large Delay CDD (FRC) for CA**

Test number	Band width	Reference Channel	OCNG Pattern	Propagation Condition	Correlation Matrix and Antenna Configuration	Reference value		UE Category
						Fraction of Maximum Throughput (%)	SNR (dB)	
1	2x20 MHz	R.30-1 TDD	OP.1 TDD (Note 1)	EVA70	2x2 Low	70	13.7	≥5
2	20MHz +15MHz z	R.30-1 TDD for 20MHz CC	OP.1 TDD (Note 1)	EVA70	2x2 Low	70	[13.0]	≥5
		R.11-9 TDD for 15MHz CC	OP.1 TDD (Note 1)	EVA70		70	[12.9]	
Note 1: The OCNG pattern applies for each CC Note 2: The applicability of requirements for different CA configurations and bandwidth combination sets is defined in 8.1.2.3.								

**Table 8.2.2.3.1\_A.1.3-3: Void**

The normative reference for this requirement is TS 36.101 [2] clause 8.2.2.3.

8.2.2.3.1\_A.1.4 Test description

8.2.2.3.1\_A.1.4.1 Initial conditions

Initial conditions are a set of test configurations the UE needs to be tested in and the steps for the SS to take with the UE to reach the correct measurement state.

Configurations of PDSCH and PDCCH before measurement are specified in Annex C.2.

Test Environment: Normal, as defined in TS 36.508 [7] clause 4.1.

Frequencies to be tested: Maximum WGap for Intra-band non-contiguous CA, otherwise Mid Range, as defined in TS 36.508 [7] clause 4.3.1.

Channel Bandwidths to be tested: Select one according to Table 8.2.2.3.1\_A.1.4.1-1.

CA Capability to be tested: Select one according to Table 8.2.2.3.1\_A.1.4.1

**Table 8.2.2.3.1\_A.1.4.1-1: Test point selection for TM3 2DL CA**

CA Capability	Bandwidth Combination	
	20+20	20+15
Inter-band CA (two bands) (CA2_A2)	Test 1	Test 2
Intra-band contiguous CA (CA2_C)	Test 1	Test 2
Intra-band non-contiguous CA (with two sub-blocks) (CA2_N2)	Test 1	Test 2
Note 1: One test point per UE supported CA capability is tested. For each UE supported CA capability, select the largest aggregated CA bandwidth combination supported by the UE within the chosen CA capability.		

1. Connect the SS, the faders and AWGN noise sources to the UE antenna connectors as shown in TS 36.508 [7] Annex A, Figure group A.36 as appropriate.
2. The parameter settings for the cell are set up according to Tables 8.2.2-1 and 8.2.2.3.1\_A.1.3-1 as appropriate.
3. Downlink signals for PCC are initially set up according to Annex C.0, C.1 and Annex C.3.2 and uplink signals according to Annex H.1 and H.3.2.
4. Propagation conditions are set according to Annex B.0.
5. Ensure the UE is in State 3A-RF according to TS 36.508 [7] clause 5.2A.2. Message contents are defined in clause 8.2.2.3.1\_A.1.4.3.

#### 8.2.2.3.1\_A.1.4.2 Test procedure

1. Configure SCC according to Annex C.0, C.1 and Annex C.3.2 for all downlink physical channels.
2. The SS shall configure SCC as per TS 36.508 [7] clause 5.2A.4. Message contents for *PhysicalConfigDedicated-DEFAULT* is defined in Table 8.2.2.3.1\_A.1.4.3-1. *PhysicalConfigDedicatedSCell-r10-DEFAULT* is defined in Table 8.2.2.3.1\_A.1.4.3-1A.
3. SS activates SCC by sending the activation MAC-CE (Refer TS 36.321 [13], clauses 5.13, 6.1.3.8). Wait for at least 2 seconds (Refer TS 36.133, clauses 8.3.3.2).
4. SS transmits PDSCH via PDCCH DCI format 2A for C\_RNTI to transmit the DL RMC according to Tables 8.2.2.3.1\_A.1.3-1 and 8.2.2.3.1\_A.1.5-1 on both PCC and SCC. The SS sends downlink MAC padding bits on the DL RMC.
5. Set the parameters of the bandwidth, MCS, reference channel, the propagation condition, the correlation matrix, antenna configuration and the SNR according to Table 8.2.2.3.1\_A.1.5-1 as appropriate.
6. Measure the average throughput per component carrier for a duration sufficient to achieve statistical significance according to Annex G clause G.3A, Table G.3A.5-7 on both PCC and SCC. Count the number of NACKs, ACKs and statDTXs on the UL during each subtest on both component carriers
7. Repeat steps from 1 to 6 for each subtest in Tables 8.2.2.3.1\_A.1.5-1 as appropriate depending on UE CA capability as defined in Table 8.2.2.3.1\_A.1.4.1-1.

#### 8.2.2.3.1\_A.1.4.3 Message contents

Message contents are according to TS 36.508 [7] clauses 5.5 and 4.6 with the following exceptions.

**Table 8.2.2.3.1\_A.1.4.3-1: *PhysicalConfigDedicated-DEFAULT*: Additional TDD PDSCH open loop spatial multiplexing performance downlink power allocation**

Derivation Path: 36.508 clause 5.5.1, Table 5.5.1.2-1			
Information Element	Value/remark	Comment	Condition
PhysicalConfigDedicated-DEFAULT ::= SEQUENCE {			
antennaInfo CHOICE {			
explicitValue ::= SEQUENCE {			
transmissionMode	tm3		
codebookSubsetRestriction CHOICE {			
n2TxAntenna-tm3	11		
}			
ue-TransmitAntennaSelection CHOICE {			
release	NULL		
}			
}			
}			

**Table 8.2.2.3.1\_A.1.4.3-1A: PhysicalConfigDedicatedSCell-r10-DEFAULT: Additional TDD PDSCH open loop spatial multiplexing performance downlink power allocation**

Derivation Path: 36.508 clause 4.6.3 Table 4.6.3-6A			
Information Element	Value/remark	Comment	Condition
PhysicalConfigDedicated SCell-r10-DEFAULT ::= SEQUENCE {			
nonUL-Configuration-r10 SEQUENCE {			
antennaInfo-r10 SEQUENCE {			
transmissionMode-r10	tm3		
codebookSubsetRestriction-r10	11		
ue-TransmitAntennaSelection CHOICE {			
release	NULL		
}			
}			
}			

8.2.2.3.1\_A.1.5 Test requirement

Table 8.2.2.3.1\_A.1.3-1 defines the primary level settings.

The fraction of maximum throughput percentage for the downlink reference measurement channels specified in Annex A clause A.3.4.2, for the throughput test shall meet or exceed the specified value in Tables 8.2.2.3.1\_A.1.5-1 for the specified SNR including test tolerances for all throughput tests.

**Table 8.2.2.3.1\_A.1.5-1: Test requirement Large Delay CDD (FRC) for CA**

Test number	Band width	Reference Channel	OCNG Pattern	Propagation Condition	Correlation Matrix and Antenna Configuration	Reference value		UE Category
						Fraction of Maximum Throughput (%)	SNR (dB)	
1	2x20 MHz	R.30-1 TDD	OP.1 TDD (Note 1)	EVA70	2x2 Low	70	14.6	≥5
2	20MHz+15MHz	R.30-1 TDD for 20MHz CC	OP.1 TDD (Note 1)	EVA70	2x2 Low	70	[13.9]	≥5
		R.11-9 TDD for 15MHz CC	OP.1 TDD (Note 1)	EVA70		70	[13.8]	
Note1: For CA capable UE, the OCNG pattern applies for each CC								
Note 2: The applicability of requirements for different CA configurations and bandwidth combination sets is defined in 8.1.2.3.								

Decide pass or fail for each subtest according to Annex G.3A.4. Decide the entire test pass or fail according to Annex G.3A.6.

8.2.2.3.1\_A.2 TDD PDSCH Open Loop Spatial Multiplexing 2x2 for CA (3DL CA)

**Editor’s notes: This test case is incomplete. The following items are missing or incomplete:**

**- The SNR values for minimum conformance and test requirements are still in brackets.**

8.2.2.3.1\_A.2.1 Test purpose

To verify the UE's ability to receive a predefined test signal, representing a multi-path fading channel that is determined by the SNR with a percentage of the information bit throughput for a specified downlink Reference Measurement Channel (RMC) not falling below a specified value for transmission on on two antenna ports using large delay CDD.

## 8.2.2.3.1\_A.2.2 Test applicability

This test case applies to all types of E-UTRA TDD release 10 and forward UE of category 5 or higher that support 3DL Intra-band contiguous CA or 3DL Inter-band CA, or 3DL with Intra-band contiguous and Inter-band CA.

This test case also applies to all types of E-UTRA TDD release 11 and forward UE of category 5 or higher that support 3DL with Intra-band non-contiguous and Inter-band CA, or 3DL with Intra-band non-contiguous and Intra-band contiguous CA.

## 8.2.2.3.1\_A.2.3 Minimum conformance requirements

For CA with 3 DL CCs, the requirements are specified in Table 8.2.2.3.1\_A.2.3-3, based on single carrier requirement specified in Table 8.2.2.3.1\_A.2.3-2, with the addition of the parameters in Table 8.2.2.3.1\_A.2.3-1 and the downlink physical channel setup according to Table C.3.2-1 in Annex C.

**Table 8.2.2.3.1\_A.2.3-1: Test Parameters for Large Delay CDD (FRC) for CA with 3DL CCs**

Parameter	Unit	Test 1, 2	
Downlink power allocation	$\rho_A$	dB	-3
	$\rho_B$	dB	-3 (Note 1)
	$\sigma$	dB	0
$N_{oc}$ at antenna port	dBm/15kHz	-98	
ACK/NACK feedback mode		PUCCH format 3	
PDSCH transmission mode		3	
Note 1: $P_B = 1$			
Note 2: Void			
Note 3: The same PDSCH transmission mode is applied to each component carrier.			

**Table 8.2.2.3.1\_A.2.3-2: Single carrier performance for multiple CA configurations**

Band-width	Reference channel	OCNG pattern	Propagation condition	Correlation matrix and antenna config.	Reference value	
					Fraction of maximum throughput (%)	SNR (dB)
1.4MHz	R.11-5 TDD	OP.1 TDD	EVA70	2x2 Low	70	[13.2]
3MHz	R.11-6 TDD	OP.1 TDD	EVA70	2x2 Low	70	[12.8]
5MHz	R.11-7 TDD	OP.1 TDD	EVA70	2x2 Low	70	[12.6]
10 MHz	R.11-8 TDD	OP.1 TDD	EVA70	2x2 Low	70	[12.8]
15MHz	R.11-9 TDD	OP.1 TDD	EVA70	2x2 Low	70	[12.9]
20MHz	R.30-1 TDD	OP.1 TDD	EVA70	2x2 Low	70	[13.0]

**Table 8.2.2.3.1\_A.2.3-3: Minimum performance (FRC) based on single carrier performance for CA with 3 DL CCs**

Test num.	CA Band-width combination	Requirement	UE category
1	3x20MHz	As specified in Table 8.2.2.3.1_A.2.3-2 per CC	$\geq 5$
2	20MHz+20MHz+15MHz	As specified in Table 8.2.2.3.1_A.2.3-2 per CC	$\geq 5$
Note 1: The applicability of requirements for different CA configurations and bandwidth combination sets is defined in 8.1.2.3			

The normative reference for this requirement is TS 36.101 [2] clause 8.2.2.3



## 8.2.2.3.1\_A.2.4 Test description

## 8.2.2.3.1\_A.2.4.1 Initial conditions

Initial conditions are a set of test configurations the UE needs to be tested in and the steps for the SS to take with the UE to reach the correct measurement state.

Configurations of PDSCH and PDCCH before measurement are specified in Annex C.2.

Test Environment: Normal, as defined in TS 36.508 [7] clause 4.1.

Frequencies to be tested: Maximum WGap for Intra-band non-contiguous CA, otherwise Mid Range, as defined in TS 36.508 [7] clause 4.3.1.

Channel Bandwidths to be tested: Select one according to Table 8.2.2.3.1\_A.2.4.1-1.

CA Capability to be tested: Select one according to Table 8.2.2.3.1\_A.2.4.1-1.

**Table 8.2.2.3.1\_A.2.4.1-1: Test point selection for TM3 3DL CA**

CA Capability	Bandwidth combination	
	3x20	20+20+15
Intra-band contiguous (CA3_C)	Test1	Test2
Inter-band CA (two bands) (CA3_A2)	Test1	Test2
Inter-band CA (three bands) (CA3_A3)	Test1	Test2
Intra-band non-contiguous CA (with two sub-blocks) (CA3_N2)	Test1	Test2
Note1: One test point per UE supported CA capability is tested. For each UE supported CA capability, select the largest aggregated CA bandwidth combination supported by the UE within the chosen CA capability.		

1. Connect the SS, the faders and AWGN noise source to the UE antenna connectors as shown in TS 36.508 [7] Annex A, Figure A.60.
2. The parameter settings for the cell are set up according to Table 8.2.2-1 and 8.2.2.3.1\_A.2.3-1 as appropriate.
3. Downlink signals for PCC are initially set up according to Annex C.0, C.1 and Annex C.3.2 and uplink signals according to Annex H.1 and H.3.2.
4. Propagation conditions are set according to Annex B.0.
5. Ensure the UE is in State 3A-RF according to TS 36.508 [7] clause 5.2A.2. Message contents are defined in clause 8.2.2.3.1\_A.2.4.3.

## 8.2.2.3.1\_A.2.4.2 Test procedure

1. Configure SCCs according to Annex C.0, C.1 and Annex C.3.2 for all downlink physical channels.
2. The SS shall configure SCCs as per TS 36.508 [7] clause 5.2A.4. Message contents are defined in clause 8.2.2.3.1\_A.2.4.3.
3. The SS activates SCCs by sending the MAC-CE according to TS 36.321 [13] clauses 5.13 and 6.1.3.8. Wait for at least 2 seconds as per TS 36.133 [4] clause 8.3.3.2.
4. The SS transmits PDSCH via PDCCH DCI format 2A for C\_RNTI to transmit the DL RMC according to Tables 8.2.2.3.1\_A.2.3-1 and 8.2.2.3.1\_A.2.3-2 on both PCC and SCCs. The SS sends downlink MAC padding bits on the DL RMC.
5. Set the parameters of the bandwidth, MCS, reference channel, the propagation condition, the correlation matrix and the SNR on each of the component carriers according to Tables 8.2.2.3.1\_A.2.5-1 as appropriate.
6. Measure the average throughput per component carrier for duration sufficient to achieve statistical significance according to Annex G clause G.3A.5 on each of the component carriers. Count the number of NACKs, ACKs and statDTXs on the UL during each subtest on each of the component carriers.

## 8.2.2.3.1\_A.2.4.3 Message contents

Message contents are according to TS 36.508 [7] subclause 4.6 with the following exceptions.

**Table 8.2.2.3.1\_A.2.4.3-1: *PhysicalConfigDedicated-DEFAULT*: Additional TDD PDSCH open loop spatial multiplexing performance downlink power allocation**

Derivation Path: 36.508 clause 5.5.1, Table 5.5.1.2-1			
Information Element	Value/remark	Comment	Condition
PhysicalConfigDedicated-DEFAULT ::= SEQUENCE {			
antennaInfo CHOICE {			
explicitValue ::= SEQUENCE {			
transmissionMode	tm3		
codebookSubsetRestriction CHOICE {			
n2TxAntenna-tm3	11		
}			
ue-TransmitAntennaSelection CHOICE {			
release	NULL		
}			
}			
}			

**Table 8.2.2.3.1\_A.2.4.3-1A: *PhysicalConfigDedicatedSCell-r10-DEFAULT*: Additional TDD PDSCH open loop spatial multiplexing performance downlink power allocation**

Derivation Path: 36.508 clause 4.6.3 Table 4.6.3-6A			
Information Element	Value/remark	Comment	Condition
PhysicalConfigDedicated SCell-r10-DEFAULT ::= SEQUENCE {			
nonUL-Configuration-r10 SEQUENCE {			
antennaInfo-r10 SEQUENCE {			
transmissionMode-r10	tm3		
codebookSubsetRestriction-r10	11	BIT STRING	
ue-TransmitAntennaSelection CHOICE {			
release	NULL		
}			
}			
}			
}			

## 8.2.2.3.1\_A.2.5 Test requirement

Table 8.2.2.3.1\_A.2.3-1 defines the primary level settings.

The fraction of maximum throughput percentage for the downlink reference measurement channels specified in Annex A clause A.3.4.2.1 for the throughput test shall meet or exceed the specified value in Table 8.2.2.3.1\_A.2.5-1 for the specified SNR including test tolerances for all throughput tests.

**Table 8.2.2.3.1\_A.2.5-1: Single carrier performance for multiple CA configurations**

Band-width	Reference channel	OCNG pattern	Propagation condition	Correlation matrix and antenna config.	Reference value	
					Fraction of maximum throughput (%)	SNR (dB)
1.4MHz	R.11-5 TDD	OP.1 TDD	EVA70	2x2 Low	70	[14.1]
3MHz	R.11-6 TDD	OP.1 TDD	EVA70	2x2 Low	70	[13.7]
5MHz	R.11-7 TDD	OP.1 TDD	EVA70	2x2 Low	70	[13.5]
10MHz	R.11-8 TDD	OP.1 TDD	EVA70	2x2 Low	70	[13.7]
15MHz	R.11-9 TDD	OP.1 TDD	EVA70	2x2 Low	70	[13.8]
20MHz	R.30-1 TDD	OP.1 TDD	EVA70	2x2 Low	70	[13.9]

**Table 8.2.2.3.1\_A.2.5-2: Test requirement (FRC) based on single carrier performance for CA with 3 DL CCs**

Test num.	CA Band-width combination	Requirement	UE category
1	3x20MHz	As specified in Table 8.2.2.3.1_A.2.5-1 per CC	≥5
2	20MHz+20MHz+15MHz	As specified in Table 8.2.2.3.1_A.2.5-1 per CC	≥5
Note 1: The applicability of requirements for different CA configurations and bandwidth combination sets is defined in 8.1.2.3			

Decide pass or fail for each subtest according to Annex G.3A.4. Decide the entire test pass or fail according to Annex G.3A.6.

#### 8.2.2.3.1A TDD Soft buffer management test

##### 8.2.2.3.1A\_A.1 TDD PDSCH Soft buffer management test for CA (2 DL CA)

###### 8.2.2.3.1A\_A.1.1 Test purpose

The test purpose is to verify UE performance with proper instantaneous buffer implementation.

###### 8.2.2.3.1A\_A.1.2 Test applicability

This test applies to E-UTRA TDD release 10 and forward UE of category 3 and 4 which support intra-band contiguous DL CA or inter-band DL CA.

This test applies also to E-UTRA TDD release 11 and forward UE of category 3 and 4 which support intra-band non-contiguous DL CA.

###### 8.2.2.3.1A\_A.1.3 Minimum conformance requirements

The requirements are specified in Table 8.2.2.3.1A\_A.1.3-2, with the addition of the parameters in Table 8.2.2.3.1A\_A.1.3-1 and the downlink physical channel setup according to Table C.3.2-1 in Annex C. The purpose is to verify UE performance with proper instantaneous buffer implementation.

**Table 8.2.2.3.1A\_A.1.3-1: Test Parameters for soft buffer management (FRC) for CA**

Parameter	Unit	Test 1-2	
Downlink power allocation	$\rho_A$	dB	-3
	$\rho_B$	dB	-3 (Note 1)
	$\sigma$	dB	0
$N_{oc}$ at antenna port	dBm/15kHz	-98	
ACK/NACK feedback mode		- (Note 2)	
PDSCH transmission mode		3	
Note 1: $P_B = 1$			
Note 2: PUCCH format 1b with channel selection is used to feedback ACK/NACK.			
Note 3: For CA test cases, the same PDSCH transmission mode is applied to each component carrier.			

**Table 8.2.2.3.1A\_A.1.3-2: Minimum performance soft buffer management test (FRC) for CA**

Test number	Bandwidth	Reference Channel	OCNG Pattern	Propagation Condition	Correlation Matrix and Antenna Configuration	Reference value		Cat
						Fraction of Maximum Throughput (%)	SNR (dB)	
1	2x20 MHz	R.30-2 TDD	OP.1 TDD (Note 1)	EVA70	2x2 Low	70	13.2	
2	2x20 MHz	R.35-1 TDD	OP.1 TDD (Note 1)	EVA5	2x2 Low	70	15.7	
Note 1: The OCNG pattern applies for each CC.								
Note 2: The applicability of requirements for different CA configurations and bandwidth combination sets is defined in 8.1.2.3.								

The normative reference for this requirement is TS 36.101 [2] clause 8.2.2.3.1A.

#### 8.2.2.3.1A\_A.1.4 Test description

##### 8.2.2.3.1A\_A.1.4.1 Initial conditions

Initial conditions are a set of test configurations the UE needs to be tested in and the steps for the SS to take with the UE to reach the correct measurement state.

Configurations of PDSCH and PDCCH before measurement are specified in Annex C.2.

Test Environment: Normal, as defined in TS 36.508 [7] clause 4.1.

Frequencies to be tested: Maximum Wgap for Intra-band non-contiguous CA, otherwise Mid Range, as defined in TS 36.508 [7] clause 4.3.1.

Channel Bandwidths to be tested: Select one according to Table 8.2.2.3.1A\_A.1.4.1-1

CA Capability to be tested: Select one according to Table 8.2.2.3.1A\_A.1.4.1-1

**Table 8.2.2.3.1A\_A.1.4.1-1: Test point selection soft buffer management tests for CA**

CA Capability	Bandwidth combination
	20+20
Inter-band CA (two bands) (CA2_A2)	Test 1 or 2
Intra-band contiguous CA (CA2_C)	Test 1 or 2
Intra-band non-contiguous CA (with two sub-blocks) (CA2_N2)	Test 1 or 2

Only one test point is tested.

Note1: Select the largest aggregated CA bandwidth combination supported by the UE among the UE supported CA capabilities.

Note2: One of the two tests per table position is selected, depending on UE category.

1. Connect the SS, the faders and AWGN noise sources to the UE antenna connectors as shown in TS 36.508 [7] Annex A, Figure group A.36 as appropriate.
2. The parameter settings for the cell are set up according to Tables 8.2.2-1 and 8.2.2.3.1A\_A.1.3-1 as appropriate.
3. Downlink signals for PCC are initially set up according to Annex C.0, C.1 and Annex C.3.2 and uplink signals according to Annex H.1 and H.3.2.
4. Propagation conditions are set according to Annex B.0.
5. Ensure the UE is in State 3A-RF according to TS 36.508 [7] clause 5.2A.2. Message contents are defined in clause 8.2.2.3.1\_A.1.4.3.

#### 8.2.2.3.1A\_A.1.4.2 Test procedure

1. Configure SCC according to Annex C.0, C.1 and Annex C.3.2 for all downlink physical channels.
2. The SS shall configure SCC as per TS 36.508 [7] clause 5.2A.4. Message contents for *PhysicalConfigDedicated-DEFAULT* is defined in Table 8.2.2.3.1A.1.4.3-1. *PhysicalConfigDedicatedSCell-r10-DEFAULT* is defined in Table 8.2.2.3.1\_A.1.4.3-1A.
3. SS activates SCC by sending the activation MAC-CE (Refer TS 36.321 [13], clauses 5.13, 6.1.3.8). Wait for at least 2 seconds (Refer TS 36.133, clauses 8.3.3.2).
4. SS transmits PDSCH via PDCCH DCI format 2A for C\_RNTI to transmit the DL RMC according to Tables 8.2.2.3.1A\_A.1.3-1 and 8.2.2.3.1A\_A.1.5-1 or 8.2.2.3.1A\_A.1.5-2 on both PCC and SCC. The SS sends downlink MAC padding bits on the DL RMC.
5. Set the parameters of the bandwidth, MCS, reference channel, the propagation condition, the correlation matrix, antenna configuration and the SNR according to Table 8.2.2.3.1A\_A.1.5-1 or 8.2.2.3.1A\_A.1.5-2 as appropriate.
6. Measure the average throughput per component carrier for a duration sufficient to achieve statistical significance according to Annex G clause G.3A, Table G.3A.5-14 on both PCC and SCC. Count the number of NACKs, ACKs and statDTXs on the UL during each subtest on both component carriers

#### 8.2.2.3.1A\_A.1.4.3 Message contents

Same Message contents as 8.2.2.3.1\_A.1.4.3.

#### 8.2.2.3.1A\_A.1.5 Test requirement

Table 8.2.2.3.1A\_A.1.3-1 defines the primary level settings.

The fraction of maximum throughput percentage for the downlink reference measurement channels specified in Annex A clause A.3.4.2, for the throughput test shall meet or exceed the specified value in Tables 8.2.2.3.1A\_A.1.5-1 for the specified SNR including test tolerances for all throughput tests.

**Table 8.2.2.3.1A\_A.1.5-1: Test requirement Large Delay CDD (FRC) for CA**

Test number	Bandwidth	Reference Channel	OCNG Pattern	Propagation Condition	Correlation Matrix and Antenna Configuration	Reference value		UE Category
						Fraction of Maximum Throughput (%)	SNR (dB)	
1	2x20 MHz	R.30-2 TDD	OP.1 TDD (Note 1)	EVA70	2x2 Low	70	14.1	3
2	2x20 MHz	R.35-1 TDD	OP.1 TDD (Note 1)	EVA5	2x2 Low	70	16.6	4

Note 1: The OCNG pattern applies for each CC.  
Note 2: The applicability of requirements for different CA configurations and bandwidth combination sets is defined in 8.1.2.3.

Decide pass or fail for each subtest according to Annex G.3A.4.

8.2.2.3.1A\_A.2 Void

8.2.2.3.1A\_A.3 Void

### 8.2.2.3.1B TDD PDSCH Open Loop Spatial Multiplexing 2x2 - Enhanced Performance Requirement Type C

Editor's notes: This test case is incomplete. The following item is missing or incomplete:

- Test tolerances are TBD

#### 8.2.2.3.1B.1 Test purpose

To verify the UE's ability to receive a predefined test signal, representing a multi-path fading channel that is determined by the SNR with a percentage of the information bit throughput for a specified downlink Reference Measurement Channel (RMC) not falling below a specified value for transmission on two antenna ports using large delay CDD.

#### 8.2.2.3.1B.2 Test applicability

This test applies to all types of E-UTRA TDD release 12 and forward UE of Category 2 or higher that support enhanced receiver Type C.

#### 8.2.2.3.1B.3 Minimum conformance requirements

The requirements are specified in terms of the percentage of information bit throughput for the downlink reference measurement channels specified in Annex A clause A.3.4.2, with the addition of the relevant parameters in Tables 8.2.2-1, 8.2.2.3.1B.3-1 and the downlink physical channel setup according to table C.3.2-1 in Annex C.

Using this configuration the fraction of maximum throughput percentage shall meet or exceed the minimum requirements specified in Tables 8.2.2.3.1B.3-2 for the specified SNR. For open-loop spatial multiplexing performance with large delay CDD is specified.

**Table 8.2.2.3.1B.3-1: Test Parameters for Large Delay CDD (FRC)**

Parameter	Unit	Test 1
Downlink power allocation	$\rho_A$	dB
	$\rho_B$	dB
	$\sigma$	dB
$N_{oc}$ at antenna port	dBm/15kHz	-98
ACK/NACK feedback mode		Bundling
PDSCH transmission mode		3
Note 1: $P_B = 1$		

**Table 8.2.2.3.1B.3-2: Enhanced Performance Requirement Type C, Large Delay CDD (FRC)**

Test number	Bandwidth	Reference Channel	OCNG Pattern	Propagation Condition	Correlation Matrix and Antenna Configuration	Reference value		UE Category
						Fraction of Maximum Throughput (%)	SNR (dB)	
1	10 MHz	R.11-1 TDD	OP.1 TDD	EVA70	2x2 Medium	70	[17.4]	≥2

The normative reference for this requirement is TS 36.101 [2] clause 8.2.2.3.1B.

#### 8.2.2.3.1B.4 Test description

##### 8.2.2.3.1B.4.1 Initial conditions

Initial conditions are a set of test configurations the UE needs to be tested in and the steps for the SS to take with the UE to reach the correct measurement state.

Configurations of PDSCH and PDCCH before measurement are specified in Annex C.2.

Test Environment: Normal, as defined in TS 36.508 [7] clause 4.1.

Frequencies to be tested: Mid Range, as defined in TS 36.508 [7] clause 4.3.1.2.

Bandwidths to be tested: As specified per test number in Table 8.2.2.3.1B.3-2 as defined in TS 36.508 [7] clause 4.3.1.2.

1. Connect the SS, the faders and AWGN noise sources to the UE antenna connectors as shown in TS 36.508 [7] Annex A, Figure A.10 for antenna configuration 2x2.
2. The parameter settings for the cell are set up according to Tables 8.2.2-1 and 8.2.2.3.1B.3-1 as appropriate.
3. Downlink signals are initially set up according to Annex C.0, C.1 and Annex C.3.2 and uplink signals according to Annex H.1 and H.3.2.
4. Propagation conditions are set according to Annex B.0.
5. Ensure the UE is in State 3A-RF according to TS 36.508 [7] clause 5.2A.2. Message contents are defined in clause 8.2.2.3.1B.4.3.

##### 8.2.2.3.1B.4.2 Test procedure

1. SS transmits PDSCH via PDCCH DCI format 2A for C\_RNTI to transmit the DL RMC according to Tables 8.2.2.3.1B.3-1 and 8.2.2.3.1B.3-2. The SS sends downlink MAC padding bits on the DL RMC.
2. Set the parameters of the bandwidth, MCS, reference channel, the propagation condition, the correlation matrix, antenna configuration and the SNR according to Table 8.2.2.3.1B.5-1 as appropriate.
3. Measure the average throughput for a duration sufficient to achieve statistical significance according to Annex G clause G.3. Count the number of NACKs, ACKs and statDTXs on the UL during each test interval and decide pass or fail according to Tables G.3.5 and G.3.6 in Annex G clause G.3.

##### 8.2.2.3.1B.4.3 Message contents

Message contents are according to TS 36.508 [7] clause 4.6 with the following exceptions.

**Table 8.2.2.3.1B.4.3-1: PhysicalConfigDedicated-DEFAULT**

Derivation Path: 36.508 Table 5.5.1.2-1			
Information Element	Value/remark	Comment	Condition
PhysicalConfigDedicated-DEFAULT ::= SEQUENCE {			
antennaInfo CHOICE {			
antennaInfoDedicated ::= SEQUENCE {			
transmissionMode	tm3		
codebookSubsetRestriction CHOICE {			
n2TxAntenna-tm3	11		
}			
ue-TransmitAntennaSelection CHOICE {			
release	NULL		
}			
}			
}			

### 8.2.2.3.1B.5 Test requirement

Table 8.2.2.3.1B.3-1 defines the primary level settings.

The fraction of maximum throughput percentage for the downlink reference measurement channels specified in Annex A clause A.3.4.2, for each throughput test shall meet or exceed the specified value in Tables 8.2.2.3.1B.5-1 for the specified SNR including test tolerances for all throughput tests.

**Table 8.2.2.3.1B.5-1: Test requirement for Enhanced Performance Requirement Type C, Large Delay CDD (FRC)**

Test number	Bandwidth	Reference Channel	OCNG Pattern	Propagation Condition	Correlation Matrix and Antenna Configuration	Reference value		UE Category
						Fraction of Maximum Throughput (%)	SNR (dB)	
1	10 MHz	R.11-1 TDD	OP.1 TDD	EVA70	2x2 Medium	70	[17.4 +TT]	≥2

### 8.2.2.3.1C TDD PDSCH Open Loop Spatial Multiplexing 2x2 with TM1 Interference – Enhanced Performance Requirement Type C

**Editor's notes: This test case is incomplete. The following items are missing or are incomplete:**

- Test tolerances are undefined
- Connection diagram is TBD
- The SNR values in minimum and test requirement are still in square brackets
- The minimum testing time in Annex G is still undefined.

#### 8.2.2.3.1C.1 Test purpose

The purpose is to verify the performance of open-loop spatial multiplexing performance with 2 transmit antennas when the PDSCH transmission in the serving cell is interfered by PDSCH of one dominant interfering cell with transmission mode 1.

#### 8.2.2.3.1C.2 Test applicability

This test applies to all types of E-UTRA TDD release 12 and forward UE of Category 2 or higher that support enhanced receiver Type C.



## 8.2.2.3.1C.3 Minimum conformance requirements

The requirements are specified in Table 8.2.2.3.1C.3-2, with the addition of parameters in Table 8.2.2.3.1C.3-1 and the downlink physical channel setup according to Annex C.3.2. In Table 8.2.2.3.1C.3-1, Cell 1 is the serving cell, and Cell 2 is interfering cell. The downlink physical channel setup is according to Annex C.3.2 for each of Cell 1 and Cell 2 respectively.

**Table 8.2.2.3.1C.3-1: Test Parameters for Large Delay CDD (FRC) with TM1 interference**

Parameter		Unit	Cell 1	Cell 2
Bandwidth		MHz	10 MHz	
Downlink power allocation	$\rho_A$	dB	-3	0
	$\rho_B$		-3 (Note 1)	0
	$\sigma$		0	0
Cell-specific reference signals			Antenna ports 0,1	Antenna port 0
Cyclic Prefix			Normal	Normal
Cell ID			0	1
Transmission mode			3	Note 2
$N_{oc}$ at antenna port		dBm/15kHz	-98	N/A
$\hat{E}_s/N_{oc}$ (Note 3)		dB	Reference Value in Table 8.2.2.3.1C.3-2	12.95
Correlation and antenna configuration			Medium (2x2)	Medium(1x2)
Number of OFDM symbols for PDCCH			2	N/A
Max number of HARQ transmissions			4	N/A
Redundancy version coding sequence			{0,1,2,3}	N/A
Note 1: $p_B = 1$				
Note 2: Downlink physical channel setup in Cell 2 in accordance with Annex C.3.2 applying OCNG pattern OP.5 TDD as defined in Annex A.5.2.5.				
Note 3: Cell 1 is the serving cell. Cell 2 is the interfering cell.				
Note 4: All cells are time-synchronous.				
Note 5: SIB-1 will not be transmitted in Cell2 in this test.				

**Table 8.2.2.3.1C.3-2: Enhanced Performance Requirement Type C, Large Delay CDD (FRC) with TM1 interference**

Test Number	Reference Channel	OCNG Pattern		Propagation Conditions (Note 1)		Reference Value		UE Category
		Cell 1	Cell 2	Cell 1	Cell 2	Fraction of Maximum Throughput (%)	SNR (dB) (Note 2)	
1	R.11-10 TDD	OP.1 TDD	OP.5 TDD	EVA70	EVA70	70	[19.6]	$\geq 2$
Note 1: The propagation conditions for Cell 1 and Cell 2 are statistically independent.								
Note 2: SNR corresponds to $\hat{E}_s/N_{oc}$ of Cell 1.								

The normative reference for this requirement is TS 36.101 [2] clause 8.2.2.3.1C.

## 8.2.2.3.1C.4 Test description

## 8.2.2.3.1C.4.1 Initial conditions

Initial conditions are a set of test configurations the UE needs to be tested in and the steps for the SS to take with the UE to reach the correct measurement state.

Configurations of PDSCH and PDCCH before measurement are specified in Annex C.2.

Test Environment: Normal, as defined in TS 36.508 [7] clause 4.1.

Frequencies to be tested: Mid Range, as defined in TS 36.508 [7] clause 4.3.1.2.

Bandwidths to be tested: As specified per test number in Table 8.2.2.3.1C.3-2 as defined in TS 36.508 [7] clause 4.3.1.2.

1. Connect the SS, the faders and AWGN noise sources to the UE antenna connectors as shown in TS 36.508 [7] Annex A, Figure TBD.
2. The parameter settings for the cell 1 are set up according to Tables 8.2.2-1 and 8.2.2.3.1C.5-1 as appropriate.
3. Downlink signals are initially set up according to Annex C.0, C.1 and Annex C.3.2 and uplink signals according to Annex H.1 and H.3.2.
4. Propagation conditions are set according to Annex B.0.
5. Ensure the UE is in State 3A-RF according to TS 36.508 [7] clause 5.2A.2. Message contents are defined in clause 8.2.2.3.1C.4.3.

**8.2.2.3.1C.4.2 Test procedure**

1. SS transmits PDSCH via PDCCH DCI format 2A for C\_RNTI to transmit the DL RMC according to Tables 8.2.2.3.1C.5-1 and 8.2.2.3.1C.5-2. The SS sends downlink MAC padding bits on the DL RMC.
2. SS sets up parameters for cell 2 according to Table 8.2.2.3.1C.5-1 as appropriate.
3. Set the parameters of the bandwidth, MCS, reference channel, the propagation condition, the correlation matrix, antenna configuration and the SNR according to Table 8.2.2.3.1C.5-1 and Table 8.2.2.3.1C.5-2 as appropriate.
4. Measure the average throughput for a duration sufficient to achieve statistical significance according to Annex G clause G.3. Count the number of NACKs, ACKs and statDTXs on the UL during each test interval and decide pass or fail according to Tables G.3.5 and G.3.6 in Annex G clause G.3.

**8.2.2.3.1C.4.3 Message contents**

Message contents are according to TS 36.508 [7] clause 4.6 with the following exceptions.

**Table 8.2.2.3.1C.4.3-1: PhysicalConfigDedicated-DEFAULT**

Derivation Path: 36.508 Table 5.5.1.2-1			
Information Element	Value/remark	Comment	Condition
PhysicalConfigDedicated-DEFAULT ::= SEQUENCE {			
antennaInfo CHOICE {			
antennaInfoDedicated ::= SEQUENCE {			
transmissionMode	tm3		
codebookSubsetRestriction CHOICE {			
n2TxAntenna-tm3	11		
}			
ue-TransmitAntennaSelection CHOICE {			
release	NULL		
}			
}			
}			
}			
}			

**8.2.2.3.1C.5 Test requirement**

Table 8.2.2.3.1C.5-1 defines the primary level settings.

The fraction of maximum throughput percentage for the downlink reference measurement channels specified in Annex A clause A.3.4.2, for each throughput test shall meet or exceed the specified value in Tables 8.2.2.3.1C.5-2 for the specified SNR including test tolerances for all throughput tests.

**Table 8.2.2.3.1C.5-1: Test Parameters for Large Delay CDD (FRC) with TM1 interference**

Parameter		Unit	Cell 1	Cell 2
Bandwidth		MHz	10 MHz	
Downlink power allocation	$\rho_A$	dB	-3	0
	$\rho_B$		-3 (Note 1)	0
	$\sigma$		0	0
Cell-specific reference signals			Antenna ports 0,1	Antenna port 0
Cyclic Prefix			Normal	Normal
Cell ID			0	1
Transmission mode			3	Note 2
$N_{oc}$ at antenna port		dBm/15kHz	-98	N/A
$\hat{E}_s/N_{oc}$ (Note 3)		dB	Reference Value in Table 8.2.2.3.1C.5-2	TBD
Correlation and antenna configuration			Medium (2x2)	Medium(1x2)
Number of OFDM symbols for PDCCH			2	N/A
Max number of HARQ transmissions			4	N/A
Redundancy version coding sequence			{0,1,2,3}	N/A
Note 1: $P_B = 1$				
Note 2: Downlink physical channel setup in Cell 2 in accordance with Annex C.3.2 applying OCNG pattern OP.5 TDD as defined in Annex A.5.2.5.				
Note 3: Cell 1 is the serving cell. Cell 2 is the interfering cell.				
Note 4: All cells are time-synchronous.				
Note 5: SIB-1 will not be transmitted in Cell2 in this test.				

**Table 8.2.2.3.1C.5-2: Test requirement for Enhanced Performance Requirement Type C, Large Delay CDD (FRC) with TM1 interference**

Test Number	Reference Channel	OCNG Pattern		Propagation Conditions (Note 1)		Reference Value		UE Category
		Cell 1	Cell 2	Cell 1	Cell 2	Fraction of Maximum Throughput (%)	SNR (dB) (Note 2)	
1	R.11-10 TDD	OP.1 TDD	OP.5 TDD	EVA70	EVA70	70	[19.6] +TT	$\geq 2$
Note 1: The propagation conditions for Cell 1 and Cell 2 are statistically independent.								
Note 2: SNR corresponds to $\hat{E}_s/N_{oc}$ of Cell 1.								

### 8.2.2.3.2 TDD PDSCH Open Loop Spatial Multiplexing 4x2

#### 8.2.2.3.2.1 Test purpose

To verify the UE's ability to receive a predefined test signal, representing a multi-path fading channel that is determined by the SNR with a percentage of the information bit throughput for a specified downlink Reference Measurement Channel (RMC) not falling below a specified value for transmission on four antenna ports using large delay CDD.

#### 8.2.2.3.2.2 Test applicability

This test applies to all types of E-UTRA TDD release 8 and forward UE of category 2-8.

#### 8.2.2.3.2.3 Minimum conformance requirements

The requirements are specified in terms of the percentage of information bit throughput for the downlink reference measurement channels specified in Annex A clause A.3.4.2, with the addition of the relevant parameters in Tables 8.2.2-1 and 8.2.2.3.2.3-1 and the downlink physical channel setup according to Table C.3.2-1 in Annex C.

Using this configuration the fraction of maximum throughput percentage shall meet or exceed the minimum requirements specified in Tables 8.2.2.3.2.3-2 for the specified SNR. For open-loop spatial multiplexing performance with large delay CDD is specified.

**Table 8.2.2.3.2.3-1: Test Parameters for Large Delay CDD (FRC)**

Parameter	Unit	Test 1	
Downlink power allocation	$\rho_A$	dB	-6
	$\rho_B$	dB	-6 (Note 1)
	$\sigma$	dB	3
$N_{oc}$ at antenna port	dBm/15kHz	-98	
ACK/NACK feedback mode		Bundling	
PDSCH transmission mode		3	
Note 1: $P_B = 1$			

**Table 8.2.2.3.2.3-2: Minimum performance Large Delay CDD (FRC)**

Test number	Bandwidth	Reference Channel	OCNG Pattern	Propagation Condition	Correlation Matrix and Antenna Configuration	Reference value		UE Category
						Fraction of Maximum Throughput (%)	SNR (dB)	
1	10 MHz	R.14 TDD	OP.1 TDD	EVA70	4x2 Low	70	14.2	$\geq 2$

The normative reference for this requirement is TS 36.101 [2] clause 8.2.2.3.

#### 8.2.2.3.2.4 Test description

##### 8.2.2.3.2.4.1 Initial conditions

Initial conditions are a set of test configurations the UE needs to be tested in and the steps for the SS to take with the UE to reach the correct measurement state.

Configurations of PDSCH and PDCCH before measurement are specified in Annex C.2.

Test Environment: Normal, as defined in TS 36.508 [7] clause 4.1.

Frequencies to be tested: Mid Range, as defined in TS 36.508 [7] clause 4.3.1.2.

Bandwidths to be tested: As specified per test number in Table 8.2.2.3.2.3-2 as defined in TS 36.508 [7] clause 4.3.1.2.

1. Connect the SS, the faders and AWGN noise sources to the UE antenna connectors as shown in TS 36.508 [7] Annex A, Figure A.11 for antenna configuration 4x2.
2. The parameter settings for the cell are set up according to Tables 8.2.2-1 and 8.2.2.3.2.3-1 as appropriate.
3. Downlink signals are initially set up according to Annex C.0, C.1 and Annex C.3.2 and uplink signals according to Annex H.1 and H.3.2.
4. Propagation conditions are set according to Annex B.0.
5. Ensure the UE is in State 3A-RF according to TS 36.508 [7] clause 5.2A.2. Message contents are defined in clause 8.2.2.3.2.4.3.

##### 8.2.2.3.2.4.2 Test procedure

1. SS transmits PDSCH via PDCCH DCI format 2A for C\_RNTI to transmit the DL RMC according to Tables 8.2.2.3.2.3-1 and 8.2.2.3.2.3-2. The SS sends downlink MAC padding bits on the DL RMC.

2. Set the parameters of the bandwidth, MCS, reference channel, the propagation condition, the correlation matrix, antenna configuration and the SNR according to Table 8.2.2.3.2.5-1 as appropriate.
3. Measure the average throughput for a duration sufficient to achieve statistical significance according to Annex G clause G.3. Count the number of NACKs, ACKs and statDTXs on the UL during each test interval and decide pass or fail according to Tables G.3.5 and G.3.6 in Annex G clause G.3.

8.2.2.3.2.4.3 Message contents

Message contents are according to TS 36.508 [7] clauses 5.5 and 4.6 with the following exceptions.

**Table 8.2.2.3.2.4.3-1: PDSCH-ConfigDedicated-DEFAULT: Additional TDD PDSCH open loop spatial multiplexing performance downlink power allocation for Test number 1**

Derivation Path: 36.508 clause 4.6.3			
Information Element	Value/remark	Comment	Condition
PDSCH-ConfigDedicated-DEFAULT ::= SEQUENCE {			
p-a	dB-6		
}			

**Table 8.2.2.3.2.4.3-2: PhysicalConfigDedicated-DEFAULT: Additional TDD PDSCH open loop spatial multiplexing performance downlink power for Test number 1**

Derivation Path: 36.508 Table 5.5.1.2-1			
Information Element	Value/remark	Comment	Condition
PhysicalConfigDedicated-DEFAULT ::= SEQUENCE {			
antennaInfo CHOICE {			
explicitValue ::= SEQUENCE {			
transmissionMode	tm3		
codebookSubsetRestriction CHOICE {			
n4TxAntenna-tm3	1111		
}			
ue-TransmitAntennaSelection CHOICE {			
release	NULL		
}			
}			
}			

8.2.2.3.2.5 Test requirement

Table 8.2.2.3.2.3-1 defines the primary level settings.

The fraction of maximum throughput percentage for the downlink reference measurement channels specified in Annex A clause A.3.4.2, for each throughput test shall meet or exceed the specified value in Tables 8.2.2.3.2.5-1 for the specified SNR including test tolerances for all throughput tests.

**Table 8.2.2.3.2.5-1: Test requirement Large Delay CDD (FRC)**

Test number	Bandwidth	Reference Channel	OCNG Pattern	Propagation Condition	Correlation Matrix and Antenna Configuration	Reference value		UE Category
						Fraction of Maximum Throughput (%)	SNR (dB)	
1	10 MHz	R.14 TDD	OP.1 TDD	EVA70	4x2 Low	70	15.1	≥2

### 8.2.2.3.3\_C TDD PDSCH Open Loop Spatial Multiplexing 2x2 for eICIC

#### 8.2.2.3.3\_C.1 TDD PDSCH Open Loop Spatial Multiplexing 2x2 for eICIC (non-MBSFN ABS)

##### 8.2.2.3.3\_C.1.1 Test purpose

To verify the UE's performance of large delay CDD with 2 transmit antennas if the PDSCH transmission in the serving cell takes place in subframes that overlap with ABS of the aggressor cell.

##### 8.2.2.3.3\_C.1.2 Test applicability

This test applies to all types of E-UTRA TDD UE release 10 and forward. Applicability requires support for FGI bit 115.

##### 8.2.2.3.3\_C.1.3 Minimum conformance requirements

The requirements are specified in terms of the percentage of information bit throughput for the downlink reference measurement channels specified in Annex A clause A.3.4.2, with the addition of the relevant parameters in Tables 8.2.2-1 and 8.2.2.3.3\_C.1.3-1, and the downlink physical channel setup according to Table C.3.2-1 in Annex C.

The requirements for non-MBSFN ABS are specified in Table 8.2.2.3.3\_C.1.3-2, with the addition of parameters in Table 8.2.2.3.3\_C.1.3-1 and the downlink physical channel setup according to Annex C.3.2 and Annex C.3.3.

Using this configuration the fraction of maximum throughput percentage shall meet or exceed the minimum requirements specified in Tables 8.2.2.3.3\_C.1.3-2 for the specified SNR. For open-loop spatial multiplexing performance with large delay CDD is specified.

Table 8.2.2.3.3\_C.1.3-1: Test Parameters for Large Delay CDD (FRC) – non-MBSFN ABS

Parameter		Unit	Cell 1	Cell 2
Uplink downlink configuration			1	1
Special subframe configuration			4	4
Downlink power allocation	$\rho_A$	dB	-3	-3
	$\rho_B$	dB	-3 (Note 1)	-3 (Note 1)
	$\sigma$	dB	0	N/A
$N_{oc}$ at antenna port	$N_{oc1}$	dBm/15kHz	-102 (Note 2)	N/A
	$N_{oc2}$	dBm/15kHz	-98 (Note 3)	N/A
	$N_{oc3}$	dBm/15kHz	-94.8 (Note 4)	N/A
$\widehat{E}_s/N_{oc2}$		dB	Reference Value in Table 8.2.2.3.3_C.1.3-2	6
BW <sub>Channel</sub>		MHz	10	10
Subframe Configuration			Non-MBSFN	Non-MBSFN
Cell Id			0	1
Time Offset between Cells		$\mu$ s	2.5 (synchronous cells)	
ABS pattern (Note 5)			N/A	0000010001, 0000000001
RLM/RRM Measurement Subframe Pattern (Note 6)			0000000001, 0000000001	N/A
CSI Subframe Sets (Note 7)	$C_{CSI,0}$		0000010001, 0000000001	N/A
	$C_{CSI,1}$		1100101000 1100111000	N/A
Number of control OFDM symbols			2	2
ACK/NACK feedback mode			Multiplexing	N/A
PDSCH transmission mode			3	N/A
Cyclic prefix			Normal	Normal
<p>Note 1: <math>P_B = 1</math>.</p> <p>Note 2: This noise is applied in OFDM symbols #1, #2, #3, #5, #6, #8, #9, #10, #12, #13 of a subframe overlapping with the aggressor ABS.</p> <p>Note 3: This noise is applied in OFDM symbols #0, #4, #7, #11 of a subframe overlapping with the aggressor ABS.</p> <p>Note 4: This noise is applied in all OFDM symbols of a subframe overlapping with aggressor non-ABS.</p> <p>Note 5: ABS pattern as defined in [14].</p> <p>Note 6: Time-domain measurement resource restriction pattern for PCell measurements as defined in [5].</p> <p>Note 7: As configured according to the time-domain measurement resource restriction pattern for CSI measurements defined in [5].</p> <p>Note 8: Cell 1 is the serving cell. Cell 2 is the aggressor cell. The number of the CRS ports in Cell1 and Cell2 is the same.</p> <p>Note 9: SIB-1 will not be transmitted in Cell2 in this test.</p>				

Table 8.2.2.3.3\_C.1.3-2: Minimum performance Large Delay CDD (FRC) – non-MBSFN ABS

Test Number	Reference Channel	OCNG Pattern		Propagation Conditions (Note 1)		Correlation Matrix and Antenna Configuration	Reference Value		UE Category
		Cell 1	Cell 2	Cell 1	Cell 2		Fraction of Maximum Throughput (%) Note 5	SNR (dB) (Note 2)	
1	R.11 TDD Note 4	OP.1 TDD	OP.1 TDD	EVA 5	EVA 5	2x2 Low	70	14.0	2-8
<p>Note 1: The propagation conditions for Cell 1 and Cell2 are statistically independent.</p> <p>Note 2: SNR corresponds to <math>\hat{E}_s / N_{oc2}</math> of cell 1.</p> <p>Note 3: The correlation matrix and antenna configuration apply for Cell 1 and Cell 2.</p> <p>Note 4: Cell 1 Reference channel is modified: PDSCH other than SIB1/paging and its associated PDCCH/PCFICH are transmitted in the serving cell subframe when the subframe is overlapped with the ABS subframe of aggressor cell and the subframe is available in the definition of the reference channel.</p> <p>Note 5: The maximum Throughput is calculated from the total Payload in 2 subframes, averaged over 20ms.</p>									

The normative reference for this requirement is TS 36.101 [2] clause 8.2.2.3.3.

#### 8.2.2.3.3\_C.1.4 Test description

##### 8.2.2.3.3\_C.1.4.1 Initial conditions

Initial conditions are a set of test configurations the UE needs to be tested in and the steps for the SS to take with the UE to reach the correct measurement state.

Configurations of PDSCH and PDCCH before measurement are specified in Annex C.2.

Test Environment: Normal, as defined in TS 36.508 [7] clause 4.1.

Frequencies to be tested: Mid Range, as defined in TS 36.508 [7] clause 4.3.1.2.

Channel Bandwidths to be tested: As specified per test number in Table 8.2.2.3.3\_C.1.3-2, as defined in TS 36.508 [7] clause 4.3.1.2

1. Connect the SS, the faders and AWGN noise sources to the UE antenna connectors as shown in TS 36.508 [7] Annex A, Figure A.40 for antenna configuration 2x2.
2. The parameter settings for the cell 1 are set up according to Tables 8.2.2-1 and 8.2.2.3.3\_C.1.3-1 as appropriate.
3. Downlink signals are initially set up according to Annex C0, C.1 and Annex C.3.2 and uplink signals according to Annex H.1 and H.3.2.
4. Propagation conditions are set according to Annex B.0.
5. Ensure the UE is in State 3A-RF according to TS 36.508 [7] clause 5.2A.2. Message contents are defined in clause 8.2.2.3.3\_C.1.4.3.

##### 8.2.2.3.3\_C.1.4.2 Test procedure

1. Set the parameters for Cell1 and Cell2 according to Tables 8.2.2.3.3\_C.1.5-1 and 8.2.2.3.3\_C.1.5-2, C.3.3-1 of Annex C.3.3 as appropriate, and SS transmits PDSCH via PDCCH DCI format 2A for C\_RNTI to transmit the DL RMC. The SS sends downlink MAC padding bits on the DL RMC. Propagation conditions are set according to Annex B clause B.2.
2. Measure the average throughput for a duration sufficient to achieve statistical significance according to Annex G clause G.3. Count the number of NACKs, ACKs and statDTXs on the UL during the test interval and decide pass or fail according to Tables G.3.5 and G.3.6 in Annex G clause G.3.



## 8.2.2.3.3\_C.1.4.3 Message contents

Message contents are according to TS 36.508 [7] clause 4.6 with the following exceptions:

**Table 8.2.2.3.3\_C.1.4.3-1: *PhysicalConfigDedicated-DEFAULT*: Additional TDD PDSCH open loop spatial multiplexing performance downlink power allocation**

Derivation Path: 36.331 clause 6.3.2			
Information Element	Value/remark	Comment	Condition
PhysicalConfigDedicated-DEFAULT ::= SEQUENCE {			
antennaInfo CHOICE {			
antennaInfoDedicated ::= SEQUENCE {			
transmissionMode	tm3		
codebookSubsetRestriction CHOICE {			
n2TxAntenna-tm3	11		
}			
ue-TransmitAntennaSelection CHOICE {			
release	NULL		
}			
}			
}			

**Table 8.2.2.3.3\_C.1.4.3-2: *RadioResourceConfigDedicated-SRB2-DRB(n, m)*: Additional TDD PDSCH open loop spatial multiplexing performance downlink power allocation**

Derivation Path: TS 36.508 [7] clause 4.6.3, Table 4.6.3-16 RadioResourceConfigDedicated-SRB2-DRB(n,m)			
Information Element	Value/remark	Comment	Condition
RadioResourceConfigDedicated-SRB2-DRB(n, m) ::= SEQUENCE {			
MeasSubframePatternPCell-r10 CHOICE {			
setup SEQUENCE {			
subframePatternTDD-r10 CHOICE {			
subframeConfig1-5-r10	'00000000010000000001'	BIT STRING (SIZE (20))	
}			
}			
}			
}			

**Table 8.2.2.3.3\_C.1.4.3-3: CQI-ReportConfig-r10-DEFAULT: Additional TDD PDSCH open loop spatial multiplexing performance downlink power allocation**

Derivation Path: 36.508 [7] clause 4.6.3, Table 4.6.3-2AA CQI-ReportConfig-r10-DEFAULT_			
Information Element	Value/remark	Comment	Condition
CQI-ReportConfig-r10-DEFAULT ::= SEQUENCE {			
cqi-ReportAperiodic-r10	Not present		
nomPDSCH-RS-EPRE-Offset	0		
cqi-ReportPeriodic-r10	Not present		
pmi-RI-Report-r9	Not present		
csi-SubframePatternConfig-r10 CHOICE {			
setup SEQUENCE {			
csi-MeasSubframeSet1-r10 CHOICE {			
subframePatternTDD-r10 CHOICE {			
subframeConfig1-5-r10	'00000100010000000001'	BIT STRING (SIZE (20))	
}			
}			
}			
csi-MeasSubframeSet2-r10 CHOICE {			
subframePatternTDD-r10 CHOICE {			
subframeConfig1-5-r10	'11001010001100111000'	BIT STRING (SIZE (20))	
}			
}			
}			
}			

#### 8.2.2.3.3\_C.1.5 Test requirement

Table 8.2.2.3.3\_C.1.5-1 defines the primary level settings.

The fraction of maximum throughput percentage for the downlink reference measurement channels specified in Annex A clause A.3.4.2 for each throughput test shall meet or exceed the specified value in Tables 8.2.2.3.3\_C.1.5-2 for the specified SNR including test tolerances for all throughput tests.

Table 8.2.2.3.3\_C.1.5-1: Test Parameters for Large Delay CDD (FRC) non-MBSFN ABS

Parameter		Unit	Cell 1	Cell 2
Uplink downlink configuration			1	1
Special subframe configuration			4	4
Downlink power allocation	$\rho_A$	dB	-3	-3
	$\rho_B$	dB	-3 (Note 1)	-3 (Note 1)
	$\sigma$	dB	0	N/A
$N_{oc}$ at antenna port	$N_{oc1}$	dBm/15kHz	-102.1 (Note 2)	N/A
	$N_{oc2}$	dBm/15kHz	-98 (Note 3)	N/A
	$N_{oc3}$	dBm/15kHz	-94.9 (Note 4)	N/A
$\hat{E}_s/N_{oc2}$		dB	Reference Value in Table 8.2.2.3.3_C.1.5-2	5.8
BW <sub>Channel</sub>		MHz	10	10
Subframe Configuration			Non-MBSFN	Non-MBSFN
Cell Id			0	1
Time Offset between Cells		$\mu$ s	2.5 (synchronous cells)	
ABS pattern (Note 5)			N/A	0000010001, 0000000001
RLM/RRM Measurement Subframe Pattern (Note 6)			0000000001, 0000000001	N/A
CSI Subframe Sets (Note 7)	$C_{CSI,0}$		0000010001, 0000000001	N/A
	$C_{CSI,1}$		1100101000 1100111000	N/A
Number of control OFDM symbols			2	2
ACK/NACK feedback mode			Multiplexing	N/A
PDSCH transmission mode			3	N/A
Cyclic prefix			Normal	Normal
<p>Note 1: <math>P_B = 1</math>.</p> <p>Note 2: This noise is applied in OFDM symbols #1, #2, #3, #5, #6, #8, #9, #10, #12, #13 of a subframe overlapping with the aggressor ABS.</p> <p>Note 3: This noise is applied in OFDM symbols #0, #4, #7, #11 of a subframe overlapping with the aggressor ABS.</p> <p>Note 4: This noise is applied in all OFDM symbols of a subframe overlapping with aggressor non-ABS.</p> <p>Note 5: ABS pattern as defined in [14].</p> <p>Note 6: Time-domain measurement resource restriction pattern for PCell measurements as defined in [5].</p> <p>Note 7: As configured according to the time-domain measurement resource restriction pattern for CSI measurements defined in [5].</p> <p>Note 8: Cell 1 is the serving cell. Cell 2 is the aggressor cell. The number of the CRS ports in Cell1 and Cell2 is the same.</p> <p>Note 9: SIB-1 will not be transmitted in Cell2 in this test.</p>				

Table 8.2.2.3.3\_C.1.5-2: Test Requirement Large Delay CDD (FRC)

Test Number	Reference Channel	OCNG Pattern		Propagation Conditions (Note 1)		Correlation Matrix and Antenna Configuration	Reference Value		UE Category
		Cell 1	Cell 2	Cell 1	Cell 2		Fraction of Maximum Throughput (%) Note 5	SNR (dB) (Note 2)	
1	R.11 TDD Note 4	OP.1 TDD	OP.1 TDD	EVA 5	EVA 5	2x2 Low	70	14.9	2-8
<p>Note 1: The propagation conditions for Cell 1 and Cell2 are statistically independent.</p> <p>Note 2: SNR corresponds to <math>\hat{E}_s / N_{oc2}</math> of cell 1.</p> <p>Note 3: The correlation matrix and antenna configuration apply for Cell 1 and Cell 2.</p> <p>Note 4: Cell 1 Reference channel is modified: PDSCH other than SIB1/paging and its associated PDCCH/PCFICH are transmitted in the serving cell subframe when the subframe is overlapped with the ABS subframe of aggressor cell and the subframe is available in the definition of the reference channel.</p> <p>Note 5: The maximum Throughput is calculated from the total Payload in 2 subframes, averaged over 20ms.</p>									

### 8.2.2.3.3\_C.2 TDD PDSCH Open Loop Spatial Multiplexing 2x2 for eICIC (MBSFN ABS)

#### 8.2.2.3.3\_C.2.1 Test purpose

To verify the UE's performance of large delay CDD with 2 transmit antennas if the PDSCH transmission in the serving cell takes place in subframes that overlap with ABS of the aggressor cell.

#### 8.2.2.3.3\_C.2.2 Test applicability

This test applies to all types of E-UTRA TDD UE release 10 and forward. Applicability requires support for FGI bit 115.

#### 8.2.2.3.3\_C.2.3 Minimum conformance requirements

The requirements are specified in terms of the percentage of information bit throughput for the downlink reference measurement channels specified in Annex A clause A.3.4.2, with the addition of the relevant parameters in Tables 8.2.2-1 and 8.2.2.3.3\_C.2.3-1 and the downlink physical channel setup according to Table C.3.2-1 in Annex C.

The requirements for MBSFN ABS are specified in Table 8.2.2.3.3\_C.2.3-2, with the addition of parameters in Table 8.2.2.3.3\_C.2.3-1 and the downlink physical channel setup according to Annex C.3.2 and Annex C.3.3.

Using this configuration the fraction of maximum throughput percentage shall meet or exceed the minimum requirements specified in Tables 8.2.2.3.3\_C.2.3-2 for the specified SNR. For open-loop spatial multiplexing performance with large delay CDD is specified.

Table 8.2.2.3.3\_C.2.3-1: Test Parameters for Large Delay CDD (FRC) – MBSFN ABS

Parameter		Unit	Cell 1	Cell 2
Uplink downlink configuration			1	1
Special subframe configuration			4	4
Downlink power allocation	$\rho_A$	dB	-3	-3
	$\rho_B$	dB	-3 (Note 1)	-3 (Note 1)
	$\sigma$	dB	0	N/A
$N_{oc}$ at antenna port	$N_{oc1}$	dBm/15kHz	-102 (Note 2)	N/A
	$N_{oc2}$	dBm/15kHz	-98 (Note 3)	N/A
	$N_{oc3}$	dBm/15kHz	-94.8 (Note 4)	N/A
$\hat{E}_s/N_{oc2}$		dB	Reference Value in Table 8.2.2.3.3_C.2.3-2	6
BW <sub>Channel</sub>		MHz	10	10
Subframe Configuration			Non-MBSFN	MBSFN
Cell Id			0	126
Time Offset between Cells		$\mu$ s	2.5 (synchronous cells)	
ABS pattern (Note 5)			N/A	000000001 000000001
RLM/RRM Measurement Subframe Pattern (Note 6)			000000001 000000001	N/A
CSI Subframe Sets (Note 7)	$C_{CSI,0}$		000000001 000000001	N/A
	$C_{CSI,1}$		1100111000 1100111000	N/A
MBSFN Subframe Allocation (Note 10)			N/A	000010
Number of control OFDM symbols			2	2
ACK/NACK feedback mode			Multiplexing	N/A
PDSCH transmission mode			3	N/A
Cyclic prefix			Normal	Normal
<p>Note 1: <math>P_B = 1</math>.</p> <p>Note 2: This noise is applied in OFDM symbols #1, #2, #3, #4, #5, #6, #7, #8, #9, #10, #11, #12, #13 of a subframe overlapping with the aggressor ABS.</p> <p>Note 3: This noise is applied in OFDM symbol #0 of a subframe overlapping with the aggressor ABS.</p> <p>Note 4: This noise is applied in all OFDM symbols of a subframe overlapping with aggressor non-ABS.</p> <p>Note 5: ABS pattern as defined in [14]. The 10<sup>th</sup> and 20<sup>th</sup> subframes indicated by ABS pattern are MBSFN ABS subframes.</p> <p>Note 6: Time-domain measurement resource restriction pattern for PCell measurements as defined in [5]</p> <p>Note 7: As configured according to the time-domain measurement resource restriction pattern for CSI measurements defined in [5].</p> <p>Note 8: Cell 1 is the serving cell. Cell 2 is the aggressor cell. The number of the CRS ports in Cell1 and Cell2 is the same.</p> <p>Note 9: SIB-1 will not be transmitted in Cell2 in this test.</p> <p>Note 10: MBSFN Subframe Allocation as defined in [5], one frame with 6 bits is chosen for MBSFN subframe allocation.</p>				

**Table 8.2.2.3.3\_C.2.3-2: Minimum performance Large Delay CDD (FRC) – MBSFN ABS**

Test Number	Reference Channel	OCNG Pattern		Propagation Conditions (Note 1)		Correlation Matrix and Antenna Configuration	Reference Value		UE Category
		Cell 1	Cell 2	Cell 1	Cell 2		Fraction of Maximum Throughput (%) Note 5	SNR (dB) (Note 2)	
1	R.11 TDD Note 4	OP.1 TDD	OP.1 TDD	EVA 5	EVA 5	2x2 Low	70	12.2	2-8
<p>Note 1: The propagation conditions for Cell 1 and Cell2 are statistically independent.</p> <p>Note 2: SNR corresponds to <math>\hat{E}_s / N_{oc2}</math> of cell 1.</p> <p>Note 3: The correlation matrix and antenna configuration apply for Cell 1 and Cell 2.</p> <p>Note 4: Cell 1 Reference channel is modified: PDSCH other than SIB1/paging and its associated PDCCH/PCFICH are transmitted in the serving cell subframe when the subframe is overlapped with the ABS subframe of aggressor cell and the subframe is available in the definition of the reference channel.</p> <p>Note 5: The maximum Throughput is calculated from the total Payload in 2 subframes, averaged over 20ms.</p>									

The normative reference for this requirement is TS 36.101 [2] clause 8.2.2.3.3.

#### 8.2.2.3.3\_C.2.4 Test description

##### 8.2.2.3.3\_C.2.4.1 Initial conditions

Initial conditions are a set of test configurations the UE needs to be tested in and the steps for the SS to take with the UE to reach the correct measurement state.

Configurations of PDSCH and PDCCH before measurement are specified in Annex C.2.

Test Environment: Normal, as defined in TS 36.508 [7] clause 4.1.

Frequencies to be tested: Mid Range, as defined in TS 36.508 [7] clause 4.3.1.2.

Channel Bandwidths to be tested: As specified per test number in Table 8.2.2.3.3\_C.2.3-2, as defined in TS 36.508 [7] clause 4.3.1.2

1. Connect the SS, the faders and AWGN noise sources to the UE antenna connectors as shown in TS 36.508 [7] Annex A, Figure A.40 for antenna configuration 2x2.
2. The parameter settings for the cell 1 are set up according to Tables 8.2.2-1 and 8.2.2.3.3\_C.2.3-1 as appropriate.
3. Downlink signals are initially set up according to Annex C0, C.1 and Annex C.3.2 and uplink signals according to Annex H.1 and H.3.2.
4. Propagation conditions are set according to Annex B.0.
5. Ensure the UE is in State 3A-RF according to TS 36.508 [7] clause 5.2A.2. Message contents are defined in clause 8.2.2.3.3\_C.2.4.3.

##### 8.2.2.3.3\_C.2.4.2 Test procedure

1. Set the parameters for Cell1 and Cell2 according to Tables 8.2.2.3.3\_C.2.5-1, 8.2.2.3.3\_C.2.5-2, C.3.3-1 of Annex C.3.3 as appropriate, and SS transmits PDSCH via PDCCH DCI format 2A for C\_RNTI to transmit the DL RMC. The SS sends downlink MAC padding bits on the DL RMC. Propagation conditions are set according to Annex B clause B.2.
2. Measure the average throughput for a duration sufficient to achieve statistical significance according to Annex G clause G.3. Count the number of NACKs, ACKs and statDTXs on the UL during the test interval and decide pass or fail according to Tables G.3.5 and G.3.6 in Annex G clause G.3.

8.2.2.3.3\_C.2.4.3 Message contents

Message contents are according to TS 36.508 [7] clause 4.6 with the following exceptions:

**Table 8.2.2.3.3\_C.2.4.3-1: *PhysicalConfigDedicated-DEFAULT*: Additional TDD PDSCH open loop spatial multiplexing performance downlink power allocation**

Derivation Path: 36.331 clause 6.3.2			
Information Element	Value/remark	Comment	Condition
PhysicalConfigDedicated-DEFAULT ::= SEQUENCE {			
antennaInfo CHOICE {			
antennaInfoDedicated ::= SEQUENCE {			
transmissionMode	tm3		
codebookSubsetRestriction CHOICE {			
n2TxAntenna-tm3	11		
}			
ue-TransmitAntennaSelection CHOICE {			
release	NULL		
}			
}			
}			

**Table 8.2.2.3.3\_C.2.4.3-2: *RadioResourceConfigDedicated-SRB2-DRB(n, m)*: Additional TDD PDSCH open loop spatial multiplexing performance downlink power allocation**

Derivation Path: TS 36.508 [7] clause 4.6.3, Table 4.6.3-16 RadioResourceConfigDedicated-SRB2-DRB(n,m)			
Information Element	Value/remark	Comment	Condition
RadioResourceConfigDedicated-SRB2-DRB(n, m) ::= SEQUENCE {			
MeasSubframePatternPCell-r10 CHOICE {			
setup SEQUENCE {			
subframePatternTDD-r10			
subframeConfig1-5-r10	'00000000010000000001'	BIT STRING (SIZE (20))	
}			
}			
}			

**Table 8.2.2.3.3\_C.2.4.3-3: CQI-ReportConfig-r10-DEFAULT: Additional TDD PDSCH open loop spatial multiplexing performance downlink power allocation**

Derivation Path: 36.508 [7] clause 4.6.3, Table 4.6.3-2AA CQI-ReportConfig-r10-DEFAULT_			
Information Element	Value/remark	Comment	Condition
CQI-ReportConfig-r10-DEFAULT ::= SEQUENCE {			
cqi-ReportAperiodic-r10	Not present		
nomPDSCH-RS-EPRE-Offset	0		
cqi-ReportPeriodic-r10	Not present		
pmi-RI-Report-r9	Not present		
csi-SubframePatternConfig-r10 CHOICE {			
setup SEQUENCE {			
csi-MeasSubframeSet1-r10 CHOICE {			
subframePatternTDD-r10 CHOICE {			
subframeConfig1-5-r10	'00000000010000000001'	BIT STRING (SIZE (20))	
}			
}			
}			
csi-MeasSubframeSet2-r10 CHOICE {			
subframePatternTDD-r10 CHOICE {			
subframeConfig1-5-r10	'11001110001100111000'	BIT STRING (SIZE (20))	
}			
}			
}			
}			

**Table 8.2.2.3.3\_C.2.4.3-4: SystemInformationBlockType3 exceptions**

Derivation Path: 36.508 [7] clause 4.6.2, Table 4.4.3.3-2 SystemInformationBlockType3			
Information Element	Value/remark	Comment	Condition
neighCellConfig	'00'B (Not all neighbour cells have the same MBSFN subframe allocation as the serving cell)		

8.2.2.3.3\_C.2.5 Test requirement

Table 8.2.2.3.3\_C.2.5-1 defines the primary level settings.

The fraction of maximum throughput percentage for the downlink reference measurement channels specified in Annex A clause A.3.4.2 for each throughput test shall meet or exceed the specified value in Tables 8.2.2.3.3\_C.2.5-2 for the specified SNR including test tolerances for all throughput tests.



Table 8.2.2.3.3\_C.2.5-1: Test Parameters for Large Delay CDD (FRC) – MBSFN ABS

Parameter		Unit	Cell 1	Cell 2
Uplink downlink configuration			1	1
Special subframe configuration			4	4
Downlink power allocation	$\rho_A$	dB	-3	-3
	$\rho_B$	dB	-3 (Note 1)	-3 (Note 1)
	$\sigma$	dB	0	N/A
$N_{oc}$ at antenna port	$N_{oc1}$	dBm/15kHz	-102.1 (Note 2)	N/A
	$N_{oc2}$	dBm/15kHz	-98 (Note 3)	N/A
	$N_{oc3}$	dBm/15kHz	-94.9 (Note 4)	N/A
$\widehat{E}_s/N_{oc2}$		dB	Reference Value in Table 8.2.2.3.3_C.2.5-2	5.8
BW <sub>Channel</sub>		MHz	10	10
Subframe Configuration			Non-MBSFN	MBSFN
Cell Id			0	126
Time Offset between Cells		$\mu$ s	2.5 (synchronous cells)	
ABS pattern (Note 5)			N/A	000000001 000000001
RLM/RRM Measurement Subframe Pattern (Note 6)			000000001 000000001	N/A
CSI Subframe Sets (Note 7)	$C_{CSI,0}$		000000001 000000001	N/A
	$C_{CSI,1}$		1100111000 1100111000	N/A
MBSFN Subframe Allocation (Note 10)			N/A	000010
Number of control OFDM symbols			2	2
ACK/NACK feedback mode			Multiplexing	N/A
PDSCH transmission mode			3	N/A
Cyclic prefix			Normal	Normal
<p>Note 1: <math>P_B = 1</math>.</p> <p>Note 2: This noise is applied in OFDM symbols #1, #2, #3, #4, #5, #6, #7, #8, #9, #10, #11, #12, #13 of a subframe overlapping with the aggressor ABS.</p> <p>Note 3: This noise is applied in OFDM symbol #0 of a subframe overlapping with the aggressor ABS.</p> <p>Note 4: This noise is applied in all OFDM symbols of a subframe overlapping with aggressor non-ABS.</p> <p>Note 5: ABS pattern as defined in [14]. The 10<sup>th</sup> and 20<sup>th</sup> subframes indicated by ABS pattern are MBSFN ABS subframes.</p> <p>Note 6: Time-domain measurement resource restriction pattern for PCell measurements as defined in [5]</p> <p>Note 7: As configured according to the time-domain measurement resource restriction pattern for CSI measurements defined in [5].</p> <p>Note 8: Cell 1 is the serving cell. Cell 2 is the aggressor cell. The number of the CRS ports in Cell1 and Cell2 is the same.</p> <p>Note 9: SIB-1 will not be transmitted in Cell2 in this test.</p> <p>Note 10: MBSFN Subframe Allocation as defined in [5], one frame with 6 bits is chosen for MBSFN subframe allocation.</p>				

**Table 8.2.2.3.3\_C.2.5-2: Test Requirement Large Delay CDD (FRC)**

Test Number	Reference Channel	OCNG Pattern		Propagation Conditions (Note 1)		Correlation Matrix and Antenna Configuration	Reference Value		UE Category
		Cell 1	Cell 2	Cell 1	Cell 2		Fraction of Maximum Throughput (%) Note 5	SNR (dB) (Note 2)	
1	R.11 TDD Note 4	OP.1 TDD	OP.1 TDD	EVA 5	EVA 5	2x2 Low	70	13.1	2-8
Note 1: The propagation conditions for Cell 1 and Cell2 are statistically independent. Note 2: SNR corresponds to of cell 1. Note 3: The correlation matrix and antenna configuration apply for Cell 1 and Cell 2. Note 4: Cell 1 Reference channel is modified: PDSCH other than SIB1/paging and its associated PDCCH/PCFICH are transmitted in the serving cell subframe when the subframe is overlapped with the ABS subframe of aggressor cell and the subframe is available in the definition of the reference channel. Note 5: The maximum Throughput is calculated from the total Payload in 2 subframes, averaged over 20ms.									

8.2.2.3.3\_D

8.2.2.3.3\_E TDD PDSCH Open Loop Spatial Multiplexing 2x2 for feICIC

8.2.2.3.3\_E.1 TDD PDSCH Open Loop Spatial Multiplexing 2x2 for feICIC (demodulation subframe overlaps with aggressor cell ABS and CRS assistance information are configured, non-MBSFN ABS)

8.2.2.3.3\_E.1.1 Test purpose

To verify the UE’s performance of large delay CDD with 2 transmit antennas if the PDSCH transmission in the serving cell takes place in subframes that overlap with ABS [9] of the aggressor cells with CRS assistance information.

8.2.2.3.3\_E.1.2 Test applicability

This test applies to all types of E-UTRA TDD UE and CRS interference handling and ss-CCH interference handling – Category 2-8 release 11 and forward. Applicability requires support of FGI bit 115.

8.2.2.3.3\_E.1.3 Minimum conformance requirements

The requirements are specified in terms of the percentage of information bit throughput for the downlink reference measurement channels specified in Annex A clause A.3.4.2, with the addition of the relevant parameters in Tables 8.2.2-1 and 8.2.2.3.3\_E.1.3-1, and the downlink physical channel setup according to Table C.3.2-1 in Annex C.

The requirements for non-MBSFN ABS are specified in Table 8.2.2.3.3\_E.1.3-2, with the addition of parameters in Table 8.2.2.3.3\_E.1.3-1 and the downlink physical channel setup according to Annex C.3.2 and Annex C.3.3.

Using this configuration the fraction of maximum throughput percentage shall meet or exceed the minimum requirements specified in Tables 8.2.2.3.3\_E.1.3-2 for the specified SNR. For open-loop spatial multiplexing performance with large delay CDD is specified.

Table 8.2.2.3.3\_E.1.3-1: Test Parameters for Large Delay CDD (FRC) – non-MBSFN ABS

Parameter		Unit	Cell 1	Cell 2	Cell 3
Uplink downlink configuration			1	1	1
Special subframe configuration			4	4	4
Downlink power allocation	$\rho_A$	dB	-3	-3	-3
	$\rho_B$	dB	-3 (Note 1)	-3 (Note 1)	-3 (Note 1)
	$\sigma$	dB	0	N/A	N/A
$N_{oc}$ at antenna port	$N_{oc1}$	dBm/15kHz	-98 (Note 2)	N/A	N/A
	$N_{oc2}$	dBm/15kHz	-98 (Note 3)	N/A	N/A
	$N_{oc3}$	dBm/15kHz	-93 (Note 4)	N/A	N/A
$\hat{E}_s / N_{oc2}$		dB	Reference Value in Table 8.2.2.3.3_E.1.3-2	Reference Value in Table 8.2.2.3.3_E.1.3-2	Reference Value in Table 8.2.2.3.3_E.1.3-2
BW <sub>Channel</sub>		MHz	10	10	10
Subframe Configuration			Non-MBSFN	Non-MBSFN	Non-MBSFN
Time Offset between Cells		μs	N/A	3	-1
Frequency shift between Cells		Hz	N/A	300	-100
Cell Id			0	1	126
ABS pattern (Note 5)			N/A	000000001 000000001	000000001 000000001
RLM/RRM Measurement Subframe Pattern (Note 6)			000000001 000000001	N/A	N/A
CSI Subframe Sets (Note7)	C <sub>CSI,0</sub>		000000001 000000001	N/A	N/A
	C <sub>CSI,1</sub>		1100111000 1100111000	N/A	N/A
Number of control OFDM symbols			2	Note 8	Note 8
ACK/NACK feedback mode			Multiplexing	N/A	N/A
PDSCH transmission mode			3	Note 9	Note 9
Cyclic prefix			Normal	Normal	Normal
<p>Note 1: <math>P_B = 1</math>.</p> <p>Note 2: This noise is applied in OFDM symbols #1, #2, #3, #5, #6, #8, #9, #10, #12, #13 of a subframe overlapping with the aggressor ABS.</p> <p>Note 3: This noise is applied in OFDM symbols #0, #4, #7, #11 of a subframe overlapping with the aggressor ABS.</p> <p>Note 4: This noise is applied in all OFDM symbols of a subframe overlapping with aggressor non-ABS</p> <p>Note 5: ABS pattern as defined in [14].</p> <p>Note 6: Time-domain measurement resource restriction pattern for PCell measurements as defined in [5]</p> <p>Note 7: As configured according to the time-domain measurement resource restriction pattern for CSI measurements defined in [7].</p> <p>Note 8: The number of control OFDM symbols is not available for ABS and is 2 for the subframe indicated by "0" of ABS pattern.</p> <p>Note 9: Downlink physical channel setup in Cell 2 and Cell 3 in accordance with Annex C.3.3 applying OCN pattern as defined in Annex A.5.</p> <p>Note 10: The number of the CRS ports in Cell1, Cell2 and Cell 3 is the same.</p> <p>Note 11: SIB-1 will not be transmitted in Cell2 and Cell 3 in this test.</p>					

Table 8.2.2.3.3\_E.1.3-2: Minimum performance Large Delay CDD (FRC) – non-MBSFN ABS

Test Number	Reference Channel	$\hat{E}_s/N_{oc2}$		OCNG Pattern			Propagation Conditions (Note1)			Correlation Matrix and Antenna Configuration (Note 2)	Reference Value		UE Category
		Cell 2	Cell 3	Cell 1	Cell 2	Cell 3	Cell 1	Cell 2	Cell 3		Fraction of Maximum Throughput (%) (Note 5)	SNR (dB) (Note 3)	
1	R.11 TDD (Note 4)	9	7	OP.1 TDD	OP.1 TDD	OP.1 TDD	EVA5	EVA5	EVA5	2x2 Low	70	14.2	2-8
2	R.35 TDD (Note 4)	9	1	OP.1 TDD	OP.1 TDD	OP.1 TDD	EVA5	EVA5	EVA5	2x2 Low	70	22.7	2-8

Note 1: The propagation conditions for Cell 1, Cell 2 and Cell 3 are statistically independent.  
Note 2: The correlation matrix and antenna configuration apply for Cell 1, Cell 2 and Cell 3.  
Note 3: SNR corresponds to  $\hat{E}_s/N_{oc2}$  of Cell 1.  
Note 4: Cell 1 reference channel is modified: PDSCH other than SIB1/paging and its associated PDCCH/PCFICH are transmitted in the serving cell subframe when the subframe is overlapped with the ABS subframe of aggressor cell and the subframe is available in the definition of the reference channel.  
Note 5: The maximum throughput is calculated from the total Payload in 2 subframes, averaged over 20ms.

The normative reference for this requirement is TS 36.101 [2] clause 8.2.2.3.3.

#### 8.2.2.3.3\_E.1.4 Test description

##### 8.2.2.3.3\_E.1.4.1 Initial conditions

Initial conditions are a set of test configurations the UE needs to be tested in and the steps for the SS to take with the UE to reach the correct measurement state.

Configurations of PDSCH and PDCCH before measurement are specified in Annex C.2.

Test Environment: Normal, as defined in TS 36.508 [7] clause 4.1.

Frequencies to be tested: Mid Range, as defined in TS 36.508 [7] clause 4.3.1.2.

Channel Bandwidths to be tested: As specified per test number in Table 8.2.2.3.3\_E.1.3-2, as defined in TS 36.508 [7] clause 4.3.1.2

1. Connect the SS, the faders and AWGN noise sources to the UE antenna connectors as shown in TS 36.508 [7] Annex A, Figure A.48 for antenna configuration 2x2.
2. The parameter settings for the cell 1 are set up according to Tables 8.2.2-1 and 8.2.2.3.3\_E.1.3-1 as appropriate.
3. Downlink signals are initially set up according to Annex C0, C.1 and Annex C.3.2 and uplink signals according to Annex H.1 and H.3.2.
4. Propagation conditions are set according to Annex B.0.
5. Ensure the UE is in State 3A-RF according to TS 36.508 [7] clause 5.2A.2 with exceptions listed in 5.2A.5. Message contents are defined in clause 8.2.2.3.3\_E.1.4.3.

##### 8.2.2.3.3\_E.1.4.2 Test procedure

1. Set the parameters for Cell1, Cell2 and Cell3 according to Tables 8.2.2.3.3\_E.1.5-1, 8.2.2.3.3\_E.1.5-2 and C.3.3-2 of Annex C.3.3 as appropriate. SS transmits PDSCH via PDCCH DCI format 2A for C\_RNTI to transmit the DL RMC. The SS sends downlink MAC padding bits on the DL RMC. Propagation conditions are set according to Annex B clause B.2.
2. Measure the average throughput for a duration sufficient to achieve statistical significance according to Annex G clause G.3. Count the number of NACKs, ACKs and statDTXs on the UL during the test interval and decide pass or fail according to Tables G.3.5 and G.3.6 in Annex G clause G.3.

## 8.2.2.3.3\_E.1.4.3 Message contents

Message contents are according to TS 36.508 [7] clause 5.2A.5.1 with the following exceptions:

**Table 8.2.2.3.3\_E.1.4.3-1: *PhysicalConfigDedicated-DEFAULT*: Additional TDD PDSCH open loop spatial multiplexing performance downlink power allocation**

Derivation Path: 36.508 clause 5.5.1.2			
Information Element	Value/remark	Comment	Condition
PhysicalConfigDedicated-DEFAULT ::= SEQUENCE {			
antennaInfo CHOICE {			
antennaInfoDedicated ::= SEQUENCE {			
transmissionMode	tm3		
codebookSubsetRestriction CHOICE {			
n2TxAntenna-tm3	11		
}			
ue-TransmitAntennaSelection CHOICE {			
release	NULL		
}			
}			
}			

**Table 8.2.2.3.3\_E.1.4.3-2: RadioResourceConfigDedicated-SRB2-DRB(n, m): Additional TDD PDSCH open loop spatial multiplexing performance downlink power allocation**

Derivation Path: TS 36.508 [7] clause 5.2A.5, Table 5.2A.5.1.1-2 RadioResourceConfigDedicated-SRB2-DRB(n,m)			
Information Element	Value/remark	Comment	Condition
RadioResourceConfigDedicated-SRB2-DRB(n, m) ::= SEQUENCE {			
MeasSubframePatternPCell-r10 CHOICE {			
setup SEQUENCE {			
subframePatternTDD-r10 CHOICE {			
subframeConfig1-5-r10	'00000000010000000001'	BIT STRING (SIZE (20))	
}			
}			
}			
neighCellsCRS-Info-r11 ::= CHOICE {			
setup SEQUENCE {			
CRS-AssistancedInfoList-r11 ::= SEQUENCE (SIZE (1..maxCellReport)) OF CRS-AssistancedInfo-r11{		2 entries	
CRS-AssistancedInfo-r11 ::= SEQUENCE {			
physCellId-r11	1		Cell 2
antennaPortsCount-r11	126		Cell 3
mbsfn-SubframeConfigList-r11 ::= SEQUENCE (SIZE (1..maxMBSFN-Allocations)) OF MBSFN-SubframeConfig{	an2		Cell 2, Cell 3
MBSFN-SubframeConfig ::= SEQUENCE {			
radioframeAllocationPeriod	n1		
radioframeAllocationOffset	0		
subframeAllocation CHOICE{			
oneFrame	'000000' B	non-MBSFN	
}			
}			
}			
}			
}			
}			
}			
}			

**Table 8.2.2.3.3\_E.1.4.3-3: PhysicalConfigDedicated-DEFAULT: Additional TDD PDSCH open loop spatial multiplexing performance downlink power allocation**

Derivation Path: 36.508 clause 5.5.1.2			
Information Element	Value/remark	Comment	Condition
PhysicalConfigDedicated-DEFAULT ::= SEQUENCE {			
cqi-ReportConfig-r10	CQI-ReportConfig-r10-DEFAULT		
}			

**Table 8.2.2.3.3\_E.1.4.3-4: CQI-ReportConfig-r10-DEFAULT: Additional TDD PDSCH open loop spatial multiplexing performance downlink power allocation**

Derivation Path: 36.508 [7] clause 4.6.3, Table 4.6.3-2AA CQI-ReportConfig-r10-DEFAULT_			
Information Element	Value/remark	Comment	Condition
CQI-ReportConfig-r10-DEFAULT ::= SEQUENCE {			
cqi-ReportAperiodic-r10	Not present		
nomPDSCH-RS-EPRE-Offset	0		
cqi-ReportPeriodic-r10	Not present		
pmi-RI-Report-r9	Not present		
csi-SubframePatternConfig-r10 CHOICE {			
setup SEQUENCE {			
csi-MeasSubframeSet1-r10 CHOICE {			
subframePatternTDD-r10 CHOICE {			
subframeConfig1-5-r10	'00000100010000000001'	BIT STRING (SIZE (20))	
}			
}			
}			
csi-MeasSubframeSet2-r10 CHOICE {			
subframePatternTDD-r10 CHOICE {			
subframeConfig1-5-r10	'11001010001100111000'	BIT STRING (SIZE (20))	
}			
}			
}			

8.2.2.3.3\_E.1.5 Test requirement

Table 8.2.2.3.3\_E.1.5-1 defines the primary level settings.

The fraction of maximum throughput percentage for the downlink reference measurement channels specified in Annex A clause A.3.4.2 for each throughput test shall meet or exceed the specified value in Tables 8.2.2.3.3\_E.1.5-2 for the specified SNR including test tolerances for all throughput tests.

Table 8.2.2.3.3\_E.1.5-1: Test Parameters for Large Delay CDD (FRC) – non-MBSFN ABS

Parameter		Unit	Cell 1	Cell 2	Cell 3
Uplink downlink configuration			1	1	1
Special subframe configuration			4	4	4
Downlink power allocation	$\rho_A$	dB	-3	-3	-3
	$\rho_B$	dB	-3 (Note 1)	-3 (Note 1)	-3 (Note 1)
	$\sigma$	dB	0	N/A	N/A
$N_{oc}$ at antenna port	$N_{oc1}$	dBm/15kHz	-98 (Note 2)	N/A	N/A
	$N_{oc2}$	dBm/15kHz	-98 (Note 3)	N/A	N/A
	$N_{oc3}$	dBm/15kHz	-93.1 (Note 4)	N/A	N/A
$\hat{E}_s / N_{oc2}$		dB	Reference Value in Table 8.2.2.3.3_E.1.3-2	Reference Value in Table 8.2.2.3.3_E.1.3-2	Reference Value in Table 8.2.2.3.3_E.1.3-2
BW <sub>Channel</sub>		MHz	10	10	10
Subframe Configuration			Non-MBSFN	Non-MBSFN	Non-MBSFN
Time Offset between Cells		μs	N/A	3	-1
Frequency shift between Cells		Hz	N/A	300	-100
Cell Id			0	1	126
ABS pattern (Note 5)			N/A	000000001 000000001	000000001 000000001
RLM/RRM Measurement Subframe Pattern (Note 6)			000000001 000000001	N/A	N/A
CSI Subframe Sets (Note7)	C <sub>CSI,0</sub>		000000001 000000001	N/A	N/A
	C <sub>CSI,1</sub>		1100111000 1100111000	N/A	N/A
Number of control OFDM symbols			2	Note 8	Note 8
ACK/NACK feedback mode			Multiplexing	N/A	N/A
PDSCH transmission mode			3	Note 9	Note 9
Cyclic prefix			Normal	Normal	Normal
<p>Note 1: <math>P_B = 1</math>.</p> <p>Note 2: This noise is applied in OFDM symbols #1, #2, #3, #5, #6, #8, #9, #10, #12, #13 of a subframe overlapping with the aggressor ABS.</p> <p>Note 3: This noise is applied in OFDM symbols #0, #4, #7, #11 of a subframe overlapping with the aggressor ABS.</p> <p>Note 4: This noise is applied in all OFDM symbols of a subframe overlapping with aggressor non-ABS</p> <p>Note 5: ABS pattern as defined in [14].</p> <p>Note 6: Time-domain measurement resource restriction pattern for PCell measurements as defined in [5]</p> <p>Note 7: As configured according to the time-domain measurement resource restriction pattern for CSI measurements defined in [7].</p> <p>Note 8: The number of control OFDM symbols is not available for ABS and is 2 for the subframe indicated by "0" of ABS pattern.</p> <p>Note 9: Downlink physical channel setup in Cell 2 and Cell 3 in accordance with Annex C.3.3 applying OCN pattern as defined in Annex A.5.</p> <p>Note 10: The number of the CRS ports in Cell1, Cell2 and Cell 3 is the same.</p> <p>Note 11: SIB-1 will not be transmitted in Cell2 and Cell 3 in this test.</p>					



Table 8.2.2.3.3\_E.1.5-2: Test Parameters for Large Delay CDD (FRC) non-MBSFN ABS

Test Number	Reference Channel	$\hat{E}_s/N_{oc2}$		OCNG Pattern			Propagation Conditions (Note1)			Correlation Matrix and Antenna Configuration (Note 2)	Reference Value		UE Category
		Cell 2	Cell 3	Cell 1	Cell 2	Cell 3	Cell 1	Cell 2	Cell 3		Fraction of Maximum Throughput (%) (Note 5)	SNR (dB) (Note 3)	
1	R.11 TDD (Note 4)	8.8	6.8	OP.1 TDD	OP.1 TDD	OP.1 TDD	EVA5	EVA5	EVA5	2x2 Low	70	15.1	2-8
2	R.35 TDD (Note 4)	8.8	0.8	OP.1 TDD	OP.1 TDD	OP.1 TDD	EVA5	EVA5	EVA5	2x2 Low	70	23.6	2-8

Note 1: The propagation conditions for Cell 1, Cell 2 and Cell 3 are statistically independent.  
Note 2: The correlation matrix and antenna configuration apply for Cell 1, Cell 2 and Cell 3.  
Note 3: SNR corresponds to  $\hat{E}_s/N_{oc2}$  of Cell 1.  
Note 4: Cell 1 reference channel is modified: PDSCH other than SIB1/paging and its associated PDCCH/PCFICH are transmitted in the serving cell subframe when the subframe is overlapped with the ABS subframe of aggressor cell and the subframe is available in the definition of the reference channel.  
Note 5: The maximum throughput is calculated from the total Payload in 2 subframes, averaged over 20ms.

#### 8.2.2.4 TDD PDSCH Closed Loop Spatial Multiplexing Performance (Cell-Specific Reference Symbols)

##### 8.2.2.4.1 TDD PDSCH Closed Loop Single/Multi Layer Spatial Multiplexing 2x2

###### 8.2.2.4.1.1 Test purpose

To verify the UE's ability to receive a predefined test signal, representing a multi-path fading channel that is determined by the SNR with a percentage of the information bit throughput for a specified downlink Reference Measurement Channel (RMC) not falling below a specified value for transmission on two antenna ports using closed loop spatial multiplexing with wideband and frequency selective precoding.

###### 8.2.2.4.1.2 Test applicability

This test applies to all types of E-UTRA TDD UE release 8.

###### 8.2.2.4.1.3 Minimum conformance requirements

The requirements are specified in terms of the percentage of information bit throughput for the downlink reference measurement channels specified in Annex A clause A.3.4.2, with the addition of the relevant parameters in Tables 8.2.2-1, 8.2.2.4.1.3-1 and 8.2.2.4.1.3-3 and the downlink physical channel setup according to Table C.3.2-1 in Annex C.

Using this configuration the fraction of maximum throughput percentage shall meet or exceed the minimum requirements specified in Tables 8.2.2.4.1.3-2 and 8.2.2.4.1.3-4 for the specified SNR. For single-layer spatial multiplexing closed loop rank-one performance with wideband and frequency selective precoding is specified. For multi-layer spatial multiplexing closed loop rank-two performance with wideband and frequency selective precoding is specified.

**Table 8.2.2.4.1.3-1: Test Parameters for Testing Single-Layer Spatial Multiplexing (FRC)**

Parameter		Unit	Test 1	Test 2
Downlink power allocation	$\rho_A$	dB	-3	-3
	$\rho_B$	dB	-3 (Note 1)	-3 (Note 1)
	$\sigma$	dB	0	0
$N_{oc}$ at antenna port		dBm/15kHz	-98	-98
Precoding granularity		PRB	6	50
PMI delay (Note 2)		ms	10 or 11	10 or 11
Reporting interval		ms	1 or 4 (Note 3)	1 or 4 (Note 3)
Reporting mode			PUSCH 1-2	PUSCH 3-1
CodeBookSubsetRestriction bitmap			001111	001111
ACK/NACK feedback mode			Multiplexing	Multiplexing
PDSCH transmission mode			4	4
Note 1: $P_B = 1$ Note 2: If the UE reports in an available uplink reporting instance at SF#n based on PMI estimation at a downlink SF not later than SF#(n-4), this reported PMI cannot be applied at the eNB downlink before SF#(n+4) Note 3: For Uplink - downlink configuration 1 the reporting interval will alternate between 1ms and 4ms				

**Table 8.2.2.4.1.3-2: Minimum performance Single-Layer Spatial Multiplexing (FRC)**

Test number	Bandwidth	Reference Channel	OCNG Pattern	Propagation Condition	Correlation Matrix and Antenna Configuration	Reference value		UE Category
						Fraction of Maximum Throughput (%)	SNR (dB)	
1	10 MHz	R.10 TDD	OP.1 TDD	EVA5	2x2 Low	70	-3.1	1-5
2	10 MHz	R.10 TDD	OP.1 TDD	EPA5	2x2 High	70	-2.8	1-5

**Table 8.2.2.4.1.3-3: Test Parameters for Testing Multi-Layer Spatial Multiplexing**

Parameter		Unit	Test 3	Test 4
Downlink power allocation	$\rho_A$	dB	-3	-3
	$\rho_B$	dB	-3 (Note 1)	-3 (Note 1)
	$\sigma$	dB	0	0
$N_{oc}$ at antenna port		dBm/15kHz	-98	-98
Precoding granularity		PRB	50	50
PMI delay (Note 2)		ms	10 or 11	10 or 11
Reporting interval		ms	1 or 4 (Note 3)	1 or 4 (Note 3)
Reporting mode			PUSCH 3-1	PUSCH 3-1
ACK/NACK feedback mode			Bundling	Bundling
CodeBookSubsetRestriction bitmap			110000	110000
PDSCH transmission mode			4	4
Note 1: $P_B = 1$ Note 2: If the UE reports in an available uplink reporting instance at subframe SF#n based on PMI estimation at a downlink SF not later than SF#(n-4), this reported PMI cannot be applied at the eNB downlink before SF#(n+4) Note 3: For Uplink - downlink configuration 1 the reporting interval will alternate between 1ms and 4ms				

**Table 8.2.2.4.1.3-4: Minimum performance Multi-Layer Spatial Multiplexing (FRC)**

Test number	Bandwidth	Reference Channel	OCNG Pattern	Propagation Condition	Correlation Matrix and Antenna Configuration	Reference value		UE Category
						Fraction of Maximum Throughput (%)	SNR (dB)	
3	10 MHz	R.11-1 TDD	OP.1 TDD	EVA5	2x2 Low	70	12.8	2-5
4	10 MHz	R.11-1 TDD	OP.1 TDD	ETU70	2x2 Low	70	13.9	2-5

The normative reference for this requirement is TS 36.101 [2] clause 8.2.2.4.

#### 8.2.2.4.1.4 Test description

##### 8.2.2.4.1.4.1 Initial conditions

Initial conditions are a set of test configurations the UE needs to be tested in and the steps for the SS to take with the UE to reach the correct measurement state.

Configurations of PDSCH and PDCCH before measurement are specified in Annex C.2.

Test Environment: Normal, as defined in TS 36.508 [7] clause 4.1.

Frequencies to be tested: Mid Range, as defined in TS 36.508 [7] clause 4.3.1.2.

Bandwidths to be tested: As specified per test number in Tables 8.2.2.4.1.3-2 and 8.2.2.4.1.3-4 as defined in TS 36.508 [7] clause 4.3.1.2.

1. Connect the SS, the faders and AWGN noise sources to the UE antenna connectors as shown in TS 36.508 [7] Annex A, Figure A.10 for antenna configuration 2x2.
2. The parameter settings for the cell are set up according to Tables 8.2.2-1, 8.2.2.4.1.3-1 and 8.2.2.4.1.3-3 as appropriate.
3. Downlink signals are initially set up according to Annex C.0, C.1 and Annex C.3.2 and uplink signals according to Annex H.1 and H.3.2.
4. Propagation conditions are set according to Annex B.0.
5. Ensure the UE is in State 3A-RF according to TS 36.508 [7] clause 5.2A.2. Message contents are defined in clause 8.2.2.4.1.4.3.

##### 8.2.2.4.1.4.2 Test procedure

1. For single-layer spatial multiplexing, SS transmits PDSCH via PDCCH DCI format 2 for C\_RNTI to transmit the DL RMC according to Tables 8.2.2.4.1.3-1 and 8.2.2.4.1.3-2. For multi-layer spatial multiplexing, SS transmits PDSCH via PDCCH DCI format 2 for C\_RNTI to transmit the DL RMC according to Tables 8.2.2.4.1.3-3 and 8.2.2.4.1.3-4. The SS sends downlink MAC padding bits on the DL RMC.
2. SS schedules the UL transmission to carry the PUSCH CQI feedback via PDCCH DCI format 0 with CQI request bit set to 1 and I\_MCS=29 and N\_PRB allocated to be less or equal to 4.
3. Set the parameters of the bandwidth, MCS, reference channel, the propagation condition, the correlation matrix, antenna configuration and the SNR according to Tables 8.2.2.4.1.5-1 and 8.2.2.4.1.5-2 as appropriate.
4. Measure the average throughput for a duration sufficient to achieve statistical significance according to Annex G clause G.3. Count the number of NACKs, ACKs and statDTXs on the UL during each test interval and decide pass or fail according to Tables G.3.5 and G.3.6 in Annex G clause G.3.
5. Repeat steps from 1 to 4 for each test interval in Tables 8.2.2.4.1.5-1 and 8.2.2.4.1.5-2 as appropriate.

##### 8.2.2.4.1.4.3 Message contents

Message contents are according to TS 36.508 [7] clause 4.6 with the following exceptions.

**Table 8.2.2.4.1.4.3-1: *PhysicalConfigDedicated-DEFAULT*: Additional TDD PDSCH closed loop single-layer spatial multiplexing performance downlink power allocation for Test number 1,2**

Derivation Path: 36.508 Table 5.5.1.2-1			
Information Element	Value/remark	Comment	Condition
PhysicalConfigDedicated-DEFAULT ::= SEQUENCE {			
antennaInfo CHOICE {			
explicitValue ::= SEQUENCE {			
transmissionMode	tm4		
codebookSubsetRestriction CHOICE {			
n2TxAntenna-tm4	001111		
}			
ue-TransmitAntennaSelection CHOICE {			
release	NULL		
}			
}			
}			

**Table 8.2.2.4.1.4.3-2: *PhysicalConfigDedicated-DEFAULT*: Additional TDD PDSCH closed loop multi-layer spatial multiplexing performance downlink power allocation for Test number 3,4**

Derivation Path: 36.508 Table 5.5.1.2-1			
Information Element	Value/remark	Comment	Condition
PhysicalConfigDedicated-DEFAULT ::= SEQUENCE {			
antennaInfo CHOICE {			
explicitValue ::= SEQUENCE {			
transmissionMode	tm4		
codebookSubsetRestriction CHOICE {			
n2TxAntenna-tm4	110000		
}			
ue-TransmitAntennaSelection CHOICE {			
release	NULL		
}			
}			
}			

**Table 8.2.2.4.1.4.3-3: *CQI-ReportConfig-DEFAULT*: Additional TDD PDSCH closed loop single -layer spatial multiplexing performance downlink power allocation for Test number 1**

Derivation Path: 36.508 Table 4.6.3-2			
Information Element	Value/remark	Comment	Condition
CQI-ReportConfig-DEFAULT ::= SEQUENCE {			
cqi-ReportModeAperiodic	rm12		
nomPDSCH-RS-EPRE-Offset	0		
cqi-ReportPeriodic	Not present		
}			

**Table 8.2.2.4.1.4.3-4: *CQI-ReportConfig-DEFAULT*: Additional TDD PDSCH closed loop single/multi-layer spatial multiplexing performance downlink power allocation for Test number 2, 3, 4**

Derivation Path: 36.508 Table 4.6.3-2			
Information Element	Value/remark	Comment	Condition
CQI-ReportConfig-DEFAULT ::= SEQUENCE {			
cqi-ReportModeAperiodic	rm31		
nomPDSCH-RS-EPRE-Offset	0		
cqi-ReportPeriodic	Not present		
}			

**Table 8.2.2.4.1.4.3-5: PUCCH-ConfigDedicated-DEFAULT: Additional TDD PDSCH closed loop single/multi-layer spatial multiplexing performance downlink power allocation for Test number 3, 4**

Derivation Path: 36.508 Table 4.6.3-9			
Information Element	Value/remark	Comment	Condition
PUCCH-ConfigDedicated-DEFAULT ::= SEQUENCE			
{			
tddAckNackFeedbackMode	bundling		
}			

#### 8.2.2.4.1.5 Test requirement

Tables 8.2.2.4.1.3-1 and 8.2.2.4.1.3-3 defines the primary level settings.

The fraction of maximum throughput percentage for the downlink reference measurement channels specified in Annex A clause A.3.4.2, for each throughput test shall meet or exceed the specified value in Tables 8.2.2.4.1.5-1 and 8.2.2.4.1.5-2 for the specified SNR including test tolerances for all throughput tests.

**Table 8.2.2.4.1.5-1: Test requirement Single-Layer Spatial Multiplexing (FRC)**

Test number	Bandwidth	Reference Channel	OCNG Pattern	Propagation Condition	Correlation Matrix and Antenna Configuration	Reference value		UE Category
						Fraction of Maximum Throughput (%)	SNR (dB)	
1	10 MHz	R.10 TDD	OP.1 TDD	EVA5	2x2 Low	70	-2.2	1-5
2	10 MHz	R.10 TDD	OP.1 TDD	EPA5	2x2 High	70	-2.0	1-5

**Table 8.2.2.4.1.5-2: Test requirement Multi-Layer Spatial Multiplexing (FRC)**

Test number	Bandwidth	Reference Channel	OCNG Pattern	Propagation Condition	Correlation Matrix and Antenna Configuration	Reference value		UE Category
						Fraction of Maximum Throughput (%)	SNR (dB)	
3	10 MHz	R.11-1 TDD	OP.1 TDD	EVA5	2x2 Low	70	13.7	2-5
4	10 MHz	R.11-1 TDD	OP.1 TDD	ETU70	2x2 Low	70	14.8	2-5

#### 8.2.2.4.1\_1 TDD PDSCH Closed Loop Single/Multi Layer Spatial Multiplexing 2x2 (Release 9 and forward)

##### 8.2.2.4.1\_1.1 Test purpose

Same test purpose as in clause 8.2.2.4.1.1.

##### 8.2.2.4.1\_1.2 Test applicability

This test applies to all types of E-UTRA TDD UE release 9 and forward.

##### 8.2.2.4.1\_1.3 Minimum conformance requirements

Same minimum conformance requirements as in clause 8.2.2.4.1.3 with the following exceptions:

- Instead of Table 8.2.2.4.1.3-2 → use Table 8.2.2.4.1\_1.3-1.
- Instead of Table 8.2.2.4.1.3-4 → use Table 8.2.2.4.1\_1.3-2.

**Table 8.2.2.4.1\_1.3-1: Minimum performance Single-Layer Spatial Multiplexing (FRC)**

Test number	Bandwidth	Reference Channel	OCNG Pattern	Propagation Condition	Correlation Matrix and Antenna Configuration	Reference value		UE Category
						Fraction of Maximum Throughput (%)	SNR (dB)	
1	10 MHz	R.10 TDD	OP.1 TDD	EVA5	2x2 Low	70	-3.1	≥1
2	10 MHz	R.10 TDD	OP.1 TDD	EPA5	2x2 High	70	-2.8	≥1

**Table 8.2.2.4.1\_1.3-2: Minimum performance Multi-Layer Spatial Multiplexing (FRC)**

Test number	Bandwidth	Reference Channel	OCNG Pattern	Propagation Condition	Correlation Matrix and Antenna Configuration	Reference value		UE Category
						Fraction of Maximum Throughput (%)	SNR (dB)	
3	10 MHz	R.35 TDD	OP.1 TDD	EPA5	2x2 Low	70	19.5	≥2
4	10 MHz	R.11-1 TDD	OP.1 TDD	ETU70	2x2 Low	70	13.9	≥2

The normative reference for this requirement is TS 36.101 [2] clause 8.2.2.4.

#### 8.2.2.4.1\_1.4 Test description

Same test description as in clause 8.2.2.4.1.4 with the following exceptions:

- Instead of Table 8.2.2.4.1.3-2 → use Table 8.2.2.4.1\_1.3-1.
- Instead of Table 8.2.2.4.1.3-4 → use Table 8.2.2.4.1\_1.3-2.
- Instead of Table 8.2.2.4.1.5-1 → use Table 8.2.2.4.1\_1.5-1.
- Instead of Table 8.2.2.4.1.5-2 → use Table 8.2.2.4.1\_1.5-2.

#### 8.2.2.4.1\_1.5 Test requirement

Same test requirements as in clause 8.2.2.4.1.5 with the following exceptions:

- Instead of Table 8.2.2.4.1.5-1 → use Table 8.2.2.4.1\_1.5-1.
- Instead of Table 8.2.2.4.1.5-2 → use Table 8.2.2.4.1\_1.5-2.

**Table 8.2.2.4.1\_1.5-1: Test requirement Single-Layer Spatial Multiplexing (FRC)**

Test number	Bandwidth	Reference Channel	OCNG Pattern	Propagation Condition	Correlation Matrix and Antenna Configuration	Reference value		UE Category
						Fraction of Maximum Throughput (%)	SNR (dB)	
1	10 MHz	R.10 TDD	OP.1 TDD	EVA5	2x2 Low	70	-2.2	≥1
2	10 MHz	R.10 TDD	OP.1 TDD	EPA5	2x2 High	70	-2.0	≥1

Table 8.2.2.4.1\_1.5-2: Test requirement Multi-Layer Spatial Multiplexing (FRC)

Test number	Bandwidth	Reference Channel	OCNG Pattern	Propagation Condition	Correlation Matrix and Antenna Configuration	Reference value		UE Category
						Fraction of Maximum Throughput (%)	SNR (dB)	
3	10 MHz	R.35 TDD	OP.1 TDD	EPA5	2x2 Low	70	+20.4	≥2
4	10 MHz	R.11-1 TDD	OP.1 TDD	ETU70	2x2 Low	70	+14.8	≥2

## 8.2.2.4.1\_A to D

8.2.2.4.1\_E TDD PDSCH Closed Loop Single/Multi Layer Spatial Multiplexing 2x2 for f eICIC

8.2.2.4.1\_E.1 TDD PDSCH Closed Loop Single/Multi Layer Spatial Multiplexing 2x2 for f eICIC (non-MBSFN ABS)

8.2.2.4.1\_E.1 Test purpose

To verify The purpose is to verify the closed loop rank-one performance with wideband precoding if the PDSCH transmission in the serving cell takes place in subframes that overlap with ABS [14] of the aggressor cell with CRS assistance information.

8.2.2.4.1\_E.1.2 Test applicability

This test applies to all types of E-UTRA TDD UE and CRS interference handling and ss-CCH interference handling – UE Category 2-8 release 11 and forward. Applicability requires support of FGI bit 115.

8.2.2.4.1\_E.1.3 Minimum conformance requirements

The requirements are specified in Table 8.2.2.4.1\_E.1.3-2, with the addition of parameters in Table 8.2.2.4.1\_E.1.3-1. In Table 8.2.2.4.1\_E.1.3-1, Cell 1 is the serving cell, and Cell 2 and Cell 3 are the aggressor cells. The downlink physical channel setup for Cell 1 is according to Annex C.3.2 and for Cell 2 and Cell 3 is according to Annex C.3.3, respectively. The CRS assistance information TS 36.331 [5] includes Cell 2 and Cell 3.

Table 8.2.2.4.1\_E.1.3-1: Test Parameters for Testing Single-Layer Spatial Multiplexing (FRC)

Parameter		Unit	Cell 1	Cell 2	Cell 3
Uplink downlink configuration			1	1	1
Special subframe configuration			4	4	4
Downlink power allocation	$\rho_A$	dB	-3	-3	-3
	$\rho_B$	dB	-3 (Note 1)	-3 (Note 1)	-3 (Note 1)
	$\sigma$	dB	0	N/A	N/A
$N_{oc}$ at antenna port	$N_{oc1}$	dBm/15kHz	-98 (Note 2)	N/A	N/A
	$N_{oc2}$	dBm/15kHz	-98 (Note 3)	N/A	N/A
	$N_{oc3}$	dBm/15kHz	-93 (Note 4)	N/A	N/A
$\hat{E}_s / N_{oc2}$		dB	Reference Value in Table 8.2.2.4.1_E.1.3-2	12	10
BW <sub>Channel</sub>		MHz	10	10	10
Subframe Configuration			Non-MBSFN	Non-MBSFN	Non-MBSFN
Time Offset between Cells		μs	N/A	3	-1
Frequency shift between Cells		Hz	N/A	300	-100
Cell Id			0	126	1
ABS pattern (Note 5)			N/A	0000000001 0000000001	0000000001 0000000001
RLM/RRM Measurement Subframe Pattern (Note 6)			0000000001 0000000001	N/A	N/A
CSI Subframe Sets (Note7)	C <sub>CSI,0</sub>		0000000001 0000000001	N/A	N/A
	C <sub>CSI,1</sub>		1100111000 1100111000	N/A	N/A
Number of control OFDM symbols			2	Note 8	Note 8
ACK/NACK feedback mode			Multiplexing	N/A	N/A
PDSCH transmission mode			6	Note 9	Note 9
Precoding granularity		PRB	50	N/A	N/A
PMI delay (Note 10)		ms	10 or 11	N/A	N/A
Reporting interval		ms	1 or 4 (Note 11)	N/A	N/A
Reporting mode			PUSCH 3-1	N/A	N/A
CodeBookSubsetRestriction bitmap			1111	N/A	N/A
Cyclic prefix			Normal	Normal	Normal



Note 1:	$P_B = 1$ .
Note 2:	This noise is applied in OFDM symbols #1, #2, #3, #5, #6, #8, #9, #10, #12, #13 of a subframe overlapping with the aggressor ABS.
Note 3:	This noise is applied in OFDM symbols #0, #4, #7, #11 of a subframe overlapping with the aggressor ABS.
Note 4:	This noise is applied in all OFDM symbols of a subframe overlapping with aggressor non-ABS
Note 5:	ABS pattern as defined in [14].
Note 6:	Time-domain measurement resource restriction pattern for PCell measurements as defined in TS 36.331 [5].
Note 7:	As configured according to the time-domain measurement resource restriction pattern for CSI measurements defined in TS 36.331 [5].
Note 8:	The number of control OFDM symbols is not available for ABS and is 2 for the subframe indicated by "0" of ABS pattern.
Note 9:	Downlink physical channel setup in Cell 2 and Cell 3 in accordance with TS 36.521-1 [10] Annex C.3.3 applying OCNG pattern as defined in TS 36.521-1 [10] Annex A.5.
Note 10:	If the UE reports in an available uplink reporting instance at subframe SF#n based on PMI estimation at a downlink SF not later than SF#(n-4), this reported PMI cannot be applied at the eNB downlink before SF#(n+4).
Note 11:	For Uplink - downlink configuration 1 the reporting interval will alternate between 1ms and 4ms.
Note 12:	The number of the CRS ports in Cell 1, Cell 2 and Cell 3 is the same.
Note 13:	SIB-1 will not be transmitted in Cell 2 and Cell 3 in this test.

**Table 8.2.2.4.1\_E.1.3-2: Minimum performance Single-Layer Spatial Multiplexing (FRC)**

Test Number	Reference Channel	OCNG Pattern			Propagation Conditions (Note1)			Correlation Matrix and Antenna Configuration (Note 2)	Reference Value		UE Category
		Cell 1	Cell 2	Cell 3	Cell 1	Cell 2	Cell 3		Fraction of Maximum Throughput (%)(Note 5)	SNR (dB) (Note 3)	
1	R.11 TDD (Note 4)	OP.1 TDD	OP.1 FDD	OP.1 TDD	EPA5	EPA5	EPA5	2x2 High	70	6.4	≥2
Note 1:	The propagation conditions for Cell 1, Cell 2 and Cell 3 are statistically independent.										
Note 2:	The correlation matrix and antenna configuration apply for Cell 1, Cell 2 and Cell 3.										
Note 3:	SNR corresponds to $\hat{E}_s / N_{oc2}$ of Cell 1.										
Note 4:	Cell 1 reference channel is modified: PDSCH other than SIB1/paging and its associated PDCCH/PCFICH are transmitted in the serving cell subframe when the subframe is overlapped with the ABS subframe of aggressor cell and the subframe is available in the definition of the reference channel.										
Note 5:	The maximum throughput is calculated from the total Payload in 2 subframes, averaged over 20ms.										

The normative reference for this requirement is TS 36.101 [2] clause 8.2.2.4.1C.

#### 8.2.2.4.1\_E.1.4 Test description

##### 8.2.2.4.1\_E.1.4.1 Initial conditions

Initial conditions are a set of test configurations the UE needs to be tested in and the steps for the SS to take with the UE to reach the correct measurement state.

Configurations of PDSCH and PDCCH before measurement are specified in Annex C.2.

Test Environment: Normal, as defined in TS 36.508 [7] clause 4.1.

Frequencies to be tested: Mid Range, as defined in TS 36.508 [7] clause 4.3.1.2.

Channel Bandwidths to be tested: As specified per test number in Table 8.2.2.4.1\_E.1.3-2 as defined in TS 36.508 [7] clause 4.3.1.2.

1. Connect the SS, the faders and AWGN noise sources to the UE antenna connectors as shown in TS 36.508 [7] Annex A, Figure A.48 for antenna configuration 2x2.
2. The parameter settings for the cell are set up according to Tables 8.2.2.4.1\_E.1.3-1 as appropriate.

3. Downlink signals are initially set up according to Annex C0, C.1 and Annex C.3.2 and uplink signals according to Annex H.1 and H.3.2.
4. Propagation conditions are set according to Annex B.0.
5. Ensure the UE is in State 3A-RF according to TS 36.508 [7] clause 5.2A.2 with exceptions listed in 5.2A.5. Message contents are defined in clause 8.2.2.4.1\_E.1.4.3.

#### 8.2.2.4.1\_E.1.4.2 Test procedure

1. Set the parameters for Cell 1, Cell 2 and Cell 3, according to Tables 8.2.2.4.1\_E.1.5-1, 8.2.2.4.1\_E.1.5-2, and C.3.3.2 of Annex C.3.3. SS transmits PDSCH via PDCCH DCI format 1B for C\_RNTI to transmit the DL RMC.
2. The SS sends downlink MAC padding bits on the DL RMC. Propagation conditions are set according to Annex B clause B.2
3. SS schedules the UL transmission to carry the PUSCH CQI feedback via PDCCH DCI format 0 with CQI request bit set to 1 and I\_MCS=29 and N\_PRB allocated to be less or equal to 4.
4. Set the parameters of the bandwidth, MCS, reference channel, the propagation condition, the correlation matrix, antenna configuration and the SNR according to Table 8.2.2.4.1\_E.1.5-2 as appropriate.
5. Measure the average throughput for a duration sufficient to achieve statistical significance according to Annex G clause G.3. Count the number of NACKs, ACKs and statDTXs on the UL during each test interval and decide pass or fail according to Tables G.3.5 and G.3.6 in Annex G clause G.3.

#### 8.2.2.4.1\_E.1.4.3 Message contents

Message contents are according to TS 36.508 [7] clause 5.2A.5.1 with the following exceptions:

**Table 8.2.2.4.1\_E.1.4.3-1: RadioResourceConfigDedicated-SRB2-DRB(n, m): Additional TDD PDSCH closed loop single-layer spatial multiplexing performance downlink power allocation**

Derivation Path: TS 36.508 [7] clause 5.2A.5, Table 5.2A.5.1.1-2 RadioResourceConfigDedicated-SRB2-DRB(n,m)			
Information Element	Value/remark	Comment	Condition
RadioResourceConfigDedicated-SRB2-DRB(n, m) ::= SEQUENCE {			
MeasSubframePatternPCell-r10 CHOICE {			
setup SEQUENCE {			
subframePatternTDD-r10 CHOICE {			
subframeConfig1-5-r10	'0000000001 0000000001'	BIT STRING (SIZE (20))	
}			
}			
}			
neighCellsCRS-Info-r11 ::= CHOICE {			
setup SEQUENCE {			
CRS-AssistancedInfoList-r11 ::= SEQUENCE (SIZE (1..maxCellReport)) OF CRS-AssistancedInfo-r11{		2 entries	
CRS-AssistancedInfo-r11 ::= SEQUENCE {			
physCellId-r11	126		Cell 2
	1		Cell 3
antennaPortsCount-r11	an2		Cell 2, Cell 3
mbsfn-SubframeConfigList-r11 ::= SEQUENCE (SIZE (1..maxMBSFN-Allocations)) OF MBSFN-SubframeConfig{			Cell 2, Cell 3
MBSFN-SubframeConfig ::= SEQUENCE {			
radioframeAllocationPeriod	n1		
radioframeAllocationOffset	0		
subframeAllocation CHOICE{			
oneFrame	'000000' B	non-MBSFN	
}			
}			
}			
}			
}			
}			
}			

**Table 8.2.2.4.1\_E.1.4.3-2: PhysicalConfigDedicated-DEFAULT: Additional TDD PDSCH closed loop single-layer spatial multiplexing performance downlink power allocation**

Derivation Path: 36.508 clause 5.5.1.2			
Information Element	Value/remark	Comment	Condition
PhysicalConfigDedicated-DEFAULT ::= SEQUENCE {			
cqi-ReportConfig-r10	CQI-ReportConfig-r10-DEFAULT		
}			

**Table 8.2.2.4.1\_E.1.4.3-3: CQI-ReportConfig-r10-DEFAULT: Additional TDD PDSCH closed loop single-layer spatial multiplexing performance downlink power allocation**

Derivation Path: 36.508 [7] clause 4.6.3, Table 4.6.3-2AA CQI-ReportConfig-r10-DEFAULT_			
Information Element	Value/remark	Comment	Condition
CQI-ReportConfig-r10-DEFAULT ::= SEQUENCE {			
cqi-ReportAperiodic-r10	rm31		
nomPDSCH-RS-EPRE-Offset	0		
cqi-ReportPeriodic-r10	Not present		
pmi-RI-Report-r9	Not present		
csi-SubframePatternConfig-r10 CHOICE {			
setup SEQUENCE {			
csi-MeasSubframeSet1-r10 CHOICE {			
subframePatternTDD-r10 CHOICE {			
subframeConfig1-5-r10	'0000000001 0000000001'	BIT STRING (SIZE (20))	
}			
}			
}			
csi-MeasSubframeSet2-r10 CHOICE {			
subframePatternTDD-r10 CHOICE {			
subframeConfig1-5-r10	'1100111000 1100111000'	BIT STRING (SIZE (20))	
}			
}			
}			
}			

**Table 8.2.1.4.1\_E.1.4.3-4: PhysicalConfigDedicated-DEFAULT: Additional TDD PDSCH closed loop single-layer spatial multiplexing performance downlink power allocation**

Derivation Path: 36.508 clause 5.5.1.2			
Information Element	Value/remark	Comment	Condition
PhysicalConfigDedicated-DEFAULT ::= SEQUENCE {			
antennaInfo CHOICE {			
antennaInfoDedicated ::= SEQUENCE {			
transmissionMode	tm6		
codebookSubsetRestriction CHOICE {			
n2TxAntenna-tm6	1111		
}			
ue-TransmitAntennaSelection CHOICE {			
release	NULL		
}			
}			
}			

**Table 8.2.1.4.1\_E.1.4.3-3-5: TDD-Config-DEFAULT: Additional TDD PDSCH closed loop single-layer spatial multiplexing performance downlink power allocation**

Derivation Path: 36.508 clause 4.6.3			
Information Element	Value/remark	Comment	Condition
TDD-Config-DEFAULT ::= SEQUENCE {			
subframeAssignment	sa1		
specialSubframePatterns	ssp4		
}			

**Table 8.2.1.4.1\_E.1.4.3-3-6: PUCCH-ConfigDedicated-DEFAULT: Additional TDD PDSCH closed loop single-layer spatial multiplexing performance downlink power allocation**

Derivation Path: 36.508 clause4.6.3			
Information Element	Value/remark	Comment	Condition
PUCCH-ConfigDedicated-DEFAULT ::= SEQUENCE			
{			
ackNackRepetition CHOICE {			
release	NULL		
}			
tddAckNackFeedbackMode	Multiplexing		
}			

#### 8.2.2.4.1\_E.1.5 Test requirement

Table 8.2.2.4\_E.1.5-1 defines the primary level settings.

The fraction of maximum throughput percentage for the downlink reference measurement channels specified in Annex A clause A.3.3.2 for each throughput test shall meet or exceed the specified value in Tables 8.2.2.4.1\_E.1.5-2 for the specified SNR including test tolerances for all throughput tests.

Table 8.2.2.4.1\_E.1.5-1: Test Parameters for Testing Single-Layer Spatial Multiplexing (FRC)

Parameter		Unit	Cell 1	Cell 2	Cell 3
Uplink downlink configuration			1	1	1
Special subframe configuration			4	4	4
Downlink power allocation	$\rho_A$	dB	-3	-3	-3
	$\rho_B$	dB	-3 (Note 1)	-3 (Note 1)	-3 (Note 1)
	$\sigma$	dB	0	N/A	N/A
$N_{oc}$ at antenna port	$N_{oc1}$	dBm/15kHz	-98 (Note 2)	N/A	N/A
	$N_{oc2}$	dBm/15kHz	-98 (Note 3)	N/A	N/A
	$N_{oc3}$	dBm/15kHz	-93.1 (Note 4)	N/A	N/A
$\hat{E}_s / N_{oc2}$		dB	Reference Value in Table 8.2.2.4.1_E.1.5-2	11.8	9.8
BW <sub>Channel</sub>		MHz	10	10	10
Subframe Configuration			Non-MBSFN	Non-MBSFN	Non-MBSFN
Time Offset between Cells		$\mu$ s	N/A	3	-1
Frequency shift between Cells		Hz	N/A	300	-100
Cell Id			0	126	1
ABS pattern (Note 5)			N/A	0000000001 0000000001	0000000001 0000000001
RLM/RRM Measurement Subframe Pattern (Note 6)			0000000001 0000000001	N/A	N/A
CSI Subframe Sets (Note7)	C <sub>CSI,0</sub>		0000000001 0000000001	N/A	N/A
	C <sub>CSI,1</sub>		1100111000 1100111000	N/A	N/A
Number of control OFDM symbols			2	Note 8	Note 8
ACK/NACK feedback mode			Multiplexing	N/A	N/A
PDSCH transmission mode			6	Note 9	Note 9
Precoding granularity		PRB	50	N/A	N/A
PMI delay (Note 10)		ms	10 or 11	N/A	N/A
Reporting interval		ms	1 or 4 (Note 11)	N/A	N/A
Reporting mode			PUSCH 3-1	N/A	N/A
CodeBookSubsetRestriction bitmap			1111	N/A	N/A
Cyclic prefix			Normal	Normal	Normal

Note 1:	$P_B = 1$ .
Note 2:	This noise is applied in OFDM symbols #1, #2, #3, #5, #6, #8, #9, #10, #12, #13 of a subframe overlapping with the aggressor ABS.
Note 3:	This noise is applied in OFDM symbols #0, #4, #7, #11 of a subframe overlapping with the aggressor ABS.
Note 4:	This noise is applied in all OFDM symbols of a subframe overlapping with aggressor non-ABS
Note 5:	ABS pattern as defined in [14].
Note 6:	Time-domain measurement resource restriction pattern for PCell measurements as defined in TS 36.331 [5].
Note 7:	As configured according to the time-domain measurement resource restriction pattern for CSI measurements defined in TS 36.331 [5].
Note 8:	The number of control OFDM symbols is not available for ABS and is 2 for the subframe indicated by "0" of ABS pattern.
Note 9:	Downlink physical channel setup in Cell 2 and Cell 3 in accordance with TS 36.521-1 [10] Annex C.3.3 applying OCNG pattern as defined in TS 36.521-1 [10] Annex A.5.
Note 10:	If the UE reports in an available uplink reporting instance at subframe SF#n based on PMI estimation at a downlink SF not later than SF#(n-4), this reported PMI cannot be applied at the eNB downlink before SF#(n+4).
Note 11:	For Uplink - downlink configuration 1 the reporting interval will alternate between 1ms and 4ms.
Note 12:	The number of the CRS ports in Cell 1, Cell 2 and Cell 3 is the same.
Note 13:	SIB-1 will not be transmitted in Cell 2 and Cell 3 in this test.

**Table 8.2.2.4.1\_E.1.5-2: Test requirement Single-Layer Spatial Multiplexing (FRC)**

Test Number	Reference Channel	OCNG Pattern			Propagation Conditions (Note1)			Correlation Matrix and Antenna Configuration (Note 2)	Reference Value		UE Category
		Cell 1	Cell 2	Cell 3	Cell 1	Cell 2	Cell 3		Fraction of Maximum Throughput (%) (Note 5)	SNR (dB) (Note 3)	
1	R.11 TDD (Note 4)	OP.1T DD	OP.1F DD	OP.1TD D	EPA5	EPA5	EPA5	2x2 High	70	7.3	≥2
Note 1: The propagation conditions for Cell 1, Cell 2 and Cell 3 are statistically independent. Note 2: The correlation matrix and antenna configuration apply for Cell 1, Cell 2 and Cell 3. Note 3: SNR corresponds to $\hat{E}_s / N_{oc2}$ of Cell 1. Note 4: Cell 1 reference channel is modified: PDSCH other than SIB1/paging and its associated PDCCH/PCFICH are transmitted in the serving cell subframe when the subframe is overlapped with the ABS subframe of aggressor cell and the subframe is available in the definition of the reference channel. Note 5: The maximum throughput is calculated from the total Payload in 2 subframes, averaged over 20ms.											

8.2.2.4.2 TDD PDSCH Closed Loop Single/Multi Layer Spatial Multiplexing 4x2

8.2.2.4.2.1 Test purpose

To verify the UE's ability to receive a predefined test signal, representing a multi-path fading channel that is determined by the SNR with a percentage of the information bit throughput for a specified downlink Reference Measurement Channel (RMC) not falling below a specified value for transmission on four antenna ports using closed loop spatial multiplexing with wideband and frequency selective precoding.

8.2.2.4.2.2 Test applicability

This test applies to all types of E-UTRA TDD UE release 8.

8.2.2.4.2.3 Minimum conformance requirements

The requirements are specified in terms of the percentage of information bit throughput for the downlink reference measurement channels specified in Annex A clause A.3.4.2, with the addition of the relevant parameters in Tables 8.2.2-1, 8.2.2.4.2.3-1 and 8.2.2.4.2.3-3 and the downlink physical channel setup according to Table C.3.2-1 in Annex C.

Using this configuration the fraction of maximum throughput percentage shall meet or exceed the minimum requirements specified in Tables 8.2.2.4.2.3-2 and 8.2.2.4.2.3-4 for the specified SNR. For single-layer spatial multiplexing closed loop rank-one performance with wideband and frequency selective precoding is specified. For multi-layer spatial multiplexing closed loop rank-two performance with wideband and frequency selective precoding is specified.

**Table 8.2.2.4.2.3-1: Test Parameters for Testing Single-Layer Spatial Multiplexing (FRC)**

Parameter	Unit	Test 1	
Downlink power allocation	$\rho_A$	dB	-6
	$\rho_B$	dB	-6 (Note 1)
	$\sigma$	dB	3
$N_{oc}$ at antenna port	dBm/15kHz	-98	
Precoding granularity	PRB	6	
PMI delay (Note 2)	ms	10 or 11	
Reporting interval	ms	1 or 4 (Note 3)	
Reporting mode		PUSCH 1-2	
CodeBookSubsetRestriction bitmap		000000000000 000000000000 000000000000 000000000111 111111111111	
ACK/NACK feedback mode		Multiplexing	
PDSCH transmission mode		4	
Note 1: $P_B = 1$ Note 2: If the UE reports in an available uplink reporting instance at subframe SF#n based on PMI estimation at a downlink SF not later than SF#(n-4), this reported PMI cannot be applied at the eNB downlink before SF#(n+4) Note 3: For Uplink - downlink configuration 1 the reporting interval will alternate between 1ms and 4ms			

**Table 8.2.2.4.2.3-2: Minimum performance Single-Layer Spatial Multiplexing (FRC)**

Test number	Bandwidth	Reference Channel	OCNG Pattern	Propagation Condition	Correlation Matrix and Antenna Configuration	Reference value		UE Category
						Fraction of Maximum Throughput (%)	SNR (dB)	
1	10 MHz	R.13 TDD	OP.1 TDD	EVA5	4x2 Low	70	-3.5	1-5



**Table 8.2.2.4.2.3-3: Test Parameters for Testing Multi-Layer Spatial Multiplexing**

Parameter	Unit	Test 2	
Downlink power allocation	$\rho_A$	dB	-6
	$\rho_B$	dB	-6 (Note 1)
	$\sigma$	dB	3
$N_{oc}$ at antenna port	dBm/15kHz	-98	
Precoding granularity	PRB	6	
PMI delay (Note 2)	ms	10 or 11	
Reporting interval	ms	1 or 4 (Note 3)	
Reporting mode		PUSCH 1-2	
ACK/NACK feedback mode		Bundling	
CodeBookSubsetRestriction bitmap		000000000000 000000000000 000000111111 111111110000 000000000000	
PDSCH transmission mode		4	
Note 1: $P_B = 1$			
Note 2: If the UE reports in an available uplink reporting instance at subframe SF#n based on PMI estimation at a downlink SF not later than SF#(n-4), this reported PMI cannot be applied at the eNB downlink before SF#(n+4)			
Note 3: For Uplink - downlink configuration 1 the reporting interval will alternate between 1ms and 4ms			

**Table 8.2.2.4.2.3-4: Minimum performance Multi-Layer Spatial Multiplexing (FRC)**

Test number	Bandwidth	Reference Channel	OCNG Pattern	Propagation Condition	Correlation Matrix and Antenna Configuration	Reference value		UE Category
						Fraction of Maximum Throughput (%)	SNR (dB)	
2	10 MHz	R.14 TDD	OP.1 TDD	EVA5	4x2 Low	70	10.7	2-5

The normative reference for this requirement is TS 36.101 [2] clause 8.2.2.4.

#### 8.2.2.4.2.4 Test description

##### 8.2.2.4.2.4.1 Initial conditions

Initial conditions are a set of test configurations the UE needs to be tested in and the steps for the SS to take with the UE to reach the correct measurement state.

Configurations of PDSCH and PDCCH before measurement are specified in Annex C.2.

Test Environment: Normal, as defined in TS 36.508 [7] clause 4.1.

Frequencies to be tested: Mid Range, as defined in TS 36.508 [7] clause 4.3.1.2.

Bandwidths to be tested: As specified per test number in Tables 8.2.2.4.2.3-2 and 8.2.2.4.2.3-4 as defined in TS 36.508 [7] clause 4.3.1.2.

1. Connect the SS, the faders and AWGN noise sources to the UE antenna connectors as shown in TS 36.508 [7] Annex A, Figure A.10 Figure A.11 for antenna configuration 4x2.
2. The parameter settings for the cell are set up according to Tables 8.2.2-1, 8.2.2.4.2.3-1 and 8.2.2.4.2.3-3 as appropriate.
3. Downlink signals are initially set up according to Annex C.0, C.1 and Annex C.3.2 and uplink signals according to Annex H.1 and H.3.2.
4. Propagation conditions are set according to Annex B.0.

5. Ensure the UE is in State 3A-RF according to TS 36.508 [7] clause 5.2A.2. Message contents are defined in clause 8.2.2.4.2.4.3.

8.2.2.4.2.4.2 Test procedure

1. For single-layer spatial multiplexing, SS transmits PDSCH via PDCCH DCI format 2 for C\_RNTI to transmit the DL RMC according to Tables 8.2.2.4.2.3-1 and 8.2.2.4.2.3-2. For multi-layer spatial multiplexing, SS transmits PDSCH via PDCCH DCI format 2 for C\_RNTI to transmit the DL RMC according to Tables 8.2.2.4.2.3-3 and 8.2.2.4.2.3-4. The SS sends downlink MAC padding bits on the DL RMC.
2. SS schedules the UL transmission to carry the PUSCH CQI feedback via PDCCH DCI format 0 with CQI request bit set to 1 and I\_MCS=29 and N\_PRB allocated to be less or equal to 4.
3. Set the parameters of the bandwidth, MCS, reference channel, the propagation condition, the correlation matrix, antenna configuration and the SNR according to Tables 8.2.2.4.2.5-1 and 8.2.2.4.2.5-2 as appropriate.
4. Measure the average throughput for a duration sufficient to achieve statistical significance according to Annex G clause G.3. Count the number of NACKs, ACKs and statDTXs on the UL during each test interval and decide pass or fail according to Tables G.3.5 and G.3.6 in Annex G clause G.3.
5. Repeat steps from 1 to 4 for each test interval in Tables 8.2.2.4.2.5-1 and 8.2.2.4.2.5-2 as appropriate.

8.2.2.4.2.4.3 Message contents

Message contents are according to TS 36.508 [7] clause 4.6 with the following exceptions.

**Table 8.2.2.4.2.4.3-1: PDSCH-ConfigDedicated-DEFAULT: Additional TDD PDSCH closed loop spatial multiplexing performance downlink power allocation for Test numbers 1,2**

Derivation Path: 36.508 clause 4.6.3			
Information Element	Value/remark	Comment	Condition
PDSCH-ConfigDedicated-DEFAULT ::= SEQUENCE {			
p-a	dB-6		
}			

**Table 8.2.2.4.2.4.3-2: PhysicalConfigDedicated-DEFAULT: Additional TDD PDSCH closed loop single-layer spatial multiplexing performance downlink power allocation for Test number 1**

Derivation Path: 36.508 Table 5.5.1.2			
Information Element	Value/remark	Comment	Condition
PhysicalConfigDedicated-DEFAULT ::= SEQUENCE {			
antennaInfo CHOICE {			
antennaInfoDedicated ::= SEQUENCE {			
transmissionMode	tm4		
codebookSubsetRestriction CHOICE {			
n4TxAntenna-tm4	00000000000000000000 00000000000000000000 00000000111111111111 1111		
}			
ue-TransmitAntennaSelection CHOICE {			
release	NULL		
}			
}			

**Table 8.2.2.4.2.4.3-3: PhysicalConfigDedicated-DEFAULT: Additional TDD PDSCH closed loop multi-layer spatial multiplexing performance downlink power allocation for Test number 2**

Derivation Path: 36.508 Table 5.5.1.2			
Information Element	Value/remark	Comment	Condition
PhysicalConfigDedicated-DEFAULT ::= SEQUENCE {			
antennaInfo CHOICE {			
antennaInfoDedicated ::= SEQUENCE {			
transmissionMode	tm4		
codebookSubsetRestriction CHOICE {			
n4TxAntenna-tm4	00000000000000000000 00000000000011111111 11111111000000000000 0000		
}			
ue-TransmitAntennaSelection CHOICE {			
release	NULL		
}			
}			

**Table 8.2.2.4.2.4.3-4: CQI-ReportConfig-DEFAULT: Additional TDD PDSCH closed loop single/multi-layer spatial multiplexing performance downlink power allocation for Test number 1, 2**

Derivation Path: 36.508 clause 4.6.3 Table 4.6.3-2			
Information Element	Value/remark	Comment	Condition
CQI-ReportConfig-DEFAULT ::= SEQUENCE {			
cqi-ReportModeAperiodic	rm12		
nomPDSCH-RS-EPRE-Offset	0		
cqi-ReportPeriodic	Not present		
}			

**Table 8.2.2.4.2.4.3-5: PUCCH-ConfigDedicated-DEFAULT: Additional TDD PDSCH closed loop single/multi-layer spatial multiplexing performance downlink power allocation for Test number 2**

Derivation Path: 36.508 Table 4.6.3-9			
Information Element	Value/remark	Comment	Condition
PUCCH-ConfigDedicated-DEFAULT ::= SEQUENCE {			
tdAckNackFeedbackMode	bundling		
}			

8.2.2.4.2.5 Test requirement

Tables 8.2.2.4.2.3-1 and 8.2.2.4.2.3-3 defines the primary level settings.

The fraction of maximum throughput percentage for the downlink reference measurement channels specified in Annex A clause A.3.4.2, for each throughput test shall meet or exceed the specified value in Tables 8.2.2.4.2.5-1 and 8.2.2.4.2.5-2 for the specified SNR including test tolerances for all throughput tests.

**Table 8.2.2.4.2.5-1: Test requirement Single-Layer Spatial Multiplexing (FRC)**

Test number	Bandwidth	Reference Channel	OCNG Pattern	Propagation Condition	Correlation Matrix and Antenna Configuration	Reference value		UE Category
						Fraction of Maximum Throughput (%)	SNR (dB)	
1	10 MHz	R.13 TDD	OP.1 TDD	EVA5	4x2 Low	70	-2.6	1-5

**Table 8.2.2.4.2.5-2: Test requirement Multi-Layer Spatial Multiplexing (FRC)**

Test number	Bandwidth	Reference Channel	OCNG Pattern	Propagation Condition	Correlation Matrix and Antenna Configuration	Reference value		UE Category
						Fraction of Maximum Throughput (%)	SNR (dB)	
2	10 MHz	R.14 TDD	OP.1 TDD	EVA5	4x2 Low	70	11.6	2-5

#### 8.2.2.4.2\_1 TDD PDSCH Closed Loop Multi Layer Spatial Multiplexing 4x2 (Release 9 and forward)

##### 8.2.2.4.2\_1.1 Test purpose

Same test purpose as in clause 8.2.2.4.2.1.

##### 8.2.2.4.2\_1.2 Test applicability

This test applies to all types of E-UTRA TDD UE release 9 and forward.

##### 8.2.2.4.2\_1.3 Minimum conformance requirements

Same minimum conformance requirements as in clause 8.2.2.4.2.3 with the following exceptions:

- Instead of Table 8.2.2.4.2.3-2 → use Table 8.2.2.4.2\_1.3-1.
- Instead of Table 8.2.2.4.2.3-4 → use Table 8.2.2.4.2\_1.3-2.

**Table 8.2.2.4.2\_1.3-2: Minimum performance Single-Layer Spatial Multiplexing (FRC)**

Test number	Bandwidth	Reference Channel	OCNG Pattern	Propagation Condition	Correlation Matrix and Antenna Configuration	Reference value		UE Category
						Fraction of Maximum Throughput (%)	SNR (dB)	
1	10 MHz	R.13 TDD	OP.1 TDD	EVA5	4x2 Low	70	-3.5	≥1

**Table 8.2.2.4.2\_1.3-2: Minimum performance Multi-Layer Spatial Multiplexing (FRC)**

Test number	Bandwidth	Reference Channel	OCNG Pattern	Propagation Condition	Correlation Matrix and Antenna Configuration	Reference value		UE Category
						Fraction of Maximum Throughput (%)	SNR (dB)	
2	10 MHz	R.36 TDD	OP.1 TDD	EPA5	4x2 Low	70	15.7	≥2

The normative reference for this requirement is TS 36.101 [2] clause 8.2.2.4.

##### 8.2.2.4.2\_1.4 Test description

Same test description as in clause 8.2.2.4.2.4 with the following exceptions:

- Instead of Table 8.2.2.4.2.3-2 → use Table 8.2.2.4.2\_1.3-1.
- Instead of Table 8.2.2.4.2.3-4 → use Table 8.2.2.4.2\_1.3-2.
- Instead of Table 8.2.2.4.2.5-1 → use Table 8.2.2.4.2\_1.5-1.
- Instead of Table 8.2.2.4.2.5-2 → use Table 8.2.2.4.2\_1.5-2.

## 8.2.2.4.2\_1.5 Test requirement

Same test requirements as in clause 8.2.2.4.2.5 with the following exceptions:

- Instead of Table 8.2.2.4.2.5-1 → use Table 8.2.2.4.2\_1.5-1.
- Instead of Table 8.2.2.4.2.5-2 → use Table 8.2.2.4.2\_1.5-2.

**Table 8.2.2.4.2\_1.5-1: Test requirement Single-Layer Spatial Multiplexing (FRC)**

Test number	Bandwidth	Reference Channel	OCNG Pattern	Propagation Condition	Correlation Matrix and Antenna Configuration	Reference value		UE Category
						Fraction of Maximum Throughput (%)	SNR (dB)	
1	10 MHz	R.13 TDD	OP.1 TDD	EVA5	4x2 Low	70	-2.6	≥1

**Table 8.2.2.4.2\_1.5-2: Test requirement Multi-Layer Spatial Multiplexing (FRC)**

Test number	Bandwidth	Reference Channel	OCNG Pattern	Propagation Condition	Correlation Matrix and Antenna Configuration	Reference value		UE Category
						Fraction of Maximum Throughput (%)	SNR (dB)	
2	10 MHz	R.36 TDD	OP.1 TDD	EPA5	4x2 Low	70	+16.6	≥2

## 8.2.2.4.2\_A TDD PDSCH Closed Loop Multi Layer Spatial Multiplexing 4x2 for CA

## 8.2.2.4.2\_A.1 TDD PDSCH Closed Loop Multi Layer Spatial Multiplexing 4x2 for CA (2DL CA)

**Editor's note: The following aspects are either missing or not yet determined:**

- SNR values in table 8.2.2.4.2\_A.1.3-3 are still in brackets in core spec.
- SNR value for 1.4 MHz channel bandwidth is still TBD

## 8.2.2.4.2\_A.1.1 Test purpose

To verify the UE's ability to receive a predefined test signal, representing a multi-path fading channel that is determined by the SNR with a percentage of the information bit throughput for a specified downlink Reference Measurement Channel (RMC) not falling below a specified value for transmission on two antenna ports using closed-loop spatial multiplexing.

## 8.2.2.4.2\_A.1.2 Test applicability

E-UTRA TDD release 10 and forward UE of category 5 or higher that supports inter-band OR intra-band contiguous DL CA

This test also applies to E-UTRA TDD release 11 and forward UE of category 5 or higher that supports intra-band non-contiguous DL CA.

## 8.2.2.4.2\_A.1.3 Minimum conformance requirements

The requirements are specified in terms of the percentage of information bit throughput for the downlink reference measurement channels specified in Annex A clause A.3.3.2, with the addition of the relevant parameters in Tables 8.2.1-1, 8.2.2.4.2\_A.1.3-1 and the downlink physical channel setup according to Table C.3.2-1 in Annex C.

Using this configuration the fraction of maximum throughput percentage shall meet or exceed the minimum requirements specified in Tables 8.2.2.4.2\_A.1.3-2 for the specified SNR. For multi-layer spatial multiplexing closed loop rank-two performance with wideband and frequency selective precoding is specified.

For CA with 2 DL CCs except for 2x20MHz, the requirements are specified in Table 8.2.2.4.2\_A.1.3-4, based on single carrier requirement specified in Table 8.2.2.4.2\_A.1.3-3.

**Table 8.2.2.4.2\_A.1.3-1: Test Parameters for Testing Multi-Layer Spatial Multiplexing for CA**

Parameter		Unit	Test 1
Downlink power allocation	$\rho_A$	dB	-6
	$\rho_B$	dB	-6 (Note 1)
	$\sigma$	dB	3
$N_{oc}$ at antenna port		dBm/15kHz	-98
Precoding granularity		PRB	8
PMI delay (Note 2)		ms	10 or 11
Reporting interval		ms	1 or 4 (Note 3)
Reporting mode			PUSCH 1-2
ACK/NACK feedback mode			PUCCH format 1b with channel selection
CodeBookSubsetRestriction bitmap			00000000000000000000000000000000 00001111111111111111100000000 00000000
CSI request field (Note 4)			'10'
PDSCH transmission mode			4
Note 1: $P_B = 1$ . Note 2: If the UE reports in an available uplink reporting instance at subframe SF#n based on PMI estimation at a downlink SF not later than SF#(n-4), this reported PMI cannot be applied at the eNB downlink before SF#(n+4) Note 3: For Uplink - downlink configuration 1 the reporting interval will alternate between 1ms and 4ms. Note 4: Multiple CC-s under test are configured as the 1 <sup>st</sup> set of serving cells by high layers. Note 5: The same PDSCH transmission mode is applied to each component carrier.			

**Table 8.2.2.4.2\_A.1.3-2: Minimum performance Multi-Layer Spatial Multiplexing (FRC) for CA**

Test number	Band width	Reference Channel	OCNG Pattern	Propagation Condition	Correlation Matrix and Antenna Configuration	Reference value		UE Category
						Fraction of Maximum Throughput (%)	SNR (dB)	
1	2x20 MHz	R.43 TDD	OP.1 TDD (Note 1)	EVA5	4x2 Low	70	11.1	≥5
2	20MHz +15MHz	R.43 TDD for 20MHz CC	OP.1 TDD (Note 1)	EVA5	4x2 Low	70	[10.7]	≥5
		R.43-5TDD for 15MHz CC	OP.1 TDD (Note 1)	EVA5		70	[10.6]	
Note 1: The OCNG pattern applies for each CC Note 2: The applicability of requirements for different CA configurations and bandwidth combination sets is defined in 8.1.2.3.								

**Table 8.2.2.4.2\_A.1.3-3: Single carrier performance for multiple CA configurations**

Bandwidth Num.	Band-width	Reference channel	OCNG pattern	Propa- gation condition	Correlation matrix and antenna config.	Reference value	
						Fraction of maximum throughput (%)	SNR (dB)

1	1.4MHz	R.43-1 TDD	OP.1 TDD	EVA5	4x2 Low	70	[TBD]
2	3MHz	R.43-2 TDD	OP.1 TDD	EVA5	4x2 Low	70	[9.8]
3	5MHz	R.43-3 TDD	OP.1 TDD	EVA5	4x2 Low	70	[10.0]
4	10 MHz	R.43-4 TDD	OP.1 TDD	EVA5	4x2 Low	70	[10.5]
5	15MHz	R.43-5 TDD	OP.1 TDD	EVA5	4x2 Low	70	[10.6]
6	20MHz	R.43 TDD	OP.1 TDD	EVA5	4x2 Low	70	[10.7]

The normative reference for this requirement is TS 36.101 [2] clause 8.2.2.4.

#### 8.2.2.4.2\_A.1.4 Test description

##### 8.2.2.4.2\_A.1.4.1 Initial conditions

Initial conditions are a set of test configurations the UE needs to be tested in and the steps for the SS to take with the UE to reach the correct measurement state.

Configurations of PDSCH and PDCCH before measurement are specified in Annex C.2.

Test Environment: Normal, as defined in TS 36.508 [7] clause 4.1.

Frequencies to be tested: Maximum WGap for Intra-band non-contiguous CA, otherwise Mid Range, as defined in TS 36.508 [7] clause 4.3.1.

Channel Bandwidths to be tested: Select one according to Table 8.2.2.4.2\_A.1.4.1-1.

CA Capability to be tested: Select one according to Table 8.2.2.3.1\_A.1.4.1

**Table 8.2.2.4.2\_A.1.4.1-1: Test point selection for TM4 2DLCA**

CA Capability	Bandwidth Combination	
	20+20	20+15
Inter-band CA (two bands) (CA2_A2)	Test 1	Test 2
Intra-band contiguous CA (CA2_C)	Test 1	Test 2
Intra-band non-contiguous CA (with two sub-blocks) (CA2_N2)	Test 1	Test 2
Note 1: Only one test point is tested. Select the largest aggregated CA bandwidth combination supported by the UE among the UE supported CA capabilities.		

1. Connect the SS, the faders and AWGN noise sources to the UE antenna connectors as shown in TS 36.508 [7] Annex A, Figure group 46 as appropriate.
2. The parameter settings for the cell are set up according to Tables 8.2.1-1, 8.2.2.4.2\_A.1.3-1 as appropriate.
3. Downlink signals for PCC are initially set up according to Annex C.1 and Annex C.3.2 and uplink signals according to Annex H.1 and H.3.2.
4. Propagation conditions are set according to Annex B.0.
5. Ensure the UE is in State 3A-RF according to TS 36.508 [7] clause 5.2A.2. Message contents are defined in clause 8.2.2.4.2\_A.1.4.3.

##### 8.2.2.4.2\_A.1.4.2 Test procedure

1. Configure SCC according to Annex C.0, C.1 and Annex C.3.2 for all downlink physical channels.

2. The SS shall configure SCC as per TS 36.508 [7] clause 5.2A.4. Message contents for *PDSCH-ConfigDedicated-DEFAULT* is defined in Table 8.2.2.4.2\_A.1.4.3-1, *PhysicalConfigDedicatedSCell-r10-DEFAULT* is defined in Table 8.2.2.4.2\_A.1.4.3-2A, *PhysicalConfigDedicated-DEFAULT* is defined in Table 8.2.2.4.2\_A.1.4.3-2, *CQI-ReportConfigSCell-DEFAULT* is defined in Table 8.2.2.4.2\_A.1.4.3-4, *CQI-ReportAperiodic-r10-DEFAULT* is defined in Table 8.2.2.4.2\_A.1.4.3-5, *CQI-ReportConfigSCell-r10-DEFAULT* is defined in Table 8.2.2.4.2\_A.1.4.3-6.
3. SS activates SCC by sending the activation MAC-CE (Refer TS 36.321 [13], clauses 5.13, 6.1.3.8). Wait for at least 2 seconds (Refer TS 36.133, clauses 8.3.3.2).
4. For multi-layer spatial multiplexing, SS transmits PDSCH via PDCCH DCI format 2 for C\_RNTI to transmit the DL RMC according to Tables 8.2.2.4.2\_A.1.3-1 and 8.2.2.4.2\_A.1.3-2 or 8.2.2.3.1\_A.1.3-4. The SS sends downlink MAC padding bits on the DL RMC.
5. SS schedules the UL transmission to carry the PUSCH CSI feedback via PDCCH DCI format 0 with CSI request bit set to '10' and I\_MCS=29 and N\_PRB allocated to be less or equal to 20.
6. Set the parameters of the bandwidth, MCS, reference channel, the propagation condition, the correlation matrix, antenna configuration and the SNR according to Tables 8.2.2.4.2\_A.1.5-1 or 8.2.2.4.2\_A.1.5-2 as appropriate.
7. Measure the average throughput for a duration sufficient to achieve statistical significance according to Annex G clause G.3. Count the number of NACKs, ACKs and statDTXs on the UL during the test interval and decide pass or fail according to Tables G.3.5 and G.3.6 in Annex G clause G.3.

8.2.2.4.2\_A.1.4.3 Message contents

Message contents are according to TS 36.508 [7] clauses 5.5 and 4.6 with the following exceptions:

**Table 8.2.2.4.2\_A.1.4.3-1: PDSCH-ConfigDedicated-DEFAULT: Additional TDD PDSCH closed loop spatial multiplexing performance downlink power allocation**

Derivation Path: TS 36.508 [7] clause 4.6.3, Table 4.6.3-6 PDSCH-ConfigDedicated-DEFAULT			
Information Element	Value/remark	Comment	Condition
PDSCH-ConfigDedicated-DEFAULT ::= SEQUENCE {			
p-a	dB-6		
}			

**Table 8.2.2.4.2\_A.1.4.3-2: PhysicalConfigDedicated-DEFAULT: Additional TDD PDSCH closed loop multi-layer spatial multiplexing performance downlink power allocation**

Derivation Path: 36.508 clause 5.5.1, Table 5.5.1.2-1			
Information Element	Value/remark	Comment	Condition
PhysicalConfigDedicated-DEFAULT ::= SEQUENCE {			
antennaInfo CHOICE {			
explicitValue ::= SEQUENCE {			
transmissionMode	tm4		
codebookSubsetRestriction CHOICE {			
n4TxAntenna-tm4	00000000000000000000 00000000000011111111 11111111000000000000 0000		
}			
ue-TransmitAntennaSelection CHOICE {			
release	NULL		
}			
}			



**Table 8.2.2.4.2\_A.1.4.3-2A: PhysicalConfigDedicatedSCell-r10-DEFAULT: Additional TDD PDSCH closed loop multi-layer spatial multiplexing performance downlink power allocation**

Derivation Path: 36.508 clause 4.6.3 Table 4.6.3-6A			
Information Element	Value/remark	Comment	Condition
PhysicalConfigDedicated SCell-r10-DEFAULT ::= SEQUENCE {			
nonUL-Configuration-r10 SEQUENCE {			
antennaInfo-r10 SEQUENCE {			
transmissionMode-r10	tm4		
codebookSubsetRestriction-r10	00000000000000000000 00000000000011111111 11111111000000000000 0000	BIT STRING	
ue-TransmitAntennaSelection CHOICE {			
release	NULL		
}			
}			
}			
cqi-ReportConfigSCell-r10	CQI-ReportConfigSCell-r10-DEFAULT		
}			

**Table 8.2.2.4.2\_A.1.4.3-3: CQI-ReportConfig-DEFAULT: Additional TDD PDSCH closed loop multi-layer spatial multiplexing performance downlink power allocation**

Derivation Path: 36.508 clause 4.6.3 Table 4.6.3-2			
Information Element	Value/remark	Comment	Condition
CQI-ReportConfig-DEFAULT ::= SEQUENCE {			
cqi-ReportModeAperiodic	rm12		
nomPDSCH-RS-EPRE-Offset	0		
cqi-ReportPeriodic	Not present		
}			

**Table 8.2.2.4.2\_A.1.4.3-4: CQI-ReportConfig-r10-DEFAULT: Additional TDD PDSCH closed loop multi-layer spatial multiplexing performance downlink power allocation**

Derivation Path: 36.508 clause 4.6.3 Table 4.6.3-2AA			
Information Element	Value/remark	Comment	Condition
CQI-ReportConfig-r10 ::= SEQUENCE {			RBC
cqi-ReportAperiodic-r10	CQI-ReportAperiodic-r10-DEFAULT		
nomPDSCH-RS-EPRE-Offset	0		
cqi-ReportPeriodic-r10	Not present		
pmi-RI-Report-r9	Not present		
csi-SubframePatternConfig-r10	Not present		
}			

**Table 8.2.2.4.2\_A.1.4.3-5: CQI-ReportAperiodic-r10-DEFAULT: Additional TDD PDSCH closed loop multi-layer spatial multiplexing performance downlink power allocation**

Derivation Path: 36.508 clause 4.6.3 Table 4.6.3-1A			
Information Element	Value/remark	Comment	Condition
CQI-ReportAperiodic-r10 ::= CHOICE {			
setup SEQUENCE {			
cqi-ReportModeAperiodic-r10	rm12		
aperiodicCSI-Trigger-r10 ::= SEQUENCE {			
trigger1-r10	11000000	P-Cell, S-Cell report	
trigger2-r10	00000000	No report	
}			
}			
}			

**Table 8.2.2.4.2\_A.1.4.3-6: CQI-ReportConfigSCell-r10-DEFAULT: Additional TDD PDSCH closed loop multi-layer spatial multiplexing performance downlink power allocation**

Derivation Path: 36.508 clause 4.6.3 Table 4.6.3-2AB			
Information Element	Value/remark	Comment	Condition
CQI-ReportConfigSCell-r10 ::= SEQUENCE {			
cqi-ReportModeAperiodic-r10	rm12		
nomPDSCH-RS-EPRE-Offset-r10	0		
cqi-ReportPeriodicSCell-r10	Not present		
pmi-RI-Report-r10	Not present		
}			

8.2.2.4.2\_A.1.5 Test requirement

Tables 8.2.2.4.2\_A.1.3-1 define the primary level settings.

The fraction of maximum throughput percentage for the downlink reference measurement channels specified in Annex A clause A.3.4.2 for each throughput test shall meet or exceed the specified value in Tables 8.2.2.4.2\_A.1.5-1 or 8.2.2.4.2\_A.1.5-2 for the specified SNR including test tolerances for all throughput tests.

**Table 8.2.2.4.2\_A.1.5-1: Test requirement Multi-Layer Spatial Multiplexing (FRC) for CA**

Test number	Band width	Reference Channel	OCNG Pattern	Propagation Condition	Correlation Matrix and Antenna Configuration	Reference value		UE Category
						Fraction of Maximum Throughput (%)	SNR (dB)	
1	2x20 MHz	R.43 TDD	OP.1 TDD (Note 1)	EVA5	4x2 Low	70	12.0	≥5
2	20MHz+15MHz	R.43 TDD for 20MHz CC	OP.1 TDD (Note 1)	EVA5	4x2 Low	70	[10.7] +TT	≥5
		R.43-5 TDD for 15MHz CC	OP.1 TDD (Note 1)	EVA5			[10.6] +TT	
Note1: For CA capable UE, the OCNG pattern applies for each CC								
Note 2: The applicability of requirements for different CA configurations and bandwidth combination sets is defined in 8.1.2.3.								

Decide pass or fail for each subtest according to Annex G.3A.4. Decide the entire test pass or fail according to Annex G.3A.6.

8.2.2.4.2\_A.2 TDD PDSCH Closed Loop Multi Layer Spatial Multiplexing 4x2 for CA (3DL CA)

Editor’s notes: This test case is incomplete. The following items are missing or incomplete:

- The SNR values for minimum conformance and test requirements are still in brackets.

#### 8.2.2.4.2\_A.2.1 Test purpose

To verify the UE's ability to receive a predefined test signal, representing a multi-path fading channel that is determined by the SNR with a percentage of the information bit throughput for a specified downlink Reference Measurement Channel (RMC) not falling below a specified value for transmission on two antenna ports using closed-loop spatial multiplexing.

#### 8.2.2.4.2\_A.2.2 Test applicability

This test case applies to all types of E-UTRA TDD release 10 and forward UE of category 5 or higher that support 3DL Intra-band contiguous CA or 3DL Inter-band CA, or 3DL with Intra-band contiguous and Inter-band CA.

This test case also applies to all types of E-UTRA TDD release 11 and forward UE of category 5 or higher that support 3DL with Intra-band non-contiguous and Inter-band CA, or 3DL with Intra-band non-contiguous and Intra-band contiguous CA.

#### 8.2.2.4.2\_A.2.3 Minimum conformance requirements

For CA with 3 DL CCs, the requirements are specified in Table 8.2.2.4.2\_A.2.3-3, based on single carrier requirement specified in Table 8.2.2.4.2\_A.2.3-2, with the addition of the parameters in Table 8.2.2.4.2\_A.2.3-1 and the downlink physical channel setup according to Table C.3.2-1 in Annex C.

**Table 8.2.2.4.2\_A.2.3-1: Test Parameters for Multi-Layer Spatial Multiplexing (FRC) for CA**

Parameter	Unit	Test 3, 4	
Downlink power allocation	$\rho_A$	dB	-6
	$\rho_B$	dB	-6 (Note 1)
	$\sigma$	dB	3
$N_{oc}$ at antenna port	dBm/15kHz	-98	
Precoding granularity	PRB	8	
PMI delay (Note 2)	ms	10 or 11	
Reporting interval	ms	1 or 4 (Note 3)	
Reporting mode		PUSCH 1-2	
ACK/NACK feedback mode		PUCCH format 3	
CodeBookSubsetRestriction bitmap		00000000000000000000000000000000 00001111111111111111111100000000 00000000	
CSI request field (Note 4)		'10'	
PDSCH transmission mode		4	
Note 1: $P_B = 1$ . Note 2: If the UE reports in an available uplink reporting instance at subframe SF#n based on PMI estimation at a downlink SF not later than SF#(n-4), this reported PMI cannot be applied at the eNB downlink before SF#(n+4) Note 3: For Uplink - downlink configuration 1 the reporting interval will alternate between 1ms and 4ms. Note 4: Multiple CC-s under test are configured as the 1 <sup>st</sup> set of serving cells by high layers. Note 5: The same PDSCH transmission mode is applied to each component carrier.			

**Table 8.2.2.4.2\_A.2.3-2: Single carrier performance for multiple CA configurations**

Band-width	Reference channel	OCNG pattern	Propagation condition	Correlation matrix and antenna config.	Reference value	
					Fraction of maximum throughput (%)	SNR (dB)
1.4MHz	R.43-1 TDD	OP.1 TDD	EVA5	4x2 Low	70	[TBD]
3MHz	R.43-2 TDD	OP.1 TDD	EVA5	4x2 Low	70	[9.8]
5MHz	R.43-3 TDD	OP.1 TDD	EVA5	4x2 Low	70	[10.0]
10MHz	R.43-4 TDD	OP.1 TDD	EVA5	4x2 Low	70	[10.5]
15MHz	R.43-5 TDD	OP.1 TDD	EVA5	4x2 Low	70	[10.6]
20MHz	R.43 TDD	OP.1 TDD	EVA5	4x2 Low	70	[10.7]

**Table 8.2.2.4.2\_A.2.3-3: Minimum performance (FRC) based on single carrier performance for CA with 3 DL CCs**

Test num.	CA Band-width combination	Requirement	UE category
1	3x20MHz	As specified in Table 8.2.2.4.2_A.2.3-2 per CC	≥5
2	20MHz+20MHz+15MHz	As specified in Table 8.2.2.4.2_A.2.3-2 per CC	≥5
Note 1: The applicability of requirements for different CA configurations and bandwidth combination sets is defined in 8.1.2.3			

The normative reference for this requirement is TS 36.101 [2] clause 8.2.2.4

8.2.2.4.2\_A.2.4 Test description

8.2.2.4.2\_A.2.4.1 Initial conditions

Initial conditions are a set of test configurations the UE needs to be tested in and the steps for the SS to take with the UE to reach the correct measurement state.

Configurations of PDSCH and PDCCH before measurement are specified in Annex C.2.

Test Environment: Normal, as defined in TS 36.508 [7] clause 4.1.

Frequencies to be tested: Maximum WGap for Intra-band non-contiguous CA, otherwise Mid Range, as defined in TS 36.508 [7] clause 4.3.1.

Channel Bandwidths to be tested: Select one according to Table 8.2.2.4.2\_A.2.4.1-1.

CA Capability to be tested: Select one according to Table 8.2.2.4.2\_A.2.4.1-1.

**Table 8.2.2.4.2\_A.2.4.1-1: Test point selection for TM4 3DL CA**

CA Capability	Bandwidth combination	
	3x20	20+20+15
Intra-band contiguous (CA3_C)	Test1	Test2
Inter-band CA (two bands) (CA3_A2)	Test1	Test2
Inter-band CA (three bands) (CA3_A3)	Test1	Test2
Intra-band non-contiguous CA (with two sub-blocks) (CA3_N2)	Test1	Test2
Note1: Only one test point is tested. Select the largest aggregated CA bandwidth combination supported by the UE among the UE supported CA capabilities.		

1. Connect the SS, the faders and AWGN noise source to the UE antenna connectors as shown in TS 36.508 [7] Annex A, Figure A.61.
2. The parameter settings for the cell are set up according to Table 8.2.2-1 and 8.2.2.4.1\_A.2.3-1 as appropriate.
3. Downlink signals for PCC are initially set up according to Annex C.0, C.1 and Annex C.3.2 and uplink signals according to Annex H.1 and H.3.2.
4. Propagation conditions are set according to Annex B.0.
5. Ensure the UE is in State 3A-RF according to TS 36.508 [7] clause 5.2A.2. Message contents are defined in clause 8.2.2.4.2\_A.2.4.3.

#### 8.2.2.4.2\_A.2.4.2 Test procedure

1. Configure SCCs according to Annex C.0, C.1 and Annex C.3.2 for all downlink physical channels.
2. The SS shall configure SCCs as per TS 36.508 [7] clause 5.2A.4. Message contents are defined in clause 8.2.2.4.2\_A.2.4.3.
3. The SS activates SCCs by sending the MAC-CE according to TS 36.321 [13] clauses 5.13 and 6.1.3.8. Wait for at least 2 seconds as per TS 36.133 [4] clause 8.3.3.2.
4. The SS transmits PDSCH via PDCCH DCI format 2 for C\_RNTI to transmit the DL RMC according to Tables 8.2.2.4.2\_A.2.3-1 and 8.2.2.4.2\_A.2.3-2 on both PCC and SCCs. The SS sends downlink MAC padding bits on the DL RMC.
5. The SS schedules the UL transmission to carry the PUSCH CSI feedback via PDCCH DCI format 0 with CSI request bit set to '10' and I\_MCS=29 and N\_PRB allocated to be less or equal to 20.
6. Set the parameters of the bandwidth, MCS, reference channel, the propagation condition, the correlation matrix and the SNR on each of the component carriers according to Tables 8.2.2.4.2\_A.2.5-1 as appropriate.
7. Measure the average throughput per component carrier for duration sufficient to achieve statistical significance according to Annex G clause G.3A.5 on each of the component carriers. Count the number of NACKs, ACKs and statDTXs on the UL during each subtest on each of the component carriers.

#### 8.2.2.4.2\_A.2.4.3 Message contents

Message contents are according to TS 36.508 [7] subclause 4.6 with the following exceptions:

**Table 8.2.2.4.2\_A.2.4.3-1: PDSCH-ConfigDedicated-DEFAULT: Additional TDD PDSCH closed loop spatial multiplexing performance downlink power allocation**

Derivation Path: TS 36.508 [7] clause 4.6.3, Table 4.6.3-6 PDSCH-ConfigDedicated-DEFAULT			
Information Element	Value/remark	Comment	Condition
PDSCH-ConfigDedicated-DEFAULT ::= SEQUENCE {			
p-a	dB-6		
}			

**Table 8.2.2.4.2\_A.2.4.3-2: PhysicalConfigDedicated-DEFAULT: Additional TDD PDSCH closed loop multi-layer spatial multiplexing performance downlink power allocation**

Derivation Path: TS 36.508 [7] clause 5.5.1.2, Table 5.5.1.2-1 PhysicalConfigDedicated-DEFAULT			
Information Element	Value/remark	Comment	Condition
PhysicalConfigDedicated-DEFAULT ::= SEQUENCE {			
antennaInfo CHOICE {			
explicitValue ::= SEQUENCE {			
transmissionMode	tm4		
codebookSubsetRestriction CHOICE {			
n4TxAntenna-tm4	00000000000000000000 00000000000011111111 11111111000000000000 0000		
}			
ue-TransmitAntennaSelection CHOICE {			
release	NULL		
}			
}			
cqi-ReportConfig-r10	CQI-ReportConfig-r10-DEFAULT		
}			

**Table 8.2.2.4.2\_A.2.4.3-2A: PhysicalConfigDedicatedSCell-r10-DEFAULT: Additional TDD PDSCH closed loop multi-layer spatial multiplexing performance downlink power allocation**

Derivation Path: 36.508 [7] clause 4.6.3, Table 4.6.3-6A			
Information Element	Value/remark	Comment	Condition
PhysicalConfigDedicatedSCell-r10-DEFAULT ::= SEQUENCE {			
nonUL-Configuration-r10 SEQUENCE {			
antennaInfo-r10 SEQUENCE {			
transmissionMode-r10	tm4		
codebookSubsetRestriction-r10	00000000000000000000 00000000000011111111 11111111000000000000 0000	BIT STRING	
ue-TransmitAntennaSelection CHOICE {			
release	NULL		
}			
}			
ul-Configuration-r10 SEQUENCE {			
cqi-ReportConfigSCell-r10	CQI-ReportConfigSCell-r10-DEFAULT		
}			
}			

**Table 8.2.2.4.2\_A.2.4.3-3: CQI-ReportConfig-DEFAULT: Additional TDD PDSCH closed loop multi-layer spatial multiplexing performance downlink power allocation**

Derivation Path: 36.508 [7] clause 4.6.3 Table 4.6.3-2			
Information Element	Value/remark	Comment	Condition
CQI-ReportConfig-DEFAULT ::= SEQUENCE {			RBC
cqi-ReportModeAperiodic	rm12		
nomPDSCH-RS-EPRE-Offset	0		
cqi-ReportPeriodic	Not present		
}			

**Table 8.2.2.4.2\_A.2.4.3-4: CQI-ReportConfig-r10-DEFAULT: Additional TDD PDSCH closed loop multi-layer spatial multiplexing performance downlink power allocation**

Derivation Path: 36.508 [7] clause 4.6.3 Table 4.6.3-2AA			
Information Element	Value/remark	Comment	Condition
CQI-ReportConfig-r10 ::= SEQUENCE {			
cqi-ReportAperiodic-r10	CQI-ReportAperiodic-r10-DEFAULT		
nomPDSCH-RS-EPRE-Offset	0		
cqi-ReportPeriodic-r10	Not present		
pmi-RI-Report-r9	Not present		
csi-SubframePatternConfig-r10	Not present		
}			

**Table 8.2.2.4.2\_A.2.4.3-5: CQI-ReportAperiodic-r10-DEFAULT: Additional TDD PDSCH closed loop multi-layer spatial multiplexing performance downlink power allocation**

Derivation Path: 36.508 clause 4.6.3 Table 4.6.3-1A			
Information Element	Value/remark	Comment	Condition
CQI-ReportAperiodic-r10 ::= CHOICE {			
setup SEQUENCE {			
cqi-ReportModeAperiodic-r10	rm12		
aperiodicCSI-Trigger-r10 ::= SEQUENCE {			
trigger1-r10	11100000	P-Cell, S-Cells report	
trigger2-r10	00000000	No report	
}			
}			
}			

**Table 8.2.2.4.2\_A.2.4.3-6: CQI-ReportConfigSCell-r10-DEFAULT: Additional TDD PDSCH closed loop multi-layer spatial multiplexing performance downlink power allocation**

Derivation Path: 36.508 clause 4.6.3 Table 4.6.3-2AB			
Information Element	Value/remark	Comment	Condition
CQI-ReportConfigSCell-r10 ::= SEQUENCE {			
cqi-ReportModeAperiodic-r10	rm12		
nomPDSCH-RS-EPRE-Offset-r10	0		
cqi-ReportPeriodicSCell-r10	Not present		
pmi-RI-Report-r10	Not present		
}			

#### 8.2.2.4.2\_A.2.5 Test requirement

Table 8.2.2.4.2\_A.2.3-1 defines the primary level settings.

The fraction of maximum throughput percentage for the downlink reference measurement channels specified in Annex A clause A.3.4.2.2 for the throughput test shall meet or exceed the specified value in Table 8.2.2.4.2\_A.2.5-1 for the specified SNR including test tolerances for all throughput tests.

**Table 8.2.2.4.2\_A.2.5-1: Single carrier performance for multiple CA configurations**

Band-width	Reference channel	OCNG pattern	Propagation condition	Correlation matrix and antenna config.	Reference value	
					Fraction of maximum throughput (%)	SNR (dB)
1.4MHz	R.43-1 TDD	OP.1 TDD	EVA5	4x2 Low	70	[TBD]
3MHz	R.43-2 TDD	OP.1 TDD	EVA5	4x2 Low	70	[10.7]
5MHz	R.43-3 TDD	OP.1 TDD	EVA5	4x2 Low	70	[10.9]
10MHz	R.43-4 TDD	OP.1 TDD	EVA5	4x2 Low	70	[11.4]
15MHz	R.43-5 TDD	OP.1 TDD	EVA5	4x2 Low	70	[11.5]
20MHz	R.43 TDD	OP.1 TDD	EVA5	4x2 Low	70	[11.6]

**Table 8.2.2.4.2\_A.2.5-2: Test requirement (FRC) based on single carrier performance for CA with 3 DL CCs**

Test num.	CA Band-width combination	Requirement	UE category
1	3x20MHz	As specified in Table 8.2.2.4.2_A.2.5-1 per CC	≥5
2	20MHz+20MHz+15MHz	As specified in Table 8.2.2.4.2_A.2.5-1 per CC	≥5
Note 1: The applicability of requirements for different CA configurations and bandwidth combination sets is defined in 8.1.2.3			

Decide pass or fail for each subtest according to Annex G.3A.4. Decide the entire test pass or fail according to Annex G.3A.6.

#### 8.2.2.4.2A TDD PDSCH Closed Loop Multi Layer Spatial Multiplexing 2x2 – Enhanced Performance Requirement Type C

**Editor's notes: This test case is incomplete. The following items are missing or are incomplete:**

- Test tolerances are undefined
- The SNR values in minimum and test requirement are still in square brackets
- The minimum testing time in Annex G is still undefined.

##### 8.2.2.4.2A.1 Test purpose

To verify the UE's ability to receive a predefined test signal, representing a multi-path fading channel that is determined by the SNR with a percentage of the information bit throughput for a specified downlink Reference Measurement Channel (RMC) not falling below a specified value for transmission on two antenna ports using closed loop rank-two spatial multiplexing with wideband and frequency selective precoding.

##### 8.2.2.4.2A.2 Test applicability

This test applies to all types of E-UTRA TDD release 12 and forward UE of Category 2 or higher that support enhanced receiver Type C.

##### 8.2.2.4.2A.3 Minimum conformance requirements

The requirements are specified in terms of the percentage of information bit throughput for the downlink reference measurement channels specified in Annex A clause A.3.4.2, with the addition of the relevant parameters in Tables 8.2.2-1 and 8.2.2.4.2A.3-1 and the downlink physical channel setup according to Table C.3.2-1 in Annex C.

Using this configuration the fraction of maximum throughput percentage shall meet or exceed the minimum requirements specified in Table 8.2.2.4.2A.3-2 for the specified SNR.



**Table 8.2.2.4.2A.3-1: Test Parameters for Testing Multi-Layer Spatial Multiplexing**

Parameter	Unit	Test 1	
Downlink power allocation	$\rho_A$	dB	-3
	$\rho_B$	dB	-3 (Note 1)
	$\sigma$	dB	0
$N_{oc}$ at antenna port	dBm/15kHz	-98	
Precoding granularity	PRB	50	
PMI delay (Note 2)	ms	10 or 11	
Reporting interval	ms	1 or 4 (Note 3)	
Reporting mode		PUSCH 3-1	
ACK/NACK feedback mode		Bundling	
CodeBookSubsetRestriction bitmap		110000	
PDSCH transmission mode		4	
Note 1: $P_B = 1$ .			
Note 2: If the UE reports in an available uplink reporting instance at subframe SF#n based on PMI estimation at a downlink SF not later than SF#(n-4), this reported PMI cannot be applied at the eNB downlink before SF#(n+4).			
Note 3: For Uplink - downlink configuration 1 the reporting interval will alternate between 1ms and 4ms.			

**Table 8.2.2.4.2A.3-2: Enhanced Performance Requirement Type C, Multi-Layer Spatial Multiplexing (FRC)**

Test number	Bandwidth	Reference Channel	OCNG Pattern	Propagation Condition	Correlation Matrix and Antenna Configuration	Reference value		UE Category
						Fraction of Maximum Throughput (%)	SNR (dB)	
1	10 MHz	R.11-1 TDD	OP.1 TDD	ETU70	2x2 Medium	70	[17.8]	$\geq 2$

The normative reference for this requirement is TS 36.101 [2] clause 8.2.2.4.2A.

#### 8.2.2.4.2A.4 Test description

##### 8.2.2.4.2A.4.1 Initial conditions

Initial conditions are a set of test configurations the UE needs to be tested in and the steps for the SS to take with the UE to reach the correct measurement state.

Configurations of PDSCH and PDCCH before measurement are specified in Annex C.2.

Test Environment: Normal, as defined in TS 36.508 [7] clause 4.1.

Frequencies to be tested: Mid Range, as defined in TS 36.508 [7] clause 4.3.1.2.

Bandwidths to be tested: As specified per test number in Table 8.2.2.4.2A.3-2 as defined in TS 36.508 [7] clause 4.3.1.2.

1. Connect the SS, the faders and AWGN noise sources to the UE antenna connectors as shown in TS 36.508 [7] Annex A, Figure A.10 for antenna configuration 2x2.
2. The parameter settings for the cell are set up according to Tables 8.2.2-1 and 8.2.2.4.2A.3-1 as appropriate.
3. Downlink signals are initially set up according to Annex C.0, C.1 and Annex C.3.2 and uplink signals according to Annex H.1 and H.3.2.
4. Propagation conditions are set according to Annex B.0.

5. Ensure the UE is in State 3A-RF according to TS 36.508 [7] clause 5.2A.2. Message contents are defined in clause 8.2.2.4.2A.4.3.

8.2.2.4.2A.4.2 Test procedure

1. SS transmits PDSCH via PDCCH DCI format 2 for C\_RNTI to transmit the DL RMC according to Tables 8.2.2.4.2A.3-1 and 8.2.2.4.2A.3-2. The SS sends downlink MAC padding bits on the DL RMC.
2. SS schedules the UL transmission to carry the PUSCH CQI feedback via PDCCH DCI format 0 with CQI request bit set to 1 and I\_MCS=29 and N\_PRB allocated to be less or equal to 4.
3. Set the parameters of the bandwidth, MCS, reference channel, the propagation condition, the correlation matrix, antenna configuration and the SNR according to Table 8.2.2.4.2A.5-1 as appropriate.
4. Measure the average throughput for a duration sufficient to achieve statistical significance according to Annex G clause G.3. Count the number of NACKs, ACKs and statDTXs on the UL during each test interval and decide pass or fail according to Tables G.3.5 and G.3.6 in Annex G clause G.3.

8.2.2.4.2A.4.3 Message contents

Message contents are according to TS 36.508 [7] clause 4.6 with the following exceptions.

**Table 8.2.2.4.2A.4.3-1: PhysicalConfigDedicated-DEFAULT**

Derivation Path: 36.508 Table 5.5.1.2-1			
Information Element	Value/remark	Comment	Condition
PhysicalConfigDedicated-DEFAULT ::= SEQUENCE {			
antennaInfo CHOICE {			
explicitValue ::= SEQUENCE {			
transmissionMode	tm4		
codebookSubsetRestriction CHOICE {			
n2TxAntenna-tm4	110000		
}			
ue-TransmitAntennaSelection CHOICE {			
release	NULL		
}			
}			

**Table 8.2.2.4.2A.4.3-2: CQI-ReportConfig-DEFAULT**

Derivation Path: 36.508 Table 4.6.3-2			
Information Element	Value/remark	Comment	Condition
CQI-ReportConfig-DEFAULT ::= SEQUENCE {			
cqi-ReportModeAperiodic	rm31		
nomPDSCH-RS-EPRE-Offset	0		
cqi-ReportPeriodic	Not present		
}			

**Table 8.2.2.4.2A.4.3-3: PUCCH-ConfigDedicated-DEFAULT**

Derivation Path: 36.508 Table 4.6.3-9			
Information Element	Value/remark	Comment	Condition
PUCCH-ConfigDedicated-DEFAULT ::= SEQUENCE {			
tddAckNackFeedbackMode	bundling		
}			

## 8.2.2.4.2A.5 Test requirement

Table 8.2.2.4.2A.3-1 defines the primary level settings.

The fraction of maximum throughput percentage for the downlink reference measurement channels specified in Annex A clause A.3.4.2, for each throughput test shall meet or exceed the specified value in Table 8.2.2.4.2A.5-1 for the specified SNR including test tolerances for all throughput tests.

**Table 8.2.2.4.2A.5-1: Test requirement for Enhanced Performance Requirement Type C, Multi-Layer Spatial Multiplexing (FRC)**

Test number	Bandwidth	Reference Channel	OCNG Pattern	Propagation Condition	Correlation Matrix and Antenna Configuration	Reference value		UE Category
						Fraction of Maximum Throughput (%)	SNR (dB)	
1	10 MHz	R.11-1 TDD	OP.1 TDD	ETU70	2x2 Medium	70	[17.8] +TT	≥2

## 8.2.2.4.3 TDD PDSCH Closed Loop Single Layer Spatial Multiplexing 2x2 with TM4 Interference Model – Enhanced Performance Requirement Type A

**Editor's note: This clause is incomplete. The following aspects are either missing or not yet determined:**

## 8.2.2.4.3.1 Test purpose

To verify the closed loop rank-one performance with wideband precoding with two transmit antennas when the PDSCH transmission in the serving cell is interfered by PDSCH of two dominant interfering cells applying transmission mode 4 interference model.

## 8.2.2.4.3.2 Test applicability

This test applies to all types of E-UTRA TDD UE release 11 and forward that support enhanced receiver Type A.

## 8.2.2.4.3.3 Minimum conformance requirements

The requirements are specified in terms of the percentage of information bit throughput for the downlink reference measurement channels specified in Annex A clause A.3.4.2, with the addition of the relevant parameters in Tables 8.2.2-1, 8.2.2.4.3.3-1 and 8.2.2.4.3.3-2 and the downlink physical channel setup according to Table C.3.2-1 in Annex C.

Using this configuration the fraction of maximum throughput percentage shall meet or exceed the minimum requirements specified in Table 8.2.2.4.3.3-2 for the specified SINR. For single-layer spatial multiplexing closed loop rank-one performance with wideband and frequency selective precoding is specified. For multi-layer spatial multiplexing closed loop rank-two performance with wideband and frequency selective precoding is specified.

**Table 8.2.2.4.3.3-1: Test Parameters for Single-Layer Spatial Multiplexing (FRC) with TM4 interference model**

Parameter		Unit	Cell 1	Cell 2	Cell 3
Downlink power allocation	$\rho_A$	dB	-3	-3	-3
	$\rho_B$	dB	-3 (Note 1)	-3	-3
	$\sigma$	dB	0	0	0
Cell-specific reference signals			Antenna ports 0,1	Antenna ports 0,1	Antenna ports 0,1
$N_{oc}$ at antenna port		dBm/15kHz	-98	N/A	N/A
DIP (Note 2)		dB	N/A	-1.73	-8.66
BW <sub>Channel</sub>		MHz	10	10	10
Cyclic Prefix			Normal	Normal	Normal
Cell Id			0	1	2
Number of control OFDM symbols			2	2	2
PDSCH transmission mode			6	N/A	N/A
Interference model			N/A	As specified in clause B.5.3	As specified in clause B.5.3
Probability of occurrence of transmission rank in interfering cells	Rank 1	%	N/A	80	80
	Rank 2	%	N/A	20	20
Precoding granularity		PRB	50	6	6
PMI delay (Note 4)		ms	10 or 11	N/A	N/A
Reporting interval		ms	5	N/A	N/A
Reporting mode			PUCCH 1-1	N/A	N/A
CodeBookSubsetRestriction bitmap			001111	N/A	N/A
ACK/NACK feedback mode			Multiplexing	N/A	N/A
<p>Note 1: <math>P_B = 1</math></p> <p>Note 2: The respective received power spectral density of each interfering cell relative to <math>N_{oc}</math> is defined by its associated DIP value as specified in clause B.5.1.</p> <p>Note 3: Cell 1 is the serving cell. Cell 2, 3 are the interfering cells.</p> <p>Note 4: If the UE reports in an available uplink reporting instance at subframe SF#n based on PMI estimation at a downlink SF not later than SF#(n-4), this reported PMI cannot be applied at the eNB downlink before SF#(n+4).</p> <p>Note 5: All cells are time-synchronous.</p>					

**Table 8.2.2.4.3.3-2: Enhanced Performance Requirement Type A, Single-Layer Spatial Multiplexing (FRC) with TM4 interference model**

Test Number	Reference Channel	OCNG Pattern			Propagation Conditions			Correlation Matrix and Antenna Configuration (Note 3)	Reference Value		UE Category
		Cell 1	Cell 2	Cell 3	Cell 1	Cell 2	Cell 3		Fraction of Maximum Throughput (%)	SINR (dB) (Note 2)	
1	R.47 TDD	OP. 1 TD D	N/A	N/A	EV A5	EV A5	EV A5	2x2 Low	70	1.1	1-8
<p>Note 1: The propagation conditions for Cell 1, Cell 2 and Cell 3 are statistically independent.</p> <p>Note 2: SINR corresponds to <math>\hat{E}_s / N_{oc}</math> of Cell 1 as defined in clause 8.1.1.</p> <p>Note 3: Correlation matrix and antenna configuration parameters apply for each of Cell 1, Cell 2 and Cell 3.</p>											

The normative reference for this requirement is TS 36.101 [2] clause 8.2.2.4.

#### 8.2.2.4.3.4 Test description

##### 8.2.2.4.3.4.1 Initial conditions

Initial conditions are a set of test configurations the UE needs to be tested in and the steps for the SS to take with the UE to reach the correct measurement state.

Configurations of PDSCH and PDCCH before measurement are specified in Annex C.2.

Test Environment: Normal, as defined in TS 36.508 [7] clause 4.1.

Frequencies to be tested: Mid Range, as defined in TS 36.508 [7] clause 4.3.1.2.

Bandwidths to be tested: As specified per test number in Tables 8.2.2.4.3.3-2 as defined in TS 36.508 [7] clause 4.3.1.2.

1. Connect the SS, the faders and AWGN noise sources to the UE antenna connectors as shown in TS 36.508 [7] Annex A, Figure A.48.
2. The parameter settings for cell1 are set up according to Tables 8.2.2-1, 8.2.2.4.3.5-1 and 8.2.2.4.3.5-2 as appropriate.
3. Downlink signals are initially set up for cell1 according to Annex C.0, C.1 and Annex C.3.2 and uplink signals according to Annex H.1 and H.3.2.
4. Propagation conditions are set according to Annex B.0.
5. Ensure the UE is in State 3A-RF according to TS 36.508 [7] clause 5.2A.2. Message contents are defined in clause 8.2.2.4.3.4.3.

##### 8.2.2.4.3.4.2 Test procedure

1. SS transmits PDSCH via PDCCH DCI format 2 for C\_RNTI to transmit the DL RMC according to Tables 8.2.2.4.3.5-1 and 8.2.2.4.3.5-2. The SS sends downlink MAC padding bits on the DL RMC.
2. SS schedules the UL transmission to carry the PUSCH CQI feedback via PDCCH DCI format 0 with CQI request bit set to 1 and I\_MCS=29 and N\_PRB allocated to be less or equal to 4.
3. Set the parameters for cell1, cell2 and cell 3 according to Tables 8.2.2.4.3.5-1.
4. Measure the average throughput for a duration sufficient to achieve statistical significance according to Annex G clause G.3. Count the number of NACKs, ACKs and statDTXs on the UL during each test interval and decide pass or fail according to Tables G.3.5 and G.3.6 in Annex G clause G.3.

##### 8.2.2.4.3.4.3 Message contents

Message contents are according to TS 36.508 [7] clause 4.6 with the following exceptions.

**Table 8.2.2.4.3.4.3-1: PhysicalConfigDedicated-DEFAULT: Additional TDD Single-Layer Spatial Multiplexing (FRC) with TM4 interference model downlink power allocation for Test number 1**

Derivation Path: 36.331 clause 6.3.2			
Information Element	Value/remark	Comment	Condition
PhysicalConfigDedicated-DEFAULT ::= SEQUENCE {			
antennaInfo CHOICE {			
antennaInfoDedicated ::= SEQUENCE {			
transmissionMode	tm6		
codebookSubsetRestriction CHOICE {			
n2TxAntenna-tm6	1111		
}			
ue-TransmitAntennaSelection CHOICE {			
Release	NULL		
}			
}			
}			

**Table 8.2.2.4.3.4.3-2: CQI-ReportPeriodic-r10**

Derivation Path: TS 36.508 [7] clause 4.6.3, Table 4.6.3-2AC CQI-ReportPeriodic-r10-DEFAULT			
Information Element	Value/remark	Comment	Condition
CQI-ReportPeriodic-r10 ::= CHOICE {			
setup SEQUENCE {			
cqi-PUCCH-ResourceIndex-r10	0		
cqi-PUCCH-ResourceIndexP1-r10	Not present		
cqi-pmi-ConfigIndex	4	TDD	
cqi-FormatIndicatorPeriodic-r10 CHOICE {			
widebandCQI-r10 SEQUENCE {			
csi-ReportMode-r10	Not present		
}			
}			
ri-ConfigIndex	NULL		
simultaneousAckNackAndCQI	FALSE		
cqi-Mask-r9	Not present		
csi-ConfigIndex-r10	Not present		
}			
}			

8.2.2.4.3.5 Test requirement

Table 8.2.2.4.3.5-1 defines the primary level settings.

**Table 8.2.2.4.3.5-1: Test Parameters for Single-Layer Spatial Multiplexing (FRC) with TM4 interference model**

Parameter		Unit	Cell 1	Cell 2	Cell 3
Downlink power allocation	$\rho_A$	dB	-3	-3	-3
	$\rho_B$	dB	-3 (Note 1)	-3	-3
	$\sigma$	dB	0	0	0
Cell-specific reference signals			Antenna ports 0,1	Antenna ports 0,1	Antenna ports 0,1
$N_{oc}$ at antenna port		dBm/15kHz	-98	N/A	N/A
DIP (Note 2)		dB	N/A	-1.44	-7.77
BW <sub>Channel</sub>		MHz	10	10	10
Cyclic Prefix			Normal	Normal	Normal
Cell Id			0	1	2
Number of control OFDM symbols			2	2	2
PDSCH transmission mode			6	N/A	N/A
Interference model			N/A	As specified in clause B.5.3	As specified in clause B.5.3
Probability of occurrence of transmission rank in interfering cells	Rank 1	%	N/A	80	80
	Rank 2	%	N/A	20	20
Precoding granularity		PRB	50	6	6
PMI delay (Note 4)		ms	10 or 11	N/A	N/A
Reporting interval		ms	5	N/A	N/A
Reporting mode			PUCCH 1-1	N/A	N/A
CodeBookSubsetRestriction bitmap			001111	N/A	N/A
ACK/NACK feedback mode			Multiplexing	N/A	N/A
Note 1: $P_B = 1$					
Note 2: The respective received power spectral density of each interfering cell relative to $N_{oc}$ is defined by its associated DIP value as specified in clause B.5.1.					
Note 3: Cell 1 is the serving cell. Cell 2, 3 are the interfering cells.					
Note 4: If the UE reports in an available uplink reporting instance at subframe SF#n based on PMI estimation at a downlink SF not later than SF#(n-4), this reported PMI cannot be applied at the eNB downlink before SF#(n+4).					
Note 5: All cells are time-synchronous.					

The fraction of maximum throughput percentage for the downlink reference measurement channels specified in Annex A clause A.3.4.2, for each throughput test shall meet or exceed the specified value in Table 8.2.2.4.3.5-2 for the specified SINR including test tolerances for all throughput tests.

**Table 8.2.2.4.3.5-2: Test requirement for Enhanced Performance Requirement Type A, Single-Layer Spatial Multiplexing (FRC) with TM4 interference model**

Test Number	Reference Channel	OCNG Pattern			Propagation Conditions			Correlation Matrix and Antenna Configuration (Note 3)	Reference Value		UE Category
		Cell 1	Cell 2	Cell 3	Cell 1	Cell 2	Cell 3		Fraction of Maximum Throughput (%)	SINR (dB) (Note 2)	
1	R.47 TDD	OP. 1 TD D	N/A	N/A	EV A5	EV A5	EV A5	2x2 Low	70	2.09	1-8
Note 1: The propagation conditions for Cell 1, Cell 2 and Cell 3 are statistically independent.											
Note 2: SINR corresponds to $\hat{E}_s / N_{oc}$ of Cell 1 as defined in clause 8.1.1.											
Note 3: Correlation matrix and antenna configuration parameters apply for each of Cell 1, Cell 2 and Cell 3.											

## 8.2.2.5

## 8.2.2.6

## 8.2.2.7 Carrier aggregation with power imbalance

Editor's Note: This test case is incomplete. The following items are missing or are incomplete:

- Connection diagram in Annex A of TS 36.508 is TBD
- Test tolerances are undefined
- Power at antenna port in test 2 is still TBD

## 8.2.2.7\_A.1 TDD Carrier aggregation with power imbalance (intra-band contiguous DL CA)

## 8.2.2.7\_A.1.1 Test purpose

To verify the ability of an intraband adjacent carrier aggregation UE to demodulate the signal transmitted by the PCell or SCell in the presence of a stronger SCell or PCell signal on an adjacent frequency. Throughput is measured on the PCell or SCell only.

## 8.2.2.7\_A.1.2 Test applicability

This test applies to all types of E-UTRA TDD UE release 10 and forward that support intra-band contiguous DL CA.

## 8.2.2.7\_A.1.3 Minimum conformance requirements

The requirements are specified in Table 8.2.2.7\_A.1.3-2, with the addition of the parameters in Table 8.2.2.7\_A.1.3-1 and the downlink physical channel setup according to table C.3.2-1 in Annex C.



Table 8.2.2.7\_A.1.3-1: Test Parameters for CA

Parameter		Unit	Test 1	Test 2
Downlink power allocation	$\rho_A$	dB	0	0
	$\rho_B$	dB	0 (Note 1)	0 (Note 1)
	$\sigma$	dB	0	0
$N_{oc}$ at antenna port		dBm/15kHz	Off (Note 2)	Off (Note 2)
Symbols for unused PRBs			OCNG (Note 3)	OCNG (Note 3)
Modulation			64 QAM	64 QAM
Maximum number of HARQ transmission			1	1
Redundancy version coding sequence			{0}	{0}
PDSCH transmission mode of PCell			1	3
PDSCH transmission mode of SCell			3	1
OCNG Pattern	PCell		OP.1 TDD	OP.5 TDD
	SCell		OP.5 TDD	OP.1 TDD
Propagation Conditions	PCell		Clause B.1	Clause B.1
	SCell		Clause B.1	Clause B.1
Correlation Matrix and Antenna	PCell		1x2	2x2
	SCell		2x2	1x2
Note 1: $P_B = 0$ .				
Note 2: No external noise sources are applied.				
Note 3: These physical resource blocks are assigned to an arbitrary number of virtual UEs with one PDSCH per virtual UE; the data transmitted over the OCNG PDSCHs shall be uncorrelated pseudo random data.				
Note 4: Void				

Table 8.2.2.7\_A.1.3-2: Minimum performance (FRC) for CA

Test Number	Bandwidth (MHz)		Reference channel		Power at antenna port (dBm/15KHz)		Reference value Fraction of Maximum Throughput (%)		UE Category
	PCell	SCell	PCell	SCell	$\hat{E}_{s\_PCell}$ for PCell	$\hat{E}_{s\_SCell}$ for SCell	PCell	SCell	
1	20	20	R.49 TDD	NA	-85	-79	85	NA	$\geq 5$
2	20	15	NA	R.49-1 TDD	-79	[-85.8]	NA	85	$\geq 5$
Note 1: The OCNG pattern for PCell is used to fill the control channel. The OCNG pattern for SCell is used to fill the control channel and PDSCH.									
Note 2: The applicability of requirements for different CA configurations and bandwidth combination sets is defined in 8.1.2.3.									

The normative reference for this requirement is TS 36.101 [2] clause 8.2.2.7.

#### 8.2.2.7\_A.1.4 Test description

##### 8.2.2.7\_A.1.4.1 Initial conditions

Initial conditions are a set of test configurations the UE needs to be tested in and the steps for the SS to take with the UE to reach the correct measurement state.

Configurations of PDSCH and PDCCH before measurement are specified in Annex C.2.

Test Environment: Normal, as defined in TS 36.508 [7] clause 4.1.

Frequencies to be tested: Mid Range, as defined in TS 36.508 [7] clause 4.3.1.

Channel Bandwidths to be tested: As specified per test number in Table 8.2.2.7\_A.1.3-2 as defined in TS 36.508 [7] clause 4.3.1.

1. Connect the SS, the faders and AWGN noise source to the UE antenna connectors as shown in TS 36.508 [7] Annex A, Figure group TBD
2. The parameter settings for the cell are set up according to Table 8.2.2-1 and 8.2.2.7\_A.1.3-1 as appropriate.
3. Downlink signals for PCC are initially set up according to Annex C0, C.1 and Annex C.3.2 and uplink signals according to Annex H.1 and H.3.2.
4. Propagation conditions are set according to Annex B.0.
5. Ensure the UE is in State 3A-RF according to TS 36.508 [7] clause 5.2A.2. Message contents are defined in clause 8.2.2.7\_A.1.4.3.

#### 8.2.2.7\_A.1.4.2 Test procedure

1. Configure SCC according to Annex C.0, C.1 and Annex C.3.2 for all downlink physical channels except control channel and PDSCH.
2. The SS shall configure SCC as per TS 36.508 [7] clause 5.2A.4. Message contents are defined in clause 8.2.2.7\_A.1.4.3
3. SS activates SCC by sending the activation MAC-CE (Refer TS 36.321 [13], clauses 5.13, 6.1.3.8). Wait for at least 2 seconds (Refer TS 36.133, clauses 8.3.3.2).
4. SS transmits PDSCH via PDCCH DCI format 1A for C\_RNTI to transmit the DL RMC according to Tables 8.2.2.7\_A.1.3-1 and 8.2.2.7\_A.1.3-2. The SS sends downlink MAC padding bits on the DL RMC.
5. Set the parameters of the bandwidth, MCS, reference channel, the propagation condition and the correlation matrix on each of the component carriers according to Tables 8.2.2.7\_A.1.5-1 as appropriate.
6. Measure the average throughput on PCC in test number 1 or measure the average throughput on SCC in test number 2 for a duration sufficient to achieve statistical significance according to Annex G clause G.3A, Table G.3A.5-6. Count the number of NACKs, ACKs and statDTXs on the UL during the test on PCC in test number 1 or on SCC in test number 2.

#### 8.2.2.7\_A.1.4.3 Message contents

Message contents are according to TS 36.508 [7] subclause 4.6. In test procedure step 3, for SCC configuration there are no additional message contents.

#### 8.2.2.7\_A.1.5 Test requirement

Table 8.2.2.7\_A.1.5-1 defines the primary level settings.

The fraction of maximum throughput percentage for the downlink reference measurement channels specified in Annex A clause A.3.4.1 for the throughput test shall meet or exceed the specified value in Table 8.2.2.7\_A.1.5-1 for the specified cell power levels including test tolerances for all throughput tests.

Table 8.2.2.7\_A.1.5-1: Test Requirement (FRC) for CA

Test Number	Bandwidth (MHz)		Reference channel		Power at antenna port (dBm/15KHz)		Reference value Fraction of Maximum Throughput (%)		UE Category
	PCell	SCell	PCell	SCell	$\hat{E}_{s\_PCell}$ for PCell	$\hat{E}_{s\_SCell}$ for SCell	PCell	SCell	
1	20	20	R.49 TDD	NA	-85+TT	-79+TT	85	NA	$\geq 5$
2	20	15	NA	R.49-1 TDD	-79+TT	[-85.8] +TT	NA	85	$\geq 5$

Note 1: The OCNG pattern for PCell is used to fill the control channel. The OCNG pattern for SCell is used to fill the control channel and PDSCH.

Note 2: The applicability of requirements for different CA configurations and bandwidth combination sets is defined in 8.1.2.3.

Decide pass or fail for each subtest according to Annex G.3A.4. Decide the entire test pass or fail according to Annex G.3A.6.

### 8.2.3 TDD FDD CA (Fixed Reference Channel)

The parameters specified in Table 8.2.3-1 are valid for all the TDD FDD CA tests unless otherwise stated.

Table 8.2.3-1: Common Test Parameters

Parameter	Unit	Value	
Uplink downlink configuration (Note 1) for TDD CC only		1	
Special subframe configuration (Note 2) for TDD CC only		4	
Inter-TTI Distance		1	
Maximum number of HARQ processes per component carrier	FDD PCell	Processes	8 for FDD and TDD CCs
	TDD PCell	Processes	11 for FDD CC; 7 for TDD CC
Maximum number of HARQ transmission		4	
Redundancy version coding sequence		{0,1,2,3} for QPSK and 16QAM {0,0,1,2} for 64QAM	
Number of OFDM symbols for PDCCH per component carrier	OFDM symbols	4 for 1.4 MHz bandwidth, 3 for 3 MHz and 5 MHz bandwidths, 2 for 10 MHz, 15 MHz and 20 MHz bandwidths	
Cyclic Prefix		Normal	
Cell_ID		0	
Cross carrier scheduling		Not configured	
ACK/NACK feedback mode		PUCCH format 3	
Downlink HARQ-ACK timing	FDD PCell		As specified in Clause 7.3.3 in TS36.213 [10]
	TDD PCell		As specified in Clause 7.3.4 in TS36.213 [10]
Note 1:	as specified in Table 4.2-2 in TS 36.211 [8].		
Note 2:	as specified in Table 4.2-1 in TS 36.211 [8].		

The applicability of the requirements are specified in Clause 8.1.2.3. The single carrier performance with different bandwidths for multiple CA configurations specified in Clause 8.2.3 cannot be applied for UE single carrier test.

The normative reference for this requirement is TS 36.101 [2] clause 8.2.3.

### 8.2.3.1\_A TDD FDD CA PDSCH Single Antenna Port Performance

#### 8.2.3.1\_A.1 TDD FDD CA PDSCH Single Antenna Port Performance for FDD PCell (2DL CA)

**Editor's note:** The following aspects are either missing or not yet determined:

The SNR values in table 8.2.3.1\_A.2.3-3 and 8.2.3.1\_A.2.3-4 are still in bracket in core spec.

Test tolerance is FFS

Message contents are FFS

##### 8.2.3.1\_A.1.1 Test purpose

To verify the UE's ability to receive a predefined test signal, representing a multi-path fading channel that is determined by the SNR with a percentage of the information bit throughput for a specified downlink Reference Measurement Channel (RMC) not falling below a specified value for transmission on a single-antenna port with different channel models and MCS.

##### 8.2.3.1\_A.1.2 Test applicability

This test applies to all types of E-UTRA FDD and TDD Release 12 and forward UE of categories 3 or higher that support E-UTRA FDD and TDD and 2DL CA with FDD as PCELL.

##### 8.2.3.1\_A.1.3 Minimum conformance requirements

The requirements are specified in terms of the percentage of information bit throughput for the downlink reference measurement channels specified in Annex A clause A.3.3.1, with the addition of the relevant parameters in Tables 8.2.1-1, 8.2.3.1\_A.2.3-1 and the downlink physical channel setup according to Table C.3.2-1 in Annex C.

Using this configuration the fraction of maximum throughput percentage shall meet or exceed the minimum requirements specified in Table 8.2.3.1\_A.1.3-4 for the specified SNR. For QPSK and 64QAM performance the bandwidths specified in Table 5.4.2.1-1 are verified.

**Table 8.2.3.1\_A.1.3-1: Test Parameters for CA**

Parameter		Unit	Test 1- 6
Downlink power allocation	$\rho_A$	dB	0
	$\rho_B$	dB	0 (Note 1)
	$\sigma$	dB	0
$N_{oc}$ at antenna port		dBm/15kHz	-98
Symbols for unused PRBs			OCNG (Note 2)
Modulation			QPSK
PDSCH transmission mode			1
Note 1: $P_B = 0$ .			
Note 2: These physical resource blocks are assigned to an arbitrary number of virtual UEs with one PDSCH per virtual UE; the data transmitted over the OCNG PDSCHs shall be uncorrelated pseudo random data, which is QPSK modulated.			
Note 3: The same PDSCH transmission mode is applied to each component carrier.			

**Table 8.2.3.1\_A.1.3-2: Single carrier performance with different bandwidths for multiple CA configurations for FDD PCell and SCell (FRC)**

Band-width	Reference Channel	OCNG Pattern	Propagation Condition	Correlation Matrix and Antenna Configuration	Reference value	
					Fraction of Maximum Throughput (%)	SNR (dB)
1.4 MHz	R.4 FDD	OP.1 FDD	EVA5	1x2 Low	70	[-1.3]
3 MHz	R.42-1 FDD	OP.1 FDD	EVA5	1x2 Low	70	[-1.1]
5MHz	R.42-2 FDD	OP.1 FDD	EVA5	1x2 Low	70	[-1.0]
10MHz	R.2 FDD	OP.1 FDD	EVA5	1x2 Low	70	[-1.7]
15MHz	R.42-3 FDD	OP.1 FDD	EVA5	1x2 Low	70	[-1.6]
20MHz	R.42 FDD	OP.1 FDD	EVA5	1x2 Low	70	[-1.7]

**Table 8.2.3.1\_A.1.3-3: Single carrier performance with different bandwidths for multiple CA configurations for TDD SCell (FRC)**

Band-width	Reference Channel	OCNG Pattern	Propagation Condition	Correlation Matrix and Antenna Configuration	Reference value	
					Fraction of Maximum Throughput (%)	SNR (dB)
1.4 MHz	R.4 TDD	OP.1 TDD	EVA5	1x2 Low	70	[-0.6]
3 MHz	R.42-1 TDD	OP.1 TDD	EVA5	1x2 Low	70	[-0.8]
5MHz	R.42-2 TDD	OP.1 TDD	EVA5	1x2 Low	70	[-1.2]
10MHz	R.2 TDD	OP.1 TDD	EVA5	1x2 Low	70	[-1.6]
15MHz	R.42-3 TDD	OP.1 TDD	EVA5	1x2 Low	70	[-1.4]
20MHz	R.42 TDD	OP.1 TDD	EVA5	1x2 Low	70	[-1.4]

**Table 8.2.3.1\_A.1.3-4: Minimum performance for multiple CA configurations with 2DL CCs (FRC)**

Test number	CA Bandwidth combination (MHz)			Minimum performance requirement	UE Category
	Total	FDD CC	TDD CC		
1	2x20	20	20	As defined in Table 8.2.3.1.1-2 and Table 8.2.3.1.1-3 per CC	≥5
2	20+10	10	20	As defined in Table 8.2.3.1.1-2 and Table 8.2.3.1.1-3 per CC	≥5
3	10+5	5	10	As defined in Table 8.2.3.1.1-2 and Table 8.2.3.1.1-3 per CC	≥3
4	20+15	15	20	As defined in Table 8.2.3.1.1-2 and Table 8.2.3.1.1-3 per CC	≥5
Note 1:	The applicability of requirements for different CA configurations and bandwidth combination sets is defined in 8.1.2.3B.				
Note 2:	30usec timing difference between PCell and any SCell is applied in inter-band CA case, where PCell can be assigned on any CC.				

The normative reference for this requirement is TS 36.101 [2] clause 8.2.3.1.

8.2.3.1\_A.1.4 Test description

8.2.3.1\_A.1.4.1 Initial conditions

Initial conditions are a set of test configurations the UE needs to be tested in and the steps for the SS to take with the UE to reach the correct measurement state.

Configurations of PDSCH and PDCCH before measurement are specified in Annex C.2.

Test Environment: Normal, as defined in TS 36.508 [7] clause 4.1.

Frequencies to be tested: Maximum WGap for Intra-band non-contiguous CA, otherwise Mid Range, as defined in TS 36.508 [7] clause 4.3.1.

Channel Bandwidths to be tested: Select one according to Table 8.2.3.1\_A.1.4.1-1.

CA Capability to be tested: Select one according to Table 8.2.3.1\_A.1.4.1-1.

**Table 8.2.3.1\_A.1.4.1-1: Test point selection for TM1 2DLCA**

CA Capability	Bandwidth combination			
	20+20	10+20	5+10	15+20
Inter-band CA2_A2	Test1	Test2	Test3	Test4
Note1: Select the first UE supported CA bandwidth combination (moving from left to right) and then choose any one of the UE supported CA capabilities				

1. Connect the SS, the faders and AWGN noise source to the UE antenna connectors as shown in TS 36.508 [7] Annex A, Figure group A.35 as appropriate.
2. The parameter settings for the cell are set up according to Table 8.2.1-1 and 8.2.3.1\_A.1.3-1 as appropriate.
3. Downlink signals for PCC are initially set up according to Annex C0, C.1 and Annex C.3.2 and uplink signals according to Annex H.1 and H.3.2.
4. Propagation conditions are set according to Annex B.0.
5. Ensure the UE is in State 3A-RF according to TS 36.508 [7] clause 5.2A.2. Message contents are defined in clause 8.2.3.1\_A.1.4.3.

#### 8.2.3.1\_A.1.4.2 Test procedure

1. Configure SCC according to Annex C0, C.1 and Annex C.3.2 for all downlink physical channels.
2. The SS shall configure SCC as per TS 36.508 [7] clause 5.2A.4. Message contents are defined in clause 8.2.3.1\_A.1.4.3
3. SS activates SCC by sending the activation MAC-CE (Refer TS 36.321 [13], clauses 5.13, 6.1.3.8). Wait for at least 2 seconds (Refer TS 36.133, clauses 8.3.3.2).
4. SS transmits PDSCH via PDCCH DCI format 1A for C\_RNTI to transmit the DL RMC according to Tables 8.2.3.1\_A.1.3-2 and 8.2.3.1\_A.1.3-3 on both PCC and SCC. The SS sends downlink MAC padding bits on the DL RMC.
5. Set the parameters of the bandwidth, MCS, reference channel, the propagation condition, the correlation matrix and the SNR on each of the component carriers according to Tables 8.2.3.1\_A.1.5-1 as appropriate.
6. Measure the average throughput per component carrier for a duration sufficient to achieve statistical significance according to Annex G clause G.3A, Table G.3A.5-1 and G.3A.5-6 on both PCC and SCC. Count the number of NACKs, ACKs and statDTXs on the UL during each subtest on both component carriers.

#### 8.2.3.1\_A.1.4.3 Message contents

FFS

#### 8.2.3.1\_A.1.5 Test requirement

Table 8.2.3.1\_A.1.3-1 defines the primary level settings.

The fraction of maximum throughput percentage for the downlink reference measurement channels specified in Annex A clause A.3.3.1 for the throughput test shall meet or exceed the specified value in Table 8.2.3.1\_A.1.5-1 for the specified SNR including test tolerances for all throughput tests.

Table 8.2.3.1\_A.5-1: Test requirement (FRC)

Test num.	Bandwidth Combination	Reference channel	OCNG pattern	Propagation condition	Correlation matrix and antenna config.	Reference value		UE category
						Fraction of maximum throughput (%)	SNR (dB)	
1	20(FDD)+20(TDD)MHz	R.42 FDD	OP.1 FDD	EVA5	1x2 Low	70	[-1.7]+TT	≥5
		R.42 TDD	OP.1 TDD			70	[-1.4]+TT	
2	10(FDD)+20(TDD)MHz	R.2 FDD For 10MHz CC	OP.1 FDD	EVA5	1x2 Low	70	[-1.7]+TT	≥5
		R.42 TDD For 20MHz CC	OP.1 TDD			70	[-1.4]+TT	
3	5(FDD)+10(TDD)MHz	R.42-2 FDD For 5MHz CC	OP.1 FDD	EVA5	1x2 Low	70	[-1.0]+TT	≥3
		R.2 TDD For 10MHz CC	OP.1 TDD			70	[-1.6]+TT	
4	15(FDD)+20(TDD)MHz	R.42-3 FDD For 15MHz CC	OP.1 FDD	EVA5	1x2 Low	70	[-1.6]+TT	≥5
		R.42 TDD For 20MHz CC	OP.1 TDD			70	[-1.4]+TT	
Note 1: The OCNG pattern applies for each CC. Note 2: 30usec or 922*Ts timing difference between two CCs is applied in inter-band CA case. Note 3: The applicability of requirements for different CA configurations and bandwidth combination sets is defined in 8.1.2.3B.								

Decide pass or fail for each subtest according to Annex G.3A.4. Decide the entire test pass or fail according to Annex G.3A.6.

## 8.2.3.1\_A.2 TDD FDD CA PDSCH Single Antenna Port Performance for TDD PCell (2DL CA)

Editor's note: The following aspects are either missing or not yet determined:

The SNR values in table 8.2.3.1\_A.2.3-3 and 8.2.3.1\_A.2.3-4 are still in bracket in core spec.

Test tolerance is FFS

Message contents are FFS

## 8.2.3.1\_A.2.1 Test purpose

To verify the UE's ability to receive a predefined test signal, representing a multi-path fading channel that is determined by the SNR with a percentage of the information bit throughput for a specified downlink Reference Measurement Channel (RMC) not falling below a specified value for transmission on a single-antenna port with different channel models and MCS.

## 8.2.3.1\_A.2.2 Test applicability

This test applies to all types of E-UTRA FDD and TDD Release 12 and forward UE of categories 3 or higher that support E-UTRA FDD and TDD and 2DL CA with TDD as PCELL.

## 8.2.3.1\_A.2.3 Minimum conformance requirements

The requirements are specified in terms of the percentage of information bit throughput for the downlink reference measurement channels specified in Annex A clause A.3.3.1, with the addition of the relevant parameters in Tables 8.2.3-1, 8.2.3.1\_A.2.3-1 and the downlink physical channel setup according to Table C.3.2-1 in Annex C.

Using this configuration the fraction of maximum throughput percentage shall meet or exceed the minimum requirements specified in Table 8.2.3.1\_A.2.3-4 for the specified SNR. For QPSK and 64QAM performance the bandwidths specified in Table 5.4.2.1-1 are verified.

**Table 8.2.3.1\_A.2.3-1: Test Parameters for CA**

Parameter		Unit	Test 1- 6
Downlink power allocation	$\rho_A$	dB	0
	$\rho_B$	dB	0 (Note 1)
	$\sigma$	dB	0
$N_{oc}$ at antenna port		dBm/15kHz	-98
Symbols for unused PRBs			OCNG (Note 2)
Modulation			QPSK
PDSCH transmission mode			1
Note 1: $P_B = 0$ .			
Note 2: These physical resource blocks are assigned to an arbitrary number of virtual UEs with one PDSCH per virtual UE; the data transmitted over the OCNG PDSCHs shall be uncorrelated pseudo random data, which is QPSK modulated.			
Note 3: The same PDSCH transmission mode is applied to each component carrier.			



**Table 8.2.3.1\_A.2.3-2: Single carrier performance with different bandwidths for multiple CA configurations for FDD SCell (FRC)**

Band-width	Reference Channel	OCNG Pattern	Propagation Condition	Correlation Matrix and Antenna Configuration	Reference value	
					Fraction of Maximum Throughput (%)	SNR (dB)
1.4 MHz	R.4 FDD	OP.1 FDD	EVA5	1x2 Low	70	[-1.3]
3 MHz	R.42-1 FDD	OP.1 FDD	EVA5	1x2 Low	70	[-1.1]
5MHz	R.42-2 FDD	OP.1 FDD	EVA5	1x2 Low	70	[-1.0]
10MHz	R.2 FDD	OP.1 FDD	EVA5	1x2 Low	70	[-1.7]
15MHz	R.42-3 FDD	OP.1 FDD	EVA5	1x2 Low	70	[-1.6]
20MHz	R.42 FDD	OP.1 FDD	EVA5	1x2 Low	70	[-1.7]

**Table 8.2.3.1\_A.2.3-3: Single carrier performance with different bandwidths for multiple CA configurations for TDD PCell and SCell (FRC)**

Band-width	Reference Channel	OCNG Pattern	Propagation Condition	Correlation Matrix and Antenna Configuration	Reference value	
					Fraction of Maximum Throughput (%)	SNR (dB)
1.4 MHz	R.4 TDD	OP.1 TDD	EVA5	1x2 Low	70	[-0.6]
3 MHz	R.42-1 TDD	OP.1 TDD	EVA5	1x2 Low	70	[-0.8]
5MHz	R.42-2 TDD	OP.1 TDD	EVA5	1x2 Low	70	[-1.2]
10MHz	R.2 TDD	OP.1 TDD	EVA5	1x2 Low	70	[-1.6]
15MHz	R.42-3 TDD	OP.1 TDD	EVA5	1x2 Low	70	[-1.4]
20MHz	R.42 TDD	OP.1 TDD	EVA5	1x2 Low	70	[-1.4]

**Table 8.2.3.1\_A.2.3-4: Minimum performance for multiple CA configurations with 2DL CCs (FRC)**

Test number	Aggregated Bandwidth (MHz)			Minimum performance requirement	UE Category
	Total	FDD CC	TDD CC		
1	2x20	20	20	As defined in Table 8.2.3.1.2-2 and Table 8.2.3.1.2-3 per CC	≥5
2	20+10	10	20	As defined in Table 8.2.3.1.2-2 and Table 8.2.3.1.2-3 per CC	≥5
3	10+5	5	10	As defined in Table 8.2.3.1.2-2 and Table 8.2.3.1.2-3 per CC	≥3
4	20+15	15	20	As defined in Table 8.2.3.1.1-2 and Table 8.2.3.1.1-3 per CC	≥5
Note 1:	The applicability of requirements for different CA configurations and bandwidth combination sets is defined in 8.1.2.3B				
Note 2:	30usec timing difference between PCell and any SCell is applied in inter-band CA case, where PCell can be assigned on any CC.				

The normative reference for this requirement is TS 36.101 [2] clause 8.2.3.1.

#### 8.2.3.1\_A.2.4 Test description

##### 8.2.3.1\_A.2.4.1 Initial conditions

Initial conditions are a set of test configurations the UE needs to be tested in and the steps for the SS to take with the UE to reach the correct measurement state.

Configurations of PDSCH and PDCCH before measurement are specified in Annex C.2.

Test Environment: Normal, as defined in TS 36.508 [7] clause 4.1.

Frequencies to be tested: Maximum WGap for Intra-band non-contiguous CA, otherwise Mid Range, as defined in TS 36.508 [7] clause 4.3.1.2.

Bandwidths to be tested: Select one according to Table 8.2.3.1\_A.1.4.1-1.

CA Capability to be tested: Select one according to Table 8.2.3.1\_A.1.4.1

**Table 8.2.3.1\_A.1.4.1-1: Test point selection for TM1 2DLCA**

CA Capability	Bandwidth Combination			
	20+20	20+10	10+5	20+15
Inter-band (CA_A_2)	Test 1	Test 2	Test3	Test4
Note1: Select the first UE supported CA bandwidth combination (moving from left to right) and then choose any one of the UE supported CA capabilities				

1. Connect the SS, the faders and AWGN noise sources to the UE antenna connectors as shown in TS 36.508 [7] Annex A, Figure group A.35 as appropriate.
2. The parameter settings for the cell are set up according to Tables 8.2.2-1, 8.2.2.1.1\_A.1.3-1 as appropriate.
3. Downlink signals for PCC are initially set up according to Annex C.0, C.1 and Annex C.3.2 and uplink signals according to Annex H.1 and H.3.2.
4. Propagation conditions are set according to Annex B.0.
5. Ensure the UE is in State 3A-RF according to TS 36.508 [7] clause 5.2A.2. Message contents are defined in clause 8.2.2.1.1\_A.1.4.3.

#### 8.2.3.1\_A.2.4.2 Test procedure

1. Configure SCC according to Annex C0, C.1 and Annex C.3.2 for all downlink physical channels.
2. The SS shall configure SCC as per TS 36.508 [7] clause 5.2A.4. Message contents are defined in clause 8.2.3.1\_A.1.4.3.
3. SS activates SCC by sending the activation MAC-CE (Refer TS 36.321 [13], clauses 5.13, 6.1.3.8). Wait for at least 2 seconds (Refer TS 36.133, clauses 8.3.3.2).
4. SS transmits PDSCH via PDCCH DCI format 1A for C\_RNTI to transmit the DL RMC according to Tables 8.2.3.1\_A.1.3-1 and 8.2.3.1\_A.1.3-2 or 8.2.3.1\_A.1.3-3 on both PCC and SCC. The SS sends downlink MAC padding bits on the DL RMC.
5. Set the parameters of the reference channel, MCS, reference channel, the propagation condition, the correlation matrix and the SNR according to Tables 8.2.3.1\_A.1.5-1 as appropriate.
6. Measure the average throughput per component carrier for a duration sufficient to achieve statistical significance according to Annex G clause G.3A, Table G.3A.5-1 and G.3A.5-6 on both PCC and SCC. Count the number of NACKs, ACKs and statDTXs on the UL during each subtest on both component carriers.

#### 8.2.3.1\_A.2.4.3 Message contents

FFS

#### 8.2.3.1\_A.2.5 Test requirement

Table 8.2.3.1\_A.1.3-1 defines the primary level settings including test tolerances for all throughput tests.

The fraction of maximum throughput percentage for the downlink reference measurement channels specified in Annex A clause 3.3.1 for the throughput test shall meet or exceed the specified value in Table 8.2.3.1\_A.1.5-1 for the specified SNR including test tolerances for all throughput tests.

**Table 8.2.2.1.1\_A.1.5-1: Test Requirement (FRC) for CA**

Test number	Bandwidth	Reference Channel	OCNG Pattern	Propagation Condition	Correlation Matrix and Antenna Configuration	Reference value		UE Category
						Fraction of Maximum Throughput (%)	SNR (dB)	
1	20(FDD)+20 (TDD)MHz	R.42 TDD	OP.1 TDD	EVA5	1x2 Low	70	[-1.4]+TT	≥5
		R.42 FDD	OP.1 FDD			70	[-1.7] +TT	
2	10(FDD)+20 (TDD)MHz	R.42 TDD	OP.1 TDD	EVA5	1x2 Low	70	[-1.4] +TT	≥5
		R.2 FDD	OP.1 FDD			70	[-1.7] +TT	
3	5(FDD)+10( TDD)MHz	R.2 TDD	OP.1 TDD	EVA5	1x2 Low	70	[-1.6] +TT	≥3
		R.42-2 FDD	OP.1 FDD			70	[-1.0] +TT	
4	20(FDD)+15 (TDD)MHz	R.42 TDD	OP.1 TDD	EVA5	1x2 Low	70	[-1.4] +TT	≥5
		R.42-3 FDD	OP.1 FDD			70	[-1.6] +TT	
Note 1: The OCNG pattern applies for each CC.								
Note 2: The applicability of requirements for different CA configurations and bandwidth combination sets is defined in 8.1.2.3B..								

### 8.2.3.1\_A.3 TDD FDD CA PDSCH Single Antenna Port Performance for FDD PCell (3DL CA)

**Editor's note: The following aspects are either missing or not yet determined:**

The SNR values in table 8.2.3.1\_A.3.3-3 and 8.2.3.1\_A.3.3-4 are still in bracket in core spec.

Test tolerance is FFS

Message contents are FFS

#### 8.2.3.1\_A.3.1 Test purpose

To verify the UE's ability to receive a predefined test signal, representing a multi-path fading channel that is determined by the SNR with a percentage of the information bit throughput for a specified downlink Reference Measurement Channel (RMC) not falling below a specified value for transmission on a single-antenna port with different channel models and MCS.

#### 8.2.3.1\_A.3.2 Test applicability

This test applies to all types of E-UTRA FDD and TDD Release 12 and forward UE of categories 3 or higher that support E-UTRA FDD and TDD and 3DL CA with FDD as PCELL.

#### 8.2.3.1\_A.3.3 Minimum conformance requirements

The requirements are specified in terms of the percentage of information bit throughput for the downlink reference measurement channels specified in Annex A clause A.3.3.1, with the addition of the relevant parameters in Tables 8.2.1-1, 8.2.3.1\_A.3.3-1 and the downlink physical channel setup according to Table C.3.2-1 in Annex C.

Using this configuration the fraction of maximum throughput percentage shall meet or exceed the minimum requirements specified in Table 8.2.3.1\_A.3.3-4 for the specified SNR. For QPSK and 64QAM performance the bandwidths specified in Table 5.4.2.1-1 are verified.

Table 8.2.3.1\_A.3.3-1: Test Parameters for CA

Parameter		Unit	Test 1- 6
Downlink power allocation	$\rho_A$	dB	0
	$\rho_B$	dB	0 (Note 1)
	$\sigma$	dB	0
$N_{oc}$ at antenna port		dBm/15kHz	-98
Symbols for unused PRBs			OCNG (Note 2)
Modulation			QPSK
PDSCH transmission mode			1
Note 1: $P_B = 0$ .			
Note 2: These physical resource blocks are assigned to an arbitrary number of virtual UEs with one PDSCH per virtual UE; the data transmitted over the OCNG PDSCHs shall be uncorrelated pseudo random data, which is QPSK modulated.			
Note 3: The same PDSCH transmission mode is applied to each component carrier.			

Table 8.2.3.1\_A.3.3-2: Single carrier performance with different bandwidths for multiple CA configurations for FDD PCell and SCell (FRC)

Band-width	Reference Channel	OCNG Pattern	Propagation Condition	Correlation Matrix and Antenna Configuration	Reference value	
					Fraction of Maximum Throughput (%)	SNR (dB)
1.4 MHz	R.4 FDD	OP.1 FDD	EVA5	1x2 Low	70	[-1.3]
3 MHz	R.42-1 FDD	OP.1 FDD	EVA5	1x2 Low	70	[-1.1]
5MHz	R.42-2 FDD	OP.1 FDD	EVA5	1x2 Low	70	[-1.0]
10MHz	R.2 FDD	OP.1 FDD	EVA5	1x2 Low	70	[-1.7]
15MHz	R.42-3 FDD	OP.1 FDD	EVA5	1x2 Low	70	[-1.6]
20MHz	R.42 FDD	OP.1 FDD	EVA5	1x2 Low	70	[-1.7]

Table 8.2.3.1\_A.3.3-3: Single carrier performance with different bandwidths for multiple CA configurations for TDD SCell (FRC)

Band-width	Reference Channel	OCNG Pattern	Propagation Condition	Correlation Matrix and Antenna Configuration	Reference value	
					Fraction of Maximum Throughput (%)	SNR (dB)
1.4 MHz	R.4 TDD	OP.1 TDD	EVA5	1x2 Low	70	[-0.6]
3 MHz	R.42-1 TDD	OP.1 TDD	EVA5	1x2 Low	70	[-0.8]
5MHz	R.42-2 TDD	OP.1 TDD	EVA5	1x2 Low	70	[-1.2]
10MHz	R.2 TDD	OP.1 TDD	EVA5	1x2 Low	70	[-1.6]
15MHz	R.42-3 TDD	OP.1 TDD	EVA5	1x2 Low	70	[-1.4]
20MHz	R.42 TDD	OP.1 TDD	EVA5	1x2 Low	70	[-1.4]

**Table 8.2.3.1\_A.3.3-4: Minimum performance for multiple CA configurations with 3DL CCs (FRC)**

Test number	CA Bandwidth combination (MHz)			Minimum performance requirement	UE Category
	Total	FDD CC	TDD CC		
1	3x20	20	2x20	As defined in Table 8.2.3.1.1-2 and Table 8.2.3.1.1-3 per CC	≥5
2	20+20+15	15	2x20	As defined in Table 8.2.3.1.1-2 and Table 8.2.3.1.1-3 per CC	≥5
3	20+20+10	10	2x20	As defined in Table 8.2.3.1.1-2 and Table 8.2.3.1.1-3 per CC	≥5
Note 1:	The applicability of requirements for different CA configurations and bandwidth combination sets is defined in 8.1.2.3B.				
Note 2:	30usec timing difference between PCell and any SCell is applied in inter-band CA case, where PCell can be assigned on any CC.				

**Table 8.2.3.1\_A.3.3-4: Minimum performance for multiple CA configurations (FRC)**

Test number	Aggregated Bandwidth (MHz)			Minimum performance requirement	UE Category
	Total	FDD CC	TDD CC		
1	2x20	20	20	As defined in Table 8.2.3.1_A.2.3-2 and Table 8.2.3.1_A.2.3-3 per CC	≥5
2	20+10	10	20	As defined in Table 8.2.3.1_A.2.3-2 and Table 8.2.3.1_A.2.3-3 per CC	≥5
3	10+5	5	10	As defined in Table 8.2.3.1_A.2.3-2 and Table 8.2.3.1_A.2.3-3 per CC	≥3
4	3x20	20	2x20	As defined in Table 8.2.3.1_A.2.3-2 and Table 8.2.3.1_A.2.3-3 per CC	≥5
5	20+20+15	15	2x20	As defined in Table 8.2.3.1_A.2.3-2 and Table 8.2.3.1_A.2.3-3 per CC	≥5
6	20+20+10	10	2x20	As defined in Table 8.2.3.1_A.2.3-2 and Table 8.2.3.1_A.2.3-3 per CC	≥5
Note 1:	The applicability of requirements for different CA configurations and bandwidth combination sets is defined in 8.1.2.3				
Note 2:	30usec timing difference between PCell and any SCell is applied in inter-band CA case, where PCell can be assigned on any CC.				

The normative reference for this requirement is TS 36.101 [2] clause 8.2.3.1.

#### 8.2.3.1\_A.3.4 Test description

##### 8.2.3.1\_A.3.4.1 Initial conditions

Initial conditions are a set of test configurations the UE needs to be tested in and the steps for the SS to take with the UE to reach the correct measurement state.

Configurations of PDSCH and PDCCH before measurement are specified in Annex C.2.

Test Environment: Normal, as defined in TS 36.508 [7] clause 4.1.

Frequencies to be tested: Maximum WGap for Intra-band non-contiguous CA, otherwise Mid Range, as defined in TS 36.508 [7] clause 4.3.1.

Channel Bandwidths to be tested: Select one according to Table 8.2.3.1\_A.3xx.

CA Capability to be tested: Select one according to Table 8.2.3.1\_A.3xx

**Table 8.2.3.1\_A.3.4.1-1: Test point selection for TM1 CA**

CA Capability	Bandwidth combination		
	3x20	20+20+15	20+10+10
Inter-band CA (three bands) CA3_A3	Test1	Test2	Test3
Inter-band CA (two bands) CA3_A2	Test1	Test2	Test3

Note1: Only one test point is tested.  
 Select left to right the first UE supported CA bandwidth combination  
 and then choose any one of the UE supported CA capabilities  
 supporting that CA bandwidth combination.

1. Connect the SS, the faders and AWGN noise source to the UE antenna connectors as shown in TS 36.508 [7] Annex A, Figure A.59.
2. The parameter settings for the cell are set up according to Table 8.2.1-1 and 8.2.3.1\_A.3.3-1 as appropriate.
3. Downlink signals for PCC are initially set up according to Annex C0, C.1 and Annex C.3.2 and uplink signals according to Annex H.1 and H.3.2.
4. Propagation conditions are set according to Annex B.0.
5. Ensure the UE is in State 3A-RF according to TS 36.508 [7] clause 5.2A.2. Message contents are defined in clause 8.2.3.1\_A.2.4.3.

#### 8.2.3.1\_A.3.4.2 Test procedure

1. Configure SCCs according to Annex C0, C.1 and Annex C.3.2 for all downlink physical channels.
2. The SS shall configure SCCs as per TS 36.508 [7] clause 5.2A.4. Message contents are defined in clause 8.2.3.1\_A.2.4.3.
3. SS activates SCCs by sending the activation MAC-CE (Refer TS 36.321 [13], clauses 5.13, 6.1.3.8). Wait for at least 2 seconds (Refer TS 36.133, clauses 8.3.3.2).
4. SS transmits PDSCH via PDCCH DCI format 1A for C\_RNTI to transmit the DL RMC according to Tables 8.2.3.1\_A.3.3-2 and 8.2.3.1\_A.3.3-3 on both PCC and SCCs. The SS sends downlink MAC padding bits on the DL RMC.
5. Set the parameters of the bandwidth, MCS, reference channel, the propagation condition, the correlation matrix and the SNR on each of the component carriers according to Tables 8.2.3.1\_A.2.5-1 as appropriate.
6. Measure the average throughput per component carrier for duration sufficient to achieve statistical significance according to Annex G clause G.3A, Table G.3A.5-2 and [G.3A.5-x] on each of the component carriers. Count the number of NACKs, ACKs and statDTXs on the UL during each subtest on each of the component carriers.

#### 8.2.3.1\_A.3.4.3 Message contents

FFS

#### 8.2.3.1\_A.3.5 Test requirement

Table 8.2.3.1\_A.3.3-1 defines the primary level settings including test tolerances for all throughput tests.

The fraction of maximum throughput percentage for the downlink reference measurement channels specified in Annex A clause 3.3.1 for the throughput test shall meet or exceed the specified value in Table 8.2.3.1\_A.3.5-1 for the specified SNR including test tolerances for all throughput tests.

Table 8.2.3.1\_A.3.5-1: Test Requirement (FRC) for CA

Test number	Bandwidth	Reference Channel	OCNG Pattern	Propagation Condition	Correlation Matrix and Antenna Configuration	Reference value		UE Category
						Fraction of Maximum Throughput (%)	SNR (dB)	
1	20(FDD)+20(TDD)+20(TDD)MHz	R.42 FDD	OP.1 FDD	EVA5	1x2 Low	70	[-1.7]+TT	≥5
		R.42 TDD	OP.1 TDD			70	[-1.4] +TT	
2	15(FDD)+20(TDD)+20(TDD)MHz	R.42-3 FDD for 15 MHz CC	OP.1 FDD	EVA5	1x2 Low	70	[-1.6] +TT	≥5
		R.42 TDD	OP.1 TDD			70	[-1.4] +TT	
3	10(FDD)+20(TDD)+20(TDD)MHz	R.2 FDD FDD for 15 MHz CC	OP.1 FDD	EVA5	1x2 Low	70	[-1.7] +TT	≥5
		R.42 TDD	OP.1 TDD			70	[-1.4] +TT	
Note 1: The OCNG pattern applies for each CC.								
Note 2: The applicability of requirements for different CA configurations and bandwidth combination sets is defined in 8.1.2.3B.								

#### 8.2.3.1\_A.4 TDD FDD CA PDSCH Single Antenna Port Performance for TDD PCell (3DL CA)

Editor's note: The following aspects are either missing or not yet determined:

The SNR values in table 8.2.3.1\_A.3.3-3 and 8.2.3.1\_A.3.3-4 are still in bracket in core spec.

Test tolerance is FFS

Message contents are FFS

##### 8.2.3.1\_A.4.1 Test purpose

To verify the UE's ability to receive a predefined test signal, representing a multi-path fading channel that is determined by the SNR with a percentage of the information bit throughput for a specified downlink Reference Measurement Channel (RMC) not falling below a specified value for transmission on a single-antenna port with different channel models and MCS.

##### 8.2.3.1\_A.4.2 Test applicability

This test applies to all types of E-UTRA FDD and TDD Release 12 and forward UE of categories 3 or higher that support E-UTRA FDD and TDD and 3DL CA with TDD as PCELL.

##### 8.2.3.1\_A.4.3 Minimum conformance requirements

The requirements are specified in terms of the percentage of information bit throughput for the downlink reference measurement channels specified in Annex A clause A.3.3.1, with the addition of the relevant parameters in Tables 8.2.3-1, 8.2.3.1\_A.4.3-1 and the downlink physical channel setup according to Table C.3.2-1 in Annex C.

Using this configuration the fraction of maximum throughput percentage shall meet or exceed the minimum requirements specified in Table 8.2.3.1\_A.4.3-4 for the specified SNR. For QPSK and 64QAM performance the bandwidths specified in Table 5.4.2.1-1 are verified.

Table 8.2.3.1\_A.4.3-1: Test Parameters for CA

Parameter		Unit	Test 1- 6
Downlink power allocation	$\rho_A$	dB	0
	$\rho_B$	dB	0 (Note 1)
	$\sigma$	dB	0
$N_{oc}$ at antenna port		dBm/15kHz	-98
Symbols for unused PRBs			OCNG (Note 2)
Modulation			QPSK
PDSCH transmission mode			1
Note 1: $P_B = 0$ .			
Note 2: These physical resource blocks are assigned to an arbitrary number of virtual UEs with one PDSCH per virtual UE; the data transmitted over the OCNG PDSCHs shall be uncorrelated pseudo random data, which is QPSK modulated.			
Note 3: The same PDSCH transmission mode is applied to each component carrier.			

Table 8.2.3.1\_A.4.3-2: Single carrier performance with different bandwidths for multiple CA configurations for FDD SCell (FRC)

Band-width	Reference Channel	OCNG Pattern	Propagation Condition	Correlation Matrix and Antenna Configuration	Reference value	
					Fraction of Maximum Throughput (%)	SNR (dB)
1.4 MHz	R.4 FDD	OP.1 FDD	EVA5	1x2 Low	70	[-1.3]
3 MHz	R.42-1 FDD	OP.1 FDD	EVA5	1x2 Low	70	[-1.1]
5MHz	R.42-2 FDD	OP.1 FDD	EVA5	1x2 Low	70	[-1.0]
10MHz	R.2 FDD	OP.1 FDD	EVA5	1x2 Low	70	[-1.7]
15MHz	R.42-3 FDD	OP.1 FDD	EVA5	1x2 Low	70	[-1.6]
20MHz	R.42 FDD	OP.1 FDD	EVA5	1x2 Low	70	[-1.7]

Table 8.2.3.1\_A.4.3-3: Single carrier performance with different bandwidths for multiple CA configurations for TDD PCell and SCell (FRC)

Band-width	Reference Channel	OCNG Pattern	Propagation Condition	Correlation Matrix and Antenna Configuration	Reference value	
					Fraction of Maximum Throughput (%)	SNR (dB)
1.4 MHz	R.4 TDD	OP.1 TDD	EVA5	1x2 Low	70	[-0.6]
3 MHz	R.42-1 TDD	OP.1 TDD	EVA5	1x2 Low	70	[-0.8]
5MHz	R.42-2 TDD	OP.1 TDD	EVA5	1x2 Low	70	[-1.2]
10MHz	R.2 TDD	OP.1 TDD	EVA5	1x2 Low	70	[-1.6]
15MHz	R.42-3 TDD	OP.1 TDD	EVA5	1x2 Low	70	[-1.4]
20MHz	R.42 TDD	OP.1 TDD	EVA5	1x2 Low	70	[-1.4]



**Table 8.2.3.1\_A.4.3-4: Minimum performance for multiple CA configurations with 3DL CCs (FRC)**

Test number	Aggregated Bandwidth (MHz)			Minimum performance requirement	UE Category
	Total	FDD CC	TDD CC		
1	3x20	20	2x20	As defined in Table 8.2.3.1.2-2 and Table 8.2.3.1.2-3 per CC	≥5
2	20+20+15	15	2x20	As defined in Table 8.2.3.1.2-2 and Table 8.2.3.1.2-3 per CC	≥5
3	20+20+10	10	2x20	As defined in Table 8.2.3.1.2-2 and Table 8.2.3.1.2-3 per CC	≥5
Note 1:	The applicability of requirements for different CA configurations and bandwidth combination sets is defined in 8.1.2.3B.				
Note 2:	30usec timing difference between PCell and any SCell is applied in inter-band CA case, where PCell can be assigned on any CC.				

The normative reference for this requirement is TS 36.101 [2] clause 8.2.3.1.

#### 8.2.3.1\_A.4.4 Test description

##### 8.2.3.1\_A.4.4.1 Initial conditions

Initial conditions are a set of test configurations the UE needs to be tested in and the steps for the SS to take with the UE to reach the correct measurement state.

Configurations of PDSCH and PDCCH before measurement are specified in Annex C.2.

Test Environment: Normal, as defined in TS 36.508 [7] clause 4.1.

Frequencies to be tested: Maximum WGap for Intra-band non-contiguous CA, otherwise Mid Range, as defined in TS 36.508 [7] clause 4.3.1.

Channel Bandwidths to be tested: Select one according to Table 8.2.3.1\_A.4.xx

CA Capability to be tested: Select one according to Table 8.2.3.1\_A.4xx

**Table 8.2.3.1\_A.4.4.1-1: Test point selection for TM1 CA**

CA Capability	Bandwidth combination		
	3x20	20+20+15	20+10+10
Inter-band CA (three bands) CA3_A3	Test1	Test2	Test3
Inter-band CA (two bands) CA3_A2	Test1	Test2	Test3
Note1: Only one test point is tested. Select left to right the first UE supported CA bandwidth combination and then choose any one of the UE supported CA capabilities supporting that CA bandwidth combination.			

1. Connect the SS, the faders and AWGN noise source to the UE antenna connectors as shown in TS 36.508 [7] Annex A, Figure A.59.
2. The parameter settings for the cell are set up according to Table 8.2.1-1 and 8.2.3.1\_A.2.3-1 as appropriate.
3. Downlink signals for PCC are initially set up according to Annex C0, C.1 and Annex C.3.2 and uplink signals according to Annex H.1 and H.3.2.
4. Propagation conditions are set according to Annex B.0.
5. Ensure the UE is in State 3A-RF according to TS 36.508 [7] clause 5.2A.2. Message contents are defined in clause 8.2.3.1\_A.2.4.3.

8.2.3.1\_A.4.4.2 Test procedure

1. Configure SCCs according to Annex C0, C.1 and Annex C.3.2 for all downlink physical channels.
2. The SS shall configure SCCs as per TS 36.508 [7] clause 5.2A.4. Message contents are defined in clause 8.2.3.1\_A.4.4.3.
3. SS activates SCCs by sending the activation MAC-CE (Refer TS 36.321 [13], clauses 5.13, 6.1.3.8). Wait for at least 2 seconds (Refer TS 36.133, clauses 8.3.3.2).
4. SS transmits PDSCH via PDCCH DCI format 1A for C\_RNTI to transmit the DL RMC according to Tables 8.2.3.1\_A.3.3-2 and 8.2.3.1\_A.3.3-3 on both PCC and SCCs. The SS sends downlink MAC padding bits on the DL RMC.
5. Set the parameters of the bandwidth, MCS, reference channel, the propagation condition, the correlation matrix and the SNR on each of the component carriers according to Tables 8.2.3.1\_A.4.5-1 as appropriate.
6. Measure the average throughput per component carrier for duration sufficient to achieve statistical significance according to Annex G clause G.3A, Table G.3A.5-2 and [G.3A.5-x] on each of the component carriers. Count the number of NACKs, ACKs and statDTXs on the UL during each subtest on each of the component carriers.

8.2.3.1\_A.4.4.3 Message contents

FFS

8.2.3.1\_A.4.5 Test requirement

Table 8.2.3.1\_A.4.3-1 defines the primary level settings including test tolerances for all throughput tests.

The fraction of maximum throughput percentage for the downlink reference measurement channels specified in Annex A clause 3.3.1 for the throughput test shall meet or exceed the specified value in Table 8.2.3.1\_A.3.5-1 for the specified SNR including test tolerances for all throughput tests.

**Table 8.2.3.1\_A.4.5-1: Test Requirement (FRC) for CA**

Test number	Bandwidth	Reference Channel	OCNG Pattern	Propagation Condition	Correlation Matrix and Antenna Configuration	Reference value		UE Category
						Fraction of Maximum Throughput (%)	SNR (dB)	
1	20(FDD)+20(TDD)+20(TDD)MHz	R.42 TDD	OP.1 TDD	EVA5	1x2 Low	70	[-1.4] +TT	≥5
		R.42 FDD	OP.1 FDD			70	[-1.7] +TT	
2	15(FDD)+20(TDD)+20(TDD)MHz	R.42 TDD	OP.1 TDD	EVA5	1x2 Low	70	[-1.4] +TT	≥5
		R.42-3 FDD for 15MHz CC	OP.1 FDD			70	[-1.6] +TT	
3	10(FDD)+20(TDD)+20(TDD)MHz	R.42 TDD	OP.1 TDD	EVA5	1x2 Low	70	[-1.4] +TT	≥5
		R.2 FDD for 10MHz CC	OP.1 FDD			70	[-1.7] +TT	
Note 1: The OCNG pattern applies for each CC.								
Note 2: The applicability of requirements for different CA configurations and bandwidth combination sets is defined in 8.1.2.3B.								

8.2.3.3.2.1 TDD FDD CA PDSCH Closed Loop Multi Layer Spatial Multiplexing 4x2 for TDD PCell (2DL CA)

Editor's note: The following aspects are either missing or not yet determined:

- SNR values are still in brackets in core spec.
- Test tolerance is FFS
- Message contents might need an update

8.2.3.3.2.1.1 Test purpose

The purpose of these tests is to verify the closed loop rank-two performance with wideband and frequency selective precoding.

8.2.3.3.2.1.2 Test applicability

This test applies to all types of E-UTRA FDD and TDD Release 12 and forward UE of categories 3 or higher that support E-UTRA FDD and TDD and 2DL CA with TDD as PCell.

8.2.3.3.2.1.3 Minimum conformance requirements

For TDD FDD CA with TDD PCell and 2DL CCs, the requirements are specified in Table 8.2.3.3.2.1.3-4 based on single carrier requirement specified in Table 8.2.3.3.2.1.3-2 and Table 8.2.3.3.2.1.3-3, with the addition of the parameters in Table 8.2.3.3.2.1.3-1 and the downlink physical channel setup according to Annex C.3.2.

The test coverage for different number of component carriers is defined in 8.1.2.4.

**Table 8.2.3.3.2.1.3-1: Test Parameters for Multi-Layer Spatial Multiplexing (FRC) for CA**

Parameter		Unit	Value
Downlink power allocation	$\rho_A$	dB	-6
	$\rho_B$	dB	-6 (Note 1)
	$\sigma$	dB	3
$N_{oc}$ at antenna port		dBm/15kHz	-98
Precoding granularity		PRB	Wideband pre-coding for 1.4MHz, 4 for 3MHz and 5MHz CCs, 6 for 10MHz CCs, 8 for 15MHz and 20MHz CCs
PMI delay (Note 2)	FDD CC	ms	8
	TDD CC	ms	10 or 11
Reporting interval	FDD CC	ms	1
	TDD CC	ms	1 or 4 (Note 3)
Reporting mode			PUSCH 1-2
CodeBookSubsetRestriction bitmap			00000000000000000000000000000000 00001111111111111111111100000000 00000000
CSI request field (Note 3)			'10'
PDSCH transmission mode			TM4
Note 1: $P_B = 1$ . Note 2: If the UE reports in an available uplink reporting instance at subframe SF#n based on PMI estimation at a downlink SF not later than SF#(n-4), this reported PMI cannot be applied at the eNB downlink before SF#(n+4). Note 3: Multiple CC-s under test are configured as the 1 <sup>st</sup> set of serving cells by higher layers. Note 4: ACK/NACK bits are transmitted using PUSCH with PUCCH format 3. Note 5: The same PDSCH transmission mode is applied to each component carrier.			

**Table 8.2.3.3.2.1.3-2: Single carrier performance with different bandwidths for multiple CA configurations for FDD SCell (FRC)**

Band-width	Reference Channel	OCNG Pattern	Propagation Condition	Correlation Matrix and Antenna Configuration	Reference value	
					Fraction of Maximum Throughput (%)	SNR (dB)
1.4 MHz	R.14-4 FDD	OP.1 FDD	EVA5	4x2 Low	70	[10.4]
3 MHz	R.14-5 FDD	OP.1 FDD	EVA5	4x2 Low	70	[9.5]
5MHz	R.14-6 FDD	OP.1 FDD	EVA5	4x2 Low	70	[9.5]
10MHz	R.14 FDD	OP.1 FDD	EVA5	4x2 Low	70	[10.1]
15MHz	R.14-7 FDD	OP.1 FDD	EVA5	4x2 Low	70	[10.1]
20MHz	R.14-3 FDD	OP.1 FDD	EVA5	4x2 Low	70	[10.3]

**Table 8.2.3.3.2.1.3-3: Single carrier performance with different bandwidths for multiple CA configurations for TDD PCell and SCell (FRC)**

Band-width	Reference Channel	OCNG Pattern	Propagation Condition	Correlation Matrix and Antenna Configuration	Reference value	
					Fraction of Maximum Throughput (%)	SNR (dB)
1.4 MHz	R.43-1 TDD	OP.1 TDD	EVA5	4x2 Low	70	[11.0]
3 MHz	R.43-2 TDD	OP.1 TDD	EVA5	4x2 Low	70	[9.8]
5MHz	R.43-3 TDD	OP.1 TDD	EVA5	4x2 Low	70	[10.0]
10MHz	R.43-4 TDD	OP.1 TDD	EVA5	4x2 Low	70	[10.5]
15MHz	R.43-5 TDD	OP.1 TDD	EVA5	4x2 Low	70	[10.6]
20MHz	R.43 TDD	OP.1 TDD	EVA5	4x2 Low	70	[10.7]

**Table 8.2.3.3.2.1.3-4: Minimum performance for multiple CA configurations with 2DL CCs (FRC)**

Test number	Aggregated Bandwidth (MHz)			Minimum performance requirement	UE Category
	Total	FDD CC	TDD CC		
1	2x20	20	20	As defined in Table 8.2.3.3.2.1.3-2 and Table 8.2.3.3.2.1.3-3 per CC	≥5
2	20+10	10	20	As defined in Table 8.2.3.3.2.1.3-2 and Table 8.2.3.3.2.1.3-3 per CC	≥5
3	10+5	5	10	As defined in Table 8.2.3.3.2.1.3-2 and Table 8.2.3.3.2.1.3-3 per CC	≥3
4	20+15	15	20	As defined in Table 8.2.3.3.3.1.3-2 and Table 8.2.3.3.2.1.3-3 per CC	≥5
Note 1:	The applicability of requirements for different CA configurations and bandwidth combination sets is defined in 8.1.2.3B				

The normative reference for this requirement is TS 36.101 [2] clause 8.2.3.3.2.

## 8.2.3.3.2.1.4 Test description

## 8.2.3.3.2.1.4.1 Initial conditions

Initial conditions are a set of test configurations the UE needs to be tested in and the steps for the SS to take with the UE to reach the correct measurement state.

Configurations of PDSCH and PDCCH before measurement are specified in Annex C.2.

Test Environment: Normal, as defined in TS 36.508 [7] clause 4.1.

Frequencies to be tested: Mid Range, as defined in TS 36.508 [7] clause 4.3.1.

Channel Bandwidths to be tested: Select one according to Table 8.2.3.3.2.1.4.1-1.

CA Capability to be tested: Select one according to Table 8.2.2.3.2.1.4.1-1.

**Table 8.2.3.3.2.1.4.1-1: Test point selection for TM4 TDD FDD 2DL CA TDD PCell**

CA Capability	Bandwidth Combination			
	20+20	20+15	20+10	10+5
Inter-band (CA_A2)	Test 1	Test 4	Test 2	Test 3
Note1: Only one test point is tested. Select the largest aggregated CA bandwidth combination supported by the UE among the UE supported CA capabilities.				

1. Connect the SS, the faders and AWGN noise sources to the UE antenna connectors as shown in TS 36.508 [7] Annex A, Figure group 46 as appropriate.
2. The parameter settings for Pcell are set up according to Tables 8.2.3-1, 8.2.3.3.2.1.3-1 as appropriate.
3. Downlink signals for PCC are initially set up according to Annex C.1 and Annex C.3.2 and uplink signals according to Annex H.1 and H.3.2.
4. Propagation conditions are set according to Annex B.0.
5. Ensure the UE is in State 3A-RF according to TS 36.508 [7] clause 5.2A.2. Message contents are defined in clause 8.2.3.3.2.1.4.3.

## 8.2.3.3.2.1.4.2 Test procedure

1. Configure SCC according to Annex C.0, C.1 and Annex C.3.2 for all downlink physical channels.
2. The SS shall configure SCC as per TS 36.508 [7] clause 5.2A.4. Message contents for *PDSCH-ConfigDedicated-DEFAULT* is defined in Table 8.2.3.3.2.1.4.3-1, *PhysicalConfigDedicatedSCell-r10-DEFAULT* is defined in Table 8.2.3.3.2.1.4.3-2A, *PhysicalConfigDedicated-DEFAULT* is defined in Table 8.2.3.3.2.1.4.3-2, *CQI-ReportConfigSCell-DEFAULT* is defined in Table 8.2.3.3.2.1.4.3-4, *CQI-ReportAperiodic-r10-DEFAULT* is defined in Table 8.2.3.3.2.1.4.3-5, *CQI-ReportConfigSCell-r10-DEFAULT* is defined in Table 8.2.3.3.2.1.4.3-6.
3. SS activates SCC by sending the activation MAC-CE (Refer TS 36.321 [13], clauses 5.13, 6.1.3.8). Wait for at least 2 seconds (Refer TS 36.133, clauses 8.3.3.2).
4. For multi-layer spatial multiplexing, SS transmits PDSCH via PDCCH DCI format 2 for C\_RNTI to transmit the DL RMC according to Tables 8.2.3.3.2.1.3-1 and 8.2.3.3.2.1.3-2 or 8.2.3.3.2.1.3-3. The SS sends downlink MAC padding bits on the DL RMC.
5. SS schedules the UL transmission to carry the PUSCH CSI feedback via PDCCH DCI format 0 with CSI request bit set to '10' and I\_MCS=29 and N\_PRB allocated to be less or equal to 20.
6. Set the parameters of the bandwidth, MCS, reference channel, the propagation condition, the correlation matrix, antenna configuration and the SNR according to Tables 8.2.3.3.2.1.5-1 or 8.2.3.3.2.1.5-2 as appropriate.

- 7. Measure the average throughput for a duration sufficient to achieve statistical significance according to Annex G clause G.3A.5. Count the number of NACKs, ACKs and statDTXs on the UL during the test interval and decide pass or fail according to Tables G.3.5 and G.3.6 in Annex G clause G.3.

8.2.3.3.2.1.4.3 Message contents

Message contents are according to TS 36.508 [7] clauses 5.5 and 4.6 with the following exceptions:

**Table 8.2.3.3.2.1.4.3-1: PDSCH-ConfigDedicated-DEFAULT**

Derivation Path: TS 36.508 [7] clause 4.6.3, Table 4.6.3-6 PDSCH-ConfigDedicated-DEFAULT			
Information Element	Value/remark	Comment	Condition
PDSCH-ConfigDedicated-DEFAULT ::= SEQUENCE {			
p-a	dB-6		
}			

**Table 8.2.3.3.2.1.4.3-2: PhysicalConfigDedicated-DEFAULT**

Derivation Path: 36.508 clause 5.5.1, Table 5.5.1.2-1			
Information Element	Value/remark	Comment	Condition
PhysicalConfigDedicated-DEFAULT ::= SEQUENCE {			
antennaInfo CHOICE {			
explicitValue ::= SEQUENCE {			
transmissionMode	tm4		
codebookSubsetRestriction CHOICE {			
n4TxAntenna-tm4	00000000000000000000 00000000000011111111 11111111000000000000 0000		
}			
ue-TransmitAntennaSelection CHOICE {			
release	NULL		
}			
}			
}			

**Table 8.2.3.3.2.1.4.3-2A: PhysicalConfigDedicatedSCell-r10-DEFAULT**

Derivation Path: 36.508 clause 4.6.3 Table 4.6.3-6A			
Information Element	Value/remark	Comment	Condition
PhysicalConfigDedicated SCell-r10-DEFAULT ::= SEQUENCE {			
nonUL-Configuration-r10 SEQUENCE {			
antennaInfo-r10 SEQUENCE {			
transmissionMode-r10	tm4		
codebookSubsetRestriction-r10	00000000000000000000 00000000000011111111 11111111000000000000 0000	BIT STRING	
ue-TransmitAntennaSelection CHOICE {			
release	NULL		
}			
}			
cqi-ReportConfigSCell-r10	CQI-ReportConfigSCell-r10-DEFAULT		
}			

**Table 8.2.3.3.2.1.4.3-3: CQI-ReportConfig-DEFAULT**

Derivation Path: 36.508 clause 4.6.3 Table 4.6.3-2			
Information Element	Value/remark	Comment	Condition
CQI-ReportConfig-DEFAULT ::= SEQUENCE {			
cqi-ReportModeAperiodic	rm12		
nomPDSCH-RS-EPRE-Offset	0		
cqi-ReportPeriodic	Not present		
}			

**Table 8.2.3.3.2.1.4.3-4: CQI-ReportConfig-r10-DEFAULT**

Derivation Path: 36.508 clause 4.6.3 Table 4.6.3-2AA			
Information Element	Value/remark	Comment	Condition
CQI-ReportConfig-r10 ::= SEQUENCE {			RBC
cqi-ReportAperiodic-r10	CQI-ReportAperiodic-r10-DEFAULT		
nomPDSCH-RS-EPRE-Offset	0		
cqi-ReportPeriodic-r10	Not present		
pmi-RI-Report-r9	Not present		
csi-SubframePatternConfig-r10	Not present		
}			

**Table 8.2.3.3.2.1.4.3-5: CQI-ReportAperiodic-r10-DEFAULT**

Derivation Path: 36.508 clause 4.6.3 Table 4.6.3-1A			
Information Element	Value/remark	Comment	Condition
CQI-ReportAperiodic-r10 ::= CHOICE {			
setup SEQUENCE {			
cqi-ReportModeAperiodic-r10	rm12		
aperiodicCSI-Trigger-r10 ::= SEQUENCE {			
trigger1-r10	11000000	P-Cell, S-Cell report	
trigger2-r10	00000000	No report	
}			
}			
}			

**Table 8.2.3.3.2.1.4.3-6: CQI-ReportConfigSCell-r10-DEFAULT**

Derivation Path: 36.508 clause 4.6.3 Table 4.6.3-2AB			
Information Element	Value/remark	Comment	Condition
CQI-ReportConfigSCell-r10 ::= SEQUENCE {			
cqi-ReportModeAperiodic-r10	rm12		
nomPDSCH-RS-EPRE-Offset-r10	0		
cqi-ReportPeriodicSCell-r10	Not present		
pmi-RI-Report-r10	Not present		
}			

#### 8.2.3.3.2.1.5 Test requirement

Tables 8.2.3.3.2.1.3-1 define the primary level settings.

For TDD FDD CA with TDD PCell and 2DL CCs, the requirements are specified in Table 8.2.3.3.2.1.5-3 based on single carrier requirement specified in Table 8.2.3.3.2.1.5-1 and Table 8.2.3.3.2.1.5-2.

The fraction of maximum throughput percentage for the downlink reference measurement channels specified in Annex A clause A.3.3.2 and A.3.4.2 for each throughput test shall meet or exceed the specified value in Tables 8.2.3.3.2.1.5-1 or 8.2.3.3.2.1.5-2 for the specified SNR including test tolerances for all throughput tests.

**Table 8.2.3.3.2.1.5-1: Single carrier test requirement with different bandwidths for multiple CA configurations for FDD SCell (FRC)**

Band-width	Reference Channel	OCNG Pattern	Propagation Condition	Correlation Matrix and Antenna Configuration	Reference value	
					Fraction of Maximum Throughput (%)	SNR (dB)
1.4 MHz	R.14-4 FDD	OP.1 FDD	EVA5	4x2 Low	70	[10.4]+TT
3 MHz	R.14-5 FDD	OP.1 FDD	EVA5	4x2 Low	70	[9.5] +TT
5MHz	R.14-6 FDD	OP.1 FDD	EVA5	4x2 Low	70	[9.5] +TT
10MHz	R.14 FDD	OP.1 FDD	EVA5	4x2 Low	70	[10.1] +TT
15MHz	R.14-7 FDD	OP.1 FDD	EVA5	4x2 Low	70	[10.1] +TT
20MHz	R.14-3 FDD	OP.1 FDD	EVA5	4x2 Low	70	[10.3] +TT

**Table 8.2.3.3.2.1.5-2: Single carrier test requirement with different bandwidths for multiple CA configurations for TDD PCell and SCell (FRC)**

Band-width	Reference Channel	OCNG Pattern	Propagation Condition	Correlation Matrix and Antenna Configuration	Reference value	
					Fraction of Maximum Throughput (%)	SNR (dB)
1.4 MHz	R.43-1 TDD	OP.1 TDD	EVA5	4x2 Low	70	[11.0] +TT
3 MHz	R.43-2 TDD	OP.1 TDD	EVA5	4x2 Low	70	[9.8] +TT
5MHz	R.43-3 TDD	OP.1 TDD	EVA5	4x2 Low	70	[10.0] +TT
10MHz	R.43-4 TDD	OP.1 TDD	EVA5	4x2 Low	70	[10.5] +TT
15MHz	R.43-5 TDD	OP.1 TDD	EVA5	4x2 Low	70	[10.6] +TT
20MHz	R.43 TDD	OP.1 TDD	EVA5	4x2 Low	70	[10.7] +TT

**Table 8.2.3.3.2.1.5-3: Test requirement for multiple CA configurations with 2DL CCs (FRC)**

Test number	Aggregated Bandwidth (MHz)			Minimum performance requirement	UE Category
	Total	FDD CC	TDD CC		
1	2x20	20	20	As defined in Table 8.2.3.3.2.1.5-1 and Table 8.2.3.3.2.1.5-2 per CC	≥5
2	20+10	10	20	As defined in Table 8.2.3.3.2.1.5-1 and Table 8.2.3.3.2.1.5-2 per CC	≥5
3	10+5	5	10	As defined in Table 8.2.3.3.2.1.5-1 and Table 8.2.3.3.2.1.5-2 per CC	≥3
4	20+15	15	20	As defined in Table 8.2.3.3.2.1.5-1 and Table 8.2.3.3.2.1.5-2 per CC	≥5
Note 1:	The applicability of requirements for different CA configurations and bandwidth combination sets is defined in 8.1.2.3B				

Decide pass or fail for each subtest according to Annex G.3A.4. Decide the entire test pass or fail according to Annex G.3A.6.



### 8.2.3.3.2.2 TDD FDD CA PDSCH Closed Loop Multi Layer Spatial Multiplexing 4x2 for TDD PCell (3DL CA)

Editor's note: The following aspects are either missing or not yet determined:

- SNR values are still in brackets in core spec.
- Test tolerance is FFS
- Message contents might need a update
- This test would be impacted by the simplification method defined in Annex C.3.5 of 36.101 which need to be further revised.

#### 8.2.3.3.2.2.1 Test purpose

The purpose of these tests is to verify the closed loop rank-two performance with wideband and frequency selective precoding.

#### 8.2.3.3.2.2.2 Test applicability

This test applies to all types of E-UTRA FDD and TDD Release 12 and forward UE of categories 5 or higher that support E-UTRA FDD and TDD and 3DL CA with TDD as PCell.

#### 8.2.3.3.2.2.3 Minimum conformance requirements

For TDD FDD CA with TDD PCell and 3DL CCs, the requirements are specified in Table 8.2.3.3.2.2.3-1 based on single carrier requirement specified in Table 8.2.3.3.2.1.3-2 and Table 8.2.3.3.2.1.3-3, with the addition of the parameters in Table 8.2.3.3.2.1.3-1 and the downlink physical channel setup according to Annex C.3.2.

The test coverage for different number of component carriers is defined in 8.1.2.4.

**Table 8.2.3.3.2.2.3-1: Minimum performance for multiple CA configurations with 3DL CCs (FRC)**

Test number	Aggregated Bandwidth (MHz)			Minimum performance requirement	UE Category
	Total	FDD CC	TDD CC		
1	3x20	20	2x20	As defined in Table 8.2.3.3.2.1.3-2 and Table 8.2.3.3.2.1.3-3 per CC	≥5
2	20+20+15	15	2x20	As defined in Table 8.2.3.3.2.1.3-2 and Table 8.2.3.3.2.1.3-3 per CC	≥5
3	20+20+10	10	2x20	As defined in Table 8.2.3.3.2.1.3-2 and Table 8.2.3.3.2.1.3-3 per CC	≥5
Note 1:	The applicability of requirements for different CA configurations and bandwidth combination sets is defined in 8.1.2.3B.				

The normative reference for this requirement is TS 36.101 [2] clause 8.2.3.3.2.

#### 8.2.3.3.2.2.4 Test description

##### 8.2.3.3.2.2.4.1 Initial conditions

Initial conditions are a set of test configurations the UE needs to be tested in and the steps for the SS to take with the UE to reach the correct measurement state.

Configurations of PDSCH and PDCCH before measurement are specified in Annex C.2.

Test Environment: Normal, as defined in TS 36.508 [7] clause 4.1.

Frequencies to be tested: Mid Range, as defined in TS 36.508 [7] clause 4.3.1.

Channel Bandwidths to be tested: Select one according to Table 8.2.3.3.2.2.4.1-1.

CA Capability to be tested: Select one according to Table 8.2.2.3.2.2.4.1

**Table 8.2.3.3.2.2.4.1-1: Test point selection for TM4 TDD FDD 3DL CA TDD PCell**

CA Capability	Bandwidth Combination		
	3x20	20+20+15	20+20+10
Inter-band CA (two bands) (CA3_A2)	Test1	Test2	Test3
Inter-band CA (three bands) (CA3_A3)	Test1	Test2	Test3
Note1: Only one test point is tested. Select the largest aggregated CA bandwidth combination supported by the UE among the UE supported CA capabilities.			

1. Connect the SS, the faders and AWGN noise sources to the UE antenna connectors as shown in TS 36.508 [7] Annex A, Figure A.61 as appropriate.
2. The parameter settings for Pcell are set up according to Tables 8.2.3-1, 8.2.3.3.2.1.3-1 as appropriate.
3. Downlink signals for PCC are initially set up according to Annex C.1 and Annex C.3.2 and uplink signals according to Annex H.1 and H.3.2.
4. Propagation conditions are set according to Annex B.0.
5. Ensure the UE is in State 3A-RF according to TS 36.508 [7] clause 5.2A.2. Message contents are defined in clause 8.2.3.3.2.2.4.3.

#### 8.2.3.3.2.1.4.2 Test procedure

1. Configure SCC according to Annex C.0, C.1 and Annex C.3.2 for all downlink physical channels.
2. The SS shall configure SCC as per TS 36.508 [7] clause 5.2A.4. Message contents for *PDSCH-ConfigDedicated-DEFAULT* is defined in Table 8.2.3.3.2.1.4.3-1, *PhysicalConfigDedicatedSCell-r10-DEFAULT* is defined in Table 8.2.3.3.2.1.4.3-2A, *PhysicalConfigDedicated-DEFAULT* is defined in Table 8.2.3.3.2.1.4.3-2, *CQI-ReportConfigSCell-DEFAULT* is defined in Table 8.2.3.3.2.1.4.3-4, *CQI-ReportAperiodic-r10-DEFAULT* is defined in Table 8.2.3.3.2.1.4.3-5, *CQI-ReportConfigSCell-r10-DEFAULT* is defined in Table 8.2.3.3.2.1.4.3-6.
3. SS activates SCCs by sending the activation MAC-CE (Refer TS 36.321 [13], clauses 5.13, 6.1.3.8). Wait for at least 2 seconds (Refer TS 36.133, clauses 8.3.3.2).
4. For multi-layer spatial multiplexing, SS transmits PDSCH via PDCCH DCI format 2 for C\_RNTI to transmit the DL RMC according to Tables 8.2.3.3.2.1.3-1 and 8.2.3.3.2.1.3-2 or 8.2.3.3.2.1.3-3. The SS sends downlink MAC padding bits on the DL RMC.
5. SS schedules the UL transmission to carry the PUSCH CSI feedback via PDCCH DCI format 0 with CSI request bit set to '10' and I\_MCS=29 and N\_PRB allocated to be less or equal to 20.
6. Set the parameters of the bandwidth, MCS, reference channel, the propagation condition, the correlation matrix, antenna configuration and the SNR according to Tables 8.2.3.3.2.1.5-1 or 8.2.3.3.2.1.5-2 as appropriate.
7. Measure the average throughput for a duration sufficient to achieve statistical significance according to Annex G clause G.3A.5. Count the number of NACKs, ACKs and statDTXs on the UL during the test interval and decide pass or fail according to Tables G.3.5 and G.3.6 in Annex G clause G.3.

#### 8.2.3.3.2.2.4.3 Message contents

Same Message contents as in clause 8.2.3.3.2.1.4.3.

#### 8.2.3.3.2.2.5 Test requirement

Tables 8.2.3.3.2.1.3-1 define the primary level settings.

For TDD FDD CA with TDD PCell and 3DL CCs, the requirements are specified in Table 8.2.3.3.2.2.5-1 based on single carrier requirement specified in Table 8.2.3.3.2.1.5-1 and Table 8.2.3.3.2.1.5-2.

The fraction of maximum throughput percentage for the downlink reference measurement channels specified in Annex A clause A.3.3.2 and A.3.4.2 for each throughput test shall meet or exceed the specified value in Tables 8.2.3.3.2.1.5-1 or 8.2.3.3.2.1.5-2 for the specified SNR including test tolerances for all throughput tests.

**Table 8.2.3.3.2.2.5-1: Test requirement for multiple CA configurations with 3DL CCs (FRC)**

Test number	Aggregated Bandwidth (MHz)			Minimum performance requirement	UE Category
	Total	FDD CC	TDD CC		
1	3x20	20	2x20	As defined in Table 8.2.3.3.2.1.5-1 and Table 8.2.3.3.2.1.5-2 per CC	≥5
2	20+20+15	15	2x20	As defined in Table 8.2.3.3.2.1.5-1 and Table 8.2.3.3.2.1.5-2 per CC	≥5
3	20+20+10	10	2x20	As defined in Table 8.2.3.3.2.1.5-1 and Table 8.2.3.3.2.1.5-2 per CC	≥5
Note 1: The applicability of requirements for different CA configurations and bandwidth combination sets is defined in 8.1.2.3B.					

Decide pass or fail for each subtest according to Annex G.3A.4. Decide the entire test pass or fail according to Annex G.3A.6.

## 8.3 Demodulation of PDSCH (User-Specific Reference Symbols)

### 8.3.1 FDD

The parameters specified in Table 8.3.1-1 are valid for FDD unless otherwise stated.

**Table 8.3.1-1: Common Test Parameters for User-specific Reference Symbols**

Parameter	Unit	Value
Cyclic prefix		Normal
Cell ID		0
Inter-TTI Distance		1
Number of HARQ processes	Processes	8
Maximum number of HARQ transmission		4
Redundancy version coding sequence		{0,1,2,3} for QPSK and 16QAM {0,0,1,2} for 64QAM
Number of OFDM symbols for PDCCH	OFDM symbols	2
Precoder update granularity		Frequency domain: 1 PRG for Transmission mode 9 and 10 Time domain: 1 ms
Note 1: Void		
Note 2: Void		

### 8.3.1.1 FDD PDSCH Single-layer Spatial Multiplexing Performance (UE-Specific Reference Symbols)

#### 8.3.1.1.1\_D FDD PDSCH Single-layer Spatial Multiplexing on antenna ports 7 or 8 without a simultaneous transmission for eDL-MIMO

##### 8.3.1.1.1\_D.1 Test purpose

To verify the UE's ability to receive a predefined test signal, representing a multi-path fading channel that is determined by the SNR with a percentage of the information bit throughput for a specified downlink Reference Measurement Channel (RMC) not falling below a specified value for single-layer transmission on antenna ports 7 or 8 without a simultaneous transmission on the other antenna port and multiple CSI reference symbols configurations with non-zero and zero transmission power.

##### 8.3.1.1.1\_D.2 Test applicability

This test applies to all types of E-UTRA FDD UE release 10 and forward that support eDL-MIMO. Applicability requires support for FGI bit 103.

##### 8.3.1.1.1\_D.3 Minimum conformance requirements

The requirements are specified in terms of the percentage of information bit throughput for the downlink reference measurement channels specified in Annex A clause A.3.3.3, with the addition of the relevant parameters in Tables 8.3.1-1, 8.3.1.1.1\_D.3-1, and the downlink physical channel setup according to Table C.3.2-1 in Annex C.3.2.

Using this configuration the fraction of maximum throughput percentage shall meet or exceed the minimum requirements specified in Table 8.3.1.1.1\_D.3-2 for the specified SNR.

**Table 8.3.1.1.1\_D.3-1: Test Parameters for Testing CDM-multiplexed DM RS (single layer) with multiple CSI-RS configurations**

parameter	Unit	Test 1	Test 2
Downlink power allocation	$\rho_A$	dB	0
	$\rho_B$	dB	0 (Note 1)
	$\sigma$	dB	-3
Cell-specific reference signals		Antenna ports 0,1	
CSI reference signals		Antenna ports 15,...,18	Antenna ports 15,...,18
Beamforming model		Annex B.4.1	Annex B.4.1
CSI-RS periodicity and subframe offset $T_{\text{CSI-RS}} / \Delta_{\text{CSI-RS}}$	Subframes	5 / 2	5 / 2
CSI reference signal configuration		0	3
Zero-power CSI-RS configuration $I_{\text{CSI-RS}} / \text{ZeroPowerCSI-RS}$ bitmap	Subframes / bitmap	3 / 0001000000000000	3 / 0001000000000000
$N_{oc}$ at antenna port	dBm/15kHz	-98	-98
Symbols for unused PRBs		OCNG (Note 4)	OCNG (Note 4)
Number of allocated resource blocks (Note 2)	PRB	50	50
Simultaneous transmission		No	Yes (Note 3, 5)
PDSCH transmission mode		9	9
<p>Note 1: <math>P_B = 1</math>.</p> <p>Note 2: The modulation symbols of the signal under test are mapped onto antenna port 7 or 8.</p> <p>Note 3: Modulation symbols of an interference signal is mapped onto the antenna port (7 or 8) not used for the input signal under test.</p> <p>Note 4: These physical resource blocks are assigned to an arbitrary number of virtual UEs with one PDSCH per virtual UE; the data transmitted over the OCNG PDSCHs shall be uncorrelated pseudo random data, which is QPSK modulated.</p> <p>Note 5: The two UEs' scrambling identities <math>n_{\text{SCID}}</math> are set to 0 for CDM-multiplexed DM RS with interfering simultaneous transmission test cases.</p>			

**Table 8.3.1.1.1\_D.3-2: Minimum performance for CDM-multiplexed DM RS without simultaneous transmission (FRC) with multiple CSI-RS configurations**

Test number	Bandwidth and MCS	Reference Channel	OCNG Pattern	Propagation Condition	Correlation Matrix and Antenna Configuration	Reference value		UE Category
						Fraction of Maximum Throughput (%)	SNR (dB)	
1	10 MHz QPSK 1/3	R.43 FDD	OP.1 FDD	EVA5	2x2 Low	70	-1	1-8

The normative reference for this requirement is TS 36.101 [2] clause 8.3.1.1.

## 8.3.1.1.1\_D.4 Test description

## 8.3.1.1.1\_D.4.1 Initial conditions

Initial conditions are a set of test configurations the UE needs to be tested in and the steps for the SS to take with the UE to reach the correct measurement state.

Configurations of PDSCH and PDCCH before measurement are specified in Annex C.2.

Test Environment: Normal, as defined in TS 36.508 [7] clause 4.1.

Frequencies to be tested: Mid Range, as defined in TS 36.508 [7] clause 4.3.1.1.

Bandwidths to be tested: 10MHz, as defined in TS 36.508 [7] clause 4.3.1.1.

1. Connect the SS, the faders and AWGN noise sources to the UE antenna connectors as shown in TS 36.508 [7] Annex A, Figure A.10.
2. The parameter settings for the cell are set up according to Tables 8.3.1-1 and 8.3.1.1.1\_D.3-1 as appropriate.
3. Downlink signals are initially set up according to Annex C0, C.1 and Annex C.3.2 and uplink signals according to Annex H.1 and H.3.2.
4. Propagation conditions are set according to Annex B.0.
5. Ensure the UE is in State 3A-RF according to TS 36.508 [7] clause 5.2A.2. Message contents are defined in clause 8.3.1.1.1\_D.4.3.

## 8.3.1.1.1\_D.4.2 Test procedure

1. SS transmits PDSCH via PDCCH DCI format 2C for C\_RNTI to transmit the DL RMC according to Tables 8.3.1.1.1\_D.3-1, 8.3.1.1.1\_D.3-2. The SS sends downlink MAC padding bits on the DL RMC.
2. Set the parameters of the bandwidth, MCS, reference channel, the propagation condition, the correlation matrix and the SNR according to Table 8.3.1.1.1\_D.5-1 as appropriate.  
BCH/CRS/PDCCH/PCFICH are sent on antenna ports 0 and 1 using two Tx antennas, while DRS/PDSCH for the test UE are sent on antenna port 7 (or 8) using two Tx antennas with beam-forming model as specified in Annex B.4.1 and precoder update granularity specified in Table 8.3.1-1. CSI-RS are sent on antenna ports 15-18 using two Tx antennas with mapping according to beam-forming model as specified in Annex B.4.1.
3. Measure the average throughput for a duration sufficient to achieve statistical significance according to Annex G clause G.3. Count the number of NACKs, ACKs and statDTXs on the UL during each test interval and decide pass or fail according to Tables G.3.5 and G.3.6 in Annex G clause G.3.

## 8.3.1.1.1\_D.4.3 Message contents

Message contents are according to TS 36.508 [7] clause 4.6 with the following exceptions:

**Table 8.3.1.1.1\_D.4.3-1: PDSCH-ConfigDedicated-DEFAULT**

Derivation Path: 36.331 clause 6.3.2			
Information Element	Value/remark	Comment	Condition
PDSCH-ConfigDedicated-DEFAULT ::= SEQUENCE {			
p-a	dB0		
}			

Table 8.3.1.1.1\_D.4.3-2: *PhysicalConfigDedicated-DEFAULT*

Derivation Path: TS 36.508 [7] clause 4.8.2.1.6 Table 4.8.2.1.6-1 PhysicalConfigDedicated-DEFAULT			
Information Element	Value/remark	Comment	Condition
PhysicalConfigDedicated-DEFAULT ::= SEQUENCE {			
antennaInfo	Not present		
antennaInfo-r10 CHOICE{			
explicitValue-r10	AntennaInfoDedicated-r10		
}			
csi-RS-Config-r10	CSI-RS-Config-r10		
}			

Table 8.3.1.1.1\_D.4.3-3: *AntennaInfoDedicated-r10*

Derivation Path: 36.331 clause 6.3.2			
Information Element	Value/remark	Comment	Condition
AntennaInfoDedicated-r10 ::= SEQUENCE {			
transmissionMode-r10	tm9-v1020		
codebookSubsetRestriction-r10	Not present	If the UE is configured with <i>transmissionMode</i> tm9, E-UTRAN only configures the field <i>codebookSubsetRestriction</i> if PMI/RI reporting is configured	
ue-TransmitAntennaSelection CHOICE {			
}			
release	NULL		
}			

**Table 8.3.1.1.1\_D.4.3-4: CSI-RS-Config-r10**

Derivation Path: 36.331 clause 6.3.2			
Information Element	Value/remark	Comment	Condition
CSI-RS-Config-r10 ::= SEQUENCE {			
csi-RS-r10 CHOICE{			
setup SEQUENCE {			
antennaPortsCount-r10	an4	Parameter represents the number of antenna ports used for transmission of CSI reference signals	
resourceConfig-r10	0	Parameter: CSI reference signal configuration	
subframeConfig-r10	2	$\Delta_{CSI-RS} = I_{CSI-RS}$ when CSI-RS SubframeConfig is from 0-4; Parameter: $I_{CSI-RS}$	
p-C-r10	-3 dB	Parameter: $P_c$ which is the assumed ratio of PDSCH EPRE to CSI-RS EPRE when UE derives CSI feedback	
}			
}			
zeroTxPowerCSI-RS-r10 CHOICE{			
setup SEQUENCE {			
zeroTxPowerResourceConfigList-r10	3	Parameter: $ZeroPowerCSI-RS$	
zeroTxPowerSubframeConfig-r10	3	Parameter: $I_{CSI-RS}$	
}			
}			
}			

8.3.1.1.1\_D.5 Test requirement

Table 8.3.1.1.1\_D.3-1 defines the primary level settings.

The fraction of maximum throughput percentage for the downlink reference measurement channels specified in Annex A clause A.3.3.3.2 for the throughput test shall meet or exceed the specified value in Table 8.3.1.1.1\_D.5-1 for the specified SNR including test tolerances for the throughput test.

**Table 8.3.1.1.1\_D.5-1: Test requirement for CDM-multiplexed DM RS without simultaneous transmission (FRC) with multiple CSI-RS configurations**

Test number	Bandwidth and MCS	Reference Channel	OCNG Pattern	Propagation Condition	Correlation Matrix and Antenna Configuration	Reference value		UE Category
						Fraction of Maximum Throughput (%)	SNR (dB)	
1	10 MHz QPSK 1/3	R.43 FDD	OP.1 FDD	EVA5	2x2 Low	70	-0.1	1-8



### 8.3.1.1.2\_D FDD PDSCH Single-layer Spatial Multiplexing on antenna ports 7 or 8 with a simultaneous transmission for eDL-MIMO

#### 8.3.1.1.2\_D.1 Test purpose

To verify the UE's ability to receive a predefined test signal, representing a multi-path fading channel that is determined by the SNR with a percentage of the information bit throughput for a specified downlink Reference Measurement Channel (RMC) not falling below a specified value for single-layer transmission on antenna ports 7 or 8 with a simultaneous transmission on the other antenna port and multiple CSI reference symbols configurations with non-zero and zero transmission power.

#### 8.3.1.1.2\_D.2 Test applicability

This test applies to all types of E-UTRA FDD UE release 10 and forward that support eDL-MIMO. Applicability requires support for FGI bit 103.

#### 8.3.1.1.2\_D.3 Minimum conformance requirements

The requirements are specified in terms of the percentage of information bit throughput for the downlink reference measurement channels specified in Annex A clause A.3.3.3, with the addition of the relevant parameters in Tables 8.3.1-1, 8.3.1.1.2\_D.3-1, and the downlink physical channel setup according to Table C.3.2-1 in Annex C.3.2.

Using this configuration the fraction of maximum throughput percentage shall meet or exceed the minimum requirements specified in Table 8.3.1.1.2\_D.3-2 for the specified SNR.

**Table 8.3.1.1.2\_D.3-1: Test Parameters for Testing CDM-multiplexed DM RS (single layer) with multiple CSI-RS configurations**

parameter	Unit	Test 1	Test 2
Downlink power allocation	$\rho_A$	dB	0
	$\rho_B$	dB	0 (Note 1)
	$\sigma$	dB	-3
Cell-specific reference signals		Antenna ports 0,1	
CSI reference signals		Antenna ports 15,...,18	Antenna ports 15,...,18
Beamforming model		Annex B.4.1	Annex B.4.1
CSI-RS periodicity and subframe offset $T_{\text{CSI-RS}} / \Delta_{\text{CSI-RS}}$	Subframes	5 / 2	5 / 2
CSI reference signal configuration		0	3
Zero-power CSI-RS configuration $I_{\text{CSI-RS}} / \text{ZeroPowerCSI-RS}$ bitmap	Subframes / bitmap	3 / 0001000000000000	3 / 0001000000000000
$N_{oc}$ at antenna port	dBm/15kHz	-98	-98
Symbols for unused PRBs		OCNG (Note 4)	OCNG (Note 4)
Number of allocated resource blocks (Note 2)	PRB	50	50
Simultaneous transmission		No	Yes (Note 3, 5)
PDSCH transmission mode		9	9
Note 1: $P_B = 1$ . Note 2: The modulation symbols of the signal under test are mapped onto antenna port 7 or 8. Note 3: Modulation symbols of an interference signal is mapped onto the antenna port (7 or 8) not used for the input signal under test. Note 4: These physical resource blocks are assigned to an arbitrary number of virtual UEs with one PDSCH per virtual UE; the data transmitted over the OCNG PDSCHs shall be uncorrelated pseudo random data, which is QPSK modulated. Note 5: The two UEs' scrambling identities $n_{\text{SCID}}$ are set to 0 for CDM-multiplexed DM RS with interfering simultaneous transmission test cases.			

**Table 8.3.1.1.2\_D.3-2: Minimum performance for CDM-multiplexed DM RS with interfering simultaneous transmission (FRC) with multiple CSI-RS configurations**

Test number	Bandwidth and MCS	Reference Channel	OCNG Pattern	Propagation Condition	Correlation Matrix and Antenna Configuration	Reference value		UE Category
						Fraction of Maximum Throughput (%)	SNR (dB)	
2	10 MHz 64QAM 1/2	R.50 FDD	OP.1 FDD	EPA5	2x2 Low	70	21.9	2-8
Note 1: The reference channel applies to both the input signal under test and the interfering signal.								

The normative reference for this requirement is TS 36.101 [2] clause 8.3.1.1.

## 8.3.1.1.2\_D.4 Test description

## 8.3.1.1.2\_D.4.1 Initial conditions

Initial conditions are a set of test configurations the UE needs to be tested in and the steps for the SS to take with the UE to reach the correct measurement state.

Configurations of PDSCH and PDCCH before measurement are specified in Annex C.2.

Test Environment: Normal, as defined in TS 36.508 [7] clause 4.1.

Frequencies to be tested: Mid Range, as defined in TS 36.508 [7] clause 4.3.1.1.

Bandwidths to be tested: 10MHz, as defined in TS 36.508 [7] clause 4.3.1.1.

1. Connect the SS, the faders and AWGN noise sources to the UE antenna connectors as shown in TS 36.508 [7] Annex A, Figure A.10.
2. The parameter settings for the cell are set up according to Tables 8.3.1-1 and 8.3.1.1.2\_D.3-1 as appropriate.
3. Downlink signals are initially set up according to Annex C0, C.1 and Annex C.3.2 and uplink signals according to Annex H.1 and H.3.2.
4. Propagation conditions are set according to Annex B.0.
5. Ensure the UE is in State 3A-RF according to TS 36.508 [7] clause 5.2A.2. Message contents are defined in clause 8.3.1.1.2\_D.4.3.

## 8.3.1.1.2\_D.4.2 Test procedure

1. SS transmits PDSCH via PDCCH DCI format 2C for C\_RNTI to transmit the DL RMC according to Tables 8.3.1.1.2\_D.3-1, 8.3.1.1.2\_D.3-2. The SS sends downlink MAC padding bits on the DL RMC.
2. Set the parameters of the bandwidth, MCS, reference channel, the propagation condition, the correlation matrix and the SNR according to Table 8.3.1.1.2\_D.5-1 as appropriate. BCH/CRS/PDCCH/PCFICH are sent on antenna ports 0 and 1 using two Tx antennas, while DRS/PDSCH for the test UE are sent on antenna port 7 (or 8) and another simultaneous transmission of DRS/PDSCH not for the test UE are sent on antenna port 8 (or 7). The DRS/PDSCH transmissions use two Tx antennas with beam-forming model as specified in Annex B.4.1 and precoder update granularity specified in Table 8.3.1-1. CSI-RS are sent on antenna ports 15-18 using two Tx antennas with mapping according to beam-forming model as specified in Annex B.4.1.
3. Measure the average throughput for a duration sufficient to achieve statistical significance according to Annex G clause G.3. Count the number of NACKs, ACKs and statDTXs on the UL during each test interval and decide pass or fail according to Tables G.3.5 and G.3.6 in Annex G clause G.3.

## 8.3.1.1.2\_D.4.3 Message contents

Message contents are according to TS 36.508 [7] clause 4.6 with the following exceptions:

**Table 8.3.1.1.2\_D.4.3-1: PDSCH-ConfigDedicated-DEFAULT**

Derivation Path: 36.331 clause 6.3.2			
Information Element	Value/remark	Comment	Condition
PDSCH-ConfigDedicated-DEFAULT ::= SEQUENCE {			
p-a	dB0		
}			

Table 8.3.1.1.2\_D.4.3-2: *PhysicalConfigDedicated-DEFAULT*

Derivation Path: TS 36.508 [7] clause 4.8.2.1.6 Table 4.8.2.1.6-1 PhysicalConfigDedicated-DEFAULT			
Information Element	Value/remark	Comment	Condition
PhysicalConfigDedicated-DEFAULT ::= SEQUENCE {			
antennaInfo	Not present		
antennaInfo-r10 CHOICE{			
explicitValue-r10	AntennaInfoDedicated-r10		
}			
csi-RS-Config-r10	CSI-RS-Config-r10		
}			

Table 8.3.1.1.2\_D.4.3-3: *AntennaInfoDedicated-r10*

Derivation Path: 36.331 clause 6.3.2			
Information Element	Value/remark	Comment	Condition
AntennaInfoDedicated-r10 ::= SEQUENCE {			
transmissionMode-r10	tm9-v1020		
codebookSubsetRestriction-r10	Not present	If the UE is configured with <i>transmissionMode</i> tm9, E-UTRAN only configures the field <i>codebookSubsetRestriction</i> if PMI/RI reporting is configured	
ue-TransmitAntennaSelection CHOICE {			
release	NULL		
}			
}			

**Table 8.3.1.1.2\_D.4.3-4: CSI-RS-Config-r10**

Derivation Path: 36.331 clause 6.3.2			
Information Element	Value/remark	Comment	Condition
CSI-RS-Config-r10 ::= SEQUENCE {			
csi-RS-r10 CHOICE{			
setup SEQUENCE {			
antennaPortsCount-r10	an4	Parameter represents the number of antenna ports used for transmission of CSI reference signals	
resourceConfig-r10	3	Parameter: CSI reference signal configuration	
subframeConfig-r10	2	$\Delta_{CSI-RS} = I_{CSI-RS}$ when CSI-RS SubframeConfig is from 0-4; Parameter: $I_{CSI-RS}$	
p-C-r10	-3 dB	Parameter: $P_c$ which is the assumed ratio of PDSCH EPRE to CSI-RS EPRE when UE derives CSI feedback	
}			
}			
zeroTxPowerCSI-RS-r10 CHOICE{			
setup SEQUENCE {			
zeroTxPowerResourceConfigList-r10	3	Parameter: $ZeroPowerCSI-RS$	
zeroTxPowerSubframeConfig-r10	2	Parameter: $I_{CSI-RS}$	
}			
}			
}			

8.3.1.1.2\_D.5 Test requirement

Table 8.3.1.1.2\_D.3-1 defines the primary level settings.

The fraction of maximum throughput percentage for the downlink reference measurement channels specified in Annex A clause A.3.3.3.2 for the throughput test shall meet or exceed the specified value in Table 8.3.1.1.2\_D.5-1 for the specified SNR including test tolerances for the throughput test.

**Table 8.3.1.1.2\_D.5-1: Test requirement for CDM-multiplexed DM RS with interfering simultaneous transmission (FRC) with multiple CSI-RS configurations**

Test number	Bandwidth and MCS	Reference Channel	OCNG Pattern	Propagation Condition	Correlation Matrix and Antenna Configuration	Reference value		UE Category
						Fraction of Maximum Throughput (%)	SNR (dB)	
2	10 MHz 64QAM 1/2	R.50 FDD	OP.1 FDD	EPA5	2x2 Low	70	22.8	2-8

Note 1: The reference channel applies to both the input signal under test and the interfering signal.

### 8.3.1.1.3 FDD PDSCH Single-layer Spatial Multiplexing on antenna ports 7 or 8 with TM9 Interference Model - Enhanced Performance Requirement Type A

#### 8.3.1.1.3.1 Test purpose

To verify the UE's ability to receive a predefined test signal, representing a multi-path fading channel that is determined by the SNR with a percentage of the information bit throughput for a specified downlink Reference Measurement Channel (RMC) not falling below a specified value for single-layer transmission on antenna ports 7 or 8 without a simultaneous transmission on the other antenna port in the serving cell when the PDSCH transmission in the serving cell is interfered by PDSCH of one dominant interfering cell applying transmission mode 9 interference model defined in clause B.5.4.

#### 8.3.1.1.3.2 Test applicability

This test applies to all types of E-UTRA FDD UE release 11 and forward that support enhanced receiver Type A.

#### 8.3.1.1.3.3 Minimum conformance requirements

The requirements are specified in terms of the percentage of information bit throughput for the downlink reference measurement channels specified in Annex A clause A.3.3.3, with the addition of the relevant parameters in Tables 8.3.1-1, 8.3.1.1.3.3-1, and the downlink physical channel setup according to Table C.3.2-1 in Annex C.3.2.

Using this configuration the fraction of maximum throughput percentage shall meet or exceed the minimum requirements specified in Table 8.3.1.1.3.3-2 for the specified SNR.

**Table 8.3.1.1.3.3-1: Test Parameters for Testing CDM-multiplexed DM RS (single layer) with TM9 interference model**

parameter		Unit	Cell 1	Cell 2
Downlink power allocation	$\rho_A$	dB	0	0
	$\rho_B$	dB	0 (Note 1)	0
	$\sigma$	dB	-3	-3
Cell-specific reference signals			Antenna ports 0,1	Antenna ports 0,1
CSI reference signals			Antenna ports 15,...,18	N/A
CSI-RS periodicity and subframe offset $T_{\text{CSI-RS}} / \Delta_{\text{CSI-RS}}$		Subframes	5 / 2	N/A
CSI reference signal configuration			0	N/A
$N_{oc}$ at antenna port		dBm/15kHz	-98	N/A
DIP (Note 2)		dB	N/A	-1.73
$BW_{\text{Channel}}$		MHz	10	10
Cyclic Prefix			Normal	Normal
Cell Id			0	126
Number of control OFDM symbols			2	2
PDSCH transmission mode			9	N/A
Beamforming model			As specified in clause B.4.3 (Note 4, 5)	N/A
Interference model			N/A	As specified in clause B.5.4
Probability of occurrence of transmission rank in interfering cells	Rank 1		N/A	70
	Rank 2		N/A	30
Precoder update granularity		PRB	50	6
PMI delay (Note 5)		Ms	8	N/A
Reporting interval		Ms	5	N/A
Reporting mode			PUCCH 1-1	N/A
CodeBookSubsetRestriction bitmap			0000000000000000 0000000000000000 0000000000000000 1111111111111111	N/A
Symbols for unused PRBs			OCNG (Note 6)	N/A
Simultaneous transmission			No simultaneous transmission on the other antenna port in (7 or 8) not used for the input signal under test	N/A
Note 1: $P_B = 1$ Note 2: The respective received power spectral density of each interfering cell relative to $N_{oc}$ is defined by its associated DIP value as specified in clause B.5.1. Note 3: The modulation symbols of the signal under test in Cell 1 are mapped onto antenna port 7 or 8. Note 4: The precoder in clause B.4.3 follows UE recommended PMI. Note 5: If the UE reports in an available uplink reporting instance at subframe SF#n based on PMI estimation at a downlink SF not later than SF#(n-4), this reported PMI				

Note 6:	cannot be applied at the eNB downlink before SF#(n+4). These physical resource blocks are assigned to an arbitrary number of virtual UEs with one PDSCH per virtual UE; the data transmitted over the OCNG PDSCHs shall be uncorrelated pseudo random data, which is QPSK modulated.
Note 7:	All cells are time-synchronous.

**Table 8.3.1.1.3.3-2: Enhanced Performance Requirement Type A, CDM-multiplexed DM RS with TM9 interference model**

Test Number	Reference Channel	OCNG Pattern		Propagation Conditions		Correlation Matrix and Antenna Configuration (Note 3)	Reference Value		UE Category
		Cell 1	Cell 2	Cell 1	Cell 2		Fraction of Maximum Throughput (%)	SINR (dB) (Note 2)	
1	R.48 FDD	OP.1 FDD	N/A	EVA5	EVA5	4x2 Low	70	-1.1	1-8
Note 1: The propagation conditions for Cell 1 and Cell 2 are statistically independent.									
Note 2: SINR corresponds to $\hat{E}_s / N_{oc}$ of Cell 1 as defined in clause 8.1.1.									
Note 3: Correlation matrix and antenna configuration parameters apply for each of Cell 1 and Cell 2.									

The normative reference for this requirement is TS 36.101 [2] clause 8.3.1.1A.

#### 8.3.1.1.3.4 Test description

##### 8.3.1.1.3.4.1 Initial conditions

Initial conditions are a set of test configurations the UE needs to be tested in and the steps for the SS to take with the UE to reach the correct measurement state.

Configurations of PDSCH and PDCCH before measurement are specified in Annex C.2.

Test Environment: Normal, as defined in TS 36.508 [7] clause 4.1.

Frequencies to be tested: Mid Range, as defined in TS 36.508 [7] clause 4.3.1.1.

Bandwidths to be tested: 10MHz, as defined in TS 36.508 [7] clause 4.3.1.1.

1. Connect the SS, the faders and AWGN noise sources to the UE antenna connectors as shown in TS 36.508 [7] Annex A, Figure A.49.
2. The parameter settings for the cell are set up according to Tables 8.3.1-1 and 8.3.1.1.3.5-1 as appropriate.
3. Downlink signals are initially set up according to Annex C0, C.1 and Annex C.3.2 and uplink signals according to Annex H.1 and H.3.2.
4. Propagation conditions are set according to Annex B.0.
5. Ensure the UE is in State 3A-RF according to TS 36.508 [7] clause 5.2A.2. Message contents are defined in clause 8.3.1.1.3.4.3.

##### 8.3.1.1.3.4.2 Test procedure

1. SS transmits PDSCH via PDCCH DCI format 2C for C\_RNTI to transmit the DL RMC according to Tables 8.3.1.1.3.5-1, 8.3.1.1.3.5-2. The SS sends downlink MAC padding bits on the DL RMC.
2. Set the parameters of the bandwidth, MCS, reference channel, the propagation condition, the correlation matrix and the SNR according to Table 8.3.1.1.3.5-2 as appropriate.  
BCH/CRS/PDCCH/PCFICH are sent on antenna ports 0 and 1 using two Tx antennas, while DRS/PDSCH for the test UE are sent on antenna port 7 (or 8) using four Tx antennas with beam-forming model as specified in



Annex B.4.3 and precoder update granularity specified in Table 8.3.1.1.3.5-1. CSI-RS are sent on antenna ports 15-18 using four Tx antennas with mapping according to beam-forming model as specified in Annex B.4.3.

3. Set the Cell2 –aggressor cell- as defined in Tables 8.3.1.1.3.5-1, 8.3.1.1.3.5-2 and according to Annex B.5.4.
4. Measure the average throughput for a duration sufficient to achieve statistical significance according to Annex G clause G.3. Count the number of NACKs, ACKs and statDTXs on the UL during each test interval and decide pass or fail according to Tables G.3.5 and G.3.6 in Annex G clause G.3.

8.3.1.1.3.4.3 Message contents

Message contents are according to TS 36.508 [7] clause 4.6 with the following exceptions:

**Table 8.3.1.1.3.4.3-1: PDSCH-ConfigDedicated-DEFAULT**

Derivation Path: TS 36.508 [7] clause 4.6.3, Table 4.6.3-6 PDSCH-ConfigDedicated-DEFAULT			
Information Element	Value/remark	Comment	Condition
PDSCH-ConfigDedicated-DEFAULT ::= SEQUENCE {			
p-a	dB0		
}			

**Table 8.3.1.1.3.4.3-2: AntennaInfoDedicated-r10**

Derivation Path: 36.331 clause 6.3.2			
Information Element	Value/remark	Comment	Condition
AntennaInfoDedicated-r10 ::= SEQUENCE {			
transmissionMode-r10	tm9-v1020		
codebookSubsetRestriction-r10	000000000000000000 000000000000000000 000000000000111111 1111111111		
ue-TransmitAntennaSelection CHOICE {			
release	NULL		
}			
}			

Table 8.3.1.1.3.4.3-3: CSI-RS-Config-r10

Derivation Path: 36.331 clause 6.3.2			
Information Element	Value/remark	Comment	Condition
CSI-RS-Config-r10 ::= SEQUENCE {			
csi-RS-r10 CHOICE{			
setup SEQUENCE {			
antennaPortsCount-r10	an4	Parameter represents the number of antenna ports used for transmission of CSI reference signals	
resourceConfig-r10	0	Parameter: CSI reference signal configuration	
subframeConfig-r10	2	$\Delta_{\text{CSI-RS}} = I_{\text{CSI-RS}}$ when CSI-RS SubframeConfig is from 0-4; Parameter: $I_{\text{CSI-RS}}$	
p-C-r10	-3 dB	Parameter: $P_c$ which is the assumed ratio of PDSCH EPRE to CSI-RS EPRE when UE derives CSI feedback	
}			
}			
zeroTxPowerCSI-RS-r10 CHOICE{			
release	NULL		
}			
}			

Table 8.3.1.1.3.4.3-4: CQI-ReportPeriodic-r10

Derivation Path: TS 36.508 [7] clause 4.6.3, Table 4.6.3-2AC CQI-ReportPeriodic-r10-DEFAULT			
Information Element	Value/remark	Comment	Condition
CQI-ReportPeriodic-r10 ::= CHOICE {			
setup SEQUENCE {			
cqi-PUCCH-ResourceIndex-r10	0		
cqi-PUCCH-ResourceIndexP1-r10	Not present		
cqi-pmi-ConfigIndex	5	FDD	
cqi-FormatIndicatorPeriodic-r10 CHOICE {			
widebandCQI-r10 SEQUENCE {			
csi-ReportMode-r10	Not present		
}			
}			
ri-ConfigIndex	483	FDD	
simultaneousAckNackAndCQI	FALSE		
cqi-Mask-r9	Not present		
csi-ConfigIndex-r10	Not present		
}			
}			

**Table 8.3.1.1.3.4.3-5: PhysicalConfigDedicated-DEFAULT**

Derivation Path: TS 36.508 [7] clause 4.8.2.1.6 Table 4.8.2.1.6-1 PhysicalConfigDedicated-DEFAULT			
Information Element	Value/remark	Comment	Condition
PhysicalConfigDedicated-DEFAULT ::= SEQUENCE {			
cqi-ReportConfig	Not present		RBC
antennaInfo	Not present		RBC
antennaInfo-r10 CHOICE{			RBC
explicitValue-r10	AntennaInfoDedicated-r10		
}			
cqi-ReportConfig-r10	CQI-ReportConfig-r10-DEFAULT using condition CQI_PERIODIC		RBC
csi-RS-Config-r10	CSI-RS-Config-r10		RBC
}			

Condition	Explanation
RBC	Used at configuration of a radio bearer combination during SRB2+DRB establishment

**Table 8.3.1.1.3.4.3-6: CQI-ReportConfig-r10-DEFAULT**

Derivation Path: TS 36.508 [7] clause 4.6.3			
Information Element	Value/remark	Comment	Condition
CQI-ReportConfig-r10 ::= SEQUENCE {			
cqi-ReportAperiodic-r10	Not Present		
pmi-RI-Report-r9	setup		
}			

#### 8.3.1.1.3.5 Test requirement

Table 8.3.1.1.3.5-1 defines the primary level settings.

**Table 8.3.1.1.3.5-1: Test Parameters for Testing CDM-multiplexed DM RS (single layer) with TM9 interference model**

parameter		Unit	Cell 1	Cell 2
Downlink power allocation	$\rho_A$	dB	0	0
	$\rho_B$	dB	0 (Note 1)	0
	$\sigma$	dB	-3	-3
Cell-specific reference signals			Antenna ports 0,1	Antenna ports 0,1
CSI reference signals			Antenna ports 15,...,18	N/A
CSI-RS periodicity and subframe offset $T_{\text{CSI-RS}} / \Delta_{\text{CSI-RS}}$		Subframes	5 / 2	N/A
CSI reference signal configuration			0	N/A
$N_{oc}$ at antenna port		dBm/15kHz	-98	N/A
DIP (Note 2)		dB	N/A	-1.45
$BW_{\text{Channel}}$		MHz	10	10
Cyclic Prefix			Normal	Normal
Cell Id			0	126
Number of control OFDM symbols			2	2
PDSCH transmission mode			9	N/A
Beamforming model			As specified in clause B.4.3 (Note 4, 5)	N/A
Interference model			N/A	As specified in clause B.5.4
Probability of occurrence of transmission rank in interfering cells	Rank 1		N/A	70
	Rank 2		N/A	30
Precoder update granularity		PRB	50	6
PMI delay (Note 5)		Ms	8	N/A
Reporting interval		Ms	5	N/A
Reporting mode			PUCCH 1-1	N/A
CodeBookSubsetRestriction bitmap			0000000000000000 0000000000000000 0000000000000000 1111111111111111	N/A
Symbols for unused PRBs			OCNG (Note 6)	N/A
Simultaneous transmission			No simultaneous transmission on the other antenna port in (7 or 8) not used for the input signal under test	N/A
Note 1: $P_B = 1$				
Note 2: The respective received power spectral density of each interfering cell relative to $N_{oc}$ is defined by its associated DIP value as specified in clause B.5.1.				
Note 3: The modulation symbols of the signal under test in Cell 1 are mapped onto antenna port 7 or 8.				
Note 4: The precoder in clause B.4.3 follows UE recommended PMI.				
Note 5: If the UE reports in an available uplink reporting instance at subframe SF#n based on PMI estimation at a downlink SF not later than SF#(n-4), this reported PMI				

Note 6:	cannot be applied at the eNB downlink before SF#(n+4). These physical resource blocks are assigned to an arbitrary number of virtual UEs with one PDSCH per virtual UE; the data transmitted over the OCNG PDSCHs shall be uncorrelated pseudo random data, which is QPSK modulated.
Note 7:	All cells are time-synchronous.

The fraction of maximum throughput percentage for the downlink reference measurement channels specified in Annex A clause A.3.3.3.2 for the throughput test shall meet or exceed the specified value in Table 8.3.1.1.3.5-2 for the specified SNR including test tolerances for the throughput test.

**Table 8.3.1.1.3.5-2: Enhanced Performance Requirement Type A, CDM-multiplexed DM RS with TM9 interference model**

Test Number	Reference Channel	OCNG Pattern		Propagation Conditions		Correlation Matrix and Antenna Configuration (Note 3)	Reference Value		UE Category
		Cell 1	Cell 2	Cell 1	Cell 2		Fraction of Maximum Throughput (%)	SINR (dB) (Note 2)	
1	R.48 FDD	OP.1 FDD	N/A	EVA5	EVA5	4x2 Low	70	-0.12	1-8
Note 1: The propagation conditions for Cell 1 and Cell 2 are statistically independent.									
Note 2: SINR corresponds to $\hat{E}_s / N_{oc}$ of Cell 1 as defined in clause 8.1.1.									
Note 3: Correlation matrix and antenna configuration parameters apply for each of Cell 1 and Cell 2.									

### 8.3.1.2 FDD PDSCH Dual-layer Spatial Multiplexing Performance (UE-Specific Reference Symbols)

#### 8.3.1.2.1\_D FDD PDSCH Dual-layer Spatial Multiplexing for eDL-MIMO

##### 8.3.1.2.1\_D.1 Test purpose

To verify the UE's rank-2 performance and ability to receive a predefined test signal, representing a multi-path fading channel that is determined by the SNR with a percentage of the information bit throughput for a specified downlink Reference Measurement Channel (RMC) not falling below a specified value for dual-layer transmission on antenna ports 7 and 8 using DM-RS with full RB allocation with multiple CSI reference symbol configurations with non-zero and zero transmission power.

##### 8.3.1.2.1\_D.2 Test applicability

This test applies to all types of E-UTRA FDD UE release 10 that support eDL-MIMO. Applicability requires support for FGI bit 103.

##### 8.3.1.2.1\_D.3 Minimum conformance requirements

The requirements are specified in terms of the percentage of information bit throughput for the downlink reference measurement channels specified in Annex A clause A.3.3.3, with the addition of the relevant parameters in Tables 8.3.1-1, 8.3.1.2.1\_D.3-1, and the downlink physical channel setup according to Table C.3.2-1 in Annex C.3.2.

Using this configuration the fraction of maximum throughput percentage shall meet or exceed the minimum requirements specified in Table 8.3.1.2.1\_D.3-2 for the specified SNR.

**Table 8.3.1.2.1\_D.3-1: Test Parameters for Testing CDM-multiplexed DM RS (dual layer) with multiple CSI-RS configurations**

parameter	Unit	Test 1	
Downlink power allocation	$\rho_A$	dB	0
	$\rho_B$	dB	0 (Note 1)
	$\sigma$	dB	-3
Cell-specific reference signals		Antenna ports 0 and 1	
CSI reference signals		Antenna ports 15,16	
Beamforming model		Annex B.4.2	
CSI-RS periodicity and subframe offset $T_{\text{CSI-RS}} / \Delta_{\text{CSI-RS}}$	Subframes	5 / 2	
CSI reference signal configuration		8	
Zero-power CSI-RS configuration $l_{\text{CSI-RS}} / \text{ZeroPowerCSI-RS}$ bitmap	Subframes / bitmap	3 / 0010000000000000	
$N_{oc}$ at antenna port	dBm/15kHz	-98	
Symbols for unused PRBs		OCNG (Note 2)	
Number of allocated resource blocks (Note 2)	PRB	50	
Simultaneous transmission		No	
PDSCH transmission mode		9	
Note 1: $P_B = 1$ . Note 2: These physical resource blocks are assigned to an arbitrary number of virtual UEs with one PDSCH per virtual UE; the data transmitted over the OCNG PDSCHs shall be uncorrelated pseudo random data, which is QPSK modulated.			

**Table 8.3.1.2.1\_D.3-2: Minimum performance for CDM-multiplexed DM RS (FRC) with multiple CSI-RS configurations**

Test number	Bandwidth and MCS	Reference Channel	OCNG Pattern	Propagation Condition	Correlation Matrix and Antenna Configuration	Reference value		UE Category
						Fraction of Maximum Throughput (%)	SNR (dB)	
1	10 MHz 16QAM 1/2	R.51 FDD	OP.1 FDD	EPA5	2x2 Low	70	13.3	2-8

The normative reference for this requirement is TS 36.101 [2] clause 8.3.1.2.

8.3.1.2.1\_D.4 Test description

8.3.1.2.1\_D.4.1 Initial conditions

Initial conditions are a set of test configurations the UE needs to be tested in and the steps for the SS to take with the UE to reach the correct measurement state.

Configurations of PDSCH and PDCCH before measurement are specified in Annex C.2.

Test Environment: Normal, as defined in TS 36.508 [7] clause 4.1.

Frequencies to be tested: Mid Range, as defined in TS 36.508 [7] clause 4.3.1.1.

Bandwidths to be tested: 10MHz, as defined in TS 36.508 [7] clause 4.3.1.1.

1. Connect the SS, the faders and AWGN noise sources to the UE antenna connectors as shown in TS 36.508 [7] Annex A, Figure A.10.
2. The parameter settings for the cell are set up according to Tables 8.3.1-1 and 8.3.1.2.1\_D.3-1 as appropriate.
3. Downlink signals are initially set up according to Annex C0, C.1 and Annex C.3.2 and uplink signals according to Annex H.1 and H.3.2.
4. Propagation conditions are set according to Annex B.0.
5. Ensure the UE is in State 3A-RF according to TS 36.508 [7] clause 5.2A.2. Message contents are defined in clause 8.3.1.2.1\_D.4.3.

8.3.1.2.1\_D.4.2 Test procedure

1. SS transmits PDSCH via PDCCH DCI format 2C for C\_RNTI to transmit the DL RMC according to Tables 8.3.1.2.1\_D.3-1, 8.3.1.2.1\_D.3-2. The SS sends downlink MAC padding bits on the DL RMC.
2. Set the parameters of the bandwidth, MCS, reference channel, the propagation condition, the correlation matrix and the SNR according to Table 8.3.1.2.1\_D.5-1 as appropriate.  
 BCH/CRS/PDCCH/PCFICH are sent on antenna ports 0 and 1 using two Tx antennas, while DRS/ PDSCH for the test UE are sent on antenna ports 7 and 8 using two Tx antennas with beam-forming model as specified in Annex B.4.2 and precoder update granularity specified in Table 8.3.1-1. CSI-RS are sent on antenna ports 15 and 16 using two Tx antennas with mapping according to beam-forming model as specified in Annex B.4.2.
3. Measure the average throughput for a duration sufficient to achieve statistical significance according to Annex G clause G.3. Count the number of NACKs, ACKs and statDTXs on the UL during each test interval and decide pass or fail according to Tables G.3.5 and G.3.6 in Annex G clause G.3.

8.3.1.2.1\_D.4.3 Message contents

Message contents are according to TS 36.508 [7] clause 4.6 with the following exceptions:

**Table 8.3.1.2.1\_D.4.3-1: PDSCH-ConfigDedicated-DEFAULT**

Derivation Path: 36.331 clause 6.3.2			
Information Element	Value/remark	Comment	Condition
PDSCH-ConfigDedicated-DEFAULT ::= SEQUENCE {			
p-a	dB0		
}			

**Table 8.3.1.2.1\_D.4.3-2: PhysicalConfigDedicated-DEFAULT**

Derivation Path: TS 36.508 [7] clause 4.8.2.1.6 Table 4.8.2.1.6-1 PhysicalConfigDedicated-DEFAULT			
Information Element	Value/remark	Comment	Condition
PhysicalConfigDedicated-DEFAULT ::= SEQUENCE {			
antennaInfo	Not present		
antennaInfo-r10 CHOICE{			
explicitValue-r10	AntennaInfoDedicated-r10		
}			
csi-RS-Config-r10	CSI-RS-Config-r10		
}			

Table 8.3.1.2.1\_D.4.3-3: *AntennaInfoDedicated-r10*

Derivation Path: 36.331 clause 6.3.2			
Information Element	Value/remark	Comment	Condition
AntennaInfoDedicated-r10 ::= SEQUENCE {			
transmissionMode-r10	tm9-v1020		
codebookSubsetRestriction-r10	Not present	If the UE is configured with <i>transmissionMode</i> tm9, E-UTRAN only configures the field <i>codebookSubsetRestriction</i> if PMI/RI reporting is configured	
ue-TransmitAntennaSelection CHOICE {			
release	NULL		
}			
}			

Table 8.3.1.2.1\_D.4.3-4: *CSI-RS-Config-r10*

Derivation Path: 36.331 clause 6.3.2			
Information Element	Value/remark	Comment	Condition
CSI-RS-Config-r10 ::= SEQUENCE {			
csi-RS-r10 CHOICE{			
setup SEQUENCE {			
antennaPortsCount-r10	an2	Parameter represents the number of antenna ports used for transmission of CSI reference signals	
resourceConfig-r10	8	Parameter: CSI reference signal configuration	
subframeConfig-r10	2	$\Delta_{\text{CSI-RS}} = I_{\text{CSI-RS}}$ when CSI-RS SubframeConfig is from 0-4; Parameter: $I_{\text{CSI-RS}}$	
p-C-r10	0	Parameter: $P_c$ which is the assumed ratio of PDSCH EPRE to CSI-RS EPRE when UE derives CSI feedback	
}			
}			
zeroTxPowerCSI-RS-r10 CHOICE{			
setup SEQUENCE {			
zeroTxPowerResourceConfigList-r10	2	Parameter: <i>ZeroPowerCSI-RS</i>	
zeroTxPowerSubframeConfig-r10	3	Parameter: $I_{\text{CSI-RS}}$	
}			
}			
}			

### 8.3.1.2.1\_D.5 Test requirement

Table 8.3.1.2.1\_D.3-1 defines the primary level settings.

The fraction of maximum throughput percentage for the downlink reference measurement channels specified in Annex A clause A.3.3.3.1 for the throughput test shall meet or exceed the specified value in Table 8.3.1.2.1\_D.5-1 for the specified SNR including test tolerances for the throughput test.



**Table 8.3.1.2.1\_D.5-1: Test requirement for CDM-multiplexed DM RS (FRC) with multiple CSI-RS configurations**

Test number	Bandwidth and MCS	Reference Channel	OCNG Pattern	Propagation Condition	Correlation Matrix and Antenna Configuration	Reference value		UE Category
						Fraction of Maximum Throughput (%)	SNR (dB)	
1	10 MHz 16QAM 1/2	R.51 FDD	OP.1 FDD	EPA5	2x2 Low	70	14.2	2-8

### 8.3.1.2.1\_D\_1 FDD PDSCH Dual-layer Spatial Multiplexing for eDL-MIMO (Release 11 and forward)

#### 8.3.1.2.1\_D\_1.1 Test purpose

To verify the UE's rank-2 performance and ability to receive a predefined test signal, representing a multi-path fading channel that is determined by the SNR with a percentage of the information bit throughput for a specified downlink Reference Measurement Channel (RMC) not falling below a specified value for dual-layer transmission on antenna ports 7 and 8 using DM-RS with full RB allocation with multiple CSI reference symbol configurations with non-zero and zero transmission power, and to verify that the UE correctly estimate SNR.

#### 8.3.1.2.1\_D\_1.2 Test applicability

This test applies to all types of E-UTRA FDD UE release 11 and forward that support eDL-MIMO.

#### 8.3.1.2.1\_D\_1.3 Minimum conformance requirements

The requirements are specified in terms of the percentage of information bit throughput for the downlink reference measurement channels specified in Annex A clause A.3.3.3, with the addition of the relevant parameters in Tables 8.3.1-1, 8.3.1.2.1\_D\_1.3-1 where Cell 1 is the serving cell and Cell 2 is the interfering cell. The downlink physical channel setup is set according to Table C.3.2-1 in Annex C.3.2.

Using this configuration the fraction of maximum throughput percentage shall meet or exceed the minimum requirements specified in Table 8.3.1.2.1\_D\_1.3-2 for the specified SNR.

**Table 8.3.1.2.1\_D\_1.3-1: Test Parameters for Testing CDM-multiplexed DM RS (dual layer) with multiple CSI-RS configurations**

parameter	Unit	Test 1		
		Cell 1	Cell 2	
Downlink power allocation	$\rho_A$	dB	4	0
	$\rho_B$	dB	4 (Note 1)	0
	$\sigma$	dB	-3	-3

Cell-specific reference signals		Antenna ports 0 and 1	Antenna ports 0 and 1
Cell ID		0	126
CSI reference signals		Antenna ports 15,16	NA
Beamforming model		Annex B.4.2	NA
CSI-RS periodicity and subframe offset $T_{CSI-RS} / \Delta_{CSI-RS}$	Subframes	5 / 2	NA
CSI reference signal configuration		8	NA
Zero-power CSI-RS configuration $l_{CSI-RS} / ZeroPowerCSI-RS$ bitmap	Subframes / bitmap	3 / 0010000000000000	NA
$N_{oc}$ at antenna port	dBm/15kHz	-98	-98
$\hat{E}_s / N_{oc}$		Reference Value in Table 8.3.1.2.1_D_1.3-2	7.25dB
Symbols for unused PRBs		OCNG (Note 2)	NA
Number of allocated resource blocks (Note 2)	PRB	50	NA
Simultaneous transmission		No	NA
PDSCH transmission mode		9	Blanked
<p>Note 1: <math>P_B = 1</math></p> <p>Note 2: These physical resource blocks are assigned to an arbitrary number of virtual UEs with one PDSCH per virtual UE; the data transmitted over the OCNG PDSCHs shall be uncorrelated pseudo random data, which is QPSK modulated.</p>			

**Table 8.3.1.2.1\_D\_1.3-2: Minimum performance for CDM-multiplexed DM RS (FRC) with multiple CSI-RS configurations**

Test number	Bandwidth and MCS	Reference Channel	OCNG Pattern		Propagation Condition		Correlation Matrix and Antenna Configuration	Reference value		UE Category
			Cell1	Cell 2	Cell 1	Cell 2		Fraction of Maximum Throughput (%)	SNR (dB)	
1	10 MHz 16QAM 1/2	R.51 FDD	OP.1 FDD	N/A	ETU5	ETU5	2x2 Low	70	14.2	≥2
<p>Note 1: The propagation conditions for Cell 1 and Cell 2 are statistically independent.</p> <p>Note 2: Correlation matrix and antenna configuration parameters apply for each of Cell 1 and Cell 2.</p> <p>Note 3: SNR corresponds to <math>\hat{E}_s / N_{oc}</math> of Cell 1.</p>										

The normative reference for this requirement is TS 36.101 [2] clause 8.3.1.2.

## 8.3.1.2.1\_D\_1.4 Test description

## 8.3.1.2.1\_D\_1.4.1 Initial conditions

Initial conditions are a set of test configurations the UE needs to be tested in and the steps for the SS to take with the UE to reach the correct measurement state.

Configurations of PDSCH and PDCCH before measurement are specified in Annex C.2.

Test Environment: Normal, as defined in TS 36.508 [7] clause 4.1.

Frequencies to be tested: Mid Range, as defined in TS 36.508 [7] clause 4.3.1.1.

Bandwidths to be tested: 10MHz, as defined in TS 36.508 [7] clause 4.3.1.1.

1. Connect the SS, the faders and AWGN noise sources to the UE antenna connectors as shown in TS 36.508 [7] Annex A, Figure A.40.
2. The parameter settings for the cell are set up according to Tables 8.3.1-1 and 8.3.1.2.1\_D\_1.3-1 as appropriate.
3. Downlink signals are initially set up according to Annex C0, C.1 and Annex C.3.2 and uplink signals according to Annex H.1 and H.3.2.
4. Propagation conditions are set according to Annex B.0.
5. Ensure the UE is in State 3A-RF according to TS 36.508 [7] clause 5.2A.2. Message contents are defined in clause 8.3.1.2.1\_D\_1.4.3.

## 8.3.1.2.1\_D\_1.4.2 Test procedure

1. SS transmits PDSCH via PDCCH DCI format 2C for C\_RNTI to transmit the DL RMC according to Tables 8.3.1.2.1\_D\_1.3-1, 8.3.1.2.1\_D\_1.3-2. The SS sends downlink MAC padding bits on the DL RMC.
2. Set the parameters of the bandwidth, MCS, reference channel, the propagation condition, the correlation matrix and the SNR according to Table 8.3.1.2.1\_D\_1.5-2 as appropriate.  
BCH/CRS/PDCCH/PCFICH are sent on antenna ports 0 and 1 using two Tx antennas, while DRS/ PDSCH for the test UE are sent on antenna ports 7 and 8 using two Tx antennas with beam-forming model as specified in Annex B.4.2 and precoder update granularity specified in Table 8.3.1-1. CSI-RS are sent on antenna ports 15 and 16 using two Tx antennas with mapping according to beam-forming model as specified in Annex B.4.2.
3. Set Cell 2 as defined in Tables 8.3.1.2.1\_D\_1.5-1 and 8.3.1.2.1\_D\_1.5-2 as appropriate.
4. Measure the average throughput for a duration sufficient to achieve statistical significance according to Annex G clause G.3. Count the number of NACKs, ACKs and statDTXs on the UL during each test interval and decide pass or fail according to Tables G.3.5 and G.3.6 in Annex G clause G.3.

## 8.3.1.2.1\_D\_1.4.3 Message contents

Message contents are according to TS 36.508 [7] clause 4.6 with the following exceptions:

**Table 8.3.1.2.1\_D\_1.4.3-1: PDSCH-ConfigDedicated-DEFAULT**

Derivation Path: 36.331 clause 6.3.2			
Information Element	Value/remark	Comment	Condition
PDSCH-ConfigDedicated-DEFAULT ::= SEQUENCE {			
p-a	dB4 for Cell 1 dB0 for Cell 2	According to each Cell in test 1	
}			

Table 8.3.1.2.1\_D\_1.4.3-2: *PhysicalConfigDedicated-DEFAULT*

Derivation Path: TS 36.508 [7] clause 4.8.2.1.6 Table 4.8.2.1.6-1 PhysicalConfigDedicated-DEFAULT			
Information Element	Value/remark	Comment	Condition
PhysicalConfigDedicated-DEFAULT ::= SEQUENCE {			
antennaInfo	Not present		
antennaInfo-r10 CHOICE{			
explicitValue-r10	AntennaInfoDedicated-r10		
}			
csi-RS-Config-r10	CSI-RS-Config-r10		
}			

Table 8.3.1.2.1\_D\_1.4.3-3: *AntennaInfoDedicated-r10*

Derivation Path: 36.331 clause 6.3.2			
Information Element	Value/remark	Comment	Condition
AntennaInfoDedicated-r10 ::= SEQUENCE {			
transmissionMode-r10	tm9-v1020		
codebookSubsetRestriction-r10	Not present	If the UE is configured with <i>transmissionMode</i> tm9, E-UTRAN only configures the field <i>codebookSubsetRestriction</i> if PMI/RI reporting is configured	
ue-TransmitAntennaSelection CHOICE {			
release	NULL		
}			
}			

**Table 8.3.1.2.1\_D\_1.4.3-4: CSI-RS-Config-r10**

Derivation Path: 36.331 clause 6.3.2			
Information Element	Value/remark	Comment	Condition
CSI-RS-Config-r10 ::= SEQUENCE {			
csi-RS-r10 CHOICE{			
setup SEQUENCE {			
antennaPortsCount-r10	an2	Parameter represents the number of antenna ports used for transmission of CSI reference signals	
resourceConfig-r10	8	Parameter: CSI reference signal configuration	
subframeConfig-r10	2	$\Delta_{\text{CSI-RS}} = I_{\text{CSI-RS}}$ when CSI-RS SubframeConfig is from 0-4; Parameter: $I_{\text{CSI-RS}}$	
p-C-r10	4 for Cell 1 0 for Cell 2	Parameter: $P_c$ which is the assumed ratio of PDSCH EPRE to CSI-RS EPRE when UE derives CSI feedback	
}			
}			
zeroTxPowerCSI-RS-r10 CHOICE{			
setup SEQUENCE {			
zeroTxPowerResourceConfigList-r10	3	Parameter: $ZeroPowerCSI-RS$	
zeroTxPowerSubframeConfig-r10	2	Parameter: $I_{\text{CSI-RS}}$	
}			
}			
}			

8.3.1.2.1\_D\_1.5 Test requirement

Table 8.3.1.2.1\_D\_1.5-1 defines the primary level settings.

The fraction of maximum throughput percentage for the downlink reference measurement channels specified in Annex A clause A.3.3.3.1 for the throughput test shall meet or exceed the specified value in Table 8.3.1.2.1\_D\_1.5-1 and 8.3.1.2.1\_D\_1.5-2 for the specified SNR including test tolerances for the throughput test.

**Table 8.3.1.2.1\_D\_1.5-1: Test Requirement for Testing CDM-multiplexed DM RS (dual layer) with multiple CSI-RS configurations**

parameter	Unit	Test 1		
		Cell 1	Cell 2	
Downlink power allocation	$\rho_A$	dB	4	0
	$\rho_B$	dB	4 (Note 1)	0
	$\sigma$	dB	-3	-3

Cell-specific reference signals		Antenna ports 0 and 1	Antenna ports 0 and 1
Cell ID		0	126
CSI reference signals		Antenna ports 15,16	NA
Beamforming model		Annex B.4.2	NA
CSI-RS periodicity and subframe offset $T_{CSI-RS} / \Delta_{CSI-RS}$	Subframes	5 / 2	NA
CSI reference signal configuration		8	NA
Zero-power CSI-RS configuration $l_{CSI-RS} / ZeroPowerCSI-RS$ bitmap	Subframes / bitmap	3 / 0010000000000000	NA
$N_{oc}$ at antenna port	dBm/15kHz	-98	-98
$\hat{E}_s / N_{oc}$		Reference Value in Table 8.3.1.2.1_D_1.5-2	6.9dB
Symbols for unused PRBs		OCNG (Note 2)	NA
Number of allocated resource blocks (Note 2)	PRB	50	NA
Simultaneous transmission		No	NA
PDSCH transmission mode		9	Blanked
Note 1: $P_B = 1$ Note 2: These physical resource blocks are assigned to an arbitrary number of virtual UEs with one PDSCH per virtual UE; the data transmitted over the OCNG PDSCHs shall be uncorrelated pseudo random data, which is QPSK modulated.			

**Table 8.3.1.2.1\_D\_1.5-2: Test requirement for CDM-multiplexed DM RS (FRC) with multiple CSI-RS configurations**

Test number	Bandwidth and MCS	Reference Channel	OCNG Pattern		Propagation Condition		Correlation Matrix and Antenna Configuration	Reference value		UE Category
			Cell1	Cell 2	Cell 1	Cell 2		Fraction of Maximum Throughput (%)	SNR (dB)	
1	10 MHz 16QAM 1/2	R.51 FDD	OP.1 FDD	N/A	ETU5	ETU5	2x2 Low	70	15.0	≥2
Note 1: The propagation conditions for Cell 1 and Cell 2 are statistically independent. Note 2: Correlation matrix and antenna configuration parameters apply for each of Cell 1 and Cell 2. Note 3: SNR corresponds to $\hat{E}_s / N_{oc}$ of Cell 1.										

8.3.1.2.2 FDD PDSCH Dual-layer Spatial Multiplexing – Enhanced Performance Requirement Type C

Editor’s notes: This test case is incomplete. The following items are missing or are incomplete:

- Test tolerances are undefined
- The SNR values in minimum and test requirement are still in square brackets
- The minimum testing time in Annex G is still undefined.
- Whether test applicability requires FGI bit or not is still TBD and this part is kept in square brackets.

#### 8.3.1.2.2.1 Test purpose

To verify the UE's rank-2 performance and ability to receive a predefined test signal, representing a multi-path fading channel that is determined by the SNR with a percentage of the information bit throughput for a specified downlink Reference Measurement Channel (RMC) not falling below a specified value for dual-layer transmission on antenna ports 7 and 8 using DM-RS with full RB allocation with multiple CSI reference symbol configurations with non-zero and zero transmission power.

#### 8.3.1.2.2.2 Test applicability

This test applies to all types of E-UTRA FDD release 12 and forward UE of Category 2 or higher that support eDL-MIMO and enhanced receiver Type C. [Applicability requires support for FGI bit 103.]

#### 8.3.1.2.2.3 Minimum conformance requirements

The requirements are specified in terms of the percentage of information bit throughput for the downlink reference measurement channels specified in Annex A clause A.3.3.3, with the addition of the relevant parameters in Tables 8.3.1-1, 8.3.1.2.2.3-1, and the downlink physical channel setup according to Table C.3.2-1 in Annex C.3.2.

Using this configuration the fraction of maximum throughput percentage shall meet or exceed the minimum requirements specified in Table 8.3.1.2.2.3-2 for the specified SNR.

**Table 8.3.1.2.3-1: Test Parameters for Testing CDM-multiplexed DM RS (dual layer) with multiple CSI-RS configurations**

parameter	Unit	Test 1	
Downlink power allocation	$\rho_A$	dB	0
	$\rho_B$	dB	0 (Note 1)
	$\sigma$	dB	-3
Cell-specific reference signals		Antenna ports 0 and 1	
CSI reference signals		Antenna ports 15,16	
Beamforming model		Annex B.4.2	
CSI-RS periodicity and subframe offset $T_{\text{CSI-RS}} / \Delta_{\text{CSI-RS}}$	Subframes	5 / 2	
CSI reference signal configuration		8	
Zero-power CSI-RS configuration $I_{\text{CSI-RS}} / \text{ZeroPowerCSI-RS}$ bitmap	Subframes / bitmap	3 / 0010000000000000	
$N_{oc}$ at antenna port	dBm/15kHz	-98	
Symbols for unused PRBs		OCNG (Note 2)	
Number of allocated resource blocks (Note 2)	PRB	50	
Simultaneous transmission		No	
PDSCH transmission mode		9	
Note 1: $P_B = 1$			
Note 2: These physical resource blocks are assigned to an arbitrary number of virtual UEs with one PDSCH per virtual UE; the data transmitted over the OCNG PDSCHs shall be uncorrelated pseudo random data, which is QPSK modulated.			

**Table 8.3.1.2.3-2: Enhanced Performance Requirement Type C for CDM-multiplexed DM RS (FRC) with multiple CSI-RS configurations**

Test number	Bandwidth and MCS	Reference Channel	OCNG Pattern	Propagation Condition	Correlation Matrix and Antenna Configuration	Reference value		UE Category
						Fraction of Maximum Throughput (%)	SNR (dB)	
1	10 MHz 16QAM 1/2	R.51 FDD	OP.1 FDD	EPA5	2x2 Medium	70	[17.4]	≥2

The normative reference for this requirement is TS 36.101 [2] clause 8.3.1.2A.

#### 8.3.1.2.2.4 Test description

##### 8.3.1.2.2.4.1 Initial conditions

Initial conditions are a set of test configurations the UE needs to be tested in and the steps for the SS to take with the UE to reach the correct measurement state.

Configurations of PDSCH and PDCCH before measurement are specified in Annex C.2.

Test Environment: Normal, as defined in TS 36.508 [7] clause 4.1.



Frequencies to be tested: Mid Range, as defined in TS 36.508 [7] clause 4.3.1.1.

Bandwidths to be tested: 10MHz, as defined in TS 36.508 [7] clause 4.3.1.1.

1. Connect the SS, the faders and AWGN noise sources to the UE antenna connectors as shown in TS 36.508 [7] Annex A, Figure A.10.
2. The parameter settings for the cell are set up according to Tables 8.3.1-1 and 8.3.1.2.2.3-1 as appropriate.
3. Downlink signals are initially set up according to Annex C0, C.1 and Annex C.3.2 and uplink signals according to Annex H.1 and H.3.2.
4. Propagation conditions are set according to Annex B.0.
5. Ensure the UE is in State 3A-RF according to TS 36.508 [7] clause 5.2A.2. Message contents are defined in clause 8.3.1.2.2.4.3.

8.3.1.2.2.4.2 Test procedure

1. SS transmits PDSCH via PDCCH DCI format 2C for C\_RNTI to transmit the DL RMC according to Tables 8.3.1.2.2.3-1, 8.3.1.2.2.3-2. The SS sends downlink MAC padding bits on the DL RMC.
2. Set the parameters of the bandwidth, MCS, reference channel, the propagation condition, the correlation matrix and the SNR according to Table 8.3.1.2.2.5-1 as appropriate.  
BCH/CRS/PDCCH/PCFICH are sent on antenna ports 0 and 1 using two Tx antennas, while DRS/ PDSCH for the test UE are sent on antenna ports 7 and 8 using two Tx antennas with beam-forming model as specified in Annex B.4.2 and precoder update granularity specified in Table 8.3.1-1. CSI-RS are sent on antenna ports 15 and 16 using two Tx antennas with mapping according to beam-forming model as specified in Annex B.4.2.
3. Measure the average throughput for a duration sufficient to achieve statistical significance according to Annex G clause G.3. Count the number of NACKs, ACKs and statDTXs on the UL during each test interval and decide pass or fail according to Tables G.3.5 and G.3.6 in Annex G clause G.3.

8.3.1.2.2.4.3 Message contents

Message contents are according to TS 36.508 [7] clause 4.6 with the following exceptions:

**Table 8.3.1.2.2.4.3-1: PDSCH-ConfigDedicated-DEFAULT**

Derivation Path: 36.331 clause 6.3.2			
Information Element	Value/remark	Comment	Condition
PDSCH-ConfigDedicated-DEFAULT ::= SEQUENCE {			
p-a	dB0		
}			

**Table 8.3.1.2.2.4.3-2: AntennaInfoDedicated-r10**

Derivation Path: 36.331 clause 6.3.2			
Information Element	Value/remark	Comment	Condition
AntennaInfoDedicated-r10 ::= SEQUENCE {			
transmissionMode-r10	tm9-v1020		
codebookSubsetRestriction-r10	Not present	If the UE is configured with <i>transmissionMode</i> tm9, E-UTRAN only configures the field <i>codebookSubsetRestriction</i> if PMI/RI reporting is configured	
}			
ue-TransmitAntennaSelection CHOICE {			
release	NULL		
}			

**Table 8.3.1.2.2.4.3-3: CSI-RS-Config**

Derivation Path: 36.331 clause 6.3.2			
Information Element	Value/remark	Comment	Condition
CSI-RS-Config-r10 ::= SEQUENCE {			
csi-RS-r10 CHOICE{			
release			
setup SEQUENCE {			
antennaPortsCount-r10	an2	Parameter represents the number of antenna ports used for transmission of CSI reference signals	
resourceConfig-r10	8	Parameter: CSI reference signal configuration	
subframeConfig-r10	2	$\Delta_{\text{CSI-RS}} = I_{\text{CSI-RS}}$ when CSI-RS SubframeConfig is from 0-4; Parameter: $I_{\text{CSI-RS}}$	
p-C-r10	0	Parameter: $P_c$ which is the assumed ratio of PDSCH EPRE to CSI-RS EPRE when UE derives CSI feedback	
}			
}			
zeroTxPowerCSI-RS-r10 CHOICE{			
release	NULL		
setup SEQUENCE {			
zeroTxPowerResourceConfigList-r10	3	Parameter: $ZeroPowerCSI-RS$	
zeroTxPowerSubframeConfig-r10	2	Parameter: $I_{\text{CSI-RS}}$	
}			
}			
}			

8.3.1.2.2.5 Test requirement

Table 8.3.1.2.2.3-1 defines the primary level settings.

The fraction of maximum throughput percentage for the downlink reference measurement channels specified in Annex A clause A.3.3.3.1 for the throughput test shall meet or exceed the specified value in Table 8.3.1.2.2.5-1 for the specified SNR including test tolerances for the throughput test.

**Table 8.3.1.2.2.5-1: Test requirement for Enhanced Performance Requirement Type C for CDM-multiplexed DM RS (FRC) with multiple CSI-RS configurations**

Test number	Bandwidth and MCS	Reference Channel	OCNG Pattern	Propagation Condition	Correlation Matrix and Antenna Configuration	Reference value		UE Category
						Fraction of Maximum Throughput (%)	SNR (dB)	
1	10 MHz 16QAM 1/2	R.51 FDD	OP.1 FDD	EPA5	2x2 Medium	70	[17.4] +TT	≥2

### 8.3.1.3 FDD PDSCH Performance with DCI format 2D and non Quasi Co-located Antenna Ports

#### 8.3.1.3.1\_F FDD PDSCH Performance with DCI format 2D, non Quasi Co-located Antenna Ports, Same Cell ID and single NZP CSI-RS resource for CoMP

##### 8.3.1.3.1\_F.1 Test purpose

To verify the UE capability of supporting non quasi-collocated antenna ports when the UE receives DCI format 2D in a scenario where the two transmission points share the same Cell ID. In particular the test verifies that the UE, configured with quasi co-location type B, performs correct tracking and compensation of the timing difference between two transmission points, channel parameters estimation and rate matching behaviour according to the 'PDSCH RE Mapping and Quasi-Co-Location Indicator' (PQI) signalling.

##### 8.3.1.3.1\_F.2 Test applicability

This test applies to E-UTRA FDD category 2-8 UE release 11 and forward, supporting Maximum CSI processes of One on a component carrier within a band with PDSCH transmission mode 10.

##### 8.3.1.3.1\_F.3 Minimum conformance requirements

The requirements are specified in Table 8.3.1.3.1\_F.3-3, with the addition of the parameters in Table 8.3.1.3.1\_F.3-1 and Table 8.3.1.3.1\_F.3-2. In table 8.3.1.3.1\_F.3-1 transmission point 1 (TP1) is the serving cell and transmission point 2 (TP2) transmits PDSCH. The downlink physical channel setup for TP1 is according to Table C.3.4-1 and for TP2 according to Table C.3.4-2.

Table 8.3.1.3.1\_F.3-1: Test Parameters for quasi co-location type B: same Cell ID

Parameter	Unit	TP 1	TP 2
Downlink power allocation	$\rho_A$	dB	0
	$\rho_B$	dB	0
	$\sigma$	dB	-3
Cell-specific reference signals		Antenna ports 0,1	(Note 2)
CSI-RS 0 antenna ports		NA	Port {15,16}
<i>qcl-CSI-RS-ConfigNZPId-r11</i> , CSI-RS 0 periodicity and subframe offset $T_{\text{CSI-RS}} / \Delta_{\text{CSI-RS}}$	Subframes	NA	5/2
<i>qcl-CSI-RS-ConfigNZPId-r11</i> , CSI-RS 0 configuration		NA	8
<i>csi-RS-ConfigZPId-r11</i> , Zero-power CSI-RS 0 periodicity and subframe offset $T_{\text{CSI-RS}} / \Delta_{\text{CSI-RS}}$	Subframe	NA	5/2
<i>csi-RS-ConfigZPId-r11</i> , Zero-power CSI-RS 0 configuration $l_{\text{CSI-RS}} / \text{ZeroPower CSI-RS bitmap}$		NA	2/ 0000010000000000
$N_{oc}$ at antenna port	dBm/15kHz z	-98	-98
SNR	dB	Reference point in Table 8.3.1.3.1_F.3-2	Reference point in Table 8.3.1.3.1_F.3-2
$BW_{\text{Channel}}$	MHz	10	10
Cyclic Prefix		Normal	Normal
Cell Id		0	0
Number of control OFDM symbols		2	2
PDSCH transmission mode		Blanked	10
Number of allocated PRB	PRB	NA	50
<i>qcl-Operation</i> , 'PDSCH RE Mapping and Quasi-Co-Location Indicator'		Type B, '00'	
Time offset between TPs	$\mu\text{s}$	NA	Reference point in Table 8.3.1.3.1_F.3-2
Frequency error between TPs	Hz	NA	0
Beamforming model		NA	As specified in clause B.4.1
Symbols for unused PRBs		NA	OCNG (Note 3)
Note 1: $P_B = 1$ Note 2: REs for antenna ports 0 and 1 CRSs have zero transmission power. Note 3: These physical resource blocks are assigned to an arbitrary number of virtual UEs with one PDSCH per virtual UE; the data transmitted over the OCNG PDSCHs shall be uncorrelated pseudo random data, which is QPSK modulated.			

**Table 8.3.1.3.1\_F.3-2: Configurations of PQI and DL transmission hypothesis for each PQI set**

PQI set index	Parameters in each PQI set		DL transmission hypothesis for each PQI Set	
	NZP CSI-RS Index (For quasi co-location)	ZP CSI-RS configuration	TP 1	TP 2
PQI set 0	CSI-RS 0	ZP CSI-RS 0	Blanked	PDSCH

**Table 8.3.1.3.1\_F.3-3: Minimum performance for quasi co-location type B: same Cell ID**

Test Number	Reference Channel	OGCN pattern		Time offset between TPs ( $\mu$ s)	Propagation Conditions (Note1)		Correlation Matrix and Antenna Configuration (Note 2)	Reference Value		UE Category
		TP1	TP2		TP1	TP2		Fraction of Maximum Throughput (%)	SNR (dB) (Note 3)	
1	R.52 FDD	NA	OP.1 FDD	2	EPA	EPA	2x2 Low	70	12.1	2-8
2	R.52 FDD	NA	OP.1 FDD	-0.5	EPA	EPA	2x2 Low	70	12.6	2-8

Note 1: The propagation conditions for TP1 and TP2 are statistically independent.  
Note 2: The correlation matrix and antenna configuration apply for TP1 and TP2.  
Note 3: SNR corresponds to  $\hat{E}_s / N_{oc}$  of TP2.

The normative reference for this requirement is TS 36.101 [2] clause 8.3.1.3.1.

#### 8.3.1.3.1\_F.4 Test description

##### 8.3.1.3.1\_F.4.1 Initial conditions

Initial conditions are a set of test configurations the UE needs to be tested in and the steps for the SS to take with the UE to reach the correct measurement state.

Configurations of PDSCH and PDCCH before measurement are specified in Annex C.2.

Test Environment: Normal, as defined in TS 36.508 [7] clause 4.1.

Frequencies to be tested: Mid Range, as defined in TS 36.508 [7] clause 4.3.1.1.

Bandwidths to be tested: 10MHz, as defined in TS 36.508 [7] clause 4.3.1.1.

1. Connect the SS, the faders and AWGN noise sources to the UE antenna connectors as shown in TS 36.508 [7] Annex A, Figure A.40 for antenna configuration 2x2.
2. The parameter settings for the TP 1 and TP 2 are set up according to table 8.3.1-1, table 8.3.1.3.1\_F.3-1 and 8.3.1.3.1\_F.3-2 as appropriate.
3. Downlink signals are initially set up according to Annex C0, C.1 and Annex C.3.2 and uplink signals according to Annex H.1 and H.3.2.
4. Propagation conditions are set according to Annex B.0.
5. Ensure the UE is in State 3A-RF according to TS 36.508 [7] clause 5.2A.2. Message contents are defined in clause 8.3.1.3.1\_F.4.3.

##### 8.3.1.3.1\_F.4.2 Test procedure

1. SS transmits PDCCH on TP 1. PQI set and PDSCH transmission hypothesis in PDCCH format 2D are configured according to Table 8.3.1.3.1\_F.3-2.

2. SS transmits PDSCH on TP 1 and TP 2 via PDCCH DCI format 2D for C\_RNTI to transmit the DL RMC according to Table 8.3.1.3.1\_F.3-3. The SS sends downlink MAC padding bits on the DL RMC.
3. Set the parameters of the reference channel, timing offset (TP 2 timing - TP 1 timing), the propagation condition, the correlation matrix and the SNR according to Table 8.3.1.3.1\_F.3-3 Test 1 as appropriate.
4. Wait for at least 1 second before measuring throughput.
5. Measure the average throughput for a duration sufficient to achieve statistical significance according to Annex G clause G.3. Count the number of NACKs, ACKs and statDTXs on the UL during the test interval and decide pass or fail according to Tables G.3.5 and G.3.6 in Annex G clause G.3.
6. Repeat steps 1 to 4 for Test 2 in Table 8.3.1.3.1\_F.3-3.

#### 8.3.1.3.1\_F.4.3 Message contents

Message contents are according to TS 36.508 [7] clause 4.6 with the following exceptions:

**Table 8.3.1.3.1\_F.4.3-1: PhysicalConfigDedicated-DEFAULT**

Derivation Path: 36.508 clause 4.6.3			
Information Element	Value/remark	Comment	Condition
PhysicalConfigDedicated-DEFAULT ::= SEQUENCE {			
pdsch-ConfigDedicated	PDSCH-ConfigDedicated-DEFAULT		
antennaInfo-r10 CHOICE {			
explicitValue-r10	AntennaInfoDedicated-r10		
}			
csi-RS-ConfigNZPToAddModList-r11	CSI-RS-ConfigNZP-r11-DEFAULT		
csi-RS-ConfigZPToAddModList-r11	CSI-RS-ConfigZP-r11-DEFAULT		
pdsch-ConfigDedicated-v1130	PDSCH-ConfigDedicated-v1130-DEFAULT		
}			

**Table 8.3.1.3.1\_F.4.3-2: PDSCH-ConfigDedicated-DEFAULT**

Derivation Path: 36.508 clause 4.6.3			
Information Element	Value/remark	Comment	Condition
PDSCH-ConfigDedicated-DEFAULT ::= SEQUENCE {			
p-a	dB-3		2TX
}			

**Table 8.3.1.3.1\_F.4.3-3: AntennaInfoDedicated-r10**

Derivation Path: 36.331 clause 6.3.2			
Information Element	Value/remark	Comment	Condition
AntennaInfoDedicated-r10 ::= SEQUENCE {			
transmissionMode-r10	tm10-v1130		
}			
ue-TransmitAntennaSelection CHOICE {			
release	NULL		
}			
}			

Table 8.3.1.3.1\_F.4.3-4: CSI-RS-ConfigNRP-r11-DEFAULT

Derivation Path: 36.508 clause 4.6.3			
Information Element	Value/remark	Comment	Condition
CSI-RS-ConfigNRP-r11 ::= SEQUENCE {			
csi-RS-ConfigNRPId-r11	1		
antennaPortsCount-r11	an2		
resourceConfig-r11	8		
subframeConfig-r11	2		
scramblingIdentity-r11	0		
qcl-CRS-Info-r11 SEQUENCE {			
qcl-ScramblingIdentity-r11	0		
crs-PortsCount-r11	n2		
mbsfn-SubframeConfigList-r11	Not present		
}			
}			

Table 8.3.1.3.1\_F.4.3-5: CSI-RS-ConfigZP-r11-DEFAULT

Derivation Path: 36.508 clause 4.6.3			
Information Element	Value/remark	Comment	Condition
CSI-RS-ConfigZP-r11 ::= SEQUENCE {			
csi-RS-ConfigZPId-r11	1		
resourceConfigList-r11	0000010000000000		
subframeConfig-r11	2		
}			

Table 8.3.1.3.1\_F.4.3-6: PDSCH-ConfigDedicated-v1130-DEFAULT

Derivation Path: 36.508 clause 4.6.3			
Information Element	Value/remark	Comment	Condition
PDSCH-ConfigDedicated-v1130 ::= SEQUENCE {			
dmrs-ConfigPDSCH-r11	DMRS-Config-r11-DEFAULT		
qcl-Operation	typeB		
re-MappingQCLConfigToAddModList-r11 SEQUENCE (SIZE (1..maxRE-MapQCL-r11)) OF SEQUENCE {	1 entry		
pdsch-RE-MappingQCL-ConfigId-r11[1]	1		
optionalSetOfFields-r11[1] SEQUENCE {			
crs-PortsCount-r11	n2		
crs-FreqShift-r11	0		
mbsfn-SubframeConfigList-r11	Not present		
pdsch-Start-r11	2		
}			
}			
}			

### 8.3.1.3.1\_F.5 Test requirement

Table 8.3.1.3.1\_F.3-1 defines the primary level settings.

The fraction of maximum throughput percentage for the downlink reference measurement channels specified in Annex A clause A.3.3.3.2 for the throughput test shall meet or exceed the specified value in Table 8.3.1.3.1\_F.5-1 for the specified SNR including test tolerances for the throughput test.

**Table 8.3.1.3.1\_F.5-1: Test requirements for quasi co-location type B: same Cell ID**

Test Number	Reference Channel	OGCN pattern		Time offset between TPs (Note 4)	Propagation Conditions (Note1)		Correlation Matrix and Antenna Configuration (Note 2)	Reference Value		UE Category
		TP1	TP2		TP1	TP2		Fraction of Maximum Throughput (%)	SNR (dB) (Note 3)	
1	R.52 FDD	NA	OP.1 FDD	57Ts	EPA	EPA	2x2 Low	70	13.0	2-8
2	R.52 FDD	NA	OP.1 FDD	-11Ts	EPA	EPA	2x2 Low	70	13.5	2-8

Note 1: The propagation conditions for TP1 and TP2 are statistically independent.  
Note 2: The correlation matrix and antenna configuration apply for TP1 and TP2.  
Note 3: SNR corresponds to  $\hat{E}_s / N_{oc}$  of TP2.  
Note 4: Timing offset in units of Ts:  $T_s = 1/(15000 \times 2048)$  seconds, the basic timing unit defined in TS 36.211 [8].

### 8.3.1.3.2\_F FDD PDSCH Performance with DCI format 2D, non Quasi Co-located Antenna Ports, Same Cell ID and multiple NZP CSI-RS resources for CoMP

#### 8.3.1.3.2\_F.1 Test purpose

To verify the UE capability of supporting non quasi-collocated antenna ports when the UE receives DCI format 2D in a scenario where the two transmission points share the same Cell ID by verifying that the UE, configured with quasi co-location type B, performs correct tracking and compensation of the timing difference between two transmission points, channel parameters estimation and rate matching behaviour according to the 'PDSCH RE Mapping and Quasi-Co-Location Indicator' (PQI) signalling.

#### 8.3.1.3.2\_F.2 Test applicability

This test applies to all types of E-UTRA FDD category 2-8 UE release 11 and forward, supporting Maximum CSI processes of Three or Four on a component carrier within a band with PDSCH transmission mode 10.

#### 8.3.1.3.2\_F.3 Minimum conformance requirements

The requirements are specified in terms of the percentage of information bit throughput for the downlink reference measurement channels specified in Annex A clause A.3.3.3, with the addition of the relevant parameters in Tables 8.3.1-1, 8.3.1.3.2\_F.3-1 and 8.3.1.3.2\_F.3-2.

In table 8.3.1.3.2\_F.2-1, transmission point 1 (TP 1) is the serving cell transmitting PDCCH, synchronization signals and PBCH, and transmission point 2 (TP 2) has same Cell ID as TP 1. Multiple NZP CSI-RS resources and ZP CSI-RS resources are configured. In each sub-frame, DL PDSCH transmission is dynamically switched between 2 TPs with multiple PDSCH RE Mapping and Quasi-Co-Location Indicator configuration (PQI). Configurations of PDSCH RE Mapping and Quasi-Co-Location Indicator and downlink transmission hypothesis are defined in Table 8.3.1.3.2\_F.3-2. The downlink physical channel setup for TP 1 is according to Table C.3.4-1 and for TP 2 according to Table C.3.4-2.

Using this configuration the fraction of maximum throughput percentage shall meet or exceed the minimum requirements specified in Table 8.3.1.3.2\_F.3-3 for the specified SNR.



**Table 8.3.1.3.2\_F.3-1: Test Parameters for timing offset compensation with DPS transmission**

Parameter		Unit	TP 1	TP 2
Downlink power allocation	$\rho_A$	dB	0	0
	$\rho_B$	dB	0 (Note 1)	0
	$\sigma$	dB	-3	-3
Beamforming model			N/A	As specified in clause B.4.1
Cell-specific reference signals			Antenna ports 0,1	(Note 2)
CSI reference signals 0			Antenna ports {15,16}	N/A
CSI-RS 0 periodicity and subframe offset $T_{CSI-RS} / \Delta_{CSI-RS}$		Subframes	5 / 2	N/A
CSI reference signal 0 configuration			0	N/A
CSI reference signals 1			N/A	Antenna ports {15,16}
CSI-RS 1 periodicity and subframe offset $T_{CSI-RS} / \Delta_{CSI-RS}$		Subframes	N/A	5 / 2
CSI reference signal 1 configuration			N/A	8
Zero-power CSI-RS 0 configuration $I_{CSI-RS} /$ ZeroPower CSI-RS bitmap		Subframes/bitmap p	2/ 0010000000000000	N/A
Zero-power CSI-RS1 configuration $I_{CSI-RS} /$ ZeroPower CSI-RS bitmaps		Subframes/bitmap p	2/ 0010000000000000	2/ 0000010000000000
$\hat{E}_s / N_{oc}$		dB	Reference Value in Table 8.3.1.3.2_F.2-3	Reference Value in Table 8.3.1.3.2_F.2-3
$N_{oc}$ at antenna port		dBm/15kHz	-98	-98
$BW_{Channel}$		MHz	10	10
Cyclic Prefix			Normal	Normal
Cell Id			0	0
Number of control OFDM symbols			2	2
Timing offset between TPs			N/A	Reference Value in Table 8.3.1.3.2_F.3-3
Frequency offset between TPs		Hz	N/A	0
Number of allocated resource blocks		PRB	50	50
PDSCH transmission mode			10	10
Probability of occurrence of PDSCH transmission (Note 3)		%	30	70
Symbols for unused PRBs			OCNG (Note 4)	OCNG (Note 4)
Note 1: $P_b = 1$ . Note 2: REs for antenna ports 0 and 1 CRSs have zero transmission power. Note 3: PDSCH transmission from TPs shall be randomly determined independently for each subframe. Probabilities of occurrence of PDSCH transmission from TPs are specified. Note 4: These physical resource blocks are assigned to an arbitrary number of virtual UEs with one PDSCH per virtual UE; the data transmitted over the OCNG PDSCHs shall be uncorrelated pseudo random data, which is QPSK modulated.				

**Table 8.3.1.3.2\_F.3-2: Configurations of PQI and DL transmission hypothesis for each PQI set**

PQI set index	Parameters in each PQI set		DL transmission hypothesis for each PQI Set	
	NZP CSI-RS Index (For quasi co-location)	ZP CSI-RS configuration	TP 1	TP 2
PQI set 0	CSI-RS 0	ZP CSI-RS 0	PDSCH	Blanked
PQI set 1	CSI-RS 1	ZP CSI-RS 1	Blanked	PDSCH

**Table 8.3.1.3.2\_F.3-3: Minimum Requirements for timing offset compensation with DPS transmission**

Test Number	Timing offset(us)	Reference Channel	OCNG Pattern		Propagation Conditions		Correlation Matrix and Antenna Configuration (Note 2)	Reference Value		UE Category
			TP 1	TP 2	TP 1	TP 2		Fraction of Maximum Throughput (%)	SNR (dB) (Note 3)	
1	2	R.53 FDD	OP.1 FDD	OP.1 FDD	EPA 5	EPA 5	2x2 Low	70	12.2	2-8
2	-0.5	R.53 FDD	OP.1 FDD	OP.1 FDD	EPA 5	EPA 5	2x2 Low	70	12.5	2-8

Note 1: The propagation conditions for TP 1 and TP 2 are statistically independent.  
Note 2: Correlation matrix and antenna configuration parameters apply for each of TP 1 and TP 2.  
Note 3: SNR corresponds to  $\hat{E}_s/N_{oc}$  of both TP 1 and TP 2 as defined in clause 8.1.1.

The normative reference for these requirements is TS 36.101 [2] clause 8.3.1.3.2.

#### 8.3.1.3.2\_F.4 Test description

##### 8.3.1.3.2\_F.4.1 Initial conditions

Initial conditions are a set of test configurations the UE needs to be tested in and the steps for the SS to take with the UE to reach the correct measurement state.

Configurations of PDSCH and PDCCH before measurement are specified in Annex C.2.

Test Environment: Normal, as defined in TS 36.508 [7] clause 4.1.

Frequencies to be tested: Mid Range, as defined in TS 36.508 [7] clause 4.3.1.2.

Channel Bandwidths to be tested: As specified per test number in Table 8.2.2.3.3\_C.1.3-2, as defined in TS 36.508 [7] clause 4.3.1.2

1. Connect the SS, the faders and AWGN noise sources to the UE antenna connectors as shown in TS 36.508 [7] Annex A, Figure A.40 for antenna configuration 2x2.
2. The parameter settings for the TP 1 and TP 2 are set up according to table 8.3.1-1, 8.3.1.3.2\_F.3-1 and 8.3.1.3.2\_F.3-2 as appropriate.
3. Downlink signals are initially set up according to Annex C0, C.1 and Annex C.3.2 and uplink signals according to Annex H.1 and H.3.2.
4. Propagation conditions are set according to Annex B.0.
5. Ensure the UE is in State 3A-RF according to TS 36.508 [7] clause 5.2A.2. Message contents are defined in clause 8.3.1.3.2\_F.4.3.

##### 8.3.1.3.2\_F.4.2 Test procedure

1. SS transmits PDCCH on TP 1. PQI set and PDSCH transmission hypothesis in PDCCH format 2D are configured according to Table 8.3.1.3.2\_F.3-2.
2. SS transmits PDSCH on TP 1 and TP 2 via PDCCH DCI format 2D for C\_RNTI to transmit the DL RMC according to Tables 8.3.1.3.2\_F.3-1 and 8.3.1.3.2\_F.3-2. The SS sends downlink MAC padding bits on the DL RMC. PDSCH transmission from TPs shall be randomly determined independently for each subframe. Probabilities of occurrence of PDSCH transmission from TPs are specified according to Table 8.3.1.3.2\_F.3-1. The probability of occurrence of PQI set in each TP is equal.
3. Set the parameters of the reference channel, timing offset (TP 2 timing - TP 1 timing), the propagation condition, the correlation matrix and the SNR according to Table 8.3.1.3.2\_F.3-3 Test 1 as appropriate.
4. Wait for at least 1 second before measuring throughput.

5. Measure the average throughput for a duration sufficient to achieve statistical significance according to Annex G clause G.3. Count the number of NACKs, ACKs and statDTXs on the UL during the test interval and decide pass or fail according to Tables G.3.5 and G.3.6 in Annex G clause G.3.
6. Repeat steps 1 to 4 for Test 2 in Table 8.3.1.3.2\_F.5-1.

#### 8.3.1.3.2\_F.4.3 Message contents

Message contents are according to TS 36.508 [7] clause 4.6 with the following exceptions:

**Table 8.3.1.3.2\_F.4.3-1: PhysicalConfigDedicated-DEFAULT**

Derivation Path: 36.508 clause 4.6.3			
Information Element	Value/remark	Comment	Condition
PhysicalConfigDedicated-DEFAULT ::= SEQUENCE {			
pdsch-ConfigDedicated	PDSCH-ConfigDedicated-DEFAULT		
antennaInfo-r10 CHOICE {			
explicitValue-r10	AntennaInfoDedicated-r10		
}			
csi-RS-ConfigNZPTToAddModList-r11	CSI-RS-ConfigNZP-r11-DEFAULT		
csi-RS-ConfigZPTToAddModList-r11	CSI-RS-ConfigZP-r11-DEFAULT		
pdsch-ConfigDedicated-v1130	PDSCH-ConfigDedicated-v1130-DEFAULT		
}			

**Table 8.3.1.3.2\_F.4.3-2: PDSCH-ConfigDedicated-DEFAULT**

Derivation Path:36.508 clause 4.6.3			
Information Element	Value/remark	Comment	Condition
PDSCH-ConfigDedicated-DEFAULT ::= SEQUENCE {			
p-a	dB-3		2TX
}			

**Table 8.3.1.3.2\_F.4.3-3: AntennaInfoDedicated-r10**

Derivation Path: 36.331 clause 6.3.2			
Information Element	Value/remark	Comment	Condition
AntennaInfoDedicated-r10 ::= SEQUENCE {			
transmissionMode-r10	tm10-v1130		
}			
ue-TransmitAntennaSelection CHOICE {			
release	NULL		
}			
}			

Table 8.3.1.3.2\_F.4.3-4: CSI-RS-ConfigNRP-r11-DEFAULT

Derivation Path: 36.508 clause 4.6.3			
Information Element	Value/remark	Comment	Condition
CSI-RS-ConfigNRP-r11 ::= SEQUENCE {			
csi-RS-ConfigNRPId-r11	For NZP CSI-RS configuration (CSI reference signals 0) = 1 NZP CSI-RS configuration (CSI reference signals 1) = 2		
antennaPortsCount-r11	an2		
resourceConfig-r11	For NZP CSI-RS configuration (CSI reference signals 0) = 0 NZP CSI-RS configuration (CSI reference signals 1) = 8		
subframeConfig-r11	2		
scramblingIdentity-r11	0		
qcl-CRS-Info-r11 SEQUENCE {			
qcl-ScramblingIdentity-r11	0		
crs-PortsCount-r11	n2		
mbsfn-SubframeConfigList-r11	Not present		
}			
}			

Table 8.3.1.3.2\_F.4.3-5: CSI-RS-ConfigZP-r11-DEFAULT

Derivation Path: 36.508 clause 4.6.3			
Information Element	Value/remark	Comment	Condition
CSI-RS-ConfigZP-r11 ::= SEQUENCE {			
csi-RS-ConfigZPId-r11	1		
resourceConfigList-r11	For Zero-power CSI-RS 0 = 0010000000000000 For Zero-power CSI-RS 1 configuration = 0000010000000000	Parameter: <i>ZeroPowerCSI-RS</i>	
subframeConfig-r11	2		
}			

**Table 8.3.1.3.2\_F.4.3-6: PDSCH-ConfigDedicated-v1130-DEFAULT**

Derivation Path: 36.508 clause 4.6.3			
Information Element	Value/remark	Comment	Condition
PDSCH-ConfigDedicated-v1130 ::= SEQUENCE {			
dmrs-ConfigPDSCH-r11	DMRS-Config-r11-DEFAULT		
qcl-Operation	typeB		
re-MappingQCLConfigToAddModList-r11 SEQUENCE (SIZE (1..maxRE-MapQCL-r11)) OF SEQUENCE {	2 entries	See Table 8.3.1.3.2_F.3-2	
pdsch-RE-MappingQCL-ConfigId-r11[1]	1	Entry 1	
optionalSetOfFields-r11[1] SEQUENCE {			
crs-PortsCount-r11	n2		
crs-FreqShift-r11	0		
mbsfn-SubframeConfigList-r11	Not present		
pdsch-Start-r11	2		
}			
csi-RS-ConfigZPId-r11[1]	1		
qcl-CSI-RS-ConfigNZPId-r11[1]	1		
pdsch-RE-MappingQCL-ConfigId-r11[1]	4	Entry 2	
optionalSetOfFields-r11[1] SEQUENCE {			
crs-PortsCount-r11	n2		
crs-FreqShift-r11	0		
mbsfn-SubframeConfigList-r11	Not present		
pdsch-Start-r11	2		
}			
csi-RS-ConfigZPId-r11[1]	2		
qcl-CSI-RS-ConfigNZPId-r11[1]	2		
}			
}			

8.3.1.3.2\_F.5 Test requirements

Table 8.3.1.3.2\_F.2-1 and 8.3.1.3.2\_F.2-2 defines the primary level setting.

The fraction of maximum throughput percentage for the downlink reference measurement channels specified in Annex A clause A.3.4.2 for each throughput test shall meet or exceed the specified value in Table 8.3.1.3.2\_F.5-1 for the specified SNR including test tolerances for all throughput tests.

**Table 8.3.1.3.2\_F.5-1: Test Requirements for timing offset compensation with DPS transmission**

Test Number	Timing offset (Note 4)	Reference Channel	OCNG Pattern		Propagation Conditions (Note 1)		Correlation Matrix and Antenna Configuration (Note 2)	Reference Value		UE Category
			TP 1	TP 2	TP 1	TP 2		Fraction of Maximum Throughput (%)	SNR (dB) (Note 3)	
1	57Ts	R.53 FDD	OP.1 FDD	OP.1 FDD	EPA5	EPA5	2x2 Low	70	13.1	2-8
2	11Ts	R.53 FDD	OP.1 FDD	OP.1 FDD	EPA5	EPA5	2x2 Low	70	13.4	2-8

Note 1: The propagation conditions for TP 1 and TP 2 are statistically independent.  
 Note 2: Correlation matrix and antenna configuration parameters apply for each of TP 1 and TP 2.  
 Note 3: SNR corresponds to  $\hat{E}_s / N_{oc}$  of both TP 1 and TP 2 as defined in clause 8.1.1.  
 Note 4: Timing offset in units of Ts:  $T_s = 1 / (15000 \times 2048)$  seconds, the basic timing unit defined in TS 36.211 [8].

### 8.3.1.3.3\_F FDD PDSCH Performance with DCI format 2D, non Quasi Co-located Antenna Ports, Different Cell ID, Colliding CRS and single NZP CSI-RS resource for CoMP

#### 8.3.1.3.3\_F.1 Test purpose

To verify the UE capability of supporting non quasi-collocated antenna ports when the UE receives DCI format 2D in a scenario where the two transmission points have different Cell ID and colliding CRS by verifying that the UE, configured with quasi co-location type B, performs correct tracking and compensation of the frequency difference between two transmission points, channel parameters estimation and rate matching behaviour according to the 'PDSCH RE Mapping and Quasi-Co-Location Indicator' (PQI) signalling.

#### 8.3.1.3.3\_F.2 Test applicability

This test applies to all types of E-UTRA FDD category 2-8 UE release 11 and forward, supporting Maximum CSI processes of One, Three or Four on a component carrier within a band with PDSCH transmission mode 10.

#### 8.3.1.3.3\_F.3 Minimum conformance requirements

The requirements are specified in terms of the percentage of information bit throughput for the downlink reference measurement channels specified in Annex A clause A.3.3.3, with the addition of the relevant parameters in Tables 8.3.1-1 and 8.3.1.3.3\_F.3-1.

In table 8.3.1.3.3\_F.3-1, transmission point 1 (TP 1) is the serving cell transmitting PDCCH, synchronization signals and PBCH, and transmission point 2 (TP 2) transmit PDSCH with different Cell ID. The downlink physical channel setup for TP 1 is according to Table C.3.4-1 and for TP 2 according to Table C.3.4-2.

Using this configuration the fraction of maximum throughput percentage shall meet or exceed the minimum requirements specified in Table 8.3.1.3.3\_F.3-2 for the specified SNR.

**Table 8.3.1.3.3\_F.3-1: Test Parameters for quasi co-location type B with different Cell ID and Colliding CRS**

parameter	Unit	TP 1	TP 2
Downlink power allocation	$\rho_A$	dB	0
	$\rho_B$	dB	0 (Note 1)
	$\sigma$	dB	-3

Beamforming model		N/A	As specified in clause B.4.2
Cell-specific reference signals		Antenna ports 0,1	Antenna ports 0,1
CSI reference signals 0		N/A	Antenna ports {15,16}
CSI-RS 0 periodicity and subframe offset $T_{CSI-RS} / \Delta_{CSI-RS}$	Subframes	N/A	5 / 2
CSI reference signal 0 configuration		N/A	0
Zero-power CSI-RS 0 configuration $l_{CSI-RS} / ZeroPower\ CSI-RS\ bitmap$	Subframes /bitmap	N/A	2/ 0010000000000000
$\hat{E}_s / N_{oc}$	dB	Reference point in Table 8.3.1.3.3_F.3-2 + 4dB	Reference Value in Table 8.3.1.3.3_F.3-2
$N_{oc}$ at antenna port	dBm/15kHz	-98	-98
$BW_{Channel}$	MHz	10	10
Cyclic Prefix		Normal	Normal
Cell Id		0	126
Number of control OFDM symbols		1	2
Timing offset between TPs	us	N/A	0
Frequency offset between TPs	Hz	N/A	200
<i>qcl-Operation, PDSCH RE Mapping and Quasi-Co-Location Indicator'</i>		Type B, '00'	
PDSCH transmission mode		Blank	10
Number of allocated resource block		N/A	50
Symbols for unused PRBs		N/A	OCNG (Note 2)
Note 1: $P_b = 1$ Note 2: These physical resource blocks are assigned to an arbitrary number of virtual UEs with one PDSCH per virtual UE; the data transmitted over the OCNG PDSCHs shall be uncorrelated pseudo random data, which is QPSK modulated.			

**Table 8.3.1.3.3\_F.3-2: Performance Requirements for quasi co-location type B with different Cell ID and Colliding CRS**

Test Number	Reference Channel	OCNG Pattern		Propagation Conditions (Note1)		Correlation Matrix and Antenna Configuration (Note 2)	Reference Value		UE Category
		TP 1	TP 2	TP 1	TP 2		Fraction of Maximum Throughput (%)	SNR (dB) (Note 3)	
1	R.54 FDD	N/A	OP.1 FDD	EPA5	ETU5	2x2 Low	70	14.4	2-8
Note 1: The propagation conditions for TP 1 and TP 2 are statistically independent. Note 2: Correlation matrix and antenna configuration parameters apply for each of TP 1 and TP 2. Note 3: SNR corresponds to $\hat{E}_s / N_{oc}$ of TP 2 as defined in clause 8.1.1.									

The normative reference for these requirements is TS 36.101 [2] clause 8.3.1.3.3.

#### 8.3.1.3.3\_F.4 Test description

##### 8.3.1.3.3\_F.4.1 Initial conditions

Initial conditions are a set of test configurations the UE needs to be tested in and the steps for the SS to take with the UE to reach the correct measurement state.

Configurations of PDSCH and PDCCH before measurement are specified in Annex C.2.

Test Environment: Normal, as defined in TS 36.508 [7] clause 4.1.

Frequencies to be tested: Mid Range, as defined in TS 36.508 [7] clause 4.3.1.2.

Channel Bandwidths to be tested: As specified per test number in Table 8.2.2.3.3\_C.1.3-2, as defined in TS 36.508 [7] clause 4.3.1.2

1. Connect the SS, the faders and AWGN noise sources to the UE antenna connectors as shown in TS 36.508 [7] Annex A, Figure A.40 for antenna configuration 2x2.
2. The parameter settings for the TP 1 are set up according to tables 8.3.1-1 and 8.3.1.3.3\_F.3-1 as appropriate.
3. Downlink signals are initially set up according to Annex C0, C.1 and Annex C.3.2 and uplink signals according to Annex H.1 and H.3.2.
4. Propagation conditions are set according to Annex B.0.
5. Ensure the UE is in State 3A-RF according to TS 36.508 [7] clause 5.2A.2. Message contents are defined in clause 8.3.1.3.3\_F.4.3.

##### 8.3.1.3.3\_F.4.2 Test procedure

1. SS transmits PDCCH DCI format 2D on TP 1 according to Tables 8.3.1.3.3\_F.3-1, 8.3.1.3.3\_F.3-2 and Annex C3.4.
2. SS transmits PDSCH on TP 2 via PDCCH DCI format 2D for C\_RNTI to transmit the DL RMC according to Tables 8.3.1.3.3\_F.3-1, 8.3.1.3.3\_F.3-2 and Annex C3.4. The SS sends downlink MAC padding bits on the DL RMC.
3. Set the parameters of the reference channel, the propagation condition, the correlation matrix and the SNR according to Table 8.3.1.3.3\_F.5-1 as appropriate.
4. Measure the average throughput for a duration sufficient to achieve statistical significance according to Annex G clause G.3. Count the number of NACKs, ACKs and statDTXs on the UL during the test interval and decide pass or fail according to Tables G.3.5 and G.3.6 in Annex G clause G.3.

##### 8.3.1.3.3\_F.4.3 Message contents

Message contents are according to TS 36.508 [7] clause 4.6 with the following exceptions:



**Table 8.3.1.3.3\_F.4.3-1: PhysicalConfigDedicated-DEFAULT**

Derivation Path: 36.508 clause 4.6.3			
Information Element	Value/remark	Comment	Condition
PhysicalConfigDedicated-DEFAULT ::= SEQUENCE {			
pdsch-ConfigDedicated	PDSCH-ConfigDedicated-DEFAULT		
antennaInfo-r10 CHOICE {			
explicitValue-r10	AntennaInfoDedicated-r10		
}			
csi-RS-ConfigNZPTToAddModList-r11	CSI-RS-ConfigNZP-r11-DEFAULT		
csi-RS-ConfigZPTToAddModList-r11	CSI-RS-ConfigZP-r11-DEFAULT		
pdsch-ConfigDedicated-v1130	PDSCH-ConfigDedicated-v1130-DEFAULT		
}			

**Table 8.3.1.3.3\_F.4.3-2: PDSCH-ConfigDedicated-DEFAULT**

Derivation Path:36.508 clause 4.6.3			
Information Element	Value/remark	Comment	Condition
PDSCH-ConfigDedicated-DEFAULT ::= SEQUENCE {			
p-a	dB-3		2TX
}			

**Table 8.3.1.3.3\_F.4.3-3: AntennaInfoDedicated-r10**

Derivation Path: 36.331 clause 6.3.2			
Information Element	Value/remark	Comment	Condition
AntennaInfoDedicated-r10 ::= SEQUENCE {			
transmissionMode-r10	tm10-v1130		
}			
ue-TransmitAntennaSelection CHOICE {			
release	NULL		
}			

**Table 8.3.1.3.3\_F.4.3-4: CSI-RS-ConfigNZP-r11-DEFAULT**

Derivation Path: 36.508 clause 4.6.3			
Information Element	Value/remark	Comment	Condition
CSI-RS-ConfigNZP-r11 ::= SEQUENCE {			
csi-RS-ConfigNZPId-r11	1		
antennaPortsCount-r11	an2		
resourceConfig-r11	0		
subframeConfig-r11	2		
scramblingIdentity-r11	126		
qcl-CRS-Info-r11 SEQUENCE {			
qcl-ScramblingIdentity-r11	0		
crs-PortsCount-r11	n2		
mbsfn-SubframeConfigList-r11	Not present		
}			

**Table 8.3.1.3.3\_F.4.3-5: CSI-RS-ConfigZP-r11-DEFAULT**

Derivation Path: 36.508 clause 4.6.3			
Information Element	Value/remark	Comment	Condition
CSI-RS-ConfigZP-r11 ::= SEQUENCE {			
csi-RS-ConfigZPId-r11	1		
resourceConfigList-r11	0010000000000000		
subframeConfig-r11	2		
}			

**Table 8.3.1.3.3\_F.4.3-6: PDSCH-ConfigDedicated-v1130-DEFAULT**

Derivation Path: 36.508 clause 4.6.3			
Information Element	Value/remark	Comment	Condition
PDSCH-ConfigDedicated-v1130 ::= SEQUENCE {			
dmrs-ConfigPDSCH-r11	DMRS-Config-r11-DEFAULT		
qcl-Operation	typeB		
re-MappingQCLConfigToAddModList-r11 SEQUENCE (SIZE (1..maxRE-MapQCL-r11)) OF SEQUENCE {	1 entry		
pdsch-RE-MappingQCL-ConfigId-r11[1]	1		
optionalSetOfFields-r11[1] SEQUENCE {			
crs-PortsCount-r11	n2		
crs-FreqShift-r11	0		
mbsfn-SubframeConfigList-r11	Not present		
pdsch-Start-r11	2		
}			
}			
}			

8.3.1.3.3\_F.5 Test requirements

Table 8.3.1.3.3\_F.3-1 defines the primary level setting.

The fraction of maximum throughput percentage for the downlink reference measurement channels specified in Annex A clause A.3.4.2 for each throughput test shall meet or exceed the specified value in Table 8.3.1.3.3\_F.5-1 for the specified SNR including test tolerances for all throughput tests.

**Table 8.3.1.3.3\_F.5-1: Test Requirements for quasi co-location type B with different Cell ID and Colliding CRS**

Test Number	Reference Channel	OCNG Pattern		Propagation Conditions (Note1)		Correlation Matrix and Antenna Configuration (Note 2)	Reference Value		UE Category
		TP 1	TP 2	TP 1	TP 2		Fraction of Maximum Throughput (%)	SNR (dB) (Note 3)	
1	R.54 FDD	N/A	OP.1 FDD	EPA5	ETU5	2x2 Low	70	15.3	2-8
Note 1: The propagation conditions for TP 1 and TP 2 are statistically independent. Note 2: Correlation matrix and antenna configuration parameters apply for each of TP 1 and TP 2. Note 3: SNR corresponds to $\hat{E}_s / N_{oc}$ of TP 2 as defined in clause 8.1.1.									

8.3.2 TDD

The parameters specified in Table 8.3.2-1 are valid for TDD unless otherwise stated.

**Table 8.3.2-1: Common Test Parameters for User-specific Reference Symbols**

Parameter	Unit	Value
Uplink downlink configuration (Note 1)		1
Special subframe configuration (Note 2)		4
Cyclic prefix		Normal
Cell ID		0
Inter-TTI Distance		1
Number of HARQ processes. All these HARQ processes are used.	Processes	7
Maximum number of HARQ transmission		4
Redundancy version coding sequence		{0,1,2,3} for QPSK and 16QAM {0,0,1,2} for 64QAM
Number of OFDM symbols for PDCCH	OFDM symbols	2
Precoder update granularity		Frequency domain: 1 PRB for Transmission mode 7 & 8, 1 PRG for Transmission mode 9 and 10 Time domain: 1 ms
ACK/NACK feedback mode		Multiplexing
Note 1: as specified in Table 4.2-2 in TS 36.211 [8].		
Note 2: as specified in Table 4.2-1 in TS 36.211 [8].		

For all test cases, the SNR is defined as:

$$SNR = \frac{\hat{E}_s^{(1)} + \hat{E}_s^{(2)}}{N_{oc}^{(1)} + N_{oc}^{(2)}}$$

where the superscript indicates the receiver antenna connector. The SNR requirement applies for the UE categories given for each test.

The normative reference for this requirement is TS 36.101 [2] clause 8.3.2.

### 8.3.2.1 TDD PDSCH Single-layer Spatial Multiplexing Performance (UE-Specific Reference Symbols)

#### 8.3.2.1.1 TDD PDSCH Single-layer Spatial Multiplexing on antenna port 5 (Release 8 and forward)

##### 8.3.2.1.1.1 Test purpose

To verify the UE's ability to receive a predefined test signal, representing a multi-path fading channel that is determined by the SNR with a percentage of the information bit throughput for a specified downlink Reference Measurement Channel (RMC) not falling below a specified value for single-layer transmission on antenna port 5 using user-specific reference signals with full RB or single RB allocation.

##### 8.3.2.1.1.2 Test applicability

This test applies to all types of E-UTRA TDD UE release 8 and forward.

## 8.3.2.1.1.3 Minimum conformance requirements

The requirements are specified in terms of the percentage of information bit throughput for the downlink reference measurement channels specified in Annex A clause A.3.4.3.1, with the addition of the relevant parameters in Tables 8.3.2-1, 8.3.2.1.1.3-1, and the downlink physical channel setup according to Table C.3.2-1 in Annex C.

Using this configuration the fraction of maximum throughput percentage shall meet or exceed the minimum requirements specified in Tables 8.3.2.1.1.3-2 for the specified SNR.

**Table 8.3.2.1.1.3-1: Test Parameters for Testing DRS**

parameter	Unit	Test 1	Test 2	Test 3	Test 4	
Downlink power allocation	$\rho_A$	dB	0	0	0	0
	$\rho_B$	dB	0 (Note 1)	0 (Note 1)	0 (Note 1)	0 (Note 1)
	$\sigma$	dB	0	0	0	0
Cell-specific reference signals	Antenna port 0					
Beamforming model	Annex B.4.1					
$N_{oc}$ at antenna port	dBm/15kHz	-98	-98	-98	-98	
Symbols for unused PRBs		OCNG (Note 2)	OCNG (Note 2)	OCNG (Note 2)	OCNG (Note 2)	
PDSCH transmission mode		7	7	7	7	
Note 1: $P_B = 0$						
Note 2: These physical resource blocks are assigned to an arbitrary number of virtual UEs with one PDSCH per virtual UE; the data transmitted over the OCNG PDSCHs shall be uncorrelated pseudo random data, which is QPSK modulated.						

**Table 8.3.2.1.1.3-2: Minimum performance DRS (FRC)**

Test number	Bandwidth and MCS	Reference Channel	OCNG Pattern	Propagation Condition	Correlation Matrix and Antenna Configuration	Reference value		UE Category
						Fraction of Maximum Throughput (%)	SNR (dB)	
1	10 MHz QPSK 1/3	R.25 TDD	OP.1 TDD	EPA5	2x2 Low	70	-0.8	$\geq 1$
2	10 MHz 16QAM 1/2	R.26 TDD	OP.1 TDD	EPA5	2x2 Low	70	7.0	$\geq 2$
3	10 MHz 64QAM 3/4	R.27 TDD	OP.1 TDD	EPA5	2x2 Low	70	17.0	$\geq 2$
4	10 MHz 16QAM 1/2	R.28 TDD	OP.1 TDD	EPA5	2x2 Low	30	1.7	$\geq 1$

The normative reference for this requirement is TS 36.101 [2] clause 8.3.2.

## 8.3.2.1.1.4 Test description

## 8.3.2.1.1.4.1 Initial conditions

Initial conditions are a set of test configurations the UE needs to be tested in and the steps for the SS to take with the UE to reach the correct measurement state.

Configurations of PDSCH and PDCCH before measurement are specified in Annex C.2.

Test Environment: Normal, as defined in TS 36.508 [7] clause 4.1.

Frequencies to be tested: Mid Range, as defined in TS 36.508 [7] clause 4.3.1.2.

Bandwidths to be tested: 10MHz, as defined in TS 36.508 [7] clause 4.3.1.2.

1. Connect the SS, the faders and AWGN noise sources to the UE antenna connectors as shown in TS 36.508 [7] Annex A, Figure A.10 for antenna configuration 2x2.
2. The parameter settings for the cell are set up according to Tables 8.3.2-1 and 8.3.2.1.1.3-1 as appropriate.
3. Downlink signals are initially set up according to Annex C0, C.1 and Annex C.3.2 and uplink signals according to Annex H.1 and H.3.2.
4. Propagation conditions are set according to Annex B.0.
5. Ensure the UE is in State 3A-RF according to TS 36.508 [7] clause 5.2A.2. Message contents are defined in clause 8.3.2.1.1.4.3.

8.3.2.1.1.4.2 Test procedure

1. SS transmits PDSCH via PDCCH DCI format 1 for C\_RNTI to transmit the DL RMC according to Tables 8.3.2.1.1.3-1, 8.3.2.1.1.3-2. The SS sends downlink MAC padding bits on the DL RMC.
2. Set the parameters of the bandwidth, MCS, reference channel, the propagation condition, the correlation matrix and the SNR according to Table 8.3.2.1.1.5-1 as appropriate.

BCH/CRS/PDCCH/PCFICH are sent on antenna port 0 using one Tx antenna, while DRS/Dedicated data for the test UE are sent on antenna port 5 using two Tx antennas with beam-forming model as specified in Annex B.4.1 and precoder update granularity specified in Table 8.3.2-1.

3. Measure the average throughput for a duration sufficient to achieve statistical significance according to Annex G clause G.3. Count the number of NACKs, ACKs and statDTXs on the UL during each test interval and decide pass or fail according to Tables G.3.5 and G.3.6 in Annex G clause G.3.
4. Repeat steps from 1 to 3 for each test interval in Tables 8.3.2.1.1.5-1 as appropriate.

8.3.2.1.1.4.3 Message contents

Message contents are according to TS 36.508 [7] clause 4.6 with the following exceptions.

**Table 8.3.2.1.1.4.3-1: PhysicalConfigDedicated-DEFAULT: Additional TDD PDSCH DRS performance downlink power allocation test point 1 requirement for Test number 1 - 4**

Derivation Path: 36.331 clause 6.3.2			
Information Element	Value/remark	Comment	Condition
PhysicalConfigDedicated-DEFAULT ::= SEQUENCE {			
antennaInfo CHOICE {			
antennaInfoDedicated ::= SEQUENCE {			
transmissionMode	tm7		
ue-TransmitAntennaSelection CHOICE {			
Release	NULL		
}			
}			
}			

8.3.2.1.1.5 Test requirement

Table 8.3.2.1.1.3-1 defines the primary level settings.

The fraction of maximum throughput percentage for the downlink reference measurement channels specified in Annex A clause A.3.4.3.1 for each throughput test shall meet or exceed the specified value in Table 8.3.2.1.1.5-1 for the specified SNR including test tolerances for all throughput tests.

Table 8.3.2.1.1.5-1: Test requirement DRS

Test number	Bandwidth and MCS	Reference Channel	OCNG Pattern	Propagation Condition	Correlation Matrix and Antenna Configuration	Reference value		UE Category
						Fraction of Maximum Throughput (%)	SNR (dB)	
1	10 MHz QPSK 1/3	R.25 TDD	OP.1 TDD	EPA5	2x2 Low	70	0.1	≥1
2	10 MHz 16QAM 1/2	R.26 TDD	OP.1 TDD	EPA5	2x2 Low	70	7.9	≥2
3	10 MHz 64QAM 3/4	R.27 TDD	OP.1 TDD	EPA5	2x2 Low	70	17.9	≥2
4	10 MHz 16QAM 1/2	R.28 TDD	OP.1 TDD	EPA5	2x2 Low	30	2.6	≥1

### 8.3.2.1.1\_1 TDD PDSCH Single-layer Spatial Multiplexing on antenna port 5 (Release 9 and forward)

#### 8.3.2.1.1\_1.1 Test purpose

Same test purpose as in clause 8.3.2.1.1.1.

#### 8.3.2.1.1\_1.2 Test applicability

This test applies to all types of E-UTRA TDD UE release 9 and forward of UE category 1.

#### 8.3.2.1.1\_1.3 Minimum conformance requirements

Same minimum conformance requirements as in clause 8.3.2.1.1.3 with the following exceptions:

- Instead of Table 8.3.2.1.1.3-1 -> use Table 8.3.2.1.1\_1.3-1.
- Instead of Table 8.3.2.1.1.3-2 -> use Table 8.3.2.1.1\_1.3-2.

Table 8.3.2.1.1\_1.3-1: Test Parameters for Testing DRS (Antenna port 5)

Parameter		Unit	Test 1 (Note 4)	Test 2	Test 3	Test 4 (Note 4)
Downlink power allocation	$\rho_A$	dB	N/A	0	0	NA
	$\rho_B$	dB		0 (Note 1)	0 (Note 1)	
	$\sigma$	dB		0	0	
Cell-specific reference signals	Antenna port 0					
Beamforming model	Annex B.4.1					
$N_{oc}$ at antenna port	dBm/15kHz	N/A	-98	-98	NA	
Symbols for unused PRBs		N/A	OCNG (Note 2)	OCNG (Note 2)	N/A	
PDSCH transmission mode		N/A	7	7	N/A	
Note 1: $P_B = 0$ Note 2: These physical resource blocks are assigned to an arbitrary number of virtual UEs with one PDSCH per virtual UE; the data transmitted over the OCNG PDSCHs shall be uncorrelated pseudo random data, which is QPSK modulated. Note 3: The modulation symbols of the signal under test are mapped onto antenna port 5. Note 4: This tests are covered in subclause 8.3.2.1.1						

**Table 8.3.2.1.1\_1.3-2: Minimum performance DRS (FRC) (Antenna port 5)**

Test number	Bandwidth and MCS	Reference Channel	OCNG Pattern	Propagation Condition	Correlation Matrix and Antenna Configuration	Reference value		UE Category
						Fraction of Maximum Throughput (%)	SNR (dB)	
1 (Note 1)	N/A							
2	5MHz 16QAM 1/2	R.26-1 TDD	OP.1 TDD	EPA5	2x2 Low	70	7.0	1
3	10 MHz 64QAM 3/4	R.27-1 TDD	OP.1 TDD	EPA5	2x2 Low	70	17.0	1
4 (Note 1)	N/A							
Note 1: These tests are covered in subclause 8.3.2.1.1								

The normative reference for this requirement is TS 36.101 [2] clause 8.3.2.

#### 8.3.2.1.1\_1.4 Test description

Same test description as in clause 8.3.2.1.1.4 with the following exceptions:

- Instead of Table 8.3.2.1.1.3-1 -> use Table 8.3.2.1.1\_1.3-1.
- Instead of Table 8.3.2.1.1.3-2 -> use Table 8.3.2.1.1\_1.3-2.
- Initial conditions - Bandwidths to be tested: Depending on the bandwidth specified per test number in Table 8.3.2.1.1\_1.3-2, as defined in TS 36.508 [7] clause 4.3.1.2.
- Instead of Table 8.3.2.1.1.5-1 -> use Table 8.3.2.1.1\_1.5-1.

#### 8.3.2.1.1\_1.5 Test requirement

Same test requirement as in clause 8.3.2.1.1.5 with the following exceptions:

- Instead of Table 8.3.2.1.1.3-1 -> use Table 8.3.2.1.1\_1.3-1.
- Instead of Table 8.3.2.1.1.5-1 -> use Table 8.3.2.1.1\_1.5-1.

**Table 8.3.2.1.1\_1.5-1: Test requirement DRS (FRC) (Antenna port 5)**

Test number	Bandwidth and MCS	Reference Channel	OCNG Pattern	Propagation Condition	Correlation Matrix and Antenna Configuration	Reference value		UE Category
						Fraction of Maximum Throughput (%)	SNR (dB)	
1 (Note 1)	N/A							
2	5MHz 16QAM 1/2	R.26-1 TDD	OP.1 TDD	EPA5	2x2 Low	70	7.9	1
3	10 MHz 64QAM 3/4	R.27-1 TDD	OP.1 TDD	EPA5	2x2 Low	70	17.9	1
4 (Note 1)	N/A							
Note 1: These tests are covered in subclause 8.3.2.1.1								

### 8.3.2.1.2 TDD PDSCH Single-layer Spatial Multiplexing on antenna port 7 or 8 without a simultaneous transmission

#### 8.3.2.1.2.1 Test purpose

To verify the UE's ability to receive a predefined test signal, representing a multi-path fading channel that is determined by the SNR with a percentage of the information bit throughput for a specified downlink Reference Measurement Channel (RMC) not falling below a specified value for single-layer transmission on antenna port 7 or 8 without a simultaneous transmission on the other antenna port using DM-RS with full RB allocation.

#### 8.3.2.1.2.2 Test applicability

This test applies to Release 9 UEs that support enhanced Dual Layer TDD (TM8) and all types of E-UTRATDD UE release 10 and forward.

#### 8.3.2.1.2.3 Minimum conformance requirements

The requirements are specified in terms of the percentage of information bit throughput for the downlink reference measurement channels specified in Annex A clause A.3.4.3.2, with the addition of the relevant parameters in Tables 8.3.2-1, 8.3.2.1.2.3-1, and the downlink physical channel setup according to Table C.3.2-1 in Annex C.

Using this configuration the fraction of maximum throughput percentage shall meet or exceed the minimum requirements specified in Tables 8.3.2.1.2.3-2 for the specified SNR.

**Table 8.3.2.1.2.3-1: Test Parameters for Testing CDM-multiplexed DM RS (single layer)**

parameter		Unit	Test 1	Test 2	Test 3	Test 4 (Note 3)	Test 5 (Note 3)
Downlink power allocation	$\rho_A$	dB	0	0	0	N/A	N/A
	$\rho_B$	dB	0 (Note 1)	0 (Note 1)	0 (Note 1)	N/A	N/A
	$\sigma$	dB	-3	-3	-3		
Cell-specific reference signals			Antenna port 0 and antenna port 1				
$N_{oc}$ at antenna port		dBm/15kHz	-98	-98	-98	N/A	N/A
Symbols for unused PRBs			OCNG (Note 4)	OCNG (Note 4)	OCNG (Note 4)	N/A	N/A
Simultaneous transmission			No	No	No	N/A	N/A
Note 1: $P_B = 1$ Note 2: The modulation symbols of the signal under test are mapped onto antenna port 7 or 8. Note 3: Test 4 and Test 5 are covered in subclause 8.3.2.1.3. Note 4: These physical resource blocks are assigned to an arbitrary number of virtual UEs with one PDSCH per virtual UE; the data transmitted over the OCNG PDSCHs shall be uncorrelated pseudo random data, which is QPSK modulated.							



**Table 8.3.2.1.2.3-2: Minimum performance for CDM-multiplexed DM RS without simultaneous transmission (FRC)**

Test number	Bandwidth and MCS	Reference Channel	OCNG Pattern	Propagation Condition	Correlation Matrix and Antenna Configuration	Reference value		UE Category
						Fraction of Maximum Throughput (%)	SNR (dB)	
1	10 MHz QPSK 1/3	R.31 TDD	OP.1 TDD	EVA5	2x2 Low	70	-1.0	≥1
2	10 MHz 16QAM 1/2	R.32 TDD	OP.1 TDD	EPA5	2x2 Medium	70	7.7	≥2
	5MHz 16QAM 1/2	R.32-1 TDD	OP.1 TDD	EPA5	2x2 Medium	70	7.7	1
3	10 MHz 64QAM 3/4	R.33 TDD	OP.1 TDD	EPA5	2x2 Low	70	17.7	≥2
	10 MHz 64QAM 3/4	R.33-1 TDD	OP.1 TDD	EPA5	2x2 Low	70	17.7	1

The normative reference for this requirement is TS 36.101 [2] clause 8.3.2.

#### 8.3.2.1.2.4 Test description

##### 8.3.2.1.2.4.1 Initial conditions

Initial conditions are a set of test configurations the UE needs to be tested in and the steps for the SS to take with the UE to reach the correct measurement state.

Configurations of PDSCH and PDCCH before measurement are specified in Annex C.2.

Test Environment: Normal, as defined in TS 36.508 [7] clause 4.1.

Frequencies to be tested: Mid Range, as defined in TS 36.508 [7] clause 4.3.1.2.

Bandwidths to be tested: Depending on the bandwidth specified per test number in Table 8.3.2.1.2.3-2, as defined in TS 36.508 [7] clause 4.3.1.2.

1. Connect the SS, the faders and AWGN noise sources to the UE antenna connectors as shown in TS 36.508 [7] Annex A, Figure A.10.
2. The parameter settings for the cell are set up according to Tables 8.3.2-1 and 8.3.2.1.2.3-1 as appropriate.
3. Downlink signals are initially set up according to Annex C0, C.1 and Annex C.3.2 and uplink signals according to Annex H.1 and H.3.2.
4. Propagation conditions are set according to Annex B.0.
5. Ensure the UE is in State 3A-RF according to TS 36.508 [7] clause 5.2A.2. Message contents are defined in clause 8.3.2.1.2.4.3.

##### 8.3.2.1.2.4.2 Test procedure

1. SS transmits PDSCH via PDCCH DCI format 2B for C\_RNTI to transmit the DL RMC according to Tables 8.3.2.1.2.3-1, 8.3.2.1.2.3-2. The SS sends downlink MAC padding bits on the DL RMC.
2. Set the parameters of the bandwidth, MCS, reference channel, the propagation condition, the correlation matrix and the SNR according to Table 8.3.2.1.2.5-1 as appropriate.  
BCH/CRS/PDCCH/PCFICH are sent on antenna ports 0 and 1 using two Tx antennas, while DRS/Dedicated data for the test UE are sent on antenna port 7 (or 8) using two Tx antennas with beam-forming model as specified in Annex B.4.1 and precoder update granularity specified in Table 8.3.2-1.
3. Measure the average throughput for a duration sufficient to achieve statistical significance according to Annex G clause G.3. Count the number of NACKs, ACKs and statDTXs on the UL during each test interval and decide pass or fail according to Tables G.3.5 and G.3.6 in Annex G clause G.3.

4. Repeat steps from 1 to 3 for each test interval in Tables 8.3.2.1.2.5-1 as appropriate.

8.3.2.1.2.4.3 Message contents

Message contents are according to TS 36.508 [7] clause 4.6 with the following exceptions.

**Table 8.3.2.1.2.4.3-1: PhysicalConfigDedicated-DEFAULT**

Derivation Path: 36.331 clause 6.3.2			
Information Element	Value/remark	Comment	Condition
PhysicalConfigDedicated-DEFAULT ::= SEQUENCE {			
antennaInfo CHOICE {			
antennaInfoDedicated ::= SEQUENCE {			
transmissionMode	tm8-v920		
}			
}			
Extension ::= SEQUENCE {			
antennaInfo-v920 ::= SEQUENCE {			
codebookSubsetRestriction-v920 CHOICE {			
n2TxAntenna-tm8-r9	111111		
}			
}			
}			
}			

8.3.2.1.2.5 Test requirement

Table 8.3.2.1.2.3-1 defines the primary level settings.

The fraction of maximum throughput percentage for the downlink reference measurement channels specified in Annex A clause A.3.4.3.2 for each throughput test shall meet or exceed the specified value in Table 8.3.2.1.2.5-1 for the specified SNR including test tolerances for all throughput tests.

**Table 8.3.2.1.2.5-1: Test requirement for CDM-multiplexed DM RS without simultaneous transmission (FRC)**

Test number	Bandwidth and MCS	Reference Channel	OCNG Pattern	Propagation Condition	Correlation Matrix and Antenna Configuration	Reference value		UE Category
						Fraction of Maximum Throughput (%)	SNR (dB)	
1	10 MHz QPSK 1/3	R.31 TDD	OP.1 TDD	EVA5	2x2 Low	70	-0.1	≥1
2	10 MHz 16QAM 1/2	R.32 TDD	OP.1 TDD	EPA5	2x2 Medium	70	8.6	≥2
	5 MHz 16QAM 1/2	R.32-1 TDD	OP.1 TDD	EPA5	2x2 Medium	70	8.6	1
3	10 MHz 64QAM 3/4	R.33 TDD	OP.1 TDD	EPA5	2x2 Low	70	18.6	≥2
	10 MHz 64QAM 3/4	R.33-1 TDD	OP.1 TDD	EPA5	2x2 Low	70	18.6	1

8.3.2.1.2\_D TDD PDSCH Single-layer Spatial Multiplexing on antenna ports 7 or 8 without a simultaneous transmission for eDL-MIMO

8.3.2.1.2\_D.1 Test purpose

To verify the UE's ability to receive a predefined test signal, representing a multi-path fading channel that is determined by the SNR with a percentage of the information bit throughput for a specified downlink Reference Measurement Channel (RMC) not falling below a specified value for single-layer transmission on antenna ports 7 or 8 without a

simultaneous transmission on the other antenna port and multiple CSI reference symbol configurations with non-zero and zero transmission power.

### 8.3.2.1.2\_D.2 Test applicability

This test applies to all types of E-UTRA TDD UE release 10 and forward that support eDL-MIMO. Applicability requires support for FGI bit 104.

### 8.3.2.1.2\_D.3 Minimum conformance requirements

The requirements are specified in terms of the percentage of information bit throughput for the downlink reference measurement channels specified in Annex A clause A.3.4.3.5, with the addition of the relevant parameters in Tables 8.3.2-1, 8.3.2.1.2\_D.3-1, and the downlink physical channel setup according to Table C.3.2-1 in Annex C.3.2.

Using this configuration the fraction of maximum throughput percentage shall meet or exceed the minimum requirements specified in Table 8.3.2.1.2\_D.3-2 for the specified SNR.

**Table 8.3.2.1.2\_D.3-1: Test Parameters for Testing CDM-multiplexed DM RS (single layer) with multiple CSI-RS configurations**

Parameter	Unit	Test 1	Test 2
Downlink power allocation	$\rho_A$	dB	0
	$\rho_B$	dB	0 (Note 1)
	$\sigma$	dB	-3
Cell-specific reference signals		Antenna ports 0,1	
CSI reference signals		Antenna ports 15,...,22	Antenna ports 15,...,18
Beamforming model		Annex B.4.1	Annex B.4.1
CSI-RS periodicity and subframe offset $T_{CSI-RS} / \Delta_{CSI-RS}$	Subframes	5 / 4	5 / 4
CSI reference signal configuration		1	3
Zero-power CSI-RS configuration $I_{CSI-RS} /$ ZeroPowerCSI-RS bitmap	Subframes / bitmap	4 / 0010000100000000	4 / 0010000000000000
$N_{oc}$ at antenna port	dBm/15kHz	-98	-98
Symbols for unused PRBs		OCNG (Note 4)	OCNG (Note 4)
Number of allocated resource blocks (Note 2)	PRB	50	50
Simultaneous transmission		No	Yes
PDSCH transmission mode		9	9
Note 1: $P_B = 1$ . Note 2: The modulation symbols of the signal under test are mapped onto antenna port 7 or 8. Note 3: Modulation symbols of an interference signal is mapped onto the antenna port (7 or 8) not used for the input signal under test. Note 4: These physical resource blocks are assigned to an arbitrary number of virtual UEs with one PDSCH per virtual UE; the data transmitted over the OCNG PDSCHs shall be uncorrelated pseudo random data, which is QPSK modulated. Note 5: The two UEs' scrambling identities $n_{SCID}$ are set to 0 for CDM-multiplexed DM RS with interfering simultaneous transmission test cases.			

**Table 8.3.2.1.2\_D.3-2: Minimum performance for CDM-multiplexed DM RS without simultaneous transmission (FRC) with multiple CSI-RS configurations**

Test number	Bandwidth and MCS	Reference Channel	OCNG Pattern	Propagation Condition	Correlation Matrix and Antenna Configuration	Reference value		UE Category
						Fraction of Maximum Throughput (%)	SNR (dB)	
1	10 MHz QPSK 1/3	R.50 TDD	OP.1 TDD	EVA5	2x2 Low	70	-0.6	1-8

The normative reference for this requirement is TS 36.101 [2] clause 8.3.2.1A.

#### 8.3.2.1.2\_D.4 Test description

##### 8.3.2.1.2\_D.4.1 Initial conditions

Initial conditions are a set of test configurations the UE needs to be tested in and the steps for the SS to take with the UE to reach the correct measurement state.

Configurations of PDSCH and PDCCH before measurement are specified in Annex C.2.

Test Environment: Normal, as defined in TS 36.508 [7] clause 4.1.

Frequencies to be tested: Mid Range, as defined in TS 36.508 [7] clause 4.3.1.2.

Bandwidths to be tested: 10MHz, as defined in TS 36.508 [7] clause 4.3.1.2.

1. Connect the SS, the faders and AWGN noise sources to the UE antenna connectors as shown in TS 36.508 [7] Annex A, Figure A.10.
2. The parameter settings for the cell are set up according to Tables 8.3.2-1 and 8.3.2.1.2\_D.3-1 as appropriate.
3. Downlink signals are initially set up according to Annex C0, C.1 and Annex C.3.2 and uplink signals according to Annex H.1 and H.3.2.
4. Propagation conditions are set according to Annex B.0.
5. Ensure the UE is in State 3A-RF according to TS 36.508 [7] clause 5.2A.2. Message contents are defined in clause 8.3.2.1.2\_D.4.3.

##### 8.3.2.1.2\_D.4.2 Test procedure

1. SS transmits PDSCH via PDCCH DCI format 2C for C\_RNTI to transmit the DL RMC according to Tables 8.3.2.1.2\_D.3-1, 8.3.2.1.2\_D.3-2. The SS sends downlink MAC padding bits on the DL RMC.
2. Set the parameters of the bandwidth, MCS, reference channel, the propagation condition, the correlation matrix and the SNR according to Table 8.3.2.1.2\_D.5-1 as appropriate.  
BCH/CRS/PDCCH/PCFICH are sent on antenna ports 0 and 1 using two Tx antennas, while DRS/ PDSCH for the test UE are sent on antenna port 7 (or 8) using two Tx antennas with beam-forming model as specified in Annex B.4.1 and precoder update granularity specified in Table 8.3.2-1. CSI-RS are sent on antenna ports 15-22 using two Tx antennas with mapping according to beam-forming model as specified in Annex B.4.1.
3. Measure the average throughput for a duration sufficient to achieve statistical significance according to Annex G clause G.3. Count the number of NACKs, ACKs and statDTXs on the UL during each test interval and decide pass or fail according to Tables G.3.5 and G.3.6 in Annex G clause G.3.

##### 8.3.2.1.2\_D.4.3 Message contents

Message contents are according to TS 36.508 [7] clause 4.6 with the following exceptions:

Table 8.3.2.1.2\_D.4.3-1: *PDSCH-ConfigDedicated-DEFAULT*

Derivation Path: 36.331 clause 6.3.2			
Information Element	Value/remark	Comment	Condition
PDSCH-ConfigDedicated-DEFAULT ::= SEQUENCE {			
p-a	dB0		
}			

Table 8.3.2.1.2\_D.4.3-2: *PhysicalConfigDedicated-DEFAULT*

Derivation Path: TS 36.508 [7] clause 4.8.2.1.6 Table 4.8.2.1.6-1 PhysicalConfigDedicated-DEFAULT			
Information Element	Value/remark	Comment	Condition
PhysicalConfigDedicated-DEFAULT ::= SEQUENCE {			
antennaInfo	Not present		
antennaInfo-r10 CHOICE{			
explicitValue-r10	AntennaInfoDedicated-r10		
}			
csi-RS-Config-r10	CSI-RS-Config-r10		
}			

Table 8.3.2.1.2\_D.4.3-3: *AntennaInfoDedicated-r10*

Derivation Path: 36.331 clause 6.3.2			
Information Element	Value/remark	Comment	Condition
AntennaInfoDedicated-r10 ::= SEQUENCE {			
transmissionMode-r10	tm9-v1020		
codebookSubsetRestriction-r10	Not present	If the UE is configured with <i>transmissionMode</i> tm9, E-UTRAN only configures the field <i>codebookSubsetRestriction</i> if PMI/RI reporting is configured	
ue-TransmitAntennaSelection CHOICE {			
release	NULL		
}			
}			

**Table 8.3.2.1.2\_D.4.3-4: CSI-RS-Config-r10**

Derivation Path: 36.331 clause 6.3.2			
Information Element	Value/remark	Comment	Condition
CSI-RS-Config-r10 ::= SEQUENCE {			
csi-RS-r10 CHOICE{			
setup SEQUENCE {			
antennaPortsCount-r10	an8	Parameter represents the number of antenna ports used for transmission of CSI reference signals	
resourceConfig-r10	1	Parameter: CSI reference signal configuration	
subframeConfig-r10	4	$\Delta_{\text{CSI-RS}} = I_{\text{CSI-RS}}$ when CSI-RS SubframeConfig is from 0-4; Parameter: $I_{\text{CSI-RS}}$	
p-C-r10	-6 dB	Parameter: $P_c$ which is the assumed ratio of PDSCH EPRE to CSI-RS EPRE when UE derives CSI feedback	
}			
}			
zeroTxPowerCSI-RS-r10 CHOICE{			
setup SEQUENCE {			
zeroTxPowerResourceConfigList-r10	2, 7	Parameter: $ZeroPower_{\text{CSI-RS}}$	
zeroTxPowerSubframeConfig-r10	4	Parameter: $I_{\text{CSI-RS}}$	
}			
}			
}			

8.3.2.1.2\_D.5 Test requirement

Table 8.3.2.1.2\_D.3-1 defines the primary level settings.

The fraction of maximum throughput percentage for the downlink reference measurement channels specified in Annex A clause A.3.4.3.5 for the throughput test shall meet or exceed the specified value in Table 8.3.2.1.2\_D.5-1 for the specified SNR including test tolerances for the throughput test.

**Table 8.3.2.1.2\_D.5-1: Test requirement for CDM-multiplexed DM RS without simultaneous transmission (FRC) with multiple CSI-RS configurations**

Test number	Bandwidth h and MCS	Reference Channel	OCNG Pattern	Propagation Condition	Correlation Matrix and Antenna Configuration	Reference value		UE Category
						Fraction of Maximum Throughput (%)	SNR (dB)	
1	10 MHz QPSK 1/3	R.50 TDD	OP.1 TDD	EVA5	2x2 Low	70	0.3	1-8

### 8.3.2.1.3 TDD PDSCH Single-layer Spatial Multiplexing on antenna port 7 or 8 with a simultaneous transmission

#### 8.3.2.1.3.1 Test purpose

To verify the UE's ability to receive a predefined test signal, representing a multi-path fading channel that is determined by the SNR with a percentage of the information bit throughput for a specified downlink Reference Measurement Channel (RMC) not falling below a specified value for single-layer transmission on antenna port 7 or 8 with a simultaneous transmission on the other antenna port using DM-RS with full RB allocation.

#### 8.3.2.1.3.2 Test applicability

This test applies to Release9 UEs that support enhanced Dual Layer TDD (TM8) and all types of E-UTRA TDD UE release 10 and forward.

#### 8.3.2.1.3.3 Minimum conformance requirements

The requirements are specified in terms of the percentage of information bit throughput for the downlink reference measurement channels specified in Annex A clause A.3.4.3.2, with the addition of the relevant parameters in Tables 8.3.2-1, 8.3.2.1.3.3-1, and the downlink physical channel setup according to Table C.3.2-1 in Annex C.

Using this configuration the fraction of maximum throughput percentage shall meet or exceed the minimum requirements specified in Tables 8.3.2.1.3.3-2 for the specified SNR.

**Table 8.3.2.1.3.3-1: Test Parameters for Testing CDM-multiplexed DM RS (single layer)**

parameter	Unit	Test 1 (Note 6)	Test 2 (Note 6)	Test 3 (Note 6)	Test 4	Test 5	
Downlink power allocation	$\rho_A$	dB	N/A	N/A	N/A	0	0
	$\rho_B$	dB	N/A	N/A	N/A	0 (Note 1)	0 (Note 1)
	$\sigma$	dB	N/A	N/A	N/A	-3	-3
Cell-specific reference signals		Antenna port 0 and antenna port 1					
Beamforming model		Annex B.4.1					
$N_{oc}$ at antenna port	dBm/15kHz	N/A	N/A	N/A	-98	-98	
Symbols for unused PRBs		N/A	N/A	N/A	OCNG (Note 4)	OCNG (Note 4)	
Simultaneous transmission		N/A	N/A	N/A	Yes (Note 3, 5)	Yes (Note 3, 5)	
PDSCH transmission mode		N/A	N/A	N/A	8	8	
Note 1: $P_B = 1$ Note 2: The modulation symbols of the signal under test are mapped onto antenna port 7 or 8. Note 3: Modulation symbols of an interference signal is mapped onto the antenna port (7 or 8) not used for the input signal under test. Note 4: These physical resource blocks are assigned to an arbitrary number of virtual UEs with one PDSCH per virtual UE; the data transmitted over the OCNG PDSCHs shall be uncorrelated pseudo random data, which is QPSK modulated. Note 5: The two UEs' scrambling identities $n_{SCID}$ are set to 0 for CDM-multiplexed DM RS with interfering simultaneous transmission test cases. Note 6: Test 1, Test 2 and Test 3 are covered in subclause 8.3.2.1.2.							

**Table 8.3.2.1.3.3-2: Minimum performance for CDM-multiplexed DM RS with interfering simultaneous transmission (FRC)**

Test number	Bandwidth and MCS	Reference Channel	OCNG Pattern	Propagation Condition	Correlation Matrix and Antenna Configuration	Reference value		UE Category
						Fraction of Maximum Throughput (%)	SNR (dB)	
4	10 MHz 16QAM 1/2	R.32 TDD (Note 1)	OP.1 TDD	EPA5	2x2 Medium	70	21.9	≥2
5	10 MHz 64QAM 1/2	R.34 TDD (Note 1)	OP.1 TDD	EPA5	2x2 Low	70	22.0	≥2

Note 1: The reference channel applies to both the input signal under test and the interfering signal.

The normative reference for this requirement is TS 36.101 [2] clause 8.3.2.

#### 8.3.2.1.3.4 Test description

##### 8.3.2.1.3.4.1 Initial conditions

Initial conditions are a set of test configurations the UE needs to be tested in and the steps for the SS to take with the UE to reach the correct measurement state.

Configurations of PDSCH and PDCCH before measurement are specified in Annex C.2.

Test Environment: Normal, as defined in TS 36.508 [7] clause 4.1.

Frequencies to be tested: Mid Range, as defined in TS 36.508 [7] clause 4.3.1.2.

Bandwidths to be tested: 10MHz, as defined in TS 36.508 [7] clause 4.3.1.2.

1. Connect the SS, the faders and AWGN noise sources to the UE antenna connectors as shown in TS 36.508 [7] Annex A, Figure A.10.
2. The parameter settings for the cell are set up according to Tables 8.3.2-1 and 8.3.2.1.3.3-1 as appropriate.
3. Downlink signals are initially set up according to Annex C0, C.1 and Annex C.3.2 and uplink signals according to Annex H.1 and H.3.2.
4. Propagation conditions are set according to Annex B.0.
5. Ensure the UE is in State 3A-RF according to TS 36.508 [7] clause 5.2A.2. Message contents are defined in clause 8.3.2.1.3.4.3.

##### 8.3.2.1.3.4.2 Test procedure

1. SS transmits PDSCH via PDCCH DCI format 2B for C\_RNTI to transmit the DL RMC according to Tables 8.3.2.1.3.3-1, 8.3.2.1.3.3-2. The SS sends downlink MAC padding bits on the DL RMC.
2. Set the parameters of the bandwidth, MCS, reference channel, the propagation condition, the correlation matrix and the SNR according to Table 8.3.2.1.3.5-1 as appropriate.  
BCH/CRS/PDCCH/PCFICH are sent on antenna ports 0 and 1 using two Tx antennas, while DRS/Dedicated data for the test UE are sent on antenna port 7 (or 8) and another simultaneous transmission of DRS/Dedicated data not for the test UE is sent on antenna port 8 (or 7). The DRS/Dedicated data transmissions use two Tx antennas with different beam-forming model as specified in Annex B.4.1 and precoder update granularity specified in Table 8.3.2-1.
3. Measure the average throughput for a duration sufficient to achieve statistical significance according to Annex G clause G.3. Count the number of NACKs, ACKs and statDTXs on the UL during each test interval and decide pass or fail according to Tables G.3.5 and G.3.6 in Annex G clause G.3.
4. Repeat steps from 1 to 3 for each test interval in Tables 8.3.2.1.3.5-1 as appropriate.



## 8.3.2.1.3.4.3 Message contents

Message contents are according to TS 36.508 [7] clause 4.6 with the following exceptions.

**Table 8.3.2.1.3.4.3-1: PhysicalConfigDedicated-DEFAULT**

Derivation Path: 36.331 clause 6.3.2			
Information Element	Value/remark	Comment	Condition
PhysicalConfigDedicated-DEFAULT ::= SEQUENCE {			
antennaInfo CHOICE {			
antennaInfoDedicated ::= SEQUENCE {			
transmissionMode	tm8-v920		
}			
}			
Extension ::= SEQUENCE {			
antennaInfo-v920 ::= SEQUENCE{			
codebookSubsetRestriction-v920 CHOICE {			
n2TxAntenna-tm8-r9	111111		
}			
}			
}			
}			

## 8.3.2.1.3.5 Test requirement

Table 8.3.2.1.3.3-1 defines the primary level settings.

The fraction of maximum throughput percentage for the downlink reference measurement channels specified in Annex A clause A.3.4.3.2 for each throughput test shall meet or exceed the specified value in Table 8.3.2.1.3.5-1 for the specified SNR including test tolerances for all throughput tests.

**Table 8.3.2.1.3.5-1: Test requirement for CDM-multiplexed DM RS with interfering simultaneous transmission (FRC)**

Test number	Bandwidth and MCS	Reference Channel	OCNG Pattern	Propagation Condition	Correlation Matrix and Antenna Configuration	Reference value		UE Category
						Fraction of Maximum Throughput (%)	SNR (dB)	
4	10 MHz 16QAM 1/2	R.32 TDD (Note 1)	OP.1 TDD	EPA5	2x2 Medium	70	22.8	≥2
5	10 MHz 64QAM 1/2	R.34 TDD (Note 1)	OP.1 TDD	EPA5	2x2 Low	70	22.9	≥2

Note 1: The reference channel applies to both the input signal under test and the interfering signal.

## 8.3.2.1.3\_D TDD PDSCH Single-layer Spatial Multiplexing on antenna ports 7 or 8 with a simultaneous transmission for eDL-MIMO

## 8.3.2.1.3\_D.1 Test purpose

To verify the UE's ability to receive a predefined test signal, representing a multi-path fading channel that is determined by the SNR with a percentage of the information bit throughput for a specified downlink Reference Measurement Channel (RMC) not falling below a specified value for single-layer transmission on antenna ports 7 or 8 with a simultaneous transmission on the other antenna port and multiple CSI reference symbol configurations with non-zero and zero transmission power.

## 8.3.2.1.3\_D.2 Test applicability

This test applies to all types of E-UTRA TDD UE release 10 and forward that support eDL-MIMO. Applicability requires support for FGI bit 103.

## 8.3.2.1.3\_D.3 Minimum conformance requirements

The requirements are specified in terms of the percentage of information bit throughput for the downlink reference measurement channels specified in Annex A clause A.3.4.3.5, with the addition of the relevant parameters in Tables 8.3.2-1, 8.3.2.1.3\_D.3-1, and the downlink physical channel setup according to Table C.3.2-1 in Annex C.3.2.

Using this configuration the fraction of maximum throughput percentage shall meet or exceed the minimum requirements specified in Table 8.3.2.1.3\_D.3-2 for the specified SNR.

**Table 8.3.2.1.3\_D.3-1: Test Parameters for Testing CDM-multiplexed DM RS (single layer) with multiple CSI-RS configurations**

Parameter		Unit	Test 1	Test 2
Downlink power allocation	$\rho_A$	dB	0	0
	$\rho_B$	dB	0 (Note 1)	0 (Note 1)
	$\sigma$	dB	-3	-3
Cell-specific reference signals			Antenna ports 0,1	
CSI reference signals			Antenna ports 15,...,22	Antenna ports 15,...,18
Beamforming model			Annex B.4.1	Annex B.4.1
CSI-RS periodicity and subframe offset $T_{CSI-RS} / \Delta_{CSI-RS}$		Subframes	5 / 4	5 / 4
CSI reference signal configuration			1	3
Zero-power CSI-RS configuration $I_{CSI-RS} /$ ZeroPowerCSI-RS bitmap		Subframes / bitmap	4 / 0010000100000000	4 / 0010000000000000
$N_{oc}$ at antenna port		dBm/15kHz	-98	-98
Symbols for unused PRBs			OCNG (Note 4)	OCNG (Note 4)
Number of allocated resource blocks (Note 2)		PRB	50	50
Simultaneous transmission			No	Yes
PDSCH transmission mode			9	9
Note 1: $P_B = 1$ .				
Note 2: The modulation symbols of the signal under test are mapped onto antenna port 7 or 8.				
Note 3: Modulation symbols of an interference signal is mapped onto the antenna port (7 or 8) not used for the input signal under test.				
Note 4: These physical resource blocks are assigned to an arbitrary number of virtual UEs with one PDSCH per virtual UE; the data transmitted over the OCNG PDSCHs shall be uncorrelated pseudo random data, which is QPSK modulated.				
Note 5: The two UEs' scrambling identities $n_{SCID}$ are set to 0 for CDM-multiplexed DM RS with interfering simultaneous transmission test cases.				

**Table 8.3.2.1.3\_D.3-2: Minimum performance for CDM-multiplexed DM RS with interfering simultaneous transmission (FRC) with multiple CSI-RS configurations**

Test number	Bandwidth and MCS	Reference Channel	OCNG Pattern	Propagation Condition	Correlation Matrix and Antenna Configuration	Reference value		UE Category
						Fraction of Maximum Throughput (%)	SNR (dB)	
2	10 MHz 64QAM 1/2	R.44 TDD	OP.1 TDD	EPA5	2x2 Low	70	22.1	2-8

Note 1: The reference channel applies to both the input signal under test and the interfering signal.

The normative reference for this requirement is TS 36.101 [2] clause 8.3.2.1A.

8.3.2.1.3\_D.4 Test description

8.3.2.1.3\_D.4.1 Initial conditions

Initial conditions are a set of test configurations the UE needs to be tested in and the steps for the SS to take with the UE to reach the correct measurement state.

Configurations of PDSCH and PDCCH before measurement are specified in Annex C.2.

Test Environment: Normal, as defined in TS 36.508 [7] clause 4.1.

Frequencies to be tested: Mid Range, as defined in TS 36.508 [7] clause 4.3.1.2.

Bandwidths to be tested: 10MHz, as defined in TS 36.508 [7] clause 4.3.1.2.

1. Connect the SS, the faders and AWGN noise sources to the UE antenna connectors as shown in TS 36.508 [7] Annex A, Figure A.10.
2. The parameter settings for the cell are set up according to Tables 8.3.2-1 and 8.3.2.1.3\_D.3-1 as appropriate.
3. Downlink signals are initially set up according to Annex C0, C.1 and Annex C.3.2 and uplink signals according to Annex H.1 and H.3.2.
4. Propagation conditions are set according to Annex B.0.
5. Ensure the UE is in State 3A-RF according to TS 36.508 [7] clause 5.2A.2. Message contents are defined in clause 8.3.2.1.3\_D.4.3.

8.3.2.1.3\_D.4.2 Test procedure

1. SS transmits PDSCH via PDCCH DCI format 2C for C\_RNTI to transmit the DL RMC according to Tables 8.3.2.1.3\_D.3-1, 8.3.2.1.3\_D.3-2. The SS sends downlink MAC padding bits on the DL RMC.
2. Set the parameters of the bandwidth, MCS, reference channel, the propagation condition, the correlation matrix and the SNR according to Table 8.3.2.1.3\_D.5-1 as appropriate. BCH/CRS/PDCCH/PCFICH are sent on antenna ports 0 and 1 using two Tx antennas, while DRS/ PDSCH for the test UE are sent on antenna port 7 (or 8) and another simultaneous transmission of DRS/PDSCH not for the test UE are sent on antenna port 8 (or 7). The DRS/PDSCH transmissions use two Tx antennas with beam-forming model as specified in Annex B.4.1 and precoder update granularity specified in Table 8.3.2-1. CSI-RS are sent on antenna ports 15-18 using two Tx antennas with mapping according to beam-forming model as specified in Annex B.4.1.
3. Measure the average throughput for a duration sufficient to achieve statistical significance according to Annex G clause G.3. Count the number of NACKs, ACKs and statDTXs on the UL during each test interval and decide pass or fail according to Tables G.3.5 and G.3.6 in Annex G clause G.3.

8.3.2.1.3\_D.4.3 Message contents

Message contents are according to TS 36.508 [7] clause 4.6 with the following exceptions:

**Table 8.3.2.1.3\_D.4.3-1: PDSCH-ConfigDedicated-DEFAULT**

Derivation Path: 36.331 clause 6.3.2			
Information Element	Value/remark	Comment	Condition
PDSCH-ConfigDedicated-DEFAULT ::= SEQUENCE {			
p-a	dB0		
}			

Table 8.3.2.1.3\_D.4.3-2: *PhysicalConfigDedicated-DEFAULT*

Derivation Path: TS 36.508 [7] clause 4.8.2.1.6 Table 4.8.2.1.6-1 PhysicalConfigDedicated-DEFAULT			
Information Element	Value/remark	Comment	Condition
PhysicalConfigDedicated-DEFAULT ::= SEQUENCE {			
antennaInfo	Not present		
antennaInfo-r10 CHOICE{			
explicitValue-r10	AntennaInfoDedicated-r10		
}			
csi-RS-Config-r10	CSI-RS-Config-r10		
}			

Table 8.3.2.1.3\_D.4.3-3: *AntennaInfoDedicated-r10*

Derivation Path: 36.331 clause 6.3.2			
Information Element	Value/remark	Comment	Condition
AntennaInfoDedicated-r10 ::= SEQUENCE {			
transmissionMode-r10	tm9-v1020		
codebookSubsetRestriction-r10	Not present	If the UE is configured with <i>transmissionMode</i> tm9, E-UTRAN only configures the field <i>codebookSubsetRestriction</i> if PMI/RI reporting is configured	
ue-TransmitAntennaSelection CHOICE {			
release	NULL		
}			
}			

**Table 8.3.2.1.3\_D.4.3-4: CSI-RS-Config-r10**

Derivation Path: 36.331 clause 6.3.2			
Information Element	Value/remark	Comment	Condition
CSI-RS-Config-r10 ::= SEQUENCE {			
csi-RS-r10 CHOICE{			
setup SEQUENCE {			
antennaPortsCount-r10	an4	Parameter represents the number of antenna ports used for transmission of CSI reference signals	
resourceConfig-r10	3	Parameter: CSI reference signal configuration	
subframeConfig-r10	4	$\Delta_{\text{CSI-RS}} = I_{\text{CSI-RS}}$ when CSI-RS SubframeConfig is from 0-4; Parameter: $I_{\text{CSI-RS}}$	
p-C-r10	-3 dB	Parameter: $P_c$ which is the assumed ratio of PDSCH EPRE to CSI-RS EPRE when UE derives CSI feedback	
}			
}			
zeroTxPowerCSI-RS-r10 CHOICE{			
setup SEQUENCE {			
zeroTxPowerResourceConfigList-r10	2	Parameter: $ZeroPowerCSI-RS$	
zeroTxPowerSubframeConfig-r10	4	Parameter: $I_{\text{CSI-RS}}$	
}			
}			
}			

8.3.2.1.3\_D.5 Test requirement

Table 8.3.2.1.3\_D.3-1 defines the primary level settings.

The fraction of maximum throughput percentage for the downlink reference measurement channels specified in Annex A clause A.3.4.3.4 for the throughput test shall meet or exceed the specified value in Table 8.3.2.1.3\_D.5-1 for the specified SNR including test tolerances for the throughput test.

**Table 8.3.2.1.3\_D.5-1: Test requirement for CDM-multiplexed DM RS with interfering simultaneous transmission (FRC) with multiple CSI-RS configurations**

Test number	Bandwidth and MCS	Reference Channel	OCNG Pattern	Propagation Condition	Correlation Matrix and Antenna Configuration	Reference value		UE Category
						Fraction of Maximum Throughput (%)	SNR (dB)	
2	10 MHz 64QAM 1/2	R.44 TDD	OP.1 TDD	EPA5	2x2 Low	70	23	2-8

Note 1: The reference channel applies to both the input signal under test and the interfering signal.

#### 8.3.2.1.4 TDD PDSCH Single-layer Spatial Multiplexing on antenna ports 7 or 8 with TM9 Interference Model - Enhanced Performance Requirement Type A

##### 8.3.2.1.4.1 Test purpose

To verify the UE's ability to receive a predefined test signal, representing a multi-path fading channel that is determined by the SNR with a percentage of the information bit throughput for a specified downlink Reference Measurement Channel (RMC) not falling below a specified value for single-layer transmission on antenna ports 7 or 8 without a simultaneous transmission on the other antenna port in the serving cell when the PDSCH transmission in the serving cell is interfered by PDSCH of one dominant interfering cell applying transmission mode 9 interference model defined in clause B.5.4.

##### 8.3.2.1.4.2 Test applicability

This test applies to all types of E-UTRA TDD UE release 11 and forward that support enhanced receiver Type A.

##### 8.3.2.1.4.3 Minimum conformance requirements

The requirements are specified in terms of the percentage of information bit throughput for the downlink reference measurement channels specified in Annex A clause A.3.4.3, with the addition of the relevant parameters in Tables 8.3.2-1, 8.3.2.1.4.3-1, and the downlink physical channel setup according to Table C.3.2-1 in Annex C.3.2.

Using this configuration the fraction of maximum throughput percentage shall meet or exceed the minimum requirements specified in Table 8.3.2.1.4.3-2 for the specified SNR.

**Table 8.3.2.1.4.3-1: Test Parameters for Testing CDM-multiplexed DM RS (single layer) with TM9 interference model**

parameter		Unit	Cell 1	Cell 2
Downlink power allocation	$\rho_A$	dB	0	0
	$\rho_B$	dB	0 (Note 1)	0
	$\sigma$	dB	-3	-3
Cell-specific reference signals			Antenna ports 0,1	Antenna ports 0,1
CSI reference signals			Antenna ports 15,...,18	N/A
CSI-RS periodicity and subframe offset $T_{\text{CSI-RS}} / \Delta_{\text{CSI-RS}}$		Subframes	5 / 4	N/A
CSI reference signal configuration			0	N/A
$N_{oc}$ at antenna port		dBm/15kHz z	-98	N/A
DIP (Note 2)		dB	N/A	-1.73
$BW_{\text{Channel}}$		MHz	10	10
Cyclic Prefix			Normal	Normal
Cell Id			0	126
Number of control OFDM symbols			2	2
PDSCH transmission mode			9	N/A
Beamforming model			As specified in clause B.4.3 (Note 4, 5)	N/A
Interference model			N/A	As specified in clause B.5.4
Probability of occurrence of transmission rank in interfering cells	Rank 1		N/A	70
	Rank 2		N/A	30
Precoder update granularity		PRB	50	6
PMI delay (Note 5)		ms	10 or 11	N/A
Reporting interval		ms	5	N/A
Reporting mode			PUCCH 1-1	N/A
CodeBookSubsetRestriction bitmap			0000000000000000 0000000000000000 0000000000000000 1111111111111111	N/A
Symbols for unused PRBs			OCNG (Note 6)	N/A
Simultaneous transmission			No simultaneous transmission on the other antenna port in (7 or 8) not used for the input signal under test	N/A
Note 1: $P_B = 1$				
Note 2: The respective received power spectral density of each interfering cell relative to $N_{oc}$ is defined by its associated DIP value as specified in clause B.5.1.				
Note 3: The modulation symbols of the signal under test in Cell 1 are mapped onto antenna port 7 or 8.				
Note 4: The precoder in clause B.4.3 follows UE recommended PMI.				
Note 5: If the UE reports in an available uplink reporting instance at subframe SF#n based on PMI estimation at a downlink SF not later than SF#(n-4), this reported PMI				

Note 6:	cannot be applied at the eNB downlink before SF#(n+4). These physical resource blocks are assigned to an arbitrary number of virtual UEs with one PDSCH per virtual UE; the data transmitted over the OCNG PDSCHs shall be uncorrelated pseudo random data, which is QPSK modulated.
Note 7:	All cells are time-synchronous.

**Table 8.3.2.1.4.3-2: Enhanced Performance Requirement Type A, CDM-multiplexed DM RS with TM9 interference model**

Test Number	Reference Channel	OCNG Pattern		Propagation Conditions		Correlation Matrix and Antenna Configuration (Note 3)	Reference Value		UE Category
		Cell 1	Cell 2	Cell 1	Cell 2		Fraction of Maximum Throughput (%)	SINR (dB) (Note 2)	
1	R.48 TDD	OP.1 TDD	N/A	EVA5	EVA5	4x2 Low	70	-1.0	1-8
Note 1: The propagation conditions for Cell 1 and Cell 2 are statistically independent.									
Note 2: SINR corresponds to $\hat{E}_s / N_{oc}$ of Cell 1 as defined in clause 8.1.1.									
Note 3: Correlation matrix and antenna configuration parameters apply for each of Cell 1 and Cell 2.									

The normative reference for this requirement is TS 36.101 [2] clause 8.3.2.1B.

#### 8.3.2.1.4.4 Test description

##### 8.3.2.1.4.4.1 Initial conditions

Initial conditions are a set of test configurations the UE needs to be tested in and the steps for the SS to take with the UE to reach the correct measurement state.

Configurations of PDSCH and PDCCH before measurement are specified in Annex C.2.

Test Environment: Normal, as defined in TS 36.508 [7] clause 4.1.

Frequencies to be tested: Mid Range, as defined in TS 36.508 [7] clause 4.3.1.2.

Bandwidths to be tested: 10MHz, as defined in TS 36.508 [7] clause 4.3.1.2.

1. Connect the SS, the faders and AWGN noise sources to the UE antenna connectors as shown in TS 36.508 [7] Annex A, Figure A.49.
2. The parameter settings for the cell are set up according to Tables 8.3.2-1 and 8.3.2.1.4.5-1 as appropriate.
3. Downlink signals are initially set up according to Annex C0, C.1 and Annex C.3.2 and uplink signals according to Annex H.1 and H.3.2.
4. Propagation conditions are set according to Annex B.0.
5. Ensure the UE is in State 3A-RF according to TS 36.508 [7] clause 5.2A.2. Message contents are defined in clause 8.3.2.1.4.4.3.

##### 8.3.2.1.4.4.2 Test procedure

1. SS transmits PDSCH via PDCCH DCI format 2C for C\_RNTI to transmit the DL RMC according to Tables 8.3.2.1.4.5-1, 8.3.2.1.4.5-2. The SS sends downlink MAC padding bits on the DL RMC.
2. Set the parameters of the bandwidth, MCS, reference channel, the propagation condition, the correlation matrix and the SNR according to Table 8.3.2.1.4.5-2 as appropriate.  
BCH/CRS/PDCCH/PCFICH are sent on antenna ports 0 and 1 using two Tx antennas, while DRS/PDSCH for the test UE are sent on antenna port 7 (or 8) using four Tx antennas with beam-forming model as specified in



Annex B.4.3 and precoder update granularity specified in Table 8.3.2.1.4.5-1. CSI-RS are sent on antenna ports 15-18 using four Tx antennas with mapping according to beam-forming model as specified in Annex B.4. 3.

3. Set the Cell2 –aggressor cell- as defined in Tables 8.3.2.1.4.5-1, 8.3.2.1.4.5-2 and according to Annex B.5.4.
4. Measure the average throughput for a duration sufficient to achieve statistical significance according to Annex G clause G.3. Count the number of NACKs, ACKs and statDTXs on the UL during each test interval and decide pass or fail according to Tables G.3.5 and G.3.6 in Annex G clause G.3.

8.3.2.1.4.4.3 Message contents

Message contents are according to TS 36.508 [7] clause 4.6 with the following exceptions:

**Table 8.3.2.1.4.4.3-1: PDSCH-ConfigDedicated-DEFAULT**

Derivation Path: TS 36.508 [7] clause 4.6.3, Table 4.6.3-6 PDSCH-ConfigDedicated-DEFAULT			
Information Element	Value/remark	Comment	Condition
PDSCH-ConfigDedicated-DEFAULT ::= SEQUENCE {			
p-a	dB0		
}			

**Table 8.3.2.1.4.4.3-2: AntennaInfoDedicated-r10**

Derivation Path: 36.331 clause 6.3.2			
Information Element	Value/remark	Comment	Condition
AntennaInfoDedicated-r10 ::= SEQUENCE {			
transmissionMode-r10	tm9-v1020		
codebookSubsetRestriction-r10	000000000000000000 000000000000000000 000000000000111111 1111111111		
ue-TransmitAntennaSelection CHOICE {			
release	NULL		
}			
}			

Table 8.3.2.1.4.4.3-3: CSI-RS-Config-r10

Derivation Path: 36.331 clause 6.3.2			
Information Element	Value/remark	Comment	Condition
CSI-RS-Config-r10 ::= SEQUENCE {			
csi-RS-r10 CHOICE{			
setup SEQUENCE {			
antennaPortsCount-r10	an4	Parameter represents the number of antenna ports used for transmission of CSI reference signals	
resourceConfig-r10	0	Parameter: CSI reference signal configuration	
subframeConfig-r10	4	$\Delta_{\text{CSI-RS}} = I_{\text{CSI-RS}}$ when CSI-RS SubframeConfig is from 0-4; Parameter: $I_{\text{CSI-RS}}$	
p-C-r10	-3 dB	Parameter: $P_c$ which is the assumed ratio of PDSCH EPRE to CSI-RS EPRE when UE derives CSI feedback	
}			
}			
zeroTxPowerCSI-RS-r10 CHOICE{			
release	NULL		
}			
}			

Table 8.3.2.1.4.4.3-4: CQI-ReportPeriodic-r10

Derivation Path: TS 36.508 [7] clause 4.6.3, Table 4.6.3-2AC CQI-ReportPeriodic-r10-DEFAULT			
Information Element	Value/remark	Comment	Condition
CQI-ReportPeriodic-r10 ::= CHOICE {			
setup SEQUENCE {			
cqi-PUCCH-ResourceIndex-r10	0		
cqi-PUCCH-ResourceIndexP1-r10	Not present		
cqi-pmi-ConfigIndex	4	TDD	
cqi-FormatIndicatorPeriodic-r10 CHOICE {			
widebandCQI-r10 SEQUENCE {			
csi-ReportMode-r10	Not present		
}			
}			
ri-ConfigIndex	484	TDD	
simultaneousAckNackAndCQI	FALSE		
cqi-Mask-r9	Not present		
csi-ConfigIndex-r10	Not present		
}			
}			

**Table 8.3.2.1.4.4.3-5: PhysicalConfigDedicated-DEFAULT**

Derivation Path: TS 36.508 [7] clause 4.8.2.1.6 Table 4.8.2.1.6-1 PhysicalConfigDedicated-DEFAULT			
Information Element	Value/remark	Comment	Condition
PhysicalConfigDedicated-DEFAULT ::= SEQUENCE {			
cqi-ReportConfig	Not present		RBC
antennaInfo	Not present		RBC
antennaInfo-r10 CHOICE{			RBC
explicitValue-r10	AntennaInfoDedicated-r10		
}			
cqi-ReportConfig-r10	CQI-ReportConfig-r10-DEFAULT using condition CQI_PERIODIC		RBC
csi-RS-Config-r10	CSI-RS-Config-r10		RBC
}			

Condition	Explanation
RBC	Used at configuration of a radio bearer combination during SRB2+DRB establishment

**Table 8.3.2.1.4.4.3-6: CQI-ReportConfig-r10-DEFAULT**

Derivation Path: TS 36.508 [7] clause 4.6.3			
Information Element	Value/remark	Comment	Condition
CQI-ReportConfig-r10 ::= SEQUENCE {			
cqi-ReportAperiodic-r10	Not Present		
pmi-RI-Report-r9	setup		
}			

#### 8.3.2.1.4.5 Test requirement

Table 8.3.2.1.4.5-1 defines the primary level settings.

**Table 8.3.2.1.4.5-1: Test Parameters for Testing CDM-multiplexed DM RS (single layer) with TM9 interference model**

parameter		Unit	Cell 1	Cell 2
Downlink power allocation	$\rho_A$	dB	0	0
	$\rho_B$	dB	0 (Note 1)	0
	$\sigma$	dB	-3	-3
Cell-specific reference signals			Antenna ports 0,1	Antenna ports 0,1
CSI reference signals			Antenna ports 15,...,18	N/A
CSI-RS periodicity and subframe offset $T_{\text{CSI-RS}} / \Delta_{\text{CSI-RS}}$		Subframes	5 / 4	N/A
CSI reference signal configuration			0	N/A
$N_{oc}$ at antenna port		dBm/15kHz	-98	N/A
DIP (Note 2)		dB	N/A	-1.45
$BW_{\text{Channel}}$		MHz	10	10
Cyclic Prefix			Normal	Normal
Cell Id			0	126
Number of control OFDM symbols			2	2
PDSCH transmission mode			9	N/A
Beamforming model			As specified in clause B.4.3 (Note 4, 5)	N/A
Interference model			N/A	As specified in clause B.5.4
Probability of occurrence of transmission rank in interfering cells	Rank 1		N/A	70
	Rank 2		N/A	30
Precoder update granularity		PRB	50	6
PMI delay (Note 5)		ms	10 or 11	N/A
Reporting interval		ms	5	N/A
Reporting mode			PUCCH 1-1	N/A
CodeBookSubsetRestriction bitmap			0000000000000000 0000000000000000 0000000000000000 1111111111111111	N/A
Symbols for unused PRBs			OCNG (Note 6)	N/A
Simultaneous transmission			No simultaneous transmission on the other antenna port in (7 or 8) not used for the input signal under test	N/A
<p>Note 1: <math>P_B = 1</math></p> <p>Note 2: The respective received power spectral density of each interfering cell relative to <math>N_{oc}</math> is defined by its associated DIP value as specified in clause B.5.1.</p> <p>Note 3: The modulation symbols of the signal under test in Cell 1 are mapped onto antenna port 7 or 8.</p> <p>Note 4: The precoder in clause B.4.3 follows UE recommended PMI.</p> <p>Note 5: If the UE reports in an available uplink reporting instance at subframe SF#n based on PMI estimation at a downlink SF not later than SF#(n-4), this reported PMI</p>				

cannot be applied at the eNB downlink before SF#(n+4).  
 Note 6: These physical resource blocks are assigned to an arbitrary number of virtual UEs with one PDSCH per virtual UE; the data transmitted over the OCNG PDSCHs shall be uncorrelated pseudo random data, which is QPSK modulated.  
 Note 7: All cells are time-synchronous.

The fraction of maximum throughput percentage for the downlink reference measurement channels specified in Annex A clause A.3.4.3.4 for the throughput test shall meet or exceed the specified value in Table 8.3.2.1.4.5-2 for the specified SNR including test tolerances for the throughput test.

**Table 8.3.2.1.4.5-2: Enhanced Performance Requirement Type A, CDM-multiplexed DM RS with TM9 interference model**

Test Number	Reference Channel	OCNG Pattern		Propagation Conditions		Correlation Matrix and Antenna Configuration (Note 3)	Reference Value		UE Category
		Cell 1	Cell 2	Cell 1	Cell 2		Fraction of Maximum Throughput (%)	SINR (dB) (Note 2)	
1	R.48 TDD	OP.1 TDD	N/A	EVA5	EVA5	4x2 Low	70	-0.02	1-8
Note 1: The propagation conditions for Cell 1 and Cell 2 are statistically independent. Note 2: SINR corresponds to $\hat{E}_s / N_{oc}$ of Cell 1 as defined in clause 8.1.1. Note 3: Correlation matrix and antenna configuration parameters apply for each of Cell 1 and Cell 2.									

### 8.3.2.2 TDD PDSCH Dual-layer Spatial Multiplexing Performance (UE-Specific Reference Symbols)

#### 8.3.2.2.1 TDD PDSCH Dual-layer Spatial Multiplexing

##### 8.3.2.2.1.1 Test purpose

To verify the UE's rank-2 performance and ability to receive a predefined test signal, representing a multi-path fading channel that is determined by the SNR with a percentage of the information bit throughput for a specified downlink Reference Measurement Channel (RMC) not falling below a specified value for dual-layer transmission on antenna ports 7 and 8 using DM-RS with full RB allocation.

##### 8.3.2.2.1.2 Test applicability

This test applies to Release 9 UEs that support enhanced Dual Layer TDD (TM8) and all types of E-UTRA TDD UE release 10 and forward.

##### 8.3.2.2.1.3 Minimum conformance requirements

The requirements are specified in terms of the percentage of information bit throughput for the downlink reference measurement channels specified in Annex A clause A.3.4.3.2, with the addition of the relevant parameters in Tables 8.3.2-1, 8.3.2.2.1.3-1, and the downlink physical channel setup according to Table C.3.2-1 in Annex C.

Using this configuration the fraction of maximum throughput percentage shall meet or exceed the minimum requirements specified in Tables 8.3.2.2.1.3-2 for the specified SNR.

**Table 8.3.2.2.1.3-1: Test Parameters for Testing CDM-multiplexed DM RS (dual layer)**

Parameter		Unit	Test 1	Test 2
Downlink power allocation	$\rho_A$	dB	0	0
	$\rho_B$	dB	0 (Note 1)	0 (Note 1)
	$\sigma$	dB	-3	-3
Cell-specific reference symbols			Antenna port 0 and antenna port 1	
Beamforming model			Annex B.4.2	
$N_{oc}$ at antenna port		dBm/15kHz	-98	-98
Symbols for unused PRBs			OCNG (Note 2)	OCNG (Note 2)
Number of allocated resource blocks		PRB	50	50
PDSCH transmission mode			8	8
Note 1: $P_B = 1$ Note 2: These physical resource blocks are assigned to an arbitrary number of virtual UEs with one PDSCH per virtual UE; the data transmitted over the OCNG PDSCHs shall be uncorrelated pseudo random data, which is QPSK modulated.				

**Table 8.3.2.2.1.3-2: Minimum performance for CDM-multiplexed DM RS (FRC)**

Test number	Bandwidth and MCS	Reference Channel	OCNG Pattern	Propagation Condition	Correlation Matrix and Antenna Configuration	Reference value		UE Category
						Fraction of Maximum Throughput (%)	SNR (dB)	
1	10 MHz QPSK 1/3	R.31 TDD	OP.1 TDD	EVA5	2x2 Low	70	4.5	$\geq 2$
2	10 MHz 16QAM 1/2	R.32 TDD	OP.1 TDD	EPA5	2x2 Medium	70	21.7	$\geq 2$

The normative reference for this requirement is TS 36.101 [2] clause 8.3.2.

#### 8.3.2.2.1.4 Test description

##### 8.3.2.2.1.4.1 Initial conditions

Initial conditions are a set of test configurations the UE needs to be tested in and the steps for the SS to take with the UE to reach the correct measurement state.

Configurations of PDSCH and PDCCH before measurement are specified in Annex C.2.

Test Environment: Normal, as defined in TS 36.508 [7] clause 4.1.

Frequencies to be tested: Mid Range, as defined in TS 36.508 [7] clause 4.3.1.2.

Bandwidths to be tested: 10MHz, as defined in TS 36.508 [7] clause 4.3.1.2.

1. Connect the SS, the faders and AWGN noise sources to the UE antenna connectors as shown in TS 36.508 [7] Annex A, Figure A.10.
2. The parameter settings for the cell are set up according to Tables 8.3.2-1 and 8.3.2.2.1.3-1 as appropriate.
3. Downlink signals are initially set up according to Annex C0, C.1 and Annex C.3.2 and uplink signals according to Annex H.1 and H.3.2.

4. Propagation conditions are set according to Annex B.0.
5. Ensure the UE is in State 3A-RF according to TS 36.508 [7] clause 5.2A.2. Message contents are defined in clause 8.3.2.2.1.4.3.

#### 8.3.2.2.1.4.2 Test procedure

1. SS transmits PDSCH via PDCCH DCI format 2B for C\_RNTI to transmit the DL RMC according to Tables 8.3.2.2.1.3-1, 8.3.2.2.1.3-2. The SS sends downlink MAC padding bits on the DL RMC.
2. Set the parameters of the bandwidth, MCS, reference channel, the propagation condition, the correlation matrix and the SNR according to Table 8.3.2.2.1.5-1 as appropriate.  
BCH/CRS/PDCCH/PCFICH are sent on antenna ports 0 and 1 using two Tx antennas, while DRS/Dedicated data for test UE are sent on antenna ports 7 and 8 using two Tx antennas with beam-forming model as specified in Annex B.4.2 and precoder update granularity specified in Table 8.3.2-1.
3. Measure the average throughput for a duration sufficient to achieve statistical significance according to Annex G clause G.3. Count the number of NACKs, ACKs and statDTXs on the UL during each test interval and decide pass or fail according to Tables G.3.5 and G.3.6 in Annex G clause G.3.
4. Repeat steps from 1 to 3 for each test interval in Tables 8.3.2.2.1.5-1 as appropriate.

#### 8.3.2.1.2.4.3 Message contents

Message contents are according to TS 36.508 [7] clause 4.6 with the following exceptions .

**Table 8.3.2.2.1.4.3-1: PhysicalConfigDedicated-DEFAULT**

Derivation Path: 36.331 clause 6.3.2			
Information Element	Value/remark	Comment	Condition
PhysicalConfigDedicated-DEFAULT ::= SEQUENCE {			
antennaInfo CHOICE {			
antennaInfoDedicated ::= SEQUENCE {			
transmissionMode	tm8-v920		
}			
}			
Extension ::= SEQUENCE {			
antennaInfo-v920 ::= SEQUENCE {			
codebookSubsetRestriction-v920 CHOICE {			
n2TxAntenna-tm8-r9	111111		
}			
}			
}			
}			

#### 8.3.2.2.1.5 Test requirement

Table 8.3.2.2.1.3-1 defines the primary level settings.

The fraction of maximum throughput percentage for the downlink reference measurement channels specified in Annex A clause A.3.4.3.2 for each throughput test shall meet or exceed the specified value in Table 8.3.2.2.1.5-1 for the specified SNR including test tolerances for all throughput tests.

**Table 8.3.2.2.1.5-1: Test requirement for CDM-multiplexed DM RS (FRC)**

Test number	Bandwidth and MCS	Reference Channel	OCNG Pattern	Propagation Condition	Correlation Matrix and Antenna Configuration	Reference value		UE Category
						Fraction of Maximum Throughput (%)	SNR (dB)	
1	10 MHz QPSK 1/3	R.31 TDD	OP.1 TDD	EVA5	2x2 Low	70	5.4	$\geq 2$
2	10 MHz 16QAM 1/2	R.32 TDD	OP.1 TDD	EPA5	2x2 Medium	70	22.6	$\geq 2$

### 8.3.2.2.1\_D TDD PDSCH Dual-layer Spatial Multiplexing for eDL-MIMO

#### 8.3.2.2.1\_D.1 Test purpose

To verify the UE's rank-2 performance and ability to receive a predefined test signal, representing a multi-path fading channel that is determined by the SNR with a percentage of the information bit throughput for a specified downlink Reference Measurement Channel (RMC) not falling below a specified value for dual-layer transmission on antenna ports 7 and 8 using DM-RS with full RB allocation with multiple CSI reference symbol configurations with non-zero and zero transmission power.

#### 8.3.2.2.1\_D.2 Test applicability

This test applies to all types of E-UTRA TDD UE release 10 that support eDL-MIMO. Applicability requires support for FGI bit 103.

#### 8.3.2.2.1\_D.3 Minimum conformance requirements

The requirements are specified in terms of the percentage of information bit throughput for the downlink reference measurement channels specified in Annex A clause A.3.4.2, with the addition of the relevant parameters in Tables 8.3.2-1, 8.3.2.2.1\_D.3-1, and the downlink physical channel setup according to Table C.3.2-1 in Annex C.3.2.

Using this configuration the fraction of maximum throughput percentage shall meet or exceed the minimum requirements specified in Table 8.3.2.2.1\_D.3-2 for the specified SNR.



**Table 8.3.2.2.1\_D.3-1: Test Parameters for Testing CDM-multiplexed DM RS (dual layer) with multiple CSI-RS configurations**

parameter		Unit	Test 1
Downlink power allocation	$\rho_A$	dB	0
	$\rho_B$	dB	0 (Note 1)
	$\sigma$	dB	-3
Cell-specific reference signals			Antenna ports 0 and 1
CSI reference signals			Antenna ports 15,16
Beamforming model			Annex B.4.2
CSI-RS periodicity and subframe offset $T_{\text{CSI-RS}} / \Delta_{\text{CSI-RS}}$		Subframes	5 / 4
CSI reference signal configuration			8
Zero-power CSI-RS configuration $I_{\text{CSI-RS}} / \text{ZeroPowerCSI-RS}$ bitmap		Subframes / bitmap	4 / 0010000000000000
$N_{oc}$ at antenna port		dBm/15kHz	-98
Symbols for unused PRBs			OCNG (Note 2)
Number of allocated resource blocks (Note 2)		PRB	50
Simultaneous transmission			No
PDSCH transmission mode			9
Note 1: $P_B = 1$ . Note 2: These physical resource blocks are assigned to an arbitrary number of virtual UEs with one PDSCH per virtual UE; the data transmitted over the OCNG PDSCHs shall be uncorrelated pseudo random data, which is QPSK modulated.			

**Table 8.3.2.2.1\_D.3-2: Minimum performance for CDM-multiplexed DM RS (FRC) with multiple CSI-RS configurations**

Test number	Bandwidth and MCS	Reference Channel	OCNG Pattern	Propagation Condition	Correlation Matrix and Antenna Configuration	Reference value		UE Category
						Fraction of Maximum Throughput (%)	SNR (dB)	
1	10 MHz 16QAM 1/2	R.51 TDD	OP.1 TDD	EPA5	2x2 Low	70	14.5	2-8

The normative reference for this requirement is TS 36.101 [2] clause 8.3.2.3.

8.3.2.2.1\_D.4 Test description

8.3.2.2.1\_D.4.1 Initial conditions

Initial conditions are a set of test configurations the UE needs to be tested in and the steps for the SS to take with the UE to reach the correct measurement state.

Configurations of PDSCH and PDCCH before measurement are specified in Annex C.2.

Test Environment: Normal, as defined in TS 36.508 [7] clause 4.1.

Frequencies to be tested: Mid Range, as defined in TS 36.508 [7] clause 4.3.1.2.

Bandwidths to be tested: 10MHz, as defined in TS 36.508 [7] clause 4.3.1.2.

1. Connect the SS, the faders and AWGN noise sources to the UE antenna connectors as shown in TS 36.508 [7] Annex A, Figure A.10.
2. The parameter settings for the cell are set up according to Tables 8.3.2-1 and 8.3.2.2.1\_D.3-1 as appropriate.
3. Downlink signals are initially set up according to Annex C0, C.1 and Annex C.3.2 and uplink signals according to Annex H.1 and H.3.2.
4. Propagation conditions are set according to Annex B.0.
5. Ensure the UE is in State 3A-RF according to TS 36.508 [7] clause 5.2A.2. Message contents are defined in clause 8.3.2.2.1\_D.4.3.

#### 8.3.2.2.1\_D.4.2 Test procedure

1. SS transmits PDSCH via PDCCH DCI format 2C for C\_RNTI to transmit the DL RMC according to Tables 8.3.2.2.1\_D.3-1, 8.3.2.2.1\_D.3-2. The SS sends downlink MAC padding bits on the DL RMC.
2. Set the parameters of the bandwidth, MCS, reference channel, the propagation condition, the correlation matrix and the SNR according to Table 8.3.2.2.1\_D.5-1 as appropriate.  
BCH/CRS/PDCCH/PCFICH are sent on antenna ports 0 and 1 using two Tx antennas, while DRS/ PDSCH for the test UE are sent on antenna port 7 and 8 using two Tx antennas with beam-forming model as specified in Annex B.4.2 and precoder update granularity specified in Table 8.3.2-1. CSI-RS are sent on antenna ports 15 and 16 using two Tx antennas with mapping according to beam-forming model as specified in Annex B.4.2.
3. Measure the average throughput for a duration sufficient to achieve statistical significance according to Annex G clause G.3. Count the number of NACKs, ACKs and statDTXs on the UL during each test interval and decide pass or fail according to Tables G.3.5 and G.3.6 in Annex G clause G.3.

#### 8.3.2.2.1\_D.4.3 Message contents

Message contents are according to TS 36.508 [7] clause 4.6 with the following exceptions:

**Table 8.3.2.2.1\_D.4.3-1: PDSCH-ConfigDedicated-DEFAULT**

Derivation Path: 36.331 clause 6.3.2			
Information Element	Value/remark	Comment	Condition
PDSCH-ConfigDedicated-DEFAULT ::= SEQUENCE {			
p-a	dB0		
}			

**Table 8.3.2.2.1\_D.4.3-2: PhysicalConfigDedicated-DEFAULT**

Derivation Path: TS 36.508 [7] clause 4.8.2.1.6 Table 4.8.2.1.6-1 PhysicalConfigDedicated-DEFAULT			
Information Element	Value/remark	Comment	Condition
PhysicalConfigDedicated-DEFAULT ::= SEQUENCE {			
antennaInfo	Not present		
antennaInfo-r10 CHOICE{			
explicitValue-r10	AntennaInfoDedicated-r10		
}			
csi-RS-Config-r10	CSI-RS-Config-r10		
}			

Table 8.3.2.2.1\_D.4.3-3: *AntennaInfoDedicated-r10*

Derivation Path: 36.331 clause 6.3.2			
Information Element	Value/remark	Comment	Condition
AntennaInfoDedicated-r10 ::= SEQUENCE {			
transmissionMode-r10	tm9-v1020		
codebookSubsetRestriction-r10	Not present	If the UE is configured with <i>transmissionMode</i> tm9, E-UTRAN only configures the field <i>codebookSubsetRestriction</i> if PMI/RI reporting is configured	
ue-TransmitAntennaSelection CHOICE {			
release	NULL		
}			
}			

Table 8.3.2.2.1\_D.4.3-4: *CSI-RS-Config-r10*

Derivation Path: 36.331 clause 6.3.2			
Information Element	Value/remark	Comment	Condition
CSI-RS-Config-r10 ::= SEQUENCE {			
csi-RS-r10 CHOICE{			
setup SEQUENCE {			
antennaPortsCount-r10	an2	Parameter represents the number of antenna ports used for transmission of CSI reference signals	
resourceConfig-r10	8	Parameter: CSI reference signal configuration	
subframeConfig-r10	4	$\Delta_{\text{CSI-RS}} = I_{\text{CSI-RS}}$ when CSI-RS SubframeConfig is from 0-4; Parameter: $I_{\text{CSI-RS}}$	
p-C-r10	0	Parameter: $P_c$ which is the assumed ratio of PDSCH EPRE to CSI-RS EPRE when UE derives CSI feedback	
}			
}			
zeroTxPowerCSI-RS-r10 CHOICE{			
setup SEQUENCE {			
zeroTxPowerResourceConfigList-r10	2	Parameter: <i>ZeroPowerCSI-RS</i>	
zeroTxPowerSubframeConfig-r10	4	Parameter: $I_{\text{CSI-RS}}$	
}			
}			
}			

## 8.3.2.2.1\_D.5 Test requirement

Table 8.3.2.2.1\_D.3-1 defines the primary level settings.

The fraction of maximum throughput percentage for the downlink reference measurement channels specified in Annex A clause A.3.4.3.3 for the throughput test shall meet or exceed the specified value in Table 8.3.2.2.1\_D.5-1 for the specified SNR including test tolerances for the throughput test.

**Table 8.3.2.2.1\_D.5-1: Test requirement for CDM-multiplexed DM RS (FRC) with multiple CSI-RS configurations**

Test number	Bandwidth and MCS	Reference Channel	OCNG Pattern	Propagation Condition	Correlation Matrix and Antenna Configuration	Reference value		UE Category
						Fraction of Maximum Throughput (%)	SNR (dB)	
1	10 MHz 16QAM 1/2	R.51 TDD	OP.1 TDD	EPA5	2x2 Low	70	15.4	2-8

### 8.3.2.2.1\_D\_1 TDD PDSCH Dual-layer Spatial Multiplexing for eDL-MIMO (Release 11 and forward)

#### 8.3.2.2.1\_D\_1.1 Test purpose

To verify the UE's rank-2 performance and ability to receive a predefined test signal, representing a multi-path fading channel that is determined by the SNR with a percentage of the information bit throughput for a specified downlink Reference Measurement Channel (RMC) not falling below a specified value for dual-layer transmission on antenna ports 7 and 8 using DM-RS with full RB allocation with multiple CSI reference symbol configurations with non-zero and zero transmission power, and to verify that the UE correctly estimate SNR.

#### 8.3.2.2.1\_D\_1.2 Test applicability

This test applies to all types of E-UTRA TDD UE release 11 and forward that support eDL-MIMO.

#### 8.3.2.2.1\_D\_1.3 Minimum conformance requirements

The requirements are specified in terms of the percentage of information bit throughput for the downlink reference measurement channels specified in Annex A clause A.3.4.2, with the addition of the relevant parameters in Tables 8.3.2-1, 8.3.2.2.1\_D\_1.3-1 where Cell 1 is the serving cell and Cell 2 is the interfering cell. The downlink physical channel setup is set according to Table C.3.2-1 in Annex C.3.2.

Using this configuration the fraction of maximum throughput percentage shall meet or exceed the minimum requirements specified in Table 8.3.2.2.1\_D\_1.3-2 for the specified SNR.

**Table 8.3.2.2.1\_D\_1.3-1: Test Parameters for Testing CDM-multiplexed DM RS (dual layer) with multiple CSI-RS configurations**

parameter		Unit	Test 1	
			Cell 1	Cell 2
Downlink power allocation	$\rho_A$	dB	4	0
	$\rho_B$	dB	4 (Note 1)	0
	$\sigma$	dB	-3	-3

Cell-specific reference signals		Antenna ports 0 and 1	Antenna ports 0 and 1
Cell ID		0	126
CSI reference signals		Antenna ports 15,16	NA
Beamforming model		Annex B.4.2	NA
CSI-RS periodicity and subframe offset $T_{\text{CSI-RS}} / \Delta_{\text{CSI-RS}}$	Subframes	5 / 4	NA
CSI reference signal configuration		8	NA
Zero-power CSI-RS configuration $l_{\text{CSI-RS}} / \text{ZeroPowerCSI-RS bitmap}$	Subframes / bitmap	4 / 0010000000000000	NA
$N_{oc}$ at antenna port	dBm/15kHz	-98	-98
$\hat{E}_s / N_{oc}$		Reference Value in Table 8.3.2.2.1_D_1.3-2	7.25dB
Symbols for unused PRBs		OCNG (Note 2)	NA
Number of allocated resource blocks (Note 2)	PRB	50	NA
Simultaneous transmission		No	NA
PDSCH transmission mode		9	Blanked
<p>Note 1: <math>P_B = 1</math></p> <p>Note 2: These physical resource blocks are assigned to an arbitrary number of virtual UEs with one PDSCH per virtual UE; the data transmitted over the OCNG PDSCHs shall be uncorrelated pseudo random data, which is QPSK modulated.</p>			

**Table 8.3.2.2.1\_D\_1.3-2: Minimum performance for CDM-multiplexed DM RS (FRC) with multiple CSI-RS configurations**

Test number	Bandwidth and MCS	Reference Channel	OCNG Pattern		Propagation Condition		Correlation Matrix and Antenna Configuration	Reference value		UE Category
			Cell 1	Cell 2	Cell 1	Cell 2		Fraction of Maximum Throughput (%)	SNR (dB)	
1	10 MHz 16QAM 1/2	R.51 TDD	OP.1 TDD	N/A	ETU5	ETU5	2x2 Low	70	14.8	≥2
<p>Note 1: The propagation conditions for Cell 1 and Cell 2 are statistically independent.</p> <p>Note 2: Correlation matrix and antenna configuration parameters apply for each of Cell 1 and Cell 2.</p> <p>Note 3: SNR corresponds to <math>\hat{E}_s / N_{oc}</math> of Cell 1.</p>										

The normative reference for this requirement is TS 36.101 [2] clause 8.3.2.3.

## 8.3.2.2.1\_D\_1.4 Test description

## 8.3.2.2.1\_D\_1.4.1 Initial conditions

Initial conditions are a set of test configurations the UE needs to be tested in and the steps for the SS to take with the UE to reach the correct measurement state.

Configurations of PDSCH and PDCCH before measurement are specified in Annex C.2.

Test Environment: Normal, as defined in TS 36.508 [7] clause 4.1.

Frequencies to be tested: Mid Range, as defined in TS 36.508 [7] clause 4.3.1.2.

Bandwidths to be tested: 10MHz, as defined in TS 36.508 [7] clause 4.3.1.2.

1. Connect the SS, the faders and AWGN noise sources to the UE antenna connectors as shown in TS 36.508 [7] Annex A, Figure A.40.
2. The parameter settings for the cell are set up according to Tables 8.3.2-1 and 8.3.2.2.1\_D\_1.3-1 as appropriate.
3. Downlink signals are initially set up according to Annex C0, C.1 and Annex C.3.2 and uplink signals according to Annex H.1 and H.3.2.
4. Propagation conditions are set according to Annex B.0.
5. Ensure the UE is in State 3A-RF according to TS 36.508 [7] clause 5.2A.2. Message contents are defined in clause 8.3.2.2.1\_D\_1.4.3.

## 8.3.2.2.1\_D\_1.4.2 Test procedure

1. SS transmits PDSCH via PDCCH DCI format 2C for C\_RNTI to transmit the DL RMC according to Tables 8.3.2.2.1\_D\_1.3-1, 8.3.2.2.1\_D\_1.3-2. The SS sends downlink MAC padding bits on the DL RMC.
2. Set the parameters of Cell 1 for the bandwidth, MCS, reference channel, the propagation condition, the correlation matrix and the SNR according to Table 8.3.2.2.1\_D.5-2 as appropriate. BCH/CRS/PDCCH/PCFICH are sent on antenna ports 0 and 1 using two Tx antennas, while DRS/ PDSCH for the test UE are sent on antenna port 7 and 8 using two Tx antennas with beam-forming model as specified in Annex B.4.2 and precoder update granularity specified in Table 8.3.2-1. CSI-RS are sent on antenna ports 15 and 16 using two Tx antennas with mapping according to beam-forming model as specified in Annex B.4.2.
3. Set Cell 2 as defined in Tables 8.3.2.2.1\_D\_1.5-1 and 8.3.2.2.1\_D\_1.5-2 as appropriate.
4. Measure the average throughput for a duration sufficient to achieve statistical significance according to Annex G clause G.3. Count the number of NACKs, ACKs and statDTXs on the UL during each test interval and decide pass or fail according to Tables G.3.5 and G.3.6 in Annex G clause G.3.

## 8.3.2.2.1\_D\_1.4.3 Message contents

Message contents are according to TS 36.508 [7] clause 4.6 with the following exceptions:

**Table 8.3.2.2.1\_D\_1.4.3-1: PDSCH-ConfigDedicated-DEFAULT**

Derivation Path: 36.331 clause 6.3.2			
Information Element	Value/remark	Comment	Condition
PDSCH-ConfigDedicated-DEFAULT ::= SEQUENCE {			
p-a	dB4 for Cell 1 dB0 for Cell 2	According to each Cell in test 1	
}			

Table 8.3.2.2.1\_D\_1.4.3-2: *PhysicalConfigDedicated-DEFAULT*

Derivation Path: TS 36.508 [7] clause 4.8.2.1.6 Table 4.8.2.1.6-1 PhysicalConfigDedicated-DEFAULT			
Information Element	Value/remark	Comment	Condition
PhysicalConfigDedicated-DEFAULT ::= SEQUENCE {			
antennaInfo	Not present		
antennaInfo-r10 CHOICE{			
explicitValue-r10	AntennaInfoDedicated-r10		
}			
csi-RS-Config-r10	CSI-RS-Config-r10		
}			

Table 8.3.2.2.1\_D\_1.4.3-3: *AntennaInfoDedicated-r10*

Derivation Path: 36.331 clause 6.3.2			
Information Element	Value/remark	Comment	Condition
AntennaInfoDedicated-r10 ::= SEQUENCE {			
transmissionMode-r10	tm9-v1020		
codebookSubsetRestriction-r10	Not present	If the UE is configured with <i>transmissionMode</i> tm9, E-UTRAN only configures the field <i>codebookSubsetRestriction</i> if PMI/RI reporting is configured	
ue-TransmitAntennaSelection CHOICE {			
release	NULL		
}			
}			

**Table 8.3.2.2.1\_D\_1.4.3-4: CSI-RS-Config-r10**

Derivation Path: 36.331 clause 6.3.2			
Information Element	Value/remark	Comment	Condition
CSI-RS-Config-r10 ::= SEQUENCE {			
csi-RS-r10 CHOICE{			
setup SEQUENCE {			
antennaPortsCount-r10	an2	Parameter represents the number of antenna ports used for transmission of CSI reference signals	
resourceConfig-r10	8	Parameter: CSI reference signal configuration	
subframeConfig-r10	4	$\Delta_{\text{CSI-RS}} = I_{\text{CSI-RS}}$ when CSI-RS SubframeConfig is from 0-4; Parameter: $I_{\text{CSI-RS}}$	
p-C-r10	4 for Cell 1 0 for Cell 2	Parameter: $P_c$ which is the assumed ratio of PDSCH EPRE to CSI-RS EPRE when UE derives CSI feedback	
}			
}			
zeroTxPowerCSI-RS-r10 CHOICE{			
setup SEQUENCE {			
zeroTxPowerResourceConfigList-r10	4	Parameter: $ZeroPowerCSI-RS$	
zeroTxPowerSubframeConfig-r10	4	Parameter: $I_{\text{CSI-RS}}$	
}			
}			
}			

8.3.2.2.1\_D\_1.5 Test requirement

Table 8.3.2.2.1\_D\_1.5-1 defines the primary level settings.

The fraction of maximum throughput percentage for the downlink reference measurement channels specified in Annex A clause A.3.3.3.3 for the throughput test shall meet or exceed the specified value in Table 8.3.2.2.1\_D\_1.5-1 and 8.3.2.2.1\_D\_1.5-2 for the specified SNR including test tolerances for the throughput test.

**Table 8.3.2.2.1\_D\_1.5-1: Test Requirement for Testing CDM-multiplexed DM RS (dual layer) with multiple CSI-RS configurations**

parameter		Unit	Test 1	
			Cell 1	Cell 2
Downlink power allocation	$\rho_A$	dB	4	0
	$\rho_B$	dB	4 (Note 1)	0
	$\sigma$	dB	-3	-3



Cell-specific reference signals		Antenna ports 0 and 1	Antenna ports 0 and 1
Cell ID		0	126
CSI reference signals		Antenna ports 15,16	NA
Beamforming model		Annex B.4.2	NA
CSI-RS periodicity and subframe offset $T_{CSI-RS} / \Delta_{CSI-RS}$	Subframes	5 / 4	NA
CSI reference signal configuration		8	NA
Zero-power CSI-RS configuration $l_{CSI-RS} / ZeroPowerCSI-RS$ bitmap	Subframes / bitmap	4 / 0010000000000000	NA
$N_{oc}$ at antenna port	dBm/15kHz	-98	-98
$\hat{E}_s / N_{oc}$		Reference Value in Table 8.3.2.2.1_D_1.5-2	6.9dB
Symbols for unused PRBs		OCNG (Note 2)	NA
Number of allocated resource blocks (Note 2)	PRB	50	NA
Simultaneous transmission		No	NA
PDSCH transmission mode		9	Blanked
Note 1: $P_B = 1$ Note 2: These physical resource blocks are assigned to an arbitrary number of virtual UEs with one PDSCH per virtual UE; the data transmitted over the OCNG PDSCHs shall be uncorrelated pseudo random data, which is QPSK modulated.			

**Table 8.3.2.2.1\_D\_1.5-2: Test requirement for CDM-multiplexed DM RS (FRC) with multiple CSI-RS configurations**

Test number	Bandwidth and MCS	Reference Channel	OCNG Pattern		Propagation Condition		Correlation Matrix and Antenna Configuration	Reference value		UE Category
			Cell 1	Cell 2	Cell 1	Cell 2		Fraction of Maximum Throughput (%)	SNR (dB)	
1	10 MHz 16QAM 1/2	R.51 TDD	OP.1 TDD	N/A	ETU5	ETU5	2x2 Low	70	15.6	≥2
Note 1: The propagation conditions for Cell 1 and Cell 2 are statistically independent. Note 2: Correlation matrix and antenna configuration parameters apply for each of Cell 1 and Cell 2. Note 3: SNR corresponds to $\hat{E}_s / N_{oc}$ of Cell 1.										

8.3.2.2.2 TDD PDSCH Dual-layer Spatial Multiplexing – Enhanced Performance Requirement Type C

Editor’s notes: This test case is incomplete. The following items are missing or are incomplete:

- Test tolerances are undefined
- The SNR values in minimum and test requirement are still in square brackets
- The minimum testing time in Annex G is still undefined.

#### 8.3.2.2.2.1 Test purpose

To verify the UE's rank-2 performance and ability to receive a predefined test signal, representing a multi-path fading channel that is determined by the SNR with a percentage of the information bit throughput for a specified downlink Reference Measurement Channel (RMC) not falling below a specified value for dual-layer transmission on antenna ports 7 and 8 using DM-RS with full RB allocation.

#### 8.3.2.2.2.2 Test applicability

This test applies to all types of E-UTRA TDD release 12 and forward UE of Category 2 or higher that support enhanced receiver Type C

#### 8.3.2.2.2.3 Minimum conformance requirements

The requirements are specified in terms of the percentage of information bit throughput for the downlink reference measurement channels specified in Annex A clause A.3.4.3.2, with the addition of the relevant parameters in Tables 8.3.2-1, 8.3.2.2.3-1, and the downlink physical channel setup according to Table C.3.2-1 in Annex C.

Using this configuration the fraction of maximum throughput percentage shall meet or exceed the minimum requirements specified in Tables 8.3.2.2.3-2 for the specified SNR.

**Table 8.3.2.2.3-1: Test Parameters for Testing CDM-multiplexed DM RS (dual layer)**

Parameter		Unit	Test 1
Downlink power allocation	$\rho_A$	dB	0
	$\rho_B$	dB	0 (Note 1)
	$\sigma$	dB	-3
Cell-specific reference symbols			Antenna port 0 and antenna port 1
Beamforming model			Annex B.4.2
$N_{oc}$ at antenna port		dBm/15kHz	-98
Symbols for unused PRBs			OCNG (Note 2)
Number of allocated resource blocks		PRB	50
PDSCH transmission mode			8
Note 1: $P_B = 1$ .			
Note 2: These physical resource blocks are assigned to an arbitrary number of virtual UEs with one PDSCH per virtual UE; the data transmitted over the OCNG PDSCHs shall be uncorrelated pseudo random data, which is QPSK modulated.			

**Table 8.3.2.2.3-2: Enhanced Performance Requirement Type C for CDM-multiplexed DM RS (FRC)**

Test number	Bandwidth and MCS	Reference Channel	OCNG Pattern	Propagation Condition	Correlation Matrix and Antenna Configuration	Reference value		UE Category
						Fraction of Maximum Throughput (%)	SNR (dB)	
1	10 MHz 16QAM 1/2	R.32 TDD	OP.1 TDD	EPA5	2x2 Medium	70	[17.0]	≥2

The normative reference for this requirement is TS 36.101 [2] clause 8.3.2.2A.

#### 8.3.2.2.2.4 Test description

##### 8.3.2.2.2.4.1 Initial conditions

Initial conditions are a set of test configurations the UE needs to be tested in and the steps for the SS to take with the UE to reach the correct measurement state.

Configurations of PDSCH and PDCCH before measurement are specified in Annex C.2.

Test Environment: Normal, as defined in TS 36.508 [7] clause 4.1.

Frequencies to be tested: Mid Range, as defined in TS 36.508 [7] clause 4.3.1.2.

Bandwidths to be tested: 10MHz, as defined in TS 36.508 [7] clause 4.3.1.2.

1. Connect the SS, the faders and AWGN noise sources to the UE antenna connectors as shown in TS 36.508 [7] Annex A, Figure A.10.
2. The parameter settings for the cell are set up according to Tables 8.3.2-1 and 8.3.2.2.2.3-1 as appropriate.
3. Downlink signals are initially set up according to Annex C0, C.1 and Annex C.3.2 and uplink signals according to Annex H.1 and H.3.2.
4. Propagation conditions are set according to Annex B.0.
5. Ensure the UE is in State 3A-RF according to TS 36.508 [7] clause 5.2A.2. Message contents are defined in clause 8.3.2.2.2.4.3.

##### 8.3.2.2.2.4.2 Test procedure

1. SS transmits PDSCH via PDCCH DCI format 2B for C\_RNTI to transmit the DL RMC according to Tables 8.3.2.2.2.3-1, 8.3.2.2.2.3-2. The SS sends downlink MAC padding bits on the DL RMC.
2. Set the parameters of the bandwidth, MCS, reference channel, the propagation condition, the correlation matrix and the SNR according to Table 8.3.2.2.2.5-1 as appropriate.  
BCH/CRS/PDCCH/PCFICH are sent on antenna ports 0 and 1 using two Tx antennas, while DRS/Dedicated data for test UE are sent on antenna ports 7 and 8 using two Tx antennas with beam-forming model as specified in Annex B.4.2 and precoder update granularity specified in Table 8.3.2-1.
3. Measure the average throughput for a duration sufficient to achieve statistical significance according to Annex G clause G.3. Count the number of NACKs, ACKs and statDTXs on the UL during each test interval and decide pass or fail according to Tables G.3.5 and G.3.6 in Annex G clause G.3.
4. Repeat steps from 1 to 3 for each test interval in Tables 8.3.2.2.2.5-1 as appropriate.

##### 8.3.2.1.2.4.3 Message contents

Message contents are according to TS 36.508 [7] clause 4.6 with the following exceptions .

**Table 8.3.2.2.4.3-1: PhysicalConfigDedicated-DEFAULT**

Derivation Path: 36.331 clause 6.3.2			
Information Element	Value/remark	Comment	Condition
PhysicalConfigDedicated-DEFAULT ::= SEQUENCE {			
antennaInfo CHOICE {			
antennaInfoDedicated ::= SEQUENCE {			
transmissionMode	tm8-v920		
}			
}			
Extension ::= SEQUENCE {			
antennaInfo-v920 ::= SEQUENCE {			
codebookSubsetRestriction-v920 CHOICE {			
n2TxAntenna-tm8-r9	111111		
}			
}			
}			
}			

#### 8.3.2.2.2.5 Test requirement

Table 8.3.2.2.3-1 defines the primary level settings.

The fraction of maximum throughput percentage for the downlink reference measurement channels specified in Annex A clause A.3.4.3.2 for each throughput test shall meet or exceed the specified value in Table 8.3.2.2.5-1 for the specified SNR including test tolerances for all throughput tests.

**Table 8.3.2.2.5-1: Test requirement for Enhanced Performance Requirement Type C for CDM-multiplexed DM RS (FRC)**

Test number	Bandwidth and MCS	Reference Channel	OCNG Pattern	Propagation Condition	Correlation Matrix and Antenna Configuration	Reference value		UE Category
						Fraction of Maximum Throughput (%)	SNR (dB)	
1	10 MHz 16QAM 1/2	R.32 TDD	OP.1 TDD	EPA5	2x2 Medium	70	[17.0] +TT	≥2

#### 8.3.2.3 Dual-Layer Spatial Multiplexing (with multiple CSI-RS configurations)

TBD

#### 8.3.2.4 TDD PDSCH Performance with DCI format 2D and non Quasi Co-located Antenna Ports

##### 8.3.2.4.1\_F TDD PDSCH Performance with DCI format 2D, non Quasi Co-located Antenna Ports, Same Cell ID and single NZP CSI-RS resource for CoMP

##### 8.3.2.4.1\_F.1 Test purpose

To verify the UE capability of supporting non quasi-collocated antenna ports when the UE receives DCI format 2D in a scenario where the two transmission points share the same Cell ID. In particular the test verifies that the UE, configured with quasi co-location type B, performs correct tracking and compensation of the timing difference between two transmission points, channel parameters estimation and rate matching behaviour according to the 'PDSCH RE Mapping and Quasi-Co-Location Indicator' (PQI) signalling.

## 8.3.2.4.1\_F.2 Test applicability

This test applies to E-UTRA TDD category 2-8 UE release 11 and forward, supporting Maximum CSI processes of One on a component carrier within a band with PDSCH transmission mode 10.

## 8.3.2.4.1\_F.3 Minimum conformance requirements

The requirements are specified in Table 8.3.2.4\_F.3-3, with the addition of the parameters in Table 8.3.2.4\_F.3-1 and Table 8.3.2.4\_F.3-2. In table 8.3.2.4\_F.3-1 transmission point 1 (TP1) is the serving cell and transmission point 2 (TP2) transmits PDSCH. The downlink physical channel setup for TP1 is according to Table C.3.4-1 and for TP2 according to Table C.3.4-2.

**Table 8.3.2.4.1\_F.3-1: Test Parameters for quasi co-location type B: same Cell ID**

Parameter	Unit	TP 1	TP 2
Downlink power allocation	$\rho_A$	dB	0
	$\rho_B$	dB	0 (Note1)
	$\sigma$	dB	-3
Cell-specific reference signals		Antenna ports 0,1	(Note 2)
CSI-RS 0 antenna ports		NA	Port {15,16}
<i>qcl-CSI-RS-ConfigNZPId-r11</i> , CSI-RS 0 periodicity and subframe offset $T_{\text{CSI-RS}} / \Delta_{\text{CSI-RS}}$	Subframes	NA	5/4
<i>qcl-CSI-RS-ConfigNZPId-r11</i> , CSI-RS 0 configuration		NA	8
<i>csi-RS-ConfigZPId-r11</i> , Zero- power CSI-RS 0 configuration $l_{\text{CSI-RS}} /$ <i>ZeroPower CSI-RS</i> bitmap		NA	4/ 0000010000000000
$N_{oc}$ at antenna port	dBm/15kHz z	-98	-98
SNR	dB	Reference point in Table 8.3.2.4_F.3-3	Reference point in Table 8.3.2.4_F.3-3
$BW_{\text{Channel}}$	MHz	10	10
Cyclic Prefix		Normal	Normal
Cell Id		0	0
Number of control OFDM symbols		2	2
PDSCH transmission mode		Blanked	10
Number of allocated PRB	PRB	NA	50
<i>qcl-Operation</i> , 'PDSCH RE Mapping and Quasi-Co- Location Indicator'		Type B, '00'	
Time offset between TPs	$\mu\text{s}$	NA	Reference point in Table 8.3.2.4_F.3-2
Frequency error between TPs	Hz	NA	0
Beamforming model		NA	As specified in clause B.4.1
Symbols for unused PRBs		NA	OCNG (Note 3)
Note 1: $P_B = 1$ Note 2: REs for antenna ports 0 and 1 have zero transmission power. Note 3: These physical resource blocks are assigned to an arbitrary number of virtual UEs with one PDSCH per virtual UE; the data transmitted over the OCNG PDSCHs shall be uncorrelated pseudo random data, which is QPSK modulated.			

Table 8.3.2.4.1\_F.3-2: Configurations of PQI and DL transmission hypothesis for each PQI set

PQI set index	Parameters in each PQI set		DL transmission hypothesis for each PQI Set	
	NZP CSI-RS Index (For quasi co-location)	ZP CSI-RS configuration	TP 1	TP 2
PQI set 0	CSI-RS 0	ZP CSI-RS 0	Blanked	PDSCH

Table 8.3.2.4.1\_F.3-3: Minimum performance for quasi co-location type B: same Cell ID

Test Number	Reference Channel	OGCN pattern		Time offset between TPs ( $\mu$ s)	Propagation Conditions (Note1)		Correlation Matrix and Antenna Configuration (Note 2)	Reference Value		UE Category
		TP1	TP2		TP1	TP2		Fraction of Maximum Throughput (%)	SNR (dB) (Note 3)	
1	R.52 TDD	NA	OP. 1 TDD	2	EP A	EPA	2x2 Low	70	12	2-8
2	R.52 TDD	NA	OP. 1 TDD	-0.5	EP A	EPA	2x2 Low	70	12.4	2-8

Note 1: The propagation conditions for TP1 and TP2 are statistically independent.  
Note 2: The correlation matrix and antenna configuration apply for TP1 and TP2.  
Note 3: SNR corresponds to  $\hat{E}_s / N_{oc}$  of TP2.

The normative reference for this requirement is TS 36.101 [2] clause 8.3.2.4.1.

#### 8.3.2.4.1\_F.4 Test description

##### 8.3.2.4.1\_F.4.1 Initial conditions

Initial conditions are a set of test configurations the UE needs to be tested in and the steps for the SS to take with the UE to reach the correct measurement state.

Configurations of PDSCH and PDCCH before measurement are specified in Annex C.2.

Test Environment: Normal, as defined in TS 36.508 [7] clause 4.1.

Frequencies to be tested: Mid Range, as defined in TS 36.508 [7] clause 4.3.1.1.

Bandwidths to be tested: 10MHz, as defined in TS 36.508 [7] clause 4.3.1.1.

1. Connect the SS, the faders and AWGN noise sources to the UE antenna connectors as shown in TS 36.508 [7] Annex A, Figure A.40 for antenna configuration 2x2.
2. The parameter settings for the TP 1 and TP 2 are set up according to table 8.3.1-1, table 8.3.2.4.1\_F.3-1 and 8.3.2.4.1\_F.3-2 as appropriate.
3. Downlink signals are initially set up according to Annex C0, C.1 and Annex C.3.2 and uplink signals according to Annex H.1 and H.3.2.
4. Propagation conditions are set according to Annex B.0.
5. Ensure the UE is in State 3A-RF according to TS 36.508 [7] clause 5.2A.2. Message contents are defined in clause 8.3.2.4.1\_F.4.3.

## 8.3.2.4.1\_F.4.2 Test procedure

1. SS transmits PDCCH on TP 1. PQI set and PDSCH transmission hypothesis in PDCCH format 2D are configured according to Table 8.3.2.4.1\_F.3-2.
2. SS transmits PDSCH on TP 1 and TP 2 via PDCCH DCI format 2D for C\_RNTI to transmit the DL RMC according to Table 8.3.2.4.1\_F.3-3. The SS sends downlink MAC padding bits on the DL RMC.
3. Set the parameters of the reference channel, timing offset (TP 2 timing - TP 1 timing), the propagation condition, the correlation matrix and the SNR according to Table 8.3.2.4.1\_F.3-3 Test 1 as appropriate.
4. Wait for at least 1 second before measuring throughput.
5. Measure the average throughput for a duration sufficient to achieve statistical significance according to Annex G clause G.3. Count the number of NACKs, ACKs and statDTXs on the UL during the test interval and decide pass or fail according to Tables G.3.5 and G.3.6 in Annex G clause G.3.
6. Repeat steps 1 to 4 for Test 2 in Table 8.3.2.4.1\_F.3-3.

## 8.3.2.4.1\_F.4.3 Message contents

**Table 8.3.2.4.1\_F.4.3-1: PhysicalConfigDedicated-DEFAULT**

Derivation Path: 36.508 clause 4.6.3			
Information Element	Value/remark	Comment	Condition
PhysicalConfigDedicated-DEFAULT ::= SEQUENCE {			
pdsch-ConfigDedicated	PDSCH-ConfigDedicated-DEFAULT		
antennaInfo-r10 CHOICE {			
explicitValue-r10	AntennaInfoDedicated-r10		
}			
csi-RS-ConfigNZPToAddModList-r11	CSI-RS-ConfigNZP-r11-DEFAULT		
csi-RS-ConfigZPToAddModList-r11	CSI-RS-ConfigZP-r11-DEFAULT		
pdsch-ConfigDedicated-v1130	PDSCH-ConfigDedicated-v1130-DEFAULT		
}			

**Table 8.3.2.4.1\_F.4.3-2: PDSCH-ConfigDedicated-DEFAULT**

Derivation Path:36.508 clause 4.6.3			
Information Element	Value/remark	Comment	Condition
PDSCH-ConfigDedicated-DEFAULT ::= SEQUENCE {			
p-a	dB-3		2TX
}			

**Table 8.3.2.4.1\_F.4.3-3: AntennaInfoDedicated-r10**

Derivation Path: 36.331 clause 6.3.2			
Information Element	Value/remark	Comment	Condition
AntennaInfoDedicated-r10 ::= SEQUENCE {			
transmissionMode-r10	tm10-v1130		
}			
ue-TransmitAntennaSelection CHOICE {			
Release	NULL		
}			
}			

Table 8.3.2.4.3\_F.4.1-4: CSI-RS-ConfigNRP-r11-DEFAULT

Derivation Path: 36.508 clause 4.6.3			
Information Element	Value/remark	Comment	Condition
CSI-RS-ConfigNRP-r11 ::= SEQUENCE {			
csi-RS-ConfigNPId-r11	1		
antennaPortsCount-r11	an2		
resourceConfig-r11	0		
subframeConfig-r11	4		
scramblingIdentity-r11	0		
qcl-CRS-Info-r11 SEQUENCE {			
qcl-ScramblingIdentity-r11	0		
crs-PortsCount-r11	n2		
mbsfn-SubframeConfigList-r11	Not present		
}			
}			

Table 8.3.2.4.3\_F.4.1-5: CSI-RS-ConfigRP-r11-DEFAULT

Derivation Path: 36.508 clause 4.6.3			
Information Element	Value/remark	Comment	Condition
CSI-RS-ConfigRP-r11 ::= SEQUENCE {			
csi-RS-ConfigRPId-r11	1		
resourceConfigList-r11	0000010000000000		
subframeConfig-r11	4		
}			

Table 8.3.2.4.3\_F.4.1-6: PDSCH-ConfigDedicated-v1130-DEFAULT

Derivation Path: 36.508 clause 4.6.3			
Information Element	Value/remark	Comment	Condition
PDSCH-ConfigDedicated-v1130 ::= SEQUENCE {			
dmrs-ConfigPDSCH-r11	DMRS-Config-r11-DEFAULT		
qcl-Operation	typeB		
re-MappingQCLConfigToAddModList-r11 SEQUENCE (SIZE (1..maxRE-MapQCL-r11)) OF SEQUENCE {	1 entry		
pdsch-RE-MappingQCL-ConfigId-r11[1]	1		
optionalSetOfFields-r11[1] SEQUENCE {			
crs-PortsCount-r11	n2		
crs-FreqShift-r11	0		
mbsfn-SubframeConfigList-r11	Not present		
pdsch-Start-r11	2		
}			
}			
}			

#### 8.3.2.4.1\_F.5 Test requirement

Table 8.3.2.4.1\_F.3-1 defines the primary level settings.

The fraction of maximum throughput percentage for the downlink reference measurement channels specified in Annex A clause A.3.3.3.2 for the throughput test shall meet or exceed the specified value in Table 8.3.2.4.1\_F.5-1 for the specified SNR including test tolerances for the throughput test.



**Table 8.3.2.4.1\_F.5-1: Minimum performance for quasi co-location type B: same Cell ID**

Test Number	Reference Channel	OGCN pattern		Time offset between TPs (Note 4)	Propagation Conditions (Note 1)		Correlation Matrix and Antenna Configuration (Note 2)	Reference Value		UE Category
		TP1	TP2		TP1	TP2		Fraction of Maximum Throughput (%)	SNR (dB) (Note 3)	
1	R.52 TDD	NA	OP. 1 TDD	57Ts	EP A	EPA	2x2 Low	70	12.9	2-8
2	R.52 TDD	NA	OP. 1 TDD	-11Ts	EP A	EPA	2x2 Low	70	13.3	2-8

Note 1: The propagation conditions for TP1 and TP2 are statistically independent.  
Note 2: The correlation matrix and antenna configuration apply for TP1 and TP2.  
Note 3: SNR corresponds to  $\hat{E}_s / N_{oc}$  of TP2.  
Note 4: Timing offset in units of Ts: Ts = 1/(15000 x 2048) seconds, the basic timing unit defined in TS 36.211 [8].

#### 8.3.2.4.2\_F TDD PDSCH Performance with DCI format 2D, non Quasi Co-located Antenna Ports, Same Cell ID and multiple NZP CSI-RS resources for CoMP

##### 8.3.2.4.2\_F.1 Test purpose

To verify the UE capability of supporting non quasi-collocated antenna ports when the UE receives DCI format 2D in a scenario where the two transmission points share the same Cell ID by verifying that the UE, configured with quasi co-location type B, performs correct tracking and compensation of the timing difference between two transmission points, channel parameters estimation and rate matching behaviour according to the 'PDSCH RE Mapping and Quasi-Co-Location Indicator' (PQI) signalling.

##### 8.3.2.4.2\_F.2 Test applicability

This test applies to all types of E-UTRA TDD category 2-8 UE release 11 and forward, supporting Maximum CSI processes of Three or Four on a component carrier within a band with PDSCH transmission mode 10.

##### 8.3.2.4.2\_F.3 Minimum conformance requirements

The requirements are specified in terms of the percentage of information bit throughput for the downlink reference measurement channels specified in Annex A clause A.3.3.3, with the addition of the relevant parameters in Tables 8.3.2-1, 8.3.2.4.2\_F.3-1 and 8.3.2.4.2\_F.3-2.

In table 8.3.2.4.2\_F.3-1, transmission point 1 (TP 1) is the serving cell transmitting PDCCH, synchronization signals and PBCH, and transmission point 2 (TP 2) has same Cell ID as TP 1. Multiple NZP CSI-RS resources and ZP CSI-RS resources are configured. In each sub-frame, DL PDSCH transmission is dynamically switched between 2 TPs with multiple PDSCH RE Mapping and Quasi-Co-Location Indicator configuration (PQI). Configurations of PDSCH RE Mapping and Quasi-Co-Location Indicator and downlink transmission hypothesis are defined in Table 8.3.2.4.2\_F.3-2. The downlink physical channel setup for TP 1 is according to Table C.3.4-1 and for TP 2 according to Table C.3.4-2.

Using this configuration the fraction of maximum throughput percentage shall meet or exceed the minimum requirements specified in Table 8.3.2.4.2\_F.3-3 for the specified SNR.

**Table 8.3.2.4.2\_F.3-1: Test Parameters for timing offset compensation with DPS transmission**

parameter	Unit	TP 1	TP 2
Downlink power allocation	$\rho_A$	dB	0
	$\rho_B$	dB	0 (Note 1)
	$\sigma$	dB	-3

Beamforming model		N/A	As specified in clause B.4.1
Cell-specific reference signals		Antenna ports 0,1	(Note 2)
CSI reference signals 0		Antenna ports {15,16}	N/A
CSI-RS 0 periodicity and subframe offset TCSI-RS / ΔCSI-RS	Subframes	5 / 4	N/A
CSI reference signal 0 configuration		0	N/A
CSI reference signals 1		N/A	Antenna ports {15,16}
CSI-RS 1 periodicity and subframe offset TCSI-RS / ΔCSI-RS	Subframes	N/A	5 / 4
CSI reference signal 1 configuration		N/A	8
Zero-power CSI-RS 0 configuration ICSI-RS / ZeroPower CSI-RS bitmap	Subframes /bitmap	4/ 0010000000000000	N/A
Zero-power CSI-RS1 configuration ICSI-RS / ZeroPower CSI-RS bitmapS	Subframes /bitmap	N/A	4/ 0000010000000000
$\hat{E}_s / N_{oc}$	dB	Reference Value in Table 8.3.2.4.2_F.3-3	Reference Value in Table 8.3.2.4.2_F.3-3
$N_{oc}$ at antenna port	dBm/15kHz	-98	-98
BWChannel	MHz	10	10
Cyclic Prefix		Normal	Normal
Cell Id		0	0
Number of control OFDM symbols		2	2
Timing offset between TPs		N/A	Reference Value in Table 8.3.2.4.2-3
Frequency offset between TPs	Hz	N/A	0
Number of allocated resource blocks	PRB	50	50
PDSCH transmission mode		10	10
Probability of occurrence of PDSCH transmission(Note 3)	%	30	70
Symbols for unused PRBs		OCNG (Note 4)	OCNG (Note 4)
<p>Note 1: <math>P_B = 1</math>.</p> <p>Note 2: REs for antenna ports 0 and 1 have zero transmission power.</p> <p>Note 3: PDSCH transmission from TPs shall be randomly determined independently for each subframe. Probabilities of occurrence of PDSCH transmission from TPs are specified.</p> <p>Note 4: These physical resource blocks are assigned to an arbitrary number of virtual UEs with one PDSCH per virtual UE; the data transmitted over the OCNG PDSCHs shall be uncorrelated pseudo random data, which is QPSK modulated.</p>			

**Table 8.3.2.4.2\_F.3-2: Configurations of PQI and DL transmission hypothesis for each PQI set**

PQI set index	Parameters in each PQI set		DL transmission hypothesis for each PQI Set	
	NZP CSI-RS Index (For quasi	ZP CSI-RS configuration	TP 1	TP 2

	co-location)			
PQI set 0	CSI-RS 0	ZP CSI-RS 0	PDSCH	Blanked
PQI set 1	CSI-RS 1	ZP CSI-RS 1	Blanked	PDSCH

**Table 8.3.2.4.2\_F.3-3: Minimum Requirements for timing offset compensation with DPS transmission**

Test Number	Timing offset(us)	Reference Channel	OCNG Pattern		Propagation Conditions		Correlation Matrix and Antenna Configuration (Note 2)	Reference Value		UE Category
			TP 1	TP 2	TP 1	TP 2		Fraction of Maximum Throughput (%)	SNR (dB) (Note 3)	
1	2	R.53 TDD	OP.1 TDD	OP.1 TDD	EPA5	EPA5	2x2 Low	70	12.3	2-8
2	-0.5	R.53 TDD	OP.1 TDD	OP.1 TDD	EPA5	EPA5	2x2 Low	70	12.5	2-8

Note 1: The propagation conditions for TP 1 and TP 2 are statistically independent.  
Note 2: Correlation matrix and antenna configuration parameters apply for each of TP 1 and TP 2.  
Note 3: SNR corresponds to  $\hat{E}_s/N_{oc}$  of both TP 1 and TP 2.

The normative reference for these requirements is TS 36.101 [2] clause 8.3.2.4.2.

#### 8.3.2.4.2\_F.4 Test description

##### 8.3.2.4.2\_F.4.1 Initial conditions

Initial conditions are a set of test configurations the UE needs to be tested in and the steps for the SS to take with the UE to reach the correct measurement state.

Configurations of PDSCH and PDCCH before measurement are specified in Annex C.2.

Test Environment: Normal, as defined in TS 36.508 [7] clause 4.1.

Frequencies to be tested: Mid Range, as defined in TS 36.508 [7] clause 4.3.1.1.

Channel Bandwidths to be tested: 10MHz, as defined in TS 36.508 [7] clause 4.3.1.1

1. Connect the SS, the faders and AWGN noise sources to the UE antenna connectors as shown in TS 36.508 [7] Annex A, Figure A.40 for antenna configuration 2x2.
2. The parameter settings for the TP 1 and TP 2 are set up according to table 8.3.1-1, 8.3.2.4.2\_F.3-1 and 8.3.2.4.2\_F.3-2 as appropriate.
3. Downlink signals are initially set up according to Annex C0, C.1 and Annex C.3.2 and uplink signals according to Annex H.1 and H.3.2.
4. Propagation conditions are set according to Annex B.0.
5. Ensure the UE is in State 3A-RF according to TS 36.508 [7] clause 5.2A.2. Message contents are defined in clause 8.3.1.3.2\_F.4.3.

##### 8.3.2.4.2\_F.4.2 Test procedure

1. SS transmits PDCCH on TP 1. PQI set and PDSCH transmission hypothesis in PDCCH format 2D are configured according to Table 8.3.2.4.2\_F.3-2.
2. SS transmits PDSCH on TP 1 and TP 2 via PDCCH DCI format 2D for C\_RNTI to transmit the DL RMC according to Tables 8.3.2.4.2\_F.3-1 and 8.3.2.4.2\_F.3-2. The SS sends downlink MAC padding bits on the DL RMC. PDSCH transmission from TPs shall be randomly determined independently for each subframe. Probabilities of occurrence of PDSCH transmission from TPs are specified according to Table 8.3.2.4.2\_F.3-1. The probability of occurrence of PQI set in each TP is equal.

3. Set the parameters of the reference channel, timing offset (TP 2 timing - TP 1 timing), the propagation condition, the correlation matrix and the SNR according to Table 8.3.2.4.2\_F.3-3 Test 1 as appropriate.
4. Wait for at least 1 second before measuring throughput.
5. Measure the average throughput for a duration sufficient to achieve statistical significance according to Annex G clause G.3. Count the number of NACKs, ACKs and statDTXs on the UL during the test interval and decide pass or fail according to Tables G.3.5 and G.3.6 in Annex G clause G.3.
6. Repeat steps 1 to 4 for Test 2 in Table 8.3.2.4.2\_F.3-3.

8.3.2.4.2\_F.4.3 Message contents

Message contents are according to TS 36.508 [7] clause 4.6 with the following exceptions:

**Table 8.3.2.4.2\_F.4.3-1: PhysicalConfigDedicated-DEFAULT**

Derivation Path: 36.508 clause 4.6.3			
Information Element	Value/remark	Comment	Condition
PhysicalConfigDedicated-DEFAULT ::= SEQUENCE {			
pdsch-ConfigDedicated	PDSCH-ConfigDedicated-DEFAULT		
antennaInfo-r10 CHOICE {			
explicitValue-r10	AntennaInfoDedicated-r10		
}			
csi-RS-ConfigNZPTToAddModList-r11	CSI-RS-ConfigNZP-r11-DEFAULT		
csi-RS-ConfigZPTToAddModList-r11	CSI-RS-ConfigZP-r11-DEFAULT		
pdsch-ConfigDedicated-v1130	PDSCH-ConfigDedicated-v1130-DEFAULT		
}			

**Table 8.3.2.4.2\_F.4.3-2: PDSCH-ConfigDedicated-DEFAULT**

Derivation Path:36.508 clause 4.6.3			
Information Element	Value/remark	Comment	Condition
PDSCH-ConfigDedicated-DEFAULT ::= SEQUENCE {			
p-a	dB-3		2TX
}			

**Table 8.3.2.4.2\_F.4.3-3: AntennaInfoDedicated-r10**

Derivation Path: 36.331 clause 6.3.2			
Information Element	Value/remark	Comment	Condition
AntennaInfoDedicated-r10 ::= SEQUENCE {			
transmissionMode-r10	tm10-v1130		
}			
ue-TransmitAntennaSelection CHOICE {			
release	NULL		
}			
}			

Table 8.3.2.4.2\_F.4.3-4: CSI-RS-ConfigNZP-r11-DEFAULT

Derivation Path: 36.508 clause 4.6.3			
Information Element	Value/remark	Comment	Condition
CSI-RS-ConfigNZP-r11 ::= SEQUENCE {			
csi-RS-ConfigNZPId-r11	For NZP CSI-RS configuration (CSI reference signals 0) = 1 NZP CSI-RS configuration (CSI reference signals 1) = 2		
antennaPortsCount-r11	an2		
resourceConfig-r11	For NZP CSI-RS configuration (CSI reference signals 0) = 0 NZP CSI-RS configuration (CSI reference signals 1) = 8		
subframeConfig-r11	4		
scramblingIdentity-r11	0		
qcl-CRS-Info-r11 SEQUENCE {			
qcl-ScramblingIdentity-r11	0		
crs-PortsCount-r11	n2		
mbsfn-SubframeConfigList-r11	Not present		
}			
}			

Table 8.3.2.4.2\_F.4.3-5: CSI-RS-ConfigZP-r11-DEFAULT

Derivation Path: 36.508 clause 4.6.3			
Information Element	Value/remark	Comment	Condition
CSI-RS-ConfigZP-r11 ::= SEQUENCE {			
csi-RS-ConfigZPId-r11	1		
resourceConfigList-r11	For Zero-power CSI-RS 0 = 0010000000000000 For Zero-power CSI-RS 1 configuration = 0000010000000000	Parameter: <i>ZeroPowerCSI-RS</i>	
subframeConfig-r11	4		
}			

**Table 8.3.2.4.2\_F.4.3-6: PDSCH-ConfigDedicated-v1130-DEFAULT**

Derivation Path: 36.508 clause 4.6.3			
Information Element	Value/remark	Comment	Condition
PDSCH-ConfigDedicated-v1130 ::= SEQUENCE {			
dmrs-ConfigPDSCH-r11	DMRS-Config-r11-DEFAULT		
qcl-Operation	typeB		
re-MappingQCLConfigToAddModList-r11 SEQUENCE (SIZE (1..maxRE-MapQCL-r11)) OF SEQUENCE {	2 entries	See Table 8.3.2.4.2_F.3-2	
pdsch-RE-MappingQCL-ConfigId-r11[1]	1	Entry 1	
optionalSetOfFields-r11[1] SEQUENCE {			
crs-PortsCount-r11	n2		
crs-FreqShift-r11	0		
mbsfn-SubframeConfigList-r11	Not present		
pdsch-Start-r11	2		
}			
csi-RS-ConfigZPId-r11[1]	1		
qcl-CSI-RS-ConfigNZPId-r11[1]	1		
pdsch-RE-MappingQCL-ConfigId-r11[1]	4	Entry 2	
optionalSetOfFields-r11[1] SEQUENCE {			
crs-PortsCount-r11	n2		
crs-FreqShift-r11	0		
mbsfn-SubframeConfigList-r11	Not present		
pdsch-Start-r11	2		
}			
csi-RS-ConfigZPId-r11[1]	2		
qcl-CSI-RS-ConfigNZPId-r11[1]	2		
}			
}			

8.3.2.4.2\_F.5 Test requirements

Table 8.3.2.4.2\_F.3-1 and 8.3.2.4.2\_F.3-2 defines the primary level setting.

The fraction of maximum throughput percentage for the downlink reference measurement channels specified in Annex A clause A.3.4.2 for each throughput test shall meet or exceed the specified value in Table 8.3.2.4.2\_F.5-1 for the specified SNR including test tolerances for all throughput tests.

**Table 8.3.2.4.2\_F.5-1: Test Requirements for timing offset compensation with DPS transmission**

Test Number	Timing offset (Note 4)	Reference Channel	OCNG Pattern		Propagation Conditions		Correlation Matrix and Antenna Configuration (Note 2)	Reference Value		UE Category
			TP 1	TP 2	TP 1	TP 2		Fraction of Maximum Throughput (%)	SNR (dB) (Note 3)	
1	57Ts	R.53 TDD	OP.1 TDD	OP.1 TDD	EPA5	EPA5	2x2 Low	70	13.2	2-8
2	11Ts	R.53 TDD	OP.1 TDD	OP.1 TDD	EPA5	EPA5	2x2 Low	70	13.4	2-8

Note 1: The propagation conditions for TP1 and TP2 are statistically independent.  
 Note 2: Correlation matrix and antenna configuration parameters apply for each of TP1 and TP2.  
 Note 3: SNR corresponds to  $\hat{E}_s / N_{oc}$  of both TP 1 and TP 2.  
 Note 4: Timing offset in units of Ts: Ts = 1/(15000 x 2048) seconds, the basic timing unit defined in TS 36.211 [8].

#### 8.3.2.4.3\_F TDD PDSCH Performance with DCI format 2D, non Quasi Co-located Antenna Ports, Different Cell ID, Colliding CRS and single NZP CSI-RS resource for CoMP

##### 8.3.2.4.3\_F.1 Test purpose

To verify the UE capability of supporting non quasi-collocated antenna ports when the UE receives DCI format 2D in a scenario where the two transmission points have different Cell ID and colliding CRS by verifying that the UE, configured with quasi co-location type B, performs correct tracking and compensation of the frequency difference between two transmission points, channel parameters estimation and rate matching behaviour according to the 'PDSCH RE Mapping and Quasi-Co-Location Indicator' (PQI) signalling.

##### 8.3.2.4.3\_F.2 Test applicability

This test applies to all types of E-UTRA TDD category 2-8 UE release 11 and forward, supporting Maximum CSI processes of One, Three or Four on a component carrier within a band with PDSCH transmission mode 10.

##### 8.3.2.4.3\_F.3 Minimum conformance requirements

The requirements are specified in terms of the percentage of information bit throughput for the downlink reference measurement channels specified in Annex A clause A.3.3.3, with the addition of the relevant parameters in Tables 8.3.2-1 and 8.3.2.4.3\_F.3-1.

In table 8.3.2.4.3\_F.3-1, transmission point 1 (TP 1) is the serving cell transmitting PDCCH, synchronization signals and PBCH, and transmission point 2 (TP 2) transmit PDSCH with different Cell ID. The downlink physical channel setup for TP 1 is according to Table C.3.4-1 and for TP 2 according to Table C.3.4-2.

Using this configuration the fraction of maximum throughput percentage shall meet or exceed the minimum requirements specified in Table 8.3.2.4.3\_F.3-2 for the specified SNR.

**Table 8.3.2.4.3\_F.3-1: Test Parameters for quasi co-location type B with different Cell ID and Colliding CRS**

parameter		Unit	TP1	TP2
Downlink power allocation	$\rho_A$	dB	0	0
	$\rho_B$	dB	0 (Note 1)	0
	$\sigma$	dB	-3	-3
Beamforming model			N/A	As specified in clause B.4.2
Cell-specific reference signals			Antenna ports 0,1	Antenna ports 0,1
CSI reference signals 0			N/A	Antenna ports {15,16}
CSI-RS 0 periodicity and subframe offset $T_{CSI-RS} / \Delta_{CSI-RS}$		Subframes	N/A	5 / 4
CSI reference signal 0 configuration			N/A	0
Zero-power CSI-RS 0 configuration $l_{CSI-RS} / \text{ZeroPower CSI-RS bitmap}$		Subframes /bitmap	N/A	4/ 0010000000000000
$\hat{E}_s / N_{oc}$		dB	Reference point in Table 8.3.2.4.3_F.3-2 + 4dB	Reference Value in Table 8.3.2.4.3_F.3-2
$N_{oc}$ at antenna port		dBm/15kHz	-98	-98
BW <sub>Channel</sub>		MHz	10	10
Cyclic Prefix			Normal	Normal
Cell Id			0	126
Number of control OFDM symbols			1	2
Timing offset between TPs		us	N/A	0
Frequency offset between TPs		Hz	N/A	200
<i>qcl-Operation</i> , 'PDSCH RE Mapping and Quasi-Co-Location Indicator'			Type B, '00'	
PDSCH transmission mode			Blank	10
Number of allocated resource block			N/A	50
Symbols for unused PRBs			N/A	OCNG(Note2)
Note 1: $P_B = 1$ . Note 2: These physical resource blocks are assigned to an arbitrary number of virtual UEs with one PDSCH per virtual UE; the data transmitted over the OCNG PDSCHs shall be uncorrelated pseudo random data, which is QPSK modulated.				

**Table 8.3.2.4.3\_F.3-2: Performance Requirements for quasi co-location type B with different Cell ID and Colliding CRS**

Test Number	Reference Channel	OCNG Pattern		Propagation Conditions (Note1)		Correlation Matrix and Antenna Configuration (Note 2)	Reference Value		UE Category
		TP 1	TP 2	TP 1	TP 2		Fraction of Maximum Throughput (%)	SNR (dB) (Note 3)	



1	R.54 TDD	N/A	OP.1 TDD	EPA5	ETU5	2x2 Low	70	14.7	2-8
Note 1: The propagation conditions for TP 1 and TP 2 are statistically independent. Note 2: Correlation matrix and antenna configuration parameters apply for each of TP 1 and TP 2. Note 3: SNR corresponds to $\widehat{E}_s/N_{oc}$ of TP2.									

The normative reference for these requirements is TS 36.101 [2] clause 8.3.2.4.3.

#### 8.3.2.4.3\_F.4 Test description

##### 8.3.2.4.3\_F.4.1 Initial conditions

Initial conditions are a set of test configurations the UE needs to be tested in and the steps for the SS to take with the UE to reach the correct measurement state.

Configurations of PDSCH and PDCCH before measurement are specified in Annex C.2.

Test Environment: Normal, as defined in TS 36.508 [7] clause 4.1.

Frequencies to be tested: Mid Range, as defined in TS 36.508 [7] clause 4.3.1.1.

Channel Bandwidths to be tested: 10MHz, as defined in TS 36.508 [7] clause 4.3.1.1.

1. Connect the SS, the faders and AWGN noise sources to the UE antenna connectors as shown in TS 36.508 [7] Annex A, Figure A.40 for antenna configuration 2x2.
2. The parameter settings for the TP 1 are set up according to tables 8.3.2-1 and 8.3.2.4.3\_F.3-1 as appropriate.
3. Downlink signals are initially set up according to Annex C0, C.1 and Annex C.3.2 and uplink signals according to Annex H.1 and H.3.2.
4. Propagation conditions are set according to Annex B.0.
5. Ensure the UE is in State 3A-RF according to TS 36.508 [7] clause 5.2A.2. Message contents are defined in clause 8.3.2.4.3\_F.4.3.

##### 8.3.2.4.3\_F.4.2 Test procedure

1. SS transmits PDCCH DCI format 2D on TP 1 according to Tables 8.3.2.4.3\_F.3-1, 8.3.2.4.3\_F.3-2 and Annex C3.4.
2. SS transmits PDSCH on TP 2 via PDCCH DCI format 2D for C\_RNTI to transmit the DL RMC according to Tables 8.3.2.4.3\_F.3-1, 8.3.2.4.3\_F.3-2 and Annex C3.4. The SS sends downlink MAC padding bits on the DL RMC.
3. Set the parameters of the reference channel, the propagation condition, the correlation matrix and the SNR according to Table 8.3.2.4.3\_F.3-2 as appropriate.
4. Measure the average throughput for a duration sufficient to achieve statistical significance according to Annex G clause G.3. Count the number of NACKs, ACKs and statDTXs on the UL during the test interval and decide pass or fail according to Tables G.3.5 and G.3.6 in Annex G clause G.3.

##### 8.3.2.4.3\_F.4.3 Message contents

Message contents are according to TS 36.508 [7] clause 4.6 with the following exceptions:

Table 8.3.2.4.3\_F.4.3-1: PhysicalConfigDedicated-DEFAULT

Derivation Path: 36.508 clause 4.6.3			
Information Element	Value/remark	Comment	Condition
PhysicalConfigDedicated-DEFAULT ::= SEQUENCE {			
pdsch-ConfigDedicated	PDSCH-ConfigDedicated-DEFAULT		
antennaInfo-r10 CHOICE {			
explicitValue-r10	AntennaInfoDedicated-r10		
}			
csi-RS-ConfigNZPTToAddModList-r11	CSI-RS-ConfigNZP-r11-DEFAULT		
csi-RS-ConfigZPTToAddModList-r11	CSI-RS-ConfigZP-r11-DEFAULT		
pdsch-ConfigDedicated-v1130	PDSCH-ConfigDedicated-v1130-DEFAULT		
}			

Table 8.3.2.4.3\_F.4.3-2: PDSCH-ConfigDedicated-DEFAULT

Derivation Path:36.508 clause 4.6.3			
Information Element	Value/remark	Comment	Condition
PDSCH-ConfigDedicated-DEFAULT ::= SEQUENCE {			
p-a	dB-3		2TX
}			

Table 8.3.2.4.3\_F.4.3-3: AntennaInfoDedicated-r10

Derivation Path: 36.331 clause 6.3.2			
Information Element	Value/remark	Comment	Condition
AntennaInfoDedicated-r10 ::= SEQUENCE {			
transmissionMode-r10	tm10-v1130		
}			
ue-TransmitAntennaSelection CHOICE {			
release	NULL		
}			

Table 8.3.2.4.3\_F.4.3-4: CSI-RS-ConfigNZP-r11-DEFAULT

Derivation Path: 36.508 clause 4.6.3			
Information Element	Value/remark	Comment	Condition
CSI-RS-ConfigNZP-r11 ::= SEQUENCE {			
csi-RS-ConfigNZPId-r11	1		
antennaPortsCount-r11	an2		
resourceConfig-r11	0		
subframeConfig-r11	4		
scramblingIdentity-r11	126		
qcl-CRS-Info-r11 SEQUENCE {			
qcl-ScramblingIdentity-r11	0		
crs-PortsCount-r11	n2		
mbsfn-SubframeConfigList-r11	Not present		
}			

Table 8.3.2.4.3\_F.4.3-5: CSI-RS-ConfigZP-r11-DEFAULT

Derivation Path: 36.508 clause 4.6.3			
Information Element	Value/remark	Comment	Condition
CSI-RS-ConfigZP-r11 ::= SEQUENCE {			
csi-RS-ConfigZPId-r11	1		
resourceConfigList-r11	0010000000000000		
subframeConfig-r11	4		
}			

Table 8.3.2.4.3\_F.4.3-6: PDSCH-ConfigDedicated-v1130-DEFAULT

Derivation Path: 36.508 clause 4.6.3			
Information Element	Value/remark	Comment	Condition
PDSCH-ConfigDedicated-v1130 ::= SEQUENCE {			
dmrs-ConfigPDSCH-r11	DMRS-Config-r11-DEFAULT		
qcl-Operation	typeB		
re-MappingQCLConfigToAddModList-r11 SEQUENCE (SIZE (1..maxRE-MapQCL-r11)) OF SEQUENCE {	1 entry		
pdsch-RE-MappingQCL-ConfigId-r11[1]	1		
optionalSetOfFields-r11[1] SEQUENCE {			
crs-PortsCount-r11	n2		
crs-FreqShift-r11	0		
mbsfn-SubframeConfigList-r11	Not present		
pdsch-Start-r11	2		
}			
}			
}			

## 8.3.2.4.3\_F.5 Test requirements

Table 8.3.2.4.3\_F.3-1 defines the primary level setting.

The fraction of maximum throughput percentage for the downlink reference measurement channels specified in Annex A clause A.3.4.2 for each throughput test shall meet or exceed the specified value in Table 8.3.2.4.3\_F.5-1 for the specified SNR including test tolerances for all throughput tests.

Table 8.3.2.4.3\_F.5-1: Test Requirements for quasi co-location type B with different Cell ID and Colliding CRS

Test Number	Reference Channel	OCNG Pattern		Propagation Conditions (Note1)		Correlation Matrix and Antenna Configuration (Note 2)	Reference Value		UE Category
		TP 1	TP 2	TP 1	TP 2		Fraction of Maximum Throughput (%)	SNR (dB) (Note 3)	
1	R.54 TDD	N/A	OP.1 TDD	EPA5	ETU5	2x2 Low	70	15.6	2-8
Note 1: The propagation conditions for TP 1 and TP 2 are statistically independent. Note 2: Correlation matrix and antenna configuration parameters apply for each of TP 1 and TP 2. Note 3: SNR corresponds to $\hat{E}_s / N_{oc}$ of TP2.									

## 8.4 Demodulation of PCFICH/PDCCH

### 8.4.1 FDD

#### 8.4.1.1 FDD PCFICH/PDCCH Single-antenna Port Performance

##### 8.4.1.1.1 Test purpose

This test verifies the demodulation performance of PCFICH/PDCCH for a single-antenna port with a given SNR for which the average probability of miss-detection of the Downlink Scheduling Grant, tested jointly on PDCCH and PCFICH of the specified reference measurement channels in A.3.5.1 remains below a given reference value.

##### 8.4.1.1.2 Test applicability

This test applies to all types of E-UTRA FDD UE release 8 and forward.

##### 8.4.1.1.3 Minimum conformance requirements

The receiver characteristics of the PDCCH/PCFICH are determined by the probability of miss-detection of the Downlink Scheduling Grant (Pm-dsg). PDCCH and PCFICH are tested jointly, i.e. a miss detection of PCFICH implies a miss detection of PDCCH.

**Table 8.4.1.1.3-1: Test Parameters for PDCCH/PCFICH**

Parameter		Unit	Single antenna port
Number of PDCCH symbols		symbols	2
Number of PHICH groups ( $N_g$ )			1
PHICH duration			Normal
Unused RE-s and PRB-s			OCNG
Cell ID			0
Downlink power allocation	PDCCH_RA PHICH_RA OCNG_RA	dB	0
	PCFICH_RB PDCCH_RB PHICH_RB OCNG_RB	dB	0
$N_{oc}$ at antenna port		dBm/15kHz	-98
Cyclic prefix			Normal
Note: PHICH power setting refer to PHICH group power, i.e. the total power of all active PHICH sequences within a PHICH group.			

For the parameters specified in Table 8.4.1.1.3-1 the average probability of a missed downlink scheduling grant (Pm-dsg) shall be below the specified value in Table 8.4.1.1.3-2.

**Table 8.4.1.1.3-2: Minimum performance PDCCH/PCFICH**

Test number	Bandwidth	Aggregation level	Reference Channel	OCNG Pattern	Propagation Condition	Antenna configuration and Correlation Matrix	Reference value	
							Pm-dsg (%)	SNR (dB)
1	10 MHz	8 CCE	R.15 FDD	OP.1 FDD	ETU70	1x2 Low	1	-1.7

The normative reference for this requirement is TS 36.101 [2] clause 8.4.1.

#### 8.4.1.1.4 Test description

##### 8.4.1.1.4.1 Initial conditions

Initial conditions are a set of test configurations the UE needs to be tested in and the steps for the SS to take with the UE to reach the correct measurement state.

Configurations of PDSCH and PDCCH before measurement are specified in Annex C.2.

Test Environment: Normal, as defined in TS 36.508 [7] clause 4.1.

Frequencies to be tested: Mid Range, as defined in TS 36.508 [7] clause 4.3.1.1.

Channel Bandwidths to be tested: 10MHz, as defined in TS 36.508 [7] clause 4.3.1.1

1. Connect the SS, the faders and AWGN noise source to the UE antenna connector (s) as shown in TS 36.508 [7] Annex A, Figure A.9.
2. The parameter settings for the cell are set up according to Table 8.4.1.1.3-1.
3. The downlink signals are initially set up according to Annex C.1 and Annex C.3.2 and uplink signals according to Annex H.1 and H.3.2.
4. Propagation conditions are set according to Annex B clause B.0.
5. Ensure the UE is in State 3A-RF according to TS 36.508 [7] clause 5.2A.2. Message contents are defined in clause 8.4.1.1.4.3.

##### 8.4.1.1.4.2 Test procedure

1. SS transmits PDSCH via PDCCH DCI format 1 for C\_RNTI to transmit the DL RMC according to Table 8.4.1.1.3-2. The details of PDCCH and PDSCH are specified in Table A.3.5.1-1 and Table A.3.5.1-2 respectively. The SS sends downlink MAC padding bits on the DL RMC.
2. Set the parameters of the propagation condition, antenna configuration, the correlation matrix and the SNR according to Table 8.4.1.1.5-1 as appropriate.
3. Measure the Pm-dsg for a duration sufficient to achieve statistical significance according to Annex G clause G.4. Count the number of NACKs, ACKs and statDTXs on the UL PUCCH during each subtest interval. Pm-dsg is the ratio (statDTX)/(NACK+ACK+statDTX). If Pm-dsg is less than the value specified in table 8.4.1.1.5-1, pass the UE. Otherwise fail the UE.

##### 8.4.1.1.4.3 Message contents

Message contents are according to TS 36.508 [7] clause 4.6.

##### 8.4.1.1.5 Test requirement

For the parameters specified in Table 8.4.1.1.3-1 the average probability of a missed downlink scheduling grant (Pm-dsg) shall be below the specified value in Table 8.4.1.1.5-1.

**Table 8.4.1.1.5-1: Test requirement PDCCH/PCFICH**

Test number	Bandwidth	Aggregation level	Reference Channel	OCNG Pattern	Propagation Condition	Antenna configuration and correlation Matrix	Reference value	
							Pm-dsg (%)	SNR (dB)
1	10 MHz	8 CCE	R.15 FDD	OP.1 FDD	ETU70	1x2 Low	1	-0.9

## 8.4.1.2 FDD PCFICH/PDCCH Transmit Diversity Performance

### 8.4.1.2.1 FDD PCFICH/PDCCH Transmit Diversity 2x2

#### 8.4.1.2.1.1 Test purpose

This test verifies the demodulation performance of PCFICH/PDCCH for transmit diversity with a given SNR for which the average probability of miss-detection of the Downlink Scheduling Grant, tested jointly on PDCCH and PCFICH of the specified reference measurement channels in A.3.5.1 remains below a given reference value.

#### 8.4.1.2.1.2 Test applicability

This test applies to all types of E-UTRA FDD UE release 8.

#### 8.4.1.2.1.3 Minimum conformance requirements

The receiver characteristics of the PDCCH/PCFICH are determined by the probability of miss-detection of the Downlink Scheduling Grant (P<sub>m-dsg</sub>). PDCCH and PCFICH are tested jointly, i.e. a miss detection of PCFICH implies a miss detection of PDCCH.

**Table 8.4.1.2.1.3-1: Test Parameters for PDCCH/PCFICH**

Parameter		Unit	Transmit diversity
Number of PDCCH symbols		symbols	2
Number of PHICH groups ( $N_g$ )			1
PHICH duration			Normal
Unused RE-s and PRB-s			OCNG
Cell ID			0
Downlink power allocation	PDCCH_RA PHICH_RA OCNG_RA	dB	-3
	PCFICH_RB PDCCH_RB PHICH_RB OCNG_RB	dB	-3
$N_{oc}$ at antenna port		dBm/15kHz	-98
Cyclic prefix			Normal
Note: PHICH power setting refer to PHICH group power, i.e. the total power of all active PHICH sequences within a PHICH group.			

For the parameters specified in Table 8.4.1.2.1.3-1 the average probability of a missed downlink scheduling grant (P<sub>m-dsg</sub>) shall be below the specified value in Table 8.4.1.2.1.3-2.

**Table 8.4.1.2.1.3-2: Minimum performance PDCCH/PCFICH 2 Tx Antenna Port**

Test number	Bandwidth	Aggregation level	Reference Channel	OCNG Pattern	Propagation Condition	Antenna configuration and correlation Matrix	Reference value	
							P <sub>m-dsg</sub> (%)	SNR (dB)
1	1.4 MHz	2 CCE	R.16 FDD	OP.1 FDD	EPA5	2 x 2 Low	1	4.3

The normative reference for this requirement is TS 36.101 [2] clause 8.4.1.

#### 8.4.1.2.1.4 Test description

##### 8.4.1.2.1.4.1 Initial conditions

Initial conditions are a set of test configurations the UE needs to be tested in and the steps for the SS to take with the UE to reach the correct measurement state.

Configurations of PDSCH and PDCCH before measurement are specified in Annex C.2.

Test Environment: Normal, as defined in TS 36.508 [7] clause 4.1.

Frequencies to be tested: Mid Range, as defined in TS 36.508 [7] clause 4.3.1.1.

Channel Bandwidths to be tested: 1.4MHz, as defined in TS 36.508 [7] clause 4.3.1.1

1. Connect the SS, the faders and AWGN noise sources to the UE antenna connector (s) as shown in TS 36.508 [7] Annex A, Figure A.10.
2. The parameter settings for the cell are set up according to Table 8.4.1.2.1.3-1.
3. The downlink signals are initially set up according to Annex C.1 and C.3.2 and uplink signals according to Annex H.1 and H.3.2.
4. Propagation conditions are set according to Annex B clauses B.0.
5. Ensure the UE is in State 3A-RF according to TS 36.508 [7] clause 5.2A.2. Message contents are defined in clause 8.4.1.2.1.4.3.

##### 8.4.1.2.1.4.2 Test procedure

1. SS transmits PDSCH via PDCCH DCI format 2 for C\_RNTI to transmit the DL RMC according to Table 8.4.1.2.1.3-2. The details of PDCCH and PDSCH are specified in Table A.3.5.1-1 and Table A.3.5.1-2 respectively. The SS sends downlink MAC padding bits on the DL RMC. Transmission scheme for the PDSCH shall be transmit diversity.
2. Set the parameters of the propagation condition, antenna configuration, the correlation matrix and the SNR according to Table 8.4.1.2.1.5-1.
3. Measure the Pm-dsg for a duration sufficient to achieve statistical significance according to Annex G clause G.4. Count the number of NACKs, ACKs and statDTXs on the UL PUCCH during each subtest interval. Pm-dsg is the ratio (statDTX)/(NACK+ACK+statDTX).

If Pm-dsg is less than the value specified in table 8.4.1.2.1.5-1, pass the UE. Otherwise fail the UE.

##### 8.4.1.2.1.4.3 Message contents

Message contents are according to TS 36.508 [7] clause 4.6 with the following exceptions:

**Table 8.4.1.2.1.4.3-1: PhysicalConfigDedicated-DEFAULT**

Derivation Path: 36.331 clause 6.3.2			
Information Element	Value/remark	Comment	Condition
PhysicalConfigDedicated-DEFAULT ::= SEQUENCE {			
antennaInfo CHOICE {			
antennaInfoDedicated ::= SEQUENCE {			
transmissionMode	tm4		
codebookSubsetRestriction CHOICE {			
n2TxAntenna-tm4	111111		
}			
ue-TransmitAntennaSelection CHOICE {			
release	NULL		
}			
}			
}			

#### 8.4.1.2.1.5 Test requirement

For the parameters specified in Table 8.4.1.2.1.3-1 the average probability of a missed downlink scheduling grant (Pm-dsg) shall be below the specified value in Table 8.4.1.2.1.5-1.

**Table 8.4.1.2.1.5-1: Test requirement PDCCH/PCFICH 2 Tx Antenna Port**

Test number	Bandwidth	Aggregation level	Reference Channel	OCNG Pattern	Propagation Condition	Antenna configuration and correlation Matrix	Reference value	
							Pm-dsg (%)	SNR (dB)
1	1.4 MHz	2 CCE	R.16 FDD	OP.1 FDD	EPA5	2 x 2 Low	1	5.3

#### 8.4.1.2.1\_1 FDD PCFICH/PDCCH Transmit Diversity 2x2 (Release 9 and forward)

##### 8.4.1.2.1\_1.1 Test purpose

This test verifies the demodulation performance of PCFICH/PDCCH for transmit diversity with a given SNR for which the average probability of miss-detection of the Downlink Scheduling Grant, tested jointly on PDCCH and PCFICH of the specified reference measurement channels in A.3.5.1 remains below a given reference value.

##### 8.4.1.2.1\_1.2 Test applicability

This test applies to all types of E-UTRA FDD UE release 9 and forward.

##### 8.4.1.2.1\_1.3 Minimum conformance requirements

The receiver characteristics of the PDCCH/PCFICH are determined by the probability of miss-detection of the Downlink Scheduling Grant (Pm-dsg). PDCCH and PCFICH are tested jointly, i.e. a miss detection of PCFICH implies a miss detection of PDCCH.



**Table 8.4.1.2.1\_1.3-1: Test Parameters for PDCCH/PCFICH**

Parameter		Unit	Transmit diversity
Number of PDCCH symbols		symbols	2
Number of PHICH groups (Ng)			1
PHICH duration			Normal
Unused RE-s and PRB-s			OCNG
Cell ID			0
Downlink power allocation	PDCCH_RA PHICH_RA OCNG_RA	dB	-3
	PCFICH_RB PDCCH_RB PHICH_RB OCNG_RB	dB	-3
$N_{oc}$ at antenna port		dBm/15kHz	-98
Cyclic prefix			Normal
Note: PHICH power setting refer to PHICH group power, i.e. the total power of all active PHICH sequences within a PHICH group.			

For the parameters specified in Table 8.4.1.2.1\_1.3-1 the average probability of a missed downlink scheduling grant (Pm-dsg) shall be below the specified value in Table 8.4.1.2.1\_1.3-2.

**Table 8.4.1.2.1\_1.3-2: Minimum performance PDCCH/PCFICH 2 Tx Antenna Port**

Test number	Bandwidth	Aggregation level	Reference Channel	OCNG Pattern	Propagation Condition	Antenna configuration and correlation Matrix	Reference value	
							Pm-dsg (%)	SNR (dB)
1	10 MHz	4 CCE	R.16_1 FDD	OP.1 FDD	EVA70	2 x 2 Low	1	-0.6

The normative reference for this requirement is TS 36.101 [2] clause 8.4.1

#### 8.4.1.2.1\_1.4 Test description

##### 8.4.1.2.1\_1.4.1 Initial conditions

Initial conditions are a set of test configurations the UE needs to be tested in and the steps for the SS to take with the UE to reach the correct measurement state.

Configurations of PDSCH and PDCCH before measurement are specified in Annex C.2.

Test Environment: Normal, as defined in TS 36.508 [7] clause 4.1.

Frequencies to be tested: Mid Range, as defined in TS 36.508 [7] clause 4.3.1.1.

Channel Bandwidths to be tested: 10MHz, as defined in TS 36.508 [7] clause 4.3.1.1

1. Connect the SS, the faders and AWGN noise sources to the UE antenna connector (s) as shown in TS 36.508 [7] Annex A, Figure A.10.
2. The parameter settings for the cell are set up according to Table 8.4.1.2.1\_1.3-1.
3. The downlink signals are initially set up according to Annex C.1 and C.3.2 and uplink signals according to Annex H.1 and H.3.2.
4. Propagation conditions are set according to Annex B clauses B.0.

5. Ensure the UE is in State 3A-RF according to TS 36.508 [7] clause 5.2A.2. Message contents are defined in clause 8.4.1.2.1\_1.4.3.

8.4.1.2.1\_1.4.2 Test procedure

1. SS transmits PDSCH via PDCCH DCI format 2 for C\_RNTI to transmit the DL RMC according to Table 8.4.1.2.1\_1.3-2. The details of PDCCH and PDSCH are specified in Table A.3.5.1-1 and Table A.3.5.1-2 respectively. The SS sends downlink MAC padding bits on the DL RMC. Transmission scheme for the PDSCH shall be transmit diversity.
2. Set the parameters of the propagation condition, antenna configuration, the correlation matrix and the SNR according to Table 8.4.1.2.1\_1.5-1.
3. Measure the Pm-dsg for a duration sufficient to achieve statistical significance according to Annex G clause G.4. Count the number of NACKs, ACKs and statDTXs on the UL PUCCH during each subtest interval. Pm-dsg is the ratio (statDTX)/(NACK+ACK+statDTX).

If Pm-dsg is less than the value specified in table 8.4.1.2.1\_1.5-1, pass the UE. Otherwise fail the UE.

8.4.1.2.1\_1.4.3 Message contents

Message contents are according to TS 36.508 [7] clause 4.6 with the following exceptions:

**Table 8.4.1.2.1\_1.4.3-1: PhysicalConfigDedicated-DEFAULT**

Derivation Path: 36.331 clause 6.3.2			
Information Element	Value/remark	Comment	Condition
PhysicalConfigDedicated-DEFAULT ::= SEQUENCE {			
antennaInfo CHOICE {			
antennaInfoDedicated ::= SEQUENCE {			
transmissionMode	tm4		
codebookSubsetRestriction CHOICE {			
n2TxAntenna-tm4	111111		
}			
ue-TransmitAntennaSelection CHOICE {			
release	NULL		
}			
}			
}			

8.4.1.2.1\_1.5 Test requirement

For the parameters specified in Table 8.4.1.2.1\_1.3-1 the average probability of a missed downlink scheduling grant (Pm-dsg) shall be below the specified value in Table 8.4.1.2.1\_1.5-1.

**Table 8.4.1.2.1\_1.5-1: Test requirement PDCCH/PCFICH 2 Tx Antenna Port**

Test number	Bandwidth	Aggregation level	Reference Channel	OCNG Pattern	Propagation Condition	Antenna configuration and correlation Matrix	Reference value	
							Pm-dsg (%)	SNR (dB)
1	10 MHz	4 CCE	R.16_1 FDD	OP.1 FDD	EVA70	2 x 2 Low	1	+0.4

## 8.4.1.2.2 FDD PCFICH/PDCCH Transmit Diversity 4x2

## 8.4.1.2.2.1 Test purpose

This test verifies the demodulation performance of PCFICH/PDCCH for transmit diversity with a given SNR for which the average probability of miss-detection of the Downlink Scheduling Grant, tested jointly on PDCCH and PCFICH of the specified reference measurement channels in A.3.5.1 remains below a given reference value.

## 8.4.1.2.2.2 Test applicability

This test applies to all types of E-UTRA FDD UE release 8.

## 8.4.1.2.2.3 Minimum conformance requirements

The receiver characteristics of the PDCCH/PCFICH are determined by the probability of miss-detection of the Downlink Scheduling Grant (Pm-dsg). PDCCH and PCFICH are tested jointly, i.e. a miss detection of PCFICH implies a miss detection of PDCCH.

**Table 8.4.1.2.2.3-1: Test Parameters for PDCCH/PCFICH**

Parameter		Unit	Transmit diversity
Number of PDCCH symbols		symbols	2
Number of PHICH groups ( $N_g$ )			1
PHICH duration			Normal
Unused RE-s and PRB-s			OCNG
Cell ID			0
Downlink power allocation	PDCCH_RA PHICH_RA OCNG_RA	dB	-3
	PCFICH_RB PDCCH_RB PHICH_RB OCNG_RB	dB	-3
$N_{oc}$ at antenna port		dBm/15kHz	-98
Cyclic prefix			Normal
Note: PHICH power setting refer to PHICH group power, i.e. the total power of all active PHICH sequences within a PHICH group.			

For the parameters specified in Table 8.4.1.2.2.3-1 the average probability of a missed downlink scheduling grant (Pm-dsg) shall be below the specified value in Table 8.4.1.2.2.3-2.

**Table 8.4.1.2.2.3-2: Minimum performance PDCCH/PCFICH 4 Tx Antenna Port**

Test number	Bandwidth	Aggregation level	Reference Channel	OCNG Pattern	Propagation Condition	Antenna configuration and correlation Matrix	Reference value	
							Pm-dsg (%)	SNR (dB)
1	10 MHz	4 CCE	R.17 FDD	OP.1 FDD	EVA5	4 x 2 Medium	1	0.9

The normative reference for this requirement is TS 36.101 [2] clause 8.4.1.

## 8.4.1.2.2.4 Test description

## 8.4.1.2.2.4.1 Initial conditions

Initial conditions are a set of test configurations the UE needs to be tested in and the steps for the SS to take with the UE to reach the correct measurement state.

Configurations of PDSCH and PDCCH before measurement are specified in Annex C.2.

Test Environment: Normal, as defined in TS 36.508 [7] clause 4.1.

Frequencies to be tested: Mid Range, as defined in TS 36.508 [7] clause 4.3.1.1.

Channel Bandwidths to be tested: 10MHz, as defined in TS 36.508 [7] clause 4.3.1.1

1. Connect the SS, the faders and AWGN noise sources to the UE antenna connector (s) as shown in TS 36.508 [7] Annex A, Figure A.11.
2. The parameter settings for the cell are set up according to Table 8.4.1.2.2.3-1.
3. The downlink signals are initially set up according to Annex C.1 and C.3.2 and uplink signals according to Annex H.1 and H.3.2.
4. Propagation conditions are set according to Annex B clauses B.0.
5. Ensure the UE is in State 3A-RF according to TS 36.508 [7] clause 5.2A.2. Message contents are defined in clause 8.4.1.2.2.4.3.

8.4.1.2.2.4.2 Test procedure

1. SS transmits PDSCH via PDCCH DCI format 2 for C\_RNTI to transmit the DL RMC according to Table 8.4.1.2.2.3-2. The details of PDCCH and PDSCH are specified in Table A.3.5.1-1 and Table A.3.5.1-2 respectively. The SS sends downlink MAC padding bits on the DL RMC. Transmission scheme for the PDSCH shall be transmit diversity.
2. Set the parameters of the propagation condition, antenna configuration, the correlation matrix and the SNR according to Table 8.4.1.2.2.5-1.
3. Measure the Pm-dsg for a duration sufficient to achieve statistical significance according to Annex G clause G.4. Count the number of NACKs, ACKs and statDTXs on the UL PUCCH during each subtest interval. Pm-dsg is the ratio (statDTX)/(NACK+ACK+statDTX). If Pm-dsg is less than the value specified in table 8.4.1.2.2.5-1, pass the UE. Otherwise fail the UE.

8.4.1.2.2.4.3 Message contents

Message contents are according to TS 36.508 [7] clause 4.6 with the following exceptions:

**Table 8.4.1.2.2.4.3-1: PhysicalConfigDedicated-DEFAULT**

Derivation Path: 36.331 clause 6.3.2			
Information Element	Value/remark	Comment	Condition
PhysicalConfigDedicated-DEFAULT ::= SEQUENCE {			
antennaInfo CHOICE {			
antennaInfoDedicated ::= SEQUENCE {			
transmissionMode	tm4		
codebookSubsetRestriction CHOICE {			
n4TxAntenna-tm4	11111111111111111111 11111111111111111111 11111111111111111111 1111		
}			
ue-TransmitAntennaSelection CHOICE {			
release	NULL		
}			
}			
}			

8.4.1.2.2.5 Test requirement

For the parameters specified in Table 8.4.1.2.2.3-1 the average probability of a missed downlink scheduling grant (Pm-dsg) shall be below the specified value in Table 8.4.1.2.2.5-1.

**Table 8.4.1.2.2.5-1: Test requirement PDCCH/PCFICH 4 Tx Antenna Port**

Test number	Bandwidth	Aggregation level	Reference Channel	OCNG Pattern	Propagation Condition	Antenna configuration and correlation Matrix	Reference value	
							Pm-dsg (%)	SNR (dB)
1	10 MHz	4 CCE	R.17 FDD	OP.1 FDD	EVA5	4 x 2 Medium	1	1.9

#### 8.4.1.2.2\_1 FDD PCFICH/PDCCH Transmit Diversity 4x2 (Release 9 and forward)

##### 8.4.1.2.2\_1.1 Test purpose

This test verifies the demodulation performance of PCFICH/PDCCH for transmit diversity with a given SNR for which the average probability of miss-detection of the Downlink Scheduling Grant, tested jointly on PDCCH and PCFICH of the specified reference measurement channels in A.3.5.1 remains below a given reference value.

##### 8.4.1.2.2\_1.2 Test applicability

This test applies to all types of E-UTRA FDD UE release 9 and forward.

##### 8.4.1.2.2\_1.3 Minimum conformance requirements

The receiver characteristics of the PDCCH/PCFICH are determined by the probability of miss-detection of the Downlink Scheduling Grant (Pm-dsg). PDCCH and PCFICH are tested jointly, i.e. a miss detection of PCFICH implies a miss detection of PDCCH.

**Table 8.4.1.2.2\_1.3-1: Test Parameters for PDCCH/PCFICH**

Parameter		Unit	Transmit diversity
Number of PDCCH symbols		symbols	2
Number of PHICH groups ( $N_g$ )			1
PHICH duration			Normal
Unused RE-s and PRB-s			OCNG
Cell ID			0
Downlink power allocation	PDCCH_RA PHICH_RA OCNG_RA	dB	-3
	PCFICH_RB PDCCH_RB PHICH_RB OCNG_RB	dB	-3
$N_{oc}$ at antenna port		dBm/15kHz	-98
Cyclic prefix			Normal
Note: PHICH power setting refer to PHICH group power, i.e. the total power of all active PHICH sequences within a PHICH group.			

For the parameters specified in Table 8.4.1.2.2\_1.3-1 the average probability of a missed downlink scheduling grant (Pm-dsg) shall be below the specified value in Table 8.4.1.2.2\_1.3-2.

**Table 8.4.1.2.2\_1.3-2: Minimum performance PDCCH/PCFICH 4 Tx Antenna Port**

Test number	Bandwidth	Aggregation level	Reference Channel	OCNG Pattern	Propagation Condition	Antenna configuration and correlation Matrix	Reference value	
							Pm-dsg (%)	SNR (dB)
1	5 MHz	2 CCE	R.17_1 FDD	OP.1 FDD	EPA5	4 x 2 Medium	1	6.3

The normative reference for this requirement is TS 36.101 [2] clause 8.4.1.

#### 8.4.1.2.2\_1.4 Test description

##### 8.4.1.2.2\_1.4.1 Initial conditions

Initial conditions are a set of test configurations the UE needs to be tested in and the steps for the SS to take with the UE to reach the correct measurement state.

Configurations of PDSCH and PDCCH before measurement are specified in Annex C.2.

Test Environment: Normal, as defined in TS 36.508 [7] clause 4.1.

Frequencies to be tested: Mid Range, as defined in TS 36.508 [7] clause 4.3.1.1.

Channel Bandwidths to be tested: 5MHz, as defined in TS 36.508 [7] clause 4.3.1.1

1. Connect the SS, the faders and AWGN noise sources to the UE antenna connector (s) as shown in TS 36.508 [7] Annex A, Figure A.11.
2. The parameter settings for the cell are set up according to Table 8.4.1.2.2\_1.3-1.
3. The downlink signals are initially set up according to Annex C.1 and C.3.2 and uplink signals according to Annex H.1 and H.3.2.
4. Propagation conditions are set according to Annex B clauses B.0.
5. Ensure the UE is in State 3A-RF according to TS 36.508 [7] clause 5.2A.2. Message contents are defined in clause 8.4.1.2.2\_1.4.3.

##### 8.4.1.2.2\_1.4.2 Test procedure

1. SS transmits PDSCH via PDCCH DCI format 2 for C\_RNTI to transmit the DL RMC according to Table 8.4.1.2.2\_1.3-2. The details of PDCCH and PDSCH are specified in Table A.3.5.1-1 and Table A.3.5.1-2 respectively. The SS sends downlink MAC padding bits on the DL RMC. Transmission scheme for the PDSCH shall be transmit diversity.
2. Set the parameters of the propagation condition, antenna configuration, the correlation matrix and the SNR according to Table 8.4.1.2.2\_1.5-1.
3. Measure the Pm-dsg for a duration sufficient to achieve statistical significance according to Annex G clause G.4. Count the number of NACKs, ACKs and statDTXs on the UL PUCCH during each subtest interval. Pm-dsg is the ratio (statDTX)/(NACK+ACK+statDTX). If Pm-dsg is less than the value specified in table 8.4.1.2.2\_1.5-1, pass the UE. Otherwise fail the UE.

##### 8.4.1.2.2\_1.4.3 Message contents

Message contents are according to TS 36.508 [7] clause 4.6 with the following exceptions:

**Table 8.4.1.2.2\_1.4.3-1: PhysicalConfigDedicated-DEFAULT**

Derivation Path: 36.331 clause 6.3.2			
Information Element	Value/remark	Comment	Condition
PhysicalConfigDedicated-DEFAULT ::= SEQUENCE {			
antennaInfo CHOICE {			
antennaInfoDedicated ::= SEQUENCE {			
transmissionMode	tm4		
codebookSubsetRestriction CHOICE {			
n4TxAntenna-tm4	11111111111111111111 11111111111111111111 11111111111111111111 1111		
}			
ue-TransmitAntennaSelection CHOICE {			
release	NULL		
}			
}			
}			

8.4.1.2.2\_1.5 Test requirement

For the parameters specified in Table 8.4.1.2.2\_1.3-1 the average probability of a missed downlink scheduling grant (Pm-dsg) shall be below the specified value in Table 8.4.1.2.2\_1.5-1.

**Table 8.4.1.2.2\_1.5-1: Test requirement PDCCH/PCFICH 4 Tx Antenna Port**

Test number	Bandwidth	Aggregation level	Reference Channel	OCNG Pattern	Propagation Condition	Antenna configuration and correlation Matrix	Reference value	
							Pm-dsg (%)	SNR (dB)
1	5 MHz	2 CCE	R.17_1 FDD	OP.1 FDD	EPA5	4 x 2 Medium	1	+7.3

8.4.1.2.3

8.4.1.2.3\_C FDD PCFICH/PDCCH Transmit Diversity 2x2 for eICIC

8.4.1.2.3\_C.1 FDD PCFICH/PDCCH Transmit Diversity 2x2 for eICIC (non-MBSFN ABS)

8.4.1.2.3\_C.1.1 Test purpose

To verify the UE's performance of transmit diversity (SFBC) with 2 transmit antennas if the PCFICH/PDCCH transmission in the serving cell takes place in subframes that overlap with ABS of the aggressor cell.

8.4.1.2.3\_C.1.2 Test applicability

This test applies to all types of E-UTRA FDD UE release 10 and forward. Applicability requires support for FGI bit 115.

8.4.1.2.3\_C.1.3 Minimum conformance requirements

The receiver characteristics of the PDCCH/PCFICH are determined by the probability of miss-detection of the Downlink Scheduling Grant (Pm-dsg). PDCCH and PCFICH are tested jointly, i.e. a miss detection of PCFICH implies a miss detection of PDCCH.

**Table 8.4.1.2.3\_C.1.3-1: Void**

For the parameters for non-MBSFN ABS specified in Table 8.4.1.2.3\_C.1.3-2, the average probability of a missed downlink scheduling grant ( $P_{m-dsg}$ ) shall be below the specified value in Table 8.4.1.2.3\_C.1.3-3. The downlink physical setup is in accordance with Annex C.3.2 and Annex C.3.3. In Table 8.4.1.2.3\_C.1.3-2, Cell 1 is the serving cell, and Cell 2 is the aggressor cell. The downlink physical channel setup for Cell 1 is according to Annex C.3.2 and for Cell 2 is according to Annex C.3.3, respectively.



**Table 8.4.1.2.3\_C.1.3-2: Test Parameters for PDCCH/PCFICH – Non-MBSFN ABS**

Parameter		Unit	Cell 1	Cell 2
Downlink power allocation	PDCCH_RA PHICH_RA OCNG_RA	dB	-3	-3
	PCFICH_RB PDCCH_RB PHICH_RB OCNG_RB	dB	-3	-3
$N_{oc}$ at antenna port	$N_{oc1}$	dBm/15kHz	-100.5 (Note 1)	N/A
	$N_{oc2}$	dBm/15kHz	-98 (Note 2)	N/A
	$N_{oc3}$	dBm/15kHz	-95.3 (Note 3)	N/A
$\widehat{E}_s/N_{oc2}$		dB	Reference Value in Table 8.4.1.2.3_C.1.3-3	1.5
BW <sub>Channel</sub>		MHz	10	10
Subframe Configuration			Non-MBSFN	Non-MBSFN
Time Offset between Cells		μs	2.5 (synchronous cells)	
Cell Id			0	1
ABS pattern (Note 4)			N/A	00000100 00000100 00000100 01000100 00000100
RLM/RRM Measurement Subframe Pattern (Note 5)			00000100 00000100 00000100 00000100	N/A
CSI Subframe Sets (Note 6)	$C_{csi,0}$		00000100 00000100 00000100 01000100 00000100	N/A
	$C_{csi,1}$		11111011 11111011 11111011 10111011 11111011	N/A
Number of control OFDM symbols			3	3
Number of PHICH groups ( $N_g$ )			1	N/A
PHICH duration			Extended	N/A
Unused RE-s and PRB-s			OCNG	OCNG
Cyclic prefix			Normal	Normal
<p>Note 1: This noise is applied in OFDM symbols #1, #2, #3, #5, #6, #8, #9, #10, #12, #13 of a subframe overlapping with the aggressor ABS.</p> <p>Note 2: This noise is applied in OFDM symbols #0, #4, #7, #11 of a subframe overlapping with the aggressor ABS.</p> <p>Note 3: This noise is applied in all OFDM symbols of a subframe overlapping with aggressor non-ABS</p> <p>Note 4: ABS pattern as defined in [14]. PDCCH/PCFICH other than that associated with SIB1/Paging are transmitted in the serving cell subframe when the subframe is overlapped with the ABS subframe of aggressor cell.</p> <p>Note 5: Time-domain measurement resource restriction pattern for PCell measurements as defined in [5];</p> <p>Note 6: As configured according to the time-domain measurement resource restriction pattern for CSI measurements defined in [5];</p> <p>Note 7: Cell 1 is the serving cell. Cell 2 is the aggressor cell. The number of the CRS ports in Cell1 and Cell2 is the same.</p> <p>Note 8: SIB-1 will not be transmitted in Cell2 in the test.</p>				

Table 8.4.1.2.3\_C.1.3-3: Minimum performance PDCCH/PCFICH – Non-MBSFN ABS

Test Number	Aggregation Level	Reference Channel	OCNG Pattern		Propagation Conditions (Note 1)		Correlation Matrix and Antenna Configuration	Reference Value	
			Cell 1	Cell 2	Cell 1	Cell 2		Pm-dsg (%)	SNR (dB) (Note 2)
1	8 CCE	R15-1 FDD	OP.1 FDD	OP.1 FDD	EVA5	EVA5	2x2 Low	1	-3.9
Note 1: The propagation conditions for Cell 1 and Cell 2 are statistically independent. Note 2: SNR corresponds to $\hat{E}_s / N_{oc2}$ of cell 1 Note 3: The correlation matrix and antenna configuration apply for Cell 1 and Cell 2.									

The normative reference for this requirement is TS 36.101 [2] clause 8.4.1.2.3

#### 8.4.1.2.3\_C.1.4 Test description

##### 8.4.1.2.3\_C.1.4.1 Initial conditions

Initial conditions are a set of test configurations the UE needs to be tested in and the steps for the SS to take with the UE to reach the correct measurement state.

Configurations of PDSCH and PDCCH before measurement are specified in Annex C.2.

Test Environment: Normal, as defined in TS 36.508 [7] clause 4.1.

Frequencies to be tested: Mid Range, as defined in TS 36.508 [7] clause 4.3.1.1.

Channel Bandwidths to be tested: 10MHz, as defined in TS 36.508 [7] clause 4.3.1.1

1. Connect the SS, the faders and AWGN noise sources to the UE antenna connector (s) as shown in TS 36.508 [7] Annex A, Figure A.40 for antenna configuration 2x2.
2. The parameter settings for the cell1 are set up according to Tables 8.4.1.2.3\_C.1.3-1 and 8.4.1.2.3\_C.1.3-2.
3. The downlink signals are initially set up according to Annex C.0, C.1 and C.3.2 and uplink signals according to Annex H.1 and H.3.2.
4. Propagation conditions are set according to Annex B clauses B.0.
5. Ensure the UE is in State 3A-RF according to TS 36.508 [7] clause 5.2A.2. Message contents are defined in clause 8.4.1.2.3\_C.1.4.3.

##### 8.4.1.2.3\_C.1.4.2 Test procedure

1. Set the parameters for Cell1 and Cell2 according to Tables 8.4.1.2.3\_C.1.5-1, 8.4.1.2.3\_C.1.5-2, C.3.3-1 of Annex C.3.3 as appropriate, and SS transmits PDSCH via PDCCH DCI format 1 for C\_RNTI to transmit the DL RMC in the subframes overlapping with ABS of the aggressor cell. The details of PDCCH and PDSCH are specified in Table A.3.5.1-1 and Table A.3.5.1-2A respectively. The SS sends downlink MAC padding bits on the DL RMC. Transmission scheme for the PDSCH shall be transmit diversity. Propagation conditions are set according to Annex B clause B.2.
2. Measure the Pm-dsg in the subframes overlapping with ABS of the aggressor cell for a duration sufficient to achieve statistical significance according to Annex G clause G.4. Count the number of NACKs, ACKs and statDTXs on the UL PUCCH during each subtest interval. Pm-dsg is the ratio (statDTX)/(NACK+ACK+statDTX).

If Pm-dsg is less than the value specified in table 8.4.1.2.3\_C.1.5-2, pass the UE. Otherwise fail the UE.

##### 8.4.1.2.3\_C.1.4.3 Message contents

Message contents are according to TS 36.508 [7] clause 4.6 with the following exceptions:

**Table 8.4.1.2.3\_C.1.4.3-1: PHICH-Config-DEFAULT**

Derivation Path: TS 36.508 [7] clause 4.6.3, Table 4.6.3-4: PHICH-Config-DEFAULT			
Information Element	Value/remark	Comment	Condition
PHICH-Config-DEFAULT ::= SEQUENCE {			
phich-Duration	extended		Cell 1
phich-Resource	one		
}			

**Table 8.4.1.2.3\_C.1.4.3-2: PhysicalConfigDedicated-DEFAULT**

Derivation Path: TS 36.508 [7] clause 5.5.1.2, Table 5.5.1.2-1 PhysicalConfigDedicated-DEFAULT			
Information Element	Value/remark	Comment	Condition
PhysicalConfigDedicated-DEFAULT ::= SEQUENCE {			
cqi-ReportConfig	Not present		
cqi-ReportConfig-r10	CQI-ReportConfig-r10-DEFAULT		
}			

**Table 8.4.1.2.3\_C.1.4.3-3: RadioResourceConfigDedicated-SRB2-DRB(n, m)**

Derivation Path: TS 36.508 [7] clause 4.6.3, Table 4.6.3-16 RadioResourceConfigDedicated-SRB2-DRB(n,m)			
Information Element	Value/remark	Comment	Condition
RadioResourceConfigDedicated-SRB2-DRB(n, m) ::= SEQUENCE {			
MeasSubframePatternPCell-r10 CHOICE {			
setup SEQUENCE {			
subframePatternFDD-r10	'00000100000001000000 0100000001000000100'	BIT STRING (SIZE (40))	
}			
}			
}			

**Table 8.4.1.2.3\_C.1.4.3-4: CQI-ReportConfig-r10-DEFAULT**

Derivation Path: 36.508 [7] clause 4.6.3, Table 4.6.3-2AA CQI-ReportConfig-r10-DEFAULT			
Information Element	Value/remark	Comment	Condition
CQI-ReportConfig-r10-DEFAULT ::= SEQUENCE {			
cqi-ReportAperiodic-r10	Not present		
nomPDSCH-RS-EPRE-Offset	0		
cqi-ReportPeriodic-r10 CHOICE{	Not present		
pmi-RI-Report-r9	Not present		
csi-SubframePatternConfig-r10 CHOICE {			
setup SEQUENCE {			
csi-MeasSubframeSet1-r10 CHOICE {			
subframePatternFDD-r10	'00000100000001000000 0100010001000000100'	BIT STRING (SIZE (40))	
}			
csi-MeasSubframeSet2-r10 CHOICE {			
subframePatternFDD-r10	'11111011111110111111 10111011101111111011'	BIT STRING (SIZE (40))	
}			
}			
}			
}			

#### 8.4.1.2.3\_C.1.5 Test requirement

For the parameters specified in Table 8.4.1.2.3\_C.1.5-1, the average probability of a missed downlink scheduling grant (Pm-dsg) shall be below the specified value in Table 8.4.1.2.3\_C.1.5-2.

**Table 8.4.1.2.3\_C.1.5-1: Test Parameters for PDCCH/PCFICH – Non-MBSFN ABS**

Parameter		Unit	Cell 1	Cell 2
Downlink power allocation	PDCCH_RA PHICH_RA OCNG_RA	dB	-3	-3
	PCFICH_RB PDCCH_RB PHICH_RB OCNG_RB	dB	-3	-3
$N_{oc}$ at antenna port	$N_{oc1}$	dBm/15kHz	-100.6 (Note 1)	N/A
	$N_{oc2}$	dBm/15kHz	-98 (Note 2)	N/A
	$N_{oc3}$	dBm/15kHz	-95.4 (Note 3)	N/A
$\hat{E}_s / N_{oc2}$		dB	Reference Value in Table 8.4.1.2.3_C.1.5-2	1.3
BW <sub>Channel</sub>		MHz	10	10
Subframe Configuration			Non-MBSFN	Non-MBSFN
Time Offset between Cells		μs	2.5 (synchronous cells)	
Cell Id			0	1
ABS pattern (Note 4)			N/A	00000100 00000100 00000100 01000100 00000100
RLM/RRM Measurement Subframe Pattern (Note 5)			00000100 00000100 00000100 00000100	N/A
CSI Subframe Sets (Note 6)	C <sub>CSI,0</sub>		00000100 00000100 00000100 01000100 00000100	N/A
	C <sub>CSI,1</sub>		11111011 11111011 11111011 10111011 11111011	N/A
Number of control OFDM symbols			3	3
Number of PHICH groups ( $N_g$ )			1	N/A
PHICH duration			Extended	N/A
Unused RE-s and PRB-s			OCNG	N/A
Cyclic prefix			Normal	Normal
<p>Note 1: This noise is applied in OFDM symbols #1, #2, #3, #5, #6, #8, #9, #10, #12, #13 of a subframe overlapping with the aggressor ABS.</p> <p>Note 2: This noise is applied in OFDM symbols #0, #4, #7, #11 of a subframe overlapping with the aggressor ABS.</p> <p>Note 3: This noise is applied in all OFDM symbols of a subframe overlapping with aggressor non-ABS</p> <p>Note 4: ABS pattern as defined in [14]. PDCCH/PCFICH other than that associated with SIB1/Paging are transmitted in the serving cell subframe when the subframe is overlapped with the ABS subframe of aggressor cell.</p> <p>Note 5: Time-domain measurement resource restriction pattern for PCell measurements as defined in [5];</p> <p>Note 6: As configured according to the time-domain measurement resource restriction pattern for CSI measurements defined in [5];</p> <p>Note 7: Cell 1 is the serving cell. Cell 2 is the aggressor cell. The number of the CRS ports in Cell1 and Cell2 is the same.</p> <p>Note 8: SIB-1 will not be transmitted in Cell2 in the test.</p>				

**Table 8.4.1.2.3\_C.1.5-2: Test Requirement PDCCH/PCFICH – Non-MBSFN ABS**

Test Number	Aggregation Level	Reference Channel	OCNG Pattern		Propagation Conditions (Note 1)		Correlation Matrix and Antenna Configuration	Reference Value	
			Cell 1	Cell 2	Cell 1	Cell 2		Pm-dsg (%)	SNR (dB) (Note 2)
1	8 CCE	R15-1 FDD	OP.1 FDD	OP.1 FDD	EVA5	EVA5	2x2 Low	1	-3
Note 1: The propagation conditions for Cell 1 and Cell 2 are statistically independent. Note 2: SNR corresponds to $\hat{E}_s / N_{oc2}$ of cell 1 Note 3: The correlation matrix and antenna configuration apply for Cell 1 and Cell 2.									

#### 8.4.1.2.3\_C.2 FDD PCFICH/PDCCH Transmit Diversity 2x2 for eICIC (MBSFN ABS)

##### 8.4.1.2.3\_C.2.1 Test purpose

To verify the UE's performance of transmit diversity (SFBC) with 2 transmit antennas if the PCFICH/PDCCH transmission in the serving cell takes place in subframes that overlap with ABS of the aggressor cell.

##### 8.4.1.2.3\_C.2.2 Test applicability

This test applies to all types of E-UTRA FDD UE release 10 and forward. Applicability requires support for FGI bit 115.

##### 8.4.1.2.3\_C.2.3 Minimum conformance requirements

The receiver characteristics of the PDCCH/PCFICH are determined by the probability of miss-detection of the Downlink Scheduling Grant (Pm-dsg). PDCCH and PCFICH are tested jointly, i.e. a miss detection of PCFICH implies a miss detection of PDCCH.

#### **Table 8.4.1.2.3\_C.2.3-1: Void**

For the parameters for MBSFN ABS specified in Table 8.4.1.2.3\_C.2.3-2, the average probability of a missed downlink scheduling grant (Pm-dsg) shall be below the specified value in Table 8.4.1.2.3\_C.2.3-3. The downlink physical setup is in accordance with Annex C.3.2 and Annex C.3.3. In Table 8.4.1.2.3\_C.2.3-2, Cell 1 is the serving cell, and Cell 2 is the aggressor cell. The downlink physical channel setup for Cell 1 is according to Annex C.3.2 and for Cell 2 is according to Annex C.3.3, respectively.

Table 8.4.1.2.3\_C.2.3-2: Test Parameters for PDCCH/PCFICH – MBSFN ABS

Parameter		Unit	Cell 1	Cell 2
Downlink power allocation	PDCCH_RA PHICH_RA OCNG_RA	dB	-3	-3
	PCFICH_RB PDCCH_RB PHICH_RB OCNG_RB	dB	-3	-3
$N_{oc}$ at antenna port	$N_{oc1}$	dBm/15kHz	-100.5 (Note 1)	N/A
	$N_{oc2}$	dBm/15kHz	-98 (Note 2)	N/A
	$N_{oc3}$	dBm/15kHz	-95.3 (Note 3)	N/A
$\hat{E}_s / N_{oc2}$		dB	Reference Value in Table 8.4.1.2.3_C.2.3-3	1.5
$BW_{Channel}$		MHz	10	10
Subframe Configuration			Non-MBSFN	MBSFN
Time Offset between Cells		$\mu$ s	2.5 (synchronous cells)	
Cell Id			0	126
ABS pattern (Note 4)			N/A	0001000000 0100000010 0000001000 0000000000
RLM/RRM Measurement Subframe Pattern (Note 5)			0001000000 0100000010 0000001000 0000000000	N/A
CSI Subframe Sets (Note 6)	$C_{CSI,0}$		0001000000 0100000010 0000001000 0000000000	N/A
	$C_{CSI,1}$		1110111111 1011111101 1111110111 1111111111	N/A
MBSFN Subframe Allocation (Note 9)			N/A	001000 100001 000100 000000
Number of control OFDM symbols			3	3
Number of PHICH groups ( $N_g$ )			1	N/A
PHICH duration			extended	N/A
Unused RE-s and PRB-s			OCNG	OCNG
Cyclic prefix			Normal	Normal

Note 1:	This noise is applied in OFDM symbols #1, #2, #3, #4, #5, #6, #7, #8, #9, #10, #11, #12, #13 of a subframe overlapping with the aggressor ABS.
Note 2:	This noise is applied in OFDM symbols #0 of a subframe overlapping with the aggressor ABS.
Note 3:	This noise is applied in all OFDM symbols of a subframe overlapping with aggressor non-ABS
Note 4:	ABS pattern as defined in [14]. The 4 <sup>th</sup> , 12 <sup>th</sup> , 19 <sup>th</sup> and 27 <sup>th</sup> subframes indicated by ABS pattern are MBSFN ABS subframes. PDSCH other than SIB1/paging and its associated PDCCH/PCFICH are transmitted in the serving cell subframe when the subframe is overlapped with the MBSFN ABS subframe of aggressor cell and the subframe is available in the definition of the reference channel.
Note 5:	Time-domain measurement resource restriction pattern for PCell measurements as defined in [5].
Note 6:	As configured according to the time-domain measurement resource restriction pattern for CSI measurements defined in [5].
Note 7:	Cell 1 is the serving cell. Cell 2 is the aggressor cell. The number of the CRS ports in Cell1 and Cell2 is the same.
Note 8:	SIB-1 will not be transmitted in Cell2 in this test.
Note 9:	MBSFN Subframe Allocation as defined in [5], four frames with 24 bits is chosen for MBSFN subframe allocation.
Note 10:	The maximum number of uplink HARQ transmission is $\leq 2$ so that each PHICH channel transmission is in a subframe protected by MBSFN ABS in this test.

**Table 8.4.1.2.3\_C.2.3-3: Minimum performance PDCCH/PCFICH – MBSFN ABS**

Test Number	Aggregation Level	Reference Channel	OCNG Pattern		Propagation Conditions (Note 1)		Correlation Matrix and Antenna Configuration	Reference Value	
			Cell 1	Cell 2	Cell 1	Cell 2		Pm-dsg (%)	SNR (dB) (Note 2)
1	8 CCE	R15-1 FDD	OP.1 FDD	OP.1 FDD	EVA5	EVA5	2x2 Low	1	-4.2
Note 1: The propagation conditions for Cell 1 and Cell2 are statistically independent.									
Note 2: SNR corresponds to $\hat{E}_s / N_{oc2}$ of cell 1.									
Note 3: The correlation matrix and antenna configuration apply for Cell 1 and Cell 2.									

The normative reference for this requirement is TS 36.101 [2] clause 8.4.1.2.3

8.4.1.2.3\_C.2.4 Test description

8.4.1.2.3\_C.2.4.1 Initial conditions

Initial conditions are a set of test configurations the UE needs to be tested in and the steps for the SS to take with the UE to reach the correct measurement state.

Configurations of PDSCH and PDCCH before measurement are specified in Annex C.2.

Test Environment: Normal, as defined in TS 36.508 [7] clause 4.1.

Frequencies to be tested: Mid Range, as defined in TS 36.508 [7] clause 4.3.1.1.

Channel Bandwidths to be tested: 10MHz, as defined in TS 36.508 [7] clause 4.3.1.1

1. Connect the SS, the faders and AWGN noise sources to the UE antenna connector (s) as shown in TS 36.508 [7] Annex A, Figure A.40 for antenna configuration 2x2.
2. The parameter settings for the cell1 are set up according to Tables 8.4.1.2.3\_C.2.3-1 and 8.4.1.2.3\_C.2.3-2.
3. The downlink signals are initially set up according to Annex C.0, C.1 and C.3.2 and uplink signals according to Annex H.1 and H.3.2.
4. Propagation conditions are set according to Annex B clauses B.0.
5. Ensure the UE is in State 3A-RF according to TS 36.508 [7] clause 5.2A.2. Message contents are defined in clause 8.4.1.2.3\_C.2.4.3.

## 8.4.1.2.3\_C.2.4.2 Test procedure

1. Set the parameters for Cell1 and Cell2 according to Tables 8.4.1.2.3\_C.2.5-1, 8.4.1.2.3\_C.2.5-2, C.3.3-1 of Annex C.3.3 as appropriate, and SS transmits PDSCH via PDCCH DCI format 1 for C\_RNTI to transmit the DL RMC in the subframes overlapping with ABS of the aggressor cell. The details of PDCCH and PDSCH are specified in Table A.3.5.1-1 and Table A.3.5.1-2A respectively. The SS sends downlink MAC padding bits on the DL RMC. Transmission scheme for the PDSCH shall be transmit diversity. Propagation conditions are set according to Annex B clause B.2.
2. Measure the Pm-dsg in the subframes overlapping with ABS of the aggressor cell for a duration sufficient to achieve statistical significance according to Annex G clause G.4. Count the number of NACKs, ACKs and statDTXs on the UL PUCCH during each subtest interval. Pm-dsg is the ratio (statDTX)/(NACK+ACK+statDTX).

If Pm-dsg is less than the value specified in table 8.4.1.2.3\_C.2.5-2, pass the UE. Otherwise fail the UE.

## 8.4.1.2.3\_C.2.4.3 Message contents

Message contents are according to TS 36.508 [7] clause 4.6 with the following exceptions:

**Table 8.4.1.2.3\_C.2.4.3-1: PHICH-Config-DEFAULT**

Derivation Path: TS 36.508 [7] clause 4.6.3, Table 4.6.3-4: PHICH-Config-DEFAULT			
Information Element	Value/remark	Comment	Condition
PHICH-Config-DEFAULT ::= SEQUENCE {			
phich-Duration	extended		Cell 1
phich-Resource	one		
}			

**Table 8.4.1.2.3\_C.2.4.3-2: SystemInformationBlockType3: Neighbor cell configuration**

Derivation Path: TS 36.508 [7] clause 4.4.3.3, Table 4.4.3.3-2: SystemInformationBlockType3			
Information Element	Value/remark	Comment	Condition
SystemInformationBlockType3 ::= SEQUENCE {			
neighCellConfig	'00'B (Not all neighbour cells have the same MBSFN subframe allocation as serving cell)		Cell 1
}			

**Table 8.4.1.2.3\_C.2.4.3-3: PhysicalConfigDedicated-DEFAULT**

Derivation Path: TS 36.508 [7] clause 5.5.1.2, Table 5.5.1.2-1 PhysicalConfigDedicated-DEFAULT			
Information Element	Value/remark	Comment	Condition
PhysicalConfigDedicated-DEFAULT ::= SEQUENCE {			
cqi-ReportConfig	Not present		
cqi-ReportConfig-r10	CQI-ReportConfig-r10-DEFAULT		
}			



**Table 8.4.1.2.3\_C.2.4.3-4: RadioResourceConfigDedicated-SRB2-DRB(n, m)**

Derivation Path: TS 36.508 [7] clause 4.6.3, Table 4.6.3-16 RadioResourceConfigDedicated-SRB2-DRB(n,m)			
Information Element	Value/remark	Comment	Condition
RadioResourceConfigDedicated-SRB2-DRB(n, m) ::= SEQUENCE {			
MeasSubframePatternPCell-r10 CHOICE {			
setup SEQUENCE {			
subframePatternFDD-r10	'00010000000100000010 00000010000000000000'	BIT STRING (SIZE (40))	
}			
}			
}			

**Table 8.4.1.2.3\_C.2.4.3-5: CQI-ReportConfig-r10-DEFAULT**

Derivation Path: 36.508 [7] clause 4.6.3, Table 4.6.3-2AA CQI-ReportConfig-r10-DEFAULT_			
Information Element	Value/remark	Comment	Condition
CQI-ReportConfig-r10-DEFAULT ::= SEQUENCE {			
cqi-ReportAperiodic-r10	Not present		
nomPDSCH-RS-EPRE-Offset	0		
cqi-ReportPeriodic-r10 CHOICE{	Not present		
pmi-RI-Report-r9	Not present		
csi-SubframePatternConfig-r10 CHOICE {			
setup SEQUENCE {			
csi-MeasSubframeSet1-r10 CHOICE {			
subframePatternFDD-r10	'00010000000100000010 00000010000000000000'	BIT STRING (SIZE (40))	
}			
csi-MeasSubframeSet2-r10 CHOICE {			
subframePatternFDD-r10	'1110111111011111101 111110111111111111'	BIT STRING (SIZE (40))	
}			
}			
}			
}			

**8.4.1.2.3\_C.2.5 Test requirement**

For the parameters specified in Table 8.4.1.2.3\_C.2.5-1, the average probability of a missed downlink scheduling grant (P<sub>m-dsg</sub>) shall be below the specified value in Table 8.4.1.2.3\_C.2.5-2.

Table 8.4.1.2.3\_C.2.5-1: Test Parameters for PDCCH/PCFICH – MBSFN ABS

Parameter		Unit	Cell 1	Cell 2
Downlink power allocation	PDCCH_RA PHICH_RA OCNG_RA	dB	-3	-3
	PCFICH_RB PDCCH_RB PHICH_RB OCNG_RB	dB	-3	-3
$N_{oc}$ at antenna port	$N_{oc1}$	dBm/15kHz	-100.6 (Note 1)	N/A
	$N_{oc2}$	dBm/15kHz	-98 (Note 2)	N/A
	$N_{oc3}$	dBm/15kHz	-95.4 (Note 3)	N/A
$\hat{E}_s / N_{oc2}$		dB	Reference Value in Table 8.4.1.2.3_C.2.5-2	1.3
$BW_{Channel}$		MHz	10	10
Subframe Configuration			Non-MBSFN	MBSFN
Time Offset between Cells		$\mu$ s	2.5 (synchronous cells)	
Cell Id			0	126
ABS pattern (Note 4)			N/A	0001000000 0100000010 0000001000 0000000000
RLM/RRM Measurement Subframe Pattern (Note 5)			0001000000 0100000010 0000001000 0000000000	N/A
CSI Subframe Sets (Note 6)	$C_{CSI,0}$		0001000000 0100000010 0000001000 0000000000	N/A
	$C_{CSI,1}$		1110111111 1011111101 1111110111 1111111111	N/A
MBSFN Subframe Allocation (Note 9)			N/A	001000 100001 000100 000000
Number of control OFDM symbols			3	3
Number of PHICH groups ( $N_g$ )			1	N/A
PHICH duration			extended	N/A
Unused RE-s and PRB-s			OCNG	OCNG
Cyclic prefix			Normal	Normal

Note 1:	This noise is applied in OFDM symbols #1, #2, #3, #4, #5, #6, #7, #8, #9, #10, #11, #12, #13 of a subframe overlapping with the aggressor ABS.
Note 2:	This noise is applied in OFDM symbols #0 of a subframe overlapping with the aggressor ABS.
Note 3:	This noise is applied in all OFDM symbols of a subframe overlapping with aggressor non-ABS
Note 4:	ABS pattern as defined in [14]. The 4 <sup>th</sup> , 12 <sup>th</sup> , 19 <sup>th</sup> and 27 <sup>th</sup> subframes indicated by ABS pattern are MBSFN ABS subframes. PDSCH other than SIB1/paging and its associated PDCCH/PCFICH are transmitted in the serving cell subframe when the subframe is overlapped with the MBSFN ABS subframe of aggressor cell and the subframe is available in the definition of the reference channel.
Note 5:	Time-domain measurement resource restriction pattern for PCell measurements as defined in [5].
Note 6:	As configured according to the time-domain measurement resource restriction pattern for CSI measurements defined in [5].
Note 7:	Cell 1 is the serving cell. Cell 2 is the aggressor cell. The number of the CRS ports in Cell1 and Cell2 is the same.
Note 8:	SIB-1 will not be transmitted in Cell2 in this test.
Note 9:	MBSFN Subframe Allocation as defined in [5], four frames with 24 bits is chosen for MBSFN subframe allocation.
Note 10:	The maximum number of uplink HARQ transmission is $\leq 2$ so that each PHICH channel transmission is in a subframe protected by MBSFN ABS in this test.

**Table 8.4.1.2.3\_C.2.5-2: Test Requirement PDCCH/PCFICH – MBSFN ABS**

Test Number	Aggregation Level	Reference Channel	OCNG Pattern		Propagation Conditions (Note 1)		Correlation Matrix and Antenna Configuration	Reference Value	
			Cell 1	Cell 2	Cell 1	Cell 2		Pm-dsg (%)	SNR (dB) (Note 2)
1	8 CCE	R15-1 FDD	OP.1 FDD	OP.1 FDD	EVA5	EVA5	2x2 Low	1	-3.3
Note 1: The propagation conditions for Cell 1 and Cell2 are statistically independent.									
Note 2: SNR corresponds to $\hat{E}_s / N_{oc2}$ of cell 1									
Note 3: The correlation matrix and antenna configuration apply for Cell 1 and Cell 2.									

8.4.1.2.3\_D

8.4.1.2.3\_E FDD PCFICH/PDCCH Transmit Diversity 2x2 for felCIC

8.4.1.2.3\_E.1 FDD PCFICH/PDCCH Transmit Diversity 2x2 for felCIC (non-MBSFN ABS)

8.4.1.2.3\_E.1.1 Test purpose

To verify the UE's performance of transmit diversity (SFBC) with 2 transmit antennas if the PCFICH/PDCCH transmission in the serving cell takes place in subframes that overlap with ABS of the aggressor cell.

8.4.1.2.3\_E.1.2 Test applicability

This test applies to all types of E-UTRA FDD UE and CRS interference handling – UE Category 2-8 release 11 and forward. Applicability requires support of FGI bit 115.

8.4.1.2.3\_E.1.3 Minimum conformance requirements

The receiver characteristics of the PDCCH/PCFICH are determined by the probability of miss-detection of the Downlink Scheduling Grant (Pm-dsg). PDCCH and PCFICH are tested jointly, i.e. a miss detection of PCFICH implies a miss detection of PDCCH.

For the parameters for non-MBSFN ABS specified in Table 8.4.1.2.3\_E.1.3-1, the average probability of a missed downlink scheduling grant (Pm-dsg) shall be below the specified value in Table 8.4.1.2.3\_E.1.3-2.

In Tables 8.4.1.2.3\_E.1.3-1 and 8.4.1.2.3\_E.1.3-2, Cell 1 is the serving cell, and Cell 2 and Cell 3 are the aggressor cells. The downlink physical channel setup for Cell 1 is according to Annex C.3.2 and for Cell 2 and Cell 3 is according to Annex C.3.3, respectively. The CRS assistance information TS 36.331 [5] including Cell 2 and Cell 3 is provided.

**Table 8.4.1.2.3\_E.1.3-1: Test Parameters for PDCCH/PCFICH – Non-MBSFN ABS**

Parameter		Unit	Cell 1	Cell 2	Cell 3
Downlink power allocation	PDCCH_RA PHICH_RA OCNG_RA	dB	-3	-3	-3
	PCFICH_RB PDCCH_RB PHICH_RB OCNG_RB	dB	-3	-3	-3
$N_{oc}$ at antenna port	$N_{oc1}$	dBm/15kHz	-98 (Note 1)	N/A	N/A
	$N_{oc2}$	dBm/15kHz	-98 (Note 2)	N/A	N/A
	$N_{oc3}$	dBm/15kHz	-93 (Note 3)	N/A	N/A
$\hat{E}_s / N_{oc2}$		dB	Reference Value in Table 8.4.1.2.3_E.1.3-2	5	3
BW <sub>Channel</sub>		MHz	10	10	10
Subframe Configuration			Non-MBSFN	Non-MBSFN	Non-MBSFN
Time Offset between Cells		μs	N/A	3	-1
Frequency shift between Cells		Hz	N/A	300	-100
Cell Id			0	126	1
ABS pattern (Note 4)			N/A	00000100 00000100 00000100 00000100 00000100	00000100 00000100 00000100 00000100 00000100
RLM/RRM Measurement Subframe Pattern (Note 5)			00000100 00000100 00000100 00000100 00000100	N/A	N/A
CSI Subframe Sets (Note 6)	C <sub>CSI,0</sub>		00000100 00000100 00000100 00000100 00000100	N/A	N/A
	C <sub>CSI,1</sub>		11111011 11111011 11111011 11111011 11111011	N/A	N/A

Number of control OFDM symbols		2	Note 7	Note 7
Number of PHICH groups ( $N_g$ )		1	N/A	N/A
PHICH duration		Normal	N/A	N/A
Unused RE-s and PRB-s		OCNG	OCNG	OCNG
Cyclic prefix		Normal	Normal	Normal
Note 1:	This noise is applied in OFDM symbols #1, #2, #3, #5, #6, #8, #9, #10, #12, #13 of a subframe overlapping with the aggressor ABS.			
Note 2:	This noise is applied in OFDM symbols #0, #4, #7, #11 of a subframe overlapping with the aggressor ABS.			
Note 3:	This noise is applied in all OFDM symbols of a subframe overlapping with aggressor non-ABS			
Note 4:	ABS pattern as defined in [14]. PDCCH/PCFICH other than that associated with SIB1/Paging are transmitted in the serving cell subframe when the subframe is overlapped with the ABS subframe of aggressor cell.			
Note 5:	Time-domain measurement resource restriction pattern for PCell measurements as defined in [5].			
Note 6:	As configured according to the time-domain measurement resource restriction pattern for CSI measurements defined in [5].			
Note 7:	The number of control OFDM symbols is not available for ABS and is 2 for the subframe indicated by "0" of ABS pattern.			
Note 8:	The number of the CRS ports in Cell 1, Cell 2 and Cell 3 is the same.			
Note 9:	SIB-1 will not be transmitted in Cell 2 and Cell 3 in the test.			

**Table 8.4.1.2.3\_E.1.3-2: Minimum performance PDCCH/PCFICH – Non-MBSFN ABS**

Test Number	Aggregation Level	Reference Channel	OCNG Pattern			Propagation Conditions (Note 1)			Correlation Matrix and Antenna Configuration (Note 2)	Reference Value	
			Cell 1	Cell 2	Cell 3	Cell 1	Cell 2	Cell 3		Pm-dsg (%)	SNR (dB) (Note 3)
1	8 CCE	R.15-2 FDD	OP.1 FDD	OP.1 FDD	OP.1 FDD	EVA5	EVA5	EVA5	2x2 Low	1	-2.2
Note 1:	The propagation conditions for Cell 1, Cell 2 and Cell 3 are statistically independent.										
Note 2:	The correlation matrix and antenna configuration apply for Cell 1, Cell 2 and Cell 3.										
Note 3:	SNR corresponds to $\bar{E}_s/N_{oc2}$ of Cell 1.										

The normative reference for this requirement is TS 36.101 [2] clause 8.4.1.2.4.

#### 8.4.1.2.3\_E.1.4 Test description

##### 8.4.1.2.3\_E.1.4.1 Initial conditions

Initial conditions are a set of test configurations the UE needs to be tested in and the steps for the SS to take with the UE to reach the correct measurement state.

Configurations of PDSCH and PDCCH before measurement are specified in Annex C.2.

Test Environment: Normal, as defined in TS 36.508 [7] clause 4.1.

Frequencies to be tested: Mid Range, as defined in TS 36.508 [7] clause 4.3.1.1.

Channel Bandwidths to be tested: 10MHz, as defined in TS 36.508 [7] clause 4.3.1.1.

1. Connect the SS, the faders and AWGN noise sources to the UE antenna connector (s) as shown in TS 36.508 [7] Annex A, Figure A.48 for antenna configuration 2x2.
2. The parameter settings for the cell1 are set up according to Tables 8.4.1.2.3\_E.1.3-1 and 8.4.1.2.3\_E.1.3-2.
3. The downlink signals are initially set up according to Annex C.0, C.1 and C.3.2 and uplink signals according to Annex H.1 and H.3.2.
4. Propagation conditions are set according to Annex B clauses B.0.
5. Ensure the UE is in State 3A-RF according to TS 36.508 [7] clause 5.2A.2 with exceptions listed in 5.2A.5. Message contents are defined in clause 8.4.1.2.3\_E.1.4.3.

8.4.1.2.3\_E.1.4.2 Test procedure

1. Set the parameters for Cell 1, Cell 2 and Cell 3, according to Tables 8.4.1.2.3\_E.1.5-1, 8.4.1.2.3\_E.1.5-2, Annex C.3.2 for Cell 1, and Annex C.3.3 for Cell 2 and Cell 3. SS transmits PDSCH via PDCCH DCI format 1 for C\_RNTI to transmit the DL RMC. The details of PDCCH and PDSCH are specified in Table A.3.5.1-1 and Table A.3.5.1-2 respectively.
2. The SS sends downlink MAC padding bits on the DL RMC. Transmission scheme for the PDSCH shall be transmit diversity. Propagation conditions are set according to Annex B clause B.2.
3. Measure the Pm-dsg in the subframes overlapping with ABS of the aggressor cell for a duration sufficient to achieve statistical significance according to Annex G clause G.4. Count the number of NACKs, ACKs and statDTXs on the UL PUCCH during each subtest interval. Pm-dsg is the ratio (statDTX)/(NACK+ACK+statDTX).

If Pm-dsg is less than the value specified in table 8.4.1.2.3\_E.1.5-2, pass the UE. Otherwise fail the UE.

8.4.1.2.3\_E.1.4.3 Message contents

Message contents are according to TS 36.508 [7] clause 5.2A.5.1 with the following exceptions:

**Table 8.4.1.2.3\_E.1.4.3-1: RadioResourceConfigDedicated-SRB2-DRB(n, m)**

Derivation Path: TS 36.508 [7] clause 4.6.3, Table 4.6.3-16 RadioResourceConfigDedicated-SRB2-DRB(n,m)			
Information Element	Value/remark	Comment	Condition
RadioResourceConfigDedicated-SRB2-DRB(n, m) ::= SEQUENCE {			
MeasSubframePatternPCell-r10 CHOICE {			
setup SEQUENCE {			
subframePatternFDD-r10	'00000100 00000100 00000100 00000100 00000100'	BIT STRING (SIZE (40))	
}			
}			
neighCellsCRS-Info-r11 ::= CHOICE {			
setup SEQUENCE {			
CRS-AssistancedInfoList-r11 ::= SEQUENCE (SIZE (1..maxCellReport)) OF CRS-AssistancedInfo-r11{		2 entries	
CRS-AssistancedInfo-r11 ::= SEQUENCE {			
physCellId-r11	126		Cell 2
	1		Cell 3
antennaPortsCount-r11	an2		Cell 2, Cell 3
mbsfn-SubframeConfigList-r11 ::= SEQUENCE (SIZE (1..maxMBSFN-Allocations)) OF MBSFN-SubframeConfig{			Cell 2, Cell 3
MBSFN-SubframeConfig ::= SEQUENCE {			
radioframeAllocationPeriod	n1		
radioframeAllocationOffset	0		
subframeAllocation CHOICE{			
oneFrame	'000000' B	non-MBSFN	
}			
}			
}			
}			
}			
}			

**Table 8.4.1.2.3\_E.1.4.3-2: PhysicalConfigDedicated-DEFAULT:**

Derivation Path: 36.508 clause 5.5.1.2			
Information Element	Value/remark	Comment	Condition
PhysicalConfigDedicated-DEFAULT ::= SEQUENCE {			
cqi-ReportConfig-r10	CQI-ReportConfig-r10-DEFAULT		
}			

**Table 8.4.1.2.3\_E.1.4.3-3: CQI-ReportConfig-r10-DEFAULT**

Derivation Path: 36.508 [7] clause 4.6.3, Table 4.6.3-2AA CQI-ReportConfig-r10-DEFAULT_			
Information Element	Value/remark	Comment	Condition
CQI-ReportConfig-r10-DEFAULT ::= SEQUENCE {			
csi-SubframePatternConfig-r10 CHOICE {			
setup SEQUENCE {			
csi-MeasSubframeSet1-r10 CHOICE {			
subframePatternFDD-r10	'00000100 00000100 00000100 00000100 00000100'	BIT STRING (SIZE (40))	
}			
csi-MeasSubframeSet2-r10 CHOICE {			
subframePatternFDD-r10	'11111011 11111011 11111011 11111011 11111011'	BIT STRING (SIZE (40))	
}			
}			
}			
}			

## 8.4.1.2.3\_E.1.5 Test requirement

For the parameters specified in Table 8.4.1.2.3\_E.1.3-1, the average probability of a missed downlink scheduling grant (Pm-dsg) shall be below the specified value in Table 8.4.1.2.3\_E.1.5-2.

**Table 8.4.1.2.3\_E.1.5-1: Test Parameters for PDCCH/PCFICH – Non-MBSFN ABS**

Parameter		Unit	Cell 1	Cell 2	Cell 3
Downlink power allocation	PDCCH_RA PHICH_RA OCNG_RA	dB	-3	-3	-3
	PCFICH_RB PDCCH_RB PHICH_RB OCNG_RB	dB	-3	-3	-3
$N_{oc}$ at antenna port	$N_{oc1}$	dBm/15kHz	-98 (Note 1)	N/A	N/A
	$N_{oc2}$	dBm/15kHz	-98 (Note 2)	N/A	N/A
	$N_{oc3}$	dBm/15kHz	-93.1 (Note 3)	N/A	N/A

$\hat{E}_s / N_{oc2}$		dB	Reference Value in Table 8.4.1.2.3_E.1.5-2	4.8	2.8
BW <sub>Channel</sub>		MHz	10	10	10
Subframe Configuration			Non-MBSFN	Non-MBSFN	Non-MBSFN
Time Offset between Cells		μs	N/A	3	-1
Frequency shift between Cells		Hz	N/A	300	-100
Cell Id			0	126	1
ABS pattern (Note 4)			N/A	00000100 00000100 00000100 00000100 00000100	00000100 00000100 00000100 00000100 00000100
RLM/RRM Measurement Subframe Pattern (Note 5)			00000100 00000100 00000100 00000100 00000100	N/A	N/A
CSI Subframe Sets (Note 6)	C <sub>CSI,0</sub>		00000100 00000100 00000100 00000100 00000100	N/A	N/A
	C <sub>CSI,1</sub>		11111011 11111011 11111011 11111011 11111011	N/A	N/A
Number of control OFDM symbols			2	Note 7	Note 7
Number of PHICH groups (N <sub>g</sub> )			1	N/A	N/A
PHICH duration			Normal	N/A	N/A
Unused RE-s and PRB-s			OCNG	OCNG	OCNG
Cyclic prefix			Normal	Normal	Normal
<p>Note 1: This noise is applied in OFDM symbols #1, #2, #3, #5, #6, #8, #9, #10, #12, #13 of a subframe overlapping with the aggressor ABS.</p> <p>Note 2: This noise is applied in OFDM symbols #0, #4, #7, #11 of a subframe overlapping with the aggressor ABS.</p> <p>Note 3: This noise is applied in all OFDM symbols of a subframe overlapping with aggressor non-ABS</p> <p>Note 4: ABS pattern as defined in [14]. PDCCH/PCFICH other than that associated with SIB1/Paging are transmitted in the serving cell subframe when the subframe is overlapped with the ABS subframe of aggressor cell.</p> <p>Note 5: Time-domain measurement resource restriction pattern for PCell measurements as defined in [5].</p> <p>Note 6: As configured according to the time-domain measurement resource restriction pattern for CSI measurements defined in [5].</p> <p>Note 7: The number of control OFDM symbols is not available for ABS and is 2 for the subframe indicated by "0" of ABS pattern.</p> <p>Note 8: The number of the CRS ports in Cell 1, Cell 2 and Cell 3 is the same.</p> <p>Note 9: SIB-1 will not be transmitted in Cell 2 and Cell 3 in the test.</p>					

**Table 8.4.1.2.3\_E.1.5-2: Test Requirement PDCCH/PCFICH – Non-MBSFN ABS**

Test Number	Aggregation Level	Reference Channel	OCNG Pattern			Propagation Conditions (Note 1)			Correlation Matrix and Antenna Configuration (Note 2)	Reference Value	
			Cell 1	Cell 2	Cell 3	Cell 1	Cell 2	Cell 3		Pm-dsg (%)	SNR (dB) (Note 3)



1	8 CCE	R.15-2 FDD	OP.1 FDD	OP.1 FDD	OP.1 FDD	EVA5	EVA5	EVA5	2x2 Low	1	-1.3
<p>Note 1: The propagation conditions for Cell 1, Cell 2 and Cell 3 are statistically independent.</p> <p>Note 2: The correlation matrix and antenna configuration apply for Cell 1, Cell 2 and Cell 3.</p> <p>Note 3: SNR corresponds to <math>\hat{E}_s/N_{oc2}</math> of Cell 1.</p>											

#### 8.4.1.2.3\_E.2 FDD PCFICH/PDCCH Transmit Diversity 2x2 for feICIC (MBSFN ABS)

##### 8.4.1.2.3\_E.2.1 Test purpose

To verify the UE's performance of transmit diversity (SFBC) with 2 transmit antennas if the PCFICH/PDCCH transmission in the serving cell takes place in subframes that overlap with ABS of the aggressor cell.

##### 8.4.1.2.3\_E.2.2 Test applicability

This test applies to all types of E-UTRA FDD UE and CRS interference handling – UE Category 2-8 release 11 and forward. Applicability requires support of FGI bit 115.

##### 8.4.1.2.3\_E.2.3 Minimum conformance requirements

The receiver characteristics of the PDCCH/PCFICH are determined by the probability of miss-detection of the Downlink Scheduling Grant (Pm-dsg). PDCCH and PCFICH are tested jointly, i.e. a miss detection of PCFICH implies a miss detection of PDCCH.

For the parameters for non-MBSFN ABS specified in Table 8.4.2.2.3\_E.2.3-1, the average probability of a missed downlink scheduling grant (Pm-dsg) shall be below the specified value in Table 8.4.1.2.3\_E.2.3-2.

In Tables 8.4.1.2.3\_E.2.3-1 and 8.4.1.2.3\_E.2.3-2, Cell 1 is the serving cell, and Cell 2 and Cell 3 are the aggressor cells. The downlink physical channel setup for Cell 1 is according to Annex C.3.2 and for Cell 2 and Cell 3 is according to Annex C.3.3, respectively. The CRS assistance information TS 36.331 [5] including Cell 2 and Cell 3 is provided.

**Table 8.4.1.2.3\_E.2.3-1: Test Parameters for PDCCH/PCFICH – MBSFN ABS**

Parameter		Unit	Cell 1	Cell 2	Cell 3
Downlink power allocation	PDCCH_RA PHICH_RA OCNG_RA	dB	-3	-3	-3
	PCFICH_RB PDCCH_RB PHICH_RB OCNG_RB	dB	-3	-3	-3
$N_{oc}$ at antenna port	$N_{oc1}$	dBm/15kHz	-98(Note 1)	N/A	N/A
	$N_{oc2}$	dBm/15kHz	-98 (Note 2)	N/A	N/A
	$N_{oc3}$	dBm/15kHz	-93 (Note 3)	N/A	N/A
$\hat{E}_s/N_{oc2}$		dB	Reference Value in Table 8.4.1.2.3_E.1.3-2	5	3
$BW_{Channel}$		MHz	10	10	10
Subframe Configuration			Non-MBSFN	MBSFN	MBSFN
Time Offset between Cells		$\mu$ s	N/A	3	-1
Frequency shift between Cells		Hz	N/A	300	-100
Cell Id			0	126	1
ABS pattern (Note 4)			N/A	0001000000 0100000010 0000001000 0000000000	0001000000 0100000010 0000001000 0000000000
RLM/RRM Measurement Subframe Pattern (Note 5)			0001000000 0100000010 0000001000 0000000000	N/A	N/A
CSI Subframe Sets (Note 6)	$C_{csi,0}$		0001000000 0100000010 0000001000 0000000000	N/A	N/A
	$C_{csi,1}$		1110111111 1011111101 1111110111 1111111111	N/A	N/A
MBSFN Subframe Allocation (Note 7)			N/A	001000 100001 000100 000000	001000 100001 000100 000000
Number of control OFDM symbols			2	Note 8	Note 8
Number of PHICH groups ( $N_g$ )			1	N/A	N/A
PHICH duration			Normal	N/A	N/A
Unused RE-s and PRB-s			OCNG	OCNG	OCNG
Cyclic prefix			Normal	Normal	Normal

Note 1:	This noise is applied in OFDM symbols #1, #2, #3, #4, #5, #6, #7, #8, #9, #10, #11, #12, #13 of a subframe overlapping with the aggressor ABS.
Note 2:	This noise is applied in OFDM symbols #0 of a subframe overlapping with the aggressor ABS.
Note 3:	This noise is applied in all OFDM symbols of a subframe overlapping with aggressor non-ABS
Note 4:	ABS pattern as defined in [14]. The 4 <sup>th</sup> , 12 <sup>th</sup> , 19 <sup>th</sup> and 27 <sup>th</sup> subframes indicated by ABS pattern are MBSFN ABS subframes. PDSCH other than SIB1/paging and its associated PDCCH/PCFICH are transmitted in the serving cell subframe when the subframe is overlapped with the MBSFN ABS subframe of aggressor cell and the subframe is available in the definition of the reference channel.
Note 5:	Time-domain measurement resource restriction pattern for PCell measurements as defined in [5].
Note 6:	As configured according to the time-domain measurement resource restriction pattern for CSI measurements defined in [5].
Note 7:	MBSFN Subframe Allocation as defined in [5], four frames with 24 bits are chosen for MBSFN subframe allocation.
Note 8:	The number of control OFDM symbols is not available for ABS and is 2 for the subframe indicated by "0" of ABS pattern.
Note 9:	The maximum number of uplink HARQ transmission is $\leq 2$ so that each PHICH channel transmission is in a subframe protected by MBSFN ABS in this test.
Note 10:	The number of the CRS ports in Cell 1, Cell 2 and Cell 3 is the same.
Note 11:	SIB-1 will not be transmitted in Cell 2 and Cell 3 in this test.

**Table 8.4.1.2.3\_E.2.3-2: Minimum performance PDCCH/PCFICH – MBSFN ABS**

Test Number	Aggregation Level	Reference Channel	OCNG Pattern			Propagation Conditions (Note 1)			Correlation Matrix and Antenna Configuration (Note 2)	Reference Value	
			Cell 1	Cell 2	Cell 3	Cell 1	Cell 2	Cell 3		Pm-dsg (%)	SNR (dB) (Note 3)
1	8 CCE	R.15-2 FDD	OP.1 FDD	OP.1 FDD	OP.1 FDD	EVA5	EVA5	EVA5	2x2 Low	1	-2.0
Note 1: The propagation conditions for Cell 1, Cell 2 and Cell 3 are statistically independent. Note 2: The correlation matrix and antenna configuration apply for Cell 1, Cell 2 and Cell 3. Note 3: SNR corresponds to $\hat{E}_s / N_{oc2}$ of Cell 1.											

The normative reference for this requirement is TS 36.101 [2] clause 8.4.1.2.4.

#### 8.4.1.2.3\_E.2.4 Test description

##### 8.4.1.2.3\_E.2.4.1 Initial conditions

Initial conditions are a set of test configurations the UE needs to be tested in and the steps for the SS to take with the UE to reach the correct measurement state.

Configurations of PDSCH and PDCCH before measurement are specified in Annex C.2.

Test Environment: Normal, as defined in TS 36.508 [7] clause 4.1.

Frequencies to be tested: Mid Range, as defined in TS 36.508 [7] clause 4.3.1.1.

Channel Bandwidths to be tested: 10MHz, as defined in TS 36.508 [7] clause 4.3.1.1

1. Connect the SS, the faders and AWGN noise sources to the UE antenna connector (s) as shown in TS 36.508 [7] Annex A, Figure A.48 for antenna configuration 2x2.
2. The parameter settings for the cell1 are set up according to Tables 8.4.1.2.3\_E.2.3-1 and 8.4.1.2.3\_E.2.3-2.
3. The downlink signals are initially set up according to Annex C.0, C.1 and C.3.2 and uplink signals according to Annex H.1 and H.3.2.
4. Propagation conditions are set according to Annex B clauses B.0.

- 5. Ensure the UE is in State 3A-RF according to TS 36.508 [7] clause 5.2A.2 with exceptions listed in 5.2A.5. Message contents are defined in clause 8.4.1.2.3\_E.2.4.3.

8.4.1.2.3\_E.2.4.2 Test procedure

1. Set the parameters for Cell 1, Cell 2 and Cell3, according to Tables 8.4.1.2.3\_E.2.5-1, 8.4.1.2.3\_E.2.5-2, Annex C.3.2 for Cell 1, and Annex C.3.3 for Cell 2 and Cell 3. SS transmits PDSCH via PDCCH DCI format 1 for C\_RNTI to transmit the DL RMC. The details of PDCCH and PDSCH are specified in Table A.3.5.1-1 and Table A.3.5.1-2 respectively. The SS sends downlink MAC padding bits on the DL RMC. Transmission scheme for the PDSCH shall be transmit diversity. Propagation conditions are set according to Annex B clause B.2.
2. Measure the Pm-dsg in the subframes overlapping with ABS of the aggressor cell for a duration sufficient to achieve statistical significance according to Annex G clause G.4. Count the number of NACKs, ACKs and statDTXs on the UL PUCCH during each subtest interval. Pm-dsg is the ratio (statDTX)/(NACK+ACK+statDTX).

If Pm-dsg is less than the value specified in table 8.4.1.2.3\_E.2.5-2, pass the UE. Otherwise fail the UE.

8.4.1.2.3\_E.2.4.3 Message contents

Message contents are according to TS 36.508 [7] clause 5.2A.5.1 with the following exceptions:

**Table 8.4.1.2.3\_E.2.4.3-1: RadioResourceConfigDedicated-SRB2-DRB(n, m)**

Derivation Path: TS 36.508 [7] clause 4.6.3, Table 4.6.3-16 RadioResourceConfigDedicated-SRB2-DRB(n,m)			
Information Element	Value/remark	Comment	Condition
RadioResourceConfigDedicated-SRB2-DRB(n, m) ::= SEQUENCE {			
MeasSubframePatternPCell-r10 CHOICE {			
setup SEQUENCE {			
subframePatternFDD-r10	'0001000000100000010 0000001000000000000'	BIT STRING (SIZE (40))	
}			
}			
neighCellsCRS-Info-r11 ::= CHOICE {			
setup SEQUENCE {			
CRS-AssistancedInfoList-r11 ::= SEQUENCE (SIZE (1..maxCellReport)) OF CRS-AssistancedInfo- r11{		2 entries	
CRS-AssistancedInfo-r11 ::= SEQUENCE {			
physCellId-r11	126		Cell 2
	1		Cell 3
antennaPortsCount-r11	an2		Cell 2, Cell 3
mbsfn-SubframeConfigList-r11 ::= SEQUENCE (SIZE (1..maxMBSFN-Allocations)) OF MBSFN- SubframeConfig{			Cell 2, Cell 3
MBSFN-SubframeConfig ::= SEQUENCE {			
radioframeAllocationPeriod	n4		
radioframeAllocationOffset	0		
subframeAllocation CHOICE{			
fourFrames	'00100010000100010000 0000' B		
}			
}			
}			
}			
}			
}			
}			
}			
}			
}			
}			
}			

**Table 8.4.1.2.3\_E.2.4.3-2: PhysicalConfigDedicated-DEFAULT:**

Derivation Path: 36.508 clause 5.5.1.2			
Information Element	Value/remark	Comment	Condition
PhysicalConfigDedicated-DEFAULT ::= SEQUENCE {			
cqi-ReportConfig-r10	CQI-ReportConfig-r10-DEFAULT		
}			

**Table 8.4.1.2.3\_E.2.4.3-3: CQI-ReportConfig-r10-DEFAULT**

Derivation Path: 36.508 [7] clause 4.6.3, Table 4.6.3-2AA CQI-ReportConfig-r10-DEFAULT_			
Information Element	Value/remark	Comment	Condition
CQI-ReportConfig-r10-DEFAULT ::= SEQUENCE {			
csi-SubframePatternConfig-r10 CHOICE {			
setup SEQUENCE {			
csi-MeasSubframeSet1-r10 CHOICE {			
subframePatternFDD-r10	'00010000000100000010 00000010000000000000'	BIT STRING (SIZE (40))	
}			
csi-MeasSubframeSet2-r10 CHOICE {			
subframePatternFDD-r10	'11101111111011111101 11111101111111111111'	BIT STRING (SIZE (40))	
}			
}			
}			
}			

**Table 8.4.1.2.3\_E.2.4.3-4: SystemInformationBlockType3**

Derivation Path: 36.508 [7] clause 4.6.2, Table 4.4.3.3-2 SystemInformationBlockType3			
Information Element	Value/remark	Comment	Condition
neighCellConfig	'00'B (Not all neighbour cells have the same MBSFN subframe allocation as the serving cell)		Cell 1

#### 8.4.1.2.3\_E.2.5 Test requirement

For the parameters specified in Table 8.4.1.2.3\_E.2.5-1, the average probability of a missed downlink scheduling grant (Pm-dsg) shall be below the specified value in Table 8.4.1.2.3\_E.2.5-2.

**Table 8.4.1.2.3\_E.2.5-1: Test Parameters for PDCCH/PCFICH – MBSFN ABS**

Parameter		Unit	Cell 1	Cell 2	Cell 3
Downlink power allocation	PDCCH_RA PHICH_RA OCNG_RA	dB	-3	-3	-3
	PCFICH_RB PDCCH_RB PHICH_RB OCNG_RB	dB	-3	-3	-3
$N_{oc}$ at antenna port	$N_{oc1}$	dBm/15kHz	-98(Note 1)	N/A	N/A
	$N_{oc2}$	dBm/15kHz	-98 (Note 2)	N/A	N/A
	$N_{oc3}$	dBm/15kHz	-93.1 (Note 3)	N/A	N/A
$\hat{E}_s / N_{oc2}$		dB	Reference Value in Table 8.4.1.2.3_E.1.5-2	4.8	2.8
$BW_{Channel}$		MHz	10	10	10
Subframe Configuration			Non-MBSFN	MBSFN	MBSFN
Time Offset between Cells		$\mu$ s	N/A	3	-1
Frequency shift between Cells		Hz	N/A	300	-100
Cell Id			0	126	1
ABS pattern (Note 4)			N/A	0001000000 0100000010 0000001000 0000000000	0001000000 0100000010 0000001000 0000000000
RLM/RRM Measurement Subframe Pattern (Note 5)			0001000000 0100000010 0000001000 0000000000	N/A	N/A
CSI Subframe Sets (Note 6)	$C_{csi,0}$		0001000000 0100000010 0000001000 0000000000	N/A	N/A
	$C_{csi,1}$		1110111111 1011111101 1111110111 1111111111	N/A	N/A
MBSFN Subframe Allocation (Note 7)			N/A	001000 100001 000100 000000	001000 100001 000100 000000
Number of control OFDM symbols			2	Note 8	Note 8
Number of PHICH groups ( $N_g$ )			1	N/A	N/A
PHICH duration			Normal	N/A	N/A
Unused RE-s and PRB-s			OCNG	OCNG	OCNG
Cyclic prefix			Normal	Normal	Normal

Note 1:	This noise is applied in OFDM symbols #1, #2, #3, #4, #5, #6, #7, #8, #9, #10, #11, #12, #13 of a subframe overlapping with the aggressor ABS.
Note 2:	This noise is applied in OFDM symbols #0 of a subframe overlapping with the aggressor ABS.
Note 3:	This noise is applied in all OFDM symbols of a subframe overlapping with aggressor non-ABS ABS pattern as defined in [14]. The 4 <sup>th</sup> , 12 <sup>th</sup> , 19 <sup>th</sup> and 27 <sup>th</sup> subframes indicated by ABS pattern are MBSFN ABS subframes. PDSCH other than SIB1/paging and its associated PDCCH/PCFICH are transmitted in the serving cell subframe when the subframe is overlapped with the MBSFN ABS subframe of aggressor cell and the subframe is available in the definition of the reference channel.
Note 4:	
Note 5:	Time-domain measurement resource restriction pattern for PCell measurements as defined in [5].
Note 6:	As configured according to the time-domain measurement resource restriction pattern for CSI measurements defined in [5].
Note 7:	MBSFN Subframe Allocation as defined in [5], four frames with 24 bits are chosen for MBSFN subframe allocation.
Note 8:	The number of control OFDM symbols is not available for ABS and is 2 for the subframe indicated by "0" of ABS pattern.
Note 9:	The maximum number of uplink HARQ transmission is ≤ 2 so that each PHICH channel transmission is in a subframe protected by MBSFN ABS in this test.
Note 10:	The number of the CRS ports in Cell 1, Cell 2 and Cell 3 is the same.
Note 11:	SIB-1 will not be transmitted in Cell 2 and Cell 3 in this test.

**Table 8.4.1.2.3\_E.2.5-2: Test Requirement PDCCH/PCFICH – MBSFN ABS**

Test Number	Aggregation Level	Reference Channel	OCNG Pattern			Propagation Conditions (Note 1)			Correlation Matrix and Antenna Configuration (Note 2)	Reference Value	
			Cell 1	Cell 2	Cell 3	Cell 1	Cell 2	Cell 3		Pm-dsg (%)	SNR (dB) (Note 3)
1	8 CCE	R.15-2 FDD	OP.1 FDD	OP.1 FDD	OP.1 FDD	EVA5	EVA5	EVA5	2x2 Low	1	-1.1
Note 1: The propagation conditions for Cell 1, Cell 2 and Cell 3 are statistically independent. Note 2: The correlation matrix and antenna configuration apply for Cell 1, Cell 2 and Cell 3. Note 3: SNR corresponds to $\hat{E}_s / N_{oc2}$ of Cell 1.											

## 8.4.2 TDD

### 8.4.2.1 TDD PCFICH/PDCCH Single-antenna Port Performance

#### 8.4.2.1.1 Test purpose

This test verifies the demodulation performance of PCFICH/PDCCH for a single-antenna port with a given SNR for which the average probability of miss-detection of the Downlink Scheduling Grant, tested jointly on PDCCH and PCFICH of the specified reference measurement channels in A.3.5.2 remains below a given reference value.

#### 8.4.2.1.2 Test applicability

This test applies to all types of E-UTRA TDD UE release 8 and forward.

#### 8.4.2.1.3 Minimum conformance requirements

The receiver characteristics of the PDCCH/PCFICH are determined by the probability of miss-detection of the Downlink Scheduling Grant (Pm-dsg). PDCCH and PCFICH are tested jointly, i.e. a miss detection of PCFICH implies a miss detection of PDCCH.

**Table 8.4.2.1.3-1: Test Parameters for PDCCH/PCFICH**

Parameter		Unit	Single antenna port
Uplink downlink configuration (Note 1)			0
Special subframe configuration (Note 2)			4
Number of PDCCH symbols		symbols	2
Number of PHICH groups ( $N_g$ )			1
PHICH duration			Normal
Unused RE-s and PRB-s			OCNG
Cell ID			0
Downlink power allocation	PDCCH_RA PHICH_RA OCNG_RA	dB	0
	PCFICH_RB PDCCH_RB PHICH_RB OCNG_RB	dB	0
$N_{oc}$ at antenna port		dBm/15kHz	-98
Cyclic prefix			Normal
ACK/NACK feedback mode			Multiplexing
Note 1: as specified in Table 4.2-2 in TS 36.211 [8]			
Note 2: as specified in Table 4.2-1 in TS 36.211 [8]			
Note 3: PHICH power setting refer to PHICH group power, i.e. the total power of all active PHICH sequences within a PHICH group.			

For the parameters specified in Table 8.4.2.1.3-1 the average probability of a missed downlink scheduling grant ( $P_{m-dsg}$ ) shall be below the specified value in Table 8.4.2.1.3-2.

**Table 8.4.2.1.3-2: Minimum performance PDCCH/PCFICH**

Test number	Bandwidth	Aggregation level	Reference Channel	OCNG Pattern	Propagation Condition	Antenna configuration and correlation Matrix	Reference value	
							$P_{m-dsg}$ (%)	SNR (dB)
1	10 MHz	8 CCE	R.15 TDD	OP.1 TDD	ETU70	1x2Low	1	-1.6

The normative reference for this requirement is TS 36.101 [2] clause 8.4.2.

#### 8.4.2.1.4 Test description

##### 8.4.2.1.4.1 Initial conditions

Initial conditions are a set of test configurations the UE needs to be tested in and the steps for the SS to take with the UE to reach the correct measurement state.

Configurations of PDSCH and PDCCH before measurement are specified in Annex C.2.

Test Environment: Normal, as defined in TS 36.508 [7] clause 4.1.

Frequencies to be tested: Mid Range, as defined in TS 36.508 [7] clause 4.3.1.2.

Channel Bandwidths to be tested: 10MHz, as defined in TS 36.508 [7] clause 4.3.1.2.

1. Connect the SS, the faders and AWGN noise source to the UE antenna connector (s) as shown in TS 36.508 [7] Annex A, Figure A.9.
2. The parameter settings for the cell are set up according to 8.4.2.1.3-1.



3. Downlink signals are initially set up according to Annex C0, C.1 and Annex C.3.2 and uplink signals according to Annex H.1 and H.3.2.
4. Propagation conditions are set according to Annex B.0.
5. Ensure the UE is in State 3A-RF according to TS 36.508 [7] clause 5.2A.2. Message contents are defined in clause 8.4.2.1.4.3.

#### 8.4.2.1.4.2 Test procedure

1. SS transmits PDSCH via PDCCH DCI format 1 for C\_RNTI to transmit the DL RMC according to Table 8.4.2.1.3-2. The details of PDCCH and PDSCH are specified in Table A.3.5.2-1 and Table A.3.5.2-2 respectively. The SS sends downlink MAC padding bits on the DL RMC.
2. Set the parameters of the propagation condition, the correlation matrix, antenna configuration and the SNR according to Tables 8.4.2.1.5-1 as appropriate.
3. Measure the Pm-dsg for a duration sufficient to achieve statistical significance according to Annex G clause G.4. Count the number of NACKs, ACKs and statDTXs on the UL PUCCH during each subtest interval. Pm-dsg is the radio (statDTX)/(NACK +ACK+statDTX). If Pm-dsg is less than the value specified in table 8.4.2.1.5-1, pass the UE. Otherwise fail the UE.

#### 8.4.2.1.4.3 Message contents

Message contents are according to TS 36.508 [7] clause 4.6 with the following exception:.

**Table 8.4.2.1.4.3-1: TDD-Configuration-DEFAULT**

Derivation Path: 36.508 clause 4.6.4			
Information Element	Value/remark	Comment	Condition
TDD-Configuration-DEFAULT ::= SEQUENCE {			
subframeAssignment	sa0		
specialSubframePatterns	Ssp4		
}			

#### 8.4.2.1.5 Test requirement

For the parameters specified in Table 8.4.2.1.3-1 the average probability of a missed downlink scheduling grant (Pm-dsg) shall be below the specified value in Table 8.4.2.1.5-1.

**Table 8.4.2.1.5-1: Test requirement PDCCH/PCFICH**

Test number	Bandwidth	Aggregation level	Reference Channel	OCNG Pattern	Propagation Condition	Antenna configuration and correlation Matrix	Reference value	
							Pm-dsg (%)	SNR (dB)
1	10 MHz	8 CCE	R.15 TDD	OP.1 TDD	ETU70	1x2Low	1	-0.8

### 8.4.2.2 TDD PCFICH/PDCCH Transmit Diversity Performance

#### 8.4.2.2.1 TDD PCFICH/PDCCH Transmit Diversity 2x2

##### 8.4.2.2.1.1 Test purpose

This test verifies the demodulation performance of PCFICH/PDCCH for transmit diversity with a given SNR for which the average probability of miss-detection of the Downlink Scheduling Grant, tested jointly on PDCCH and PCFICH of the specified reference measurement channels in A.3.5.2 remains below a given reference value.

## 8.4.2.2.1.2 Test applicability

This test applies to all types of E-UTRA TDD UE release 8.

## 8.4.2.2.1.3 Minimum conformance requirements

The receiver characteristics of the PDCCH/PCFICH are determined by the probability of miss-detection of the Downlink Scheduling Grant (Pm-dsg). PDCCH and PCFICH are tested jointly, i.e. a miss detection of PCFICH implies a miss detection of PDCCH.

**Table 8.4.2.2.1.3-1: Test Parameters for PDCCH/PCFICH**

Parameter		Unit	Transmit diversity
Uplink downlink configuration (Note 1)			0
Special subframe configuration (Note 2)			4
Number of PDCCH symbols		symbols	2
Number of PHICH groups ( $N_g$ )			1
PHICH duration			Normal
Unused RE-s and PRB-s			OCNG
Cell ID			0
Downlink power allocation	PDCCH_RA PHICH_RA OCNG_RA	dB	-3
	PCFICH_RB PDCCH_RB PHICH_RB OCNG_RB	dB	-3
$N_{oc}$ at antenna port		dBm/15kHz	-98
Cyclic prefix			Normal
ACK/NACK feedback mode			Multiplexing
Note 1: as specified in Table 4.2-2 in TS 36.211 [8]			
Note 2: as specified in Table 4.2-1 in TS 36.211 [8]			
Note 3: PHICH power setting refer to PHICH group power, i.e. the total power of all active PHICH sequences within a PHICH group			

For the parameters specified in Table 8.4.2.2.1.3-1 the average probability of a missed downlink scheduling grant (Pm-dsg) shall be below the specified value in Table 8.4.2.2.1.3-2.

**Table 8.4.2.2.1.3-2: Minimum performance PDCCH/PCFICH 2 Tx Antenna Port**

Test number	Bandwidth	Aggregation level	Reference Channel	OCNG Pattern	Propagation Condition	Antenna configuration and correlation Matrix	Reference value	
							Pm-dsg (%)	SNR (dB)
1	1.4 MHz	2 CCE	R.16 TDD	OP.1 TDD	EPA5	2 x 2 Low	1	4.2

The normative reference for this requirement is TS 36.101 [2] clause 8.4.2.

## 8.4.2.2.1.4 Test description

## 8.4.2.2.1.4.1 Initial conditions

Initial conditions are a set of test configurations the UE needs to be tested in and the steps for the SS to take with the UE to reach the correct measurement state.

Configurations of PDSCH and PDCCH before measurement are specified in Annex C.2.

Test Environment: Normal, as defined in TS 36.508 [7] clause 4.1.

Frequencies to be tested: Mid Range, as defined in TS 36.508 [7] clause 4.3.1.1.

Channel Bandwidths to be tested: 1.4MHz, as defined in TS 36.508 [7] clause 4.3.1.1

1. Connect the SS, the faders and AWGN noise sources to the UE antenna connectors as shown in TS 36.508 [7] Annex A, Figure A.10.
2. The parameter settings for the cell are set up according to 8.4.2.2.1.3-1.
3. Downlink signals are initially set up according to Annex C0, C.1 and C.3.2 and uplink signals according to Annex H.1 and H.3.2.
4. Propagation conditions are set according to Annex B.0.
5. Ensure the UE is in State 3A-RF according to TS 36.508 [7] clause 5.2A.2. Message contents are defined in clause 8.4.2.2.1.4.3.

#### 8.4.2.2.1.4.2 Test procedure

1. SS transmits PDSCH via PDCCH DCI format 2 for C\_RNTI to transmit the DL RMC according to Table 8.4.2.2.1.3-2. The details of PDCCH and PDSCH are specified in Table A.3.5.2-1 and Table A.3.5.2-2 respectively. The SS sends downlink MAC padding bits on the DL RMC. Transmission scheme for the PDSCH shall be transmit diversity.
2. Set the parameters of the propagation condition, the correlation matrix, antenna configuration and the SNR according to Tables 8.4.2.2.1.5-1 as appropriate.
3. Measure the Pm-dsg for a duration sufficient to achieve statistical significance according to Annex G clause G.4. Count the number of NACKs, ACKs and statDTXs on the UL PUCCH during each subtest interval. Pm-dsg is the radio (statDTX)/(NACK + ACK + statDTX). If Pm-dsg is less than the value specified in table 8.4.2.2.1.5-1, pass the UE. Otherwise fail the UE

#### 8.4.2.2.1.4.3 Message contents

Message contents are according to TS 36.508 [7] clause 4.6 with the following exception:.

**Table 8.4.2.2.1.4.3-1: TDD-Configuration-DEFAULT**

Derivation Path: 36.508 clause 4.6.4			
Information Element	Value/remark	Comment	Condition
TDD-Configuration-DEFAULT ::= SEQUENCE {			
subframeAssignment	Sa0		
specialSubframePatterns	Ssp4		
}			

**Table 8.4.2.2.1.4.3-2: PhysicalConfigDedicated-DEFAULT**

Derivation Path: 36.331 clause 6.3.2			
Information Element	Value/remark	Comment	Condition
PhysicalConfigDedicated-DEFAULT ::= SEQUENCE {			
antennaInfo CHOICE {			
antennaInfoDedicated ::= SEQUENCE {			
transmissionMode	tm4		
codebookSubsetRestriction CHOICE {			
n2TxAntenna-tm4	111111		
}			
ue-TransmitAntennaSelection CHOICE {			
release	NULL		
}			
}			

## 8.4.2.2.1.5 Test requirement

For the parameters specified in Table 8.4.2.2.1.3-1 the average probability of a missed downlink scheduling grant (Pm-dsg) shall be below the specified value in Table 8.4.2.2.1.5-1.

**Table 8.4.2.2.1.5-1: Test requirement PDCCH/PCFICH 2 Tx Antenna Port**

Test number	Bandwidth	Aggregation level	Reference Channel	OCNG Pattern	Propagation Condition	Antenna configuration and correlation Matrix	Reference value	
							Pm-dsg (%)	SNR (dB)
1	1.4 MHz	2 CCE	[R.16 TDD]	OP.1 TDD	EPA5	2 x 2 Low	1	5.2

## 8.4.2.2.1\_1 TDD PCFICH/PDCCH Transmit Diversity 2x2 (Release 9 and forward)

## 8.4.2.2.1\_1.1 Test purpose

This test verifies the demodulation performance of PCFICH/PDCCH for transmit diversity with a given SNR for which the average probability of miss-detection of the Downlink Scheduling Grant, tested jointly on PDCCH and PCFICH of the specified reference measurement channels in A.3.5.2 remains below a given reference value.

## 8.4.2.2.1\_1.2 Test applicability

This test applies to all types of E-UTRA TDD UE release 9 and forward.

## 8.4.2.2.1\_1.3 Minimum conformance requirements

The receiver characteristics of the PDCCH/PCFICH are determined by the probability of miss-detection of the Downlink Scheduling Grant (Pm-dsg). PDCCH and PCFICH are tested jointly, i.e. a miss detection of PCFICH implies a miss detection of PDCCH.

**Table 8.4.2.2.1\_1.3-1: Test Parameters for PDCCH/PCFICH**

Parameter		Unit	Transmit diversity
Uplink downlink configuration (Note 1)			0
Special subframe configuration (Note 2)			4
Number of PDCCH symbols		symbols	2
Number of PHICH groups ( $N_g$ )			1
PHICH duration			Normal
Unused RE-s and PRB-s			OCNG
Cell ID			0
Downlink power allocation	PDCCH_RA PHICH_RA OCNG_RA	dB	-3
	PCFICH_RB PDCCH_RB PHICH_RB OCNG_RB	dB	-3
$N_{oc}$ at antenna port		dBm/15kHz	-98
Cyclic prefix			Normal
ACK/NACK feedback mode			Multiplexing
Note 1: as specified in Table 4.2-2 in TS 36.211 [8]			
Note 2: as specified in Table 4.2-1 in TS 36.211 [8]			
Note 3: PHICH power setting refer to PHICH group power, i.e. the total power of all active PHICH sequences within a PHICH group			

For the parameters specified in Table 8.4.2.2.1\_1.3-1 the average probability of a missed downlink scheduling grant (Pm-dsg) shall be below the specified value in Table 8.4.2.2.1\_1.3-2.

**Table 8.4.2.2.1\_1.3-2: Minimum performance PDCCH/PCFICH 2 Tx Antenna Port**

Test number	Bandwidth	Aggregation level	Reference Channel	OCNG Pattern	Propagation Condition	Antenna configuration and correlation Matrix	Reference value	
							Pm-dsg (%)	SNR (dB)
1	10 MHz	4 CCE	R.16_1 TDD	OP.1 TDD	EVA70	2 x 2 Low	1	0.1

The normative reference for this requirement is TS 36.101 [2] clause 8.4.2.

#### 8.4.2.2.1\_1.4 Test description

##### 8.4.2.2.1\_1.4.1 Initial conditions

Initial conditions are a set of test configurations the UE needs to be tested in and the steps for the SS to take with the UE to reach the correct measurement state.

Configurations of PDSCH and PDCCH before measurement are specified in Annex C.2.

Test Environment: Normal, as defined in TS 36.508 [7] clause 4.1.

Frequencies to be tested: Mid Range, as defined in TS 36.508 [7] clause 4.3.1.1.

Channel Bandwidths to be tested: 10MHz, as defined in TS 36.508 [7] clause 4.3.1.1

1. Connect the SS, the faders and AWGN noise sources to the UE antenna connectors as shown in TS 36.508 [7] Annex A, Figure A.10.
2. The parameter settings for the cell are set up according to 8.4.2.2.1\_1.3-1.
3. Downlink signals are initially set up according to Annex C0, C.1 and C.3.2 and uplink signals according to Annex H.1 and H.3.2.
4. Propagation conditions are set according to Annex B.0.
5. Ensure the UE is in State 3A-RF according to TS 36.508 [7] clause 5.2A.2. Message contents are defined in clause 8.4.2.2.1\_1.4.3.

##### 8.4.2.2.1\_1.4.2 Test procedure

1. SS transmits PDSCH via PDCCH DCI format 2 for C\_RNTI to transmit the DL RMC according to Table 8.4.2.2.1\_1.3-2. The details of PDCCH and PDSCH are specified in Table A.3.5.2-1 and Table A.3.5.2-2 respectively. The SS sends downlink MAC padding bits on the DL RMC. Transmission scheme for the PDSCH shall be transmit diversity.
2. Set the parameters of the propagation condition, the correlation matrix, antenna configuration and the SNR according to Tables 8.4.2.2.1\_1.5-1 as appropriate.
3. Measure the Pm-dsg for a duration sufficient to achieve statistical significance according to Annex G clause G.4. Count the number of NACKs, ACKs and statDTXs on the UL PUCCH during each subtest interval. Pm-dsg is the ratio (statDTX)/(NACK + ACK + statDTX). If Pm-dsg is less than the value specified in table 8.4.2.2.1\_1.5-1, pass the UE. Otherwise fail the UE

##### 8.4.2.2.1\_1.4.3 Message contents

Message contents are according to TS 36.508 [7] clause 4.6 with the following exception:.

**Table 8.4.2.2.1\_1.4.3-1: TDD-Configuration-DEFAULT**

Derivation Path: 36.508 clause 4.6.4			
Information Element	Value/remark	Comment	Condition
TDD-Configuration-DEFAULT ::= SEQUENCE {			
subframeAssignment	Sa0		
specialSubframePatterns	Ssp4		
}			

**Table 8.4.2.2.1\_1.4.3-2: PhysicalConfigDedicated-DEFAULT**

Derivation Path: 36.331 clause 6.3.2			
Information Element	Value/remark	Comment	Condition
PhysicalConfigDedicated-DEFAULT ::= SEQUENCE {			
antennaInfo CHOICE {			
antennaInfoDedicated ::= SEQUENCE {			
transmissionMode	tm4		
codebookSubsetRestriction CHOICE {			
n2TxAntenna-tm4	111111		
}			
ue-TransmitAntennaSelection CHOICE {			
release	NULL		
}			
}			
}			

#### 8.4.2.2.1\_1.5 Test requirement

For the parameters specified in Table 8.4.2.2.1\_1.3-1 the average probability of a missed downlink scheduling grant (Pm-dsg) shall be below the specified value in Table 8.4.2.2.1\_1.5-1.

**Table 8.4.2.2.1\_1.5-1: Test requirement PDCCH/PCFICH 2 Tx Antenna Port**

Test number	Bandwidth	Aggregation level	Reference Channel	OCNG Pattern	Propagation Condition	Antenna configuration and correlation Matrix	Reference value	
							Pm-dsg (%)	SNR (dB)
1	10 MHz	4 CCE	R.16_1 TDD	OP.1 TDD	EVA70	2 x 2 Low	1	+1.0

#### 8.4.2.2.2 TDD PCFICH/PDCCH Transmit Diversity 4x2

##### 8.4.2.2.2.1 Test purpose

This test verifies the demodulation performance of PCFICH/PDCCH for transmit diversity with a given SNR for which the average probability of miss-detection of the Downlink Scheduling Grant, tested jointly on PDCCH and PCFICH of the specified reference measurement channels in A.3.5.2 remains below a given reference value.

##### 8.4.2.2.2.2 Test applicability

This test applies to all types of E-UTRA TDD UE release 8.

##### 8.4.2.2.2.3 Minimum conformance requirements

The receiver characteristics of the PDCCH/PCFICH are determined by the probability of miss-detection of the Downlink Scheduling Grant (Pm-dsg). PDCCH and PCFICH are tested jointly, i.e. a miss detection of PCFICH implies a miss detection of PDCCH.

**Table 8.4.2.2.3-1: Test Parameters for PDCCH/PCFICH**

Parameter		Unit	Transmit diversity
Uplink downlink configuration (Note 1)			0
Special subframe configuration (Note 2)			4
Number of PDCCH symbols		symbols	2
Number of PHICH groups ( $N_g$ )			1
PHICH duration			Normal
Unused RE-s and PRB-s			OCNG
Cell ID			0
Downlink power allocation	PDCCH_RA PHICH_RA OCNG_RA	dB	-3
	PCFICH_RB PDCCH_RB PHICH_RB OCNG_RB	dB	-3
$N_{oc}$ at antenna port		dBm/15kHz	-98
Cyclic prefix			Normal
ACK/NACK feedback mode			Multiplexing
Note 1: as specified in Table 4.2-2 in TS 36.211 [8]			
Note 2: as specified in Table 4.2-1 in TS 36.211 [8]			
Note 3: PHICH power setting refer to PHICH group power, i.e. the total power of all active PHICH sequences within a PHICH group.			

For the parameters specified in Table 8.4.2.2.3-1 the average probability of a missed downlink scheduling grant ( $P_{m-dsg}$ ) shall be below the specified value in Table 8.4.2.2.3-2.

**Table 8.4.2.2.3-2: Minimum performance PDCCH/PCFICH 2 Tx Antenna Port**

Test number	Bandwidth	Aggregation level	Reference Channel	OCNG Pattern	Propagation Condition	Antenna configuration and correlation Matrix	Reference value	
							$P_{m-dsg}$ (%)	SNR (dB)
1	10 MHz	4 CCE	R.17 TDD	OP.1 TDD	EVA5	4 x 2 Medium	1	1.2

The normative reference for this requirement is TS 36.101 [2] clause 8.4.2.

#### 8.4.2.2.2.4 Test description

##### 8.4.2.2.2.4.1 Initial conditions

Initial conditions are a set of test configurations the UE needs to be tested in and the steps for the SS to take with the UE to reach the correct measurement state.

Configurations of PDSCH and PDCCH before measurement are specified in Annex C.2.

Test Environment: Normal, as defined in TS 36.508 [7] clause 4.1.

Frequencies to be tested: Mid Range, as defined in TS 36.508 [7] clause 4.3.1.1.

Channel Bandwidths to be tested: 10 MHz, as defined in TS 36.508 [7] clause 4.3.1.1

1. Connect the SS, the faders and AWGN noise sources to the UE antenna connectors as shown in TS 36.508 [7] Annex A, Figure A.11.
2. The parameter settings for the cell are set up according to 8.4.2.2.3-1.

3. Downlink signals are initially set up according to Annex C0, C.1 and C.3.2 and uplink signals according to Annex H.1 and H.3.2.
4. Propagation conditions are set according to Annex B.0.
5. Ensure the UE is in State 3A-RF according to TS 36.508 [7] clause 5.2A.2. Message contents are defined in clause 8.4.2.2.4.3.

8.4.2.2.4.2 Test procedure

1. SS transmits PDSCH via PDCCH DCI format 2 for C\_RNTI to transmit the DL RMC according to Table 8.4.2.2.3-2. The details of PDCCH and PDSCH are specified in Table A.3.5.2-1 and Table A.3.5.2-2 respectively. The SS sends downlink MAC padding bits on the DL RMC. Transmission scheme for the PDSCH shall be transmit diversity.
2. Set the parameters of the propagation condition, the correlation matrix, antenna configuration and the SNR according to Tables 8.4.2.2.5-1 as appropriate.
3. Measure the Pm-dsg for a duration sufficient to achieve statistical significance according to Annex G clause G.4. Count the number of NACKs, ACKs and statDTXs on the UL PUCCH during each subtest interval. Pm-dsg is the radio (statDTX)/(NACK +ACK+statDTX). If Pm-dsg is less than the value specified in table 8.4.2.2.5-1, pass the UE. Otherwise fail the UE

8.4.2.2.4.3 Message contents

Message contents are according to TS 36.508 [7] clause 4.6 with the following exception:

**Table 8.4.2.2.4.3-1: TDD-Configuration-DEFAULT**

Derivation Path: 36.508 clause 4.6.4			
Information Element	Value/remark	Comment	Condition
TDD-Configuration-DEFAULT ::= SEQUENCE {			
subframeAssignment	Sa0		
specialSubframePatterns	Ssp4		
}			

**Table 8.4.2.2.4.3-2: PhysicalConfigDedicated-DEFAULT**

Derivation Path: 36.331 clause 6.3.2			
Information Element	Value/remark	Comment	Condition
PhysicalConfigDedicated-DEFAULT ::= SEQUENCE {			
antennaInfo CHOICE {			
antennaInfoDedicated ::= SEQUENCE {			
transmissionMode	tm4		
codebookSubsetRestriction CHOICE {			
n4TxAntenna-tm4	11111111111111111111 11111111111111111111 11111111111111111111 1111		
}			
}			
ue-TransmitAntennaSelection CHOICE {			
release	NULL		
}			
}			

8.4.2.2.5 Test requirement

For the parameters specified in Table 8.4.2.2.3-1 the average probability of a missed downlink scheduling grant (Pm-dsg) shall be below the specified value in Table 8.4.2.2.5-1.



Table 8.4.2.2.5-1: Test requirement PDCCH/PCFICH 2 Tx Antenna Port

Test number	Bandwidth	Aggregation level	Reference Channel	OCNG Pattern	Propagation Condition	Antenna configuration and correlation Matrix	Reference value	
							Pm-dsg (%)	SNR (dB)
1	10 MHz	4 CCE	R.17 TDD	OP.1 TDD	EVA5	4 x 2 Medium	1	2.2

## 8.4.2.2.2\_1 TDD PCFICH/PDCCH Transmit Diversity 4x2 (Release 9 and forward)

## 8.4.2.2.2\_1.1 Test purpose

This test verifies the demodulation performance of PCFICH/PDCCH for transmit diversity with a given SNR for which the average probability of miss-detection of the Downlink Scheduling Grant, tested jointly on PDCCH and PCFICH of the specified reference measurement channels in A.3.5.2 remains below a given reference value.

## 8.4.2.2.2\_1.2 Test applicability

This test applies to all types of E-UTRA TDD UE release 9 and forward.

## 8.4.2.2.2\_1.3 Minimum conformance requirements

The receiver characteristics of the PDCCH/PCFICH are determined by the probability of miss-detection of the Downlink Scheduling Grant (Pm-dsg). PDCCH and PCFICH are tested jointly, i.e. a miss detection of PCFICH implies a miss detection of PDCCH.

Table 8.4.2.2\_1.3-1: Test Parameters for PDCCH/PCFICH

Parameter	Unit	Transmit diversity	
Uplink downlink configuration (Note 1)		0	
Special subframe configuration (Note 2)		4	
Number of PDCCH symbols	symbols	2	
Number of PHICH groups (Ng)		1	
PHICH duration		Normal	
Unused RE-s and PRB-s		OCNG	
Cell ID		0	
Downlink power allocation	PDCCH_RA PHICH_RA OCNG_RA	dB	-3
	PCFICH_RB PDCCH_RB PHICH_RB OCNG_RB	dB	-3
$N_{oc}$ at antenna port	dBm/15kHz	-98	
Cyclic prefix		Normal	
ACK/NACK feedback mode		Multiplexing	
Note 1: as specified in Table 4.2-2 in TS 36.211 [8] Note 2: as specified in Table 4.2-1 in TS 36.211 [8] Note 3: PHICH power setting refer to PHICH group power, i.e. the total power of all active PHICH sequences within a PHICH group.			

For the parameters specified in Table 8.4.2.2.2\_1.3-1 the average probability of a missed downlink scheduling grant (Pm-dsg) shall be below the specified value in Table 8.4.2.2.2\_1.3-2.

**Table 8.4.2.2.2\_1.3-2: Minimum performance PDCCH/PCFICH 2 Tx Antenna Port**

Test number	Bandwidth	Aggregation level	Reference Channel	OCNG Pattern	Propagation Condition	Antenna configuration and correlation Matrix	Reference value	
							Pm-dsg (%)	SNR (dB)
1	5 MHz	2 CCE	R.17_1 TDD	OP.1 TDD	EPA5	4 x 2 Medium	1	6.5

The normative reference for this requirement is TS 36.101 [2] clause 8.4.2.

#### 8.4.2.2.2\_1.4 Test description

##### 8.4.2.2.2\_1.4.1 Initial conditions

Initial conditions are a set of test configurations the UE needs to be tested in and the steps for the SS to take with the UE to reach the correct measurement state.

Configurations of PDSCH and PDCCH before measurement are specified in Annex C.2.

Test Environment: Normal, as defined in TS 36.508 [7] clause 4.1.

Frequencies to be tested: Mid Range, as defined in TS 36.508 [7] clause 4.3.1.1.

Channel Bandwidths to be tested: 5 MHz, as defined in TS 36.508 [7] clause 4.3.1.1

1. Connect the SS, the faders and AWGN noise sources to the UE antenna connectors as shown in TS 36.508 [7] Annex A, Figure A.11.
2. The parameter settings for the cell are set up according to 8.4.2.2.2\_1.3-1.
3. Downlink signals are initially set up according to Annex C0, C.1 and C.3.2 and uplink signals according to Annex H.1 and H.3.2.
4. Propagation conditions are set according to Annex B.0.
5. Ensure the UE is in State 3A-RF according to TS 36.508 [7] clause 5.2A.2. Message contents are defined in clause 8.4.2.2.2\_1.4.3.

##### 8.4.2.2.2\_1.4.2 Test procedure

1. SS transmits PDSCH via PDCCH DCI format 2 for C\_RNTI to transmit the DL RMC according to Table 8.4.2.2.2\_1.3-2. The details of PDCCH and PDSCH are specified in Table A.3.5.2-1 and Table A.3.5.2-2 respectively. The SS sends downlink MAC padding bits on the DL RMC. Transmission scheme for the PDSCH shall be transmit diversity.
2. Set the parameters of the propagation condition, the correlation matrix, antenna configuration and the SNR according to Tables 8.4.2.2.2\_1.5-1 as appropriate.
3. Measure the Pm-dsg for a duration sufficient to achieve statistical significance according to Annex G clause G.4. Count the number of NACKs, ACKs and statDTXs on the UL PUCCH during each subtest interval. Pm-dsg is the ratio (statDTX)/(NACK + ACK + statDTX). If Pm-dsg is less than the value specified in table 8.4.2.2.2\_1.5-1, pass the UE. Otherwise fail the UE

##### 8.4.2.2.2\_1.4.3 Message contents

Message contents are according to TS 36.508 [7] clause 4.6 with the following exception:

**Table 8.4.2.2.2\_1.4.3-1: TDD-Configuration-DEFAULT**

Derivation Path: 36.508 clause 4.6.4			
Information Element	Value/remark	Comment	Condition
TDD-Configuration-DEFAULT ::= SEQUENCE {			
subframeAssignment	Sa0		
specialSubframePatterns	Ssp4		
}			

**Table 8.4.2.2.2\_1.4.3-2: PhysicalConfigDedicated-DEFAULT**

Derivation Path: 36.331 clause 6.3.2			
Information Element	Value/remark	Comment	Condition
PhysicalConfigDedicated-DEFAULT ::= SEQUENCE {			
antennaInfo CHOICE {			
antennaInfoDedicated ::= SEQUENCE {			
transmissionMode	tm4		
codebookSubsetRestriction CHOICE {			
n4TxAntenna-tm4	11111111111111111111 11111111111111111111 11111111111111111111 1111		
}			
ue-TransmitAntennaSelection CHOICE {			
release	NULL		
}			
}			
}			
}			

8.4.2.2.2\_1.5 Test requirement

For the parameters specified in Table 8.4.2.2.2.3-1 the average probability of a missed downlink scheduling grant (Pm-dsg) shall be below the specified value in Table 8.4.2.2.2\_1.5-1.

**Table 8.4.2.2.2\_1.5-1: Test requirement PDCCH/PCFICH 2 Tx Antenna Port**

Test number	Bandwidth	Aggregation level	Reference Channel	OCNG Pattern	Propagation Condition	Antenna configuration and correlation Matrix	Reference value	
							Pm-dsg (%)	SNR (dB)
1	5 MHz	2 CCE	R.17_1 TDD	OP.1 TDD	EPA5	4 x 2 Medium	1	+7.5

8.4.2.2.3\_C TDD PCFICH/PDCCH Transmit Diversity 2x2 for eICIC

8.4.2.2.3\_C.1 TDD PCFICH/PDCCH Transmit Diversity 2x2 for eICIC (non-MBSFN ABS)

8.4.2.2.3\_C.1.1 Test purpose

To verify the UE's performance of transmit diversity (SFBC) with 2 transmit antennas if the PCFICH/PDCCH transmission in the serving cell takes place in subframes that overlap with ABS of the aggressor cell.

8.4.2.2.3\_C.1.2 Test applicability

This test applies to all types of E-UTRA TDD UE release 10 and forward. Applicability requires support for FGI bit 115.

#### 8.4.2.2.3\_C.1.3 Minimum conformance requirements

The receiver characteristics of the PDCCH/PCFICH are determined by the probability of miss-detection of the Downlink Scheduling Grant (Pm-dsg). PDCCH and PCFICH are tested jointly, i.e. a miss detection of PCFICH implies a miss detection of PDCCH.

##### **Table 8.4.2.2.3\_C.1.3-1: Void**

For the parameters for non-MBSFN ABS specified in Table 8.4.2.2.3\_C.1.3-2, the average probability of a missed downlink scheduling grant (Pm-dsg) shall be below the specified value in Table 8.4.2.2.3\_C.1.3-3. The downlink physical setup is in accordance with Annex C.3.2 and Annex C.3.3. In Table 8.4.2.2.3\_C.1.3-2, Cell 1 is the serving cell, and Cell 2 is the aggressor cell. The downlink physical channel setup for Cell 1 is according to Annex C.3.2 and for Cell 2 is according to Annex C.3.3, respectively.

Table 8.4.2.2.3\_C.1.3-2: Test Parameters for PDCCH/PCFICH – Non-MBSFN ABS

Parameter		Unit	Cell 1	Cell 2
Uplink downlink configuration			1	1
Special subframe configuration			4	4
Downlink power allocation	PDCCH_RA PHICH_RA OCNG_RA	dB	-3	-3
	PCFICH_RB PDCCH_RB PHICH_RB OCNG_RB	dB	-3	-3
$N_{oc}$ at antenna port	$N_{oc1}$	dBm/15kHz	-100.5 (Note 1)	N/A
	$N_{oc2}$	dBm/15kHz	-98 (Note 2)	N/A
	$N_{oc3}$	dBm/15kHz	-95.3 (Note 3)	N/A
$\hat{E}_s / N_{oc2}$		dB	Reference Value in Table 8.4.2.2.3_C.1.3-3	1.5
$BW_{Channel}$		MHz	10	10
Subframe Configuration			Non-MBSFN	Non-MBSFN
Time Offset between Cells		$\mu$ s	2.5 (synchronous cells)	
Cell Id			0	1
ABS pattern (Note 4)			N/A	0000010001 0000000001
RLM/RRM Measurement Subframe Pattern(Note 5)			0000000001 0000000001	N/A
CSI Subframe Sets(Note 6)	$C_{CSI,0}$		0000010001 0000000001	N/A
	$C_{CSI,1}$		1100101000 1100111000	N/A
Number of control OFDM symbols			3	3
ACK/NACK feedback mode			Multiplexing	N/A
Number of PHICH groups ( $N_g$ )			1	N/A
PHICH duration			extended	N/A
Unused RE-s and PRB-s			OCNG	OCNG
Cyclic prefix			Normal	Normal
<p>Note 1: This noise is applied in OFDM symbols #1, #2, #3, #5, #6, #8, #9, #10,#12, #13 of a subframe overlapping with the aggressor ABS.</p> <p>Note 2: This noise is applied in OFDM symbols #0, #4, #7, #11 of a subframe overlapping with the aggressor ABS.</p> <p>Note 3: This noise is applied in OFDM symbols of a subframe overlapping with aggressor non-ABS</p> <p>Note 4: ABS pattern as defined in [14]. PDCCH/PCFICH other than that associated with SIB1/Paging are transmitted in the serving cell subframe when the subframe is overlapped with the ABS subframe of aggressor cell.</p> <p>Note 5: Time-domain measurement resource restriction pattern for PCell measurements as defined in [5].</p> <p>Note 6: As configured according to the time-domain measurement resource restriction pattern for CSI measurements defined in [5].</p> <p>Note 7: Cell 1 is the serving cell. Cell 2 is the aggressor cell. The number of the CRS ports in Cell1 and Cell2 is the same.</p> <p>Note 8: SIB-1 will not be transmitted in Cell2 in the test.</p>				

Table 8.4.2.2.3\_C.1.3-3: Minimum performance PDCCH/PCFICH – Non-MBSFN ABS

Test Number	Aggregation Level	Reference Channel	OCNG Pattern		Propagation Conditions (Note 1)		Correlation Matrix and Antenna Configuration	Reference Value	
			Cell 1	Cell 2	Cell 1	Cell 2		Pm-dsg (%)	SNR (dB) (Note 2)
1	8 CCE	R15-1 TDD	OP.1 TDD	OP.1 TDD	EVA5	EVA5	2x2 Low	1	-3.9
Note 1: The propagation conditions for Cell 1 and Cell 2 are statistically independent. Note 2: SNR corresponds to $\hat{E}_s/N_{oc2}$ of cell 1. Note 3: The correlation matrix and antenna configuration apply for Cell 1 and Cell 2.									

The normative reference for this requirement is TS 36.101 [2] clause 8.4.2.2.3

#### 8.4.2.2.3\_C.1.4 Test description

##### 8.4.2.2.3\_C.1.4.1 Initial conditions

Initial conditions are a set of test configurations the UE needs to be tested in and the steps for the SS to take with the UE to reach the correct measurement state.

Configurations of PDSCH and PDCCH before measurement are specified in Annex C.2.

Test Environment: Normal, as defined in TS 36.508 [7] clause 4.1.

Frequencies to be tested: Mid Range, as defined in TS 36.508 [7] clause 4.3.1.2.

Channel Bandwidths to be tested: 10MHz, as defined in TS 36.508 [7] clause 4.3.1.2

1. Connect the SS, the faders and AWGN noise sources to the UE antenna connector (s) as shown in TS 36.508 [7] Annex A, Figure A.40 for antenna configuration 2x2.
2. The parameter settings for the cell1 are set up according to Tables 8.4.2.2.3\_C.1.3-1 and 8.4.2.2.3\_C.1.3-2.
3. The downlink signals are initially set up according to Annex C0, C.1 and C.3.2 and uplink signals according to Annex H.1 and H.3.2.
4. Propagation conditions are set according to Annex B clauses B.0.
5. Ensure the UE is in State 3A-RF according to TS 36.508 [7] clause 5.2A.2. Message contents are defined in clause 8.4.2.2.3\_C.1.4.3.

##### 8.4.2.2.3\_C.1.4.2 Test procedure

1. Set the parameters for Cell1 and Cell2 according to Tables 8.4.2.2.3\_C.1.3-2, 8.4.2.2.3\_C.1.5-1, C.3.3-1 of Annex C.3.3 as appropriate, and SS transmits PDSCH via PDCCH DCI format 1 for C\_RNTI to transmit the DL RMC in the subframes overlapping with ABS of the aggressor cell. The details of PDCCH and PDSCH are specified in Table A.3.5.2-1 and Table A.3.5.2-2A respectively. The SS sends downlink MAC padding bits on the DL RMC. Transmission scheme for the PDSCH shall be transmit diversity. Propagation conditions are set according to Annex B clause B.2.
2. Measure the Pm-dsg in the subframes overlapping with ABS of the aggressor cell for a duration sufficient to achieve statistical significance according to Annex G clause G.4. Count the number of NACKs, ACKs and statDTXs on the UL PUCCH during each subtest interval. Pm-dsg is the ratio (statDTX)/(NACK+ACK+statDTX).

If Pm-dsg is less than the value specified in table 8.4.2.2.3\_C.1.5-2, pass the UE. Otherwise fail the UE.

## 8.4.2.2.3\_C.1.4.3 Message contents

Message contents are according to TS 36.508 [7] clause 4.6 with the following exceptions:

**Table 8.4.2.2.3\_C.1.4.3-1: PHICH-Config-DEFAULT**

Derivation Path: TS 36.508 [7] clause 4.6.3, Table 4.6.3-4: PHICH-Config-DEFAULT			
Information Element	Value/remark	Comment	Condition
PHICH-Config-DEFAULT ::= SEQUENCE {			
phich-Duration	extended		Cell 1
phich-Resource	one		
}			

**Table 8.4.2.2.3\_C.1.4.3-2: PhysicalConfigDedicated-DEFAULT**

Derivation Path: TS 36.508 [7] clause 5.5.1.2, Table 5.5.1.2-1 PhysicalConfigDedicated-DEFAULT			
Information Element	Value/remark	Comment	Condition
PhysicalConfigDedicated-DEFAULT ::= SEQUENCE {			
cqi-ReportConfig	Not present		
cqi-ReportConfig-r10	CQI-ReportConfig-r10-DEFAULT		
}			

**Table 8.4.2.2.3\_C.1.4.3-3: RadioResourceConfigDedicated-SRB2-DRB(n, m)**

Derivation Path: TS 36.508 [7] clause 4.6.3, Table 4.6.3-16 RadioResourceConfigDedicated-SRB2-DRB(n,m)			
Information Element	Value/remark	Comment	Condition
RadioResourceConfigDedicated-SRB2-DRB(n, m) ::= SEQUENCE {			
MeasSubframePatternPCell-r10 CHOICE {			
setup SEQUENCE {			
subframePatternTDD-r10 CHOICE {			
subframeConfig1-5-r10	'00000000010000000001'	BIT STRING (SIZE (20))	
}			
}			
}			
}			

Table 8.4.2.2.3\_C.1.4.3-4: CQI-ReportConfig-r10-DEFAULT

Derivation Path: 36.508 [7] clause 4.6.3, Table 4.6.3-2AA CQI-ReportConfig-r10-DEFAULT_			
Information Element	Value/remark	Comment	Condition
CQI-ReportConfig-r10-DEFAULT ::= SEQUENCE {			
cqi-ReportAperiodic-r10	Not present		
nomPDSCH-RS-EPRE-Offset	0		
cqi-ReportPeriodic-r10 CHOICE{	Not present		
pmi-RI-Report-r9	Not present		
}			
csi-SubframePatternConfig-r10 CHOICE {			
setup SEQUENCE {			
csi-MeasSubframeSet1-r10 CHOICE {			
subframePatternTDD-r10 CHOICE {			
subframeConfig1-5-r10	'00000100010000000001'	BIT STRING (SIZE (20))	
}			
}			
}			
csi-MeasSubframeSet2-r10 CHOICE {			
subframePatternTDD-r10 CHOICE {			
subframeConfig1-5-r10	'11001010001100111000'	BIT STRING (SIZE (20))	
}			
}			
}			
}			

## 8.4.2.2.3\_C.1.5 Test requirement

For the parameters specified in Table 8.4.2.2.3\_C.1.5-1, the average probability of a missed downlink scheduling grant (P<sub>m-dsg</sub>) shall be below the specified value in Table 8.4.2.2.3\_C.1.5-2.



**Table 8.4.2.2.3\_C.1.5-1: Test Parameters for PDCCH/PCFICH – Non-MBSFN ABS**

Parameter		Unit	Cell 1	Cell 2
Uplink downlink configuration			1	1
Special subframe configuration			4	4
Downlink power allocation	PDCCH_RA PHICH_RA OCNG_RA	dB	-3	-3
	PCFICH_RB PDCCH_RB PHICH_RB OCNG_RB	dB	-3	-3
$N_{oc}$ at antenna port	$N_{oc1}$	dBm/15kHz	-100.6 (Note 1)	N/A
	$N_{oc2}$	dBm/15kHz	-98 (Note 2)	N/A
	$N_{oc3}$	dBm/15kHz	-95.4 (Note 3)	N/A
$\hat{E}_s / N_{oc2}$		dB	Reference Value in Table 8.4.2.2.3_C.1.5-2	1.3
$BW_{Channel}$		MHz	10	10
Subframe Configuration			Non-MBSFN	Non-MBSFN
Time Offset between Cells		$\mu$ s	2.5 (synchronous cells)	
Cell Id			0	1
ABS pattern (Note 4)			N/A	0000010001 0000000001
RLM/RRM Measurement Subframe Pattern(Note 5)			0000000001 0000000001	N/A
CSI Subframe Sets(Note 6)	$C_{CSI,0}$		0000010001 0000000001	N/A
	$C_{CSI,1}$		1100101000 1100111000	N/A
Number of control OFDM symbols			3	3
ACK/NACK feedback mode			Multiplexing	N/A
Number of PHICH groups ( $N_g$ )			1	N/A
PHICH duration			extended	N/A
Unused RE-s and PRB-s			OCNG	OCNG
Cyclic prefix			Normal	Normal
Note 1:	This noise is applied in OFDM symbols #1, #2, #3, #5, #6, #8, #9, #10,#12, #13 of a subframe overlapping with the aggressor ABS.			
Note 2:	This noise is applied in OFDM symbols #0, #4, #7, #11 of a subframe overlapping with the aggressor ABS.			
Note 3:	This noise is applied in OFDM symbols of a subframe overlapping with aggressor non-ABS			
Note 4:	ABS pattern as defined in [14]. PDCCH/PCFICH other than that associated with SIB1/Paging are transmitted in the serving cell subframe when the subframe is overlapped with the ABS subframe of aggressor cell.			
Note 5:	Time-domain measurement resource restriction pattern for PCell measurements as defined in [5].			
Note 6:	As configured according to the time-domain measurement resource restriction pattern for CSI measurements defined in [5].			
Note 7:	Cell 1 is the serving cell. Cell 2 is the aggressor cell. The number of the CRS ports in Cell1 and Cell2 is the same.			
Note 8:	SIB-1 will not be transmitted in Cell2 in the test.			

**Table 8.4.2.2.3\_C.1.5-2: Test Requirement PDCCH/PCFICH – Non-MBSFN ABS**

Test Number	Aggregation Level	Reference Channel	OCNG Pattern		Propagation Conditions (Note 1)		Correlation Matrix and Antenna Configuration	Reference Value	
			Cell 1	Cell 2	Cell 1	Cell 2		Pm-dsg (%)	SNR (dB) (Note 2)
1	8 CCE	R15-1 TDD	OP.1 TDD	OP.1 TDD	EVA5	EVA5	2x2 Low	1	-3
Note 1: The propagation conditions for Cell 1 and Cell 2 are statistically independent. Note 2: SNR corresponds to $\hat{E}_s / N_{oc2}$ of cell 1. Note 3: The correlation matrix and antenna configuration apply for Cell 1 and Cell 2.									

**8.4.2.2.3\_C.2 TDD PCFICH/PDCCH Transmit Diversity 2x2 for eICIC (MBSFN ABS)****8.4.2.2.3\_C.2.1 Test purpose**

To verify the UE's performance of transmit diversity (SFBC) with 2 transmit antennas if the PCFICH/PDCCH transmission in the serving cell takes place in subframes that overlap with ABS of the aggressor cell.

**8.4.2.2.3\_C.2.2 Test applicability**

This test applies to all types of E-UTRA TDD UE release 10 and forward. Applicability requires support for FGI bit 115.

**8.4.2.2.3\_C.2.3 Minimum conformance requirements**

The receiver characteristics of the PDCCH/PCFICH are determined by the probability of miss-detection of the Downlink Scheduling Grant (Pm-dsg). PDCCH and PCFICH are tested jointly, i.e. a miss detection of PCFICH implies a miss detection of PDCCH.

**Table 8.4.2.2.3\_C.2.3-1: Void**

For the parameters for MBSFN ABS specified in Table 8.4.2.2.3\_C.2.3-2, the average probability of a missed downlink scheduling grant (Pm-dsg) shall be below the specified value in Table 8.4.2.2.3\_C.2.3-3.

The downlink physical setup is in accordance with Annex C.3.2 and Annex C.3.3. In Table 8.4.2.2.3\_C.2.3-2, Cell 1 is the serving cell, and Cell 2 is the aggressor cell. The downlink physical channel setup for Cell 1 is according to Annex C.3.2 and for Cell 2 is according to Annex C.3.3, respectively.

Table 8.4.2.2.3\_C.2.3-2: Minimum performance PDCCH/PCFICH – MBSFN ABS

Parameter		Unit	Cell 1	Cell 2
Uplink downlink configuration			1	1
Special subframe configuration			4	4
Downlink power allocation	PDCCH_RA PHICH_RA OCNG_RA	dB	-3	-3
	PCFICH_RB PDCCH_RB PHICH_RB OCNG_RB	dB	-3	-3
$N_{oc}$ at antenna port	$N_{oc1}$	dBm/15kHz	-100.5 (Note 1)	N/A
	$N_{oc2}$	dBm/15kHz	-98 (Note 2)	N/A
	$N_{oc3}$	dBm/15kHz	-95.3 (Note 3)	N/A
$\hat{E}_s / N_{oc2}$		dB	Reference Value in Table 8.4.2.2.3_C.2.3-3	1.5
BW <sub>Channel</sub>		MHz	10	10
Subframe Configuration			Non-MBSFN	MBSFN
Time Offset between Cells		μs	2.5 (synchronous cells)	
Cell Id			0	126
ABS pattern (Note 4)			N/A	000000001 000000001
RLM/RRM Measurement Subframe Pattern(Note 5)			000000001 000000001	N/A
CSI Subframe Sets(Note 6)	C <sub>CSI,0</sub>		000000001 000000001	N/A
	C <sub>CSI,1</sub>		1100111000 1100111000	N/A
MBSFN Subframe Allocation (Note 9)			N/A	000010
Number of control OFDM symbols			3	3
ACK/NACK feedback mode			Multiplexing	N/A
Number of PHICH groups ( $N_g$ )			1	N/A
PHICH duration			extended	N/A
Unused RE-s and PRB-s			OCNG	OCNG
Cyclic prefix			Normal	Normal
<p>Note 1: This noise is applied in OFDM symbols #1, #2, #3, #4, #5, #6, #7, #8, #9, #10, #11, #12, #13 of a subframe overlapping with the aggressor ABS.</p> <p>Note 2: This noise is applied in OFDM symbols #0 of a subframe overlapping with the aggressor ABS.</p> <p>Note 3: This noise is applied in OFDM symbols of a subframe overlapping with aggressor non-ABS</p> <p>Note 4: ABS pattern as defined in [14]. The 10<sup>th</sup> and 20<sup>th</sup> subframes indicated by ABS pattern are MBSFN ABS subframes. PDSCH other than SIB1/paging and its associated PDCCH/PCFICH are transmitted in the serving cell subframe when the subframe is overlapped with the MBSFN ABS subframe of aggressor cell and the subframe is available in the definition of the reference channel.</p> <p>Note 5: Time-domain measurement resource restriction pattern for PCell measurements as defined in [5].</p> <p>Note 6: As configured according to the time-domain measurement resource restriction pattern for CSI measurements defined in [5].</p> <p>Note 7: Cell 1 is the serving cell. Cell 2 is the aggressor cell. The number of the CRS ports in Cell1 and Cell2 is the same.</p> <p>Note 8: SIB-1 will not be transmitted in Cell2 in this test.</p> <p>Note 9: MBSFN Subframe Allocation as defined in [5], one frame with 6 bits is chosen for MBSFN subframe allocation.</p>				

Table 8.4.2.2.3\_C.2.3-3: Minimum performance PDCCH/PCFICH – MBSFN ABS

Test Number	Aggregation Level	Reference Channel	OCNG Pattern		Propagation Conditions(Note 1)		Correlation Matrix and Antenna Configuration	Reference Value	
			Cell 1	Cell 2	Cell 1	Cell 2		Pm-dsg (%)	SNR (dB) (Note 2)
1	8 CCE	R15-1 TDD	OP.1 TDD	OP.1 TDD	EVA5	EVA5	2x2 Low	1	-4.1

Note 1: The propagation conditions for Cell 1 and Cell2 are statistically independent.

Note 2: SNR corresponds to  $\hat{E}_s / N_{oc2}$  of cell 1.

Note 3: The correlation matrix and antenna configuration apply for Cell 1 and Cell 2.

The normative reference for this requirement is TS 36.101 [2] clause 8.4.2.2.3

#### 8.4.2.2.3\_C.2.4 Test description

##### 8.4.2.2.3\_C.2.4.1 Initial conditions

Initial conditions are a set of test configurations the UE needs to be tested in and the steps for the SS to take with the UE to reach the correct measurement state.

Configurations of PDSCH and PDCCH before measurement are specified in Annex C.2.

Test Environment: Normal, as defined in TS 36.508 [7] clause 4.1.

Frequencies to be tested: Mid Range, as defined in TS 36.508 [7] clause 4.3.1.2.

Channel Bandwidths to be tested: 10MHz, as defined in TS 36.508 [7] clause 4.3.1.2

1. Connect the SS, the faders and AWGN noise sources to the UE antenna connector (s) as shown in TS 36.508 [7] Annex A, Figure A.40 for antenna configuration 2x2.
2. The parameter settings for the cell1 are set up according to Tables 8.4.2.2.3\_C.2.3-1.
3. The downlink signals are initially set up according to Annex C0, C.1 and C.3.2 and uplink signals according to Annex H.1 and H.3.2.
4. Propagation conditions are set according to Annex B clauses B.0.
5. Ensure the UE is in State 3A-RF according to TS 36.508 [7] clause 5.2A.2. Message contents are defined in clause 8.4.2.2.3\_C.2.4.3.

##### 8.4.2.2.3\_C.2.4.2 Test procedure

1. Set the parameters for Cell1 and Cell2 according to Tables 8.4.2.2.3\_C.2.3-2, 8.4.2.2.3\_C.2.5-1, C.3.3-1 of Annex C.3.3 as appropriate, and SS transmits PDSCH via PDCCH DCI format 1 for C\_RNTI to transmit the DL RMC in the subframes overlapping with ABS of the aggressor cell. The details of PDCCH and PDSCH are specified in Table A.3.5.2-1 and Table A.3.5.2-2A respectively. The SS sends downlink MAC padding bits on the DL RMC. Transmission scheme for the PDSCH shall be transmit diversity. Propagation conditions are set according to Annex B clause B.2.
2. Measure the Pm-dsg in the subframes overlapping with ABS of the aggressor cell for a duration sufficient to achieve statistical significance according to Annex G clause G.4. Count the number of NACKs, ACKs and statDTXs on the UL PUCCH during each subtest interval. Pm-dsg is the ratio (statDTX)/(NACK+ACK+statDTX).

If Pm-dsg is less than the value specified in table 8.4.2.2.3\_C.2.5-2, pass the UE. Otherwise fail the UE.

##### 8.4.2.2.3\_C.2.4.3 Message contents

Message contents are according to TS 36.508 [7] clause 4.6 with the following exceptions:

**Table 8.4.2.2.3\_C.2.4.3-1: PHICH-Config-DEFAULT**

Derivation Path: TS 36.508 [7] clause 4.6.3, Table 4.6.3-4: PHICH-Config-DEFAULT			
Information Element	Value/remark	Comment	Condition
PHICH-Config-DEFAULT ::= SEQUENCE {			
phich-Duration	extended		Cell 1
phich-Resource	one		
}			

**Table 8.4.2.2.3\_C.2.4.3-2: SystemInformationBlockType3: Neighbour cell configuration**

Derivation Path: TS 36.508 [7] clause 4.4.3.3, Table 4.4.3.3-2: SystemInformationBlockType3			
Information Element	Value/remark	Comment	Condition
SystemInformationBlockType3 ::= SEQUENCE {			
neighCellConfig	'00'B (Not all neighbour cells have the same MBSFN subframe allocation as serving cell)		Cell 1
}			

**Table 8.4.2.2.3\_C.2.4.3-3: PhysicalConfigDedicated-DEFAULT**

Derivation Path: TS 36.508 [7] clause 5.5.1.2, Table 5.5.1.2-1 PhysicalConfigDedicated-DEFAULT			
Information Element	Value/remark	Comment	Condition
PhysicalConfigDedicated-DEFAULT ::= SEQUENCE {			
cqi-ReportConfig	Not present		
cqi-ReportConfig-r10	CQI-ReportConfig-r10-DEFAULT		
}			

**Table 8.4.2.2.3\_C.2.4.3-4: RadioResourceConfigDedicated-SRB2-DRB(n, m)**

Derivation Path: TS 36.508 [7] clause 4.6.3, Table 4.6.3-16 RadioResourceConfigDedicated-SRB2-DRB(n,m)			
Information Element	Value/remark	Comment	Condition
RadioResourceConfigDedicated-SRB2-DRB(n, m) ::= SEQUENCE {			
MeasSubframePatternPCell-r10 CHOICE {			
setup SEQUENCE {			
subframePatternTDD-r10 CHOICE {			
subframeConfig1-5-r10	'00000000010000000001'	BIT STRING (SIZE (20))	
}			
}			
}			

Table 8.4.2.2.3\_C.2.4.3-5: CQI-ReportConfig-r10-DEFAULT

Derivation Path: 36.508 [7] clause 4.6.3, Table 4.6.3-2AA CQI-ReportConfig-r10-DEFAULT_			
Information Element	Value/remark	Comment	Condition
CQI-ReportConfig-r10-DEFAULT ::= SEQUENCE {			
cqi-ReportAperiodic-r10	Not present		
nomPDSCH-RS-EPRE-Offset	0		
cqi-ReportPeriodic-r10 CHOICE{	Not present		
pmi-RI-Report-r9	Not present		
csi-SubframePatternConfig-r10 CHOICE {			
setup SEQUENCE {			
csi-MeasSubframeSet1-r10 CHOICE {			
subframePatternTDD-r10 CHOICE {			
subframeConfig1-5-r10	'00000000010000000001'	BIT STRING (SIZE (20))	
}			
}			
}			
csi-MeasSubframeSet2-r10 CHOICE {			
subframePatternTDD-r10 CHOICE {			
subframeConfig1-5-r10	'11001110001100111000'	BIT STRING (SIZE (20))	
}			
}			
}			

## 8.4.2.2.3\_C.2.5 Test requirement

For the parameters specified in Table 8.4.2.2.3\_C.2.5-1, the average probability of a missed downlink scheduling grant (P<sub>m-dsg</sub>) shall be below the specified value in Table 8.4.2.2.3\_C.2.5-2.

Table 8.4.2.2.3\_C.2.5-1: Minimum performance PDCCH/PCFICH – MBSFN ABS

Parameter		Unit	Cell 1	Cell 2
Uplink downlink configuration			1	1
Special subframe configuration			4	4
Downlink power allocation	PDCCH_RA PHICH_RA OCNG_RA	dB	-3	-3
	PCFICH_RB PDCCH_RB PHICH_RB OCNG_RB	dB	-3	-3
$N_{oc}$ at antenna port	$N_{oc1}$	dBm/15kHz	-100.6 (Note 1)	N/A
	$N_{oc2}$	dBm/15kHz	-98 (Note 2)	N/A
	$N_{oc3}$	dBm/15kHz	-95.4 (Note 3)	N/A
$\hat{E}_s / N_{oc2}$		dB	Reference Value in Table 8.4.2.2.3_C.2.5-2	1.3
BW <sub>Channel</sub>		MHz	10	10
Subframe Configuration			Non-MBSFN	MBSFN
Time Offset between Cells		Ms	2.5 (synchronous cells)	
Cell Id			0	126
ABS pattern (Note 4)			N/A	0000000001 0000000001
RLM/RRM Measurement Subframe Pattern(Note 5)			0000000001 0000000001	N/A
CSI Subframe Sets(Note 6)	$C_{csi,0}$		0000000001 0000000001	N/A
	$C_{csi,1}$		1100111000 1100111000	N/A
MBSFN Subframe Allocation (Note 9)			N/A	000010
Number of control OFDM symbols			3	3
ACK/NACK feedback mode			Multiplexing	N/A
Number of PHICH groups ( $N_g$ )			1	N/A
PHICH duration			extended	N/A
Unused RE-s and PRB-s			OCNG	OCNG
Cyclic prefix			Normal	Normal
<p>Note 1: This noise is applied in OFDM symbols #1, #2, #3, #4, #5, #6, #7, #8, #9, #10, #11, #12, #13 of a subframe overlapping with the aggressor ABS.</p> <p>Note 2: This noise is applied in OFDM symbols #0 of a subframe overlapping with the aggressor ABS.</p> <p>Note 3: This noise is applied in OFDM symbols of a subframe overlapping with aggressor non-ABS</p> <p>Note 4: ABS pattern as defined in [14]. The 10<sup>th</sup> and 20<sup>th</sup> subframes indicated by ABS pattern are MBSFN ABS subframes. PDSCH other than SIB1/paging and its associated PDCCH/PCFICH are transmitted in the serving cell subframe when the subframe is overlapped with the MBSFN ABS subframe of aggressor cell and the subframe is available in the definition of the reference channel.</p> <p>Note 5: Time-domain measurement resource restriction pattern for PCell measurements as defined in [5].</p> <p>Note 6: As configured according to the time-domain measurement resource restriction pattern for CSI measurements defined in [5].</p> <p>Note 7: Cell 1 is the serving cell. Cell 2 is the aggressor cell. The number of the CRS ports in Cell1 and Cell2 is the same.</p> <p>Note 8: SIB-1 will not be transmitted in Cell2 in this test.</p> <p>Note 9: MBSFN Subframe Allocation as defined in [5], one frame with 6 bits is chosen for MBSFN subframe allocation.</p>				

Table 8.4.2.2.3\_C.2.5-2: Test Requirement PDCCH/PCFICH – MBSFN ABS

Test Number	Aggregation Level	Reference Channel	OCNG Pattern		Propagation Conditions(Note 1)		Correlation Matrix and Antenna Configuration	Reference Value	
			Cell 1	Cell 2	Cell 1	Cell 2		Pm-dsg (%)	SNR (dB) (Note 2)
1	8 CCE	R15-1 TDD	OP.1 TDD	OP.1 TDD	EVA5	EVA5	2x2 Low	1	-3.2

Note 1: The propagation conditions for Cell 1 and Cell2 are statistically independent.

Note 2: SNR corresponds to  $\hat{E}_s / N_{oc2}$  of cell 1.

## 8.4.2.2.3\_D

8.4.2.2.3\_E TDD PCFICH/PDCCH Transmit Diversity 2x2 for felCIC

8.4.2.2.3\_E.1 TDD PCFICH/PDCCH Transmit Diversity 2x2 for felCIC (non-MBSFN ABS)

8.4.2.2.3\_E.1.1 Test purpose

To verify the UE's performance of transmit diversity (SFBC) with 2 transmit antennas if the PCFICH/PDCCH transmission in the serving cell takes place in subframes that overlap with ABS of the aggressor cell.

8.4.2.2.3\_E.1.2 Test applicability

This test applies to all types of E-UTRA TDD UE and CRS interference handling and ss-CCH interference handling – UE Category 2-8 release 11 and forward. Applicability requires support of FGI bit 115.

8.4.2.2.3\_E.1.3 Minimum conformance requirements

The receiver characteristics of the PDCCH/PCFICH are determined by the probability of miss-detection of the Downlink Scheduling Grant (Pm-dsg). PDCCH and PCFICH are tested jointly, i.e. a miss detection of PCFICH implies a miss detection of PDCCH.

For the parameters for non-MBSFN ABS specified in Table 8.4.2.2.3\_E.1.3-1, the average probability of a missed downlink scheduling grant (Pm-dsg) shall be below the specified value in Table 8.4.2.2.3\_E.1.3-2.

In Tables 8.4.2.2.3\_E.1.3-1 and 8.4.2.2.3\_E.1.3-2, Cell 1 is the serving cell, and Cell 2 and Cell 3 are the aggressor cells. The downlink physical channel setup for Cell 1 is according to Annex C.3.2 and for Cell 2 and Cell 3 is according to Annex C.3.3, respectively. The CRS assistance information TS 36.331 [5] including Cell 2 and Cell 3 is provided.



Table 8.4.2.2.3\_E.1.3-1: Test Parameters for PDCCH/PCFICH – Non-MBSFN ABS

Parameter		Unit	Cell 1	Cell 2	Cell 3
Uplink downlink configuration			1	1	1
Special subframe configuration			4	4	4
Downlink power allocation	PDCCH_RA PHICH_RA OCNG_RA	dB	-3	-3	-3
	PCFICH_RB PDCCH_RB PHICH_RB OCNG_RB	dB	-3	-3	-3
$N_{oc}$ at antenna port	$N_{oc1}$	dBm/15kHz	-98(Note 1)	N/A	N/A
	$N_{oc2}$	dBm/15kHz	-98 (Note 2)	N/A	N/A
	$N_{oc3}$	dBm/15kHz	-93 (Note 3)	N/A	N/A
$\hat{E}_s/N_{oc2}$		dB	Reference Value in Table 8.4.2.2.3_E.1.3-2	5	3
BW <sub>Channel</sub>		MHz	10	10	10
Subframe Configuration			Non-MBSFN	Non-MBSFN	Non-MBSFN
Time Offset between Cells		μs	N/A	3	-1
Frequency shift between Cells		Hz	N/A	300	-100
Cell Id			0	126	1
ABS pattern (Note 4)			N/A	0000000001 0000000001	0000000001 0000000001
RLM/RRM Measurement Subframe Pattern (Note 5)			0000000001 0000000001	N/A	N/A
CSI Subframe Sets (Note 6)	C <sub>CSI,0</sub>		0000000001 0000000001	N/A	N/A
	C <sub>CSI,1</sub>		1100111000 1100111000	N/A	N/A
Number of control OFDM symbols			2	Note 7	Note 7
ACK/NACK feedback mode			Multiplexing	N/A	N/A
Number of PHICH groups ( $N_g$ )			1	N/A	N/A
PHICH duration			Normal	N/A	N/A
Unused RE-s and PRB-s			OCNG	OCNG	OCNG
Cyclic prefix			Normal	Normal	Normal
<p>Note 1: This noise is applied in OFDM symbols #1, #2, #3, #5, #6, #8, #9, #10, #12, #13 of a subframe overlapping with the aggressor ABS.</p> <p>Note 2: This noise is applied in OFDM symbols #0, #4, #7, #11 of a subframe overlapping with the aggressor ABS.</p> <p>Note 3: This noise is applied in all OFDM symbols of a subframe overlapping with aggressor non-ABS</p> <p>Note 4: ABS pattern as defined in [14]. PDCCH/PCFICH other than that associated with SIB1/Paging are transmitted in the serving cell subframe when the subframe is overlapped with the ABS subframe of aggressor cell.</p> <p>Note 5: Time-domain measurement resource restriction pattern for PCell measurements as defined in TS 36.331 [5].</p> <p>Note 6: As configured according to the time-domain measurement resource restriction pattern for CSI measurements defined in TS 36.331 [5].</p> <p>Note 7: The number of control OFDM symbols is not available for ABS and is 2 for the subframe indicated by "0" of ABS pattern.</p> <p>Note 8: The number of the CRS ports in Cell 1, Cell 2 and Cell 3 is the same.</p> <p>Note 9: SIB-1 will not be transmitted in Cell 2 and Cell 3 in the test.</p>					

Table 8.4.2.2.3\_E.1.3-2: Minimum performance PDCCH/PCFICH – Non-MBSFN ABS

Test Number	Aggregation Level	Reference Channel	OCNG Pattern			Propagation Conditions (Note 1)			Correlation Matrix and Antenna Configuration (Note 2)	Reference Value	
			Cell 1	Cell 2	Cell 3	Cell 1	Cell 2	Cell 3		Pm-dsg (%)	SNR (dB) (Note 3)
1	8 CCE	R.15-2 TDD	OP.1 TDD	OP.1 TDD	OP.1 TDD	EVA5	EVA5	EVA5	2x2 Low	1	-2.0
Note 1: The propagation conditions for Cell 1, Cell 2 and Cell 3 are statistically independent. Note 2: The correlation matrix and antenna configuration apply for Cell 1, Cell 2 and Cell 3. Note 3: SNR corresponds to $\hat{E}_s / N_{oc2}$ of Cell 1.											

The normative reference for this requirement is TS 36.101 [2] clause 8.4.2.2.4.

#### 8.4.2.2.3\_E.1.4 Test description

##### 8.4.2.2.3\_E.1.4.1 Initial conditions

Initial conditions are a set of test configurations the UE needs to be tested in and the steps for the SS to take with the UE to reach the correct measurement state.

Configurations of PDSCH and PDCCH before measurement are specified in Annex C.2.

Test Environment: Normal, as defined in TS 36.508 [7] clause 4.1.

Frequencies to be tested: Mid Range, as defined in TS 36.508 [7] clause 4.3.1.2.

Channel Bandwidths to be tested: 10MHz, as defined in TS 36.508 [7] clause 4.3.1.2.

1. Connect the SS, the faders and AWGN noise sources to the UE antenna connector (s) as shown in TS 36.508 [7] Annex A, Figure A.48 for antenna configuration 2x2.
2. The parameter settings for the cell1 are set up according to Tables 8.4.2.2.3\_E.1.3-1 and 8.4.2.2.3\_E.1.3-2.
3. The downlink signals are initially set up according to Annex C.0, C.1 and C.3.2 and uplink signals according to Annex H.1 and H.3.2.
4. Propagation conditions are set according to Annex B clauses B.0.
5. Ensure the UE is in State 3A-RF according to TS 36.508 [7] clause 5.2A.2 with exceptions listed in 5.2A.5. Message contents are defined in clause 8.4.2.2.3\_E.1.4.3.

##### 8.4.2.2.3\_E.1.4.2 Test procedure

1. Set the parameters for Cell 1, Cell 2 and Cell 3, according to Tables 8.4.2.2.3\_E.1.5-1, 8.4.2.2.3\_E.1.5-2, Annex C.3.2 for Cell 1, and Annex C.3.3 for Cell 2 and Cell 3. SS transmits PDSCH via PDCCH DCI format 1 for C\_RNTI to transmit the DL RMC. The details of PDCCH and PDSCH are specified in Table A.3.5.2-1 and Table A.3.5.2-2A respectively.
2. The SS sends downlink MAC padding bits on the DL RMC. Transmission scheme for the PDSCH shall be transmit diversity. Propagation conditions are set according to Annex B clause B.2.
3. Measure the Pm-dsg in the subframes overlapping with ABS of the aggressor cell for a duration sufficient to achieve statistical significance according to Annex G clause G.4. Count the number of NACKs, ACKs and statDTXs on the UL PUCCH during each subtest interval. Pm-dsg is the ratio (statDTX)/(NACK+ACK+statDTX).

If Pm-dsg is less than the value specified in table 8.4.2.2.3\_E.1.5-2, pass the UE. Otherwise fail the UE.

8.4.2.2.3\_E.1.4.3 Message contents

Message contents are according to TS 36.508 [7] clause 5.2A.5.1 with the following exceptions:

**Table 8.4.2.2.3\_E.1.4.3-1: RadioResourceConfigDedicated-SRB2-DRB(n, m)**

Derivation Path: TS 36.508 [7] clause 4.6.3, Table 4.6.3-16 RadioResourceConfigDedicated-SRB2-DRB(n,m)			
Information Element	Value/remark	Comment	Condition
RadioResourceConfigDedicated-SRB2-DRB(n, m) ::= SEQUENCE {			
MeasSubframePatternPCell-r10 CHOICE {			
setup SEQUENCE {			
subframePatternTDD-r10 CHOICE {			
subframeConfig1-5-r10	'0000000001 0000000001'	BIT STRING (SIZE (20))	
}			
}			
}			
neighCellsCRS-Info-r11 ::= CHOICE {			
setup SEQUENCE {			
CRS-AssistancedInfoList-r11 ::= SEQUENCE (SIZE (1..maxCellReport)) OF CRS-AssistancedInfo-r11{		2 entries	
CRS-AssistancedInfo-r11 ::= SEQUENCE {			
physCellId-r11	126		Cell 2
	1		Cell 3
antennaPortsCount-r11	an2		Cell 2, Cell 3
mbsfn-SubframeConfigList-r11 ::= SEQUENCE (SIZE (1..maxMBSFN-Allocations)) OF MBSFN-SubframeConfig{			Cell 2, Cell 3
MBSFN-SubframeConfig ::= SEQUENCE {			
radioframeAllocationPeriod	n1		
radioframeAllocationOffset	0		
subframeAllocation CHOICE{			
oneFrame	'000000' B	non-MBSFN	
}			
}			
}			
}			
}			
}			
}			

**Table 8.4.2.2.3\_E.1.4.3-2: PhysicalConfigDedicated-DEFAULT:**

Derivation Path: 36.508 clause 5.5.1.2			
Information Element	Value/remark	Comment	Condition
PhysicalConfigDedicated-DEFAULT ::= SEQUENCE {			
cqi-ReportConfig-r10	CQI-ReportConfig-r10-DEFAULT		
}			

**Table 8.4.2.2.3\_E.1.4.3-3: CQI-ReportConfig-r10-DEFAULT**

Derivation Path: 36.508 [7] clause 4.6.3, Table 4.6.3-2AA CQI-ReportConfig-r10-DEFAULT_			
Information Element	Value/remark	Comment	Condition
CQI-ReportConfig-r10-DEFAULT ::= SEQUENCE {			
csi-SubframePatternConfig-r10 CHOICE {			
setup SEQUENCE {			
csi-MeasSubframeSet1-r10 CHOICE {			
subframePatternTDD-r10 CHOICE {			
subframeConfig1-5-r10	'0000000001 0000000001'	BIT STRING (SIZE (20))	
}			
}			
csi-MeasSubframeSet2-r10 CHOICE {			
subframePatternTDD-r10 CHOICE {			
subframeConfig1-5-r10	'1100111000 1100111000'	BIT STRING (SIZE (20))	
}			
}			
}			
}			

**Table 8.4.2.2.3\_E.1.4.3-2-4: TDD-Config-DEFAULT**

Derivation Path: 36.508 clause 4.6.3			
Information Element	Value/remark	Comment	Condition
TDD-Config-DEFAULT ::= SEQUENCE {			
subframeAssignment	sa1		
specialSubframePatterns	ssp4		
}			

**Table 8.4.2.2.3\_E.1.4.3-2-5: PUCCH-ConfigDedicated-DEFAULT**

Derivation Path: 36.508 clause 4.6.3			
Information Element	Value/remark	Comment	Condition
PUCCH-ConfigDedicated-DEFAULT ::= SEQUENCE {			
ackNackRepetition CHOICE {			
release	NULL		
}			
tddAckNackFeedbackMode	Multiplexing		
}			

**8.4.2.2.3\_E.1.5 Test requirement**

For the parameters specified in Table 8.4.2.2.3\_E.1.5-1, the average probability of a missed downlink scheduling grant (P<sub>m-dsg</sub>) shall be below the specified value in Table 8.4.2.2.3\_E.1.5-2.

Table 8.4.2.2.3\_E.1.5-1: Test Parameters for PDCCH/PCFICH – Non-MBSFN ABS

Parameter		Unit	Cell 1	Cell 2	Cell 3
Uplink downlink configuration			1	1	1
Special subframe configuration			4	4	4
Downlink power allocation	PDCCH_RA PHICH_RA OCNG_RA	dB	-3	-3	-3
	PCFICH_RB PDCCH_RB PHICH_RB OCNG_RB	dB	-3	-3	-3
$N_{oc}$ at antenna port	$N_{oc1}$	dBm/15kHz	-98(Note 1)	N/A	N/A
	$N_{oc2}$	dBm/15kHz	-98 (Note 2)	N/A	N/A
	$N_{oc3}$	dBm/15kHz	-93.1 (Note 3)	N/A	N/A
$\hat{E}_s/N_{oc2}$		dB	Reference Value in Table 8.4.2.2.3_E.1.5-2	4.8	2.8
BW <sub>Channel</sub>		MHz	10	10	10
Subframe Configuration			Non-MBSFN	Non-MBSFN	Non-MBSFN
Time Offset between Cells		μs	N/A	3	-1
Frequency shift between Cells		Hz	N/A	300	-100
Cell Id			0	126	1
ABS pattern (Note 4)			N/A	000000001 000000001	000000001 000000001
RLM/RRM Measurement Subframe Pattern (Note 5)			000000001 000000001	N/A	N/A
CSI Subframe Sets (Note 6)	C <sub>CSI,0</sub>		000000001 000000001	N/A	N/A
	C <sub>CSI,1</sub>		1100111000 1100111000	N/A	N/A
Number of control OFDM symbols			2	Note 7	Note 7
ACK/NACK feedback mode			Multiplexing	N/A	N/A
Number of PHICH groups ( $N_g$ )			1	N/A	N/A
PHICH duration			Normal	N/A	N/A
Unused RE-s and PRB-s			OCNG	OCNG	OCNG
Cyclic prefix			Normal	Normal	Normal
<p>Note 1: This noise is applied in OFDM symbols #1, #2, #3, #5, #6, #8, #9, #10, #12, #13 of a subframe overlapping with the aggressor ABS.</p> <p>Note 2: This noise is applied in OFDM symbols #0, #4, #7, #11 of a subframe overlapping with the aggressor ABS.</p> <p>Note 3: This noise is applied in all OFDM symbols of a subframe overlapping with aggressor non-ABS</p> <p>Note 4: ABS pattern as defined in [14]. PDCCH/PCFICH other than that associated with SIB1/Paging are transmitted in the serving cell subframe when the subframe is overlapped with the ABS subframe of aggressor cell.</p> <p>Note 5: Time-domain measurement resource restriction pattern for PCell measurements as defined in TS 36.331 [5].</p> <p>Note 6: As configured according to the time-domain measurement resource restriction pattern for CSI measurements defined in TS 36.331 [5].</p> <p>Note 7: The number of control OFDM symbols is not available for ABS and is 2 for the subframe indicated by "0" of ABS pattern.</p> <p>Note 8: The number of the CRS ports in Cell 1, Cell 2 and Cell 3 is the same.</p> <p>Note 9: SIB-1 will not be transmitted in Cell 2 and Cell 3 in the test.</p>					

Table 8.4.2.2.3\_E.1.5-2: Test Requirement PDCCH/PCFICH – Non-MBSFN ABS

Test Number	Aggregation Level	Reference Channel	OCNG Pattern			Propagation Conditions (Note 1)			Correlation Matrix and Antenna Configuration (Note 2)	Reference Value	
			Cell 1	Cell 2	Cell 3	Cell 1	Cell 2	Cell 3		Pm-dsg (%)	SNR (dB) (Note 3)
1	8 CCE	R.15-2 TDD	OP.1 TDD	OP.1 TDD	OP.1 TDD	EVA5	EVA5	EVA5	2x2 Low	1	-1.1
Note 1: The propagation conditions for Cell 1, Cell 2 and Cell 3 are statistically independent. Note 2: The correlation matrix and antenna configuration apply for Cell 1, Cell 2 and Cell 3. Note 3: SNR corresponds to $\hat{E}_s / N_{oc2}$ of Cell 1.											

#### 8.4.2.2.3\_E.2 TDD PCFICH/PDCCH Transmit Diversity 2x2 for feICIC (MBSFN ABS)

##### 8.4.2.2.3\_E.2.1 Test purpose

To verify the UE's performance of transmit diversity (SFBC) with 2 transmit antennas if the PCFICH/PDCCH transmission in the serving cell takes place in subframes that overlap with ABS of the aggressor cell.

##### 8.4.2.2.3\_E.2.2 Test applicability

This test applies to all types of E-UTRA TDD UE and CRS interference handling and ss-CCH interference handling – UE Category 2-8 release 11 and forward. Applicability requires support of FGI bit 115.

##### 8.4.2.2.3\_E.2.3 Minimum conformance requirements

The receiver characteristics of the PDCCH/PCFICH are determined by the probability of miss-detection of the Downlink Scheduling Grant (Pm-dsg). PDCCH and PCFICH are tested jointly, i.e. a miss detection of PCFICH implies a miss detection of PDCCH.

For the parameters for non-MBSFN ABS specified in Table 8.4.2.2.3\_E.2.3-1, the average probability of a missed downlink scheduling grant (Pm-dsg) shall be below the specified value in Table 8.4.2.2.3\_E.2.3-2.

In Tables 8.4.2.2.3\_E.2.3-1 and 8.4.2.2.3\_E.2.3-2, Cell 1 is the serving cell, and Cell 2 and Cell 3 are the aggressor cells. The downlink physical channel setup for Cell 1 is according to Annex C.3.2 and for Cell 2 and Cell 3 is according to Annex C.3.3, respectively. The CRS assistance information TS 36.331 [5] including Cell 2 and Cell 3 is provided.

Table 8.4.2.2.3\_E.2.3-1: Test Parameters for PDCCH/PCFICH – MBSFN ABS

Parameter		Unit	Cell 1	Cell 2	Cell 3
Uplink downlink configuration			1	1	1
Special subframe configuration			4	4	4
Downlink power allocation	PDCCH_RA PHICH_RA OCNG_RA	dB	-3	-3	-3
	PCFICH_RB PDCCH_RB PHICH_RB OCNG_RB	dB	-3	-3	-3
$N_{oc}$ at antenna port	$N_{oc1}$	dBm/15kHz	-98(Note 1)	N/A	N/A
	$N_{oc2}$	dBm/15kHz	-98 (Note 2)	N/A	N/A
	$N_{oc3}$	dBm/15kHz	-93 (Note 3)	N/A	N/A
$\hat{E}_s/N_{oc2}$		dB	Reference Value in Table 8.4.2.2.3_E.2.3 -2	5	3
BW <sub>Channel</sub>		MHz	10	10	10
Subframe Configuration			Non-MBSFN	MBSFN	MBSFN
Time Offset between Cells		μs	N/A	3	-1
Frequency shift between Cells		Hz	N/A	300	-100
Cell Id			0	126	1
ABS pattern (Note 4)			N/A	000000001 000000001	000000001 000000001
RLM/RRM Measurement Subframe Pattern (Note 5)			000000001 000000001	N/A	N/A
CSI Subframe Sets (Note 6)	C <sub>CSI,0</sub>		000000001 000000001	N/A	N/A
	C <sub>CSI,1</sub>		1100111000 1100111000	N/A	N/A
MBSFN Subframe Allocation (Note 7)			N/A	000010	000010
Number of control OFDM symbols			2	Note 8	Note 8
ACK/NACK feedback mode			Multiplexing	N/A	N/A
Number of PHICH groups ( $N_g$ )			1	N/A	N/A
PHICH duration			Normal	N/A	N/A
Unused RE-s and PRB-s			OCNG	OCNG	OCNG
Cyclic prefix			Normal	Normal	Normal
<p>Note 1: This noise is applied in OFDM symbols #1, #2, #3, #4, #5, #6, #7, #8, #9, #10, #11, #12, #13 of a subframe overlapping with the aggressor ABS.</p> <p>Note 2: This noise is applied in OFDM symbols #0 of a subframe overlapping with the aggressor ABS.</p> <p>Note 3: This noise is applied in OFDM symbols of a subframe overlapping with aggressor non-ABS</p> <p>Note 4: ABS pattern as defined in [14]. The 10<sup>th</sup> and 20<sup>th</sup> subframes indicated by ABS pattern are MBSFN ABS subframes. PDSCH other than SIB1/paging and its associated PDCCH/PCFICH are transmitted in the serving cell subframe when the subframe is overlapped with the MBSFN ABS subframe of aggressor cell and the subframe is available in the definition of the reference channel.</p> <p>Note 5: Time-domain measurement resource restriction pattern for PCell measurements as defined in TS 36.331 [5].</p> <p>Note 6: As configured according to the time-domain measurement resource restriction pattern for CSI measurements defined in TS 36.331 [5].</p> <p>Note 7: MBSFN Subframe Allocation as defined in [7], one frame with 6 bits is chosen for MBSFN subframe allocation.</p> <p>Note 8: The number of control OFDM symbols is not available for ABS and is 2 for the subframe indicated by "0" of ABS pattern.</p> <p>Note 9: Cell 1 is the serving cell. Cell 2 is the aggressor cell. The number of the CRS ports in Cell 1 and Cell 2 is the same.</p> <p>Note 10: SIB-1 will not be transmitted in Cell 2 in this test.</p>					

Table 8.4.2.2.3\_E.2.3-2: Minimum performance PDCCH/PCFICH – MBSFN ABS

Test Number	Aggregation Level	Reference Channel	OCNG Pattern			Propagation Conditions (Note 1)			Correlation Matrix and Antenna Configuration (Note 2)	Reference Value	
			Cell 1	Cell 2	Cell 3	Cell 1	Cell 2	Cell 3		Pm-dsg (%)	SNR (dB) (Note 3)
1	8 CCE	R.15-2 TDD	OP.1 TDD	OP.1 TDD	OP.1 TDD	EVA5	EVA5	EVA5	2x2 Low	1	-1.8
Note 1: The propagation conditions for Cell 1, Cell 2 and Cell 3 are statistically independent. Note 2: The correlation matrix and antenna configuration apply for Cell 1, Cell 2 and Cell 3. Note 3: SNR corresponds to $\hat{E}_s / N_{oc2}$ of Cell 1.											

The normative reference for this requirement is TS 36.101 [2] clause 8.4.2.2.4.

#### 8.4.2.2.3\_E.2.4 Test description

##### 8.4.2.2.3\_E.2.4.1 Initial conditions

Initial conditions are a set of test configurations the UE needs to be tested in and the steps for the SS to take with the UE to reach the correct measurement state.

Configurations of PDSCH and PDCCH before measurement are specified in Annex C.2.

Test Environment: Normal, as defined in TS 36.508 [7] clause 4.1.

Frequencies to be tested: Mid Range, as defined in TS 36.508 [7] clause 4.3.1.2.

Channel Bandwidths to be tested: 10MHz, as defined in TS 36.508 [7] clause 4.3.1.2

1. Connect the SS, the faders and AWGN noise sources to the UE antenna connector (s) as shown in TS 36.508 [7] Annex A, Figure A.48 for antenna configuration 2x2.
2. The parameter settings for the cell1 are set up according to Tables 8.4.2.2.3\_E.2.3-1 and 8.4.2.2.3\_E.2.3-2.
3. The downlink signals are initially set up according to Annex C0, C.1 and C.3.2 and uplink signals according to Annex H.1 and H.3.2.
4. Propagation conditions are set according to Annex B clauses B.0.
5. Ensure the UE is in State 3A-RF according to TS 36.508 [7] clause 5.2A.2 with exceptions listed in 5.2A.5. Message contents are defined in clause 8.4.2.2.3\_E.2.4.3.

##### 8.4.2.2.3\_E.2.4.2 Test procedure

1. Set the parameters for Cell1, Cell2 and Cell3, according to Tables 8.4.2.2.3\_E.2.5-1, 8.4.2.2.3\_E.2.5-2, Annex C.3.2 for Cell 1, and Annex C.3.3 for Cell 2 and Cell 3. SS transmits PDSCH via PDCCH DCI format 1 for C\_RNTI to transmit the DL RMC. The details of PDCCH and PDSCH are specified in Table A.3.5.2-1 and Table A.3.5.2-2A respectively.
2. The SS sends downlink MAC padding bits on the DL RMC. Transmission scheme for the PDSCH shall be transmit diversity. Propagation conditions are set according to Annex B clause B.2.
3. Measure the Pm-dsg in the subframes overlapping with ABS of the aggressor cell for a duration sufficient to achieve statistical significance according to Annex G clause G.4. Count the number of NACKs, ACKs and statDTXs on the UL PUCCH during each subtest interval. Pm-dsg is the ratio (statDTX)/(NACK+ACK+statDTX).

If Pm-dsg is less than the value specified in table 8.4.2.2.3\_E.2.5-2, pass the UE. Otherwise fail the UE.



8.4.2.2.3\_E.2.4.3 Message contents

Message contents are according to TS 36.508 [7] clause 5.2A.5.1 with the following exceptions:

**Table 8.4.2.2.3\_E.2.4.3-1: RadioResourceConfigDedicated-SRB2-DRB(n, m)**

Derivation Path: TS 36.508 [7] clause 4.6.3, Table 4.6.3-16 RadioResourceConfigDedicated-SRB2-DRB(n,m)			
Information Element	Value/remark	Comment	Condition
RadioResourceConfigDedicated-SRB2-DRB(n, m) ::= SEQUENCE {			
MeasSubframePatternPCell-r10 CHOICE {			
setup SEQUENCE {			
subframePatternTDD-r10 CHOICE {			
subframeConfig1-5-r10	'0000000001000000001'	BIT STRING (SIZE (20))	
}			
}			
}			
neighCellsCRS-Info-r11 ::= CHOICE {			
setup SEQUENCE {			
CRS-AssistancedInfoList-r11 ::= SEQUENCE (SIZE (1..maxCellReport)) OF CRS-AssistancedInfo-r11{		2 entries	
CRS-AssistancedInfo-r11 ::= SEQUENCE {			
physCellId-r11	126		Cell 2
	1		Cell 3
antennaPortsCount-r11	an2		Cell 2, Cell 3
mbsfn-SubframeConfigList-r11 ::= SEQUENCE (SIZE (1..maxMBSFN-Allocations)) OF MBSFN-SubframeConfig{			Cell 2, Cell 3
MBSFN-SubframeConfig ::= SEQUENCE {			
radioframeAllocationPeriod	n1		
radioframeAllocationOffset	0		
subframeAllocation CHOICE{			
oneFrame	'000010' B		
}			
}			
}			
}			
}			
}			
}			

**Table 8.4.2.2.3\_E.1.4.3-2: PhysicalConfigDedicated-DEFAULT:**

Derivation Path: 36.508 clause 5.5.1.2			
Information Element	Value/remark	Comment	Condition
PhysicalConfigDedicated-DEFAULT ::= SEQUENCE {			
cqi-ReportConfig-r10	CQI-ReportConfig-r10-DEFAULT		
}			

**Table 8.4.2.2.3\_E.2.4.3-3: CQI-ReportConfig-r10-DEFAULT**

Derivation Path: 36.508 [7] clause 4.6.3, Table 4.6.3-2AA CQI-ReportConfig-r10-DEFAULT_			
Information Element	Value/remark	Comment	Condition
CQI-ReportConfig-r10-DEFAULT ::= SEQUENCE {			
csi-SubframePatternConfig-r10 CHOICE {			
setup SEQUENCE {			
csi-MeasSubframeSet1-r10 CHOICE {			
subframePatternTDD-r10 CHOICE {			
subframeConfig1-5-r10	'00000000010000000001'	BIT STRING (SIZE (20))	
}			
}			
csi-MeasSubframeSet2-r10 CHOICE {			
subframePatternTDD-r10 CHOICE {			
subframeConfig1-5-r10	'11001110001100111000'	BIT STRING (SIZE (20))	
}			
}			
}			
}			

**Table 8.4.2.2.3\_E.2.4.3-4: TDD-Config-DEFAULT**

Derivation Path: 36.508 clause 4.6.3			
Information Element	Value/remark	Comment	Condition
TDD-Config-DEFAULT ::= SEQUENCE {			
subframeAssignment	sa1		
specialSubframePatterns	ssp4		
}			

**Table 8.4.2.2.3\_E.2.4.3-5: PUCCH-ConfigDedicated-DEFAULT**

Derivation Path: 36.508 clause 4.6.3			
Information Element	Value/remark	Comment	Condition
PUCCH-ConfigDedicated-DEFAULT ::= SEQUENCE {			
ackNackRepetition CHOICE {			
release	NULL		
}			
tdtAckNackFeedbackMode	Multiplexing		
}			

**Table 8.4.2.2.3\_E.2.4.3-6: SystemInformationBlockType3**

Derivation Path: 36.508 [7] clause 4.6.2, Table 4.4.3.3-2 SystemInformationBlockType3			
Information Element	Value/remark	Comment	Condition
neighCellConfig	'00'B (Not all neighbour cells have the same MBSFN subframe allocation as the serving cell)		Cell 1

#### 8.4.2.2.3\_E.2.5 Test requirement

For the parameters specified in Table 8.4.2.2.3\_E.2.5-1, the average probability of a missed downlink scheduling grant (Pm-dsg) shall be below the specified value in Table 8.4.2.2.3\_E.2.5-2.

Table 8.4.2.2.3\_E.2.5-1: Test Parameters for PDCCH/PCFICH – MBSFN ABS

Parameter		Unit	Cell 1	Cell 2	Cell 3
Uplink downlink configuration			1	1	1
Special subframe configuration			4	4	4
Downlink power allocation	PDCCH_RA PHICH_RA OCNG_RA	dB	-3	-3	-3
	PCFICH_RB PDCCH_RB PHICH_RB OCNG_RB	dB	-3	-3	-3
$N_{oc}$ at antenna port	$N_{oc1}$	dBm/15kHz	-98(Note 1)	N/A	N/A
	$N_{oc2}$	dBm/15kHz	-98 (Note 2)	N/A	N/A
	$N_{oc3}$	dBm/15kHz	-93.1 (Note 3)	N/A	N/A
$\hat{E}_s/N_{oc2}$		dB	Reference Value in Table 8.4.2.2.3_E.2.5-2	4.8	2.8
BW <sub>Channel</sub>		MHz	10	10	10
Subframe Configuration			Non-MBSFN	MBSFN	MBSFN
Time Offset between Cells		μs	N/A	3	-1
Frequency shift between Cells		Hz	N/A	300	-100
Cell Id			0	126	1
ABS pattern (Note 4)			N/A	000000001 000000001	000000001 000000001
RLM/RRM Measurement Subframe Pattern (Note 5)			000000001 000000001	N/A	N/A
CSI Subframe Sets (Note 6)	C <sub>CSI,0</sub>		000000001 000000001	N/A	N/A
	C <sub>CSI,1</sub>		1100111000 1100111000	N/A	N/A
MBSFN Subframe Allocation (Note 7)			N/A	000010	000010
Number of control OFDM symbols			2	Note 8	Note 8
ACK/NACK feedback mode			Multiplexing	N/A	N/A
Number of PHICH groups ( $N_g$ )			1	N/A	N/A
PHICH duration			Normal	N/A	N/A
Unused RE-s and PRB-s			OCNG	OCNG	OCNG
Cyclic prefix			Normal	Normal	Normal
<p>Note 1: This noise is applied in OFDM symbols #1, #2, #3, #4, #5, #6, #7, #8, #9, #10, #11, #12, #13 of a subframe overlapping with the aggressor ABS.</p> <p>Note 2: This noise is applied in OFDM symbols #0 of a subframe overlapping with the aggressor ABS.</p> <p>Note 3: This noise is applied in OFDM symbols of a subframe overlapping with aggressor non-ABS</p> <p>Note 4: ABS pattern as defined in [14]. The 10<sup>th</sup> and 20<sup>th</sup> subframes indicated by ABS pattern are MBSFN ABS subframes. PDSCH other than SIB1/paging and its associated PDCCH/PCFICH are transmitted in the serving cell subframe when the subframe is overlapped with the MBSFN ABS subframe of aggressor cell and the subframe is available in the definition of the reference channel.</p> <p>Note 5: Time-domain measurement resource restriction pattern for PCell measurements as defined in TS 36.331 [5].</p> <p>Note 6: As configured according to the time-domain measurement resource restriction pattern for CSI measurements defined in TS 36.331 [5].</p> <p>Note 7: MBSFN Subframe Allocation as defined in [7], one frame with 6 bits is chosen for MBSFN subframe allocation.</p> <p>Note 8: The number of control OFDM symbols is not available for ABS and is 2 for the subframe indicated by "0" of ABS pattern.</p> <p>Note 9: Cell 1 is the serving cell. Cell 2 is the aggressor cell. The number of the CRS ports in Cell 1 and Cell 2 is the same.</p> <p>Note 10: SIB-1 will not be transmitted in Cell 2 in this test.</p>					

Table 8.4.2.2.3\_E.2.5-2: Test Requirement PDCCH/PCFICH – MBSFN ABS

Test Number	Aggregation Level	Reference Channel	OCNG Pattern			Propagation Conditions (Note 1)			Correlation Matrix and Antenna Configuration (Note 2)	Reference Value	
			Cell 1	Cell 2	Cell 3	Cell 1	Cell 2	Cell3		Pm-dsg (%)	SNR (dB) (Note 3)
1	8 CCE	R.15-2 TDD	OP.1 TDD	OP.1 TDD	OP.1 TDD	EVA5	EVA5	EVA5	2x2 Low	1	-0.9
Note 1: The propagation conditions for Cell 1, Cell 2 and Cell 3 are statistically independent. Note 2: The correlation matrix and antenna configuration apply for Cell 1, Cell 2 and Cell 3. Note 3: SNR corresponds to $\hat{E}_s / N_{oc2}$ of Cell 1.											

## 8.5 Demodulation of PHICH

### 8.5.1 FDD

#### 8.5.1.1 FDD PHICH Single-antenna Port Performance

##### 8.5.1.1.1 Test purpose

This test verifies the demodulation performance of PHICH for a single antenna port with a given SNR for which the average probability of miss detection of Hybrid Indicator ("ACK to NACK") of the specified reference measurement channels remains below a specified value.

##### 8.5.1.1.2 Test applicability

This test applies to all types of E-UTRA FDD UE release 8 and forward.

##### 8.5.1.1.3 Minimum conformance requirements

The receiver characteristics of the PHICH are determined by the probability of miss-detecting an ACK for a NACK (Pm-an). It is assumed that there is no bias applied to the detection of ACK and NACK (zero-threshold detection).

**Table 8.5.1.1.3-1: Test Parameters for PHICH**

Parameter		Unit	Single antenna port
Downlink power allocation	PDCCH_RA PHICH_RA OCNG_RA	dB	0
	PCFICH_RB PDCCH_RB PHICH_RB OCNG_RB	dB	0
PHICH duration			Normal
Number of PHICH groups (Note 1)			Ng = 1
PDCCH Content		UL Grant should be included with the proper information aligned with A.3.6.	
Unused RE-s and PRB-s			OCNG
Cell ID			0
$N_{oc}$ at antenna port		dBm/15kHz	-98
Cyclic prefix			Normal
Note 1: according to Clause 6.9 in TS 36.211 [8]			
Note 2: PHICH power settings refer to PHICH group power, i.e. the total power of all active PHICH sequences within a PHICH group.			

For the parameters specified in Table 8.5.1.1.3-1 the average probability of a miss-detecting an ACK for a NACK ( $P_{m-an}$ ) shall be below the specified value in Table 8.5.1.1.3-2.

**Table 8.5.1.1.3-2: Minimum performance PHICH**

Test number	Bandwidth	Reference Channel	OCNG Pattern	Propagation Condition	Antenna configuration and correlation Matrix	Reference value	
						$P_{m-an}$ (%)	SNR (dB)
1	10 MHz	R.18	OP.1 FDD	ETU70	1 x 2 Low	0.1	5.5
2	10 MHz	R.24	OP.1 FDD	ETU70	1 x 2 Low	0.1	0.6

The normative reference for this requirement is TS 36.101 [2] clause 8.5.

#### 8.5.1.1.4 Test description

##### 8.5.1.1.4.1 Initial conditions

Initial conditions are a set of test configurations the UE needs to be tested in and the steps for the SS to take with the UE to reach the correct measurement state.

Configurations of PDSCH and PDCCH before measurement are specified in Annex C.2.

Test Environment: Normal as defined in TS 36.508 [7] clause 4.1.

Frequencies to be tested: Mid Range as defined in TS 36.508 [7] clause 4.3.1.1.

Channel Bandwidths to be tested: 10 MHz, as defined in TS 36.508 [7] clause 4.3.1.1

1. Connect the SS, the faders and AWGN noise sources to the UE antenna connector (s) as shown in TS 36.508 [7] Annex A, Figure A.9.
2. The parameter settings for the cell are set up according to Table 8.5.1.1.3-1.
3. Downlink signals are initially set up according to Annex C0, C.1 and Annex C.3.2 and uplink signals according to Annex H.1 and H.3.2.

4. Propagation conditions are set according to Annex B.0.
5. Ensure the UE is in State 3A-RF according to TS 36.508 [7] clause 5.2A.2. Message contents are defined in clause 8.5.1.1.4.3.

8.5.1.1.4.2 Test procedure

1. Set the parameters of bandwidth, reference Channel, the propagation condition, antenna configuration, the correlation matrix and the SNR according to Table 8.5.1.1.5-1 Test 1 as appropriate.
2. SS shall schedule PUSCH transmissions according to Annex A.2.2.1.1 Table A.2.2.1.1-1 to happen during 8 consecutive uplink TTIs via PDCCH DCI format 0 with new data indicator set to true. Since the UE has no payload, the UE shall send uplink MAC padding bits in PUSCH. SS upon receiving the PUSCH transmissions will transmit the associated ACKs. PHICH is set according to Annex 3.6 Table A.3.6-1. SS will only transmit PDCCH to schedule PUSCH transmission in the appropriate sub-frames. Table 8.5.1.1.4.2-1 indicates the transmissions for one cycle.

**Table 8.5.1.1.4.2-1: PHICH test pattern**

TTI	1-4	5-8	9-12	13-16	17-20	21-24
PDCCH	S	S	-	-	S	S
PHICH	-	-	A	A	-	-
PUSCH		T	T	R	R	T
UL HARQ Process	1-4	5-8	1-4	5-8	1-4	5-8
Note 1: This table gives an example test pattern for HARQ process for FDD PHICH test Note 2: Following notation is used: S: represents sending PDCCH DCI format 0 to schedule a future PUSCH transmission A: represents the ACK transmission on PHICH T: represents a scheduled PUSCH transmission R: represents a potential PUSCH re-transmission due to a missed ACK						

3. SS will only monitor for uplink retransmissions due to ACK missed-detections. Such re-transmissions (if they occur) will potentially happen in TTI 13 to 20. DTxs on TTI 13 to 20 are counted as successful ACK receptions while any transmission on these TTIs is counted as NACKs.
4. Repeat steps 1 – 3 for a duration sufficient to achieve statistical significance according to Annex G clause G.4 and measure Pm-an. Pm-an is (NACK) / (ACK + NACK).  
If Pm-an is less than the value specified in table 8.5.1.1.5-1, pass the UE. Otherwise fail the UE.
5. Repeat the same procedure (steps 1 to 3 ) with test conditions according to the Table 8.5.1.1.5-1 for Test 2.

8.5.1.1.4.3 Message contents

Message contents are according to TS 36.508 [7] clause 4.6, with the following exceptions

**Table 8.5.1.1.4.3-1: MAC-MainConfig-RBC**

Derivation Path: TS 36.508 [7] clause 4.8.2.1.5, Table 4.8.2.1.5-1			
Information Element	Value/remark	Comment	Condition
MAC-MainConfig-RBC ::= SEQUENCE {			
dl-SCH-Config SEQUENCE {	Not present		
ul-SCH-Config SEQUENCE {			
maxHARQ-Tx	n2	Only one retransmission per UL HARQ	

8.5.1.1.5 Test requirement

For the parameters specified in Table 8.5.1.1.3-1 the average probability of a miss-detecting ACK for NACK (Pm-dsg) shall be below the specified value in Table 8.5.1.1.5-1.

**Table 8.5.1.1.5-1: Test requirement PHICH**

Test number	Bandwidth	Reference Channel	OCNG Pattern	Propagation Condition	Antenna configuration and correlation Matrix	Reference value	
						Pm-an (%)	SNR (dB)
1	10 MHz	R.18	OP.1 FDD	ETU70	1 x 2 Low	0.1	6.4
2	10 MHz	R.24	OP.1 FDD	ETU70	1 x 2 Low	0.1	1.5

## 8.5.1.2 FDD PHICH Transmit Diversity Performance

### 8.5.1.2.1 FDD PHICH Transmit Diversity 2x2

#### 8.5.1.2.1.1 Test purpose

This test verifies the demodulation performance of PHICH for transmit diversity with a given SNR for which the average probability of miss detection of Hybrid Indicator ("ACK to NACK") of the specified reference measurement channels remains below a specified value.

#### 8.5.1.2.1.2 Test applicability

This test applies to all types of E-UTRA FDD UE release 8.

#### 8.5.1.2.1.3 Minimum conformance requirements

The receiver characteristics of the PHICH are determined by the probability of miss-detecting an ACK for a NACK (Pm-an). It is assumed that there is no bias applied to the detection of ACK and NACK (zero-threshold detection).

**Table 8.5.1.2.1.3-1: Test Parameters for PHICH**

Parameter		Unit	Transmit diversity
Downlink power allocation	PDCCH_RA PHICH_RA OCNG_RA	dB	-3
	PCFICH_RB PDCCH_RB PHICH_RB OCNG_RB	dB	-3
PHICH duration			Normal
Number of PHICH groups (Note 1)			Ng = 1
PDCCH Content		UL Grant should be included with the proper information aligned with A.3.6.	
Unused RE-s and PRB-s			OCNG
Cell ID			0
$N_{oc}$ at antenna port		dBm/15kHz	-98
Cyclic prefix			Normal
Note 1: according to Clause 6.9 in TS 36.211 [8]			
Note 2: PHICH power settings refer to PHICH group power, i.e. the total power of all active PHICH sequences within a PHICH group.			

For the parameters specified in Table 8.5.1.2.1.3-1 the average probability of a miss-detecting an ACK for a NACK (Pm-an) shall be below the specified value in Table 8.5.1.2.1.3-2

**Table 8.5.1.2.1.3-2: Minimum performance PHICH 2 Tx Antenna Port**

Test number	Bandwidth	Reference Channel	OCNG Pattern	Propagation Condition	Antenna configuration and correlation Matrix	Reference value	
						Pm-an (%)	SNR (dB)
1	1.4 MHz	R.19	OP.1 FDD	EPA5	2 x 2 Low	0.1	5.6
1A	5MHz (Note 1)	R.19-1	OP.1 FDD	EVA 70	2x2 Low	0.1	4

Note 1: Test case applicability is defined in 8.1.2.1.

The normative reference for this requirement is TS 36.101 [2] clause 8.5.1.

#### 8.5.1.2.1.4 Test description

##### 8.5.1.2.1.4.1 Initial conditions

Test Environment: Normal as defined in TS 36.508 [7] clause 4.1.

Frequencies to be tested: Mid Range as defined in TS 36.508 [7] clause 4.3.1.1.

Channel Bandwidths to be tested: Depending on the bandwidth specified per test number in Table 8.5.1.2.1.3-2, as defined in TS 36.508 [7] clause 4.3.1.1

1. Connect the SS, the faders and AWGN noise sources to the UE antenna connector (s) as shown in TS 36.508 [7] Annex A, Figure A.10.
2. The parameter settings for the cell are set up according to Table 8.5.1.2.1.3-1.
3. Downlink signals are initially set up according to Annex C.1 and C.3.2 and uplink signals according to Annex H.1 and H.3.2.
4. Propagation conditions are set according to Annex B clauses B.0.
5. Ensure the UE is in State 3A-RF according to TS 36.508 [7] clause 5.2A.2. Message contents are defined in clause 8.5.1.2.1.4.3.

##### 8.5.1.2.1.4.2 Test procedure

1. Set the parameters of bandwidth, reference Channel, the propagation condition, antenna configuration, the correlation matrix and the SNR according to Table 8.5.1.2.1.5-1.
2. SS shall schedule PUSCH transmissions according to Annex A.2.2.1.1 Table A.2.2.1.1-1 to happen during 8 consecutive uplink TTIs via PDCCH DCI format 0 with new data indicator set to true. Since the UE has no payload, the UE shall send uplink MAC padding bits in PUSCH. SS upon receiving the PUSCH transmissions will transmit the associated ACKs. PHICH is set according to Annex 3.6 Table A.3.6-1. SS will only transmit PDCCH to schedule PUSCH transmission in the appropriate sub-frames. Table 8.5.1.2.1.4.2-1 indicates the transmissions for one cycle.



**Table 8.5.1.2.1.4.2-1: PHICH test pattern**

TTI	1-4	5-8	9-12	13-16	17-20	21-24
PDCCH	S	S	-	-	S	S
PHICH	-	-	A	A	-	-
PUSCH		T	T	R	R	T
UL HARQ Process	1-4	5-8	1-4	5-8	1-4	5-8
Note 1:	This table gives an example test pattern for HARQ process for FDD PHICH test					
Note 2:	Following notation is used: S: represents sending PDCCH DCI format 0 to schedule a future PUSCH transmission A: represents the ACK transmission on PHICH T: represents a scheduled PUSCH transmission R: represents a potential PUSCH re-transmission due to a missed ACK					

- SS will only monitor for uplink retransmissions due to ACK missed-detections. Such re-transmissions (if they occur) will potentially happen in TTI 13 to 20. DTXs on TTI 13 to 20 are counted as successful ACK receptions while any transmission on these TTIs is counted as NACKs.
- Repeat steps 1 – 3 for a duration sufficient to achieve statistical significance according to Annex G clause G.4 and measure P<sub>m-an</sub>. P<sub>m-an</sub> is (NACK) / (ACK + NACK).  
If P<sub>m-an</sub> is less than the value specified in table 8.5.1.2.1.5-1, pass the UE. Otherwise fail the UE.

#### 8.5.1.2.1.4.3 Message contents

Message contents are according to TS 36.508 [7] clause 4.6 with the following exceptions

**Table 8.5.1.2.1.4.3-1: MAC-MainConfig-RBC**

Derivation Path: TS 36.508 [7] clause 4.8.2.1.5, Table 4.8.2.1.5-1			
Information Element	Value/remark	Comment	Condition
MAC-MainConfig-RBC ::= SEQUENCE {			
dl-SCH-Config SEQUENCE {	Not present		
ul-SCH-Config SEQUENCE {			
maxHARQ-Tx	n2	Only one retransmission per UL HARQ	

#### 8.5.1.2.1.5 Test requirement

For the parameters specified in Table 8.5.1.2.1.3-1 the average probability of a miss-detecting ACK for NACK (P<sub>m-dsg</sub>) shall be below the specified value in Table 8.5.1.2.1.5-1.

**Table 8.5.1.2.1.5-1: Test requirement PHICH 2 Tx Antenna Port**

Test number	Bandwidth	Reference Channel	OCNG Pattern	Propagation Condition	Antenna configuration and correlation Matrix	Reference value	
						P <sub>m-an</sub> (%)	SNR (dB)
1	1.4 MHz	R.19	OP.1 FDD	EPA5	2 x 2 Low	0.1	6.7
1A	5MHz (Note 1)	R.19-1	OP.1 FDD	EVA 70	2x2 Low	0.1	5.1

Note 1: Test case is applicable (according to sub clause 8.1.2.1) to UE's which, from the E-UTRA operating bands defined in Table 5.2-1, support only E-UTRA band 31.

## 8.5.1.2.1\_1 FDD PHICH Transmit Diversity 2x2 (Release 9 and forward)

## 8.5.1.2.1\_1.1 Test purpose

This test verifies the demodulation performance of PHICH for transmit diversity with a given SNR for which the average probability of miss detection of Hybrid Indicator ("ACK to NACK") of the specified reference measurement channels remains below a specified value.

## 8.5.1.2.1\_1.2 Test applicability

This test applies to all types of E-UTRA FDD UE release 9 and forward.

## 8.5.1.2.1\_1.3 Minimum conformance requirements

The receiver characteristics of the PHICH are determined by the probability of miss-detecting an ACK for a NACK (Pm-an). It is assumed that there is no bias applied to the detection of ACK and NACK (zero-threshold detection).

**Table 8.5.1.2.1\_1.3-1: Test Parameters for PHICH**

Parameter		Unit	Transmit diversity
Downlink power allocation	PDCCH_RA PHICH_RA OCNG_RA	dB	-3
	PCFICH_RB PDCCH_RB PHICH_RB OCNG_RB	dB	-3
PHICH duration			Normal
Number of PHICH groups (Note 1)			Ng = 1
PDCCH Content		UL Grant should be included with the proper information aligned with A.3.6.	
Unused RE-s and PRB-s		OCNG	
Cell ID			0
$N_{oc}$ at antenna port		dBm/15kHz	-98
Cyclic prefix			Normal
Note 1: according to Clause 6.9 in TS 36.211 [8] Note 2: PHICH power settings refer to PHICH group power, i.e. the total power of all active PHICH sequences within a PHICH group.			

For the parameters specified in Table 8.5.1.2.1\_1.3-1 the average probability of a miss-detecting an ACK for a NACK (Pm-an) shall be below the specified value in Table 8.5.1.2.1\_1.3-2

**Table 8.5.1.2.1\_1.3-2: Minimum performance PHICH 2 Tx Antenna Port**

Test number	Bandwidth	Reference Channel	OCNG Pattern	Propagation Condition	Antenna configuration and correlation Matrix	Reference value	
						Pm-an (%)	SNR (dB)
1	10 MHz	R.19_1	OP.1 FDD	EVA70	2 x 2 Low	0.1	4.4
1A	5MHz (Note 1)	R.19-1	OP.1 FDD	EVA 70	2x2 Low	0.1	4
Note 1: Test case applicability is defined in 8.1.2.1.							

The normative reference for this requirement is TS 36.101 [2] clause 8.5.1.

## 8.5.1.2.1\_1.4 Test description

## 8.5.1.2.1\_1.4.1 Initial conditions

Test Environment: Normal as defined in TS 36.508 [7] clause 4.1.

Frequencies to be tested: Mid Range as defined in TS 36.508 [7] clause 4.3.1.1.

Channel Bandwidths to be tested: As specified per test number in Table 8.5.1.2.1\_1.3-2 as defined in TS 36.508 [7] clause 4.3.1.1

1. Connect the SS, the faders and AWGN noise sources to the UE antenna connector (s) as shown in TS 36.508 [7] Annex A, Figure A.10.
2. The parameter settings for the cell are set up according to Table 8.5.1.2.1\_1.3-1.
3. Downlink signals are initially set up according to Annex C.1 and C.3.2 and uplink signals according to Annex H.1 and H.3.2.
4. Propagation conditions are set according to Annex B clauses B.0.
5. Ensure the UE is in State 3A-RF according to TS 36.508 [7] clause 5.2A.2. Message contents are defined in clause 8.5.1.2.1\_1.4.3.

## 8.5.1.2.1\_1.4.2 Test procedure

1. Set the parameters of bandwidth, reference Channel, the propagation condition, antenna configuration, the correlation matrix and the SNR according to Table 8.5.1.2.1\_1.5-1.
2. SS shall schedule PUSCH transmissions according to Annex A.2.2.1.1 Table A.2.2.1.1-1 to happen during 8 consecutive uplink TTIs via PDCCH DCI format 0 with new data indicator set to true. Since the UE has no payload, the UE shall send uplink MAC padding bits in PUSCH. SS upon receiving the PUSCH transmissions will transmit the associated ACKs. PHICH is set according to Annex 3.6 Table A.3.6-1. SS will only transmit PDCCH to schedule PUSCH transmission in the appropriate sub-frames. Table 8.5.1.2.1\_1.4.2-1 indicates the transmissions for one cycle.

**Table 8.5.1.2.1\_1.4.2-1: PHICH test pattern**

TTI	1-4	5-8	9-12	13-16	17-20	21-24
PDCCH	S	S	-	-	S	S
PHICH	-	-	A	A	-	-
PUSCH		T	T	R	R	T
UL HARQ Process	1-4	5-8	1-4	5-8	1-4	5-8
Note 1:	This table gives an example test pattern for HARQ process for FDD PHICH test					
Note 2:	Following notation is used: S: represents sending PDCCH DCI format 0 to schedule a future PUSCH transmission A: represents the ACK transmission on PHICH T: represents a scheduled PUSCH transmission R: represents a potential PUSCH re-transmission due to a missed ACK					

3. SS will only monitor for uplink retransmissions due to ACK missed-detections. Such re-transmissions (if they occur) will potentially happen in TTI 13 to 20. DTXs on TTI 13 to 20 are counted as successful ACK receptions while any transmission on these TTIs is counted as NACKs.
4. Repeat steps 1 – 3 for a duration sufficient to achieve statistical significance according to Annex G clause G.4 and measure Pm-an. Pm-an is (NACK) / (ACK + NACK).  
If Pm-an is less than the value specified in table 8.5.1.2.1\_1.5-1, pass the UE. Otherwise fail the UE.

## 8.5.1.2.1\_1.4.3 Message contents

Message contents are according to TS 36.508 [7] clause 4.6 with the following exceptions

**Table 8.5.1.2.1\_1.4.3-1: MAC-MainConfig-RBC**

Derivation Path: TS 36.508 [7] clause 4.8.2.1.5, Table 4.8.2.1.5-1			
Information Element	Value/remark	Comment	Condition
MAC-MainConfig-RBC ::= SEQUENCE {			
dl-SCH-Config SEQUENCE {}	Not present		
ul-SCH-Config SEQUENCE {			
maxHARQ-Tx	n2	Only one retransmission per UL HARQ	

#### 8.5.1.2.1\_1.5 Test requirement

For the parameters specified in Table 8.5.1.2.1\_1.3-1 the average probability of a miss-detecting ACK for NACK (P<sub>m-dsg</sub>) shall be below the specified value in Table 8.5.1.2.1\_1.5-1.

**Table 8.5.1.2.1\_1.5-1: Test requirement PHICH 2 Tx Antenna Port**

Test number	Bandwidth	Reference Channel	OCNG Pattern	Propagation Condition	Antenna configuration and correlation Matrix	Reference value	
						P <sub>m-an</sub> (%)	SNR (dB)
1	10 MHz	R.19_1	OP.1 FDD	EVA70	2 x 2 Low	0.1	+5.5
1A	5MHz (Note 1)	R.19-1	OP.1 FDD	EVA 70	2x2 Low	0.1	+5.1

Note 1: Test case is applicable (according to sub clause 8.1.2.1) to UE's which, from the E-UTRA operating bands defined in Table 5.2-1, support only E-UTRA band 31.

#### 8.5.1.2.2 FDD PHICH Transmit Diversity 4x2

##### 8.5.1.2.2.1 Test purpose

This test verifies the demodulation performance of PHICH for transmit diversity with a given SNR for which the average probability of miss detection of Hybrid Indicator ("ACK to NACK") of the specified reference measurement channels remains below a specified value.

##### 8.5.1.2.2.2 Test applicability

This test applies to all types of E-UTRA FDD UE release 8.

##### 8.5.1.2.2.3 Minimum conformance requirements

The receiver characteristics of the PHICH are determined by the probability of miss-detecting an ACK for a NACK (P<sub>m-an</sub>). It is assumed that there is no bias applied to the detection of ACK and NACK (zero-threshold detection).

**Table 8.5.1.2.2.3-1: Test Parameters for PHICH**

Parameter		Unit	Transmit diversity
Downlink power allocation	PDCCH_RA PHICH_RA OCNG_RA	dB	-3
	PCFICH_RB PDCCH_RB PHICH_RB OCNG_RB	dB	-3
PHICH duration			Normal
Number of PHICH groups (Note 1)			Ng = 1
PDCCH Content		UL Grant should be included with the proper information aligned with A.3.6.	
Unused RE-s and PRB-s			OCNG
Cell ID			0
$N_{oc}$ at antenna port		dBm/15kHz	-98
Cyclic prefix			Normal
Note 1: according to Clause 6.9 in TS 36.211 [8]			
Note 2: PHICH power settings refer to PHICH group power, i.e. the total power of all active PHICH sequences within a PHICH group.			

For the parameters specified in Table 8.5.1.2.2.3-1 the average probability of a miss-detecting an ACK for a NACK ( $P_{m-an}$ ) shall be below the specified value in Table 8.5.1.2.2.3-2.

**Table 8.5.1.2.2.3-2: Minimum performance PHICH 4 Tx Antenna Port**

Test number	Bandwidth	Reference Channel	OCNG Pattern	Propagation Condition	Antenna configuration and correlation Matrix	Reference value	
						$P_{m-an}$ (%)	SNR (dB)
1	10 MHz	R.20	OP.1 FDD	EVA5	4 x 2 Medium	0.1	6.0

The normative reference for this requirement is TS 36.101 [2] clause 8.5.1.

#### 8.5.1.2.2.4 Test description

##### 8.5.1.2.2.4.1 Initial conditions

Test Environment: Normal as defined in TS 36.508 [7] clause 4.1.

Frequencies to be tested: Mid Range as defined in TS 36.508 [7] clause 4.3.1.1.

Channel Bandwidths to be tested: 10 MHz, as defined in TS 36.508 [7] clause 4.3.1.1

1. Connect the SS, the faders and AWGN noise sources to the UE antenna connector (s) as shown in TS 36.508 [7] Annex A, Figure A.11.
2. The parameter settings for the cell are set up according to Table 8.5.1.2.2.3-1.
3. Downlink signals are initially set up according to Annex C.1 and C.3.2 and uplink signals according to Annex H.1 and H.3.2.
4. Propagation conditions are set according to Annex B clauses B.0.
5. Ensure the UE is in State 3A-RF according to TS 36.508 [7] clause 5.2A.2. Message contents are defined in clause 8.5.1.2.2.4.3.

8.5.1.2.2.4.2 Test procedure

1. Set the parameters of bandwidth, reference Channel, the propagation condition, antenna configuration, the correlation matrix and the SNR according to Table 8.5.1.2.2.5-1.
2. SS shall schedule PUSCH transmissions according to Annex A.2.2.1.1 Table A.2.2.1.1-1 to happen during 8 consecutive uplink TTIs via PDCCH DCI format 0 with new data indicator set to true. Since the UE has no payload, the UE shall send uplink MAC padding bits in PUSCH. SS upon receiving the PUSCH transmissions will transmit the associated ACKs. PHICH is set according to Annex 3.6 Table A.3.6-1. SS will only transmit PDCCH to schedule PUSCH transmission in the appropriate sub-frames. Table 8.5.1.2.2.4.2-1 indicates the transmissions for one cycle.

**Table 8.5.1.2.2.4.2-1: PHICH test pattern**

TTI	1-4	5-8	9-12	13-16	17-20	21-24
PDCCH	S	S	-	-	S	S
PHICH	-	-	A	A	-	-
PUSCH		T	T	R	R	T
UL HARQ Process	1-4	5-8	1-4	5-8	1-4	5-8
Note 1:	This table gives an example test pattern for HARQ process for FDD PHICH test					
Note 2:	Following notation is used: S: represents sending PDCCH DCI format 0 to schedule a future PUSCH transmission A: represents the ACK transmission on PHICH T: represents a scheduled PUSCH transmission R: represents a potential PUSCH re-transmission due to a missed ACK					

3. SS will only monitor for uplink retransmissions due to ACK missed-detections. Such re-transmissions (if they occur) will potentially happen in TTI 13 to 20. DTxs on TTI 13 to 20 are counted as successful ACK receptions while any transmission on these TTIs is counted as NACKs.
4. Repeat steps 1 – 3 for a duration sufficient to achieve statistical significance according to Annex G clause G.4 and measure Pm-an. Pm-an is (NACK) / (ACK + NACK). If Pm-an is less than the value specified in table 8.5.1.2.2.5-1, pass the UE. Otherwise fail the UE.

8.5.1.2.2.4.3 Message contents

Message contents are according to TS 36.508 [7] clause 4.6 with the following exceptions

**Table 8.5.1.2.2.4.3-1: MAC-MainConfig-RBC**

Derivation Path: TS 36.508 [7] clause 4.8.2.1.5, Table 4.8.2.1.5-1			
Information Element	Value/remark	Comment	Condition
MAC-MainConfig-RBC ::= SEQUENCE {			
dl-SCH-Config SEQUENCE {	Not present		
ul-SCH-Config SEQUENCE {			
maxHARQ-Tx	n2	Only one retransmission per UL HARQ	

8.5.1.2.2.5 Test requirement

For the parameters specified in Table 8.5.1.2.2.3-1 the average probability of a miss-detecting ACK for NACK (Pm-dsg) shall be below the specified value in Table 8.5.1.2.2.5-1.

**Table 8.5.1.2.2.5-1: Test requirement PHICH 4 Tx Antenna Port**

Test number	Bandwidth	Reference Channel	OCNG Pattern	Propagation Condition	Antenna configuration and correlation Matrix	Reference value	
						Pm-an (%)	SNR (dB)
1	10 MHz	R.20	OP.1 FDD	EVA5	4 x 2 Medium	0.1	7.0

## 8.5.1.2.2\_1 FDD PHICH Transmit Diversity 4x2 (Release 9 and forward)

## 8.5.1.2.2\_1.1 Test purpose

This test verifies the demodulation performance of PHICH for transmit diversity with a given SNR for which the average probability of miss detection of Hybrid Indicator ("ACK to NACK") of the specified reference measurement channels remains below a specified value.

## 8.5.1.2.2\_1.2 Test applicability

This test applies to all types of E-UTRA FDD UE release 9 and forward.

## 8.5.1.2.2\_1.3 Minimum conformance requirements

The receiver characteristics of the PHICH are determined by the probability of miss-detecting an ACK for a NACK (P<sub>m-an</sub>). It is assumed that there is no bias applied to the detection of ACK and NACK (zero-threshold detection).

**Table 8.5.1.2.2\_1.3-1: Test Parameters for PHICH**

Parameter		Unit	Transmit diversity
Downlink power allocation	PDCCH_RA PHICH_RA OCNG_RA	dB	-3
	PCFICH_RB PDCCH_RB PHICH_RB OCNG_RB	dB	-3
PHICH duration			Normal
Number of PHICH groups (Note 1)			Ng = 1
PDCCH Content		UL Grant should be included with the proper information aligned with A.3.6.	
Unused RE-s and PRB-s		OCNG	
Cell ID			0
$N_{oc}$ at antenna port		dBm/15kHz	-98
Cyclic prefix			Normal
Note 1: according to Clause 6.9 in TS 36.211 [8] Note 2: PHICH power settings refer to PHICH group power, i.e. the total power of all active PHICH sequences within a PHICH group.			

For the parameters specified in Table 8.5.1.2.2\_1.3-1 the average probability of a miss-detecting an ACK for a NACK (P<sub>m-an</sub>) shall be below the specified value in Table 8.5.1.2.2\_1.3-2.

**Table 8.5.1.2.2\_1.3-2: Minimum performance PHICH 4 Tx Antenna Port**

Test number	Bandwidth	Reference Channel	OCNG Pattern	Propagation Condition	Antenna configuration and correlation Matrix	Reference value	
						P <sub>m-an</sub> (%)	SNR (dB)
1	5 MHz	R.20_1	OP.1 FDD	EPA5	4 x 2 Medium	0.1	6.1

The normative reference for this requirement is TS 36.101 [2] clause 8.5.1.

8.5.1.2.2\_1.4 Test description

8.5.1.2.2\_1.4.1 Initial conditions

Test Environment: Normal as defined in TS 36.508 [7] clause 4.1.

Frequencies to be tested: Mid Range as defined in TS 36.508 [7] clause 4.3.1.1.

Channel Bandwidths to be tested: 5 MHz, as defined in TS 36.508 [7] clause 4.3.1.1

1. Connect the SS, the faders and AWGN noise sources to the UE antenna connector (s) as shown in TS 36.508 [7] Annex A, Figure A.11.
2. The parameter settings for the cell are set up according to Table 8.5.1.2.2\_1.3-1.
3. Downlink signals are initially set up according to Annex C.1 and C.3.2 and uplink signals according to Annex H.1 and H.3.2.
4. Propagation conditions are set according to Annex B clauses B.0.
5. Ensure the UE is in State 3A-RF according to TS 36.508 [7] clause 5.2A.2. Message contents are defined in clause 8.5.1.2.2\_1.4.3.

8.5.1.2.2\_1.4.2 Test procedure

1. Set the parameters of bandwidth, reference Channel, the propagation condition, antenna configuration, the correlation matrix and the SNR according to Table 8.5.1.2.2\_1.5-1.
2. SS shall schedule PUSCH transmissions according to Annex A.2.2.1.1 Table A.2.2.1.1-1 to happen during 8 consecutive uplink TTIs via PDCCH DCI format 0 with new data indicator set to true. Since the UE has no payload, the UE shall send uplink MAC padding bits in PUSCH. SS upon receiving the PUSCH transmissions will transmit the associated ACKs. PHICH is set according to Annex 3.6 Table A.3.6-1. SS will only transmit PDCCH to schedule PUSCH transmission in the appropriate sub-frames. Table 8.5.1.2.2\_1.4.2-1 indicates the transmissions for one cycle.

**Table 8.5.1.2.2\_1.4.2-1: PHICH test pattern**

TTI	1-4	5-8	9-12	13-16	17-20	21-24
PDCCH	S	S	-	-	S	S
PHICH	-	-	A	A	-	-
PUSCH		T	T	R	R	T
UL HARQ Process	1-4	5-8	1-4	5-8	1-4	5-8
Note 1: This table gives an example test pattern for HARQ process for FDD PHICH test Note 2: Following notation is used: S: represents sending PDCCH DCI format 0 to schedule a future PUSCH transmission A: represents the ACK transmission on PHICH T: represents a scheduled PUSCH transmission R: represents a potential PUSCH re-transmission due to a missed ACK						

3. SS will only monitor for uplink retransmissions due to ACK missed-detections. Such re-transmissions (if they occur) will potentially happen in TTI 13 to 20. DTXs on TTI 13 to 20 are counted as successful ACK receptions while any transmission on these TTIs is counted as NACKs.
4. Repeat steps 1 – 3 for a duration sufficient to achieve statistical significance according to Annex G clause G.4 and measure Pm-an. Pm-an is (NACK) / (ACK + NACK). If Pm-an is less than the value specified in table 8.5.1.2.2\_1.5-1, pass the UE. Otherwise fail the UE.

8.5.1.2.2\_1.4.3 Message contents

Message contents are according to TS 36.508 [7] clause 4.6 with the following exceptions



**Table 8.5.1.2.2\_1.4.3-1: MAC-MainConfig-RBC**

Derivation Path: TS 36.508 [7] clause 4.8.2.1.5, Table 4.8.2.1.5-1			
Information Element	Value/remark	Comment	Condition
MAC-MainConfig-RBC ::= SEQUENCE {			
dl-SCH-Config SEQUENCE {}	Not present		
ul-SCH-Config SEQUENCE {			
maxHARQ-Tx	n2	Only one retransmission per UL HARQ	

#### 8.5.1.2.2\_1.5 Test requirement

For the parameters specified in Table 8.5.1.2.2\_1.3-1 the average probability of a miss-detecting ACK for NACK (Pm-dsg) shall be below the specified value in Table 8.5.1.2.2\_1.5-1.

**Table 8.5.1.2.2\_1.5-1: Test requirement PHICH 4 Tx Antenna Port**

Test number	Bandwidth	Reference Channel	OCNG Pattern	Propagation Condition	Antenna configuration and correlation Matrix	Reference value	
						Pm-an (%)	SNR (dB)
1	5 MHz	R.20_1	OP.1 FDD	EPA5	4 x 2 Medium	0.1	+7.1

#### 8.5.1.2.3

##### 8.5.1.2.3\_A

##### 8.5.1.2.3\_B

##### 8.5.1.2.3\_C FDD PHICH Transmit Diversity 2x2 for eICIC

##### 8.5.1.2.3\_C.1 FDD PHICH Transmit Diversity 2x2 for eICIC (non-MBSFN ABS)

##### 8.5.1.2.3\_C.1.1 Test purpose

This test verifies the demodulation performance of PHICH for transmit diversity with a given SNR for which the average probability of miss detection of Hybrid Indicator ("ACK to NACK") of the specified reference measurement channels remains below a specified value.

##### 8.5.1.2.3\_C.1.2 Test applicability

This test applies to all types of E-UTRA FDD UE release 10 and forward. Applicability requires support for FGI bit 115.

##### 8.5.1.2.3\_C.1.3 Minimum conformance requirements

The receiver characteristics of the PHICH are determined by the probability of miss-detecting an ACK for a NACK (Pm-an). It is assumed that there is no bias applied to the detection of ACK and NACK (zero-threshold detection).

Table 8.5.1.2.3\_C.1.3-1: Test Parameters for PHICH

Parameter	Unit	Unit	Cell 1	Cell 2
Downlink power allocation	PDCCH_RA PHICH_RA OCNG_RA	dB	-3	-3
	PCFICH_RB PDCCH_RB PHICH_RB OCNG_RB	dB	-3	-3
$N_{oc}$ at antenna port	$N_{oc1}$	dBm/15kHz	-100.5 (Note 1)	N/A
	$N_{oc2}$	dBm/15kHz	-98 (Note 2)	N/A
	$N_{oc3}$	dBm/15kHz	-95.3 (Note 3)	N/A
$\hat{E}_s/N_{oc2}$		dB	Reference Value in Table 8.5.1.2.3_C.1.3-2	1.5
$BW_{Channel}$		MHz	10	10
Subframe Configuration			Non-MBSFN	Non-MBSFN
Time Offset between Cells		$\mu$ s	2.5 (synchronous cells)	
Cell Id			0	1
ABS pattern (Note 4)			N/A	00000100 00000100 00000100 01000100 00000100
RLM/RRM Measurement Subframe Pattern (Note 5)			00000100 00000100 00000100 00000100 00000100	N/A
CSI Subframe Sets (Note 6)	$C_{CSI,0}$		00000100 00000100 00000100 01000100 00000100	N/A
	$C_{CSI,1}$		11111011 11111011 11111011 10111011 11111011	N/A
Number of control OFDM symbols			3	3
Number of PHICH groups ( $N_g$ )			1	N/A
PHICH duration			extended	N/A
Unused RE-s and PRB-s			OCNG	OCNG
Cyclic prefix			Normal	Normal
Note 1:	This noise is applied in OFDM symbols #1, #2, #3, #5, #6, #8, #9, #10, #12, #13 of a subframe overlapping with the aggressor ABS			
Note 2:	This noise is applied in OFDM symbols #0, #4, #7, #11 of a subframe overlapping with the aggressor ABS			
Note 3:	This noise is applied in OFDM symbols of a subframe overlapping with aggressor non-ABS			
Note 4:	ABS pattern as defined in [14]. PHICH is transmitted in the serving cell subframe when the subframe is overlapped with the ABS subframe of aggressor cell but not in the 26 <sup>th</sup> subframe indicated by the ABS pattern.			
Note 5:	Time-domain measurement resource restriction pattern for PCell measurements as defined in [5]			
Note 6:	As configured according to the time-domain measurement resource restriction pattern for CSI measurements defined in [5]			
Note 7:	Cell 1 is the serving cell. Cell 2 is the aggressor cell. The number of the CRS ports in Cell1 and Cell2 is the same.			
Note 8:	SIB-1 will not be transmitted in Cell2 in the test.			

For the parameters specified in Table 8.5.1.2.3\_C.1.3-1, the average probability of a miss-detecting an ACK for a NACK (Pm-an) shall be below the specified value in Table 8.5.1.2.3\_C.1.3-2. In Table 8.5.1.2.3\_C.1.3-1, Cell 1 is the serving cell, and Cell 2 is the aggressor cell. The downlink physical channel setup for Cell 1 is according to Annex C.3.2 and for Cell 2 is according to Annex C.3.3, respectively.

**Table 8.5.1.2.3\_C.1.3-2: Minimum performance PHICH**

Test Number	Reference Channel	OCNG Pattern		Propagation Conditions (Note 1)		Antenna Configuration and Correlation Matrix	Reference Value	
		Cell 1	Cell 2	Cell 1	Cell 2		Pm-an (%)	SNR (dB) (Note 2)
1	R.19_1	OP.1 FDD	OP.1 FDD	EPA5	EPA5	2x2 Low	0.1	4.6
Note 1: The propagation conditions for Cell 1 and Cell 2 are statistically independent.								
Note 2: SNR corresponds to $\hat{E}_s / N_{oc2}$ of cell 1.								
Note 3: The correlation matrix and antenna configuration apply for Cell 1 and Cell 2.								

The normative reference for this requirement is TS 36.101 [2] clause 8.5.1.2.3.

#### 8.5.1.2.3\_C.1.4 Test description

##### 8.5.1.2.3\_C.1.4.1 Initial conditions

Initial conditions are a set of test configurations the UE needs to be tested in and the steps for the SS to take with the UE to reach the correct measurement state.

Test Environment: Normal as defined in TS 36.508 [7] clause 4.1.

Frequencies to be tested: Mid Range as defined in TS 36.508 [7] clause 4.3.1.1.

Channel Bandwidths to be tested: 10 MHz, as defined in TS 36.508 [7] clause 4.3.1.1

1. Connect the SS, the faders and AWGN noise sources to the UE antenna connector (s) as shown in TS 36.508 [7] Annex A, Figure A.40 for antenna transmit diversity 2x2 configuration.
2. The parameter settings for the cell are set up according to Table 8.5.1.2.3\_C.1.3-1 and 8.5.1.2.3\_C.1.3-2.
3. Downlink signals are initially set up according to Annex C.0, C.1, C.3.2 and C.3.3 and uplink signals according to Annex H.1 and H.3.2.
4. Propagation conditions are set according to Annex B clauses B.0.
5. Ensure the UE is in State 3A-RF according to TS 36.508 [7] clause 5.2A.2. Message contents are defined in clause 8.5.1.2.3\_C.1.4.3.

##### 8.5.1.2.3\_C.1.4.2 Test procedure

1. Set the parameters for Cell1 and Cell2 according to Tables 8.5.1.2.3\_C.1.5-1, 8.5.1.2.3\_C.1.5-2, C.3.3-1 of Annex C.3.3 as appropriate. Propagation conditions are set according to Annex B clause B.2.
2. SS shall schedule PUSCH transmissions according to Annex A.2.2.1.1 Table A.2.2.1.1-1 via PDCCH DCI format 0 with the new data indicator set to true. Since the UE has no payload, the UE shall send uplink MAC padding bits in PUSCH. SS upon receiving the PUSCH transmission will transmit the associated ACK. PHICH is set according to Annex 3.6 Table A.3.6-1. SS will only transmit PDCCH to schedule PUSCH transmission in the appropriate TTI-s. Table 8.5.1.2.3\_C.1.4.2-1 indicates the transmissions for two cycles.

**Table 8.5.1.2.3\_C.1.4.2-1: PHICH test pattern**

TTI	6	10	14	18	22	26	30	34	38
PDCCH	S	-	-	-	S	-	-	-	S
PUSCH	-	T	-	R	-	T	-	R	-
PHICH	-	-	A	-	-	-	A	-	-
Note 1:	This table gives an example test pattern for HARQ process for FDD PHICH test								
Note 2:	Following notation is used: S: represents sending PDCCH DCI format 0 to schedule a future PUSCH transmission A: represents the ACK transmission on PHICH T: represents a scheduled PUSCH transmission R: represents a potential PUSCH re-transmission due to a missed ACK								
Note 3:	In the other TTI-s there are no DCI-0, PHICH and PUSCH transmissions								

- SS will monitor for uplink retransmissions due to ACK missed-detection. Such re-transmission (if it occurs) will potentially happen in TTI 18 (34 and so on). DTX from the UE side on this TTI is counted as successful ACK receptions while any transmission on this TTI is counted as NACK.
- Repeat steps 1 – 3 for a duration sufficient to achieve statistical significance according to Annex G clause G.4 and measure P<sub>m-an</sub>. P<sub>m-an</sub> is (NACK) / (ACK + NACK).  
If P<sub>m-an</sub> is less than the value specified in table 8.5.1.2.3\_C.1.5-2, pass the UE. Otherwise fail the UE.

#### 8.5.1.2.3\_C.1.4.3 Message contents

Message contents are according to TS 36.508 [7] clause 4.6 with the following exceptions

**Table 8.5.1.2.3\_C.1.4.3-1: PHICH-Config**

Derivation Path: TS 36.508 [7] clause 4.6.3, Table 4.6.3-4			
Information Element	Value/remark	Comment	Condition
PHICH-Config-DEFAULT ::= SEQUENCE {			
phich-Duration	extended		Cell 1
phich-Resource	one		
}			

**Table 8.5.1.2.3\_C.1.4.3-2: MAC-MainConfig-RBC**

Derivation Path: TS 36.508 [7] clause 4.8.2.1.5, Table 4.8.2.1.5-1			
Information Element	Value/remark	Comment	Condition
MAC-MainConfig-RBC ::= SEQUENCE {			
dl-SCH-Config SEQUENCE {}	Not present		
ul-SCH-Config SEQUENCE {			
maxHARQ-Tx	n2	Only one retransmission per UL HARQ	

**Table 8.5.1.2.3\_C.1.4.3-3: RadioResourceConfigDedicated-SRB2-DRB(n, m)**

Derivation Path: TS 36.508 [7] clause 4.6.3, Table 4.6.3-16 RadioResourceConfigDedicated-SRB2-DRB(n,m)			
Information Element	Value/remark	Comment	Condition
RadioResourceConfigDedicated-SRB2-DRB(n, m) ::= SEQUENCE {			
MeasSubframePatternPCell-r10 CHOICE {			
setup SEQUENCE {			
subframePatternFDD-r10	'00000100000001000000 01000000010000000100'	BIT STRING (SIZE (40))	
}			
}			
}			

**Table 8.5.1.2.3\_C.1.4.3-4: CQI-ReportConfig-r10-DEFAULT**

Derivation Path: 36.508 [7] clause 4.6.3, Table 4.6.3-2AA CQI-ReportConfig-r10-DEFAULT			
Information Element	Value/remark	Comment	Condition
CQI-ReportConfig-r10-DEFAULT ::= SEQUENCE {			
csi-SubframePatternConfig-r10 CHOICE {			
setup SEQUENCE {			
csi-MeasSubframeSet1-r10 CHOICE {			
subframePatternFDD-r10	'00000100000001000000 01000100010000000100'	BIT STRING (SIZE (40))	
}			
csi-MeasSubframeSet2-r10 CHOICE {			
subframePatternFDD-r10	'11111011111110111111 10111011101111111011'	BIT STRING (SIZE (40))	
}			
}			
}			
}			

**8.5.1.2.3\_C.1.5 Test requirement**

For the parameters specified in Table 8.5.1.2.3\_C.1.5-1, the average probability of a miss-detecting ACK for NACK ( $P_{m-dsg}$ ) shall be below the specified value in Table 8.5.1.2.3\_C.1.5-2.

Table 8.5.1.2.3\_C.1.5-1: Test Parameters for PHICH

Parameter	Unit	Cell 1	Cell 2	
Downlink power allocation	PDCCH_RA PHICH_RA OCNG_RA	dB	-3	-3
	PCFICH_RB PDCCH_RB PHICH_RB OCNG_RB	dB	-3	-3
$N_{oc}$ at antenna port	$N_{oc1}$	dBm/15kHz	-100.6 (Note 1)	N/A
	$N_{oc2}$	dBm/15kHz	-98 (Note 2)	N/A
	$N_{oc3}$	dBm/15kHz	-95.4 (Note 3)	N/A
$\hat{E}_s/N_{oc2}$		dB	Reference Value in Table 8.5.1.2.3_C.1.5-2	1.3
$BW_{Channel}$		MHz	10	10
Subframe Configuration			Non-MBSFN	Non-MBSFN
Time Offset between Cells		$\mu$ s	2.5 (synchronous cells)	
Cell Id			0	1
ABS pattern (Note 4)			N/A	00000100 00000100 00000100 01000100 00000100
RLM/RRM Measurement Subframe Pattern (Note 5)			00000100 00000100 00000100 00000100 00000100	N/A
CSI Subframe Sets (Note 6)	$C_{CSI,0}$		00000100 00000100 00000100 01000100 00000100	N/A
	$C_{CSI,1}$		11111011 11111011 11111011 10111011 11111011	N/A
Number of control OFDM symbols			3	3
Number of PHICH groups ( $N_g$ )			1	N/A
PHICH duration			extended	N/A
Unused RE-s and PRB-s			OCNG	OCNG
Cyclic prefix			Normal	Normal
Note 1:	This noise is applied in OFDM symbols #1, #2, #3, #5, #6, #8, #9, #10, #12, #13 of a subframe overlapping with the aggressor ABS			
Note 2:	This noise is applied in OFDM symbols #0, #4, #7, #11 of a subframe overlapping with the aggressor ABS			
Note 3:	This noise is applied in OFDM symbols of a subframe overlapping with aggressor non-ABS			
Note 4:	ABS pattern as defined in [14]. PHICH is transmitted in the serving cell subframe when the subframe is overlapped with the ABS subframe of aggressor cell but not in the 26 <sup>th</sup> subframe indicated by the ABS pattern.			
Note 5:	Time-domain measurement resource restriction pattern for PCell measurements as defined in [5]			
Note 6:	As configured according to the time-domain measurement resource restriction pattern for CSI measurements defined in [5]			
Note 7:	Cell 1 is the serving cell. Cell 2 is the aggressor cell. The number of the CRS ports in Cell1 and Cell2 is the same.			
Note 8:	SIB-1 will not be transmitted in Cell2 in the test.			

**Table 8.5.1.2.3\_C.1.5-2: Test requirement FDD PHICH Transmit Diversity 2x2 for eICIC (non-MBSFN ABS)**

Test Number	Reference Channel	OCNG Pattern		Propagation Conditions (Note 1)		Antenna Configuration and Correlation Matrix	Reference Value	
		Cell 1	Cell 2	Cell 1	Cell 2		Pm-an (%)	SNR (dB) (Note 2)
1	R.19_1	OP.1 FDD	OP.1 FDD	EPA5	EPA5	2x2 Low	0.1	5.5
Note 1: The propagation conditions for Cell 1 and Cell 2 are statistically independent. Note 2: SNR corresponds to $\hat{E}_s / N_{oc2}$ of cell 1. Note 3: The correlation matrix and antenna configuration apply for Cell 1 and Cell 2.								

## 8.5.1.2.3\_D

## 8.5.1.2.3\_E FDD PHICH Transmit Diversity 2x2 for feICIC

## 8.5.1.2.3\_E.1 FDD PHICH Transmit Diversity 2x2 for feICIC (non-MBSFN ABS)

## 8.5.1.2.3\_E.1.1 Test purpose

This test verifies the demodulation performance of PHICH for transmit diversity with a given SNR for which the average probability of miss detection of Hybrid Indicator ("ACK to NACK") of the specified reference measurement channels remains below a specified value where PHICH transmission subframes overlap with ABS of the aggressor cell.

## 8.5.1.2.3\_E.1.2 Test applicability

This test applies to all types of E-UTRA FDD UE and CRS interference handling – UE Category 2-8 release 11 and forward. Applicability requires support of FGI bit 115.

## 8.5.1.2.3\_E.1.3 Minimum conformance requirements

The receiver characteristics of the PHICH are determined by the probability of miss-detecting an ACK for a NACK (Pm-an). It is assumed that there is no bias applied to the detection of ACK and NACK (zero-threshold detection).

Table 8.5.1.2.3\_E.1.3-1: Test Parameters for PHICH

Parameter		Unit	Cell 1	Cell 2	Cell 3
Downlink power allocation	PDCCH_RA PHICH_RA OCNG_RA	dB	-3	-3	-3
	PCFICH_RB PDCCH_RB PHICH_RB OCNG_RB	dB	-3	-3	-3
$N_{oc}$ at antenna port	$N_{oc1}$	dBm/15kHz	-98 (Note 1)	N/A	N/A
	$N_{oc2}$	dBm/15kHz	-98 (Note 2)	N/A	N/A
	$N_{oc3}$	dBm/15kHz	-93 (Note 3)	N/A	N/A
$\hat{E}_s / N_{oc2}$		dB	Reference Value in Table 8.5.1.2.3_E.1.3-2	5	3
$BW_{Channel}$		MHz	10	10	10
Subframe Configuration			Non-MBSFN	Non-MBSFN	Non-MBSFN
Time Offset between Cells		$\mu$ s	N/A	3	-1
Frequency shift between Cells		Hz	N/A	300	-100
Cell Id			0	126	1
PDCCH Content			UL Grant should be included with the proper information aligned with A.3.6.	N/A	N/A
ABS pattern (Note 4)			N/A	00000100 00000100 00000100 00000100 00000100	00000100 00000100 00000100 00000100 00000100
RLM/RRM Measurement Subframe Pattern (Note 5)			00000100 00000100 00000100 00000100 00000100	N/A	N/A
CSI Subframe Sets (Note 6)	$C_{CSI,0}$		00000100 00000100 00000100 00000100 00000100	N/A	N/A
	$C_{CSI,1}$		11111011 11111011 11111011 11111011 11111011	N/A	N/A
Number of control OFDM symbols			2	Note 7	Note 7
Number of PHICH groups ( $N_g$ )			1	N/A	N/A
PHICH duration			Normal	N/A	N/A
Unused RE-s and PRB-s			OCNG	OCNG	OCNG
Cyclic prefix			Normal	Normal	Normal



Note 1:	This noise is applied in OFDM symbols #1, #2, #3, #5, #6, #8, #9, #10, #12, #13 of a subframe overlapping with the aggressor ABS
Note 2:	This noise is applied in OFDM symbols #0, #4, #7, #11 of a subframe overlapping with the aggressor ABS
Note 3:	This noise is applied in OFDM symbols of a subframe overlapping with aggressor non-ABS
Note 4:	ABS pattern as defined in [9]. PHICH is transmitted in the serving cell subframe when the subframe is overlapped with the ABS subframe of aggressor cell but not in the 26 <sup>th</sup> subframe indicated by the ABS pattern.
Note 5:	Time-domain measurement resource restriction pattern for PCell measurements as defined in [7]
Note 6:	As configured according to the time-domain measurement resource restriction pattern for CSI measurements defined in [7]
Note 7:	The number of control OFDM symbols is not available for ABS and is 2 for the subframe indicated by "0" of ABS pattern.
Note 8:	The number of the CRS ports in Cell 1, Cell 2 and Cell 3 is the same.
Note 9:	SIB-1 will not be transmitted in Cell 2 and Cell 3 in the test.

For the parameters specified in Table 8.5.1.2.3\_E.1.3-1, the average probability of a miss-detecting an ACK for a NACK (Pm-an) shall be below the specified value in Table 8.5.1.2.3\_E.1.3-2. In Table 8.5.1.2.3\_E.1.3-1, Cell 1 is the serving cell, and Cell 2 and Cell 3 are the aggressor cell. The downlink physical channel setup for Cell 1 is according to Annex C.3.2 and for Cell 2 and Cell 3 is according to Annex C.3.3, respectively. The CRS assistance information is provided for Cell 2 and Cell 3.

**Table 8.5.1.2.3\_E.1.3-2: Minimum performance PHICH 2 Tx Antenna Port**

Test Number	Reference Channel	OCNG Pattern			Propagation Conditions (Note 1)			Antenna Configuration and Correlation Matrix (Note 2)	Reference Value	
		Cell 1	Cell 2	Cell 3	Cell 1	Cell 2	Cell 3		Pm-an (%)	SNR (dB) (Note 3)
1	R.19_1	OP.1 FDD	OP.1 FDD	OP.1 FDD	EPA5	EVA5	EVA5	2x2 Low	0.1	5.0
Note 1:		The propagation conditions for Cell 1, Cell 2 and Cell 3 are statistically independent.								
Note 2:		The correlation matrix and antenna configuration apply for Cell 1, Cell 2 and Cell 3.								
Note 3:		SNR corresponds to $\hat{E}_s / N_{oc2}$ of Cell 1.								

The normative reference for this requirement is TS 36.101 [2] clause 8.5.1.2.4.

#### 8.5.1.2.3\_E.1.4 Test description

##### 8.5.1.2.3\_E.1.4.1 Initial conditions

Initial conditions are a set of test configurations the UE needs to be tested in and the steps for the SS to take with the UE to reach the correct measurement state.

Test Environment: Normal as defined in TS 36.508 [7] clause 4.1.

Frequencies to be tested: Mid Range as defined in TS 36.508 [7] clause 4.3.1.1.

Channel Bandwidths to be tested: 10 MHz, as defined in TS 36.508 [7] clause 4.3.1.1

1. Connect the SS, the faders and AWGN noise sources to the UE antenna connector (s) as shown in TS 36.508 [7] Annex A, Figure A.48 for antenna transmit diversity 2x2 configuration.
2. The parameter settings for the cell are set up according to Table 8.5.1.2.3\_E.1.3-1 and 8.5.1.2.3\_E.1.3-2.
3. Downlink signals are initially set up according to Annex C.0, C.1, C.3.2 and C.3.3 and uplink signals according to Annex H.1 and H.3.2.
4. Propagation conditions are set according to Annex B clauses B.0.
5. Ensure the UE is in State 3A-RF according to TS 36.508 [7] clause 5.2A.2 with exceptions listed in 5.2A.5. Message contents are defined in clause 8.5.1.2.3\_E.1.4.3.

8.5.1.2.3\_E.1.4.2 Test procedure

1. Set the parameters for Cell1, Cell2 and Cell3 according to Tables 8.5.1.2.3\_E.1.3-1, 8.5.1.2.3\_E.1.5-1 and C.3.3-2 of Annex C.3.3 as appropriate. Propagation conditions are set according to Annex B clause B.2.
2. SS shall schedule PUSCH transmissions according to Annex A.2.2.1.1 Table A.2.2.1.1-1 via PDCCH DCI format 0 with the new data indicator set to true. Since the UE has no payload, the UE shall send uplink MAC padding bits in PUSCH. SS upon receiving the PUSCH transmission will transmit the associated ACK. PHICH is set according to Annex 3.6 Table A.3.6-1. SS will only transmit PDCCH to schedule PUSCH transmission in the appropriate TTI-s. Table 8.5.1.2.3\_E.1.4.2-1 indicates the transmissions for two cycles.

**Table 8.5.1.2.3\_E.1.4.2-1: PHICH test pattern**

TTI	6	10	14	18	22	26	30	34	38
PDCCH	S	-	-	-	S	-	-	-	S
PUSCH	-	T	-	R	-	T	-	R	-
PHICH	-	-	A	-	-	-	A	-	-
Note 1:	This table gives an example test pattern for HARQ process for FDD PHICH test								
Note 2:	Following notation is used: S: represents sending PDCCH DCI format 0 to schedule a future PUSCH transmission A: represents the ACK transmission on PHICH T: represents a scheduled PUSCH transmission R: represents a potential PUSCH re-transmission due to a missed ACK								
Note 3:	In the other TTI-s there are no DCI-0, PHICH and PUSCH transmissions								

3. SS will monitor for uplink retransmissions due to ACK missed-detection. Such re-transmission (if it occurs) will potentially happen in TTI 18 (34 and so on). DTX from the UE side on this TTI is counted as successful ACK receptions while any transmission on this TTI is counted as NACK.
4. Repeat steps 1 – 3 for a duration sufficient to achieve statistical significance according to Annex G clause G.4 and measure Pm-an in the subframes overlapping with ABS of the aggressor cell. Pm-an is (NACK) / (ACK + NACK).  
If Pm-an is less than the value specified in table 8.5.1.2.3\_E.1.5-2, pass the UE. Otherwise fail the UE.

8.5.1.2.3\_E.1.4.3 Message contents

Message contents are according to TS 36.508 [7] clause 5.2A.5.1 with the following exceptions

**Table 8.5.1.2.3\_E.1.4.3-1: MAC-MainConfig-RBC**

Derivation Path: TS 36.508 [7] clause 4.8.2.1.5, Table 4.8.2.1.5-1			
Information Element	Value/remark	Comment	Condition
MAC-MainConfig-RBC ::= SEQUENCE {			
dl-SCH-Config SEQUENCE {}	Not present		
ul-SCH-Config SEQUENCE {			
maxHARQ-Tx	n2	Only one retransmission per UL HARQ	

**Table 8.5.1.2.3\_E.1.4.3-2: RadioResourceConfigDedicated-SRB2-DRB(n, m)**

Derivation Path: TS 36.508 [7] clause 4.6.3, Table 4.6.3-16 RadioResourceConfigDedicated-SRB2-DRB(n,m)			
Information Element	Value/remark	Comment	Condition
RadioResourceConfigDedicated-SRB2-DRB(n, m) ::= SEQUENCE {			
MeasSubframePatternPCell-r10 CHOICE {			
setup SEQUENCE {			
subframePatternFDD-r10	'00000100000001000000 01000000010000000100'	BIT STRING (SIZE (40))	
}			
}			
neighCellsCRS-Info-r11 ::= CHOICE {			
setup SEQUENCE {			
CRS-AssistancedInfoList-r11 ::= SEQUENCE (SIZE (1..maxCellReport)) OF CRS-AssistancedInfo- r11{		2 entries	
CRS-AssistancedInfo-r11 ::= SEQUENCE {			
physCellId-r11	126		Cell 2
	1		Cell 3
antennaPortsCount-r11	an2		Cell 2, Cell 3
mbsfn-SubframeConfigList-r11 ::= SEQUENCE (SIZE (1..maxMBSFN-Allocations)) OF MBSFN- SubframeConfig{			Cell 2, Cell 3
MBSFN-SubframeConfig ::= SEQUENCE {			
radioframeAllocationPeriod	n1		
radioframeAllocationOffset	0		
subframeAllocation CHOICE{			
oneFrame	'000000' B	non-MBSFN	
}			
}			
}			
}			
}			
}			

**Table 8.5.1.2.3\_E.1.4.3-3: CQI-ReportConfig-r10-DEFAULT**

Derivation Path: 36.508 [7] clause 4.6.3, Table 4.6.3-2AA CQI-ReportConfig-r10-DEFAULT			
Information Element	Value/remark	Comment	Condition
CQI-ReportConfig-r10-DEFAULT ::= SEQUENCE {			
csi-SubframePatternConfig-r10 CHOICE {			
setup SEQUENCE {			
csi-MeasSubframeSet1-r10 CHOICE {			
subframePatternFDD-r10	'00000100000001000000 01000000010000000100'	BIT STRING (SIZE (40))	
}			
csi-MeasSubframeSet2-r10 CHOICE {			
subframePatternFDD-r10	'11111011111110111111 1011111110111111011'	BIT STRING (SIZE (40))	
}			
}			
}			
}			

8.5.1.2.3\_E.1.5 Test requirement

For the parameters specified in Table 8.5.1.2.3\_E.1.5-1, the average probability of a miss-detecting ACK for NACK (Pm-dsg) shall be below the specified value in Table 8.5.1.2.3\_E.1.5-2.

Table 8.5.1.2.3\_E.1.5-1: Test Parameters for PHICH

Parameter		Unit	Cell 1	Cell 2	Cell 3
Downlink power allocation	PDCCH_RA PHICH_RA OCNG_RA	dB	-3	-3	-3
	PCFICH_RB PDCCH_RB PHICH_RB OCNG_RB	dB	-3	-3	-3
$N_{oc}$ at antenna port	$N_{oc1}$	dBm/15kHz	-98 (Note 1)	N/A	N/A
	$N_{oc2}$	dBm/15kHz	-98 (Note 2)	N/A	N/A
	$N_{oc3}$	dBm/15kHz	-93.1 (Note 3)	N/A	N/A
$\hat{E}_s / N_{oc2}$		dB	Reference Value in Table 8.5.1.2.3_E.1.5-2	4.8	2.8
$BW_{Channel}$		MHz	10	10	10
Subframe Configuration			Non-MBSFN	Non-MBSFN	Non-MBSFN
Time Offset between Cells		$\mu$ s	N/A	3	-1
Frequency shift between Cells		Hz	N/A	300	-100
Cell Id			0	126	1
PDCCH Content			UL Grant should be included with the proper information aligned with A.3.6.	N/A	N/A
ABS pattern (Note 4)			N/A	00000100 00000100 00000100 00000100 00000100	00000100 00000100 00000100 00000100 00000100
RLM/RRM Measurement Subframe Pattern (Note 5)			00000100 00000100 00000100 00000100 00000100	N/A	N/A
CSI Subframe Sets (Note 6)	$C_{CSI,0}$		00000100 00000100 00000100 00000100 00000100	N/A	N/A
	$C_{CSI,1}$		11111011 11111011 11111011 11111011 11111011	N/A	N/A
Number of control OFDM symbols			2	Note 7	Note 7
Number of PHICH groups ( $N_g$ )			1	N/A	N/A
PHICH duration			Normal	N/A	N/A
Unused RE-s and PRB-s			OCNG	OCNG	OCNG
Cyclic prefix			Normal	Normal	Normal

Note 1:	This noise is applied in OFDM symbols #1, #2, #3, #5, #6, #8, #9, #10, #12, #13 of a subframe overlapping with the aggressor ABS
Note 2:	This noise is applied in OFDM symbols #0, #4, #7, #11 of a subframe overlapping with the aggressor ABS
Note 3:	This noise is applied in OFDM symbols of a subframe overlapping with aggressor non-ABS
Note 4:	ABS pattern as defined in [9]. PHICH is transmitted in the serving cell subframe when the subframe is overlapped with the ABS subframe of aggressor cell but not in the 26 <sup>th</sup> subframe indicated by the ABS pattern.
Note 5:	Time-domain measurement resource restriction pattern for PCell measurements as defined in [7]
Note 6:	As configured according to the time-domain measurement resource restriction pattern for CSI measurements defined in [7]
Note 7:	The number of control OFDM symbols is not available for ABS and is 2 for the subframe indicated by "0" of ABS pattern.
Note 8:	The number of the CRS ports in Cell 1, Cell 2 and Cell 3 is the same.
Note 9:	SIB-1 will not be transmitted in Cell 2 and Cell 3 in the test.

**Table 8.5.1.2.3\_E.1.5-2: Test requirement FDD PHICH Transmit Diversity 2x2 for feICIC (non-MBSFN ABS)**

Test Number	Reference Channel	OCNG Pattern			Propagation Conditions (Note 1)			Antenna Configuration and Correlation Matrix (Note 2)	Reference Value	
		Cell 1	Cell 2	Cell 3	Cell 1	Cell 2	Cell 3		Pm-an (%)	SNR (dB) (Note 3)
1	R.19_1	OP.1 FDD	OP.1 FDD	OP.1 FDD	EPA5	EVA5	EVA5	2x2 Low	0.1	5.9
Note 1: The propagation conditions for Cell 1, Cell 2 and Cell 3 are statistically independent. Note 2: The correlation matrix and antenna configuration apply for Cell 1, Cell 2 and Cell 3. Note 3: SNR corresponds to $\hat{E}_s / N_{oc2}$ of Cell 1.										

## 8.5.2 TDD

### 8.5.2.1 TDD PHICH Single-antenna Port Performance

#### 8.5.2.1.1 Test purpose

This test verifies the demodulation performance of PHICH for a single antenna port with a given SNR for which a certain Hybrid Indicator detection error rate (i.e. missed detection of "NACK to ACK" and "ACK to NACK") of the specified reference measurement channels is achieved.

#### 8.5.2.1.2 Test applicability

This test applies to all types of E-UTRA TDD UE release 8 and forward.

#### 8.5.2.1.3 Minimum conformance requirements

The receiver characteristics of the PHICH are determined by the probability of miss-detecting an ACK for a NACK (Pm-an). It is assumed that there is no bias applied to the detection of ACK and NACK (zero-threshold detection).

**Table 8.5.2.1.3-1: Test Parameters for PHICH**

Parameter		Unit	Single antenna port
Uplink downlink configuration (Note 1)			1
Special subframe configuration (Note 2)			4
Downlink power allocation	PDCCH_RA PHICH_RA OCNG_RA	dB	0
	PCFICH_RB PDCCH_RB PHICH_RB OCNG_RB	dB	0
PHICH duration			Normal
Number of PHICH groups (Note 3)			$N_g = 1$
Cell ID			0
PDCCH Content		UL Grant should be included with the proper information aligned with A.3.6.	
Unused RE-s and PRB-s			OCNG
$N_{oc}$ at antenna port		dBm/15kHz	-98
Cyclic prefix			Normal
ACK/NACK feedback mode			Multiplexing
Note 1: as specified in Table 4.2-2 in TS 36.211 [8] Note 2: as specified in Table 4.2-1 in TS 36.211 [8] Note 3: according to Clause 6.9 in TS 36.211 [8] Note 4: PHICH power settings refer to PHICH group power, i.e. the total power of all active PHICH sequences within a PHICH group.			

For the parameters specified in Table 8.5.2.1.3-1 the average probability of a miss-detecting ACK for NACK ( $P_{m-an}$ ) shall be below the specified value in Table 8.5.2.1.3-2.

**Table 8.5.2.1.3-2: Minimum performance of PHICH**

Test number	Bandwidth	Reference Channel	OCNG Pattern	Propagation Condition	Antenna configuration and correlation Matrix	Reference value	
						$P_{m-an}$ (%)	SNR (dB)
1	10 MHz	R.18	OP.1 TDD	ETU70	1 x 2 Low	0.1	5.8
2	10 MHz	R.24	OP.1 TDD	ETU70	1 x 2 Low	0.1	1.3

The normative reference for this requirement is TS 36.101 [2] clause 8.5.2.

#### 8.5.2.1.4 Test description

##### 8.5.2.1.4.1 Initial conditions

Initial conditions are a set of test configurations the UE needs to be tested in and the steps for the SS to take with the UE to reach the correct measurement state.

Configurations of PDSCH and PDCCH before measurement are specified in Annex C.2.

Test Environment: Normal, as defined in TS 36.508 [7] clause 4.1

Frequencies to be tested: Mid Range, as defined in TS 36.508 [7] clause 4.3.1.1

Bandwidths to be tested: As specified per test number in Tables 8.5.2.1.3-2 as defined in TS 36.508 [7] clause 4.3.1.2.

1. Connect the SS, the faders and AWGN noise source to the UE antenna connector (s) as shown in TS 36.508 [7] Annex a, Figure A.9.
2. The parameter settings for the cell are set up according to 8.5.2.1.3-1.
3. Downlink signals are initially set up according to Annex C0, C.1 and Annex C.3.2 and uplink signals according to Annex H.1 and H.3.2.
4. Propagation conditions are set according to Annex B.0.
5. Ensure the UE is in State 3A-RF according to TS 36.508 [7] clause 5.2A.2. Message contents are defined in clause 8.5.2.1.4.3.

8.5.2.1.4.2 Test procedure

1. Set the parameters of bandwidth, reference Channel, the propagation condition, antenna configuration, the correlation matrix and the SNR according to Table 8.5.2.1.5-1 Test 1 as appropriate.
2. In Each HARQ process (4 HARQ processes for UL/DL configuration 1); SS shall schedule PUSCH transmissions according to Annex A.2.3.1.1 Table A.2.3.1.1-1 via PDCCH DCI format 0 with new data indicator set to true. Since the UE has no payload, the UE shall send uplink MAC padding bits in PUSCH. SS upon receiving the PUSCH transmissions shall transmit the associated ACKs. PHICH is set according to Annex 3.6 Table A.3.6-1. SS will only transmit PDCCH to schedule PUSCH transmission in the appropriate sub-frames. Table 8.5.2.1.4.2-1 indicates the transmissions for one cycle.
3. SS will only monitor for uplink retransmissions due to ACK missed-detections. DTX from the UE side is counted as successful ACK reception, while any transmission on these subframes is counted as NACKs.

**Table 8.5.2.1.4.2-1: PHICH test pattern**

Subframe Index	0	1	2	3	4	5	6	7	8	9	0	1	2	3	4	5	6	7	8	9
PDCCH		S			S		S			S										
PHICH												A			A		A			A
PUSCH			R?	R?				T	T				T	T					R?	R?
HARQ process		1	3	4	2		3	1	2	4		1	3	4	2		3	1	2	4
Note 1:	This table gives an example test pattern for HARQ process for TDD PHICH test																			
Note 2:	Following notation is used: S: represents sending PDCCH DCI format 0 to schedule a future PUSCH transmission A: represents the ACK transmission on PHICH T: represents a scheduled PUSCH transmission R: represents a potential PUSCH re-transmission due to a missed ACK																			
Note 3:	TDD UL/DL configuration 1 is used here, special subframe is denoted as blue																			

4. Repeat steps 1 – 3 for a duration sufficient to achieve statistical significance according to Annex G clause G.4 and measure Pm-an. Pm-an is (NACK) / (ACK + NACK).  
  
If Pm-an is less than the value specified in table 8.5.2.1.5-1, pass the UE. Otherwise fail the UE.
5. Repeat the same procedure (steps 1 to 4 ) with test conditions according to the Table 8.5.2.1.5-1 for Test 2.

8.5.2.1.4.3 Message contents

Message contents are according to TS 36.508 [7] clause 4.6, with the following exceptions

**Table 8.5.1.1.4.3-1: MAC-MainConfig-RBC**

Derivation Path: TS 36.508 [7] clause 4.8.2.1.5, Table 4.8.2.1.5-1			
Information Element	Value/remark	Comment	Condition
MAC-MainConfig-RBC ::= SEQUENCE {			
dl-SCH-Config SEQUENCE {}	Not present		
ul-SCH-Config SEQUENCE {			
maxHARQ-Tx	n2	Only one retransmission per UL HARQ	

### 8.5.2.1.5 Test requirement

For the parameters specified in Table 8.5.2.1.3-1 the average probability of a miss-detecting ACK for NACK ( $P_{m-an}$ ) shall be below the specified value in Table 8.5.2.1.5-1.

**Table 8.5.2.1.5-1: Test requirement of PHICH**

Test number	Bandwidth	Reference Channel	OCNG Pattern	Propagation Condition	Antenna configuration and correlation Matrix	Reference value	
						$P_{m-an}$ (%)	SNR (dB)
1	10 MHz	R.18	OP.1 TDD	ETU70	1 x 2 Low	0.1	6.7
2	10 MHz	R.24	OP.1 TDD	ETU70	1 x 2 Low	0.1	2.2

### 8.5.2.2 TDD PHICH Transmit Diversity Performance

#### 8.5.2.2.1 TDD PHICH Transmit Diversity 2x2

##### 8.5.2.2.1.1 Test purpose

This test verifies the demodulation performance of PHICH for transmit diversity with a given SNR for which a certain Hybrid Indicator detection error rate (i.e. missed detection of "NACK to ACK" and "ACK to NACK") of the specified reference measurement channels is achieved.

##### 8.5.2.2.1.2 Test applicability

This test applies to all types of E-UTRA TDD UE release 8.

##### 8.5.2.2.1.3 Minimum conformance requirements

The receiver characteristics of the PHICH are determined by the probability of miss-detecting an ACK for a NACK ( $P_{m-an}$ ). It is assumed that there is no bias applied to the detection of ACK and NACK (zero-threshold detection).



**Table 8.5.2.2.1.3-1: Test Parameters for PHICH**

Parameter		Unit	Transmit diversity
Uplink downlink configuration (Note 1)			1
Special subframe configuration (Note 2)			4
Downlink power allocation	PDCCH_RA PHICH_RA OCNG_RA	dB	-3
	PCFICH_RB PDCCH_RB PHICH_RB OCNG_RB	dB	-3
PHICH duration			Normal
Number of PHICH groups (Note 3)			$N_g = 1$
Cell ID			0
PDCCH Content		UL Grant should be included with the proper information aligned with A.3.6.	
Unused RE-s and PRB-s			OCNG
$N_{oc}$ at antenna port		dBm/15kHz	-98
Cyclic prefix			Normal
ACK/NACK feedback mode			Multiplexing
Note 1: as specified in Table 4.2-2 in TS 36.211 [8] Note 2: as specified in Table 4.2-1 in TS 36.211 [8] Note 3: according to Clause 6.9 in TS 36.211 [8] Note 4: PHICH power settings refer to PHICH group power, i.e. the total power of all active PHICH sequences within a PHICH group.			

For the parameters specified in Table 8.5.2.2.1.3-1 the average probability of a miss-detecting ACK for NACK ( $P_{m-an}$ ) shall be below the specified value in Table 8.5.2.2.1.3-2.

**Table 8.5.2.2.1.3-2: Minimum performance of PHICH 2 Tx Antenna Port**

Test number	Bandwidth	Reference Channel	OCNG Pattern	Propagation Condition	Antenna configuration and correlation Matrix	Reference value	
						$P_{m-an}$ (%)	SNR (dB)
1	1.4 MHz	R.19	OP.1 TDD	EPA5	2 x 2 Low	0.1	5.3

The normative reference for this requirement is TS 36.101 [2] clause 8.5.2.

#### 8.5.2.2.1.4 Test description

##### 8.5.2.2.1.4.1 Initial conditions

Test Environment: Normal, as defined in TS 36.508 [7] clause 4.1

Frequencies to be tested: Mid Range, as defined in TS 36.508 [7] clause 4.3.1.2

Bandwidths to be tested: 1.4 MHz, as defined in TS 36.508 [7] clause 4.3.1.2.

1. Connect the SS, the faders and AWGN noise sources to the UE antenna connector (s) as shown in TS 36.508 [7] Annex A Figure A.10.
2. The parameter settings for the cell are set up according to Table 8.5.2.2.1.3-1.

3. Downlink signals are initially set up according to Annex C.1 and Annex C.3.2 and uplink signals according to Annex H.1 and H.3.2.
4. Propagation conditions are set according to Annex B clause B.0.
5. Ensure the UE is in State 3A-RF according to TS 36.508 [7] clause 5.2A.2. Message contents are defined in clause 8.5.2.2.1.4.3.

8.5.2.2.1.4.2 Test procedure

1. Set the parameters of bandwidth, reference Channel, the propagation condition, antenna configuration, the correlation matrix and the SNR according to Table 8.5.2.2.1.5-1.
2. In Each HARQ process (4 HARQ processes for UL/DL configuration 1), SS shall schedule PUSCH transmissions according to Annex A.2.3.1.1 Table A.2.3.1.1-1 via PDCCH DCI format 0 with new data indicator set to true. Since the UE has no payload, the UE shall send uplink MAC padding bits in PUSCH. SS upon receiving the PUSCH transmissions shall transmit the associated ACKs. PHICH is set according to Annex 3.6 Table A.3.6-1. SS will only transmit PDCCH to schedule PUSCH transmission in the appropriate sub-frames. Table 8.5.2.2.1.4.2-1 indicates the transmissions for one cycle.
3. SS will only monitor for uplink retransmissions due to ACK missed-detections. DTX from the UE side is counted as successful ACK reception, while any transmission on these subframes is counted as NACKs.
4. Repeat steps 1 – 3 for a duration sufficient to achieve statistical significance according to Annex G clause G.4 and measure Pm-an. Pm-an is (NACK) / (ACK + NACK).

If Pm-an is less than the value specified in table 8.5.2.2.1.5-1, pass the UE. Otherwise fail the UE.

**Table 8.5.2.2.1.4.2-1: PHICH test pattern**

Subframe Index	0	1	2	3	4	5	6	7	8	9	0	1	2	3	4	5	6	7	8	9
PDCCH		S			S		S			S										
PHICH												A			A		A			A
PUSCH			R?	R?				T	T				T	T				R?	R?	
HARQ process		1	3	4	2		3	1	2	4		1	3	4	2		3	1	2	4
Note 1: This table gives an example test pattern for HARQ process for TDD PHICH test Note 2: Following notation is used: S: represents sending PDCCH DCI format 0 to schedule a future PUSCH transmission A: represents the ACK transmission on PHICH T: represents a scheduled PUSCH transmission R: represents a potential PUSCH re-transmission due to a missed ACK Note 3: TDD UL/DL configuration 1 is used here, special subframe is denoted as blue																				

8.5.2.2.1.4.3 Message contents

Message contents are according to TS 36.508 [7] clause 4.6, with the following exceptions:

**Table 8.5.2.2.1.4.3-1: MAC-MainConfig-RBC**

Derivation Path: TS 36.508 [7] clause 4.8.2.1.5, Table 4.8.2.1.5-1			
Information Element	Value/remark	Comment	Condition
MAC-MainConfig-RBC ::= SEQUENCE {			
dl-SCH-Config SEQUENCE {	Not present		
ul-SCH-Config SEQUENCE {			
maxHARQ-Tx	n2	Only one retransmission per UL HARQ	
...			

## 8.5.2.2.1.5 Test requirement

For the parameters specified in Table 8.5.2.2.1.3-1 the average probability of a miss-detecting ACK for NACK ( $P_{m-an}$ ) shall be below the specified value in Table 8.5.2.2.1.5-1.

**Table 8.5.2.2.1.5-1: Test requirement of PHICH 2 Tx Antenna Port**

Test number	Bandwidth	Reference Channel	OCNG Pattern	Propagation Condition	Antenna configuration and correlation Matrix	Reference value	
						$P_{m-an}$ (%)	SNR (dB)
1	1.4 MHz	R.19	OP.1 TDD	EPA5	2 x 2 Low	0.1	6.4

## 8.5.2.2.1\_1 TDD PHICH Transmit Diversity 2x2 (Release 9 and forward)

## 8.5.2.2.1\_1.1 Test purpose

This test verifies the demodulation performance of PHICH for transmit diversity with a given SNR for which a certain Hybrid Indicator detection error rate (i.e. missed detection of "NACK to ACK" and "ACK to NACK") of the specified reference measurement channels is achieved.

## 8.5.2.2.1\_1.2 Test applicability

This test applies to all types of E-UTRA TDD UE release 9 and forward.

## 8.5.2.2.1\_1.3 Minimum conformance requirements

The receiver characteristics of the PHICH are determined by the probability of miss-detecting an ACK for a NACK ( $P_{m-an}$ ). It is assumed that there is no bias applied to the detection of ACK and NACK (zero-threshold detection).

**Table 8.5.2.2.1\_1.3-1: Test Parameters for PHICH**

Parameter		Unit	Transmit diversity
Uplink downlink configuration (Note 1)			1
Special subframe configuration (Note 2)			4
Downlink power allocation	PDCCH_RA PHICH_RA OCNG_RA	dB	-3
	PCFICH_RB PDCCH_RB PHICH_RB OCNG_RB	dB	-3
PHICH duration			Normal
Number of PHICH groups (Note 3)			$N_g = 1$
Cell ID			0
PDCCH Content		UL Grant should be included with the proper information aligned with A.3.6.	
Unused RE-s and PRB-s		OCNG	
$N_{oc}$ at antenna port		dBm/15kHz	-98
Cyclic prefix			Normal
ACK/NACK feedback mode			Multiplexing
Note 1: as specified in Table 4.2-2 in TS 36.211 [8] Note 2: as specified in Table 4.2-1 in TS 36.211 [8] Note 3: according to Clause 6.9 in TS 36.211 [8] Note 4: PHICH power settings refer to PHICH group power, i.e. the total power of all active PHICH sequences within a PHICH group.			

For the parameters specified in Table 8.5.2.2.1\_1.3-1 the average probability of a miss-detecting ACK for NACK ( $P_{m-an}$ ) shall be below the specified value in Table 8.5.2.2.1\_1.3-2.

**Table 8.5.2.2.1\_1.3-2: Minimum performance of PHICH 2 Tx Antenna Port**

Test number	Bandwidth	Reference Channel	OCNG Pattern	Propagation Condition	Antenna configuration and correlation Matrix	Reference value	
						$P_{m-an}$ (%)	SNR (dB)
1	10 MHz	R.19_1	OP.1 TDD	EVA70	2 x 2 Low	0.1	4.2

The normative reference for this requirement is TS 36.101 [2] clause 8.5.2.

8.5.2.2.1\_1.4 Test description

8.5.2.2.1\_1.4.1 Initial conditions

Test Environment: Normal, as defined in TS 36.508 [7] clause 4.1

Frequencies to be tested: Mid Range, as defined in TS 36.508 [7] clause 4.3.1.2

Bandwidths to be tested: 10 MHz, as defined in TS 36.508 [7] clause 4.3.1.2.

1. Connect the SS, the faders and AWGN noise sources to the UE antenna connector (s) as shown in TS 36.508 [7] Annex A Figure A.10.
2. The parameter settings for the cell are set up according to Table 8.5.2.2.1\_1.3-1.
3. Downlink signals are initially set up according to Annex C.1 and Annex C.3.2 and uplink signals according to Annex H.1 and H.3.2.

4. Propagation conditions are set according to Annex B clause B.0.
5. Ensure the UE is in State 3A-RF according to TS 36.508 [7] clause 5.2A.2. Message contents are defined in clause 8.5.2.2.1\_1.4.3.

8.5.2.2.1\_1.4.2 Test procedure

1. Set the parameters of bandwidth, reference Channel, the propagation condition, antenna configuration, the correlation matrix and the SNR according to Table 8.5.2.2.1\_1.5-1.
2. In Each HARQ process (4 HARQ processes for UL/DL configuration 1), SS shall schedule PUSCH transmissions according to Annex A.2.3.1.1 Table A.2.3.1.1-1 via PDCCH DCI format 0 with new data indicator set to true. Since the UE has no payload, the UE shall send uplink MAC padding bits in PUSCH. SS upon receiving the PUSCH transmissions shall transmit the associated ACKs. PHICH is set according to Annex 3.6 Table A.3.6-1. SS will only transmit PDCCH to schedule PUSCH transmission in the appropriate sub-frames. Table 8.5.2.2.1\_1.4.2-1 indicates the transmissions for one cycle.
3. SS will only monitor for uplink retransmissions due to ACK missed-detections. DTX from the UE side is counted as successful ACK reception, while any transmission on these subframes is counted as NACKs.
4. Repeat steps 1 – 3 for a duration sufficient to achieve statistical significance according to Annex G clause G.4 and measure Pm-an. Pm-an is (NACK) / (ACK + NACK).

If Pm-an is less than the value specified in table 8.5.2.2.1\_1.5-1, pass the UE. Otherwise fail the UE.

**Table 8.5.2.2.1\_1.4.2-1: PHICH test pattern**

Subframe Index	0	1	2	3	4	5	6	7	8	9	0	1	2	3	4	5	6	7	8	9
PDCCH		S			S		S			S										
PHICH												A			A		A			A
PUSCH			R?	R?				T	T				T	T					R?	R?
HARQ process		1	3	4	2		3	1	2	4		1	3	4	2		3	1	2	4

Note 1: This table gives an example test pattern for HARQ process for TDD PHICH test  
 Note 2: Following notation is used:  
 S: represents sending PDCCH DCI format 0 to schedule a future PUSCH transmission  
 A: represents the ACK transmission on PHICH  
 T: represents a scheduled PUSCH transmission  
 R: represents a potential PUSCH re-transmission due to a missed ACK  
 Note 3: TDD UL/DL configuration 1 is used here, special subframe is denoted as blue

8.5.2.2.1\_1.4.3 Message contents

Message contents are according to TS 36.508 [7] clause 4.6, with the following exceptions:

**Table 8.5.2.2.1\_1.4.3-1: MAC-MainConfig-RBC**

Derivation Path: TS 36.508 [7] clause 4.8.2.1.5, Table 4.8.2.1.5-1			
Information Element	Value/remark	Comment	Condition
MAC-MainConfig-RBC ::= SEQUENCE {			
dl-SCH-Config SEQUENCE {	Not present		
ul-SCH-Config SEQUENCE {			
maxHARQ-Tx	n2	Only one retransmission per UL HARQ	

8.5.2.2.1\_1.5 Test requirement

For the parameters specified in Table 8.5.2.2.1\_1.3-1 the average probability of a miss-detecting ACK for NACK (Pm-an) shall be below the specified value in Table 8.5.2.2.1\_1.5-1.

Table 8.5.2.2.1\_1.5-1: Test requirement of PHICH 2 Tx Antenna Port

Test number	Bandwidth	Reference Channel	OCNG Pattern	Propagation Condition	Antenna configuration and correlation Matrix	Reference value	
						Pm-an (%)	SNR (dB)
1	10 MHz	R.19_1	OP.1 TDD	EVA70	2 x 2 Low	0.1	+5.3

## 8.5.2.2.2 TDD PHICH Transmit Diversity 4x2

## 8.5.2.2.2.1 Test purpose

This test verifies the demodulation performance of PHICH for transmit diversity with a given SNR for which a certain Hybrid Indicator detection error rate (i.e. missed detection of "NACK to ACK" and "ACK to NACK") of the specified reference measurement channels is achieved.

## 8.5.2.2.2.2 Test applicability

This test applies to all types of E-UTRA TDD UE release 8.

## 8.5.2.2.2.3 Minimum conformance requirements

The receiver characteristics of the PHICH are determined by the probability of miss-detecting an ACK for a NACK (Pm-an). It is assumed that there is no bias applied to the detection of ACK and NACK (zero-threshold detection).

Table 8.5.2.2.3-1: Test Parameters for PHICH

Parameter		Unit	Transmit diversity
Uplink downlink configuration (Note 1)			1
Special subframe configuration (Note 2)			4
Downlink power allocation	PDCCH_RA PHICH_RA OCNG_RA	dB	-3
	PCFICH_RB PDCCH_RB PHICH_RB OCNG_RB	dB	-3
PHICH duration			Normal
Number of PHICH groups (Note 3)			Ng = 1
Cell ID			0
PDCCH Content		UL Grant should be included with the proper information aligned with A.3.6.	
Unused RE-s and PRB-s			OCNG
$N_{oc}$ at antenna port		dBm/15kHz	-98
Cyclic prefix			Normal
ACK/NACK feedback mode			Multiplexing
Note 1: as specified in Table 4.2-2 in TS 36.211 [8] Note 2: as specified in Table 4.2-1 in TS 36.211 [8] Note 3: according to Clause 6.9 in TS 36.211 [8] Note 4: PHICH power settings refer to PHICH group power, i.e. the total power of all active PHICH sequences within a PHICH group.			

For the parameters specified in Table 8.5.2.2.3-1 the average probability of a miss-detecting ACK for NACK (Pm-an) shall be below the specified value in Table 8.5.2.2.3-2.

**Table 8.5.2.2.3-2: Minimum performance of PHICH 4 Tx Antenna port**

Test number	Bandwidth	Reference Channel	OCNG Pattern	Propagation Condition	Antenna configuration and correlation Matrix	Reference value	
						Pm-an (%)	SNR (dB)
1	10 MHz	R.20	OP.1 TDD	EVA5	4 x 2 Medium	0.1	6.1

The normative reference for this requirement is TS 36.101 [2] clause 8.5.2.

#### 8.5.2.2.2.4 Test description

##### 8.5.2.2.2.4.1 Initial conditions

Test Environment: Normal, as defined in TS 36.508 [7] clause 4.1

Frequencies to be tested: Mid Range, as defined in TS 36.508 [7] clause 4.3.1.2

Channel Bandwidths to be tested: 10 MHz, as defined in TS 36.508 [7] clause 4.3.1.2.

1. Connect the SS, the faders and AWGN noise sources to the UE antenna connector (s) as shown in TS 36.508 [7] Annex A, Figure A.11.
2. The parameter settings for the cell are set up according to Table 8.5.2.2.3-1.
3. Downlink signals are initially set up according to Annex C.1 and Annex C.3.2 and uplink signals according to Annex H.1 and H.3.2.
4. Propagation conditions are set according to Annex B clause B.0.
5. Ensure the UE is in State 3A-RF according to TS 36.508 [7] clause 5.2A.2. Message contents are defined in clause 8.5.2.2.4.3.

##### 8.5.2.2.2.4.2 Test procedure

1. Set the parameters of bandwidth, reference Channel, the propagation condition, antenna configuration, the correlation matrix and the SNR according to Table 8.5.2.2.5-1.
2. In Each HARQ process (4 HARQ processes for UL/DL configuration 1), SS shall schedule PUSCH transmissions according to Annex A.2.3.1.1 Table A.2.3.1.1-1 via PDCCH DCI format 0 with new data indicator set to true. Since the UE has no payload, the UE shall send uplink MAC padding bits in PUSCH. SS upon receiving the PUSCH transmissions shall transmit the associated ACKs. PHICH is set according to Annex 3.6 Table A.3.6-1. SS will only transmit PDCCH to schedule PUSCH transmission in the appropriate sub-frames. Table 8.5.2.2.4.2-1 indicates the transmissions for one cycle.
3. SS will only monitor for uplink retransmissions due to ACK missed-detections. DTX from the UE side is counted as successful ACK reception, while any transmission on these subframes is counted as NACKs.
4. Repeat steps 1 – 3 for a duration sufficient to achieve statistical significance according to Annex G clause G.4 and measure Pm-an. Pm-an is (NACK) / (ACK + NACK).

If Pm-an is less than the value specified in table 8.5.2.2.5-1, pass the UE. Otherwise fail the UE.

**Table 8.5.2.2.4.2-1: PHICH test pattern**

<b>Subframe Index</b>	0	1	2	3	4	5	6	7	8	9	0	1	2	3	4	5	6	7	8	9
PDCCH		S			S		S			S										
PHICH												A			A		A			A
PUSCH			R?	R?				T	T				T	T					R?	R?
HARQ process		1	3	4	2		3	1	2	4		1	3	4	2		3	1	2	4
Note 1:	This table gives an example test pattern for HARQ process for TDD PHICH test																			
Note 2:	Following notation is used: S: represents sending PDCCH DCI format 0 to schedule a future PUSCH transmission A: represents the ACK transmission on PHICH T: represents a scheduled PUSCH transmission R: represents a potential PUSCH re-transmission due to a missed ACK																			
Note 3:	TDD UL/DL configuration 1 is used here, special subframe is denoted as blue																			

8.5.2.2.4.3 Message contents

Message contents are according to TS 36.508 [7] clause 4.6, with the following exceptions:

**Table 8.5.2.2.4.3-1: MAC-MainConfig-RBC**

Derivation Path: TS 36.508 [7] clause 4.8.2.1.5, Table 4.8.2.1.5-1			
Information Element	Value/remark	Comment	Condition
MAC-MainConfig-RBC ::= SEQUENCE {			
dl-SCH-Config SEQUENCE {	Not present		
ul-SCH-Config SEQUENCE {			
maxHARQ-Tx	n2	Only one retransmission per UL HARQ	
...			

8.5.2.2.5 Test requirement

For the parameters specified in Table 8.5.2.2.3-1 the average probability of a miss-detecting ACK for NACK (Pm-an) shall be below the specified value in Table 8.5.2.2.5-1.

**Table 8.5.2.2.5-1: Test requirement of PHICH 4 Tx Antenna Port**

Test number	Bandwidth	Reference Channel	OCNG Pattern	Propagation Condition	Antenna configuration and correlation Matrix	Reference value	
						Pm-an (%)	SNR (dB)
1	10 MHz	R.20	OP.1 TDD	EVA5	4 x 2 Medium	0.1	7.1

8.5.2.2.2\_1 TDD PHICH Transmit Diversity 4x2 (Release 9 and forward)

8.5.2.2.2\_1.1 Test purpose

This test verifies the demodulation performance of PHICH for transmit diversity with a given SNR for which a certain Hybrid Indicator detection error rate (i.e. missed detection of "NACK to ACK" and "ACK to NACK") of the specified reference measurement channels is achieved.

8.5.2.2.2\_1.2 Test applicability

This test applies to all types of E-UTRA TDD UE release 9 and forward.

8.5.2.2.2\_1.3 Minimum conformance requirements

The receiver characteristics of the PHICH are determined by the probability of miss-detecting an ACK for a NACK (Pm-an). It is assumed that there is no bias applied to the detection of ACK and NACK (zero-threshold detection).



**Table 8.5.2.2.2\_1.3-1: Test Parameters for PHICH**

Parameter		Unit	Transmit diversity
Uplink downlink configuration (Note 1)			1
Special subframe configuration (Note 2)			4
Downlink power allocation	PDCCH_RA PHICH_RA OCNG_RA	dB	-3
	PCFICH_RB PDCCH_RB PHICH_RB OCNG_RB	dB	-3
PHICH duration			Normal
Number of PHICH groups (Note 3)			$N_g = 1$
Cell ID			0
PDCCH Content		UL Grant should be included with the proper information aligned with A.3.6, other PDCCH resource shall be occupied by non-zero data.	
Unused RE-s and PRB-s		OCNG	
$N_{oc}$ at antenna port		dBm/15kHz	-98
Cyclic prefix			Normal
ACK/NACK feedback mode			Multiplexing
Note 1: as specified in Table 4.2-2 in TS 36.211 [8] Note 2: as specified in Table 4.2-1 in TS 36.211 [8] Note 3: according to Clause 6.9 in TS 36.211 [8] Note 4: PHICH power settings refer to PHICH group power, i.e. the total power of all active PHICH sequences within a PHICH group.			

For the parameters specified in Table 8.5.2.2.2\_1.3-1 the average probability of a miss-detecting ACK for NACK ( $P_{m-an}$ ) shall be below the specified value in Table 8.5.2.2.2\_1.3-2.

**Table 8.5.2.2.2\_1.3-2: Minimum performance of PHICH 4 Tx Antenna port**

Test number	Bandwidth	Reference Channel	OCNG Pattern	Propagation Condition	Antenna configuration and correlation Matrix	Reference value	
						$P_{m-an}$ (%)	SNR (dB)
1	5 MHz	R.20_1	OP.1 TDD	EPA5	4 x 2 Medium	0.1	6.2

The normative reference for this requirement is TS 36.101 [2] clause 8.5.2.

8.5.2.2.2\_1.4 Test description

8.5.2.2.2\_1.4.1 Initial conditions

Test Environment: Normal, as defined in TS 36.508 [7] clause 4.1

Frequencies to be tested: Mid Range, as defined in TS 36.508 [7] clause 4.3.1.2

Channel Bandwidths to be tested: 5 MHz, as defined in TS 36.508 [7] clause 4.3.1.2.

1. Connect the SS, the faders and AWGN noise sources to the UE antenna connector (s) as shown in TS 36.508 [7] Annex A, Figure A.11.
2. The parameter settings for the cell are set up according to Table 8.5.2.2.2\_1.3-1.

3. Downlink signals are initially set up according to Annex C.1 and Annex C.3.2 and uplink signals according to Annex H.1 and H.3.2.
4. Propagation conditions are set according to Annex B clause B.0.
5. Ensure the UE is in State 3A-RF according to TS 36.508 [7] clause 5.2A.2. Message contents are defined in clause 8.5.2.2.2\_1.4.3.

8.5.2.2.2\_1.4.2 Test procedure

1. Set the parameters of bandwidth, reference Channel, the propagation condition, antenna configuration, the correlation matrix and the SNR according to Table 8.5.2.2.2\_1.5-1.
2. In Each HARQ process (4 HARQ processes for UL/DL configuration 1), SS shall schedule PUSCH transmissions according to Annex A.2.3.1.1 Table A.2.3.1.1-1 via PDCCH DCI format 0 with new data indicator set to true. Since the UE has no payload, the UE shall send uplink MAC padding bits in PUSCH. SS upon receiving the PUSCH transmissions shall transmit the associated ACKs. PHICH is set according to Annex 3.6 Table A.3.6-1. SS will only transmit PDCCH to schedule PUSCH transmission in the appropriate sub-frames. Table 8.5.2.2.2\_1.4.2-1 indicates the transmissions for one cycle.
3. SS will only monitor for uplink retransmissions due to ACK missed-detections. DTX from the UE side is counted as successful ACK reception, while any transmission on these subframes is counted as NACKs.
4. Repeat steps 1 – 3 for a duration sufficient to achieve statistical significance according to Annex G clause G.4 and measure Pm-an. Pm-an is (NACK) / (ACK + NACK).

If Pm-an is less than the value specified in table 8.5.2.2.2\_1.5-1, pass the UE. Otherwise fail the UE.

**Table 8.5.2.2.2\_1.4.2-1: PHICH test pattern**

Subframe Index	0	1	2	3	4	5	6	7	8	9	0	1	2	3	4	5	6	7	8	9
PDCCH		S			S		S			S										
PHICH												A			A		A			A
PUSCH			R?	R?				T	T				T	T				R?	R?	
HARQ process		1	3	4	2		3	1	2	4		1	3	4	2		3	1	2	4

Note 1: This table gives an example test pattern for HARQ process for TDD PHICH test  
 Note 2: Following notation is used:  
 S: represents sending PDCCH DCI format 0 to schedule a future PUSCH transmission  
 A: represents the ACK transmission on PHICH  
 T: represents a scheduled PUSCH transmission  
 R: represents a potential PUSCH re-transmission due to a missed ACK  
 Note 3: TDD UL/DL configuration 1 is used here, special subframe is denoted as blue

8.5.2.2.2\_1.4.3 Message contents

Message contents are according to TS 36.508 [7] clause 4.6, with the following exceptions:

**Table 8.5.2.2.2\_1.4.3-1: MAC-MainConfig-RBC**

Derivation Path: TS 36.508 [7] clause 4.8.2.1.5, Table 4.8.2.1.5-1			
Information Element	Value/remark	Comment	Condition
MAC-MainConfig-RBC ::= SEQUENCE {			
dl-SCH-Config SEQUENCE {	Not present		
ul-SCH-Config SEQUENCE {			
maxHARQ-Tx	n2	Only one retransmission per UL HARQ	

## 8.5.2.2.2\_1.5 Test requirement

For the parameters specified in Table 8.5.2.2.2\_1.3-1 the average probability of a miss-detecting ACK for NACK (Pm-an) shall be below the specified value in Table 8.5.2.2.2\_1.5-1.

**Table 8.5.2.2.2\_1.5-1: Test requirement of PHICH 4 Tx Antenna Port**

Test number	Bandwidth	Reference Channel	OCNG Pattern	Propagation Condition	Antenna configuration and correlation Matrix	Reference value	
						Pm-an (%)	SNR (dB)
1	5 MHz	R.20_1	OP.1 TDD	EPA5	4 x 2 Medium	0.1	+7.2

## 8.5.2.2.3

## 8.5.2.2.3\_A

## 8.5.2.2.3\_B

## 8.5.2.2.3\_C TDD PHICH Transmit Diversity 2x2 for eICIC

## 8.5.2.2.3\_C.1 TDD PHICH Transmit Diversity 2x2 for eICIC (non-MBSFN ABS)

## 8.5.2.2.3\_C.1.1 Test purpose

This test verifies the demodulation performance of PHICH for transmit diversity with a given SNR for which a certain Hybrid Indicator detection error rate (i.e. missed detection of "NACK to ACK" and "ACK to NACK") of the specified reference measurement channels is achieved.

## 8.5.2.2.3\_C.1.2 Test applicability

This test applies to all types of E-UTRA TDD UE release 10 and forward. Applicability requires support for FGI bit 115.

## 8.5.2.2.3\_C.1.3 Minimum conformance requirements

The receiver characteristics of the PHICH are determined by the probability of miss-detecting an ACK for a NACK (Pm-an). It is assumed that there is no bias applied to the detection of ACK and NACK (zero-threshold detection).

Table 8.5.2.2.3\_C.1.3-1: Test Parameters for PHICH

Parameter		Unit	Cell 1	Cell 2
Uplink downlink configuration			1	1
Special subframe configuration			4	4
Downlink power allocation	PDCCH_RA PHICH_RA OCNG_RA	dB	-3	-3
	PCFICH_RB PDCCH_RB PHICH_RB OCNG_RB	dB	-3	-3
$N_{oc}$ at antenna port	$N_{oc1}$	dBm/15kHz	-100.5 (Note 1)	N/A
	$N_{oc2}$	dBm/15kHz	-98 (Note 2)	N/A
	$N_{oc3}$	dBm/15kHz	-95.3 (Note 3)	N/A
$\hat{E}_s / N_{oc2}$		dB	Reference Value in Table 8.5.2.2.3_C.1.3-2	1.5
BW <sub>Channel</sub>		MHz	10	10
Subframe Configuration			Non-MBSFN	Non-MBSFN
Time Offset between Cells		μs	2.5 (synchronous cells)	
Cell Id			0	1
ABS pattern (Note 4)			N/A	0000010001 0000000001
RLM/RRM Measurement Subframe Pattern (Note 5)			0000000001 0000000001	N/A
CSI Subframe Sets (Note 6)	$C_{CSI,0}$		0000010001 0000000001	N/A
	$C_{CSI,1}$		1100101000 1100111000	N/A
Number of control OFDM symbols			3	3
ACK/NACK feedback mode			Multiplexing	N/A
Number of PHICH groups ( $N_g$ )			1	N/A
PHICH duration			extended	N/A
Unused RE-s and PRB-s			OCNG	OCNG
Cyclic prefix			Normal	Normal
<p>Note 1: This noise is applied in OFDM symbols #1, #2, #3, #5, #6, #8, #9, #10, #12, #13 of a subframe overlapping with the aggressor ABS</p> <p>Note 2: This noise is applied in OFDM symbols #0, #4, #7, #11 of a subframe overlapping with the aggressor ABS</p> <p>Note 3: This noise is applied in OFDM symbols of a subframe overlapping with aggressor non-ABS</p> <p>Note 4: ABS pattern as defined in [14]. PHICH is transmitted in the serving cell subframe when the subframe is overlapped with the ABS subframe of aggressor cell but not in subframe 5</p> <p>Note 5: Time-domain measurement resource restriction pattern for PCell measurements as defined in [5]</p> <p>Note 6: As configured according to the time-domain measurement resource restriction pattern for CSI measurements defined in [5]</p> <p>Note 7: Cell 1 is the serving cell. Cell 2 is the aggressor cell. The number of the CRS ports in Cell1 and Cell2 is the same.</p> <p>Note 8: SIB-1 will not be transmitted in Cell2 in the test.</p>				

For the parameters specified in Table 8.5.2.2.3\_C.1.3-1 the average probability of a miss-detecting ACK for NACK ( $P_{m-an}$ ) shall be below the specified value in Table 8.5.2.2.3\_C.1.3-2. The downlink physical setup is in accordance with Annex C.3.2 and Annex C.3.3, In Table 8.5.2.2.3\_C.1.3-1, Cell 1 is the serving cell, and Cell 2 is the aggressor cell. The downlink physical channel setup for Cell 1 is according to Annex C.3.2 and for Cell 2 is according to Annex C.3.3, respectively.

**Table 8.5.2.2.3\_C.1.3-2: Minimum performance of PHICH 2 Tx Antenna Port**

Test Number	Reference Channel	OCNG Pattern		Propagation Conditions (Note 1)		Antenna Configuration and Correlation Matrix	Reference Value	
		Cell 1	Cell 2	Cell 1	Cell 2		Pm-an (%)	SNR (dB) (Note 2)
1	R.19_1	OP.1 TDD	OP.1 TDD	EPA5	EPA5	2x2 Low	0.1	4.6
Note 1: The propagation conditions for Cell 1 and Cell 2 are statistically independent.								
Note 2: SNR corresponds to $\hat{E}_s / N_{oc2}$ of cell 1.								
Note 3: The correlation matrix and antenna configuration apply for Cell 1 and Cell 2.								

The normative reference for this requirement is TS 36.101 [2] clause 8.5.2.2.3.

#### 8.5.2.2.3\_C.1.4 Test description

##### 8.5.2.2.3\_C.1.4.1 Initial conditions

Test Environment: Normal, as defined in TS 36.508 [7] clause 4.1

Frequencies to be tested: Mid Range, as defined in TS 36.508 [7] clause 4.3.1.2

Bandwidths to be tested: 10 MHz, as defined in TS 36.508 [7] clause 4.3.1.2.

1. Connect the SS, the faders and AWGN noise sources to the UE antenna connector (s) as shown in TS 36.508 [7] Annex A Figure A.40 for antenna transmit diversity 2x2 configuration .
2. The parameter settings for the cell are set up according to Table 8.5.2.2.3\_C.1.3-1.
3. Downlink signals are initially set up according to Annex C.0, C.1 and Annex C.3.2 and uplink signals according to Annex H.1 and H.3.2.
4. Propagation conditions are set according to Annex B clause B.0.
5. Ensure the UE is in State 3A-RF according to TS 36.508 [7] clause 5.2A.2. Message contents are defined in clause 8.5.2.2.3\_C.1.4.3.

##### 8.5.2.2.3\_C.1.4.2 Test procedure

1. Set the parameters for Cell1 and Cell2 according to Tables 8.5.2.2.3\_C.1.3-1, 8.5.2.2.3\_C.1.5-1, C.3.3-1 of Annex C.3.3 as appropriate. Propagation conditions are set according to Annex B clause B.2.
2. SS shall schedule PUSCH transmissions according to Annex A.2.3.1.1 Table A.2.3.1.1-1 via PDCCH DCI format 0 with the new data indicator set to true. Since the UE has no payload, the UE shall send uplink MAC padding bits in PUSCH. SS upon receiving the PUSCH transmission shall transmit the associated ACK. PHICH is set according to Annex 3.6 Table A.3.6-1. SS will only transmit PDCCH to schedule PUSCH transmission in the appropriate TTI-s. Table 8.5.2.2.3\_C.1.4.2-1 indicates the transmissions for two cycles.
3. SS will only monitor for uplink retransmissions due to ACK missed-detection. Such re-transmission (if it occurs) will potentially happen in TTI 24 (44 and so on). DTX from the UE side on this TTI is counted as successful ACK reception, while any transmission on this TTI is counted as NACK.
4. Repeat steps 1 – 3 for a duration sufficient to achieve statistical significance according to Annex G clause G.4 and measure Pm-an. Pm-an is (NACK) / (ACK + NACK).

If Pm-an is less than the value specified in table 8.5.2.2.3\_C.1.5-2, pass the UE. Otherwise fail the UE.

**Table 8.5.2.2.3\_C.1.4.2-1: PHICH test pattern**

TTI	10	14	20	24	30	34	40	44	50
PDCCH	S	-	-	-	S	-	-	-	S
PUSCH	-	T	-	R	-	T	-	R	-
PHICH	-	-	A	-	-	-	A	-	-
Note 1:	This table gives an example test pattern for HARQ process for TDD PHICH test								
Note 2:	Following notation is used: S: represents sending PDCCH DCI format 0 to schedule a future PUSCH transmission A: represents the ACK transmission on PHICH T: represents a scheduled PUSCH transmission R: represents a potential PUSCH re-transmission due to a missed ACK								
Note 3:	TDD UL/DL configuration 1 is used here								
Note 4:	In the other TTI-s there are no DCI-0, PHICH and PUSCH transmissions								

8.5.2.2.3\_C.1.4.3 Message contents

Message contents are according to TS 36.508 [7] clause 4.6, with the following exceptions:

**Table 8.5.2.2.3\_C.1.4.3-1: PHICH-Config**

Derivation Path: TS 36.508 [7] clause 4.6.3, Table 4.6.3-4			
Information Element	Value/remark	Comment	Condition
PHICH-Config-DEFAULT ::= SEQUENCE {			
phich-Duration	extended		Cell 1
phich-Resource	One		
}			

**Table 8.5.2.2.3\_C.1.4.3-2: MAC-MainConfig-RBC**

Derivation Path: TS 36.508 [7] clause 4.8.2.1.5, Table 4.8.2.1.5-1			
Information Element	Value/remark	Comment	Condition
MAC-MainConfig-RBC ::= SEQUENCE {			
dl-SCH-Config SEQUENCE {	Not present		
ul-SCH-Config SEQUENCE {			
maxHARQ-Tx	n2	Only one retransmission per UL HARQ	
...			

**Table 8.5.2.2.3\_C.1.4.3-3: RadioResourceConfigDedicated-SRB2-DRB(n, m)**

Derivation Path: TS 36.508 [7] clause 4.6.3, Table 4.6.3-16 RadioResourceConfigDedicated-SRB2-DRB(n,m)			
Information Element	Value/remark	Comment	Condition
RadioResourceConfigDedicated-SRB2-DRB(n, m) ::= SEQUENCE {			
MeasSubframePatternPCell-r10 CHOICE {			
setup SEQUENCE {			
subframePatternTDD-r10 CHOICE {			
subframeConfig1-5-r10	'00000000010000000001'	BIT STRING (SIZE (20))	
}			
}			
}			
}			

Table 8.5.2.2.3\_C.1.4.3-4: CQI-ReportConfig-r10-DEFAULT

Derivation Path: 36.508 [7] clause 4.6.3, Table 4.6.3-2AA CQI-ReportConfig-r10-DEFAULT_			
Information Element	Value/remark	Comment	Condition
CQI-ReportConfig-r10-DEFAULT ::= SEQUENCE {			
csi-SubframePatternConfig-r10 CHOICE {			
setup SEQUENCE {			
csi-MeasSubframeSet1-r10 CHOICE {			
subframePatternTDD-r10 CHOICE {			
subframeConfig1-5-r10	'00000100010000000001'	BIT STRING (SIZE (20))	
}			
}			
csi-MeasSubframeSet2-r10 CHOICE {			
subframePatternTDD-r10 CHOICE {			
subframeConfig1-5-r10	'11001010001100111000'	BIT STRING (SIZE (20))	
}			
}			
}			
}			

## 8.5.2.2.3\_C.1.5 Test requirement

For the parameters specified in Table 8.5.2.2.3\_C.1.5-1 the average probability of a miss-detecting ACK for NACK (P<sub>m-an</sub>) shall be below the specified value in Table 8.5.2.2.3\_C.1.5-2.

**Table 8.5.2.2.3\_C.1.5-1: Test Parameters for PHICH**

Parameter		Unit	Cell 1	Cell 2
Uplink downlink configuration			1	1
Special subframe configuration			4	4
Downlink power allocation	PDCCH_RA PHICH_RA OCNG_RA	dB	-3	-3
	PCFICH_RB PDCCH_RB PHICH_RB OCNG_RB	dB	-3	-3
$N_{oc}$ at antenna port	$N_{oc1}$	dBm/15kHz	-100.6 (Note 1)	N/A
	$N_{oc2}$	dBm/15kHz	-98 (Note 2)	N/A
	$N_{oc3}$	dBm/15kHz	-95.4 (Note 3)	N/A
$\hat{E}_s / N_{oc2}$		dB	Reference Value in Table 8.5.2.2.3_C.1.5-2	1.3
BW <sub>Channel</sub>		MHz	10	10
Subframe Configuration			Non-MBSFN	Non-MBSFN
Time Offset between Cells		μs	2.5 (synchronous cells)	
Cell Id			0	1
ABS pattern (Note 4)			N/A	0000010001 0000000001
RLM/RRM Measurement Subframe Pattern (Note 5)			0000000001 0000000001	N/A
CSI Subframe Sets (Note 6)	C <sub>CSI,0</sub>		0000010001 0000000001	N/A
	C <sub>CSI,1</sub>		1100101000 1100111000	N/A
Number of control OFDM symbols			3	3
ACK/NACK feedback mode			Multiplexing	N/A
Number of PHICH groups ( $N_g$ )			1	N/A
PHICH duration			extended	N/A
Unused RE-s and PRB-s			OCNG	OCNG
Cyclic prefix			Normal	Normal
<p>Note 1: This noise is applied in OFDM symbols #1, #2, #3, #5, #6, #8, #9, #10,#12, #13 of a subframe overlapping with the aggressor ABS</p> <p>Note 2: This noise is applied in OFDM symbols #0, #4, #7, #11 of a subframe overlapping with the aggressor ABS</p> <p>Note 3: This noise is applied in OFDM symbols of a subframe overlapping with aggressor non-ABS</p> <p>Note 4: ABS pattern as defined in [14]. PHICH is transmitted in the serving cell subframe when the subframe is overlapped with the ABS subframe of aggressor cell but not in subframe 5</p> <p>Note 5: Time-domain measurement resource restriction pattern for PCell measurements as defined in [5]</p> <p>Note 6: As configured according to the time-domain measurement resource restriction pattern for CSI measurements defined in [5]</p> <p>Note 7: Cell 1 is the serving cell. Cell 2 is the aggressor cell. The number of the CRS ports in Cell1 and Cell2 is the same.</p> <p>Note 8: SIB-1 will not be transmitted in Cell2 in the test.</p>				

**Table 8.5.2.2.3\_C.1.5-2: Test requirement of PHICH 2 Tx Antenna Port**

Test number	Bandwidth	Reference Channel	OCNG Pattern	Propagation Condition	Antenna configuration and correlation Matrix	Reference value	
						Pm-an (%)	SNR (dB)
1	10 MHz	R.19_1	OP.1 TDD	EPA5	2 x 2 Low	0.1	5.5



#### 8.5.2.2.3\_D

#### 8.5.2.2.3\_E TDD PHICH Transmit Diversity 2x2 for feICIC

#### 8.5.2.2.3\_E.1 TDD PHICH Transmit Diversity 2x2 for feICIC (non-MBSFN ABS)

##### 8.5.2.2.3\_E.1.1 Test purpose

This test verifies the demodulation performance of PHICH for transmit diversity with a given SNR for which a certain Hybrid Indicator detection error rate (i.e. missed detection of "NACK to ACK" and "ACK to NACK") of the specified reference measurement channels is achieved where PHICH transmission subframes overlap with ABS of the aggressor cell.

##### 8.5.2.2.3\_E.1.2 Test applicability

This test applies to all types of E-UTRA FDD UE and CRS interference handling and ss-CCH interference handling – UE Category 2-8 release 11 and forward. Applicability requires support of FGI bit 115.

##### 8.5.2.2.3\_E.1.3 Minimum conformance requirements

The receiver characteristics of the PHICH are determined by the probability of miss-detecting an ACK for a NACK ( $P_{m-an}$ ). It is assumed that there is no bias applied to the detection of ACK and NACK (zero-threshold detection).

Table 8.5.2.2.3\_E.1.3-1: Test Parameters for PHICH

Parameter		Unit	Cell 1	Cell 2	Cell 3
Uplink downlink configuration			1	1	1
Special subframe configuration			4	4	4
Downlink power allocation	PDCCH_RA PHICH_RA OCNG_RA	dB	-3	-3	-3
	PCFICH_RB PDCCH_RB PHICH_RB OCNG_RB	dB	-3	-3	-3
$N_{oc}$ at antenna port	$N_{oc1}$	dBm/15kHz	-98 (Note 1)	N/A	N/A
	$N_{oc2}$	dBm/15kHz	-98 (Note 2)	N/A	N/A
	$N_{oc3}$	dBm/15kHz	-93 (Note 3)	N/A	N/A
$\hat{E}_s/N_{oc2}$		dB	Reference Value in Table 8.5.2.2.3_E.1.3-2	5	3
BW <sub>Channel</sub>		MHz	10	10	10
Subframe Configuration			Non-MBSFN	Non-MBSFN	Non-MBSFN
Time Offset between Cells		μs	N/A	3	-1
Frequency shift between Cells		Hz	N/A	300	-100
Cell Id			0	126	1
PDCCH Content			UL Grant should be included with the proper information aligned with A.3.6.	N/A	N/A
ABS pattern (Note 4)			N/A	0000000001 0000000001	0000000001 0000000001
RLM/RRM Measurement Subframe Pattern (Note 5)			0000000001 0000000001	N/A	N/A
CSI Subframe Sets (Note 6)	C <sub>CSI,0</sub>		0000000001 0000000001	N/A	N/A
	C <sub>CSI,1</sub>		1100111000 1100111000	N/A	N/A
Number of control OFDM symbols			2	Note 7	Note 7
ACK/NACK feedback mode			Multiplexing	N/A	N/A
Number of PHICH groups ( $N_g$ )			1	N/A	N/A
PHICH duration			Normal	N/A	N/A
Unused RE-s and PRB-s			OCNG	OCNG	OCNG
Cyclic prefix			Normal	Normal	Normal
<p>Note 1: This noise is applied in OFDM symbols #1, #2, #3, #5, #6, #8, #9, #10,#12, #13 of a subframe overlapping with the aggressor ABS</p> <p>Note 2: This noise is applied in OFDM symbols #0, #4, #7, #11 of a subframe overlapping with the aggressor ABS</p> <p>Note 3: This noise is applied in OFDM symbols of a subframe overlapping with aggressor non-ABS</p> <p>Note 4: ABS pattern as defined in [9]. PHICH is transmitted in the serving cell subframe when the subframe is overlapped with the ABS subframe of aggressor cell but not in subframe 5</p> <p>Note 5: Time-domain measurement resource restriction pattern for PCell measurements as defined in [7]</p> <p>Note 6: As configured according to the time-domain measurement resource restriction pattern for CSI measurements defined in [7]</p> <p>Note 7: The number of control OFDM symbols is not available for ABS and is 2 for the subframe indicated by "0" of ABS pattern.</p> <p>Note 8: The number of the CRS ports in Cell 1, Cell 2 and Cell 3 is the same.</p> <p>Note 9: SIB-1 will not be transmitted in Cell 2 and Cell 3 in the test.</p>					

For the parameters specified in Table 8.5.2.2.3\_E.1.3-1 the average probability of a miss-detecting ACK for NACK ( $P_{m-an}$ ) shall be below the specified value in Table 8.5.2.2.3\_E.1.3-2. The downlink physical setup is in accordance with Annex C.3.2 and Annex C.3.3, In Table 8.5.2.2.3\_E.1.3-1, Cell 1 is the serving cell, and Cell 2 and Cell 3 are the aggressor cell. The downlink physical channel setup for Cell 1 is according to Annex C.3.2 and for Cell 2 and Cell 3 is according to Annex C.3.3, respectively. The CRS assistance information is provided for Cell 2 and Cell 3.

**Table 8.5.2.2.3\_E.1.3-2: Minimum performance of PHICH 2 Tx Antenna Port**

Test Number	Reference Channel	OCNG Pattern			Propagation Conditions (Note 1)			Antenna Configuration and Correlation Matrix (Note 2)	Reference Value	
		Cell 1	Cell 2	Cell 3	Cell 1	Cell 2	Cell 3		Pm-an (%)	SNR (dB) (Note 3)
1	R.19_1	OP.1 TDD	OP.1 TDD	OP.1 TDD	EPA5	EVA5	EVA5	2x2 Low	0.1	5.7
Note 1: The propagation conditions for Cell 1, Cell 2 and Cell 3 are statistically independent. Note 2: The correlation matrix and antenna configuration apply for Cell 1, Cell 2 and Cell 3. Note 3: SNR corresponds to $\hat{E}_s / N_{oc2}$ of Cell 1.										

The normative reference for this requirement is TS 36.101 [2] clause 8.5.2.2.4.

#### 8.5.2.2.3\_E.1.4 Test description

##### 8.5.2.2.3\_E.1.4.1 Initial conditions

Test Environment: Normal, as defined in TS 36.508 [7] clause 4.1

Frequencies to be tested: Mid Range, as defined in TS 36.508 [7] clause 4.3.1.2

Bandwidths to be tested: 10 MHz, as defined in TS 36.508 [7] clause 4.3.1.2.

1. Connect the SS, the faders and AWGN noise sources to the UE antenna connector (s) as shown in TS 36.508 [7] Annex A Figure A.48 for antenna transmit diversity 2x2 configuration.
2. The parameter settings for the cell are set up according to Table 8.5.2.2.3\_E.1.3-1.
3. Downlink signals are initially set up according to Annex C.0, C.1 and Annex C.3.2 and uplink signals according to Annex H.1 and H.3.2.
4. Propagation conditions are set according to Annex B clause B.0.
5. Ensure the UE is in State 3A-RF according to TS 36.508 [7] clause 5.2A.2 with exceptions listed in 5.2A.5. Message contents are defined in clause 8.5.2.2.3\_E.1.4.3.

##### 8.5.2.2.3\_E.1.4.2 Test procedure

1. Set the parameters for Cell1, Cell2 and Cell3 according to Tables 8.5.2.2.3\_E.1.3-1, 8.5.2.2.3\_E.1.5-1 and C.3.3-2 of Annex C.3.3 as appropriate. Propagation conditions are set according to Annex B clause B.2.
2. SS shall schedule PUSCH transmissions according to Annex A.2.3.1.1 Table A.2.3.1.1-1 via PDCCH DCI format 0 with the new data indicator set to true. Since the UE has no payload, the UE shall send uplink MAC padding bits in PUSCH. SS upon receiving the PUSCH transmission shall transmit the associated ACK. PHICH is set according to Annex 3.6 Table A.3.6-1. SS will only transmit PDCCH to schedule PUSCH transmission in the appropriate TTI-s. Table 8.5.2.2.3\_E.1.4.2-1 indicates the transmissions for two cycles.
3. SS will only monitor for uplink retransmissions due to ACK missed-detection. Such re-transmission (if it occurs) will potentially happen in TTI 24 (44 and so on). DTX from the UE side on this TTI is counted as successful ACK reception, while any transmission on this TTI is counted as NACK.
4. Repeat steps 1 – 3 for a duration sufficient to achieve statistical significance according to Annex G clause G.4 and measure  $P_{m-an}$  in the subframes overlapping with ABS of the aggressor cell.  $P_{m-an}$  is (NACK) / (ACK + NACK).

If  $P_{m-an}$  is less than the value specified in table 8.5.2.2.3\_E.1.5-2, pass the UE. Otherwise fail the UE.

**Table 8.5.2.2.3\_E.1.4.2-1: PHICH test pattern**

TTI	10	14	20	24	30	34	40	44	50
PDCCH	S	-	-	-	S	-	-	-	S
PUSCH	-	T	-	R	-	T	-	R	-
PHICH	-	-	A	-	-	-	A	-	-
Note 1:	This table gives an example test pattern for HARQ process for FDD PHICH test								
Note 2:	Following notation is used: S: represents sending PDCCH DCI format 0 to schedule a future PUSCH transmission A: represents the ACK transmission on PHICH T: represents a scheduled PUSCH transmission R: represents a potential PUSCH re-transmission due to a missed ACK								
Note 3:	TDD UL/DL configuration 1 is used here								
Note 4:	In the other TTI-s there are no DCI-0, PHICH and PUSCH transmissions								

## 8.5.2.2.3\_E.1.4.3 Message contents

Message contents are according to TS 36.508 [7] clause 5.2A.5.1, with the following exceptions:

**Table 8.5.2.2.3\_E.1.4.3-1: MAC-MainConfig-RBC**

Derivation Path: TS 36.508 [7] clause 4.8.2.1.5, Table 4.8.2.1.5-1			
Information Element	Value/remark	Comment	Condition
MAC-MainConfig-RBC ::= SEQUENCE {			
dl-SCH-Config SEQUENCE {}	Not present		
ul-SCH-Config SEQUENCE {			
maxHARQ-Tx	n2	Only one retransmission per UL HARQ	

**Table 8.5.2.2.3\_E.1.4.3-2: RadioResourceConfigDedicated-SRB2-DRB(n, m)**

Derivation Path: TS 36.508 [7] clause 4.6.3, Table 4.6.3-16 RadioResourceConfigDedicated-SRB2-DRB(n,m)			
Information Element	Value/remark	Comment	Condition
RadioResourceConfigDedicated-SRB2-DRB(n, m) ::= SEQUENCE {			
MeasSubframePatternPCell-r10 CHOICE {			
setup SEQUENCE {			
subframePatternTDD-r10 CHOICE {			
subframeConfig1-5-r10	'000000000100000000'	BIT STRING (SIZE (20))	
}			
}			
}			
neighCellsCRS-Info-r11 ::= CHOICE {			
setup SEQUENCE {			
CRS-AssistancedInfoList-r11 ::= SEQUENCE (SIZE (1..maxCellReport)) OF CRS-AssistancedInfo-r11{		2 entries	
CRS-AssistancedInfo-r11 ::= SEQUENCE {			
physCellId-r11	126		Cell 2
antennaPortsCount-r11	1		Cell 3
antennaPortsCount-r11	an2		Cell 2, Cell 3
mbsfn-SubframeConfigList-r11 ::= SEQUENCE (SIZE (1..maxMBSFN-Allocations)) OF MBSFN-SubframeConfig{			Cell 2, Cell 3
MBSFN-SubframeConfig ::= SEQUENCE {			
radioframeAllocationPeriod	n1		
radioframeAllocationOffset	0		
subframeAllocation CHOICE{			
oneFrame	'000000' B	non-MBSFN	
}			
}			
}			
}			
}			
}			
}			
}			

**Table 8.5.2.2.3\_E.1.4.3-3: CQI-ReportConfig-r10-DEFAULT**

Derivation Path: 36.508 [7] clause 4.6.3, Table 4.6.3-2AA CQI-ReportConfig-r10-DEFAULT_			
Information Element	Value/remark	Comment	Condition
CQI-ReportConfig-r10-DEFAULT ::= SEQUENCE {			
csi-SubframePatternConfig-r10 CHOICE {			
setup SEQUENCE {			
csi-MeasSubframeSet1-r10 CHOICE {			
subframePatternTDD-r10 CHOICE {			
subframeConfig1-5-r10	'00000000010000000001'	BIT STRING (SIZE (20))	
}			
}			
csi-MeasSubframeSet2-r10 CHOICE {			
subframePatternTDD-r10 CHOICE {			
subframeConfig1-5-r10	'11001110001100111000'	BIT STRING (SIZE (20))	
}			
}			
}			
}			
}			

## 8.5.2.2.3\_E.1.5 Test requirement

For the parameters specified in Table 8.5.2.2.3\_E.1.5-1 the average probability of a miss-detecting ACK for NACK (Pm-an) shall be below the specified value in Table 8.5.2.2.3\_E.1.5-2.

Table 8.5.2.2.3\_E.1.5-1: Test Parameters for PHICH

Parameter		Unit	Cell 1	Cell 2	Cell 3
Uplink downlink configuration			1	1	1
Special subframe configuration			4	4	4
Downlink power allocation	PDCCH_RA PHICH_RA OCNG_RA	dB	-3	-3	-3
	PCFICH_RB PDCCH_RB PHICH_RB OCNG_RB	dB	-3	-3	-3
$N_{oc}$ at antenna port	$N_{oc1}$	dBm/15kHz	-98 (Note 1)	N/A	N/A
	$N_{oc2}$	dBm/15kHz	-98 (Note 2)	N/A	N/A
	$N_{oc3}$	dBm/15kHz	-93.1 (Note 3)	N/A	N/A
$\hat{E}_s/N_{oc2}$		dB	Reference Value in Table 8.5.2.2.3_E.1.5-2	4.8	2.8
$BW_{Channel}$		MHz	10	10	10
Subframe Configuration			Non-MBSFN	Non-MBSFN	Non-MBSFN
Time Offset between Cells		$\mu$ s	N/A	3	-1
Frequency shift between Cells		Hz	N/A	300	-100
Cell Id			0	126	1
PDCCH Content			UL Grant should be included with the proper information aligned with A.3.6.	N/A	N/A
ABS pattern (Note 4)			N/A	000000001 000000001	000000001 000000001
RLM/RRM Measurement Subframe Pattern (Note 5)			000000001 000000001	N/A	N/A
CSI Subframe Sets (Note 6)	$C_{CSI,0}$		000000001 000000001	N/A	N/A
	$C_{CSI,1}$		1100111000 1100111000	N/A	N/A

Number of control OFDM symbols		2	Note 7	Note 7
ACK/NACK feedback mode		Multiplexing	N/A	N/A
Number of PHICH groups ( $N_g$ )		1	N/A	N/A
PHICH duration		Normal	N/A	N/A
Unused RE-s and PRB-s		OCNG	OCNG	OCNG
Cyclic prefix		Normal	Normal	Normal
Note 1:	This noise is applied in OFDM symbols #1, #2, #3, #5, #6, #8, #9, #10, #12, #13 of a subframe overlapping with the aggressor ABS			
Note 2:	This noise is applied in OFDM symbols #0, #4, #7, #11 of a subframe overlapping with the aggressor ABS			
Note 3:	This noise is applied in OFDM symbols of a subframe overlapping with aggressor non-ABS			
Note 4:	ABS pattern as defined in [9]. PHICH is transmitted in the serving cell subframe when the subframe is overlapped with the ABS subframe of aggressor cell but not in subframe 5			
Note 5:	Time-domain measurement resource restriction pattern for PCell measurements as defined in [7]			
Note 6:	As configured according to the time-domain measurement resource restriction pattern for CSI measurements defined in [7]			
Note 7:	The number of control OFDM symbols is not available for ABS and is 2 for the subframe indicated by "0" of ABS pattern.			
Note 8:	The number of the CRS ports in Cell 1, Cell 2 and Cell 3 is the same.			
Note 9:	SIB-1 will not be transmitted in Cell 2 and Cell 3 in the test.			

**Table 8.5.2.2.3\_E.1.5-2: Test requirement TDD PHICH Transmit Diversity 2x2 for feICIC (non-MBSFN ABS)**

Test Number	Reference Channel	OCNG Pattern			Propagation Conditions (Note 1)			Antenna Configuration and Correlation Matrix (Note 2)	Reference Value	
		Cell 1	Cell 2	Cell 3	Cell 1	Cell 2	Cell 3		Pm-an (%)	SNR (dB) (Note 3)
1	R.19_1	OP.1 TDD	OP.1 TDD	OP.1 TDD	EPA5	EVA5	EVA5	2x2 Low	0.1	6.6
Note 1:	The propagation conditions for Cell 1, Cell 2 and Cell 3 are statistically independent.									
Note 2:	The correlation matrix and antenna configuration apply for Cell 1, Cell 2 and Cell 3.									
Note 3:	SNR corresponds to $\hat{E}_s / N_{oc2}$ of Cell 1.									

## 8.6 Demodulation of PBCH

RAN4 will specify the PBCH performance requirements and has recommended that these requirements do not need to be tested.

## 8.7 Sustained downlink data rate provided by lower layers

### 8.7.1 FDD

The parameters specified in Table 8.7.1-1 are valid for all FDD tests unless otherwise stated.

**Table 8.7.1-1: Common Test Parameters (FDD)**

Parameter	Unit	Value
Cyclic prefix		Normal
Cell ID		0 (Note 1)
Inter-TTI Distance		1
Number of HARQ processes	Processes	Downlink: 8 Uplink: 8
Maximum number of HARQ transmission		Downlink: 4 Uplink: 1
Scheduling of retransmissions		1. Retransmissions use the same Transport Block Size (TBS) as the initial transmission. 2. HARQ processes are scheduled consecutively, independent of the fact, whether retransmissions (for negatively acknowledged HARQ processes) or new transmissions (for positively acknowledged HARQ processes) occur. 3. Despite of 1) and 2) the number of RB-s to be allocated in each SF remains firm as specified in the RMC. Thus in case of RMC-s with SF dependent allocation, for retransmissions the TBS and the modulation scheme (MCS) are indicated implicitly ( $29 \leq I_{MCS} \leq 31$ ) according to TS 36.213 [10] subclause 7.1.7.2.
Redundancy version coding sequence		{0,0,1,2} for 64QAM
Number of OFDM symbols for PDCCH	OFDM symbols	1
Cross carrier scheduling		Not configured
Propagation condition		Static propagation condition No external noise sources are applied
Note 1: For CA tests, Cell ID = 0 applies to P-Cell, Cell ID = n (where n is 1, 2, 3..) applies to S-Celln (where n is 1, 2, 3..), respectively		

The normative reference for this requirement is TS 36.101[2] clause 8.7.1.

## 8.7.1.1 FDD sustained data rate performance

### 8.7.1.1.1 Test purpose

The purpose of the test is to verify that the Layer 1 and Layer 2 correctly process in a sustained manner the received packets corresponding to the maximum number of DL-SCH transport block bits received within a TTI for the UE category indicated. The sustained downlink data rate shall be verified in terms of the success rate of delivered PDCP SDU(s) by Layer 2. The test case below specifies the RF conditions and the required success rate of delivered TB by Layer 1 to meet the sustained data rate requirement. The size of the TB per TTI corresponds to the largest possible DL-SCH transport block for each UE category using the maximum number of layers for spatial multiplexing. Transmission modes 1 and 3 are used with radio conditions resembling a scenario where sustained maximum data rates are available. Test case is selected according to table 8.7.1.1.1-1 depending on UE capability for CA and EPDCCH.

**Table 8.7.1.1.1-1: SDR test applicability**

	Single carrier UE not supporting EPDCCH	CA UE not supporting EPDCCH	Single carrier UE supporting EPDCCH	CA UE supporting EPDCCH



FDD	8.7.1.1, 8.7.1.1_1	8.7.1.1_A	8.7.3.1	8.7.1.1_A, 8.7.3.1
-----	--------------------	-----------	---------	--------------------

### 8.7.1.1.2 Test applicability

This test applies to E-UTRA FDD Release 9 and forward UE of category 1 to 4.

### 8.7.1.1.3 Minimum requirements

**Table 8.7.1.1.3-1: Void**

The requirements are specified in Table 8.7.1.1.3-3, with the addition of the parameters in Table 8.7.1.1.3-2 and the downlink physical channel setup according to Annex C.3.2. The test points are applied to UE category as specified in Table 8.7.1.1.3-4. The TB success rate shall be sustained during at least 300 frames.

**Table 8.7.1.1.3-2: Test Parameters for sustained downlink data rate (FDD)**

Test	Bandwidth (MHz)	Transmission mode	Antenna configuration	Codebook subset restriction	Downlink power allocation (dB)			$\hat{E}_s$ at antenna port (dBm/15 kHz)	Symbols for unused PRBs
					$\rho_A$	$\rho_B$	$\sigma$		
1	10	1	1 x 2	N/A	0	0	0	-85	OP.6 FDD
2	10	3	2 x 2	10	-3	-3	0	-85	OP.1 FDD
3, 4, 6	20	3	2 x 2	10	-3	-3	0	-85	OP.1 FDD
3A	10	3	2 x 2	10	-3	-3	0	-85	OP.1 FDD
3C, 4B	15	3	2 x 2	10	-3	-3	0	-85	OP.1 FDD

**Table 8.7.1.1.3-3: Minimum Requirement (FDD)**

Test	Number of bits of a DL-SCH transport block received within a TTI	Measurement channel	Reference value
			TB success rate [%]
1	10296	R.31-1 FDD	95
2	25456	R.31-2 FDD	95
3	51024	R.31-3 FDD	95
3A	36696 (Note 2)	R.31-3A FDD	85
3C	51024	R.31-3C FDD	85
4	75376 (Note 3)	R.31-4 FDD	85
4B	55056 (Note 5)	R.31-4B FDD	85
6	75376 (Note 3)	R.31-4 FDD	85

Note 1: For 2 layer transmissions, 2 transport blocks are received within a TTI.  
Note 2: 35160 bits for sub-frame 5.  
Note 3: 71112 bits for sub-frame 5.  
Note 4: The TB success rate is defined as TB success rate = 100% \*  $N_{DL\_correct\_rx} / (N_{DL\_newtx} + N_{DL\_retx})$ , where  $N_{DL\_newtx}$  is the number of newly transmitted DL transport blocks,  $N_{DL\_retx}$  is the number of retransmitted DL transport blocks, and  $N_{DL\_correct\_rx}$  is the number of correctly received DL transport blocks.  
Note 5: 52752 bits for sub-frame 5.

**Table 8.7.1.1.3-4: Test points for sustained data rate (FRC)**

CA config	Maximum supported Bandwidth (MHz)	Category 1	Category 2	Category 3	Category 4	Category 6	Category 7
Single carrier	10	1	2	3A	3A	-	-
	15	-	-	3C	4B	-	-
	20	-	-	3	4	6	6
Note 1: If UE can be tested for CA configuration, single carrier test is skipped.							
Note 2: For non-CA UE, test is selected for maximum supported bandwidth.							

The normative reference for this requirement is TS 36.101[2] clause 8.7.1

8.7.1.1.4 Test description

8.7.1.1.4.1 Initial conditions

**Table 8.7.1.1.4.1-1: Further test parameters per test**

Test	DL Measurement channel	UL Measurement channel	TB <sub>size</sub> per Codeword	Number of PDCP SDU per Codeword	PDCP SDU size [Octets] Calculation (Note 1)	PDCP SDU size [Octets]
1	R.31-1 FDD	R.1-1 FDD	10296	1	$\text{FLOOR}((\text{TB}_{\text{size}} - 96)/8)$	1275
2	R.31-2 FDD	R.1-2 FDD	25456	3	$\text{FLOOR}((\text{TB}_{\text{size}} - 152)/24)$	1054
3	R.31-3 FDD	R.1-3 FDD	51024	5	$\text{FLOOR}((\text{TB}_{\text{size}} - 208)/40)$	1270
3A	R.31-3A FDD	R.1-3A FDD	36696 (Note 3)	4	$\text{FLOOR}((\text{TB}_{\text{size}} - 184)/32)$	1141
3C	R.31-3C FDD	TBD	51024	5	$\text{FLOOR}((\text{TB}_{\text{size}} - 208)/40)$	1270
4	R.31-4 FDD	R.1-4 FDD	75376 (Note 4)	7	$\text{FLOOR}((\text{TB}_{\text{size}} - 264)/56)$	1341
4B	R.31-4B FDD	TBD	55056 (Note 5)	5	$\text{FLOOR}((\text{TB}_{\text{size}} - 208)/40)$	1371
<p>Note 1: Transport block size under test according to applicable Fixed Reference Channel for sustained data-rate test in annex A.3.9. In case of varying TBS across SFs of the RMC, only the maximum TBS is used for PDCP SDU size calculation.</p> <p>Note 2: Each PDCP SDU is limited to 1500 octets (to keep below maximum SDU size of ESM as specified in TS 24.301 clause 9.9.4.12).</p> <p>The PDCP SDU size of each PDCP SDU is:</p> $\text{PDCP SDU size} = (\text{TB}_{\text{size}} - N \cdot \text{PDCP header size} - \text{AMD PDU header size} - \text{MAC header size} - \text{Size of RLC STATUS PDU}) / N,$ <p>where PDCP header size is 16 bits for the RLC AM and 12-bit SN case; AMD PDU header size is <math>\text{CEIL}[(16+(N-1) \cdot 12)/8]</math> bytes which includes 16 bit standard AM header and (N-1) Length indicators; and MAC header size = R/R/E/LCID/F/L MAC subheader (24 bits for MAC SDU for RLC STATUS PDU with 15 bit LI) + R/R/E/LCID MAC subheader (8 bits for MAC SDU for RLC Data PDU) = 32 bits. The size of RLC STATUS PDU including one ACK_SN field and one NACK_SN field is 32 bits (if no STATUS PDU is sent or if the size of the STATUS PDU is less than 32 bits then padding will be used to fill the 32 bits). This gives: <math>\text{PDCP SDU size} = 8 \cdot \text{FLOOR}((\text{TB}_{\text{size}} - N \cdot 16 - 8 \cdot \text{CEIL}[(16+(N-1) \cdot 12)/8] - 64)/(8 \cdot N))</math> bits.</p> <p>The calculation of PDCP SDU sizes does not consider timing advance MAC CE as timing advance is not transmitted by SS for RF test cases, and the header sizes are informative and may vary during the test.</p> <p>Note 3: 35160 bits for sub-frame 5</p> <p>Note 4: 71112 bits for sub-frame 5</p> <p>Note 5: 52752 bits for sub-frame 5.</p>						

Initial conditions are a set of test configurations the UE needs to be tested in and the steps for the SS to take with the UE to reach the correct measurement state.

Configurations of PDSCH and PDCCH before measurement are specified in Annex C.2.

Test Environment: Normal as defined in TS 36.508 [7] clause 4.1.

Frequencies to be tested: Mid Range as defined in TS 36.508 [7] clause 4.3.1.1.

Channel Bandwidths to be tested: according to Table 8.7.1.1.5-2 depending on the UE category according to Table 8.7.1.1.5-3.

1. Connect the SS to the UE antenna connector(s) as shown in TS 36.508 [7] Annex A, Figure A.3 for test 1 and Figure A.10 for tests 2-4 (without using faders and AWGN generators).
2. The parameter settings for the cell are set up according to Table 8.7.1.1.5-2 and Table 8.7.1.1.5-1 depending on the UE category according to Table 8.7.1.1.5-3.
3. Downlink signals are initially set up according to Annex C0, C.1 and Annex C.3.2 and uplink signals according to Annex H.1 and H.3.2.
4. Propagation conditions are set according to Annex B.0.
5. Ensure the UE is in State 4A-RF according to TS 36.508 [7] clause 5.2A.3. Message contents are defined in clause 8.7.1.1.4.3. PhysicalConfigDedicated-DEFAULT for transmission mode 3 is defined in Table 8.7.1.1.4.3-3.

#### 8.7.1.1.4.2 Test procedure

1. Propagation conditions are set according to Annex B.1 (No external noise sources are applied).
2. The SS looks up  $TB_{size}$  in Table 8.7.1.1.4.1-1 for the tests to be performed depending on the UE category according to Table 8.7.1.1.5-3.
3. SS sets the counters  $N_{DL\_newtx}$ ,  $N_{DL\_retx}$ ,  $N_{UL\_PDCP}$ , and  $N_{DL\_PDCP}$  to 0.
4. For each new DL HARQ transmission the SS generates sufficient PDCP SDUs to fill up the TB in accordance with Table 8.7.1.1.4.1-1 (Note 1). The SS ciphers the PDCP SDUs, concatenates the resultant PDCP PDUs to form an RLC PDU and then a MAC PDU. The SS transmits the MAC PDU. The SS increments then  $N_{DL\_newtx}$  by one and  $N_{DL\_PDCP}$  by the number of new PDCP SDUs (Note 1) included in the sent MAC PDU.
5. If PHY requests a DL HARQ retransmission, the SS performs a HARQ retransmission and increments  $N_{DL\_retx}$  by one.
6. Steps 4 to 5 are repeated at every TTI for at least 300 frames and the SS waits for 300ms to let any HARQ retransmissions and RLC retransmissions to finish.
7. For each PDCP SDU received at the SS, if the content of the data matches that of the truncated version of the original PDCP SDU generated at the SS, the SS increments  $N_{UL\_PDCP}$  by one
8. The SS calculates the TB success rate as  $A = 100\% * N_{DL\_newtx} / (N_{DL\_newtx} + N_{DL\_retx})$ . Measurements are not based on UE feedback but on SS counters instead ( $N_{DL\_newtx}$  and  $N_{DL\_retx}$ ) in order to validate HARQ feedback received from the UE.
9. The SS calculates the PDCP SDU loss as  $B = N_{DL\_PDCP} - N_{UL\_PDCP}$
10. The UE passes the test if  $A \geq$  "corresponding TB success rates according to Table 8.7.1.1.5-1" and  $B = 0$ .

NOTE 1: In case of RLC PDU retransmission, the number of new required PDCP SDUs is as many as to fill the rest of TB.

#### 8.7.1.1.4.3 Message contents

Message contents are according to TS 36.508 [7] clause 4.6 and 4.7A, with the following exceptions:

**Table 8.7.1.1.4.3-1: CLOSE UE TEST LOOP (in the preamble)**

Derivation Path: 36.509 clause 6.1			
Information Element	Value/remark	Comment	Condition
Protocol discriminator	1 1 1 1		
Skip indicator	0 0 0 0		
Message type	1 0 0 0 0 0 0 0		
UE test loop mode	0 0 0 0 0 0 0 0	UE test loop mode A	
UE test loop mode A LB setup			
Length of UE test loop mode A LB setup list in bytes	0 0 0 0 0 0 1 1	Length of one LB setup DRB (3 bytes)	
LB setup DRB	0 0 0 0 0 0 0 0, 0 0 1 0 1 0 0 0, 0 0 0 Q4 Q3 Q2 Q1 Q0	UL PDCP SDU size = 40 bits (5 bytes) Q4..Q0 = Data Radio Bearer identity number for the default radio bearer. See 36.509 clause 6.1	
UE test loop mode B LB setup	Not present		

**Table 8.7.1.1.4.3-2: SecurityModeCommand (in the preamble)**

Derivation Path: TS 36.508 clause 4.6.1 table 4.6.1-19			
Information Element	Value/remark	Comment	Condition
SecurityModeCommand ::= SEQUENCE {			
criticalExtensions CHOICE {			
c1 CHOICE{			
securityModeCommand-r8 SEQUENCE {			
securityConfiguration SEQUENCE {			
cipheringAlgorithm	eea2		
nextHopChainingCount	Not present		
}			
nonCriticalExtension SEQUENCE {}	Not present		
}			
}			
}			
}			

**Table 8.7.1.1.4.3-3: PhysicalConfigDedicated-DEFAULT**

Derivation Path: 36.508 clause 4.8.2.1.6-1			
Information Element	Value/remark	Comment	Condition
PhysicalConfigDedicated-DEFAULT ::= SEQUENCE {			
antennaInfo CHOICE {			
explicitValue ::= SEQUENCE {			
transmissionMode	tm3		Transmission mode 3
codebookSubsetRestriction CHOICE {			
n2TxAntenna-tm3	10		
}			
ue-TransmitAntennaSelection CHOICE {			
release	NULL		
}			
}			
}			
}			

8.7.1.1.5 Test requirement

The requirements are specified in Table 8.7.1.1.5-1 depending on the UE category according to Table 8.7.1.1.5-3. The PDCP SDU success rate shall be sustained during at least 300 frames.

Table 8.7.1.1.5-1: Test requirements per test

Test	Number of bits of a DL-SCH transport block received within a TTI	Measurement channel	Reference value
			TB success rate [%]
1	10296	R.31-1 FDD	95
2	25456	R.31-2 FDD	95
3	51024	R.31-3 FDD	95
3A	36696 (Note 2)	R.31-3A FDD	85
3C	51024	R.31-3C FDD	85
4	75376 (Note 3)	R.31-4 FDD	85
4B	55056 (Note 5)	R.31-4B FDD	85

Note 1: For 2 layer transmissions, 2 transport blocks are received within a TTI.  
Note 2: 35160 bits for sub-frame 5.  
Note 3: 71112 bits for sub-frame 5.  
Note 4: The TB success rate is defined as TB success rate =  $100\% \cdot N_{DL\_correct\_rx} / (N_{DL\_newtx} + N_{DL\_retx})$ , where  $N_{DL\_newtx}$  is the number of newly transmitted DL transport blocks,  $N_{DL\_retx}$  is the number of retransmitted DL transport blocks, and  $N_{DL\_correct\_rx}$  is the number of correctly received DL transport blocks.  
Note 5: 52752bits for sub-frame 5.

Table 8.7.1.1.5-2: Test parameters per test

Test	Bandwidth (MHz)	Transmission mode	Antenna configuration	Codebook subset restriction	Downlink power allocation (dB)			$\hat{E}_s$ at antenna port (dBm/15kHz)	Symbols for unused PRBs
					$\rho_A$	$\rho_B$	$\sigma$		
1	10	1	1 x 2	N/A	0	0	0	-85	OP.6 FDD
2	10	3	2 x 2	10	-3	-3	0	-85	OP.1 FDD
3,4	20	3	2 x 2	10	-3	-3	0	-85	OP.1 FDD
3A	10	3	2 x 2	10	-3	-3	0	-85	OP.1 FDD
3C, 4B	15	3	2 x 2	10	-3	-3	0	-85	OP.1 FDD

Table 8.7.1.1.5-3: Test applicability per UE category

CA config	Maximum supported Bandwidth (MHz)	Category 1	Category 2	Category 3	Category 4	Category 6	Category 7
Single carrier	10	1	2	3A	3A	-	-
	15	-	-	3C	4B	-	-
	20	-	-	3	4	-	-

Note 1: If UE can be tested for CA configuration, single carrier test is skipped.  
Note 2: For non-CA UE, test is selected for maximum supported bandwidth.

### 8.7.1.1\_1 FDD sustained data rate performance (Rel-10 and forward)

#### 8.7.1.1\_1.1 Test purpose

Same test purpose as in clause 8.7.1.1.

#### 8.7.1.1\_1.2 Test applicability

This test case applies to E-UTRA FDD UE release 10 and forward of UE category 6 and 7.

#### 8.7.1.1\_1.3 Minimum requirements

Same minimum conformance requirements as in clause 8.7.1.1.3.

8.7.1.1\_1.4 Test description

Same test description as in clause 8.7.1.1.4 with the following exceptions:

- Connection diagram Figure A.10 (without using faders and AWGN generators).
- Instead of Table 8.7.1.1.4.1-1 -> use Table 8.7.1.1\_1.4-1.
- Instead of Table 8.7.1.1.5-1 -> use Table 8.7.1.1\_1.5-1.
- Instead of Table 8.7.1.1.5-2 -> use Table 8.7.1.1\_1.5-2.
- Instead of Table 8.7.1.1.5-3 -> use Table 8.7.1.1\_1.5-3.

**Table 8.7.1.1\_1.4-1: Further test parameters per test**

Test	DL Measurement channel	UL Measurement Channel	TB <sub>size</sub> per Codeword	Number of PDCP SDU per Codeword	PDCP SDU size [Octets] Calculation (Note 1)	PDCP SDU size [Octets]
6	R.31-4 FDD	R.1-4 FDD	75376 (Note 3)	7	FLOOR((TB <sub>size</sub> - 264)/56))	1341
<p>Note 1: Transport block size under test according to applicable Fixed Reference Channel for sustained data-rate test in annex A.3.9. In case of varying TBS across SFs of the RMC, only the maximum TBS is used for PDCP SDU size calculation.</p> <p>Note 2: Each PDCP SDU is limited to 1500 octets (to keep below maximum SDU size of ESM as specified in TS 24.301 clause 9.9.4.12).</p> <p>The PDCP SDU size of each PDCP SDU is:</p> <p>PDCP SDU size = (TB<sub>size</sub> - N*PDCP header size - AMD PDU header size - MAC header size - Size of Timing Advance - Size of RLC STATUS PDU) / N,</p> <p>where PDCP header size is 16 bits for the RLC AM and 12-bit SN case; AMD PDU header size is CEIL((16+(N-1)*12)/8) bytes which includes 16 bit standard AM header and (N-1) Length indicators; and MAC header size = R/R/E/LCID/F/L MAC subheader (24 bits for MAC SDU for RLC STATUS PDU with 15 bit LI) + R/R/E/LCID MAC subheader (8 bits for MAC SDU for RLC data PDU) = 32 bits. The size of RLC STATUS PDU including one ACK_SN field and one NACK_SN field is 32 bits (if no STATUS PDU is sent or if the size of the STATUS PDU is less than 32 bits then padding will be used to fill the 32 bits). This gives: PDCP SDU size = 8*FLOOR((TB<sub>size</sub> - N*16 - 8*CEIL((16+(N-1)*12)/8) - 64)/(8*N)) bits.</p> <p>The calculation of PDCP SDU sizes does not consider timing advance MAC CE as timing advance is not transmitted by SS for RF test cases, and the header sizes are informative and may vary during the test.</p> <p>Note 3: 71112 bits for sub-frame 5</p>						

8.7.1.1\_1.5 Test requirement

The requirements are specified in Table 8.7.1.1\_1.5-1 depending on the UE category according to Table 8.7.1.1\_1.5-3. The PDCP SDU success rate shall be sustained during at least 300 frames.

**Table 8.7.1.1\_1.5-1: Test requirements per test**

Test	Number of bits of a DL-SCH transport block received within a TTI	Measurement channel	Reference value
			TB success rate [%]
6	75376 (Note 2)	R.31-4 FDD	85
<p>Note 1: For 2 layer transmissions, 2 transport blocks are received within a TTI.</p> <p>Note 2: 71112 bits for sub-frame 5.</p> <p>Note 3: The TB success rate is defined as TB success rate = 100%*N<sub>DL_correct_rx</sub> / (N<sub>DL_newtx</sub> + N<sub>DL_retx</sub>), where N<sub>DL_newtx</sub> is the number of newly transmitted DL transport blocks, N<sub>DL_retx</sub> is the number of retransmitted DL transport blocks, and N<sub>DL_correct_rx</sub> is the number of correctly received DL transport blocks.</p>			

Table 8.7.1.1\_1.5-2: Test parameters per test

Test	Bandwidth (MHz)	Transmission mode	Antenna configuration	Codebook subset restriction	Downlink power allocation (dB)			$\hat{E}_s$ at antenna port (dBm/15kHz)	Symbols for unused PRBs
					$\rho_A$	$\rho_B$	$\sigma$		
6	20	3	2 x 2	10	-3	-3	0	-85	OP.1 FDD

Table 8.7.1.1\_1.5-3: Test applicability per UE category

CA config	Maximum supported Bandwidth (MHz)	Category 1	Category 2	Category 3	Category 4	Category 6	Category 7
Single carrier	20	-	-	-	-	6	6
Note 1: If UE can be tested for CA configuration, single carrier test is skipped.							
Note 2: For non-CA UE, test is selected for maximum supported bandwidth.							

### 8.7.1.1\_A FDD sustained data rate performance for CA

#### 8.7.1.1\_A.1 FDD Sustained data rate performance for CA (2DL CA)

##### 8.7.1.1\_A.1.1 Test purpose

Same test purpose as 8.7.1.1

##### 8.7.1.1\_A.1.2 Test applicability

This test applies to E-UTRA FDD release 10 and forward UEs of category 3, 4, 6 and 7 which support inter-band OR intra-band contiguous DL CA.

This test also applies to E-UTRA FDD release 11 and forward UEs of category 3, 4, 6 and 7 which support intra band non-contiguous DL CA.

##### 8.7.1.1\_A.1.3 Minimum requirements

Table 8.7.1.1\_A.1.3-1: Void

The requirements are specified in Table 8.7.1.1\_A.1.3-3, with the addition of the parameters in Table 8.7.1.1\_A.1.3-2 and the downlink physical channel setup according to Annex C.3.2. The test points are applied to UE category, CA capability and bandwidth combination with maximum aggregated bandwidth as specified in Table 8.7.1.1\_A.1.3-4. The TB success rate shall be sustained during at least 300 frames.

Table 8.7.1.1\_A.1.3-2: Test Parameters for sustained downlink data rate for CA (FDD)

Test	Bandwidth (MHz)	Transmission mode	Antenna configuration	Codebook subset restriction	Downlink power allocation (dB)			$\hat{E}_s$ at antenna port (dBm/15kHz)	Symbols for unused PRBs
					$\rho_A$	$\rho_B$	$\sigma$		
3A	10	3	2 x 2	10	-3	-3	0	-85	OP.1 FDD
3B, 4A	2x10	3	2 x 2	10	-3	-3	0	-85	OP.1 FDD
3C, 4B	15	3	2 x 2	10	-3	-3	0	-85	OP.1 FDD
6A	2x20	3	2 x 2	10	-3	-3	0	-85	OP.1 FDD
6B	10+15	3	2 x 2	10	-3	-3	0	-85	OP.1 FDD
6C	10+20	3	2 x 2	10	-3	-3	0	-85	OP.1 FDD
6D	15+20	3	2 x 2	10	-3	-3	0	-85	OP.1 FDD
6E	2x15	3	2 x 2	10	-3	-3	0	-85	OP.1 FDD
Note 1: For CA test cases, PUCCH format 1b with channel selection is used to feedback ACK/NACK for Test 1-6E, and PUCCH format 3 is used to feedback ACK/NACK for Test 7-7G.									

Table 8.7.1.1\_A.1.3-3: Minimum requirement for CA (FDD)

Test	Number of bits of a DL-SCH transport block received within a TTI	Measurement channel	Reference value
			TB success rate [%]
3A	36696 (Note 2)	R.31-3A FDD	85
3B	25456	R.31-2 FDD	95
3C	51024	R.31-3C FDD	85
4A	36696 (Note 2)	R.31-3A FDD	85
4B	55056 (Note 5)	R.31-4B FDD	85
6A	75376 (Note 3)	R.31-4 FDD	85
6B	36696 (Note 2) for 10MHz CC 55056 for 15MHz CC	R.31-3A FDD for 10MHz CC R.31-5 FDD for 15MHz CC	85
6C	36696 (Note 2) for 10MHz CC 75376 (Note 3) for 20MHz CC	R.31-3A FDD for 10MHz CC R.31-4 FDD for 20MHz CC	85
6D	55056 for 15MHz CC 75376 (Note 3) for 20MHz CC	R.31-5 FDD for 15MHz CC R.31-4 FDD for 20MHz CC	85
6E	55056 (Note 5) for two 15MHz CCs	R.31-4B FDD for two 15MHz CCs	85
Note 1:	For 2 layer transmissions, 2 transport blocks are received within a TTI.		
Note 2:	35160 bits for sub-frame 5.		
Note 3:	71112 bits for sub-frame 5.		
Note 4:	The TB success rate is defined as $TB\ success\ rate = 100\% * N_{DL\_correct\_rx} / (N_{DL\_newtx} + N_{DL\_retx})$ , where $N_{DL\_newtx}$ is the number of newly transmitted DL transport blocks, $N_{DL\_retx}$ is the number of retransmitted DL transport blocks, and $N_{DL\_correct\_rx}$ is the number of correctly received DL transport blocks.		
Note 5:	52752bits for sub-frame 5.		
Note 6:	15840bits for sub-frame 0 and 5.		

Table 8.7.1.1\_A.1.3-4: Test points for sustained data rate for CA (FRC)

CA config	Maximum supported Bandwidth/ Bandwidth combination (MHz)	Cat. 1	Cat. 2	Cat. 3	Cat. 4	Cat. 6,7	Cat. 9,10
CA with 2CCs	10+10	-	-	3B	4A	4A	4A
	10+15	-	-	3B	4A	6B	6B
	10+20	-	-	3B	4A	6C	6C
	15+15	-	-	3B	4A	6E	6E
	15+20	-	-	3B	4A	6D	6D
	20+20	-	-	3B or 3 (Note 4)	4A or 4 (Note 4)	6A	6A
Note 1:	Void.						
Note 2:	For non-CA UE, test is selected for maximum supported bandwidth.						
Note 3:	Void.						
Note 4:	If the intra-band contiguous CA is the only CA configuration supported by category 3 or 4 UE, the single carrier test is selected, i.e., Test 3 for UE category 3 and Test 4 for UE category 4. Otherwise, Test 3B applies for category 3 UE and Test 4A applies for category 4 UE.						
Note 5:	The applicability of requirements for different CA configurations and bandwidth combination sets is defined in TS 36.101 [2] 8.1.2.3.						

The normative reference for this requirement is TS 36.101[2] clause 8.7.1



8.7.1.1\_A.1.4 Test description

8.7.1.1\_A.1.4.1 Initial conditions

Table 8.7.1.1\_A.1.4.1-1: Further test parameters per test

Test	DL Measurement channel	UL Measurement channel	TBsize per Codeword per Component Carrier	Number of PDCP SDU per Codeword	PDCP SDU size [Octets] Calculation (Note 1)	PDCP SDU size [Octets]
3B	R.31-2 FDD	R.1-2 FDD	25456	3	$\text{FLOOR}((\text{TBsize} - 152)/24)$	1054
4A	R.31-3A FDD	R.1-3A FDD	36696 (Note 3)	4	$\text{FLOOR}((\text{TBsize} - 184)/32)$	1141
6A	R.31-4 FDD	R.1-4 FDD	75376 (Note 4)	7	$\text{FLOOR}((\text{TBsize} - 264)/56)$	1341
6B	R.31-3A FDD for 10MHz carrier CC R.31-5 FDD for 15MHz CC	R.1-4B FDD	36696 (Note 3) for 10MHz CC 55056 for 15MHz CC	4 for 10MHz CC 6 for 15 MHz CC	$\text{FLOOR}((\text{TBsize} - 184)/32)$ for 10MHz CC $\text{FLOOR}((\text{TBsize} - 240)/48)$ for 15 MHz CC	1141 for 10MHz CC 1142 for 15MHz CC
6C	R.31-3A FDD for 10MHz CC R.31-4 FDD for 20MHz CC	R.1-4 FDD	36696 (Note 3) for 10MHz CC 75376 (Note 4) for 20MHz CC	4 for 10MHz CC 7 for 20 MHz CC	$\text{FLOOR}((\text{TBsize} - 184)/32)$ for 10MHz CC $\text{FLOOR}((\text{TBsize} - 264)/56)$ for 20 MHz CC	1141 for 10MHz CC 1341 for 20MHz CC
6D	R.31-5 FDD for 15MHz CC R.31-4 FDD for 20MHz CC	R.1-4 FDD	55056 for 15MHz CC 75376 (Note 4) for 20MHz CC	6 for 15MHz CC 7 for 20 MHz CC	$\text{FLOOR}((\text{TBsize} - 240)/48)$ for 15 MHz CC $\text{FLOOR}((\text{TBsize} - 264)/56)$ for 20 MHz CC	1142 for 15MHz CC 1341 for 20MHz CC
6E	R.31-4B FDD for two 15MHz CCs	R.1-4B FDD	55056 (Note 5) for two 15MHz CCs	6 for two 15MHz CCs	$\text{FLOOR}((\text{TBsize} - 240)/48)$ for two 15 MHz CCs	1142 for two 15MHz CCs
Note 1:	Transport block size under test according to applicable Fixed Reference Channel for sustained data-rate test in annex A.3.9. In case of varying TBS across SFs of the RMC, only the maximum TBS is used for PDCP SDU size calculation. In case of different resulting PDCP SDU sizes among component carriers, the smaller calculated PDCP SDU size is used across all the carriers.					
Note 2:	Each PDCP SDU is limited to 1500 octets (to keep below maximum SDU size of ESM as specified in TS 24.301 clause 9.9.4.12). The PDCP SDU size of each PDCP SDU is: $\text{PDCP SDU size} = (\text{TBsize} - N \cdot \text{PDCP header size} - \text{AMD PDU header size} - \text{MAC header size} - \text{Size of RLC STATUS PDU}) / N$ , where PDCP header size is 16 bits for the RLC AM and 12-bit SN case; AMD PDU header size is $\text{CEIL}[(16 + (N-1) \cdot 12)/8]$ bytes which includes 16 bit standard AM header and (N-1) Length indicators; and MAC header size = R/R/E/LCID/F/L MAC subheader (24 bits for MAC SDU for RLC STATUS PDU with 15 bit LI) + R/R/E/LCID MAC subheader (8 bits for MAC SDU for RLC Data PDU) = 32 bits. The size of RLC STATUS PDU including one ACK_SN field and one NACK_SN field is 32 bits (if no STATUS PDU is sent or if the size of the STATUS PDU is less than 32 bits then padding will be used to fill the 32 bits). This gives: $\text{PDCP SDU size} = 8 \cdot \text{FLOOR}((\text{TBsize} - N \cdot 16 - 8 \cdot \text{CEIL}[(16 + (N-1) \cdot 12)/8] - 64) / (8 \cdot N))$ bits. The calculation of PDCP SDU sizes does not consider timing advance MAC CE as timing advance is not transmitted by SS for RF test cases, and the header sizes are informative and may vary during the test.					
Note 3:	35160 bits for sub-frame 5.					
Note 4:	71112 bits for sub-frame 5.					
Note 5:	52752 bits for sub-frame 5.					

Initial conditions are a set of test configurations the UE needs to be tested in and the steps for the SS to take with the UE to reach the correct measurement state.

Configurations of PDSCH and PDCCH before measurement are specified in Annex C.2.

Test Environment: Normal as defined in TS 36.508 [7] clause 4.1.

Frequencies to be tested: Maximum WGap for Intra-band non-contiguous CA, otherwise Mid Range as defined in TS 36.508 [7] clause 4.3.1.1.

Channel Bandwidths to be tested: according to Table 8.7.1.1\_A.1.5-2 depending on the UE category according to Table 8.7.1.1\_A.1.5-3.

1. Connect the SS to the UE antenna connector(s) as shown in TS 36.508 [7] Annex A, Figure group A.36 (without using faders and AWGN generators).
2. The parameter settings for the cell are set up according to Table 8.7.1.5-2 and Table 8.7.1.1\_A.1.5-1 depending on the UE category according to Table 8.7.1.1\_A.1.5-3.
3. Downlink signals for PCC are initially set up according to Annex C0, C.1 and Annex C.3.2 and uplink signals according to Annex H.1 and H.3.2.
4. Propagation conditions are set according to Annex B.0.
5. Ensure the UE is in State 4A-RF according to TS 36.508 [7] clause 5.2A.3. Message contents are defined in clause 8.7.1.1\_A.1.4.3.

#### 8.7.1.1\_A.1.4.2 Test procedure

1. Configure SCC according to Annex C.0, C.1 and Annex C.3.2 for all downlink physical channels.
2. The SS shall configure SCC as per TS 36.508 [7] clause 5.2A.4. PhysicalConfigDedicated-DEFAULT is defined in Table 8.7.1.1\_A.1.4.3-3, PhysicalConfigDedicatedSCell-r10-DEFAULT is defined in Table 8.7.1.1\_A.1.4.3-3A.
3. SS activates SCC by sending the activation MAC-CE (Refer TS 36.321 [13], clauses 5.13, 6.1.3.8). Wait for at least 2 seconds (Refer TS 36.133, clauses 8.3.3.2).
4. Propagation conditions are set according to Annex B.1 (No external noise sources are applied).
5. The SS looks up  $TB_{size}$  in Table 8.7.1.1\_A.1.4.1-1 for the tests to be performed depending on the UE category according to Table 8.7.1.1\_A.1.5-3.
6. SS sets the counters,  $N_{DL\_newtx}$ ,  $N_{DL\_retx}$ ,  $N_{UL\_PDCP}$ , and  $N_{DL\_PDCP}$  to 0.
7. For each new DL HARQ transmission the SS generates sufficient PDCP SDUs to fill up the TB in accordance with Table 8.7.1.1\_A.1.4.1-1 (Note 1). The SS ciphers the PDCP SDUs, concatenates the resultant PDCP PDUs to form an RLC PDU and then a MAC PDU. The SS transmits the MAC PDU. The SS increments then  $N_{DL\_newtx}$  by one and  $N_{DL\_PDCP}$  by the number of new PDCP SDUs (Note 1) included in the sent MAC PDU.
8. If PHY requests a DL HARQ retransmission, the SS performs a HARQ retransmission and increments  $N_{DL\_retx}$  by one.
9. Steps 7 to 8 are repeated at every TTI for at least 300 frames and the SS waits for 300ms to let any HARQ retransmissions and RLC retransmissions to finish.
10. For each PDCP SDU received at the SS, if the content of the data matches that of the truncated version of the original PDCP SDU generated at the SS, the SS increments  $N_{UL\_PDCP}$  by one
11. The SS calculates the TB success rate as  $A = 100\% * N_{DL\_newtx} / (N_{DL\_newtx} + N_{DL\_retx})$ . Measurements are not based on UE feedback but on SS counters instead ( $N_{DL\_newtx}$  and  $N_{DL\_retx}$ ) in order to validate HARQ feedback received from the UE.
12. The SS calculates the PDCP SDU loss as  $B = N_{DL\_PDCP} - N_{UL\_PDCP}$
13. The UE passes the test if  $A \geq$  "corresponding TB success rate according to Table 8.7.1.1\_A.1.5-1" and  $B = 0$ .

NOTE 1: In case of RLC PDU retransmission, the number of new required PDCP SDUs is as many as to fill the rest of TB.

8.7.1.1\_A.1.4.3 Message contents

Message contents are according to TS 36.508 [7] clauses 5.5 and 4.6 and 4.7A, with the following exceptions:

**Table 8.7.1.1\_A.1.4.3-1: CLOSE UE TEST LOOP (in the preamble)**

Derivation Path: 36.509 clause 6.1			
Information Element	Value/remark	Comment	Condition
Protocol discriminator	1 1 1 1		
Skip indicator	0 0 0 0		
Message type	1 0 0 0 0 0 0 0		
UE test loop mode	0 0 0 0 0 0 0 0	UE test loop mode A	
UE test loop mode A LB setup			
Length of UE test loop mode A LB setup list in bytes	0 0 0 0 0 0 1 1	Length of one LB setup DRB (3 bytes)	
LB setup DRB	0 0 0 0 0 0 0 0, 0 0 1 0 1 0 0 0, 0 0 0 Q4 Q3 Q2 Q1 Q0	UL PDCP SDU size = 40 bits (5 bytes) Q4..Q0 = Data Radio Bearer identity number for the default radio bearer. See 36.509 clause 6.1	
UE test loop mode B LB setup	Not present		

**Table 8.7.1.1\_A.1.4.3-2: SecurityModeCommand (in the preamble)**

Derivation Path: TS 36.508 clause 4.6.1 table 4.6.1-19			
Information Element	Value/remark	Comment	Condition
SecurityModeCommand ::= SEQUENCE {			
criticalExtensions CHOICE {			
c1 CHOICE{			
securityModeCommand-r8 SEQUENCE {			
securityConfiguration SEQUENCE {			
cipheringAlgorithm	eea2		
nextHopChainingCount	Not present		
}			
nonCriticalExtension SEQUENCE {}	Not present		
}			
}			
}			
}			

**Table 8.7.1.1\_A.1.4.3-3: PhysicalConfigDedicated-DEFAULT**

Derivation Path: 36.508 clause 5.5.1, Table 5.5.1.2-1			
Information Element	Value/remark	Comment	Condition
PhysicalConfigDedicated-DEFAULT ::= SEQUENCE {			
antennaInfo CHOICE {			
explicitValue ::= SEQUENCE {			
transmissionMode	tm3		Transmission mode 3
codebookSubsetRestriction CHOICE {			
n2TxAntenna-tm3	10		
}			
ue-TransmitAntennaSelection CHOICE {			
release	NULL		
}			
}			

**Table 8.7.1.1\_A.1.4.3-3A: PhysicalConfigDedicatedSCell-r10-DEFAULT**

Derivation Path: 36.508 clause 4.6.3 Table 4.6.3-6A			
Information Element	Value/remark	Comment	Condition
PhysicalConfigDedicatedSCell-r10-DEFAULT ::= SEQUENCE {			
nonUL-Configuration-r10 SEQUENCE {			
antennaInfo-r10 CHOICE {			
transmissionMode-r10	tm3		Transmission mode 3
codebookSubsetRestriction-r10	10		
ue-TransmitAntennaSelection CHOICE {			
release	NULL		
}			
}			
}			

#### 8.7.1.1\_A.1.5 Test requirement

The requirements are specified in Table 8.7.1.1\_A.1.5-1 depending on the UE category according to Table 8.7.1.1\_A.1.5-3. The PDCP SDU success rate shall be sustained during at least 300 frames.

Table 8.7.1.1\_A.1.5-1: Test requirements per test

Test	Number of bits of a DL-SCH transport block received within a TTI	Measurement channel	Reference value
			TB success rate [%]
3B	25456	R.31-2 FDD	95
4A	36696 (Note 2)	R.31-3A FDD	85
6A	75376 (Note 3) for 20MHz CC	R.31-4 FDD for 20MHz CC	85
6B	36696 (Note 2) for 10MHz CC	R.31-3A FDD for 10MHz CC	85
6C	55056 for 15MHz CC	R.31-5 FDD for 15MHz CC	85
	36696 (Note 2) for 10MHz CC	R.31-3A FDD for 10MHz CC	
6D	75376 (Note 3) for 20MHz CC	R.31-4 FDD for 20MHz CC	85
	55056 for 15MHz CC	R.31-5 FDD for 15MHz CC	
6E	75376 (Note 3) for 20MHz CC	R.31-4 FDD for 20MHz CC	85
6E	55056 (Note 6) for two 15MHz CCs	R.31-4B FDD for two 15MHz CCs	85

Note 1: For 2 layer transmissions, 2 transport blocks are received within a TTI.  
Note 2: 35160 bits for sub-frame 5.  
Note 3: 71112 bits for sub-frame 5.  
Note 4: The TB success rate is defined as TB success rate = 100%\*N<sub>DL\_correct\_rx</sub> / (N<sub>DL\_newtx</sub> + N<sub>DL\_retx</sub>), where N<sub>DL\_newtx</sub> is the number of newly transmitted DL transport blocks, N<sub>DL\_retx</sub> is the number of retransmitted DL transport blocks, and N<sub>DL\_correct\_rx</sub> is the number of correctly received DL transport blocks.  
Note 5: For category 6 and 7 UE, select one CA configuration among CA configurations corresponding to largest aggregated CA bandwidth signalled by UE.  
Note 6: 52752 bits for sub-frame 5.  
Note 7: In case of different resulting PDCP SDU sizes among component carriers, the smaller calculated PDCP SDU size is used across all the carriers.

Table 8.7.1.1\_A.1.5-2: Test parameters per test

Test	Bandwidth (MHz)	Transmission mode	Antenna configuration	Codebook subset restriction	Downlink power allocation (dB)			$\hat{E}_s$ at antenna port (dBm/15kHz)	Symbols for unused PRBs
					$\rho_A$	$\rho_B$	$\sigma$		
3B, 4A	2x10	3	2 x 2	10	-3	-3	0	-85	OP.1 FDD
6A	2x20	3	2 x 2	10	-3	-3	0	-85	OP.1 FDD
6B	10+15	3	2 x 2	10	-3	-3	0	-85	OP.1 FDD
6C	10+20	3	2 x 2	10	-3	-3	0	-85	OP.1 FDD
6D	15+20	3	2 x 2	10	-3	-3	0	-85	OP.1 FDD
6E	2x15	3	2 x 2	10	-3	-3	0	-85	OP.1 FDD

Note 1: PUCCH format 1b with channel selection is used to feedback ACK/NACK.

Table 8.7.1.1\_A.1.5-3: Test applicability per UE category

CA config	Maximum supported Bandwidth/ Bandwidth combination (MHz)	Cat. 1	Cat. 2	Cat. 3	Cat. 4	Cat. 6,7	Cat. 9,10
CA with 2CCs	10+10	-	-	3B	4A	4A	4A
	10+15	-	-	3B	4A	6B	6B
	10+20	-	-	3B	4A	6C	6C
	15+15	-	-	3B	4A	6E	6E
	15+20	-	-	3B	4A	6D	6D
	20+20	-	-	3B or 3 (Note 4)	4A or 4 (Note 4)	6A	6A
Note 1:	Void.						
Note 2:	For non-CA UE, test is selected for maximum supported bandwidth.						
Note 3:	Void.						
Note 4:	If the intra-band contiguous CA is the only CA configuration supported by category 3 or 4 UE, the single carrier test is selected, i.e., Test 3 for UE category 3 and Test 4 for UE category 4. Otherwise, Test 3B applies for category 3 UE and Test 4A applies for category 4 UE.						
Note 5:	The applicability of requirements for different CA configurations and bandwidth combination sets is defined in 8.1.2.3.						
Note 6:	Select the largest aggregated CA bandwidth combination supported by the UE among the UE supported CA capabilities. Only one test point to be tested						

### 8.7.1.1\_A.2 FDD Sustained data rate performance for CA (3DL CA)

Editor's notes: This test case is incomplete. The following items are missing or incomplete:

- RMC R.31-6 FDD definition for 5MHz BW in Table A.3.9.1-2 still has error.
- PDCCH Aggregation Level in Table C.3.2-5 for 5MH BW is TBD.
- Test requirements are still with square brackets.

#### 8.7.1.1\_A.2.1 Test purpose

Same test purpose as 8.7.1.1.

#### 8.7.1.1\_A.2.2 Test applicability

This test case applies to all types of E-UTRA FDD UE release 10 and forward of UE category 6, 7, 9, 10, 11 and 12 that support 3DL Intra-band contiguous CA or 3DL Inter-band CA or 3DL with Intra-band contiguous and Inter-band CA.

This test case also applies to all types of E-UTRA FDD UE release 11 and forward of UE category 6, 7, 9, 10, 11 and 12 that support 3DL with Intra-band non-contiguous and Inter-band CA or 3DL with Intra-band non-contiguous and Intra-band contiguous CA.

#### 8.7.1.1\_A.2.3 Minimum conformance requirements

For UE not supporting 256QAM, the requirements are specified in Table 8.7.1.1\_A.2.3-2, with the addition of the parameters in Table 8.7.1.1\_A.2.3-1 and the downlink physical channel setup according to Table C.3.2-1 in Annex C. The test points are applied to UE category and bandwidth combination with maximum aggregated bandwidth as specified in Table 8.7.1.1\_A.2.3-3. The TB success rate shall be sustained during at least 300 frames.

Table 8.7.1.1\_A.2.3-1: test parameters for sustained downlink data rate (FDD 64QAM)

Test	Bandwidth (MHz)	Transmission mode	Antenna configuration	Codebook subset restriction	Downlink power allocation (dB)			$\hat{E}_s$ at antenna port (dBm/15kHz)	Symbols for unused PRBs
					$\rho_A$	$\rho_B$	$\sigma$		
6A	2x20	3	2 x 2	10	-3	-3	0	-85	OP.1 FDD
6D	15+20	3	2 x 2	10	-3	-3	0	-85	OP.1 FDD
7	3x20	3	2 x 2	10	-3	-3	0	-85	OP.1 FDD
7A	15+20+20	3	2 x 2	10	-3	-3	0	-85	OP.1 FDD
7B	10+20+20	3	2 x 2	10	-3	-3	0	-85	OP.1 FDD
7C	15+15+20	3	2 x 2	10	-3	-3	0	-85	OP.1 FDD
7D	10+15+20	3	2 x 2	10	-3	-3	0	-85	OP.1 FDD
7E	10+10+20	3	2 x 2	10	-3	-3	0	-85	OP.1 FDD
7F	10+15+15	3	2 x 2	10	-3	-3	0	-85	OP.1 FDD
7G	5+10+20	3	2 x 2	10	-3	-3	0	-85	OP.1 FDD

Note 1: For CA test cases, PUCCH format 1b with channel selection is used to feedback ACK/NACK for Test 1-6E, and PUCCH format 3 is used to feedback ACK/NACK for Test 7-7G.

Table 8.7.1.1\_A.2.3-2: Minimum requirement (FDD 64QAM)

Test	Number of bits of a DL-SCH transport block received within a TTI	Measurement channel	Reference value
			TB success rate [%]
6A	75376 (Note 3)	R.31-4 FDD	85
6D	55056 for 15MHz CC 75376 (Note 3) for 20MHz CC	R.31-5 FDD for 15MHz CC R.31-4 FDD for 20MHz CC	85
7	75376 (Note 3)	R.31-4 FDD	[85]
7A	55056 (Note 5) for 15MHz CC 75376 (Note 3) for 20MHz CC	R.31-5 FDD for 15MHz CC R.31-4 FDD for 20MHz CC	[85]
7B	36696 (Note 2) for 10MHz CC 75376 (Note 3) for 20MHz CC	R.31-3A FDD for 10MHz CC R.31-4 FDD for 20MHz CC	[85]
7C	55056 (Note 5) for 15MHz CC 75376 (Note 3) for 20MHz CC	R.31-5 FDD for 15MHz CC R.31-4 FDD for 20MHz CC	85
7D	36696 (Note 2) for 10MHz CC 55056 (Note 5) for 15MHz CC 75376 (Note 3) for 20MHz CC	R.31-3A FDD for 10MHz CC R.31-5 FDD for 15MHz CC R.31-4 FDD for 20MHz CC	[85]
7E	36696 (Note 2) for 10MHz CC 75376 (Note 3) for 20MHz CC	R.31-3A FDD for 10MHz CC R.31-4 FDD for 20MHz CC	[85]
7F	36696 (Note 2) for 10MHz CC 55056 (Note 5) for 15MHz CC	R.31-3A FDD for 10MHz CC R.31-5 FDD for 15MHz CC	[85]
7G	18336 (Note 6) for 5MHz CC 36696 (Note 2) for 10MHz CC 75376 (Note 3) for 20MHz CC	R.31-6 FDD for 5MHz CC R.31-3A FDD for 10MHz CC R.31-4 FDD for 20MHz CC	[85]

Note 1: For 2 layer transmissions, 2 transport blocks are received within a TTI.  
Note 2: 35160 bits for sub-frame 5.  
Note 3: 71112 bits for sub-frame 5.  
Note 4: The TB success rate is defined as TB success rate = 100% \*  $N_{DL\_correct\_rx} / (N_{DL\_newtx} + N_{DL\_retx})$ , where  $N_{DL\_newtx}$  is the number of newly transmitted DL transport blocks,  $N_{DL\_retx}$  is the number of retransmitted DL transport blocks, and  $N_{DL\_correct\_rx}$  is the number of correctly received DL transport blocks.  
Note 5: 52752bits for sub-frame 5.  
Note 6: 15840bits for sub-frame 0 and 5.

Table 8.7.1.1\_A.2.3-3: Test points for sustained data rate (FRC 64QAM)

CA config	Maximum supported Bandwidth/ Bandwidth combination (MHz)	Cat. 1	Cat. 2	Cat. 3	Cat. 4	Cat. 6,7	Cat. 9,10	Cat 11, 12
CA with 3CCs	3x20	-	-	-	-	6A	7	7
	15+20+20	-	-	-	-	6A	7A	7A
	10+20+20	-	-	-	-	6A	7B	7B
	15+15+20	-	-	-	-	6D	7C	7C
	10+15+20	-	-	-	-	6D	7D	7D
	10+10+20	-	-	-	-	7E	7E	7E
	10+15+15	-	-	-	-	7F	7F	7F
	5+10+20	-	-	-	-	7G	7G	7G
Note 1:	Void.							
Note 2:	For non-CA UE, test is selected for maximum supported bandwidth.							
Note 3:	Void.							
Note 4:	If the intra-band contiguous CA is the only CA configuration supported by category 3 or 4 UE, the single carrier test is selected, i.e., Test 3 for UE category 3 and Test 4 for UE category 4. Otherwise, Test 3B applies for category 3 UE and Test 4A applies for category 4 UE.							
Note 5:	The applicability of requirements for different CA configurations and bandwidth combination sets is defined in 8.1.2.3.							

The normative reference for this requirement is TS 36.101 [2] clause 8.7.1.



8.7.1.1\_A.2.4 Test description

8.7.1.1\_A.2.4.1 Initial conditions

Table 8.7.1.1\_A.2.4.1-1: Further test parameters per test

Test	DL Measurement channel	UL Measurement channel	TBsize per Codeword per Component Carrier	Number of PDCP SDU per Codeword	PDCP SDU size [Octets] Calculation (Note 1)	PDCP SDU size [Octets]
6A	R.31-4 FDD for two 20MHz CCs	R.1-4 FDD	75376 (Note 4)	7 for two 20MHz CCs	$\text{FLOOR}((\text{TBsize} - 264)/56)$	1341 for two 20MHz CCs
6D	R.31-5 FDD for 15MHz CC R.31-4 FDD for 20MHz CC	R.1-4 FDD	55056 for 15MHz CC	6 for 15MHz CC	$\text{FLOOR}((\text{TBsize} - 240)/48)$ for 15 MHz CC	1142 for 15MHz CC
			75376 (Note 4) for 20MHz CC	7 for 20 MHz CC	$\text{FLOOR}((\text{TBsize} - 264)/56)$ for 20 MHz CC	1341 for 20MHz CC
7	R.31-4 FDD for three 20MHz CCs	R.1-4 FDD	75376 (Note 4)	7 for three 20MHz CCs	$\text{FLOOR}((\text{TBsize} - 264)/56)$	1341 for three 20MHz CCs
7A	R.31-5 FDD for 15MHz CC R.31-4 FDD for 20MHz CC	R.1-4 FDD	55056 for 15MHz CC	6 for 15MHz CC	$\text{FLOOR}((\text{TBsize} - 240)/48)$ for 15 MHz CC	1142 for 15MHz CC
			75376 (Note 4) for 20MHz CC	7 for 20 MHz CC	$\text{FLOOR}((\text{TBsize} - 264)/56)$ for 20 MHz CC	1341 for 20MHz CC
7B	R.31-3A FDD for 10MHz CC R.31-4 FDD for 20MHz CC	R.1-4 FDD	36696 (Note 3) for 10MHz CC	4 for 10MHz CC	$\text{FLOOR}((\text{TBsize} - 184)/32)$ for 10MHz CC	1141 for 10MHz CC
			75376 (Note 4) for 20MHz CC	7 for 20 MHz CC	$\text{FLOOR}((\text{TBsize} - 264)/56)$ for 20 MHz CC	1341 for 20MHz CC
7C	R.31-5 FDD for 15MHz CC R.31-4 FDD for 20MHz CC	R.1-4 FDD	55056 for 15MHz CC	6 for 15MHz CC	$\text{FLOOR}((\text{TBsize} - 240)/48)$ for 15 MHz CC	1142 for 15MHz CC
			75376 (Note 4) for 20MHz CC	7 for 20 MHz CC	$\text{FLOOR}((\text{TBsize} - 264)/56)$ for 20 MHz CC	1341 for 20MHz CC
7D	R.31-3A FDD for 10MHz CC R.31-5 FDD for 15MHz CC R.31-4 FDD for 20MHz CC	R.1-4 FDD	36696 (Note 3) for 10MHz CC	4 for 10MHz CC	$\text{FLOOR}((\text{TBsize} - 184)/32)$ for 10MHz CC	1141 for 10MHz CC
			55056 for 15MHz CC	6 for 15MHz CC	$\text{FLOOR}((\text{TBsize} - 240)/48)$ for 15 MHz CC	1142 for 15MHz CC
			75376 (Note 4) for 20MHz CC	7 for 20 MHz CC	$\text{FLOOR}((\text{TBsize} - 264)/56)$ for 20 MHz CC	1341 for 20MHz CC
7E	R.31-3A FDD for 10MHz CC R.31-4 FDD for 20MHz CC	R.1-4 FDD	36696 (Note 3) for 10MHz CC	4 for 10MHz CC	$\text{FLOOR}((\text{TBsize} - 184)/32)$ for 10MHz CC	1141 for 10MHz CC
			75376 (Note 4) for 20MHz CC	7 for 20 MHz CC	$\text{FLOOR}((\text{TBsize} - 264)/56)$ for 20 MHz CC	1341 for 20MHz CC
7F	R.31-3A FDD for 10MHz CC R.31-5 FDD	R.1-4B FDD	36696 (Note 3) for 10MHz CC	4 for 10MHz CC	$\text{FLOOR}((\text{TBsize} - 184)/32)$ for 10MHz CC	1141 for 10MHz CC

	for 15MHz CC		55056 for 15MHz CC	6 for 15MHz CC	$\text{FLOOR}((\text{TB}_{\text{size}} - 240)/48)$ for 15 MHz CC	1142 for 15MHz CC
7G	R.31-6 FDD for 5MHz CC R.31-3A FDD for 10MHz CC R.31-4 FDD for 20MHz CC	R.1-4 FDD	18336 (Note 6) for 5MHz CC 36696 (Note 3) for 10MHz CC 75376 (Note 4) for 20MHz CC	2 for 5MHz CC 4 for 10MHz CC 7 for 20 MHz CC	$\text{FLOOR}((\text{TB}_{\text{size}} - 128)/16)$ for 5MHz CC $\text{FLOOR}((\text{TB}_{\text{size}} - 184)/32)$ for 10MHz CC $\text{FLOOR}((\text{TB}_{\text{size}} - 264)/56)$ for 20 MHz CC	1138 for 5MHz CC 1141 for 10MHz CC 1341 for 20MHz CC
<p>Note 1: Transport block size under test according to applicable Fixed Reference Channel for sustained data-rate test in annex A.3.9. In case of varying TBS across SFs of the RMC, only the maximum TBS is used for PDCP SDU size calculation. In case of different resulting PDCP SDU sizes among component carriers, the smaller calculated PDCP SDU size is used across all the carriers.</p> <p>Note 2: Each PDCP SDU is limited to 1500 octets (to keep below maximum SDU size of ESM as specified in TS 24.301 clause 9.9.4.12). The PDCP SDU size of each PDCP SDU is: PDCP SDU size = <math>(\text{TB}_{\text{size}} - N * \text{PDCP header size} - \text{AMD PDU header size} - \text{MAC header size} - \text{Size of RLC STATUS PDU}) / N</math>, where PDCP header size is 16 bits for the RLC AM and 12-bit SN case; AMD PDU header size is <math>\text{CEIL}[(16 + (N-1) * 12) / 8]</math> bytes which includes 16 bit standard AM header and (N-1) Length indicators; and MAC header size = <math>R/R/E/LCID/F/L</math> MAC subheader (24 bits for MAC SDU for RLC STATUS PDU with 15 bit LI) + <math>R/R/E/LCID</math> MAC subheader (8 bits for MAC SDU for RLC Data PDU) = 32 bits. The size of RLC STATUS PDU including one ACK_SN field and one NACK_SN field is 32 bits (if no STATUS PDU is sent or if the size of the STATUS PDU is less than 32 bits then padding will be used to fill the 32 bits). This gives: PDCP SDU size = <math>8 * \text{FLOOR}((\text{TB}_{\text{size}} - N * 16 - 8 * \text{CEIL}[(16 + (N-1) * 12) / 8] - 64) / (8 * N))</math> bits. The calculation of PDCP SDU sizes does not consider timing advance MAC CE as timing advance is not transmitted by SS for RF test cases, and the header sizes are informative and may vary during the test.</p> <p>Note 3: 35160 bits for sub-frame 5. Note 4: 71112 bits for sub-frame 5. Note 5: 52752 bits for sub-frame 5. Note 6: 15840bits for sub-frame 0 and 5.</p>						

Initial conditions are a set of test configurations the UE needs to be tested in and the steps for the SS to take with the UE to reach the correct measurement state.

Configurations of PDSCH and PDCCH before measurement are specified in Annex C.2.

Test Environment: Normal as defined in TS 36.508 [7] clause 4.1.

Frequencies to be tested: Maximum WGap for Intra-band non-contiguous CA, otherwise Mid Range as defined in TS 36.508 [7] clause 4.3.1.1.

Channel Bandwidths to be tested: according to Table 8.7.1.1\_A.2.5-2 depending on the UE category according to Table 8.7.1.1\_A.2.5-3.

1. Connect the SS to the UE antenna connector(s) as shown in TS 36.508 [7] Annex A, Figure group A.60 (without using faders and AWGN generators).
2. The parameter settings for the cell are set up according to Table 8.7.1-1 and Table 8.7.1.1\_A.2.5-1 depending on the UE category according to Table 8.7.1.1\_A.2.5-3.
3. Downlink signals for PCC are initially set up according to Annex C.0, C.1 and Annex C.3.2 and uplink signals according to Annex H.1 and H.3.2.
4. Propagation conditions are set according to Annex B.0.
5. Ensure the UE is in State 4A-RF according to TS 36.508 [7] clause 5.2A.3. Message contents are defined in clause 8.7.1.1\_A.2.4.3.

## 8.7.1.1\_A.2.4.2 Test procedure

1. Configure SCCs according to Annex C.0, C.1 and Annex C.3.2 for all downlink physical channels.
2. The SS shall configure SCCs as per TS 36.508 [7] clause 5.2A.4 with two SCCs configured. PhysicalConfigDedicated-DEFAULT is defined in Table 8.7.1.1\_A.2.4.3-3, PhysicalConfigDedicatedSCell-r10-DEFAULT is defined in Table 8.7.1.1\_A.2.4.3-3A.
3. The SS activates SCCs by sending the activation MAC-CE (Refer TS 36.321 [13], clauses 5.13,6.1.3.8). Wait for at least 2 seconds (Refer TS 36.133, clauses 8.3.3.2).
4. Propagation conditions are set according to Annex B.1 (No external noise sources are applied).
5. The SS looks up  $TB_{size}$  in Table 8.7.1.1\_A.2.4.1-1 for the tests to be performed depending on the UE category according to Table 8.7.1.1\_A.2.5-3.
6. The SS sets the counters,  $N_{DL\_newtx}$ ,  $N_{DL\_retx}$ ,  $N_{UL\_PDCP}$ , and  $N_{DL\_PDCP}$  to 0.
7. For each new DL HARQ transmission the SS generates sufficient PDCP SDUs to fill up the TB in accordance with Table 8.7.1.1\_A.2.4.1-1 (Note 1). The SS ciphers the PDCP SDUs, concatenates the resultant PDCP PDUs to form an RLC PDU and then a MAC PDU. The SS transmits the MAC PDU. The SS increments then  $N_{DL\_newtx}$  by one and  $N_{DL\_PDCP}$  by the number of new PDCP SDUs (Note 1) included in the sent MAC PDU.
8. If PHY requests a DL HARQ retransmission, the SS performs a HARQ retransmission and increments  $N_{DL\_retx}$  by one.
9. Steps 7 to 8 are repeated at every TTI for at least 300 frames and the SS waits for 300ms to let any HARQ retransmissions and RLC retransmissions to finish.
10. For each PDCP SDU received at the SS, if the content of the data matches that of the truncated version of the original PDCP SDU generated at the SS, the SS increments  $N_{UL\_PDCP}$  by one
11. The SS calculates the TB success rate as  $A = 100\% * N_{DL\_newtx} / (N_{DL\_newtx} + N_{DL\_retx})$ . Measurements are not based on UE feedback but on SS counters instead ( $N_{DL\_newtx}$  and  $N_{DL\_retx}$ ) in order to validate HARQ feedback received from the UE.
12. The SS calculates the PDCP SDU loss as  $B = N_{DL\_PDCP} - N_{UL\_PDCP}$
13. The UE passes the test if  $A \geq$  "corresponding TB success rate according to Table 8.7.1.1\_A.2.5-1" and  $B = 0$ .

NOTE 1: In case of RLC PDU retransmission, the number of new required PDCP SDUs is as many as to fill the rest of TB.

## 8.7.1.1\_A.2.4.3 Message contents

Message contents are according to TS 36.508 [7] clauses 5.5 and 4.6 and 4.7A, with the following exceptions:

**Table 8.7.1.1\_A.2.4.3-1: CLOSE UE TEST LOOP (in the preamble)**

Derivation Path: 36.508 clause 4.7A table 4.7A-3 with condition UE TEST LOOP MODE A			
Information Element	Value/remark	Comment	Condition
UE test loop mode A LB setup			
Length of UE test loop mode A LB setup list in bytes	0 0 0 0 0 1 1	Length of one LB setup DRB (3 bytes)	
LB setup DRB	0 0 0 0 0 0 0, 0 0 1 0 1 0 0 0, 0 0 0 Q4 Q3 Q2 Q1 Q0	UL PDCP SDU size = 40 bits (5 bytes) Q4..Q0 = Data Radio Bearer identity number for the default radio bearer. See 36.509 clause 6.1	

**Table 8.7.1.1\_A.2.4.3-2: SecurityModeCommand (in the preamble)**

Derivation Path: TS 36.508 clause 4.6.1 table 4.6.1-19			
Information Element	Value/remark	Comment	Condition
SecurityModeCommand ::= SEQUENCE {			
criticalExtensions CHOICE {			
c1 CHOICE{			
securityModeCommand-r8 SEQUENCE {			
securityConfiguration SEQUENCE {			
cipheringAlgorithm	eea2		
nextHopChainingCount	Not present		
}			
nonCriticalExtension SEQUENCE {}	Not present		
}			
}			
}			

**Table 8.7.1.1\_A.2.4.3-3: PhysicalConfigDedicated-DEFAULT**

Derivation Path: 36.508 clause 5.5.1, Table 5.5.1.2-1			
Information Element	Value/remark	Comment	Condition
PhysicalConfigDedicated-DEFAULT ::= SEQUENCE {			
antennaInfo CHOICE {			
explicitValue ::= SEQUENCE {			
transmissionMode	tm3		Transmission mode 3
codebookSubsetRestriction CHOICE {			
n2TxAntenna-tm3	10		
}			
ue-TransmitAntennaSelection CHOICE {			
release	NULL		
}			
}			

**Table 8.7.1.1\_A.2.4.3-3A: PhysicalConfigDedicatedSCell-r10-DEFAULT**

Derivation Path: 36.508 clause 4.6.3 Table 4.6.3-6A			
Information Element	Value/remark	Comment	Condition
PhysicalConfigDedicatedSCell-r10-DEFAULT ::= SEQUENCE {			
nonUL-Configuration-r10 SEQUENCE {			
antennaInfo-r10 CHOICE {			
transmissionMode-r10	tm3		Transmission mode 3
codebookSubsetRestriction-r10	10		
ue-TransmitAntennaSelection CHOICE {			
release	NULL		
}			
}			

8.7.1.1\_A.2.5 Test requirement

The requirements are specified in Table 8.7.1.1\_A.2.5-1 depending on the UE category according to Table 8.7.1.1\_A.2.5-3. The PDCP SDU success rate shall be sustained during at least 300 frames.

Table 8.7.1.1\_A.2.5-1: Minimum requirement

Test	Number of bits of a DL-SCH transport block received within a TTI	Measurement channel	Reference value
			TB success rate [%]
6A	75376 (Note 3)	R.31-4 FDD	85
6D	55056 for 15MHz CC 75376 (Note 3) for 20MHz CC	R.31-5 FDD for 15MHz CC R.31-4 FDD for 20MHz CC	85
7	75376 (Note 3)	R.31-4 FDD	[85]
7A	55056 (Note 5) for 15MHz CC 75376 (Note 3) for 20MHz CC	R.31-5 FDD for 15MHz CC R.31-4 FDD for 20MHz CC	[85]
7B	36696 (Note 2) for 10MHz CC 75376 (Note 3) for 20MHz CC	R.31-3A FDD for 10MHz CC R.31-4 FDD for 20MHz CC	[85]
7C	55056 (Note 5) for 15MHz CC 75376 (Note 3) for 20MHz CC	R.31-5 FDD for 15MHz CC R.31-4 FDD for 20MHz CC	85
7D	36696 (Note 2) for 10MHz CC 55056 (Note 5) for 15MHz CC 75376 (Note 3) for 20MHz CC	R.31-3A FDD for 10MHz CC R.31-5 FDD for 15MHz CC R.31-4 FDD for 20MHz CC	[85]
7E	36696 (Note 2) for 10MHz CC 75376 (Note 3) for 20MHz CC	R.31-3A FDD for 10MHz CC R.31-4 FDD for 20MHz CC	[85]
7F	36696 (Note 2) for 10MHz CC 55056 (Note 5) for 15MHz CC	R.31-3A FDD for 10MHz CC R.31-5 FDD for 15MHz CC	[85]
7G	18336 (Note 6) for 5MHz CC 36696 (Note 2) for 10MHz CC 75376 (Note 3) for 20MHz CC	R.31-6 FDD for 5MHz CC R.31-3A FDD for 10MHz CC R.31-4 FDD for 20MHz CC	[85]
Note 1: For 2 layer transmissions, 2 transport blocks are received within a TTI. Note 2: 35160 bits for sub-frame 5. Note 3: 71112 bits for sub-frame 5. Note 4: The TB success rate is defined as TB success rate = $100\% \cdot N_{DL\_correct\_rx} / (N_{DL\_newtx} + N_{DL\_retx})$ , where $N_{DL\_newtx}$ is the number of newly transmitted DL transport blocks, $N_{DL\_retx}$ is the number of retransmitted DL transport blocks, and $N_{DL\_correct\_rx}$ is the number of correctly received DL transport blocks. Note 5: 52752bits for sub-frame 5. Note 6: 15840bits for sub-frame 0 and 5.			

Table 8.7.1.1\_A.2.5-2: test parameters per test

Test	Bandwidth (MHz)	Transmission mode	Antenna configuration	Codebook subset restriction	Downlink power allocation (dB)			$\hat{E}_s$ at antenna port (dBm/15kHz)	Symbols for unused PRBs
					$\rho_A$	$\rho_B$	$\sigma$		
6A	2x20	3	2 x 2	10	-3	-3	0	-85	OP.1 FDD
6D	15+20	3	2 x 2	10	-3	-3	0	-85	OP.1 FDD
7	3x20	3	2 x 2	10	-3	-3	0	-85	OP.1 FDD
7A	15+20+20	3	2 x 2	10	-3	-3	0	-85	OP.1 FDD
7B	10+20+20	3	2 x 2	10	-3	-3	0	-85	OP.1 FDD
7C	15+15+20	3	2 x 2	10	-3	-3	0	-85	OP.1 FDD
7D	10+15+20	3	2 x 2	10	-3	-3	0	-85	OP.1 FDD
7E	10+10+20	3	2 x 2	10	-3	-3	0	-85	OP.1 FDD
7F	10+15+15	3	2 x 2	10	-3	-3	0	-85	OP.1 FDD
7G	5+10+20	3	2 x 2	10	-3	-3	0	-85	OP.1 FDD
Note 1: PUCCH format 1b with channel selection is used to feedback ACK/NACK for Tests 6A and 6D, and PUCCH format 3 is used to feedback ACK/NACK for Test 7-7G.									

Table 8.7.1.1\_A.2.5-3: Test points per UE category

CA config	Maximum supported Bandwidth/ Bandwidth combination (MHz)	Cat. 1	Cat. 2	Cat. 3	Cat. 4	Cat. 6,7	Cat. 9,10	Cat 11, 12
CA with 3CCs	3x20	-	-	-	-	6A	7	7
	15+20+20	-	-	-	-	6A	7A	7A
	10+20+20	-	-	-	-	6A	7B	7B
	15+15+20	-	-	-	-	6D	7C	7C
	10+15+20	-	-	-	-	6D	7D	7D
	10+10+20	-	-	-	-	7E	7E	7E
	10+15+15	-	-	-	-	7F	7F	7F
5+10+20	-	-	-	-	7G	7G	7G	
Note 1:	Void.							
Note 2:	Void.							
Note 3:	Void.							
Note 4:	Void.							
Note 5:	The applicability of requirements for different CA configurations and bandwidth combination sets is defined in 8.1.2.3.							
Note 6:	Only one test point is tested. Select the largest aggregated CA bandwidth combination supported by the UE among the UE supported CA capabilities.							

8.7.1.1\_A.3 Void

## 8.7.2 TDD

The parameters specified in Table 8.7.2-1 are valid for all TDD tests unless otherwise stated.

**Table 8.7.2-1: Common Test Parameters (TDD)**

Parameter	Unit	Value
Special subframe configuration (Note 1)		4
Cyclic prefix		Normal
Cell ID		0 (Note2)
Inter-TTI Distance		1
Maximum number of HARQ transmission		Downlink: 4 Uplink: 1
Redundancy version coding sequence		{0,0,1,2} for 64QAM
Scheduling of retransmissions		1. Retransmissions use the same Transport Block Size (TBS) as the initial transmission. 2. HARQ processes are scheduled consecutively, independent of the fact, whether retransmissions (for negatively acknowledged HARQ processes) or new transmissions (for positively acknowledged HARQ processes) occur. 3. Despite of 1) and 2) the number of RB-s to be allocated in each SF remains firm as specified in the RMC. Thus in case of RMC-s with SF dependent allocation, for retransmissions the TBS and the modulation scheme (MCS) are indicated implicitly ( $29 \leq I_{MCS} \leq 31$ ) according to TS 36.213 [10] subclause 7.1.7.2.
Number of OFDM symbols for PDCCH	OFDM symbols	1
Cross carrier scheduling		Not configured
Propagation conditions		Static propagation condition No external noise sources are applied
Note 1:	as specified in Table 4.2-1 in TS 36.211 [4].	
Note 2:	For CA tests, Cell ID = 0 applies to P-Cell, Cell ID = n (where n is 1, 2, 3..) applies to S-Celln (where n is 1, 2, 3..), respectively.	

The normative reference for this requirement is TS 36.101[2] clause 8.7.2.

## 8.7.2.1 TDD sustained data rate performance

### 8.7.2.1.1 Test purpose

The purpose of the test is to verify that the Layer 1 and Layer 2 correctly process in a sustained manner the received packets corresponding to the maximum number of DL-SCH transport block bits received within a TTI for the UE category indicated. The sustained downlink data rate shall be verified in terms of the success rate of delivered PDCP SDU(s) by Layer 2. The test case below specifies the RF conditions and the required success rate of delivered TB by Layer 1 to meet the sustained data rate requirement. The size of the TB per TTI corresponds to the largest possible DL-SCH transport block for each UE category using the maximum number of layers for spatial multiplexing. Transmission modes 1 and 3 are used with radio conditions resembling a scenario where sustained maximum data rates are available. Test case is selected according to table 8.7.2.1.1-1 depending on UE capability for CA and EPDCCH.

**Table 8.7.2.1.1-1: SDR test applicability**

	Single carrier UE not supporting EPDCCH	CA UE not supporting EPDCCH	Single carrier UE supporting EPDCCH	CA UE supporting EPDCCH

TDD	8.7.2.1, 8.7.2.1_1	8.7.2.1_A	8.7.4.1	8.7.2.1_A, 8.7.4.1
-----	--------------------	-----------	---------	--------------------

### 8.7.2.1.2 Test applicability

This test applies to E-UTRA TDD UE release 9 and forward UEs of category 1 to 4.

### 8.7.2.1.3 Minimum requirements

**Table 8.7.2.1.3-1: Void**

The requirements are specified in Table 8.7.2.1.3-3, with the addition of the parameters in Table 8.7.2.1.3-2 and the downlink physical channel setup according to Annex C.3.2. The test points are applied to UE category as specified in Table 8.7.2.1.3-4. The TB success rate shall be sustained during at least 300 frames.

**Table 8.7.2.1.3-2: Test parameters for sustained downlink data rate (TDD)**

Test	Bandwidth (MHz)	Transmission mode	Antenna configuration	Codebook subset restriction	Downlink power allocation (dB)			$\hat{E}_s$ at antenna port (dBm/15 kHz)	ACK/NACK feedback mode	Symbols for unused PRBs
					$\rho_A$	$\rho_B$	$\sigma$			
1	10	1	1 x 2	N/A	0	0	0	-85	Bundling	OP.6 TDD
2	10	3	2 x 2	10	-3	-3	0	-85	Bundling	OP.1 TDD
3	20	3	2 x 2	10	-3	-3	0	-85	Bundling	OP.1 TDD
3A	15	3	2 x 2	10	-3	-3	0	-85	Multiplexing	OP.2 TDD
4,6	20	3	2 x 2	10	-3	-3	0	-85	Multiplexing	OP.1 TDD

**Table 8.7.2.1.3-3: Minimum requirement (TDD)**

Test	Number of bits of a DL-SCH transport block received within a TTI for normal/special sub-frame	Measurement channel	Reference value
			TB success rate [%]
1	10296/0	R.31-1 TDD	95
2	25456/0	R.31-2 TDD	95
3	51024/0	R.31-3 TDD	95
3A	51024/0	R.31-3A TDD	85
4	75376/0 (Note 2)	R.31-4 TDD	85
6	75376/0 (Note 2)	R.31-4 TDD	85

Note 1: For 2 layer transmissions, 2 transport blocks are received within a TTI.  
Note 2: 71112 bits for sub-frame 5.  
Note 3: The TB success rate is defined as TB success rate = 100% \*  $N_{DL\_correct\_rx} / (N_{DL\_newtx} + N_{DL\_retx})$ , where  $N_{DL\_newtx}$  is the number of newly transmitted DL transport blocks,  $N_{DL\_retx}$  is the number of retransmitted DL transport blocks, and  $N_{DL\_correct\_rx}$  is the number of correctly received DL transport blocks.



Table 8.7.2.1.3-4: Test points for sustained data rate (FRC)

CA config	Bandwidth (MHz)	Category 1	Category 2	Category 3	Category 4	Category 6	Category 7
Single carrier	10	1	2	-	-	-	-
	15	-	-	3A	3A	-	-
	20	-	-	3	4	6	6
Note 1: If UE can be tested for CA configuration, single carrier test is skipped.							
Note 2: For non-CA UE, test is selected for maximum supported bandwidth.							

The normative reference for this requirement is TS 36.101[2] clause 8.7.2

#### 8.7.2.1.4 Test description

##### 8.7.2.1.4.1 Initial conditions

Table 8.7.2.1.4.1-1: Further test parameters per test

Test	DL Measurement channel	UL Measurement Channel	TB <sub>size</sub> per Codeword	Number of PDCP SDU per Codeword for normal/special sub-frame	PDCP SDU size [Octets] Calculation (Note 1)	PDCP SDU size [Octets] for normal/special sub-frame
1	R.31-1 TDD	R.1-1 TDD	10296	1/0	$\text{FLOOR}((\text{TB}_{\text{size}} - 96)/8)$	1275/0
2	R.31-2 TDD	R.1-2 TDD	25456	3/0	$\text{FLOOR}((\text{TB}_{\text{size}} - 152)/24)$	1054/0
3	R.31-3 TDD	R.1-3 TDD	51024	5/0	$\text{FLOOR}((\text{TB}_{\text{size}} - 208)/40)$	1270/0
3A	R.31-3B TDD	R.1-3B TDD	51024	4/0	$\text{FLOOR}((\text{TB}_{\text{size}} - 184)/32)$ "	1588
4	R.31-4 TDD	R.1-4 TDD	75376 (Note 3)	7/0	$\text{FLOOR}((\text{TB}_{\text{size}} - 264)/56)$	1341/0
<p>Note 1: Transport block size under test according to applicable Fixed Reference Channel for sustained data-rate test in annex A.3.9. In case of varying TBS across SFs of the RMC, only the maximum TBS is used for PDCP SDU size calculation.</p> <p>Note 2: Each PDCP SDU is limited to 1500 octets (to keep below maximum SDU size of ESM as specified in TS 24.301 clause 9.9.4.12).</p> <p>The PDCP SDU size of each PDCP SDU is:</p> $\text{PDCP SDU size} = (\text{TB}_{\text{size}} - N \cdot \text{PDCP header size} - \text{AMD PDU header size} - \text{MAC header size} - \text{Size of Timing Advance} - \text{Size of RLC STATUS PDU}) / N,$ <p>where PDCP header size is 16 bits for the RLC AM and 12-bit SN case; AMD PDU header size is <math>\text{CEIL}[(16 + (N-1) \cdot 12)/8]</math> bytes which includes 16 bit standard AM header and (N-1) Length indicators; and MAC header size = R/R/E/LCID/F/L MAC subheader (24 bits for MAC SDU for RLC STATUS PDU with 15 bit LI) + R/R/E/LCID MAC subheader (8 bits for MAC SDU for RLC data PDU) = 32 bits. The size of RLC STATUS PDU including one ACK_SN field and one NACK_SN field is 32 bits (if no STATUS PDU is sent or if the size of the STATUS PDU is less than 32 bits then padding will be used to fill the 32 bits). This gives: <math>\text{PDCP SDU size} = 8 \cdot \text{FLOOR}((\text{TB}_{\text{size}} - N \cdot 16 - 8 \cdot \text{CEIL}[(16 + (N-1) \cdot 12)/8] - 64) / (8 \cdot N))</math> bits.</p> <p>The calculation of PDCP SDU sizes does not consider timing advance MAC CE as timing advance is not transmitted by SS for RF test cases, and the header sizes are informative and may vary during the test.</p> <p>Note 3: 71112 bits for sub-frame 5.</p>						

Initial conditions are a set of test configurations the UE needs to be tested in and the steps for the SS to take with the UE to reach the correct measurement state.

Configurations of PDSCH and PDCCH before measurement are specified in Annex C.2.

Test Environment: Normal as defined in TS 36.508 [7] clause 4.1.

Frequencies to be tested: Mid Range as defined in TS 36.508 [7] clause 4.3.1.1.

Channel Bandwidths to be tested: according to Table 8.7.2.1.5-2 depending on the UE category according to Table 8.7.2.1.5-3.

1. Connect the SS, to the UE antenna connector(s) as shown in TS 36.508 [7] Annex A, Figure A.3 for test 1 and Figure A.10 for tests 2-5 (without using faders and AWGN generators).
2. The parameter settings for the cell are set up according to Table 8.7.2.1.5-2 and Table 8.7.2.1.5-1 depending on the UE category according to Table 8.7.2.1.5-3.
3. Downlink signals are initially set up according to Annex C0, C.1 and Annex C.3.2 and uplink signals according to Annex H.1 and H.3.2.
4. Propagation conditions are set according to Annex B.0.
5. Ensure the UE is in State 4A-RF according to TS 36.508 [7] clause 5.2A.3. Message contents are defined in clause 8.7.2.1.4.3. PhysicalConfigDedicated-DEFAULT for transmission mode 3 is defined in Table 8.7.2.1.4.3-3.

#### 8.7.2.1.4.2 Test procedure

1. Propagation conditions are set according to Annex B.1. No external noise sources are applied.
2. The SS looks up  $TB_{size}$  in Table 8.7.2.1.4.1-1 for the tests to be performed depending on the UE category according to Table 8.7.2.1.5-3.
3. SS sets the counters  $N_{DL\_newtx}$ ,  $N_{DL\_retr}$ ,  $N_{UL\_PDCP}$ , and  $N_{DL\_PDCP}$  to 0.
4. For each new DL HARQ transmission the SS generates sufficient PDCP SDUs to fill up the TB in accordance with Table 8.7.2.1.4.1-1 (Note 1). The SS ciphers the PDCP SDUs, concatenates the resultant PDCP PDUs to form an RLC PDU and then a MAC PDU. The SS transmits the MAC PDU. The SS increments then  $N_{DL\_newtx}$  by one and  $N_{DL\_PDCP}$  by the number of new PDCP SDUs (Note 1) included in the sent MAC PDU.
5. If PHY requests a DL HARQ retransmission, the SS performs a HARQ retransmission and increments  $N_{DL\_retr}$  by one.
6. Steps 4 to 5 are repeated at every TTI for at least 300 frames and the SS waits for 300ms to let any HARQ retransmissions and RLC retransmissions to finish.
7. For each PDCP SDU received at the SS, if the content of the data matches that of the truncated version of the original PDCP SDU generated at the SS, the SS increments  $N_{UL\_PDCP}$  by one.
8. The SS calculates the TB success rate as  $A = 100\% * N_{DL\_newtx} / (N_{DL\_newtx} + N_{DL\_retr})$ . Measurements are not based on UE feedback but on SS counters instead ( $N_{DL\_newtx}$  and  $N_{DL\_retr}$ ) in order to validate HARQ feedback received from the UE.
9. The SS calculates the PDCP SDU loss as  $B = N_{DL\_PDCP} - N_{UL\_PDCP}$
10. The UE passes the test if  $A \geq$  "corresponding TB success rates according to Table 8.7.2.1.5-1" and  $B = 0$ .

NOTE 1 In case of RLC PDU retransmission, the number of new required PDCP SDUs is as many as to fill the rest of TB.

#### 8.7.2.1.4.3 Message contents

Message contents are according to TS 36.508 [7] clause 4.6 and 4.7A, with the following exceptions:

**Table 8.7.2.1.4.3-1: CLOSE UE TEST LOOP (in the preamble)**

Derivation Path: 36.509 clause 6.1			
Information Element	Value/remark	Comment	Condition
Protocol discriminator	1 1 1 1		
Skip indicator	0 0 0 0		
Message type	1 0 0 0 0 0 0		
UE test loop mode	0 0 0 0 0 0 0	UE test loop mode A	
UE test loop mode A LB setup			
Length of UE test loop mode A LB setup list in bytes	0 0 0 0 0 1 1	Length of one LB setup DRB (3 bytes)	
LB setup DRB	0 0 0 0 0 0 0, 0 0 1 0 1 0 0 0, 0 0 0 Q4 Q3 Q2 Q1 Q0	UL PDCP SDU size = 40 bits (5 bytes) Q4..Q0 = Data Radio Bearer identity number for the default radio bearer. See 36.509 clause 6.1.	
UE test loop mode B LB setup	Not present		

**Table 8.7.2.1.4.3-2: SecurityModeCommand (in the preamble)**

Derivation Path: TS 36.508 clause 4.6.1 table 4.6.1-19			
Information Element	Value/remark	Comment	Condition
SecurityModeCommand ::= SEQUENCE {			
criticalExtensions CHOICE {			
c1 CHOICE{			
securityModeCommand-r8 SEQUENCE {			
securityConfiguration SEQUENCE {			
cipheringAlgorithm	eea2		
nextHopChainingCount	Not present		
}			
nonCriticalExtension SEQUENCE {}	Not present		
}			
}			
}			
}			

**Table 8.7.2.1.4.3-3: PhysicalConfigDedicated-DEFAULT**

Derivation Path: 36.508 clause 4.8.2.1.6-1			
Information Element	Value/remark	Comment	Condition
PhysicalConfigDedicated-DEFAULT ::= SEQUENCE {			
antennaInfo CHOICE {			
explicitValue ::= SEQUENCE {			
transmissionMode	tm1 for Test 1 tm3 for other Test 2, 3, 3B and 4		
codebookSubsetRestriction CHOICE {			
n2TxAntenna-tm3	Not present for Test 1 10 for other Test 2, 3, 3B and 4		
}			
ue-TransmitAntennaSelection CHOICE {			
release	NULL		
}			
}			
}			
}			

## 8.7.2.1.5 Test requirement

The requirements are specified in Table 8.7.2.1.5-1 depending on the UE category according to Table 8.7.2.1.5-3. The PDCP SDU success rate shall be sustained during at least 300 frames.

Table 8.7.2.1.5-1: Test requirements per test

Test	Number of bits of a DL-SCH transport block received within a TTI for normal/special sub-frame	Measurement channel	Reference value
			TB success rate [%]
1	10296/0	R.31-1 TDD	95
2	25456/0	R.31-2 TDD	95
3	51024/0	R.31-3 TDD	95
3A	51024/0	R.31-3A TDD	85
4	75376/0 (Note 2)	R.31-4 TDD	85

Note 1: For 2 layer transmissions, 2 transport blocks are received within a TTI.  
Note 2: 71112 bits for sub-frame 5.  
Note 3: The TB success rate is defined as TB success rate = 100% \*  $N_{DL\_correct\_rx} / (N_{DL\_newtx} + N_{DL\_retx})$ , where  $N_{DL\_newtx}$  is the number of newly transmitted DL transport blocks,  $N_{DL\_retx}$  is the number of retransmitted DL transport blocks, and  $N_{DL\_correct\_rx}$  is the number of correctly received DL transport blocks.

Table 8.7.2.1.5-2: Test parameters per test

Test	Bandwidth (MHz)	Transmission mode	Antenna configuration	Codebook subset restriction	Downlink power allocation (dB)			$\hat{E}_s$ at antenna port (dBm/15kHz)	ACK/NACK feedback mode	Symbols for unused PRBs
					$\rho_A$	$\rho_B$	$\sigma$			
1	10	1	1 x 2	N/A	0	0	0	-85	Bundling	OP.6 TDD
2	10	3	2 x 2	10	-3	-3	0	-85	Bundling	OP.1 TDD
3	20	3	2 x 2	10	-3	-3	0	-85	Bundling	OP.1 TDD
3A	15	3	2 x 2	10	-3	-3	0	-85	Multiplexing	OP.2 TDD
4	20	3	2 x 2	10	-3	-3	0	-85	Multiplexing	OP.1 TDD

Note 1: N/A.

Table 8.7.2.1.5-3: Test applicability per UE category

CA config	Bandwidth (MHz)	Category 1	Category 2	Category 3	Category 4	Category 6	Category 7
Single carrier	10	1	2	-	-	-	-
	15	-	-	3A	3A	-	-
	20	-	-	3	4	-	-

Note 1: If UE can be tested for CA configuration, single carrier test is skipped.  
Note 2: For non-CA UE, test is selected for maximum supported bandwidth.

## 8.7.2.1\_1 TDD sustained data rate performance (Rel-10 and forward)

## 8.7.2.1\_1.1 Test purpose

Same test purpose as in clause 8.7.2.1.

## 8.7.2.1\_1.2 Test applicability

This test case applies to E-UTRA TDD release 10 and forward of UEs category 6 and 7.

## 8.7.2.1\_1.3 Minimum requirements

Table 8.7.2.1\_1.3-1: Void

Same minimum conformance requirements as in clause 8.7.2.1.3.

## 8.7.2.1\_1.4 Test description

Same test description as in clause 8.7.2.1.4 with the following exceptions:

- Connection diagram Figure A.10 (without using faders and AWGN generators).
- Instead of Table 8.7.2.1.4.1-1 -> use Table 8.7.2.1\_1.4-1.
- Instead of Table 8.7.2.1.5-1 -> use Table 8.7.2.1\_1.5-1.
- Instead of Table 8.7.2.1.5-2 -> use Table 8.7.2.1\_1.5-2.
- Instead of Table 8.7.2.1.5-3 -> use Table 8.7.2.1\_1.5-3.

**Table 8.7.2.1\_1.4-1: Further test parameters per test**

Test	DL Measurement channel	UL Measurement Channel	TB <sub>size</sub> per Codeword	Number of PDCP SDU per Codeword for normal/special sub-frame	PDCP SDU size [Octets] Calculation (Note 1)	PDCP SDU size [Octets] for normal/special sub-frame
6	R31-4 TDD	R.1-4 TDD	75376 (Note 3)	7/0	FLOOR((TB <sub>size</sub> – 264)/56)	1341/0
Note 1:	Transport block size under test according to applicable Fixed Reference Channel for sustained data-rate test in annex A.3.9. In case of varying TBS across SFs of the RMC, only the maximum TBS is used for PDCP SDU size calculation.					
Note 2:	Each PDCP SDU is limited to 1500 octets (to keep below maximum SDU size of ESM as specified in TS 24.301 clause 9.9.4.12).					
	The PDCP SDU size of each PDCP SDU is:					
	PDCP SDU size = (TB <sub>size</sub> – N*PDCP header size - AMD PDU header size - MAC header size – Size of Timing Advance - Size of RLC STATUS PDU) / N,					
	where PDCP header size is 16 bits for the RLC AM and 12-bit SN case; AMD PDU header size is CEIL[(16+(N-1)*12)/8] bytes which includes 16 bit standard AM header and (N-1) Length indicators; and MAC header size = R/R/E/LCID/F/L MAC subheader (24 bits for MAC SDU for RLC STATUS PDU with 15 bit LI) + R/R/E/LCID MAC subheader (8 bits for MAC SDU for RLC data PDU) = 32 bits. The size of RLC STATUS PDU including one ACK_SN field and one NACK_SN field is 32 bits (if no STATUS PDU is sent or if the size of the STATUS PDU is less than 32 bits then padding will be used to fill the 32 bits). This gives: PDCP SDU size = 8*FLOOR((TB <sub>size</sub> – N*16- 8*CEIL((16+(N-1)*12)/8) – 64)/(8*N)) bits.					
	The calculation of PDCP SDU sizes does not consider timing advance MAC CE as timing advance is not transmitted by SS for RF test cases, and the header sizes are informative and may vary during the test.					
Note 3:	71112 bits for sub-frame 5.					

## 8.7.2.1\_1.5 Test requirement

The requirements are specified in Table 8.7.2.1.5-1 depending on the UE category according to Table 8.7.2.1\_1.5-3. The TB success rate shall be sustained during at least 300 frames.

**Table 8.7.2.1\_1.5-1: Test requirements for sustained downlink data rate (TDD)**

Test	Number of bits of a DL-SCH transport block received within a TTI for normal/special sub-frame	Measurement channel	Reference value
			TB success rate [%]
6	75376/0 (Note 2)	R.31-4 TDD	85
Note 1:	For 2 layer transmissions, 2 transport blocks are received within a TTI.		
Note 2:	71112 bits for sub-frame 5.		
Note 3:	The TB success rate is defined as TB success rate = 100%*N <sub>DL_correct_rx</sub> / (N <sub>DL_newtx</sub> + N <sub>DL_retx</sub> ), where N <sub>DL_newtx</sub> is the number of newly transmitted DL transport blocks, N <sub>DL_retx</sub> is the number of retransmitted DL transport blocks, and N <sub>DL_correct_rx</sub> is the number of correctly received DL transport blocks.		

Table 8.7.2.1\_1.5-2: Test parameters per test

Test	Bandwidth (MHz)	Transmission mode	Antenna configuration	Codebook subset restriction	Downlink power allocation (dB)			$\hat{E}_s$ at antenna port (dBm/15kHz)	ACK/NACK feedback mode	Symbols for unused PRBs
					$\rho_A$	$\rho_B$	$\sigma$			
6	20	3	2 x 2	10	-3	-3	0	-85	Multiplexing	OP.1 TDD
Note 1: N/A.										

Table 8.7.2.1\_1.5-3: Test applicability per UE category

CA config	Bandwidth/ Bandwidth combination (MHz)	Category 1	Category 2	Category 3	Category 4	Category 6	Category 7
Single carrier	20	-	-	-	-	6	6
Note 1: If UE can be tested for CA configuration, single carrier test is skipped.							
Note 2: For non-CA UE, test is selected for maximum supported bandwidth.							

### 8.7.2.1\_A TDD sustained data rate performance for CA

#### 8.7.2.1\_A.1 TDD sustained data rate performance for CA (2DL CA)

##### 8.7.2.1\_A.1.1 Test purpose

Same test purpose as in clause 8.7.2.1.

##### 8.7.2.1\_A.1.2 Test applicability

This test applies to E-UTRA TDD release 10 and forward UEs of category 3, 4, 6, 7, 9 and 10 which support inter-band DL CA OR intra-band contiguous DL CA.

This test also applies to E-UTRA TDD release 11 and forward UEs of category 3, 4, 6, 7, 9 and 10 which support intra band non-contiguous DL CA.

##### 8.7.2.1\_A.1.3 Minimum requirements

For UE not supporting 256QAM, the requirements are specified in Table 8.7.2.1\_A.1.3-3, with the addition of the parameters in Table 8.7.2.1\_A.1.3-2 and the downlink physical channel setup according to Annex C.3.2. The test points are applied to UE category and bandwidth combination with maximum aggregated bandwidth as specified in Table 8.7.2.1\_A.1.3-4. The TB success rate shall be sustained during at least 300 frames.

Table 8.7.2.1\_A.1.3-1: Void

Table 8.7.2.1\_A.1.3-2: Test parameters for sustained downlink data rate for CA (TDD 64QAM)

Test	Bandwidth (MHz)	Transmission mode	Antenna configuration	Codebook subset restriction	Downlink power allocation (dB)			$\hat{E}_s$ at antenna port (dBm/15kHz)	ACK/NACK feedback mode	Symbols for unused PRBs
					$\rho_A$	$\rho_B$	$\sigma$			
3	20	3	2 x 2	10	-3	-3	0	-85	Bundling	OP.1 TDD
4	20	3	2 x 2	10	-3	-3	0	-85	Multiplexing	OP.1 TDD
6A	2x20	3	2 x 2	10	-3	-3	0	-85	- (Note 1)	OP.1 TDD
6B	20+15	3	2 x 2	10	-3	-3	0	-85	(Note 1)	OP.1 TDD

Note 1: PUCCH format 1b with channel selection is used to feedback ACK/NACK.

Table 8.7.2.1\_A.1.3-3: Minimum requirement for CA (TDD 64QAM)

Test	Number of bits of a DL-SCH transport block received within a TTI for normal/special sub-frame	Measurement channel	Reference value
			TB success rate [%]
3	51024/0	R31-3 TDD	95
4	75376/0 (Note 2)	R31-4 TDD	85
6A	75376/0 (Note 2)	R.31-4 TDD	85
6B	55056/0 for 15MHz CC 75376/0 for 20MHz CC (Note 2)	R.31-5 TDD for 15MHz CC R.31-4 TDD for 20MHz CC	[85]

Note 1: For 2 layer transmissions, 2 transport blocks are received within a TTI.  
Note 2: 71112 bits for sub-frame 5.  
Note 3: The TB success rate is defined as TB success rate = 100% \*  $N_{DL\_correct\_rx} / (N_{DL\_newtx} + N_{DL\_retx})$ , where  $N_{DL\_newtx}$  is the number of newly transmitted DL transport blocks,  $N_{DL\_retx}$  is the number of retransmitted DL transport blocks, and  $N_{DL\_correct\_rx}$  is the number of correctly received DL transport blocks.

Table 8.7.2.1\_A.1.3-4: Test points for sustained data rate for CA (FRC 64QAM)

CA config	Bandwidth/ Bandwidth combination (MHz)	Cat. 1	Cat. 2	Cat. 3	Cat. 4	Cat. 6,7	Cat. 9, 10	Cat 11, 12
CA with 2CCs	20+20	-	--	3(Note 4)	4 (Note 4)	6A	6A	-
	15+20	-	-	3(Note 4)	4 (Note 4)	6B	6B	-

Note 1: Void.  
Note 2: For non-CA UE, test is selected for maximum supported bandwidth.  
Note 3: Void.  
Note 4: If the intra-band contiguous CA is the only CA configuration supported by category 3 or 4 UE, single carrier test is selected.  
Note 5: The applicability of requirements for different CA configurations and bandwidth combination sets is defined in 8.1.2.3.

The normative reference for this requirement is TS 36.101[2] clause 8.7.2

8.7.2.1\_A.1.4 Test description

8.7.2.1\_A.1.4.1 Initial conditions

**Table 8.7.2.1\_A.1.4.1-1: Further test parameters per test**

Test	DL Measurement channel	UL Measurement channel	TB <sub>size</sub> per Codeword per Component Carrier	Number of PDCP SDU per Codeword for normal/special sub-frame	PDCP SDU size [Octets] Calculation (Note 1)	PDCP SDU size [Octets] for normal/special sub-frame
6A	R.31-4 TDD	R.1-4 TDD	75376 (Note 3)	7/0	$\text{FLOOR}((\text{TB}_{\text{size}} - 264)/56)$	1341/0
6B	R.31-5 TDD for 15MHz CC R.31-4 TDD for 20MHz CC	R.1-4 TDD	55056/0 for 15MHz CC 75376/0 for 20MHz CC (Note 3)	6 for 15MHz CC 7 for 20 MHz CC	$\text{FLOOR}((\text{TB}_{\text{size}} - 240)/48)$ for 15 MHz CC $\text{FLOOR}((\text{TB}_{\text{size}} - 264)/56)$ for 20 MHz CC	1142 for 15MHz CC 1341 for 20MHz CC
Note 1:	Transport block size under test according to applicable Fixed Reference Channel for sustained data-rate test in annex A.3.9. In case of varying TBS across SFs of the RMC, only the maximum TBS is used for PDCP SDU size calculation. In case of different resulting PDCP SDU sizes among component carriers, the smaller calculated PDCP SDU size is used across all the carriers.					
Note 2:	Each PDCP SDU is limited to 1500 octets (to keep below maximum SDU size of ESM as specified in TS 24.301 clause 9.9.4.12).  The PDCP SDU size of each PDCP SDU is:  $\text{PDCP SDU size} = (\text{TB}_{\text{size}} - \text{N} \times \text{PDCP header size} - \text{AMD PDU header size} - \text{MAC header size} - \text{Size of RLC STATUS PDU}) / \text{N}$ ,  where PDCP header size is 16 bits for the RLC AM and 12-bit SN case; AMD PDU header size is $\text{CEIL}[(16 + (\text{N} - 1) \times 12) / 8]$ bytes which includes 16 bit standard AM header and (N-1) Length indicators; and MAC header size = R/R/E/LCID/F/L MAC subheader (24 bits for MAC SDU for RLC STATUS PDU with 15 bit LI) + R/R/E/LCID MAC subheader (8 bits for MAC SDU for RLC Data PDU) = 32 bits. The size of RLC STATUS PDU including one ACK_SN field and one NACK_SN field is 32 bits (if no STATUS PDU is sent or if the size of the STATUS PDU is less than 32 bits then padding will be used to fill the 32 bits). This gives: $\text{PDCP SDU size} = 8 \times \text{FLOOR}((\text{TB}_{\text{size}} - \text{N} \times 16 - 8 \times \text{CEIL}[(16 + (\text{N} - 1) \times 12) / 8] - 64) / (8 \times \text{N}))$ bits.  The calculation of PDCP SDU sizes does not consider timing advance MAC CE as timing advance is not transmitted by SS for RF test cases, and the header sizes are informative and may vary during the test.					
Note 3:	71112 bits for sub-frame 5					

Initial conditions are a set of test configurations the UE needs to be tested in and the steps for the SS to take with the UE to reach the correct measurement state.

Configurations of PDSCH and PDCCH before measurement are specified in Annex C.2.

Test Environment: Normal as defined in TS 36.508 [7] clause 4.1.

Frequencies to be tested: Maximum WGap for Intra-band non-contiguous CA, otherwise Mid Range as defined in TS 36.508 [7] clause 4.3.1.2.

Channel Bandwidths to be tested: according to Table 8.7.2.1\_A.1.5-2 depending on the UE category according to Table 8.7.2.1\_A.1.5-3.

1. Connect the SS to the UE antenna connector(s) as shown in TS 36.508 [7] Annex A, Figure group A.36 (without using faders and AWGN generators).
2. The parameter settings for the cell are set up according to Table 8.7.2.1\_A.1.5-2 and Table 8.7.2.1\_A.1.5-1 depending on the UE category according to Table 8.7.2.1\_A.1.5-3.
3. Downlink signals for PCC are initially set up according to Annex C.0, C.1 and Annex C.3.2 and uplink signals according to Annex H.1 and H.3.2.



4. Propagation conditions are set according to Annex B.0.
5. Ensure the UE is in State 4A-RF according to TS 36.508 [7] clause 5.2A.3/4.5.4.5. Message contents are defined in clause 8.7.2.1\_A.1.4.3.

#### 8.7.2.1\_A.1.4.2 Test procedure

1. Configure SCC according to Annex C.0, C.1 and Annex C.3.2 for all downlink physical channels.
2. The SS shall configure SCC as per TS 36.508 [7] clause 5.2A.4. PhysicalConfigDedicated-DEFAULT is defined in Table 8.7.2.1\_A.1.4.3-1, PhysicalConfigDedicatedSCell-r10-DEFAULT is defined in Table 8.7.2.1\_A.1.4.3-1A.
3. The SS activates SCC by sending the activation MAC-CE (Refer TS 36.321 [13], clauses 5.13, 6.1.3.8). Wait for at least 2 seconds (Refer TS 36.133, clauses 8.3.3.2).
4. Propagation conditions are set according to Annex B.1. No external noise sources are applied.
5. The SS looks up  $TB_{size}$  in Table 8.7.2.1\_A.1.4.1-1 for the tests to be performed depending on the UE category according to Table 8.7.2.1\_A.1.5-3.
6. SS sets the counters  $N_{DL\_newtx}$ ,  $N_{DL\_retx}$ ,  $N_{UL\_PDCP}$ , and  $N_{DL\_PDCP}$  to 0.
7. For each new DL HARQ transmission the SS generates sufficient PDCP SDUs to fill up the TB in accordance with Table 8.7.2.1\_A.1.4.1-1 (Note 1). The SS ciphers the PDCP SDUs, concatenates the resultant PDCP PDUs to form an RLC PDU and then a MAC PDU. The SS transmits the MAC PDU. The SS increments then  $N_{DL\_newtx}$  by one and  $N_{DL\_PDCP}$  by the number of new PDCP SDUs (Note 1) included in the sent MAC PDU.
8. If PHY requests a DL HARQ retransmission, the SS performs a HARQ retransmission and increments  $N_{DL\_retx}$  by one.
9. Steps 7 to 8 are repeated at every TTI for at least 300 frames and the SS waits for 300ms to let any HARQ retransmissions and RLC retransmissions to finish.
10. For each PDCP SDU received at the SS, if the content of the data matches that of the truncated version of the original PDCP SDU generated at the SS, the SS increments  $N_{UL\_PDCP}$  by one
11. The SS calculates the TB success rate as  $A = 100\% * N_{DL\_newtx} / (N_{DL\_newtx} + N_{DL\_retx})$ . Measurements are not based on UE feedback but on SS counters instead ( $N_{DL\_newtx}$  and  $N_{DL\_retx}$ ) in order to validate HARQ feedback received from the UE.
11. The SS calculates the PDCP SDU loss as  $B = N_{DL\_PDCP} - N_{UL\_PDCP}$
12. The UE passes the test if  $A \geq$  "corresponding TB success rate according to Table 8.7.2.1\_A.1.5-1" and  $B = 0$ .

NOTE 1: In case of RLC PDU retransmission, the number of new required PDCP SDUs is as many as to fill the rest of TB.

#### 8.7.2.1\_A.1.4.3 Message contents

Same message contents as in clause 8.7.2.1.4.3 with the following exceptions:

**Table 8.7.2.1\_A.1.4.3-1: PhysicalConfigDedicated-DEFAULT**

Derivation Path: 36.508 clause 4.8.2.1.6-1			
Information Element	Value/remark	Comment	Condition
PhysicalConfigDedicated-DEFAULT ::= SEQUENCE {			
antennaInfo CHOICE {			
explicitValue ::= SEQUENCE {			
transmissionMode	tm3		Transmission mode 3
codebookSubsetRestriction CHOICE {			
n2TxAntenna-tm3	10		
}			
ue-TransmitAntennaSelection CHOICE {			
release	NULL		
}			
}			

**Table 8.7.2.1\_A.1.4.3-1A: PhysicalConfigDedicatedSCell-r10-DEFAULT**

Derivation Path: 36.508 clause 4.6.3 Table 4.6.3-6A			
Information Element	Value/remark	Comment	Condition
PhysicalConfigDedicatedSCell-r10-DEFAULT ::= SEQUENCE {			
nonUL-Configuration-r10 SEQUENCE {			
antennaInfo-r10 CHOICE {			
transmissionMode-r10	tm3		Transmission mode 3
codebookSubsetRestriction-r10	10		
ue-TransmitAntennaSelection CHOICE {			
release	NULL		
}			
}			
}			

8.7.2.1\_A.1.5 Test requirement

The requirements are specified in Table 8.7.2.1\_A.1.5-1 depending on the UE category according to Table 8.7.2.1\_A.1.5-3. The TB success rate shall be sustained during at least 300 frames.

**Table 8.7.2.1\_A.1.5-1: Test requirements per test**

Test	Number of bits of a DL-SCH transport block received within a TTI for normal/special sub-frame	Measurement channel	Reference value
			TB success rate [%]
6A	75376/0 (Note 2)	R.31-4 TDD	85
6B	55056/0 for 15MHz CC 75376/0 for 20MHz CC (Note 2)	R.31-5 TDD for 15MHz CC R.31-4 TDD for 20MHz CC	[85]
Note 1: For 2 layer transmissions, 2 transport blocks are received within a TTI. Note 2: 71112 bits for sub-frame 5. Note 3: The TB success rate is defined as TB success rate = $100\% \cdot N_{DL\_correct\_rx} / (N_{DL\_newtx} + N_{DL\_retx})$ , where $N_{DL\_newtx}$ is the number of newly transmitted DL transport blocks, $N_{DL\_retx}$ is the number of retransmitted DL transport blocks, and $N_{DL\_correct\_rx}$ is the number of correctly received DL transport blocks.			

Table 8.7.2.1\_A.1.5-2: Test parameters per test

Test	Bandwidth (MHz)	Transmission mode	Antenna configuration	Codebook subset restriction	Downlink power allocation (dB)			$\hat{E}_s$ at antenna port (dBm/15kHz)	ACK/NACK feedback mode	Symbols for unused PRBs
					$\rho_A$	$\rho_B$	$\sigma$			
6A	2x20	3	2 x 2	10	-3	-3	0	-85	- (Note 1)	OP.1 TDD
6B	20+15	3	2 x 2	10	-3	-3	0	-85	(Note 1)	OP.1 TDD

Note 1: PUCCH format 1b with channel selection is used to feedback ACK/NACK.

Table 8.7.2.1\_A.1.5-3: Test applicability per UE category

CA config	Bandwidth/ Bandwidth combination (MHz)	Cat. 1	Cat. 2	Cat. 3	Cat. 4	Cat. 6,7	Cat. 9, 10	Cat 11, 12
CA with 2CCs	20+20	-	--	3(Note 4)	4 (Note 4)	6A	6A	-
	15+20	-	-	3(Note 4)	4 (Note 4)	6B	6B	-

Note 1: Void.  
Note 2: For non-CA UE, test is selected for maximum supported bandwidth.  
Note 3: Void.  
Note 4: If the intra-band contiguous CA is the only CA configuration supported by category 3 or 4 UE, single carrier test is selected.  
Note 5: The applicability of requirements for different CA configurations and bandwidth combination sets is defined in 8.1.2.3.  
Note 6: Select the largest aggregated CA bandwidth combination supported by the UE among the UE supported CA capabilities. Only one test point to be tested.

8.7.2.1\_A.2 Void

8.7.2.1\_A.3 Void

8.7.2.1\_A.4 TDD Sustained data rate performance for CA (3DL CA)

**Editor's notes: This test case is incomplete. The following items are missing or incomplete:**

**- TB success rate requirements are still with square brackets.**

8.7.2.1\_A.4.1 Test purpose

Same test purpose as in clause 8.7.2.1.

8.7.2.1\_A.4.2 Test applicability

This test case applies to all types of E-UTRA TDD UE release 10 and forward of UE category 6, 7, 9, 10, 11 and 12 that support 3DL Intra-band contiguous CA or 3DL Inter-band CA or 3DL with Intra-band contiguous and Inter-band CA.

This test case also applies to all types of E-UTRA TDD UE release 11 and forward of UE category 6, 7, 9, 10, 11 and 12 that support 3DL with Intra-band non-contiguous and Inter-band CA or 3DL with Intra-band non-contiguous and Intra-band contiguous CA.

8.7.2.1\_A.4.3 Minimum conformance requirements

For UE not supporting 256QAM, the requirements are specified in Table 8.7.2.1\_A.4.3-2, with the addition of the parameters in Table 8.7.2.1\_A.4.3-1 and the downlink physical channel setup according to Table C.3.2-1 in Annex C. The test points are applied to UE category and bandwidth combination with maximum aggregated bandwidth as specified in Table 8.7.2.1\_A.4.3-3. The TB success rate shall be sustained during at least 300 frames.

Table 8.7.2.1\_A.4.3-1: test parameters for sustained downlink data rate (TDD 64QAM)

Test	Bandwidth (MHz)	Transmission mode	Antenna configuration	Codebook subset restriction	Downlink power allocation (dB)			$\hat{E}_s$ at antenna port (dBm/15 kHz)	ACK/NACK feedback mode	Symbols for unused PRBs
					$\rho_A$	$\rho_B$	$\sigma$			
6A	2x20	3	2 x 2	10	-3	-3	0	-85	- (Note 1)	OP.1 TDD
7	3x20	3	2 x 2	10	-3	-3	0	-85	(Note 2)	OP.1 TDD
7A	15+20+20	3	2 x 2	10	-3	-3	0	-85	(Note 2)	OP.1 TDD

Note 1: PUCCH format 1b with channel selection is used to feedback ACK/NACK.  
Note 2: PUCCH format 3 is used to feedback ACK/NACK.

Table 8.7.2.1\_A.4.3-2: Minimum requirement (TDD 64QAM)

Test	Number of bits of a DL-SCH transport block received within a TTI for normal/special sub-frame	Measurement channel	Reference value
			TB success rate [%]
6A	75376/0 (Note 2)	R.31-4 TDD	85
7	75376/0 (Note 2)	R.31-4 TDD	[85]
7A	55056/0 for 15MHz CC 75376/0 for 20MHz CC (Note 2)	R.31-5 TDD for 15MHz CC R.31-4 TDD for 20MHz CC	[85]

Note 1: For 2 layer transmissions, 2 transport blocks are received within a TTI.  
Note 2: 71112 bits for sub-frame 5.  
Note 3: The TB success rate is defined as TB success rate = 100% \*  $N_{DL\_correct\_rx} / (N_{DL\_newtx} + N_{DL\_retx})$ , where  $N_{DL\_newtx}$  is the number of newly transmitted DL transport blocks,  $N_{DL\_retx}$  is the number of retransmitted DL transport blocks, and  $N_{DL\_correct\_rx}$  is the number of correctly received DL transport blocks.

Table 8.7.2.1\_A.4.3-3: Test points for sustained data rate (FRC 64QAM)

CA config	Bandwidth/ Bandwidth combination (MHz)	Cat. 1	Cat. 2	Cat. 3	Cat. 4	Cat. 6,7	Cat. 9, 10	Cat 11, 12
CA with 3 CCs	3x20	-	-	-	-	6A	7	7
	15+20+20	-	-	-	-	6A	7A	7A

Note 1: Void.  
Note 2: For non-CA UE, test is selected for maximum supported bandwidth.  
Note 3: Void.  
Note 4: If the intra-band contiguous CA is the only CA configuration supported by category 3 or 4 UE, single carrier test is selected.  
Note 5: The applicability of requirements for different CA configurations and bandwidth combination sets is defined in 8.1.2.3.

The normative reference for this requirement is TS 36.101 [2] clause 8.7.2.

8.7.2.1\_A.4.4 Test description

8.7.2.1\_A.4.4.1 Initial conditions

**Table 8.7.2.1\_A.4.4.1-1: Further test parameters per test**

Test	DL Measurement channel	UL Measurement channel	TBsize per Codeword per Component Carrier	Number of PDCP SDU per Codeword	PDCP SDU size [Octets] Calculation (Note 1)	PDCP SDU size [Octets]
6A	R.31-4 TDD for two 20MHz CCs	R.1-4 TDD	75376 (Note 3)	7 for two 20MHz CCs	$FLOOR((TB_{size} - 264)/56)$	1341 for two 20MHz CCs
7	R.31-4 TDD for three 20MHz CCs	R.1-4 TDD	75376 (Note 3)	7 for three 20MHz CCs	$FLOOR((TB_{size} - 264)/56)$	1341 for three 20MHz CCs
7A	R.31-5 TDD for 15MHz CC R.31-4 TDD for 20MHz CC	R.1-4 TDD	55056 for 15MHz CC 75376 (Note 3) for 20MHz CC	6 for 15MHz CC 7 for 20 MHz CC	$FLOOR((TB_{size} - 240)/48)$ for 15 MHz CC $FLOOR((TB_{size} - 264)/56)$ for 20 MHz CC	1142 for 15MHz CC 1341 for 20MHz CC
Note 1:	Transport block size under test according to applicable Fixed Reference Channel for sustained data-rate test in annex A.3.9. In case of varying TBS across SFs of the RMC, only the maximum TBS is used for PDCP SDU size calculation. In case of different resulting PDCP SDU sizes among component carriers, the smaller calculated PDCP SDU size is used across all the carriers.					
Note 2:	Each PDCP SDU is limited to 1500 octets (to keep below maximum SDU size of ESM as specified in TS 24.301 clause 9.9.4.12). The PDCP SDU size of each PDCP SDU is: $PDCP\ SDU\ size = (TB_{size} - N * PDCP\ header\ size - AMD\ PDU\ header\ size - MAC\ header\ size - Size\ of\ RLC\ STATUS\ PDU) / N$ , where PDCP header size is 16 bits for the RLC AM and 12-bit SN case; AMD PDU header size is $CEIL[(16+(N-1)*12)/8]$ bytes which includes 16 bit standard AM header and (N-1) Length indicators; and MAC header size = R/R/E/LCID/F/L MAC subheader (24 bits for MAC SDU for RLC STATUS PDU with 15 bit LI) + R/R/E/LCID MAC subheader (8 bits for MAC SDU for RLC Data PDU) = 32 bits. The size of RLC STATUS PDU including one ACK_SN field and one NACK_SN field is 32 bits (if no STATUS PDU is sent or if the size of the STATUS PDU is less than 32 bits then padding will be used to fill the 32 bits). This gives: $PDCP\ SDU\ size = 8 * FLOOR((TB_{size} - N * 16 - 8 * CEIL[(16+(N-1)*12)/8] - 64) / (8 * N))$ bits. The calculation of PDCP SDU sizes does not consider timing advance MAC CE as timing advance is not transmitted by SS for RF test cases, and the header sizes are informative and may vary during the test.					
Note 3:	71112 bits for sub-frame 5.					

Initial conditions are a set of test configurations the UE needs to be tested in and the steps for the SS to take with the UE to reach the correct measurement state.

Configurations of PDSCH and PDCCH before measurement are specified in Annex C.2.

Test Environment: Normal as defined in TS 36.508 [7] clause 4.1.

Frequencies to be tested: Maximum WGap for Intra-band non-contiguous CA, otherwise Mid Range as defined in TS 36.508 [7] clause 4.3.1.2.

Channel Bandwidths to be tested: according to Table 8.7.2.1\_A.4.5-2 depending on the UE category according to Table 8.7.2.1\_A.4.5-3.

1. Connect the SS to the UE antenna connector(s) as shown in TS 36.508 [7] Annex A, Figure group A.60 (without using faders and AWGN generators).
2. The parameter settings for the cell are set up according to Table 8.7.2-1 and Table 8.7.2.1\_A.4.5-1 depending on the UE category according to Table 8.7.2.1\_A.4.5-3.

3. Downlink signals for PCC are initially set up according to Annex C.0, C.1 and Annex C.3.2 and uplink signals according to Annex H.1 and H.3.2.
4. Propagation conditions are set according to Annex B.0.
5. Ensure the UE is in State 4A-RF according to TS 36.508 [7] clause 5.2A.3. Message contents are defined in clause 8.7.2.1\_A.2.4.3.

#### 8.7.2.1\_A.4.4.2 Test procedure

1. Configure SCCs according to Annex C.0, C.1 and Annex C.3.2 for all downlink physical channels.
2. The SS shall configure SCCs as per TS 36.508 [7] clause 5.2A.4 with two SCCs configured. PhysicalConfigDedicated-DEFAULT is defined in Table 8.7.2.1\_A.4.4.3-3, PhysicalConfigDedicatedSCell-r10-DEFAULT is defined in Table 8.7.2.1\_A.4.4.3-3A.
3. The SS activates SCCs by sending the activation MAC-CE (Refer TS 36.321 [13], clauses 5.13, 6.1.3.8). Wait for at least 2 seconds (Refer TS 36.133, clauses 8.3.3.2).
4. Propagation conditions are set according to Annex B.1 (No external noise sources are applied).
5. The SS looks up  $TB_{size}$  in Table 8.7.2.1\_A.4.4.1-1 for the tests to be performed depending on the UE category according to Table 8.7.2.1\_A.4.5-3.
6. The SS sets the counters,  $N_{DL\_newtx}$ ,  $N_{DL\_retr}$ ,  $N_{UL\_PDCP}$ , and  $N_{DL\_PDCP}$  to 0.
7. For each new DL HARQ transmission the SS generates sufficient PDCP SDUs to fill up the TB in accordance with Table 8.7.2.1\_A.4.4.1-1 (Note 1). The SS ciphers the PDCP SDUs, concatenates the resultant PDCP PDUs to form an RLC PDU and then a MAC PDU. The SS transmits the MAC PDU. The SS increments then  $N_{DL\_newtx}$  by one and  $N_{DL\_PDCP}$  by the number of new PDCP SDUs (Note 1) included in the sent MAC PDU.
8. If PHY requests a DL HARQ retransmission, the SS performs a HARQ retransmission and increments  $N_{DL\_retr}$  by one.
9. Steps 7 to 8 are repeated at every TTI for at least 300 frames and the SS waits for 300ms to let any HARQ retransmissions and RLC retransmissions to finish.
10. For each PDCP SDU received at the SS, if the content of the data matches that of the truncated version of the original PDCP SDU generated at the SS, the SS increments  $N_{UL\_PDCP}$  by one
11. The SS calculates the TB success rate as  $A = 100\% * N_{DL\_newtx} / (N_{DL\_newtx} + N_{DL\_retr})$ . Measurements are not based on UE feedback but on SS counters instead ( $N_{DL\_newtx}$  and  $N_{DL\_retr}$ ) in order to validate HARQ feedback received from the UE.
12. The SS calculates the PDCP SDU loss as  $B = N_{DL\_PDCP} - N_{UL\_PDCP}$
13. The UE passes the test if  $A \geq$  "corresponding TB success rate according to Table 8.7.2.1\_A.4.5-1" and  $B = 0$ .

NOTE 1: In case of RLC PDU retransmission, the number of new required PDCP SDUs is as many as to fill the rest of TB.

#### 8.7.2.1\_A.4.4.3 Message contents

Message contents are according to TS 36.508 [7] clauses 5.5 and 4.6 and 4.7A, with the following exceptions:

**Table 8.7.2.1\_A.4.4.3-1: CLOSE UE TEST LOOP (in the preamble)**

Derivation Path: 36.508 clause 4.7A table 4.7A-3 with condition UE TEST LOOP MODE A			
Information Element	Value/remark	Comment	Condition
UE test loop mode A LB setup			
Length of UE test loop mode A LB setup list in bytes	0 0 0 0 0 1 1	Length of one LB setup DRB (3 bytes)	
LB setup DRB	0 0 0 0 0 0 0, 0 0 1 0 1 0 0 0, 0 0 0 Q4 Q3 Q2 Q1 Q0	UL PDCP SDU size = 40 bits (5 bytes) Q4..Q0 = Data Radio Bearer identity number for the default radio bearer. See 36.509 clause 6.1	

**Table 8.7.2.1\_A.4.4.3-2: SecurityModeCommand (in the preamble)**

Derivation Path: TS 36.508 clause 4.6.1 table 4.6.1-19			
Information Element	Value/remark	Comment	Condition
SecurityModeCommand ::= SEQUENCE {			
criticalExtensions CHOICE {			
c1 CHOICE{			
securityModeCommand-r8 SEQUENCE {			
securityConfiguration SEQUENCE {			
cipheringAlgorithm	eea2		
nextHopChainingCount	Not present		
}			
nonCriticalExtension SEQUENCE {}	Not present		
}			
}			
}			
}			

**Table 8.7.2.1\_A.4.4.3-3: PhysicalConfigDedicated-DEFAULT**

Derivation Path: 36.508 clause 5.5.1, Table 5.5.1.2-1			
Information Element	Value/remark	Comment	Condition
PhysicalConfigDedicated-DEFAULT ::= SEQUENCE {			
antennaInfo CHOICE {			
explicitValue ::= SEQUENCE {			
transmissionMode	tm3		Transmission mode 3
codebookSubsetRestriction CHOICE {			
n2TxAntenna-tm3	10		
}			
ue-TransmitAntennaSelection CHOICE {			
release	NULL		
}			
}			
}			
}			

**Table 8.7.2.1\_A.4.4.3-3A: PhysicalConfigDedicatedSCell-r10-DEFAULT**

Derivation Path: 36.508 clause 4.6.3 Table 4.6.3-6A			
Information Element	Value/remark	Comment	Condition
PhysicalConfigDedicatedSCell-r10-DEFAULT ::= SEQUENCE {			
nonUL-Configuration-r10 SEQUENCE {			
antennaInfo-r10 CHOICE {			
transmissionMode-r10	tm3		Transmission mode 3
codebookSubsetRestriction-r10	10		
ue-TransmitAntennaSelection CHOICE {			
release	NULL		
}			
}			
}			

8.7.2.1\_A.4.5 Test requirement

The requirements are specified in Table 8.7.2.1\_A.2.5-1 depending on the UE category according to Table 8.7.2.1\_A.2.5-3. The PDCP SDU success rate shall be sustained during at least 300 frames.

**Table 8.7.2.1\_A.4.5-1: Minimum requirement**

Test	Number of bits of a DL-SCH transport block received within a TTI for normal/special sub-frame	Measurement channel	Reference value
			TB success rate [%]
6A	75376/0 (Note 2)	R.31-4 TDD	85
7	75376/0 (Note 2)	R.31-4 TDD	[85]
7A	55056/0 for 15MHz CC 75376/0 for 20MHz CC (Note 2)	R.31-5 TDD for 15MHz CC R.31-4 TDD for 20MHz CC	[85]

Note 1: For 2 layer transmissions, 2 transport blocks are received within a TTI.  
 Note 2: 71112 bits for sub-frame 5.  
 Note 3: The TB success rate is defined as TB success rate = 100%\*N<sub>DL\_correct\_rx</sub>/ (N<sub>DL\_newtx</sub> + N<sub>DL\_retx</sub>), where N<sub>DL\_newtx</sub> is the number of newly transmitted DL transport blocks, N<sub>DL\_retx</sub> is the number of retransmitted DL transport blocks, and N<sub>DL\_correct\_rx</sub> is the number of correctly received DL transport blocks.

**Table 8.7.2.1\_A.4.5-2: test parameters per test**

Test	Bandwidth (MHz)	Transmission mode	Antenna configuration	Codebook subset restriction	Downlink power allocation (dB)			$\hat{E}_s$ at antenna port (dBm/15 kHz)	ACK/NACK feedback mode	Symbols for unused PRBs
					$\rho_A$	$\rho_B$	$\sigma$			
6A	2x20	3	2 x 2	10	-3	-3	0	-85	- (Note 1)	OP.1 TDD
7	3x20	3	2 x 2	10	-3	-3	0	-85	(Note 2)	OP.1 TDD
7A	15+20+20	3	2 x 2	10	-3	-3	0	-85	(Note 2)	OP.1 TDD

Note 1: PUCCH format 1b with channel selection is used to feedback ACK/NACK.  
 Note 2: PUCCH format 3 is used to feedback ACK/NACK.



Table 8.7.2.1\_A.4.5-3: Test points per UE category

CA config	Bandwidth/ Bandwidth combination (MHz)	Cat. 1	Cat. 2	Cat. 3	Cat. 4	Cat. 6,7	Cat. 9, 10	Cat 11, 12
CA with 3 CCs	3x20	-	-	-	-	6A	7	7
	15+20+20	-	-	-	-	6A	7A	7A
Note 1: Void. Note 2: For non-CA UE, test is selected for maximum supported bandwidth. Note 3: Void. Note 4: If the intra-band contiguous CA is the only CA configuration supported by category 3 or 4 UE, single carrier test is selected. Note 5: The applicability of requirements for different CA configurations and bandwidth combination sets is defined in 8.1.2.3. Note 6: Only one test point is tested. Select the largest aggregated CA bandwidth combination supported by the UE among the UE supported CA capabilities.								

### 8.7.3 FDD (EPDCCH scheduling)

The parameters specified in Table 8.7.3-1 are valid for all FDD tests unless otherwise stated.

**Table 8.7.3-1: Common test parameters (FDD)**

Parameter	Unit	Value
Cyclic prefix		Normal
Cell ID		0
Inter-TTI Distance		1
Number of HARQ processes per component carrier	Processes	8
Maximum number of HARQ transmission		4
Redundancy version coding sequence		{0,0,1,2} for 64QAM
Number of OFDM symbols for PDCCH per component carrier	OFDM symbols	1
Cross carrier scheduling		Not configured
Number of EPDCCH sets		1
EPDCCH transmission type		Localized
Number of PRB per EPDCCH set and EPDCCH PRB pair allocation		2 PRB pairs 10MHz BW: Resource blocks $n_{PRB} = 48, 49$ 15MHz BW: Resource blocks $n_{PRB} = 70, 71$ 20MHz BW: Resource blocks $n_{PRB} = 98, 99$
EPDCCH Starting Symbol		Derived from CFI (i.e. default behaviour)
ECCE Aggregation Level		2 ECCEs
Number of EREGs per ECCE		4
EPDCCH scheduling		EPDCCH candidate is randomly assigned in each subframe
EPDCCH precoder (Note 1)		Fixed PMI 0
EPDCCH monitoring SF pattern		1111111111 0000000000 1111111111 0000000000
Timing advance	$\mu$ s	100
Propagation condition		Static propagation condition No external noise sources are applied
Note 1: EPDCCH precoder parameters are defined for tests with 2 x 2 antenna configuration		

The normative reference for this requirement is TS 36.101[2] clause 8.7.3

### 8.7.3.1 FDD sustained data rate performance for EPDCCH scheduling

#### 8.7.3.1.1 Test purpose

Same test purpose as in clause 8.7.1.1.

#### 8.7.3.1.2 Test applicability

This test applies to all types of E-UTRA FDD UE Release 11 and forward supporting EPDCCH.

## 8.7.3.1.3 Minimum requirements

Table 8.7.3.1.3-1: Void

The requirements are specified in Table 8.7.3.1.3-3, with the addition of the parameters in Table 8.7.3.1.3-2 and the downlink physical channel setup according to Annex C.3.2. The test points are applied to UE category, CA capability and bandwidth combination with maximum aggregated bandwidth as specified in Table 8.7.3.1.3-4. The TB success rate shall be sustained during at least 300 frames.

Table 8.7.3.1.3-2: Test parameters for SDR test for PDSCH scheduled by EPDCCH (FDD)

Test	Bandwidth (MHz)	Transmission mode	Antenna configuration	Codebook subset restriction	Downlink power allocation (dB)				$\hat{E}_s$ at antenna port (dBm/15kHz)	Symbols for unused PRBs
					$\rho_A$	$\rho_B$	$\sigma$	$\delta$		
1	10	1	1 x 2	N/A	0	0	0	0	-85	OP.6 FDD
2	10	3	2 x 2	10	-3	-3	0	3	-85	OP.1 FDD
3,4,6	20	3	2 x 2	10	-3	-3	0	3	-85	OP.1 FDD
3A	10	3	2 x 2	10	-3	-3	0	3	-85	OP.1 FDD
3C, 4B	15	3	2 x 2	10	-3	-3	0	3	-85	OP.1 FDD

Table 8.7.3.1.3-3: Minimum requirement (FDD)

Test	Number of bits of a DL-SCH transport block received within a TTI	Measurement channel	Reference value
			TB success rate [%]
1	10296	R.31E-1 FDD	95
2	25456	R.31E-2 FDD	95
3	51024	R.31E-3 FDD	95
3A	36696 (Note 2)	R.31E-3A FDD	85
3C	51024	R.31E-3C FDD	85
4	75376 (Note 3)	R.31E-4 FDD	85
4B	55056 (Note 5)	R.31E-4B FDD	85
6	75376 (Note 3)	R.31E-4 FDD	85

Note 1: For 2 layer transmissions, 2 transport blocks are received within a TTI.  
Note 2: 35160 bits for sub-frame 5.  
Note 3: 71112 bits for sub-frame 5.  
Note 4: The TB success rate is defined as TB success rate = 100% \*  $N_{DL\_correct\_rx} / (N_{DL\_newtx} + N_{DL\_retx})$ , where  $N_{DL\_newtx}$  is the number of newly transmitted DL transport blocks,  $N_{DL\_retx}$  is the number of retransmitted DL transport blocks, and  $N_{DL\_correct\_rx}$  is the number of correctly received DL transport blocks.  
Note 5: 52752 bits for sub-frame 5.

Table 8.7.3.1.3-4: Test points for sustained data rate (FRC)

CA config	Bandwidth (MHz)	Category 1	Category 2	Category 3	Category 4	Category 6	Category 7
Single carrier	10	1	2	3A	3A	-	-
	15	-	-	3C	4B	-	-
	20	-	-	3	4	6	6

Note 1: The test is selected for maximum supported bandwidth.

The normative reference for this requirement is TS 36.101[2] clause 8.7.3

## 8.7.3.1.4 Test description

## 8.7.3.1.4.1 Initial conditions

Table 8.7.3.1.4.1-1: Further test parameters per test

Test	DL Measurement channel	UL Measurement channel	TB <sub>size</sub> per Codeword	Number of PDCP SDU per Codeword	PDCP SDU size [Octets] Calculation (Note 1)	PDCP SDU size [Octets]
1	R31E-1 FDD	R.1-1 FDD	10296	1	$\text{FLOOR}((\text{TB}_{\text{size}} - 96)/8)$	
2	R31E-2 FDD	R.1-2 FDD	25456	3	$\text{FLOOR}((\text{TB}_{\text{size}} - 152)/24)$	
3	R31E-3 FDD	R.1-3 FDD	51024	5	$\text{FLOOR}((\text{TB}_{\text{size}} - 208)/40)$	
3A	R31E-3A FDD	R.1-3A FDD	36696 (Note 3)	4	$\text{FLOOR}((\text{TB}_{\text{size}} - 184)/32)$	
3C	R31E-3C FDD	R.1-3C FDD	51024	5	$\text{FLOOR}((\text{TB}_{\text{size}} - 208)/40)$	
4	R31E-4 FDD	R.1-4 FDD	75376 (Note 4)	7	$\text{FLOOR}((\text{TB}_{\text{size}} - 264)/56)$	
4B	R31E-4B FDD	R.1-4 FDD	55056 (Note 5)	5	$\text{FLOOR}((\text{TB}_{\text{size}} - 208)/40)$	
6	R31E-4 FDD	R.1-4 FDD	75376 (Note 4)	7	$\text{FLOOR}((\text{TB}_{\text{size}} - 264)/56)$	

Note 1: Transport block size under test according to applicable Fixed Reference Channel for sustained data-rate test in annex A.3.9. In case of varying TBS across SFs of the RMC, only the maximum TBS is used for PDCP SDU size calculation.

Note 2: Each PDCP SDU is limited to 1500 octets (to keep below maximum SDU size of ESM as specified in TS 24.301 clause 9.9.4.12).  
The PDCP SDU size of each PDCP SDU is:  
PDCP SDU size = (TB<sub>size</sub> – N\*PDCP header size - AMD PDU header size - MAC header size - Size of RLC STATUS PDU) / N,  
where PDCP header size is 16 bits for the RLC AM and 12-bit SN case; AMD PDU header size is CEIL[(16+(N-1)\*12)/8] bytes which includes 16 bit standard AM header and (N-1) Length indicators; and MAC header size = R/R/E/LCID/F/L MAC subheader (24 bits for MAC SDU for RLC STATUS PDU with 15 bit LI) + R/R/E/LCID MAC subheader (8 bits for MAC SDU for RLC Data PDU) = 32 bits. The size of RLC STATUS PDU including one ACK\_SN field and one NACK\_SN field is 32 bits (if no STATUS PDU is sent or if the size of the STATUS PDU is less than 32 bits then padding will be used to fill the 32 bits). This gives: PDCP SDU size = 8\*FLOOR((TB<sub>size</sub> – N\*16 - 8\*CEIL((16+(N-1)\*12)/8) – 64)/(8\*N)) bits.  
The calculation of PDCP SDU sizes does not consider timing advance MAC CE as timing advance is not transmitted by SS for RF test cases, and the header sizes are informative and may vary during the test.

Note 3: 35160 bits for sub-frame 5  
Note 4: 71112 bits for sub-frame 5  
Note 5: 52752 bits for sub-frame 5.

Initial conditions are a set of test configurations the UE needs to be tested in and the steps for the SS to take with the UE to reach the correct measurement state.

Configurations of PDSCH and EPDCCH before measurement are specified in Annex C.2.

Test Environment: Normal as defined in TS 36.508 [7] clause 4.1.

Frequencies to be tested: Mid Range as defined in TS 36.508 [7] clause 4.3.1.1.

Channel Bandwidths to be tested: According to table 8.7.3.1.3-2.

1. Connect the SS to the UE antenna connector(s) as shown in TS 36.508 [7] Annex A, Figure A.3 for test 1 and Figure A.10 for tests 2-6.
2. The parameter settings for the cell are set up according to Table 8.7.3.1.5-1 and Table 8.7.3.1.5-2.
3. Downlink signals are initially set up according to Annex C0, C.1 and Annex C.3.2 and uplink signals according to Annex H.1 and H.3.2.

4. Propagation conditions are set according to Annex B.0.
5. Ensure the UE is in State 4 (Loopback activated) according to TS 36.508 [7] clause 4.5.4. Message contents are defined in clause 8.7.3.1.4.3.

#### 8.7.3.1.4.2 Test procedure

1. Propagation conditions are set according to Annex B.1. No external noise sources are applied.
2. The SS looks up  $TB_{size}$  in table 8.7.3.1.4.1-1 according to the UE category under test.
3. SS sets the counters  $N_{DL\_newtx}$ ,  $N_{DL\_retx}$ ,  $N_{UL\_PDCP}$ , and  $N_{DL\_PDCP}$  to 0.
4. SS sends Timing Advance Command MAC CE with timing advance 100us to UE.
5. For each new DL HARQ transmission the SS generates sufficient PDCP SDUs to fill up the TB in accordance with Table 8.7.3.1.4.1-1 (Note 1). The SS ciphers the PDCP SDUs, concatenates the resultant PDCP PDUs to form an RLC PDU and then a MAC PDU. The SS transmits the MAC PDU. The SS increments then  $N_{DL\_newtx}$  by one and  $N_{DL\_PDCP}$  by the number of new PDCP SDUs (Note 1) included in the sent MAC PDU.
6. If PHY requests a DL HARQ retransmission, the SS performs a HARQ retransmission and increments  $N_{DL\_retx}$  by one.
7. Steps 5 to 6 are repeated at every TTI for at least 300 frames and the SS waits for 300ms to let any HARQ retransmissions and RLC retransmissions to finish.
8. For each PDCP SDU received at the SS, if the content of the data matches that of the truncated version of the original PDCP SDU generated at the SS, the SS increments  $N_{UL\_PDCP}$  by one
9. The SS calculates the TB success rate as  $A = 100\% * N_{DL\_newtx} / (N_{DL\_newtx} + N_{DL\_retx})$ . Measurements are not based on UE feedback but on SS counters instead ( $N_{DL\_newtx}$  and  $N_{DL\_retx}$ ) in order to validate HARQ feedback received from the UE.
10. The SS calculates the PDCP SDU loss as  $B = N_{DL\_PDCP} - N_{UL\_PDCP}$
11. The UE passes the test if  $A \geq$  "corresponding TB success rates according to Table 8.7.3.1.5-1" and  $B = 0$ .

NOTE 1: In case of RLC PDU retransmission, the number of new required PDCP SDUs is as many as to fill the rest of TB.

#### 8.7.3.1.4.3 Message contents

Message contents are according to TS 36.508 [7] clause 4.6 and 4.7A, with the following exceptions:

**Table 8.7.3.1.4.3-1: CLOSE UE TEST LOOP (in the preamble)**

Derivation Path: 36.509 clause 6.1			
Information Element	Value/remark	Comment	Condition
Protocol discriminator	1 1 1 1		
Skip indicator	0 0 0 0		
Message type	1 0 0 0 0 0 0 0		
UE test loop mode	0 0 0 0 0 0 0 0	UE test loop mode A	
UE test loop mode A LB setup			
Length of UE test loop mode A LB setup list in bytes	0 0 0 0 0 0 1 1	Length of one LB setup DRB (3 bytes)	
LB setup DRB	0 0 0 0 0 0 0 0, 0 0 1 0 1 0 0 0, 0 0 0 Q4 Q3 Q2 Q1 Q0	UL PDCP SDU size = 40 bits (5 bytes) Q4..Q0 = Data Radio Bearer identity number for the default radio bearer. See 36.509 clause 6.1	
UE test loop mode B LB setup	Not present		

**Table 8.7.3.1.4.3-2: SecurityModeCommand (in the preamble)**

Derivation Path: TS 36.508 clause 4.6.1 table 4.6.1-19			
Information Element	Value/remark	Comment	Condition
SecurityModeCommand ::= SEQUENCE {			
criticalExtensions CHOICE {			
c1 CHOICE{			
securityModeCommand-r8 SEQUENCE {			
securityConfiguration SEQUENCE {			
cipheringAlgorithm	eea2		
nextHopChainingCount	Not present		
}			
nonCriticalExtension SEQUENCE {}	Not present		
}			
}			
}			
}			

Table 8.7.3.1.4.3-3: EPDCCH-Config-r11-DEFAULT

Derivation Path: 36.508 clause 4.6			
Information Element	Value/remark	Comment	Condition
EPDCCH-Config-r11 ::= SEQUENCE{			
config-r11 CHOICE {			
setup SEQUENCE {			
subframePatternConfig-r11	1111111111 0000000000 1111111111 0000000000		
startSymbol-r11	Not present	Derived from CFI	
setConfigToReleaseList-r11	Null		
setConfigToAddModList-r11 SEQUENCE {	1 entry		
setConfigId-r11[1]	0		
transmissionType-r11[1]	localized		
resourceBlockAssignment-r11[1] SEQUENCE{			
numberPRB-Pairs-r11	n2		
resourceBlockAssignment-r11	0000 or 1001	0000 for Bandwidth 10MHz and 20MHz; 1001 only for Bandwidth 15MHz	
}			
}			
}			

### 8.7.3.1.5 Test requirement

The requirements are specified in Table 8.7.3.1.5-1. The PDCP SDU success rate shall be sustained during at least 300 frames.

Table 8.7.3.1.5-1: Test requirements per test

Test	Number of bits of a DL-SCH transport block received within a TTI	Measurement channel	Reference value
			TB success rate [%]
1	10296	R.31E-1 FDD	95
2	25456	R.31E-2 FDD	95
3	51024	R.31E-3 FDD	95
3A	36696 (Note 2)	R.31E-3A FDD	85
3C	51024	R.31E-3C FDD	85
4	75376 (Note 3)	R.31E-4 FDD	85
4B	55056 (Note 5)	R.31E-4B FDD	85
6	75376 (Note 3)	R.31E-4 FDD	85
Note 1:	For 2 layer transmissions, 2 transport blocks are received within a TTI.		
Note 2:	35160 bits for sub-frame 5.		
Note 3:	71112 bits for sub-frame 5.		
Note 4:	The TB success rate is defined as $TB\ success\ rate = 100\% * N_{DL\_correct\_rx} / (N_{DL\_newtx} + N_{DL\_retx})$ , where $N_{DL\_newtx}$ is the number of newly transmitted DL transport blocks, $N_{DL\_retx}$ is the number of retransmitted DL transport blocks, and $N_{DL\_correct\_rx}$ is the number of correctly received DL transport blocks.		
Note 5:	52752 bits for sub-frame 5.		

Table 8.7.3.1.5-2: Test parameters per test

Test	Bandwidth (MHz)	Transmission mode	Antenna configuration	Codebook subset restriction	Downlink power allocation (dB)				$\hat{E}_s$ at antenna port (dBm/15kHz)	Symbols for unused PRBs
					$\rho_A$	$\rho_B$	$\sigma$	$\delta$		
1	10	1	1 x 2	N/A	0	0	0	0	-85	OP.6 FDD
2	10	3	2 x 2	10	-3	-3	0	3	-85	OP.1 FDD
3,4,6	20	3	2 x 2	10	-3	-3	0	3	-85	OP.1 FDD
3A	10	3	2 x 2	10	-3	-3	0	3	-85	OP.1 FDD
3C, 4B	15	3	2 x 2	10	-3	-3	0	3	-85	OP.1 FDD

Table 8.7.3.1.5-3: Test applicability per UE category

CA config	Bandwidth (MHz)	Category 1	Category 2	Category 3	Category 4	Category 6	Category 7
Single carrier	10	1	2	3A	3A	-	-
	15	-	-	3C	4B	-	-
	20	-	-	3	4	6	6

Note 1: The test is selected for maximum supported bandwidth.

## 8.7.4 TDD (EPDCCH scheduling)

The parameters specified in Table 8.7.4- 1 are valid for all TDD tests unless otherwise stated.



**Table 8.7.4-1: Common test parameters (TDD)**

Parameter	Unit	Value
Special subframe configuration (Note 1)		4
Cyclic prefix		Normal
Cell ID		0
Inter-TTI Distance		1
Maximum number of HARQ transmission		4
Redundancy version coding sequence		{0,0,1,2} for 64QAM
Number of OFDM symbols for PDCCH per component carrier	OFDM symbols	1
Cross carrier scheduling		Not configured
Number of EPDCCH sets		1
EPDCCH transmission type		Localized
Number of PRB per EPDCCH set and EPDCCH PRB pair allocation		2 PRB pairs 10MHz BW: Resource blocks $n_{PRB} = 48, 49$ 15MHz BW: Resource blocks $n_{PRB} = 70, 71$ 20MHz BW: Resource blocks $n_{PRB} = 98, 99$
EPDCCH Starting Symbol		Derived from CFI (i.e. default behaviour)
ECCE Aggregation Level		2 ECCEs
Number of EREGs per ECCE		4 for normal subframe and 8 for special subframe
EPDCCH scheduling		EPDCCH candidate is randomly assigned in each subframe
EPDCCH precoder (Note 2)		Fixed PMI 0
EPDCCH monitoring SF pattern		UL-DL configuration 1: 1101111111 0000000000 UL-DL configuration 5: 1100111001 0000000000
Timing advance	$\mu\text{s}$	100
Propagation condition		Static propagation condition No external noise sources are applied
Note 1:	As specified in Table 4.2-1 in TS 36.211 [4].	
Note 2:	EPDCCH precoder parameters are defined for tests with 2 x 2 antenna configuration	

The normative reference for this requirement is TS 36.101[2] clause 8.7.4.

#### 8.7.4.1 TDD sustained data rate performance for EPDCCH scheduling

##### 8.7.4.1.1 Test purpose

Same test purpose as in clause 8.7.2.1.

##### 8.7.4.1.2 Test applicability

This test applies to all types of E-UTRA FDD UE Release 11 and forward supporting EPDCCH.

## 8.7.4.1.3 Minimum requirements

Table 8.7.4.1.3-1: Void

The requirements are specified in Table 8.7.4.1.3-3, with the addition of the parameters in Table 8.7.4.1.3-2 and the downlink physical channel setup according to Annex C.3.2. The test points are applied to UE category, CA capability and bandwidth combination with maximum aggregated bandwidth as specified in Table 8.7.4.1.3-4. The TB success rate shall be sustained during at least 300 frames.

Table 8.7.4.1.3-2: Test parameters for SDR test for PDSCH scheduled by EPDCCH (TDD)

	Bandwidth (MHz)	Transmission mode	Antenna configuration	Codebook subset restriction	Downlink power allocation (dB)				$\hat{E}_s$ at antenna port (dBm/15kHz)	Symbols for unused PRBs	ACK/NACK feedback mode
					$\rho_A$	$\rho_B$	$\sigma$	$\delta$			
1	10	1	1 x 2	N/A	0	0	0	0	-85	OP.6 TDD	Bundling
2	10	3	2 x 2	10	-3	-3	0	3	-85	OP.1 TDD	Bundling
3	20	3	2 x 2	10	-3	-3	0	3	-85	OP.1 TDD	Bundling
3A	15	3	2 x 2	10	-3	-3	0	3	-85	OP.2 TDD	Multiplexing
4,6	20	3	2 x 2	10	-3	-3	0	3	-85	OP.1 TDD	Multiplexing

Table 8.7.4.1.3-3: Minimum requirement (TDD)

Test	Number of bits of a DL-SCH transport block received within a TTI for normal/special sub-frame	Measurement channel	Reference value
			TB success rate [%]
1	10296/0	R.31E-1 TDD	95
2	25456/0	R.31E-2 TDD	95
3	51024/0	R.31E-3 TDD	95
3A	51024/0	R.31E-3A TDD	85
4	75376/0 (Note 2)	R.31E-4 TDD	85
6	75376/0 (Note 2)	R.31E-4 TDD	85

Note 1: For 2 layer transmissions, 2 transport blocks are received within a TTI.  
Note 2: 71112 bits for sub-frame 5.  
Note 3: The TB success rate is defined as TB success rate = 100% \*  $N_{DL\_correct\_rx} / (N_{DL\_newtx} + N_{DL\_retx})$ , where  $N_{DL\_newtx}$  is the number of newly transmitted DL transport blocks,  $N_{DL\_retx}$  is the number of retransmitted DL transport blocks, and  $N_{DL\_correct\_rx}$  is the number of correctly received DL transport blocks.

Table 8.7.4.1.3-4: Test points for sustained data rate (FRC)

CA config	Bandwidth/ Bandwidth combination (MHz)	Category 1	Category 2	Category 3	Category 4	Category 6	Category 7
Single carrier	10	1	2	-	-	-	-
	15	-	-	3A	3A	-	-
	20	-	-	3	4	6	6

Note 1: The test is selected for maximum supported bandwidth.

The normative reference for this requirement is TS 36.101[2] clause 8.7.4

## 8.7.4.1.4 Test description

## 8.7.4.1.4.1 Initial conditions

**Table 8.7.4.1.4.1-1: Further test parameters per test**

Test	DL Measurement channel	UL Measurement channel	TB <sub>size</sub> per Codeword	Number of PDCP SDU per Codeword	PDCP SDU size [Octets] Calculation (Note 1)	PDCP SDU size [Octets]
1	R.31E-1 TDD	R.1-1 TDD	10296	1/0	$\text{FLOOR}((\text{TB}_{\text{size}} - 96)/8)$	
2	R.31E-2 TDD	R.1-2 TDD	25456	3/0	$\text{FLOOR}((\text{TB}_{\text{size}} - 152)/24)$	
3	R.31E-3 TDD	R.1-3 TDD	51024	5/0	$\text{FLOOR}((\text{TB}_{\text{size}} - 208)/40)$	
3A	R.31E-3A TDD	R.1-3B TDD	51024	4/0	$\text{FLOOR}((\text{TB}_{\text{size}} - 184)/32)$ "	
4	R.31E-4 TDD	R.1-4 TDD	75376 (Note 3)	7/0	$\text{FLOOR}((\text{TB}_{\text{size}} - 264)/56)$	
6	R.31E-4 TDD	R.1-4 TDD	75376 (Note 3)	7/0	$\text{FLOOR}((\text{TB}_{\text{size}} - 264)/56)$	

Note 1: Transport block size under test according to applicable Fixed Reference Channel for sustained data-rate test in annex A.3.9. In case of varying TBS across SFs of the RMC, only the maximum TBS is used for PDCP SDU size calculation.

Note 2: Each PDCP SDU is limited to 1500 octets (to keep below maximum SDU size of ESM as specified in TS 24.301 clause 9.9.4.12).  
The PDCP SDU size of each PDCP SDU is:  
PDCP SDU size = (TB<sub>size</sub> – N\*PDCP header size - AMD PDU header size - MAC header size - Size of RLC STATUS PDU) / N,  
where PDCP header size is 16 bits for the RLC AM and 12-bit SN case; AMD PDU header size is  $\text{CEIL}[(16+(N-1)*12)/8]$  bytes which includes 16 bit standard AM header and (N-1) Length indicators; and MAC header size = R/R/E/LCID/F/L MAC subheader (24 bits for MAC SDU for RLC STATUS PDU with 15 bit LI) + R/R/E/LCID MAC subheader (8 bits for MAC SDU for RLC Data PDU) = 32 bits. The size of RLC STATUS PDU including one ACK\_SN field and one NACK\_SN field is 32 bits (if no STATUS PDU is sent or if the size of the STATUS PDU is less than 32 bits then padding will be used to fill the 32 bits). This gives: PDCP SDU size =  $8*\text{FLOOR}((\text{TB}_{\text{size}} - N*16 - 8*\text{CEIL}[(16+(N-1)*12)/8] - 64)/(8*N))$  bits.  
The calculation of PDCP SDU sizes does not consider timing advance MAC CE as timing advance is not transmitted by SS for RF test cases, and the header sizes are informative and may vary during the test.

Note 3: 71112 bits for sub-frame 5.

Initial conditions are a set of test configurations the UE needs to be tested in and the steps for the SS to take with the UE to reach the correct measurement state.

Configurations of PDSCH and PDCCH before measurement are specified in Annex C.2.

Test Environment: Normal as defined in TS 36.508 [7] clause 4.1.

Frequencies to be tested: Mid Range as defined in TS 36.508 [7] clause 4.3.1.1.

Channel Bandwidths to be tested: According to table 8.7.4.1.3-2.

1. Connect the SS to the UE antenna connector(s) as shown in TS 36.508 [7] Annex A, Figure A.3 for test 1 and Figure A.10 for tests 2-6.
2. The parameter settings for the cell are set up according to Table 8.7.4.1.5-1 and Table 8.7.4.1.5-2.
3. Downlink signals are initially set up according to Annex C0, C.1 and Annex C.3.2 and uplink signals according to Annex H.1 and H.3.2.
4. Propagation conditions are set according to Annex B.0.
5. Ensure the UE is in State 4 (Loopback activated) according to TS 36.508 [7] clause 4.5.4. Message contents are defined in clause 8.7.4.1.4.3.

## 8.7.4.1.4.2 Test procedure

1. Propagation conditions are set according to Annex B.1. No external noise sources are applied.
2. The SS looks up  $TB_{size}$  in table 8.7.4.1.4.1-1 according to the UE category under test.
3. SS sets the counters  $N_{DL\_newtx}$ ,  $N_{DL\_retr}$ ,  $N_{UL\_PDCP}$ , and  $N_{DL\_PDCP}$  to 0.
4. SS sends Timing Advance Command MAC CE with timing advance 100us to UE.
5. For each new DL HARQ transmission the SS generates sufficient PDCP SDUs to fill up the TB in accordance with Table 8.7.4.1.4.1-1 (Note 1). The SS ciphers the PDCP SDUs, concatenates the resultant PDCP PDUs to form an RLC PDU and then a MAC PDU. The SS transmits the MAC PDU. The SS increments then  $N_{DL\_newtx}$  by one and  $N_{DL\_PDCP}$  by the number of new PDCP SDUs (Note 1) included in the sent MAC PDU.
6. If PHY requests a DL HARQ retransmission, the SS performs a HARQ retransmission and increments  $N_{DL\_retr}$  by one.
7. Steps 5 to 6 are repeated at every TTI for at least 300 frames and the SS waits for 300ms to let any HARQ retransmissions and RLC retransmissions to finish.
8. For each PDCP SDU received at the SS, if the content of the data matches that of the truncated version of the original PDCP SDU generated at the SS, the SS increments  $N_{UL\_PDCP}$  by one
9. The SS calculates the TB success rate as  $A = 100\% * N_{DL\_newtx} / (N_{DL\_newtx} + N_{DL\_retr})$ . Measurements are not based on UE feedback but on SS counters instead ( $N_{DL\_newtx}$  and  $N_{DL\_retr}$ ) in order to validate HARQ feedback received from the UE.
10. The SS calculates the PDCP SDU loss as  $B = N_{DL\_PDCP} - N_{UL\_PDCP}$
11. The UE passes the test if  $A \geq$  "corresponding TB success rates according to Table 8.7.4.1.5-1" and  $B = 0$ .

NOTE 1: In case of RLC PDU retransmission, the number of new required PDCP SDUs is as many as to fill the rest of TB.

## 8.7.4.1.4.3 Message contents

Message contents are according to TS 36.508 [7] clause 4.6 and 4.7A, with the following exceptions:

**Table 8.7.4.1.4.3-1: CLOSE UE TEST LOOP (in the preamble)**

Derivation Path: 36.509 clause 6.1			
Information Element	Value/remark	Comment	Condition
Protocol discriminator	1 1 1 1		
Skip indicator	0 0 0 0		
Message type	1 0 0 0 0 0 0 0		
UE test loop mode	0 0 0 0 0 0 0 0	UE test loop mode A	
UE test loop mode A LB setup			
Length of UE test loop mode A LB setup list in bytes	0 0 0 0 0 0 1 1	Length of one LB setup DRB (3 bytes)	
LB setup DRB	0 0 0 0 0 0 0 0, 0 0 101 0 0 0, 0 0 0 Q4 Q3 Q2 Q1 Q0	UL PDCP SDU size = 40 bits (5 bytes) Q4..Q0 = Data Radio Bearer identity number for the default radio bearer. See 36.509 clause 6.1.	
UE test loop mode B LB setup	Not present		

Table 8.7.4.1.4.3-2: SecurityModeCommand (in the preamble)

Derivation Path: TS 36.508 clause 4.6.1 table 4.6.1-19			
Information Element	Value/remark	Comment	Condition
SecurityModeCommand ::= SEQUENCE {			
criticalExtensions CHOICE {			
c1 CHOICE{			
securityModeCommand-r8 SEQUENCE {			
securityConfiguration SEQUENCE {			
cipheringAlgorithm	eea2		
nextHopChainingCount	Not present		
}			
nonCriticalExtension SEQUENCE {}	Not present		
}			
}			
}			

Table 8.7.4.1.4.3-3: EPDCCH-Config-r11-DEFAULT

Derivation Path: 36.508 clause 4.6			
Information Element	Value/remark	Comment	Condition
EPDCCH-Config-r11 ::= SEQUENCE{			
config-r11 CHOICE {			
setup SEQUENCE {			
subframePatternConfig-r11	1101111111 000000000 or 1100111001 000000000	1101111111 000000000 for UL- DL configuration 1 and 1100111001 000000000 for UL- DL configuration 5	
startSymbol-r11	Not present	Derived from CFI	
setConfigToReleaseList-r11	Null		
setConfigToAddModList-r11 SEQUENCE {	1 entry		
setConfigId-r11[1]	0		
transmissionType-r11[1]	localized		
resourceBlockAssignment-r11[1] SEQUENCE{			
numberPRB-Pairs-r11	n2		
resourceBlockAssignment-r11	0000 or 1001	0000 for Bandwidth 10MHz and 20MHz; 1001 only for Bandwidth 15MHz	
}			
}			
}			
}			

Table 8.7.4.1.4.3-4: TDD-Config-DEFAULT

Derivation Path: 36.508 clause 4.6			
Information Element	Value/remark	Comment	Condition
TDD-Config-DEFAULT ::= SEQUENCE {			
subframeAssignment	sa1 or sa5	The two cases will be configured for each test	
specialSubframePatterns	Ssp4		
}			

## 8.7.4.1.5 Test requirement

The requirements are specified in Table 8.7.4.1.5-1. The PDCP SDU success rate shall be sustained during at least 300 frames.

Table 8.7.4.1.5-1: Test requirements per test

Test	Number of bits of a DL-SCH transport block received within a TTI for normal/special sub-frame	Measurement channel	Reference value
			TB success rate [%]
1	10296/0	R.31E-1 TDD	95
2	25456/0	R.31E-2 TDD	95
3	51024/0	R.31E-3 TDD	95
3A	51024/0	R.31E-3A TDD	85
4	75376/0 (Note 2)	R.31E-4 TDD	85
6	75376/0 (Note 2)	R.31E-4 TDD	85

Note 1: For 2 layer transmissions, 2 transport blocks are received within a TTI.  
Note 2: 71112 bits for sub-frame 5.  
Note 3: The TB success rate is defined as TB success rate = 100% \*  $N_{DL\_correct\_rx} / (N_{DL\_newtx} + N_{DL\_retx})$ , where  $N_{DL\_newtx}$  is the number of newly transmitted DL transport blocks,  $N_{DL\_retx}$  is the number of retransmitted DL transport blocks, and  $N_{DL\_correct\_rx}$  is the number of correctly received DL transport blocks.

Table 8.7.4.1.5-2: Test parameters per test

	Bandwidth (MHz)	Transmission mode	Antenna configuration	Codebook subset restriction	Downlink power allocation (dB)				$\hat{E}_s$ at antenna port (dBm/15kHz)	Symbols for unused PRBs	ACK/NACK feedback mode
					$\rho_A$	$\rho_B$	$\sigma$	$\delta$			
1	10	1	1 x 2	N/A	0	0	0	0	-85	OP.6 TDD	Bundling
2	10	3	2 x 2	10	-3	-3	0	3	-85	OP.1 TDD	Bundling
3	20	3	2 x 2	10	-3	-3	0	3	-85	OP.1 TDD	Bundling
3A	15	3	2 x 2	10	-3	-3	0	3	-85	OP.2 TDD	Multiplexing
4,6	20	3	2 x 2	10	-3	-3	0	3	-85	OP.1 TDD	Multiplexing

Table 8.7.4.1.5-3: Test applicability per UE category

CA config	Bandwidth/Bandwidth combination (MHz)	Category 1	Category 2	Category 3	Category 4	Category 6	Category 7
Single carrier	10	1	2	-	-	-	-
	15	-	-	3A	3A	-	-
	20	-	-	3	4	6	6

Note 1: The test is selected for maximum supported bandwidth.

## 8.7.5 TDD FDD CA Sustained data rate performance

The parameters specified in Table 8.7.5-1 are valid for all TDD FDD CA tests unless otherwise stated.

Table 8.7.5-1: Common Test Parameters (TDD FDD CA)

Parameter		Unit	Value
Uplink downlink configuration (Note 1) for TDD CC			1
Special subframe configuration (Note 2) for TDD CC			4
Downlink power allocation	$\rho_A$	dB	-3
	$\rho_B$	dB	-3
	$\sigma$	dB	0
Cyclic prefix			Normal
Cell ID			0
Inter-TTI Distance			1
Maximum number of HARQ processes per component carrier	FDD PCell	Processes	8 for FDD and TDD CCs
	TDD PCell	Processes	11 for FDD CC; 7 for TDD CC
Maximum number of HARQ transmission			4
Redundancy version coding sequence			{0,0,1,2} for 64QAM, 256QAM
Number of OFDM symbols for PDCCH per component carrier		OFDM symbols	1
Cross carrier scheduling			Not configured
Propagation condition			Static propagation condition No external noise sources are applied
Transmission mode			TM3
Codebook subset restriction			10
Antenna configuration			2 x 2
$\hat{E}_s$ at antenna port (dBm/15kHz)			-85
Symbols for unused PRBs			OP.1 FDD for FDD CC, OP.1 TDD for TDD CC
ACK/NACK feedback mode			PUCCH format 3
Downlink HARQ-ACK timing	FDD PCell		As specified in Clause 7.3.3 in TS36.213 [6]
	TDD PCell		As specified in Clause 7.3.4 in TS36.213 [6]
Note 1:		as specified in Table 4.2-2 in TS 36.211 [4].	
Note 2:		as specified in Table 4.2-1 in TS 36.211 [4].	

The normative reference for this requirement is TS 36.101[2] clause 8.7.5.

### 8.7.5.1 TDD FDD CA Sustained data rate performance for FDD PCell

#### 8.7.5.1.1 TDD FDD CA Sustained data rate performance for FDD PCell (2DL CA)

**Editor's notes: This test case is incomplete. The following items are missing or incomplete:**

- TB success rate requirements are still with square brackets.
- Scheduling of retransmissions needs to be specified.

##### 8.7.5.1.1.1 Test purpose

Same test purpose as in clause 8.7.1.1.

## 8.7.5.1.1.2 Test applicability

This test applies to all types of UE Release 12 and forward of UE category 3, 4, 6, 7, 9 and 10 that support E-UTRA FDD and TDD, 2DL TDD-FDD CA with FDD as PCell.

## 8.7.5.1.1.3 Minimum requirements

For UE not supporting 256QAM, the requirements for TDD FDD CA with FDD PCell are specified in Table 8.7.5.1.1.3-1 with the additional parameters specified in Table 8.7.5-1, and the downlink physical channel setup according to Annex C.3.2. The test points are applied to UE category and bandwidth combination with maximum aggregated bandwidth as specified in Table 8.7.5.1.1.3-2. The TB success rate shall be sustained during at least 300 frames.

The applicability of the requirements are specified in Clause 8.1.2.3B. The test coverage for different number of component carriers is defined in 8.1.2.4.

**Table 8.7.5.1.1.3-1: test parameters for sustained downlink data rate (TDD FDD CA 64QAM)**

Test number	Bandwidth (MHz)			Number of bits of a DL-SCH transport block received within a TTI (for normal/special subframe for TDD, except for subframe #5)		Measurement channel		Reference value
	Total	FDD CC	TDD CC	FDD CC	TDD CC	FDD CC	TDD CC	TB success rate [%]
1	2x20	20	20	75376	75376/0	R.31-4 FDD	R.31-4 TDD	[85]
2	10+20	10	20	36696	75376/0	R.31-3A FDD	R.31-4 TDD	[85]
2A	15+20	15	20	55056	75376/0	R.31-5 FDD	R.31-4 TDD	[85]
3	10+10	10	10	36696	36696/0	R.31-3A FDD	R.31-6 TDD	[85]
4	5+10	5	10	18336	36696/0	R.31-6 FDD	R.31-6 TDD	[85]

**Table 8.7.5.1.1.3-2: Test points for sustained data rate (FRC 64QAM)**

CA config	Maximum supported Bandwidth/ Bandwidth combination (MHz)			Cat. 1	Cat. 2	Cat. 3	Cat. 4	Cat. 6, 7	Cat. 9,10	Cat 11, 12
	Total	FDD CC	TDD CC							
CA with 2CCs	2x20	20	20	-	-	3	3	1	1	-
	10+20	10	20	-	-	3	3	2	2	-
	15+20	15	20	-	-	3	3	2A	2A	-
	10+10	10	10	-	-	3	3	3	3	-
	5+10	5	10	-	-	4	4	4	4	-

Note 1: Void  
Note 2: Void.

The normative reference for this requirement is TS 36.101[2] clause 8.7.5.1



## 8.7.5.1.1.4 Test description

## 8.7.5.1.1.4.1 Initial conditions

Table 8.7.5.1.1.4.1-1: Further test parameters per test

Test number		1	2	2A	3	4
Bandwidth	FDD CC	20	10	15	10	5
	TDD CC	20	20	20	10	10
DL Measurement channel	FDD CC	R.31-4 FDD	R.31-3A FDD	R.31-5 FDD	R.31-3A FDD	R.31-6 FDD
	TDD CC	R.31-4 TDD	R.31-4 TDD	R.31-4 TDD	R.31-6 TDD	R.31-6 TDD
UL channel	FDD CC	R.1-4 FDD	R.1-4 FDD	R.1-4 FDD	R.1-4 FDD	R.1-4 FDD
	TDD CC	NA	NA	NA	NA	NA
TBSize per Codeword	FDD CC	75376	36696	55056	36696	18336
	TDD CC	75376/0	75376/0	75376/0	36696/0	36696/0
Number of PDCP SDU per Codeword	FDD CC	7	4	6	4	2
	TDD CC	7	7	7	4	4
PDCP SDU size [Octets] Calculation (Note 1)	FDD CC	$\text{FLOOR}((\text{TBSize} - 264)/56)$	$\text{FLOOR}((\text{TBSize} - 184)/32)$	$\text{FLOOR}((\text{TBSize} - 240)/48)$	$\text{FLOOR}((\text{TBSize} - 184)/32)$	$\text{FLOOR}((\text{TBSize} - 128)/16)$
	TDD CC	$\text{FLOOR}((\text{TBSize} - 264)/56)$	$\text{FLOOR}((\text{TBSize} - 264)/56)$	$\text{FLOOR}((\text{TBSize} - 264)/56)$	$\text{FLOOR}((\text{TBSize} - 184)/32)$	$\text{FLOOR}((\text{TBSize} - 184)/32)$
PDCP SDU size [Octets]	FDD CC	1341	1141	1142	1141	1138
	TDD CC	1341	1341	1341	1141	1141
<p>Note 1: Transport block size under test according to applicable Fixed Reference Channel for sustained data-rate test in annex A.3.9. In case of varying TBS across SFs of the RMC, only the maximum TBS is used for PDCP SDU size calculation. In case of different resulting PDCP SDU sizes among component carriers, the smaller calculated PDCP SDU size is used across all the carriers.</p> <p>Note 2: Each PDCP SDU is limited to 1500 octets (to keep below maximum SDU size of ESM as specified in TS 24.301 clause 9.9.4.12). The PDCP SDU size of each PDCP SDU is: PDCP SDU size = (TBSize – N*PDCP header size - AMD PDU header size - MAC header size - Size of RLC STATUS PDU) / N, where PDCP header size is 16 bits for the RLC AM and 12-bit SN case; AMD PDU header size is <math>\text{CEIL}[(16+(N-1)*12)/8]</math> bytes which includes 16 bit standard AM header and (N-1) Length indicators; and MAC header size = R/R/E/LCID/F/L MAC subheader (24 bits for MAC SDU for RLC STATUS PDU with 15 bit LI) + R/R/E/LCID MAC subheader (8 bits for MAC SDU for RLC Data PDU) = 32 bits. The size of RLC STATUS PDU including one ACK_SN field and one NACK_SN field is 32 bits (if no STATUS PDU is sent or if the size of the STATUS PDU is less than 32 bits then padding will be used to fill the 32 bits). This gives: PDCP SDU size = <math>8*\text{FLOOR}((\text{TBSize} - N*16 - 8*\text{CEIL}[(16+(N-1)*12)/8] - 64)/(8*N)</math> bits. The calculation of PDCP SDU sizes does not consider timing advance MAC CE as timing advance is not transmitted by SS for RF test cases, and the header sizes are informative and may vary during the test.</p>						

Initial conditions are a set of test configurations the UE needs to be tested in and the steps for the SS to take with the UE to reach the correct measurement state.

Configurations of PDSCH and PDCCH before measurement are specified in Annex C.2.

Test Environment: Normal as defined in TS 36.508 [7] clause 4.1.

Frequencies to be tested: Mid Range as defined in TS 36.508 [7] clause 4.3.1.1.

Channel Bandwidths to be tested: According to Table 8.7.5.1.1.5-1 depending on the UE category according to Table 8.7.5.1.1.5-2.

1. Connect the SS to the UE antenna connector(s) as shown in TS 36.508 [7] Annex A, Figure group A.36 (without using faders and AWGN generators).
2. The parameter settings for the cell are set up according to Table 8.7.5-1 and Table 8.7.5.1.1.5-1 depending on the UE category according to Table 8.7.5.1.1.5-2.
3. Downlink signals are initially set up according to Annex C.0, C.1 and Annex C.3.2 and uplink signals according to Annex H.1 and H.3.2.

4. Propagation conditions are set according to Annex B.0.
5. Ensure the UE is in State 4A-RF according to TS 36.508 [7] clause 4.5.4. Message contents are defined in clause 8.7.5.1.1.4.3.

#### 8.7.5.1.1.4.2 Test procedure

1. Configure SCC according to Annex C.0, C.1 and Annex C.3.2 for all downlink physical channels.
2. The SS shall configure SCC as per TS 36.508 [7] clause 5.2A.4 with SCC configured. PhysicalConfigDedicated-DEFAULT is defined in Table 8.7.5.1.1.4.3-3, PhysicalConfigDedicatedSCell-r10-DEFAULT is defined in Table 8.7.5.1.1.4.3-3A.
3. The SS activates SCC by sending the activation MAC-CE (Refer TS 36.321 [13], clauses 5.13,6.1.3.8). Wait for at least 2 seconds (Refer TS 36.133, clauses 8.3.3.2).
4. Propagation conditions are set according to Annex B.1 (No external noise sources are applied).
5. The SS looks up  $TB_{size}$  in Table 8.7.5.1.1.4.1-1 for the tests to be performed depending on the UE category according to Table 8.7.5.1.1.5-2.
6. The SS sets the counters,  $N_{DL\_newtx}$ ,  $N_{DL\_retx}$ ,  $N_{UL\_PDCP}$ , and  $N_{DL\_PDCP}$  to 0.
7. For each new DL HARQ transmission the SS generates sufficient PDCP SDUs to fill up the TB in accordance with Table 8.7.5.1.1.4.1-1 (Note 1). The SS ciphers the PDCP SDUs, concatenates the resultant PDCP PDUs to form an RLC PDU and then a MAC PDU. The SS transmits the MAC PDU. The SS increments then  $N_{DL\_newtx}$  by one and  $N_{DL\_PDCP}$  by the number of new PDCP SDUs (Note 1) included in the sent MAC PDU.
8. If PHY requests a DL HARQ retransmission, the SS performs a HARQ retransmission and increments  $N_{DL\_retx}$  by one.
9. Steps 7 to 8 are repeated at every TTI for at least 300 frames and the SS waits for 300ms to let any HARQ retransmissions and RLC retransmissions to finish.
10. For each PDCP SDU received at the SS, if the content of the data matches that of the truncated version of the original PDCP SDU generated at the SS, the SS increments  $N_{UL\_PDCP}$  by one
11. The SS calculates the TB success rate as  $A = 100\% * N_{DL\_newtx} / (N_{DL\_newtx} + N_{DL\_retx})$ . Measurements are not based on UE feedback but on SS counters instead ( $N_{DL\_newtx}$  and  $N_{DL\_retx}$ ) in order to validate HARQ feedback received from the UE.
12. The SS calculates the PDCP SDU loss as  $B = N_{DL\_PDCP} - N_{UL\_PDCP}$
13. The UE passes the test if  $A \geq$  "corresponding TB success rate according to Table 8.7.5.1.1.5-1" and  $B = 0$ .

NOTE 1: In case of RLC PDU retransmission, the number of new required PDCP SDUs is as many as to fill the rest of TB.

#### 8.7.5.1.1.4.3 Message contents

Message contents are according to TS 36.508 [7] clause 4.6 and 4.7A, with the following exceptions:

**Table 8.7.5.1.1.4.3-1: CLOSE UE TEST LOOP (in the preamble)**

Derivation Path: 36.508 clause 4.7A table 4.7A-3 with condition UE TEST LOOP MODE A			
Information Element	Value/remark	Comment	Condition
UE test loop mode A LB setup			
Length of UE test loop mode A LB setup list in bytes	0 0 0 0 0 1 1	Length of one LB setup DRB (3 bytes)	
LB setup DRB	0 0 0 0 0 0 0, 0 0 1 0 1 0 0 0, 0 0 0 Q4 Q3 Q2 Q1 Q0	UL PDCP SDU size = 40 bits (5 bytes) Q4..Q0 = Data Radio Bearer identity number for the default radio bearer. See 36.509 clause 6.1	

**Table 8.7.5.1.1.4.3-2: SecurityModeCommand (in the preamble)**

Derivation Path: TS 36.508 clause 4.6.1 table 4.6.1-19			
Information Element	Value/remark	Comment	Condition
SecurityModeCommand ::= SEQUENCE {			
criticalExtensions CHOICE {			
c1 CHOICE{			
securityModeCommand-r8 SEQUENCE {			
securityConfiguration SEQUENCE {			
cipheringAlgorithm	eea2		
nextHopChainingCount	Not present		
}			
nonCriticalExtension SEQUENCE {}	Not present		
}			
}			
}			
}			

**Table 8.7.5.1.1.4.3-3: PhysicalConfigDedicated-DEFAULT**

Derivation Path: 36.508 clause 5.5.1, Table 5.5.1.2-1			
Information Element	Value/remark	Comment	Condition
PhysicalConfigDedicated-DEFAULT ::= SEQUENCE {			
antennaInfo CHOICE {			
explicitValue ::= SEQUENCE {			
transmissionMode	tm3		Transmission mode 3
codebookSubsetRestriction CHOICE {			
n2TxAntenna-tm3	10		
}			
ue-TransmitAntennaSelection CHOICE {			
release	NULL		
}			
}			
}			
}			

**Table 8.7.5.1.1.4.3-3A: PhysicalConfigDedicatedSCell-r10-DEFAULT**

Derivation Path: 36.508 clause 4.6.3 Table 4.6.3-6A			
Information Element	Value/remark	Comment	Condition
PhysicalConfigDedicatedSCell-r10-DEFAULT ::= SEQUENCE {			
nonUL-Configuration-r10 SEQUENCE {			
antennaInfo-r10 CHOICE {			
transmissionMode-r10	tm3		Transmission mode 3
codebookSubsetRestriction-r10	10		
ue-TransmitAntennaSelection CHOICE {			
release	NULL		
}			
}			
}			

**Table 8.7.5.1.1.4.3-4: TDD-Config-DEFAULT**

Derivation Path: 36.508 clause 4.6			
Information Element	Value/remark	Comment	Condition
TDD-Config-DEFAULT ::= SEQUENCE {			
subframeAssignment	sa1		
specialSubframePatterns	Ssp4		
}			

8.7.5.1.1.5 Test requirement

The requirements are specified in Table 8.7.5.1.1.5-1 depending on the UE category according to Table 8.7.5.1.1.5-2. The PDCP SDU success rate shall be sustained during at least 300 frames.

**Table 8.7.5.1.1.5-1: Test requirements per test**

Test number	Bandwidth (MHz)			Number of bits of a DL-SCH transport block received within a TTI (for normal/special subframe for TDD, except for subframe #5)		Measurement channel		Reference value
	Total	FDD CC	TDD CC	FDD CC	TDD CC	FDD CC	TDD CC	TB success rate [%]
1	2x20	20	20	75376	75376/0	R.31-4 FDD	R.31-4 TDD	[85]
2	10+20	10	20	36696	75376/0	R.31-3A FDD	R.31-4 TDD	[85]
2A	15+20	15	20	55056	75376/0	R.31-5 FDD	R.31-4 TDD	[85]
3	10+10	10	10	36696	36696/0	R.31-3A FDD	R.31-6 TDD	[85]
4	5+10	5	10	18336	36696/0	R.31-6 FDD	R.31-6 TDD	[85]
Note 1:	For 2 layer transmissions, 2 transport blocks are received within a TTI.							
Note 2:	The TB success rate is defined as TB success rate = 100%*N <sub>DL_correct_rx</sub> / (N <sub>DL_newtx</sub> + N <sub>DL_retx</sub> ), where N <sub>DL_newtx</sub> is the number of newly transmitted DL transport blocks, N <sub>DL_retx</sub> is the number of retransmitted DL transport blocks, and N <sub>DL_correct_rx</sub> is the number of correctly received DL transport blocks.							

Table 8.7.5.1.1.5-2: Test applicability per UE category

CA config	Maximum supported Bandwidth/ Bandwidth combination (MHz)			Cat. 1	Cat. 2	Cat. 3	Cat. 4	Cat. 6, 7	Cat. 9,10	Cat 11, 12
	Total	FDD CC	TDD CC							
CA with 2CCs	2x20	20	20	-	-	3	3	1	1	-
	10+20	10	20	-	-	3	3	2	2	-
	15+20	15	20	-	-	3	3	2A	2A	-
	10+10	10	10	-	-	3	3	3	3	-
	5+10	5	10	-	-	4	4	4	4	-
Note 1:	Only one test point is tested. Select the largest aggregated CA bandwidth combination supported by the UE among the UE supported CA capabilities.									

### 8.7.5.1.2 TDD FDD CA Sustained data rate performance for FDD PCell (3DL CA)

Editor's notes: This test case is incomplete. The following items are missing or incomplete:

- TB success rate requirements are still with square brackets.
- Scheduling of retransmissions needs to be specified.

#### 8.7.5.1.2.1 Test purpose

Same test purpose as in clause 8.7.1.1.

#### 8.7.5.1.2.2 Test applicability

This test applies to all types of UE Release 12 and forward of UE category 6, 7, 9, 10, 11 and 12 that support E-UTRA FDD and TDD, 3DL TDD-FDD CA with FDD as PCell.

#### 8.7.5.1.2.3 Minimum requirements

For UE not supporting 256QAM, the requirements for TDD FDD CA with FDD PCell are specified in Table 8.7.5.1.2.3-1 with the additional parameters specified in Table 8.7.5-1, and the downlink physical channel setup according to Annex C.3.2. The test points are applied to UE category and bandwidth combination with maximum aggregated bandwidth as specified in Table 8.7.5.1.2.3-2. The TB success rate shall be sustained during at least 300 frames.

The applicability of the requirements are specified in Clause 8.1.2.3B. The test coverage for different number of component carriers is defined in 8.1.2.4.

**Table 8.7.5.1.2.3-1: test parameters for sustained downlink data rate (TDD FDD CA 64QAM)**

Test number	Bandwidth (MHz)			Number of bits of a DL-SCH transport block received within a TTI (for normal/special subframe for TDD, except for subframe #5)		Measurement channel		Reference value
	Total	FDD CC	TDD CC	FDD CC	TDD CC	FDD CC	TDD CC	TB success rate [%]
1	2x20	20	20	75376	75376/0	R.31-4 FDD	R.31-4 TDD	[85]
2	10+20	10	20	36696	75376/0	R.31-3A FDD	R.31-4 TDD	[85]
2A	15+20	15	20	55056	75376/0	R.31-5 FDD	R.31-4 TDD	[85]
5	3x20	20	2x20	75376	75376/0	R.31-4 FDD	R.31-4 TDD	[85]
6	15+20+20	15	2x20	55056	75376/0	R.31-5 FDD	R.31-4 TDD	[85]
7	10+20+20	10	2x20	36696	75376/0	R.31-3A FDD	R.31-4 TDD	[85]

**Table 8.7.5.1.2.3-2: Test points for sustained data rate (FRC 64QAM)**

CA config	Maximum supported Bandwidth/ Bandwidth combination (MHz)			Cat. 1	Cat. 2	Cat. 3	Cat. 4	Cat. 6, 7	Cat. 9,10	Cat 11, 12
	Total	FDD CC	TDD CC							
CA with 3CCs	3x20	20	2x20	-	-	-	-	1	5	5
	15+20+20	15	2x20	-	-	-	-	2A	6	6
	10+20+20	10	2x20	-	-	-	-	2	7	7
Note 1: Void										
Note 2: Void.										

The normative reference for this requirement is TS 36.101[2] clause 8.7.5.1

## 8.7.5.1.2.4 Test description

## 8.7.5.1.2.4.1 Initial conditions

Table 8.7.5.1.2.4.1-1: Further test parameters per test

Test number		1	2	2A	5	6	7
Bandwidth	FDD CC	20	10	15	20	15	10
	TDD CC	20	20	20	2x20	2x20	2x20
DL Measurement channel	FDD CC	R.31-4 FDD	R.31-3A FDD	R.31-5 FDD	R.31-4 FDD	R.31-5 FDD	R.31-3A FDD
	TDD CC	R.31-4 TDD	R.31-4 TDD	R.31-4 TDD	R.31-4 TDD	R.31-4 TDD	R.31-4 TDD
UL channel	FDD CC	R.1-4 FDD	R.1-4 FDD	R.1-4 FDD	R.1-4 FDD	R.1-4 FDD	R.1-4 FDD
	TDD CC	NA	NA	NA	NA	NA	NA
TBSize per Codeword	FDD CC	75376	36696	55056	75376	55056	36696
	TDD CC	75376/0	75376/0	75376/0	75376/0	75376/0	75376/0
Number of PDCP SDU per Codeword	FDD CC	7	4	6	7	6	4
	TDD CC	7	7	7	7	7	7
PDCP SDU size [Octets] Calculation (Note 1)	FDD CC	$\text{FLOOR}((\text{TBSize} - 264)/56)$	$\text{FLOOR}((\text{TBSize} - 184)/32)$	$\text{FLOOR}((\text{TBSize} - 240)/48)$	$\text{FLOOR}((\text{TBSize} - 264)/56)$	$\text{FLOOR}((\text{TBSize} - 240)/48)$	$\text{FLOOR}((\text{TBSize} - 184)/32)$
	TDD CC	$\text{FLOOR}((\text{TBSize} - 264)/56)$	$\text{FLOOR}((\text{TBSize} - 264)/56)$	$\text{FLOOR}((\text{TBSize} - 264)/56)$	$\text{FLOOR}((\text{TBSize} - 264)/56)$	$\text{FLOOR}((\text{TBSize} - 264)/56)$	$\text{FLOOR}((\text{TBSize} - 264)/56)$
PDCP SDU size [Octets]	FDD CC	1341	1141	1142	1341	1142	1141
	TDD CC	1341	1341	1341	1341	1341	1341
Note 1:	Transport block size under test according to applicable Fixed Reference Channel for sustained data-rate test in annex A.3.9. In case of varying TBS across SFs of the RMC, only the maximum TBS is used for PDCP SDU size calculation. In case of different resulting PDCP SDU sizes among component carriers, the smaller calculated PDCP SDU size is used across all the carriers.						
Note 2:	Each PDCP SDU is limited to 1500 octets (to keep below maximum SDU size of ESM as specified in TS 24.301 clause 9.9.4.12). The PDCP SDU size of each PDCP SDU is: PDCP SDU size = (TBSize – N*PDCP header size - AMD PDU header size - MAC header size - Size of RLC STATUS PDU) / N, where PDCP header size is 16 bits for the RLC AM and 12-bit SN case; AMD PDU header size is $\text{CEIL}[(16+(N-1)*12)/8]$ bytes which includes 16 bit standard AM header and (N-1) Length indicators; and MAC header size = R/R/E/LCID/F/L MAC subheader (24 bits for MAC SDU for RLC STATUS PDU with 15 bit LI) + R/R/E/LCID MAC subheader (8 bits for MAC SDU for RLC Data PDU) = 32 bits. The size of RLC STATUS PDU including one ACK_SN field and one NACK_SN field is 32 bits (if no STATUS PDU is sent or if the size of the STATUS PDU is less than 32 bits then padding will be used to fill the 32 bits). This gives: PDCP SDU size = $8*\text{FLOOR}((\text{TBSize} - N*16 - 8*\text{CEIL}[(16+(N-1)*12)/8] - 64)/(8*N))$ bits. The calculation of PDCP SDU sizes does not consider timing advance MAC CE as timing advance is not transmitted by SS for RF test cases, and the header sizes are informative and may vary during the test.						

Initial conditions are a set of test configurations the UE needs to be tested in and the steps for the SS to take with the UE to reach the correct measurement state.

Configurations of PDSCH and PDCCH before measurement are specified in Annex C.2.

Test Environment: Normal as defined in TS 36.508 [7] clause 4.1.

Frequencies to be tested: Mid Range as defined in TS 36.508 [7] clause 4.3.1.1.

Channel Bandwidths to be tested: According to Table 8.7.5.1.2.5-1 depending on the UE category according to Table 8.7.5.1.2.5-2.

1. Connect the SS to the UE antenna connector(s) as shown in TS 36.508 [7] Annex A, Figure group A.60 (without using faders and AWGN generators).
2. The parameter settings for the cell are set up according to Table 8.7.5-1 and Table 8.7.5.1.2.5-1 depending on the UE category according to Table 8.7.5.1.2.5-2.
3. Downlink signals are initially set up according to Annex C.0, C.1 and Annex C.3.2 and uplink signals according to Annex H.1 and H.3.2.
4. Propagation conditions are set according to Annex B.0.
5. Ensure the UE is in State 4A-RF according to TS 36.508 [7] clause 4.5.4. Message contents are defined in clause 8.7.5.1.2.4.3.

#### 8.7.5.1.2.4.2 Test procedure

1. Configure SCCs according to Annex C.0, C.1 and Annex C.3.2 for all downlink physical channels.
2. The SS shall configure SCCs as per TS 36.508 [7] clause 5.2A.4 with SCCs configured. PhysicalConfigDedicated-DEFAULT is defined in Table 8.7.5.1.2.4.3-3, PhysicalConfigDedicatedSCell-r10-DEFAULT is defined in Table 8.7.5.1.2.4.3-3A.
3. The SS activates SCCs by sending the activation MAC-CE (Refer TS 36.321 [13], clauses 5.13, 6.1.3.8). Wait for at least 2 seconds (Refer TS 36.133, clauses 8.3.3.2).
4. Propagation conditions are set according to Annex B.1 (No external noise sources are applied).
5. The SS looks up  $TB_{size}$  in Table 8.7.5.1.2.4.1-1 for the tests to be performed depending on the UE category according to Table 8.7.5.1.2.5-2.
6. The SS sets the counters,  $N_{DL\_newtx}$ ,  $N_{DL\_retr}$ ,  $N_{UL\_PDCP}$ , and  $N_{DL\_PDCP}$  to 0.
7. For each new DL HARQ transmission the SS generates sufficient PDCP SDUs to fill up the TB in accordance with Table 8.7.5.1.2.4.1-1 (Note 1). The SS ciphers the PDCP SDUs, concatenates the resultant PDCP PDUs to form an RLC PDU and then a MAC PDU. The SS transmits the MAC PDU. The SS increments then  $N_{DL\_newtx}$  by one and  $N_{DL\_PDCP}$  by the number of new PDCP SDUs (Note 1) included in the sent MAC PDU.
8. If PHY requests a DL HARQ retransmission, the SS performs a HARQ retransmission and increments  $N_{DL\_retr}$  by one.
9. Steps 7 to 8 are repeated at every TTI for at least 300 frames and the SS waits for 300ms to let any HARQ retransmissions and RLC retransmissions to finish.
10. For each PDCP SDU received at the SS, if the content of the data matches that of the truncated version of the original PDCP SDU generated at the SS, the SS increments  $N_{UL\_PDCP}$  by one
11. The SS calculates the TB success rate as  $A = 100\% * N_{DL\_newtx} / (N_{DL\_newtx} + N_{DL\_retr})$ . Measurements are not based on UE feedback but on SS counters instead ( $N_{DL\_newtx}$  and  $N_{DL\_retr}$ ) in order to validate HARQ feedback received from the UE.
12. The SS calculates the PDCP SDU loss as  $B = N_{DL\_PDCP} - N_{UL\_PDCP}$
13. The UE passes the test if  $A \geq$  "corresponding TB success rate according to Table 8.7.5.1.2.5-1" and  $B = 0$ .

NOTE 1: In case of RLC PDU retransmission, the number of new required PDCP SDUs is as many as to fill the rest of TB.

#### 8.7.5.1.2.4.3 Message contents

Message contents are according to TS 36.508 [7] clause 4.6 and 4.7A, with the following exceptions:



**Table 8.7.5.1.2.4.3-1: CLOSE UE TEST LOOP (in the preamble)**

Derivation Path: 36.508 clause 4.7A table 4.7A-3 with condition UE TEST LOOP MODE A			
Information Element	Value/remark	Comment	Condition
UE test loop mode A LB setup			
Length of UE test loop mode A LB setup list in bytes	0 0 0 0 0 0 1 1	Length of one LB setup DRB (3 bytes)	
LB setup DRB	0 0 0 0 0 0 0 0, 0 0 1 0 1 0 0 0, 0 0 0 Q4 Q3 Q2 Q1 Q0	UL PDCP SDU size = 40 bits (5 bytes) Q4..Q0 = Data Radio Bearer identity number for the default radio bearer. See 36.509 clause 6.1	

**Table 8.7.5.1.2.4.3-2: SecurityModeCommand (in the preamble)**

Derivation Path: TS 36.508 clause 4.6.1 table 4.6.1-19			
Information Element	Value/remark	Comment	Condition
SecurityModeCommand ::= SEQUENCE {			
criticalExtensions CHOICE {			
c1 CHOICE{			
securityModeCommand-r8 SEQUENCE {			
securityConfiguration SEQUENCE {			
cipheringAlgorithm	eea2		
nextHopChainingCount	Not present		
}			
nonCriticalExtension SEQUENCE {}	Not present		
}			
}			
}			
}			

**Table 8.7.5.1.2.4.3-3: PhysicalConfigDedicated-DEFAULT**

Derivation Path: 36.508 clause 5.5.1, Table 5.5.1.2-1			
Information Element	Value/remark	Comment	Condition
PhysicalConfigDedicated-DEFAULT ::= SEQUENCE {			
antennaInfo CHOICE {			
explicitValue ::= SEQUENCE {			
transmissionMode	tm3		Transmission mode 3
codebookSubsetRestriction CHOICE {			
n2TxAntenna-tm3	10		
}			
ue-TransmitAntennaSelection CHOICE {			
release	NULL		
}			
}			
}			
}			

**Table 8.7.5.1.2.4.3-3A: PhysicalConfigDedicatedSCell-r10-DEFAULT**

Derivation Path: 36.508 clause 4.6.3 Table 4.6.3-6A			
Information Element	Value/remark	Comment	Condition
PhysicalConfigDedicatedSCell-r10-DEFAULT ::= SEQUENCE {			
nonUL-Configuration-r10 SEQUENCE {			
antennaInfo-r10 CHOICE {			
transmissionMode-r10	tm3		Transmission mode 3
codebookSubsetRestriction-r10	10		
ue-TransmitAntennaSelection CHOICE {			
release	NULL		
}			
}			
}			

**Table 8.7.5.1.2.4.3-4: TDD-Config-DEFAULT**

Derivation Path: 36.508 clause 4.6			
Information Element	Value/remark	Comment	Condition
TDD-Config-DEFAULT ::= SEQUENCE {			
subframeAssignment	sa1		
specialSubframePatterns	Ssp4		
}			

### 8.7.5.1.2.5 Test requirement

The requirements are specified in Table 8.7.5.1.2.5-1 depending on the UE category according to Table 8.7.5.1.2.5-2. The PDCP SDU success rate shall be sustained during at least 300 frames.

**Table 8.7.5.1.2.5-1: Test requirements per test**

Test number	Bandwidth (MHz)			Number of bits of a DL-SCH transport block received within a TTI (for normal/special subframe for TDD, except for subframe #5)		Measurement channel		Reference value
	Total	FDD CC	TDD CC	FDD CC	TDD CC	FDD CC	TDD CC	TB success rate [%]
1	2x20	20	20	75376	75376/0	R.31-4 FDD	R.31-4 TDD	[85]
2	10+20	10	20	36696	75376/0	R.31-3A FDD	R.31-4 TDD	[85]
2A	15+20	15	20	55056	75376/0	R.31-5 FDD	R.31-4 TDD	[85]
5	3x20	20	2x20	75376	75376/0	R.31-4 FDD	R.31-4 TDD	[85]
6	15+20+20	15	2x20	55056	75376/0	R.31-5 FDD	R.31-4 TDD	[85]
7	10+20+20	10	2x20	36696	75376/0	R.31-3A FDD	R.31-4 TDD	[85]

Table 8.7.5.1.2.5-2: Test applicability per UE category

CA config	Maximum supported Bandwidth/ Bandwidth combination (MHz)			Cat. 1	Cat. 2	Cat. 3	Cat. 4	Cat. 6, 7	Cat. 9,10	Cat 11, 12
	Total	FDD CC	TDD CC							
CA with 3CCs	3x20	20	2x20	-	-	-	-	1	5	5
	15+20+20	15	2x20	-	-	-	-	2A	6	6
	10+20+20	10	2x20	-	-	-	-	2	7	7
Note1: Only one test point is tested. Select the largest aggregated CA bandwidth combination supported by the UE among the UE supported CA capabilities.										

## 8.7.5.2 TDD FDD CA Sustained data rate performance for TDD PCell

### 8.7.5.2.1 TDD FDD CA Sustained data rate performance for TDD PCell (2DL CA)

Editor's notes: This test case is incomplete. The following items are missing or incomplete:

- TB success rate requirements are still with square brackets.
- Scheduling of retransmissions needs to be specified.

#### 8.7.5.2.1.1 Test purpose

Same test purpose as in clause 8.7.2.1.

#### 8.7.5.2.1.2 Test applicability

This test applies to all types of UE Release 12 and forward of UE category 3, 4, 6, 7, 9 and 10 that support E-UTRA FDD and TDD, 2DL TDD-FDD CA with TDD as PCell.

#### 8.7.5.2.1.3 Minimum requirements

For UE not supporting 256QAM, the requirements for TDD FDD CA with FDD PCell are specified in Table 8.7.5.2.1.3-1 with the additional parameters specified in Table 8.7.5-1, and the downlink physical channel setup according to Annex C.3.2. The test points are applied to UE category and bandwidth combination with maximum aggregated bandwidth as specified in Table 8.7.5.2.1.3-2. The TB success rate shall be sustained during at least 300 frames.

The applicability of the requirements are specified in Clause 8.1.2.3B. The test coverage for different number of component carriers is defined in 8.1.2.4.

Table 8.7.5.2.1.3-1: test parameters for sustained downlink data rate (TDD FDD CA 64QAM)

Test number	Bandwidth (MHz)			Number of bits of a DL-SCH transport block received within a TTI (for normal/special subframe for TDD, except for subframe #5)		Measurement channel		Reference value
	Total	FDD CC	TDD CC	FDD CC	TDD CC	FDD CC	TDD CC	TB success rate [%]
1	2x20	20	20	75376	75376/0	R.31-4 FDD	R.31-4 TDD	[85]
2	10+20	10	20	36696	75376/0	R.31-3A FDD	R.31-4 TDD	[85]
2A	15+20	15	20	55056	75376/0	R.31-5 FDD	R.31-4 TDD	[85]
3	10+10	10	10	36696	36696/0	R.31-3A FDD	R.31-6 TDD	[85]
4	5+10	5	10	18336	36696/0	R.31-6 FDD	R.31-6 TDD	[85]

Table 8.7.5.2.1.3-2: Test points for sustained data rate (FRC 64QAM)

CA config	Maximum supported Bandwidth/ Bandwidth combination (MHz)			Cat. 1	Cat. 2	Cat. 3	Cat. 4	Cat. 6, 7	Cat. 9,10	Cat 11, 12
	Total	FDD CC	TDD CC							
CA with 2CCs	2x20	20	20	-	-	3	3	1	1	-
	10+20	10	20	-	-	3	3	2	2	-
	15+20	15	20	-	-	3	3	2A	2A	-
	10+10	10	10			3	3	3	3	-
	5+10	5	10	-	-	4	4	4	4	-
Note 1: Void										
Note 2: Void										

The normative reference for this requirement is TS 36.101[2] clause 8.7.5.2

## 8.7.5.2.1.4 Test description

## 8.7.5.2.1.4.1 Initial conditions

**Table 8.7.5.2.1.4.1-1: Further test parameters per test**

Test number		1	2	2A	3	4
Bandwidth	FDD CC	20	10	15	10	5
	TDD CC	20	20	20	10	10
DL Measurement channel	FDD CC	R.31-4 FDD	R.31-3A FDD	R.31-5 FDD	R.31-3A FDD	R.31-6 FDD
	TDD CC	R.31-4 TDD	R.31-4 TDD	R.31-4 TDD	R.31-6 TDD	R.31-6 TDD
UL channel	FDD CC	NA	NA	NA	NA	NA
	TDD CC	R.1-4 TDD	R.1-4 TDD	R.1-4 TDD	R.1-4 TDD	R.1-4 TDD
TBSize per Codeword	FDD CC	75376	36696	55056	36696	18336
	TDD CC	75376/0	75376/0	75376/0	36696/0	36696/0
Number of PDCP SDU per Codeword	FDD CC	7	4	6	4	2
	TDD CC	7	7	7	4	4
PDCP SDU size [Octets] Calculation (Note 1)	FDD CC	$\text{FLOOR}((\text{TBSize} - 264)/56)$	$\text{FLOOR}((\text{TBSize} - 184)/32)$	$\text{FLOOR}((\text{TBSize} - 240)/48)$	$\text{FLOOR}((\text{TBSize} - 184)/32)$	$\text{FLOOR}((\text{TBSize} - 128)/16)$
	TDD CC	$\text{FLOOR}((\text{TBSize} - 264)/56)$	$\text{FLOOR}((\text{TBSize} - 264)/56)$	$\text{FLOOR}((\text{TBSize} - 264)/56)$	$\text{FLOOR}((\text{TBSize} - 184)/32)$	$\text{FLOOR}((\text{TBSize} - 184)/32)$
PDCP SDU size [Octets]	FDD CC	1341	1141	1142	1141	1138
	TDD CC	1341	1341	1341	1141	1141
<p>Note 1: Transport block size under test according to applicable Fixed Reference Channel for sustained data-rate test in annex A.3.9. In case of varying TBS across SFs of the RMC, only the maximum TBS is used for PDCP SDU size calculation. In case of different resulting PDCP SDU sizes among component carriers, the smaller calculated PDCP SDU size is used across all the carriers.</p> <p>Note 2: Each PDCP SDU is limited to 1500 octets (to keep below maximum SDU size of ESM as specified in TS 24.301 clause 9.9.4.12). The PDCP SDU size of each PDCP SDU is:  <math>\text{PDCP SDU size} = (\text{TBSize} - \text{N} \times \text{PDCP header size} - \text{AMD PDU header size} - \text{MAC header size} - \text{Size of RLC STATUS PDU}) / \text{N}</math>,  where PDCP header size is 16 bits for the RLC AM and 12-bit SN case; AMD PDU header size is <math>\text{CEIL}[(16 + (\text{N} - 1) \times 12) / 8]</math> bytes which includes 16 bit standard AM header and (N-1) Length indicators; and MAC header size = R/R/E/LCID/F/L MAC subheader (24 bits for MAC SDU for RLC STATUS PDU with 15 bit LI) + R/R/E/LCID MAC subheader (8 bits for MAC SDU for RLC Data PDU) = 32 bits. The size of RLC STATUS PDU including one ACK_SN field and one NACK_SN field is 32 bits (if no STATUS PDU is sent or if the size of the STATUS PDU is less than 32 bits then padding will be used to fill the 32 bits). This gives:  <math>\text{PDCP SDU size} = 8 \times \text{FLOOR}((\text{TBSize} - \text{N} \times 16 - 8 \times \text{CEIL}[(16 + (\text{N} - 1) \times 12) / 8] - 64) / (8 \times \text{N}))</math> bits.  The calculation of PDCP SDU sizes does not consider timing advance MAC CE as timing advance is not transmitted by SS for RF test cases, and the header sizes are informative and may vary during the test.</p>						

Initial conditions are a set of test configurations the UE needs to be tested in and the steps for the SS to take with the UE to reach the correct measurement state.

Configurations of PDSCH and PDCCH before measurement are specified in Annex C.2.

Test Environment: Normal as defined in TS 36.508 [7] clause 4.1.

Frequencies to be tested: Mid Range as defined in TS 36.508 [7] clause 4.3.1.1.

Channel Bandwidths to be tested: According to Table 8.7.5.2.1.5-1 depending on the UE category according to Table 8.7.5.2.1.5-2.

1. Connect the SS to the UE antenna connector(s) as shown in TS 36.508 [7] Annex A, Figure group A.36 (without using faders and AWGN generators).
2. The parameter settings for the cell are set up according to Table 8.7.5-1 and Table 8.7.5.2.1.5-1 depending on the UE category according to Table 8.7.5.2.1.5-2.
3. Downlink signals are initially set up according to Annex C.0, C.1 and Annex C.3.2 and uplink signals according to Annex H.1 and H.3.2.

4. Propagation conditions are set according to Annex B.0.
5. Ensure the UE is in State 4A-RF according to TS 36.508 [7] clause 4.5.4. Message contents are defined in clause 8.7.5.2.1.4.3.

#### 8.7.5.2.1.4.2 Test procedure

1. Configure SCC according to Annex C.0, C.1 and Annex C.3.2 for all downlink physical channels.
2. The SS shall configure SCC as per TS 36.508 [7] clause 5.2A.4 with SCC configured. PhysicalConfigDedicated-DEFAULT is defined in Table 8.7.5.2.1.4.3-3, PhysicalConfigDedicatedSCell-r10-DEFAULT is defined in Table 8.7.5.2.1.4.3-3A.
3. The SS activates SCC by sending the activation MAC-CE (Refer TS 36.321 [13], clauses 5.13, 6.1.3.8). Wait for at least 2 seconds (Refer TS 36.133, clauses 8.3.3.2).
4. Propagation conditions are set according to Annex B.1 (No external noise sources are applied).
5. The SS looks up  $TB_{size}$  in Table 8.7.5.2.1.4.1-1 for the tests to be performed depending on the UE category according to Table 8.7.5.2.1.5-2.
6. The SS sets the counters,  $N_{DL\_newtx}$ ,  $N_{DL\_retx}$ ,  $N_{UL\_PDCP}$ , and  $N_{DL\_PDCP}$  to 0.
7. For each new DL HARQ transmission the SS generates sufficient PDCP SDUs to fill up the TB in accordance with Table 8.7.5.2.1.4.1-1 (Note 1). The SS ciphers the PDCP SDUs, concatenates the resultant PDCP PDUs to form an RLC PDU and then a MAC PDU. The SS transmits the MAC PDU. The SS increments then  $N_{DL\_newtx}$  by one and  $N_{DL\_PDCP}$  by the number of new PDCP SDUs (Note 1) included in the sent MAC PDU.
8. If PHY requests a DL HARQ retransmission, the SS performs a HARQ retransmission and increments  $N_{DL\_retx}$  by one.
9. Steps 7 to 8 are repeated at every TTI for at least 300 frames and the SS waits for 300ms to let any HARQ retransmissions and RLC retransmissions to finish.
10. For each PDCP SDU received at the SS, if the content of the data matches that of the truncated version of the original PDCP SDU generated at the SS, the SS increments  $N_{UL\_PDCP}$  by one
11. The SS calculates the TB success rate as  $A = 100\% * N_{DL\_newtx} / (N_{DL\_newtx} + N_{DL\_retx})$ . Measurements are not based on UE feedback but on SS counters instead ( $N_{DL\_newtx}$  and  $N_{DL\_retx}$ ) in order to validate HARQ feedback received from the UE.
12. The SS calculates the PDCP SDU loss as  $B = N_{DL\_PDCP} - N_{UL\_PDCP}$
13. The UE passes the test if  $A \geq$  "corresponding TB success rate according to Table 8.7.5.2.1.5-1" and  $B = 0$ .

NOTE 1: In case of RLC PDU retransmission, the number of new required PDCP SDUs is as many as to fill the rest of TB.

#### 8.7.5.2.1.4.3 Message contents

Message contents are according to TS 36.508 [7] clause 4.6 and 4.7A, with the following exceptions:

**Table 8.7.5.2.1.4.3-1: CLOSE UE TEST LOOP (in the preamble)**

Derivation Path: 36.508 clause 4.7A table 4.7A-3 with condition UE TEST LOOP MODE A			
Information Element	Value/remark	Comment	Condition
UE test loop mode A LB setup			
Length of UE test loop mode A LB setup list in bytes	0 0 0 0 0 1 1	Length of one LB setup DRB (3 bytes)	
LB setup DRB	0 0 0 0 0 0 0, 0 0 1 0 1 0 0 0, 0 0 0 Q4 Q3 Q2 Q1 Q0	UL PDCP SDU size = 40 bits (5 bytes) Q4..Q0 = Data Radio Bearer identity number for the default radio bearer. See 36.509 clause 6.1	

**Table 8.7.5.2.1.4.3-2: SecurityModeCommand (in the preamble)**

Derivation Path: TS 36.508 clause 4.6.1 table 4.6.1-19			
Information Element	Value/remark	Comment	Condition
SecurityModeCommand ::= SEQUENCE {			
criticalExtensions CHOICE {			
c1 CHOICE{			
securityModeCommand-r8 SEQUENCE {			
securityConfiguration SEQUENCE {			
cipheringAlgorithm	eea2		
nextHopChainingCount	Not present		
}			
nonCriticalExtension SEQUENCE {}	Not present		
}			
}			
}			
}			

**Table 8.7.5.2.1.4.3-3: PhysicalConfigDedicated-DEFAULT**

Derivation Path: 36.508 clause 5.5.1, Table 5.5.1.2-1			
Information Element	Value/remark	Comment	Condition
PhysicalConfigDedicated-DEFAULT ::= SEQUENCE {			
antennaInfo CHOICE {			
explicitValue ::= SEQUENCE {			
transmissionMode	tm3		Transmission mode 3
codebookSubsetRestriction CHOICE {			
n2TxAntenna-tm3	10		
}			
ue-TransmitAntennaSelection CHOICE {			
release	NULL		
}			
}			
}			
}			

**Table 8.7.5.2.1.4.3-3A: PhysicalConfigDedicatedSCell-r10-DEFAULT**

Derivation Path: 36.508 clause 4.6.3 Table 4.6.3-6A			
Information Element	Value/remark	Comment	Condition
PhysicalConfigDedicatedSCell-r10-DEFAULT ::= SEQUENCE {			
nonUL-Configuration-r10 SEQUENCE {			
antennaInfo-r10 CHOICE {			
transmissionMode-r10	tm3		Transmission mode 3
codebookSubsetRestriction-r10	10		
ue-TransmitAntennaSelection CHOICE {			
release	NULL		
}			
}			
}			

**Table 8.7.5.2.1.4.3-4: TDD-Config-DEFAULT**

Derivation Path: 36.508 clause 4.6			
Information Element	Value/remark	Comment	Condition
TDD-Config-DEFAULT ::= SEQUENCE {			
subframeAssignment	sa1		
specialSubframePatterns	Ssp4		
}			

### 8.7.5.2.1.5 Test requirement

The requirements are specified in Table 8.7.5.2.1.5-1 depending on the UE category according to Table 8.7.5.2.1.5-2. The PDCP SDU success rate shall be sustained during at least 300 frames.

**Table 8.7.5.2.1.5-1: Test requirements per test**

Test number	Bandwidth (MHz)			Number of bits of a DL-SCH transport block received within a TTI (for normal/special subframe for TDD, except for subframe #5)		Measurement channel		Reference value
	Total	FDD CC	TDD CC	FDD CC	TDD CC	FDD CC	TDD CC	
1	2x20	20	20	75376	75376/0	R.31-4 FDD	R.31-4 TDD	[85]
2	10+20	10	20	36696	75376/0	R.31-3A FDD	R.31-4 TDD	[85]
2A	15+20	15	20	55056	75376/0	R.31-5 FDD	R.31-4 TDD	[85]
3	10+10	10	10	36696	36696/0	R.31-3A FDD	R.31-6 TDD	[85]
4	5+10	5	10	18336	36696/0	R.31-6 FDD	R.31-6 TDD	[85]
Note 1:	For 2 layer transmissions, 2 transport blocks are received within a TTI.							
Note 2:	The TB success rate is defined as TB success rate = 100%*NDL_correct_rx/ (NDL_newtx + NDL_retx), where NDL_newtx is the number of newly transmitted DL transport blocks, NDL_retx is the number of retransmitted DL transport blocks, and NDL_correct_rx is the number of correctly received DL transport blocks.							



Table 8.7.5.2.1.5-2: Test applicability per UE category

CA config	Maximum supported Bandwidth/ Bandwidth combination (MHz)			Cat. 1	Cat. 2	Cat. 3	Cat. 4	Cat. 6, 7	Cat. 9,10	Cat 11, 12
	Total	FDD CC	TDD CC							
CA with 2CCs	2x20	20	20	-	-	3	3	1	1	-
	10+20	10	20	-	-	3	3	2	2	-
	15+20	15	20	-	-	3	3	2A	2A	-
	10+10	10	10			3	3	3	3	-
	5+10	5	10	-	-	4	4	4	4	-
Note 1: Only one test point is tested. Select the largest aggregated CA bandwidth combination supported by the UE among the UE supported CA capabilities.										

### 8.7.5.2.2 TDD FDD CA Sustained data rate performance for TDD PCell (3DL CA)

Editor's notes: This test case is incomplete. The following items are missing or incomplete:

- TB success rate requirements are still with square brackets.
- Scheduling of retransmissions needs to be specified.

#### 8.7.5.2.2.1 Test purpose

Same test purpose as in clause 8.7.2.1.

#### 8.7.5.2.2.2 Test applicability

This test applies to all types of UE Release 12 and forward of UE category 6, 7, 9, 10, 11 and 12 that support E-UTRA FDD and TDD, 3DL TDD-FDD CA with TDD as PCell.

#### 8.7.5.2.2.3 Minimum requirements

For UE not supporting 256QAM, the requirements for TDD FDD CA with TDD PCell are specified in Table 8.7.5.2-1 with the additional parameters specified in Table 8.7.5-1, and the downlink physical channel setup according to Annex C.3.2. The test points are applied to UE category and bandwidth combination with maximum aggregated bandwidth as specified in Table 8.7.5.2-2. The TB success rate shall be sustained during at least 300 frames.

The applicability of the requirements are specified in Clause 8.1.2.3B. The test coverage for different number of component carriers is defined in 8.1.2.4.

Table 8.7.5.2-1: test parameters for sustained downlink data rate (TDD FDD CA 64QAM)

Test number	Bandwidth (MHz)			Number of bits of a DL-SCH transport block received within a TTI (for normal/special subframe for TDD, except for subframe #5)		Measurement channel		Reference value
	Total	FDD CC	TDD CC	FDD CC	TDD CC	FDD CC	TDD CC	TB success rate [%]
1	2x20	20	20	75376	75376/0	R.31-4 FDD	R.31-4 TDD	[85]
2	10+20	10	20	36696	75376/0	R.31-3A FDD	R.31-4 TDD	[85]
2A	15+20	15	20	55056	75376/0	R.31-5 FDD	R.31-4 TDD	[85]
3	10+10	10	10	36696	36696/0	R.31-3A FDD	R.31-6 TDD	[85]
4	5+10	5	10	18336	36696/0	R.31-6 FDD	R.31-6 TDD	[85]
5	3x20	20	2x20	75376	75376/0	R.31-4 FDD	R.31-4 TDD	[85]
6	15+20+20	15	2x20	55056	75376/0	R.31-5 FDD	R.31-4 TDD	[85]
7	10+20+20	10	2x20	36696	75376/0	R.31-3A FDD	R.31-4 TDD	[85]

Table 8.7.5.2-2: Test points for sustained data rate (FRC 64QAM)

CA config	Maximum supported Bandwidth/ Bandwidth combination (MHz)			Cat. 1	Cat. 2	Cat. 3	Cat. 4	Cat. 6, 7	Cat. 9,10	Cat 11, 12
	Total	FDD CC	TDD CC							
CA with 3CCs	3x20	20	2x20	-	-	-	-	1	5	5
	15+20+20	15	2x20	-	-	-	-	2A	6	6
	10+20+20	10	2x20	-	-	-	-	2	7	7
Note 1: Void										
Note 2: Void.										

The normative reference for this requirement is TS 36.101[2] clause 8.7.5.2

## 8.7.5.2.2.4 Test description

## 8.7.5.2.2.4.1 Initial conditions

Table 8.7.5.2.2.4.1-1: Further test parameters per test

Test number		1	2	2A	5	6	7
Bandwidth	FDD CC	20	10	15	20	15	10
	TDD CC	20	20	20	2x20	2x20	2x20
DL Measurement channel	FDD CC	R.31-4 FDD	R.31-3A FDD	R.31-5 FDD	R.31-4 FDD	R.31-5 FDD	R.31-3A FDD
	TDD CC	R.31-4 TDD	R.31-4 TDD	R.31-4 TDD	R.31-4 TDD	R.31-4 TDD	R.31-4 TDD
UL channel	FDD CC	NA	NA	NA	NA	NA	NA
	TDD CC	R.1-4 TDD	R.1-4 TDD	R.1-4 TDD	R.1-4 TDD	R.1-4 TDD	R.1-4 TDD
TBSize per Codeword	FDD CC	75376	36696	55056	75376	55056	36696
	TDD CC	75376/0	75376/0	75376/0	75376/0	75376/0	75376/0
Number of PDCP SDU per Codeword	FDD CC	7	4	6	7	6	4
	TDD CC	7	7	7	7	7	7
PDCP SDU size [Octets] Calculation (Note 1)	FDD CC	$\text{FLOOR}((\text{TBSize} - \text{Bsize} - 264)/56)$	$\text{FLOOR}((\text{TBSize} - 184)/32)$	$\text{FLOOR}((\text{TBSize} - 240)/48)$	$\text{FLOOR}((\text{TBSize} - 264)/56)$	$\text{FLOOR}((\text{TBSize} - 240)/48)$	$\text{FLOOR}((\text{TBSize} - 184)/32)$
	TDD CC	$\text{FLOOR}((\text{TBSize} - 264)/56)$	$\text{FLOOR}((\text{TBSize} - 264)/56)$	$\text{FLOOR}((\text{TBSize} - 264)/56)$	$\text{FLOOR}((\text{TBSize} - 264)/56)$	$\text{FLOOR}((\text{TBSize} - 264)/56)$	$\text{FLOOR}((\text{TBSize} - 264)/56)$
PDCP SDU size [Octets]	FDD CC	1341	1141	1142	1341	1142	1141
	TDD CC	1341	1341	1341	1341	1341	1341
<p>Note 1: Transport block size under test according to applicable Fixed Reference Channel for sustained data-rate test in annex A.3.9. In case of varying TBS across SFs of the RMC, only the maximum TBS is used for PDCP SDU size calculation. In case of different resulting PDCP SDU sizes among component carriers, the smaller calculated PDCP SDU size is used across all the carriers.</p> <p>Note 2: Each PDCP SDU is limited to 1500 octets (to keep below maximum SDU size of ESM as specified in TS 24.301 clause 9.9.4.12).  The PDCP SDU size of each PDCP SDU is:  PDCP SDU size = (TBSize – N*PDCP header size - AMD PDU header size - MAC header size - Size of RLC STATUS PDU) / N,  where PDCP header size is 16 bits for the RLC AM and 12-bit SN case; AMD PDU header size is <math>\text{CEIL}[(16+(N-1)*12)/8]</math> bytes which includes 16 bit standard AM header and (N-1) Length indicators; and MAC header size = R/R/E/LCID/F/L MAC subheader (8 bits for MAC SDU for RLC STATUS PDU with 15 bit LI) + R/R/E/LCID MAC subheader (8 bits for MAC SDU for RLC Data PDU) = 32 bits. The size of RLC STATUS PDU including one ACK_SN field and one NACK_SN field is 32 bits (if no STATUS PDU is sent or if the size of the STATUS PDU is less than 32 bits then padding will be used to fill the 32 bits). This gives:  PDCP SDU size = <math>8 * \text{FLOOR}((\text{TBSize} - N * 16 - 8 * \text{CEIL}[(16+(N-1)*12)/8] - 64) / (8 * N))</math> bits.  The calculation of PDCP SDU sizes does not consider timing advance MAC CE as timing advance is not transmitted by SS for RF test cases, and the header sizes are informative and may vary during the test.</p>							

Initial conditions are a set of test configurations the UE needs to be tested in and the steps for the SS to take with the UE to reach the correct measurement state.

Configurations of PDSCH and PDCCH before measurement are specified in Annex C.2.

Test Environment: Normal as defined in TS 36.508 [7] clause 4.1.

Frequencies to be tested: Mid Range as defined in TS 36.508 [7] clause 4.3.1.1.

Channel Bandwidths to be tested: According to Table 8.7.5.2.2.5-1 depending on the UE category according to Table 8.7.5.2.2.5-2.

1. Connect the SS to the UE antenna connector(s) as shown in TS 36.508 [7] Annex A, Figure group A.60 (without using faders and AWGN generators).

2. The parameter settings for the cell are set up according to Table 8.7.5-1 and Table 8.7.5.2.2.5-1 depending on the UE category according to Table 8.7.5.2.2.5-2.
3. Downlink signals are initially set up according to Annex C.0, C.1 and Annex C.3.2 and uplink signals according to Annex H.1 and H.3.2.
4. Propagation conditions are set according to Annex B.0.
5. Ensure the UE is in State 4A-RF according to TS 36.508 [7] clause 4.5.4. Message contents are defined in clause 8.7.5.2.2.4.3.

#### 8.7.5.2.2.4.2 Test procedure

1. Configure SCCs according to Annex C.0, C.1 and Annex C.3.2 for all downlink physical channels.
2. The SS shall configure SCCs as per TS 36.508 [7] clause 5.2A.4 with SCCs configured. PhysicalConfigDedicated-DEFAULT is defined in Table 8.7.5.2.2.4.3-3, PhysicalConfigDedicatedSCell-r10-DEFAULT is defined in Table 8.7.5.2.2.4.3-3A.
3. The SS activates SCCs by sending the activation MAC-CE (Refer TS 36.321 [13], clauses 5.13, 6.1.3.8). Wait for at least 2 seconds (Refer TS 36.133, clauses 8.3.3.2).
4. Propagation conditions are set according to Annex B.1 (No external noise sources are applied).
5. The SS looks up  $TB_{size}$  in Table 8.7.5.2.2.4.1-1 for the tests to be performed depending on the UE category according to Table 8.7.5.2.2.5-2.
6. The SS sets the counters,  $N_{DL\_newtx}$ ,  $N_{DL\_retx}$ ,  $N_{UL\_PDCP}$ , and  $N_{DL\_PDCP}$  to 0.
7. For each new DL HARQ transmission the SS generates sufficient PDCP SDUs to fill up the TB in accordance with Table 8.7.5.2.2.4.1-1 (Note 1). The SS ciphers the PDCP SDUs, concatenates the resultant PDCP PDUs to form an RLC PDU and then a MAC PDU. The SS transmits the MAC PDU. The SS increments then  $N_{DL\_newtx}$  by one and  $N_{DL\_PDCP}$  by the number of new PDCP SDUs (Note 1) included in the sent MAC PDU.
8. If PHY requests a DL HARQ retransmission, the SS performs a HARQ retransmission and increments  $N_{DL\_retx}$  by one.
9. Steps 7 to 8 are repeated at every TTI for at least 300 frames and the SS waits for 300ms to let any HARQ retransmissions and RLC retransmissions to finish.
10. For each PDCP SDU received at the SS, if the content of the data matches that of the truncated version of the original PDCP SDU generated at the SS, the SS increments  $N_{UL\_PDCP}$  by one
11. The SS calculates the TB success rate as  $A = 100\% * N_{DL\_newtx} / (N_{DL\_newtx} + N_{DL\_retx})$ . Measurements are not based on UE feedback but on SS counters instead ( $N_{DL\_newtx}$  and  $N_{DL\_retx}$ ) in order to validate HARQ feedback received from the UE.
12. The SS calculates the PDCP SDU loss as  $B = N_{DL\_PDCP} - N_{UL\_PDCP}$
13. The UE passes the test if  $A \geq$  "corresponding TB success rate according to Table 8.7.5.2.2.5-1" and  $B = 0$ .

NOTE 1: In case of RLC PDU retransmission, the number of new required PDCP SDUs is as many as to fill the rest of TB.

#### 8.7.5.2.2.4.3 Message contents

Message contents are according to TS 36.508 [7] clause 4.6 and 4.7A, with the following exceptions:

**Table 8.7.5.2.2.4.3-1: CLOSE UE TEST LOOP (in the preamble)**

Derivation Path: 36.508 clause 4.7A table 4.7A-3 with condition UE TEST LOOP MODE A			
Information Element	Value/remark	Comment	Condition
UE test loop mode A LB setup			
Length of UE test loop mode A LB setup list in bytes	0 0 0 0 0 0 1 1	Length of one LB setup DRB (3 bytes)	
LB setup DRB	0 0 0 0 0 0 0 0, 0 0 1 0 1 0 0 0, 0 0 0 Q4 Q3 Q2 Q1 Q0	UL PDCP SDU size = 40 bits (5 bytes) Q4..Q0 = Data Radio Bearer identity number for the default radio bearer. See 36.509 clause 6.1	

**Table 8.7.5.2.2.4.3-2: SecurityModeCommand (in the preamble)**

Derivation Path: TS 36.508 clause 4.6.1 table 4.6.1-19			
Information Element	Value/remark	Comment	Condition
SecurityModeCommand ::= SEQUENCE {			
criticalExtensions CHOICE {			
c1 CHOICE{			
securityModeCommand-r8 SEQUENCE {			
securityConfiguration SEQUENCE {			
cipheringAlgorithm	eea2		
nextHopChainingCount	Not present		
}			
nonCriticalExtension SEQUENCE {}	Not present		
}			
}			
}			
}			

**Table 8.7.5.2.2.4.3-3: PhysicalConfigDedicated-DEFAULT**

Derivation Path: 36.508 clause 5.5.1, Table 5.5.1.2-1			
Information Element	Value/remark	Comment	Condition
PhysicalConfigDedicated-DEFAULT ::= SEQUENCE {			
antennaInfo CHOICE {			
explicitValue ::= SEQUENCE {			
transmissionMode	tm3		Transmission mode 3
codebookSubsetRestriction CHOICE {			
n2TxAntenna-tm3	10		
}			
ue-TransmitAntennaSelection CHOICE {			
release	NULL		
}			
}			
}			
}			

**Table 8.7.5.2.2.4.3-3A: PhysicalConfigDedicatedSCell-r10-DEFAULT**

Derivation Path: 36.508 clause 4.6.3 Table 4.6.3-6A			
Information Element	Value/remark	Comment	Condition
PhysicalConfigDedicatedSCell-r10-DEFAULT ::= SEQUENCE {			
nonUL-Configuration-r10 SEQUENCE {			
antennaInfo-r10 CHOICE {			
transmissionMode-r10	tm3		Transmission mode 3
codebookSubsetRestriction-r10	10		
ue-TransmitAntennaSelection CHOICE {			
release	NULL		
}			
}			
}			

**Table 8.7.5.2.2.4.3-4: TDD-Config-DEFAULT**

Derivation Path: 36.508 clause 4.6			
Information Element	Value/remark	Comment	Condition
TDD-Config-DEFAULT ::= SEQUENCE {			
subframeAssignment	sa1		
specialSubframePatterns	Ssp4		
}			

#### 8.7.5.2.2.5 Test requirement

The requirements are specified in Table 8.7.5.2.2.5-1 depending on the UE category according to Table 8.7.5.2.2.5-2. The PDCP SDU success rate shall be sustained during at least 300 frames.

**Table 8.7.5.2.2.5-1: Test requirements per test**

Test number	Bandwidth (MHz)			Number of bits of a DL-SCH transport block received within a TTI (for normal/special subframe for TDD, except for subframe #5)		Measurement channel		Reference value
	Total	FDD CC	TDD CC	FDD CC	TDD CC	FDD CC	TDD CC	TB success rate [%]
1	2x20	20	20	75376	75376/0	R.31-4 FDD	R.31-4 TDD	[85]
2	10+20	10	20	36696	75376/0	R.31-3A FDD	R.31-4 TDD	[85]
2A	15+20	15	20	55056	75376/0	R.31-5 FDD	R.31-4 TDD	[85]
5	3x20	20	2x20	75376	75376/0	R.31-4 FDD	R.31-4 TDD	[85]
6	15+20+20	15	2x20	55056	75376/0	R.31-5 FDD	R.31-4 TDD	[85]
7	10+20+20	10	2x20	36696	75376/0	R.31-3A FDD	R.31-4 TDD	[85]

Table 8.7.5.2.2.5-2: Test applicability per UE category

CA configuration	Maximum supported Bandwidth/ Bandwidth combination (MHz)			Cat. 1	Cat. 2	Cat. 3	Cat. 4	Cat. 6, 7	Cat. 9,10	Cat 11, 12
	Total	FDD CC	TDD CC							
CA	3x20	20	2x20	-	-	-	-	1	5	5
with	15+20+20	15	2x20	-	-	-	-	2A	6	6
3CCs	10+20+20	10	2x20	-	-	-	-	2	7	7

Note 1: Only one test point is tested. Select the largest aggregated CA bandwidth combination supported by the UE among the UE supported CA capabilities.

## 8.8 Demodulation of EPDCCH

### 8.8.1 Distributed Transmission

#### 8.8.1.1 FDD distributed EPDCCH performance

##### 8.8.1.1.1 Test purpose

This test verifies the receiver characteristics of the EPDCCH which are determined by the probability of miss-detection of the Downlink Scheduling Grant (Pm-dsg). EPDCCH and PCFICH are tested jointly, i.e. a miss detection of PCFICH implies a miss detection of EPDCCH.

##### 8.8.1.1.2 Test applicability

This test applies to all types of E-UTRA FDD UE release 11 and forward supporting EPDCCH.

##### 8.8.1.1.3 Minimum conformance requirements

The parameters specified in Table 8.8.1.1.3-1 are valid for all FDD distributed EPDCCH tests unless otherwise stated.

**Table 8.8.1.1.3-1: Test Parameters for Distributed EPDCCH**

Parameter	Unit	Value	
Number of PDCCH symbols	symbols	2 (Note 1)	
PHICH duration		Normal	
Unused RE-s and PRB-s		OCNG	
Cell ID		0	
Downlink power allocation	$\rho_A$	dB	-3
	$\rho_B$	dB	-3
	$\sigma$	dB	0
	$\delta$	dB	3
$N_{oc}$ at antenna port	dBm/15 kHz	-98	
Cyclic prefix		Normal	
Subframe Configuration		Non-MBSFN	
Precoder Update Granularity	PRB	1	
	ms	1	
Beamforming Pre-Coder		Annex B.4.4	
Cell Specific Reference Signal		Port 0 and 1	
Number of EPDCCH Sets Configured		2 (Note 2)	
Number of PRB per EPDCCH Set		4 (1 <sup>st</sup> Set)	
		8 (2 <sup>nd</sup> Set)	
EPDCCH Subframe Monitoring		NA	
PDSCH TM		TM3	
DCI Format		2A	
Note 1:	The starting symbol for EPDCCH is derived from the PCFICH. RRC signalling <i>epdcch-StartSymbol-r11</i> is not configured.		
Note 2:	The two sets are distributed EPDCCH sets and non-overlapping with PRB = {3, 17, 31, 45} for the first set and PRB = {0, 7, 14, 21, 28, 35, 42, 49} for the second set. EPDCCH is scheduled in the first set for Test 1 and second set for Test 2, respectively. Both sets are always configured.		

For the parameters specified in Table 8.8.1.1.3-1 the average probability of a missed downlink scheduling grant ( $P_{m-dsg}$ ) shall be below the specified value in Table 8.8.1.1.3-2. The downlink physical setup is in accordance with Annex C.3.2.

**Table 8.8.1.1.3-2: Minimum performance Distributed EPDCCH**

Test number	Band width	Aggregation level	Reference Channel	OCNG Pattern	Propagation Condition	Antenna configuration and correlation Matrix	Reference value	
							$P_{m-dsg}$ (%)	SNR (dB)
1	10 MHz	4 ECCE	R.55 FDD	OP.7 FDD	EVA5	2 x 2 Low	1	2.6
2	10 MHz	16 ECCE	R.56 FDD	OP.7 FDD	EVA70	2 x 2 Low	1	-3.2

The normative reference for this requirement is TS 36.101 [2] clause 8.8.1.1.

#### 8.8.1.1.4 Test description

##### 8.8.1.1.4.1 Initial conditions

Initial conditions are a set of test configurations the UE needs to be tested in and the steps for the SS to take with the UE to reach the correct measurement state.

Configurations of PDSCH and EPDCCH before measurement are specified in Annex C.2.

Test Environment: Normal, as defined in TS 36.508 [7] clause 4.1.



Frequencies to be tested: Mid Range, as defined in TS 36.508 [7] clause 4.3.1.1.

Channel Bandwidths to be tested: 10MHz, as defined in TS 36.508 [7] clause 4.3.1.1.

1. Connect the SS, the faders and AWGN noise source to the UE antenna connector (s) as shown in TS 36.508 [7] Annex A, Figure A.10.
2. The parameter settings for the cell are set up according to Table 8.8.1.1.3-1.
3. The downlink signals are initially set up according to Annex C.1 and Annex C.3.2 and uplink signals according to Annex H.1 and H.3.2.
4. Propagation conditions are set according to Annex B clause B.0.
5. Ensure the UE is in State 3A-RF according to TS 36.508 [7] clause 5.2A.2. Message contents are defined in clause 8.8.1.1.4.3.

#### 8.8.1.1.4.2 Test procedure

1. SS transmits PDSCH via EPDCCH DCI format 2A for C\_RNTI to transmit the DL RMC according to Table 8.8.1.1.3-2. The details of EPDCCH and PDSCH are specified in Table A.3.10.1-1 and Table A.3.5.1-2 respectively. The SS sends downlink MAC padding bits on the DL RMC.
2. Set the parameters of the propagation condition, antenna configuration, the correlation matrix and the SNR according to Table 8.8.1.1.5-1 as appropriate.
3. Measure the Pm-dsg for a duration sufficient to achieve statistical significance according to Annex G clause G.4. Count the number of NACKs, ACKs and statDTXs on the UL PUCCH during each subtest interval. Pm-dsg is the ratio (statDTX)/(NACK+ACK+statDTX). If Pm-dsg is less than the value specified in table 8.8.1.1.5-1, pass the UE. Otherwise fail the UE.

#### 8.8.1.1.4.3 Message contents

Message contents are according to TS 36.508 [7] clause 4.6 with the following exception:

**Table 8.8.1.1.4.3-1: EPDCCH-Config-r11-DEFAULT**

Derivation Path: 36.508 clause 4.6.3, Table 4.6.3-2B, Condition: FDD
----------------------------------------------------------------------

#### 8.8.1.1.5 Test requirement

For the parameters specified in Table 8.8.1.1.3-1 the average probability of a missed downlink scheduling grant (Pm-dsg) shall be below the specified value in Table 8.8.1.1.5-1.

**Table 8.8.1.1.5-1: Test requirement Distributed EPDCCH**

Test number	Band width	Aggregation level	Reference Channel	OCNG Pattern	Propagation Condition	Antenna configuration and correlation Matrix	Reference value	
							Pm-dsg (%)	SNR (dB)
1	10 MHz	4 ECCE	R.55 FDD	OP.7 FDD	EVA5	2 x 2 Low	1	3.5
2	10 MHz	16 ECCE	R.56 FDD	OP.7 FDD	EVA70	2 x 2 Low	1	-2.3

## 8.8.1.2 TDD distributed EPDCCH performance

### 8.8.1.2.1 Test purpose

This test verifies the receiver characteristics of the EPDCCH which are determined by the probability of miss-detection of the Downlink Scheduling Grant (Pm-dsg). EPDCCH and PCFICH are tested jointly, i.e. a miss detection of PCFICH implies a miss detection of EPDCCH.

### 8.8.1.2.2 Test applicability

This test applies to all types of E-UTRA TDD UE release 11 and forward supporting EPDCCH.

### 8.8.1.2.3 Minimum conformance requirements

The parameters specified in Table 8.8.1.2.3-1 are valid for all TDD distributed EPDCCH tests unless otherwise stated.

**Table 8.8.1.2.3-1: Test Parameters for Distributed EPDCCH**

Parameter		Unit	Value
Number of PDCCH symbols		symbols	2 (Note 1)
PHICH duration			Normal
Unused RE-s and PRB-s			OCNG
Cell ID			0
Downlink power allocation	$\rho_A$	dB	-3
	$\rho_B$	dB	-3
	$\sigma$	dB	0
	$\delta$	dB	3
$N_{oc}$ at antenna port		dBm/15 kHz	-98
Cyclic prefix			Normal
Subframe Configuration			Non-MBSFN
Precoder Update Granularity	PRB		1
	ms		1
Beamforming Pre-Coder			Annex B.4.4
Cell Specific Reference Signal			Port 0 and 1
Number of EPDCCH Sets Configured			2 (Note 2)
Number of PRB per EPDCCH Set			4 (1 <sup>st</sup> Set) 8 (2 <sup>nd</sup> Set)
EPDCCH Subframe Monitoring			NA
PDSCH TM			TM3
DCI Format			2A
TDD UL/DL Configuration			0
TDD Special Subframe			1 (Note 3)
Note 1:	The starting symbol for EPDCCH is derived from the PCFICH. RRC signalling <i>epdcch-StartSymbol-r11</i> is not configured.		
Note 2:	The two sets are distributed EPDCCH sets and non-overlapping with PRB = {3, 17, 31, 45} for the first set and PRB = {0, 7, 14, 21, 28, 35, 42, 49} for the second set. EPDCCH is scheduled in the first set for Test 1 and second set for Test 2, respectively. Both sets are always configured.		
Note 3:	Demodulation performance is averaged over normal and special subframe.		

For the parameters specified in Table 8.8.1.2.3-1 the average probability of a missed downlink scheduling grant (Pm-dsg) shall be below the specified value in Table 8.8.1.2.3-2. The downlink physical setup is in accordance with Annex C.3.2.

**Table 8.8.1.2.3-2: Minimum performance Distributed EPDCCH**

Test number	Band width	Aggregation level	Reference Channel	OCNG Pattern	Propagation Condition	Antenna configuration and correlation Matrix	Reference value	
							Pm-dsg (%)	SNR (dB)
1	10 MHz	4 ECCE	R.55 TDD	OP.7 TDD	EVA5	2 x 2 Low	1	2.8
2	10 MHz	16 ECCE	R.56 TDD	OP.7 TDD	EVA70	2 x 2 Low	1	-3.1

The normative reference for this requirement is TS 36.101 [2] clause 8.8.1.2

#### 8.8.1.2.4 Test description

##### 8.8.1.2.4.1 Initial conditions

Initial conditions are a set of test configurations the UE needs to be tested in and the steps for the SS to take with the UE to reach the correct measurement state.

Configurations of PDSCH and EPDCCH before measurement are specified in Annex C.2.

Test Environment: Normal, as defined in TS 36.508 [7] clause 4.1.

Frequencies to be tested: Mid Range, as defined in TS 36.508 [7] clause 4.3.1.2.

Channel Bandwidths to be tested: 10MHz, as defined in TS 36.508 [7] clause 4.3.1.2.

1. Connect the SS, the faders and AWGN noise source to the UE antenna connector (s) as shown in TS 36.508 [7] Annex A, Figure A.10.
2. The parameter settings for the cell are set up according to 8.8.1.2.3-1.
3. Downlink signals are initially set up according to Annex C0, C.1 and Annex C.3.2 and uplink signals according to Annex H.1 and H.3.2.
4. Propagation conditions are set according to Annex B.0.
5. Ensure the UE is in State 3A-RF according to TS 36.508 [7] clause 5.2A.2. Message contents are defined in clause 8.8.1.2.4.3.

##### 8.8.1.2.4.2 Test procedure

1. SS transmits PDSCH via EPDCCH DCI format 2A for C\_RNTI to transmit the DL RMC according to Table 8.8.1.2.3-2. The details of EPDCCH and PDSCH are specified in Table A.3.10.2-1 and Table A.3.5.2-2 respectively. The SS sends downlink MAC padding bits on the DL RMC.
2. Set the parameters of the propagation condition, the correlation matrix, antenna configuration and the SNR according to Tables 8.8.1.2.5-1 as appropriate.
3. Measure the Pm-dsg for a duration sufficient to achieve statistical significance according to Annex G clause G.4. Count the number of NACKs, ACKs and statDTXs on the UL PUCCH during each subtest interval. Pm-dsg is the ratio (statDTX)/(NACK + ACK + statDTX). If Pm-dsg is less than the value specified in table 8.8.1.2.5-1, pass the UE. Otherwise fail the UE.

##### 8.8.1.2.4.3 Message contents

Message contents are according to TS 36.508 [7] clause 4.6 with the following exception:

**Table 8.8.1.2.4.3-1: EPDCCH-Config-r11-DEFAULT**

Derivation Path: 36.508 clause 4.6.3, Table 4.6.3-2B, Condition: TDD
----------------------------------------------------------------------

Table 8.8.1.2.4.3-2: TDD-Config-DEFAULT

Derivation Path: 36.508 clause 4.6			
Information Element	Value/remark	Comment	Condition
TDD-Config-DEFAULT ::= SEQUENCE {			
subframeAssignment	sa0		
specialSubframePatterns	Ssp1		
}			

### 8.8.1.2.5 Test requirement

For the parameters specified in Table 8.8.1.2.3-1 the average probability of a missed downlink scheduling grant (Pm-dsg) shall be below the specified value in Table 8.8.1.2.5-1.

Table 8.8.1.2.5-1: Test requirement Distributed EPDCCH

Test number	Band width	Aggregation level	Reference Channel	OCNG Pattern	Propagation Condition	Antenna configuration and correlation Matrix	Reference value	
							Pm-dsg (%)	SNR (dB)
1	10 MHz	4 ECCE	R.55 TDD	OP.7 TDD	EVA5	2 x 2 Low	1	3.7
2	10 MHz	16 ECCE	R.56 TDD	OP.7 TDD	EVA70	2 x 2 Low	1	-2.2

## 8.8.2 Localized Transmission with TM9

### 8.8.2.1 FDD localized EPDCCH performance with TM9

Editor's notes: The following items are missing or incomplete:

- Test Tolerance

#### 8.8.2.1.1 Test purpose

This test verifies the receiver characteristics of the EPDCCH which are determined by the probability of miss-detection of the Downlink Scheduling Grant (Pm-dsg). In this test, EPDCCH and PCFICH are not tested jointly.

#### 8.8.2.1.2 Test applicability

This test applies to all types of E-UTRA FDD UE release 11 and forward supporting EPDCCH and FGI bit 103.

#### 8.8.2.1.3 Minimum conformance requirements

The parameters specified in Table 8.8.2.1.3-1 are valid for all FDD TM9 localized ePDCCH tests unless otherwise stated.

Table 8.8.2.1.3-1: Test Parameters for Localized EPDCCH

Parameter		Unit	Value
Number of PDCCH symbols		symbols	1 (Note 1)
EPDCCH starting symbol		symbols	2 (Note 1)
PHICH duration			Normal
Unused RE-s and PRB-s			OCNG
Cell ID			0
Downlink power allocation	$\rho_A$	dB	0
	$\rho_B$	dB	0
	$\sigma$	dB	-3
	$\delta$	dB	0
$N_{oc}$ at antenna port		dBm/15 kHz	-98
Cyclic prefix			Normal
Subframe Configuration			Non-MBSFN
Precoder Update Granularity	PRB		1
	ms		1
Beamforming Pre-Coder			Annex B.4.5
Cell Specific Reference Signal			Port 0 and 1
CSI-RS Reference Signal			Port 15 and 16
CSI-RS reference signal resource configuration			0
CSI reference signal subframe configuration $l_{CSI-RS}$			2
ZP-CSI-RS configuration bitmap			0000010000000000
ZP-CSI-RS subframe configuration $l_{ZP-CSI-RS}$			2
Number of EPDCCH Sets			2 (Note 2)
EPDCCH Subframe Monitoring pattern <i>subframePatternConfig-r11</i>			1111111110 1111111101 1111111011 1111110111 (Note 3)
PDSCH TM			TM9
Note 1: The starting symbol for EPDCCH is signalled with <i>epdcch-StartSymbol-r11</i> . However, CFI is set to 1.			
Note 2: The first set is distributed transmission with PRB = {0, 49} and the second set is localized transmission with PRB = {0, 7, 14, 21, 28, 35, 42, 49}. ePDCCH is scheduled in the second set for all tests.			
Note 3: EPDCCH is scheduled in every SF. UE is required to monitor ePDCCH for UE-specific search space only in SFs configured by <i>subframePatternConfig-r11</i> . Legacy PDCCH is not scheduled.			

For the parameters specified in Table 8.8.2.1.3-1 the average probability of a missed downlink scheduling grant (Pm-dsg) shall be below the specified value in Table 8.8.2.1.3-2. EPDCCH subframe monitoring is configured and the subframe monitoring requirement in EPDCCH restricted subframes is statDTX of 99.9%. The downlink physical setup is in accordance with Annex C.3.2.

Table 8.8.2.1.3-2: Minimum performance Localized EPDCCH with TM9

Test number	Bandwidth	Aggregation level	Reference Channel	OCNG Pattern	Propagation Condition	Antenna configuration and correlation Matrix	Reference value	
							Pm-dsg (%)	SNR (dB)
1	10 MHz	2 ECCE	R.57 FDD	OP.7 FDD	EVA5	2 x 2 Low	1	12.2
2	10 MHz	8 ECCE	R.58 FDD	OP.7 FDD	EVA5	2 x 2 Low	1	2.5

The normative reference for this requirement is TS 36.101 [2] clause 8.8.2.1.

#### 8.8.2.1.4 Test description

##### 8.8.2.1.4.1 Initial conditions

Initial conditions are a set of test configurations the UE needs to be tested in and the steps for the SS to take with the UE to reach the correct measurement state.

Configurations of PDSCH and EPDCCH before measurement are specified in Annex C.2.

Test Environment: Normal, as defined in TS 36.508 [7] clause 4.1.

Frequencies to be tested: Mid Range, as defined in TS 36.508 [7] clause 4.3.1.1.

Channel Bandwidths to be tested: 10MHz, as defined in TS 36.508 [7] clause 4.3.1.1

1. Connect the SS, the faders and AWGN noise source to the UE antenna connector (s) as shown in TS 36.508 [7] Annex A, Figure A.10.
2. The parameter settings for the cell are set up according to Table 8.8.2.1.3-1.
3. The downlink signals are initially set up according to Annex C.1 and Annex C.3.2 and uplink signals according to Annex H.1 and H.3.2.
4. Propagation conditions are set according to Annex B clause B.0.
5. Ensure the UE is in State 3A-RF according to TS 36.508 [7] clause 5.2A.2. Message contents are defined in clause 8.8.2.1.4.3.

##### 8.8.2.1.4.2 Test procedure

1. SS transmits PDSCH via EPDCCH DCI format 2C for C\_RNTI to transmit the DL RMC according to Table 8.8.2.1.3-2. The details of EPDCCH and PDSCH are specified in Table A.3.10.1-1 and Table A.3.5.1-2 respectively. The SS sends downlink MAC padding bits on the DL RMC.
2. Set the parameters of the propagation condition, antenna configuration, the correlation matrix and the SNR according to Table 8.8.2.1.5-1 as appropriate.
3. Measure the Pm-dsg on monitoring subframes for a duration sufficient to achieve statistical significance according to Annex G clause G.4. Count the number of NACKs, ACKs and statDTXs on the UL PUCCH during each subtest interval for monitoring subframes. Pm-dsg is the ratio (statDTX)/(NACK+ACK+statDTX). Also, count the number of statDTX on the UL PUCCH for unmonitoring subframes and calculate the ratio of (number of statDTX on the UL PUCCH for unmonitoring subframes)/(the number of configured unmonitoring subframes). If Pm-dsg is less than the value specified in table 8.8.2.1.5-1 and the ratio of statDTX on the UL PUCCH for unmonitoring subframes is no less than 99.9%+TT, pass the UE. Otherwise fail the UE.

##### 8.8.2.1.4.3 Message contents

Message contents are according to TS 36.508 [7] clause 4.6 with the following exception:

**Table 8.8.2.1.4.3-1: EPDCCH-Config-r11-DEFAULT**

Derivation Path: 36.508 clause 4.6.3, Table 4.6.3-2B, condition: FDD, TM9
---------------------------------------------------------------------------

**Table 8.8.2.1.4.3-2: PhysicalConfigDedicated-DEFAULT**

Derivation Path: 36.331 clause 6.3.2			
Information Element	Value/remark	Comment	Condition
PhysicalConfigDedicated-DEFAULT ::= SEQUENCE {			
antennaInfo	Not present		
antennaInfo-r10 CHOICE {			
antennaInfoDedicated-r10 ::= SEQUENCE {			
transmissionMode-r10	tm9-v1020		
codebookSubsetRestriction-r10	111111		
ue-TransmitAntennaSelection CHOICE {			
release	NULL		
}			
}			
}			

### 8.8.2.1.5 Test requirement

For the parameters specified in Table 8.8.2.1.3-1 the average probability of a missed downlink scheduling grant (Pm-dsg) shall be below the specified value in Table 8.8.2.1.5-1. EPDCCH subframe monitoring is configured and the subframe monitoring requirement in EPDCCH restricted subframes is no less than statDTX of 99.9%+TT.

**Table 8.8.2.1.5-1: Test requirement localized EPDCCH with TM9**

Test number	Bandwidth	Aggregation level	Reference Channel	OCNG Pattern	Propagation Condition	Antenna configuration and correlation Matrix	Reference value	
							Pm-dsg (%)	SNR (dB)
1	10 MHz	2 ECCE	R.57 FDD	OP.7 FDD	EVA5	2 x 2 Low	1	13.1
2	10 MHz	8 ECCE	R.58 FDD	OP.7 FDD	EVA5	2 x 2 Low	1	3.4

### 8.8.2.2 TDD localized EPDCCH performance with TM9

**Editor's notes:** The following items are missing or incomplete:

- **Test Tolerance**

#### 8.8.2.2.1 Test purpose

This test verifies the receiver characteristics of the EPDCCH which are determined by the probability of miss-detection of the Downlink Scheduling Grant (Pm-dsg). In this test, EPDCCH and PCFICH are not tested jointly.

#### 8.8.2.2.2 Test applicability

This test applies to all types of E-UTRA TDD UE release 11 and forward supporting EPDCCH and FGI bit 103.

#### 8.8.2.2.3 Minimum conformance requirements

The parameters specified in Table 8.8.2.2.3-1 are valid for all TDD TM9 localized ePDCCH tests unless otherwise stated.

Table 8.8.2.3-1: Test Parameters for Localized EPDCCH with TM9

Parameter		Unit	Value
Number of PDCCH symbols		symbols	1 (Note 1)
EPDCCH starting symbol		symbols	2 (Note 1)
PHICH duration			Normal
Unused RE-s and PRB-s			OCNG
Cell ID			0
Downlink power allocation	$\rho_A$	dB	0
	$\rho_B$	dB	0
	$\sigma$	dB	-3
	$\delta$	dB	0
$N_{oc}$ at antenna port		dBm/15 kHz	-98
Cyclic prefix			Normal
Subframe Configuration			Non-MBSFN
Precoder Update Granularity	PRB		1
	ms		1
Beamforming Pre-Coder			Annex B.4.5
Cell Specific Reference Signal			Port 0 and 1
CSI-RS Reference Signal			Port 15 and 16
CSI-RS reference signal resource configuration			0
CSI reference signal subframe configuration $l_{CSI-RS}$			0
ZP-CSI-RS configuration bitmap			0000010000000000
ZP-CSI-RS subframe configuration $l_{ZP-CSI-RS}$			0
Number of EPDCCH Sets			2 (Note 2)
EPDCCH Subframe Monitoring pattern <i>subframePatternConfig-r11</i>			1100011000 1100010000 1100011000 1100001000 1100011000 1000011000 1100011000 (Note 3)
PDSCH TM			TM9
TDD UL/DL Configuration			0
TDD Special Subframe			1 (Note 4)
Note 1: The starting symbol for EPDCCH is signalled with <i>epdcch-StartSymbol-r11</i> . However, CFI is set to 1.			
Note 2: The first set is distributed transmission with PRB = {0, 49} and the second set is localized transmission with PRB = {0, 7, 14, 21, 28, 35, 42, 49}. ePDCCH is scheduled in the second set for all tests.			
Note 3: EPDCCH is scheduled in every SF. UE is required to monitor ePDCCH for UE-specific search space only in SFs configured by <i>subframePatternConfig-r11</i> . Legacy PDCCH is not scheduled.			
Note 4: Demodulation performance is averaged over normal and special subframe.			

For the parameters specified in Table 8.8.2.3-1 the average probability of a missed downlink scheduling grant (Pm-dsg) shall be below the specified value in Table 8.8.2.3-2. EPDCCH subframe monitoring is configured and the subframe monitoring requirement in EPDCCH restricted subframes is statDTX of 99.9%.

The downlink physical setup is in accordance with Annex C.3.2.

Table 8.8.2.3-2: Minimum performance Localized EPDCCH with TM9

Test number	Band width	Aggregation level	Reference Channel	OCNG Pattern	Propagation Condition	Antenna configuration and correlation Matrix	Reference value	
							Pm-dsg (%)	SNR (dB)
1	10 MHz	2 ECCE	R.57 TDD	OP.7 TDD	EVA5	2 x 2 Low	1	12.8
2	10 MHz	8 ECCE	R.58 TDD	OP.7 TDD	EVA5	2 x 2 Low	1	2.0

The normative reference for this requirement is TS 36.101 [2] clause 8.8.2.2.



## 8.8.2.2.4 Test description

## 8.8.2.2.4.1 Initial conditions

Initial conditions are a set of test configurations the UE needs to be tested in and the steps for the SS to take with the UE to reach the correct measurement state.

Configurations of PDSCH and EPDCCH before measurement are specified in Annex C.2.

Test Environment: Normal, as defined in TS 36.508 [7] clause 4.1.

Frequencies to be tested: Mid Range, as defined in TS 36.508 [7] clause 4.3.1.2.

Channel Bandwidths to be tested: 10MHz, as defined in TS 36.508 [7] clause 4.3.1.2.

1. Connect the SS, the faders and AWGN noise source to the UE antenna connector (s) as shown in TS 36.508 [7] Annex A, Figure A.10.
2. The parameter settings for the cell are set up according to 8.8.2.2.3-1.
3. Downlink signals are initially set up according to Annex C0, C.1 and Annex C.3.2 and uplink signals according to Annex H.1 and H.3.2.
4. Propagation conditions are set according to Annex B.0.
5. Ensure the UE is in State 3A-RF according to TS 36.508 [7] clause 5.2A.2. Message contents are defined in clause 8.8.2.2.4.3.

## 8.8.2.2.4.2 Test procedure

1. SS transmits PDSCH via EPDCCH DCI format 2C for C\_RNTI to transmit the DL RMC according to Table 8.8.2.2.3-2. The details of EPDCCH and PDSCH are specified in Table A.3.10.2-1 and Table A.3.5.2-2 respectively. The SS sends downlink MAC padding bits on the DL RMC.
2. Set the parameters of the propagation condition, the correlation matrix, antenna configuration and the SNR according to Tables 8.8.2.2.5-1 as appropriate.
3. Measure the Pm-dsg on monitoring subframes for a duration sufficient to achieve statistical significance according to Annex G clause G.4. Count the number of NACKs, ACKs and statDTXs on the UL PUCCH during each subtest interval for monitoring subframes. Pm-dsg is the ratio (statDTX)/(NACK+ACK+statDTX). Also, count the number of statDTX on the UL PUCCH for unmonitoring subframes and calculate the ratio of (number of statDTX on the UL PUCCH for unmonitoring subframes)/(the number of configured unmonitoring subframes). If Pm-dsg is less than the value specified in table 8.8.2.2.5-1 and the ratio of statDTX on the UL PUCCH for unmonitoring subframes is no less than 99.9%+TT, pass the UE. Otherwise fail the UE.

## 8.8.2.2.4.3 Message contents

Message contents are according to TS 36.508 [7] clause 4.6 with the following exception:.

**Table 8.8.2.2.4.3-1: EPDCCH-Config-r11-DEFAULT**

Derivation Path: 36.508 clause 4.6.3, Table 4.6.3-2B, condition: TDD, TM9
---------------------------------------------------------------------------

**Table 8.8.2.2.4.3-2: TDD-Config-DEFAULT**

Derivation Path: 36.508 clause 4.6			
Information Element	Value/remark	Comment	Condition
TDD-Config-DEFAULT ::= SEQUENCE {			
subframeAssignment	sa0		
specialSubframePatterns	ssp1		
}			

**Table 8.8.2.2.4.3-3: PhysicalConfigDedicated-DEFAULT**

Derivation Path: 36.331 clause 6.3.2			
Information Element	Value/remark	Comment	Condition
PhysicalConfigDedicated-DEFAULT ::= SEQUENCE {			
antennaInfo	Not present		
antennaInfo-r10 CHOICE {			
antennaInfoDedicated-r10 ::= SEQUENCE {			
transmissionMode-r10	tm9-v1020		
codebookSubsetRestriction-r10	111111		
ue-TransmitAntennaSelection CHOICE {			
release	NULL		
}			
}			
}			

### 8.8.2.2.5 Test requirement

For the parameters specified in Table 8.8.2.2.3-1 the average probability of a missed downlink scheduling grant (Pm-dsg) shall be below the specified value in Table 8.8.2.2.5-1. EPDCCH subframe monitoring is configured and the subframe monitoring requirement in EPDCCH restricted subframes is no less than statDTX of 99.9%+TT.

**Table 8.8.2.2.5-1: Test requirement Localized EPDCCH with TM9**

Test number	Band width	Aggregation level	Reference Channel	OCNG Pattern	Propagation Condition	Antenna configuration and correlation Matrix	Reference value	
							Pm-dsg (%)	SNR (dB)
1	10 MHz	2 ECCE	R.57 TDD	OP.7 TDD	EVA5	2 x 2 Low	1	13.7
2	10 MHz	8 ECCE	R.58 TDD	OP.7 TDD	EVA5	2 x 2 Low	1	2.9

## 8.8.3 Localized transmission with TM10 Type B quasi co-location type

### 8.8.3.1 FDD localized EPDCCH transmission with TM10 Type B quasi co-location type

#### 8.8.3.1.1 Test purpose

This test verifies the receiver characteristics of the EPDCCH which are determined by the probability of miss-detection of the Downlink Scheduling Grant (Pm-dsg). In this test, EPDCCH and PCFICH are not tested jointly.

#### 8.8.3.1.2 Test applicability

This test applies to all types of E-UTRA FDD UE release 11 and forward supporting EPDCCH with multiple CSI processes on a component carrier within a band with PDSCH transmission mode 10.

#### 8.8.3.1.3 Minimum conformance requirements

For the parameters specified in Table 8.8.3.1.3-1 the average probability of a missed downlink scheduling grant (Pm-dsg) shall be below the specified value in Table 8.8.3.1.3-2. In Table 8.8.3.1.3-1, transmission point 1 (TP 1) is the serving cell. The downlink physical setup is accordance with Annex C.3.2.

**Table 8.8.3.1.3-1: Test Parameters for Localized Transmission TM10 Type B quasi co-location type**

Parameter		Unit	Test 1		Test 2	
			TP 1	TP 2	TP 1	TP 2
PHICH duration			Normal			
Downlink power allocation	$\rho_A$	dB	0			
	$\rho_B$	dB	0			
	$\sigma$	dB	-3			
	$\delta$	dB	0			
$\hat{E}_s/N_{oc}$		dB	0dB power imbalance is considered between TP 1 and TP 2,	Reference value in Table 8.8.3.1.3-2	Reference value in Table 8.8.3.1.3-2	Reference value in Table 8.8.3.1.3-2
$N_{oc}$ at antenna port		dBm/15kHz	-98			
Bandwidth		MHz	10	10	10	10
Number of configured EPDCCH Sets			2 (Note 1)		2 (Note1)	
EPDCCH-PRB-Set ID (setConfigId)			0	1	0	1
Transmission type of EPDCCH-PRB-set			Localized	Localized	Localized	Localized
Number of PRB pair per EPDCCH-PRB-set		PRB	8	8	8	8
EPDCCH beamforming model			Annex B.4.5	Annex B.4.5	Annex B.4.5	Annex B.4.5
PDSCH transmission mode			TM10	TM10	TM10	TM10
PDSCH transmission scheduling			Blanked in all the subframes	Transmit in all the subframes	Probability of occurrence of PDSCH transmission is 30% (Note 3)	Probability of occurrence of PDSCH transmission is 70% (Note 3)
Non-zero power CSI reference signal (NZPId=1)	CSI reference signal configuration		N/A	0	N/A	0
	CSI reference signal subframe configuration $I_{CSI-RS}$		N/A	2	N/A	2
Non-zero power CSI reference signal (NZPId=2)	CSI reference signal configuration		N/A	N/A	10	N/A
	CSI reference signal subframe configuration $I_{CSI-RS}$		N/A	N/A	2	N/A
Zero power CSI reference signal (ZPId=1)	CSI-RS Configuration list (ZeroPowerCSI-RS bitmap)	Bitmap	N/A	000001000000000	N/A	100001000000000
	CSI-RS subframe configuration $I_{CSI-RS}$		N/A	2	N/A	2
Zero power CSI reference signal (ZPId=2)	CSI-RS Configuration list (ZeroPowerCSI-RS bitmap)	Bitmap	N/A	N/A	100001000000000	N/A
	CSI-RS subframe configuration $I_{CSI-RS}$		N/A	N/A	2	N/A
PQI set 0 (Note 4)	Non-Zero power CSI RS Identity (NZPId)		N/A	1	N/A	1

	Zero power CSI RS Identity (ZPId)		N/A	1	N/A	1
PQI set 1 (Note 4)	Non-Zero power CSI RS Identity (NZPId)		N/A	N/A	2	N/A
	Zero power CSI RS Identity (ZPId)		N/A	N/A	2	N/A
Number of PDCCH symbols	Symbols	1 (Note 2)				
EPDCCH starting position		pdsch-Start-r11=2 (Note 2)	pdsch-Start-r11=2 (Note 2)	pdsch-Start-r11=2 (Note 2)	pdsch-Start-r11=2 (Note 2)	
Subframe configuration		Non-MBSFN	Non-MBSFN	Non-MBSFN	Non-MBSFN	
Time offset between TPs	$\mu$ s	N/A	2	N/A	2	
Frequency shift between TPs	Hz	N/A	200	N/A	200	
Cell ID		0	126	0	126	
Note 1:	Resource blocks $n_{PRB} = 0, 7, 14, 21, 28, 35, 42, 49$ are allocated for both the first set and the second set.					
Note 2:	The starting OFDM symbol for EPDCCH is determined from the higher layer signalling pdsch-Start-r11. And CFI is set to 1.					
Note 3:	The TP from which PDSCH is transmitted shall be randomly determined independently for each subframe. Probabilities of occurrence of PDSCH transmission from TP 1 and TP 2 are specified.					
Note 4:	For PQI set 0, PDSCH and EPDCCH are transmitted from TP 2. For PQI set 1, PDSCH and EPDCCH are transmitted from TP1. EPDCCH and PDSCH are transmitted from same TP.					

Table 8.8.3.1.3-2: Minimum Performance

Test number	Aggregation level	Reference Channel	OCNG Pattern	Propagation Condition	Antenna configuration and correlation Matrix	Reference value	
						Pm-dsg (%)	SNR (dB)
1	2 ECCE	R.59 FDD	OP.7 FDD	EVA5	2 x 2 Low	1	13.4
2	2 ECCE	R.59 FDD	OP.7 FDD	EVA5	2 x 2 Low	1	13.4

The normative reference for this requirement is TS 36.101 [2] clause 8.8.3.1.

#### 8.8.3.1.4 Test description

##### 8.8.3.1.4.1 Initial conditions

Initial conditions are a set of test configurations the UE needs to be tested in and the steps for the SS to take with the UE to reach the correct measurement state.

Configurations of PDSCH and EPDCCH before measurement are specified in Annex C.2.

Test Environment: Normal, as defined in TS 36.508 [7] clause 4.1.

Frequencies to be tested: Mid Range, as defined in TS 36.508 [7] clause 4.3.1.1.

Channel Bandwidths to be tested: 10MHz, as defined in TS 36.508 [7] clause 4.3.1.1.

1. Connect the SS, the faders and AWGN noise source to the UE antenna connector (s) as shown in TS 36.508 [7] Annex A, Figure A.40.
2. The parameter settings for the cell are set up according to Table 8.8.3.1.3-1.
3. The downlink signals are initially set up according to Annex C.1 and Annex C.3.2 and uplink signals according to Annex H.1 and H.3.2.
4. Propagation conditions are set according to Annex B clause B.0.
5. Ensure the UE is in State 3A-RF according to TS 36.508 [7] clause 5.2A.2. Message contents are defined in clause 8.8.3.1.4.3.

#### 8.8.3.1.4.2 Test procedure

1. SS transmits PDSCH via EPDCCH DCI format 2D for C\_RNTI to transmit the DL RMC according to Table 8.8.3.1.3-2. The details of EPDCCH and PDSCH are specified in Table A.3.10.1-1 and Table A.3.5.1-2 respectively. The SS sends downlink MAC padding bits on the DL RMC.
2. Set the parameters of the propagation condition, antenna configuration, the correlation matrix and the SNR according to Table 8.8.3.1.5-1 as appropriate.
3. Measure the Pm-dsg for a duration sufficient to achieve statistical significance according to Annex G clause G.4. Count the number of NACKs, ACKs and statDTXs on the UL PUCCH during each subtest interval. Pm-dsg is the ratio (statDTX)/(NACK+ACK+statDTX). If Pm-dsg is less than the value specified in table 8.8.3.1.5-1, pass the UE. Otherwise fail the UE.

#### 8.8.3.1.4.3 Message contents

Message contents are according to TS 36.508 [7] clause 4.6 with the following exception:

**Table 8.8.3.1.4.3-1: EPDCCH-Config-r11-DEFAULT**

Derivation Path: 36.508 clause 4.6.3, Table 4.6.3-2B, Condition: FDD, TM10
----------------------------------------------------------------------------

Table 8.8.3.1.4.3-2: PDSCH-ConfigDedicated-v1130

Derivation Path: 36.508 clause 4.6.3, Table 4.6.3-6AA			
Information Element	Value/remark	Comment	Condition
PDSCH-ConfigDedicated-v1130 ::= SEQUENCE {			
dmrs-ConfigPDSCH-r11	DMRS-Config-r11-DEFAULT		
qcl-Operation	typeB		
re-MappingQCLConfigToReleaseList-r11	Not present		
re-MappingQCLConfigToAddModList-r11	2 entries		
SEQUENCE (SIZE (1..maxRE-MapQCL-r11)) OF SEQUENCE {			
pdsch-RE-MappingQCL-ConfigId-r11[1]	0		
optionalSetOfFields-r11[1] SEQUENCE {			
crs-PortsCount-r11	n2		
crs-FreqShift-r11	0		
mbsfn-SubframeConfigList-r11 CHOICE {			
release	NULL		
setup SEQUENCE {			
subframeConfigList	Not present		
}			
}			
pdsch-Start-r11	n2		
}			
csi-RS-ConfigZPId-r11[1]	1		
qcl-CSIRS-ConfigNZPId-r11[1]	1		
pdsch-RE-MappingQCL-ConfigId-r11[2]	2		
optionalSetOfFields-r11[2] SEQUENCE {			
crs-PortsCount-r11	n2		
crs-FreqShift-r11	0		
mbsfn-SubframeConfigList-r11 CHOICE {			
release	Null		
setup SEQUENCE {			
subframeConfigList	Not present		
}			
}			
pdsch-Start-r11	n2		
}			
csi-RS-ConfigZPId-r11[2]	2		
qcl-CSIRS-ConfigNZPId-r11[2]	2		
}			
}			
}			

Table 8.8.3.1.4.3-3: PhysicalConfigDedicated-DEFAULT

Derivation Path: 36.331 clause 6.3.2			
Information Element	Value/remark	Comment	Condition
PhysicalConfigDedicated-DEFAULT ::= SEQUENCE {			
antennaInfo	Not present		
antennaInfo-r10 CHOICE {			
antennaInfoDedicated-r10 ::= SEQUENCE {			
transmissionMode-r10	tm10-v1130		
codebookSubsetRestriction-r10	FFS		
ue-TransmitAntennaSelection CHOICE {			
release	NULL		
}			
}			
}			
}			
}			

### 8.8.3.1.5 Test requirement

For the parameters specified in Table 8.8.3.1.3-1 the average probability of a missed downlink scheduling grant (Pm-dsg) shall be below the specified value in Table 8.8.3.1.5-1.

**Table 8.8.3.1.5-1: Test Performance**

Test number	Aggregation level	Reference Channel	OCNG Pattern	Propagation Condition	Antenna configuration and correlation Matrix	Reference value	
						Pm-dsg (%)	SNR (dB)
1	2 ECCE	R.59 FDD	OP.7 FDD	EVA5	2 x 2 Low	1	14.3
2	2 ECCE	R.59 FDD	OP.7 FDD	EVA5	2 x 2 Low	1	14.3

### 8.8.3.2 TDD localized EPDCCH transmission with TM10 Type B quasi co-location type

#### 8.8.3.2.1 Test purpose

This test verifies the receiver characteristics of the EPDCCH which are determined by the probability of miss-detection of the Downlink Scheduling Grant (Pm-dsg). In this test, EPDCCH and PCFICH are not tested jointly.

#### 8.8.3.2.2 Test applicability

This test applies to all types of E-UTRA TDD UE release 11 and forward supporting EPDCCH with multiple CSI processes on a component carrier within a band with PDSCH transmission mode 10.

#### 8.8.3.2.3 Minimum conformance requirements

For the parameters specified in Table 8.8.3.2.3-1 the average probability of a missed downlink scheduling grant (Pm-dsg) shall be below the specified value in Table 8.8.3.2.3-2. In Table 8.8.3.2.3-1, transmission point 1 (TP1) is the serving cell. The downlink physical setup is accordance with Annex C.3.2.

Table 8.8.3.2.3-1: Test Parameters for Localized Transmission TM10 Type B quasi co-location type

Parameter		Unit	Test 1		Test 2	
			TP 1	TP 2	TP 1	TP 2
PHICH duration			Normal			
Downlink power allocation	$\rho_A$	dB	0			
	$\rho_B$	dB	0			
	$\sigma$	dB	-3			
	$\delta$	dB	0			
$\hat{E}_s/N_{oc}$		dB	0dB power imbalance is considered between TP 1 and TP 2,	Reference value in Table 8.8.3.2.3-2	Reference value in Table 8.8.3.2.3-2	Reference value in Table 8.8.3.2.3-2
$N_{oc}$ at antenna port		dBm/15kHz	-98			
Bandwidth		MHz	10	10	10	10
Number of EPDCCH Sets			2 (Note 1)		2 (Note1)	
EPDCCH-PRB-Set ID (setConfigId)			0	1	0	1
Transmission type of EPDCCH-PRB-set			Localized	Localized	Localized	Localized
Number of PRB pair per EPDCCH-PRB-set		PRB	8	8	8	8
EPDCCH beamforming model			Annex B.4.5	Annex B.4.5	Annex B.4.5	Annex B.4.5
PDSCH transmission mode			TM10	TM10	TM10	TM10
PDSCH transmission scheduling			Blanked in all the subframes	Transmit in all the subframes	Probability of occurrence of PDSCH transmission is 30% (Note 3)	Probability of occurrence of PDSCH transmission is 70% (Note 3)
CSI reference signal configurations			Antenna ports 15,16	Antenna ports 15,16	Antenna ports 15,16	Antenna ports 15,16
Non-zero power CSI reference signal (NZPId=1)	CSI reference signal configuration		N/A	0	N/A	0
	CSI reference signal subframe configuration $l_{CSI-RS}$		N/A	0	N/A	0
Non-zero power CSI reference signal (NZPId=2)	CSI reference signal configuration		N/A	N/A	10	N/A
	CSI reference signal subframe configuration $l_{CSI-RS}$		N/A	N/A	0	N/A
Zero power CSI reference signal (ZPId=1)	CSI-RS Configuration list (ZeroPowerCSI-RS bitmap)	Bitmap	N/A	000001000000000	N/A	100001000000000
	CSI-RS subframe configuration $l_{CSI-RS}$		N/A	0	N/A	0
Zero power CSI reference signal (ZPId=2)	CSI-RS Configuration list (ZeroPowerCSI-RS bitmap)	Bitmap	N/A	N/A	100001000000000	N/A
	CSI-RS subframe configuration $l_{CSI-RS}$		N/A	N/A	0	N/A



PQI set 0 (Note 4)	Non-Zero power CSI RS Identity (NZPId)		N/A	1	N/A	1
	Zero power CSI RS Identity (ZPId)		N/A	1	N/A	1
PQI set 1 (Note 4)	Non-Zero power CSI RS Identity (NZPId)		N/A	N/A	2	N/A
	Zero power CSI RS Identity (ZPId)		N/A	N/A	2	N/A
Number of PDCCH symbols	Symbols	1 (Note 2)				
EPDCCH starting position		pdsch-Start-r11=2 (Note 2)	pdsch-Start-r11=2 (Note 2)	pdsch-Start-r11=2 (Note 2)	pdsch-Start-r11=2 (Note 2)	
Subframe configuration		Non-MBSFN	Non-MBSFN	Non-MBSFN	Non-MBSFN	
Time offset between TPs	$\mu$ s	N/A	2	N/A	2	
Frequency shift between TPs	Hz	N/A	200	N/A	200	
Cell ID		0	126	0	126	
TDD UL/DL configuration		0				
TDD special subframe		1				
Note 1:	Resource blocks $n_{PRB} = 0, 7, 14, 21, 28, 35, 42, 49$ are allocated for both the first set and the second set.					
Note 2:	The starting OFDM symbol for EPDCCH is determined from the higher layer signalling pdsch-Start-r11. And CFI is set to 1.					
Note 3:	The TP from which PDSCH is transmitted shall be randomly determined independently for each subframe. Probabilities of occurrence of PDSCH transmission from TP 1 and TP 2 are specified.					
Note 4:	For PQI set 0, PDSCH and EPDCCH are transmitted from TP 2. For PQI set 1, PDSCH and EPDCCH are transmitted from TP1. EPDCCH and PDSCH are transmitted from same TP.					

Table 8.8.3.2.3-2: Minimum Performance

Test number	Aggregation level	Reference Channel	OCNG Pattern	Propagation Condition	Antenna configuration and correlation Matrix	Reference value	
						Pm-dsg (%)	SNR (dB)
1	2 ECCE	R.59 TDD	OP.7 TDD	EVA5	2 x 2 Low	1	13.6
2	2 ECCE	R.59 TDD	OP.7 TDD	EVA5	2 x 2 Low	1	13.6

The normative reference for this requirement is TS 36.101 [2] clause 8.8.3.2.

### 8.8.3.2.4 Test description

#### 8.8.3.2.4.1 Initial conditions

Initial conditions are a set of test configurations the UE needs to be tested in and the steps for the SS to take with the UE to reach the correct measurement state.

Configurations of PDSCH and EPDCCH before measurement are specified in Annex C.2.

Test Environment: Normal, as defined in TS 36.508 [7] clause 4.1.

Frequencies to be tested: Mid Range, as defined in TS 36.508 [7] clause 4.3.1.2.

Channel Bandwidths to be tested: 10MHz, as defined in TS 36.508 [7] clause 4.3.1.2.

1. Connect the SS, the faders and AWGN noise source to the UE antenna connector (s) as shown in TS 36.508 [7] Annex A, Figure A.40.
2. The parameter settings for the cell are set up according to 8.8.3.2.3-1.
3. Downlink signals are initially set up according to Annex C0, C.1 and Annex C.3.2 and uplink signals according to Annex H.1 and H.3.2.

4. Propagation conditions are set according to Annex B.0.
5. Ensure the UE is in State 3A-RF according to TS 36.508 [7] clause 5.2A.2. Message contents are defined in clause 8.8.3.2.4.3.

#### 8.8.3.2.4.2 Test procedure

1. SS transmits PDSCH via EPDCCH DCI format 2D for C\_RNTI to transmit the DL RMC according to Table 8.8.3.2.3-2. The details of EPDCCH and PDSCH are specified in Table A.3.10.2-1 and Table A.3.5.2-2 respectively. The SS sends downlink MAC padding bits on the DL RMC.
2. Set the parameters of the propagation condition, the correlation matrix, antenna configuration and the SNR according to Table 8.8.3.2.5-1 as appropriate.
3. Measure the Pm-dsg for a duration sufficient to achieve statistical significance according to Annex G clause G.4. Count the number of NACKs, ACKs and statDTXs on the UL PUCCH during each subtest interval. Pm-dsg is the ratio (statDTX)/(NACK + ACK + statDTX). If Pm-dsg is less than the value specified in table 8.8.3.2.5-1 pass the UE. Otherwise fail the UE.

#### 8.8.3.2.4.3 Message contents

Message contents are according to TS 36.508 [7] clause 4.6 with the following exception:

**Table 8.8.3.2.4.3-1: EPDCCH-Config-r11-DEFAULT**

Derivation Path: 36.508 clause 4.6.3, Table 4.6.3-2B, Condition: TDD, TM10
----------------------------------------------------------------------------

**Table 8.8.3.2.4.3-2: PDSCH-ConfigDedicated-v1130-DEFAULT**

Derivation Path: 36.508 clause 4.6.3, Table 4.6.3-6AA			
Information Element	Value/remark	Comment	Condition
PDSCH-ConfigDedicated-v1130 ::= SEQUENCE {			
dmrs-ConfigPDSCH-r11	DMRS-Config-r11-DEFAULT		
qcl-Operation	typeB		
re-MappingQCLConfigToReleaseList-r11	Not present		
re-MappingQCLConfigToAddModList-r11	2 entries		
SEQUENCE (SIZE (1..maxRE-MapQCL-r11)) OF SEQUENCE {			
pdsch-RE-MappingQCL-ConfigId-r11[1]	0		
optionalSetOfFields-r11[1] SEQUENCE {			
crs-PortsCount-r11	n2		
crs-FreqShift-r11	0		
mbsfn-SubframeConfigList-r11 CHOICE {			
release	NULL		
setup SEQUENCE {			
subframeConfigList	Not present		
}			
}			
pdsch-Start-r11	n2		
}			
csi-RS-ConfigZPId-r11[1]	1		
qcl-CSIRS-ConfigNZPId-r11[1]	1		
pdsch-RE-MappingQCL-ConfigId-r11[2]	2		
optionalSetOfFields-r11[2] SEQUENCE {			
crs-PortsCount-r11	n2		
crs-FreqShift-r11	0		
mbsfn-SubframeConfigList-r11 CHOICE {			
release	NULL		
setup SEQUENCE {			
subframeConfigList	Not present		
}			
}			
pdsch-Start-r11	n2		
}			
csi-RS-ConfigZPId-r11[2]	2		
qcl-CSIRS-ConfigNZPId-r11[2]	2		
}			
}			

**Table 8.8.3.2.4.3-3: PhysicalConfigDedicated-DEFAULT**

Derivation Path: 36.331 clause 6.3.2			
Information Element	Value/remark	Comment	Condition
PhysicalConfigDedicated-DEFAULT ::= SEQUENCE {			
antennaInfo	Not present		
antennaInfo-r10 CHOICE {			
antennaInfoDedicated-r10 ::= SEQUENCE {			
transmissionMode-r10	tm10-v1130		
codebookSubsetRestriction-r10	FFS		
ue-TransmitAntennaSelection CHOICE {			
release	NULL		
}			
}			
}			
}			

### 8.8.3.2.5 Test requirement

For the parameters specified in Table 8.8.3.2.3-1 the average probability of a missed downlink scheduling grant (P<sub>m-dsg</sub>) shall be below the specified value in Table 8.8.3.2.5-1.

**Table 8.8.3.2.5-1: Test Performance**

Test number	Aggregation level	Reference Channel	OCNG Pattern	Propagation Condition	Antenna configuration and correlation Matrix	Reference value	
						P <sub>m-dsg</sub> (%)	SNR (dB)
1	2 ECCE	R.59 TDD	OP.7 TDD	EVA5	2 x 2 Low	1	14.5
2	2 ECCE	R.59 TDD	OP.7 TDD	EVA5	2 x 2 Low	1	14.5

## 8.9 Demodulation (Single receiver antenna)

The SNR definition is given in Clause 8.1.1 where the number of receiver antennas  $N_{RX}$  assumed for the minimum performance requirement in this clause is 1.

### 8.9.1 PDSCH

#### 8.9.1.1 FDD and half-duplex FDD (Fixed Reference Channel)

The parameters specified in Table 8.9.1.1-1 are valid for FDD and half-duplex FDD tests unless otherwise stated.

**Table 8.9.1.1-1: Common Test Parameters (FDD and half-duplex FDD)**

Parameter	Unit	Value
Inter-TTI Distance		1
Number of HARQ processes per component carrier	Processes	8
Maximum number of HARQ transmission		4
Redundancy version coding sequence		{0,1,2,3} for QPSK and 16QAM {0,0,1,2} for 64QAM
Number of OFDM symbols for PDCCH per component carrier	OFDM symbols	4 for 1.4 MHz bandwidth, 3 for 3 MHz and 5 MHz bandwidths, 2 for 10 MHz, 15 MHz and 20 MHz bandwidths
Cyclic Prefix		Normal
Precoder update granularity		Frequency domain: 1 PRG Time domain: 1 ms for transmission mode 9

The normative reference for this requirement is TS 36.101 [2] clause 8.9.1.

#### 8.9.1.1.1 Transmit diversity performance (Cell-Specific Reference Symbols)

**Editor's Note: This test case is incomplete. The following items are missing or are incomplete:**

- Connection diagram in Annex A of TS 36.508 is TBD
- Test tolerances are undefined
- The minimum test time need to be added to Annex G
- Applicability spec needs to be updated
- RMCs are TBD

- Test Procedure is TBD

#### 8.9.1.1.1.1 Test purpose

To verify the UE's ability to receive a predefined test signal, representing a multi-path fading channel that is determined by the SNR with a percentage of the information bit throughput for a specified downlink Reference Measurement Channel (RMC) not falling below a specified value for transmission on two antenna ports using transmit diversity.

#### 8.9.1.1.1.2 Test applicability

This test applies to all types of E-UTRA FDD UE release 12 and forward of UE category 0.

#### 8.9.1.1.1.3 Minimum conformance requirements

The requirements are specified in terms of the percentage of information bit throughput for the downlink reference measurement channels specified in Annex A clause [A.3.3.2], with the addition of the relevant parameters in Tables 8.9.1.1-1 and 8.9.1.2.1.3-1 and the downlink physical channel setup according to Table C.3.2-1 in Annex C.3.2.

Using this configuration the fraction of maximum throughput percentage shall meet or exceed the minimum requirements specified in Table 8.9.1.1.3-2 for the specified SNR. For transmit diversity (SFBC) performance with 2 transmitter antennas (SFBC) as specified.

**Table 8.9.1.1.3-1: Test Parameters for Transmit diversity Performance (FRC)**

Parameter		Unit	Test 1
Downlink power allocation	$\rho_A$	dB	-3
	$\rho_B$	dB	-3 (Note 1)
	$\sigma$	dB	0
$N_{oc}$ at antenna port		dBm/15kHz	-98
PDSCH transmission mode			2
Note 1: $P_B = 1$ .			

**Table 8.9.1.1.3-2: Minimum performance Transmit Diversity (FRC)**

Test number	Bandwidth and MCS	Reference Channel	OCNG Pattern	Propagation Condition	Correlation Matrix and Antenna Configuration	Reference value		UE downlink category
						Fraction of Maximum Throughput (%)	SNR (dB)	
1	10 MHz 16QAM 1/2	R.xx FDD	OP.1 FDD	EPA5	2x1 Low	70	9.0	0

#### 8.9.1.1.1.4 Test description

##### 8.9.1.1.1.4.1 Initial conditions

Initial conditions are a set of test configurations the UE needs to be tested in and the steps for the SS to take with the UE to reach the correct measurement state.

Configurations of PDSCH and PDCCH before measurement are specified in Annex C.2.

Test Environment: Normal, as defined in TS 36.508 [7] clause 4.1.

Frequencies to be tested: Mid Range, as defined in TS 36.508 [7] clause 4.3.1.1.

Channel Bandwidths to be tested: As specified per test number in Table 8.9.1.1.1.3-2 as defined in TS 36.508 [7] clause 4.3.1.1.

1. Connect the SS, the faders and AWGN noise sources to the UE antenna connectors as shown in TS 36.508 [7] Annex A, Figure TBD for antenna configuration 2x1.
2. The parameter settings for the cell are set up according to Tables 8.9.1.1-1 and 8.9.1.1.1.3-1 as appropriate.
3. Downlink signals are initially set up according to Annex C.0, C.1 and Annex C.3.2 and uplink signals according to Annex H.1 and H.3.2.
4. Propagation conditions are set according to Annex B.0.
5. Ensure the UE is in State 3A-RF according to TS 36.508 [7] clause 5.2A.2. Message contents are defined in clause 8.9.1.1.1.4.3.

#### 8.9.1.1.1.4.2 Test procedure

FFS

#### 8.9.1.1.1.4.3 Message contents

Message contents are according to TS 36.508 [7] clause 4.6.

#### 8.9.1.1.1.5 Test requirement

Table 8.9.1.1.1.3-1 defines the primary level settings.

The fraction of maximum throughput percentage for the downlink reference measurement channels specified in Annex A clause [A.3.3.2] for each throughput test shall meet or exceed the specified value in Table 8.9.1.1.1.5-1 for the specified SNR including test tolerances for all throughput tests.

**Table 8.9.1.1.1.5-1: Minimum performance Transmit Diversity (FRC)**

Test number	Bandwidth and MCS	Reference Channel	OCNG Pattern	Propagation Condition	Correlation Matrix and Antenna Configuration	Reference value		UE downlink category
						Fraction of Maximum Throughput (%)	SNR (dB)	
1	10 MHz 16QAM 1/2	R.xx FDD	OP.1 FDD	EPA5	2x1 Low	70	9.0+T T	0

## 9 Reporting of Channel State Information

### 9.1 General

For the cases in this clause it is expected that the UE will not always detect the PDCCH, resulting in a statDTX for the uplink ACK/NACK transmission. The downlink configuration for evaluating CQI performance does not use retransmission. Therefore any BLER and Throughput calculations must exclude any packets where the UE may have attempted to combine data from more than one transmission due to missed new data indicators from lost PDCCH transmissions. Thus in all test cases in which there are not retransmission (Max number of HARQ transmissions = 1), if the number of consecutive discarded statDTX for any one process is an odd number including one, also discard the next response for that HARQ process regardless whether it is an ACK or NACK. In the calculation of Throughput the discarded ACK / NACK is considered as a statDTX.

This section includes requirements for the reporting of channel state information (CSI). For all test cases in this section,

the definition of SNR is in accordance with the one given in clause 8.1.1, where  $SNR = \frac{\sum \hat{I}_{or}^{(j)}}{\sum N_{oc}^{(j)}}$ .

The fading of the signals and the AWGN signals applied to each receiver antenna connector shall be uncorrelated. The levels of the test signal applied to each of the antenna connectors shall be as defined in the respective test cases.

The UE performance in this section is considered to be operating band independent. Therefore, the required performance in the respective test cases can be verified in one of the operating bands supported by the UE under test. All the test points supported by the bands of the multiband UE (based on channel bandwidth, DL and UL configuration) need to be tested.

For CA testing, unless otherwise stated, the logical carriers PCC / SCC are mapped on physical frequencies as defined in Table 9.1-1.

**Table 9.1-1: PCC/SCCs frequency mapping**

CA Configuration	PCC-SCC mapping	Notes
Intra-band CA	CC1-CC2	1
Inter-band CA (CA_x-y)	Bx-By (if not supported by the UE, then By-Bx)	2
Note 1:	Notation CCi-CCj means PCC on component carrier CCi and SCC on component carrier CCj, with CCi/j frequencies defined in the corresponding intra-band contiguous / non-contiguous CA band in TS 36.508.	
Note 2:	Notation Bi-Bj means PCC on component Band i and SCC on component Band j, with single Band i/j frequencies defined in TS 36.508.	

#### 9.1.1 Applicability of requirements

##### 9.1.1.1 Applicability of requirements for different channel bandwidths

In Clause 9 the test cases may be defined with different channel bandwidth to verify the same CSI requirement.

Test cases defined for 5MHz channel bandwidth that reference this clause are applicable to UEs that support only Band 31.

##### 9.1.1.2 Applicability and test rules for different CA configurations and bandwidth combination sets

The performance requirement for CA CQI tests in Clause 9 are defined independent of CA configurations and bandwidth combination sets specified in Clause 5.4.2A.1. For UEs supporting different CA configurations and bandwidth combination sets, the applicability and test rules are defined for the tests for 2 DL CCs in Table 9.1.1.2-1. For simplicity, CA configuration below refers to combination of CA configuration and bandwidth combination set.

**Table 9.1.1.2-1: Applicability and test rules for CA UE CQI tests with 2 DL CCs**

Tests	CA capability where the tests apply	CA configuration from the selected CA capability where the tests apply	CA Bandwidth combination to be tested in priority order	No. of the supported bandwidth combinations to be tested from each selected CA configuration
CA tests with 2CCs in Clause 9.6.1.1_A	Any of one of the supported CA capabilities	Any one of the supported FDD CA configurations	10+10 MHz, 20+20 MHz, 5+5 MHz, and 10MHz+5MHz.	1
CA tests with 2CCs in Clause 9.6.1.2_A	Any of one of the supported CA capabilities with largest aggregated CA bandwidth combination	Any one of the supported TDD CA configurations with largest aggregated CA bandwidth combination	Largest aggregated CA bandwidth combination	1
Note 1: The applicability and test rules are specified in this table, unless otherwise stated.				

**9.1.1.2A Applicability and test rules for different TDD-FDD CA configurations and bandwidth combination sets**

The performance requirement for TDD-FDD CA CQI tests in Clause 9 are defined independent of CA configurations and bandwidth combination sets specified in Clause 5.4.2A.1. For UEs supporting different CA configurations and bandwidth combination sets, the applicability and test rules are defined for the tests for 2 DL TDD-FDD CA in Table 9.1.1.2A-1 and for 3 DL TDD-FDD CA in Table 9.1.1.2A-2. For simplicity, CA configuration below refers to combination of CA configuration and bandwidth combination set.

**Table 9.1.1.2A-1: Applicability and test rules for CA UE CQI tests for TDD-FDD CA with 2DL CCs**

Tests	CA capability where the tests apply	CA configuration from the selected CA capability where the tests apply	CA Bandwidth combination to be tested in priority order
CA tests with 2CCs in Clause 9.6.1.3	Any of one of the supported CA capabilities	Any one of the supported TDD-FDD CA configurations with FDD PCell with largest aggregated CA bandwidth combination	Largest aggregated CA bandwidth combination
CA tests with 2CCs in Clause 9.6.1.4	Any of one of the supported CA capabilities	Any one of the supported TDD-FDD CA configurations with TDD PCell with largest aggregated CA bandwidth combination	Largest aggregated CA bandwidth combination
Note 1: The applicability and test rules are specified in this table, unless otherwise stated.			
Note 2: Number of the supported bandwidth combinations to be tested from each selected CA configuration is 1.			



**Table 9.1.1.2A-2: Applicability and test rules for CA UE CQI tests for TDD-FDD CA with 3DL CCs**

Tests	CA capability where the tests apply	CA configuration from the selected CA capability where the tests apply	CA Bandwidth combination to be tested in priority order
CA tests with 3CCs in Clause 9.6.1.3	Any of one of the supported CA capabilities	Any one of the supported TDD-FDD CA configurations with FDD PCell with largest aggregated CA bandwidth combination	Largest aggregated CA bandwidth combination
CA tests with 3CCs in Clause 9.6.1.4	Any of one of the supported CA capabilities	Any one of the supported TDD-FDD CA configurations with TDD PCell with largest aggregated CA bandwidth combination	Largest aggregated CA bandwidth combination
Note 1:	The applicability and test rules are specified in this table, unless otherwise stated.		
Note 2:	Number of the supported bandwidth combinations to be tested from each selected CA configuration is 1.		

### 9.1.1.3 Test coverage for different number of component carriers

For FDD CA tests specified in 9.6.1.1\_A, among all supported CA capabilities, if corresponding CA tests with the largest number of CCs supported by the UE are tested, the test coverage can be considered fulfilled without executing the CA tests with less than the largest number of CCs supported by the UE.

For TDD CA tests specified in 9.6.1.2\_A, among all supported CA capabilities, if corresponding CA tests with the largest number of CCs supported by the UE are tested, the test coverage can be considered fulfilled without executing the CA tests with less than the largest number of CCs supported by the UE.

For TDD FDD CA tests specified in 9.6.1.3 and 9.6.1.4, among all supported CA capabilities, if corresponding CA tests with the largest number of CCs supported by the UE are tested, the test coverage can be considered fulfilled without executing the TDD FDD CA tests with less than the largest number of CCs supported by the UE.

## 9.2 CQI Reporting under AWGN conditions

The reporting accuracy of the channel quality indicator (CQI) under frequency non-selective conditions is determined by the reporting variance and the BLER performance using the transport format indicated by the reported CQI median. The purpose is to verify that the reported CQI values are in accordance with the CQI definition given in TS 36.213 [10] clause 7.2. To account for sensitivity of the input SNR the reporting definition is considered to be verified if the reporting accuracy is met for at least one of two SNR levels separated by an offset of 1 dB.

### 9.2.1 CQI Reporting under AWGN conditions - PUCCH 1-0 (Cell-Specific Reference Symbols)

#### 9.2.1.1 FDD CQI Reporting under AWGN conditions – PUCCH 1-0

**Editor's notes: This test case is incomplete and awaiting for RAN4 decision:**

- Some test parameters in Table 9.2.1.1.3-2 are still in square brackets

- The applicability of requirements to and test settings for UE Category 1 is in RAN4 under investigation.

##### 9.2.1.1.1 Test purpose

To verify the variance of the wideband CQI reports is within the limits defined and a PDSCH BLER of 10% falls between the transport format based median CQI-1 and median CQI or the transport format based median CQI and median CQI +1.

##### 9.2.1.1.2 Test applicability

This test applies to E-UTRA FDD UE release 8 and forward.

### 9.2.1.1.3 Minimum conformance requirements

The following requirements apply to UE Category  $\geq 1$ . For the parameters specified in Table 9.2.1.1.3-1 and Table 9.2.1.1.3-2, and using the downlink physical channels specified in tables C.3.2-1 and C.3.2-2, the reported CQI value according to RC.1 FDD / RC.14 FDD in Table A.4-1 shall be in the range of  $\pm 1$  of the reported median more than 90% of the time. If the PDSCH BLER using the transport format indicated by median CQI is less than or equal to 0.1, the BLER using the transport format indicated by the (median CQI +1) shall be greater than 0.1. If the PDSCH BLER using the transport format indicated by the median CQI is greater than 0.1, the BLER using transport format indicated by (median CQI -1) shall be less than or equal to 0.1

The applicability of the requirement with 5MHz bandwidth as specified in Table 9.2.1.1.3-2 is defined in clause 9.1.1.1.

**Table 9.2.1.1.3-1: PUCCH 1-0 static test**

Parameter		Unit	Test 1		Test 2	
Bandwidth		MHz	10			
PDSCH transmission mode			1			
Downlink power allocation	$\rho_A$	dB	0			
	$\rho_B$	dB	0			
	$\sigma$	dB	0			
Propagation condition and antenna configuration			AWGN (1 x 2)			
SNR (Note 2)		dB	0	1	6	7
$\hat{I}_{or}^{(j)}$		dB[mW/15kHz]	-98	-97	-92	-91
$N_{oc}^{(j)}$		dB[mW/15kHz]	-98		-98	
Max number of HARQ transmissions			1			
Physical channel for CQI reporting			PUCCH Format 2			
PUCCH Report Type			4			
Reporting periodicity		ms	$N_P = 5$			
<i>cqi-pmi-ConfigurationIndex</i>			6			
Note 1: Reference measurement channel RC.1 FDD according to Table A.4-1 with one sided dynamic OCNG Pattern OP.1 FDD as described in Annex A.5.1.1.						
Note 2: For each test, the minimum requirements shall be fulfilled for at least one of the two SNR(s) and the respective wanted signal input level.						

Table 9.2.1.1.3-2: PUCCH 1-0 static test (FDD 5MHz)

Parameter		Unit	Test 1		Test 2	
Bandwidth		MHz			5	
PDSCH transmission mode					1	
Downlink power allocation	$\rho_A$	dB			0	
	$\rho_B$	dB			0	
	$\sigma$	dB			0	
Propagation condition and antenna configuration			AWGN (1 x 2)			
SNR (Note 2)		dB	[0]	[1]	[6]	[7]
$\hat{I}_{or}^{(j)}$		dB[mW/15kHz]	[-98]	[-97]	[-92]	[-91]
$N_{oc}^{(j)}$		dB[mW/15kHz]	-98		-98	
Max number of HARQ transmissions			1			
Physical channel for CQI reporting			PUCCH Format 2			
PUCCH Report Type			4			
Reporting periodicity		ms	$N_{pd} = 5$			
<i>cqi-pmi-ConfigurationIndex</i>			6			
Note 1: Reference measurement channel RC.14 FDD according to Table A.4-1 with one sided dynamic OCNG Pattern OP.1 FDD as described in Annex A.5.1.1.						
Note 2: For each test, the minimum requirements shall be fulfilled for at least one of the two SNR(s) and the respective wanted signal input level.						

The normative reference for this requirement is TS 36.101 [2] clause 9.2.1.1.

#### 9.2.1.1.4 Test description

##### 9.2.1.1.4.1 Initial conditions

Initial conditions are a set of test configurations the UE needs to be tested in and the steps for the SS to take with the UE to reach the correct measurement state.

Configurations of PDSCH and PDCCH before measurement are specified in Annex C.2.

Test Environment: Normal as defined in TS 36.508 [7] clause 4.1.

Frequencies to be tested: Mid Range as defined in TS 36.508 [7] clause 4.3.1.1.

Channel Bandwidths to be tested: 10MHz for tests defined in 9.2.1.1.3-1 and 5MHz for tests defined in Table 9.2.1.1.3-2, as defined in TS 36.508 [7] clause 4.3.1.1

1. Connect the SS, faders and AWGN noise source to the UE antenna connector(s) as shown in TS 36.508 [7] Annex A, Figure A.9.
2. The parameter settings for the cell are set up according to Table 9.2.1.1.3-1.
3. Downlink signals are initially set up according to Annex C.0, C.1 and Annex C.3.2 and uplink signals according to Annex H.1 and H.3.2.
4. Propagation conditions are set according to Annex B.0.
5. Ensure the UE is in State 3A-RF according to TS 36.508 [7] clause 5.2A.2. Message contents are defined in clause 9.2.1.1.4.3.

##### 9.2.1.1.4.2 Test procedure

1. Set the parameters of bandwidth, reference Channel, the propagation condition, antenna configuration and the SNR according to Table 9.2.1.1.3-1 for 10MHz tests or Table 9.2.1.1.3-2 for 5MHz tests as appropriate.

2. The SS shall transmit PDSCH via PDCCH DCI format 1A for C\_RNTI to transmit the DL RMC according to CQI value 8 and keep it regardless of the wideband CQI value sent by the UE. The SS sends downlink MAC padding bits on the DL RMC. Continue transmission of the PDSCH until 2000 wideband CQI reports have been gathered. In this process the SS collects wideband CQI reports every 5 ms and also cases where UE transmits nothing in its CQI timing are also counted as wideband CQI reports.
3. Set up a relative frequency distribution for the reported wideband CQI-values, Calculate the median value (wideband Median CQI is the wideband CQI that is at or crosses 50% distribution from the lower wideband CQI side). This CQI-value is declared as wideband Median CQI value.
4. If Median CQI is not equal to 1 or 15 and 1800 or more of the wideband CQI values are in the range  $(\text{Median CQI} - 1) \leq \text{Median CQI} \leq (\text{Median CQI} + 1)$  then continue with step 5, otherwise go to step 8.
5. The SS shall transmit PDSCH via PDCCH DCI format 1A for C\_RNTI to transmit the DL RMC according to the wideband median-CQI value and shall not react to the UE's wideband CQI reports. The SS sends downlink MAC padding bits on the DL RMC. For any PDSCH transmitted by the SS, record the associated ACK, NACK and statDTX responses. The responses are then filtered as follows: for the sequence of responses for each HARQ process, discard all the statDTX responses. Continue to gather data until the number of filtered ACK+NACK responses reaches 1000.

For the filtered ACK and NACK responses if the ratio  $(\text{NACK} / \text{ACK} + \text{NACK}) \leq 0.1$  then go to step 6, otherwise go to step 7.

6. The SS shall transmit PDSCH via PDCCH DCI format 1A for C\_RNTI to transmit the DL RMC according to the wideband median-CQI+1 value and shall not react to the UE's wideband CQI reports. The SS sends downlink MAC padding bits on the DL RMC. For any PDSCH, transmitted by the SS, record and filter the ACK, NACK and statDTX responses as in step 5 until 1000 filtered ACK+NACK responses are gathered.

If the ratio  $(\text{NACK} / \text{ACK} + \text{NACK}) > 0.1$

then pass the UE for this test and go to step 9, otherwise go to step 8.

7. The SS shall transmit PDSCH via PDCCH DCI format 1A for C\_RNTI to transmit the DL RMC according to the wideband median-CQI-1 value and shall not react to the UE's wideband CQI reports. The SS sends downlink MAC padding bits on the DL RMC. For any PDSCH, transmitted by the SS, record and filter the ACK, NACK and statDTX responses as in step 5 until 1000 filtered ACK+NACK responses are gathered.

If the ratio  $(\text{NACK} / \text{ACK} + \text{NACK}) \leq 0.1$

then pass the UE for this test and go to step 9, otherwise go to step 8.

8. If both SNR points of the test have not been tested, then repeat the same procedure (steps 1 to 7) for the other SNR point as appropriate. Otherwise fail the UE.

9. If both tests have not been done, then repeat the same procedure (steps 1 to 8) with test conditions according to the table 9.2.1.1.3-1 for 10MHz or table 9.2.1.1.3-2 for 5MHz for the other Test as appropriate. Otherwise pass the UE.

#### 9.2.1.1.4.3 Message contents

Message contents are according to TS 36.508 [7] clause 4.6 with the following exceptions:

**Table 9.2.1.1.4.3-1: PhysicalConfigDedicated-DEFAULT**

Derivation Path: 36.508 clause 5.5.1.2			
Information Element	Value/remark	Comment	Condition
PhysicalConfigDedicated-DEFAULT ::= SEQUENCE {			
cqi-ReportConfig	<i>CQI-ReportConfig-DEFAULT</i>		
}			

Table 9.2.1.1.4.3-2: CQI-ReportConfig-DEFAULT

Derivation Path: 36.508 clause 4.6.3			
Information Element	Value/remark	Comment	Condition
CQI-ReportConfig-DEFAULT ::= SEQUENCE {			
cqi-ReportModeAperiodic	Not present		
nomPDSCH-RS-EPRE-Offset	0		
cqi-ReportPeriodic CHOICE {			
setup SEQUENCE {			
cqi-PUCCH-ResourceIndex	0		
cqi-pmi-ConfigIndex	6	(see Table 7.2.2-1A in TS 36.213)	
cqi-FormatIndicatorPeriodic CHOICE {			
widebandCQI	NULL		
}			
ri-ConfigIndex	NULL	(see Table 7.2.2-1B in TS 36.213)	
simultaneousAckNackAndCQI	FALSE		
}			
}			
}			

#### 9.2.1.1.5 Test requirement

The pass fail decision is as specified in the test procedure in clause 9.2.1.1.4.2.

There are no parameters in the test setup or measurement process whose variation impacts the results so there are no applicable test tolerances for this test.

#### 9.2.1.2 TDD CQI Reporting under AWGN conditions – PUCCH 1-0

**Editor's note:** - The applicability of requirements to and test settings for UE Category 1 is in RAN4 under investigation.

##### 9.2.1.2.1 Test purpose

To verify the variance of the wideband CQI reports is within the limits defined and a PDSCH BLER of 10% falls between the transport format based on wideband median CQI-1 and wideband median CQI or the transport format based on wideband median CQI and wideband median CQI +1.

##### 9.2.1.2.2 Test applicability

This test applies to E-UTRA TDD UE release 8 and forward.

##### 9.2.1.2.3 Minimum conformance requirements

The following requirements apply to UE Category  $\geq 1$ . For the parameters specified in Table 9.2.1.2.3-1, and using the downlink physical channels specified in tables C.3.2-1 and C.3.2-2, the reported CQI value according to RC.1 TDD in Table A.4-1 shall be in the range of  $\pm 1$  of the reported median more than 90% of the time. If the PDSCH BLER using the transport format indicated by median CQI is less than or equal to 0.1, the BLER using the transport format indicated by the (median CQI +1) shall be greater than 0.1. If the PDSCH BLER using the transport format indicated by the median CQI is greater than 0.1, the BLER using transport format indicated by (median CQI -1) shall be less than or equal to 0.1.

Table 9.2.1.2.3-1: PUCCH 1-0 static test (TDD)

Parameter		Unit	Test 1		Test 2	
Bandwidth		MHz			10	
PDSCH transmission mode					1	
Uplink downlink configuration					2	
Special subframe configuration					4	
Downlink power allocation	$\rho_A$	dB			0	
	$\rho_B$	dB			0	
	$\sigma$	dB			0	
Propagation condition and antenna configuration			AWGN (1 x 2)			
SNR (Note 2)		dB	0	1	6	7
$\hat{I}_{or}^{(j)}$		dB[mW/15kHz]	-98	-97	-92	-91
$N_{oc}^{(j)}$		dB[mW/15kHz]	-98		-98	
Maximum number of HARQ transmissions			1			
Physical channel for CQI reporting			PUSCH (Note 3)			
PUCCH Report Type			4			
Reporting periodicity		ms	$N_p = 5$			
<i>cqi-pmi-ConfigurationIndex</i>			3			
ACK/NACK feedback mode			Multiplexing			
Note 1:		Reference measurement channel RC.1 TDD according to clause A.4-1 with one sided dynamic OCNG Pattern OP.1 TDD as described in Annex A.5.2.1				
Note 2:		For each test, the minimum requirements shall be fulfilled for at least one of the two SNR(s) and the respective wanted signal input level.				
Note 3:		To avoid collisions between CQI reports and HARQ-ACK it is necessary to report both on PUSCH instead of PUCCH. PDCCH DCI format 0 shall be transmitted in downlink SF#3 and #8 to allow periodic CQI to multiplex with the HARQ-ACK on PUSCH in uplink subframe SF#7 and #2.				

The normative reference for this requirement is TS 36.101 [2] clause 9.2.1.2.

#### 9.2.1.2.4 Test description

##### 9.2.1.2.4.1 Initial conditions

Initial conditions are a set of test configurations the UE needs to be tested in and the steps for the SS to take with the UE to reach the correct measurement state.

Configurations of PDSCH and PDCCH before measurement are specified in Annex C.2.

Test Environment: Normal as defined in TS 36.508 [7] clause 4.1.

Frequencies to be tested: Mid Range as defined in TS 36.508 [7] clause 4.3.1.2.

Channel Bandwidths to be tested: 10MHz, as defined in TS 36.508 [7] clause 4.3.1.2

1. Connect the SS, faders and AWGN noise source to the UE antenna connector (s) as shown in TS 36.508 [7] Annex A, Figure A.9.
2. The parameter settings for the cell are set up according to Table 9.2.1.2.3-1.
3. Downlink signals are initially set up according to Annex C0, C.1 and Annex C.3.2 and uplink signals according to Annex H.1 and H.3.2.
4. Propagation conditions are set according to Annex B.0
5. Ensure the UE is in State 3A-RF according to TS 36.508 [7] clause 5.2A.2. Message contents are defined in clause 9.2.1.2.4.3.

## 9.2.1.2.4.2 Test procedure

1. Set the parameters of bandwidth, reference Channel, the propagation condition, antenna configuration and the SNR according to Table 9.2.1.2.3-1 as appropriate.
2. The SS shall transmit PDSCH via PDCCH DCI format 1A for C\_RNTI to transmit the DL RMC according to CQI value 8 and keep it regardless of the wideband CQI value sent by the UE. The SS sends downlink MAC padding bits on the DL RMC. The SS sends uplink scheduling information via PDCCH DCI format 0 with CQI request bit set to 0 to schedule UL RMC in subframe #2 and subframe #7 (Table A.4.1-2). The UE will send ACK/NACK and periodic CQI report using PUSCH. Continue transmission of the PDSCH until 2000 wideband CQI reports have been gathered. In this process the SS collects wideband CQI reports every 5 ms and also cases where UE transmits nothing in its CQI timing are counted as wideband CQI reports.
3. Set up a relative frequency distribution for the reported wideband CQI-values, Calculate the median value (wideband Median CQI is the CQI that is at or crosses 50% distribution from the lower wideband CQI side). This CQI-value is declared as wideband Median CQI value.
4. If Median CQI is not equal to 1 or 15 and 1800 or more of the wideband CQI values are in the range (Median CQI - 1)  $\leq$  Median CQI  $\leq$  (Median CQI + 1) then continue with step 5, otherwise go to step 8.
5. The SS shall transmit PDSCH via PDCCH DCI format 1A for C\_RNTI to transmit the DL RMC according to the wideband median-CQI value and shall not react to the UE's wideband CQI reports. The SS sends downlink MAC padding bits on the DL RMC. The SS sends uplink scheduling information via PDCCH DCI format 0 with CQI request bit set to 0 to schedule UL RMC in subframe #2 and subframe #7 (Table A.4.1-2). The UE will send ACK/NACK and periodic CQI report using PUSCH. For any PDSCH transmitted by the SS, record the associated ACK, NACK and statDTX responses. *In case statDTX cannot be differentiated from NACK due to multiplexing effect, evaluate the feedback as a NACK* The responses are then filtered as follows: for the sequence of responses for each HARQ process, discard all the statDTX responses. Continue to gather data until the number of filtered ACK+NACK responses reaches 1000.

For the filtered ACK and NACK responses if the ratio (NACK / (ACK + NACK))  $\leq$  0.1 then go to step 6, otherwise go to step 7.

6. The SS shall transmit PDSCH via PDCCH DCI format 1A for C\_RNTI to transmit the DL RMC according to the wideband median-CQI+1 value and shall not react to the UE's wideband CQI reports. The SS sends downlink MAC padding bits on the DL RMC. The SS sends uplink scheduling information via PDCCH DCI format 0 with CQI request bit set to 0 to schedule UL RMC in subframe #2 and subframe #7 (Table A.4.1-2). The UE will send ACK/NACK and periodic CQI report using PUSCH. For any PDSCH, transmitted by the SS, record and filter the ACK, NACK and statDTX responses as in step 5 until 1000 filtered ACK+NACK responses are gathered. *In case statDTX cannot be differentiated from NACK due to multiplexing effect, evaluate the feedback as a NACK*

If the ratio (NACK / (ACK + NACK)) > 0.1

then pass the UE for this test and go to step 9, otherwise go to step 8.

7. The SS shall transmit PDSCH via PDCCH DCI format 1A for C\_RNTI to transmit the DL RMC according to the wideband median-CQI-1 value and shall not react to the UE's wideband CQI reports. The SS sends downlink MAC padding bits on the DL RMC. The SS sends uplink scheduling information via PDCCH DCI format 0 with CQI request bit set to 0 to schedule UL RMC in subframe #2 and subframe #7 (Table A.4.1-2). The UE will send ACK/NACK and periodic CQI report using PUSCH. For any PDSCH, transmitted by the SS, record and filter the ACK, NACK and statDTX responses as in step 5 until 1000 filtered ACK+NACK responses are gathered. *In case statDTX cannot be differentiated from NACK due to multiplexing effect, evaluate the feedback as a NACK*

If the ratio (NACK / (ACK + NACK))  $\leq$  0.1

then pass the UE for this test and go to step 9, otherwise go to step 8.

8. If both SNR points of the test have not been tested, then repeat the same procedure (steps 1 to 7) for the other SNR point as appropriate. Otherwise fail the UE.
9. If both tests have not been done, then repeat the same procedure (steps 1 to 8) with test conditions according to the table 9.2.1.2.3-1 for the other Test as appropriate. Otherwise pass the UE.

## 9.2.1.2.4.3 Message contents

Message contents are according to TS 36.508 [7] clause 4.6 with the following exceptions:

**Table 9.2.1.2.4.3-1: PhysicalConfigDedicated-DEFAULT**

Derivation Path: 36.508 clause 5.5.1.2			
Information Element	Value/remark	Comment	Condition
PhysicalConfigDedicated-DEFAULT ::= SEQUENCE {			
cqi-ReportConfig	<i>CQI-ReportConfig-DEFAULT</i>		
}			

**Table 9.2.1.2.4.3-2: CQI-ReportConfig-DEFAULT**

Derivation Path: 36.508 clause 4.6.3			
Information Element	Value/remark	Comment	Condition
CQI-ReportConfig-DEFAULT ::= SEQUENCE {			
cqi-ReportModeAperiodic	Not present		
nomPDSCH-RS-EPRE-Offset	0		
cqi-ReportPeriodic CHOICE {			
setup SEQUENCE {			
cqi-PUCCH-ResourceIndex	0		
cqi-pmi-ConfigIndex	3		
cqi-FormatIndicatorPeriodic CHOICE {			
widebandCQI	NULL		
}			
ri-ConfigIndex	NULL		
simultaneousAckNackAndCQI	FALSE		
}			
}			

**Table 9.2.1.2.4.3-3: TDD-Config-DEFAULT**

Derivation Path: 36.508 clause 4.6.3			
Information Element	Value/remark	Comment	Condition
TDD-Config-DEFAULT ::= SEQUENCE {			
subframeAssignment	sa2		
specialSubframePatterns	ssp4		
}			

## 9.2.1.2.5 Test requirement

The pass fail decision is as specified in the test procedure in clause 9.2.1.2.4.2.

There are no parameters in the test setup or measurement process whose variation impacts the results so there are no applicable test tolerances for this test.

## 9.2.1.3

## 9.2.1.3\_C FDD CQI Reporting under AWGN conditions – PUCCH 1-0 for eICIC

## 9.2.1.3\_C.1 FDD CQI Reporting under AWGN conditions – PUCCH 1-0 for eICIC (non-MBSFN ABS)

## 9.2.1.3\_C.1.1 Test purpose

To verify the variance of the wideband CQI reports - in subframes overlapping with aggressor cell ABS and non-ABS subframes - is within the limits defined and a PDSCH BLER of 10% falls between the transport format based median CQI-1 and median CQI or the transport format based median CQI and median CQI +1.



### 9.2.1.3\_C.1.2 Test applicability

This test applies to E-UTRA FDD UE Category 1-8 - release 10 and forward. Applicability requires support for FGI bit 115.

### 9.2.1.3\_C.1.3 Minimum conformance requirements

For the parameters specified in Table 9.2.1.3\_C.1.3-1, and using the downlink physical channels specified in tables C.3.2-1 for Cell 1, C.3.3-1 for Cell 2 and C.3.2-2, the reported CQI value according to RC.2 FDD / RC.6 FDD in Table A.4-1 in subframes overlapping with aggressor cell ABS and non-ABS subframes shall be in the range of  $\pm 1$  of the reported median more than 90% of the time. If the PDSCH BLER in non-ABS subframes using the transport format indicated by median CQI obtained by reports in CSI subframe sets  $C_{CSI,1}$  is less than or equal to 0.1, the BLER in non-ABS subframes using the transport format indicated by the (median CQI + 1) shall be greater than 0.1. If the PDSCH BLER in non-ABS subframes using the transport format indicated by the median CQI is greater than 0.1, the BLER in non-ABS subframes using transport format indicated by (median CQI - 1) shall be less than or equal to 0.1. The value of the median CQI obtained by reports in CSI subframe sets  $C_{CSI,0}$  minus the median CQI obtained by reports in CSI subframe sets  $C_{CSI,1}$  shall be larger than or equal to 2 and less than or equal to 5 in Test 1 and shall be larger than or equal to 0 and less than or equal to 1 in Test 2.

Table 9.2.1.3\_C.1.3-1: PUCCH 1-0 static test (FDD)

Parameter		Unit	Test 1			Test 2		
			Cell 1	Cell 2		Cell 1	Cell 2	
Bandwidth		MHz	10			10		
PDSCH transmission mode			2	Note 9		2	Note 9	
Downlink power allocation	$\rho_A$	dB	-3			-3		
	$\rho_B$	dB	-3			-3		
	$\sigma$	dB	0			0		
Propagation condition and antenna configuration			Clause B.1 (2x2)			Clause B.1 (2x2)		
$\hat{E}_s/N_{oc2}$ (Note 1)		dB	4	5	6	4	5	-12
$N_{oc}^{(j)}$ at antenna port	$N_{oc1}^{(j)}$	dBm/15kHz	-102 (Note 6)		N/A	-98(Note 6)		N/A
	$N_{oc2}^{(j)}$	dBm/15kHz	-98 (Note 7)		N/A	-98(Note 7)		N/A
	$N_{oc3}^{(j)}$	dBm/15kHz	-94.8 (Note 8)		N/A	-98(Note 8)		N/A
$\hat{I}_{or}^{(j)}$		dB[mW/15kHz]	-94	-93	-92	-94	-93	-110
Subframe Configuration			Non-MBSFN		Non-MBSFN	Non-MBSFN		Non-MBSFN
Cell Id			0		1	0		1
Time Offset between Cells		$\mu$ s	2.5 (synchronous cells)			2.5 (synchronous cells)		
ABS pattern (Note 2)			N/A		01010101 01010101 01010101 01010101 01010101	N/A		01010101 01010101 01010101 01010101 01010101
RLM/RRM Measurement Subframe Pattern (Note 4)			00000100 00000100 00000100 00000100 00000100		N/A	00000100 00000100 00000100 00000100 00000100		N/A
CSI Subframe Sets (Note 3)	$C_{CSI,0}$		01010101 01010101 01010101 01010101 01010101		N/A	01010101 01010101 01010101 01010101 01010101		N/A
	$C_{CSI,1}$		10101010 10101010 10101010 10101010 10101010		N/A	10101010 10101010 10101010 10101010 10101010		N/A
Number of control OFDM symbols			3			3		
Max number of HARQ transmissions			1			1		
Physical channel for $C_{CSI,0}$ CQI reporting			PUCCH Format 2			PUCCH Format 2		
Physical channel for $C_{CSI,1}$ CQI reporting			PUSCH (Note 11)			PUSCH (Note 11)		
PUCCH Report Type			4			4		
Reporting periodicity		Ms	$N_{pd} = 5$			$N_{pd} = 5$		
$cqi-pmi-ConfigurationIndex_{C_{CSI,0}}$ (Note 12)			6	N/A		6	N/A	
$cqi-pmi-ConfigurationIndex2_{C_{CSI,1}}$ (Note 13)			5	N/A		5	N/A	

Note 1:	For each test, the minimum requirements shall be fulfilled for at least one of the two SNR(s) and the respective wanted signal input level.
Note 2:	ABS pattern as defined in [14].
Note 3:	As configured according to the time-domain measurement resource restriction pattern for CSI measurements defined in [5]
Note 4:	Time-domain measurement resource restriction pattern for PCell measurements as defined in [5]
Note 5:	Cell 1 is the serving cell. Cell 2 is the aggressor cell.
Note 6:	This noise is applied in OFDM symbols #1, #2, #3, #5, #6, #8, #9, #10, #12, #13 of a subframe overlapping with the aggressor ABS.
Note 7:	This noise is applied in OFDM symbols #0, #4, #7, #11 of a subframe overlapping with the aggressor ABS.
Note 8:	This noise is applied in all OFDM symbols of a subframe overlapping with aggressor non-ABS.
Note 9:	Downlink physical channel setup in Cell 2 in accordance with Annex C.3.3 applying OCNG pattern as defined in Annex A.5.1.5
Note 10:	Reference measurement channel in Cell 1 RC.2 FDD according to Table A.4-1 for UE Category 2-8 with one sided dynamic OCNG Pattern OP.1 FDD as described in Annex A.5.1.1, and RC.6 FDD according to Table A.4-1 for Category 1 with one/two sided dynamic OCNG Pattern OP.1/2 FDD as described in Annex A.5.1.1 and A.5.1.2.
Note 11:	To avoid collisions between HARQ-ACK and wideband CQI it is necessary to report both on PUSCH instead of PUCCH. PDCCH DCI format 0 shall be transmitted in downlink SF#4 and #9 to allow periodic CQI to multiplex with the HARQ-ACK on PUSCH in uplink subframe SF#8 and #3.
Note 12:	<i>cqi-pmi-ConfigurationIndex</i> is applied for $C_{CSI,0}$ .
Note 13:	<i>cqi-pmi-ConfigurationIndex2</i> is applied for $C_{CSI,1}$ .

The normative reference for this requirement is TS 36.101 [2] clause 9.2.1.3.

#### 9.2.1.3\_C.1.4 Test description

##### 9.2.1.3\_C.1.4.1 Initial conditions

Initial conditions are a set of test configurations the UE needs to be tested in and the steps for the SS to take with the UE to reach the correct measurement state.

Configurations of PDSCH and PDCCH before measurement are specified in Annex C.2.

Test Environment: Normal as defined in TS 36.508 [7] clause 4.1.

Frequencies to be tested: Mid Range as defined in TS 36.508 [7] clause 4.3.1.1.

Channel Bandwidths to be tested: 10MHz, as defined in TS 36.508 [7] clause 4.3.1.1

1. Connect the SS, faders and AWGN noise source to the UE antenna connector (s) as shown in TS 36.508 [7] Annex A, Figure A.40.
2. The parameter settings for the cell are set up according to Table 9.2.1.3\_C.1.3-1.
3. Downlink signals are initially set up according to Annex C0, C.1 and Annex C.3.2 and uplink signals according to Annex H.1 and H.3.2.
4. Propagation conditions are set according to Annex B.0.
5. Ensure the UE is in State 3A-RF according to TS 36.508 [7] clause 5.2A.2. Message contents are defined in clause 9.2.1.3\_C.1.4.3.

##### 9.2.1.3\_C.1.4.2 Test procedure

1. Set the parameters of bandwidth, reference Channel, the propagation condition, antenna configuration and the SNR according to Tables 9.2.1.3\_C.1.3-1 and C.3.3-1 of Annex C.3.3 as appropriate.
2. The SS shall transmit PDSCH via PDCCH DCI format 1A for  $C_{RNTI}$  to transmit the DL RMC according to CQI value 8 and keep it regardless of the wideband CQI value sent by the UE. The SS sends downlink MAC padding bits on the DL RMC. The SS sends uplink scheduling information via PDCCH DCI format 0 with CQI request bit set to 0 in downlink SF#4 and #9 to schedule UL RMC in uplink SF#8 and #3 (Table A.4.1-1). The UE will send ACK/NACK and periodic CQI report for subframe set  $C_{CSI,0}$  using PUCCH and for subframe set  $C_{CSI,1}$  using PUSCH. Continue transmission of the PDSCH until 2000 wideband CQI reports, respectively for

subframe set  $C_{CSI,0}$  and for subframe set  $C_{CSI,1}$ , have been gathered. In this process the SS collects wideband CQI reports every 5 ms and also cases where UE transmits nothing in its CQI timing are also counted as wideband CQI reports.

3. Set up a relative frequency distribution for the reported wideband CQI-values for subframe set  $C_{CSI,0}$  and for subframe set  $C_{CSI,1}$ . Calculate respectively the median value (wideband Median CQI is the wideband CQI that is at or crosses 50% distribution from the lower wideband CQI side). These CQI-values are declared respectively as wideband Median CQI<sub>0</sub> and Median CQI<sub>1</sub>.
4. If Median CQI<sub>0</sub> is not equal to 1 or 15, and 1800 or more of the wideband CQI values for subframe set  $C_{CSI,0}$  are in the range  $(\text{Median CQI}_0 - 1) \leq \text{Median CQI}_0 \leq (\text{Median CQI}_0 + 1)$  AND Median CQI<sub>1</sub> is not equal to 1 or 15, and 1800 or more of the wideband CQI values for subframe set  $C_{CSI,1}$  are in the range  $(\text{Median CQI}_1 - 1) \leq \text{Median CQI}_1 \leq (\text{Median CQI}_1 + 1)$  AND the difference Median CQI<sub>0</sub> minus Median CQI<sub>1</sub> is  $2 \leq (\text{Median CQI}_0 - \text{Median CQI}_1) \leq 5$  for Test 1 and  $0 \leq (\text{Median CQI}_0 - \text{Median CQI}_1) \leq 1$  for Test 2, then continue with step 5, otherwise go to step 8.
5. The SS shall transmit PDSCH via PDCCH DCI format 1A for  $C\_RNTI$  to transmit the DL RMC only in non-ABS subframes according to the wideband Median CQI<sub>1</sub> value and shall not react to the UE's wideband CQI reports. The SS sends downlink MAC padding bits on the DL RMC. The SS sends uplink scheduling information via PDCCH DCI format 0 with CQI request bit set to 0 in downlink SF#4 and #9 to schedule UL RMC in uplink SF#8 and #3 (Table A.4.1-1). The UE will send ACK/NACK and periodic CQI report for subframe set  $C_{CSI,0}$  using PUCCH and for subframe set  $C_{CSI,1}$  using PUSCH. For any PDSCH transmitted by the SS, record the associated ACK, NACK and statDTX responses. The responses are then filtered as follows: for the sequence of responses for each HARQ process, discard all the statDTX responses. Continue to gather data until the number of filtered ACK+NACK responses reaches 1000.

For the filtered ACK and NACK responses if the ratio  $(\text{NACK} / \text{ACK} + \text{NACK}) \leq 0.1$  then go to step 6, otherwise go to step 7.

6. The SS shall transmit PDSCH via PDCCH DCI format 1A for  $C\_RNTI$  to transmit the DL RMC only in non-ABS subframes according to the wideband Median CQI<sub>1</sub>+1 value and shall not react to the UE's wideband CQI reports. The SS sends downlink MAC padding bits on the DL RMC. The SS sends uplink scheduling information via PDCCH DCI format 0 with CQI request bit set to 0 in downlink SF#4 and #9 to schedule UL RMC in uplink SF#8 and #3 (Table A.4.1-1). The UE will send ACK/NACK and periodic CQI report for subframe set  $C_{CSI,0}$  using PUCCH and for subframe set  $C_{CSI,1}$  using PUSCH. For any PDSCH, transmitted by the SS, record and filter the ACK, NACK and statDTX responses as in step 5 until 1000 filtered ACK+NACK responses are gathered.

If the ratio  $(\text{NACK} / \text{ACK} + \text{NACK}) > 0.1$

then pass the UE for this test and go to step 9, otherwise go to step 8.

7. The SS shall transmit PDSCH via PDCCH DCI format 1A for  $C\_RNTI$  to transmit the DL RMC only in non-ABS subframes according to the wideband Median CQI<sub>1</sub>-1 value and shall not react to the UE's wideband CQI reports. The SS sends downlink MAC padding bits on the DL RMC. The SS sends uplink scheduling information via PDCCH DCI format 0 with CQI request bit set to 0 in downlink SF#4 and #9 to schedule UL RMC in uplink SF#8 and #3 (Table A.4.1-1). The UE will send ACK/NACK and periodic CQI report for subframe set  $C_{CSI,0}$  using PUCCH and for subframe set  $C_{CSI,1}$  using PUSCH. For any PDSCH, transmitted by the SS, record and filter the ACK, NACK and statDTX responses as in step 5 until 1000 filtered ACK+NACK responses are gathered.

If the ratio  $(\text{NACK} / \text{ACK} + \text{NACK}) \leq 0.1$

then pass the UE for this test and go to step 9, otherwise go to step 8.

8. If both SNR points of the test have not been tested, then repeat the same procedure (steps 1 to 7) for the other SNR point as appropriate. Otherwise fail the UE.
9. If both tests have not been done, then repeat the same procedure (steps 1 to 8) with test conditions according to the table 9.2.1.3\_C.1.3-1 for the other Test as appropriate. Otherwise pass the UE.

## 9.2.1.3\_C.1.4.3 Message contents

Message contents are according to TS 36.508 [7] clause 4.6 with the following exceptions:

**Table 9.2.1.3\_C.1.4.3-1: PhysicalConfigDedicated-DEFAULT**

Derivation Path: 36.508 clause 5.5.1.2 Table 5.5.1.2-1			
Information Element	Value/remark	Comment	Condition
PhysicalConfigDedicated-DEFAULT ::= SEQUENCE {			
cqi-ReportConfig	<i>Not present</i>		
cqi-ReportConfig-r10	<i>CQI-ReportConfig-r10-DEFAULT</i>		
}			

**Table 9.2.1.3\_C.1.4.3-2: RadioResourceConfigDedicated-SRB2-DRB(n, m)**

Derivation Path: TS 36.508 [7] clause 4.6.3, Table 4.6.3-16			
Information Element	Value/remark	Comment	Condition
RadioResourceConfigDedicated-SRB2-DRB(n, m) ::= SEQUENCE {			
MeasSubframePatternPCell-r10 CHOICE {	setup		
setup SEQUENCE {	subframePatternFDD-r10		
subframePatternFDD-r10	'0000010000000100 0000010000000100 00000100'	BIT STRING (SIZE (40))	
}			
}			
}			

Table 9.2.1.3\_C.1.4.3-3: CQI-ReportConfig-r10-DEFAULT

Derivation Path: 36.508 [7] clause 4.6.3, Table 4.6.3-2AA			
Information Element	Value/remark	Comment	Condition
CQI-ReportConfig-r10-DEFAULT ::= SEQUENCE {			
cqi-ReportAperiodic-r10	Not present		
nomPDSCH-RS-EPRE-Offset	0		
cqi-ReportPeriodic-r10 CHOICE{			
setup SEQUENCE{			
cqi-PUCCH-ResourceIndex-r10	0		
cqi-PUCCH-ResourceIndexP1-r10	Not present		
cqi-pmi-ConfigIndex	6		
cqi-FormatIndicatorPeriodic-r10 CHOICE {			
widebandCQI-r10 SEQUENCE {			
csi-ReportMode-r10	Not present		
}			
}			
}			
ri-ConfigIndex	NULL		
simultaneousAckNackAndCQI	FALSE		
cqi-Mask-r9	Not present		
csi-ConfigIndex-r10 CHOICE{			
setup SEQUENCE{			
cqi-pmi-ConfigIndex2-r10	5		
ri-Configindex2-r10	NULL		
}			
}			
pmi-RI-Report-r9	Not present		
csi-SubframePatternConfig-r10 CHOICE {			
setup SEQUENCE {			
csi-MeasSubframeSet1-r10 CHOICE {			
subframePatternFDD-r10	'0101010101010101 0101010101010101 01010101'	BIT STRING (SIZE (40))	
}			
csi-MeasSubframeSet2-r10 CHOICE {			
subframePatternFDD-r10	'1010101010101010 1010101010101010 10101010'	BIT STRING (SIZE (40))	
}			
}			
}			
}			

## 9.2.1.3\_C.1.5 Test requirement

The pass fail decision is as specified in the test procedure in clause 9.2.1.3\_C.1.4.2.

## 9.2.1.4

## 9.2.1.4\_C TDD CQI Reporting under AWGN conditions – PUCCH 1-0 for eICIC

## 9.2.1.4\_C.1 TDD CQI Reporting under AWGN conditions – PUCCH 1-0 for eICIC (non-MBSFN ABS)

## 9.2.1.4\_C.1.1 Test purpose

To verify the variance of the wideband CQI reports - in subframes overlapping with aggressor cell ABS and non-ABS subframes - is within the limits defined and a PDSCH BLER of 10% falls between the transport format based median CQI-1 and median CQI or the transport format based median CQI and median CQI +1.

#### 9.2.1.4\_C.1.2 Test applicability

This test applies to E-UTRA TDD UE Category 1-8 release 10 and forward. Applicability requires support for FGI bit115.

#### 9.2.1.4\_C.1.3 Minimum conformance requirements

For the parameters specified in Table 9.2.1.4\_C.1.3-1, and using the downlink physical channels specified in tables C.3.2-1 for Cell 1, C.3.3-1 for Cell2 and C.3.2-2, the reported CQI value according to RC.2 TDD / RC.6 TDD in Table A.4-1 in subframes overlapping with aggressor cell ABS and non-ABS subframes shall be in the range of  $\pm 1$  of the reported median more than 90% of the time. If the PDSCH BLER in non-ABS subframes using the transport format indicated by median CQI obtained by reports in CSI subframe sets  $C_{CSI,1}$  is less than or equal to 0.1, the BLER in non-ABS subframes using the transport format indicated by the (median CQI + 1) shall be greater than 0.1. If the PDSCH BLER in non-ABS subframes using the transport format indicated by the median CQI is greater than 0.1, the BLER in non-ABS subframes using transport format indicated by (median CQI - 1) shall be less than or equal to 0.1. The value of the median CQI obtained by reports in CSI subframe sets  $C_{CSI,0}$  minus the median CQI obtained by reports in CSI subframe sets  $C_{CSI,1}$  shall be larger than or equal to 2 and less than or equal to 5 in Test 1 and shall be larger than or equal to 0 and less than or equal to 1 in Test 2.

Table 9.2.1.4\_C.1.3-1: PUCCH 1-0 static test (TDD)

Parameter	Unit	Test 1			Test 2			
		Cell 1	Cell 2	Cell 1	Cell 2	Cell 1	Cell 2	
Bandwidth	MHz	10			10			
PDSCH transmission mode		2	Note 9	2	Note 9			
Uplink downlink configuration		1			1			
Special subframe configuration		4			4			
Downlink power allocation	$\rho_A$	dB			-3			
	$\rho_B$	dB			-3			
	$\sigma$	dB			0			
Propagation condition and antenna configuration		Clause B.1 (2x2)			Clause B.1 (2x2)			
$\hat{E}_s / N_{oc2}$ (Note 1)	dB	4	5	6	4	5	-12	
$N_{oc}^{(j)}$ at antenna port	$N_{oc1}^{(j)}$	dBm/15kHz		-102(Note 6)	N/A		-98(Note 6)	N/A
	$N_{oc2}^{(j)}$	dBm/15kHz		-98(Note 7)	N/A		-98(Note 7)	N/A
	$N_{oc3}^{(j)}$	dBm/15kHz		-94.8(Note 8)	N/A		-98(Note 8)	N/A
$\hat{I}_{or}^{(j)}$	dB[mW/15kHz]	-94	-93	-92	-94	-93	-110	
Subframe Configuration		Non-MBSFN		Non-MBSFN	Non-MBSFN		Non-MBSFN	
Cell Id		0		1	0		1	
Time Offset between Cells	$\mu$ s	2.5 (synchronous cells)			2.5 (synchronous cells)			
ABS pattern (Note 2)		N/A		0100010001 0100010001	N/A		0100010001 0100010001	
RLM/RRM Measurement Subframe Pattern (Note 4)		0000000001 0000000001		N/A		0000000001 0000000001		
CSI Subframe Sets (Note 3)	$C_{CSI,0}$	0100010001 0100010001		N/A		0100010001 0100010001		
	$C_{CSI,1}$	1000101000 1000101000		N/A		1000101000 1000101000		
Number of control OFDM symbols		3			3			
Max number of HARQ transmissions		1			1			
Physical channel for $C_{CSI,0}$ CQI reporting		PUCCH Format 2			PUCCH Format 2			
Physical channel for $C_{CSI,1}$ CQI reporting		PUSCH (Note 11)			PUSCH (Note 11)			
PUCCH Report Type		4			4			
Reporting periodicity	ms	$N_{pd} = 5$			$N_{pd} = 5$			
<i>cqi-pmi-ConfigurationIndex</i> $C_{CSI,0}$ (Note 12)		3	N/A		3	N/A		
<i>cqi-pmi-ConfigurationIndex2</i> $C_{CSI,1}$ (Note 13)		4	N/A		4	N/A		
ACK/NACK feedback mode		Multiplexing			Multiplexing			



Note 1:	For each test, the minimum requirements shall be fulfilled for at least one of the two SNR(s) and the respective wanted signal input level.
Note 2:	ABS pattern as defined in [14].
Note 3:	As configured according to the time-domain measurement resource restriction pattern for CSI measurements defined in [5].
Note 4:	Time-domain measurement resource restriction pattern for PCell measurements as defined in [5]
Note 5:	Cell 1 is the serving cell. Cell 2 is the aggressor cell. The number of the CRS ports in Cell1 and Cell2 is the same.
Note 6:	This noise is applied in OFDM symbols #1, #2, #3, #5, #6, #8, #9, #10, #12, #13 of a subframe overlapping with the aggressor ABS.
Note 7:	This noise is applied in OFDM symbols #0, #4, #7, #11 of a subframe overlapping with the aggressor ABS
Note 8:	This noise is applied in all OFDM symbols of a subframe overlapping with aggressor non-ABS.
Note 9:	Downlink physical channel setup in Cell 2 in accordance with Annex C.3.3 applying OCNB pattern as defined in Annex A.5.2.5.
Note 10:	Reference measurement channel in Cell 1 RC.2 TDD according to Table A.4-1 for UE Category 2-8 with one sided dynamic OCNB Pattern OP.1 TDD as described in Annex A.5.2.1, and RC.6 TDD according to Table A.4-1 for Category 1 with one/two sided dynamic OCNB Pattern OP.1/2 TDD as described in Annex A.5.2.1 and Annex A.5.2.2.
Note 11:	To avoid collisions between HARQ-ACK and wideband CQI it is necessary to report both on PUSCH instead of PUCCH. PDCCH DCI format 0 shall be transmitted in downlink SF#4 and #9 to allow periodic CQI to multiplex with the HARQ-ACK on PUSCH in uplink subframe SF#8 and #3.
Note 12:	<i>cqi-pmi-ConfigurationIndex</i> is applied for $C_{CSI,0}$ .
Note 13:	<i>cqi-pmi-ConfigurationIndex2</i> is applied for $C_{CSI,1}$ .

The normative reference for this requirement is TS 36.101 [2] clause 9.2.1.4.

#### 9.2.1.4\_C.1.4 Test description

##### 9.2.1.4.\_C.14.1 Initial conditions

Initial conditions are a set of test configurations the UE needs to be tested in and the steps for the SS to take with the UE to reach the correct measurement state.

Configurations of PDSCH and PDCCH before measurement are specified in Annex C.2.

Test Environment: Normal as defined in TS 36.508 [7] clause 4.1.

Frequencies to be tested: Mid Range as defined in TS 36.508 [7] clause 4.3.1.2.

Channel Bandwidths to be tested: 10MHz, as defined in TS 36.508 [7] clause 4.3.1.2

1. Connect the SS, faders and AWGN noise source to the UE antenna connector (s) as shown in TS 36.508 [7] Annex A, Figure A.40.
2. The parameter settings for the cell are set up according to Table 9.2.1.4\_C.1.3-1.
3. Downlink signals are initially set up according to Annex C0, C.1 and Annex C.3.2 and uplink signals according to Annex H.1 and H.3.2.
4. Propagation conditions are set according to Annex B.0
5. Ensure the UE is in State 3A-RF according to TS 36.508 [7] clause 5.2A.2. Message contents are defined in clause 9.2.1.4\_C.1.4.3.

##### 9.2.1.4\_C.1.4.2 Test procedure

1. Set the parameters of bandwidth, reference Channel, the propagation condition, antenna configuration and the SNR according to Table 9.2.1.4\_C.1.3-1 and C.3.3-1 of Annex C.3.3 as appropriate.
2. The SS shall transmit PDSCH via PDCCH DCI format 1A for  $C_{RNTI}$  to transmit the DL RMC according to CQI value 8 and keep it regardless of the wideband CQI value sent by the UE. The SS sends downlink MAC padding bits on the DL RMC. The SS sends uplink scheduling information via PDCCH DCI format 0 with CQI request bit set to 0 in downlink SF#4 and #9 to schedule UL RMC in uplink SF #8 and #3 (Table A.4.1-2). The UE will send ACK/NACK and periodic CQI report for subframe set  $C_{CSI,0}$  using PUCCH and for subframe set  $C_{CSI,1}$  using PUSCH. Continue transmission of the PDSCH until 2000 wideband CQI reports, respectively for

subframe set  $C_{CSI,0}$  and for subframe set  $C_{CSI,1}$ , have been gathered. In this process the SS collects wideband CQI reports every 5 ms and also cases where UE transmits nothing in its CQI timing are counted as wideband CQI reports.

3. Set up a relative frequency distribution for the reported wideband CQI-values for subframe set  $C_{CSI,0}$  and for subframe set  $C_{CSI,1}$ . Calculate respectively the median value (wideband Median CQI is the CQI that is at or crosses 50% distribution from the lower wideband CQI side). These CQI-values are declared respectively as wideband Median CQI<sub>0</sub> and Median CQI<sub>1</sub>.
4. If Median CQI<sub>0</sub> is not equal to 1 or 15, and 1800 or more of the wideband CQI values for subframe set  $C_{CSI,0}$  are in the range  $(\text{Median CQI}_0 - 1) \leq \text{Median CQI}_0 \leq (\text{Median CQI}_0 + 1)$  AND Median CQI<sub>1</sub> is not equal to 1 or 15, and 1800 or more of the wideband CQI values for subframe set  $C_{CSI,1}$  are in the range  $(\text{Median CQI}_1 - 1) \leq \text{Median CQI}_1 \leq (\text{Median CQI}_1 + 1)$  AND the difference Median CQI<sub>0</sub> minus Median CQI<sub>1</sub> is  $2 \leq (\text{Median CQI}_0 - \text{Median CQI}_1) \leq 5$  for Test 1 and  $0 \leq (\text{Median CQI}_0 - \text{Median CQI}_1) \leq 1$  for Test 2, then continue with step 5, otherwise go to step 8.
5. The SS shall transmit PDSCH via PDCCH DCI format 1A for  $C\_RNTI$  to transmit the DL RMC only in non-ABS subframes according to the wideband Median CQI<sub>1</sub> value and shall not react to the UE's wideband CQI reports. The SS sends downlink MAC padding bits on the DL RMC. The SS sends uplink scheduling information via PDCCH DCI format 0 with CQI request bit set to 0 in downlink SF#4 and #9 to schedule UL RMC in uplink SF #8 and #3 (Table A.4.1-2). The UE will send ACK/NACK and periodic CQI report for subframe set  $C_{CSI,0}$  using PUCCH and for subframe set  $C_{CSI,1}$  using PUSCH. For any PDSCH transmitted by the SS, record the associated ACK, NACK and statDTX responses. In case statDTX can not be differentiated from NACK due to multiplexing effect, evaluate the feedback as a NACK. The responses are then filtered as follows: for the sequence of responses for each HARQ process, discard all the statDTX responses. Continue to gather data until the number of filtered ACK+NACK responses reaches 1000.

For the filtered ACK and NACK responses if the ratio  $(\text{NACK} / \text{ACK} + \text{NACK}) \leq 0.1$  then go to step 6, otherwise go to step 7.

6. The SS shall transmit PDSCH via PDCCH DCI format 1A for  $C\_RNTI$  to transmit the DL RMC only in non-ABS subframes according to the wideband Median CQI<sub>1</sub>+1 value and shall not react to the UE's wideband CQI reports. The SS sends downlink MAC padding bits on the DL RMC. The SS sends uplink scheduling information via PDCCH DCI format 0 with CQI request bit set to 0 in downlink SF#4 and #9 to schedule UL RMC in uplink SF #8 and #3 (Table A.4.1-2). The UE will send ACK/NACK and periodic CQI report for subframe set  $C_{CSI,0}$  using PUCCH and for subframe set  $C_{CSI,1}$  using PUSCH. For any PDSCH, transmitted by the SS, record and filter the ACK, NACK and statDTX responses as in step 5 until 1000 filtered ACK+NACK responses are gathered. *In case statDTX can not be differentiated from NACK due to multiplexing effect, evaluate the feedback as a NACK*

If the ratio  $(\text{NACK} / \text{ACK} + \text{NACK}) > 0.1$

then pass the UE for this test and go to step 9, otherwise go to step 8.

7. The SS shall transmit PDSCH via PDCCH DCI format 1A for  $C\_RNTI$  to transmit the DL RMC only in non-ABS subframes according to the wideband Median-CQI<sub>1</sub>-1 value and shall not react to the UE's wideband CQI reports. The SS sends downlink MAC padding bits on the DL RMC. The SS sends uplink scheduling information via PDCCH DCI format 0 with CQI request bit set to 0 in downlink SF#4 and #9 to schedule UL RMC in uplink SF #8 and #3 (Table A.4.1-2). The UE will send ACK/NACK and periodic CQI report for subframe set  $C_{CSI,0}$  using PUCCH and for subframe set  $C_{CSI,1}$  using PUSCH. For any PDSCH, transmitted by the SS, record and filter the ACK, NACK and statDTX responses as in step 5 until 1000 filtered ACK+NACK responses are gathered. *In case statDTX can not be differentiated from NACK due to multiplexing effect, evaluate the feedback as a NACK*

If the ratio  $(\text{NACK} / \text{ACK} + \text{NACK}) \leq 0.1$

then pass the UE for this test and go to step 9, otherwise go to step 8.

8. If both SNR points of the test have not been tested, then repeat the same procedure (steps 1 to 7) for the other SNR point as appropriate. Otherwise fail the UE.

9. If both tests have not been done, then repeat the same procedure (steps 1 to 8) with test conditions according to the table 9.2.1.4\_C.1.3-1 for the other Test as appropriate. Otherwise pass the UE.

#### 9.2.1.4\_C.1.4.3 Message contents

Message contents are according to TS 36.508 [7] clause 4.6 with the following exceptions:

**Table 9.2.1.4\_C.1.4.3-1: PhysicalConfigDedicated-DEFAULT**

Derivation Path: 36.508 clause 5.5.1.2 Table 5.5.1.2-1			
Information Element	Value/remark	Comment	Condition
PhysicalConfigDedicated-DEFAULT ::= SEQUENCE {			
cqi-ReportConfig	<i>Not present</i>		
cqi-ReportConfig-r10	<i>CQI-ReportConfig-r10-DEFAULT</i>		
}			

**Table 9.2.1.4\_C.1.4.3-2: RadioResourceConfigDedicated-SRB2-DRB(n, m)**

Derivation Path: TS 36.508 [7] clause 4.6.3, Table 4.6.3-16			
Information Element	Value/remark	Comment	Condition
RadioResourceConfigDedicated-SRB2-DRB(n, m) ::= SEQUENCE {			
MeasSubframePatternPCell-r10 CHOICE {			
setup SEQUENCE {			
subframePatternTDD-r10 CHOICE{			
subframeConfig1-5-r10	'0000000001 0000000001'	BIT STRING (SIZE (20))	
}			
}			
}			
}			

Table 9.2.1.4\_C.1.4.3-3: CQI-ReportConfig-r10-DEFAULT

Derivation Path: 36.508 [7] clause 4.6.3, Table 4.6.3-2AA			
Information Element	Value/remark	Comment	Condition
CQI-ReportConfig-r10-DEFAULT ::= SEQUENCE {			
cqi-ReportAperiodic-r10	Not present		
nomPDSCH-RS-EPRE-Offset	0		
cqi-ReportPeriodic-r10 CHOICE{			
setup SEQUENCE{			
cqi-PUCCH-ResourceIndex-r10	0		
cqi-PUCCH-ResourceIndexP1-r10	Not present		
cqi-pmi-ConfigIndex	3		
cqi-FormatIndicatorPeriodic-r10 CHOICE {			
widebandCQI-r10 SEQUENCE {			
csi-ReportMode-r10	Not present		
}			
}			
ri-ConfigIndex	NULL		
simultaneousAckNackAndCQI	FALSE		
cqi-Mask-r9	Not present		
csi-ConfigIndex-r10 CHOICE{			
setup SEQUENCE{			
cqi-pmi-ConfigIndex2-r10	4		
ri-Configindex2-r10	NULL		
}			
}			
pmi-RI-Report-r9	Not present		
csi-SubframePatternConfig-r10 CHOICE {			
setup SEQUENCE {			
csi-MeasSubframeSet1-r10 CHOICE {			
subframePatternTDD-r10 CHOICE {			
subframeConfig1-5-r10	'0100010001 0100010001'	BIT STRING (SIZE (20))	
}			
}			
csi-MeasSubframeSet2-r10 CHOICE {			
subframePatternTDD-r10 CHOICE {			
subframeConfig1-5-r10	'1000101000 1000101000'	BIT STRING (SIZE (20))	
}			
}			
}			
}			
}			

Table 9.2.1.4\_C.1.4.3-4: TDD-Config-DEFAULT

Derivation Path: 36.508 clause 4.6.3			
Information Element	Value/remark	Comment	Condition
TDD-Config-DEFAULT ::= SEQUENCE {			
subframeAssignment	sa1		
specialSubframePatterns	ssp4		
}			

## 9.2.1.4\_C.1.5 Test requirement

The pass fail decision is as specified in the test procedure in clause 9.2.1.4\_C.1.4.2.

## 9.2.1.5

### 9.2.1.5\_E FDD CQI Reporting under AWGN conditions – PUCCH 1-0 for feICIC

#### 9.2.1.5\_E.1 FDD CQI Reporting under AWGN conditions – PUCCH 1-0 for feICIC (non-MBSFN ABS)

##### 9.2.1.5\_E.1.1 Test purpose

To verify the variance of the wideband CQI reports - in subframes overlapping with aggressor cell ABS and non-ABS subframes is within the limits defined and a PDSCH BLER of 10% falls between the transport format based median CQI-1 and median CQI or the transport format based median CQI and median CQI +1.

##### 9.2.1.5\_E.1.2 Test applicability

This test applies to E-UTRA FDD UE and CRS interference handling - UE Category 2-8 - release 11 and forward. Applicability requires support of FGI bit 115.

##### 9.2.1.5\_E.1.3 Minimum conformance requirements

For the parameters specified in Table 9.2.1.5\_E.1.3-1, and using the downlink physical channels specified in tables C.3.2-1 for Cell 1, C.3.3-2 for Cell 2 and Cell 3, and C.3.2-2, the reported CQI value according to RC.2 FDD in Table A.4-1 in subframes overlapping with aggressor cell ABS and non-ABS subframes shall be in the range of  $\pm 1$  of the reported median more than 90% of the time.

For test 1, if the PDSCH BLER in ABS subframes using the transport format indicated by median CQI obtained by reports in CSI subframe sets  $C_{CSL0}$  is less than or equal to 0.1, the BLER in ABS subframes using the transport format indicated by the (median CQI + 1) shall be greater than 0.1. If the PDSCH BLER in ABS subframes using the transport format indicated by the median CQI is greater than 0.1, the BLER in ABS subframes using transport format indicated by (median CQI – 1) shall be less than or equal to 0.1.

For test 2, if the PDSCH BLER in ABS subframes using the transport format indicated by median CQI obtained by reports in CSI subframe sets  $C_{CSL0}$  is less than or equal to 0.1, the BLER in ABS subframes using the transport format indicated by the (median CQI + 1) shall be greater than 0.1. If the PDSCH BLER in ABS subframes using the transport format indicated by the median CQI is greater than 0.1, the BLER in ABS subframes using transport format indicated by (median CQI – 1) shall be less than or equal to 0.1.

For test 2, if the PDSCH BLER in non-ABS subframes using the transport format indicated by median CQI obtained by reports in CSI subframe sets  $C_{CSL1}$  is less than or equal to 0.1, the BLER in non-ABS subframes using the transport format indicated by the (median CQI + 2) shall be greater than 0.1. If the PDSCH BLER in non-ABS subframes using the transport format indicated by the median CQI is greater than 0.1, the BLER in non-ABS subframes using transport format indicated by (median CQI – 1) shall be less than or equal to 0.1.

Table 9.2.1.5\_E.1.3-1: PUCCH 1-0 static test (FDD)

Parameter	Unit	Test 1			Test 2		
		Cell 1		Cell 2 and 3	Cell 1		Cell 2 and 3
Bandwidth	MHz	10			10		
PDSCH transmission mode		2		Note 10	2		Note 10
Downlink power allocation	$\rho_A$	-3			-3		
	$\rho_B$	-3			-3		
	$\sigma$	0			0		
Propagation condition and antenna configuration		Clause B.1 (2x2)			Clause B.1 (2x2)		
$\widehat{E}_s/N_{oc2}$ (Note 1)	dB	4	5	Cell 2: 12 Cell 3: 10	13	14	Cell 2: 12 Cell 3: 10
$N_{oc}^{(j)}$ at antenna port	$N_{oc1}^{(j)}$	-98 (Note 7)		N/A	-98 (Note 7)		N/A
	$N_{oc2}^{(j)}$	-98 (Note 8)		N/A	-98 (Note 8)		N/A
	$N_{oc3}^{(j)}$	-93 (Note 9)		N/A	-93 (Note 9)		N/A
Subframe Configuration		Non-MBSFN		Non-MBSFN	Non-MBSFN		Non-MBSFN
Cell Id		0		Cell 2: 6 Cell 3: 1	0		Cell 2: 6 Cell 3: 1
Time Offset between Cells	$\mu$ s	Cell 2: 3 usec Cell 3: -1usec			Cell 2: 3 usec Cell 3: -1usec		
Frequency Shift between Cells	Hz	Cell 2: 300Hz Cell 3: -100Hz			Cell 2: 300Hz Cell 3: -100Hz		
ABS pattern (Note 2)		N/A		01010101 01010101 01010101 01010101 01010101	N/A		01010101 01010101 01010101 01010101 01010101
RLM/RRM Measurement Subframe Pattern (Note 4)		00000100 00000100 00000100 00000100 00000100		N/A	00000100 00000100 00000100 00000100 00000100		N/A
CSI Subframe Sets (Note 3)	$C_{CSI,0}$	01010101 01010101 01010101 01010101 01010101		N/A	01010101 01010101 01010101 01010101 01010101		N/A
	$C_{CSI,1}$	10101010 10101010 10101010 10101010 10101010		N/A	10101010 10101010 10101010 10101010 10101010		N/A
Number of control OFDM symbols		3			3		
Max number of HARQ transmissions		1			1		
Physical channel for $C_{CSI,0}$ CQI reporting		PUCCH Format 2			PUCCH Format 2		
Physical channel for $C_{CSI,1}$ CQI reporting		PUSCH (Note 12)			PUSCH (Note 12)		
PUCCH Report Type		4			4		
Reporting periodicity	Ms	$N_{pd} = 5$			$N_{pd} = 5$		
<i>cqi-pmi-ConfigurationIndex</i> $C_{CSI,0}$ (Note 13)		6		N/A	6		N/A
<i>cqi-pmi-ConfigurationIndex2</i> $C_{CSI,1}$ (Note 14)		5		N/A	5		N/A

Note 1:	For each test, the minimum requirements shall be fulfilled for at least one of the two SNR(s) and the respective wanted signal input level.
Note 2:	ABS pattern as defined in [9].
Note 3:	Time-domain measurement resource restriction pattern for PCell measurements as defined in TS 36.331 [5].
Note 4:	As configured according to the time-domain measurement resource restriction pattern for CSI measurements defined in TS 36.331 [5].
Note 5:	Time-domain measurement resource restriction pattern for PCell measurements as defined in TS 36.331 [5].
Note 6:	Cell 1 is the serving cell. Cell 2 and Cell 3 are the aggressor cells. The number of the CRS ports in Cell 1, Cell 2, and Cell 3 are the same.
Note 7:	This noise is applied in OFDM symbols #1, #2, #3, #5, #6, #8, #9, #10, #12, #13 of a subframe overlapping with the aggressor ABS.
Note 8:	This noise is applied in OFDM symbols #0, #4, #7, #11 of a subframe overlapping with the aggressor ABS.
Note 9:	This noise is applied in all OFDM symbols of a subframe overlapping with aggressor non-ABS.
Note 10:	Downlink physical channel setup in Cell 2 and Cell 3 in accordance with Annex TS 36.521-1 [10] C.3.3 applying OCN pattern as defined in TS 36.521-1 [10] Annex A.5.1.5
Note 11:	Reference measurement channel in Cell 1 RC.2 FDD according to Table A.4-1 with one sided dynamic OCN Pattern OP.1 FDD as described in Annex A.5.1.1.
Note 12:	To avoid collisions between HARQ-ACK and wideband CQI it is necessary to report both on PUSCH instead of PUCCH. PDCCH DCI format 0 shall be transmitted in downlink SF#4 and #9 to allow periodic CQI to multiplex with the HARQ-ACK on PUSCH in uplink subframe SF#8 and #3.
Note 13:	<i>cqi-pmi-ConfigurationIndex</i> is applied for $C_{CSI,0}$ .
Note 14:	<i>cqi-pmi-ConfigurationIndex2</i> is applied for $C_{CSI,1}$ .

The normative reference for this requirement is TS 36.101 [2] clause 9.2.1.5.

### 9.2.1.5\_E.1.4 Test description

#### 9.2.1.5\_E.1.4.1 Initial conditions

Initial conditions are a set of test configurations the UE needs to be tested in and the steps for the SS to take with the UE to reach the correct measurement state.

Configurations of PDSCH and PDCCH before measurement are specified in Annex C.2.

Test Environment: Normal as defined in TS 36.508 [7] clause 4.1.

Frequencies to be tested: Mid Range as defined in TS 36.508 [7] clause 4.3.1.1.

Channel Bandwidths to be tested: 10MHz, as defined in TS 36.508 [7] clause 4.3.1.1

1. Connect the SS, AWGN noise source to the UE antenna connector (s) as shown in TS 36.508 [7] Annex A, Figure A.48 (without faders) for antenna configuration 2x2.
2. The parameter settings for the cell are set up according to Table 9.2.1.5\_E.1.3-1.
3. Downlink signals are initially set up according to Annex C0, C.1 and Annex C.3.2 and uplink signals according to Annex H.1 and H.3.2.
4. Propagation conditions are set according to Annex B.0.
5. Ensure the UE is in State 3A-RF according to TS 36.508 [7] clause 5.2A.2 with exceptions listed in 5.2A.5. Message contents are defined in clause 9.2.1.5\_E.1.4.3.

#### 9.2.1.5\_E.1.4.2 Test procedure

1. Set the parameters of bandwidth, reference channel, the propagation condition, antenna configuration and the SNR according to Table 9.2.1.5\_E.1.3-1 as appropriate.
2. The SS shall transmit PDSCH via PDCCH DCI format 1A for  $C_{RNTI}$  to transmit the DL RMC according to CQI value 8 and keep it regardless of the wideband CQI value sent by the UE. The SS sends downlink MAC padding bits on the DL RMC. The SS sends uplink scheduling information via PDCCH DCI format 0 with CQI request bit set to 0 in downlink SF#4 and #9 to schedule UL RMC in uplink SF#8 and #3 (Table A.4.1-1). The

UE will send ACK/NACK and periodic CQI report for subframe set  $C_{CSI,0}$  using PUCCH and for subframe set  $C_{CSI,1}$  using PUSCH. Continue transmission of the PDSCH until 2000 wideband CQI reports, respectively for subframe set  $C_{CSI,0}$  and for subframe set  $C_{CSI,1}$ , have been gathered. In this process the SS collects wideband CQI reports every 5 ms and also cases where UE transmits nothing in its CQI timing are also counted as wideband CQI reports.

3. Set up a relative frequency distribution for the reported wideband CQI-values for subframe set  $C_{CSI,0}$  and for subframe set  $C_{CSI,1}$ . Calculate respectively the median value (wideband Median CQI is the wideband CQI that is at or crosses 50% distribution from the lower wideband CQI side). These CQI-values are declared as wideband Median CQI<sub>0</sub> and Median CQI<sub>1</sub>.
4. If Median CQI is not equal to 1 or 15 and 1800 or more of the wideband CQI values for subframe set  $C_{CSI,0}$  are in the range  $(\text{Median CQI}_0 - 1) \leq \text{Median CQI}_0 \leq (\text{Median CQI}_0 + 1)$  AND Median CQI<sub>1</sub> is not equal to 1 or 15, and 1800 or more of the wideband CQI values for subframe set  $C_{CSI,1}$  are in the range  $(\text{Median CQI}_1 - 1) \leq \text{Median CQI}_1 \leq (\text{Median CQI}_1 + 1)$ , then continue with step 5, otherwise go to step 8.

For Test1

5. The SS shall transmit PDSCH via PDCCH DCI format 1A for  $C_{RNTI}$  to transmit the DL RMC only in ABS subframes according to the wideband median- CQI<sub>0</sub> value and shall not react to the UE's wideband CQI reports. The SS sends downlink MAC padding bits on the DL RMC. For any PDSCH transmitted by the SS, record the associated ACK, NACK and statDTX responses. The responses are then filtered as follows: for the sequence of responses for each HARQ process, discard all the statDTX responses. Continue to gather data until the number of filtered ACK+NACK responses reaches 1000.

For the filtered ACK and NACK responses if the ratio  $(\text{NACK} / \text{ACK} + \text{NACK}) \leq 0.1$  then go to step 6, otherwise go to step 7.

6. The SS shall transmit PDSCH via PDCCH DCI format 1A for  $C_{RNTI}$  to transmit the DL RMC only in ABS subframes according to the wideband median- CQI<sub>0</sub>+1 value and shall not react to the UE's wideband CQI reports. The SS sends downlink MAC padding bits on the DL RMC. For any PDSCH, transmitted by the SS, record and filter the ACK, NACK and statDTX responses as in step 5 until 1000 filtered ACK+NACK responses are gathered.

If the ratio  $(\text{NACK} / \text{ACK} + \text{NACK}) > 0.1$

then pass the UE for this test and go to step 13, otherwise go to step 8.

7. The SS shall transmit PDSCH via PDCCH DCI format 1A for  $C_{RNTI}$  to transmit the DL RMC only in ABS subframes according to the wideband median- CQI<sub>0</sub>-1 value and shall not react to the UE's wideband CQI reports. The SS sends downlink MAC padding bits on the DL RMC. For any PDSCH, transmitted by the SS, record and filter the ACK, NACK and statDTX responses as in step 5 until 1000 filtered ACK+NACK responses are gathered.

If the ratio  $(\text{NACK} / \text{ACK} + \text{NACK}) \leq 0.1$

then pass the UE for this test and go to step 13, otherwise go to step 8.

8. If both SNR points of the test have not been tested, then repeat the same procedure (steps 1 to 7) for the other SNR point as appropriate. Otherwise fail the UE.

For Test2

5. The SS shall transmit PDSCH via PDCCH DCI format 1A for  $C_{RNTI}$  to transmit the DL RMC in ABS subframes according to the wideband median- CQI<sub>0</sub> value and Non-ABS subframes according to the wideband median- CQI<sub>1</sub> value, and the SS shall not react to the UE's wideband CQI reports. The SS sends downlink MAC padding bits on the DL RMC. For any PDSCH transmitted by the SS, record the associated ACK, NACK and statDTX responses. The responses are then filtered as follows: for the sequence of responses for each HARQ process, discard all the statDTX responses. Continue to gather data until the number of filtered ACK+NACK responses reaches 1000.

For the filtered ACK and NACK responses in ABS and/or Non-ABS subframes if the ratio  $(\text{NACK} / \text{ACK} + \text{NACK}) \leq 0.1$  then go to step 6.



For the filtered ACK and NACK responses only in Non-ABS subframes if the ratio  $(\text{NACK} / \text{ACK} + \text{NACK}) \leq 0.1$  then go to step 7.

For the filtered ACK and NACK responses only in ABS subframes if the ratio  $(\text{NACK} / \text{ACK} + \text{NACK}) \leq 0.1$  then go to step 8, otherwise go to step 11.

6. The SS shall transmit PDSCH via PDCCH DCI format 1A for  $C\_RNTI$  to transmit the DL RMC in ABS subframes according to the wideband median-  $CQI_{0+1}$  value and Non-ABS subframes according to the wideband median-  $CQI_{1+2}$  value, and the SS shall not react to the UE's wideband CQI reports. The SS sends downlink MAC padding bits on the DL RMC. For any PDSCH, transmitted by the SS, record and filter the ACK, NACK and statDTX responses as in step 5 until 1000 filtered ACK+NACK responses are gathered.

For the filtered ACK and NACK responses in ABS and/or Non-ABS subframes if the ratio  $(\text{NACK} / \text{ACK} + \text{NACK}) > 0.1$  then pass the UE for this test and go to step 13.

For the filtered ACK and NACK responses only in ABS subframes if the ratio  $(\text{NACK} / \text{ACK} + \text{NACK}) > 0.1$  then pass the UE for this test and go to step 9.

For the filtered ACK and NACK responses only in Non-ABS subframes if the ratio  $(\text{NACK} / \text{ACK} + \text{NACK}) > 0.1$  then pass the UE for this test and go to step 10, otherwise go to step 11.

7. The SS shall transmit PDSCH via PDCCH DCI format 1A for  $C\_RNTI$  to transmit the DL RMC only in Non-ABS subframes according to the wideband median-  $CQI_{1+2}$  value, and the SS shall not react to the UE's wideband CQI reports. The SS sends downlink MAC padding bits on the DL RMC. For any PDSCH, transmitted by the SS, record and filter the ACK, NACK and statDTX responses as in step 5 until 1000 filtered ACK+NACK responses are gathered.

If the ratio  $(\text{NACK} / \text{ACK} + \text{NACK}) > 0.1$  then pass the UE for this test and in step 10, otherwise go to step 11

8. The SS shall transmit PDSCH via PDCCH DCI format 1A for  $C\_RNTI$  to transmit the DL RMC only in ABS subframes according to the wideband median-  $CQI_{0+1}$  value, and the SS shall not react to the UE's wideband CQI reports. The SS sends downlink MAC padding bits on the DL RMC. For any PDSCH, transmitted by the SS, record and filter the ACK, NACK and statDTX responses as in step 5 until 1000 filtered ACK+NACK responses are gathered.

If the ratio  $(\text{NACK} / \text{ACK} + \text{NACK}) > 0.1$  then pass the UE for this test and in step 9, otherwise go to step 11.

9. The SS shall transmit PDSCH via PDCCH DCI format 1A for  $C\_RNTI$  to transmit the DL RMC only in Non-ABS subframes according to the wideband median-  $CQI_{1-1}$  value, and the SS shall not react to the UE's wideband CQI reports. The SS sends downlink MAC padding bits on the DL RMC. For any PDSCH, transmitted by the SS, record and filter the ACK, NACK and statDTX responses as in step 5 until 1000 filtered ACK+NACK responses are gathered.

If the ratio  $(\text{NACK} / \text{ACK} + \text{NACK}) \leq 0.1$  then pass the UE for this test and go to step 13, otherwise go to step 12.

10. The SS shall transmit PDSCH via PDCCH DCI format 1A for  $C\_RNTI$  to transmit the DL RMC only in ABS subframes according to the wideband median-  $CQI_{0-1}$  value, and the SS shall not react to the UE's wideband CQI reports. The SS sends downlink MAC padding bits on the DL RMC. For any PDSCH, transmitted by the SS, record and filter the ACK, NACK and statDTX responses as in step 5 until 1000 filtered ACK+NACK responses are gathered.

If the ratio  $(\text{NACK} / \text{ACK} + \text{NACK}) \leq 0.1$  then pass the UE for this test and go to step 13, otherwise go to step 12.

11. The SS shall transmit PDSCH via PDCCH DCI format 1A for  $C\_RNTI$  to transmit the DL RMC in ABS subframes according to the wideband median-  $CQI_{0-1}$  value, Non-ABS subframes according to the wideband median-  $CQI_{1-1}$  value, and the SS shall not react to the UE's wideband CQI reports. The SS sends downlink MAC padding bits on the DL RMC. For any PDSCH, transmitted by the SS, record and filter the ACK, NACK and statDTX responses as in step 5 until 1000 filtered ACK+NACK responses are gathered.

For the filtered ACK and NACK responses in ABS and/or Non-ABS subframes if the ratio  $(\text{NACK} / \text{ACK} + \text{NACK}) \leq 0.1$  then pass the UE for this test and go to step 13, otherwise go to step 12.

12. If both SNR points of the test have not been tested, then repeat the same procedure (steps 1 to 11) for the other SNR point as appropriate. Otherwise fail the UE.13. If both tests have not been done, then repeat the same procedure (For Test1 steps 1 to 8, For Test2 steps 1 to 12) with test conditions according to the table 9.2.1.5\_E.1.3-1 for the other Test as appropriate. Otherwise pass the UE.

9.2.1.5\_E.1.4.3 Message contents

Message contents are according to TS 36.508 [7] clause 5.2A.5.1 with the following exceptions:

**Table 9.2.1.5\_E.1.4.3-1: RadioResourceConfigDedicated-SRB2-DRB(n, m): Additional FDD PUCCH 1-0 static test performance downlink power allocation**

Derivation Path: TS 36.508 [7] clause 4.6.3, Table 4.6.3-16 RadioResourceConfigDedicated-SRB2-DRB(n,m)			
Information Element	Value/remark	Comment	Condition
RadioResourceConfigDedicated-SRB2-DRB(n, m) ::= SEQUENCE {			
MeasSubframePatternPCell-r10 CHOICE {			
setup SEQUENCE {			
subframePatternFDD-r10	'0000010000000100 0000010000000100 00000100'	BIT STRING (SIZE (40))	
}			
}			
neighCellsCRS-Info-r11 ::= CHOICE {			
setup SEQUENCE {			
CRS-AssistanceInfoList-r11 ::= SEQUENCE (SIZE (1..maxCellReport)) OF CRS-AssistanceInfo-r11{		2 entries	
CRS-AssistanceInfo-r11 ::= SEQUENCE {			
physCellId-r11	6		Cell 2
	1		Cell 3
antennaPortsCount-r11	an2		Cell 2, Cell 3
mbsfn-SubframeConfigList-r11 ::= SEQUENCE (SIZE (1..maxMBSFN-Allocations)) OF MBSFN-SubframeConfig{			Cell 2, Cell 3
MBSFN-SubframeConfig ::= SEQUENCE {			
radioframeAllocationPeriod	n1		
radioframeAllocationOffset	0		
subframeAllocation CHOICE{			
oneFrame	'000000' B	non-MBSFN	
}			
}			
}			
}			
}			
}			
}			
}			

**Table 9.2.1.5\_E.1.4.3-2: PhysicalConfigDedicated-DEFAULT: Additional FDD PUCCH 1-0 static test performance downlink power allocation**

Derivation Path: 36.508 clause 5.5.1.2			
Information Element	Value/remark	Comment	Condition
PhysicalConfigDedicated-DEFAULT ::= SEQUENCE {			
cqi-ReportConfig	Not present		
cqi-ReportConfig-r10	CQI-ReportConfig-r10-DEFAULT		
cqi-ReportConfig- v1130	CQI-ReportConfig-v1130-DEFAULT		
}			

**Table 9.2.1.5\_E.1.4.3-3: CQI-ReportConfig-r10-DEFAULT: Additional FDD PUCCH 1-0 static test performance downlink power allocation**

Derivation Path: 36.508 [7] clause 4.6.3, Table 4.6.3-2AA CQI-ReportConfig-r10-DEFAULT_			
Information Element	Value/remark	Comment	Condition
CQI-ReportConfig-r10-DEFAULT ::= SEQUENCE {			
cqi-ReportAperiodic-r10	Not present		
nomPDSCH-RS-EPRE-Offset	0		
cqi-ReportPeriodic-r10	Not present		
pmi-RI-Report-r9	Not present		
csi-SubframePatternConfig-r10 CHOICE {			
setup SEQUENCE {			
csi-MeasSubframeSet1-r10 CHOICE {			
subframePatternFDD-r10	'0101010101010101 0101010101010101 01010101'	BIT STRING (SIZE (40))	
}			
csi-MeasSubframeSet2-r10 CHOICE {			
subframePatternFDD-r10	'1010101010101010 1010101010101010 10101010'	BIT STRING (SIZE (40))	
}			
}			
}			
}			

**Table 9.2.1.5\_E.1.4.3-4: CQI-ReportConfig- v1130-DEFAULT: Additional FDD PUCCH 1-0 static test performance downlink power allocation**

Derivation Path: 36.508 clause 4.6.3			
Information Element	Value/remark	Comment	Condition
CQI-ReportConfig-v1130 ::= SEQUENCE {			
cqi-ReportPeriodic-v1130 SEQUENCE {			
simultaneousAckNackAndCQI-Format3-r11	Not present		
cqi-ReportPeriodicProcExtToReleaseList-r11	Not present		
cqi-ReportPeriodicProcExtToAddModList-r11	1 entry		
SEQUENCE (SIZE (1..maxCQI-ProcExt-r11)) OF SEQUENCE {			
cqi-ReportPeriodicProcExtId-r11[1] SEQUENCE {			
cqi-ReportPeriodicProcExtId-r11	1		
cqi-pmi-ConfigIndex-r11	6	CSI process 0 (C <sub>CSI,0</sub> ) (see Table 7.2.2-1A in TS 36.213)	
cqi-FormatIndicatorPeriodic-r11 CHOICE {			
widebandCQI-r11 SEQUENCE {			
csi-ReportMode-r11	Not present		
}			
subbandCQI-r11 SEQUENCE {			
k	Not present		
periodicityFactor-r11	Not present		
}			
}			
ri-ConfigIndex-r11	Not present		
csi-ConfigIndex-r11 CHOICE {			
setup SEQUENCE {			
cqi-pmi-ConfigIndex2-r11	5	CSI process 1 (C <sub>CSI,1</sub> ) (see Table 7.2.2-1A in TS 36.213)	
ri-ConfigIndex2-r11	Not present		
}			
}			
}			
}			

### 9.2.1.5\_E.1.5 Test requirement

The pass fail decision is as specified in the test procedure in clause 9.2.1.5\_E.1.4.2.

There are no parameters in the test setup or measurement process whose variation impacts the results so there are no applicable test tolerances for this test.

### 9.2.1.6

#### 9.2.1.6\_E TDD CQI Reporting under AWGN conditions – PUCCH 1-0 for feICIC

##### 9.2.1.6\_E.1 TDD CQI Reporting under AWGN conditions – PUCCH 1-0 for feICIC (non-MBSFN ABS)

##### 9.2.1.6\_E.1.1 Test purpose

To verify the variance of the wideband CQI reports - in subframes overlapping with aggressor cell ABS and non-ABS subframes is within the limits defined and a PDSCH BLER of 10% falls between the transport format based median CQI-1 and median CQI or the transport format based median CQI and median CQI +1.

### 9.2.1.6\_E.1.2 Test applicability

This test applies to E-UTRA TDD UE and CRS interference handling and ss-CCH interference handling - UE Category 2-8 - release 11 and forward. Applicability requires support of FGI bit 115.

### 9.2.1.6\_E.1.3 Minimum conformance requirements

For the parameters specified in Table 9.2.1.6\_E.1.3-1, and using the downlink physical channels specified in tables C.3.2-1 for Cell 1, C.3.3-2 for Cell 2 and Cell 3, and C.3.2-2, the reported CQI value according to RC.2 TDD in Table A.4-1 in subframes overlapping with aggressor cell ABS and non-ABS subframes shall be in the range of  $\pm 1$  of the reported median more than 90% of the time.

For test 1, if the PDSCH BLER in ABS subframes using the transport format indicated by median CQI obtained by reports in CSI subframe sets  $C_{CSI,0}$  is less than or equal to 0.1, the BLER in ABS subframes using the transport format indicated by the (median CQI + 1) shall be greater than 0.1. If the PDSCH BLER in ABS subframes using the transport format indicated by the median CQI is greater than 0.1, the BLER in ABS subframes using transport format indicated by (median CQI - 1) shall be less than or equal to 0.1.

For test 2, if the PDSCH BLER in ABS subframes using the transport format indicated by median CQI obtained by reports in CSI subframe sets  $C_{CSI,0}$  is less than or equal to 0.1, the BLER in ABS subframes using the transport format indicated by the (median CQI + 1) shall be greater than 0.1. If the PDSCH BLER in ABS subframes using the transport format indicated by the median CQI is greater than 0.1, the BLER in ABS subframes using transport format indicated by (median CQI - 1) shall be less than or equal to 0.1.

For test 2, if the PDSCH BLER in non-ABS subframes using the transport format indicated by median CQI obtained by reports in CSI subframe sets  $C_{CSI,1}$  is less than or equal to 0.1, the BLER in non-ABS subframes using the transport format indicated by the (median CQI + 2) shall be greater than 0.1. If the PDSCH BLER in non-ABS subframes using the transport format indicated by the median CQI is greater than 0.1, the BLER in non-ABS subframes using transport format indicated by (median CQI - 1) shall be less than or equal to 0.1.

Table 9.2.1.6\_E.1.3-1: PUCCH 1-0 static test (TDD)

Parameter	Unit	Test 1			Test 2		
		Cell 1	Cell 2 and 3		Cell 1	Cell 2 and 3	
Bandwidth	MHz	10			10		
PDSCH transmission mode		2	Note 10		2	Note 10	
Uplink downlink configuration		1			1		
Special subframe configuration		4			4		
Downlink power allocation	$\rho_A$	dB			-3		
	$\rho_B$	dB			-3		
	$\sigma$	dB			0		
Propagation condition and antenna configuration		Clause B.1 (2x2)			Clause B.1 (2x2)		
$\hat{E}_s / N_{oc2}$ (Note 1)	dB	4	5	Cell 2: 12 Cell 3: 10	13	14	Cell 2: 12 Cell 3: 10
$N_{oc}^{(j)}$ at antenna port	$N_{oc1}^{(j)}$	dBm/15kHz		-98 (Note 7)	N/A		-98 (Note 7)
	$N_{oc2}^{(j)}$	dBm/15kHz		-98 (Note 8)	N/A		-98 (Note 8)
	$N_{oc3}^{(j)}$	dBm/15kHz		-93 (Note 9)	N/A		-93 (Note 9)
Subframe Configuration		Non-MBSFN		Non-MBSFN	Non-MBSFN		Non-MBSFN
Cell Id		0		Cell 2: 6 Cell 3: 1	0		Cell 2: 6 Cell 3: 1
Time Offset between Cells	$\mu$ s	Cell 2: 3 usec Cell 3: -1usec			Cell 2: 3 usec Cell 3: -1usec		
Frequency shift between Cells	Hz	Cell 2: 300Hz Cell 3: -100Hz			Cell 2: 300Hz Cell 3: -100Hz		
ABS pattern (Note 2)		N/A		0100010001 0100010001	N/A		0100010001 0100010001
RLM/RRM Measurement Subframe Pattern (Note 4)		0000000001 0000000001		N/A		0000000001 0000000001	
CSI Subframe Sets (Note 3)	$C_{CSI,0}$	0100010001 0100010001		N/A		0100010001 0100010001	
	$C_{CSI,1}$	1000101000 1000101000		N/A		1000101000 1000101000	
Number of control OFDM symbols		3			3		
Max number of HARQ transmissions		1			1		
Physical channel for $C_{CSI,0}$ CQI reporting		PUCCH Format 2			PUCCH Format 2		
Physical channel for $C_{CSI,1}$ CQI reporting		PUSCH (Note 12)			PUSCH (Note 12)		
PUCCH Report Type		4			4		
Reporting periodicity	ms	$N_{pd} = 5$			$N_{pd} = 5$		
$cqi-pmi-ConfigurationIndex$ $C_{CSI,0}$ (Note 13)		3	N/A		3	N/A	
$cqi-pmi-ConfigurationIndex2$ $C_{CSI,1}$ (Note 14)		4	N/A		4	N/A	
ACK/NACK feedback mode		Multiplexing			Multiplexing		

Note 1:	For each test, the minimum requirements shall be fulfilled for at least one of the two SNR(s) and the respective wanted signal input level.
Note 2:	ABS pattern as defined in [9].
Note 3:	Time-domain measurement resource restriction pattern for PCell measurements as defined in TS 36.331 [5].
Note 4:	As configured according to the time-domain measurement resource restriction pattern for CSI measurements defined in TS 36.331 [5].
Note 5:	Time-domain measurement resource restriction pattern for PCell measurements as defined in TS 36.331 [5].
Note 6:	Cell 1 is the serving cell. Cell 2 and Cell 3 are the aggressor cells. The number of the CRS ports in Cell 1, Cell 2, and Cell 3 is the same.
Note 7:	This noise is applied in OFDM symbols #1, #2, #3, #5, #6, #8, #9, #10, #12, #13 of a subframe overlapping with the aggressor ABS.
Note 8:	This noise is applied in OFDM symbols #0, #4, #7, #11 of a subframe overlapping with the aggressor ABS
Note 9:	This noise is applied in all OFDM symbols of a subframe overlapping with aggressor non-ABS.
Note 10:	Downlink physical channel setup in Cell 2 and Cell 3 in accordance with TS 36.521-1 [10] Annex C.3.3 applying OCNG pattern as defined in TS 36.521-1 [10] Annex A.5.2.5.
Note 11:	Reference measurement channel in Cell 1 RC.2 TDD according to Table A.4-1 with one sided dynamic OCNG Pattern OP.1 TDD as described in Annex A.5.2.1.
Note 12:	To avoid collisions between HARQ-ACK and wideband CQI it is necessary to report both on PUSCH instead of PUCCH. PDCCH DCI format 0 shall be transmitted in downlink SF#4 and #9 to allow periodic CQI to multiplex with the HARQ-ACK on PUSCH in uplink subframe SF#8 and #3.
Note 13:	<i>cqi-pmi-ConfigurationIndex</i> is applied for $C_{CSI,0}$ .
Note 14:	<i>cqi-pmi-ConfigurationIndex2</i> is applied for $C_{CSI,1}$ .

The normative reference for this requirement is TS 36.101 [2] clause 9.2.1.6.

## 9.2.1.6\_E.1.4 Test description

### 9.2.1.6\_E.1.4.1 Initial conditions

Initial conditions are a set of test configurations the UE needs to be tested in and the steps for the SS to take with the UE to reach the correct measurement state.

Configurations of PDSCH and PDCCH before measurement are specified in Annex C.2.

Test Environment: Normal as defined in TS 36.508 [7] clause 4.1.

Frequencies to be tested: Mid Range as defined in TS 36.508 [7] clause 4.3.1.2.

Channel Bandwidths to be tested: 10MHz, as defined in TS 36.508 [7] clause 4.3.1.2

1. Connect the SS, AWGN noise source to the UE antenna connector (s) as shown in TS 36.508 [7] Annex A, Figure A.48 (without faders) for antenna configuration 2x2.
2. The parameter settings for the cell are set up according to Table 9.2.1.6\_E.1.3-1.
3. Downlink signals are initially set up according to Annex C0, C.1 and Annex C.3.2 and uplink signals according to Annex H.1 and H.3.2.
4. Propagation conditions are set according to Annex B.0
5. Ensure the UE is in State 3A-RF according to TS 36.508 [7] clause 5.2A.2 with exceptions listed in 5.2A.5. Message contents are defined in clause 9.2.1.6\_E.1.4.3.

### 9.2.1.6\_E.1.4.2 Test procedure

1. Set the parameters of bandwidth, reference channel, the propagation condition, antenna configuration and the SNR according to Table 9.2.1.6\_E.1.3-1 as appropriate.
2. The SS shall transmit PDSCH via PDCCH DCI format 1A for  $C_{RNTI}$  to transmit the DL RMC according to CQI value 8 and keep it regardless of the wideband CQI value sent by the UE. The SS sends downlink MAC padding bits on the DL RMC. The SS sends uplink scheduling information via PDCCH DCI format 0 with CQI request bit set to 0 in downlink SF#4 and #9 to schedule UL RMC in subframe #8 and subframe #3 (Table A.4.1-2). The UE will send ACK/NACK and periodic CQI report for subframe set  $C_{CSI,0}$  using PUCCH and for

subframe set  $C_{\text{CSI},1}$  using PUSCH. Continue transmission of the PDSCH until 2000 wideband CQI reports, respectively for subframe set  $C_{\text{CSI},0}$  and for subframe set  $C_{\text{CSI},1}$ , have been gathered. In this process the SS collects wideband CQI reports every 5 ms and also cases where UE transmits nothing in its CQI timing are counted as wideband CQI reports.

3. Set up a relative frequency distribution for the reported wideband CQI-values for subframe set  $C_{\text{CSI},0}$  and for subframe set  $C_{\text{CSI},1}$ . Calculate respectively the median value (wideband Median CQI is the CQI that is at or crosses 50% distribution from the lower wideband CQI side). These CQI-values are declared as wideband Median CQI<sub>0</sub> and Median CQI<sub>1</sub>.
4. If Median CQI is not equal to 1 or 15 and 1800 or more of the wideband CQI values for subframe set  $C_{\text{CSI},0}$  are in the range  $(\text{Median CQI}_0 - 1) \leq \text{Median CQI}_0 \leq (\text{Median CQI}_0 + 1)$  AND Median CQI<sub>1</sub> is not equal to 1 or 15, and 1800 or more of the wideband CQI values for subframe set  $C_{\text{CSI},1}$  are in the range  $(\text{Median CQI}_1 - 1) \leq \text{Median CQI}_1 \leq (\text{Median CQI}_1 + 1)$  AND the difference Median CQI<sub>0</sub> minus Median CQI<sub>1</sub> is  $2 \leq (\text{Median CQI}_0 - \text{Median CQI}_1) \leq 5$  for Test 1 and  $0 \leq (\text{Median CQI}_0 - \text{Median CQI}_1) \leq 1$  for Test 2, then continue with step 5, otherwise go to step 8.
5. The SS shall transmit PDSCH via PDCCH DCI format 1A for  $C_{\text{RNTI}}$  to transmit the DL RMC according to the wideband median-CQI value and shall not react to the UE's wideband CQI reports. The SS sends downlink MAC padding bits on the DL RMC. The SS sends uplink scheduling information via PDCCH DCI format 0 with CQI request bit set to 0 to schedule UL RMC in subframe #8 and subframe #3 (Table A.4.1-2). The UE will send ACK/NACK and periodic CQI report using PUSCH. For any PDSCH transmitted by the SS, record the associated ACK, NACK and statDTX responses. *In case statDTX can not be differentiated from NACK due to multiplexing effect, evaluate the feedback as a NACK* The responses are then filtered as follows: for the sequence of responses for each HARQ process, discard all the statDTX responses. Continue to gather data until the number of filtered ACK+NACK responses reaches 1000.

For the filtered ACK and NACK responses if the ratio  $(\text{NACK} / \text{ACK} + \text{NACK}) \leq 0.1$  then go to step 6, otherwise go to step 7.

6. The SS shall transmit PDSCH via PDCCH DCI format 1A for  $C_{\text{RNTI}}$  to transmit the DL RMC according to the wideband median-CQI+1 value and shall not react to the UE's wideband CQI reports. The SS sends downlink MAC padding bits on the DL RMC. The SS sends uplink scheduling information via PDCCH DCI format 0 with CQI request bit set to 0 to schedule UL RMC in subframe #8 and subframe #3 (Table A.4.1-2). The UE will send ACK/NACK and periodic CQI report using PUSCH. For any PDSCH, transmitted by the SS, record and filter the ACK, NACK and statDTX responses as in step 5 until 1000 filtered ACK+NACK responses are gathered. *In case statDTX can not be differentiated from NACK due to multiplexing effect, evaluate the feedback as a NACK*

If the ratio  $(\text{NACK} / \text{ACK} + \text{NACK}) > 0.1$

then pass the UE for this test and go to step 9, otherwise go to step 8.

7. The SS shall transmit PDSCH via PDCCH DCI format 1A for  $C_{\text{RNTI}}$  to transmit the DL RMC according to the wideband median-CQI-1 value and shall not react to the UE's wideband CQI reports. The SS sends downlink MAC padding bits on the DL RMC. The SS sends uplink scheduling information via PDCCH DCI format 0 with CQI request bit set to 0 to schedule UL RMC in subframe #8 and subframe #3 (Table A.4.1-2). The UE will send ACK/NACK and periodic CQI report using PUSCH. For any PDSCH, transmitted by the SS, record and filter the ACK, NACK and statDTX responses as in step 5 until 1000 filtered ACK+NACK responses are gathered. *In case statDTX can not be differentiated from NACK due to multiplexing effect, evaluate the feedback as a NACK*

If the ratio  $(\text{NACK} / \text{ACK} + \text{NACK}) \leq 0.1$

then pass the UE for this test and go to step 9, otherwise go to step 8.

8. If both SNR points of the test have not been tested, then repeat the same procedure (steps 1 to 7) for the other SNR point as appropriate. Otherwise fail the UE.
9. If both tests have not been done, then repeat the same procedure (steps 1 to 8) with test conditions according to the table 9.2.1.6\_E.1.3-1 for the other Test as appropriate. Otherwise pass the UE.



9.2.1.6\_E.1.4.3 Message contents

Message contents are according to TS 36.508 [7] clause 5.2A.5.1 with the following exceptions:

**Table 9.2.1.6\_E.1.4.3-1: RadioResourceConfigDedicated-SRB2-DRB(n, m): Additional TDD PUCCH 1-0 static test performance downlink power allocation**

Derivation Path: TS 36.508 [7] clause 4.6.3, Table 4.6.3-16 RadioResourceConfigDedicated-SRB2-DRB(n,m)			
Information Element	Value/remark	Comment	Condition
RadioResourceConfigDedicated-SRB2-DRB(n, m) ::= SEQUENCE {			
MeasSubframePatternPCell-r10 CHOICE {			
setup SEQUENCE {			
subframePatternTDD-r10 CHOICE {			
subframeConfig1-5-r10	'0000000001 0000000001'	BIT STRING (SIZE (20))	
}			
}			
}			
}			

**Table 9.2.1.6\_E.1.4.3-2: PhysicalConfigDedicated-DEFAULT: Additional TDD PUCCH 1-0 static test performance downlink power allocation**

Derivation Path: 36.508 clause 5.5.1.2			
Information Element	Value/remark	Comment	Condition
PhysicalConfigDedicated-DEFAULT ::= SEQUENCE {			
cqi-ReportConfig-r10	CQI-ReportConfig-r10- DEFAULT		
cqi-ReportConfig- v1130	CQI-ReportConfig-v1130- DEFAULT		
}			

**Table 9.2.1.6\_E.1.4.3-3: CQI-ReportConfig-r10-DEFAULT: Additional TDD PUCCH 1-0 static test performance downlink power allocation**

Derivation Path: 36.508 [7] clause 4.6.3, Table 4.6.3-2AA CQI-ReportConfig-r10-DEFAULT			
Information Element	Value/remark	Comment	Condition
CQI-ReportConfig-r10-DEFAULT ::= SEQUENCE {			
cqi-ReportAperiodic-r10	Not present		
nomPDSCH-RS-EPRE-Offset	0		
cqi-ReportPeriodic-r10	Not present		
pmi-RI-Report-r9	Not present		
csi-SubframePatternConfig-r10 CHOICE {			
setup SEQUENCE {			
csi-MeasSubframeSet1-r10 CHOICE {			
subframePatternTDD-r10 CHOICE {			
subframeConfig1-5-r10	'0100010001 0100010001'	BIT STRING (SIZE (20))	
}			
}			
}			
csi-MeasSubframeSet2-r10 CHOICE {			
subframePatternTDD-r10 CHOICE {			
subframeConfig1-5-r10	'1000101000 1000101000'	BIT STRING (SIZE (20))	
}			
}			
}			

**Table 9.2.1.6\_E.1.4.3-4: CQI-ReportPeriodic- v1130-DEFAULT: TDD PUCCH 1-0 static test performance downlink power allocation**

Derivation Path: 36.508 clause 4.6.3			
Information Element	Value/remark	Comment	Condition
CQI-ReportConfig-v1130 ::= SEQUENCE {			
cqi-ReportPeriodic-v1130 SEQUENCE {			
simultaneousAckNackAndCQI-Format3-r11	Not present		
cqi-ReportPeriodicProcExtToReleaseList-r11	Not present		
cqi-ReportPeriodicProcExtToAddModList-r11	1 entry		
SEQUENCE (SIZE (1..maxCQI-ProcExt-r11)) OF SEQUENCE {			
cqi-ReportPeriodicProcExtId-r11[1] SEQUENCE {			
cqi-ReportPeriodicProcExtId-r11	1		
cqi-pmi-ConfigIndex-r11	3	CSI process 0 (C <sub>CSI,0</sub> ) (see Table 7.2.2-1A in TS 36.213)	
cqi-FormatIndicatorPeriodic-r11 CHOICE {			
widebandCQI-r11 SEQUENCE {			
csi-ReportMode-r11	Not present		
}			
subbandCQI-r11 SEQUENCE {			
k	Not present		
periodicityFactor-r11	Not present		
}			
}			
ri-ConfigIndex-r11	Not present		
csi-ConfigIndex-r11 CHOICE {			
release	NULL		
setup SEQUENCE {			
cqi-pmi-ConfigIndex2-r11	4	CSI process 1 (C <sub>CSI,1</sub> ) (see Table 7.2.2-1A in TS 36.213)	
ri-ConfigIndex2-r11	Not present		
}			
}			
}			
}			

**Table 9.2.1.6\_E.1.4.3-5: TDD-Config-DEFAULT: Additional TDD PUCCH 1-0 static test performance downlink power allocation**

Derivation Path: 36.508 clause 4.6.3			
Information Element	Value/remark	Comment	Condition
TDD-Config-DEFAULT ::= SEQUENCE {			
subframeAssignment	sa1		
specialSubframePatterns	ssp4		
}			

**Table 9.2.1.6\_E.1.4.3-6: PUCCH-ConfigDedicated-DEFAULT: Additional TDD PUCCH 1-0 static test performance downlink power allocation**

Derivation Path: 36.508 clause4.6.3			
Information Element	Value/remark	Comment	Condition
PUCCH-ConfigDedicated-DEFAULT ::= SEQUENCE			
{			
ackNackRepetition CHOICE {			
release	NULL		
}			
tddAckNackFeedbackMode	Multiplexing		
}			

### 9.2.1.6\_E.1.5 Test requirement

The pass fail decision is as specified in the test procedure in clause 9.2.16\_E.1.4.2.

There are no parameters in the test setup or measurement process whose variation impacts the results so there are no applicable test tolerances for this test.

## 9.2.2 CQI Reporting under AWGN conditions - PUCCH 1-1 (Cell-Specific Reference Symbols)

### 9.2.2.1 FDD CQI Reporting under AWGN conditions – PUCCH 1-1

#### 9.2.2.1.1 Test purpose

To verify the variance of the wideband spatial differential CQI between codeword #0 and codeword #1 are within the limits defined and for both codeword #0 and codeword #1, the PDSCH BLER using the transport format indicated by the respective median  $CQI_0 - 1$  and median  $CQI_1 - 1$  shall be less than or equal to 0.1 and the PDSCH BLER using the transport format indicated by the respective median  $CQI_0 + 1$  and median  $CQI_1 + 1$  shall be greater than or equal to 0.1.

#### 9.2.2.1.2 Test applicability

This test applies to E-UTRA FDD release 8 and forward UEs of Category 2 and onwards.

#### 9.2.2.1.3 Minimum conformance requirements

The minimum requirements for dual codeword transmission are defined in terms of a reporting spread of the wideband CQI value for codeword #1, and their BLER performance using the transport format indicated by the reported CQI median of codeword #0 and codeword #1. The precoding used at the transmitter is a fixed precoding matrix specified by the bitmap parameter *codebookSubsetRestriction*. The propagation condition assumed for the minimum performance requirement is defined in subclause B.1.

The following requirements apply to UE Category  $\geq 2$ . For the parameters specified in table 9.2.2.1.3-1, and using the downlink physical channels specified in tables C.3.2-1 and C.3.2-2, the reported offset level of the wideband spatial differential CQI for codeword #1 (Table 7.2.2 in TS 36.213 [10]) shall be used to determine the wideband CQI index for codeword #1 as

$$\text{wideband } CQI_1 = \text{wideband } CQI_0 - \text{Codeword 1 offset level}$$

The wideband  $CQI_1$  shall be within the set  $\{\text{median } CQI_1 - 1, \text{median } CQI_1, \text{median } CQI_1 + 1\}$  for more than 90% of the time, where the resulting wideband values  $CQI_1$  shall be used to determine the median CQI values for codeword #1. For both codewords #0 and #1, the PDSCH BLER using the transport format indicated by the respective median  $CQI_0 - 1$  and median  $CQI_1 - 1$  shall be less than or equal to 0.1. Furthermore, for both codewords #0 and #1, the PDSCH BLER using the transport format indicated by the respective median  $CQI_0 + 1$  and median  $CQI_1 + 1$  shall be greater than or equal to 0.1.

Table 9.2.2.1.3-1: PUCCH 1-1 static test (FDD)

Parameter		Unit	Test 1		Test 2	
Bandwidth		MHz	10			
PDSCH transmission mode			4			
Downlink power allocation	$\rho_A$	dB	-3			
	$\rho_B$	dB	-3			
	$\sigma$	dB	0			
Propagation condition and antenna configuration			Clause B.1 (2 x 2)			
CodeBookSubsetRestriction bitmap			010000			
SNR (Note 2)		dB	10	11	16	17
$\hat{I}_{or}^{(j)}$		dB[mW/15kHz]	-88	-87	-82	-81
$N_{oc}^{(j)}$		dB[mW/15kHz]	-98		-98	
Max number of HARQ transmissions			1			
Physical channel for CQI/PMI reporting			PUCCH Format 2			
PUCCH Report Type for CQI/PMI			2			
PUCCH Report Type for RI			3			
Reporting periodicity		ms	$N_P = 5$			
<i>cqi-pmi-ConfigurationIndex</i>			6			
<i>ri-ConfigIndex</i>			1 (Note 3)			
<p>Note 1: Reference measurement channel RC.2 FDD according to Table A.4-1 with one sided dynamic OCNG Pattern OP.1 FDD as described in Annex A.5.1.1</p> <p>Note 2: For each test, the minimum requirements shall be fulfilled for at least one of the two SNR(s) and the respective wanted signal input level.</p> <p>Note 3: It is intended to have UL collisions between RI reports and HARQ-ACK, since the RI reports shall not be used by the eNB in this test.</p>						

The normative reference for this requirement is TS 36.101 [2] clause 9.2.2.1.

#### 9.2.2.1.4 Test description

##### 9.2.2.1.4.1 Initial conditions

Initial conditions are a set of test configurations the UE needs to be tested in and the steps for the SS to take with the UE to reach the correct measurement state.

Configurations of PDSCH and PDCCH before measurement are specified in Annex C.2.

Test Environment: Normal as defined in TS 36.508 [7] clause 4.1.

Frequencies to be tested: Mid Range as defined in TS 36.508 [7] clause 4.3.1.1.

Channel Bandwidths to be tested: 10MHz, as defined in TS 36.508 [7] clause 4.3.1.1

1. Connect the SS, faders and AWGN noise source to the UE antenna connector (s) as shown in TS 36.508 [7] Annex A, Figure A.10.
2. The parameter settings for the cell are set up according to Table 9.2.2.1.3-1.
3. Downlink signals are initially set up according to Annex C0, C.1 and Annex C.3.2 and uplink signals according to Annex H.1 and H.3.2.
4. Propagation conditions are set according to Annex B.0.
5. Ensure the UE is in State 3A-RF according to TS 36.508 [7] clause 5.2A.2. Message contents are defined in clause 9.2.2.1.4.3.

## 9.2.2.1.4.2 Test procedure

1. Set the parameters of bandwidth, reference Channel, the propagation condition, antenna configuration and the SNR according to Table 9.2.2.1.3-1 as appropriate.
2. The SS shall transmit PDSCH via PDCCH DCI format 2 for C\_RNTI to transmit the DL RMC including two codewords with spatial multiplexing both according to CQI value 8 and keep them regardless of the wideband CQI value sent by the UE. The SS sends downlink MAC padding bits on the DL RMC. The SS shall use a fixed precoding matrix specified by the bitmap parameter *codebookSubsetRestriction*. Continue transmission of the PDSCH until 2000 wideband and wideband spatial differential CQI reports have been gathered. In this process the SS collects wideband and wideband spatial differential CQI reports every 5 ms and also cases where UE transmits nothing in its CQI timing are also counted as wideband and wideband spatial differential CQI reports respectively.
3. From each wideband CQI report, wideband CQI<sub>0</sub> is defined as Wideband CQI of codeword #0 and wideband CQI<sub>1</sub> is calculated according to clause 9.2.2.1.3. Codeword 1 offset level is selected from {0,1,2,3,-4,-3,-2,-1}. Set up a relative frequency distribution for the wideband CQI-values, reported. Calculate the median value (wideband Median CQI is the CQI that is at or crosses 50% distribution from the lower wideband CQI side) for each codewords. Wideband Median CQI<sub>0</sub> is based on the wideband CQI<sub>0</sub> and wideband median CQI<sub>1</sub> is based on the wideband CQI<sub>1</sub>.
4. If Median CQI is not equal to 1 or 15 and 1800 or more of the wideband CQI<sub>1</sub> values are in the range (Median CQI<sub>1</sub> - 1) ≤ Median CQI ≤ (Median CQI<sub>1</sub> + 1) then continue with step 5, otherwise go to step 7.
5. The SS shall transmit PDSCH via PDCCH DCI format 2 for C\_RNTI to transmit the DL RMC including two codewords with spatial multiplexing where the transport format of codeword #0 is according to the wideband median- CQI<sub>0</sub>- 1 and the transport format of codeword #1 is according to the wideband median CQI<sub>1</sub>- 1. The SS sends downlink MAC padding bits on the DL RMC. The SS shall not react to the any wideband CQI reports from UE and shall use a fixed precoding matrix specified by the bitmap parameter *codebookSubsetRestriction*. For any PDSCH transmitted by the SS, record the associated ACK, NACK and statDTX responses for each codewords respectively. The responses are then filtered as follows: for the sequence of responses for each HARQ process, discard all the statDTX responses. Continue to gather data until the number of filtered ACK+NACK responses for each codewords reaches 1000.

If the ratio (NACK /ACK + NACK) ≤ 0.1 for both codeword #0 and codeword #1

then and go to step 6, otherwise go to step 7.

6. The SS shall transmit PDSCH via PDCCH DCI format 2 for C\_RNTI to transmit the DL RMC including two codewords with spatial multiplexing where the transport format of codeword #0 is according to the wideband median-CQI<sub>0</sub> + 1 and the transport format of codeword #1 is according to the wideband median-CQI<sub>1</sub> + 1. The SS sends downlink MAC padding bits on the DL RMC. The SS shall not react to the any wideband CQI reports from UE and shall use a fixed precoding matrix specified by the bitmap parameter *codebookSubsetRestriction*. For any PDSCH transmitted by the SS, record the associated ACK, NACK and statDTX responses for each codewords respectively. The responses are then filtered as follows: for the sequence of responses for each HARQ process, discard all the statDTX responses. Continue to gather data until the number of filtered ACK+NACK responses for each codewords reaches 1000.

If the ratio (NACK /ACK + NACK) ≥ 0.1 for both codeword #0 and codeword #1

then pass the UE for this test and go to step 8, otherwise go to step 7.

7. If both SNR points of the test have not been tested, then repeat the same procedure (steps 1 to 6) for the other SNR point as appropriate. Otherwise fail the UE.
8. If both tests have not been done, then repeat the same procedure (steps 1 to 7) with test conditions according to the table 9.2.2.1.3-1 for the other Test as appropriate. Otherwise pass the UE.

## 9.2.2.1.4.3 Message contents

Message contents are according to TS 36.508 [7] clause 4.6 with the following exceptions:

**Table 9.2.2.1.4.3-1: PhysicalConfigDedicated-DEFAULT**

Derivation Path: 36.508 clause 5.5.1.2			
Information Element	Value/remark	Comment	Condition
PhysicalConfigDedicated-DEFAULT ::= SEQUENCE {			
cqi-ReportConfig	<i>CQI-ReportConfig-DEFAULT</i>		
antennaInfo CHOICE {			
antennaInfoDedicated ::= SEQUENCE {			
transmissionMode	tm4		
}			
codebookSubsetRestriction CHOICE {			
n2TxAntenna-tm4	010000		
ue-TransmitAntennaSelection CHOICE {			
release	NULL		
}			
}			

**Table 9.2.2.1.4.3-2: PDSCH-ConfigDedicated-DEFAULT**

Derivation Path: 36.508 clause 4.6.3			
Information Element	Value/remark	Comment	Condition
PDSCH-ConfigDedicated-DEFAULT ::= SEQUENCE {			
p-a	dB-3		
}			

**Table 9.2.2.1.4.3-3: CQI-ReportConfig-DEFAULT**

Derivation Path: 36.508 clause 4.6.3			
Information Element	Value/remark	Comment	Condition
CQI-ReportConfig-DEFAULT ::= SEQUENCE {			
cqi-ReportModeAperiodic	Not present		
nomPDSCH-RS-EPRE-Offset	0		
cqi-ReportPeriodic CHOICE {			
setup SEQUENCE {			
cqi-PUCCH-ResourceIndex	0		
cqi-pmi-ConfigIndex	6	(see Table 7.2.2-1A in TS 36.213)	
cqi-FormatIndicatorPeriodic CHOICE {			
widebandCQI	NULL		
}			
ri-ConfigIndex	1	(see Table 7.2.2-1B in TS 36.213)	
simultaneousAckNackAndCQI	FALSE		
}			
}			

### 9.2.2.1.5 Test requirement

The pass fail decision is as specified in the test procedure in clause 9.2.2.1.4.2.

There are no parameters in the test setup or measurement process whose variation impacts the results so there are no applicable test tolerances for this test.

### 9.2.2.1\_D.5 Test requirement

The pass fail decision is as specified in the test procedure in clause 9.2.2.1\_D.4.2.

[TT TBD]

## 9.2.2.2 TDD CQI Reporting under AWGN conditions – PUCCH 1-1

### 9.2.2.2.1 Test purpose

To verify the variance of the wideband spatial differential CQI between codeword #0 and codeword #1 are within the limits defined and for both codeword #0 and codeword #1, the PDSCH BLER using the transport format indicated by the respective wideband median  $CQI_0 - 1$  and wideband median  $CQI_1 - 1$  shall be less than or equal to 0.1 and the PDSCH BLER using the transport format indicated by the respective wideband median  $CQI_0 + 1$  and wideband median  $CQI_1 + 1$  shall be greater than or equal to 0.1.

### 9.2.2.2.2 Test applicability

This test applies to E-UTRA TDD release 8 and forward UEs of Category 2 and onwards.

### 9.2.2.2.3 Minimum conformance requirements

The following requirements apply to UE Category  $\geq 2$ . For the parameters specified in table 9.2.2.2.3-1, and using the downlink physical channels specified in tables C.3.2-1 and C.3.2-2, the reported offset level of the wideband spatial differential CQI for codeword #1 (Table 7.2.2 in TS 36.213 [10]) shall be used to determine the wideband CQI index for codeword #1 as:

$$\text{wideband } CQI_1 = \text{wideband } CQI_0 - \text{Codeword 1 offset level}$$

The wideband  $CQI_1$  shall be within the set  $\{\text{median } CQI_1 - 1, \text{median } CQI_1, \text{median } CQI_1 + 1\}$  for more than 90% of the time, where the resulting wideband values  $CQI_1$  shall be used to determine the median CQI values for codeword #1. For both codewords #0 and #1, the PDSCH BLER using the transport format indicated by the respective median  $CQI_0 - 1$  and median  $CQI_1 - 1$  shall be less than or equal to 0.1. Furthermore, for both codewords #0 and #1, the PDSCH BLER using the transport format indicated by the respective median  $CQI_0 + 1$  and median  $CQI_1 + 1$  shall be greater than or equal to 0.1.

Table 9.2.2.3-1: PUCCH 1-1 static test (TDD)

Parameter		Unit	Test 1		Test 2	
Bandwidth		MHz			10	
PDSCH transmission mode					4	
Uplink downlink configuration					2	
Special subframe configuration					4	
Downlink power allocation	$\rho_A$	dB			-3	
	$\rho_B$	dB			-3	
	$\sigma$	dB			0	
Propagation condition and antenna configuration			Clause B.1 (2 x 2)			
CodeBookSubsetRestriction bitmap			010000			
SNR (Note 2)		dB	10	11	16	17
$\hat{I}_{or}^{(j)}$		dB[mW/15kHz]	-88	-87	-82	-81
$N_{oc}^{(j)}$		dB[mW/15kHz]	-98		-98	
Maximum number of HARQ transmissions			1			
Physical channel for CQI/PMI reporting			PUSCH (Note 3)			
PUCCH Report Type			2			
Reporting periodicity		ms	$N_P = 5$			
<i>cqi-pmi-ConfigurationIndex</i>			3			
<i>ri-ConfigIndex</i>			805 (Note 4)			
ACK/NACK feedback mode			Multiplexing			
<p>Note 1: Reference measurement channel RC.2 TDD according to Table A.4-1 with one sided dynamic OCNG Pattern OP.1 TDD as described in Annex A.5.2.1</p> <p>Note 2: For each test, the minimum requirements shall be fulfilled for at least one of the two SNR(s) and the respective wanted signal input level.</p> <p>Note 3: To avoid collisions between CQI/PMI reports and HARQ-ACK it is necessary to report both on PUSCH instead of PUCCH. PDCCH DCI format 0 shall be transmitted in downlink SF#3 and #8 to allow periodic CQI/PMI to multiplex with the HARQ-ACK on PUSCH in uplink subframe SF#7 and #2.</p> <p>Note 4: RI reporting interval is set to the maximum allowable length of 160ms to minimise collisions between RI, CQI/PMI and HARQ-ACK reports. In the case when all three reports collide, it is expected that CQI/PMI reports will be dropped, while RI and HARQ-ACK will be multiplexed. At eNB, CQI report collection shall be skipped every 160ms during performance verification.</p>						

The normative reference for this requirement is TS 36.101 [2] clause 9.2.2.2.

#### 9.2.2.2.4 Test description

##### 9.2.2.2.4.1 Initial conditions

Initial conditions are a set of test configurations the UE needs to be tested in and the steps for the SS to take with the UE to reach the correct measurement state.

Configurations of PDSCH and PDCCH before measurement are specified in Annex C.2.

Test Environment: Normal as defined in TS 36.508 [7] clause 4.1.

Frequencies to be tested: Mid Range as defined in TS 36.508 [7] clause 4.3.1.2.

Channel Bandwidths to be tested: 10MHz, as defined in TS 36.508 [7] clause 4.3.1.2

1. Connect the SS, faders and AWGN noise source to the UE antenna connector (s) as shown in TS 36.508 [7] Annex A, Figure A.10.
2. The parameter settings for the cell are set up according to Table 9.2.2.3-1.



3. Downlink signals are initially set up according to Annex C0, C.1 and Annex C.3.2 and uplink signals according to Annex H1 and H.3.2.
4. Propagation conditions are set according to Annex B.0.
5. Ensure the UE is in State 3A-RF according to TS 36.508 [7] clause 5.2A.2. Message contents are defined in clause 9.2.2.2.4.3.

#### 9.2.2.2.4.2 Test procedure

1. Set the parameters of bandwidth, reference Channel, the propagation condition, antenna configuration and the SNR according to Table 9.2.2.2.3-1 as appropriate.
2. The SS shall transmit PDSCH via PDCCH DCI format 2 for C\_RNTI to transmit the DL RMC including two codewords with spatial multiplexing both according to CQI value 8 and keep them regardless of the wideband CQI value sent by the UE. The SS sends downlink MAC padding bits on the DL RMC. The SS shall use a fixed precoding matrix specified by the bitmap parameter *codebookSubsetRestriction*. The SS sends uplink scheduling information via PDCCH DCI format 0 with CQI request bit set to 0 to schedule UL RMC in subframe #2 and subframe #7 (Table A.4.1-2). The UE will send ACK/NACK and periodic CQI report using PUSCH. Continue transmission of the PDSCH until 2000 wideband and wideband spatial differential CQI reports have been gathered. In this process the SS collects wideband and wideband spatial differential CQI reports every 5 ms and also cases where UE transmits nothing in its CQI timing are counted as wideband and wideband spatial differential CQI reports respectively.
3. From each wideband CQI report, wideband CQI<sub>0</sub> is defined as Wideband CQI of codeword #0 and wideband CQI<sub>1</sub> is calculated according to clause 9.2.2.2.3. Codeword 1 offset level is selected from {0,1,2,3,-4,-3,-2,-1}. Set up a relative frequency distribution for the wideband CQI-values, reported. Calculate the median value (wideband Median CQI is the CQI that is at or crosses 50% distribution from the lower wideband CQI side) for each codewords. Wideband Median CQI<sub>0</sub> is based on the wideband CQI<sub>0</sub> and wideband median CQI<sub>1</sub> is based on the wideband CQI<sub>1</sub>.
4. If Median CQI is not equal to 1 or 15 and 1800 or more of the wideband CQI<sub>1</sub> values are in the range (Median CQI<sub>1</sub> - 1) ≤ Median CQI ≤ (Median CQI<sub>1</sub> + 1) then continue with step 5, otherwise go to step 7.
5. The SS shall transmit PDSCH via PDCCH DCI format 2 for C\_RNTI to transmit the DL RMC including two codewords with spatial multiplexing where the transport format of codeword #0 is according to the wideband median- CQI<sub>0</sub>- 1 and the transport format of codeword #1 is according to the wideband median CQI<sub>1</sub>- 1. The SS sends downlink MAC padding bits on the DL RMC. The SS shall not react to the any wideband CQI reports from UE and shall use a fixed precoding matrix specified by the bitmap parameter *codebookSubsetRestriction*. The SS sends uplink scheduling information via PDCCH DCI format 0 with CQI request bit set to 0 to schedule UL RMC in subframe #2 and subframe #7 (Table A.4.1-2). The UE will send ACK/NACK and periodic CQI report using PUSCH. For any PDSCH transmitted by the SS, record the associated ACK, NACK and statDTX responses for each codewords respectively. *In case statDTX can not be differentiated from NACK due to multiplexing effect, evaluate the feedback as a NACK* The responses are then filtered as follows: for the sequence of responses for each HARQ process, discard all the statDTX responses. Continue to gather data until the number of filtered ACK+NACK responses for each codewords reaches 1000.  
  
If the ratio (NACK /ACK + NACK ) ≤ 0.1  
  
then, and go to step 6, otherwise go to step 7.
6. The SS shall transmit PDSCH via PDCCH DCI format 2 for C\_RNTI to transmit the DL RMC including two codewords with spatial multiplexing where the transport format of codeword #0 is according to the wideband median-CQI<sub>0</sub> + 1 and the transport format of codeword #1 is according to the wideband median-CQI<sub>1</sub> + 1. The SS sends downlink MAC padding bits on the DL RMC. The SS shall not react to the any wideband CQI reports from UE and shall use a fixed precoding matrix specified by the bitmap parameter *codebookSubsetRestriction*. The SS sends uplink scheduling information via PDCCH DCI format 0 with CQI request bit set to 0 to schedule UL RMC in subframe #2 and subframe #7 (Table A.4.1-2). The UE will send ACK/NACK and periodic CQI report using PUSCH. For any PDSCH transmitted by the SS, record the associated ACK, NACK and statDTX responses for each codewords respectively. *In case statDTX can not be differentiated from NACK due to multiplexing effect, evaluate the feedback as a NACK* The responses are then filtered as follows: for the sequence of responses for each HARQ process, discard all the statDTX responses. Continue to gather data until the number of filtered ACK+NACK responses for each codewords reaches 1000.

If the ratio (NACK /ACK + NACK)  $\geq$  0.1

then pass the UE for this test and go to step 8, otherwise go to step 7.

7. If both SNR points of the test have not been tested, then repeat the same procedure (steps 1 to 6) for the other SNR point as appropriate. Otherwise fail the UE.
8. If both tests have not been done, then repeat the same procedure (steps 1 to 7) with test conditions according to the table 9.2.2.2.3-1 for the other Test as appropriate. Otherwise pass the UE.

#### 9.2.2.2.4.3 Message contents

Message contents are according to TS 36.508 [7] clause 4.6 with the following exceptions:

**Table 9.2.2.2.4.3-1: PhysicalConfigDedicated-DEFAULT**

Derivation Path: 36.508 clause 5.5.1.2			
Information Element	Value/remark	Comment	Condition
PhysicalConfigDedicated-DEFAULT ::= SEQUENCE {			
cqi-ReportConfig	<i>CQI-ReportConfig-DEFAULT</i>		
antennaInfo CHOICE {			
antennaInfoDedicated ::= SEQUENCE {			
transmissionMode	tm4		
}			
codebookSubsetRestriction CHOICE {			
n2TxAntenna-tm4	010000		
ue-TransmitAntennaSelection CHOICE {			
release	NULL		
}			
}			

**Table 9.2.2.2.4.3-2: PDSCH-ConfigDedicated-DEFAULT**

Derivation Path: TS 36.508 [7] clause 4.6.3, Table 4.6.3-6 PDSCH-ConfigDedicated-DEFAULT			
Information Element	Value/remark	Comment	Condition
PDSCH-ConfigDedicated-DEFAULT ::= SEQUENCE {			
p-a	dB-3		
}			

**Table 9.2.2.2.4.3-3: CQI-ReportConfig-DEFAULT**

Derivation Path: 36.508 clause 4.6.3			
Information Element	Value/remark	Comment	Condition
CQI-ReportConfig-DEFAULT ::= SEQUENCE {			
cqi-ReportModeAperiodic	Not present		
nomPDSCH-RS-EPRE-Offset	0		
cqi-ReportPeriodic CHOICE {			
setup SEQUENCE {			
cqi-PUCCH-ResourceIndex	0		
cqi-pmi-ConfigIndex	3		
cqi-FormatIndicatorPeriodic CHOICE {			
widebandCQI	NULL		
}			
ri-ConfigIndex	805		
simultaneousAckNackAndCQI	FALSE		
}			
}			

Table 9.2.2.4.3-4: TDD-Config-DEFAULT

Derivation Path: 36.508 clause 4.6.3			
Information Element	Value/remark	Comment	Condition
TDD-Config-DEFAULT ::= SEQUENCE {			
subframeAssignment	Sa2		
specialSubframePatterns	Ssp4		
}			

#### 9.2.2.2.5 Test requirement

The pass fail decision is as specified in the test procedure in clause 9.2.2.2.4.2.

There are no parameters in the test setup or measurement process whose variation impacts the results so there are no applicable test tolerances for this test.

### 9.2.3 CQI Reporting under AWGN conditions - PUCCH 1-1 (CSI Reference Symbols)

#### 9.2.3.1\_D FDD CQI Reporting under AWGN conditions – PUCCH 1-1 for eDL-MIMO

##### 9.2.3.1\_D.1 Test purpose

To verify the variance of the wideband spatial differential CQI between codeword #0 and codeword #1 are within the limits defined and for both codeword #0 and codeword #1, the PDSCH BLER using the transport format indicated by the respective median  $CQI_0 - 1$  and median  $CQI_1 - 1$  shall be less than or equal to 0.1 and the PDSCH BLER using the transport format indicated by the respective median  $CQI_0 + 1$  and median  $CQI_1 + 1$  shall be greater than or equal to 0.1.

##### 9.2.3.1\_D.2 Test applicability

This test applies to all types of E-UTRA FDD release 10 and forward UEs of Category 2 and onwards that support eDL-MIMO. Applicability requires support for FGI bit 103.

##### 9.2.3.1\_D.3 Minimum conformance requirements

The minimum requirements for dual codeword transmission are defined in terms of a reporting spread of the wideband CQI value for codeword #1, and their BLER performance using the transport format indicated by the reported CQI median of codeword #0 and codeword #1. The precoding used at the transmitter is a fixed precoding matrix specified by the bitmap parameter *codebookSubsetRestriction*. The propagation condition assumed for the minimum performance requirement is defined in subclause B.1.

The following requirements apply to UE Category  $\geq 2$ . For the parameters specified in table 9.2.3.1\_D.3-1, and using the downlink physical channels specified in tables C.3.2-1 and C.3.2-2, the reported offset level of the wideband spatial differential CQI for codeword #1 (Table 7.2 -2 in TS 36.213 [10]) shall be used to determine the wideband CQI index for codeword #1 as:

$$\text{wideband } CQI_1 = \text{wideband } CQI_0 - \text{Codeword 1 offset level}$$

The wideband  $CQI_1$  shall be within the set  $\{\text{median } CQI_1 - 1, \text{median } CQI_1, \text{median } CQI_1 + 1\}$  for more than 90% of the time, where the resulting wideband values  $CQI_1$  shall be used to determine the median CQI values for codeword #1. For both codewords #0 and #1, the PDSCH BLER using the transport format indicated by the respective median  $CQI_0 - 1$  and median  $CQI_1 - 1$  shall be less than or equal to 0.1. Furthermore, for both codewords #0 and #1, the PDSCH BLER using the transport format indicated by the respective median  $CQI_0 + 1$  and median  $CQI_1 + 1$  shall be greater than or equal to 0.1.

Table 9.2.3.1\_D.3-1: PUCCH 1-1 static test (FDD)

Parameter		Unit	Test 1		Test 2	
Bandwidth		MHz	10			
PDSCH transmission mode			9			
Downlink power allocation	$\rho_A$	dB	0			
	$\rho_B$	dB	0			
	$P_c$	dB	-3			
	$\sigma$	dB	-3			
Cell-specific reference signals			Antenna ports 0, 1			
CSI reference signals			Antenna ports 15,...,18			
Beamforming model			As specified in Annex B.4.3			
CSI-RS periodicity and subframe offset $T_{\text{CSI-RS}} / \Delta_{\text{CSI-RS}}$			5/1			
CSI reference signal configuration			0			
Propagation condition and antenna configuration			Clause B.1 (4 x 2)			
CodeBookSubsetRestriction bitmap			0x0000 0000 0100 0000			
SNR (Note 2)		dB	7	8	13	14
$\hat{I}_{or}^{(j)}$		dB[mW/15kHz]	-91	-90	-85	-84
$N_{oc}^{(j)}$		dB[mW/15kHz]	-98		-98	
Max number of HARQ transmissions			1			
Physical channel for CQI/PMI reporting			PUSCH (Note 3)			
PUCCH Report Type for CQI/PMI			2			
Physical channel for RI reporting			PUCCH Format 2			
PUCCH Report Type for RI			3			
Reporting periodicity		ms	$N_{pd} = 5$			
CQI delay		ms	8			
<i>cqi-pmi-ConfigurationIndex</i>			2			
<i>ri-ConfigIndex</i>			1			
<p>Note 1: Reference measurement channel RC.7 FDD according to Table A.4-1 with one sided dynamic OCNG Pattern OP.1 FDD as described in Annex A.5.1.1.</p> <p>Note 2: For each test, the minimum requirements shall be fulfilled for at least one of the two SNR(s) and the respective wanted signal input level.</p> <p>Note 3: To avoid collisions between CQI/PMI reports and HARQ-ACK it is necessary to report both on PUSCH instead of PUCCH. PDCCH DCI format 0 shall be transmitted in downlink SF#1 and #6 to allow periodic CQI/PMI to multiplex with the HARQ-ACK on PUSCH in uplink SF#0 and #5.</p>						

The normative reference for this requirement is TS 36.101 [2] clause 9.2.3.1.

### 9.2.3.1\_D.4 Test description

#### 9.2.3.1\_D.4.1 Initial conditions

Initial conditions are a set of test configurations the UE needs to be tested in and the steps for the SS to take with the UE to reach the correct measurement state.

Configurations of PDSCH and PDCCH before measurement are specified in Annex C.2.

Test Environment: Normal as defined in TS 36.508 [7] clause 4.1.

Frequencies to be tested: Mid Range as defined in TS 36.508 [7] clause 4.3.1.1.

Channel Bandwidths to be tested: 10MHz, as defined in TS 36.508 [7] clause 4.3.1.1

1. Connect the SS, faders and AWGN noise source to the UE antenna connector (s) as shown in TS 36.508 [7] Annex A, Figure A.11.
2. The parameter settings for the cell are set up according to Table 9.2.3.1\_D.3-1.

3. Downlink signals are initially set up according to Annex C.0, C.1 and Annex C.3.2 and uplink signals according to Annex H.1 and H.3.2.
4. Propagation conditions are set according to Annex B.0.
5. Ensure the UE is in State 3A-RF according to TS 36.508 [7] clause 5.2A.2. Message contents are defined in clause 9.2.3.1\_D.4.3.

#### 9.2.3.1\_D.4.2 Test procedure

1. Set the parameters of bandwidth, reference channel, the propagation condition, antenna configuration and the SNR according to Table 9.2.3.1\_D.3-1 as appropriate.
2. The SS shall transmit PDSCH via PDCCH DCI format 2C for C\_RNTI to transmit the DL RMC including two codewords with spatial multiplexing both according to CQI value 8 and keep them regardless of the wideband CQI value sent by the UE. The SS sends downlink MAC padding bits on the DL RMC. The SS shall use a fixed precoding matrix specified by the bitmap parameter *codebookSubsetRestriction*. The SS sends uplink scheduling information via PDCCH DCI format 0 with CQI request bit set to 0 to schedule UL RMC in subframe #0 and subframe #5 (Table A.4.1-1). The UE will send ACK/NACK and periodic CQI report using PUSCH. Continue transmission of the PDSCH until 2000 wideband and wideband spatial differential CQI reports have been gathered. In this process the SS collects wideband and wideband spatial differential CQI reports every 5 ms and also cases where UE transmits nothing in its CQI timing are also counted as wideband and wideband spatial differential CQI reports respectively.
3. From each wideband CQI report, wideband CQI<sub>0</sub> is defined as Wideband CQI of codeword #0 and wideband CQI<sub>1</sub> is calculated according to clause 9.2.3.1\_D.3. Codeword 1 offset level is selected from {0,1,2,3,-4,-3,-2,-1}. Set up a relative frequency distribution for the wideband CQI-values, reported. Calculate the median value (wideband Median CQI is the CQI that is at or crosses 50% distribution from the lower wideband CQI side) for each codewords. Wideband Median CQI<sub>0</sub> is based on the wideband CQI<sub>0</sub> and wideband median CQI<sub>1</sub> is based on the wideband CQI<sub>1</sub>.
4. If Median CQI is not equal to 1 or 15 and 1800 or more of the wideband CQI<sub>1</sub> values are in the range (Median CQI<sub>1</sub> - 1) ≤ Median CQI ≤ (Median CQI<sub>1</sub> + 1) then continue with step 5, otherwise go to step 7.
5. The SS shall transmit PDSCH via PDCCH DCI format 2C for C\_RNTI to transmit the DL RMC including two codewords with spatial multiplexing where the transport format of codeword #0 is according to the wideband median- CQI<sub>0</sub>- 1 and the transport format of codeword #1 is according to the wideband median CQI<sub>1</sub>- 1. The SS sends downlink MAC padding bits on the DL RMC. The SS shall not react to the any wideband CQI reports from UE and shall use a fixed precoding matrix specified by the bitmap parameter *codebookSubsetRestriction*. The SS sends uplink scheduling information via PDCCH DCI format 0 with CQI request bit set to 0 to schedule UL RMC in subframe #0 and subframe #5 (Table A.4.1-1). The UE will send ACK/NACK and periodic CQI report using PUSCH. For any PDSCH transmitted by the SS, record the associated ACK, NACK and statDTX responses for each codewords respectively. The responses are then filtered as follows: for the sequence of responses for each HARQ process, discard all the statDTX responses. Continue to gather data until the number of filtered ACK+NACK responses for each codewords reaches 1000.

If the ratio (NACK /ACK + NACK) ≤ 0.1 for both codeword #0 and codeword #1

then and go to step 6, otherwise go to step 7.

6. The SS shall transmit PDSCH via PDCCH DCI format 2C for C\_RNTI to transmit the DL RMC including two codewords with spatial multiplexing where the transport format of codeword #0 is according to the wideband median-CQI<sub>0</sub> + 1 and the transport format of codeword #1 is according to the wideband median-CQI<sub>1</sub> + 1. The SS sends downlink MAC padding bits on the DL RMC. The SS shall not react to the any wideband CQI reports from UE and shall use a fixed precoding matrix specified by the bitmap parameter *codebookSubsetRestriction*. The SS sends uplink scheduling information via PDCCH DCI format 0 with CQI request bit set to 0 to schedule UL RMC in subframe #0 and subframe #5 (Table A.4.1-1). The UE will send ACK/NACK and periodic CQI report using PUSCH. For any PDSCH transmitted by the SS, record the associated ACK, NACK and statDTX responses for each codewords respectively. The responses are then filtered as follows: for the sequence of responses for each HARQ process, discard all the statDTX responses. Continue to gather data until the number of filtered ACK+NACK responses for each codewords reaches 1000.

If the ratio (NACK /ACK + NACK) ≥ 0.1 for both codeword #0 and codeword #1

then pass the UE for this test and go to step 8, otherwise go to step 7.

7. If both SNR points of the test have not been tested, then repeat the same procedure (steps 1 to 6) for the other SNR point as appropriate. Otherwise fail the UE.
8. If both tests have not been done, then repeat the same procedure (steps 1 to 7) with test conditions according to the table 9.2.3.1\_D.3-1 for the other Test as appropriate. Otherwise pass the UE.

#### 9.2.3.1\_D.4.3 Message contents

Message contents are according to TS 36.508 [7] clause 4.6 with the following exceptions:

**Table 9.2.3.1\_D.4.3-1: PhysicalConfigDedicated-DEFAULT**

Derivation Path: 36.508 clause 4.6.3			
Information Element	Value/remark	Comment	Condition
PhysicalConfigDedicated-DEFAULT ::= SEQUENCE {			
cqi-ReportConfig	Not present		RBC
antennaInfo	Not present		RBC
antennaInfo-r10 CHOICE {			RBC
explicitValue-r10	AntennaInfoDedicated-r10		
}			
cqi-ReportConfig-r10	CQI-ReportConfig-r10-DEFAULT		RBC
csi-RS-Config-r10	CSI-RS-Config-r10		RBC
}			

Condition	Explanation
RBC	Used at configuration of a radio bearer combination during SRB2+DRB establishment

**Table 9.2.3.1\_D.4.3-2: PDSCH-ConfigDedicated-DEFAULT**

Derivation Path: 36.331 clause 6.3.2			
Information Element	Value/remark	Comment	Condition
PDSCH-ConfigDedicated-DEFAULT ::= SEQUENCE {			
p-a	dB0		
}			

**Table 9.2.3.1\_D.4.3-3: AntennaInfoDedicated-r10**

Derivation Path: 36.331 clause 6.3.2			
Information Element	Value/remark	Comment	Condition
AntennaInfoDedicated-r10 ::= SEQUENCE {			
transmissionMode-r10	tm9-v1020		
codebookSubsetRestriction-r10	0x0000 0000 0100 0000		
ue-TransmitAntennaSelection CHOICE {			
release	NULL		
}			
}			

**Table 9.2.3.1\_D.4.3-4: CQI-ReportConfig-r10-DEFAULT**

Derivation Path: 36.508 clause 4.6.3			
Information Element	Value/remark	Comment	Condition
CQI-ReportConfig-r10 ::= SEQUENCE {			
cqi-ReportAperiodic-r10	Not Present		
nomPDSCH-RS-EPRE-Offset	0		
cqi-ReportPeriodic-r10	CQI-ReportPeriodic-r10-DEFAULT		
pmi-RI-Report-r9	setup		
}			

**Table 9.2.3.1\_D.4.3-5: CQI-ReportPeriodic-r10-DEFAULT**

Derivation Path: 36.508 clause 4.6.3			
Information Element	Value/remark	Comment	Condition
CQI-ReportPeriodic-r10 ::= CHOICE {			
setup SEQUENCE {			
cqi-PUCCH-ResourceIndex-r10	0		
cqi-PUCCH-ResourceIndexP1-r10	Not present		
cqi-pmi-ConfigIndex	2	(see Table 7.2.2-1A in TS 36.213)	
cqi-FormatIndicatorPeriodic-r10 CHOICE {			
widebandCQI-r10 SEQUENCE {			
csi-ReportMode-r10	Not present		
}			
ri-ConfigIndex	1	(see Table 7.2.2-1B in TS 36.213)	
simultaneousAckNackAndCQI	FALSE		
}			
}			

Table 9.2.3.1\_D.4.3-6: CSI-RS-Config

Derivation Path: 36.331 clause 6.3.2			
Information Element	Value/remark	Comment	Condition
CSI-RS-Config-r10 ::= SEQUENCE {			
csi-RS-r10 CHOICE{			
setup SEQUENCE {			
antennaPortsCount-r10	an4	Parameter represents the number of antenna ports used for transmission of CSI reference signals	
resourceConfig-r10	0	Parameter: CSI reference signal configuration	
subframeConfig-r10	1	$\Delta_{\text{CSI-RS}} = I_{\text{CSI-RS}}$ when CSI-RS SubframeConfig is from 0-4; Parameter: $I_{\text{CSI-RS}}$	
p-C-r10	-3	Parameter: $P_c$ which is the assumed ratio of PDSCH EPRE to CSI-RS EPRE when UE derives CSI feedback	
}			
}			
zeroTxPowerCSI-RS-r10 CHOICE{			
release	NULL		
}			
}			

### 9.2.3.1\_D.5 Test requirement

The pass fail decision is as specified in the test procedure in clause 9.2.3.1\_D.4.2.

There are no parameters in the test setup or measurement process whose variation impacts the results so there are no applicable test tolerances for this test.

### 9.2.3.2\_D TDD CQI Reporting under AWGN conditions – PUCCH 1-1 for eDL-MIMO

#### 9.2.3.2\_D.1 Test purpose

To verify the variance of the wideband spatial differential CQI between codeword #0 and codeword #1 are within the limits defined and for both codeword #0 and codeword #1, the PDSCH BLER using the transport format indicated by the respective median  $\text{CQI}_0 - 1$  and median  $\text{CQI}_1 - 1$  shall be less than or equal to 0.1 and the PDSCH BLER using the transport format indicated by the respective median  $\text{CQI}_0 + 1$  and median  $\text{CQI}_1 + 1$  shall be greater than or equal to 0.1.

#### 9.2.3.2\_D.2 Test applicability

This test applies to all types of E-UTRA TDD release 10 and forward UEs of Category 2 and onwards that support eDL-MIMO. Applicability requires support for FGI bit 104.

#### 9.2.3.2\_D.3 Minimum conformance requirements

The following requirements apply to UE Category  $\geq 2$ . The minimum requirements for dual codeword transmission are defined in terms of a reporting spread of the wideband CQI value for codeword #1, and their BLER performance using the transport format indicated by the reported CQI median of codeword #0 and codeword #1. The precoding used at the



transmitter is a fixed precoding matrix specified by the bitmap parameter *codebookSubsetRestriction*. The propagation condition assumed for the minimum performance requirement is defined in subclause B.1.

For the parameters specified in table 9.2.3.2\_D.3-1, and using the downlink physical channels specified in tables C.3.2-1 and C.3.2-2, the reported offset level of the wideband spatial differential CQI for codeword #1 (Table 7.2 -2 in TS 36.213 [10]) shall be used to determine the wideband CQI index for codeword #1 as

$$\text{wideband CQI}_1 = \text{wideband CQI}_0 - \text{Codeword 1 offset level}$$

The wideband  $\text{CQI}_1$  shall be within the set  $\{\text{median CQI}_1 - 1, \text{median CQI}_1, \text{median CQI}_1 + 1\}$  for more than 90% of the time, where the resulting wideband values  $\text{CQI}_1$  shall be used to determine the median CQI values for codeword #1. For both codewords #0 and #1, the PDSCH BLER using the transport format indicated by the respective median  $\text{CQI}_0 - 1$  and median  $\text{CQI}_1 - 1$  shall be less than or equal to 0.1. Furthermore, for both codewords #0 and #1, the PDSCH BLER using the transport format indicated by the respective median  $\text{CQI}_0 + 1$  and median  $\text{CQI}_1 + 1$  shall be greater than or equal to 0.1.

Table 9.2.3.2\_D.3-1: PUCCH 1-1 submode 1 static test (TDD)

Parameter		Unit	Test 1		Test 2	
Bandwidth		MHz	10			
PDSCH transmission mode			9			
Uplink downlink configuration			2			
Special subframe configuration			4			
Downlink power allocation	$\rho_A$	dB	0			
	$\rho_B$	dB	0			
	$P_c$	dB	-6			
	$\sigma$	dB	-3			
CRS reference signals			Antenna ports 0, 1			
CSI reference signals			Antenna ports 15,...,22			
Beamforming model			As specified in Annex B.4.3			
CSI-RS periodicity and subframe offset $T_{\text{CSI-RS}} / \Delta_{\text{CSI-RS}}$			5/3			
CSI reference signal configuration			0			
Propagation condition and antenna configuration			Clause B.1 (8 x 2)			
CodeBookSubsetRestriction bitmap			0x0000 0000 0020 0000 0000 0001 0000			
SNR (Note 2)		dB	4	5	10	11
$\hat{I}_{or}^{(j)}$		dB[mW/15kHz]	-94	-93	-88	-87
$N_{oc}^{(j)}$		dB[mW/15kHz]	-98		-98	
Max number of HARQ transmissions			1			
Physical channel for CQI/PMI reporting			PUSCH (Note 3)			
PUCCH Report Type for CQI/second PMI			2b			
Physical channel for RI reporting			PUSCH			
PUCCH Report Type for RI/ first PMI			5			
Reporting periodicity		ms	$N_{pd} = 5$			
CQI delay		ms	10 or 11			
<i>cqi-pmi-ConfigurationIndex</i>			3			
<i>ri-ConfigIndex</i>			805 (Note 4)			
ACK/NACK feedback mode			Multiplexing			
Note 1: Reference measurement channel RC.7 TDD according to Table A.4-1 with one sided dynamic OCNG Pattern OP.1 TDD as described in Annex A.5.2.1.						
Note 2: For each test, the minimum requirements shall be fulfilled for at least one of the two SNR(s) and the respective wanted signal input level.						
Note 3: To avoid collisions between CQI/PMI reports and HARQ-ACK it is necessary to report both on PUSCH instead of PUCCH. PDCCH DCI format 0 shall be transmitted in downlink SF#3 and #8 to allow periodic CQI/PMI to multiplex with the HARQ-ACK on PUSCH in uplink SF#7 and #2.						
Note 4: RI reporting interval is set to the maximum allowable length of 160ms to minimise collisions between RI, CQI/PMI and HARQ-ACK reports. In the case when all three reports collide, it is expected that CQI/PMI reports will be dropped, while RI and HARQ-ACK will be multiplexed. At eNB, CQI report collection shall be skipped every 160ms during performance verification.						

The normative reference for this requirement is TS 36.101 [2] clause 9.2.3.2.

### 9.2.3.2\_D.4 Test description

#### 9.2.3.2\_D.4.1 Initial conditions

Initial conditions are a set of test configurations the UE needs to be tested in and the steps for the SS to take with the UE to reach the correct measurement state.

Configurations of PDSCH and PDCCH before measurement are specified in Annex C.2.

Test Environment: Normal as defined in TS 36.508 [7] clause 4.1.

Frequencies to be tested: Mid Range as defined in TS 36.508 [7] clause 4.3.1.2.

Channel Bandwidths to be tested: 10MHz, as defined in TS 36.508 [7] clause 4.3.1.2

1. Connect the SS, faders and AWGN noise source to the UE antenna connector (s) as shown in TS 36.508 [7] Annex A, Figure 47.
2. The parameter settings for the cell are set up according to Table 9.2.3.2\_D.3-1.
3. Downlink signals are initially set up according to Annex C.0, C.1 and Annex C.3.2 and uplink signals according to Annex H.1 and H.3.2.
4. Propagation conditions are set according to Annex B.0.
5. Ensure the UE is in State 3A-RF according to TS 36.508 [7] clause 5.2A.2. Message contents are defined in clause 9.2.3.2\_D.4.3.

#### 9.2.3.2\_D.4.2 Test procedure

1. Set the parameters of bandwidth, reference channel, the propagation condition, antenna configuration and the SNR according to Table 9.2.3.2\_D.3-1 as appropriate.
2. The SS shall transmit PDSCH via PDCCH DCI format 2C for C\_RNTI to transmit the DL RMC including two codewords with spatial multiplexing both according to CQI value 8 and keep them regardless of the wideband CQI value sent by the UE. The SS sends downlink MAC padding bits on the DL RMC. The SS shall use a fixed precoding matrix specified by the bitmap parameter *codebookSubsetRestriction*. The SS sends uplink scheduling information via PDCCH DCI format 0 with CQI request bit set to 0 to schedule UL RMC in subframe #2 and subframe #7 (Table A.4.1-2). The UE will send ACK/NACK and periodic CQI report using PUSCH. Continue transmission of the PDSCH until 2000 wideband and wideband spatial differential CQI reports have been gathered. In this process the SS collects wideband and wideband spatial differential CQI reports every 5 ms and also cases where UE transmits nothing in its CQI timing are counted as wideband and wideband spatial differential CQI reports respectively.
3. From each wideband CQI report, wideband CQI<sub>0</sub> is defined as Wideband CQI of codeword #0 and wideband CQI<sub>1</sub> is calculated according to clause 9.2.3.2\_D.3. Codeword 1 offset level is selected from {0,1,2,3,-4,-3,-2,-1}. Set up a relative frequency distribution for the wideband CQI-values, reported. Calculate the median value (wideband Median CQI is the CQI that is at or crosses 50% distribution from the lower wideband CQI side) for each codewords. Wideband Median CQI<sub>0</sub> is based on the wideband CQI<sub>0</sub> and wideband median CQI<sub>1</sub> is based on the wideband CQI<sub>1</sub>.
4. If Median CQI is not equal to 1 or 15 and 1800 or more of the wideband CQI<sub>1</sub> values are in the range (Median CQI<sub>1</sub> - 1) ≤ Median CQI ≤ (Median CQI<sub>1</sub> + 1) then continue with step 5, otherwise go to step 7.
5. The SS shall transmit PDSCH via PDCCH DCI format 2C for C\_RNTI to transmit the DL RMC including two codewords with spatial multiplexing where the transport format of codeword #0 is according to the wideband median- CQI<sub>0</sub>- 1 and the transport format of codeword #1 is according to the wideband median CQI<sub>1</sub>- 1. The SS sends downlink MAC padding bits on the DL RMC. The SS shall not react to the any wideband CQI reports from UE and shall use a fixed precoding matrix specified by the bitmap parameter *codebookSubsetRestriction*. The SS sends uplink scheduling information via PDCCH DCI format 0 with CQI request bit set to 0 to schedule UL RMC in subframe #2 and subframe #7 (Table A.4.1-2). The UE will send ACK/NACK and periodic CQI report using PUSCH. For any PDSCH transmitted by the SS, record the associated ACK, NACK and statDTX responses for each codewords respectively. *In case statDTX can not be differentiated from NACK due to multiplexing effect, evaluate the feedback as a NACK* The responses are then filtered as follows: for the sequence of responses for each HARQ process, discard all the statDTX responses. Continue to gather data until the number of filtered ACK+NACK responses for each codewords reaches 1000.

If the ratio (NACK /ACK + NACK) ≤ 0.1

then, and go to step 6, otherwise go to step 7.

6. The SS shall transmit PDSCH via PDCCH DCI format 2C for C\_RNTI to transmit the DL RMC including two codewords with spatial multiplexing where the transport format of codeword #0 is according to the wideband median-CQI<sub>0</sub> + 1 and the transport format of codeword #1 is according to the wideband median-CQI<sub>1</sub> + 1. The SS sends downlink MAC padding bits on the DL RMC. The SS shall not react to the any wideband CQI reports

from UE and shall use a fixed precoding matrix specified by the bitmap parameter *codebookSubsetRestriction*. The SS sends uplink scheduling information via PDCCH DCI format 0 with CQI request bit set to 0 to schedule UL RMC in subframe #2 and subframe #7 (Table A.4.1-2). The UE will send ACK/NACK and periodic CQI report using PUSCH. For any PDSCH transmitted by the SS, record the associated ACK, NACK and statDTX responses for each codewords respectively. *In case statDTX can not be differentiated from NACK due to multiplexing effect, evaluate the feedback as a NACK*. The responses are then filtered as follows: for the sequence of responses for each HARQ process, discard all the statDTX responses. Continue to gather data until the number of filtered ACK+NACK responses for each codewords reaches 1000.

If the ratio (NACK /ACK + NACK) ≥ 0.1

then pass the UE for this test and go to step 8, otherwise go to step 7.

7. If both SNR points of the test have not been tested, then repeat the same procedure (steps 1 to 6) for the other SNR point as appropriate. Otherwise fail the UE.
8. If both tests have not been done, then repeat the same procedure (steps 1 to 7) with test conditions according to the table 9.2.3.2\_D.3-1 for the other Test as appropriate. Otherwise pass the UE.

9.2.3.2\_D.4.3 Message contents

Message contents are according to TS 36.508 [7] clause 4.6 with the following exceptions:

**Table 9.2.3.2\_D.4.3-1: PhysicalConfigDedicated-DEFAULT**

Derivation Path: 36.508 clause 5.5.1.2			
Information Element	Value/remark	Comment	Condition
PhysicalConfigDedicated-DEFAULT ::= SEQUENCE {			
cqi-ReportConfig	Not present		RBC
antennaInfo	Not present		RBC
antennaInfo-r10 CHOICE{			RBC
explicitValue-r10	AntennaInfoDedicated-r10		
}			
cqi-ReportConfig-r10	CQI-ReportConfig-r10-DEFAULT		RBC
csi-RS-Config-r10	CSI-RS-Config-r10		RBC
}			

Condition	Explanation
RBC	Used at configuration of a radio bearer combination during SRB2+DRB establishment

**Table 9.2.3.2\_D.4.3-2: PDSCH-ConfigDedicated-DEFAULT**

Derivation Path: TS 36.508 [7] clause 4.6.3, Table 4.6.3-6 PDSCH-ConfigDedicated-DEFAULT			
Information Element	Value/remark	Comment	Condition
PDSCH-ConfigDedicated-DEFAULT ::= SEQUENCE {			
p-a	dB0		
}			

Table 9.2.3.2\_D.4.3-3: *AntennaInfoDedicated-r10*

Derivation Path: 36.331 clause 6.3.2			
Information Element	Value/remark	Comment	Condition
AntennaInfoDedicated-r10 ::= SEQUENCE {			
transmissionMode-r10	tm9-v1020		
codebookSubsetRestriction-r10	0x0000 0000 0020 0000 0000 0001 0000		
ue-TransmitAntennaSelection CHOICE {			
release	NULL		
}			
}			

Table 9.2.3.2\_D.4.3-4: *CQI-ReportConfig-r10-DEFAULT*

Derivation Path: 36.508 clause 4.6.3			
Information Element	Value/remark	Comment	Condition
CQI-ReportConfig-r10 ::= SEQUENCE {			
cqi-ReportAperiodic-r10	Not Present		
nomPDSCH-RS-EPRE-Offset	0		
cqi-ReportPeriodic-r10	CQI-ReportPeriodic-r10- DEFAULT		
pmi-RI-Report-r9	setup		
}			

Table 9.2.3.2\_D.4.3-5: *CQI-ReportPeriodic-r10-DEFAULT*

Derivation Path: 36.508 clause 4.6.3			
Information Element	Value/remark	Comment	Condition
CQI-ReportPeriodic-r10 ::= CHOICE {			
setup SEQUENCE {			
cqi-PUCCH-ResourceIndex-r10	0		
cqi-PUCCH-ResourceIndexP1-r10	Not present		
cqi-pmi-ConfigIndex	3	(see Table 7.2.2- 1A in TS 36.213)	
cqi-FormatIndicatorPeriodic-r10 CHOICE {			
widebandCQI-r10 SEQUENCE {			
csi-ReportMode-r10	submode1		
}			
ri-ConfigIndex	805	(see Table 7.2.2- 1B in TS 36.213)	
simultaneousAckNackAndCQI	FALSE		
}			
}			

Table 9.2.3.2\_D.4.3-6: *TDD-Config-DEFAULT*

Derivation Path: 36.508 clause 4.6.3			
Information Element	Value/remark	Comment	Condition
TDD-Config-DEFAULT ::= SEQUENCE {			
subframeAssignment	sa2		
specialSubframePatterns	ssp4		
}			

Table 9.2.3.2\_D.4.3-7: PUCCH-ConfigDedicated-DEFAULT

Derivation Path: 36.331 clause 6.3.2			
Information Element	Value/remark	Comment	Condition
PUCCH-ConfigDedicated-DEFAULT ::= SEQUENCE {			
ackNackRepetition CHOICE {			
release	NULL		
}			
tddAckNackFeedbackMode	Multiplexing	Multiplexing is selected as default to align with RAN4's assumptions in RF tests.	TDD
}			

Table 9.2.3.2\_D.4.3-8: CSI-RS-Config

Derivation Path: 36.331 clause 6.3.2			
Information Element	Value/remark	Comment	Condition
CSI-RS-Config-r10 ::= SEQUENCE {			
csi-RS-r10 CHOICE{			
setup SEQUENCE {			
antennaPortsCount-r10	an8	Parameter represents the number of antenna ports used for transmission of CSI reference signals	
resourceConfig-r10	0	Parameter: CSI reference signal configuration	
subframeConfig-r10	3	$\Delta_{\text{CSI-RS}} = I_{\text{CSI-RS}}$ when CSI-RS SubframeConfig is from 0-4; Parameter: $I_{\text{CSI-RS}}$	
p-C-r10	-6	Parameter: $P_c$ which is the assumed ratio of PDSCH EPRE to CSI-RS EPRE when UE derives CSI feedback	
}			
}			
zeroTxPowerCSI-RS-r10 CHOICE{			
release	NULL		
}			
}			

### 9.2.3.2\_D.5 Test requirement

The pass fail decision is as specified in the test procedure in clause 9.2.3.2\_D.4.2.

There are no parameters in the test setup or measurement process whose variation impacts the results so there are no applicable test tolerances for this test.

## 9.2.4 CQI Reporting under AWGN conditions - Single CSI Process

### 9.2.4.1\_F FDD CQI Reporting under AWGN conditions - Single CSI Process for CoMP

#### 9.2.4.1\_F.1 Test purpose

To verify compliance to the minimum requirements for dual codeword transmission being defined in terms of a reporting spread of the wideband CQI value for codeword #1, and their BLER performance using the transport format indicated by the reported CQI median of codeword #0 and codeword #1. The precoding used at the transmitter is a fixed precoding matrix specified by the bitmap parameter *codebookSubsetRestriction*.

#### 9.2.4.1\_F.2 Test applicability

This test applies to all types of E-UTRA FDD category 2-8 UEs release 11 and forward, supporting Maximum CSI processes of One, Three or Four on a component carrier within a band with PDSCH transmission mode 10.

#### 9.2.4.1\_F.3 Minimum conformance requirements

The minimum requirements for dual codeword transmission are defined in terms of a reporting spread of the wideband CQI value for codeword #1, and their BLER performance using the transport format indicated by the reported CQI median of codeword #0 and codeword #1. The precoding used at the transmitter is a fixed precoding matrix specified by the bitmap parameter *codebookSubsetRestriction*. The propagation condition assumed for the minimum performance requirement is defined in subclause B.1.

For the parameters specified in table 9.2.4.1\_F-1, and using the downlink physical channels specified in tables C.3.4-1 and C.3.4-2, the reported offset level of the wideband spatial differential CQI for codeword #1 (Table 7.2-2 in TS 36.213 [6]) shall be used to determine the wideband CQI index for codeword #1 as

$$\text{wideband CQI}_1 = \text{wideband CQI}_0 - \text{Codeword 1 offset level}$$

The wideband CQI<sub>1</sub> shall be within the set {median CQI<sub>1</sub> -1, median CQI<sub>1</sub>, median CQI<sub>1</sub> +1} for more than 90% of the time, where the resulting wideband values CQI<sub>1</sub> shall be used to determine the median CQI values for codeword #1. For both codewords #0 and #1, the PDSCH BLER using the transport format indicated by the respective median CQI<sub>0</sub> - 1 and median CQI<sub>1</sub> - 1 shall be less than or equal to 0.1. Furthermore, for both codewords #0 and #1, the PDSCH BLER using the transport format indicated by the respective median CQI<sub>0</sub> + 1 and median CQI<sub>1</sub> + 1 shall be greater than or equal to 0.1.

Table 9.2.4.1\_F.3-1: PUCCH 1-1 static test (FDD)

Parameter	Unit	Test 1			Test 2		
		TP1	TP2		TP1	TP2	
Bandwidth	MHz	10					
PDSCH transmission mode		10					
Downlink power allocation (Note 1)	$\rho_A$	dB	0	0	0	0	0
	$\rho_B$	dB	0	0	0	0	0
	$P_c$	dB	-3	-3	-3	-3	-3
	$\sigma$	dB	-3	N/A	-3	N/A	N/A
Cell ID		0			0		
Cell-specific reference signals		Antenna ports 0, 1	(Note 2)		Antenna ports 0, 1	(Note 2)	
CSI reference signals		Antenna ports 15, ..., 18	N/A		Antenna ports 15, ..., 18	N/A	
CSI-RS periodicity and subframe offset $T_{\text{CSI-RS}} / \Delta_{\text{CSI-RS}}$		5/1	N/A		5/1	N/A	
CSI-RS configuration		0	N/A		0	N/A	
Zero-Power CSI-RS configuration $I_{\text{CSI-RS}} / \text{ZeroPowerCSI-RS}$ bitmap		1 / 001000000000 0000	1 / 100000000000 00000		1 / 001000000000 0000	1 / 100000000000 00000	
CSI-IM configuration $I_{\text{CSI-RS}} / \text{ZeroPowerCSI-RS}$ bitmap		1 / 001000000000 0000	N/A		1 / 001000000000 0000	N/A	
CSI process configuration Signal/Interference/Reporting mode		CSI-RS/CSI-IM/PUCCH 1-1			CSI-RS/CSI-IM/PUCCH 1-1		
Propagation condition and antenna configuration		Clause B.1 (4 x 2)	Clause B.1 (2 x 2)		Clause B.1 (4 x 2)	Clause B.1 (2 x 2)	
CodeBookSubsetRestriction bitmap		0x0000 0000 0100 0000	100000		0x0000 0000 0100 0000	100000	
SNR (Note 3)	dB	20	6	7	20	14	15
$\hat{I}_{or}^{(j)}$	dB[mW/15kHz]	-78	-92	-91	-78	-84	-83
$N_{oc}^{(j)}$	dB[mW/15kHz]	-98			-98		
Modulation / Information bit payload		(Note 4)	QPSK / 4392		(Note 4)	QPSK / 4392	
Max number of HARQ transmissions		1	N/A		1	N/A	
Physical channel for CQI/PMI reporting		PUSCH (Note 5)	N/A		PUSCH (Note 5)	N/A	
PUCCH Report Type for CQI/PMI		2	N/A		2	N/A	
PUCCH Report Type for RI		3	N/A		3	N/A	
Reporting periodicity	ms	$N_{pd} = 5$	N/A		$N_{pd} = 5$	N/A	
CQI Delay	ms	8	N/A		8	N/A	
cqi-pmi-ConfigurationIndex		2	N/A		2	N/A	
ri-ConfigIndex		1	N/A		1	N/A	
PDSCH scheduled sub-frames		1,2,3,4,6,7,8,9			1,2,3,4,6,7,8,9		
Timing offset between TPs	us	0			0		
Frequency offset between TPs	Hz	0			0		
Note 1:	Reference measurement channel RC.10 FDD according to Table A.4-1 with one sided dynamic OCNG Pattern OP.1 FDD as described in Annex A.5.1.1.						
Note 2:	REs for antenna ports 0 and 1 CRS have zero transmission power.						
Note 3:	For each test, the minimum requirements shall be fulfilled for at least one of the two SNR(s) and the respective wanted signal input level.						
Note 4:	N/A						
Note 5:	To avoid collisions between CQI/PMI reports and HARQ-ACK it is necessary to report both on PUSCH instead of PUCCH. PDCCH DCI format 0 shall be transmitted in downlink SF#1 and #6 to allow periodic CQI/PMI to multiplex with the HARQ-ACK on PUSCH in uplink SF#0 and #5.						



#### 9.2.4.1\_F.4 Test description

##### 9.2.4.1\_F.4.1 Initial conditions

Initial conditions are a set of test configurations the UE needs to be tested in and the steps for the SS to take with the UE to reach the correct measurement state.

Configurations of PDSCH and PDCCH before measurement are specified in Annex C.2.

Test Environment: Normal as defined in TS 36.508 [7] clause 4.1.

Frequencies to be tested: Mid Range as defined in TS 36.508 [7] clause 4.3.1.1.

Channel Bandwidths to be tested: 10MHz, as defined in TS 36.508 [7] clause 4.3.1.1

1. Connect the SS and AWGN noise source(s) to the UE antenna connector(s) as shown in TS 36.508 [7] Annex A. Figure 52 (without faders).
2. Downlink signals are initially set up according to Annex C.0, C.1 and Annex C.3.4 and uplink signals according to Annex H.1 and H.3.2.
3. Propagation conditions are set according to Annex B.0.
4. Ensure the UE is in State 3A-RF according to TS 36.508 [7] clause 5.2A.2. Message contents are defined in clause 9.2.4.1\_F.4.3.

##### 9.2.4.1\_F.4.2 Test procedure

1. Set the parameters of bandwidth, reference channel, the propagation condition, antenna configuration and the SNR according to Table 9.2.4.1\_F.3-1 as appropriate.
2. The SS shall transmit PDSCH on TP1 via PDCCH DCI format 2D for C\_RNTI to transmit the DL RMC including two codewords with spatial multiplexing both according to CQI value 8 and keep them regardless of the wideband CQI value sent by the UE. The SS shall transmit PDSCH not addressed to UE on TP2. The SS sends downlink MAC padding bits on the DL RMC. The SS shall use a fixed precoding matrix specified by the bitmap parameter *codebookSubsetRestriction*. The SS sends uplink scheduling information on TP1 via PDCCH DCI format 0 with CQI request bit set to 0 to schedule UL RMC in subframe #0 and subframe #5 (Table A.4.1-1). The UE will send periodic CQI report using PUSCH. Continue transmission of the PDSCH until 2000 wideband and wideband spatial differential CQI reports have been gathered. In this process the SS collects wideband and wideband spatial differential CQI reports every 5 ms and also cases where UE transmits nothing in its CQI timing are also counted as wideband and wideband spatial differential CQI reports respectively.
3. From each wideband CQI report, wideband CQI<sub>0</sub> is defined as Wideband CQI of codeword #0 and wideband CQI<sub>1</sub> is calculated according to clause 9.2.4.1\_F.3. Codeword 1 offset level is selected from {0,1,2,3,-4,-3,-2,-1}. Set up a relative frequency distribution for the wideband CQI-values, reported. Calculate the median value (wideband Median CQI is the CQI that is at or crosses 50% distribution from the lower wideband CQI side) for each codewords. Wideband Median CQI<sub>0</sub> is based on the wideband CQI<sub>0</sub> and wideband median CQI<sub>1</sub> is based on the wideband CQI<sub>1</sub>.
4. If Median CQI is not equal to 1 or 15 and 1800 or more of the wideband CQI<sub>1</sub> values are in the range (Median CQI<sub>1</sub> - 1) ≤ Median CQI ≤ (Median CQI<sub>1</sub> + 1) then continue with step 5, otherwise go to step 7.
5. The SS shall transmit PDSCH on TP1 via PDCCH DCI format 2D for C\_RNTI to transmit the DL RMC including two codewords with spatial multiplexing where the transport format of codeword #0 is according to the wideband median CQI<sub>0</sub> - 1 and the transport format of codeword #1 is according to the wideband median CQI<sub>1</sub> - 1. The SS shall transmit PDSCH not addressed to UE on TP2. The SS sends downlink MAC padding bits on the DL RMC. The SS shall not react to the any wideband CQI reports from UE and shall use a fixed precoding matrix specified by the bitmap parameter *codebookSubsetRestriction*. The SS sends uplink scheduling information on TP1 via PDCCH DCI format 0 with CQI request bit set to 0 to schedule UL RMC in subframe #0 and subframe #5 (Table A.4.1-1). The UE will send periodic CQI report using PUSCH. For any PDSCH transmitted by the SS, record the associated ACK, NACK and statDTX responses for each codewords respectively. The responses are then filtered as follows: for the sequence of responses for each HARQ process, discard all the statDTX responses. Continue to gather data until the number of filtered ACK+NACK responses for each codewords reaches 1000.

If the ratio  $NACK / (ACK + NACK) \leq 0.1$  for both codeword #0 and codeword #1 then and go to step 6, otherwise go to step 7.

6. The SS shall transmit PDSCH on TP1 via PDCCH DCI format 2D for C\_RNTI to transmit the DL RMC including two codewords with spatial multiplexing where the transport format of codeword #0 is according to the wideband median-CQI<sub>0</sub> + 1 and the transport format of codeword #1 is according to the wideband median-CQI<sub>1</sub> + 1. The SS shall transmit PDSCH not addressed to UE on TP2. The SS sends downlink MAC padding bits on the DL RMC. The SS shall not react to the any wideband CQI reports from UE and shall use a fixed precoding matrix specified by the bitmap parameter *codebookSubsetRestriction*. The SS sends uplink scheduling information on TP1 via PDCCH DCI format 0 with CQI request bit set to 0 to schedule UL RMC in subframe #0 and subframe #5 (Table A.4.1-1). The UE will send periodic CQI report using PUSCH. For any PDSCH transmitted by the SS, record the associated ACK, NACK and statDTX responses for each codewords respectively. The responses are then filtered as follows: for the sequence of responses for each HARQ process, discard all the statDTX responses. Continue to gather data until the number of filtered ACK+NACK responses for each codewords reaches 1000.

If the ratio  $NACK / (ACK + NACK) \geq 0.1$  for both codeword #0 and codeword #1 then pass the UE for this test and go to step 8, otherwise go to step 7.

7. If both SNR points of the test have not been tested, then repeat the same procedure (steps 1 to 6) for the other SNR point as appropriate. Otherwise fail the UE.
8. If both tests have not been done, then repeat the same procedure (steps 1 to 7) with test conditions according to the table 9.2.4.1\_F.3-1 for the other Test as appropriate. Otherwise pass the UE.

9.2.4.1\_F.4.3 Message contents

Message contents are according to TS 36.508 [7] clause 4.6 with the following exceptions.

**Table 9.2.4.1\_F.4.3-1: PhysicalConfigDedicated-DEFAULT**

Derivation Path: 36.508 clause 4.8.2, Condition DL_CoMP			
Information Element	Value/remark	Comment	Condition
PhysicalConfigDedicated-DEFAULT ::= SEQUENCE {			
pdsch-ConfigDedicated	PDSCH-ConfigDedicated-DEFAULT		
antennaInfo-r10 CHOICE {			
explicitValue-r10	AntennaInfoDedicated-r10		
}			
cqi-ReportConfig-r10	CQI-ReportConfig-r10-DEFAULT		
csi-RS-ConfigNZPToAddModList-r11 SEQUENCE (SIZE (1..maxCSI-RS-NZP-r11)) OF {	1 entry		
CSI-RS-ConfigNZP-r11[1]	CSI-RS-ConfigNZP-r11-DEFAULT		
}			
csi-RS-ConfigZPToAddModList-r11 SEQUENCE (SIZE (1..maxCSI-RS-ZP-r11)) OF {	1 entry		
CSI-RS-ConfigZP-r11[1]	CSI-RS-ConfigZP-r11-DEFAULT		
}			
cqi-ReportConfig-v1130	CQI-ReportConfig-v1130-DEFAULT		
}			

**Table 9.2.4.1\_F.4.3-2: PDSCH-ConfigDedicated-DEFAULT**

Derivation Path: 36.508 clause 4.6.3			
Information Element	Value/remark	Comment	Condition
PDSCH-ConfigDedicated-DEFAULT ::= SEQUENCE {			
p-a	dB-3	Due to 4TX	
}			

Table 9.2.4.1\_F.4.3-3: *AntennaInfoDedicated-r10*

Derivation Path: 36.331 clause 6.3.2			
Information Element	Value/remark	Comment	Condition
AntennaInfoDedicated-r10 ::= SEQUENCE {			
transmissionMode-r10	tm10-v1130		
codebookSubsetRestriction-r10	0x0000 0000 0100 0000		
ue-TransmitAntennaSelection CHOICE {			
release	NULL		
}			
}			

Table 9.2.4.1\_F.4.3-4: *CQI-ReportConfig-r10-DEFAULT*

Derivation Path: 36.508 clause 4.6.3			
Information Element	Value/remark	Comment	Condition
CQI-ReportConfig-r10 ::= SEQUENCE {			
cqi-ReportModeAperiodic-r10	Not Present		
nomPDSCH-RS-EPRE-Offset	0		
cqi-ReportPeriodic-r10	CQI-ReportPeriodic-r10-DEFAULT	Using r10 periodic reporting only, since only 1 process	
}			

Table 9.2.4.1\_F.4.3-5: *CQI-ReportPeriodic-r10-DEFAULT*

Derivation Path: 36.508 clause 4.6.3			
Information Element	Value/remark	Comment	Condition
CQI-ReportPeriodic-r10 ::= CHOICE {			
setup SEQUENCE {			
cqi-pmi-ConfigIndex	2	SF#0 and #5 (see Table 7.2.2-1A in TS 36.213)	
ri-ConfigIndex	1	SF#4 and #9 (see Table 7.2.2-1B in TS 36.213)	
}			
}			

Table 9.2.4.1\_F.4.3-6: *CSI-RS-ConfigNZIP-r11-DEFAULT*

Derivation Path: 36.508 clause 4.6.3			
Information Element	Value/remark	Comment	Condition
CSI-RS-ConfigNZIP-r11 ::= SEQUENCE {		Non-Zero Power CSI-RS	
csi-RS-ConfigNZPId-r11	1		
antennaPortsCount-r11	An4		
resourceConfig-r11	0	Parameter: CSI reference signal configuration	
subframeConfig-r11	1	$\Delta_{\text{CSI-RS}} = I_{\text{CSI-RS}}$ when CSI-RS SubframeConfig is from 0-4; Parameter: $I_{\text{CSI-RS}}$	
}			

Table 9.2.4.1\_F.4.3-7: CSI-RS-ConfigZP-r11-DEFAULT

Derivation Path: 36.508 clause 4.6.3			
Information Element	Value/remark	Comment	Condition
CSI-RS-ConfigZP-r11 ::= SEQUENCE {		Zero Power CSI-RS - CSI-IM process must use a ZP CSI-RS resource.	
csi-RS-ConfigZPId-r11	1		
resourceConfigList-r11	0x0010000000000000	A bitmap because >1 possible	
subframeConfig-r11	1	$\Delta_{\text{CSI-RS}} = I_{\text{CSI-RS}}$ when CSI-RS SubframeConfig is from 0-4; Parameter: $I_{\text{CSI-RS}}$	
}			

Table 9.2.4.1\_F.4.3-8: CQI-ReportConfig-v1130-DEFAULT

Derivation Path: 36.508 clause 4.6.3			
Information Element	Value/remark	Comment	Condition
CQI-ReportConfig-v1130 ::= SEQUENCE {			
cqi-ReportPeriodic-v1130 SEQUENCE {			
cqi-ReportPeriodicProcExtToAddModList-r11	Not present	Using r10 periodic process only, additional extension processes not needed	
}			
cqi-ReportBoth-r11 SEQUENCE {			
csi-IM-ConfigToReleaseList-r11	Not present		
csi-IM-ConfigToAddModList-r11 SEQUENCE (SIZE (1..maxCSI-IM-r11)) OF SEQUENCE {	1 entry	CSI-IM Element	
csi-IM-ConfigId-r11[1]	1		
resourceConfig-r11[1]	2	Has to be one of the ZP configs, 2 corresponds to 0x0010...	
subframeConfig-r11[1]	1		
}			
csi-ProcessToReleaseList-r11	Not present		
csi-ProcessToAddModList-r11 SEQUENCE (SIZE (1..maxCSI-Proc-r11)) OF SEQUENCE {	1 entry	CSI-RS-Process Element	
csi-ProcessId-r11[1]	1		
csi-RS-ConfigNZPId-r11[1]	1		
csi-IM-ConfigId-r11[1]	1		
p-C-AndCBSRList-r11[1] SEQUENCE (SIZE (1..2)) OF SEQUENCE {	1 entry		
p-C-r11[1]	-3		
codebookSubsetRestriction-r11[1]	0x0000 0000 0100 0000		
}			
cqi-ReportPeriodicProclId-r11[1]	0	0 is the process defined in CQI-ReportPeriodic.r10	
}			
}			

#### 9.2.4.1\_F.5 Test requirement

The pass fail decision is as specified in the test procedure in clause 9.2.4.1\_F.4.2.

There are no parameters in the test setup or measurement process whose variation impacts the results so there are no applicable test tolerances for this test.

## 9.2.4.2\_F TDD CQI Reporting under AWGN conditions - Single CSI Process for CoMP

### 9.2.4.2\_F.1 Test purpose

To verify compliance to the minimum requirements for dual codeword transmission being defined in terms of a reporting spread of the wideband CQI value for codeword #1, and their BLER performance using the transport format indicated by the reported CQI median of codeword #0 and codeword #1. The precoding used at the transmitter is a fixed precoding matrix specified by the bitmap parameter *codebookSubsetRestriction*.

### 9.2.4.2\_F.2 Test applicability

This test applies to all types of E-UTRA TDD category 2-8 UEs release 11 and forward, supporting Maximum CSI processes of One, Three or Four on a component carrier within a band with PDSCH transmission mode 10.

### 9.2.4.2\_F.3 Minimum conformance requirements

The following requirements apply to UE Category 2-8. For the parameters specified in table 9.2.4.2\_F.3-1, and using the downlink physical channels specified in tables C.3.4-1 and C.3.4-2, the reported offset level of the wideband spatial differential CQI for codeword #1 (Table 7.2-2 in TS 36.213) shall be used to determine the wideband CQI index for codeword #1 as

$$\text{wideband CQI}_1 = \text{wideband CQI}_0 - \text{Codeword 1 offset level}$$

The wideband  $\text{CQI}_1$  shall be within the set  $\{\text{median CQI}_1 - 1, \text{median CQI}_1, \text{median CQI}_1 + 1\}$  for more than 90% of the time, where the resulting wideband values  $\text{CQI}_1$  shall be used to determine the median CQI values for codeword #1. For both codewords #0 and #1, the PDSCH BLER using the transport format indicated by the respective median  $\text{CQI}_0 - 1$  and median  $\text{CQI}_1 - 1$  shall be less than or equal to 0.1. Furthermore, for both codewords #0 and #1, the PDSCH BLER using the transport format indicated by the respective median  $\text{CQI}_0 + 1$  and median  $\text{CQI}_1 + 1$  shall be greater than or equal to 0.1.

Table 9.2.4.2\_F.3-1: PUCCH 1-1 static test (TDD)

Parameter		Unit	Test 1			Test 2		
			TP1	TP2		TP1	TP2	
Bandwidth		MHz	10					
PDSCH transmission mode			10					
Uplink downlink configuration			2					
Special subframe configuration			4					
Downlink power allocation (Note 1)	$\rho_A$	dB	0	0	0	0	0	
	$\rho_B$	dB	0	0	0	0	0	
	$P_c$	dB	-6	-6	-6	-6	-6	
	$\sigma$	dB	-3	N/A	-3	N/A	N/A	
Cell ID			0			0		
Cell-specific reference signals			Antenna ports 0, 1	(Note 2)	Antenna ports 0, 1	(Note 2)		
CSI reference signals			Antenna ports 15, ..., 22	N/A	Antenna ports 15, ..., 22	N/A		
CSI-RS periodicity and subframe offset $T_{CSI-RS} / \Delta_{CSI-RS}$			5/3	N/A	5/3	N/A		
CSI-RS configuration			0	N/A	0	N/A		
Zero-Power CSI-RS configuration $I_{CSI-RS} / ZeroPowerCSI-RS$ bitmap			3 / 001000000000 0000	3 / 10000100000 00000	3 / 001000000000 0000	3 / 10000100000 00000		
CSI-IM configuration $I_{CSI-RS} / ZeroPowerCSI-RS$ bitmap			3 / 001000000000 0000	N/A	3 / 001000000000 0000	N/A		
CSI process configuration Signal/Interference/Reporting mode			CSI-RS/CSI-IM/PUCCH 1-1			CSI-RS/CSI-IM/PUCCH 1-1		
Propagation condition and antenna configuration			Clause B.1 (8 x 2)	Clause B.1 (2 x 2)	Clause B.1 (8 x 2)	Clause B.1 (2 x 2)		
CodeBookSubsetRestriction bitmap			0x0000 0000 0000 0000 0000 0001 0000	100000	0x0000 0000 0000 0000 0000 0001 0000	100000		
SNR (Note 3)		dB	17	6	7	17	14	15
$\hat{I}_{or}^{(j)}$		dB[mW/15kHz]	-81	-92	-91	-81	-84	-83
$N_{oc}^{(j)}$		dB[mW/15kHz]	-98			-98		
Modulation / Information bit payload			(Note 4)	QPSK / 4392		(Note 4)	QPSK / 4392	
Max number of HARQ transmissions			1	N/A		1	N/A	
Physical channel for CQI/PMI reporting			PUSCH (Note 5)	N/A		PUSCH (Note 5)	N/A	
PUCCH Report Type for CQI/second PMI			2b	N/A		2b	N/A	
Physical channel for RI reporting			PUSCH	N/A		PUSCH	N/A	
PUCCH Report Type for RI/ first PMI			5	N/A		5	N/A	
Reporting periodicity		ms	$N_{pd} = 5$	N/A		$N_{pd} = 5$	N/A	
CQI Delay		ms	10 or 11	N/A		10 or 11	N/A	
cqi-pmi-ConfigurationIndex			3	N/A		3	N/A	
ri-ConfigIndex			805 (Note 6)	N/A		805 (Note 6)	N/A	
ACK/NACK feedback mode			Multiplexing	N/A		Multiplexing	N/A	
PDSCH scheduled sub-frames			3,4,8,9			3,4,8,9		
Timing offset between TPs		us	0			0		
Frequency offset between TPs		Hz	0			0		

Note 1:	Reference measurement channel RC.10 TDD according to Table A.4-1 with one sided dynamic OCNG Pattern OP.1 TDD as described in Annex A.5.2.1.
Note 2:	REs for antenna ports 0 and 1 CRS have zero transmission power.
Note 3:	For each test, the minimum requirements shall be fulfilled for at least one of the two SNR(s) and the respective wanted signal input level.
Note 4:	N/A
Note 5:	To avoid collisions between CQI/PMI reports and HARQ-ACK it is necessary to report both on PUSCH instead of PUCCH. PDCCH DCI format 0 shall be transmitted in downlink SF#3 and #8 to allow periodic CQI/PMI to multiplex with the HARQ-ACK on PUSCH in uplink SF#7 and #2.
Note 6:	RI reporting interval is set to the maximum allowable length of 160ms to minimise collisions between RI, CQI/PMI and HARQ-ACK reports. In the case when all three reports collide, it is expected that CQI/PMI reports will be dropped, while RI and HARQ-ACK will be multiplexed. At eNB, CQI report collection shall be skipped every 160ms during performance verification.

The normative reference for this requirement is TS 36.101 clause 9.2.4.2.

#### 9.2.4.2\_F.4 Test description

##### 9.2.4.2\_F.4.1 Initial conditions

Initial conditions are a set of test configurations the UE needs to be tested in and the steps for the SS to take with the UE to reach the correct measurement state.

Configurations of PDSCH and PDCCH before measurement are specified in Annex C.2.

Test Environment: Normal as defined in TS 36.508 [7] clause 4.1.

Frequencies to be tested: Mid Range as defined in TS 36.508 [7] clause 4.3.1.1.

Channel Bandwidths to be tested: 10MHz, as defined in TS 36.508 [7] clause 4.3.1.1

1. Connect the SS and AWGN noise source to the UE antenna connector (s) as shown in TS 36.508 [7] Annex A, Figure A.53(without faders).
2. Downlink signals are initially set up according to Annex C.0, C.1 and Annex C.3.4 and uplink signals according to Annex H.1 and H.3.2.
3. Propagation conditions are set according to Annex B.0.
4. Ensure the UE is in State 3A-RF according to TS 36.508 [7] clause 5.2A.2. Message contents are defined in clause 9.2.4.2\_F.4.3.

##### 9.2.4.2\_F.4.2 Test procedure

1. Set the parameters of bandwidth, reference channel, the propagation condition, antenna configuration and the SNR according to Table 9.2.4.2\_F.3-1 as appropriate.
2. The SS shall transmit PDSCH on TP1 via PDCCH DCI format 2D for C\_RNTI to transmit the DL RMC including two codewords with spatial multiplexing both according to CQI value 8 and keep them regardless of the wideband CQI value sent by the UE. The SS shall transmit PDSCH not addressed to UE on TP2. The SS sends downlink MAC padding bits on the DL RMC. The SS shall use a fixed precoding matrix specified by the bitmap parameter *codebookSubsetRestriction*. The SS sends uplink scheduling information on TP1 via PDCCH DCI format 0 with CQI request bit set to 0 to schedule UL RMC in subframe # 2 and subframe #7 (Table A.4.1-2). The UE will send periodic CQI report using PUSCH. Continue transmission of the PDSCH until 2000 wideband and wideband spatial differential CQI reports have been gathered. In this process the SS collects wideband and wideband spatial differential CQI reports every 5 ms and also cases where UE transmits nothing in its CQI timing are also counted as wideband and wideband spatial differential CQI reports respectively.
3. From each wideband CQI report, wideband CQI0 is defined as Wideband CQI of codeword #0 and wideband CQI1 is calculated according to clause 9.2.4.2\_F.3. Codeword 1 offset level is selected from {0,1,2,3,-4,-3,-2,-1}. Set up a relative frequency distribution for the wideband CQI-values, reported. Calculate the median value (wideband Median CQI is the CQI that is at or crosses 50% distribution from the lower wideband CQI side) for each codewords. Wideband Median CQI0 is based on the wideband CQI0 and wideband median CQI1 is based on the wideband CQI1.

4. If Median CQI is not equal to 1 or 15 and 1800 or more of the wideband CQI1 values are in the range  $(\text{Median CQI1} - 1) \leq \text{Median CQI} \leq (\text{Median CQI1} + 1)$  then continue with step 5, otherwise go to step 7.
5. The SS shall transmit PDSCH on TP1 via PDCCH DCI format 2D for C\_RNTI to transmit the DL RMC including two codewords with spatial multiplexing where the transport format of codeword #0 is according to the wideband median- CQI0 - 1 and the transport format of codeword #1 is according to the wideband median CQI1 -- 1. The SS shall transmit PDSCH not addressed to UE on TP2. The SS sends downlink MAC padding bits on the DL RMC. The SS shall not react to the any wideband CQI reports from UE and shall use a fixed precoding matrix specified by the bitmap parameter *codebookSubsetRestriction*. The SS sends uplink scheduling information on TP1 via PDCCH DCI format 0 with CQI request bit set to 0 to schedule UL RMC in subframe #2 and subframe #7 (Table A.4.1-2). The UE will send periodic CQI report using PUSCH. For any PDSCH transmitted by the SS, record the associated ACK, NACK and statDTX responses for each codewords respectively. The responses are then filtered as follows: for the sequence of responses for each HARQ process, discard all the statDTX responses. Continue to gather data until the number of filtered ACK+NACK responses for each codewords reaches 1000.

If the ratio  $\text{NACK} / (\text{ACK} + \text{NACK}) \leq 0.1$  for both codeword #0 and codeword #1 then go to step 6, otherwise go to step 7.

6. The SS shall transmit PDSCH on TP1 via PDCCH DCI format 2D for C\_RNTI to transmit the DL RMC including two codewords with spatial multiplexing where the transport format of codeword #0 is according to the wideband medianCQI0 + 1 and the transport format of codeword #1 is according to the wideband median-CQI1 + 1. The SS shall transmit PDSCH not addressed to UE on TP2. The SS sends downlink MAC padding bits on the DL RMC. The SS shall not react to the any wideband CQI reports from UE and shall use a fixed precoding matrix specified by the bitmap parameter *codebookSubsetRestriction*. The SS sends uplink scheduling information on TP1 via PDCCH DCI format 0 with CQI request bit set to 0 to schedule UL RMC in subframe #2 and subframe #7 (Table A.4.1-2). The UE will send periodic CQI report using PUSCH. For any PDSCH transmitted by the SS, record the associated ACK, NACK and statDTX responses for each codewords respectively. The responses are then filtered as follows: for the sequence of responses for each HARQ process, discard all the statDTX responses. Continue to gather data until the number of filtered ACK+NACK responses for each codewords reaches 1000.

If the ratio  $\text{NACK} / (\text{ACK} + \text{NACK}) \geq 0.1$  for both codeword #0 and codeword #1 then pass the UE for this test and go to step 8, otherwise go to step 7.

7. If both SNR points of the test have not been tested, then repeat the same procedure (steps 1 to 6) for the other SNR point as appropriate. Otherwise fail the UE.
8. If both tests have not been done, then repeat the same procedure (steps 1 to 7) with test conditions according to the table 9.2.4.2\_F.3-1 for the other Test as appropriate. Otherwise pass the UE.

#### 9.2.4.2\_F.4.3 Message contents

Message contents are according to TS 36.508 [7] clause 4.6 with the following exceptions.



**Table 9.2.4.2\_F.4.3-1: PhysicalConfigDedicated-DEFAULT**

Derivation Path: 36.508 clause 4.8.2, Condition DL_CoMP			
Information Element	Value/remark	Comment	Condition
PhysicalConfigDedicated-DEFAULT ::= SEQUENCE {			
pdsch-ConfigDedicated	PDSCH-ConfigDedicated-DEFAULT		
antennaInfo-r10 CHOICE {			
explicitValue-r10	AntennaInfoDedicated-r10		
}			
cqi-ReportConfig-r10	CQI-ReportConfig-r10-DEFAULT		
csi-RS-ConfigNZPToAddModList-r11 SEQUENCE (SIZE (1..maxCSI-RS-NZP-r11)) OF {	1 entry		
CSI-RS-ConfigNRP-r11[1]	CSI-RS-ConfigNRP-r11-DEFAULT		
}			
csi-RS-ConfigZPToAddModList-r11 SEQUENCE (SIZE (1..maxCSI-RS-ZP-r11)) OF {	1 entry		
CSI-RS-ConfigZP-r11[1]	CSI-RS-ConfigZP-r11-DEFAULT		
}			
cqi-ReportConfig-v1130	CQI-ReportConfig-v1130-DEFAULT		
}			

**Table 9.2.4.2\_F.4.3-2: PDSCH-ConfigDedicated-DEFAULT**

Derivation Path: 36.508 clause 4.6.3			
Information Element	Value/remark	Comment	Condition
PDSCH-ConfigDedicated-DEFAULT ::= SEQUENCE {			
p-a	dB-3	Due to 8TX	
}			

**Table 9.2.4.2\_F.4.3-3: AntennaInfoDedicated-r10**

Derivation Path: 36.331 clause 6.3.2			
Information Element	Value/remark	Comment	Condition
AntennaInfoDedicated-r10 ::= SEQUENCE {			
transmissionMode-r10	tm10-v1130		
codebookSubsetRestriction-r10	0x0000 0000 0000 0000 0000 0001 0000		
ue-TransmitAntennaSelection CHOICE {			
release	NULL		
}			
}			

**Table 9.2.4.2\_F.4.3-4: CQI-ReportConfig-r10-DEFAULT**

Derivation Path: 36.508 clause 4.6.3			
Information Element	Value/remark	Comment	Condition
CQI-ReportConfig-r10 ::= SEQUENCE {			
cqi-ReportModeAperiodic-r10	Not Present		
nomPDSCH-RS-EPRE-Offset	0		
cqi-ReportPeriodic-r10	CQI-ReportPeriodic-r10-DEFAULT	Using r10 periodic reporting only, since only 1 process	
}			

Table 9.2.4.2\_F.4.3-5: CQI-ReportPeriodic-r10-DEFAULT

Derivation Path: 36.508 clause 4.6.3			
Information Element	Value/remark	Comment	Condition
CQI-ReportPeriodic-r10 ::= CHOICE {			
setup SEQUENCE {			
cqi-pmi-ConfigIndex	3	SF #2 and #7(see Table 7.2.2-1C in TS 36.213)	
ri-ConfigIndex	805	Maximum 32*5=160ms periodicity for minimal cqi-pmi conflicts(see Table 7.2.2-1B in TS 36.213)	
}			
}			

Table 9.2.4.2\_F.4.3-6: CSI-RS-ConfigNQP-r11-DEFAULT

Derivation Path: 36.508 clause 4.6.3			
Information Element	Value/remark	Comment	Condition
CSI-RS-ConfigNQP-r11 ::= SEQUENCE {		Non-Zero Power CSI-RS	
csi-RS-ConfigNZPId-r11	1		
antennaPortsCount-r11	An8		
resourceConfig-r11	0	Parameter: CSI reference signal configuration	
subframeConfig-r11	3	$\Delta_{\text{CSI-RS}} = I_{\text{CSI-RS}}$ when CSI-RS SubframeConfig is from 0-4; Parameter: $I_{\text{CSI-RS}}$	
}			

Table 9.2.4.2\_F.4.3-7: CSI-RS-ConfigZP-r11-DEFAULT

Derivation Path: 36.508 clause 4.6.3			
Information Element	Value/remark	Comment	Condition
CSI-RS-ConfigZP-r11 ::= SEQUENCE {		Zero Power CSI-RS - CSI-IM process must use a ZP CSI-RS resource.	
csi-RS-ConfigZPId-r11	1		
resourceConfigList-r11	0x0010000000000000	A bitmap because >1 possible	
subframeConfig-r11	3	$\Delta_{\text{CSI-RS}} = I_{\text{CSI-RS}}$ when CSI-RS SubframeConfig is from 0-4; Parameter: $I_{\text{CSI-RS}}$	
}			

Table 9.2.4.2\_F.4.3-8: CQI-ReportConfig-v1130-DEFAULT

Derivation Path: 36.508 clause 4.6.3			
Information Element	Value/remark	Comment	Condition
CQI-ReportConfig-v1130 ::= SEQUENCE {			
cqi-ReportPeriodic-v1130 SEQUENCE {			
cqi-ReportPeriodicProcExtToAddModList-r11	Not present	Using r10 periodic process only, additional extension processes not needed	
}			
cqi-ReportBoth-r11 SEQUENCE {			
csi-IM-ConfigToAddModList-r11 SEQUENCE (SIZE (1..maxCSI-IM-r11)) OF SEQUENCE {	1 entry	CSI-IM Element	
csi-IM-ConfigId-r11[1]	1		
resourceConfig-r11[1]	2	Has to be one of the ZP configs, 2 corresponds to 0x0010...	
subframeConfig-r11[1]	3		
}			
csi-ProcessToAddModList-r11 SEQUENCE (SIZE (1..maxCSI-Proc-r11)) OF SEQUENCE {	1 entry	CSI-RS-Process Element	
csi-ProcessId-r11[1]	1		
csi-RS-ConfigNZPId-r11[1]	1		
csi-IM-ConfigId-r11[1]	1		
p-C-AndCBSRList-r11[1] SEQUENCE (SIZE (1..2)) OF SEQUENCE {	1 entry		
p-C-r11[1]	-6		
codebookSubsetRestriction-r11[1]	0x0000 0000 0000 0000 0000 0001 0000		
}			
cqi-ReportPeriodicProcId-r11[1]	0	0 is the process defined in CQI-ReportPeriodic.r10	
}			
}			

Table 9.2.4.2\_F.4.3-9: TDD-Config-DEFAULT

Derivation Path: 36.508 clause 4.6.3			
Information Element	Value/remark	Comment	Condition
TDD-Config-DEFAULT ::= SEQUENCE {			
subframeAssignment	Sa2		
specialSubframePatterns	Ssp4		
}			

### 9.2.4.2\_F.5 Test requirement

The pass fail decision is as specified in the test procedure in clause 9.2.4.2\_F.4.2.

There are no parameters in the test setup or measurement process whose variation impacts the results so there are no applicable test tolerances for this test.

## 9.3 CQI Reporting under fading conditions

### 9.3.1 Frequency-selective scheduling mode

The accuracy of sub-band channel quality indicator (CQI) reporting under frequency selective fading conditions is determined by a double-sided percentile of the reported differential CQI offset level 0 per sub-band, and the relative increase of the throughput obtained when transmitting on any one of the sub-bands with the highest reported differential CQI offset level the corresponding transport format compared to the case for which a fixed format is transmitted on any

sub-band in set of TS 36.213 [10]. To account for sensitivity of the input SNR the sub-band CQI reporting under frequency selective fading conditions is considered to be verified if the reporting accuracy is met for at least one of two SNR levels separated by an offset of 1 dB.

### 9.3.1.1 CQI Reporting under fading conditions – PUSCH 3-0 (Cell-Specific Reference Symbols)

#### 9.3.1.1.1 FDD CQI Reporting under fading conditions – PUSCH 3-0

##### 9.3.1.1.1.1 Test purpose

To verify that preferred sub-bands can be used for frequently-selective scheduling.

##### 9.3.1.1.1.2 Test applicability

This test applies to all types of E-UTRA FDD UE release 8 and forward.

##### 9.3.1.1.1.3 Minimum conformance requirements

For the parameters specified in Table 9.3.1.1.1.3-1, and using the downlink physical channels specified in Annex C, the minimum requirements are specified in Table 9.3.1.1.1.3-2 and by the following

- a) a sub-band differential CQI offset level of 0 shall be reported at least  $\alpha$  % of the time but less than  $\beta$  % for each sub-band;
- b) the ratio of the throughput obtained when transmitting a randomly selected sub-band among the sub-bands with the highest differential CQI offset level the corresponding TBS and that obtained when transmitting the TBS indicated by the reported wideband CQI median on a randomly selected sub-band in set  $S$  shall be  $\geq \gamma$ ;
- c) when transmitting a randomly selected sub-band among the sub-bands with the highest differential CQI offset level the corresponding TBS, the average BLER for the indicated transport formats shall be greater or equal to 0.05.

The requirements only apply for sub-bands of full size and the random scheduling across the sub-bands is done by selecting a new sub-band in each TTI.

**Table 9.3.1.1.1.3-1: Sub-band test for single antenna transmission (FDD)**

Parameter		Unit	Test 1		Test 2	
Bandwidth		MHz	10 MHz			
Transmission mode			1 (port 0)			
Downlink power allocation	$\rho_A$	dB	0			
	$\rho_B$	dB	0			
	$\sigma$	dB	0			
SNR (Note 3)		dB	9	10	14	15
$\hat{I}_{or}^{(j)}$		dB[mW/15kHz]	-89	-88	-84	-83
$N_{oc}^{(j)}$		dB[mW/15kHz]	-98		-98	
Propagation channel			Clause B.2.4 with $\tau_d = 0.45 \mu s$ , $a = 1$ , $f_D = 5$ Hz			
Antenna configuration			1x2			
Reporting interval		ms	5			
CQI delay		ms	8			
Reporting mode			PUSCH 3-0			
Sub-band size		RB	6 (full size)			
Max number of HARQ transmissions			1			
<p>Note 1: If the UE reports in an available uplink reporting instance at subframe SF#n based on CQI estimation at a downlink subframe not later than SF#(n-4), this reported subband or wideband CQI cannot be applied at the eNB downlink before SF#(n+4).</p> <p>Note 2: Reference measurement channel RC.3 FDD according to Table A.4-1 with one/two sided dynamic OCNG Pattern OP.1/2 FDD as described in Annex A.5.1.1/2.</p> <p>Note 3: For each test, the minimum requirements shall be fulfilled for at least one of the two SNR(s) and the respective wanted signal input level.</p>						

**Table 9.3.1.1.1.3-2: Minimum requirement (FDD)**

Parameter	Test 1	Test 2
$\alpha$ [%]	2	2
$\beta$ [%]	55	55
$\gamma$	1.1	1.1
UE Category	1-8	1-8

The normative reference for this requirement is TS 36.101 [2] clause 9.3.1.1.1.

#### 9.3.1.1.1.4 Test description

##### 9.3.1.1.1.4.1 Initial conditions

Initial conditions are a set of test configurations the UE needs to be tested in and the steps for the SS to take with the UE to reach the correct measurement state.

Configurations of PDSCH and PDCCH before measurement are specified in Annex C.2.

Test Environment: Normal as defined in TS 36.508 [7] clause 4.1.

Frequencies to be tested: Mid Range as defined in TS 36.508 [7] clause 4.3.1.1.

Channel Bandwidths to be tested: 10MHz, as defined in TS 36.508 [7] clause 4.3.1.1

1. Connect the SS, faders and AWGN noise source to the UE antenna connector (s) as shown in TS 36.508 [7] Annex A, Figure A.9.
2. The parameter settings for the cell are set up according to Table 9.3.1.1.1.3-1.

3. Downlink signals are initially set up according to Annex C0, C.1 and Annex C.3.2, and uplink signals according to Annex H.1 and H.3.2.
4. Propagation conditions are set according to Annex B.0.
5. Ensure the UE is in State 3A-RF according to TS 36.508 [7] clause 5.2A.2. Message contents are defined in clause 9.3.1.1.1.4.3.

#### 9.3.1.1.1.4.2 Test procedure

1. Set the parameters of bandwidth, reference Channel, the propagation condition, antenna configuration and the SNR according to Table 9.3.1.1.1.3-1 as appropriate.
2. The SS shall transmit PDSCH via PDCCH DCI format 1A for C\_RNTI to transmit the DL RMC according to CQI value 8 and keep it regardless of the wideband and subband CQI value sent by the UE. Continue transmission of the PDSCH until 2000 wideband CQI reports and full-size subband CQI reports for each full-size subband have been gathered. The SS sends downlink MAC padding bits on the DL RMC. SS schedules the UL transmission every 5 ms to carry the PUSCH CQI feedback via PDCCH DCI format 0 with CQI request bit set to 1 and I\_MCS=29 and N\_PRB allocated to be less or equal to 4. In this process the SS collects wideband CQI reports every 5 ms and also cases where UE transmits nothing in its CQI timing are counted as wideband CQI and full-size subband CQI reports.
3. Set up a relative frequency distribution for the reported wideband CQI-values, Calculate the median value (wideband Median CQI is the CQI that is at or crosses 50% distribution from the lower wideband CQI side). This CQI-value is declared as wideband Median CQI value.
4. Check if " $2000 \cdot \alpha \% / 100 \leq \text{number of CQI reports with index } 0 \text{ for each full-size subband} \leq 2000 \cdot \beta \% / 100$ ". (2000= No of full-size subband reports, 100 because of %) If yes, continue with step5, otherwise goto step 7.
5. The SS shall transmit PDSCH via PDCCH DCI format 1A for C\_RNTI to transmit the DL RMC according to the wideband median-CQI value in an each TTI randomly selected full-size subband regardless of UE wideband and full-size subband CQI report. Note that each full-size subband is selected in equal probability. The SS sends downlink MAC padding bits on the DL RMC. SS schedules the UL transmission every 5 ms to carry the PUSCH CQI feedback via PDCCH DCI format 0 with CQI request bit set to 1 and I\_MCS=29 and N\_PRB allocated to be less or equal to 4. Measure the average throughput according to Annex G.5.3. Declare the throughput as  $t_{median}$ .
6. The SS shall transmit PDSCH via PDCCH DCI format 1A for C\_RNTI to transmit the DL RMC according to the highest UE reported full-size subband CQI value in one full-size subband selected among the subbands in which UE reports the highest full-size subband CQI. Subband differential CQI offset level is selected from {0, 1, 2, -1}. Note that the SS shall send PDSCH in the same full-size subband until next UE report is available. In case when same full-size subbands are reported subsequently as subbands with highest full-size subband CQI, the SS shall select for transmission a different subband with respect to the last selection. The SS sends downlink MAC padding bits on the DL RMC. SS schedules the UL transmission every 5 ms to carry the PUSCH CQI feedback via PDCCH DCI format 0 with CQI request bit set to 1 and I\_MCS=29 and N\_PRB allocated to be less or equal to 4. Measure the average throughput and (NACK / (ACK + NACK)) according to Annex G.5.3. Declare the throughput as  $t_{subband}$ . If the ratio  $(t_{subband} / t_{median}) \geq \gamma$  and (NACK / (ACK + NACK))  $\geq 0.05$ , pass the UE for this test and go to step 8. Otherwise, go to step 7.
7. If both SNR points of the test have not been tested, then repeat the same procedure (steps 1 to 6) for the other SNR point as appropriate. Otherwise fail the UE.
8. If both tests have not been done, then repeat the same procedure (steps 1 to 7) with test conditions according to the table 9.3.1.1.1.3-1 for the other Test as appropriate. Otherwise pass the UE.

#### 9.3.1.1.1.4.3 Message contents

Message contents are according to TS 36.508 [7] clause 4.6 with the following exceptions:

**Table 9.3.1.1.4.3-1: PhysicalConfigDedicated-DEFAULT**

Derivation Path: 36.508 clause 5.5.1.2			
Information Element	Value/remark	Comment	Condition
PhysicalConfigDedicated-DEFAULT ::= SEQUENCE {			
cqi-ReportConfig	CQI-ReportConfig-DEFAULT		
}			

**Table 9.3.1.1.4.3-2: CQI-ReportConfig-DEFAULT**

Derivation Path: 36.508 clause 4.6.3			
Information Element	Value/remark	Comment	Condition
CQI-ReportConfig-DEFAULT ::= SEQUENCE {			
cqi-ReportModeAperiodic	rm30		
nomPDSCH-RS-EPRE-Offset	0		
cqi-ReportPeriodic	Not present		
}			

## 9.3.1.1.1.5 Test requirement

**Table 9.3.1.1.5-1: Test requirement (FDD)**

Parameter	Test 1	Test 2
$\alpha$ [%]	2	2
$\beta$ [%]	55	55
$\gamma$	1.09	1.09
BLER	0.05	0.05

To pass the test,  $\alpha$  and  $\beta$  and  $\gamma$  and BLER must be fulfilled.

To pass the test, Test 1 and Test 2 must be passed.

To pass the test, one **or** the other SNR point within one test must be fulfilled.

## 9.3.1.1.2 TDD CQI Reporting under fading conditions – PUSCH 3-0

## 9.3.1.1.2.1 Test purpose

To verify that preferred sub-bands can be used for frequently-selective scheduling.

## 9.3.1.1.2.2 Test applicability

This test applies to all types of E-UTRA TDD UE release 8 and forward.

## 9.3.1.1.2.3 Minimum conformance requirements

For the parameters specified in Table 9.3.1.1.2.3-1, and using the downlink physical channels specified in Annex C, the minimum requirements are specified in Table 9.3.1.1.2.3-2 and by the following

- a sub-band differential CQI offset level of 0 shall be reported at least  $\alpha$  % of the time but less than  $\beta$  % for each sub-band;
- the ratio of the throughput obtained when transmitting on a randomly selected sub-band among the sub-bands with the highest differential CQI offset level the corresponding TBS and that obtained when transmitting the TBS indicated by the reported wideband CQI median on a randomly selected sub-band in set  $S$  shall be  $\geq \gamma$ ;

- c) when transmitting on a randomly selected sub-band among the sub-bands with the highest differential CQI offset level the corresponding TBS, the average BLER for the indicated transport formats shall be greater or equal to 0.05.

The requirements only apply for sub-bands of full size and the random scheduling across the sub-bands is done by selecting a new sub-band in each available downlink transmission instance].

**Table 9.3.1.1.2.3-1: Sub-band test for single antenna transmission (TDD)**

Parameter		Unit	Test 1		Test 2	
Bandwidth		MHz	10 MHz			
Transmission mode			1 (port 0)			
Downlink power allocation	$\rho_A$	dB	0			
	$\rho_B$	dB	0			
	$\sigma$	dB	0			
Uplink downlink configuration			2			
Special subframe configuration			4			
SNR		dB	9	10	14	15
$N_{oc}^{(j)}$		dB[mW/15kHz]	-98		-98	
$\hat{I}_{or}^{(j)}$		dB[mW/15kHz]	-89	-88	-84	-83
Propagation channel			Clause B.2.4 with $\tau_d = 0.45 \mu\text{s}$ $a = 1, f_D = 5 \text{ Hz}$			
Antenna configuration			1 x 2			
Reporting interval		ms	5			
Minimum CQI delay		ms	10 or 11			
Reporting mode			PUSCH 3-0			
Sub-band size		RB	6 (full size)			
Max number of HARQ transmissions			1			
ACK/NACK feedback mode			Multiplexing			
<p>Note 1: If the UE reports in an available uplink reporting instance at subframe SF#n based on CQI estimation at a downlink subframe not later than SF#(n-4), this reported subband or wideband CQI cannot be applied at the eNB downlink before SF#(n+4)</p> <p>Note 2: Reference measurement channel RC.3 TDD according to Table A.4-1 with one/two sided dynamic OCNG Pattern OP.1/2 TDD as described in Annex A.5.2.1/2.</p> <p>Note 3: For each test, the minimum requirements shall be fulfilled for at least one of the two SNR(s) and the respective wanted signal input level.</p>						

**Table 9.3.1.1.2.3-2: Minimum requirement (TDD)**

Parameter	Test 1	Test 2
$\alpha$ [%]	2	2
$\beta$ [%]	55	55
$\gamma$	1.1	1.1
UE Category	1-8	1-8

The normative reference for this requirement is TS 36.101 [2] clause 9.2.1.1.

#### 9.3.1.1.2.4 Test description

##### 9.3.1.1.2.4.1 Initial conditions

Initial conditions are a set of test configurations the UE needs to be tested in and the steps for the SS to take with the UE to reach the correct measurement state.



Configurations of PDSCH and PDCCH before measurement are specified in Annex C.2.

Test Environment: Normal as defined in TS 36.508 [7] clause 4.1.

Frequencies to be tested: Mid Range as defined in TS 36.508 [7] clause 4.3.1.2.

Channel Bandwidths to be tested: 10MHz, as defined in TS 36.508 [7] clause 4.3.1.2

1. Connect the SS to the UE antenna connector (s) as shown in TS 36.508 [7] Annex A, Figure A.9.
2. The parameter settings for the cell are set up according to Table 9.3.1.1.2.3-1.
3. Downlink signals are initially set up according to Annex C0, C.1 and Annex C.3.2, and uplink signals according to Annex H.1 and H.3.2.
4. Propagation conditions are set according to Annex B.0
5. Ensure the UE is in State 3A-RF according to TS 36.508 [7] clause 5.2A.2. Message contents are defined in clause 9.3.1.1.2.4.3.

#### 9.3.1.1.2.4.2 Test procedure

1. Set the parameters of bandwidth, reference Channel, the propagation condition, antenna configuration and the SNR according to Table 9.3.1.1.2.3-1 as appropriate.
2. The SS shall transmit PDSCH via PDCCH DCI format 1A for C\_RNTI to transmit the DL RMC according to CQI value 8 and keep it regardless of the wideband and full-size subband CQI value sent by the UE. Continue transmission of the PDSCH until 2000 wideband CQI reports and full-size subband CQI report for each full-size subband have been gathered. The SS sends downlink MAC padding bits on the DL RMC. SS schedules the UL transmission in subframe #2 and subframe #7 to carry the PUSCH CQI feedback via PDCCH DCI format 0 with CQI request bit set to 1 and I\_MCS=29 and N\_PRB allocated to be less or equal to 4. In this process the SS collects wideband CQI reports every 5 ms and also cases where UE transmits nothing in its CQI timing are counted as wideband CQI and full-size subband CQI reports.
3. Set up a relative frequency distribution for the reported wideband CQI-values, Calculate the median value (wideband Median CQI is the CQI that is at or crosses 50% distribution from the lower wideband CQI side). This CQI-value is declared as wideband Median CQI value.
4. For each subband, if subband CQI of index 0 is reported, at least  $\alpha$  % but less than  $\beta$  % of 2000 full-size subband CQI report, then continue to step 5, otherwise, go to step 7.
5. The SS shall send PDSCH via PDCCH DCI format 1A for C\_RNTI to transmit the DL RMC according to the wideband median-CQI value in an each available downlink transmission instance randomly selected full-size subband regardless of UE wideband and subband CQI report. Note that each full-size subband is selected in equal probability. The SS sends downlink MAC padding bits on the DL RMC. SS schedules the UL transmission in subframe #2 and subframe #7 to carry the PUSCH CQI feedback via PDCCH DCI format 0 with CQI request bit set to 1 and I\_MCS=29 and N\_PRB allocated to be less or equal to 4. Measure the average throughput according to Annex G.5.3 Declare the throughput as  $t_{median}$ .
6. The SS shall transmit PDSCH via PDCCH DCI format 1A for C\_RNTI to transmit the DL RMC according to the highest UE reported full-size subband CQI value in one full-size subband selected among the sub-bands in which UE report the highest full-size subband CQI. Subband differential CQI offset level is selected from {0, 1, 2, -1}. Note that the SS shall send PDSCH in the same full-size subband until next UE report is available. In case when same full-size subbands are reported subsequently as subbands with highest full-size subband CQI, the SS shall select for transmission a different subband with respect to the last selection. The SS sends downlink MAC padding bits on the DL RMC. SS schedules the UL transmission in subframe #2 and subframe #7 to carry the PUSCH CQI feedback via PDCCH DCI format 0 with CQI request bit set to 1 and I\_MCS=29 and N\_PRB allocated to be less or equal to 4. Measure the average throughput and (NACK / (ACK + NACK)) according to Annex G.5.3. Declare the throughput as  $t_{subband}$ . If the ratio  $(t_{subband} / t_{median}) \geq \gamma$  and (NACK / (ACK + NACK))  $\geq 0.05$ , pass the UE and go to step 8. Otherwise, go to step 7.
7. If both SNR points of the test have not been tested, then repeat the same procedure (steps 1 to 6) for the other SNR point as appropriate. Otherwise fail the UE.

8. If both tests have not been done, then repeat the same procedure (steps 1 to 7) with test conditions according to the table 9.3.1.1.2.3-1 for the other test as appropriate.

#### 9.3.1.1.2.4.3 Message contents

Message contents are according to TS 36.508 [7] clause 4.6 with the following exceptions:

**Table 9.3.1.1.2.4.3-1: PhysicalConfigDedicated-DEFAULT**

Derivation Path: 36.508 clause 5.5.1.2			
Information Element	Value/remark	Comment	Condition
PhysicalConfigDedicated-DEFAULT ::= SEQUENCE {			
cqi-ReportConfig	<i>CQI-ReportConfig-DEFAULT</i>		
}			

**Table 9.3.1.1.2.4.3-2: CQI-ReportConfig-DEFAULT**

Derivation Path: 36.508 clause 4.6.3			
Information Element	Value/remark	Comment	Condition
CQI-ReportConfig-DEFAULT ::= SEQUENCE {			
cqi-ReportModeAperiodic	rm30		
nomPDSCH-RS-EPRE-Offset	0		
cqi-ReportPeriodic	Not present		
}			

**Table 9.3.1.1.2.4.3-3: TDD-Config-DEFAULT**

Derivation Path: 36.508 clause 4.6.3			
Information Element	Value/remark	Comment	Condition
TDD-Config-DEFAULT ::= SEQUENCE {			
subframeAssignment	Sa2		
specialSubframePatterns	Ssp4		
}			

#### 9.3.1.1.2.5 Test requirement

**Table 9.3.1.1.2.5-1: Test requirement (TDD)**

Parameter	Test 1	Test 2
$\alpha$ [%]	2	2
$\beta$ [%]	55	55
$\gamma$	1.09	1.09
BLER	0.05	0.05

To pass the test,  $\alpha$  and  $\beta$  and  $\gamma$  and BLER must be fulfilled.

To pass the test, Test 1 and Test 2 must be passed.

To pass the test, one **or** the other SNR point within one test must be fulfilled.

### 9.3.1.2 CQI Reporting under fading conditions – PUSCH 3-1 (CSI Reference Symbols)

#### 9.3.1.2.1\_D FDD CQI Reporting under fading conditions – PUSCH 3-1 for eDL MIMO

##### 9.3.1.2.1\_D.1 Test purpose

To verify that preferred sub-bands can be used for frequently-selective scheduling.

##### 9.3.1.2.1\_D.2 Test applicability

This test applies to all types of E-UTRA FDD UE release 10 and forward that supports eDL MIMO. Applicability requires support for FGI bit 103.

##### 9.3.1.2.1\_D.3 Minimum conformance requirements

For the parameters specified in Table 9.3.1.2.1\_D.3-1, and using the downlink physical channels specified in Annex C.3.2, the minimum requirements are specified in Table 9.3.1.2.1\_D.3-2 and by the following:

- a) a sub-band differential CQI offset level of 0 shall be reported at least  $\alpha$  % of the time but less than  $\beta$  % for each sub-band;
- b) the ratio of the throughput obtained when transmitting a randomly selected sub-band among the sub-bands with the highest differential CQI offset level the corresponding TBS and that obtained when transmitting the TBS indicated by the reported wideband CQI median on a randomly selected sub-band in set  $S$  shall be  $\geq \gamma$ ;
- c) when transmitting a randomly selected sub-band among the sub-bands with the highest differential CQI offset level the corresponding TBS, the average BLER for the indicated transport formats shall be greater or equal to 0.05.

The requirements only apply for sub-bands of full size and the random scheduling across the sub-bands is done by selecting a new sub-band in each TTI.

Table 9.3.1.2.1\_D.3-1: Sub-band test for FDD

Parameter		Unit	Test 1		Test 2	
Bandwidth		MHz	10 MHz			
Transmission mode			9			
Downlink power allocation	$\rho_A$	dB	0			
	$\rho_B$	dB	0			
	$P_c$	dB	0			
	$\sigma$	dB	0			
SNR (Note 3)		dB	4	5	11	12
$\hat{I}_{or}^{(j)}$		dB[mW/15kHz]	-94	-93	-87	86
$N_{oc}^{(j)}$		dB[mW/15kHz]	-98		-98	
Propagation channel			Clause B.2.4 with $\tau_d = 0.45 \mu s, a = 1, f_D = 5 \text{ Hz}$			
Antenna configuration			2x2			
CRS reference signals			Antenna port 0			
CSI reference signals			Antenna ports 15, 16			
Beamforming model			Annex B.4.3			
CSI-RS periodicity and subframe offset $T_{\text{CSI-RS}} / \Delta_{\text{CSI-RS}}$			5/ 1			
CSI-RS reference signal configuration			4			
CodeBookSubsetRestriction bitmap			000001			
Reporting interval (Note 4)		Ms	5			
CQI delay		Ms	8			
Reporting mode			PUSCH 3-1			
Sub-band size		RB	6 (full size)			
Max number of HARQ transmissions			1			
<p>Note 1: If the UE reports in an available uplink reporting instance at subframe SF#n based on CQI estimation at a downlink subframe not later than SF#(n-4), this reported subband or wideband CQI cannot be applied at the eNB downlink before SF#(n+4)</p> <p>Note 2: Reference measurement channel RC.8 FDD according to Table A.4-1 with one/two sided dynamic OCNB Pattern OP.1/2 FDD as described in Annex A.5.1.1/2.</p> <p>Note 3: For each test, the minimum requirements shall be fulfilled for at least one of the two SNR(s) and the respective wanted signal input level.</p> <p>Note 4: PDCCH DCI format 0 with a trigger for aperiodic CQI shall be transmitted in downlink SF#1 and #6 to allow aperiodic CQI/PMI/RI to be transmitted in uplink SF#0 and #5.</p>						

Table 9.3.1.2.1\_D.3-2: Minimum requirement (FDD)

Parameter	Test 1	Test 2
$\alpha$ [%]	2	2
$\beta$ [%]	40	40
$\gamma$	1.1	1.1
UE Category	1-8	1-8

The normative reference for this requirement is TS 36.101 [2] clause 9.3.1.2.1.

#### 9.3.1.2.1\_D.4 Test description

##### 9.3.1.2.1\_D.4.1 Initial conditions

Initial conditions are a set of test configurations the UE needs to be tested in and the steps for the SS to take with the UE to reach the correct measurement state.

Configurations of PDSCH and PDCCH before measurement are specified in Annex C.2.

Test Environment: Normal as defined in TS 36.508 [7] clause 4.1.

Frequencies to be tested: Mid Range as defined in TS 36.508 [7] clause 4.3.1.1.

Channel Bandwidths to be tested: 10MHz, as defined in TS 36.508 [7] clause 4.3.1.1

1. Connect the SS, faders and AWGN noise source to the UE antenna connector (s) as shown in TS 36.508 [7] Annex A, Figure A.10.
2. The parameter settings for the cell are set up according to Table 9.3.1.2.1\_D.3-1.
3. Downlink signals are initially set up according to Annex C0, C.1 and Annex C.3.2, and uplink signals according to Annex H.1 and H.3.2.
4. Propagation conditions are set according to Annex B.0.
5. Ensure the UE is in State 3A-RF according to TS 36.508 [7] clause 5.2A.2. Message contents are defined in clause 9.3.1.2.1\_D.4.3.

#### 9.3.1.2.1\_D.4.2 Test procedure

1. Set the parameters of bandwidth, reference Channel, the propagation condition, antenna configuration and the SNR according to Table 9.3.1.2.1\_D.3-1 as appropriate.
2. The SS shall transmit PDSCH via PDCCH DCI format 2C for C\_RNTI to transmit the DL RMC according to CQI value 8 and keep it regardless of the wideband and subband CQI value sent by the UE. Continue transmission of the PDSCH until 2000 wideband CQI reports and full-size subband CQI reports for each full-size subband have been gathered. The SS sends downlink MAC padding bits on the DL RMC. SS schedules the UL transmission in subframe #0 and subframe #5 to carry the PUSCH CQI feedback via PDCCH DCI format 0 with CQI request bit set to 1 and I\_MCS=29 and N\_PRB allocated to be less or equal to 4. In this process the SS collects wideband CQI reports every 5 ms and also cases where UE transmits nothing in its CQI timing are counted as wideband CQI and full-size subband CQI reports.
3. Set up a relative frequency distribution for the reported wideband CQI-values, Calculate the median value (wideband Median CQI is the CQI that is at or crosses 50% distribution from the lower wideband CQI side). This CQI-value is declared as wideband Median CQI value.
4. Check if " $2000 * \alpha \% / 100 \leq \text{number of CQI reports with index } 0 \text{ for each full-size subband} \leq 2000 * \beta \% / 100$ ". (2000= No of full-size subband reports, 100 because of %) If yes, continue with step 5, otherwise goto step 7.
5. The SS shall transmit PDSCH via PDCCH DCI format 2C for C\_RNTI to transmit the DL RMC according to the wideband median-CQI value in an each TTI randomly selected full-size subband regardless of UE wideband and full-size subband CQI report. Note that each full-size subband is selected in equal probability. The SS sends downlink MAC padding bits on the DL RMC. SS schedules the UL transmission in subframe #0 and subframe #5 to carry the PUSCH CQI feedback via PDCCH DCI format 0 with CQI request bit set to 1 and I\_MCS=29 and N\_PRB allocated to be less or equal to 4. Measure the average throughput according to Annex G.5.3. Declare the throughput as  $t_{median}$ .
6. The SS shall transmit PDSCH via PDCCH DCI format 2C for C\_RNTI to transmit the DL RMC according to the highest UE reported full-size subband CQI value in one full-size subband selected among the subbands in which UE reports the highest full-size subband CQI. Subband differential CQI offset level is selected from {0, 1, 2, -1}. Note that the SS shall send PDSCH in the same full-size subband until next UE report is available. In case when same full-size subbands are reported subsequently as subbands with highest full-size subband CQI, the SS shall select for transmission a different subband with respect to the last selection. The SS sends downlink MAC padding bits on the DL RMC. SS schedules the UL transmission in subframe #0 and subframe #5 to carry the PUSCH CQI feedback via PDCCH DCI format 0 with CQI request bit set to 1 and I\_MCS=29 and N\_PRB allocated to be less or equal to 4. Measure the average throughput and  $(\text{NACK} / (\text{ACK} + \text{NACK}))$  according to Annex G.5.3. Declare the throughput as  $t_{subband}$ . If the ratio  $(t_{subband} / t_{median}) \geq \gamma$  and  $(\text{NACK} / (\text{ACK} + \text{NACK})) \geq 0.05$ , pass the UE for this test and go to step 8. Otherwise, go to step 7.
7. If both SNR points of the test have not been tested, then repeat the same procedure (steps 1 to 6) for the other SNR point as appropriate. Otherwise fail the UE.
8. If both tests have not been done, then repeat the same procedure (steps 1 to 7) with test conditions according to the table 9.3.1.2.1\_D.3-1 for the other Test as appropriate. Otherwise pass the UE.

## 9.3.1.2.1\_D.4.3 Message contents

Message contents are according to TS 36.508 [7] clause 4.6 with the following exceptions:

**Table 9.3.1.2.1\_D.4.3-1: PhysicalConfigDedicated-DEFAULT**

Derivation Path: 36.508 clause 4.6.3			
Information Element	Value/remark	Comment	Condition
PhysicalConfigDedicated-DEFAULT ::= SEQUENCE {			
cqi-ReportConfig-r10	CQI-ReportConfig-r10-DEFAULT		
antennaInfo	Not present		
antennaInfo-r10 CHOICE {			
explicitValue-r10	AntennaInfoDedicated-r10		
}			
csi-RS-Config-r10	CSI-RS-Config-r10		
}			

**Table 9.3.1.2.1\_D.4.3-2: PDSCH-ConfigDedicated-DEFAULT**

Derivation Path: 36.508 clause 4.6.3			
Information Element	Value/remark	Comment	Condition
PDSCH-ConfigDedicated-DEFAULT ::= SEQUENCE {			
p-a	dB0		
}			

**Table 9.3.1.2.1\_D.4.3-3: AntennaInfoDedicated-r10**

Derivation Path: 36.331 clause 6.3.2			
Information Element	Value/remark	Comment	Condition
AntennaInfoDedicated-r10 ::= SEQUENCE {			
transmissionMode-r10	tm9-v1020		
codebookSubsetRestriction-r10	000001		
}			
ue-TransmitAntennaSelection CHOICE {			
release	NULL		
}			

**Table 9.3.1.2.1\_D.4.3-4: CQI-ReportConfig-r10-DEFAULT**

Derivation Path: 36.508 clause 4.6.3			
Information Element	Value/remark	Comment	Condition
CQI-ReportConfig-r10 ::= SEQUENCE {			
cqi-ReportAperiodic-r10	rm31		
nomPDSCH-RS-EPRE-Offset	0		
cqi-ReportPeriodic-r10	Not present		
pmi-RI-Report-r9	setup		
}			

Table 9.3.1.2.1\_D.4.3-5: CSI-RS-Config

Derivation Path: 36.331 clause 6.3.2			
Information Element	Value/remark	Comment	Condition
CSI-RS-Config-r10 ::= SEQUENCE {			
csi-RS-r10 CHOICE{			
release	NULL		
setup SEQUENCE {			
antennaPortsCount-r10	an2	Parameter represents the number of antenna ports used for transmission of CSI reference signals	
resourceConfig-r10	4	Parameter: CSI reference signal configuration	
subframeConfig-r10	1	$\Delta_{\text{CSI-RS}} = I_{\text{CSI-RS}}$ when CSI-RS SubframeConfig is from 0-4; Parameter: $I_{\text{CSI-RS}}$	
p-C-r10	0	Parameter: $P_c$ which is the assumed ratio of PDSCH EPRE to CSI-RS EPRE when UE derives CSI feedback	
}			
}			
zeroTxPowerCSI-RS-r10 CHOICE{			
release	NULL		
}			
}			

## 9.3.1.2.1\_D.5 Test requirement

Table 9.3.1. 2.1.5-1: Test requirement (FDD)

Parameter	Test 1	Test 2
$\alpha$ [%]	2	2
$\beta$ [%]	40	40
$\gamma$	1.09	1.09
UE Category	1-8	1-8
BLER	0.05	0.05

To pass the test,  $\alpha$  and  $\beta$  and  $\gamma$  and BLER must be fulfilled.

To pass the test, Test 1 and Test 2 must be passed.

To pass the test, one **or** the other SNR point within one test must be fulfilled.

## 9.3.1.2.2\_D TDD CQI Reporting under fading conditions – PUSCH 3-1 for eDL MIMO

## 9.3.1.2.2\_D.1 Test purpose

To verify that preferred sub-bands can be used for frequently-selective scheduling.

#### 9.3.1.2.2\_D.2 Test applicability

This test applies to all types of E-UTRA TDD UE release 10 and forward that supports eDL MIMO. Applicability requires support for FGI bit 103.

#### 9.3.1.2.2\_D.3 Minimum conformance requirements

For the parameters specified in Table 9.3.1.2.2\_D.3-1, and using the downlink physical channels specified in Annex C.3.2, the minimum requirements are specified in Table 9.3.1.2.2\_D.3-2 and by the following:

- a) a sub-band differential CQI offset level of 0 shall be reported at least  $\alpha\%$  of the time but less than  $\beta\%$  for each sub-band;
- b) the ratio of the throughput obtained when transmitting a randomly selected sub-band among the sub-bands with the highest differential CQI offset level the corresponding TBS and that obtained when transmitting the TBS indicated by the reported wideband CQI median on a randomly selected sub-band in set  $S$  shall be  $\geq \gamma$ ;
- c) when transmitting a randomly selected sub-band among the sub-bands with the highest differential CQI offset level the corresponding TBS, the average BLER for the indicated transport formats shall be greater or equal to 0.05.

The requirements only apply for sub-bands of full size and the random scheduling across the sub-bands is done by selecting a new sub-band in each TTI.



Table 9.3.1.2.2\_D.3-1: Sub-band test for TDD

Parameter		Unit	Test 1		Test 2	
Bandwidth		MHz	10 MHz			
Transmission mode			9			
Uplink downlink configuration			2			
Special subframe configuration			4			
Downlink power allocation	$\rho_A$	dB	0			
	$\rho_B$	dB	0			
	$P_c$	dB	0			
	$\sigma$	dB	0			
SNR (Note 3)		dB	4	5	11	12
$\hat{I}_{or}^{(j)}$		dB[mW/15kHz]	-94	-93	-87	-86
$N_{oc}^{(j)}$		dB[mW/15kHz]	-98		-98	
Propagation channel			Clause B.2.4 with $\tau_d = 0.45 \mu s, a = 1, f_D = 5 \text{ Hz}$			
Antenna configuration			2x2			
CRS reference signals			Antenna port 0			
CSI reference signals			Antenna ports 15,16			
Beamforming model			Annex B.4.3			
CSI-RS periodicity and subframe offset $T_{\text{CSI-RS}} / \Delta_{\text{CSI-RS}}$			5/3			
CSI-RS reference signal configuration			4			
CodeBookSubsetRestriction bitmap			000001			
Reporting interval (Note 4)		ms	5			
CQI delay		ms	10			
Reporting mode			PUSCH 3-1			
Sub-band size		RB	6 (full size)			
Max number of HARQ transmissions			1			
ACK/NACK feedback mode			Multiplexing			
<p>Note 1: If the UE reports in an available uplink reporting instance at subframe SF#n based on CQI estimation at a downlink subframe not later than SF#(n-4), this reported subband or wideband CQI cannot be applied at the eNB downlink before SF#(n+4)</p> <p>Note 2: Reference measurement channel RC.8 TDD according to Table A.4-1 with one/two sided dynamic OCN Pattern OP.1/2 TDD as described in Annex A.5.2.1/2.</p> <p>Note 3: For each test, the minimum requirements shall be fulfilled for at least one of the two SNR(s) and the respective wanted signal input level.</p> <p>Note 4: PDCCH DCI format 0 with a trigger for aperiodic CQI shall be transmitted in downlink SF#3 and #8 to allow aperiodic CQI/PMI/RI to be transmitted on uplink SF#2 and #7.</p>						

Table 9.3.1.2.2\_D.3-2: Minimum requirement (TDD)

Parameter	Test 1	Test 2
$\alpha$ [%]	2	2
$\beta$ [%]	40	40
$\gamma$	1.1	1.1
UE Category	1-8	1-8

The normative reference for this requirement is TS 36.101 [2] clause 9.3.1.2.2.

#### 9.3.1.2.2\_D.4 Test description

##### 9.3.1.2.2\_D.4.1 Initial conditions

Initial conditions are a set of test configurations the UE needs to be tested in and the steps for the SS to take with the UE to reach the correct measurement state.

Configurations of PDSCH and PDCCH before measurement are specified in Annex C.2.

Test Environment: Normal as defined in TS 36.508 [7] clause 4.1.

Frequencies to be tested: Mid Range as defined in TS 36.508 [7] clause 4.3.1.2.

Channel Bandwidths to be tested: 10MHz, as defined in TS 36.508 [7] clause 4.3.1.2

1. Connect the SS, faders and AWGN noise source to the UE antenna connector (s) as shown in TS 36.508 [7] Annex A, Figure A.10.
2. The parameter settings for the cell are set up according to Table 9.3.1.2.2\_D.3-1.
3. Downlink signals are initially set up according to Annex C0, C.1 and Annex C.3.2, and uplink signals according to Annex H.1 and H.3.2.
4. Propagation conditions are set according to Annex B.0.
5. Ensure the UE is in State 3A-RF according to TS 36.508 [7] clause 5.2A.2. Message contents are defined in clause 9.3.1.2.2\_D.4.3.

#### 9.3.1.2.2\_D.4.2 Test procedure

1. Set the parameters of bandwidth, reference Channel, the propagation condition, antenna configuration and the SNR according to Table 9.3.1.2.2\_D.3-1 as appropriate.
2. The SS shall transmit PDSCH via PDCCH DCI format 2C for C\_RNTI to transmit the DL RMC according to CQI value 10 and keep it regardless of the wideband and full-size subband CQI value sent by the UE. Continue transmission of the PDSCH until 2000 wideband CQI reports and full-size subband CQI report for each full-size subband have been gathered. The SS sends downlink MAC padding bits on the DL RMC. SS schedules the UL transmission in subframe #2 and subframe #7 to carry the PUSCH CQI feedback via PDCCH DCI format 0 with CQI request bit set to 1 and I\_MCS=29 and N\_PRB allocated to be less or equal to 4. In this process the SS collects wideband CQI reports every 5 ms and also cases where UE transmits nothing in its CQI timing are counted as wideband CQI and full-size subband CQI reports.
3. Set up a relative frequency distribution for the reported wideband CQI-values, Calculate the median value (wideband Median CQI is the CQI that is at or crosses 50% distribution from the lower wideband CQI side). This CQI-value is declared as wideband Median CQI value.
4. For each subband, if subband CQI of index 0 is reported, at least  $\alpha$  % but less than  $\beta$  % of 2000 full-size subband CQI report, then continue to step 5, otherwise, go to step 7.
5. The SS shall send PDSCH via PDCCH DCI format 2C for C\_RNTI to transmit the DL RMC according to the wideband median-CQI value in an each available downlink transmission instance randomly selected full-size subband regardless of UE wideband and subband CQI report. Note that each full-size subband is selected in equal probability. The SS sends downlink MAC padding bits on the DL RMC. SS schedules the UL transmission in subframe #2 and subframe #7 to carry the PUSCH CQI feedback via PDCCH DCI format 0 with CQI request bit set to 1 and I\_MCS=29 and N\_PRB allocated to be less or equal to 4. Measure the average throughput according to Annex G.5.3 Declare the throughput as  $t_{median}$ .
6. The SS shall transmit PDSCH via PDCCH DCI format 2C for C\_RNTI to transmit the DL RMC according to the highest UE reported full-size subband CQI value in one full-size subband selected among the sub-bands in which UE report the highest full-size subband CQI. Subband differential CQI offset level is selected from {0, 1, 2, -1}. Note that the SS shall send PDSCH in the same full-size subband until next UE report is available. In case when same full-size subbands are reported subsequently as subbands with highest full-size subband CQI, the SS shall select for transmission a different subband with respect to the last selection. The SS sends downlink MAC padding bits on the DL RMC. SS schedules the UL transmission in subframe #2 and subframe #7 to carry the PUSCH CQI feedback via PDCCH DCI format 0 with CQI request bit set to 1 and I\_MCS=29 and N\_PRB allocated to be less or equal to 4. Measure the average throughput and (NACK / (ACK + NACK)) according to Annex G.5.3. Declare the throughput as  $t_{subband}$ . If the ratio  $(t_{subband} / t_{median}) \geq \gamma$  and (NACK / (ACK + NACK))  $\geq 0.05$ , pass the UE and go to step 8. Otherwise, go to step 7.
7. If both SNR points of the test have not been tested, then repeat the same procedure (steps 1 to 6) for the other SNR point as appropriate. Otherwise fail the UE.

8. If both tests have not been done, then repeat the same procedure (steps 1 to 7) with test conditions according to the table 9.3.1.2.2\_D.3-1 for the other test as appropriate.

#### 9.3.1.2.2\_D.4.3 Message contents

Message contents are according to TS 36.508 [7] clause 4.6 with the following exceptions:

**Table 9.3.1.2.2\_D.4.3-1: PhysicalConfigDedicated-DEFAULT**

Derivation Path: 36.508 clause 4.6.3			
Information Element	Value/remark	Comment	Condition
PhysicalConfigDedicated-DEFAULT ::= SEQUENCE {			
cqi-ReportConfig-r10	<i>CQI-ReportConfig-r10-DEFAULT</i>		
antennaInfo	Not present		
antennaInfo-r10 CHOICE {			
explicitValue-r10	AntennaInfoDedicated-r10		
}			
csi-RS-Config-r10	CSI-RS-Config-r10		
}			

**Table 9.3.1.2.2\_D.4.3-2: PDSCH-ConfigDedicated-DEFAULT**

Derivation Path: 36.508 clause 4.6.3			
Information Element	Value/remark	Comment	Condition
PDSCH-ConfigDedicated-DEFAULT ::= SEQUENCE {			
p-a	dB0		
}			

**Table 9.3.1.2.2\_D.4.3-3: AntennaInfoDedicated-r10**

Derivation Path: 36.331 clause 6.3.2			
Information Element	Value/remark	Comment	Condition
AntennaInfoDedicated-r10 ::= SEQUENCE {			
transmissionMode-r10	tm9-v1020		
codebookSubsetRestriction-r10	000001		
}			
ue-TransmitAntennaSelection CHOICE {			
release	NULL		
}			

**Table 9.3.1.2.2\_D.4.3-4: CQI-ReportConfig-r10-DEFAULT**

Derivation Path: 36.508 clause 4.6.3			
Information Element	Value/remark	Comment	Condition
CQI-ReportConfig-r10 ::= SEQUENCE {			
cqi-ReportAperiodic-r10	rm31		
nomPDSCH-RS-EPRE-Offset	0		
cqi-ReportPeriodic-r10	Not present		
pmi-RI-Report-r9	setup		
}			

Table 9.3.1.2.2\_D.4.3-5: TDD-Config-DEFAULT

Derivation Path: 36.508 clause 4.6.3			
Information Element	Value/remark	Comment	Condition
TDD-Config-DEFAULT ::= SEQUENCE {			
subframeAssignment	sa2		
specialSubframePatterns	ssp4		
}			

Table 9.3.1.2.2\_D.4.3-6: PUCCH-ConfigDedicated-DEFAULT

Derivation Path: 36.508 clause 4.6.3			
Information Element	Value/remark	Comment	Condition
PUCCH-ConfigDedicated-DEFAULT ::= SEQUENCE {			
ackNackRepetition CHOICE {			
release	NULL		
}			
tddAckNackFeedbackMode	Multiplexing	Multiplexing is selected as default to align with RAN4's assumptions in RF tests.	TDD
}			

Table 9.3.1.2.2\_D.4.3-7: CSI-RS-Config

Derivation Path: 36.331 clause 6.3.2			
Information Element	Value/remark	Comment	Condition
CSI-RS-Config-r10 ::= SEQUENCE {			
csi-RS-r10 CHOICE{			
release	NULL		
setup SEQUENCE {			
antennaPortsCount-r10	an2	Parameter represents the number of antenna ports used for transmission of CSI reference signals	
resourceConfig-r10	4	Parameter: CSI reference signal configuration	
subframeConfig-r10	3	$\Delta_{\text{CSI-RS}} = I_{\text{CSI-RS}}$ when CSI-RS SubframeConfig is from 0-4; Parameter: $I_{\text{CSI-RS}}$	
p-C-r10	0	Parameter: $P_c$ which is the assumed ratio of PDSCH EPRE to CSI-RS EPRE when UE derives CSI feedback	
}			
}			
zeroTxPowerCSI-RS-r10 CHOICE{			
release	NULL		
}			
}			

## 9.3.1.2.2\_D.5 Test requirement

**Table 9.3.1.2.2.5-1: Test requirement (TDD)**

Parameter	Test 1	Test 2
$\alpha$ [%]	2	2
$\beta$ [%]	40	40
$\gamma$	1.09	1.09
UE Category	1-8	1-8
BLER	0.05	0.05

To pass the test,  $\alpha$  and  $\beta$  and  $\gamma$  and BLER must be fulfilled.

To pass the test, Test 1 and Test 2 must be passed.

To pass the test, one **or** the other SNR point within one test must be fulfilled.

### 9.3.1.3 CQI Reporting under fading conditions – PUSCH 3-0 (Cell-Specific Reference Symbols)

#### 9.3.1.3.1

##### 9.3.1.3.1\_E FDD CQI Reporting under fading conditions – PUSCH 3-0 for feICIC

##### 9.3.1.3.1\_E.1 FDD CQI Reporting under fading conditions – PUSCH 3-0 for feICIC (non-MBSFN ABS)

###### 9.3.1.3.1\_E.1.1 Test purpose

To verify that preferred sub-bands can be used for frequently-selective scheduling.

###### 9.3.1.3.1\_E.1.2 Test applicability

This test applies to all types of E-UTRA FDD UE and CRS interference handling release 11 and forward. Applicability requires support of FGI bit 115.

###### 9.3.1.3.1\_E.1.3 Minimum conformance requirements

For the parameters specified in Table 9.3.1.3.1\_E.1.3-1, and using the downlink physical channels specified in Annex C.3.2, the minimum requirements are specified in Table 9.3.1.3.1\_E.1.3-2 and by the following

- a sub-band differential CQI offset level of 0 shall be reported at least  $\alpha$  % of the time but less than  $\beta$  % for each sub-band;
- the ratio of the throughput in ABS subframes obtained when transmitting a randomly selected sub-band among the sub-bands with the highest differential CQI offset level the corresponding TBS and that obtained when transmitting the TBS indicated by the reported wideband CQI median on a randomly selected sub-band in set  $S$  shall be  $\geq \gamma$ ;
- when transmitting a randomly selected sub-band among the sub-bands with the highest differential CQI offset level the corresponding TBS, the average BLER for the indicated transport formats shall be greater or equal to  $\epsilon$ .

The requirements only apply for sub-bands of full size and the random scheduling across the sub-bands is done by selecting a new sub-band in each TTI for FDD, each available downlink transmission instance for TDD. T

**Table 9.3.1.3.1\_E.1.3-1: Sub-band test for single antenna transmission (FDD)**

Parameter		Unit	Test 1			Test 2		
			Cell 1		Cell 2 and 3	Cell 1		Cell 2 and 3
Bandwidth		MHz	10			10		
PDSCH transmission mode			1		Note 10	1		Note 10
Downlink power allocation	$\rho_A$	dB	0			0		
	$\rho_B$	dB	0			0		
	$\sigma$	dB	0			0		
Propagation condition			Clause B.2.4 with Td = 0.45 us, a = 1, fd = 5 Hz		EVA5 Low antenna correlation	Clause B.2.4 with Td = 0.45 us, a = 1, fd = 5 Hz		EVA5 Low antenna correlation
Antenna configuration			1x2			1x2		
$\widehat{E}_s / N_{oc2}$ (Note 1)		dB	4	5	Cell 2: 12 Cell 3: 10	14	15	Cell 2: 12 Cell 3: 10
$N_{oc}^{(j)}$ at antenna port	$N_{oc1}^{(j)}$	dBm/15kHz	-98 (Note 7)		N/A	-98 (Note 7)		N/A
	$N_{oc2}^{(j)}$	dBm/15kHz	-98 (Note 8)		N/A	-98 (Note 8)		N/A
	$N_{oc3}^{(j)}$	dBm/15kHz	-93 (Note 9)		N/A	-93 (Note 9)		N/A
Subframe Configuration			Non-MBSFN		Non-MBSFN	Non-MBSFN		Non-MBSFN
Cell Id			0		Cell 2: 6 Cell 3: 1	0		Cell 2: 6 Cell 3: 1
Time Offset between Cells		$\mu$ s	Cell 2: 3 usec Cell 3: -1usec			Cell 2: 3 usec Cell 3: -1usec		
Frequency Shift between Cells		Hz	Cell 2: 300Hz Cell 3: -100Hz			Cell 2: 300Hz Cell 3: -100Hz		
ABS pattern (Note 2)			N/A		01010101 01010101 01010101 01010101 01010101	N/A		01010101 01010101 01010101 01010101 01010101
RLM/RRM Measurement Subframe Pattern (Note 4)			00000100 00000100 00000100 00000100 00000100		N/A	00000100 00000100 00000100 00000100 00000100		N/A
CSI Subframe Sets (Note 3)	$C_{CSI,0}$		01010101 01010101 01010101 01010101 01010101		N/A	01010101 01010101 01010101 01010101 01010101		N/A
	$C_{CSI,1}$		10101010 10101010 10101010 10101010 10101010		N/A	10101010 10101010 10101010 10101010 10101010		N/A
Number of control OFDM symbols			3			3		
Max number of HARQ transmissions			1			1		
CQI delay		ms	8					
Reporting interval (Note 13)		ms	10					
Reporting mode			PUSCH 3-0					
Sub-band size		RB	6 (full size)					

Note 1:	For each test, the minimum requirements shall be fulfilled for at least one of the two SNR(s) and the respective wanted signal input level.
Note 2:	ABS pattern as defined in [9]. PDSCH other than SIB1/paging and its associated PDCCH/PCFICH are transmitted in the serving cell subframe when the subframe is overlapped with the ABS subframe of aggressor cell and the subframe is available in the definition of the reference channel.
Note 3:	Time-domain measurement resource restriction pattern for PCell measurements as defined in TS 36.331 [5].
Note 4:	As configured according to the time-domain measurement resource restriction pattern for CSI measurements defined in TS 36331 [5].
Note 5:	Time-domain measurement resource restriction pattern for PCell measurements as defined in TS 36.331 [5].
Note 6:	Cell 1 is the serving cell. Cell 2 and Cell 3 are the aggressor cells. The number of the CRS ports in Cell 1, Cell 2, and Cell 3 are the same.
Note 7:	This noise is applied in OFDM symbols #1, #2, #3, #5, #6, #8, #9, #10, #12, #13 of a subframe overlapping with the aggressor ABS.
Note 8:	This noise is applied in OFDM symbols #0, #4, #7, #11 of a subframe overlapping with the aggressor ABS.
Note 9:	This noise is applied in all OFDM symbols of a subframe overlapping with aggressor non-ABS.
Note 10:	Downlink physical channel setup in Cell 2 and Cell 3 in accordance with TS 36.521-1 [10] Annex C.3.3 applying OCNNG pattern as defined in TS 36.521-1 [10] Annex A.5.1.5.
Note 11:	Reference measurement channel in Cell 1 RC.3 FDD according to Table A.4-1 with one/two sided dynamic OCNNG Pattern OP.1/2 FDD as described in Annex A.5.1.1/2.
Note 12:	If the UE reports in an available uplink reporting instance at subframe SF#n based on CQI estimation at a downlink subframe not later than SF#(n-4), this reported subband or wideband CQI cannot be applied at the eNB downlink before SF#(n+4).
Note 13:	The CSI reporting is such that reference subframes belong to $C_{csi,0}$ .

**Table 9.3.1.3.1\_E.1.3-2: Minimum requirement (FDD)**

	Test 1	Test 2
$\alpha$ [%]	2	2
$\beta$ [%]	55	55
$\gamma$	1.1	1.1
$\varepsilon$	0.01	0.01
UE Category	$\geq 1$	$\geq 1$

The normative reference for this requirement is TS 36.101 [2] clause 9.3.1.1.3.

#### 9.3.1.3.1\_E.1.4 Test description

##### 9.3.1.3.1\_E.1.4.1 Initial conditions

Initial conditions are a set of test configurations the UE needs to be tested in and the steps for the SS to take with the UE to reach the correct measurement state.

Configurations of PDSCH and PDCCH before measurement are specified in Annex C.2.

Test Environment: Normal as defined in TS 36.508 [7] clause 4.1.

Frequencies to be tested: Mid Range as defined in TS 36.508 [7] clause 4.3.1.1.

Channel Bandwidths to be tested: 10MHz, as defined in TS 36.508 [7] clause 4.3.1.1

1. Connect the SS, faders and AWGN noise source to the UE antenna connector (s) as shown in TS 36.508 [7] Annex A, Figure A.54 for antenna configuration 1x2.
2. The parameter settings for the cell are set up according to Table 9.3.1.3.1\_E.1.3-1.
3. Downlink signals are initially set up according to Annex C0, C.1 and Annex C.3.2, and uplink signals according to Annex H.1 and H.3.2.
4. Propagation conditions are set according to Annex B.0.

5. Ensure the UE is in State 3A-RF according to TS 36.508 [7] clause 5.2A.2 with exceptions listed in 5.2A.5. Message contents are defined in clause 9.3.1.3.1\_E.1.4.3.

#### 9.3.1.3.1\_E.1.4.2 Test procedure

1. Set the parameters of bandwidth, reference channel, the propagation condition, antenna configuration and the SNR according to Table 9.3.1.3.1\_E.1.3-1 as appropriate.
2. The SS shall transmit PDSCH via PDCCH DCI format 1A for C\_RNTI to transmit the DL RMC in ABS protected subframes according to CQI value 8 and keep it regardless of the wideband and subband CQI value sent by the UE. Continue transmission of the PDSCH until 2000 wideband CQI reports and full-size subband CQI reports for each full-size subband for subframe set  $C_{CSL0}$  have been gathered. The SS sends downlink MAC padding bits on the DL RMC. SS schedules the UL transmission every 10 ms to carry the PUSCH CQI feedback via PDCCH DCI format 0 (transmitted in SF#3) with CQI request bit set to 1 and I\_MCS=29 and N\_PRB allocated to be less or equal to 4. In this process the SS collects wideband CQI reports every 10 ms and also cases where UE transmits nothing in its CQI timing are counted as wideband CQI and full-size subband CQI reports.
3. Set up a relative frequency distribution for the reported wideband CQI-values for subframe set  $C_{CSL0}$ . Calculate the median value (wideband Median CQI is the CQI that is at or crosses 50% distribution from the lower wideband CQI side). This CQI-value is declared as wideband Median CQI<sub>0</sub>.
4. Check if “ $2000 * \alpha \% / 100 \leq \text{number of CQI reports with index 0 for each full-size subband} \leq 2000 * \beta \% / 100$ ”. (2000= No of full-size subband reports, 100 because of %) If yes, continue with step5, otherwise goto step 7.
5. The SS shall transmit PDSCH via PDCCH DCI format 1A for C\_RNTI to transmit the DL RMC in ABS protected subframes according to the wideband Median CQI<sub>0</sub> in each downlink transmission instance randomly selected full-size subband regardless of UE wideband and full-size subband CQI report. Note that each full-size subband is selected in equal probability. The SS sends downlink MAC padding bits on the DL RMC. SS schedules the UL transmission every 10 ms to carry the PUSCH CQI feedback via PDCCH DCI format 0 (transmitted in SF#3) with CQI request bit set to 1 and I\_MCS=29 and N\_PRB allocated to be less or equal to 4. Measure the average throughput during ABS according to Annex G.5.3. Declare the throughput as  $t_{median}$ .
6. The SS shall transmit PDSCH via PDCCH DCI format 1A for C\_RNTI to transmit the DL RMC in ABS protected subframes according to the highest UE reported full-size subband CQI value in one full-size subband selected among the subbands in which UE reports the highest full-size subband CQI. Subband differential CQI offset level is selected from {0, 1, 2, -1}. Note that the SS shall send PDSCH in the same full-size subband until next UE report is available. In case when same full-size subbands are reported subsequently as subbands with highest full-size subband CQI, the SS shall select for transmission a different subband with respect to the last selection. The SS sends downlink MAC padding bits on the DL RMC. SS schedules the UL transmission every 10 ms to carry the PUSCH CQI feedback via PDCCH DCI format 0 (transmitted in SF#3) with CQI request bit set to 1 and I\_MCS=29 and N\_PRB allocated to be less or equal to 4. Measure the average throughput during ABS and (NACK / (ACK + NACK)) according to Annex G.5.3. Declare the throughput as  $t_{subband}$ . If the ratio  $(t_{subband} / t_{median}) \geq \gamma$  and (NACK / (ACK + NACK))  $\geq \varepsilon$ , pass the UE for this test and go to step 8. Otherwise, go to step 7.
7. If both SNR points of the test have not been tested, then repeat the same procedure (steps 1 to 6) for the other SNR point as appropriate. Otherwise fail the UE.
8. If both tests have not been done, then repeat the same procedure (steps 1 to 7) with test conditions according to the table 9.3.1.3.1\_E.1.3-1 for the other Test as appropriate. Otherwise pass the UE.

#### 9.3.1.3.1\_E.1.4.3 Message contents

Message contents are according to TS 36.508 [7] clause 5.2A.5.1 with the following exceptions:



**Table 9.3.1.3.1\_E.1.4.3-1: RadioResourceConfigDedicated-SRB2-DRB(n, m)**

Derivation Path: TS 36.508 [7] clause 4.6.3, Table 4.6.3-16 RadioResourceConfigDedicated-SRB2-DRB(n,m)			
Information Element	Value/remark	Comment	Condition
RadioResourceConfigDedicated-SRB2-DRB(n, m) ::= SEQUENCE {			
MeasSubframePatternPCell-r10 CHOICE {			
setup SEQUENCE {			
subframePatternFDD-r10	'00000100000000100 00000100000000100 00000100'	BIT STRING (SIZE (40))	
}			
}			
neighCellsCRS-Info-r11 ::= CHOICE {			
setup SEQUENCE {			
CRS-AssistanceInfoList-r11 ::= SEQUENCE (SIZE (1..maxCellReport)) OF CRS-AssistanceInfo-r11{		2 entries	
CRS-AssistanceInfo-r11 ::= SEQUENCE {			
physCellId-r11	6		Cell 2
	1		Cell 3
antennaPortsCount-r11	an1		Cell 2, Cell 3
mbsfn-SubframeConfigList-r11 ::= SEQUENCE (SIZE (1..maxMBSFN-Allocations)) OF MBSFN-SubframeConfig{			Cell 2, Cell 3
MBSFN-SubframeConfig ::= SEQUENCE {			
radioframeAllocationPeriod	n1		
radioframeAllocationOffset	0		
subframeAllocation CHOICE{			
oneFrame	'000000' B	non-MBSFN	
}			
}			
}			
}			
}			
}			
}			
}			

**Table 9.3.1.3.1\_E.1.4.3-2: PhysicalConfigDedicated-DEFAULT**

Derivation Path: 36.508 clause 5.5.1.2			
Information Element	Value/remark	Comment	Condition
PhysicalConfigDedicated-DEFAULT ::= SEQUENCE {			
cqi-ReportConfig	Not present		
cqi-ReportConfig-r10	CQI-ReportConfig-r10-DEFAULT		
}			

**Table 9.3.1.3.1\_E.1-3: CQI-ReportConfig-r10-DEFAULT**

Derivation Path: 36.508 [7] clause 4.6.3, Table 4.6.3-2AA CQI-ReportConfig-r10-DEFAULT_			
Information Element	Value/remark	Comment	Condition
CQI-ReportConfig-r10-DEFAULT ::= SEQUENCE {			
cqi-ReportAperiodic-r10	rm30		
nomPDSCH-RS-EPRE-Offset	0		
cqi-ReportPeriodic-r10	Not present		
pmi-RI-Report-r9	Not present		
csi-SubframePatternConfig-r10 CHOICE {			
setup SEQUENCE {			
csi-MeasSubframeSet1-r10 CHOICE {			
subframePatternFDD-r10	'0101010101010101 0101010101010101 01010101'	BIT STRING (SIZE (40))	
}			
csi-MeasSubframeSet2-r10 CHOICE {			
subframePatternFDD-r10	'1010101010101010 1010101010101010 10101010'	BIT STRING (SIZE (40))	
}			
}			
}			
}			

## 9.3.1.3.1\_E.1.5 Test requirement

**Table 9.3.1.3.1\_E.1.5-1: Test requirement (FDD)**

	Test 1	Test 2
$\alpha$ [%]	2	2
$\beta$ [%]	55	55
$\gamma$	1.09	1.09
$\varepsilon$	0.01	0.01
UE Category	$\geq 1$	$\geq 1$

To pass the test,  $\alpha$  and  $\beta$  and  $\gamma$  and BLER must be fulfilled.

To pass the test, Test 1 and Test 2 must be passed.

To pass the test, one **or** the other SNR point within one test must be fulfilled.

## 9.3.1.3.2

## 9.3.1.3.2\_E TDD CQI Reporting under fading conditions – PUSCH 3-0 for feICIC

## 9.3.1.3.2\_E.1 TDD CQI Reporting under fading conditions – PUSCH 3-0 for feICIC (non-MBSFN ABS)

## 9.3.1.3.2\_E.1.1 Test purpose

To verify that preferred sub-bands can be used for frequently-selective scheduling.

## 9.3.1.3.2\_E.1.2 Test applicability

This test applies to all types of E-UTRA TDD UE and CRS interference handling and ss-CCH interference handling release 11 and forward. Applicability requires support of FGI bit 115.

## 9.3.1.3.2\_E.1.3 Minimum conformance requirements

For the parameters specified in Table 9.3.1.3.2\_E.1.3-1, and using the downlink physical channels specified in Annex C.3.2, the minimum requirements are specified in Table 9.3.1.3.2\_E.1.3-2 and by the following

- a) a sub-band differential CQI offset level of 0 shall be reported at least  $\alpha$  % of the time but less than  $\beta$  % for each sub-band;
- b) the ratio of the throughput in ABS subframes obtained when transmitting a randomly selected sub-band among the sub-bands with the highest differential CQI offset level the corresponding TBS and that obtained when transmitting the TBS indicated by the reported wideband CQI median on a randomly selected sub-band in set  $S$  shall be  $\geq \gamma$ ;
- c) when transmitting a randomly selected sub-band among the sub-bands with the highest differential CQI offset level the corresponding TBS, the average BLER for the indicated transport formats shall be greater or equal to  $\epsilon$ .

The requirements only apply for sub-bands of full size and the random scheduling across the sub-bands is done by selecting a new sub-band in each TTI for FDD, each available downlink transmission instance for TDD.6.

**Table 9.3.1.3.2\_E.1.3-1: Sub-band test for single antenna transmission (TDD)**

Parameter	Unit	Test 1		Test 2	
		Cell 1	Cell 2 and 3	Cell 1	Cell 2 and 3
Bandwidth	MHz	10		10	
PDSCH transmission mode		1	Note 10	1	Note 10
Uplink downlink configuration		1		1	
Special subframe configuration		4		4	
Downlink power allocation	$\rho_A$	0		0	
	$\rho_B$	0		0	
	$\sigma$	0		0	
Propagation condition		Clause B.2.4 with Td = 0.45 us, a = 1, fd = 5 Hz	EVA5 Low antenna correlation	Clause B.2.4 with Td = 0.45 us, a = 1, fd = 5 Hz	EVA5 Low antenna correlation
Antenna configuration		1x2		1x2	
$\hat{E}_s / N_{oc2}$ (Note 1)	dB	4	5	Cell 2: 12 Cell 3: 10	14 15 Cell 2: 12 Cell 3: 10
$N_{oc}^{(j)}$ at antenna port	$N_{oc1}^{(j)}$	-98 (Note 7)		N/A	
	$N_{oc2}^{(j)}$	-98 (Note 8)		N/A	
	$N_{oc3}^{(j)}$	-93 (Note 9)		N/A	
Subframe Configuration		Non-MBSFN	Non-MBSFN	Non-MBSFN	Non-MBSFN
Cell Id		0	Cell 2: 6 Cell 3: 1	0	Cell 2: 6 Cell 3: 1
Time Offset between Cells	$\mu$ s	Cell 2: 3 usec Cell 3: -1usec		Cell 2: 3 usec Cell 3: -1usec	
Frequency shift between Cells	Hz	Cell 2: 300Hz Cell 3: -100Hz		Cell 2: 300Hz Cell 3: -100Hz	
ABS pattern (Note 2)		N/A	0100010001 0100010001	N/A	0100010001 0100010001
RLM/RRM Measurement Subframe Pattern (Note 4)		0000000001 0000000001	N/A	0000000001 0000000001	N/A
CSI Subframe Sets (Note 3)	$C_{CSI,0}$	0100010001 0100010001	N/A	0100010001 0100010001	N/A
	$C_{CSI,1}$	1000101000 1000101000	N/A	1000101000 1000101000	N/A
Number of control OFDM symbols		3		3	
Max number of HARQ transmissions		1		1	
CQI delay	ms	14			
Reporting interval (Note 13)	ms	10			
Reporting mode		PUSCH 3-0			
Sub-band size	RB	6 (full size)			
ACK/NACK feedback mode		Multiplexing		Multiplexing	

Note 1:	For each test, the minimum requirements shall be fulfilled for at least one of the two SNR(s) and the respective wanted signal input level.
Note 2:	ABS pattern as defined in [9]. PDSCH other than SIB1/paging and its associated PDCCH/PCFICH are transmitted in the serving cell subframe when the subframe is overlapped with the ABS subframe of aggressor cell and the subframe is available in the definition of the reference channel.
Note 3:	Time-domain measurement resource restriction pattern for PCell measurements as defined in TS 36.331 [5].
Note 4:	As configured according to the time-domain measurement resource restriction pattern for CSI measurements defined in TS 36.331 [5].
Note 5:	Time-domain measurement resource restriction pattern for PCell measurements as defined in TS 36.331 [5].
Note 6:	Cell 1 is the serving cell. Cell 2 and Cell 3 are the aggressor cells. The number of the CRS ports in Cell1, Cell 2, and Cell 3 is the same.
Note 7:	This noise is applied in OFDM symbols #1, #2, #3, #5, #6, #8, #9, #10, #12, #13 of a subframe overlapping with the aggressor ABS.
Note 8:	This noise is applied in OFDM symbols #0, #4, #7, #11 of a subframe overlapping with the aggressor ABS.
Note 9:	This noise is applied in all OFDM symbols of a subframe overlapping with aggressor non-ABS.
Note 10:	Downlink physical channel setup in Cell 2 and Cell 3 in accordance with TS 36.521-1 [10] Annex C.3.3 applying OCNG pattern as defined in TS 36.521-1 [10] Annex A.5.2.5
Note 11:	Reference measurement channel in Cell 1 RC.3 TDD according to Table A.4-1 with one/two sided dynamic OCNG Pattern OP.1/2 TDD as described in Annex A.5.2.1/2.
Note 12:	If the UE reports in an available uplink reporting instance at subframe SF#n based on CQI estimation at a downlink subframe not later than SF#(n-4), this reported subband or wideband CQI cannot be applied at the eNB downlink before SF#(n+4).
Note 13:	The CSI reporting is such that reference subframes belong to $C_{csi,0}$ .

**Table 9.3.1.3.2\_E.1.3-2: Minimum requirement (TDD)**

	Test 1	Test 2
$\alpha$ [%]	2	2
$\beta$ [%]	55	55
$\gamma$	1.1	1.1
$\varepsilon$	0.01	0.01
UE Category	$\geq 1$	$\geq 1$

The normative reference for this requirement is TS 36.101 [2] clause 9.3.1.14.

#### 9.3.1.3.2\_E.1.4 Test description

##### 9.3.1.3.2\_E.1.4.1 Initial conditions

Initial conditions are a set of test configurations the UE needs to be tested in and the steps for the SS to take with the UE to reach the correct measurement state.

Configurations of PDSCH and PDCCH before measurement are specified in Annex C.2.

Test Environment: Normal as defined in TS 36.508 [7] clause 4.1.

Frequencies to be tested: Mid Range as defined in TS 36.508 [7] clause 4.3.1.2.

Channel Bandwidths to be tested: 10MHz, as defined in TS 36.508 [7] clause 4.3.1.2

1. Connect the SS to the UE antenna connector (s) as shown in TS 36.508 [7] Annex A, Figure A.54 for antenna configuration 1x2.
2. The parameter settings for the cell are set up according to Table 9.3.1.3.2\_E.1.3-1.
3. Downlink signals are initially set up according to Annex C0, C.1 and Annex C.3.2, and uplink signals according to Annex H.1 and H.3.2.
4. Propagation conditions are set according to Annex B.0
5. Ensure the UE is in State 3A-RF according to TS 36.508 [7] clause 5.2A.2 with exceptions listed in 5.2A.5. Message contents are defined in clause 9.3.1.3.2\_E.1.4.3.

## 9.3.1.3.2\_E.1.4.2 Test procedure

1. Set the parameters of bandwidth, reference channel, the propagation condition, antenna configuration and the SNR according to Table 9.3.1.3.2\_E.1.3-1 as appropriate.
2. The SS shall transmit PDSCH via PDCCH DCI format 1A for C\_RNTI to transmit the DL RMC in ABS protected subframes according to CQI value 8 and keep it regardless of the wideband and full-size subband CQI value sent by the UE. Continue transmission of the PDSCH until 2000 wideband CQI reports and full-size subband CQI report for each full-size subband for subframe set C<sub>CSI,0</sub> have been gathered. The SS sends downlink MAC padding bits on the DL RMC. SS schedules the UL transmission in subframe #7 to carry the PUSCH CQI feedback via PDCCH DCI format 0 (transmitted in DL SF#1) with CQI request bit set to 1 and I\_MCS=29 and N\_PRB allocated to be less or equal to 4. In this process the SS collects wideband CQI reports every 10 ms and also cases where UE transmits nothing in its CQI timing are counted as wideband CQI and full-size subband CQI reports.
3. Set up a relative frequency distribution for the reported wideband CQI-values for subframe set C<sub>CSI,0</sub>. Calculate the median value (wideband Median CQI is the CQI that is at or crosses 50% distribution from the lower wideband CQI side). This CQI-value is declared as wideband Median CQI<sub>0</sub>.
4. For each subband, if subband CQI of index 0 is reported, at least  $\alpha$  % but less than  $\beta$  % of 2000 full-size subband CQI report, then continue to step 5, otherwise, go to step 7.
5. The SS shall send PDSCH via PDCCH DCI format 1A for C\_RNTI to transmit the DL RMC in ABS protected subframes according to the wideband Median CQI<sub>0</sub> in each downlink transmission instance randomly selected full-size subband regardless of UE wideband and subband CQI report. Note that each full-size subband is selected in equal probability. The SS sends downlink MAC padding bits on the DL RMC. SS schedules the UL transmission in subframe #7 to carry the PUSCH CQI feedback via PDCCH DCI format 0 (transmitted in DL SF#1) with CQI request bit set to 1 and I\_MCS=29 and N\_PRB allocated to be less or equal to 4. Measure the average throughput during ABS according to Annex G.5.3 Declare the throughput as  $t_{median}$ .
6. The SS shall transmit PDSCH via PDCCH DCI format 1A for C\_RNTI to transmit the DL RMC in ABS protected subframes according to the highest UE reported full-size subband CQI value in one full-size subband selected among the sub-bands in which UE report the highest full-size subband CQI. Subband differential CQI offset level is selected from {0, 1, 2, -1}. Note that the SS shall send PDSCH in the same full-size subband until next UE report is available. In case when same full-size subbands are reported subsequently as subbands with highest full-size subband CQI, the SS shall select for transmission a different subband with respect to the last selection. The SS sends downlink MAC padding bits on the DL RMC. SS schedules the UL transmission in subframe #7 to carry the PUSCH CQI feedback via PDCCH DCI format 0 (transmitted in DL SF#1) with CQI request bit set to 1 and I\_MCS=29 and N\_PRB allocated to be less or equal to 4. Measure the average throughput during ABS and (NACK/(ACK + NACK)) according to Annex G.5.3. Declare the throughput as  $t_{subband}$ . If the ratio  $(t_{subband} / t_{median}) \geq \gamma$  and (NACK/(ACK + NACK))  $\geq 0.05$ , pass the UE and go to step 8. Otherwise, go to step 7.
7. If both SNR points of the test have not been tested, then repeat the same procedure (steps 1 to 6) for the other SNR point as appropriate. Otherwise fail the UE.
8. If both tests have not been done, then repeat the same procedure (steps 1 to 7) with test conditions according to the table 9.3.1.3.2\_E.1.3-1 for the other test as appropriate.

## 9.3.1.3.2\_E.1.4.3 Message contents

Message contents are according to TS 36.508 [7] clause 5.2A.5.1 with the following exceptions:

**Table 9.3.1.3.2\_E.1.4.3-1: RadioResourceConfigDedicated-SRB2-DRB(n, m)**

Derivation Path: TS 36.508 [7] clause 4.6.3, Table 4.6.3-16 RadioResourceConfigDedicated-SRB2-DRB(n,m)			
Information Element	Value/remark	Comment	Condition
RadioResourceConfigDedicated-SRB2-DRB(n, m) ::= SEQUENCE {			
MeasSubframePatternPCell-r10 CHOICE {			
setup SEQUENCE {			
subframePatternTDD-r10 CHOICE {			
subframeConfig1-5-r10	0000000001 0000000001'	BIT STRING (SIZE (20))	
}			
}			
}			
}			

**Table 9.3.1.3.2\_E.1.4.3-2: PhysicalConfigDedicated-DEFAULT**

Derivation Path: 36.508 clause 5.5.1.2			
Information Element	Value/remark	Comment	Condition
PhysicalConfigDedicated-DEFAULT ::= SEQUENCE {			
cqi-ReportConfig-r10	CQI-ReportConfig-r10- DEFAULT		
}			

**Table 9.3.1.3.2\_E.1.4.3-3: CQI-ReportConfig-r10-DEFAULT**

Derivation Path: 36.508 [7] clause 4.6.3, Table 4.6.3-2AA CQI-ReportConfig-r10-DEFAULT_			
Information Element	Value/remark	Comment	Condition
CQI-ReportConfig-r10-DEFAULT ::= SEQUENCE {			
cqi-ReportAperiodic-r10	rm30		
nomPDSCH-RS-EPRE-Offset	0		
cqi-ReportPeriodic-r10	Not present		
pmi-RI-Report-r9	Not present		
csi-SubframePatternConfig-r10 CHOICE {			
setup SEQUENCE {			
csi-MeasSubframeSet1-r10 CHOICE {			
subframePatternTDD-r10 CHOICE {			
subframeConfig1-5-r10	'0100010001 0100010001'	BIT STRING (SIZE (20))	
}			
}			
csi-MeasSubframeSet2-r10 CHOICE {			
subframePatternTDD-r10 CHOICE {			
subframeConfig1-5-r10	'1000101000 1000101000'	BIT STRING (SIZE (20))	
}			
}			
}			
}			

**Table 9.3.1.3.2\_E.1.4.3-4: TDD-Config-DEFAULT**

Derivation Path: 36.508 clause 4.6.3			
Information Element	Value/remark	Comment	Condition
TDD-Config-DEFAULT ::= SEQUENCE {			
subframeAssignment	sa1		
specialSubframePatterns	ssp4		
}			

**Table 9.3.1.3.2\_E.1.4.3-5: PUSCH-ConfigDedicated-DEFAULT**

Derivation Path: 36.508 clause 4.6.3			
Information Element	Value/remark	Comment	Condition
PUSCH-ConfigDedicated-DEFAULT ::= SEQUENCE			
{			
ackNackRepetition CHOICE {			
release	NULL		
}			
tddAckNackFeedbackMode	Multiplexing		
}			

## 9.3.1.3.2\_E.1.5 Test requirement

**Table 9.3.1.3.2\_E.1.5-1: Test requirement (TDD)**

	Test 1	Test 2
$\alpha$ [%]	2	2
$\beta$ [%]	55	55
$\gamma$	1.09	1.09
$\varepsilon$	0.01	0.01
UE Category	$\geq 1$	$\geq 1$

To pass the test,  $\alpha$  and  $\beta$  and  $\gamma$  and BLER must be fulfilled.

To pass the test, Test 1 and Test 2 must be passed.

To pass the test, one **or** the other SNR point within one test must be fulfilled.

## 9.3.2 Frequency non-selective scheduling mode

The reporting accuracy of the channel quality indicator (CQI) under frequency non-selective fading conditions is determined by the reporting variance, and the relative increase of the throughput obtained when the transport format transmitted is that indicated by the reported CQI compared to the case for which a fixed transport format configured according to the reported median CQI is transmitted. In addition, the reporting accuracy is determined by a minimum BLER using the transport formats indicated by the reported CQI. To account for sensitivity of the input SNR the CQI reporting under frequency non-selective fading conditions is considered to be verified if the reporting accuracy is met for at least one of two SNR levels separated by an offset of 1 dB.

### 9.3.2.1 CQI Reporting under fading conditions – PUCCH 1-0 (Cell-Specific Reference Symbols)

#### 9.3.2.1.1 FDD CQI Reporting under fading conditions – PUCCH 1-0

##### 9.3.2.1.1.1 Test purpose

To verify that the UE is tracking the channel variations and selecting the largest transport format possible according to the prevailing channel state for frequently non-selective scheduling

##### 9.3.2.1.1.2 Test applicability

This test applies to E-UTRA FDD UE release 8 and forward of UE category  $\geq 2$ .

##### 9.3.2.1.1.3 Minimum conformance requirements

For the parameters specified in Table 9.3.2.1.1.3-1 and Table 9.3.2.1.1.3-3, and using the downlink physical channels specified in Annex C, the minimum requirements are specified in Table 9.3.2.1.1.3-2 and Table 9.3.2.1.1.3-4 and by the following:



- a) CQI index not in the set {median CQI -1, median CQI, median CQI +1} shall be reported at least  $\alpha$  % of the time;
- b) the ratio of the throughput obtained when transmitting the transport format indicated by each reported wideband CQI index and that obtained when transmitting a fixed transport format configured according to the wideband CQI median shall be  $\geq \gamma$ ;
- c) when transmitting the transport format indicated by each reported wideband CQI index, the average BLER for the indicated transport formats shall be greater or equal to 0.02

The applicability of the requirement with 5MHz bandwidth as specified in Table 9.3.2.1.1-3 and Table 9.3.2.1.1-4 is defined in clause 9.1.1.1.

**Table 9.3.2.1.1.3-1 Fading test for single antenna (FDD)**

Parameter		Unit	Test 1		Test 2	
Bandwidth		MHz	10 MHz			
Transmission mode			1 (port 0)			
Downlink power allocation	$\rho_A$	dB	0			
	$\rho_B$	dB	0			
	$\sigma$	dB	0			
SNR (Note 3)		dB	6	7	12	13
$\hat{I}_{or}^{(j)}$		dB[mW/15kHz]	-92	-91	-86	-85
$N_{oc}^{(j)}$		dB[mW/15kHz]	-98		-98	
Propagation channel			EPA5			
Correlation and antenna configuration			High (1 x 2)			
Reporting mode			PUCCH 1-0			
Reporting periodicity		ms	$N_P = 2$			
CQI delay		ms	8			
Physical channel for CQI reporting			PUSCH (Note 4)			
PUCCH Report Type			4			
<i>cqi-pmi-ConfigurationIndex</i>			1			
Max number of HARQ transmissions			1			
<p>Note 1: If the UE reports in an available uplink reporting instance at subframe SF#n based on CQI estimation at a downlink SF not later than SF#(n-4), this reported wideband CQI cannot be applied at the eNB downlink before SF#(n+4)</p> <p>Note 2: Reference measurement channel RC.1 FDD according to Table A.4-1 for Category 2-8 with one sided dynamic OCNG Pattern OP.1 FDD as described in Annex A.5.1.1 and RC.4 FDD according to Table A.4-1 for Category 1 with one/two sided dynamic OCNG Pattern OP.1/2 FDD as described in Annex A.5.1.1/2.</p> <p>Note 3: For each test, the minimum requirements shall be fulfilled for at least one of the two SNR(s) and the respective wanted signal input level.</p> <p>Note 4: To avoid collisions between CQI reports and HARQ-ACK it is necessary to report both on PUSCH instead of PUCCH. PDCCH DCI format 0 shall be transmitted in downlink SF#1, #3, #7 and #9 to allow periodic CQI to multiplex with the HARQ-ACK on PUSCH in uplink subframe SF#5, #7, #1 and #3.</p>						

**Table 9.3.2.1.1.3-2 Minimum requirement (FDD)**

Parameter	Test 1	Test 2
$\alpha$ [%]	20	20
$\gamma$	1.05	1.05
UE Category	1-8	1-8

**Table 9.3.2.1.1.3-3: Fading test for single antenna (FDD)**

Parameter	Unit	Test 1		Test 2	
Bandwidth	MHz	5 MHz			
Transmission mode		1 (port 0)			
Downlink power allocation	$\rho_A$	dB			
	$\rho_B$	dB			
	$\sigma$	dB			
SNR (Note 3)	dB	6	7	12	13
$\hat{I}_{or}^{(j)}$	dB[mW/15kHz]	-92	-91	-86	-85
$N_{oc}^{(j)}$	dB[mW/15kHz]	-98		-98	
Propagation channel		EPA5			
Correlation and antenna configuration		High (1 x 2)			
Reporting mode		PUCCH 1-0			
Reporting periodicity	ms	$N_{pd} = 2$			
CQI delay	ms	8			
Physical channel for CQI reporting		PUSCH (Note 4)			
PUCCH Report Type		4			
<i>cqi-pmi-ConfigurationIndex</i>		1			
Max number of HARQ transmissions		1			
<p>Note 1: If the UE reports in an available uplink reporting instance at subframe SF#n based on CQI estimation at a downlink SF not later than SF#(n-4), this reported wideband CQI cannot be applied at the eNB downlink before SF#(n+4)</p> <p>Note 2: Reference measurement channel RC.14 FDD according to Table A.4-1 for Category 2-8 with one sided dynamic OCNG Pattern OP.1 FDD as described in Annex A.5.1.1 and RC.15 FDD according to Table A.4-1 for Category 1 with one/two sided dynamic OCNG Pattern OP.1/2 FDD as described in Annex A.5.1.1/2.</p> <p>Note 3: For each test, the minimum requirements shall be fulfilled for at least one of the two SNR(s) and the respective wanted signal input level.</p> <p>Note 4: To avoid collisions between CQI reports and HARQ-ACK it is necessary to report both on PUSCH instead of PUCCH. PDCCH DCI format 0 shall be transmitted in downlink SF#1, #3, #7 and #9 to allow periodic CQI to multiplex with the HARQ-ACK on PUSCH in uplink subframe SF#5, #7, #1 and #3.</p>					

**Table 9.3.2.1.1.3-4: Minimum requirement (FDD)**

	Test 1	Test 2
$\alpha$ [%]	20	20
$\gamma$	1.05	1.05
UE Category	1-8	1-8

The normative reference for this requirement is TS 36.101 [2] clause 9.3.2.1.1.

#### 9.3.2.1.1.4 Test description

##### 9.3.2.1.1.4.1 Initial conditions

Initial conditions are a set of test configurations the UE needs to be tested in and the steps for the SS to take with the UE to reach the correct measurement state.

Configurations of PDSCH and PDCCH before measurement are specified in Annex C.2.

Test Environment: Normal as defined in TS 36.508 [7] clause 4.1.

Frequencies to be tested: Mid Range as defined in TS 36.508 [7] clause 4.3.1.1.

Channel Bandwidths to be tested: 10MHz for tests defined in 9.3.2.1.1.3-1 and 5MHz for tests defined in Table 9.3.2.1.1.3-2, as defined in TS 36.508 [7] clause 4.3.1.1

1. Connect the SS, faders and AWGN noise source to the UE antenna connector (s) as shown in TS 36.508 [7] Annex A, Figure A.9.
2. The parameter settings for the cell are set up according to Table 9.3.2.1.1.3-1.
3. Downlink signals are initially set up according to Annex C.0, C.1 and Annex C.3.2, and uplink signals according to Annex H.3.2.
4. Propagation conditions are set according to Annex B.0.
5. Ensure the UE is in State 3A-RF according to TS 36.508 [7] clause 5.2A.2. Message contents are defined in clause 9.3.2.1.1.4.3.

#### 9.3.2.1.1.4.2 Test procedure

1. Set the parameters of bandwidth, the propagation condition, antenna configuration and measurement channel according to Table 9.3.2.1.1.3-1 for 10MHz tests or Table 9.3.2.1.1.3-2 for 5MHz tests as appropriate.
2. The SS shall transmit PDSCH via PDCCH DCI format 1A for C\_RNTI to transmit the DL RMC according to CQI value 8 and keep it regardless of the wideband CQI value sent by the UE. The SS sends downlink MAC padding bits on the DL RMC. The SS sends uplink scheduling information via PDCCH DCI format 0 with CQI request bit set to 0 to schedule UL RMC in subframe #1,#3,#5 and subframe #7 (Table A.4.1-1). The UE will send ACK/NACK and periodic CQI report using PUSCH. Continue transmission of the PDSCH until 100000 wideband CQI reports have been gathered. In this process the SS collects wideband CQI reports every 2 ms and also cases where UE transmits nothing in its CQI timing are counted as wideband CQI reports.
3. Set up a relative frequency distribution for the reported wideband CQI-values, reported. Calculate the median value (wideband Median CQI is the wideband CQI that is at or crosses 50% distribution from the lower wideband CQI side). This CQI-value is declared as wideband Median CQI value.
4. If less than  $(100-\alpha)/100 \cdot 100000$  of the wideband CQI values are in the range  $(\text{Median CQI} - 1) \leq \text{Median CQI} \leq (\text{Median CQI} + 1)$  then continue with step 5, otherwise go to step 7.
5. The SS shall transmit PDSCH via PDCCH DCI format 1A for C\_RNTI to transmit the DL RMC according to the wideband median-CQI value regardless of UE wideband CQI report. The SS sends downlink MAC padding bits on the DL RMC. The SS sends uplink scheduling information via PDCCH DCI format 0 with CQI request bit set to 0 to schedule UL RMC in subframe #1,#3,#5 and subframe #7 (Table A.4.1-1). The UE will send ACK/NACK and periodic CQI report using PUSCH. Measure the average throughput according to Annex G.5.3. Declare the throughput as  $t_{median}$ .
6. The SS shall transmit PDSCH via PDCCH DCI format 1A for C\_RNTI to transmit the DL RMC according to the wideband CQI value reported from UE. The SS sends downlink MAC padding bits on the DL RMC. The SS sends uplink scheduling information via PDCCH DCI format 0 with CQI request bit set to 0 to schedule UL RMC in subframe #1,#3,#5 and subframe #7 (Table A.4.1-1). The UE will send ACK/NACK and periodic CQI report using PUSCH. Measure the average throughput according to Annex G.5.3. Declare the throughput as  $t_{wideband}$ . For any PDSCH transmitted by the SS, record the associated ACK, NACK and statDTX responses. The responses are then filtered as follows: for the sequence of responses for each HARQ process, discard all the statDTX responses.  
If the ratio  $(t_{wideband} / t_{median}) \geq \gamma$  and ratio  $(\text{NACK} / (\text{ACK} + \text{NACK}))$  is greater or equal to 0.02, then pass the UE for this test and go to step 8. Otherwise go to step 7.
7. If both SNR points of the test have not been tested, then repeat the same procedure (steps 1 to 6) for the other SNR point as appropriate. Otherwise fail the UE.
8. If both tests have not been done, then repeat the same procedure (steps 1 to 7) with test conditions according to the table 9.3.2.1.1.3-1 for 10MHz or table 9.3.2.1.1.3-2 for 5MHz for the other Test as appropriate. Otherwise pass the UE.

## 9.3.2.1.1.4.3 Message contents

Message contents are according to TS 36.508 [7] clause 4.6 with the following exceptions:

**Table 9.3.2.1.1.4.3-1: PhysicalConfigDedicated-DEFAULT**

Derivation Path: 36.508 clause 5.5.1.2			
Information Element	Value/remark	Comment	Condition
PhysicalConfigDedicated-DEFAULT ::= SEQUENCE {			
cqi-ReportConfig	<i>CQI-ReportConfig-DEFAULT</i>		
}			

**Table 9.3.2.1.1.4.3-2: CQI-ReportConfig-DEFAULT**

Derivation Path: 36.508 clause 4.6.3			
Information Element	Value/remark	Comment	Condition
CQI-ReportConfig-DEFAULT ::= SEQUENCE {			
cqi-ReportModeAperiodic	Not present		
nomPDSCH-RS-EPRE-Offset	0		
cqi-ReportPeriodic CHOICE {			
setup SEQUENCE {			
cqi-PUCCH-ResourceIndex	0		
cqi-pmi-ConfigIndex	1	(see Table 7.2.2-1A in TS 36.213)	
cqi-FormatIndicatorPeriodic CHOICE {			
widebandCQI	NULL		
}			
ri-ConfigIndex	NULL	(see Table 7.2.2-1B in TS 36.213)	
simultaneousAckNackAndCQI	FALSE		
}			
}			

## 9.3.2.1.1.5 Test requirement

The applicability of the test requirement with 5MHz bandwidth as specified in Table 9.3.2.1.5-2 is defined in clause 9.1.1.1.

**Table 9.3.2.1.1.5-1: Test requirement (10MHz FDD)**

Parameter	Test 1	Test 2
$\alpha$ [%]	20	20
$\gamma$	1.04	1.04
BLER	0.02	0.02
UE category	2-8	2-8

**Table 9.3.2.1.1.5-2: Minimum requirement (5MHz FDD)**

	Test 1	Test 2
$\alpha$ [%]	20	20
$\gamma$	1.04	1.04
BLER	0.02	0.02
UE Category	2-8	2-8

To pass the test,  $\alpha$  and  $\gamma$  and BLER must be fulfilled.

To pass the test, Test 1 and Test 2 must be passed.

To pass the test, one **or** the other SNR point within one test must be fulfilled.

### 9.3.2.1.1\_1 FDD CQI Reporting under fading conditions - PUCCH 1-0 (Release 9 and forward)

#### 9.3.2.1.1\_1.1 Test purpose

Same test purpose as in clause 9.3.2.1.1.1.

#### 9.3.2.1.1\_1.2 Test applicability

This test applies to E-UTRA FDD UE release 9 and forward of UE category 1.

#### 9.3.2.1.1\_1.3 Minimum conformance requirements

Same minimum conformance requirements as in clause 9.3.2.1.1.3.

#### 9.3.2.1.1\_1.4 Test description

##### 9.3.2.1.1\_1.4.1 Initial conditions

Same initial conditions as in clause 9.3.2.1.1.4.1.

##### 9.3.2.1.1\_1.4.2 Test procedure

Same test procedure as in clause 9.3.2.1.1.4.2.

##### 9.3.2.1.1\_1.4.3 Message contents

Same message contents as in clause 9.3.2.1.1.4.3.

##### 9.3.2.1.1\_1.5 Test requirement

Same test requirements as in clause 9.3.2.1.1.5 with the following exceptions:

Instead of table 9.3.2.1.1.5.1-> use table 9.3.2.1.1\_1.5-1 below for 10MHz bandwidth tests:

**Table 9.3.2.1.1\_1.5-1: Test requirement (FDD)**

Parameter	Test 1	Test 2
$\alpha$ [%]	20	20
$\gamma$	1.04	1.04
BLER	0.02	0.02
UE category	1	1

Or instead of table 9.3.2.1.1.5.2-> use table 9.3.2.1.1\_1.5-2 below for 5MHz bandwidth tests:

**Table 9.3.2.1.1\_1.5-2: Test requirement (5MHz FDD)**

	Test 1	Test 2
$\alpha$ [%]	20	20
$\gamma$	1.04	1.04
BLER	0.02	0.02
UE Category	1	1

### 9.3.2.1.2 TDD CQI Reporting under fading conditions – PUCCH 1-0

#### 9.3.2.1.2.1 Test purpose

To verify that the UE is tracking the channel variations and selecting the transport format according to the prevailing channel state for frequently non-selective scheduling

#### 9.3.2.1.2.2 Test applicability

This test applies to E-UTRA TDD UE release 8 and forward of UE category  $\geq 2$ .

#### 9.3.2.1.2.3 Minimum conformance requirements

For the parameters specified in Table 9.3.2.1.2.3-1, and using the downlink physical channels specified in Annex C, the minimum requirements are specified in Table 9.3.2.1.2.3-2 and by the following

- a) a CQI index not in the set {median CQI -1, median CQI, median CQI +1} shall be reported at least  $\alpha\%$  of the time;
- b) the ratio of the throughput obtained when transmitting the transport format indicated by each reported wideband CQI index and that obtained when transmitting a fixed transport format configured according to the wideband CQI median shall be  $\geq \gamma$ ;
- c) when transmitting the transport format indicated by each reported wideband CQI index, the average BLER for the indicated transport formats shall be greater or equal to 0.02

**Table 9.3.2.1.2.3-1: Fading test for single antenna (TDD)**

Parameter		Unit	Test 1		Test 2	
Bandwidth		MHz	10 MHz			
Transmission mode			1 (port 0)			
Downlink power allocation	$\rho_A$	dB	0			
	$\rho_B$	dB	0			
	$\sigma$	dB	0			
Uplink downlink configuration			2			
Special subframe configuration			4			
SNR		dB	6	7	12	13
$N_{oc}^{(j)}$		dB[mW/15kHz]	-98		-98	
$\hat{I}_{or}^{(j)}$		dB[mW/15kHz]	-92	-91	-86	-85
Propagation channel			EPA5			
Correlation and antenna configuration			High (1 x 2)			
Reporting mode			PUCCH 1-0			
Reporting periodicity		ms	$N_P = 5$			
CQI delay		ms	10 or 11			
Physical channel for CQI reporting			PUSCH (Note 4)			
PUCCH Report Type			4			
cqi-pmi-ConfigurationIndex			3			
Max number of HARQ transmissions			1			
ACK/NACK feedback mode			Multiplexing			
<p>Note 1: If the UE reports in an available uplink reporting instance at subframe SF#n based on CQI estimation at a downlink SF not later than SF#(n-4), this reported wideband CQI cannot be applied at the eNB downlink before SF#(n+4)</p> <p>Note 2: Reference measurement channel RC.1 TDD according to Table A.4-1 for Category 2-8 with one sided dynamic OCNG Pattern OP.1 TDD as described in Annex A.5.2.1 and RC.4 TDD according to Table A.4-1 for Category 1 with one/two sided dynamic OCNG Pattern OP.1/2 TDD as described in Annex A.5.2.1/2.</p> <p>Note 3: For each test, the minimum requirements shall be fulfilled for at least one of the two SNR(s) and the respective wanted signal input level.</p> <p>Note 4: To avoid collisions between CQI reports and HARQ-ACK it is necessary to report both on PUSCH instead of PUCCH. PDCCH DCI format 0 shall be transmitted in downlink SF#3 and #8 to allow periodic CQI to multiplex with the HARQ-ACK on PUSCH in uplink subframe SF#7 and #2.</p>						

**Table 9.3.2.1.2.3-2: Minimum requirement (TDD)**

Parameter	Test 1	Test 2
$\alpha$ [%]	20	20
$\gamma$	1.05	1.05
UE Category	1-8	1-8

The normative reference for this requirement is TS 36.101 [2] clause 9.3.2.1.2.

#### 9.3.2.1.2.4 Test description

##### 9.3.2.1.2.4.1 Initial conditions

Initial conditions are a set of test configurations the UE needs to be tested in and the steps for the SS to take with the UE to reach the correct measurement state.

Configurations of PDSCH and PDCCH before measurement are specified in Annex C.2.

Test Environment: Normal as defined in TS 36.508 [7] clause 4.1.

Frequencies to be tested: Mid Range as defined in TS 36.508 [7] clause 4.3.1.2.

Channel Bandwidths to be tested: 10MHz, as defined in TS 36.508 [7] clause 4.3.1.2

1. Connect the SS to the UE antenna connector (s) as shown in TS 36.508 [7] Annex A, Figure A.9.
2. The parameter settings for the cell are set up according to Table 9.3.2.1.2.3-1.
3. Downlink signals are initially set up according to Annex C0, C.1 and Annex C.3.2, and uplink signals according to Annex H.3.2.
4. Propagation conditions are set according to Annex B.0.
5. Ensure the UE is in State 3A-RF according to TS 36.508 [7] clause 5.2A.2. Message contents are defined in clause 9.3.2.1.2.4.3.

##### 9.3.2.1.2.4.2 Test procedure

1. Set the parameters of bandwidth, the propagation condition, antenna configuration and measurement channel according to Table 9.3.2.1.2.3-1 as appropriate.
2. The SS shall transmit PDSCH via PDCCH DCI format 1A for C\_RNTI to transmit the DL RMC according to CQI value 8 and keep it regardless of the wideband CQI value sent by the UE. The SS sends downlink MAC padding bits on the DL RMC. The SS sends uplink scheduling information via PDCCH DCI format 0 with CQI request bit set to 0 to schedule UL RMC in subframe #2 and subframe #7 (Table A.4.1-2). The UE will send ACK/NACK and periodic CQI report using PUSCH Continue transmission of the PDSCH until 100000 wideband CQI reports have been gathered. In this process the SS collects wideband CQI reports every 5 ms and also cases where UE transmits nothing in its CQI timing are counted as wideband CQI reports.
3. Set up a relative frequency distribution for the reported wideband CQI-values, reported. Calculate the median value (wideband Median CQI is the wideband CQI that is at or crosses 50% distribution from the lower wideband CQI side). This CQI-value is declared as wideband Median CQI value.
4. If less than  $(100-\alpha)/100 \cdot 100000$  of the wideband CQI values are in the range  $(\text{Median CQI} - 1) \leq \text{Median CQI} \leq (\text{Median CQI} + 1)$  then continue with step 5, otherwise go to step 7.
5. The SS shall transmit PDSCH via PDCCH DCI format 1A for C\_RNTI to transmit the DL RMC according to the wideband median-CQI value regardless of UE wideband CQI report. The SS sends downlink MAC padding bits on the DL RMC. The SS sends uplink scheduling information via PDCCH DCI format 0 with CQI request bit set to 0 to schedule UL RMC in subframe #2 and subframe #7 (Table A.4.1-2). The UE will send ACK/NACK and periodic CQI report using PUSCH. Measure the average throughput for a duration sufficient to achieve statistical significance according to Annex G clause G.3. Declare the throughput as  $t_{median}$ .
6. The SS shall transmit PDSCH via PDCCH DCI format 1A for C\_RNTI to transmit the DL RMC according to the wideband CQI value reported from UE. The SS sends downlink MAC padding bits on the DL RMC. The SS sends uplink scheduling information via PDCCH DCI format 0 with CQI request bit set to 0 to schedule UL RMC in subframe #2 and subframe #7 (Table A.4.1-2). The UE will send ACK/NACK and periodic CQI report using PUSCH Measure the average throughput for a duration sufficient to achieve statistical significance according to Annex G clause G.3. Declare the throughput as  $t_{wideband}$ . For any PDSCH transmitted by the SS, record the associated ACK, NACK and statDTX responses. The responses are then filtered as follows: for the sequence of responses for each HARQ process, discard all the statDTX responses.



If the ratio  $(t_{wideband} / t_{median}) \geq \gamma$  and ratio  $(NACK / (ACK + NACK))$  is greater or equal to 0.02, then pass the UE and go to step 8. Otherwise go to step 7.

7. If both SNR points of the test have not been tested, then repeat the same procedure (steps 1 to 6) for the other SNR point as appropriate. Otherwise fail the UE.
8. If both tests have not been done, repeat the same procedure (steps 1 to 7) with test conditions according to the table 9.3.2.1.2.3-1 for the other test as appropriate.

9.3.2.1.2.4.3 Message contents

Message contents are according to TS 36.508 [7] clause 4.6 with the following exceptions:

**Table 9.3.2.1.2.4.3-1: PhysicalConfigDedicated-DEFAULT**

Derivation Path: 36.508 clause 5.5.1.2			
Information Element	Value/remark	Comment	Condition
PhysicalConfigDedicated-DEFAULT ::= SEQUENCE {			
cqi-ReportConfig	<i>CQI-ReportConfig-DEFAULT</i>		
}			

**Table 9.3.2.1.2.4.3-2: CQI-ReportConfig-DEFAULT**

Derivation Path: 36.508 clause 4.6.3			
Information Element	Value/remark	Comment	Condition
CQI-ReportConfig-DEFAULT ::= SEQUENCE {			
cqi-ReportModeAperiodic	Not present		
nomPDSCH-RS-EPRE-Offset	0		
cqi-ReportPeriodic CHOICE {			
setup SEQUENCE {			
cqi-PUCCH-ResourceIndex	0		
cqi-pmi-ConfigIndex	3	(see Table 7.2.2-1C in TS 36.213)	
cqi-FormatIndicatorPeriodic CHOICE {			
widebandCQI	NULL		
}			
ri-ConfigIndex	NULL	(see Table 7.2.2-1B in TS 36.213)	
simultaneousAckNackAndCQI	FALSE		
}			
}			

**Table 9.3.2.1.2.4.3-3: TDD-Config-DEFAULT**

Derivation Path: 36.508 clause 4.6.3			
Information Element	Value/remark	Comment	Condition
TDD-Config-DEFAULT ::= SEQUENCE {			
subframeAssignment	Sa2		
specialSubframePatterns	Ssp4		
}			

## 9.3.2.1.2.5 Test requirement

**Table 9.3.2.1.2.5-1: Test requirement (TDD)**

Parameter	Test 1	Test 2
$\alpha$ [%]	20	20
$\gamma$	1.04	1.04
BLER	0.02	0.02
UE category	2-8	2-8

To pass the test,  $\alpha$  and  $\gamma$  and BLER must be fulfilled.

To pass the test, Test 1 and Test 2 must be passed.

To pass the test, one **or** the other SNR point within one test must be fulfilled.

## 9.3.2.1.2\_1 TDD CQI Reporting under fading conditions - PUCCH 1-0 (Release 9 and forward)

## 9.3.2.1.2\_2.1 Test purpose

Same test purpose as in clause 9.3.2.1.2.1.

## 9.3.2.1.2\_1.2 Test applicability

This test applies to E-UTRA TDD UE release 9 and forward of UE category 1.

## 9.3.2.1.2\_1.3 Minimum conformance requirements

Same minimum conformance requirements as in clause 9.3.2.1.2.3.

## 9.3.2.1.2\_1.4 Test description

## 9.3.2.1.2\_1.4.1 Initial conditions

Same initial conditions as in clause 9.3.2.1.2.4.1.

## 9.3.2.1.2\_1.4.2 Test procedure

Same test procedure as in clause 9.3.2.1.2.4.2.

## 9.3.2.1.2\_1.4.3 Message contents

Same message contents as in clause 9.3.2.1.2.4.3.

## 9.3.2.1.2\_1.5 Test requirement

Same test requirements as in clause 9.3.2.1.2.5 with the following exceptions:

Instead of table 9.3.2.1.2.5-1 use table 9.3.2.1.2\_1.5-1 below:

**Table 9.3.2.1.2\_1.5-1: Test requirement (TDD)**

Parameter	Test 1	Test 2
$\alpha$ [%]	20	20
$\gamma$	1.04	1.04
BLER	0.02	0.02
UE category	1	1

### 9.3.2.2 CQI Reporting under fading conditions – PUCCH 1-1 (CSI Reference Symbols)

#### 9.3.2.2.1\_D FDD CQI Reporting under fading conditions – PUCCH 1-1 for eDL-MIMO

##### 9.3.2.2.1\_D.1 Test purpose

To verify that the UE is tracking the channel variations and selecting the largest transport format possible according to the prevailing channel state for frequently non-selective scheduling.

##### 9.3.2.2.1\_D.2 Test applicability

This test applies to all types of E-UTRA FDD UE release 10 and forward of Category 2-8 that support eDL-MIMO. Applicability requires support for FGI bit 103.

##### 9.3.2.2.1\_D.3 Minimum conformance requirements

For the parameters specified in Table 9.3.2.2.1\_D.3-1, and using the downlink physical channels specified in Annex C.3.2, the minimum requirements are specified in Table 9.3.2.2.1\_D.3-2 and by the following:

- a) CQI index not in the set {median CQI -1, median CQI, median CQI +1} shall be reported at least  $\alpha$  % of the time;
- b) The ratio of the throughput obtained when transmitting the transport format indicated by each reported wideband CQI index and that obtained when transmitting a fixed transport format configured according to the wideband CQI median shall be  $\geq \gamma$ ;
- c) When transmitting the transport format indicated by each reported wideband CQI index, the average BLER for the indicated transport formats shall be greater or equal to 0.02.

Table 9.3.2.2.1\_D.3-1: Fading test for FDD

Parameter	Unit	Test 1		Test 2	
Bandwidth	MHz	10 MHz			
Transmission mode		9			
Downlink power allocation	$\rho_A$	dB			
	$\rho_B$	dB			
	$P_C$	dB			
	$\sigma$	dB			
SNR (Note 3)	dB	2	3	7	8
$\hat{I}_{or}^{(j)}$	dB[mW/15kHz]	-96	-95	-91	-90
$N_{oc}^{(j)}$	dB[mW/15kHz]	-98		-98	
Propagation channel		EPA5			
Correlation and antenna configuration		ULA High (4 x 2)			
Cell-specific reference signals		Antenna ports 0,1			
CSI reference signals		Antenna ports 15,...,18			
Beamforming model		As specified in Annex B.4.3			
CSI-RS periodicity and subframe offset $T_{\text{CSI-RS}} / \Delta_{\text{CSI-RS}}$		5/1			
CSI-RS reference signal configuration		2			
CodeBookSubsetRestriction bitmap		0x0000 0000 0000 0001			
Reporting mode		PUCCH 1-1			
Reporting periodicity	ms	$N_{pd} = 5$			
CQI delay	ms	8			
Physical channel for CQI/ PMI reporting		PUSCH (Note 4)			
PUCCH Report Type for CQI/PMI		2			
PUCCH channel for RI reporting		PUCCH Format 2			
PUCCH report type for RI		3			
<i>cqi-pmi-ConfigurationIndex</i>		2			
<i>ri-ConfigIndex</i>		1			
Max number of HARQ transmissions		1			
Note 1:	If the UE reports in an available uplink reporting instance at subframe SF#n based on CQI estimation at a downlink SF not later than SF#(n-4), this reported wideband CQI cannot be applied at the eNB downlink before SF#(n+4).				
Note 2:	Reference measurement channel RC.7 FDD according to Table A.4-1 with one sided dynamic OCNG Pattern OP.1 FDD as described in Annex A.5.1.1.				
Note 3:	For each test, the minimum requirements shall be fulfilled for at least one of the two SNR(s) and the respective wanted signal input level.				
Note 4:	To avoid collisions between CQI/ PMI reports and HARQ-ACK it is necessary to report both on PUSCH instead of PUCCH. PDCCH DCI format 0 shall be transmitted in downlink SF#1 and #6 to allow periodic CQI/ PMI to multiplex with the HARQ-ACK on PUSCH in uplink subframe SF#0 and #5.				

Table 9.3.2.2.1\_D.3-2: Minimum requirement (FDD)

	Test 1	Test 2
$\alpha$ [%]	20	20
$\gamma$	1.05	1.05
UE Category	2-8	2-8

The normative reference for this requirement is TS 36.101 [2] clause 9.3.2.2.1.

9.3.2.2.1\_D.4 Test description

9.3.2.2.1\_D.4.1 Initial conditions

Initial conditions are a set of test configurations the UE needs to be tested in and the steps for the SS to take with the UE to reach the correct measurement state.

Configurations of PDSCH and PDCCH before measurement are specified in Annex C.2.

Test Environment: Normal as defined in TS 36.508 [7] clause 4.1.

Frequencies to be tested: Mid Range as defined in TS 36.508 [7] clause 4.3.1.1.

Channel Bandwidths to be tested: 10MHz, as defined in TS 36.508 [7] clause 4.3.1.1

1. Connect the SS, faders and AWGN noise source to the UE antenna connector (s) as shown in TS 36.508 [7] Annex A, Figure A.11.
2. The parameter settings for the cell are set up according to Table 9.3.2.2.1\_D.3-1.
3. Downlink signals are initially set up according to Annex C.0, C.1 and Annex C.3.2, and uplink signals according to Annex H.3.2.
4. Propagation conditions are set according to Annex B.0.
5. Ensure the UE is in State 3A-RF according to TS 36.508 [7] clause 5.2A.2. Message contents are defined in clause 9.3.2.2.1\_D.4.3.

#### 9.3.2.2.1\_D.4.2 Test procedure

1. Set the parameters of bandwidth, the propagation condition, antenna configuration and measurement channel according to Table 9.3.2.2.1\_D.3-1 as appropriate.
2. The SS shall transmit PDSCH via PDCCH DCI format 2C for C\_RNTI to transmit the DL RMC according to CQI value 8 and keep it regardless of the wideband CQI value sent by the UE. The SS sends downlink MAC padding bits on the DL RMC. The SS sends uplink scheduling information via PDCCH DCI format 0 with CQI request bit set to 0 to schedule UL RMC in subframe #0 and subframe #5 (Table A.4.1-1). The UE will send ACK/NACK and periodic CQI report using PUSCH. Continue transmission of the PDSCH until 2000 wideband CQI reports have been gathered. In this process the SS collects wideband CQI reports every 5 ms and also cases where UE transmits nothing in its CQI timing are counted as wideband CQI reports.
3. Set up a relative frequency distribution for the reported wideband CQI-values, reported. Calculate the median value (wideband Median CQI is the wideband CQI that is at or crosses 50% distribution from the lower wideband CQI side). This CQI-value is declared as wideband Median CQI value.
4. If less than  $(100-\alpha)/100 \cdot 2000$  of the wideband CQI values are in the range  $(\text{Median CQI} - 1) \leq \text{Median CQI} \leq (\text{Median CQI} + 1)$  then continue with step 5, otherwise go to step 7.
5. The SS shall transmit PDSCH via PDCCH DCI format 2C for C\_RNTI to transmit the DL RMC according to the wideband median-CQI value regardless of UE wideband CQI report. The SS sends downlink MAC padding bits on the DL RMC. The SS sends uplink scheduling information via PDCCH DCI format 0 with CQI request bit set to 0 to schedule UL RMC in subframe #0 and subframe #5 (Table A.4.1-1). The UE will send ACK/NACK and periodic CQI report using PUSCH. Measure the average throughput according to Annex G.5.3. Declare the throughput as  $t_{median}$ .
6. The SS shall transmit PDSCH via PDCCH DCI format 2C for C\_RNTI to transmit the DL RMC according to the wideband CQI value reported from UE. The SS sends downlink MAC padding bits on the DL RMC. The SS sends uplink scheduling information via PDCCH DCI format 0 with CQI request bit set to 0 to schedule UL RMC in subframe #0 and subframe #5 (Table A.4.1-1). The UE will send ACK/NACK and periodic CQI report using PUSCH. Measure the average throughput according to Annex G.5.3. Declare the throughput as  $t_{wideband}$ . For any PDSCH transmitted by the SS, record the associated ACK, NACK and statDTX responses. The responses are then filtered as follows: for the sequence of responses for each HARQ process, discard all the statDTX responses. If the ratio  $(t_{wideband} / t_{median}) \geq \gamma$  and ratio  $(\text{NACK} / (\text{ACK} + \text{NACK}))$  is greater or equal to 0.02, then pass the UE for this test and go to step 8. Otherwise go to step 7.
7. If both SNR points of the test have not been tested, then repeat the same procedure (steps 1 to 6) for the other SNR point as appropriate. Otherwise fail the UE.

8. If both tests have not been done, repeat the same procedure (steps 1 to 7) with test conditions according to the table 9.3.2.2.1\_D.3-1 for the other test as appropriate.

#### 9.3.2.2.1\_D.4.3 Message contents

Message contents are according to TS 36.508 [7] clause 4.6 with the following exceptions:

**Table 9.3.2.2.1\_D.4.3-1: PhysicalConfigDedicated-DEFAULT**

Derivation Path: 36.508 clause 5.5.1.2			
Information Element	Value/remark	Comment	Condition
PhysicalConfigDedicated-DEFAULT ::= SEQUENCE {			
antennaInfo	Not Present		
antennaInfo-r10 CHOICE {			
explicitValue-r10	AntennaInfoDedicated-r10		
}			
cqi-ReportConfig-r10	CQI-ReportConfig-r10-DEFAULT		
csi-ReportConfig-r10	CSI-RS-Config-r10		
}			

**Table 9.3.2.2.1\_D.4.3-2: PDSCH-ConfigDedicated-DEFAULT**

Derivation Path: 36.508 clause 4.6.3			
Information Element	Value/remark	Comment	Condition
PDSCH-ConfigDedicated-DEFAULT ::= SEQUENCE {			
p-a	dB0		
}			

**Table 9.3.2.2.1\_D.4.3-3: AntennaInfoDedicated-r10**

Derivation Path: 36.331 clause 6.3.2			
Information Element	Value/remark	Comment	Condition
AntennaInfoDedicated-r10 ::= SEQUENCE {			
transmissionMode-r10	tm9-v1020		
codebookSubsetRestriction-r10	0x0000 0000 0000 0001		
ue-TransmitAntennaSelection CHOICE {			
release	NULL		
}			
}			

**Table 9.3.2.2.1\_D.4.3-4: CQI-ReportConfig-r10-DEFAULT**

Derivation Path: 36.508 clause 4.6.3			
Information Element	Value/remark	Comment	Condition
CQI-ReportConfig-r10 ::= SEQUENCE {			
cqi-ReportAperiodic-r10	Not Present		
nomPDSCH-RS-EPRE-Offset	0		
cqi-ReportPeriodic-r10	CQI-ReportPeriodic-r10-DEFAULT		
pmi-RI-Report-r9	setup		
}			

Table 9.3.2.2.1\_D.4.3-5: CQI-ReportPeriodic-r10-DEFAULT

Derivation Path: 36.508 clause 4.6.3			
Information Element	Value/remark	Comment	Condition
CQI-ReportPeriodic-r10 ::= CHOICE {			
setup SEQUENCE {			
cqi-PUCCH-ResourceIndex-r10	0		
cqi-PUCCH-ResourceIndexP1-r10	Not present		
cqi-pmi-ConfigIndex	2	(see Table 7.2.2-1A in TS 36.213)	
cqi-FormatIndicatorPeriodic-r10 CHOICE {			
widebandCQI-r10 SEQUENCE {			
csi-ReportMode-r10	Not present		
}			
ri-ConfigIndex	1	(see Table 7.2.2-1B in TS 36.213)	
simultaneousAckNackAndCQI	FALSE		
}			
}			

Table 9.3.2.2.1\_D.4.3-6: CSI-RS-Config-r10

Derivation Path: 36.331 clause 6.3.2			
Information Element	Value/remark	Comment	Condition
CSI-RS-Config-r10 ::= SEQUENCE {			
csi-RS-r10 CHOICE{			
setup SEQUENCE {			
antennaPortsCount-r10	an4	Parameter represents the number of antenna ports used for transmission of CSI reference signals	
resourceConfig-r10	2	Parameter: CSI reference signal configuration	
subframeConfig-r10	1	$\Delta_{\text{CSI-RS}} = I_{\text{CSI-RS}}$ when CSI-RS SubframeConfig is from 0-4; Parameter: $I_{\text{CSI-RS}}$	
p-C-r10	-3	Parameter: $P_c$ which is the assumed ratio of PDSCH EPRE to CSI-RS EPRE when UE derives CSI feedback	
}			
}			
zeroTxPowerCSI-RS-r10 CHOICE{			
release	NULL		
}			
}			

## 9.3.2.2.1\_D.5 Test requirement

**Table 9.3.2.2.1\_D.3-2: Test requirement (FDD)**

	Test 1	Test 2
$\alpha$ [%]	20	20
$\gamma$	1.04	1.04
UE Category	2-8	2-8
BLER	0.02	0.02

To pass the test,  $\alpha$  and  $\gamma$  and BLER must be fulfilled.

To pass the test, Test 1 and Test 2 must be passed.

To pass the test, one **or** the other SNR point within one test must be fulfilled.

## 9.3.2.2.2\_D TDD CQI Reporting under fading conditions – PUCCH 1-1 for eDL-MIMO

## 9.3.2.2.2\_D.1 Test purpose

To verify that the UE is tracking the channel variations and selecting the largest transport format possible according to the prevailing channel state for frequently non-selective scheduling.

## 9.3.2.2.2\_D.2 Test applicability

This test applies to all types of E-UTRA TDD UE release 10 and forward of Category 2-8 that support eDL-MIMO. Applicability requires support for FGI bits 104 and 110.

## 9.3.2.2.2\_D.3 Minimum conformance requirements

For the parameters specified in Table 9.3.2.2.2\_D.3-1, and using the downlink physical channels specified in Annex C.3.2, the minimum requirements are specified in Table 9.3.2.2.2\_D.3-2 and by the following:

- CQI index not in the set {median CQI -1, median CQI, median CQI +1} shall be reported at least  $\alpha$  % of the time;
- The ratio of the throughput obtained when transmitting the transport format indicated by each reported wideband CQI index and that obtained when transmitting a fixed transport format configured according to the wideband CQI median shall be  $\geq \gamma$ ;
- When transmitting the transport format indicated by each reported wideband CQI index, the average BLER for the indicated transport formats shall be greater or equal to 0.02.



Table 9.3.2.2.2\_D.3-1: Fading test for TDD

Parameter		Unit	Test 1		Test 2	
Bandwidth		MHz	10 MHz			
Transmission mode			9			
Uplink downlink configuration			2			
Special subframe configuration			4			
Downlink power allocation	$\rho_A$	dB	0			
	$\rho_B$	dB	0			
	$P_C$	dB	-6			
	$\sigma$	dB	-3			
SNR (Note 3)		dB	1	2	7	8
$\hat{I}_{or}^{(j)}$		dB[mW/15kHz]	-97	-96	-91	-90
$N_{oc}^{(j)}$		dB[mW/15kHz]	-98		-98	
Propagation channel			EPA5			
Correlation and antenna configuration			XP High (8 x 2)			
CRS reference signals			Antenna ports 0, 1			
CSI reference signals			Antenna ports 15,...,22			
Beamforming model			As specified in Annex B.4.3			
CSI-RS periodicity and subframe offset $T_{CSI-RS} / \Delta_{CSI-RS}$			5/ 3			
CSI-RS reference signal configuration			2			
CodeBookSubsetRestriction bitmap			0x0000 0000 0000 0020 0000 0000 0001			
Reporting mode			PUCCH 1-1 (Sub-mode: 2)			
Reporting periodicity		ms	$N_{pd} = 5$			
CQI delay		ms	10			
Physical channel for CQI/ PMI reporting			PUSCH (Note 4)			
PUCCH Report Type for CQI/ PMI			2c			
Physical channel for RI reporting			PUCCH Format 2			
PUCCH report type for RI			3			
<i>cqi-pmi-ConfigurationIndex</i>			3			
<i>ri-ConfigIndex</i>			805 (Note 5)			
Max number of HARQ transmissions			1			
ACK/NACK feedback mode			Multiplexing			
<p>Note 1: If the UE reports in an available uplink reporting instance at subframe SF#n based on CQI estimation at a downlink SF not later than SF#(n-4), this reported wideband CQI cannot be applied at the eNB downlink before SF#(n+4)</p> <p>Note 2: Reference measurement channel RC.7 TDD according to Table A.4-1 with one sided dynamic OCNG Pattern OP.1 TDD as described in Annex A.5.2.1.</p> <p>Note 3: For each test, the minimum requirements shall be fulfilled for at least one of the two SNR(s) and the respective wanted signal input level.</p> <p>Note 4: To avoid collisions between CQI/ PMI reports and HARQ-ACK it is necessary to report both on PUSCH instead of PUCCH. PDCCH DCI format 0 shall be transmitted in downlink SF#3 and #8 to allow periodic CQI/ PMI to multiplex with the HARQ-ACK on PUSCH in uplink subframe SF#2 and #7.</p> <p>Note 5: RI reporting interval is set to the maximum allowable length of 160ms to minimise collisions between RI, CQI/PMI and HARQ-ACK reports. In the case when all three reports collide, it is expected that CQI/PMI reports will be dropped, while RI and HARQ-ACK will be multiplexed. At eNB, CQI report collection shall be skipped every 160ms during performance verification and the reported CQI in subframe SF#7 of the previous frame is applied in downlink subframes until a new CQI (after CQI/PMI dropping) is available.</p>						

Table 9.3.2.2.2\_D.3-2: Minimum requirement (TDD)

	Test 1	Test 2
$\alpha$ [%]	20	20
$\gamma$	1.05	1.05
UE Category	2-8	2-8

The normative reference for this requirement is TS 36.101 [2] clause 9.3.2.2.2.

#### 9.3.2.2.2\_D.4 Test description

##### 9.3.2.2.2\_D.4.1 Initial conditions

Initial conditions are a set of test configurations the UE needs to be tested in and the steps for the SS to take with the UE to reach the correct measurement state.

Configurations of PDSCH and PDCCH before measurement are specified in Annex C.2.

Test Environment: Normal as defined in TS 36.508 [7] clause 4.1.

Frequencies to be tested: Mid Range as defined in TS 36.508 [7] clause 4.3.1.2.

Channel Bandwidths to be tested: 10MHz, as defined in TS 36.508 [7] clause 4.3.1.2.

1. Connect the SS to the UE antenna connector (s) as shown in TS 36.508 [7] Annex A, Figure 47.
2. The parameter settings for the cell are set up according to Table 9.3.2.2.2\_D.3-1.
3. Downlink signals are initially set up according to Annex C.0, C.1 and Annex C.3.2, and uplink signals according to Annex H.3.2.
4. Propagation conditions are set according to Annex B.0.
5. Ensure the UE is in State 3A-RF according to TS 36.508 [7] clause 5.2A.2. Message contents are defined in clause 9.3.2.2.2\_D.4.3.

##### 9.3.2.2.2\_D.4.2 Test procedure

1. Set the parameters of bandwidth, the propagation condition, antenna configuration and measurement channel according to Table 9.3.2.2.2\_D.3-1 as appropriate.
2. The SS shall transmit PDSCH via PDCCH DCI format 2C for C\_RNTI to transmit the DL RMC according to CQI value 8 and keep it regardless of the wideband CQI value sent by the UE. The SS sends downlink MAC padding bits on the DL RMC. The SS sends uplink scheduling information via PDCCH DCI format 0 with CQI request bit set to 0 to schedule UL RMC in subframe #2 and subframe #7 (Table A.4.1-2). The UE will send ACK/NACK and periodic CQI report using PUSCH. Continue transmission of the PDSCH until 2000 wideband CQI reports have been gathered. In this process the SS collects wideband CQI reports every 5 ms and also cases where UE transmits nothing in its CQI timing are counted as wideband CQI reports.
3. Set up a relative frequency distribution for the reported wideband CQI-values, reported. Calculate the median value (wideband Median CQI is the wideband CQI that is at or crosses 50% distribution from the lower wideband CQI side). This CQI-value is declared as wideband Median CQI value.
4. If less than  $(100-\alpha)/100 \cdot 2000$  of the wideband CQI values are in the range  $(\text{Median CQI} - 1) \leq \text{Median CQI} \leq (\text{Median CQI} + 1)$  then continue with step 5, otherwise go to step 7.
5. The SS shall transmit PDSCH via PDCCH DCI format 2C for C\_RNTI to transmit the DL RMC according to the wideband median-CQI value regardless of UE wideband CQI report. The SS sends downlink MAC padding bits on the DL RMC. The SS sends uplink scheduling information via PDCCH DCI format 0 with CQI request bit set to 0 to schedule UL RMC in subframe #2 and subframe #7 (Table A.4.1-2). The UE will send ACK/NACK and periodic CQI report using PUSCH. Measure the average throughput for a duration sufficient to achieve statistical significance according to Annex G clause G.3. Declare the throughput as  $t_{median}$ .
6. The SS shall transmit PDSCH via PDCCH DCI format 2C for C\_RNTI to transmit the DL RMC according to the wideband CQI value reported from UE. The SS sends downlink MAC padding bits on the DL RMC. The SS sends uplink scheduling information via PDCCH DCI format 0 with CQI request bit set to 0 to schedule UL RMC in subframe #2 and subframe #7 (Table A.4.1-2). The UE will send ACK/NACK and periodic CQI report using PUSCH. Measure the average throughput for a duration sufficient to achieve statistical significance according to Annex G clause G.3. Declare the throughput as  $t_{wideband}$ . For any PDSCH transmitted by the SS, record the associated ACK, NACK and statDTX responses. The responses are then filtered as follows: for the

sequence of responses for each HARQ process, discard all the statDTX responses.

If the ratio ( $t_{wideband} / t_{median}$ )  $\geq \gamma$  and ratio (NACK / (ACK + NACK)) is greater or equal to 0.02, then pass the UE and go to step 8. Otherwise go to step 7.

7. If both SNR points of the test have not been tested, then repeat the same procedure (steps 1 to 6) for the other SNR point as appropriate. Otherwise fail the UE.
8. If both tests have not been done, repeat the same procedure (steps 1 to 7) with test conditions according to the table 9.3.2.2.2\_D.3-1 for the other test as appropriate.

#### 9.3.2.2.2\_D.4.3 Message contents

Message contents are according to TS 36.508 [7] clause 4.6 with the following exceptions:

**Table 9.3.2.2.2\_D.4.3-1: PhysicalConfigDedicated-DEFAULT**

Derivation Path: 36.508 clause 4.6.3			
Information Element	Value/remark	Comment	Condition
PhysicalConfigDedicated-DEFAULT ::= SEQUENCE {			
antennaInfo	Not Present		
antennaInfo-r10 CHOICE {			
explicitValue-r10	AntennaInfoDedicated-r10		
}			
cqi-ReportConfig-r10	CQI-ReportConfig-r10-DEFAULT		
csi-ReportConfig-r10	CSI-RS-Config-r10		
}			

**Table 9.3.2.2.2\_D.4.3-2: PDSCH-ConfigDedicated-DEFAULT**

Derivation Path: TS 36.508 [7] clause 4.6.3, Table 4.6.3-6 PDSCH-ConfigDedicated-DEFAULT			
Information Element	Value/remark	Comment	Condition
PDSCH-ConfigDedicated-DEFAULT ::= SEQUENCE {			
p-a	dB0		
}			

**Table 9.3.2.2.2\_D.4.3-3: AntennaInfoDedicated-r10**

Derivation Path: 36.331 clause 6.3.2			
Information Element	Value/remark	Comment	Condition
AntennaInfoDedicated-r10 ::= SEQUENCE {			
transmissionMode-r10	tm9-v1020		
codebookSubsetRestriction-r10	0x0000 0000 0000 0020 0000 0000 0001		
ue-TransmitAntennaSelection CHOICE {			
release	NULL		
}			
}			

**Table 9.3.2.2.2\_D.4.3-4: CQI-ReportConfig-r10-DEFAULT**

Derivation Path: 36.508 clause 4.6.3			
Information Element	Value/remark	Comment	Condition
CQI-ReportConfig-r10 ::= SEQUENCE {			
cqi-ReportAperiodic-r10	Not Present		
nomPDSCH-RS-EPRE-Offset	0		
cqi-ReportPeriodic-r10	CQI-ReportPeriodic-r10-DEFAULT		
Pmi-RI-Report-r9	setup		
}			

**Table 9.3.2.2.2\_D.4.3-5: CQI-ReportPeriodic-r10-DEFAULT**

Derivation Path: 36.508 clause 4.6.3			
Information Element	Value/remark	Comment	Condition
CQI-ReportPeriodic-r10 ::= CHOICE {			
setup SEQUENCE {			
cqi-PUCCH-ResourceIndex-r10	0		
cqi-PUCCH-ResourceIndexP1-r10	Not present		
cqi-pmi-ConfigIndex	3	(see Table 7.2.2-1A in TS 36.213)	
cqi-FormatIndicatorPeriodic-r10 CHOICE {			
widebandCQI-r10 SEQUENCE {			
csi-ReportMode-r10	submode2		
}			
ri-ConfigIndex	805	(see Table 7.2.2-1B in TS 36.213)	
simultaneousAckNackAndCQI	FALSE		
}			
}			

**Table 9.3.2.2.2\_D.4.3-6: TDD-Config-DEFAULT**

Derivation Path: 36.508 clause 4.6.3			
Information Element	Value/remark	Comment	Condition
TDD-Config-DEFAULT ::= SEQUENCE {			
subframeAssignment	sa2		
specialSubframePatterns	ssp4		
}			

**Table 9.3.2.2.2\_D.4.3-7: PUCCH-ConfigDedicated-DEFAULT**

Derivation Path: 36.508 clause 4.6.3			
Information Element	Value/remark	Comment	Condition
PUCCH-ConfigDedicated-DEFAULT ::= SEQUENCE {			
ackNackRepetition CHOICE {			
release	NULL		
}			
tddAckNackFeedbackMode	Multiplexing	Multiplexing is selected as default to align with RAN4's assumptions in RF tests.	TDD
}			

Table 9.3.2.2.2\_D.4.3-8: CSI-RS-Config-r10

Derivation Path: 36.331 clause 6.3.2			
Information Element	Value/remark	Comment	Condition
CSI-RS-Config-r10 ::= SEQUENCE {			
csi-RS-r10 CHOICE{			
setup SEQUENCE {			
antennaPortsCount-r10	an8	Parameter represents the number of antenna ports used for transmission of CSI reference signals	
resourceConfig-r10	2	Parameter: CSI reference signal configuration	
subframeConfig-r10	3	$\Delta_{\text{CSI-RS}} = I_{\text{CSI-RS}}$ when CSI-RS SubframeConfig is from 0-4; Parameter: $I_{\text{CSI-RS}}$	
p-C-r10	-6	Parameter: $P_c$ which is the assumed ratio of PDSCH EPRE to CSI-RS EPRE when UE derives CSI feedback	
}			
}			
zeroTxPowerCSI-RS-r10 CHOICE{			
release	NULL		
}			
}			

## 9.3.2.2.2\_D.5 Test requirement

Table 9.3.2.2.2\_D.5-1: Test requirement (TDD)

	Test 1	Test 2
$\alpha$ [%]	20	20
$\gamma$	1.04	1.04
UE Category	2-8	2-8
BLER	0.02	0.02

To pass the test,  $\alpha$  and  $\gamma$  and BLER must be fulfilled.

To pass the test, Test 1 and Test 2 must be passed.

To pass the test, one **or** the other SNR point within one test must be fulfilled.

### 9.3.3 Frequency-selective interference

The accuracy of sub-band channel quality indicator (CQI) reporting under frequency selective interference conditions is determined by a double-sided percentile of the reported differential CQI offset level +2 for a preferred sub-band, and the relative increase of the throughput obtained when transmitting on any one of the sub-bands with the highest reported differential CQI offset level the corresponding transport format compared to the case for which a fixed format is transmitted on any sub-band in set of TS 36.213 [10]. The purpose is to verify that preferred sub-bands are used for frequently-selective scheduling under frequency-selective interference conditions.

### 9.3.3.1 CQI Reporting under fading conditions and frequency-selective interference – PUSCH 3-0 (Cell-Specific Reference Symbols)

#### 9.3.3.1.1 FDD CQI Reporting under fading conditions and frequency-selective interference – PUSCH 3-0

##### 9.3.3.1.1.1 Test purpose

To verify that preferred sub-bands can be used for frequently-selective scheduling with frequency-selective interference situation.

##### 9.3.3.1.1.2 Test applicability

This test applies to all types of E-UTRA FDD UE release 8 and forward.

##### 9.3.3.1.1.3 Minimum conformance requirements

For the parameters specified in Table 9.3.3.1.1.3-1, and using the downlink physical channels specified in Annex C, the minimum requirements are specified in Table 9.3.3.1.1.3-2 and by the following:

- a) a sub-band differential CQI offset level of +2 shall be reported at least  $\alpha$  % for at least one of the sub-bands of full size at the channel edges;
- b) the ratio of the throughput obtained when transmitting on a randomly selected sub-band among the sub-bands with the highest differential CQI offset level the corresponding TBS and that obtained when transmitting the TBS indicated by the reported wideband CQI median on a randomly selected sub-band in set  $S$  shall be  $\geq \gamma$ ;

The requirements only apply for sub-bands of full size and the random scheduling across the sub-bands is done by selecting a new sub-band in each TTI for FDD, each available downlink transmission instance for TDD. Sub-bands of a size smaller than full size are excluded from the test.

**Table 9.3.3.1.1.3-1 Sub-band test for single antenna transmission (FDD)**

Parameter	Unit	Test 1	Test 2
Bandwidth	MHz	10 MHz	10 MHz
Transmission mode		1 (port 0)	1 (port 0)
Downlink power allocation	$\rho_A$	dB	0
	$\rho_B$	dB	0
	$\sigma$	dB	0
$I_{ot}^{(j)}$ for RB 0...5 Note 3	dB[mW/15kHz]	-102	-93
$I_{ot}^{(j)}$ for RB 6...41 Note 3	dB[mW/15kHz]	-93	-93
$I_{ot}^{(j)}$ for RB 42...49 Note 3	dB[mW/15kHz]	-93	-102
$\hat{I}_{or}^{(j)}$	dB[mW/15kHz]	-94	-94
Max number of HARQ transmissions		1	
Propagation channel		Clause B.2.4 with $\tau_d = 0.45 \mu\text{s}$ , $a = 1$ , $f_D = 5 \text{ Hz}$	
Reporting interval	ms	5	
Antenna configuration		1 x 2	
CQI delay	ms	8	
Reporting mode		PUSCH 3-0	
Sub-band size	RB	6 (full size)	
<p>Note 1: If the UE reports in an available uplink reporting instance at subframe SF#n based on CQI estimation at a downlink subframe not later than SF#(n-4), this reported subband or wideband CQI cannot be applied at the eNB downlink before SF#(n+4)</p> <p>Note 2: Reference measurement channel RC.3 FDD according to Table A.4-1 with one/two sided dynamic OCNG Pattern OP.1/2 FDD as described in Annex A.5.1.1/2</p> <p>Note 3: lot shall be modelled as connecting Gaussian distributed uncorrelated interference source for each UE receive antenna port. The received power spectral density of the interfering signal as measured at the UE antenna connector is to be scaled accordingly for different RB groups.</p>			

**Table 9.3.3.1.1.3-2: Minimum requirement (FDD)**

Parameter	Test 1	Test 2
$\alpha$ [%]	60	60
$\gamma$	1.6	1.6
UE Category	1-8	1-8

The normative reference for this requirement is TS 36.101 [2] clause 9.3.3.1.1.

#### 9.3.3.1.1.4 Test description

##### 9.3.3.1.1.4.1 Initial conditions

Initial conditions are a set of test configurations the UE needs to be tested in and the steps for the SS to take with the UE to reach the correct measurement state.

Configurations of PDSCH and PDCCH before measurement are specified in Annex C.2.

Test Environment: Normal as defined in TS 36.508 [7] clause 4.1.

Frequencies to be tested: Mid Range as defined in TS 36.508 [7] clause 4.3.1.1.

Channel Bandwidths to be tested: 10MHz, as defined in TS 36.508 [7] clause 4.3.1.1

1. Connect the SS, interfering source and faders to the UE antenna connector (s) as shown in TS 36.508 [7] Annex A, Figure A.21.
2. The parameter settings for the cell are set up according to Table 9.3.3.1.1.3-1.
3. Downlink signals are initially set up according to Annex C.1 and Annex C.3.2, and uplink signals according to Annex H.1 and H.3.2.
4. Propagation conditions are set according to Annex B.0.
5. Ensure the UE is in State 3A-RF according to TS 36.508 [7] clause 5.2A.2. Message contents are defined in clause 9.3.3.1.1.4.3.

#### 9.3.3.1.1.4.2 Test procedure

1. Set the parameters of bandwidth, the propagation condition, antenna configuration and measurement channel according to Table 9.3.3.1.1.3-1 as appropriate.
2. The SS shall transmit PDSCH via PDCCH DCI format 1A for C\_RNTI to transmit the DL RMC according to CQI value 8 and keep it regardless of the wideband and subband CQI value sent by the UE. Continue transmission of the PDSCH until 2000 wideband CQI reports and full-size subband CQI reports for each full-size subband have been gathered. The SS sends downlink MAC padding bits on the DL RMC. SS schedules the UL transmission every 5 ms to carry the PUSCH CQI feedback via PDCCH DCI format 0 with CQI request bit set to 1 and I\_MCS=29 and N\_PRB allocated to be less or equal to 4. In this process the SS collects wideband CQI reports every 5 ms and also cases where UE transmits nothing in its CQI timing are counted as wideband CQI and full-size subband CQI reports.
3. Set up a relative frequency distribution for the reported wideband CQI-values, Calculate the median value (wideband Median CQI is the CQI that is at or crosses 50% distribution from the lower wideband CQI side). This CQI-value is declared as wideband Median CQI value.
4. If for at least one of the full-size subbands at the channel edges, a subband differential CQI offset level of +2 is reported in  $\alpha$  % or more of 2000 reports, then continue with step 5, otherwise fail the UE.
5. The SS shall transmit PDSCH via PDCCH DCI format 1A for C\_RNTI to transmit the DL RMC on an each TTI randomly selected full-size subband using the transport format according to the wideband median-CQI value regardless of UE wideband or subband CQI report. Note that each full-size subband shall be selected in the equal probability The SS sends downlink MAC padding bits on the DL RMC. SS schedules the UL transmission every 5 ms to carry the PUSCH CQI feedback via PDCCH DCI format 0 with CQI request bit set to 1 and I\_MCS=29 and N\_PRB allocated to be less or equal to 4. Measure the average throughput according to Annex G.5.3.

Declare the throughput as  $t_{median}$ .

6. The SS shall transmit PDSCH via PDCCH DCI format 1A for C\_RNTI to transmit the DL RMC according to the highest UE reported full-size subband CQI value in one full-size subband selected among the sub-bands in which UE reports the highest full-size subband CQI. Subband differential CQI offset level is selected from {0, 1, 2, -1}. Note that the SS shall send PDSCH in the same full-size subband until next UE report is available. In case when same full-size subbands are reported subsequently as subbands with highest full-size subband CQI, the SS shall select for transmission a different subband with respect to the last selection. The SS sends downlink MAC padding bits on the DL RMC. SS schedules the UL transmission every 5 ms to carry the PUSCH CQI feedback via PDCCH DCI format 0 with CQI request bit set to 1 and I\_MCS=29 and N\_PRB allocated to be less or equal to 4. Measure the average throughput according to Annex G.5.3. Declare the throughput as  $t_{subband}$ . Count the number of NACKs, ACKs and statDTXs on the UL during the test interval.  
If  $t_{subband} / t_{median} \geq \gamma$ , then pass the UE for this test and go to step 7. Otherwise fail the UE.
7. If both tests have not been done, then repeat the same procedure (steps 1 to 6) with test conditions according to the table 9.3.3.1.1.3-1 for the other Test as appropriate. Otherwise pass the UE.



## 9.3.3.1.1.4.3 Message contents

**Table 9.3.3.1.1.4.3-1: PhysicalConfigDedicated-DEFAULT**

Derivation Path: 36.508 clause 5.5.1.2			
Information Element	Value/remark	Comment	Condition
PhysicalConfigDedicated-DEFAULT ::= SEQUENCE {			
cqi-ReportConfig	<i>CQI-ReportConfig-DEFAULT</i>		
}			

**Table 9.3.3.1.1.4.3-2: CQI-ReportConfig-DEFAULT**

Derivation Path: 36.508 clause 4.6.3			
Information Element	Value/remark	Comment	Condition
CQI-ReportConfig-DEFAULT ::= SEQUENCE {			
cqi-ReportModeAperiodic	rm30		
nomPDSCH-RS-EPRE-Offset	0		
cqi-ReportPeriodic CHOICE {	Not present		
}			
}			

## 9.3.3.1.1.5 Test requirement

**Table 9.3.3.1.1.5-1: Test requirement (FDD)**

Parameter	Test 1	Test 2
$\alpha$ [%]	40	40
$\gamma$	1.50	1.50

## 9.3.3.1.2 TDD CQI Reporting under fading conditions and frequency-selective interference – PUSCH 3-0

## 9.3.3.1.2.1 Test purpose

To verify that preferred sub-bands can be used for frequently-selective scheduling with frequency-selective interference situation.

## 9.3.3.1.2.2 Test applicability

This test applies to all types of E-UTRA TDD UE release 8 and forward.

## 9.3.3.1.2.3 Minimum conformance requirements

For the parameters specified in Table 9.3.3.1.2.3-1, and using the downlink physical channels specified in Annex C, the minimum requirements are specified in Table 9.3.3.1.2.3-2 and by the following:

- a sub-band differential CQI offset level of +2 shall be reported at least  $\alpha$  % for at least one of the sub-bands of full size at the channel edges;
- the ratio of the throughput obtained when transmitting on any one of the sub-bands with the highest differential CQI offset level the corresponding TBS and that obtained when transmitting the TBS indicated by the reported wideband CQI median on a randomly selected sub-band in set  $S$  shall be  $\geq \gamma$ ;

The requirements only apply for sub-bands of full size and the random scheduling across the sub-bands is done by selecting a new sub-band in each TTI for FDD, each available downlink transmission instance for TDD. Sub-bands of a size smaller than full size are excluded from the test.

**Table 9.3.3.1.2.3-1: Sub-band test for single antenna transmission (TDD)**

Parameter	Unit	Test 1	Test 2
Bandwidth	MHz	10 MHz	10 MHz
Transmission mode		1 (port 0)	1 (port 0)
Downlink power allocation	$\rho_A$	dB	0
	$\rho_B$	dB	0
	$\sigma$	dB	0
Uplink downlink configuration		2	
Special subframe configuration		4	
$I_{ot}^{(j)}$ for RB 0...[5] Note 3	dB[mW/15kHz]	-102	-93
$I_{ot}^{(j)}$ for RB 6...[41] Note 3	dB[mW/15kHz]	-93	-93
$I_{ot}^{(j)}$ for RB [42]...49 Note 3	dB[mW/15kHz]	-93	-102
$\hat{I}_{or}^{(j)}$	dB[mW/15kHz]	-94	-94
Max number of HARQ transmissions		1	
Propagation channel		Clause B.2.4 with $\tau_d = 0.45 \mu s$ , $a = 1$ , $f_D = 5$ Hz	
Antenna configuration		1 x 2	
Reporting interval	ms	5	
CQI delay	ms	10 or 11	
Reporting mode		PUSCH 3-0	
Sub-band size	RB	6 (full size)	
ACK/NACK feedback mode		Multiplexing	
Note 1:	If the UE reports in an available uplink reporting instance at subframe SF#n based on CQI estimation at a downlink subframe not later than SF#(n-4), this reported subband or wideband CQI cannot be applied at the eNB downlink before SF#(n+4)		
Note 2:	Reference measurement channel RC.3 TDD according to table A.4-1 with one/two sided dynamic OCNG Pattern OP.1/2 TDD as described in Annex A.5.2.1/2.		
Note 3:	lot shall be modelled as connecting Gaussian distributed uncorrelated interference source for each UE receive antenna port. The received power spectral density of the interfering signal as measured at the UE antenna connector is to be scaled accordingly for different RB groups.		

**Table 9.3.3.1.2.3-2: Minimum requirement (TDD)**

Parameter	Test 1	Test 2
$\alpha$ [%]	60	60
$\gamma$	1.6	1.6
UE Category	1-8	1-8

The normative reference for this requirement is TS 36.101 [2] clause 9.3.3.1.2.

#### 9.3.3.1.2.4 Test description

##### 9.3.3.1.2.4.1 Initial conditions

Initial conditions are a set of test configurations the UE needs to be tested in and the steps for the SS to take with the UE to reach the correct measurement state.

Configurations of PDSCH and PDCCH before measurement are specified in Annex C.2.

Test Environment: Normal as defined in TS 36.508 [7] clause 4.1.

Frequencies to be tested: Mid Range as defined in TS 36.508 [7] clause 4.3.1.1.

Channel Bandwidths to be tested: 10MHz, as defined in TS 36.508 [7] clause 4.3.1.1

1. Connect the SS, faders and interfering source to the UE antenna connector (s) as shown in TS 36.508 [7] Annex A, Figure A.21.
2. The parameter settings for the cell are set up according to Table 9.3.3.1.2.3-1.
3. Downlink signals are initially set up according to Annex C.1 and Annex C.3.2, and uplink signals according to Annex H.1 and H.3.2.
4. Propagation conditions are set according to Annex B.0.
5. Ensure the UE is in State 3A-RF according to TS 36.508 [7] clause 5.2A.2. Message contents are defined in clause 9.3.3.1.2.4.3.

#### 9.3.3.1.2.4.2 Test procedure

1. Set the parameters of bandwidth, the propagation condition, antenna configuration and measurement channel according to Table 9.3.3.1.2.3-1 as appropriate.
2. The SS shall transmit PDSCH via PDCCH DCI format 1A for C\_RNTI to transmit the DL RMC according to CQI value 8 and keep it regardless of the wideband and subband CQI value sent by the UE. Continue transmission of the PDSCH until 2000 wideband CQI reports and full-size subband CQI reports for each full-size subband have been gathered. The SS sends downlink MAC padding bits on the DL RMC. SS schedules the UL transmission in subframe #2 and subframe #7 to carry the PUSCH CQI feedback via PDCCH DCI format 0 with CQI request bit set to 1 and I\_MCS=29 and N\_PRB allocated to be less or equal to 4. In this process the SS collects wideband CQI reports every 5 ms and also cases where UE transmits nothing in its CQI timing are counted as wideband CQI and full-size subband CQI reports.
3. Set up a relative frequency distribution for the reported wideband CQI-values, Calculate the median value (wideband Median CQI is the CQI that is at or crosses 50% distribution from the lower wideband CQI side). This CQI-value is declared as wideband Median CQI value.
4. If for at least one of the full-size subbands at the channel edges, a subband differential CQI offset level of +2 is reported in  $\alpha$  % or more of 2000 reports, then continue with step 5, otherwise fail the UE.
5. The SS shall transmit PDSCH via PDCCH DCI format 1A for C\_RNTI to transmit the DL RMC in an each available downlink transmission instance randomly selected full-size subband using the transport format according to the wideband median-CQI value regardless of UE wideband or subband CQI report. Note that each full-size subband shall be selected in the equal probability. The SS sends downlink MAC padding bits on the DL RMC. SS schedules the UL transmission in subframe #2 and subframe #7 to carry the PUSCH CQI feedback via PDCCH DCI format 0 with CQI request bit set to 1 and I\_MCS=29 and N\_PRB allocated to be less or equal to 4. Measure the average throughput according to Annex G.5.3. Declare the throughput as  $t_{median}$ .
6. The SS shall transmit PDSCH via PDCCH DCI format 1A for C\_RNTI to transmit the DL RMC according to the highest UE reported full-size subband CQI value in one full-size subband selected among the sub-bands in which UE reports the highest full-size subband CQI. Subband differential CQI offset level is selected from {0, 1, 2, -1}. Note that the SS shall send PDSCH in the same full-size subband until next UE report is available. In case when same full-size subbands are reported subsequently as subbands with highest full-size subband CQI, the SS shall select for transmission a different subband with respect to the last selection. The SS sends downlink MAC padding bits on the DL RMC. SS schedules the UL transmission in subframe #2 and subframe #7 to carry the PUSCH CQI feedback via PDCCH DCI format 0 with CQI request bit set to 1 and I\_MCS=29 and N\_PRB allocated to be less or equal to 4. Measure the average throughput according to Annex G.5.3. Declare the throughput as  $t_{subband}$ . Count the number of NACKs, ACKs and statDTXs on the UL during the test interval. If  $t_{subband} / t_{median} \geq \gamma$ , then pass the UE for this test and go to step 7. Otherwise fail the UE.

7. If both tests have not been done, then repeat the same procedure (steps 1 to 6) with test conditions according to the table 9.3.3.1.2.3-1 for the other Test as appropriate. Otherwise pass the UE.

#### 9.3.3.1.2.4.3 Message contents

Message contents are according to TS 36.508 [7] clause 4.6 with the following exceptions:

**Table 9.3.3.1.2.4.3-1: PhysicalConfigDedicated-DEFAULT**

Derivation Path: 36.508 clause 5.5.1.2			
Information Element	Value/remark	Comment	Condition
PhysicalConfigDedicated-DEFAULT ::= SEQUENCE {			
cqi-ReportConfig	<i>CQI-ReportConfig-DEFAULT</i>		
}			

**Table 9.3.3.1.2.4.3-2: CQI-ReportConfig-DEFAULT**

Derivation Path: 36.508 clause 4.6.3			
Information Element	Value/remark	Comment	Condition
CQI-ReportConfig-DEFAULT ::= SEQUENCE {			
cqi-ReportModeAperiodic	rm30		
nomPDSCH-RS-EPRE-Offset	0		
cqi-ReportPeriodic CHOICE {	Not present		
}			
}			

**Table 9.3.3.1.2.4.3-3: TDD-Config-DEFAULT**

Derivation Path: 36.508 clause 4.6.3			
Information Element	Value/remark	Comment	Condition
TDD-Config-DEFAULT ::= SEQUENCE {			
subframeAssignment	Sa2		
specialSubframePatterns	Ssp4		
}			

#### 9.3.3.1.2.5 Test requirement

**Table 9.3.3.1.2.5-1: Test requirement (TDD)**

Parameter	Test 1	Test 2
$\alpha$ [%]	40	40
$\gamma$	1.50	1.50

### 9.3.4 UE-selected subband CQI

The accuracy of UE-selected subband channel quality indicator (CQI) reporting under frequency-selective fading conditions is determined by the relative increase of the throughput obtained when transmitting on the UE-selected subbands with the corresponding transport format compared to the case for which a fixed format is transmitted on any subband in set  $S$  of TS 36.213 [10]. The purpose is to verify that correct subbands are accurately reported for frequency-selective scheduling. To account for sensitivity of the input SNR the subband CQI reporting under frequency-selective fading conditions is considered to be verified if the reporting accuracy is met for at least one of two SNR levels separated by an offset of 1 dB.

### 9.3.4.1 CQI Reporting under fading conditions – PUSCH 2-0 (Cell-Specific Reference Symbols)

#### 9.3.4.1.1 FDD CQI Reporting under fading conditions – PUSCH 2-0

##### 9.3.4.1.1.1 Test purpose

To verify that UE-selected sub-bands can be used for frequently-selective scheduling.

##### 9.3.4.1.1.2 Test applicability

This test applies to all types of E-UTRA FDD UE release 9 and forward. Applicability requires support for FGI bit 1.

##### 9.3.4.1.1.3 Minimum conformance requirements

For the parameters specified in Table 9.3.4.1.1.3-1, and using the downlink physical channels specified in Annex C, the minimum requirements are specified in Table 9.3.4.1.1.3-2 and by the following:

- a) the ratio of the throughput obtained when transmitting on a randomly selected subband among the best  $M$  subbands reported by the UE the corresponding TBS and that obtained when transmitting the TBS indicated by the reported wideband CQI median on a randomly selected subband in set  $S$  shall be  $\geq \gamma$ ;

The requirements only apply for subbands of full size and the random scheduling across the subbands is done by selecting a new subband in each TTI for FDD. The transport block size TBS (wideband CQI median) is that resulting from the code rate which is closest to that indicated by the wideband CQI median and the  $N_{PRB}$  entry in Table 7.1.7.2.1-1 of TS 36.213 [10] that corresponds to the subband size.

**Table 9.3.4.1.1.3-1: Subband test for single antenna transmission (FDD)**

Parameter		Unit	Test 1		Test 2	
Bandwidth		MHz	10 MHz			
Transmission mode			1 (port 0)			
Downlink power allocation	$\rho_A$	dB	0			
	$\rho_B$	dB	0			
	$\sigma$	dB	0			
SNR (Note 3)		dB	9	10	14	15
$\hat{I}_{or}^{(j)}$		dB[mW/15kHz]	-89	-88	-84	-83
$N_{oc}^{(j)}$		dB[mW/15kHz]	-98		-98	
Propagation channel			Clause B.2.4 with $\tau_d = 0.45 \mu s$ , $a = 1$ , $f_D = 5$ Hz			
Reporting interval		ms	5			
CQI delay		ms	8			
Reporting mode			PUSCH 2-0			
Max number of HARQ transmissions			1			
Subband size ( $k$ )		RBs	3 (full size)			
Number of preferred subbands ( $M$ )			5			
<p>Note 1: If the UE reports in an available uplink reporting instance at subframe SF#<math>n</math> based on CQI estimation at a downlink subframe not later than SF#<math>(n-4)</math>, this reported subband or wideband CQI cannot be applied at the eNB downlink before SF#<math>(n+4)</math></p> <p>Note 2: Reference measurement channel RC.5 FDD according to Table A.4-1 with one/two sided dynamic OCNG Pattern OP.1/2 FDD as described in Annex A.5.1.1/2.</p> <p>Note 3: For each test, the minimum requirements shall be fulfilled for at least one of the two SNR(s) and the respective wanted signal input level.</p>						

**Table 9.3.4.1.1.3-2: Minimum requirement (FDD)**

	Test 1	Test 2
$\gamma$	1.2	1.2
UE Category	1-8	1-8

The normative reference for this requirement is TS 36.101 [2] clause 9.3.4.1.1.

#### 9.3.4.1.1.4 Test description

##### 9.3.4.1.1.4.1 Initial conditions

Initial conditions are a set of test configurations the UE needs to be tested in and the steps for the SS to take with the UE to reach the correct measurement state.

Configurations of PDSCH and PDCCH before measurement are specified in Annex C.2.

Test Environment: Normal as defined in TS 36.508 [7] clause 4.1.

Frequencies to be tested: Mid Range as defined in TS 36.508 [7] clause 4.3.1.1.

Channel Bandwidths to be tested: 10MHz, as defined in TS 36.508 [7] clause 4.3.1.1

1. Connect the SS and faders to the UE antenna connector (s) as shown in TS 36.508 [7] Annex A, Figure A.9.
2. The parameter settings for the cell are set up according to Table 9.3.4.1.1.3-1.
3. Downlink signals are initially set up according to Annex C.1 and Annex C.3.2, and uplink signals according to Annex H.1 and H.3.2.
4. Propagation conditions are set according to Annex B.0.
5. Ensure the UE is in State 3A-RF according to TS 36.508 [7] clause 5.2A.2. Message contents are defined in clause 9.3.4.1.1.4.3.

##### 9.3.4.1.1.4.2 Test procedure

1. Set the parameters of bandwidth, the propagation condition, antenna configuration and measurement channel according to Table 9.3.4.1.1.3-1 as appropriate.
2. The SS shall transmit PDSCH via PDCCH DCI format 1A for C\_RNTI to transmit the DL RMC according to CQI value 8 and keep it regardless of the wideband and subband CQI value sent by the UE. Continue transmission of the PDSCH until 2000 wideband CQI reports and full-size subband CQI reports for each full-size subband have been gathered. The SS sends downlink MAC padding bits on the DL RMC. SS schedules the UL transmission every 5 ms to carry the PUSCH CQI feedback via PDCCH DCI format 0 with CQI request bit set to 1 and L\_MCS=29 and N\_PRB allocated to be less or equal to 4. In this process the SS collects wideband CQI reports every 5 ms and also cases where UE transmits nothing in its CQI timing are counted as wideband CQI and full-size subband CQI reports.
3. Set up a relative frequency distribution for the reported wideband CQI-values, Calculate the median value (wideband Median CQI is the CQI that is at or crosses 50% distribution from the lower wideband CQI side). This CQI-value is declared as wideband Median CQI value.
4. The SS shall transmit PDSCH via PDCCH DCI format 1A for C\_RNTI to transmit the DL RMC on a randomly selected full-size subband using the transport format according to the wideband median-CQI value regardless of UE wideband or subband CQI report. Note that each full-size subband shall be selected in the equal probability. The SS sends downlink MAC padding bits on the DL RMC. SS schedules the UL transmission every 5 ms to carry the PUSCH CQI feedback via PDCCH DCI format 0 with CQI request bit set to 1 and L\_MCS=29 and N\_PRB allocated to be less or equal to 4. Measure the average throughput according to Annex G.5.3. Declare the throughput as  $t_{median}$ .
5. The SS shall transmit PDSCH via PDCCH DCI format 1A for C\_RNTI to transmit the DL RMC in one full-size subband selected among the M subbands reported by the UE and with the corresponding TBS. Differential CQI offset level is selected from {1, 2, 3, 4}. Note that the SS shall send PDSCH in the same full-size subband until

next UE report is available. In case when same full-size subbands are reported subsequently, the SS shall select for transmission a different subband with respect to the last selection. The SS sends downlink MAC padding bits on the DL RMC. SS schedules the UL transmission every 5 ms to carry the PUSCH CQI feedback via PDCCH DCI format 0 with CQI request bit set to 1 and I\_MCS=29 and N\_PRB allocated to be less or equal to 4.

Measure the average throughput according to Annex G.5.3. Declare the throughput as  $t_{subband}$ . Count the number of NACKs, ACKs and statDTXs on the UL during the test interval.

If  $t_{subband} / t_{median} \geq \gamma$ , then pass the UE for this test and go to step 7. Otherwise go to step 6.

6. If both SNR points of the test have not been tested, then repeat the same procedure (steps 1 to 5) for the other SNR point as appropriate. Otherwise fail the UE.
7. If both tests have not been done, then repeat the same procedure (steps 1 to 5) with test conditions according to the table 9.3.4.1.1.3-1 for the other Test as appropriate. Otherwise pass the UE.

9.3.4.1.1.4.3 Message contents

**Table 9.3.4.1.1.4.3-1: PhysicalConfigDedicated-DEFAULT**

Derivation Path: 36.508 clause 5.5.1.2			
Information Element	Value/remark	Comment	Condition
PhysicalConfigDedicated-DEFAULT ::= SEQUENCE {			
cqi-ReportConfig	CQI-ReportConfig-DEFAULT		
}			

**Table 9.3.4.1.1.4.3-2: CQI-ReportConfig-DEFAULT**

Derivation Path: 36.508 clause 4.6.3			
Information Element	Value/remark	Comment	Condition
CQI-ReportConfig-DEFAULT ::= SEQUENCE {			
cqi-ReportModeAperiodic	rm20		
nomPDSCH-RS-EPRE-Offset	0		
cqi-ReportPeriodic CHOICE {	Not present		
}			
}			

9.3.4.1.1.5 Test requirement

**Table 9.3.4.1.1.5-1: Test requirement (FDD)**

	Test 1	Test 2
$\gamma$	1.19	1.19
UE Category	1-8	1-8

9.3.4.1.2 TDD CQI Reporting under fading conditions – PUSCH 2-0

9.3.4.1.2.1 Test purpose

To verify that UE-selected sub-bands can be used for frequently-selective scheduling.

9.3.4.1.2.2 Test applicability

This test applies to all types of E-UTRA TDD UE release 9 and forward. Applicability requires support for FGI bit 1.

9.3.4.1.2.3 Minimum conformance requirements

For the parameters specified in Table 9.3.4.1.2.3-1, and using the downlink physical channels specified in Annex C, the minimum requirements are specified in Table 9.3.4.1.2.3-2 and by the following:

- a) the ratio of the throughput obtained when transmitting on a randomly selected subband among the best  $M$  subbands reported by the UE the corresponding TBS and that obtained when transmitting the TBS indicated by the reported wideband CQI median on a randomly selected subband in set  $S$  shall be  $\geq \gamma$ ;

The requirements only apply for subbands of full size and the random scheduling across the subbands is done by selecting a new subband in each available downlink transmission instance for TDD. The transport block size TBS (wideband CQI median) is that resulting from the code rate which is closest to that indicated by the wideband CQI median and the  $N_{PRB}$  entry in Table 7.1.7.2.1-1 of TS 36.213 [10] that corresponds to the subband size.

**Table 9.3.4.1.2.3-1: Sub-band test for single antenna transmission (TDD)**

Parameter		Unit	Test 1		Test 2	
Bandwidth		MHz	10 MHz			
Transmission mode			1 (port 0)			
Downlink power allocation	$\rho_A$	dB	0			
	$\rho_B$	dB	0			
	$\sigma$	dB	0			
Uplink downlink configuration			2			
Special subframe configuration			4			
SNR (Note 3)		dB	9	10	14	15
$\hat{I}_{or}^{(j)}$		dB[mW/15kHz]	-89	-88	-84	-83
$N_{oc}^{(j)}$		dB[mW/15kHz]	-98		-98	
Propagation channel			Clause B.2.4 with $\tau_d = 0.45 \mu s$ , $a = 1$ , $f_D = 5$ Hz			
Reporting interval		ms	5			
CQI delay		ms	10 or 11			
Reporting mode			PUSCH 2-0			
Max number of HARQ transmissions			1			
Subband size ( $k$ )		RBs	3 (full size)			
Number of preferred subbands ( $M$ )			5			
ACK/NACK feedback mode			Multiplexing			
<p>Note 1: If the UE reports in an available uplink reporting instance at subframe SF#<math>n</math> based on CQI estimation at a downlink subframe not later than SF#(n-4), this reported subband or wideband CQI cannot be applied at the eNB downlink before SF#(n+4)</p> <p>Note 2: Reference measurement channel RC.5 TDD according to Table A.4-1 with one/two sided dynamic OCNG Pattern OP.1/2 TDD as described in Annex A.5.2.1/2.</p> <p>Note 3: For each test, the minimum requirements shall be fulfilled for at least one of the two SNR(s) and the respective wanted signal input level.</p>						

**Table 9.3.4.1.2.3-2: Minimum requirement (TDD)**

	Test 1	Test 2
$\gamma$	1.2	1.2
UE Category	1-8	1-8

The normative reference for this requirement is TS 36.101 [2] clause 9.3.4.1.2.



#### 9.3.4.1.2.4 Test description

##### 9.3.4.1.2.4.1 Initial conditions

Initial conditions are a set of test configurations the UE needs to be tested in and the steps for the SS to take with the UE to reach the correct measurement state.

Configurations of PDSCH and PDCCH before measurement are specified in Annex C.2.

Test Environment: Normal as defined in TS 36.508 [7] clause 4.1.

Frequencies to be tested: Mid Range as defined in TS 36.508 [7] clause 4.3.1.1.

Channel Bandwidths to be tested: 10MHz, as defined in TS 36.508 [7] clause 4.3.1.1

1. Connect the SS, faders and AWGN noise source to the UE antenna connector (s) as shown in TS 36.508 [7] Annex A, Figure A.9.
2. The parameter settings for the cell are set up according to Table 9.3.4.1.2.3-1.
3. Downlink signals are initially set up according to Annex C.1 and Annex C.3.2, and uplink signals according to Annex H.1 and H.3.2.
4. Propagation conditions are set according to Annex B.0.
5. Ensure the UE is in State 3A-RF according to TS 36.508 [7] clause 5.2A.2. Message contents are defined in clause 9.3.4.1.2.4.3.

##### 9.3.4.1.2.4.2 Test procedure

1. Set the parameters of bandwidth, the propagation condition, antenna configuration and measurement channel according to Table 9.3.4.1.2.3-1 as appropriate.
2. The SS shall transmit PDSCH via PDCCH DCI format 1A for C\_RNTI to transmit the DL RMC according to CQI value 8 and keep it regardless of the wideband and subband CQI value sent by the UE. Continue transmission of the PDSCH until 2000 wideband CQI reports and full-size subband CQI reports for each full-size subband have been gathered. The SS sends downlink MAC padding bits on the DL RMC. SS schedules the UL transmission in subframe #2 and subframe #7 to carry the PUSCH CQI feedback via PDCCH DCI format 0 with CQI request bit set to 1 and I\_MCS=29 and N\_PRB allocated to be less or equal to 4. In this process the SS collects wideband CQI reports every 5 ms and also cases where UE transmits nothing in its CQI timing are counted as wideband CQI and full-size subband CQI reports.
3. Set up a relative frequency distribution for the reported wideband CQI-values, Calculate the median value (wideband Median CQI is the CQI that is at or crosses 50% distribution from the lower wideband CQI side). This CQI-value is declared as wideband Median CQI value.
4. The SS shall transmit PDSCH via PDCCH DCI format 1A for C\_RNTI to transmit the DL RMC on a randomly selected full-size subband using the transport format according to the wideband median-CQI value regardless of UE wideband or subband CQI report. Note that each full-size subband shall be selected in the equal probability. The SS sends downlink MAC padding bits on the DL RMC. SS schedules the UL transmission in subframe #2 and subframe #7 to carry the PUSCH CQI feedback via PDCCH DCI format 0 with CQI request bit set to 1 and I\_MCS=29 and N\_PRB allocated to be less or equal to 4. Measure the average throughput according to Annex G.5.3. Declare the throughput as  $t_{median}$ .
5. The SS shall transmit PDSCH via PDCCH DCI format 1A for C\_RNTI to transmit the DL RMC in one full-size subband selected among the M subbands reported by the UE and with the corresponding TBS. Differential CQI offset level is selected from {1, 2, 3, 4}. Note that the SS shall send PDSCH in the same full-size until next UE report is available. In case when same full-size subbands are reported subsequently, the SS shall select for transmission a different subband with respect to the last selection. The SS sends downlink MAC padding bits on the DL RMC. SS schedules the UL transmission in subframe #2 and subframe #7 to carry the PUSCH CQI feedback via PDCCH DCI format 0 with CQI request bit set to 1 and I\_MCS=29 and N\_PRB allocated to be less or equal to 4. Measure the average throughput according to Annex G.5.3. Declare the throughput as  $t_{subband}$ .

Count the number of NACKs, ACKs and statDTXs on the UL during the test interval.

If  $t_{subband} / t_{median} \geq \gamma$ , then pass the UE for this test and go to step 7. Otherwise go to step 6.

6. If both SNR points of the test have not been tested, then repeat the same procedure (steps 1 to 5) for the other SNR point as appropriate. Otherwise fail the UE.
7. If both tests have not been done, then repeat the same procedure (steps 1 to 6) with test conditions according to the table 9.3.4.1.2.3-1 for the other Test as appropriate. Otherwise pass the UE.

#### 9.3.4.1.2.4.3 Message contents

Message contents are according to TS 36.508 [7] clause 4.6 with the following exceptions:

**Table 9.3.4.1.2.4.3-1: PhysicalConfigDedicated-DEFAULT**

Derivation Path: 36.508 clause 5.5.1.2			
Information Element	Value/remark	Comment	Condition
PhysicalConfigDedicated-DEFAULT ::= SEQUENCE {			
cqi-ReportConfig	<i>CQI-ReportConfig-DEFAULT</i>		
}			

**Table 9.3.4.1.2.4.3-2: CQI-ReportConfig-DEFAULT**

Derivation Path: 36.508 clause 4.6.3			
Information Element	Value/remark	Comment	Condition
CQI-ReportConfig-DEFAULT ::= SEQUENCE {			
cqi-ReportModeAperiodic	rm20		
nomPDSCH-RS-EPRE-Offset	0		
cqi-ReportPeriodic CHOICE {	Not present		
}			
}			

**Table 9.3.4.1.2.4.3-3: TDD-Config-DEFAULT**

Derivation Path: 36.508 clause 4.6.3			
Information Element	Value/remark	Comment	Condition
TDD-Config-DEFAULT ::= SEQUENCE {			
subframeAssignment	Sa2		
specialSubframePatterns	Ssp4		
}			

#### 9.3.4.1.2.5 Test requirement

**Table 9.3.4.1.2.5-1: Test requirement (TDD)**

	Test 1	Test 2
$\gamma$	1.19	1.19
UE Category	1-8	1-8

### 9.3.4.2 CQI Reporting under fading conditions – PUCCH 2-0 (Cell-Specific Reference Symbols)

#### 9.3.4.2.1 FDD CQI Reporting under fading conditions – PUCCH 2-0

##### 9.3.4.2.1.1 Test purpose

To verify that UE-selected sub-bands can be used for frequently-selective scheduling.

#### 9.3.4.2.1.2 Test applicability

This test applies to all types of E-UTRA FDD UE release 9 and forward. Applicability requires support for FGI bit 2.

#### 9.3.4.2.1.3 Minimum conformance requirements

For the parameters specified in Table 9.3.4.2.1.3-1, and using the downlink physical channels specified in Annex C, the minimum requirements are specified in Table 9.3.4.2.1.3-2 and by the following

- a) the ratio of the throughput obtained when transmitting on subbands reported by the UE the corresponding TBS and that obtained when transmitting the TBS indicated by the reported wideband CQI median on a randomly selected subband in set  $S$  shall be  $\geq \gamma$ ;

The requirements only apply for subbands of full size and the random scheduling across the subbands is done by selecting a new subband in each TTI for FDD. The transport block size TBS (wideband CQI median) is that resulting from the code rate which is closest to that indicated by the wideband CQI median and the  $N_{\text{PRB}}$  entry in Table 7.1.7.2.1-1 of TS 36.213 [10] that corresponds to the subband size.

**Table 9.3.4.2.1.3-1: Subband test for single antenna transmission (FDD)**

Parameter	Unit	Test 1		Test 2	
Bandwidth	MHz	10 MHz			
Transmission mode		1 (port 0)			
Downlink power allocation	$\rho_A$	dB			
	$\rho_B$	dB			
	$\sigma$	dB			
SNR (Note 3)	dB	8	9	13	14
$\hat{I}_{or}^{(j)}$	dB[mW/15kHz]	-90	-89	-85	-84
$N_{oc}^{(j)}$	dB[mW/15kHz]	-98		-98	
Propagation channel		Clause B.2.4 with $\tau_d = 0.45 \mu s$ , $a = 1$ , $f_D = 5$ Hz			
Reporting periodicity	ms	$N_p = 2$			
CQI delay	ms	8			
Physical channel for CQI reporting		PUSCH (Note 4)			
PUCCH Report Type for wideband CQI		4			
PUCCH Report Type for subband CQI		1			
Max number of HARQ transmissions		1			
Subband size ( $k$ )	RBs	6 (full size)			
Number of bandwidth parts ( $J$ )		3			
$K$		1			
$cqi-pmi-ConfigIndex$		1			
Note 1:	If the UE reports in an available uplink reporting instance at subframe SF#n based on CQI estimation at a downlink subframe not later than SF#(n-4), this reported subband or wideband CQI cannot be applied at the eNB downlink before SF#(n+4)				
Note 2:	Reference measurement channel RC.3 FDD according to Table A.4-1 with one/two sided dynamic OCNG Pattern OP.1/2 FDD as described in Annex A.5.1.1/2.				
Note 3:	For each test, the minimum requirements shall be fulfilled for at least one of the two SNR(s) and the respective wanted signal input level.				
Note 4:	To avoid collisions between CQI reports and HARQ-ACK it is necessary to report both on PUSCH instead of PUCCH. PDCCH DCI format 0 shall be transmitted in downlink SF#1, #3, #7 and #9 to allow periodic CQI to multiplex with the HARQ-ACK on PUSCH in uplink subframe SF#5, #7, #1 and #3.				
Note 5:	CQI reports for the short subband (having 2RBs in the last bandwidth part) are to be disregarded and data scheduling according to the most recent subband CQI report for bandwidth part with $j=1$ .				
Note 6:	In the case where wideband CQI is reported, data is to be scheduled according to the most recently used subband CQI report.				

**Table 9.3.4.2.1.3-2: Minimum requirement (FDD)**

	Test 1	Test 2
$\gamma$	1.15	1.15
UE Category	1-8	1-8

The normative reference for this requirement is TS 36.101 [2] clause 9.3.4.2.1.

#### 9.3.4.2.1.4 Test description

##### 9.3.4.2.1.4.1 Initial conditions

Initial conditions are a set of test configurations the UE needs to be tested in and the steps for the SS to take with the UE to reach the correct measurement state.

Configurations of PDSCH and PDCCH before measurement are specified in Annex C.2.

Test Environment: Normal as defined in TS 36.508 [7] clause 4.1.

Frequencies to be tested: Mid Range as defined in TS 36.508 [7] clause 4.3.1.1.

Channel Bandwidths to be tested: 10MHz, as defined in TS 36.508 [7] clause 4.3.1.1

1. Connect the SS and faders to the UE antenna connector (s) as shown in TS 36.508 [7] Annex A, Figure A.9.
2. The parameter settings for the cell are set up according to Table 9.3.4.2.1.3-1.
3. Downlink signals are initially set up according to Annex C.1 and Annex C.3.2, and uplink signals according to Annex H.1 and H.3.2.
4. Propagation conditions are set according to Annex B.0.
5. Ensure the UE is in State 3A-RF according to TS 36.508 [7] clause 5.2A.2. Message contents are defined in clause 9.3.4.2.1.4.3.

##### 9.3.4.2.1.4.2 Test procedure

1. Set the parameters of bandwidth, the propagation condition, antenna configuration and measurement channel according to Table 9.3.4.2.1.3-1 as appropriate.
2. The SS shall transmit PDSCH via PDCCH DCI format 1A for C\_RNTI to transmit the DL RMC according to CQI value 8 and keep it regardless of the wideband and subband CQI value sent by the UE. Continue transmission of the PDSCH until 2000 wideband CQI reports and full-size subband CQI reports for each full-size subband have been gathered. The SS sends downlink MAC padding bits on the DL RMC. The SS sends uplink scheduling information via PDCCH DCI format 0 with CQI request bit set to 0 to schedule UL RMC in subframe #1, #3, #5 and subframe #7 (Table A.4.1-1). The UE will send ACK/NACK and periodic CQI report using PUSCH. In this process the SS collects wideband CQI reports and also cases where UE transmits nothing in its wideband CQI timing are counted as wideband CQI reports.
3. Set up a relative frequency distribution for the reported wideband CQI-values, Calculate the median value (wideband Median CQI is the CQI that is at or crosses 50% distribution from the lower wideband CQI side). This CQI-value is declared as wideband Median CQI value.
4. The SS shall transmit PDSCH via PDCCH DCI format 1A for C\_RNTI to transmit the DL RMC on a randomly selected full-size subband using the transport format according to the wideband median-CQI value regardless of UE wideband or subband CQI report. Note that each full-size subband shall be selected in the equal probability. The SS sends downlink MAC padding bits on the DL RMC. The SS sends uplink scheduling information via PDCCH DCI format 0 with CQI request bit set to 0 to schedule UL RMC in subframe #1, #3, #5 and subframe #7 (Table A.4.1-1). The UE will send ACK/NACK and periodic CQI report using PUSCH. Measure the average throughput according to Annex G.5.3. Declare the throughput as  $t_{median}$ .
5. The SS shall transmit PDSCH via PDCCH DCI format 1A for C\_RNTI to transmit the DL RMC in the full-size subband reported by the UE and with the corresponding TBS. When the UE reports a non-full-size SB, the SS schedules the recent reported SB for bandwidth part with  $j=1$  and with the corresponding TBS. Note that the SS shall send PDSCH in the same full-size subband until next subband UE report is available. The SS sends downlink MAC padding bits on the DL RMC. The SS sends uplink scheduling information via PDCCH DCI format 0 with CQI request bit set to 0 to schedule UL RMC in subframe #1, #3, #5 and subframe #7 (Table A.4.1-1). The UE will send ACK/NACK and periodic CQI report using PUSCH. Measure the average throughput according to Annex G.5.3. Declare the throughput as  $t_{subband}$ . Count the number of NACKs, ACKs and statDTXs on the UL during the test interval.

If  $t_{subband} / t_{median} \geq \gamma$ , then pass the UE for this test and go to step 7. Otherwise go to step 6.

6. If both SNR points of the test have not been tested, then repeat the same procedure (steps 1 to 5) for the other SNR point as appropriate. Otherwise fail the UE.
7. If both tests have not been done, then repeat the same procedure (steps 1 to 6) with test conditions according to the table 9.3.4.2.1.3-1 for the other Test as appropriate. Otherwise pass the UE.

#### 9.3.4.1.1.4.3 Message contents

**Table 9.3.4.2.1.4.3-1: PhysicalConfigDedicated-DEFAULT**

Derivation Path: 36.508 clause 5.5.1.2			
Information Element	Value/remark	Comment	Condition
PhysicalConfigDedicated-DEFAULT ::= SEQUENCE {			
cqi-ReportConfig	<i>CQI-ReportConfig-DEFAULT</i>		
}			

**Table 9.3.4.2.1.4.3-2: CQI-ReportConfig-DEFAULT**

Derivation Path: 36.508 clause 4.6.3			
Information Element	Value/remark	Comment	Condition
CQI-ReportConfig-DEFAULT ::= SEQUENCE {			
cqi-ReportModeAperiodic	Not present		
nomPDSCH-RS-EPRE-Offset	0		
cqi-ReportPeriodic CHOICE {			
setup SEQUENCE {			
cqi-PUCCH-ResourceIndex	0		
cqi-pmi-ConfigIndex	1	(see Table 7.2.2-1A in TS 36.213)	
cqi-FormatIndicatorPeriodic CHOICE {			
subbandCQI	1		
}			
ri-ConfigIndex	483	(see Table 7.2.2-1B in TS 36.213)	
simultaneousAckNackAndCQI	FALSE		
}			
}			
}			

#### 9.3.4.2.1.5 Test requirement

**Table 9.3.4.2.1.5-1: Test requirement (FDD)**

	Test 1	Test 2
$\gamma$	1.14	1.14
UE Category	1-8	1-8

#### 9.3.4.2.2 TDD CQI Reporting under fading conditions – PUCCH 2-0

##### 9.3.4.2.2.1 Test purpose

To verify that UE-selected sub-bands can be used for frequently-selective scheduling.

##### 9.3.4.2.2.2 Test applicability

This test applies to all types of E-UTRA TDD UE release 9 and forward. Applicability requires support for FGI bit 2.

##### 9.3.4.2.2.3 Minimum conformance requirements

For the parameters specified in Table 9.3.4.2.2.3-1, and using the downlink physical channels specified in Annex C, the minimum requirements are specified in Table 9.3.4.2.2.3-2 and by the following:

- a) the ratio of the throughput obtained when transmitting on subbands reported by the UE the corresponding TBS and that obtained when transmitting the TBS indicated by the reported wideband CQI median on a randomly selected subband in set  $S$  shall be  $\geq \gamma$ ;

The requirements only apply for subbands of full size and the random scheduling across the subbands is done by selecting a new subband in each available downlink transmission instance for TDD. The transport block size TBS (wideband CQI median) is that resulting from the code rate which is closest to that indicated by the wideband CQI median and the  $N_{\text{PRB}}$  entry in Table 7.1.7.2.1-1 of TS 36.213 [10] that corresponds to the subband size.

Table 9.3.4.2.3-1: Sub-band test for single antenna transmission (TDD)

Parameter		Unit	Test 1		Test 2	
Bandwidth		MHz	10 MHz			
Transmission mode			1 (port 0)			
Downlink power allocation	$\rho_A$	dB	0			
	$\rho_B$	dB	0			
	$\sigma$	dB	0			
Uplink downlink configuration			2			
Special subframe configuration			4			
SNR (Note 3)		dB	8	9	13	14
$\hat{I}_{or}^{(j)}$		dB[mW/15kHz]	-90	-89	-85	-84
$N_{oc}^{(j)}$		dB[mW/15kHz]	-98		-98	
Propagation channel			Clause B.2.4 with $\tau_d = 0.45 \mu s$ , $a = 1$ , $f_D = 5$ Hz			
Reporting periodicity		ms	$N_p = 5$			
CQI delay		ms	10 or 11			
Physical channel for CQI reporting			PUSCH (Note 4)			
PUCCH Report Type for wideband CQI			4			
PUCCH Report Type for subband CQI			1			
Max number of HARQ transmissions			1			
Subband size ( $k$ )		RBs	6 (full size)			
Number of bandwidth parts ( $J$ )			3			
K			1			
$cqi-pmi-ConfigIndex$			3			
ACK/NACK feedback mode			Multiplexing			
<p>Note 1: If the UE reports in an available uplink reporting instance at subframe SF#n based on CQI estimation at a downlink subframe not later than SF#(n-4), this reported subband or wideband CQI cannot be applied at the eNB downlink before SF#(n+4)</p> <p>Note 2: Reference measurement channel RC.3 TDD according to Table A.4-1 with one/two sided dynamic OCNG Pattern OP.1/2 TDD as described in Annex A.5.2.1/2.</p> <p>Note 3: For each test, the minimum requirements shall be fulfilled for at least one of the two SNR(s) and the respective wanted signal input level.</p> <p>Note 4: To avoid collisions between CQI reports and HARQ-ACK it is necessary to report both on PUSCH instead of PUCCH. PDCCH DCI format 0 shall be transmitted in downlink SF#3 and #8 to allow periodic CQI to multiplex with the HARQ-ACK on PUSCH in uplink subframe SF#7 and #2.</p> <p>Note 5: CQI reports for the short subband (having 2RBs in the last bandwidth part) are to be disregarded and data scheduling according to the most recent subband CQI report for bandwidth part with <math>j=1</math>.</p> <p>Note 6: In the case where wideband CQI is reported, data is to be scheduled according to the most recently used subband CQI report.</p>						

Table 9.3.4.2.3-2: Minimum requirement (TDD)

	Test 1	Test 2
$\gamma$	1.15	1.15
UE Category	1-8	1-8



The normative reference for this requirement is TS 36.101 [2] clause 9.3.4.2.2.

#### 9.3.4.2.2.4 Test description

##### 9.3.4.2.2.4.1 Initial conditions

Initial conditions are a set of test configurations the UE needs to be tested in and the steps for the SS to take with the UE to reach the correct measurement state.

Configurations of PDSCH and PDCCH before measurement are specified in Annex C.2.

Test Environment: Normal as defined in TS 36.508 [7] clause 4.1.

Frequencies to be tested: Mid Range as defined in TS 36.508 [7] clause 4.3.1.1.

Channel Bandwidths to be tested: 10MHz, as defined in TS 36.508 [7] clause 4.3.1.1

1. Connect the SS, faders and AWGN noise source to the UE antenna connector (s) as shown in TS 36.508 [7] Annex A, Figure A.9.
2. The parameter settings for the cell are set up according to Table 9.3.4.2.2.3-1.
3. Downlink signals are initially set up according to Annex C.1 and Annex C.3.2, and uplink signals according to Annex H.1 and H.3.2.
4. Propagation conditions are set according to Annex B.0.
5. Ensure the UE is in State 3A-RF according to TS 36.508 [7] clause 5.2A.2. Message contents are defined in clause 9.3.4.2.2.4.3.

##### 9.3.4.2.2.4.2 Test procedure

1. Set the parameters of bandwidth, the propagation condition, antenna configuration and measurement channel according to Table 9.3.4.2.2.3-1 as appropriate.
2. The SS shall transmit PDSCH via PDCCH DCI format 1A for C\_RNTI to transmit the DL RMC according to CQI value 8 and keep it regardless of the wideband and subband CQI value sent by the UE. Continue transmission of the PDSCH until 2000 wideband CQI reports and full-size subband CQI reports for each full-size subband have been gathered. The SS sends downlink MAC padding bits on the DL RMC. The SS sends uplink scheduling information via PDCCH DCI format 0 with CQI request bit set to 0 to schedule UL RMC in subframe #2 and subframe #7 (Table A.4.1-2). The UE will send ACK/NACK and periodic CQI report using PUSCH. In this process the SS collects wideband CQI reports and also cases where UE transmits nothing in its wideband CQI timing are counted as wideband CQI reports.
3. Set up a relative frequency distribution for the reported wideband CQI-values, Calculate the median value (wideband Median CQI is the CQI that is at or crosses 50% distribution from the lower wideband CQI side). This CQI-value is declared as wideband Median CQI value.
4. The SS shall transmit PDSCH via PDCCH DCI format 1A for C\_RNTI to transmit the DL RMC on a randomly selected full-size subband using the transport format according to the wideband median-CQI value regardless of UE wideband or subband CQI report. Note that each full-size subband shall be selected in the equal probability. The SS sends downlink MAC padding bits on the DL RMC. The SS sends uplink scheduling information via PDCCH DCI format 0 with CQI request bit set to 0 to schedule UL RMC in subframe #2 and subframe #7 (Table A.4.1-2). The UE will send ACK/NACK and periodic CQI report using PUSCH. Measure the average throughput according to Annex G.5.3. Declare the throughput as  $t_{median}$ .
5. The SS shall transmit PDSCH via PDCCH DCI format 1A for C\_RNTI to transmit the DL RMC in the full-size subband reported by the UE and with the corresponding TBS. When the UE reports a non-full-size SB, the SS schedules the recent reported SB for bandwidth part with  $j=1$  and with the corresponding TBS. Note that the SS shall send PDSCH in the same full-size subband until next subband UE report is available. The SS sends downlink MAC padding bits on the DL RMC. The SS sends uplink scheduling information via PDCCH DCI format 0 with CQI request bit set to 0 to schedule UL RMC in subframe #2 and subframe #7 (Table A.4.1-2). The UE will send ACK/NACK and periodic CQI report using PUSCH. Measure the average throughput

according to Annex G.5.3. Declare the throughput as  $t_{subband}$ . Count the number of NACKs, ACKs and statDTXs on the UL during the test interval.

If  $t_{subband} / t_{median} \geq \gamma$ , then pass the UE for this test and go to step 7. Otherwise go to step 6.

6. If both SNR points of the test have not been tested, then repeat the same procedure (steps 1 to 5) for the other SNR point as appropriate. Otherwise fail the UE.
7. If both tests have not been done, then repeat the same procedure (steps 1 to 6) with test conditions according to the table 9.3.4.2.2.3-1 for the other Test as appropriate. Otherwise pass the UE.

#### 9.3.4.2.2.4.3 Message contents

Message contents are according to TS 36.508 [7] clause 4.6 with the following exceptions:

**Table 9.3.4.2.2.4.3-1: PhysicalConfigDedicated-DEFAULT**

Derivation Path: 36.508 clause 5.5.1.2			
Information Element	Value/remark	Comment	Condition
PhysicalConfigDedicated-DEFAULT ::= SEQUENCE {			
cqi-ReportConfig	CQI-ReportConfig-DEFAULT		
}			

**Table 9.3.4.2.2.4.3-2: CQI-ReportConfig-DEFAULT**

Derivation Path: 36.508 clause 4.6.3			
Information Element	Value/remark	Comment	Condition
CQI-ReportConfig-DEFAULT ::= SEQUENCE {			
cqi-ReportModeAperiodic	Not present		
nomPDSCH-RS-EPRE-Offset	0		
cqi-ReportPeriodic CHOICE {			
setup SEQUENCE {			
cqi-PUCCH-ResourceIndex	0		
cqi-pmi-ConfigIndex	3	(see Table 7.2.2-1A in TS 36.213)	
cqi-FormatIndicatorPeriodic CHOICE {			
subbandCQI	1		
}			
ri-ConfigIndex	484	(see Table 7.2.2-1B in TS 36.213)	
simultaneousAckNackAndCQI	FALSE		
}			
}			

**Table 9.3.4.2.2.4.3-3: TDD-Config-DEFAULT**

Derivation Path: 36.508 clause 4.6.3			
Information Element	Value/remark	Comment	Condition
TDD-Config-DEFAULT ::= SEQUENCE {			
subframeAssignment	Sa2		
specialSubframePatterns	Ssp4		
}			

#### 9.3.4.2.2.5 Test requirement

**Table 9.3.4.2.2.5-1: Test requirement (TDD)**

	Test 1	Test 2
$\gamma$	1.14	1.14
UE Category	1-8	1-8

## 9.3.5 Additional requirements for enhanced receiver Type A

### 9.3.5.1 PUCCH 1-0 (Cell-Specific Reference Symbol)

#### 9.3.5.1.1 FDD CQI Reporting under fading conditions - PUCCH 1-0 - Enhanced Performance Requirement Type A

##### 9.3.5.1.1.1 Test purpose

The purpose of the test is to verify that the reporting of the channel quality is based on the receiver of the enhanced Type A. Performance requirements are specified in terms of the relative increase of the throughput obtained when the transport format is that indicated by the reported CQI subject to an interference model compared to the case with a white Gaussian noise model, and a requirement on the minimum BLER of the transmitted transport formats indicated by the reported CQI subject to an interference model.

##### 9.3.5.1.1.2 Test applicability

This test applies to all types of E-UTRA FDD UE release 11 and forward that support enhanced receiver Type A.

##### 9.3.5.1.1.3 Minimum conformance requirements

For the parameters specified in Table 9.3.5.1.1.3-1, and using the downlink physical channels specified in Annex C, the minimum requirements are specified in Table 9.3.5.1.1.3-2 and by the following

- a) the ratio of the throughput obtained when transmitting the transport format indicated by each reported wideband CQI index subject to an interference source with specified DIP and that obtained when transmitting the transport format indicated by each reported wideband CQI index subject to a white Gaussian noise source shall be  $\geq \gamma$ ;
- b) when transmitting the transport format indicated by each reported wideband CQI index subject to an interference source with specified DIP, the average BLER for the indicated transport formats shall be greater than or equal to 2%.

**Table 9.3.5.1.1.3-1: Fading test for single antenna (FDD)**

Parameter	Unit	Cell 1	Cell 2
Bandwidth	MHz	10 MHz	
Transmission mode		1 (port 0)	
Cyclic Prefix		Normal	Normal
Cell ID		0	1
SINR (Note 8)	dB	-2	N/A
$N_{oc}^{(j)}$	dB[mW/15kHz]	-98	N/A
Propagation channel		EPA5	Static (Note 7)
Correlation and antenna configuration		Low (1 x 2)	(1 x 2)
DIP (Note 4)	dB	N/A	-0.41
Reference measurement channel		Note 2	R.2 FDD
Reporting mode		PUCCH 1-0	N/A
Reporting periodicity	ms	$N_{pd} = 2$	N/A
CQI delay	ms	8	N/A
Physical channel for CQI reporting		PUSCH (Note 3)	N/A
PUCCH Report Type		4	N/A
<i>cqi-pmi-ConfigurationIndex</i>		1	N/A
Max number of HARQ transmissions		1	N/A
<p>Note 1: If the UE reports in an available uplink reporting instance at subframe SF#n based on CQI estimation at a downlink SF not later than SF#(n-4), this reported wideband CQI cannot be applied at the eNB downlink before SF#(n+4)</p> <p>Note 2: Reference measurement channel RC.1 FDD according to Table A.4-1 for Category 2-8 with one sided dynamic OCNG Pattern OP.1 FDD as described in Annex A.5.1.1 and RC.4 FDD according to Table A.4-1 for Category 1 with one/two sided dynamic OCNG Pattern OP.1/2 FDD as described in Annex A.5.1.1/2.</p> <p>Note 3: To avoid collisions between CQI reports and HARQ-ACK it is necessary to report both on PUSCH instead of PUCCH. PDCCH DCI format 0 shall be transmitted in downlink SF#1, #3, #7 and #9 to allow periodic CQI to multiplex with the HARQ-ACK on PUSCH in uplink subframe SF#5, #7, #1 and #3.</p> <p>Note 4: The respective received power spectral density of each interfering cell relative to <math>N_{oc}</math> is defined by its associated DIP value as specified in clause B.5.1.</p> <p>Note 5: Two cells are considered in which Cell 1 is the serving cell and Cell 2 is the interfering cell. The number of the CRS ports in both cells is the same. Interfering cell is fully loaded.</p> <p>Note 6: Both cells are time-synchronous.</p> <p>Note 7: Static channel is used for the interference model. In case for white Gaussian noise model Cell 2 is not present.</p> <p>Note 8: SINR corresponds to <math>\hat{E}_s / N_{oc}</math> of Cell 1 as defined in clause 8.1.1.</p>			

**Table 9.3.5.1.1.3-2: Minimum requirement (FDD)**

$\gamma$	1.8
UE Category	1-8

The normative reference for this requirement is TS 36.101 [2] clause 9.3.5.1.1.

#### 9.3.5.1.1.4 Test description

##### 9.3.5.1.1.4.1 Initial conditions

Initial conditions are a set of test configurations the UE needs to be tested in and the steps for the SS to take with the UE to reach the correct measurement state.

Configurations of PDSCH and PDCCH before measurement are specified in Annex C.2.

Test Environment: Normal as defined in TS 36.508 [7] clause 4.1.

Frequencies to be tested: Mid Range as defined in TS 36.508 [7] clause 4.3.1.1.

Channel Bandwidths to be tested: 10MHz, as defined in TS 36.508 [7] clause 4.3.1.1

1. Connect the SS and faders to the UE antenna connector (s) as shown in TS 36.508 [7] Annex A, Figure A.50.
2. The parameter settings for the cell 1 are set up according to Table 9.3.5.1.1.3-1.
3. Downlink signals are initially set up according to Annex C.1 and Annex C.3.2, and uplink signals according to Annex H.1 and H.3.2.
4. Propagation conditions are set according to Annex B.0.
5. Ensure the UE is in State 3A-RF according to TS 36.508 [7] clause 5.2A.2. Message contents are defined in clause 9.3.5.1.1.4.3.

##### 9.3.5.1.1.4.2 Test procedure

1. Set the cell 1 and 2 parameters of bandwidth, the propagation condition, antenna configuration and measurement channel according to Table 9.3.5.1.1.3-1 as appropriate.
2. The SS shall transmit PDSCH via PDCCH DCI format 1A for C\_RNTI to transmit the DL RMC according to the wideband CQI value reported from UE. The SS sends downlink MAC padding bits on the DL RMC. The SS sends uplink scheduling information via PDCCH DCI format 0 with CQI request bit set to 0 to schedule UL RMC in subframe #1,#3,#5 and subframe #7 (Table A.4.1-1). The UE will send ACK/NACK and periodic CQI report using PUSCH. Measure the average throughput according to Annex G.5.3. Declare the throughput as  $t_{\text{wideband\_interference}}$ . The responses are then filtered as follows: for the sequence of responses for each HARQ process, discard all the statDTX responses.
3. Deactivate i.e., stop transmitting anything from the cell 2 and set the cell 1 parameters of bandwidth, the propagation condition, antenna configuration and measurement channel according to Table 9.3.5.1.1.3-1 as appropriate.
4. The SS shall transmit PDSCH via PDCCH DCI format 1A for C\_RNTI to transmit the DL RMC according to the wideband CQI value reported from UE. The SS sends downlink MAC padding bits on the DL RMC. The SS sends uplink scheduling information via PDCCH DCI format 0 with CQI request bit set to 0 to schedule UL RMC in subframe #1,#3,#5 and subframe #7 (Table A.4.1-1). The UE will send ACK/NACK and periodic CQI report using PUSCH. Measure the average throughput according to Annex G.5.3. Declare the throughput as  $t_{\text{wideband\_gaussian\_noise}}$ .
5. If the ratio  $(t_{\text{wideband\_interference}} / t_{\text{wideband\_gaussian\_noise}}) \geq \gamma$  and ratio (NACK / (ACK + NACK)) calculated in step 2 is greater or equal to 0.02, then pass the UE for this test. Otherwise fail the UE.

##### 9.3.5.1.1.4.3 Message contents

Message contents are according to TS 36.508 [7] clause 4.6 with the following exceptions:

Table 9.3.5.1.1.4.3-1: PhysicalConfigDedicated-DEFAULT

Derivation Path: 36.508 clause 5.5.1.2			
Information Element	Value/remark	Comment	Condition
PhysicalConfigDedicated-DEFAULT ::= SEQUENCE {			
cqi-ReportConfig	<i>CQI-ReportConfig-DEFAULT</i>		
}			

Table 9.3.5.1.1.4.3-2: CQI-ReportConfig-DEFAULT

Derivation Path: 36.508 clause 4.6.3			
Information Element	Value/remark	Comment	Condition
CQI-ReportConfig-DEFAULT ::= SEQUENCE {			
cqi-ReportModeAperiodic	Not present		
nomPDSCH-RS-EPRE-Offset	0		
cqi-ReportPeriodic CHOICE {			
setup SEQUENCE {			
cqi-PUCCH-ResourceIndex	0		
cqi-pmi-ConfigIndex	1	(see Table 7.2.2-1A in TS 36.213)	
cqi-FormatIndicatorPeriodic CHOICE {			
widebandCQI	NULL		
}			
ri-ConfigIndex	NULL	(see Table 7.2.2-1B in TS 36.213)	
simultaneousAckNackAndCQI	FALSE		
}			
}			

## 9.3.5.1.1.5 Test requirement

**Table 9.3.5.1.1.5-1: Test Parameters for Fading test with single antenna (FDD)**

Parameter	Unit	Cell 1	Cell 2
Bandwidth	MHz	10 MHz	
Transmission mode		1 (port 0)	
Cyclic Prefix		Normal	Normal
Cell ID		0	1
SINR (Note 8)	dB	-1.97	N/A
$N_{oc}^{(j)}$	dB[mW/15kHz]	-98	N/A
Propagation channel		EPA5	Static (Note 7)
Correlation and antenna configuration		Low (1 x 2)	(1 x 2)
DIP (Note 4)	dB	N/A	-0.38
Reference measurement channel		Note 2	R.2 FDD
Reporting mode		PUCCH 1-0	N/A
Reporting periodicity	ms	$N_{pd} = 2$	N/A
CQI delay	ms	8	N/A
Physical channel for CQI reporting		PUSCH (Note 3)	N/A
PUCCH Report Type		4	N/A
<i>cqi-pmi-ConfigurationIndex</i>		1	N/A
Max number of HARQ transmissions		1	N/A
<p>Note 1: If the UE reports in an available uplink reporting instance at subframe SF#n based on CQI estimation at a downlink SF not later than SF#(n-4), this reported wideband CQI cannot be applied at the eNB downlink before SF#(n+4)</p> <p>Note 2: Reference measurement channel RC.1 FDD according to Table A.4-1 for Category 2-8 with one sided dynamic OCNG Pattern OP.1 FDD as described in Annex A.5.1.1 and RC.4 FDD according to Table A.4-1 for Category 1 with one/two sided dynamic OCNG Pattern OP.1/2 FDD as described in Annex A.5.1.1/2.</p> <p>Note 3: To avoid collisions between CQI reports and HARQ-ACK it is necessary to report both on PUSCH instead of PUCCH. PDCCH DCI format 0 shall be transmitted in downlink SF#1, #3, #7 and #9 to allow periodic CQI to multiplex with the HARQ-ACK on PUSCH in uplink subframe SF#5, #7, #1 and #3.</p> <p>Note 4: The respective received power spectral density of each interfering cell relative to <math>N_{oc}'</math> is defined by its associated DIP value as specified in clause B.5.1.</p> <p>Note 5: Two cells are considered in which Cell 1 is the serving cell and Cell 2 is the interfering cell. The number of the CRS ports in both cells is the same. Interfering cell is fully loaded.</p> <p>Note 6: Both cells are time-synchronous.</p> <p>Note 7: Static channel is used for the interference model. In case for white Gaussian noise model Cell 2 is not present.</p> <p>Note 8: SINR corresponds to <math>\widehat{E}_s / N_{oc}'</math> of Cell 1 as defined in clause 8.1.1.</p>			

**Table 9.3.5.1.1.5-2: Test requirement (FDD)**

$\gamma$	1.79
UE Category	1-8

### 9.3.5.1.2 TDD CQI Reporting under fading conditions - PUCCH 1-0 - Enhanced Performance Requirement Type A

#### 9.3.5.1.2.1 Test purpose

The purpose of the test is to verify that the reporting of the channel quality is based on the receiver of the enhanced Type A. Performance requirements are specified in terms of the relative increase of the throughput obtained when the transport format is that indicated by the reported CQI subject to an interference model compared to the case with a white Gaussian noise model, and a requirement on the minimum BLER of the transmitted transport formats indicated by the reported CQI subject to an interference model.

#### 9.3.5.1.2.2 Test applicability

This test applies to all types of E-UTRA TDD UE release 11 and forward that support enhanced receiver Type A.

#### 9.3.5.1.2.3 Minimum conformance requirements

For the parameters specified in Table 9.3.5.1.2.3-1, and using the downlink physical channels specified in Annex C, the minimum requirements are specified in Table 9.3.5.1.2.3-2 and by the following

- a) the ratio of the throughput obtained when transmitting the transport format indicated by each reported wideband CQI index subject to an interference source with specified DIP and that obtained when transmitting the transport format indicated by each reported wideband CQI index subject to a white Gaussian noise source shall be  $\geq \gamma$ ;
- b) when transmitting the transport format indicated by each reported wideband CQI index subject to an interference source with specified DIP, the average BLER for the indicated transport formats shall be greater than or equal to 2%.



**Table 9.3.5.1.2.3-1: Fading test for single antenna (TDD)**

Parameter	Unit	Cell 1	Cell 2
Bandwidth	MHz	10 MHz	
Transmission mode		1 (port 0)	
Uplink downlink configuration		2	
Special subframe configuration		4	
Cyclic Prefix		Normal	Normal
Cell ID		0	1
SINR (Note 8)	dB	-2	N/A
$N_{oc}^{(j)}$	dB[mW/15kHz]	-98	-98
Propagation channel		EPA5	Static (Note 7)
Correlation and antenna configuration		Low (1 x 2)	(1 x 2)
DIP (Note 4)	dB	N/A	-0.41
Reference measurement channel		Note 2	R.2 TDD
Reporting mode		PUCCH 1-0	N/A
Reporting periodicity	ms	$N_{pd} = 5$	N/A
CQI delay	ms	10 or 11	N/A
Physical channel for CQI reporting		PUSCH (Note 3)	N/A
PUCCH Report Type		4	N/A
<i>cqi-pmi-ConfigurationIndex</i>		3	N/A
Max number of HARQ transmissions		1	N/A
ACK/NACK feedback mode		Multiplexing	N/A
<p>Note 1: If the UE reports in an available uplink reporting instance at subframe SF#n based on CQI estimation at a downlink SF not later than SF#(n-4), this reported wideband CQI cannot be applied at the eNB downlink before SF#(n+4)</p> <p>Note 2: Reference measurement channel RC.1 TDD according to Table A.4-1 for Category 2-8 with one sided dynamic OCNG Pattern OP.1 TDD as described in Annex A.5.2.1 and RC.4 TDD according to Table A.4-1 for Category 1 with one/two sided dynamic OCNG Pattern OP.1/2 TDD as described in Annex A.5.2.1/2.</p> <p>Note 3: To avoid collisions between CQI reports and HARQ-ACK it is necessary to report both on PUSCH instead of PUCCH. PDCCH DCI format 0 shall be transmitted in downlink SF#3 and #8 to allow periodic CQI to multiplex with the HARQ-ACK on PUSCH in uplink subframe SF#7 and #2.</p> <p>Note 4: The respective received power spectral density of each interfering cell relative to <math>N_{oc}</math> is defined by its associated DIP value as specified in clause B.5.1.</p> <p>Note 5: Two cells are considered in which Cell 1 is the serving cell and Cell 2 is the interfering cell. The number of the CRS ports in both cells is the same. Interfering cell is fully loaded.</p> <p>Note 6: Both cells are time-synchronous.</p> <p>Note 7: Static channel is used for the interference model. In case for white Gaussian noise model Cell 2 is not present.</p> <p>Note 8: SINR corresponds to <math>\hat{E}_s / N_{oc}</math> of Cell 1 as defined in clause 8.1.1.</p>			

**Table 9.3.5.1.2.3-2: Minimum requirement (TDD)**

$\gamma$	1.8
UE Category	1-8

The normative reference for this requirement is TS 36.101 [2] clause 9.3.5.1.2.

#### 9.3.5.1.2.4 Test description

##### 9.3.5.1.2.4.1 Initial conditions

Initial conditions are a set of test configurations the UE needs to be tested in and the steps for the SS to take with the UE to reach the correct measurement state.

Configurations of PDSCH and PDCCH before measurement are specified in Annex C.2.

Test Environment: Normal as defined in TS 36.508 [7] clause 4.1.

Frequencies to be tested: Mid Range as defined in TS 36.508 [7] clause 4.3.1.1.

Channel Bandwidths to be tested: 10MHz, as defined in TS 36.508 [7] clause 4.3.1.1

1. Connect the SS and faders to the UE antenna connector (s) as shown in TS 36.508 [7] Annex A, Figure A.50.
2. The parameter settings for the cell 1 are set up according to Table 9.3.5.1.2.3-1.
3. Downlink signals are initially set up according to Annex C.1 and Annex C.3.2, and uplink signals according to Annex H.1 and H.3.2.
4. Propagation conditions are set according to Annex B.0.
5. Ensure the UE is in State 3A-RF according to TS 36.508 [7] clause 5.2A.2. Message contents are defined in clause 9.3.5.1.2.4.3.

##### 9.3.5.1.2.4.2 Test procedure

1. Set the cell 1 and 2 parameters of bandwidth, the propagation condition, antenna configuration and measurement channel according to Table 9.3.5.1.2.3-1 as appropriate.
2. The SS shall transmit PDSCH via PDCCH DCI format 1A for C\_RNTI to transmit the DL RMC according to the wideband CQI value reported from UE. The SS sends downlink MAC padding bits on the DL RMC. The SS sends uplink scheduling information via PDCCH DCI format 0 with CQI request bit set to 0 to schedule UL RMC in subframe #2 and #7 (Table A.4.1-2). The UE will send ACK/NACK and periodic CQI report using PUSCH. Measure the average throughput according to Annex G.5.3. Declare the throughput as  $t_{\text{wideband\_interference}}$ . The responses are then filtered as follows: for the sequence of responses for each HARQ process, discard all the statDTX responses.
3. Deactivate i.e., stop transmitting anything from the cell 2 and set the cell 1 parameters of bandwidth, the propagation condition, antenna configuration and measurement channel according to Table 9.3.5.1.2.3-1 as appropriate.
4. The SS shall transmit PDSCH via PDCCH DCI format 1A for C\_RNTI to transmit the DL RMC according to the wideband CQI value reported from UE. The SS sends downlink MAC padding bits on the DL RMC. The SS sends uplink scheduling information via PDCCH DCI format 0 with CQI request bit set to 0 to schedule UL RMC in subframe #2 and #7 (Table A.4.1-2). The UE will send ACK/NACK and periodic CQI report using PUSCH. Measure the average throughput according to Annex G.5.3. Declare the throughput as  $t_{\text{wideband\_gaussian\_noise}}$ .
5. If the ratio  $(t_{\text{wideband\_interference}} / t_{\text{wideband\_gaussian\_noise}}) \geq \gamma$  and ratio (NACK / (ACK + NACK)) calculated in step 2 is greater or equal to 0.02, then pass the UE for this test. Otherwise fail the UE.

##### 9.3.5.1.2.4.3 Message contents

Message contents are according to TS 36.508 [7] clause 4.6 with the following exceptions:

Table 9.3.5.1.2.4.3-1: PhysicalConfigDedicated-DEFAULT

Derivation Path: 36.508 clause 5.5.1.2			
Information Element	Value/remark	Comment	Condition
PhysicalConfigDedicated-DEFAULT ::= SEQUENCE {			
cqi-ReportConfig	<i>CQI-ReportConfig-DEFAULT</i>		
}			

Table 9.3.5.1.2.4.3-2: CQI-ReportConfig-DEFAULT

Derivation Path: 36.508 clause 4.6.3			
Information Element	Value/remark	Comment	Condition
CQI-ReportConfig-DEFAULT ::= SEQUENCE {			
cqi-ReportModeAperiodic	Not present		
nomPDSCH-RS-EPRE-Offset	0		
cqi-ReportPeriodic CHOICE {			
setup SEQUENCE {			
cqi-PUCCH-ResourceIndex	0		
cqi-pmi-ConfigIndex	1	(see Table 7.2.2-1A in TS 36.213)	
cqi-FormatIndicatorPeriodic CHOICE {			
widebandCQI	NULL		
}			
ri-ConfigIndex	NULL	(see Table 7.2.2-1B in TS 36.213)	
simultaneousAckNackAndCQI	FALSE		
}			
}			

## 9.3.5.1.2.5 Test requirement

Table 9.3.5.1.2.5-1: Test Parameters for Fading test with single antenna (TDD)

Parameter	Unit	Cell 1	Cell 2
Bandwidth	MHz	10 MHz	
Transmission mode		1 (port 0)	
Uplink downlink configuration		2	
Special subframe configuration		4	
Cyclic Prefix		Normal	Normal
Cell ID		0	1
SINR (Note 8)	dB	-1.97	N/A
$N_{oc}^{(j)}$	dB[mW/15kHz]	-98	-98
Propagation channel		EPA5	Static (Note 7)
Correlation and antenna configuration		Low (1 x 2)	(1 x 2)
DIP (Note 4)	dB	N/A	-0.38
Reference measurement channel		Note 2	R.2 TDD
Reporting mode		PUCCH 1-0	N/A
Reporting periodicity	ms	$N_{pd} = 5$	N/A
CQI delay	ms	10 or 11	N/A
Physical channel for CQI reporting		PUSCH (Note 3)	N/A
PUCCH Report Type		4	N/A
<i>cqi-pmi-ConfigurationIndex</i>		3	N/A
Max number of HARQ transmissions		1	N/A
ACK/NACK feedback mode		Multiplexing	N/A
<p>Note 1: If the UE reports in an available uplink reporting instance at subframe SF#n based on CQI estimation at a downlink SF not later than SF#(n-4), this reported wideband CQI cannot be applied at the eNB downlink before SF#(n+4)</p> <p>Note 2: Reference measurement channel RC.1 TDD according to Table A.4-1 for Category 2-8 with one sided dynamic OCNG Pattern OP.1 TDD as described in Annex A.5.2.1 and RC.4 TDD according to Table A.4-1 for Category 1 with one/two sided dynamic OCNG Pattern OP.1/2 TDD as described in Annex A.5.2.1/2.</p> <p>Note 3: To avoid collisions between CQI reports and HARQ-ACK it is necessary to report both on PUSCH instead of PUCCH. PDCCH DCI format 0 shall be transmitted in downlink SF#3 and #8 to allow periodic CQI to multiplex with the HARQ-ACK on PUSCH in uplink subframe SF#7 and #2.</p> <p>Note 4: The respective received power spectral density of each interfering cell relative to <math>N_{oc}</math> is defined by its associated DIP value as specified in clause B.5.1.</p> <p>Note 5: Two cells are considered in which Cell 1 is the serving cell and Cell 2 is the interfering cell. The number of the CRS ports in both cells is the same. Interfering cell is fully loaded.</p> <p>Note 6: Both cells are time-synchronous.</p> <p>Note 7: Static channel is used for the interference model. In case for white Gaussian noise model Cell 2 is not present.</p> <p>Note 8: SINR corresponds to <math>\hat{E}_s / N_{oc}</math> of Cell 1 as defined in clause 8.1.1.</p>			

**Table 9.3.5.1.2.5-2: Test requirement (TDD)**

$\gamma$	1.79
UE Category	1-8

### 9.3.5.2 PUCCH 1-1 (CSI Reference Symbol)

#### 9.3.5.2.1 FDD CQI Reporting under fading conditions - PUCCH 1-1 - Enhanced Performance Requirement Type A

##### 9.3.5.2.1.1 Test purpose

The purpose of the test is to verify that the reporting of the channel quality is based on the receiver of the enhanced Type A. Performance requirements are specified in terms of the relative increase of the throughput obtained when the transport format is that indicated by the reported CQI subject to an interference model compared to the case with a white Gaussian noise model, and a requirement on the minimum BLER of the transmitted transport formats indicated by the reported CQI subject to an interference model.

##### 9.3.5.2.1.2 Test applicability

This test applies to all types of E-UTRA FDD UE release 11 and forward of Category 2-8 that support enhanced receiver Type A.

##### 9.3.5.2.1.3 Minimum conformance requirements

For the parameters specified in Table 9.3.5.2.1.3-1, and using the downlink physical channels specified in Annex C, the minimum requirements are specified in Table 9.3.5.2.1.3-2 and by the following

- a) the ratio of the throughput obtained when transmitting the transport format indicated by each reported wideband CQI index subject to an interference source with specified DIP and that obtained when transmitting the transport format indicated by each reported wideband CQI index subject to a white Gaussian noise source shall be  $\geq \gamma$ ;
- b) when transmitting the transport format indicated by each reported wideband CQI index subject to an interference source with specified DIP, the average BLER for the indicated transport formats shall be greater than or equal to 2%.

**Table 9.3.5.2.1.3-1: Fading test for single antenna (FDD)**

Parameter	Unit	Cell 1	Cell 2
Bandwidth	MHz	10 MHz	
Transmission mode		9	
Cyclic Prefix		Normal	Normal
Cell ID		0	1
SINR (Note 8)	dB	-2	N/A
$N_{oc}^{(j)}$	dB[mW/15kHz]	-98	N/A
Propagation channel		EPA5	Static (Note 7)
Correlation and antenna configuration		Low (2 x 2)	(1 x 2)
DIP (Note 4)	dB	N/A	-0.41
Cell-specific reference signals		Antenna ports 0,1	Antenna port 0
CSI reference signals		Antenna ports 15,16	N/A
CSI-RS periodicity and subframe offset		5/1	N/A
CSI-RS reference signal configuration		2	N/A
Zero-power CSI-RS configuration $I_{CSI-RS}$ / ZeroPowerCSI-RS bitmap	Subframes / bitmap	N/A	1 / 00100000000000
CodeBookSubsetRestriction bitmap		001111	N/A
Reference measurement channel		Note 2	R.2 FDD
Reporting mode		PUCCH 1-1	N/A
Reporting periodicity	ms	$N_{pd} = 5$	N/A
CQI delay	ms	8	N/A
Physical channel for CQI/PMI reporting		PUSCH (Note 3)	N/A
PUCCH Report Type for CQI/PMI		2	N/A
PUCCH channel for RI reporting		PUCCH Format 2	N/A
PUCCH Report Type for RI		3	N/A
<i>cqi-pmi-ConfigurationIndex</i>		2	N/A
<i>ri-ConfigIndex</i>		1	N/A
Max number of HARQ transmissions		1	N/A
Note 1:	If the UE reports in an available uplink reporting instance at subframe SF#n based on CQI estimation at a downlink SF not later than SF#(n-4), this reported wideband CQI cannot be applied at the eNB downlink before SF#(n+4)		
Note 2:	Reference measurement channel RC.11 FDD according to Table A.4-1 with one sided dynamic OCNG Pattern OP.1 FDD as described in Annex A.5.1.1.		
Note 3:	To avoid collisions between CQI/ PMI reports and HARQ-ACK it is necessary to report both on PUSCH instead of PUCCH. PDCCH DCI format 0 shall be transmitted in downlink SF#1 and #6 to allow periodic CQI/ PMI to multiplex with the HARQ-ACK on PUSCH in uplink subframe SF#0 and #5.		
Note 4:	The respective received power spectral density of each interfering cell relative to $N_{oc}$ is defined by its associated DIP value as specified in clause B.5.1.		
Note 5:	Two cells are considered in which Cell 1 is the serving cell and Cell 2 is the interfering cell. Interfering cell is fully loaded.		
Note 6:	Both cells are time-synchronous.		
Note 7:	Static channel is used for the interference model. In case for white Gaussian noise model Cell 2 is not present.		

Note 8: SINR corresponds to  $\hat{E}_s / N_{oc}$  of Cell 1 as defined in clause 8.1.1.

**Table 9.3.5.2.1.3-2: Minimum requirement (FDD)**

$\gamma$	1.8
UE Category	2-8

The normative reference for this requirement is TS 36.101 [2] clause 9.3.5.2.1.

#### 9.3.5.2.1.4 Test description

##### 9.3.5.2.1.4.1 Initial conditions

Initial conditions are a set of test configurations the UE needs to be tested in and the steps for the SS to take with the UE to reach the correct measurement state.

Configurations of PDSCH and PDCCH before measurement are specified in Annex C.2.

Test Environment: Normal as defined in TS 36.508 [7] clause 4.1.

Frequencies to be tested: Mid Range as defined in TS 36.508 [7] clause 4.3.1.1.

Channel Bandwidths to be tested: 10MHz, as defined in TS 36.508 [7] clause 4.3.1.1

1. Connect the SS and faders to the UE antenna connector (s) as shown in TS 36.508 [7] Annex A, Figure A.51.
2. The parameter settings for the cell 1 are set up according to Table 9.3.5.2.1.5-1.
3. Downlink signals are initially set up according to Annex C.1 and Annex C.3.2, and uplink signals according to Annex H.1 and H.3.2.
4. Propagation conditions are set according to Annex B.0.
5. Ensure the UE is in State 3A-RF according to TS 36.508 [7] clause 5.2A.2. Message contents are defined in clause 9.3.5.2.1.4.3.

##### 9.3.5.2.1.4.2 Test procedure

1. Set the cell 1 and 2 parameters of bandwidth, the propagation condition, antenna configuration and measurement channel according to Table 9.3.5.2.1.5-1 as appropriate.
2. The SS shall transmit PDSCH via PDCCH DCI format 1A for C\_RNTI to transmit the DL RMC according to the wideband CQI value reported from UE. The SS sends downlink MAC padding bits on the DL RMC. The SS sends uplink scheduling information via PDCCH DCI format 0 with CQI request bit set to 0 to schedule UL RMC in subframe #0 and subframe #5 (Table A.4.1-1). The UE will send ACK/NACK and periodic CQI report using PUSCH. Measure the average throughput according to Annex G.5.3. Declare the throughput as  $t_{\text{wideband\_interference}}$ . The responses are then filtered as follows: for the sequence of responses for each HARQ process, discard all the statDTX responses.
3. Deactivate i.e., stop transmitting anything from the cell 2 and set the cell 1 parameters of bandwidth, the propagation condition, antenna configuration and measurement channel according to Table 9.3.5.2.1.5-1 as appropriate.
4. The SS shall transmit PDSCH via PDCCH DCI format 1A for C\_RNTI to transmit the DL RMC according to the wideband CQI value reported from UE. The SS sends downlink MAC padding bits on the DL RMC. The SS sends uplink scheduling information via PDCCH DCI format 0 with CQI request bit set to 0 to schedule UL RMC in subframe #0 and subframe #5 (Table A.4.1-1). The UE will send ACK/NACK and periodic CQI report using PUSCH. Measure the average throughput according to Annex G.5.3. Declare the throughput as  $t_{\text{wideband\_gaussian\_noise}}$ .

5. If the ratio ( $t_{\text{wideband\_interference}} / t_{\text{wideband\_gaussian\_noise}}$ )  $\geq \gamma$  in Table 9.3.5.2.1.5-2 and ratio (NACK / (ACK + NACK)) calculated in step 2 is greater or equal to 0.02, then pass the UE for this test. Otherwise fail the UE.

#### 9.3.5.2.1.4.3 Message contents

Message contents are according to TS 36.508 [7] clause 4.6 with the following exceptions:

**Table 9.3.5.2.1.4.3-1: PhysicalConfigDedicated-DEFAULT**

Derivation Path: 36.508 clause 5.5.1.2			
Information Element	Value/remark	Comment	Condition
PhysicalConfigDedicated-DEFAULT ::= SEQUENCE {			
cqi-ReportConfig	Not present		RBC
antennaInfo	Not present		RBC
antennaInfo-r10 CHOICE{			RBC
explicitValue-r10	AntennaInfoDedicated-r10		
}			
cqi-ReportConfig-r10	CQI-ReportConfig-r10-DEFAULT		RBC
csi-RS-Config-r10	CSI-RS-Config-r10		RBC
}			

Condition	Explanation
RBC	Used at configuration of a radio bearer combination during SRB2+DRB establishment

**Table 9.3.5.2.1.4.3-2: AntennaInfoDedicated-r10**

Derivation Path: 36.331 clause 6.3.2			
Information Element	Value/remark	Comment	Condition
AntennaInfoDedicated-r10 ::= SEQUENCE {			
transmissionMode-r10	tm9-v1020		
codebookSubsetRestriction-r10	001111		
ue-TransmitAntennaSelection CHOICE {			
release	NULL		
}			
}			

**Table 9.3.5.2.1.4.3-3: CQI-ReportConfig-r10-DEFAULT**

Derivation Path: 36.508 clause 4.6.3			
Information Element	Value/remark	Comment	Condition
CQI-ReportConfig-r10 ::= SEQUENCE {			
cqi-ReportAperiodic-r10	Not Present		
cqi-ReportPeriodic-r10	CQI-ReportPeriodic-r10-DEFAULT		
pmi-RI-Report-r9	setup		
}			



Table 9.3.5.2.1.4.3-4: CQI-ReportPeriodic-r10-DEFAULT

Derivation Path: 36.508 clause 4.6.3			
Information Element	Value/remark	Comment	Condition
CQI-ReportPeriodic-r10 ::= CHOICE {			
setup SEQUENCE {			
cqi-PUCCH-ResourceIndex-r10	0		
cqi-PUCCH-ResourceIndexP1-r10	Not present		
cqi-pmi-ConfigIndex	2		
cqi-FormatIndicatorPeriodic-r10 CHOICE {			
widebandCQI-r10 SEQUENCE {			
csi-ReportMode-r10	Not present		
}			
ri-ConfigIndex	1		
simultaneousAckNackAndCQI	FALSE		
}			
}			

Table 9.3.5.2.1.4.3-5: CSI-RS-Config

Derivation Path: 36.331 clause 6.3.2			
Information Element	Value/remark	Comment	Condition
CSI-RS-Config-r10 ::= SEQUENCE {			
csi-RS-r10 CHOICE{			
setup SEQUENCE {			
antennaPortsCount-r10	an2	Parameter represents the number of antenna ports used for transmission of CSI reference signals	
resourceConfig-r10	2	Parameter: CSI reference signal configuration	
subframeConfig-r10	1	$\Delta_{\text{CSI-RS}} = I_{\text{CSI-RS}}$ when CSI-RS SubframeConfig is from 0-4; Parameter: $I_{\text{CSI-RS}}$	
p-C-r10	0	Parameter: $P_c$ which is the assumed ratio of PDSCH EPRE to CSI-RS EPRE when UE derives CSI feedback	
}			
}			
zeroTxPowerCSI-RS-r10 CHOICE{			
release	NULL		
}			
}			

## 9.3.5.2.1.5

## Test requirement

Table 9.3.5.2.1.5-1: Test Parameters for fading test for single antenna (FDD)

Parameter	Unit	Cell 1	Cell 2
Bandwidth	MHz	10 MHz	
Transmission mode		9	
Cyclic Prefix		Normal	Normal
Cell ID		0	1
SINR (Note 8)	dB	-1.97	N/A
$N_{oc}^{(j)}$	dB[mW/15kHz]	-98	N/A
Propagation channel		EPA5	Static (Note 7)
Correlation and antenna configuration		Low (2 x 2)	(1 x 2)
DIP (Note 4)	dB	N/A	-0.38
Cell-specific reference signals		Antenna ports 0,1	Antenna port 0
CSI reference signals		Antenna ports 15,16	N/A
CSI-RS periodicity and subframe offset		5/1	N/A
CSI-RS reference signal configuration		2	N/A
Zero-power CSI-RS configuration $I_{CSI-RS}$ / ZeroPowerCSI-RS bitmap	Subframes / bitmap	N/A	1 / 00100000000000
CodeBookSubsetRestriction bitmap		001111	N/A
Reference measurement channel		Note 2	R.2 FDD
Reporting mode		PUCCH 1-1	N/A
Reporting periodicity	ms	$N_{pd} = 5$	N/A
CQI delay	ms	8	N/A
Physical channel for CQI/PMI reporting		PUSCH (Note 3)	N/A
PUCCH Report Type for CQI/PMI		2	N/A
PUCCH channel for RI reporting		PUCCH Format 2	N/A
PUCCH Report Type for RI		3	N/A
<i>cqi-pmi-ConfigurationIndex</i>		2	N/A
<i>ri-ConfigIndex</i>		1	N/A
Max number of HARQ transmissions		1	N/A
Note 1:	If the UE reports in an available uplink reporting instance at subframe SF#n based on CQI estimation at a downlink SF not later than SF#(n-4), this reported wideband CQI cannot be applied at the eNB downlink before SF#(n+4)		
Note 2:	Reference measurement channel RC.11 FDD according to Table A.4-1 with one sided dynamic OCNG Pattern OP.1 FDD as described in Annex A.5.1.1.		
Note 3:	To avoid collisions between CQI/ PMI reports and HARQ-ACK it is necessary to report both on PUSCH instead of PUCCH. PDCCH DCI format 0 shall be transmitted in downlink SF#1 and #6 to allow periodic CQI/ PMI to multiplex with the HARQ-ACK on PUSCH in uplink subframe SF#0 and #5.		
Note 4:	The respective received power spectral density of each interfering cell relative to $N_{oc}$ is defined by its associated DIP value as specified in clause B.5.1.		
Note 5:	Two cells are considered in which Cell 1 is the serving cell and Cell 2 is the interfering cell. Interfering cell is fully loaded.		
Note 6:	Both cells are time-synchronous.		

Note 7:	Static channel is used for the interference model. In case for white Gaussian noise model Cell 2 is not present.
Note 8:	SINR corresponds to $\hat{E}_s / N_{oc}$ of Cell 1 as defined in clause 8.1.1.

**Table 9.3.5.2.1.52:- Test requirement (FDD)**

$\gamma$	1.79
UE Category	2-8

### 9.3.5.2.2 TDD CQI Reporting under fading conditions - PUCCH 1-1 - Enhanced Performance Requirement Type A

**Editor's notes: This test case is incomplete. The following items are missing or are incomplete:**

**- Message contents are FFS**

#### 9.3.5.2.2.1 Test purpose

The purpose of the test is to verify that the reporting of the channel quality is based on the receiver of the enhanced Type A. Performance requirements are specified in terms of the relative increase of the throughput obtained when the transport format is that indicated by the reported CQI subject to an interference model compared to the case with a white Gaussian noise model, and a requirement on the minimum BLER of the transmitted transport formats indicated by the reported CQI subject to an interference model.

#### 9.3.5.2.2.2 Test applicability

This test applies to all types of E-UTRA TDD UE release 11 and forward of Category 2-8 that support enhanced receiver Type A.

#### 9.3.5.2.2.3 Minimum conformance requirements

For the parameters specified in Table 9.3.5.2.2.3-1, and using the downlink physical channels specified in Annex C, the minimum requirements are specified in 9.3.5.2.2.3-2 and by the following

- the ratio of the throughput obtained when transmitting the transport format indicated by each reported wideband CQI index subject to an interference source with specified DIP and that obtained when transmitting the transport format indicated by each reported wideband CQI index subject to a white Gaussian noise source shall be  $\geq \gamma$ ;
- when transmitting the transport format indicated by each reported wideband CQI index subject to an interference source with specified DIP, the average BLER for the indicated transport formats shall be greater than or equal to 2%.

Table 9.3.5.2.2.3-1: Fading test for single antenna (TDD)

Parameter	Unit	Cell 1	Cell 2
Bandwidth	MHz	10 MHz	
Transmission mode		9	
Uplink downlink configuration		2	
Special subframe configuration		4	
Cyclic Prefix		Normal	Normal
Cell ID		0	1
SINR (Note 8)	dB	-2	N/A
$N_{oc}^{(j)}$	dB[mW/15kHz]	-98	-98
Propagation channel		EPA5	Static (Note 7)
Correlation and antenna configuration		Low (2 x 2)	(1 x 2)
DIP (Note 4)	dB	N/A	-0.41
Cell-specific reference signals		Antenna ports 0,1	Antenna port 0
CSI reference signals		Antenna ports 15,16	N/A
CSI-RS periodicity and subframe offset		5/3	N/A
CSI-RS reference signal configuration		2	N/A
Zero-power CSI-RS configuration $I_{CSI-RS}$ / ZeroPowerCSI-RS bitmap	Subframes / bitmap	N/A	3 / 001000000000 0000
CodeBookSubsetRestriction bitmap		001111	N/A
Reference measurement channel		Note 2	R.2 TDD
Reporting mode		PUCCH 1-1 (Sub-mode: 2)	N/A
Reporting periodicity	ms	$N_{pd} = 5$	N/A
CQI delay	ms	10	N/A
Physical channel for CQI/PMI reporting		PUSCH (Note 3)	N/A
PUCCH Report Type for CQI/PMI		2c	N/A
Physical channel for RI reporting		PUCCH Format 2	N/A
PUCCH Report Type for RI		3	N/A
<i>cqi-pmi-ConfigurationIndex</i>		3	N/A
<i>ri-ConfigIndex</i>		805 (Note 9)	N/A
Max number of HARQ transmissions		1	N/A
ACK/NACK feedback mode		Multiplexing	N/A
Note 1:	If the UE reports in an available uplink reporting instance at subframe SF#n based on CQI estimation at a downlink SF not later than SF#(n-4), this reported wideband CQI cannot be applied at the eNB downlink before SF#(n+4)		
Note 2:	Reference measurement channel RC.11 TDD according to Table A.4-1 with one sided dynamic OCNG Pattern OP.1 TDD as described in Annex A.5.2.1.		
Note 3:	To avoid collisions between CQI/ PMI reports and HARQ-ACK it is necessary to report both on PUSCH instead of PUCCH. PDCCH DCI format 0 shall be transmitted in downlink SF#3 and #8 to allow periodic CQI/ PMI to multiplex with the HARQ-ACK on PUSCH in uplink subframe SF#2 and #7.		
Note 4:	The respective received power spectral density of each interfering		

	cell relative to $N_{oc}$ is defined by its associated DIP value as specified in clause B.5.1.
Note 5:	Two cells are considered in which Cell 1 is the serving cell and Cell 2 is the interfering cell. Interfering cell is fully loaded.
Note 6:	Both cells are time-synchronous.
Note 7:	Static channel is used for the interference model. In case for white Gaussian noise model Cell 2 is not present.
Note 8:	SINR corresponds to $\hat{E}_s/N_{oc}$ of Cell 1 as defined in clause 8.1.1.
Note 9:	RI reporting interval is set to the maximum allowable length of 160ms to minimise collisions between RI, CQI/PMI and HARQ-ACK reports. In the case when all three reports collide, it is expected that CQI/PMI reports will be dropped, while RI and HARQ-ACK will be multiplexed. At eNB, CQI report collection shall be skipped every 160ms during performance verification and the reported CQI in subframe SF#7 of the previous frame is applied in downlink subframes until a new CQI (after CQI/PMI dropping) is available.

**Table 9.3.5.2.3-2: Minimum requirement (TDD)**

$\gamma$	1.8
UE Category	2-8

The normative reference for this requirement is TS 36.101 [2] clause 9.3.5.2.2.

#### 9.3.5.2.2.4 Test description

##### 9.3.5.2.2.4.1 Initial conditions

Initial conditions are a set of test configurations the UE needs to be tested in and the steps for the SS to take with the UE to reach the correct measurement state.

Configurations of PDSCH and PDCCH before measurement are specified in Annex C.2.

Test Environment: Normal as defined in TS 36.508 [7] clause 4.1.

Frequencies to be tested: Mid Range as defined in TS 36.508 [7] clause 4.3.1.1.

Channel Bandwidths to be tested: 10MHz, as defined in TS 36.508 [7] clause 4.3.1.1

1. Connect the SS and faders to the UE antenna connector (s) as shown in TS 36.508 [7] Annex A, Figure A.51.
2. The parameter settings for the cell 1 are set up according to Table 9.3.5.2.2.5-1.
3. Downlink signals are initially set up according to Annex C.1 and Annex C.3.2, and uplink signals according to Annex H.1 and H.3.2.
4. Propagation conditions are set according to Annex B.0.
5. Ensure the UE is in State 3A-RF according to TS 36.508 [7] clause 5.2A.2. Message contents are defined in clause 9.3.5.2.2.4.3.

##### 9.3.5.2.2.4.2 Test procedure

1. Set the cell 1 and 2 parameters of bandwidth, the propagation condition, antenna configuration and measurement channel according to Table 9.3.5.2.2.5-1 as appropriate.
2. The SS shall transmit PDSCH via PDCCH DCI format 1A for C\_RNTI to transmit the DL RMC according to the wideband CQI value reported from UE. The SS sends downlink MAC padding bits on the DL RMC. The SS sends uplink scheduling information via PDCCH DCI format 0 with CQI request bit set to 0 to schedule UL RMC in subframe #2 and subframe #7 (Table A.4.1-2). The UE will send ACK/NACK and periodic CQI report using PUSCH. Measure the average throughput according to Annex G.5.3. Declare the throughput as

$t_{\text{wideband\_interference}}$  · The responses are then filtered as follows: for the sequence of responses for each HARQ process, discard all the statDTX responses.

3. Deactivate i.e., stop transmitting anything from the cell 2 and set the cell 1 parameters of bandwidth, the propagation condition, antenna configuration and measurement channel according to Table 9.3.5.2.2.5-1 as appropriate.
4. The SS shall transmit PDSCH via PDCCH DCI format 1A for C\_RNTI to transmit the DL RMC according to the wideband CQI value reported from UE. The SS sends downlink MAC padding bits on the DL RMC. The SS sends uplink scheduling information via PDCCH DCI format 0 with CQI request bit set to 0 to schedule UL RMC in subframe #2 and subframe #7 (Table A.4.1-2). The UE will send ACK/NACK and periodic CQI report using PUSCH. Measure the average throughput according to Annex G.5.3. Declare the throughput as

$t_{\text{wideband\_gaussian\_noise}}$  ·

5. If the ratio ( $t_{\text{wideband\_interference}} / t_{\text{wideband\_gaussian\_noise}}$ )  $\geq \gamma$  in Table 9.3.5.2.2.5-2 and ratio (NACK / (ACK + NACK)) calculated in step 2 is greater or equal to 0.02, then pass the UE for this test. Otherwise fail the UE.

#### 9.3.5.2.2.4.3 Message contents

Message contents are according to TS 36.508 [7] clause 4.6 with the following exceptions:

FFS

## 9.3.5.2.2.5

## Test requirement

Table 9.3.5.2.2.5-1: Test parameters for fading test for single antenna (TDD)

Parameter	Unit	Cell 1	Cell 2
Bandwidth	MHz	10 MHz	
Transmission mode		9	
Uplink downlink configuration		2	
Special subframe configuration		4	
Cyclic Prefix		Normal	Normal
Cell ID		0	1
SINR (Note 8)	dB	-1.97	N/A
$N_{oc}^{(j)}$	dB[mW/15kHz]	-98	-98
Propagation channel		EPA5	Static (Note 7)
Correlation and antenna configuration		Low (2 x 2)	(1 x 2)
DIP (Note 4)	dB	N/A	-0.38
Cell-specific reference signals		Antenna ports 0,1	Antenna port 0
CSI reference signals		Antenna ports 15,16	N/A
CSI-RS periodicity and subframe offset		5/3	N/A
CSI-RS reference signal configuration		2	N/A
Zero-power CSI-RS configuration $I_{CSI-RS}$ / ZeroPowerCSI-RS bitmap	Subframes / bitmap	N/A	3 / 001000000000 0000
CodeBookSubsetRestriction bitmap		001111	N/A
Reference measurement channel		Note 2	R.2 TDD
Reporting mode		PUCCH 1-1 (Sub-mode: 2)	N/A
Reporting periodicity	ms	$N_{pd} = 5$	N/A
CQI delay	ms	10	N/A
Physical channel for CQI/PMI reporting		PUSCH (Note 3)	N/A
PUCCH Report Type for CQI/PMI		2c	N/A
Physical channel for RI reporting		PUCCH Format 2	N/A
PUCCH Report Type for RI		3	N/A
<i>cqi-pmi-ConfigurationIndex</i>		3	N/A
<i>ri-ConfigIndex</i>		805 (Note 9)	N/A
Max number of HARQ transmissions		1	N/A
ACK/NACK feedback mode		Multiplexing	N/A
Note 1:	If the UE reports in an available uplink reporting instance at subframe SF#n based on CQI estimation at a downlink SF not later than SF#(n-4), this reported wideband CQI cannot be applied at the eNB downlink before SF#(n+4)		
Note 2:	Reference measurement channel RC.11 TDD according to Table A.4-1 with one sided dynamic OCNG Pattern OP.1 TDD as described in Annex A.5.2.1.		
Note 3:	To avoid collisions between CQI/ PMI reports and HARQ-ACK it is necessary to report both on PUSCH instead of PUCCH. PDCCH DCI format 0 shall be transmitted in downlink SF#3 and #8 to allow periodic CQI/ PMI to multiplex with the HARQ-ACK on PUSCH in		

Note 4:	uplink subframe SF#2 and #7. The respective received power spectral density of each interfering cell relative to $N_{oc}$ is defined by its associated DIP value as specified in clause B.5.1.
Note 5:	Two cells are considered in which Cell 1 is the serving cell and Cell 2 is the interfering cell. Interfering cell is fully loaded.
Note 6:	Both cells are time-synchronous.
Note 7:	Static channel is used for the interference model. In case for white Gaussian noise model Cell 2 is not present.
Note 8:	SINR corresponds to $\widehat{E}_s / N_{oc}$ of Cell 1 as defined in clause 8.1.1.
Note 9:	RI reporting interval is set to the maximum allowable length of 160ms to minimise collisions between RI, CQI/PMI and HARQ-ACK reports. In the case when all three reports collide, it is expected that CQI/PMI reports will be dropped, while RI and HARQ-ACK will be multiplexed. At eNB, CQI report collection shall be skipped every 160ms during performance verification and the reported CQI in subframe SF#7 of the previous frame is applied in downlink subframes until a new CQI (after CQI/PMI dropping) is available.

**Table 9.3.5.2.2.5-2: Minimum requirement (TDD)**

$\gamma$	179.
UE Category	2-8

## 9.3.6 CQI Reporting under fading conditions (With multiple CSI processes)

### 9.3.6.1\_F FDD CQI Reporting under fading conditions with CSI processes for CoMP

#### 9.3.6.1\_F.1 FDD CQI Reporting under fading conditions with Single CSI process for CoMP

##### 9.3.6.1\_F.1.1 Test purpose

The purpose of the test is to verify the reporting accuracy of the CQI and the UE processing capability for single CSI process.

##### 9.3.6.1\_F.1.2 Test applicability

This test applies to all types of E-UTRA FDD UEs release 11 and forward, supporting Maximum CSI processes of One on a component carrier within a band with PDSCH transmission mode 10.

##### 9.3.6.1\_F.1.3 Minimum conformance requirements

Each CSI process is associated with a CSI-RS resource and a CSI-IM resource as shown in Table 9.3.6.1\_F.1.3-1. For UE supports one CSI process, CSI process 2 is configured and the corresponding requirements shall be fulfilled. For UE supports three CSI processes, CSI processes 0, 1 and 2 are configured and the corresponding requirements shall be fulfilled. For UE supports four CSI processes, CSI processes 0, 1, 2 and 3 are configured and the corresponding requirements shall be fulfilled. And the Table 9.3.6.1\_F.1.3-1 is valid for FDD and TDD.

**Table 9.3.6.1\_F.1.3-1: Configuration of CSI processes**

	CSI process 0	CSI process 1	CSI process 2	CSI process 3
CSI-RS resource	CSI-RS signal 0	CSI-RS signal 1	CSI-RS signal 0	CSI-RS signal 1
CSI-IM resource	CSI-IM resource 0	CSI-IM resource 0	CSI-IM resource 1	CSI-IM resource 2

For the parameters specified in Table 9.3.6.1\_F.1.3-2, and using the downlink physical channels specified in Annex C.3.2, the minimum requirements are specified in Table 9.3.6.1\_F.1.3-3 and by the following:



- a) a sub-band differential CQI offset level of 0 shall be reported at least  $\alpha\%$  of the time but less than  $\beta\%$  for each sub-band for CSI process 1, 2, or 3;
- b) a CQI index not in the set {median CQI -1, median CQI, median CQI +1} shall be reported at least  $\delta\%$  of the time for CSI process 0;
- c) the difference of the median CQIs of the reported wideband CQI for configured CSI processes shall be greater or equal to the values as in Table 9.3.6.1\_F.1.3-4;
- d) the ratio of the throughput obtained when transmitting on a randomly selected sub-band among the sub-bands with the highest differential CQI offset level the corresponding TBS and that obtained when transmitting the TBS indicated by the reported wideband CQI median on a randomly selected sub-band in set  $S$  shall be  $\geq \gamma$ ;
- e) when transmitting on a randomly selected sub-band among the sub-bands with the highest differential CQI offset level the corresponding TBS, the average BLER for the indicated transport formats shall be greater or equal to 0.02.

The requirements only apply for sub-bands of full size and the random scheduling across the sub-bands is done by selecting a new sub-band in each TTI for FDD, each available downlink transmission instance for TDD. Sub-bands of a size smaller than full size are excluded from the test.

Table 9.3.6.1\_F.1.3-2: Fading test for FDD

Parameter		Unit	Test 1				Test 2			
			TP1		TP2		TP1		TP2	
Bandwidth		MHz	10 MHz				10 MHz			
Transmission mode			10		10		10		10	
Downlink power allocation	$\rho_A$	dB	0				0			
	$\rho_B$	dB	0				0			
	$P_c$	dB	-3		0		-3		0	
	$\sigma$	dB	-3				-3			
SNR (Note 7)		dB	10	11	7	8	14	15	9	10
$\hat{I}_{or}^{(j)}$		dB[mW/15kHz]	-88	-87	-91	-90	-84	-85	-89	-88
$N_{oc}^{(j)}$		dB[mW/15kHz]	-98				-98			
Propagation channel			EPA 5 Low		Clause B.2.4.1 with $\tau_d = 0.45 \mu s$ , $a = 1$ , $f_D = 5 \text{ Hz}$		EPA 5 Low		Clause B.2.4.1 with $\tau_d = 0.45 \mu s$ , $a = 1$ , $f_D = 5 \text{ Hz}$	
Antenna configuration			4x2		2x2		4x2		2x2	
Beamforming Model			As specified in Section B.4.3				As specified in Section B.4.3			
Timing offset between TPs		us	0				0			
Frequency offset between TPs		Hz	0				0			
Cell-specific reference signals			Antenna ports 0,1				Antenna ports 0,1			
CSI-RS signal 0			Antenna ports 15,...,18		N/A		Antenna ports 15,...,18		N/A	
CSI-RS 0 periodicity and subframe offset $T_{\text{CSI-RS}} / \Delta_{\text{CSI-RS}}$			5/1		N/A		5/1		N/A	
CSI-RS 0 configuration			0		N/A		0		N/A	
CSI-RS signal 1			N/A		Antenna ports 15,16		N/A		Antenna ports 15,16	
CSI-RS 1 periodicity and subframe offset $T_{\text{CSI-RS}} / \Delta_{\text{CSI-RS}}$			N/A		5/1		N/A		5/1	
CSI-RS 1 configuration			N/A		5		N/A		5	
Zero-power CSI-RS 0 configuration $I_{\text{CSI-RS}} / \text{ZeroPowerCSI-RS}$ bitmap			N/A		1 / 111000000000 0000		N/A		1 / 111000000000 0000	
Zero-power CSI-RS 1 configuration $I_{\text{CSI-RS}} / \text{ZeroPowerCSI-RS}$ bitmap			1 / 00100110000 00000		N/A		1 / 00100110000 00000		N/A	
CSI-IM 0 periodicity and subframe offset $T_{\text{CSI-IM}} / \Delta_{\text{CSI-IM}}$			5/1		5/1		5/1		5/1	
CSI-IM 0 configuration			2		2		2		2	
CSI-IM 1 periodicity and subframe offset $T_{\text{CSI-IM}} / \Delta_{\text{CSI-IM}}$			5/1		N/A		5/1		N/A	
CSI-IM 1 configuration			6		N/A		6		N/A	
CSI-IM 2 periodicity and subframe offset $T_{\text{CSI-IM}} / \Delta_{\text{CSI-IM}}$			N/A		5/1		N/A		5/1	
CSI-IM 2 configuration			N/A		1		N/A		1	
CSI process 0	CSI-RS		CSI-RS 0				CSI-RS 0			
	CSI-IM		CSI-IM 0				CSI-IM 0			
	Reporting mode		PUCCH 1-1				PUCCH 1-1			
	CodeBookSubsetRestriction bitmap		0x0000 0000 0000 0001				0x0000 0000 0000 0001			
	Reporting periodicity	ms	$N_{pd} = 5$				$N_{pd} = 5$			
	CQI delay	ms	10				10			
	Physical channel for CQI/ PMI reporting		PUSCH (Note 6)				PUSCH (Note 6)			
	PUCCH Report Type for CQI/PMI		2				2			
	PUCCH channel		PUCCH Format 2				PUCCH Format 2			

	for RI reporting				
	PUCCH report type for RI		3		3
	<i>cqi-pmi-ConfigurationIndex</i>		2		2
	<i>ri-ConfigIndex</i>		1		1
CSI process 1	CSI-RS		CSI-RS 1		CSI-RS 1
	CSI-IM		CSI-IM 0		CSI-IM 0
	Reporting mode		PUSCH 3-1		PUSCH 3-1
	CodeBookSubsetRestriction bitmap		000001		000001
	Reporting interval (Note 9)	ms	5		5
	CQI delay	ms	10		10
	Sub-band size	RB	6 (full size)		6 (full size)
CSI process 2	CSI-RS		CSI-RS 0		CSI-RS 0
	CSI-IM		CSI-IM 1		CSI-IM 1
	Reporting mode		PUSCH 3-1		PUSCH 3-1
	CodeBookSubsetRestriction bitmap		0x0000 0000 0000 0001		0x0000 0000 0000 0001
	Reporting interval (Note 9)	ms	5		5
	CQI delay	ms	10		10
	Sub-band size	RB	6 (full size) (Note 8)		6 (full size) (Note 8)
CSI process 3	CSI-RS		CSI-RS 1		CSI-RS 1
	CSI-IM		CSI-IM 2		CSI-IM 2
	Reporting mode		PUSCH 3-1		PUSCH 3-1
	CodeBookSubsetRestriction bitmap		000001		000001
	Reporting interval (Note 9)	ms	5		5
	CQI delay	ms	10		10
	Sub-band size	RB	6 (full size)		6 (full size)
CSI process for PDSCH scheduling			CSI process 2		CSI process 2
Cell ID		0	6	0	6
Quasi-co-located CSI-RS		CSI-RS 0	CSI-RS 1	CSI-RS 0	CSI-RS 1
Quasi-co-located CRS		Same Cell ID as Cell 1	Same Cell ID as Cell 2	Same Cell ID as Cell 1	Same Cell ID as Cell 2
PMI for subframe 2, 3, 4, 7, 8 and 9		0x0000 0000 0000 0001	100000	0x0000 0000 0000 0001	100000
PMI for subframe 1 and 6		0x0000 0000 0001 0000	100000	0x0000 0000 0001 0000	100000
Max number of HARQ transmissions		1	N/A	1	N/A
Note 1:	If the UE reports in an available uplink reporting instance at subframe SF#n based on CQI estimation at a downlink SF not later than SF#(n-4), this reported wideband CQI cannot be applied at the eNB downlink before SF#(n+4)				
Note 2:	3 symbols allocated to PDCCH.				
Note 3:	Reference measurement channel RC.12 FDD according to Table A.4-1. PDSCH transmission is scheduled on subframe 2, 3, 4, 7, 8 and 9 from TP1.				
Note 4:	TM10 OCNG as specified in A.5.1.8 is transmitted on subframe 1 and 6 from TP1.				
Note 5:	TM10 OCNG as specified in A.5.1.8 is transmitted on subframe 1, 2, 3, 4, 6, 7, 8 and 9 from TP2.				
Note 6:	To avoid collisions between CQI/PMI reports and HARQ-ACK it is necessary to report both on PUSCH instead of PUCCH. PDCCH DCI format 0 shall be transmitted in downlink SF#1 and #6 to allow periodic CQI/PMI to multiplex with the HARQ-ACK on PUSCH in uplink SF#0 and #5.				
Note 7:	For each test, the minimum requirements shall be fulfilled for at least one of the two SNR(s) and the respective wanted signal input level.				
Note 8:	PDCCH DCI format 0 with a trigger for aperiodic CQI shall be transmitted in downlink SF#1 and #6 to allow aperiodic CQI/PMI/RI to be transmitted in uplink SF#0 and #5.				
Note 9:	For these sub-bands which are not selected for PDSCH transmission, TM10 OCNG should be transmitted.				

**Table 9.3.6.1\_F.1.3-3: Minimum requirement (FDD)**

	CSI process 0	CSI process 1	CSI process 2	CSI process 3
$\alpha$ [%]	N/A	2	2	2
$\beta$ [%]	N/A	40	40	40
$\delta$ [%]	10	N/A	N/A	N/A
$\gamma$	N/A	N/A	1.02	N/A
UE Category	$\geq 1$			

**Table 9.3.6.1\_F.1.3-4: Minimum median CQI difference between configured CSI processes (FDD)**

	CSI process 1	CSI process 2	CSI process 3
CSI process 0	N/A	1	3
UE Category	$\geq 1$		

The normative reference for this requirement is TS 36.101 [2] clause 9.3.6.1.

#### 9.3.6.1\_F.1.4 Test description

##### 9.3.6.1\_F.1.4.1 Initial conditions

Initial conditions are a set of test configurations the UE needs to be tested in and the steps for the SS to take with the UE to reach the correct measurement state.

Configurations of PDSCH and PDCCH before measurement are specified in Annex C.2.

Test Environment: Normal as defined in TS 36.508 [7] clause 4.1.

Frequencies to be tested: Mid Range as defined in TS 36.508 [7] clause 4.3.1.1.

Channel Bandwidths to be tested: 10MHz, as defined in TS 36.508 [7] clause 4.3.1.1

1. Connect the SS, faders and AWGN noise source to the UE antenna connector (s) as shown in TS 36.508 [7] Annex A, Figure A.52.
2. The parameter settings for the cell are set up according to Table 9.3.6.1\_F.1.3-2.
3. Downlink signals are initially set up according to Annex C.0, C.1 and Annex C.3.2, and uplink signals according to Annex H.1 and H.3.2.
4. Propagation conditions are set according to Annex B.0.
5. Ensure the UE is in State 3A-RF according to TS 36.508 [7] clause 5.2A.2. Message contents are defined in clause 9.3.6.1\_F.1.4.3.

##### 9.3.6.1\_F.1.4.2 Test procedure

1. Set the parameters of bandwidth, reference Channel, the propagation condition, antenna configuration and the SNR according to Table 9.3.6.1\_F.1.3-2 as appropriate.
2. The SS shall transmit PDSCH via PDCCH DCI format 2D for C\_RNTI to transmit the DL RMC according to CQI value 8 and keep it regardless of the wideband and subband CQI value sent by the UE. Continue transmission of the PDSCH until 2000 wideband CQI reports and full-size subband CQI reports for each full-size subband have been gathered for CSI process 2. The SS sends downlink MAC padding bits on the DL RMC. SS schedules the UL transmission in subframe #0 and subframe #5 to carry the PUSCH CQI feedback for CSI process 2 via PDCCH DCI format 0 with CQI request bit set to 1 and I\_MCS=29 and N\_PRB allocated to be less or equal to 4. In this process the SS collects wideband CQI reports every 5 ms and also cases where UE transmits nothing in its CQI timing are counted as wideband CQI and full-size subband CQI reports.
3. Set up a relative frequency distribution for the reported wideband CQI-values, Calculate the median value (wideband Median CQI is the CQI that is at or crosses 50% distribution from the lower wideband CQI side). This CQI-value is declared as wideband Median CQI value.

4. Check if “ $2000 * \alpha \% / 100 \leq$  number of CQI reports with index 0 for each full-size subband  $\leq 2000 * \beta \% / 100$ ” for CSI process 2. (2000= No of full-size subband reports, 100 because of %) If yes, continue with step5, otherwise goto step 7.
5. The SS shall transmit PDSCH via PDCCH DCI format 2D for C\_RNTI to transmit the DL RMC according to the wideband median-CQI value in an each TTI randomly selected full-size subband regardless of UE wideband and full-size subband CQI report based on CSI process 2. Note that each full-size subband is selected in equal probability. The SS sends downlink MAC padding bits on the DL RMC. SS schedules the UL transmission in subframe #0 and subframe #5 to carry the PUSCH CQI feedback via PDCCH DCI format 0 with CQI request bit set to 1 and I\_MCS=29 and N\_PRB allocated to be less or equal to 4. Measure the average throughput according to Annex G.5.3. Declare the throughput as  $t_{median}$ .
6. The SS shall transmit PDSCH via PDCCH DCI format 2D for C\_RNTI to transmit the DL RMC according to the highest UE reported full-size subband CQI value in one full-size subband selected among the subbands in which UE reports the highest full-size subband CQI based on CSI process 2. Subband differential CQI offset level is selected from {0, 1, 2, -1}. Note that the SS shall send PDSCH in the same full-size subband until next UE report is available. In case when same full-size subbands are reported subsequently as subbands with highest full-size subband CQI, the SS shall select for transmission a different subband with respect to the last selection. The SS sends downlink MAC padding bits on the DL RMC. SS schedules the UL transmission in subframe #0 and subframe #5 to carry the PUSCH CQI feedback via PDCCH DCI format 0 with CQI request bit set to 1 and I\_MCS=29 and N\_PRB allocated to be less or equal to 4. Measure the average throughput and (NACK / (ACK + NACK)) according to Annex G.5.3. Declare the throughput as  $t_{subband}$ . If the ratio  $(t_{subband} / t_{median}) \geq \gamma$  and (NACK / (ACK + NACK))  $\geq 0.02$ , pass the UE for this test and go to step 8. Otherwise, go to step 7.
7. If both SNR points of the test have not been tested, then repeat the same procedure (steps 1 to 6) for the other SNR point as appropriate. Otherwise fail the UE.
8. If both tests have not been done, then repeat the same procedure (steps 1 to 7) with test conditions according to the table 9.3.6.1\_F.1.3-2 for the other Test as appropriate. Otherwise pass the UE.

#### 9.3.6.1\_F.1.4.3 Message contents

Message contents are according to TS 36.508 [7] clause 4.6 with the following exception:

Table 9.3.6.1\_F.1.4.3-1: CQI-ReportConfig-v1130-DEFAULT

Derivation Path: 36.508 clause 4.6.3, Table 4.6.3-2ABA			
Information Element	Value/remark	Comment	Condition
CQI-ReportConfig-v1130 ::= SEQUENCE {			
cqi-ReportPeriodic-v1130 SEQUENCE {			
simultaneousAckNackAndCQI-Format3-r11	Not present	PUCCH Format 2	
cqi-ReportPeriodicProcExtToReleaseList-r11	Not present		
cqi-ReportPeriodicProcExtToAddModList-r11	1 entry		
SEQUENCE (SIZE (1..maxCQI-ProcExt-r11)) OF SEQUENCE {			
cqi-ReportPeriodicProcExtId-r11[1] SEQUENCE {			
cqi-ReportPeriodicProcExtId-r11	1		
cqi-pmi-ConfigIndex-r11	2		
cqi-FormatIndicatorPeriodic-r11 CHOICE {			
widebandCQI-r11 SEQUENCE {			
csi-ReportMode-r11	submode1		
}			
subbandCQI-r11	Not present	PUCCH 1-1	
}			
ri-ConfigIndex-r11	1		
csi-ConfigIndex-r11	Not present		
}			
}			
cqi-ReportBoth-r11 SEQUENCE {			
csi-IM-ConfigToReleaseList-r11	Not present		
csi-IM-ConfigToAddModList-r11 SEQUENCE (SIZE (1..maxCSI-IM-r11)) OF SEQUENCE {	1 entry		
csi-IM-ConfigId-r11[1]	2	CSI-IM 1	
resourceConfig-r11[1]	6		
subframeConfig-r11[1]	1		
}			
csi-ProcessToReleaseList-r11	Not present		
csi-ProcessToAddModList-r11 SEQUENCE (SIZE (1..maxCSI-Proc-r11)) OF SEQUENCE {	1 entry		
csi-ProcessId-r11[1]	3	CSI process 2	
csi-RS-ConfigNZPId-r11[1]	1		
csi-IM-ConfigId-r11[1]	2		
p-C-AndCBSRList-r11[1] SEQUENCE (SIZE (1..2)) OF SEQUENCE {	1 entry		
p-C-r11[1]	-3		
codebookSubsetRestriction-r11[1]	0x0000 0000 0000 0001		
}			
cqi-ReportBothProc-r11[1] SEQUENCE {			
ri-Ref-CSI-ProcessId-r11	3		
pmi-RI-Report-r11	setup		
}			
cqi-ReportPeriodicProcId-r11[1]	Not present		
cqi-ReportAperiodicProc-r11[1] SEQUENCE {			
cqi-ReportModeAperiodic-r11	rm31		
trigger01-r11	1		
trigger10-r11	1		
trigger11-r11	1		
}			
}			
}			
}			
}			

**Table 9.3.6.1\_F.1.4.3-2: PhysicalConfigDedicated-DEFAULT**

Derivation Path: 36.331 clause 6.3.2			
Information Element	Value/remark	Comment	Condition
PhysicalConfigDedicated ::= SEQUENCE {			
csi-RS-ConfigNZPToAddModList-r11 SEQUENCE (SIZE (1..maxCSI-RS-NZP-r11)) OF SEQUENCE {	1 entry		
csi-RS-ConfigNZPId-r11[1]	1	CSI-RS signal 0	
antennaPortsCount-r11[1]	an4		
resourceConfig-r11[1]	0		
subframeConfig-r11[1]	1		
qcl-CRS-Info-r11 SEQUENCE[1] {			
crs-PortsCount-r11[1]	n2		
mbsfn-SubframeConfigList-r11 CHOICE[1]	Not present		
}			
}			
csi-RS-ConfigZPToAddModList-r11 SEQUENCE (SIZE (1..maxCSI-RS-ZP-r11)) OF SEQUENCE {			
csi-RS-ConfigZPId-r11[1]	1	Zero-power CSI-RS 0	
resourceConfigList-r11[1]	1110000000000000	For TP2	
subframeConfig-r11[1]	1		
csi-RS-ConfigZPId-r11[2]	2	Zero-power CSI-RS 1	
resourceConfigList-r11[2]	0010011000000000	For TP1	
subframeConfig-r11[2]	1		
}			
}			

## 9.3.6.1\_F.1.5 Test requirement

**Table 9.3.6.1\_F.1.5-1: Test requirement (FDD)**

	CSI process 2
$\alpha$ [%]	2
$\beta$ [%]	40
$\delta$ [%]	N/A
$\gamma$	1.01
UE Category	$\geq 1$

To pass the test,  $\alpha$  and  $\beta$  and  $\delta$  and  $\gamma$  and BLER must be fulfilled.

To pass the test, Test 1 and Test 2 must be passed.

To pass the test, one or the other SNR point within one test must be fulfilled.

## 9.3.6.1\_F.2 FDD CQI Reporting under fading conditions with Three CSI processes for CoMP

## 9.3.6.1\_F.2.1 Test purpose

The purpose of the test is to verify the reporting accuracy of the CQI and the UE processing capability for Three CSI processes.

## 9.3.6.1\_F.2.2 Test applicability

This test applies to all types of E-UTRA FDD UEs release 11 and forward, supporting Maximum CSI processes of Three on a component carrier within a band with PDSCH transmission mode 10.

## 9.3.6.1\_F.2.3 Minimum conformance requirements

Same minimum conformance requirements as in clause 9.3.6.1\_F.1.3.

### 9.3.6.1\_F.2.4 Test description

#### 9.3.6.1\_F.2.4.1 Initial conditions

Initial conditions are a set of test configurations the UE needs to be tested in and the steps for the SS to take with the UE to reach the correct measurement state.

Configurations of PDSCH and PDCCH before measurement are specified in Annex C.2.

Test Environment: Normal as defined in TS 36.508 [7] clause 4.1.

Frequencies to be tested: Mid Range as defined in TS 36.508 [7] clause 4.3.1.1.

Channel Bandwidths to be tested: 10MHz, as defined in TS 36.508 [7] clause 4.3.1.1

1. Connect the SS, faders and AWGN noise source to the UE antenna connector (s) as shown in TS 36.508 [7] Annex A, Figure A.52.
2. The parameter settings for the cell are set up according to Table 9.3.6.1\_F.1.3-2.
3. Downlink signals are initially set up according to Annex C.0, C.1 and Annex C.3.2, and uplink signals according to Annex H.1 and H.3.2.
4. Propagation conditions are set according to Annex B.0.
5. Ensure the UE is in State 3A-RF according to TS 36.508 [7] clause 5.2A.2. Message contents are defined in clause 9.3.6.1\_F.2.4.3.

#### 9.3.6.1\_F.2.4.2 Test procedure

1. Set the parameters of bandwidth, reference Channel, the propagation condition, antenna configuration and the SNR according to Table 9.3.6.1\_F.1.3-2 as appropriate.
2. The SS shall transmit PDSCH via PDCCH DCI format 2D for C\_RNTI to transmit the DL RMC according to CQI value 8 and keep it regardless of the wideband and subband CQI value sent by the UE. Continue transmission of the PDSCH until 2000 wideband CQI reports and full-size subband CQI reports for each full-size subband have been gathered for each of CSI process 0, 1 and 2. The SS sends downlink MAC padding bits on the DL RMC. SS schedules the UL transmission in subframe #0 and subframe #5 to carry the PUSCH CQI feedback for CSI process 1 and 2 via PDCCH DCI format 0 with CQI request bit set to 1 and I\_MCS=29 and N\_PRB allocated to be less or equal to 4. But for CSI process 0, SS schedules the UL transmission in subframe #0 and subframe #5 to carry the PUCCH CQI feedback. In this process the SS collects wideband CQI reports every 5 ms and also cases where UE transmits nothing in its CQI timing are counted as wideband CQI and full-size subband CQI reports.
3. Set up a relative frequency distribution for the reported wideband CQI-values, Calculate the median value (wideband Median CQI is the CQI that is at or crosses 50% distribution from the lower wideband CQI side). This CQI-value is declared as wideband Median CQI value.
4. Check if " $2000 \cdot \alpha \% / 100 \leq \text{number of CQI reports with index } 0 \text{ for each full-size subband} \leq 2000 \cdot \beta \% / 100$ " for CSI process 1 and 2. And check if the number of CQI index not in the set {median CQI -1, median CQI, median CQI +1} shall be reported at least  $2000 \cdot \delta \% / 100$  for CSI process 0. And check if the difference of the median CQIs of the reported wideband CQI for configured CSI processes 0, 1 and 2 shall be greater or equal to the values as in Table 9.3.6.1\_F.2.5-2. ( $2000 = \text{No of full-size subband reports, } 100 \text{ because of } \%$ ). If yes, continue with step 5, otherwise goto step 7.
5. The SS shall transmit PDSCH via PDCCH DCI format 2D for C\_RNTI to transmit the DL RMC according to the wideband median-CQI value in an each TTI randomly selected full-size subband regardless of UE wideband and full-size subband CQI report based on CSI process 2. Note that each full-size subband is selected in equal probability. The SS sends downlink MAC padding bits on the DL RMC. SS schedules the UL transmission in subframe #0 and subframe #5 to carry the PUSCH CQI feedback via PDCCH DCI format 0 with CQI request bit set to 1 and I\_MCS=29 and N\_PRB allocated to be less or equal to 4. Measure the average throughput according to Annex G.5.3. Declare the throughput as  $t_{median}$ .



6. The SS shall transmit PDSCH via PDCCH DCI format 2D for C\_RNTI to transmit the DL RMC according to the highest UE reported full-size subband CQI value in one full-size subband selected among the subbands in which UE reports the highest full-size subband CQI based on CSI process 2. Subband differential CQI offset level is selected from {0, 1, 2, -1}. Note that the SS shall send PDSCH in the same full-size subband until next UE report is available. In case when same full-size subbands are reported subsequently as subbands with highest full-size subband CQI, the SS shall select for transmission a different subband with respect to the last selection. The SS sends downlink MAC padding bits on the DL RMC. SS schedules the UL transmission in subframe #0 and subframe #5 to carry the PUSCH CQI feedback via PDCCH DCI format 0 with CQI request bit set to 1 and L\_MCS=29 and N\_PRB allocated to be less or equal to 4. Measure the average throughput and (NACK / (ACK + NACK)) according to Annex G.5.3. Declare the throughput as  $t_{subband}$ . If the ratio  $(t_{subband} / t_{median}) \geq \gamma$  and  $(NACK / (ACK + NACK)) \geq 0.02$ , pass the UE for this test and go to step 8. Otherwise, go to step 7.
7. If both SNR points of the test have not been tested, then repeat the same procedure (steps 1 to 6) for the other SNR point as appropriate. Otherwise fail the UE.
8. If both tests have not been done, then repeat the same procedure (steps 1 to 7) with test conditions according to table 9.3.6.1\_F.1.3-2 for the other Test as appropriate. Otherwise pass the UE.

#### 9.3.6.1\_F.2.4.3 Message contents

Message contents are according to TS 36.508 [7] clause 4.6 with the following exception:

Table 9.3.6.1\_F.2.4.3-1: CQI-ReportConfig-v1130-DEFAULT

Derivation Path: 36.508 clause 4.6.3, Table 4.6.3-2ABA			
Information Element	Value/remark	Comment	Condition
CQI-ReportConfig-v1130 ::= SEQUENCE {			
cqi-ReportPeriodic-v1130 SEQUENCE {			
simultaneousAckNackAndCQI-Format3-r11	Not present	PUCCH Format 2	
cqi-ReportPeriodicProcExtToReleaseList-r11	Not present		
cqi-ReportPeriodicProcExtToAddModList-r11	1 entry		
SEQUENCE (SIZE (1..maxCQI-ProcExt-r11)) OF SEQUENCE {			
cqi-ReportPeriodicProcExtId-r11[1] SEQUENCE {			
cqi-ReportPeriodicProcExtId-r11	1		
cqi-pmi-ConfigIndex-r11	2		
cqi-FormatIndicatorPeriodic-r11 CHOICE {			
widebandCQI-r11 SEQUENCE {			
csi-ReportMode-r11	submode1		
}			
subbandCQI-r11	Not present	PUCCH 1-1	
}			
ri-ConfigIndex-r11	1		
csi-ConfigIndex-r11	Not present		
}			
}			
cqi-ReportBoth-r11 SEQUENCE {			
csi-IM-ConfigToReleaseList-r11	Not present		
csi-IM-ConfigToAddModList-r11 SEQUENCE (SIZE (1..maxCSI-IM-r11)) OF SEQUENCE {	3 entries		
csi-IM-ConfigId-r11[1]	1	CSI-IM 0	
resourceConfig-r11[1]	2		
subframeConfig-r11[1]	1		
csi-IM-ConfigId-r11[2]	2	CSI-IM 1	
resourceConfig-r11[2]	6		
subframeConfig-r11[2]	1		
}			
csi-ProcessToReleaseList-r11	Not present		
csi-ProcessToAddModList-r11 SEQUENCE (SIZE (1..maxCSI-Proc-r11)) OF SEQUENCE {	3 entries		
csi-ProcessId-r11[1]	1	CSI process 0	
csi-RS-ConfigNZPId-r11[1]	1		
csi-IM-ConfigId-r11[1]	1		
p-C-AndCBSRList-r11[1] SEQUENCE (SIZE (1..2)) OF SEQUENCE {	1 entry		
p-C-r11[1]	-3		
codebookSubsetRestriction-r11[1]	0x0000 0000 0000 0001		
}			
cqi-ReportBothProc-r11[1] SEQUENCE {			
ri-Ref-CSI-ProcessId-r11	1		
pmi-RI-Report-r11	setup		
}			
cqi-ReportPeriodicProcId-r11[1]	1		
cqi-ReportAperiodicProc-r11[1]	Not present		
csi-ProcessId-r11[2]	2	CSI process 1	
csi-RS-ConfigNZPId-r11[2]	2		
csi-IM-ConfigId-r11[2]	1		
p-C-AndCBSRList-r11[2] SEQUENCE (SIZE (1..2)) OF SEQUENCE {	1 entry		
p-C-r11[2]	0		
codebookSubsetRestriction-r11[2]	000001		
}			
cqi-ReportBothProc-r11[2] SEQUENCE {			
ri-Ref-CSI-ProcessId-r11	2		
pmi-RI-Report-r11	setup		
}			

cqi-ReportPeriodicProclD-r11[2]	Not present		
cqi-ReportAperiodicProc-r11[2] SEQUENCE {			
cqi-ReportModeAperiodic-r11	rm31		
trigger01-r11	1		
trigger10-r11	1		
trigger11-r11	1		
}			
csi-ProcessId-r11[3]	3	CSI process 2	
csi-RS-ConfigNZPId-r11[3]	1		
csi-IM-ConfigId-r11[3]	2		
p-C-AndCBSRList-r11[3] SEQUENCE (SIZE (1..2)) OF SEQUENCE {	1 entry		
p-C-r11[3]	-3		
codebookSubsetRestriction-r11[3]	0x0000 0000 0000 0001		
}			
cqi-ReportBothProc-r11[3] SEQUENCE {			
ri-Ref-CSI-ProcessId-r11	3		
pmi-RI-Report-r11	setup		
}			
cqi-ReportPeriodicProclD-r11[3]	Not present		
cqi-ReportAperiodicProc-r11[3] SEQUENCE {			
cqi-ReportModeAperiodic-r11	rm31		
trigger01-r11	1		
trigger10-r11	1		
trigger11-r11	1		
}			
}			
}			
}			
}			

**Table 9.3.6.1\_F.2.4.3-2: PhysicalConfigDedicated-DEFAULT**

Derivation Path: 36.331 clause 6.3.2			
Information Element	Value/remark	Comment	Condition
PhysicalConfigDedicated ::= SEQUENCE {			
csi-RS-ConfigNZPToAddModList-r11 SEQUENCE (SIZE (1..maxCSI-RS-NZP-r11)) OF SEQUENCE {	2 entries		
csi-RS-ConfigNZPId-r11[1]	1	CSI-RS signal 0	
antennaPortsCount-r11[1]	an4		
resourceConfig-r11[1]	0		
subframeConfig-r11[1]	1		
qcl-CRS-Info-r11 SEQUENCE[1] {			
crs-PortsCount-r11[1]	n2		
mbsfn-SubframeConfigList-r11 CHOICE[1]	Not present		
}			
csi-RS-ConfigNZPId-r11[2]	2	CSI-RS signal 1	
antennaPortsCount-r11[2]	an2		
resourceConfig-r11[2]	5		
subframeConfig-r11[2]	1		
qcl-CRS-Info-r11 SEQUENCE[2] {			
crs-PortsCount-r11[2]	n2		
mbsfn-SubframeConfigList-r11 CHOICE[2]	Not present		
}			
}			
csi-RS-ConfigZPToAddModList-r11 SEQUENCE (SIZE (1..maxCSI-RS-ZP-r11)) OF SEQUENCE {			
csi-RS-ConfigZPId-r11[1]	1	Zero-power CSI-RS 0	
resourceConfigList-r11[1]	1110000000000000	For TP2	
subframeConfig-r11[1]	1		
csi-RS-ConfigZPId-r11[2]	2	Zero-power CSI-RS 1	
resourceConfigList-r11[2]	0010011000000000	For TP1	
subframeConfig-r11[2]	1		
}			
}			

9.3.6.1\_F.2.5 Test requirement

**Table 9.3.6.1\_F.2.5-1: Test requirement (FDD)**

	CSI process 0	CSI process 1	CSI process 2
$\alpha$ [%]	N/A	2	2
$\beta$ [%]	N/A	40	40
$\delta$ [%]	10	N/A	N/A
$\gamma$	N/A	N/A	1.01
UE Category	$\geq 1$		

**Table 9.3.6.1\_F.2.5-2: Minimum median CQI difference between configured CSI processes (FDD)**

	CSI process 1	CSI process 2
CSI process 0	N/A	1
UE Category	$\geq 1$	

To pass the test,  $\alpha$  and  $\beta$  and  $\delta$  and  $\gamma$  and BLER must be fulfilled.

To pass the test, Test 1 and Test 2 must be passed.

To pass the test, one or the other SNR point within one test must be fulfilled.

### 9.3.6.1\_F.3 FDD CQI Reporting under fading conditions with Four CSI processes for CoMP

#### 9.3.6.1\_F.3.1 Test purpose

The purpose of the test is to verify the reporting accuracy of the CQI and the UE processing capability for Four CSI processes.

#### 9.3.6.1\_F.3.2 Test applicability

This test applies to all types of E-UTRA FDD UEs release 11 and forward, supporting Maximum CSI processes of Four on a component carrier within a band with PDSCH transmission mode 10.

#### 9.3.6.1\_F.3.3 Minimum conformance requirements

Same minimum conformance requirements as in clause 9.3.6.1\_F.1.3.

#### 9.3.6.1\_F.3.4 Test description

##### 9.3.6.1\_F.3.4.1 Initial conditions

Initial conditions are a set of test configurations the UE needs to be tested in and the steps for the SS to take with the UE to reach the correct measurement state.

Configurations of PDSCH and PDCCH before measurement are specified in Annex C.2.

Test Environment: Normal as defined in TS 36.508 [7] clause 4.1.

Frequencies to be tested: Mid Range as defined in TS 36.508 [7] clause 4.3.1.1.

Channel Bandwidths to be tested: 10MHz, as defined in TS 36.508 [7] clause 4.3.1.1

1. Connect the SS, faders and AWGN noise source to the UE antenna connector (s) as shown in TS 36.508 [7] Annex A, Figure A.52.
2. The parameter settings for the cell are set up according to Table 9.3.6.1\_F.1.3-2.
3. Downlink signals are initially set up according to Annex C.0, C.1 and Annex C.3.2, and uplink signals according to Annex H.1 and H.3.2.
4. Propagation conditions are set according to Annex B.0.
5. Ensure the UE is in State 3A-RF according to TS 36.508 [7] clause 5.2A.2. Message contents are defined in clause 9.3.6.1\_F.3.4.3.

##### 9.3.6.1\_F.3.4.2 Test procedure

1. Set the parameters of bandwidth, reference Channel, the propagation condition, antenna configuration and the SNR according to Table 9.3.6.1\_F.1.3-2 as appropriate.
2. The SS shall transmit PDSCH via PDCCH DCI format 2D for C\_RNTI to transmit the DL RMC according to CQI value 8 and keep it regardless of the wideband and subband CQI value sent by the UE. Continue transmission of the PDSCH until 2000 wideband CQI reports and full-size subband CQI reports for each full-size subband have been gathered for each of CSI process 0, 1, 2, and 3. The SS sends downlink MAC padding bits on the DL RMC. SS schedules the UL transmission in subframe #0 and subframe #5 to carry the PUSCH CQI feedback for CSI process 1, 2, and 3 via PDCCH DCI format 0 with CQI request bit set to 1 and I\_MCS=29 and N\_PRB allocated to be less or equal to 4. But for CSI process 0, SS schedules the UL transmission in subframe #0 and subframe #5 to carry the PUCCH CQI feedback. In this process the SS collects wideband CQI reports every 5 ms and also cases where UE transmits nothing in its CQI timing are counted as wideband CQI and full-size subband CQI reports.
3. Set up a relative frequency distribution for the reported wideband CQI-values, Calculate the median value (wideband Median CQI is the CQI that is at or crosses 50% distribution from the lower wideband CQI side). This CQI-value is declared as wideband Median CQI value.

4. Check if “ $2000 * \alpha \% / 100 \leq$  number of CQI reports with index 0 for each full-size subband  $\leq 2000 * \beta \% / 100$ ” for CSI process 1, 2 and 3. And check if the number of CQI index not in the set {median CQI -1, median CQI, median CQI +1} shall be reported at least  $2000 * \delta \% / 100$  for CSI process 0. And check if the difference of the median CQIs of the reported wideband CQI for configured CSI processes 0, 1, 2 and 3 shall be greater or equal to the values as in Table 9.3.6.1\_F.3.5-2. (2000= No of full-size subband reports, 100 because of %). If yes, continue with step 5, otherwise goto step 7.
5. The SS shall transmit PDSCH via PDCCH DCI format 2D for C\_RNTI to transmit the DL RMC according to the wideband median-CQI value in an each TTI randomly selected full-size subband regardless of UE wideband and full-size subband CQI report based on CSI process 2. Note that each full-size subband is selected in equal probability. The SS sends downlink MAC padding bits on the DL RMC. SS schedules the UL transmission in subframe #0 and subframe #5 to carry the PUSCH CQI feedback via PDCCH DCI format 0 with CQI request bit set to 1 and I\_MCS=29 and N\_PRB allocated to be less or equal to 4. Measure the average throughput according to Annex G.5.3. Declare the throughput as  $t_{median}$ .
6. The SS shall transmit PDSCH via PDCCH DCI format 2D for C\_RNTI to transmit the DL RMC according to the highest UE reported full-size subband CQI value in one full-size subband selected among the subbands in which UE reports the highest full-size subband CQI based on CSI process 2. Subband differential CQI offset level is selected from {0, 1, 2, -1}. Note that the SS shall send PDSCH in the same full-size subband until next UE report is available. In case when same full-size subbands are reported subsequently as subbands with highest full-size subband CQI, the SS shall select for transmission a different subband with respect to the last selection. The SS sends downlink MAC padding bits on the DL RMC. SS schedules the UL transmission in subframe #0 and subframe #5 to carry the PUSCH CQI feedback via PDCCH DCI format 0 with CQI request bit set to 1 and I\_MCS=29 and N\_PRB allocated to be less or equal to 4. Measure the average throughput and (NACK / (ACK + NACK)) according to Annex G.5.3. Declare the throughput as  $t_{subband}$ . If the ratio  $(t_{subband} / t_{median}) \geq \gamma$  and  $(NACK / (ACK + NACK)) \geq 0.02$ , pass the UE for this test and go to step 8. Otherwise, go to step 7.
7. If both SNR points of the test have not been tested, then repeat the same procedure (steps 1 to 6) for the other SNR point as appropriate. Otherwise fail the UE.
8. If both tests have not been done, then repeat the same procedure (steps 1 to 7) with test conditions according to table 9.3.6.1\_F.1.3-2 for the other Test as appropriate. Otherwise pass the UE.

#### 9.3.6.1\_F.3.4.3 Message contents

Message contents are according to TS 36.508 [7] clause 4.6 with the following exception:

Table 9.3.6.1\_F.3.4.3-1: CQI-ReportConfig-v1130-DEFAULT

Derivation Path: 36.508 clause 4.6.3, Table 4.6.3-2ABA			
Information Element	Value/remark	Comment	Condition
CQI-ReportConfig-v1130 ::= SEQUENCE {			
cqi-ReportPeriodic-v1130 SEQUENCE {			
simultaneousAckNackAndCQI-Format3-r11	Not present	PUCCH Format 2	
cqi-ReportPeriodicProcExtToReleaseList-r11	Not present		
cqi-ReportPeriodicProcExtToAddModList-r11	1 entry		
SEQUENCE (SIZE (1..maxCQI-ProcExt-r11)) OF SEQUENCE {			
cqi-ReportPeriodicProcExtId-r11[1] SEQUENCE {			
cqi-ReportPeriodicProcExtId-r11	1		
cqi-pmi-ConfigIndex-r11	2		
cqi-FormatIndicatorPeriodic-r11 CHOICE {			
widebandCQI-r11 SEQUENCE {			
csi-ReportMode-r11	submode1		
}			
subbandCQI-r11	Not present	PUCCH 1-1	
}			
ri-ConfigIndex-r11	1		
csi-ConfigIndex-r11	Not present		
}			
}			
cqi-ReportBoth-r11 SEQUENCE {			
csi-IM-ConfigToReleaseList-r11	Not present		
csi-IM-ConfigToAddModList-r11 SEQUENCE (SIZE (1..maxCSI-IM-r11)) OF SEQUENCE {	3 entries		
csi-IM-ConfigId-r11[1]	1	CSI-IM 0	
resourceConfig-r11[1]	2		
subframeConfig-r11[1]	1		
csi-IM-ConfigId-r11[2]	2	CSI-IM 1	
resourceConfig-r11[2]	6		
subframeConfig-r11[2]	1		
csi-IM-ConfigId-r11[3]	3	CSI-IM 2	
resourceConfig-r11[3]	1		
subframeConfig-r11[3]	1		
}			
csi-ProcessToReleaseList-r11	Not present		
csi-ProcessToAddModList-r11 SEQUENCE (SIZE (1..maxCSI-Proc-r11)) OF SEQUENCE {	4 entries		
csi-ProcessId-r11[1]	1	CSI process 0	
csi-RS-ConfigNZPId-r11[1]	1		
csi-IM-ConfigId-r11[1]	1		
p-C-AndCBSRList-r11[1] SEQUENCE (SIZE (1..2)) OF SEQUENCE {	1 entry		
p-C-r11[1]	-3		
codebookSubsetRestriction-r11[1]	0x0000 0000 0000 0001		
}			
cqi-ReportBothProc-r11[1] SEQUENCE {			
ri-Ref-CSI-ProcessId-r11	1		
pmi-RI-Report-r11	setup		
}			
cqi-ReportPeriodicProcId-r11[1]	1		
cqi-ReportAperiodicProc-r11[1]	Not present		
csi-ProcessId-r11[2]	2	CSI process 1	
csi-RS-ConfigNZPId-r11[2]	2		
csi-IM-ConfigId-r11[2]	1		
p-C-AndCBSRList-r11[2] SEQUENCE (SIZE (1..2)) OF SEQUENCE {	1 entry		
p-C-r11[2]	0		
codebookSubsetRestriction-r11[2]	000001		
}			
cqi-ReportBothProc-r11[2] SEQUENCE {			

ri-Ref-CSI-ProcessId-r11	2		
pmi-RI-Report-r11	setup		
}			
cqi-ReportPeriodicProcId-r11[2]	Not present		
cqi-ReportAperiodicProc-r11[2] SEQUENCE {			
cqi-ReportModeAperiodic-r11	rm31		
trigger01-r11	1		
trigger10-r11	1		
trigger11-r11	1		
}			
csi-ProcessId-r11[3]	3	CSI process 2	
csi-RS-ConfigNZPId-r11[3]	1		
csi-IM-ConfigId-r11[3]	2		
p-C-AndCBSRList-r11[3] SEQUENCE (SIZE (1..2)) OF SEQUENCE {	1 entry		
p-C-r11[3]	-3		
codebookSubsetRestriction-r11[3]	0x0000 0000 0000 0001		
}			
cqi-ReportBothProc-r11[3] SEQUENCE {			
ri-Ref-CSI-ProcessId-r11	3		
pmi-RI-Report-r11	setup		
}			
cqi-ReportPeriodicProcId-r11[3]	Not present		
cqi-ReportAperiodicProc-r11[3] SEQUENCE {			
cqi-ReportModeAperiodic-r11	rm31		
trigger01-r11	1		
trigger10-r11	1		
trigger11-r11	1		
}			
csi-ProcessId-r11[4]	4	CSI process 3	
csi-RS-ConfigNZPId-r11[4]	2		
csi-IM-ConfigId-r11[4]	3		
p-C-AndCBSRList-r11[4] SEQUENCE (SIZE (1..2)) OF SEQUENCE {	1 entry		
p-C-r11[4]	0		
codebookSubsetRestriction-r11[4]	000001		
}			
cqi-ReportBothProc-r11[4] SEQUENCE {			
ri-Ref-CSI-ProcessId-r11	4		
pmi-RI-Report-r11	setup		
}			
cqi-ReportPeriodicProcId-r11[4]	Not present		
cqi-ReportAperiodicProc-r11[4] SEQUENCE {			
cqi-ReportModeAperiodic-r11	rm31		
trigger01-r11	1		
trigger10-r11	1		
trigger11-r11	1		
}			
}			
}			
}			



Table 9.3.6.1\_F.3.4.3-2: PhysicalConfigDedicated-DEFAULT

Derivation Path: 36.331 clause 6.3.2			
Information Element	Value/remark	Comment	Condition
PhysicalConfigDedicated ::= SEQUENCE {			
csi-RS-ConfigNZPToAddModList-r11 SEQUENCE (SIZE (1..maxCSI-RS-NZP-r11)) OF SEQUENCE {	2 entries		
csi-RS-ConfigNZPId-r11[1]	1	CSI-RS signal 0	
antennaPortsCount-r11[1]	an4		
resourceConfig-r11[1]	0		
subframeConfig-r11[1]	1		
qcl-CRS-Info-r11 SEQUENCE[1] {			
crs-PortsCount-r11[1]	n2		
mbsfn-SubframeConfigList-r11 CHOICE[1]	Not present		
}			
csi-RS-ConfigNZPId-r11[2]	2	CSI-RS signal 1	
antennaPortsCount-r11[2]	an2		
resourceConfig-r11[2]	5		
subframeConfig-r11[2]	1		
qcl-CRS-Info-r11 SEQUENCE[2] {			
crs-PortsCount-r11[2]	n2		
mbsfn-SubframeConfigList-r11 CHOICE[2]	Not present		
}			
}			
csi-RS-ConfigZPToAddModList-r11 SEQUENCE (SIZE (1..maxCSI-RS-ZP-r11)) OF SEQUENCE {			
csi-RS-ConfigZPId-r11[1]	1	Zero-power CSI-RS 0	
resourceConfigList-r11[1]	1110000000000000	For TP2	
subframeConfig-r11[1]	1		
csi-RS-ConfigZPId-r11[2]	2	Zero-power CSI-RS 1	
resourceConfigList-r11[2]	0010011000000000	For TP1	
subframeConfig-r11[2]	1		
}			
}			

## 9.3.6.1\_F.3.5 Test requirement

Table 9.3.6.1\_F.3.5-1: Test requirement (FDD)

	CSI process 0	CSI process 1	CSI process 2	CSI process 3
$\alpha$ [%]	N/A	2	2	2
$\beta$ [%]	N/A	40	40	40
$\delta$ [%]	10	N/A	N/A	N/A
$\gamma$	N/A	N/A	1.01	N/A
UE Category	$\geq 1$			

Table 9.3.6.1\_F.3.5-2: Minimum median CQI difference between configured CSI processes (FDD)

	CSI process 1	CSI process 2	CSI process 3
CSI process 0	N/A	1	3
UE Category	$\geq 1$		

To pass the test,  $\alpha$  and  $\beta$  and  $\delta$  and  $\gamma$  and BLER must be fulfilled.

To pass the test, Test 1 and Test 2 must be passed.

To pass the test, one or the other SNR point within one test must be fulfilled.

### 9.3.6.2\_F TDD CQI Reporting under fading conditions with CSI processes for CoMP

#### 9.3.6.2\_F.1 TDD CQI Reporting under fading conditions with Single CSI process for CoMP

##### 9.3.6.2\_F.1.1 Test purpose

The purpose of the test is to verify the reporting accuracy of the CQI and the UE processing capability for single CSI process.

##### 9.3.6.2\_F.1.2 Test applicability

This test applies to all types of E-UTRA TDD UEs release 11 and forward, supporting Maximum CSI processes of One on a component carrier within a band with PDSCH transmission mode 10.

##### 9.3.6.2\_F.1.3 Minimum conformance requirements

For the parameters specified in Table 9.3.6.2\_F.1.3-1, and using the downlink physical channels specified in Annex C.3.2, the minimum requirements are specified in Table 9.3.6.2\_F.1.3-2 and by the following:

- a) a sub-band differential CQI offset level of 0 shall be reported at least  $\alpha\%$  of the time but less than  $\beta\%$  for each sub-band for CSI process 1, 2, or 3;
- b) a CQI index not in the set {median CQI -1, median CQI, median CQI +1} shall be reported at least  $\delta\%$  of the time for CSI process 0;
- c) the difference of the median CQIs of the reported wideband CQI for configured CSI processes shall be greater or equal to the values as in Table 9.3.6.2\_F.1.3-3;
- d) the ratio of the throughput obtained when transmitting on a randomly selected sub-band among the sub-bands with the highest differential CQI offset level the corresponding TBS and that obtained when transmitting the TBS indicated by the reported wideband CQI median on a randomly selected sub-band in set  $S$  shall be  $\geq \gamma$ ;
- e) when transmitting on a randomly selected sub-band among the sub-bands with the highest differential CQI offset level the corresponding TBS, the average BLER for the indicated transport formats shall be greater or equal to 0.02.

The requirements only apply for sub-bands of full size and the random scheduling across the sub-bands is done by selecting a new sub-band in each TTI for FDD, each available downlink transmission instance for TDD. Sub-bands of a size smaller than full size are excluded from the test.

Table 9.3.6.2\_F.1.3-1: Fading test for TDD

Parameter		Unit	Test 1				Test 2			
			TP1		TP2		TP1		TP2	
Bandwidth		MHz	10 MHz				10 MHz			
Transmission mode			10		10		10		10	
Uplink downlink configuration			2		2		2		2	
Special subframe configuration			4		4		4		4	
Downlink power allocation	$\rho_A$	dB	0				0			
	$\rho_B$	dB	0				0			
	$P_C$	dB	-3		0		-3		0	
	$\sigma$	dB	-3				-3			
SNR (Note 7)		dB	10	11	7	8	14	15	9	10
$\hat{I}_{or}^{(j)}$		dB[mW/15kHz]	-88	-87	-91	-90	-84	-85	-89	-88
$N_{oc}^{(j)}$		dB[mW/15kHz]	-98				-98			
Propagation channel			EPA 5 Low		Clause B.2.4.1 with $\tau_d = 0.45 \mu s$ , $a = 1$ , $f_D = 5$ Hz		EPA 5 Low		Clause B.2.4.1 with $\tau_d = 0.45 \mu s$ , $a = 1$ , $f_D = 5$ Hz	
Antenna configuration			4x2		2x2		4x2		2x2	
Beamforming Model			As specified in Section B.4.3				As specified in Section B.4.3			
Timing offset between TPs		us	0				0			
Frequency offset between TPs		Hz	0				0			
Cell-specific reference signals			Antenna ports 0,1				Antenna ports 0,1			
CSI-RS signal 0			Antenna ports 15,..., 18		N/A		Antenna ports 15,..., 18		N/A	
CSI-RS 0 periodicity and subframe offset $T_{CSI-RS} / \Delta_{CSI-RS}$			5/3		N/A		5/3		N/A	
CSI-RS 0 configuration			0		N/A		0		N/A	
CSI-RS signal 1			N/A		Antenna ports 15, 16		N/A		Antenna ports 15, 16	
CSI-RS 1 periodicity and subframe offset $T_{CSI-RS} / \Delta_{CSI-RS}$			N/A		5/3		N/A		5/3	
CSI-RS 1 configuration			N/A		5		N/A		5	
Zero-power CSI-RS 0 configuration $I_{CSI-RS} / ZeroPowerCSI-RS$ bitmap			N/A		3 / 1110000000000000		N/A		3 / 1110000000000000	
Zero-power CSI-RS 1 configuration $I_{CSI-RS} / ZeroPowerCSI-RS$ bitmap			3 / 0010011000000000		N/A		3 / 0010011000000000		N/A	
CSI-IM 0 periodicity and subframe offset $T_{CSI-RS} / \Delta_{CSI-RS}$			5/3		5/3		5/3		5/3	
CSI-IM 0 configuration			2		2		2		2	
CSI-IM 1 periodicity and subframe offset $T_{CSI-RS} / \Delta_{CSI-RS}$			5/3		N/A		5/3		N/A	
CSI-IM 1 configuration			6		N/A		6		N/A	
CSI-IM 2 periodicity and subframe offset $T_{CSI-RS} / \Delta_{CSI-RS}$			N/A		5/3		N/A		5/3	
CSI-IM 2 configuration			N/A		1		N/A		1	
CSI process 0	CSI-RS		CSI-RS 0				CSI-RS 0			
	CSI-IM		CSI-IM 0				CSI-IM 0			
	Reporting mode		PUCCH 1-1				PUCCH 1-1			
	CodeBookSubsetRestriction bitmap		0x0000 0000 0000 0001				0x0000 0000 0000 0001			
	Reporting periodicity	ms	$N_{pd} = 5$				$N_{pd} = 5$			
	CQI delay	ms	12				12			
	Physical channel for CQI/ PMI reporting		PUSCH (Note 6)				PUSCH (Note 6)			
	PUCCH Report		2				2			

	Type for CQI/PMI				
	PUCCH channel for RI reporting		PUCCH Format 2		PUCCH Format 2
	PUCCH report type for RI		3		3
	<i>cqi-pmi-ConfigurationIndex</i>		3		3
	<i>ri-ConfigIndex</i>		805 (Note 10)		805 (Note 10)
CSI process 1	CSI-RS		CSI-RS 1		CSI-RS 1
	CSI-IM		CSI-IM 0		CSI-IM 0
	Reporting mode		PUSCH 3-1		PUSCH 3-1
	CodeBookSubsetRestriction bitmap		000001		000001
	Reporting interval (Note 9)	ms	5		5
	CQI delay	ms	12		12
	Sub-band size	RB	6 (full size)		6 (full size)
CSI process 2	CSI-RS		CSI-RS 0		CSI-RS 0
	CSI-IM		CSI-IM 1		CSI-IM 1
	Reporting mode		PUSCH 3-1		PUSCH 3-1
	CodeBookSubsetRestriction bitmap		0x0000 0000 0000 0001		0x0000 0000 0000 0001
	Reporting interval (Note 9)	ms	5		5
	CQI delay	ms	12		12
	Sub-band size	RB	6 (full size) (Note 8)		6 (full size) (Note 8)
CSI process 3	CSI-RS		CSI-RS 1		CSI-RS 1
	CSI-IM		CSI-IM 2		CSI-IM 2
	Reporting mode		PUSCH 3-1		PUSCH 3-1
	CodeBookSubsetRestriction bitmap		000001		000001
	Reporting interval (Note 9)	ms	5		5
	CQI delay	ms	12		12
	Sub-band size	RB	6 (full size)		6 (full size)
CSI process for PDSCH scheduling			CSI process 2		CSI process 2
Cell ID		0	6	0	6
Quasi-co-located CSI-RS		CSI-RS 0	CSI-RS 1	CSI-RS 0	CSI-RS 1
Quasi-co-located CRS		Same Cell ID as Cell 1	Same Cell ID as Cell 2	Same Cell ID as Cell 1	Same Cell ID as Cell 2
PMI for subframe 4 and 9		0x0000 0000 0000 0001	100000	0x0000 0000 0000 0001	100000
PMI for subframe 3 and 8		0x0000 0000 0001 0000	100000	0x0000 0000 0001 0000	100000
Max number of HARQ transmissions		1	N/A	1	N/A
ACK/NACK feedback mode		Multiplexing	N/A	Multiplexing	N/A
Note 1:	If the UE reports in an available uplink reporting instance at subframe SF#n based on CQI estimation at a downlink SF not later than SF#(n-4), this reported wideband CQI cannot be applied at the eNB downlink before SF#(n+4)				
Note 2:	3 symbols allocated to PDCCH				
Note 3:	Reference measurement channel RC.12 TDD according to Table A.4-1. PDSCH transmission is scheduled on subframe 4 and 9 from TP1.				
Note 4:	TM10 OCNG is transmitted as specified in A.5.2.8 on subframe 3 and 8 from TP1.				
Note 5:	TM10 OCNG is transmitted as specified in A.5.2.8 on subframe 3, 4, 8 and 9 from TP2				
Note 6:	To avoid collisions between CQI/PMI reports and HARQ-ACK it is necessary to report both on PUSCH instead of PUCCH. PDCCH DCI format 0 shall be transmitted in downlink SF#3 and #8 to allow periodic CQI/PMI to multiplex with the HARQ-ACK on PUSCH in uplink SF#7 and #2.				
Note 7:	For each test, the minimum requirements shall be fulfilled for at least one of the two SNR(s) and the respective wanted signal input level.				
Note 8:	PDCCH DCI format 0 with a trigger for aperiodic CQI shall be transmitted in downlink SF#3 and #8 to allow aperiodic CQI/PMI/RI to be transmitted in uplink SF#7 and #2.				
Note 9:	For these sub-bands which are not selected for PDSCH transmission, TM10 OCNG should be transmitted.				
Note 10:	RI reporting interval is set to the maximum allowable length of 160ms to minimise collisions between RI, CQI/PMI and HARQ-ACK reports. In the case when all three reports collide, it is expected that CQI/PMI reports will be dropped, while RI and HARQ-ACK will be multiplexed. At eNB, CQI report collection shall be skipped every 160ms during performance verification and the reported CQI in subframe SF#7 of the previous frame is applied in downlink subframes until a new CQI (after CQI/PMI dropping) is available.				

**Table 9.3.6.2\_F.1.3-2: Minimum requirement (TDD)**

	CSI process 0	CSI process 1	CSI process 2	CSI process 3
$\alpha$ [%]	N/A	2	2	2
$\beta$ [%]	N/A	40	40	40
$\delta$ [%]	10	N/A	N/A	N/A
$\gamma$	N/A	N/A	1.02	N/A
UE Category	$\geq 1$			

**Table 9.3.6.2\_F.1.3-3: Minimum median CQI difference between configured CSI processes (TDD)**

	CSI process 1	CSI process 2	CSI process 3
CSI process 0	N/A	1	3
UE Category	$\geq 1$		

The normative reference for this requirement is TS 36.101 [2] clause 9.3.6.2.

#### 9.3.6.2\_F.1.4 Test description

##### 9.3.6.2\_F.1.4.1 Initial conditions

Initial conditions are a set of test configurations the UE needs to be tested in and the steps for the SS to take with the UE to reach the correct measurement state.

Configurations of PDSCH and PDCCH before measurement are specified in Annex C.2.

Test Environment: Normal as defined in TS 36.508 [7] clause 4.1.

Frequencies to be tested: Mid Range as defined in TS 36.508 [7] clause 4.3.1.2.

Channel Bandwidths to be tested: 10MHz, as defined in TS 36.508 [7] clause 4.3.1.2

1. Connect the SS, faders and AWGN noise source to the UE antenna connector (s) as shown in TS 36.508 [7] Annex A, Figure A.52.
2. The parameter settings for the cell are set up according to Table 9.3.6.2\_F.1.3-1.
3. Downlink signals are initially set up according to Annex C.0, C.1 and Annex C.3.2, and uplink signals according to Annex H.1 and H.3.2.
4. Propagation conditions are set according to Annex B.0.
5. Ensure the UE is in State 3A-RF according to TS 36.508 [7] clause 5.2A.2. Message contents are defined in clause 9.3.6.2\_F.1.4.3.

##### 9.3.6.2\_F.1.4.2 Test procedure

1. Set the parameters of bandwidth, reference Channel, the propagation condition, antenna configuration and the SNR according to Table 9.3.6.2\_F.1.3-1 as appropriate.
2. The SS shall transmit PDSCH via PDCCH DCI format 2D for C\_RNTI to transmit the DL RMC according to CQI value 10 and keep it regardless of the wideband and full-size subband CQI value sent by the UE. Continue transmission of the PDSCH until 2000 wideband CQI reports and full-size subband CQI report for each full-size subband have been gathered for CSI process 2. The SS sends downlink MAC padding bits on the DL RMC. SS schedules the UL transmission in subframe #2 and subframe #7 to carry the PUSCH CQI feedback for CSI process 2 via PDCCH DCI format 0 with CQI request bit set to 1 and I\_MCS=29 and N\_PRB allocated to be less or equal to 4. In this process the SS collects wideband CQI reports every 5 ms and also cases where UE transmits nothing in its CQI timing are counted as wideband CQI and full-size subband CQI reports.
3. Set up a relative frequency distribution for the reported wideband CQI-values, Calculate the median value (wideband Median CQI is the CQI that is at or crosses 50% distribution from the lower wideband CQI side). This CQI-value is declared as wideband Median CQI value.

4. Check if “ $2000 * \alpha \% / 100 \leq$  number of CQI reports with index 0 for each full-size subband  $\leq 2000 * \beta \% / 100$ ” for CSI process 2. (2000= No of full-size subband reports, 100 because of %). If yes, continue with step 5, otherwise goto step 7.
5. The SS shall send PDSCH via PDCCH DCI format 2D for C\_RNTI to transmit the DL RMC according to the wideband median-CQI value in an each available downlink transmission instance randomly selected full-size subband regardless of UE wideband and subband CQI report based on CSI process 2. Note that each full-size subband is selected in equal probability. The SS sends downlink MAC padding bits on the DL RMC. SS schedules the UL transmission in subframe #2 and subframe #7 to carry the PUSCH CQI feedback via PDCCH DCI format 0 with CQI request bit set to 1 and I\_MCS=29 and N\_PRB allocated to be less or equal to 4. Measure the average throughput according to Annex G.5.3 Declare the throughput as  $t_{median}$ .
6. The SS shall transmit PDSCH via PDCCH DCI format 2D for C\_RNTI to transmit the DL RMC according to the highest UE reported full-size subband CQI value in one full-size subband selected among the sub-bands in which UE report the highest full-size subband CQI based on CSI process 2. Subband differential CQI offset level is selected from {0, 1, 2, -1}. Note that the SS shall send PDSCH in the same full-size subband until next UE report is available. In case when same full-size subbands are reported subsequently as subbands with highest full-size subband CQI, the SS shall select for transmission a different subband with respect to the last selection. The SS sends downlink MAC padding bits on the DL RMC. SS schedules the UL transmission in subframe #2 and subframe #7 to carry the PUSCH CQI feedback via PDCCH DCI format 0 with CQI request bit set to 1 and I\_MCS=29 and N\_PRB allocated to be less or equal to 4. Measure the average throughput and (NACK / (ACK + NACK)) according to Annex G.5.3. Declare the throughput as  $t_{subband}$ . If the ratio  $(t_{subband} / t_{median}) \geq \gamma$  and (NACK / (ACK + NACK))  $\geq 0.02$ , pass the UE and go to step 8. Otherwise, go to step 7.
7. If both SNR points of the test have not been tested, then repeat the same procedure (steps 1 to 6) for the other SNR point as appropriate. Otherwise fail the UE.
8. If both tests have not been done, then repeat the same procedure (steps 1 to 7) with test conditions according to table 9.3.6.2\_F.1.3-1 for the other test as appropriate.

#### 9.3.6.2\_F.1.4.3 Message contents

Message contents are according to TS 36.508 [7] clause 4.6 with the following exception:

**Table 9.3.6.2\_F.1.4.3-1: CQI-ReportConfig-v1130-DEFAULT**

Derivation Path: 36.508 clause 4.6.3, Table 4.6.3-2ABA			
Information Element	Value/remark	Comment	Condition
CQI-ReportConfig-v1130 ::= SEQUENCE {			
cqi-ReportPeriodic-v1130 SEQUENCE {			
simultaneousAckNackAndCQI-Format3-r11	Not present	PUCCH Format 2	
cqi-ReportPeriodicProcExtToReleaseList-r11	Not present		
cqi-ReportPeriodicProcExtToAddModList-r11	1 entry		
SEQUENCE (SIZE (1..maxCQI-ProcExt-r11)) OF SEQUENCE {			
cqi-ReportPeriodicProcExtId-r11[1] SEQUENCE {			
cqi-ReportPeriodicProcExtId-r11	1		
cqi-pmi-ConfigIndex-r11	3		
cqi-FormatIndicatorPeriodic-r11 CHOICE {			
widebandCQI-r11 SEQUENCE {			
csi-ReportMode-r11	submode1		
}			
subbandCQI-r11	Not present	PUCCH 1-1	
}			
ri-ConfigIndex-r11	805		
csi-ConfigIndex-r11	Not present		
}			
}			
cqi-ReportBoth-r11 SEQUENCE {			
csi-IM-ConfigToReleaseList-r11	Not present		
csi-IM-ConfigToAddModList-r11 SEQUENCE (SIZE (1..maxCSI-IM-r11)) OF SEQUENCE {	1 entry		
csi-IM-ConfigId-r11[1]	2	CSI-IM 1	
resourceConfig-r11[1]	6		
subframeConfig-r11[1]	3		
}			
csi-ProcessToReleaseList-r11	Not present		
csi-ProcessToAddModList-r11 SEQUENCE (SIZE (1..maxCSI-Proc-r11)) OF SEQUENCE {	1 entry		
csi-ProcessId-r11[1]	3	CSI process 2	
csi-RS-ConfigNZPId-r11[1]	1		
csi-IM-ConfigId-r11[1]	2		
p-C-AndCBSRLList-r11[1] SEQUENCE (SIZE (1..2)) OF SEQUENCE {	1 entry		
p-C-r11[1]	-3		
codebookSubsetRestriction-r11[1]	0x0000 0000 0000 0001		
}			
cqi-ReportBothProc-r11[1] SEQUENCE {			
ri-Ref-CSI-ProcessId-r11	3		
pmi-RI-Report-r11	setup		
}			
cqi-ReportPeriodicProclD-r11[1]	Not present		
cqi-ReportAperiodicProc-r11[1] SEQUENCE {			
cqi-ReportModeAperiodic-r11	rm31		
trigger01-r11	1		
trigger10-r11	1		
trigger11-r11	1		
}			
}			
}			
}			

Table 9.3.6.2\_F.1.4.3-2: PhysicalConfigDedicated-DEFAULT

Derivation Path: 36.331 clause 6.3.2			
Information Element	Value/remark	Comment	Condition
PhysicalConfigDedicated ::= SEQUENCE {			
csi-RS-ConfigNZPToAddModList-r11 SEQUENCE (SIZE (1..maxCSI-RS-NZP-r11)) OF SEQUENCE {	1 entry		
csi-RS-ConfigNZPId-r11[1]	1	CSI-RS signal 0	
antennaPortsCount-r11[1]	an4		
resourceConfig-r11[1]	0		
subframeConfig-r11[1]	3		
qcl-CRS-Info-r11 SEQUENCE[1] {			
crs-PortsCount-r11[1]	n2		
mbsfn-SubframeConfigList-r11 CHOICE[1]	Not present		
}			
}			
csi-RS-ConfigZPToAddModList-r11 SEQUENCE (SIZE (1..maxCSI-RS-ZP-r11)) OF SEQUENCE {			
csi-RS-ConfigZPId-r11[1]	1	Zero-power CSI-RS 0	
resourceConfigList-r11[1]	1110000000000000	For TP2	
subframeConfig-r11[1]	3		
csi-RS-ConfigZPId-r11[2]	2	Zero-power CSI-RS 1	
resourceConfigList-r11[2]	0010011000000000	For TP1	
subframeConfig-r11[2]	3		
}			
}			

## 9.3.6.2\_F.1.5 Test requirement

Table 9.3.6.2\_F.1.5-1: Test requirement (TDD)

	CSI process 2
$\alpha$ [%]	2
$\beta$ [%]	40
$\delta$ [%]	N/A
$\gamma$	1.01
UE Category	$\geq 1$

To pass the test,  $\alpha$  and  $\beta$  and  $\delta$  and  $\gamma$  and BLER must be fulfilled.

To pass the test, Test 1 and Test 2 must be passed.

To pass the test, one **or** the other SNR point within one test must be fulfilled.

## 9.3.6.2\_F.2 TDD CQI Reporting under fading conditions with Three CSI processes for CoMP

## 9.3.6.2\_F.2.1 Test purpose

The purpose of the test is to verify the reporting accuracy of the CQI and the UE processing capability for Three CSI processes.

## 9.3.6.2\_F.2.2 Test applicability

This test applies to all types of E-UTRA TDD UEs release 11 and forward, supporting Maximum CSI processes of Three on a component carrier within a band with PDSCH transmission mode 10.

## 9.3.6.2\_F.2.3 Minimum conformance requirements

Same minimum conformance requirements as in clause 9.3.6.2\_F.1.3.



### 9.3.6.2\_F.2.4 Test description

#### 9.3.6.2\_F.2.4.1 Initial conditions

Initial conditions are a set of test configurations the UE needs to be tested in and the steps for the SS to take with the UE to reach the correct measurement state.

Configurations of PDSCH and PDCCH before measurement are specified in Annex C.2.

Test Environment: Normal as defined in TS 36.508 [7] clause 4.1.

Frequencies to be tested: Mid Range as defined in TS 36.508 [7] clause 4.3.1.2.

Channel Bandwidths to be tested: 10MHz, as defined in TS 36.508 [7] clause 4.3.1.2

1. Connect the SS, faders and AWGN noise source to the UE antenna connector (s) as shown in TS 36.508 [7] Annex A, Figure A.52.
2. The parameter settings for the cell are set up according to Table 9.3.6.2\_F.1.3-1.
3. Downlink signals are initially set up according to Annex C.0, C.1 and Annex C.3.2, and uplink signals according to Annex H.1 and H.3.2.
4. Propagation conditions are set according to Annex B.0.
5. Ensure the UE is in State 3A-RF according to TS 36.508 [7] clause 5.2A.2. Message contents are defined in clause 9.3.6.2\_F.2.4.3.

#### 9.3.6.2\_F.2.4.2 Test procedure

1. Set the parameters of bandwidth, reference Channel, the propagation condition, antenna configuration and the SNR according to Table 9.3.6.2\_F.1.3-1 as appropriate.
2. The SS shall transmit PDSCH via PDCCH DCI format 2D for C\_RNTI to transmit the DL RMC according to CQI value 10, and keep it regardless of the wideband and full-size subband CQI value sent by the UE. Continue transmission of the PDSCH until 2000 wideband CQI reports and full-size subband CQI report for each full-size subband have been gathered for each of CSI process 0, 1 and 2. The SS sends downlink MAC padding bits on the DL RMC. SS schedules the UL transmission in subframe #2 and subframe #7 to carry the PUSCH CQI feedback for CSI process 1 and 2 via PDCCH DCI format 0 with CQI request bit set to 1 and I\_MCS=29 and N\_PRB allocated to be less or equal to 4. But for CSI process 0, SS schedules the UL transmission in subframe #0 and subframe #5 to carry the PUCCH CQI feedback. In this process the SS collects wideband CQI reports every 5 ms and also cases where UE transmits nothing in its CQI timing are counted as wideband CQI and full-size subband CQI reports.
3. Set up a relative frequency distribution for the reported wideband CQI-values, Calculate the median value (wideband Median CQI is the CQI that is at or crosses 50% distribution from the lower wideband CQI side). This CQI-value is declared as wideband Median CQI value.
4. Check if " $2000 \cdot \alpha \% / 100 \leq \text{number of CQI reports with index } 0 \text{ for each full-size subband} \leq 2000 \cdot \beta \% / 100$ " for CSI process 1 and 2. And check if the number of CQI index not in the set {median CQI -1, median CQI, median CQI +1} shall be reported at least  $2000 \cdot \delta \% / 100$  for CSI process 0. And check if the difference of the median CQIs of the reported wideband CQI for configured CSI processes 0, 1 and 2 shall be greater or equal to the values as in Table 9.3.6.2\_F.2.5-2.  
(2000= No of full-size subband reports, 100 because of %) If yes, continue with step5, otherwise goto step 7.
5. The SS shall send PDSCH via PDCCH DCI format 2D for C\_RNTI to transmit the DL RMC according to the wideband median-CQI value in an each available downlink transmission instance randomly selected full-size subband regardless of UE wideband and subband CQI report based on CSI process 2. Note that each full-size subband is selected in equal probability. The SS sends downlink MAC padding bits on the DL RMC. SS schedules the UL transmission in subframe #2 and subframe #7 to carry the PUSCH CQI feedback via PDCCH DCI format 0 with CQI request bit set to 1 and I\_MCS=29 and N\_PRB allocated to be less or equal to 4.  
Measure the average throughput according to Annex G.5.3 Declare the throughput as  $t_{median}$ .

6. The SS shall transmit PDSCH via PDCCH DCI format 2D for C\_RNTI to transmit the DL RMC according to the highest UE reported full-size subband CQI value in one full-size subband selected among the sub-bands in which UE report the highest full-size subband CQI based on CSI process 2. Subband differential CQI offset level is selected from {0, 1, 2, -1}. Note that the SS shall send PDSCH in the same full-size subband until next UE report is available. In case when same full-size subbands are reported subsequently as subbands with highest full-size subband CQI, the SS shall select for transmission a different subband with respect to the last selection. The SS sends downlink MAC padding bits on the DL RMC. SS schedules the UL transmission in subframe #2 and subframe #7 to carry the PUSCH CQI feedback via PDCCH DCI format 0 with CQI request bit set to 1 and L\_MCS=29 and N\_PRB allocated to be less or equal to 4. Measure the average throughput and (NACK / (ACK + NACK)) according to Annex G.5.3. Declare the throughput as  $t_{subband}$ . If the ratio  $(t_{subband} / t_{median}) \geq \gamma$  and  $(NACK / (ACK + NACK)) \geq FFS$ , pass the UE and go to step 8. Otherwise, go to step 7.
7. If both SNR points of the test have not been tested, then repeat the same procedure (steps 1 to 6) for the other SNR point as appropriate. Otherwise fail the UE.
8. If both tests have not been done, then repeat the same procedure (steps 1 to 7) with test conditions according to the table 9.3.6.2\_F.1.3-1 for the other test as appropriate.

#### 9.3.6.2\_F.2.4.3 Message contents

Message contents are according to TS 36.508 [7] clause 4.6 with the following exception:

Table 9.3.6.2\_F.2.4.3-1: CQI-ReportConfig-v1130-DEFAULT

Derivation Path: 36.508 clause 4.6.3, Table 4.6.3-2ABA			
Information Element	Value/remark	Comment	Condition
CQI-ReportConfig-v1130 ::= SEQUENCE {			
cqi-ReportPeriodic-v1130 SEQUENCE {			
simultaneousAckNackAndCQI-Format3-r11	Not present	PUCCH Format 2	
cqi-ReportPeriodicProcExtToReleaseList-r11	Not present		
cqi-ReportPeriodicProcExtToAddModList-r11	1 entry		
SEQUENCE (SIZE (1..maxCQI-ProcExt-r11)) OF SEQUENCE {			
cqi-ReportPeriodicProcExtId-r11[1] SEQUENCE {			
cqi-ReportPeriodicProcExtId-r11	1		
cqi-pmi-ConfigIndex-r11	3		
cqi-FormatIndicatorPeriodic-r11 CHOICE {			
widebandCQI-r11 SEQUENCE {			
csi-ReportMode-r11	submode1		
}			
subbandCQI-r11	Not present	PUCCH 1-1	
}			
ri-ConfigIndex-r11	805		
csi-ConfigIndex-r11	Not present		
}			
}			
cqi-ReportBoth-r11 SEQUENCE {			
csi-IM-ConfigToReleaseList-r11	Not present		
csi-IM-ConfigToAddModList-r11 SEQUENCE (SIZE (1..maxCSI-IM-r11)) OF SEQUENCE {	3 entries		
csi-IM-ConfigId-r11[1]	1	CSI-IM 0	
resourceConfig-r11[1]	2		
subframeConfig-r11[1]	3		
csi-IM-ConfigId-r11[2]	2	CSI-IM 1	
resourceConfig-r11[2]	6		
subframeConfig-r11[2]	3		
}			
csi-ProcessToReleaseList-r11	Not present		
csi-ProcessToAddModList-r11 SEQUENCE (SIZE (1..maxCSI-Proc-r11)) OF SEQUENCE {	4 entries		
csi-ProcessId-r11[1]	1	CSI process 0	
csi-RS-ConfigNZPId-r11[1]	1		
csi-IM-ConfigId-r11[1]	1		
p-C-AndCBSRList-r11[1] SEQUENCE (SIZE (1..2)) OF SEQUENCE {	1 entry		
p-C-r11[1]	-3		
codebookSubsetRestriction-r11[1]	0x0000 0000 0000 0001		
}			
cqi-ReportBothProc-r11[1] SEQUENCE {			
ri-Ref-CSI-ProcessId-r11	1		
pmi-RI-Report-r11	setup		
}			
cqi-ReportPeriodicProcId-r11[1]	1		
cqi-ReportAperiodicProc-r11[1]	Not present		
csi-ProcessId-r11[2]	2	CSI process 1	
csi-RS-ConfigNZPId-r11[2]	2		
csi-IM-ConfigId-r11[2]	1		
p-C-AndCBSRList-r11[2] SEQUENCE (SIZE (1..2)) OF SEQUENCE {	1 entry		
p-C-r11[2]	0		
codebookSubsetRestriction-r11[2]	000001		
}			
cqi-ReportBothProc-r11[2] SEQUENCE {			
ri-Ref-CSI-ProcessId-r11	2		
pmi-RI-Report-r11	setup		
}			

cqi-ReportPeriodicProclD-r11[2]	Not present		
cqi-ReportAperiodicProc-r11[2] SEQUENCE {			
cqi-ReportModeAperiodic-r11	rm31		
trigger01-r11	1		
trigger10-r11	1		
trigger11-r11	1		
}			
csi-ProcessId-r11[3]	3	CSI process 2	
csi-RS-ConfigNZPId-r11[3]	1		
csi-IM-ConfigId-r11[3]	2		
p-C-AndCBSRList-r11[3] SEQUENCE (SIZE (1..2)) OF SEQUENCE {	1 entry		
p-C-r11[3]	-3		
codebookSubsetRestriction-r11[3]	0x0000 0000 0000 0001		
}			
cqi-ReportBothProc-r11[3] SEQUENCE {			
ri-Ref-CSI-ProcessId-r11	3		
pmi-RI-Report-r11	setup		
}			
cqi-ReportPeriodicProclD-r11[3]	Not present		
cqi-ReportAperiodicProc-r11[3] SEQUENCE {			
cqi-ReportModeAperiodic-r11	rm31		
trigger01-r11	1		
trigger10-r11	1		
trigger11-r11	1		
}			
}			
}			
}			
}			

**Table 9.3.6.2\_F.2.4.3-2: PhysicalConfigDedicated-DEFAULT**

Derivation Path: 36.331 clause 6.3.2			
Information Element	Value/remark	Comment	Condition
PhysicalConfigDedicated ::= SEQUENCE {			
csi-RS-ConfigNZPToAddModList-r11 SEQUENCE (SIZE (1..maxCSI-RS-NZP-r11)) OF SEQUENCE {	2 entries		
csi-RS-ConfigNZPId-r11[1]	1	CSI-RS signal 0	
antennaPortsCount-r11[1]	an4		
resourceConfig-r11[1]	0		
subframeConfig-r11[1]	3		
qcl-CRS-Info-r11 SEQUENCE[1] {			
crs-PortsCount-r11[1]	n2		
mbsfn-SubframeConfigList-r11 CHOICE[1]	Not present		
}			
csi-RS-ConfigNZPId-r11[2]	2	CSI-RS signal 1	
antennaPortsCount-r11[2]	an2		
resourceConfig-r11[2]	5		
subframeConfig-r11[2]	3		
qcl-CRS-Info-r11 SEQUENCE[2] {			
crs-PortsCount-r11[2]	n2		
mbsfn-SubframeConfigList-r11 CHOICE[2]	Not present		
}			
}			
csi-RS-ConfigZPToAddModList-r11 SEQUENCE (SIZE (1..maxCSI-RS-ZP-r11)) OF SEQUENCE {			
csi-RS-ConfigZPId-r11[1]	1	Zero-power CSI-RS 0	
resourceConfigList-r11[1]	1110000000000000	For TP2	
subframeConfig-r11[1]	3		
csi-RS-ConfigZPId-r11[2]	2	Zero-power CSI-RS 1	
resourceConfigList-r11[2]	0010011000000000	For TP1	
subframeConfig-r11[2]	3		
}			
}			

9.3.6.2\_F.2.5 Test requirement

**Table 9.3.6.2\_F.2.5-1: Test requirement (TDD)**

	CSI process 0	CSI process 1	CSI process 2
$\alpha$ [%]	N/A	2	2
$\beta$ [%]	N/A	40	40
$\delta$ [%]	10	N/A	N/A
$\gamma$	N/A	N/A	1.01
UE Category	$\geq 1$		

**Table 9.3.6.2\_F.2.5-2: Minimum median CQI difference between configured CSI processes (TDD)**

	CSI process 1	CSI process 2
CSI process 0	N/A	1
UE Category	$\geq 1$	

To pass the test,  $\alpha$  and  $\beta$  and  $\delta$  and  $\gamma$  and BLER must be fulfilled.

To pass the test, Test 1 and Test 2 must be passed.

To pass the test, one or the other SNR point within one test must be fulfilled.

### 9.3.6.2\_F.3 TDD CQI Reporting under fading conditions with Four CSI processes for CoMP

#### 9.3.6.2\_F.3.1 Test purpose

The purpose of the test is to verify the reporting accuracy of the CQI and the UE processing capability for Four CSI processes.

#### 9.3.6.2\_F.3.2 Test applicability

This test applies to all types of E-UTRA TDD UEs release 11 and forward, supporting Maximum CSI processes of Four on a component carrier within a band with PDSCH transmission mode 10.

#### 9.3.6.2\_F.3.3 Minimum conformance requirements

Same minimum conformance requirements as in clause 9.3.6.2\_F.1.3.

#### 9.3.6.2\_F.3.4 Test description

##### 9.3.6.2\_F.3.4.1 Initial conditions

Initial conditions are a set of test configurations the UE needs to be tested in and the steps for the SS to take with the UE to reach the correct measurement state.

Configurations of PDSCH and PDCCH before measurement are specified in Annex C.2.

Test Environment: Normal as defined in TS 36.508 [7] clause 4.1.

Frequencies to be tested: Mid Range as defined in TS 36.508 [7] clause 4.3.1.2.

Channel Bandwidths to be tested: 10MHz, as defined in TS 36.508 [7] clause 4.3.1.2

1. Connect the SS, faders and AWGN noise source to the UE antenna connector (s) as shown in TS 36.508 [7] Annex A, Figure A.52.
2. The parameter settings for the cell are set up according to Table 9.3.6.2\_F.1.3-1.
3. Downlink signals are initially set up according to Annex C.0, C.1 and Annex C.3.2, and uplink signals according to Annex H.1 and H.3.2.
4. Propagation conditions are set according to Annex B.0.
5. Ensure the UE is in State 3A-RF according to TS 36.508 [7] clause 5.2A.2. Message contents are defined in clause 9.3.6.2\_F.3.4.3.

##### 9.3.6.2\_F.3.4.2 Test procedure

1. Set the parameters of bandwidth, reference Channel, the propagation condition, antenna configuration and the SNR according to Table 9.3.6.2\_F.1.3-1 as appropriate.
2. The SS shall transmit PDSCH via PDCCH DCI format 2D for C\_RNTI to transmit the DL RMC according to CQI value 10 and keep it regardless of the wideband and full-size subband CQI value sent by the UE. Continue transmission of the PDSCH until 2000 wideband CQI reports and full-size subband CQI report for each full-size subband have been gathered for each of CSI process 0, 1, 2, and 3. The SS sends downlink MAC padding bits on the DL RMC. SS schedules the UL transmission in subframe #2 and subframe #7 to carry the PUSCH CQI feedback for CSI process 1, 2, and 3 via PDCCH DCI format 0 with CQI request bit set to 1 and I\_MCS=29 and N\_PRB allocated to be less or equal to 4. But for CSI process 0, SS schedules the UL transmission in subframe #0 and subframe #5 to carry the PUCCH CQI feedback. In this process the SS collects wideband CQI reports every 5 ms and also cases where UE transmits nothing in its CQI timing are counted as wideband CQI and full-size subband CQI reports.
3. Set up a relative frequency distribution for the reported wideband CQI-values, Calculate the median value (wideband Median CQI is the CQI that is at or crosses 50% distribution from the lower wideband CQI side). This CQI-value is declared as wideband Median CQI value.

4. Check if “ $2000 \cdot \alpha \% / 100 \leq$  number of CQI reports with index 0 for each full-size subband  $\leq 2000 \cdot \beta \% / 100$ ” for CSI process 1, 2 and 3. And check if the number of CQI index not in the set {median CQI -1, median CQI, median CQI +1} shall be reported at least  $2000 \cdot \delta \% / 100$  for CSI process 0. And check if the difference of the median CQIs of the reported wideband CQI for configured CSI processes 0, 1, 2 and 3 shall be greater or equal to the values as in Table 9.3.6.2\_F.3.5-2. (2000= No of full-size subband reports, 100 because of %). If yes, continue with step 5, otherwise goto step 7.
5. The SS shall send PDSCH via PDCCH DCI format 2D for C\_RNTI to transmit the DL RMC according to the wideband median-CQI value in an each available downlink transmission instance randomly selected full-size subband regardless of UE wideband and subband CQI report based on CSI process 2. Note that each full-size subband is selected in equal probability. The SS sends downlink MAC padding bits on the DL RMC. SS schedules the UL transmission in subframe #2 and subframe #7 to carry the PUSCH CQI feedback via PDCCH DCI format 0 with CQI request bit set to 1 and I\_MCS=29 and N\_PRB allocated to be less or equal to 4. Measure the average throughput according to Annex G.5.3 Declare the throughput as  $t_{median}$ .
6. The SS shall transmit PDSCH via PDCCH DCI format 2D for C\_RNTI to transmit the DL RMC according to the highest UE reported full-size subband CQI value in one full-size subband selected among the sub-bands in which UE report the highest full-size subband CQI based on CSI process 2. Subband differential CQI offset level is selected from {0, 1, 2, -1}. Note that the SS shall send PDSCH in the same full-size subband until next UE report is available. In case when same full-size subbands are reported subsequently as subbands with highest full-size subband CQI, the SS shall select for transmission a different subband with respect to the last selection. The SS sends downlink MAC padding bits on the DL RMC. SS schedules the UL transmission in subframe #2 and subframe #7 to carry the PUSCH CQI feedback via PDCCH DCI format 0 with CQI request bit set to 1 and I\_MCS=29 and N\_PRB allocated to be less or equal to 4. Measure the average throughput and (NACK / (ACK + NACK)) according to Annex G.5.3. Declare the throughput as  $t_{subband}$ . If the ratio  $(t_{subband} / t_{median}) \geq \gamma$  and (NACK / (ACK + NACK))  $\geq 0.02$ , pass the UE and go to step 8. Otherwise, go to step 7.
7. If both SNR points of the test have not been tested, then repeat the same procedure (steps 1 to 6) for the other SNR point as appropriate. Otherwise fail the UE.
8. If both tests have not been done, then repeat the same procedure (steps 1 to 7) with test conditions according to table 9.3.6.2\_F.1.3-1 for the other test as appropriate.

#### 9.3.6.2\_F.3.4.3 Message contents

Message contents are according to TS 36.508 [7] clause 4.6 with the following exception:

Table 9.3.6.2\_F.3.4.3-1: CQI-ReportConfig-v1130-DEFAULT

Derivation Path: 36.508 clause 4.6.3, Table 4.6.3-2ABA			
Information Element	Value/remark	Comment	Condition
CQI-ReportConfig-v1130 ::= SEQUENCE {			
cqi-ReportPeriodic-v1130 SEQUENCE {			
simultaneousAckNackAndCQI-Format3-r11	Not present	PUCCH Format 2	
cqi-ReportPeriodicProcExtToReleaseList-r11	Not present		
cqi-ReportPeriodicProcExtToAddModList-r11	1 entry		
SEQUENCE (SIZE (1..maxCQI-ProcExt-r11)) OF SEQUENCE {			
cqi-ReportPeriodicProcExtId-r11[1] SEQUENCE {			
cqi-ReportPeriodicProcExtId-r11	1		
cqi-pmi-ConfigIndex-r11	3		
cqi-FormatIndicatorPeriodic-r11 CHOICE {			
widebandCQI-r11 SEQUENCE {			
csi-ReportMode-r11	submode1		
}			
subbandCQI-r11	Not present	PUCCH 1-1	
}			
ri-ConfigIndex-r11	805		
csi-ConfigIndex-r11	Not present		
}			
}			
cqi-ReportBoth-r11 SEQUENCE {			
csi-IM-ConfigToReleaseList-r11	Not present		
csi-IM-ConfigToAddModList-r11 SEQUENCE (SIZE (1..maxCSI-IM-r11)) OF SEQUENCE {	3 entries		
csi-IM-ConfigId-r11[1]	1	CSI-IM 0	
resourceConfig-r11[1]	2		
subframeConfig-r11[1]	3		
csi-IM-ConfigId-r11[2]	2	CSI-IM 1	
resourceConfig-r11[2]	6		
subframeConfig-r11[2]	3		
csi-IM-ConfigId-r11[3]	3	CSI-IM 2	
resourceConfig-r11[3]	1		
subframeConfig-r11[3]	3		
}			
csi-ProcessToReleaseList-r11	Not present		
csi-ProcessToAddModList-r11 SEQUENCE (SIZE (1..maxCSI-Proc-r11)) OF SEQUENCE {	4 entries		
csi-ProcessId-r11[1]	1	CSI process 0	
csi-RS-ConfigNZPId-r11[1]	1		
csi-IM-ConfigId-r11[1]	1		
p-C-AndCBSRList-r11[1] SEQUENCE (SIZE (1..2)) OF SEQUENCE {	1 entry		
p-C-r11[1]	-3		
codebookSubsetRestriction-r11[1]	0x0000 0000 0000 0001		
}			
cqi-ReportBothProc-r11[1] SEQUENCE {			
ri-Ref-CSI-ProcessId-r11	1		
pmi-RI-Report-r11	setup		
}			
cqi-ReportPeriodicProcId-r11[1]	1		
cqi-ReportAperiodicProc-r11[1]	Not present		
csi-ProcessId-r11[2]	2	CSI process 1	
csi-RS-ConfigNZPId-r11[2]	2		
csi-IM-ConfigId-r11[2]	1		
p-C-AndCBSRList-r11[2] SEQUENCE (SIZE (1..2)) OF SEQUENCE {	1 entry		
p-C-r11[2]	0		
codebookSubsetRestriction-r11[2]	000001		
}			
cqi-ReportBothProc-r11[2] SEQUENCE {			



ri-Ref-CSI-ProcessId-r11	2		
pmi-RI-Report-r11	setup		
}			
cqi-ReportPeriodicProcId-r11[2]	Not present		
cqi-ReportAperiodicProc-r11[2] SEQUENCE {			
cqi-ReportModeAperiodic-r11	rm31		
trigger01-r11	1		
trigger10-r11	1		
trigger11-r11	1		
}			
csi-ProcessId-r11[3]	3	CSI process 2	
csi-RS-ConfigNZPId-r11[3]	1		
csi-IM-ConfigId-r11[3]	2		
p-C-AndCBSRList-r11[3] SEQUENCE (SIZE (1..2)) OF SEQUENCE {	1 entry		
p-C-r11[3]	-3		
codebookSubsetRestriction-r11[3]	0x0000 0000 0000 0001		
}			
cqi-ReportBothProc-r11[3] SEQUENCE {			
ri-Ref-CSI-ProcessId-r11	3		
pmi-RI-Report-r11	setup		
}			
cqi-ReportPeriodicProcId-r11[3]	Not present		
cqi-ReportAperiodicProc-r11[3] SEQUENCE {			
cqi-ReportModeAperiodic-r11	rm31		
trigger01-r11	1		
trigger10-r11	1		
trigger11-r11	1		
}			
csi-ProcessId-r11[4]	4	CSI process 3	
csi-RS-ConfigNZPId-r11[4]	2		
csi-IM-ConfigId-r11[4]	3		
p-C-AndCBSRList-r11[4] SEQUENCE (SIZE (1..2)) OF SEQUENCE {	1 entry		
p-C-r11[4]	0		
codebookSubsetRestriction-r11[4]	000001		
}			
cqi-ReportBothProc-r11[4] SEQUENCE {			
ri-Ref-CSI-ProcessId-r11	4		
pmi-RI-Report-r11	setup		
}			
cqi-ReportPeriodicProcId-r11[4]	Not present		
cqi-ReportAperiodicProc-r11[4] SEQUENCE {			
cqi-ReportModeAperiodic-r11	rm31		
trigger01-r11	1		
trigger10-r11	1		
trigger11-r11	1		
}			
}			
}			
}			

**Table 9.3.6.2\_F.3.4.3-2: PhysicalConfigDedicated-DEFAULT**

Derivation Path: 36.331 clause 6.3.2			
Information Element	Value/remark	Comment	Condition
PhysicalConfigDedicated ::= SEQUENCE {			
csi-RS-ConfigNZPToAddModList-r11 SEQUENCE (SIZE (1..maxCSI-RS-NZP-r11)) OF SEQUENCE {	2 entries		
csi-RS-ConfigNZPId-r11[1]	1	CSI-RS signal 0	
antennaPortsCount-r11[1]	an4		
resourceConfig-r11[1]	0		
subframeConfig-r11[1]	3		
qcl-CRS-Info-r11 SEQUENCE[1] {			
crs-PortsCount-r11[1]	n2		
mbsfn-SubframeConfigList-r11 CHOICE[1]	Not present		
}			
csi-RS-ConfigNZPId-r11[2]	2	CSI-RS signal 1	
antennaPortsCount-r11[2]	an2		
resourceConfig-r11[2]	5		
subframeConfig-r11[2]	3		
qcl-CRS-Info-r11 SEQUENCE[2] {			
crs-PortsCount-r11[2]	n2		
mbsfn-SubframeConfigList-r11 CHOICE[2]	Not present		
}			
}			
csi-RS-ConfigZPToAddModList-r11 SEQUENCE (SIZE (1..maxCSI-RS-ZP-r11)) OF SEQUENCE {			
csi-RS-ConfigZPId-r11[1]	1	Zero-power CSI-RS 0	
resourceConfigList-r11[1]	1110000000000000	For TP2	
subframeConfig-r11[1]	3		
csi-RS-ConfigZPId-r11[2]	2	Zero-power CSI-RS 1	
resourceConfigList-r11[2]	0010011000000000	For TP1	
subframeConfig-r11[2]	3		
}			
}			

9.3.6.2\_F.3.5 Test requirement

**Table 9.3.6.2\_F.3.5-1: Test requirement (TDD)**

	CSI process 0	CSI process 1	CSI process 2	CSI process 3
$\alpha$ [%]	N/A	2	2	2
$\beta$ [%]	N/A	40	40	40
$\delta$ [%]	10	N/A	N/A	N/A
$\gamma$	N/A	N/A	1.01	N/A
UE Category	≥1			

**Table 9.3.6.2\_F.3.5-2: Minimum median CQI difference between configured CSI processes (TDD)**

	CSI process 1	CSI process 2	CSI process 3
CSI process 0	N/A	1	3
UE Category	≥1		

To pass the test,  $\alpha$  and  $\beta$  and  $\delta$  and  $\gamma$  and BLER must be fulfilled.

To pass the test, Test 1 and Test 2 must be passed.

To pass the test, one or the other SNR point within one test must be fulfilled.

## 9.3.7 PUSCH 3-2 for eDL MIMO Enhancement

### 9.3.7.1\_G FDD CQI Reporting under fading conditions - PUSCH 3-2 for eDL MIMO Enhancement

Editor's notes: This test case is incomplete. The following item is missing or incomplete:

- Some test parameters are still in square brackets
- Missing test tolerances
- RAN WG5 is waiting on feedback on whether Release 10 Feature Group Indicator 103 is necessary for the Release 12 test cases.

#### 9.3.7.1\_G.1 Test purpose

The purpose of the test is to verify the reporting accuracy of the sub band CQI and sub band PMI operation.

#### 9.3.7.1\_G.2 Test applicability

This test applies to all types of E-UTRA FDD UE releases 12 and forward that support eDL-MIMO Enhancement. Applicability requires support for FGI bit [FFS].

#### 9.3.7.1\_G.3 Minimum conformance requirements

For the parameters specified in Table 9.3.7.1\_G.3-1, and using the downlink physical channels specified in Annex C.3.2, the minimum requirements are specified in Table 9.3.7.1\_G.3-2 and by the following.

- a) the ratio of the throughput obtained when transmitting based on UE PUSCH 3-2 reported wideband CQI and subband PMI and that obtained when transmitting based on PUSCH 3-1 reported wideband CQI and wideband PMI shall be  $\geq \alpha$ ;
- b) The ratio of the throughput obtained when transmitting on a randomly selected sub-band among the sub-bands with the highest differential CQI offset level the corresponding TBS based on UE PUSCH 3-2 reported subband CQI and subband PMI and that obtained when transmitting on a randomly selected sub-band in set S based on PUSCH 1-2 reported wideband CQI and subband PMI shall be  $\geq \beta$ ;

The transport block sizes TBS for wideband CQI and subband CQI are selected according to RC.16 FDD for test 1 and according to RC.17 FDD for test 2.

Table 9.3.7.1\_G.3-1: Sub-band test for FDD

Parameter		Unit	Test 1		Test 2	
Bandwidth		MHz	10MHz			
PDSCH resource allocation		RB	50PRB		a subband, 6PRB	
Transmission mode			TM6		TM9	
Downlink power allocation	$\rho_A$	dB	-6		0	
	$\rho_B$	dB	-6		0	
	$P_c$	dB	-		-3	
	$\sigma$	dB	3		-3	
SNR (Note 3)		dB	[0]	[1]	[5]	[6]
$\hat{I}_{or}^{(j)}$		dB[mW/15kHz]	[-98]	[-97]	[-93]	[-92]
$N_{oc}^{(j)}$		dB[mW/15kHz]	-98	-98	-98	-98
Propagation channel			EVA5		EVA5	
Antenna configuration			4x2 ULA low		4x2 XP high (Note 4)	
Beamforming Model			-		B.4.3	
CRS reference signals			Antenna ports 0, 1, 2, 3		Antenna ports 0, 1	
Time offset between TX antenna (Note 5)		ns	65		-	
CSI reference signals			-		Antenna ports 15, 16, 17, 18	
CSI-RS periodicity and subframe offset $T_{CSI-RS} / \Delta_{CSI-RS}$			-		5/ 1	
CSI-RS reference signal configuration alternativeCodebookEnabledFor4TX			-		4	
CodeBookSubsetRestriction bitmap			No		Yes	
CodeBookSubsetRestriction bitmap			0x0000 0000 0000 FFFF		0x0000 0000 0000 FFFF 0000 FFFF	
Reporting interval (Note 6)		ms	5		5	
CQI delay		ms	8		8	
Reporting mode			PUSCH 3-2, PUSCH 3-1		PUSCH 3-2, PUSCH 1-2	
Sub-band size		RB	6 (full size)		6 (full size)	
Max number of HARQ transmissions			1		1	
<p>Note 1: If the UE reports in an available uplink reporting instance at subframe SF#n based on CQI estimation at a downlink subframe not later than SF#(n-4), this reported subband or wideband CQI cannot be applied at the eNB downlink before SF#(n+4)</p> <p>Note 2: Reference measurement channel according to Table A.4-1 with one/two sided dynamic OCNG Pattern OP.1/2 FDD as described in Annex A.5.1.1/2.</p> <p>Note 3: For each test, the minimum requirements shall be fulfilled for at least one of the two SNR(s) and the respective wanted signal input level.</p> <p>Note 4: Randomization of the principle beam direction shall be used as specified in B.2.3A.4.</p> <p>Note 5: The values of time offset are [0ns 65ns 0ns 65ns] for antenna port [0, 1, 2, 3] respectively.</p> <p>Note 6: PDCCH DCI format 0 with a trigger for aperiodic CQI shall be transmitted in downlink SF#1 and #6 to allow aperiodic CQI/PMI/RI to be transmitted in uplink SF#0 and #5.</p>						

Table 9.3.7.1\_G.3-2: Minimum requirement (FDD)

	Test 1	Test 2
$\alpha$	[1.05]	-
$\beta$	-	[1.15]
UE Category	$\geq 1$	$\geq 1$

The normative reference for this requirement is TS 36.101 [2] clause 9.3.7.1.

#### 9.3.7.1\_G.4 Test description

##### 9.3.7.1\_G.4.1 Initial conditions

Initial conditions are a set of test configurations the UE needs to be tested in and the steps for the SS to take with the UE to reach the correct measurement state.

Configurations of PDSCH and PDCCH before measurement are specified in Annex C.2.

Test Environment: Normal as defined in TS 36.508 [7] clause 4.1.

Frequencies to be tested: Mid Range as defined in TS 36.508 [7] clause 4.3.1.1.

Channel Bandwidths to be tested: 10MHz, as defined in TS 36.508 [7] clause 4.3.1.1

1. Connect the SS, faders and AWGN noise source to the UE antenna connector (s) as shown in TS 36.508 [7] Annex A, Figure A.11.
2. The parameter settings for the cell are set up according to Table 9.3.7.1\_G.3-1.
3. Downlink signals are initially set up according to Annex C.0, C.1 and Annex C.3.2 and uplink signals according to Annex H.1 and H.3.2.
4. Propagation conditions are set according to Annex B.0.
5. Ensure the UE is in State 3A-RF according to TS 36.508 [7] clause 5.2A.2. Message contents are defined in clause 9.3.7.1\_G.4.3.

#### 9.3.7.1\_G.4.2 Test procedure

1. Set the parameters of bandwidth, reference Channel, the propagation condition, antenna configuration and the SNR according to Table 9.3.7.1\_G.3-1 as appropriate.

For Test1

2. The SS shall transmit PDSCH via PDCCH DCI format 1B for C\_RNTI to transmit the DL RMC according to the wideband and subband CQI value sent by the UE and according to the wideband and subband PMI value sent by the UE. Continue transmission of the PDSCH until 2000 wideband CQI reports, wideband PMI reports, full-size subband CQI reports, and full-size subband PMI reports for each full-size subband have been gathered. The SS sends downlink MAC padding bits on the DL RMC. SS schedules the UL transmission in subframe #0 and subframe #5 to carry the PUSCH CQI feedback via PDCCH DCI format 0 with CQI request bit set to 1 and I\_MCS=29 and N\_PRB allocated to be less or equal to 4. In this process the SS collects wideband CQI reports every 5 ms and also cases where UE transmits nothing in its CQI timing are counted as wideband CQI and full-size subband CQI reports.
3. The SS shall transmit PDSCH via PDCCH DCI format 1B for C\_RNTI to transmit the DL RMC according to the wideband CQI value and wideband PMI value. The SS sends downlink MAC padding bits on the DL RMC. SS schedules the UL transmission in subframe #0 and subframe #5 to carry the PUSCH 3-1 CQI feedback via PDCCH DCI format 0 with CQI request bit set to 1 and I\_MCS=29 and N\_PRB allocated to be less or equal to 4. Measure the average throughput according to Annex G.5.3. Declare the throughput as  $t_{wideband}$ .
4. The SS sends uplink scheduling information via PDCCH DCI format 0 with CQI request bit to 0 to schedule UL RMC in every subframe (Table A.4.1-1).
5. The SS shall transmit an RRC Connection Reconfiguration message to set reporting mode according to Table 9.3.7.1\_G.3-1.
6. The UE shall transmit RRC Connection Reconfiguration Complete message.
7. The SS shall transmit PDSCH via PDCCH DCI format 1B for C\_RNTI to transmit the DL RMC according to the wideband CQI value and subband PMI value. The SS sends downlink MAC padding bits on the DL RMC. SS schedules the UL transmission in subframe #0 and subframe #5 to carry the PUSCH 3-2 CQI feedback via PDCCH DCI format 0 with CQI request bit set to 1 and I\_MCS=29 and N\_PRB allocated to be less or equal to 4. Measure the average throughput according to Annex G.5.3. Declare the throughput as  $t_{subband}$ .
8. If the ratio  $(t_{subband} / t_{wideband}) \geq \alpha$  which is specified in Table 9.3.7.1\_G.5-1, pass the UE for this test and go to step 16. Otherwise, go to step 15.

For Test2

9. The SS shall transmit PDSCH via PDCCH DCI format 2C for C\_RNTI to transmit the DL RMC according to the wideband and subband CQI value sent by the UE and according to the wideband and subband PMI value sent by

the UE. Continue transmission of the PDSCH until 2000 wideband CQI reports, wideband PMI reports, full-size subband CQI reports, and full-size subband PMI reports for each full-size subband have been gathered. The SS sends downlink MAC padding bits on the DL RMC. SS schedules the UL transmission in subframe #0 and subframe #5 to carry the PUSCH CQI feedback via PDCCH DCI format 0 with CQI request bit set to 1 and  $I_{MCS}=29$  and  $N_{PRB}$  allocated to be less or equal to 4. In this process the SS collects wideband CQI reports every 5 ms and also cases where UE transmits nothing in its CQI timing are counted as wideband CQI and full-size subband CQI reports.

10. The SS shall send PDSCH via PDCCH DCI format 2C for  $C_{RNTI}$  to transmit the DL RMC according to the wideband CQI value and subband PMI value in each available downlink transmission instance randomly selected full-size subband. Note that each full-size subband is selected in equal probability. The SS sends downlink MAC padding bits on the DL RMC. SS schedules the UL transmission in subframe #0 and subframe #5 to carry the PUSCH 1-2 CQI feedback via PDCCH DCI format 0 with CQI request bit set to 1 and  $I_{MCS}=29$  and  $N_{PRB}$  allocated to be less or equal to 4. Measure the average throughput according to Annex G.5.3. Declare the throughput as  $t_{wideband}$ .
11. The SS sends uplink scheduling information via PDCCH DCI format 0 with CQI request bit to 0 to schedule UL RMC in every subframe (Table A.4.1-1).
12. The SS shall transmit an RRC Connection Reconfiguration message to set **reporting mode** according to Table 9.3.7.1\_G.3-1.
13. The UE shall transmit RRC Connection Reconfiguration Complete message.
14. The SS shall transmit PDSCH via PDCCH DCI format 2C for  $C_{RNTI}$  to transmit the DL RMC according to the highest UE reported full-size subband CQI value and full-size subband PMI value in one full-size subband selected among the subbands in which UE reports the highest full-size subband CQI and full-size subband PMI. Subband differential CQI offset level is selected from {0, 1, 2, -1}. Note that the SS shall send PDSCH in the same full-size subband until next UE report is available. In case when same full-size subbands are reported subsequently as subbands with highest full-size subband CQI, the SS shall select for transmission a different subband with respect to the last selection. The SS sends downlink MAC padding bits on the DL RMC. SS schedules the UL transmission in subframe #0 and subframe #5 to carry the PUSCH 3-2 CQI feedback via PDCCH DCI format 0 with CQI request bit set to 1 and  $I_{MCS}=29$  and  $N_{PRB}$  allocated to be less or equal to 4. Measure the average throughput according to Annex G.5.3. Declare the throughput as  $t_{subband}$ . If the ratio  $(t_{subband} / t_{wideband}) \geq \beta$  which is specified in Table 9.3.7.1\_G.5-1, pass the UE for this test and go to step 16. Otherwise, go to step 15.
15. If both SNR points of the test have not been tested, then repeat the same procedure (steps 1 to 14) for the other SNR point as appropriate. Otherwise fail the UE.
16. If both tests have not been done, then repeat the same procedure (steps 1 to 15) with test conditions according to the Table 9.3.7.1\_G.3-1 for the other Test as appropriate. Otherwise pass the UE.

#### 9.3.7.1\_G.4.3 Message contents

Message contents are according to TS 36.508 [7] clause 4.6 with the following exceptions:

**Table 9.3.7.1\_G.4.3-1: PhysicalConfigDedicated-DEFAULT**

Derivation Path: 36.331 clause 6.3.2			
Information Element	Value/remark	Comment	Condition
PhysicalConfigDedicated-DEFAULT ::= SEQUENCE {			
cqi-ReportConfig	CQI-ReportConfig-DEFAULT	Test 1	
antennaInfo CHOICE {		Test 1	
antennaInfoDedicated ::= SEQUENCE {			
transmissionMode	tm6		
codebookSubsetRestriction CHOICE{			
n4TxAntenna-tm6	1111111111111111		
}			
ue-TransmitAntennaSelection CHOICE {			
release	NULL		
}			
}			
antennaInfo	Not present	Test 2	
antennaInfo-r10 CHOICE {		Test 2	
explicitValue-r10	AntennaInfoDedicated-r10		
}			
cqi-ReportConfig-r10	CQI-ReportConfig-r10-DEFAULT	Test 2	
csi-RS-Config-r10	CSI-RS-Config-r10	Test 2	
antennaInfo-v1250	AntennaInfoDedicated-v1250	Test 2	
}			

**Table 9.3.7.1\_G.4.3-2: PDSCH-ConfigDedicated-DEFAULT**

Derivation Path: 36.508 clause 4.6.3			
Information Element	Value/remark	Comment	Condition
PDSCH-ConfigDedicated-DEFAULT ::= SEQUENCE {			
p-a	dB-6	Test 1	
	dB0	Test 2	
}			

**Table 9.3.7.1\_G.4.3-3: CQI-ReportConfig-DEFAULT**

Derivation Path: 36.331 clause 6.3.2			
Information Element	Value/remark	Comment	Condition
CQI-ReportConfig-DEFAULT ::= SEQUENCE {			
cqi-ReportModeAperiodic	rm32-v1250, rm31	Test 1	
nomPDSCH-RS-EPRE-Offset	0		
cqi-ReportPeriodic	Not present		
}			

**Table 9.3.7.1\_G.4.3-4: AntennaInfoDedicated-r10**

Derivation Path: 36.331 clause 6.3.2			
Information Element	Value/remark	Comment	Condition
AntennaInfoDedicated-r10 ::= SEQUENCE {			
transmissionMode-r10	tm9-v1020	Test 2	
codebookSubsetRestriction-r10	0x0000 0000 0000 FFFF 0000 FFFF	Test 2	
ue-TransmitAntennaSelection CHOICE {			
release	NULL		
}			
}			

**Table 9.3.7.1\_G.4.3-5: AntennaInfoDedicated-v1250**

Derivation Path: 36.331 clause 6.3.2			
Information Element	Value/remark	Comment	Condition
AntennaInfoDedicated-v1250 ::= SEQUENCE {			
alternativeCodebookEnabledFor4TX-r12	TRUE	Test 2	
}			

**Table 9.3.7.1\_G.4.3-6: CQI-ReportConfig-r10-DEFAULT**

Derivation Path: 36.508 clause 4.6.3			
Information Element	Value/remark	Comment	Condition
CQI-ReportConfig-r10 ::= SEQUENCE {			
cqi-ReportModeAperiodic-r10	rm32-v1250, rm12	Test 2	
nomPDSCH-RS-EPRE-Offset	0		
cqi-ReportPeriodic-r10	Not present		
}			

**Table 9.3.7.1\_G.4.3-7: CSI-RS-Config**

Derivation Path: 36.331 clause 6.3.2			
Information Element	Value/remark	Comment	Condition
CSI-RS-Config-r10 ::= SEQUENCE {			
csi-RS-r10 CHOICE{			
release	NULL		
setup SEQUENCE {			
antennaPortsCount-r10	an4	Parameter represents the number of antenna ports used for transmission of CSI reference signals	
resourceConfig-r10	4	Parameter: CSI reference signal configuration	
subframeConfig-r10	1	$\Delta_{\text{CSI-RS}} = I_{\text{CSI-RS}}$ when CSI-RS SubframeConfig is from 0-4; Parameter: $I_{\text{CSI-RS}}$	
p-C-r10	-3	Parameter: $P_c$ which is the assumed ratio of PDSCH EPRE to CSI-RS EPRE when UE derives CSI feedback	
}			
}			
}			

## 9.3.7.1\_G.5 Test requirement

**Table 9.3.7.1\_G.5-1: Test requirement (FDD)**

	Test 1	Test 2
$\alpha$	[1.05]+TT	-
$\beta$	-	[1.15]+TT
UE Category	$\geq 1$	$\geq 1$

To pass the test,  $\alpha$  and  $\beta$  must be fulfilled.



To pass the test, Test 1 and Test 2 must be passed.

To pass the test, one **or** the other SNR point within one test must be fulfilled.

### 9.3.7.2\_G TDD CQI Reporting under fading conditions - PUSCH 3-2 for eDL MIMO Enhancement

**Editor's notes: This test case is incomplete. The following item is missing or incomplete:**

- Some test parameters are still in square brackets

- Missing test tolerances

- RAN WG5 is waiting on feedback on whether Release 10 Feature Group Indicator 103 is necessary for the Release 12 test cases.

#### 9.3.7.2\_G.1 Test purpose

The purpose of the test is to verify the reporting accuracy of the sub band CQI and sub band PMI operation.

#### 9.3.7.2\_G.2 Test applicability

This test applies to all types of E-UTRA TDD UE releases 12 and forward that support eDL-MIMO Enhancement. Applicability requires support for FGI bit [FFS].

#### 9.3.7.2\_G.3 Minimum conformance requirements

For the parameters specified in Table 9.3.7.2\_G.3-1, and using the downlink physical channels specified in Annex C.3.2, the minimum requirements are specified in Table 9.3.7.2\_G.3-2 and by the following.

- a) the ratio of the throughput obtained when transmitting based on UE PUSCH 3-2 reported wideband CQI and subband PMI and that obtained when transmitting based on PUSCH 3-1 reported wideband CQI and wideband PMI shall be  $\geq \alpha$ ;
- b) The ratio of the throughput obtained when transmitting on a randomly selected sub-band among the sub-bands with the highest differential CQI offset level the corresponding TBS based on UE PUSCH3-2 reported subband CQI and subband PMI and that obtained when transmitting on a randomly selected sub-band in set S based on PUSCH 1-2 reported wideband CQI and subband PMI shall be  $\geq \beta$ ;

The transport block sizes TBS for wideband CQI and subband CQI are selected according to RC.14 TDD for test 1 and RC.15 TDD for test 2.

**Table 9.3.7.2\_G.3-1: Sub-band test for TDD**

Parameter		Unit	Test 1		Test 2	
Bandwidth		MHz	10MHz			
PDSCH resource allocation		RB	50PRB		a subband, 6PRB	
Transmission mode			TM6		TM9	
Uplink downlink configuration			1		1	
Special subframe configuration			4		4	
Downlink power allocation	$\rho_A$	dB	-6		0	
	$\rho_B$	dB	-6		0	
	$P_C$	dB	-		-3	
	$\sigma$	dB	3		-3	
SNR (Note 3)		dB	[0]	[1]	[5]	[6]
$\hat{I}_{or}^{(j)}$		dB[mW/15kHz]	[-98]	[-97]	[-93]	[-92]
$N_{oc}^{(j)}$		dB[mW/15kHz]	-98	-98	-98	-98
Propagation channel			EVA5		EVA5	
Antenna configuration			4x2 ULA low		4x2 XP high (Note 4)	
Beamforming Model			-		B.4.3	
CRS reference signals			Antenna ports 0, 1, 2, 3		Antenna ports 0, 1	
Time offset between TX antenna (Note 5)		ns	65		-	
CSI reference signals			-		Antenna ports 15, 16, 17, 18	
CSI-RS periodicity and subframe offset $T_{CSI-RS} / \Delta_{CSI-RS}$			-		5/ 4	
CSI-RS reference signal configuration alternativeCodebookEnabledFor4TX			No		Yes	
CodeBookSubsetRestriction bitmap			0x0000 0000 0000 FFFF		0x0000 0000 0000 FFFF 0000 FFFF	
Reporting interval (Note 6)		ms	5		5	
CQI delay		ms	8		8	
Reporting mode			PUSCH 3-2, PUSCH 3-1		PUSCH 3-2, PUSCH 1-2	
Sub-band size		RB	6 (full size)		6 (full size)	
Max number of HARQ transmissions			1		1	
<p>Note 1: If the UE reports in an available uplink reporting instance at subframe SF#n based on CQI estimation at a downlink subframe not later than SF#(n-4), this reported subband or wideband CQI cannot be applied at the eNB downlink before SF#(n+4)</p> <p>Note 2: Reference measurement channel according to Table A.4-1 with one/two sided dynamic OCNG Pattern OP.1/2 FDD as described in Annex A.5.1.1/2.</p> <p>Note 3: For each test, the minimum requirements shall be fulfilled for at least one of the two SNR(s) and the respective wanted signal input level.</p> <p>Note 4: Randomization of the principle beam direction shall be used as specified in B.2.3A.4.</p> <p>Note 5: The values of time offset are [0ns 65ns 0ns 65ns] for antenna port [0, 1, 2, 3] respectively.</p> <p>Note 6: PDCCH DCI format 0 with a trigger for aperiodic CQI shall be transmitted in downlink SF#4 and #9 to allow aperiodic CQI/PMI/RI to be transmitted in uplink SF#3 and #8.</p>						

**Table 9.3.7.2\_G.3-2: Minimum requirement (TDD)**

	Test 1	Test 2
$\alpha$	[1.05]	-
$\beta$	-	[1.15]
UE Category	$\geq 1$	$\geq 1$

The normative reference for this requirement is TS 36.101 [2] clause 9.3.7.2.

9.3.7.2\_G.4 Test description

9.3.7.2\_G.4.1 Initial conditions

Initial conditions are a set of test configurations the UE needs to be tested in and the steps for the SS to take with the UE to reach the correct measurement state.

Configurations of PDSCH and PDCCH before measurement are specified in Annex C.2.

Test Environment: Normal as defined in TS 36.508 [7] clause 4.1.

Frequencies to be tested: Mid Range as defined in TS 36.508 [7] clause 4.3.1.2.

Channel Bandwidths to be tested: 10MHz, as defined in TS 36.508 [7] clause 4.3.1.2

1. Connect the SS, faders and AWGN noise source to the UE antenna connector (s) as shown in TS 36.508 [7] Annex A, Figure A.11.
2. The parameter settings for the cell are set up according to Table 9.3.7.2\_G.3-1.
3. Downlink signals are initially set up according to Annex C.0, C.1 and Annex C.3.2, and uplink signals according to Annex H.1 and H.3.2.
4. Propagation conditions are set according to Annex B.0.
5. Ensure the UE is in State 3A-RF according to TS 36.508 [7] clause 5.2A.2. Message contents are defined in clause 9.3.7.2\_G.4.3.

#### 9.3.7.2\_G.4.2 Test procedure

1. Set the parameters of bandwidth, reference Channel, the propagation condition, antenna configuration and the SNR according to Table 9.3.7.2\_G.3-1 as appropriate.

For Test1

2. The SS shall transmit PDSCH via PDCCH DCI format 1B for C\_RNTI to transmit the DL RMC according to the wideband and subband CQI value sent by the UE and according to the wideband and subband PMI value sent by the UE. Continue transmission of the PDSCH until 2000 wideband CQI reports, wideband PMI reports, full-size subband CQI reports, and full-size subband PMI reports for each full-size subband have been gathered. The SS sends downlink MAC padding bits on the DL RMC. SS schedules the UL transmission in subframe #3 and subframe #8 to carry the PUSCH CQI feedback via PDCCH DCI format 0 with CQI request bit set to 1 and I\_MCS=29 and N\_PRB allocated to be less or equal to 4. In this process the SS collects wideband CQI reports every 5 ms and also cases where UE transmits nothing in its CQI timing are counted as wideband CQI and full-size subband CQI reports.
3. The SS shall transmit PDSCH via PDCCH DCI format 1B for C\_RNTI to transmit the DL RMC according to the wideband CQI value and wideband PMI value. The SS sends downlink MAC padding bits on the DL RMC. SS schedules the UL transmission in subframe #3 and subframe #8 to carry the PUSCH 3-1 CQI feedback via PDCCH DCI format 0 with CQI request bit set to 1 and I\_MCS=29 and N\_PRB allocated to be less or equal to 4. Measure the average throughput according to Annex G.5.3. Declare the throughput as  $t_{wideband}$ .
4. The SS sends uplink scheduling information via PDCCH DCI format 0 with CQI request bit to 0 to schedule UL RMC in subframe#3 and #8 (Table A.4.1-2).
5. The SS shall transmit an RRC Connection Reconfiguration message to set reporting mode according to Table 9.3.7.2\_G.3-1.
6. The UE shall transmit RRC Connection Reconfiguration Complete message.
7. The SS shall transmit PDSCH via PDCCH DCI format 1B for C\_RNTI to transmit the DL RMC according to the wideband CQI value and subband PMI value. The SS sends downlink MAC padding bits on the DL RMC. SS schedules the UL transmission in subframe #3 and subframe #8 to carry the PUSCH 3-2 CQI feedback via PDCCH DCI format 0 with CQI request bit set to 1 and I\_MCS=29 and N\_PRB allocated to be less or equal to 4. Measure the average throughput according to Annex G.5.3. Declare the throughput as  $t_{subband}$ .
8. If the ratio  $(t_{subband} / t_{wideband}) \geq \alpha$  which is specified in Table 9.3.7.2\_G.5-1, pass the UE for this test and go to step 16. Otherwise, go to step 15.

For Test2

9. The SS shall transmit PDSCH via PDCCH DCI format 2C for C\_RNTI to transmit the DL RMC according to the wideband and subband CQI value sent by the UE and according to the wideband and subband PMI value sent by the UE. Continue transmission of the PDSCH until 2000 wideband CQI reports, wideband PMI reports, full-size subband CQI reports, and full-size subband PMI reports for each full-size subband have been gathered. The SS sends downlink MAC padding bits on the DL RMC. SS schedules the UL transmission in subframe #3 and subframe #8 to carry the PUSCH CQI feedback via PDCCH DCI format 0 with CQI request bit set to 1 and I\_MCS=29 and N\_PRB allocated to be less or equal to 4. In this process the SS collects wideband CQI reports every 5 ms and also cases where UE transmits nothing in its CQI timing are counted as wideband CQI and full-size subband CQI reports.
10. The SS shall send PDSCH via PDCCH DCI format 2C for C\_RNTI to transmit the DL RMC according to the wideband CQI value and subband PMI value in each available downlink transmission instance randomly selected full-size subband. Note that each full-size subband is selected in equal probability. The SS sends downlink MAC padding bits on the DL RMC. SS schedules the UL transmission in subframe #3 and subframe #8 to carry the PUSCH 1-2 CQI feedback via PDCCH DCI format 0 with CQI request bit set to 1 and I\_MCS=29 and N\_PRB allocated to be less or equal to 4. Measure the average throughput according to Annex G.5.3. Declare the throughput as  $t_{wideband}$ .
11. The SS sends uplink scheduling information via PDCCH DCI format 0 with CQI request bit to 0 to schedule UL RMC in subframe#3 and #8 (Table A.4.1-2).
12. The SS shall transmit an RRC Connection Reconfiguration message to set **reporting mode** according to Table 9.3.7.2\_G.3-1.
13. The UE shall transmit RRC Connection Reconfiguration Complete message.
14. The SS shall transmit PDSCH via PDCCH DCI format 2C for C\_RNTI to transmit the DL RMC according to the highest UE reported full-size subband CQI value and full-size subband PMI value in one full-size subband selected among the subbands in which UE reports the highest full-size subband CQI and full-size subband PMI. Subband differential CQI offset level is selected from {0, 1, 2, -1}. Note that the SS shall send PDSCH in the same full-size subband until next UE report is available. In case when same full-size subbands are reported subsequently as subbands with highest full-size subband CQI, the SS shall select for transmission a different subband with respect to the last selection. The SS sends downlink MAC padding bits on the DL RMC. SS schedules the UL transmission in subframe #3 and subframe #8 to carry the PUSCH 3-2 CQI feedback via PDCCH DCI format 0 with CQI request bit set to 1 and I\_MCS=29 and N\_PRB allocated to be less or equal to 4. Measure the average throughput according to Annex G.5.3. Declare the throughput as  $t_{subband}$ . If the ratio  $(t_{subband} / t_{wideband}) \geq \beta$  which is specified in Table 9.3.7.2\_G.5-1, pass the UE for this test and go to step 16. Otherwise, go to step 15.
15. If both SNR points of the test have not been tested, then repeat the same procedure (steps 1 to 14) for the other SNR point as appropriate. Otherwise fail the UE.
16. If both tests have not been done, then repeat the same procedure (steps 1 to 15) with test conditions according to the Table 9.3.7.2\_G.3-1 for the other Test as appropriate. Otherwise pass the UE.

#### 9.3.7.2\_G.4.3 Message contents

Message contents are according to TS 36.508 [7] clause 4.6 with the following exceptions:

**Table 9.3.7.2\_G.4.3-1: PhysicalConfigDedicated-DEFAULT**

Derivation Path: 36.331 clause 6.3.2			
Information Element	Value/remark	Comment	Condition
PhysicalConfigDedicated-DEFAULT ::= SEQUENCE {			
cqi-ReportConfig	CQI-ReportConfig-DEFAULT	Test 1	
antennaInfo CHOICE {		Test 1	
antennaInfoDedicated ::= SEQUENCE {			
transmissionMode	tm6		
codebookSubsetRestriction CHOICE{			
n4TxAntenna-tm6	1111111111111111		
}			
ue-TransmitAntennaSelection CHOICE {			
release	NULL		
}			
}			
antennaInfo	Not present	Test 2	
antennaInfo-r10 CHOICE {		Test 2	
explicitValue-r10	AntennaInfoDedicated-r10		
}			
cqi-ReportConfig-r10	CQI-ReportConfig-r10-DEFAULT	Test 2	
csi-RS-Config-r10	CSI-RS-Config-r10	Test 2	
antennaInfo-v1250	AntennaInfoDedicated-v1250	Test 2	
}			

**Table 9.3.7.2\_G.4.3-2: PDSCH-ConfigDedicated-DEFAULT**

Derivation Path: 36.508 clause 4.6.3			
Information Element	Value/remark	Comment	Condition
PDSCH-ConfigDedicated-DEFAULT ::= SEQUENCE {			
p-a	dB-6	Test 1	
	dB0	Test 2	
}			

**Table 9.3.7.2\_G.4.3-3: CQI-ReportConfig-DEFAULT**

Derivation Path: 36.331 clause 6.3.2			
Information Element	Value/remark	Comment	Condition
CQI-ReportConfig-DEFAULT ::= SEQUENCE {			
cqi-ReportModeAperiodic	rm32-v1250, rm31	Test 1	
nomPDSCH-RS-EPRE-Offset	0		
cqi-ReportPeriodic	Not present		
}			

**Table 9.3.7.2\_G.4.3-4: AntennaInfoDedicated-r10**

Derivation Path: 36.331 clause 6.3.2			
Information Element	Value/remark	Comment	Condition
AntennaInfoDedicated-r10 ::= SEQUENCE {			
transmissionMode-r10	tm9-v1020	Test 2	
codebookSubsetRestriction-r10	0x0000 0000 0000 FFFF 0000 FFFF	Test 2	
ue-TransmitAntennaSelection CHOICE {			
release	NULL		
}			
}			

Table 9.3.7.2\_G.4.3-5: *AntennaInfoDedicated-v1250*

Derivation Path: 36.331 clause 6.3.2			
Information Element	Value/remark	Comment	Condition
AntennaInfoDedicated-v1250 ::= SEQUENCE {			
alternativeCodebookEnabledFor4TX-r12	TRUE	Test 2	
}			

Table 9.3.7.2\_G.4.3-6: *CQI-ReportConfig-r10-DEFAULT*

Derivation Path: 36.508 clause 4.6.3			
Information Element	Value/remark	Comment	Condition
CQI-ReportConfig-r10 ::= SEQUENCE {			
cqi-ReportModeAperiodic-r10	rm32-v1250, rm12	Test 2	
nomPDSCH-RS-EPRE-Offset	0		
cqi-ReportPeriodic-r10	Not present		
}			

Table 9.3.7.2\_G.4.3-7: *CSI-RS-Config, Test 2*

Derivation Path: 36.331 clause 6.3.2			
Information Element	Value/remark	Comment	Condition
CSI-RS-Config-r10 ::= SEQUENCE {			
csi-RS-r10 CHOICE{			
release	NULL		
setup SEQUENCE {			
antennaPortsCount-r10	an4	Parameter represents the number of antenna ports used for transmission of CSI reference signals	
resourceConfig-r10	4	Parameter: CSI reference signal configuration	
subframeConfig-r10	4	$\Delta_{\text{CSI-RS}} = I_{\text{CSI-RS}}$ when CSI-RS SubframeConfig is from 0-4; Parameter: $I_{\text{CSI-RS}}$	
p-C-r10	-3	Parameter: $P_c$ which is the assumed ratio of PDSCH EPRE to CSI-RS EPRE when UE derives CSI feedback	
}			
}			
}			

Table 9.3.7.2\_G.4.3-7: *TDD-Config-DEFAULT*

Derivation Path: 36.508 clause 4.6.3			
Information Element	Value/remark	Comment	Condition
TDD-Config-DEFAULT ::= SEQUENCE {			
subframeAssignment	sa1		
specialSubframePatterns	ssp4		
}			

## 9.3.7.2\_G.5 Test requirement

**Table 9.3.7.2\_G.3-1: Test requirement (TDD)**

	Test 1	Test 2
$\alpha$	[1.05] +TT	-
$\beta$	-	[1.15] +TT
UE Category	$\geq 1$	$\geq 1$

To pass the test,  $\alpha$  and  $\beta$  must be fulfilled.

To pass the test, Test 1 and Test 2 must be passed.

To pass the test, one **or** the other SNR point within one test must be fulfilled.

## 9.4 Reporting of Precoding Matrix Indicator (PMI)

The minimum performance requirements of PMI reporting are defined based on the precoding gain, expressed as the relative increase in throughput when the transmitter is configured according to the UE reports compared to the case when the transmitter is using random precoding. When the transmitter uses random precoding, for each PDSCH allocation a precoder is randomly generated and applied to the PDSCH. A fixed transport format (FRC) configured.

The requirements for transmission mode 6 and transmission mode 9 with 4 TX are specified in terms of the ratio

$$\gamma = \frac{t_{ue}}{t_{rnd}}$$

In the definition of  $\gamma$ , for PUSCH 3-1 single PMI and PUSCH 1-2 multiple PMI requirements,  $t_{rnd}$  is 60% of the maximum throughput obtained at  $SNR_{rnd}$  using random precoding, and  $t_{ue}$  the throughput measured at  $SNR_{rnd}$  with precoders configured according to the UE reports.

For the PUCCH 2-1 single PMI requirement,  $t_{rnd}$  is 60% of the maximum throughput obtained at  $SNR_{rnd}$  using random precoding on a randomly selected full-size subband in set S subbands, and  $t_{ue}$  the throughput measured at  $SNR_{rnd}$  with both the precoder and the preferred full-size subband applied according to the UE reports;

For PUSCH 2-2 multiple PMI requirements,  $t_{rnd}$  is 60% of the maximum throughput obtained at  $SNR_{rnd}$  using random precoding on a randomly selected full-size subband in set S subbands, and  $t_{ue}$  the throughput measured at  $SNR_{rnd}$  with both the subband precoder and a randomly selected full-size subband (within the preferred subbands) applied according to the UE reports.

The requirements for transmission mode 9 with 8 TX and transmission mode 9 with 4TX enhanced codebook are specified in terms of the ratio

$$\gamma = \frac{t_{ue, follow1, follow2}}{t_{rnd1, rnd2}}$$

In the definition of  $\gamma$ , for PUSCH 3-1 single PMI and PUSCH 1-2 multiple PMI requirements,  $t_{follow1, follow2}$  is 70% of the maximum throughput obtained at  $SNR_{follow1, follow2}$  using the precoders configured according to the UE reports, and  $t_{rnd1, rnd2}$  is the throughput measured at  $SNR_{follow1, follow2}$  with random precoding.

## 9.4.1 Single PMI

### 9.4.1.1 PMI Reporting – PUSCH 3-1 (Single PMI) (Cell-Specific Reference Symbols)

#### 9.4.1.1.1 FDD PMI Reporting – PUSCH 3-1 (Single PMI)

##### 9.4.1.1.1.1 Test purpose

To test the accuracy of the Precoding Matrix Indicator (PMI) reporting such that the system throughput is maximized based on the precoders configured according to the UE reports.

##### 9.4.1.1.1.2 Test applicability

This test applies to all types of E-UTRA FDD UE release 8 and forward.

##### 9.4.1.1.1.3 Minimum conformance requirements

For the parameters specified in Table 9.4.1.1.1.3-1, and using the downlink physical channels specified in Annex C, the minimum requirements are specified in Table 9.4.1.1.1.3-2.

**Table 9.4.1.1.1.3-1: PMI test for single-layer (FDD)**

Parameter		Unit	Test 1
Bandwidth		MHz	10
Transmission mode			6
Propagation channel			EVA5
Precoding granularity		PRB	50
Correlation and antenna configuration			Low 2 x 2
Downlink power allocation	$\rho_A$	dB	-3
	$\rho_B$	dB	-3
	$\sigma$	dB	0
$N_{oc}^{(j)}$		dB[mW/15kHz]	-98
Reporting mode			PUSCH 3-1
Reporting interval		ms	1
PMI delay (Note 2)		ms	8
Measurement channel			R.10 FDD
OCNG Pattern			OP.1 FDD
Max number of HARQ transmissions			4
Redundancy version coding sequence			{0,1,2,3}
Note 1:	For random precoder selection, the precoder shall be updated in each TTI (1 ms granularity)		
Note 2:	If the UE reports in an available uplink reporting instance at subframe SF#n based on PMI estimation at a downlink SF not later than SF#(n-4), this reported PMI cannot be applied at the eNB downlink before SF#(n+4).		

**Table 9.4.1.1.1.3-2: Minimum requirement (FDD)**

Parameter	Test 1
$\gamma$	1.1
UE Category	$\geq 1$

The normative reference for this requirement is TS 36.101 [2] clause 9.4.1.1.1.



#### 9.4.1.1.1.4 Test description

##### 9.4.1.1.1.4.1 Initial conditions

Initial conditions are a set of test configurations the UE needs to be tested in and the steps for the SS to take with the UE to reach the correct measurement state.

Configurations of PDSCH and PDCCH before measurement are specified in Annex C.2.

Test Environment: Normal as defined in TS 36.508 [7] clause 4.1.

Frequencies to be tested: Mid Range as defined in TS 36.508 [7] clause 4.3.1.1.

Channel Bandwidths to be tested: 10MHz, as defined in TS 36.508 [7] clause 4.3.1.1

1. Connect the SS to the UE antenna connector (s) as shown in TS 36.508 [7] Annex A, Figure A.10.
2. The parameter settings for the cell are set up according to Table 9.4.1.1.1.3-1.
3. Downlink signals are initially set up according to Annex C.1 and Annex C.3.2, and uplink signals according to Annex H.1 and H.3.2.
4. Propagation conditions are set according to Annex B clause B.0
5. Ensure the UE is in State 3A-RF according to TS 36.508 [7] clause 5.2A.2. Message contents are defined in clause 9.4.1.1.1.4.3.

##### 9.4.1.1.1.4.2 Test procedure

1. Set the parameters of bandwidth, the propagation condition, antenna configuration and measurement channel according to Table 9.4.1.1.1.3-1 as appropriate.
2. The SS shall transmit PDSCH via PDCCH DCI format 1B for C\_RNTI to transmit the DL RMC with randomly selected precoding matrix from codebook (Table 6.3.4.2.3-1 in TS 36.211 [8]) every subframe regardless of PMI reports from the UE. Note that each precoding matrix shall be selected in equal probabilities. The SS sends downlink MAC padding bits on the DL RMC. SS schedules the UL transmission to carry the PUSCH CQI feedback via PDCCH DCI format 0 with CQI request bit set to 1 and I\_MCS=29 and N\_PRB allocated to be less or equal to 4. Establish  $t_{rnd}$  and  $SNR_{rnd}$  according to annex G.5.2
3. Set SNR to  $SNR_{rnd}$ . The SS shall transmit PDSCH with precoding matrix according to PMI report from the UE. The SS sends downlink MAC padding bits on the DL RMC. SS schedules the UL transmission to carry the PUSCH CQI feedback via PDCCH DCI format 0 with CQI request bit set to 1 and I\_MCS=29 and N\_PRB allocated to be less or equal to 4 every subframe. Measure  $t_{ue}$  according to Annex G.5.3
4. Calculate  $\gamma = \frac{t_{ue}}{t_{rnd}}$ . If the ratio (throughput /  $t_{rnd}$ )  $\geq \gamma$  which is specified in table 9.4.1.1.1.5-1, then the test is pass. Otherwise, the test is fail.

##### 9.4.1.1.1.4.3 Message contents

Message contents are according to TS 36.508 [7] clause 4.6 with the following exceptions:

**Table 9.4.1.1.1.4.3-1: PhysicalConfigDedicated-DEFAULT**

Derivation Path: 36.508 clause 5.5.1.2			
Information Element	Value/remark	Comment	Condition
PhysicalConfigDedicated-DEFAULT ::= SEQUENCE {			
cqi-ReportConfig	CQI-ReportConfig-DEFAULT		
antennaInfo CHOICE {			
explicitValue	AntennaInfoDedicated		
}			
}			

**Table 9.4.1.1.1.4.3-2: AntennaInfoDedicated**

Derivation Path: 36.331 clause 6.3.2			
Information Element	Value/remark	Comment	Condition
AntennaInfoDedicated ::= SEQUENCE {			
transmissionMode	tm6		
codebookSubsetRestriction CHOICE{			
n2TxAntenna-tm6	1111		
}			
ue-TransmitAntennaSelection CHOICE{			
release	NULL		
}			

**Table 9.4.1.1.1.4.3-3: CQI-ReportConfig-DEFAULT**

Derivation Path: 36.508 clause 4.6.3			
Information Element	Value/remark	Comment	Condition
CQI-ReportConfig-DEFAULT ::= SEQUENCE {			
cqi-ReportModeAperiodic	rm31		
nomPDSCH-RS-EPRE-Offset	0		
cqi-ReportPeriodic	Not present		
}			

#### 9.4.1.1.1.5 Test requirement

**Table 9.4.1.1.1.5-1: Test requirement (FDD)**

Parameter	Test 1
$\gamma$	1.09

The ratio of throughput using precoding matrix of PMI reports from the UE to using random precoding matrix shall equal or exceed the value specified in table 9.4.1.1.1.5.

#### 9.4.1.1.2 TDD PMI Reporting – PUSCH 3-1 (Single PMI)

##### 9.4.1.1.2.1 Test purpose

To test the accuracy of the Precoding Matrix Indicator (PMI) reporting such that the system throughput is maximized based on the precoders configured according to the UE reports.

##### 9.4.1.1.2.2 Test applicability

This test applies to all types of E-UTRA TDD UE release 8 and forward.

##### 9.4.1.1.2.3 Minimum conformance requirements

For the parameters specified in Table 9.4.1.1.2.3-1, and using the downlink physical channels specified in Annex C, the minimum requirements are specified in 9.4.1.1.2.3-2.

**Table 9.4.1.1.2.3-1: PMI test for single-layer (TDD)**

Parameter	Unit	Test 1	
Bandwidth	MHz	10	
Transmission mode		6	
Uplink downlink configuration		1	
Special subframe configuration		4	
Propagation channel		EVA5	
Precoding granularity	PRB	50	
Correlation and antenna configuration		Low 2 x 2	
Downlink power allocation	$\rho_A$	dB	-3
	$\rho_B$	dB	-3
	$\sigma$	dB	0
$N_{oc}^{(j)}$	dB[mW/15kHz]	-98	
Reporting mode		PUSCH 3-1	
Reporting interval	ms	1	
Minimum PMI delay (Node-2)	ms	10 or 11	
Measurement channel		R.10 TDD	
OCNG Pattern		OP.1 TDD	
Max number of HARQ transmissions		4	
Redundancy version coding sequence		{0,1,2,3}	
ACK/NACK feedback mode		Multiplexing	
Note 1: For random precoder selection, the precoder shall be updated in each available downlink transmission instance Note 2: If the UE reports in an available uplink reporting instance at subframe SF#n based on PMI estimation at a downlink SF not later than SF#(n-4), this reported PMI cannot be applied at the eNB downlink before SF#(n+4)			

**Table 9.4.1.1.2.3-2: Minimum requirement (TDD)**

Parameter	Test 1
$\gamma$	1.1
UE Category	$\geq 1$

The normative reference for this requirement is TS 36.101 [2] clause 9.4.1.1.2.

#### 9.4.1.1.2.4 Test description

##### 9.4.1.1.2.4.1 Initial conditions

Initial conditions are a set of test configurations the UE needs to be tested in and the steps for the SS to take with the UE to reach the correct measurement state.

Configurations of PDSCH and PDCCH before measurement are specified in Annex C.2.

Test Environment: Normal as defined in TS 36.508 [7] clause 4.1.

Frequencies to be tested: Mid Range as defined in TS 36.508 [7] clause 4.3.1.2.

Channel Bandwidths to be tested: 10MHz, as defined in TS 36.508 [7] clause 4.3.1.2

1. Connect the SS to the UE antenna connector (s) as shown in TS 36.508 [7] Annex A, Figure A.10.
2. The parameter settings for the cell are set up according to Table 9.4.1.1.2.3-1.
3. Downlink signals are initially set up according to Annex C.1 and Annex C.3.2, and uplink signals according to Annex H.1 and H.3.2.
4. Propagation conditions are set according to Annex B clause B.0
5. Ensure the UE is in State 3A-RF according to TS 36.508 [7] clause 5.2A.2. Message contents are defined in clause 9.4.1.1.2.4.3.

9.4.1.1.2.4.2 Test procedure

1. Set the bandwidth, propagation condition, antenna configuration and measurement channel parameters according to Table 9.4.1.1.2.3-1 as appropriate.
2. The SS shall transmit PDSCH via PDCCH DCI format 1B for C\_RNTI to transmit the DL RMC with randomly selected precoding matrix from codebook (Table 6.3.4.2.3-1 in TS 36.211 [8]) every subframe regardless of PMI reports from the UE. Note that each precoding matrix shall be selected in equal probabilities. The SS sends downlink MAC padding bits on the DL RMC. SS schedules the UL transmission to carry the PUSCH CQI feedback via PDCCH DCI format 0 with CQI request bit set to 1 and I\_MCS=29 and N\_PRB allocated to be less or equal to 4. Establish  $t_{md}$  and  $SNR_{md}$  according to annex G.5.2.
3. Set SNR to  $SNR_{md}$ . The SS shall transmit PDSCH with precoding matrix according to PMI report from the UE. The SS sends downlink MAC padding bits on the DL RMC. SS schedules the UL transmission to carry the PUSCH CQI feedback via PDCCH DCI format 0 with CQI request bit set to 1 and I\_MCS=29 and N\_PRB allocated to be less or equal to 4. Measure  $t_{ue}$  according to Annex G.5.3

4. Calculate  $\gamma = \frac{t_{ue}}{t_{md}}$

9.4.1.1.2.4.3 Message contents

Message contents are according to TS 36.508 [7] clause 4.6 with the following exceptions:

**Table 9.4.1.1.2.4.3-1: PhysicalConfigDedicated-DEFAULT**

Derivation Path: 36.508 clause 5.5.1.2			
Information Element	Value/remark	Comment	Condition
PhysicalConfigDedicated-DEFAULT ::= SEQUENCE {			
cqi-ReportConfig	CQI-ReportConfig-DEFAULT		
antennaInfo CHOICE {			
explicitValue	AntennaInfoDedicated		
}			
}			

**Table 9.4.1.1.2.4.3-2: AntennaInfoDedicated**

Derivation Path: 36.331 clause 6.3.2			
Information Element	Value/remark	Comment	Condition
AntennaInfoDedicated ::= SEQUENCE {			
transmissionMode	tm6		
codebookSubsetRestriction CHOICE{			
n2TxAntenna-tm6	1111		
}			
ue-TransmitAntennaSelection CHOICE{			
release	NULL		
}			

**Table 9.4.1.1.2.4.3-3: CQI-ReportConfig-DEFAULT**

Derivation Path: 36.508 clause 4.6.3			
Information Element	Value/remark	Comment	Condition
CQI-ReportConfig-DEFAULT ::= SEQUENCE {			
cqi-ReportModeAperiodic	rm31		
nomPDSCH-RS-EPRE-Offset	0		
cqi-ReportPeriodic	Not present		
}			

9.4.1.1.2.5 Test requirement

**Table 9.4.1.1.2.5-1: Test requirement (TDD)**

Parameter	Test 1
$\gamma$	1.09

9.4.1.2 PMI Reporting – PUCCH 2-1 (Single PMI) (Cell-Specific Reference Symbols)

9.4.1.2.1 FDD PMI Reporting – PUCCH 2-1 (Single PMI)

9.4.1.2.1.1 Test purpose

To test the accuracy of the Precoding Matrix Indicator (PMI) reporting such that the system throughput is maximized based on the precoders configured according to the UE reports.

9.4.1.2.1.2 Test applicability

This test applies to all types of E-UTRA FDD UE release 9 and forward. Applicability requires support for FGI bit 2.

9.4.1.2.1.3 Minimum conformance requirements

For the parameters specified in Table 9.4.1.2.1.3-1, and using the downlink physical channels specified in Annex C, the minimum requirements are specified in Table 9.4.1.2.1.3-2.

**Table 9.4.1.2.1.3-1: PMI test for single-layer (FDD)**

Parameter		Unit	Test 1
Bandwidth		MHz	10
Transmission mode			6
Propagation channel			EVA5
Correlation and antenna configuration			Low 4 x 2
Downlink power allocation	$\rho_A$	dB	-6
	$\rho_B$	dB	-6
	$\sigma$	dB	3
$N_{oc}^{(j)}$		dB[mW/15kHz]	-98
PMI delay		ms	8 or 9
Reporting mode			PUCCH 2-1 (Note 6)
Reporting periodicity		ms	$N_p = 2$
Physical channel for CQI reporting			PUSCH (Note 3)
PUCCH Report Type for wideband CQI/PMI			2
PUCCH Report Type for subband CQI			1
Measurement channel			R.14-1 FDD
OCNG Pattern			OP. 1/2 FDD
Precoding granularity		PRB	6 (full size)
Number of bandwidth parts ( $J$ )			3
K			1
<i>cqi-pmi-ConfigIndex</i>			1
Max number of HARQ transmissions			4
Redundancy version coding sequence			{0,1,2,3}
<p>Note 1: For random precoder selection, the precoder shall be updated every two TTI (2 ms granularity)</p> <p>Note 2: If the UE reports in an available uplink reporting instance at subframe SF#n based on PMI estimation at a downlink SF not later than SF#(n-4), this reported PMI cannot be applied at the eNB downlink before SF#(n+4).</p> <p>Note 3: To avoid collisions between HARQ-ACK and wideband CQI/PMI or subband CQI, it is necessary to report both on PUSCH instead of PUCCH. PDCCH DCI format 0 shall be transmitted in downlink SF#1, #3, #7 and #9 to allow periodic CQI to multiplex with the HARQ-ACK on PUSCH in uplink subframe SF#5, #7, #1 and #3.</p> <p>Note 4: Reports for the short subband (having 2RBs in the last bandwidth part) are to be disregarded and instead data is to be transmitted on the most recently used subband for bandwidth part with <math>j=1</math>.</p> <p>Note 5: In the case where wideband PMI is reported, data is to be transmitted on the most recently used subband.</p> <p>Note 6: The bit field for PMI confirmation in DCI format 1B shall be mapped to "0" and TPMI information shall indicate the codebook index used in Table 6.3.4.2.3-2 of TS 36.211 [4] according to the latest PMI report on PUCCH.</p>			

**Table 9.4.1.2.1.3-2: Minimum requirement (FDD)**

	Test 1
$\gamma$	1.2
UE Category	$\geq 1$

The normative reference for this requirement is TS 36.101 [2] clause 9.4.1.2.1.

#### 9.4.1.2.1.4 Test description

##### 9.4.1.2.1.4.1 Initial conditions

Initial conditions are a set of test configurations the UE needs to be tested in and the steps for the SS to take with the UE to reach the correct measurement state.

Configurations of PDSCH and PDCCH before measurement are specified in Annex C.2.

Test Environment: Normal as defined in TS 36.508 [7] clause 4.1.

Frequencies to be tested: Mid Range as defined in TS 36.508 [7] clause 4.3.1.1.

Channel Bandwidths to be tested: 10MHz, as defined in TS 36.508 [7] clause 4.3.1.1

1. Connect the SS to the UE antenna connector (s) as shown in TS 36.508 [7] Annex A, Figure A.11.
2. The parameter settings for the cell are set up according to Table 9.4.1.2.1.3-1.
3. Downlink signals are initially set up according to Annex C.1 and Annex C.3.2, and uplink signals according to Annex H.1 and H.3.2.
4. Propagation conditions are set according to Annex B clause B.0
5. Ensure the UE is in State 3A-RF according to TS 36.508 [7] clause 5.2A.2. Message contents are defined in clause 9.4.1.2.1.4.3.

##### 9.4.1.2.1.4.2 Test procedure

1. Set the parameters of bandwidth, the propagation condition, antenna configuration and measurement channel according to Table 9.4.1.2.1.3-1 as appropriate.
2. The SS shall transmit every subframe PDSCH via PDCCH DCI format 1B for C\_RNTI to transmit the DL RMC (R.14-1 FDD) on a randomly selected full-size subband with a randomly selected precoding matrix from the codebook (Table 6.3.4.2.3-2 in TS 36.211 [8]), regardless of the SB and PMI reports from the UE. Note that each full-size subband and each precoding matrix shall be selected in equal probability. The SS sends downlink MAC padding bits on the DL RMC. The SS shall transmit PDCCH DCI format 0 in downlink SF#1, #3, #7 and #9 to schedule UL RMC in uplink subframes #5, #7, #1 and #3 (Table A.4.1-1). The UE will send ACK/NACK and periodic CSI reports using PUSCH.  
Establish  $t_{md}$  and  $SNR_{md}$  according to annex G.5.2.
3. Set SNR to  $SNR_{md}$ . The SS shall transmit every subframe PDSCH via PDCCH DCI format 1B for C\_RNTI to transmit the DL RMC (R.14-1 FDD) on the full-size subband and with the latest precoding matrix reported by the UE. When the UE reports a non-full-size subband, the SS schedules the recent reported subband for bandwidth part with  $j=1$  with the latest reported precoding matrix. Note that the SS shall send PDSCH in the same full-size subband and with the latest reported precoding matrix until next UE subband report is available. The SS sends downlink MAC padding bits on the DL RMC.  
The SS shall transmit PDCCH DCI format 0 in downlink SF#1, #3, #7 and #9 to schedule UL RMC in uplink subframes #5, #7, #1 and #3 (Table A.4.1-1). The UE will send ACK/NACK and periodic CSI reports using PUSCH. Measure  $t_{ue}$  according to Annex G.5.3.
4. Calculate  $\gamma = \frac{t_{ue}}{t_{md}}$ . If the ratio (throughput /  $t_{md}$ )  $\geq \gamma$  which is specified in table 9.4.1.2.2.5-1, then the test is pass. Otherwise, the test is fail.

##### 9.4.1.2.1.4.3 Message contents

Message contents are according to TS 36.508 [7] clause 4.6 with the following exceptions:

**Table 9.4.1.2.1.4.3-1: PhysicalConfigDedicated-DEFAULT**

Derivation Path: 36.508 clause 5.5.1.2			
Information Element	Value/remark	Comment	Condition
PhysicalConfigDedicated-DEFAULT ::= SEQUENCE {			
cqi-ReportConfig	CQI-ReportConfig-DEFAULT		
antennaInfo CHOICE {			
explicitValue	AntennaInfoDedicated		
}			
}			

**Table 9.4.1.2.1.4.3-2: AntennaInfoDedicated**

Derivation Path: 36.331 clause 6.3.2			
Information Element	Value/remark	Comment	Condition
AntennaInfoDedicated ::= SEQUENCE {			
transmissionMode	tm6		
codebookSubsetRestriction CHOICE{			
n4TxAntenna-tm6	1111111111111111		
}			
ue-TransmitAntennaSelection CHOICE{			
release	NULL		
}			
}			

**Table 9.4.1.2.1.4.3-3: CQI-ReportConfig-DEFAULT**

Derivation Path: 36.508 clause 4.6.3			
Information Element	Value/remark	Comment	Condition
CQI-ReportConfig-DEFAULT ::= SEQUENCE {			
cqi-ReportModeAperiodic	Not present		
nomPDSCH-RS-EPRE-Offset	0		
cqi-ReportPeriodic CHOICE {			
setup SEQUENCE {			
cqi-PUCCH-ResourceIndex	0		
cqi-pmi-ConfigIndex	1	(see Table 7.2.2-1A in TS 36.213)	
cqi-FormatIndicatorPeriodic CHOICE {			
subbandCQI	1		
}			
ri-ConfigIndex	483	(see Table 7.2.2-1B in TS 36.213)	
simultaneousAckNackAndCQI	FALSE		
}			
}			

## 9.4.1.2.1.5 Test requirement

**Table 9.4.1.2.1.5-1: Test requirement (FDD)**

	Test 1
$\gamma$	1.19
UE Category	$\geq 1$

The ratio of throughput using precoding matrix of PMI reports from the UE to using random precoding matrix shall equal or exceed the value specified in table 9.4.1.2.1.5.



#### 9.4.1.2.2 TDD PMI Reporting – PUCCH 2-1 (Single PMI)

##### 9.4.1.2.2.1 Test purpose

To test the accuracy of the Precoding Matrix Indicator (PMI) reporting such that the system throughput is maximized based on the precoders configured according to the UE reports.

##### 9.4.1.2.2.2 Test applicability

This test applies to all types of E-UTRA TDD UE release 9 and forward. Applicability requires support for FGI bit 2.

##### 9.4.1.2.2.3 Minimum conformance requirements

For the parameters specified in Table 9.4.1.2.2.3-1, and using the downlink physical channels specified in Annex C, the minimum requirements are specified in 9.4.1.2.2.3-2.

Table 9.4.1.2.2.3-1: PMI test for single-layer (TDD)

Parameter	Unit	Test 1	
Bandwidth	MHz	10	
Transmission mode		6	
Uplink downlink configuration		1	
Special subframe configuration		4	
Propagation channel		EVA5	
Correlation and antenna configuration		Low 4 x 2	
Downlink power allocation	$\rho_A$	dB	-6
	$\rho_B$	dB	-6
	$\sigma$	dB	3
$N_{oc}^{(j)}$	dB[mW/15kHz]	-98	
PMI delay	ms	10	
Reporting mode		PUCCH 2-1 (Note 6)	
Reporting periodicity	ms	$N_p = 5$	
Physical channel for CQI reporting		PUSCH (Note 3)	
PUCCH Report Type for wideband CQI/PMI		2	
PUCCH Report Type for subband CQI		1	
Measurement channel		R.14-1 TDD	
OCNG Pattern		OP.1/2 TDD	
Precoding granularity	PRB	6 (full size)	
Number of bandwidth parts ( $J$ )		3	
$K$		1	
$cqi-pmi-ConfigIndex$		4	
Max number of HARQ transmissions		4	
Redundancy version coding sequence		{0,1,2,3}	
ACK/NACK feedback mode		Multiplexing	
<p>Note 1: For random precoder selection, the precoder shall be updated in each available downlink transmission instance</p> <p>Note 2: If the UE reports in an available uplink reporting instance at subframe SF#n based on PMI estimation at a downlink SF not later than SF#(n-4), this reported PMI cannot be applied at the eNB downlink before SF#(n+4)</p> <p>Note 3: To avoid collisions between HARQ-ACK and wideband CQI/PMI or subband CQI it is necessary to report both on PUSCH instead of PUCCH. PDCCH DCI format 0 shall be transmitted in downlink SF#4 and #9 to allow periodic CQI to multiplex with the HARQ-ACK on PUSCH in uplink subframe SF#8 and #3.</p> <p>Note 4: Reports for the short subband (having 2RBs in the last bandwidth part) are to be disregarded and instead data is to be transmitted on the most recently used subband for bandwidth part with j=1.</p> <p>Note 5: In the case where wideband PMI is reported, data is to be transmitted on the most recently used subband.</p> <p>Note 6: The bit field for PMI confirmation in DCI format 1B shall be mapped to "0" and TPMI information shall indicate the codebook index used in Table 6.3.4.2.3-2 of TS 36.211 [4] according to the latest PMI report on PUCCH.</p>			

Table 9.4.1.2.2.3-2: Minimum requirement (TDD)

Parameter	Test 1
$\gamma$	1.2
UE Category	$\geq 1$

The normative reference for this requirement is TS 36.101 [2] clause 9.4.1.2.2.

#### 9.4.1.2.2.4 Test description

##### 9.4.1.2.2.4.1 Initial conditions

Initial conditions are a set of test configurations the UE needs to be tested in and the steps for the SS to take with the UE to reach the correct measurement state.

Configurations of PDSCH and PDCCH before measurement are specified in Annex C.2.

Test Environment: Normal as defined in TS 36.508 [7] clause 4.1.

Frequencies to be tested: Mid Range as defined in TS 36.508 [7] clause 4.3.1.2.

Channel Bandwidths to be tested: 10MHz, as defined in TS 36.508 [7] clause 4.3.1.2

1. Connect the SS to the UE antenna connector (s) as shown in TS 36.508 [7] Annex A, Figure A.11.
2. The parameter settings for the cell are set up according to Table 9.4.1.2.2.3-1.
3. Downlink signals are initially set up according to Annex C.1 and Annex C.3.2, and uplink signals according to Annex H.1 and H.3.2.
4. Propagation conditions are set according to Annex B clause B.0
5. Ensure the UE is in State 3A-RF according to TS 36.508 [7] clause 5.2A.2. Message contents are defined in clause 9.4.1.2.2.4.3.

##### 9.4.1.2.2.4.2 Test procedure

1. Set the bandwidth, propagation condition, antenna configuration and measurement channel parameters according to Table 9.4.1.2.2.3-1 as appropriate.
2. The SS shall transmit every subframe PDSCH via PDCCH DCI format 1B for C\_RNTI to transmit the DL RMC (R.14-1 TDD) on a randomly selected full-size subband with a randomly selected precoding matrix from the codebook (Table 6.3.4.2.3-2 in TS 36.211 [8]), regardless of the SB and PMI reports from the UE. Note that each full-size subband and each precoding matrix shall be selected in equal probability. The SS sends downlink MAC padding bits on the DL RMC.  
The SS shall transmit PDCCH DCI format 0 in downlink SF#4 and #9 to schedule UL RMC in uplink subframes #8 and #3 (Table A.4.1-2). The UE will send ACK/NACK and periodic CSI reports using PUSCH.  
Establish  $t_{md}$  and  $SNR_{md}$  according to annex G.5.2.
3. Set SNR to  $SNR_{md}$ . The SS shall transmit every subframe PDSCH via PDCCH DCI format 1B for C\_RNTI to transmit the DL RMC (R.14-1 TDD) on the full-size subband and with the latest precoding matrix reported by the UE. When the UE reports a non-full-size subband, the SS schedules the recent reported subband for bandwidth part with  $j=1$  with the latest reported precoding matrix. Note that the SS shall send PDSCH in the same full-size subband and with the latest reported precoding matrix until next UE subband report is available. The SS sends downlink MAC padding bits on the DL RMC.  
The SS shall transmit PDCCH DCI format 0 in downlink SF#4 and #9 to schedule UL RMC in uplink subframes #8 and #3 (Table A.4.1-2). The UE will send ACK/NACK and periodic CSI reports using PUSCH.  
Measure  $t_{ue}$  according to Annex G.5.3.
4. Calculate  $\gamma = \frac{t_{ue}}{t_{md}}$ . If the ratio (throughput /  $t_{md}$ )  $\geq \gamma$  which is specified in table 9.4.1.2.2.5-1, then the test is pass. Otherwise, the test is fail.

##### 9.4.1.2.2.4.3 Message contents

Message contents are according to TS 36.508 [7] clause 4.6 with the following exceptions:

Table 9.4.1.2.2.4.3-1: *PhysicalConfigDedicated-DEFAULT*

Derivation Path: 36.508 clause 5.5.1.2			
Information Element	Value/remark	Comment	Condition
PhysicalConfigDedicated-DEFAULT ::= SEQUENCE {			
cqi-ReportConfig	CQI-ReportConfig-DEFAULT		
antennaInfo CHOICE {			
explicitValue	AntennaInfoDedicated		
}			
}			

Table 9.4.1.2.2.4.3-2: *AntennaInfoDedicated*

Derivation Path: 36.331 clause 6.3.2			
Information Element	Value/remark	Comment	Condition
AntennaInfoDedicated ::= SEQUENCE {			
transmissionMode	tm6		
codebookSubsetRestriction CHOICE{			
n4TxAntenna-tm6	1111111111111111		
}			
ue-TransmitAntennaSelection CHOICE{			
release	NULL		
}			
}			

Table 9.4.1.2.2.4.3-3: *CQI-ReportConfig-DEFAULT*

Derivation Path: 36.508 clause 4.6.3			
Information Element	Value/remark	Comment	Condition
CQI-ReportConfig-DEFAULT ::= SEQUENCE {			
cqi-ReportModeAperiodic	Not present		
nomPDSCH-RS-EPRE-Offset	0		
cqi-ReportPeriodic CHOICE {			
setup SEQUENCE {			
cqi-PUCCH-ResourceIndex	0		
cqi-pmi-ConfigIndex	4	(see Table 7.2.2-1A in TS 36.213)	
cqi-FormatIndicatorPeriodic CHOICE {			
subbandCQI	1		
}			
ri-ConfigIndex	484	(see Table 7.2.2-1B in TS 36.213)	
simultaneousAckNackAndCQI	FALSE		
}			
}			

## 9.4.1.2.2.5

## Test requirement

Table 9.4.1.2.2.5-1: Test requirement (TDD)

Parameter	Test 1
$\gamma$	1.19
UE Category	$\geq 1$

### 9.4.1.3 PMI Reporting – PUSCH 3-1 (Single PMI) (CSI Reference Symbols)

#### 9.4.1.3.1

##### 9.4.1.3.1\_D FDD Reporting of PMI – PUSCH 3-1 (Single PMI) for eDL MIMO

###### 9.4.1.3.1\_D.1 Test purpose

To test the accuracy of the Precoding Matrix Indicator (PMI) reporting such that the system throughput is maximized based on the precoders configured according to the UE reports.

###### 9.4.1.3.1\_D.2 Test applicability

This test applies to all types of E-UTRA FDD UE release 10 and forward that support eDL-MIMO. Applicability requires support for FGI bit 103.

###### 9.4.1.3.1\_D.3 Minimum conformance requirements

For the parameters specified in Table 9.4.1.3.1\_D.3-1, and using the downlink physical channels specified in Annex C.3.2, the minimum requirements are specified in Table 9.4.1.3.1\_D.3-2.

**Table 9.4.1.3.1\_D.3-1: PMI test for single-layer (FDD)**

Parameter	Unit	Test 1	
Bandwidth	MHz	10	
Transmission mode		9	
Propagation channel		EPA5	
Precoding granularity	PRB	50	
Correlation and antenna configuration		Low ULA 4 x 2	
Cell-specific reference signals		Antenna ports 0,1	
CSI reference signals		Antenna ports 15,...,18	
Beamforming model		Annex B.4.3	
CSI-RS periodicity and subframe offset $T_{\text{CSI-RS}} / \Delta_{\text{CSI-RS}}$		5/ 1	
CSI-RS reference signal configuration		6	
CodeBookSubsetRestriction bitmap		0x0000 0000 0000 FFFF	
Downlink power allocation	$\rho_A$	dB	0
	$\rho_B$	dB	0
	$P_c$	dB	-3
	$\sigma$	dB	-3
$N_{oc}^{(j)}$	dB[mW/15kHz]	-98	
Reporting mode		PUSCH 3-1	
Reporting interval	ms	5	
PMI delay (Note 2)	ms	8	
Measurement channel		R.44 FDD	
OCNG Pattern		OP.1 FDD	
Max number of HARQ transmissions		4	
Redundancy version coding sequence		{0,1,2,3}	
<p>Note 1: For random precoder selection, the precoder shall be updated in each TTI (1 ms granularity).</p> <p>Note 2: If the UE reports in an available uplink reporting instance at subframe SF#n based on PMI estimation at a downlink SF not later than SF#(n-4), this reported PMI cannot be applied at the eNB downlink before SF#(n+4).</p> <p>Note 3: PDSCH_RA= 0 dB, PDSCH_RB= 0 dB in order to have the same PDSCH and OCNG power per subcarrier at the receiver.</p>			

**Table 9.4.1.3.1\_D.3-2: Minimum requirement (FDD)**

Parameter	Test 1
$\gamma$	1.2
UE Category	$\geq 1$

The normative reference for this requirement is TS 36.101 [2] clause 9.4.1.3.1.

9.4.1.3.1\_D.4 Test description

9.4.1.3.1\_D.4.1 Initial conditions

Initial conditions are a set of test configurations the UE needs to be tested in and the steps for the SS to take with the UE to reach the correct measurement state.

Configurations of PDSCH and PDCCH before measurement are specified in Annex C.2.

Test Environment: Normal as defined in TS 36.508 [7] clause 4.1.

Frequencies to be tested: Mid Range as defined in TS 36.508 [7] clause 4.3.1.1.

Channel Bandwidths to be tested: 10MHz, as defined in TS 36.508 [7] clause 4.3.1.1

1. Connect the SS to the UE antenna connector (s) as shown in TS 36.508 [7] Annex A, Figure A.11.
2. The parameter settings for the cell are set up according to Table 9.4.1.3.1\_D.3-1.
3. Downlink signals are initially set up according to Annex C.1 and Annex C.3.2, and uplink signals according to Annex H.1 and H.3.2.
4. Propagation conditions are set according to Annex B clause B.0
5. Ensure the UE is in State 3A-RF according to TS 36.508 [7] clause 5.2A.2. Message contents are defined in clause 9.4.1.3.1\_D.4.3.

#### 9.4.1.3.1\_D.4.2 Test procedure

1. Set the parameters of bandwidth, the propagation condition, antenna configuration and measurement channel according to Table 9.4.1.3.1\_D.3-1 as appropriate.
2. The SS shall transmit PDSCH via PDCCH DCI format 2C for C\_RNTI to transmit the DL RMC with randomly selected precoding matrix from codebook (Table 6.3.4.2.3-2 in TS 36.211 [8]) every subframe regardless of PMI reports from the UE. Note that each precoding matrix shall be selected in equal probabilities. The SS sends downlink MAC padding bits on the DL RMC. SS schedules the UL transmission to carry the PUSCH CQI feedback via PDCCH DCI format 0 with CQI request bit set to 1 and I\_MCS=29 and N\_PRB allocated to be less or equal to 4. Establish  $t_{rd}$  and  $SNR_{rd}$  according to annex G.5.2
3. Set SNR to  $SNR_{rd}$ . The SS shall transmit PDSCH with precoding matrix according to PMI report from the UE. The SS sends downlink MAC padding bits on the DL RMC. SS schedules the UL transmission to carry the PUSCH CQI feedback via PDCCH DCI format 0 with CQI request bit set to 1 and I\_MCS=29 and N\_PRB allocated to be less or equal to 4 in subframe #0, #5. Measure  $t_{ue}$  according to Annex G.5.3
4. Calculate  $\gamma = \frac{t_{ue}}{t_{rd}}$ . If the ratio (throughput /  $t_{rd}$ )  $\geq \gamma$  which is specified in table 9.4.1.3.1\_D.5-1, then the test is pass. Otherwise, the test is fail.

#### 9.4.1.3.1\_D.4.3 Message contents

Message contents are according to TS 36.508 [7] clause 4.6 with the following exceptions:

**Table 9.4.1.3.1\_D.4.3-1: PhysicalConfigDedicated-DEFAULT**

Derivation Path: 36.508 clause 5.5.1.2			
Information Element	Value/remark	Comment	Condition
PhysicalConfigDedicated-DEFAULT ::= SEQUENCE {			
cqi-ReportConfig-r10	CQI-ReportConfig-r10-DEFAULT		
antennaInfo	Not present		
antennaInfo-r10 CHOICE {			
explicitValue-r10	AntennaInfoDedicated-r10		
}			
csi-RS-Config-r10	CSI-RS-Config-r10		
}			

**Table 9.4.1.3.1\_D.4.3-2: PDSCH-ConfigDedicated-DEFAULT**

Derivation Path: 36.508 clause 4.6.3			
Information Element	Value/remark	Comment	Condition
PDSCH-ConfigDedicated-DEFAULT ::= SEQUENCE {			
p-a	dB0		
}			

**Table 9.4.1.3.1\_D.4.3-3: AntennaInfoDedicated-r10**

Derivation Path: 36.331 clause 6.3.2			
Information Element	Value/remark	Comment	Condition
AntennaInfoDedicated-r10 ::= SEQUENCE {			
transmissionMode-r10	tm9-v1020		
codebookSubsetRestriction-r10	0x0000 0000 0000 FFFF		
ue-TransmitAntennaSelection CHOICE{			
release	NULL		
}			
}			

**Table 9.4.1.3.1\_D.4.3-4: CQI-ReportConfig-r10-DEFAULT**

Derivation Path: 36.508 clause 4.6.3			
Information Element	Value/remark	Comment	Condition
CQI-ReportConfig-r10 ::= SEQUENCE {			
cqi-ReportAperiodic-r10	rm31		
nomPDSCH-RS-EPRE-Offset	0		
cqi-ReportPeriodic-r10	Not present		
pmi-RI-Report-r9	setup		
}			



Table 9.4.1.3.1\_D.4.3-5: CSI-RS-Config

Derivation Path: 36.331 clause 6.3.2			
Information Element	Value/remark	Comment	Condition
CSI-RS-Config-r10 ::= SEQUENCE {			
csi-RS-r10 CHOICE{			
setup SEQUENCE {			
antennaPortsCount-r10	an4	Parameter represents the number of antenna ports used for transmission of CSI reference signals	
resourceConfig-r10	6	Parameter: CSI reference signal configuration	
subframeConfig-r10	1	$\Delta_{\text{CSI-RS}} = I_{\text{CSI-RS}}$ when CSI-RS SubframeConfig is from 0-4; Parameter: $I_{\text{CSI-RS}}$	
p-C-r10	-3	Parameter: $P_c$ which is the assumed ratio of PDSCH EPRE to CSI-RS EPRE when UE derives CSI feedback	
}			
}			
zeroTxPowerCSI-RS-r10 CHOICE{			
release	NULL		
}			
}			

## 9.4.1.3.1\_D.5 Test requirement

Table 9.4.1.3.1\_D.5-1: Test requirement (FDD)

Parameter	Test 1
$\gamma$	1.19

The ratio of throughput using precoding matrix of PMI reports from the UE to using random precoding matrix shall equal or exceed the value specified in table 9.4.1.1.1\_D.5.

## 9.4.1.3.2\_D TDD Reporting of PMI – PUSCH 3-1 (Single PMI) for eDL-MIMO

## 9.4.1.3.2\_D.1 Test purpose

To test the accuracy of the Precoding Matrix Indicator (PMI) reporting such that the system throughput is maximized based on the precoders configured according to the UE reports.

## 9.4.1.3.2\_D.2 Test applicability

This test applies to all types of E-UTRA TDD UE release 10 and forward that support eDL-MIMO. Applicability requires support for FGI bit 104.

## 9.4.1.3.2\_D.3 Minimum conformance requirements

For the parameters specified in Table 9.4.1.3.2\_D.3-1, and using the downlink physical channels specified in Annex C.3.2, the minimum requirements are specified in Table 9.4.1.3.2\_D.3-2.

**Table 9.4.1.3.2\_D.3-1: PMI test for single-layer (TDD)**

Parameter	Unit	Test 1	
Bandwidth	MHz	10	
Transmission mode		9	
Uplink downlink configuration		1	
Special subframe configuration		4	
Propagation channel		EVA5	
Precoding granularity	PRB	50	
Antenna configuration		8 x 2	
Correlation modelling		High, Cross polarized	
Cell-specific reference signals		Antenna ports 0,1	
CSI reference signals		Antenna ports 15,...,22	
Beamforming model		Annex B.4.3	
CSI-RS periodicity and subframe offset $T_{\text{CSI-RS}} / \Delta_{\text{CSI-RS}}$		5/ 4	
CSI-RS reference signal configuration		0	
CodeBookSubsetRestriction bitmap		0x0000 0000 001F FFE0 0000 0000 FFFF	
Downlink power allocation	$\rho_A$	dB	0
	$\rho_B$	dB	0
	$P_c$	dB	-6
	$\sigma$	dB	-3
$N_{oc}^{(j)}$	dB[mW/15kHz]	-98	
Reporting mode		PUSCH 3-1	
Reporting interval	ms	5	
PMI delay (Note 2)	ms	10	
Measurement channel		R.45-1 TDD for UE Category 1, R.45 TDD for UE Category 2-8	
OCNG Pattern		OP.1 TDD	
Max number of HARQ transmissions		4	
Redundancy version coding sequence		{0,1,2,3}	
ACK/NACK feedback mode		Multiplexing	
Note 1:	For random precoder selection, the precoder shall be updated in each TTI (1 ms granularity).		
Note 2:	If the UE reports in an available uplink reporting instance at subframe SF#n based on PMI estimation at a downlink SF not later than SF#(n-4), this reported PMI cannot be applied at the eNB downlink before SF#(n+4).		
Note 3:	PDCCH DCI format 0 with a trigger for aperiodic CQI shall be transmitted in downlink SF#4 and #9 to allow aperiodic CQI/PMI/RI to be transmitted on uplink SF#3 and #8.		
Note 4:	Randomization of the principle beam direction shall be used as specified in B.2.3A.4		

**Table 9.4.1.3.2\_D.3-2: Minimum requirement (TDD)**

Parameter	Test 1
$\gamma$	3
UE Category	$\geq 1$

The normative reference for this requirement is TS 36.101 [2] clause 9.4.1.3.2.

#### 9.4.1.3.2\_D.4 Test description

##### 9.4.1.3.2\_D.4.1 Initial conditions

Initial conditions are a set of test configurations the UE needs to be tested in and the steps for the SS to take with the UE to reach the correct measurement state.

Configurations of PDSCH and PDCCH before measurement are specified in Annex C.2.

Test Environment: Normal as defined in TS 36.508 [7] clause 4.1.

Frequencies to be tested: Mid Range as defined in TS 36.508 [7] clause 4.3.1.2.

Channel Bandwidths to be tested: 10MHz, as defined in TS 36.508 [7] clause 4.3.1.2

1. Connect the SS to the UE antenna connector (s) as shown in TS 36.508 [7] Annex A, Figure 47.
2. The parameter settings for the cell are set up according to Table 9.4.1.3.2\_D.3-1.
3. Downlink signals are initially set up according to Annex C.1 and Annex C.3.2, and uplink signals according to Annex H.1 and H.3.2.
4. Propagation conditions are set according to Annex B clause B.0
5. Ensure the UE is in State 3A-RF according to TS 36.508 [7] clause 5.2A.2. Message contents are defined in clause 9.4.1.3.2\_D.4.3.

##### 9.4.1.3.2\_D.4.2 Test procedure

1. Set the bandwidth, propagation condition, antenna configuration and measurement channel parameters according to Table 9.4.1.3.2\_D.3-1 as appropriate.
2. The SS shall transmit PDSCH via PDCCH DCI format 2C for C\_RNTI to transmit the DL RMC with randomly selected precoding matrix from codebook (Table 7.2.4-1 in TS 36.213 [10]) every subframe regardless of PMI reports from the UE. Note that each precoding matrix shall be selected in equal probabilities. The SS sends downlink MAC padding bits on the DL RMC. SS schedules the UL transmission to carry the PUSCH CQI feedback via PDCCH DCI format 0 with CQI request bit set to 1 and I\_MCS=29 and N\_PRB allocated to be less or equal to 4. Establish  $t_{rd}$  and  $SNR_{rd}$  according to annex G.5.2.
3. Set SNR to  $SNR_{rd}$ . The SS shall transmit PDSCH with precoding matrix according to PMI report from the UE. The SS sends downlink MAC padding bits on the DL RMC. SS schedules the UL transmission to carry the PUSCH CQI feedback via PDCCH DCI format 0 with CQI request bit set to 1 and I\_MCS=29 and N\_PRB allocated to be less or equal to 4. Measure  $t_{ue}$  according to Annex G.5.3
4. Calculate  $\gamma = \frac{t_{ue}}{t_{rd}}$ . If the ratio (throughput /  $t_{rd}$ )  $\geq \gamma$  which is specified in table 9.4.1.3.2\_D.5-1, then the test is pass. Otherwise, the test is fail.

##### 9.4.1.3.2\_D.4.3 Message contents

Message contents are according to TS 36.508 [7] clause 4.6 with the following exceptions:

**Table 9.4.1.3.2\_D.4.3-1: PhysicalConfigDedicated-DEFAULT**

Derivation Path: 36.508 clause 5.5.1.2			
Information Element	Value/remark	Comment	Condition
PhysicalConfigDedicated-DEFAULT ::= SEQUENCE {			
cqi-ReportConfig-r10	CQI-ReportConfig-r10-DEFAULT		
antennaInfo	Not present		
antennaInfo-r10 CHOICE {			
explicitValue-r10	AntennaInfoDedicated-r10		
}			
csi-RS-Config-r10	CSI-RS-Config-r10		
}			

**Table 9.4.1.3.2\_D.4.3-2: PDSCH-ConfigDedicated-DEFAULT**

Derivation Path: 36.508 clause 4.6.3			
Information Element	Value/remark	Comment	Condition
PDSCH-ConfigDedicated-DEFAULT ::= SEQUENCE {			
p-a	dB0		
}			

**Table 9.4.1.3.2\_D.4.3-3: AntennaInfoDedicated-r10**

Derivation Path: 36.331 clause 6.3.2			
Information Element	Value/remark	Comment	Condition
AntennaInfoDedicated-r10 ::= SEQUENCE {			
transmissionMode-r10	tm9-v1020		
codebookSubsetRestriction-r10	0x0000 0000 001F FFE0 0000 0000 FFFF		
ue-TransmitAntennaSelection CHOICE{			
release	NULL		
}			
}			

**Table 9.4.1.3.2\_D.4.3-4: CQI-ReportConfig-r10-DEFAULT**

Derivation Path: 36.508 clause 4.6.3			
Information Element	Value/remark	Comment	Condition
CQI-ReportConfig-r10 ::= SEQUENCE {			
cqi-ReportAperiodic-r10	rm31		
nomPDSCH-RS-EPRE-Offset	0		
cqi-ReportPeriodic-r10	Not present		
pmi-RI-Report-r9	setup		
}			

**Table 9.4.1.3.2\_D.4.3-5: TDD-Config-DEFAULT**

Derivation Path: 36.508 clause 4.6.3			
Information Element	Value/remark	Comment	Condition
TDD-Config-DEFAULT ::= SEQUENCE {			
subframeAssignment	sa1		
specialSubframePatterns	ssp4		
}			

**Table 9.4.1.3.2\_D.4.3-6: PUCCH-ConfigDedicated-DEFAULT**

Derivation Path: 36.508 clause 4.6.3			
Information Element	Value/remark	Comment	Condition
PUCCH-ConfigDedicated-DEFAULT ::= SEQUENCE {			
ackNackRepetition CHOICE {			
release	NULL		
}			
tddAckNackFeedbackMode	Multiplexing	Multiplexing is selected as default to align with RAN4's assumptions in RF tests.	TDD
}			

**Table 9.4.1.3.2\_D.4.3-7: CSI-RS-Config**

Derivation Path: 36.331 clause 6.3.2			
Information Element	Value/remark	Comment	Condition
CSI-RS-Config-r10 ::= SEQUENCE {			
csi-RS-r10 CHOICE{			
setup SEQUENCE {			
antennaPortsCount-r10	an8	Parameter represents the number of antenna ports used for transmission of CSI reference signals	
resourceConfig-r10	0	Parameter: CSI reference signal configuration	
subframeConfig-r10	4	$\Delta_{\text{CSI-RS}} = I_{\text{CSI-RS}}$ when CSI-RS SubframeConfig is from 0-4; Parameter: $I_{\text{CSI-RS}}$	
p-C-r10	-6	Parameter: $P_c$ which is the assumed ratio of PDSCH EPRE to CSI-RS EPRE when UE derives CSI feedback	
}			
}			
zeroTxPowerCSI-RS-r10 CHOICE{			
release	NULL		
}			
}			

9.4.1.3.2\_D.5 Test requirement

**Table 9.4.1.3.2\_D.5-1: Test requirement (TDD)**

Parameter	Test 1
$\gamma$	3.49

The ratio of throughput using precoding matrix of PMI reports from the UE to using random precoding matrix shall equal or exceed the value specified in table 9.4.1.3.2\_D.5.

#### 9.4.1.4 PMI Reporting – PUCCH 1-1 (Single PMI) (CSI Reference Symbol)

##### 9.4.1.4.1\_G FDD PMI Reporting with 4Tx enhanced codebook – PUCCH 1-1 (Single PMI) for eDL MIMO Enhancement

Editor's notes: This test case is incomplete. The following item is missing or incomplete:

- Missing test tolerances
- RAN WG5 is waiting on feedback on whether Release 10 Feature Group Indicator 103 is necessary for the Release 12 test cases.
- High XP 4x2 definition is missing in TS 36.101[]

##### 9.4.1.4.1\_G.1 Test purpose

To verify reporting accuracy of the Precoding Matrix Indicator (PMI) reporting with 4Tx enhanced codebook (Single PMI) for eDL MIMO Enhancement.

##### 9.4.1.4.1\_G.2 Test applicability

This test applies to all types of E-UTRA FDD UE releases 12 and forward that support eDL-MIMO Enhancement. Applicability requires support for FGI bit [FFS].

##### 9.4.1.4.1\_G.3 Minimum conformance requirements

For the parameters specified in Table 9.4.1.4.1\_G.3-1, and using the downlink physical channels specified in Annex C.3.2, the minimum requirements are specified in Table 9.4.1.4.1\_G.3-2.

Table 9.4.1.4.1\_G.3-1: PMI test for single-layer (FDD)

Parameter	Unit	Test 1	
Bandwidth	MHz	10	
Transmission mode		9	
Propagation channel		EPA5	
Precoding granularity	PRB	50	
Correlation and antenna configuration		High XP 4 x 2	
Beamforming model		Annex B.4.3	
Cell-specific reference signals		Antenna ports 0,1	
CSI reference signals		Antenna ports 15,...,18	
CSI-RS periodicity and subframe offset $T_{\text{CSI-RS}} / I_{\text{CSI-RS}}$		5/ 1	
CSI-RS reference signal configuration		6	
CodeBookSubsetRestriction bitmap		0x0000 0000 0000 FFFF 0000 00FF	
Downlink power allocation	$\rho_A$	dB	0
	$\rho_B$	dB	0
	$P_c$	dB	-3
	$\sigma$	dB	-3
$N_{oc}^{(j)}$	dB[mW/15kHz]	-98	
Reporting mode		PUCCH 1-1 submode1	
Reporting interval	ms	5	
PMI delay (Note 2)	ms	10	
Physical channel for CQI/PMI reporting		PUSCH (Note 3)	
PUCCH Report Type for CQI/second PMI		2b	
Physical channel for RI reporting		PUSCH	
PUCCH Report Type for RI/first PMI		5	
<i>cqi-pmi-ConfigurationIndex</i>		4	
<i>ri-ConfigIndex</i>		1	
Measurement channel		R.60 FDD	
OCNG Pattern		OP.1 FDD	
Max number of HARQ transmissions		4	
Redundancy version coding sequence		{0,1,2,3}	
Note 1:	For random precoder selection, the precoder shall be updated in each TTI (1 ms granularity)		
Note 2:	If the UE reports in an available uplink reporting instance at subframe SF#n based on PMI estimation at a downlink SF not later than SF#(n-4), this reported PMI cannot be applied at the eNB downlink before SF#(n+4).		
Note 3:	To avoid collisions between CQI/PMI reports and HARQ-ACK it is necessary to report both on PUSCH instead of PUCCH.		
Note 4:	PDSCH_RA= 0 dB, PDSCH_RB= 0 dB in order to have the same PDSCH and OCNG power per subcarrier at the receiver.		
Note 5:	Randomization of the principle beam direction shall be used as specified in B.2.3A.4		

**Table 9.4.1.4.1\_G.3-2: Minimum requirement (FDD)**

Parameter	Test 1
$\gamma$	1.8
UE Category	$\geq 1$

The normative reference for this requirement is TS 36.101 [2] clause 9.4.1.1.1.

#### 9.4.1.4.1\_G.4 Test description

##### 9.4.1.4.1\_G.4.1 Initial conditions

Initial conditions are a set of test configurations the UE needs to be tested in and the steps for the SS to take with the UE to reach the correct measurement state.

Configurations of PDSCH and PDCCH before measurement are specified in Annex C.2.

Test Environment: Normal as defined in TS 36.508 [7] clause 4.1.

Frequencies to be tested: Mid Range as defined in TS 36.508 [7] clause 4.3.1.1.

Channel Bandwidths to be tested: 10MHz, as defined in TS 36.508 [7] clause 4.3.1.1.

1. Connect the SS to the UE antenna connector (s) as shown in TS 36.508 [7] Annex A, Figure A.11.
2. The parameter settings for the cell are set up according to Table 9.4.1.4.1\_G.3-1.
3. Downlink signals are initially set up according to Annex C.1 and Annex C.3.2, and uplink signals according to Annex H.1 and H.3.2.
4. Propagation conditions are set according to Annex B clause B.0
5. Ensure the UE is in State 3A-RF according to TS 36.508 [7] clause 5.2A.2. Message contents are defined in 9.4.1.4.1\_G.4.3.

##### 9.4.1.4.1\_G.4.2 Test procedure

1. Set the parameters of bandwidth, the propagation condition, antenna configuration and measurement channel according to Table 9.4.1.4.1\_G.3-1 as appropriate.
2. The SS shall transmit PDSCH via PDCCH DCI format 2C for C\_RNTI to transmit the DL RMC with randomly selected precoding matrix from codebook (Table 7.2.4-0A in TS 36.213 [10]) every subframe regardless of PMI reports from the UE. Note that each precoding matrix shall be selected in equal probabilities. The SS sends downlink MAC padding bits on the DL RMC. The SS shall transmit PDCCH DCI format 0 in downlink SF#3 and #8 to schedule to schedule UL RMC in subframe #2 and #7 (Table A.4.1-1). Establish  $t_{rnd}$  and  $SNR_{rnd}$  according to annex G.5.2.
3. Set SNR to  $SNR_{rnd}$ . The SS shall transmit PDSCH with precoding matrix according to PMI report from the UE. The SS sends downlink MAC padding bits on the DL RMC. The SS shall transmit PDCCH DCI format 0 in downlink SF#3 and #8 to schedule to schedule UL RMC in subframe #2 and #7 (Table A.4.1-1). Measure the average throughput. Measure  $t_{ue}$  according to Annex G.5.3.

$$\gamma = \frac{t_{ue}}{t_{rnd}}$$

4. Calculate

##### 9.4.1.4.1\_G.4.3 Message contents

Message contents are according to TS 36.508 [7] clause 4.6 with the following exceptions:



**Table 9.4.1.4.1\_G.4.3-1: PhysicalConfigDedicated-DEFAULT**

Derivation Path: 36.331 clause 6.3.2			
Information Element	Value/remark	Comment	Condition
PhysicalConfigDedicated ::= SEQUENCE {			
antennaInfo	Not present		
antennaInfo-r10 CHOICE {			
explicitValue-r10	AntennaInfoDedicated-r10		
}			
cqi-ReportConfig-r10	CQI-ReportConfig-r10-DEFAULT		
csi-RS-Config-r10	CSI-RS-Config-r10		
antennaInfo-v1250	AntennaInfoDedicated-v1250		
}			

**Table 9.4.1.4.1\_G.4.3-2: PDSCH-ConfigDedicated-DEFAULT**

Derivation Path: 36.508 clause 4.6.3			
Information Element	Value/remark	Comment	Condition
PDSCH-ConfigDedicated-DEFAULT ::= SEQUENCE {			
p-a	dB0		
}			

**Table 9.4.1.4.1\_G.4.3-3: AntennaInfoDedicated-r10**

Derivation Path: 36.331 clause 6.3.2			
Information Element	Value/remark	Comment	Condition
AntennaInfoDedicated-r10 ::= SEQUENCE {			
transmissionMode-r10	tm9-v1020		
codebookSubsetRestriction-r10	0x0000 0000 0000 FFFF 0000 00FF		
ue-TransmitAntennaSelection CHOICE {			
release	NULL		
}			
}			

**Table 9.4.1.4.1\_G.4.3-4: AntennaInfoDedicated-v1250**

Derivation Path: 36.331 clause 6.3.2			
Information Element	Value/remark	Comment	Condition
AntennaInfoDedicated-v1250 ::= SEQUENCE {			
alternativeCodebookEnabledFor4TX-r12	TRUE		
}			

**Table 9.4.1.4.1\_G.4.3-5: CQI-ReportConfig-r10-DEFAULT**

Derivation Path: 36.508 clause 4.6.3			
Information Element	Value/remark	Comment	Condition
CQI-ReportConfig-r10 ::= SEQUENCE {			
cqi-ReportModeAperiodic-r10	Not present		
nomPDSCH-RS-EPRE-Offset	0		
cqi-ReportPeriodic-r10	CQI-ReportPeriodic-r10-DEFAULT		
pmi-RI-Report-r9	setup		
}			

**Table 9.4.1.4.1\_G.4.3-6: CQI-ReportPeriodic-r10-DEFAULT**

Derivation Path: 36.508 clause 4.6.3			
Information Element	Value/remark	Comment	Condition
CQI-ReportPeriodic-r10 ::= CHOICE {			
setup SEQUENCE {			
cqi-pmi-ConfigIndex	4	(see Table 7.2.2-1A in TS 36.213)	
cqi-FormatIndicatorPeriodic-r10			
CHOICE {			
widebandCQI-r10 SEQUENCE {			
csi-ReportMode-r10	submode1		
}			
ri-ConfigIndex	1		
}			
}			

**Table 9.4.1.4.1\_G.4.3-7: CSI-RS-Config**

Derivation Path: 36.331 clause 6.3.2			
Information Element	Value/remark	Comment	Condition
CSI-RS-Config-r10 ::= SEQUENCE {			
csi-RS-r10 CHOICE{			
release	NULL		
setup SEQUENCE {			
antennaPortsCount-r10	an4	Parameter represents the number of antenna ports used for transmission of CSI reference signals	
resourceConfig-r10	6	Parameter: CSI reference signal configuration	
subframeConfig-r10	1	$\Delta_{CSI-RS} = I_{CSI-RS}$ when CSI-RS SubframeConfig is from 0-4; Parameter: $I_{CSI-RS}$	
p-C-r10	-3	Parameter: $P_c$ which is the assumed ratio of PDSCH EPRE to CSI-RS EPRE when UE derives CSI feedback	
}			
}			
}			

9.4.1.4.1\_G.5 Test requirement

**Table 9.4.1.4.1\_G.5 -1: Test requirement (FDD)**

Parameter	Test 1
$\gamma$	1.8 +TT
UE Category	$\geq 1$

The ratio of throughput using precoding matrix of PMI reports from the UE to using random precoding matrix shall equal or exceed the value specified in Table 9.4.1.4.1\_G.5-1.

#### 9.4.1.4.2\_G TDD PMI Reporting with 4Tx enhanced codebook – PUCCH 1-1 (Single PMI) for eDL MIMO Enhancement

Editor's notes: This test case is incomplete. The following item is missing or incomplete:

- Missing test tolerances
- RAN WG5 is waiting on feedback on whether Release 10 Feature Group Indicator 103 is necessary for the Release 12 test cases.
- High XP 4x2 definition is missing in TS 36.101[]

##### 9.4.1.4.2\_G.1 Test purpose

To verify reporting accuracy of the Precoding Matrix Indicator (PMI) reporting with 4Tx enhanced codebook (Single PMI) for eDL MIMO Enhancement.

##### 9.4.1.4.2\_G.2 Test applicability

This test applies to all types of E-UTRA TDD UE release 12 and forward that support eDL-MIMO Enhancement. Applicability requires support for FGI bit [FFS].

##### 9.4.1.4.2\_G.3 Minimum conformance requirements

For the parameters specified in Table 9.4.1.4.2\_G.3-1, and using the downlink physical channels specified in Annex C.3.2, the minimum requirements are specified in Table 9.4.1.4.2\_G.3-2.

Table 9.4.1.4.2\_G.3-1: PMI test for single-layer (TDD)

Parameter		Unit	Test 1
Bandwidth		MHz	10
Transmission mode			9
Uplink downlink configuration			1
Special subframe configuration			4
Propagation channel			EPA5
Precoding granularity		PRB	50
Correlation and antenna configuration			High XP 4 x 2
Beamforming model			Annex B.4.3
Cell-specific reference signals			Antenna ports 0,1
CSI reference signals			Antenna ports 15,...,18
CSI-RS periodicity and subframe offset $T_{\text{CSI-RS}} / I_{\text{CSI-RS}}$			5/ 4
CSI-RS reference signal configuration			6
CodeBookSubsetRestriction bitmap			0x0000 0000 0000 FFFF 0000 00FF
Downlink power allocation	$\rho_A$	dB	0
	$\rho_B$	dB	0
	$P_c$	dB	-3
	$\sigma$	dB	-3
$N_{oc}^{(j)}$		dB[mW/15kHz]	-98
Reporting mode			PUCCH 1-1 submode1
Reporting interval		ms	5
PMI delay (Note 2)		ms	15
Physical channel for CQI/PMI reporting			PUSCH (Note 3)
PUCCH Report Type for CQI/second PMI			2b
Physical channel for RI reporting			PUSCH
PUCCH Report Type for RI/first PMI			5
<i>cqi-pmi-ConfigurationIndex</i>			4
<i>ri-ConfigIndex</i>			1
Measurement channel			R.60 TDD
OCNG Pattern			OP.1 TDD
Max number of HARQ transmissions			4
Redundancy version coding sequence			{0,1,2,3}
ACK/NACK feedback mode			Multiplexing
<p>Note 1: For random precoder selection, the precoder shall be updated in each TTI (1 ms granularity)</p> <p>Note 2: If the UE reports in an available uplink reporting instance at subframe SF#n based on PMI estimation at a downlink SF not later than SF#(n-4), this reported PMI cannot be applied at the eNB downlink before SF#(n+4).</p> <p>Note 3: To avoid collisions between CQI/PMI reports and HARQ-ACK it is necessary to report both on PUSCH instead of PUCCH.</p> <p>Note 4: PDCCH DCI format 0 with a trigger for aperiodic CQI shall be transmitted in downlink SF#4 and #9 to allow aperiodic CQI/PMI/RI to be transmitted on uplink SF#3 and #8.</p> <p>Note 5: Randomization of the principle beam direction shall be used as specified in B.2.3A.4.</p>			

**Table 9.4.1.4.2\_G.3-2: Minimum requirement (TDD)**

Parameter	Test 1
$\gamma$	1.8
UE Category	$\geq 1$

The normative reference for this requirement is TS 36.101 [2] clause 9.4.1.1.2.

#### 9.4.1.4.2\_G.4 Test description

##### 9.4.1.4.2\_G.4.1 Initial conditions

Initial conditions are a set of test configurations the UE needs to be tested in and the steps for the SS to take with the UE to reach the correct measurement state.

Configurations of PDSCH and PDCCH before measurement are specified in Annex C.2.

Test Environment: Normal as defined in TS 36.508 [7] clause 4.1.

Frequencies to be tested: Mid Range as defined in TS 36.508 [7] clause 4.3.1.2.

Channel Bandwidths to be tested: 10MHz, as defined in TS 36.508 [7] clause 4.3.1.2.

1. Connect the SS to the UE antenna connector (s) as shown in TS 36.508 [7] Annex A, Figure A.11.
2. The parameter settings for the cell are set up according to Table 9.4.1.4.2\_G.3-1.
3. Downlink signals are initially set up according to Annex C.1 and Annex C.3.2, and uplink signals according to Annex H.1 and H.3.2.
4. Propagation conditions are set according to Annex B clause B.0
5. Ensure the UE is in State 3A-RF according to TS 36.508 [7] clause 5.2A.2. Message contents are defined in clause 9.4.1.4.2\_G.4.3.

##### 9.4.1.4.2\_G.4.2 Test procedure

1. Set the bandwidth, propagation condition, antenna configuration and measurement channel parameters according to Table 9.4.1.4.2\_G.3-1 as appropriate.
2. The SS shall transmit PDSCH via PDCCH DCI format 2C for C\_RNTI to transmit the DL RMC with randomly selected precoding matrix from codebook (Table 7.2.4-0A in TS 36.213 [10]) every subframe regardless of PMI reports from the UE. Note that each precoding matrix shall be selected in equal probabilities. The SS sends downlink MAC padding bits on the DL RMC. The SS shall transmit PDCCH DCI format 0 in downlink SF#4 and #9 to schedule to schedule UL RMC in subframe #3 and #8 (Table A.4.1-2). Establish  $t_{rnd}$  and  $SNR_{rnd}$  according to annex G.5.2
3. Set SNR to  $SNR_{rnd}$ . The SS shall transmit PDSCH with precoding matrix according to PMI report from the UE. The SS sends downlink MAC padding bits on the DL RMC. The SS shall transmit PDCCH DCI format 0 in downlink SF#4 and #9 to schedule to schedule UL RMC in subframe #3 and #8 (Table A.4.1-2). Measure  $t_{ue}$  according to Annex G.5.3
4. Calculate  $\gamma = \frac{t_{ue}}{t_{rnd}}$

##### 9.4.1.4.2\_G.4.3 Message contents

Message contents are according to TS 36.508 [7] clause 4.6 with the following exceptions:

**Table 9.4.1.4.2\_G.4.3-1: PhysicalConfigDedicated-DEFAULT**

Derivation Path: 36.331 clause 6.3.2			
Information Element	Value/remark	Comment	Condition
PhysicalConfigDedicated ::= SEQUENCE {			
antennaInfo	Not present		
antennaInfo-r10 CHOICE {			
explicitValue-r10	AntennaInfoDedicated-r10		
}			
cqi-ReportConfig-r10	CQI-ReportConfig-r10-DEFAULT		
csi-RS-Config-r10	CSI-RS-Config-r10		
antennaInfo-v1250	AntennaInfoDedicated-v1250		
}			

**Table 9.4.1.4.2\_G.4.3-2: PDSCH-ConfigDedicated-DEFAULT**

Derivation Path: 36.508 clause 4.6.3			
Information Element	Value/remark	Comment	Condition
PDSCH-ConfigDedicated-DEFAULT ::= SEQUENCE {			
p-a	dB0		
}			

**Table 9.4.1.4.2\_G.4.3-3: AntennaInfoDedicated-r10**

Derivation Path: 36.331 clause 6.3.2			
Information Element	Value/remark	Comment	Condition
AntennaInfoDedicated-r10 ::= SEQUENCE {			
transmissionMode-r10	tm9-v1020		
codebookSubsetRestriction-r10	0x0000 0000 0000 FFFF 0000 00FF		
ue-TransmitAntennaSelection CHOICE {			
release	NULL		
}			
}			

**Table 9.4.1.4.2\_G.4.3-4: AntennaInfoDedicated-v1250**

Derivation Path: 36.331 clause 6.3.2			
Information Element	Value/remark	Comment	Condition
AntennaInfoDedicated-v1250 ::= SEQUENCE {			
alternativeCodebookEnabledFor4TX-r12	TRUE		
}			

**Table 9.4.1.4.2\_G.4.3-5: CQI-ReportConfig-r10-DEFAULT**

Derivation Path: 36.508 clause 4.6.3			
Information Element	Value/remark	Comment	Condition
CQI-ReportConfig-r10 ::= SEQUENCE {			
cqi-ReportModeAperiodic-r10	Not present		
nomPDSCH-RS-EPRE-Offset	0		
cqi-ReportPeriodic-r10	CQI-ReportPeriodic-r10-DEFAULT		
pmi-RI-Report-r9	setup		
}			

**Table 9.4.1.4.2\_G.4.3-6: CQI-ReportPeriodic-r10-DEFAULT**

Derivation Path: 36.508 clause 4.6.3			
Information Element	Value/remark	Comment	Condition
CQI-ReportPeriodic-r10 ::= CHOICE {			
setup SEQUENCE {			
cqi-pmi-ConfigIndex	4	(see Table 7.2.2-1C in TS 36.213)	
cqi-FormatIndicatorPeriodic-r10			
CHOICE {			
widebandCQI-r10			
SEQUENCE {			
csi-ReportMode-r10	submode1		
}			
ri-ConfigIndex	1		
}			
}			
}			

**Table 9.4.1.4.2\_G.4.3-7: CSI-RS-Config**

Derivation Path: 36.331 clause 6.3.2			
Information Element	Value/remark	Comment	Condition
CSI-RS-Config-r10 ::= SEQUENCE {			
csi-RS-r10 CHOICE{			
release	NULL		
setup SEQUENCE {			
antennaPortsCount-r10	an4	Parameter represents the number of antenna ports used for transmission of CSI reference signals	
resourceConfig-r10	6	Parameter: CSI reference signal configuration	
subframeConfig-r10	4	$\Delta_{\text{CSI-RS}} = I_{\text{CSI-RS}}$ when CSI-RS SubframeConfig is from 0-4; Parameter: $I_{\text{CSI-RS}}$	
p-C-r10	-3	Parameter: $P_c$ which is the assumed ratio of PDSCH EPRE to CSI-RS EPRE when UE derives CSI feedback	
}			
}			
}			

**Table 9.4.1.4.2\_G.4.3-8: TDD-Config-DEFAULT**

Derivation Path: 36.508 clause 4.6.3			
Information Element	Value/remark	Comment	Condition
TDD-Config-DEFAULT ::= SEQUENCE {			
subframeAssignment	sa1		
specialSubframePatterns	ssp4		
}			

**Table 9.4.1.4.2\_G.4.3-9: PUCCH-ConfigDedicated-DEFAULT**

Derivation Path: 36.331 clause 6.3.2			
Information Element	Value/remark	Comment	Condition
PUCCH-ConfigDedicated-DEFAULT ::= SEQUENCE			
{			
ackNackRepetition CHOICE {			
Release	NULL		
}			
tddAckNackFeedbackMode	Multiplexing	Multiplexing is selected as default to align with RAN4's assumptions in RF tests.	TDD
}			

#### 9.4.1.4.2\_G.5 Test requirement

**Table 9.4.1.4.2\_G.5 -1: Test requirement (FDD)**

Parameter	Test 1
$\gamma$	1.8 +TT
UE Category	$\geq 1$

The ratio of throughput using precoding matrix of PMI reports from the UE to using random precoding matrix shall equal or exceed the value specified in Table 9.4.1.4.2\_G.5-1.

## 9.4.2 Multiple PMI

### 9.4.2.1 PMI Reporting – PUSCH 1-2 (Multiple PMI) (Cell-Specific Reference Symbols)

#### 9.4.2.1.1 FDD PMI Reporting – PUSCH 1-2 (Multiple PMI)

##### 9.4.2.1.1.1 Test purpose

To test the accuracy of the Precoding Matrix Indicator (PMI) reporting such that the system throughput is maximized based on the precoders configured according to the UE reports.

##### 9.4.2.1.1.2 Test applicability

This test applies to E-UTRA FDD UE release 8 of UE category 2-5.

##### 9.4.2.1.1.3 Minimum conformance requirements

For the parameters specified in Table 9.4.2.1.1.3-1, and using the downlink physical channels specified in Annex C, the minimum requirements are specified in Table 9.4.2.1.1.3-2.



**Table 9.4.2.1.1.3-1 PMI test for single-layer (FDD)**

Parameter		Unit	Test 1
Bandwidth		MHz	20
Transmission mode			6
Propagation channel			EPA5
Precoding granularity (only for reporting and following PMI)		PRB	8
Correlation and antenna configuration			Low 2 x 2
Downlink power allocation	$\rho_A$	dB	-3
	$\rho_B$	dB	-3
	$\sigma$	dB	0
$N_{oc}^{(j)}$		dB[mW/15kHz]	-98
Reporting mode			PUSCH 1-2
Reporting interval		ms	1
PMI delay		ms	8
Measurement channel			R.30 FDD
OCNG Pattern			OP.1 FDD
Max number of HARQ transmissions			4
Redundancy version coding sequence			{0,1,2,3}
Note 1: For random precoder selection, the precoders shall be updated in each TTI (1 ms granularity)			
Note 2: If the UE reports in an available uplink reporting instance at subframe SF#n based on PMI estimation at a downlink SF not later than SF#(n-4), this reported PMI cannot be applied at the eNB downlink before SF#(n+4)			

**Table 9.4.2.1.1.3-2: Minimum requirement (FDD)**

Parameter	Test 1
$\gamma$	1,2
UE Category	2-5

The normative reference for this requirement is TS 36.101 [2] clause 9.4.2.1.1.

#### 9.4.2.1.1.4 Test description

##### 9.4.2.1.1.4.1 Initial conditions

Initial conditions are a set of test configurations the UE needs to be tested in and the steps for the SS to take with the UE to reach the correct measurement state.

Configurations of PDSCH and PDCCH before measurement are specified in Annex C.2.

Test Environment: Normal as defined in TS 36.508 [7] clause 4.1.

Frequencies to be tested: Mid Range as defined in TS 36.508 [7] clause 4.3.1.1.

Channel Bandwidths to be tested: 20MHz, as defined in TS 36.508 [7] clause 4.3.1.1

1. Connect the SS to the UE antenna connector (s) as shown in TS 36.508 [7] Annex A, Figure A.10.
2. The parameter settings for the cell are set up according to Table 9.4.2.1.1.3-1.
3. Downlink signals are initially set up according to Annex C.1 and Annex C.3.2, and uplink signals according to Annex H.1 and H.3.2.
4. Propagation conditions are set according to Annex B clause B.0

5. Ensure the UE is in State 3A-RF according to TS 36.508 [7] clause 5.2A.2. Message contents are defined in clause 9.4.2.1.1.4.3.

9.4.2.1.1.4.2 Test procedure

1. Set the parameters of bandwidth, the propagation condition, antenna configuration and measurement channel according to Table 9.4.2.1.1.3-1 as appropriate.
2. The SS shall transmit PDSCH via PDCCH DCI format 1B for C\_RNTI to transmit the DL RMC with randomly selected precoding matrix from codebook (Table 6.3.4.2.3-1 in TS 36.211 [8]) every subframe regardless of PMI reports from the UE. Note that each precoding matrix shall be selected in equal probabilities. The SS sends downlink MAC padding bits on the DL RMC SS schedules the UL transmission to carry the PUSCH CQI feedback via PDCCH DCI format 0 with CQI request bit set to 1 and I\_MCS=29 and N\_PRB allocated to be less or equal to 4. Establish  $t_{md}$  and  $SNR_{md}$  according to annex G.5.2
3. Set SNR to  $SNR_{md}$ . The SS shall transmit PDSCH with precoding matrix according to PMI report from the UE. The SS sends downlink MAC padding bits on the DL RMC SS schedules the UL transmission to carry the PUSCH CQI feedback via PDCCH DCI format 0 with CQI request bit set to 1 and I\_MCS=29 and N\_PRB allocated to be less or equal to 4 every subframe. Measure the average throughput. Measure  $t_{ue}$  according to Annex G.5.3

4. Calculate  $\gamma = \frac{t_{ue}}{t_{md}}$

9.4.2.1.1.4.3 Message contents

Message contents are according to TS 36.508 [7] clause 4.6 with the following exceptions:

**Table 9.4.2.1.1.4.3-1: PhysicalConfigDedicated-DEFAULT**

Derivation Path: 36.508 clause 5.5.1.2			
Information Element	Value/remark	Comment	Condition
PhysicalConfigDedicated-DEFAULT ::= SEQUENCE {			
cqi-ReportConfig	CQI-ReportConfig-DEFAULT		
antennaInfo CHOICE {			
explicitValue	AntennaInfoDedicated		
}			
}			

**Table 9.4.2.1.1.4.3-2: AntennaInfoDedicated**

Derivation Path: 36.331 clause 6.3.2			
Information Element	Value/remark	Comment	Condition
AntennaInfoDedicated ::= SEQUENCE {			
transmissionMode	tm6		
codebookSubsetRestriction CHOICE{			
n2TxAntenna-tm6	1111		
}			
ue-TransmitAntennaSelection CHOICE{			
release	NULL		
}			
}			

**Table 9.4.2.1.1.4.3-3: CQI-ReportConfig-DEFAULT**

Derivation Path: 36.508 clause 4.6.3			
Information Element	Value/remark	Comment	Condition
CQI-ReportConfig-DEFAULT ::= SEQUENCE {			
cqi-ReportModeAperiodic	rm12		
nomPDSCH-RS-EPRE-Offset	0		
cqi-ReportPeriodic	Not present		
}			

9.4.2.1.1.5 Test requirement

**Table 9.4.2.1.1.5-1: Test requirement (FDD)**

Parameter	Test 1
$\gamma$	1.19
UE Category	2-5

9.4.2.1.1\_1 FDD PMI Reporting – PUSCH 1-2 (Multiple PMI) (Release 9 and forward)

9.4.2.1.1\_1.1 Test purpose

To test the accuracy of the Precoding Matrix Indicator (PMI) reporting such that the system throughput is maximized based on the precoders configured according to the UE reports.

9.4.2.1.1\_1.2 Test applicability

This test applies to all types of E-UTRA FDD UE release 9 and forward.

9.4.2.1.1\_1.3 Minimum conformance requirements

For the parameters specified in Table 9.4.2.1.1\_1.3-1, and using the downlink physical channels specified in Annex C, the minimum requirements are specified in Table 9.4.2.1.1\_1.3-2.

**Table 9.4.2.1.1\_1.3-1: PMI test for single-layer (FDD)**

Parameter		Unit	Test 1
Bandwidth		MHz	10
Transmission mode			6
Propagation channel			EPA5
Precoding granularity (only for reporting and following PMI)		PRB	6
Correlation and antenna configuration			Low 2 x 2
Downlink power allocation	$\rho_A$	dB	-3
	$\rho_B$	dB	-3
	$\sigma$	dB	0
$N_{oc}^{(j)}$		dB[mW/15kHz]	-98
Reporting mode			PUSCH 1-2
Reporting interval		ms	1
PMI delay		ms	8
Measurement channel			R.11-3 FDD for UE Category 1, R.11 FDD for UE Category 2-8
OCNG Pattern			OP.1/2 FDD
Max number of HARQ transmissions			4
Redundancy version coding sequence			{0,1,2,3}
Note 1: For random precoder selection, the precoders shall be updated in each TTI (1 ms granularity) Note 2: If the UE reports in an available uplink reporting instance at subframe SF#n based on PMI estimation at a downlink SF not later than SF#(n-4), this reported PMI cannot be applied at the eNB downlink before SF#(n+4) Note 3: One/two sided dynamic OCNG Pattern OP.1/2 FDD as described in Annex A.5.1.1/2 shall be used.			

**Table 9.4.2.1.1\_1.3-2: Minimum requirement (FDD)**

Parameter	Test 1
$\gamma$	1.2
UE Category	$\geq 1$

The normative reference for this requirement is TS 36.101 [2] clause 9.4.2.1.1.

#### 9.4.2.1.1\_1.4 Test description

##### 9.4.2.1.1\_1.4.1 Initial conditions

Initial conditions are a set of test configurations the UE needs to be tested in and the steps for the SS to take with the UE to reach the correct measurement state.

Configurations of PDSCH and PDCCH before measurement are specified in Annex C.2.

Test Environment: Normal as defined in TS 36.508 [7] clause 4.1.

Frequencies to be tested: Mid Range as defined in TS 36.508 [7] clause 4.3.1.1.

Channel Bandwidths to be tested: 10MHz, as defined in TS 36.508 [7] clause 4.3.1.1

1. Connect the SS to the UE antenna connector (s) as shown in TS 36.508 [7] Annex A, Figure A.10.
2. The parameter settings for the cell are set up according to Table 9.4.2.1.1\_1.3-1.
3. Downlink signals are initially set up according to Annex C.1 and Annex C.3.2, and uplink signals according to Annex H.1 and H.3.2.
4. Propagation conditions are set according to Annex B clause B.0
5. Ensure the UE is in State 3A-RF according to TS 36.508 [7] clause 5.2A.2. Message contents are defined in clause 9.4.2.1.1\_1.4.3.

9.4.2.1.1\_1.4.2 Test procedure

1. Set the parameters of bandwidth, the propagation condition, antenna configuration and measurement channel according to Table 9.4.2.1.1\_1.3-1 as appropriate.
2. The SS shall transmit PDSCH via PDCCH DCI format 1B for C\_RNTI to transmit the DL RMC (R.11-3 FDD for UE Category 1 with allocation centred within the transmission bandwidth configuration or R.11 FDD for UE Category 2-8) with randomly selected precoding matrix from codebook (Table 6.3.4.2.3-1 in TS 36.211 [8]) every subframe regardless of PMI reports from the UE. Note that each precoding matrix shall be selected in equal probabilities. The SS sends downlink MAC padding bits on the DL RMC SS schedules the UL transmission to carry the PUSCH CQI feedback via PDCCH DCI format 0 with CQI request bit set to 1 and I\_MCS=29 and N\_PRB allocated to be less or equal to 4. Establish  $t_{rd}$  and  $SNR_{rd}$  according to annex G.5.2
3. Set SNR to  $SNR_{rd}$ . The SS shall transmit PDSCH via PDCCH DCI format 1B for C-RNTI to transmit the DL RMC (R.11-3 FDD for UE Category 1 with allocation centred within the transmission bandwidth configuration or R.11 FDD for UE Category 2-8) with precoding matrix according to PMI report from the UE. The SS sends downlink MAC padding bits on the DL RMC SS schedules the UL transmission to carry the PUSCH CQI feedback via PDCCH DCI format 0 with CQI request bit set to 1 and I\_MCS=29 and N\_PRB allocated to be less or equal to 4 every subframe. Measure the average throughput.  
Measure  $t_{ue}$  according to Annex G.5.3

4. Calculate  $\gamma = \frac{t_{ue}}{t_{rd}}$

9.4.2.1.1\_1.4.3 Message contents

Message contents are according to TS 36.508 [7] clause 4.6 with the following exceptions:

**Table 9.4.2.1.1\_1.4.3-1: PhysicalConfigDedicated-DEFAULT**

Derivation Path: 36.508 clause 5.5.1.2			
Information Element	Value/remark	Comment	Condition
PhysicalConfigDedicated-DEFAULT ::= SEQUENCE {			
cqi-ReportConfig	CQI-ReportConfig-DEFAULT		
antennaInfo CHOICE {			
explicitValue	AntennaInfoDedicated		
}			
}			

**Table 9.4.2.1.1\_1.4.3-2: AntennaInfoDedicated**

Derivation Path: 36.331 clause 6.3.2			
Information Element	Value/remark	Comment	Condition
AntennaInfoDedicated ::= SEQUENCE {			
transmissionMode	tm6		
codebookSubsetRestriction CHOICE{			
n2TxAntenna-tm6	1111		
}			
ue-TransmitAntennaSelection CHOICE{			
release	NULL		
}			
}			

**Table 9.4.2.1.1\_1.4.3-3: CQI-ReportConfig-DEFAULT**

Derivation Path: 36.508 clause 4.6.3			
Information Element	Value/remark	Comment	Condition
CQI-ReportConfig-DEFAULT ::= SEQUENCE {			
cqi-ReportModeAperiodic	rm12		
nomPDSCH-RS-EPRE-Offset	0		
cqi-ReportPeriodic	Not present		
}			

9.4.2.1.1\_1.5 Test requirement

**Table 9.4.2.1.1\_1.5-1: Test requirement (FDD)**

Parameter	Test 1
$\gamma$	1.19
UE Category	$\geq 1$

9.4.2.1.2 TDD PMI Reporting – PUSCH 1-2 (Multiple PMI)

9.4.2.1.2.1 Test purpose

To test the accuracy of the Precoding Matrix Indicator (PMI) reporting such that the system throughput is maximized based on the precoders configured according to the UE reports.

9.4.2.1.2.2 Test applicability

This test applies to E-UTRA TDD UE release 8 of UE category 2-5.

9.4.2.1.2.3 Minimum conformance requirements

For the parameters specified in Table 9.4.2.1.2.3-1, and using the downlink physical channels specified in Annex C, the minimum requirements are specified in Table 9.4.2.1.2.3-2.

**Table 9.4.2.1.2.3-1: PMI test for single-layer (TDD)**

Parameter		Unit	Test 1
Bandwidth		MHz	20
Transmission mode			6
Uplink downlink configuration			1
Special subframe configuration			4
Propagation channel			EPA5
Precoding granularity (only for reporting and following PMI)		PRB	8
Correlation and antenna configuration			Low 2 x 2
Downlink power allocation	$\rho_A$	dB	-3
	$\rho_B$	dB	-3
	$\sigma$	dB	0
$N_{oc}^{(j)}$		dB[mW/15kHz]	-98
Reporting mode			PUSCH 1-2
Reporting interval		ms	1
Minimum PMI delay		ms	10 or 11
Measurement channel			R.30 TDD
OCNG Pattern			OP.1 TDD
Max number of HARQ transmissions			4
Redundancy version coding sequence			{0,1,2,3}
ACK/NACK feedback mode			Multiplexing
Note 1: For random precoder selection, the precoders shall be updated in each available downlink transmission instance Note 2: If the UE reports in an available uplink reporting instance at subframe SF#n based on PMI estimation at a downlink SF not later than SF#(n-4), this reported PMI cannot be applied at the eNB downlink before SF#(n+4)			

**Table 9.4.2.1.2.3-2: Minimum requirement (TDD)**

Parameter	Test 1
$\gamma$	1.2
UE Category	2-5

The normative reference for this requirement is TS 36.101 [2] clause 9.4.2.1.2.

#### 9.4.2.1.2.4 Test description

##### 9.4.2.1.2.4.1 Initial conditions

Initial conditions are a set of test configurations the UE needs to be tested in and the steps for the SS to take with the UE to reach the correct measurement state.

Configurations of PDSCH and PDCCH before measurement are specified in Annex C.2.

Test Environment: Normal as defined in TS 36.508 [7] clause 4.1.

Frequencies to be tested: Mid Range as defined in TS 36.508 [7] clause 4.3.1.2.

Channel Bandwidths to be tested: 20MHz, as defined in TS 36.508 [7] clause 4.3.1.2

1. Connect the SS to the UE antenna connector (s) as shown in TS 36.508 [7] Annex A, Figure A.10.

2. The parameter settings for the cell are set up according to Table 9.4.2.1.2.3-1.
3. Downlink signals are initially set up according to Annex C.1 and Annex C.3.2, and uplink signals according to Annex H.1 and H.3.2.
4. Propagation conditions are set according to Annex B clause B.0
5. Ensure the UE is in State 3A-RF according to TS 36.508 [7] clause 5.2A.2. Message contents are defined in clause 9.4.2.1.2.4.3.

#### 9.4.2.1.2.4.2 Test procedure

1. Set the bandwidth, propagation condition, antenna configuration and measurement channel parameters according to Table 9.4.2.1.2.3-1 as appropriate.
2. The SS shall transmit PDSCH via PDCCH DCI format 1B for C\_RNTI to transmit the DL RMC with randomly selected precoding matrix from codebook (Table 6.3.4.2.3-1 in TS 36.211 [8]) every subframe regardless of PMI reports from the UE. Note that each precoding matrix shall be selected in equal probabilities. The SS sends downlink MAC padding bits on the DL RMC. SS schedules the UL transmission to carry the PUSCH CQI feedback via PDCCH DCI format 0 with CQI request bit set to 1 and I\_MCS=29 and N\_PRB allocated to be less or equal to 4. Establish  $t_{md}$  and  $SNR_{md}$  according to annex G.5.2
3. Set SNR to  $SNR_{md}$ . The SS shall transmit PDSCH with precoding matrix according to PMI report from the UE. The SS sends downlink MAC padding bits on the DL RMC. SS schedules the UL transmission to carry the PUSCH CQI feedback via PDCCH DCI format 0 with CQI request bit set to 1 and I\_MCS=29 and N\_PRB allocated to be less or equal to 4. Measure  $t_{ue}$  according to Annex G.5.3
4. Calculate  $\gamma = \frac{t_{ue}}{t_{md}}$

#### 9.4.2.1.2.4.3 Message contents

Message contents are according to TS 36.508 [7] clause 4.6 with the following exceptions:

**Table 9.4.2.1.2.4.3-1: PhysicalConfigDedicated-DEFAULT**

Derivation Path: 36.508 clause 5.5.1.2			
Information Element	Value/remark	Comment	Condition
PhysicalConfigDedicated-DEFAULT ::= SEQUENCE {			
cqi-ReportConfig	CQI-ReportConfig-DEFAULT		
antennaInfo CHOICE {			
explicitValue	AntennaInfoDedicated		
}			
}			

**Table 9.4.2.1.2.4.3-2: AntennaInfoDedicated**

Derivation Path: 36.331 clause 6.3.2			
Information Element	Value/remark	Comment	Condition
AntennaInfoDedicated ::= SEQUENCE {			
transmissionMode	tm6		
codebookSubsetRestriction CHOICE{			
n2TxAntenna-tm6	1111		
}			
ue-TransmitAntennaSelection CHOICE{			
release	NULL		
}			



**Table 9.4.2.1.2.4.3-3: CQI-ReportConfig-DEFAULT**

Derivation Path: 36.508 clause 4.6.3			
Information Element	Value/remark	Comment	Condition
CQI-ReportConfig-DEFAULT ::= SEQUENCE {			
cqi-ReportModeAperiodic	rm12		
nomPDSCH-RS-EPRE-Offset	0		
cqi-ReportPeriodic	Not present		
}			

9.4.2.1.2.5 Test requirement

**Table 9.4.2.1.2.5-1: Test requirement (TDD)**

Parameter	Test 1
$\gamma$	1.19
UE Category	2-5

9.4.2.1.2\_1 TDD PMI Reporting – PUSCH 1-2 (Multiple PMI) (Release 9 and forward)

9.4.2.1.2\_1.1 Test purpose

To test the accuracy of the Precoding Matrix Indicator (PMI) reporting such that the system throughput is maximized based on the precoders configured according to the UE reports.

9.4.2.1.2\_1.2 Test applicability

This test applies to all types of E-UTRA TDD UE release 9 and forward.

9.4.2.1.2\_1.3 Minimum conformance requirements

For the parameters specified in Table 9.4.2.1.2\_1.3-1, and using the downlink physical channels specified in Annex C, the minimum requirements are specified in Table 9.4.2.1.2\_1.3-2.

**Table 9.4.2.1.2\_1.3-1: PMI test for single-layer (TDD)**

Parameter		Unit	Test 1
Bandwidth		MHz	10
Transmission mode			6
Uplink downlink configuration			1
Special subframe configuration			4
Propagation channel			EPA5
Precoding granularity (only for reporting and following PMI)		PRB	6
Correlation and antenna configuration			Low 2 x 2
Downlink power allocation	$\rho_A$	dB	-3
	$\rho_B$	dB	-3
	$\sigma$	dB	0
$N_{oc}^{(j)}$		dB[mW/15kHz]	-98
Reporting mode			PUSCH 1-2
Reporting interval		ms	1
PMI delay		ms	10 or 11
Measurement channel			R.11-3 TDD for UE Category 1 R.11 TDD for UE Category 2-8
OCNG Pattern			OP.1/2 TDD
Max number of HARQ transmissions			4
Redundancy version coding sequence			{0,1,2,3}
ACK/NACK feedback mode			Multiplexing
<p>Note 1: For random precoder selection, the precoders shall be updated in each available downlink transmission instance</p> <p>Note 2: If the UE reports in an available uplink reporting instance at subframe SF#n based on PMI estimation at a downlink SF not later than SF#(n-4), this reported PMI cannot be applied at the eNB downlink before SF#(n+4)</p> <p>Note 3: One/two sided dynamic OCNG Pattern OP.1/2 TDD as described in Annex A.5.2.1/2 shall be used.</p>			

**Table 9.4.2.1.2\_1.3-2: Minimum requirement (TDD)**

Parameter	Test 1
$\gamma$	1.2
UE Category	$\geq 1$

The normative reference for this requirement is TS 36.101 [2] clause 9.4.2.1.2.

9.4.2.1.2\_1.4 Test description

9.4.2.1.2\_1.4.1 Initial conditions

Initial conditions are a set of test configurations the UE needs to be tested in and the steps for the SS to take with the UE to reach the correct measurement state.

Configurations of PDSCH and PDCCH before measurement are specified in Annex C.2.

Test Environment: Normal as defined in TS 36.508 [7] clause 4.1.

Frequencies to be tested: Mid Range as defined in TS 36.508 [7] clause 4.3.1.2.

Channel Bandwidths to be tested: 10MHz, as defined in TS 36.508 [7] clause 4.3.1.2

1. Connect the SS to the UE antenna connector (s) as shown in TS 36.508 [7] Annex A, Figure A.10.
2. The parameter settings for the cell are set up according to Table 9.4.2.1.2\_1.3-1.
3. Downlink signals are initially set up according to Annex C.1 and Annex C.3.2, and uplink signals according to Annex H.1 and H.3.2.
4. Propagation conditions are set according to Annex B clause B.0
5. Ensure the UE is in State 3A-RF according to TS 36.508 [7] clause 5.2A.2. Message contents are defined in clause 9.4.2.1.2\_1.4.3.

#### 9.4.2.1.2\_1.4.2 Test procedure

1. Set the bandwidth, propagation condition, antenna configuration and measurement channel parameters according to Table 9.4.2.1.2\_1.3-1 as appropriate.
2. The SS shall transmit PDSCH via PDCCH DCI format 1B for C\_RNTI to transmit the DL RMC (R.11-3 TDD for UE Category 1 with allocation centred within the transmission bandwidth configuration or R.11 TDD for UE Category 2-8) with randomly selected precoding matrix from codebook (Table 6.3.4.2.3-1 in TS 36.211 [8]) every subframe regardless of PMI reports from the UE. Note that each precoding matrix shall be selected in equal probabilities. The SS sends downlink MAC padding bits on the DL RMC. SS schedules the UL transmission to carry the PUSCH CQI feedback via PDCCH DCI format 0 with CQI request bit set to 1 and I\_MCS=29 and N\_PRB allocated to be less or equal to 4. Establish  $t_{md}$  and  $SNR_{md}$  according to annex G.5.2
3. Set SNR to  $SNR_{md}$ . The SS shall transmit PDSCH via PDCCH DCI format 1B for C-RNTI to transmit the DL RMC (R.11-3 TDD for UE Category 1 with allocation centred within the transmission bandwidth configuration or R.11 TDD for UE Category 2-8) with precoding matrix according to PMI report from the UE. The SS sends downlink MAC padding bits on the DL RMC. SS schedules the UL transmission to carry the PUSCH CQI feedback via PDCCH DCI format 0 with CQI request bit set to 1 and I\_MCS=29 and N\_PRB allocated to be less or equal to 4. Measure  $t_{ue}$  according to Annex G.5.3

4. Calculate  $\gamma = \frac{t_{ue}}{t_{md}}$

#### 9.4.2.1.2\_1.4.3 Message contents

Message contents are according to TS 36.508 [7] clause 4.6 with the following exceptions:

**Table 9.4.2.1.2\_1.4.3-1: PhysicalConfigDedicated-DEFAULT**

Derivation Path: 36.508 clause 5.5.1.2			
Information Element	Value/remark	Comment	Condition
PhysicalConfigDedicated-DEFAULT ::= SEQUENCE {			
cqi-ReportConfig	CQI-ReportConfig-DEFAULT		
antennaInfo CHOICE {			
explicitValue	AntennaInfoDedicated		
}			
}			

**Table 9.4.2.1.2\_1.4.3-2: AntennaInfoDedicated**

Derivation Path: 36.331 clause 6.3.2			
Information Element	Value/remark	Comment	Condition
AntennaInfoDedicated ::= SEQUENCE {			
transmissionMode	tm6		
codebookSubsetRestriction CHOICE{			
n2TxAntenna-tm6	1111		
}			
ue-TransmitAntennaSelection CHOICE{			
release	NULL		
}			
}			

**Table 9.4.2.1.2\_1.4.3-3: CQI-ReportConfig-DEFAULT**

Derivation Path: 36.508 clause 4.6.3			
Information Element	Value/remark	Comment	Condition
CQI-ReportConfig-DEFAULT ::= SEQUENCE {			
cqi-ReportModeAperiodic	rm12		
nomPDSCH-RS-EPRE-Offset	0		
cqi-ReportPeriodic	Not present		
}			

## 9.4.2.1.2\_1.5 Test requirement

**Table 9.4.2.1.2\_1.5-1: Test requirement (TDD)**

Parameter	Test 1
$\gamma$	1.19
UE Category	$\geq 1$

## 9.4.2.2 PMI Reporting – PUSCH 2-2 (Multiple PMI) (Cell-Specific Reference Symbols)

## 9.4.2.2.1 FDD PMI Reporting – PUSCH 2-2 (Multiple PMI)

## 9.4.2.2.1.1 Test purpose

To test the accuracy of the Precoding Matrix Indicator (PMI) reporting such that the system throughput is maximized based on the precoders configured according to the UE reports.

## 9.4.2.2.1.2 Test applicability

This test applies to all types of E-UTRA FDD UE release 9 and forward. Applicability requires support of FGI bit 1.

## 9.4.2.2.1.3 Minimum conformance requirements

For the parameters specified in Table 9.4.2.2.1.3-1, and using the downlink physical channels specified in Annex C, the minimum requirements are specified in Table 9.4.2.2.1.3-2.

**Table 9.4.2.2.1.3-1: PMI test for single-layer (FDD)**

Parameter		Unit	Test 1
Bandwidth		MHz	10
Transmission mode			6
Propagation channel			EVA5
Correlation and antenna configuration			Low 4 x 2
Downlink power allocation	$\rho_A$	dB	-6
	$\rho_B$	dB	-6
	$\sigma$	dB	3
$N_{oc}^{(j)}$		dB[mW/15kHz]	-98
PMI delay		ms	8
Reporting mode			PUSCH 2-2
Reporting interval		ms	1
Measurement channel			R.14-2 FDD
OCNG Pattern			OP.1/2 FDD
Subband size ( $k$ )		RBs	3 (full size)
Number of preferred subbands ( $M$ )			5
Max number of HARQ transmissions			4
Redundancy version coding sequence			{0,1,2,3}
Note 1: For random precoder selection, the precoder shall be updated in each TTI (1 ms granularity)			
Note 2: If the UE reports in an available uplink reporting instance at subframe SF#n based on PMI estimation at a downlink SF not later than SF#(n-4), this reported PMI cannot be applied at the eNB downlink before SF#(n+4)			
Note 3: One/two sided dynamic OCNG Pattern OP.1/2 FDD as described in Annex A.5.1.1/2 shall be used			

**Table 9.4.2.2.1.3-2: Minimum requirement (FDD)**

	Test 1
$\gamma$	1.2
UE Category	$\geq 1$

The normative reference for this requirement is TS 36.101 [2] clause 9.4.2.2.1.

#### 9.4.2.2.1.4 Test description

##### 9.4.2.2.1.4.1 Initial conditions

Initial conditions are a set of test configurations the UE needs to be tested in and the steps for the SS to take with the UE to reach the correct measurement state.

Configurations of PDSCH and PDCCH before measurement are specified in Annex C.2.

Test Environment: Normal as defined in TS 36.508 [7] clause 4.1.

Frequencies to be tested: Mid Range as defined in TS 36.508 [7] clause 4.3.1.1.

Channel Bandwidths to be tested: 10MHz, as defined in TS 36.508 [7] clause 4.3.1.1

1. Connect the SS to the UE antenna connector (s) as shown in TS 36.508 [7] Annex A, Figure A.11.
2. The parameter settings for the cell are set up according to Table 9.4.2.2.1.3-1.
3. Downlink signals are initially set up according to Annex C.1 and Annex C.3.2, and uplink signals according to Annex H.1 and H.3.2.

4. Propagation conditions are set according to Annex B clause B.0
5. Ensure the UE is in State 3A-RF according to TS 36.508 [7] clause 5.2A.2. Message contents are defined in clause 9.4.2.2.1.4.3.

9.4.2.2.1.4.2 Test procedure

1. Set the parameters of bandwidth, the propagation condition, antenna configuration and measurement channel according to Table 9.4.2.2.1.3-1 as appropriate.
2. The SS shall transmit every subframe PDSCH via PDCCH DCI format 1B for C\_RNTI to transmit the DL RMC (R.14-2 FDD) on a randomly selected full-size subband with a randomly selected precoding matrix from the codebook (Table 6.3.4.2.3-2 in TS 36.211 [8]), regardless of the SB and PMI reports from the UE. Note that each full-size subband and each precoding matrix shall be selected in equal probability. The SS sends downlink MAC padding bits on the DL RMC.  
The SS shall transmit PDCCH DCI format 0 with CQI request bit set to 1 and I\_MCS=29 and N\_PRB allocated to be less or equal to 4. The UE will send aperiodic CSI report on PUSCH.  
Establish  $t_{md}$  and  $SNR_{md}$  according to annex G.5.2.
3. Set SNR to  $SNR_{md}$ . The SS shall transmit every subframe PDSCH via PDCCH DCI format 1B for C\_RNTI to transmit the DL RMC (R.14-2 FDD) on one full-size subband selected among the M preferred subbands and the corresponding subband precoding matrix reported by the UE. Note that the SS shall send PDSCH in the same full-size subband until next UE report is available. In case when same M preferred subbands are reported subsequently, the SS shall select for transmission a different subband with respect to the last selection. The SS sends downlink MAC padding bits on the DL RMC.  
The SS shall transmit PDCCH DCI format 0 with CQI request bit set to 1 and I\_MCS=29 and N\_PRB allocated to be less or equal to 4. The UE will send aperiodic CSI report on PUSCH.  
Measure  $t_{ue}$  according to Annex G.5.3.

4. Calculate  $\gamma = \frac{t_{ue}}{t_{md}}$

9.4.2.2.1.4.3 Message contents

Message contents are according to TS 36.508 [7] clause 4.6 with the following exceptions:

**Table 9.4.2.2.1.4.3-1: PhysicalConfigDedicated-DEFAULT**

Derivation Path: 36.508 clause 5.5.1.2			
Information Element	Value/remark	Comment	Condition
PhysicalConfigDedicated-DEFAULT ::= SEQUENCE {			
cqi-ReportConfig	CQI-ReportConfig-DEFAULT		
antennaInfo CHOICE {			
explicitValue	AntennaInfoDedicated		
}			
}			

**Table 9.4.2.2.1.4.3-2: AntennaInfoDedicated**

Derivation Path: 36.331 clause 6.3.2			
Information Element	Value/remark	Comment	Condition
AntennaInfoDedicated ::= SEQUENCE {			
transmissionMode	tm6		
codebookSubsetRestriction CHOICE{			
n4TxAntenna-tm6	1111111111111111		
}			
ue-TransmitAntennaSelection CHOICE{			
release	NULL		
}			
}			

**Table 9.4.2.2.1.4.3-3: CQI-ReportConfig-DEFAULT**

Derivation Path: 36.508 clause 4.6.3			
Information Element	Value/remark	Comment	Condition
CQI-ReportConfig-DEFAULT ::= SEQUENCE {			
cqi-ReportModeAperiodic	rm22		
nomPDSCH-RS-EPRE-Offset	0		
cqi-ReportPeriodic	Not present		
}			

9.4.2.2.1.5 Test requirement

**Table 9.4.2.2.1.5-1: Test requirement (FDD)**

	Test 1
$\gamma$	1.19
UE Category	$\geq 1$

9.4.2.2.2 TDD PMI Reporting – PUSCH 2-2 (Multiple PMI)

9.4.2.2.2.1 Test purpose

To test the accuracy of the Precoding Matrix Indicator (PMI) reporting such that the system throughput is maximized based on the precoders configured according to the UE reports.

9.4.2.2.2.2 Test applicability

This test applies to all types of E-UTRA TDD UE release 9 and forward. Applicability requires support of FGI bit 1.

9.4.2.2.2.3 Minimum conformance requirements

For the parameters specified in Table 9.4.2.2.2.3-1, and using the downlink physical channels specified in Annex C, the minimum requirements are specified in Table 9.4.2.2.2.3-2.

**Table 9.4.2.2.3-1: PMI test for single-layer (TDD)**

Parameter	Unit	Test 1	
Bandwidth	MHz	10	
Transmission mode		6	
Uplink downlink configuration		1	
Special subframe configuration		4	
Propagation channel		EVA5	
Correlation and antenna configuration		Low 4 x 2	
Downlink power allocation	$\rho_A$	dB	-6
	$\rho_B$	dB	-6
	$\sigma$	dB	3
$N_{oc}^{(j)}$	dB[mW/15kHz]	-98	
PMI delay	ms	10	
Reporting mode		PUSCH 2-2	
Reporting interval	ms	1	
Measurement channel		R.14-2 TDD	
OCNG Pattern		OP.1/2 TDD	
Subband size ( $k$ )	RBs	3 (full size)	
Number of preferred subbands ( $M$ )		5	
Max number of HARQ transmissions		4	
Redundancy version coding sequence		{0,1,2,3}	
ACK/NACK feedback mode		Multiplexing	
Note 1: For random precoder selection, the precoders shall be updated in each available downlink transmission instance Note 2: If the UE reports in an available uplink reporting instance at subframe SF# $n$ based on PMI estimation at a downlink SF not later than SF#(n-4), this reported PMI cannot be applied at the eNB downlink before SF#(n+4) Note 3: One/two sided dynamic OCNG Pattern OP.1/2 TDD as described in Annex A.5.2.1/2 shall be used			

**Table 9.4.2.2.3-2: Minimum requirement (TDD)**

	Test 1
$\gamma$	1.15
UE Category	$\geq 1$

The normative reference for this requirement is TS 36.101 [2] clause 9.4.2.2.2.

#### 9.4.2.2.2.4 Test description

##### 9.4.2.2.2.4.1 Initial conditions

Initial conditions are a set of test configurations the UE needs to be tested in and the steps for the SS to take with the UE to reach the correct measurement state.

Configurations of PDSCH and PDCCH before measurement are specified in Annex C.2.

Test Environment: Normal as defined in TS 36.508 [7] clause 4.1.

Frequencies to be tested: Mid Range as defined in TS 36.508 [7] clause 4.3.1.2.

Channel Bandwidths to be tested: 10MHz, as defined in TS 36.508 [7] clause 4.3.1.2



1. Connect the SS to the UE antenna connector (s) as shown in TS 36.508 [7] Annex A, Figure A.11.
2. The parameter settings for the cell are set up according to Table 9.4.2.2.3-1.
3. Downlink signals are initially set up according to Annex C.1 and Annex C.3.2, and uplink signals according to Annex H.1 and H.3.2.
4. Propagation conditions are set according to Annex B clause B.0
5. Ensure the UE is in State 3A-RF according to TS 36.508 [7] clause 5.2A.2. Message contents are defined in clause 9.4.2.2.4.3.

9.4.2.2.4.2 Test procedure

1. Set the bandwidth, propagation condition, antenna configuration and measurement channel parameters according to Table 9.4.2.2.3-1 as appropriate.
2. The SS shall transmit every subframe PDSCH via PDCCH DCI format 1B for C\_RNTI to transmit the DL RMC (R.14-2 TDD) on a randomly selected full-size subband with a randomly selected precoding matrix from the codebook (Table 6.3.4.2.3-2 in TS 36.211 [8]), regardless of the SB and PMI reports from the UE. Note that each full-size subband and each precoding matrix shall be selected in equal probability. The SS sends downlink MAC padding bits on the DL RMC.  
The SS shall transmit PDCCH DCI format 0 with CQI request bit set to 1 and I\_MCS=29 and N\_PRB allocated to be less or equal to 4. The UE will send aperiodic CSI report on PUSCH.  
Establish  $t_{md}$  and  $SNR_{md}$  according to annex G.5.2.
3. Set SNR to  $SNR_{md}$ . The SS shall transmit every subframe PDSCH via PDCCH DCI format 1B for C\_RNTI to transmit the DL RMC (R.14-2 TDD) on one full-size subband selected among the M preferred subbands and the corresponding subband precoding matrix reported by the UE. Note that the SS shall send PDSCH in the same full-size subband until next UE report is available. In case when same M preferred subbands are reported subsequently, the SS shall select for transmission a different subband with respect to the last selection. The SS sends downlink MAC padding bits on the DL RMC.  
The SS shall transmit PDCCH DCI format 0 with CQI request bit set to 1 and I\_MCS=29 and N\_PRB allocated to be less or equal to 4. The UE will send aperiodic CSI report on PUSCH.  
Measure  $t_{ue}$  according to Annex G.5.3.

4. Calculate 
$$\gamma = \frac{t_{ue}}{t_{md}}$$

9.4.2.2.4.3 Message contents

Message contents are according to TS 36.508 [7] clause 4.6 with the following exceptions:

**Table 9.4.2.2.4.3-1: PhysicalConfigDedicated-DEFAULT**

Derivation Path: 36.508 clause 5.5.1.2			
Information Element	Value/remark	Comment	Condition
PhysicalConfigDedicated-DEFAULT ::= SEQUENCE {			
cqi-ReportConfig	CQI-ReportConfig-DEFAULT		
antennaInfo CHOICE {			
explicitValue	AntennaInfoDedicated		
}			
}			

**Table 9.4.2.2.4.3-2: AntennaInfoDedicated**

Derivation Path: 36.331 clause 6.3.2			
Information Element	Value/remark	Comment	Condition
AntennaInfoDedicated ::= SEQUENCE {			
transmissionMode	tm6		
codebookSubsetRestriction CHOICE{			
n4TxAntenna-tm6	111111111111111111		
}			
ue-TransmitAntennaSelection CHOICE{			
release	NULL		
}			
}			

**Table 9.4.2.2.4.3-3: CQI-ReportConfig-DEFAULT**

Derivation Path: 36.508 clause 4.6.3			
Information Element	Value/remark	Comment	Condition
CQI-ReportConfig-DEFAULT ::= SEQUENCE {			
cqi-ReportModeAperiodic	rm22		
nomPDSCH-RS-EPRE-Offset	0		
cqi-ReportPeriodic	Not present		
}			

9.4.2.2.2.5 Test requirement

**Table 9.4.2.2.5-1: Test requirement (TDD)**

	Test 1
$\gamma$	1.14
UE Category	$\geq 1$

9.4.2.3 PMI Reporting – PUSCH 1-2 (Multiple PMI) (CSI Reference Symbols)

9.4.2.3.1

9.4.2.3.1\_D FDD PMI Reporting - PUSCH 1-2 (Multiple PMI) for eDL-MIMO

9.4.2.3.1\_D.1 Test purpose

To test the accuracy of the Precoding Matrix Indicator (PMI) reporting such that the system throughput is maximized based on the precoders configured according to the UE reports.

9.4.2.3.1\_D.2 Test applicability

This test applies to all types of E-UTRA FDD UE release 10 and forward that support eDL-MIMO. Applicability requires support for FGI bit 103.

9.4.2.3.1\_D.3 Minimum conformance requirements

For the parameters specified in Table 9.4.2.3.1\_D.3-1, and using the downlink physical channels specified in Annex C.3.2, the minimum requirements are specified in Table 9.4.2.3.1\_D.3-2.

Table 9.4.2.3.1\_D.3-1: PMI test for single-layer (FDD) for eDL-MIMO

Parameter		Unit	Test 1
Bandwidth		MHz	10
Transmission mode			9
Propagation channel			EVA5
Precoding granularity (only for reporting and following PMI)		PRB	6
Correlation and antenna configuration			Low ULA 4 x 2
Cell-specific reference signals			Antenna ports 0,1
CSI reference signals			Antenna ports 15,...,18
Beamforming model			Annex B.4.3
CSI-RS periodicity and subframe offset $T_{\text{CSI-RS}} / \Delta_{\text{CSI-RS}}$			5/ 1
CSI-RS reference signal configuration			8
CodeBookSubsetRestriction restriction bitmap			0x0000 0000 0000 FFFF
Downlink power allocation	$\rho_A$	dB	0
	$\rho_B$	dB	0
	$P_c$	dB	-3
	$\sigma$	dB	-3
$N_{oc}^{(j)}$		dB[mW/15kHz]	-98
Reporting mode			PUSCH 1-2
Reporting interval		ms	5
PMI delay		ms	8
Measurement channel			R.45-1 FDD for UE Category 1, R.45 FDD for UE Category 2-8
OCNG Pattern			OP.1/2 FDD
Max number of HARQ transmissions			4
Redundancy version coding sequence			{0,1,2,3}
<p>Note 1: For random precoder selection, the precoders shall be updated in each TTI (1 ms granularity).</p> <p>Note 2: If the UE reports in an available uplink reporting instance at subframe SF#n based on PMI estimation at a downlink SF not later than SF#(n-4), this reported PMI cannot be applied at the eNB downlink before SF#(n+4).</p> <p>Note 3: One/two sided dynamic OCNG Pattern OP.1/2 FDD as described in Annex A.5.1.1/2 shall be used.</p> <p>Note 4: PDSCH_RA= 0 dB, PDSCH_RB= 0 dB in order to have the same PDSCH and OCNG power per subcarrier at the receiver.</p>			

Table 9.4.2.3.1\_D.3-2: Minimum requirement (FDD) for eDL-MIMO

Parameter	Test 1
$\gamma$	1.3
UE Category	$\geq 1$

The normative reference for this requirement is TS 36.101 [2] clause 9.4.2.3.1.

#### 9.4.2.3.1\_D.4 Test description

##### 9.4.2.3.1\_D.4.1 Initial conditions

Initial conditions are a set of test configurations the UE needs to be tested in and the steps for the SS to take with the UE to reach the correct measurement state.

Configurations of PDSCH and PDCCH before measurement are specified in Annex C.2.

Test Environment: Normal as defined in TS 36.508 [7] clause 4.1.

Frequencies to be tested: Mid Range as defined in TS 36.508 [7] clause 4.3.1.1.

Channel Bandwidths to be tested: 10MHz, as defined in TS 36.508 [7] clause 4.3.1.1

1. Connect the SS to the UE antenna connector (s) as shown in TS 36.508 [7] Annex A, Figure A.11.
2. The parameter settings for the cell are set up according to Table 9.4.2.3.1\_D.3-1.
3. Downlink signals are initially set up according to Annex C.1 and Annex C.3.2, and uplink signals according to Annex H.1 and H.3.2.
4. Propagation conditions are set according to Annex B clause B.0
5. Ensure the UE is in State 3A-RF according to TS 36.508 [7] clause 5.2A.2. Message contents are defined in clause 9.4.2.3.1\_D.4.3.

##### 9.4.2.3.1\_D.4.2 Test procedure

1. Set the parameters of bandwidth, the propagation condition, antenna configuration and measurement channel according to Table 9.4.2.3.1\_D.3-1 as appropriate.
2. The SS shall transmit PDSCH via PDCCH DCI format 2C for C\_RNTI to transmit the DL RMC with randomly selected precoding matrix from codebook (Table 6.3.4.2.3-2 in TS 36.211 [8]) every subframe regardless of PMI reports from the UE. Note that each precoding matrix shall be selected in equal probabilities. The SS sends downlink MAC padding bits on the DL RMC SS schedules the UL transmission to carry the PUSCH CQI feedback via PDCCH DCI format 0 with CQI request bit set to 1 and I\_MCS=29 and N\_PRB allocated to be less or equal to 4. Establish  $t_{rnd}$  and  $SNR_{rnd}$  according to annex G.5.2
3. Set SNR to  $SNR_{rnd}$ . The SS shall transmit PDSCH with precoding matrix according to PMI report from the UE. The SS sends downlink MAC padding bits on the DL RMC SS schedules the UL transmission to carry the PUSCH CQI feedback via PDCCH DCI format 0 with CQI request bit set to 1 and I\_MCS=29 and N\_PRB allocated to be less or equal to 4 in subframe #0, #5. Measure the average throughput. Measure  $t_{ue}$  according to Annex G.5.3
4. Calculate  $\gamma = \frac{t_{ue}}{t_{rnd}}$ . If the ratio (throughput /  $t_{rnd}$ )  $\geq \gamma$  which is specified in table 9.4.2.3.1\_D.5-1, then the test is pass. Otherwise, the test is fail.

##### 9.4.2.3.1\_D.4.3 Message contents

Message contents are according to TS 36.508 [7] clause 4.6 with the following exceptions:

**Table 9.4.2.3.1\_D.4.3-1: PhysicalConfigDedicated-DEFAULT**

Derivation Path: 36.508 clause 5.5.1.2			
Information Element	Value/remark	Comment	Condition
PhysicalConfigDedicated-DEFAULT ::= SEQUENCE {			
cqi-ReportConfig-r10	CQI-ReportConfig-r10-DEFAULT		
antennaInfo	Not present		
antennaInfo-r10 CHOICE {			
explicitValue-r10	AntennaInfoDedicated-r10		
}			
csi-RS-Config-r10	CSI-RS-Config-r10		
}			

**Table 9.4.2.3.1\_D.4.3-2: PDSCH-ConfigDedicated-DEFAULT**

Derivation Path: 36.508 clause 4.6.3			
Information Element	Value/remark	Comment	Condition
PDSCH-ConfigDedicated-DEFAULT ::= SEQUENCE {			
p-a	dB0		
}			

**Table 9.4.2.3.1\_D.4.3-3: AntennaInfoDedicated-r10**

Derivation Path: 36.331 clause 6.3.2			
Information Element	Value/remark	Comment	Condition
AntennaInfoDedicated-r10 ::= SEQUENCE {			
transmissionMode-r10	tm9-v1020		
codebookSubsetRestriction-r10	0x0000 0000 0000 FFFF		
ue-TransmitAntennaSelection CHOICE{			
release	NULL		
}			
}			

**Table 9.4.2.3.1\_D.4.3-4: CQI-ReportConfig-r10-DEFAULT**

Derivation Path: 36.508 clause 4.6.3			
Information Element	Value/remark	Comment	Condition
CQI-ReportConfig-r10 ::= SEQUENCE {			
cqi-ReportAperiodic-r10	rm12		
nomPDSCH-RS-EPRE-Offset	0		
cqi-ReportPeriodic-r10	Not present		
pmi-RI-Report-r9	setup		
}			

Table 9.4.2.3.1\_D.4.3-5: CSI-RS-Config

Derivation Path: 36.331 clause 6.3.2			
Information Element	Value/remark	Comment	Condition
CSI-RS-Config-r10 ::= SEQUENCE {			
csi-RS-r10 CHOICE{			
setup SEQUENCE {			
antennaPortsCount-r10	an4	Parameter represents the number of antenna ports used for transmission of CSI reference signals	
resourceConfig-r10	8	Parameter: CSI reference signal configuration	
subframeConfig-r10	1	$\Delta_{\text{CSI-RS}} = I_{\text{CSI-RS}}$ when CSI-RS SubframeConfig is from 0-4; Parameter: $I_{\text{CSI-RS}}$	
p-C-r10	-3	Parameter: $P_c$ which is the assumed ratio of PDSCH EPRE to CSI-RS EPRE when UE derives CSI feedback	
}			
}			
zeroTxPowerCSI-RS-r10 CHOICE{			
release	NULL		
}			
}			

## 9.4.2.3.1\_D.5 Test requirement

Table 9.4.2.3.1\_D.5-1: Test requirement (FDD) for eDL-MIMO

Parameter	Test 1
$\gamma$	1.29
UE Category	$\geq 1$

## 9.4.2.3.2\_D TDD PMI Reporting - PUSCH 1-2 (Multiple PMI) for eDL-MIMO

## 9.4.2.3.2\_D.1 Test purpose

To test the accuracy of the Precoding Matrix Indicator (PMI) reporting such that the system throughput is maximized based on the precoders configured according to the UE reports.

## 9.4.2.3.2\_D.2 Test applicability

This test applies to all types of E-UTRA TDD UE release 10 and forward that support eDL-MIMO. Applicability requires support for FGI bit 104.

## 9.4.2.3.2\_D.3 Minimum conformance requirements

For the parameters specified in Table 9.4.2.3.2\_D.3-1, and using the downlink physical channels specified in Annex C.3.2, the minimum requirements are specified in Table 9.4.2.3.2\_D.3-2.

Table 9.4.2.3.2\_D.3-1: PMI test for single-layer (TDD) for eDL-MIMO

Parameter		Unit	Test 1
Bandwidth		MHz	10
Transmission mode			9
Uplink downlink configuration			1
Special subframe configuration			4
Propagation channel			EVA5
Precoding granularity (only for reporting and following PMI)		PRB	6
Antenna configuration			8 x 2
Correlation modelling			High, Cross polarized
Cell-specific reference signals			Antenna ports 0,1
CSI reference signals			Antenna ports 15,...,22
Beamforming model			Annex B.4.3
CSI-RS periodicity and subframe offset $T_{\text{CSI-RS}} / \Delta_{\text{CSI-RS}}$			5/ 4
CSI-RS reference signal configuration			4
CodeBookSubsetRestriction bitmap			0x0000 0000 001F FFE0 0000 0000 FFFF
Downlink power allocation	$\rho_A$	dB	0
	$\rho_B$	dB	0
	$P_c$	dB	-6
	$\sigma$	dB	-3
$N_{oc}^{(j)}$		dB[mW/15kHz]	-98
Reporting mode			PUSCH 1-2
Reporting interval		ms	5 (Note 4)
PMI delay		ms	10
Measurement channel			R.45-1 TDD for UE Category 1, R.45 TDD for UE Category 2-8
OCNG Pattern			OP.1/2 TDD
Max number of HARQ transmissions			4
Redundancy version coding sequence			{0,1,2,3}
ACK/NACK feedback mode			Multiplexing
<p>Note 1: For random precoder selection, the precoders shall be updated in each TTI (1 ms granularity).</p> <p>Note 2: If the UE reports in an available uplink reporting instance at subframe SF#n based on PMI estimation at a downlink SF not later than SF#(n-4), this reported PMI cannot be applied at the eNB downlink before SF#(n+4).</p> <p>Note 3: One/two sided dynamic OCNG Pattern OP.1/2 TDD as described in Annex A.5.2.1/2 shall be used.</p> <p>Note 4: PDCCH DCI format 0 with a trigger for aperiodic CQI shall be transmitted in downlink SF#4 and #9 to allow aperiodic CQI/PMI/RI to be transmitted</p>			

Note 5: on uplink SF#3 and #8. Randomization of the principle beam direction shall be used as specified in B.2.3A.4
------------------------------------------------------------------------------------------------------------------------

**Table 9.4.2.3.2\_D.3-2: Minimum requirement (TDD) for eDL-MIMO**

Parameter	Test 1
$\gamma$	3.5
UE Category	$\geq 1$

The normative reference for this requirement is TS 36.101 [2] clause 9.4.2.3.2.

#### 9.4.2.3.2\_D.4 Test description

##### 9.4.2.3.2\_D.4.1 Initial conditions

Initial conditions are a set of test configurations the UE needs to be tested in and the steps for the SS to take with the UE to reach the correct measurement state.

Configurations of PDSCH and PDCCH before measurement are specified in Annex C.2.

Test Environment: Normal as defined in TS 36.508 [7] clause 4.1.

Frequencies to be tested: Mid Range as defined in TS 36.508 [7] clause 4.3.1.2.

Channel Bandwidths to be tested: 10MHz, as defined in TS 36.508 [7] clause 4.3.1.2.

1. Connect the SS to the UE antenna connector (s) as shown in TS 36.508 [7] Annex A, Figure 47.
2. The parameter settings for the cell are set up according to Table 9.4.2.3.2\_D.3-1.
3. Downlink signals are initially set up according to Annex C.1 and Annex C.3.2, and uplink signals according to Annex H.1 and H.3.2.
4. Propagation conditions are set according to Annex B clause B.0
5. Ensure the UE is in State 3A-RF according to TS 36.508 [7] clause 5.2A.2. Message contents are defined in clause 9.4.2.3.2\_D.4.3.

##### 9.4.2.3.2\_D.4.2 Test procedure

1. Set the bandwidth, propagation condition, antenna configuration and measurement channel parameters according to Table 9.4.2.3.2\_D.3-1 as appropriate.
2. The SS shall transmit PDSCH via PDCCH DCI format 2C for C\_RNTI to transmit the DL RMC with randomly selected precoding matrix from codebook (Table 7.2.4-1 in TS 36.213 [10]) every subframe regardless of PMI reports from the UE. Note that each precoding matrix shall be selected in equal probabilities. The SS sends downlink MAC padding bits on the DL RMC. SS schedules the UL transmission to carry the PUSCH CQI feedback via PDCCH DCI format 0 with CQI request bit set to 1 and I\_MCS=29 and N\_PRB allocated to be less or equal to 4. Establish  $t_{rnd}$  and  $SNR_{rnd}$  according to annex G.5.2.
3. Set SNR to  $SNR_{rnd}$ . The SS shall transmit PDSCH with precoding matrix according to PMI report from the UE. The SS sends downlink MAC padding bits on the DL RMC. SS schedules the UL transmission to carry the PUSCH CQI feedback via PDCCH DCI format 0 with CQI request bit set to 1 and I\_MCS=29 and N\_PRB allocated to be less or equal to 4. Measure  $t_{ue}$  according to Annex G.5.3.
4. Calculate  $\gamma = \frac{t_{ue}}{t_{rnd}}$ . If the ratio (throughput /  $t_{rnd}$ )  $\geq \gamma$  which is specified in table 9.4.2.3.2\_D.5-1, then the test is pass. Otherwise, the test is fail.



## 9.4.2.3.2\_D.4.3 Message contents

Message contents are according to TS 36.508 [7] clause 4.6 with the following exceptions:

**Table 9.4.2.3.2\_D.4.3-1: PhysicalConfigDedicated-DEFAULT**

Derivation Path: 36.508 clause 5.5.1.2			
Information Element	Value/remark	Comment	Condition
PhysicalConfigDedicated-DEFAULT ::= SEQUENCE {			
cqi-ReportConfig-r10	CQI-ReportConfig-r10-DEFAULT		
antennaInfo	Not present		
antennaInfo-r10 CHOICE {			
explicitValue-r10	AntennaInfoDedicated-r10		
}			
csi-RS-Config-r10	CSI-RS-Config-r10		
}			

**Table 9.4.2.3.2\_D.4.3-2: PDSCH-ConfigDedicated-DEFAULT**

Derivation Path: 36.508 clause 4.6.3			
Information Element	Value/remark	Comment	Condition
PDSCH-ConfigDedicated-DEFAULT ::= SEQUENCE {			
p-a	dB0		
}			

**Table 9.4.2.3.2\_D.4.3-3: AntennaInfoDedicated-r10**

Derivation Path: 36.331 clause 6.3.2			
Information Element	Value/remark	Comment	Condition
AntennaInfoDedicated-r10 ::= SEQUENCE {			
transmissionMode-r10	tm9-v1020		
codebookSubsetRestriction-r10	0x0000 0000 001F FFE0 0000 0000 FFFF		
ue-TransmitAntennaSelection CHOICE{			
release	NULL		
}			
}			

**Table 9.4.2.3.2\_D.4.3-4: CQI-ReportConfig-r10-DEFAULT**

Derivation Path: 36.508 clause 4.6.3			
Information Element	Value/remark	Comment	Condition
CQI-ReportConfig-r10 ::= SEQUENCE {			
cqi-ReportAperiodic-r10	rm12		
nomPDSCH-RS-EPRE-Offset	0		
cqi-ReportPeriodic-r10	Not present		
pmi-RI-Report-r9	setup		
}			

Table 9.4.2.3.2\_D.4.3-5: PUCCH-ConfigDedicated-DEFAULT

Derivation Path: 36.508 clause 4.6.3			
Information Element	Value/remark	Comment	Condition
PUCCH-ConfigDedicated-DEFAULT ::= SEQUENCE {			
ackNackRepetition CHOICE {			
release	NULL		
}			
tddAckNackFeedbackMode	Multiplexing	Multiplexing is selected as default to align with RAN4's assumptions in RF tests.	TDD
}			

Table 9.4.2.3.2\_D.4.3-6: TDD-Config-DEFAULT

Derivation Path: 36.508 clause 4.6.3			
Information Element	Value/remark	Comment	Condition
TDD-Config-DEFAULT ::= SEQUENCE {			
subframeAssignment	sa1		
specialSubframePatterns	ssp4		
}			

Table 9.4.2.3.2\_D.4.3-7: CSI-RS-Config

Derivation Path: 36.331 clause 6.3.2			
Information Element	Value/remark	Comment	Condition
CSI-RS-Config-r10 ::= SEQUENCE {			
csi-RS-r10 CHOICE{			
setup SEQUENCE {			
antennaPortsCount-r10	an8	Parameter represents the number of antenna ports used for transmission of CSI reference signals	
resourceConfig-r10	4	Parameter: CSI reference signal configuration	
subframeConfig-r10	4	$\Delta_{\text{CSI-RS}} = I_{\text{CSI-RS}}$ when CSI-RS SubframeConfig is from 0-4; Parameter: $I_{\text{CSI-RS}}$	
p-C-r10	-6	Parameter: $P_c$ which is the assumed ratio of PDSCH EPRE to CSI-RS EPRE when UE derives CSI feedback	
}			
}			
zeroTxPowerCSI-RS-r10 CHOICE{			
release	NULL		
}			
}			

9.4.2.3.2\_D.5 Test requirement

**Table 9.4.2.3.2\_D.5-1: Test requirement (TDD) for eDL-MIMO**

Parameter	Test 1
$\gamma$	3.49
UE Category	$\geq 1$

9.4.2.3.3\_G FDD PMI Reporting with 4Tx enhanced codebook - PUSCH 1-2 (Multiple PMI) for eDL-MIMO Enhancement

**Editor's notes: This test case is incomplete. The following item is missing or incomplete:**

- FGI bit TBD

- Test tolerances are TBD

9.4.2.3.3\_G.1 Test purpose

To verify reporting accuracy of the Precoding Matrix Indicator (PMI) reporting with 4Tx enhanced codebook (Multiple PMI) for eDL MIMO Enhancement.

9.4.2.3.3\_G.2 Test applicability

This test applies to all types of E-UTRA FDD UE releases 12 and forward that support eDL-MIMO Enhancement. Applicability requires support for FGI bit [TBD].

9.4.2.3.3\_G.3 Minimum conformance requirements

For the parameter specified in Table 9.4.2.3.3\_G.3-1, and using the downlink physical channels specified in Annex C.3.2, the minimum requirements are specified in Table 9.4.2.3.3\_G.3-2.

Table 9.4.2.3.3\_G.3-1: PMI test for dual-layer (FDD) for eDL-MIMO Enhancement

Parameter		Unit	Test 1
Bandwidth		MHz	10
Transmission mode			9
Propagation channel			EVA5
Precoding granularity (only for reporting and following PMI)		PRB	6
Correlation and antenna configuration			High XP 4 x 2
Beamforming model			Annex B.4.3
Cell-specific reference signals			Antenna ports 0,1
CSI reference signals			Antenna ports 15,...,18
CSI-RS periodicity and subframe offset $T_{\text{CSI-RS}} / I_{\text{CSI-RS}}$			5/ 1
CSI-RS reference signal configuration			8
CodeBookSubsetRestriction bitmap			0x0000 0000 FFFF 0000 FFFF 0000
Downlink power allocation	$\rho_A$	dB	0
	$\rho_B$	dB	0
	$P_c$	dB	-3
	$\sigma$	dB	-3
$N_{oc}^{(j)}$		dB[mW/15kHz]	-98
Reporting mode			PUSCH1-2
Reporting interval		ms	5
PMI delay (Note 2)		ms	8
Measurement channel			R.45-1 FDD for UE Category 1, R.45 FDD for UE Category 2-8
Rank Number of PDSCH			2
OCNG Pattern			OP.1 FDD
Max number of HARQ transmissions			4
Redundancy version coding sequence			{0,1,2,3}
Note 1: For random precoder selection, the precoder shall be updated in each TTI (1 ms granularity)			
Note 2: If the UE reports in an available uplink reporting instance at subframe SF#n based on PMI estimation at a downlink SF not later than SF#(n-4), this reported PMI cannot be applied at the eNB downlink before SF#(n+4).			
Note 3: One/two sided dynamic OCNG Pattern OP.1/2 FDD as described in Annex A.5.1.1/2 shall be used.			
Note 4: PDSCH_RA= 0 dB, PDSCH_RB= 0 dB in order to have the same PDSCH and OCNG power per subcarrier at the receiver.			
Note 5: Randomization of the principle beam direction shall be used as specified in B.2.3A.4			

Table 9.4.2.3.3\_G.3-2: Minimum requirement (FDD) for eDL-MIMO Enhancement

Parameter	Test 1
$\gamma$	1.2
UE Category	$\geq 1$

The normative reference for this requirement is TS 36.101 [2] clause 9.4.2.3.3.

#### 9.4.2.3.3\_G.4 Test description

##### 9.4.2.3.3\_G.4.1 Initial conditions

Initial conditions are a set of test configurations the UE needs to be tested in and the steps for the SS to take with the UE to reach the correct measurement state.

Configurations of PDSCH and PDCCH before measurement are specified in Annex C.2.

Test Environment: Normal as defined in TS 36.508 [7] clause 4.1.

Frequencies to be tested: Mid Range as defined in TS 36.508 [7] clause 4.3.1.1.

Channel Bandwidths to be tested: 10MHz, as defined in TS 36.508 [7] clause 4.3.1.1.

1. Connect the SS to the UE antenna connector (s) as shown in TS 36.508 [7] Annex A, Figure A.11 .
2. The parameter settings for the cell are set up according to Table 9.4.2.3.3\_G.3-1.
3. Downlink signals are initially set up according to Annex C.1 and Annex C.3.2, and uplink signals according to Annex H.1 and H.3.2.
4. Propagation conditions are set according to Annex B clause B.0.
5. Ensure the UE is in State 3A-RF according to TS 36.508 [7] clause 5.2A.2. Message contents are defined in 9.4.2.3.3\_G.4.3.

##### 9.4.2.3.3\_G.4.2 Test procedure

1. Set the parameters of bandwidth, the propagation condition, antenna configuration and measurement channel according to Table 9.4.2.3.3\_G.3-1 as appropriate.
2. The SS shall transmit PDSCH via PDCCH DCI format 2C for C\_RNTI to transmit the DL RMC with randomly selected precoding matrix from codebook (Table 6.3.4.2.3-2 in TS 36.211 [8]) every subframe regardless of PMI reports from the UE. Note that each precoding matrix shall be selected in equal probabilities. The SS sends downlink MAC padding bits on the DL RMC SS schedules the UL transmission to carry the PUSCH CQI feedback via PDCCH DCI format 0 with CQI request bit set to 1 and I\_MCS=29 and N\_PRB allocated to be less or equal to 4. Establish  $t_{rd}$  and  $SNR_{rd}$  according to annex G.5.2.
3. Set SNR to  $SNR_{rd}$ . The SS shall transmit PDSCH with precoding matrix according to PMI report from the UE. The SS sends downlink MAC padding bits on the DL RMC SS schedules the UL transmission to carry the PUSCH CQI feedback via PDCCH DCI format 0 with CQI request bit set to 1 and I\_MCS=29 and N\_PRB allocated to be less or equal to 4 every subframe. Measure the average throughput. Measure  $t_{ue}$  according to Annex G.5.3.
4. Calculate  $\gamma = \frac{t_{ue}}{t_{rd}}$

##### 9.4.2.3.3\_G.4.3 Message contents

Message contents are according to TS 36.508 [7] clause 4.6 with the following exceptions:

**Table 9.4.2.3.3\_G.4.3-1: PhysicalConfigDedicated**

Derivation Path: 36.331 clause 6.3.2			
Information Element	Value/remark	Comment	Condition
PhysicalConfigDedicated ::= SEQUENCE {			
antennaInfo-r10 CHOICE {			
explicitValue-r10	AntennaInfoDedicated-r10		
}			
cqi-ReportConfig-r10	CQI-ReportConfig-r10-DEFAULT		
antennaInfo-v1250	AntennaInfoDedicated-v1250		
}			

**Table 9.4.2.3.3\_G.4.3-2: PDSCH-ConfigDedicated-DEFAULT**

Derivation Path: 36.508 clause 4.6.3			
Information Element	Value/remark	Comment	Condition
PDSCH-ConfigDedicated-DEFAULT ::= SEQUENCE {			
p-a	dB0		
}			

**Table 9.4.2.3.3\_G.4.3-3: AntennaInfoDedicated-r10**

Derivation Path: 36.331 clause 6.3.2			
Information Element	Value/remark	Comment	Condition
AntennaInfoDedicated-r10 ::= SEQUENCE {			
transmissionMode-r10	tm9-v1020		
codebookSubsetRestriction-r10	0x0000 0000 FFFF 0000 FFFF 0000		
ue-TransmitAntennaSelection CHOICE {			
release	NULL		
}			
}			

**Table 9.4.2.3.3\_G.4.3-4: AntennaInfoDedicated-v1250**

Derivation Path: 36.331 clause 6.3.2			
Information Element	Value/remark	Comment	Condition
AntennaInfoDedicated-v1250 ::= SEQUENCE {			
alternativeCodebookEnabledFor4TX-r12	TRUE		
}			

**Table 9.4.2.3.3\_G.4.3-5: CQI-ReportConfig-r10-DEFAULT**

Derivation Path: 36.508 clause 4.6.3			
Information Element	Value/remark	Comment	Condition
CQI-ReportConfig-r10 ::= SEQUENCE {			
cqi-ReportModeAperiodic-r10	rm12		
nomPDSCH-RS-EPRE-Offset	0		
cqi-ReportPeriodic-r10	Not present		
}			

**Table 9.4.2.3.3\_G.4.3-6: CSI-RS-Config**

Derivation Path: 36.331 clause 6.3.2			
Information Element	Value/remark	Comment	Condition
CSI-RS-Config-r10 ::= SEQUENCE {			
csi-RS-r10 CHOICE{			
release	NULL		
setup SEQUENCE {			
antennaPortsCount-r10	an4	Parameter represents the number of antenna ports used for transmission of CSI reference signals	
resourceConfig-r10	8	Parameter: CSI reference signal configuration	
subframeConfig-r10	1	$\Delta_{\text{CSI-RS}} = I_{\text{CSI-RS}}$ when CSI-RS SubframeConfig is from 0-4; Parameter: $I_{\text{CSI-RS}}$	
p-C-r10	-3	Parameter: $P_c$ which is the assumed ratio of PDSCH EPRE to CSI-RS EPRE when UE derives CSI feedback	
}			
}			
}			

9.4.2.3.3\_G.5 Test requirement

**Table 9.4.2.3.3\_G.5-1: Test requirement (FDD) for eDL-MIMO Enhancement**

Parameter	Test 1
$\gamma$	1.2 + TT
UE Category	$\geq 1$

9.4.2.3.4\_G TDD PMI Reporting with 4Tx enhanced codebook - PUSCH 1-2 (Multiple PMI) for eDL-MIMO Enhancement

Editor’s notes: This test case is incomplete. The following item is missing or incomplete:

- FGI bit TBD
- Test tolerances are TBD

9.4.2.3.4\_G.1 Test purpose

To verify reporting accuracy of the Precoding Matrix Indicator (PMI) reporting with 4Tx enhanced codebook (Multiple PMI) for eDL MIMO Enhancement.

9.4.2.3.4\_G.2 Test applicability

This test applies to all types of E-UTRA TDD UE release 12 and forward that support eDL-MIMO Enhancement. Applicability requires support for FGI bit [TBD].

#### 9.4.2.3.4\_G.3 Minimum conformance requirements

For the parameters specified in Table 9.4.2.3.4\_G.3-1, and using the downlink physical channels specified in Annex C.3.2, the minimum requirements are specified in 9.4.2.3.4\_G.3-2.



Table 9.4.2.3.4\_G.3-1: PMI test for dual-layer (TDD) for eDL-MIMO Enhancement

Parameter	Unit	Test 1	
Bandwidth	MHz	10	
Transmission mode		9	
Uplink downlink configuration		1	
Special subframe configuration		4	
Propagation channel		EVA5	
Precoding granularity (only for reporting and following PMI)	PRB	6	
Correlation and antenna configuration		XP High 4 x 2	
Beamforming model		Annex B.4.3	
Cell-specific reference signals		Antenna ports 0,1	
CSI reference signals		Antenna ports 15,...,18	
CSI-RS periodicity and subframe offset $T_{\text{CSI-RS}} / I_{\text{CSI-RS}}$		5/ 4	
CSI-RS reference signal configuration		4	
CodeBookSubsetRestriction bitmap		0x0000 0000 FFFF 0000 FFFF 0000	
Downlink power allocation	$\rho_A$	dB	0
	$\rho_B$	dB	0
	$P_c$	dB	-3
	$\sigma$	dB	-3
$N_{oc}^{(j)}$	dB[mW/15kHz]	-98	
Reporting mode		PUSCH1-2	
Reporting interval	ms	5	
PMI delay (Note 2)	ms	10	
Measurement channel		R.61-1 TDD for UE Category 1, R.61 TDD for UE Category 2-8	
Rank Number of PDSCH		2	
OCNG Pattern		OP.1 TDD	
Max number of HARQ transmissions		4	
Redundancy version coding sequence		{0,1,2,3}	
ACK/NACK feedback mode		Multiplexing	
Note 1:	For random precoder selection, the precoder shall be updated in each TTI (1 ms granularity)		
Note 2:	If the UE reports in an available uplink reporting instance at subframe SF#n based on PMI estimation at a downlink SF not later than SF#(n-4), this reported PMI cannot be applied at the eNB downlink before SF#(n+4).		
Note 3:	One/two sided dynamic OCNG Pattern OP.1/2 TDD as described in Annex A.5.1.1/2 shall be used.		
Note 4:	PDCCH DCI format 0 with a trigger for aperiodic CQI shall be transmitted in downlink SF#4 and #9 to allow aperiodic CQI/PMI/RI to be transmitted on uplink SF#3 and #8.		
Note 5:	Randomization of the principle beam direction shall be used as specified in B.2.3A.4.		

**Table 9.4.2.3.4\_G.3-2: Minimum requirement (TDD) for eDL-MIMO Enhancement**

Parameter	Test 1
$\gamma$	1.2
UE Category	$\geq 1$

The normative reference for this requirement is TS 36.101 [2] clause 9.4.2.3.4.

#### 9.4.2.3.4\_G.4 Test description

##### 9.4.2.3.4\_G.4.1 Initial conditions

Initial conditions are a set of test configurations the UE needs to be tested in and the steps for the SS to take with the UE to reach the correct measurement state.

Configurations of PDSCH and PDCCH before measurement are specified in Annex C.2.

Test Environment: Normal as defined in TS 36.508 [7] clause 4.1.

Frequencies to be tested: Mid Range as defined in TS 36.508 [7] clause 4.3.1.2.

Channel Bandwidths to be tested: 10MHz, as defined in TS 36.508 [7] clause 4.3.1.2.

1. Connect the SS to the UE antenna connector (s) as shown in TS 36.508 [7] Annex A, Figure A.11.
2. The parameter settings for the cell are set up according to Table 9.4.2.3.4\_G.3-1.
3. Downlink signals are initially set up according to Annex C.1 and Annex C.3.2, and uplink signals according to Annex H.1 and H.3.2.
4. Propagation conditions are set according to Annex B clause B.0
5. Ensure the UE is in State 3A-RF according to TS 36.508 [7] clause 5.2A.2. Message contents are defined in clause 9.4.2.3.4\_G.4.3.

##### 9.4.2.3.4\_G.4.2 Test procedure

1. Set the bandwidth, propagation condition, antenna configuration and measurement channel parameters according to Table 9.4.2.3.4\_G.3-1 as appropriate.
2. The SS shall transmit PDSCH via PDCCH DCI format 2C for C\_RNTI to transmit the DL RMC with randomly selected precoding matrix from codebook (Table 6.3.4.2.3-2 in TS 36.213 [10]) every subframe regardless of PMI reports from the UE. Note that each precoding matrix shall be selected in equal probabilities. The SS sends downlink MAC padding bits on the DL RMC. SS schedules the UL transmission to carry the PUSCH CQI feedback via PDCCH DCI format 0 with CQI request bit set to 1 and I\_MCS=29 and N\_PRB allocated to be less or equal to 4. Establish  $t_{md}$  and  $SNR_{md}$  according to annex G.5.2
3. Set SNR to  $SNR_{md}$ . The SS shall transmit PDSCH with precoding matrix according to PMI report from the UE. The SS sends downlink MAC padding bits on the DL RMC. SS schedules the UL transmission to carry the PUSCH CQI feedback via PDCCH DCI format 0 with CQI request bit set to 1 and I\_MCS=29 and N\_PRB allocated to be less or equal to 4. Measure  $t_{ue}$  according to Annex G.5.3

4. Calculate  $\gamma = \frac{t_{ue}}{t_{md}}$

##### 9.4.2.3.4\_G.4.3 Message contents

Message contents are according to TS 36.508 [7] clause 4.6 with the following exceptions:

**Table 9.4.2.3.4\_G.4.3-1: PhysicalConfigDedicated**

Derivation Path: 36.331 clause 6.3.2			
Information Element	Value/remark	Comment	Condition
PhysicalConfigDedicated ::= SEQUENCE {			
antennaInfo-r10 CHOICE {			
explicitValue-r10	AntennaInfoDedicated-r10		
}			
cqi-ReportConfig-r10	CQI-ReportConfig-r10-DEFAULT		
antennaInfo-v1250	AntennaInfoDedicated-v1250		
}			

**Table 9.4.2.3.4\_G.4.3-2: PDSCH-ConfigDedicated-DEFAULT**

Derivation Path: 36.508 clause 4.6.3			
Information Element	Value/remark	Comment	Condition
PDSCH-ConfigDedicated-DEFAULT ::= SEQUENCE {			
p-a	dB0		
}			

**Table 9.4.2.3.4\_G.4.3-3: AntennaInfoDedicated-r10**

Derivation Path: 36.331 clause 6.3.2			
Information Element	Value/remark	Comment	Condition
AntennaInfoDedicated-r10 ::= SEQUENCE {			
transmissionMode-r10	tm9-v1020		
codebookSubsetRestriction-r10	0x0000 0000 FFFF 0000 FFFF 0000		
ue-TransmitAntennaSelection CHOICE {			
release	NULL		
}			
}			

**Table 9.4.2.3.4\_G.4.3-4: AntennaInfoDedicated-v1250**

Derivation Path: 36.331 clause 6.3.2			
Information Element	Value/remark	Comment	Condition
AntennaInfoDedicated-v1250 ::= SEQUENCE {			
alternativeCodebookEnabledFor4TX-r12	TRUE		
}			

**Table 9.4.2.3.4\_G.4.3-5: CQI-ReportConfig-r10-DEFAULT**

Derivation Path: 36.508 clause 4.6.3			
Information Element	Value/remark	Comment	Condition
CQI-ReportConfig-r10 ::= SEQUENCE {			
cqi-ReportModeAperiodic-r10	rm12		
nomPDSCH-RS-EPRE-Offset	0		
cqi-ReportPeriodic-r10	Not present		
}			

**Table 9.4.2.3.4\_G.4.3-6: CSI-RS-Config**

Derivation Path: 36.331 clause 6.3.2			
Information Element	Value/remark	Comment	Condition
CSI-RS-Config-r10 ::= SEQUENCE {			
csi-RS-r10 CHOICE {			
release	NULL		
setup SEQUENCE {			
antennaPortsCount-r10	an4	Parameter represents the number of antenna ports used for transmission of CSI reference signals	
resourceConfig-r10	4	Parameter: CSI reference signal configuration	
subframeConfig-r10	4	$\Delta_{\text{CSI-RS}} = I_{\text{CSI-RS}}$ when CSI-RS SubframeConfig is from 0-4; Parameter: $I_{\text{CSI-RS}}$	
p-C-r10	-3	Parameter: $P_c$ which is the assumed ratio of PDSCH EPRE to CSI-RS EPRE when UE derives CSI feedback	
}			
}			
}			

**Table 9.4.2.3.4\_G.4.3-7: TDD-Config-DEFAULT**

Derivation Path: 36.508 clause 4.6.3			
Information Element	Value/remark	Comment	Condition
TDD-Config-DEFAULT ::= SEQUENCE {			
subframeAssignment	sa1		
specialSubframePatterns	ssp4		
}			

**Table 9.4.2.3.4\_G.4.3-8: PUCCH-ConfigDedicated-DEFAULT**

Derivation Path: 36.331 clause 6.3.2			
Information Element	Value/remark	Comment	Condition
PUCCH-ConfigDedicated-DEFAULT ::= SEQUENCE {			
ackNackRepetition CHOICE {			
Release	NULL		
}			
tddAckNackFeedbackMode	Multiplexing	Multiplexing is selected as default to align with RAN4's assumptions in RF tests	TDD
}			

## 9.4.2.3.4\_G.5 Test requirement

**Table 9.4.2.3.4\_G.5-1: Test requirement (TDD) for eDL-MIMO Enhancement**

Parameter	Test 1
$\gamma$	1.2 + TT
UE Category	$\geq 1$

## 9.5 Reporting of Rank Indicator (RI)

The purpose of this test is to verify that the reported rank indicator accurately represents the channel rank. The accuracy of RI (CQI) reporting is determined by the relative increase of the throughput obtained when transmitting based on the reported rank compared to the case for which a fixed rank is used for transmission. Transmission mode 4 is used with the specified CodebookSubSetRestriction.

For fixed rank 1 transmission, the RI and PMI reporting is restricted to two single-layer precoders, For fixed rank 2 transmission, the RI and PMI reporting is restricted to one two-layer precoder, For follow RI transmission, the RI and PMI reporting is restricted to select the union of these precoders. Channels with low and high correlation are used to ensure that RI reporting reflects the channel condition.

### 9.5.1 RI Reporting (Cell-Specific Reference Symbols)

#### 9.5.1.1 FDD RI Reporting– PUCCH 1-1

##### 9.5.1.1.1 Test purpose

To verify that the reported rank indicator accurately represents the channel rank.

##### 9.5.1.1.2 Test applicability

This test applies to E-UTRA FDD UE release 8 and 9 of UE category  $\geq 2$ .

##### 9.5.1.1.3 Minimum conformance requirements

The minimum performance requirement in Table 9.5.1.1.3-2 is defined as

- a) The ratio of the throughput obtained when transmitting based on UE reported RI and that obtained when transmitting with fixed rank 1 shall be  $\geq \gamma_1$ ;
- b) The ratio of the throughput obtained when transmitting based on UE reported RI and that obtained when transmitting with fixed rank 2 shall be  $\geq \gamma_2$ ;

For the parameters specified in Table 9.5.1.1.3-1, and using the downlink physical channels specified in Annex C, the minimum requirements are specified in Table 9.5.1.1.3-2.

Table 9.5.1.1.3-1: RI Test (FDD)

Parameter	Unit	Test 1	Test 2	Test 3
Bandwidth	MHz		10	
PDSCH transmission mode			4	
Downlink power allocation	$\rho_A$	dB	-3	
	$\rho_B$	dB	-3	
	$\sigma$	dB	0	
CodeBookSubsetRestriction bitmap		000011 for fixed RI = 1 010000 for fixed RI = 2 010011 for UE reported RI		
Propagation condition and antenna configuration		2 x 2 EPA5		
Antenna correlation		Low	Low	High
RI configuration		Fixed RI=2 and follow RI	Fixed RI=1 and follow RI	Fixed RI=2 and follow RI
SNR	dB	0	20	20
$N_{oc}^{(j)}$	dB[mW/15kHz]	-98	-98	-98
$\hat{I}_{or}^{(j)}$	dB[mW/15kHz]	-98	-78	-78
Maximum number of HARQ transmissions		1		
Reporting mode		PUCCH 1-1 (Note 4)		
Physical channel for CQI/PMI reporting		PUCCH Format 2		
PUCCH Report Type for CQI/PMI		2		
Physical channel for RI reporting		PUSCH (Note 3)		
PUCCH Report Type for RI		3		
Reporting periodicity	ms	$N_p = 5$		
PMI and CQI delay	ms	8		
<i>cqi-pmi-ConfigurationIndex</i>		6		
<i>ri-ConfigurationInd</i>		1 (Note 5)		
Note 1:	If the UE reports in an available uplink reporting instance at subframe SF#n based on PMI and CQI estimation at a downlink subframe not later than SF#(n-4), this reported PMI and wideband CQI cannot be applied at the eNB downlink before SF#(n+4).			
Note 2:	Reference measurement channel RC.2 FDD according to Table A.4-1 with one sided dynamic OCNG Pattern OP.1 FDD as described in Annex A.5.1.1.			
Note 3:	To avoid collisions between RI reports and HARQ-ACK it is necessary to report both on PUSCH instead of PUCCH. PDCCH DCI format 0 shall be transmitted in downlink SF#4 and #9 to allow periodic RI to multiplex with the HARQ-ACK on PUSCH in uplink subframe SF#8 and #3.			
Note 4:	The bit field for precoding information in DCI format 2 shall be mapped as: - For reported RI = 1 and PMI = 0 >> precoding information bit field index = 1 - For reported RI = 1 and PMI = 1 >> precoding information bit field index = 2 - For reported RI = 2 and PMI = 0 >> precoding information bit field index = 0			
Note 5:	To avoid the ambiguity of SS behaviour when applying CQI and PMI during rank switching, RI reports are to be applied at the SS with one subframe delay in addition to Note 1 to align with CQI and PMI reports.			

Table 9.5.1.1.3-2: Minimum requirement (FDD)

Parameter	Test 1	Test 2	Test 3
$\gamma_1$	N/A	1.05	N/A
$\gamma_2$	1	N/A	1.1
UE Category	2-8	2-8	2-8

The normative reference for this requirement is TS 36.101 [2] clause 9.5.1.1.

#### 9.5.1.1.4 Test description

##### 9.5.1.1.4.1 Initial conditions

Initial conditions are a set of test configurations the UE needs to be tested in and the steps for the SS to take with the UE to reach the correct measurement state.

Configurations of PDSCH and PDCCH before measurement are specified in Annex C.2.

Test Environment: Normal as defined in TS 36.508 [7] clause 4.1.

Frequencies to be tested: Mid Range as defined in TS 36.508 [7] clause 4.3.1.1.

Channel Bandwidths to be tested: 10MHz, as defined in TS 36.508 [7] clause 4.3.1.1

1. Connect the SS, faders and AWGN noise source to the UE antenna connector (s) as shown in TS 36.508 [7] Annex A, Figure A.10.
2. The parameter settings for the cell are set up according to Table 9.5.1.1.3-1.
3. Downlink signals are initially set up according to Annex C.1 and Annex C.3.2, and uplink signals according to Annex H.1 and H.3.2.
4. Propagation conditions are set according to Annex B.0.
5. Ensure the UE is in State 3A-RF according to TS 36.508 [7] clause 5.2A.2. Message contents are defined in clause 9.5.1.1.4.3.

##### 9.5.1.1.4.2 Test procedure

1. Set the parameters of bandwidth, reference Channel, the propagation condition, antenna configuration, antenna correlation, CodeBookSubsetRestriction for fixed Rank and the SNR according to Table 9.5.1.1.3-1 as appropriate.
2. The SS shall send PDSCH via PDCCH DCI format 2 for C\_RNTI to transmit the DL RMC according to the UE reported CQI, PMI and RI. In case of CQI reports for two codewords (codeword #0 and #1), the CQI offset level for codeword #1 is selected from {0,1,2,3,-4,-3,-2,-1}. The SS sends downlink MAC padding bits on the DL RMC. The SS sends uplink scheduling information via PDCCH DCI format 0 with CQI request bit set to 0 to schedule UL RMC in subframe #3 and #8 (Table A.4.1-1). Measure the  $t_{fix}$  according to annex G.5.3.
3. Propagation conditions are set according to Annex B.1.
4. The SS sends uplink scheduling information via PDCCH DCI format 0 to schedule UL RMC in every subframe (Table A.4.1-1).
5. The SS shall transmit an RRC Connection Reconfiguration message to set codebookSubsetRestriction as for UE reported RI according to Table 9.5.1.1.3-1.
6. The UE shall transmit RRC Connection Reconfiguration Complete message.
7. Propagation conditions are set according to Table 9.5.1.1.3-1.
8. The SS shall send PDSCH via PDCCH DCI format 2 for C\_RNTI to transmit the DL RMC according to the UE reported CQI, PMI and RI. In case of CQI reports for two codewords (codeword #0 and #1), the CQI offset level for codeword #1 is selected from {0,1,2,3,-4,-3,-2,-1}. The SS sends downlink MAC padding bits on the DL RMC. The SS sends uplink scheduling information via PDCCH DCI format 0 with CQI request bit set to 0 to schedule UL RMC in subframe #3 and #8 (Table A.4.1-1). Measure  $t_{reported}$  according to Annex G.5.3  
If the ratio ( $t_{reported} / t_{fix}$ ) satisfies the requirement in Table 9.5.1.1.5-1, then pass the UE for this test and go to step 9. Otherwise, fail the UE.
9. If all tests have not been done, then repeat the same procedure (steps 1 to 8) with test conditions according to the Table 9.5.1.1.3-2 for the other Tests as appropriate. Otherwise pass the UE.

## 9.5.1.1.4.3 Message contents

Message contents are according to TS 36.508 [7] clause 4.6 with the following exceptions:

**Table 9.5.1.1.4.3-1: PhysicalConfigDedicated-DEFAULT**

Derivation Path: 36.508 clause 4.6.3			
Information Element	Value/remark	Comment	Condition
RadioResourceConfigDedicated-SRB2-DRB(n, m) ::= SEQUENCE {			
physicalConfigDedicated	PhysicalConfigDedicated - DEFAULT using condition RBC		
}			

**Table 9.5.1.1.4.3-2: PhysicalConfigDedicated-DEFAULT**

Derivation Path: 36.508 clause 5.5.1.2			
Information Element	Value/remark	Comment	Condition
PhysicalConfigDedicated-DEFAULT ::= SEQUENCE {			
cqi-ReportConfig	<i>CQI-ReportConfig-DEFAULT</i>		RBC
antennaInfo CHOICE {			
antennaInfoDedicated ::= SEQUENCE {			
transmissionMode	tm4		
}			
codebookSubsetRestriction CHOICE {			
N2TxAntenna-tm4	According to each test		
ue-TransmitAntennaSelection CHOICE {			
release	NULL		
}			
}			

**Table 9.5.1.1.4.3-3: PDSCH-ConfigDedicated-DEFAULT**

Derivation Path: 36.331 clause 6.3.2			
Information Element	Value/remark	Comment	Condition
PDSCH-ConfigDedicated-DEFAULT ::= SEQUENCE {			
p-a	dB-3		
}			



**Table 9.5.1.1.4.3-4: CQI-ReportConfig-DEFAULT**

Derivation Path: 36.508 clause 4.6.3			
Information Element	Value/remark	Comment	Condition
CQI-ReportConfig-DEFAULT ::= SEQUENCE {			
cqi-ReportModeAperiodic	Not present		
nomPDSCH-RS-EPRE-Offset	0		
cqi-ReportPeriodic CHOICE {			
setup SEQUENCE {			
cqi-PUCCH-ResourceIndex	0		
cqi-pmi-ConfigIndex	6	(see Table 7.2.2-1A in TS 36.213)	
cqi-FormatIndicatorPeriodic CHOICE {			
widebandCQI	NULL		
}			
ri-ConfigIndex	1	(see Table 7.2.2-1B in TS 36.213)	
simultaneousAckNackAndCQI	FALSE		
}			
}			
}			

#### 9.5.1.1.5 Test requirement

**Table 9.5.1.1.5-1: Test requirement (FDD)**

Parameter	Test 1	Test 2	Test 3
$\gamma_1$	N/A	1.04	N/A
$\gamma_2$	0.99	N/A	1.09
UE Category	2-8	2-8	2-8

#### 9.5.1.1\_1 FDD RI Reporting– PUCCH 1-1 (Release 10)

##### 9.5.1.1\_1.1 Test purpose

Same test purpose as in clause 9.5.1.1.1.

##### 9.5.1.1\_1.2 Test applicability

This test applies to E-UTRA FDD UE release 10 of UE category  $\geq 2$ .

##### 9.5.1.1\_1.3 Minimum conformance requirements

Same minimum conformance requirements as in clause 9.5.1.1.3 with the following exceptions:

- Instead of Table 9.5.1.1.3-1 → use Table 9.5.1.1\_1.3-1.
- Instead of Table 9.5.1.1.3-2 → use Table 9.5.1.1\_1.3-2.

Table 9.5.1.1\_1.3-1: RI Test (FDD)

Parameter		Unit	Test 1	Test 2	Test 3	
Bandwidth		MHz			10	
PDSCH transmission mode					4	
Downlink power allocation	$\rho_A$	dB			-3	
	$\rho_B$	dB			-3	
	$\sigma$	dB			0	
CodeBookSubsetRestriction bitmap			000011 for fixed RI = 1 010000 for fixed RI = 2 010011 for UE reported RI			
Propagation condition and antenna configuration			2 x 2 EPA5			
Antenna correlation			Low	Low	High	
RI configuration			Fixed RI=2 and follow RI	Fixed RI=1 and follow RI	Fixed RI=1 and follow RI	Fixed RI=2 and follow RI
SNR		dB	0	20	20	20
$N_{oc}^{(j)}$		dB[mW/15kHz]	-98	-98	-98	-98
$\hat{I}_{or}^{(j)}$		dB[mW/15kHz]	-98	-78	-78	-78
Maximum number of HARQ transmissions			1			
Reporting mode			PUCCH 1-1 (Note 4)			
Physical channel for CQI/PMI reporting			PUCCH Format 2			
PUCCH Report Type for CQI/PMI			2			
Physical channel for RI reporting			PUSCH (Note 3)			
PUCCH Report Type for RI			3			
Reporting periodicity		ms	$N_P = 5$			
PMI and CQI delay		ms	8			
<i>cqi-pmi-ConfigurationIndex</i>			6			
<i>ri-ConfigurationInd</i>			1 (Note 5)			
<p>Note 1: If the UE reports in an available uplink reporting instance at subframe SF#n based on PMI and CQI estimation at a downlink subframe not later than SF#(n-4), this reported PMI and wideband CQI cannot be applied at the eNB downlink before SF#(n+4).</p> <p>Note 2: Reference measurement channel RC.2 FDD according to Table A.4-1 with one sided dynamic OCNG Pattern OP.1 FDD as described in Annex A.5.1.1.</p> <p>Note 3: To avoid collisions between RI reports and HARQ-ACK it is necessary to report both on PUSCH instead of PUCCH. PDCCH DCI format 0 shall be transmitted in downlink SF#4 and #9 to allow periodic RI to multiplex with the HARQ-ACK on PUSCH in uplink subframe SF#8 and #3.</p> <p>Note 4: The bit field for precoding information in DCI format 2 shall be mapped as:  - For reported RI = 1 and PMI = 0 &gt;&gt; precoding information bit field index = 1  - For reported RI = 1 and PMI = 1 &gt;&gt; precoding information bit field index = 2  - For reported RI = 2 and PMI = 0 &gt;&gt; precoding information bit field index = 0</p> <p>Note 5: To avoid the ambiguity of SS behaviour when applying CQI and PMI during rank switching, RI reports are to be applied at the SS with one subframe delay in addition to Note 1 to align with CQI and PMI reports.</p>						

Table 9.5.1.1\_1.3-2: Minimum requirement (FDD)

Parameter	Test 1	Test 2	Test 3
$\gamma_1$	N/A	1.05	0.9 (Note 1)
$\gamma_2$	1	N/A	1.1 (Note 1)
UE Category	2-8	2-8	2-8
Note 1: For Test 3, the minimum requirements shall be fulfilled for at least one of $\gamma_1$ or $\gamma_2$ .			

## 9.5.1.1\_1.4 Test description

Same test description as in clause 9.5.1.1.4 with the following exceptions:

- Instead of Table 9.5.1.1.3-1 → use Table 9.5.1.1\_1.3-1.
- Instead of Table 9.5.1.1.3-2 → use Table 9.5.1.1\_1.3-2.
- Instead of Table 9.5.1.1.5-1 → use Table 9.5.1.1\_1.5-1.

#### 9.5.1.1\_1.4.1 Initial conditions

Same initial conditions as in clause 9.5.1.1.4.1.

#### 9.5.1.1\_1.4.2 Test procedure

1. Set the parameters of bandwidth, reference Channel, the propagation condition, antenna configuration, antenna correlation, CodeBookSubsetRestriction for fixed Rank and the SNR according to Table 9.5.1.1\_1.3-1 as appropriate.
2. The SS shall send PDSCH via PDCCH DCI format 2 for C\_RNTI to transmit the DL RMC according to the UE reported CQI, PMI and RI. In case of CQI reports for two codewords (codeword #0 and #1), the CQI offset level for codeword #1 is selected from {0,1,2,3,-4,-3,-2,-1}. The SS sends downlink MAC padding bits on the DL RMC. The SS sends uplink scheduling information via PDCCH DCI format 0 with CQI request bit set to 0 to schedule UL RMC in subframe #3 and #8 (Table A.4.1-1). Measure the  $t_{fix}$  according to annex G.5.3.
3. Propagation conditions are set according to Annex B.1.
4. For Test 3 the SS repeats steps 1 to 3 to get two values for  $t_{fix}$ , one value for fixed Rank 1 case and the other value for fixed Rank 2 case.
5. The SS sends uplink scheduling information via PDCCH DCI format 0 to schedule UL RMC in every subframe (Table A.4.1-1).
6. The SS shall transmit an RRC Connection Reconfiguration message to set codebookSubsetRestriction as for UE reported RI according to Table 9.5.1.1\_1.3-1.
7. The UE shall transmit RRC Connection Reconfiguration Complete message.
8. Propagation conditions are set according to Table 9.5.1.1\_1.3-1.
9. The SS shall send PDSCH via PDCCH DCI format 2 for C\_RNTI to transmit the DL RMC according to the UE reported CQI, PMI and RI. In case of CQI reports for two codewords (codeword #0 and #1), the CQI offset level for codeword #1 is selected from {0,1,2,3,-4,-3,-2,-1}. The SS sends downlink MAC padding bits on the DL RMC. The SS sends uplink scheduling information via PDCCH DCI format 0 with CQI request bit set to 0 to schedule UL RMC in subframe #3 and #8 (Table A.4.1-1). Measure  $t_{reported}$  according to Annex G.5.3
10. For Test 1 and Test 2 if the ratio ( $t_{reported} / t_{fix}$ ) satisfies the requirement in Table 9.5.1.1\_1.5-1, then pass the UE for Test 1 and Test 2.
11. For Test 3 if the ratio ( $t_{reported} / t_{fix}$ ) satisfies at least one of the  $\gamma_1$  or  $\gamma_2$  requirements in Table 9.5.1.1\_1.5-1, then pass the UE for Test 3.
12. For a complete test case to pass the UE has to pass all test cases 1, 2 and 3. Otherwise, fail the UE.
13. If all tests have not been done, then repeat the same procedure (steps 1 to 12) with test conditions according to the Table 9.5.1.1\_1.3-2 for the other Tests as appropriate.

#### 9.5.1.1\_1.4.3 Message contents

Same message contents as in clause 9.5.1.1.4.3.

#### 9.5.1.1\_1.5 Test requirement

Same test requirements as in clause 9.5.1.1.5 with the following exceptions:

- Instead of Table 9.5.1.1.5-1 → use Table 9.5.1.1\_1.5-1

**Table 9.5.1.1\_1.5-1: Test requirement (FDD)**

Parameter	Test 1	Test 2	Test 3
$\gamma_1$	N/A	1.04	0.89 (Note 1)
$\gamma_2$	0.99	N/A	1.09 (Note 1)
UE Category	2-8	2-8	2-8
Note 1: For Test 3, the minimum requirements shall be fulfilled for at least one of $\gamma_1$ or $\gamma_2$ .			

## 9.5.1.1\_2 FDD RI Reporting– PUCCH 1-1 (Release 11)

### 9.5.1.1\_2.1 Test purpose

Same test purpose as in clause 9.5.1.1.1.

### 9.5.1.1\_2.2 Test applicability

This test applies to E-UTRA FDD UE release 11 and forward of UE category  $\geq 2$ .

### 9.5.1.1\_2.3 Minimum conformance requirements

Same minimum conformance requirements as in clause 9.5.1.1.3 with the following exceptions:

- Instead of Table 9.5.1.1.3-1 → use Table 9.5.1.1\_2.3-1.
- Instead of Table 9.5.1.1.3-2 → use Table 9.5.1.1\_2.3-2.

Table 9.5.1.1\_2.3-1: RI Test (FDD)

Parameter	Unit	Test 1	Test 2	Test 3
Bandwidth	MHz		10	
PDSCH transmission mode			4	
Downlink power allocation	$\rho_A$	dB	-3	
	$\rho_B$	dB	-3	
	$\sigma$	dB	0	
Propagation condition and antenna configuration		2 x 2 EPA5		
CodeBookSubsetRestriction bitmap		000011 for fixed RI = 1 010000 for fixed RI = 2 010011 for UE reported RI		
Antenna correlation		Low	Low	High
RI configuration		Fixed RI=2 and follow RI	Fixed RI=1 and follow RI	Fixed RI=1 and follow RI
SNR	dB	0	20	20
$N_{oc}^{(j)}$	dB[mW/15kHz]	-98	-98	-98
$\hat{I}_{or}^{(j)}$	dB[mW/15kHz]	-98	-78	-78
Maximum number of HARQ transmissions		1		
Reporting mode		PUCCH 1-1 (Note 4)		
Physical channel for CQI/PMI reporting		PUCCH Format 2		
PUCCH Report Type for CQI/PMI		2		
Physical channel for RI reporting		PUSCH (Note 3)		
PUCCH Report Type for RI		3		
Reporting periodicity	ms	$N_{pd}=5$		
PMI and CQI delay	ms	8		
<i>cqi-pmi-ConfigurationIndex</i>		6		
<i>ri-ConfigurationInd</i>		1 (Note 5)		
<p>Note 1: If the UE reports in an available uplink reporting instance at subframe SF#n based on PMI and CQI estimation at a downlink subframe not later than SF#(n-4), this reported PMI and wideband CQI cannot be applied at the eNB downlink before SF#(n+4).</p> <p>Note 2: Reference measurement channel RC.2 FDD according to Table A.4-1 with one sided dynamic OCNG Pattern OP.1 FDD as described in Annex A.5.1.1.</p> <p>Note 3: To avoid collisions between RI reports and HARQ-ACK it is necessary to report both on PUSCH instead of PUCCH. PDCCH DCI format 0 shall be transmitted in downlink SF#4 and #9 to allow periodic RI to multiplex with the HARQ-ACK on PUSCH in uplink subframe SF#8 and #3.</p> <p>Note 4: The bit field for precoding information in DCI format 2 shall be mapped as:  - For reported RI = 1 and PMI = 0 &gt;&gt; precoding information bit field index = 1  - For reported RI = 1 and PMI = 1 &gt;&gt; precoding information bit field index = 2  - For reported RI = 2 and PMI = 0 &gt;&gt; precoding information bit field index = 0</p> <p>Note 5: To avoid the ambiguity of TE behaviour when applying CQI and PMI during rank switching, RI reports are to be applied at the TE with one subframe delay in addition to Note 1 to align with CQI and PMI reports.</p>				

Table 9.5.1.1\_2.3-2: Minimum requirement (FDD)

Parameter	Test 1	Test 2	Test 3
$\gamma_1$	N/A	1.05	0.9
$\gamma_2$	1	N/A	N/A
UE Category	2-8	2-8	2-8

## 9.5.1.1\_2.4 Test description

Same test description as in clause 9.5.1.1.4 with the following exceptions:

- Instead of Table 9.5.1.1.3-1 → use Table 9.5.1.1\_2.3-1.
- Instead of Table 9.5.1.1.3-2 → use Table 9.5.1.1\_2.3-2.
- Instead of Table 9.5.1.1.5-1 → use Table 9.5.1.1\_2.5-1.

### 9.5.1.1\_2.5 Test requirement

Same test requirements as in clause 9.5.1.1.5 with the following exceptions:

- Instead of Table 9.5.1.1.5-1 → use Table 9.5.1.1\_2.5-1

**Table 9.5.1.1\_2.5-1: Test requirement (FDD)**

Parameter	Test 1	Test 2	Test 3
$\gamma_1$	N/A	1.04	0.89
$\gamma_2$	0.99	N/A	N/A
UE Category	2-8	2-8	2-8

### 9.5.1.2 TDD RI Reporting – PUSCH 3-1

#### 9.5.1.2.1 Test purpose

To verify that the reported rank indicator accurately represents the channel rank.

#### 9.5.1.2.2 Test applicability

This test applies to E-UTRA TDD UE release 8 and 9, which support UE Category  $\geq 2$ .

#### 9.5.1.2.3 Minimum conformance requirements

The minimum performance requirement in Table 9.5.1.2.3-2 is defined as

- a) The ratio of the throughput obtained when transmitting based on UE reported RI and that obtained when transmitting with fixed rank 1 shall be  $\geq \gamma_1$ ;
- b) The ratio of the throughput obtained when transmitting based on UE reported RI and that obtained when transmitting with fixed rank 2 shall be  $\geq \gamma_2$ ;

For the parameters specified in Table 9.5.1.2.3-1, and using the downlink physical channels specified in Annex C, the minimum requirements are specified in Table 9.5.1.2.3-2.

**Table 9.5.1.2.3-1: RI Test (TDD)**

Parameter	Unit	Test 1	Test 2	Test 3
Bandwidth	MHz		10	
PDSCH transmission mode			4	
Downlink power allocation	$\rho_A$	dB	-3	
	$\rho_B$	dB	-3	
	$\sigma$	dB	0	
Uplink downlink configuration			2	
Special subframe configuration			4	
Propagation condition and antenna configuration			2 x 2 EPA5	
CodeBookSubsetRestriction bitmap			000011 for fixed RI = 1 010000 for fixed RI = 2 010011 for UE reported RI	
Antenna correlation		Low	Low	High
RI configuration		Fixed RI=2 and follow RI	Fixed RI=1 and follow RI	Fixed RI=2 and follow RI
SNR	dB	0	20	20
$N_{oc}^{(j)}$	dB[mW/15kHz]	-98	-98	-98
$\hat{I}_{or}^{(j)}$	dB[mW/15kHz]	-98	-78	-78
Maximum number of HARQ transmissions		1		
Reporting mode		PUSCH 3-1 (Note 3)		
Reporting interval	ms	5		
PMI and CQI delay	ms	10 or 11		
ACK/NACK feedback mode		Bundling		
Note 1: If the UE reports in an available uplink reporting instance at subframe SF#n based on PMI and CQI estimation at a downlink subframe not later than SF#(n-4), this reported PMI and wideband CQI cannot be applied at the eNB downlink before SF#(n+4).				
Note 2: Reference measurement channel RC.2 TDD according to Table A.4-1 with one sided dynamic OCNG Pattern OP.1 TDD as described in Annex A.5.2.1.				
Note 3: Reported wideband CQI and PMI are used and sub-band CQI is discarded.				

**Table 9.5.1.2.3-2: Minimum requirement (TDD)**

Parameter	Test 1	Test 2	Test 3
$\gamma_1$	N/A	1.05	N/A
$\gamma_2$	1	N/A	1.1
UE Category	2-8	2-8	2-8

The normative reference for this requirement is TS 36.101 [2] clause 9.5.1.2.

#### 9.5.1.2.4 Test description

##### 9.5.1.2.4.1 Initial conditions

Initial conditions are a set of test configurations the UE needs to be tested in and the steps for the SS to take with the UE to reach the correct measurement state.

Configurations of PDSCH and PDCCH before measurement are specified in Annex C.2.

Test Environment: Normal as defined in TS 36.508 [7] clause 4.1.

Frequencies to be tested: Mid Range as defined in TS 36.508 [7] clause 4.3.1.2.

Channel Bandwidths to be tested: 10MHz, as defined in TS 36.508 [7] clause 4.3.1.2

1. Connect the SS, faders and AWGN noise source to the UE antenna connector (s) as shown in TS 36.508 [7] Annex A, Figure A.10.

2. The parameter settings for the cell are set up according to Table 9.5.1.2.3-1.
3. Downlink signals are initially set up according to Annex C.1 and Annex C.3.2, and uplink signals according to Annex H.1 and H.3.2.
4. Propagation conditions are set according to Annex B.0.
5. Ensure the UE is in State 3A-RF according to TS 36.508 [7] clause 5.2A.2. Message contents are defined in clause 9.5.1.2.4.3.

#### 9.5.1.2.4.2 Test procedure

1. Set the parameters of bandwidth, reference Channel, the propagation condition, antenna configuration, antenna correlation, CodeBookSubsetRestriction for fixed Rank and the SNR according to Table 9.5.1.2.3-1 as appropriate.
2. The SS shall send PDSCH via PDCCH DCI format 2 for C\_RNTI to transmit the DL RMC according to the UE reported CQI (wideband CQI), PMI and RI. The SS sends downlink MAC padding bits on the DL RMC. The SS schedules the UL transmission to carry the PUSCH CQI feedback via PDCCH DCI format 0 with CQI request bit set to 1 and I\_MCS=29 and N\_PRB allocated to be less or equal to 4. Measure the  $t_{fix}$  according to annex G.5.3
3. Propagation conditions are set according to Annex B.1.
4. The SS sends uplink scheduling information via PDCCH DCI format 0 with CQI request bit to 0 to schedule UL RMC in subframe#2 and #7 (Table A.4.1-2).
5. The SS shall transmit an RRC Connection Reconfiguration message to set codebookSubsetRestriction as for UE reported RI according to Table 9.5.1.2.3-1.
6. The UE shall transmit RRC Connection Reconfiguration Complete message.
7. Propagation conditions are set according to Table 9.5.1.2.3-1.
8. The SS shall send PDSCH via PDCCH DCI format 2 for C\_RNTI to transmit the DL RMC according to the UE reported CQI (wideband CQI), PMI and RI. The SS sends downlink MAC padding bits on the DL RMC. The SS schedules the UL transmission to carry the PUSCH CQI feedback via PDCCH DCI format 0 with CQI request bit set to 1 and I\_MCS=29 and N\_PRB allocated to be less or equal to 4. Measure  $t_{reported}$  according to Annex G.5.3  
If the ratio ( $t_{reported} / t_{fix}$ ) satisfies the requirement in Table 9.5.1.2.5-1, then pass the UE for this test and go to step 9. Otherwise, fail the UE.
9. If all tests have not been done, then repeat the same procedure (steps 1 to 8) with test conditions according to the Table 9.5.1.2.3-2 for the other Tests as appropriate. Otherwise pass the UE.

#### 9.5.1.2.4.3 Message contents

Message contents are according to TS 36.508 [7] clause 4.6 with the following exceptions:



**Table 9.5.1.2.4.3-1: PhysicalConfigDedicated-DEFAULT**

Derivation Path: 36.508 clause 5.5.1.2			
Information Element	Value/remark	Comment	Condition
PhysicalConfigDedicated-DEFAULT ::= SEQUENCE {			
cqi-ReportConfig	<i>CQI-ReportConfig-DEFAULT</i>		
antennaInfo CHOICE {			
antennaInfoDedicated ::= SEQUENCE {			
transmissionMode	tm4		
}			
codebookSubsetRestriction CHOICE {			
N2TxAntenna-tm4	According to each test		
ue-TransmitAntennaSelection CHOICE {			
release	NULL		
}			
}			

**Table 9.5.1.2.4.3-2: PDSCH-ConfigDedicated-DEFAULT**

Derivation Path: 36.331 clause 6.3.2			
Information Element	Value/remark	Comment	Condition
PDSCH-ConfigDedicated-DEFAULT ::= SEQUENCE {			
p-a	dB-3		
}			

**Table 9.5.1.2.4.3-3: CQI-ReportConfig-DEFAULT**

Derivation Path: 36.508 clause 4.6.3			
Information Element	Value/remark	Comment	Condition
CQI-ReportConfig-DEFAULT ::= SEQUENCE {			
cqi-ReportModeAperiodic	rm31		
nomPDSCH-RS-EPRE-Offset	0		
cqi-ReportPeriodic CHOICE {	Not Present		
}			
}			

**Table 9.5.1.2.4.3-4: PUCCH-ConfigDedicated-DEFAULT**

Derivation Path: 36.331 clause 6.3.2			
Information Element	Value/remark	Comment	Condition
PUCCH-ConfigDedicated-DEFAULT ::= SEQUENCE {			
ackNackRepetition CHOICE {			
release	NULL		
}			
tddAckNackFeedbackMode	Bundling	Multiplexing is selected as default to align with RAN4's assumptions in RF tests.	TDD
}			

## 9.5.1.2.5 Test requirement

**Table 9.5.1.2.5-1: Test requirement (TDD)**

Parameter	Test 1	Test 2	Test 3
$\gamma_1$	N/A	1.04	N/A
$\gamma_2$	0.99	N/A	1.09
UE Category	2-8	2-8	2-8

## 9.5.1.2\_1 TDD RI Reporting – PUSCH 3-1 (Release 10)

## 9.5.1.2\_1.1 Test purpose

Same test purpose as in clause 9.5.1.2.1.

## 9.5.1.2\_1.2 Test applicability

This test applies to E-UTRA TDD UE release 10, which supports UE Category  $\geq 2$ .

## 9.5.1.2\_1.3 Minimum conformance requirements

Same minimum conformance requirements as in clause 9.5.1.2.3 with the following exceptions:

- Instead of Table 9.5.1.2.3-1 → use Table 9.5.1.2\_1.3-1.
- Instead of Table 9.5.1.2.3-2 → use Table 9.5.1.2\_1.3-2.

Table 9.5.1.2\_1.3-1: RI Test (TDD)

Parameter	Unit	Test 1	Test 2	Test 3	
Bandwidth	MHz			10	
PDSCH transmission mode				4	
Downlink power allocation	$\rho_A$	dB		-3	
	$\rho_B$	dB		-3	
	$\sigma$	dB		0	
Uplink downlink configuration				2	
Special subframe configuration				4	
Propagation condition and antenna configuration				2 x 2 EPA5	
CodeBookSubsetRestriction bitmap				000011 for fixed RI = 1 010000 for fixed RI = 2 010011 for UE reported RI	
Antenna correlation		Low	Low	High	High
RI configuration		Fixed RI=2 and follow RI	Fixed RI=1 and follow RI	Fixed RI=1 and follow RI	Fixed RI=2 and follow RI
SNR	dB	0	20	20	20
$N_{oc}^{(j)}$	dB[mW/15kHz]	-98	-98	-98	-98
$\hat{I}_{or}^{(j)}$	dB[mW/15kHz]	-98	-78	-78	-78
Maximum number of HARQ transmissions				1	
Reporting mode				PUSCH 3-1 (Note 3)	
Reporting interval	ms			5	
PMI and CQI delay	ms			10 or 11	
ACK/NACK feedback mode				Bundling	
Note 1:	If the UE reports in an available uplink reporting instance at subframe SF#n based on PMI and CQI estimation at a downlink subframe not later than SF#(n-4), this reported PMI and wideband CQI cannot be applied at the eNB downlink before SF#(n+4).				
Note 2:	Reference measurement channel RC.2 TDD according to Table A.4-1 with one sided dynamic OCNG Pattern OP.1 TDD as described in Annex A.5.2.1.				
Note 3:	Reported wideband CQI and PMI are used and sub-band CQI is discarded.				

Table 9.5.1.2\_1.3-2: Minimum requirement (TDD)

Parameter	Test 1	Test 2	Test 3
$\gamma_1$	N/A	1.05	0.9 (Note 1)
$\gamma_2$	1	N/A	1.1 (Note 1)
UE Category	2-8	2-8	2-8
Note 1:	For Test 3, the minimum requirements shall be fulfilled for at least one of $\gamma_1$ or $\gamma_2$ .		

#### 9.5.1.2\_1.4 Test description

##### 9.5.1.2\_1.4.1 Initial conditions

Same initial conditions as in clause 9.5.1.2.4.1.

##### 9.5.1.2\_1.4.2 Test procedure

1. Set the parameters of bandwidth, reference Channel, the propagation condition, antenna configuration, antenna correlation, CodeBookSubsetRestriction for fixed Rank and the SNR according to Table 9.5.1.2\_1.3-1 as appropriate.
2. The SS shall send PDSCH via PDCCH DCI format 2 for C\_RNTI to transmit the DL RMC according to the UE reported CQI (wideband CQI), PMI and RI. The SS sends downlink MAC padding bits on the DL RMC. The SS schedules the UL transmission to carry the PUSCH CQI feedback via PDCCH DCI format 0 with CQI request

bit set to 1 and I\_MCS=29 and N\_PRB allocated to be less or equal to 4. Measure the  $t_{fix}$  according to annex G.5.3

3. Propagation conditions are set according to Annex B.1.
4. For Test 3 the SS repeats steps 1 to 3 to get two values for  $t_{fix}$ , one value for fixed Rank 1 case and the other value for fixed Rank 2 case.
5. The SS sends uplink scheduling information via PDCCH DCI format 0 with CQI request bit to 0 to schedule UL RMC in subframe#2 and #7 (Table A.4.1-2).
6. The SS shall transmit an RRC Connection Reconfiguration message to set codebookSubsetRestriction as for UE reported RI according to Table 9.5.1.2\_1.3-1.
7. The UE shall transmit RRC Connection Reconfiguration Complete message.
8. Propagation conditions are set according to Table 9.5.1.2\_1.3-1.
9. The SS shall send PDSCH via PDCCH DCI format 2 for C\_RNTI to transmit the DL RMC according to the UE reported CQI (wideband CQI), PMI and RI. The SS sends downlink MAC padding bits on the DL RMC. The SS schedules the UL transmission to carry the PUSCH CQI feedback via PDCCH DCI format 0 with CQI request bit set to 1 and I\_MCS=29 and N\_PRB allocated to be less or equal to 4. Measure  $t_{reported}$  according to Annex G.5.3
10. For Test 1 and Test 2 if the ratio ( $t_{reported} / t_{fix}$ ) satisfies the requirement in Table 9.5.1.2\_1.5-1, then pass the UE for Test 1 and Test 2.
11. For Test 3 if the ratio ( $t_{reported} / t_{fix}$ ) satisfies at least one of the  $\gamma_1$  or  $\gamma_2$  requirements in Table 9.5.1.2\_1.5-1, then pass the UE for Test 3.
12. For a complete test case to pass the UE has to pass all test cases 1, 2 and 3. Otherwise, fail the UE
13. If all tests have not been done, then repeat the same procedure (steps 1 to 12) with test conditions according to the Table 9.5.1.2\_1.3-2 for the other Tests as appropriate.

#### 9.5.1.2\_1.4.3 Message contents

Same message contents as in clause 9.5.1.2.4.3.

#### 9.5.1.2\_1.5 Test requirement

Same test requirements as in clause 9.5.1.2.5 with the following exceptions:

- Instead of Table 9.5.1.2.5-1 → use Table 9.5.1.2\_1.5-1

**Table 9.5.1.2\_1.5-1: Test requirement (TDD)**

Parameter	Test 1	Test 2	Test 3
$\gamma_1$	N/A	1.04	0.89 (Note 1)
$\gamma_2$	0.99	N/A	1.09 (Note 1)
UE Category	2-8	2-8	2-8
Note 1: For Test 3, the minimum requirements shall be fulfilled for at least one of $\gamma_1$ or $\gamma_2$ .			

#### 9.5.1.2\_2 TDD RI Reporting – PUSCH 3-1 (Release 11)

##### 9.5.1.2\_2.1 Test purpose

Same test purpose as in clause 9.5.1.2.1.

## 9.5.1.2\_2.2 Test applicability

This test applies to E-UTRA TDD UE release 11 and forward, which supports UE Category  $\geq 2$ .

## 9.5.1.2\_2.3 Minimum conformance requirements

Same minimum conformance requirements as in clause 9.5.1.2.3 with the following exceptions:

- Instead of Table 9.5.1.2.3-1 → use Table 9.5.1.2\_2.3-1.
- Instead of Table 9.5.1.2.3-2 → use Table 9.5.1.2\_2.3-2.

**Table 9.5.1.2\_2.3-1: RI Test (TDD)**

Parameter	Unit	Test 1	Test 2	Test 3
Bandwidth	MHz	10		
PDSCH transmission mode		4		
Downlink power allocation	$\rho_A$	dB	-3	
	$\rho_B$	dB	-3	
	$\sigma$	dB	0	
Uplink downlink configuration		2		
Special subframe configuration		4		
Propagation condition and antenna configuration		2 x 2 EPA5		
CodeBookSubsetRestriction bitmap		000011 for fixed RI = 1 010000 for fixed RI = 2 010011 for UE reported RI		
Antenna correlation		Low	Low	High
RI configuration		Fixed RI=2 and follow RI	Fixed RI=1 and follow RI	Fixed RI=1 and follow RI
SNR	dB	0	20	20
$N_{oc}^{(j)}$	dB[mW/15kHz]	-98	-98	-98
$\hat{I}_{or}^{(j)}$	dB[mW/15kHz]	-98	-78	-78
Maximum number of HARQ transmissions		1		
Reporting mode		PUSCH 3-1 (Note 3)		
Reporting interval	ms	5		
PMI and CQI delay	ms	10 or 11		
ACK/NACK feedback mode		Bundling		
Note 1:	If the UE reports in an available uplink reporting instance at subframe SF#n based on PMI and CQI estimation at a downlink subframe not later than SF#(n-4), this reported PMI and wideband CQI cannot be applied at the eNB downlink before SF#(n+4).			
Note 2:	Reference measurement channel RC.2 TDD according to Table A.4-1 with one sided dynamic OCNG Pattern OP.1 TDD as described in Annex A.5.2.1.			
Note 3:	Reported wideband CQI and PMI are used and sub-band CQI is discarded.			

**Table 9.5.1.2\_2.3-2: Minimum requirement (TDD)**

Parameter	Test 1	Test 2	Test 3
$\gamma_1$	N/A	1.05	0.9
$\gamma_2$	1	N/A	N/A
UE Category	2-8	2-8	2-8

## 9.5.1.2\_2.4 Test description

Same test description as in clause 9.5.1.2.4 with the following exceptions:

- Instead of Table 9.5.1.2.3-1 → use Table 9.5.1.2\_2.3-1.

- Instead of Table 9.5.1.2.3-2 → use Table 9.5.1.2\_2.3-2.
- Instead of Table 9.5.1.2.5-1 → use Table 9.5.1.2\_2.5-1.

### 9.5.1.2\_2.5 Test requirement

Same test requirements as in clause 9.5.1.2.5 with the following exceptions:

- Instead of Table 9.5.1.2.5-1 → use Table 9.5.1.2\_2.5-1

**Table 9.5.1.2\_2.5-1: Test requirement (TDD)**

Parameter	Test 1	Test 2	Test 3
$\gamma_1$	N/A	1.04	0.89
$\gamma_2$	0.99	N/A	N/A
UE Category	2-8	2-8	2-8

## 9.5.2 RI Reporting (CSI Reference Symbols)

### 9.5.2.1

#### 9.5.2.1\_D FDD RI Reporting- PUCCH 1-1 for eDL-MIMO

##### 9.5.2.1\_D.1 Test purpose

To verify that the reported rank indicator accurately represents the channel rank.

##### 9.5.2.1\_D.2 Test applicability

This test applies to E-UTRA FDD UE release 10 and forward of Category 2-8 that support eDL-MIMO. Applicability requires support for FGI bit 103.

##### 9.5.2.1\_D.3 Minimum conformance requirements

The minimum performance requirement in Table 9.5.2.1\_D.3-2 is defined as

- a) The ratio of the throughput obtained when transmitting based on UE reported RI and that obtained when transmitting with fixed rank 1 shall be  $\geq \gamma_1$ ;
- b) The ratio of the throughput obtained when transmitting based on UE reported RI and that obtained when transmitting with fixed rank 2 shall be  $\geq \gamma_2$ ;

For the parameters specified in Table 9.5.2.1\_D.3-1, and using the downlink physical channels specified in Annex C.3.2, the minimum requirements are specified in Table 9.5.2.1\_D.3-2.

Table 9.5.2.1\_D.3-1: RI Test (FDD) for eDL-MIMO

Parameter	Unit	Test 1	Test 2	Test 3
Bandwidth	MHz		10	
PDSCH transmission mode			9	
Downlink power allocation	$\rho_A$	dB	0	
	$\rho_B$	dB	0	
	$P_C$	dB	0	
	$\sigma$	dB	0	
Propagation condition and antenna configuration		2 x 2 EPA5		
Cell-specific reference signals		Antenna ports 0		
CSI reference signals		Antenna ports 15, 16		
Beamforming model		As specified in Annex B.4.3		
CSI-RS periodicity and subframe offset $T_{\text{CSI-RS}} / \Delta_{\text{CSI-RS}}$		5/1		
CSI reference signal configuration		6		
CodeBookSubsetRestriction bitmap		000011 for fixed RI = 1 010000 for fixed RI = 2 010011 for UE reported RI		
Antenna correlation		Low	Low	High
RI configuration		Fixed RI=2 and follow RI	Fixed RI=1 and follow RI	Fixed RI=1 and follow RI
SNR	dB	0	20	20
$N_{oc}^{(j)}$	dB[mW/15kHz]	-98	-98	-98
$\hat{I}_{or}^{(j)}$	dB[mW/15kHz]	-98	-78	-78
Maximum number of HARQ transmissions		1		
Reporting mode		PUCCH 1-1		
Physical channel for CQI/PMI reporting		PUSCH (Note 3)		
PUCCH Report Type for CQI/PMI		2		
Physical channel for RI reporting		PUCCH Format 2		
PUCCH Report Type for RI		3		
Reporting periodicity	ms	$N_{pd} = 5$		
PMI and CQI delay	ms	8		
<i>cqi-pmi-ConfigurationIndex</i>		2		
<i>ri-ConfigurationInd</i>		1 (Note 4)		
Note 1:	If the UE reports in an available uplink reporting instance at subframe SF#n based on PMI and CQI estimation at a downlink subframe not later than SF#(n-4), this reported PMI and wideband CQI cannot be applied at the eNB downlink before SF#(n+4).			
Note 2:	Reference measurement channel RC.9 FDD according to Table A.4-1 with one sided dynamic OCNG Pattern OP.1 FDD as described in Annex A.5.1.1.			
Note 3:	To avoid collisions between CQI/PMI reports and HARQ-ACK it is necessary to report both on PUSCH instead of PUCCH. PDCCH DCI format 0 shall be transmitted in downlink SF#1 and #6 to allow periodic CQI/ PMI to multiplex with the HARQ-ACK on PUSCH in uplink SF#0 and #5.			
Note 4:	To avoid the ambiguity of TE behaviour when applying CQI and PMI during rank switching, RI reports are to be applied at the TE with one subframe delay in addition to Note 1 to align with CQI and PMI reports.			

Table 9.5.2.1\_D.3-2: Minimum requirement (FDD) for eDL-MIMO

Parameter	Test 1	Test 2	Test 3
$\gamma_1$	N/A	1.05	0.9
$\gamma_2$	1	N/A	N/A
UE Category	2-8	2-8	2-8

The normative reference for this requirement is TS 36.101 [2] clause 9.5.2.1.

#### 9.5.2.1\_D.4 Test description

##### 9.5.2.1\_D.4.1 Initial conditions

Initial conditions are a set of test configurations the UE needs to be tested in and the steps for the SS to take with the UE to reach the correct measurement state.

Configurations of PDSCH and PDCCH before measurement are specified in Annex C.2.

Test Environment: Normal as defined in TS 36.508 [7] clause 4.1.

Frequencies to be tested: Mid Range as defined in TS 36.508 [7] clause 4.3.1.1.

Channel Bandwidths to be tested: 10MHz, as defined in TS 36.508 [7] clause 4.3.1.1

1. Connect the SS, faders and AWGN noise source to the UE antenna connector (s) as shown in TS 36.508 [7] Annex A, Figure A.10.
2. The parameter settings for the cell are set up according to Table 9.5.2.1\_D.3-1.
3. Downlink signals are initially set up according to Annex C.1 and Annex C.3.2, and uplink signals according to Annex H.1 and H.3.2.
4. Propagation conditions are set according to Annex B.0.
5. Ensure the UE is in State 3A-RF according to TS 36.508 [7] clause 5.2A.2. Message contents are defined in clause 9.5.2.1\_D.4.3.

##### 9.5.2.1\_D.4.2 Test procedure

1. Set the parameters of bandwidth, reference channel, the propagation condition, antenna configuration, antenna correlation, CodeBookSubsetRestriction for fixed Rank and the SNR according to Table 9.5.2.1\_D.3-1 as appropriate.
2. The SS shall send PDSCH via PDCCH DCI format 2C for C\_RNTI to transmit the DL RMC according to the UE reported CQI, PMI and RI. In case of CQI reports for two codewords (codeword #0 and #1), the CQI offset level for codeword #1 is selected from {0,1,2,3,-4,-3,-2,-1}. The SS sends downlink MAC padding bits on the DL RMC. The SS sends uplink scheduling information via PDCCH DCI format 0 with CQI request bit set to 0 to schedule UL RMC in subframe #0 and #5 (Table A.4.1-1). Measure the  $t_{fix}$  according to annex G.5.3.
3. Propagation conditions are set according to Annex B.1.
4. The SS sends uplink scheduling information via PDCCH DCI format 0 to schedule UL RMC in every subframe (Table A.4.1-1).
5. The SS shall transmit an RRC Connection Reconfiguration message to set codebookSubsetRestriction as for UE reported RI according to Table 9.5.2.1\_D.3-1.
6. The UE shall transmit RRC Connection Reconfiguration Complete message.
7. Propagation conditions are set according to Table 9.5.2.1\_D.3-1.
8. The SS shall send PDSCH via PDCCH DCI format 2C for C\_RNTI to transmit the DL RMC according to the UE reported CQI, PMI and RI. In case of CQI reports for two codewords (codeword #0 and #1), the CQI offset level for codeword #1 is selected from {0,1,2,3,-4,-3,-2,-1}. The SS sends downlink MAC padding bits on the DL RMC. The SS sends uplink scheduling information via PDCCH DCI format 0 with CQI request bit set to 0 to schedule UL RMC in subframe #0 and #5 (Table A.4.1-1). Measure  $t_{reported}$  according to Annex G.5.3

If the ratio ( $t_{reported} / t_{fix}$ ) satisfies the requirement in Table 9.5.2.1\_D.5-1, then pass the UE for this test and go to step 9. Otherwise, fail the UE.



9. If all tests have not been done, then repeat the same procedure (steps 1 to 8) with test conditions according to the Table 9.5.2.1\_D.3-2 for the other Tests as appropriate. Otherwise pass the UE.

#### 9.5.2.1\_D.4.3 Message contents

Message contents are according to TS 36.508 [7] clause 4.6 with the following exceptions:

**Table 9.5.2.1\_D.4.3-1: PhysicalConfigDedicated-DEFAULT**

Derivation Path: 36.508 clause 4.6.3			
Information Element	Value/remark	Comment	Condition
PhysicalConfigDedicated-DEFAULT ::= SEQUENCE {			
antennaInfo	Not present		
antennaInfo-r10 CHOICE{			RBC
explicitValue-r10	AntennaInfoDedicated-r10		
}			
cqi-ReportConfig-r10	CQI-ReportConfig-r10-DEFAULT		RBC
csi-RS-Config-r10	CSI-RS-Config-r10		RBC
}			

**Table 9.5.2.1\_D.4.3-2: PDSCH-ConfigDedicated-DEFAULT**

Derivation Path: 36.508 clause 6.3.2			
Information Element	Value/remark	Comment	Condition
PDSCH-ConfigDedicated-DEFAULT ::= SEQUENCE {			
p-a	dB0		
}			

**Table 9.5.2.1\_D.4.3-3: AntennaInfoDedicated-r10**

Derivation Path: 36.331 clause 6.3.2			
Information Element	Value/remark	Comment	Condition
AntennaInfoDedicated-r10 ::= SEQUENCE {			
transmissionMode-r10	tm9-v1020		
codebookSubsetRestriction-r10	According to each test	000011 for fixed RI = 1 010000 for fixed RI = 2 010011 for UE reported RI	
ue-TransmitAntennaSelection CHOICE {			
release	NULL		
}			
}			

**Table 9.5.2.1\_D.4.3-4: CQI-ReportConfig-r10-DEFAULT**

Derivation Path: 36.508 clause 4.6.3			
Information Element	Value/remark	Comment	Condition
CQI-ReportConfig-r10 ::= SEQUENCE {			
cqi-ReportAperiodic-r10	Not Present		
nomPDSCH-RS-EPRE-Offset	0		
cqi-ReportPeriodic-r10	CQI-ReportPeriodic-r10-DEFAULT		
pmi-RI-Report-r9	setup		
}			

**Table 9.5.2.1\_D.4.3-5: CQI-ReportPeriodic-r10-DEFAULT**

Derivation Path: 36.508 clause 4.6.3			
Information Element	Value/remark	Comment	Condition
CQI-ReportPeriodic-r10 ::= CHOICE {			
setup SEQUENCE {			
cqi-PUCCH-ResourceIndex-r10	0		
cqi-PUCCH-ResourceIndexP1-r10	Not present		
cqi-pmi-ConfigIndex	2	(see Table 7.2.2-1A in TS 36.213)	
cqi-FormatIndicatorPeriodic-r10 CHOICE {			
widebandCQI-r10 SEQUENCE {			
csi-ReportMode-r10	Not present		
}			
ri-ConfigIndex	1	(see Table 7.2.2-1B in TS 36.213)	
simultaneousAckNackAndCQI	FALSE		
}			
}			

**Table 9.5.2.1\_D.4.3-6: CSI-RS-Config**

Derivation Path: 36.331 clause 6.3.2			
Information Element	Value/remark	Comment	Condition
CSI-RS-Config-r10 ::= SEQUENCE {			
csi-RS-r10 CHOICE{			
setup SEQUENCE {			
antennaPortsCount-r10	an2	Parameter represents the number of antenna ports used for transmission of CSI reference signals	
resourceConfig-r10	6	Parameter: CSI reference signal configuration	
subframeConfig-r10	1	$\Delta_{CSI-RS} = I_{CSI-RS}$ when CSI-RS SubframeConfig is from 0-4; Parameter: $I_{CSI-RS}$	
p-C-r10	0	Parameter: $P_c$ which is the assumed ratio of PDSCH EPRE to CSI-RS EPRE when UE derives CSI feedback	
}			
}			
zeroTxPowerCSI-RS-r10 CHOICE{			
release	NULL		
}			
}			

## 9.5.2.1\_D.5 Test requirement

**Table 9.5.2.1\_D.5-1: Test requirement (FDD) for eDL-MIMO**

Parameter	Test 1	Test 2	Test 3
$\gamma_1$	N/A	1.04	0.89
$\gamma_2$	0.99	N/A	N/A
UE Category	2-8	2-8	2-8

## 9.5.2.2\_D TDD RI Reporting- PUCCH 1-1 for eDL-MIMO

## 9.5.2.2\_D.1 Test purpose

To verify that the reported rank indicator accurately represents the channel rank.

## 9.5.2.2\_D.2 Test applicability

This test applies to E-UTRA TDD UE Release 10 and forward of Category 2-8 that support eDL-MIMO. Applicability requires support for FGI bit 103.

## 9.5.2.2\_D.3 Minimum conformance requirements

The minimum performance requirement in Table 9.5.2.2\_D.3-2 is defined as:

- a) The ratio of the throughput obtained when transmitting based on UE reported RI and that obtained when transmitting with fixed rank 1 shall be  $\geq \gamma_1$ ;
- b) The ratio of the throughput obtained when transmitting based on UE reported RI and that obtained when transmitting with fixed rank 2 shall be  $\geq \gamma_2$ ;

For the parameters specified in Table 9.5.2.2\_D.3-1, and using the downlink physical channels specified in Annex C.3.2, the minimum requirements are specified in Table 9.5.2.2\_D.3-2.

Table 9.5.2.2\_D.3-1: RI Test (TDD) for eDL-MIMO

Parameter		Unit	Test 1	Test 2	Test 3
Bandwidth		MHz		10	
PDSCH transmission mode				9	
Downlink power allocation	$\rho_A$	dB		0	
	$\rho_B$	dB		0	
	$P_c$	dB		0	
	$\sigma$	dB		0	
Uplink downlink configuration				1	
Special subframe configuration				4	
Propagation condition and antenna configuration				2 x 2 EPA5	
Cell-specific reference signals				Antenna ports 0	
CSI reference signals				Antenna ports 15, 16	
CSI reference signal configuration				4	
Beamforming model				As specified in Annex B.4.3	
CSI-RS periodicity and subframe offset $T_{\text{CSI-RS}} / \Delta_{\text{CSI-RS}}$				5/4	
CodeBookSubsetRestriction bitmap				000011 for fixed RI = 1 010000 for fixed RI = 2 010011 for UE reported RI	
Antenna correlation			Low	Low	High
RI configuration			Fixed RI=2 and follow RI	Fixed RI=1 and follow RI	Fixed RI=1 and follow RI
SNR		dB	0	20	20
$N_{oc}^{(j)}$		dB[mW/15kHz]	-98	-98	-98
$\hat{I}_{or}^{(j)}$		dB[mW/15kHz]	-98	-78	-78
Maximum number of HARQ transmissions			1		
Reporting mode			PUCCH 1-1		
Physical channel for CQI/ PMI reporting			PUSCH (Note 3)		
PUCCH report type for CQI/ PMI			2		
Physical channel for RI reporting			PUCCH Format 2		
Reporting periodicity		ms	$N_{pd} = 5$		
PMI and CQI delay		ms	10		
ACK/NACK feedback mode			Bundling		
<i>cqi-pmi-ConfigurationIndex</i>			4		
<i>ri-ConfigurationInd</i>			1		
<p>Note 1: If the UE reports in an available uplink reporting instance at subframe SF#n based on PMI and CQI estimation at a downlink subframe not later than SF#(n-4), this reported PMI and wideband CQI cannot be applied at the eNB downlink before SF#(n+4).</p> <p>Note 2: Reference measurement channel RC.9 TDD according to Table A.4-1 with one sided dynamic OCNG Pattern OP.1 TDD as described in Annex A.5.2.1.</p> <p>Note 3: To avoid collisions between CQI/PMI reports and HARQ-ACK it is necessary to report both on PUSCH instead of PUCCH. PDCCH DCI format 0 shall be transmitted in downlink SF#4 and #9 to allow periodic CQI/PMI to multiplex with the HARQ-ACK on PUSCH in uplink SF#3 and #8.</p>					

Table 9.5.2.2\_D.3-2: Minimum requirement (TDD) for eDL-MIMO

Parameter	Test 1	Test 2	Test 3
$\gamma_1$	N/A	1.05	0.9
$\gamma_2$	1	N/A	N/A
UE Category	2-8	2-8	2-8

The normative reference for this requirement is TS 36.101 [2] clause 9.5.2.2.

#### 9.5.2.2\_D.4 Test description

##### 9.5.2.2\_D.4.1 Initial conditions

Initial conditions are a set of test configurations the UE needs to be tested in and the steps for the SS to take with the UE to reach the correct measurement state.

Configurations of PDSCH and PDCCH before measurement are specified in Annex C.2.

Test Environment: Normal as defined in TS 36.508 [7] clause 4.1.

Frequencies to be tested: Mid Range as defined in TS 36.508 [7] clause 4.3.1.2.

Channel Bandwidths to be tested: 10MHz, as defined in TS 36.508 [7] clause 4.3.1.2.

1. Connect the SS, faders and AWGN noise source to the UE antenna connector (s) as shown in TS 36.508 [7] Annex A, Figure A.10.
2. The parameter settings for the cell are set up according to Table 9.5.2.2\_D.3-1.
3. Downlink signals are initially set up according to Annex C.1 and Annex C.3.2, and uplink signals according to Annex H.1 and H.3.2.
4. Propagation conditions are set according to Annex B.0.
5. Ensure the UE is in State 3A-RF according to TS 36.508 [7] clause 5.2A.2. Message contents are defined in clause 9.5.2.2\_D.4.3.

##### 9.5.1.2\_D.4.2 Test procedure

1. Set the parameters of bandwidth, reference channel, the propagation condition, antenna configuration, antenna correlation, CodeBookSubsetRestriction for fixed Rank and the SNR according to Table 9.5.2.2\_D.3-1 as appropriate.
2. The SS shall send PDSCH via PDCCH DCI format 2C for C\_RNTI to transmit the DL RMC according to the UE reported CQI (wideband CQI), PMI and RI. The SS sends downlink MAC padding bits on the DL RMC. The SS sends uplink scheduling information via PDCCH DCI format 0 with CQI request bit set to 0 to schedule UL RMC in subframe #3 and #8 (Table A.4.1-2). Measure the  $t_{fix}$  according to annex G.5.3
3. Propagation conditions are set according to Annex B.1.
4. The SS sends uplink scheduling information via PDCCH DCI format 0 with CQI request bit to 0 to schedule UL RMC in subframe#3 and #8 (Table A.4.1-2).
5. The SS shall transmit an RRC Connection Reconfiguration message to set codebookSubsetRestriction as for UE reported RI according to Table 9.5.2.2\_D.3-1.
6. The UE shall transmit RRC Connection Reconfiguration Complete message.
7. Propagation conditions are set according to Table 9.5.2.2\_D.3-1.
8. The SS shall send PDSCH via PDCCH DCI format 2C for C\_RNTI to transmit the DL RMC according to the UE reported CQI (wideband CQI), PMI and RI. The SS sends downlink MAC padding bits on the DL RMC. The SS sends uplink scheduling information via PDCCH DCI format 0 with CQI request bit set to 0 to schedule UL RMC in subframe #3 and subframe #8 (Table A.4.1-2). Measure  $t_{reported}$  according to Annex G.5.3  
If the ratio ( $t_{reported} / t_{fix}$ ) satisfies the requirement in Table 9.5.2.2\_D.5-1, then pass the UE for this test and go to step 9. Otherwise, fail the UE.
9. If all tests have not been done, then repeat the same procedure (steps 1 to 8) with test conditions according to the Table 9.5.2.2\_D.3-2 for the other Tests as appropriate. Otherwise pass the UE.

## 9.5.2.2\_D.4.3 Message contents

Message contents are according to TS 36.508 [7] clause 4.6 with the following exceptions:

**Table 9.5.2.2\_D.4.3-1: PhysicalConfigDedicated-DEFAULT**

Derivation Path: 36.508 clause 4.6.3			
Information Element	Value/remark	Comment	Condition
PhysicalConfigDedicated-DEFAULT ::= SEQUENCE {			
antennaInfo	Not present		
antennaInfo-r10 CHOICE {			RBC
explicitValue-r10	AntennaInfoDedicated-r10		
}			
cqi-ReportConfig-r10	CQI-ReportConfig-r10-DEFAULT		RBC
csi-RS-Config-r10	CSI-RS-Config-r10		RBC
}			

**Table 9.5.2.2\_D.4.3-2: PDSCH-ConfigDedicated-DEFAULT**

Derivation Path: 36.508 clause 6.3.2			
Information Element	Value/remark	Comment	Condition
PDSCH-ConfigDedicated-DEFAULT ::= SEQUENCE {			
p-a	dB0		
}			

**Table 9.5.2.2\_D.4.3-3: AntennaInfoDedicated-r10**

Derivation Path: 36.331 clause 6.3.2			
Information Element	Value/remark	Comment	Condition
AntennaInfoDedicated-r10 ::= SEQUENCE {			
transmissionMode-r10	tm9-v1020		
codebookSubsetRestriction-r10	According to each test	000011 for fixed RI = 1 010000 for fixed RI = 2 010011 for UE reported RI	
ue-TransmitAntennaSelection CHOICE {			
release	NULL		
}			
}			

**Table 9.5.2.2\_D.4.3-4: CQI-ReportConfig-r10-DEFAULT**

Derivation Path: 36.508 clause 4.6.3			
Information Element	Value/remark	Comment	Condition
CQI-ReportConfig-r10 ::= SEQUENCE {			
cqi-ReportAperiodic-r10	Not Present		
nomPDSCH-RS-EPRE-Offset	0		
cqi-ReportPeriodic-r10	CQI-ReportPeriodic-r10-DEFAULT		
pmi-RI-Report-r9	setup		
}			

Table 9.5.2.2\_D.4.3-5: CQI-ReportPeriodic-r10-DEFAULT

Derivation Path: 36.508 clause 4.6.3			
Information Element	Value/remark	Comment	Condition
CQI-ReportPeriodic-r10 ::= CHOICE {			
setup SEQUENCE {			
cqi-PUCCH-ResourceIndex-r10	0		
cqi-PUCCH-ResourceIndexP1-r10	Not present		
cqi-pmi-ConfigIndex	4	(see Table 7.2.2-1A in TS 36.213)	
cqi-FormatIndicatorPeriodic-r10 CHOICE {			
widebandCQI-r10 SEQUENCE {			
csi-ReportMode-r10	Not present		
}			
ri-ConfigIndex	1	(see Table 7.2.2-1B in TS 36.213)	
simultaneousAckNackAndCQI	FALSE		
}			
}			

Table 9.5.2.2\_D.4.3-6: PUCCH-ConfigDedicated-DEFAULT

Derivation Path: 36.331 clause 6.3.2			
Information Element	Value/remark	Comment	Condition
PUCCH-ConfigDedicated-DEFAULT ::= SEQUENCE {			
ackNackRepetition CHOICE {			
release	NULL		
}			
tddAckNackFeedbackMode	Bundling	Multiplexing is selected as default to align with RAN4's assumptions in RF tests.	TDD
}			

Table 9.5.2.2\_D.4.3-7: TDD-Config-DEFAULT

Derivation Path: 36.508 clause 4.6.3			
Information Element	Value/remark	Comment	Condition
TDD-Config-DEFAULT ::= SEQUENCE {			
subframeAssignment	sa1		
specialSubframePatterns	ssp4		
}			

Table 9.5.2.2\_D.4.3-8: CSI-RS-Config

Derivation Path: 36.331 clause 6.3.2			
Information Element	Value/remark	Comment	Condition
CSI-RS-Config-r10 ::= SEQUENCE {			
csi-RS-r10 CHOICE{			
setup SEQUENCE {			
antennaPortsCount-r10	an2	Parameter represents the number of antenna ports used for transmission of CSI reference signals	
resourceConfig-r10	4	Parameter: CSI reference signal configuration	
subframeConfig-r10	4	$\Delta_{\text{CSI-RS}} = I_{\text{CSI-RS}}$ when CSI-RS SubframeConfig is from 0-4; Parameter: $I_{\text{CSI-RS}}$	
p-C-r10	0	Parameter: $P_c$ which is the assumed ratio of PDSCH EPRE to CSI-RS EPRE when UE derives CSI feedback	
}			
}			
zeroTxPowerCSI-RS-r10 CHOICE{			
release	NULL		
}			
}			

## 9.5.2.2\_D.5 Test requirement

Table 9.5.2.2\_D.5-1: Test requirement (TDD) for eDL-MIMO

Parameter	Test 1	Test 2	Test 3
$\gamma_1$	N/A	1.04	0.89
$\gamma_2$	0.99	N/A	N/A
UE Category	2-8	2-8	2-8

## 9.5.3 RI Reporting (two CSI subframe sets are configured)

## 9.5.3.1\_C FDD RI Reporting – PUCCH 1-0 for eICIC

## 9.5.3.1\_C.1 FDD RI Reporting – PUCCH 1-0 for eICIC (non-MBSFN ABS)

## 9.5.3.1\_C.1.1 Test purpose

To verify that the reported rank indicator accurately represents the channel rank under time domain resource restriction i.e. in case two CSI subframe sets are configured.

## 9.5.3.1\_C.1.2 Test applicability

This test applies to all types of E-UTRA FDD UE - Category 2-8 - release 10 and forward. Applicability requires support for FGI bit 115.



### 9.5.3.1\_C.1.3 Minimum conformance requirements

The minimum performance requirement in Table 9.5.3.1\_C.1.3-2 is defined as

- a) The ratio of the throughput obtained when transmitting based on UE reported RI and that obtained when transmitting with fixed rank 1 shall be  $\geq \gamma_1$

For the parameters specified in Table 9.5.3.1\_C.1.3-1, and using the downlink physical channels specified in Annex C.3.2, the minimum requirements are specified in Table 9.5.3.1\_C.1.3-2.

Table 9.5.3.1\_C.1.3-1: RI Test (FDD)

Parameter	Unit	Test 1		Test 2		
		Cell 1	Cell 2	Cell 1	Cell 2	
Bandwidth	MHz	10		10		
PDSCH transmission mode		3	Note 10	3	Note 10	
Downlink power allocation	$\rho_A$	-3		-3		
	$\rho_B$	-3		-3		
	$\sigma$	0		0		
Propagation condition and antenna configuration		2 x 2 EPA5		2 x 2 EPA5		
CodeBookSubsetRestriction bitmap		01 for fixed RI = 1 10 for fixed RI = 2 11 for UE reported RI	N/A	01 for fixed RI = 1 10 for fixed RI = 2 11 for UE reported RI	N/A	
Antenna correlation		Low		Low		
RI configuration		Fixed RI=1 and follow RI	N/A	Fixed RI=1 and follow RI	N/A	
$\hat{E}_s / N_{oc2}$	dB	0	-12	20	6	
$N_{oc}^{(j)}$	$N_{oc1}^{(j)}$	dBmW/15kHz z	-98 (Note 3)	N/A	-102 (Note 3)	N/A
	$N_{oc2}^{(j)}$		-98 (Note 4)	N/A	-98 (Note 4)	N/A
	$N_{oc3}^{(j)}$		-98 (Note 5)	N/A	-94.8 (Note 5)	N/A
$\hat{I}_{or}^{(j)}$	dB[mW/15k Hz]	-98	-110	-78	-92	
Subframe Configuration		Non-MBSFN	Non-MBSFN	Non-MBSFN	Non-MBSFN	
Cell Id		0	1	0	1	
Time Offset between Cells	$\mu$ s	2.5 (synchronous cells)		2.5 (synchronous cells)		
ABS Pattern (Note 6)		N/A	10000000 10000000 10000000 10000000 10000000	N/A	10000000 10000000 10000000 10000000 10000000	
RLM/RRM Measurement Subframe Pattern (Note 7)			10000000 10000000 10000000 10000000 10000000	N/A	10000000 10000000 10000000 10000000 10000000	
CSI Subframe Sets (Note 8)	$C_{CSI,0}$		10000000 10000000 10000000 10000000 10000000	N/A	10000000 10000000 10000000 10000000 10000000	
	$C_{CSI,1}$		01111111 01111111 01111111 01111111 01111111		01111111 01111111 01111111 01111111 01111111	
Number of control OFDM Symbols		3	3	3	3	
Maximum number of HARQ transmissions		1		1		
Reporting mode		PUCCH 1-0		PUCCH 1-0		
Physical channel for CQI reporting		PUCCH Format 2		PUCCH Format 2		
PUCCH Report Type for CQI		4		4		

Physical channel for RI reporting		PUCCH Format 2		PUCCH Format 2	
PUCCH Report Type for RI		3		3	
Reporting periodicity	ms	$N_{pd}=10$		$N_{pd}=10$	
<i>cqi-pmi-ConfigurationIndex</i>		11		11	
<i>ri-ConfigurationInd</i>		5		5	
<i>cqi-pmi-ConfigurationIndex2</i>		10		10	
<i>ri-ConfigurationInd2</i>		2		2	
Cyclic prefix		Normal	Normal	Normal	Normal
Note 1:	If the UE reports in an available uplink reporting instance at subframe SF#n based on CQI estimation at a downlink subframe not later than SF#(n-4), this reported wideband CQI cannot be applied at the eNB downlink before SF#(n+4).				
Note 2:	Reference measurement channel in Cell 1 RC.2 FDD according to Table A.4-1 with one sided dynamic OCNG Pattern OP.1 FDD as described in Annex A.5.1.1.				
Note 3:	This noise is applied in OFDM symbols #1, #2, #3, #5, #6, #8, #9, #10,#12, #13 of a subframe overlapping with the aggressor ABS.				
Note 4:	This noise is applied in OFDM symbols #0, #4, #7, #11 of a subframe overlapping with the aggressor ABS.				
Note 5:	This noise is applied in all OFDM symbols of a subframe overlapping with aggressor non-ABS.				
Note 6:	ABS pattern as defined in TS 36.423 [14]. PDSCH other than SIB1/paging and its associated PDCCH/PCFICH are transmitted in the serving cell subframe when the subframe is overlapped with the ABS subframe of aggressor cell and the subframe is available in the definition of the reference channel.				
Note 7:	Time-domain measurement resource restriction pattern for PCell measurements as defined in TS 36.331 [5].				
Note 8:	As configured according to the time-domain measurement resource restriction pattern for CSI measurements defined in TS 36.331 [5].				
Note 9:	Cell 1 is the serving cell. Cell 2 is the aggressor cell. The number of the CRS ports in Cell 1 and Cell 2 is the same.				
Note 10:	Downlink physical channel setup in Cell 2 in accordance with Annex C.3.3 applying OCNG pattern OP.5 FDD as defined in Annex A.5.1.5.				

**Table 9.5.3.1\_C.1.3-2: Minimum requirement (FDD)**

	Test 1	Test 2
$\gamma$	0.9	1.05
UE Category	2-8	2-8

The normative reference for this requirement is TS 36.101 [2] clause 9.5.3.1.

#### 9.5.3.1\_C.1.4 Test description

##### 9.5.3.1\_C.1.4.1 Initial conditions

Initial conditions are a set of test configurations the UE needs to be tested in and the steps for the SS to take with the UE to reach the correct measurement state.

Configurations of PDSCH and PDCCH before measurement are specified in Annex C.2.

Test Environment: Normal as defined in TS 36.508 [7] clause 4.1.

Frequencies to be tested: Mid Range as defined in TS 36.508 [7] clause 4.3.1.1.

Channel Bandwidths to be tested: 10MHz, as defined in TS 36.508 [7] clause 4.3.1.1

1. Connect the SS, faders and AWGN noise source to the UE antenna connector (s) as shown in TS 36.508 [7] Annex A, FigureA.40.
2. The parameter settings for the cell are set up according to Table 9.5.3.1\_C.1.3-1.
3. Downlink signals are initially set up according to Annex C0, C.1 and Annex C.3.2, and uplink signals according to Annex H.1 and H.3.2.
4. Propagation conditions are set according to Annex B.0.

5. Ensure the UE is in State 3A-RF (in Cell 1) according to TS 36.508 [7] clause 5.2A.2. Message contents are defined in clause 9.5.3.1\_C.1.4.3.

#### 9.5.3.1\_C.1.4.2 Test procedure

1. Set the parameters of bandwidth, reference channel, propagation condition, antenna configuration, antenna correlation, CodeBookSubsetRestriction for fixed Rank and the SNR according to Table 9.5.3.1\_C.1.3-1 and C.3.3-1 of Annex C.3.3 as appropriate.
2. The SS shall send PDSCH via PDCCH DCI format 2A for C\_RNTI to transmit the DL RMC according to the UE reported CQI and RI. In case of CQI reports for two codewords (codeword #0 and #1), the CQI offset level for codeword #1 is selected from {0,1,2,3,-4,-3,-2,-1}. The SS sends downlink MAC padding bits on the DL RMC.
3. Measure the  $t_{fix}$  according to annex G.5.3.
4. Propagation conditions are set according to Annex B.1.
5. The SS sends uplink scheduling information via PDCCH DCI format 0 to schedule UL RMC in every subframe (Table A.4.1-1).
6. The SS shall transmit an RRC Connection Reconfiguration message to set codebookSubsetRestriction as for UE reported RI according to Table 9.5.3.1\_C.1.3-1.
7. The UE shall transmit RRC Connection Reconfiguration Complete message.
8. Propagation conditions are set according to Table 9.5.3.1\_C.1.3-1.
9. The SS shall send PDSCH via PDCCH DCI format 2A for C\_RNTI to transmit the DL RMC according to the UE reported CQI and RI. In case of CQI reports for two codewords (codeword #0 and #1), the CQI offset level for codeword #1 is selected from {0,1,2,3,-4,-3,-2,-1}. The SS sends downlink MAC padding bits on the DL RMC.
10. Measure  $t_{reported}$  according to Annex G.5.3  
If the ratio ( $t_{reported} / t_{fix}$ ) satisfies the requirement in Table 9.5.3.1\_C.1.5-1, then pass the UE for this test and go to step 11. Otherwise, fail the UE.
11. If all tests have not been done, then repeat the same procedure (steps 1 to 10) with test conditions according to the Table 9.5.3.1\_C.1.3-1 for the other Tests as appropriate. Otherwise pass the UE.

#### 9.5.3.1\_C.1.4.3 Message contents

Message contents are according to TS 36.508 [7] clause 4.6 with the following exceptions:

Table 9.5.3.1\_C.1.4.3-1: *PhysicalConfigDedicated-DEFAULT*

Derivation Path: 36.508 clause 5.5.1.2 Table 5.5.1.2-1			
Information Element	Value/remark	Comment	Condition
PhysicalConfigDedicated-DEFAULT ::= SEQUENCE {			
antennaInfo CHOICE {			
antennaInfoDedicated ::= SEQUENCE {			
transmissionMode	tm3		
codebookSubsetRestriction CHOICE {			
n2TxAntenna-tm3	According to each test		
}			
ue-TransmitAntennaSelection CHOICE {	Release		
release	NULL		
}			
}			
cqi-ReportConfig	<i>Not present</i>		
cqi-ReportConfig-r10	<i>CQI-ReportConfig-r10-DEFAULT</i>		
}			

Table 9.5.3.1\_C.1.4.3-2: *RadioResourceConfigDedicated-SRB2-DRB(n, m)*

Derivation Path: TS 36.508 [7] clause 4.6.3, Table 4.6.3-16 RadioResourceConfigDedicated-SRB2-DRB(n,m)			
Information Element	Value/remark	Comment	Condition
RadioResourceConfigDedicated-SRB2-DRB(n, m) ::= SEQUENCE {			
MeasSubframePatternPCell-r10 CHOICE {			
setup SEQUENCE {			
subframePatternFDD-r10	'10000000100000001000 00001000000010000000'	BIT STRING (SIZE (40))	
}			
}			
}			

**Table 9.5.3.1\_C.1.4.3-3: CQI-ReportConfig-r10-DEFAULT**

Derivation Path: 36.508 [7] clause 4.6.3, Table 4.6.3-2AA CQI-ReportConfig-r10-DEFAULT_			
Information Element	Value/remark	Comment	Condition
CQI-ReportConfig-r10-DEFAULT ::= SEQUENCE {			
cqi-ReportAperiodic-r10	Not present		
nomPDSCH-RS-EPRE-Offset	0		
cqi-ReportPeriodic-r10 CHOICE{			
setup SEQUENCE{			
cqi-PUCCH-ResourceIndex-r10	0		
cqi-PUCCH-ResourceIndexP1-r10	Not present		
cqi-pmi-ConfigIndex	11		
cqi-FormatIndicatorPeriodic-r10 CHOICE {			
widebandCQI-r10 SEQUENCE {			
csi-ReportMode-r10	Not present		
}			
ri-ConfigIndex	5		
simultaneousAckNackAndCQI	FALSE		
cqi-Mask-r9	Not present		
csi-ConfigIndex-r10 CHOICE{			
setup SEQUENCE{			
cqi-pmi-ConfigIndex2-r10	10		
ri-Configindex2-r10	2		
}			
}			
}			
}			
pmi-RI-Report-r9	Not present		
csi-SubframePatternConfig-r10 CHOICE {			
setup SEQUENCE {			
csi-MeasSubframeSet1-r10 CHOICE {			
subframePatternFDD-r10	'10000000100000001000 00001000000010000000'	BIT STRING (SIZE (40))	
}			
csi-MeasSubframeSet2-r10 CHOICE {			
subframePatternFDD-r10	'01111111011111110111 11110111111101111111'	BIT STRING (SIZE (40))	
}			
}			
}			
}			

9.5.3.1\_C.1.5 Test requirement

**Table 9.5.3.1\_C.1.5-1: Minimum requirement (FDD)**

	Test 1	Test 2
$\gamma$	0.89	1.04
UE Category	2-8	2-8

9.5.3.2\_C TDD RI Reporting – PUCCH 1-0 for eICIC

9.5.3.2\_C.1 TDD RI Reporting – PUCCH 1-0 for eICIC (non-MBSFN ABS)

9.5.3.2\_C.1.1 Test purpose

To verify that the reported rank indicator accurately represents the channel rank under time domain resource restriction i.e. in case two CSI subframe sets are configured.

### 9.5.3.2\_C.1.2 Test applicability

This test applies to all types of E-UTRA TDD UE - Category 2-8 -release 10 and forward. Applicability requires support for FGI bit 115.

### 9.5.3.2\_C.1.3 Minimum conformance requirements

The minimum performance requirement in Table 9.5.3.2\_C.1.3-2 is defined as:

- a) The ratio of the throughput obtained when transmitting based on UE reported RI and that obtained when transmitting with fixed rank 1 shall be  $\geq \gamma_1$ .

For the parameters specified in Table 9.5.3.2\_C.1.3-1, and using the downlink physical channels specified in Annex C.3.2, the minimum requirements are specified in Table 9.5.3.2\_C.1.3-2.

Table 9.5.3.2\_C.1.3-1: RI Test (TDD)

Parameter		Unit	Test1		Test2	
			Cell 1	Cell 2	Cell 1	Cell 2
Bandwidth		MHz	10		10	
PDSCH transmission mode			3	Note 11	3	Note 11
Uplink downlink configuration			1		1	
Special subframe configuration			4		4	
Downlink power allocation	$\rho_A$	dB	-3		-3	
	$\rho_B$	dB	-3		-3	
	$\sigma$	dB	0		0	
Propagation condition and antenna configuration			2 x 2 EPA5		2 x 2 EPA5	
CodeBookSubsetRestriction bitmap			01 for fixed RI = 1 10 for fixed RI = 2 11 for UE reported RI	N/A	01 for fixed RI = 1 10 for fixed RI = 2 11 for UE reported RI	N/A
Antenna correlation			Low		Low	
RI configuration			Fixed RI=1 and follow RI	N/A	Fixed RI=1 and follow RI	N/A
$\widehat{E}_s / N_{oc2}$		dB	0	-12	20	6
$N_{oc}^{(j)}$	$N_{oc1}^{(j)}$	dB[mW/15k Hz]	-98 (Note 4)	N/A	-102 (Note 4)	N/A
	$N_{oc2}^{(j)}$		-98 (Note 5)	N/A	-98 (Note 5)	N/A
	$N_{oc3}^{(j)}$		-98 (Note 6)	N/A	-94.8 (Note 6)	N/A
$\widehat{I}_{or}^{(j)}$		dB[mW/15k Hz]	-98	-110	-78	-92
Subframe Configuration			Non-MBSFN	Non-MBSFN	Non-MBSFN	Non-MBSFN
Cell Id			0	1	0	1
Time Offset between Cells		$\mu$ s	2.5 (synchronous cells)		2.5 (synchronous cells)	
ABS Pattern (Note 7)			N/A	0000000 001 0000000 001	N/A	000000001 000000001
RLM/RRM Measurement Subframe Pattern (Note 8)			00000000 01 00000000 01	N/A	000000001 000000001	N/A
CSI Subframe Sets (Note 9)	$C_{CSI,0}$		00000000 01 00000000 01	N/A	000000001 000000001	N/A
	$C_{CSI,1}$		11001110 00 11001110 00		1100111000 1100111000	
Number of control OFDM Symbols			3	3	3	3
Maximum number of HARQ transmissions			1		1	
Reporting mode			PUCCH 1-0		PUCCH 1-0	
Physical channel for $C_{CSI,0}$ CQI and RI reporting			PUCCH Format 2		PUCCH Format 2	
PUCCH Report Type for CQI			4		4	



Physical channel for C <sub>CSI,1</sub> CQI and RI reporting		PUSCH (Note 3)		PUSCH (Note 3)	
PUCCH Report Type for RI		3		3	
Reporting periodicity	ms	$N_{pd}=10$		$N_{pd}=10$	
ACK/NACK feedback mode		Multiplexing		Multiplexing	
<i>cqi-pmi-ConfigurationIndex</i>		8		8	
<i>ri-ConfigurationInd</i>		5		5	
<i>cqi-pmi-ConfigurationIndex2</i>		9		9	
<i>ri-ConfigurationInd2</i>		0		0	
Cyclic prefix		Normal	Normal	Normal	Normal
Note 1:	If the UE reports in an available uplink reporting instance at subframe SF#n based on CQI estimation at a downlink subframe not later than SF#(n-4), this reported wideband CQI cannot be applied at the eNB downlink before SF#(n+4).				
Note 2:	Reference measurement channel in Cell 1 RC.2 TDD according to Table A.4-1 with one sided dynamic OCNG Pattern OP.1 TDD as described in Annex A.5.2.1.				
Note 3:	To avoid collisions between RI/CQI reports and HARQ-ACK it is necessary to report them on PUSCH instead of PUCCH. PDCCH DCI format 0 shall be transmitted in downlink SF#9 to allow periodic RI/CQI to multiplex with the HARQ-ACK on PUSCH in uplink subframe #3.				
Note 4:	This noise is applied in OFDM symbols #1, #2, #3, #5, #6, #8, #9, #10, #12, #13 of a subframe overlapping with the aggressor ABS				
Note 5:	This noise is applied in OFDM symbols #0, #4, #7, #11 of a subframe overlapping with the aggressor ABS.				
Note 6:	This noise is applied in all OFDM symbols of a subframe overlapping with aggressor non-ABS.				
Note 7:	ABS pattern as defined in TS 36.423 [14]. PDSCH other than SIB1/paging and its associated PDCCH/PCFICH are transmitted in the serving cell subframe when the subframe is overlapped with the ABS subframe of aggressor cell and the subframe is available in the definition of the reference channel.				
Note 8:	Time-domain measurement resource restriction pattern for PCell measurements as defined in TS 36.331 [5].				
Note 9:	As configured according to the time-domain measurement resource restriction pattern for CSI measurements defined in TS 36.331 [5].				
Note 10:	Cell 1 is the serving cell. Cell 2 is the aggressor cell. The number of the CRS ports in Cell 1 and Cell 2 is the same.				
Note 11:	Downlink physical channel setup in Cell 2 in accordance with Annex C.3.3 applying OCNG pattern OP.5 TDD as defined in Annex A.5.2.5.				

**Table 9.5.3.2\_C.1.3-2: Minimum requirement (TDD)**

	Test 1	Test 2
$\gamma$	0.9	1.05
UE Category	2-8	2-8

The normative reference for this requirement is TS 36.101 [2] clause 9.5.3.2.

#### 9.5.3.2\_C.1.4 Test description

##### 9.5.3.2\_C.1.4.1 Initial conditions

Initial conditions are a set of test configurations the UE needs to be tested in and the steps for the SS to take with the UE to reach the correct measurement state.

Configurations of PDSCH and PDCCH before measurement are specified in Annex C.2.

Test Environment: Normal as defined in TS 36.508 [7] clause 4.1.

Frequencies to be tested: Mid Range as defined in TS 36.508 [7] clause 4.3.1.1.

Channel Bandwidths to be tested: 10MHz, as defined in TS 36.508 [7] clause 4.3.1.1

1. Connect the SS, faders and AWGN noise source to the UE antenna connector (s) as shown in TS 36.508 [7] Annex A, Figure A.40.
2. The parameter settings for the cell are set up according to Table 9.5.3.2\_C.1.3-1.

3. Downlink signals are initially set up according to Annex C0, C.1 and Annex C.3.2, and uplink signals according to Annex H.1 and H.3.2.
4. Propagation conditions are set according to Annex B.0.
5. Ensure the UE is in State 3A-RF according to TS 36.508 [7] clause 5.2A.2. Message contents are defined in clause 9.5.3.2\_C.1.4.3.

#### 9.5.3.2\_C.1.4.2 Test procedure

1. Set the parameters of bandwidth, reference channel, propagation condition, antenna configuration, antenna correlation, CodeBookSubsetRestriction for fixed Rank and the SNR according to Table 9.5.3.2\_C.1.3-1 and C.3.3-1 of Annex C.3.3 as appropriate.
2. The SS shall send PDSCH in via PDCCH DCI format 2A for C\_RNTI to transmit the DL RMC according to the UE reported CQI and RI. In case of CQI reports for two codewords (codeword #0 and #1), the CQI offset level for codeword #1 is selected from {0,1,2,3,-4,-3,-2,-1}. The SS sends downlink MAC padding bits on the DL RMC.  
The SS sends uplink scheduling information via PDCCH DCI format 0 in subframe #9 with CQI request bit set to 0 to schedule UL RMC in subframe #3 (Table A.4.1-2).
3. Measure the  $t_{fix}$  according to annex G.5.3.
4. Propagation conditions are set according to Annex B.1.
5. The SS sends uplink scheduling information via PDCCH DCI format 0 to schedule UL RMC in subframe #3 and #8 (Table A.4.1-2).
6. The SS shall transmit an RRC Connection Reconfiguration message to set codebookSubsetRestriction as for UE reported RI according to Table 9.5.3.2\_C.1.3-1.
7. The UE shall transmit RRC Connection Reconfiguration Complete message.
8. Propagation conditions are set according to Table 9.5.3.2\_C.1.3-1.
9. The SS shall send PDSCH via PDCCH DCI format 2A for C\_RNTI to transmit the DL RMC according to the UE reported CQI and RI. In case of CQI reports for two codewords (codeword #0 and #1), the CQI offset level for codeword #1 is selected from {0,1,2,3,-4,-3,-2,-1}. The SS sends downlink MAC padding bits on the DL RMC.  
The SS sends uplink scheduling information via PDCCH DCI format 0 in subframe #9 with CQI request bit set to 0 to schedule UL RMC in subframe #3 (Table A.4.1-2).
10. Measure  $t_{reported}$  according to Annex G.5.3  
If the ratio ( $t_{reported} / t_{fix}$ ) satisfies the requirement in Table 9.5.3.2\_C.1.5-1, then pass the UE for this test and go to step 11. Otherwise, fail the UE.
11. If all tests have not been done, then repeat the same procedure (steps 1 to 10) with test conditions according to the Table 9.5.3.2\_C.1.3-1 for the other Tests as appropriate. Otherwise pass the UE.

#### 9.5.3.2\_C.1.4.3 Message contents

Message contents are according to TS 36.508 [7] clause 4.6 with the following exceptions:

Table 9.5.3.2\_C.1.4.3-1: *PhysicalConfigDedicated-DEFAULT*

Derivation Path: 36.508 clause 5.5.1.2 Table 5.5.1.2-1			
Information Element	Value/remark	Comment	Condition
PhysicalConfigDedicated-DEFAULT ::= SEQUENCE {			
antennaInfo CHOICE {			
antennaInfoDedicated ::= SEQUENCE {			
transmissionMode	tm3		
codebookSubsetRestriction CHOICE {			
n2TxAntenna-tm3	According to each test		
}			
ue-TransmitAntennaSelection CHOICE {	Release		
release	NULL		
}			
}			
cqi-ReportConfig	<i>Not present</i>		
cqi-ReportConfig-r10	<i>CQI-ReportConfig-r10-DEFAULT</i>		
}			

Table 9.5.3.2\_C.1.4.3-2: *RadioResourceConfigDedicated-SRB2-DRB(n, m)*

Derivation Path: TS 36.508 [7] clause 4.6.3, Table 4.6.3-16 RadioResourceConfigDedicated-SRB2-DRB(n,m)			
Information Element	Value/remark	Comment	Condition
RadioResourceConfigDedicated-SRB2-DRB(n, m) ::= SEQUENCE {			
MeasSubframePatternPCell-r10 CHOICE {			
setup SEQUENCE {			
subframePatternTDD-r10 CHOICE{			
subframeConfig1-5-r10	'00000000010000000001'	BIT STRING (SIZE (20))	
}			
}			
}			
}			

**Table 9.5.3.2\_C.1.4.3-3: CQI-ReportConfig-r10-DEFAULT**

Derivation Path: 36.508 [7] clause 4.6.3, Table 4.6.3-2AA CQI-ReportConfig-r10-DEFAULT_			
Information Element	Value/remark	Comment	Condition
CQI-ReportConfig-r10-DEFAULT ::= SEQUENCE {			
cqi-ReportAperiodic-r10	Not present		
nomPDSCH-RS-EPRE-Offset	0		
cqi-ReportPeriodic-r10 CHOICE{			
setup SEQUENCE{			
cqi-PUCCH-ResourceIndex-r10	0		
cqi-PUCCH-ResourceIndexP1-r10	Not present		
cqi-pmi-ConfigIndex	8		
cqi-FormatIndicatorPeriodic-r10 CHOICE {			
widebandCQI-r10 SEQUENCE {			
csi-ReportMode-r10	Not present		
}			
ri-ConfigIndex	5		
simultaneousAckNackAndCQI	FALSE		
cqi-Mask-r9	Not present		
csi-ConfigIndex-r10 CHOICE{			
setup SEQUENCE{			
cqi-pmi-ConfigIndex2-r10	9		
ri-Configindex2-r10	0		
}			
}			
}			
}			
pmi-RI-Report-r9	Not present		
csi-SubframePatternConfig-r10 CHOICE {			
setup SEQUENCE {			
csi-MeasSubframeSet1-r10 CHOICE {			
subframePatternTDD-r10 CHOICE {			
subframeConfig1-5-r10	'00000000010000000001'	BIT STRING (SIZE (20))	
}			
}			
csi-MeasSubframeSet2-r10 CHOICE {			
subframePatternTDD-r10 CHOICE {			
subframeConfig1-5-r10	'11001110001100111000'	BIT STRING (SIZE (20))	
}			
}			
}			
}			
}			

**Table 9.5.3.2\_C.1.4.3-4: TDD-Config-DEFAULT**

Derivation Path: 36.508 clause 4.6.3			
Information Element	Value/remark	Comment	Condition
TDD-Config-DEFAULT ::= SEQUENCE {			
subframeAssignment	sa1		
specialSubframePatterns	ssp4		
}			

9.5.3.2\_C.1.5 Test requirement

**Table 9.5.3.2\_C.1.5-1: Minimum requirement (TDD)**

	Test 1	Test 2
$\eta$	0.89	1.04
UE Category	2-8	2-8

## 9.5.4 RI Reporting (two CSI subframe sets and CRS assistance information are configured)

### 9.5.4.1\_E FDD RI Reporting – PUCCH 1-0 for feICIC

#### 9.5.4.1\_E.1 FDD RI Reporting – PUCCH 1-0 for feICIC (non-MBSFN ABS)

##### 9.5.4.1\_E.1.1 Test purpose

To verify that the reported rank indicator accurately represents the channel rank under time domain resource restriction i.e. in case two CSI subframe sets are configured.

##### 9.5.4.1\_E.1.2 Test applicability

This test applies to all types of E-UTRA FDD UE and CRS interference handling – UE Category 2-8 release 11 and forward. Applicability requires support of FGI bit 115.

##### 9.5.4.1\_E.1.3 Minimum conformance requirements

The minimum performance requirement in Table 9.5.4.1\_E.1.3-2 is defined as:

- a) The ratio of the throughput obtained when transmitting based on UE reported RI and that obtained when transmitting with fixed rank 1 shall be  $\geq \gamma_1$ .
- b) The ratio of the throughput obtained when transmitting based on UE reported RI and that obtained when transmitting with fixed rank 2 shall be  $\geq \gamma_2$ ;

In Table 9.5.4.1\_E.1.3-1, Cell 1 is the serving cell, and Cell 2 and Cell 3 are the aggressor cells. The downlink physical channel setup for Cell 1 is according to Annex C.3.2 and for Cell 2 and Cell 3 is according to Annex C.3.3, respectively. The CRS assistance information [5] including Cell 2 and Cell 3 is provided.

Table 9.5.4.1\_E.1.3-1: RI Test (FDD)

Parameter		Unit	Cell 1	Cell 2	Cell 3
Bandwidth		MHz	10	10	10
PDSCH transmission mode			3	As defined in Note 1	As defined in Note 1
Downlink power allocation	$\rho_A$	dB	-3	-3	-3
	$\rho_B$	dB	-3	-3	-3
	$\sigma$	dB	0	N/A	N/A
Propagation condition and antenna configuration			2x2 EPA5 (Note 2)	2x2 EPA5 (Note 2)	2x2 EPA5 (Note 2)
CodeBookSubsetRestriction bitmap			01 for fixed RI = 1 10 for fixed RI = 2 11 for UE reported RI	As defined in Note 1	As defined in Note 1
$N_{oc}$ at antenna port	$N_{oc1}$	dB[mW/15k Hz]	-98 (Note 3)	N/A	N/A
	$N_{oc2}$	dBmW/15kHz	-98 (Note 4)	N/A	N/A
	$N_{oc3}$	dB[mW/15k Hz]	-93 (Note 5)	N/A	N/A
$\hat{E}_s/N_{oc2}$		dB	Reference Value in Table 9.5.4.1_E.1.3-2 for each test	12	10
$\hat{I}_{or}^{(j)}$		dB[mW/15k Hz]	Reference Value in Table 9.5.4.1_E.1.3-2 for each test	-86	-88
Subframe Configuration			Non-MBSFN	Non-MBSFN	Non-MBSFN
Time Offset between Cells		$\mu$ s	N/A	3	-1
Frequency shift between Cells		Hz	N/A	300	-100
Cell Id			0	126	1
ABS pattern (Note 6)			N/A	10000000 10000000 10000000 10000000 10000000	10000000 10000000 10000000 10000000 10000000
RLM/RRM Measurement Subframe Pattern (Note 7)			10000000 10000000 10000000 10000000 10000000	N/A	N/A
CSI Subframe Sets (Note 8)	$C_{CSI,0}$		10000000 10000000 10000000 10000000 10000000	N/A	N/A
	$C_{CSI,1}$		01111111 01111111 01111111 01111111 01111111	N/A	N/A
Number of control OFDM symbols			3	Note 9	Note 9
Maximum number of HARQ transmissions			1	N/A	N/A
Reporting mode			PUCCH 1-0	N/A	N/A
Physical channel for CQI reporting			PUCCH format 2	N/A	N/A
PUCCH Report Type for CQI			4	N/A	N/A
Physical channel for RI reporting			PUCCH Format 2	N/A	N/A

PUCCH Report Type for RI		3	N/A	N/A
Reporting periodicity	ms	$N_{pd}=10$	N/A	N/A
<i>cqi-pmi-ConfigurationIndex</i>		11	N/A	N/A
<i>ri-ConfigurationInd</i>		5	N/A	N/A
<i>cqi-pmi-ConfigurationIndex2</i>		10	N/A	N/A
<i>ri-ConfigurationInd2</i>		2	N/A	N/A
Cyclic prefix		Normal	Normal	Normal
Note 1:	Downlink physical channel setup in Cell 2 and Cell 3 in accordance with Annex TS 36.521-1 [10] C.3.3 applying OCNG pattern OP.5 FDD as defined in TS 36.521-1 [10] Annex A.5.1.5.			
Note 2:	The propagation conditions for Cell 1, Cell 2 and Cell 3 are statistically independent.			
Note 3:	This noise is applied in OFDM symbols #1, #2, #3, #5, #6, #8, #9, #10, #12, #13 of a subframe overlapping with the aggressor ABS.			
Note 4:	This noise is applied in OFDM symbols #0, #4, #7, #11 of a subframe overlapping with the aggressor ABS.			
Note 5:	This noise is applied in all OFDM symbols of a subframe overlapping with aggressor non-ABS			
Note 6:	ABS pattern as defined in TS 36.423 [14]. PDSCH other than SIB1/paging and its associated PDCCH/PCFICH are transmitted in the serving cell subframe when the subframe is overlapped with the ABS subframe of aggressor cell and the subframe is available in the definition of the reference channel.			
Note 7:	Time-domain measurement resource restriction pattern for PCell measurements as defined in TS 36.331 [5].			
Note 8:	As configured according to the time-domain measurement resource restriction pattern for CSI measurements defined in TS 36.331 [5].			
Note 9:	The number of control OFDM symbols is not available for ABS and is 3 for the subframe indicated by "0" of ABS pattern.			
Note 10:	If the UE reports in an available uplink reporting instance at subframe SF#n based on CQI estimation at a downlink subframe not later than SF#(n-4), this reported wideband CQI cannot be applied at the eNB downlink before SF#(n+4).			
Note 11:	Reference measurement channel in Cell 1 RC.2 FDD according to Table A.4-1 with one sided dynamic OCNG Pattern OP.1 FDD as described in Annex A.5.1.1.			
Note 12:	The number of the CRS ports in Cell 1, Cell 2 and Cell 3 is the same.			
Note 13:	SIB-1 will not be transmitted in Cell 2 and Cell 3 in this test.			

Table 9.5.4.1\_E.1.3-2: Minimum requirement (FDD)

	Test 1	Test 2	Test 3
$\hat{E}_s / N_{oc2}$ for Cell 1 (dB)	4	20	20
$\hat{I}_{or}^{(j)}$ for Cell 1 (dB[mW/15kHz])	-94	-78	-78
Antenna correlation	High for Cell 1, low for Cell 2 and Cell 3	Low for Cell 1, Cell 2 and Cell 3	High for Cell 1, low for Cell 2 and Cell 3
$\eta_1$	N/A	1.05	0.9
$\eta_2$	1.05	N/A	N/A
UE Category	$\geq 2$	$\geq 2$	$\geq 2$

The normative reference for this requirement is TS 36.101 [2] clause 9.5.4.1.

#### 9.5.4.1\_E1.4 Test description

##### 9.5.4.1\_E.1.4.1 Initial conditions

Initial conditions are a set of test configurations the UE needs to be tested in and the steps for the SS to take with the UE to reach the correct measurement state.

Configurations of PDSCH and PDCCH before measurement are specified in Annex C.2.

Test Environment: Normal as defined in TS 36.508 [7] clause 4.1.

Frequencies to be tested: Mid Range as defined in TS 36.508 [7] clause 4.3.1.1.

Channel Bandwidths to be tested: 10MHz, as defined in TS 36.508 [7] clause 4.3.1.1

1. Connect the SS, faders and AWGN noise source to the UE antenna connector (s) as shown in TS 36.508 [7] Annex A, Figure A.48 for antenna configuration 2x2.

2. The parameter settings for the cell are set up according to Table 9.5.4.1\_E.1.3-1.
3. Downlink signals are initially set up according to Annex C0, C.1 and Annex C.3.2, and uplink signals according to Annex H.1 and H.3.2.
4. Propagation conditions are set according to Annex B.0.
5. Ensure the UE is in State 3A-RF (in Cell 1) according to TS 36.508 [7] clause 5.2A.2 with exceptions listed in 5.2A.5. Message contents are defined in clause 9.5.4.1\_E.1.4.3.

#### 9.5.4.1\_E.1.4.2 Test procedure

1. Set the parameters of bandwidth, reference channel, propagation condition, antenna configuration, antenna correlation, CodeBookSubsetRestriction for fixed Rank and the SNR according to Table 9.5.4.1\_E.1.3-1 as appropriate.
2. Set the Cell 2 and Cell 3 as defined in Table 9.5.4.1\_E.1.3-1 and according to Annex C3.3.
3. The SS shall send PDSCH via PDCCH DCI format 2A for C\_RNTI to transmit the DL RMC according to the UE reported CQI and RI. In case of CQI reports for two codewords (codeword #0 and #1), the CQI offset level for codeword #1 is selected from {0,1,2,3,-4,-3,-2,-1}. The SS sends downlink MAC padding bits on the DL RMC.
4. Measure  $t_{fix}$  during ABS according to annex G.5.3.
5. Propagation conditions are set according to Annex B.1.
6. The SS sends uplink scheduling information via PDCCH DCI format 0 to schedule UL RMC in every subframe (Table A.4.1-1).
7. The SS shall transmit an RRC Connection Reconfiguration message to set codebookSubsetRestriction as for UE reported RI according to Table 9.5.4.1\_E.1.3-1.
8. The UE shall transmit RRC Connection Reconfiguration Complete message.
9. Propagation conditions are set according to Table 9.5.4.1\_E.1.3-1.
10. The SS shall send PDSCH via PDCCH DCI format 2A for C\_RNTI to transmit the DL RMC according to the UE reported CQI and RI. In case of CQI reports for two codewords (codeword #0 and #1), the CQI offset level for codeword #1 is selected from {0,1,2,3,-4,-3,-2,-1}. The SS sends downlink MAC padding bits on the DL RMC.
11. Measure  $t_{reported}$  during ABS according to Annex G.5.3  
If the ratio ( $t_{reported} / t_{fix}$ ) satisfies the requirement in Table 9.5.4.1\_E.1.5-1, then pass the UE for this test and go to step 12. Otherwise, fail the UE.
12. If all tests have not been done, then repeat the same procedure (steps 1 to 11) with test conditions according to the Table 9.5.4.1\_E.1.3-1 for the other Tests as appropriate. Otherwise pass the UE.

#### 9.5.4.1\_E.1.4.3 Message contents

Message contents are according to TS 36.508 [7] clause 5.2A.5.1 with the following exceptions:



**Table 9.5.4.1\_E.1.4.3-1: RadioResourceConfigDedicated-SRB2-DRB(n, m): Additional FDD RI test performance downlink power allocation**

Derivation Path: TS 36.508 [7] clause 4.6.3, Table 4.6.3-16 RadioResourceConfigDedicated-SRB2-DRB(n,m)			
Information Element	Value/remark	Comment	Condition
RadioResourceConfigDedicated-SRB2-DRB(n, m) ::= SEQUENCE {			
MeasSubframePatternPCell-r10 CHOICE {			
setup SEQUENCE {			
subframePatternFDD-r10	'1000000010000000 1000000010000000 10000000'	BIT STRING (SIZE (40))	
}			
}			
neighCellsCRS-Info-r11 ::= CHOICE {			
setup SEQUENCE {			
CRS-AssistanceInfoList-r11 ::= SEQUENCE (SIZE (1..maxCellReport)) OF CRS-AssistanceInfo-r11{		2 entries	
CRS-AssistanceInfo-r11 ::= SEQUENCE {			
physCellId-r11	126		Cell 2
antennaPortsCount-r11	1		Cell 3
mbsfn-SubframeConfigList-r11 ::= SEQUENCE (SIZE (1..maxMBSFN-Allocations)) OF MBSFN-SubframeConfig{	an2		Cell 2, Cell 3
MBSFN-SubframeConfig ::= SEQUENCE {			
radioframeAllocationPeriod	n1		
radioframeAllocationOffset	0		
subframeAllocation CHOICE{			
oneFrame	'000000' B	non-MBSFN	
}			
}			
}			
}			
}			
}			
}			
}			

**Table 9.5.4.1\_E.1.4.3-2: PhysicalConfigDedicated-DEFAULT: Additional FDD RI test performance downlink power allocation**

Derivation Path: 36.508 clause 5.5.1.2			
Information Element	Value/remark	Comment	Condition
PhysicalConfigDedicated-DEFAULT ::= SEQUENCE {			
cqi-ReportConfig	Not present		
antennaInfo	Not present		
antennaInfo-r10 CHOICE {			
explicitValue-r10	AntennaInfoDedicated-r10		
}			
cqi-ReportConfig-r10	CQI-ReportConfig-r10-DEFAULT		
cqi-ReportConfig- v1130	CQI-ReportConfig-v1130-DEFAULT		
}			

**Table 9.5.4.1\_E.1.4.3-3: CQI-ReportConfig-r10-DEFAULT: Additional FDD RI test performance downlink power allocation**

Derivation Path: 36.508 [7] clause 4.6.3, Table 4.6.3-2AA CQI-ReportConfig-r10-DEFAULT_			
Information Element	Value/remark	Comment	Condition
CQI-ReportConfig-r10-DEFAULT ::= SEQUENCE {			
cqi-ReportAperiodic-r10	Not present		
nomPDSCH-RS-EPRE-Offset	0		
cqi-ReportPeriodic-r10	Not present		
pmi-RI-Report-r9	Not present		
csi-SubframePatternConfig-r10 CHOICE {			
setup SEQUENCE {			
csi-MeasSubframeSet1-r10 CHOICE {			
subframePatternFDD-r10	'1000000010000000 1000000010000000 10000000'	BIT STRING (SIZE (40))	
}			
csi-MeasSubframeSet2-r10 CHOICE {			
subframePatternFDD-r10	'01111111 01111111 01111111 01111111 01111111'	BIT STRING (SIZE (40))	
}			
}			
}			
}			

**Table 9.5.4.1\_E.1.4.3-4: CQI-ReportPeriodic- v1130-DEFAULT: Additional FDD RI test performance downlink power allocation**

Derivation Path: 36.508 clause 4.6.3			
Information Element	Value/remark	Comment	Condition
CQI-ReportConfig-v1130 ::= SEQUENCE {			
cqi-ReportPeriodic-v1130 SEQUENCE {			
simultaneousAckNackAndCQI-Format3-r11	Not present		
cqi-ReportPeriodicProcExtToReleaseList-r11	Not present		
cqi-ReportPeriodicProcExtToAddModList-r11	1 entry		
SEQUENCE (SIZE (1..maxCQI-ProcExt-r11)) OF SEQUENCE {			
cqi-ReportPeriodicProcExtId-r11[1] SEQUENCE {			
cqi-ReportPeriodicProcExtId-r11	1		
cqi-pmi-ConfigIndex-r11	11	CSI process 0 (C <sub>CSI,0</sub> ) (see Table 7.2.2-1A in TS 36.213)	
cqi-FormatIndicatorPeriodic-r11 CHOICE {			
widebandCQI-r11 SEQUENCE {			
csi-ReportMode-r11	Not present		
}			
subbandCQI-r11 SEQUENCE {			
k	Not present		
periodicityFactor-r11	Not present		
}			
}			
ri-ConfigIndex-r11	5	(see Table 7.2.2-1B in TS 36.213)	
csi-ConfigIndex-r11 CHOICE {			
setup SEQUENCE {			
cqi-pmi-ConfigIndex2-r11	10	CSI process 1 (C <sub>CSI,1</sub> ) (see Table 7.2.2-1A in TS 36.213)	
ri-ConfigIndex2-r11	2	(see Table 7.2.2-1B in TS 36.213)	
}			
}			
}			
}			

**Table 9.5.4.1\_E.1.4.3-5: AntennaInfoDedicated-r10: Additional FDD RI test performance downlink power allocation**

Derivation Path: 36.331 clause 6.3.2			
Information Element	Value/remark	Comment	Condition
AntennaInfoDedicated-r10 ::= SEQUENCE { transmissionMode-r10	tm3 for Cell 1  Cell 2 and Cell 3 according to test	Downlink physical channel setup in Cell 2 and Cell 3 in accordance with Annex TS 36.521-1 [10] C.3.3 applying OCNB pattern OP.5 FDD as defined in TS 36.521-1 [10] Annex A.5.1.5.	
codebookSubsetRestriction-r10	01 for fixed RI = 1 10 for fixed RI = 2 11 for UE reported RI for Cell 1  Cell 2 and Cell 3 according to testt	Downlink physical channel setup in Cell 2 and Cell 3 in accordance with Annex TS 36.521-1 [10] C.3.3 applying OCNB pattern OP.5 FDD as defined in TS 36.521-1 [10] Annex A.5.1.5.	
}			
ue-TransmitAntennaSelection CHOICE { release	NULL		
}			

## 9.5.4.1\_E.1.5 Test requirement

**Table 9.5.4.1\_E.1.5-1: Test requirement (FDD)**

	Test 1	Test 2	Test 3
$\hat{E}_s / N_{oc2}$ for Cell 1 (dB)	4	20	20
$\hat{I}_{or}^{(j)}$ for Cell 1 (dB[mW/15kHz])	-94	-78	-78
Antenna correlation	High for Cell 1, low for Cell 2 and Cell 3	Low for Cell 1, Cell 2 and Cell 3	High for Cell 1, low for Cell 2 and Cell 3
$\gamma_1$	N/A	1.04	0.89
$\gamma_2$	1.04	N/A	N/A
UE Category	$\geq 2$	$\geq 2$	$\geq 2$

## 9.5.4.2\_E TDD RI Reporting – PUCCH 1-0 for feICIC

## 9.5.4.2\_E.1 TDD RI Reporting – PUCCH 1-0 for feICIC (non-MBSFN ABS)

## 9.5.4.2\_E.1.1 Test purpose

To verify that the reported rank indicator accurately represents the channel rank under time domain resource restriction i.e. in case two CSI subframe sets are configured.

## 9.5.4.2\_E.1.2 Test applicability

This test applies to all types of E-UTRA TDD UE and CRS interference handling and ss-CCH interference handling – UE Category 2-8 release 11 and forward. Applicability requires support of FGI bit 115.

## 9.5.4.2\_E.1.3 Minimum conformance requirements

The minimum performance requirement in Table 9.5.4.2\_E.1.3-2 is defined as:

- a) The ratio of the throughput obtained when transmitting based on UE reported RI and that obtained when transmitting with fixed rank 1 shall be  $\geq \gamma_1$ .
- b) The ratio of the throughput obtained when transmitting based on UE reported RI and that obtained when transmitting with fixed rank 2 shall be  $\geq \gamma_2$ ;

In Table 9.5.4.2\_E.1.3-1, Cell 1 is the serving cell, and Cell 2 and Cell 3 are the aggressor cells. The downlink physical channel setup for Cell 1 is according to Annex C.3.2 and for Cell 2 and Cell 3 is according to Annex C.3.3, respectively. The CRS assistance information [5] including Cell 2 and Cell 3 is provided.

Table 9.5.4.2\_E.1.3-1: RI Test (TDD)

Parameter		Unit	Cell 1	Cell 2	Cell 3
Bandwidth		MHz	10	10	10
PDSCH transmission mode			3	As defined in Note 1	As defined in Note 1
Uplink downlink configuration			1	1	1
Special subframe configuration			4	4	4
Downlink power allocation	$\rho_A$	dB	-3	-3	-3
	$\rho_B$	dB	-3	-3	-3
	$\sigma$	dB	0	N/A	N/A
Propagation condition and antenna configuration			2x2 EPA5 (Note 2)	2x2 EPA5 (Note 2)	2x2 EPA5 (Note 2)
CodeBookSubsetRestriction bitmap			01 for fixed RI = 1 10 for fixed RI = 2 11 for UE reported RI	As defined in Note 1	As defined in Note 1
$N_{oc}$ at antenna port	$N_{oc1}$	dB[mW/15k Hz]	-98](Note 3)	N/A	N/A
	$N_{oc2}$	dB[mW/15k Hz]	-98 (Note 4)	N/A	N/A
	$N_{oc3}$	dB[mW/15k Hz]	-93 (Note 5)	N/A	N/A
$\hat{E}_s / N_{oc2}$		dB	Reference Value in Table 9.5.4.2_E.1.3-2 for each test	12	10
$\hat{I}_{or}^{(j)}$		dB[mW/15k Hz]	Reference Value in Table 9.5.4.2_E.1.3-2 for each test	-86	-88
Subframe Configuration			Non-MBSFN	Non-MBSFN	Non-MBSFN
Time Offset between Cells		$\mu$ s	N/A	3	-1
Frequency shift between Cells		Hz	N/A	300	-100
Cell Id			0	126	1
ABS pattern (Note 6)			N/A	000000001 000000001	000000001 000000001
RLM/RRM Measurement Subframe Pattern (Note 7)			000000001 000000001	N/A	N/A
CSI Subframe Sets (Note 8)	$C_{CSI,0}$		000000001 000000001	N/A	N/A
	$C_{CSI,1}$		1100111000 1100111000	N/A	N/A
Number of control OFDM symbols			3	Note 9	Note 9
Maximum number of HARQ transmissions			1	N/A	N/A
Reporting mode			PUCCH 1-0	N/A	N/A
Physical channel for $C_{CSI,0}$ CQI and RI reporting			PUCCH format 2	N/A	N/A
Physical channel for $C_{CSI,1}$ CQI and RI reporting			PUSCH (Note )	N/A	N/A
PUCCH Report Type for CQI			4	N/A	N/A
PUCCH Report Type for RI			3	N/A	N/A
Reporting periodicity		ms	$N_{pd}= 10$	N/A	N/A
ACK/NACK feedback mode			Multiplexing	N/A	N/A
<i>cqi-pmi-ConfigurationIndex</i>			8	N/A	N/A
<i>ri-ConfigurationInd</i>			5	N/A	N/A
<i>cqi-pmi-ConfigurationIndex2</i>			9	N/A	N/A
<i>ri-ConfigurationInd2</i>			0	N/A	N/A
Cyclic prefix			Normal	Normal	Normal

Note 1:	Downlink physical channel setup in Cell 2 in accordance with TS 36.521-1 [10] Annex C.3.3 applying OCN pattern OP.5 TDD as defined in TS 36.521-1 [10] Annex A.5.2.5.
Note 2:	The propagation conditions for Cell 1, Cell 2 and Cell 3 are statistically independent.
Note 3:	This noise is applied in OFDM symbols #1, #2, #3, #5, #6, #8, #9, #10, #12, #13 of a subframe overlapping with the aggressor ABS.
Note 4:	This noise is applied in OFDM symbols #0, #4, #7, #11 of a subframe overlapping with the aggressor ABS.
Note 5:	This noise is applied in all OFDM symbols of a subframe overlapping with aggressor non-ABS.
Note 6:	ABS pattern as defined in [9]. PDSCH other than SIB1/paging and its associated PDCCH/PCFICH are transmitted in the serving cell subframe when the subframe is overlapped with the ABS subframe of aggressor cell and the subframe is available in the definition of the reference channel.
Note 7:	Time-domain measurement resource restriction pattern for PCell measurements as defined in TS 36.331 [5].
Note 8:	As configured according to the time-domain measurement resource restriction pattern for CSI measurements defined in TS 36.331[5].
Note 9:	The number of control OFDM symbols is not available for ABS and is 3 for the subframe indicated by "0" of ABS pattern.
Note 10:	If the UE reports in an available uplink reporting instance at subframe SF#n based on CQI estimation at a downlink subframe not later than SF#(n-4), this reported wideband CQI cannot be applied at the eNB downlink before SF#(n+4).
Note 11:	Reference measurement channel in Cell 1 RC.2 TDD according to Table A.4-1 with one sided dynamic OCN Pattern OP.1 TDD as described in Annex A.5.2.1.
Note 12:	The number of the CRS ports in Cell 1, Cell 2 and Cell 3 is the same.
Note 13:	SIB-1 will not be transmitted in Cell 2 and Cell 3 in this test.
Note 14:	To avoid collisions between RI/CQI reports and HARQ-ACK it is necessary to report them on PUSCH instead of PUCCH. PDCCH DCI format 0 shall be transmitted in downlink SF#4 and #9 to allow periodic RI/CQI to multiplex with the HARQ-ACK on PUSCH in uplink subframe SF#8 and #3.

**Table 9.5.4.2\_E.1.3-2: Minimum requirement (TDD)**

	Test 1	Test 2	Test 3
$\hat{E}_s / N_{oc2}$ for Cell 1 (dB)	4	20	20
$\hat{I}_{or}^{(j)}$ for Cell 1 (dB[mW/15kHz])	-94	-78	-78
Antenna correlation	High for Cell 1, low for Cell 2 and Cell 3	Low for Cell 1, Cell 2 and Cell 3	High for Cell 1, low for Cell 2 and Cell 3
$\gamma_1$	N/A	1.05	0.9
$\gamma_2$	1.05	N/A	N/A
UE Category	$\geq 2$	$\geq 2$	$\geq 2$

The normative reference for this requirement is TS 36.101 [2] clause 9.5.4.2.

#### 9.5.4.2\_E1.4 Test description

##### 9.5.4.2\_E.1.4.1 Initial conditions

Initial conditions are a set of test configurations the UE needs to be tested in and the steps for the SS to take with the UE to reach the correct measurement state.

Configurations of PDSCH and PDCCH before measurement are specified in Annex C.2.

Test Environment: Normal as defined in TS 36.508 [7] clause 4.1.

Frequencies to be tested: Mid Range as defined in TS 36.508 [7] clause 4.3.1.2.

Channel Bandwidths to be tested: 10MHz, as defined in TS 36.508 [7] clause 4.3.1.2.

1. Connect the SS, faders and AWGN noise source to the UE antenna connector (s) as shown in TS 36.508 [7] Annex A, Figure A.48 for antenna configuration 2x2.
2. The parameter settings for the cell are set up according to Table 9.5.4.2\_E.1.3-1.

3. Downlink signals are initially set up according to Annex C0, C.1 and Annex C.3.2, and uplink signals according to Annex H.1 and H.3.2.
4. Propagation conditions are set according to Annex B.0.
5. Ensure the UE is in State 3A-RF according to TS 36.508 [7] clause 5.2A.2 with exceptions listed in 5.2A.5. Message contents are defined in clause 9.5.4.2\_E.1.4.3.

#### 9.5.4.2\_E.1.4.2 Test procedure

1. Set the parameters of bandwidth, reference channel, propagation condition, antenna configuration, antenna correlation, CodeBookSubsetRestriction for fixed Rank and the SNR according to Table 9.5.4.2\_E.1.3-1 as appropriate.
2. Set the Cell 2 and Cell 3 as defined in Tables 9.5.4.2\_E.1.3-1 and according to Annex C3.3.
3. The SS shall send PDSCH in via PDCCH DCI format 2A for C\_RNTI to transmit the DL RMC according to the UE reported CQI and RI. In case of CQI reports for two codewords (codeword #0 and #1), the CQI offset level for codeword #1 is selected from {0,1,2,3,-4,-3,-2,-1}. The SS sends downlink MAC padding bits on the DL RMC.  
The SS sends uplink scheduling information via PDCCH DCI format 0 in subframe #4 and #9 with CQI request bit set to 0 to schedule UL RMC in subframe #8 and #3 (Table A.4.1-2).
4. Measure  $t_{fix}$  during ABS according to annex G.5.3.
5. Propagation conditions are set according to Annex B.1.
6. The SS sends uplink scheduling information via PDCCH DCI format 0 to schedule UL RMC in subframe #3 and #8 (Table A.4.1-2).
7. The SS shall transmit an RRC Connection Reconfiguration message to set codebookSubsetRestriction as for UE reported RI according to Table 9.5.4.2\_E.1.3-1.
8. The UE shall transmit RRC Connection Reconfiguration Complete message.
9. Propagation conditions are set according to Table 9.5.4.2\_E.1.3-1.
10. The SS shall send PDSCH via PDCCH DCI format 2A for C\_RNTI to transmit the DL RMC according to the UE reported CQI and RI. In case of CQI reports for two codewords (codeword #0 and #1), the CQI offset level for codeword #1 is selected from {0,1,2,3,-4,-3,-2,-1}. The SS sends downlink MAC padding bits on the DL RMC.  
The SS sends uplink scheduling information via PDCCH DCI format 0 in subframe #4 and #9 with CQI request bit set to 0 to schedule UL RMC in subframe #8 and #3 (Table A.4.1-2).
11. Measure  $t_{reported}$  during ABS according to Annex G.5.3  
If the ratio ( $t_{reported} / t_{fix}$ ) satisfies the requirement in Table 9.5.4.2\_E.1.5-1, then pass the UE for this test and go to step 12. Otherwise, fail the UE.
12. If all tests have not been done, then repeat the same procedure (steps 1 to 11) with test conditions according to the Table 9.5.4.2\_E.1.3-1 for the other Tests as appropriate. Otherwise pass the UE.

#### 9.5.4.2\_E.1.4.3 Message contents

Message contents are according to TS 36.508 [7] clause 5.2A.5.1 with the following exceptions:



**Table 9.5.4.2\_E.1.4.3-1: RadioResourceConfigDedicated-SRB2-DRB(n, m): Additional TDD RI test performance downlink power allocation**

Derivation Path: TS 36.508 [7] clause 4.6.3, Table 4.6.3-16 RadioResourceConfigDedicated-SRB2-DRB(n,m)			
Information Element	Value/remark	Comment	Condition
RadioResourceConfigDedicated-SRB2-DRB(n, m) ::= SEQUENCE {			
MeasSubframePatternPCell-r10 CHOICE {			
setup SEQUENCE {			
subframePatternTDD-r10 CHOICE {			
subframeConfig1-5-r10	'0000000001 0000000001'	BIT STRING (SIZE (20))	
}			
}			
}			
}			

**Table 9.5.4.2\_E.1.4.3-2: PhysicalConfigDedicated-DEFAULT: Additional TDD RI test performance downlink power allocation**

Derivation Path: 36.508 clause 5.5.1.2			
Information Element	Value/remark	Comment	Condition
PhysicalConfigDedicated-DEFAULT ::= SEQUENCE {			
antennaInfo CHOICE {			
explicitValue	AntennaInfoDedicated-r10		
}			
cqi-ReportConfig-r10	CQI-ReportConfig-r10-DEFAULT		
cqi-ReportConfig-v1130	CQI-ReportConfig-v1130-DEFAULT		
}			

**Table 9.5.4.2\_E.1.4.3-3: CQI-ReportConfig-r10-DEFAULT: Additional TDD RI test performance downlink power allocation**

Derivation Path: 36.508 [7] clause 4.6.3, Table 4.6.3-2AA CQI-ReportConfig-r10-DEFAULT_			
Information Element	Value/remark	Comment	Condition
CQI-ReportConfig-r10-DEFAULT ::= SEQUENCE {			
cqi-ReportAperiodic-r10	Not present		
nomPDSCH-RS-EPRE-Offset	0		
cqi-ReportPeriodic-r10	CQI-ReportPeriodic-r10-DEFAULT		
pmi-RI-Report-r9	Not present		
csi-SubframePatternConfig-r10 CHOICE {			
setup SEQUENCE {			
csi-MeasSubframeSet1-r10 CHOICE {			
subframePatternTDD-r10 CHOICE {			
subframeConfig1-5-r10	'0000000001 0000000001'	BIT STRING (SIZE (20))	
}			
}			
csi-MeasSubframeSet2-r10 CHOICE {			
subframePatternTDD-r10 CHOICE {			
subframeConfig1-5-r10	'1100111000 1100111000'	BIT STRING (SIZE (20))	
}			
}			
}			
}			



**Table 9.5.4.2\_E.1.4.3-6: AntennaInfoDedicated-r10: Additional TDD RI test performance downlink power allocation**

Derivation Path: 36.331 clause 6.3.2			
Information Element	Value/remark	Comment	Condition
AntennaInfoDedicated-r10 ::= SEQUENCE { transmissionMode-r10	tm3 for Cell 1  Cell 2 and Cell 3 according to test	Downlink physical channel setup in Cell 2 and Cell 3 in accordance with TS 36.521-1 [10] Annex C.3.3 applying OCNG pattern OP.5 TDD as defined in TS 36.521-1 [10] Annex A.5.2.5.	
codebookSubsetRestriction-r10	01 for fixed RI = 1 10 for fixed RI = 2 11 for UE reported RI for Cell 1  Cell 2 and Cell 3 according to test	Downlink physical channel setup in Cell 2 and Cell 3 in accordance with TS 36.521-1 [10] Annex C.3.3 applying OCNG pattern OP.5 TDD as defined in TS 36.521-1 [10] Annex A.5.2.5.	
}			
ue-TransmitAntennaSelection CHOICE {			
release	NULL		
}			

**Table 9.5.4.2\_E.1.4.3-7: TDD-Config-DEFAULT: Additional TDD RI test performance downlink power allocation**

Derivation Path: 36.508 clause 4.6.3			
Information Element	Value/remark	Comment	Condition
TDD-Config-DEFAULT ::= SEQUENCE {			
subframeAssignment	sa1		
specialSubframePatterns	ssp4		
}			

**Table 9.5.4.2\_E.1.4.3-8: PUCCH-ConfigDedicated-DEFAULT: Additional TDD RI test performance downlink power allocation**

Derivation Path: 36.508 clause 4.6.3			
Information Element	Value/remark	Comment	Condition
PUCCH-ConfigDedicated-DEFAULT ::= SEQUENCE {			
ackNackRepetition CHOICE {			
release	NULL		
}			
tddAckNackFeedbackMode	Multiplexing		
}			

## 9.5.4.2\_E.1.5 Test requirement

**Table 9.5.4.2\_E.1.5-1: Test requirement (TDD)**

	Test 1	Test 2	Test 3
$\hat{E}_s/N_{oc2}$ for Cell 1 (dB)	4	20	20
$\hat{I}_{or}^{(j)}$ for Cell 1 (dB[mW/15kHz])	-94	-78	-78
Antenna correlation	High for Cell 1, low for Cell 2 and Cell 3	Low for Cell 1, Cell 2 and Cell 3	High for Cell 1, low for Cell 2 and Cell 3
$\gamma_1$	N/A	1.04	0.89
$\gamma_2$	1.04	N/A	N/A
UE Category	$\geq 2$	$\geq 2$	$\geq 2$

## 9.5.5 RI Reporting (with CSI processes)

## 9.5.5.1\_F FDD RI Reporting with CSI processes for CoMP

## 9.5.5.1\_F.1 FDD RI Reporting with Single CSI process for CoMP

## 9.5.5.1\_F.1.1 Test purpose

To verify that the reported rank indicator accurately represents the channel rank with one CSI process configured.

## 9.5.5.1\_F.1.2 Test applicability

This test applies to all types of E-UTRA FDD category 2-8 UEs release 11 and forward, supporting Maximum CSI processes of One on a component carrier within a band with PDSCH transmission mode 10.

## 9.5.5.1\_F.1.3 Minimum conformance requirements

Each CSI process is associated with a CSI-RS resource and a CSI-IM resource as shown in Table 9.5.5.1\_F.1.3-1. For UE supports one CSI process CSI process 0 is configured for Test 1 and Test 2, but CSI process 1 is not configured for Test 2. The corresponding  $\gamma$  requirements for Test 1 and Test 2 shall be fulfilled. The requirement on reported RI for CSI process 1 in Test 2 is not applicable.

For UE supports multiple CSI processes, CSI process 0 is configured for Test 1 and CSI processes 0 and 1 are configured for Test 2. The corresponding  $\gamma$  requirements for Test 1 and Test 2 shall be fulfilled, and also the requirement on reported RI for CSI process 1 in Test 2.

The minimum performance requirement in Table 9.5.5.1\_F.1.3-2 is defined as:

- The ratio of the throughput obtained when transmitting based on UE reported RI and that obtained when transmitting with fixed rank 1 shall be  $\geq \gamma_1$ .
- The ratio of the throughput obtained when transmitting based on UE reported RI and that obtained when transmitting with fixed rank 2 shall be  $\geq \gamma_2$ ;
- For Test 2, the RI reported for CSI process 1 shall be the same as the most recent RI reported for CSI process 0 if UE is configured with multiple CSI processes.

For the parameters specified in Table 9.5.5.1\_F.1.3-2, and using the downlink physical channels specified in Annex C.3.2, the minimum requirements are specified in Table 9.5.5.1\_F.1.3-3.

**Table 9.5.5.1\_F.1.3-1: Configuration of CSI processes**

	CSI process 0	CSI process 1
CSI-RS resource	CSI-RS signal 0	CSI-RS signal 1
CSI-IM resource	CSI-IM resource 0	CSI-IM resource 1

Table 9.5.5.1\_F.1.3-2: Test Parameters for RI Reporting with Single CSI process for CoMP (FDD)

Parameter	Unit	Test 1		Test 2	
		TP1	TP2	TP1	TP2
Bandwidth	MHz	10 MHz		10 MHz	
Transmission mode		10	10	10	10
Downlink power allocation	$\rho_A$	0		0	
	$\rho_B$	0		0	
	$P_c$	0	0	0	0
	$\sigma$	0		0	
SNR	dB	0	0	20	20
$\hat{I}_{or}^{(j)}$	dB[mW/15kHz]	-98	-98	-78	-78
$N_{oc}^{(j)}$	dB[mW/15kHz]	-98		-98	
Propagation channel		EPA 5 Low	EPA 5 Low	EPA 5 Low	EPA 5 High
Antenna configuration		2x2	2x2	2x2	2x2
Beamforming Model		As specified in Section B.4.3		As specified in Section B.4.3	
Timing offset between TPs	us	0		0	
Frequency offset between TPs	Hz	0		0	
Cell-specific reference signals		Antenna ports 0		Antenna ports 0	
CSI-RS signal 0		Antenna ports 15,16	N/A	Antenna ports 15,16	N/A
CSI-RS 0 periodicity and subframe offset $T_{CSI-RS} / \Delta_{CSI-RS}$		5/1	N/A	5/1	N/A
CSI-RS 0 configuration		0	N/A	0	N/A
CSI-RS signal 1		N/A	Antenna ports 15,16	N/A	Antenna ports 15,16
CSI-RS 1 periodicity and subframe offset $T_{CSI-RS} / \Delta_{CSI-RS}$		N/A	5/1	N/A	5/1
CSI-RS 1 configuration		N/A	3	N/A	3
Zero-power CSI-RS 0 configuration $I_{CSI-RS} / \text{ZeroPowerCSI-RS}$ bitmap		N/A	1 / 1000000000 00000	N/A	1 / 1000000000 00000
Zero-power CSI-RS 1 configuration $I_{CSI-RS} / \text{ZeroPowerCSI-RS}$ bitmap		1 / 0001000000 00000	N/A	1 / 0001000000 00000	N/A
CSI-IM 0 periodicity and subframe offset $T_{CSI-IM} / \Delta_{CSI-IM}$		5/1	N/A	5/1	N/A
CSI-IM 0 configuration		2	N/A	2	N/A
CSI-IM 1 periodicity and subframe offset $T_{CSI-IM} / \Delta_{CSI-IM}$		N/A	5/1	N/A	5/1
CSI-IM 1 configuration		N/A	6	N/A	6
RI configuration		Fixed RI=2 and follow RI	N/A	Fixed RI=1 and follow RI	N/A
Physical channel for CQI/PMI reporting		PUSCH (Note 6)	N/A	PUSCH (Note 6)	PUSCH (Note 6)
PUCCH Report Type for CQI/PMI		2	N/A	2	2
Physical channel for RI reporting		PUCCH Format 2	N/A	PUCCH Format 2	PUCCH Format 2
PUCCH Report Type for RI		3	N/A	3	3

CSI process 0 (Note 7)	CSI-RS		CSI-RS 0	N/A	CSI-RS 0	N/A
	CSI-IM		CSI-IM 0	N/A	CSI-IM 0	N/A
	Reporting mode		PUCCH 1-1	N/A	PUCCH 1-1	N/A
	Reporting periodicity	ms	$N_{pd} = 5$	N/A	$N_{pd} = 5$	N/A
	CQI delay	ms	8	N/A	10	N/A
	<i>cqi-pmi-ConfigurationIndex</i>		6	N/A	6	N/A
	<i>ri-ConfigIndex</i>		1	N/A	1	N/A
CSI process 1 (Note 7, Note 9)	CSI-RS		N/A	N/A	N/A	CSI-RS 1
	CSI-IM		N/A	N/A	N/A	CSI-IM 1
	Reporting mode		N/A	N/A	N/A	PUCCH 1-1
	Reporting periodicity	ms	N/A	N/A	N/A	$N_{pd} = 5$
	CQI delay	ms	N/A	N/A	N/A	10
	<i>cqi-pmi-ConfigurationIndex</i>		N/A	N/A	N/A	4
	<i>ri-ConfigIndex</i>		N/A	N/A	N/A	1
CSI process for PDSCH scheduling			CSI process 0		CSI process 0	
Cell ID			0	6	0	6
Quasi-co-located CSI-RS			CSI-RS 0	CSI-RS 1	CSI-RS 0	CSI-RS 1
Quasi-co-located CRS			Same Cell ID as Cell 1	Same Cell ID as Cell 2	Same Cell ID as Cell 1	Same Cell ID as Cell 2
PMI for subframe 2, 3, 4, 7, 8 and 9			010000 for fixed RI = 2 010011 for UE reported RI	100000	000011 for fixed RI = 1 010011 for UE reported RI	N/A
PMI for subframe 1 and 6			100000	100000	100000	N/A
Max number of HARQ transmissions			1	N/A	1	N/A
Note 1:	If the UE reports in an available uplink reporting instance at subframe SF#n based on CQI estimation at a downlink SF not later than SF#(n-4), this reported wideband CQI cannot be applied at the eNB downlink before SF#(n+4).					
Note 2:	3 symbols allocated to PDCCH.					
Note 3:	Reference measurement channel RC.13 FDD according to Table A.4-1. PDSCH transmission is scheduled on subframe 2, 3, 4, 7, 8 and 9 from TP1.					
Note 4:	TM10 OCNG is transmitted as specified in A.5.1.8 is transmitted on subframe 1 and 6 from TP1.					
Note 5:	TM10 OCNG is transmitted as specified in A.5.1.8 is transmitted on subframe 1, 2, 3, 4, 6, 7, 8 and 9 from TP2 for Test 1; TP2 is blanked for Test 2.					
Note 6:	To avoid collisions between CQI/PMI reports and HARQ-ACK it is necessary to report both on PUSCH instead of PUCCH. PDCCH DCI format 0 shall be transmitted in downlink SF#1 and #6 to allow periodic CQI/PMI to multiplex with the HARQ-ACK on PUSCH in uplink SF#0 and #5.					
Note 7:	If UE supports multiple CSI processes, CSI process 0 is configured as 'RI-reference CSI process' for CSI process 1.					
Note 8:	PDCCH DCI format 0 with a trigger for aperiodic CQI shall be transmitted in downlink SF#1 and #6 to allow aperiodic CQI/PMI/RI to be transmitted in uplink SF#0 and #5.					
Note 9:	If UE supports one CSI process, CSI process 1 is not configured in Test 2.					

**Table 9.5.5.1\_F.1.3-3: Minimum requirements for RI Reporting with Single CSI process for CoMP (FDD)**

	Test 1	Test 2
$\gamma_1$	N/A	1.0
$\gamma_2$	1.0	N/A
UE Category	$\geq 2$	$\geq 2$

The normative reference for this requirement is TS 36.101 [2] clause 9.5.5.1.

#### 9.5.5.1\_F.1.4 Test description

#### 9.5.5.1\_F.1.4.1 Initial conditions

Initial conditions are a set of test configurations the UE needs to be tested in and the steps for the SS to take with the UE to reach the correct measurement state.

Configurations of PDSCH and PDCCH before measurement are specified in Annex C.2.

Test Environment: Normal as defined in TS 36.508 [7] clause 4.1.

Frequencies to be tested: Mid Range as defined in TS 36.508 [7] clause 4.3.1.1.

Channel Bandwidths to be tested: 10MHz, as defined in TS 36.508 [7] clause 4.3.1.1.

1. Connect the SS, faders and AWGN noise source to the UE antenna connector (s) as shown in TS 36.508 [7] Annex A, Figure A.40 for antenna configuration 2x2.
2. The parameter settings for the cell are set up according to Table 9.5.5.1\_F.1.3-2.
3. Downlink signals are initially set up according to Annex C.1 and Annex C.3.2, and uplink signals according to Annex H.1 and H.3.2.
4. Propagation conditions are set according to Annex B.0.
5. Ensure the UE is in State 3A-RF according to TS 36.508 [7] clause 5.2A.2. Message contents are defined in clause 9.5.5.1\_F.1.4.3.

#### 9.5.5.1\_F.1.4.2 Test procedure

1. Set the parameters of bandwidth, reference channel, propagation condition, antenna configuration, antenna correlation, CodeBookSubsetRestriction, PMI for subframe for fixed Rank and the SNR according to Table 9.5.5.1\_F.1.3-1 and C.3.3-1 of Annex C.3.3 as appropriate.
2. The SS shall send PDSCH via PDCCH DCI format 2D for C\_RNTI to transmit the DL RMC according to the UE reported CQI (wideband CQI), PMI and RI. The SS sends downlink MAC padding bits on the DL RMC. The SS sends uplink scheduling information via PDCCH DCI format 0 with CQI request bit set to 0 to schedule UL RMC in subframe #0 and #5 (Table A.4.1-1).
3. Measure the  $t_{fix}$  (fixed Rank 1 or fixed Rank 2) according to annex G.5.3.
4. Propagation conditions are set according to Annex B.1.
5. The SS sends uplink scheduling information via PDCCH DCI format 0 to schedule UL RMC in every subframe (Table A.4.1-1).
6. The SS shall transmit an RRC Connection Reconfiguration message to set codebookSubsetRestriction as for UE reported RI according to Table 9.5.5.1\_F.1.3-1.
7. The UE shall transmit RRC Connection Reconfiguration Complete message.
8. Propagation conditions are set according to Table 9.5.5.1\_F.1.3-1.
9. The SS shall send PDSCH via PDCCH DCI format 2D for C\_RNTI to transmit the DL RMC according to the UE reported CQI (wideband CQI), PMI and RI. The SS sends downlink MAC padding bits on the DL RMC. The SS sends uplink scheduling information via PDCCH DCI format 0 with CQI request bit set to 0 to schedule UL RMC in subframe #0 and #5 (Table A.4.1-1).
10. Measure  $t_{reported}$  according to Annex G.5.3  
If the ratio  $(t_{reported} / t_{fix})$  satisfies the requirement in Table 9.5.5.1\_F.1.5-1, then pass the UE for this test and go to step 11. Otherwise, fail the UE.
11. If all tests have not been done, then repeat the same procedure (steps 1 to 10) with test conditions according to the Table 9.5.5.1\_F.1.3-1 for the other Tests as appropriate. Otherwise pass the UE.

#### 9.5.5.1\_F.1.4.3 Message contents

Message contents are according to TS 36.508 [7] clause 4.6 with the following exceptions:

Table 9.5.5.1\_F.1.4.3-1: PhysicalConfigDedicated-DEFAULT

Derivation Path: 36.508 clause 4.6.3			
Information Element	Value/remark	Comment	Condition
PhysicalConfigDedicated-DEFAULT ::= SEQUENCE {			
pdsch-ConfigDedicated	<i>PDSCH-ConfigDedicated-DEFAULT</i>		
antennaInfo-r10 CHOICE {			
explicitValue-r10	AntennaInfoDedicated-r10		
}			
csi-RS-ConfigZPToAddModList-r11	<i>CSI-RS-ConfigZP-r11-DEFAULT</i>		
cqi-ReportConfig-v1130	<i>CQI-ReportConfig-v1130-DEFAULT</i>		
}			

Table 9.5.5.1\_F.1.4.3-2: PDSCH-ConfigDedicated-DEFAULT

Derivation Path: 36.508 clause 4.6.3			
Information Element	Value/remark	Comment	Condition
PDSCH-ConfigDedicated-DEFAULT ::= SEQUENCE {			
p-a	dB0		
}			

Table 9.5.5.1\_F.1.4.3-3: AntennaInfoDedicated-r10

Derivation Path: 36.331 clause 6.3.2			
Information Element	Value/remark	Comment	Condition
AntennaInfoDedicated-r10 ::= SEQUENCE {			
transmissionMode-r10	tm10-v1130		
ue-TransmitAntennaSelection CHOICE {			
release	NULL		
}			
}			



**Table 9.5.5.1\_F.1.4.3-4: CQI-ReportConfig-v1130-DEFAULT**

Derivation Path: 36.508 clause 4.6.3			
Information Element	Value/remark	Comment	Condition
CQI-ReportConfig-v1130 ::= SEQUENCE {			
cqi-ReportPeriodic-v1130 SEQUENCE {			
cqi-ReportPeriodicProcExtToAddModList-r11 SEQUENCE (SIZE (1..maxCQI-ProcExt-r11)) OF SEQUENCE {	1 entry		
cqi-ReportPeriodicProcExtId-r11[1] SEQUENCE {			
cqi-ReportPeriodicProcExtId-r11	1		
cqi-pmi-ConfigIndex-r11	6	CSI process 0	
}			9
ri-ConfigIndex-r11	1	CSI process 0	
csi-ConfigIndex-r11 CHOICE {			
setup SEQUENCE {			
cqi-pmi-ConfigIndex2-r11	According to each test	For CSI process 1: Test 1 = N/A Test 2 = 4	
ri-ConfigIndex2-r11	According to each test	For CSI process 1: Test 1 = N/A Test 2 = 1	
}			
}			
}			
}			

**Table 9.5.5.1\_F.1.4.3-5: CSI-RS-ConfigZP-r11-DEFAULT**

Derivation Path: 36.3508 clause 4.6.3			
Information Element	Value/remark	Comment	Condition
CSI-RS-ConfigZP-r11 ::= SEQUENCE {			
csi-RS-ConfigZPId-r11	1		
resourceConfigList-r11	For Zero-power CSI-RS 0 = 0011000000000000 For Zero-power CSI-RS 1 configuration = 1000001000000000	Parameter: ZeroPowerCSI-RS	
subframeConfig-r11	1	$\Delta_{CSI-RS} = I_{CSI-RS}$ when CSI-RS SubframeConfig is from 0-4; Parameter: $I_{CSI-RS}$	
}			

9.5.5.1\_F.1.5 Test requirement

**Table 9.5.5.1\_F.1.5-1: Test requirements for RI Reporting with Single CSI process for CoMP (FDD)**

	Test 1	Test 2
$\gamma_1$	N/A	0.99
$\gamma_2$	0.99	N/A
UE Category	$\geq 2$	$\geq 2$

### 9.5.5.1\_F.2 FDD RI Reporting with Multiple CSI processes for CoMP

**Editor's Note: The test procedure to test the reported RI requirement for CSI process 1 in Test 2 for multiple CSI process is TBD**

#### 9.5.5.1\_F.2.1 Test purpose

To verify that the reported rank indicator accurately represents the channel rank with multiple CSI process configured.

#### 9.5.5.1\_F.2.2 Test applicability

This test applies to all types of E-UTRA FDD category 2-8 UEs release 11 and forward, supporting Maximum CSI processes of Three or Four on a component carrier within a band with PDSCH transmission mode 10.

#### 9.5.5.1\_F.2.3 Minimum conformance requirements

Same minimum conformance requirements as in clause 9.5.5.1\_F.1.3

#### [Text skipped here] 9.5.5.1\_F.2.4 Test description

##### 9.5.5.1\_F.2.4.1 Initial conditions

Initial conditions are a set of test configurations the UE needs to be tested in and the steps for the SS to take with the UE to reach the correct measurement state.

Configurations of PDSCH and PDCCH before measurement are specified in Annex C.2.

Test Environment: Normal as defined in TS 36.508 [7] clause 4.1.

Frequencies to be tested: Mid Range as defined in TS 36.508 [7] clause 4.3.1.1.

Channel Bandwidths to be tested: 10MHz, as defined in TS 36.508 [7] clause 4.3.1.1.

1. Connect the SS, faders and AWGN noise source to the UE antenna connector (s) as shown in TS 36.508 [7] Annex A, Figure A.40 for antenna configuration 2x2.
2. The parameter settings for the cell are set up according to Table 9.5.5.1\_F.2.3-2.
3. Downlink signals are initially set up according to Annex C.1 and Annex C.3.2, and uplink signals according to Annex H.1 and H.3.2.
4. Propagation conditions are set according to Annex B.0.
5. Ensure the UE is in State 3A-RF according to TS 36.508 [7] clause 5.2A.2. Message contents are defined in clause 9.5.5.1\_F.2.4.3.

##### 9.5.5.1\_F.2.4.2 Test procedure

1. Set the parameters of bandwidth, reference channel, propagation condition, antenna configuration, antenna correlation, CodeBookSubsetRestriction, PMI for subframe for fixed Rank and the SNR according to Table 9.5.5.1\_F.1.3-2 and C.3.3-1 of Annex C.3.3 as appropriate.
2. The SS shall send PDSCH via PDCCH DCI format 2D for C<sub>RNTI</sub> to transmit the DL RMC according to the UE reported CQI (wideband CQI), PMI and RI. The SS sends downlink MAC padding bits on the DL RMC. The transport format to be used is defined in Annex A.4 Table 4.3-e. The SS sends uplink scheduling information via PDCCH DCI format 0 with CQI request bit set to 0 to schedule UL RMC in subframe #0 and #5 (Table A.4.1-1).
3. Measure the  $t_{fix}$  (fixed Rank 1 or fixed Rank 2) according to annex G.5.3.
4. Propagation conditions are set according to Annex B.1.
5. The SS sends uplink scheduling information via PDCCH DCI format 0 to schedule UL RMC in every subframe (Table A.4.1-1).

6. The SS shall transmit an RRC Connection Reconfiguration message to set codebookSubsetRestriction as for UE reported RI according to Table 9.5.5.1\_F.1.3-2.
7. The UE shall transmit RRC Connection Reconfiguration Complete message.
8. Propagation conditions are set according to Table 9.5.5.1\_F.1.3-2.
9. The SS shall send PDSCH via PDCCH DCI format 2D for C\_RNTI to transmit the DL RMC according to the UE reported CQI (wideband CQI), PMI and RI. The SS sends downlink MAC padding bits on the DL RMC. The transport format to be used is defined in Annex A.4 Table 4.3-e. The SS sends uplink scheduling information via PDCCH DCI format 0 with CQI request bit set to 0 to schedule UL RMC in subframe #0 and #5 (Table A.4.1-1).
10. Measure  $t_{reported}$  according to Annex G.5.3  
 If the ratio ( $t_{reported} / t_{fix}$ ) satisfies the requirement in Table 9.5.5.1\_F.2.5-1, then pass the UE for this test and go to step 11. Otherwise, fail the UE.
11. If all tests have not been done, then repeat the same procedure (steps 1 to 10) with test conditions according to the Table 9.5.5.1\_F.1.3-2 for the other Tests as appropriate. Otherwise pass the UE.

9.5.5.1\_F.2.4.3 Message contents

Message contents are according to TS 36.508 [7] clause 4.6 with the following exceptions:

**Table 9.5.5.1\_F.2.4.3-1: PhysicalConfigDedicated-DEFAULT**

Derivation Path: 36.508 clause 4.6.3			
Information Element	Value/remark	Comment	Condition
RadioResourceConfigDedicated-SRB2-DRB(n, m) ::= SEQUENCE {			
physicalConfigDedicated	<i>CQI-ReportConfig-r10-DEFAULT</i> using condition RBC		
antennaInfo CHOICE {			
explicitValue	AntennaInfoDedicated		
}			
}			

**Table 9.5.5.1\_F.2.4.3-2: PDSCH-ConfigDedicated-DEFAULT**

Derivation Path: 36.331 clause 6.3.2			
Information Element	Value/remark	Comment	Condition
PDSCH-ConfigDedicated-DEFAULT ::= SEQUENCE {			
p-a	dB0		
}			

**Table 9.5.5.1\_F.2.4.3-3: AntennaInfoDedicated-r10**

Derivation Path: 36.331 clause 6.3.2			
Information Element	Value/remark	Comment	Condition
AntennaInfoDedicated-r10 ::= SEQUENCE {			
transmissionMode-r10	tm10-v1130		
}			
ue-TransmitAntennaSelection CHOICE {			
release	NULL		
}			

Table 9.5.5.1\_F.2.4.3-4: CQI-ReportConfig-r10-DEFAULT

Derivation Path: 36.508 clause 4.6.3			
Information Element	Value/remark	Comment	Condition
CQI-ReportConfig-r10 ::= SEQUENCE {			
cqi-ReportModeAperiodic-r10	Not Present		
nomPDSCH-RS-EPRE-Offset	0		
cqi-ReportPeriodic-r10	CQI-ReportPeriodic-r10-DEFAULT		
}			

Table 9.5.5.1\_F.2.4.3-5: CQI-ReportConfig- v1130-DEFAULT

Derivation Path: 36.508 clause 4.6.3			
Information Element	Value/remark	Comment	Condition
CQI-ReportConfig-v1130 ::= SEQUENCE {			
cqi-ReportPeriodic-v1130 SEQUENCE {			
cqi-ReportPeriodicProcExtToAddModList-r11 SEQUENCE (SIZE (1..maxCQI-ProcExt-r11)) OF SEQUENCE {	1 entry		
cqi-ReportPeriodicProcExtId-r11[1] SEQUENCE {			
cqi-ReportPeriodicProcExtId-r11	1		
cqi-pmi-ConfigIndex-r11	6	CSI process 0	
}			
ri-ConfigIndex-r11	1	CSI process 0	
csi-ConfigIndex-r11 CHOICE {			
setup SEQUENCE {			
cqi-pmi-ConfigIndex2-r11	According to each test	For CSI process 1: Test 1 = N/A Test 2 = 4	
ri-ConfigIndex2-r11	According to each test	For CSI process 1: Test 1 = N/A Test 2 = 1	
}			
}			
}			
}			

**Table 9.5.5.1\_F.2.4.3-6: CSI-RS-Config**

Derivation Path: 36.331 clause 6.3.2			
Information Element	Value/remark	Comment	Condition
CSI-RS-Config-r10 ::= SEQUENCE {			
csi-RS-r10 CHOICE {			
release	NULL		
setup SEQUENCE {			
antennaPortsCount-r10	an2	Parameter represents the number of antenna ports used for transmission of CSI reference signals	
resourceConfig-r10	For CSI-RS 0 configuration = 0 For CSI-RS1 configuration = 3	Parameter: CSI reference signal configuration	
subframeConfig-r10	1	$\Delta_{\text{CSI-RS}} = I_{\text{CSI-RS}}$ when CSI-RS SubframeConfig is from 0-4; Parameter: $I_{\text{CSI-RS}}$	
p-C-r10	0	Parameter: $P_c$ which is the assumed ratio of PDSCH EPRE to CSI-RS EPRE when UE derives CSI feedback	
}			
}			
zeroTxPowerCSI-RS-r10 CHOICE {			
release			
setup SEQUENCE {			
zeroTxPowerResourceConfigList-r10	5		
zeroTxPowerSubframeConfig-r10	1		
}			
}			
}			

**Table 9.5.5.1\_F.2.4.3-7: CSI-Process**

Derivation Path: 36.331 clause 6.3.2			
Information Element	Value/remark	Comment	Condition
CSI-Process-r11 ::= SEQUENCE {			
CSI-ProcessId-r11	1		
CSI-RS-ConfigNZPId-r11	According to each CSI process	For CSI-RS 0 = 1 For CSI-RS 1 = 2	
CSI-IM-ConfigId-r11	1		
p-C-AndCBSRList-r11 SEQUENCE (SIZE (1..2)) OF SEQUENCE {	1 entry		
p-C-r11	0		
codebookSubsetRestriction-r11	According to each test		
}			

## 9.5.5.1\_F.2.5 Test requirement

**Table 9.5.5.1\_F.2.5-1: Test requirements for RI Reporting with Multiple CSI processes for CoMP (FDD)**

	Test 1	Test 2
$\gamma_1$	N/A	0.99
$\gamma_2$	0.99	N/A
UE Category	$\geq 2$	$\geq 2$

## 9.5.5.2\_F TDD RI Reporting with CSI processes for CoMP

## 9.5.5.2\_F.1 TDD RI Reporting with Single CSI process for CoMP

## 9.5.5.2\_F.1.1 Test purpose

To verify that the reported rank indicator accurately represents the channel rank with one CSI process configured.

## 9.5.5.2\_F.1.2 Test applicability

This test applies to all types of E-UTRA TDD category 2-8 UEs release 11 and forward, supporting Maximum CSI processes of One on a component carrier within a band with PDSCH transmission mode 10.

## 9.5.5.2\_F.1.3 Minimum conformance requirements

Each CSI process is associated with a CSI-RS resource and a CSI-IM resource as shown in Table 9.5.5.2\_F.1.3-1. For UE supports one CSI process CSI process 0 is configured for Test 1 and Test 2, but CSI process 1 is not configured for Test 2. The corresponding  $\gamma$  requirements for Test 1 and Test 2 shall be fulfilled. The requirement on reported RI for CSI process 1 in Test 2 is not applicable.

For UE supports multiple CSI processes, CSI process 0 is configured for Test 1 and CSI processes 0 and 1 are configured for Test 2. The corresponding  $\gamma$  requirements for Test 1 and Test 2 shall be fulfilled, and also the requirement on reported RI for CSI process 1 in Test 2.

The minimum performance requirement in Table 9.5.5.2\_F.1.3-2 is defined as:

- The ratio of the throughput obtained when transmitting based on UE reported RI and that obtained when transmitting with fixed rank 1 shall be  $\geq \gamma_1$ .
- The ratio of the throughput obtained when transmitting based on UE reported RI and that obtained when transmitting with fixed rank 2 shall be  $\geq \gamma_2$ ;
- For Test 2, the RI reported for CSI process 1 shall be the same as the most recent RI reported for CSI process 0 if UE is configured with multiple CSI processes

For the parameters specified in Table 9.5.5.2\_F.1.3-2, and using the downlink physical channels specified in Annex C.3.2, the minimum requirements are specified in Table 9.5.5.2\_F.1.3-3.

**Table 9.5.5.2\_F.1.3-1: Configuration of CSI processes**

	CSI process 0	CSI process 1
CSI-RS resource	CSI-RS signal 0	CSI-RS signal 1
CSI-IM resource	CSI-IM resource 0	CSI-IM resource 1

Table 9.5.5.2\_F.1.3-2: Test Parameters for RI Reporting with Single CSI process for CoMP (TDD)

Parameter		Unit	Test 1		Test 2	
			TP1	TP2	TP1	TP2
Bandwidth		MHz	10 MHz		10 MHz	
Transmission mode			10	10	10	10
Downlink power allocation	$\rho_A$	dB	0		0	
	$\rho_B$	dB	0		0	
	$P_c$	dB	0	0	0	0
	$\sigma$	dB	0		0	
Uplink downlink configuration			2	2	2	2
Special subframe configuration			4	4	4	4
SNR		dB	0	0	20	20
$\hat{I}_{or}^{(j)}$		dB[mW/15kHz]	-98	-98	-78	-78
$N_{oc}^{(j)}$		dB[mW/15kHz]	-98		-98	
Propagation channel			EPA 5 Low	EPA 5 Low	EPA 5 Low	EPA 5 High
Antenna configuration			2x2	2x2	2x2	2x2
Beamforming Model			As specified in Section B.4.3		As specified in Section B.4.3	
Timing offset between TPs		us	0		0	
Frequency offset between TPs		Hz	0		0	
Cell-specific reference signals			Antenna ports 0		Antenna ports 0	
CSI-RS signal 0			Antenna ports 15,16	N/A	Antenna ports 15,16	N/A
CSI-RS 0 periodicity and subframe offset $T_{CSI-RS} / \Delta_{CSI-RS}$			5/3	N/A	5/3	N/A
CSI-RS 0 configuration			0	N/A	0	N/A
CSI-RS signal 1			N/A	Antenna ports 15,16	N/A	Antenna ports 15,16
CSI-RS 1 periodicity and subframe offset $T_{CSI-RS} / \Delta_{CSI-RS}$			N/A	5/3	N/A	5/3
CSI-RS 1 configuration			N/A	3	N/A	3
Zero-power CSI-RS 0 configuration $l_{CSI-RS} / ZeroPowerCSI-RS$ bitmap			N/A	3 / 10000010000 00000	N/A	3 / 10000010000 00000
Zero-power CSI-RS 1 configuration $l_{CSI-RS} / ZeroPowerCSI-RS$ bitmap			3 / 00110000000 00000	N/A	3 / 00110000000 00000	N/A
CSI-IM 0 periodicity and subframe offset $T_{CSI-RS} / \Delta_{CSI-RS}$			5/3	N/A	5/3	N/A
CSI-IM 0 configuration			2	N/A	2	N/A
CSI-IM 1 periodicity and subframe offset $T_{CSI-RS} / \Delta_{CSI-RS}$			N/A	5/3	N/A	5/3
CSI-IM 1 configuration			N/A	6	N/A	6
RI configuration			Fixed RI=2 and follow RI	N/A	Fixed RI=1 and follow RI	N/A
CSI process 0 (Note 6, 7)	CSI-RS		CSI-RS 0	N/A	CSI-RS 0	N/A
	CSI-IM		CSI-IM 0	N/A	CSI-IM 0	N/A
	Reporting mode		PUSCH 3-1	N/A	PUSCH 3-1	N/A
	Reporting Interval	ms	5	N/A	5	N/A
	CQI delay	ms	11	N/A	11	N/A
CSI process 1 (Note 6, 7, 9)	CSI-RS		N/A	N/A	N/A	CSI-RS 1
	CSI-IM		N/A	N/A	N/A	CSI-IM 1
	Reporting mode		N/A	N/A	N/A	PUSCH 3-1
	Reporting Interval	ms	N/A	N/A	N/A	5
	CQI delay	ms	N/A	N/A	N/A	11
CSI process for PDSCH scheduling			CSI process 0		CSI process 0	
Cell ID			0	6	0	6
Quasi-co-located CSI-RS			CSI-RS 0	CSI-RS 1	CSI-RS 0	CSI-RS 1
Quasi-co-located CRS			Same Cell ID as Cell 1	Same Cell ID as Cell 2	Same Cell ID as Cell 1	Same Cell ID as Cell 2
PMI for subframe 4 and 9			010000 for fixed RI = 2 010011 for UE	100000	000011 for fixed RI = 1 010011 for UE	N/A

		reported RI		reported RI	
PMI for subframe 3 and 8		100000	100000	100000	N/A
Max number of HARQ transmissions		1	N/A	1	N/A
ACK/NACK feedback mode		Multiplexing	N/A	Multiplexing	N/A
Note 1:	If the UE reports in an available uplink reporting instance at subframe SF#n based on CQI estimation at a downlink SF not later than SF#(n-4), this reported wideband CQI cannot be applied at the eNB downlink before SF#(n+4)				
Note 2:	3 symbols allocated to PDCCH				
Note 3:	Reference measurement channel RC.13 TDD according to Table A.4-1. PDSCH transmission is scheduled on subframe 4 and 9 from TP1.				
Note 4:	TM10 OCNG as specified in A.5.2.8 is transmitted on subframe 3 and 8 from TP1.				
Note 5:	TM10 OCNG as specified in A.5.2.8 is transmitted on subframe 3, 4, 8 and 9 from TP2 for Test 1; TP2 is blanked for Test 2.				
Note 6:	Reported wideband CQI and PMI are used and sub-band CQI is discarded.				
Note 7:	If UE supports multiple CSI processes, CSI process 0 is configured as 'RI-reference CSI process' for CSI process 1.				
Note 8:	PDCCH DCI format 0 with a trigger for aperiodic CQI shall be transmitted in downlink SF#3 and #8 to allow aperiodic CQI/PMI/RI to be transmitted in uplink SF#7 and #2.				
Note 9:	If UE supports one CSI process, CSI process 1 is not configured in Test 2.				

**Table 9.5.5.2\_F.1.3-3: Minimum requirements for RI Reporting with Single CSI process for CoMP (TDD)**

	Test 1	Test 2
$\gamma_1$	N/A	1.0
$\gamma_2$	1.0	N/A
UE Category	2-8	2-8

The normative reference for this requirement is TS 36.101 [2] clause 9.5.5.2.

#### 9.5.5.2\_F.1.4 Test description

##### 9.5.5.2\_F.1.4.1 Initial conditions

Initial conditions are a set of test configurations the UE needs to be tested in and the steps for the SS to take with the UE to reach the correct measurement state.

Configurations of PDSCH and PDCCH before measurement are specified in Annex C.2.

Test Environment: Normal as defined in TS 36.508 [7] clause 4.1.

Frequencies to be tested: Mid Range as defined in TS 36.508 [7] clause 4.3.1.2.

Channel Bandwidths to be tested: 10MHz, as defined in TS 36.508 [7] clause 4.3.1.2.

1. Connect the SS, faders and AWGN noise source to the UE antenna connector (s) as shown in TS 36.508 [7] Annex A, Figure A.40 for antenna configuration 2x2.
2. The parameter settings for the cell are set up according to Table 9.5.5.2\_F.1.3-2.
3. Downlink signals are initially set up according to Annex C.1 and Annex C.3.2, and uplink signals according to Annex H.1 and H.3.2.
4. Propagation conditions are set according to Annex B.0.
5. Ensure the UE is in State 3A-RF according to TS 36.508 [7] clause 5.2A.2. Message contents are defined in clause 9.5.5.2\_F.1.4.3.

##### 9.5.5.2\_F.1.4.2 Test procedure

1. Set the parameters of bandwidth, reference channel, propagation condition, antenna configuration, antenna correlation, CodeBookSubsetRestriction, PMI for subframe for fixed Rank and the SNR according to Table 9.5.5.2\_F.1.3-1 as and C.3.3-1 of Annex C.3.3 as appropriate.



2. The SS shall send PDSCH in via PDCCH DCI format 2C for C\_RNTI to transmit the DL RMC according to the UE reported CQI (wideband CQI), PMI and RI. The SS sends downlink MAC padding bits on the DL RMC. The SS sends uplink scheduling information via PDCCH DCI format 0 to schedule UL RMC in subframe #2 and #7 (Table A.4.1-2).
3. Measure the  $t_{fix}$  according to annex G.5.3.
4. Propagation conditions are set according to Annex B.1.
5. The SS sends uplink scheduling information via PDCCH DCI format 0 to schedule UL RMC in subframe #2 and #7 (Table A.4.1-2).
6. The SS shall transmit an RRC Connection Reconfiguration message to set codebookSubsetRestriction as for UE reported RI according to Table 9.5.5.2\_F.1.3-1.
7. The UE shall transmit RRC Connection Reconfiguration Complete message.
8. Propagation conditions are set according to Table 9.5.5.2\_F.1.3-1.
9. The SS shall send PDSCH via PDCCH DCI format 2C for C\_RNTI to transmit the DL RMC according to the UE reported CQI (wideband CQI), PMI and RI. The SS sends downlink MAC padding bits on the DL RMC. The SS sends uplink scheduling information via PDCCH DCI format 0 in subframe #2 and #7 (Table A.4.1-2).
10. Measure  $t_{reported}$  according to Annex G.5.3.  
If the ratio ( $t_{reported} / t_{fix}$ ) satisfies the requirement in Table 9.5.5.2\_F.1.5-1, then pass the UE for this test and go to step 12. Otherwise, fail the UE.
11. If all tests have not been done, then repeat the same procedure (steps 1 to 10) with test conditions according to the Table 9.5.5.2\_F.1.3-1 for the other Tests as appropriate. Otherwise pass the UE.

#### 9.5.5.2\_F.1.4.3 Message contents

Message contents are according to TS 36.508 [7] clause 4.6 with the following exceptions:

**Table 9.5.5.2\_F.1.4.3-1: PhysicalConfigDedicated-DEFAULT**

Derivation Path: 36.508 clause 4.6.3			
Information Element	Value/remark	Comment	Condition
PhysicalConfigDedicated-DEFAULT ::= SEQUENCE {			
pdsch-ConfigDedicated	<i>PDSCH-ConfigDedicated-DEFAULT</i>		
antennaInfo-r10 CHOICE {			
explicitValue-r10	AntennaInfoDedicated-r10		
}			
csi-RS-ConfigZPToAddModList-r11	<i>CSI-RS-ConfigZP-r11-DEFAULT</i>		
cqi-ReportConfig-v1130	<i>CQI-ReportConfig-v1130-DEFAULT</i>		
}			

**Table 9.5.5.2\_F.1.4.3-2: PDSCH-ConfigDedicated-DEFAULT**

Derivation Path: 36.508 clause 4.6.3			
Information Element	Value/remark	Comment	Condition
PDSCH-ConfigDedicated-DEFAULT ::= SEQUENCE {			
p-a	dB0		
}			

**Table 9.5.5.2\_F.1.4.3-3: AntennaInfoDedicated-r10**

Derivation Path: 36.331 clause 6.3.2			
Information Element	Value/remark	Comment	Condition
AntennaInfoDedicated-r10 ::= SEQUENCE {			
transmissionMode-r10	tm10-v1130		
ue-TransmitAntennaSelection CHOICE {			
release	NULL		
}			
}			

**Table 9.5.5.2\_F.1.4.3-4: CQI-ReportConfig- v1130-DEFAULT**

Derivation Path: 36.508 clause 4.6.3			
Information Element	Value/remark	Comment	Condition
CQI-ReportConfig-v1130 ::= SEQUENCE {			
cqi-ReportPeriodic-v1130 SEQUENCE {			
cqi-ReportPeriodicProcExtToAddModList-r11 SEQUENCE (SIZE (1..maxCQI-ProcExt-r11)) OF SEQUENCE {	1 entry		
cqi-ReportPeriodicProcExtId-r11[1] SEQUENCE {			
cqi-ReportPeriodicProcExtId-r11	1		
cqi-pmi-ConfigIndex-r11	10	CSI process 0	
ri-ConfigIndex-r11	1	CSI process 0	
csi-ConfigIndex-r11 CHOICE {			
setup SEQUENCE {			
cqi-pmi-ConfigIndex2-r11	According to each test	For CSI process 1: Test 1 = N/A Test 2 = 15	
ri-ConfigIndex2-r11	According to each test	For CSI process 1: Test 1 = N/A Test 2 = 1	
}			
}			
}			
}			
}			
}			

**Table 9.5.5.2\_F.1.4.3-5: CSI-RS-ConfigZP-r11-DEFAULT**

Derivation Path: 36.3508 clause 4.6.3			
Information Element	Value/remark	Comment	Condition
CSI-RS-ConfigZP-r11 ::= SEQUENCE {			
csi-RS-ConfigZPId-r11	1		
resourceConfigList-r11	For Zero-power CSI-RS 0 = 0011000000000000 For Zero-power CSI-RS 1 configuration = 1000001000000000	Parameter: <i>ZeroPowerCSI-RS</i>	
subframeConfig-r11	3	$\Delta_{\text{CSI-RS}} = I_{\text{CSI-RS}}$ when CSI-RS SubframeConfig is from 0-4; Parameter: $I_{\text{CSI-RS}}$	
}			

## 9.5.5.2\_F.1.5 Test requirement

**Table 9.5.5.2\_F.1.5-1: Test requirements for RI Reporting with Single CSI process for CoMP (FDD)**

	Test 1	Test 2
$\gamma_1$	N/A	0.99
$\gamma_2$	0.99	N/A
UE Category	$\geq 2$	$\geq 2$

## 9.5.5.2\_F.2 TDD RI Reporting with Multiple CSI processes for CoMP

**Editor's Note: The test procedure to test the reported RI requirement for CSI process 1 in Test 2 for multiple CSI process is TBD**

## 9.5.5.2\_F.2.1 Test purpose

To verify that the reported rank indicator accurately represents the channel rank with Multiple CSI processes configured.

## 9.5.5.2\_F.2.2 Test applicability

This test applies to all types of E-UTRA TDD category 2-8 UEs release 11 and forward, supporting Maximum CSI processes of Three or Four on a component carrier within a band with PDSCH transmission mode 10.

## 9.5.5.2\_F.2.3 Minimum conformance requirements

Same minimum conformance requirements as in clause 9.5.5.2\_F.1.3

## 9.5.5.2\_F.2.4 Test description

## 9.5.5.2\_F.2.4.1 Initial conditions

Initial conditions are a set of test configurations the UE needs to be tested in and the steps for the SS to take with the UE to reach the correct measurement state.

Configurations of PDSCH and PDCCH before measurement are specified in Annex C.2.

Test Environment: Normal as defined in TS 36.508 [7] clause 4.1.

Frequencies to be tested: Mid Range as defined in TS 36.508 [7] clause 4.3.1.2.

Channel Bandwidths to be tested: 10MHz, as defined in TS 36.508 [7] clause 4.3.1.2.

1. Connect the SS, faders and AWGN noise source to the UE antenna connector (s) as shown in TS 36.508 [7] Annex A, Figure A.40 for antenna configuration 2x2.
2. The parameter settings for the cell are set up according to Table 9.5.5.2\_F.2.3-2.
3. Downlink signals are initially set up according to Annex C.1 and Annex C.3.2, and uplink signals according to Annex H.1 and H.3.2.
4. Propagation conditions are set according to Annex B.0.
5. Ensure the UE is in State 3A-RF according to TS 36.508 [7] clause 5.2A.2. Message contents are defined in clause 9.5.5.2\_F.2.4.3.

## 9.5.5.2\_F.2.4.2 Test procedure

1. Set the parameters of bandwidth, reference channel, propagation condition, antenna configuration, antenna correlation, CodeBookSubsetRestriction, PMI for subframe for fixed Rank and the SNR according to Table 9.5.5.2\_F.1.3-2 as and C.3.3-1 of Annex C.3.3 as appropriate.

2. The SS shall send PDSCH in via PDCCH DCI format 2C for C\_RNTI to transmit the DL RMC according to the UE reported CQI (wideband CQI), PMI and RI. The SS sends downlink MAC padding bits on the DL RMC. The SS sends uplink scheduling information via PDCCH DCI format 0 to schedule UL RMC in subframe #2 and #7 (Table A.4.1-2).
3. Measure the  $t_{fix}$  according to annex G.5.3.
4. Propagation conditions are set according to Annex B.1.
5. The SS sends uplink scheduling information via PDCCH DCI format 0 to schedule UL RMC in subframe #2 and #7 (Table A.4.1-2).
6. The SS shall transmit an RRC Connection Reconfiguration message to set codebookSubsetRestriction as for UE reported RI according to Table 9.5.5.2\_F.1.3-2.
7. The UE shall transmit RRC Connection Reconfiguration Complete message.
8. Propagation conditions are set according to Table 9.5.5.2\_F.1.3-2.
9. The SS shall send PDSCH via PDCCH DCI format 2C for C\_RNTI to transmit the DL RMC according to the UE reported CQI (wideband CQI), PMI and RI. The SS sends downlink MAC padding bits on the DL RMC. The SS sends uplink scheduling information via PDCCH DCI format 0 to schedule UL RMC in subframe #2 and #7 (Table A.4.1-2).
10. Measure  $t_{reported}$  according to Annex G.5.3  
If the ratio ( $t_{reported} / t_{fix}$ ) satisfies the requirement in Table 9.5.5.2\_F.2.5-1, then pass the UE for this test and go to step 12. Otherwise, fail the UE.
11. If all tests have not been done, then repeat the same procedure (steps 1 to 10) with test conditions according to the Table 9.5.5.2\_F.1.3-2 for the other Tests as appropriate. Otherwise pass the UE.

#### 9.5.5.2\_F.2.4.3 Message contents

Message contents are according to TS 36.508 [7] clause 4.6 with the following exceptions:

**Table 9.5.5.2\_F.2.4.3-1: PhysicalConfigDedicated-DEFAULT**

Derivation Path: 36.508 clause 4.6.3			
Information Element	Value/remark	Comment	Condition
RadioResourceConfigDedicated-SRB2-DRB(n, m) ::= SEQUENCE {			
physicalConfigDedicated	<i>CQI-ReportConfig-r10-DEFAULT</i> using condition RBC		
antennaInfo CHOICE {			
explicitValue	AntennaInfoDedicated		
}			
}			

**Table 9.5.5.2\_F.2.4.3-2: PDSCH-ConfigDedicated-DEFAULT**

Derivation Path: 36.331 clause 6.3.2			
Information Element	Value/remark	Comment	Condition
PDSCH-ConfigDedicated-DEFAULT ::= SEQUENCE {			
p-a	dB0		
}			

Table 9.5.5.2\_F.2.4.3-3: *AntennaInfoDedicated-r10*

Derivation Path: 36.331 clause 6.3.2			
Information Element	Value/remark	Comment	Condition
AntennaInfoDedicated-r10 ::= SEQUENCE {			
transmissionMode-r10	tm10-v1130		
}			
ue-TransmitAntennaSelection CHOICE {			
release	NULL		
}			

Table 9.5.5.2\_F.2.4.3-4: *CQI-ReportConfig- v1130-DEFAULT*

Derivation Path: 36.508 clause 4.6.3			
Information Element	Value/remark	Comment	Condition
CQI-ReportConfig-v1130 ::= SEQUENCE {			
cqi-ReportPeriodic-v1130 SEQUENCE {			
cqi-ReportPeriodicProcExtToAddModList-r11	1 entry		
SEQUENCE (SIZE (1..maxCQI-ProcExt-r11)) OF			
SEQUENCE {			
cqi-ReportPeriodicProcExtId-r11[1] SEQUENCE			
{			
cqi-ReportPeriodicProcExtId-r11	1		
cqi-pmi-ConfigIndex-r11	6	CSI process 0	
}			
ri-ConfigIndex-r11	1	CSI process 0	
csi-ConfigIndex-r11 CHOICE {			
setup SEQUENCE {			
cqi-pmi-ConfigIndex2-r11	According to each test	For CSI process 1: Test 1 = N/A Test 2 = 4	
ri-ConfigIndex2-r11	According to each test	For CSI process 1: Test 1 = N/A Test 2 = 1	
}			
}			
}			
}			
}			
}			

**Table 9.5.5.2\_F.2.4.3-5: CSI-RS-Config**

Derivation Path: 36.331 clause 6.3.2			
Information Element	Value/remark	Comment	Condition
CSI-RS-Config-r10 ::= SEQUENCE {			
csi-RS-r10 CHOICE {			
release	NULL		
setup SEQUENCE {			
antennaPortsCount-r10	an2	Parameter represents the number of antenna ports used for transmission of CSI reference signals	
resourceConfig-r10	For CSI-RS 0 configuration = 0 For CSI-RS1 configuration = 3	Parameter: CSI reference signal configuration	
subframeConfig-r10	3	$\Delta_{\text{CSI-RS}} = I_{\text{CSI-RS}}$ when CSI-RS SubframeConfig is from 0-4; Parameter: $I_{\text{CSI-RS}}$	
p-C-r10	0	Parameter: $P_c$ which is the assumed ratio of PDSCH EPRE to CSI-RS EPRE when UE derives CSI feedback	
}			
}			
zeroTxPowerCSI-RS-r10 CHOICE {			
release			
setup SEQUENCE {			
zeroTxPowerResourceConfigList-r10	5		
zeroTxPowerSubframeConfig-r10	3		
}			
}			
}			

**Table 9.5.5.2\_F.2.4.3-6: CSI-Process**

Derivation Path: 36.331 clause 6.3.2			
Information Element	Value/remark	Comment	Condition
CSI-Process-r11 ::= SEQUENCE {			
CSI-ProcessId-r11	1		
CSI-RS-ConfigNZPId-r11	According to each CSI process	For CSI-RS 0 = 1 For CSI-RS 1 = 2	
CSI-IM-ConfigId-r11	1		
p-C-AndCBSRList-r11 SEQUENCE (SIZE (1..2)) OF SEQUENCE {	1 entry		
p-C-r11	0		
codebookSubsetRestriction-r11	According to each test		
}			

## 9.5.5.2\_F.2.5 Test requirement

**Table 9.5.5.2\_F.2.5-1: Test requirements for RI Reporting with Multiple CSI processes for CoMP (TDD)**

	Test 1	Test 2
$\gamma_1$	N/A	0.99
$\gamma_2$	0.99	N/A
UE Category	$\geq 2$	$\geq 2$

## 9.6 Additional requirements for carrier aggregation

This clause includes requirements for the reporting of channel state information (CSI) with the UE configured for carrier aggregation. The purpose is to verify that the channel state for each cell is correctly reported with multiple cells configured for periodic reporting.

Unless otherwise stated, the logical carriers PCC / SCC are mapped on physical frequencies as defined in Table 9.6-1.

**Table 9.6-1: PCC/SCCs frequency mapping**

CA Configuration	PCC-SCC mapping	Notes
Intra-band CA	CC1-CC2	1
Inter-band CA (CA <sub>x-y</sub> )	Bx-By (if not supported by the UE, then By-Bx)	2
Note 1:	Notation C <i>C</i> <sub>i</sub> -C <i>C</i> <sub>j</sub> means PCC on component carrier C <i>C</i> <sub>i</sub> and SCC on component carrier C <i>C</i> <sub>j</sub> , with C <i>C</i> <sub>i</sub> / <sub>j</sub> frequencies defined in the corresponding intra-band contiguous / non-contiguous CA band in TS 36.508.	
Note 2:	Notation B <i>i</i> -B <i>j</i> means PCC on component Band <i>i</i> and SCC on component Band <i>j</i> , with single Band <i>i</i> / <sub>j</sub> frequencies defined in TS 36.508.	

### 9.6.1 Periodic reporting on multiple cells (Cell-Specific Reference Symbols)

#### 9.6.1.1\_A FDD CQI Reporting under AWGN conditions – PUCCH 1-0 for CA

##### 9.6.1.1\_A.1 FDD CQI Reporting under AWGN conditions – PUCCH 1-0 for CA(2DL CA)

###### 9.6.1.1\_A.1.1 Test purpose

To verify that the UE reports different CQI indices for Pcell and Scell if each cell experiences a different SNR.

###### 9.6.1.1\_A.1.2 Test applicability

This test applies to

all types of E-UTRA FDD release 10 and forward UE of category 3 or higher that support inter-band OR intra-band contiguous DL CA.

This test also applies to all types of E-UTRA FDD release 11 and forward UE of category 3 or higher that support intra-band non contiguous DL CA.

###### 9.6.1.1\_A.1.3 Minimum conformance requirements

The following requirements apply to UE Category  $\geq 3$ . For the parameters specified in Table 9.6.1.1\_A.1.3-1 and Table 9.6.1.1\_A.1.3-2, and using the downlink physical channels specified in tables C.3.2-1 and C.3.2-2 on each cell, the difference between the wideband CQI indices of Pcell and Scell reported shall be such that

$$\text{wideband CQI}_{\text{Pcell}} - \text{wideband CQI}_{\text{Scell}} \geq 2$$

for more than 90% of the time.

**Table 9.6.1.1\_A.1.3-1: Parameters for PUCCH 1-0 static test on multiple cells (FDD)**

Parameter		Unit	Pcell	Scell
PDSCH transmission mode				1
Downlink power allocation	$\rho_A$	dB		0
	$\rho_B$	dB		0
Propagation condition and antenna configuration			AWGN (1 x 2)	
SNR		dB	10	4
$\hat{I}_{or}^{(j)}$		dB[mW/15kHz]	-88	-94
$N_{oc}^{(j)}$		dB[mW/15kHz]	-98	-98
Physical channel for CQI reporting			PUCCH Format 2	
PUCCH Report Type			4	
Reporting periodicity		Ms	$N_{pd} = 10$	
<i>cqi-pmi-ConfigurationIndex</i>			11	16 [shift of 5 ms relative to Pcell]
Note 1: 3 symbols are allocated to PDCCH. No PDSCH for user data is scheduled for the UE with one sided dynamic OCNG Pattern OP.1 FDD as described in Annex A.5.1.1.				

**Table 9.6.1.1\_A.1.3-2: PUCCH 1-0 static test (FDD)**

Test number	Bandwidth combination
1	10MHz for both cells
2	20MHz for both cells
3	5MHz for both cells
4	5MHz for PCell and 10MHz for SCell
Note 1: The applicability of requirements for different CA configurations and bandwidth combination sets is defined in 9.1.1.2.	

The normative reference for this requirement is TS 36.101 [2] clause 9.6.1.1.

#### 9.6.1.1\_A.1.4 Test description

##### 9.6.1.1\_A.1.4.1 Initial conditions

Initial conditions are a set of test configurations the UE needs to be tested in and the steps for the SS to take with the UE to reach the correct measurement state.

Configurations of PDSCH and PDCCH before measurement are specified in Annex C.2.

Test Environment: Normal as defined in TS 36.508 [7] clause 4.1.

Frequencies to be tested: Maximum Wgap for Intra-band non-contiguous CA, otherwise Mid Range, as defined in TS 36.508 [7] clause 4.3.1.

Channel Bandwidths to be tested: Select one according to Table 9.6.1.1\_A.1.4.1-1.

CA Capability to be tested: Select one according to Table 9.6.1.1\_A.1.4.1-1

**Table 9.6.1.1\_A.1.4.1-1: Test point selection for PUCCH 1-0 static test**

CA Applicability	Bandwidth combination			
	10+10	20+20	5+5	5+10
Inter-band CA (two bands) (CA2_A2)	Test 1	Test 2	Test 3	Test4



Intra-band contiguous CA (CA2_C)	Test 1	Test 2	Test 3	Test4
Intra-band non-contiguous CA (with two sub-blocks) (CA2_N2)	Test 1	Test 2	Test 3	Test4
Note 1: Select the first UE supported CA bandwidth combination (moving from left to right) and then choose any one of the UE supported CA capabilities.				

1. Connect the SS and AWGN noise source to the UE antenna connector (s) as shown in TS 36.508 [7] Annex A, Figure group A.45 as appropriate.
2. The parameter settings for the cell are set up according to Table 9.6.1.1\_A.1.3-1.
3. Downlink signals are initially set up according to Annex C.0, C.1 and Annex C.3.2 and uplink signals according to Annex H.1 and H.3.2.
4. Propagation conditions are set according to Annex B.0.
5. Ensure the UE is in State 3A-RF according to TS 36.508 [7] clause 5.2A.2. Message contents are defined in clause 9.6.1.1\_A.1.4.3.

9.6.1.1\_A.1.4.2 Test procedure

1. Configure SCC according to Annex C.0, C.1 and Annex C.3.2 for all downlink physical channels.
2. The SS shall configure SCC as per TS 36.508 [7] clause 5.2A.4. Message contents for *RadioResourceConfigDedicatedSCell-r10-DEFAULT* are defined Table 9.6.1.1\_A.1.4.3-4, *PhysicalConfigDedicatedSCell-r10-DEFAULT* is defined in Table 9.6.1.1\_A.1.4.3-5, *CQI-ReportConfigSCell-r10-DEFAULT* is defined in Table 9.6.1.1\_A.1.4.3-6, *CQI-ReportPeriodic-r10-DEFAULT* is defined in Table 9.6.1.1\_A.1.4.3-7.
3. SS activates SCC by sending the activation MAC-CE (Refer TS 36.321 [13], clauses 5.13, 6.1.3.8). Wait for at least 2 seconds (Refer TS 36.133, clauses 8.3.3.2).
4. Set the parameters of bandwidth, reference channel, propagation condition, antenna configuration and the SNR according to Table 9.6.1.1\_A.1.3-1 as appropriate.
5. The SS shall start gathering CQI reports. No PDSCH for user data is scheduled for the UE.
6. Continue gathering CQI reports until 2000 wideband CQI reports have been gathered for each P-Cell and S-Cell. For each CSI report calculate the respective difference  $CQI_{P,S} = \text{wideband } CQI_{Pcell} - \text{wideband } CQI_{Scell}$ .
7. If more than 1800 values of  $CQI_{P,S}$  are  $\geq 2$  pass the UE. Otherwise fail the UE.

9.6.1.1\_A.1.4.3 Message contents

Message contents are according to TS 36.508 [7] clause 4.6 with the following exceptions:

**Table 9.6.1.1\_A.1.4.3-1: *RadioResourceConfigDedicated-DEFAULT***

Derivation Path: 36.508 clause 4.6.3			
Information Element	Value/remark	Comment	Condition
RadioResourceConfigDedicated-SRB2-DRB(n, m) ::= SEQUENCE {			
physicalConfigDedicated	<i>PhysicalConfigDedicated - DEFAULT</i>		RBC
}			

**Table 9.6.1.1\_A.1.4.3-2: PhysicalConfigDedicated-DEFAULT**

Derivation Path: 36.508 clause 5.5.1.2			
Information Element	Value/remark	Comment	Condition
PhysicalConfigDedicated-DEFAULT ::= SEQUENCE {			
cqi-ReportConfig	<i>CQI-ReportConfig-DEFAULT</i>		RBC
}			

**Table 9.6.1.1\_A.1.4.3-3: CQI-ReportPeriodic-DEFAULT**

Derivation Path: 36.508 clause 4.6.3			
Information Element	Value/remark	Comment	Condition
CQI-ReportConfig-DEFAULT ::= SEQUENCE {			
cqi-ReportModeAperiodic	Not present		
nomPDSCH-RS-EPRE-Offset	0		
cqi-ReportPeriodic CHOICE {	setup		
setup SEQUENCE {			
cqi-PUCCH-ResourceIndex	0		
cqi-pmi-ConfigIndex	11	(see Table 7.2.2-1A in TS 36.213)	
cqi-FormatIndicatorPeriodic CHOICE {	widebandCQI		
widebandCQI	NULL		
}			
ri-ConfigIndex	NULL	(see Table 7.2.2-1B in TS 36.213)	
simultaneousAckNackAndCQI	FALSE		
}			
}			
}			

**Table 9.6.1.1\_A.1.4.3-4: RadioResourceConfigDedicatedSCell-r10-DEFAULT**

Derivation Path: 36.508 clause 4.6.3			
Information Element	Value/remark	Comment	Condition
RadioResourceConfigDedicatedSCell-r10 ::= SEQUENCE {			
physicalConfigDedicatedSCell-r10	<i>PhysicalConfigDedicatedSCell-r10-DEFAULT</i>		
}			

**Table 9.6.1.1\_A.1.4.3-5: PhysicalConfigDedicatedSCell-r10-DEFAULT**

Derivation Path: 36.508 clause 4.6.3			
Information Element	Value/remark	Comment	Condition
PhysicalConfigDedicatedSCell-r10-DEFAULT ::= SEQUENCE {			
ul-Configuration-r10			
ul-Configuration-r10 SEQUENCE {			
cqi-ReportConfigSCell-r10	<i>CQI-ReportConfigSCell-r10-DEFAULT</i>		
}			
}			

**Table 9.6.1.1\_A.1.4.3-6: CQI-ReportConfigSCell-r10-DEFAULT**

Derivation Path: 36.508 clause 4.6.3			
Information Element	Value/remark	Comment	Condition
CQI-ReportConfigSCell-r10 ::= SEQUENCE {			
cqi-ReportModeAperiodic-r10	Not present		
nomPDSCH-RS-EPRE-Offset-r10	0		
cqi-ReportPeriodicSCell-r10			
	<i>CQI-ReportPeriodic-r10-DEFAULT</i>		CQI_PERIODIC
pmi-RI-Report-r10	Not present		
}			

**Table 9.6.1.1\_A.1.4.3-7: CQI-ReportPeriodic-r10-DEFAULT**

Derivation Path: 36.508 clause 4.6.3			
Information Element	Value/remark	Comment	Condition
CQI-ReportPeriodic-r10 ::= CHOICE {			
setup SEQUENCE {			
cqi-PUCCH-ResourceIndex-r10	0		
cqi-PUCCH-ResourceIndexP1-r10	Not present		
cqi-pmi-ConfigIndex	16		
cqi-FormatIndicatorPeriodic-r10 CHOICE {			
widebandCQI-r10 SEQUENCE {			
csi-ReportMode-r10	Not present		
}			
ri-ConfigIndex	NULL		
simultaneousAckNackAndCQI	FALSE		
cqi-Mask-r9	Not present		
csi-ConfigIndex-r10	Not present		
}			
}			

#### 9.6.1.1\_A.1.5 Test requirement

The pass fail decision is as specified in the test procedure in clause 9.6.1.1\_A.1.4.2.

There are no parameters in the test setup or measurement process whose variation impacts the results so there are no applicable test tolerances for this test.

#### 9.6.1.1\_A.2 FDD CQI Reporting under AWGN conditions – PUCCH 1-0 for CA (3DL CA)

##### 9.6.1.1\_A.2.1 Test purpose

To verify that the UE reports different CQI indices for Pcell and SCells if each cell experiences a different SNR.

##### 9.6.1.1\_A.2.2 Test applicability

This test case applies to all types of E-UTRA FDD release 10 and forward UE of category 5 or higher that support 3DL Intra-band contiguous CA or 3DL Inter-band CA, or 3DL with Intra-band contiguous and Inter-band CA.

This test case also applies to all types of E-UTRA FDD release 11 and forward UE of category 5 or higher that support 3DL with Intra-band non-contiguous and Inter-band CA, or 3DL with Intra-band non-contiguous and Intra-band contiguous CA.

##### 9.6.1.1\_A.2.3 Minimum conformance requirements

The following requirements apply to UE Category  $\geq 5$ . For the parameters specified in Table 9.6.1.1\_A.2.3-1 and Table 9.6.1.1\_A.2.3-2, and using the downlink physical channels specified in tables C.3.2-1 and C.3.2-2 on each cell, the

difference between the wideband CQI indices of Pcell and SCell1 reported, and the difference between the wideband CQI indices of SCell1 and SCell2 reported shall be such that

$$\text{wideband CQI}_{\text{Pcell}} - \text{wideband CQI}_{\text{SCell1}} \geq 2$$

$$\text{wideband CQI}_{\text{SCell1}} - \text{wideband CQI}_{\text{SCell2}} \geq 2$$

for more than 90% of the time.

**Table 9.6.1.1\_A.2.3-1: Parameters for PUCCH 1-0 static test on multiple cells (FDD, 3 DL CA)**

Parameter		Unit	Pcell	Scell1	Scell2
PDSCH transmission mode			1		
Downlink power allocation	$\rho_A$	dB	0		
	$\rho_B$	dB	0		
Propagation condition and antenna configuration			AWGN (1 x 2)		
SNR		dB	12	6	0
$\hat{I}_{or}^{(j)}$		dB[mW/15kHz]	-86	-92	-98
$N_{oc}^{(j)}$		dB[mW/15kHz]	-98	-98	-98
Physical channel for CQI reporting			PUCCH Format 2		
PUCCH Report Type			4		
Reporting periodicity		ms	$N_{pd} = 20$		
<i>cqi-pmi-ConfigurationIndex</i>			21	26 [shift of 5 ms relative to Pcell]	31 [shift of 10 ms relative to Pcell]
Note 1: 3 symbols are allocated to PDCCH. No PDSCH for user data is scheduled for the UE with one sided dynamic OCNB Pattern OP.1 FDD as described in Annex A.5.1.1.					

**Table 9.6.1.1\_A.2.3-2: PUCCH 1-0 static test (FDD, 3DL CA)**

Test number	Bandwidth combination (MHz)
1	3x20
2	20+20+15
3	20+20+10
4	20+15+15
5	20+15+10
6	20+10+10
7	15+15+10
8	20+10+5
Note 1: The applicability of requirements for different CA configurations and bandwidth combination sets is defined in 9.1.1.2.	

The normative reference for this requirement is TS 36.101 [2] clause 9.6.1.1.

#### 9.6.1.1\_A.2.4 Test description

##### 9.6.1.1\_A.2.4.1 Initial conditions

Initial conditions are a set of test configurations the UE needs to be tested in and the steps for the SS to take with the UE to reach the correct measurement state.

Configurations of PDSCH and PDCCH before measurement are specified in Annex C.2.

Test Environment: Normal as defined in TS 36.508 [7] clause 4.1.

Frequencies to be tested: Maximum Wgap for Intra-band non-contiguous CA, otherwise Mid Range, as defined in TS 36.508 [7] clause 4.3.1.

Channel Bandwidths to be tested: Select one according to Table 9.6.1.1\_A.2.4.1-1.

CA Capability to be tested: Select one according to Table 9.6.1.1\_A.2.4.1-1.

**Table 9.6.1.1\_A.2.4.1-1: Test point selection for PUCCH 1-0 static test**

CA Applicability	Bandwidth combination							
	3x20	20+20+15	20+20+10	20+15+15	20+15+10	20+10+10	15+15+10	20+10+5
Intra-band contiguous (CA_C)	Test 1	Test 2	Test 3	Test4	Test5	Test6	Test7	Test8
Inter-band (CA_A_2)	Test 1	Test 2	Test 3	Test4	Test5	Test6	Test7	Test8
Inter-band (CA_A_3)	Test 1	Test 2	Test 3	Test4	Test5	Test6	Test7	Test8
Intra-band non-contiguous (CA_N)	Test 1	Test 2	Test 3	Test4	Test5	Test6	Test7	Test8
Note 1: Only one test point is tested. Select the first UE supported CA bandwidth combination (moving from left to right) and choose any one of the UE supported CA capabilities supporting that CA bandwidth combination.								

1. Connect the SS and AWGN noise source to the UE antenna connector (s) as shown in TS 36.508 [7] Annex A, Figure A.59 without faders.
2. The parameter settings for the cell are set up according to Table 9.6.1.1\_A.2.3-1.
3. Downlink signals are initially set up according to Annex C.0, C.1 and Annex C.3.2 and uplink signals according to Annex H.1 and H.3.2.
4. Propagation conditions are set according to Annex B.0.
5. Ensure the UE is in State 3A-RF according to TS 36.508 [7] clause 5.2A.2. Message contents are defined in clause 9.6.1.1\_A.2.4.3.

#### 9.6.1.1\_A.2.4.2 Test procedure

1. Configure SCCs according to Annex C.0, C.1 and Annex C.3.2 for all downlink physical channels.
2. The SS shall configure SCCs as per TS 36.508 [7] clause 5.2A.4. Message contents for *RadioResourceConfigDedicatedSCell-r10-DEFAULT* are defined Table 9.6.1.1\_A.2.4.3-4, *PhysicalConfigDedicatedSCell-r10-DEFAULT* is defined in Table 9.6.1.1\_A.2.4.3-5, *CQI-ReportConfigSCell-r10-DEFAULT* is defined in Table 9.6.1.1\_A.2.4.3-6, *CQI-ReportPeriodic-r10-DEFAULT* is defined in Table 9.6.1.1\_A.2.4.3-7.
3. SS activates SCCs by sending the activation MAC-CE (Refer TS 36.321 [13], clauses 5.13, 6.1.3.8). Wait for at least 2 seconds (Refer TS 36.133, clauses 8.3.3.2).
4. Set the parameters of bandwidth, reference channel, propagation condition, antenna configuration and the SNR according to Table 9.6.1.1\_A.2.3-1 as appropriate.
5. The SS shall start gathering CQI reports. No PDSCH for user data is scheduled for the UE.
6. Continue gathering CQI reports until 2000 wideband CQI reports have been gathered for each P-Cell and S-Cells. For each CSI report calculate the respective difference  $CQI_{P-S1} = \text{wideband } CQI_{Pcell} - \text{wideband } CQI_{Scell1}$  and the respective difference  $CQI_{S1-S2} = \text{wideband } CQI_{Scell1} - \text{wideband } CQI_{Scell2}$ .
7. If more than 1800 values of  $CQI_{P-S1}$  are  $\geq 2$  and more than 1800 values of  $CQI_{S1-S2}$  are  $\geq 2$ , pass the UE. Otherwise fail the UE.

## 9.6.1.1\_A.2.4.3 Message contents

Message contents are according to TS 36.508 [7] clause 4.6 with the following exceptions:

**Table 9.6.1.1\_A.2.4.3-1: RadioResourceConfigDedicated-DEFAULT**

Derivation Path: 36.508 clause 4.6.3			
Information Element	Value/remark	Comment	Condition
RadioResourceConfigDedicated-SRB2-DRB(n, m) ::= SEQUENCE {			
physicalConfigDedicated	<i>PhysicalConfigDedicated - DEFAULT</i>		RBC
}			

**Table 9.6.1.1\_A.2.4.3-2: PhysicalConfigDedicated-DEFAULT**

Derivation Path: 36.508 clause 5.5.1.2			
Information Element	Value/remark	Comment	Condition
PhysicalConfigDedicated-DEFAULT ::= SEQUENCE {			
cqi-ReportConfig	<i>CQI-ReportConfig-DEFAULT</i>		RBC
}			

**Table 9.6.1.1\_A.2.4.3-3: CQI-ReportPeriodic-DEFAULT**

Derivation Path: 36.508 clause 4.6.3			
Information Element	Value/remark	Comment	Condition
CQI-ReportConfig-DEFAULT ::= SEQUENCE {			
cqi-ReportModeAperiodic	Not present		
nomPDSCH-RS-EPRE-Offset	0		
cqi-ReportPeriodic CHOICE {	setup		
setup SEQUENCE {			
cqi-PUCCH-ResourceIndex	0		
cqi-pmi-ConfigIndex	21	(see Table 7.2.2-1A in TS 36.213)	
cqi-FormatIndicatorPeriodic CHOICE {	widebandCQI		
widebandCQI	NULL		
}			
ri-ConfigIndex	NULL	(see Table 7.2.2-1B in TS 36.213)	
simultaneousAckNackAndCQI	FALSE		
}			
}			

**Table 9.6.1.1\_A.2.4.3-4: RadioResourceConfigDedicatedSCell-r10-DEFAULT**

Derivation Path: 36.508 clause 4.6.3			
Information Element	Value/remark	Comment	Condition
RadioResourceConfigDedicatedSCell-r10 ::= SEQUENCE {			
physicalConfigDedicatedSCell-r10	<i>PhysicalConfigDedicatedSCell-r10-DEFAULT</i>		
}			

**Table 9.6.1.1\_A.2.4.3-5: PhysicalConfigDedicatedSCell-r10-DEFAULT**

Derivation Path: 36.508 clause 4.6.3			
Information Element	Value/remark	Comment	Condition
PhysicalConfigDedicatedSCell-r10-DEFAULT ::= SEQUENCE {			
ul-Configuration-r10			
ul-Configuration-r10 SEQUENCE {			
cqi-ReportConfigSCell-r10	CQI-ReportConfigSCell-r10-DEFAULT		
}			
}			

**Table 9.6.1.1\_A.2.4.3-6: CQI-ReportConfigSCell-r10-DEFAULT**

Derivation Path: 36.508 clause 4.6.3			
Information Element	Value/remark	Comment	Condition
CQI-ReportConfigSCell-r10 ::= SEQUENCE {			
cqi-ReportModeAperiodic-r10	Not present		
nomPDSCH-RS-EPRE-Offset-r10	0		
cqi-ReportPeriodicSCell-r10			
	CQI-ReportPeriodic-r10-DEFAULT		CQI_PERIODIC
pmi-RI-Report-r10	Not present		
}			

**Table 9.6.1.1\_A.2.4.3-7: CQI-ReportPeriodic-r10-DEFAULT**

Derivation Path: 36.508 clause 4.6.3			
Information Element	Value/remark	Comment	Condition
CQI-ReportPeriodic-r10 ::= CHOICE {			
setup SEQUENCE {			
cqi-PUCCH-ResourceIndex-r10	0		
cqi-PUCCH-ResourceIndexP1-r10	Not present		
cqi-pmi-ConfigIndex	26		Scell1
	31		Scell2
cqi-FormatIndicatorPeriodic-r10 CHOICE {			
widebandCQI-r10 SEQUENCE {			
csi-ReportMode-r10	Not present		
}			
ri-ConfigIndex	NULL		
simultaneousAckNackAndCQI	FALSE		
cqi-Mask-r9	Not present		
csi-ConfigIndex-r10	Not present		
}			
}			

#### 9.6.1.1\_A.2.5 Test requirement

The pass fail decision is as specified in the test procedure in clause 9.6.1.1\_A.2.4.2.

There are no parameters in the test setup or measurement process whose variation impacts the results so there are no applicable test tolerances for this test.

### 9.6.1.2\_A TDD CQI Reporting under AWGN conditions – PUCCH 1-0 for CA

#### 9.6.1.2\_A.1 TDD CQI Reporting under AWGN conditions – PUCCH 1-0 for CA (2DL CA)

##### 9.6.1.2\_A.1.1 Test purpose

To verify that the UE reports different CQI indices for Pcell and Scell if each cell experiences a different SNR.

##### 9.6.1.2\_A.1.2 Test applicability

This test applies to all types of E-UTRA TDD UE release 10 and forward with category 3 or higher that support intra-band contiguous DL CA or inter band DL CA.

This test applies to all types of E-UTRA TDD UE release 11 and forward with category 3 or higher that support intra-band non-contiguous DL CA.

##### 9.6.1.2\_A.1.3 Minimum conformance requirements

The following requirements apply to UE Category  $\geq 3$ . For the parameters specified in Table 9.6.1.2\_A.1.3-1 and Table 9.6.1.2\_A.1.3-2, and using the downlink physical channels specified in tables C.3.2-1 and C.3.2-2 on each cell, the difference between the wideband CQI indices of Pcell and Scell reported shall be such that

$$\text{wideband CQI}_{\text{Pcell}} - \text{wideband CQI}_{\text{Scell}} \geq 2$$

for more than 90% of the time.

**Table 9.6.1.2\_A.1.3-1: PUCCH 1-0 static test on multiple cells (TDD, 2 DL CA)**

Parameter		Unit	Pcell	Scell
PDSCH transmission mode				1
Uplink downlink configuration				2
Special subframe configuration				4
Downlink power allocation	$\rho_A$	dB		0
	$\rho_B$	dB		0
Propagation condition and antenna configuration			AWGN (1 x 2)	
SNR		dB	10	4
$\hat{I}_{or}^{(j)}$		dB[mW/15kHz]	-88	-94
$N_{oc}^{(j)}$		dB[mW/15kHz]	-98	-98
Physical channel for CQI reporting			PUCCH Format 2	
PUCCH Report Type				4
Reporting periodicity		ms	$N_{pd} = 10$	
<i>cqi-pmi-ConfigurationIndex</i>			8	13 [shift of 5 ms relative to Pcell]
Note 1: 3 symbols are allocated to PDCCH. No PDSCH for user data is scheduled for the UE with one sided dynamic OCNG Pattern OP.1 TDD as described in Annex A.5.2.1.				

**Table 9.6.1.2\_A.1.3-2: PUCCH 1-0 static test (TDD, 2 DL CA)**

Test number	Bandwidth combination
1	20MHz for both cells
2	15MHz for PCell and 20MHz for SCell
Note 1: The applicability of requirements for different CA configurations and bandwidth combination sets is defined in 9.1.1.2.	

The normative reference for this requirement is TS 36.101 [2] clause 9.6.1.2.



## 9.6.1.2\_A.1.4 Test description

## 9.6.1.2\_A.1.4.1 Initial conditions

Initial conditions are a set of test configurations the UE needs to be tested in and the steps for the SS to take with the UE to reach the correct measurement state.

Configurations of PDSCH and PDCCH before measurement are specified in Annex C.2.

Test Environment: Normal as defined in TS 36.508 [7] clause 4.1.

Frequencies to be tested: Maximum Wgap for Intra-band non-contiguous CA otherwise Mid Range as defined in TS 36.508 [7] clause 4.3.1.

Channel Bandwidths to be tested: Select one according to Table 9.6.1.2\_A.1.4.1-1.

CA Capability to be tested: Select one according to Table 9.6.1.2\_A.1.4.1-1.

**Table 9.6.1.2\_A.1.4.1-1: Test point selection for CQI Reporting under AWGN conditions – PUCCH 1-0 for 2DL CA**

CA Capability	Bandwidth Combination	
	20+20	20+15
Inter-band CA (two bands) (CA2_A2)	Test 1	N/A
Intra-band contiguous CA (CA2_C)	Test 1	Test 2
Intra-band non-contiguous CA (with two sub-blocks) (CA2_N2)	Test 1	N/A
Note 1: Select the first UE supported CA bandwidth combination (moving from left to right) and then choose any one of the UE supported CA capabilities.		

1. Connect the SS and AWGN noise source to the UE antenna connector (s) as shown in TS 36.508 [7] Annex A, Figure group A.45 as appropriate.
2. The parameter settings for the cell are set up according to Table 9.6.1.2\_A.1.3-1.
3. Downlink signals are initially set up according to Annex C.0, C.1 and Annex C.3.2 and uplink signals according to Annex H.1 and H.3.2.
4. Propagation conditions are set according to Annex B.0.
5. Ensure the UE is in State 3A-RF according to TS 36.508 [7] clause 5.2A.2. Message contents are defined in clause 9.6.1.2\_A.1.4.3.

## 9.6.1.2\_A.1.4.2 Test procedure

1. Configure SCC according to Annex C.0, C.1 and Annex C.3.2 for all downlink physical channels.
2. The SS shall configure SCC as per TS 36.508 [7] clause 5.2A.4. Message contents for *RadioResourceConfigDedicatedSCell-r10-DEFAULT* are defined Table 9.6.1.2\_A.1.4.3-4, *PhysicalConfigDedicatedSCell-r10-DEFAULT* is defined in Table 9.6.1.2\_A.1.4.3-5, *CQI-ReportConfigSCell-r10-DEFAULT* is defined in Table 9.6.1.2\_A.1.4.3-6, *CQI-ReportPeriodic-r10-DEFAULT* is defined in Table 9.6.1.2\_A.1.4.3-7.
3. SS activates SCC by sending the activation MAC-CE (Refer TS 36.321 [13], clauses 5.13, 6.1.3.8). Wait for at least 2 seconds (Refer TS 36.133, clauses 8.3.3.2).
4. Set the parameters of bandwidth, reference channel, propagation condition, antenna configuration and the SNR according to Table 9.6.1.2\_A.1.3-1 as appropriate.
5. The SS shall start gathering CQI reports. No PDSCH for user data is scheduled for the UE.
6. Continue gathering CQI reports until 2000 wideband CQI reports have been gathered for each P-Cell and S-Cell. For each CSI report calculate the respective difference  $CQI_{P,S} = \text{wideband } CQI_{P_{cell}} - \text{wideband } CQI_{S_{cell}}$ .

7. If more than 1800 values of  $CQI_{P,S}$  are  $\geq 2$  pass the UE. Otherwise fail the UE.

#### 9.6.1.2\_A.1.4.3 Message contents

Message contents are according to TS 36.508 [7] clause 4.6 with the following exceptions:

**Table 9.6.1.2\_A.1.4.3-1: RadioResourceConfigDedicated-DEFAULT**

Derivation Path: 36.508 clause 4.6.3			
Information Element	Value/remark	Comment	Condition
RadioResourceConfigDedicated-SRB2-DRB(n, m) ::= SEQUENCE {			
physicalConfigDedicated	<i>PhysicalConfigDedicated - DEFAULT</i>		RBC
}			

**Table 9.6.1.2\_A.1.4.3-2: PhysicalConfigDedicated-DEFAULT**

Derivation Path: 36.508 clause 5.5.1.2			
Information Element	Value/remark	Comment	Condition
PhysicalConfigDedicated-DEFAULT ::= SEQUENCE {			
cqi-ReportConfig	<i>CQI-ReportConfig-DEFAULT</i>		RBC
}			

**Table 9.6.1.2\_A.1.4.3-3: CQI-ReportPeriodic-DEFAULT**

Derivation Path: 36.508 clause 4.6.3			
Information Element	Value/remark	Comment	Condition
CQI-ReportConfig-DEFAULT ::= SEQUENCE {			
cqi-ReportModeAperiodic	Not present		
nomPDSCH-RS-EPRE-Offset	0		
cqi-ReportPeriodic CHOICE {			
setup SEQUENCE {			
cqi-PUCCH-ResourceIndex	0		
cqi-pmi-ConfigIndex	8	(see Table 7.2.2-1A in TS 36.213)	
cqi-FormatIndicatorPeriodic CHOICE {			
widebandCQI	NULL		
}			
ri-ConfigIndex	NULL	(see Table 7.2.2-1B in TS 36.213)	
simultaneousAckNackAndCQI	FALSE		
}			
}			

**Table 9.6.1.2\_A.1.4.3-4: RadioResourceConfigDedicatedSCell-r10-DEFAULT**

Derivation Path: 36.508 clause 4.6.3			
Information Element	Value/remark	Comment	Condition
RadioResourceConfigDedicatedSCell-r10 ::= SEQUENCE {			
physicalConfigDedicatedSCell-r10	<i>PhysicalConfigDedicatedSCell-r10-DEFAULT</i>		
}			

**Table 9.6.1.2\_A.1.4.3-5: PhysicalConfigDedicatedSCell-r10-DEFAULT**

Derivation Path: 36.508 clause 4.6.3			
Information Element	Value/remark	Comment	Condition
PhysicalConfigDedicatedSCell-r10-DEFAULT ::= SEQUENCE {			
ul-Configuration-r10			
ul-Configuration-r10 SEQUENCE {			
cqi-ReportConfigSCell-r10	<i>CQI-ReportConfigSCell-r10-DEFAULT</i>		
}			
}			

**Table 9.6.1.2\_A.1.4.3-6: CQI-ReportConfigSCell-r10-DEFAULT**

Derivation Path: 36.508 clause 4.6.3			
Information Element	Value/remark	Comment	Condition
CQI-ReportConfigSCell-r10 ::= SEQUENCE {			
cqi-ReportModeAperiodic-r10	Not present		
nomPDSCH-RS-EPRE-Offset-r10	0		
cqi-ReportPeriodicSCell-r10			
	<i>CQI-ReportPeriodic-r10-DEFAULT</i>		CQI_PERIODIC
pmi-RI-Report-r10	Not present		
}			

**Table 9.6.1.2\_A.1.4.3-7: CQI-ReportPeriodic-r10-DEFAULT**

Derivation Path: 36.508 clause 4.6.3			
Information Element	Value/remark	Comment	Condition
CQI-ReportPeriodic-r10 ::= CHOICE {			
setup SEQUENCE {			
cqi-PUCCH-ResourceIndex-r10	0		
cqi-PUCCH-ResourceIndexP1-r10	Not present		
cqi-pmi-ConfigIndex	13		
cqi-FormatIndicatorPeriodic-r10 CHOICE {			
widebandCQI-r10 SEQUENCE {			
csi-ReportMode-r10	Not present		
}			
ri-ConfigIndex	NULL		
simultaneousAckNackAndCQI	FALSE		
cqi-Mask-r9	Not present		
csi-ConfigIndex-r10	Not present		
}			
}			

#### 9.6.1.2\_A.1.5 Test requirement

The pass fail decision is as specified in the test procedure in clause 9.6.1.2\_A.1.4.2.

There are no parameters in the test setup or measurement process whose variation impacts the results so there are no applicable test tolerances for this test.

#### 9.6.1.2\_A.2 TDD CQI Reporting under AWGN conditions – PUCCH 1-0 for CA (3DL CA)

##### 9.6.1.2\_A.2.1 Test purpose

To verify that the UE reports different CQI indices for Pcell and SCells if each cell experiences a different SNR.

## 9.6.1.2\_A.2.2 Test applicability

This test case applies to all types of E-UTRA TDD release 10 and forward UE of category 5 or higher that support 3DL Intra-band contiguous CA or 3DL Inter-band CA, or 3DL with Intra-band contiguous and Inter-band CA.

This test case also applies to all types of E-UTRA TDD release 11 and forward UE of category 5 or higher that support 3DL Intra-band non-contiguous CA or 3DL with Intra-band non-contiguous and Inter-band CA, or 3DL with Intra-band non-contiguous and Intra-band contiguous CA.

## 9.6.1.2\_A.2.3 Minimum conformance requirements

The following requirements apply to UE Category  $\geq 5$ . For the parameters specified in Table 9.6.1.2\_A.2.3-1 and Table 9.6.1.2\_A.2.3-2, and using the downlink physical channels specified in tables C.3.2-1 and C.3.2-2 on each cell, the difference between the wideband CQI indices of Pcell and Scell1 reported, and the difference between the wideband CQI indices of Scell1 and Scell2 reported shall be such that

$$\text{wideband CQI}_{\text{Pcell}} - \text{wideband CQI}_{\text{Scell1}} \geq 2$$

$$\text{wideband CQI}_{\text{Scell1}} - \text{wideband CQI}_{\text{Scell2}} \geq 2$$

for more than 90% of the time.

**Table 9.6.1.2\_A.2.3-1: Parameters for PUCCH 1-0 static test on multiple cells (TDD, 3 DL CA)**

Parameter		Unit	Pcell	Scell1	Scell2
PDSCH transmission mode				1	
Uplink downlink configuration				2	
Special subframe configuration				4	
Downlink power allocation	$\rho_A$	dB		0	
	$\rho_B$	dB		0	
Propagation condition and antenna configuration			AWGN (1 x 2)		
SNR		dB	12	6	0
$\hat{I}_{or}^{(j)}$		dB[mW/15kHz]	-86	-92	-98
$N_{oc}^{(j)}$		dB[mW/15kHz]	-98	-98	-98
Physical channel for CQI reporting			PUCCH Format 2		
PUCCH Report Type			4		
Reporting periodicity		ms	$N_{pd} = 20$		
<i>cqi-pmi-ConfigurationIndex</i>			18	23 [shift of 5 ms relative to Pcell]	28 [shift of 10 ms relative to Pcell]
Note 1: 3 symbols are allocated to PDCCH. No PDSCH for user data is scheduled for the UE with one sided dynamic OCNB Pattern OP.1 TDD as described in Annex A.5.2.1.					

**Table 9.6.1.2\_A.2.3-2: PUCCH 1-0 static test (TDD, 3DL CA)**

Test number	Bandwidth combination (MHz)
1	3x20
2	20+20+15
Note 1: The applicability of requirements for different CA configurations and bandwidth combination sets is defined in 9.1.1.2.	

The normative reference for this requirement is TS 36.101 [2] clause 9.6.1.2.

## 9.6.1.2\_A.2.4 Test description

## 9.6.1.2\_A.2.4.1 Initial conditions

Initial conditions are a set of test configurations the UE needs to be tested in and the steps for the SS to take with the UE to reach the correct measurement state.

Configurations of PDSCH and PDCCH before measurement are specified in Annex C.2.

Test Environment: Normal as defined in TS 36.508 [7] clause 4.1.

Frequencies to be tested: Maximum Wgap for Intra-band non-contiguous CA, otherwise Mid Range, as defined in TS 36.508 [7] clause 4.3.1.

Channel Bandwidths to be tested: Select one according to Table 9.6.1.2\_A.2.4.1-1.

CA Capability to be tested: Select one according to Table 9.6.1.2\_A.2.4.1-1

**Table 9.6.1.2\_A.2.4.1-1: Test point selection for PUCCH 1-0 static test**

CA Applicability	Bandwidth combination	
	3x20	20+20+15
Intra-band contiguous (CA_C)	Test 1	Test 2
Inter-band (CA_A_2)	Test 1	Test 2
Inter-band (CA_A_3)	Test 1	Test 2
Intra-band non-contiguous (CA_N)	Test 1	Test 2
Note 1: Only one test point is tested. Select the first UE supported CA bandwidth combination (moving from left to right) and choose any one of the UE supported CA capabilities supporting that CA bandwidth combination.		

1. Connect the SS and AWGN noise source to the UE antenna connector (s) as shown in TS 36.508 [7] Annex A, Figure A.59 without faders.
2. The parameter settings for the cell are set up according to Table 9.6.1.2\_A.2.3-1.
3. Downlink signals are initially set up according to Annex C.0, C.1 and Annex C.3.2 and uplink signals according to Annex H.1 and H.3.2.
4. Propagation conditions are set according to Annex B.0.
5. Ensure the UE is in State 3A-RF according to TS 36.508 [7] clause 5.2A.2. Message contents are defined in clause 9.6.1.2\_A.2.4.3.

## 9.6.1.2\_A.2.4.2 Test procedure

1. Configure SCCs according to Annex C.0, C.1 and Annex C.3.2 for all downlink physical channels.
2. The SS shall configure SCCs as per TS 36.508 [7] clause 5.2A.4. Message contents for *RadioResourceConfigDedicatedSCell-r10-DEFAULT* are defined Table 9.6.1.2\_A.2.4.3-4, *PhysicalConfigDedicatedSCell-r10-DEFAULT* is defined in Table 9.6.1.2\_A.2.4.3-5, *CQI-ReportConfigSCell-r10-DEFAULT* is defined in Table 9.6.1.2\_A.2.4.3-6, *CQI-ReportPeriodic-r10-DEFAULT* is defined in Table 9.6.1.2\_A.2.4.3-7.
3. SS activates SCCs by sending the activation MAC-CE (Refer TS 36.321 [13], clauses 5.13, 6.1.3.8). Wait for at least 2 seconds (Refer TS 36.133, clauses 8.3.3.2).

4. Set the parameters of bandwidth, reference channel, propagation condition, antenna configuration and the SNR according to Table 9.6.1.2\_A.2.3-1 as appropriate.
5. The SS shall start gathering CQI reports. No PDSCH for user data is scheduled for the UE.
6. Continue gathering CQI reports until 2000 wideband CQI reports have been gathered for each P-Cell and S-Cells. For each CSI report calculate the respective difference  $CQI_{P,S1} = \text{wideband } CQI_{Pcell} - \text{wideband } CQI_{Scell1}$  and the respective difference  $CQI_{S1-S2} = \text{wideband } CQI_{Scell1} - \text{wideband } CQI_{Scell2}$ .
7. If more than 1800 values of  $CQI_{P,S1}$  are  $\geq 2$  and more than 1800 values of  $CQI_{S1-S2}$  are  $\geq 2$ , pass the UE. Otherwise fail the UE.

#### 9.6.1.2\_A.2.4.3 Message contents

Message contents are according to TS 36.508 [7] clause 4.6 with the following exceptions:

**Table 9.6.1.2\_A.2.4.3-1: RadioResourceConfigDedicated-DEFAULT**

Derivation Path: 36.508 clause 4.6.3			
Information Element	Value/remark	Comment	Condition
RadioResourceConfigDedicated-SRB2-DRB(n, m) ::= SEQUENCE {			
physicalConfigDedicated	<i>PhysicalConfigDedicated</i> - DEFAULT		RBC
}			

**Table 9.6.1.2\_A.2.4.3-2: PhysicalConfigDedicated-DEFAULT**

Derivation Path: 36.508 clause 5.5.1.2			
Information Element	Value/remark	Comment	Condition
PhysicalConfigDedicated-DEFAULT ::= SEQUENCE {			
cqi-ReportConfig	<i>CQI-ReportConfig</i> - DEFAULT		RBC
}			

**Table 9.6.1.2\_A.2.4.3-3: CQI-ReportPeriodic-DEFAULT**

Derivation Path: 36.508 clause 4.6.3			
Information Element	Value/remark	Comment	Condition
CQI-ReportConfig-DEFAULT ::= SEQUENCE {			
cqi-ReportModeAperiodic	Not present		
nomPDSCH-RS-EPRE-Offset	0		
cqi-ReportPeriodic CHOICE {			
setup SEQUENCE {			
cqi-PUCCH-ResourceIndex	0		
cqi-pmi-ConfigIndex	18	(see Table 7.2.2-1A in TS 36.213)	
cqi-FormatIndicatorPeriodic CHOICE {			
widebandCQI	NULL		
}			
ri-ConfigIndex	NULL	(see Table 7.2.2-1B in TS 36.213)	
simultaneousAckNackAndCQI	FALSE		
}			
}			

**Table 9.6.1.2\_A.2.4.3-4: RadioResourceConfigDedicatedSCell-r10-DEFAULT**

Derivation Path: 36.508 clause 4.6.3			
Information Element	Value/remark	Comment	Condition
RadioResourceConfigDedicatedSCell-r10 ::= SEQUENCE {			
physicalConfigDedicatedSCell-r10	<i>PhysicalConfigDedicatedSCell-r10-DEFAULT</i>		
}			

**Table 9.6.1.2\_A.2.4.3-5: PhysicalConfigDedicatedSCell-r10-DEFAULT**

Derivation Path: 36.508 clause 4.6.3			
Information Element	Value/remark	Comment	Condition
PhysicalConfigDedicatedSCell-r10-DEFAULT ::= SEQUENCE {			
ul-Configuration-r10			
ul-Configuration-r10 SEQUENCE {			
cqi-ReportConfigSCell-r10	<i>CQI-ReportConfigSCell-r10-DEFAULT</i>		
}			
}			

**Table 9.6.1.2\_A.2.4.3-6: CQI-ReportConfigSCell-r10-DEFAULT**

Derivation Path: 36.508 clause 4.6.3			
Information Element	Value/remark	Comment	Condition
CQI-ReportConfigSCell-r10 ::= SEQUENCE {			
cqi-ReportModeAperiodic-r10	Not present		
nomPDSCH-RS-EPRE-Offset-r10	0		
cqi-ReportPeriodicSCell-r10			
	<i>CQI-ReportPeriodic-r10-DEFAULT</i>		CQI_PERIODIC
pmi-RI-Report-r10	Not present		
}			

**Table 9.6.1.2\_A.2.4.3-7: CQI-ReportPeriodic-r10-DEFAULT**

Derivation Path: 36.508 clause 4.6.3			
Information Element	Value/remark	Comment	Condition
CQI-ReportPeriodic-r10 ::= CHOICE {			
setup SEQUENCE {			
cqi-PUCCH-ResourceIndex-r10	0		
cqi-PUCCH-ResourceIndexP1-r10	Not present		
cqi-pmi-ConfigIndex	23		Scell1
	28		Scell2
cqi-FormatIndicatorPeriodic-r10 CHOICE {			
widebandCQI-r10 SEQUENCE {			
csi-ReportMode-r10	Not present		
}			
ri-ConfigIndex	NULL		
simultaneousAckNackAndCQI	FALSE		
cqi-Mask-r9	Not present		
csi-ConfigIndex-r10	Not present		
}			
}			

## 9.6.1.2\_A.2.5 Test requirement

The pass fail decision is as specified in the test procedure in clause 9.6.1.2\_A.2.4.2.

There are no parameters in the test setup or measurement process whose variation impacts the results so there are no applicable test tolerances for this test.

### 9.6.1.3 TDD-FDD CA for FDD PCell

#### 9.6.1.3.1 TDD FDD CA CQI Reporting under AWGN conditions – PUCCH 1-0 for FDD PCell (2DL CA)

*Editor's note: This test case is incomplete. The following aspects are either missing or not yet determined:*

- *The uncertainties and test tolerances are undefined*

##### 9.6.1.3.1.1 Test purpose

To verify that the UE reports different CQI indices for FDD PCell and SCell if each cell experiences a different SNR.

##### 9.6.1.3.1.2 Test applicability

This test applies to all types of E-UTRA FDD and TDD UE release 12 and forward that support 2DL CA with FDD as PCell (UE categories 3 and onwards).

##### 9.6.1.3.1.3 Minimum conformance requirements

The following requirements apply to UE Category  $\geq 3$ . For TDD-FDD CA with FDD PCell with 2 DL CC, for the parameters specified in Table 9.6.1.3.1.3-1 and Table 9.6.1.3.1.3-2, and using the downlink physical channels specified in tables C.3.2-1 and C.3.2-2 on each cell, the difference between the wideband CQI indices of Pcell and SCell reported shall be such that

$$\text{wideband CQI}_{\text{Pcell}} - \text{wideband CQI}_{\text{Scell}} \geq 2$$

for more than 90% of the time.

**Table 9.6.1.3.1.3-1: PUCCH 1-0 static test on multiple cells (TDD-FDD CA with FDD PCell, 2DL CA)**

Parameter		Unit	PCell	SCell
PDSCH transmission mode				1
Uplink downlink configuration			N/A	2
Special subframe configuration			N/A	4
Downlink power allocation	$\rho_A$	dB		0
	$\rho_B$	dB		0
Propagation condition and antenna configuration			AWGN (1 x 2)	
SNR		dB	10	4
$\hat{I}_{or}^{(j)}$		dB[mW/15kHz]	-88	-94
$N_{oc}^{(j)}$		dB[mW/15kHz]	-98	-98
Physical channel for CQI reporting			PUCCH Format 2	
PUCCH Report Type			4	
Reporting periodicity		ms	$N_{pd} = 10$	
<i>cqi-pmi-ConfigurationIndex</i>			9	14 (shift of 5 ms relative to Pcell)
Note 1: 3 symbols are allocated to PDCCH. No PDSCH for user data is scheduled for the UE with one sided dynamic OCNG Pattern OP.1 TDD as described in Annex A.5.2.1.				



**Table 9.6.1.3.1.3-2: PUCCH 1-0 static test (TDD-FDD CA with FDD PCell, 2DL CA)**

Test number	Bandwidth combination
1	20MHz for FDD cell and 20MHz for TDD cell
2	10MHz for FDD cell and 20MHz for TDD cell
3	5MHz for FDD cell and 10MHz for TDD cell
4	15MHz for FDD cell and 20MHz for TDD cell
Note 1: The applicability of requirements for different CA configurations and bandwidth combination sets is defined in 9.1.1.2A. The test coverage for different number of component carriers is defined in 9.1.1.3.	

The normative reference for this requirement is TS 36.101 [2] clause 9.6.1.3.

#### 9.6.1.3.1.4 Test description

##### 9.6.1.3.1.4.1 Initial conditions

Initial conditions are a set of test configurations the UE needs to be tested in and the steps for the SS to take with the UE to reach the correct measurement state.

Configurations of PDSCH and PDCCH before measurement are specified in Annex C.2.

Test Environment: Normal as defined in TS 36.508 [7] clause 4.1.

Frequencies to be tested: Maximum Wgap for Intra-band non-contiguous CA otherwise Mid Range as defined in TS 36.508 [7] clause 4.3.1.

Channel Bandwidths to be tested: Select one according to Table 9.6.1.3.1.4.1-1.

CA Capability to be tested: Select one according to Table 9.6.1.3.1.4.1-1.

**Table 9.6.1.3.1.4.1-1: Test point selection for CQI Reporting under AWGN conditions – PUCCH 1-0 for FDD PCell (2DL CA)**

CA Applicability	Bandwidth combination			
	20+20	10+20	5+10	15+20
Inter-band (CA_A_2)	Test 1	Test 2	Test 3	Test4
Intra-band contiguous (CA_C)	Test 1	Test 2	Test 3	Test4
Intra-band non-contiguous (CA_N)	Test 1	Test 2	Test 3	Test4
Note 1: Only one test point is tested. Select the first UE supported CA bandwidth combination (moving from left to right) and choose any one of the UE supported CA capabilities supporting that CA bandwidth combination.				

1. Connect the SS and AWGN noise source to the UE antenna connector (s) as shown in TS 36.508 [7] Annex A, Figure group A.45 as appropriate.
2. The parameter settings for the cell are set up according to Table 9.6.1.3.1.3-1.
3. Downlink signals are initially set up according to Annex C.0, C.1 and Annex C.3.2 and uplink signals according to Annex H.1 and H.3.2.
4. Propagation conditions are set according to Annex B.0.
5. Ensure the UE is in State 3A-RF according to TS 36.508 [7] clause 5.2A.2. Message contents are defined in clause 9.6.1.3.1.4.3.

## 9.6.1.3.1.4.2 Test procedure

1. Configure SCC according to Annex C.0, C.1 and Annex C.3.2 for all downlink physical channels.
2. The SS shall configure SCC as per TS 36.508 [7] clause 5.2A.4. Message contents for *RadioResourceConfigDedicatedSCell-r10-DEFAULT* are defined Table 9.6.1.3.1.4.3-4, *PhysicalConfigDedicatedSCell-r10-DEFAULT* is defined in Table 9.6.1.3.1.4.3-5, *CQI-ReportConfigSCell-r10-DEFAULT* is defined in Table 9.6.1.3.1.4.3-6, *CQI-ReportPeriodic-r10-DEFAULT* is defined in Table 9.6.1.3.1.4.3-7.
3. SS activates SCC by sending the activation MAC-CE (Refer TS 36.321 [13], clauses 5.13, 6.1.3.8). Wait for at least 2 seconds (Refer TS 36.133, clauses 8.3.3.2).
4. Set the parameters of bandwidth, reference channel, propagation condition, antenna configuration and the SNR according to Table 9.6.1.3.1.3-1 as appropriate.
5. The SS shall start gathering CQI reports. No PDSCH for user data is scheduled for the UE.
6. Continue gathering CQI reports until 2000 wideband CQI reports have been gathered for each P-Cell and S-Cell. For each CSI report calculate the respective difference  $CQI_{P,S} = \text{wideband } CQI_{Pcell} - \text{wideband } CQI_{Scell}$ .
7. If more than 1800 values of  $CQI_{P,S}$  are  $\geq 2$  pass the UE. Otherwise fail the UE.

## 9.6.1.3.1.4.3 Message contents

Message contents are according to TS 36.508 [7] clause 4.6 with the following exceptions:

**Table 9.6.1.3.1.4.3-1: *RadioResourceConfigDedicated-DEFAULT***

Derivation Path: 36.508 clause 4.6.3			
Information Element	Value/remark	Comment	Condition
RadioResourceConfigDedicated-SRB2-DRB(n, m) ::= SEQUENCE {			
physicalConfigDedicated	<i>PhysicalConfigDedicated-DEFAULT</i>		RBC
}			

**Table 9.6.1.3.1.4.3-2: *PhysicalConfigDedicated-DEFAULT***

Derivation Path: 36.508 clause 5.5.1.2			
Information Element	Value/remark	Comment	Condition
PhysicalConfigDedicated-DEFAULT ::= SEQUENCE {			
cqi-ReportConfig	<i>CQI-ReportConfig-DEFAULT</i>		RBC
}			

**Table 9.6.1.3.1.4.3-3: CQI-ReportPeriodic-DEFAULT**

Derivation Path: 36.508 clause 4.6.3			
Information Element	Value/remark	Comment	Condition
CQI-ReportConfig-DEFAULT ::= SEQUENCE {			
cqi-ReportModeAperiodic	Not present		
nomPDSCH-RS-EPRE-Offset	0		
cqi-ReportPeriodic CHOICE {			
setup SEQUENCE {			
cqi-PUCCH-ResourceIndex	0		
cqi-pmi-ConfigIndex	9	(see Table 7.2.2-1A in TS 36.213)	
cqi-FormatIndicatorPeriodic CHOICE {			
widebandCQI	NULL		
}			
ri-ConfigIndex	NULL	(see Table 7.2.2-1B in TS 36.213)	
simultaneousAckNackAndCQI	FALSE		
}			
}			

**Table 9.6.1.3.1.4.3-4: RadioResourceConfigDedicatedSCell-r10-DEFAULT**

Derivation Path: 36.508 clause 4.6.3			
Information Element	Value/remark	Comment	Condition
RadioResourceConfigDedicatedSCell-r10 ::= SEQUENCE {			
physicalConfigDedicatedSCell-r10	<i>PhysicalConfigDedicatedSCell-r10-DEFAULT</i>		
}			

**Table 9.6.1.3.1.4.3-5: PhysicalConfigDedicatedSCell-r10-DEFAULT**

Derivation Path: 36.508 clause 4.6.3			
Information Element	Value/remark	Comment	Condition
PhysicalConfigDedicatedSCell-r10-DEFAULT ::= SEQUENCE {			
ul-Configuration-r10			
ul-Configuration-r10 SEQUENCE {			
cqi-ReportConfigSCell-r10	<i>CQI-ReportConfigSCell-r10-DEFAULT</i>		
}			
}			

**Table 9.6.1.3.1.4.3-6: CQI-ReportConfigSCell-r10-DEFAULT**

Derivation Path: 36.508 clause 4.6.3			
Information Element	Value/remark	Comment	Condition
CQI-ReportConfigSCell-r10 ::= SEQUENCE {			
cqi-ReportModeAperiodic-r10	Not present		
nomPDSCH-RS-EPRE-Offset-r10	0		
cqi-ReportPeriodicSCell-r10			
	<i>CQI-ReportPeriodic-r10-DEFAULT</i>		CQI_PERIODIC
pmi-RI-Report-r10	Not present		
}			

Table 9.6.1.3.1.4.3-7: CQI-ReportPeriodic-r10-DEFAULT

Derivation Path: 36.508 clause 4.6.3			
Information Element	Value/remark	Comment	Condition
CQI-ReportPeriodic-r10 ::= CHOICE {			
setup SEQUENCE {			
cqi-PUCCH-ResourceIndex-r10	0		
cqi-PUCCH-ResourceIndexP1-r10	Not present		
cqi-pmi-ConfigIndex	14		
cqi-FormatIndicatorPeriodic-r10 CHOICE {			
widebandCQI-r10 SEQUENCE {			
csi-ReportMode-r10	Not present		
}			
ri-ConfigIndex	NULL		
simultaneousAckNackAndCQI	FALSE		
cqi-Mask-r9	Not present		
csi-ConfigIndex-r10	Not present		
}			
}			

#### 9.6.1.3.1.5 Test requirement

The pass fail decision is as specified in the test procedure in clause 9.6.1.3.1.4.2.

There are no parameters in the test setup or measurement process whose variation impacts the results so there are no applicable test tolerances for this test.

#### 9.6.1.3.2 TDD FDD CQI Reporting under AWGN conditions – PUCCH 1-0 for FDD PCell (3DL CA)

*Editor's note: This test case is incomplete. The following aspects are either missing or not yet determined:*

- *Message content exceptions are TBD*
- *The uncertainties and test tolerances are undefined*

#### 9.6.1.3.2.1 Test purpose

To verify that the UE reports different CQI indices for FDD PCell and SCells if each cell experiences a different SNR.

#### 9.6.1.3.2.2 Test applicability

This test applies to all types of E-UTRA FDD and TDD UE release 12 and forward that support 3DL CA with FDD as PCell (UE categories 5 and onwards).

#### 9.6.1.3.2.3 Minimum conformance requirements

The following requirements apply to UE Category  $\geq 5$ . For TDD-FDD CA with FDD PCell with 3DL CC, for the parameters specified in Table 9.6.1.3.2.3-1 and Table 9.6.1.3.2.3-2, and using the downlink physical channels specified in tables C.3.2-1 and C.3.2-2 on each cell, the difference between the wideband CQI indices of Pcell and Scell1 reported, and the difference between the wideband CQI indices of Scell1 and Scell2 reported shall be such that

$$\text{wideband CQI}_{\text{Pcell}} - \text{wideband CQI}_{\text{Scell1}} \geq 2$$

$$\text{wideband CQI}_{\text{Scell1}} - \text{wideband CQI}_{\text{Scell2}} \geq 2$$

for more than 90% of the time.

**Table 9.6.1.3.2.3-1: Parameters for PUCCH 1-0 static test on multiple cells (TDD-FDD CA with FDD PCell, 3DL CA)**

Parameter		Unit	PCell	SCell1	SCell2
PDSCH transmission mode				1	
Uplink downlink configuration			N/A	2 if SCell1 is TDD Cell N/A if SCell1 is FDD Cell	2
Special subframe configuration			N/A	4 if SCell1 is TDD Cell N/A if SCell1 is FDD Cell	4
Downlink power allocation	$\rho_A$	dB	0		
	$\rho_B$	dB	0		
Propagation condition and antenna configuration			AWGN (1 x 2)		
SNR		dB	12	6	0
$\hat{I}_{or}^{(j)}$		dB[mW/15kHz]	-86	-92	-98
$N_{oc}^{(j)}$		dB[mW/15kHz]	-98	-98	-98
Physical channel for CQI reporting			PUCCH Format 2		
PUCCH Report Type			4		
Reporting periodicity		ms	$N_{pd} = 20$		
<i>cqi-pmi-ConfigurationIndex</i>			19	24 (shift of 5 ms relative to Pcell)	29 (shift of 10 ms relative to Pcell)
Note 1: 3 symbols are allocated to PDCCH. No PDSCH for user data is scheduled for the UE with one sided dynamic OCN Pattern OP.1 TDD as described in Annex A.5.2.1.					

**Table 9.6.1.3.2.3-2: PUCCH 1-0 static test (TDD-FDD CA with FDD PCell, 3DL CA)**

Test number	Bandwidth combination (MHz)
1	20MHz for FDD cell and 2x20MHz for TDD cell
2	15MHz for FDD cell and 2x20MHz for TDD cell
3	10MHz for FDD cell and 2x20MHz for TDD cell
Note 1: The applicability of requirements for different CA configurations and bandwidth combination sets is defined in 9.1.1.2A. The test coverage for different number of component carriers is defined in 9.1.1.3.	

The normative reference for this requirement is TS 36.101 [2] clause 9.6.1.3.

#### 9.6.1.3.2.4 Test description

##### 9.6.1.3.2.4.1 Initial conditions

Initial conditions are a set of test configurations the UE needs to be tested in and the steps for the SS to take with the UE to reach the correct measurement state.

Configurations of PDSCH and PDCCH before measurement are specified in Annex C.2.

Test Environment: Normal as defined in TS 36.508 [7] clause 4.1.

Frequencies to be tested: Maximum Wgap for Intra-band non-contiguous CA, otherwise Mid Range, as defined in TS 36.508 [7] clause 4.3.1.

Channel Bandwidths to be tested: Select one according to Table 9.6.1.3.2.4.1-1.

CA Capability to be tested: Select one according to Table 9.6.1.3.2.4.1-1

**Table 9.6.1.3.2.4.1-1: Test point selection for CQI Reporting under AWGN conditions – PUCCH 1-0 for FDD PCell (3DL CA)**

CA Applicability	Bandwidth combination		
	20+2x20	15+2x20	10+2x20
Intra-band contiguous (CA_C)	Test 1	Test 2	Test 3
Inter-band (CA_A_2)	Test 1	Test 2	Test 3
Inter-band (CA_A_3)	Test 1	Test 2	Test 3
Intra-band non-contiguous (CA_N)	Test 1	Test 2	Test 3
Note 1: Only one test point is tested. Select the first UE supported CA bandwidth combination (moving from left to right) and choose any one of the UE supported CA capabilities supporting that CA bandwidth combination.			

1. Connect the SS and AWGN noise source to the UE antenna connector (s) as shown in TS 36.508 [7] Annex A, Figure A.59 without faders.
2. The parameter settings for the cell are set up according to Table 9.6.1.3.2.3-1.
3. Downlink signals are initially set up according to Annex C.0, C.1 and Annex C.3.2 and uplink signals according to Annex H.1 and H.3.2.
4. Propagation conditions are set according to Annex B.0.
5. Ensure the UE is in State 3A-RF according to TS 36.508 [7] clause 5.2A.2. Message contents are defined in clause 9.6.1.3.2.4.3.

#### 9.6.1.3.2.4.2 Test procedure

1. Configure SCCs according to Annex C.0, C.1 and Annex C.3.2 for all downlink physical channels.
2. The SS shall configure SCCs as per TS 36.508 [7] clause 5.2A.4. Message contents for *RadioResourceConfigDedicatedSCell-r10-DEFAULT* are defined Table 9.6.1.3.2.4.3-4, *PhysicalConfigDedicatedSCell-r10-DEFAULT* is defined in Table 9.6.1.3.2.4.3-5, *CQI-ReportConfigSCell-r10-DEFAULT* is defined in Table 9.6.1.3.2.4.3-6, *CQI-ReportPeriodic-r10-DEFAULT* is defined in Table 9.6.1.3.2.4.3-7.
3. SS activates SCCs by sending the activation MAC-CE (Refer TS 36.321 [13], clauses 5.13, 6.1.3.8). Wait for at least 2 seconds (Refer TS 36.133, clauses 8.3.3.2).
4. Set the parameters of bandwidth, reference channel, propagation condition, antenna configuration and the SNR according to Table 9.6.1.3.2.3-1 as appropriate.
5. The SS shall start gathering CQI reports. No PDSCH for user data is scheduled for the UE.
6. Continue gathering CQI reports until 2000 wideband CQI reports have been gathered for each P-Cell and S-Cells. For each CSI report calculate the respective difference  $CQI_{P-S1} = \text{wideband } CQI_{Pcell} - \text{wideband } CQI_{Scell1}$  and the respective difference  $CQI_{S1-S2} = \text{wideband } CQI_{Scell1} - \text{wideband } CQI_{Scell2}$ .
7. If more than 1800 values of  $CQI_{P-S1}$  are  $\geq 2$  and more than 1800 values of  $CQI_{S1-S2}$  are  $\geq 2$ , pass the UE. Otherwise fail the UE.

#### 9.6.1.3.2.4.3 Message contents

Message contents are according to TS 36.508 [7] clause 4.6 with the following exceptions:

TBD

## 9.6.1.3.2.5 Test requirement

The pass fail decision is as specified in the test procedure in clause 9.6.1.3.2.4.2.

There are no parameters in the test setup or measurement process whose variation impacts the results so there are no applicable test tolerances for this test.

## 9.6.1.4 TDD-FDD CA for TDD PCell

## 9.6.1.4.1 TDD FDD CA CQI Reporting under AWGN conditions – PUCCH 1-0 for TDD PCell (2DL CA)

*Editor's note: This test case is incomplete. The following aspects are either missing or not yet determined:*

- *The uncertainties and test tolerances are undefined*

## 9.6.1.4.1.1 Test purpose

To verify that the UE reports different CQI indices for TDD PCell and SCell if each cell experiences a different SNR.

## 9.6.1.4.1.2 Test applicability

This test applies to all types of E-UTRA FDD and TDD UE release 12 and forward that support 2DL CA with TDD PCell (UE categories 3 and onwards).

## 9.6.1.4.1.3 Minimum conformance requirements

The following requirements apply to UE Category  $\geq 3$ . For TDD-FDD CA with TDD PCell with 2 DL CC, for the parameters specified in Table 9.6.1.4.1.3-1 and Table 9.6.1.4.1.3-2, and using the downlink physical channels specified in tables C.3.2-1 and C.3.2-2 on each cell, the difference between the wideband CQI indices of Pcell and SCell reported shall be such that

$$\text{wideband CQI}_{\text{Pcell}} - \text{wideband CQI}_{\text{Scell}} \geq 2$$

for more than 90% of the time.

**Table 9.6.1.4.1.3-1: PUCCH 1-0 static test on multiple cells (TDD-FDD CA with TDD PCell, 2 DL CA)**

Parameter	Unit	PCell	SCell
PDSCH transmission mode			1
Uplink downlink configuration		2	N/A
Special subframe configuration		4	N/A
Downlink power allocation	$\rho_A$	dB	0
	$\rho_B$	dB	0
Propagation condition and antenna configuration		AWGN (1 x 2)	
SNR	dB	10	4
$\hat{I}_{or}^{(j)}$	dB[mW/15kHz]	-88	-94
$N_{oc}^{(j)}$	dB[mW/15kHz]	-98	-98
Physical channel for CQI reporting		PUCCH Format 2	
PUCCH Report Type		4	
Reporting periodicity	ms	$N_{pd} = 10$	
<i>cqi-pmi-ConfigurationIndex</i>		8	13 (shift of 5 ms relative to Pcell)
Note 1:	3 symbols are allocated to PDCCH. No PDSCH for user data is scheduled for the UE with one sided dynamic OCNG Pattern OP.1 TDD as described in Annex A.5.2.1.		

**Table 9.6.1.4.1.3-2: PUCCH 1-0 static test (TDD-FDD CA with TDD PCell, 2 DL CA)**

Test number	Bandwidth combination
1	20MHz for TDD cell and 20MHz for FDD cell
2	20MHz for TDD cell and 10MHz for FDD cell
3	10MHz for TDD cell and 5MHz for FDD cell
4	20MHz for TDD cell and 15MHz for FDD cell
Note 1: The applicability of requirements for different CA configurations and bandwidth combination sets is defined in 9.1.1.2A. The test coverage for different number of component carriers is defined in 9.1.1.3.	

The normative reference for this requirement is TS 36.101 [2] clause 9.6.1.4.

#### 9.6.1.4.1.4 Test description

##### 9.6.1.4.1.4.1 Initial conditions

Initial conditions are a set of test configurations the UE needs to be tested in and the steps for the SS to take with the UE to reach the correct measurement state.

Configurations of PDSCH and PDCCH before measurement are specified in Annex C.2.

Test Environment: Normal as defined in TS 36.508 [7] clause 4.1.

Frequencies to be tested: Maximum Wgap for Intra-band non-contiguous CA otherwise Mid Range as defined in TS 36.508 [7] clause 4.3.1.

Channel Bandwidths to be tested: Select one according to Table 9.6.1.4.1.4.1-1.

CA Capability to be tested: Select one according to Table 9.6.1.4.1.4.1-1.

**Table 9.6.1.4.1.4.1-1: Test point selection for CQI Reporting under AWGN conditions – PUCCH 1-0 for TDD PCell (2DL CA)**

CA Applicability	Bandwidth combination			
	20+20	20+10	10+5	20+15
Inter-band (CA_A_2)	Test 1	Test 2	Test 3	Test4
Intra-band contiguous (CA_C)	Test 1	Test 2	Test 3	Test4
Intra-band non-contiguous (CA_N)	Test 1	Test 2	Test 3	Test4
Note 1: Only one test point is tested. Select the first UE supported CA bandwidth combination (moving from left to right) and choose any one of the UE supported CA capabilities supporting that CA bandwidth combination.				

1. Connect the SS and AWGN noise source to the UE antenna connector (s) as shown in TS 36.508 [7] Annex A, Figure group A.45 as appropriate.
2. The parameter settings for the cell are set up according to Table 9.6.1.4.1.3-1.
3. Downlink signals are initially set up according to Annex C.0, C.1 and Annex C.3.2 and uplink signals according to Annex H.1 and H.3.2.
4. Propagation conditions are set according to Annex B.0.
5. Ensure the UE is in State 3A-RF according to TS 36.508 [7] clause 5.2A.2. Message contents are defined in clause 9.6.1.4.1.4.3.



9.6.1.4.1.4.2 Test procedure

1. Configure SCC according to Annex C.0, C.1 and Annex C.3.2 for all downlink physical channels.
2. The SS shall configure SCC as per TS 36.508 [7] clause 5.2A.4. Message contents for *RadioResourceConfigDedicatedSCell-r10-DEFAULT* are defined Table 9.6.1.4.1.4.3-4, *PhysicalConfigDedicatedSCell-r10-DEFAULT* is defined in Table 9.6.1.4.1.4.3-5, *CQI-ReportConfigSCell-r10-DEFAULT* is defined in Table 9.6.1.4.1.4.3-6, *CQI-ReportPeriodic-r10-DEFAULT* is defined in Table 9.6.1.4.1.4.3-7.
3. SS activates SCC by sending the activation MAC-CE (Refer TS 36.321 [13], clauses 5.13, 6.1.3.8). Wait for at least 2 seconds (Refer TS 36.133, clauses 8.3.3.2).
4. Set the parameters of bandwidth, reference channel, propagation condition, antenna configuration and the SNR according to Table 9.6.1.4.1.3-1 as appropriate.
5. The SS shall start gathering CQI reports. No PDSCH for user data is scheduled for the UE.
6. Continue gathering CQI reports until 2000 wideband CQI reports have been gathered for each P-Cell and S-Cell. For each CSI report calculate the respective difference  $CQI_{P,S} = \text{wideband } CQI_{Pcell} - \text{wideband } CQI_{Scell}$ .
7. If more than 1800 values of  $CQI_{P,S}$  are  $\geq 2$  pass the UE. Otherwise fail the UE.

9.6.1.4.1.4.3 Message contents

Message contents are according to TS 36.508 [7] clause 4.6 with the following exceptions:

**Table 9.6.1.4.1.4.3-1: *RadioResourceConfigDedicated-DEFAULT***

Derivation Path: 36.508 clause 4.6.3			
Information Element	Value/remark	Comment	Condition
RadioResourceConfigDedicated-SRB2-DRB(n, m) ::= SEQUENCE {			
physicalConfigDedicated	<i>PhysicalConfigDedicated-DEFAULT</i>		RBC
}			

**Table 9.6.1.4.1.4.3-2: *PhysicalConfigDedicated-DEFAULT***

Derivation Path: 36.508 clause 5.5.1.2			
Information Element	Value/remark	Comment	Condition
PhysicalConfigDedicated-DEFAULT ::= SEQUENCE {			
cqi-ReportConfig	<i>CQI-ReportConfig-DEFAULT</i>		RBC
}			

**Table 9.6.1.4.1.4.3-3: CQI-ReportPeriodic-DEFAULT**

Derivation Path: 36.508 clause 4.6.3			
Information Element	Value/remark	Comment	Condition
CQI-ReportConfig-DEFAULT ::= SEQUENCE {			
cqi-ReportModeAperiodic	Not present		
nomPDSCH-RS-EPRE-Offset	0		
cqi-ReportPeriodic CHOICE {			
setup SEQUENCE {			
cqi-PUCCH-ResourceIndex	0		
cqi-pmi-ConfigIndex	8	(see Table 7.2.2-1A in TS 36.213)	
cqi-FormatIndicatorPeriodic CHOICE {			
widebandCQI	NULL		
}			
ri-ConfigIndex	NULL	(see Table 7.2.2-1B in TS 36.213)	
simultaneousAckNackAndCQI	FALSE		
}			
}			

**Table 9.6.1.4.1.4.3-4: RadioResourceConfigDedicatedSCell-r10-DEFAULT**

Derivation Path: 36.508 clause 4.6.3			
Information Element	Value/remark	Comment	Condition
RadioResourceConfigDedicatedSCell-r10 ::= SEQUENCE {			
physicalConfigDedicatedSCell-r10	<i>PhysicalConfigDedicatedSCell-r10-DEFAULT</i>		
}			

**Table 9.6.1.4.1.4.3-5: PhysicalConfigDedicatedSCell-r10-DEFAULT**

Derivation Path: 36.508 clause 4.6.3			
Information Element	Value/remark	Comment	Condition
PhysicalConfigDedicatedSCell-r10-DEFAULT ::= SEQUENCE {			
ul-Configuration-r10			
ul-Configuration-r10 SEQUENCE {			
cqi-ReportConfigSCell-r10	<i>CQI-ReportConfigSCell-r10-DEFAULT</i>		
}			
}			

**Table 9.6.1.4.1.4.3-6: CQI-ReportConfigSCell-r10-DEFAULT**

Derivation Path: 36.508 clause 4.6.3			
Information Element	Value/remark	Comment	Condition
CQI-ReportConfigSCell-r10 ::= SEQUENCE {			
cqi-ReportModeAperiodic-r10	Not present		
nomPDSCH-RS-EPRE-Offset-r10	0		
cqi-ReportPeriodicSCell-r10			
	<i>CQI-ReportPeriodic-r10-DEFAULT</i>		CQI_PERIODIC
pmi-RI-Report-r10	Not present		
}			

Table 9.6.1.4.1.4.3-7: CQI-ReportPeriodic-r10-DEFAULT

Derivation Path: 36.508 clause 4.6.3			
Information Element	Value/remark	Comment	Condition
CQI-ReportPeriodic-r10 ::= CHOICE {			
setup SEQUENCE {			
cqi-PUCCH-ResourceIndex-r10	0		
cqi-PUCCH-ResourceIndexP1-r10	Not present		
cqi-pmi-ConfigIndex	13		
cqi-FormatIndicatorPeriodic-r10 CHOICE {			
widebandCQI-r10 SEQUENCE {			
csi-ReportMode-r10	Not present		
}			
ri-ConfigIndex	NULL		
simultaneousAckNackAndCQI	FALSE		
cqi-Mask-r9	Not present		
csi-ConfigIndex-r10	Not present		
}			
}			

#### 9.6.1.4.1.5 Test requirement

The pass fail decision is as specified in the test procedure in clause 9.6.1.4.1.4.2.

There are no parameters in the test setup or measurement process whose variation impacts the results so there are no applicable test tolerances for this test.

#### 9.6.1.4.2 TDD FDD CQI Reporting under AWGN conditions – PUCCH 1-0 for TDD PCell (3DL CA)

*Editor's note: This test case is incomplete. The following aspects are either missing or not yet determined:*

- *Message content exceptions are TBD*
- *The uncertainties and test tolerances are undefined*

#### 9.6.1.4.2.1 Test purpose

To verify that the UE reports different CQI indices for TDD PCell and SCells if each cell experiences a different SNR.

#### 9.6.1.4.2.2 Test applicability

This test applies to all types of E-UTRA FDD and TDD UE release 12 and forward that support 3DL CA with TDD as PCell (UE categories 5 and onwards).

#### 9.6.1.4.2.3 Minimum conformance requirements

The following requirements apply to UE Category  $\geq 5$ . For TDD-FDD CA with TDD PCell with 3 DL CC, for the parameters specified in Table 9.6.1.4.2.3-1 and Table 9.6.1.4.2.3-2, and using the downlink physical channels specified in tables C.3.2-1 and C.3.2-2 on each cell, the difference between the wideband CQI indices of Pcell and Scell1 reported, and the difference between the wideband CQI indices of Scell1 and Scell2 reported shall be such that

$$\text{wideband CQI}_{\text{Pcell}} - \text{wideband CQI}_{\text{Scell1}} \geq 2$$

$$\text{wideband CQI}_{\text{Scell1}} - \text{wideband CQI}_{\text{Scell2}} \geq 2$$

for more than 90% of the time.

**Table 9.6.1.4.2.3-1: Parameters for PUCCH 1-0 static test on multiple cells (TDD-FDD CA with TDD PCell, 3DL CA)**

Parameter		Unit	PCell	SCell1	SCell2
PDSCH transmission mode				1	
Uplink downlink configuration			2	2 if SCell1 is TDD Cell N/A if SCell1 is FDD Cell	N/A
Special subframe configuration			4	4 if SCell1 is TDD Cell N/A if SCell1 is FDD Cell	N/A
Downlink power allocation	$\rho_A$	dB	0		
	$\rho_B$	dB	0		
Propagation condition and antenna configuration			AWGN (1 x 2)		
SNR		dB	12	6	0
$\hat{I}_{or}^{(j)}$		dB[mW/15kHz]	-86	-92	-98
$N_{oc}^{(j)}$		dB[mW/15kHz]	-98	-98	-98
Physical channel for CQI reporting			PUCCH Format 2		
PUCCH Report Type			4		
Reporting periodicity		ms	$N_{pd} = 20$		
<i>cqi-pmi-ConfigurationIndex</i>			18	23 (shift of 5 ms relative to Pcell)	28 (shift of 10 ms relative to Pcell)
Note 1: 3 symbols are allocated to PDCCH. No PDSCH for user data is scheduled for the UE with one sided dynamic OCN Pattern OP.1 TDD as described in Annex A.5.2.1.					

**Table 9.6.1.4.2.3-2: PUCCH 1-0 static test (TDD-FDD CA with TDD PCell, 3DL CA)**

Test number	Bandwidth combination (MHz)
1	2x20MHz for TDD cell and 20MHz for FDD cell
2	2x20MHz for TDD cell and 15MHz for FDD cell
3	2x20MHz for TDD cell and 10MHz for FDD cell
Note 1: The applicability of requirements for different CA configurations and bandwidth combination sets is defined in 9.1.1.2A. The test coverage for different number of component carriers is defined in 9.1.1.3.	

The normative reference for this requirement is TS 36.101 [2] clause 9.6.1.4.

#### 9.6.1.4.2.4 Test description

##### 9.6.1.4.2.4.1 Initial conditions

Initial conditions are a set of test configurations the UE needs to be tested in and the steps for the SS to take with the UE to reach the correct measurement state.

Configurations of PDSCH and PDCCH before measurement are specified in Annex C.2.

Test Environment: Normal as defined in TS 36.508 [7] clause 4.1.

Frequencies to be tested: Maximum Wgap for Intra-band non-contiguous CA, otherwise Mid Range, as defined in TS 36.508 [7] clause 4.3.1.

Channel Bandwidths to be tested: Select one according to Table 9.6.1.4.2.4.1-1.

CA Capability to be tested: Select one according to Table 9.6.1.4.2.4.1-1.

**Table 9.6.1.4.2.4.1-1: Test point selection for CQI Reporting under AWGN conditions – PUCCH 1-0 for TDD PCell (3DL CA)**

CA Applicability	Bandwidth combination		
	2x20+20	2x20+15	2x20+10
Intra-band contiguous (CA_C)	Test 1	Test 2	Test 3
Inter-band (CA_A_2)	Test 1	Test 2	Test 3
Inter-band (CA_A_3)	Test 1	Test 2	Test 3
Intra-band non-contiguous (CA_N)	Test 1	Test 2	Test 3
Note 1: Only one test point is tested. Select the first UE supported CA bandwidth combination (moving from left to right) and choose any one of the UE supported CA capabilities supporting that CA bandwidth combination.			

1. Connect the SS and AWGN noise source to the UE antenna connector (s) as shown in TS 36.508 [7] Annex A, Figure A.59 without faders.
2. The parameter settings for the cell are set up according to Table 9.6.1.4.2.3-1.
3. Downlink signals are initially set up according to Annex C.0, C.1 and Annex C.3.2 and uplink signals according to Annex H.1 and H.3.2.
4. Propagation conditions are set according to Annex B.0.
5. Ensure the UE is in State 3A-RF according to TS 36.508 [7] clause 5.2A.2. Message contents are defined in clause 9.6.1.4.2.4.3.

#### 9.6.1.4.2.4.2 Test procedure

1. Configure SCCs according to Annex C.0, C.1 and Annex C.3.2 for all downlink physical channels.
2. The SS shall configure SCCs as per TS 36.508 [7] clause 5.2A.4. Message contents for *RadioResourceConfigDedicatedSCell-r10-DEFAULT* are defined Table 9.6.1.4.2.4.3-4, *PhysicalConfigDedicatedSCell-r10-DEFAULT* is defined in Table 9.6.1.4.2.4.3-5, *CQI-ReportConfigSCell-r10-DEFAULT* is defined in Table 9.6.1.4.2.4.3-6, *CQI-ReportPeriodic-r10-DEFAULT* is defined in Table 9.6.1.4.2.4.3-7.
3. SS activates SCCs by sending the activation MAC-CE (Refer TS 36.321 [13], clauses 5.13, 6.1.3.8). Wait for at least 2 seconds (Refer TS 36.133, clauses 8.3.3.2).
4. Set the parameters of bandwidth, reference channel, propagation condition, antenna configuration and the SNR according to Table 9.6.1.4.2.3-1 as appropriate.
5. The SS shall start gathering CQI reports. No PDSCH for user data is scheduled for the UE.
6. Continue gathering CQI reports until 2000 wideband CQI reports have been gathered for each P-Cell and S-Cells. For each CSI report calculate the respective difference  $CQI_{P-S1} = \text{wideband } CQI_{Pcell} - \text{wideband } CQI_{Scell1}$  and the respective difference  $CQI_{S1-S2} = \text{wideband } CQI_{Scell1} - \text{wideband } CQI_{Scell2}$ .
7. If more than 1800 values of  $CQI_{P-S1}$  are  $\geq 2$  and more than 1800 values of  $CQI_{S1-S2}$  are  $\geq 2$ , pass the UE. Otherwise fail the UE.

#### 9.6.1.4.2.4.3 Message contents

Message contents are according to TS 36.508 [7] clause 4.6 with the following exceptions:

TBD

#### 9.6.1.4.2.5 Test requirement

The pass fail decision is as specified in the test procedure in clause 9.6.1.4.2.4.2.

There are no parameters in the test setup or measurement process whose variation impacts the results so there are no applicable test tolerances for this test.

## 9.7 CSI reporting for UE DL category 0

The number of receiver antennas  $N_{RX}$  assumed for the minimum performance requirement in this clause is 1.

### 9.7.1 CQI reporting definition under AWGN conditions

#### 9.7.1.1 FDD and Half duplex FDD CQI reporting definition under AWGN conditions for UE category 0

**Editor's Note: This test case is incomplete. The following items are missing or are incomplete:**

- Connection diagram in Annex A of TS 36.508 is TBD
- Annex F.1.5 needs to be updated.
- The minimum test time need to be added to Annex G
- Applicability spec needs to be updated
- RMCs are TBD
- Minimum requirement table contains brackets
- Test Procedure is TBD

##### 9.7.1.1.1 Test purpose

To verify the variance of the wideband CQI reports is within the limits defined and a PDSCH BLER of 10% falls between the transport format based median CQI-1 and median CQI or the transport format based median CQI and median CQI +1.

##### 9.7.1.1.2 Test applicability

This test applies to E-UTRA FDD UE release 12 and forward of UE category 0.

##### 9.7.1.1.3 Minimum conformance requirements

The following requirements apply to DL UE Category 0. For the parameters specified in Table 9.7.1.1.3-1 and using the downlink physical channels specified in tables C.3.2-1 and C.3.2-2, the reported CQI value according to TBD in Table A.4-1 shall be in the range of  $\pm 1$  of the reported median more than 90% of the time. If the PDSCH BLER using the transport format indicated by median CQI is less than or equal to 0.1, the BLER using the transport format indicated by the (median CQI + 1) shall be greater than 0.1. If the PDSCH BLER using the transport format indicated by the median CQI is greater than 0.1, the BLER using transport format indicated by (median CQI - 1) shall be less than or equal to 0.1.

**Table 9.7.1.1.3-1: PUCCH 1-0 static test (FDD and half-duplex FDD)**

Parameter		Unit	Test 1		Test 2	
Bandwidth		MHz	10			
PDSCH transmission mode			1			
Downlink power allocation	$\rho_A$	dB	0			
	$\rho_B$	dB	0			
	$\sigma$	dB	0			
Propagation condition and antenna configuration			AWGN (1 x 1)			
SNR (Note 2)		dB	[0]	[1]	[6]	[7]
$\hat{I}_{or}^{(j)}$		dB[mW/15kHz]	-98	-97	-92	-91
$N_{oc}^{(j)}$		dB[mW/15kHz]	-98		-98	
Max number of HARQ transmissions			1			
Physical channel for CQI reporting			PUCCH Format 2			
PUCCH Report Type			4			
Reporting periodicity		ms	$N_{pd} = 40$			
<i>cqi-pmi-ConfigurationIndex</i>			41			
Note 1: Reference measurement channel RC.16 FDD according to Table A.4-1 with one sided dynamic OCNG Pattern OP.1 FDD as described in Annex A.5.1.1.						
Note 2: For each test, the minimum requirements shall be fulfilled for at least one of the two SNR(s) and the respective wanted signal input level.						

The normative reference for this requirement is TS 36.101 [2] clause 9.7.1.1.

#### 9.7.1.1.4 Test description

##### 9.7.1.1.4.1 Initial conditions

Initial conditions are a set of test configurations the UE needs to be tested in and the steps for the SS to take with the UE to reach the correct measurement state.

Configurations of PDSCH and PDCCH before measurement are specified in Annex C.2.

Test Environment: Normal as defined in TS 36.508 [7] clause 4.1.

Frequencies to be tested: Mid Range as defined in TS 36.508 [7] clause 4.3.1.1.

Channel Bandwidths to be tested: 10MHz for tests defined in 9.7.1.1.3-1 as defined in TS 36.508 [7] clause 4.3.1.1

1. Connect the SS, faders and AWGN noise source to the UE antenna connector(s) as shown in TS 36.508 [7] Annex A, Figure TBD.
2. The parameter settings for the cell are set up according to Table 9.7.1.1.3-1.
3. Downlink signals are initially set up according to Annex C.0, C.1 and Annex C.3.2 and uplink signals according to Annex H.1 and H.3.2.
4. Propagation conditions are set according to Annex B.0.
5. Ensure the UE is in State 3A-RF according to TS 36.508 [7] clause 5.2A.2. Message contents are defined in clause 9.7.1.1.4.3.

##### 9.7.1.1.4.2 Test procedure

TBD

## 9.7.1.1.4.3 Message contents

Message contents are according to TS 36.508 [7] clause 4.6 with the following exceptions:

**Table 9.7.1.1.4.3-1: PhysicalConfigDedicated-DEFAULT**

Derivation Path: 36.508 clause 5.5.1.2			
Information Element	Value/remark	Comment	Condition
PhysicalConfigDedicated-DEFAULT ::= SEQUENCE {			
cqi-ReportConfig	<i>CQI-ReportConfig-DEFAULT</i>		
}			

**Table 9.7.1.1.4.3-2: CQI-ReportConfig-DEFAULT**

Derivation Path: 36.508 clause 4.6.3			
Information Element	Value/remark	Comment	Condition
CQI-ReportConfig-DEFAULT ::= SEQUENCE {			
cqi-ReportModeAperiodic	Not present		
nomPDSCH-RS-EPRE-Offset	0		
cqi-ReportPeriodic CHOICE {			
setup SEQUENCE {			
cqi-PUCCH-ResourceIndex	0		
cqi-pmi-ConfigIndex	6	(see Table 7.2.2-1A in TS 36.213)	
cqi-FormatIndicatorPeriodic CHOICE {			
widebandCQI	NULL		
}			
ri-ConfigIndex	NULL	(see Table 7.2.2-1B in TS 36.213)	
simultaneousAckNackAndCQI	FALSE		
}			
}			

## 9.7.1.1.5 Test requirement

The pass fail decision is as specified in the test procedure in clause 9.7.1.1.4.2.

There are no parameters in the test setup or measurement process whose variation impacts the results so there are no applicable test tolerances for this test.

## 9.7.1.2 TDD CQI reporting definition under AWGN conditions for UE category 0

**Editor's Note: This test case is incomplete. The following items are missing or are incomplete:**

- Connection diagram in Annex A of TS 36.508 is TBD
- Annex F.1.5 needs to be updated.
- The minimum test time need to be added to Annex G
- Applicability spec needs to be updated- Minimum requirement table contains brackets
- Test Procedure is TBD

## 9.7.1.2.1 Test purpose

To verify the variance of the wideband CQI reports is within the limits defined and a PDSCH BLER of 10% falls between the transport format based median CQI-1 and median CQI or the transport format based median CQI and median CQI +1.



### 9.7.1.2.2 Test applicability

This test applies to E-UTRA TDD UE release 12 and forward of UE category 0.

### 9.7.1.2.3 Minimum conformance requirements

The following requirements apply to DL UE Category 0. For the parameters specified in Table 9.7.1.2.3-1 and using the downlink physical channels specified in tables C.3.2-1 and C.3.2-2, the reported CQI value according to RC.16 TDD in Table A.4-1 shall be in the range of  $\pm 1$  of the reported median more than 90% of the time. If the PDSCH BLER using the transport format indicated by median CQI is less than or equal to 0.1, the BLER using the transport format indicated by the (median CQI + 1) shall be greater than 0.1. If the PDSCH BLER using the transport format indicated by the median CQI is greater than 0.1, the BLER using transport format indicated by (median CQI – 1) shall be less than or equal to 0.1.

**Table 9.7.1.2.3-1: PUCCH 1-0 static test (TDD)**

Parameter	Unit	Test 1		Test 2	
Bandwidth	MHz	10			
PDSCH transmission mode		1			
Uplink downlink configuration		2			
Special subframe configuration		4			
Downlink power allocation	$\rho_A$	dB	0		
	$\rho_B$	dB	0		
	$\sigma$	dB	0		
Propagation condition and antenna configuration		AWGN (1 x 1)			
SNR (Note 2)	dB	[0]	[1]	[6]	[7]
$\hat{I}_{or}^{(j)}$	dB[mW/15kHz]	[-98]	[-97]	[-92]	[-91]
$N_{oc}^{(j)}$	dB[mW/15kHz]	-98		-98	
Max number of HARQ transmissions		1			
Physical channel for CQI reporting		PUSCH (Note 3)			
PUCCH Report Type		4			
Reporting periodicity	ms	$N_{pd} = 5$			
<i>cqi-pmi-ConfigurationIndex</i>		3			
ACK/NACK feedback mode		Multiplexing			
Note 1:	Reference measurement channel RC.16 TDD according to Table A.4-1 with one sided dynamic OCNG Pattern OP.1 TDD as described in Annex A.5.2.1.				
Note 2:	For each test, the minimum requirements shall be fulfilled for at least one of the two SNR(s) and the respective wanted signal input level.				
Note 3:	To avoid collisions between CQI reports and HARQ-ACK it is necessary to report both on PUSCH instead of PUCCH. PDCCH DCI format 0 shall be transmitted in downlink SF#3 and #8 to allow periodic CQI to multiplex with the HARQ-ACK on PUSCH in uplink subframe SF#7 and #2.				

The normative reference for this requirement is TS 36.101 [2] clause 9.7.1.2.

### 9.7.1.2.4 Test description

#### 9.7.1.2.4.1 Initial conditions

Initial conditions are a set of test configurations the UE needs to be tested in and the steps for the SS to take with the UE to reach the correct measurement state.

Configurations of PDSCH and PDCCH before measurement are specified in Annex C.2.

Test Environment: Normal as defined in TS 36.508 [7] clause 4.1.

Frequencies to be tested: Mid Range as defined in TS 36.508 [7] clause 4.3.1.1.

Channel Bandwidths to be tested: 10MHz for tests defined in 9.7.1.2.3-1 as defined in TS 36.508 [7] clause 4.3.1.1

1. Connect the SS, faders and AWGN noise source to the UE antenna connector(s) as shown in TS 36.508 [7] Annex A, Figure TBD.
2. The parameter settings for the cell are set up according to Table 9.7.1.2.3-1.
3. Downlink signals are initially set up according to Annex C.0, C.1 and Annex C.3.2 and uplink signals according to Annex H.1 and H.3.2.
4. Propagation conditions are set according to Annex B.0.
5. Ensure the UE is in State 3A-RF according to TS 36.508 [7] clause 5.2A.2. Message contents are defined in clause 9.7.1.2.4.3.

#### 9.7.1.2.4.2 Test procedure

TBD

#### 9.7.1.2.4.3 Message contents

Message contents are according to TS 36.508 [7] clause 4.6 with the following exceptions:

**Table 9.7.1.2.4.3-1: PhysicalConfigDedicated-DEFAULT**

Derivation Path: 36.508 clause 5.5.1.2			
Information Element	Value/remark	Comment	Condition
PhysicalConfigDedicated-DEFAULT ::= SEQUENCE {			
cqi-ReportConfig	<i>CQI-ReportConfig-DEFAULT</i>		
}			

**Table 9.7.1.2.4.3-2: CQI-ReportConfig-DEFAULT**

Derivation Path: 36.508 clause 4.6.3			
Information Element	Value/remark	Comment	Condition
CQI-ReportConfig-DEFAULT ::= SEQUENCE {			
cqi-ReportModeAperiodic	Not present		
nomPDSCH-RS-EPRE-Offset	0		
cqi-ReportPeriodic CHOICE {			
setup SEQUENCE {			
cqi-PUCCH-ResourceIndex	0		
cqi-pmi-ConfigIndex	6	(see Table 7.2.2-1C in TS 36.213)	
cqi-FormatIndicatorPeriodic CHOICE {			
widebandCQI	NULL		
}			
ri-ConfigIndex	NULL	(see Table 7.2.2-1B in TS 36.213)	
simultaneousAckNackAndCQI	FALSE		
}			
}			

#### 9.7.1.2.5 Test requirement

The pass fail decision is as specified in the test procedure in clause 9.7.1.2.4.2.

There are no parameters in the test setup or measurement process whose variation impacts the results so there are no applicable test tolerances for this test.

## 10 MBMS Performance

### 10.1 FDD MBMS performance (Fixed Reference Channel)

#### 10.1.1 Test purpose

This test verifies the performance of FDD MBMS with a given SNR for which the average BLER remains below a given reference value.

#### 10.1.2 Test applicability

This test applies to all types of E-UTRA FDD UE supporting MBMS release 9 and forward.

#### 10.1.3 Minimum conformance requirements

The parameters specified in Table 10.1.3-1 are valid for all FDD tests unless otherwise stated. For the requirements defined in this section, the difference between CRS EPRE and the MBSFN RS EPRE should be set to 0 dB as the UE demodulation performance might be different when this condition is not met (e.g. in scenarios where power offsets are present, such as scenarios when reserved cells are present).

**Table 10.1.3-1: Common Test Parameters (FDD)**

Parameter	Unit	Value
Number of HARQ processes	Processes	None
Subcarrier spacing	kHz	15 kHz
Allocated subframes per Radio Frame (Note 1)		6 subframes
Number of OFDM symbols for PDCCH		2
Cyclic Prefix		Extended
Note 1: For FDD mode, up to 6 subframes (#1/2/3/6/7/8) are available for MBMS, in line with TS 36.331.		

The receive characteristic of MBMS is determined by the BLER. The requirement is valid for all RRC states for which the UE has capabilities for MBMS.

For the parameters specified in Table 10.1.3-1 and Table 10.1.3-2 and Annex A.3.8.1, the average downlink SNR shall be below the specified value for the BLER shown in Table 10.1.3-3.

**Table 10.1.3-2: Test Parameters for Testing**

Parameter	Unit	Test 1-4	
Downlink power allocation	$\rho_A$	dB	0
	$\rho_B$	dB	0 (Note 1)
$N_{oc}$ at antenna port	dBm/15kHz	-98	
Note 1: $P_B = 0$			

Table 10.1.3-3: Minimum performance

Test number	Bandwidth	Reference Channel	OCNG Pattern	Propagation condition	Correlation Matrix and antenna	Reference value		MBMS UE Category
						BLER (%)	SNR(dB)	
1	10 MHz	R.37 FDD	OP.4 FDD	MBSFN channel model (Table B.2.6-1)	1x2 low	1	4.1	$\geq 1$
2	10 MHz	R.38 FDD	OP.4 FDD				11.0	$\geq 1$
3	10 MHz	R.39 FDD	OP.4 FDD				20.1	$\geq 2$
	5 MHz	R.39-1 FDD	OP.4 FDD				20.5	1
4	1.4 MHz	R.40 FDD	OP.4 FDD				6.6	$\geq 1$

The normative reference for this requirement is TS 36.101 [2] clause 10.1.

## 10.1.4 Test description

### 10.1.4.1 Initial conditions

Test Environment: Normal, as defined in TS 36.508 [7] clause 4.1.

Frequencies to be tested: Mid Range, as defined in TS 36.508 [7] clause 4.3.1.

Channel Bandwidths to be tested: As specified per test number in Table 10.1.3-3 as defined in TS 36.508 [7] clause 4.3.1.

1. Connect the SS, the faders and AWGN noise source to the UE antenna connector (s) as shown in TS 36.508 [7] Annex A, Figure A.9.
2. The parameter settings for the cell are set up according to Table 10.1.3-1.
3. The downlink signals are initially set up according to Annex C.1 and Annex C.3.2 and uplink signals according to Annex H.1 and H.3.2.
4. Propagation conditions are set according to Annex B clause B.0.
5. Ensure the UE is in State 2A-RF according to TS 36.508 [7] clause 5.2A.1A. Message contents are defined in clause 10.1.4.3.
6. SS transmits *MBSFNAreaConfiguration* message. Message content is defined in clause 10.1.4.3.
7. Wait for a period equal to the MCCH modification period to make sure the UE has received the *MBSFNAreaConfiguration* message.
8. SS continues with the generic procedures described in TS 36.508 [7] clause 4.5.3A.3 and 4.5.4.3 and ensures the UE is in State 4 according to TS 36.508 [7] clause 4.5.4 and the UE test loop Mode C is activated. Message contents are defined in clause 10.1.4.3.
9. SS is configured to include 10 MBMS packets in one TB.

### 10.1.4.2 Test procedure

1. Initialise the variables  $M_{tot}$  and  $M_{ok}$  as 0. Set the parameters of bandwidth, reference channel, the propagation condition, antenna configuration and the SNR according to Table 10.1.5-1 as appropriate.
2. SS shall send MBMS Packets on the MTCH radio bearer for the test time specified in Table G.6.4-1. SS stores the number of the transmitted MBMS Packets on the MTCH in the current test iteration in the variable  $M_{tot}$ .
3. SS shall send a "UE TEST LOOP MODE C MBMS PACKET COUNTER REQUEST" message and wait for the UE to respond with a "UE TEST LOOP MODE C MBMS PACKET COUNTER RESPONSE" reporting the

received MBMS Packet counter value. Message contents are defined in clause 10.1.4.3. SS calculates the variable  $M_{ok}$  as (current counter value - counter value at last test iteration).

4. SS shall compute the BLER as the following:

$$\text{The BLER} = (M_{\text{tot}} - M_{\text{ok}}) / M_{\text{tot}}$$

5. Repeat steps from 1 to 4 for each subtest in Table 10.1.5-1 as appropriate.

### 10.1.4.3 Message contents

Message contents are according to TS 36.508 [7] clauses 4.4, 4.6 and 4.7A with following exceptions:

**Table 10.1.4.3-1: SystemInformationBlockType2: Additional FDD MBMS performance (Fixed Reference Channel)**

Derivation Path: 36.508 table 4.4.3.3-1			
Information Element	Value/remark	Comment	Condition
SystemInformationBlockType2 ::= SEQUENCE {			
mbsfn-SubframeConfigList SEQUENCE (SIZE (1..maxMBSFN-Allocations)) OF SEQUENCE {			
radioframeAllocationPeriod	n1		
radioframeAllocationOffset	0		
subframeAllocation CHOICE{			
oneFrame	'111111' B		
}			
}			
}			

**Table 10.1.4.3-2: MBSFNAreaConfiguration message: Additional FDD MBMS performance (Fixed Reference Channel)**

Derivation Path: 36.508, Table 4.6.1-4A			
Information Element	Value/remark	Comment	Condition
MBSFNAreaConfiguration-r9 ::= SEQUENCE {			
commonSF-Alloc-r9 SEQUENCE (SIZE (1..maxMBSFN-Allocations)) OF SEQUENCE {			
radioframeAllocationPeriod	n1		
radioframeAllocationOffset	0		
subframeAllocation CHOICE {			
oneFrame	'111111' B		
}			
}			
commonSF-AllocPeriod-r9	rf8		
pmch-InfoList-r9 SEQUENCE (SIZE (0..maxPMCH-PerMBSFN)) OF SEQUENCE {			
pmch-Config-r9 SEQUENCE {			
sf-AllocEnd-r9	47	48 active subframes in 8 Radio-frames	
dataMCS-r9	4	Test number 1 and 4	R.37 FDD R.40 FDD
	12	Test number 2	R.38 FDD
	20	Test number 3	R.39 FDD R.39-1 FDD
mch-SchedulingPeriod-r9	rf8		
}			
...			
}			

**Table 10.1.4.3-3: ACTIVATE TEST MODE: Additional FDD MBMS performance (Fixed Reference Channel)**

Derivation Path: 36.508, Table 4.7A-1, condition UE TEST LOOP MODE C

**Table 10.1.4.3-4: CLOSE UE TEST LOOP: Additional FDD MBMS performance (Fixed Reference Channel)**

Derivation Path: 36.508, Table 4.7A-3, condition UE TEST LOOP MODE C

**Table 10.1.4.3-5: SystemInformationBlockType13: Additional FDD MBMS performance (Fixed Reference Channel)**

Derivation Path: 36.508 table 4.4.3.3-13			
Information Element	Value/remark	Comment	Condition
SystemInformationBlockType13 ::= SEQUENCE {			
mbsfn-AreaInfoList-r9 SEQUENCE			
(SIZE(1..maxMBSFN-Area)) OF SEQUENCE {			
mcch-Config-r9 SEQUENCE {			
mcch-RepetitionPeriod-r9	rf32		
mcch-Offset-r9	0		
mcch-ModificationPeriod-r9	rf512		
sf-AllocInfo-r9	'100000' B		
signallingMCS-r9	n7	Test number 1 and 4	QPSK
	n13	Test number 2	16QAM
	n19	Test number 3	64QAM
}			
}			
notificationConfig-r9 SEQUENCE {			
notificationRepetitionCoeff-r9	n4		
notificationOffset-r9	0		
notificationSF-Index-r9	1	Subframe #1	
}			
}			

## 10.1.5 Test requirement

For the parameters specified in Table 10.1.3-1, Table 10.1.3-2, Annex A.3.8.1, and SNR in Table 10.1.5-1, the value for the BLER in step 4 shall be below the test limit in Annex G.6.3 for all subtests shown in Table 10.1.5-1.

**Table 10.1.5-1: Test requirement**

Test number	Bandwidth	Reference Channel	OCNG Pattern	Propagation condition	Correlation Matrix and antenna	Reference value		MBMS UE Category
						BLER (%)	SNR(dB)	
1	10 MHz	R.37 FDD	OP.4 FDD	MBSFN channel model (Table B.2.6-1)	1x2 low	1	5	≥1
2	10 MHz	R.38 FDD	OP.4 FDD				11.9	≥1
3	10 MHz	R.39 FDD	OP.4 FDD				21.0	≥2
	5 MHz	R.39-1 FDD	OP.4 FDD				21.4	1
4	1.4 MHz	R.40 FDD	OP.4 FDD				7.5	≥1

## 10.2 TDD MBMS performance (Fixed Reference Channel)

### 10.2.1 Test purpose

This test verifies the performance of TDD MBMS with a given SNR for which the average BLER remains below a given reference value.

### 10.2.2 Test applicability

This test applies to all types of E-UTRA TDD UE supporting MBMS release 9 and forward.

### 10.2.3 Minimum conformance requirements

The parameters specified in Table 10.2.3-1 are valid for all TDD tests unless otherwise stated. For the requirements defined in this section, the difference between CRS EPRE and the MBSFN RS EPRE should be set to 0 dB as the UE demodulation performance might be different when this condition is not met (e.g. in scenarios where power offsets are present, such as scenarios when reserved cells are present).

**Table 10.2.3-1: Common Test Parameters (TDD)**

Parameter	Unit	Value
Number of HARQ processes	Processes	None
Subcarrier spacing	kHz	15 kHz
Allocated subframes per Radio Frame (Note 1)		5 subframes
Number of OFDM symbols for PDCCH		2
Cyclic Prefix		Extended
Note 1: For TDD mode, in line with TS 36.331, Uplink-Downlink Configuration 5 is proposed, up to 5 subframes (#3/4/7/8/9) are available for MBMS.		

The receive characteristic of MBMS is determined by the BLER. The requirement is valid for all RRC states for which the UE has capabilities for MBMS.

For the parameters specified in Table 10.2.3-1 and Table 10.2.3-2 and Annex A.3.8.2, the average downlink SNR shall be below the specified value for the BLER shown in Table 10.2.3-3.

**Table 10.2.3-2: Test Parameters for Testing**

Parameter	Unit	Test 1-4
Downlink power allocation	$\rho_A$	dB
	$\rho_B$	dB
$N_{oc}$ at antenna port	dBm/15kHz	-98
Note 1: $P_B = 0$		

Table 10.2.3-3: Minimum performance

Test number	Bandwidth	Reference Channel	OCNG Pattern	Propagation condition	Correlation Matrix and antenna	Reference value		MBMS UE Category
						BLER (%)	SNR(dB)	
1	10 MHz	R.37 TDD	OP.4 TDD	MBSFN channel model (Table B.2.6-1)	1x2 low	1	3.4	$\geq 1$
2	10 MHz	R.38 TDD	OP.4 TDD				11.1	$\geq 1$
3	10 MHz	R.39 TDD	OP.4 TDD				20.1	$\geq 2$
	5MHz	R.39-1 TDD	OP.4 TDD				20.5	1
4	1.4 MHz	R.40 TDD	OP.4 TDD				5.8	$\geq 1$

The normative reference for this requirement is TS 36.101 [2] clause 10.2.

## 10.2.4 Test description

### 10.2.4.1 Initial conditions

Test Environment: Normal, as defined in TS 36.508 [7] clause 4.1.

Frequencies to be tested: Mid Range, as defined in TS 36.508 [7] clause 4.3.1.

Channel Bandwidths to be tested: As specified per test number in Table 10.2.3-3 as defined in TS 36.508 [7] clause 4.3.1.

1. Connect the SS, the faders and AWGN noise source to the UE antenna connector (s) as shown in TS 36.508 [7] Annex A, Figure A.9.
2. The parameter settings for the cell are set up according to Table 10.2.3-1.
3. The downlink signals are initially set up according to Annex C.1 and Annex C.3.2 and uplink signals according to Annex H.1 and H.3.2.
4. Propagation conditions are set according to Annex B clause B.0.
5. Ensure the UE is in State 2A-RF according to TS 36.508 [7] clause 5.2A.1A. Message contents are defined in clause 10.2.4.3.
6. SS transmits *MBSFNAreaConfiguration* message. Message content is defined in clause 10.2.4.3.
7. Wait for a period equal to the MCCH modification period to make sure the UE has received the *MBSFNAreaConfiguration* message.
8. SS continues with the generic procedures described in TS 36.508 [7] clause 4.5.3A.3 and 4.5.4.3 and ensures the UE is in State 4 according to TS 36.508 [7] clause 4.5.4 and the UE test loop Mode C is activated. Message contents are defined in clause 10.2.4.3.
9. SS is configured to include 10 MBMS packets in one TB.

### 10.2.4.2 Test procedure

1. Initialise the variables  $M_{tot}$  and  $M_{ok}$  as 0. Set the parameters of bandwidth, reference channel, the propagation condition, antenna configuration and the SNR according to Table 10.2.5-1 as appropriate.
2. SS shall send MBMS Packets on the MTCH radio bearer for the test time specified in Table G.6.4-1. SS stores the number of the transmitted MBMS Packets on the MTCH in the current test iteration in the variable  $M_{tot}$ .
3. SS shall send a "UE TEST LOOP MODE C MBMS PACKET COUNTER REQUEST" message and wait for the UE to respond with a "UE TEST LOOP MODE C MBMS PACKET COUNTER RESPONSE" reporting the



received MBMS Packet counter value. Message contents are defined in clause 10.2.4.3. SS calculates the variable  $M_{ok}$  as (current counter value - counter value at last test iteration).

4. SS shall compute the BLER as the following:

$$\text{The BLER} = (M_{\text{tot}} - M_{\text{ok}}) / M_{\text{tot}}$$

5. Repeat steps from 1 to 4 for each subtest in Table 10.2.5-1 as appropriate.

### 10.2.4.3 Message contents

Message contents are according to TS 36.508 [7] clauses 4.4, 4.6 and 4.7A with following exceptions:

**Table 10.2.4.3-1: SystemInformationBlockType2: Additional TDD MBMS performance (Fixed Reference Channel)**

Derivation Path: 36.508 table 4.4.3.3-1			
Information Element	Value/remark	Comment	Condition
SystemInformationBlockType2 ::= SEQUENCE {			
mbsfn-SubframeConfigList SEQUENCE (SIZE (1..maxMBSFN-Allocations)) OF SEQUENCE {			
radioframeAllocationPeriod	n1		
radioframeAllocationOffset	0		
subframeAllocation CHOICE{			
oneFrame	'111110' B	The last bit is not used	
}			
}			
}			

**Table 10.2.4.3-2: MBSFNAreaConfiguration message: Additional TDD MBMS performance (Fixed Reference Channel)**

Derivation Path: 36.508, Table 4.6.1-4A			
Information Element	Value/remark	Comment	Condition
MBSFNAreaConfiguration-r9 ::= SEQUENCE {			
commonSF-Alloc-r9 SEQUENCE (SIZE (1..maxMBSFN-Allocations)) OF SEQUENCE {			
radioframeAllocationPeriod	n1		
radioframeAllocationOffset	0		
subframeAllocation CHOICE {			
oneFrame	'111110' B	The last bit is not used	
}			
}			
commonSF-AllocPeriod-r9	rf8		
pmch-InfoList-r9 SEQUENCE (SIZE (0..maxPMCH-PerMBSFN)) OF SEQUENCE {			
pmch-Config-r9 SEQUENCE {			
sf-AllocEnd-r9	39	40 active subframes in 8 Radio-frames	
dataMCS-r9	4	Test number 1 and 4	R.37 TDD R.40 TDD
}	12	Test number 2	R.38 TDD
}	20	Test number 3	R.39 TDD R.39-1 TDD
mch-SchedulingPeriod-r9	rf8		
}			
}			

**Table 10.2.4.3-3: ACTIVATE TEST MODE: Additional TDD MBMS performance (Fixed Reference Channel)**

Derivation Path: 36.508, Table 4.7A-1, condition UE TEST LOOP MODE C

**Table 10.2.4.3-4: CLOSE UE TEST LOOP: Additional TDD MBMS performance (Fixed Reference Channel)**

Derivation Path: 36.508, Table 4.7A-3, condition UE TEST LOOP MODE C

**Table 10.2.4.3-5: SystemInformationBlockType13: Additional TDD MBMS performance (Fixed Reference Channel)**

Derivation Path: 36.508 table 4.4.3.3-13			
Information Element	Value/remark	Comment	Condition
SystemInformationBlockType13 ::= SEQUENCE {			
mbsfn-AreaInfoList-r9 SEQUENCE (SIZE(1..maxMBSFN-Area)) OF SEQUENCE {			
mcch-Config-r9 SEQUENCE {			
mcch-RepetitionPeriod-r9	rf32		
mcch-Offset-r9	0		
mcch-ModificationPeriod-r9	rf512		
sf-AllocInfo-r9	'100000' B		
signallingMCS-r9	n7	Test number 1 and 4	QPSK
	n13	Test number 2	16QAM
	n19	Test number 3	64QAM
}			
}			
notificationConfig-r9 SEQUENCE {			
notificationRepetitionCoeff-r9	n4		
notificationOffset-r9	0		
notificationSF-Index-r9	1	Subframe #3	
}			
}			

**Table 10.2.4.3-6: TDD-Config-DEFAULT: Additional TDD MBMS performance (Fixed Reference Channel)**

Derivation Path: TS 36.508 Table 5.3.1-1			
Information Element	Value/remark	Comment	Condition
TDD-Config-DEFAULT ::= SEQUENCE {			
subframeAssignment	sa5		
}			

**Table 10.2.4.3-7: PUCCH-ConfigDedicated-DEFAULT: Additional TDD MBMS performance (Fixed Reference Channel)**

Derivation Path: 36.508 Table 4.6.3-9			
Information Element	Value/remark	Comment	Condition
PUCCH-ConfigDedicated-DEFAULT ::= SEQUENCE {			
tddAckNackFeedbackMode	bundling		
}			

## 10.2.5 Test requirement

For the parameters specified in Table 10.2.3-1, Table 10.2.3-2, Annex A.3.8.2, and SNR in Table 10.2.5-1, the value for the BLER in step 4 shall be below the test limit in Annex G.6.3 for all subtests shown in Table 10.2.5-1.

Table 10.2.5-1: Test requirement

Test number	Bandwidth	Reference Channel	OCNG Pattern	Propagation condition	Correlation Matrix and antenna	Reference value		MBMS UE Category
						BLER (%)	SNR(dB)	
1	10 MHz	R.37 TDD	OP.4 TDD	MBSFN channel model (Table B.2.6-1)	1x2 low	1	4.3	$\geq 1$
2	10 MHz	R.38 TDD	OP.4 TDD				12	$\geq 1$
3	10 MHz	R.39 TDD	OP.4 TDD				21.0	$\geq 2$
	5MHz	R.39-1 TDD	OP.4 TDD				21.4	1
4	1.4 MHz	R.40 TDD	OP.4 TDD				6.7	$\geq 1$

# Annex A (normative): Measurement Channels

## A.1 General

A schematic overview of the encoding process for the reference measurement channels is provided in Figure A-1.

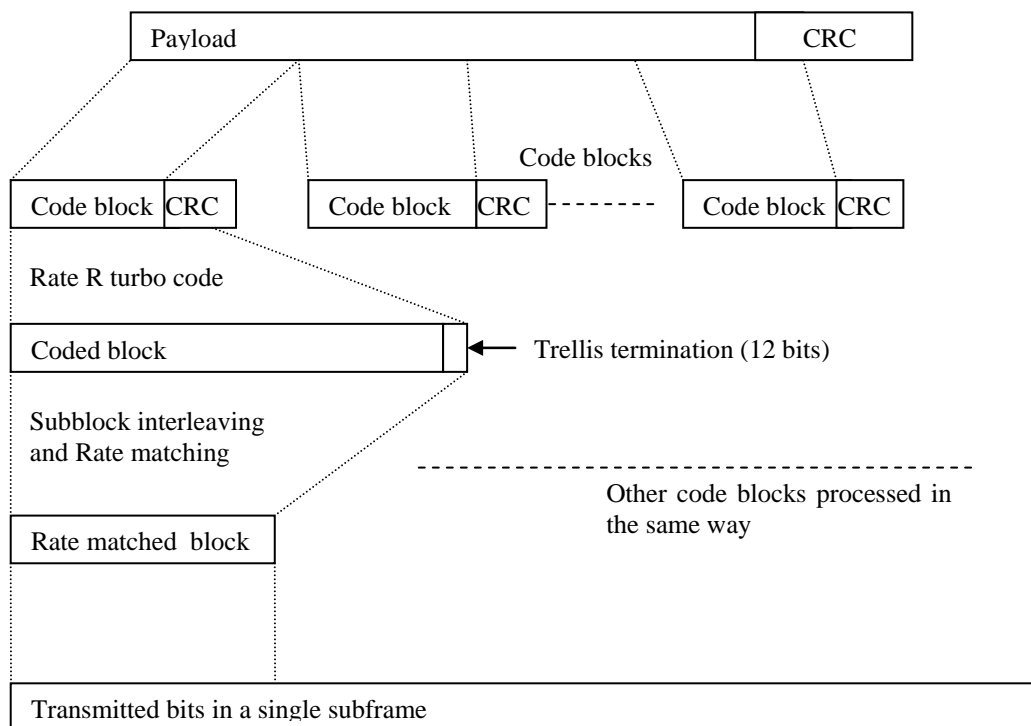

**Figure A-1: Schematic overview of the encoding process**

The throughput values defined in the measurement channels specified in Annex A, are calculated and are valid per data stream (codeword). For multi-stream (more than one codeword) transmissions, the throughput referenced in the minimum requirements is the sum of throughputs of all data streams (codewords).

The UE category entry in the definition of the reference measurement channels in Annex A is only informative and reveals the UE categories, which can support the corresponding measurement channel. Whether the measurement channel is used for testing a certain UE category or not is specified in the individual test cases.

Rate matching process in Figure A-1 is dependent on the parameter “Total number of Soft Channel bits” which has been defined for each UE category in TS 36.306 [15] clause 4.1. The SS shall use the Soft Channel bits size according to the UE category.

## A.2 UL reference measurement channels

### A.2.1 General

#### A.2.1.1 Applicability and common parameters

The following sections define the UL signal applicable to the Transmitter Characteristics (clause 6) and for the Receiver Characteristics (clause 7) where the UL signal is relevant.

The Reference channels in this section assume transmission of PUSCH and Demodulation Reference signal only. The following conditions apply:

- 1 HARQ transmission
- Cyclic Prefix normal
- PUSCH hopping off
- Link adaptation off
- Demodulation Reference signal as per TS 36.211 [8] clause 5.5.2.1.2.

Where ACK/NACK is transmitted, it is assumed to be multiplexed on PUSCH as per TS 36.212 [9] subclause 5.2.2.6.

- ACK/NACK 1 bit
- ACK/NACK mapping adjacent to Demodulation Reference symbol
- ACK/NACK resources punctured into data
- Max number of resources for ACK/NACK: 4 SC-FDMA symbols per subframe
- No CQI transmitted, no RI transmitted

#### A.2.1.2 Determination of payload size

The algorithm for determining the payload size  $A$  is as follows; given a desired coding rate  $R$  and radio block allocation  $N_{RB}$ :

1. Calculate the number of channel bits  $N_{ch}$  that can be transmitted during the first transmission of a given sub-frame.
2. Find  $A$  such that the resulting coding rate is as close to  $R$  as possible, that is,

$$\min \left| R - (A + 24) / N_{ch} \right|,$$

subject to

- a)  $A$  is a valid TB size according to clause 7.1.7 of TS 36.213 [10] assuming an allocation of  $N_{RB}$  resource blocks.
  - b) Segmentation is not included in this formula, but should be considered in the TBS calculation.
  - c) For RMC-s, which at the nominal target coding rate do not cover all the possible UE categories for the given modulation, reduce the target coding rate gradually (within the same modulation), until the maximal possible number of UE categories is covered.
3. If there is more than one  $A$  that minimises the equation above, then the larger value is chosen per default.

### A.2.1.3 Overview of UL reference measurement channels

In Table A.2.1.3-1 are listed the UL reference measurement channels specified in annexes A.2.2 and A.2.3 of this release of TS 36.521-1. This table is informative and serves only to a better overview. The reference for the concrete reference measurement channels and corresponding implementation's parameters as to be used for testing are annexes A.2.2 and A.2.3 as appropriate.

**Table A.2.1.3-1: Overview of UL reference measurement channels**

Duplex	Table	Name	B W	Mod	TCR	RB	RB Off set	UE Cat eg	Notes
<b>FDD, Full RB allocation, QPSK</b>									
FDD	Table A.2.2.1.1-1		1.4	QPSK	1/3	6		≥ 1	
FDD	Table A.2.2.1.1-1		3	QPSK	1/3	15		≥ 1	
FDD	Table A.2.2.1.1-1		5	QPSK	1/3	25		≥ 1	
FDD	Table A.2.2.1.1-1		10	QPSK	1/3	50		≥ 1	
FDD	Table A.2.2.1.1-1		15	QPSK	1/5	75		≥ 1	
FDD	Table A.2.2.1.1-1		20	QPSK	1/6	100		≥ 1	
FDD / HD-FDD	Table A.2.2.1.1-1a		1.4	QPSK	1/3	6		0	
FDD / HD-FDD	Table A.2.2.1.1-1a		3	QPSK	1/5	15		0	
FDD / HD-FDD	Table A.2.2.1.1-1a		5	QPSK	1/8	25		0	
FDD / HD-FDD	Table A.2.2.1.1-1a		10	QPSK	[1/10 ]	[36]		0	
FDD / HD-FDD	Table A.2.2.1.1-1a		15	QPSK	[1/10 ]	[36]		0	
FDD / HD-FDD	Table A.2.2.1.1-1a		20	QPSK	[1/10 ]	[36]		0	
<b>FDD, Full RB allocation, 16-QAM</b>									
FDD	Table A.2.2.1.2-1		1.4	16QAM	3/4	6		≥ 1	
FDD	Table A.2.2.1.2-1		3	16QAM	1/2	15		≥ 1	
FDD	Table A.2.2.1.2-1		5	16QAM	1/3	25		≥ 1	
FDD	Table A.2.2.1.2-1		10	16QAM	3/4	50		≥ 2	
FDD	Table A.2.2.1.2-1		15	16QAM	1/2	75		≥ 2	
FDD	Table A.2.2.1.2-1		20	16QAM	1/3	100		≥ 2	
FDD / HD-FDD	Table A.2.2.1.2-1a		1.4	16QAM	1/3	5		0	
FDD / HD-FDD	Table A.2.2.1.2-1a		3	16QAM	1/3	5		0	
FDD / HD-FDD	Table A.2.2.1.2-1a		5	16QAM	1/3	5		0	
FDD / HD-FDD	Table A.2.2.1.2-1a		10	16QAM	1/3	5		0	
FDD / HD-FDD	Table A.2.2.1.2-1a		15	16QAM	1/3	5		0	
FDD / HD-FDD	Table A.2.2.1.2-1a		20	16QAM	1/3	5		0	
<b>FDD, Partial RB allocation, QPSK</b>									

FDD	Table A.2.2.2.1-1		1.4 - 20	QPSK	1/3	1		$\geq 1$	
FDD	Table A.2.2.2.1-1		1.4 - 20	QPSK	1/3	2		$\geq 1$	
FDD	Table A.2.2.2.1-1		1.4 - 20	QPSK	1/3	3		$\geq 1$	
FDD	Table A.2.2.2.1-1		1.4 - 20	QPSK	1/3	4		$\geq 1$	
FDD	Table A.2.2.2.1-1		1.4 - 20	QPSK	1/3	5		$\geq 1$	
FDD	Table A.2.2.2.1-1		3 - 20	QPSK	1/3	6		$\geq 1$	
FDD	Table A.2.2.2.1-1		3 - 20	QPSK	1/3	8		$\geq 1$	
FDD	Table A.2.2.2.1-1		3 - 20	QPSK	1/3	9		$\geq 1$	
FDD	Table A.2.2.2.1-1		3 - 20	QPSK	1/3	10		$\geq 1$	
FDD	Table A.2.2.2.1-1		3 - 20	QPSK	1/3	12		$\geq 1$	
FDD	Table A.2.2.2.1-1		5 - 20	QPSK	1/3	15		$\geq 1$	
FDD	Table A.2.2.2.1-1		5 - 20	QPSK	1/3	16		$\geq 1$	
FDD	Table A.2.2.2.1-1		5 - 20	QPSK	1/3	18		$\geq 1$	
FDD	Table A.2.2.2.1-1		5 - 20	QPSK	1/3	20		$\geq 1$	
FDD	Table A.2.2.2.1-1		5 - 20	QPSK	1/3	24		$\geq 1$	
FDD	Table A.2.2.2.1-1		10 - 20	QPSK	1/3	25		$\geq 1$	
FDD	Table A.2.2.2.1-1		10 - 20	QPSK	1/3	27		$\geq 1$	
FDD	Table A.2.2.2.1-1		10 - 20	QPSK	1/3	30		$\geq 1$	
FDD	Table A.2.2.2.1-1		10 - 20	QPSK	1/3	32		$\geq 1$	
FDD	Table A.2.2.2.1-1		10 - 20	QPSK	1/3	36		$\geq 1$	
FDD	Table A.2.2.2.1-1		10 - 20	QPSK	1/3	40		$\geq 1$	
FDD	Table A.2.2.2.1-1		10 - 20	QPSK	1/3	45		$\geq 1$	
FDD	Table A.2.2.2.1-1		10 - 20	QPSK	1/3	48		$\geq 1$	
FDD	Table A.2.2.2.1-1		15 - 20	QPSK	1/3	50		$\geq 1$	
FDD	Table A.2.2.2.1-1		15 - 20	QPSK	1/3	54		$\geq 1$	
FDD	Table A.2.2.2.1-1		15 - 20	QPSK	1/4	60		$\geq 1$	
FDD	Table A.2.2.2.1-1		15 - 20	QPSK	1/4	64		$\geq 1$	
FDD	Table A.2.2.2.1-1		15 - 20	QPSK	1/4	72		$\geq 1$	
FDD	Table A.2.2.2.1-1		20	QPSK	1/5	75		$\geq 1$	
FDD	Table A.2.2.2.1-1		20	QPSK	1/5	80		$\geq 1$	
FDD	Table A.2.2.2.1-1		20	QPSK	1/5	81		$\geq 1$	
FDD	Table A.2.2.2.1-1		20	QPSK	1/6	90		$\geq 1$	
FDD	Table A.2.2.2.1-1		20	QPSK	1/6	96		$\geq 1$	
FDD / HD-FDD	Table A.2.2.2.1-1a		1.4 - 20	QPSK	1/3	1		0	
FDD / HD-FDD	Table A.2.2.2.1-1a		1.4 - 20	QPSK	1/3	2		0	
FDD / HD-FDD	Table A.2.2.2.1-1a		1.4 - 20	QPSK	1/3	3		0	
FDD / HD-FDD	Table A.2.2.2.1-1a		1.4 - 20	QPSK	1/3	4		0	
FDD / HD-FDD	Table A.2.2.2.1-1a		1.4 - 20	QPSK	1/3	5		0	
FDD / HD-FDD	Table A.2.2.2.1-1a		3-20	QPSK	1/3	6		0	
FDD / HD-FDD	Table A.2.2.2.1-1a		3-20	QPSK	1/3	8		0	
FDD / HD-FDD	Table A.2.2.2.1-1a		3-20	QPSK	1/3	9		0	
FDD / HD-FDD	Table A.2.2.2.1-1a		3-20	QPSK	1/3	10		0	
FDD / HD-FDD	Table A.2.2.2.1-1a		3-20	QPSK	1/4	12		0	
FDD / HD-FDD	Table A.2.2.2.1-1a		5-20	QPSK	1/5	15		0	
FDD / HD-FDD	Table A.2.2.2.1-1a		5-20	QPSK	1/5	16		0	

FDD / HD-FDD	Table A.2.2.2.1-1a		5-20	QPSK	1/6	18		0	
FDD / HD-FDD	Table A.2.2.2.1-1a		5-20	QPSK	1/6	20		0	
FDD / HD-FDD	Table A.2.2.2.1-1a		5-20	QPSK	1/8	24		0	
FDD / HD-FDD	Table A.2.2.2.1-1a		10-20	QPSK	1/8	25		0	
FDD / HD-FDD	Table A.2.2.2.1-1a		10-20	QPSK	1/8	27		0	
FDD / HD-FDD	Table A.2.2.2.1-1a		10-20	QPSK	1/10	30		0	
<b>FDD, Partial RB allocation, 16-QAM</b>									



FDD	Table A.2.2.2.2-1		1.4 - 20	16QAM	3/4	1		≥ 1	
FDD	Table A.2.2.2.2-1		1.4 - 20	16QAM	3/4	2		≥ 1	
FDD	Table A.2.2.2.2-1		1.4 - 20	16QAM	3/4	3		≥ 1	
FDD	Table A.2.2.2.2-1		1.4 - 20	16QAM	3/4	4		≥ 1	
FDD	Table A.2.2.2.2-1		1.4 - 20	16QAM	3/4	5		≥ 1	
FDD	Table A.2.2.2.2-1		3 - 20	16QAM	3/4	6		≥ 1	
FDD	Table A.2.2.2.2-1		3 - 20	16QAM	3/4	8		≥ 1	
FDD	Table A.2.2.2.2-1		3 - 20	16QAM	3/4	9		≥ 1	
FDD	Table A.2.2.2.2-1		3 - 20	16QAM	3/4	10		≥ 1	
FDD	Table A.2.2.2.2-1		3 - 20	16QAM	3/4	12		≥ 1	
FDD	Table A.2.2.2.2-1		5 - 20	16QAM	1/2	15		≥ 1	
FDD	Table A.2.2.2.2-1		5 - 20	16QAM	1/2	16		≥ 1	
FDD	Table A.2.2.2.2-1		5 - 20	16QAM	1/2	18		≥ 1	
FDD	Table A.2.2.2.2-1		5 - 20	16QAM	1/3	20		≥ 1	
FDD	Table A.2.2.2.2-1		5 - 20	16QAM	1/3	24		≥ 1	
FDD	Table A.2.2.2.2-1		10 - 20	16QAM	1/3	25		≥ 1	
FDD	Table A.2.2.2.2-1		10 - 20	16QAM	1/3	27		≥ 1	
FDD	Table A.2.2.2.2-1		10 - 20	16QAM	3/4	30		≥ 2	
FDD	Table A.2.2.2.2-1		10 - 20	16QAM	3/4	32		≥ 2	
FDD	Table A.2.2.2.2-1		10 - 20	16QAM	3/4	36		≥ 2	
FDD	Table A.2.2.2.2-1		10 - 20	16QAM	3/4	40		≥ 2	
FDD	Table A.2.2.2.2-1		10 - 20	16QAM	3/4	45		≥ 2	
FDD	Table A.2.2.2.2-1		10 - 20	16QAM	3/4	48		≥ 2	
FDD	Table A.2.2.2.2-1		15 - 20	16QAM	3/4	50		≥ 2	
FDD	Table A.2.2.2.2-1		15 - 20	16QAM	3/4	54		≥ 2	
FDD	Table A.2.2.2.2-1		15 - 20	16QAM	2/3	60		≥ 2	
FDD	Table A.2.2.2.2-1		15 - 20	16QAM	2/3	64		≥ 2	
FDD	Table A.2.2.2.2-1		15 - 20	16QAM	1/2	72		≥ 2	
FDD	Table A.2.2.2.2-1		20	16QAM	1/2	75		≥ 2	
FDD	Table A.2.2.2.2-1		20	16QAM	1/2	80		≥ 2	
FDD	Table A.2.2.2.2-1		20	16QAM	1/2	81		≥ 2	
FDD	Table A.2.2.2.2-1		20	16QAM	2/5	90		≥ 2	
FDD	Table A.2.2.2.2-1		20	16QAM	2/5	96		≥ 2	
FDD / HD-FDD	Table A.2.2.2.2-1a		1.4 - 20	16QAM	3/4	1		0	
FDD / HD-FDD	Table A.2.2.2.2-1a		1.4 - 20	16QAM	3/4	2		0	
FDD / HD-FDD	Table A.2.2.2.2-1a		1.4 - 20	16QAM	2/5	4		0	
<b>FDD, Sustained data rate</b>									
FDD	Table A.2.2.3-1	R.1-1 FDD	10	QPSK	0.31	40		≥ 1	
FDD	Table A.2.2.3-1	R.1-2 FDD	10	QPSK	0.31	40		≥ 1	
FDD	Table A.2.2.3-1	R.1-3 FDD	20	QPSK	0.31	90		≥ 2	
FDD	Table A.2.2.3-1	R.1-3A FDD	10	QPSK	0.31	40		≥ 1	
FDD	Table A.2.2.3-1	R.1-4 FDD	20	QPSK	0.31	40		≥ 2	
FDD	Table A.2.2.3-1	R.1-4B FDD	15	QPSK	0.31	60		≥ 1	
<b>TDD, Full RB allocation, QPSK</b>									
TDD	Table A.2.3.1.1-1		1.4	QPSK	1/3	6		≥ 1	
TDD	Table A.2.3.1.1-1		3	QPSK	1/3	15		≥ 1	
TDD	Table A.2.3.1.1-1		5	QPSK	1/3	25		≥ 1	

TDD	Table A.2.3.1.1-1		10	QPSK	1/3	50		$\geq 1$	
TDD	Table A.2.3.1.1-1		15	QPSK	1/5	75		$\geq 1$	
TDD	Table A.2.3.1.1-1		20	QPSK	1/6	100		$\geq 1$	
TDD	Table A.2.3.1.1-1a		1.4	QPSK	1/3	6		0	
TDD	Table A.2.3.1.1-1a		3	QPSK	1/5	15		0	
TDD	Table A.2.3.1.1-1a		5	QPSK	1/8	25		0	
TDD	Table A.2.3.1.1-1a		10	QPSK	$\left[ \frac{1}{10} \right]$	[36]		0	
TDD	Table A.2.3.1.1-1a		15	QPSK	$\left[ \frac{1}{10} \right]$	[36]		0	
TDD	Table A.2.3.1.1-1a		20	QPSK	$\left[ \frac{1}{10} \right]$	[36]		0	
<b>TDD, Full RB allocation, 16-QAM</b>									
TDD	Table A.2.3.1.2-1		1.4	16QAM	3/4	6		$\geq 1$	
TDD	Table A.2.3.1.2-1		3	16QAM	1/2	15		$\geq 1$	
TDD	Table A.2.3.1.2-1		5	16QAM	1/3	25		$\geq 1$	
TDD	Table A.2.3.1.2-1		10	16QAM	3/4	50		$\geq 2$	
TDD	Table A.2.3.1.2-1		15	16QAM	1/2	75		$\geq 2$	
TDD	Table A.2.3.1.2-1		20	16QAM	1/3	100		$\geq 2$	
TDD	Table A.2.3.1.2-1		20	16QAM	1/3	100		$\geq 2$	
TDD	Table A.2.3.1.2-1a		1.4	16QAM	1/3	5		0	
TDD	Table A.2.3.1.2-1a		3	16QAM	1/3	5		0	
TDD	Table A.2.3.1.2-1a		5	16QAM	1/3	5		0	
TDD	Table A.2.3.1.2-1a		10	16QAM	1/3	5		0	
TDD	Table A.2.3.1.2-1a		15	16QAM	1/3	5		0	
TDD	Table A.2.3.1.2-1a		20	16QAM	1/3	5		0	
<b>TDD, Partial RB allocation, QPSK</b>									

TDD	Table A.2.3.2.1-1		1.4 - 20	QPSK	1/3	1		$\geq 1$	
TDD	Table A.2.3.2.1-1		1.4 - 20	QPSK	1/3	2		$\geq 1$	
TDD	Table A.2.3.2.1-1		1.4 - 20	QPSK	1/3	3		$\geq 1$	
TDD	Table A.2.3.2.1-1		1.4 - 20	QPSK	1/3	4		$\geq 1$	
TDD	Table A.2.3.2.1-1		1.4 - 20	QPSK	1/3	5		$\geq 1$	
TDD	Table A.2.3.2.1-1		3 - 20	QPSK	1/3	6		$\geq 1$	
TDD	Table A.2.3.2.1-1		3 - 20	QPSK	1/3	8		$\geq 1$	
TDD	Table A.2.3.2.1-1		3 - 20	QPSK	1/3	9		$\geq 1$	
TDD	Table A.2.3.2.1-1		3 - 20	QPSK	1/3	10		$\geq 1$	
TDD	Table A.2.3.2.1-1		3 - 20	QPSK	1/3	12		$\geq 1$	
TDD	Table A.2.3.2.1-1		5 - 20	QPSK	1/3	15		$\geq 1$	
TDD	Table A.2.3.2.1-1		5 - 20	QPSK	1/3	16		$\geq 1$	
TDD	Table A.2.3.2.1-1		5 - 20	QPSK	1/3	18		$\geq 1$	
TDD	Table A.2.3.2.1-1		5 - 20	QPSK	1/3	20		$\geq 1$	
TDD	Table A.2.3.2.1-1		5 - 20	QPSK	1/3	24		$\geq 1$	
TDD	Table A.2.3.2.1-1		10 - 20	QPSK	1/3	25		$\geq 1$	
TDD	Table A.2.3.2.1-1		10 - 20	QPSK	1/3	27		$\geq 1$	
TDD	Table A.2.3.2.1-1		10 - 20	QPSK	1/3	30		$\geq 1$	
TDD	Table A.2.3.2.1-1		10 - 20	QPSK	1/3	32		$\geq 1$	
TDD	Table A.2.3.2.1-1		10 - 20	QPSK	1/3	36		$\geq 1$	
TDD	Table A.2.3.2.1-1		10 - 20	QPSK	1/3	40		$\geq 1$	
TDD	Table A.2.3.2.1-1		10 - 20	QPSK	1/3	45		$\geq 1$	
TDD	Table A.2.3.2.1-1		10 - 20	QPSK	1/3	48		$\geq 1$	
TDD	Table A.2.3.2.1-1		15 - 20	QPSK	1/3	50		$\geq 1$	
TDD	Table A.2.3.2.1-1		15 - 20	QPSK	1/3	54		$\geq 1$	
TDD	Table A.2.3.2.1-1		15 - 20	QPSK	1/4	60		$\geq 1$	
TDD	Table A.2.3.2.1-1		15 - 20	QPSK	1/4	64		$\geq 1$	
TDD	Table A.2.3.2.1-1		15 - 20	QPSK	1/4	72		$\geq 1$	
TDD	Table A.2.3.2.1-1		20	QPSK	1/5	75		$\geq 1$	
TDD	Table A.2.3.2.1-1		20	QPSK	1/5	80		$\geq 1$	
TDD	Table A.2.3.2.1-1		20	QPSK	1/5	81		$\geq 1$	
TDD	Table A.2.3.2.1-1		20	QPSK	1/6	90		$\geq 1$	
TDD	Table A.2.3.2.1-1		20	QPSK	1/6	96		$\geq 1$	
TDD	Table A.2.3.2.1-1a		1.4 - 20	QPSK	1/3	1		0	
TDD	Table A.2.3.2.1-1a		1.4 - 20	QPSK	1/3	2		0	
TDD	Table A.2.3.2.1-1a		1.4 - 20	QPSK	1/3	3		0	
TDD	Table A.2.3.2.1-1a		1.4 - 20	QPSK	1/3	4		0	
TDD	Table A.2.3.2.1-1a		1.4 - 20	QPSK	1/3	5		0	
TDD	Table A.2.3.2.1-1a		3-20	QPSK	1/3	6		0	
TDD	Table A.2.3.2.1-1a		3-20	QPSK	1/3	8		0	
TDD	Table A.2.3.2.1-1a		3-20	QPSK	1/3	9		0	
TDD	Table A.2.3.2.1-1a		3-20	QPSK	1/3	10		0	
TDD	Table A.2.3.2.1-1a		3-20	QPSK	1/4	12		0	
TDD	Table A.2.3.2.1-1a		5-20	QPSK	1/5	15		0	
TDD	Table A.2.3.2.1-1a		5-20	QPSK	1/5	16		0	
TDD	Table A.2.3.2.1-1a		5-20	QPSK	1/6	18		0	
TDD	Table A.2.3.2.1-1a		5-20	QPSK	1/6	20		0	
TDD	Table A.2.3.2.1-1a		5-20	QPSK	1/8	24		0	

TDD	Table A.2.3.2.1-1a		10-20	QPSK	1/8	25		0	
TDD	Table A.2.3.2.1-1a		10-20	QPSK	1/8	27		0	
TDD	Table A.2.3.2.1-1a		10-20	QPSK	1/10	30		0	
<b>TDD, Partial RB allocation, 16-QAM</b>									
TDD	Table A.2.3.2.2-1		1.4 - 20	16QAM	3/4	1		≥ 1	
TDD	Table A.2.3.2.2-1		1.4 - 20	16QAM	3/4	2		≥ 1	
TDD	Table A.2.3.2.2-1		1.4 - 20	16QAM	3/4	3		≥ 1	
TDD	Table A.2.3.2.2-1		1.4 - 20	16QAM	3/4	4		≥ 1	
TDD	Table A.2.3.2.2-1		1.4 - 20	16QAM	3/4	5		≥ 1	
TDD	Table A.2.3.2.2-1		3 - 20	16QAM	3/4	6		≥ 1	
TDD	Table A.2.3.2.2-1		3 - 20	16QAM	3/4	8		≥ 1	
TDD	Table A.2.3.2.2-1		3 - 20	16QAM	3/4	9		≥ 1	
TDD	Table A.2.3.2.2-1		3 - 20	16QAM	3/4	10		≥ 1	
TDD	Table A.2.3.2.2-1		3 - 20	16QAM	3/4	12		≥ 1	
TDD	Table A.2.3.2.2-1		5 - 20	16QAM	1/2	15		≥ 1	
TDD	Table A.2.3.2.2-1		5 - 20	16QAM	1/2	16		≥ 1	
TDD	Table A.2.3.2.2-1		5 - 20	16QAM	1/2	18		≥ 1	
TDD	Table A.2.3.2.2-1		5 - 20	16QAM	1/3	20		≥ 1	
TDD	Table A.2.3.2.2-1		5 - 20	16QAM	1/3	24		≥ 1	
TDD	Table A.2.3.2.2-1		10 - 20	16QAM	1/3	25		≥ 1	
TDD	Table A.2.3.2.2-1		10 - 20	16QAM	1/3	27		≥ 1	
TDD	Table A.2.3.2.2-1		10 - 20	16QAM	3/4	30		≥ 2	
TDD	Table A.2.3.2.2-1		10 - 20	16QAM	3/4	32		≥ 2	
TDD	Table A.2.3.2.2-1		10 - 20	16QAM	3/4	36		≥ 2	
TDD	Table A.2.3.2.2-1		10 - 20	16QAM	3/4	40		≥ 2	
TDD	Table A.2.3.2.2-1		10 - 20	16QAM	3/4	45		≥ 2	
TDD	Table A.2.3.2.2-1		10 - 20	16QAM	3/4	48		≥ 2	
TDD	Table A.2.3.2.2-1		15 - 20	16QAM	3/4	50		≥ 2	
TDD	Table A.2.3.2.2-1		15 - 20	16QAM	3/4	54		≥ 2	
TDD	Table A.2.3.2.2-1		15 - 20	16QAM	2/3	60		≥ 2	
TDD	Table A.2.3.2.2-1		15 - 20	16QAM	2/3	64		≥ 2	
TDD	Table A.2.3.2.2-1		15 - 20	16QAM	1/2	72		≥ 2	
TDD	Table A.2.3.2.2-1		20	16QAM	1/2	75		≥ 2	
TDD	Table A.2.3.2.2-1		20	16QAM	1/2	80		≥ 2	
TDD	Table A.2.3.2.2-1		20	16QAM	1/2	81		≥ 2	
TDD	Table A.2.3.2.2-1		20	16QAM	2/5	90		≥ 2	
TDD	Table A.2.3.2.2-1		20	16QAM	2/5	96		≥ 2	
TDD	Table A.2.3.2.2-1a		1.4 - 20	16QAM	3/4	1		0	
TDD	Table A.2.3.2.2-1a		1.4 - 20	16QAM	3/4	2		0	
TDD	Table A.2.3.2.2-1a		1.4 - 20	16QAM	2/5	4		0	
<b>TDD, Sustained data rate</b>									
TDD	Table A.2.3.3-1	R.1-1 TDD	10	QPSK	0.43	40		≥ 1	
TDD	Table A.2.3.3-1	R.1-2 TDD	10	QPSK	0.61	40		≥ 2	
TDD	Table A.2.3.3-1	R.1-3 TDD	20	QPSK	0.49	90		≥ 2	
TDD	Table A.2.3.3-1	R.1-3B TDD	15	QPSK	0.42	60		≥ 2	
TDD	Table A.2.3.3-1	R.1-4 TDD	20	QPSK	0.49	90		≥ 2	

## A.2.2 Reference measurement channels for FDD

### A.2.2.1 Full RB allocation

#### A.2.2.1.1 QPSK

**Table A.2.2.1.1-1: Reference Channels for QPSK with full RB allocation**

Parameter	Unit	Value					
		1.4	3	5	10	15	20
Channel bandwidth	<b>MHz</b>	1.4	3	5	10	15	20
Allocated resource blocks		6	15	25	50	75	100
DFT-OFDM Symbols per Sub-Frame		12	12	12	12	12	12
Modulation		QPSK	QPSK	QPSK	QPSK	QPSK	QPSK
Target Coding rate		1/3	1/3	1/3	1/3	1/5	1/6
Payload size	Bits	600	1544	2216	5160	4392	4584
Transport block CRC	Bits	24	24	24	24	24	24
Number of code blocks per Sub-Frame (Note 1)		1	1	1	1	1	1
Total number of bits per Sub-Frame (Note 1)	Bits	1728	4320	7200	14400	21600	28800
Total symbols per Sub-Frame		864	2160	3600	7200	10800	14400
UE Category		≥ 1	≥ 1	≥ 1	≥ 1	≥ 1	≥ 1
Note 1: If more than one Code Block is present, an additional CRC sequence of L = 24 Bits is attached to each Code Block (otherwise L = 0 Bit)							

**Table A.2.2.1.1-1a: Reference Channels for QPSK with full/maximum RB allocation for UE category 0**

Parameter	Unit	Value					
		1.4	3	5	10	15	20
Channel bandwidth	MHz	1.4	3	5	10	15	20
Allocated resource blocks		6	15	25	[36]	[36]	[36]
DFT-OFDM Symbols per Sub-Frame		12	12	12	12	12	12
Modulation		QPSK	QPSK	QPSK	QPSK	QPSK	QPSK
Target Coding rate		1/3	1/5	1/8	[1/10]	[1/10]	[1/10]
Payload size	Bits	600	872	904	[1000]	[1000]	[1000]
Transport block CRC	Bits	24	24	24	24	24	24
Number of code blocks per Sub-Frame		1	1	1	1	1	1
Total number of bits per Sub-Frame	Bits	1728	4320	7200	[1036 8]	[1036 8]	[1036 8]
Total symbols per Sub-Frame		864	2160	3600	[5184]	[5184]	[5184]
UE Category		0	0	0	0	0	0
NOTE 1: If more than one Code Block is present, an additional CRC sequence of L = 24 Bits is attached to each Code Block (otherwise L = 0 Bit).							
NOTE 2: For HD-FDD UE, the uplink subframes are scheduled at the 4th, 5th, 6th, 12th, 13th, 14th, 20th, 21st, 22nd, 28th, 29th, 30th, 36th, 37th, and 38th subframes every 40ms. Information bit payload is available if uplink subframe is scheduled.							

## A.2.2.1.2 16-QAM

Table A.2.2.1.2-1: Reference Channels for 16-QAM with full RB allocation

Parameter	Unit	Value					
		1.4	3	5	10	15	20
Channel bandwidth	MHz	1.4	3	5	10	15	20
Allocated resource blocks		6	15	25	50	75	100
DFT-OFDM Symbols per Sub-Frame		12	12	12	12	12	12
Modulation		16QAM	16QAM	16QAM	16QAM	16QAM	16QAM
Target Coding rate		3/4	1/2	1/3	3/4	1/2	1/3
Payload size	Bits	2600	4264	4968	21384	21384	19848
Transport block CRC	Bits	24	24	24	24	24	24
Number of code blocks per Sub-Frame (Note 1)		1	1	1	4	4	4
Total number of bits per Sub-Frame	Bits	3456	8640	14400	28800	43200	57600
Total symbols per Sub-Frame		864	2160	3600	7200	10800	14400
UE Category		≥ 1	≥ 1	≥ 1	≥ 2	≥ 2	≥ 2

Note 1: If more than one Code Block is present, an additional CRC sequence of L = 24 Bits is attached to each Code Block (otherwise L = 0 Bit)

Table A.2.2.1.2-1a: Reference Channels for 16-QAM with maximum RB allocation for UE category 0

Parameter	Unit	Value					
		1.4	3	5	10	15	20
Channel bandwidth	MHz	1.4	3	5	10	15	20
Allocated resource blocks		5	5	5	5	5	5
DFT-OFDM Symbols per Sub-Frame		12	12	12	12	12	12
Modulation		16QAM	16QAM	16QAM	16QAM	16QAM	16QAM
Target Coding rate		1/3	1/3	1/3	1/3	1/3	1/3
Payload size	Bits	872	872	872	872	872	872
Transport block CRC	Bits	24	24	24	24	24	24
Number of code blocks per Sub-Frame		1	1	1	1	1	1
Total number of bits per Sub-Frame	Bits	2880	2880	2880	2880	2880	2880
Total symbols per Sub-Frame		720	720	720	720	720	720
UE Category		0	0	0	0	0	0

NOTE 1: If more than one Code Block is present, an additional CRC sequence of L = 24 Bits is attached to each Code Block (otherwise L = 0 Bit).

NOTE 2: For HD-FDD UE, the uplink subframes are scheduled at the 4th, 5th, 6th, 12th, 13th, 14th, 20th, 21st, 22nd, 28th, 29th, 30th, 36th, 37th, and 38th subframes every 40ms. Information bit payload is available if uplink subframe is scheduled.

## A.2.2.1.3 64-QAM

[FFS]

## A.2.2.2 Partial RB allocation

For each channel bandwidth, various partial RB allocations are specified. The number of allocated RBs is chosen according to values specified in the Tx and Rx requirements. The single allocated RB case is included.

The allocated RBs are contiguous and start from one end of the channel bandwidth. A single allocated RB is at one end of the channel bandwidth.

## A.2.2.2.1 QPSK

Table A.2.2.2.1-1: Reference Channels for QPSK with partial RB allocation

Parameter	Ch BW	Allocated RBs	DFT-OFDM Symbols per Sub-Frame	Mod'n	Target Coding rate	Payload size	Transport block CRC	Number of code blocks per Sub-Frame (Note 1)	Total number of bits per Sub-Frame	Total symbols per Sub-Frame	UE Category
Unit	MHz					Bits	Bits		Bits		
	1.4 - 20	1	12	QPSK	1/3	72	24	1	288	144	≥ 1
	1.4 - 20	2	12	QPSK	1/3	176	24	1	576	288	≥ 1
	1.4 - 20	3	12	QPSK	1/3	256	24	1	864	432	≥ 1
	1.4 - 20	4	12	QPSK	1/3	392	24	1	1152	576	≥ 1
	1.4 - 20	5	12	QPSK	1/3	424	24	1	1440	720	≥ 1
	3-20	6	12	QPSK	1/3	600	24	1	1728	864	≥ 1
	3-20	8	12	QPSK	1/3	808	24	1	2304	1152	≥ 1
	3-20	9	12	QPSK	1/3	776	24	1	2592	1296	≥ 1
	3-20	10	12	QPSK	1/3	872	24	1	2880	1440	≥ 1
	3-20	12	12	QPSK	1/3	1224	24	1	3456	1728	≥ 1
	5-20	15	12	QPSK	1/3	1320	24	1	4320	2160	≥ 1
	5-20	16	12	QPSK	1/3	1384	24	1	4608	2304	≥ 1
	5-20	18	12	QPSK	1/3	1864	24	1	5184	2592	≥ 1
	5-20	20	12	QPSK	1/3	1736	24	1	5760	2880	≥ 1
	5-20	24	12	QPSK	1/3	2472	24	1	6912	3456	≥ 1
	10-20	25	12	QPSK	1/3	2216	24	1	7200	3600	≥ 1
	10-20	27	12	QPSK	1/3	2792	24	1	7776	3888	≥ 1
	10-20	30	12	QPSK	1/3	2664	24	1	8640	4320	≥ 1
	10-20	32	12	QPSK	1/3	2792	24	1	9216	4608	≥ 1
	10-20	36	12	QPSK	1/3	3752	24	1	10368	5184	≥ 1
	10-20	40	12	QPSK	1/3	4136	24	1	11520	5760	≥ 1
	10-20	45	12	QPSK	1/3	4008	24	1	12960	6480	≥ 1
	10-20	48	12	QPSK	1/3	4264	24	1	13824	6912	≥ 1
	15 - 20	50	12	QPSK	1/3	5160	24	1	14400	7200	≥ 1
	15 - 20	54	12	QPSK	1/3	4776	24	1	15552	7776	≥ 1
	15 - 20	60	12	QPSK	1/4	4264	24	1	17280	8640	≥ 1
	15 - 20	64	12	QPSK	1/4	4584	24	1	18432	9216	≥ 1
	15 - 20	72	12	QPSK	1/4	5160	24	1	20736	10368	≥ 1
	20	75	12	QPSK	1/5	4392	24	1	21600	10800	≥ 1
	20	80	12	QPSK	1/5	4776	24	1	23040	11520	≥ 1
	20	81	12	QPSK	1/5	4776	24	1	23328	11664	≥ 1
	20	90	12	QPSK	1/6	4008	24	1	25920	12960	≥ 1
	20	96	12	QPSK	1/6	4264	24	1	27648	13824	≥ 1

Note 1: If more than one Code Block is present, an additional CRC sequence of L = 24 Bits is attached to each Code Block (otherwise L = 0 Bit)

Table A.2.2.2.1-1a: Reference Channels for QPSK with partial RB allocation for UE category 0

Parameter	Ch BW	Allocated RBs	DFT-OFDM Symbols per Sub-Frame	Mod'n	Target Coding rate	Payload size	Transport block CRC	Number of code blocks per Sub-Frame (Note 1)	Total number of bits per Sub-Frame	Total symbols per Sub-Frame	UE Category
Unit	MHz					Bits	Bits		Bits		
	1.4 - 20	1	12	QPSK	1/3	72	24	1	288	144	0
	1.4 - 20	2	12	QPSK	1/3	176	24	1	576	288	0
	1.4 - 20	3	12	QPSK	1/3	256	24	1	864	432	0
	1.4 - 20	4	12	QPSK	1/3	392	24	1	1152	576	0
	1.4 - 20	5	12	QPSK	1/3	424	24	1	1440	720	0
	3-20	6	12	QPSK	1/3	600	24	1	1728	864	0
	3-20	8	12	QPSK	1/3	808	24	1	2304	1152	0
	3-20	9	12	QPSK	1/3	776	24	1	2592	1296	0
	3-20	10	12	QPSK	1/3	872	24	1	2880	1440	0
	3-20	12	12	QPSK	1/4	840	24	1	3456	1728	0
	5-20	15	12	QPSK	1/5	872	24	1	4320	2160	0
	5-20	16	12	QPSK	1/5	904	24	1	4608	2304	0
	5-20	18	12	QPSK	1/6	776	24	1	5184	2592	0
	5-20	20	12	QPSK	1/6	872	24	1	5760	2880	0
	5-20	24	12	QPSK	1/8	872	24	1	6912	3456	0
	10-20	25	12	QPSK	1/8	904	24	1	7200	3600	0
	10-20	27	12	QPSK	1/8	968	24	1	7776	3888	0
	10-20	30	12	QPSK	1/10	808	24	1	8640	4320	0
Note 1:	If more than one Code Block is present, an additional CRC sequence of L = 24 Bits is attached to each Code Block (otherwise L = 0 Bit).										
Note 2:	For HD-FDD UE, the uplink subframes are scheduled at the 4th, 5th, 6th, 12th, 13th, 14th, 20th, 21st, 22nd, 28th, 29th, 30th, 36th, 37th, and 38th subframes every 40ms. Information bit payload is available if uplink subframe is scheduled.										



## A.2.2.2.2 16-QAM

Table A.2.2.2-1: Reference Channels for 16-QAM with partial RB allocation

Parameter	Ch BW	Allocated RBs	DFT-OFDM Symbols per Sub-Frame	Mod'n	Target Coding rate	Payload size	Transport block CRC	Number of code blocks per Sub-Frame (Note 1)	Total number of bits per Sub-Frame	Total symbols per Sub-Frame	UE Category
Unit	MHz					Bits	Bits		Bits		
	1.4 - 20	1	12	16QAM	3/4	408	24	1	576	144	≥ 1
	1.4 - 20	2	12	16QAM	3/4	840	24	1	1152	288	≥ 1
	1.4 - 20	3	12	16QAM	3/4	1288	24	1	1728	432	≥ 1
	1.4 - 20	4	12	16QAM	3/4	1736	24	1	2304	576	≥ 1
	1.4 - 20	5	12	16QAM	3/4	2152	24	1	2880	720	≥ 1
	3-20	6	12	16QAM	3/4	2600	24	1	3456	864	≥ 1
	3-20	8	12	16QAM	3/4	3496	24	1	4608	1152	≥ 1
	3-20	9	12	16QAM	3/4	3880	24	1	5184	1296	≥ 1
	3-20	10	12	16QAM	3/4	4264	24	1	5760	1440	≥ 1
	3-20	12	12	16QAM	3/4	5160	24	1	6912	1728	≥ 1
	5-20	15	12	16QAM	1/2	4264	24	1	8640	2160	≥ 1
	5-20	16	12	16QAM	1/2	4584	24	1	9216	2304	≥ 1
	5-20	18	12	16QAM	1/2	5160	24	1	10368	2592	≥ 1
	5-20	20	12	16QAM	1/3	4008	24	1	11520	2880	≥ 1
	5-20	24	12	16QAM	1/3	4776	24	1	13824	3456	≥ 1
	10-20	25	12	16QAM	1/3	4968	24	1	14400	3600	≥ 1
	10-20	27	12	16QAM	1/3	4776	24	1	15552	3888	≥ 1
	10-20	30	12	16QAM	3/4	12960	24	3	17280	4320	≥ 2
	10-20	32	12	16QAM	3/4	13536	24	3	18432	4608	≥ 2
	10-20	36	12	16QAM	3/4	15264	24	3	20736	5184	≥ 2
	10-20	40	12	16QAM	3/4	16992	24	3	23040	5760	≥ 2
	10-20	45	12	16QAM	3/4	19080	24	4	25920	6480	≥ 2
	10-20	48	12	16QAM	3/4	20616	24	4	27648	6912	≥ 2
	15 - 20	50	12	16QAM	3/4	21384	24	4	28800	7200	≥ 2
	15 - 20	54	12	16QAM	3/4	22920	24	4	31104	7776	≥ 2
	15 - 20	60	12	16QAM	2/3	23688	24	4	34560	8640	≥ 2
	15 - 20	64	12	16QAM	2/3	25456	24	4	36864	9216	≥ 2

				M							
	15 - 20	72	12	16QAM	1/2	20616	24	4	41472	10368	$\geq 2$
	20	75	12	16QAM	1/2	21384	24	4	43200	10800	$\geq 2$
	20	80	12	16QAM	1/2	22920	24	4	46080	11520	$\geq 2$
	20	81	12	16QAM	1/2	22920	24	4	46656	11664	$\geq 2$
	20	90	12	16QAM	2/5	20616	24	4	51840	12960	$\geq 2$
	20	96	12	16QAM	2/5	22152	24	4	55296	13824	$\geq 2$
Note 1: If more than one Code Block is present, an additional CRC sequence of L = 24 Bits is attached to each Code Block (otherwise L = 0 Bit)											

Table A.2.2.2-1a: Reference Channels for 16-QAM with partial RB allocation for UE category 0

Parameter	Ch BW	Allocated RBs	DFT-OFDM Symbols per Sub-Frame	Mod'n	Target Coding rate	Payload size	Transport block CRC	Number of code blocks per Sub-Frame (Note 1)	Total number of bits per Sub-Frame	Total symbols per Sub-Frame	UE Category
Unit	MHz					Bits	Bits		Bits		
	1.4 - 20	1	12	16QAM	3/4	408	24	1	576	144	0
	1.4 - 20	2	12	16QAM	3/4	840	24	1	1152	288	0
	1.4 - 20	4	12	16QAM	2/5	904	24	1	2304	576	0
Note 1: If more than one Code Block is present, an additional CRC sequence of L = 24 Bits is attached to each Code Block (otherwise L = 0 Bit).											
Note 2: For HD-FDD UE, the uplink subframes are scheduled at the 4th, 5th, 6th, 12th, 13th, 14th, 20th, 21st, 22nd, 28th, 29th, 30th, 36th, 37th, and 38th subframes every 40ms. Information bit payload is available if uplink subframe is scheduled.											

## A.2.2.2.3 64-QAM

[FFS]

### A.2.2.3 Reference measurement channels for sustained downlink data rate provided by lower layers

**Table A.2.2.3-1: Uplink Reference Channels for sustained data-rate test (FDD)**

Parameter	Unit	Value					
		R.1-1 FDD	R.1-2 FDD	R.1-3 FDD	R.1-3A FDD	R.1-4 FDD	R.1-4B FDD
Reference Channel							
Channel Bandwidth	MHz	10	10	20	10	20	15
Allocated Resource Blocks		40 (Note 2)	40 (Note 2)	90 (Note 3)	40(Note 2)	90 (Note 3)	60 (Note 4)
Allocated Sub-Frames per Radio-Frame		10	10	10	10	10	10
DFT-OFDM Symbols per Sub-Frame		12	12	12	12	12	12
Modulation		QPSK	QPSK	QPSK	QPSK	QPSK	QPSK
Coding Rate		0.31	0.31	0.31	0.31	0.31	0.31
Information Bit Payload per Sub-Frame	Bits	3496	3496	7992	3496	7992	5352
Number of Code Blocks per Sub-Frame (Note 1)		1	1	2	1	2	2
Modulation Symbols per Sub-Frame		5760	5760	12960	5760	12960	5760
Binary Channel Bits per Sub-Frame		11520	11520	25920	11520	25920	17260
Max Throughput over 1 Radio-Frame	Mbps	3.496	3.496	7.992	3.496	7.992	5.352
UE Category		≥ 1	≥ 1	≥ 2	≥ 1	≥ 2	≥ 1
Note 1: If more than one Code Block is present, an additional CRC sequence of L = 24 Bits is attached to each Code Block (otherwise L = 0 Bit)							
Note 2: RB-s 5-44 allocated with PUSCH.							
Note 3: RB-s 5-94 allocated with PUSCH.							
Note 4: RB-s 7-66 allocated with PUSCH.							

### A.2.3 Reference measurement channels for TDD

For TDD the measurement channel is based on DL/UL configuration ratio of 2DL:2UL.

#### A.2.3.1 Full RB allocation

##### A.2.3.1.1 QPSK

**Table A.2.3.1.1-1: Reference Channels for QPSK with full RB allocation**

Parameter	Unit	Value					
		1,4	3	5	10	15	20
Channel bandwidth	MHz	1,4	3	5	10	15	20
Allocated resource blocks		6	15	25	50	75	100
Uplink-Downlink Configuration (Note 2)		1	1	1	1	1	1
DFT-OFDM Symbols per Sub-Frame		12	12	12	12	12	12
Modulation		QPSK	QPSK	QPSK	QPSK	QPSK	QPSK
Target Coding rate		1/3	1/3	1/3	1/3	1/5	1/6
Payload size							
For Sub-Frame 2,3,7,8	Bits	600	1544	2216	5160	4392	4584
Transport block CRC	Bits	24	24	24	24	24	24
Number of code blocks per Sub-Frame (Note 1)		1	1	1	1	1	1
Total number of bits per Sub-Frame							
For Sub-Frame 2,3,7,8	Bits	1728	4320	7200	14400	21600	28800
Total symbols per Sub-Frame							
For Sub-Frame 2,3,7,8		864	2160	3600	7200	10800	14400
UE Category		≥ 1	≥ 1	≥ 1	≥ 1	≥ 1	≥ 1
Note 1: If more than one Code Block is present, an additional CRC sequence of L = 24 Bits is attached to each Code Block (otherwise L = 0 Bit)							
Note 2: As per Table 4.2-2 in TS 36.211 [8]							

Table A.2.3.1.1-1a: Reference Channels for QPSK with full/maximum RB allocation for UE category 0

Parameter	Unit	Value					
		1.4	3	5	10	15	20
Channel bandwidth	MHz	1.4	3	5	10	15	20
Allocated resource blocks		6	15	25	[36]	[36]	[36]
Uplink-Downlink Configuration (Note 2)		1	1	1	1	1	1
DFT-OFDM Symbols per Sub-Frame		12	12	12	12	12	12
Modulation		QPSK	QPSK	QPSK	QPSK	QPSK	QPSK
Target Coding rate		1/3	1/5	1/8	[1/10]	[1/10]	[1/10]
Payload size							
For Sub-Frame 2,3,7,8	Bits	600	872	904	[1000]	[1000]	[1000]
Transport block CRC	Bits	24	24	24	24	24	24
Number of code blocks per Sub-Frame (Note 1)							
For Sub-Frame 2,3,7,8		1	1	1	1	1	1
Total number of bits per Sub-Frame							
For Sub-Frame 2,3,7,8	Bits	1728	4320	7200	[10368]	[10368]	[10368]
Total symbols per Sub-Frame							
For Sub-Frame 2,3,7,8		864	2160	3600	[5184]	[5184]	[5184]
UE Category		0	0	0	0	0	0
NOTE 1: If more than one Code Block is present, an additional CRC sequence of L = 24 Bits is attached to each Code Block (otherwise L = 0 Bit)							
NOTE 2: As per Table 4.2-2 in TS 36.211 [8]							

## A.2.3.1.2 16-QAM

Table A.2.3.1.2-1: Reference Channels for 16-QAM with full RB allocation

Parameter	Unit	Value					
		1.4	3	5	10	15	20
Channel bandwidth	MHz	1.4	3	5	10	15	20
Allocated resource blocks		6	15	25	50	75	100
Uplink-Downlink Configuration (Note 2)		1	1	1	1	1	1
DFT-OFDM Symbols per Sub-Frame		12	12	12	12	12	12
Modulation		16QAM	16QAM	16QAM	16QAM	16QAM	16QAM
Target Coding rate		3/4	1/2	1/3	3/4	1/2	1/3
Payload size							
For Sub-Frame 2,3,7,8	Bits	2600	4264	4968	21384	21384	19848
Transport block CRC	Bits	24	24	24	24	24	24
Number of code blocks - C		1	1	1	4	4	4
Total number of bits per Sub-Frame							
For Sub-Frame 2,3,7,8	Bits	3456	8640	14400	28800	43200	57600
Total symbols per Sub-Frame							
For Sub-Frame 2,3,7,8		864	2160	3600	7200	10800	14400
UE Category		≥ 1	≥ 1	≥ 1	≥ 2	≥ 2	≥ 2
Note 1: If more than one Code Block is present, an additional CRC sequence of L = 24 Bits is attached to each Code Block (otherwise L = 0 Bit)							
Note 2: As per Table 4.2-2 in TS 36.211 [8]							

**Table A.2.3.1.2-1a: Reference Channels for 16-QAM with maximum RB allocation for UE category 0**

Parameter	Unit	Value					
		1.4	3	5	10	15	20
Channel bandwidth	MHz	1.4	3	5	10	15	20
Allocated resource blocks		5	5	5	5	5	5
Uplink-Downlink Configuration (Note 2)		1	1	1	1	1	1
DFT-OFDM Symbols per Sub-Frame		12	12	12	12	12	12
Modulation		16QAM	16QAM	16QAM	16QAM	16QAM	16QAM
Target Coding rate		1/3	1/3	1/3	1/3	1/3	1/3
Payload size							
For Sub-Frame 2,3,7,8	Bits	872	872	872	872	872	872
Transport block CRC	Bits	24	24	24	24	24	24
Number of code blocks per Sub-Frame (Note 1)							
For Sub-Frame 2,3,7,8		1	1	1	1	1	1
Total number of bits per Sub-Frame							
For Sub-Frame 2,3,7,8	Bits	2880	2880	2880	2880	2880	2880
Total symbols per Sub-Frame							
For Sub-Frame 2,3,7,8		720	720	720	720	720	720
UE Category		0	0	0	0	0	0
NOTE 1: If more than one Code Block is present, an additional CRC sequence of L = 24 Bits is attached to each Code Block (otherwise L = 0 Bit)							
NOTE 2: As per Table 4.2-2 in TS 36.211 [8]							

### A.2.3.1.3 64-QAM

[FFS]

### A.2.3.2 Partial RB allocation

For each channel bandwidth, various partial RB allocations are specified. The number of allocated RBs is chosen according to values specified in the Tx and Rx requirements. The single allocated RB case is included.

The allocated RBs are contiguous and start from one end of the channel bandwidth. A single allocated RB is at one end of the channel bandwidth.

## A.2.3.2.1 QPSK

Table A.2.3.2.1-1: Reference Channels for QPSK with partial RB allocation

Parameter	Ch BW	Allocated RBs	UDL Configuration (Note 2)	DFT-OFDM Symbols per Sub-Frame	Mod'n	Target Coding rate	Payload size for Sub-Frame 2, 3, 7, 8	Transport block CRC	Number of code blocks per Sub-Frame (Note 1)	Total number of bits per Sub-Frame for Sub-Frame 2, 3, 7, 8	Total symbols per Sub-Frame for Sub-Frame 2, 3, 7, 8	UE Category
Unit	MHz						Bits	Bits		Bits		
	1.4-20	1	1	12	QPSK	1/3	72	24	1	288	144	≥ 1
	1.4-20	2	1	12	QPSK	1/3	176	24	1	576	288	≥ 1
	1.4-20	3	1	12	QPSK	1/3	256	24	1	864	432	≥ 1
	1.4-20	4	1	12	QPSK	1/3	392	24	1	1152	576	≥ 1
	1.4-20	5	1	12	QPSK	1/3	424	24	1	1440	720	≥ 1
	3-20	6	1	12	QPSK	1/3	600	24	1	1728	864	≥ 1
	3-20	8	1	12	QPSK	1/3	808	24	1	2304	1152	≥ 1
	3-20	9	1	12	QPSK	1/3	776	24	1	2592	1296	≥ 1
	3-20	10	1	12	QPSK	1/3	872	24	1	2880	1440	≥ 1
	3-20	12	1	12	QPSK	1/3	1224	24	1	3456	1728	≥ 1
	5-20	15	1	12	QPSK	1/3	1320	24	1	4320	2160	≥ 1
	5-20	16	1	12	QPSK	1/3	1384	24	1	4608	2304	≥ 1
	5-20	18	1	12	QPSK	1/3	1864	24	1	5184	2592	≥ 1
	5-20	20	1	12	QPSK	1/3	1736	24	1	5760	2880	≥ 1
	5-20	24	1	12	QPSK	1/3	2472	24	1	6912	3456	≥ 1
	10-20	25	1	12	QPSK	1/3	2216	24	1	7200	3600	≥ 1
	10-20	27	1	12	QPSK	1/3	2792	24	1	7776	3888	≥ 1
	10-20	30	1	12	QPSK	1/3	2664	24	1	8640	4320	≥ 1
	10-20	32	1	12	QPSK	1/3	2792	24	1	9216	4608	≥ 1
	10-20	36	1	12	QPSK	1/3	3752	24	1	10368	5184	≥ 1
	10-20	40	1	12	QPSK	1/3	4136	24	1	11520	5760	≥ 1
	10-20	45	1	12	QPSK	1/3	4008	24	1	12960	6480	≥ 1
	10-20	48	1	12	QPSK	1/3	4264	24	1	13824	6912	≥ 1
	15-20	50	1	12	QPSK	1/3	5160	24	1	14400	7200	≥ 1
	15-20	54	1	12	QPSK	1/3	4776	24	1	15552	7776	≥ 1
	15-20	60	1	12	QPSK	1/4	4264	24	1	17280	8640	≥ 1
	15-20	64	1	12	QPSK	1/4	4584	24	1	18432	9216	≥ 1
	15-20	72	1	12	QPSK	1/4	5160	24	1	20736	10368	≥ 1
	20	75	1	12	QPSK	1/5	4392	24	1	21600	10800	≥ 1
	20	80	1	12	QPSK	1/5	4776	24	1	23040	11520	≥ 1
	20	81	1	12	QPSK	1/5	4776	24	1	23328	11664	≥ 1
	20	90	1	12	QPSK	1/6	4008	24	1	25920	12960	≥ 1
	20	96	1	12	QPSK	1/6	4264	24	1	27648	13824	≥ 1

Note 1: If more than one Code Block is present, an additional CRC sequence of L = 24 Bits is attached to each Code Block (otherwise L = 0 Bit)

Note 2: As per Table 4.2-2 in TS 36.211 [8]

Table A.2.3.2.1-1a: Reference Channels for QPSK with partial RB allocation for UE category 0

Parameter	Ch BW	Allocated RBs	UDL Configuration (Note 2)	DFT-OFDM Symbols per Sub-Frame	Mod'n	Target Coding rate	Payload size for Sub-Frame 2, 3, 7, 8	Transport block CRC	Number of code blocks per Sub-Frame (Note 1)	Total number of bits per Sub-Frame for Sub-Frame 2, 3, 7, 8	Total symbols per Sub-Frame for Sub-Frame 2, 3, 7, 8	UE Category
Unit	MHz						Bits	Bits		Bits		
	1.4 - 20	1	1	12	QPSK	1/3	72	24	1	288	144	0
	1.4 - 20	2	1	12	QPSK	1/3	176	24	1	576	288	0
	1.4 - 20	3	1	12	QPSK	1/3	256	24	1	864	432	0
	1.4 - 20	4	1	12	QPSK	1/3	392	24	1	1152	576	0
	1.4 - 20	5	1	12	QPSK	1/3	424	24	1	1440	720	0
	3-20	6	1	12	QPSK	1/3	600	24	1	1728	864	0
	3-20	8	1	12	QPSK	1/3	808	24	1	2304	1152	0
	3-20	9	1	12	QPSK	1/3	776	24	1	2592	1296	0
	3-20	10	1	12	QPSK	1/3	872	24	1	2880	1440	0
	3-20	12	1	12	QPSK	1/4	840	24	1	3456	1728	0
	5-20	15	1	12	QPSK	1/5	872	24	1	4320	2160	0
	5-20	16	1	12	QPSK	1/5	904	24	1	4608	2304	0
	5-20	18	1	12	QPSK	1/6	776	24	1	5184	2592	0
	5-20	20	1	12	QPSK	1/6	872	24	1	5760	2880	0
	5-20	24	1	12	QPSK	1/8	872	24	1	6912	3456	0
	10-20	25	1	12	QPSK	1/8	904	24	1	7200	3600	0
	10-20	27	1	12	QPSK	1/8	968	24	1	7776	3888	0
	10-20	30	1	12	QPSK	1/10	808	24	1	8640	4320	0

Note 1: If more than one Code Block is present, an additional CRC sequence of L = 24 Bits is attached to each Code Block (otherwise L = 0 Bit)

Note 2: As per Table 4.2-2 in TS 36.211 [8]

## A.2.3.2.2 16-QAM

Table A.2.3.2.2-1: Reference Channels for 16-QAM with partial RB allocation

Parameter	Ch BW	Allocated RBs	UDL Configuration (Note 2)	DFT-OFDM Symbols per Sub-Frame	Mod'n	Target Coding rate	Payload size for Sub-Frame 2, 3, 7, 8	Transport block CRC	Number of code blocks per Sub-Frame (Note 1)	Total number of bits per Sub-Frame for Sub-Frame 2, 3, 7, 8	Total symbols per Sub-Frame for Sub-Frame 2, 3, 7, 8	UE Category
Unit	MHz						Bits	Bits		Bits		
	1.4-20	1	1	12	16QAM	3/4	408	24	1	576	144	≥ 1
	1.4-20	2	1	12	16QAM	3/4	840	24	1	1152	288	≥ 1
	1.4-20	3	1	12	16QAM	3/4	1288	24	1	1728	432	≥ 1
	1.4-20	4	1	12	16QAM	3/4	1736	24	1	2304	576	≥ 1
	1.4-20	5	1	12	16QAM	3/4	2152	24	1	2880	720	≥ 1
	3-20	6	1	12	16QAM	3/4	2600	24	1	3456	864	≥ 1
	3-20	8	1	12	16QAM	3/4	3496	24	1	4608	1152	≥ 1
	3-20	9	1	12	16QAM	3/4	3880	24	1	5184	1296	≥ 1
	3-20	10	1	12	16QAM	3/4	4264	24	1	5760	1440	≥ 1
	3-20	12	1	12	16QAM	3/4	5160	24	1	6912	1728	≥ 1
	5-20	15	1	12	16QAM	1/2	4264	24	1	8640	2160	≥ 1
	5-20	16	1	12	16QAM	1/2	4584	24	1	9216	2304	≥ 1
	5-20	18	1	12	16QAM	1/2	5160	24	1	10368	2592	≥ 1
	5-20	20	1	12	16QAM	1/3	4008	24	1	11520	2880	≥ 1
	5-20	24	1	12	16QAM	1/3	4776	24	1	13824	3456	≥ 1
	10-20	25	1	12	16QAM	1/3	4968	24	1	14400	3600	≥ 1
	10-20	27	1	12	16QAM	1/3	4776	24	1	15552	3888	≥ 1
	10-20	30	1	12	16QAM	3/4	12960	24	3	17280	4320	≥ 2
	10-20	32	1	12	16QAM	3/4	13536	24	3	18432	4608	≥ 2
	10-20	36	1	12	16QAM	3/4	15264	24	3	20736	5184	≥ 2
	10-20	40	1	12	16QAM	3/4	16992	24	3	23040	5760	≥ 2
	10-20	45	1	12	16QAM	3/4	19080	24	4	25920	6480	≥ 2
	10-20	48	1	12	16QAM	3/4	20616	24	4	27648	6912	≥ 2
	15-20	50	1	12	16QAM	3/4	21384	24	4	28800	7200	≥ 2
	15-20	54	1	12	16QAM	3/4	22920	24	4	31104	7776	≥ 2



	15-20	60	1	12	16QAM	2/3	23688	24	4	34560	8640	$\geq 2$
	15-20	64	1	12	16QAM	2/3	25456	24	4	36864	9216	$\geq 2$
	15-20	72	1	12	16QAM	1/2	20616	24	4	41472	10368	$\geq 2$
	20	75	1	12	16QAM	1/2	21384	24	4	43200	10800	$\geq 2$
	20	80	1	12	16QAM	1/2	22920	24	4	46080	11520	$\geq 2$
	20	81	1	12	16QAM	1/2	22920	24	4	46656	11664	$\geq 2$
	20	90	1	12	16QAM	2/5	20616	24	4	51840	12960	$\geq 2$
	20	96	1	12	16QAM	2/5	22152	24	4	55296	13824	$\geq 2$
Note 1: If more than one Code Block is present, an additional CRC sequence of L = 24 Bits is attached to each Code Block (otherwise L = 0 Bit)												
Note 2: As per Table 4.2-2 in TS 36.211 [8]												

Table A.2.3.2.2-1a: Reference Channels for 16QAM with partial RB allocation UE category 0

Parameter	Ch BW	Allocated RBs	UDL Configuration (Note 2)	DFT-OFDM Symbols per Sub-Frame	Mod'n	Target Coding rate	Payload size for Sub-Frame 2, 3, 7, 8	Transport block CRC	Number of code blocks per Sub-Frame (Note 1)	Total number of bits per Sub-Frame for Sub-Frame 2, 3, 7, 8	Total symbols per Sub-Frame for Sub-Frame 2, 3, 7, 8	UE Category
Unit	MHz						Bits	Bits		Bits		
	1.4 - 20	1	1	12	16QAM	3/4	408	24	1	576	144	0
	1.4 - 20	2		12	16QAM	3/4	840	24	1	1152	288	0
	1.4 - 20	4		12	16QAM	2/5	904	24	1	2304	576	0
Note 1: If more than one Code Block is present, an additional CRC sequence of L = 24 Bits is attached to each Code Block (otherwise L = 0 Bit)												
Note 2: As per Table 4.2-2 in TS 36.211 [8]												

## A.2.3.2.3 64-QAM

[FFS]

### A.2.3.3 Reference measurement channels for sustained downlink data rate provided by lower layers

**Table A.2.3.3-1: Uplink Reference Channels for sustained data-rate test (TDD)**

Parameter	Unit	Value				
		R.1-1 TDD	R.1-2 TDD	R.1-3 TDD	R.1-3B TDD	R.1-4 TDD
Reference Channel						
Channel Bandwidth	MHz	10	10	20	15	20
Uplink-Downlink Configuration (Note 2)		5	5	5	1	1
Allocated Resource Blocks		40 (Note 3)	40 (Note 3)	90 (Note 5)	60 (Note 4)	90 (Note 5)
Allocated Sub-Frames per Radio-Frame		1	1	1	1	1
DFT-OFDM Symbols per Sub-Frame		12	12	12	12	12
Modulation		QPSK	QPSK	QPSK	QPSK	QPSK
Coding Rate						
For Sub-Frame 2		0.43	0.61	0.49	0.42	0.49
For Sub-Frame 3,7,8		n/a	n/a	n/a	0.42	0.49
Information Bit Payload per Sub-Frame	Bits					
For Sub-Frame 2		4968	6968	12576	7224	12576
For Sub-Frame 3,7,8		0	0	0	7224	12576
Number of Code Blocks per Sub-Frame (Note 1)						
For Sub-Frame 2		1	2	3	2	3
For Sub-Frame 3,7,8		0	0	0	2	3
Modulation Symbols per Sub-Frame						
For Sub-Frame 2		5760	5760	12960	8640	10240
For Sub-Frame 3,7,8		0	0	0	8640	10240
Binary Channel Bits per Sub-Frame						
For Sub-Frame 2		11520	11520	25920	17280	25920
For Sub-Frame 3,7,8		n/a	n/a	n/a	17280	25920
Max Throughput over 1 Radio-Frame	Mbps	0.4968	0.6968	1.2576	2.8896	5.0304
UE Category		≥ 1	≥ 2	≥ 2	≥ 2	≥ 2
Note 1: If more than one Code Block is present, an additional CRC sequence of L = 24 Bits is attached to each Code Block (otherwise L = 0 Bit)						
Note 2: As per Table 4.2-2 in TS 36.211 [8]						
Note 3: RB-s 5-44 allocated with PUSCH.						
Note 4: RB-s 7-66 allocated with PUSCH.						
Note 5: RB-s 5-94 allocated with PUSCH.						

## A.3 DL reference measurement channels

### A.3.1 General

The number of available channel bits varies across the sub-frames due to PBCH and PSS/SSS overhead. The payload size per sub-frame is varied in order to keep the code rate constant throughout a frame.

No user data is scheduled on subframes #5 in order to facilitate the transmission of system information blocks (SIB).

The algorithm for determining the payload size  $A$  is as follows; given a desired coding rate  $R$  and radio block allocation  $N_{RB}$

1. Calculate the number of channel bits  $N_{ch}$  that can be transmitted during the first transmission of a given sub-frame.
2. Find  $A$  such that the resulting coding rate is as close to  $R$  as possible, that is,

$$\min |R - (A + 24) / N_{ch}|,$$

subject to

- a)  $A$  is a valid TB size (according to TS 36.213 [10] clause 7.1.7) assuming an allocation of  $N_{RB}$  resource blocks
  - b) Segmentation is not included in this formula, but should be considered in the TBS calculation
3. If there is more than one  $A$  that minimizes the equation above, then the larger value is chosen per default.
  4. For TDD, the measurement channel is based on DL/UL configuration ratio of 2DL+DwPTS (12 OFDM symbol); 2UL.

### A.3.1.1 Overview of DL reference measurement channels

In Table A.3.1.1-1 are listed the DL reference measurement channels specified in annexes A.3.2 to A.3.10 of this release of TS 36.521-1. This table is informative and serves only to a better overview. The reference for the concrete reference measurement channels and corresponding implementation's parameters as to be used for testing are annexes A.3.2 to A.3.10 as appropriate.

Table A.3.1.1-1: Overview of DL reference measurement channels

Duple x	Table	Name	B W	Mod	TCR	RB	RB Off set	UE Cat eg	Notes
<b>FDD, Receiver requirements</b>									
FDD	Table A.3.2-1		1.4	QPSK	1/3	6		≥ 1	
FDD	Table A.3.2-1		3	QPSK	1/3	15		≥ 1	
FDD	Table A.3.2-1		5	QPSK	1/3	25		≥ 1	
FDD	Table A.3.2-1		10	QPSK	1/3	50		≥ 1	
FDD	Table A.3.2-1		15	QPSK	1/3	75		≥ 1	
FDD	Table A.3.2-1		20	QPSK	1/3	100		≥ 1	
FDD / HD- FDD	Table A.3.2-1a		1.4	QPSK	1/3	6		0	
FDD / HD- FDD	Table A.3.2-1a		3	QPSK	1/3	14		0	
FDD / HD- FDD	Table A.3.2-1a		5	QPSK	1/3	14		0	
FDD / HD- FDD	Table A.3.2-1a		10	QPSK	1/3	14		0	
FDD / HD- FDD	Table A.3.2-1a		15	QPSK	1/3	14		0	
FDD / HD- FDD	Table A.3.2-1a		20	QPSK	1/3	14		0	
<b>TDD, Receiver requirements</b>									
TDD	Table A.3.2-2		1.4	QPSK	1/3	6		≥ 1	
TDD	Table A.3.2-2		3	QPSK	1/3	15		≥ 1	
TDD	Table A.3.2-2		5	QPSK	1/3	25		≥ 1	
TDD	Table A.3.2-2		10	QPSK	1/3	50		≥ 1	
TDD	Table A.3.2-2		15	QPSK	1/3	75		≥ 1	
TDD	Table A.3.2-2		20	QPSK	1/3	100		≥ 1	
TDD	Table A.3.2-2a		1.4	QPSK	1/3	6		0	
TDD	Table A.3.2-2a		3	QPSK	1/3	14		0	
TDD	Table A.3.2-2a		5	QPSK	1/3	14		0	
TDD	Table A.3.2-2a		10	QPSK	1/3	14		0	
TDD	Table A.3.2-2a		15	QPSK	1/3	14		0	
TDD	Table A.3.2-2a		20	QPSK	1/3	14		0	
<b>FDD, Receiver requirements, Maximum input level for UE Categories 3-5</b>									
FDD	Table A.3.2-3		1.4	64QAM	3/4	6		-	
FDD	Table A.3.2-3		3	64QAM	3/4	15		-	
FDD	Table A.3.2-3		5	64QAM	3/4	25		-	
FDD	Table A.3.2-3		10	64QAM	3/4	50		-	
FDD	Table A.3.2-3		15	64QAM	3/4	75		-	
FDD	Table A.3.2-3		20	64QAM	3/4	100		-	
<b>FDD, Receiver requirements, Maximum input level for UE Categories 1</b>									
FDD	Table A.3.2-3a		1.4	64QAM	3/4	6		-	
FDD	Table A.3.2-3a		3	64QAM	3/4	15		-	
FDD	Table A.3.2-3a		5	64QAM	3/4	18		-	
FDD	Table A.3.2-3a		10	64QAM	3/4	17		-	
FDD	Table A.3.2-3a		15	64QAM	3/4	17		-	

FDD	Table A.3.2-3a		20	64QAM	3/4	17		-	
<b>FDD, Receiver requirements, Maximum input level for UE Categories 2</b>									
FDD	Table A.3.2-3b		1.4	64QAM	3/4	6		-	
FDD	Table A.3.2-3b		3	64QAM	3/4	15		-	
FDD	Table A.3.2-3b		5	64QAM	3/4	25		-	
FDD	Table A.3.2-3b		10	64QAM	3/4	50		-	
FDD	Table A.3.2-3b		15	64QAM	3/4	75		-	
FDD	Table A.3.2-3b		20	64QAM	3/4	83		-	
<b>FDD, Receiver requirements, Maximum input level for UE Categories 0</b>									
FDD	Table A.3.2-3c		1.4	64QAM	3/4	2		-	
FDD	Table A.3.2-3c		3	64QAM	3/4	2		-	
FDD	Table A.3.2-3c		5	64QAM	3/4	2		-	
FDD	Table A.3.2-3c		10	64QAM	3/4	2		-	
FDD	Table A.3.2-3c		15	64QAM	3/4	2		-	
FDD	Table A.3.2-3c		20	64QAM	3/4	2		-	
<b>TDD, Receiver requirements, Maximum input level for UE Categories 3-5</b>									
TDD	Table A.3.2-4		1.4	64QAM	3/4	6		-	
TDD	Table A.3.2-4		3	64QAM	3/4	15		-	
TDD	Table A.3.2-4		5	64QAM	3/4	25		-	
TDD	Table A.3.2-4		10	64QAM	3/4	50		-	
TDD	Table A.3.2-4		15	64QAM	3/4	75		-	
TDD	Table A.3.2-4		20	64QAM	3/4	100		-	
<b>TDD, Receiver requirements, Maximum input level for UE Categories 1</b>									
TDD	Table A.3.2-4a		1.4	64QAM	3/4	6		-	
TDD	Table A.3.2-4a		3	64QAM	3/4	15		-	
TDD	Table A.3.2-4a		5	64QAM	3/4	18		-	
TDD	Table A.3.2-4a		10	64QAM	3/4	17		-	
TDD	Table A.3.2-4a		15	64QAM	3/4	17		-	
TDD	Table A.3.2-4a		20	64QAM	3/4	17		-	
<b>TDD, Receiver requirements, Maximum input level for UE Categories 2</b>									
TDD	Table A.3.2-4b		1.4	64QAM	3/4	6		-	
TDD	Table A.3.2-4b		3	64QAM	3/4	15		-	
TDD	Table A.3.2-4b		5	64QAM	3/4	25		-	
TDD	Table A.3.2-4b		10	64QAM	3/4	50		-	
TDD	Table A.3.2-4b		15	64QAM	3/4	75		-	
TDD	Table A.3.2-4b		20	64QAM	3/4	83		-	
<b>TDD, Receiver requirements, Maximum input level for UE DL Categories 0</b>									
TDD	Table A.3.2-4c		1.4	64QAM	3/4	2		-	
TDD	Table A.3.2-4c		3	64QAM	3/4	2		-	
TDD	Table A.3.2-4c		5	64QAM	3/4	2		-	
TDD	Table A.3.2-4c		10	64QAM	3/4	2		-	
TDD	Table A.3.2-4c		15	64QAM	3/4	2		-	
TDD	Table A.3.2-4c		20	64QAM	3/4	2		-	
<b>FDD, Receiver requirements, Maximum input level for UE Categories 11/12/13/14/15</b>									
FDD	Table A.3.2-5		1.4	256QAM	4/5	6		-	
FDD	Table A.3.2-5		3	256QAM	4/5	15		-	
FDD	Table A.3.2-5		5	256QAM	4/5	25		-	
FDD	Table A.3.2-5		10	256QAM	4/5	50		-	

FDD	Table A.3.2-5		15	256QAM	4/5	75		-	
FDD	Table A.3.2-5		20	256QAM	4/5	100		-	
<b>TDD, Receiver requirements, Maximum input level for UE Categories 11/12/13/14/15</b>									
TDD	Table A.3.2-6		1.4	256QAM	4/5	6		-	
TDD	Table A.3.2-6		3	256QAM	4/5	15		-	
TDD	Table A.3.2-6		5	256QAM	4/5	25		-	
TDD	Table A.3.2-6		10	256QAM	4/5	50		-	
TDD	Table A.3.2-6		15	256QAM	4/5	75		-	
TDD	Table A.3.2-6		20	256QAM	4/5	100		-	
<b>FDD, Transmitter requirements</b>									
FDD	Table A.3.2A-1		1.4	QPSK	1/8-1/3	3		≥ 1	
FDD	Table A.3.2A-1		3	QPSK	1/3	4		≥ 1	
FDD	Table A.3.2A-1		5	QPSK	1/3	8		≥ 1	
FDD	Table A.3.2A-1		10	QPSK	1/3	16		≥ 1	
FDD	Table A.3.2A-1		15	QPSK	1/3	25		≥ 1	
FDD	Table A.3.2A-1		20	QPSK	1/3	30		≥ 1	
<b>TDD, Transmitter requirements</b>									
TDD	Table A.3.2A-2		1.4	QPSK	1/8-1/3	3		≥ 1	
TDD	Table A.3.2A-2		3	QPSK	1/3	4		≥ 1	
TDD	Table A.3.2A-2		5	QPSK	1/3	8		≥ 1	
TDD	Table A.3.2A-2		10	QPSK	1/3	16		≥ 1	
TDD	Table A.3.2A-2		15	QPSK	1/3	25		≥ 1	
TDD	Table A.3.2A-2		20	QPSK	1/3	30		≥ 1	
<b>FDD, PDSCH Performance, Single-antenna transmission (CRS)</b>									
FDD	Table A.3.3.1-1	R.4 FDD	1.4	QPSK	1/3	6		≥ 1	
FDD	Table A.3.3.1-1	R.42 FDD	20	QPSK	1/3	100		≥ 1	
FDD	Table A.3.3.1-1	R.42-1 FDD	3	QPSK	1/3	15		≥ 1	
FDD	Table A.3.3.1-1	R.42-2 FDD	5	QPSK	1/3	25		≥ 1	
FDD	Table A.3.3.1-1	R.42-3 FDD	15	QPSK	1/3	75		≥ 1	
FDD	Table A.3.3.1-1	R.2 FDD	10	QPSK	1/3	50		≥ 1	
FDD	Table A.3.3.1-2	R.3-1 FDD	5	16QAM	1/2	25		≥ 1	
FDD	Table A.3.3.1-2	R.3 FDD	10	16QAM	1/2	50		≥ 2	
FDD	Table A.3.3.1-3	R.5 FDD	3	64QAM	3/4	15		≥ 1	
FDD	Table A.3.3.1-3	R.6 FDD	5	64QAM	3/4	25		≥ 2	
FDD	Table A.3.3.1-3	R.7 FDD	10	64QAM	3/4	50		≥ 2	
FDD	Table A.3.3.1-3	R.8 FDD	15	64QAM	3/4	75		≥ 2	
FDD	Table A.3.3.1-3	R.9 FDD	20	64QAM	3/4	100		≥ 3	
FDD	Table A.3.3.1-3a	R.6-1 FDD	5	64QAM	3/4	18		≥ 1	
FDD	Table A.3.3.1-3a	R.7-1 FDD	10	64QAM	3/4	17		≥ 1	
FDD	Table A.3.3.1-3a	R.8-1 FDD	15	64QAM	3/4	17		≥ 1	
FDD	Table A.3.3.1-3a	R.9-1 FDD	20	64QAM	3/4	17		≥ 1	
FDD	Table A.3.3.1-3a	R.9-2 FDD	20	64QAM	3/4	83		≥ 2	
FDD	Table A.3.3.1-6	R.41 FDD	10	QPSK	1/10	50		≥ 1	
<b>FDD, PDSCH Performance, Single-antenna transmission (CRS), Single PRB (Channel edge)</b>									
FDD	Table A.3.3.1-4	R.0 FDD	3	16QAM	1/2	1		≥ 1	
FDD	Table A.3.3.1-4	R.1 FDD	10 / 20	16QAM	1/2	1		≥ 1	
<b>FDD, PDSCH Performance, Single-antenna transmission (CRS), Single PRB (MBSFN Configuration)</b>									

FDD	Table A.3.3.1-5	R.29 FDD	10	16QAM	1/2	1		≥ 1	
<b>FDD, Pcell PDSCH Performance, CA with power imbalance</b>									
FDD	Table A.3.3.1-7	R.49 FDD	20	64QAM	0.84-0.87	100		≥ 5	
FDD	Table A.3.3.1-7	R.49-1 FDD	10	64QAM	0.84 - 0.87	50		≥ 2	
FDD	Table A.3.3.1-7	R.49-2 FDD	5	64QAM	0.84 - 0.86	25		≥ 2	
<b>FDD, PDSCH Performance, Multi-antenna transmission (CRS), Two antenna ports</b>									
FDD	Table A.3.3.2.1-1	R.10 FDD	10	QPSK	1/3	50		≥ 1	
FDD	Table A.3.3.2.1-1	R.10-2 FDD	5	QPSK	1/3	25		≥ 1	
FDD	Table A.3.3.2.1-1	R.11 FDD	10	16QAM	1/2	50		≥ 2	
FDD	Table A.3.3.2.1-1	R.11-1 FDD	10	16QAM	1/2	50		≥ 2	
FDD	Table A.3.3.2.1-1	R.11-2 FDD	5	16QAM	1/2	25		≥ 1	
FDD	Table A.3.3.2.1-1	R.11-3 FDD	10	16QAM	1/2	40		≥ 1	
FDD	Table A.3.3.2.1-1	R.11-4 FDD	10	QPSK	1/2	50		≥ 1	
FDD	Table A.3.3.2.1-1	R.30 FDD	20	16QAM	1/2	100		≥ 2	
FDD	Table A.3.3.2.1-1	R.30-1 FDD	15	16QAM	1/2	75		≥ 2	
FDD	Table A.3.3.2.1-1	R.35 FDD	10	64QAM	1/2	50		≥ 2	
FDD	Table A.3.3.2.1-1	R.35-1 FDD	20	64QAM	0.39	100		≥ 2	
FDD	Table A.3.3.2.1-1	R.35-2 FDD	15	64QAM	0.39	75		≥ 2	
FDD	Table A.3.3.2.1-1	R.35-3 FDD	10	64QAM	0.39	50		≥ 2	
FDD	Table A.3.3.2.1-2	R.35-4 FDD	10	64QAM	0.47	50		≥ 2	
FDD	Table A.3.3.2.1-2	R.46 FDD	10	QPSK		50		≥ 1	
FDD	Table A.3.3.2.1-2	R.47 FDD	10	16QAM		50		≥ 1	
FDD	Table A.3.3.2.1-2	R.11-5 FDD	1.4	16QAM	1/2	6		≥ 1	
FDD	Table A.3.3.2.1-2	R.11-6 FDD	3	16QAM	1/2	15		≥ 1	
FDD	Table A.3.3.2.1-2	R.11-7 FDD	15	16QAM	1/2	75		≥ 2	
FDD	Table A.3.3.2.1-2	R.11-8 FDD	10	QPSK	3/5	50		≥ 2	
FDD	Table A.3.3.2.1-3	R. 62 FDD	10	16QAM	1/2	3		0	
FDD	Table A.3.3.2.1-3	R.63 FDD	10	64QAM	1/2	1		0	
<b>FDD, PDSCH Performance, Multi-antenna transmission (CRS), Four antenna ports</b>									
FDD	Table A.3.3.2.2-1	R.12 FDD	1.4	QPSK	1/3	6		≥ 1	
FDD	Table A.3.3.2.2-1	R.13 FDD	10	QPSK	1/3	50		≥ 1	
FDD	Table A.3.3.2.2-1	R.14 FDD	10	16QAM	1/2	50		≥ 2	
FDD	Table A.3.3.2.2-1	R.14-1 FDD	10	16QAM	1/2	6		≥ 1	
FDD	Table A.3.3.2.2-1	R.14-2 FDD	10	16QAM	1/2	3		≥ 1	
FDD	Table A.3.3.2.2-1	R.14-3 FDD	20	16QAM	1/2	100		≥ 1	
FDD	Table A.3.3.2.2-1	R.36 FDD	10	64QAM	1/2	50		≥ 2	
FDD	Table A.3.3.2.2-1	R.14-4 FDD	1.4	16QAM	1/2	6		≥ 1	
FDD	Table A.3.3.2.2-1	R.14-5 FDD	3	16QAM	1/2	15		≥ 1	
FDD	Table A.3.3.2.2-1	R.14-6 FDD	5	16QAM	1/2	25		≥ 1	
FDD	Table A.3.3.2.2-1	R.14-7 FDD	15	16QAM	1/2	75		≥ 2	
<b>FDD, PDSCH Performance (UE specific RS) Two antenna ports (CSI-RS)</b>									
FDD	Table A.3.3.3.1-1	R.51 FDD	10	16QAM	1/2	50		≥ 2	
FDD	Table A.3.3.3.1-2	R.52 FDD	10	64QAM	1/2	50		≥ 2	
FDD	Table A.3.3.3.1-2	R.53 FDD	10	64QAM	1/2	50		≥ 2	
FDD	Table A.3.3.3.1-2	R.54 FDD	10	16QAM	1/2	50		≥ 2	

<b>FDD, PDSCH Performance (UE specific RS) Four antenna ports (CSI-RS)</b>									
FDD	Table A.3.3.3.2-1	R.43 FDD	10	QPSK	1/3	50		≥ 1	
FDD	Table A.3.3.3.2-1	R.50 FDD	10	64QAM	1/2	50		≥ 2	
FDD	Table A.3.3.3.2-2	R.44 FDD	10	QPSK	1/3	50		≥ 1	
FDD	Table A.3.3.3.2-2	R.45 FDD	10	16QAM	1/2	50		≥ 2	
FDD	Table A.3.3.3.2-2	R.45-1 FDD	10	16QAM	1/2	39		≥ 1	
FDD	Table A.3.3.3.2-1	R.48 FDD	10	QPSK		50		≥ 1	
FDD	Table A.3.3.3.2-2	R.60 FDD	10	QPSK	1/2	50		≥ 1	
FDD	Table A.3.3.3.2-3	R.64 FDD	10	QPSK	1/3	6		0	
<b>TDD, PDSCH Performance, Single-antenna transmission (CRS)</b>									
TDD	Table A.3.4.1-1	R.4 TDD	1.4	QPSK	1/3	6		≥ 1	
TDD	Table A.3.4.1-1	R.42 TDD	20	QPSK	1/3	100		≥ 1	
TDD	Table A.3.4.1-1	R.2 TDD	10	QPSK	1/3	50		≥ 1	
TDD	Table A.3.4.1-1	R.2A TDD	10	QPSK	1/3	50		≥ 1	
TDD	Table A.3.4.1-1	R.42-1 TDD	3	QPSK	1/3	15		≥ 1	
TDD	Table A.3.4.1-1	R.42-2 TDD	5	QPSK	1/3	25		≥ 1	
TDD	Table A.3.4.1-1	R.42-3 TDD	15	QPSK	1/3	75		≥ 1	
TDD	Table A.3.4.1-2	R.3-1 TDD	5	16QAM	1/2	25		≥ 1	
TDD	Table A.3.4.1-2	R.3 TDD	10	16QAM	1/2	50		≥ 2	
TDD	Table A.3.4.1-3	R.5 TDD	3	64QAM	3/4	15		≥ 1	
TDD	Table A.3.4.1-3	R.6 TDD	5	64QAM	3/4	25		≥ 2	
TDD	Table A.3.4.1-3	R.7 TDD	10	64QAM	3/4	50		≥ 2	
TDD	Table A.3.4.1-3	R.8 TDD	15	64QAM	3/4	75		≥ 2	
TDD	Table A.3.4.1-3	R.9 TDD	20	64QAM	3/4	100		≥ 3	
TDD	Table A.3.4.1-3a	R.6-1 TDD	5	64QAM	3/4	18		≥ 1	
TDD	Table A.3.4.1-3a	R.7-1 TDD	10	64QAM	3/4	17		≥ 1	
TDD	Table A.3.4.1-3a	R.8-1 TDD	15	64QAM	3/4	17		≥ 1	
TDD	Table A.3.4.1-3a	R.9-1 TDD	20	64QAM	3/4	17		≥ 1	
TDD	Table A.3.4.1-3a	R.9-2 TDD	20	64QAM	3/4	83		≥ 2	
TDD	Table A.3.4.1-6	R.41 TDD	10	QPSK	1/10	50		≥ 1	
<b>TDD, PDSCH Performance, Single-antenna transmission (CRS), Single PRB (Channel edge)</b>									
TDD	Table A.3.4.1-4	R.0 TDD	3	16QAM	1/2	1		≥ 1	
TDD	Table A.3.4.1-4	R.1 TDD	10 / 20	16QAM	1/2	1		≥ 1	
<b>TDD, PDSCH Performance, Single-antenna transmission (CRS), Single PRB (MBSFN Configuration)</b>									
TDD	Table A.3.4.1-5	R.29 TDD	10	16QAM	1/2	1		≥ 1	
<b>TDD, PDSCH Performance: Carrier aggregation with power imbalance</b>									
TDD	Table A.3.4.1-7	R.49 TDD	20	64QAM	0.81-0.87	100		≥ 5	
TDD	Table A.3.4.1-7	R.49-1 TDD	15	64QAM	0.80-0.86	75		≥ 3	
<b>TDD, PDSCH Performance, Multi-antenna transmission (CRS), Two antenna ports</b>									
TDD	Table A.3.4.2.1-1	R.10 TDD	10	QPSK	1/3	50		≥ 1	
TDD	Table A.3.4.2.1-1	R.11 TDD	10	16QAM	1/2	50		≥ 2	
TDD	Table A.3.4.2.1-1	R.11-1 TDD	10	16QAM	1/2	50		≥ 2	
TDD	Table A.3.4.2.1-1	R.11-2 TDD	5	16QAM	1/2	25		≥ 1	
TDD	Table A.3.4.2.1-1	R.11-3 TDD	10	16QAM	1/2	40		≥ 1	
TDD	Table A.3.4.2.1-1	R.11-4 TDD	10	QPSK	1/2	50		≥ 1	
TDD	Table A.3.4.2.1-1	R.30 TDD	20	16QAM	1/2	100		≥ 2	
TDD	Table A.3.4.2.1-1	R.30-1 TDD	20	16QAM	1/2	100		≥ 2	



TDD	Table A.3.4.2.1-1	R.30-2 TDD	20	16QAM	1/2	100		$\geq 2$	
TDD	Table A.3.4.2.1-1	R.35 TDD	10	64QAM	1/2	50		$\geq 2$	
TDD	Table A.3.4.2.1-1	R.35-1 TDD	20	64QAM	0.39	100		$\geq 2$	
TDD	Table A.3.4.2.1-2	R.35-2 TDD	10	64QAM	0.47	50		$\geq 2$	
TDD	Table A.3.4.2.1-2	R.46 TDD	10	QPSK	0.39	50		$\geq 1$	
TDD	Table A.3.4.2.1-2	R.47 TDD	10	16QAM	1/2	50		$\geq 1$	
TDD	Table A.3.4.2.1-2	R.11-5 TDD	1.4	16QAM	1/2	6		$\geq 1$	
TDD	Table A.3.4.2.1-2	R.11-6 TDD	3	16QAM	1/2	15		$\geq 1$	
TDD	Table A.3.4.2.1-2	R.11-7 TDD	5	16QAM	1/2	25		$\geq 1$	
TDD	Table A.3.4.2.1-2	R.11-8 TDD	10	16QAM	1/2	50		$\geq 2$	
TDD	Table A.3.4.2.1-2	R.11-9 TDD	15	16QAM	1/2	75		$\geq 2$	
TDD	Table A.3.4.2.1-2	R.11-10 TDD	10	QPSK	3/5	50		$\geq 2$	
TDD	Table A.3.4.2.1-3	R.62 TDD	10	16QAM	1/2	3		0	
TDD	Table A.3.4.2.1-3	R.63 TDD	10	64QAM	1/2	1		0	
<b>TDD, PDSCH Performance, Multi-antenna transmission (CRS), Four antenna ports</b>									
TDD	Table A.3.4.2.2-1	R.12 TDD	1.4	QPSK	1/3	6		$\geq 1$	
TDD	Table A.3.4.2.2-1	R.13 TDD	10	QPSK	1/3	50		$\geq 1$	
TDD	Table A.3.4.2.2-1	R.14 TDD	10	16QAM	1/2	50		$\geq 2$	
TDD	Table A.3.4.2.2-1	R.14-1 TDD	10	16QAM	1/2	6		$\geq 1$	
TDD	Table A.3.4.2.2-1	R.14-2 TDD	10	16QAM	1/2	3		$\geq 1$	
TDD	Table A.3.4.2.2-1	R.43 TDD	20	16QAM	1/2	100		$\geq 2$	
TDD	Table A.3.4.2.2-1	R.36 TDD	10	64QAM	1/2	50		$\geq 2$	
TDD	Table A.3.4.2.2-1	R.43-1 TDD	1.4	16QAM	1/2	6		$\geq 1$	
TDD	Table A.3.4.2.2-1	R.43-2 TDD	3	16QAM	1/2	15		$\geq 1$	
TDD	Table A.3.4.2.2-1	R.43-3 TDD	5	16QAM	1/2	25		$\geq 1$	
TDD	Table A.3.4.2.2-1	R.43-4 TDD	10	16QAM	1/2	50		$\geq 2$	
TDD	Table A.3.4.2.2-1	R.43-5 TDD	15	16QAM	1/2	75		$\geq 2$	
<b>TDD, PDSCH Performance, Single antenna port (DRS)</b>									
TDD	Table A.3.4.3.1-1	R.25 TDD	10	QPSK	1/3	50		$\geq 1$	
TDD	Table A.3.4.3.1-1	R.26 TDD	10	16QAM	1/2	50		$\geq 2$	
TDD	Table A.3.4.3.1-1	R.26-1 TDD	5	16QAM	1/2	25		$\geq 1$	
TDD	Table A.3.4.3.1-1	R.27 TDD	10	64QAM	3/4	50		$\geq 2$	
TDD	Table A.3.4.3.1-1	R.27-1 TDD	10	64QAM	3/4	18		$\geq 1$	
TDD	Table A.3.4.3.1-1	R.28 TDD	10	16QAM	1/2	1		$\geq 1$	
<b>TDD, PDSCH Performance, Two antenna ports (DRS)</b>									
TDD	Table A.3.4.3.2-1	R.31 TDD	10	QPSK	1/3	50		$\geq 1$	
TDD	Table A.3.4.3.2-1	R.32 TDD	10	16QAM	1/2	50		$\geq 2$	
TDD	Table A.3.4.3.2-1	R.32-1 TDD	5	16QAM	1/2	[25]		$\geq 1$	
TDD	Table A.3.4.3.2-1	R.33 TDD	10	64QAM	3/4	50		$\geq 2$	
TDD	Table A.3.4.3.2-1	R.33-1 TDD	10	64QAM	3/4	[18]		$\geq 1$	
TDD	Table A.3.4.3.2-1	R.34 TDD	10	64QAM	1/2	50		$\geq 2$	
<b>TDD, PDSCH Performance (UE specific RS) Two antenna ports (CSI-RS)</b>									
TDD	Table A.3.4.3.3-1	R.51 TDD	10	16QAM	1/2	50		$\geq 2$	
TDD	Table A.3.4.3.3-2	R.52 TDD	10	64QAM	1/2	50		$\geq 2$	
TDD	Table A.3.4.3.3-2	R.52 TDD	10	64QAM	1/2	50		$\geq 2$	
TDD	Table A.3.4.3.3-2	R.52 TDD	10	16QAM	1/2	50		$\geq 2$	
<b>TDD, PDSCH Performance (UE specific RS) Four antenna ports (CSI-RS)</b>									
TDD	Table A.3.4.3.4-1	R.44 TDD	10	64QAM	1/2	50		$\geq 2$	

TDD	Table A.3.4.3.4-1	R.48 TDD	10	QPSK		50		≥ 1	
TDD	Table A.3.4.3.4-2	R.60 TDD	10	QPSK	1/2	50		≥ 1	
TDD	Table A.3.4.3.4-2	R.61 TDD	10	16QAM	1/2	50		≥ 2	
TDD	Table A.3.4.3.4-2	R.61-1 TDD	10	16QAM	1/2	50		≥ 1	
TDD	Table A.3.4.3.4-3	R.64 TDD	10	QPSK	1/3	6		0	
<b>TDD, PDSCH Performance (UE specific RS) Eight antenna ports (CSI-RS)</b>									
TDD	Table A.3.4.3.5-1	R.51 TDD	10	QPSK	1/3	50		≥ 1	
TDD	Table A.3.4.3.5-2	R.45 TDD	10	16QAM	1/2	50		≥ 2	
TDD	Table A.3.4.3.5-2	R.45-1 TDD	10	16QAM	1/2	39		≥ 1	
<b>FDD, PDCCH / PCFICH Performance</b>									
FDD	Table A.3.5.1-1	R.15 FDD	10	PDCCH					
FDD	Table A.3.5.1-1	R.15-1 FDD	10	PDCCH					
FDD	Table A.3.5.1-1	R.15-2 FDD	10	PDCCH					
FDD	Table A.3.5.1-1	R.16 FDD	1.4	PDCCH					
FDD	Table A.3.5.1-1	R.17 FDD	10	PDCCH					
FDD	Table A.3.5.1-1A	R.16_1 FDD	10	PDCCH					
FDD	Table A.3.5.1-1A	R.17_1 FDD	5	PDCCH					
FDD	Table A.3.5.1-2		10	QPSK	1/3	50		≥ 1	
FDD	Table A.3.5.1-2		1.4	QPSK	1/3	6		≥ 1	
FDD	Table A.3.5.1-2		10	QPSK	1/3	50		≥ 1	
FDD	Table A.3.5.1-2		10	QPSK	1/3	50		≥ 1	
FDD	Table A.3.5.1-2		5	QPSK	1/3	25		≥ 1	
FDD	Table A.3.5.1-2A		10	QPSK	1/3	50		≥ 1	
<b>TDD, PDCCH / PCFICH Performance</b>									
TDD	Table A.3.5.2-1	R.15 TDD	10	PDCCH					
TDD	Table A.3.5.2-1	R.15-1 TDD	10	PDCCH					
TDD	Table A.3.5.2-1	R.15-2 TDD	10	PDCCH					
TDD	Table A.3.5.2-1	R.16 TDD	1.4	PDCCH					
TDD	Table A.3.5.2-1	R.17 TDD	10	PDCCH					
TDD	Table A.3.5.2-1A	R.16_1 TDD	10	PDCCH					
TDD	Table A.3.5.2-1A	R.17_1 TDD	5	PDCCH					
TDD	Table A.3.5.2-2		10	QPSK	1/3	50		≥ 1	
TDD	Table A.3.5.2-2		1.4	QPSK	1/3	6		≥ 1	
TDD	Table A.3.5.2-2		10	QPSK	1/3	50		≥ 1	
TDD	Table A.3.5.2-2		10	QPSK	1/3	50		≥ 1	
TDD	Table A.3.5.2-2		5	QPSK	1/3	25		≥ 1	
TDD	Table A.3.5.2-2A		10	QPSK	1/3	50		≥ 1	
<b>FDD / TDD, PHICH Performance</b>									
FDD / TDD	Table A.3.6-1	R.18	10	PHICH					
FDD / TDD	Table A.3.6-1	R.19	1.4	PHICH					
FDD / TDD	Table A.3.6-1	R.19-1	5	PHICH					
FDD / TDD	Table A.3.6-1	R.20	10	PHICH					
FDD / TDD	Table A.3.6-1	R.24	10	PHICH					
FDD / TDD	Table A.3.6-1A	R.19_1	10	PHICH					
FDD / TDD	Table A.3.6-1A	R.20_1	5	PHICH					
<b>FDD, PMCH Performance</b>									

FDD	Table A.3.8.1-1	R.40 FDD	1.4	QPSK	1/3	6		$\geq 1$	
FDD	Table A.3.8.1-1	R.37 FDD	10	QPSK	1/3	50		$\geq 1$	
FDD	Table A.3.8.1-2	R.38 FDD	10	16QAM	1/2	50		$\geq 1$	
FDD	Table A.3.8.1-3	R.39-1 FDD	5	64QAM	2/3	25		$\geq 1$	
FDD	Table A.3.8.1-3	R.39 FDD	10	64QAM	2/3	50		$\geq 2$	
<b>TDD, PMCH Performance</b>									
TDD	Table A.3.8.2-1	R.40 TDD	1.4	QPSK	1/3	6		$\geq 1$	
TDD	Table A.3.8.2-1	R.37 TDD	10	QPSK	1/3	50		$\geq 1$	
TDD	Table A.3.8.2-2	R.38 TDD	10	16QAM	1/2	50		$\geq 1$	
TDD	Table A.3.8.2-3	R.39-1 TDD	5	64QAM	2/3	25		$\geq 1$	
TDD	Table A.3.8.2-3	R.39 TDD	10	64QAM	2/3	50		$\geq 2$	
<b>FDD, Sustained data rate (CRS)</b>									
FDD	Table A.3.9.1-1	R.31-1 FDD	10	64QAM	0.40			$\geq 1$	
FDD	Table A.3.9.1-1	R.31-2 FDD	10	64QAM	0.59-0.64			$\geq 2$	
FDD	Table A.3.9.1-1	R.31-3 FDD	20	64QAM	0.59-0.62			$\geq 2$	
FDD	Table A.3.9.1-1	R.31-3A FDD	10	64QAM	0.85-0.90			$\geq 2$	
FDD	Table A.3.9.1-1	R.31-3C FDD	15	64QAM	0.87-0.91			$\geq 3$	
FDD	Table A.3.9.1-1	R.31-4 FDD	20	64QAM	0.87-0.90			$\geq 3$	
FDD	Table A.3.9.1-1	R.31-4B FDD	15	64QAM	0.85-0.88			$\geq 4$	
FDD	Table A.3.9.1-1	R.31-5 FDD	15	64QAM	0.85-0.91			$\geq 3$	
FDD	Table A.3.9.1-2	R.31-6 FDD	15	64QAM	0.83-0.85			$\geq 2$	
<b>TDD, Sustained data rate (CRS)</b>									
TDD	Table A.3.9.2-1	R.31-1 TDD	10	64QAM	0.40			$\geq 1$	
TDD	Table A.3.9.2-1	R.31-2 TDD	10	64QAM	0.59-0.64			$\geq 2$	
TDD	Table A.3.9.2-1	R.31-3 TDD	20	64QAM	0.59-0.62			$\geq 2$	
TDD	Table A.3.9.2-1	R.31-3A TDD	15	64QAM	0.87-0.90			$\geq 2$	
TDD	Table A.3.9.2-1	R.31-4 TDD	20	64QAM	0.87-0.90			$\geq 3$	
TDD	Table A.3.9.2-1	R.31-5 TDD	15	64QAM	0.87-0.88			$\geq 3$	
<b>FDD, Sustained data rate test with EPDCCH scheduling (CRS)</b>									
FDD	Table A.3.9.3-1	R.31E-1 FDD	10	64QAM	0.40-0.41			$\geq 1$	
FDD	Table A.3.9.3-1	R.31E-2 FDD	10	64QAM	0.59-0.66			$\geq 2$	
FDD	Table A.3.9.3-1	R.31E-3 FDD	20	64QAM	0.59-0.63			$\geq 2$	
FDD	Table A.3.9.3-1	R.31E-3A FDD	10	64QAM	0.85-0.92			$\geq 2$	
FDD	Table A.3.9.3-1	R.31E-3C FDD	15	64QAM	0.87-0.92			$\geq 3$	
FDD	Table A.3.9.3-1	R.31E-4 FDD	20	64QAM	0.87-0.91			$\geq 3$	
FDD	Table A.3.9.3-1	R.31E-4B FDD	15	64QAM	0.85-0.90			$\geq 4$	
<b>TDD, Sustained data rate test with EPDCCH scheduling (CRS)</b>									
TDD	Table A.3.9.4-1	R.31E-1 TDD	10	64QAM	0.40-0.41			$\geq 1$	
TDD	Table A.3.9.4-1	R.31E-2 TDD	10	64QAM	0.59-0.65			$\geq 2$	
TDD	Table A.3.9.4-1	R.31E-3 TDD	20	64QAM	0.59-0.63			$\geq 2$	
TDD	Table A.3.9.4-1	R.31E-3A TDD	15	64QAM	0.87-0.92			$\geq 2$	

TDD	Table A.3.9.4-1	R.31E-4 TDD	20	64QAM	0.87-0.90				$\geq 3$	
<b>FDD, EPDCCH Performance</b>										
FDD	Table A.3.10.1-1	R.55 FDD	10	EPDCC H						
FDD	Table A.3.10.1-1	R.56 FDD	10	EPDCC H						
FDD	Table A.3.10.1-1	R.57 FDD	10	EPDCC H						
FDD	Table A.3.10.1-1	R.58 FDD	10	EPDCC H						
FDD	Table A.3.10.1-1	R.59 FDD	10	EPDCC H						
<b>TDD, EPDCCH Performance</b>										
TDD	Table A.3.10.2-1	R.55 TDD	10	EPDCC H						
TDD	Table A.3.10.2-1	R.56 TDD	10	EPDCC H		x				
TDD	Table A.3.10.2-1	R.57 TDD	10	EPDCC H						
TDD	Table A.3.10.2-1	R.58 TDD	10	EPDCC H						
TDD	Table A.3.10.2-1	R.59 TDD	10	EPDCC H						

## A.3.2 Reference measurement channel for receiver characteristics

Tables A.3.2-1 and A.3.2-2 are applicable for measurements on the Receiver Characteristics (clause 7) with the exception of sub-clause 7.4 (Maximum input level).

Tables A.3.2-3, A.3.2-3a, A.3.2-3b, A.3.2-4, A.3.2-4a and A.3.2-4b are applicable for sub-clause 7.4 (Maximum input level).

Tables A.3.2-1 and A.3.2-2 also apply for the modulated interferer used in Clauses 7.5, 7.6 and 7.8 with test specific bandwidths.

Table A.3.2-1: Fixed Reference Channel for Receiver Requirements (FDD)

Parameter	Unit	Value					
		1.4	3	5	10	15	20
Channel bandwidth	MHz	1.4	3	5	10	15	20
Allocated resource blocks		6	15	25	50	75	100
Subcarriers per resource block		12	12	12	12	12	12
Allocated subframes per Radio Frame		9	9	9	9	9	9
Modulation		QPSK	QPSK	QPSK	QPSK	QPSK	QPSK
Target Coding Rate		1/3	1/3	1/3	1/3	1/3	1/3
Number of HARQ Processes	Processes	8	8	8	8	8	8
Maximum number of HARQ transmissions		1	1	1	1	1	1
Information Bit Payload per Sub-Frame							
For Sub-Frames 1,2,3,4,6,7,8,9	Bits	408	1320	2216	4392	6712	8760
For Sub-Frame 5	Bits	n/a	n/a	n/a	n/a	n/a	n/a
For Sub-Frame 0	Bits	152	872	1800	4392	6712	8760
Transport block CRC	Bits	24	24	24	24	24	24
Number of Code Blocks per Sub-Frame (Note 3)							
For Sub-Frames 1,2,3,4,6,7,8,9	Bits	1	1	1	1	2	2
For Sub-Frame 5	Bits	n/a	n/a	n/a	n/a	n/a	n/a
For Sub-Frame 0	Bits	1	1	1	1	2	2
Binary Channel Bits Per Sub-Frame							
For Sub-Frames 1,2,3,4,6,7,8,9	Bits	1368	3780	6300	13800	20700	27600
For Sub-Frame 5	Bits	n/a	n/a	n/a	n/a	n/a	n/a
For Sub-Frame 0	Bits	528	2940	5460	12960	19860	26760
Max. Throughput averaged over 1 frame	kbps	341.6	1143. 2	1952. 8	3952. 8	6040. 8	7884
UE Category		≥ 1	≥ 1	≥ 1	≥ 1	≥ 1	≥ 1
Note 1:	2 symbols allocated to PDCCH for 20 MHz, 15 MHz and 10MHz channel BW. 3 symbols allocated to PDCCH for 5 MHz and 3 MHz. 4 symbols allocated to PDCCH for 1.4 MHz						
Note 2:	Reference signal, Synchronization signals and PBCH allocated as per TS 36.211 [8]						
Note 3:	If more than one Code Block is present, an additional CRC sequence of L = 24 Bits is attached to each Code Block (otherwise L = 0 Bit)						

**Table A.3.2-1a: Fixed Reference Channel for Receiver Requirements for UE Category 0 (FDD)**

Parameter	Unit	Value					
		1.4	3	5	10	15	20
Channel bandwidth	MHz	1.4	3	5	10	15	20
Allocated resource blocks		6	14	14	14	14	14
Subcarriers per resource block		12	12	12	12	12	12
Allocated subframes per Radio Frame		9	9	9	9	9	9
Modulation		QPSK	QPSK	QPSK	QPSK	QPSK	QPSK
Target Coding Rate		1/3	1/3	1/3	1/3	1/3	1/3
Number of HARQ Processes	Processes	[8]	[8]	[8]	[8]	[8]	[8]
Maximum number of HARQ transmissions		1	1	1	1	1	1
Information Bit Payload per Sub-Frame							
For Sub-Frames 1,2,3,4,6,7,8,9	Bits	408	1000	1000	1000	1000	1000
For Sub-Frame 5	Bits	N/A	N/A	N/A	N/A	N/A	N/A
For Sub-Frame 0 (Note 3)	Bits	152	840	840	904	904	904
Transport block CRC	Bits	24	24	24	24	24	24
Number of Code Blocks per Sub-Frame							
For Sub-Frames 1,2,3,4,6,7,8,9	Bits	1	1	1	1	1	1
For Sub-Frame 5	Bits	N/A	N/A	N/A	N/A	N/A	N/A
For Sub-Frame 0	Bits	1	1	1	1	1	1
Binary Channel Bits Per Sub-Frame							
For Sub-Frames 1,2,3,4,6,7,8,9	Bits	1368	3528	3528	3864	3864	3864
For Sub-Frame 5	Bits	N/A	N/A	N/A	N/A	N/A	N/A
For Sub-Frame 0 (Note 3)	Bits	528	2688	2688	3024	3024	3024
Max. Throughput averaged over 1 frame	kbps	341.6	884	884	890.4	890.4	890.4
UE DL Category		0	0	0	0	0	0
Note 1:	2 symbols allocated to PDCCH for 20 MHz, 15 MHz and 10MHz channel BW. 3 symbols allocated to PDCCH for 5 MHz and 3 MHz. 4 symbols allocated to PDCCH for 1.4 MHz.						
Note 2:	Reference signal, Synchronization signals and PBCH allocated as per TS 36.211 [8].						
Note 3:	For Sub-Frame 0, it is assumed the 6PRBs are allocated in the centre of the channel where some REs of the same PRBs are occupied by PBCH and synchronization signals.						
Note 4:	For HD-FDD UE, the downlink subframes are scheduled at the 0th, 1st, 2nd, 8th, 9th, 10th, 16th, 17th, 18th, 24th, 25th, 26th, 32nd, 33rd, 34th subframes every 40ms. Information bit payload is available if downlink subframe is scheduled.						

Table A.3.2-2: Fixed Reference Channel for Receiver Requirements (TDD)

Parameter	Unit	Value					
		1.4	3	5	10	15	20
Channel Bandwidth	MHz	1.4	3	5	10	15	20
Allocated resource blocks		6	15	25	50	75	100
Uplink-Downlink Configuration (Note 6)		1	1	1	1	1	1
Allocated subframes per Radio Frame (D+S)		3	3+2	3+2	3+2	3+2	3+2
Number of HARQ Processes	Processes	7	7	7	7	7	7
Maximum number of HARQ transmission		1	1	1	1	1	1
Modulation		QPSK	QPSK	QPSK	QPSK	QPSK	QPSK
Target coding rate		1/3	1/3	1/3	1/3	1/3	1/3
Information Bit Payload per Sub-Frame	Bits						
For Sub-Frame 4, 9		408	1320	2216	4392	6712	8760
For Sub-Frame 1, 6		n/a	968	1544	3240	4968	6712
For Sub-Frame 5		n/a	n/a	n/a	n/a	n/a	n/a
For Sub-Frame 0		208	1064	1800	4392	6712	8760
Transport block CRC	Bits	24	24	24	24	24	24
Number of Code Blocks per Sub-Frame (Note 4)							
For Sub-Frame 4, 9		1	1	1	1	2	2
For Sub-Frame 1, 6		n/a	1	1	1	1	2
For Sub-Frame 5		n/a	n/a	n/a	n/a	n/a	n/a
For Sub-Frame 0		1	1	1	1	2	2
Binary Channel Bits Per Sub-Frame	Bits						
For Sub-Frame 4, 9		1368	3780	6300	13800	20700	27600
For Sub-Frame 1, 6		n/a	3276	5556	11256	16956	22656
For Sub-Frame 5		n/a	n/a	n/a	n/a	n/a	n/a
For Sub-Frame 0		672	3084	5604	13104	20004	26904
Max. Throughput averaged over 1 frame	kbps	102.4	564	932	1965.6	3007.2	3970.4
UE Category		≥ 1	≥ 1	≥ 1	≥ 1	≥ 1	≥ 1
Note 1:	For normal subframes(0,4,5,9), 2 symbols allocated to PDCCH for 20 MHz, 15 MHz and 10 MHz channel BW; 3 symbols allocated to PDCCH for 5 MHz and 3 MHz; 4 symbols allocated to PDCCH for 1.4 MHz. For special subframe (1&6), only 2 OFDM symbols are allocated to PDCCH for all BWs.						
Note 2:	For 1.4MHz, no data shall be scheduled on special subframes (1&6) to avoid problems with insufficient PDCCH performance						
Note 3:	Reference signal, Synchronization signals and PBCH allocated as per TS 36.211 [8]						
Note 4:	If more than one Code Block is present, an additional CRC sequence of L = 24 Bits is attached to each Code Block (otherwise L = 0 Bit).						
Note 5:	As per Table 4.2-2 in TS 36.211 [8]						

**Table A.3.2-2a: Fixed Reference Channel for Receiver Requirements for UE Category 0 (TDD)**

Parameter	Unit	Value					
		1.4	3	5	10	15	20
Channel Bandwidth	MHz	1.4	3	5	10	15	20
Allocated resource blocks		6	14	14	14	14	14
Uplink-Downlink Configuration (Note 5)		1	1	1	1	1	1
Allocated subframes per Radio Frame (D+S)		3	3+2	3+2	3+2	3+2	3+2
Number of HARQ Processes	Processes	[7]	[7]	[7]	[7]	[7]	[7]
Maximum number of HARQ transmission		1	1	1	1	1	1
Modulation		QPSK	QPSK	QPSK	QPSK	QPSK	QPSK
Target coding rate		1/3	1/3	1/3	1/3	1/3	1/3
Information Bit Payload per Sub-Frame	Bits						
For Sub-Frame 4, 9		408	1000	1000	1000	1000	1000
For Sub-Frame 1, 6		N/A	872	872	872	872	872
For Sub-Frame 5		N/A	N/A	N/A	N/A	N/A	N/A
For Sub-Frame 0		208	1000	1000	1000	1000	1000
Transport block CRC	Bits	24	24	24	24	24	24
Number of Code Blocks per Sub-Frame (Note 4)							
For Sub-Frame 4, 9		1	1	1	1	1	1
For Sub-Frame 1, 6		N/A	1	1	1	1	1
For Sub-Frame 5		N/A	N/A	N/A	N/A	N/A	N/A
For Sub-Frame 0		1	1	1	1	1	1
Binary Channel Bits Per Sub-Frame	Bits						
For Sub-Frame 4, 9		1368	3528	3528	3864	3864	3864
For Sub-Frame 1, 6		N/A	3048	3048	3048	3048	3048
For Sub-Frame 5		N/A	N/A	N/A	N/A	N/A	N/A
For Sub-Frame 0		672	2832	2832	3168	3168	3168
Max. Throughput averaged over 1 frame	kbps	102.4	474.4	474.4	474.4	474.4	474.4
UE DL Category		0	0	0	0	0	0
Note 1:	For normal subframes(0,4,5,9), 2 symbols allocated to PDCCH for 20 MHz, 15 MHz and 10 MHz channel BW; 3 symbols allocated to PDCCH for 5 MHz and 3 MHz; 4 symbols allocated to PDCCH for 1.4 MHz. For special subframe (1&6), only 2 OFDM symbols are allocated to PDCCH for all BWs.						
Note 2:	For 1.4MHz, no data shall be scheduled on special subframes(1&6) to avoid problems with insufficient PDCCH performance						
Note 3:	Reference signal, Synchronization signals and PBCH allocated as per TS 36.211 [8]						
Note 4:	If more than one Code Block is present, an additional CRC sequence of L = 24 Bits is attached to each Code Block (otherwise L = 0 Bit).						
Note 5:	As per Table 4.2-2 in TS 36.211 [8]						



Table A.3.2-3: Fixed Reference Channel for Maximum input level for UE Categories 3-8 (FDD)

Parameter	Unit	Value					
		1.4	3	5	10	15	20
Channel bandwidth	MHz	1.4	3	5	10	15	20
Allocated resource blocks		6	15	25	50	75	100
Subcarriers per resource block		12	12	12	12	12	12
Allocated subframes per Radio Frame		8	9	9	9	9	9
Modulation		64QAM	64QAM	64QAM	64QAM	64QAM	64QAM
Target Coding Rate		3/4	3/4	3/4	3/4	3/4	3/4
Number of HARQ Processes	Processes	8	8	8	8	8	8
Maximum number of HARQ transmissions		1	1	1	1	1	1
Information Bit Payload per Sub-Frame							
For Sub-Frames 1,2,3,4,6,7,8,9	Bits	2984	8504	14112	30576	46888	61664
For Sub-Frame 5	Bits	n/a	n/a	n/a	n/a	n/a	n/a
For Sub-Frame 0	Bits	n/a	6456	12576	28336	45352	61664
Transport block CRC	Bits	24	24	24	24	24	24
Number of Code Blocks per Sub-Frame (Note 3)							
For Sub-Frames 1,2,3,4,6,7,8,9		1	2	3	5	8	11
For Sub-Frame 5		n/a	n/a	n/a	n/a	n/a	n/a
For Sub-Frame 0		n/a	2	3	5	8	11
Binary Channel Bits Per Sub-Frame							
For Sub-Frames 1,2,3,4,6,7,8,9	Bits	4104	11340	18900	41400	62100	82800
For Sub-Frame 5	Bits	n/a	n/a	n/a	n/a	n/a	n/a
For Sub-Frame 0	Bits	n/a	8820	16380	38880	59580	80280
Max. Throughput averaged over 1 frame	kbps	2387.2	7448.8	12547	27294	42046	55498
Note 1:	2 symbols allocated to PDCCH for 20 MHz, 15 MHz and 10 MHz channel BW. 3 symbols allocated to PDCCH for 5 MHz and 3 MHz. 4 symbols allocated to PDCCH for 1.4 MHz						
Note 2:	Reference signal, Synchronization signals and PBCH allocated as per TS 36.211 [8]						
Note 3:	If more than one Code Block is present, an additional CRC sequence of L = 24 Bits is attached to each Code Block (otherwise L = 0 Bit)						

Table A.3.2-3a: Fixed Reference Channel for Maximum input level for UE Category 1 (FDD)

Parameter	Unit	Value					
		1.4	3	5	10	15	20
Channel bandwidth	MHz	1.4	3	5	10	15	20
Allocated resource blocks		6	15	18	17	17	17
Subcarriers per resource block		12	12	12	12	12	12
Allocated subframes per Radio Frame		8	9	9	9	9	9
Modulation		64QAM	64QAM	64QAM	64QAM	64QAM	64QAM
Target Coding Rate		3/4	3/4	3/4	3/4	3/4	3/4
Number of HARQ Processes	Processes	8	8	8	8	8	8
Maximum number of HARQ transmissions		1	1	1	1	1	1
Information Bit Payload							
For Sub-Frames 1,2,3,4,6,7,8,9	Bits	2984	8504	10296	10296	10296	10296
For Sub-Frame 5	Bits	n/a	n/a	n/a	n/a	n/a	n/a
For Sub-Frame 0	Bits	n/a	6456	8248	10296	10296	10296
Transport block CRC	Bits	24	24	24	24	24	24
Number of Code Blocks per Sub-Frame (Note 3)							
For Sub-Frames 1,2,3,4,6,7,8,9		1	2	2	2	2	2
For Sub-Frame 5		n/a	n/a	n/a	n/a	n/a	n/a
For Sub-Frame 0		n/a	2	2	2	2	2
Binary Channel Bits Per Sub-Frame							
For Sub-Frames 1,2,3,4,6,7,8,9	Bits	4104	11340	13608	14076	14076	14076
For Sub-Frame 5	Bits	n/a	n/a	n/a	n/a	n/a	n/a
For Sub-Frame 0	Bits	n/a	8820	11088	14076	14076	14076
Max. Throughput averaged over 1 frame	kbps	2387.2	7448.8	9079.6	9266.4	9266.4	9266.4
Note 1:	2 symbols allocated to PDCCH for 20 MHz, 15 MHz and 10 MHz channel BW. 3 symbols allocated to PDCCH for 5 MHz and 3 MHz. 4 symbols allocated to PDCCH for 1.4 MHz						
Note 2:	Reference signal, Synchronization signals and PBCH allocated as per TS 36.211 [8]						
Note 3:	If more than one Code Block is present, an additional CRC sequence of L = 24 Bits is attached to each Code Block (otherwise L = 0 Bit)						

**Table A.3.2-3b: Fixed Reference Channel for Maximum input level for UE Category 2 (FDD)**

Parameter	Unit	Value					
		1.4	3	5	10	15	20
Channel bandwidth	MHz	1.4	3	5	10	15	20
Allocated resource blocks		6	15	25	50	75	83
Subcarriers per resource block		12	12	12	12	12	12
Allocated subframes per Radio Frame		8	9	9	9	9	9
Modulation		64QAM	64QAM	64QAM	64QAM	64QAM	64QAM
Target Coding Rate		3/4	3/4	3/4	3/4	3/4	3/4
Number of HARQ Processes	Processes	8	8	8	8	8	8
Maximum number of HARQ transmissions		1	1	1	1	1	1
Information Bit Payload							
For Sub-Frames 1,2,3,4,6,7,8,9	Bits	2984	8504	14112	30576	46888	51024
For Sub-Frame 5	Bits	n/a	n/a	n/a	n/a	n/a	n/a
For Sub-Frame 0	Bits	n/a	6456	12576	28336	45352	51024
Transport block CRC	Bits	24	24	24	24	24	24
Number of Code Blocks per Sub-Frame (Note 3)							
For Sub-Frames 1,2,3,4,6,7,8,9		1	2	3	5	8	9
For Sub-Frame 5		n/a	n/a	n/a	n/a	n/a	n/a
For Sub-Frame 0		n/a	2	3	5	8	9
Binary Channel Bits Per Sub-Frame							
For Sub-Frames 1,2,3,4,6,7,8,9	Bits	4104	11340	18900	41400	62100	68724
For Sub-Frame 5	Bits	n/a	n/a	n/a	n/a	n/a	n/a
For Sub-Frame 0	Bits	n/a	8820	16380	38880	59580	66204
Max. Throughput averaged over 1 frame	kbps	2387.2	7448.8	12547	27294	42046	45922
Note 1:	2 symbols allocated to PDCCH for 20 MHz, 15 MHz and 10 MHz channel BW. 3 symbols allocated to PDCCH for 5 MHz and 3 MHz. 4 symbols allocated to PDCCH for 1.4 MHz						
Note 2:	Reference signal, Synchronization signals and PBCH allocated as per TS 36.211 [8]						
Note 3:	If more than one Code Block is present, an additional CRC sequence of L = 24 Bits is attached to each Code Block (otherwise L = 0 Bit)						

**Table A.3.2-3c: Fixed Reference Channel for Maximum input level for UE DL Category 0 (FDD)**

Parameter	Unit	Value					
		1.4	3	5	10	15	20
Channel bandwidth	MHz	1.4	3	5	10	15	20
Allocated resource blocks		2	2	2	2	2	2
Subcarriers per resource block		12	12	12	12	12	12
Allocated subframes per Radio Frame		8	9	9	9	9	9
Modulation		64QAM	64QAM	64QAM	64QAM	64QAM	64QAM
Target Coding Rate		3/4	3/4	3/4	3/4	3/4	3/4
Number of HARQ Processes	Processes	[8]	[8]	[8]	[8]	[8]	[8]
Maximum number of HARQ transmissions		1	1	1	1	1	1
Information Bit Payload							
For Sub-Frames 1,2,3,4,6,7,8,9	Bits	1000	1000	1000	1000	1000	1000
For Sub-Frame 5	Bits	N/A	N/A	N/A	N/A	N/A	N/A
For Sub-Frame 0 (Note 3)	Bits	N/A	1000	1000	1000	1000	1000
Transport block CRC	Bits	24	24	24	24	24	24
Number of Code Blocks per Sub-Frame							
For Sub-Frames 1,2,3,4,6,7,8,9		1	1	1	1	1	1
For Sub-Frame 5		N/A	N/A	N/A	N/A	N/A	N/A
For Sub-Frame 0		N/A	1	1	1	1	1
Binary Channel Bits Per Sub-Frame							
For Sub-Frames 1,2,3,4,6,7,8,9	Bits	1368	1512	1512	1656	1656	1656
For Sub-Frame 5	Bits	N/A	N/A	N/A	N/A	N/A	N/A
For Sub-Frame 0 (Note 3)	Bits	N/A	1512	1512	1656	1656	1656
Max. Throughput averaged over 1 frame	kbps	800	900	900	900	900	900
Note 1:	2 symbols allocated to PDCCH for 20 MHz, 15 MHz and 10 MHz channel BW. 3 symbols allocated to PDCCH for 5 MHz and 3 MHz. 4 symbols allocated to PDCCH for 1.4 MHz.						
Note 2:	Reference signal, Synchronization signals and PBCH allocated as per TS 36.211 [8].						
Note 3:	For Sub-Frame 0, it is assumed that the allocated 2PRBs are scheduled on the RBs other than the center 6PRBs as most of the symbols are occupied by PBCH and synchronization signals.						

Table A.3.2-4: Fixed Reference Channel for Maximum input level for UE Categories 3-8 (TDD)

Parameter	Unit	Value					
		1.4	3	5	10	15	20
Channel bandwidth	MHz	1.4	3	5	10	15	20
Allocated resource blocks		6	15	25	50	75	100
Subcarriers per resource block		12	12	12	12	12	12
Uplink-Downlink Configuration (Note 6)		1	1	1	1	1	1
Allocated subframes per Radio Frame		2	3+2	3+2	3+2	3+2	3+2
Modulation		64QAM	64QAM	64QAM	64QAM	64QAM	64QAM
Target Coding Rate		3/4	3/4	3/4	3/4	3/4	3/4
Number of HARQ Processes	Processes	7	7	7	7	7	7
Maximum number of HARQ transmissions		1	1	1	1	1	1
Information Bit Payload per Sub-Frame							
For Sub-Frames 4,9	Bits	2984	8504	14112	30576	46888	61664
For Sub-Frames 1,6	Bits	n/a	6968	11448	23688	35160	46888
For Sub-Frame 5	Bits	n/a	n/a	n/a	n/a	n/a	n/a
For Sub-Frame 0	Bits	n/a	6968	12576	30576	45352	61664
Transport block CRC	Bits	24	24	24	24	24	24
Number of Code Blocks per Sub-Frame (Note 4)							
For Sub-Frames 4,9		1	2	3	5	8	11
For Sub-Frames 1,6		n/a	2	2	4	6	8
For Sub-Frame 5		n/a	n/a	n/a	n/a	n/a	n/a
For Sub-Frame 0		n/a	2	3	5	8	11
Binary Channel Bits per Sub-Frame							
For Sub-Frames 4,9	Bits	4104	11340	18900	41400	62100	82800
For Sub-Frames 1,6		n/a	9828	16668	33768	50868	67968
For Sub-Frame 5	Bits	n/a	n/a	n/a	n/a	n/a	n/a
For Sub-Frame 0	Bits	n/a	9252	16812	39312	60012	80712
Max. Throughput averaged over 1 frame	kbps	596.8	3791.2	6369.6	13910	20945	27877
Note 1:	For normal subframes(0,4,5,9), 2 symbols allocated to PDCCH for 20 MHz, 15 MHz and 10 MHz channel BW; 3 symbols allocated to PDCCH for 5 MHz and 3 MHz; 4 symbols allocated to PDCCH for 1.4 MHz. For special subframe (1&6), only 2 OFDM symbols are allocated to PDCCH for all BWs.						
Note 2:	For 1.4MHz, no data shall be scheduled on special subframes(1&6) to avoid problems with insufficient PDCCH performance						
Note 3:	Reference signal, Synchronization signals and PBCH allocated as per TS 36.211 [8]						
Note 4:	If more than one Code Block is present, an additional CRC sequence of L = 24 Bits is attached to each Code Block (otherwise L = 0 Bit).						
Note 5:	As per Table 4.2-2 in TS 36.211 [8]						

Table A.3.2-4a: Fixed Reference Channel for Maximum input level for UE Category 1 (TDD)

Parameter	Unit	Value					
		1.4	3	5	10	15	20
Channel bandwidth	MHz	1.4	3	5	10	15	20
Allocated resource blocks		6	15	18	17	17	17
Subcarriers per resource block		12	12	12	12	12	12
Uplink-Downlink Configuration (Note 5)		1	1	1	1	1	1
Allocated subframes per Radio Frame		2	3+2	3+2	3+2	3+2	3+2
Modulation		64QAM	64QAM	64QAM	64QAM	64QAM	64QAM
Target Coding Rate		3/4	3/4	3/4	3/4	3/4	3/4
Number of HARQ Processes	Processes	7	7	7	7	7	7
Maximum number of HARQ transmissions		1	1	1	1	1	1
Information Bit Payload per Sub-Frame							
For Sub-Frames 4,9	Bits	2984	8504	10296	10296	10296	10296
For Sub-Frames 1,6	Bits	n/a	6968	8248	7480	7480	7480
For Sub-Frame 5	Bits	n/a	n/a	n/a	n/a	n/a	n/a
For Sub-Frame 0	Bits	n/a	6968	8248	10296	10296	10296
Transport block CRC	Bits	24	24	24	24	24	24
Number of Code Blocks per Sub-Frame (Note 4)							
For Sub-Frames 4,9		1	2	2	2	2	2
For Sub-Frames 1,6		n/a	2	2	2	2	2
For Sub-Frame 5		n/a	n/a	n/a	n/a	n/a	n/a
For Sub-Frame 0		n/a	2	2	2	2	2
Binary Channel Bits per Sub-Frame							
For Sub-Frames 4,9	Bits	4104	11340	13608	14076	14076	14076
For Sub-Frames 1,6		n/a	9828	11880	11628	11628	11628
For Sub-Frame 5	Bits	n/a	n/a	n/a	n/a	n/a	n/a
For Sub-Frame 0	Bits	n/a	9252	11520	14076	14076	14076
Max. Throughput averaged over 1 frame	kbps	596.8	3791.2	4533.6	4584.8	4584.8	4584.8
Note 1:	For normal subframes(0,4,5,9), 2 symbols allocated to PDCCH for 20 MHz, 15 MHz and 10 MHz channel BW; 3 symbols allocated to PDCCH for 5 MHz and 3 MHz; 4 symbols allocated to PDCCH for 1.4 MHz. For special subframe (1&6), only 2 OFDM symbols are allocated to PDCCH for all BWs.						
Note 2:	For 1.4MHz, no data shall be scheduled on special subframes(1&6) to avoid problems with insufficient PDCCH performance						
Note 3:	Reference signal, Synchronization signals and PBCH allocated as per TS 36.211 [8]						
Note 4:	If more than one Code Block is present, an additional CRC sequence of L = 24 Bits is attached to each Code Block (otherwise L = 0 Bit)						
Note 5:	As per Table 4.2-2 in TS 36.211 [8]						

Table A.3.2-4b: Fixed Reference Channel for Maximum input level for UE Category 2 (TDD)

Parameter	Unit	Value					
		1.4	3	5	10	15	20
Channel bandwidth	MHz	1.4	3	5	10	15	20
Allocated resource blocks		6	15	25	50	75	83
Subcarriers per resource block		12	12	12	12	12	12
Uplink-Downlink Configuration (Note 5)		1	1	1	1	1	1
Allocated subframes per Radio Frame		2	3+2	3+2	3+2	3+2	3+2
Modulation		64QAM	64QAM	64QAM	64QAM	64QAM	64QAM
Target Coding Rate		3/4	3/4	3/4	3/4	3/4	3/4
Number of HARQ Processes	Processes	7	7	7	7	7	7
Maximum number of HARQ transmissions		1	1	1	1	1	1
Information Bit Payload per Sub-Frame							
For Sub-Frames 4,9	Bits	2984	8504	14112	30576	46888	51024
For Sub-Frames 1,6	Bits	n/a	6968	11448	23688	35160	39232
For Sub-Frame 5	Bits	n/a	n/a	n/a	n/a	n/a	n/a
For Sub-Frame 0	Bits	n/a	6968	12576	30576	45352	51024
Transport block CRC	Bits	24	24	24	24	24	24
Number of Code Blocks per Sub-Frame (Note 4)							
For Sub-Frames 4,9		1	2	3	5	8	9
For Sub-Frames 1,6		n/a	2	3	5	7	7
For Sub-Frame 5		n/a	n/a	n/a	n/a	n/a	n/a
For Sub-Frame 0		n/a	2	3	5	8	9
Binary Channel Bits per Sub-Frame							
For Sub-Frames 4,9	Bits	4104	11340	18900	41400	62100	68724
For Sub-Frames 1,6		n/a	9828	16668	33768	50868	56340
For Sub-Frame 5	Bits	n/a	n/a	n/a	n/a	n/a	n/a
For Sub-Frame 0	Bits	n/a	9252	16380	39312	60012	66636
Max. Throughput averaged over 1 frame	kbps	596.8	3791.2	6369.6	13910	20945	23154
Note 1:	For normal subframes(0,4,5,9), 2 symbols allocated to PDCCH for 20 MHz, 15 MHz and 10 MHz channel BW; 3 symbols allocated to PDCCH for 5 MHz and 3 MHz; 4 symbols allocated to PDCCH for 1.4 MHz. For special subframe (1&6), only 2 OFDM symbols are allocated to PDCCH for all BWs.						
Note 2:	For 1.4MHz, no data shall be scheduled on special subframes(1&6) to avoid problems with insufficient PDCCH performance						
Note 3:	Reference signal, Synchronization signals and PBCH allocated as per TS 36.211 [8]						
Note 4:	If more than one Code Block is present, an additional CRC sequence of L = 24 Bits is attached to each Code Block (otherwise L = 0 Bit)						
Note 5:	As per Table 4.2-2 in TS 36.211 [8]						

**Table A.3.2-4c: Fixed Reference Channel for Maximum input level for UE DL Category 0 (TDD)**

Parameter	Unit	Value					
		1.4	3	5	10	15	20
Channel bandwidth	MHz	1.4	3	5	10	15	20
Allocated resource blocks		2	2	2	2	2	2
Subcarriers per resource block		12	12	12	12	12	12
Uplink-Downlink Configuration (Note 5)		1	1	1	1	1	1
Allocated subframes per Radio Frame		2	3+2	3+2	3+2	3+2	3+2
Modulation		64QAM	64QAM	64QAM	64QAM	64QAM	64QAM
Target Coding Rate		3/4	3/4	3/4	3/4	3/4	3/4
Number of HARQ Processes	Processes	[7]	[7]	[7]	[7]	[7]	[7]
Maximum number of HARQ transmissions		1	1	1	1	1	1
Information Bit Payload per Sub-Frame							
For Sub-Frames 4,9	Bits	1000	1000	1000	1000	1000	1000
For Sub-Frames 1,6	Bits	N/A	712	712	712	712	712
For Sub-Frame 5	Bits	N/A	N/A	N/A	N/A	N/A	N/A
For Sub-Frame 0	Bits	N/A	1000	1000	1000	1000	1000
Transport block CRC	Bits	24	24	24	24	24	24
Number of Code Blocks per Sub-Frame (Note 4)							
For Sub-Frames 4,9		1	1	1	1	1	1
For Sub-Frames 1,6		N/A	1	1	1	1	1
For Sub-Frame 5		N/A	N/A	N/A	N/A	N/A	N/A
For Sub-Frame 0		N/A	1	1	1	1	1
Binary Channel Bits per Sub-Frame							
For Sub-Frames 4,9	Bits	1368	1512	1512	1656	1656	1656
For Sub-Frames 1,6		N/A	1224	1224	1368	1368	1368
For Sub-Frame 5	Bits	N/A	N/A	N/A	N/A	N/A	N/A
For Sub-Frame 0	Bits	N/A	1512	1512	1656	1656	1656
Max. Throughput averaged over 1 frame	kbps	200	442.4	442.4	442.4	442.4	442.4
Note 1:	For normal subframes(0,4,5,9), 2 symbols allocated to PDCCH for 20 MHz, 15 MHz and 10 MHz channel BW; 3 symbols allocated to PDCCH for 5 MHz and 3 MHz; 4 symbols allocated to PDCCH for 1.4 MHz. For special subframe (1&6), only 2 OFDM symbols are allocated to PDCCH for all BWs.						
Note 2:	For 1.4MHz, no data shall be scheduled on special subframes(1&6) to avoid problems with insufficient PDCCH performance.						
Note 3:	Reference signal, Synchronization signals and PBCH allocated as per TS 36.211 [8].						
Note 4:	If more than one Code Block is present, an additional CRC sequence of L = 24 Bits is attached to each Code Block (otherwise L = 0 Bit).						
Note 5:	As per Table 4.2-2 in TS 36.211 [8].						

**Table A.3.2-5: Fixed Reference Channel for Maximum input level for UE Categories 11/12/13/14/15 (FDD)**

Parameter	Unit	Value					
		1.4	3	5	10	15	20
Channel bandwidth	MHz	1.4	3	5	10	15	20
Allocated resource blocks		6	15	25	50	75	100
Subcarriers per resource block		12	12	12	12	12	12
Allocated subframes per Radio Frame		8	9	9	9	9	9
Modulation		256QAM	256QAM	256QAM	256QAM	256QAM	256QAM
Target Coding Rate		4/5	4/5	4/5	4/5	4/5	4/5
Number of HARQ Processes	Processes	8	8	8	8	8	8
Maximum number of HARQ transmissions		1	1	1	1	1	1
Information Bit Payload per Sub-Frame							
For Sub-Frames 1,2,3,4,6,7,8,9	Bits	4392	12216	19848	42368	63776	84760
For Sub-Frame 5	Bits	N/A	N/A	N/A	N/A	N/A	N/A
For Sub-Frame 0	Bits	N/A	9912	17568	40576	63776	84760
Transport block CRC	Bits	24	24	24	24	24	24
Number of Code Blocks per Sub-Frame (Note 3)							
For Sub-Frames 1,2,3,4,6,7,8,9		1	2	4	7	11	14
For Sub-Frame 5		N/A	N/A	N/A	N/A	N/A	N/A
For Sub-Frame 0		N/A	2	3	7	11	14
Binary Channel Bits Per Sub-Frame							
For Sub-Frames 1,2,3,4,6,7,8,9	Bits	5472	15120	25200	55200	82800	110400
For Sub-Frame 5	Bits	N/A	N/A	N/A	N/A	N/A	N/A
For Sub-Frame 0	Bits	N/A	12210	22290	51840	79440	107040
Max. Throughput averaged over 1 frame	kbps	3513.6	10764	17635.2	37952	57398.4	76284
Note 1:	2 symbols allocated to PDCCH for 20 MHz, 15 MHz and 10 MHz channel BW. 3 symbols allocated to PDCCH for 5 MHz and 3 MHz. 4 symbols allocated to PDCCH for 1.4 MHz.						
Note 2:	Reference signal, Synchronization signals and PBCH allocated as per TS 36.211 [8].						
Note 3:	If more than one Code Block is present, an additional CRC sequence of L = 24 Bits is attached to each Code Block (otherwise L = 0 Bit).						

**Table A.3.2-6: Fixed Reference Channel for Maximum input level for UE Categories 11/12/13/14/15 (TDD)**

Parameter	Unit	Value					
		1.4	3	5	10	15	20
Channel bandwidth	MHz	1.4	3	5	10	15	20
Allocated resource blocks		6	15	25	50	75	100
Subcarriers per resource block		12	12	12	12	12	12
Uplink-Downlink Configuration (Note 5)		1	1	1	1	1	1
Allocated subframes per Radio Frame		2	3+2	3+2	3+2	3+2	3+2
Modulation		256QAM	256QAM	256QAM	256QAM	256QAM	256QAM
Target Coding Rate		4/5	4/5	4/5	4/5	4/5	4/5
Number of HARQ Processes	Processes	7	7	7	7	7	7
Maximum number of HARQ transmissions		1	1	1	1	1	1
Information Bit Payload per Sub-Frame							
For Sub-Frames 4,9	Bits	4392	12216	19848	42368	63776	84760
For Sub-Frames 1,6	Bits	N/A	10680	17568	36696	55056	75376
For Sub-Frame 5	Bits	N/A	N/A	N/A	N/A	N/A	N/A
For Sub-Frame 0	Bits	N/A	9912	17568	42368	63776	84760
Transport block CRC	Bits	24	24	24	24	24	24
Number of Code Blocks per Sub-Frame (Note 4)							
For Sub-Frames 4,9		1	2	4	7	11	14
For Sub-Frames 1,6		N/A	2	3	6	9	13
For Sub-Frame 5		N/A	N/A	N/A	N/A	N/A	N/A
For Sub-Frame 0		N/A	2	3	7	11	14
Binary Channel Bits per Sub-Frame							
For Sub-Frames 4,9	Bits	5472	15120	25200	55200	82800	110400
For Sub-Frames 1,6		N/A	13104	22224	45024	67824	90624
For Sub-Frame 5	Bits	N/A	N/A	N/A	N/A	N/A	N/A
For Sub-Frame 0	Bits	N/A	12336	22416	52416	80016	107616
Max. Throughput averaged over 1 frame	kbps	878.4	5570.4	9240	20049.6	30144	40503.2
Note 1:	For normal subframes (0,4,5,9), 2 symbols allocated to PDCCH for 20 MHz, 15 MHz and 10 MHz channel BW; 3 symbols allocated to PDCCH for 5 MHz and 3 MHz; 4 symbols allocated to PDCCH for 1.4 MHz. For special subframe (1&6), only 2 OFDM symbols are allocated to PDCCH for all BWs.						
Note 2:	For 1.4MHz, no data shall be scheduled on special subframes (1&6) to avoid problems with insufficient PDCCH performance.						
Note 3:	Reference signal, Synchronization signals and PBCH allocated as per TS 36.211 [8].						
Note 4:	If more than one Code Block is present, an additional CRC sequence of L = 24 Bits is attached to each Code Block (otherwise L = 0 Bit).						
Note 5:	As per Table 4.2-2 in TS 36.211 [8].						

## A.3.2A Downlink Reference measurement channel for TX characteristics

Tables A.3.2A-1 and A.3.2A-2 describes the reference measurement channels to be used on the downlink during Transmitter Characteristics (clause 6) for FDD and TDD respectively. The number of allocated resource blocks have been defined (partial allocation) to allow the transmission of PBCH, PSS/SSS and system information mapped on PDSCH.



**Table A.3.2A-1: Fixed DL PDSCH Dedicated Reference Channel for TX Requirements (FDD)**

Parameter	Unit	Value					
		1.4	3	5	10	15	20
Channel bandwidth	MHz	1.4	3	5	10	15	20
Allocated resource blocks		3	4	8	16	25	30
Subcarriers per resource block		12	12	12	12	12	12
Allocated subframes per Radio Frame		10	10	10	10	10	10
Modulation		QPSK	QPSK	QPSK	QPSK	QPSK	QPSK
Target Coding Rate		(Note 4)	1/3	1/3	1/3	1/3	1/3
Number of HARQ Processes	Processes	8	8	8	8	8	8
Maximum number of HARQ transmissions		1	1	1	1	1	1
Information Bit Payload							
For Sub-Frames 0, 1, 2, 3, 4, 5, 6, 7, 8, 9	Bits	88	328	680	1384	2216	2664
Transport block CRC	Bits	24	24	24	24	24	24
Number of Code Blocks per Sub-Frame		1	1	1	1	1	1
Code block CRC size	Bits	0	0	0	0	0	0
Binary Channel Bits Per Sub-Frame							
For Sub-Frames 1, 2, 3, 4, 6, 7, 8, 9	Bits	684	1008	2016	4416	6900	8280
For Sub-Frames 5		540	1008	2016	4416	6900	8280
For Sub-Frames 0		264	1008	2016	4416	6900	8280
Max. Throughput averaged over 1 frame	kbps	88	328	680	1384	2216	2664
UE-Category		≥ 1	≥ 1	≥ 1	≥ 1	≥ 1	≥ 1
Note 1:	2 symbols allocated to PDCCH for 20 MHz, 15 MHz and 10MHz channel BW. 3 symbols allocated to PDCCH for 5 MHz and 3 MHz. 4 symbols allocated to PDCCH for 1.4 MHz						
Note 2:	Reference signal, Synchronization signals and PBCH allocated as per TS 36.211 [8]						
Note 3:	The PDSCH shall be assigned to the UE under test with a set of allocated localized virtual resource blocks starting from one end of the channel.						
Note 4:	To ensure constant transport block size in 1.4MHz, the code rate for subframes varies approx. within {1/8-1/3}						

Table A.3.2A-2: Fixed DL PDSCH Dedicated Reference Channel for TX Requirements (TDD)

Parameter	Unit	Value					
		1.4	3	5	10	15	20
Channel Bandwidth	MHz	1.4	3	5	10	15	20
Allocated resource blocks		3	4	8	16	25	30
Uplink-Downlink Configuration (Note 6)		1	1	1	1	1	1
Allocated subframes per Radio Frame (D+S)		4	4	4	4	4	4
Number of HARQ Processes	Processes	7	7	7	7	7	7
Maximum number of HARQ transmission		1	1	1	1	1	1
Modulation		QPSK	QPSK	QPSK	QPSK	QPSK	QPSK
Target coding rate		(Note 5)	1/3	1/3	1/3	1/3	1/3
Information Bit Payload per Sub-Frame	Bits						
For Sub-Frame 1, 6		n/a	n/a	n/a	n/a	n/a	n/a
For Sub-Frame 0, 4, 5, 9		88	328	680	1384	2216	2664
Transport block CRC	Bits	24	24	24	24	24	24
Number of Code Blocks		1	1	1	1	1	1
Code block CRC size		0	0	0	0	0	0
Binary Channel Bits Per Sub-Frame	Bits						
For Sub-Frame 1, 6		n/a	n/a	n/a	n/a	n/a	n/a
For Sub-Frame 4, 9		684	1008	2016	4416	6900	8280
For Sub-Frame 0		336	1008	2016	4416	6900	8280
For Sub-Frame 5		612	1008	2016	4416	6900	8280
Max. Throughput averaged over one frame	kbps	35.2	131.2	272	553.6	886.4	1065.6
UE-Category		≥ 1	≥ 1	≥ 1	≥ 1	≥ 1	≥ 1
Note 1:	For normal subframes (0,4,5,9), 2 symbols allocated to PDCCH for 20 MHz, 15 MHz and 10 MHz channel BW; 3 symbols allocated to PDCCH for 5 MHz and 3 MHz; 4 symbols allocated to PDCCH for 1.4 MHz. For special subframe (1&6), only 2 OFDM symbols are allocated to PDCCH for all BWs.						
Note 2:	For simplicity, no data shall be scheduled on special subframes (1&6).						
Note 3:	Reference signal, Synchronization signals and PBCH allocated as per TS 36.211 [8]						
Note 4:	The PDSCH shall be assigned to the UE under test with a set of allocated localized virtual resource blocks starting from one end of the channel.						
Note 5:	To ensure constant transport block size in 1.4MHz, the code rate for subframes varies approx. within {1/8-1/3}.						
Note 6:	As per Table 4.2-2 in TS 36.211 [8]						

## A.3.3 Reference measurement channel for PDSCH performance requirements (FDD)

### A.3.3.1 Single-antenna transmission (Common Reference Symbols)

**Table A.3.3.1-1: Fixed Reference Channel QPSK R=1/3**

Parameter	Unit	Value					
		R.4 FDD	R.42 FDD	R.42-1 FDD	R.42-2 FDD	R.42-3 FDD	R.2 FDD
Reference channel							
Channel bandwidth	MHz	1.4	20	3	5	15	10
Allocated resource blocks (Note 4)		6	100	15	25	75	50
Allocated subframes per Radio Frame		9	9	9	9	9	9
Modulation		QPSK	QPSK	QPSK	QPSK	QPSK	QPSK
Target Coding Rate		1/3	1/3	1/3	1/3	1/3	1/3
Information Bit Payload (Note 4)							
For Sub-Frames 1,2,3,4,6,7,8,9	Bits	408	8760	1320	2216	6712	4392
For Sub-Frame 5	Bits	N/A	N/A	N/A	N/A	N/A	N/A
For Sub-Frame 0	Bits	152	8760	1064	1800	6712	4392
Number of Code Blocks (Notes 3 and 4)							
For Sub-Frames 1,2,3,4,6,7,8,9		1	2	1	1	2	1
For Sub-Frame 5		N/A	N/A	N/A	N/A	N/A	N/A
For Sub-Frame 0		1	2	1	1	2	1
Binary Channel Bits (Note 4)							
For Sub-Frames 1,2,3,4,6,7,8,9	Bits	1368	27600	3780	6300	20700	13800
For Sub-Frame 5	Bits	N/A	N/A	N/A	N/A	N/A	N/A
For Sub-Frame 0	Bits	528	26760	2940	5460	19860	12960
Max. Throughput averaged over 1 frame (Note 4)	Mbps	0.342	7.884	1.162	1.953	6.041	3.953
UE Category		≥ 1	≥ 1	≥ 1	≥ 1	≥ 1	≥ 1
Note 1:	2 symbols allocated to PDCCH for 20 MHz, 15 MHz and 10 MHz channel BW; 3 symbols allocated to PDCCH for 5 MHz and 3 MHz; 4 symbols allocated to PDCCH for 1.4 MHz.						
Note 2:	Reference signal, synchronization signals and PBCH allocated as per TS 36.211 [8].						
Note 3:	If more than one Code Block is present, an additional CRC sequence of L = 24 Bits is attached to each Code Block (otherwise L = 0 Bit).						
Note 4:	Given per component carrier per codeword.						

Table A.3.3.1-2: Fixed Reference Channel 16QAM R=1/2

Parameter	Unit	Value					
				R.3-1 FDD	R.3 FDD		
Reference channel							
Channel bandwidth	MHz	1.4	3	5	10	15	20
Allocated resource blocks				25	50		
Allocated subframes per Radio Frame				9	9		
Modulation				16QAM	16QAM		
Target Coding Rate				1/2	1/2		
Information Bit Payload							
For Sub-Frames 1,2,3,4,6,7,8,9	Bits			6456	14112		
For Sub-Frame 5	Bits			n/a	n/a		
For Sub-Frame 0	Bits			5736	12960		
Number of Code Blocks per Sub-Frame (see Note 3)							
For Sub-Frames 1,2,3,4,6,7,8,9				2	3		
For Sub-Frame 5				n/a	n/a		
For Sub-Frame 0				1	3		
Binary Channel Bits Per Sub-Frame							
For Sub-Frames 1,2,3,4,6,7,8,9	Bits			12600	27600		
For Sub-Frame 5	Bits			n/a	n/a		
For Sub-Frame 0	Bits			10920	25920		
Max. Throughput averaged over 1 frame	Mbps			5.738	12.586		
UE Category				≥ 1	≥ 2		
Note 1:	2 symbols allocated to PDCCH for 20 MHz, 15 MHz and 10 MHz channel BW; 3 symbols allocated to PDCCH for 5 MHz and 3 MHz; 4 symbols allocated to PDCCH for 1.4 MHz						
Note 2:	Reference signal, synchronization signals and PBCH allocated as per TS 36.211 [8]						
Note 3:	If more than one Code Block is present, an additional CRC sequence of L = 24 Bits is attached to each Code Block (otherwise L = 0 Bit)						

Table A.3.3.1-3: Fixed Reference Channel 64QAM R=3/4

Parameter	Unit	Value					
			R.5 FDD	R.6 FDD	R.7 FDD	R.8 FDD	R.9 FDD
Reference channel							
Channel bandwidth	MHz	1.4	3	5	10	15	20
Allocated resource blocks			15	25	50	75	100
Allocated subframes per Radio Frame			9	9	9	9	9
Modulation		64QAM	64QAM	64QAM	64QAM	64QAM	64QAM
Target Coding Rate		3/4	3/4	3/4	3/4	3/4	3/4
Information Bit Payload							
For Sub-Frames 1,2,3,4,6,7,8,9	Bits		8504	14112	30576	46888	61664
For Sub-Frame 5	Bits		n/a	n/a	n/a	n/a	n/a
For Sub-Frame 0	Bits		6456	12576	28336	45352	61664
Number of Code Blocks per Sub-Frame (see Note 3)			2	3	5	8	11
Binary Channel Bits Per Sub-Frame							
For Sub-Frames 1,2,3,4,6,7,8,9	Bits		11340	18900	41400	62100	82800
For Sub-Frame 5	Bits		n/a	n/a	n/a	n/a	n/a
For Sub-Frame 0	Bits		8820	16380	38880	59580	80280
Max. Throughput averaged over 1 frame	Mbps		7.449	12.547	27.294	42.046	55.498
UE Category			≥ 1	≥ 2	≥ 2	≥ 2	≥ 3
Note 1:	2 symbols allocated to PDCCH for 20 MHz, 15 MHz and 10 MHz channel BW; 3 symbols allocated to PDCCH for 5 MHz and 3 MHz; 4 symbols allocated to PDCCH for 1.4 MHz						
Note 2:	Reference signal, synchronization signals and PBCH allocated as per TS 36.211 [8]						
Note 3:	If more than one Code Block is present, an additional CRC sequence of L = 24 Bits is attached to each Code Block (otherwise L = 0 Bit)						

Table A.3.3.1-3a: Fixed Reference Channel 64QAM R=3/4

Parameter	Unit	Value				
		R.6-1 FDD	R.7-1 FDD	R.8-1 FDD	R.9-1 FDD	R.9-2 FDD
Reference channel						
Channel bandwidth	MHz	5	10	15	20	20
Allocated resource blocks (Note 3)		18	17	17	17	83
Allocated subframes per Radio Frame		9	9	9	9	9
Modulation		64QAM	64QAM	64QAM	64QAM	64QAM
Target Coding Rate		3/4	3/4	3/4	3/4	3/4
Information Bit Payload						
For Sub-Frames 1,2,3,4,6,7,8,9	Bits	10296	10296	10296	10296	51024
For Sub-Frame 5	Bits	n/a	n/a	n/a	n/a	n/a
For Sub-Frame 0	Bits	8248	10296	10296	10296	51024
Number of Code Blocks per Sub-Frame (Note 4)						
For Sub-Frames 1,2,3,4,6,7,8,9		2	2	2	2	9
For Sub-Frame 5		n/a	n/a	n/a	n/a	n/a
For Sub-Frame 0		2	2	2	2	9
Binary Channel Bits Per Sub-Frame						
For Sub-Frames 1,2,3,4,6,7,8,9	Bits	13608	14076	14076	14076	68724
For Sub-Frame 5	Bits	n/a	n/a	n/a	n/a	n/a
For Sub-Frame 0	Bits	11088	14076	14076	14076	66204
Max. Throughput averaged over 1 frame	Mbps		9.266	9.266	9.266	45.922
UE Category			≥ 1	≥ 1	≥ 1	≥ 2
Note 1:	2 symbols allocated to PDCCH for 20 MHz, 15 MHz and 10 MHz channel BW; 3 symbols allocated to PDCCH for 5 MHz and 3 MHz; 4 symbols allocated to PDCCH for 1.4 MHz					
Note 2:	Reference signal, synchronization signals and PBCH allocated as per TS 36.211 [8]					
Note 3:	Localized allocation started from RB #0 is applied.					
Note 4:	If more than one Code Block is present, an additional CRC sequence of L = 24 Bits is attached to each Code Block (otherwise L = 0 Bit)					

Table A.3.3.1-4: Fixed Reference Channel Single PRB (Channel Edge)

Parameter	Unit	Value				
		R.0 FDD		R.1 FDD		
Reference channel						
Channel bandwidth	MHz	1.4	3	5	10/20	15
Allocated resource blocks			1		1	
Allocated subframes per Radio Frame			9		9	
Modulation			16QAM		16QAM	
Target Coding Rate			1/2		1/2	
Information Bit Payload						
For Sub-Frames 1,2,3,4,6,7,8,9	Bits		224		256	
For Sub-Frame 5	Bits		n/a		n/a	
For Sub-Frame 0	Bits		224		256	
Number of Code Blocks per Sub-Frame (see Note 3)			1		1	
Binary Channel Bits Per Sub-Frame						
For Sub-Frames 1,2,3,4,6,7,8,9	Bits		504		552	
For Sub-Frame 5	Bits		n/a		n/a	
For Sub-Frame 0	Bits		504		552	
Max. Throughput averaged over 1 frame	Mbps		0.202		0.230	
UE Category			≥ 1		≥ 1	
Note 1:	2 symbols allocated to PDCCH for 20 MHz, 15 MHz and 10 MHz channel BW; 3 symbols allocated to PDCCH for 5 MHz and 3 MHz; 4 symbols allocated to PDCCH for 1.4 MHz					
Note 2:	Reference signal, synchronization signals and PBCH allocated as per TS 36.211 [8]					
Note 3:	If more than one Code Block is present, an additional CRC sequence of L = 24 Bits is attached to each Code Block (otherwise L = 0 Bit)					

**Table A.3.3.1-5: Fixed Reference Channel Single PRB (MBSFN Configuration)**

Parameter	Unit	Value
Reference channel		R.29 FDD (MBSFN)
Channel bandwidth	MHz	10
Allocated resource blocks		1
MBSFN Configuration (Note 3)		111111
Allocated subframes per Radio Frame		3
Modulation		16QAM
Target Coding Rate		1/2
Information Bit Payload		
For Sub-Frames 4,9	Bits	256
For Sub-Frame 5	Bits	n/a
For Sub-Frame 0	Bits	256
For Sub-Frame 1,2,3,6,7,8	Bits	0 (MBSFN)
Number of Code Blocks per Sub-Frame (see Note 4)		1
For Sub-Frames 4,9		1
For Sub-Frame 5		n/a
For Sub-Frame 0		1
For Sub-Frame 1,2,3,6,7,8		0 (MBSFN)
Binary Channel Bits Per Sub-Frame		
For Sub-Frames 4,9	Bits	552
For Sub-Frame 5	Bits	n/a
For Sub-Frame 0	Bits	552
For Sub-Frame 1,2,3,6,7,8	Bits	0 (MBSFN)
Max. Throughput averaged over 1 frame	kbps	76.8
UE Category		≥ 1
Note 1:	2 symbols allocated to PDCCH	
Note 2:	Reference signal, synchronization signals and PBCH allocated as per TS 36.211 [8]	
Note 3:	MBSFN Subframe Allocation as defined in [5], one frame with 6 bits is chosen for MBSFN subframe allocation	
Note 4:	If more than one Code Block is present, an additional CRC sequence of L = 24 Bits is attached to each Code Block (otherwise L = 0 Bit)	

Table A.3.3.1-6: Fixed Reference Channel QPSK R=1/10

Parameter	Unit	Value					
					R.41 FDD		
Reference channel							
Channel bandwidth	MHz	1.4	3	5	10	15	20
Allocated resource blocks (Note 3)					50		
Allocated subframes per Radio Frame					9		
Modulation					QPSK		
Target Coding Rate					1/10		
Information Bit Payload							
For Sub-Frames 1,2,3,4,6,7,8,9	Bits				1384		
For Sub-Frame 5	Bits				N/A		
For Sub-Frame 0	Bits				1384		
Number of Code Blocks per Sub-Frame (Note 3)							
For Sub-Frames 1,2,3,4,6,7,8,9					1		
For Sub-Frame 5					N/A		
For Sub-Frame 0					1		
Binary Channel Bits Per Sub-Frame							
For Sub-Frames 1,2,3,4,6,7,8,9	Bits				13800		
For Sub-Frame 5	Bits				N/A		
For Sub-Frame 0	Bits				12960		
Max. Throughput averaged over 1 frame	Mbps				1.246		
UE Category					≥ 1		
<p>Note 1: 2 symbols allocated to PDCCH for 20 MHz, 15 MHz and 10 MHz channel BW; 3 symbols allocated to PDCCH for 5 MHz and 3 MHz; 4 symbols allocated to PDCCH for 1.4 MHz.</p> <p>Note 2: Reference signal, synchronization signals and PBCH allocated as per TS 36.211 [8].</p> <p>Note 3: If more than one Code Block is present, an additional CRC sequence of L = 24 Bits is attached to each Code Block (otherwise L = 0 Bit).</p>							

Table A.3.3.1-7: PCell Fixed Reference Channel for CA demodulation with power imbalance

Parameter	Unit	Value		
		R.49 FDD	R.49-1 FDD	R.49-2 FDD
Reference channel		R.49 FDD	R.49-1 FDD	R.49-2 FDD
Channel bandwidth	MHz	20	10	5
Allocated resource blocks		100	50	25
Allocated subframes per Radio Frame		9	9	9
Modulation		64QAM	64QAM	64QAM
Coding Rate				
For Sub-Frame 1,2,3,4,6,7,8,9,		0.84	0.84	0.84
For Sub-Frame 5		N/A	N/A	N/A
For Sub-Frame 0		0.87	0.87	0.86
Information Bit Payload				
For Sub-Frames 1,2,3,4,6,7,8,9	Bits	63776	31704	15840
For Sub-Frame 5	Bits	N/A	N/A	N/A
For Sub-Frame 0		63776	30576	14112
Number of Code Blocks per Sub-Frame (Note 3)				
For Sub-Frames 0,1,2,3,4,6,7,8,9	Code Blocks	11	6	3
For Sub-Frame 5	Code Blocks	N/A	N/A	N/A
Binary Channel Bits Per Sub-Frame			5	3
For Sub-Frames 1,2,3,4,6,7,8,9	Bits	75600		
For Sub-Frame 5	Bits	N/A	37800	18900
For Sub-Frame 0	Bits	73080	N/A	N/A
Max. Throughput averaged over 1 frame	Mbps	57.398	35280	16380
UE Category		≥5	≥2	≥2
<p>Note 1: 3 symbols allocated to PDCCH.</p> <p>Note 2: Reference signal, synchronization signals and PBCH allocated as per TS 36.211 [4].</p> <p>Note 3: If more than one Code Block is present, an additional CRC sequence of L = 24 Bits is attached to each Code Block (otherwise L = 0 Bit).</p>				

### A.3.3.2 Multi-antenna transmission (Common Reference Symbols)

#### A.3.3.2.1 Two antenna ports

**Table A.3.3.2.1-1: Fixed Reference Channel two antenna ports**

Parameter	Unit	Value													
		R.10 FDD	R.10-2 FDD	R.11 FDD	R.11-1 FDD	R.11-2 FDD	R.11-3 FDD <small>Note 5</small>	R.11-4 FDD	R.30 FDD	R.30-1 FDD	R.35 FDD	R.35-1 FDD	R.35-2 FDD	R.35-3 FDD	
Channel bandwidth	MHz	10	5	10	10	5	10	10	20	15	10	20	15	10	
Allocated resource blocks (Note 4)		50	25	50	50	25	40	50	100	75	50	100	75	50	
Allocated subframes per radio frame		9	9	9	9	9	9	9	9	8	9	8	8	8	
Modulation		QPSK	QPSK	16QAM	16QAM	16QAM	16QAM	QPSK	16QAM	16QAM	64QAM	64QAM	64QAM	64QAM	
Target Coding Rate		1/3	1/3	1/2	1/2	1/2	1/2	1/2	1/2	1/2	1/2	0.39	0.39	0.39	
Information Bit Rate (Note 4)															
For Sub-Frames 2,3,4,6,7,8,9	Bits	4392	1800	12960	12960	5736	10296	6968	25456	19080	19848	30576	22920	15216	
For Sub-Frame 5	Bits	N/A	N/A	N/A	N/A	N/A	N/A	N/A	N/A	N/A	N/A	N/A	N/A	N/A	
For Sub-Frame 1	Bits	4392	1800	12960	N/A	4968	10296	6968	25456	N/A	18336	N/A	N/A	N/A	
Number of Code Blocks (Notes 3 and 4)															
For Sub-Frames 2,3,4,6,7,8,9	Bits	1	1	3	3	1	2	2	5	4	4	5	4	3	
For Sub-Frame 5	Bits	N/A	N/A	N/A	N/A	N/A	N/A	N/A	N/A	N/A	N/A	N/A	N/A	N/A	
For Sub-Frame 1	Bits	1	1	3	N/A	1	2	2	5	N/A	3	N/A	N/A	N/A	
Binary Channels (Note 4)															
For Sub-Frames 2,3,4,6,7,8,9	Bits	13200	6000	26400	26400	12000	21120	13200	52800	39600	39600	79200	59400	39600	
For Sub-Frame 5	Bits	N/A	N/A	N/A	N/A	N/A	N/A	N/A	N/A	N/A	N/A	N/A	N/A	N/A	
For Sub-Frame 1	Bits	12384	5184	24768	N/A	10368	19488	12384	51168	N/A	37152	N/A	N/A	N/A	
Max. Throughput averaged over 1 ms (Note 4)	Mbps	3.953	1.620	11.664	10.368	5.086	9.266	6.271	22.910	15.264	17.712	24.461	18.336	12.288	
Category		≥ 1	≥ 1	≥ 2	≥ 2	≥ 1	≥ 1	≥ 1	≥ 2	≥ 2	≥ 2	≥ 2	≥ 2	≥ 2	

Note 1: 2 symbols allocated to PDCCH for 20 MHz, 15 MHz and 10 MHz channel BW; 3 symbols allocated to PDCCH for 5 MHz and 3 MHz; 4 symbols allocated to PDCCH for 1.4 MHz.

Note 2: Reference signal, synchronization signals and PBCH allocated as per TS 36.211 [8].

Note 3: If more than one Code Block is present, an additional CRC sequence of L = 24 Bits is attached to each Code Block (otherwise L = 0 Bits).

Note 4: Given per component carrier per codeword.

Note 5: For R.11-3 resource blocks of RB6–RB45 are allocated.



Table A.3.3.2.1-2: Fixed Reference Channel two antenna ports

Parameter	Unit	Value							
		R.46 FDD	R.47 FDD	R.35-4 FDD	R.11- 5 FDD	R.11- 6 FDD	R.11- 7 FDD	R.11- 8 FDD	
Reference channel									
Channel bandwidth	MHz	10	10	10	1.4	3	15	10	
Allocated resource blocks (Note 4)		50	50	50	6	15	75	50	
Allocated subframes per Radio Frame		9	9	9	9	9	9	9	
Modulation		QPSK	16QAM	64QAM	16QA M	16QA M	16QA M	QPS K	
Target Coding Rate		0.39	1/3	0.47	1/2	1/2	1/2	3/5	
Information Bit Payload (Note 4)									
For Sub-Frames 1,2,3,4,6,7,8,9	Bits	5160	8760	18336	1352	3368	1908 0	7992	
For Sub-Frame 5	Bits	n/a	n/a	N/A	N/A	N/A	N/A	N/A	
For Sub-Frame 0	Bits	5160	8760	16416	N/A	2664	1908 0	6968	
Number of Code Blocks (Notes 3 and 4)									
For Sub-Frames 1,2,3,4,6,7,8,9	Bits	1	2	3	1	1	4	2	
For Sub-Frame 5	Bits	n/a	n/a	N/A	N/A	N/A	N/A	N/A	
For Sub-Frame 0	Bits	1	2	3	1	1	4	2	
Binary Channel Bits (Note 4)									
For Sub-Frames 1,2,3,4,6,7,8,9	Bits	13200	26400	39600	2592	7200	3960 0	1320 0	
For Sub-Frame 5	Bits	n/a	n/a	N/A	N/A	N/A	N/A	N/A	
For Sub-Frame 0	Bits	12384	24768	37152	N/A	5568	3796 8	1238 4	
Max. Throughput averaged over 1 frame (Note 4)	Mbps	4.644	7.884	16.310	1.082	2.961	17.17 2	7.09 04	
UE Category		≥ 1	≥ 1	≥ 2	≥ 1	≥ 1	≥ 2	≥ 2	
Note 1:	2 symbols allocated to PDCCH for 20 MHz, 15 MHz and 10 MHz channel BW; 3 symbols allocated to PDCCH for 5 MHz and 3 MHz; 4 symbols allocated to PDCCH for 1.4 MHz								
Note 2:	Reference signal, synchronization signals and PBCH allocated as per TS 36.211 [8]								
Note 3:	If more than one Code Block is present, an additional CRC sequence of L = 24 Bits is attached to each Code Block (otherwise L = 0 Bit)								
Note 4:	Given per component carrier per codeword.								

**Table A.3.3.2.1-3: Fixed Reference Channel two antenna ports for UE category 0**

Parameter	Unit	Value	
		R.62 FDD	R.63 FDD
Reference channel		R.62 FDD	R.63 FDD
Channel bandwidth	MHz	10	10
Allocated resource blocks (Note 4)		3	1
Allocated DL subframes per 4 Radio Frames (Note 3)		15	15
Modulation		16QAM	64QAM
Target Coding Rate		1/2	1/2
Information Bit Payload			
For Sub-Frames 0,1,2,3,4,5,6,7,8,9	Bits	744	408
Number of Code Blocks			
For Sub-Frames 0,1,2,3,4,5,6,7,8,9	Code blocks	1	1
Binary Channel Bits			
For Sub-Frames 0,1,2,3,4,5,6,7,8,9	Bits	1584	792
Max. Throughput averaged over 4 frames	Mbps	0.279	0.153
UE DL Category		0	0
Note 1:	2 symbols allocated to PDCCH.		
Note 2:	Reference signal, synchronization signals and PBCH allocated as per TS 36.211 [8].		
Note 3:	The downlink subframes are scheduled at the 0th, 1st, 2nd, 8th, 9th, 10th, 16th, 17th, 18th, 24th, 25th, 26th, 32nd, 33rd, 34th subframes every 40ms. Information bit payload is available if downlink subframe is scheduled.		
Note 4:	Allocated PRB positions start from {10, 11, ..., 10+N-1}, where N is the number of allocated resource blocks.		

## A.3.3.2.2 Four antenna ports

Table A.3.3.2.2-1: Fixed Reference Channel four antenna ports

Parameter	Unit	Value										
		R.12 FDD	R.13 FDD	R.14 FDD	R.14-1 FDD	R.14-2 FDD	R.14-3 FDD	R.36 FDD	R.14-4 FDD	R.14-5 FDD	R.14-6 FDD	R.14-7 FDD
Reference channel												
Channel bandwidth	MHz	1.4	10	10	10	10	20	10	1.4	3	5	15
Allocated resource blocks (Note 4)		6	50	50	6	3	100	50	6	15	25	75
Allocated subframes per Radio Frame		9	9	9	8	8	9	9	9	9	9	9
Modulation		QPS K	QPS K	16Q AM	16QA M	16QA M	16QA M	64Q AM	16QA M	16QA M	16QA M	16QA M
Target Coding Rate		1/3	1/3	1/2	1/2	1/2	1/2	1/2	1/2	1/2	1/2	1/2
Information Bit Payload (Note 4)												
For Sub-Frames 1,2,3,4,6,7,8,9	Bits	408	4392	12960	1544	744	[25456]	18336	1192	3368	5736	19080
For Sub-Frame 5	Bits	N/A	N/A	N/A	N/A	N/A	n/a	N/A	N/A	N/A	N/A	N/A
For Sub-Frame 0	Bits	152	3624	11448	N/A	N/A	[22920]	18336	N/A	2664	4968	19080
Number of Code Blocks (Notes 3 and 4)												
For Sub-Frames 1,2,3,4,6,7,8,9		1	1	3	1	1	5	3	1	1	1	4
For Sub-Frame 5		N/A	N/A	N/A	N/A	N/A	n/a	N/A	N/A	N/A	N/A	N/A
For Sub-Frame 0		1	1	2	N/A	N/A	4	3	N/A	1	1	4
Binary Channel Bits (Note 4)												
For Sub-Frames 1,2,3,4,6,7,8,9	Bits	1248	12800	25600	3072	1536	51200	38400	2496	6960	11600	38400
For Sub-Frame 5	Bits	N/A	N/A	N/A	N/A	N/A	n/a	N/A	N/A	N/A	N/A	N/A
For Sub-Frame 0	Bits	480	12032	24064	N/A	N/A	49664	36096	N/A	5424	10064	36864
Max. Throughput averaged over 1 frame (Note 4)	Mbps	0.342	3.876	11.513	1.235	0.595	[22.656]	16.502	0.954	2.961	5.086	17.172
UE Category		≥ 1	≥ 1	≥ 2	≥ 1	≥ 1	≥ 2	≥ 2	≥ 1	≥ 1	≥ 1	≥ 2
Note 1:	2 symbols allocated to PDCCH for 20 MHz, 15 MHz and 10 MHz channel BW; 3 symbols allocated to PDCCH for 5 MHz and 3 MHz; 4 symbols allocated to PDCCH for 1.4 MHz.											
Note 2:	Reference signal, synchronization signals and PBCH allocated as per TS 36.211 [8].											
Note 3:	If more than one Code Block is present, an additional CRC sequence of L = 24 Bits is attached to each Code Block (otherwise L = 0 Bit).											
Note 4:	Given per component carrier per codeword.											

## A.3.3.3 Reference Measurement Channel for UE-Specific Reference Symbols

## A.3.3.3.1 Two antenna port (CSI-RS)

The reference measurement channels in Table A.3.3.3.1-1 apply for verifying demodulation performance for UE-specific reference symbols with two cell-specific antenna ports and two CSI-RS antenna ports.

**Table A.3.3.3.1-1: Fixed Reference Channel for CDM-multiplexed DM RS with two CSI-RS antenna ports**

Parameter	Unit	Value
Reference channel		R.51 FDD
Channel bandwidth	MHz	10
Allocated resource blocks		50 (Note 3)
Allocated subframes per Radio Frame		9
Modulation		16QAM
Target Coding Rate		1/2
Information Bit Payload		
For Sub-Frames 1,4,6,9	Bits	11448
For Sub-Frames 2,3,7,8	Bits	11448
For Sub-Frame 5	Bits	n/a
For Sub-Frame 0	Bits	9528
Number of Code Blocks (Note 4)		
For Sub-Frames 1,4,6,9	Code blocks	2
For Sub-Frames 2,3,7,8	Code blocks	2
For Sub-Frame 5	Bits	n/a
For Sub-Frame 0	Bits	2
Binary Channel Bits		
For Sub-Frames 1,4,6,9	Bits	24000
For Sub-Frames 2,7		23600
For Sub-Frames 3,8		23200
For Sub-Frame 5	Bits	n/a
For Sub-Frame 0	Bits	19680
Max. Throughput averaged over 1 frame	Mbps	10.1112
UE Category		≥ 2
Note 1:	2 symbols allocated to PDCCH.	
Note 2:	Reference signal, synchronization signals and PBCH allocated as per TS 36.211 [8].	
Note 3:	50 resource blocks are allocated in sub-frames 1, 2, 3, 4, 6, 7, 8, 9 and 41 resource blocks (RB0–RB20 and RB30–RB49) are allocated in sub-frame 0.	
Note 4:	If more than one Code Block is present, an additional CRC sequence of L = 24 Bits is attached to each Code Block (otherwise L = 0 Bit).	

The reference measurement channels in Table A3.3.3.1-2 apply for verifying demodulation performance for UE-specific reference symbols with two cell specific antenna ports and two CSI-RS antenna ports with ZP CSI-RS and NZP CSI-RS in same subframe.

**Table A.3.3.3.1-2: Fixed Reference Channel for CDM-multiplexed DM RS with two CSI-RS antenna ports with ZP CSI-RS and NZP CSI-RS**

Parameter	Unit	Value		
		R.52 FDD	R.53 FDD	R.54 FDD
Reference channel		R.52 FDD	R.53 FDD	R.54 FDD
Channel bandwidth	MHz	10	10	10
Allocated resource blocks		50 (Note 3)	50 (Note 3)	50 (Note 3)
Allocated subframes per Radio Frame		9	9	9
Modulation		64QAM	64QAM	16QAM
Target Coding Rate		1/2	1/2	1/2
Information Bit Payload				
For Sub-Frames 1,3,4,6,8,9	Bits	18336	18336	11448
For Sub-Frames 2,7	Bits	16416	16416	11448
For Sub-Frame 5	Bits	n/a	n/a	n/a
For Sub-Frame 0	Bits	14688	14688	9528
Number of Code Blocks (Note 4)				
For Sub-Frames 1,3,4,6,8,9	Code blocks	3	3	2
For Sub-Frames 2, 7	Code blocks	3	3	2
For Sub-Frame 5	Bits	n/a	n/a	n/a
For Sub-Frame 0	Bits	3	3	2
Binary Channel Bits				
For Sub-Frames 1,3,4,6,8,9	Bits	36000	36000	24000
For Sub-Frames 2,7		34200	33600	22800
For Sub-Frame 5	Bits	n/a	n/a	n/a
For Sub-Frame 0	Bits	29520	29520	19680
Max. Throughput averaged over 1 frame	Mbps	15.7536	15.7536	10.1112
Note 1:	2 symbols allocated to PDCCH.			
Note 2:	Reference signal, synchronization signals and PBCH allocated as per TS 36.211 [8].			
Note 3:	50 resource blocks are allocated in sub-frames 1, 2, 3, 4, 6, 7, 8, 9 and 41 resource blocks (RB0–RB20 and RB30–RB49) are allocated in sub-frame 0.			
Note 4:	If more than one Code Block is present, an additional CRC sequence of L = 24 Bits is attached to each Code Block (otherwise L = 0 Bit).			

### A.3.3.3.2 Four antenna ports (CSI-RS)

The reference measurement channels in Table A.3.3.3.2-1 apply for verifying demodulation performance for UE-specific reference symbols with two cell-specific antenna ports and four CSI-RS antenna ports.

**Table A.3.3.3.2-1: Fixed Reference Channel for CDM-multiplexed DM RS with four CSI-RS antenna ports**

Parameter	Unit	Value		
		R.43 FDD	R.48 FDD	R.50 FDD
Reference channel		R.43 FDD	R.48 FDD	R.50 FDD
Channel bandwidth	MHz	10	10	10
Allocated resource blocks		50 (Note 3)	50 (Note 3)	50 (Note 3)
Allocated subframes per Radio Frame		9	9	9
Modulation		QPSK	QPSK	64QAM
Target Coding Rate		1/3		1/2
Information Bit Payload				
For Sub-Frames 1,4,6,9	Bits	3624	6200	18336
For Sub-Frames 2,3,7,8	Bits	3624	6200	16416
For Sub-Frame 5	Bits	n/a	n/a	n/a
For Sub-Frame 0	Bits	2984	4968	14688
Number of Code Blocks (Note 4)				
For Sub-Frames 1,4,6,9	Code blocks	1	2	3
For Sub-Frames 2,3,7,8	Code blocks	1	2	3
For Sub-Frame 5	Bits	n/a	n/a	n/a
For Sub-Frame 0	Bits	1	1	3
Binary Channel Bits				
For Sub-Frames 1,4,6,9	Bits	12000	12000	36000
For Sub-Frames 2,7		11600	11600	34800
For Sub-Frames 3,8		11600	12000	34800
For Sub-Frame 5	Bits	n/a	n/a	n/a
For Sub-Frame 0	Bits	9840	9840	29520
Max. Throughput averaged over 1 frame	Mbps	3.1976	5.4568	15.3696
UE Category		≥ 1	≥ 1	≥ 2
Note 1:	2 symbols allocated to PDCCH.			
Note 2:	Reference signal, synchronization signals and PBCH allocated as per TS 36.211 [8].			
Note 3:	50 resource blocks are allocated in sub-frames 1, 2, 3, 4, 6, 7, 8, 9 and 41 resource blocks (RB0–RB20 and RB30–RB49) are allocated in sub-frame 0.			
Note 4:	If more than one Code Block is present, an additional CRC sequence of L = 24 Bits is attached to each Code Block (otherwise L = 0 Bit).			

The reference measurement channels in Table A.3.3.3.2-2 apply for verifying FDD PMI accuracy measurement with two CRS antenna ports and four CSI-RS antenna ports.

Table A.3.3.3.2-2: Fixed Reference Channel for four antenna ports (CSI-RS)

Parameter	Unit	Value			
		R.44 FDD	R.45 FDD	R.45-1 FDD	R.60 FDD
Reference channel					
Channel bandwidth	MHz	10	10	10	10
Allocated resource blocks		50 <sup>3</sup>	50 <sup>3</sup>	39	50 <sup>3</sup>
Allocated subframes per Radio Frame		10	10	10	10
Modulation		QPSK	16QAM	16QAM	QPSK
Target Coding Rate		1/3	1/2	1/2	1/2
Information Bit Payload					
For Sub-Frames (Non CSI-RS subframe)	Bits	3624	11448	8760	6200
For Sub-Frames (CSI-RS subframe)	Bits	3624	11448	8760	6200
For Sub-Frames (ZeroPowerCSI-RS subframe)	Bits	n/a	n/a	n/a	N/A
For Sub-Frame 5	Bits	n/a	n/a	n/a	N/A
For Sub-Frame 0	Bits	2984	9528	8760	N/A
Number of Code Blocks per Sub-Frame (Note 4)					
For Sub-Frames (Non CSI-RS subframe)		1	2	2	2
For Sub-Frames (CSI-RS subframe)		1	2	2	2
For Sub-Frames (ZeroPowerCSI-RS subframe)	Bits	n/a	n/a	n/a	N/A
For Sub-Frame 5		n/a	n/a	n/a	N/A
For Sub-Frame 0		1	2	2	N/A
Binary Channel Bits Per Sub-Frame					
For Sub-Frames (Non CSI-RS subframe)	Bits	12000	24000	18720	12000
For Sub-Frames (CSI-RS subframe)	Bits	11600	23200	18096	11600
For Sub-Frames (ZeroPowerCSI-RS subframe)	Bits	n/a	n/a	n/a	N/A
For Sub-Frame 5	Bits	n/a	n/a	n/a	N/A
For Sub-Frame 0	Bits	9840	19680	18720	N/A
Max. Throughput averaged over 1 frame	Mbps	3.1976	10.1112	7.884	4.96
UE Category		≥ 1	≥ 2	≥ 1	≥ 1
Note 1:	2 symbols allocated to PDCCH for 20 MHz, 15 MHz and 10 MHz channel BW; 3 symbols allocated to PDCCH for 5 MHz and 3 MHz; 4 symbols allocated to PDCCH for 1.4 MHz.				
Note 2:	Reference signal, synchronization signals and PBCH allocated as per TS 36.211 [8].				
Note 3:	For R.44 and R.45, 50 resource blocks are allocated in sub-frames 1, 2, 3, 4, 6, 7, 8, 9 and 41 resource blocks (RB0-RB20 and RB30-RB49) are allocated in sub-frame 0.				
Note 4:	If more than one Code Block is present, an additional CRC sequence of L = 24 Bits is attached to each Code Block (otherwise L = 0 Bit).				

**Table A.3.3.3.2-3: Fixed Reference Channel for CDM-multiplexed DM RS with four CSI-RS antenna ports**

Parameter	Unit	Value
Reference channel		R.64 FDD
Channel bandwidth	MHz	10
Allocated resource blocks (Note 4)		6
Allocated subframes per 4 Radio Frames		15
Modulation		QPSK
Target Coding Rate		1/3
Information Bit Payload		
For Sub-Frames 0,1,4,5,6,9 (Note 3)	Bits	504
For Sub-Frames 2,3,7,8 (Note 3)	Bits	504
Number of Code Blocks		
For Sub-Frames 0,1,4,5,6,9	Code blocks	1
For Sub-Frames 2,3,7,8	Code blocks	1
Binary Channel Bits		
For Sub-Frames 0,1,4,5,6,9	Bits	1440
For Sub-Frames 2,3,7,8	Bits	1392
Max. Throughput averaged over 4 frames	Mbps	0.189
UE DL Category		0
Note 1:	2 symbols allocated to PDCCH.	
Note 2:	Reference signal, synchronization signals and PBCH allocated as per TS 36.211 [8].	
Note 3:	The downlink subframes are scheduled at the 0th, 1st, 2nd, 8th, 9th, 10th, 16th, 17th, 18th, 24th, 25th, 26th, 32nd, 33rd, 34th subframes every 40ms. Information bit payload is available if downlink subframe is scheduled.	
Note 4:	Allocated PRB positions start from {10, 11, ..., 10+N-1}, where N is the number of allocated resource blocks.	



## A.3.4 Reference measurement channel for PDSCH performance requirements (TDD)

### A.3.4.1 Single-antenna transmission (Common Reference Symbols)

**Table A.3.4.1-1: Fixed Reference Channel QPSK R=1/3**

Parameter	Unit	Value						
		R.4 TDD	R.42 TDD	R.2A TDD	R.2 TDD	R.42-1 TDD	R.42-2 TDD	R.42-3 TDD
Reference channel		R.4 TDD	R.42 TDD	R.2A TDD	R.2 TDD	R.42-1 TDD	R.42-2 TDD	R.42-3 TDD
Channel bandwidth	MHz	1.4	20	10	10	3	5	15
Allocated resource blocks (Note 6)		6	100	50	50	15	25	75
Uplink-Downlink Configuration (Note 4)		1	1	2	1	1	1	1
Allocated subframes per Radio Frame (D+S)		3	3+2	5+2	3+2	3+2	3+2	3+2
Modulation		QPSK	QPSK	QPSK	QPSK	QPSK	QPSK	QPSK
Target Coding Rate		1/3	1/3	1/3	1/3	1/3	1/3	1/3
Information Bit Payload (Note 6)								
For Sub-Frames 4,9	Bits	408	8760	4392	4392	1320	2216	6712
For Sub-Frames 1,6	Bits	N/A	7736	3240	3240	1128	1864	5992
For Sub-Frames 3,8	Bits	N/A	N/A	4392	N/A	N/A	N/A	N/A
For Sub-Frame 5	Bits	N/A	N/A	N/A	N/A	N/A	N/A	N/A
For Sub-Frame 0	Bits	208	8760	4392	4392	1064	1800	6712
Number of Code Blocks (Notes 5 and 6)								
For Sub-Frames 4,9		1	2	1	1	1	1	2
For Sub-Frames 1,6		N/A	2	1	1	1	1	1
For Sub-Frames 3,8		N/A	N/A	1	N/A	N/A	N/A	N/A
For Sub-Frame 5		N/A	N/A	N/A	N/A	N/A	N/A	N/A
For Sub-Frame 0		1	2	1	1	1	1	2
Binary Channel Bits (Note 6)								
For Sub-Frames 4,9	Bits	1368	27600	13800	13800	3780	6300	20700
For Sub-Frames 1,6	Bits	N/A	22656	11256	11256	3276	5556	16956
For Sub-Frames 3,8		N/A	N/A	13800	N/A	N/A	N/A	N/A
For Sub-Frame 5	Bits	N/A	N/A	N/A	N/A	N/A	N/A	N/A
For Sub-Frame 0	Bits	672	26904	13104	13104	3084	5604	20004
Max. Throughput averaged over 1 frame (Note 6)	Mbps	0.102	4.175	2.844	1.966	0.596	0.996	3.212
UE Category		≥ 1	≥ 1	≥ 1	≥ 1	≥ 1	≥ 1	≥ 1
Note 1:	2 symbols allocated to PDCCH for 20 MHz, 15 MHz and 10 MHz channel BW; 3 symbols allocated to PDCCH for 5 MHz and 3 MHz; 4 symbols allocated to PDCCH for 1.4 MHz. For subframe 1&6, only 2 OFDM symbols are allocated to PDCCH.							
Note 2:	For BW=1.4 MHz, the information bit payloads of special subframes are set to zero (no scheduling) to avoid problems with insufficient PDCCH performance at the test point.							
Note 3:	Reference signal, synchronization signals and PBCH allocated as per TS 36.211 [8].							
Note 4:	As per Table 4.2-2 in TS 36.211 [8].							
Note 5:	If more than one Code Block is present, an additional CRC sequence of L = 24 Bits is attached to each Code Block (otherwise L = 0 Bit).							
Note 6:	Given per component carrier per codeword.							

Table A.3.4.1-2: Fixed Reference Channel 16QAM R=1/2

Parameter	Unit	Value					
				R.3-1 TDD	R.3 TDD		
Reference channel							
Channel bandwidth	MHz	1.4	3	5	10	15	20
Allocated resource blocks				25	50		
Uplink-Downlink Configuration (Note 3)				1	1		
Allocated subframes per Radio Frame (D+S)				3+2	3+2		
Modulation				16QAM	16QAM		
Target Coding Rate				1/2	1/2		
Information Bit Payload							
For Sub-Frames 4,9	Bits			6456	14112		
For Sub-Frames 1,6	Bits			5160	11448		
For Sub-Frame 5	Bits			n/a	n/a		
For Sub-Frame 0	Bits			5736	12960		
Number of Code Blocks per Sub-Frame (see Note 4)							
For Sub-Frames 4,9				2	3		
For Sub-Frames 1,6				1	2		
For Sub-Frame 5				n/a	n/a		
For Sub-Frame 0				1	3		
Binary Channel Bits Per Sub-Frame							
For Sub-Frames 4,9	Bits			12600	27600		
For Sub-Frames 1,6	Bits			11112	22512		
For Sub-Frame 5	Bits			n/a	n/a		
For Sub-Frame 0	Bits			11208	26208		
Max. Throughput averaged over 1 frame	Mbps			2.897	6.408		
UE Category				≥ 1	≥ 2		
Note 1:	2 symbols allocated to PDCCH for 20 MHz, 15 MHz and 10 MHz channel BW; 3 symbols allocated to PDCCH for 5 MHz and 3 MHz; 4 symbols allocated to PDCCH for 1.4 MHz. For subframe 1&6, only 2 OFDM symbols are allocated to PDCCH.						
Note 2:	Reference signal, synchronization signals and PBCH allocated as per TS 36.211 [8]						
Note 3:	As per Table 4.2-2 in TS 36.211 [8]						
Note 4:	If more than one Code Block is present, an additional CRC sequence of L = 24 Bits is attached to each Code Block (otherwise L = 0 Bit)						

Table A.3.4.1-3: Fixed Reference Channel 64QAM R=3/4

Parameter	Unit	Value					
			R.5 TDD	R.6 TDD	R.7 TDD	R.8 TDD	R.9 TDD
Reference channel							
Channel bandwidth	MHz	1.4	3	5	10	15	20
Allocated resource blocks			15	25	50	75	100
Uplink-Downlink Configuration (Note 3)			1	1	1	1	1
Allocated subframes per Radio Frame (D+S)			3+2	3+2	3+2	3+2	3+2
Modulation		64QAM	64QAM	64QAM	64QAM	64QAM	64QAM
Target Coding Rate			3/4	3/4	3/4	3/4	3/4
Information Bit Payload							
For Sub-Frames 4,9	Bits		8504	14112	30576	46888	61664
For Sub-Frames 1,6	Bits		6968	11448	23688	35160	46888
For Sub-Frame 5	Bits		n/a	n/a	n/a	n/a	n/a
For Sub-Frame 0	Bits		6968	12576	30576	45352	61664
Number of Code Blocks per Sub-Frame (see Note 4)							
For Sub-Frames 4,9			2	3	5	8	11
For Sub-Frames 1,6			2	2	4	6	8
For Sub-Frame 5			n/a	n/a	n/a	n/a	n/a
For Sub-Frame 0			2	3	5	8	11
Binary Channel Bits Per Sub-Frame							
For Sub-Frames 4,9	Bits		11340	18900	41400	62100	82800
For Sub-Frames 1,6	Bits		9828	16668	33768	50868	67968
For Sub-Frame 5	Bits		n/a	n/a	n/a	n/a	n/a
For Sub-Frame 0	Bits		9252	16812	39312	60012	80712
Max. Throughput averaged over 1 frame	Mbps		3.791	6.370	13.910	20.945	27.877
UE Category			≥ 1	≥ 2	≥ 2	≥ 2	≥ 3
Note 1:	2 symbols allocated to PDCCH for 20 MHz, 15 MHz and 10 MHz channel BW; 3 symbols allocated to PDCCH for 5 MHz and 3 MHz; 4 symbols allocated to PDCCH for 1.4 MHz. For subframe 1&6, only 2 OFDM symbols are allocated to PDCCH.						
Note 2:	Reference signal, synchronization signals and PBCH allocated as per TS 36.211 [8]						
Note 3:	As per Table 4.2-2 TS 36.211 [8]						
Note 4:	If more than one Code Block is present, an additional CRC sequence of L = 24 Bits is attached to each Code Block (otherwise L = 0 Bit)						

Table A.3.4.1-3a: Fixed Reference Channel 64QAM R=3/4

Parameter	Unit	Value				
		R.6-1 TDD	R.7-1 TDD	R.8-1 TDD	R.9-1 TDD	R.9-2 TDD
Reference channel						
Channel bandwidth	MHz	5	10	15	20	20
Allocated resource blocks (Note 3)		18	17	17	17	83
Uplink-Downlink Configuration (Note 4)		1	1	1	1	1
Allocated subframes per Radio Frame (D+S)		3+2	3+2	3+2	3+2	3+2
Modulation		64QAM	64QAM	64QAM	64QAM	64QAM
Target Coding Rate		3/4	3/4	3/4	3/4	3/4
Information Bit Payload						
For Sub-Frames 4,9	Bits	10296	10296	10296	10296	51024
For Sub-Frames 1,6	Bits	8248	7480	7480	7480	39232
For Sub-Frame 5	Bits	n/a	n/a	n/a	n/a	n/a
For Sub-Frame 0	Bits	8248	10296	10296	10296	51024
Number of Code Blocks per Sub-Frame (Note 5)						
For Sub-Frames 4,9		2	2	2	2	9
For Sub-Frames 1,6		2	2	2	2	7
For Sub-Frame 5		n/a	n/a	n/a	n/a	n/a
For Sub-Frame 0		2	2	2	2	9
Binary Channel Bits Per Sub-Frame						
For Sub-Frames 4,9	Bits	13608	14076	14076	14076	68724
For Sub-Frames 1,6	Bits	11880	11628	11628	11628	56340
For Sub-Frame 5	Bits	n/a	n/a	n/a	n/a	n/a
For Sub-Frame 0	Bits	11520	14076	14076	14076	66636
Max. Throughput averaged over 1 frame	Mbps	4.534	4.585	4.585	4.585	23.154
UE Category		≥ 1	≥ 1	≥ 1	≥ 1	≥ 2
Note 1:	2 symbols allocated to PDCCH for 20 MHz, 15 MHz and 10 MHz channel BW; 3 symbols allocated to PDCCH for 5 MHz and 3 MHz; 4 symbols allocated to PDCCH for 1.4 MHz. For subframe 1&6, only 2 OFDM symbols are allocated to PDCCH.					
Note 2:	Reference signal, synchronization signals and PBCH allocated as per TS 36.211 [8]					
Note 3:	Localized allocation started from RB #0 is applied.					
Note 4:	As per Table 4.2-2 TS 36.211 [8]					
Note 5:	If more than one Code Block is present, an additional CRC sequence of L = 24 Bits is attached to each Code Block (otherwise L = 0 Bit)					

Table A.3.4.1-4: Fixed Reference Channel Single PRB

Parameter	Unit	Value					
			R.0 TDD		R.1 TDD		
Reference channel							
Channel bandwidth	MHz	1.4	3	5	10/20	15	20
Allocated resource blocks			1		1		
Uplink-Downlink Configuration (Note 3)			1		1		
Allocated subframes per Radio Frame (D+S)			3+2		3+2		
Modulation			16QAM		16QAM		
Target Coding Rate			1/2		1/2		
Information Bit Payload							
For Sub-Frames 4,9	Bits		224		256		
For Sub-Frames 1,6	Bits		208		208		
For Sub-Frame 5	Bits		n/a		n/a		
For Sub-Frame 0	Bits		224		256		
Number of Code Blocks per Sub-Frame (Note 4)							
For Sub-Frames 4,9			1		1		
For Sub-Frames 1,6			1		1		
For Sub-Frame 5			n/a		n/a		
For Sub-Frame 0			1		1		
Binary Channel Bits Per Sub-Frame							
For Sub-Frames 4,9	Bits		504		552		
For Sub-Frames 1,6	Bits		456		456		
For Sub-Frame 5	Bits		n/a		n/a		
For Sub-Frame 0	Bits		504		552		
Max. Throughput averaged over 1 frame	Mbps		0.109		0.118		
UE Category			≥ 1		≥ 1		
Note 1:	2 symbols allocated to PDCCH for 20 MHz, 15 MHz and 10 MHz channel BW; 3 symbols allocated to PDCCH for 5 MHz and 3 MHz; 4 symbols allocated to PDCCH for 1.4 MHz. For subframe 1&6, only 2 OFDM symbols are allocated to PDCCH.						
Note 2:	Reference signal, synchronization signals and PBCH allocated as per TS 36.211 [8]						
Note 3:	As per Table 4.2-2 in TS 36.211 [8]						
Note 4:	If more than one Code Block is present, an additional CRC sequence of L = 24 Bits is attached to each Code Block (otherwise L = 0 Bit)						

**Table A.3.4.1-5: Fixed Reference Channel Single PRB (MBSFN Configuration)**

Parameter	Unit	Value
Reference channel		R.29 TDD (MBSFN)
Channel bandwidth	MHz	10
Allocated resource blocks		1
MBSFN Configuration		010010
Uplink-Downlink Configuration (Note 4)		1
Allocated subframes per Radio Frame (D+S)		1+2
Modulation		16QAM
Target Coding Rate		1/2
Information Bit Payload		
For Sub-Frames 4,9	Bits	0 (MBSFN)
For Sub-Frames 1,6	Bits	208
For Sub-Frame 5	Bits	n/a
For Sub-Frame 0	Bits	256
Number of Code Blocks per Sub-Frame (Note 4)		
For Sub-Frames 4,9	Bits	0 (MBSFN)
For Sub-Frames 1,6	Bits	1
For Sub-Frame 5	Bits	n/a
Binary Channel Bits Per Sub-Frame		
For Sub-Frames 4,9	Bits	0 (MBSFN)
For Sub-Frames 1,6	Bits	456
For Sub-Frame 5	Bits	n/a
For Sub-Frame 0	Bits	552
Max. Throughput averaged over 1 frame	kbps	67.2
UE Category		≥ 1
Note 1:	2 symbols allocated to PDCCH	
Note 2:	Reference signal, synchronization signals and PBCH allocated as per TS 36.211 [8]	
Note 3:	MBSFN Subframe Allocation as defined in [5], one frame with 6 bits is chosen for MBSFN subframe allocation	
Note 4:	As per Table 4.2-2 in TS 36.211 [8]	
Note 5:	If more than one Code Block is present, an additional CRC sequence of L = 24 Bits is attached to each Code Block (otherwise L = 0 Bit)	

Table A.3.4.1-7: Fixed Reference Channel for CA demodulation with power imbalance

Parameter	Unit	Value	
		R.49 TDD	R.49-1 TDD
Reference channel		R.49 TDD	R.49-1 TDD
Channel bandwidth	MHz	20	15
Allocated resource blocks		100	75
Uplink-Downlink Configuration (Note 1)		1	1
Allocated subframes per Radio Frame (D+S)		3+2	3+2
Modulation		64QAM	64QAM
Number of OFDM symbols for PDCCH per component carrier			
For Sub-Frames 0,4,5,9	OFDM symbols	3	3
For Sub-Frames 1,6	OFDM symbols	2	2
Target Coding Rate			
For Sub-Frames 4,9		0.84	0.83
For Sub-Frames 1,6		0.81	0.80
For Sub-Frames 5		N/A	N/A
For Sub-Frames 0		0.87	0.86
Information Bit Payload			
For Sub-Frames 0, 4, 9	Bits	63776	46888
For Sub-Frame 1,6	Bits	55056	40576
For Sub-Frame 5	Bits	N/A	N/A
Number of Code Blocks per Sub-Frame (Note 2)			
For Sub-Frames 0, 4, 9	Code Blocks	11	8
For Sub-Frame 1,6	Code Blocks	9	7
For Sub-Frame 5	Code Blocks	N/A	N/A
Binary Channel Bits Per Sub-Frame			
For Sub-Frames 4,9	Bits	75600	56700
For Sub-Frame 1,6	Bits	67968	50868
For Sub-Frame 5	Bits	N/A	N/A
For Sub-Frame 0	Bits	73512	54612
Max. Throughput averaged over 1 frame	Mbps	30.144	22.182
UE Category		≥5	≥3
Note 1: Reference signal, synchronization signals and PBC allocated as per TS 36.211 [4].			
Note 2: If more than one Code Block is present, an additional CRC sequence of L = 24 Bits is attached to each Code Block (otherwise L = 0 Bit).			

## A.3.4.2 Multi-antenna transmission (Common Reference Symbols)

### A.3.4.2.1 Two antenna ports

**Table A.3.4.2.1-1: Fixed Reference Channel two antenna ports**

Parameter	Unit	Value										
		R.10 TDD	R.11 TDD	R.11-1 TDD	R.11-2 TDD	R.11-3 TDD (Note 6)	R.11-4 TDD	R.30 TDD	R.30-1 TDD	R.30-2 TDD	R.35 TDD	R.35-1 TDD
Reference channel												
Channel bandwidth	MHz	10	10	10	5	10	10	20	20	20	10	20
Allocated resource blocks		50	50	50	25	40	50	100	100	100	50	100
Uplink-Downlink Configuration (Note 3)		1	1	1	1	1	1	1	1	1	1	1
Allocated subframes per Radio Frame (D+S)		3+2	3+2	2+2	3+2	3+2	2	3+2	+2	2	2+2	2
Modulation		QPSK	16QA M	16QA M	16QA M	16QA M	QPSK	16QA M	16QA M	16QA M	64QA M	64QA M
Target Coding Rate		1/3	1/2	1/2	1/2	1/2	1/2	1/2	1/2	1/2	1/2	0.39
Information Bit Payload (Note 5)												
For Sub-Frames 4,9	Bits	4392	12960	12960	5736	10296	6968	25456	25456	25456	19848	30576
For Sub-Frames 1,6		3240	9528	9528	5160	9144	n/a	22920	21384	n/a	15840	n/a
For Sub-Frame 5	Bits	n/a	n/a	n/a	n/a	n/a	n/a	n/a	n/a	n/a	n/a	n/a
For Sub-Frame 0	Bits	4392	12960	n/a	4968	10296	n/a	25456	n/a	n/a	n/a	n/a
Number of Code Blocks per Sub-Frame (Note 4 and 5)												
For Sub-Frames 4,9		1	3	3	1	2	2	5	5	5	4	5
For Sub-Frames 1,6		1	2	2	1	2	n/a	4	4	n/a	3	n/a
For Sub-Frame 5		n/a	n/a	n/a	n/a	n/a	n/a	n/a	n/a	n/a	n/a	n/a
For Sub-Frame 0		1	3	n/a	1	2	n/a	5	n/a	n/a	n/a	n/a
Binary Channel Bits Per Sub-Frame (Note 5)												
For Sub-Frames 4,9	Bits	13200	26400	26400	12000	21120	13200	52800	52800	52800	39600	79200
For Sub-Frames 1,6		10656	21312	21312	10512	16992	10656	42912	42912	n/a	31968	n/a
For Sub-Frame 5	Bits	n/a	n/a	n/a	n/a	n/a	n/a	n/a	n/a	n/a	n/a	n/a
For Sub-Frame 0	Bits	12528	25056	n/a	10656	19776	12528	51456	n/a	n/a	n/a	n/a
Max. Throughput averaged over 1 frame (Note 5)	Mbps	1.966	5.794	4.498	2.676	4.918	1.39	12.22 1	9.368	5.091	7.138	6.115
UE Category		≥ 1	≥ 2	≥ 2	≥ 1	≥ 1	≥ 1	≥ 2	≥ 2	≥ 2	≥ 2	≥ 2
Note 1:	2 symbols allocated to PDCCH for 20 MHz, 15 MHz and 10 MHz channel BW; 3 symbols allocated to PDCCH for 5 MHz and 3 MHz; 4 symbols allocated to PDCCH for 1.4 MHz. For subframe 1&6, only 2 OFDM symbols are allocated to PDCCH.											
Note 2:	Reference signal, synchronization signals and PBCH allocated as per TS 36.211 [8].											
Note 3:	As per Table 4.2-2 in TS 36.211 [8].											
Note 4:	If more than one Code Block is present, an additional CRC sequence of L = 24 Bits is attached to each Code Block (otherwise L = 0 Bit).											
Note 5:	Given per component carrier per codeword.											
Note 6:	For R.11-3 resource blocks of RB6–RB45 are allocated.											



Table A.3.4.2.1-2: Fixed Reference Channel two antenna ports

Parameter	Unit	Value								
		R.46 TDD	R.47 TDD	R.35-2 TDD	R.11-5 TDD	R.11-6 TDD	R.11-7 TDD	R.11-8 TDD	R.11-9 TDD	R.11-10 TDD
Reference channel										
Channel bandwidth	MHz	10	10	10	1.4	3	5	10	15	10
Allocated resource blocks (Note 5)		50	50	50	6	15	25	50	75	50
Uplink-Downlink Configuration (Note 3)		1	1	1	1	1	1	1	1	1
Allocated subframes per Radio Frame (D+S)		3+2	3+2	2+2	2+2	2+2	2+2	2+2	2+2	3+2
Modulation		QPSK	16QAM	64QAM	16QAM	16QAM	16QAM	16QAM	16QAM	QPSK
Target Coding Rate				0.47	1/2	1/2	1/2	1/2	1/2	3/5
Information Bit Payload (Note 5)										
For Sub-Frames 4,9	Bits	5160	8760	18336	1352	3368	5736	12960	19080	7992
For Sub-Frames 1,6		3880	7480	14688	1128	3112	5160	10680	15840	5736
For Sub-Frame 5	Bits	N/A	N/A	N/A	N/A	N/A	N/A	N/A	N/A	N/A
For Sub-Frame 0	Bits	5160	8760	N/A	N/A	N/A	N/A	N/A	N/A	7992
Number of Code Blocks (Notes 4 and 5)										
For Sub-Frames 4,9		1	2	3	1	1	1	3	4	2
For Sub-Frames 1,6		1	2	3	1	1	1	2	3	1
For Sub-Frame 5		N/A	N/A	N/A	N/A	N/A	N/A	N/A	N/A	N/A
For Sub-Frame 0		1	2	N/A	N/A	N/A	N/A	N/A	N/A	2
Binary Channel Bits (Note 5)										
For Sub-Frames 4,9	Bits	13200	26400	39600	2592	7200	12000	26400	39600	13200
For Sub-Frames 1,6		10656	21312	31968	2304	6192	10512	21312	32112	10656
For Sub-Frame 5	Bits	N/A	N/A	N/A	N/A	N/A	N/A	N/A	N/A	N/A
For Sub-Frame 0	Bits	12528	25056	N/A	N/A	N/A	N/A	N/A	N/A	12528
Max. Throughput averaged over 1 frame (Note 5)	Mbps	2.324	4.124	6.604	0.496	1.296	2.179	4.498	6.984	3.5448
UE Category		≥ 1	≥ 1	≥ 2	≥ 1	≥ 1	≥ 1	≥ 2	≥ 2	≥ 2
Note 1:	2 symbols allocated to PDCCH for 20 MHz, 15 MHz and 10 MHz channel BW; 3 symbols allocated to PDCCH for 5 MHz and 3 MHz; 4 symbols allocated to PDCCH for 1.4 MHz. For subframe 1&6, only 2 OFDM symbols are allocated to PDCCH.									
Note 2:	Reference signal, synchronization signals and PBCH allocated as per TS 36.211 [8].									
Note 3:	As per Table 4.2-2 in TS 36.211 [8].									
Note 4:	If more than one Code Block is present, an additional CRC sequence of L = 24 Bits is attached to each Code Block (otherwise L = 0 Bit).									
Note 5:	Given per component carrier per codeword									

**Table A.3.4.2.1-3: Fixed Reference Channel two antenna ports for UE category 0**

Parameter	Unit	Value	
		R.62 TDD	R.63 TDD
Reference channel			
Channel bandwidth	MHz	10	10
Allocated resource blocks (Note 4)		3	1
Uplink-Downlink Configuration (Note 3)		1	1
Allocated subframes per Radio Frame (D+S)		4+2	4+2
Modulation		16QAM	64QAM
Target Coding Rate		1/2	1/2
Information Bit Payload			
For Sub-Frames 0,4,5,9	Bits	744	408
For Sub-Frames 1,6	Bits	440	280
Number of Code Blocks			
For Sub-Frames 0,4,5,9	Code blocks	1	1
For Sub-Frames 1,6	Clode blocls	1	1
Binary Channel Bits			
For Sub-Frames 0,4,5,9	Bits	1584	792
For Sub-Frames 1,6		1296	648
Max. Throughput averaged over 1 frame	Mbps	0.3856	0.2192
UE DL Category		0	0
Note 1:	2 symbols allocated to PDCCH.		
Note 2:	Reference signal, synchronization signals and PBCH allocated as per TS 36.211 [8].		
Note 3:	As per Table 4.2-2 in TS 36.211 [8].		
Note 4:	Allocated PRB positions start from {10, 11, ..., 10+N-1}, where N is the number of allocated resource blocks.		

## A.3.4.2.2 Four antenna ports

Table A.3.4.2.2-1: Fixed Reference Channel four antenna ports

Parameter	Unit	Value												
		R.12 TDD	R.13 TDD	R.14 TDD	R.14-1 TDD	R.14-2 TDD	R.43 TDD	R.36 TDD	R.43-1 TDD	R.43-2 TDD	R.43-3 TDD	R.43-4 TDD	R.43-5 TDD	
Reference channel														
Channel bandwidth	MHz	1.4	10	10	10	10	20	10	1.4	3	5	10	15	
Allocated resource blocks (Note 6)		6	50	50	6	3	100	50	6	15	25	50	75	
Uplink-Downlink Configuration (Note 4)		1	1	1	1	1	1	1	1	1	1	1	1	
Allocated subframes per Radio Frame (D+S)		3	3+2	2+2	2	2	2+2	2+2	2	2+2	2+2	2+2	2+2	
Modulation		QPS K	QPS K	16Q AM	16QA M	16QA M	16Q AM	64Q AM	16QA M	16QA M	16QA M	16QA M	16QA M	
Target Coding Rate		1/3	1/3	1/2	1/2	1/2	1/2	1/2	1/2	1/2	1/2	1/2	1/2	
Information Bit Payload (Note 6)														
For Sub-Frames 4,9	Bits	408	4392	1296 0	1544	744	2545 6	1833 6	1192	3368	5736	12960	19080	
For Sub-Frames 1,6	Bits	N/A	3240	9528	N/A	N/A	2138 4	1584 0	N/A	2856	5160	10680	15840	
For Sub-Frame 5	Bits	N/A	N/A	N/A	N/A	N/A	N/A	N/A	N/A	N/A	N/A	N/A	N/A	
For Sub-Frame 0	Bits	208	4392	N/A	N/A	N/A	N/A	N/A	N/A	N/A	N/A	N/A	N/A	
Number of Code Blocks (Notes 5 and 6)														
For Sub-Frames 4,9		1	1	3	1	1	5	3	1	1	1	3	4	
For Sub-Frames 1,6		N/A	1	2	N/A	N/A	4	3	N/A	1	1	2	3	
For Sub-Frame 5		N/A	N/A	N/A	N/A	N/A	N/A	N/A	N/A	N/A	N/A	N/A	N/A	
For Sub-Frame 0		1	1	N/A	N/A	N/A	N/A	N/A	N/A	N/A	N/A	N/A	N/A	
Binary Channel Bits (Note 6)														
For Sub-Frames 4,9	Bits	1248	1280 0	2560 0	3072	1536	5120 0	3840 0	2496	6960	11600	25600	38400	
For Sub-Frames 1,6		N/A	1025 6	2051 2	N/A	N/A	4131 2	3076 8	N/A	5952	10112	20512	30912	
For Sub-Frame 5	Bits	N/A	N/A	N/A	N/A	N/A	N/A	N/A	N/A	N/A	N/A	N/A	N/A	
For Sub-Frame 0	Bits	624	1217 6	N/A	N/A	N/A	N/A	N/A	N/A	N/A	N/A	N/A	N/A	
Max. Throughput averaged over 1 frame (Note 6)	Mbps	0.10 2	1.96 6	4.49 8	0.309	0.149	9.36 8	6.83 5	0.238	1.245	2.179	4.728	6.984	
UE Category		≥ 1	≥ 1	≥ 2	≥ 1	≥ 1	≥ 2	≥ 2	≥ 1	≥ 1	≥ 1	≥ 2	≥ 2	
Note 1:	2 symbols allocated to PDCCH for 20 MHz, 15 MHz and 10 MHz channel BW; 3 symbols allocated to PDCCH for 5 MHz and 3 MHz; 4 symbols allocated to PDCCH for 1.4 MHz. For subframe 1&6, only 2 OFDM symbols are allocated to PDCCH.													
Note 2:	For BW=1.4 MHz, the information bit payloads of special subframes are set to zero (no scheduling) to avoid problems with insufficient PDCCH performance at the test point.													
Note 3:	Reference signal, synchronization signals and PBCH allocated as per TS 36.211 [8].													
Note 4:	As per Table 4.2-2 in TS 36.211 [8].													
Note 5:	If more than one Code Block is present, an additional CRC sequence of L = 24 Bits is attached to each Code Block (otherwise L = 0 Bit).													
Note 6:	Given per component carrier per codeword.													

### A.3.4.3 Reference Measurement Channels for UE-Specific Reference Symbols

#### A.3.4.3.1 Single antenna port (Cell Specific)

The reference measurement channels in Table A.3.4.3.1-1 apply for verifying demodulation performance for UE-specific reference symbols with one cell-specific antenna port.

**Table A.3.4.3.1-1: Fixed Reference Channel for DRS**

Parameter	Unit	Value					
		R.25 TDD	R.26 TDD	R.26-1 TDD	R.27 TDD	R.27-1 TDD	R.28 TDD
Reference channel							
Channel bandwidth	MHz	10	10	5	10	10	10
Allocated resource blocks		50 <sup>4</sup>	50 <sup>4</sup>	25 <sup>4</sup>	50 <sup>4</sup>	18 <sup>6</sup>	1
Uplink-Downlink Configuration (Note 3)		1	1	1	1	1	1
Allocated subframes per Radio Frame (D+S)		3+2	3+2	3+2	3+2	3+2	3+2
Modulation		QPSK	16QAM	16QAM	64QAM	64QAM	16QAM
Target Coding Rate		1/3	1/2	1/2	3/4	3/4	1/2
Information Bit Payload							
For Sub-Frames 4,9	Bits	4392	12960	5736	28336	10296	224
For Sub-Frames 1,6	Bits	3240	9528	4584	22920	8248	176
For Sub-Frame 5	Bits	n/a	n/a	n/a	n/a	n/a	n/a
For Sub-Frame 0	Bits	2984	9528	3880	22152	10296	224
Number of Code Blocks per Sub-Frame (see Note 5)							
For Sub-Frames 4,9		1	3	1	5	2	1
For Sub-Frames 1,6		1	2	1	4	2	1
For Sub-Frame 5		n/a	n/a	n/a	n/a	n/a	n/a
For Sub-Frame 0		1	2	1	4	2	1
Binary Channel Bits Per Sub-Frame							
For Sub-Frames 4,9	Bits	12600	25200	11400	37800	13608	504
For Sub-Frames 1,6	Bits	10356	20712	10212	31068	11340	420
For Sub-Frame 5	Bits	n/a	n/a	n/a	n/a	n/a	n/a
For Sub-Frame 0	Bits	10332	20664	7752	30996	13608	504
Max. Throughput averaged over 1 frame	Mbps	1.825	5.450	2.452	12.466	4.738	0.102
UE Category		≥ 1	≥ 2	≥ 1	≥ 2	≥ 1	≥ 1
Note 1:	2 symbols allocated to PDCCH for 20 MHz, 15 MHz and 10 MHz channel BW; 3 symbols allocated to PDCCH for 5 MHz and 3 MHz; 4 symbols allocated to PDCCH for 1.4 MHz. For subframe 1&6, only 2 OFDM symbols are allocated to PDCCH.						
Note 2:	Reference signal, synchronization signals and PBCH allocated as per TS 36.211 [8].						
Note 3:	as per Table 4.2-2 in TS 36.211 [8].						
Note 4:	For R.25, R.26 and R.27, 50 resource blocks are allocated in sub-frames 1, 4, 6, 9 and 41 resource blocks (RB0–RB20 and RB30–RB49) are allocated in sub-frame 0. For R.26-1, 25 resource blocks are allocated in sub-frames 1, 4, 6, 9 and 17 resource blocks (RB0–RB7 and RB16–RB24) are allocated in sub-frame 0.						
Note 5:	If more than one Code Block is present, an additional CRC sequence of L = 24 Bits is attached to each Code Block (otherwise L = 0 Bit).						
Note 6:	Localized allocation started from RB #0 is applied.						

#### A.3.4.3.2 Two antenna ports (Cell Specific)

The reference measurement channels in Table A.3.4.3.2-1 apply for verifying demodulation performance for CDM-multiplexed UE specific reference symbols with two cell-specific antenna ports.

Table A.3.4.3.2-1: Fixed Reference Channel for CDM-multiplexed DM RS

Parameter	Unit	Value					
		R.31 TDD	R.32 TDD	R.32-1 TDD	R.33 TDD	R.33-1 TDD	R.34 TDD
Reference channel							
Channel bandwidth	MHz	10	10	5	10	10	10
Allocated resource blocks		50 <sup>a</sup>	50 <sup>a</sup>	25 <sup>a</sup>	50 <sup>a</sup>	18 <sup>b</sup>	50 <sup>a</sup>
Uplink-Downlink Configuration (Note 3)		1	1	1	1	1	1
Allocated subframes per Radio Frame (D+S)		3+2	3+2	3+2	3+2	3+2	3+2
Modulation		QPSK	16QAM	16QAM	64QAM	64QAM	64QAM
Target Coding Rate		1/3	1/2	1/2	3/4	3/4	1/2
Information Bit Payload							
For Sub-Frames 4,9	Bits	3624	11448	5736	27376	9528	18336
For Sub-Frames 1,6		2664	7736	3112	16992	7480	11832
For Sub-Frame 5	Bits	n/a	n/a	n/a	n/a	n/a	n/a
For Sub-Frame 0	Bits	2984	9528	3496	22152	9528	14688
Number of Code Blocks per Sub-Frame (Note 5)							
For Sub-Frames 4,9		1	2	1	5	2	3
For Sub-Frames 1,6		1	2	1	3	2	2
For Sub-Frame 5		n/a	n/a	n/a	n/a	n/a	n/a
For Sub-Frame 0		1	2	1	4	2	3
Binary Channel Bits Per Sub-Frame							
For Sub-Frames 4,9	Bits	12000	24000	10800	36000	12960	36000
For Sub-Frames 1,6		7872	15744	6528	23616	10368	23616
For Sub-Frame 5	Bits	n/a	n/a	n/a	n/a	n/a	n/a
For Sub-Frame 0	Bits	9840	19680	7344	29520	12960	29520
Max. Throughput averaged over 1 frame	Mbps	1.556	4.79	2.119	11.089	4.354	7.502
UE Category		≥ 1	≥ 2	≥ 1	≥ 2	≥ 1	≥ 2
Note 1:	2 symbols allocated to PDCCH for 20 MHz, 15 MHz and 10 MHz channel BW; 3 symbols allocated to PDCCH for 5 MHz and 3 MHz; 4 symbols allocated to PDCCH for 1.4 MHz. For subframe 1&6, only 2 OFDM symbols are allocated to PDCCH.						
Note 2:	Reference signal, synchronization signals and PBCH allocated as per TS 36.211 [8].						
Note 3:	as per Table 4.2-2 in TS 36.211 [8].						
Note 4:	For R.31, R.32, R.33 and R.34, 50 resource blocks are allocated in sub-frames 4, 9 and 41 resource blocks (RB0–RB20 and RB30–RB49) are allocated in sub-frame 0 and the DwPTS portion of sub-frames 1, 6. For R.32-1, 25 resource blocks are allocated in sub-frames 4, 9 and 17 resource blocks (RB0–RB7 and RB16–RB24) are allocated in sub-frame 0 and the DwPTS portion of sub-frames 1, 6.						
Note 5:	If more than one Code Block is present, an additional CRC sequence of L = 24 Bits is attached to each Code Block (otherwise L = 0 Bit).						
Note 6:	Localized allocation started from RB#0 is applied.						

### A.3.4.3.3 Two antenna ports (CSI-RS)

The reference measurement channels in Table A.3.4.3.3-1 apply for verifying demodulation performance for CDM-multiplexed UE specific reference symbols with two cell-specific antenna ports and two CSI-RS antenna ports.

**Table A.3.4.3.3-1: Fixed Reference Channel for CDM-multiplexed DM RS with two CSI-RS antenna ports**

Parameter	Unit	Value
Reference channel		R.51 TDD
Channel bandwidth	MHz	10
Allocated resource blocks		50 (Note 5)
Uplink-Downlink Configuration (Note 3)		1
Allocated subframes per Radio Frame (D+S)		3+2
Modulation		16QAM
Target Coding Rate		1/2
Information Bit Payload		
For Sub-Frames 4,9 (non CSI-RS subframe)	Bits	11448
For Sub-Frame 4,9	Bits	11448
For Sub-Frames 1,6	Bits	7736
For Sub-Frame 5	Bits	n/a
For Sub-Frame 0	Bits	9528
Number of Code Blocks (Note 4)		
For Sub-Frames 4, 9 (non CSI-RS subframe)	Code blocks	2
For Sub-Frames 4,9	Code blocks	2
For Sub-Frames 1,6	Code blocks	2
For Sub-Frame 5		n/a
For Sub-Frame 0	Code blocks	2
Binary Channel Bits		
For Sub-Frames 4, 9 (non CSI-RS subframe)	Bits	24000
For Sub-Frames 4,9		22800
For Sub-Frames 1,6		15744
For Sub-Frame 5	Bits	n/a
For Sub-Frame 0	Bits	19680
Max. Throughput averaged over 1 frame	Mbps	4.7896
UE Category		≥ 2
Note 1:	2 symbols allocated to PDCCH.	
Note 2:	Reference signal, synchronization signals and PBCH allocated as per TS 36.211 [8].	
Note 3:	as per Table 4.2-2 in TS 36.211 [8].	
Note 4:	If more than one Code Block is present, an additional CRC sequence of L = 24 Bits is attached to each Code Block (otherwise L = 0 Bit).	
Note 5:	50 resource blocks are allocated in sub-frames 4, 9 and 41 resource blocks (RB0–RB20 and RB30–RB49) are allocated in sub-frame 0 and the DwPTS portion of sub-frames 1, 6.	

The reference measurement channels in Table A3.4.3.3-2 apply for verifying demodulation performance for UE-specific reference symbols with two cell specific antenna ports and two CSI-RS antenna ports with ZP CSI-RS and NZP CSI-RS in same subframe.

**Table A.3.4.3.3-2: Fixed Reference Channel for CDM-multiplexed DM RS with two CSI-RS antenna ports with ZP CSI-RS and NZP CSI-RS**

Parameter	Unit	Value		
		R.52 TDD	R.53 TDD	R.54 TDD
Reference channel		R.52 TDD	R.53 TDD	R.54 TDD
Channel bandwidth	MHz	10	10	10
Allocated resource blocks		50 (Note 5)	50 (Note 5)	50 (Note 5)
Uplink-Downlink Configuration (Note 3)		1	1	1
Allocated subframes per Radio Frame (D+S)		3+2	3+2	3+2
Modulation		64QAM	64QAM	16QAM
Target Coding Rate		1/2	1/2	1/2
Information Bit Payload				
For Sub-Frame 4,9	Bits	16416	16416	11448
For Sub-Frames 1,6	Bits	11832	11832	7736
For Sub-Frame 5	Bits	n/a	n/a	n/a
For Sub-Frame 0	Bits	14688	14688	9528
Number of Code Blocks (Note 4)				
For Sub-Frames 4,9	Code blocks	3	3	2
For Sub-Frames 1,6	Code blocks	2	2	2
For Sub-Frame 5		n/a	n/a	n/a
For Sub-Frame 0	Code blocks	3	3	2
Binary Channel Bits				
For Sub-Frames 4,9		34200	33600	22800
For Sub-Frames 1,6		23616	23616	15744
For Sub-Frame 5	Bits	n/a	n/a	n/a
For Sub-Frame 0	Bits	29520	29520	19680
Max. Throughput averaged over 1 frame	Mbps	7.1184	7.1184	4.7896
UE Category		≥ 2	≥ 2	≥ 2
Note 1: 2 symbols allocated to PDCCH. Note 2: Reference signal, synchronization signals and PBCH allocated as per TS 36.211 [8]. Note 3: as per Table 4.2-2 in TS 36.211 [4]. Note 4: If more than one Code Block is present, an additional CRC sequence of L = 24 Bits is attached to each Code Block (otherwise L = 0 Bit). Note 5: 50 resource blocks are allocated in sub-frames 4, 9 and 41 resource blocks (RB0–RB20 and RB30–RB49) are allocated in sub-frame 0 and the DwPTS portion of sub-frames 1, 6.				

#### A.3.4.3.4 Four antenna ports (CSI-RS)

The reference measurement channels in Table A.3.4.3.4-1 apply for verifying demodulation performance for CDM-multiplexed UE specific reference symbols with two cell-specific antenna ports and four CSI-RS antenna ports.

**Table A.3.4.3.4-1: Fixed Reference Channel for CDM-multiplexed DM RS with four CSI-RS antenna ports**

Parameter	Unit	Value	
Reference channel		R.44 TDD	R.48 TDD
Channel bandwidth	MHz	10	10
Allocated resource blocks		50 (Note 4)	50 (Note 4)
Uplink-Downlink Configuration (Note 3)		1	1
Allocated subframes per Radio Frame (D+S)		3+2	3+2
Modulation		64QAM	QPSK
Target Coding Rate		1/2	
Information Bit Payload			
For Sub-Frames 4,9 (non CSI-RS subframe)	Bits	18336	n/a
For Sub-Frames 4,9 (CSI-RS subframe)	Bits	16416	6200
For Sub-Frames 1,6		11832	4264
For Sub-Frame 5	Bits	n/a	n/a
For Sub-Frame 0	Bits	14688	4968
Number of Code Blocks per Sub-Frame (Note 5)			
For Sub-Frames 4,9 (non CSI-RS subframe)		3	2
For Sub-Frames 4,9 (CSI-RS subframe)		3	2
For Sub-Frames 1,6		2	1
For Sub-Frame 5		n/a	n/a
For Sub-Frame 0		3	1
Binary Channel Bits Per Sub-Frame			
For Sub-Frames 4,9 (non CSI-RS subframe)	Bits	36000	12000
For Sub-Frames 4,9 (CSI-RS subframe)	Bits	33600	11600
For Sub-Frames 1,6		23616	7872
For Sub-Frame 5	Bits	n/a	n/a
For Sub-Frame 0	Bits	29520	9840
Max. Throughput averaged over 1 frame	Mbps	7.1184	2.5896
UE Category		$\geq 2$	$\geq 1$
Note 1:	2 symbols allocated to PDCCH		
Note 2:	Reference signal, synchronization signals and PBCH allocated as per TS 36.211 [8].		
Note 3:	as per Table 4.2-2 in TS 36.211 [8].		
Note 4:	50 resource blocks are allocated in sub-frames 4, 9 and 41 resource blocks (RB0–RB20 and RB30–RB49) are allocated in sub-frame 0 and the DwPTS portion of sub-frames 1, 6.		
Note 5:	If more than one Code Block is present, an additional CRC sequence of L = 24 Bits is attached to each Code Block (otherwise L = 0 Bit).		

The reference measurement channels in Table A.3.4.3.4-2 apply for verifying TDD PMI accuracy measurement with two CRS antenna ports and four CSI-RS antenna ports.



Table A.3.4.3.4-2: Fixed Reference Channel for four antenna ports (CSI-RS)

Parameter	Unit	Value		
		R.60 TDD	R.61 TDD	R.61-1 TDD
Reference channel		R.60 TDD	R.61 TDD	R.61-1 TDD
Channel bandwidth	MHz	10	10	10
Allocated resource blocks		50 <sup>4</sup>	50 <sup>4</sup>	39 <sup>5</sup>
Uplink-Downlink Configuration (Note 3)		1	1	1
Allocated subframes per Radio Frame (D+S)		4+2	4+2	4+2
Allocated subframes per Radio Frame		10	10	10
Modulation		QPSK	16QAM	16QAM
Target Coding Rate		1/2	1/2	1/2
Information Bit Payload				
For Sub-Frames 4 and 9 (Non CSI-RS subframe)	Bits	N/A	N/A	N/A
For Sub-Frames 4 and 9 (CSI-RS subframe)	Bits	6200	11448	8760
For Sub-Frames 1,6	Bits	N/A	7736	7480
For Sub-Frame 5	Bits	N/A	N/A	N/A
For Sub-Frame 0	Bits	N/A	9528	8760
Number of Code Blocks per Sub-Frame (Note 6)				
For Sub-Frames 4 and 9 (Non CSI-RS subframe)		N/A	N/A	N/A
For Sub-Frames 4 and 9 (CSI-RS subframe)		2	2	2
For Sub-Frames 1,6		N/A	2	2
For Sub-Frame 5		N/A	N/A	N/A
For Sub-Frame 0		N/A	2	2
Binary Channel Bits Per Sub-Frame				
For Sub-Frames 4 and 9 (Non CSI-RS subframe)	Bits	N/A	N/A	N/A
For Sub-Frames 4 and 9 (CSI-RS subframe)	Bits	11600	23200	18096
For Sub-Frames 1,6	Bits	N/A	15744	14976
For Sub-Frame 5	Bits	N/A	N/A	N/A
For Sub-Frame 0	Bits	N/A	19680	18720
Max. Throughput averaged over 1 frame	Mbps	1.24	4.7896	4.1240
UE Category		≥ 1	≥ 2	≥ 1
Note 1:	2 symbols allocated to PDCCH for 20 MHz, 15 MHz and 10 MHz channel BW; 3 symbols allocated to PDCCH for 5 MHz and 3 MHz; 4 symbols allocated to PDCCH for 1.4 MHz. For subframe 1 and 6, only 2 OFDM symbols are allocated to PDCCH.			
Note 2:	Reference signal, synchronization signals and PBCH allocated as per TS 36.211 [4].			
Note 3:	As per Table 4.2-2 in TS 36.211 [8].			
Note 4:	For R.60 and R.61, 50 resource blocks are allocated in sub-frames 4, 9 and 41 resource blocks (RB0–RB20 and RB30–RB49) are allocated in sub-frame 0 and the DwPTS portion of sub-frames 1 and 6.			
Note 5:	For R.61-1, 39 resource blocks (RB0–RB20 and RB30–RB47) are allocated in sub-frame 0, 1, 4, 6 and 9.			
Note 6:	If more than one Code Block is present, an additional CRC sequence of L = 24 Bits is attached to each Code Block (otherwise L = 0 Bit).			
Note 7:	Localized allocation started from RB #0 is applied.			

**Table A.3.4.3.4-3: Fixed Reference Channel for CDM-multiplexed DM RS with four CSI-RS antenna ports**

Parameter	Unit	Value
Reference channel		R.64 TDD
Channel bandwidth	MHz	10
Allocated resource blocks (Note 4)		6
Uplink-Downlink Configuration (Note 3)		1
Allocated subframes per Radio Frame (D+S)		4+2
Modulation		QPSK
Target Coding Rate		1/3
Information Bit Payload		
For Sub-Frames 4,9 (non CSI-RS subframe)	Bits	504
For Sub-Frames 4,9 (CSI-RS subframe)	Bits	504
For Sub-Frames 1,6		256
For Sub-Frames 0,5	Bits	504
Number of Code Blocks per Sub-Frame		
For Sub-Frames 4,9 (non CSI-RS subframe)	Code blocks	1
For Sub-Frames 4,9 (CSI-RS subframe)	Code blocks	1
For Sub-Frames 1,6	Code blocks	1
For Sub-Frames 0,5	Code blocks	1
Binary Channel Bits Per Sub-Frame		
For Sub-Frames 4,9 (non CSI-RS subframe)	Bits	1440
For Sub-Frames 4,9 (CSI-RS subframe)	Bits	1352
For Sub-Frames 1,6		1152
For Sub-Frames 0,5	Bits	1440
Max. Throughput averaged over 1 frame	Mbps	0.2528
UE DL Category		0
Note 1:	2 symbols allocated to PDCCH.	
Note 2:	Reference signal, synchronization signals and PBCH allocated as per TS 36.211 [8].	
Note 3:	as per Table 4.2-2 in TS 36.211 [4].	
Note 4:	Allocated PRB positions start from {10, 11, ..., 10+N-1}, where N is the number of allocated resource blocks.	

#### A.3.4.3.5 Eight antenna ports (CSI-RS)

The reference measurement channels in Table A.3.4.3.5-1 apply for verifying demodulation performance for CDM-multiplexed UE specific reference symbols with two cell-specific antenna ports and eight CSI-RS antenna ports.

**Table A.3.4.3.5-1: Fixed Reference Channel for CDM-multiplexed DM RS with eight CSI-RS antenna ports**

Parameter	Unit	Value
Reference channel		R.50 TDD
Channel bandwidth	MHz	10
Allocated resource blocks		50 (Note 4)
Uplink-Downlink Configuration (Note 3)		1
Allocated subframes per Radio Frame (D+S)		3+2
Modulation		QPSK
Target Coding Rate		1/3
Information Bit Payload		
For Sub-Frames 4,9 (non CSI-RS subframe)	Bits	3624
For Sub-Frames 4,9 (CSI-RS subframe)	Bits	3624
For Sub-Frames 1,6		2664
For Sub-Frame 5	Bits	n/a
For Sub-Frame 0	Bits	2984
Number of Code Blocks per Sub-Frame (Note 5)		
For Sub-Frames 4,9 (non CSI-RS subframe)		1
For Sub-Frames 4,9 (CSI-RS subframe)		1
For Sub-Frames 1,6		1
For Sub-Frame 5		n/a
For Sub-Frame 0		1
Binary Channel Bits Per Sub-Frame		
For Sub-Frames 4,9 (non CSI-RS subframe)	Bits	12000
For Sub-Frames 4,9 (CSI-RS subframe)	Bits	10400
For Sub-Frames 1,6		7872
For Sub-Frame 5	Bits	n/a
For Sub-Frame 0	Bits	9840
Max. Throughput averaged over 1 frame	Mbps	1.556
UE Category		$\geq 1$
Note 1: 2 symbols allocated to PDCCH. Note 2: Reference signal, synchronization signals and PBCH allocated as per TS 36.211 [8]. Note 3: as per Table 4.2-2 in TS 36.211 [8]. Note 4: 50 resource blocks are allocated in sub-frames 4, 9 and 41 resource blocks (RB0–RB20 and RB30–RB49) are allocated in sub-frame 0 and the DwPTS portion of sub-frames 1, 6. Note 5: If more than one Code Block is present, an additional CRC sequence of L = 24 Bits is attached to each Code Block (otherwise L = 0 Bit).		

The reference measurement channels in Table A.3.4.3.5-2 apply for verifying TDD PMI accuracy measurement with two CRS antenna ports and eight CSI-RS antenna ports.

Table A.3.4.3.5-2: Fixed Reference Channel for eight antenna ports (CSI-RS)

Parameter	Unit	Value	
		R.45 TDD	R.45-1 TDD
Reference channel			
Channel bandwidth	MHz	10	10
Allocated resource blocks		50 <sup>†</sup>	39
Uplink-Downlink Configuration (Note 3)		1	1
Allocated subframes per Radio Frame (D+S)		4+2	4+2
Allocated subframes per Radio Frame		10	10
Modulation		16QAM	16QAM
Target Coding Rate		1/2	1/2
Information Bit Payload			
For Sub-Frames 4 and 9 (Non CSI-RS subframe)	Bits	n/a	n/a
For Sub-Frames 4 and 9 (CSI-RS subframe)	Bits	11448	8760
For Sub-Frames 1,6	Bits	7736	7480
For Sub-Frame 5	Bits	n/a	n/a
For Sub-Frame 0	Bits	9528	8760
Number of Code Blocks per Sub-Frame (Note 5)			
For Sub-Frames 4 and 9 (Non CSI-RS subframe)		n/a	n/a
For Sub-Frames 4 and 9 (CSI-RS subframe)		2	2
For Sub-Frames 1,6		2	2
For Sub-Frame 5		n/a	n/a
For Sub-Frame 0		2	2
Binary Channel Bits Per Sub-Frame			
For Sub-Frames 4 and 9 (Non CSI-RS subframe)	Bits	n/a	n/a
For Sub-Frames 4 and 9 (CSI-RS subframe)	Bits	22400	17472
For Sub-Frames 1,6	Bits	15744	14976
For Sub-Frame 5	Bits	n/a	n/a
For Sub-Frame 0	Bits	19680	18720
Max. Throughput averaged over 1 frame	Mbps	4.7896	4.1240
UE Category		≥ 2	≥ 1
Note 1:	2 symbols allocated to PDCCH for 20 MHz, 15 MHz and 10 MHz channel BW; 3 symbols allocated to PDCCH for 5 MHz and 3 MHz; 4 symbols allocated to PDCCH for 1.4 MHz. For subframe 1&6, only 2 OFDM symbols are allocated to PDCCH.		
Note 2:	Reference signal, synchronization signals and PBCH allocated as per TS 36.211 [8].		
Note 3:	As per Table 4.2-2 in TS 36.211 [8].		
Note 4:	For R.45, 50 resource blocks are allocated in sub-frames 4, 9 and 41 resource blocks (RB0-RB20 and RB30-RB49) are allocated in sub-frame 0 and the DwPTS portion of sub-frames 1, 6.		
Note 5:	If more than one Code Block is present, an additional CRC sequence of L = 24 Bits is attached to each Code Block (otherwise L = 0 Bit).		
Note 6:	Localized allocation started from RB #0 is applied.		

## A.3.5 Reference measurement channels for PDCCH/PCFICH performance requirements

### A.3.5.1 FDD

**Table A.3.5.1-1: Reference Channel FDD**

Parameter	Unit	Value				
		R.15 FDD	R.15-1 FDD	R.15-2 FDD	R.16 FDD	R.17 FDD
Reference channel						
Number of transmitter antennas		1	2	2	2	4
Channel bandwidth	MHz	10	10	10	1.4	10
Number of OFDM symbols for PDCCH	symbols	2	3	2	2	2
Aggregation level	CCE	8	8	8	2	4
DCI Format		Format 1	Format 1	Format 1	Format 2	Format 2
Cell ID		0	0	0	0	0
Payload (without CRC)	Bits	31	31	31	31	46

**Table A.3.5.1-1A: Reference Channel FDD**

Parameter	Unit	Value	
		R.16_1 FDD	R.17_1 FDD
Reference channel			
Number of transmitter antennas		2	4
Channel bandwidth	MHz	10	5
Number of OFDM symbols for PDCCH	symbols	2	2
Aggregation level	CCE	4	2
DCI Format		Format 2	Format 2
Cell ID		0	0
Payload (without CRC)	Bits	43	42

**Table A.3.5.1-2: Additional PDSCH Reference Channel FDD**

Parameter	Unit	Value				
		1	2	2	4	4
Number of transmitter antennas		1	2	2	4	4
Channel bandwidth	MHz	10	1.4	10	10	5
Allocated Resource Blocks		50	6	50	50	25
Modulation		QPSK	QPSK	QPSK	QPSK	QPSK
Target Coding Rate		1/3	1/3	1/3	1/3	1/3
Information Bit Payload						
For Sub-Frames 1,2,3,4,6,7,8,9	Bits	4392	504	4392	4392	2216
For Sub-Frame 5		n/a	n/a	n/a	n/a	n/a
For Sub-Frame 0	Bits	4392	256	4392	3624	1800
Number of Code Blocks per Sub-Frame						
For Sub-Frames 1,2,3,4,6,7,8,9		1	1	1	1	1
For Sub-Frame 5		n/a	n/a	n/a	n/a	n/a
For Sub-Frame 0		1	1	1	1	1
Binary Channel Bits Per Sub-Frame						
For Sub-Frames 1,2,3,4,6,7,8,9	Bits	13800	1584	13200	12800	6400
For Sub-Frame 5	Bits	n/a	n/a	n/a	n/a	n/a
For Sub-Frame 0		12960	768	12384	12032	5632
Max. Throughput averaged over 1 frame	Mbps	3.953	0.429	3.953	3.876	1.953
UE Category		≥ 1	≥ 1	≥ 1	≥ 1	≥ 1

Note 1: 2 symbols allocated to PDCCH for all BW.

**Table A.3.5.1-2A: Additional PDSCH Reference Channel FDD**

Parameter	Unit	Value
Number of transmitter antennas		2
Channel bandwidth	MHz	10
Allocated Resource Blocks		50
Modulation		QPSK
Target Coding Rate		1/3
Information Bit Payload		
For Sub-Frames 1,2,3,4,6,7,8,9	Bits	3624
For Sub-Frame 5		n/a
For Sub-Frame 0	Bits	3624
Number of Code Blocks per Sub-Frame		
For Sub-Frames 1,2,3,4,6,7,8,9		1
For Sub-Frame 5		n/a
For Sub-Frame 0		1
Binary Channel Bits Per Sub-Frame		
For Sub-Frames 1,2,3,4,6,7,8,9	Bits	12000
For Sub-Frame 5	Bits	n/a
For Sub-Frame 0		11184
Max. Throughput averaged over 1 frame	Mbps	3.262
UE Category		≥ 1
Note 1: 3 symbols allocated to PDCCH for all BW.		

### A.3.5.2 TDD

**Table A.3.5.2-1: Reference Channel TDD**

Parameter	Unit	Value				
		R.15 TDD	R.15-1 TDD	R.15-2 TDD	R.16 TDD	R.17 TDD
Reference channel						
Number of transmitter antennas		1	2	2	2	4
Channel bandwidth	MHz	10	10	10	1.4	10
Number of OFDM symbols for PDCCH	symbols	2	3	2	2	2
Aggregation level	CCE	8	8	8	2	4
DCI Format		Format 1	Format 1	Format 1	Format 2	Format 2
Cell ID		0	0	0	0	0
Payload (without CRC)	Bits	34	34	34	34	49

**Table A.3.5.2-1A: Reference Channel TDD**

Parameter	Unit	Value	
Reference channel		R.16_1 TDD	R.17_1 TDD
Number of transmitter antennas		2	4
Channel bandwidth	MHz	10	5
Number of OFDM symbols for PDCCH	symbols	2	2
Aggregation level	CCE	4	2
DCI Format		Format 2	Format 2
Cell ID		0	0
Payload (without CRC)	Bits	46	45

Table A.3.5.2-2: Additional PDSCH Reference Channel TDD

Parameter	Unit	Value				
		1	2	4	5	6
Number of transmitter antennas		1	2	4	5	6
Channel bandwidth	MHz	10	1.4	10	10	5
Uplink-Downlink Configuration (Note 2)		0	0	0	0	0
Allocated Resource Blocks		50	6	50	50	25
Modulation		QPSK	QPSK	QPSK	QPSK	QPSK
Target Coding Rate		1/3	1/3	1/3	1/3	1/3
Information Bit Payload						
For Sub-Frame 1,6	Bits	3240	328	3240	3240	1544
For Sub-Frame 5	Bits	n/a	n/a	n/a	n/a	n/a
For Sub-Frame 0	Bits	4392	256	4392	4392	1800
Number of Code Blocks per Sub-Frame						
For Sub-Frame 1,6		1	1	1	1	1
For Sub-Frame 5	Bits	n/a	n/a	n/a	n/a	n/a
For Sub-Frame 0		1	1	1	1	1
Binary Channel Bits Per Sub-Frame						
For Sub-Frame 1,6	Bits	11256	1152	10656	10256	5056
For Sub-Frame 5	Bits	n/a	n/a	n/a	n/a	n/a
For Sub-Frame 0	Bits	13104	936	12528	12176	5776
Max. Throughput averaged over 1 frame	Mbps	1.087	0.091	1.087	1.164	0.489
UE Category		≥ 1	≥ 1	≥ 1	≥ 1	≥ 1
Note 1: 2 symbols allocated to PDCCH for all BW.						
Note 2: As per Table 4.2-2 in TS 36.211 [8].						

Table A.3.5.2-2A: Additional PDSCH Reference Channel TDD

Parameter	Unit	Value	
		1	2
Number of transmitter antennas		2	2
Channel bandwidth	MHz	10 (Note 1)	10 (Note 2)
Uplink-Downlink Configuration (Note 3)		1	1
Special subframe configuration		4	4
Allocated Resource Blocks		50	50
Modulation		QPSK	QPSK
Target Coding Rate		1/3	1/3
Information Bit Payload			
For Sub-Frame 4,9	Bits	4392	3624
For Sub-Frame 1,6	Bits	3240	3240
For Sub-Frame 5	Bits	n/a	n/a
For Sub-Frame 0	Bits	4392	3624
Number of Code Blocks per Sub-Frame			
For Sub-Frame 4,9		1	1
For Sub-Frame 1,6		1	1
For Sub-Frame 5		n/a	n/a
For Sub-Frame 0		1	1
Binary Channel Bits Per Sub-Frame			
For Sub-Frame 4,9	Bits	13200	12000
For Sub-Frame 1,6	Bits	10656	10656
For Sub-Frame 5	Bits	n/a	n/a
For Sub-Frame 0	Bits	12528	11328
Max. Throughput averaged over 1 frame	Mbps	1.9656	1.7352
UE Category		≥ 1	≥ 1
Note 1: 2 symbols allocated to PDCCH.			
Note 2: 3 symbols allocated to PDCCH.			
Note 3: As per Table 4.2-2 in TS 36.211 [8].			

## A.3.6 Reference measurement channels for PHICH performance requirements

**Table A.3.6-1: Reference Channel FDD/TDD**

Parameter	Unit	Value				
		R.18	R.19	R.19-1	R.20	R.24
Reference channel		R.18	R.19	R.19-1	R.20	R.24
Number of transmitter antennas		1	2	2	4	1
Channel bandwidth	MHz	10	1.4	5	10	10
User roles (Note 1)		[W I1 I2]	[W I1 I2]	W I1 I2	[W I1 I2]	[W I1]
Resource allocation (Note 2)		[(0,0) (0,1) (0,4)]	[(0,0) (0,1) (0,4)]	(0,0) (0,1) (0,4)	[(0,0) (0,1) (0,4)]	[(0,0) (0,1) (0,4)]
Power offsets (Note 3)	dB	[-4 0 -3]	[-4 0 -3]	-4 0 -3	[-4 0 -3]	[+3 0]
Payload (Note 4)		[A R R]	[A R R]	A R R	[A R R]	[A R]
Note 1: W=wanted user, I1=interfering user 1, I2=interfering user 2. Note 2: The resource allocation per user is given as (N_group_PHICH, N_seq_PHICH). Note 3: The power offsets (per user) represent the difference of the power of BPSK modulated symbol per PHICH relative to the first interfering user. Note 4: A=fixed ACK, R=random ACK/NACK.						

**Table A.3.6-1A: Reference Channel FDD/TDD**

Parameter	Unit	Value	
		R.19_1	R.20_1
Reference channel		R.19_1	R.20_1
Number of transmitter antennas		2	4
Channel bandwidth	MHz	10	5
User roles (Note 1)		[W I1 I2]	[W I1 I2]
Resource allocation (Note 2)		[(0,0) (0,1) (0,4)]	[(0,0) (0,1) (0,4)]
Power offsets (Note 3)	dB	[-4 0 -3]	[-4 0 -3]
Payload (Note 4)		[A R R]	[A R R]
Note 1: W=wanted user, I1=interfering user 1, I2=interfering user 2. Note 2: The resource allocation per user is given as (N_group_PHICH, N_seq_PHICH). Note 3: The power offsets (per user) represent the difference of the power of BPSK modulated symbol per PHICH relative to the first interfering user. Note 4: A=fixed ACK, R=random ACK/NACK.			



## A.3.7 [FFS]

## A.3.8 Reference measurement channels for MBMS performance requirements

## A.3.8.1 FDD

Table A.3.8.1-1: Fixed Reference Channel QPSK R=1/3

Parameter	PMCH						
	Unit	Value					
Reference channel		R.40 FDD			R.37 FDD		
Channel bandwidth	MHz	1.4	3	5	10	15	20
Allocated resource blocks		6			50		
Allocated subframes per Radio Frame (Note 1)		6			6		
Modulation		QPSK			QPSK		
Target Coding Rate		1/3			1/3		
Information Bit Payload (Note 2)							
For Sub-Frames 1,2,3,6,7,8	Bits	408			3624		
For Sub-Frames 0,4,5,9	Bits	n/a			n/a		
Number of Code Blocks per Subframe (Note 3)		1			1		
Binary Channel Bits Per Subframe							
For Sub-Frames 1,2,3,6,7,8	Bits	1224			10200		
For Sub-Frames 0,4,5,9	Bits	n/a			n/a		
MBMS UE Category		≥ 1			≥ 1		
Note 1: For FDD mode, up to 6 subframes (#1/2/3/6/7/8) are available for MBMS, in line with TS 36.331. Note 2: 2 OFDM symbols are reserved for PDCCH; and reference signal allocated as per TS 36.211. Note 3: If more than one Code Block is present, an additional CRC sequence of L = 24 Bits is attached to each Code Block (otherwise L = 0 Bit).							

Table A.3.8.1-2: Fixed Reference Channel 16QAM R=1/2

Parameter	PMCH						
	Unit	Value					
Reference channel					R.38 FDD		
Channel bandwidth	MHz	1.4	3	5	10	15	20
Allocated resource blocks					50		
Allocated subframes per Radio Frame (Note 1)					6		
Modulation					16QAM		
Target Coding Rate					1/2		
Information Bit Payload (Note 2)							
For Sub-Frames 1,2,3,6,7,8	Bits				9912		
For Sub-Frames 0,4,5,9	Bits				n/a		
Number of Code Blocks per Subframe (Note 3)					2		
Binary Channel Bits Per Subframe							
For Sub-Frames 1,2,3,6,7,8	Bits				20400		
For Sub-Frames 0,4,5,9	Bits				n/a		
MBMS UE Category					≥ 1		
Note 1: For FDD mode, up to 6 subframes (#1/2/3/6/7/8) are available for MBMS, in line with TS 36.331. Note 2: 2 OFDM symbols are reserved for PDCCH; and reference signal allocated as per TS 36.211. Note 3: If more than one Code Block is present, an additional CRC sequence of L = 24 Bits is attached to each Code Block (otherwise L = 0 Bit).							

Table A.3.8.1-3: Fixed Reference Channel 64QAM R=2/3

Parameter	PMCH						
	Unit	Value					
Reference channel				R.39-1 FDD	R.39 FDD		
Channel bandwidth	MHz	1.4	3	5	10	15	20
Allocated resource blocks				25	50		
Allocated subframes per Radio Frame(Note1)				6	6		
Modulation				64QAM	64QAM		
Target Coding Rate				2/3	2/3		
Information Bit Payload (Note 2)							
For Sub-Frames 1,2,3,6,7,8	Bits			9912	19848		
For Sub-Frames 0,4,5,9	Bits			n/a	n/a		
Number of Code Blocks per Sub-Frame (Note 3)				2	4		
Binary Channel Bits Per Subframe							
For Sub-Frames 1,2,3,6,7,8	Bits			15300	30600		
For Sub-Frames 0,4,5,9	Bits			n/a	n/a		
MBMS UE Category				≥ 1	≥ 2		
Note 1: For FDD mode, up to 6 subframes (#1/2/3/6/7/8) are available for MBMS, in line with TS 36.331. Note 2: 2 OFDM symbols are reserved for PDCCH; and reference signal allocated as per TS 36.211. Note 3: If more than one Code Block is present, an additional CRC sequence of L = 24 Bits is attached to each Code Block (otherwise L = 0 Bit).							

## A.3.8.2 TDD

Table A.3.8.2-1: Fixed Reference Channel QPSK R=1/3

Parameter	PMCH						
	Unit	Value					
Reference channel		R.40 TDD			R.37 TDD		
Channel bandwidth	MHz	1.4	3	5	10	15	20
Allocated resource blocks		6			50		
Uplink-Downlink Configuration(Note 1)		5			5		
Allocated subframes per Radio Frame		5			5		
Modulation		QPSK			QPSK		
Target Coding Rate		1/3			1/3		
Information Bit Payload (Note 2)							
For Sub-Frames 3,4,7,8,9	Bits	408			3624		
For Sub-Frames 0,1,2,5,6	Bits	n/a			n/a		
Number of Code Blocks per Subframe (Note 3)		1			1		
Binary Channel Bits Per Subframe							
For Sub-Frames 3,4,7,8,9	Bits	1224			10200		
For Sub-Frames 0,1,2,5,6	Bits	n/a			n/a		
MBMS UE Category		≥ 1			≥ 1		
Note 1: For TDD mode, in line with TS 36.331, Uplink-Downlink Configuration 5 is proposed, up to 5 subframes (#3/4/7/8/9) are available for MBMS. Note 2: 2 OFDM symbols are reserved for PDCCH; reference signal allocated as per TS 36.211. Note 3: If more than one Code Block is present, an additional CRC sequence of L = 24 Bits is attached to each Code Block (otherwise L = 0 Bit).							

Table A.3.8.2-2: Fixed Reference Channel 16QAM R=1/2

Parameter	PMCH						
	Unit	Value					
Reference channel					R.38 TDD		
Channel bandwidth	MHz	1.4	3	5	10	15	20
Allocated resource blocks					50		
Uplink-Downlink Configuration(Note 1)					5		
Allocated subframes per Radio Frame					5		
Modulation					16QAM		
Target Coding Rate					1/2		
Information Bit Payload (Note 2)							
For Sub-Frames 3,4,7,8,9	Bits				9912		
For Sub-Frames 0,1,2,5,6	Bits				n/a		
Number of Code Blocks per Subframe (Note 3)					2		
Binary Channel Bits Per Subframe							
For Sub-Frames 3,4,7,8,9	Bits				20400		
For Sub-Frames 0,1,2,5,6	Bits				n/a		
MBMS UE Category					≥ 1		
Note 1: For TDD mode, in line with TS 36.331, Uplink-Downlink Configuration 5 is proposed, up to 5 subframes (#3/4/7/8/9) are available for MBMS. Note 2: 2 OFDM symbols are reserved for PDCCH; reference signal allocated as per TS 36.211. Note 3: If more than one Code Block is present, an additional CRC sequence of L = 24 Bits is attached to each Code Block (otherwise L = 0 Bit).							

Table A.3.8.2-3: Fixed Reference Channel 64QAM R=2/3

Parameter	PMCH						
	Unit	Value					
Reference channel				R.39-1 TDD	R.39 TDD		
Channel bandwidth	MHz	1.4	3	5	10	15	20
Allocated resource blocks				25	50		
Uplink-Downlink Configuration(Note 1)				5	5		
Allocated subframes per Radio Frame				5	5		
Modulation				64QAM	64QAM		
Target Coding Rate				2/3	2/3		
Information Bit Payload (Note 2)							
For Sub-Frames 3,4,7,8,9	Bits			9912	19848		
For Sub-Frames 0,1,2,5,6	Bits			n/a	n/a		
Number of Code Blocks per Sub-Frame (Note 3)				2	4		
Binary Channel Bits Per Subframe							
For Sub-Frames 3,4,7,8,9	Bits			15300	30600		
For Sub-Frames 0,1,2,5,6	Bits			n/a	n/a		
MBMS UE Category				≥ 1	≥ 2		
Note 1: For TDD mode, in line with TS 36.331, Uplink-Downlink Configuration 5 is proposed, up to 5 subframes (#3/4/7/8/9) are available for MBMS. Note 2: 2 OFDM symbols are reserved for PDCCH; reference signal allocated as per TS 36.211. Note 3: If more than one Code Block is present, an additional CRC sequence of L = 24 Bits is attached to each Code Block (otherwise L = 0 Bit).							

## A.3.9 Reference measurement channels for sustained downlink data rate provided by lower layers

### A.3.9.1 FDD

**Table A.3.9.1-1: Fixed Reference Channel for sustained data-rate test (FDD)**

Parameter	Unit	Value							
		R.31-1 FDD	R.31-2 FDD	R.31-3 FDD	R.31-3A FDD	R.31-3C FDD	R.31-4 FDD	R.31-4B FDD	R.31-5 FDD
Reference channel									
Channel bandwidth	MHz	10	10	20	10	15	20	15	15
Allocated resource blocks (Note 8)		Note 5	Note 6	Note 7	Note 6	Note 10	Note 7	Note 11	Note 9
Allocated subframes per Radio Frame		10	10	10	10	10	10	10	10
Modulation		64QAM	64QAM	64QAM	64QAM	64QAM	64QAM	64QAM	64QAM
Coding Rate									
For Sub-Frame 1,2,3,4,6,7,8,9,		0.40	0.59	0.59	0.85	0.87	0.88	0.85	0.85
For Sub-Frame 5		0.40	0.64	0.62	0.89	0.88	0.87	0.87	0.91
For Sub-Frame 0		0.40	0.63	0.61	0.90	0.91	0.90	0.88	0.88
Information Bit Payload (Note 8)									
For Sub-Frames 1,2,3,4,6,7,8,9	Bits	10296	25456	51024	36696	51024	75376	55056	55056
For Sub-Frame 5	Bits	10296	25456	51024	35160	51024	71112	52752	52752
For Sub-Frame 0	Bits	10296	25456	51024	36696	51024	75376	55056	55056
Number of Code Blocks (Notes 3 and 8)									
For Sub-Frames 1,2,3,4,6,7,8,9	Bits	2	5	9	6	9	13	9	9
For Sub-Frame 5	Bits	2	5	9	6	9	12	9	9
For Sub-Frame 0	Bits	2	5	9	6	9	13	9	9
Binary Channel Bits (Note 8)									
For Sub-Frames 1,2,3,4,6,7,8,9	Bits	26100	43200	86400	43200	58752	86400	64800	64800
For Sub-Frame 5	Bits	26100	39744	82080	39744	57888	82080	60480	60480
For Sub-Frame 0	Bits	26100	40752	83952	40752	56304	83952	62352	62352
Number of layers		1	2	2	2	2	2	2	2
Max. Throughput averaged over 1 frame (Note 8)	Mbps	10.296	25.456	51.024	36.542	51.024	74.950	54.826	54.826
UE Categories		≥ 1	≥ 2	≥ 2	≥ 2	≥ 3	≥ 3	≥ 4	≥ 3
Note 1:	1 symbol allocated to PDCCH for all tests.								
Note 2:	Reference signal, synchronization signals and PBCH allocated as per TS 36.211 [8].								
Note 3:	If more than one Code Block is present, an additional CRC sequence of L = 24 Bits is attached to each Code Block (otherwise L = 0 Bit).								
Note 4:	Resource blocks $n_{PRB} = 0..2$ are allocated for SIB transmissions in sub-frame 5 for all bandwidths.								
Note 5:	Resource blocks $n_{PRB} = 6..14,30..49$ are allocated for the user data in all sub-frames.								
Note 6:	Resource blocks $n_{PRB} = 3..49$ are allocated for the user data in sub-frame 5, and resource blocks $n_{PRB} = 0..49$ in sub-frames 0,1,2,3,4,6,7,8,9.								
Note 7:	Resource blocks $n_{PRB} = 4..99$ are allocated for the user data in sub-frame 5, and resource blocks $n_{PRB} = 0..99$ in sub-frames 0,1,2,3,4,6,7,8,9.								
Note 8:	Given per component carrier per codeword.								
Note 9:	Resource blocks $n_{PRB} = 4..74$ are allocated for the user data in sub-frame 5, and resource blocks $n_{PRB} = 0..74$ in sub-frames 0,1,2,3,4,6,7,8,9.								
Note 10:	Resource blocks $n_{PRB} = 4..71$ are allocated for the user data in sub-frames 0,1,2,3,4,5,6,7,8,9.								
Note 11:	Resource blocks $n_{PRB} = 4..74$ are allocated for the user data in sub-frame 5, and resource blocks $n_{PRB} = 0..74$ in sub-frames 0,1,2,3,4,6,7,8,9.								

Table A.3.9.1-2: Fixed Reference Channel for sustained data-rate test (FDD)

Parameter	Unit	Value						
Reference channel		R.31-6 FDD						
Channel bandwidth	MHz	5						
Allocated resource blocks (Note 8)		Note 4						
Allocated subframes per Radio Frame		10						
Modulation		64QAM						
Coding Rate								
For Sub-Frame 1,2,3,4,6,7,8,9,		0.85						
For Sub-Frame 5		0.83						
For Sub-Frame 0		0.83						
Information Bit Payload (Note 8)								
For Sub-Frames 1,2,3,4,6,7,8,9	Bits	18336						
For Sub-Frame 5	Bits	15840						
For Sub-Frame 0	Bits	15840						
Number of Code Blocks (Notes 3 and 8)								
For Sub-Frames 1,2,3,4,6,7,8,9	Bits	3						
For Sub-Frame 5	Bits	3						
For Sub-Frame 0	Bits	3						
Binary Channel Bits (Note 8)								
For Sub-Frames 1,2,3,4,6,7,8,9	Bits	21600						
For Sub-Frame 5	Bits	19008						
For Sub-Frame 0	Bits	19152						
Number of layers		2						
Max. Throughput averaged over 1 frame (Note 8)	Mbps	17.837						
UE Categories		$\geq 2$						
Note 1:	1 symbol allocated to PDCCH for all tests.							
Note 2:	Reference signal, synchronization signals and PBCH allocated as per TS 36.211 [8].							
Note 3:	If more than one Code Block is present, an additional CRC sequence of L = 24 Bits is attached to each Code Block (otherwise L = 0 Bit).							
Note 4:	Resource blocks $n_{PRB} = 2..24$ are allocated for the user data in sub-frame 5, and resource blocks $n_{PRB} = 0..24$ in sub-frames 0,1,2,3,4,6,7,8,9.							

## A.3.9.2 TDD

Table A.3.9.2-1: Fixed Reference Channel for sustained data-rate test (TDD)

Parameter	Unit	Value					
		R.31-1 TDD	R.31-2 TDD	R.31-3 TDD	R.31-3A TDD	R.31-4 TDD	R.31-5 TDD
Reference channel							
Channel bandwidth	MHz	10	10	20	15	20	15
Allocated resource blocks		Note 6	Note 7	Note 8	Note 9	Note 8	Note 11
Uplink-Downlink Configuration (Note 3)		5	5	5	1	1	1
Number of HARQ Processes per component carrier	Processes	15	15	15	7	7	7
Allocated subframes per Radio Frame (D+S)		8+1	8+1	8+1	4+2	4+2	4
Modulation		64QAM	64QAM	64QAM	64QAM	64QAM	64QAM
Coding Rate							
For Sub-Frames 4,9		0.40	0.59	0.59	0.87	0.88	0.85
For Sub-Frames 3,7,8		0.40	0.59	0.59	n/a	n/a	N/A
For Sub-Frame 1		n/a	n/a	n/a	n/a	n/a	N/A
For Sub-Frame 5		0.40	0.64	0.62	0.88	0.87	0.87
For Sub-Frame 6		0.40	0.60	0.60	n/a	n/a	N/A
For Sub-Frame 0		0.40	0.62	0.61	0.90	0.90	0.88
Information Bit Payload							
For Sub-Frames 4,9	Bits	10296	25456	51024	51024	75376	55056
For Sub-Frames 3,7,8	Bits	10296	25456	51024	0	0	0
For Sub-Frame 1	Bits	0	0	0	0	0	0
For Sub-Frame 5	Bits	10296	25456	51024	51024	71112	52752
For Sub-Frame 6	Bits	10296	25456	51024	0	0	0
For Sub-Frame 0	Bits	10296	25456	51024	51024	75376	55056
Number of Code Blocks per Sub-Frame (Note 4)							
For Sub-Frames 4,9		2	5	9	9	13	9
For Sub-Frames 3,7,8		2	5	9	n/a	n/a	N/A
For Sub-Frame 1		n/a	n/a	n/a	n/a	n/a	N/A
For Sub-Frame 5		2	5	9	9	12	9
For Sub-Frame 6		2	5	9	n/a	n/a	N/A
For Sub-Frame 0		2	5	9	9	13	9
Binary Channel Bits Per Sub-Frame							
For Sub-Frames 4,9	Bits	26100	43200	86400	58752	86400	64800
For Sub-Frames 3,7,8	Bits	26100	43200	86400	n/a	n/a	0
For Sub-Frame 1	Bits	n/a	n/a	n/a	n/a	n/a	0
For Sub-Frame 5	Bits	26100	40176	82512	58320	82512	60912
For Sub-Frame 6	Bits	26100	42768	85968	n/a	n/a	N/A
For Sub-Frame 0	Bits	26100	41184	84384	56736	84384	62784
Number of layers		1	2	2	2	2	2
Max. Throughput averaged over 1 frame	Mbps	8.237	20.365	40.819	20.409	29.724	25.330
UE Category		≥ 1	≥ 2	≥ 2	≥ 2	≥ 3	≥ 3
Note 1:	1 symbol allocated to PDCCH for all tests						
Note 2:	Reference signal, synchronization signals and PBCH allocated as per TS 36.211 [8]						
Note 3:	As per Table 4.2-2 in TS 36.211 [8]						
Note 4:	If more than one Code Block is present, an additional CRC sequence of L = 24 Bits is attached to each Code Block (otherwise L = 0 Bit)						
Note 5:	Resource blocks $n_{PRB} = 0..2$ are allocated for SIB transmissions in sub-frame 5 for all bandwidths						
Note 6:	Resource blocks $n_{PRB} = 6..14,30..49$ are allocated for the user data in all subframes						
Note 7:	Resource blocks $n_{PRB} = 3..49$ are allocated for the user data in sub-frame 5, and resource blocks $n_{PRB} = 0..49$ in sub-frames 0,3,4,6,7,8,9						
Note 8:	Resource blocks $n_{PRB} = 4..99$ are allocated for the user data in sub-frame 5, and resource blocks $n_{PRB} = 0..99$ in sub-frames 0,3,4,6,7,8,9						
Note 9:	Resource blocks $n_{PRB} = 4..71$ are allocated for the user data in all sub-frames						
Note 10:	Given per component carrier per codeword.						
Note 11:	Resource blocks $n_{PRB} = 4..74$ are allocated for the user data in sub-frame 5, and resource blocks $n_{PRB} = 0..74$ in other downlink sub-frames.						

## A.3.9.3 FDD (EPDCCH scheduling)

Table A.3.9.3-1: Fixed Reference Channel for sustained data-rate test with EPDCCH scheduling (FDD)

Parameter	Unit	Value						
		R.31E-1 FDD	R.31E-2 FDD	R.31E-3 FDD	R.31E-3A FDD	R.31E-3C FDD	R.31E-4 FDD	R.31E-4B FDD
Reference channel								
Channel bandwidth	MHz	10	10	20	10	15	20	15
Allocated resource blocks (Note 8)		Note 5	Note 6	Note 7	Note 6	Note 9	Note 7	Note 10
Allocated subframes per Radio Frame		10	10	10	10	10	10	10
Modulation		64QAM	64QAM	64QAM	64QAM	64QAM	64QAM	64QAM
Coding Rate (subframes with PDCCH USS monitoring)								
For Sub-Frame 1,2,3,4,6,7,8,9,		0.3972	0.5926	0.5933	0.8533	0.8725	0.8763	0.8533
For Sub-Frame 5		0.3972	0.6441	0.6246	0.8889	0.8855	0.8702	0.8762
For Sub-Frame 0		0.3972	0.6282	0.6106	0.9046	0.9105	0.9018	0.8868
Coding Rate (subframes with EPDCCH USS monitoring)								
For Sub-Frame 1,2,3,4,6,7,8,9,		0.4114	0.6047	0.5993	0.8707	0.8855	0.8851	0.8649
For Sub-Frame 5		0.4114	0.6584	0.6312	0.9086	0.8990	0.8794	0.8889
For Sub-Frame 0		0.4114	0.6418	0.6170	0.9242	0.9246	0.9112	0.8993
Information Bit Payload (Note 8)								
For Sub-Frames 1,2,3,4,6,7,8,9	Bits	10296	25456	51024	36696	51024	75376	55056
For Sub-Frame 5	Bits	10296	25456	51024	35160	51024	71112	52752
For Sub-Frame 0	Bits	10296	25456	51024	36696	51024	75376	55056
Number of Code Blocks (Notes 3 and 8)								
For Sub-Frames 1,2,3,4,6,7,8,9	Bits	2	5	9	6	9	13	9
For Sub-Frame 5	Bits	2	5	9	6	9	12	9
For Sub-Frame 0	Bits	2	5	9	6	9	13	9
Binary Channel Bits (Note 8) (subframes with PDCCH USS monitoring)								
For Sub-Frames 1,2,3,4,6,7,8,9	Bits	26100	43200	86400	43200	58752	86400	64800
For Sub-Frame 5	Bits	26100	39744	82080	39744	57888	82080	60480
For Sub-Frame 0	Bits	26100	40752	83952	40752	56304	83952	62352
Binary Channel Bits (Note 8) (subframes with EPDCCH USS monitoring)								
For Sub-Frames 1,2,3,4,6,7,8,9	Bits	25200	42336	85536	42336	57888	85536	63936
For Sub-Frame 5	Bits	25200	38880	81216	38880	57024	81216	59616
For Sub-Frame 0	Bits	25200	39888	83088	39888	55440	83088	61488
Number of layers		1	2	2	2	2	2	2
Max. Throughput averaged over 1 frame (Note 8)	Mbps	10.296	25.456	51.024	36.542	51.024	74.950	54.826
UE Categories		≥ 1	≥ 2	≥ 2	≥ 2	≥ 3	≥ 3	≥ 4
Note 1:	1 symbol allocated to PDCCH for all tests.							
Note 2:	Reference signal, synchronization signals and PBCH allocated as per TS 36.211.							
Note 3:	If more than one Code Block is present, an additional CRC sequence of L = 24 Bits is attached to each Code Block (otherwise L = 0 Bit).							
Note 4:	Resource blocks $n_{PRB} = 0..2$ are allocated for SIB transmissions in sub-frame 5 for all bandwidths.							
Note 5:	Resource blocks $n_{PRB} = 6..14,30..49$ are allocated for the user data in all sub-frames.							
Note 6:	Resource blocks $n_{PRB} = 3..49$ are allocated for the user data in sub-frame 5, and resource blocks $n_{PRB} = 0..49$ in sub-frames 0,1,2,3,4,6,7,8,9.							
Note 7:	Resource blocks $n_{PRB} = 4..99$ are allocated for the user data in sub-frame 5, and resource blocks $n_{PRB} = 0..99$ in sub-frames 0,1,2,3,4,6,7,8,9.							
Note 8:	Given per component carrier per codeword.							
Note 9:	Resource blocks $n_{PRB} = 4..71$ are allocated for the user data in sub-frames 0,1,2,3,4,5,6,7,8,9.							
Note 10:	Resource blocks $n_{PRB} = 4..74$ are allocated for the user data in sub-frame 5, and resource blocks $n_{PRB} = 0..74$ in sub-frames 0,1,2,3,4,6,7,8,9.							

## A.3.9.4 TDD (EPDCCH scheduling)

Table A.3.9.4-1: Fixed Reference Channel for sustained data-rate with EPDCCH scheduling (TDD)

Parameter	Unit	Value				
		R.31E-1 TDD	R.31E-2 TDD	R.31E-3 TDD	R.31E-3A TDD	R.31E-4 TDD
Reference channel						
Channel bandwidth	MHz	10	10	20	15	20
Allocated resource blocks		Note 6	Note 7	Note 8	Note 9	Note 8
Uplink-Downlink Configuration (Note 3)		5	5	5	1	1
Number of HARQ Processes per component carrier	Processes	15	15	15	7	7
Allocated subframes per Radio Frame (D+S)		8+1	8+1	8+1	4	4
Coding Rate (subframes with PDCCH USS monitoring)						
For Sub-Frames 4,9		0.3972	0.5926	0.5933	0.8725	0.8763
For Sub-Frames 3,7,8		0.3972	0.5926	0.5933	N/A	N/A
For Sub-Frames 1		N/A	N/A	N/A	N/A	N/A
For Sub-Frames 5		0.3972	0.6372	0.6213	0.8790	0.8656
For Sub-Frames 6		0.3972	0.5986	0.5963	N/A	N/A
For Sub-Frames 0		0.3972	0.6216	0.6075	0.9036	0.8972
Coding Rate (subframes with EPDCCH USS monitoring)						
For Sub-Frames 4,9		0.4114	0.6047	0.5993	0.8856	0.8851
For Sub-Frames 3,7,8		0.4114	0.6047	0.5993	N/A	N/A
For Sub-Frames 1		N/A	N/A	N/A	N/A	N/A
For Sub-Frames 5		0.4114	0.6512	0.6279	0.8922	0.8748
For Sub-Frames 6		0.4114	0.6109	0.6024	N/A	N/A
For Sub-Frames 0		0.4114	0.6349	0.6138	0.9175	0.9065
Information Bit Payload						
For Sub-Frames 4,9	Bits	10296	25456	51024	51024	75376
For Sub-Frames 3,7,8	Bits	10296	25456	51024	N/A	N/A
For Sub-Frame 1	Bits	0	0	0	N/A	N/A
For Sub-Frame 5	Bits	10296	25456	51024	51024	71112
For Sub-Frame 6	Bits	10296	25456	51024	N/A	N/A
For Sub-Frame 0	Bits	10296	25456	51024	51024	75376
Number of Code Blocks per Sub-Frame (Note 4)						
For Sub-Frames 4,9		2	5	9	9	13
For Sub-Frames 3,7,8		2	5	9	N/A	N/A
For Sub-Frame 1		N/A	N/A	N/A	N/A	N/A
For Sub-Frame 5		2	5	9	9	12
For Sub-Frame 6	Bits	2	5	9	N/A	N/A
For Sub-Frame 0		2	5	9	9	13
Binary Channel Bits per Sub-Frame (subframes with PDCCH USS monitoring)						
For Sub-Frames 4,9	Bits	26100	43200	86400	58752	86400
For Sub-Frames 3,7,8	Bits	26100	43200	86400	N/A	N/A
For Sub-Frame 1	Bits	0	0	0	N/A	N/A
For Sub-Frame 5	Bits	26100	40176	82512	58320	82512
For Sub-Frame 6	Bits	26100	42768	85968	N/A	N/A
For Sub-Frame 0	Bits	26100	41184	84384	56736	84384
Binary Channel Bits per Sub-Frame (subframes with EPDCCH USS monitoring)						
For Sub-Frames 4,9	Bits	25200	42336	85536	57888	85536
For Sub-Frames 3,7,8	Bits	25200	42336	85536	N/A	N/A
For Sub-Frame 1	Bits	0	0	0	N/A	N/A
For Sub-Frame 5	Bits	25200	39312	81648	57456	81648
For Sub-Frame 6	Bits	25200	41904	85104	N/A	N/A



For Sub-Frame 0	Bits	25200	40320	83520	55872	83520
Number of layers		1	2	2	2	2
Max. Throughput averaged over 1 frame (Note 10)	Mbps	8.237	20.365	40.819	20.409	29.724
UE Category		$\geq 1$	$\geq 2$	$\geq 2$	$\geq 2$	$\geq 3$
Note 1: 1 symbol allocated to PDCCH for all tests. Note 2: Reference signal, synchronization signals and PBCH allocated as per TS 36.211 [8]. Note 3: As per Table 4.2-2 in TS 36.211 [8]. Note 4: If more than one Code Block is present, an additional CRC sequence of L = 24 Bits is attached to each Code Block (otherwise L = 0 Bit). Note 5: Resource blocks $n_{PRB} = 0..2$ are allocated for SIB transmissions in sub-frame 5 for all bandwidths. Note 6: Resource blocks $n_{PRB} = 6..14,30..49$ are allocated for the user data in all subframes. Note 7: Resource blocks $n_{PRB} = 3..49$ are allocated for the user data in sub-frame 5, and resource blocks $n_{PRB} = 0..49$ in sub-frames 0,3,4,6,7,8,9. Note 8: Resource blocks $n_{PRB} = 4..99$ are allocated for the user data in sub-frame 5, and resource blocks $n_{PRB} = 0..99$ in sub-frames 0,3,4,6,7,8,9. Note 9: Resource blocks $n_{PRB} = 4..71$ are allocated for the user data in all sub-frames Note10: Given per component carrier per codeword.						

## A.3.10 Reference Measurement Channels for EPDCCH performance requirements

### A.3.10.1 FDD

**Table A.3.10.1-1: Reference Channel FDD**

Parameter	Unit	Value					
		R.55 FDD	R.56 FDD	R.57 FDD	R.58 FDD	R.59 FDD	
Reference channel							
Number of transmitter antennas		2	2	2	2	2	
Channel bandwidth	MHz	10	10	10	10	10	
Number of OFDM symbols for PDCCH	symbols	2	2	1	1	1	
Aggregation level	ECCE	4	16	2	8	2	
DCI Format		2A	2A	2C	2C	2D	

### A.3.10.2 TDD

**Table A.3.10.2-1: Reference Channel TDD**

Parameter	Unit	Value					
		R.55 TDD	R.56 TDD	R.57 TDD	R.58 TDD	R.59 TDD	
Reference channel							
Number of transmitter antennas		2	2	2	2	2	
Channel bandwidth	MHz	10	10	10	10	10	
Number of OFDM symbols for PDCCH	symbols	2	2	1	1	1	
Aggregation level	CCE	4	16	2	8	2	
DCI Format		2A	2A	2C	2C	2D	

## A.4 CQI reference measurement channels

This section defines the DL signal applicable to the reporting of channel quality information (Clause 9.2, 9.3 and 9.5).

In Table A.4-1 are specified the reference channels. Table A.4-13 specifies the mapping of CQI index to modulation coding scheme, which complies with the CQI definition specified in Section 7.2.3 of [10].

Table A.4-0: Void

Table A.4-1: CSI reference measurement channels

RMC Name	Duplex	CH-BW	Alloc. RB-s	UL/DL Config	Alloc. SF-s	MCS Scheme	Nr. HARQ Proc.	Max. nr HARQ Trans.	Notes
<b>1 CRS Port</b>									
RC.1 FDD	FDD	10	50	-		MCS.1	8	1	
RC.1 TDD	TDD	10	50	Note 3		MCS.1	10	1	
RC.3 FDD	FDD	10	6	-		MCS.10	8	1	
RC.3 TDD	TDD	10	6	Note 3		MCS.10	10 or 7 (Note 9)	1	
RC.4 FDD	FDD	10	15	-		MCS.15	8	1	Note 6
RC.4 TDD	TDD	10	15	Note 3		MCS.15	10	1	Note 6
RC.5 FDD	FDD	10	3	-		MCS.17	8	1	
RC.5 TDD	TDD	10	3	Note 3		MCS.17	10	1	
RC.14 FDD	FDD	5	25	-		MCS.14	8	1	
RC.15 FDD	FDD	5	15	-		MCS.15	8	1	Note 6
RC.16 FDD	FDD/HD-FDD	10	2			MCS.20	8	1	Note 8,10
RC.16 TDD	TDD	10	2	Note 3		MCS.20	10	1	Note 8
<b>2 CRS Ports</b>									
RC.2 FDD	FDD	10	50	-		MCS.2	8	1	
RC.2 TDD	TDD	10	50	Note 3		MCS.2	10 or 7 (Note 9)	1	
RC.6 FDD	FDD	10	15	-		MCS.16	8	1	Note 6
RC.6 TDD	TDD	10	15	Note 3		MCS.16	7	1	Note 6
<b>4 CRS Ports</b>									
RC.16 FDD	FDD	10	50	-		MCS.18	8	1	
RC.14 TDD	TDD	10	50	Note 3		MCS.18	7	1	
<b>1 CRS Port + CSI-RS</b>									
RC.8 FDD	FDD	10	6	-	Non CSI-RS	MCS.11	8	1	
					2 CSI-RS	MCS.12			
RC.8 TDD	TDD	10	6	Note 3	Non CSI-RS	MCS.11	10	1	
					2 CSI-RS	MCS.12			
RC.9 FDD	FDD	10	50	-	Non CSI-RS	MCS.3	8	1	
					2 CSI-RS	MCS.4			
RC.9 TDD	TDD	10	50	Note 3	Non CSI-RS	MCS.3	7	1	
					2 CSI-RS	MCS.4			
<b>2 CRS Port + CSI-RS</b>									
RC.7 FDD	FDD	10	50	-	Non CSI-RS	MCS.5	8	1	
					4 CSI-RS	MCS.7			
RC.7 TDD	TDD	10	50	Note 3	Non CSI-RS	MCS.5	10	1	
					8 CSI-RS	MCS.8			
RC.11 FDD	FDD	10	50	-	Non CSI-RS	MCS.5	8	1	
					2 CSI-RS	MCS.6			
RC.11 TDD	TDD	10	50	Note 3	Non CSI-RS	MCS.5	10	1	
					2 CSI-RS	MCS.6			
RC.17 FDD	FDD	10	6	-	Non CSI-RS	MCS.13	8	1	

					4 CSI-RS	MCS.19			
RC.15 TDD	TDD	10	6	Note 3	Non CSI-RS	MCS.13	7	1	
					4 CSI-RS	MCS.19			
<b>1 CRS Port + CSI-RS + CSI-IM</b>									
RC.13 FDD	FDD	10	50	-	Non CSI-RS/IM	MCS.3	8	1	
					CSI-RS/IM	N/A			
RC.13 TDD	TDD	10	50	Note 3	Non CSI-RS/IM	MCS.3	10	1	
					CSI-RS/IM	N/A			
<b>2 CRS Port + CSI-RS + CSI-IM</b>									
RC.10 FDD	FDD	10	50	-	Non CSI-RS	MCS.5	8	1	
					4 CSI-RS, 1 CSI process	MCS.8			
RC.10 TDD	TDD	10	50	Note 3	Non CSI-RS	MCS.5	10	1	
					8 CSI-RS, 1 CSI process	MCS.9			
RC.12 FDD	FDD	10	6	-	Non CSI-RS/IM	MCS.13	8	1	
					CSI-RS/IM	N/A			
RC.12 TDD	TDD	10	6	Note 3	Non CSI-RS/IM	MCS.13	10	1	
					CSI-RS/IM	N/A			
<p>Note 1: 3 symbols allocated to PDCCH.</p> <p>Note 2: For FDD only subframes 1, 2, 3, 4, 6, 7, 8 and 9 are allocated to avoid PBCH and synchronization signal overhead.</p> <p>Note 3: TDD UL-DL configuration as specified in the individual tests.</p> <p>Note 4: For TDD when UL-DL configuration 1 is used only subframes 4 and 9 are allocated to avoid PBCH and synchronization signal overhead.</p> <p>Note 5: For TDD when UL-DL configuration 2 is used only subframes 3, 4, 8, and 9 are allocated to avoid PBCH and synchronization signal overhead.</p> <p>Note 6: Centred within the Transmission Bandwidth Configuration (Figure 5.4.2-1).</p> <p>Note 7: Only subframes 2, 3, 4, 7, 8 and 9 are allocated to avoid PBCH and synchronization signal overhead.</p> <p>Note 8: Allocate PDSCH on 5th and 6th PRBs within a subband.</p> <p>Note 9: The number of HARQ processes is 10 for TDD UL/DL configuration 2 and 7 for TDD UL/DL configuration 1.</p> <p>Note 10: The downlink subframes are scheduled at the 1st, 2nd, 8th, 9th, 16th, 17th, 18th, 24th, 26th, 32nd, 33rd, 34th subframes every 40ms. Information bit payload is available if downlink subframe is scheduled.(starting from 0th subframe).</p>									

Table A.4-1a to Table A.4-1d: Void

Table A.4-2: Void

Table A.4-2a to Table A.4-2d: Void

Table A.4-3: Void

Table A.4-3a to Table A.4-3k: Void

Table A.4-4: Void

Table A.4-4a: Void

Table A.4-5: Void

Table A.4-5a: Void

Table A.4-6: Void

Table A.4-6a: Void

Table A.4-6b: Void

Table A.4-7 to Table A.4.12: Void

Table A.4-13: Mapping of CQI Index to Modulation coding scheme (MCS)

CQI Index			0	1	2	3	4	5	6	7	8	9	10	11	12	13	14	15	Notes
Target Coding Rate			OOR	0.0762	0.1172	0.1885	0.3008	0.4385	0.5879	0.3691	0.4785	0.6016	0.4551	0.5537	0.6504	0.7539	0.8525	0.9258	
Modulation			OOR	QPSK						16QAM			64QAM						
MCS Scheme	PRB	Available RE-s	Imcs																
MCS.1	50	6300	DTX	0	0	2	4	6	8	11	13	16	18	21	23	25	27	27	
MCS.2	50	6000	DTX	0	0	2	4	6	8	11	13	15	18	20	22	24	26	27	
MCS.3	50	5700	DTX	0	0	2	4	6	8	10	13	15	17	19	21	23	25	26	
MCS.4	50	5600	DTX	0	0	2	4	6	7	10	12	14	17	19	21	23	25	26	
MCS.5	50	5400	DTX	0	0	2	3	5	7	10	12	14	17	19	21	23	24	25	
MCS.6	50	5300	DTX	0	0	1	3	5	7	10	12	14	17	19	21	22	24	25	
MCS.7	50	5200	DTX	0	0	1	3	5	7	10	12	14	17	18	20	22	24	25	
MCS.8	50	5000	DTX	0	0	1	3	5	7	10	12	13	17	18	20	22	23	24	
MCS.9	50	4800	DTX	0	0	1	3	5	7	10	12	13	17	18	20	22	23	24	
MCS.10	6	756	DTX	0	0	2	4	6	8	11	13	16	19	21	23	25	27	27	
MCS.11	6	684	DTX	0	0	2	4	6	8	11	13	14	17	20	21	23	25	27	
MCS.12	6	672	DTX	0	0	1	4	6	8	10	12	14	17	19	21	23	25	26	
MCS.13	6	648	DTX	0	0	2	4	6	8	11	13	15	18	20	22	24	26	27	
MCS.14	25	3150	DTX	0	0	2	4	6	8	11	13	16	18	21	23	25	27	27	
MCS.15	15	1890	DTX	0	0	2	4	6	8	11	13	16	18	21	23	25	27	27	
MCS.16	15	1800	DTX	0	0	2	4	6	8	11	13	15	18	20	22	24	26	27	
MCS.17	3	378	DTX	0	1	2	5	7	9	12	13	16	19	21	23	25	27	27	
MCS.18	50	5800	DTX	0	0	2	4	6	8	11	13	15	17	20	22	23	26	27	

MCS.19	6	624	DTX	0	0	1	3	5	7	10	12	14	17	18	20	22	24	25	
Note 1:	Mapping between Imcs and TBS according to Tables 7.1.7.1-1 and 7.1.7.2.1-1 in TS 36.213 [6].																		
Note 2:	3 symbols allocated to PDCCH.																		
Note 3:	Sub-frame#0 and #5 are not used for the corresponding requirement. The next subframe (i.e. sub-frame#1 or #6) shall be used for potential retransmissions.																		

## A.4.1 Additional CSI reference measurement channels

This section defines additional reference measurement channels for CSI testing, required to run the test properly according to the test parameters.

**Table A.4.1-1: Uplink reference channels for transmitting CSI reports on PUSCH, when being in a PUCCH reporting mode (FDD)**

Parameter	Unit	Value					
Channel bandwidth	MHz	10					
Allocated resource blocks		6					
DFT-OFDM Symbols per Sub-Frame		12					
Modulation		QPSK					
Target Coding rate		1/3					
Allocated Sub-Frames		Note 1					
Payload size	Bits	600					
Transport block CRC	Bits	24					
Number of code blocks per Sub-Frame (Note 2)		1					
Total number of bits per Sub-Frame	Bits	1728					
Total symbols per Sub-Frame		864					
UE Category		≥ 1					
Note 1:	All subframes, if not other specified. In case of allocation of only certain subframes, as specified in the test case, the remaining subframes are not allocated with data. All the allocation details specified in the reference channel are valid only for the allocated subframes.						
Note 2:	If more than one Code Block is present, an additional CRC sequence of L = 24 Bits is attached to each Code Block (otherwise L = 0 Bit)						

**Table A.4.1-2: Uplink reference channels for transmitting CSI reports on PUSCH, when being in a PUCCH reporting mode (TDD)**

Parameter	Unit	Value					
Channel bandwidth	MHz	10	10				
Allocated resource blocks		6	6				
Uplink-Downlink Configuration (Note 1)		1	2				
DFT-OFDM Symbols per Sub-Frame		12	12				
Modulation		QPSK	QPSK				
Target Coding rate		1/3	1/3				
Allocated Sub-Frames		Note 2	Note 2				
Payload size	Bits	600	600				
Transport block CRC	Bits	24	24				
Number of code blocks per Sub-Frame (Note 3)		1	1				
Total number of bits per Sub-Frame	Bits	1728	1728				
Total symbols per Sub-Frame		864	864				
UE Category		≥ 1	≥ 1				
Note 1:	As per Table 4.2-2 in TS 36.211 [4].						
Note 2:	All uplink subframes, if not other specified. In case of allocation of only certain uplink subframes, as specified in the test case, the remaining uplink subframes are not allocated with data. All the allocation details specified in the reference channel are valid only for the allocated uplink subframes.						
Note 3:	If more than one Code Block is present, an additional CRC sequence of L = 24 Bits is attached to each Code Block (otherwise L = 0 Bit).						

## A.5 OFDMA Channel Noise Generator (OCNG)

### A.5.1 OCNG Patterns for FDD

The following OCNG patterns are used for modelling allocations to virtual UEs (which are not under test). The OCNG pattern for each sub frame specifies the allocations that shall be filled with OCNG, and furthermore, the relative power level of each such allocation.

In each test case the OCNG is expressed by parameters OCNG\_RA and OCNG\_RB which together with a relative power level ( $\gamma$ ) specifies the PDSCH EPRE-to-RS EPRE ratios in OFDM symbols with and without reference symbols, respectively. The relative power, which is used for modelling boosting per virtual UE allocation, is expressed by:

$$\gamma_i = PDSCH_{i\_RA} / OCNG\_RA = PDSCH_{i\_RB} / OCNG\_RB,$$

where  $\gamma_i$  denotes the relative power level of the  $i$ :th virtual UE. The parameter settings of OCNG\_RA, OCNG\_RB, and the set of relative power levels  $\gamma$  are chosen such that when also taking allocations to the UE under test into account, as given by a PDSCH reference channel, a transmitted power spectral density that is constant on an OFDM symbol basis is targeted.

Moreover the OCNG pattern is accompanied by a PCFICH/PDCCH/PHICH reference channel which specifies the control region. For any aggregation and PHICH allocation, the PDCCH and any unused PHICH groups are padded with resource element groups with a power level given respectively by PDCCH\_RA/RB and PHICH\_RA/RB as specified in the test case such that a total power spectral density in the control region that is constant on an OFDM symbol basis is targeted.

#### A.5.1.1 OCNG FDD pattern 1: One sided dynamic OCNG FDD pattern

This OCNG Pattern fills with OCNG all empty PRB-s (PRB-s with no allocation of data or system information) of the DL sub-frames, when the unallocated area is continuous in frequency domain (one sided).

**Table A.5.1.1-1: OP.1 FDD: One sided dynamic OCNG FDD Pattern**

Relative power level $\gamma_{PRB}$ [dB]			PDSCH Data
Subframe			
0	5	1 – 4, 6 – 9	
Allocation			
First unallocated PRB – Last unallocated PRB	First unallocated PRB – Last unallocated PRB	First unallocated PRB – Last unallocated PRB	
0	0	0	Note 1
Note 1: These physical resource blocks are assigned to an arbitrary number of virtual UEs with one PDSCH per virtual UE; the data transmitted over the OCNG PDSCHs shall be uncorrelated pseudo random data, which is QPSK modulated. The parameter $\gamma_{PRB}$ is used to scale the power of PDSCH.			
Note 2: If two or more transmit antennas with CRS are used in the test, the OCNG shall be transmitted to the virtual users by all the transmit antennas with CRS according to transmission mode 2. The parameter $\gamma_{PRB}$ applies to each antenna port separately, so the transmit power is equal between all the transmit antennas with CRS used in the test. The antenna transmission modes are specified in section 7.1 in 3GPP TS 36.213.			

### A.5.1.2 OCNG FDD pattern 2: Two sided dynamic OCNG FDD pattern

This OCNG Pattern fills with OCNG all empty PRB-s (PRB-s with no allocation of data or system information) of the DL sub-frames, when the unallocated area is discontinuous in frequency domain (divided in two parts by the allocated area – two sided), starts with PRB 0 and ends with PRB  $N_{RB} - 1$ .

**Table A.5.1.2-1: OP.2 FDD: Two sided dynamic OCNG FDD Pattern**

Relative power level $\gamma_{PRB}$ [dB]			PDSCH Data
Subframe			
0	5	1 – 4, 6 – 9	
Allocation			
0 – (First allocated PRB-1) and (Last allocated PRB+1) – ( $N_{RB} - 1$ )	0 – (First allocated PRB-1) and (Last allocated PRB+1) – ( $N_{RB} - 1$ )	0 – (First allocated PRB-1) and (Last allocated PRB+1) – ( $N_{RB} - 1$ )	
0	0	0	Note 1
<p>Note 1: These physical resource blocks are assigned to an arbitrary number of virtual UEs with one PDSCH per virtual UE; the data transmitted over the OCNG PDSCHs shall be uncorrelated pseudo random data, which is QPSK modulated. The parameter <math>\gamma_{PRB}</math> is used to scale the power of PDSCH.</p> <p>Note 2: If two or more transmit antennas with CRS are used in the test, the OCNG shall be transmitted to the virtual users by all the transmit antennas with CRS according to transmission mode 2. The parameter <math>\gamma_{PRB}</math> applies to each antenna port separately, so the transmit power is equal between all the transmit antennas with CRS used in the test. The antenna transmission modes are specified in section 7.1 in 3GPP TS 36.213.</p>			

### A.5.1.3 OCNG FDD pattern 3: 49 RB OCNG allocation with MBSFN in 10 MHz

**Table A.5.1.3-1: OP.3 FDD: OCNG FDD Pattern 3**

Allocation $n_{PRB}$	Relative power level $\gamma_{PRB}$ [dB]				PDSCH Data	PMCH Data
	Subframe					
	0	5	4, 9	1 – 3, 6 – 8		

1 – 49	0	0 (Allocation: all empty PRB-s)	0	N/A	Note 1	N/A
0 – 49	N/A	N/A	N/A	0	N/A	Note 2
<p>Note 1: These physical resource blocks are assigned to an arbitrary number of virtual UEs with one PDSCH per virtual UE; the data transmitted over the OCNG PDSCHs shall be uncorrelated pseudo random data, which is QPSK modulated. The parameter <math>\gamma_{PRB}</math> is used to scale the power of PDSCH.</p> <p>Note 2: Each physical resource block (PRB) is assigned to MBSFN transmission. The data in each PRB shall be uncorrelated with data in other PRBs over the period of any measurement. The MBSFN data shall be QPSK modulated. PMCH subframes shall contain cell-specific Reference Signals only in the first symbol of the first time slot. The parameter <math>\gamma_{PRB}</math> is used to scale the power of PMCH.</p> <p>Note 3: If two or more transmit antennas are used in the test, the OCNG shall be transmitted to the virtual users by all the transmit antennas according to transmission mode 2. The transmit power shall be equally split between all the transmit antennas used in the test. The antenna transmission modes are specified in section 7.1 in 3GPP TS 36.213.</p> <p>N/A: Not Applicable</p>						

### A.5.1.4 OCNG FDD pattern 4: One sided dynamic OCNG FDD pattern for MBMS transmission

This OCNG Pattern fills with OCNG all empty PRB-s (PRB-s with no allocation of data or system information) of the DL sub-frames, when the unallocated area is continuous in frequency domain (one sided) and MBMS performance is tested.

**Table A.5.1.4-1: OP.4 FDD: One sided dynamic OCNG FDD Pattern for MBMS transmission**

Allocation $n_{PRB}$	Relative power level $\gamma_{PRB}$ [dB]			PDSCH Data	PMCH Data
	Subframe				
	0, 4, 9	5	1 – 3, 6 – 8		
First unallocated PRB – Last unallocated PRB	0	0 (Allocation: all empty PRB-s)	N/A	Note 1	N/A
First unallocated PRB – Last unallocated PRB	N/A	N/A	N/A	N/A	Note 2
<p>Note 1: These physical resource blocks are assigned to an arbitrary number of virtual UEs with one PDSCH per virtual UE; the data transmitted over the OCNG PDSCHs shall be uncorrelated pseudo random data, which is QPSK modulated. The parameter <math>\gamma_{PRB}</math> is used to scale the power of PDSCH.</p> <p>Note 2: Each physical resource block (PRB) is assigned to MBSFN transmission. The data in each PRB shall be uncorrelated with data in other PRBs over the period of any measurement. The MBSFN data shall be QPSK modulated. PMCH subframes shall contain cell-specific Reference Signals only in the first symbol of the first time slot. The parameter <math>\gamma_{PRB}</math> is used to scale the power of PMCH.</p> <p>Note 3: If two or more transmit antennas are used in the test, the OCNG shall be transmitted to the virtual users by all the transmit antennas according to transmission mode 2. The transmit power shall be equally split between all the transmit antennas used in the test. The antenna transmission modes are specified in section 7.1 in 3GPP TS 36.213.</p> <p>N/A: Not Applicable</p>					



### A.5.1.5 OCNG FDD pattern 5: One sided dynamic 16QAM modulated OCNG FDD pattern

This OCNG Pattern fills with OCNG all empty PRB-s (PRB-s with no allocation of data or system information) of DL sub-frames, when the unallocated area is continuous in the frequency domain (one sided).

**Table A.5.1.5-1: OP.5 FDD: One sided dynamic 16QAM modulated OCNG FDD Pattern**

Relative power level $\gamma_{PRB}$ [dB]			PDSCH Data
Subframe			
0	5	1 – 4, 6 – 9	
Allocation			
First unallocated PRB – Last unallocated PRB	First unallocated PRB – Last unallocated PRB	First unallocated PRB – Last unallocated PRB	
0	0	0	Note 1
<p>Note 1: These physical resource blocks are assigned to an arbitrary number of virtual UEs with one PDSCH per virtual UE; the data transmitted over the OCNG PDSCHs shall be uncorrelated pseudo random data, which is 16QAM modulated. The parameter <math>\gamma_{PRB}</math> is used to scale the power of PDSCH.</p> <p>Note 2: If two or more transmit antennas with CRS are used in the test, the OCNG shall be transmitted to the virtual users by all the transmit antennas with CRS according to transmission mode 3 (Large Delay CDD). The parameter <math>\gamma_{PRB}</math> applies to each antenna port separately, so the transmit power is equal between all the transmit antennas with CRS used in the test. The antenna transmission modes are specified in section 7.1 in 3GPP TS 36.213.</p>			

### A.5.1.6 OCNG FDD pattern 6: dynamic OCNG FDD pattern when user data is in 2 non-contiguous blocks

This OCNG Pattern fills with OCNG all empty PRB-s (PRB-s with no allocation of data or system information) of the DL sub-frames, when the unallocated area is discontinuous in frequency domain (divided in two parts by the first allocated block). The second allocated block ends with PRB  $N_{RB} - 1$ .

**Table A.5.1.6-1: OP.6 FDD: OCNG FDD Pattern when user data is in 2 non-contiguous blocks**

Relative power level $\gamma_{PRB}$ [dB]			PDSCH Data
Subframe			
0	5	1 – 4, 6 – 9	
Allocation			
0 – (First allocated PRB of first block -1) and (Last allocated PRB of first block +1) – (First allocated PRB of second block -1)	0 – (First allocated PRB of first block -1) and (Last allocated PRB of first block +1) – (First allocated PRB of second block -1)	0 – (First allocated PRB of first block -1) and (Last allocated PRB of first block +1) – (First allocated PRB of second block -1)	
0	0	0	Note 1
<p>Note 1: These physical resource blocks are assigned to an arbitrary number of virtual UEs with one PDSCH per virtual UE; the data transmitted over the OCNG PDSCHs shall be uncorrelated pseudo random data, which is QPSK modulated. The parameter <math>\gamma_{PRB}</math> is used to scale the power of PDSCH.</p> <p>Note 2: If two or more transmit antennas with CRS are used in the test, the OCNG shall be transmitted to the virtual users by all the transmit antennas with CRS according to transmission mode 2. The parameter <math>\gamma_{PRB}</math> applies to each antenna port separately, so the transmit power is equal between all the transmit antennas with CRS used in the test. The antenna transmission modes are specified in section 7.1 in 3GPP TS 36.213.</p>			

### A.5.1.7 OCNG FDD pattern 7: dynamic OCNG FDD pattern when user data is in multiple non-contiguous blocks

This OCNG Pattern fills with OCNG all empty PRB-s (PRB-s with no allocation of data, EPDCCH or system information) of the DL sub-frames, when the unallocated area is discontinuous in frequency domain (divided in multiple parts by the  $M$  allocated blocks for data transmission). The  $m$ -th allocated block starts with RPB  $N_{Start,m}$  and ends with PRB  $N_{End,m} - 1$ , where  $m = 1, \dots, M$ . The system bandwidth starts with RPB 0 and ends with  $N_{RB} - 1$ .

**Table A.5.1.7-1: OP.7 FDD: OCNG FDD Pattern when user data is in multiple non-contiguous blocks**

Relative power level $\gamma_{PRB}$ [dB]			PDSCH Data
Subframe			
0	5	1 – 4, 6 – 9	
Allocation			
0 – (PRB $N_{Start,1} - 1$ ) ... (PRB $N_{End,(m-1)} - 1$ ) – (PRB $N_{Start,m} - 1$ ) ... (PRB $N_{End,M} - 1$ ) – (PRB $N_{RB} - 1$ )	0 – (PRB $N_{Start,1} - 1$ ) ... (PRB $N_{End,(m-1)} - 1$ ) – (PRB $N_{Start,m} - 1$ ) ... (PRB $N_{End,M} - 1$ ) – (PRB $N_{RB} - 1$ )	0 – (PRB $N_{Start,1} - 1$ ) ... (PRB $N_{End,(m-1)} - 1$ ) – (PRB $N_{Start,m} - 1$ ) ... (PRB $N_{End,M} - 1$ ) – (PRB $N_{RB} - 1$ )	
0	0	0	Note 1
<p>Note 1: These physical resource blocks are assigned to an arbitrary number of virtual UEs with one PDSCH per virtual UE; the data transmitted over the OCNG PDSCHs shall be uncorrelated pseudo random data, which is QPSK modulated. The parameter <math>\gamma_{PRB}</math> is used to scale the power of PDSCH.</p> <p>Note 2: If two or more transmit antennas with CRS are used in the test, the OCNG shall be transmitted to the virtual users by all the transmit antennas with CRS according to transmission mode 2. The parameter <math>\gamma_{PRB}</math> applies to each antenna port separately, so the transmit power is equal between all the transmit antennas with CRS used in the test. The antenna transmission modes are specified in section 7.1 in 3GPP TS 36.213 [10].</p>			

### A.5.1.8 OCNG FDD pattern 8: One sided dynamic OCNG FDD pattern for TM10 transmission

This OCNG Pattern fills with OCNG all empty PRB-s (PRB-s with no allocation of data or system information) of the DL sub-frames, when the unallocated area is continuous in frequency domain (one sided).

**Table A.5.1.8-1: OP.8 FDD: One sided dynamic OCNG FDD Pattern**

Relative power level $\gamma_{PRB}$ [dB]			PDSCH Data
Subframe			
0	5	1 – 4, 6 – 9	
Allocation			
First unallocated PRB – Last unallocated PRB	First unallocated PRB – Last unallocated PRB	First unallocated PRB – Last unallocated PRB	
0	0	0	Note 1,2,3
<p>Note 1: These physical resource blocks are assigned to an arbitrary number of virtual UEs with one PDSCH per virtual UE; the data transmitted over the OCNG PDSCHs shall be uncorrelated pseudo random data, which is 16QAM modulated. The parameter <math>\gamma_{PRB}</math> is used to scale the power of PDSCH.</p> <p>Note 2: The OCNG shall be transmitted to the virtual users by all the transmit antennas according to transmission mode10. The transmit power is equal between all the transmit antennas used in the test. The antenna transmission modes are specified in section 7.1 in 3GPP TS 36.213 [10].</p> <p>Note 3: The detailed test set-up for TM10 transmission i.e. PMI configuration is specified to each test case.</p>			

## A.5.2 OCNG Patterns for TDD

The following OCNG patterns are used for modelling allocations to virtual UEs (which are not under test). The OCNG pattern for each sub frame specifies the allocations that shall be filled with OCNG, and furthermore, the relative power level of each such allocation.

In each test case the OCNG is expressed by parameters OCNG\_RA and OCNG\_RB which together with a relative power level ( $\gamma$ ) specifies the PDSCH EPRE-to-RS EPRE ratios in OFDM symbols with and without reference symbols, respectively. The relative power, which is used for modelling boosting per virtual UE allocation, is expressed by:

$$\gamma_i = PDSCH_i\_RA / OCNG\_RA = PDSCH_i\_RB / OCNG\_RB,$$

where  $\gamma_i$  denotes the relative power level of the  $i$ :th virtual UE. The parameter settings of OCNG\_RA, OCNG\_RB, and the set of relative power levels  $\gamma$  are chosen such that when also taking allocations to the UE under test into account, as given by a PDSCH reference channel, a transmitted power spectral density that is constant on an OFDM symbol basis is targeted.

Moreover the OCNG pattern is accompanied by a PCFICH/PDCCH/PHICH reference channel which specifies the control region. For any aggregation and PHICH allocation, the PDCCH and any unused PHICH groups are padded with resource element groups with a power level given respectively by PDCCH\_RA/RB and PHICH\_RA/RB as specified in the test case such that a total power spectral density in the control region that is constant on an OFDM symbol basis is targeted.

### A.5.2.1 OCNG TDD pattern 1: One sided dynamic OCNG TDD pattern

This OCNG Pattern fills with OCNG all empty PRB-s (PRB-s with no allocation of data or system information) of the subframes available for DL transmission (depending on TDD UL/DL configuration), when the unallocated area is continuous in frequency domain (one sided).

**Table A.5.2.1-1: OP.1 TDD: One sided dynamic OCNG TDD Pattern**

Relative power level $\gamma_{PRB}$ [dB]				PDSCH Data
Subframe (only if available for DL)				
0	5	3, 4, 7, 8, 9 and 6 (as normal subframe) <sup>Note 2</sup>	1 and 6 (as special subframe) <sup>Note 2</sup>	
Allocation				
First unallocated PRB –	First unallocated PRB –	First unallocated PRB –	First unallocated PRB –	
Last unallocated PRB	Last unallocated PRB	Last unallocated PRB	Last unallocated PRB	
0	0	0	0	<b>Note 1</b>
<p>Note 1: These physical resource blocks are assigned to an arbitrary number of virtual UEs with one PDSCH per virtual UE; the data transmitted over the OCNG PDSCHs shall be uncorrelated pseudo random data, which is QPSK modulated. The parameter <math>\gamma_{PRB}</math> is used to scale the power of PDSCH.</p> <p>Note 2: Subframes available for DL transmission depends on the Uplink-Downlink configuration in Table 4.2-2 in 3GPP TS 36.211.</p> <p>Note 3: If two or more transmit antennas with CRS are used in the test, the OCNG shall be transmitted to the virtual users by all the transmit antennas with CRS according to transmission mode 2. The parameter <math>\gamma_{PRB}</math> applies to each antenna port separately, so the transmit power is equal between all the transmit antennas with CRS used in the test. The antenna transmission modes are specified in section 7.1 in 3GPP TS 36.213.</p>				

### A.5.2.2 OCNG TDD pattern 2: Two sided dynamic OCNG TDD pattern

This OCNG Pattern fills with OCNG all empty PRB-s (PRB-s with no allocation of data or system information) of the subframes available for DL transmission (depending on TDD UL/DL configuration), when the unallocated area is discontinuous in frequency domain (divided in two parts by the allocated area – two sided), starts with PRB 0 and ends with PRB  $N_{RB} - 1$ .

**Table A.5.2.2-1: OP.2 TDD: Two sided dynamic OCNG TDD Pattern**

Relative power level $\gamma_{PRB}$ [dB]				PDSCH Data
Subframe (only if available for DL)				
0	5	3, 4, 6, 7, 8, 9 (6 as normal subframe) <sup>Note 2</sup>	1,6 (6 as special subframe) <sup>Note 2</sup>	
Allocation				
0 – (First allocated PRB-1) and (Last allocated PRB+1) – ( $N_{RB} - 1$ )	0 – (First allocated PRB-1) and (Last allocated PRB+1) – ( $N_{RB} - 1$ )	0 – (First allocated PRB-1) and (Last allocated PRB+1) – ( $N_{RB} - 1$ )	0 – (First allocated PRB-1) and (Last allocated PRB+1) – ( $N_{RB} - 1$ )	
0	0	0	0	Note 1
<p>Note 1: These physical resource blocks are assigned to an arbitrary number of virtual UEs with one PDSCH per virtual UE; the data transmitted over the OCNG PDSCHs shall be uncorrelated pseudo random data, which is QPSK modulated. The parameter <math>\gamma_{PRB}</math> is used to scale the power of PDSCH.</p> <p>Note 2: Subframes available for DL transmission depends on the Uplink-Downlink configuration in Table 4.2-2 in 3GPP TS 36.211.</p> <p>Note 3: If two or more transmit antennas with CRS are used in the test, the OCNG shall be transmitted to the virtual users by all the transmit antennas with CRS according to transmission mode 2. The parameter <math>\gamma_{PRB}</math> applies to each antenna port separately, so the transmit power is equal between all the transmit antennas with CRS used in the test. The antenna transmission modes are specified in section 7.1 in 3GPP TS 36.213.</p>				

### A.5.2.3 OCNG TDD pattern 3: 49 RB OCNG allocation with MBSFN in 10 MHz

**Table A.5.2.3-1: OP.3 TDD: OCNG TDD Pattern 3 for 5ms downlink-to-uplink switch-point periodicity**

Allocation $n_{PRB}$	Relative power level $\gamma_{PRB}$ [dB]				PDSCH Data	PMCH Data
	Subframe					
	0	5	4, 9 <sup>Note 2</sup>	1, 6		
1 – 49	0	0 (Allocation: all empty PRB-s)	N/A	0	Note 1	N/A
0 – 49	N/A	N/A	0	N/A	N/A	Note 3
<p>Note 1: These physical resource blocks are assigned to an arbitrary number of virtual UEs with one PDSCH per virtual UE; the data transmitted over the OCNG PDSCHs shall be uncorrelated pseudo random data, which is QPSK modulated. The parameter <math>\gamma_{PRB}</math> is used to scale the power of PDSCH.</p> <p>Note 2: Subframes available for DL transmission depends on the Uplink-Downlink configuration in Table 4.2-2 in 3GPP TS 36.211.</p> <p>Note 3: Each physical resource block (PRB) is assigned to MBSFN transmission. The data in each PRB shall be uncorrelated with data in other PRBs over the period of any measurement. The MBSFN data shall be QPSK modulated. PMCH symbols shall not contain cell-specific Reference Signals</p> <p>Note 4: If two or more transmit antennas are used in the test, the OCNG shall be transmitted to the virtual users by all the transmit antennas according to transmission mode 2. The transmit power shall be equally split between all the transmit antennas used in the test. The antenna transmission modes are specified in section 7.1 in 3GPP TS 36.213.</p>						
N/A: Not Applicable						

### A.5.2.4 OCNG TDD pattern 4: One sided dynamic OCNG TDD pattern for MBMS transmission

This OCNG Pattern fills with OCNG all empty PRB-s (PRB-s with no allocation of data or system information) of the DL sub-frames, when the unallocated area is continuous in frequency domain (one sided) and MBMS performance is tested.

**Table A.5.2.4-1: OP.4 TDD: One sided dynamic OCNG TDD Pattern for MBMS transmission**

Allocation $n_{PRB}$	Relative power level $\gamma_{PRB}$ [dB]				PDSCH Data	PMCH Data
	Subframe (only for DL)					
	0 and 6 (as normal subframe)	1 (as special subframe)	5	3, 4, 7 – 9		
First unallocated PRB – Last unallocated PRB	0	0 (Allocation: all empty PRB-s of DwPTS)	0 (Allocation: all empty PRB-s)	N/A	Note 1	N/A
First unallocated PRB – Last unallocated PRB	N/A	N/A	N/A	N/A	N/A	Note2
<p>Note 1: These physical resource blocks are assigned to an arbitrary number of virtual UEs with one PDSCH per virtual UE; the data transmitted over the OCNG PDSCHs shall be uncorrelated pseudo random data, which is QPSK modulated. The parameter <math>\gamma_{PRB}</math> is used to scale the power of PDSCH.</p> <p>Note 2: Each physical resource block (PRB) is assigned to MBSFN transmission. The data in each PRB shall be uncorrelated with data in other PRBs over the period of any measurement. The MBSFN data shall be QPSK modulated. PMCH symbols shall not contain cell-specific Reference Signals.</p> <p>Note 3: If two or more transmit antennas are used in the test, the OCNG shall be transmitted to the virtual users by all the transmit antennas according to transmission mode 2. The transmit power shall be equally split between all the transmit antennas used in the test. The antenna transmission modes are specified in section 7.1 in 3GPP TS 36.213.</p>						
N/A Not Applicable						

### A.5.2.5 OCNG TDD pattern 5: One sided dynamic 16QAM modulated OCNG TDD pattern

This OCNG Pattern fills with OCNG all empty PRB-s (PRB-s with no allocation of data or system information) of the sub-frames available for DL transmission (depending on TDD UL/DL configuration), when the unallocated area is continuous in frequency domain (one sided).

**Table A.5.2.5-1: OP.5 TDD: One sided dynamic 16QAM modulated OCNG TDD Pattern**

Relative power level $\gamma_{PRB}$ [dB]				PDSCH Data
Subframe (only if available for DL)				
0	5	3, 4, 7, 8, 9 and 6 (as normal subframe) <small>Note 2</small>	1 and 6 (as special subframe) <small>Note 2</small>	
Allocation				
First unallocated PRB –	First unallocated PRB –	First unallocated PRB –	First unallocated PRB –	
Last unallocated PRB	Last unallocated PRB	Last unallocated PRB	Last unallocated PRB	
0	0	0	0	Note 1
<p>Note 1: These physical resource blocks are assigned to an arbitrary number of virtual UEs with one PDSCH per virtual UE; the data transmitted over the OCNG PDSCHs shall be uncorrelated pseudo random data, which is 16QAM modulated. The parameter <math>\gamma_{PRB}</math> is used to scale the power of PDSCH.</p> <p>Note 2: Subframes available for DL transmission depends on the Uplink-Downlink configuration in Table 4.2-2 in 3GPP TS 36.211</p> <p>Note 3: If two or more transmit antennas with CRS are used in the test, the OCNG shall be transmitted to the virtual users by all the transmit antennas with CRS according to transmission mode 3 (Large Delay CDD). The parameter <math>\gamma_{PRB}</math> applies to each antenna port separately, so the transmit power is equal between all the transmit antennas with CRS used in the test. The antenna transmission modes are specified in section 7.1 in 3GPP TS 36.213.</p>				

### A.5.2.6 OCNG TDD pattern 6: dynamic OCNG TDD pattern when user data is in 2 non-contiguous blocks

This OCNG Pattern fills with OCNG all empty PRB-s (PRB-s with no allocation of data or system information) of the subframes available for DL transmission (depending on TDD UL/DL configuration), when the unallocated area is discontinuous in frequency domain (divided in two parts by the first allocated block). The second allocated block ends with PRB  $N_{RB} - 1$ .

**Table A.5.2.6-1: OP.6 TDD: OCNG TDD Pattern when user data is in 2 non-contiguous blocks**

Relative power level $\gamma_{PRB}$ [dB]				PDSCH Data
Subframe (only if available for DL)				
0	5	3, 4, 6, 7, 8, 9 (6 as normal subframe) <small>Note 2</small>	1,6 (6 as special subframe) <small>Note 2</small>	
Allocation				
0 – (First allocated PRB of first block -1) and (Last allocated PRB of first block +1) – (First allocated PRB of second block -1)	0 – (First allocated PRB of first block -1) and (Last allocated PRB of first block +1) – (First allocated PRB of second block -1)	0 – (First allocated PRB of first block -1) and (Last allocated PRB of first block +1) – (First allocated PRB of second block -1)	0 – (First allocated PRB of first block -1) and (Last allocated PRB of first block +1) – (First allocated PRB of second block -1)	
0	0	0	0	
<p>Note 1: These physical resource blocks are assigned to an arbitrary number of virtual UEs with one PDSCH per virtual UE; the data transmitted over the OCNG PDSCHs shall be uncorrelated pseudo random data, which is QPSK modulated. The parameter <math>\gamma_{PRB}</math> is used to scale the power of PDSCH.</p> <p>Note 2: Subframes available for DL transmission depends on the Uplink-Downlink configuration in Table 4.2-2 in 3GPP TS 36.211</p> <p>Note 3: If two or more transmit antennas with CRS are used in the test, the OCNG shall be transmitted to the virtual users by all the transmit antennas with CRS according to transmission mode 2. The parameter <math>\gamma_{PRB}</math> applies to each antenna port separately, so the transmit power is equal between all the transmit antennas with CRS used in the test. The antenna transmission modes are specified in section 7.1 in 3GPP TS 36.213.</p>				

### A.5.2.7 OCNG TDD pattern 7: dynamic OCNG TDD pattern when user data is in multiple non-contiguous blocks

This OCNG Pattern fills with OCNG all empty PRB-s (PRB-s with no allocation of data, EPDCCH or system information) of the DL sub-frames, when the unallocated area is discontinuous in frequency domain (divided in multiple parts by the  $M$  allocated blocks for data transmission). The  $m$ -th allocated block starts with RPB  $N_{Start,m}$  and ends with PRB  $N_{End,m} - 1$ , where  $m = 1, \dots, M$ . The system bandwidth starts with RPB 0 and ends with  $N_{RB} - 1$ .

**Table A.5.2.7-1: OP.7 TDD: OCNG TDD Pattern when user data is in multiple non-contiguous blocks**

Relative power level $\gamma_{PRB}$ [dB]				PDSCH Data
Subframe (only if available for DL)				
0	5	3, 4, 6, 7, 8, 9 (6 as normal subframe) <small>Note 2</small>	1,6 (6 as special subframe) <small>Note 2</small>	
Allocation				
0 – (PRB $N_{Start,1} - 1$ ) ... (PRB $N_{End,(m-1)} -$ (PRB $N_{Start,m} - 1$ ) ... (PRB $N_{End,M} -$ (PRB $N_{RB} - 1$ )	0 – (PRB $N_{Start,1} - 1$ ) ... (PRB $N_{End,(m-1)} -$ (PRB $N_{Start,m} - 1$ ) ... (PRB $N_{End,M} -$ (PRB $N_{RB} - 1$ )	0 – (PRB $N_{Start,1} - 1$ ) ... (PRB $N_{End,(m-1)} -$ (PRB $N_{Start,m} - 1$ ) ... (PRB $N_{End,M} -$ (PRB $N_{RB} - 1$ )	0 – (PRB $N_{Start,1} - 1$ ) ... (PRB $N_{End,(m-1)} -$ (PRB $N_{Start,m} - 1$ ) ... (PRB $N_{End,M} -$ (PRB $N_{RB} - 1$ )	
0	0	0	0	Note 1
<p>Note 1: These physical resource blocks are assigned to an arbitrary number of virtual UEs with one PDSCH per virtual UE; the data transmitted over the OCNG PDSCHs shall be uncorrelated pseudo random data, which is QPSK modulated. The parameter <math>\gamma_{PRB}</math> is used to scale the power of PDSCH.</p> <p>Note 2: Subframes available for DL transmission depends on the Uplink-Downlink configuration in Table 4.2-2 in 3GPP TS 36.211 [8].</p> <p>Note 3: If two or more transmit antennas with CRS are used in the test, the OCNG shall be transmitted to the virtual users by all the transmit antennas with CRS according to transmission mode 2. The parameter <math>\gamma_{PRB}</math> applies to each antenna port separately, so the transmit power is equal between all the transmit antennas with CRS used in the test. The antenna transmission modes are specified in section 7.1 in 3GPP TS 36.213 [10].</p>				

### A.5.2.8 OCNG TDD pattern 8: One sided dynamic OCNG TDD pattern for TM10 transmission

This OCNG Pattern fills with OCNG all empty PRB-s (PRB-s with no allocation of data or system information) of the DL sub-frames, when the unallocated area is continuous in frequency domain (one sided).



Table A.5.2.8-1: OP.8 TDD: One sided dynamic OCNG TDD Pattern

Relative power level $\gamma_{PRB}$ [dB]			PDSCH Data
Subframe			
0	5	1 – 4, 6 – 9	
Allocation			
First unallocated PRB – Last unallocated PRB	First unallocated PRB – Last unallocated PRB	First unallocated PRB – Last unallocated PRB	
0	0	0	
Note 1: These physical resource blocks are assigned to an arbitrary number of virtual UEs with one PDSCH per virtual UE; the data transmitted over the OCNG PDSCHs shall be uncorrelated pseudo random data, which is 16QAM modulated. The parameter $\gamma_{PRB}$ is used to scale the power of PDSCH.			Note 1,2,3
Note 2: The OCNG shall be transmitted to the virtual users by all the transmit antennas according to transmission mode10. The transmit power is equal between all the transmit antennas used in the test. The antenna transmission modes are specified in section 7.1 in 3GPP TS 36.213 [10].			
Note 3: The detailed test set-up for TM10 transmission i.e. PMI configuration is specified to each test case.			

---

## Annex B (normative): Propagation Conditions

The propagation conditions and channel models for various environments are specified. For each environment a propagation model is used to evaluate the propagation pathloss due to the distance. Channel models are formed by combining delay profiles with a Doppler spectrum, with the addition of correlation properties in the case of a multi-antenna scenario.

---

### B.0 No interference

The downlink connection between the System Simulator and the UE is without Additive White Gaussian Noise, and has no fading or multipath effects.

---

### B.1 Static propagation condition

The downlink connection between the System Simulator and the UE is an Additive White Gaussian Noise (AWGN) environment (unless otherwise stated) with no fading or multipath effects.

For 1 port transmission the channel matrix is defined in the frequency domain by

$$\mathbf{H} = \begin{pmatrix} 1 \\ 1 \end{pmatrix}.$$

For 2 port transmission the channel matrix is defined in the frequency domain by

$$\mathbf{H} = \begin{pmatrix} 1 & j \\ 1 & -j \end{pmatrix}$$

For 4 port transmission the channel matrix is defined in the frequency domain by

$$\mathbf{H} = \begin{bmatrix} 1 & 1 & j & j \\ 1 & 1 & -j & -j \end{bmatrix}$$

For 8 port transmission the channel matrix is defined in the frequency domain by

$$\mathbf{H} = \begin{bmatrix} 1 & 1 & 1 & 1 & j & j & j & j \\ 1 & 1 & 1 & 1 & -j & -j & -j & -j \end{bmatrix}$$

#### B.1.1 Definition of Additive White Gaussian Noise (AWGN) Interferer

Note that the AWGN interferer can be used in static propagation conditions, or in conjunction with multi-path fading.

The acceptable uncertainties of the AWGN interferer are defined in Annex F.

---

### B.2 Multi-path fading Propagation Conditions

The multipath propagation conditions consist of several parts:

- A delay profile in the form of a "tapped delay-line", characterized by a number of taps at fixed positions on a sampling grid. The profile can be further characterized by the r.m.s. delay spread and the maximum delay spanned by the taps.
- A combination of channel model parameters that include the Delay profile and the Doppler spectrum that is characterized by a classical spectrum shape and a maximum Doppler frequency
- A set of correlation matrices defining the correlation between the UE and eNodeB antennas in case of multi-antenna systems.

## B.2.1 Delay profiles

The delay profiles are selected to be representative of low, medium and high delay spread environments. The resulting model parameters are defined in Table B.2.1-1 and the tapped delay line models are defined in Tables B.2.1-2, B.2.1-3 and B.2.1-4.

**Table B.2.1-1: Delay profiles for E-UTRA channel models**

Model	Number of channel taps	Delay spread (r.m.s.)	Maximum excess tap delay (span)
Extended Pedestrian A (EPA)	7	45 ns	410 ns
Extended Vehicular A model (EVA)	9	357 ns	2510 ns
Extended Typical Urban model (ETU)	9	991 ns	5000 ns

**Table B.2.1-2: Extended Pedestrian A model (EPA)**

Excess tap delay [ns]	Relative power [dB]
0	0.0
30	-1.0
70	-2.0
90	-3.0
110	-8.0
190	-17.2
410	-20.8

**Table B.2.1-3: Extended Vehicular A model (EVA)**

Excess tap delay [ns]	Relative power [dB]
0	0.0
30	-1.5
150	-1.4
310	-3.6
370	-0.6
710	-9.1
1090	-7.0
1730	-12.0
2510	-16.9

**Table B.2.1-4: Extended Typical Urban model (ETU)**

Excess tap delay [ns]	Relative power [dB]
0	-1.0
50	-1.0
120	-1.0
200	0.0
230	0.0
500	0.0
1600	-3.0
2300	-5.0
5000	-7.0

## B.2.2 Combinations of channel model parameters

Table B.2.2-1 shows propagation conditions that are used for the performance measurements in multi-path fading environment for low, medium and high Doppler frequencies.

**Table B.2.2-1: Channel model parameters**

Model	Maximum Doppler frequency
EPA 5Hz	5 Hz
EVA 5Hz	5 Hz
EVA 70Hz	70 Hz
EVA 200Hz	200 Hz
ETU 30Hz	30 Hz
ETU 70Hz	70 Hz
ETU 300Hz	300 Hz

## B.2.3 MIMO Channel Correlation Matrices

The MIMO channel correlation matrices defined in B.2.3 apply for the antenna configuration using uniform linear arrays at both eNodeB and UE.

### B.2.3.1 Definition of MIMO Correlation Matrices

Table B.2.3.1-1 defines the correlation matrix for the eNodeB

**Table B.2.3.1-1: eNodeB correlation matrix**

	One antenna	Two antennas	Four antennas
eNode B Correlation	$R_{eNB} = 1$	$R_{eNB} = \begin{pmatrix} 1 & \alpha \\ \alpha^* & 1 \end{pmatrix}$	$R_{eNB} = \begin{pmatrix} 1 & \alpha^{1/9} & \alpha^{4/9} & \alpha \\ \alpha^{1/9*} & 1 & \alpha^{1/9} & \alpha^{4/9} \\ \alpha^{4/9*} & \alpha^{1/9*} & 1 & \alpha^{1/9} \\ \alpha^* & \alpha^{4/9*} & \alpha^{1/9*} & 1 \end{pmatrix}$

Table B.2.3.1-2 defines the correlation matrix for the UE:

**Table B.2.3.1-2: UE correlation matrix**

	One antenna	Two antennas	Four antennas
UE Correlation	$R_{UE} = 1$	$R_{UE} = \begin{pmatrix} 1 & \beta \\ \beta^* & 1 \end{pmatrix}$	$R_{UE} = \begin{pmatrix} 1 & \beta^{1/9} & \beta^{4/9} & \beta \\ \beta^{1/9*} & 1 & \beta^{1/9} & \beta^{4/9} \\ \beta^{4/9*} & \beta^{1/9*} & 1 & \beta^{1/9} \\ \beta^* & \beta^{4/9*} & \beta^{1/9*} & 1 \end{pmatrix}$

Table B.2.3.1-3 defines the channel spatial correlation matrix  $R_{spat}$ . The parameters,  $\alpha$  and  $\beta$  in Table B.2.3.1-3 defines the spatial correlation between the antennas at the eNodeB and UE.

**Table B.2.3.1-3:  $R_{spat}$  correlation matrices**

1x2 case	$R_{spat} = R_{UE} = \begin{bmatrix} 1 & \beta \\ \beta^* & 1 \end{bmatrix}$
2x2 case	$R_{spat} = R_{eNB} \otimes R_{UE} = \begin{bmatrix} 1 & \alpha \\ \alpha^* & 1 \end{bmatrix} \otimes \begin{bmatrix} 1 & \beta \\ \beta^* & 1 \end{bmatrix} = \begin{bmatrix} 1 & \beta & \alpha & \alpha\beta \\ \beta^* & 1 & \alpha\beta^* & \alpha \\ \alpha^* & \alpha^* \beta & 1 & \beta \\ \alpha^* \beta^* & \alpha^* & \beta^* & 1 \end{bmatrix}$
4x2 case	$R_{spat} = R_{eNB} \otimes R_{UE} = \begin{bmatrix} 1 & \alpha^{1/9} & \alpha^{4/9} & \alpha \\ \alpha^{1/9*} & 1 & \alpha^{1/9} & \alpha^{4/9} \\ \alpha^{4/9*} & \alpha^{1/9*} & 1 & \alpha^{1/9} \\ \alpha^* & \alpha^{4/9*} & \alpha^{1/9*} & 1 \end{bmatrix} \otimes \begin{bmatrix} 1 & \beta \\ \beta^* & 1 \end{bmatrix}$
4x4 case	$R_{spat} = R_{eNB} \otimes R_{UE} = \begin{bmatrix} 1 & \alpha^{1/9} & \alpha^{4/9} & \alpha \\ \alpha^{1/9*} & 1 & \alpha^{1/9} & \alpha^{4/9} \\ \alpha^{4/9*} & \alpha^{1/9*} & 1 & \alpha^{1/9} \\ \alpha^* & \alpha^{4/9*} & \alpha^{1/9*} & 1 \end{bmatrix} \otimes \begin{bmatrix} 1 & \beta^{1/9} & \beta^{4/9} & \beta \\ \beta^{1/9*} & 1 & \beta^{1/9} & \beta^{4/9} \\ \beta^{4/9*} & \beta^{1/9*} & 1 & \beta^{1/9} \\ \beta^* & \beta^{4/9*} & \beta^{1/9*} & 1 \end{bmatrix}$

For cases with more antennas at either eNodeB or UE or both, the channel spatial correlation matrix can still be expressed as the Kronecker product of  $R_{eNB}$  and  $R_{UE}$  according to  $R_{spat} = R_{eNB} \otimes R_{UE}$ .

### B.2.3.2 MIMO Correlation Matrices at High, Medium and Low Level

The  $\alpha$  and  $\beta$  for different correlation types are given in Table B.2.3.2-1.

**Table B.2.3.2-1**

Low correlation		Medium Correlation		High Correlation	
$\alpha$	$\beta$	$\alpha$	$\beta$	$\alpha$	$\beta$
0	0	0.3	0.9	0.9	0.9

The correlation matrices for high, medium and low correlation are defined in Table B.2.3.2-2, B.2.3.2-3 and B.2.3.2-4, as below.

The values in the Table B.2.3.2-2 table have been adjusted for the 4x2 and 4x4 high correlation cases to insure the correlation matrix is positive semi-definite after round-off to 4 digit precision. This is done using the equation:

$$\mathbf{R}_{high} = [\mathbf{R}_{spatial} + a\mathbf{I}_n]/(1 + a)$$

Where the value “a” is a scaling factor such that the smallest value is used to obtain a positive semi-definite result. For the 4x2 high correlation case, a=0.00010. For the 4x4 high correlation case, a=0.00012.

The same method is used to adjust the 4x4 medium correlation matrix in Table B.2.3.2-3 to insure the correlation matrix is positive semi-definite after round-off to 4 digit precision with a = 0.00012.

**Table B.2.3.2-2: MIMO correlation matrices for high correlation**

1x2 case	$R_{high} = \begin{pmatrix} 1 & 0.9 \\ 0.9 & 1 \end{pmatrix}$	
2x2 case	$R_{high} = \begin{pmatrix} 1 & 0.9 & 0.9 & 0.81 \\ 0.9 & 1 & 0.81 & 0.9 \\ 0.9 & 0.81 & 1 & 0.9 \\ 0.81 & 0.9 & 0.9 & 1 \end{pmatrix}$	
4x2 case	$R_{high} =$	$\begin{bmatrix} 1.0000 & 0.8999 & 0.9883 & 0.8894 & 0.9542 & 0.8587 & 0.8999 & 0.8099 \\ 0.8999 & 1.0000 & 0.8894 & 0.9883 & 0.8587 & 0.9542 & 0.8099 & 0.8999 \\ 0.9883 & 0.8894 & 1.0000 & 0.8999 & 0.9883 & 0.8894 & 0.9542 & 0.8587 \\ 0.8894 & 0.9883 & 0.8999 & 1.0000 & 0.8894 & 0.9883 & 0.8587 & 0.9542 \\ 0.9542 & 0.8587 & 0.9883 & 0.8894 & 1.0000 & 0.8999 & 0.9883 & 0.8894 \\ 0.8587 & 0.9542 & 0.8894 & 0.9883 & 0.8999 & 1.0000 & 0.8894 & 0.9883 \\ 0.8999 & 0.8099 & 0.9542 & 0.8587 & 0.9883 & 0.8894 & 1.0000 & 0.8999 \\ 0.8099 & 0.8999 & 0.8587 & 0.9542 & 0.8894 & 0.9883 & 0.8999 & 1.0000 \end{bmatrix}$
4x4 case	$R_{high} =$	$\begin{bmatrix} 1.0000 & 0.9882 & 0.9541 & 0.8999 & 0.9882 & 0.9767 & 0.9430 & 0.8894 & 0.9541 & 0.9430 & 0.9105 & 0.8587 & 0.8999 & 0.8894 & 0.8587 & 0.8099 \\ 0.9882 & 1.0000 & 0.9882 & 0.9541 & 0.9767 & 0.9882 & 0.9767 & 0.9430 & 0.9430 & 0.9541 & 0.9430 & 0.9105 & 0.8894 & 0.8999 & 0.8894 & 0.8587 \\ 0.9541 & 0.9882 & 1.0000 & 0.9882 & 0.9430 & 0.9767 & 0.9882 & 0.9767 & 0.9105 & 0.9430 & 0.9541 & 0.9430 & 0.8587 & 0.8894 & 0.8999 & 0.8894 \\ 0.8999 & 0.9541 & 0.9882 & 1.0000 & 0.8894 & 0.9430 & 0.9767 & 0.9882 & 0.8587 & 0.9105 & 0.9430 & 0.9541 & 0.8099 & 0.8587 & 0.8894 & 0.8999 \\ 0.9882 & 0.9767 & 0.9430 & 0.8894 & 1.0000 & 0.9882 & 0.9541 & 0.8999 & 0.9882 & 0.9767 & 0.9430 & 0.8894 & 0.9541 & 0.9430 & 0.9105 & 0.8587 \\ 0.9767 & 0.9882 & 0.9767 & 0.9430 & 0.9882 & 1.0000 & 0.9882 & 0.9541 & 0.9767 & 0.9882 & 0.9767 & 0.9430 & 0.9430 & 0.9541 & 0.9430 & 0.9105 \\ 0.9430 & 0.9767 & 0.9882 & 0.9767 & 0.9541 & 0.9882 & 1.0000 & 0.9882 & 0.9430 & 0.9767 & 0.9882 & 0.9767 & 0.9105 & 0.9430 & 0.9541 & 0.9430 \\ 0.8894 & 0.9430 & 0.9767 & 0.9882 & 0.8999 & 0.9541 & 0.9882 & 1.0000 & 0.8894 & 0.9430 & 0.9767 & 0.9882 & 0.8587 & 0.9105 & 0.9430 & 0.9541 \\ 0.9541 & 0.9430 & 0.9105 & 0.8587 & 0.9882 & 0.9767 & 0.9430 & 0.8894 & 1.0000 & 0.9882 & 0.9541 & 0.8999 & 0.9882 & 0.9767 & 0.9430 & 0.8894 \\ 0.9430 & 0.9541 & 0.9430 & 0.9105 & 0.9767 & 0.9882 & 0.9767 & 0.9430 & 0.9882 & 1.0000 & 0.9882 & 0.9541 & 0.9767 & 0.9882 & 0.9767 & 0.9430 \\ 0.9105 & 0.9430 & 0.9541 & 0.9430 & 0.9430 & 0.9767 & 0.9882 & 0.9767 & 0.9541 & 0.9882 & 1.0000 & 0.9882 & 0.9430 & 0.9767 & 0.9882 & 0.9767 \\ 0.8587 & 0.9105 & 0.9430 & 0.9541 & 0.8894 & 0.9430 & 0.9767 & 0.9882 & 0.8999 & 0.9541 & 0.9882 & 1.0000 & 0.8894 & 0.9430 & 0.9767 & 0.9882 \\ 0.8999 & 0.8894 & 0.8587 & 0.8099 & 0.9541 & 0.9430 & 0.9105 & 0.8587 & 0.9882 & 0.9767 & 0.9430 & 0.8894 & 1.0000 & 0.9882 & 0.9541 & 0.8999 \\ 0.8894 & 0.8999 & 0.8894 & 0.8587 & 0.9430 & 0.9541 & 0.9430 & 0.9105 & 0.9767 & 0.9882 & 0.9767 & 0.9430 & 0.9882 & 1.0000 & 0.9882 & 0.9541 \\ 0.8587 & 0.8894 & 0.8999 & 0.8894 & 0.9105 & 0.9430 & 0.9541 & 0.9430 & 0.9430 & 0.9767 & 0.9882 & 0.9767 & 0.9541 & 0.9882 & 1.0000 & 0.9882 \\ 0.8099 & 0.8587 & 0.8894 & 0.8999 & 0.8587 & 0.9105 & 0.9430 & 0.9541 & 0.8894 & 0.9430 & 0.9767 & 0.9882 & 0.8999 & 0.9541 & 0.9882 & 1.0000 \end{bmatrix}$

**Table B.2.3.2-3: MIMO correlation matrices for medium correlation**

1x2 case	N/A
2x2 case	$R_{medium} = \begin{pmatrix} 1 & 0.9 & 0.3 & 0.27 \\ 0.9 & 1 & 0.27 & 0.3 \\ 0.3 & 0.27 & 1 & 0.9 \\ 0.27 & 0.3 & 0.9 & 1 \end{pmatrix}$
4x2 case	$R_{medium} = \begin{pmatrix} 1.0000 & 0.9000 & 0.8748 & 0.7873 & 0.5856 & 0.5271 & 0.3000 & 0.2700 \\ 0.9000 & 1.0000 & 0.7873 & 0.8748 & 0.5271 & 0.5856 & 0.2700 & 0.3000 \\ 0.8748 & 0.7873 & 1.0000 & 0.9000 & 0.8748 & 0.7873 & 0.5856 & 0.5271 \\ 0.7873 & 0.8748 & 0.9000 & 1.0000 & 0.7873 & 0.8748 & 0.5271 & 0.5856 \\ 0.5856 & 0.5271 & 0.8748 & 0.7873 & 1.0000 & 0.9000 & 0.8748 & 0.7873 \\ 0.5271 & 0.5856 & 0.7873 & 0.8748 & 0.9000 & 1.0000 & 0.7873 & 0.8748 \\ 0.3000 & 0.2700 & 0.5856 & 0.5271 & 0.8748 & 0.7873 & 1.0000 & 0.9000 \\ 0.2700 & 0.3000 & 0.5271 & 0.5856 & 0.7873 & 0.8748 & 0.9000 & 1.0000 \end{pmatrix}$
4x4 case	$R_{medium} = \begin{pmatrix} 1.0000 & 0.9882 & 0.9541 & 0.8999 & 0.8747 & 0.8645 & 0.8347 & 0.7872 & 0.5855 & 0.5787 & 0.5588 & 0.5270 & 0.3000 & 0.2965 & 0.2862 & 0.2700 \\ 0.9882 & 1.0000 & 0.9882 & 0.9541 & 0.8645 & 0.8747 & 0.8645 & 0.8347 & 0.5787 & 0.5855 & 0.5787 & 0.5588 & 0.2965 & 0.3000 & 0.2965 & 0.2862 \\ 0.9541 & 0.9882 & 1.0000 & 0.9882 & 0.8347 & 0.8645 & 0.8747 & 0.8645 & 0.5588 & 0.5787 & 0.5855 & 0.5787 & 0.2862 & 0.2965 & 0.3000 & 0.2965 \\ 0.8999 & 0.9541 & 0.9882 & 1.0000 & 0.7872 & 0.8347 & 0.8645 & 0.8747 & 0.5270 & 0.5588 & 0.5787 & 0.5855 & 0.2700 & 0.2862 & 0.2965 & 0.3000 \\ 0.8747 & 0.8645 & 0.8347 & 0.7872 & 1.0000 & 0.9882 & 0.9541 & 0.8999 & 0.8747 & 0.8645 & 0.8347 & 0.7872 & 0.5855 & 0.5787 & 0.5588 & 0.5270 \\ 0.8645 & 0.8747 & 0.8645 & 0.8347 & 0.9882 & 1.0000 & 0.9882 & 0.9541 & 0.8645 & 0.8747 & 0.8645 & 0.8347 & 0.5787 & 0.5855 & 0.5787 & 0.5588 \\ 0.8347 & 0.8645 & 0.8747 & 0.8645 & 0.9541 & 0.9882 & 1.0000 & 0.9882 & 0.8347 & 0.8645 & 0.8747 & 0.8645 & 0.5588 & 0.5787 & 0.5855 & 0.5787 \\ 0.7872 & 0.8347 & 0.8645 & 0.8747 & 0.8999 & 0.9541 & 0.9882 & 1.0000 & 0.7872 & 0.8347 & 0.8645 & 0.8747 & 0.5270 & 0.5588 & 0.5787 & 0.5855 \\ 0.5855 & 0.5787 & 0.5588 & 0.5270 & 0.8747 & 0.8645 & 0.8347 & 0.7872 & 1.0000 & 0.9882 & 0.9541 & 0.8999 & 0.8747 & 0.8645 & 0.8347 & 0.7872 \\ 0.5787 & 0.5855 & 0.5787 & 0.5588 & 0.8645 & 0.8747 & 0.8645 & 0.8347 & 0.9882 & 1.0000 & 0.9882 & 0.9541 & 0.8645 & 0.8747 & 0.8645 & 0.8347 \\ 0.5588 & 0.5787 & 0.5855 & 0.5787 & 0.8347 & 0.8645 & 0.8747 & 0.8645 & 0.9541 & 0.9882 & 1.0000 & 0.9882 & 0.8347 & 0.8645 & 0.8747 & 0.8645 \\ 0.5270 & 0.5588 & 0.5787 & 0.5855 & 0.7872 & 0.8347 & 0.8645 & 0.8747 & 0.8999 & 0.9541 & 0.9882 & 1.0000 & 0.7872 & 0.8347 & 0.8645 & 0.8747 \\ 0.3000 & 0.2965 & 0.2862 & 0.2700 & 0.5855 & 0.5787 & 0.5588 & 0.5270 & 0.8747 & 0.8645 & 0.8347 & 0.7872 & 1.0000 & 0.9882 & 0.9541 & 0.8999 \\ 0.2965 & 0.3000 & 0.2965 & 0.2862 & 0.5787 & 0.5855 & 0.5787 & 0.5588 & 0.8645 & 0.8747 & 0.8645 & 0.8347 & 0.9882 & 1.0000 & 0.9882 & 0.9541 \\ 0.2862 & 0.2965 & 0.3000 & 0.2965 & 0.5588 & 0.5787 & 0.5855 & 0.5787 & 0.8347 & 0.8645 & 0.8747 & 0.8645 & 0.9541 & 0.9882 & 1.0000 & 0.9882 \\ 0.2700 & 0.2862 & 0.2965 & 0.3000 & 0.5270 & 0.5588 & 0.5787 & 0.5855 & 0.7872 & 0.8347 & 0.8645 & 0.8747 & 0.8999 & 0.9541 & 0.9882 & 1.0000 \end{pmatrix}$

**Table B.2.3.2-4: MIMO correlation matrices for low correlation**

1x2 case	$R_{low} = \mathbf{I}_2$
2x2 case	$R_{low} = \mathbf{I}_4$
4x2 case	$R_{low} = \mathbf{I}_8$
4x4 case	$R_{low} = \mathbf{I}_{16}$

In Table B.2.3.2-4,  $\mathbf{I}_d$  is the  $d \times d$  identity matrix.

### B.2.3A MIMO Channel Correlation Matrices using cross polarized antennas

The MIMO channel correlation matrices defined in B.2.3A apply for the antenna configuration using cross polarized antennas at both eNodeB and UE. The cross-polarized antenna elements with +/-45 degrees polarization slant angles are deployed at eNB and cross-polarized antenna elements with +90/0 degrees polarization slant angles are deployed at UE.

For the cross-polarized antennas, the N antennas are labelled such that antennas for one polarization are listed from 1 to N/2 and antennas for the other polarization are listed from N/2+1 to N, where N is the number of transmit or receive antennas.

### B.2.3A.1 Definition of MIMO Correlation Matrices using cross polarized antennas

For the channel spatial correlation matrix, the following is used:

$$R_{spat} = P(R_{eNB} \otimes \Gamma \otimes R_{UE})P^T$$

Where

- $R_{UE}$  is the spatial correlation matrix at the UE with same polarization,
- $R_{eNB}$  is the spatial correlation matrix at the eNB with same polarization,
- $\Gamma$  is a polarization correlation matrix, and
- $(\bullet)^T$  denotes transpose.

The matrix  $\Gamma$  is defined as

$$\Gamma = \begin{bmatrix} 1 & 0 & -\gamma & 0 \\ 0 & 1 & 0 & \gamma \\ -\gamma & 0 & 1 & 0 \\ 0 & \gamma & 0 & 1 \end{bmatrix}$$

A permutation matrix  $P$  element is defined as:

$$P(a,b) = \begin{cases} 1 & \text{for } a = (j-1)N_r + i \text{ and } b = 2(j-1)N_r + i, \quad i = 1, \dots, N_r, j = 1, \dots, N_t/2 \\ 1 & \text{for } a = (j-1)N_r + i \text{ and } b = 2(j - N_t/2)N_r - N_r + i, \quad i = 1, \dots, N_r, j = N_t/2 + 1, \dots, N_t \\ 0 & \text{otherwise} \end{cases}$$

Where  $N_t$  and  $N_r$  is the number of transmitter and receiver respectively. This is used to map the spatial correlation coefficients in accordance with the antenna element labelling system described in B.2.3A.

### B.2.3A.2 Spatial Correlation Matrices using cross polarized antennas at eNB and UE sides

#### B.2.3A.2.1 Spatial Correlation Matrices at eNB side

For 2-antenna transmitter using one pair of cross-polarized antenna elements,  $R_{eNB} = 1$ .

For 4-antenna transmitter using two pairs of cross-polarized antenna elements,  $R_{eNB} = \begin{pmatrix} 1 & \alpha \\ \alpha^* & 1 \end{pmatrix}$ .

For 8-antenna transmitter using four pairs of cross-polarized antenna elements,  $R_{eNB} = \begin{pmatrix} 1 & \alpha^{1/9} & \alpha^{4/9} & \alpha \\ \alpha^{1/9*} & 1 & \alpha^{1/9} & \alpha^{4/9} \\ \alpha^{4/9*} & \alpha^{1/9*} & 1 & \alpha^{1/9} \\ \alpha^* & \alpha^{4/9*} & \alpha^{1/9*} & 1 \end{pmatrix}$ .

#### B.2.3A.2.2 Spatial Correlation Matrices at UE side

For 2-antenna transmitter using one pair of cross-polarized antenna elements,  $R_{UE} = 1$ .

For 4-antenna transmitter using two pairs of cross-polarized antenna elements,  $R_{UE} = \begin{pmatrix} 1 & \beta \\ \beta^* & 1 \end{pmatrix}$ .



### B.2.3A.3 MIMO Correlation Matrices using cross polarized antennas

The values for parameters  $\alpha$ ,  $\beta$  and  $\gamma$  for low correlation and high spatial correlation are given in Table B.2.3A.3-1.

**Table B.2.3A.3-1**

High spatial correlation		
$\alpha$	$\beta$	$\gamma$
0.9	0.9	0.3
Note 1: Value of $\alpha$ applies when more than one pair of cross-polarized antenna elements at eNB side.		
Note 2: Value of $\beta$ applies when more than one pair of cross-polarized antenna elements at UE side.		

The correlation matrices for high spatial and low correlation are defined in Table B.2.3A.3-2 as below.

The values in Table B.2.3A.3-2 have been adjusted to insure the correlation matrix is positive semi-definite after round-off to 4 digit precision. This is done using the equation:

$$R_{high} = [R_{spat} + aI_n] / (1 + a)$$

Where the value "a" is a scaling factor such that the smallest value is used to obtain a positive semi-definite result. For the 8x2 high spatial correlation case, a=0.00010.

**Table B.2.3A.3-2: MIMO correlation matrices for high spatial correlation**

8x2 case	$R_{high} =$
	1.0000 0.0000 0.9883 0.0000 0.9542 0.0000 0.8999 0.0000 0.0000 -0.3000 0.0000 -0.2965 0.0000 -0.2862 0.0000 -0.2700 0.0000
	0.0000 1.0000 0.0000 0.9883 0.0000 0.9542 0.0000 0.8999 0.0000 0.3000 0.0000 0.2965 0.0000 0.2862 0.0000 0.2700 0.0000
	0.9883 0.0000 1.0000 0.0000 0.9883 0.0000 0.9542 0.0000 -0.2965 0.0000 -0.3000 0.0000 -0.2965 0.0000 -0.2862 0.0000 0.0000
	0.0000 0.9883 0.0000 1.0000 0.0000 0.9883 0.0000 0.9542 0.0000 0.2965 0.0000 0.3000 0.0000 0.2965 0.0000 0.2862 0.0000
	0.9542 0.0000 0.9883 0.0000 1.0000 0.0000 0.9883 0.0000 -0.2862 0.0000 -0.2965 0.0000 -0.3000 0.0000 -0.2965 0.0000 0.0000
	0.0000 0.9542 0.0000 0.9883 0.0000 1.0000 0.0000 0.9883 0.0000 0.2862 0.0000 0.2965 0.0000 0.3000 0.0000 0.2965 0.0000
	0.8999 0.0000 0.9542 0.0000 0.9883 0.0000 1.0000 0.0000 -0.2700 0.0000 -0.2862 0.0000 -0.2965 0.0000 -0.3000 0.0000 0.0000
	0.0000 0.8999 0.0000 0.9542 0.0000 0.9883 0.0000 1.0000 0.0000 0.2700 0.0000 0.2862 0.0000 0.2965 0.0000 0.3000 0.0000
	-0.3000 0.0000 -0.2965 0.0000 -0.2862 0.0000 -0.2700 0.0000 1.0000 0.0000 0.9883 0.0000 0.9542 0.0000 0.8999 0.0000 0.0000
	0.0000 0.3000 0.0000 0.2965 0.0000 0.2862 0.0000 0.2700 0.0000 1.0000 0.0000 0.9883 0.0000 0.9542 0.0000 0.8999 0.0000
	-0.2965 0.0000 -0.3000 0.0000 -0.2965 0.0000 -0.2862 0.0000 0.9883 0.0000 1.0000 0.0000 0.9883 0.0000 0.9542 0.0000 0.0000
	0.0000 0.2965 0.0000 0.3000 0.0000 0.2965 0.0000 0.2862 0.0000 0.9883 0.0000 1.0000 0.0000 0.9883 0.0000 0.9542 0.0000
	-0.2862 0.0000 -0.2965 0.0000 -0.3000 0.0000 -0.2965 0.0000 0.9542 0.0000 0.9883 0.0000 1.0000 0.0000 0.9883 0.0000 0.0000
	0.0000 0.2862 0.0000 0.2965 0.0000 0.3000 0.0000 0.2965 0.0000 0.9542 0.0000 0.9883 0.0000 1.0000 0.0000 0.9883 0.0000
	-0.2700 0.0000 -0.2862 0.0000 -0.2965 0.0000 -0.3000 0.0000 0.8999 0.0000 0.9542 0.0000 0.9883 0.0000 1.0000 0.0000 0.0000
	0.0000 0.2700 0.0000 0.2862 0.0000 0.2965 0.0000 0.3000 0.0000 0.8999 0.0000 0.9542 0.0000 0.9883 0.0000 1.0000 0.0000

### B.2.3A.4 Beam steering approach

Given the channel spatial correlation matrix in B.2.3A.1, the corresponding random channel matrix  $H$  can be calculated. The signal model for the k-th subframe is denoted as:

$$y = HD_{\theta_k} Wx + n$$

Where

- H is the N-r xNt channel matrix per subcarrier.
- $D_{\theta_k}$  is the steering matrix,

For 8 transmission antennas,  $D_{\theta_k} = \begin{bmatrix} 1 & 0 \\ 0 & 1 \end{bmatrix} \otimes \begin{bmatrix} 1 & 0 & 0 & 0 \\ 0 & e^{j\theta_k} & 0 & 0 \\ 0 & 0 & e^{j2\theta_k} & 0 \\ 0 & 0 & 0 & e^{j3\theta_k} \end{bmatrix};$

For 4 transmission antennas,  $D_{\theta_k} = \begin{bmatrix} 1 & 0 \\ 0 & 1 \end{bmatrix} \otimes \begin{bmatrix} 1 & 0 \\ 0 & e^{j\theta_k} \end{bmatrix}$ .

- $\theta_k$  controls the phase variation, and the phase for k-th subframe is denoted by  $\theta_k = \theta_0 + \Delta\theta \cdot k$ , where  $\theta_0$  is the random start value with the uniform distribution, i.e.  $\theta_0 \in [0, 2\pi]$ ,  $\Delta\theta$  is the step of phase variation, which is defined in Table B.2.3A.4-1, and  $k$  is the linear increment of 1 for every subframe throughout the simulation,
- $W$  is the precoding matrix for  $N_t$  transmission antennas,
- $y$  is the received signal,  $x$  is the transmitted signal, and  $n$  is AWGN.

**Table B.2.3A.4-1: The step of phase variation**

Variation Step	Value (rad/subframe)
$\Delta\theta$	$1.2566 \times 10^{-3}$

## B.2.4 Propagation conditions for CQI tests

[For Channel Quality Indication (CQI) tests, the following additional multi-path profile is used:

$$h(t, \tau) = \delta(\tau) + a \exp(-i2\pi f_D t) \delta(\tau - \tau_d)$$

in continuous time  $(t, \tau)$  representation, with  $\tau_d$  the delay,  $a$  a constant and  $f_D$  the Doppler frequency.]

## B.2.5 FFS

## B.2.6 MBSFN Propagation Channel Profile

Table B.2.6-1 shows propagation conditions that are used for the MBSFN performance requirements in multi-path fading environment in an extended delay spread environment.

**Table B.2.6-1: Propagation Conditions for Multi-Path Fading Environments for MBSFN Performance Requirements in an extended delay spread environment**

Extended Delay Spread	
Maximum Doppler frequency [5Hz]	
Relative Delay [ns]	Relative Mean Power [dB]
0	0
30	-1.5
150	-1.4
310	-3.6
370	-0.6
1090	-7.0
12490	-10
12520	-11.5
12640	-11.4
12800	-13.6
12860	-10.6
13580	-17.0
27490	-20
27520	-21.5
27640	-21.4
27800	-23.6
27860	-20.6
28580	-27.0

### B.3 High speed train scenario

The high speed train condition for the test of the baseband performance is a non fading propagation channel with one tap. Doppler shift is given by

$$f_s(t) = f_d \cos \theta(t) \quad (\text{B.3.1})$$

where  $f_s(t)$  is the Doppler shift and  $f_d$  is the maximum Doppler frequency. The cosine of angle  $\theta(t)$  is given by

$$\cos \theta(t) = \frac{D_s/2 - vt}{\sqrt{D_{\min}^2 + (D_s/2 - vt)^2}}, \quad 0 \leq t \leq D_s/v \quad (\text{B.3.2})$$

$$\cos \theta(t) = \frac{-1.5D_s + vt}{\sqrt{D_{\min}^2 + (-1.5D_s + vt)^2}}, \quad D_s/v < t \leq 2D_s/v \quad (\text{B.3.3})$$

$$\cos \theta(t) = \cos \theta(t \bmod (2D_s/v)), \quad t > 2D_s/v \quad (\text{B.3.4})$$

where  $D_s/2$  is the initial distance of the train from eNodeB, and  $D_{\min}$  is eNodeB Railway track distance, both in meters;  $v$  is the velocity of the train in m/s,  $t$  is time in seconds.

Doppler shift and cosine angle are given by equation B.3.1 and B.3.2-B.3.4 respectively, where the required input parameters listed in table B.3-1 and the resulting Doppler shift is shown in Figure B.3-1 are applied for all frequency bands.

**Table B.3-1: High speed train scenario**

Parameter	Value
$D_s$	300 m
$D_{\min}$	2 m
$v$	300 km/h
$f_d$	750 Hz

NOTE 1: Parameters for HST conditions in table B.3-1 including  $f_d$  and Doppler shift trajectories presented on figure B.3-1 were derived from Band7 and are applied for performance verification in all frequency bands.

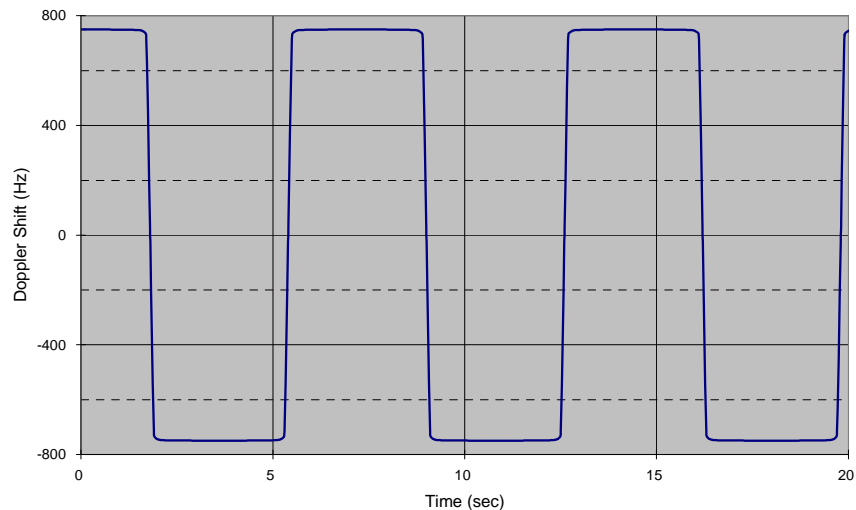

**Figure B.3-1: Doppler shift trajectory**

For 1x2 antenna configuration, the same  $h(t,\tau)$  is used to describe the channel between every pair of Tx and Rx.

For 2x2 antenna configuration, the same  $h(t,\tau)$  is used to describe the channel between every pair of Tx and Rx with phase shift according to  $\mathbf{H} = \begin{pmatrix} 1 & j \\ 1 & -j \end{pmatrix}$ .

## B.4 Beamforming Model

### B.4.1 Single-layer random beamforming (Antenna port 5, 7 or 8)

Single-layer transmission on antenna port 5 or on antenna port 7 or 8 without a simultaneous transmission on the other antenna port, is defined by using a precoder vector  $W(i)$  of size  $2 \times 1$  randomly selected with the number of layers  $\nu = 1$  from Table 6.3.4.2.3-1 in TS 36.211 [8] as beamforming weights. This precoder takes as an input the

signal  $y^{(p)}(i)$ ,  $i = 0, 1, \dots, M_{\text{symp}}^{\text{ap}} - 1$ , for antenna port  $p \in \{5, 7, 8\}$ , with  $M_{\text{symp}}^{\text{ap}}$  the number of modulation symbols including the user-specific reference symbols (DRS), and generates a block of signals  $y_{\text{bf}}(i) = [y_{\text{bf}}(i) \ \tilde{y}_{\text{bf}}(i)]^T$  the elements of which are to be mapped onto the same physical RE but transmitted on different antenna elements:

$$\begin{bmatrix} y_{\text{bf}}(i) \\ \tilde{y}_{\text{bf}}(i) \end{bmatrix} = W(i)y^{(p)}(i)$$

Single-layer transmission on antenna port 7 or 8 with a simultaneous transmission on the other antenna port, is defined by using a pair of precoder vectors  $W_1(i)$  and  $W_2(i)$  each of size  $2 \times 1$ , which are not identical and randomly selected with the number of layers  $\nu = 1$  from Table 6.3.4.2.3-1 in TS 36.211 [8], as beamforming weights, and normalizing the transmit power as follows:

$$\begin{bmatrix} y_{\text{bf}}(i) \\ \tilde{y}_{\text{bf}}(i) \end{bmatrix} = \frac{1}{\sqrt{2}} (W_1(i)y^{(7)}(i) + W_2(i)y^{(8)}(i))$$

The precoder update granularity is specific to a test case.

The CSI reference symbols  $a_{k,l}^{(p)}$  satisfying  $p \bmod 2 = 1$ ,  $p \in \{15, 16, \dots, 22\}$ , are transmitted on the same physical antenna element as the modulation symbols  $y_{\text{bf}}(i)$ . The CSI reference symbols  $a_{k,l}^{(p)}$  satisfying  $p \bmod 2 = 0$ ,  $p \in \{15, 16, \dots, 22\}$ , are transmitted on the same physical antenna element as the modulation symbols  $\tilde{y}_{\text{bf}}(i)$ .

## B.4.2 Dual-layer random beamforming (antenna ports 7 and 8)

Dual-layer transmission on antenna ports 7 and 8 is defined by using a precoder matrix  $W(i)$  of size  $2 \times 2$  randomly selected with the number of layers  $\nu = 2$  from Table 6.3.4.2.3-1 in TS 36.211 [8] as beamforming weights. This precoder takes as an input a block of signals for antenna ports 7 and 8,  $y(i) = [y^{(7)}(i) \ y^{(8)}(i)]^T$ ,  $i = 0, 1, \dots, M_{\text{symp}}^{\text{ap}} - 1$ , with  $M_{\text{symp}}^{\text{ap}}$  being the number of modulation symbols per antenna port including the user-specific reference symbols, and generates a block of signals  $y_{\text{bf}}(i) = [y_{\text{bf}}(i) \ \tilde{y}_{\text{bf}}(i)]^T$  the elements of which are to be mapped onto the same physical RE but transmitted on different antenna elements:

$$\begin{bmatrix} y_{\text{bf}}(i) \\ \tilde{y}_{\text{bf}}(i) \end{bmatrix} = W(i) \begin{bmatrix} y^{(7)}(i) \\ y^{(8)}(i) \end{bmatrix},$$

The precoder update granularity is specific to a test case.

The CSI reference symbols  $a_{k,l}^{(p)}$  satisfying  $p \bmod 2 = 1$ ,  $p \in \{15, 16, \dots, 22\}$ , are transmitted on the same physical antenna element as the modulation symbols  $y_{\text{bf}}(i)$ . The CSI reference symbols  $a_{k,l}^{(p)}$  satisfying  $p \bmod 2 = 0$ ,  $p \in \{15, 16, \dots, 22\}$ , are transmitted on the same physical antenna element as the modulation symbols  $\tilde{y}_{\text{bf}}(i)$ .

## B.4.3 Generic beamforming model (antenna ports 7-14)

The transmission on antenna port(s)  $p = 7, 8, \dots, \nu + 6$  is defined by using a precoder matrix  $W(i)$  of size  $N_{\text{CSI}} \times \nu$ , where  $N_{\text{CSI}}$  is the number of CSI reference signals configured per test and  $\nu$  is the number of spatial layers. This precoder takes as an input a block of signals for antenna port(s)  $p = 7, 8, \dots, \nu + 6$ ,

$y^{(p)}(i) = [y^{(7)}(i) \ y^{(8)}(i) \ \dots \ y^{(\nu+6)}(i)]$ ,  $i = 0, 1, \dots, M_{\text{symp}}^{\text{ap}} - 1$ , with  $M_{\text{symp}}^{\text{ap}}$  being the number of modulation symbols per antenna port including the user-specific reference symbols (DM-RS), and generates a block of signals

$y_{bf}^{(q)}(i) = [y_{bf}^{(0)}(i) \ y_{bf}^{(1)}(i) \ \dots \ y_{bf}^{(N_{CSI}-1)}(i)]^T$  the elements of which are to be mapped onto the same time-frequency index pair  $(k, l)$  but transmitted on different physical antenna elements:

$$\begin{bmatrix} y_{bf}^{(0)}(i) \\ y_{bf}^{(1)}(i) \\ \vdots \\ y_{bf}^{(N_{CSI}-1)}(i) \end{bmatrix} = W(i) \begin{bmatrix} y^{(7)}(i) \\ y^{(8)}(i) \\ \vdots \\ y^{(6+\nu)}(i) \end{bmatrix}$$

The precoder matrix  $W(i)$  is specific to a test case.

The physical antenna elements are identified by indices  $j = 0, 1, \dots, N_{ANT} - 1$ , where  $N_{ANT} = N_{CSI}$  is the number of physical antenna elements configured per test.

Modulation symbols  $y_{bf}^{(q)}(i)$  with (i.e. beamformed PDSCH and DM-RS) are mapped to the physical antenna index .

Modulation symbols with  $p \in \{0, 1, \dots, P - 1\}$  (i.e. PBCH, PDCCH, PHICH, PCFICH) are mapped to the physical antenna index  $j = p$ , where  $P$  is the number of cell-specific reference signals configured per test.

Modulation symbols  $a_{k,l}^{(p)}$  with  $p \in \{0, 1, \dots, P - 1\}$  (i.e. CRS) are mapped to the physical antenna index  $j = p$ , where  $P$  is the number of cell-specific reference signals configured per test.

Modulation symbols  $a_{k,l}^{(p)}$  with  $p \in \{15, 16, \dots, 14 + N_{CSI}\}$  (i.e. CSI-RS) are mapped to the physical antenna index  $j = p - 15$ , where  $N_{CSI}$  is the number of CSI reference signals configured per test.

#### B.4.4 Random beamforming for EPDCCH distributed transmission (Antenna port 107 and 109)

EPDCCH distributed transmission on antenna port 107 and antenna port 109 is defined by using a pair of precoder vectors  $W_1(i)$  and  $W_2(i)$  each of size  $2 \times 1$ , which are not identical and randomly selected per EPDCCH PRB pair with the number of layers  $\nu = 1$  from Table 6.3.4.2.3-1 in [8], as beamforming weights. This precoder takes as an input the signal  $y^{(p)}(i)$ ,  $i = 0, 1, \dots, M_{\text{symp}}^{\text{ap}} - 1$ , for antenna port  $p \in \{107, 109\}$ , with  $M_{\text{symp}}^{\text{ap}}$  the number of modulation symbols including the user-specific reference symbols (DMRS), and generates a block of signals  $y_{bf}(i) = [y_{bf}(i) \ \tilde{y}_{bf}(i)]^T$ . When EPDCCH is associated with port 107, the transmitted block of signals is denoted as

$$\begin{bmatrix} y_{bf}(i) \\ \tilde{y}_{bf}(i) \end{bmatrix} = W_1(i) y^{(107)}(i).$$

When EPDCCH is associated with port 109, the transmitted block of signals is denoted as

$$\begin{bmatrix} y_{bf}(i) \\ \tilde{y}_{bf}(i) \end{bmatrix} = W_2(i) y^{(109)}(i).$$

#### B.4.5 Random beamforming for EPDCCH localized transmission (Antenna port 107, 108, 109 or 110)

EPDCCH localized transmission on antenna port 107, 108, 109 or 110 is defined by using a precoder vector  $W(i)$  of size  $2 \times 1$  randomly selected with the number of layers  $\nu = 1$  from Table 6.3.4.2.3-1 in [8] as beamforming weights.

This precoder takes as an input the signal  $y^{(p)}(i)$ ,  $i = 0, 1, \dots, M_{\text{symp}}^{\text{ap}} - 1$ , for antenna port  $p \in \{107, 108, 109, 110\}$ , with

$M_{\text{symb}}^{\text{ap}}$  the number of modulation symbols including the user-specific reference symbols (DMRS), and generates a block of signals  $y_{bf}(i) = [y_{bf}(i) \ \tilde{y}_{bf}(i)]^T$  the elements of which are to be mapped onto the same physical RE but transmitted on different antenna elements:

$$\begin{bmatrix} y_{bf}(i) \\ \tilde{y}_{bf}(i) \end{bmatrix} = W(i)y^{(p)}(i).$$

## B.5 Interference models for enhanced performance requirements Type-A

This clause provides a description for the modelling of interfering cell transmissions for enhanced performance requirements Type-A including: definition of dominant interferer proportion, transmission mode 3, 4 and 9 type of interference modelling.

### B.5.1 Dominant interferer proportion

Each interfering cell involved in enhanced performance requirements Type-A is characterized by its associated dominant interferer proportion (DIP) value:

$$DIP_i = \frac{\hat{I}_{or(i+1)}}{N_{oc}'},$$

where is  $\hat{I}_{or(i+1)}$  is the average received power spectral density from the  $i$ -th strongest interfering cell involved in the requirement scenario ( $\hat{I}_{or(1)}$  is assumed to be the power spectral density associated with the serving cell) and

$N_{oc}' = \sum_{j=2}^N \hat{I}_{or(j)} + N_{oc}$  where  $N_{oc}$  is the average power spectral density of a white noise source consistent with the definition provided in subclause 3.2 and  $N$  is the total number of cells involved in a given requirement scenario.

### B.5.2 Transmission mode 3 interference model

This subclause provides transmission mode 3 interference modelling for each explicitly modelled interfering cell in the requirement scenario. In each subframe, each interfering cell shall transmit randomly modulated data over the entire PDSCH region and the full transmission bandwidth. Transmitted physical channels shall include PSS, SSS and PBCH.

For each subframe and each CQI subband as defined in subclause 7.2 of [10], a transmission rank shall be randomly determined independently from other CQI subbands as well as other interfering cells. Probabilities of occurrence of each possible transmission rank are as specified in the requirement scenario.

For rank-1 transmission over a subband, precoding for transmit diversity for the number of antenna ports in the requirement scenario shall be applied to 16QAM randomly modulated layer symbols, as specified in subclause 6.3.4.3 of [8].

For rank-2 transmission over a subband, precoding for spatial multiplexing with large delay CDD over two layers for the number of antenna ports in the requirement scenario shall be applied to 16QAM randomly modulated layer symbols, as specified in subclause 6.3.4.2.2 of [8].

For unallocated REs in the control region, precoding for transmit diversity for the number of antenna ports in the requirement scenario shall be applied to QPSK randomly modulated layer symbols, as specified in subclause 6.3.4.3 of [8]. The EPRE ratio for these REs shall be as defined for PDCCH in Annex C.3.2.

### B.5.3 Transmission mode 4 interference model

This subclause provides transmission mode 4 interference modelling for each explicitly modelled interfering cell in the requirement scenario. In each subframe, each interfering cell shall transmit randomly modulated data over the entire PDSCH region and the full transmission bandwidth. Transmitted physical channels shall include PSS, SSS and PBCH.

For each subframe and each CQI subband as defined in subclause 7.2 of [10], a transmission rank shall be randomly determined independently from other CQI subbands as well as other interfering cells. Probabilities of occurrence of each possible transmission rank are as specified in the requirement scenario.

For each subframe and CQI subband, a precoding matrix for the number of layers  $v$  associated to the selected rank shall be selected randomly from Table 6.3.4.2.3-1 of [8]. Note that codebook index 0 shall be excluded from random precoder selection when the number of layers is  $v = 2$ .

Precoding for spatial multiplexing with cell-specific reference signals for the number of antenna ports in the requirement scenario shall be applied to 16QAM randomly modulated layer symbols, as specified in subclause 6.3.4.2.1 of [8] with the selected precoding matrices for each subframe and each CQI subband.

For unallocated REs in the control region, precoding for transmit diversity for the number of antenna ports in the requirement scenario shall be applied to QPSK randomly modulated layer symbols, as specified in subclause 6.3.4.3 of [8]. The EPRE ratio for these REs shall be as defined for PDCCH in Annex C.3.2.

### B.5.4 Transmission mode 9 interference model

This subclause provides transmission mode 9 interference modelling for each explicitly modelled interfering cell in the requirement scenario. In each subframe, each interfering cell shall transmit randomly modulated data over the entire PDSCH region and the full transmission bandwidth. Transmitted physical channels shall include PSS, SSS and PBCH.

For each subframe and each CQI subband as defined in subclause 7.2 of [10], a transmission rank shall be randomly determined independently from other CQI subbands as well as other interfering cells. Probabilities of occurrence of each possible transmission rank are as specified in the requirement scenario.

For each subframe and each CQI subband, a precoding matrix for the number of layers  $v$  associated to the selected rank shall be selected randomly from Table 6.3.4.2.3-2 of [8].

The generic beamforming model in subclause B.4.3 shall be applied assuming cell-specific reference signals and CSI reference signals as specified in the requirement scenario. Random precoding with selected rank and precoding matrices for each subframe and each CQI subband shall be applied to 16QAM randomly modulated layer symbols including the user-specific reference symbols over antenna port 7 when the rank is one and antenna ports 7, 8 when the rank is two.

For unallocated REs in the control region, precoding for transmit diversity for the number of antenna ports in the requirement scenario shall be applied to QPSK randomly modulated layer symbols, as specified in subclause 6.3.4.3 of [8]. The EPRE ratio for these REs shall be as defined for PDCCH in Annex C.3.2.



## Annex C (normative): Downlink Physical Channels

This annex specifies the downlink physical channels that are needed for setting a connection and channels that are needed during a connection.

### C.0 Downlink signal levels

The downlink power settings in Table C.0-1 are used unless otherwise specified in a test case.

If the UE has two Rx antennas, the downlink signal is applied to each one. Both UE Rx antennas shall be connected.

If the UE has one Rx antenna, the downlink signal is applied to it.

**Table C.0-1: Default Downlink power levels**

	Unit	Channel bandwidth					
		1.4 MHz	3 MHz	5 MHz	10 MHz	15 MHz	20 MHz
Number of RBs		6	15	25	50	75	100
Channel BW Power	dBm	-66	-62	-60	-57	-55	-54
RS EPRE	dBm/15kHz	-85	-85	-85	-85	-85	-85
Note 1: The channel bandwidth powers and RB allocations are informative, based on -85dBm/15kHz RS_EPRES, then scaled according to the number of RBs and rounded to the nearest integer dBm value. Full RE allocation with no boost or deboost is assumed in this calculation, but allocation may vary during setup.							
Note 2: The power level is specified at each UE Rx antenna.							

The default signal level uncertainty is +/-3dB at each test port, for any level specified. If the uncertainty value is critical for the test purpose, a tighter uncertainty is specified for the related test case in Annex F.

### C.1 General

Table C.1-1 describes the mapping of downlink physical channels and signals to physical resources for FDD.

Table C.1-2 describes the mapping of downlink physical channels and signals to physical resources for TDD.

**Table C.1-1: Mapping of downlink physical channels and signals to physical resources for FDD**

Physical channel	Time Domain Location	Frequency Domain Location	Note
RS	Symbols 0, 4 of each subframe for antenna port 0 & 1 Symbol 1 of each subframe for antenna port 2 & 3	Downlink system bandwidth dependent	Mapping rule is specified in TS 36.211 6.10.1.2 - CELL_ID = 0
PBCH	Symbols 0 to 3 of slot 1 of subframe 0 of each radio frame	Occupies 72 subcarriers centred on the DC subcarrier	Mapping rule is specified in TS 36.211 Section 6.6.4 (Note 2)
PSS	Symbol 6 of slot 0 and 10 of each radio frame	Occupies 62 subcarriers centred on the DC subcarrier. Additional 10 subcarriers (5 on each side) adjacent to the centred 62 subcarriers are reserved.	Mapping rule is specified in TS 36.211 Section 6.11.1.2
SSS	Symbol 5 of slots 0 and 10 of each radio frame	Occupies 62 subcarriers centred on the DC subcarrier. Additional 10 subcarriers (5 on each side) adjacent to the centred 62 subcarriers are reserved.	Mapping rule is specified in TS 36.211 Section 6.11.2.2
PCFICH	Symbol 0 of each subframe	Downlink system bandwidth dependent. Maps into 4 REGs uniformly spread in the frequency domain over the whole system bandwidth.	Mapping rule is specified in TS 36.211 Section 6.7.4 (Note 1) - CELL_ID = 0
PHICH	Symbol 0 of each subframe	Downlink system bandwidth dependent. Each PHICH group maps into 3 REGs in the frequency domain on the REGs not assigned to PCFICH over the whole system bandwidth	Mapping rule is specified in TS 36.211 Section 6.9.3 (Note 1) - CELL_ID = 0 - Ng = 1 - Normal PHICH duration - Number of PHICH groups = $1(BW=1.4MHz)/2(BW=3MHz)/4(BW=5MHz)/7(BW=10MHz)/10(BW=15MHz)/13(BW=20MHz)$
PDCCH	Symbols 0, 1, 2, 3 of each subframe for 1.4 MHz  Symbols 0, 1, 2, of each subframe for 3 and 5 MHz  Symbols 0, 1 of each subframe for 10, 15 and 20 MHz	The remaining REGs not allocated to both PCFICH and PHICH are used for PDCCH	Mapping rule is specified in TS 36.211 Section 6.8.5 (Note 1)
PDSCH	All remaining OFDM symbols of each subframe not allocated to PDCCH	For Subframe 0, REs not allocated to RS, PSS, SSS and PBCH, is allocated to PDSCH  For Subframe 5, REs not allocated to RS, PSS and SSS, is allocated to PDSCH  For other subframes, REs not allocated to RS, is allocated to PDSCH	Note that there are reserved REs that are not used for transmission of any physical channels (Note 3 ) & (Note 4) which need to be taken into account when allocating REs to PDSCH

Note 1: In case a single cell-specific RS is configured, cell-specific RS shall be assume to be present on antenna ports 0 and 1 for the purpose of mapping a symbol-quadruplet to a REG (resource-element group). (See TS 36.211 Section 6.2.4).

Note 2: PBCH is mapped into RE assuming RS from 4 antennas are used at the eNB transmitter, irrespective of the actual number of Tx antenna. Resource elements assumed to be reserved for RS but not used for transmission of RS shall not be used for transmission of any physical channel. (See TS 36.211 Section 6.6.4).

Note 3: In slot 0 and slot 10 of each radio frame, there are reserved REs for PSS and SSS that are not used for transmission of any physical channels. (See TS 36.211 Section 6.11.1.2 & 6.11.2.2).

Note 4: REs used for RS transmission on any of the antenna ports in a slot shall not be used for any transmission on any other antenna port in the same slot and set to zero. (See TS 36.211 Section 6.10.1.2).

Table C.1-2: Mapping of downlink physical channels and signals to physical resources for TDD

Physical channel	Time Domain Location	Frequency Domain Location	Note
RS	Symbols 0, 4 of each subframe for antenna port 0 & 1 Symbol 1 of each subframe for antenna port 2 & 3	Downlink system bandwidth dependent.	Mapping rule is specified in TS 36.211[8] 6.10.1.2 - CELL_ID = 0
PBCH	Symbols 0 to 3 of slot 1 of subframe 0 of each radio frame	Occupies 72 subcarriers centred on the DC subcarrier	Mapping rule is specified in TS 36.211[8] Section 6.6.4 (Note 3)
PSS	Symbol 2 of slot 2 and 12 of each radio frame	Occupies 62 subcarriers centred on the DC subcarrier. Additional 10 subcarriers (5 on each side) adjacent to the centred 62 subcarriers are reserved.	Mapping rule is specified in TS 36.211[8] Section 6.11.1.2
SSS	Symbol 6 of slots 1 and 11 of each radio frame	Occupies 62 subcarriers centred on the DC subcarrier. Additional 10 subcarriers (5 on each side) adjacent to the centred 62 subcarriers are reserved.	Mapping rule is specified in TS 36.211[8] Section 6.11.2.2
PCFICH	Symbol 0 of each subframe and special subframe	Downlink system bandwidth dependent. Maps into 4 REGs uniformly spread in the frequency domain over the whole system bandwidth	Mapping rule is specified in TS 36.211[8] Section 6.7.4 (Note 2) - CELL_ID = 0
PHICH	Symbol 0 of each subframe and special subframe	Downlink system bandwidth dependent. Each PHICH group maps into 3 REGs in the frequency domain on the REGs not assigned to PCFICH over the whole system bandwidth	Mapping rule is specified in TS 36.211[8] Section 6.9.3 (Note 2) - CELL_ID = 0 - Ng = 1 - Normal PHICH duration - Number of PHICH groups = $1(BW=1.4MHz)/2(BW=3MHz)/4(BW=5MHz)/7(BW=10MHz)/10(BW=15MHz)/13(BW=20MHz)$
PDCCH	For normal subframes(0,4,5,9) Symbols 0, 1, 2, 3 of each subframe for 1.4 MHz Symbols 0, 1, 2, of each subframe for 3 and 5 MHz Symbols 0, 1 of each subframe for 10, 15 and 20 MHz  For special subframe (1&6) Symbols 0, 1 of each subframe for all BWs	The remaining REGs not allocated to both PCFICH and PHICH are used for PDCCH	Mapping rule is specified in TS 36.211[8] Section 6.8.5 (Note 2)
PDSCH	,All remaining OFDM symbols of each subframe not allocated to PDCCH with the following exception: For 1.4MHz,no data shall be scheduled on special subframes (1&6) to avoid problems with insufficient PDCCH performance	For Subframe 0, REs not allocated to RS, SSS and PBCH, is allocated to PDSCH  For Subframe 5, REs not allocated to RS and SSS, is allocated to PDSCH  For Subframe 1 and 6, REs not allocated to RS, PSS, GP and UpPTS is allocated to PDSCH  For other downlink subframes, REs not allocated to RS is allocated to PDSCH	Note that there are reserved REs that are not used for transmission of any physical channels (Note 4 ) & (Note 5) which need to be taken into account when allocating REs to PDSCH
<p>Note 1: The mapping is based on the default TDD configuration for subframe assignment and special subframe patterns (see 36.508 [7]subclause 4.6.3)</p> <p>Note 2: In case a single cell-specific RS is configured, cell-specific RS shall be assume to be present on antenna ports 0 and 1 for the purpose of mapping a symbol-quadruplet to a REG (resource-element group). (See TS 36.211[8] Section 6.2.4).</p> <p>Note 3: PBCH is mapped into RE assuming RS from 4 antennas are used at the eNB transmitter, irrespective of the actual number of Tx antenna. Resource elements assumed to be reserved for RS but not used for transmission of RS shall not be used for transmission of any physical channel. (See TS 36.211[8] Section</p>			

6.6.4).

Note 4: In slot 1,2,11 and 12 of each radio frame, there are reserved REs for PSS and SSS that are not used for transmission of any physical channels. (See TS 36.211[8] Section 6.11.1.2 & 6.11.2.2).

Note 5: REs used for RS transmission on any of the antenna ports in a slot shall not be used for any transmission on any other antenna port in the same slot and set to zero. (See TS 36.211[8] Section 6.10.1.2).

## C.2 Set-up

Table C.2-1 describes the downlink Physical Channels that are required for connection set up.

**Table C.2-1: Downlink Physical Channels required for connection set-up**

Physical Channel	EPRE Ratio	Note
<b>PBCH</b>	PBCH_RA = 0 dB	
	PBCH_RB = 0 dB	
<b>PSS</b>	PSS_RA = 0 dB	
<b>SSS</b>	SSS_RA = 0 dB	
<b>PCFICH</b>	PCFICH_RB = 0 dB	
<b>PDCCH</b>	PDCCH_RA = 0 dB	
	PDCCH_RB = 0 dB	
<b>PDSCH</b>	PDSCH_RA = 0 dB	
	PDSCH_RB = 0 dB	
<b>PHICH</b>	PHICH_RA = 0 dB	Note 2
	PHICH_RB = 0 dB	
Note 1: No boosting is applied.		
Note 2: PHICH group power, i.e. the total power of all active PHICH sequences within a PHICH group.		

Table C.2-2 describes the configuration of PDSCH and PDCCH before measurement for FDD and Table C.2-3 for TDD.

**Table C.2-2: PDSCH and PDCCH configuration for FDD**

Parameter	Unit	Value	Comments
Allocated resource blocks		6	
MCS Index		-	TB Size with transmitting message in 1TTI
Number of HARQ processes	Processes	8	
Maximum number of HARQ transmission		5	
Aggregation level	CCE	2	Note 4
DCI Format for PDSCH		Format 1A	
DCI Format for PUSCH		Format 0	
Note 1: 2 symbols allocated to PDCCH for 20 MHz, 15 MHz and 10 MHz channel BW. 3 symbols allocated to PDCCH for 5 MHz and 3 MHz. 4 symbols allocated to PDCCH for 1.4 MHz.			
Note 2: Reference signal, Synchronization signals and PBCH allocated as per TS 36.211 [8].			
Note 3: The PDSCH shall be occupied 6 resource blocks centred on the DC subcarrier.			
Note 4: For PDCCH using SI-RNTI, Aggregation level:			
a) Tables C.3.0-3, C.3.1-3, and C.3.2-3 for RF tests			
b) Table A.2.1-1 of 36.521-3 for RRM tests.			

**Table C.2-3: PDSCH and PDCCH configuration for TDD**

Parameter	Unit	Value	Comments
Allocated resource blocks		6	
MCS Index		0	TB Size with transmitting message in 1TTI
Number of HARQ processes (Note 1)	Processes	7	
Maximum number of HARQ transmission		4	
Aggregation level	CCE	2	Note 5
DCI Format for PDSCH		Format 1A	
DCI Format for PUSCH		Format 0	
Note 1:	Number of HARQ processes shall be determined by UL/DL configuration, for configuration other than 1, the process number shall be set per TS 36.213 [10] Table 8-1.		
Note 2:	For normal downlink subframes, 2 symbols allocated to PDCCH for 20 MHz, 15 MHz and 10 MHz channel BW. 3 symbols allocated to PDCCH for 5 MHz and 3 MHz. 4 symbols allocated to PDCCH for 1.4 MHz. For special subframe (1&6), only 2 OFDM symbols are allocated to PDCCH for all BWs.		
Note 3:	Reference signal, Synchronization signals and PBCH allocated as per TS 36.211 [8].		
Note 4:	The PDSCH shall be occupied 6 resource blocks centred on the DC subcarrier.		
Note 5:	For PDCCH using SI-RNTI, Aggregation level: a) Tables C.3.0-3, C.3.1-3, and C.3.2-3 for RF tests b) Table A.2.2-1 of 36.521-3 for RRM tests		

## C.3 Connection

The following clauses describes the downlink Physical Channels that are transmitted during a connection i.e., when measurements are done.

### C.3.0 Measurement of Transmitter Characteristics

Table C.3.0-1 is applicable for measurements on the Transmitter Characteristics (clause 6).

**Table C.3.0-1: Downlink Physical Channels transmitted during a connection (FDD and TDD)**

Physical Channel	EPRE Ratio	Note
PBCH	PBCH_RA = 0 dB	
	PBCH_RB = 0 dB	
PSS	PSS_RA = 0 dB	
SSS	SSS_RA = 0 dB	
PCFICH	PCFICH_RB = 0 dB	
PDCCH	PDCCH_RA = 0 dB	
	PDCCH_RB = 0 dB	
PDSCH	PDSCH_RA = 0 dB	
	PDSCH_RB = 0 dB	
PHICH	PHICH_RB = 0 dB	Note 1, Note 2
Note 1: PHICH group power, i.e. the total power of all active PHICH sequences within a PHICH group.		
Note 2: For CA tests with 1 UL, no PHICH resources are assigned to the DUT in the SCell.		
Note 3: Unused PDCCH resources and PHICH groups are padded with resource element groups with power level given respectively by PDCCH_RA/RB and PHICH_RB, such that a total power spectral density in the control region that is constant on an OFDM symbol basis is targeted.		

NOTE 1: No boosting is applied.

**Table C.3.0-2: Power allocation for OFDM symbols and reference signals**

Parameter	Unit	Value	Note
Transmitted power spectral density $I_{or}$	dBm/15 kHz	Test specific	1. $I_{or}$ shall be kept constant throughout all OFDM symbols
Cell-specific reference signal power ratio $E_{RS} / I_{or}$		0 dB	

**Table C.3.0-3: PDCCH Aggregation Level (in CCE-s)**

Bandwidth	DCI for DL (SI-RNTI)	DCI for DL (C-RNTI)	DCI for UL (C-RNTI)	Notes
1.4 MHz	4	1	1	Note 1
3 MHz	4	4	4	Note 1
5 MHz	4	4	4	Note 1
10 MHz	8	8	8	Note 1
15 MHz	8	8	8	Note 1
20 MHz	8	8	8	Note 1

Note 1: No DL data allocated on TDD special subframes

## C.3.1 Measurement of Receiver Characteristics

Table C.3.1-1 is applicable for measurements on the Receiver Characteristics (clause 7).

**Table C.3.1-1: Downlink Physical Channels transmitted during a connection (FDD and TDD)**

Physical Channel	EPRE Ratio	Note
PBCH	PBCH_RA = 0 dB	
	PBCH_RB = 0 dB	
PSS	PSS_RA = 0 dB	
SSS	SSS_RA = 0 dB	
PCFICH	PCFICH_RB = 0 dB	
PDCCH	PDCCH_RA = 0 dB	
	PDCCH_RB = 0 dB	
PDSCH	PDSCH_RA = 0 dB	
	PDSCH_RB = 0 dB	
PHICH	PHICH_RB = 0 dB	Note 1, Note 2
OCNG	OCNG_RA = 0 dB	
	OCNG_RB = 0 dB	

Note 1: PHICH group power, i.e. the total power of all active PHICH sequences within a PHICH group.  
Note 2: For CA tests with 1 UL, no PHICH resources are assigned to the DUT in the SCell. In such case PHICH of SCell is entirely part of OCNG pattern used.

NOTE 1: No boosting is applied.

**Table C.3.1-2: Power allocation for OFDM symbols and reference signals**

Parameter	Unit	Value	Note
Transmitted power spectral density $I_{or}$	dBm/15 kHz	Test specific	1. $I_{or}$ shall be kept constant throughout all OFDM symbols
Cell-specific reference signal power ratio $E_{RS} / I_{or}$		0 dB	

Table C.3.1-3: PDCCH Aggregation Level (in CCE-s)

Bandwidth	DCI for DL (SI-RNTI)	DCI for DL (C-RNTI)	DCI for UL (C-RNTI)	Notes
1.4 MHz	4	4	2	Note 1, 2
3 MHz	4	4	2	Note 2
5 MHz	8	8	4	Note 2
10 MHz	8	8	8	Note 2
15 MHz	8	8	8	Note 2
20 MHz	8	8	8	Note 2
Note 1: No DL data allocated on TDD special subframes				
Note 2: No DL data allocated on subframe 5				

## C.3.2 Measurement of Performance requirements

Table C.3.2-1 is applicable for measurements in which uniform RS-to-EPRE boosting for all downlink physical channels.

Table C.3.2-1: Downlink Physical Channels transmitted during a connection (FDD and TDD)

Physical Channel	EPRE Ratio	Note
PBCH	PBCH_RA = $\rho_A + \sigma$	
	PBCH_RB = $\rho_B + \sigma$	
PSS	PSS_RA = 0 (Note 4)	
SSS	SSS_RA = 0 (Note 4)	
PCFICH	PCFICH_RB = $\rho_B + \sigma$	
PDCCH	PDCCH_RA = $\rho_A + \sigma$	
	PDCCH_RB = $\rho_B + \sigma$	
EPDCCH	EPDCCH_RA = $\rho_A$	
	EPDCCH_RB = $\rho_B$	
PDSCH	PDSCH_RA = $\rho_A$	
	PDSCH_RB = $\rho_B$	
PMCH	PMCH_RA = $\rho_A$	
	PMCH_RB = $\rho_B$	
MBSFN RS	MBSFN_RS_RA = $\rho_A$	
	MBSFN_RS_RB = $\rho_B$	
PHICH	PHICH_RB = $\rho_B + \sigma$	Note 1, Note 2
OCNG	OCNG_RA = $\rho_A + \sigma$	
	OCNG_RB = $\rho_B + \sigma$	
Note 1: PHICH group power, i.e. the total power of all active PHICH sequences within a PHICH group. Note 2: For CA tests with 1 UL, no PHICH resources are assigned to the DUT in the SCell. In such case PHICH of SCell is entirely part of OCNG pattern used.		

NOTE 1:  $\rho_A$  denotes the ratio of PDSCH EPRE to cell-specific RS EPRE among PDSCH REs in all the OFDM symbols not containing cell-specific RS.  $\rho_B$  denotes the ratio of PDSCH EPRE to cell-specific RS EPRE among PDSCH REs in all the OFDM symbols containing cell-specific RS.

NOTE 2:  $\rho_A = \rho_B = 0$  dB means no RS boosting.

NOTE 3: MBSFN RS and OCNG are not defined downlink physical channels in [8].

NOTE 4: Assuming PSS and SSS transmitted on a single antenna port.

NOTE 5:  $\rho_A$ ,  $\rho_B$ , and  $\sigma$  are test specific,  $\sigma = 0$  dB otherwise.

NOTE 6: For TM8, TM9 and TM10,  $\rho_A$  and  $\rho_B$  are used for the purpose of the test set up only.

**Table C.3.2-2: Power allocation for OFDM symbols and reference signals**

Parameter	Unit	Value	Note
Total transmitted power spectral density $I_{or}$	dBm/15 kHz	Test specific	1. $I_{or}$ shall be kept constant throughout all OFDM symbols
Cell-specific reference signal power ratio $E_{RS} / I_{or}$		Test specific	1. Applies for antenna port $p$
Energy per resource element EPRE		Test specific	1. The complex-valued symbols $y^{(p)}(i)$ and $a_{k,l}^{(p)}$ defined in [8] shall conform to the given EPRE value. 2. For TM8, TM9 and TM10, the reference point for EPRE is before the precoder in Annex B.4.

**Table C.3.2-3: PDCCH Aggregation Level (in CCE-s) for PDSCH demodulation and PMI performance tests**

Bandwidth	DCI for DL (SI-RNTI)	DCI for DL (C-RNTI)	DCI for UL (C-RNTI)	Notes
1.4 MHz	4	4	2	Note 1, 2
3 MHz	4	4	2	Note 2
5 MHz	8	8	4	Note 2
10 MHz	8	8	8	Note 2
15 MHz	8	8	8	Note 2
20 MHz	8	8	8	Note 2
Note 1: No DL data allocated on TDD special subframes				
Note 2: No DL data allocated on subframe 5				

**Table C.3.2-4: PDCCH Aggregation Level for CQI and RI performance tests (in CCE-s)**

Bandwidth	DCI for DL (SI-RNTI)	DCI for DL (C-RNTI)	DCI for UL (C-RNTI)	Notes
1.4 MHz				
3 MHz				
5 MHz				
10 MHz	8	8	8	Note 1,2
15 MHz				
20 MHz				
Note 1: 3 symbols allocated to PDCCH				
Note 2: No DL data allocated on subframes 0 and 5 for FDD and 0, 1, 5 and 6 for TDD				



**Table C.3.2-5: PDCCH Aggregation Level for sustained downlink data rate performance tests (in CCE-s)**

Bandwidth	DCI for DL (SI-RNTI)	DCI for DL (C-RNTI)	DCI for UL (C-RNTI)	Notes
1.4 MHz				
3 MHz				
5 MHz				
10 MHz	4	4	4	Note 1,2,4
15 MHz	4	8	4	Note 1,3,4
20 MHz	8	8	8	Note 1,3,4
Note 1: 1 symbol allocated to PDCCH Note 2: On subframe 5 Aggregation level 2 is used to transmit DCI for DL(C-RNTI) and UL(C-RNTI). Note 3: On subframe 5, Aggregation level 4 is used to transmit DCI for DL(C-RNTI) and UL(C-RNTI). Note 4: No DL data allocated on subframes 1 for TDD.				

### C.3.3 Aggressor cell power allocation for Measurement of Performance Requirements when ABS is Configured

For the performance requirements and channel state information reporting when ABS is configured, the power allocation for the physical channels of the aggressor cell in non-ABS and ABS is listed in Table C.3.3-1.

**Table C.3.3-1: Downlink physical channels transmitted in aggressor cell when ABS is configured in this cell**

Physical Channel	Parameters	Unit	EPRE Ratio	
			Non-ABS	ABS
PBCH	PBCH_RA	dB	$\rho_A$	Note 1
	PBCH_RB	dB	$\rho_B$	Note 1
PSS	PSS_RA	dB	$\rho_A$	Note 1
SSS	SSS_RA	dB	$\rho_A$	Note 1
PCFICH	PCFICH_RB	dB	$\rho_B$	Note 1
PHICH	PHICH_RA	dB	$\rho_A$	Note 1
	PHICH_RB	dB	$\rho_B$	Note 1
PDCCH	PDCCH_RA	dB	$\rho_A$	Note 1
	PDCCH_RB	dB	$\rho_B$	Note 1
PDSCH	PDSCH_RA	dB	N/A	Note 1
	PDSCH_RB	dB	N/A	Note 1
OCNG	OCNG_RA	dB	$\rho_A$	Note 1
	OCNG_RB	dB	$\rho_B$	Note 1
Note 1: $-\infty$ dB is allocated for this channel in this test.				

**Table C.3.3-2: Downlink physical channels transmitted in aggressor cell when ABS is configured in this cell when the CRS assistance information is provided**

Physical Channel	Parameters	Unit	EPRE Ratio	
			Non-ABS	ABS
PBCH	PBCH_RA	dB	$\rho_A$	$\rho_A$
	PBCH_RB	dB	$\rho_B$	$\rho_B$
PSS	PSS_RA	dB	$\rho_A$	$\rho_A$
SSS	SSS_RA	dB	$\rho_A$	$\rho_A$
PCFICH	PCFICH_RB	dB	$\rho_B$	Note 1
PHICH	PHICH_RA	dB	$\rho_A$	Note 1
	PHICH_RB	dB	$\rho_B$	Note 1
PDCCH	PDCCH_RA	dB	$\rho_A$	Note 1
	PDCCH_RB	dB	$\rho_B$	Note 1
PDSCH	PDSCH_RA	dB	N/A	Note 1
	PDSCH_RB	dB	N/A	Note 1
OCNG	OCNG_RA	dB	$\rho_A$	Note 1
	OCNG_RB	dB	$\rho_B$	Note 1

Note 1:  $-\infty$  dB is allocated for this channel in this test.

### C.3.4 Power Allocation for Measurement of Performance Requirements when Quasi Co-location Type B: same Cell ID

For the performance requirements related to quasi-colocation type B behaviour when transmission points share the same Cell ID, the power allocation for the physical channels of the serving cell is listed in table C.3.4-1 and the power allocation for the physical channels of the cell transmitting PDSCH is listed in table C.3-4-2

**Table C.3.4-1: Downlink physical channels transmitted in the serving cell (TP1)**

Physical Channel	EPRE Ratio
PBCH	PBCH_RA = $\rho_A + \sigma$
	PBCH_RB = $\rho_B + \sigma$
PSS	PSS_RA = 0 (Note 2)
SSS	SSS_RA = 0 (Note 2)
PDSCH	PDSCH_RA = $\rho_A$
	PDSCH_RB = $\rho_B$
PCFICH	PCFICH_RB = $\rho_B + \sigma$
PDCCH	PDCCH_RA = $\rho_A + \sigma$
	PDCCH_RB = $\rho_B + \sigma$

NOTE 1:  $\rho_A = \rho_B = 0$  dB means no RS boosting.

NOTE 2: Assuming PSS and SSS transmitted on a single antenna port.

NOTE 3:  $\rho_A$ ,  $\rho_B$  and  $\sigma$  are test specific.

**Table C.3.4-2: Downlink physical channels for the transmission point transmitting PDSCH (TP2)**

Physical Channel	Value
PDSCH	Test Specific

---

## Annex D (normative): Characteristics of the Interfering Signal

### D.1 General

Some RF performance requirements for the E-UTRA UE receiver are defined with interfering signals present in addition to the wanted signal. When the wanted channel band width is wider than or equal to 5MHz, a modulated 5MHz full band width E-UTRA down link signal, and in some cases an additional CW signal, are used. For wanted channel band widths below 5MHz, the band width of the modulated interferer should be equal to the channel band width of the wanted signal.

---

### D.2 Interference signals

Table D.2-1 describes the modulated interferer for different channel band width options.

**Table D.2-1: Description of modulated E-UTRA interferer**

	Channel bandwidth					
	1.4 MHz	3 MHz	5 MHz	10 MHz	15 MHz	20 MHz
RB	6	15	25	25	25	25
BW <sub>Interferer</sub>	1.4 MHz	3 MHz	5 MHz	5 MHz	5 MHz	5 MHz

---

# Annex E (normative): Global In-Channel TX-Test

Note: Clauses E.2.2 to E.5.9.3 are descriptions, which assume no power ramping adjacent to the measurement period. *Power ramping adjacent to the measurement period requires exclusion periods, described in clause E.7*

---

## E.1 General

The global in-channel TX test enables the measurement of all relevant parameters that describe the in-channel quality of the output signal of the TX under test in a single measurement process.

The parameters describing the in-channel quality of a transmitter, however, are not necessarily independent. The algorithm chosen for description inside this annex places particular emphasis on the exclusion of all interdependencies among the parameters.

---

## E.2 Signals and results

### E.2.1 Basic principle

The process is based on the comparison of the actual **output signal of the TX under test**, received by an ideal receiver, with a **reference signal**, that is generated by the measuring equipment and represents an ideal error free received signal. All signals are represented as equivalent (generally complex) baseband signals.

The description below uses numbers as examples. These numbers are taken from frame structure 1 with normal CP length and 20 MHz bandwidth. The application of the text below, however, is not restricted to this frame structure and bandwidth.

### E.2.2 Output signal of the TX under test

The output signal of the TX under test is acquired by the measuring equipment and stored for further processing. It is sampled at a sampling rate of 30.72 Msps. In the time domain it comprises at least 10 uplink subframes. The measurement period is derived by concatenating the correct number of individual uplink slots until the correct measurement period is reached. The output signal is named  $z(v)$ . Each slot is modelled as a signal with the following parameters: demodulated data content, carrier frequency, amplitude and phase for each subcarrier, timing, carrier leakage.

NOTE 1: TDD

For frame structure type 2, subframes with special fields (UpPTS) do not undergo any evaluation. Since the uplink subframes are not continuous, the 20 slots should be extracted from more than 1 continuous radio frame:

Figure E.2.2-1 is an example for uplink-downlink configuration 1 (DSUUDDSUUD) as specified in TS 36.211 [8] Table 4.2-2, assuming all uplink subframes are active.

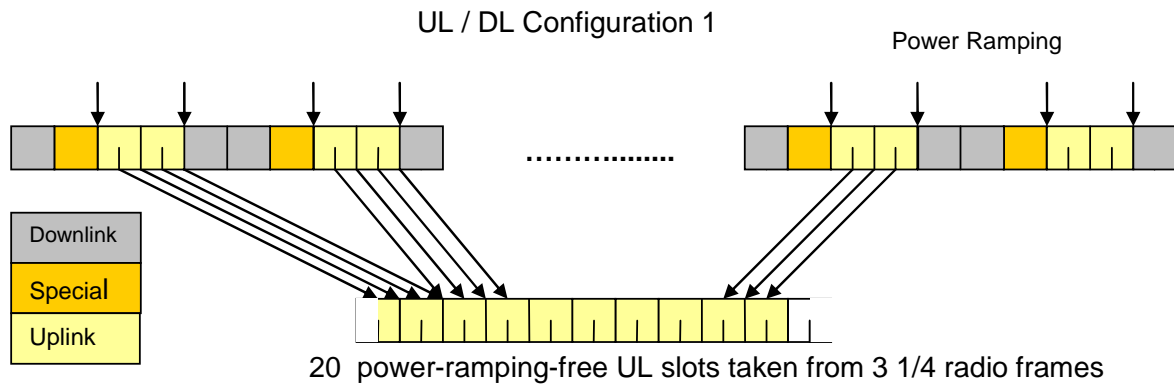

Figure E.2.2-1: Example of uplink – downlink configuration 1

## E.2.3 Reference signal

Two types of reference signal are defined:

The reference signal  $i_1(v)$  is constructed by the measuring equipment according to the relevant TX specifications, using the following parameters: demodulated data content, nominal carrier frequency, nominal amplitude and phase for each subcarrier, nominal timing, no carrier leakage. It is represented as a sequence of samples at a sampling rate of 30.72 Msps in the time domain.

The reference signal  $i_2(v)$  is constructed by the measuring equipment according to the relevant TX specifications, using the following parameters: restricted data content: nominal reference symbols, (all modulation symbols for user data symbols are set to 0V), nominal carrier frequency, nominal amplitude and phase for each applicable subcarrier, nominal timing, no carrier leakage. It is represented as a sequence of samples at a sampling rate of 30.72 Msps in the time domain.

NOTE: The PUCCH is off during the time under test.

## E.2.4 Measurement results

The measurement results, achieved by the global in channel TX test are the following:

- Carrier Frequency error
- EVM (Error Vector Magnitude)
- Carrier leakage
- Unwanted emissions, falling into non allocated resource blocks.
- EVM equalizer spectrum flatness

## E.2.5 Measurement points

The unwanted emission falling into non-allocated RB(s) is calculated directly after the FFT as described below. In contrast to this, the EVM for the allocated RB(s) is calculated after the IDFT. The samples after the TX-RX chain equalizer are used to calculate EVM equalizer spectrum flatness. Carrier frequency error and carrier leakage is calculated in the block “RF correction”.

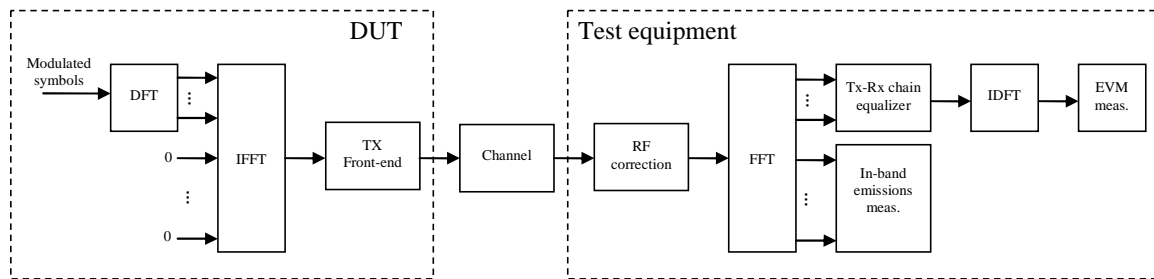

Figure E.2.5-1: EVM measurement points

## E.3 Signal processing

### E.3.1 Pre FFT minimization process

Before applying the pre-FFT minimization process,  $z(v)$  and  $i(v)$  are portioned into 20 pieces, comprising one slot each. Each slot is processed separately. Sample timing, Carrier frequency and carrier leakage in  $z(v)$  are jointly varied in order to minimise the difference between  $z(v)$  and  $i(v)$ . Best fit (minimum difference) is achieved when the RMS difference value between  $z(v)$  and  $i(v)$  is an absolute minimum.

The carrier frequency variation and the IQ variation are the measurement results: Carrier Frequency Error and Carrier leakage.

From the acquired samples 20 carrier frequencies and 20 carrier leakages can be derived.

NOTE 1: The minimisation process, to derive carrier leakage and RF error can be supported by Post FFT operations. However the minimisation process defined in the pre FFT domain comprises all acquired samples (i.e. it does not exclude the samples in between the FFT widths and it does not exclude the bandwidth outside the transmission bandwidth configuration)

NOTE 2: The algorithm would allow to derive Carrier Frequency error and Sample Frequency error of the TX under test separately. However there are no requirements for Sample Frequency error. Hence the algorithm models the RF and the sample frequency commonly (not independently). It returns one error and does not distinguish between both.

After this process the samples  $z(v)$  are called  $z^0(v)$ .

### E.3.2 Timing of the FFT window

The FFT window length is 2048 samples per OFDM symbol. 7 FFTs (14336 samples) cover less than the acquired number of samples (15360 samples) The position in time for FFT must be determined.

In an ideal signal, the FFT may start at any instant within the cyclic prefix without causing an error. The TX filter, however, reduces the window. The EVM requirements shall be met within a window  $W < CP$ . There are three different instants for FFT:

Centre of the reduced window, called  $\Delta\tilde{c}$ ,  $\Delta\tilde{c} - W/2$  and  $\Delta\tilde{c} + W/2$ .

The timing of the measured signal is determined in the pre FFT domain as follows, using  $z^0(v)$  and  $i_2(v)$  :

1. The measured signal is delay spread by the TX filter. Hence the distinct borders between the OFDM symbols and between Data and CP are also spread and the timing is not obvious.
2. In the Reference Signal  $i_2(v)$  the timing is known.
3. Correlation between (1.) and (2.) will result in a correlation peak. The meaning of the correlation peak is approx. the "impulse response" of the TX filter. The meaning of "impulse response" assumes that the autocorrelation of

the reference signal  $i_2(v)$  is a Dirac peak and that the correlation between the reference signal  $i_2(v)$  and the data in the measured signal is 0. The correlation peak, (the highest, or in case of more than one, the earliest) indicates the timing in the measured signal.

From the acquired samples 20 timings can be derived.

For all calculations, except EVM, the number of samples in  $z^0(v)$  is reduced to 7 blocks of samples, comprising 2048 samples (FFT width) and starting with  $\Delta\tilde{c}$  in each OFDM symbol including the demodulation reference signal.

For the EVM calculation the output signal under test is reduced to 14 blocks of samples, comprising 2048 samples (FFT width) and starting with  $\Delta\tilde{c} -W/2$  and  $\Delta\tilde{c} +W/2$  in each OFDM symbol including the demodulation reference signal.

The number of samples, used for FFT is reduced compared to  $z^0(v)$ . This subset of samples is called  $z'(v)$ .

The timing of the centre  $\Delta\tilde{c}$  with respect to the different CP length in a slot is as follows: (Frame structure 1, normal CP length)

$\Delta\tilde{c}$  is on  $T_f=72$  within the CP of length 144 (in OFDM symbol 1 to 6)

$\Delta\tilde{c}$  is on  $T_f=88$  (=160-72) within the CP of length 160 (in OFDM symbol 0)

### E.3.3 Post FFT equalisation

Perform 7 FFTs on  $z'(v)$ , one for each OFDM symbol in a slot using the timing  $\Delta\tilde{c}$ , including the demodulation reference symbol. The result is an array of samples, 7 in the time axis  $t$  times 2048 in the frequency axis  $f$ . The samples represent the DFT coded data symbols (in OFDM-symbol 0,1,2,4,5 and 6 in each slot) and demodulation reference symbols (OFDM symbol 3 in each slot) in the allocated RBs and inband emissions in the non allocated RBs within the transmission BW.

Only the allocated resource blocks in the frequency domain are used for equalisation.

The nominal demodulation reference symbols and nominal DFT coded data symbols are used to equalize the measured data symbols. (Location for equalization see Figure E.2.5-1)

NOTE: The nomenclature inside this note is local and not valid outside.

The nominal DFT coded data symbols are created by a demodulation process. The location to gain the demodulated data symbols is "EVM" in Figure E.2.5-1. A demodulation process as follows is recommended:

1. Equalize the measured DFT coded data symbols using the reference symbols for equalisation. Result: Equalized DFT coded data symbols
2. iDFT transform the equalized DFT coded data symbols: Result: Equalized data symbols
3. Decide for the nearest constellation point: Result: Nominal data symbols
4. DFT transform the nominal data symbols: Result: Nominal DFT coded data symbols

At this stage we have an array of Measured DFT coded data-Symbols and reference-Symbols ( $MS(f,t)$ )

versus an array of Nominal DFT coded data-Symbols and reference Symbols ( $NS(f,t)$ )

(complex, the arrays comprise 6 DFT coded data symbols and 1 demodulation reference symbol in the time axis and the number of allocated subcarriers in the frequency axis.)

$MS(f,t)$  and  $NS(f,t)$  are processed with a least square (LS) estimator, to derive one equalizer coefficient per time slot and per allocated subcarrier.  $EC(f)$

$$EC(f) = \frac{\sum_{t=0}^6 NS(f,t)^* NS(f,t)}{\sum_{t=0}^6 NS(f,t)^* MS(f,t)}$$

With \* denoting complex conjugation.

EC(f) are used to equalize the DFT-coded data symbols. The measured DFT-coded data and the references symbols are equalized by:

$$Z'(f,t) = MS(f,t) \cdot EC(f)$$

With · denoting multiplication.

Z'(f,t), restricted to the data symbol (excluding t=3) is used to calculate EVM, as described in E.4.1.

EC(f) is used in E.4.4 to calculate EVM equalizer spectral flatness.

NOTE: although an exclusion period for EVM may be applicable in E.7, the post FFT minimisation process is done over 7 symbols (6 DFT-coded data symbols and 1 reference symbol).

The samples of the non allocated resource blocks within the transmission bandwidth configuration in the post FFT domain are called Y(f,t) (f covering the non allocated subcarriers within the transmission bandwidth configuration, t covering the OFDM symbols during 1 slot).

## E.4 Derivation of the results

### E.4.1 EVM

For EVM create two sets of Z'(f,t), according to the timing "  $\Delta\tilde{c} - W/2$  and  $\Delta\tilde{c} + W/2$ " using the equalizer coefficients from E.3.3.

Perform the iDFTs on Z'(f,t). The IDFT-decoding preserves the meaning of t but transforms the variable f (representing the allocated sub carriers) into an another variable g, covering the same count and representing the demodulated symbols. The samples in the post IDFT domain are called  $iZ'(g, t)$ . The equivalent ideal samples are called  $iI(g,t)$ . Those samples of Z'(f,t), carrying the reference symbols (=symbol 3) are not iDFT processed.

The EVM is the difference between the ideal waveform and the measured and equalized waveform for the allocated RB(s)

$$EVM = \sqrt{\frac{\sum_{t \in T} \sum_{g \in G} |iZ'(g, t) - iI(g, t)|^2}{|G| \cdot |T| \cdot P_0}},$$

where

t covers the count of demodulated symbols with the considered modulation scheme being active within the measurement period, (i.e. symbol 0,1,2,4,5 and 6 in each slot,  $\Rightarrow |T|=6$ )

g covers the count of demodulated symbols with the considered modulation scheme being active within the allocated bandwidth. ( $|G|=12 \cdot L_{CRBS}$  (with  $L_{CRBS}$  : number of allocated resource blocks)).

$iZ'(g, t)$  are the samples of the signal evaluated for the EVM.

$iI(g, t)$  is the ideal signal reconstructed by the measurement equipment, and

$P_0$  is the average power of the ideal signal. For normalized modulation symbols  $P_0$  is equal to 1.

From the acquired samples 40 EVM value can be derived, 20 values for the timing  $\Delta\tilde{c} - W/2$  and 20 values for the timing  $\Delta\tilde{c} + W/2$



## E.4.2 Averaged EVM

EVM is averaged over all basic EVM measurements.

The averaging comprises 20 UL slots (for frame structure 2: excluding special fields(UpPTS))

$$\overline{EVM} = \sqrt{\frac{1}{20} \sum_{i=1}^{20} EVM_i^2}$$

The averaging is done separately for timing!  $\Delta\tilde{c} -W/2$  and  $\Delta\tilde{c} +W/2$  leading to  $\overline{EVM}_l$  and  $\overline{EVM}_h$

$EVM_{\text{final}} = \max(\overline{EVM}_l, \overline{EVM}_h)$  is compared against the test requirements.

## E.4.3 In-band emissions measurement

The in-band emissions are a measure of the interference falling into the non-allocated resources blocks.

Explanatory Note:

The inband emission measurement is only meaningful with allocated RBs next to non allocated RB. The allocated RBs are necessary but not under test. The non allocated RBs are under test. The RB allocation for this test is as follows: The allocated RBs are at one end of the channel BW, leaving the other end unallocated. The number of allocated RBs is smaller than half of the number of RBs, available in the channel BW. This means that the vicinity of the carrier in the centre is unallocated.

There are 3 types of inband emissions:

1. General
2. IQ image
3. Carrier leakage

*Carrier leakage* are inband emissions next to the carrier.

*IQ image* are inband emissions symmetrically (with respect to the carrier) on the other side of the allocated RBs.

*General* are applied to all unallocated RBs.

For each evaluated RB, the minimum requirement is calculated as the higher of  $P_{RB} - 30$  dB and the power sum of all limit values (General, IQ Image or Carrier leakage) that apply.

In specific the following combinations:

- Power (General)
- Power (General + Carrier leakage)
- Power (General + IQ Image)

1 and 2 is expressed in terms of power in one non allocated RB under test, normalized to the average power of an allocated RB (unit dB).

3 is expressed in terms of power in one non allocated RB, normalized to the power of all allocated RBs. (unit dBc).

This is the reason for two formulas *Emissions relative*.

Create one set of  $Y(t,f)$  per slot according to the timing “ $\Delta\tilde{c}$ ”

For the non-allocated RBs below the in-band emissions are calculated as follows

$$Emissions_{absolute}(\Delta_{RB}) = \begin{cases} \frac{1}{|T_s|} \sum_{t \in T_s} \sum_{c_l + (12 \cdot \Delta_{RB} + 1) \cdot \Delta f}^{c_l + (12 \cdot \Delta_{RB} + 11) \cdot \Delta f} |Y(t, f)|^2, \Delta_{RB} < 0 \\ \frac{1}{|T_s|} \sum_{t \in T_s} \sum_{c_h + (12 \cdot \Delta_{RB} - 11) \cdot \Delta f}^{c_h + (12 \cdot \Delta_{RB} - 1) \cdot \Delta f} |Y(t, f)|^2, \Delta_{RB} > 0 \end{cases}$$

where

the upper formula represents the in band emissions below the allocated frequency block and the lower one the in band emissions above the allocated frequency block.

$T_s$  is a set of  $|T_s|$  SC-FDMA symbols with the considered modulation scheme being active within the measurement period,

$\Delta_{RB}$  is the starting frequency offset between the allocated RB and the measured non-allocated RB (e.g.  $\Delta_{RB} = 1$  for the first upper or  $\Delta_{RB} = -1$  for the first lower adjacent RB),

$f_{min}$  and  $f_{max}$  are the lower and upper edge of the UL transmission BW configuration,

$c_l$  and  $c_h$  are the lower and upper edge of the allocated BW,

$\Delta f$  is 15kHz, and

$Y(t, f)$  is the frequency domain signal evaluated for in-band emissions as defined in the subsection E.3.3

The allocated RB power per RB and the total allocated RB power are given by:

$$P_{RB} = \frac{1}{|T_s| \cdot L_{CRBs}} \sum_{t \in T_s} \sum_{c_1}^{c_1 + (12 \cdot L_{CRBs} - 1) \cdot \Delta f} |MS(t, f)|^2 \text{ [dBm/180 kHz]}$$

$$P_{All-RBs} = \frac{1}{|T_s|} \sum_{t \in T_s} \sum_{c_1}^{c_1 + (12 \cdot L_{CRBs} - 1) \cdot \Delta f} |MS(t, f)|^2 \text{ [dBm]}$$

The relative in-band emissions, applicable for General and IQ image, are given by:

$$Emissions_{relative}(\Delta_{RB}) = 10 \cdot \log_{10} \left( \frac{Emissions_{absolute}(\Delta_{RB})}{\frac{1}{|T_s| \cdot L_{CRBs}} \sum_{t \in T_s} \sum_{c_1}^{c_1 + (12 \cdot L_{CRBs} - 1) \cdot \Delta f} |MS(t, f)|^2} \right) \text{ [dB]}$$

$$= Emissions_{absolute}(\Delta_{RB}) \text{ [dBm/180 kHz]} - P_{RB} \text{ [dBm/180 kHz]}$$

where

$L_{CRBs}$  is the number of allocated resource blocks,

and

$MS(t, f)$  is the frequency domain samples for the allocated bandwidth, as defined in the subsection E.3.3.

The relative in-band emissions, applicable for carrier leakage, is given by:

$$\begin{aligned}
Emissions_{relative} &= 10 \cdot \log_{10} \left( \frac{Emissions_{absolute}(RBnextDC)}{\frac{1}{|T_s|} \sum_{t \in T_s} \sum_{c_1}^{c_1 + (12 \cdot L_{CRBS} - 1) \cdot \Delta f} |MS(t, f)|^2} \right) [\text{dBc}] \\
&= Emissions_{absolute}(RBnextDC) [\text{dBm}/180\text{kHz}] - P_{All-RBs} [\text{dBm}]
\end{aligned}$$

where RBnextDC means: Resource Block next to the carrier.

This is one RB, namely the central one in case of an odd number of RBs in the channel BW.

This is one pair of RBs, namely the immediately adjacent RBs to the carrier in case of an even number of RBs in the channel BW.

Although an exclusion period may be applicable in the time domain, when evaluating EVM (clause E.7), the inband emissions measurement interval is defined over one complete slot in the time domain.

From the acquired samples 20 functions for general in band emissions and IQ image inband emissions can be derived. 20 values or 20 pairs of carrier leakage inband emissions can be derived. They are compared against different limits.

## E.4.4 EVM equalizer spectrum flatness

For EVM equalizer spectrum flatness use EC(f) as defined in E.3.3. Note, EC(f) represents equalizer coefficient

$f \in F$ ,  $f$  is the allocated subcarriers within the transmission bandwidth ( $|F|=12 \cdot L_{CRBS}$ )

From the acquired samples 20 functions EC(f) can be derived.

EC(f) is broken down to 2 functions:

$$EC_1(f), f \in \text{Range 1}$$

$$EC_2(f), f \in \text{Range 2}$$

Where Range 1 and Range 2 are as defined in Table 6.5.2.4.5-1 for normal condition and Table 6.5.2.4.5-2 for extreme condition

The following peak to peak ripple is calculated:

$$RP_1 = 20 * \log (\max (| EC_1 (f) |) / \min (| EC_1 (f) |)) , \text{which denote the maximum ripple in Range 1}$$

$$RP_2 = 20 * \log (\max (| EC_2 (f) |) / \min (| EC_2 (f) |)) , \text{which denote the maximum ripple in Range 2}$$

$$RP_{12} = 20 * \log (\max (| EC_1 (f) |) / \min (| EC_2 (f) |)) , \text{which denote the maximum ripple between the upper side of Range 1 and lower side of Range 2}$$

$$RP_{21} = 20 * \log (\max (| EC_2 (f) |) / \min (| EC_1 (f) |)) , \text{which denote the maximum ripple between the upper side of Range 2 and lower side of Range 1}$$

## E.4.5 Frequency error and Carrier leakage

See E.3.1.

### E.4.6 EVM of Demodulation reference symbols (EVM<sub>DMRS</sub>)

For the purpose of EVM<sub>DMRS</sub>, the steps E.2.2 to E.4.2 are repeated 6 times, constituting 6 EVM<sub>DMRS</sub> sub-periods. The only purpose of the repetition is to cover the longer gross measurement period of EVM<sub>DMRS</sub> (120 time slots) and to derive the FFT window timing per sub-period.

The bigger of the EVM results in one 20 TS period corresponding to the timing!  $\Delta\tilde{c} -W/2$  or  $\Delta\tilde{c} +W/2$  is compared against the limit. (Clause E.4.2) This timing is re-used for EVM<sub>DMRS</sub> in the equivalent EVM<sub>DMRS</sub> sub-period.

For EVM the demodulation reference symbols are excluded, while the data symbols are used. For EVM<sub>DMRS</sub> the data symbols are excluded, while the demodulation references symbols are used. This is illustrated in figure E.4.6-1

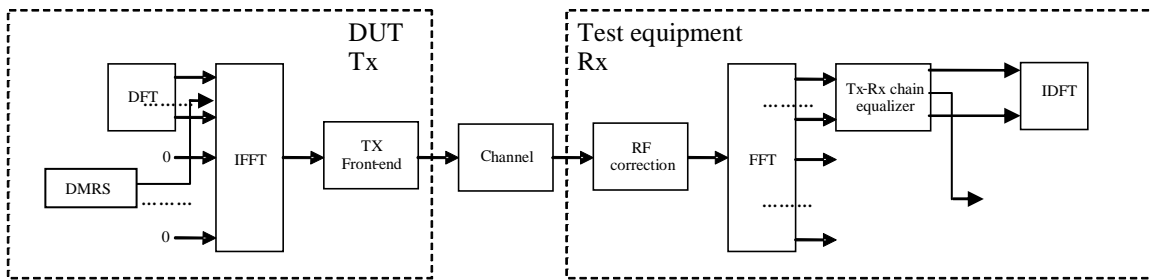

Figure E.4.6-1: EVM<sub>DMRS</sub> measurement points

Re-use the following formula from E.3.3:

$$Z'(f,t) = MS(f,t) \cdot EC(f)$$

To calculate EVM<sub>DMRS</sub>, the data symbol (t=0,1,2,4,5,6) in Z'(f,t) are excluded and only the reference symbol (t=3) is used.

The EVM<sub>DMRS</sub> is the difference between the ideal waveform and the measured and equalized waveform for the allocated RB(s)

$$EVM_{DMRS} = \sqrt{\frac{\sum_{t \in T} \sum_{f \in F} |Z'(f,t) - I(f,t)|^2}{|T| \cdot P_0 \cdot |F|}},$$

where

t covers the count of demodulation reference symbols (i.e. only symbol 3 in each slot, so count =1)

f covers the count of demodulation reference symbols within the allocated bandwidth. (|F|=12\* $L_{CRBs}$  (with  $L_{CRBs}$ : number of allocated resource blocks)).

$Z'(f,t)$  are the samples of the signal evaluated for the EVM<sub>DMRS</sub>

$I(f,t)$  is the ideal signal reconstructed by the measurement equipment, and

$P_0$  is the average power of the ideal signal. For normalized modulation symbols  $P_0$  is equal to 1.

20 such results are generated per measurement sub-period.

#### E.4.6.1 1<sup>st</sup> average for EVM<sub>DMRS</sub>

EVM<sub>DMRS</sub> is averaged over all basic EVM<sub>DMRS</sub> measurements in one sub-period

The averaging comprises 20 UL slots (for frame structure 2: excluding special fields(UpPTS))

$$1stEVM_{DMRS} = \sqrt{\frac{1}{20} \sum_{i=1}^{20} EVM_{DMRS_i}^2}$$

The timing is taken from the EVM for the data. 6 of those results are achieved from the samples. In general the timing is not the same for each result.

#### E.4.6.2 Final average for $EVM_{DMRS}$

$$finalEVM_{DMRS} = \sqrt{\frac{1}{6} \sum_{i=1}^6 1stEVM_{DMRS_i}^2}$$

---

## E.5 EVM and inband emissions for PUCCH

For the purpose of worst case testing, the PUCCH shall be located on the edges of the Transmission Bandwidth Configuration (6,15,25,50,75,100 RBs).

The EVM for PUCCH ( $EVM_{PUCCH}$ ) is averaged over 20 slots. At least 20 TSs shall be transmitted by the UE without power change. SRS multiplexing shall be avoided during this period. The following transition periods are applicable: One OFDM symbol on each side of the slot border (instant of band edge alternation).

The description below is generic in the sense that all 6 PUCCH formats are covered. Although the number of OFDM symbols in one slot is 6 or 7 (depending on the cyclic prefix length), the text below uses 7 without excluding 6.

### E.5.1 Basic principle

The basis principle is the same as described in E.2.1

### E.5.2 Output signal of the TX under test

The output signal of the TX under test is processed same as described in E.2.2

### E.5.3 Reference signal

The reference signal is defined same as in E.2.3. Same as in E.2.3,  $i_1(v)$  is the ideal reference for  $EVM_{PUCCH}$  and  $i_2(v)$  is used to estimate the FFT window timing.

Note PUSCH is off during the PUCCH measurement period.

### E.5.4 Measurement results

The measurement results are:

- $EVM_{PUCCH}$
- Inband emissions with the sub-results: General in-band emission, IQ image (according to: 36.101. Annex F.4, Clause starting with: "At this stage the ....")

### E.5.5 Measurement points

The measurement points are illustrated in the figure below:

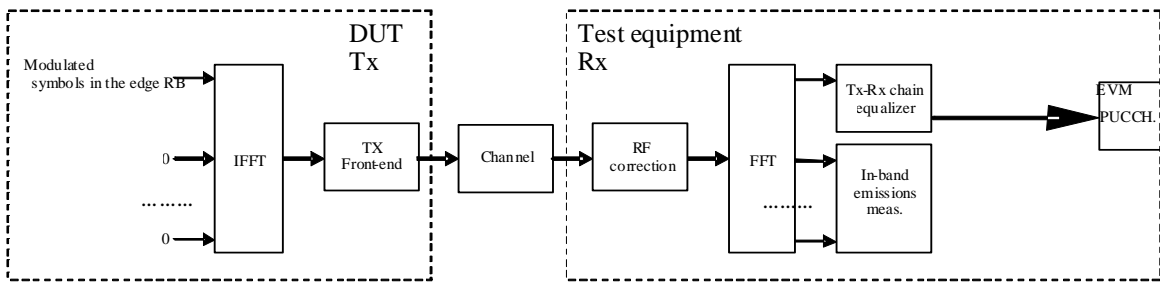

Figure E.5.5-1

## E.5.6 Pre FFT minimization process

The pre FFT minimisation process is the same as describes in clause E.3.1.

NOTE: although an exclusion period for  $EVM_{PUCCH}$  is applicable in E.5.9.1, the pre FFT minimisation process is done over the complete slot.

RF error, and carrier leakage are necessary for best fit of the measured signal towards the ideal signal in the pre FFT domain. However they are not used to compare them against the limits.

## E.5.7 Timing of the FFT window

Timing of the FFT window is estimated with the same method as described in E.3.2.

## E.5.8 Post FFT equalisation

The post FFT equalisation is described separately without reference to E.3.3:

Perform 7 FFTs on  $z'(v)$ , one for each OFDM symbol in a slot using the timing  $\Delta\tilde{c}$ , including the demodulation reference symbol. The result is an array of samples, 7 in the time axis  $t$  times 2048 in the frequency axis  $f$ . The samples represent the OFDM symbols (data and reference symbols) in the allocated RBs and inband emissions in the non allocated RBs within the transmission BW.

Only the allocated resource blocks in the frequency domain are used for equalisation.

The nominal reference symbols and **nominal** OFDM data symbols are used to equalize the measured data symbols.

Note: (The nomenclature inside this note is local and not valid outside)

The nominal OFDM data symbols are created by a demodulation process. A demodulation process as follows is recommended:

1. Equalize the measured OFDM data symbols using the reference symbols for equalisation. Result: Equalized OFDM data symbols
2. Decide for the nearest constellation point, however not independent for each subcarrier in the RB. 12 constellation points are decided dependent, using the applicable CAZAC sequence. Result: Nominal OFDM data symbols

At this stage we have an array of Measured data-Symbols and reference-Symbols ( $MS(f,t)$ )

versus an array of Nominal data-Symbols and reference Symbols ( $NS(f,t)$ )

The arrays comprise in sum 7 data and reference symbols, depending on the PUCCH format, in the time axis and the number of allocated sub-carriers in the frequency axis.

$MS(f,t)$  and  $NS(f,t)$  are processed with a least square (LS) estimator, to derive one equalizer coefficient per time slot and per allocated subcarrier.  $EC(f)$

$$EC(f) = \frac{\sum_{t=0}^6 NS(f,t)^* NS(f,t)}{\sum_{t=0}^6 MS(f,t)^* NS(f,t)}$$

With \* denoting complex conjugation.

EC(f) are used to equalize the OFDM data together with the demodulation reference symbols by:

$$Z'(f,t) = MS(f,t) \cdot EC(f)$$

With · denoting multiplication.

Z'(f,t) is used to calculate EVM<sub>PUCCH</sub>, as described in E.5.9.1

NOTE: although an exclusion period for EVM<sub>PUCCH</sub> is applicable in E.5.9.1, the post FFT minimisation process is done over 7 OFDM symbols.

The samples of the non allocated resource blocks within the transmission bandwidth configuration in the post FFT domain are called Y(f,t) (f covering the non allocated subcarriers within the transmission bandwidth configuration, t covering the OFDM symbols during 1 slot).

## E.5.9 Derivation of the results

### E.5.9.1 EVM<sub>PUCCH</sub>

For EVM<sub>PUCCH</sub> create two sets of Z'(f,t), according to the timing "  $\Delta\tilde{c} - W/2$  and  $\Delta\tilde{c} + W/2$ " using the equalizer coefficients from E.5.8

The EVM<sub>PUCCH</sub> is the difference between the ideal waveform and the measured and equalized waveform for the allocated RB(s)

$$EVM_{PUCCH} = \sqrt{\frac{\sum_{t \in T} \sum_{f \in F} |Z'(f,t) - I(f,t)|^2}{|T| \cdot P_0 \cdot |F|}},$$

where

the OFDM symbols next to slot borders (instant of band edge alternation) are excluded:

t covers less than the count of demodulated symbols in the slot (|T|= 5)

f covers the count of subcarriers within the allocated bandwidth. (|F|=12)

Z'(f,t) are the samples of the signal evaluated for the EVM<sub>PUCCH</sub>

I(f,t) is the ideal signal reconstructed by the measurement equipment, and

P<sub>0</sub> is the average power of the ideal signal. For normalized modulation symbols P<sub>0</sub> is equal to 1.

From the acquired samples 40 EVM<sub>PUCCH</sub> value can be derived, 20 values for the timing  $\Delta\tilde{c} - W/2$  and 20 values for the timing  $\Delta\tilde{c} + W/2$

### E.5.9.2 Averaged EVM<sub>PUCCH</sub>

EVM<sub>PUCCH</sub> is averaged over all basic EVM<sub>PUCCH</sub> measurements

The averaging comprises 20 UL slots (for frame structure 2: excluding special fields(UpPTS))

$$\overline{EVM}_{PUCCH} = \sqrt{\frac{1}{20} \sum_{i=1}^{20} EVM_{PUCCH,i}^2}$$

The averaging is done separately for timing!  $\Delta\tilde{c} -W/2$  and  $\Delta\tilde{c} +W/2$  leading to  $\overline{EVM}_{PUCCH,low}$  and  $\overline{EVM}_{PUCCH,high}$

$EVM_{PUCCH,final} = \max(\overline{EVM}_{PUCCH,low}, \overline{EVM}_{PUCCH,high})$  is compared against the test requirements.

### E.5.9.3 In-band emissions measurement

The in-band emissions are a measure of the interference falling into the non-allocated resources blocks

Create one set of  $Y(t,f)$  per slot according to the timing “ $\Delta\tilde{c}$ ”

For the non-allocated RBs the in-band emissions are calculated as follows

$$Emissions_{absolute}(\Delta_{RB}) = \begin{cases} \frac{1}{|T_s|} \sum_{t \in T_s} \sum_{c_l + (12 \cdot \Delta_{RB} + 11) \cdot \Delta f}^{\max(f_{min}, (c_l + 12 \cdot \Delta_{RB} \cdot \Delta f))} |Y(t, f)|^2, \Delta_{RB} < 0 \\ \frac{1}{|T_s|} \sum_{t \in T_s} \sum_{c_h + (12 \cdot \Delta_{RB} - 11) \cdot \Delta f}^{\min(f_{max}, (c_h + 12 \cdot \Delta_{RB} \cdot \Delta f))} |Y(t, f)|^2, \Delta_{RB} > 0 \end{cases},$$

where

the upper formula represents the inband emissions below the allocated frequency block and the lower one the inband emissions above the allocated frequency block.

$T_s$  is a set of  $|T_s|$  OFDM symbols in the measurement period,

$\Delta_{RB}$  is the starting frequency offset between the allocated RB and the measured non-allocated RB (e.g.  $\Delta_{RB} = 1$  for the first upper or  $\Delta_{RB} = -1$  for the first lower adjacent RB),

$f_{min}$  and  $f_{max}$  are the lower and upper edge of the UL system BW,

$c_l$  and  $c_h$  are the lower and upper edge of the allocated BW,

$\Delta f$  is 15kHz, and

$Y(t, f)$  is the frequency domain signal evaluated for in-band emissions as defined in the subsection E.5.8

The relative in-band emissions are, given by

$$Emissions_{relative}(\Delta_{RB}) = 10 * \log_{10} \frac{Emissions_{absolute}(\Delta_{RB})}{\frac{1}{|T_s|} \cdot L_{CRBs} \sum_{t \in T_s} \sum_{c_1}^{c_1 + (12 \cdot L_{CRBs} - 1) \cdot \Delta f} |MS(t, f)|^2} [dB]$$

where

$L_{CRBs}$  is the number of allocated RBs, which is always 1 in case of PUCCH

and  $MS(t, f)$  is the frequency domain samples for the allocated bandwidth, as defined in the subsection E.5.8



Although an exclusion period for EVM is applicable in E.5.9.1, the inband emissions measurement interval is defined over one complete slot in the time domain.

From the acquired samples 20 functions for inband emissions can be derived.

Since the PUCCH allocation is always on the upper or lower band-edge, the opposite to the allocated one represents the IQ image, and the remaining inner RBs represent the general inband emissions. They are compared against different limits.

---

## E.6 EVM for PRACH

The description below is generic in the sense that all 5 PRACH formats are covered. The numbers, used in the text below are taken from PRACH format#0 without excluding the other formats. The sampling rate for the PUSCH, 30.72 Msps in the time domain, is re-used for the PRACH. The carrier spacing of the PUSCH is 12 (format 0 to 3) and 2 (format 4) times of the PRACH. This results in an oversampling factor of 12 (format 0 to 3) and 2 (format 4), when acquiring the time samples for the PRACH. The pre-FFT algorithms (clauses E.6.6 and E.6.7) use all time samples, although oversampled. For the FFT the time samples are decimated by the factor of 12 (format 0 to 3) and 2 (format 4), resulting in the same FFT size as for the other transmit modulation tests (2048). Decimation requires a decision, which samples are used and which ones are rejected. The algorithm in E.6.6, Timing of the FFT window, can also be used to decide about the used samples.

### E.6.1 Basic principle

The basis principle is the same as described in E.2.1

### E.6.2 Output signal of the TX under test

The output signal of the TX under test is processed same as described in E.2.2

The measurement period is different:

- 2 PRACH preambles are recorded for format 0 and 1,
- 1 PRACH preamble is recorded for format 2 and 3, each containing 1 CP and 2 preamble sequences
- 10 RPRACH preambles are recorded for format 4.

### E.6.3 Reference signal

The test description in 6.5.2.1.4.1A is based on non contention based access:

- PRACH configuration index (responsible for Preamble format, System frame number and subframe number)
- Preamble ID
- Preamble power

signalled to the UE, defines the reference signal unambiguously, such that no demodulation process is necessary to gain the reference signal.

The reference signal  $i(v)$  is constructed by the measuring equipment according to the relevant TX specifications, using the following parameters: the applicable Zadoff Chu sequence, nominal carrier frequency, nominal amplitude and phase for each subcarrier, nominal timing, no carrier leakage. It is represented as a sequence of samples at a sampling rate of 30.72 Msps in the time domain.

### E.6.4 Measurement results

The measurement result is:

- EVMPRACH

## E.6.5 Measurement points

The measurement points are illustrated in the figure below:

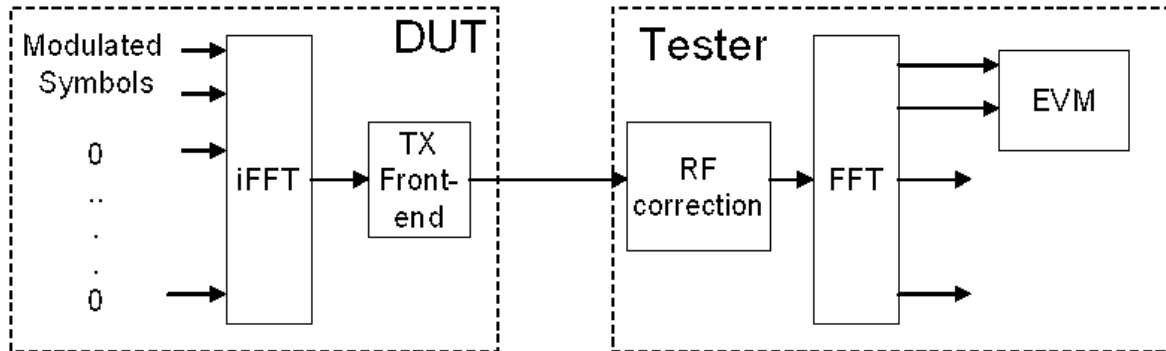

Figure E.6.5-1

## E.6.6 Pre FFT minimization process

The pre-FFT minimization process is applied to each PRACH preamble separately. The time period for the pre-FFT minimisation process includes the complete CP and Zadoff-Chu sequence (in other words, the power transition period is per definition outside of this time period) Sample timing, Carrier frequency and carrier leakage in  $z(v)$  are jointly varied in order to minimise the difference between  $z(v)$  and  $i(v)$ . Best fit (minimum difference) is achieved when the RMS difference value between  $z(v)$  and  $i(v)$  is an absolute minimum.

After this process the samples  $z(v)$  are called  $z^0(v)$ .

RF error, and carrier leakage are necessary for best fit of the measured signal towards the ideal signal in the pre FFT domain. However they are not used to compare them against the limits.

## E.6.7 Timing of the FFT window

The FFT window length is 24576 samples for preamble format 0, however in the measurement period is at least 27744 samples are taken. The position in time for FFT must be determined.

In an ideal signal, the FFT may start at any instant within the cyclic prefix without causing an error. The TX filter, however, reduces the window. The EVM requirements shall be met within a window  $W < CP$ .

The reference instant for the FFT start is the centre of the reduced window, called  $\Delta\tilde{c}$ ,

EVM is measured at the following two instants:  $\Delta\tilde{c} - W/2$  and  $\Delta\tilde{c} + W/2$ .

The timing of the measured signal  $z^0(v)$  with respect to the ideal signal  $i(v)$  is determined in the pre FFT domain as follows:

Correlation between  $z^0(v)$  and  $i(v)$  will result in a correlation peak. The meaning of the correlation peak is approx. the “impulse response” of the TX filter. The correlation peak, (the highest, or in case of more than one, the earliest) indicates the timing in the measured signal with respect to the ideal signal.

$W$  is different for different preamble formats and shown in Table E.6.7-1.

Table E.6.7-1EVM window length for PRACH

Preamble format	Cyclic prefix length <sup>1</sup> $N_{cp}$	Nominal FFT size <sup>2</sup>	EVM window length $W$ in FFT samples	Ratio of $W$ to CP <sup>3</sup>
0	3168	24576	3072	96.7%
1	21024	24576	20928	99.5%
2	6240	49152	6144	98.5%
3	21024	49152	20928	99.5%
4	448	4096	432	96.4%
Note 1: The unit is number of samples, sampling rate of 30.72MHz is assumed				
Note 2: Decimation of time samples by 12(format 0 to 3) and factor 2 (format 4) is assumed, leading to a uniform FFT size of 2048 for all formats.				
Note 3: These percentages are informative				

The number of samples, used for FFT is reduced compared to  $z^0(v)$ . This subset of samples is called  $z'(v)$ .

The sample frequency 30.72 MHz is oversampled with respect to the PRACH-subcarrier spacing of 1.25kHz (format 0 to 3) and 7.5kHz (format 4). EVM is based on 2048 samples per PRACH preamble and requires decimation of the time samples by the factor of 12 (format 0 to 3) and factor 2 (format 4). The final number of samples per PRACH preamble, used for FFT is reduced compared to  $z'(v)$  by the factor of 12 (format 0 to 3) and factor 2 (format 4). This subset of samples is called  $z''(v)$ .

## E.6.8 Post FFT equalisation

Equalisation is not applicable for the PRACH.

## E.6.9 Derivation of the results

### E.6.9.1 $EVM_{PRACH}$

Perform FFT on  $z'(v)$  and  $i(v)$  using the FFT timing  $\Delta\tilde{c} - W/2$  and  $\Delta\tilde{c} + W/2$ .

For format 2 and 3 the first and the repeated preamble sequence are FFT-converted separately. using the standard FFT length of 2048

The  $EVM_{PRACH}$  is the difference between the ideal waveform and the measured and equalized waveform for the allocated RB(s).

$$EVM_{PRACH} = \sqrt{\frac{\sum_{f \in F} |Z'(f) - I(f)|^2}{N_{ZC} \cdot P_0}},$$

where

$f$  covers the count of demodulated symbols within the allocated bandwidth.

$Z'(f)$  are the samples of the signal evaluated for the  $EVM_{PRACH}$

$I(f)$  is the ideal signal reconstructed by the measurement equipment, and

$P_0$  is the average power of the ideal signal. For normalized modulation symbols  $P_0$  is equal to 1.

$N_{ZC}$  is random access preamble sequence length.

From the acquired samples 4  $EVM_{PRACH}$  value can be derived, 2 values for the timing  $\Delta\tilde{c} -W/2$  and 2 values for the timing  $\Delta\tilde{c} +W/2$  (4 and 2 applies for format 0,1,2,3. 20 and 10 applies for format 4).

### E.6.9.2 Averaged $EVM_{PRACH}$

The PRACH EVM,  $EVM_{PRACH}$ , is averaged over two preamble sequence measurements for preamble formats 0, 1, 2, 3, and it is averaged over 10 preamble sequence measurements for preamble format 4.

$$\overline{EVM}_{PRACH} = \sqrt{\frac{1}{2} \sum_{i=1}^2 EVM_{PRACH_i}^2} \text{ for preamble formats 0,1,2,3}$$

$$\overline{EVM}_{PRACH} = \sqrt{\frac{1}{10} \sum_{i=1}^{10} EVM_{PRACH_i}^2} \text{ for preamble format 4}$$

The averaging is done separately for timing;  $\Delta\tilde{c} -W/2$  and  $\Delta\tilde{c} +W/2$  leading to  $\overline{EVM}_{PRACH,low}$  and  $\overline{EVM}_{PRACH,high}$

$EVM_{PRACH,final} = \max(\overline{EVM}_{PRACH,low}, \overline{EVM}_{PRACH,high})$  is compared against the test requirements.

## E.7 EVM with exclusion period

### E.7.1 General

EVM with exclusion periods is defined in clause 6.5.2.1.1, third paragraph. For PUCCH entire symbols are excluded, if applicable. For PUSCH fractions of symbols are excluded, if applicable. The exclusion period for PUSCH is defined at the air interface, leading to exclusion periods in the EVM domain. The necessary mapping is described in this clause.

### E.7.2 The model

The exclusion period in the time domain has corresponding periods in the quasi time domains (Table E.7.2). The mapping of corresponding periods needs only scaling and cyclic shifting.

The algorithm below uses a sampling frequency 30.72 MHz and FFT-width 2048 for all bandwidths. Bandwidth-adapted sampling frequencies and FFT-widths are not excluded. Only normal cyclic prefix is mentioned in the model without excluding the extended CP.

**Table. E.7.2: Model for mapping exclusion period in the time domain**

Operation	TX			Channel	EVM meter					
		D F T			i F F T		F F T		iD F T	
Meaning	Modulation symbols		Precoded symbols		BB samples	BB samples		Precoded symbols		demodulated symbols
No of samples	allocated Sub Carriers		allocated subcarriers + unallocated subcarriers = 2048		allocated subcarriers + unallocated subcarriers + CP samples	2048, position depending on EVM window		allocated subcarriers		allocated subcarriers
Domain	Quasi time domain		Frequency domain		Time domain	Time domain		Frequency domain		Quasi time domain
text below		1	2	3	4	7	7	8	9	11

1. A sequence of complex valued modulation symbols are Transform-Precoded (DFT) according to 36.211 clause 5.3.3. The size of this transformation is the number of allocated subcarriers.
2. The outcome of (1) is supplemented by 0 for the non allocated subcarriers. In sum 2048 subcarriers.
3. The baseband time signal (without CP) is then calculated by a iFFT according to 36.211 clause 5.6
4. (3) is then supplemented by a cyclic prefix (144 or 160 samples) leading to 2192 or 2208 samples. (144 CP samples = 144 tail samples from the data field)
5. (4) is transmitted over the channel and sampled by the EVM meter.
6. In case of an exclusion period those samples of (5) are marked, where the exclusion applies. The exclusion period is an unbroken leading or lagging exclusion period next to a subframe or timeslot boarder.
7. Depending on early or late EVM-window a subset of 2048 samples (out of 2192 or 2208 samples) are the input for the subsequent FFT . These samples may or may not comprise marked samples. The result are 2048 frequency domain samples.
8. The non allocated subcarriers are removed from the 2048 samples.
9. (8) is then iDFT transformed. The result are demodulated complex valued symbols in the same domain as (1)
10. Step 7, 8 and 9 are modified by an equalizer algorithm.  
For the purpose of this clause, the equalizer partly re-does step 4 (CP insertion):  
The equalizer algorithm cuts that subset of CP samples, covered by the FFT, from the head and copies it to the tail of the data field.
11. The result of (10) is: complex valued symbols in the same sequence as in (1) They are compared with (1) symbol by symbol for EVM. Due to exclusion in the time domain (6) we have marked corresponding symbols, which are disregarded for EVM.
12. From step 1 to 4 the number of samples is expanded. A subset of expanded samples is marked as excluded. Form step 6 to step 9 the number of samples is compressed, leading to a non integer number of samples, marked as excluded. The number of marked samples in this domain is rounded up at the expense of the EVM samples

### E.7.3 Illustration

The figures below illustrate the cyclic shift due to the equalizer and scaling.

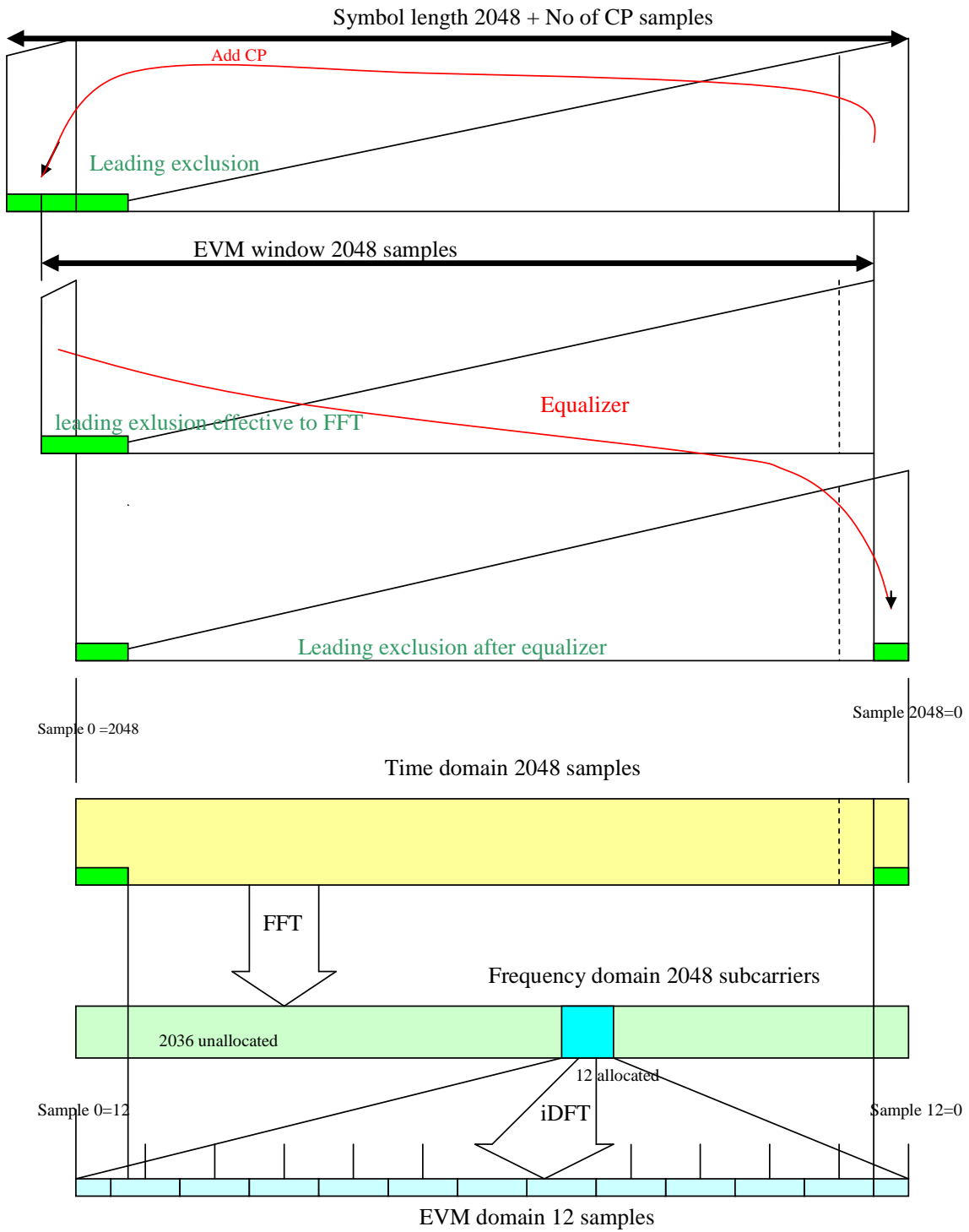

Figure E.7.3-1: leading exclusion period (when number of RBs=1)

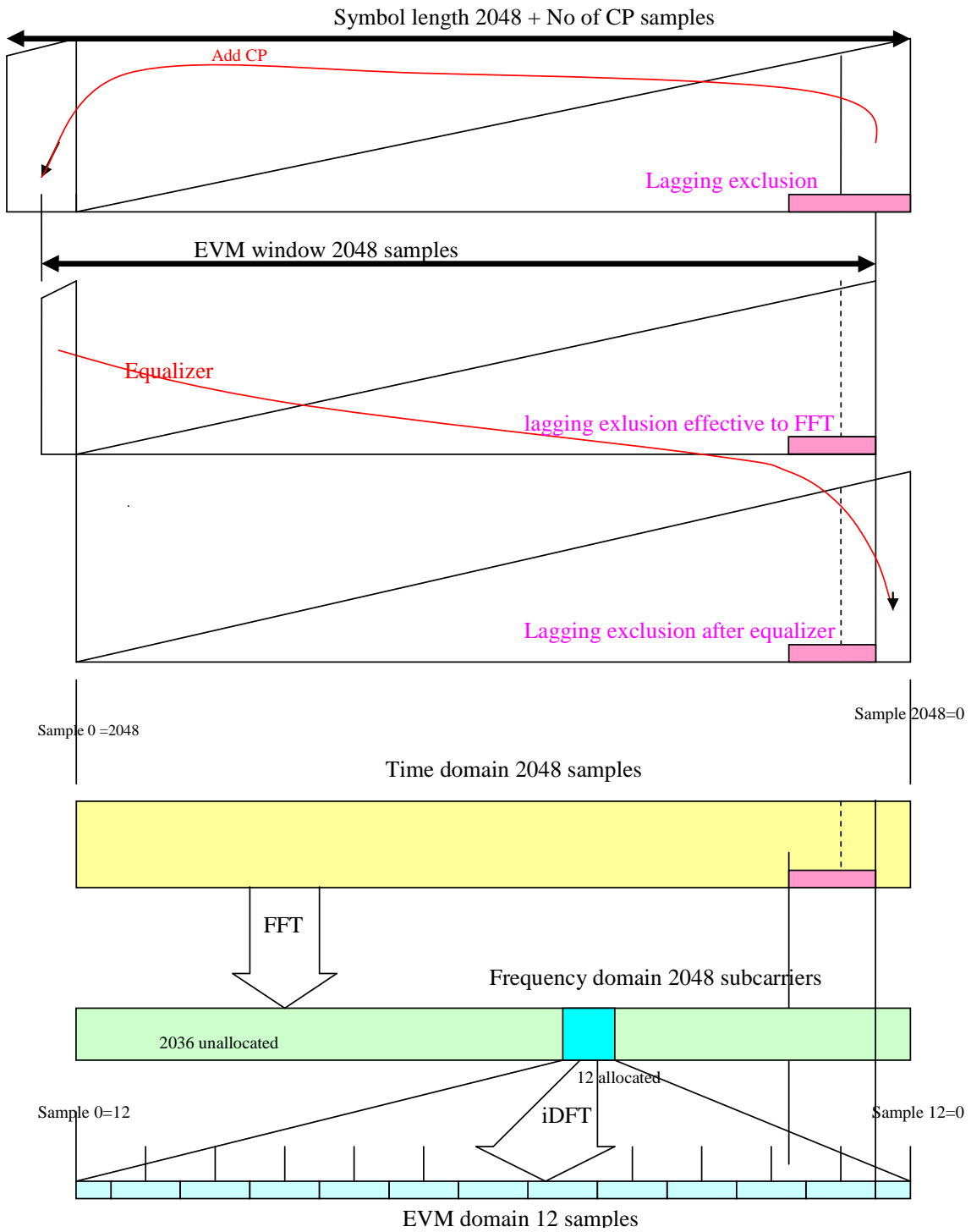

Figure E.7.3-2: lagging exclusion period (when number of RBs=1)

Legend to figure E.7.3-1

The figure contains 6 related subfigures.

The upper 3 triangles illustrate the cyclic shift due to EVM windowing and equalizer.

The lower 3 boxes illustrate the mapping from the time domain, where the exclusion period is defined, into the EVM domain, where EVM samples are actually excluded.

#### Cyclic shift

The leading exclusion period covers the entire CP and a part of the data field. The EVM window masks a part of the exclusion period. For the purpose of this annex, the equalizer re-arranges the time domain samples into the original order, splitting the exclusion period into two parts.

#### Mapping

The split exclusion period (after cyclic shift) is copied from above. The frequency domain is derived by Fast Fourier Transformation from the time domain and represent the frequency domain with 2048 subcarriers, 12 of them are allocated, the rest is unallocated. The 12 allocated subcarriers are iDFT transformed into the EVM domain comprising 12 samples. Note that all 3 domains are displayed cyclically: the leftmost sample is identical to the rightmost sample.

The two transformations map the time domain into the EVM domain, carrying out a compression of samples 12/2048. In spite of the compression, there is a correspondence of ranges in the time domain and in the EVM domain. One sample in the EVM domain comprises a range, which is influenced from (and only from) the equivalent samples in the time domain vertically above. Note that this correspondence holds irrespective of the position of the 12 allocated samples in the frequency domain.

#### Example leading exclusion (figure E.7.3-1)

Sample No in the EVM domain	Influence(exclusion) from the time domain	EVM exclusion
12=0	full	excluded
1	partly	excluded
2 to 11	none	counted

#### Example lagging exclusion example (figure E.7.3-2)

Sample No in the EVM domain	Influence(exclusion) from the time domain	EVM exclusion
12=0	none	counted
1 to 9	none	counted
10	partly	excluded
11	full	excluded

## E.7.4 Formula

The exclusion period is defined in  $\mu\text{s}$  at the air interface.

Convert the  $\mu\text{s}$ 's into No of samples in the time domain.

No of exclusion samples (before EVM windowing and equalizer) is calculated from:

No of exclusion sample =  $\text{ceil}(30.72 * \text{Exclusion } \mu\text{s})$

then, EVM windowing and equalizer is applied by 2048 samples based cyclic shift process.

(the upper 3 triangles illustrate in fig. E.7.3-1 and -2.)

Determine the indices  $k$ , to be excluded in the time domain, according to fig. E.7.3-1 and -2



(after application of EVM windowing and equaliser, original sample order,

$\mathbf{k}$  = subset from the set (0 to 2047) )

The indices  $\mathbf{l}$  in the EVM domain, to be excluded, are:

$$\mathbf{l} = [ \text{round} (\mathbf{k} * 12 * L_{\text{CRBs}} / 2048) ] \bmod (12 * L_{\text{CRBs}})$$

with  $L_{\text{CRBs}}$  number of allocated resource blocks

---

## Annex F (normative): Measurement uncertainties and Test Tolerances

### F.1 Acceptable uncertainty of Test System (normative)

The maximum acceptable uncertainty of the Test System is specified below for each test, where appropriate. The Test System shall enable the stimulus signals in the test case to be adjusted to within the specified range, and the equipment under test to be measured with an uncertainty not exceeding the specified values. All ranges and uncertainties are absolute values, and are valid for a confidence level of 95 %, unless otherwise stated.

A confidence level of 95 % is the measurement uncertainty tolerance interval for a specific measurement that contains 95 % of the performance of a population of test equipment.

For RF tests it should be noted that the uncertainties in clause F.1 apply to the Test System operating into a nominal 50 ohm load and do not include system effects due to mismatch between the DUT and the Test System.

The downlink signal uncertainties apply at each receiver antenna connector.

#### F.1.1 Measurement of test environments

The measurement accuracy of the UE test environments defined in TS 36.508 subclause 4.1, Test environments shall be.

- Pressure  $\pm 5$  kPa.
- Temperature  $\pm 2$  degrees.
- Relative Humidity  $\pm 5$  %.
- DC Voltage  $\pm 1,0$  %.
- AC Voltage  $\pm 1,5$  %.
- Vibration 10 %.
- Vibration frequency 0,1 Hz.

The above values shall apply unless the test environment is otherwise controlled and the specification for the control of the test environment specifies the uncertainty for the parameter.

## F.1.2 Measurement of transmitter

Table F.1.2-1: Maximum Test System Uncertainty for transmitter tests

Subclause	Maximum Test System Uncertainty	Derivation of Test System Uncertainty
6.2.2 UE Maximum Output Power	$\pm 0.7$ dB, $f \leq 3.0$ GHz $\pm 1.0$ dB, $3.0$ GHz $< f \leq 4.2$ GHz	
6.2.2_1 Maximum Output Power for HPUE	$\pm 0.7$ dB, $f \leq 3.0$ GHz	
6.2.2A.1 UE Maximum Output Power for CA (intra-band contiguous DL CA and UL CA)	Same as 6.2.2 for each CC	
6.2.2A.2 UE Maximum Output Power for CA (inter-band DL CA and UL CA)	Same as 6.2.2 for each CC	
6.2.2B UE Maximum Output Power for UL-MIMO	Same as 6.2.2 for each antenna	
6.2.2E UE Maximum Output Power for UE category 0	Same as 6.2.2	
6.2.3 Maximum Power Reduction	$\pm 0.7$ dB, $f \leq 3.0$ GHz $\pm 1.0$ dB, $3.0$ GHz $< f \leq 4.2$ GHz	
6.2.3_1 Maximum Power Reduction (MPR) for HPUE	$\pm 0.7$ dB, $f \leq 3.0$ GHz	
6.2.3A.1 Maximum Power Reduction (MPR) for CA (intra-band contiguous DL CA and UL CA)	Same as 6.2.3 for sum of powers of all CCs	
6.2.3A.2 Maximum Power Reduction (MPR) for CA (inter-band DL CA and UL CA)	Same as 6.2.3 for sum of powers of all CCs	
6.2.3A.3 Maximum Power Reduction (MPR) for CA (intra-band non-contiguous DL CA and UL CA)	Same as 6.2.3 for sum of powers of all CCs	
6.2.3B Maximum Power Reduction (MPR) for UL-MIMO	Same as 6.2.3 for each antenna	
6.2.3_2 Maximum Power Reduction (MPR) for Multi-Cluster PUSCH	Same as 6.2.3	
6.2.4 UE Maximum Output Power with additional requirements	$\pm 0.7$ dB, $f \leq 3.0$ GHz $\pm 1.0$ dB, $3.0$ GHz $< f \leq 4.2$ GHz	
6.2.4_1 Additional Maximum Power Reduction (A-MPR) for HPUE	$\pm 0.7$ dB, $f \leq 3.0$ GHz	
6.2.4A.1 Additional Maximum Power Reduction (A-MPR) for CA (intra-band contiguous DL CA and UL CA)	Same as 6.2.4 for sum of powers of all CCs	
6.2.4B Additional Maximum Power Reduction (A-MPR) for UL-MIMO	Same as 6.2.4 for each antenna	
6.2.5 Configured UE transmitted Output Power	$\pm 0.7$ dB, $f \leq 3.0$ GHz $\pm 1.0$ dB, $3.0$ GHz $< f \leq 4.2$ GHz	
6.2.5_1 Configured UE transmitted Output Power for HPUE	$\pm 0.7$ dB, $f \leq 3.0$ GHz	
6.2.5A.1 Configured UE transmitted Output Power for CA (intra-band contiguous DL CA and UL CA)	Same as 6.2.5 for each CC	

6.2.5A.2 Configured UE transmitted Output Power for CA (inter-band DL CA and UL CA)	Same as 6.2.5 for each CC	
6.2.5A.3 Configured UE transmitted Output Power for CA (intra-band non-contiguous DL CA and UL CA)	Same as 6.2.5 for each CC	
6.2.5B Configured UE transmitted output power for UL-MIMO	Same as 6.2.5 for each antenna	
6.3.2 Minimum Output Power	$\pm 1.0$ dB, $f \leq 3.0$ GHz $\pm 1.3$ dB, $3.0$ GHz $< f \leq 4.2$ GHz	
6.3.2A.1 Minimum Output Power for CA (intra-band contiguous DL CA and UL CA)	Same as 6.3.2 for each CC	
6.3.2B Minimum Output Power for UL-MIMO	Same as 6.3.2 for each antenna	
6.3.3 Transmission ON/OFF Power	Transmission OFF Power: $\pm 1.5$ dB, $f \leq 3.0$ GHz $\pm 1.8$ dB, $3.0$ GHz $< f \leq 4.2$ GHz	
6.3.3A.1 UE Transmit OFF power for CA (intra-band contiguous DL CA and UL CA)	Same as 6.3.3 for each CC	
6.3.3A.2 UE Transmit OFF power for CA (inter-band DL CA and UL CA)	Same as 6.3.3A.1	
6.3.3A.3 UE Transmit OFF power for CA (intra-band non-contiguous DL CA and UL CA)	Same as 6.3.3 for each CC	
6.3.3B UE Transmit OFF power for UL-MIMO	Same as 6.3.3 for each antenna	
6.3.4.1 General ON/OFF time mask	Transmission ON/OFF Power: $\pm 1.5$ dB, $f \leq 3.0$ GHz $\pm 1.8$ dB, $3.0$ GHz $< f \leq 4.2$ GHz	
6.3.4.2 PRACH and SRS time mask	Transmission ON/OFF Power: $\pm 1.5$ dB, $f \leq 3.0$ GHz $\pm 1.8$ dB, $3.0$ GHz $< f \leq 4.2$ GHz	
6.3.4A.1.2 General ON/OFF time mask for CA (inter-band DL CA and UL CA)	Same as 6.3.4A.1.1	
6.3.4A.1.1 General ON/OFF time mask for CA (intra-band contiguous DL CA and UL CA)	Same as 6.3.4.1 for each CC	
6.3.4A.1.3 General ON/OFF time mask for CA (intra-band non-contiguous DL CA and UL CA)	Same as 6.3.4.1 for each CC	
6.3.4B.1 General ON/OFF time mask for UL-MIMO	Same as 6.3.4.1 for each antenna	

6.3.5.1 Power Control Absolute power tolerance	$\pm 1.0$ dB, $f \leq 3.0$ GHz $\pm 1.4$ dB, $3.0$ GHz $< f \leq 4.2$ GHz	Overall system uncertainty comprises two quantities: 1. Downlink signal level uncertainty 2. Uplink level measurement uncertainty Items 1 and 2 are assumed to be uncorrelated so can be root sum squared. Test System uncertainty = [SQRT (DL level uncert <sup>2</sup> + UL measurement uncert <sup>2</sup> )] $f \leq 3.0$ GHz DL signal level uncert $\pm 0.7$ dB UL meas't uncert $\pm 0.7$ dB  3.0GHz $< f \leq 4.2$ GHz DL signal level uncert $\pm 1.0$ dB UL meas't uncert $\pm 1.0$ dB
6.3.5.2 Power Control Relative power tolerance	$\pm 0.7$ dB	
6.3.5_1.1 Power Control Absolute power tolerance for HPUE	$\pm 1.0$ dB, $f \leq 3.0$ GHz	
6.3.5_1.2 Power Control Relative power tolerance for HPUE	$\pm 0.7$ dB	
6.3.5A.1.1 Power Control Absolute power tolerance for CA (intra-band contiguous DL CA and UL CA)	Same as 6.3.5.1 for each CC	
6.3.5A.2.1 Power Control Relative power tolerance for CA (intra-band contiguous DL CA and UL CA)	Same as 6.3.5.2 for each CC	
6.3.5B.1 Power Control Absolute Power Tolerance for UL- MIMO	Same as 6.3.5.1 for each antenna	
6.3.5B.2 Power Control Relative power tolerance for UL-MIMO	Same as 6.3.5.2 for each antenna	
6.3.5.3 Aggregate power control tolerance	$\pm 0.7$ dB	
6.3.5_1.3 Aggregate power control tolerance for HPUE	$\pm 0.7$ dB	
6.3.5A.3.1 Aggregate power control tolerance for CA (intra-band contiguous DL CA and UL CA)	Same as 6.3.5.3 for each CC	
6.3.5B.3 Aggregate power control tolerance for UL- MIMO	Same as 6.3.5.3 for each antenna	
6.5.1 Frequency Error	$\pm 15$ Hz DL Signal level: $\pm 0.7$ dB, $f \leq 3.0$ GHz DL Signal level: $\pm 1.0$ dB, $3.0$ GHz $< f \leq 4.2$ GHz	
6.5.1A.1 Frequency error for CA (intra-band contiguous DL CA and UL CA)	TBD	
6.5.1B Frequency Error for UL-MIMO	Same as 6.5.1 for each antenna DL signal level same as 6.5.1	
6.5.2.1 Error Vector Magnitude	PUSCH: $\pm 2.5\%$ PUCCH: $\pm 2.5\%$ PRACH: $\pm 2.5\%$	
6.5.2A.1.1 Error Vector Magnitude (EVM) for CA (intra-band contiguous DL CA and UL CA)	Same as 6.5.2.1	

6.5.2B.1 Error Vector Magnitude (EVM) for UL-MIMO	Same as 6.5.2.1 for each antenna	
6.5.2.1A PUSCH-EVM with exclusion period	PUSCH : $\pm 2.5\%$	

6.5.2.2 Carrier leakage	±0.8dB	
6.5.2A.2.1 Carrier leakage for CA (intra-band contiguous DL CA and UL CA)	TBD	
6.5.2.3 In-band emissions for non allocated RB	±0.8dB	
6.5.2.4 EVM equalizer Spectrum flatness	±1.4dB	
6.5.2A.3.1 In-band emissions for non allocated RB for CA (intra-band contiguous DL CA and UL CA)	TBD	
6.5.2B.1 Error vector magnitude (EVM) for UL-MIMO	TBD	
6.5.2B.2 Carrier leakage for UL-MIMO	Same as 6.5.2.2 for each antenna	
6.5.2B.3 In-band emissions for non allocated RB for UL-MIMO	Same as 6.5.2.3 for each antenna	
6.5.2B.4 EVM equalizer spectrum flatness for UL-MIMO	Same as 6.5.2.4 for each antenna	
6.6.1 Occupied bandwidth	1.4MHz, 3MHz: 30kHz 5MHz, 10MHz: 100kHz 15MHz, 20MHz: 300kHz	
6.6.1A.1 Occupied bandwidth for CA (intra-band contiguous DL CA and UL CA)	1.4MHz, 3MHz: 30kHz 5MHz, 10MHz: 100kHz 15MHz, 20MHz: 300kHz 20MHz < f ≤ 40MHz: 500kHz	
6.6.1A.2 Occupied bandwidth for CA (inter-band DL CA and UL CA)	Same as 6.6.1 for each CC	
6.6.1A.3 Occupied bandwidth for CA (intra-band non-contiguous DL CA and UL CA)	1.4MHz, 3MHz: 30kHz 5MHz, 10MHz: 100kHz 15MHz, 20MHz: 300kHz	
6.6.1B Occupied bandwidth for UL-MIMO	Same as 6.6.1 for each antenna	
6.6.2.1 Spectrum Emission Mask	±1.5 dB, f ≤ 3.0GHz ±1.8 dB, 3.0GHz < f ≤ 4.2GHz	
6.6.2.1_1 Spectrum Emission Mask for Multi-Cluster PUSCH	Same as 6.6.2.1	
6.6.2.1A.1 Spectrum emission mask for CA (intra-band contiguous DL CA and UL CA)	Same as 6.6.2.1	
6.6.2.1A.2 Spectrum Emission Mask for CA (inter-band DL CA and UL CA)	Same as 6.6.2.1 and 6.6.2.2	
6.6.2.1A.3 Spectrum Emission Mask for CA (intra-band non-contiguous DL CA and UL CA)	Same as 6.6.2.1	
6.6.2.1B Spectrum Emission Mask for UL-MIMO	Same as 6.6.2.1 for each antenna	
6.6.2.2 Additional Spectrum Emission Mask	±1.5 dB, f ≤ 3.0GHz ±1.8 dB, 3.0GHz < f ≤ 4.2GHz	
6.6.2.2A Additional Spectrum Emission Mask for CA	±1.5 dB, f ≤ 3.0GHz ±1.8 dB, 3.0GHz < f ≤ 4.2GHz	
6.6.2.3_2 Adjacent Channel Leakage power Ratio for Multi-Cluster PUSCH	Same as 6.6.2.3	

6.6.2.3 Adjacent Channel Leakage power Ratio	$\pm 0.8$ dB	
6.6.2.3_1 Adjacent Channel Leakage power Ratio for HPUE	$\pm 0.8$ dB	
6.6.2.3A.1 Adjacent Channel Leakage power Ratio for CA (intra-band contiguous DL CA and UL CA)	$\pm 0.8$ dB	
6.6.2.3A.2 Adjacent Channel Leakage power Ratio for CA (inter-band DL CA and UL CA)	$\pm 0.8$ dB	
6.6.2.3B Adjacent Channel Leakage power Ratio for UL-MIMO	Same as 6.6.2.3 for each antenna	
6.6.2.4 Additional ACLR requirements	$\pm 0.8$ dB	
6.6.3.1 Transmitter Spurious emissions	9kHz < f ≤ 4 GHz: $\pm 2.0$ dB 4 GHz < f ≤ 19 GHz: $\pm 4.0$ dB	
6.6.3.1_1 Transmitter Spurious emissions for Multi-Cluster PUSCH	Same as 6.6.3.1	
6.6.3.1A.1 Transmitter Spurious emissions for CA (intra-band contiguous DL CA and UL CA)	Same as 6.6.3.1	
6.6.3.1A.2 Transmitter Spurious emissions for CA (inter-band DL CA and UL CA)	Same as 6.6.3.1	
6.6.3B.1 Transmitter Spurious emissions for UL-MIMO	Same as 6.6.3.1, at each antenna used for transmission	The overall UL power is the linear sum of the output powers over all Tx antenna connectors
6.6.3.2 Spurious emission band UE co-existence	$\pm 2.0$ dB for results > -60 dBm, f ≤ 3.0GHz $\pm 2.5$ dB, 3.0GHz < f ≤ 4.2GHz $\pm 3.0$ dB for results ≤ -60 dBm, f ≤ 3.0GHz $\pm 3.6$ dB, 3.0GHz < f ≤ 4.2GHz	
6.6.3.2A.1 Spurious emission band UE co-existence for CA (intra-band contiguous DL CA and UL CA)	Same as 6.6.3.2	
6.6.3.2A.2 Spurious emission band UE co-existence for CA (inter-band DL CA and UL CA)	Same as 6.6.3.2	
6.6.3.3 Additional spurious emissions	9kHz < f ≤ 4 GHz: $\pm 2.0$ dB  NS-07 769 ≤ f ≤ 775 MHz: $\pm 1.5$ dB	
6.6.3.3A.1 Additional spurious emissions for CA (intra-band contiguous DL CA and UL CA)	9kHz < f ≤ 4 GHz: $\pm 2.0$ dB	
6.6.3B.2 Spurious emission band UE co-existence for UL-MIMO	Same as 6.6.3.2 at each antenna used for transmission	
6.6.3B.3 Additional spurious emissions for UL-MIMO	Same as 6.6.3.3, at each antenna used for transmission	



6.7 Transmit intermodulation	$\pm 2.6$ dB, $f \leq 3.0$ GHz $\pm 3.6$ dB, $3.0$ GHz $< f \leq 4.2$ GHz	<p>Overall system uncertainty comprises four quantities:</p> <ol style="list-style-type: none"> <li>1. Wanted signal setting error</li> <li>2. CW Interferer level error</li> <li>3. Wanted signal meas. error</li> <li>4. Intermodulation product measurement error</li> </ol> <p>The relative level of the wanted signal and the CW interferer has 2 x effect on the intermodulation product.</p> <p>Items 1, 2, 3 and 4 are assumed to be uncorrelated so can be root sum squared to provide the combined effect.</p> <p>Test System uncertainty = <math>\text{SQRT} [(2 \times \text{SQRT} (\text{Wanted\_setting\_error}^2 + \text{CW\_level\_error}^2))^2 + \text{Wanted\_level\_meas\_error}^2 + \text{Intermodulation\_product\_measurement\_error}^2]</math></p> <p><math>f \leq 3.0</math>GHz  Wanted signal setting <math>\pm 0.7</math>dB  CW Interferer level <math>\pm 1.0</math>dB  Wanted signal meas <math>\pm 0.7</math>dB  Intermodulation product measurement error <math>\pm 0.7</math>dB</p> <p><math>3.0</math>GHz <math>&lt; f \leq 4.2</math>GHz  Wanted signal setting <math>\pm 1.0</math>dB  CW Interferer level <math>\pm 1.3</math>dB  Wanted signal meas <math>\pm 1.0</math>dB  Intermodulation product measurement error <math>\pm 1.0</math>dB</p>
6.7A.1 Transmit intermodulation	Same as 6.7, at each antenna used for transmission	
6.8B Time alignment error for UL-MIMO	$\pm 25$ ns	

## F.1.3 Measurement of receiver

**Table F.1.3-1: Maximum Test System Uncertainty for receiver tests**

Subclause	Maximum Test System Uncertainty <sup>1</sup>	Derivation of Test System Uncertainty
7.3 Reference sensitivity power level	Downlink power $\pm 0.7$ dB, $f \leq 3.0$ GHz $\pm 1.0$ dB, $3.0$ GHz $< f \leq 4.2$ GHz	
7.3A.1 Reference sensitivity level for CA (intra-band contiguous DL CA and UL CA)	Same as 7.3 for each CC	
7.3A.2 Reference sensitivity level for CA (intra-band contiguous DL CA without UL CA)	Same as 7.3A.1	
7.3A.3 Reference sensitivity level for CA (inter-band DL CA without UL CA)	Same as 7.3A.1	
7.3A.4 Reference sensitivity level for CA (intra-band non-contiguous DL CA without UL CA)	Same as 7.3A.1	
7.3A.5 Reference sensitivity level for CA (3DL CA without UL CA)	Same as 7.3A.1	
7.3A.6 Reference sensitivity level for CA (inter-band DL CA and UL CA)	Same as 7.3A.1	
7.3B Reference Sensitivity Level for UL-MIMO	Same as 7.3	
7.3E Reference Sensitivity Level for UE category 0	Same as 7.3	
7.4 Maximum input level	Downlink power $\pm 0.7$ dB, $f \leq 3.0$ GHz $\pm 1.0$ dB, $3.0$ GHz $< f \leq 4.2$ GHz Uplink power measurement $\pm 0.7$ dB, $f \leq 3.0$ GHz $\pm 1.0$ dB, $3.0$ GHz $< f \leq 4.2$ GHz	
7.4A.1 Maximum input level for CA (intra band contiguous DL CA and UL CA)	Same as 7.4 for each CC	Uncertainties apply for each CC
7.4A.2 Maximum input level for CA (intra band contiguous DL CA without UL CA)	Downlink power same as 7.4 for each CC Uplink power measurement same as 7.4	Uncertainties apply for each CC
7.4A.3 Maximum input level for CA (inter-band DL CA without UL CA)	Downlink power same as 7.4 for each CC Uplink power measurement same as 7.4	Uncertainties apply for each CC
7.4A.4 Maximum input level for CA (intra band non-contiguous DL CA without UL CA)	Downlink power same as 7.4 for each CC Uplink power measurement same as 7.4	Uncertainties apply for each CC
7.4A.5 Maximum input level for CA (3DL CA without UL CA)	Downlink power same as 7.4 for each CC Uplink power measurement same as 7.4	Uncertainties apply for each CC
7.4B Maximum Input Level for UL-MIMO	Downlink power same as 7.4 Uplink power measurement same as 7.4, at each antenna connector used for transmission	The overall UL power is the linear sum of the output powers over all Tx antenna connectors

7.5 Adjacent Channel Selectivity (ACS)	ACS value $\pm 1.1$ dB, $f \leq 3.0$ GHz $\pm 1.5$ dB, $3.0$ GHz $< f \leq 4.2$ GHz Uplink power measurement $\pm 0.7$ dB, $f \leq 3.0$ GHz $\pm 1.0$ dB, $3.0$ GHz $< f \leq 4.2$ GHz	Overall ACS uncertainty comprises three quantities: 1. Wanted signal level error 2. Interferer signal level error 3. Additional impact of interferer ACLR  Items 1 and 2 are assumed to be uncorrelated so can be root sum squared to provide the ratio error of the two signals. The interferer ACLR effect is systematic, and is added arithmetically.  Test System uncertainty = [SQRT (wanted_level_error <sup>2</sup> + interferer_level_error <sup>2</sup> )] + ACLR effect.  $f \leq 3.0$ GHz Wanted signal level $\pm 0.7$ dB Interferer signal level $\pm 0.7$ dB $3.0$ GHz $< f \leq 4.2$ GHz Wanted signal level $\pm 1.0$ dB Interferer signal level $\pm 1.0$ dB  $f \leq 4.2$ GHz Impact of interferer ACLR 0.1dB
7.5A.1 Adjacent Channel Selectivity (ACS) for CA (intra band contiguous DL CA and UL CA)	Same as 7.5 for each CC	Same as 7.5 The wanted signal level uncertainty applies for each CC. Overall ACS uncertainty calculation includes the uncertainty for wanted level error only once, as the uncertainty of other CCs is not expected to have any significant effect.
7.5A.2 Adjacent Channel Selectivity (ACS) for CA (intra band contiguous DL CA without UL CA)	Downlink power same as 7.5 Uplink power measurement same as 7.5	The wanted signal level uncertainty applies for each CC
7.5A.3 Adjacent Channel Selectivity (ACS) for CA (inter band DL CA without UL CA)	Downlink power same as 7.5 Uplink power measurement same as 7.5	The wanted signal level uncertainty applies for each CC
7.5A.4 Adjacent Channel Selectivity (ACS) for CA (intra-band non-contiguous DL CA without UL CA)	Downlink power same as 7.5 Uplink power measurement same as 7.5	The wanted signal level uncertainty applies for each CC
7.5A.5 Adjacent Channel Selectivity (ACS) for 3DL CA without UL CA	Downlink power same as 7.5 Uplink power measurement same as 7.5	The wanted signal level uncertainty applies for each CC
7.5B Adjacent Channel Selectivity (ACS) for UL-MIMO	ACS value same as 7.5 Uplink power measurement same as 7.5, at each antenna connector used for transmission	The overall UL power is the linear sum of the output powers over all Tx antenna connectors

7.6.1 In-band blocking	Blocking $\pm 1.4$ dB, $f \leq 3.0$ GHz $\pm 1.8$ dB, $3.0$ GHz $< f \leq 4.2$ GHz Uplink power measurement $\pm 0.7$ dB, $f \leq 3.0$ GHz $\pm 1.0$ dB, $3.0$ GHz $< f \leq 4.2$ GHz	Overall blocking uncertainty can have these contributions: 1. Wanted signal level error 2. Interferer signal level error 3. Interferer ACLR 4. Interferer broadband noise Items 1 and 2 are assumed to be uncorrelated so can be root sum squared to provide the ratio error of the two signals. The Interferer ACLR or Broadband noise effect is systematic, and is added arithmetically. Test System uncertainty = [SQRT (wanted_level_error <sup>2</sup> + interferer_level_error <sup>2</sup> )] + ACLR effect + Broadband noise effect. <u>In-band blocking, using modulated interferer:</u> $f \leq 3.0$ GHz Wanted signal level $\pm 0.7$ dB Interferer signal level: $\pm 0.7$ dB $3.0$ GHz $< f \leq 4.2$ GHz Wanted signal level $\pm 1.0$ dB Interferer signal level $\pm 1.0$ dB $f \leq 4.2$ GHz Interferer ACLR 0.4dB Broadband noise not applicable
7.6.1A.1 In-band blocking for CA (intra band contiguous DL CA and UL CA)	Same as 7.6.1 for each CC	Same as 7.6.1  The wanted signal level uncertainty applies for each CC.  Overall blocking uncertainty calculation includes the uncertainty for wanted level error only once, as the uncertainty of other CCs is not expected to have any significant effect.
7.6.1A.2 In-band blocking for CA (intra band contiguous DL CA without UL CA)	Same as 7.6.1A.1	Same as 7.6.1A.1
7.6.1A.3 In-band blocking for CA (inter band DL CA without UL CA)	Same as 7.6.1A.1	Same as 7.6.1A.1
7.6.1A.4 In-band blocking for CA (intra-band non-contiguous DL CA without UL CA)	Same as 7.6.1A.1	Same as 7.6.1A.1
7.6.1A.5 In-band blocking for CA (3DL CA without UL CA)	Same as 7.6.1A.1	Same as 7.6.1A.1
7.6.1B In-band blocking for UL-MIMO	Blocking same as 7.6.1  Uplink power measurement same as 7.6.1, at each antenna connector used for transmission	The overall UL power is the linear sum of the output powers over all Tx antenna connectors

7.6.2 Out-of-band blocking	<p>Wanted signal <math>f \leq 3.0\text{GHz}</math>            Blocking, <math>1\text{MHz} &lt; f_{\text{interferer}} \leq 3\text{GHz}</math>: <math>\pm 1.3\text{ dB}</math>            Blocking, <math>3\text{GHz} &lt; f_{\text{interferer}} \leq 12.75\text{GHz}</math>: <math>\pm 3.2\text{ dB}</math>            Uplink power measurement <math>\pm 0.7\text{ dB}</math></p> <p>Wanted signal <math>3.0\text{GHz} &lt; f \leq 4.2\text{GHz}</math>            Blocking, <math>1\text{MHz} &lt; f_{\text{interferer}} \leq 3\text{GHz}</math>: <math>\pm 1.5\text{ dB}</math>            Blocking, <math>3\text{GHz} &lt; f_{\text{interferer}} \leq 12.75\text{GHz}</math>: <math>\pm 3.3\text{ dB}</math>            Uplink power measurement <math>\pm 1.0\text{ dB}</math></p>	<p>Out of band blocking, using CW interferer:  <math>f \leq 3.0\text{GHz}</math>            Wanted signal level <math>\pm 0.7\text{dB}</math>  <math>3.0\text{GHz} &lt; f \leq 4.2\text{GHz}</math>            Wanted signal level <math>\pm 1.0\text{dB}</math>            Interferer signal level:  <math>\pm 1.0\text{dB}</math> up to <math>3\text{GHz}</math>  <math>\pm 3.0\text{dB}</math> up to <math>12.75\text{GHz}</math>            Interferer ACLR not applicable            Impact of interferer            Broadband noise <math>0.1\text{dB}</math></p> <p>Figures are combined to give Test System uncertainty, using formula given for 7.6.1</p>
7.6.2A.1 Out-of-band blocking for CA (intra band contiguous DL CA and UL CA)	Same as 7.6.2 for each CC	<p>Same as 7.6.2            The wanted signal level uncertainty applies for each CC.            Overall blocking uncertainty calculation includes the uncertainty for wanted level error only once, as the uncertainty of other CCs is not expected to have any significant effect.</p>
7.6.2A.2 Out-of-band blocking for CA (intra band contiguous DL CA without UL CA)	Same as 7.6.2A.1	Same as 7.6.2A.1
7.6.2A.3 Out-of-band blocking for CA (inter band DL CA without UL CA)	Same as 7.6.2A.1	Same as 7.6.2A.1
7.6.2A.4 Out-of-band blocking for CA (intra-band non-contiguous DL CA without UL CA)	Same as 7.6.2A.1	Same as 7.6.2A.1
7.6.2A.5 Out-of-band blocking for CA (3DL CA without UL CA)	Same as 7.6.2A.1	Same as 7.6.2A.1
7.6.2B Out-of-band blocking for UL-MIMO	<p>Blocking same as 7.6.2</p> <p>Uplink power measurement same as 7.6.2, at each antenna connector used for transmission</p>	<p>The overall UL power is the linear sum of the output powers over all Tx antenna connectors</p>
7.6.3 Narrow band blocking	<p>Blocking <math>\pm 1.3\text{ dB}</math>, <math>f \leq 3.0\text{GHz}</math>  <math>\pm 1.8\text{ dB}</math>, <math>3.0\text{GHz} &lt; f \leq 4.2\text{GHz}</math>            Uplink power measurement <math>\pm 0.7\text{ dB}</math>, <math>f \leq 3.0\text{GHz}</math>  <math>\pm 1.0\text{ dB}</math>, <math>3.0\text{GHz} &lt; f \leq 4.2\text{GHz}</math></p>	<p>Narrow band blocking, using CW interferer:            Wanted signal level <math>\pm 0.7\text{dB}</math>            Interferer signal level:  <math>\pm 1.0\text{dB}</math>            Interferer ACLR not applicable            Impact of interferer            Broadband noise <math>0.1\text{dB}</math></p> <p>Figures are combined to give Test System uncertainty, using formula given for 7.6.1</p>
7.6.3A.1 Narrow band blocking for CA (intra band contiguous DL CA and UL CA)	Same as 7.6.3 for each CC	<p>Same as 7.6.3            The wanted signal level uncertainty applies for each CC.            Overall blocking uncertainty calculation includes the uncertainty for wanted level error only once, as the uncertainty of other CCs is not expected to have any significant effect.</p>

7.6.3A.2 Narrow band blocking for CA (intra band contiguous DL CA without UL CA)	Same as 7.6.3A.1	Same as 7.6.3A.1
7.6.3A.3 Narrow band blocking for CA (inter band DL CA without UL CA)	Same as 7.6.3A.1	Same as 7.6.3A.1
7.6.3A.4 Narrow band blocking for CA (intra-band non-contiguous DL CA without UL CA)	Same as 7.6.3A.1	Same as 7.6.3A.1
7.6.3A.5 Narrow band blocking for CA (3DL CA without UL CA)	Same as 7.6.3A.1	Same as 7.6.3A.1
7.6.3B Narrow band blocking for UL-MIMO	Blocking same as 7.6.3 Uplink power measurement same as 7.6.3, at each antenna connector used for transmission	The overall UL power is the linear sum of the output powers over all Tx antenna connectors
7.7 Spurious response	Same as 7.6.2	Same as 7.6.2.
7.7A.1 Spurious response for CA (intra band contiguous DL CA and UL CA)	Same as 7.6.2A.1	Same as 7.6.2A.1
7.7A.2 Spurious response for CA (intra band contiguous DL CA without UL CA)	Same as 7.6.2A.1	Same as 7.6.2A.1
7.7A.3 Spurious response for CA (inter band DL CA without UL CA)	Same as 7.6.2A.1	Same as 7.6.2A.1
7.7A.4 Spurious response for CA (intra-band non-contiguous DL CA without UL CA)	Same as 7.6.2A.1	Same as 7.6.2A.1
7.7A.5 Spurious response for CA (3DL CA without UL CA)	Same as 7.6.2A.1	Same as 7.6.2A.1
7.7B Spurious response for UL-MIMO	Same as 7.7 Uplink power measurement same as 7.6.2, at each antenna connector used for transmission	The overall UL power is the linear sum of the output powers over all Tx antenna connectors

7.8.1 Wide band intermodulation	Intermodulation $\pm 1.4$ dB, $f \leq 3.0$ GHz $\pm 2.6$ dB, $3.0$ GHz $< f \leq 4.2$ GHz Uplink power measurement $\pm 0.7$ dB, $f \leq 3.0$ GHz $\pm 1.0$ dB, $3.0$ GHz $< f \leq 4.2$ GHz	Overall intermodulation uncertainty comprises three quantities: 1. Wanted signal level error 2. CW Interferer level error 3. Modulated Interferer level error  Effect of interferer ACLR has not been included as modulated interferer has larger frequency offset The effect of the closer CW signal has twice the effect. Items 1, 2 and 3 are assumed to be uncorrelated so can be root sum squared to provide the combined effect of the three signals. Test System uncertainty = $\text{SQRT} [(2 \times \text{CW\_level\_error})^2 + (\text{mod interferer\_level\_error})^2 + (\text{wanted signal\_level\_error})^2]$ $f \leq 3.0$ GHz Wanted signal level $\pm 0.7$ dB CW Interferer level $\pm 0.5$ dB Mod Interferer level $\pm 0.7$ dB $3.0$ GHz $< f \leq 4.2$ GHz Wanted signal level $\pm 1.0$ dB CW Interferer level $\pm 0.8$ dB Mod Interferer level $\pm 1.0$ dB
7.8.1A.1 Wideband intermodulation for CA (intra band contiguous DL CA and UL CA)	Same as 7.8.1 for each CC	Same as 7.8.1 The wanted signal level uncertainty applies for each CC. Overall intermodulation uncertainty calculation includes the uncertainty for wanted level error only once, as the uncertainty of other CCs is not expected to have any significant effect.
7.8.1A.2 Wideband intermodulation for CA (intra band contiguous DL CA without UL CA)	Same as 7.8.1A.1	Same as 7.8.1A.1
7.8.1A.3 Wideband intermodulation for CA (inter band DL CA without UL CA)	Same as 7.8.1A.1	Same as 7.8.1A.1
7.8.1A.4 Wideband intermodulation for CA (intra band non-contiguous DL CA without UL CA)	Same as 7.8.1A.1	Same as 7.8.1A.1
7.8.1B Wide band intermodulation for UL-MIMO	Intermodulation same as 7.8.1  Uplink power measurement same as 7.8.1, at each antenna connector used for transmission	The overall UL power is the linear sum of the output powers over all Tx antenna connectors
7.9 Spurious emissions	$30$ MHz $\leq f \leq 4.0$ GHz: $\pm 2.0$ dB $4$ GHz $< f \leq 19$ GHz: $\pm 4.0$ dB	
7.9A Spurious emissions for CA	$30$ MHz $\leq f \leq 4.0$ GHz: $\pm 2.0$ dB $4$ GHz $< f \leq 12.75$ GHz: $\pm 4.0$ dB	
Note 1: Unless otherwise noted, only the Test System stimulus error is considered here. The effect of errors in the throughput measurements due to finite test duration is not considered.		

## F.1.4 Measurement of performance requirements

**Table F.1.4-1: Maximum Test System Uncertainty for Performance Requirements**

Subclause	Maximum Test System Uncertainty <sup>1</sup>	Derivation of Test System Uncertainty
8.2.1.1.1 Multiple PRBs - Propagation Condition EVA5 - Propagation Condition ETU70 - Propagation Condition ETU300	± 0.8 dB	Overall system uncertainty for fading conditions comprises three quantities: 1. Signal-to-noise ratio uncertainty 2. Fading profile power uncertainty 3. Effect of AWGN flatness and signal flatness  Items 1, 2 and 3 are assumed to be uncorrelated so can be root sum squared: AWGN flatness and signal flatness has x 0.25 effect on the required SNR, so use sensitivity factor of x 0.25 for the uncertainty contribution. Test System uncertainty = $\text{SQRT}(\text{Signal-to-noise ratio uncertainty}^2 + \text{Fading profile power uncertainty}^2 + (0.25 \times \text{AWGN flatness and signal flatness})^2)$ Signal-to-noise ratio uncertainty ±0.3 dB Fading profile power uncertainty ±0.5 dB for single Tx AWGN flatness and signal flatness ±2.0 dB
8.2.1.1.1 Multiple PRBs - Propagation Condition HST	± 0.6 dB	Overall system uncertainty for HST condition comprises two quantities: 1. Signal-to-noise ratio uncertainty 2. Effect of AWGN flatness and signal flatness  Items 1 and 2 are assumed to be uncorrelated so can be root sum squared: AWGN flatness and signal flatness has x 0.25 effect on the required SNR, so use sensitivity factor of x 0.25 for the uncertainty contribution. Test System uncertainty = $\text{SQRT}(\text{Signal-to-noise ratio uncertainty}^2 + (0.25 \times \text{AWGN flatness and signal flatness})^2)$ Signal-to-noise ratio uncertainty ±0.3 dB AWGN flatness and signal flatness ±2.0 dB
8.2.1.1.1 Single PRB - Propagation Condition ETU70	± 0.8 dB	Overall system uncertainty for fading condition comprises three quantities: 1. Average Signal-to-noise ratio uncertainty 2. Signal-to noise ratio variation for single PRB 3. Fading profile power uncertainty  Items 1, 2 and 3 are assumed to be uncorrelated so can be root sum squared: Test System uncertainty = $\text{SQRT}(\text{Average signal-to-noise ratio uncertainty}^2 + \text{Signal-to-noise ratio variation}^2 + \text{Fading profile power uncertainty}^2)$ Signal-to-noise ratio uncertainty ±0.3 dB Signal-to-noise ratio variation ±0.5 dB Fading profile power uncertainty ±0.5 dB for single Tx
8.2.1.1.1_A.1	Same as 8.2.1.1.1 Multiple PRBs, for each CC	Same as 8.2.1.1.1 Multiple PRBs Calculation applies for each CC
8.2.1.1.1_A.2	Same as 8.2.1.1.1 Multiple PRBs, for each CC	Same as 8.2.1.1.1 Multiple PRBs Calculation applies for each CC
8.2.1.1.1_1 Multiple PRBs - Propagation Condition EVA5 - Propagation Condition ETU70 - Propagation Condition ETU300	Same as 8.2.1.1.1 Multiple PRBs Propagation EVA5, ETU70, ETU300	



8.2.1.1.1_2 Multiple PRB - Propagation Condition EVA5	Same as 8.2.1.1.1 Multiple PRBs Propagation EVA5	
8.2.1.1.2 Single PRB	± 0.8 dB	Same as 8.2.1.1.1 Single PRB
8.2.1.2.1 - Propagation Condition EVA5	± 0.9 dB	Overall system uncertainty for fading conditions comprises three quantities: 1. Signal-to-noise ratio uncertainty 2. Fading profile power uncertainty 3. Effect of AWGN flatness and signal flatness  Items 1, 2 and 3 are assumed to be uncorrelated so can be root sum squared: AWGN flatness and signal flatness has x 0.25 effect on the required SNR, so use sensitivity factor of x 0.25 for the uncertainty contribution. Test System uncertainty = SQRT (Signal-to-noise ratio uncertainty <sup>2</sup> + Fading profile power uncertainty <sup>2</sup> + (0.25 x AWGN flatness and signal flatness) <sup>2</sup> ) Signal-to-noise ratio uncertainty ±0.3 dB Fading profile power uncertainty ±0.7 dB for Tx Diversity AWGN flatness and signal flatness ±2.0 dB
8.2.1.2.1 - Propagation Condition HST	± 0.6 dB	Overall system uncertainty for HST condition comprises two quantities: 1. Signal-to-noise ratio uncertainty 2. Effect of AWGN flatness and signal flatness  Items 1 and 2 are assumed to be uncorrelated so can be root sum squared: AWGN flatness and signal flatness has x 0.25 effect on the required SNR, so use sensitivity factor of x 0.25 for the uncertainty contribution. Test System uncertainty = SQRT (Signal-to-noise ratio uncertainty <sup>2</sup> + (0.25 x AWGN flatness and signal flatness) <sup>2</sup> ) Signal-to-noise ratio uncertainty ±0.3 dB AWGN flatness and signal flatness ±2.0 dB
8.2.1.2.1_1 - Propagation Condition EVA5	Same as 8.2.1.2.1 Propagation EVA5	
8.2.1.2.2	± 0.9 dB	Same as 8.2.1.2.1 Propagation Condition EVA5
8.2.1.2.2_1	Same as 8.2.1.2.2	

<p>8.2.1.2.3_C.1</p>	<p><u>Symbols #0, 4.. during ABS:</u>  <math>\hat{E}_{s1}/N_{oc2} \pm 0.9</math> dB  <math>\hat{E}_{s2}/\hat{E}_{s1} \pm 1.1</math> dB</p> <p><u>Symbols #1, 2.. during ABS:</u>  <math>\hat{E}_{s1}/N_{oc1} \pm 1.0</math> dB</p> <p><u>All symbols during non-ABS:</u>  <math>\hat{E}_{s1}/N_{oc3} \pm 1.0</math> dB</p>	<p>System uncertainties comprise a number of quantities which are selected according to their applicability in the equations below.</p> <p>Uncertainties are assumed to be uncorrelated, so can be root sum squared.          AWGN flatness and signal flatness has x 0.25 effect on the required SNR, so use sensitivity factor of x 0.25 for the uncertainty contribution.</p> <p>Symbols #0, 4.. means 0, 4, 7, 11          Symbols #1, 2.. means 1-3, 5, 6, 8-10, 12, 13</p> <p><u>Symbols #0, 4.. during ABS:</u>  <math>\hat{E}_{s1}/N_{oc2}</math> uncertainty = SQRT (Cell 1 SNR uncertainty<sup>2</sup> + Cell 1 Fading profile power uncertainty<sup>2</sup> + (0.25 x AWGN flatness and signal flatness)<sup>2</sup>)  <math>\hat{E}_{s2}/\hat{E}_{s1}</math> uncertainty = SQRT (Cell 1 SNR uncertainty<sup>2</sup> + Cell 1 Fading profile power uncertainty<sup>2</sup> + Cell 2 SNR uncertainty<sup>2</sup> + Cell 2 Fading profile power uncertainty<sup>2</sup>)</p> <p><u>Symbols #1, 2.. during ABS:</u>  <math>\hat{E}_{s1}/N_{oc1}</math> uncertainty = SQRT (Cell 1 SNR uncertainty<sup>2</sup> + Cell 1 Fading profile power uncertainty<sup>2</sup> + (0.25 x AWGN flatness and signal flatness)<sup>2</sup> + <math>N_{oc1}/N_{oc2}</math> uncertainty<sup>2</sup>)</p> <p><u>All symbols during non-ABS:</u>  <math>\hat{E}_{s1}/N_{oc3}</math> uncertainty = SQRT (Cell 1 SNR uncertainty<sup>2</sup> + Cell 1 Fading profile power uncertainty<sup>2</sup> + (0.25 x AWGN flatness and signal flatness)<sup>2</sup> + <math>N_{oc3}/N_{oc2}</math> uncertainty<sup>2</sup>)</p> <p><u>Component uncertainties:</u>          Cell 1 SNR uncertainty (<math>E_{s1} / N_{oc2}</math> ratio before fading) <math>\pm 0.3</math> dB          Cell 2 SNR uncertainty (<math>E_{s2} / N_{oc2}</math> ratio before fading) <math>\pm 0.3</math> dB          Fading profile power uncertainty <math>\pm 0.7</math> dB for Tx Diversity          AWGN flatness and signal flatness <math>\pm 2.0</math> dB  <math>N_{oc1}/N_{oc2}</math> and <math>N_{oc3}/N_{oc2}</math> uncertainty <math>\pm 0.3</math> dB</p>
----------------------	--------------------------------------------------------------------------------------------------------------------------------------------------------------------------------------------------------------------------------------------------------------------------------------------------------------------------------------------	---------------------------------------------------------------------------------------------------------------------------------------------------------------------------------------------------------------------------------------------------------------------------------------------------------------------------------------------------------------------------------------------------------------------------------------------------------------------------------------------------------------------------------------------------------------------------------------------------------------------------------------------------------------------------------------------------------------------------------------------------------------------------------------------------------------------------------------------------------------------------------------------------------------------------------------------------------------------------------------------------------------------------------------------------------------------------------------------------------------------------------------------------------------------------------------------------------------------------------------------------------------------------------------------------------------------------------------------------------------------------------------------------------------------------------------------------------------------------------------------------------------------------------------------------------------------------------------------------------------------------------------------------------------------------------------------------------------------------------------------------------------------------------------------------------------------------------------------------------------------------------------------------------------------------------------------------------------------------------------------------------------------------------------------------------------------------------------------------------------------------------------------------------------------------------

<p>8.2.1.2.3_E.1 - Propagation Condition EVA5</p>	<p><u>Symbols #0, 4.. during ABS:</u>  <math>\hat{E}s_1/N_{oc2} \pm 0.9\text{dB}</math>  <math>\hat{E}s_2/\hat{E}s_1 \pm 1.1\text{dB}</math>  <math>\hat{E}s_3/\hat{E}s_1 \pm 1.1\text{dB}</math></p> <p><u>Symbols #1, 2.. during ABS:</u>  <math>\hat{E}s_1/N_{oc1} \pm 1.0\text{dB}</math></p> <p><u>All symbols during non-ABS:</u>  <math>\hat{E}s_1/N_{oc3} \pm 1.0\text{dB}</math></p>	<p>System uncertainties comprise a number of quantities which are selected according to their applicability in the equations below.</p> <p>Uncertainties are assumed to be uncorrelated, so can be root sum squared.</p> <p>AWGN flatness and signal flatness has x 0.25 effect on the required SNR, so use sensitivity factor of x 0.25 for the uncertainty contribution.</p> <p>Symbols #0, 4.. means 0, 4, 7, 11          Symbols #1, 2.. means 1-3, 5, 6, 8-10, 12, 13</p> <p><u>Symbols #0, 4.. during ABS:</u>  <math>\hat{E}s_1/N_{oc2}</math> uncertainty = SQRT (Cell 1 SNR uncertainty<sup>2</sup> + Cell 1 Fading profile power uncertainty<sup>2</sup> + (0.25 x AWGN flatness and signal flatness)<sup>2</sup>)</p> <p><math>\hat{E}s_2/\hat{E}s_1</math> uncertainty = SQRT (Cell 1 SNR uncertainty<sup>2</sup> + Cell 1 Fading profile power uncertainty<sup>2</sup> + Cell 2 SNR uncertainty<sup>2</sup> + Cell 2 Fading profile power uncertainty<sup>2</sup>)</p> <p><math>\hat{E}s_3/\hat{E}s_1</math> uncertainty = SQRT (Cell 1 SNR uncertainty<sup>2</sup> + Cell 1 Fading profile power uncertainty<sup>2</sup> + Cell 3 SNR uncertainty<sup>2</sup> + Cell 3 Fading profile power uncertainty<sup>2</sup>)</p> <p><u>Symbols #1, 2.. during ABS:</u>  <math>\hat{E}s_1/N_{oc1}</math> uncertainty = SQRT (Cell 1 SNR uncertainty<sup>2</sup> + Cell 1 Fading profile power uncertainty<sup>2</sup> + (0.25 x AWGN flatness and signal flatness)<sup>2</sup> + <math>N_{oc1}/N_{oc2}</math> uncertainty<sup>2</sup>)</p> <p><u>All symbols during non-ABS:</u>  <math>\hat{E}s_1/N_{oc3}</math> uncertainty = SQRT (Cell 1 SNR uncertainty<sup>2</sup> + Cell 1 Fading profile power uncertainty<sup>2</sup> + (0.25 x AWGN flatness and signal flatness)<sup>2</sup> + <math>N_{oc3}/N_{oc2}</math> uncertainty<sup>2</sup>)</p> <p><u>Component uncertainties:</u>          SNR uncertainty <math>\pm 0.3</math> dB          Fading profile power uncertainty <math>\pm 0.7</math> dB for MIMO          AWGN flatness and signal flatness <math>\pm 2.0</math> dB  <math>N_{oc1}/N_{oc2}</math> and <math>N_{oc3}/N_{oc2}</math> uncertainty <math>\pm 0.3</math> dB</p>
<p>8.2.1.2.4</p>	<p><math>\hat{E}s/N_{oc} \pm 0.8</math> dB for each cell</p>	<p>Overall system uncertainty for fading conditions comprises two quantities:</p> <ol style="list-style-type: none"> <li>1. Signal-to-noise ratio uncertainty</li> <li>2. Fading profile power uncertainty</li> </ol> <p>Items 1 and 2 are assumed to be uncorrelated so can be root sum squared:          Test System uncertainty = SQRT (Signal-to-noise ratio uncertainty<sup>2</sup> + Fading profile power uncertainty<sup>2</sup>)          Signal-to-noise ratio uncertainty <math>\pm 0.3</math> dB          Fading profile power uncertainty <math>\pm 0.7</math> dB for Tx Diversity</p> <p><i>AWGN flatness and signal flatness <math>\pm 2.0</math> dB not expected to have any significant effect</i></p>

8.2.1.3.1	± 0.9 dB	<p>Overall system uncertainty for fading conditions comprises three quantities:</p> <ol style="list-style-type: none"> <li>1. Signal-to-noise ratio uncertainty</li> <li>2. Fading profile power uncertainty</li> <li>3. Effect of AWGN flatness and signal flatness</li> </ol> <p>Items 1, 2 and 3 are assumed to be uncorrelated so can be root sum squared: AWGN flatness and signal flatness has x 0.25 effect on the required SNR, so use sensitivity factor of x 0.25 for the uncertainty contribution. Test System uncertainty = <math>\text{SQRT}(\text{Signal-to-noise ratio uncertainty}^2 + \text{Fading profile power uncertainty}^2 + (0.25 \times \text{AWGN flatness and signal flatness})^2)</math></p> <p>Signal-to-noise ratio uncertainty ±0.3 dB  Fading profile power uncertainty ±0.7 dB for MIMO  AWGN flatness and signal flatness ±2.0 dB</p>
8.2.1.3.1_1	Same as 8.2.1.3.1	Same as 8.2.1.3.1
8.2.1.3.1_A.1	Same as 8.2.1.3.1 for each CC	Same as 8.2.1.3.1 Calculation applies for each CC
8.2.1.3.1_A.2 FDD PDSCH Open Loop Spatial Multiplexing 2x2 for CA (3DL CA)	Same as 8.2.1.3.1 for each CC	Same as 8.2.1.3.1 Calculation applies for each CC
8.2.1.3.1A_A.1	Same as 8.2.1.3.1 for each CC	Same as 8.2.1.3.1 Calculation applies for each CC
8.2.1.3.2	± 0.9 dB	Same as 8.2.1.3.1

<p>8.2.1.3.3_C.1</p>	<p><u>Symbols #0, 4.. during ABS:</u>  <math>\hat{E}_{s1}/N_{oc2} \pm 0.9</math> dB  <math>\hat{E}_{s2}/\hat{E}_{s1} \pm 1.1</math> dB</p> <p><u>Symbols #1, 2.. during ABS:</u>  <math>\hat{E}_{s1}/N_{oc1} \pm 1.0</math> dB</p> <p><u>All symbols during non-ABS:</u>  <math>\hat{E}_{s1}/N_{oc3} \pm 1.0</math> dB</p>	<p>System uncertainties comprise a number of quantities which are selected according to their applicability in the equations below.</p> <p>Uncertainties are assumed to be uncorrelated, so can be root sum squared.          AWGN flatness and signal flatness has x 0.25 effect on the required SNR, so use sensitivity factor of x 0.25 for the uncertainty contribution.</p> <p>Symbols #0, 4.. means 0, 4, 7, 11          Symbols #1, 2.. means 1-3, 5, 6, 8-10, 12, 13</p> <p><u>Symbols #0, 4.. during ABS:</u>  <math>\hat{E}_{s1}/N_{oc2}</math> uncertainty = SQRT (Cell 1 SNR uncertainty<sup>2</sup> + Cell 1 Fading profile power uncertainty<sup>2</sup> + (0.25 x AWGN flatness and signal flatness)<sup>2</sup>)  <math>\hat{E}_{s2}/\hat{E}_{s1}</math> uncertainty = SQRT (Cell 1 SNR uncertainty<sup>2</sup> + Cell 1 Fading profile power uncertainty<sup>2</sup> + Cell 2 SNR uncertainty<sup>2</sup> + Cell 2 Fading profile power uncertainty<sup>2</sup>)</p> <p><u>Symbols #1, 2.. during ABS:</u>  <math>\hat{E}_{s1}/N_{oc1}</math> uncertainty = SQRT (Cell 1 SNR uncertainty<sup>2</sup> + Cell 1 Fading profile power uncertainty<sup>2</sup> + (0.25 x AWGN flatness and signal flatness)<sup>2</sup> + <math>N_{oc1}/N_{oc2}</math> uncertainty<sup>2</sup>)</p> <p><u>All symbols during non-ABS:</u>  <math>\hat{E}_{s1}/N_{oc3}</math> uncertainty = SQRT (Cell 1 SNR uncertainty<sup>2</sup> + Cell 1 Fading profile power uncertainty<sup>2</sup> + (0.25 x AWGN flatness and signal flatness)<sup>2</sup> + <math>N_{oc3}/N_{oc2}</math> uncertainty<sup>2</sup>)</p> <p><u>Component uncertainties:</u>          Cell 1 SNR uncertainty (<math>E_{s1} / N_{oc2}</math> ratio before fading) <math>\pm 0.3</math> dB          Cell 2 SNR uncertainty (<math>E_{s2} / N_{oc2}</math> ratio before fading) <math>\pm 0.3</math> dB          Fading profile power uncertainty <math>\pm 0.7</math> dB for MIMO          AWGN flatness and signal flatness <math>\pm 2.0</math> dB  <math>N_{oc1}/N_{oc2}</math> and <math>N_{oc3}/N_{oc2}</math> uncertainty <math>\pm 0.3</math> dB</p>
----------------------	--------------------------------------------------------------------------------------------------------------------------------------------------------------------------------------------------------------------------------------------------------------------------------------------------------------------------------------------	-------------------------------------------------------------------------------------------------------------------------------------------------------------------------------------------------------------------------------------------------------------------------------------------------------------------------------------------------------------------------------------------------------------------------------------------------------------------------------------------------------------------------------------------------------------------------------------------------------------------------------------------------------------------------------------------------------------------------------------------------------------------------------------------------------------------------------------------------------------------------------------------------------------------------------------------------------------------------------------------------------------------------------------------------------------------------------------------------------------------------------------------------------------------------------------------------------------------------------------------------------------------------------------------------------------------------------------------------------------------------------------------------------------------------------------------------------------------------------------------------------------------------------------------------------------------------------------------------------------------------------------------------------------------------------------------------------------------------------------------------------------------------------------------------------------------------------------------------------------------------------------------------------------------------------------------------------------------------------------------------------------------------------------------------------------------------------------------------------------------------------------------------------------------------

<p>8.2.1.3.3_C.2</p>	<p><u>Symbol #0 during ABS:</u>  <math>\hat{E}_{s1}/N_{oc2} \pm 0.9</math> dB  <math>\hat{E}_{s2}/\hat{E}_{s1} \pm 1.1</math> dB</p> <p><u>Symbols #1..13 during ABS:</u>  <math>\hat{E}_{s1}/N_{oc1} \pm 1.0</math> dB</p> <p><u>All symbols during non-ABS:</u>  <math>\hat{E}_{s1}/N_{oc3} \pm 1.0</math> dB</p>	<p>System uncertainties comprise a number of quantities which are selected according to their applicability in the equations below.</p> <p>Uncertainties are assumed to be uncorrelated, so can be root sum squared.          AWGN flatness and signal flatness has x 0.25 effect on the required SNR, so use sensitivity factor of x 0.25 for the uncertainty contribution.</p> <p><u>Symbol #0 during ABS:</u>  <math>\hat{E}_{s1}/N_{oc2}</math> uncertainty = SQRT (Cell 1 SNR uncertainty<sup>2</sup> + Cell 1 Fading profile power uncertainty<sup>2</sup> + (0.25 x AWGN flatness and signal flatness)<sup>2</sup>)  <math>\hat{E}_{s2}/\hat{E}_{s1}</math> uncertainty = SQRT (Cell 1 SNR uncertainty<sup>2</sup> + Cell 1 Fading profile power uncertainty<sup>2</sup> + Cell 2 SNR uncertainty<sup>2</sup> + Cell 2 Fading profile power uncertainty<sup>2</sup>)</p> <p><u>Symbols #1..13 during ABS:</u>  <math>\hat{E}_{s1}/N_{oc1}</math> uncertainty = SQRT (Cell 1 SNR uncertainty<sup>2</sup> + Cell 1 Fading profile power uncertainty<sup>2</sup> + (0.25 x AWGN flatness and signal flatness)<sup>2</sup> + <math>N_{oc1}/N_{oc2}</math> uncertainty<sup>2</sup>)</p> <p><u>All symbols during non-ABS:</u>  <math>\hat{E}_{s1}/N_{oc3}</math> uncertainty = SQRT (Cell 1 SNR uncertainty<sup>2</sup> + Cell 1 Fading profile power uncertainty<sup>2</sup> + (0.25 x AWGN flatness and signal flatness)<sup>2</sup> + <math>N_{oc3}/N_{oc2}</math> uncertainty<sup>2</sup>)</p> <p><u>Component uncertainties:</u>          Cell 1 SNR uncertainty (<math>E_{s1} / N_{oc2}</math> ratio before fading) <math>\pm 0.3</math> dB          Cell 2 SNR uncertainty (<math>E_{s2} / N_{oc2}</math> ratio before fading) <math>\pm 0.3</math> dB          Fading profile power uncertainty <math>\pm 0.7</math> dB for MIMO          AWGN flatness and signal flatness <math>\pm 2.0</math> dB  <math>N_{oc1}/N_{oc2}</math> and <math>N_{oc3}/N_{oc2}</math> uncertainty <math>\pm 0.3</math> dB</p>
----------------------	-------------------------------------------------------------------------------------------------------------------------------------------------------------------------------------------------------------------------------------------------------------------------------------------------------------------------------------	--------------------------------------------------------------------------------------------------------------------------------------------------------------------------------------------------------------------------------------------------------------------------------------------------------------------------------------------------------------------------------------------------------------------------------------------------------------------------------------------------------------------------------------------------------------------------------------------------------------------------------------------------------------------------------------------------------------------------------------------------------------------------------------------------------------------------------------------------------------------------------------------------------------------------------------------------------------------------------------------------------------------------------------------------------------------------------------------------------------------------------------------------------------------------------------------------------------------------------------------------------------------------------------------------------------------------------------------------------------------------------------------------------------------------------------------------------------------------------------------------------------------------------------------------------------------------------------------------------------------------------------------------------------------------------------------------------------------------------------------------------------------------------------------------------------------------------------------------------------------------------------------------------------------------------------------------------------------------------------------------------------------------------------------------------------

<p>8.2.1.3.3_E.1 - Propagation Condition EVA5</p>	<p><u>Symbols #0, 4.. during ABS:</u>  <math>\hat{E}_{s1}/N_{oc2} \pm 0.9\text{dB}</math>  <math>\hat{E}_{s2}/\hat{E}_{s1} \pm 1.1\text{dB}</math>  <math>\hat{E}_{s3}/\hat{E}_{s1} \pm 1.1\text{dB}</math></p> <p><u>Symbols #1, 2.. during ABS:</u>  <math>\hat{E}_{s1}/N_{oc1} \pm 1.0\text{dB}</math></p> <p><u>All symbols during non-ABS:</u>  <math>\hat{E}_{s1}/N_{oc3} \pm 1.0\text{dB}</math></p>	<p>System uncertainties comprise a number of quantities which are selected according to their applicability in the equations below.</p> <p>Uncertainties are assumed to be uncorrelated, so can be root sum squared.</p> <p>AWGN flatness and signal flatness has x 0.25 effect on the required SNR, so use sensitivity factor of x 0.25 for the uncertainty contribution.</p> <p>Symbols #0, 4.. means 0, 4, 7, 11          Symbols #1, 2.. means 1-3, 5, 6, 8-10, 12, 13</p> <p><u>Symbols #0, 4.. during ABS:</u>  <math>\hat{E}_{s1}/N_{oc2}</math> uncertainty = SQRT (Cell 1 SNR uncertainty<sup>2</sup> + Cell 1 Fading profile power uncertainty<sup>2</sup> + (0.25 x AWGN flatness and signal flatness)<sup>2</sup>)</p> <p><math>\hat{E}_{s2}/\hat{E}_{s1}</math> uncertainty = SQRT (Cell 1 SNR uncertainty<sup>2</sup> + Cell 1 Fading profile power uncertainty<sup>2</sup> + Cell 2 SNR uncertainty<sup>2</sup> + Cell 2 Fading profile power uncertainty<sup>2</sup>)</p> <p><math>\hat{E}_{s3}/\hat{E}_{s1}</math> uncertainty = SQRT (Cell 1 SNR uncertainty<sup>2</sup> + Cell 1 Fading profile power uncertainty<sup>2</sup> + Cell 3 SNR uncertainty<sup>2</sup> + Cell 3 Fading profile power uncertainty<sup>2</sup>)</p> <p><u>Symbols #1, 2.. during ABS:</u>  <math>\hat{E}_{s1}/N_{oc1}</math> uncertainty = SQRT (Cell 1 SNR uncertainty<sup>2</sup> + Cell 1 Fading profile power uncertainty<sup>2</sup> + (0.25 x AWGN flatness and signal flatness)<sup>2</sup> + <math>N_{oc1}/N_{oc2}</math> uncertainty<sup>2</sup>)</p> <p><u>All symbols during non-ABS:</u>  <math>\hat{E}_{s1}/N_{oc3}</math> uncertainty = SQRT (Cell 1 SNR uncertainty<sup>2</sup> + Cell 1 Fading profile power uncertainty<sup>2</sup> + (0.25 x AWGN flatness and signal flatness)<sup>2</sup> + <math>N_{oc3}/N_{oc2}</math> uncertainty<sup>2</sup>)</p> <p><u>Component uncertainties:</u>          SNR uncertainty <math>\pm 0.3</math> dB          Fading profile power uncertainty <math>\pm 0.7</math> dB for MIMO          AWGN flatness and signal flatness <math>\pm 2.0</math> dB  <math>N_{oc1}/N_{oc2}</math> and <math>N_{oc3}/N_{oc2}</math> uncertainty <math>\pm 0.3</math> dB</p>
<p>8.2.1.4.1</p>	<p><math>\pm 0.9</math> dB</p>	<p>Same as 8.2.1.3.1</p>
<p>8.2.1.4.1_1</p>	<p>Same as 8.2.1.4.1</p>	

<p>8.2.1.4.1_E.1 - Propagation Condition EPA5</p>	<p><u>Symbols #0, 4.. during ABS:</u>  <math>\hat{E}_{s1}/N_{oc2} \pm 0.9</math> dB  <math>\hat{E}_{s2}/\hat{E}_{s1} \pm 1.1</math> dB  <math>\hat{E}_{s3}/\hat{E}_{s1} \pm 1.1</math> dB</p> <p><u>Symbols #1, 2.. during ABS:</u>  <math>\hat{E}_{s1}/N_{oc1} \pm 1.0</math> dB</p> <p><u>All symbols during non-ABS:</u>  <math>\hat{E}_{s1}/N_{oc3} \pm 1.0</math> dB</p>	<p>System uncertainties comprise a number of quantities which are selected according to their applicability in the equations below.</p> <p>Uncertainties are assumed to be uncorrelated, so can be root sum squared.</p> <p>AWGN flatness and signal flatness has x 0.25 effect on the required SNR, so use sensitivity factor of x 0.25 for the uncertainty contribution.</p> <p>Symbols #0, 4.. means 0, 4, 7, 11          Symbols #1, 2.. means 1-3, 5, 6, 8-10, 12, 13</p> <p><u>Symbols #0, 4.. during ABS:</u>  <math>\hat{E}_{s1}/N_{oc2}</math> uncertainty = SQRT (Cell 1 SNR uncertainty<sup>2</sup> + Cell 1 Fading profile power uncertainty<sup>2</sup> + (0.25 x AWGN flatness and signal flatness)<sup>2</sup>)</p> <p><math>\hat{E}_{s2}/\hat{E}_{s1}</math> uncertainty = SQRT (Cell 1 SNR uncertainty<sup>2</sup> + Cell 1 Fading profile power uncertainty<sup>2</sup> + Cell 2 SNR uncertainty<sup>2</sup> + Cell 2 Fading profile power uncertainty<sup>2</sup>)</p> <p><math>\hat{E}_{s3}/\hat{E}_{s1}</math> uncertainty = SQRT (Cell 1 SNR uncertainty<sup>2</sup> + Cell 1 Fading profile power uncertainty<sup>2</sup> + Cell 3 SNR uncertainty<sup>2</sup> + Cell 3 Fading profile power uncertainty<sup>2</sup>)</p> <p><u>Symbols #1, 2.. during ABS:</u>  <math>\hat{E}_{s1}/N_{oc1}</math> uncertainty = SQRT (Cell 1 SNR uncertainty<sup>2</sup> + Cell 1 Fading profile power uncertainty<sup>2</sup> + (0.25 x AWGN flatness and signal flatness)<sup>2</sup> + <math>N_{oc1}/N_{oc2}</math> uncertainty<sup>2</sup>)</p> <p><u>All symbols during non-ABS:</u>  <math>\hat{E}_{s1}/N_{oc3}</math> uncertainty = SQRT (Cell 1 SNR uncertainty<sup>2</sup> + Cell 1 Fading profile power uncertainty<sup>2</sup> + (0.25 x AWGN flatness and signal flatness)<sup>2</sup> + <math>N_{oc3}/N_{oc2}</math> uncertainty<sup>2</sup>)</p> <p><u>Component uncertainties:</u>          SNR uncertainty <math>\pm 0.3</math> dB          Fading profile power uncertainty <math>\pm 0.7</math> dB for MIMO          AWGN flatness and signal flatness <math>\pm 2.0</math> dB  <math>N_{oc1}/N_{oc2}</math> and <math>N_{oc3}/N_{oc2}</math> uncertainty <math>\pm 0.3</math> dB</p>
<p>8.2.1.4.2</p>	<p><math>\pm 0.9</math> dB</p>	<p>Same as 8.2.1.3.1</p>
<p>8.2.1.4.2_1</p>	<p>Same as 8.2.1.4.2</p>	
<p>8.2.1.4.2_A.1</p>	<p>Same as 8.2.1.4.2 for each CC</p>	<p>Same as 8.2.1.3.1          Calculation applies for each CC</p>
<p>8.2.1.4.2_A.2</p>	<p>Same as 8.2.1.4.2 for each CC</p>	<p>Same as 8.2.1.3.1          Calculation applies for each CC</p>



8.2.1.4.3	$\bar{E}_s/N_{oc} \pm 0.8$ dB for each cell	<p>Overall system uncertainty for fading conditions comprises two quantities:</p> <ol style="list-style-type: none"> <li>1. Signal-to-noise ratio uncertainty</li> <li>2. Fading profile power uncertainty</li> </ol> <p>Items 1 and 2 are assumed to be uncorrelated so can be root sum squared:  Test System uncertainty = <math>\text{SQRT}(\text{Signal-to-noise ratio uncertainty}^2 + \text{Fading profile power uncertainty}^2)</math>  Signal-to-noise ratio uncertainty <math>\pm 0.3</math> dB  Fading profile power uncertainty <math>\pm 0.7</math> dB for Tx Diversity</p> <p>AWGN flatness and signal flatness <math>\pm 2.0</math> dB not expected to have any significant effect</p>
8.2.1.7.1 A.1	TBD	TBD
8.2.2.1.1 Multiple PRBs - Propagation Condition EVA5 - Propagation Condition ETU70 - Propagation Condition ETU300	$\pm 0.8$ dB	<p>Overall system uncertainty for fading conditions comprises three quantities:</p> <ol style="list-style-type: none"> <li>1. Signal-to-noise ratio uncertainty</li> <li>2. Fading profile power uncertainty</li> <li>3. Effect of AWGN flatness and signal flatness</li> </ol> <p>Items 1, 2 and 3 are assumed to be uncorrelated so can be root sum squared:  AWGN flatness and signal flatness has x 0.25 effect on the required SNR, so use sensitivity factor of x 0.25 for the uncertainty contribution.  Test System uncertainty = <math>\text{SQRT}(\text{Signal-to-noise ratio uncertainty}^2 + \text{Fading profile power uncertainty}^2 + (0.25 \times \text{AWGN flatness and signal flatness})^2)</math>  Signal-to-noise ratio uncertainty <math>\pm 0.3</math> dB  Fading profile power uncertainty <math>\pm 0.5</math> dB for single Tx  AWGN flatness and signal flatness <math>\pm 2.0</math> dB</p>
8.2.2.1.1 Multiple PRBs - Propagation Condition HST	$\pm 0.6$ dB	<p>Overall system uncertainty for HST condition comprises two quantities:</p> <ol style="list-style-type: none"> <li>1. Signal-to-noise ratio uncertainty</li> <li>2. Effect of AWGN flatness and signal flatness</li> </ol> <p>Items 1 and 2 are assumed to be uncorrelated so can be root sum squared:  AWGN flatness and signal flatness has x 0.25 effect on the required SNR, so use sensitivity factor of x 0.25 for the uncertainty contribution.  Test System uncertainty = <math>\text{SQRT}(\text{Signal-to-noise ratio uncertainty}^2 + (0.25 \times \text{AWGN flatness and signal flatness})^2)</math>  Signal-to-noise ratio uncertainty <math>\pm 0.3</math> dB  AWGN flatness and signal flatness <math>\pm 2.0</math> dB</p>
8.2.2.1.1 Single PRB - Propagation Condition ETU70	$\pm 0.8$ dB	<p>Overall system uncertainty for fading condition comprises three quantities:</p> <ol style="list-style-type: none"> <li>1. Average Signal-to-noise ratio uncertainty</li> <li>2. Signal-to noise ratio variation for single PRB</li> <li>3. Fading profile power uncertainty</li> </ol> <p>Items 1, 2 and 3 are assumed to be uncorrelated so can be root sum squared:  Test System uncertainty = <math>\text{SQRT}(\text{Average signal-to-noise ratio uncertainty}^2 + \text{Signal-to-noise ratio variation}^2 + \text{Fading profile power uncertainty}^2)</math>  Signal-to-noise ratio uncertainty <math>\pm 0.3</math> dB  Signal-to-noise ratio variation <math>\pm 0.5</math> dB  Fading profile power uncertainty <math>\pm 0.5</math> dB for single Tx</p>

8.2.2.1.1_1 Multiple PRBs - Propagation Condition EVA5 - Propagation Condition ETU70 - Propagation Condition ETU300	Same as 8.2.2.1.1 Multiple PRBs Propagation EVA5, ETU70, ETU300	
8.2.2.1.1_2 Multiple PRB - Propagation Condition EVA5	Same as 8.2.2.1.1 Multiple PRBs Propagation EVA5	
8.2.2.1.1_A.1	Same as 8.2.2.1.1 Multiple PRBs for each CC	Same as 8.2.2.1.1 Multiple PRBs Calculation applies for each CC
8.2.2.1.1_A.2	Same as 8.2.2.1.1 Multiple PRBs for each CC	Same as 8.2.2.1.1 Multiple PRBs Calculation applies for each CC
8.2.2.1.2 Single PRB	± 0.8 dB	Same as 8.2.2.1.1 Single PRB
8.2.2.2.1 - Propagation Condition EVA5	± 0.9 dB	Overall system uncertainty for fading conditions comprises three quantities: 1. Signal-to-noise ratio uncertainty 2. Fading profile power uncertainty 3. Effect of AWGN flatness and signal flatness  Items 1, 2 and 3 are assumed to be uncorrelated so can be root sum squared: AWGN flatness and signal flatness has x 0.25 effect on the required SNR, so use sensitivity factor of x 0.25 for the uncertainty contribution. Test System uncertainty = SQRT (Signal-to-noise ratio uncertainty <sup>2</sup> + Fading profile power uncertainty <sup>2</sup> + (0.25 x AWGN flatness and signal flatness) <sup>2</sup> ) Signal-to-noise ratio uncertainty ±0.3 dB Fading profile power uncertainty ±0.7 dB for Tx Diversity AWGN flatness and signal flatness ±2.0 dB
8.2.2.2.1 - Propagation Condition HST	± 0.6 dB	Overall system uncertainty for HST condition comprises two quantities: 1. Signal-to-noise ratio uncertainty 2. Effect of AWGN flatness and signal flatness  Items 1 and 2 are assumed to be uncorrelated so can be root sum squared: AWGN flatness and signal flatness has x 0.25 effect on the required SNR, so use sensitivity factor of x 0.25 for the uncertainty contribution. Test System uncertainty = SQRT (Signal-to-noise ratio uncertainty <sup>2</sup> + (0.25 x AWGN flatness and signal flatness) <sup>2</sup> ) Signal-to-noise ratio uncertainty ±0.3 dB AWGN flatness and signal flatness ±2.0 dB
8.2.2.2.1_1 - Propagation Condition EVA5	Same as 8.2.2.2.1 Propagation EVA5	
8.2.2.2.2	± 0.9 dB	Same as 8.2.2.2.1 Propagation Condition EVA5
8.2.2.2.2_1	Same as 8.2.2.2.2	
8.2.2.2.3_C.1	Same as 8.2.1.2.3_C.1	Same as 8.2.1.2.3_C.1
8.2.2.2.3_E.1 - Propagation Condition EVA5	Same as 8.2.1.2.3_E.1	Same as 8.2.1.2.3_E.1

8.2.2.2.4	$\bar{E}_s/N_{oc} \pm 0.8$ dB for each cell	<p>Overall system uncertainty for fading conditions comprises two quantities:</p> <ol style="list-style-type: none"> <li>1. Signal-to-noise ratio uncertainty</li> <li>2. Fading profile power uncertainty</li> </ol> <p>Items 1 and 2 are assumed to be uncorrelated so can be root sum squared:  Test System uncertainty = SQRT (Signal-to-noise ratio uncertainty<sup>2</sup> + Fading profile power uncertainty<sup>2</sup>)  Signal-to-noise ratio uncertainty <math>\pm 0.3</math> dB  Fading profile power uncertainty <math>\pm 0.7</math> dB for Tx Diversity</p> <p><i>AWGN flatness and signal flatness <math>\pm 2.0</math> dB not expected to have any significant effect</i></p>
8.2.2.3.1	$\pm 0.9$ dB	<p>Overall system uncertainty for fading conditions comprises three quantities:</p> <ol style="list-style-type: none"> <li>1. Signal-to-noise ratio uncertainty</li> <li>2. Fading profile power uncertainty</li> <li>3. Effect of AWGN flatness and signal flatness</li> </ol> <p>Items 1, 2 and 3 are assumed to be uncorrelated so can be root sum squared:  AWGN flatness and signal flatness has x 0.25 effect on the required SNR, so use sensitivity factor of x 0.25 for the uncertainty contribution.  Test System uncertainty = SQRT (Signal-to-noise ratio uncertainty<sup>2</sup> + Fading profile power uncertainty<sup>2</sup> + (0.25 x AWGN flatness and signal flatness)<sup>2</sup>)  Signal-to-noise ratio uncertainty <math>\pm 0.3</math> dB  Fading profile power uncertainty <math>\pm 0.7</math> dB for MIMO  AWGN flatness and signal flatness <math>\pm 2.0</math> dB</p>
8.2.2.3.1_1	Same as 8.2.2.3.1	Same as 8.2.2.3.1
8.2.2.3.1_A.1	Same as 8.2.2.3.1 for each CC	Same as 8.2.2.3.1 Calculation applies for each CC
8.2.2.3.1_A.2 TDD PDSCH Open Loop Spatial Multiplexing 2x2 for CA (3 DL CA)	Same as 8.2.2.3.1 for each CC	Same as 8.2.2.3.1 Calculation applies for each CC
8.2.2.3.1A_A.1	Same as 8.2.2.3.1 for each CC	Same as 8.2.2.3.1 Calculation applies for each CC
8.2.2.3.2	$\pm 0.9$ dB	Same as 8.2.2.3.1
8.2.2.3.3_C.1	Same as 8.2.1.3.3_C.1	Same as 8.2.1.3.3_C.1
8.2.2.3.3_C.2	Same as 8.2.1.3.3_C.2	Same as 8.2.1.3.3_C.2
8.2.2.3.3_E.1 - Propagation Condition EVA5	Same as 8.2.1.3.3_E.1	Same as 8.2.1.3.3_E.1
8.2.2.4.1	$\pm 0.9$ dB	Same as 8.2.2.3.1
8.2.2.4.1_1	Same as 8.2.2.4.1	
8.2.2.4.1_E.1 - Propagation Condition EPA5	Same as 8.2.1.4.1_E.1	Same as 8.2.1.4.1_E.1
8.2.2.4.2	$\pm 0.9$ dB	Same as 8.2.2.3.1
8.2.2.4.2_1	Same as 8.2.2.4.2	
8.2.2.4.2_A.1	Same as 8.2.2.4.2 for each CC	Same as 8.2.2.3.1 Calculation applies for each CC
8.2.2.4.2_A.2 TDD PDSCH Closed Loop Multi Layer Spatial Multiplexing 4x2 for CA (3DL CA)	Same as 8.2.2.4.2 for each CC	Same as 8.2.2.3.1 Calculation applies for each CC

8.2.2.4.3	$\bar{E}_s/N_{oc} \pm 0.8$ dB for each cell	<p>Overall system uncertainty for fading conditions comprises two quantities:</p> <ol style="list-style-type: none"> <li>1. Signal-to-noise ratio uncertainty</li> <li>2. Fading profile power uncertainty</li> </ol> <p>Items 1 and 2 are assumed to be uncorrelated so can be root sum squared:  Test System uncertainty = SQRT (Signal-to-noise ratio uncertainty<sup>2</sup> + Fading profile power uncertainty<sup>2</sup>)  Signal-to-noise ratio uncertainty <math>\pm 0.3</math> dB  Fading profile power uncertainty <math>\pm 0.7</math> dB for Tx Diversity</p> <p><i>AWGN flatness and signal flatness <math>\pm 2.0</math> dB not expected to have any significant effect</i></p>
8.2.2.7.1_A.1	TBD	TBD
8.3.1.1.1_D	$\pm 0.9$ dB	<p>Overall system uncertainty for fading conditions comprises three quantities:</p> <ol style="list-style-type: none"> <li>1. Signal-to-noise ratio uncertainty</li> <li>2. Fading profile power uncertainty</li> <li>3. Effect of AWGN flatness and signal flatness</li> </ol> <p>Items 1, 2 and 3 are assumed to be uncorrelated so can be root sum squared:  AWGN flatness and signal flatness has x 0.25 effect on the required SNR, so use sensitivity factor of x 0.25 for the uncertainty contribution.  Test System uncertainty = SQRT (Signal-to-noise ratio uncertainty<sup>2</sup> + Fading profile power uncertainty<sup>2</sup> + (0.25 x AWGN flatness and signal flatness)<sup>2</sup>)  Signal-to-noise ratio uncertainty <math>\pm 0.3</math> dB  Fading profile power uncertainty <math>\pm 0.7</math> dB for MIMO  AWGN flatness and signal flatness <math>\pm 2.0</math> dB</p>
8.3.1.1.2_D	$\pm 0.9$ dB	Same as 8.3.1.1.1_D
8.3.1.1.3	$\bar{E}_s/N_{oc} \pm 0.8$ dB for each cell	<p>Overall system uncertainty for fading conditions comprises two quantities:</p> <ol style="list-style-type: none"> <li>1. Signal-to-noise ratio uncertainty</li> <li>2. Fading profile power uncertainty</li> </ol> <p>Items 1 and 2 are assumed to be uncorrelated so can be root sum squared:  Test System uncertainty = SQRT (Signal-to-noise ratio uncertainty<sup>2</sup> + Fading profile power uncertainty<sup>2</sup>)  Signal-to-noise ratio uncertainty <math>\pm 0.3</math> dB  Fading profile power uncertainty <math>\pm 0.7</math> dB for Tx Diversity</p> <p><i>AWGN flatness and signal flatness <math>\pm 2.0</math> dB not expected to have any significant effect</i></p>
8.3.1.2.1_D	$\pm 0.9$ dB	Same as 8.3.1.1.1_D

8.3.1.2.1_D_1	$\hat{E}s/N_{oc} \pm 0.8$ dB for each cell	<p>Overall system uncertainty for fading conditions comprises two quantities:</p> <ol style="list-style-type: none"> <li>1. Signal-to-noise ratio uncertainty</li> <li>2. Fading profile power uncertainty</li> </ol> <p>Items 1 and 2 are assumed to be uncorrelated so can be root sum squared:  Test System uncertainty = SQRT (Signal-to-noise ratio uncertainty<sup>2</sup> + Fading profile power uncertainty<sup>2</sup>)  Signal-to-noise ratio uncertainty <math>\pm 0.3</math> dB  Fading profile power uncertainty <math>\pm 0.7</math> dB for MIMO</p> <p><i>AWGN flatness and signal flatness <math>\pm 2.0</math> dB not expected to have any significant effect</i></p>
8.3.1.3.1_F	$\hat{E}s/N_{oc} \pm 0.9$ dB for each TP  Time alignment error TP 2 relative to TP1: $\pm 130$ ns ( $\pm 4T_s$ )	<p>Overall system uncertainty for fading conditions comprises three quantities:</p> <ol style="list-style-type: none"> <li>1. Signal-to-noise ratio uncertainty</li> <li>2. Fading profile power uncertainty</li> <li>3. Effect of AWGN flatness and signal flatness</li> </ol> <p>Items 1, 2 and 3 are assumed to be uncorrelated so can be root sum squared:  AWGN flatness and signal flatness has x 0.25 effect on the required SNR, so use sensitivity factor of x 0.25 for the uncertainty contribution.  Test System uncertainty = SQRT (Signal-to-noise ratio uncertainty<sup>2</sup> + Fading profile power uncertainty<sup>2</sup> + (0.25 x AWGN flatness and signal flatness)<sup>2</sup>)  Signal-to-noise ratio uncertainty <math>\pm 0.3</math> dB  Fading profile power uncertainty <math>\pm 0.7</math> dB for MIMO  AWGN flatness and signal flatness <math>\pm 2.0</math> dB</p>
8.3.1.3.2_F	$\hat{E}s/N_{oc} \pm 0.9$ dB for each TP  Time alignment error TP 2 relative to TP1: $\pm 130$ ns ( $\pm 4T_s$ )	Same as 8.3.1.3.1_F
8.3.1.3.3_F	$\hat{E}s/N_{oc} \pm 0.9$ dB for each TP	Same as 8.3.1.3.1_F
8.3.2.1.1	$\pm 0.9$ dB	<p>Overall system uncertainty for fading conditions comprises three quantities:</p> <ol style="list-style-type: none"> <li>1. Signal-to-noise ratio uncertainty</li> <li>2. Fading profile power uncertainty</li> <li>3. Effect of AWGN flatness and signal flatness</li> </ol> <p>Items 1, 2 and 3 are assumed to be uncorrelated so can be root sum squared:  AWGN flatness and signal flatness has x 0.25 effect on the required SNR, so use sensitivity factor of x 0.25 for the uncertainty contribution.  Test System uncertainty = SQRT (Signal-to-noise ratio uncertainty<sup>2</sup> + Fading profile power uncertainty<sup>2</sup> + (0.25 x AWGN flatness and signal flatness)<sup>2</sup>)  Signal-to-noise ratio uncertainty <math>\pm 0.3</math> dB  Fading profile power uncertainty <math>\pm 0.7</math> dB for Tx Diversity  AWGN flatness and signal flatness <math>\pm 2.0</math> dB</p>
8.3.2.1.1_1	$\pm 0.9$ dB	Same as 8.3.2.1.1
8.3.2.1.2	$\pm 0.9$ dB	Same as 8.2.2.3.1
8.3.2.1.2_D	$\pm 0.9$ dB	Same as 8.2.2.3.1
8.3.2.1.3	$\pm 0.9$ dB	Same as 8.2.2.3.1
8.3.2.1.3_D	$\pm 0.9$ dB	Same as 8.2.2.3.1

8.3.2.1.4	$\bar{E}_s/N_{oc} \pm 0.8$ dB for each cell	<p>Overall system uncertainty for fading conditions comprises two quantities:</p> <ol style="list-style-type: none"> <li>1. Signal-to-noise ratio uncertainty</li> <li>2. Fading profile power uncertainty</li> </ol> <p>Items 1 and 2 are assumed to be uncorrelated so can be root sum squared:  Test System uncertainty = SQRT (Signal-to-noise ratio uncertainty<sup>2</sup> + Fading profile power uncertainty<sup>2</sup>)  Signal-to-noise ratio uncertainty <math>\pm 0.3</math> dB  Fading profile power uncertainty <math>\pm 0.7</math> dB for Tx Diversity</p> <p><i>AWGN flatness and signal flatness <math>\pm 2.0</math> dB not expected to have any significant effect</i></p>
8.3.2.2.1	$\pm 0.9$ dB	Same as 8.2.2.3.1
8.3.2.2.1_D	$\pm 0.9$ dB	Same as 8.2.2.3.1
8.3.2.2.1_D_1	$\bar{E}_s/N_{oc} \pm 0.8$ dB for each cell	Same as 8.3.1.2.1_D_1
8.3.2.4.1_F	$\bar{E}_s/N_{oc} \pm 0.9$ dB for each TP  Time alignment error TP 2 relative to TP1: $\pm 130$ ns ( $\pm 4T_s$ )	<p>Overall system uncertainty for fading conditions comprises three quantities:</p> <ol style="list-style-type: none"> <li>1. Signal-to-noise ratio uncertainty</li> <li>2. Fading profile power uncertainty</li> <li>3. Effect of AWGN flatness and signal flatness</li> </ol> <p>Items 1, 2 and 3 are assumed to be uncorrelated so can be root sum squared:  AWGN flatness and signal flatness has x 0.25 effect on the required SNR, so use sensitivity factor of x 0.25 for the uncertainty contribution.  Test System uncertainty = SQRT (Signal-to-noise ratio uncertainty<sup>2</sup> + Fading profile power uncertainty<sup>2</sup> + (0.25 x AWGN flatness and signal flatness)<sup>2</sup>)  Signal-to-noise ratio uncertainty <math>\pm 0.3</math> dB  Fading profile power uncertainty <math>\pm 0.7</math> dB for MIMO  AWGN flatness and signal flatness <math>\pm 2.0</math> dB</p>
8.3.2.4.2_F	$\bar{E}_s/N_{oc} \pm 0.9$ dB for each TP  Time alignment error TP 2 relative to TP1: $\pm 130$ ns ( $\pm 4T_s$ )	Same as 8.3.2.4.1_F
8.3.2.4.3_F	$\bar{E}_s/N_{oc} \pm 0.9$ dB for each TP	Same as 8.3.2.4.1_F

8.4.1.1	± 0.8 dB	<p>Overall system uncertainty for fading conditions comprises four quantities:</p> <ol style="list-style-type: none"> <li>1. Signal-to-noise ratio uncertainty</li> <li>2. Fading profile power uncertainty</li> <li>3. Effect of AWGN flatness and signal flatness</li> <li>4. Result variation due to finite test time</li> </ol> <p>Items 1, 2, 3 and 4 are assumed to be uncorrelated so can be root sum squared: AWGN flatness and signal flatness has x 0.25 effect on the required SNR, so use sensitivity factor of x 0.25 for the uncertainty contribution. Test System uncertainty = <math>\text{SQRT}(\text{Signal-to-noise ratio uncertainty}^2 + \text{Fading profile power uncertainty}^2 + (0.25 \times \text{AWGN flatness and signal flatness})^2 + \text{variation due to finite test time}^2)</math></p> <p>Signal-to-noise ratio uncertainty ±0.3 dB  Fading profile power uncertainty ±0.5 dB for single Tx  AWGN flatness and signal flatness ±2.0 dB  Result variation due to finite test time ±0.2 dB</p>
8.4.1.2.1	± 1.0 dB	<p>Overall system uncertainty for fading conditions comprises four quantities:</p> <ol style="list-style-type: none"> <li>1. Signal-to-noise ratio uncertainty</li> <li>2. Fading profile power uncertainty</li> <li>3. Effect of AWGN flatness and signal flatness</li> <li>4. Result variation due to finite test time</li> </ol> <p>Items 1, 2, 3 and 4 are assumed to be uncorrelated so can be root sum squared: AWGN flatness and signal flatness has x 0.25 effect on the required SNR, so use sensitivity factor of x 0.25 for the uncertainty contribution. Test System uncertainty = <math>\text{SQRT}(\text{Signal-to-noise ratio uncertainty}^2 + \text{Fading profile power uncertainty}^2 + (0.25 \times \text{AWGN flatness and signal flatness})^2 + \text{variation due to finite test time}^2)</math></p> <p>Signal-to-noise ratio uncertainty ±0.3 dB  Fading profile power uncertainty ±0.7 dB for Tx Diversity  AWGN flatness and signal flatness ±2.0 dB  Result variation due to finite test time ±0.4 dB</p>
8.4.1.2.1_1	Same as 8.4.1.2.1	
8.4.1.2.2	± 1.0 dB	<p>Overall system uncertainty for fading conditions comprises four quantities:</p> <ol style="list-style-type: none"> <li>1. Signal-to-noise ratio uncertainty</li> <li>2. Fading profile power uncertainty</li> <li>3. Effect of AWGN flatness and signal flatness</li> <li>4. Result variation due to finite test time</li> </ol> <p>Items 1, 2, 3 and 4 are assumed to be uncorrelated so can be root sum squared: AWGN flatness and signal flatness has x 0.25 effect on the required SNR, so use sensitivity factor of x 0.25 for the uncertainty contribution. Test System uncertainty = <math>\text{SQRT}(\text{Signal-to-noise ratio uncertainty}^2 + \text{Fading profile power uncertainty}^2 + (0.25 \times \text{AWGN flatness and signal flatness})^2 + \text{variation due to finite test time}^2)</math></p> <p>Signal-to-noise ratio uncertainty ±0.3 dB  Fading profile power uncertainty ±0.7 dB for MIMO  AWGN flatness and signal flatness ±2.0 dB  Result variation due to finite test time ±0.4 dB</p>
8.4.1.2.2_1	Same as 8.4.1.2.2	

<p>8.4.1.2.3_C.1</p>	<p><u>Symbols #0, 4.. during ABS:</u>  <math>\hat{E}s_1/N_{oc2} \pm 0.9</math> dB  <math>\hat{E}s_2/\hat{E}s_1 \pm 1.1</math> dB</p> <p><u>Symbols #1, 2.. during ABS:</u>  <math>\hat{E}s_1/N_{oc1} \pm 1.0</math> dB</p> <p><u>All symbols during non-ABS:</u>  <math>\hat{E}s_1/N_{oc3} \pm 1.0</math> dB</p>	<p>System uncertainties comprise a number of quantities which are selected according to their applicability in the equations below.</p> <p>Uncertainties are assumed to be uncorrelated, so can be root sum squared.          AWGN flatness and signal flatness has x 0.25 effect on the required SNR, so use sensitivity factor of x 0.25 for the uncertainty contribution.</p> <p>Symbols #0, 4.. means 0, 4, 7, 11          Symbols #1, 2.. means 1-3, 5, 6, 8-10, 12, 13</p> <p><u>Symbols #0, 4.. during ABS:</u>  <math>\hat{E}s_1/N_{oc2}</math> uncertainty = SQRT (Cell 1 SNR uncertainty<sup>2</sup> + Cell 1 Fading profile power uncertainty<sup>2</sup> + (0.25 x AWGN flatness and signal flatness)<sup>2</sup>)  <math>\hat{E}s_2/\hat{E}s_1</math> uncertainty = SQRT (Cell 1 SNR uncertainty<sup>2</sup> + Cell 1 Fading profile power uncertainty<sup>2</sup> + Cell 2 SNR uncertainty<sup>2</sup> + Cell 2 Fading profile power uncertainty<sup>2</sup>)</p> <p><u>Symbols #1, 2.. during ABS:</u>  <math>\hat{E}s_1/N_{oc1}</math> uncertainty = SQRT (Cell 1 SNR uncertainty<sup>2</sup> + Cell 1 Fading profile power uncertainty<sup>2</sup> + (0.25 x AWGN flatness and signal flatness)<sup>2</sup> + <math>N_{oc1}/N_{oc2}</math> uncertainty<sup>2</sup>)</p> <p><u>All symbols during non-ABS:</u>  <math>\hat{E}s_1/N_{oc3}</math> uncertainty = SQRT (Cell 1 SNR uncertainty<sup>2</sup> + Cell 1 Fading profile power uncertainty<sup>2</sup> + (0.25 x AWGN flatness and signal flatness)<sup>2</sup> + <math>N_{oc3}/N_{oc2}</math> uncertainty<sup>2</sup>)</p> <p><u>Component uncertainties:</u>          SNR uncertainty <math>\pm 0.3</math> dB          Fading profile power uncertainty <math>\pm 0.7</math> dB for Tx Diversity          AWGN flatness and signal flatness <math>\pm 2.0</math> dB  <math>N_{oc1}/N_{oc2}</math> and <math>N_{oc3}/N_{oc2}</math> uncertainty <math>\pm 0.3</math> dB</p>
----------------------	----------------------------------------------------------------------------------------------------------------------------------------------------------------------------------------------------------------------------------------------------------------------------------------------------------------------------------	--------------------------------------------------------------------------------------------------------------------------------------------------------------------------------------------------------------------------------------------------------------------------------------------------------------------------------------------------------------------------------------------------------------------------------------------------------------------------------------------------------------------------------------------------------------------------------------------------------------------------------------------------------------------------------------------------------------------------------------------------------------------------------------------------------------------------------------------------------------------------------------------------------------------------------------------------------------------------------------------------------------------------------------------------------------------------------------------------------------------------------------------------------------------------------------------------------------------------------------------------------------------------------------------------------------------------------------------------------------------------------------------------------------------------------------------------------------------------------------------------------------------------------------------------------------------------------------------------------------------------------------------------------------------------------------------------------------------------------------------------------------------------------------------------------------------------------------------------------------------------------------------------------------------------------------------------------------------------------------------



<p>8.4.1.2.3_C.2</p>	<p><u>Symbols #0, 4.. during ABS:</u>  <math>\hat{E}s_1/N_{oc2} \pm 0.9</math> dB  <math>\hat{E}s_2/\hat{E}s_1 \pm 1.1</math> dB</p> <p><u>Symbols #1, 2.. during ABS:</u>  <math>\hat{E}s_1/N_{oc1} \pm 1.0</math> dB</p> <p><u>All symbols during non-ABS:</u>  <math>\hat{E}s_1/N_{oc3} \pm 1.0</math> dB</p>	<p>System uncertainties comprise a number of quantities which are selected according to their applicability in the equations below.</p> <p>Uncertainties are assumed to be uncorrelated, so can be root sum squared.          AWGN flatness and signal flatness has x 0.25 effect on the required SNR, so use sensitivity factor of x 0.25 for the uncertainty contribution.</p> <p>Symbols #0, 4.. means 0, 4, 7, 11          Symbols #1, 2.. means 1-3, 5, 6, 8-10, 12, 13</p> <p><u>Symbols #0, 4.. during ABS:</u>  <math>\hat{E}s_1/N_{oc2}</math> uncertainty = SQRT (Cell 1 SNR uncertainty<sup>2</sup> + Cell 1 Fading profile power uncertainty<sup>2</sup> + (0.25 x AWGN flatness and signal flatness)<sup>2</sup>)  <math>\hat{E}s_2/\hat{E}s_1</math> uncertainty = SQRT (Cell 1 SNR uncertainty<sup>2</sup> + Cell 1 Fading profile power uncertainty<sup>2</sup> + Cell 2 SNR uncertainty<sup>2</sup> + Cell 2 Fading profile power uncertainty<sup>2</sup>)</p> <p><u>Symbols #1, 2.. during ABS:</u>  <math>\hat{E}s_1/N_{oc1}</math> uncertainty = SQRT (Cell 1 SNR uncertainty<sup>2</sup> + Cell 1 Fading profile power uncertainty<sup>2</sup> + (0.25 x AWGN flatness and signal flatness)<sup>2</sup> + <math>N_{oc1}/N_{oc2}</math> uncertainty<sup>2</sup>)</p> <p><u>All symbols during non-ABS:</u>  <math>\hat{E}s_1/N_{oc3}</math> uncertainty = SQRT (Cell 1 SNR uncertainty<sup>2</sup> + Cell 1 Fading profile power uncertainty<sup>2</sup> + (0.25 x AWGN flatness and signal flatness)<sup>2</sup> + <math>N_{oc3}/N_{oc2}</math> uncertainty<sup>2</sup>)</p> <p><u>Component uncertainties:</u>          SNR uncertainty ±0.3 dB          Fading profile power uncertainty ±0.7 dB for Tx Diversity          AWGN flatness and signal flatness ±2.0 dB  <math>N_{oc1}/N_{oc2}</math> and <math>N_{oc3}/N_{oc2}</math> uncertainty ±0.3 dB</p>
----------------------	----------------------------------------------------------------------------------------------------------------------------------------------------------------------------------------------------------------------------------------------------------------------------------------------------------------------------------	----------------------------------------------------------------------------------------------------------------------------------------------------------------------------------------------------------------------------------------------------------------------------------------------------------------------------------------------------------------------------------------------------------------------------------------------------------------------------------------------------------------------------------------------------------------------------------------------------------------------------------------------------------------------------------------------------------------------------------------------------------------------------------------------------------------------------------------------------------------------------------------------------------------------------------------------------------------------------------------------------------------------------------------------------------------------------------------------------------------------------------------------------------------------------------------------------------------------------------------------------------------------------------------------------------------------------------------------------------------------------------------------------------------------------------------------------------------------------------------------------------------------------------------------------------------------------------------------------------------------------------------------------------------------------------------------------------------------------------------------------------------------------------------------------------------------------------------------------------------------------------------------------------------------------

<p>8.4.1.2.3_E.1 - Propagation Condition EVA5</p>	<p><u>Symbols #0, 4.. during ABS:</u>  <math>\hat{E}_{s1}/N_{oc2} \pm 0.9</math> dB  <math>\hat{E}_{s2}/\hat{E}_{s1} \pm 1.1</math> dB  <math>\hat{E}_{s3}/\hat{E}_{s1} \pm 1.1</math> dB</p> <p><u>Symbols #1, 2.. during ABS:</u>  <math>\hat{E}_{s1}/N_{oc1} \pm 1.0</math> dB</p> <p><u>All symbols during non-ABS:</u>  <math>\hat{E}_{s1}/N_{oc3} \pm 1.0</math> dB</p>	<p>System uncertainties comprise a number of quantities which are selected according to their applicability in the equations below.</p> <p>Uncertainties are assumed to be uncorrelated, so can be root sum squared.</p> <p>AWGN flatness and signal flatness has x 0.25 effect on the required SNR, so use sensitivity factor of x 0.25 for the uncertainty contribution.</p> <p>Symbols #0, 4.. means 0, 4, 7, 11          Symbols #1, 2.. means 1-3, 5, 6, 8-10, 12, 13</p> <p><u>Symbols #0, 4.. during ABS:</u>  <math>\hat{E}_{s1}/N_{oc2}</math> uncertainty = SQRT (Cell 1 SNR uncertainty<sup>2</sup> + Cell 1 Fading profile power uncertainty<sup>2</sup> + (0.25 x AWGN flatness and signal flatness)<sup>2</sup>)</p> <p><math>\hat{E}_{s2}/\hat{E}_{s1}</math> uncertainty = SQRT (Cell 1 SNR uncertainty<sup>2</sup> + Cell 1 Fading profile power uncertainty<sup>2</sup> + Cell 2 SNR uncertainty<sup>2</sup> + Cell 2 Fading profile power uncertainty<sup>2</sup>)</p> <p><math>\hat{E}_{s3}/\hat{E}_{s1}</math> uncertainty = SQRT (Cell 1 SNR uncertainty<sup>2</sup> + Cell 1 Fading profile power uncertainty<sup>2</sup> + Cell 3 SNR uncertainty<sup>2</sup> + Cell 3 Fading profile power uncertainty<sup>2</sup>)</p> <p><u>Symbols #1, 2.. during ABS:</u>  <math>\hat{E}_{s1}/N_{oc1}</math> uncertainty = SQRT (Cell 1 SNR uncertainty<sup>2</sup> + Cell 1 Fading profile power uncertainty<sup>2</sup> + (0.25 x AWGN flatness and signal flatness)<sup>2</sup> + <math>N_{oc1}/N_{oc2}</math> uncertainty<sup>2</sup>)</p> <p><u>All symbols during non-ABS:</u>  <math>\hat{E}_{s1}/N_{oc3}</math> uncertainty = SQRT (Cell 1 SNR uncertainty<sup>2</sup> + Cell 1 Fading profile power uncertainty<sup>2</sup> + (0.25 x AWGN flatness and signal flatness)<sup>2</sup> + <math>N_{oc3}/N_{oc2}</math> uncertainty<sup>2</sup>)</p> <p><u>Component uncertainties:</u>          SNR uncertainty <math>\pm 0.3</math> dB          Fading profile power uncertainty <math>\pm 0.7</math> dB for MIMO          AWGN flatness and signal flatness <math>\pm 2.0</math> dB  <math>N_{oc1}/N_{oc2}</math> and <math>N_{oc3}/N_{oc2}</math> uncertainty <math>\pm 0.3</math> dB</p>
<p>8.4.1.2.3_E.2 - Propagation Condition EVA5</p>	<p>Same as 8.4.1.2.3_E.1</p>	<p>Same as 8.4.1.2.3_E.1</p>

8.4.2.1	± 0.8 dB	<p>Overall system uncertainty for fading conditions comprises four quantities:</p> <ol style="list-style-type: none"> <li>1. Signal-to-noise ratio uncertainty</li> <li>2. Fading profile power uncertainty</li> <li>3. Effect of AWGN flatness and signal flatness</li> <li>4. Result variation due to finite test time</li> </ol> <p>Items 1, 2, 3 and 4 are assumed to be uncorrelated so can be root sum squared: AWGN flatness and signal flatness has x 0.25 effect on the required SNR, so use sensitivity factor of x 0.25 for the uncertainty contribution. Test System uncertainty = <math>\text{SQRT}(\text{Signal-to-noise ratio uncertainty}^2 + \text{Fading profile power uncertainty}^2 + (0.25 \times \text{AWGN flatness and signal flatness})^2 + \text{variation due to finite test time}^2)</math></p> <p>Signal-to-noise ratio uncertainty ±0.3 dB                  Fading profile power uncertainty ±0.5 dB for single Tx                  AWGN flatness and signal flatness ±2.0 dB                  Result variation due to finite test time ±0.2 dB</p>
8.4.2.2.1	± 1.0 dB	<p>Overall system uncertainty for fading conditions comprises four quantities:</p> <ol style="list-style-type: none"> <li>1. Signal-to-noise ratio uncertainty</li> <li>2. Fading profile power uncertainty</li> <li>3. Effect of AWGN flatness and signal flatness</li> <li>4. Result variation due to finite test time</li> </ol> <p>Items 1, 2, 3 and 4 are assumed to be uncorrelated so can be root sum squared: AWGN flatness and signal flatness has x 0.25 effect on the required SNR, so use sensitivity factor of x 0.25 for the uncertainty contribution. Test System uncertainty = <math>\text{SQRT}(\text{Signal-to-noise ratio uncertainty}^2 + \text{Fading profile power uncertainty}^2 + (0.25 \times \text{AWGN flatness and signal flatness})^2 + \text{variation due to finite test time}^2)</math></p> <p>Signal-to-noise ratio uncertainty ±0.3 dB                  Fading profile power uncertainty ±0.7 dB for Tx Diversity                  AWGN flatness and signal flatness ±2.0 dB                  Result variation due to finite test time ±0.4 dB</p>
8.4.2.2.1_1	Same as 8.4.2.2.1	
8.4.2.2.2	± 1.0 dB	<p>Overall system uncertainty for fading conditions comprises four quantities:</p> <ol style="list-style-type: none"> <li>1. Signal-to-noise ratio uncertainty</li> <li>2. Fading profile power uncertainty</li> <li>3. Effect of AWGN flatness and signal flatness</li> <li>4. Result variation due to finite test time</li> </ol> <p>Items 1, 2, 3 and 4 are assumed to be uncorrelated so can be root sum squared: AWGN flatness and signal flatness has x 0.25 effect on the required SNR, so use sensitivity factor of x 0.25 for the uncertainty contribution. Test System uncertainty = <math>\text{SQRT}(\text{Signal-to-noise ratio uncertainty}^2 + \text{Fading profile power uncertainty}^2 + (0.25 \times \text{AWGN flatness and signal flatness})^2 + \text{variation due to finite test time}^2)</math></p> <p>Signal-to-noise ratio uncertainty ±0.3 dB                  Fading profile power uncertainty ±0.7 dB for MIMO                  AWGN flatness and signal flatness ±2.0 dB                  Result variation due to finite test time ±0.4 dB</p>
8.4.2.2.2_1	Same as 8.4.2.2.2	

8.4.2.2.3_C.1	Same as 8.4.1.2.3_C.1	
8.4.2.2.3_C.2	Same as 8.4.1.2.3_C.2	
<p>8.4.2.2.3_E.1 - Propagation Condition EVA5</p>	<p><u>Symbols #0, 4.. during ABS:</u>  <math>\hat{E}_{s1}/N_{oc2} \pm 0.9</math> dB  <math>\hat{E}_{s2}/\hat{E}_{s1} \pm 1.1</math> dB  <math>\hat{E}_{s3}/\hat{E}_{s1} \pm 1.1</math> dB</p> <p><u>Symbols #1, 2.. during ABS:</u>  <math>\hat{E}_{s1}/N_{oc1} \pm 1.0</math> dB</p> <p><u>All symbols during non-ABS:</u>  <math>\hat{E}_{s1}/N_{oc3} \pm 1.0</math> dB</p>	<p>System uncertainties comprise a number of quantities which are selected according to their applicability in the equations below.</p> <p>Uncertainties are assumed to be uncorrelated, so can be root sum squared.</p> <p>AWGN flatness and signal flatness has x 0.25 effect on the required SNR, so use sensitivity factor of x 0.25 for the uncertainty contribution.</p> <p>Symbols #0, 4.. means 0, 4, 7, 11          Symbols #1, 2.. means 1-3, 5, 6, 8-10, 12, 13</p> <p><u>Symbols #0, 4.. during ABS:</u>  <math>\hat{E}_{s1}/N_{oc2}</math> uncertainty = SQRT (Cell 1 SNR uncertainty<sup>2</sup> + Cell 1 Fading profile power uncertainty<sup>2</sup> + (0.25 x AWGN flatness and signal flatness)<sup>2</sup>)</p> <p><math>\hat{E}_{s2}/\hat{E}_{s1}</math> uncertainty = SQRT (Cell 1 SNR uncertainty<sup>2</sup> + Cell 1 Fading profile power uncertainty<sup>2</sup> + Cell 2 SNR uncertainty<sup>2</sup> + Cell 2 Fading profile power uncertainty<sup>2</sup>)</p> <p><math>\hat{E}_{s3}/\hat{E}_{s1}</math> uncertainty = SQRT (Cell 1 SNR uncertainty<sup>2</sup> + Cell 1 Fading profile power uncertainty<sup>2</sup> + Cell 3 SNR uncertainty<sup>2</sup> + Cell 3 Fading profile power uncertainty<sup>2</sup>)</p> <p><u>Symbols #1, 2.. during ABS:</u>  <math>\hat{E}_{s1}/N_{oc1}</math> uncertainty = SQRT (Cell 1 SNR uncertainty<sup>2</sup> + Cell 1 Fading profile power uncertainty<sup>2</sup> + (0.25 x AWGN flatness and signal flatness)<sup>2</sup> + <math>N_{oc1}/N_{oc2}</math> uncertainty<sup>2</sup>)</p> <p><u>All symbols during non-ABS:</u>  <math>\hat{E}_{s1}/N_{oc3}</math> uncertainty = SQRT (Cell 1 SNR uncertainty<sup>2</sup> + Cell 1 Fading profile power uncertainty<sup>2</sup> + (0.25 x AWGN flatness and signal flatness)<sup>2</sup> + <math>N_{oc3}/N_{oc2}</math> uncertainty<sup>2</sup>)</p> <p><u>Component uncertainties:</u>          SNR uncertainty ±0.3 dB          Fading profile power uncertainty ±0.7 dB for MIMO          AWGN flatness and signal flatness ±2.0 dB  <math>N_{oc1}/N_{oc2}</math> and <math>N_{oc3}/N_{oc2}</math> uncertainty ±0.3 dB</p>
<p>8.4.2.2.3_E.2 - Propagation Condition EVA5</p>	Same as 8.4.2.2.3_E.1	Same as 8.4.2.2.3_E.1

8.5.1.1	± 0.9 dB	<p>Overall system uncertainty for fading conditions comprises four quantities:</p> <ol style="list-style-type: none"> <li>1. Signal-to-noise ratio uncertainty</li> <li>2. Fading profile power uncertainty</li> <li>3. Effect of AWGN flatness and signal flatness</li> <li>4. Result variation due to finite test time</li> </ol> <p>Items 1, 2, 3 and 4 are assumed to be uncorrelated so can be root sum squared: AWGN flatness and signal flatness has x 0.25 effect on the required SNR, so use sensitivity factor of x 0.25 for the uncertainty contribution. Test System uncertainty = <math>\text{SQRT}(\text{Signal-to-noise ratio uncertainty}^2 + \text{Fading profile power uncertainty}^2 + (0.25 \times \text{AWGN flatness and signal flatness})^2 + \text{variation due to finite test time}^2)</math></p> <p>Signal-to-noise ratio uncertainty ±0.3 dB  Fading profile power uncertainty ±0.5 dB for single Tx  AWGN flatness and signal flatness ±2.0 dB  Result variation due to finite test time ±0.4 dB</p>
8.5.1.2.1	± 1.1 dB	<p>Overall system uncertainty for fading conditions comprises four quantities:</p> <ol style="list-style-type: none"> <li>1. Signal-to-noise ratio uncertainty</li> <li>2. Fading profile power uncertainty</li> <li>3. Effect of AWGN flatness and signal flatness</li> <li>4. Result variation due to finite test time</li> </ol> <p>Items 1, 2, 3 and 4 are assumed to be uncorrelated so can be root sum squared: AWGN flatness and signal flatness has x 0.25 effect on the required SNR, so use sensitivity factor of x 0.25 for the uncertainty contribution. Test System uncertainty = <math>\text{SQRT}(\text{Signal-to-noise ratio uncertainty}^2 + \text{Fading profile power uncertainty}^2 + (0.25 \times \text{AWGN flatness and signal flatness})^2 + \text{variation due to finite test time}^2)</math></p> <p>Signal-to-noise ratio uncertainty ±0.3 dB  Fading profile power uncertainty ±0.7 dB for Tx Diversity  AWGN flatness and signal flatness ±2.0 dB  Result variation due to finite test time ±0.6 dB</p>
8.5.1.2.1_1	Same as 8.5.1.2.1	
8.5.1.2.2	± 1.0 dB	<p>Overall system uncertainty for fading conditions comprises four quantities:</p> <ol style="list-style-type: none"> <li>1. Signal-to-noise ratio uncertainty</li> <li>2. Fading profile power uncertainty</li> <li>3. Effect of AWGN flatness and signal flatness</li> <li>4. Result variation due to finite test time</li> </ol> <p>Items 1, 2, 3 and 4 are assumed to be uncorrelated so can be root sum squared: AWGN flatness and signal flatness has x 0.25 effect on the required SNR, so use sensitivity factor of x 0.25 for the uncertainty contribution. Test System uncertainty = <math>\text{SQRT}(\text{Signal-to-noise ratio uncertainty}^2 + \text{Fading profile power uncertainty}^2 + (0.25 \times \text{AWGN flatness and signal flatness})^2 + \text{variation due to finite test time}^2)</math></p> <p>Signal-to-noise ratio uncertainty ±0.3 dB  Fading profile power uncertainty ±0.7 dB for MIMO  AWGN flatness and signal flatness ±2.0 dB  Result variation due to finite test time ±0.4 dB</p>
8.5.1.2.2_1	Same as 8.5.1.2.2	

<p>8.5.1.2.3_C.1</p>	<p><u>Symbols #0, 4.. during ABS:</u>  <math>\hat{E}s_1/N_{oc2} \pm 0.9</math> dB  <math>\hat{E}s_2/\hat{E}s_1 \pm 1.1</math> dB</p> <p><u>Symbols #1, 2.. during ABS:</u>  <math>\hat{E}s_1/N_{oc1} \pm 1.0</math> dB</p> <p><u>All symbols during non-ABS:</u>  <math>\hat{E}s_1/N_{oc3} \pm 1.0</math> dB</p>	<p>System uncertainties comprise a number of quantities which are selected according to their applicability in the equations below.</p> <p>Uncertainties are assumed to be uncorrelated, so can be root sum squared.          AWGN flatness and signal flatness has x 0.25 effect on the required SNR, so use sensitivity factor of x 0.25 for the uncertainty contribution.</p> <p>Symbols #0, 4.. means 0, 4, 7, 11          Symbols #1, 2.. means 1-3, 5, 6, 8-10, 12, 13</p> <p><u>Symbols #0, 4.. during ABS:</u>  <math>\hat{E}s_1/N_{oc2}</math> uncertainty = SQRT (Cell 1 SNR uncertainty<sup>2</sup> + Cell 1 Fading profile power uncertainty<sup>2</sup> + (0.25 x AWGN flatness and signal flatness)<sup>2</sup>)  <math>\hat{E}s_2/\hat{E}s_1</math> uncertainty = SQRT (Cell 1 SNR uncertainty<sup>2</sup> + Cell 1 Fading profile power uncertainty<sup>2</sup> + Cell 2 SNR uncertainty<sup>2</sup> + Cell 2 Fading profile power uncertainty<sup>2</sup>)</p> <p><u>Symbols #1, 2.. during ABS:</u>  <math>\hat{E}s_1/N_{oc1}</math> uncertainty = SQRT (Cell 1 SNR uncertainty<sup>2</sup> + Cell 1 Fading profile power uncertainty<sup>2</sup> + (0.25 x AWGN flatness and signal flatness)<sup>2</sup> + <math>N_{oc1}/N_{oc2}</math> uncertainty<sup>2</sup>)</p> <p><u>All symbols during non-ABS:</u>  <math>\hat{E}s_1/N_{oc3}</math> uncertainty = SQRT (Cell 1 SNR uncertainty<sup>2</sup> + Cell 1 Fading profile power uncertainty<sup>2</sup> + (0.25 x AWGN flatness and signal flatness)<sup>2</sup> + <math>N_{oc3}/N_{oc2}</math> uncertainty<sup>2</sup>)</p> <p><u>Component uncertainties:</u>          SNR uncertainty <math>\pm 0.3</math> dB          Fading profile power uncertainty <math>\pm 0.7</math> dB for Tx Diversity          AWGN flatness and signal flatness <math>\pm 2.0</math> dB  <math>N_{oc1}/N_{oc2}</math> and <math>N_{oc3}/N_{oc2}</math> uncertainty <math>\pm 0.3</math> dB</p>
----------------------	----------------------------------------------------------------------------------------------------------------------------------------------------------------------------------------------------------------------------------------------------------------------------------------------------------------------------------	--------------------------------------------------------------------------------------------------------------------------------------------------------------------------------------------------------------------------------------------------------------------------------------------------------------------------------------------------------------------------------------------------------------------------------------------------------------------------------------------------------------------------------------------------------------------------------------------------------------------------------------------------------------------------------------------------------------------------------------------------------------------------------------------------------------------------------------------------------------------------------------------------------------------------------------------------------------------------------------------------------------------------------------------------------------------------------------------------------------------------------------------------------------------------------------------------------------------------------------------------------------------------------------------------------------------------------------------------------------------------------------------------------------------------------------------------------------------------------------------------------------------------------------------------------------------------------------------------------------------------------------------------------------------------------------------------------------------------------------------------------------------------------------------------------------------------------------------------------------------------------------------------------------------------------------------------------------------------------------------

<p>8.5.1.2.3_E.1</p>	<p><u>Symbols #0, 4.. during ABS:</u>  <math>\hat{E}_{s1}/N_{oc2} \pm 0.9</math> dB  <math>\hat{E}_{s2}/\hat{E}_{s1} \pm 1.1</math> dB  <math>\hat{E}_{s3}/\hat{E}_{s1} \pm 1.1</math> dB</p> <p><u>Symbols #1, 2.. during ABS:</u>  <math>\hat{E}_{s1}/N_{oc1} \pm 1.0</math> dB</p> <p><u>All symbols during non-ABS:</u>  <math>\hat{E}_{s1}/N_{oc3} \pm 1.0</math> dB</p>	<p>System uncertainties comprise a number of quantities which are selected according to their applicability in the equations below.</p> <p>Uncertainties are assumed to be uncorrelated, so can be root sum squared.</p> <p>AWGN flatness and signal flatness has x 0.25 effect on the required SNR, so use sensitivity factor of x 0.25 for the uncertainty contribution.</p> <p>Symbols #0, 4.. means 0, 4, 7, 11          Symbols #1, 2.. means 1-3, 5, 6, 8-10, 12, 13</p> <p><u>Symbols #0, 4.. during ABS:</u>  <math>\hat{E}_{s1}/N_{oc2}</math> uncertainty = SQRT (Cell 1 SNR uncertainty<sup>2</sup> + Cell 1 Fading profile power uncertainty<sup>2</sup> + (0.25 x AWGN flatness and signal flatness)<sup>2</sup>)</p> <p><math>\hat{E}_{s2}/\hat{E}_{s1}</math> uncertainty = SQRT (Cell 1 SNR uncertainty<sup>2</sup> + Cell 1 Fading profile power uncertainty<sup>2</sup> + Cell 2 SNR uncertainty<sup>2</sup> + Cell 2 Fading profile power uncertainty<sup>2</sup>)</p> <p><math>\hat{E}_{s3}/\hat{E}_{s1}</math> uncertainty = SQRT (Cell 1 SNR uncertainty<sup>2</sup> + Cell 1 Fading profile power uncertainty<sup>2</sup> + Cell 3 SNR uncertainty<sup>2</sup> + Cell 3 Fading profile power uncertainty<sup>2</sup>)</p> <p><u>Symbols #1, 2.. during ABS:</u>  <math>\hat{E}_{s1}/N_{oc1}</math> uncertainty = SQRT (Cell 1 SNR uncertainty<sup>2</sup> + Cell 1 Fading profile power uncertainty<sup>2</sup> + (0.25 x AWGN flatness and signal flatness)<sup>2</sup> + <math>N_{oc1}/N_{oc2}</math> uncertainty<sup>2</sup>)</p> <p><u>All symbols during non-ABS:</u>  <math>\hat{E}_{s1}/N_{oc3}</math> uncertainty = SQRT (Cell 1 SNR uncertainty<sup>2</sup> + Cell 1 Fading profile power uncertainty<sup>2</sup> + (0.25 x AWGN flatness and signal flatness)<sup>2</sup> + <math>N_{oc3}/N_{oc2}</math> uncertainty<sup>2</sup>)</p> <p><u>Component uncertainties:</u>          SNR uncertainty <math>\pm 0.3</math> dB          Fading profile power uncertainty <math>\pm 0.7</math> dB for MIMO          AWGN flatness and signal flatness <math>\pm 2.0</math> dB  <math>N_{oc1}/N_{oc2}</math> and <math>N_{oc3}/N_{oc2}</math> uncertainty <math>\pm 0.3</math> dB</p>
----------------------	---------------------------------------------------------------------------------------------------------------------------------------------------------------------------------------------------------------------------------------------------------------------------------------------------------------------------------------------------------------------------------------------------	-------------------------------------------------------------------------------------------------------------------------------------------------------------------------------------------------------------------------------------------------------------------------------------------------------------------------------------------------------------------------------------------------------------------------------------------------------------------------------------------------------------------------------------------------------------------------------------------------------------------------------------------------------------------------------------------------------------------------------------------------------------------------------------------------------------------------------------------------------------------------------------------------------------------------------------------------------------------------------------------------------------------------------------------------------------------------------------------------------------------------------------------------------------------------------------------------------------------------------------------------------------------------------------------------------------------------------------------------------------------------------------------------------------------------------------------------------------------------------------------------------------------------------------------------------------------------------------------------------------------------------------------------------------------------------------------------------------------------------------------------------------------------------------------------------------------------------------------------------------------------------------------------------------------------------------------------------------------------------------------------------------------------------------------------------------------------------------------------------------------------------------------------------------------------------------------------------------------------------------------------

8.5.2.1	± 0.9 dB	<p>Overall system uncertainty for fading conditions comprises four quantities:</p> <ol style="list-style-type: none"> <li>1. Signal-to-noise ratio uncertainty</li> <li>2. Fading profile power uncertainty</li> <li>3. Effect of AWGN flatness and signal flatness</li> <li>4. Result variation due to finite test time</li> </ol> <p>Items 1, 2, 3 and 4 are assumed to be uncorrelated so can be root sum squared: AWGN flatness and signal flatness has x 0.25 effect on the required SNR, so use sensitivity factor of x 0.25 for the uncertainty contribution. Test System uncertainty = <math>\text{SQRT}(\text{Signal-to-noise ratio uncertainty}^2 + \text{Fading profile power uncertainty}^2 + (0.25 \times \text{AWGN flatness and signal flatness})^2 + \text{variation due to finite test time}^2)</math></p> <p>Signal-to-noise ratio uncertainty ±0.3 dB  Fading profile power uncertainty ±0.5 dB for single Tx  AWGN flatness and signal flatness ±2.0 dB  Result variation due to finite test time ±0.4 dB</p>
8.5.2.2.1	± 1.1 dB	<p>Overall system uncertainty for fading conditions comprises four quantities:</p> <ol style="list-style-type: none"> <li>1. Signal-to-noise ratio uncertainty</li> <li>2. Fading profile power uncertainty</li> <li>3. Effect of AWGN flatness and signal flatness</li> <li>4. Result variation due to finite test time</li> </ol> <p>Items 1, 2, 3 and 4 are assumed to be uncorrelated so can be root sum squared: AWGN flatness and signal flatness has x 0.25 effect on the required SNR, so use sensitivity factor of x 0.25 for the uncertainty contribution. Test System uncertainty = <math>\text{SQRT}(\text{Signal-to-noise ratio uncertainty}^2 + \text{Fading profile power uncertainty}^2 + (0.25 \times \text{AWGN flatness and signal flatness})^2 + \text{variation due to finite test time}^2)</math></p> <p>Signal-to-noise ratio uncertainty ±0.3 dB  Fading profile power uncertainty ±0.7 dB for Tx Diversity  AWGN flatness and signal flatness ±2.0 dB  Result variation due to finite test time ±0.6 dB</p>
8.5.1.2.2_1	Same as 8.5.2.2.1	
8.5.2.2.2	± 1.0 dB	<p>Overall system uncertainty for fading conditions comprises four quantities:</p> <ol style="list-style-type: none"> <li>1. Signal-to-noise ratio uncertainty</li> <li>2. Fading profile power uncertainty</li> <li>3. Effect of AWGN flatness and signal flatness</li> <li>4. Result variation due to finite test time</li> </ol> <p>Items 1, 2, 3 and 4 are assumed to be uncorrelated so can be root sum squared: AWGN flatness and signal flatness has x 0.25 effect on the required SNR, so use sensitivity factor of x 0.25 for the uncertainty contribution. Test System uncertainty = <math>\text{SQRT}(\text{Signal-to-noise ratio uncertainty}^2 + \text{Fading profile power uncertainty}^2 + (0.25 \times \text{AWGN flatness and signal flatness})^2 + \text{variation due to finite test time}^2)</math></p> <p>Signal-to-noise ratio uncertainty ±0.3 dB  Fading profile power uncertainty ±0.7 dB for MIMO  AWGN flatness and signal flatness ±2.0 dB  Result variation due to finite test time ±0.4 dB</p>
8.5.2.2.2_1	Same as 8.5.2.2.2	



8.5.2.2.3_C.1	Same as 8.5.1.2.3_C.1	
8.5.2.2.3_E.1	Same as 8.5.1.2.3_E.1	
8.7.1.1	Downlink absolute power uncertainty, averaged over $BW_{\text{Config}}$ $\pm 1.0$ dB  Downlink EVM $\leq 3\%$	3% EVM is equivalent to a Test system downlink SNR of 30.5dB. The noise from the Test system is then sufficiently below that required for the UE to demodulate the signal with the required % success rate. Under these conditions the UE throughput is limited by the Reference measurement channel and the UE capability, and not by the Test system EVM.
8.7.1.1_1	Same as 8.7.1.1	Same as 8.7.1.1
8.7.1.1_A.1	Same as 8.7.1.1 for each CC	Same as 8.7.1.1 Calculation applies for each CC
8.7.1.1_A.2	Same as 8.7.1.1 for each CC	Same as 8.7.1.1 Calculation applies for each CC
8.7.2.1	Same as 8.7.1.1	Same as 8.7.1.1
8.7.2.1_1	Same as 8.7.2.1	Same as 8.7.2.1
8.7.2.1_A.1	Same as 8.7.2.1 for each CC	Same as 8.7.2.1 Calculation applies for each CC
8.7.2.1_A.2	Same as 8.7.2.1 for each CC	Same as 8.7.2.1 Calculation applies for each CC
8.7.3.1	Same as 8.7.1.1	Same as 8.7.1.1
8.7.4.1	Same as 8.7.3.1	Same as 8.7.3.1
8.7.5.1.1 TDD FDD CA Sustained data rate performance for FDD PCell (2DL CA)	Same as 8.7.1.1	Same as 8.7.1.1
8.7.5.1.2 TDD FDD CA Sustained data rate performance for FDD PCell (3DL CA)	Same as 8.7.1.1	Same as 8.7.1.1
8.7.5.2.1 TDD FDD CA Sustained data rate performance for TDD PCell (2DL CA)	Same as 8.7.2.1	Same as 8.7.2.1
8.7.5.2.2 TDD FDD CA Sustained data rate performance for TDD PCell (3DL CA)	Same as 8.7.2.1	Same as 8.7.2.1
8.8.1.1	$\pm 0.9$ dB	Overall system uncertainty for fading conditions comprises four quantities: 1. Signal-to-noise ratio uncertainty 2. Fading profile power uncertainty 3. Effect of AWGN flatness and signal flatness 4. Result variation due to finite test time  Items 1, 2, 3 and 4 are assumed to be uncorrelated so can be root sum squared: AWGN flatness and signal flatness has x 0.25 effect on the required SNR, so use sensitivity factor of x 0.25 for the uncertainty contribution. Test System uncertainty = SQRT (Signal-to-noise ratio uncertainty <sup>2</sup> + Fading profile power uncertainty <sup>2</sup> + (0.25 x AWGN flatness and signal flatness) <sup>2</sup> + variation due to finite test time <sup>2</sup> ) Signal-to-noise ratio uncertainty $\pm 0.3$ dB Fading profile power uncertainty $\pm 0.7$ dB for Tx Diversity AWGN flatness and signal flatness $\pm 2.0$ dB Result variation due to finite test time $\pm 0.2$ dB
8.8.1.2	Same as 8.8.1.1	Same as 8.8.1.1
8.8.2.1	Same as 8.8.1.1	Same as 8.8.1.1
8.8.2.2	Same as 8.8.1.1	Same as 8.8.1.1
8.8.3.1	Same as 8.8.1.1	Same as 8.8.1.1
8.8.3.2	Same as 8.8.1.1	Same as 8.8.1.1

10.1	$\pm 0.9$ dB	Overall system uncertainty for fading conditions comprises three quantities: 1. Signal-to-noise ratio uncertainty 2. Fading profile power uncertainty 3. Effect of AWGN flatness and signal flatness  Items 1, 2 and 3 are assumed to be uncorrelated so can be root sum squared: AWGN flatness and signal flatness has x 0.25 effect on the required SNR, so use sensitivity factor of x 0.25 for the uncertainty contribution. Test System uncertainty = $\text{SQRT}(\text{Signal-to-noise ratio uncertainty}^2 + \text{Fading profile power uncertainty}^2 + (0.25 \times \text{AWGN flatness and signal flatness})^2)$ Signal-to-noise ratio uncertainty $\pm 0.3$ dB Fading profile power uncertainty $\pm 0.7$ dB for Tx Diversity AWGN flatness and signal flatness $\pm 2.0$ dB
10.2	$\pm 0.9$ dB	Same as 10.1
[Other tests FFS]		
In addition, the following Test System uncertainties and related constraints apply:		
AWGN Bandwidth		$\geq 1.08\text{MHz}, 2.7\text{MHz}, 4.5\text{MHz}, 9\text{MHz}, 13.5\text{MHz}, 18\text{MHz};$ $N_{\text{RB}} \times 180\text{kHz}$ according to $BW_{\text{Config}}$
AWGN absolute power uncertainty, averaged over $BW_{\text{Config}}$ <sup>Note 4</sup>		$\pm 3$ dB
AWGN flatness and signal flatness, max deviation for any Resource Block, relative to average over $BW_{\text{Config}}$		$\pm 2$ dB
AWGN peak to average ratio		$\geq 10$ dB @0.001%
Signal-to noise ratio uncertainty, averaged over downlink transmission Bandwidth		$\pm 0.3$ dB (includes uncertainty in precoding applied by the test system, where applicable)
Signal-to noise ratio variation for any resource block, relative to average over downlink transmission Bandwidth		$\pm 0.5$ dB
$N_{\text{oc}2}$ absolute power uncertainty, averaged over $BW_{\text{Config}}$ <sup>Note 5</sup>		$\pm 3$ dB
$N_{\text{oc}1} / N_{\text{oc}2}$ ratio uncertainty, averaged over $BW_{\text{Config}}$ <sup>Note 5</sup>		$\pm 0.3$ dB
$N_{\text{oc}3} / N_{\text{oc}2}$ ratio uncertainty, averaged over $BW_{\text{Config}}$ <sup>Note 5</sup>		$\pm 0.3$ dB
$E_s / N_{\text{oc}2}$ ratio (SNR) uncertainty, averaged over downlink transmission Bandwidth <sup>Note 5</sup>		$\pm 0.3$ dB (includes uncertainty in precoding applied by the test system, where applicable)
Fading profile power uncertainty		Test-specific
Fading profile delay uncertainty, relative to frame timing		$\pm 5$ ns (excludes absolute errors related to baseband timing)
CA performance requirements only: Relative frequency error between carriers		30Hz, measured over a 1ms period, and maximum carrier spacing 80MHz
<p>Note 1: Only the overall stimulus error is considered here. The effect of errors in the throughput measurements due to finite test duration is not considered.</p> <p>Note 2: The AWGN or <math>N_{\text{oc}x}</math> parameters apply to all test cases except 8.7.1 and 8.7.2. The fading parameters apply to test cases using fading</p> <p>Note 3: In CA test cases using multiple component carriers (CCs), the uncertainties and related constraints apply for each CC.</p> <p>Note 4: Applies for test cases which specify <math>N_{\text{oc}}</math>, a single value that remains constant with time.</p> <p>Note 5: Applies for test cases which specify <math>N_{\text{oc}1}</math>, <math>N_{\text{oc}2}</math> and <math>N_{\text{oc}3}</math>, that are symbol or subframe specific.</p>		

## F.1.5 Measurement of Channel State Information reporting

**Table F.1.5-1: Maximum Test System Uncertainty for Channel State Information reporting**

Subclause	Maximum Test System Uncertainty <sup>1</sup>	Derivation of Test System Uncertainty
9.2.1.1 FDD CQI Reporting under AWGN conditions – PUCCH 1-0	$\pm 0.3$ dB	Signal-to-noise ratio uncertainty $\pm 0.3$ dB  <i>AWGN flatness and signal flatness <math>\pm 2.0</math> dB not expected to have any significant effect</i>  <i>AWGN absolute power uncertainty <math>\pm 3.0</math> dB not expected to have any significant effect</i>
9.2.1.2 TDD CQI Reporting under AWGN conditions – PUCCH 1-0	$\pm 0.3$ dB	Same as 9.2.1.1
9.2.1.3_C.1 FDD CQI Reporting under AWGN conditions – PUCCH 1-0 for eICIC (non-MBSFN ABS)	$N_{oc2}$ $N_{oc1} / N_{oc2}$ $N_{oc3} / N_{oc2}$ Cell 1 $E_s / N_{oc2}$ Cell 2 $E_s / N_{oc2}$	$N_{oc2}$ , $N_{oc}$ ratios and $E_s / N_{oc2}$ ratios are generic values as specified at end of this table
9.2.1.4_C.1 TDD CQI Reporting under AWGN conditions – PUCCH 1-0 for eICIC (non-MBSFN ABS)	$N_{oc2}$ $N_{oc1} / N_{oc2}$ $N_{oc3} / N_{oc2}$ Cell 1 $E_s / N_{oc2}$ Cell 2 $E_s / N_{oc2}$	$N_{oc2}$ , $N_{oc}$ ratios and $E_s / N_{oc2}$ ratios are generic values as specified at end of this table
9.2.1.5_E.1 FDD CQI Reporting under AWGN conditions - PUCCH 1-0 for feICIC (non-MBSFN ABS)	$N_{oc2}$ $N_{oc1} / N_{oc2}$ $N_{oc3} / N_{oc2}$ Cell 1 $E_s / N_{oc2}$ Cell 2 $E_s / N_{oc2}$ Cell 3 $E_s / N_{oc2}$	$N_{oc2}$ , $N_{oc}$ ratios and $E_s / N_{oc2}$ ratios are generic values as specified at end of this table
9.2.1.6_E.1 TDD CQI Reporting under AWGN conditions - PUCCH 1-0 for feICIC (non-MBSFN ABS)	$N_{oc2}$ $N_{oc1} / N_{oc2}$ $N_{oc3} / N_{oc2}$ Cell 1 $E_s / N_{oc2}$ Cell 2 $E_s / N_{oc2}$ Cell 3 $E_s / N_{oc2}$	$N_{oc2}$ , $N_{oc}$ ratios and $E_s / N_{oc2}$ ratios are generic values as specified at end of this table
9.2.2.1 FDD CQI Reporting under AWGN conditions – PUCCH 1-1	$\pm 0.3$ dB	Signal-to-noise ratio uncertainty $\pm 0.3$ dB  <i>AWGN flatness and signal flatness <math>\pm 2.0</math> dB not expected to have any significant effect</i>  <i>AWGN absolute power uncertainty <math>\pm 3.0</math> dB not expected to have any significant effect</i>
9.2.2.2 TDD CQI Reporting under AWGN conditions – PUCCH 1-1	$\pm 0.3$ dB	Same as 9.2.1.1
9.2.3.1_D FDD CQI Reporting under AWGN conditions – PUCCH 1-1 for eDL-MIMO	$\pm 0.3$ dB	Same as 9.2.2.1
9.2.3.2_D TDD CQI Reporting under AWGN conditions – PUCCH 1-1 for eDL-MIMO	$\pm 0.3$ dB	Same as 9.2.2.1
9.2.4.1_F FDD CQI Reporting under AWGN conditions - Single CSI Process for CoMP	$\pm 0.3$ dB	Same as 9.2.2.1
9.2.4.2_F TDD CQI Reporting under AWGN conditions - Single CSI Process for CoMP	$\pm 0.3$ dB	Same as 9.2.2.1

9.3.1.1.1 FDD CQI Reporting under fading conditions – PUSCH 3-0	$\pm 0.6$ dB	<p>Overall system uncertainty for fading conditions comprises two quantities:</p> <ol style="list-style-type: none"> <li>1. Signal-to-noise ratio uncertainty <math>\pm 0.3</math> dB</li> <li>2. Fading profile power uncertainty <math>\pm 0.5</math> dB</li> </ol> <p>Items 1 and 2 are assumed to be uncorrelated so can be root sum squared:</p> <p>Test System uncertainty = <math>\text{SQRT}(\text{Signal-to-noise ratio uncertainty}^2 + \text{Fading profile power uncertainty}^2)</math></p> <p><i>AWGN flatness and signal flatness <math>\pm 2.0</math> dB not expected to have any significant effect</i></p> <p><i>AWGN absolute power uncertainty <math>\pm 3.0</math> dB not expected to have any significant effect</i></p>
9.3.1.1.2 TDD CQI Reporting under fading conditions – PUSCH 3-0	$\pm 0.6$ dB	Same as 9.3.1.1.1
9.3.1.2.1_D FDD CQI Reporting under fading conditions – PUSCH 3-1 for eDL-MIMO	$\pm 0.6$ dB	Same as 9.3.1.1.1
9.3.1.2.2_D TDD CQI Reporting under fading conditions – PUSCH 3-1 for eDL-MIMO	$\pm 0.6$ dB	Same as 9.3.1.1.1
9.3.1.3.1_E.1 FDD CQI Reporting under fading conditions - PUSCH 3-0 for feICIC (non-MBSFN ABS)	$N_{oc2}$ $N_{oc1} / N_{oc2}$ $N_{oc3} / N_{oc2}$ Cell 1 $E_s / N_{oc2}$ Cell 2 $E_s / N_{oc2}$ Cell 3 $E_s / N_{oc2}$  Fading profile power uncertainty $\pm 0.5$ dB	$N_{oc2}$ , $N_{oc}$ ratios and $E_s / N_{oc2}$ ratios are generic values as specified at end of this table
9.3.1.3.2_E.1 TDD CQI Reporting under fading conditions - PUSCH 3-0 for feICIC (non-MBSFN ABS)	$N_{oc2}$ $N_{oc1} / N_{oc2}$ $N_{oc3} / N_{oc2}$ Cell 1 $E_s / N_{oc2}$ Cell 2 $E_s / N_{oc2}$ Cell 3 $E_s / N_{oc2}$  Fading profile power uncertainty $\pm 0.5$ dB	$N_{oc2}$ , $N_{oc}$ ratios and $E_s / N_{oc2}$ ratios are generic values as specified at end of this table
9.3.2.1.1 FDD CQI Reporting under fading conditions – PUCCH 1-0	$\pm 0.6$ dB	<p>Overall system uncertainty for fading conditions comprises two quantities:</p> <ol style="list-style-type: none"> <li>1. Signal-to-noise ratio uncertainty <math>\pm 0.3</math> dB</li> <li>2. Fading profile power uncertainty <math>\pm 0.5</math> dB</li> </ol> <p>Items 1 and 2 are assumed to be uncorrelated so can be root sum squared:</p> <p>Test System uncertainty = <math>\text{SQRT}(\text{Signal-to-noise ratio uncertainty}^2 + \text{Fading profile power uncertainty}^2)</math></p> <p><i>AWGN flatness and signal flatness <math>\pm 2.0</math> dB not expected to have any significant effect</i></p> <p><i>AWGN absolute power uncertainty <math>\pm 3.0</math> dB not expected to have any significant effect</i></p>
9.3.2.1.1_1 FDD CQI Reporting under fading conditions – PUCCH 1-0	$\pm 0.6$ dB	Same as 9.3.2.1.1
9.3.2.1.2 TDD CQI Reporting under fading conditions – PUCCH 1-0	$\pm 0.6$ dB	Same as 9.3.2.1.1
9.3.2.1.2_1 TDD CQI Reporting under fading conditions – PUCCH 1-0	$\pm 0.6$ dB	Same as 9.3.2.1.1

9.3.2.2.1_D FDD CQI Reporting under fading conditions – PUCCH 1-1 for eDL-MIMO	$\pm 0.6$ dB	Same as 9.3.2.1.1
9.3.2.2.2_D TDD CQI Reporting under fading conditions – PUCCH 1-1 for eDL-MIMO	$\pm 0.6$ dB	Same as 9.3.2.1.1
9.3.3.1.1 FDD CQI Reporting under fading conditions and frequency-selective interference – PUSCH 3-0	$\pm 1.2$ dB	<p>Overall system uncertainty for fading conditions comprises two quantities:</p> <ol style="list-style-type: none"> <li>1. Ior/lot ratio uncertainty <math>\pm 1.0</math> dB</li> <li>2. Fading profile power uncertainty <math>\pm 0.5</math> dB</li> </ol> <p>Items 1 and 2 are assumed to be uncorrelated so can be root sum squared:</p> <p>Test System uncertainty = SQRT (Ior/lot ratio uncertainty<sup>2</sup> + Fading profile power uncertainty<sup>2</sup>)</p> <p><i>Ior absolute power uncertainty <math>\pm 3.0</math> dB not expected to have any significant effect</i></p>
9.3.3.1.2 TDD CQI Reporting under fading conditions and frequency-selective interference – PUSCH 3-0	$\pm 1.2$ dB	Same as 9.3.3.1.1
9.3.4.1.1 FDD CQI Reporting under fading conditions – PUSCH 2-0	$\pm 0.6$ dB	<p>Overall system uncertainty for fading conditions comprises two quantities:</p> <ol style="list-style-type: none"> <li>1. Signal-to-noise ratio uncertainty <math>\pm 0.3</math> dB</li> <li>2. Fading profile power uncertainty <math>\pm 0.5</math> dB</li> </ol> <p>Items 1 and 2 are assumed to be uncorrelated so can be root sum squared:</p> <p>Test System uncertainty = SQRT (Signal-to-noise ratio uncertainty<sup>2</sup> + Fading profile power uncertainty<sup>2</sup>)</p> <p><i>AWGN flatness and signal flatness <math>\pm 2.0</math> dB not expected to have any significant effect</i></p> <p><i>AWGN absolute power uncertainty <math>\pm 3.0</math> dB not expected to have any significant effect</i></p>
9.3.4.1.2 TDD CQI Reporting under fading conditions – PUSCH 2-0	$\pm 0.6$ dB	Same as 9.3.4.1.1
9.3.4.2.1 FDD CQI Reporting under fading conditions – PUCCH 2-0	$\pm 0.6$ dB	Same as 9.3.4.1.1
9.3.4.2.2 TDD CQI Reporting under fading conditions – PUCCH 2-0	$\pm 0.6$ dB	Same as 9.3.4.1.1
9.3.5.1.1 FDD CQI Reporting under fading conditions - PUCCH 1-0 - Enhanced Performance Requirement Type A	$\hat{E}s_1/N_{oc} \pm 0.6$ dB $\hat{E}s_2/N_{oc} \pm 0.3$ dB	<p>Overall system uncertainty for fading conditions on Cell 1 comprises two quantities:</p> <ol style="list-style-type: none"> <li>1. Signal-to-noise ratio uncertainty <math>\pm 0.3</math> dB</li> <li>2. Fading profile power uncertainty <math>\pm 0.5</math> dB for single Tx</li> </ol> <p>Items 1 and 2 are assumed to be uncorrelated so can be root sum squared:</p> <p>Test System uncertainty = SQRT (Signal-to-noise ratio uncertainty<sup>2</sup> + Fading profile power uncertainty<sup>2</sup>)</p> <p><i>AWGN flatness and signal flatness <math>\pm 2.0</math> dB not expected to have any significant effect</i></p> <p><i>AWGN absolute power uncertainty <math>\pm 3.0</math> dB not expected to have any significant effect</i></p>
9.3.5.1.2 TDD CQI Reporting under fading conditions - PUCCH 1-0 - Enhanced Performance Requirement Type A	Same as 9.3.5.1.1	Same as 9.3.5.1.1

9.3.5.2.1 FDD CQI Reporting under fading conditions - PUCCH 1-1 - Enhanced Performance Requirement Type A	$\hat{E}s_1/N_{oc} \pm 0.8$ dB $\hat{E}s_2/N_{oc} \pm 0.3$ dB	Overall system uncertainty for fading conditions on Cell 1 comprises two quantities: 1. Signal-to-noise ratio uncertainty $\pm 0.3$ dB 2. Fading profile power uncertainty $\pm 0.5$ dB for two Tx antennas.  Items 1 and 2 are assumed to be uncorrelated so can be root sum squared: Test System uncertainty = SQRT (Signal-to-noise ratio uncertainty <sup>2</sup> + Fading profile power uncertainty <sup>2</sup> )  <i>AWGN flatness and signal flatness <math>\pm 2.0</math> dB not expected to have any significant effect</i>  <i>AWGN absolute power uncertainty <math>\pm 3.0</math> dB not expected to have any significant effect</i>
9.3.5.2.2 TDD CQI Reporting under fading conditions - PUCCH 1-1 - Enhanced Performance Requirement Type A	Same as 9.3.5.2.1	Same as 9.3.5.2.1
9.3.6.1_F.1 FDD CQI Reporting under fading conditions Single CSI processes for CoMP	$\hat{E}s/N_{oc} \pm 0.8$ dB	Overall system uncertainty for fading conditions on TP1 and TP2 comprises two quantities: 1. Signal-to-noise ratio uncertainty $\pm 0.3$ dB 2. Fading profile power uncertainty $\pm 0.7$ dB for multiple Tx  Items 1 and 2 are assumed to be uncorrelated so can be root sum squared: Test System uncertainty = SQRT (Signal-to-noise ratio uncertainty <sup>2</sup> + Fading profile power uncertainty <sup>2</sup> )  <i>AWGN flatness and signal flatness <math>\pm 2.0</math> dB not expected to have any significant effect</i>  <i>AWGN absolute power uncertainty <math>\pm 3.0</math> dB not expected to have any significant effect</i>
9.3.6.1_F.2 FDD CQI Reporting under fading conditions Three CSI processes for CoMP	Same as 9.3.6.1_F.1	Same as 9.3.6.1_F.1
9.3.6.1_F.3 FDD CQI Reporting under fading conditions Four CSI processes for CoMP	Same as 9.3.6.1_F.1	Same as 9.3.6.1_F.1
9.3.6.2_F.1 TDD CQI Reporting under fading conditions Single CSI processes for CoMP	$\hat{E}s/N_{oc} \pm 0.8$ dB	Overall system uncertainty for fading conditions on TP1 and TP2 comprises two quantities: 1. Signal-to-noise ratio uncertainty $\pm 0.3$ dB 2. Fading profile power uncertainty $\pm 0.7$ dB for multiple Tx  Items 1 and 2 are assumed to be uncorrelated so can be root sum squared: Test System uncertainty = SQRT (Signal-to-noise ratio uncertainty <sup>2</sup> + Fading profile power uncertainty <sup>2</sup> )  <i>AWGN flatness and signal flatness <math>\pm 2.0</math> dB not expected to have any significant effect</i>  <i>AWGN absolute power uncertainty <math>\pm 3.0</math> dB not expected to have any significant effect</i>
9.3.6.2_F.2 TDD CQI Reporting under fading conditions Three CSI processes for CoMP	Same as 9.3.6.2_F.1	Same as 9.3.6.2_F.1
9.3.6.2_F.3 TDD CQI Reporting under fading conditions Four CSI processes for CoMP	Same as 9.3.6.2_F.1	Same as 9.3.6.2_F.1

9.4.1.1.1 FDD PMI Reporting – PUSCH 3-1 (Single PMI)	± 0.6 dB	<p>Overall system uncertainty for fading conditions comprises two quantities:</p> <ol style="list-style-type: none"> <li>1. Signal-to-noise ratio uncertainty ±0.3 dB</li> <li>2. Fading profile power uncertainty ±0.5 dB</li> </ol> <p>Items 1 and 2 are assumed to be uncorrelated so can be root sum squared:</p> <p>Test System uncertainty = SQRT (Signal-to-noise ratio uncertainty<sup>2</sup> + Fading profile power uncertainty<sup>2</sup>)</p> <p><i>AWGN flatness and signal flatness ±2.0 dB not expected to have any significant effect</i></p> <p><i>AWGN absolute power uncertainty ±3.0 dB not expected to have any significant effect</i></p>
9.4.1.1.2 TDD PMI Reporting – PUSCH 3-1 (Single PMI)	± 0.6 dB	Same as 9.4.1.1.1
9.4.1.2.1 FDD PMI Reporting – PUCCH 2-1 (Single PMI)	± 0.6 dB	<p>Overall system uncertainty for fading conditions comprises two quantities:</p> <ol style="list-style-type: none"> <li>1. Signal-to-noise ratio uncertainty ±0.3 dB</li> <li>2. Fading profile power uncertainty ±0.5 dB</li> </ol> <p>Items 1 and 2 are assumed to be uncorrelated so can be root sum squared:</p> <p>Test System uncertainty = SQRT (Signal-to-noise ratio uncertainty<sup>2</sup> + Fading profile power uncertainty<sup>2</sup>)</p> <p><i>AWGN flatness and signal flatness ±2.0 dB not expected to have any significant effect</i></p> <p><i>AWGN absolute power uncertainty ±3.0 dB not expected to have any significant effect</i></p>
9.4.1.2.2 TDD PMI Reporting – PUCCH 2-1 (Single PMI)	± 0.6 dB	Same as 9.4.1.2.1
9.4.1.3.1_D FDD Reporting of PMI – PUSCH 3-1 (Single PMI) for eDL-MIMO	± 0.6 dB	Same as 9.4.1.1.1
9.4.1.3.2_D TDD Reporting of PMI – PUSCH 3-1 (Single PMI) for eDL-MIMO	± 0.6 dB	Same as 9.4.1.1.1
9.4.2.1.1 FDD PMI Reporting – PUSCH 1-2 (Multiple PMI)	± 0.6 dB	<p>Overall system uncertainty for fading conditions comprises two quantities:</p> <ol style="list-style-type: none"> <li>1. Signal-to-noise ratio uncertainty ±0.3 dB</li> <li>2. Fading profile power uncertainty ±0.5 dB</li> </ol> <p>Items 1 and 2 are assumed to be uncorrelated so can be root sum squared:</p> <p>Test System uncertainty = SQRT (Signal-to-noise ratio uncertainty<sup>2</sup> + Fading profile power uncertainty<sup>2</sup>)</p> <p><i>AWGN flatness and signal flatness ±2.0 dB not expected to have any significant effect</i></p> <p><i>AWGN absolute power uncertainty ±3.0 dB not expected to have any significant effect</i></p>
9.4.2.1.1_1 FDD PMI Reporting – PUSCH 1-2 (Multiple PMI)	± 0.6 dB	Same as 9.4.2.1.1
9.4.2.1.2 TDD PMI Reporting – PUSCH 1-2 (Multiple PMI)	± 0.6 dB	Same as 9.4.2.1.1
9.4.2.1.2_1 TDD PMI Reporting – PUSCH 1-2 (Multiple PMI)	± 0.6 dB	Same as 9.4.2.1.1
9.4.2.2.1 FDD PMI Reporting – PUSCH 2-2 (Multiple PMI)	± 0.6 dB	Same as 9.4.2.1.1
9.4.2.2.2 TDD PMI Reporting – PUSCH 2-2 (Multiple PMI)	± 0.6 dB	Same as 9.4.2.1.1

9.4.2.3.1_D FDD PMI Reporting – PUSCH 1-2 (Multiple PMI) for eDL-MIMO	$\pm 0.6$ dB	Same as 9.4.2.1.1
9.4.2.3.2_D TDD PMI Reporting – PUSCH 1-2 (Multiple PMI) for eDL-MIMO	$\pm 0.6$ dB	Same as 9.4.2.1.1
9.5.1.1 FDD RI Reporting– PUCCH 1-1	$\pm 0.8$ dB	Overall system uncertainty for fading conditions comprises two quantities:  1. Signal-to-noise ratio uncertainty $\pm 0.3$ dB 2. Fading profile power uncertainty $\pm 0.7$ dB for MIMO  Items 1 and 2 are assumed to be uncorrelated so can be root sum squared:  Test System uncertainty = SQRT (Signal-to-noise ratio uncertainty <sup>2</sup> + Fading profile power uncertainty <sup>2</sup> )  <i>AWGN flatness and signal flatness <math>\pm 2.0</math> dB not expected to have any significant effect</i>  <i>AWGN absolute power uncertainty <math>\pm 3.0</math> dB not expected to have any significant effect</i>
9.5.1.1_1 FDD RI Reporting– PUCCH 1-1 (Release 10)	$\pm 0.8$ dB	Same as 9.5.1.1
9.5.1.1_2 FDD RI Reporting– PUCCH 1-1 (Release 11)	$\pm 0.8$ dB	Same as 9.5.1.1
9.5.1.2 TDD RI Reporting– PUSCH 3-1	$\pm 0.8$ dB	Same as 9.5.1.1
9.5.1.2_1 TDD RI Reporting– PUSCH 3-1 (Release 10)	$\pm 0.8$ dB	Same as 9.5.1.1
9.5.1.2_2 TDD RI Reporting– PUSCH 3-1 (Release 11)	$\pm 0.8$ dB	Same as 9.5.1.1
9.5.2.1_D FDD RI Reporting – PUCCH 1-1 for eDL-MIMO	$\pm 0.8$ dB	Same as 9.5.1.1
9.5.2.2_D TDD RI Reporting – PUCCH 1-1 for eDL-MIMO	$\pm 0.8$ dB	Same as 9.5.1.1
9.5.3.1_C.1 FDD RI Reporting – PUCCH 1-0 for eICIC (non-MBSFN ABS)	$N_{oc2}$ $N_{oc1} / N_{oc2}$ $N_{oc3} / N_{oc2}$ Cell 1 $E_s / N_{oc2}$ Cell 2 $E_s / N_{oc2}$  Fading profile power uncertainty $\pm 0.7$ dB for MIMO	$N_{oc2}$ , $N_{oc}$ ratios and $E_s / N_{oc2}$ ratios are generic values as specified at end of this table
9.5.3.2_C.1 TDD RI Reporting – PUCCH 1-0 for eICIC (non-MBSFN ABS)	$N_{oc2}$ $N_{oc1} / N_{oc2}$ $N_{oc3} / N_{oc2}$ Cell 1 $E_s / N_{oc2}$ Cell 2 $E_s / N_{oc2}$  Fading profile power uncertainty $\pm 0.7$ dB for MIMO	$N_{oc2}$ , $N_{oc}$ ratios and $E_s / N_{oc2}$ ratios are generic values as specified at end of this table
9.5.4.1_E.1 FDD RI Reporting - PUCCH 1-0 for feICIC (non-MBSFN ABS)	$N_{oc2}$ $N_{oc1} / N_{oc2}$ $N_{oc3} / N_{oc2}$ Cell 1 $E_s / N_{oc2}$ Cell 2 $E_s / N_{oc2}$ Cell 3 $E_s / N_{oc2}$  Fading profile power uncertainty $\pm 0.7$ dB for MIMO	$N_{oc2}$ , $N_{oc}$ ratios and $E_s / N_{oc2}$ ratios are generic values as specified at end of this table



9.5.4.2_E.1 TDD RI Reporting - PUCCH 1-0 for feICIC (non-MBSFN ABS)	$N_{oc2}$ $N_{oc1} / N_{oc2}$ $N_{oc3} / N_{oc2}$ Cell 1 $E_s / N_{oc2}$ Cell 2 $E_s / N_{oc2}$ Cell 3 $E_s / N_{oc2}$  Fading profile power uncertainty $\pm 0.7$ dB for MIMO	$N_{oc2}$ , $N_{oc}$ ratios and $E_s / N_{oc2}$ ratios are generic values as specified at end of this table
9.5.5.1_F.1 FDD RI Reporting with Single CSI process for CoMP	$\pm 0.8$ dB for each TP	Overall system uncertainty for fading conditions comprises two quantities: 1. Signal-to-noise ratio uncertainty $\pm 0.3$ dB 2. Fading profile power uncertainty $\pm 0.7$ dB for MIMO  Items 1 and 2 are assumed to be uncorrelated so can be root sum squared:  Test System uncertainty = SQRT (Signal-to-noise ratio uncertainty <sup>2</sup> + Fading profile power uncertainty <sup>2</sup> )  <i>AWGN flatness and signal flatness <math>\pm 2.0</math> dB not expected to have any significant effect</i>  <i>AWGN absolute power uncertainty <math>\pm 3.0</math> dB not expected to have any significant effect</i>
9.5.5.1_F.2 FDD RI Reporting with Multiple CSI processes for CoMP	$\pm 0.8$ dB for each TP	Overall system uncertainty for fading conditions comprises two quantities: 1. Signal-to-noise ratio uncertainty $\pm 0.3$ dB 2. Fading profile power uncertainty $\pm 0.7$ dB for MIMO  Items 1 and 2 are assumed to be uncorrelated so can be root sum squared:  Test System uncertainty = SQRT (Signal-to-noise ratio uncertainty <sup>2</sup> + Fading profile power uncertainty <sup>2</sup> )  <i>AWGN flatness and signal flatness <math>\pm 2.0</math> dB not expected to have any significant effect</i>  <i>AWGN absolute power uncertainty <math>\pm 3.0</math> dB not expected to have any significant effect</i>
9.5.5.2_F.1 TDD RI Reporting with Single CSI process for CoMP	$\pm 0.8$ dB for each TP	Same as 9.5.5.1_F.1
9.5.5.2_F.2 TDD RI Reporting with Multiple CSI processes for CoMP	$\pm 0.8$ dB for each TP	Same as 9.5.5.1_F.2
9.6.1.1_A.1 FDD CQI Reporting under AWGN conditions – PUCCH 1-0 for CA (2DL CA)	$\pm 0.3$ dB for each CC	Signal-to-noise ratio uncertainty $\pm 0.3$ dB  <i>AWGN flatness and signal flatness <math>\pm 2.0</math> dB not expected to have any significant effect</i>  <i>AWGN absolute power uncertainty <math>\pm 3.0</math> dB not expected to have any significant effect</i>
9.6.1.1_A.2 FDD CQI Reporting under AWGN conditions – PUCCH 1-0 (3DL CA)	Same as 9.6.1.1_A.1	Same as 9.6.1.1_A.1
9.6.1.2_A.1 TDD CQI Reporting under AWGN conditions – PUCCH 1-0 for 2DL CA	Same as 9.6.1.1_A.1	Same as 9.6.1.1_A.1
9.6.1.2_A.2 TDD CQI Reporting under AWGN conditions – PUCCH 1-0 (3DL CA)	Same as 9.6.1.1_A.1	Same as 9.6.1.1_A.1
In addition, the following Test System uncertainties and related constraints apply:		
AWGN Bandwidth		$\geq 1.08$ MHz, 2.7MHz, 4.5MHz, 9MHz, 13.5MHz, 18MHz; $N_{RB} \times 180$ kHz according to $BW_{Config}$

AWGN absolute power uncertainty, averaged over $BW_{Config}$ <sup>Note 4</sup>	±3 dB
AWGN flatness and signal flatness, max deviation for any Resource Block, relative to average over $BW_{Config}$	±2 dB
AWGN peak to average ratio	≥10 dB @0.001%
Signal-to noise ratio uncertainty, averaged over downlink transmission Bandwidth	±0.3 dB (includes uncertainty in precoding applied by the test system, where applicable)
Signal-to noise ratio variation for any resource block, relative to average over downlink transmission Bandwidth	±0.5 dB
$N_{oc2}$ absolute power uncertainty, averaged over $BW_{Config}$ <sup>Note 5</sup>	±3 dB
$N_{oc1} / N_{oc2}$ ratio uncertainty, averaged over $BW_{Config}$ <sup>Note 5</sup>	±0.3 dB
$N_{oc3} / N_{oc2}$ ratio uncertainty, averaged over $BW_{Config}$ <sup>Note 5</sup>	±0.3 dB
$E_s / N_{oc2}$ ratio (SNR) uncertainty, averaged over downlink transmission Bandwidth <sup>Note 5</sup>	±0.3 dB (includes uncertainty in precoding applied by the test system, where applicable)
Fading profile power uncertainty	Test-specific
Fading profile delay uncertainty, relative to frame timing	±5 ns (excludes absolute errors related to baseband timing)
Downlink channel matrix uncertainties:	
Tx phase error, as shown in Figure F.1.5-1	$\Theta_{Tx} = \begin{bmatrix} e^{j\theta_1} & 0 & \dots & 0 \\ 0 & e^{j\theta_2} & \ddots & 0 \\ \vdots & \ddots & \ddots & \vdots \\ 0 & 0 & \dots & e^{j\theta_{N_{Tx}}} \end{bmatrix}$ <p><math>\theta_n</math> is defined for each Tx antenna up to <math>N_{Tx}</math>  <math>\theta_n \in (-\theta_{MAX}, \theta_{MAX})</math>  <math>\theta_{MAX} \leq 10^\circ</math>  <math>\theta_n</math> is constant for the duration of the test</p>
Rx phase error, as shown in Figure F.1.5-1	$\Theta_{Rx} = \begin{bmatrix} e^{j\theta_1} & 0 & \dots & 0 \\ 0 & e^{j\theta_2} & \ddots & 0 \\ \vdots & \ddots & \ddots & \vdots \\ 0 & 0 & \dots & e^{j\theta_{N_{Rx}}} \end{bmatrix}$ <p><math>\theta_n</math> is defined for each Rx antenna up to <math>N_{Rx}</math>  There is no constraint on the value of <math>\theta_n</math> except that it is constant for the duration of the test</p>
Note 1:	Only the overall stimulus error is considered. The effect of errors in the throughput measurements due to finite test duration is not considered.
Note 2:	The AWGN parameters apply to all test cases except 9.3.3.1.1 and 9.3.3.1.2. The fading parameters apply to test cases using fading
Note 3:	Downlink channel matrix uncertainties apply to eDL-MIMO CSI test cases
Note 4:	Applies for test cases which specify $N_{oc}$ , a single value that remains constant with time.
Note 5:	Applies for test cases which specify $N_{oc1}$ , $N_{oc2}$ and $N_{oc3}$ , that are symbol or subframe specific.

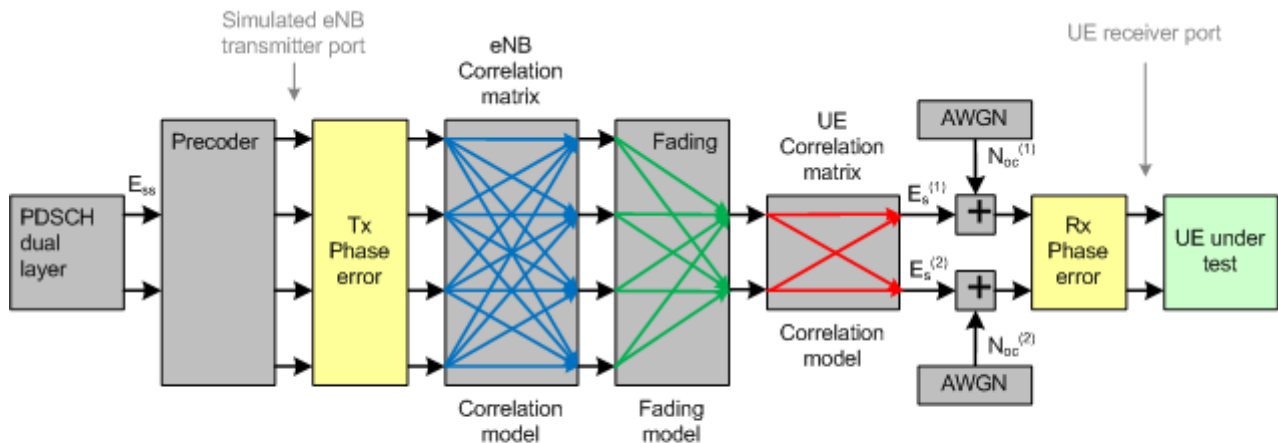

Example for dual layer PDSCH, 4Tx antennas x 2Rx antennas, fading propagation, with correlation and AWGN

Figure F.1.5-1: Location of Tx Phase error and Rx Phase error for eDL-MIMO (Informative)

## F.2 Interpretation of measurement results (normative)

The measurement results returned by the Test System are compared – without any modification – against the Test Requirements as defined by the shared risk principle.

The Shared Risk principle is defined in ETR 273-1-2 clause 6.5.

The actual measurement uncertainty of the Test System for the measurement of each parameter shall be included in the test report.

The recorded value for the Test System uncertainty shall be, for each measurement, equal to or lower than the appropriate figure in clause F.1 of the present document.

If the Test System for a test is known to have a measurement uncertainty greater than that specified in clause F.1, it is still permitted to use this apparatus provided that an adjustment is made value as follows:

Any additional uncertainty in the Test System over and above that specified in clause F.1 shall be used to tighten the Test Requirement, making the test harder to pass. For some tests, for example receiver tests, this may require modification of stimulus signals. This procedure will ensure that a Test System not compliant with clause F.1 does not increase the chance of passing a device under test where that device would otherwise have failed the test if a Test System compliant with clause F.1 had been used.

## F.3 Test Tolerance and Derivation of Test Requirements (informative)

The Test Requirements in the present document have been calculated by relaxing the Minimum Requirements of the core specification using the Test Tolerances defined in this clause. When the Test Tolerance is zero, the Test Requirement will be the same as the Minimum Requirement. When the Test Tolerance is non-zero, the Test Requirements will differ from the Minimum Requirements, and the formula used for the relaxation is given in this clause.

The Test Tolerances are derived from Test System uncertainties, regulatory requirements and criticality to system performance. As a result, the Test Tolerances may sometimes be set to zero.

The test tolerances should not be modified for any reason e.g. to take account of commonly known test system errors (such as mismatch, cable loss, etc.).

The downlink Test Tolerances apply at each receiver antenna connector.

### F.3.1 Measurement of test environments

The UE test environments are set to the values defined in TS 36.508 subclause 4.1, without any relaxation. The applied Test Tolerance is therefore zero.

## F.3.2 Measurement of transmitter

Table F.3.2-1: Derivation of Test Requirements (Transmitter tests)

Test	Minimum Requirement in TS 36.101	Test Tolerance (TT)	Test Requirement in TS 36.521-1
6.2.2 UE Maximum Output Power	$f \leq 3.0\text{GHz}$ Power class 1: [FFS] Power class 2: [FFS] Power class 3: 23dBm $\pm 2$ dB Power class 4: [FFS]  $3.0\text{GHz} < f \leq 4.2\text{GHz}$ Power class 3: 23dBm +2/-3 dB	0.7 dB 0.7 dB 0.7 dB 0.7 dB  1.0 dB	Formula: Upper limit + TT, Lower limit - TT  Power class 1: [FFS] Power class 2: [FFS] Power class 3: 23dBm $\pm 2.7$ dB Power class 4: [FFS]  Power class 3: 23dBm +3.0/-4.0 dB
6.2.2_1 UE Maximum Output Power for HPUE	$f \leq 3.0\text{GHz}$ Power class 1: 31dBm +2/-3dB	0.7dB	Formula: Upper limit + TT, Lower limit - TT  Power class 1: 31dBm +2.7/-3.7dB
6.2.2A.1 UE Maximum Output Power for CA (intra-band contiguous DL CA and UL CA)	Same as 6.2.2	Same as 6.2.2	Same as 6.2.2
6.2.2A.2 UE Maximum Output Power for CA (inter-band DL CA and UL CA)	Same as 6.2.2	Same as 6.2.2	Same as 6.2.2
6.2.2B UE Maximum Output Power for UL-MIMO	$f \leq 3.0\text{GHz}$ Power class 1: [FFS] Power class 2: [FFS] Power class 3: 23dBm +2/-3 dB Power class 4: [FFS]  $3.0\text{GHz} < f \leq 4.2\text{GHz}$ Power class 3: 23dBm +2/-4 dB	Same as 6.2.2	Formula: Upper limit +TT, Lower limit - TT  Power class 1: [FFS] Power class 2: [FFS] Power class 3: 23dBm +2.7/-3.7 dB Power class 4: [FFS]  Power class 3: 23dBm +3.0/-5.0 dB  Uplink power measurement applies to overall UL power, which is the linear sum of the output powers over all Tx antenna connectors
6.2.2E UE Maximum Output Power UE category 0	Same as 6.2.2	Same as 6.2.2	Same as 6.2.2
6.2.3 Maximum Power Reduction	Power class 3  $f \leq 3.0\text{GHz}$ QPSK: MPR $\leq 1$ dB 16QAM: MPR $\leq 1$ dB 16QAM: MPR $\leq 2$ dB  $3.0\text{GHz} < f \leq 4.2\text{GHz}$ QPSK: MPR $\leq 1$ dB 16QAM: MPR $\leq 1$ dB 16QAM: MPR $\leq 2$ dB	0.7 dB 0.7 dB 0.7 dB  1.0 dB 1.0 dB 1.0 dB	Formula: Upper limit + TT, Lower limit – MPR – TT Power class 3:  QPSK: 23dBm +2.7 / - 3.7dB 16QAM: 23dBm +2.7 / - 3.7dB 16QAM: 23dBm +2.7 / - 4.7dB  QPSK: 23dBm +3.0 / - 5.0dB 16QAM: 23dBm +3.0 / - 5.0dB 16QAM: 23dBm +3.0 / - 6.0dB
6.2.3_1 Maximum Power Reduction for HPUE	Power class 1  $f \leq 3.0\text{GHz}$ QPSK: MPR $\leq 1$ dB 16QAM: MPR $\leq 1$ dB 16QAM: MPR $\leq 2$ dB	0.7 dB 0.7 dB 0.7 dB	Formula: Upper limit + TT, Lower limit – MPR – TT Power class 1: QPSK: 31dBm +2.7 / - 4.7dB 16QAM: 31dBm +2.7 / - 4.7dB 16QAM: 31dBm +2.7 / - 5.7dB
6.2.3_2 UE Maximum	Same as 6.2.2	Same as	Same as 6.2.2

Output Power for Multi-Cluster PUSCH		6.2.2	
6.2.3A.1 Maximum Power Reduction (MPR) for CA (intra-band contiguous DL CA and UL CA)	<p>Power class 3</p> <p><math>f \leq 3.0\text{GHz}</math>  MPR = 0dB  MPR = 1dB  MPR = 2dB  MPR = 3dB  MPR = 8.5dB</p> <p><math>3.0\text{GHz} &lt; f \leq 4.2\text{GHz}</math>  MPR = 0dB  MPR = 1dB  MPR = 2dB  MPR = 3dB  MPR = 8.5dB</p>	<p>0.7 dB  0.7 dB  0.7 dB  0.7 dB  0.7 dB</p> <p>1.0 dB  1.0 dB  1.0 dB  1.0 dB  1.0 dB</p>	<p>Formula:  Upper limit: <math>+T(P_{\text{CMAX}_H}) + TT</math>,  Lower limit: <math>-T(P_{\text{CMAX}_L}) - \text{MPR} - TT</math>  <math>P_{\text{CMAX}_H} = P_{\text{PowerClass}}</math>  <math>P_{\text{CMAX}_L} = P_{\text{PowerClass}} - \text{MPR}</math>  Power class 3:  23dBm +2.7 / - 2.7dB  23dBm +2.7 / - 3.7dB  23dBm +2.7 / - 4.7dB  23dBm +2.7 / - 6.2dB  23dBm +2.7 / - 14.2dB</p> <p>23dBm +3.0 / - 4.0dB (+2/-3 limit for B42)  23dBm +3.0 / - 4.0dB  23dBm +3.0 / - 5.0dB  23dBm +3.0 / - 6.5dB  23dBm +3.0 / - 14.5dB</p>
6.2.3A.2 Maximum Power Reduction (MPR) for CA (inter-band DL CA and UL CA)	<p>Power class 3</p> <p><math>f \leq 3.0\text{GHz}</math>  MPR = 0dB  MPR = 1dB  MPR = 2dB</p>	<p>0.7 dB  0.7 dB  0.7 dB</p>	<p>Formula:  Upper limit: <math>+T(P_{\text{CMAX}_H}) + TT</math>,  Lower limit: <math>-T(P_{\text{CMAX}_L}) - \text{MPR} - TT</math>  <math>P_{\text{CMAX}_H} = P_{\text{PowerClass}}</math>  <math>P_{\text{CMAX}_L} = \text{MIN}(\text{linear sum of } P_{\text{PowerClass}} - \text{MPR}_c - \Delta T_{C,c}, 23 \text{ dBm})</math>  Power class 3:  23dBm +2.7 / - 3.7 dB  23dBm +2.7 / - 3.7 dB  23dBm +2.7 / - 3.7 dB</p>
6.2.3A.3 Maximum Power Reduction (MPR) for CA (intra-band non-contiguous DL CA and UL CA)	<p>Power class 3</p> <p><math>f \leq 3.0\text{GHz}</math>  MPR = 7 dB  MPR = 12 dB  MPR = 18 dB</p>	<p>0.7 dB  0.7 dB  0.7 dB</p>	<p>Formula:  Upper limit: <math>+T(P_{\text{CMAX}_H}) + TT</math>,  Lower limit: <math>-T(P_{\text{CMAX}_L}) - \text{MPR} - TT</math>  <math>P_{\text{CMAX}_H} = P_{\text{PowerClass}}</math>  <math>P_{\text{CMAX}_L} = P_{\text{PowerClass}} - \text{MPR} - \Delta T_C</math> (dBm)  Power class 3:  23dBm +2.7 / - 12.7 dB  23dBm +2.7 / - 18.7 dB  23dBm +2.7 / - 25.7 dB</p>
6.2.3B Maximum Power Reduction (MPR) for UL-MIMO	Same as 6.2.3	Same as 6.2.3	<p>Same as 6.2.3</p> <p>Uplink power measurement applies to overall UL power, which is the linear sum of the output powers over all Tx antenna connectors</p>
6.2.4 UE Maximum Output Power with additional requirements	<p>For the UE maximum output power modified by MPR and A-MPR, the power limits specified in TS 36.101 [2] clause 6.2.5 apply.</p> <p>For transmission bandwidths (Figure 5.4.2-1) confined within <math>FUL_{\text{low}}</math> and <math>FUL_{\text{low}} + 4 \text{ MHz}</math> or <math>FUL_{\text{high}} - 4 \text{ MHz}</math> and <math>FUL_{\text{high}}</math>, the power requirement is relaxed by reducing the lower tolerance limit by 1.5 dB.</p>	0.7 dB	<p>Formula:  Upper limit + TT,  A: Lower limit - TT,  B: (UE Maximum Output Power from 6.2.2) - <math>T(P_{\text{CMAX}}) - \text{MPR} - TT</math>,  C: (UE Maximum Output Power from 6.2.2) - <math>T(P_{\text{CMAX}}) - A - \text{MPR} - TT</math>,  D: (UE Maximum Output Power from 6.2.2) - <math>T(P_{\text{CMAX}}) - A - \text{MPR} - \text{MPR} - TT</math></p>

	<p>Power class 3:</p> <p>QPSK: <math>MPR \leq 1\text{dB}</math></p> <p>16QAM: Depending on the number RB allocated:          16QAM: <math>MPR \leq 1\text{dB}</math>          16QAM: <math>MPR \leq 2\text{dB}</math></p> <p>For network signalled value NS_03 , NS_04 (5MHz only), NS_05, to NS_06: A-MPR <math>\leq 1\text{dB}</math></p> <p>For network signalled value NS-04; Depending on the RB_start and RB allocation (10MHz, 15MHz and 20MHz):</p> <p>For 10MHz          Region A with RB_start=0 – 12: A-MPR <math>\leq 3\text{dB}</math>.</p> <p>Region B with RB_start=13 – 36 : A-MPR <math>\leq 2\text{dB}</math>.</p> <p>Region C with RB_start=37 – 49 : A-MPR <math>\leq 3\text{dB}</math>.</p> <p>For 15MHz</p> <p>Region A with RB_start=0 – 18: A-MPR <math>\leq 3\text{dB}</math>.</p> <p>Region B with RB_start=19 – 55 : A-MPR <math>\leq 2\text{dB}</math>.</p> <p>Region C with RB_start=56 – 74 : A-MPR <math>\leq 3\text{dB}</math>.</p> <p>For 20MHz</p> <p>Region A with RB_start=0 – 24: A-MPR <math>\leq 3\text{dB}</math>.</p> <p>Region B with RB_start=25 – 74 : A-MPR <math>\leq 2\text{dB}</math>.</p> <p>Region C with RB_start=75 – 99 : A-MPR <math>\leq 3\text{dB}</math>.</p> <p>For network signalled value NS-11; Depending on the RB_start and RB allocation (15MHz and 20MHz):</p> <p>For 15MHz <math>F_c &lt; 2012.5</math>          Region A with RB_start=0 – 4: A-MPR <math>\leq 15\text{dB}</math>.</p> <p>Region B with RB_start=5 – 21: A-MPR <math>\leq 7\text{dB}</math> (<math>L_{CRB}=7-50</math>) or <math>\leq 10\text{dB}</math> (<math>L_{CRB}=0-6</math> &amp; <math>\geq 50</math>).</p> <p>Region C with RB_start=22 – 56: A-MPR <math>\leq 0\text{dB}</math> (<math>L_{CRB}=\leq 25</math>) or <math>\leq</math></p>	<p>Power class 3:</p> <p>Test Requirement Configuration ID versus Formula Above</p> <p>Network signalled value NS_03:</p> <p>[A]:2, 5, 10, 15, 20, 25          [B]:1, 3, 7          [C]:9, 14, 19, 24          [D]:4, 6, 8, 11, 12, 13, 16, 17, 18, 21, 22, 23, 26, 27</p> <p>Network signalled value NS_04 (5, 10, 15, 20MHz):</p> <p>[A] 3          [B] 10, 11, 19, 20, 28, 29          [C] 2, 6, 7, 13, 14, 15, 16, 23, 24, 25, 32          [D] 1, 4, 5, 8, 9, 12, 17, 18, 21, 22, 26, 27, 30, 31</p> <p>Network signalled value NS_05:</p> <p>[A] 1, 3, 4, 8, 9, 14, 15,          [B] 2, 5, 10, 11, 16, 17          [C] None          [D] 6, 7, 12, 13, 18, 19</p> <p>Network signalled value NS_06:</p> <p>[A]:2, 5, 8, 11, 14, 17          [B]:1, 3, 4, 6, 7, 9, 10, 12, 13, 15, 16, 18          [C]:None          [D]:None</p> <p>Network signalled value NS_07:</p> <p>[A]:3, 8, 12          [B]:7, 9          [C]:1, 2, 5, 13, 15          [D]:4, 6, 10, 11, 14, 16</p> <p>Network signalled value NS_08:</p> <p>[A]:1, 2, 4, 5, 12          [B]:3, 6, 11, 13          [C]:None          [D]:7, 8, 9, 10, 14, 15, 16, 17</p> <p>Network signalled value NS_11:</p> <p>[A]: 5c, 6b, 10c, 11c, 25          [B]:8b, 12c, 13c, 14c, 17a, 17b, 21a, 21b, 28          [C]:5a, 5b, 6a, 6c, 10a, 10b, 11, 11b, 15a, 15b, 16a, 16b, 24          [D]: 1a, 1b, 2a, 2b, 3a, 3b, 4a, 4b ,, 7a,7b,7c, 8a, 8c, 9a, 9b,9c, 12a, 12b, 13a, 13b, 14a, 14b, 18a, 18b, 19a, 19b, 20a, 20b, 22a, 22b, 23a, 23b, 26, 27, 29, 30</p>
--	------------------------------------------------------------------------------------------------------------------------------------------------------------------------------------------------------------------------------------------------------------------------------------------------------------------------------------------------------------------------------------------------------------------------------------------------------------------------------------------------------------------------------------------------------------------------------------------------------------------------------------------------------------------------------------------------------------------------------------------------------------------------------------------------------------------------------------------------------------------------------------------------------------------------------------------------------------------------------------------------------------------------------------------------------------------------------------------------------------------------------------------------------------------------------------------------------------------------------------------------------------------------------------------------------------------------------------------------------------------------------------------------------------------------------------------------------------------------------------------------------------------------------------------------------------------------------------------------------------------------------------------------------------------------------------------------------------------------------------------------------------------------------------------------------	------------------------------------------------------------------------------------------------------------------------------------------------------------------------------------------------------------------------------------------------------------------------------------------------------------------------------------------------------------------------------------------------------------------------------------------------------------------------------------------------------------------------------------------------------------------------------------------------------------------------------------------------------------------------------------------------------------------------------------------------------------------------------------------------------------------------------------------------------------------------------------------------------------------------------------------------------------------------------------------------------------------------------------------------------------------------------------------------------------------------------------------------------------------------------------------------------------------------------------------------------------------------------------------------------------------------------------------------------------------------------------------------------------------------------------------------------------------------------------------------------------------------------------------------------------------------------------------------------------

	<p>6dB (<math>L_{CRB} &gt; 25</math>).</p> <p>Region D with RB_start=57 – 74: A-MPR <math>\leq 15</math>dB.</p> <p>For 15MHz <math>F_c = 2012.5</math> Region A with RB_start=0 – 12: A-MPR <math>\leq 10</math>dB.</p> <p>Region B with RB_start=13 – 39: A-MPR <math>\leq 6</math>dB (<math>L_{CRB} \geq 30</math>) or <math>\leq 0</math>dB (<math>L_{CRB} &lt; 30</math>).</p> <p>Region C with RB_start=40 – 65: A-MPR <math>\leq 2</math>dB.</p> <p>Region D with RB_start=66 – 74: A-MPR <math>\leq 6.5</math>dB.</p> <p>For 20MHz Region A with RB_start=0 – 12: A-MPR <math>\leq 15</math>dB.</p> <p>Region B with RB_start=13 – 29: A-MPR <math>\leq 7</math>dB (<math>L_{CRB} = 10-60</math>) or <math>\leq 10</math>dB (<math>L_{CRB} = 1-9</math> &amp; <math>&gt; 60</math>).</p> <p>Region C with RB_start=30 – 68: A-MPR <math>\leq 0</math>dB (<math>L_{CRB} = 1-24</math>) or <math>\leq 7</math>dB (<math>L_{CRB} \geq 25</math>).</p> <p>Region D with RB_start=69 – 99: A-MPR <math>\leq 15</math>dB.</p> <p>For network signalled value NS-20; Depending on the RB_start and RB allocation (5MHz, 10MHz, 15MHz and 20MHz):</p> <p>For 5MHz Region A with RB_start=<math>\leq 24</math>: A-MPR <math>\leq 17</math>dB.</p> <p>Region B with RB_start=0 – 3: A-MPR <math>\leq 1</math>dB (<math>L_{CRB} = 15-19</math>) or <math>\leq 4</math>dB (<math>L_{CRB} \geq 20</math>).</p> <p>Region C with RB_start=4 – 6: A-MPR <math>\leq 2</math>dB.</p> <p>Region D with RB_start=<math>\leq 24</math>: A-MPR <math>\leq 0</math>dB.</p> <p>For 10MHz <math>F_c = 2005</math> Region A with RB_start=0 – 25: A-MPR <math>\leq 16</math>dB.</p> <p>Region B with RB_start=26 – 34: A-MPR <math>\leq 2</math>dB (<math>L_{CRB} = 8-15</math>) or <math>\leq 5</math>dB (<math>L_{CRB} &gt; 15</math>).</p> <p>Region C with RB_start=35 – 49: A-MPR <math>\leq 6</math>dB.</p> <p>For 10MHz <math>F_c = 2015</math> Region A with RB_start=0 – 5: A-MPR <math>\leq 4</math>dB.</p>	<p>Network signalled value NS_12:</p> <p>[A]: 3, 8, 13 [B]: None [C]: 1, 4, 6, 11 [D]: 2, 5, 7, 9, 10, 12, 14, 15</p> <p>Network signalled value NS_13:</p> <p>[A]: None [B]: 3, 4 [C]: 1 [D]: 2, 5</p> <p>Network signalled value NS_14:</p> <p>[A]: None [B]: 2, 4, 7, 9 [C]: 1, 6 [D]: 3, 5, 8, 10</p> <p>Network signalled value NS_15:</p> <p>[A]: 1, 7, 14 [B]: 3, 6, 10, 15, 19, 21, 22, 25 [C]: 12, 13 [D]: 2, 4, 5, 8, 9, 11, 16, 17, 18, 20, 23, 24, 26</p> <p>Network signalled value NS_20:</p> <p>[A]: 1b, 1c, 1d, 6b, 7b [B]: 2d, 3d, 4d, 5d, 9b [C]: 1a, 6a, 7a, 11, 18, 19 [D]: 2a, 2b, 2c, 3a, 3b, 3c, 4a, 4b, 4c, 5a, 5b, 5c, 8a, 8b, 9a, 10a, 11b, 12, 13, 14, 15, 16, 17, 20, 21, 22, 23, 24, 25, 26</p>
--	-----------------------------------------------------------------------------------------------------------------------------------------------------------------------------------------------------------------------------------------------------------------------------------------------------------------------------------------------------------------------------------------------------------------------------------------------------------------------------------------------------------------------------------------------------------------------------------------------------------------------------------------------------------------------------------------------------------------------------------------------------------------------------------------------------------------------------------------------------------------------------------------------------------------------------------------------------------------------------------------------------------------------------------------------------------------------------------------------------------------------------------------------------------------------------------------------------------------------------------------------------------------------------------------------------------------------------------------------------------------------------------------------------------------------------------------------------------------------------------------------------------------------------------------------------------------------------------------------------------------------------------------------------------------------------------------------------------------------------------------------------------------------------------------------------------------------------------------------------------------------------------------------------------------------------------------------------------------------------------------------------------------------------------------------------------------------------	------------------------------------------------------------------------------------------------------------------------------------------------------------------------------------------------------------------------------------------------------------------------------------------------------------------------------------------------------------------------------------------------------------------------------------------------------------------------------------------------------------------------------------------------------------------------------------------------------------------------------------------------------------------------------------------------------------------------------------------------------------------------------------------



	<p>Region B with RB_start=6 – 10: A-MPR ≤ 2dB.</p> <p>For 15MHz Region A with RB_start=0 – 14: A-MPR ≤ 11dB (L<sub>CRB</sub>=1-9 &amp; 40-5) or ≤ 6dB (L<sub>CRB</sub>= 10-39).</p> <p>Region B with RB_start=15 – 24: A-MPR ≤ 1dB (L<sub>CRB</sub>=24-29) or ≤ 7dB (L<sub>CRB</sub>≥30).</p> <p>Region C with RB_start=25 – 39: A-MPR ≤ 5dB.</p> <p>Region D with RB_start=61 – 74: A-MPR ≤ 6dB.</p> <p>For 20MHz Region A with RB_start=0 – 21: A-MPR ≤ 17dB.</p> <p>Region B with RB_start=22 – 31: A-MPR ≤ 12dB (L<sub>CRB</sub>=1-9 &amp; 31-75) or ≤ 6dB (L<sub>CRB</sub>=10-30).</p> <p>Region C with RB_start=32 – 38: A-MPR ≤ 9dB.</p> <p>Region D with RB_start=39 – 49: A-MPR ≤ 7dB.</p> <p>Region E with RB_start=50 – 69: A-MPR ≤ 5dB.</p> <p>Region F with RB_start=70 – 99: A-MPR ≤ 16dB.</p>		
<p>6.2.4_1 Additional Maximum Power Reduction (A-MPR) for HPUE</p>	<p>For the UE maximum output power modified by MPR and A-MPR, the power limits specified in TS 36.101 [2] clause 6.2.5 apply.</p> <p>For transmission bandwidths (Figure 5.4.2-1) confined within FUL<sub>low</sub> and FUL<sub>low</sub> + 4 MHz or FUL<sub>high</sub> – 4 MHz and FUL<sub>high</sub>, the power requirement is relaxed by reducing the lower tolerance limit by 1.5 dB.</p> <p>Power class 1:</p> <p>QPSK: MPR ≤ 1dB</p> <p>16QAM: Depending on the number RB allocated: 16QAM: MPR ≤ 1dB 16QAM: MPR ≤ 2dB Power class 1: For network signalled value NS_06: A-MPR 0dB</p>	<p>0.7dB</p>	<p>Formula: Upper limit + TT, (UE Maximum Output Power from 6.2.2) - T(P<sub>CMAX</sub>) - A-MPR - MPR - TT</p>
<p>6.2.4A.1 Additional</p>	<p>Power class 3:</p>	<p>Same as</p>	<p>Formula:</p>

Maximum Power Reduction (A-MPR) for CA (intra-band contiguous DL CA and UL CA)	For network signalled value CA_NS_01: [TBD]  For network signalled value CA_NS_02: [TBD]  For network signalled value CA_NS_03: [TBD]	6.2.4	Upper limit: $+T(P_{\text{CMAX}_H}) + TT$ , Lower limit: $-T(P_{\text{CMAX}_L}) - A\text{-MPR} - TT$ $P_{\text{CMAX}_H} = P_{\text{PowerClass}}$ $P_{\text{CMAX}_L} = P_{\text{PowerClass}} - A\text{-MPR}$
6.2.4B Additional Maximum Power Reduction (A-MPR) for UL-MIMO	Same as 6.2.4	Same as 6.2.4	Same as 6.2.4  Uplink power measurement applies to overall UL power, which is the linear sum of the output powers over all Tx antenna connectors
6.2.5 Configured UE transmitted Output Power	$f \leq 3.0\text{GHz}$ $13 \leq \text{PCMAX} < 18 \pm 5.0$ $8 \leq \text{PCMAX} < 13 \pm 6.0$ $-40 \leq \text{PCMAX} < 8 \pm 7.0$  $3.0\text{GHz} < f \leq 4.2\text{GHz}$ $13 \leq \text{PCMAX} < 18 \pm 5.0$ $8 \leq \text{PCMAX} < 13 \pm 6.0$ $-40 \leq \text{PCMAX} < 8 \pm 7.0$	0.7 dB 0.7 dB 0.7 dB  1.0 dB 1.0 dB 1.0 dB	Formula: Upper limit + TT, Lower limit – TT  $13 \leq \text{PCMAX} < 18 \pm 5.7$ $8 \leq \text{PCMAX} < 13 \pm 6.7$ $-40 \leq \text{PCMAX} < 8 \pm 7.7$  $13 \leq \text{PCMAX} < 18 \pm 6.0$ $8 \leq \text{PCMAX} < 13 \pm 7.0$ $-40 \leq \text{PCMAX} < 8 \pm 8.0$
6.2.5_1 Configured UE transmitted Output Power for HPUE	$f \leq 3.0\text{GHz}$ $23 \leq \text{PCMAX} < 33 \pm 2.0$ $13 \leq \text{PCMAX} < 18 \pm 5.0$ $8 \leq \text{PCMAX} < 13 \pm 6.0$ $-40 \leq \text{PCMAX} < 8 \pm 7.0$	0.7 dB 0.7 dB 0.7 dB 0.7 dB	Formula: Upper limit + TT, Lower limit – TT  $23 \leq \text{PCMAX} < 33 \pm 2.7$ $13 \leq \text{PCMAX} < 18 \pm 5.7$ $8 \leq \text{PCMAX} < 13 \pm 6.7$ $-40 \leq \text{PCMAX} < 8 \pm 7.7$
6.2.5A.1 Configured UE transmitted Output Power for CA (intra-band contiguous DL CA and UL CA)	$f \leq 3.0\text{GHz}$ $13 \leq \text{PCMAX} < 18 \pm 5.0$ $8 \leq \text{PCMAX} < 13 \pm 6.0$ $-40 \leq \text{PCMAX} < 8 \pm 7.0$  $3.0\text{GHz} < f \leq 4.2\text{GHz}$ $13 \leq \text{PCMAX} < 18 \pm 5.0$ $8 \leq \text{PCMAX} < 13 \pm 6.0$ $-40 \leq \text{PCMAX} < 8 \pm 7.0$	0.7 dB 0.7 dB 0.7 dB  1.0 dB 1.0 dB 1.0 dB	Formula: Upper limit + TT, Lower limit – TT  $13 \leq \text{PCMAX} < 18 \pm 5.7$ $8 \leq \text{PCMAX} < 13 \pm 6.7$ $-40 \leq \text{PCMAX} < 8 \pm 7.7$  $13 \leq \text{PCMAX} < 18 \pm 6.0$ $8 \leq \text{PCMAX} < 13 \pm 7.0$ $-40 \leq \text{PCMAX} < 8 \pm 8.0$
6.2.5A.2 Configured UE transmitted Output Power for CA (inter-band DL CA and UL CA)	$f \leq 3.0\text{GHz}$ $16 \leq \text{PCMAX} < 20 \pm 5.0$ $11 \leq \text{PCMAX} < 16 \pm 6.0$ $-40 \leq \text{PCMAX} < 11 \pm 7.0$	0.7 dB 0.7 dB 0.7 dB	Formula: Upper limit + TT, Lower limit – TT  $16 \leq \text{PCMAX} < 20 \pm 5.7$ $11 \leq \text{PCMAX} < 16 \pm 6.7$ $-40 \leq \text{PCMAX} < 11 \pm 7.7$
6.2.5A.3 Configured UE transmitted Output Power for CA (intra-band non-contiguous DL CA and UL CA)	$f \leq 3.0\text{GHz}$ $13 \leq \text{PCMAX} < 18 \pm 5.0$ $8 \leq \text{PCMAX} < 13 \pm 6.0$ $-40 \leq \text{PCMAX} < 8 \pm 7.0$	0.7 dB 0.7 dB 0.7 dB	Formula: Upper limit + TT, Lower limit – TT  $13 \leq \text{PCMAX} < 18 \pm 5.7$ $8 \leq \text{PCMAX} < 13 \pm 6.7$ $-40 \leq \text{PCMAX} < 8 \pm 7.7$
6.2.5B Configured UE transmitted output power for UL-MIMO	$f \leq 3.0\text{GHz}$ $[16] \leq \text{PCMAX} < [20] \pm [5.0]$ $[11] \leq \text{PCMAX} < [16] \pm [6.0]$ $[-40] \leq \text{PCMAX} < [11] \pm [7.0]$  $3.0\text{GHz} < f \leq 4.2\text{GHz}$ $[16] \leq \text{PCMAX} < [20] \pm [5.0]$	Same as 6.2.5	Formula: Upper limit + TT, Lower limit – TT  $[16] \leq \text{PCMAX} < [20] \pm [5.7]$ $[11] \leq \text{PCMAX} < [16] \pm [6.7]$ $[-40] \leq \text{PCMAX} < [11] \pm [7.7]$  $[16] \leq \text{PCMAX} < [20] \pm [6.0]$

	[11] ≤ PCMAX < [16] ± [6.0] [-40] ≤ PCMAX < [11] ± [7.0]		[11] ≤ PCMAX < [16] ± [7.0] [-40] ≤ PCMAX < [11] ± [8.0]  Uplink power measurement applies to overall UL power, which is the linear sum of the output powers over all Tx antenna connectors
6.3.2 Minimum Output Power	<u>f ≤ 3.0GHz</u> -40 dBm  <u>3.0GHz &lt; f ≤ 4.2GHz</u> -40 dBm	1.0 dB  1.3 dB	Formula: Minimum Requirement + TT UE min. output power = -39 dBm  UE min. output power = -38.7 dBm
6.3.2A.1 Minimum Output Power for CA (intra-band contiguous DL CA and UL CA)	Same as 6.3.2	Same as 6.3.2	[Same as 6.3.2
6.3.2B Minimum Output Power for UL-MIMO	Same as 6.3.2	Same as 6.3.2	Same as 6.3.2  Uplink power measurement applies to overall UL power, which is the linear sum of the output powers over all Tx antenna connectors
6.3.3 Transmission ON/OFF Power	<u>f ≤ 3.0GHz</u> ≤ -50 dBm  <u>3.0GHz &lt; f ≤ 4.2GHz</u> ≤ -50 dBm	1.5 dB  1.8 dB	Formula: Minimum Requirement + TT UE OFF Power ≤ -48.5 dBm  UE OFF Power ≤ -48.2 dBm
6.3.3A.1 UE Transmit OFF power for CA (intra-band contiguous DL CA and UL CA)	Same as 6.3.3	Same as 6.3.3	Same as 6.3.3
6.3.3A.2 Transmit OFF Power for CA (inter-band DL CA and UL CA)	Same as 6.3.3	Same as 6.3.3	Same as 6.3.3
6.3.3A.3 UE Transmit OFF power for CA (intra-band non-contiguous DL CA and UL CA)	Same as 6.3.3	Same as 6.3.3	Same as 6.3.3
6.3.3B UE Transmit OFF power for UL-MIMO	Same as 6.3.3	Same as 6.3.3	Same as 6.3.3  Uplink power measurement applies to each Tx antenna connector
6.3.4.1 General ON/OFF time mask	<u>f ≤ 3.0GHz</u> OFF Power ≤ -50 dBm ON Power BW dependent  <u>3.0GHz &lt; f ≤ 4.2GHz</u> OFF Power ≤ -50 dBm ON Power BW dependent  Transmission ON Power value depends on the test parameters. In the particular test case parameters the ON power measurement has minimum requirements of ±6.0 dB	1.5 dB 1.5 dB  1.8 dB 1.8 dB	Formulae: OFF Power Minimum Req't + TT ON Power Upper limit + TT, Lower limit – TT  UE OFF Power ≤ -48.5 dBm UE ON Power: Test value ± 7.5 dB  UE OFF Power ≤ -48.2 dBm UE ON Power: Test value ± 7.8 dB
6.3.4A.1.1 General ON/OFF time mask for CA (intra-band contiguous DL CA and UL CA)	Same as 6.3.4.1 for each CC	Same as 6.3.4.1	Same as 6.3.4.1 for each CC
6.3.4A.1.2 General ON/OFF time mask for CA	Same as 6.3.4.1	Same as 6.3.4.1	Same as 6.3.4.1

(inter-band DL CA and UL CA)			
6.3.4A.1.3 General ON/OFF time mask for CA (intra-band non-contiguous DL CA and UL CA)	Same as 6.3.4.1 for each CC	Same as 6.3.4.1	Same as 6.3.4.1 for each CC
6.3.4B.1 General ON/OFF time mask for UL-MIMO	Same as 6.3.4.1	Same as 6.3.4.1	Same as 6.3.4.1 Uplink OFF power measurement applies to each Tx antenna connector Uplink ON power measurement applies to [FFS]
6.3.4.2 PRACH and SRS time mask	<p><math>f \leq 3.0\text{GHz}</math> OFF Power <math>\leq -50</math> dBm ON Power BW dependent</p> <p><math>3.0\text{GHz} &lt; f \leq 4.2\text{GHz}</math> OFF Power <math>\leq -50</math> dBm ON Power BW dependent</p> <p>Transmission ON Power value depends on the test parameters. In the particular test case parameters the ON power measurement has minimum requirements of <math>\pm 6.0</math> dB</p>	<p>1.5 dB 1.5 dB</p> <p>1.8 dB 1.8 dB</p>	<p>Formulae: OFF Power Minimum Req't + TT ON Power Upper limit + TT, Lower limit – TT</p> <p>UE OFF Power <math>\leq -48.5</math> dBm UE ON Power: Test value <math>\pm 7.5</math> dB</p> <p>UE OFF Power <math>\leq -48.2</math> dBm UE ON Power: Test value <math>\pm 7.8</math> dB</p>
6.3.5.1 Power Control Absolute power tolerance	<p><math>f \leq 3.0\text{GHz}</math> Normal conditions <math>\pm 9.0</math> dB Extreme conditions <math>\pm 12.0</math> dB</p> <p><math>3.0\text{GHz} &lt; f \leq 4.2\text{GHz}</math> Normal conditions <math>\pm 9.0</math> dB Extreme conditions <math>\pm 12.0</math> dB</p>	<p>1.0 dB 1.0 dB</p> <p>1.4 dB 1.4 dB</p>	<p>Formula: Upper limit + TT, Lower limit – TT</p> <p>Normal conditions <math>\pm 10.0</math> dB Extreme conditions <math>\pm 13.0</math> dB</p> <p>Normal conditions <math>\pm 10.4</math> dB Extreme conditions <math>\pm 13.4</math> dB</p>
6.3.5_1.1 Power Control Absolute power tolerance for HPUE	<p><math>f \leq 3.0\text{GHz}</math> Normal conditions <math>\pm 9.0</math> dB Extreme conditions <math>\pm 12.0</math> dB</p>	<p>1.0 dB 1.0 dB</p>	<p>Formula: Upper limit + TT, Lower limit – TT</p> <p>Normal conditions <math>\pm 10.0</math> dB Extreme conditions <math>\pm 13.0</math> dB</p>
6.3.5_1.2 Power Control Relative power tolerance for HPUE	Same as 6.3.5.2	Same as 6.3.5.2	Same as 6.3.5.2
6.3.5_1.3 Aggregate power control tolerance for HPUE	Same as 6.3.5.3	Same as 6.3.5.3	Same as 6.3.5.3
6.3.5A.1.1 Power Control Absolute power tolerance for CA (intra-band contiguous DL CA and UL CA)	TBD	Same as 6.3.5.1	TBD
6.3.5B.1 Power Control Absolute Power Tolerance for UL- MIMO	Same as 6.3.5.1	Same as 6.3.5.1	Same as 6.3.5.1 Uplink power measurement applies to overall UL power, which is the linear sum of the output powers over all Tx antenna connectors
6.3.5.2 Power Control Relative power tolerance	<p>TS 36.101 [2] clause 6.3.5.1</p> <p>All combinations of PUSCH and PUCCH transitions:</p> <p><math>\Delta P &lt; 2</math>; <math>\pm 2.5</math> dB <math>2 \leq \Delta P &lt; 3</math>; <math>\pm 3.0</math> dB</p>	0.7 dB	<p>Formula: Upper limit + TT, Lower limit – TT All combinations of PUSCH and PUCCH transitions:</p> <p><math>\Delta P &lt; 2</math>; <math>\pm 3.2</math> dB <math>2 \leq \Delta P &lt; 3</math>; <math>\pm 3.7</math> dB</p>

	$3 \leq \Delta P < 4$ ; $\pm 3.5$ dB $4 \leq \Delta P \leq 10$ ; $\pm 4.0$ dB $10 \leq \Delta P < 15$ ; $\pm 5.0$ dB $15 \leq \Delta P$ ; $\pm 6.0$ dB		$3 \leq \Delta P < 4$ ; $\pm 4.2$ dB $4 \leq \Delta P < 10$ ; $\pm 4.7$ dB $10 \leq \Delta P < 15$ ; $\pm 5.7$ dB $15 \leq \Delta P$ ; $\pm 6.7$ dB
6.3.5.3 Aggregate power control tolerance	Aggregate power control tolerance within 21 ms:  PUCCH = $\pm 2.5$ dB PUSCH = $\pm 3.5$ dB	0.7 dB	Formula: Upper limit + TT, Lower limit - TT PUCCH = $\pm 3.2$ dB PUSCH = $\pm 4.2$ dB
6.3.5A.2.1 Power Control Relative power tolerance for CA (intra-band contiguous DL CA and UL CA)	TBD	Same as 6.3.5.2	TBD
6.3.5B.2 Power Control Relative power tolerance for UL-MIMO	Same as 6.3.5.2	Same as 6.3.5.2	Same as 6.3.5.2  Uplink power measurement applies to overall UL power, which is the linear sum of the output powers over all Tx antenna connectors
6.3.5A.3.1 Aggregate power control tolerance for CA (intra-band contiguous DL CA and UL CA)	Same as 6.3.5.3	Same as 6.3.5.3	Same as 6.3.5.3
6.3.5B.3 Aggregate power control tolerance for UL-MIMO	Same as 6.3.5.3	Same as 6.3.5.3	Same as 6.3.5.3  Uplink power measurement applies to overall UL power, which is the linear sum of the output powers over all Tx antenna connectors
6.5.1 Frequency Error	Modulated carrier, $f \leq 4.2$ GHz Within $\pm 0.1$ ppm compared to the received carrier frequency  $f \leq 3.0$ GHz DL power: Refsens  $3.0$ GHz < $f \leq 4.2$ GHz DL power: Refsens	15 Hz  0.7 dB  1.0 dB	Formulae: Modulated carrier frequency: Upper limit + TT, Lower limit - TT DL power: Refsens + TT  Modulated carrier frequency error = $\pm(0.1 \text{ ppm} + 15 \text{ Hz})$  Refsens +0.7dB  Refsens +1.0dB
6.5.1A.1 Frequency error for CA (intra-band contiguous DL CA and UL CA)	Same as 6.5.1A.1	Same as 6.5.1A.1	Same as 6.5.1A.1
6.5.1A.2 Frequency Error for CA (inter-band DL CA and UL CA)	Same as 6.5.1A.1 per CC	Same as 6.5.1A.1 per CC	Same as 6.5.1A.1 per CC
6.5.1B Frequency Error for UL-MIMO	Same as 6.5.1	Same as 6.5.1	Same as 6.5.1
6.5.2.1 Error Vector Magnitude	EVM limit: BPSK :17.5 % QPSK: 17.5 % 16QAM: 12.5 %	0%	Formula: Minimum Requirement + TT
6.5.2.1A PUSCH-EVM with exclusion period	EVM limit: QPSK: 17.5 % 16QAM: 12.5 %	0%	Formula: Minimum Requirement + TT
6.5.2A.1.1 Error Vector Magnitude (EVM) for CA (intra-band contiguous DL CA and UL CA)	Same as 6.5.2.1	Same as 6.5.2.1	Same as 6.5.2.1
6.5.2B.1 Error Vector Magnitude (EVM) for UL-MIMO	Same as 6.5.2.1	Same as 6.5.2.1	Same as 6.5.2.1  Uplink power measurement window applies to overall UL power, which is the linear sum of the output powers

6.5.2.2 Carrier leakage	<p>For Output power &gt;0 dBm -25dBc</p> <p>For -30 dBm ≤ Output power ≤ 0 dBm -20dBc</p> <p>For -40 dBm ≤ Output power &lt; -30 dBm -10dBc</p>	0.8dB	<p>over all Tx antenna connectors</p> <p>Formula: Minimum Requirement + TT</p>
6.5.2.3 In-band emissions for non allocated RB	<p>For general emissions:  <math display="block">\max \left\{ -25 - 10 \cdot \log_{10} (N_{RB} / L_{CRF}) \right.</math> <math display="block">20 \cdot \log_{10} EVM - 3 - 5 \cdot ( \Delta_{RB}  - 1)</math> <math display="block">\left. - 57 \text{ dBm} / 180 \text{ kHz} - P_{RB} \right\}</math> <p>For IQ image: -25dB</p> <p>For Carrier leakage:</p> <p>Output power &gt;0 dBm -25dBc</p> <p>-30 dBm ≤ Output power ≤ 0 dBm -20dBc</p> <p>-40 dBm ≤ Output power &lt; -30 dBm -10dBc</p> <p>For each evaluated RB, the test requirement is calculated as the higher of <math>P_{RB} - 30</math> dB and the power sum of all limit values (General, IQ Image or Carrier leakage)</p> </p>	0.8dB	<p>Formula: Minimum Requirement + TT</p>
6.5.2.4 EVM equalizer Spectrum flatness	<p>Normal conditions.</p> <p>If (F-FUL_low ≥ [3MHz]) &amp; (FUL_high-F ≥ [3MHz]) 4 dB else 8 dB</p> <p>maximum coefficient in Range 1 - the minimum coefficient in Range 2 5 dB the maximum coefficient in Range 2 - the minimum coefficient in Range 7 dB Extreme conditions:</p> <p>If (F-FUL_low ≥ [5MHz]) &amp; (FUL_high-F ≥ [5MHz]) 4 dB else 12 dB</p> <p>maximum coefficient in Range 1 - the minimum coefficient in Range 2 6 dB the maximum coefficient in Range 2 - the minimum coefficient in Range 10 dB</p>	1.4dB	<p>Formula: Minimum Requirement + TT</p>

6.5.2A.2.1 Carrier leakage for CA (intra-band contiguous DL CA and UL CA)	TBD	TBD	TBD
6.5.2A.3.1 In-band emissions for non allocated RB for CA (intra-band contiguous DL CA and UL CA)	TBD	TBD	TBD
6.5.2B.1 Error vector magnitude (EVM) for UL-MIMO	TBD	TBD	TBD
6.5.2B.2 Carrier leakage for UL-MIMO	Same as 6.5.2.2	Same as 6.5.2.2	Same as 6.5.2.2 Uplink power measurement window applies to overall UL power, which is the linear sum of the output powers over all Tx antenna connectors
6.5.2B.3 In-band emissions for non allocated RB for UL-MIMO	Same as 6.5.2.3	Same as 6.5.2.3	Same as 6.5.2.3 Uplink power measurement window applies to overall UL power, which is the linear sum of the output powers over all Tx antenna connectors
6.5.2B.4 EVM equalizer spectrum flatness for UL-MIMO	Same as 6.5.2.4	Same as 6.5.2.4	Same as 6.5.2.4
6.6.1 Occupied bandwidth	For 1.4 MHz channel bandwidth: Occupied channel bandwidth = 1.4 MHz  For 3.0 MHz channel bandwidth: Occupied channel bandwidth = 3.0 MHz  For 5 MHz channel bandwidth: Occupied channel bandwidth = 5 MHz  For 10 MHz channel bandwidth: Occupied channel bandwidth = 10 MHz  For 15 MHz channel bandwidth: Occupied channel bandwidth = 15 MHz  For 20 MHz channel bandwidth: Occupied channel bandwidth = 20 MHz	0kHz	Formula: Minimum Requirement + TT
6.6.1A.1 Occupied bandwidth for CA (intra-band contiguous DL CA and UL CA)	For 13 MHz channel bandwidth: Occupied channel bandwidth = [13] MHz  For 15 MHz channel bandwidth: Occupied channel bandwidth = [15] MHz  For 20 MHz channel bandwidth: Occupied channel bandwidth = [20] MHz  For 35 MHz channel bandwidth: Occupied channel bandwidth = [35] MHz  For 40 MHz channel bandwidth: Occupied channel bandwidth	Same as 6.6.1	Same as 6.6.1

	= $[40]$ MHz		
6.6.1A.2 Occupied bandwidth for CA (inter-band DL CA and UL CA)	Same as 6.6.1 per CC	Same as 6.6.1 per CC	Same as 6.6.1 per CC
6.6.1A.3	Same as 6.6.1 for each CC	Same as 6.6.1	Same as 6.6.1 for each CC
6.6.1B Occupied bandwidth for UL-MIMO	Same as 6.6.1	Same as 6.6.1	Same as 6.6.1
6.6.2.1 Spectrum Emission Mask	For 1.4 MHz BW: -10 dBm / 30kHz -25dBm to -10dBm / 1MHz For 3 MHz BW: -13 dBm / 30kHz -25dBm to -10dBm / 1MHz For 5 MHz BW: -15dBm / 30kHz -25dBm to -10dBm / 1MHz For 10 MHz BW: -18dBm / 30kHz -25dBm to -10dBm / 1MHz For 15 MHz BW: -20dBm / 30kHz -25dBm to -10dBm / 1MHz For 20 MHz BW: -21dBm / 30kHz -25dBm to -10dBm / 1MHz	All cases:  $f \leq 3.0\text{GHz}$ 1.5dB  $3.0\text{GHz} < f \leq 4.2\text{GHz}$ 1.8dB	Formula: Minimum Requirement + TT  Note: The Test Tolerance would be 0dB for $\Delta f_{\text{OoB}} \geq 2 \times \text{Channel Bandwidth}$ , but taking into account the filter position, the Test requirements specified all have $\Delta f_{\text{OoB}} < 2 \times \text{Channel Bandwidth}$
6.6.2.1_1 Spectrum Emission Mask for Multi-Cluster PUSCH	Same as 6.6.2.1	Same as 6.6.2.1	Same as 6.6.2.1
6.6.2.1A.1 Spectrum emission mask for CA (intra-band contiguous DL CA and UL CA)	For 24.95 MHz BW: -22 dBm / 30kHz -25 dBm to - 10 dBm / 1 MHz For 29.9 MHz BW: -22.5 dBm / 30kHz -25dBm to -10dBm / 1MHz For 30 MHz BW: -22.5 dBm / 30kHz -25dBm to -10dBm / 1MHz For 34.85 MHz BW: -23.5dBm / 30kHz -25dBm to -10dBm / 1MHz For 39.8 MHz BW: -24dBm / 30kHz -25dBm to -10dBm / 1MHz	Same as 6.6.2.1	Same as 6.6.2.1
6.6.2.1A.2 Spectrum emission mask for CA (inter-band DL CA and UL CA)	Same as 6.6.2.1 per CC	Same as 6.6.2.1 per CC	Same as 6.6.2.1 per CC
6.6.2.1A.3 Spectrum Emission Mask for CA (intra-band non-contiguous DL CA and UL CA)	Same as 6.6.2.1 for each CC	Same as 6.6.2.1	Same as 6.6.2.1 for each CC
6.6.2.1B Spectrum Emission Mask for UL-MIMO	Same as 6.6.2.1	Same as 6.6.2.1	Same as 6.6.2.1
6.6.2.2 Additional Spectrum Emission Mask	For 1.4 MHz BW: NS_03, NS_04 -10 dBm / 30 kHz -25 dBm to -13 dBm / 1MHz  NS_06 or NS_07 -13 dBm / 30 kHz -13 dBm / 100 kHz -25 dBm to -13 dBm / 1MHz  For 3 MHz BW: NS_03, NS_04 -13 dBm / 30 kHz	All cases:  $f \leq 3.0\text{GHz}$ 1.5dB  $3.0\text{GHz} < f \leq 4.2\text{GHz}$ 1.8dB	Formula: Minimum Requirement + TT  Note: The Test Tolerance would be 0dB for $\Delta f_{\text{OoB}} \geq 2 \times \text{Channel Bandwidth}$ , but taking into account the filter position, the Test requirements specified all have $\Delta f_{\text{OoB}} < 2 \times \text{Channel Bandwidth}$



	<p>-25 dBm to -13 dBm / 1 MHz</p> <p>NS_06 or NS_07 -13 dBm / 30 kHz -13 dBm / 100kHz -25 dBm to -13 dBm / 1 MHz</p> <p>For 5 MHz BW: NS_03, NS_04 -15 dBm / 30 kHz -25 dBm to -13 dBm / 1 MHz</p> <p>NS_06 or NS_07 -15 dBm / 30 kHz -13 dBm / 100 kHz -25 dBm to -13 dBm / 1 MHz</p> <p>For 10 MHz BW: NS_03, NS_04, -18 dBm / 30 kHz -25 dBm to -13dBm / 1 MHz</p> <p>NS_06 or NS_07 -18 dBm / 30 kHz -13 dBm / 100 kHz -25 dBm to -13dBm / 1 MHz</p> <p>For 15 MHz BW: NS_03, NS_04 -20 dBm / 30kHz -25 dBm to -13 dBm / 1 MHz</p> <p>For 20 MHz BW: NS_03, NS_04 -21 dBm / 30 kHz -25 dBm to -13 dBm / 1 MHz</p>		
6.6.2.2A Additional Spectrum Emission Mask for CA	For network signalled value CA_NS_04: -21dBm/30kHz to -22.5dBm/kHz, BW-dependent, for 0-1MHz -13dBm/1MHz for 1MHz-5.5MHz -25dBm/1MHz beyond 5.5MHz	Same as 6.6.2.2	Same as 6.6.2.2
6.6.2.2B Additional Spectrum Emission Mask for UL-MIMO	Same as 6.6.2.2	Same as 6.6.2.2	Same as 6.6.2.2
6.6.2.3 Adjacent Channel Leakage power Ratio	<p>If the adjacent channel power is greater than -50 dBm then the ACLR shall be higher than the values specified below.</p> <p>E-UTRA ACLR: 30 dB</p> <p>UTRA ACLR: 33 dB for UTRA ACLR 1 36 dB for UTRA ACLR 2</p>	<p>0 dB</p> <p>0.8 dB</p> <p>0.8 dB 0.8 dB</p>	<p>Formula: ACLR Minimum Requirement + TT</p> <p>Formula: ACLR Minimum Requirement - TT E-UTRA ACLR: 29.2 dB</p> <p>UTRA ACLR: 32.2 dB for UTRA ACLR 1 35.2 dB for UTRA ACLR 2</p>
6.6.2.3_1 Adjacent Channel Leakage power Ratio for HPUE	<p>If the adjacent channel power is greater than -50 dBm then the ACLR shall be higher than the values specified below.</p> <p>E-UTRA ACLR: 37 dB</p>	<p>0dB</p> <p>0.8dB</p>	<p>Formula: ACLR Minimum Requirement + TT</p> <p>Formula: ACLR Minimum Requirement - TT E-UTRA ACLR: 36.2 dB</p>
6.6.2.3_2 Adjacent Channel Leakage power Ratio for Multi-Cluster PUSCH	Same as 6.6.2.3	Same as 6.6.2.3	Same as 6.6.2.3
6.6.2.3A.1 Adjacent Channel Leakage power	If the adjacent channel power is greater than -50 dBm then the	0 dB	Formula: ACLR Minimum Requirement + TT

Ratio for CA (intra-band contiguous DL CA and UL CA)	<p>ACLR shall be higher than the values specified below.</p> <p>UTRA ACLR: 33 dB for UTRA ACLR 1 36 dB for UTRA ACLR 2</p> <p>E-UTRA ACLR: 30 dB</p>	<p>0.8 dB 0.8 dB</p> <p>0.8 dB</p>	<p>Formula: ACLR Minimum Requirement - TT</p> <p>UTRA ACLR: 32.2 dB for UTRA ACLR 1 35.2 dB for UTRA ACLR 2</p> <p>E-UTRA ACLR: 29.2 dB</p>
6.6.2.3A.2 Adjacent Channel Leakage power Ratio for CA (intra-band contiguous DL CA and UL CA)	Same as 6.6.2.3 per component carrier	Same as 6.6.2.3 per component carrier	Same as 6.6.2.3 per component carrier
6.6.2.3B Adjacent Channel Leakage power Ratio for UL-MIMO	Same as 6.6.2.3	Same as 6.6.2.3	Same as 6.6.2.3
6.6.2.4 Additional ACLR requirements	<p>If the adjacent channel power is greater than -50 dBm then the ACLR shall be higher than the values specified below.</p> <p>E-UTRA ACLR: 43 dB for UTRA ACLR 2</p>	<p>0 dB</p> <p>0.8 dB</p>	<p>Formula: ACLR Minimum Requirement + TT</p> <p>Formula: ACLR Minimum Requirement – TT</p> <p>E-UTRA ACLR: 42.2 dB for UTRA ACLR 2</p>
6.6.3.1 Transmitter Spurious emissions	<p>9 kHz ≤ f &lt; 150 kHz: -36dBm / 1kHz</p> <p>150 kHz ≤ f &lt; 30 MHz: -36dBm / 10kHz</p> <p>30 MHz ≤ f &lt; 1 GHz: -36dBm / 100kHz</p> <p>1 GHz ≤ f &lt; 12.75 GHz: -30dBm / 1MHz</p> <p>12.75 GHz ≤ f &lt; 19 GHz: -30dBm / 1MHz</p>	0 dB	<p>Formula: Minimum Requirement + TT</p>
6.6.3.1_1 Transmitter Spurious emissions for Multi-Cluster PUSCH	Same as 6.6.3.1	Same as 6.6.3.1	Formula: Minimum Requirement + TT
6.6.3.1A.1 Transmitter Spurious emissions for CA (intra-band contiguous DL CA and UL CA)	TBD	Same as 6.6.3.1	TBD
6.6.3.1A.2 Transmitter Spurious emissions for CA (inter-band DL CA and UL CA)	Same as 6.6.3.1 per CC	Same as 6.6.3.1 per CC	Same as 6.6.3.1 per CC
6.6.3B.1 Transmitter Spurious emissions for UL-MIMO	Same as 6.6.3.1	Same as 6.6.3.1	Formula: Minimum Requirement + TT
6.6.3.2 Spurious emission band UE co-existence	<p>-35 dBm / 6.25kHz</p> <p>-36 dBm / 100kHz</p> <p>-41 dBm / 300kHz</p> <p>-37 dBm / 1MHz</p> <p>-40 dBm / 1MHz</p> <p>-50 dBm / 1MHz</p> <p>Frequencies as detailed in core requirement</p>	0 dB	Formula: Minimum Requirement + TT
6.6.3.2A.1 Spurious emission band UE co-existence for CA (intra-	TBD	TBD	TBD

band contiguous DL CA and UL CA)			
6.6.3.3 Additional spurious emissions	NS_05 $1884.5\text{MHz} \leq f \leq 1915.7\text{MHz}$ : -41dBm / 300kHz NS_07 $769\text{MHz} \leq f \leq 775\text{MHz}$ -57dBm / 6.25kHz NS_08 $860\text{MHz} \leq f \leq 895\text{MHz}$ -40dBm / 1MHz NS_09 $1475.9\text{MHz} \leq f \leq 1510.9\text{MHz}$ -35dBm / 1MHz	0 dB  1.5dB  0 dB  0 dB	Formula: Minimum Requirement + TT -41dBm / 300kHz  -55.5 dBm / 6.25kHz  -40dBm / 1MHz  -35dBm / 1MHz
6.6.3.3A.1 Additional spurious emissions for CA (intra-band contiguous DL CA and UL CA)	CA_NS_01 E-UTRA band 34: -50dBm / 1MHz $1884.5\text{MHz} \leq f \leq 1915.7\text{MHz}$ : -41dBm / 300kHz  CA_NS_02 E-UTRA band 33: -50dBm / 1MHz E-UTRA band 34: -50dBm / 1MHz  CA_NS_03 E-UTRA band 34: -50dBm / 1MHz E-UTRA band 39: -50dBm / 1MHz	0 dB  0 dB  0 dB  0 dB  0 dB	Formula: Minimum Requirement + TT  -50 MHz / 1MHz  -41 dBm / 300kHz  -50 MHz / 1MHz  -50 MHz / 1MHz  -50 MHz / 1MHz
6.6.3B.2 Spurious emission band UE co-existence for UL-MIMO	Same as 6.6.3.2	Same as 6.6.3.2	Formula: Minimum Requirement + TT
6.6.3B.3 Additional spurious emissions for UL-MIMO	Same as 6.6.3.3	Same as 6.6.3.3	Formula: Minimum Requirement + TT
6.7 Transmit intermodulation	Intermodulation Product 5MHz -29 dBc 10MHz -35 dBc CW Interferer level = -40 dBc	0 dB	Formula: CW interferer Minimum Requirement– TT  Intermod Products limits remain unchanged.  CW interferer level = -40 dBc
6.7A.1 Transmit intermodulation	Same as 6.7	Same as 6.7	Same as 6.7
6.7B Transmit intermodulation for UL-MIMO	Same as 6.7	Same as 6.7	Same as 6.7
6.8B Time alignment error for UL-MIMO	The Time Alignment Error (TAE) shall not exceed 130 ns	25 ns	Formula: Minimum Requirement+ TT

### F.3.3 Measurement of receiver

Table F.3.3-1: Derivation of Test Requirements (Receiver tests)

Test	Minimum Requirement in TS 36.101	Test Tolerance (TT)	Test Requirement in TS 36.521-1
7.3 Reference sensitivity power level	<p>Reference sensitivity power level:</p> <p>For 1.4MHz -102.2dBm -103.2dBm -105.2dBm -106.2dBm</p> <p>For 3MHz -99.2dBm -100.2dBm -102.2dBm</p> <p>For 5MHz -97dBm -98dBm -98.5dBm -99dBm -100dBm -96.5dBm Band 9 with Multi band</p> <p>For 10MHz -94dBm -95dBm -95.5dBm -96dBm -97dBm -93.5dBm Band 9 with Multi band</p> <p>For 15MHz -92.2dBm -93.2dBm -93.7dBm -94.2dBm -95.2dBm -91.7dBm Band 9 with Multi band</p> <p>For 20MHz -91dBm -92dBm -93dBm -94dBm -90.5dBm Band 9 with Multi band</p> <p>T-put limit = 95% of maximum for the Ref Meas channel</p>	<p>All cases:</p> <p><math>f \leq 3.0\text{GHz}</math> 0.7dB</p> <p><math>3.0\text{GHz} &lt; f \leq 4.2\text{GHz}</math> 1.0 dB</p>	<p>Formula: Reference sensitivity power level + TT</p> <p>T-put limit unchanged</p>
7.3A.1 Reference sensitivity level for CA (intra-band contiguous DL CA and UL CA)	<p><u>PCC and SCC</u> Value in Table 7.3.1</p> <p>PCC and SCC values are each increased by <math>\Delta R_{IB,c}</math> in Table 7.3.3-1A or Table 7.3.1-1B where applicable</p>	Same as 7.3	<p><u>PCC and SCC</u> Value in TS 36.101 Table 7.3.1+TT</p> <p>PCC and SCC values are each increased by <math>\Delta R_{IB,c}</math> in Table 7.3.3-1A where applicable</p> <p>T-put limit unchanged</p>

	T-put limit = 95% of maximum for the Ref Meas channel		
7.3A.2 Reference sensitivity level for CA (intra-band contiguous DL CA without UL CA)	Same as 7.3A.1	Same as 7.3	Same as 7.3A.1
7.3A.3 Reference sensitivity level for CA (inter-band DL CA without UL CA)	<u>PCC and SCC</u> Value in Table 7.3.1  Exceptions in Tables 7.3.1A-0a, 7.3.1A-0bA, 7.3.1A-0d  PCC and SCC values are each increased by $\Delta R_{IB,c}$ in Table 7.3.3-1A or Table 7.3.1-1B where applicable  T-put limit = 95% of maximum for the Ref Meas channel	Same as 7.3	<u>PCC and SCC</u> Value in TS 36.101 Table 7.3.1+TT  Exceptions in TS 36.101 Tables 7.3.1A-0a, 7.3.1A-0bA, 7.3.1A-0d+TT  PCC and SCC values are each increased by $\Delta R_{IB,c}$ in Table 7.3.3-1A where applicable  T-put limit unchanged
7.3A.4 Reference sensitivity level for CA (intra-band non-contiguous DL CA without UL CA)	<u>PCC</u> Value in Table 7.3.1  <u>SCC</u> Value in Table 7.3.1 + $\Delta R_{IBNC}$ in Table 7.3.1A-3  PCC and SCC values are each increased by $\Delta R_{IB,c}$ in Table 7.3.3-1A or Table 7.3.1-1B where applicable  T-put limit = 95% of maximum for the Ref Meas channel	Same as 7.3	<u>PCC</u> Value in TS 36.101 Table 7.3.1+TT  <u>SCC</u> Value in TS 36.101 Table 7.3.1+TT + $\Delta R_{IBNC}$ in TS 36.101 Table 7.3.1A-3  PCC and SCC values are each increased by $\Delta R_{IB,c}$ in Table 7.3.3-1A where applicable  T-put limit unchanged
7.3A.5 Reference sensitivity level for CA (3DL CA without UL CA)	<u>PCC and SCCs</u> Value in Table 7.3.1  Exceptions in Tables 7.3.1A-0a, 7.3.1A-0bC, 7.3.1A-0d  PCC and SCCs values are each increased by $\Delta R_{IB,c}$ in Table 7.3.1A-3, 7.3.1-1B or/and $\Delta R_{IBNC}$ in Table 7.3.1A-3 where applicable  T-put limit = 95% of maximum for the Ref Meas channel	Same as 7.3	<u>PCC and SCC</u> Value in TS 36.101 Table 7.3.1+TT  Exceptions in TS 36.101 Tables 7.3.1A-0a, 7.3.1A-0bC, 7.3.1A-0d +TT  PCC and SCCs values are each increased by $\Delta R_{IB,c}$ in Table 7.3.3-1A, 7.3.3-1B or/and $\Delta R_{IBNC}$ in TS 36.101 Table 7.3.1A-3 where applicable  T-put limit unchanged
7.3A.6 Reference sensitivity level for CA (inter-band DL CA and UL CA)	TBD	TBD	TBD
7.3B Reference Sensitivity Level for UL-MIMO	Same as 7.3	Same as 7.3	Same as 7.3
7.3E Reference Sensitivity Level for UE category 0	Same as 7.3	<u>Same as 7.3</u>	Same as 7.3
7.4 Maximum input level	Signal level -25dBm  T-put limit = 95% of maximum for the Ref Meas channel  Uplink power	$f \leq 3.0\text{GHz}$ 0.7 dB  $3.0\text{GHz} < f \leq 4.2\text{GHz}$ 1.0 dB  $f \leq 3.0\text{GHz}$ 0dB, -3.4dB  $3.0\text{GHz} < f \leq 4.2\text{GHz}$ 0dB, -4.0dB	Formula: Maximum input level - TT  Signal level: $f \leq 3.0\text{GHz}$ : -25.7 dBm $3.0\text{GHz} < f \leq 4.2\text{GHz}$ : -26.0 dBm  T-put limit unchanged  Uplink power measurement window comprises four quantities: 1. UE power step size 1dB 2. UE Power step tolerance $\pm 1\text{dB}$ 3. Test system power measurement at top of window: $f \leq 3.0\text{GHz} \pm 0.7\text{ dB}$

			<p>3.0GHz &lt; f ≤ 4.2GHz ±1.0 dB.</p> <p>4. Test system power measurement at bottom of window:  f ≤ 3.0GHz ±0.7 dB  3.0GHz &lt; f ≤ 4.2GHz ±1.0 dB.</p> <p>Items 1 to 4 are added arithmetically:  Overall UL power window size:  f ≤ 3.0GHz:  (1dB+1dB+0.7dB+0.7dB) =3.4dB  3.0GHz &lt; f ≤ 4.2GHz:  (1dB+1dB+1dB+1dB) =4dB</p> <p>Top of window is aligned to UL power requirement, hence +0dB, -3.4dB or +0dB, -4.0dB according to frequency</p>
7.4A.1 Maximum input level for CA (intra band contiguous DL CA and UL CA)	<p>Signal level for each CC as specified  T-put limit = 95% of maximum for the Ref Meas channel</p> <p>Uplink power</p>	<p><math>f \leq 3.0\text{GHz}</math>  0.7 dB</p> <p><math>3.0\text{GHz} &lt; f \leq 4.2\text{GHz}</math>  1.0 dB</p> <p><math>f \leq 3.0\text{GHz}</math>  0dB, -3.4dB</p> <p><math>3.0\text{GHz} &lt; f \leq 4.2\text{GHz}</math>  0dB, -4.0dB</p>	<p>Formula: Signal level for each CC - TT  T-put limit unchanged</p> <p>Uplink power measurement window is calculated in the same way as 7.4, but the target power for each CC is scaled according to the allocation:  For PCC: <math>10\log(P_{L_{CRB}}/N_{RB\_alloc})</math>  For SCC: <math>10\log(S_{L_{CRB}}/N_{RB\_alloc})</math></p>
7.4A.2 Maximum input level for CA (intra band contiguous DL CA without UL CA)	<p>Signal level for each CC as specified  T-put limit = 95% of maximum for the Ref Meas channel</p> <p>Uplink power</p>	<p><math>f \leq 3.0\text{GHz}</math>  0.7 dB</p> <p><math>3.0\text{GHz} &lt; f \leq 4.2\text{GHz}</math>  1.0 dB</p> <p><math>f \leq 3.0\text{GHz}</math>  0dB, -3.4dB</p> <p><math>3.0\text{GHz} &lt; f \leq 4.2\text{GHz}</math>  0dB, -4.0dB</p>	<p>Formula: Signal level for each CC - TT  T-put limit unchanged</p> <p>Uplink power measurement window same as 7.4</p>
7.4A.3 Maximum input level for CA (inter-band DL CA without UL CA)	<p>Signal level -25dBm  T-put limit = 95% of maximum for the Ref Meas channel</p> <p>Uplink power</p>	<p><math>f \leq 3.0\text{GHz}</math>  0.7 dB</p> <p><math>3.0\text{GHz} &lt; f \leq 4.2\text{GHz}</math>  1.0 dB</p> <p><math>f \leq 3.0\text{GHz}</math>  0dB, -3.4dB</p> <p><math>3.0\text{GHz} &lt; f \leq 4.2\text{GHz}</math>  0dB, -4.0dB</p>	<p>Formula: Maximum input level - TT  Signal level:  f ≤ 3.0GHz: -25.7 dBm  3.0GHz &lt; f ≤ 4.2GHz: -26.0 dBm  T-put limit unchanged</p> <p>Uplink power measurement window same as 7.4</p>
7.4A.4 Maximum input level for CA (intra band non-contiguous DL CA without UL CA)	<p>Signal level -25dBm  T-put limit = 95% of maximum for the Ref Meas channel</p> <p>Uplink power</p>	<p><math>f \leq 3.0\text{GHz}</math>  0.7 dB</p> <p><math>3.0\text{GHz} &lt; f \leq 4.2\text{GHz}</math>  1.0 dB</p> <p><math>f \leq 3.0\text{GHz}</math>  0dB, -3.4dB</p> <p><math>3.0\text{GHz} &lt; f \leq 4.2\text{GHz}</math>  0dB, -4.0dB</p>	<p>Formula: Maximum input level - TT  Signal level:  f ≤ 3.0GHz: -25.7 dBm  3.0GHz &lt; f ≤ 4.2GHz: -26.0 dBm  T-put limit unchanged</p> <p>Uplink power measurement window same as 7.4</p>



	the Ref Meas channel  Uplink power	$f \leq 3.0\text{GHz}$ 0dB, -3.4dB  $3.0\text{GHz} < f \leq 4.2\text{GHz}$ 0dB, -4.0dB	
7.5A.2 Adjacent Channel Selectivity (ACS) for CA (intra band contiguous DL CA without UL CA)	Same as 7.5A.1	Same as 7.5A.1	Same as 7.5A.1
7.5A.3 Adjacent Channel Selectivity (ACS) for CA (inter band DL CA without UL CA)	Same as 7.5 for each CC	Same as 7.5	Same as 7.5 for each CC
7.5A.4 Adjacent Channel Selectivity (ACS) for CA (intra-band non-contiguous DL CA without UL CA)	FFS	FFS	FFS
7.5A.5 Adjacent Channel Selectivity (ACS) for 3DL CA without UL CA	<u>Intra-band contiguous DL CA</u>  <u>Case 1:</u> Wanted signal power: (REFSENS + 14 dB)  Interferer signal power For CA BW Class B, Class C: (Aggregated power + 22.5 dB) For CA BW Class D: (Aggregated power + 20.7 dB)  <u>Case 2:</u> Wanted signal power: For CA BW Class B: -50.5 + 10log( $N_{RB,c}/N_{RB,agg}$ ) dBm For CA BW Class C: -47.5 + 10log( $N_{RB,c}/N_{RB,agg}$ ) dBm For CA BW Class D: -43.9 + 10log( $N_{RB,c}/N_{RB,agg}$ ) dBm  Interferer signal power -25 dBm  <u>Inter-band CA</u> Same as 7.5 for each CC  T-put limit = 95% of maximum for the Ref Meas channel  Uplink power	0 dB	Formula:  Wanted signal power + TT  Interferer signal power unchanged  T-put limit unchanged  Uplink power measurement window same as 7.4A.1
7.5B Adjacent Channel Selectivity (ACS) for UL-MIMO	Same as 7.5	Same as 7.5	Same as 7.5  Uplink power measurement window applies to overall UL power, which is the linear sum of the output powers over all Tx antenna connectors
7.6.1 In-band blocking	Wanted signal power: (REFSENS + BW dependent value)  Interferer signal power:	0 dB	Formula: Wanted signal power + TT  Interferer signal power unchanged  T-put limit unchanged



	-56dBm or -44dBm  T-put limit = 95% of maximum for the Ref Meas channel  Uplink power	$f \leq 3.0\text{GHz}$ 0dB, -3.4dB  $3.0\text{GHz} < f \leq 4.2\text{GHz}$ 0dB, -4.0dB	Uplink power measurement window same as 7.4
7.6.1A.1 In-band blocking for CA (intra band contiguous DL CA and UL CA)	Wanted signal power: (REFSENS + CA BW Class specific value) Interferer signal power: -56dBm or -44dBm T-put limit = 95% of maximum for the Ref Meas channel  Uplink power	Same as 7.6.1	Formula: Wanted signal power + TT  Interferer signal power unchanged  T-put limit unchanged  Uplink power measurement window same as 7.4A.1
7.6.1A.2 In-band blocking for CA (intra band contiguous DL CA without UL CA)	Same as 7.6.1A.1	Same as 7.6.1A.1	Same as 7.6.1A.1
7.6.1A.3 In-band blocking for CA (inter band DL CA without UL CA)	Same as 7.6.1A.1	Same as 7.6.1A.1	Same as 7.6.1A.1
7.6.1A.4 In-band blocking for CA (intra-band non-contiguous DL CA without UL CA)	Same as 7.6.1A.1	Same as 7.6.1A.1	Same as 7.6.1A.1
7.6.1A.5 In-band blocking for CA (3DL CA without UL CA)	Same as 7.6.1A.1	Same as 7.6.1A.1	Same as 7.6.1A.1
7.6.1B In-band blocking for UL-MIMO	Same as 7.6.1	Same as 7.6.1	Same as 7.6.1  Uplink power measurement window applies to overall UL power, which is the linear sum of the output powers over all Tx antenna connectors
7.6.2 Out of-band blocking	Wanted signal power: (REFSENS + BW dependent value)  Interferer signal power: -44dBm, -30dBm or -15dBm  T-put limit = 95% of maximum for the Ref Meas channel  Uplink power	0 dB  $f \leq 3.0\text{GHz}$ 0dB, -3.4dB  $3.0\text{GHz} < f \leq 4.2\text{GHz}$ 0dB, -4.0dB	Formula: Wanted signal power + TT  Interferer signal power unchanged  T-put limit unchanged  Uplink power measurement window same as 7.4
7.6.2A.1 Out-of-band blocking for CA (intra band contiguous DL CA and UL CA)	Wanted signal power: (REFSENS + CA BW Class specific value) Interferer signal power: -44dBm, -30dBm or -15dBm T-put limit = 95% of maximum for the Ref Meas channel  Uplink power	Same as 7.6.2	Formula: Wanted signal power + TT  Interferer signal power unchanged  T-put limit unchanged  Uplink power measurement window same as 7.4A.1
7.6.2A.2 Out-of-band blocking for CA (intra band contiguous DL CA without UL CA)	Same as 7.6.2A.1	Same as 7.6.2A.1	Same as 7.6.2A.1
7.6.2A.3 Out-of-band	Same as 7.6.2A.1	Same as	Same as 7.6.2A.1

blocking for CA (inter band DL CA without UL CA)		7.6.2A.1	
7.6.2A.4 Out-of-band blocking for CA (intra-band non-contiguous DL CA without UL CA)	Same as 7.6.2A.1	Same as 7.6.2A.1	Same as 7.6.2A.1
7.6.2A.5 Out-of-band blocking for CA (3DL CA without UL CA)	Same as 7.6.2A.1	Same as 7.6.2A.1	Same as 7.6.2A.1
7.6.2B Out-of-band blocking for UL-MIMO	Same as 7.6.2	Same as 7.6.2	Same as 7.6.2 Uplink power measurement window applies to overall UL power, which is the linear sum of the output powers over all Tx antenna connectors
7.6.3 Narrow band blocking	Wanted signal power,,: (REFSENS + BW dependent value) Interferer signal power: -55dBm T-put limit = 95% of maximum for the Ref Meas channel  Uplink power	0 dB  $f \leq 3.0\text{GHz}$ 0dB, -3.4dB  $3.0\text{GHz} < f \leq 4.2\text{GHz}$ 0dB, -4.0dB	Formula: Wanted signal power + TT  Interferer signal power unchanged  T-put limit unchanged  Uplink power measurement window same as 7.4
7.6.3A.1 Narrow band blocking for CA (intra band contiguous DL CA and UL CA)	Wanted signal power: (REFSENS + CA BW Class specific value) Interferer signal power: -55dBm T-put limit = 95% of maximum for the Ref Meas channel  Uplink power	Same as 7.6.3	Formula: Wanted signal power + TT  Interferer signal power unchanged  T-put limit unchanged  Uplink power measurement window same as 7.4A.1
7.6.3A.2 Narrow band blocking for CA (intra band contiguous DL CA without UL CA)	Same as 7.6.3A.1	Same as 7.6.3A.1	Same as 7.6.3A.1
7.6.3A.3 Narrow band blocking for CA (inter band DL CA without UL CA)	Same as 7.6.3A.1	Same as 7.6.3A.1	Same as 7.6.3A.1
7.6.3A.4 Narrow band blocking for CA (intra-band non-contiguous DL CA without UL CA)	Same as 7.6.3A.1	Same as 7.6.3A.1	Same as 7.6.3A.1
7.6.3A.5 Narrow band blocking for CA (3DL CA without UL CA)	Same as 7.6.3A.1	Same as 7.6.3A.1	Same as 7.6.3A.1
7.6.3B Narrow band blocking for UL-MIMO	Same as 7.6.3	Same as 7.6.3	Same as 7.6.3 Uplink power measurement window applies to overall UL power, which is the linear sum of the output powers over all Tx antenna connectors
7.7 Spurious response	Wanted signal power: (REFSENS + BW dependent value)  Interferer signal power: -44dBm  T-put limit = 95% of maximum for the Ref Meas channel	0 dB	Formula: Wanted signal power + TT  Interferer signal power unchanged  T-put limit unchanged  Uplink power measurement window same as 7.4

	Uplink power	$f \leq 3.0\text{GHz}$ 0dB, -3.4dB  $3.0\text{GHz} < f \leq 4.2\text{GHz}$ 0dB, -4.0dB	
7.7A.1 Spurious response for CA (intra band contiguous DL CA and UL CA)	<p>Wanted signal power: (REFSENS + CA BW Class specific value) Interferer signal power: -44dBm T-put limit = 95% of maximum for the Ref Meas channel</p> <p>Uplink power</p>	Same as 7.7	<p>Formula: Wanted signal power + TT</p> <p>Interferer signal power unchanged</p> <p>T-put limit unchanged</p> <p>Uplink power measurement window same as 7.4A.1</p>
7.7A.2 Spurious response for CA (intra band contiguous DL CA without UL CA)	Same as 7.7A.1	Same as 7.7A.1	Same as 7.7A.1
7.7A.3 Spurious response for CA (inter band DL CA without UL CA)	Same as 7.7A.1	Same as 7.7A.1	Same as 7.7A.1
7.7A.4 Spurious response for CA (intra-band non-contiguous DL CA without UL CA)	Same as 7.7A.1	Same as 7.7A.1	Same as 7.7A.1
7.7A.5 Spurious response for CA (3DL CA without UL CA)	Same as 7.7A.1	Same as 7.7A.1	Same as 7.7A.1
7.7B Spurious response for UL-MIMO	Same as 7.7	Same as 7.7	<p>Same as 7.7</p> <p>Uplink power measurement window applies to overall UL power, which is the linear sum of the output powers over all Tx antenna connectors</p>
7.8.1 Wide band intermodulation	<p>Wanted signal power: For 1.4 MHz BW: (REFSENS + 12 dB) For 3 MHz BW: (REFSENS + 8 dB) For 5 MHz and 10MHz BW: (REFSENS + 6 dB) For 15 MHz BW: (REFSENS + 7 dB) For 20 MHz BW: (REFSENS + 9 dB)</p> <p><u>CW</u> Interferer power, all BWs: -46 dBm</p> <p><u>Modulated</u> Interferer power:, all BWs: -46 dBm</p> <p>T-put limit = 95% of maximum for the Ref Meas channel</p> <p>Uplink power</p>	<p>0 dB</p> <p><math>f \leq 3.0\text{GHz}</math> 0dB, -3.4dB   <math>3.0\text{GHz} &lt; f \leq 4.2\text{GHz}</math> 0dB, -4.0dB</p>	<p>Formula: Wanted signal power +TT</p> <p>CW Interferer signal power unchanged</p> <p>Modulated Interferer signal power unchanged</p> <p>T-put limit unchanged</p> <p>Uplink power measurement window same as 7.4</p>
7.8.1A.1 Wideband intermodulation for CA (intra band contiguous DL CA and UL CA)	Wanted signal power: (REFSENS + CA BW Class specific value)	0 dB	Formula: Wanted signal power +TT

	<p><u>CW</u> Interferer power, all BWs: -46 dBm</p> <p><u>Modulated</u> Interferer power:, all BWs: -46 dBm</p> <p>T-put limit = 95% of maximum for the Ref Meas channel</p> <p>Uplink power</p>	<p><math>f \leq 3.0\text{GHz}</math> 0dB, -3.4dB</p> <p><math>3.0\text{GHz} &lt; f \leq 4.2\text{GHz}</math> 0dB, -4.0dB</p>	<p>CW Interferer signal power unchanged</p> <p>Modulated Interferer signal power unchanged</p> <p>T-put limit unchanged</p> <p>Uplink power measurement window same as 7.4 A.1</p>
7.8.1A.2 Wideband intermodulation for CA (intra band contiguous DL CA without UL CA)	Same as 7.8.1A.1	Same as 7.8.1A.1	Same as 7.8.1A.1
7.8.1A.3 Wideband intermodulation for CA (inter band DL CA without UL CA)	Same as 7.8.1A.1	Same as 7.8.1A.1	Same as 7.8.1A.1
7.8.1A.4 Wideband intermodulation for CA (intra band non-contiguous DL CA without UL CA)	Same as 7.8.1A.1	Same as 7.8.1A.1	Same as 7.8.1A.1
7.8.1B Wide band intermodulation for UL-MIMO	Same as 7.8.1	Same as 7.8.1	<p>Same as 7.8.1</p> <p>Uplink power measurement window applies to overall UL power, which is the linear sum of the output powers over all Tx antenna connectors</p>
7.9 Spurious emissions	<p><math>30\text{MHz} \leq f &lt; 1\text{GHz}</math>: -57dBm / 100kHz</p> <p><math>1\text{GHz} \leq f \leq 12.75\text{GHz}</math>: -47dBm / 1MHz</p> <p><math>12.75\text{GHz} \leq f \leq 19\text{GHz}</math>: -47dBm / 1MHz</p>	0 dB	Formula: Minimum Requirement + TT
7.9A Spurious emissions for CA	<p><math>30\text{MHz} \leq f &lt; 1\text{GHz}</math>: -57dBm / 100kHz</p> <p><math>1\text{GHz} \leq f \leq 12.75\text{GHz}</math>: -47dBm / 1MHz</p>	0 dB	Formula: Minimum Requirement + TT

## F.3.4 Measurement of performance requirements

Table F.3.4-1: Derivation of Test Requirements (performance tests)

Test	Minimum Requirement in TS 36.101	Test Tolerance (TT)	Test Requirement in TS 36.521-1
8.2.1.1.1 Multiple PRBs - Prop'n Condition EVA5 - Prop'n Condition ETU70 - Prop'n Condition ETU300	SNRs as specified	0.8dB	Formula: SNR + TT T-put limit unchanged
8.2.1.1.1 Multiple PRBs - Prop'n Condition HST	SNR as specified	0.6dB	Formula: SNR + TT T-put limit unchanged
8.2.1.1.1 Single PRB - Prop'n Condition ETU70	SNRs as specified	0.8dB	Formula: SNR + TT T-put limit unchanged
8.2.1.1.1_1 Multiple PRBs - Prop'n Condition EVA5 - Prop'n Condition ETU70 - Prop'n Condition ETU300	SNRs as specified	Same as 8.2.1.1.1 Multiple PRBs Propagation EVA5, ETU70, ETU300	Formula: SNR + TT T-put limit unchanged
8.2.1.1.1_2 Multiple PRB - Prop'n Condition EVA5	SNRs as specified	Same as 8.2.1.1.1 Multiple PRBs Propagation EVA5	Formula: SNR + TT T-put limit unchanged
8.2.1.1.1_A.1	SNRs as specified	Same as 8.2.1.1.1 Multiple PRBs, for each CC	Formula: SNR + TT T-put limit unchanged
8.2.1.1.1_A.2	SNRs as specified	Same as 8.2.1.1.1 Multiple PRBs for each CC	Formula: SNR + TT T-put limit unchanged
8.2.1.1.2 Single PRB	SNR as specified	0.8dB	Formula: SNR + TT T-put limit unchanged
8.2.1.2.1 - Prop'n Condition EVA5	SNR as specified	0.9 dB	Formula: SNR + TT T-put limit unchanged
8.2.1.2.1 - Prop'n Condition HST	SNR as specified	0.6 dB	Formula: SNR + TT T-put limit unchanged
8.2.1.2.1_1 - Prop'n Condition EVA5	SNR as specified	Same as 8.2.1.2.1	Formula: SNR + TT T-put limit unchanged
8.2.1.2.2	SNR as specified	0.9 dB	Formula: SNR + TT T-put limit unchanged
8.2.1.2.2_1	SNR as specified	Same as 8.2.1.2.2	Formula: SNR + TT T-put limit unchanged

8.2.1.2.3_C.1	$N_{oc1}$ : -102dBm/15kHz $N_{oc2}$ : -98dBm/15kHz $N_{oc3}$ : -94.8dBm/15kHz $\hat{E}_{s1} / N_{oc2}$ : +3.4dB $\hat{E}_{s2} / N_{oc2}$ : +6dB	-0.1dB 0dB -0.1dB +0.9dB -0.2dB	$N_{oc1}$ : -102.1dBm/15kHz $N_{oc2}$ : -98dBm/15kHz $N_{oc3}$ : -94.9dBm/15kHz $\hat{E}_{s1} / N_{oc2}$ : +4.3dB $\hat{E}_{s2} / N_{oc2}$ : +5.8dB  Formulae for Test Tolerance values: $N_{oc1}$ : $-(\hat{E}_{s1}/N_{oc1}$ uncertainty - $\hat{E}_{s1}/N_{oc2}$ uncertainty) $N_{oc2}$ : unchanged $N_{oc3}$ : $-(\hat{E}_{s1}/N_{oc3}$ uncertainty - $\hat{E}_{s1}/N_{oc2}$ uncertainty) $\hat{E}_{s1} / N_{oc2}$ : $+\hat{E}_{s1}/N_{oc2}$ uncertainty $\hat{E}_{s2} / N_{oc2}$ : $-(\hat{E}_{s2}/\hat{E}_{s1}$ uncertainty - $\hat{E}_{s1}/N_{oc2}$ uncertainty) T-put limit unchanged  The analysis is recorded in 3GPP TR 36.904 [17]
8.2.1.2.3_E.1 - Prop'n Condition EVA5	$N_{oc1}$ : -98dBm/15kHz $N_{oc2}$ : -98dBm/15kHz $N_{oc3}$ : -93dBm/15kHz $\hat{E}_{s1} / N_{oc2}$ : +3.4dB $\hat{E}_{s2} / N_{oc2}$ : +12dB $\hat{E}_{s3} / N_{oc2}$ : +10dB	0dB 0dB -0.1dB +0.9dB -0.2dB -0.2dB	$N_{oc1}$ : -98dBm/15kHz $N_{oc2}$ : -98dBm/15kHz $N_{oc3}$ : -93.1dBm/15kHz $\hat{E}_{s1} / N_{oc2}$ : +4.3dB $\hat{E}_{s2} / N_{oc2}$ : +11.8dB $\hat{E}_{s3} / N_{oc2}$ : +9.8dB  The analysis is recorded in 3GPP TR 36.904 [17] T-put limit unchanged
8.2.1.2.4	$N_{oc}$ : -98dBm/15kHz DIP 1: -2.23dB DIP 1: -8.06dB SINR: -1.10dB	0dB +0.35dB +0.85dB +0.95dB	$N_{oc}$ : -98dBm/15kHz DIP 1: -1.88dB DIP 1: -7.21dB SINR: -0.15dB T-put limit unchanged  The analysis is recorded in 3GPP TR 36.904 [17]
8.2.1.3.1	SNR as specified	0.9 dB	Formula: SNR + TT T-put limit unchanged
8.2.1.3.1_1	SNR as specified	Same as 8.2.1.3.1	Formula: SNR + TT T-put limit unchanged
8.2.1.3.1_A.1	SNR as specified	0.9 dB	Formula: SNR + TT T-put limit unchanged
8.2.1.3.1_A.2	SNR as specified	0.9 dB	Formula: SNR + TT T-put limit unchanged
8.2.1.3.1A_A.1	SNR as specified	0.9 dB	Formula: SNR + TT T-put limit unchanged
8.2.1.3.2	SNR as specified	0.9 dB	Formula: SNR + TT T-put limit unchanged
8.2.1.3.3_C.1	$N_{oc1}$ : -102dBm/15kHz $N_{oc2}$ : -98dBm/15kHz $N_{oc3}$ : -94.8dBm/15kHz $\hat{E}_{s1} / N_{oc2}$ : +13.3dB $\hat{E}_{s2} / N_{oc2}$ : +6dB	-0.1dB 0dB -0.1dB +0.9dB -0.2dB	$N_{oc1}$ : -102.1dBm/15kHz $N_{oc2}$ : -98dBm/15kHz $N_{oc3}$ : -94.9dBm/15kHz $\hat{E}_{s1} / N_{oc2}$ : +14.2dB $\hat{E}_{s2} / N_{oc2}$ : +5.8dB  Formulae for Test Tolerance values: $N_{oc1}$ : $-(\hat{E}_{s1}/N_{oc1}$ uncertainty - $\hat{E}_{s1}/N_{oc2}$ uncertainty) $N_{oc2}$ : unchanged $N_{oc3}$ : $-(\hat{E}_{s1}/N_{oc3}$ uncertainty - $\hat{E}_{s1}/N_{oc2}$ uncertainty) $\hat{E}_{s1} / N_{oc2}$ : $+\hat{E}_{s1}/N_{oc2}$ uncertainty $\hat{E}_{s2} / N_{oc2}$ : $-(\hat{E}_{s2}/\hat{E}_{s1}$ uncertainty - $\hat{E}_{s1}/N_{oc2}$ uncertainty) T-put limit unchanged

8.2.1.3.3_C.2	$N_{oc1}$ : -102dBm/15kHz $N_{oc2}$ : -98dBm/15kHz $N_{oc3}$ : -94.8dBm/15kHz $\hat{E}_{S1} / N_{oc2}$ : +12.0dB $\hat{E}_{S2} / N_{oc2}$ : +6dB	-0.1dB 0dB -0.1dB +0.9dB -0.2dB	$N_{oc1}$ : -102.1dBm/15kHz $N_{oc2}$ : -98dBm/15kHz $N_{oc3}$ : -94.9dBm/15kHz $\hat{E}_{S1} / N_{oc2}$ : +12.9dB $\hat{E}_{S2} / N_{oc2}$ : +5.8dB  Formulae for Test Tolerance values: $N_{oc1}$ : $-(\hat{E}_{S1}/N_{oc1}$ uncertainty - $\hat{E}_{S1}/N_{oc2}$ uncertainty) $N_{oc2}$ : unchanged $N_{oc3}$ : $-(\hat{E}_{S1}/N_{oc3}$ uncertainty - $\hat{E}_{S1}/N_{oc2}$ uncertainty) $\hat{E}_{S1} / N_{oc2}$ : $+\hat{E}_{S1}/N_{oc2}$ uncertainty $\hat{E}_{S2} / N_{oc2}$ : $-(\hat{E}_{S2}/\hat{E}_{S1}$ uncertainty - $\hat{E}_{S1}/N_{oc2}$ uncertainty) T-put limit unchanged
8.2.1.3.3_E.1 - Prop'n Condition EVA5	$N_{oc1}$ : -98dBm/15kHz $N_{oc2}$ : -98dBm/15kHz $N_{oc3}$ : -93dBm/15kHz Test 1 $\hat{E}_{S1} / N_{oc2}$ : + 13.9dB $\hat{E}_{S2} / N_{oc2}$ : + 9dB $\hat{E}_{S3} / N_{oc2}$ : + 7dB Test 2 $\hat{E}_{S1} / N_{oc2}$ : +22.6dB $\hat{E}_{S2} / N_{oc2}$ : +9dB +1dB $\hat{E}_{S3} / N_{oc2}$ :	0dB 0dB -0.1dB  +0.9dB -0.2dB -0.2dB  +0.9dB -0.2dB -0.2dB	$N_{oc1}$ : -98dBm/15kHz $N_{oc2}$ : -98dBm/15kHz $N_{oc3}$ : - 93.1 dBm/15kHz  $\hat{E}_{S1} / N_{oc2}$ : + 14.8 dB $\hat{E}_{S2} / N_{oc2}$ : + 8.8dB $\hat{E}_{S3} / N_{oc2}$ : + 6.8 dB  $\hat{E}_{S1} / N_{oc2}$ : +23.5dB $\hat{E}_{S2} / N_{oc2}$ : +8.8dB $\hat{E}_{S3} / N_{oc2}$ : +0.8dB  The analysis is recorded in 3GPP TR 36.904 [17] T-put limit unchanged
8.2.1.4.1	SNRs as specified	0.9 dB	Formula: SNR + TT T-put limit unchanged
8.2.1.4.1_1	SNR as specified	Same as 8.2.1.4.1	Formula: SNR + TT T-put limit unchanged
8.2.1.4.1_E.1 - Prop'n Condition EPA5	$N_{oc1}$ : -98 dBm/15kHz $N_{oc2}$ : -98 dBm/15kHz $N_{oc3}$ : -93 dBm/15kHz $\hat{E}_{S1} / N_{oc2}$ : +6.1 dB $\hat{E}_{S2} / N_{oc2}$ : +12 dB $\hat{E}_{S3} / N_{oc2}$ : +10 dB	0 dB 0 dB -0.1 dB +0.9 dB -0.2 dB -0.2 dB	$N_{oc1}$ : -98 dBm/15kHz $N_{oc2}$ : -98 dBm/15kHz $N_{oc3}$ : -93.1 dBm/15kHz $\hat{E}_{S1} / N_{oc2}$ : +7.0 dB $\hat{E}_{S2} / N_{oc2}$ : +11.8 dB $\hat{E}_{S3} / N_{oc2}$ : +9.8 dB  The analysis is recorded in 3GPP TR 36.904 [17] T-put limit unchanged
8.2.1.4.2	SNRs as specified	0.9 dB	Formula: SNR + TT T-put limit unchanged
8.2.1.4.2_1	SNR as specified	Same as 8.2.1.4.2	Formula: SNR + TT T-put limit unchanged
8.2.1.4.2_A.1	SNR as specified	Same as 8.2.1.4.2 for each CC	Formula: SNR + TT T-put limit unchanged
8.2.1.4.2_A.2	SNR as specified	Same as 8.2.1.4.2 for each CC	Formula: SNR + TT T-put limit unchanged
8.2.1.4.3	$N_{oc}$ : -98dBm/15kHz DIP 1: -1.73dB DIP 1: -8.66dB SINR: 0.8dB	0dB +0.29dB +0.89dB +0.99dB	$N_{oc}$ : -98dBm/15kHz DIP 1: -1.44dB DIP 1: -7.77dB SINR: 1.79dB T-put limit unchanged
8.2.1.7.1_A.1	TBD	TBD	TBD
8.2.2.1.1 Multiple PRBs - Prop'n Condition EVA5 - Prop'n Condition ETU70 - Prop'n Condition ETU300	SNRs as specified	0.8dB	Formula: SNR + TT T-put limit unchanged
8.2.2.1.1 Multiple PRBs - Prop'n Condition HST	SNR as specified	0.6dB	Formula: SNR + TT T-put limit unchanged

8.2.2.1.1 Single PRB - Prop'n Condition ETU70	SNRs as specified	0.8dB	Formula: SNR + TT T-put limit unchanged
8.2.2.1.1_1 Multiple PRBs - Prop'n Condition EVA5 - Prop'n Condition ETU70 - Prop'n Condition ETU300	SNRs as specified	Same as 8.2.2.1.1 Multiple PRBs Propagation EVA5, ETU70, ETU300	Formula: SNR + TT T-put limit unchanged
8.2.2.1.1_2 Multiple PRB - Prop'n Condition EVA5	SNRs as specified	Same as 8.2.2.1.1 Multiple PRBs Propagation EVA5	Formula: SNR + TT T-put limit unchanged
8.2.2.1.1_A.1	SNRs as specified	8.2.2.1.1 Multiple PRBs for each CC	Formula: SNR + TT T-put limit unchanged
8.2.2.1.1_A.2	SNRs as specified	8.2.2.1.1 Multiple PRBs for each CC	Formula: SNR + TT T-put limit unchanged
8.2.2.1.2 Single PRB	SNR as specified	0.8dB	Formula: SNR + TT T-put limit unchanged
8.2.2.2.1 - Prop'n Condition EVA5	SNR as specified	0.9 dB	Formula: SNR + TT T-put limit unchanged
8.2.2.2.1 - Prop'n Condition HST	SNR as specified	0.6 dB	Formula: SNR + TT T-put limit unchanged
8.2.2.2.1_1 - Prop'n Condition EVA5	SNR as specified	Same as 8.2.2.2.1	Formula: SNR + TT T-put limit unchanged
8.2.2.2.2	SNR as specified	0.9 dB	Formula: SNR + TT T-put limit unchanged
8.2.2.2.2_1	SNR as specified	Same as 8.2.2.2.2	Formula: SNR + TT T-put limit unchanged
8.2.2.2.3_C.1	$N_{oc1}$ : -102dBm/15kHz $N_{oc2}$ : -98dBm/15kHz $N_{oc3}$ : -94.8dBm/15kHz $\hat{E}_{s1} / N_{oc2}$ : +3.8dB $\hat{E}_{s2} / N_{oc2}$ : +6dB	-0.1dB 0dB -0.1dB +0.9dB -0.2dB	$N_{oc1}$ : -102.1dBm/15kHz $N_{oc2}$ : -98dBm/15kHz $N_{oc3}$ : -94.9dBm/15kHz $\hat{E}_{s1} / N_{oc2}$ : +4.7dB $\hat{E}_{s2} / N_{oc2}$ : +5.8dB  Formulae for Test Tolerance values: $N_{oc1}$ : $-(\hat{E}_{s1}/N_{oc1}$ uncertainty - $\hat{E}_{s1}/N_{oc2}$ uncertainty) $N_{oc2}$ : unchanged $N_{oc3}$ : $-(\hat{E}_{s1}/N_{oc3}$ uncertainty - $\hat{E}_{s1}/N_{oc2}$ uncertainty) $\hat{E}_{s1} / N_{oc2}$ : $+\hat{E}_{s1}/N_{oc2}$ uncertainty $\hat{E}_{s2} / N_{oc2}$ : $-(\hat{E}_{s2}/\hat{E}_{s1}$ uncertainty - $\hat{E}_{s1}/N_{oc2}$ uncertainty) T-put limit unchanged  The analysis is recorded in 3GPP TR 36.904 [17]
8.2.2.2.3_E.1 - Prop'n Condition EVA5	$N_{oc1}$ : [-98dBm/15kHz ] $N_{oc2}$ : -98dBm/15kHz $N_{oc3}$ : -93dBm/15kHz $\hat{E}_{s1} / N_{oc2}$ : +3.5dB $\hat{E}_{s2} / N_{oc2}$ : +12dB $\hat{E}_{s3} / N_{oc2}$ : +10dB	0dB 0dB -0.1dB +0.9dB -0.2dB -0.2dB	$N_{oc1}$ : -98dBm/15kHz $N_{oc2}$ : -98dBm/15kHz $N_{oc3}$ : -93.1dBm/15kHz $\hat{E}_{s1} / N_{oc2}$ : +4.4dB $\hat{E}_{s2} / N_{oc2}$ : +11.8dB $\hat{E}_{s3} / N_{oc2}$ : +9.8dB  The analysis is recorded in 3GPP TR 36.904 [17] T-put limit unchanged



8.2.2.2.4	$N_{oc}$ : -98dBm/15kHz DIP 1: -1.73dB DIP 2: -8.66dB SINR: -1.4dB	0 dB +0.29dB +0.89dB +0.99dB	$N_{oc}$ : -98dBm/15kHz DIP1: -1.44dB DIP2: -7.77 SINR: -0.41dB T-put limit unchanged  The analysis is recorded in 3GPP TR 36.904 [17]
8.2.2.3.1	SNR as specified	0.9 dB	Formula: SNR + TT T-put limit unchanged
8.2.2.3.1_1	SNR as specified	Same as 8.2.2.3.1	Formula: SNR + TT T-put limit unchanged
8.2.2.3.1_2	SNR as specified	Same as 8.2.2.3.1	Formula: SNR + TT T-put limit unchanged
8.2.2.3.1_A.1	SNRs as specified	Same as 8.2.2.3.1 for each CC	Formula: SNR + TT T-put limit unchanged
8.2.2.3.1_A.2	SNRs as specified	Same as 8.2.2.3.1 for each CC	Formula: SNR + TT T-put limit unchanged
8.2.2.3.1A_A.1	SNRs as specified	Same as 8.2.2.3.1 for each CC	Formula: SNR + TT T-put limit unchanged
8.2.2.3.2	SNR as specified	0.9 dB	Formula: SNR + TT T-put limit unchanged
8.2.2.3.3_C.1	$N_{oc1}$ : -102dBm/15kHz $N_{oc2}$ : -98dBm/15kHz $N_{oc3}$ : -94.8dBm/15kHz $\hat{E}_{s1} / N_{oc2}$ : +14.0dB $\hat{E}_{s2} / N_{oc2}$ : +6dB	-0.1dB 0dB -0.1dB +0.9dB -0.2dB	$N_{oc1}$ : -102.1dBm/15kHz $N_{oc2}$ : -98dBm/15kHz $N_{oc3}$ : -94.9dBm/15kHz $\hat{E}_{s1} / N_{oc2}$ : +14.9dB $\hat{E}_{s2} / N_{oc2}$ : +5.8dB  Formuale for Test Tolerance values: $N_{oc1}$ : $-(\hat{E}_{s1}/N_{oc1}$ uncertainty - $\hat{E}_{s1}/N_{oc2}$ uncertainty) $N_{oc2}$ : unchanged $N_{oc3}$ : $-(\hat{E}_{s1}/N_{oc3}$ uncertainty - $\hat{E}_{s1}/N_{oc2}$ uncertainty) $\hat{E}_{s1} / N_{oc2}$ : $+\hat{E}_{s1}/N_{oc2}$ uncertainty $\hat{E}_{s2} / N_{oc2}$ : $-(\hat{E}_{s2}/\hat{E}_{s1}$ uncertainty - $\hat{E}_{s1}/N_{oc2}$ uncertainty) T-put limit unchanged
8.2.2.3.3_C.2	$N_{oc1}$ : -102dBm/15kHz $N_{oc2}$ : -98dBm/15kHz $N_{oc3}$ : -94.8dBm/15kHz $\hat{E}_{s1} / N_{oc2}$ : +12.2dB $\hat{E}_{s2} / N_{oc2}$ : +6dB	-0.1dB 0dB -0.1dB +0.9dB -0.2dB	$N_{oc1}$ : -102.1dBm/15kHz $N_{oc2}$ : -98dBm/15kHz $N_{oc3}$ : -94.9dBm/15kHz $\hat{E}_{s1} / N_{oc2}$ : +13.1dB $\hat{E}_{s2} / N_{oc2}$ : +5.8dB  Formuale for Test Tolerance values: $N_{oc1}$ : $-(\hat{E}_{s1}/N_{oc1}$ uncertainty - $\hat{E}_{s1}/N_{oc2}$ uncertainty) $N_{oc2}$ : unchanged $N_{oc3}$ : $-(\hat{E}_{s1}/N_{oc3}$ uncertainty - $\hat{E}_{s1}/N_{oc2}$ uncertainty) $\hat{E}_{s1} / N_{oc2}$ : $+\hat{E}_{s1}/N_{oc2}$ uncertainty $\hat{E}_{s2} / N_{oc2}$ : $-(\hat{E}_{s2}/\hat{E}_{s1}$ uncertainty - $\hat{E}_{s1}/N_{oc2}$ uncertainty) T-put limit unchanged

8.2.2.3.3_E.1 - Prop'n Condition EVA5	N <sub>oc1</sub> : -98dBm/15kHz N <sub>oc2</sub> : -98dBm/15kHz N <sub>oc3</sub> : -93dBm/15kHz Test 1 $\hat{E}_{S1} / N_{oc2}$ : + 14.2 dB $\hat{E}_{S2} / N_{oc2}$ : + 9 dB $\hat{E}_{S3} / N_{oc2}$ : + 7 dB Test 2 $\hat{E}_{S1} / N_{oc2}$ : +22.7dB $\hat{E}_{S2} / N_{oc2}$ : +9dB $\hat{E}_{S3} / N_{oc2}$ : +1dB	0dB 0dB -0.1dB  +0.9dB -0.2dB -0.2dB  +0.9dB -0.2dB -0.2dB	N <sub>oc1</sub> : -98dBm/15kHz N <sub>oc2</sub> : -98dBm/15kHz N <sub>oc3</sub> : -93.1dBm/15kHz  $\hat{E}_{S1} / N_{oc2}$ : + 15.1 dB $\hat{E}_{S2} / N_{oc2}$ : + 8.8 dB $\hat{E}_{S3} / N_{oc2}$ : + 6.8 dB  $\hat{E}_{S1} / N_{oc2}$ : +23.6dB $\hat{E}_{S2} / N_{oc2}$ : +8.8dB $\hat{E}_{S3} / N_{oc2}$ : +0.8dB  The analysis is recorded in 3GPP TR 36.904 [17] T-put limit unchanged
8.2.2.4.1	SNRs as specified	0.9 dB	Formula: SNR + TT T-put limit unchanged
8.2.2.4.1_1	SNR as specified	Same as 8.2.2.4.1	Formula: SNR + TT T-put limit unchanged
8.2.2.4.1_E.1 - Prop'n Condition EPA5	N <sub>oc1</sub> : -98 dBm/15kHz N <sub>oc2</sub> : -98 dBm/15kHz N <sub>oc3</sub> : -93 dBm/15kHz $\hat{E}_{S1} / N_{oc2}$ : +6.4 dB $\hat{E}_{S2} / N_{oc2}$ : +12 dB $\hat{E}_{S3} / N_{oc2}$ : +10 dB	0 dB 0 dB -0.1 dB +0.9 dB -0.2 dB -0.2 dB	N <sub>oc1</sub> : -98 dBm/15kHz N <sub>oc2</sub> : -98 dBm/15kHz N <sub>oc3</sub> : -93.1 dBm/15kHz $\hat{E}_{S1} / N_{oc2}$ : +7.3 dB $\hat{E}_{S2} / N_{oc2}$ : +11.8 dB $\hat{E}_{S3} / N_{oc2}$ : +9.8 dB  The analysis is recorded in 3GPP TR 36.904 [17] T-put limit unchanged
8.2.2.4.2	SNRs as specified	0.9 dB	Formula: SNR + TT T-put limit unchanged
8.2.2.4.2_1	SNR as specified	Same as 8.2.2.4.2	Formula: SNR + TT T-put limit unchanged
8.2.2.4.2_A.1	SNR as specified	Same as 8.2.2.4.2 for each CC	Formula: SNR + TT T-put limit unchanged
8.2.2.4.2_A.2	SNR as specified	Same as 8.2.2.4.2 for each CC	Formula: SNR + TT T-put limit unchanged
8.2.2.4.3	N <sub>oc</sub> : -98dBm/15kHz DIP 1: -1.73dB DIP 2: -8.66dB SINR: 1.1dB	0 dB +0.29dB +0.89dB +0.99dB	N <sub>oc</sub> : -98dBm/15kHz DIP1: -1.44dB DIP2: -7.77 SINR: 2.09dB T-put limit unchanged  The analysis is recorded in 3GPP TR 36.904 [17]
8.2.2.7.1_A.1	TBD	TBD	TBD
8.3.1.1.1_D	SNR as specified	0.9 dB	Formula: SNR + TT T-put limit unchanged
8.3.1.1.2_D	SNR as specified	0.9 dB	Formula: SNR + TT T-put limit unchanged
8.3.1.1.3	N <sub>oc</sub> : -98dBm/15kHz DIP 1: -1.73dB SINR: -1.10dB	0 dB +0.28dB +0.98dB	N <sub>oc</sub> : -98dBm/15kHz DIP1: -1.45dB SINR: -0.12dB T-put limit unchanged  The analysis is recorded in 3GPP TR 36.904 [17]
8.3.1.2.1_D	SNR as specified	0.9 dB	Formula: SNR + TT T-put limit unchanged

8.3.1.2.1_D_1	$N_{oc}$ : -98dBm/15kHz $\hat{E}_{s1} / N_{oc}$ : +14.2 dB $\hat{E}_{s2} / N_{oc}$ : +7.25 dB	0 dB +0.8 dB -0.35 dB	$N_{oc}$ : -98dBm/15kHz $\hat{E}_{s1} / N_{oc}$ : +15.0 dB $\hat{E}_{s2} / N_{oc}$ : +6.9 dB T-put limit unchanged  The analysis is recorded in 3GPP TR 36.904 [17]
8.3.1.3.1_F	SNR as specified Test 1: 2us Test 2: -0.5us	0.9 dB -0.145us +0.142us	Formula: SNR + TT Test 1: 57Ts Test 2: -11Ts Timings: (Offset – uncertainty), then rounded to integer multiple of Ts  T-put limit unchanged
8.3.1.3.2_F	SNR as specified Test 1: 2us Test 2: -0.5us	0.9 dB -0.145us +0.142us	Formula: SNR + TT Test 1: 57Ts Test 2: -11Ts Timings: (Offset – uncertainty), then rounded to integer multiple of Ts  T-put limit unchanged
8.3.1.3.3_F	SNR as specified Test 1: 2us Test 2: -0.5us	0.9 dB -0.145us +0.142us	Formula: SNR + TT Test 1: 57Ts Test 2: -11Ts Timings: (Offset - uncertainty), then rounded to integer multiple of Ts  T-put limit unchanged
8.3.2.1.1	SNRs as specified	0.9 dB	Formula: SNR + TT T-put limit unchanged
8.3.2.1.1_1	SNRs as specified	0.9 dB	Formula: SNR + TT T-put limit unchanged
8.3.2.1.2	SNRs as specified	0.9 dB	Formula: SNR + TT T-put limit unchanged
8.3.2.1.2_D	SNR as specified	0.9 dB	Formula: SNR + TT T-put limit unchanged
8.3.2.1.3	SNRs as specified	0.9 dB	Formula: SNR + TT T-put limit unchanged
8.3.2.1.3_D	SNR as specified	0.9 dB	Formula: SNR + TT T-put limit unchanged
8.3.2.1.4	$N_{oc}$ : -98dBm/15kHz DIP 1: -1.73dB SINR: -1.0dB	0 dB +0.28dB +0.98dB	$N_{oc}$ : -98dBm/15kHz DIP1: -1.45dB SINR: -0.02dB T-put limit unchanged  The analysis is recorded in 3GPP TR 36.904 [17]
8.3.2.2.1	SNRs as specified	0.9 dB	Formula: SNR + TT T-put limit unchanged
8.3.2.2.1_D	SNR as specified	0.9 dB	Formula: SNR + TT T-put limit unchanged
8.3.2.2.1_D_1	$N_{oc}$ : -98dBm/15kHz $\hat{E}_{s1} / N_{oc}$ : +14.8 dB $\hat{E}_{s2} / N_{oc}$ : +7.25 dB	0 dB +0.8 dB -0.35 dB	$N_{oc}$ : -98dBm/15kHz $\hat{E}_{s1} / N_{oc}$ : +15.6 dB $\hat{E}_{s2} / N_{oc}$ : +6.9 dB T-put limit unchanged  The analysis is recorded in 3GPP TR 36.904 [17]
8.3.2.4.1_F	SNR as specified Test 1: 2us Test 2: -0.5us	0.9 dB -0.145us +0.142us	Formula: SNR + TT Test 1: 57Ts Test 2: -11Ts Timings: (Offset – uncertainty), then rounded to integer multiple of Ts  T-put limit unchanged

8.3.2.4.2_F	SNR as specified Test 1: 2us Test 2: -0.5us	0.9 dB -0.145us +0.142us	Formula: SNR + TT Test 1: 57Ts Test 2: -11Ts Timings: (Offset - uncertainty), then rounded to integer multiple of Ts  T-put limit unchanged
8.3.2.4.3_F	SNR as specified Test 1: 2us Test 2: -0.5us	0.9 dB -0.145us +0.142us	Formula: SNR + TT Test 1: 57Ts Test 2: -11Ts Timings: (Offset - uncertainty), then rounded to integer multiple of Ts  T-put limit unchanged
8.4.1.1	SNR as specified	0.8 dB	Formula: SNR + TT T-put limit unchanged
8.4.1.2.1	SNR as specified	1.0 dB	Formula: SNR + TT T-put limit unchanged
8.4.1.2.1_1	SNR as specified	Same as 8.4.1.2.1	Formula: SNR + TT T-put limit unchanged
8.4.1.2.2	SNR as specified	1.0 dB	Formula: SNR + TT T-put limit unchanged
8.4.1.2.2_1	SNR as specified	Same as 8.4.1.2.2	Formula: SNR + TT T-put limit unchanged
8.4.1.2.3_C.1	$N_{oc1}$ : -100.5dBm/15kHz $N_{oc2}$ : -98dBm/15kHz $N_{oc3}$ : -95.3dBm/15kHz $\hat{E}_{s1} / N_{oc2}$ : -3.9dB $\hat{E}_{s2} / N_{oc2}$ : +1.5dB	-0.1dB 0dB -0.1dB +0.9dB -0.2dB	$N_{oc1}$ : -100.6dBm/15kHz $N_{oc2}$ : -98dBm/15kHz $N_{oc3}$ : -95.4dBm/15kHz $\hat{E}_{s1} / N_{oc2}$ : -3dB $\hat{E}_{s2} / N_{oc2}$ : +1.3dB  Formula for Test Tolerance values: $N_{oc1}$ : $-(\hat{E}_{s1}/N_{oc1}$ uncertainty - $\hat{E}_{s1}/N_{oc2}$ uncertainty) $N_{oc2}$ : unchanged $N_{oc3}$ : $-(\hat{E}_{s1}/N_{oc3}$ uncertainty - $\hat{E}_{s1}/N_{oc2}$ uncertainty) $\hat{E}_{s1} / N_{oc2}$ : $+\hat{E}_{s1}/N_{oc2}$ uncertainty $\hat{E}_{s2} / N_{oc2}$ : $-(\hat{E}_{s2}/\hat{E}_{s1}$ uncertainty - $\hat{E}_{s1}/N_{oc2}$ uncertainty) T-put limit unchanged
8.4.1.2.3_C.2	$N_{oc1}$ : -100.5dBm/15kHz $N_{oc2}$ : -98dBm/15kHz $N_{oc3}$ : -95.3dBm/15kHz $\hat{E}_{s1} / N_{oc2}$ : -4.2dB $\hat{E}_{s2} / N_{oc2}$ : +1.5dB	-0.1dB 0dB -0.1dB +0.9dB -0.2dB	$N_{oc1}$ : -100.6dBm/15kHz $N_{oc2}$ : -98dBm/15kHz $N_{oc3}$ : -95.4dBm/15kHz $\hat{E}_{s1} / N_{oc2}$ : -3.3dB $\hat{E}_{s2} / N_{oc2}$ : +1.3dB  Formula for Test Tolerance values: $N_{oc1}$ : $-(\hat{E}_{s1}/N_{oc1}$ uncertainty - $\hat{E}_{s1}/N_{oc2}$ uncertainty) $N_{oc2}$ : unchanged $N_{oc3}$ : $-(\hat{E}_{s1}/N_{oc3}$ uncertainty - $\hat{E}_{s1}/N_{oc2}$ uncertainty) $\hat{E}_{s1} / N_{oc2}$ : $+\hat{E}_{s1}/N_{oc2}$ uncertainty $\hat{E}_{s2} / N_{oc2}$ : $-(\hat{E}_{s2}/\hat{E}_{s1}$ uncertainty - $\hat{E}_{s1}/N_{oc2}$ uncertainty) T-put limit unchanged
8.4.1.2.3_E.1 - Prop'n Condition EVA5	$N_{oc1}$ : -98 dBm/15kHz $N_{oc2}$ : -98 dBm/15kHz $N_{oc3}$ : -93 dBm/15kHz $\hat{E}_{s1} / N_{oc2}$ : -2.2 dB $\hat{E}_{s2} / N_{oc2}$ : +5 dB $\hat{E}_{s3} / N_{oc2}$ : +3 dB	0 dB 0 dB -0.1 dB +0.9 dB -0.2 dB -0.2 dB	$N_{oc1}$ : -98 dBm/15kHz $N_{oc2}$ : -98 dBm/15kHz $N_{oc3}$ : -93.1 dBm/15kHz $\hat{E}_{s1} / N_{oc2}$ : -1.3 dB $\hat{E}_{s2} / N_{oc2}$ : +4.8 dB $\hat{E}_{s3} / N_{oc2}$ : +2.8 dB The analysis is recorded in 3GPP TR 36.904 [17] Pm-dsg limit unchanged

<p>8.4.1.2.3_E.2 - Prop'n Condition EVA5</p>	<p><math>N_{oc1}</math>: -98 dBm/15kHz <math>N_{oc2}</math>: -98 dBm/15kHz <math>N_{oc3}</math>: -93 dBm/15kHz <math>\hat{E}_{s1} / N_{oc2}</math>: -2 dB <math>\hat{E}_{s2} / N_{oc2}</math>: +5 dB <math>\hat{E}_{s3} / N_{oc2}</math>: +3 dB</p>	<p>0 dB 0 dB -0.1 dB +0.9 dB -0.2 dB -0.2 dB</p>	<p><math>N_{oc1}</math>: -98 dBm/15kHz <math>N_{oc2}</math>: -98 dBm/15kHz <math>N_{oc3}</math>: -93.1 dBm/15kHz <math>\hat{E}_{s1} / N_{oc2}</math>: -1.1 dB <math>\hat{E}_{s2} / N_{oc2}</math>: +4.8 dB <math>\hat{E}_{s3} / N_{oc2}</math>: +2.8 dB</p> <p>The analysis is recorded in 3GPP TR 36.904 [17] Pm-dsg limit unchanged</p>
<p>8.4.2.1</p>	<p>SNR as specified</p>	<p>0.8 dB</p>	<p>Formula: SNR + TT T-put limit unchanged</p>
<p>8.4.2.2.1</p>	<p>SNR as specified</p>	<p>1.0 dB</p>	<p>Formula: SNR + TT T-put limit unchanged</p>
<p>8.4.2.2.1_1</p>	<p>SNR as specified</p>	<p>Same as 8.4.2.2.1</p>	<p>Formula: SNR + TT T-put limit unchanged</p>
<p>8.4.2.2.2</p>	<p>SNR as specified</p>	<p>1.0 dB</p>	<p>Formula: SNR + TT T-put limit unchanged</p>
<p>8.4.2.2.2_1</p>	<p>SNR as specified</p>	<p>Same as 8.4.2.2.2</p>	<p>Formula: SNR + TT T-put limit unchanged</p>
<p>8.4.2.2.3_C.1</p>	<p><math>N_{oc1}</math>: -100.5dBm/15kHz <math>N_{oc2}</math>: -98dBm/15kHz <math>N_{oc3}</math>: -95.3dBm/15kHz <math>\hat{E}_{s1} / N_{oc2}</math>: -3.9dB <math>\hat{E}_{s2} / N_{oc2}</math>: +1.5dB</p>	<p>-0.1dB 0dB -0.1dB +0.9dB -0.2dB</p>	<p><math>N_{oc1}</math>: -100.6dBm/15kHz <math>N_{oc2}</math>: -98dBm/15kHz <math>N_{oc3}</math>: -95.4dBm/15kHz <math>\hat{E}_{s1} / N_{oc2}</math>: -3dB <math>\hat{E}_{s2} / N_{oc2}</math>: +1.3dB</p> <p>Formula for Test Tolerance values: <math>N_{oc1}</math>: <math>-(\hat{E}_{s1}/N_{oc1} \text{ uncertainty} - \hat{E}_{s1}/N_{oc2} \text{ uncertainty})</math> <math>N_{oc2}</math>: unchanged <math>N_{oc3}</math>: <math>-(\hat{E}_{s1}/N_{oc3} \text{ uncertainty} - \hat{E}_{s1}/N_{oc2} \text{ uncertainty})</math> <math>\hat{E}_{s1} / N_{oc2}</math>: <math>+\hat{E}_{s1}/N_{oc2} \text{ uncertainty}</math> <math>\hat{E}_{s2} / N_{oc2}</math>: <math>-(\hat{E}_{s2}/\hat{E}_{s1} \text{ uncertainty} - \hat{E}_{s1}/N_{oc2} \text{ uncertainty})</math> T-put limit unchanged</p>
<p>8.4.2.2.3_C.2</p>	<p><math>N_{oc1}</math>: -100.5dBm/15kHz <math>N_{oc2}</math>: -98dBm/15kHz <math>N_{oc3}</math>: -95.3dBm/15kHz <math>\hat{E}_{s1} / N_{oc2}</math>: -4.1dB <math>\hat{E}_{s2} / N_{oc2}</math>: +1.5dB</p>	<p>-0.1dB 0dB -0.1dB +0.9dB -0.2dB</p>	<p><math>N_{oc1}</math>: -100.6dBm/15kHz <math>N_{oc2}</math>: -98dBm/15kHz <math>N_{oc3}</math>: -95.4dBm/15kHz <math>\hat{E}_{s1} / N_{oc2}</math>: -3.2dB <math>\hat{E}_{s2} / N_{oc2}</math>: +1.3dB</p> <p>Formula for Test Tolerance values: <math>N_{oc1}</math>: <math>-(\hat{E}_{s1}/N_{oc1} \text{ uncertainty} - \hat{E}_{s1}/N_{oc2} \text{ uncertainty})</math> <math>N_{oc2}</math>: unchanged <math>N_{oc3}</math>: <math>-(\hat{E}_{s1}/N_{oc3} \text{ uncertainty} - \hat{E}_{s1}/N_{oc2} \text{ uncertainty})</math> <math>\hat{E}_{s1} / N_{oc2}</math>: <math>+\hat{E}_{s1}/N_{oc2} \text{ uncertainty}</math> <math>\hat{E}_{s2} / N_{oc2}</math>: <math>-(\hat{E}_{s2}/\hat{E}_{s1} \text{ uncertainty} - \hat{E}_{s1}/N_{oc2} \text{ uncertainty})</math> T-put limit unchanged</p>
<p>8.4.2.2.3_E.1 - Prop'n Condition EVA5</p>	<p><math>N_{oc1}</math>: -98 dBm/15kHz <math>N_{oc2}</math>: -98 dBm/15kHz <math>N_{oc3}</math>: -93 dBm/15kHz <math>\hat{E}_{s1} / N_{oc2}</math>: -2 dB <math>\hat{E}_{s2} / N_{oc2}</math>: +5 dB <math>\hat{E}_{s3} / N_{oc2}</math>: +3 dB</p>	<p>0 dB 0 dB -0.1 dB +0.9 dB -0.2 dB -0.2 dB</p>	<p><math>N_{oc1}</math>: -98 dBm/15kHz <math>N_{oc2}</math>: -98 dBm/15kHz <math>N_{oc3}</math>: -93.1 dBm/15kHz <math>\hat{E}_{s1} / N_{oc2}</math>: -1.1 dB <math>\hat{E}_{s2} / N_{oc2}</math>: +4.8 dB <math>\hat{E}_{s3} / N_{oc2}</math>: +2.8 dB</p> <p>The analysis is recorded in 3GPP TR 36.904 [17] Pm-dsg limit unchanged</p>

8.4.2.2.3_E.2 - Prop'n Condition EVA5	$N_{oc1}$ : -98 dBm/15kHz $N_{oc2}$ : -98 dBm/15kHz $N_{oc3}$ : -93 dBm/15kHz $\hat{E}_{s1} / N_{oc2}$ : -1.8 dB: $\hat{E}_{s2} / N_{oc2}$ : +5 dB $\hat{E}_{s3} / N_{oc2}$ : +3 dB	0 dB 0 dB -0.1 dB +0.9 dB -0.2 dB -0.2 dB	$N_{oc1}$ : -98 dBm/15kHz $N_{oc2}$ : -98 dBm/15kHz $N_{oc3}$ : -93.1 dBm/15kHz $\hat{E}_{s1} / N_{oc2}$ : -0.9 dB $\hat{E}_{s2} / N_{oc2}$ : +4.8 dB $\hat{E}_{s3} / N_{oc2}$ : +2.8 dB  The analysis is recorded in 3GPP TR 36.904 [17] Pm-dsg limit unchanged
8.5.1.1	SNRs as specified	0.9 dB	Formula: SNR + TT T-put limit unchanged
8.5.1.2.1	SNR as specified	1.1 dB	Formula: SNR + TT T-put limit unchanged
8.5.1.2.1_1	SNR as specified	Same as 8.5.1.2.1	Formula: SNR + TT T-put limit unchanged
8.5.1.2.2	SNR as specified	1.0 dB	Formula: SNR + TT T-put limit unchanged
8.5.1.2.3_C.1	$N_{oc1}$ : -100.5dBm/15kHz $N_{oc2}$ : -98dBm/15kHz $N_{oc3}$ : -95.3dBm/15kHz $\hat{E}_{s1} / N_{oc2}$ : +4.6dB $\hat{E}_{s2} / N_{oc2}$ : +1.5dB	-0.1dB 0dB -0.1dB +0.9dB -0.2dB	$N_{oc1}$ : -100.6dBm/15kHz $N_{oc2}$ : -98dBm/15kHz $N_{oc3}$ : -95.4dBm/15kHz $\hat{E}_{s1} / N_{oc2}$ : +5.5dB $\hat{E}_{s2} / N_{oc2}$ : +1.3dB  Formula for Test Tolerance values: $N_{oc1}$ : $-(\hat{E}_{s1}/N_{oc1}$ uncertainty - $\hat{E}_{s1}/N_{oc2}$ uncertainty) $N_{oc2}$ : unchanged $N_{oc3}$ : $-(\hat{E}_{s1}/N_{oc3}$ uncertainty - $\hat{E}_{s1}/N_{oc2}$ uncertainty) $\hat{E}_{s1} / N_{oc2}$ : $+\hat{E}_{s1}/N_{oc2}$ uncertainty $\hat{E}_{s2} / N_{oc2}$ : $-(\hat{E}_{s2}/\hat{E}_{s1}$ uncertainty - $\hat{E}_{s1}/N_{oc2}$ uncertainty) T-put limit unchanged
8.5.1.2.3_E.1	$N_{oc1}$ : -98 dBm/15kHz $N_{oc2}$ : -98 dBm/15kHz $N_{oc3}$ : -93 dBm/15kHz $\hat{E}_{s1} / N_{oc2}$ : +5 dB $\hat{E}_{s2} / N_{oc2}$ : +5 dB $\hat{E}_{s3} / N_{oc2}$ : +3 dB	0 dB 0 dB -0.1 dB +0.9 dB -0.2 dB -0.2 dB	$N_{oc1}$ : -98 dBm/15kHz $N_{oc2}$ : -98 dBm/15kHz $N_{oc3}$ : -93.1 dBm/15kHz $\hat{E}_{s1} / N_{oc2}$ : +5.9 dB $\hat{E}_{s2} / N_{oc2}$ : +4.8 dB $\hat{E}_{s3} / N_{oc2}$ : +2.8 dB The analysis is recorded in 3GPP TR 36.904 [17] Pm-an limit unchanged
8.5.1.2.2_1	SNR as specified	Same as 8.5.1.2.2	Formula: SNR + TT T-put limit unchanged
8.5.2.1	SNRs as specified	0.9 dB	Formula: SNR + TT T-put limit unchanged
8.5.2.2.1	SNR as specified	1.1 dB	Formula: SNR + TT T-put limit unchanged
8.5.2.2.1_1	SNR as specified	Same as 8.5.2.2.1	Formula: SNR + TT T-put limit unchanged
8.5.2.2.2	SNR as specified	1.0 dB	Formula: SNR + TT T-put limit unchanged
8.5.2.2.2_1	SNR as specified	Same as 8.5.2.2.2	Formula: SNR + TT T-put limit unchanged

8.5.2.2.3_C.1	$N_{oc1}$ : -100.5dBm/15kHz $N_{oc2}$ : -98dBm/15kHz $N_{oc3}$ : -95.3dBm/15kHz $\hat{E}_{s1} / N_{oc2}$ : +4.6dB $\hat{E}_{s2} / N_{oc2}$ : +1.5dB	-0.1dB 0dB -0.1dB +0.9dB -0.2dB	$N_{oc1}$ : -100.6dBm/15kHz $N_{oc2}$ : -98dBm/15kHz $N_{oc3}$ : -95.4dBm/15kHz $\hat{E}_{s1} / N_{oc2}$ : +5.5dB $\hat{E}_{s2} / N_{oc2}$ : +1.3dB  Formula for Test Tolerance values: $N_{oc1}$ : $-(\hat{E}_{s1}/N_{oc1}$ uncertainty - $\hat{E}_{s1}/N_{oc2}$ uncertainty) $N_{oc2}$ : unchanged $N_{oc3}$ : $-(\hat{E}_{s1}/N_{oc3}$ uncertainty - $\hat{E}_{s1}/N_{oc2}$ uncertainty) $\hat{E}_{s1} / N_{oc2}$ : $+\hat{E}_{s1}/N_{oc2}$ uncertainty $\hat{E}_{s2} / N_{oc2}$ : $-(\hat{E}_{s2}/\hat{E}_{s1}$ uncertainty - $\hat{E}_{s1}/N_{oc2}$ uncertainty) T-put limit unchanged
8.5.2.2.3_E.1	$N_{oc1}$ : -98 dBm/15kHz $N_{oc2}$ : -98 dBm/15kHz $N_{oc3}$ : -93 dBm/15kHz $\hat{E}_{s1} / N_{oc2}$ : +5.7 dB $\hat{E}_{s2} / N_{oc2}$ : +5 dB $\hat{E}_{s3} / N_{oc2}$ : +3 dB	0 dB 0 dB -0.1 dB +0.9 dB -0.2 dB -0.2 dB	$N_{oc1}$ : -98 dBm/15kHz $N_{oc2}$ : -98 dBm/15kHz $N_{oc3}$ : -93.1 dBm/15kHz $\hat{E}_{s1} / N_{oc2}$ : +6.6 dB $\hat{E}_{s2} / N_{oc2}$ : +4.8 dB $\hat{E}_{s3} / N_{oc2}$ : +2.8 dB The analysis is recorded in 3GPP TR 36.904 [17] Pm-an limit unchanged
8.7.1.1 FDD sustained data rate performance	Downlink power -85dBm/15kHz	0 dB	Formula: Downlink power + TT T-put limit unchanged
8.7.1.1_1	Same as 8.7.1.1	Same as 8.7.1.1	Formula: Downlink power + TT T-put limit unchanged
8.7.1.1_A.1	Same as 8.7.1.1	Same as 8.7.1.1	Formula: Downlink power + TT T-put limit unchanged
8.7.1.1_A.2	Same as 8.7.1.1	Same as 8.7.1.1	Formula: Downlink power + TT T-put limit unchanged
8.7.2.1 TDD sustained data rate performance	Same as 8.7.1.1	Same as 8.7.1.1	Same as 8.7.1.1
8.7.2.1_1	Same as 8.7.2.1	Same as 8.7.2.1	Formula: Downlink power + TT T-put limit unchanged
8.7.2.1_A.1	Same as 8.7.2.1	Same as 8.7.2.1 for each CC	Formula: Downlink power + TT T-put limit unchanged
8.7.2.1_A.2	Same as 8.7.2.1	Same as 8.7.2.1 for each CC	Formula: Downlink power + TT T-put limit unchanged
8.7.3.1 FDD sustained data rate performance for EPDCCH scheduling	Same as 8.7.1.1	Same as 8.7.1.1	Formula: Downlink power + TT T-put limit unchanged
8.7.4.1 TDD sustained data rate performance for EPDCCH scheduling	Same as 8.7.2.1	Same as 8.7.2.1	Same as 8.7.2.1
8.7.5.1.1 TDD FDD CA Sustained data rate performance for FDD PCell (2DL CA)	Same as 8.7.1.1	Same as 8.7.1.1	Same as 8.7.1.1
8.7.5.1.2 TDD FDD CA Sustained data rate performance for FDD PCell (3DL CA)	Same as 8.7.1.1	Same as 8.7.1.1	Same as 8.7.1.1
8.7.5.2.1 TDD FDD CA Sustained data rate performance for TDD PCell (2DL CA)	Same as 8.7.2.1	Same as 8.7.2.1	Same as 8.7.2.1
8.7.5.2.2 TDD FDD CA Sustained data rate performance for TDD PCell (3DL CA)	Same as 8.7.2.1	Same as 8.7.2.1	Same as 8.7.2.1
8.8.1.1 FDD distributed EPDCCH performance	SNR as specified	0.9dB	Formula: SNR + TT Pm-dsg limit unchanged
8.8.1.2 TDD distributed EPDCCH performance	SNR as specified	0.9dB	Formula: SNR + TT Pm-dsg limit unchanged

8.8.2.1 FDD localized EPDCCH performance with TM9	SNR as specified	0.9dB	Formula: SNR + TT Pm-dsg limit unchanged
8.8.2.2 TDD localized EPDCCH performance with TM9	SNR as specified	0.9dB	Formula: SNR + TT Pm-dsg limit unchanged
8.8.3.1 FDD localized EPDCCH transmission with TM10 Type B quasi co-location type	SNR as specified	0.9dB	Formula: SNR + TT Pm-dsg limit unchanged
8.8.3.2 TDD localized EPDCCH transmission with TM10 Type B quasi co-location type	SNR as specified	0.9dB	Formula: SNR + TT Pm-dsg limit unchanged
10.1	SNR as specified	0.9dB	Formula: SNR + TT T-put limit unchanged
10.2	SNR as specified	0.9dB	Formula: SNR + TT T-put limit unchanged
[Other tests FFS]			



## F.3.5 Measurement of Channel State Information reporting

Table F.3.5-1: Derivation of Test Requirements (Channel State Information reporting tests)

Test	Minimum Requirement in TS 36.101	Test Tolerance (TT)	Test Requirement in TS 36.521-1
9.2.1.1 FDD CQI Reporting under AWGN conditions – PUCCH 1-0	SNRs as specified Limits as in the Test Procedure	No test tolerances applied	SNR and limits unchanged
9.2.1.2 TDD CQI Reporting under AWGN conditions – PUCCH 1-0	SNRs as specified Limits as in the Test Procedure	No test tolerances applied	SNR and limits unchanged
9.2.1.3_C.1 FDD CQI Reporting under AWGN conditions – PUCCH 1-0 for eICIC (non-MBSFN ABS)	Values as specified Limits as in the Test Procedure	No test tolerances applied	The analysis is recorded in 3GPP TR 36.904 [17]
9.2.1.4_C.1 TDD CQI Reporting under AWGN conditions – PUCCH 1-0 for eICIC (non-MBSFN ABS)	Values as specified Limits as in the Test Procedure	No test tolerances applied	The analysis is recorded in 3GPP TR 36.904 [17]
9.2.1.5_E.1 FDD CQI Reporting under AWGN conditions - PUCCH 1-0 for feICIC (non-MBSFN ABS)	Values as specified Limits as in the Test Procedure	No test tolerances applied	The analysis is recorded in 3GPP TR 36.904 [17]
9.2.1.6_E.1 TDD CQI Reporting under fading conditions - PUSCH 3-0 for feICIC (non-MBSFN ABS)	Values as specified Limits as in the Test Procedure	No test tolerances applied	The analysis is recorded in 3GPP TR 36.904 [17]
9.2.2.1 FDD CQI Reporting under AWGN conditions – PUCCH 1-1	SNRs as specified Limits as in the Test Procedure	No test tolerances applied	SNR and limits unchanged
9.2.2.2 TDD CQI Reporting under AWGN conditions – PUCCH 1-1	SNRs as specified Limits as in the Test Procedure	No test tolerances applied	SNR and limits unchanged
9.2.3.1_D FDD CQI Reporting under AWGN conditions – PUCCH 1-1 for eDL-MIMO	SNRs as specified Limits as in the Test Procedure	No test tolerances applied	SNR and limits unchanged
9.2.3.2_D TDD CQI Reporting under AWGN conditions – PUCCH 1-1 for eDL-MIMO	SNRs as specified Limits as in the Test Procedure	No test tolerances applied	SNR and limits unchanged
9.2.4.1_F FDD CQI Reporting under AWGN conditions - Single CSI Process for CoMP	SNRs as specified Limits as in the Test Procedure	No test tolerances applied	SNR and limits unchanged
9.2.4.2_F TDD CQI Reporting under AWGN conditions - Single CSI Process for CoMP	SNRs as specified Limits as in the Test Procedure	No test tolerances applied	SNR and limits unchanged
9.3.1.1.1 FDD CQI Reporting under fading conditions – PUSCH 3-0	SNRs as specified $\alpha$ 2% $\beta$ 55% $\gamma$ 1.10 BLER 0.05	SNR 0dB $\alpha$ 0% $\beta$ 0% $\gamma$ 0.01 BLER 0	SNR unchanged $\alpha$ limit unchanged $\beta$ limit unchanged $\gamma$ 1.09 as per Table G.5.4-1 BLER limit unchanged
9.3.1.1.2 TDD CQI Reporting under fading conditions – PUSCH 3-0	Same as 9.3.1.1.1	Same as 9.3.1.1.1	Same as 9.3.1.1.1

9.3.1.2.1_D FDD CQI Reporting under fading conditions – PUSCH 3-1 for eDL-MIMO	Same as 9.3.1.1.1	Same as 9.3.1.1.1	Same as 9.3.1.1.1
9.3.1.2.2_D TDD CQI Reporting under fading conditions – PUSCH 3-1 for eDL-MIMO	Same as 9.3.1.1.1	Same as 9.3.1.1.1	Same as 9.3.1.1.1
9.3.1.3.1_E.1 FDD CQI Reporting under fading conditions - PUSCH 3-0 for feICIC (non-MBSFN ABS)	SNRs as specified $\alpha$ 2% $\beta$ 55% $\gamma$ 1.10 BLER 0.01	SNR 0dB $\alpha$ 0% $\beta$ 0% $\gamma$ 0.01 BLER 0	SNR unchanged $\alpha$ limit unchanged $\beta$ limit unchanged $\gamma$ 1.09 as per Table G.5.4-1 BLER limit unchanged  The analysis is recorded in 3GPP TR 36.904 [17]
9.3.1.3.2_E.1 TDD CQI Reporting under fading conditions - PUSCH 3-0 for feICIC (non-MBSFN ABS)	Same as 9.3.1.3.1_E.1	Same as 9.3.1.3.1_E.1	Same as 9.3.1.3.1_E.1
9.3.2.1.1 FDD CQI Reporting under fading conditions – PUCCH 1-0	SNRs as specified $\alpha$ 20% $\gamma$ 1.05 BLER 0.02	SNR 0dB $\alpha$ 0% $\gamma$ 0.01 BLER 0	SNR and $\alpha$ , BLER limits unchanged $\alpha$ limit unchanged $\gamma$ 1.04 as per Table G.5.4-1 BLER limit unchanged
9.3.2.1.1_1 FDD CQI Reporting under fading conditions – PUCCH 1-0	Same as 9.3.2.1.1	Same as 9.3.2.1.1	Same as 9.3.2.1.1
9.3.2.1.2 TDD CQI Reporting under fading conditions – PUCCH 1-0	Same as 9.3.2.1.1	Same as 9.3.2.1.1	Same as 9.3.2.1.1
9.3.2.1.2_1 TDD CQI Reporting under fading conditions – PUCCH 1-0	Same as 9.3.2.1.1	Same as 9.3.2.1.1	Same as 9.3.2.1.1
9.3.2.2.1_D FDD CQI Reporting under fading conditions – PUCCH 1-1 for eDL-MIMO	Same as 9.3.2.1.1	Same as 9.3.2.1.1	Same as 9.3.2.1.1
9.3.2.2.2_D TDD CQI Reporting under fading conditions – PUCCH 1-1 for eDL-MIMO	Same as 9.3.2.1.1	Same as 9.3.2.1.1	Same as 9.3.2.1.1

9.3.3.1.1 FDD CQI Reporting under fading conditions and frequency-selective interference – PUSCH 3-0	lor and lot as specified $\alpha$ 60% $\gamma$ 1.60	lor, lot 0dB $\alpha$ 20% $\gamma$ 0.10	lor and lot unchanged $\alpha$ 40%, Formula: Min Req't – Test Tol $\gamma$ 1.50, Formula: Min Req't – Test Tol  The effect of AWGN flatness and signal flatness on the $\alpha$ requirement was derived by simulation.  AWGN flatness / signal flatness and the statistical effect of a finite test time both affect the T-put result. The Test Tolerance comprises two quantities:  1. Effect of AWGN flatness and signal flatness, derived by simulation  2. Statistical effect as per Table G.5.4-1  Items 1 and 2 are assumed to be uncorrelated so can be root sum squared  T-put requirement Test Tol = SQRT (AWGN flatness and signal flatness effect <sup>2</sup> + Statistical effect <sup>2</sup> )  AWGN flatness and signal flatness effect 0.1, Statistical effect 0.01, giving overall effect 0.10
9.3.3.1.2 TDD CQI Reporting under fading conditions and frequency-selective interference – PUSCH 3-0	Same as 9.3.3.1.1	Same as 9.3.3.1.1	Same as 9.3.3.1.1
9.3.4.1.1 FDD CQI Reporting under fading conditions – PUSCH 2-0	SNRs as specified Limits as in the Test Procedure $\gamma$ 1.2	$\gamma$ 0.01	SNR unchanged $\gamma$ 1.19 as per Table G.5.4-1
9.3.4.1.2 TDD CQI Reporting under fading conditions – PUSCH 2-0	Same as 9.3.4.1.1	Same as 9.3.4.1.1	Same as 9.3.4.1.1
9.3.4.2.1 FDD CQI Reporting under fading conditions – PUCCH 2-0	SNRs as specified Limits as in the Test Procedure $\gamma$ 1.15	$\gamma$ 0.01	SNR unchanged $\gamma$ 1.14 as per Table G.5.4-1
9.3.4.2.2 TDD CQI Reporting under fading conditions – PUCCH 2-0	Same as 9.3.4.2.1	Same as 9.3.4.2.1	Same as 9.3.4.2.1
9.3.5.1.1 FDD CQI Reporting under fading conditions - PUCCH 1-0 - Enhanced Performance Requirement Type A	$N_{oc}$ : -98dBm/15kHz DIP 1: -0.41dB SINR: -2.00dB $\gamma$ 1.8 BLER 0.02	0dB +0.03dB +0.03dB $\gamma$ 0.01	$N_{oc}$ : -98dBm/15kHz DIP 1: -0.38dB SINR: -1.97dB $\gamma$ 1.79 as per Table G.5.4-1 BLER limit unchanged  The analysis is recorded in 3GPP TR 36.904 [17]
9.3.5.1.2 TDD CQI Reporting under fading conditions - PUCCH 1-0 - Enhanced Performance Requirement Type A	Same as 9.3.5.1.1	Same as 9.3.5.1.1	Same as 9.3.5.1.1
9.3.5.2.1 FDD CQI Reporting under fading conditions - PUCCH 1-1 - Enhanced Performance Requirement Type A	Same as 9.3.5.1.1 Same as 9.3.5.1.1	Same as 9.3.5.1.1	Same as 9.3.5.1.1

9.3.5.2.2 TDD CQI Reporting under fading conditions - PUCCH 1-1 - Enhanced Performance Requirement Type A	Same as 9.3.5.1.1	Same as 9.3.5.1.1	
9.3.6.1_F FDD CQI Reporting under fading conditions Single CSI processes for CoMP	$\gamma$ 1.02	$\gamma$ 0.01	$\gamma$ 1.01 as per Table G.5.4-1
9.3.6.1_F.2 FDD CQI Reporting under fading conditions Three CSI processes for CoMP	Same as 9.3.6.1_F.1	Same as 9.3.6.1_F.1	Same as 9.3.6.1_F.1
9.3.6.1_F.3 FDD CQI Reporting under fading conditions Four CSI processes for CoMP	Same as 9.3.6.1_F.1	Same as 9.3.6.1_F.1	Same as 9.3.6.1_F.1
9.3.6.2_F.1 TDD CQI Reporting under fading conditions Single CSI processes for CoMP	$\gamma$ 1.02	$\gamma$ 0.01	$\gamma$ 1.01 as per Table G.5.4-1
9.3.6.2_F.2 TDD CQI Reporting under fading conditions Three CSI processes for CoMP	Same as 9.3.6.2_F.1	Same as 9.3.6.2_F.1	Same as 9.3.6.2_F.1
9.3.6.2_F.3 TDD CQI Reporting under fading conditions Four CSI processes for CoMP	Same as 9.3.6.2_F.1	Same as 9.3.6.2_F.1	Same as 9.3.6.2_F.1
9.4.1.1.1 FDD PMI Reporting – PUSCH 3-1 (Single PMI)	$\gamma$ 1.10	$\gamma$ 0.01	$\gamma$ 1.09 as per Table G.5.4-1
9.4.1.1.2 TDD PMI Reporting – PUSCH 3-1 (Single PMI)	Same as 9.4.1.1.1	Same as 9.4.1.1.1	Same as 9.4.1.1.1
9.4.1.2.1 FDD PMI Reporting – PUCCH 2-1 (Single PMI)	$N_{oc}$ as specified in test procedure  $\gamma$ 1.2	  $\gamma$ 0.01	$N_{oc}$ unchanged lor/ $N_{oc} = SNR_{md}$ is a result of an approach according to G.5.2 and is reused unchanged as setting in procedure step 3. $\gamma$ 1.19 as per Table G.5.4-1
9.4.1.2.2 TDD PMI Reporting – PUCCH 2-1 (Single PMI)	Same as 9.4.1.2.1	Same as 9.4.1.2.1	Same as 9.4.1.2.1
9.4.1.3.1_D FDD Reporting of PMI – PUSCH 3-1 (Single PMI) for eDL-MIMO	Same as 9.4.1.2.1	Same as 9.4.1.2.1	Same as 9.4.1.2.1
9.4.1.3.2_D TDD Reporting of PMI – PUSCH 3-1 (Single PMI) for eDL-MIMO	Same as 9.4.1.2.1	Same as 9.4.1.2.1	Same as 9.4.1.2.1
9.4.2.1.1 FDD PMI Reporting – PUSCH 1-2 (Multiple PMI)	$N_{oc}$ as specified in test procedure  $\gamma$ 1.20	$\gamma$ 0.01	$N_{oc}$ unchanged lor/ $N_{oc} = SNR_{md}$ is a result of an approach according to G.5.2 and is reused unchanged as setting in procedure step 3. $\gamma$ 1.19 as per Table G.5.4-1
9.4.2.1.1_1 FDD PMI Reporting – PUSCH 1-2 (Multiple PMI)	Same as 9.4.2.1.1	Same as 9.4.2.1.1	Same as 9.4.2.1.1
9.4.2.1.2 TDD PMI Reporting – PUSCH 1-2 (Multiple PMI)	Same as 9.4.2.1.1	Same as 9.4.2.1.1	Same as 9.4.2.1.1
9.4.2.1.2_1 TDD PMI Reporting – PUSCH 1-2 (Multiple PMI)	Same as in 9.4.2.1.1	Same as in 9.4.2.1.1	Same as in 9.4.2.1.1

9.4.2.2.1 FDD PMI Reporting – PUSCH 2-2 (Multiple PMI)	Same as in 9.4.2.1.1	Same as in 9.4.2.1.1	Same as in 9.4.2.1.1
9.4.2.2.2 TDD PMI Reporting – PUSCH 2-2 (Multiple PMI)	$N_{oc}$ as specified in test procedure  $\gamma$ 1.15	$\gamma$ 0.01	$N_{oc}$ unchanged  $I_{or}/N_{oc}=\text{SNR}_{\text{rmd}}$ is a result of an approach according to G.5.2 and is reused unchanged as setting in procedure step 3.  $\gamma$ 1.14 as per Table G.5.4-1
9.4.2.3.1_D FDD PMI Reporting – PUSCH 1-2 (Multiple PMI) for eDL-MIMO	$N_{oc}$ as specified in test procedure  $\gamma$ 1.30	$\gamma$ 0.01	$N_{oc}$ unchanged  $I_{or}/N_{oc}=\text{SNR}_{\text{rmd}}$ is a result of an approach according to G.5.2 and is reused unchanged as setting in procedure step 3.  $\gamma$ 1.29 as per Table G.5.4-1
9.4.2.3.2_D TDD PMI Reporting – PUSCH 1-2 (Multiple PMI) for eDL-MIMO	$N_{oc}$ as specified in test procedure  $\gamma$ 3.50	$\gamma$ 0.01	$N_{oc}$ unchanged  $I_{or}/N_{oc}=\text{SNR}_{\text{rmd}}$ is a result of an approach according to G.5.2 and is reused unchanged as setting in procedure step 3.  $\gamma$ 3.49 as per Table G.5.4-1
9.5.1.1 FDD RI Reporting– PUCCH 1-1	SNRs as specified Test 1: $\gamma_2$ 1.00 Test 2: $\gamma_1$ 1.05 Test 3: $\gamma_2$ 1.10	SNR 0dB $\gamma_2$ 0.01 $\gamma_1$ 0.01 $\gamma_2$ 0.01	SNR unchanged $\gamma_2$ 0.99 as per Table G.5.4-1 $\gamma_1$ 1.04 as per Table G.5.4-1 $\gamma_2$ 1.09 as per Table G.5.4-1
9.5.1.1_1 FDD RI Reporting– PUCCH 1-1 (Release 10)	SNRs as specified Test 1: $\gamma_2$ 1.00 Test 2: $\gamma_1$ 1.05 Test 3: $\gamma_1$ 0.90, $\gamma_2$ 1.10	SNR 0dB $\gamma_2$ 0.01 $\gamma_1$ 0.01 $\gamma_2$ 0.01	SNR unchanged $\gamma_2$ 0.99 as per Table G.5.4-1 $\gamma_1$ 1.04 as per Table G.5.4-1 $\gamma_1$ 0.89, $\gamma_2$ 1.09 as per Table G.5.4-1
9.5.1.1_2 FDD RI Reporting– PUCCH 1-1 (Release 11)	SNRs as specified Test 1: $\gamma_2$ 1.00 Test 2: $\gamma_1$ 1.05 Test 3: $\gamma_1$ 0.90	SNR 0dB $\gamma_2$ 0.01 $\gamma_1$ 0.01 $\gamma_1$ 0.01	SNR unchanged $\gamma_2$ 0.99 as per Table G.5.4-1 $\gamma_1$ 1.04 as per Table G.5.4-1 $\gamma_1$ 0.89 as per Table G.5.4-1
9.5.1.2 TDD RI Reporting– PUSCH 3-1	Same as 9.5.1.1	Same as 9.5.1.1	Same as 9.5.1.1
9.5.1.2_1 TDD RI Reporting– PUSCH 3-1 (Release 10)	Same as 9.5.1.1_1	Same as 9.5.1.1_1	Same as 9.5.1.1_1
9.5.1.2_2 TDD RI Reporting– PUSCH 3-1 (Release 11)	Same as 9.5.1.1_2	Same as 9.5.1.1_2	Same as 9.5.1.1_2
9.5.2.1_D FDD RI Reporting – PUCCH 1-1 for eDL-MIMO	SNR as specified Test 1: $\gamma_2$ 1.00 Test 2: $\gamma_1$ 1.05 Test 3: $\gamma_1$ 0.9	SNR 0dB $\gamma_2$ 0.01 $\gamma_1$ 0.01 $\gamma_2$ 0.01	SNR unchanged $\gamma_2$ 0.99 as per Table G.5.4-1 $\gamma_1$ 1.04 as per Table G.5.4-1 $\gamma_1$ 0.89 as per Table G.5.4-1
9.5.2.2_D TDD RI Reporting – PUCCH 1-1 for eDL-MIMO	SNR as specified Test 1: $\gamma_2$ 1.00 Test 2: $\gamma_1$ 1.05 Test 3: $\gamma_1$ 0.9	SNR 0dB $\gamma_2$ 0.01 $\gamma_1$ 0.01 $\gamma_2$ 0.01	SNR unchanged $\gamma_2$ 0.99 as per Table G.5.4-1 $\gamma_1$ 1.04 as per Table G.5.4-1 $\gamma_1$ 0.89 as per Table G.5.4-1
9.5.3.1_C.1 FDD RI Reporting – PUCCH 1-0 for eCIC (non-MBSFN ABS)	SNRs as specified Test 1: $\gamma_1$ 0.90 Test 2: $\gamma_1$ 1.05	SNR 0dB $\gamma_1$ 0.01 $\gamma_1$ 0.01	SNR unchanged $\gamma_1$ 0.89 as per Table G.5.4-1 $\gamma_1$ 1.04 as per Table G.5.4-1  The analysis is recorded in 3GPP TR 36.904 [17]
9.5.3.2_C.1 TDD RI Reporting – PUCCH 1-0 for eCIC (non-MBSFN ABS)	SNRs as specified Test 1: $\gamma_1$ 0.90 Test 2: $\gamma_1$ 1.05	SNR 0dB $\gamma_1$ 0.01 $\gamma_1$ 0.01	SNR unchanged $\gamma_1$ 0.89 as per Table G.5.4-1 $\gamma_1$ 1.04 as per Table G.5.4-1  The analysis is recorded in 3GPP TR 36.904 [17]

9.5.4.1_E.1 FDD RI Reporting - PUCCH 1-0 for feICIC (non-MBSFN ABS)	SNR as specified Test 1: $\gamma_2$ 1.05 Test 2: $\gamma_1$ 1.05 Test 3: $\gamma_1$ 0.9	SNR 0dB $\gamma_2$ 0.01 $\gamma_1$ 0.01 $\gamma_1$ 0.01	SNR unchanged $\gamma_2$ 1.04 as per Table G.5.4-1 $\gamma_1$ 1.04 as per Table G.5.4-1 $\gamma_1$ 0.89 as per Table G.5.4-1  The analysis is recorded in 3GPP TR 36.904 [17]
9.5.4.2_E.1 TDD RI Reporting - PUCCH 1-0 for feICIC (non-MBSFN ABS)	Same as 9.5.4.1_E.1	Same as 9.5.4.1_E.1	Same as 9.5.4.1_E.1
9.5.5.1_F.1 FDD RI Reporting with Single CSI process for CoMP	SNRs as specified Test 1: $\gamma_2$ 1.00 Test 2: $\gamma_1$ 1.00	SNR 0dB $\gamma_2$ 0.01 $\gamma_1$ 0.01	SNR unchanged $\gamma_2$ 0.99 as per Table G.5.4-1 $\gamma_1$ 0.99 as per Table G.5.4-1
9.5.5.1_F.2 FDD RI Reporting with Multiple CSI processes for CoMP	SNRs as specified Test 1: $\gamma_2$ 1.00 Test 2: $\gamma_1$ 1.00	SNR 20dB $\gamma_2$ 0.01 $\gamma_1$ 0.01	SNR unchanged $\gamma_2$ 0.99 as per Table G.5.4-1 $\gamma_1$ 0.99 as per Table G.5.4-1
9.5.5.2_F.1 TDD RI Reporting with Single CSI process for CoMP	Same as 9.5.5.1_F.1	Same as 9.5.5.1_F.1	Same as 9.5.5.1_F.1
9.5.5.2_F.2 TDD RI Reporting with Multiple CSI processes for CoMP	Same as 9.5.5.2_F.1	Same as 9.5.5.2_F.1	Same as 9.5.5.2_F.1
9.6.1.1_A.1 FDD CQI Reporting under AWGN conditions – PUCCH 1-0 for CA (2DL CA)	SNRs as specified Limits as in the Test Procedure	No test tolerances applied	SNR and limits unchanged
9.6.1.1_A.2 FDD CQI Reporting under AWGN conditions – PUCCH 1-0 (3DL CA)	SNRs as specified Limits as in the Test Procedure	No test tolerances applied	SNR ratios each have an uncertainty of $\pm 0.3$ dB. For uncorrelated uncertainties, the overall uncertainty in the SNR difference between any two CCs would be $\text{SQRT}(0.3^2 + 0.3^2) = 0.42\text{dB}$ . This could widen the Median CQI difference, but the uncertainty is significantly less than one reported CQI step. Relaxing the allowed Median CQI difference would relax the test excessively, so in this case the Test requirement should be left unchanged.
9.6.1.2_A.1 TDD CQI Reporting under AWGN conditions – PUCCH 1-0 for 2DL CA	Same as 9.6.1.1_A.1	Same as 9.6.1.1_A.1	Same as 9.6.1.1_A.1
9.6.1.2_A.2 TDD CQI Reporting under AWGN conditions – PUCCH 1-0 (3DL CA)	Same as 9.6.1.1_A.2	Same as 9.6.1.1_A.2	Same as 9.6.1.1_A.2

---

# Annex G (normative): Statistical Testing

## G.1 General

FFS.

---

## G.2 Statistical testing of receiver characteristics

### G.2.1 General

The test of receiver characteristics is two fold.

1. A signal or a combination of signals is offered to the RX port(s) of the receiver.
2. The ability of the receiver to demodulate /decode this signal is verified by measuring the throughput.

In (2) is the statistical aspect of the test and is treated here.

The minimum requirement for all receiver tests is >95% of the maximum throughput.

All receiver tests are performed in static propagation conditions. No fading conditions are applied.

### G.2.2 Mapping throughput to error ratio

- a) The measured information bit throughput  $R$  is defined as the sum (in kilobits) of the information bit payloads successfully received during the test interval, divided by the duration of the test interval (in seconds).
- b) In measurement practice the UE indicates successfully received information bit payload by signalling an ACK to the SS.  
If payload is received, but damaged and cannot be decoded, the UE signals a NACK.
- c) Only the ACK and NACK signals, not the data bits received, are accessible to the SS.  
The number of bits is known in the SS from knowledge of what payload was sent.
- d) For the reference measurement channel, applied for testing, the number of bits is different in different subframes, however in a radio frame it is fixed during one test.
- e) The time in the measurement interval is composed of successfully received subframes (ACK), unsuccessfully received subframes (NACK) and no reception at all (DTX-subframes).
- f) DTX-subframes may occur regularly according to the applicable reference measurement channel (regDTX).  
In real live networks this is the time when other UEs are served. In TDD these are the UL and special subframes. regDTX vary from test to test but are fixed within the test.
- g) Additional DTX-subframes occur statistically when the UE is not responding ACK or NACK where it should. (statDTX)  
This may happen when the UE was not expecting data or decided that the data were not intended for it.

The pass / fail decision is done by observing the:

- number of NACKs
- number of ACKs and
- number of statDTXs (regDTX is implicitly known to the SS)

The ratio  $(NACK + statDTX)/(NACK + statDTX + ACK)$  is the Error Ratio (ER). Taking into account the time consumed by the ACK, NACK, and DTX-TTIs (regular and statistical), ER can be mapped unambiguously to throughput for any single reference measurement channel test.

## G.2.3 Design of the test

The test is defined by the following design principles (see clause G.x, Theory....):

1. The early decision concept is applied.
2. A second limit is introduced: Bad DUT factor  $M > 1$
3. To decide the test pass:

Supplier risk is applied based on the Bad DUT quality

To decide the test fail

Customer Risk is applied based on the specified DUT quality

The test is defined by the following parameters:

1. Limit ER = 0.05 (Throughput limit = 95%)
2. Bad DUT factor  $M = 1.5$  (selectivity)
3. Confidence level CL = 95% (for specified DUT and Bad DUT-quality)

## G.2.4 Numerical definition of the pass fail limits

**Table G.2.4-1: pass fail limits**

ne	ns <sub>p</sub>	ns <sub>f</sub>	ne	ns <sub>p</sub>	ns <sub>f</sub>	ne	ns <sub>p</sub>	ns <sub>f</sub>	ne	ns <sub>p</sub>	ns <sub>f</sub>
0	67	NA	39	763	500	78	1366	1148	117	1951	1828
1	95	NA	40	778	516	79	1381	1166	118	1965	1845
2	119	2	41	794	532	80	1396	1183	119	1980	1863
3	141	7	42	810	548	81	1412	1200	120	1995	1881
4	162	14	43	826	564	82	1427	1217	121	2010	1899
5	183	22	44	842	580	83	1442	1234	122	2025	1916
6	202	32	45	858	596	84	1457	1252	123	2039	1934
7	222	42	46	873	612	85	1472	1269	124	2054	1952
8	241	53	47	889	629	86	1487	1286	125	2069	1969
9	259	64	48	905	645	87	1502	1303	126	2084	1987
10	278	76	49	920	661	88	1517	1321	127	2099	2005
11	296	88	50	936	678	89	1532	1338	128	2113	2023
12	314	100	51	952	694	90	1547	1355	129	2128	2040
13	332	113	52	967	711	91	1562	1373	130	2143	2058
14	349	126	53	983	727	92	1577	1390	131	2158	2076
15	367	140	54	998	744	93	1592	1407	132	2172	2094
16	384	153	55	1014	760	94	1607	1425	133	2187	2111
17	401	167	56	1029	777	95	1623	1442	134	2202	2129
18	418	181	57	1045	793	96	1637	1459	135	2217	2147
19	435	195	58	1060	810	97	1652	1477	136	2231	2165
20	452	209	59	1076	827	98	1667	1494	137	2246	2183
21	469	224	60	1091	844	99	1682	1512	138	2261	2201
22	486	238	61	1106	860	100	1697	1529	139	2275	2218
23	503	253	62	1122	877	101	1712	1547	140	2290	2236
24	519	268	63	1137	894	102	1727	1564	141	2305	2254



25	536	283	64	1153	911	103	1742	1582	142	2320	2272
26	552	298	65	1168	928	104	1757	1599	143	2334	2290
27	569	313	66	1183	944	105	1772	1617	144	2349	2308
28	585	328	67	1199	961	106	1787	1634	145	2364	2326
29	602	343	68	1214	978	107	1802	1652	146	2378	2344
30	618	359	69	1229	995	108	1817	1669	147	2393	2361
31	634	374	70	1244	1012	109	1832	1687	148	2408	2379
32	650	389	71	1260	1029	110	1847	1704	149	2422	2397
33	667	405	72	1275	1046	111	1861	1722	150	2437	2415
34	683	421	73	1290	1063	112	1876	1740	151	2452	2433
35	699	436	74	1305	1080	113	1891	1757	152	2466	2451
36	715	452	75	1321	1097	114	1906	1775	153*)	NA	2469
37	731	468	76	1336	1114	115	1921	1793			
38	747	484	77	1351	1131	116	1936	1810	*) note 2 in G.2.5		

NOTE 1: The first column is the number of errors (ne = number of NACK + statDTX)

NOTE 2: The second column is the number of samples for the pass limit (ns<sub>p</sub>, ns=Number of Samples= number of NACK + statDTX + ACK)

NOTE 3: The third column is the number of samples for the fail limit (ns<sub>f</sub>)

## G.2.5 Pass fail decision rules

The pass fail decision rules apply for a single test, comprising one component in the test vector. The over all Pass /Fail conditions are defined in clause G.2.1.5.

Having observed 0 errors, pass the test at 67+ samples, otherwise continue

Having observed 1 error, pass the test at 95+ otherwise continue

Having observed 2 errors, pass the test at 119+ samples, fail the test at 2- samples, otherwise continue

Etc. etc.

Having observed 151 errors, pass the test at 2452+ samples, fail the test at 2433- samples, otherwise continue

Having observed 152 errors, pass the test at 2466+ samples, fail the test at 2451- samples.

Where x+ means: x or more, x- means x or less

NOTE 1: an ideal DUT passes after 67 samples. The maximum test time is 2466 samples.

NOTE 2: It is allowed to deviate from the early decision concept by postponing the decision (pass/fail or continue). Postponing the decision to or beyond the end of Table G.2.4-1 requires a pass fail decision against the test limit: pass the DUT for ER<0.0618, otherwise fail.

## G.2.6 Test conditions for receiver tests

**Table G.2.6-1: Test conditions for receiver tests**

Test	Statistical independence	Number of components in the test vector, as specified in the test requirements and initial conditions of the applicable test	Over all Pass/Fail condition
7.3 Reference sensitivity level	Yes: the inherent receiver noise is assumed to be AWGN	tbd	To pass 7.3 each component in the test vector must pass
7.4 Maximum input level	Unclear: in case, clipping causes errors, errors are data dependent. Statistical independence is assumed.	tbd	To pass 7.4 each component in the test vector must pass
7.4A.3 Maximum input level for CA (inter-band DL CA without UL CA)	Unclear: in case, clipping causes errors, errors are data dependent. Statistical independence is assumed.	tbd	To pass 7.4A.3 each component in the test vector must pass
7.5 Adjacent Channel Selectivity (ACS)	Unclear: errors are data dependent on the interferers data. Statistical independence is assumed.	tbd	To pass 7.5 each component in the test vector must pass
7.5A.3 Adjacent Channel Selectivity (ACS) for CA (inter-band DL CA without UL CA)	Unclear: errors are data dependent on the interferers data. Statistical independence is assumed.	tbd	To pass 7.5A.3 each component in the test vector must pass
7.6.1 In-band blocking	Unclear: errors are data dependent on the interferers data. Statistical independence is assumed.	tbd	To pass 7.6.1 each component in the test vector must pass
7.6.1A.3 In-band blocking for CA (inter-band DL CA without UL CA)	Unclear: errors are data dependent on the interferers data. Statistical independence is assumed.	tbd	To pass 7.6.1A.3 each component in the test vector must pass
7.6.2 Out of-band blocking	yes: it is assumed that the CW interferer causes errors, which are independent and time invariant.	tbd	To pass 7.6.2, all except [tbd] components in the test vector must pass
7.6.2A.3 Out-of-band blocking for CA (inter-band DL CA without UL CA)	yes: it is assumed that the CW interferer causes errors, which are independent and time invariant.	tbd	To pass 7.6.2A.3, all except [tbd] components in the test vector must pass
7.6.3 Narrow band blocking	yes: it is assumed that the CW interferer causes errors, which are independent and time invariant.	tbd	To pass 7.6.3 each component in the test vector must pass
7.6.3A.3 Narrow band blocking for CA (inter-band DL CA without UL CA)	yes: it is assumed that the CW interferer causes errors, which are independent and time invariant.	tbd	To pass 7.6.3A.3 each component in the test vector must pass
7.7 Spurious response	yes: it is assumed that the CW interferer causes errors, which are independent and time invariant.	tbd	To pass 7.7 each component in the test vector must pass
7.7A.3 Spurious response for CA (inter-band DL CA without UL CA)	yes: it is assumed that the CW interferer causes errors, which are independent and time invariant.	tbd	To pass 7.7A.3 each component in the test vector must pass
7.8.1 Wide band	Unclear: errors are dependent on	tbd	To pass 7.8.1 each component in

Intermodulation	the data content of the interferer. Statistical independence is assumed.		the test vector must pass
7.8.1A.3 Wideband intermodulation for CA (inter-band DL CA without UL CA)	Unclear: errors are dependent on the data content of the interferer. Statistical independence is assumed.	tbd	To pass 7.8.1A.3 each component in the test vector must pass

## G.2A Statistical testing of receiver characteristics with CA

### G.2A.1 General

G.2.1 applies.

### G.2A.2 Mapping throughput to error ratio

The test is defined by the following design principles (see clause G.x, Theory...):

1. The standard concept is applied. (not the early decision concept).
2. A second limit is introduced, defining the Bad DUT.
3. To decide the test pass:
  - Supplier risk is applied based on the Bad DUT quality.
  - To decide the test fail.
  - Customer Risk is applied based on the specified DUT quality.

The test is defined by the following parameters:

- 1) Limit Error Ratio = 0.05 (95% throughput is tested).
- 2) Bad DUT factor M=1.5 (selectivity).
- 3) Confidence level CL = 95% (for specified DUT and Bad DUT-quality).

### G.2A.4 Pass fail limits

Apply 1003 samples to the DUT per CC.

Decide pass per CC in case of  $\leq 62$  errors, otherwise fail.

NOTE 1: The pass fail decision is done individually for each CC. The pass fail decision for one component in the test vector is as follows: pass if all CCs or SCC only according to the test cases pass, otherwise fail. The overall pass fail decision is according to clause G.2A.6

NOTE 2: It is allowed to apply more samples to the DUT, common for all CCs, (e.g. up to an integer number of frames). Use the ratio (62/1003) for the pass fail decision.

NOTE 3:  $62/1003 = 0.0618$ , the same test limit is used at the end of Table G.2.4-1

### G.2A.5 void

## G.2A.6 Test conditions for receiver tests with CA

Table G.2A.6-1: Test conditions for receiver tests with CA

Test	Statistical independence	Number of components in the test vector, as specified in the test requirements and initial conditions of the applicable test Note 1	Over all Pass/Fail condition Note 1
7.3A Reference sensitivity level for CA	Yes: the inherent receiver noise is assumed to be AWGN	tbd	To pass 7.3A each component in the test vector must pass
7.4A Maximum input level for CA	Unclear: in case, clipping causes errors, errors are data dependent. Statistical independence is assumed.	tbd	To pass 7.4A each component in the test vector must pass
7.5A Adjacent Channel Selectivity (ACS) for CA	Unclear: errors are data dependent on the interferers data. Statistical independence is assumed.	tbd	To pass 7.5A each component in the test vector must pass
7.6.1A In-band blocking for CA	Unclear: errors are data dependent on the interferers data. Statistical independence is assumed.	tbd	To pass 7.6.1A each component in the test vector must pass
7.6.2.A Out-of-band blocking for CA	yes: it is assumed that the CW interferer causes errors, which are independent and time invariant.	tbd	To pass 7.6.2A, all except [tbd] components in the test vector must pass
7.6.3A Narrow band blocking for CA	yes: it is assumed that the CW interferer causes errors, which are independent and time invariant.	tbd	To pass 7.6.3A each component in the test vector must pass
7.7A Spurious response for CA	yes: it is assumed that the CW interferer causes errors, which are independent and time invariant.	tbd	To pass 7.7A each component in the test vector must pass
7.8.1A Wide band Intermodulation	[place holder]		
Note 1:	A DUT with marginal performance on one component in the test vector passes this component with a confidence level of 95%, which is a false fail probability of 5%. All components in the test vector shall pass, to pass the test, For more than 1 component, performing marginal, there is an increased probability of a false fail for the test.		

## G.3 Statistical testing of Performance Requirements with throughput

### G.3.1 General

The test of receiver performance characteristics is two fold.

1. A signal or a combination of signals is offered to the RX port(s) of the receiver.
2. The ability of the receiver to demodulate /decode this signal is verified by measuring the throughput.

In (2) is the statistical aspect of the test and is treated here.

The minimum requirement for all receiver performance tests is either 70% or 30% of the maximum throughput.

All receiver performance tests are performed in fading conditions. In addition to the statistical considerations, this requires the definition of a minimum test time.

## G.3.2 Mapping throughput to error ratio

G.2.2 applies

## G.3.3 Design of the test

The test is defined by the following design principles (see clause G.x, Theory...):

1. The standard concept is applied. (not the early decision concept)
2. A second limit is introduced: The second limit is different, whether 30% or 70% throughput is tested.
3. To decide the test pass:

Supplier risk is applied based on the Bad DUT quality

To decide the test fail:

Customer Risk is applied based on the specified DUT quality

The test is defined by the following parameters:

- 1a) Limit Error Ratio = 0.3 (in case 70% Throughput is tested) or
- 1b) Limit Throughput = 0.3 (in case 30% Throughput is tested)
- 2a) Bad DUT factor  $M=1.378$  (selectivity)
- 2b) Bad DUT factor  $m=0.692$  (selectivity)
  - justification see: TS 34.121 Clause F.6.3.3
- 3) Confidence level  $CL = 95\%$  (for specified DUT and Bad DUT-quality)

## G.3.4 Pass Fail limit

Testing Throughput = 30%, then the test limit is

Number of successes (ACK) / number of samples  $\geq 59 / 233$

Testing Throughput = 70% then the test limit is

Number of fails (NACK and statDTX) / number of samples  $\leq 66 / 184$

We have to distinguish 3 cases:

- a) The duration for the number of samples (233 or 184) is greater than the minimum test time:

Then the number of samples (233 or 184) is predefined and the decision is done according to the number of events (59 successes or 66 fails)

- b) Since subframe 0 and 5 contain less bits than the remaining subframes, it is allowed to predefine a number of samples contained in an integer number of frames. In this case test-limit-ratio applies.

- c) The minimum test time is greater than the duration for the number of samples:

The minimum test time is predefined and the decision is done comparing the measured ratio at that instant against the test-limit-ratio.

NOTE: The test time for most of the tests is governed by the Minimum Test Time

### G.3.5 Minimum Test time

If a pass fail decision in G.3.4 can be achieved earlier than the minimum test time, then the test shall not be decided, but continued until the minimum test time is elapsed.

The tables below contain the minimum number of subframes for FDD and TDD.

By simulations the minimum number of active subframes (carrying DL payload) was derived (MNAS),

then adding inactive subframes to the active ones (e.g. subframe 5 contains no DL payload. For TDD additional subframes contain no DL payload)

then rounding up to full thousand and

then adding a bias of 1000 (BMNSF).

Simulation method to derive minimum test time:

With a level, corresponding a throughput at the test limit (here 30% or 70% of the max. throughput) the preliminary throughput versus time converges towards the final throughput. The allowance of  $\pm 0.2$  dB around the above mentioned level is predefined by RAN5 to find the minimum test time. The allowance of  $\pm 0.2$  dB maps through the function “final throughput versus level” into a throughput corridor. The minimum test time is achieved when the preliminary throughput escapes the corridor the last time. The two functions “final throughput versus level” and “preliminary throughput versus time” are simulation results, which are done individual for each demodulation scenario. HST-scenarios and scenarios with  $MNAS \geq 50000$  are derived differently.

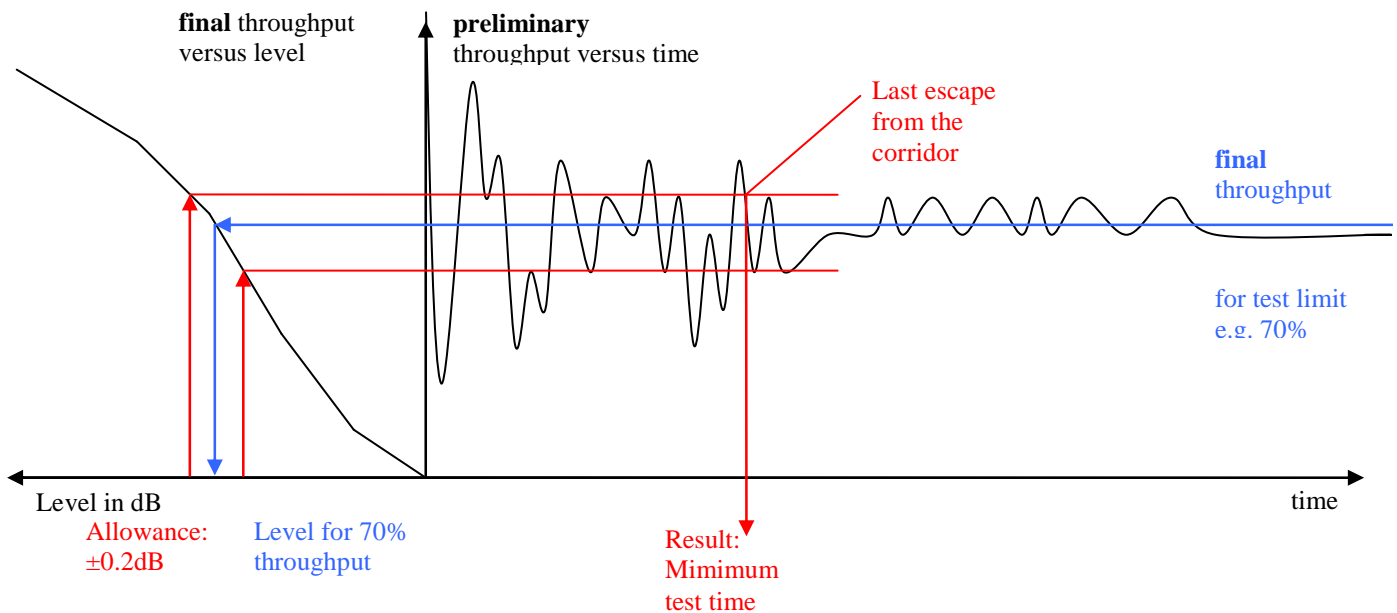

Figure G.3.5-1: Simulation method to derive minimum test time

Table G.3.5-1: Minimum Test time for PDSCH Single Antenna Port Performance

Test No	Demod. scenario	Demodulation scenario plain text:  RMC (Bandwidth, allocated RBs, modulation, coding) Antenna (configuration, correlation) Propagation condition, Doppler [additional parameters, if applicable]  (info only)	Minimum Number of Active Subframes (MNAS) to reach the corridor  (Simulation, info only)	Minimum Number of Subframes (MNS) to reach the corridor  (MNS = active and inactive subframes)  (Calculation, info only)		Biased Minimum Number of SubFrames (BMNSF)  BMNSF= $1000 * \left\lceil \frac{MNS}{1000} \right\rceil + 1000$  (mandatory)	
				FDD	TDD	FDD	TDD
				1	[1.1]	R.2 (10 MHz, full, QPSK, 1/3) (1x2 Low) EVA,5	38 764
2	[1.2]	R.2 (10 MHz, full, QPSK, 1/3) (1x2 Low) ETU,70	2 764	3 072	5 528	5 000	7 000
3	[1.3]	R.2 (10 MHz, full, QPSK, 1/3) (1x2 Low) ETU,300	1 424	1 583	2 848	3 000	4 000
4	[1.4]	R.2 (10 MHz, full, QPSK, 1/3) (1x2) HST	28 800	NA	NA	28 800	57 600
5	[2.1]	R.4 (1.4 MHz, full, QPSK, 1/3) (1x2 Low) EVA,5	44 354	49 283	147 847	51 000	149 000
6	[1.5]	R.3 (10 MHz, full, 16QAM, ½) (1x2 Low) EVA,5	39 020	43 356	78 040	45 000	80 000
		R.3-1 (5 MHz, full, 16QAM, ½) (1x2 Low) EVA,5	39 020	43 356	78 040	45 000	80 000
6 Rel-9		R.3-1 (5MHz, full, 16QAM, ½) (1x2 Low) EVA5	39 020 (MNAS is not simulated, but estimated based on similar scenario in Table G.3.5-1 Test6)	43 356	78 040	45 000	80 000
7	[1.6]	R.3 (10 MHz, full, 16QAM, ½) (1x2 Low) ETU,70	1 366	1 518	2 732	3 000	4 000
		R.3-1 (5 MHz, full, 16QAM, ½) (1x2 Low) ETU70	1 366	1 518	2 732	3 000	4 000
7 Rel-9		R.3-1 (5MHz, full, 16QAM, ½) (1x2 Low) ETU70	1 366 (MNAS is not simulated, but	1 518	2 732	3 000	4 000

			estimated based on similar scenario in Table G.3.5-1 Test7)				
8	[1.7]	R.3 (10 MHz, full, 16QAM, ½) (1x2 High) ETU,300	3 189	3 544	6 378	5 000	8 000
		R.3-1 (5MHz, full, 16QAM, ½) (1x2 High) ETU300	3 189	3 544	6 378	5 000	8 000
8 Rel- 9		R.3-1 (5MHz, full, 16QAM, ½) (1x2 High) ETU300	3 189 (MNAS is not simulated, but estimated based on similar scenario in Table G.3.5-1 Test8)	3 544	6 378	5 000	8 000
9	[2.2]	R.5 (3 MHz, full, 64QAM, ¾) (1x2 Low) EVA,5	50 000	55 556	100 000	57 000	101 000
10	[2.3]	R.6 (5 MHz, full, 64QAM, 3/4) (1x2 Low) EVA,5	48 847	54 275	97 694	56 000	99 000
10 Rel- 9		R.6-1 (5MHz, partial, 64QAM, ¾) (1x2 Low) EVA5	48 847 (MNAS is not simulated, but estimated based on similar scenario in Table G.3.5-1 Test10)	54 275	97 694	56 000	99 000
11	[1.8]	R.7 (10 MHz, full, 64QAM, ¾) (1x2 Low) EVA,5	46 524	51 694	93 048	53 000	95 000
11 Rel- 9		R.7-1 (10MHz, partial, 64QAM, ¾) (1x2 Low) EVA5	46 524 (MNAS is not simulated, but estimated based on similar scenario in Table G.3.5-1 Test11)	51 694	93 048	53 000	95 000
12	[1.9]	R.7 (10 MHz, full, 64QAM, ¾) (1x2 Low) ETU,70	4 722	5 247	9 444	7 000	11 000
12 Rel- 9		R.7-1 (10MHz, partial, 64QAM, ¾) (1x2 Low) ETU70	4 722 (MNAS is not simulated, but	5 247	9 444	7 000	11 000



			estimated based on similar scenario in Table G.3.5-1 Test12)				
13	[1.10]	R.7 (10 MHz, full, 64 QAM, 3/4) (1x2High) EVA,5	100 000	111 112	200 000	113 000	201 000
13 Rel-9		R.7-1 (10MHz, partial, 64QAM, ¾) (1x2 High) EVA5	100 000 (MNAS is not simulated, but estimated based on similar scenario in Table G.3.5-1 Test13)	111 112	200 000	113 000	201 000
14	[2.4]	R.8 (15 MHz, full, 64QAM, ¾) (1x2 Low) EVA,5	48 434	53 816	96 868	55 000	98 000
14 Rel-9		R.8-1 (15MHz, partial, 64QAM, ¾) (1x2 Low) EVA5	48 434 (MNAS is not simulated, but estimated based on similar scenario in Table G.3.5-1 Test14)	53 816	96 868	55 000	98 000
15	[2.5]	R.9 (20 MHz, full, 64QAM,3/4) (1x2 Low) EVA,5	100 000	111 112	200 000	113 000	201 000
15 Rel-9		R.9-1 (20MHz, partial, 64QAM, ¾) (1x2 Low) EVA5	100 000 (MNAS is not simulated, but estimated based on similar scenario in Table G.3.5-1 Test15)	111 112	200 000	113 000	201 000
15 Rel-9		R.9-2 (20MHz, partial, 64QAM, ¾) (1x2 Low) EVA5	100 000 (MNAS is not simulated, but estimated based on similar scenario in Table G.3.5-1 Test15)	111 112	200 000	113 000	201 000
16	[3.1]	R.0 (3 MHz, 1PRB,16QAM, ½) (1x2 Low) ETU,70	5 710	6 345	11 420	8 000	13 000
17	[3.2]	R.1	9 234	10 260	18 468	12 000	20 000

		(10MHz, 1PRB, 16QAM, $\frac{1}{2}$ ) (1x2 Low) ETU, 70					
18	[3.3]	R.1 (20MHz, 1PRB, 16QAM, $\frac{1}{2}$ ) (1x2 Low) ETU, 70	13 373	14 859	26 746	16 000	28 000

Table G.3.5-2: Minimum Test time for PDSCH Single Antenna Port Performance with 1 PRB

Test No	Demod. scenario	Demodulation scenario (info only)	MNAS (Simulation)	MNS (Calculation)		MNSF (Min No Sub Frames, mandatory)	
				FDD	TDD	FDD	TDD
1	[3.4]	R.29 (10MHz, 1PRB, 16QAM, $\frac{1}{2}$ ) (1x2 Low) ETU, 70 [MBSFN]	5 246	17 487	17 487	19 000	19 000

Table G.3.5-3: Minimum Test time for PDSCH Transmit diversity 2x2

Test No	Demod. scenario	Demodulation scenario (info only)	MNAS (Simulation)	MNS (Calculation)		MNSF (Min No Sub Frames, mandatory)	
				FDD	TDD	FDD	TDD
1	[7.1]	R.11 (10MHz, full, 16QAM, $\frac{1}{2}$ ) (2x2 Med) EVA, 5 [SFBC, Space Frequency Block Code]	50 000	55 556	100 000	57 000	101 000
		R.11-1 (5MHz, full, 16QAM, $\frac{1}{2}$ ) (2x2 Med) EVA5 [SFBC, Space Frequency Block Code]	50 000	55 556	100 000	57 000	101 000
1 Rel-9		R.11-2 (5MHz, full, 16QAM, $\frac{1}{2}$ ) (2x2 Med) EVA5 [SFBC]	50 000 (MNAS is not simulated, but estimated based on similar scenario in Table G.3.5-3 Test1)	55 556	100 000	57 000	101 000
2	[7.2]	R.10 (10MHz, Full, QPSK, 1/3) (2x2) HST [SFBC]	28 800	NA	NA	28 800	57 600

Table G.3.5-3a: Minimum Test time for PDSCH Transmit diversity 2x2 for eICIC

Test No	Demod. scenario	Demodulation scenario (info only)	MNAS (Simulation)	MNSF (Min No Sub Frames, mandatory)	
				FDD	TDD

1	[ ]	R.11-4 (10MHz, full, QPSK, ½) (2x2 Med) EVA,5 [SFBC, Space Frequency Block Code]	50 000 (MNAS is not simulated, but estimated based on similar scenario in Table G.3.5-3 Test1)	224 000	501 000
---	-----	-------------------------------------------------------------------------------------------------	---------------------------------------------------------------------------------------------------------	---------	---------

**Table G.3.5-3b: Minimum Test time for PDSCH Transmit diversity 2x2 for feICIC**

Test No	Demod. scenario	Demodulation scenario (info only)	MNAS (Simulation)	MNSF (Min No Sub Frames, mandatory)	
				FDD	TDD
1	[ ]	R.11-4 (10MHz, full, QPSK, ½) (2x2 Med) EVA,5 [SFBC, Space Frequency Block Code]	50 000 MNAS is not simulated, but estimated based on similar scenario in Table G.3.5-3 Test1	224 000	501 000

**Table G.3.5-4: Minimum Test time for PDSCH Transmit diversity 4x2**

Test No	Demod. scenario	Demodulation scenario (info only)	MNAS (Simulation)	MNS (Calculation)		MNSF (Min No Sub Frames, mandatory)	
				FDD	TDD	FDD	TDD
1	[7.3]	R.12 (1.4MHz, full, QPSK, 1/3) (4x2 med) EPA,5 [SFBC-FSTD, SFBC- Frequency Shifted Transmit Diversity]	150 000	166 667	300 000	168 000	301 000
1 Rel- 9		R.13 (10 MHz, full, QPSK, 1/3) (4x2 Low) ETU70 [SFBC-FSTD]	10 000 (MNAS is not simulated, but estimated based on similar scenarios in Table G.3.5-4 Test1)	11 112	20 000	13 000	21 000

Table G.3.5-5: Minimum Test time for PDSCH Open Loop Spatial Multiplexing 2x2

Test No	Demod. scenario	Demodulation scenario (info only)	MNAS (Simulation)	MNS (Calculation)		MNSF (Min No Sub Frames, mandatory)	
				FDD	TDD	FDD	TDD
1 FDD	[6.1]	R.11 (10MHz, Full, 16QAM, ½) (2x2 Low) EVA70 [LD-CDD, Large Delay-Cyclic Delay Diversity]	7 600	8 445	-	10 000	-
1 TDD	[6.1]	R.11-1 (10MHz, Full, 16QAM, ½) (2x2 Low) EVA70 [LD-CDD, Large Delay-Cyclic Delay Diversity]	7 600	-	19 000	-	20 000
2		R.11-2 (5MHz, Full, 16QAM, ½) (2x2 Low) EVA,70 [LD-CDD, Large Delay-Cyclic Delay Diversity]	7 600 (MNAS is not simulated, just follow the similar 10MHz test scenario in Test 1)	8 445	-	10 000	-

Table G.3.5-5a: Minimum Test time for PDSCH Open Loop Spatial Multiplexing 2x2 for eICIC

Test No	Demod. scenario	Demodulation scenario (info only)	MNAS (Simulation)	MNSF (Min No Sub Frames, mandatory)	
				FDD	TDD
1	[]	R.11 (10MHz, Full, 16QAM, ½) (2x2 Low) EVA,5 [LD-CDD, Large Delay-Cyclic Delay Diversity, Non-MBSFN ABS]	7 600 (MNAS is not simulated, but estimated based on similar scenario in Table G.3.5-5 Test1)	35 000	77 000
1	[]	R.11 (10MHz, Full, 16QAM, ½) (2x2 Low) EVA,5 [LD-CDD, Large Delay-Cyclic Delay Diversity, MBSFN ABS]	7 600 (MNAS is not simulated, but estimated based on similar scenario in Table G.3.5-3 Test1)	77 000	77 000

Table G.3.5-5b: Minimum Test time for PDSCH Open Loop Spatial Multiplexing 2x2 for fICIC

Test No	Demod. scenario	Demodulation scenario (info only)	MNAS (Simulation)	MNSF (Min No Sub Frames, mandatory)	
				FDD	TDD
1	[]	R.11 (10MHz, Full, 16QAM, ½) (2x2 Low) EVA,5 [LD-CDD, Large Delay-Cyclic Delay Diversity]	7 600 MNAS is not simulated, but estimated based on similar scenario in Table G.3.5-5 Test1	35 000	77 000
2	[]	R.35 (10MHz, full, 64QAM, ½) (2x2 Low) EVA,5 [LD-CDD, Large Delay-Cyclic Delay Diversity]	7 600 MNAS is not simulated, but estimated based on similar scenario in Table G.3.5-5 Test1	35 000	77 000

Table G.3.5-6: Minimum Test time for PDSCH Open Loop Spacial Multiplexing 4x2

Test No	Demod. scenario	Demodulation scenario (info only)	MNAS (Simulation)	MNS (Calculation)		MNSF (Min No Sub Frames, mandatory)	
				FDD	TDD	FDD	TDD
1	[6.2]	R.14 (10MHz, full, 16 QAM, ½) (4x2 low) EVA,70 [LD-CDD]	4 860	5 400	12 150	7 000	14 000

Table G.3.5-7: Minimum Test time for PDSCH Closed Loop Single/Multilayer Spatial Multiplexing 2x2

Test No	Demod. scenario	Demodulation scenario (info only)	MNAS (Simulation)	MNS (Calculation)		MNSF (Min No Sub Frames, mandatory)	
				FDD	TDD	FDD	TDD
1	[4.1]	R.10 (10MHz, Full, QPSK, 1/3) (2x2 Low) EVA5 [SCW, Single CodeWord]	49 140	54 600	98 280	56 000	100 000
1A		R.10-2 (5MHz, Full, QPSK, 1/3) (2x2 Low) EVA5 [SCW, Single CodeWord]	49 140	54 600	98 280	56 000	100 000
2	[4.2]	R.10 (10MHz, Full, QPSK, 1/3) (2x2 High) EPA5 [SCW]	50 000	55 556	100 000	57 000	101 000
3 FDD	[5.1]	R.11 (10MHz, full, 16QAM, ½) (2x2Low) EVA5 [MCW, Multiple Code Word]	34 266	38 074	-	40 000	-
3 TDD	[5.1]	R.11-1 (10MHz, full, 16QAM, ½) (2x2Low) EVA5 [MCW, Multiple Code Word]	34 266	-	85 665	-	87 000
3 Rel-9		R.35 (10MHz, full, 64QAM, ½) (2x2 Low) EPA5 [MCW]	48 000 (MNAS is not simulated, but estimated based on similar scenarios in Table G.3.5-12 Test5)	53 333	120 000	55 000	121 000
4 FDD	[5.2]	R.11 (10MHz, full, 16QAM, ½) (2x2Low) ETU70 [MCW]	2 736	3 040	-	5 000	-
4 TDD	[5.2]	R.11-1 (10MHz, full, 16QAM, ½) (2x2Low) ETU70 [MCW]	2 736	-	6840	-	8000
4A		R.11-2 (5MHz, full, 16QAM, ½) (2x2Low) ETU70 [MCW]	2 736	3 040	-	5 000	-

**Table G.3.5-8: Minimum Test time for PDSCH Closed Loop Single/Multilayer Spatial Multiplexing 4x2**

Test No	Demod. scenario	Demodulation scenario (info only)	MNAS (Simulation)	MNS (Calculation)		MNSF (Min No Sub Frames, mandatory)	
				FDD	TDD	FDD	TDD
1	[4.3]	R.13 (10 MHz, Full, QPSK, 1/3) (4x2 Low) EVA,5 [SCW]	26 528	29 476	53 056	31 000	55 000
2	[5.3]	R.14 (10MHz, Full, 16QAM, ½) (4x2low) EVA5 [MCW]	26 066	28 963	65 165	30 000	67 000
2 Rel-9		R.36 (10MHz, full, 64QAM 1/2) (4x2 Low) EPA5 [MCW]	30 000 (MNAS is not simulated, but estimated based on similar scenarios in Table G.3.5-4 Test1)	33 333	75 000	35 000	76 000

**Table G.3.5-9: Minimum Test time for PDSCH Single-layer Spatial Multiplexing on antenna port 5 (Release 8 and forward)**

Test No	Demod. scenario	Demodulation scenario (info only)	MNAS (Simulation)	MNS (Calculation)		MNSF (Min No Sub Frames, mandatory)	
				FDD	TDD	FDD	TDD
1	[11.1]	R.25 (10 MHz, full, QPSK, 1/3) (1x2 Low) EPA,5	38 879	43 199	77 758	45 000	79 000
2	[11.2]	R.26 (10MHz, full, 16QAM, ½) (1x2 Low) EPA5	47 781	53 090	95 562	55 000	97 000
3	[11.3]	R.27 (10MHz, full, 64QAM, 3/4) (1x2 Low) EPA,5	48 685	54 095	97 370	56 000	99 000
4	[11.4]	R.28 (10MHz, 1PRB, 16QAM, ½) (1x2 Low) EPA,5	100 000	111 112	200 000	113 000	201 000

**Table G.3.5-10: Minimum Test time for PDSCH Single-layer Spatial Multiplexing on antenna port 5 (Release 9 and forward)**

Test No	Demod. scenario	Demodulation scenario (info only)	MNAS (Simulation)	MNSF (Min No Sub Frames, mandatory)	
				FDD	TDD
1 NA					
2	[ ]	R.26 (5MHz, full, 16QAM ½) (2x2 Low) EPA5	Note: MNAS is not simulated. Because of same demodulation scenario except for antenna configuration, MNSF is reused from Table G.3.5-9, Test 2	55 000	97 000
3	[ ]	R.27 (10MHz, part, 64QAM 3/4) (2x2 Low) EPA,5	Note: MNAS is not simulated. Because of same demodulation scenario except for antenna configuration, MNSF is reused from Table G.3.5-9, Test 3	56 000	99 000
4 NA					

**Table G.3.5-11: Minimum Test time for PDSCH Single-layer Spatial Multiplexing on antenna port 7 or 8 without simultaneous transmission**

Test No	Demod. scenario	Demodulation scenario (info only)	MNAS (Simulation)	MNSF (Min No Sub Frames, mandatory)	
				FDD	TDD
1	[ ]	R.31 (10 MHz, full, QPSK, 1/3) (2x2 Low) EVA,5	Note: MNAS is not simulated. Because of same demodulation scenario except for RMC, antenna configuration, MNSF is reused from Table G.3.5-9, Test 1	45 000	79 000
2	[ ]	R.32 (10MHz, full, 16QAM, ½) (2x2 Medium) EPA5	Note: MNAS is not simulated. Because of same demodulation scenario except for RMC, antenna configuration, MNSF is reused from Table G.3.5-9, Test 2	55 000	97 000
		R.32-1 (5MHz, full, 16QAM, ½) (2x2 Medium) EPA5	Note: MNAS is not simulated. Because of same demodulation scenario except for RMC, channel BW, antenna configuration, MNSF is reused from Table G.3.5-9, Test 2		
3	[ ]	R.33 (10MHz, full, 64QAM, 3/4) (2x2 Low) EPA,5	Note: MNAS is not simulated. Because of same demodulation scenario except for RMC, antenna configuration, MNSF is reused from Table G.3.5-9, Test 3	56 000	99 000
		R.33-1 (10MHz, part, 64QAM, 3/4) (2x2 Low) EPA5	Note: MNAS is not simulated. Because of same demodulation scenario except for RMC, allocation, antenna configuration, MNSF is reused from Table G.3.5-9, Test 3		



**Table G.3.5-12: Minimum Test time for PDSCH Single-layer Spatial Multiplexing on antenna port 7 or 8 with a simultaneous transmission**

Test No	Demod. scenario	Demodulation scenario (info only)	MNAS (Simulation)	MNSF (Min No Sub Frames, mandatory)	
				FDD	TDD
4	[ ]	R.32 (10MHz, full, 16QAM, 1/2) (2x2 Medium) EPA,5	Note: MNAS is not simulated. Because of same demodulation scenario except for RMC number, antenna configuration, MNSF is reused from Table G.3.5-9, Test 2	55 000	97 000
5	[ ]	R.34 (10MHz, full, 64QAM, 1/2) (2x2 Low) EPA,5	Note: MNAS is not simulated. Because of same demodulation scenario except for RMC number, target coding rate, antenna configuration, MNSF is reused from Table G.3.5-9, Test 3	56 000	99 000

**Table G.3.5-12a: Minimum Test time for PDSCH Single-layer Spatial Multiplexing on antenna port 7 or 8 without simultaneous transmission for eDL-MIMO**

Test No	Demod. scenario	Demodulation scenario (info only)	MNAS (Simulation)	MNSF (Min No Sub Frames, mandatory)	
				FDD	TDD
1	[ ]	R.43 FDD, R50 TDD (10 MHz, full, QSPK, 1/3) (2x2 Low) EVA,5	Note: MNAS is not simulated. Because of same demodulation scenario except for RMC, antenna configuration, propagation condition, MNSF is reused from Table G.3.5-9, Test 1	45 000	79 000

**Table G.3.5-12b: Minimum Test time for PDSCH Single-layer Spatial Multiplexing on antenna port 7 or 8 with a simultaneous transmission for eDL-MIMO**

Test No	Demod. scenario	Demodulation scenario (info only)	MNAS (Simulation)	MNSF (Min No Sub Frames, mandatory)	
				FDD	TDD
2	[ ]	R.50 FDD, R.44 TDD (10MHz, full, 64QAM, 1/2) (2x2 Low) EPA,5	Note: MNAS is not simulated. Because of same demodulation scenario except for RMC, target coding rate, antenna configuration, MNSF is reused from Table G.3.5-9, Test 3	56 000	99 000

**Table G.3.5-12c: Minimum Test time for PDSCH Single-layer Spatial Multiplexing for FeICIC**

Test No	Demod. scenario	Demodulation scenario (info only)	MNAS (Simulation)	MNSF (Min No Sub Frames, mandatory)	
				FDD	TDD
1	[ ]	R.11 FDD, R11 TDD (10 MHz, full, 16QAM, 1/2) (2x2 High) EPA, 5	Note: MNAS is not simulated. Because of same demodulation scenario except for RMC, antenna configuration, propagation condition, MNSF is reused from Table G.3.5-9, Test 1	55 000	97 000

**Table G.3.5-13: Minimum Test time for PDSCH Dual-layer Spatial Multiplexing**

Test No	Demod. scenario	Demodulation scenario (info only)	MNAS (Simulation)	MNSF (Min No Sub Frames, mandatory)	
				FDD	TDD
1	[ ]	R.31 (10 MHz, full, QPSK, 1/3) (2x2 Low) EVA,5	Note: MNAS is not simulated. Because of same demodulation scenario except for RMC, antenna configuration, MNSF is reused from Table G.3.5-9, Test 1	[45 000]	[79 000]
2	[ ]	R.32 (10MHz, full, 16QAM, 1/2) (2x2 Medium) EPA5	Note: MNAS is not simulated. Because of same demodulation scenario except for RMC, antenna configuration, MNSF is reused from Table G.3.5-9, Test 2	[55 000]	[97 000]

**Table G.3.5-13a: Minimum Test time for PDSCH Dual-layer Spatial Multiplexing for eDL-MIMO**

Test No	Demod. scenario	Demodulation scenario (info only)	MNAS (Simulation)	MNSF (Min No Sub Frames, mandatory)	
				FDD	TDD
1	[ ]	R.51 (10MHz, full, 16QAM, 1/2) (2x2 Low) EPA5	Note: MNAS is not simulated. Because of same demodulation scenario except for RMC, antenna configuration, MNSF is reused from Table G.3.5-9, Test 2	55 000	97 000

**Table G.3.5-14: Minimum Test time for PDSCH transmit Diversity 2x2 with TM3 Interference Model – Enhanced Performance Type A**

Test No	Demod. scenario	Demodulation scenario (info only)	MNAS (Simulation)	MNSF (Min No Sub Frames, mandatory)	
				FDD	TDD
1		R.46 (10MHz, full, QPSK, 1/2) (2x2 Low) EVA70	Note: MNAS is not simulated. It is estimated based on other similar test cases using EVA70 or ETU70 propagation conditions	15 000	-

**Table G.3.5-15: Minimum Test time for PDSCH Closed Loop Single Layer Spatial Multiplexing 2x2 with TM4 Interference Model – Enhanced Performance Type A**

Test No	Demod. scenario	Demodulation scenario (info only)	MNAS (Simulation)	MNSF (Min No Sub Frames, mandatory)	
				FDD	TDD
1		R.47 (10MHz, full, 16QAM, 1/3) (2x2 Low) EVA5	Note: MNAS is not simulated. It is estimated based on other similar test cases using EVA5 or ETU70 propagation conditions	56 000	-

**Table G.3.5-16: Minimum Test time for PDSCH Single-layer Spatial Multiplexing on antenna ports 7 or 8 with TM9 Interference Model – Enhanced Performance Type A**

Test No	Demod. scenario	Demodulation scenario (info only)	MNAS (Simulation)	MNSF (Min No Sub Frames, mandatory)	
				FDD	TDD
1		R.48 (10MHz, full, QPSK, 1/2) (4x2 Low) EVA5	Note: MNAS is not simulated. It is estimated based on other similar test cases using EVA5 propagation conditions	57 000	101 000

## G.3.6 Test conditions for receiver performance tests

**Table G.3.6: Test conditions for receiver performance tests**

**Table G.3.6-1: Single Antenna Port Performance (Cell-specific Reference Symbols) for test case 8.2.1.1 and 8.2.2.1 demodulation of PDSCH**

Test	Statistical independence	Number of components in the test vector, as specified in the test requirements and initial conditions of the applicable test				Over all Pass/Fail condition
8.2.1.1 FDD PDSCH Single Antenna Port Performance (Cell- Specific Reference Symbols)	subframes are independent	CAT	1	2	3-5	To pass 8.2.1.1 and 8.2.2.1 each component in the test vector must pass  For UEs, supporting multiple E_UTRA-bands (number of bands =B), the number of repetitions must be multiplied by B.
		QPSK	5	5	5	
		16QAM	0	3	3	
8.2.1.2 TDD PDSCH Single Antenna Port Performance (Cell- Specific Reference Symbols)	subframes are independent	64 QAM	1	6	7	If a test is defined over a BW>(BW of the E_UTRA band), the test is not applicable and reduces the number of repetitions.  If a test is defined over a BW, which is not supported in the E_UTRAN band, the test is not applicable and reduces the number of repetitions.
		1PRB	4	4	4	
		$\Sigma$	10	18	19	

**Table G.3.6-2: Transmit Diversity Performance (Cell-specific Reference Symbols) for test case 8.2.1.2 and 8.2.2.2 demodulation of PDSCH**

Test	Statistical independence	Number of components in the test vector, as specified in the test requirements and initial conditions of the applicable test				Over all Pass/Fail condition
8.2.1.2 FDD PDSCH Transmit Diversity Performance (Cell-Specific Reference Symbols)	subframes are independent	CAT	1	2	3-5	To pass 8.2.1.2 and 8.2.2.2 each component in the test vector must pass  For UEs, supporting multiple E_UTRA-bands (number of bands =B), the number of repetitions must be multiplied by B.
		QPSK	2	2	2	
8.2.2.2 TDD PDSCH Transmit Diversity Performance (Cell-Specific Reference Symbols)	subframes are independent	16QAM	0	1	1	If a test is defined over a BW, which is not supported in the E_UTRAN band, the test is not applicable and reduces the number of repetitions.
		Σ	2	3	3	

**Table G.3.6-3: Open Loop Spatial Multiplexing Performance (Cell-specific Reference Symbols) for test case 8.2.1.3 and 8.2.2.3 demodulation of PDSCH**

Test	Statistical independence	Number of components in the test vector, as specified in the test requirements and initial conditions of the applicable test				Over all Pass/Fail condition
8.2.1.3 FDD PDSCH Open Loop Spatial Multiplexing Performance (Cell-Specific Reference Symbols)	subframes are independent	CAT	1	2	3-5	To pass 8.2.1.3 and 8.2.2.3 each component in the test vector must pass
		16QAM	0	2	2	
8.2.2.3 TDD PDSCH Open Loop Spatial Multiplexing Performance (Cell-Specific Reference Symbols)	subframes are independent	Σ	0	2	2	

**Table G.3.6-4: Closed Loop Spatial Multiplexing Performance (Cell-specific Reference Symbols) for test case 8.2.1.4 and 8.2.2.4 demodulation of PDSCH**

Test	Statistical independence	Number of components in the test vector, as specified in the test requirements and initial conditions of the applicable test				Over all Pass/Fail condition
8.2.1.4 FDD PDSCH Closed Loop Spatial Multiplexing Performance (Cell- Specific Reference Symbols)	subframes are independent	CAT	1	2	3-5	To pass 8.2.1.4 and 8.2.2.4 each component in the test vector must pass
		Single layer QPSK	3	3	3	
8.2.2.4 TDD PDSCH Closed Loop Spatial Multiplexing Performance (Cell- Specific Reference Symbols)	subframes are independent	Multi layer 16QAM	0	3	3	
		Σ	3	6	6	

**Table G.3.6-5: TDD PDSCH Single-layer Spatial Multiplexing on antenna port 5 (Release 8 and forward)**

Test	Statistical independence	Number of components in the test vector, as specified in the test requirements and initial conditions of the applicable test				Over all Pass/Fail condition
8.3.2.1.1 TDD PDSCH Single-layer Spatial Multiplexing on antenna port 5 (Release 8 and forward)	subframes are independent	CAT	1	2	3-5	To pass 8.3.2.1 each component in the test vector must pass
		QPSK	1	1	1	
		16QAM	1	2	2	
		64 QAM	0	1	1	
		Σ	2	4	4	

**Table G.3.6-6: TDD PDSCH Single-layer Spatial Multiplexing on antenna port 5 (Release 9 and forward)**

Test	Statistical independence	Number of components in the test vector, as specified in the test requirements and initial conditions of the applicable test				Over all Pass/Fail condition
		CAT	1	2	3-5	
8.3.2.1.1_1 TDD PDSCH Single-layer Spatial Multiplexing on antenna port 5 (Release 9 and forward)	subframes are independent	16QAM	1	0	0	To pass 8.3.2.1.1_1 each component in the test vector must pass
		64 QAM	1	0	0	
		$\Sigma$	2	0	0	

**Table G.3.6-7: TDD PDSCH Single-layer Spatial Multiplexing on antenna port 7 or 8 without a simultaneous transmission**

Test	Statistical independence	Number of components in the test vector, as specified in the test requirements and initial conditions of the applicable test				Over all Pass/Fail condition
		CAT	1	2-5		
8.3.2.1.2 TDD PDSCH Single-layer Spatial Multiplexing on antenna port 7 or 8 without a simultaneous transmission	subframes are independent	QPSK	1	1		To pass 8.3.2.1.2 each component in the test vector must pass
		16QAM	1	1		
		64 QAM	1	1		
		$\Sigma$	3	3		

**Table G.3.6-8: TDD PDSCH Single-layer Spatial Multiplexing on antenna port 7 or 8 with a simultaneous transmission**

Test	Statistical independence	Number of components in the test vector, as specified in the test requirements and initial conditions of the applicable test				Over all Pass/Fail condition
		CAT	1	2-5		
8.3.2.1.3 TDD PDSCH Single-layer Spatial Multiplexing on antenna port 7 or 8 with a simultaneous transmission	subframes are independent	16QAM	0	1		To pass 8.3.2.1.3 each component in the test vector must pass
		64 QAM	0	1		
		$\Sigma$	0	2		

**Table G.3.6-8a: PDSCH Single-layer Spatial Multiplexing on antenna port 7 or 8 without a simultaneous transmission for eDL-MIMO**

Test	Statistical independence	Number of components in the test vector, as specified in the test requirements and initial conditions of the applicable test				Over all Pass/Fail condition
8.3.1.1.1_D FDD PDSCH Single-layer Spatial Multiplexing on antenna port 7 or 8 without a simultaneous transmission	subframes are independent	CAT	1-8			To pass 8.3.1.1.1_D and 8.3.2.1.2_D each component in the test vector must pass
		QPSK	1			
8.3.2.1.2_D TDD PDSCH Single-layer Spatial Multiplexing on antenna port 7 or 8 without a simultaneous transmission	subframes are independent	QPSK	1			
		$\Sigma$	2			

**Table G.3.6-8b: PDSCH Single-layer Spatial Multiplexing on antenna port 7 or 8 with a simultaneous transmission for eDL-MIMO**

Test	Statistical independence	Number of components in the test vector, as specified in the test requirements and initial conditions of the applicable test				Over all Pass/Fail condition
8.3.1.1.2_D FDD PDSCH Single-layer Spatial Multiplexing on antenna port 7 or 8 with a simultaneous transmission for eDL- MIMO	subframes are independent	CAT	1	2-8		To pass 8.3.1.1.2_D and 8.3.2.1.3_D each component in the test vector must pass
		64QAM	0	1		
8.3.2.1.3_D TDD PDSCH Single-layer Spatial Multiplexing on antenna port 7 or 8 with a simultaneous transmission for eDL- MIMO	subframes are independent	64QAM	0	1		
		$\Sigma$	0	2		



**Table G.3.6-8c: PDSCH Single-layer Spatial Multiplexing on antenna ports 7 or 8 with TM9 Interference Model - Enhanced Performance Requirement Type A**

Test	Statistical independence	Number of components in the test vector, as specified in the test requirements and initial conditions of the applicable test				Over all Pass/Fail condition
8.3.1.1.3 FDD PDSCH Single-layer Spatial Multiplexing on antenna ports 7 or 8 with TM9 Interference Model - Enhanced Performance Requirement Type A	subframes are independent	CAT	1-8			To pass 8.3.1.1.3 and 8.3.2.1.4 each component in the test vector must pass
		QPSK	1			
8.3.2.1.4 TDD PDSCH Single-layer Spatial Multiplexing on antenna ports 7 or 8 with TM9 Interference Model - Enhanced Performance Requirement Type A	subframes are independent	QPSK	1			
		$\Sigma$	2			

**Table G.3.6-9: TDD PDSCH Dual-layer Spatial Multiplexing**

Test	Statistical independence	Number of components in the test vector, as specified in the test requirements and initial conditions of the applicable test				Over all Pass/Fail condition
8.3.2.2.1 TDD PDSCH Dual-layer Spatial Multiplexing	subframes are independent	CAT	1	2	3-5	To pass 8.3.2.2.1 each component in the test vector must pass
		QPSK	1	1	1	
		16QAM	1	2	2	
		64 QAM	0	1	1	
		$\Sigma$	2	4	4	

Table G.3.6-9a: PDSCH Dual-layer Spatial Multiplexing for eDL-MIMO

Test	Statistical independence	Number of components in the test vector, as specified in the test requirements and initial conditions of the applicable test				Over all Pass/Fail condition
8.3.1.2.1_D FDD PDSCH Dual-layer Spatial Multiplexing for eDL- MIMO	subframes are independent	CAT	1	2-8		To pass 8.3.1.2.1_D and 8.3.2.2.1_D each component in the test vector must pass
		16QAM	0	1		
8.3.2.2.1_D TDD PDSCH Dual-layer Spatial Multiplexing for eDL- MIMO	subframes are independent	16QAM	0	1		
		$\Sigma$	0	2		

## G.3A Statistical testing of Performance Requirements with throughput for CA

### G.3A.1 General

The minimum requirements for performance tests in fading conditions in clause 8 with respect to CA are 70% of the maximum throughput. The minimum requirements in static conditions in clause 8 with respect to CA are [TBD]. Statistical tests in static propagation conditions lead to a statistically justified number of samples (testtime) and a test limit. The fading conditions require a minimum test time, overriding the statistically justified test time. It can be found in Tables G.3A.5. The statistically justified test limit is also used for the tests under fading conditions. The throughput is measured on both carriers in parallel (unless otherwise stated). The test for both carriers need the same time. The sum of the CC's throughput is compared against the limit, where the limit is the sum of the individual carrier's limit.

### G.3A.2 Mapping throughput to error ratio

G.2.2 applies separate for each CC

### G.3A.3 Design of the test

The test is defined by the following design principles (see clause G.x, Theory...):

1. The standard concept is applied (not the early decision concept).
2. A second limit is introduced, defining the Bad DUT.
3. To decide the test pass:
  - Supplier risk is applied based on the Bad DUT quality.
  - To decide the test fails.
  - Customer Risk is applied based on the specified DUT quality.

The test is defined by the following parameters:

- 1) Limit Error Ratio = 0.3.  
(in case 70% throughput is tested , otherwise [TBD]).
- 2) Bad DUT factor M = 1.378 (selectivity) justification see: TS 34.121 Clause F.6.3.3.  
(M = 1.378 is tied to 70% throughput, otherwise M is [TBD].)
- 3) Confidence level CL = 95% (for specified DUT and Bad DUT-quality).

### G.3A.4 Pass Fail limit

Testing with the parameters from G.3A.3 (70% throughput, M = 1.378, CL95%): Apply 184 samples to the DUT per CC and count the errors for each CC. The test limit to pass for one CC is  $\leq 66$  errors, however this is not individually applicable for CA.

Pass fail decision for one test point in CA: The sum of the CC's errors is compared against the test limit, where the test limit is the sum of the individual carrier's test limit.

It is allowed to apply more samples, in parallel for all CCs, to the DUT (e.g. up to an integer number of frames).

In fading conditions it is necessary to apply more samples, in parallel for all CCs, to the DUT, as in fading conditions the minimum test time overrides the statistically justified test time.

When more samples are applied, decide against the ratio  $66/184 = 0.3587$ .

Testing with parameters from G.3A.3 ([TBD]% throughput, M = [TBD], CL = 95%) is [TBD].

### G.3A.5 Minimum test time

In contrast to G.3.5, where the minimum test time is derived from simulations, the test time here is selected without simulation utilising test time information from similar demodulation scenarios in non-CA test cases and while maintaining the reasonable testing time.

Note MNAS values in this clause may need to be changed in future if current MNAS values turn out to be too short for giving stable CA throughput results.

**Table G.3A.5-1: Minimum Test time FDD PDSCH Single Antenna Port Performance for CA (2DL CA)**

Clause 8.2.1.1.1_A.1 Test No	Demodulation scenario plain text:  RMC (Bandwidth, allocated RBs, modulation, coding) Antenna (configuration, correlation) Propagation condition, Doppler [additional parameters, if applicable]  (info only)	Minimum Number of Active Subframes in each CC	Minimum Number of Subframes (MNS) in each CC
			(MNS = active and inactive subframes) FDD
1	R.2FDD (2x10 MHz,full,QPSK,1/3) (1x2 Low) EVA5	50 000	55 556
2	R.42FDD (2x20 MHz,full,QPSK,1/3) (1x2 Low) EVA5	50 000	55 556

Table G.3A.5-1A: Minimum Test time FDD PDSCH Single Antenna Port Performance for CA (3DL CA)

Clause 8.2.1.1.1_A.2 Test No	Demodulation scenario plain text:  RMC (Bandwidth, allocated RBs, modulation, coding) Antenna (configuration, correlation) Propagation condition, Doppler [additional parameters, if applicable]  (info only)	Minimum Number of Active Subframes in each CC	Minimum Number of Subframes (MNS) in each CC  (MNS = active and inactive subframes)
			FDD
1	R.42FDD (3x20 MHz,full,QPSK,1/3) (1x2 Low) EVA5	50 000	55 556
2	R.42FDD + R.42-3FDD (20+20+15 MHz,full,QPSK,1/3) (1x2 Low) EVA5	50 000	55 556
3	R.42FDD + R.2FDD (20+20+10 MHz,full,QPSK,1/3) (1x2 Low) EVA5	50 000	55 556
4	R.42FDD + R.42-3FDD (20+15+15 MHz,full,QPSK,1/3) (1x2 Low) EVA5	50 000	55 556
5	R.42FDD + R.42-3FDD + R.2FDD (20+15+10 MHz,full,QPSK,1/3) (1x2 Low) EVA5	50 000	55 556
6	R.42FDD + R.2FDD (20+10+10 MHz,full,QPSK,1/3) (1x2 Low) EVA5	50 000	55 556
7	R.42-3FDD + R.2FDD (15+15+10 MHz,full,QPSK,1/3) (1x2 Low) EVA5	50 000	55 556
8	R.42FDD + R.2FDD + R.42-2FDD (20+10+5 MHz,full,QPSK,1/3) (1x2 Low) EVA5	50 000	55 556

Table G.3A.5-2: Minimum Test time FDD PDSCH Open Loop Spatial Multiplexing 2x2 (2DL CA)

Clause 8.2.1.3.1_A.1 Test No	Demodulation scenario plain text:  RMC (Bandwidth, allocated RBs, modulation, coding) Antenna (configuration, correlation) Propagation condition, Doppler [additional parameters, if applicable]  (info only)	Minimum Number of Active Subframes in each CC	Minimum Number of Subframes (MNS) in each CC  (MNS = active and inactive subframes)
			FDD
1	R.11 FDD (2x10 MHz, full 16QAM, 1/2), (2x2 Low) EVA70	10 000	11 112
2	R.30 FDD (2x20 MHz, full 16QAM, 1/2), (2x2 Low) EVA70	10 000	11 112
3	R.11-2 FDD (2x5 MHz, full 16QAM, 1/2), (2x2 Low) EVA70	10 000	11 112

Table G.3A.5-2A: Minimum Test time FDD PDSCH Open Loop Spatial Multiplexing 2x2 (3DL CA)

Clause 8.2.1.3.1_A.2 Test No	Demodulation scenario plain text:  RMC (Bandwidth, allocated RBs, modulation, coding) Antenna (configuration, correlation) Propagation condition, Doppler [additional parameters, if applicable]  (info only)	Minimum Number of Active Subframes in each CC	Minimum Number of Subframes (MNS) in each CC  (MNS = active and inactive subframes)
			FDD
1	R.30 FDD (3x20 MHz, full 16QAM, 1/2), (2x2 Low) EVA70	10 000	11 112
2	R.30 FDD + R.11-7 FDD (20+20+15 MHz, full 16QAM, 1/2), (2x2 Low) EVA70	10 000	11 112
3	R.30 FDD + R.11 FDD (20+20+10 MHz, full 16QAM, 1/2), (2x2 Low) EVA70	10 000	11 112
4	R.30 FDD + R.11-7 FDD (20+15+15 MHz, full 16QAM, 1/2), (2x2 Low) EVA70	10 000	11 112
5	R.30 FDD + R.11-7 FDD + R.11 FDD (20+15+10 MHz, full 16QAM, 1/2), (2x2 Low) EVA70	10 000	11 112
6	R.30 FDD + R.11 FDD (20+10+10 MHz, full 16QAM, 1/2), (2x2 Low) EVA70	10 000	11 112
7	R.11-7 FDD + R.11 FDD (15+15+10 MHz, full 16QAM, 1/2), (2x2 Low) EVA70	10 000	11 112
8	R.30 FDD + R.11 FDD + R.11-2 FDD (20+10+5 MHz, full 16QAM, 1/2), (2x2 Low) EVA70	10 000	11 112

**Table G.3A.5-3: Minimum Test time FDD PDSCH Closed Loop Multi Layer Spatial Multiplexing 4x2 (2DL CA)**

Clause 8.2.1.4.2_A.1 Test No	Demodulation scenario plain text:  RMC (Bandwidth, allocated RBs, modulation, coding) Antenna (configuration, correlation) Propagation condition, Doppler [additional parameters, if applicable]  (info only)	Minimum Number of Active Subframes in each CC	Minimum Number of Subframes (MNS) in each CC  (MNS = active and inactive subframes)
			FDD
1	R.14-3 FDD (2x20 MHz, full, 16QAM, 1/2) (4x2 Low) EVA5	50 000	55 556
2	R.14FDD (2x10 MHz, full, 16QAM, 1/2) (4x2 Low) EVA 5	50 000	55 556

**Table G.3A.5-3A: Minimum Test time FDD PDSCH Closed Loop Multi Layer Spatial Multiplexing 4x2 (3DL CA)**

Clause 8.2.1.4.2_A.2 Test No	Demodulation scenario plain text:  RMC (Bandwidth, allocated RBs, modulation, coding) Antenna (configuration, correlation) Propagation condition, Doppler [additional parameters, if applicable]  (info only)	Minimum Number of Active Subframes in each CC	Minimum Number of Subframes (MNS) in each CC  (MNS = active and inactive subframes)
			FDD
1	R.14-3 FDD (3x20 MHz,full,16QAM,1/2) (4x2 Low) EVA5	50 000	55 556
2	R.14-3 FDD + R.14-7 FDD (20+20+15 MHz,full,16QAM, 1/2) (4x2 Low) EVA 5	50 000	55 556
3	R.14-3 FDD + R.14 FDD (20+20+10 MHz,full,16QAM, 1/2) (4x2 Low) EVA 5	50 000	55 556
4	R.14-3 FDD + R.14-7 FDD (20+15+15 MHz,full,16QAM, 1/2) (4x2 Low) EVA 5	50 000	55 556
5	R.14-3 FDD + R.14-7 FDD + R.14 FDD (20+15+10 MHz,full,16QAM, 1/2) (4x2 Low) EVA 5	50 000	55 556
6	R.14-3 FDD + R.14 FDD (20+10+10 MHz,full,16QAM, 1/2) (4x2 Low) EVA 5	50 000	55 556
7	R.14-7 FDD + R.14 FDD (15+15+10 MHz,full,16QAM, 1/2) (4x2 Low) EVA 5	50 000	55 556
8	R.14-3 FDD + R.14 FDD + R.14-6 FDD (20+10+5 MHz,full,16QAM, 1/2) (4x2 Low) EVA 5	50 000	55 556

Table G.3A.5-4: Void

Table G.3A.5-4A: Void

Table G.3A.5-5: Void

Table G.3A.5-6: Minimum Test time TDD PDSCH Single Antenna Port 2 DL CA Performance

Clause 8.2.2.1.1_A.1 Test No	Demodulation scenario plain text:  RMC (Bandwidth, allocated RBs, modulation, coding) Antenna (configuration, correlation) Propagation condition, Doppler [additional parameters, if applicable]  (info only)	Minimum Number of Active Subframes in each CC	Minimum Number of Subframes (MNS) in each CC  (MNS = active and inactive subframes)
			TDD
1	R.42TDD (2x20 MHz,full,QPSK,1/3) (1x2 Low) EVA5	50 000	100 000
2	R.42TDD (20 MHz,full,QPSK,1/3) (1x2 Low) EVA5	50 000	100 000
	R.42-3 TDD (1x2 Low) EVA5		

Table G.3A.5-6A: Minimum Test time TDD PDSCH Single Antenna Port Performance for CA (3DL CA)

Clause 8.2.2.1.1_A.2 Test No	Demodulation scenario plain text:  RMC (Bandwidth, allocated RBs, modulation, coding) Antenna (configuration, correlation) Propagation condition, Doppler [additional parameters, if applicable]  (info only)	Minimum Number of Active Subframes in each CC	Minimum Number of Subframes (MNS) in each CC  (MNS = active and inactive subframes)
			FDD
1	R.42TDD (3x20 MHz,full,QPSK,1/3) (1x2 Low) EVA5	50 000	100 000
2	R.42TDD + R.42-3TDD (20+20+15 MHz,full,QPSK,1/3) (1x2 Low) EVA5	50 000	100 000



Table G.3A.5-7: Minimum Test time TDD PDSCH Open Loop Spatial Multiplexing 2x2 2DL CA

Clause 8.2.2.3.1_A.1 Test No	Demodulation scenario plain text:  RMC (Bandwidth, allocated RBs, modulation, coding) Antenna (configuration, correlation) Propagation condition, Doppler [additional parameters, if applicable]  <b>(info only)</b>	Minimum Number of Active Subframes in each CC	Minimum Number of Subframes (MNS) in each CC  (MNS = active and inactive subframes)
			TDD
1	R.30-1 TDD (2x20 MHz, full,16QAM,1/2) (2x2 Low) EVA70	10 000	20 000
2	R.30-1 TDD (20 MHz, full,16QAM,1/2) (2x2 Low) EVA70	10 000	20 000
	[TBD] (2x2 Low) EVA70		

Table G.3A.5-7A: Minimum Test time TDD PDSCH Open Loop Spatial Multiplexing 2x2 3DL CA

Clause 8.2.2.3.1_A.2 Test No	Demodulation scenario plain text:  RMC (Bandwidth, allocated RBs, modulation, coding) Antenna (configuration, correlation) Propagation condition, Doppler [additional parameters, if applicable]  <b>(info only)</b>	Minimum Number of Active Subframes in each CC	Minimum Number of Subframes (MNS) in each CC  (MNS = active and inactive subframes)
			TDD
1	R.30-1 TDD (3x20 MHz, full,16QAM,1/2) (2x2 Low) EVA70	10 000	20 000
2	R.30-1 TDD + R.11-9 TDD (20+20+15 MHz, full,16QAM,1/2) (2x2 Low) EVA70	10 000	20 000

**Table G.3A.5-8: Minimum Test time TDD PDSCH Closed Loop Multi Layer Spatial Multiplexing 4x2 2DL CA**

Clause 8.2.2.4.2_A.1 Test No	Demodulation scenario plain text:  RMC (Bandwidth, allocated RBs, modulation, coding) Antenna (configuration, correlation) Propagation condition, Doppler [additional parameters, if applicable]  (info only)	Minimum Number of Active Subframes in each CC	Minimum Number of Subframes (MNS) in each CC  (MNS = active and inactive subframes)
			TDD
1	R.43TDD (2x20 MHz,full,16QAM, 1/2) (4x2 Low) EVA 5	50 000	100 000
2	R.43TDD (20 MHz,full,16QAM, 1/2) (4x2 Low) EVA 5	50 000	100 000
	R.43-5 TDD (15 MHz, full, 16QAM,1/2) (4x2 Low) EVA 5		

**Table G.3A.5-8A: Minimum Test time TDD PDSCH Closed Loop Multi Layer Spatial Multiplexing 4x2 3DL CA**

Clause 8.2.2.4.2_A.2 Test No	Demodulation scenario plain text:  RMC (Bandwidth, allocated RBs, modulation, coding) Antenna (configuration, correlation) Propagation condition, Doppler [additional parameters, if applicable]  (info only)	Minimum Number of Active Subframes in each CC	Minimum Number of Subframes (MNS) in each CC  (MNS = active and inactive subframes)
			TDD
1	R.43 TDD (3x20 MHz,full,16QAM, 1/2) (4x2 Low) EVA 5	50 000	100 000
2	R.43 TDD + R.43-5 TDD (20+20+15 MHz,full,16QAM, 1/2) (4x2 Low) EVA 5	50 000	50 000

Table G.3A.5-9: Void

Table G.3A.5-10Void

**Table G.3A.5-11: Minimum Test time TDD PDSCH Closed Loop Multi Layer Spatial Multiplexing 4x2  
(intra band non-contiguous DL CA)**

<b>Clause 8.2.2.4.2_A.3</b> <b>Test No</b>	<b>Demodulation scenario plain text:</b>  <b>RMC (Bandwidth, allocated RBs, modulation, coding)</b> <b>Antenna (configuration, correlation)</b> <b>Propagation condition, Doppler [additional parameters, if applicable]</b>  <b>(info only)</b>	<b>Minimum Number of Active Subframes in each CC</b>	<b>Minimum Number of Subframes (MNS) in each CC</b> <b>(MNS = active and inactive subframes)</b>
			<b>TDD</b>
1	R.43TDD (2x20 MHz, full, 16QAM, 1/2) (4x2 Low) EVA 5	50 000	100 000

Table G.3A.5-12: Minimum Test time FDD PDSCH Soft buffer management test (2 DL CA)

Clause 8.2.1.3.1A_A.1 Test No	Demodulation scenario plain text:  RMC (Bandwidth, allocated RBs, modulation, coding) Antenna (configuration, correlation) Propagation condition, Doppler [additional parameters, if applicable]  (info only)	Minimum Number of Active Subframes in each CC	Minimum Number of Subframes (MNS) in each CC
			(MNS = active and inactive subframes) FDD
1	R.30 FDD (2x20 MHz, full 16QAM, 1/2) (2x2 Low) EVA70	10 000	11112
2	R.35-2 FDD (15MHz, full 64QAM, 0.39) (2x2 Low) EVA5	10 000	12500
	R.35-3 FDD (10MHz, full 64QAM, 0.39) (2x2 Low) EVA5	10 000	12500
3	R.30 FDD (20 MHz, full 16QAM, 1/2) (2x2 Low) EVA70	10 000	11112
	R.11 FDD (2x10 MHz, full 16QAM, 1/2) (2x2 Low) EVA70	10 000	11112
4	R.30 FDD (20 MHz, full 16QAM, 1/2) (2x2 Low) EVA70	10 000	11112
	R.30-1 FDD (15 MHz, full 16QAM, 1/2) (2x2 Low) EVA70	10 000	12500
5	R.35-1 FDD (2x20 MHz, full 64QAM, 0.39) (2x2 Low) EVA5	10 000	12500
6	R.35-1 FDD (20 MHz, full 64QAM, 0.39) (2x2 Low) EVA5	10 000	12500
	R.35-3 FDD (10MHz, full 64QAM, 0.39) (2x2 Low) EVA5	10 000	12500
7	R.35-1 FDD (20 MHz, full 64QAM, 0.39) (2x2 Low) EVA5	10 000	12500
	R.35-2 FDD (15MHz, full 64QAM, 0.39) (2x2 Low) EVA5	10 000	12500

Table G.3A.5-14: Minimum Test time TDD PDSCH Soft buffer management test (2 DL CA)

Clause 8.2.2.3.1A_A.1 Test No	Demodulation scenario plain text:  RMC (Bandwidth, allocated RBs, modulation, coding) Antenna (configuration, correlation) Propagation condition, Doppler [additional parameters, if applicable]  (info only)	Minimum Number of Active Subframes in each CC	Minimum Number of Subframes (MNS) in each CC  (MNS = active and inactive subframes)
			TDD
1	R.30-2 TDD (2x20 MHz,full,16QAM,1/3) (2x2 Low) EVA70	10 000	50 000
2	R.35-1 TDD (2x20 MHz,full,64QAM,1/3) (2x2 Low) EVA5	10 000	50 000

Table G.3A.5-15: Minimum Test time TDD power imbalance test (2 DL CA)

Clause 8.2.2.7_A.1 Test No	Demodulation scenario plain text:  RMC (Bandwidth, allocated RBs, modulation, coding) Antenna (configuration, correlation) Propagation condition, Doppler [additional parameters, if applicable]  (info only)	Minimum Number of Active Subframes	Minimum Number of Subframes (MNS) in the measured CC  (MNS = active and inactive subframes)
			TDD
1	R.49 TDD for PCC (20 MHz,full, 64QAM, 0.81-087) (1x2) OCNG for SCC	10 000 in PCC	20 000
2	OCNG for PCC R.49-1 TDD for SCC (15 MHz,full, 64QAM, 0.80-0.86) (1x2)	10 000 in SCC	20 000

## G.3A.6 Test conditions

**Table G.3A.6-1: Test conditions for CA performance tests**

Test	Statistical independence	Number of components in the test vector, as specified in the test requirements and initial conditions of the applicable test	Over all Pass/Fail condition
8.2.1.1.1_A.1 FDD PDSCH Single Antenna Port Performance for CA (2DL CA)	subframes are independent	1	To pass the test case all applicable components in the test vector must pass
8.2.1.1.1_A.2 FDD PDSCH Single Antenna Port Performance for CA (3DL CA)	subframes are independent	1	To pass the test case all applicable components in the test vector must pass
8.2.1.3.1_A.1 FDD PDSCH Open Loop Spatial Multiplexing 2x2 for CA (2DL CA)	subframes are independent	1	To pass the test case all applicable components in the test vector must pass
8.2.1.3.1_A.2 FDD PDSCH Open Loop Spatial Multiplexing 2x2 for CA (3DL CA)	subframes are independent	1	To pass the test case all applicable components in the test vector must pass
8.2.1.3.1A_A.1 FDD PDSCH Soft buffer management test for CA (2 DL CA)	subframes are independent	1	To pass the test case all applicable components in the test vector must pass
8.2.1.4.2_A.1 FDD PDSCH Closed Loop Multi Layer Spatial Multiplexing 4 x 2 for CA (2DL CA)	subframes are independent	1	To pass the test case all applicable components in the test vector must pass
8.2.1.4.2_A.2 FDD PDSCH Closed Loop Multi Layer Spatial Multiplexing 4 x 2 for CA (3DL CA)	subframes are independent	1	To pass the test case all applicable components in the test vector must pass
8.2.2.1.1_A.1 TDD PDSCH Single Antenna Port Performance for CA (2DL CA)	subframes are independent	1	To pass the test case all applicable components in the test vector must pass
8.2.2.1.1_A.2 TDD PDSCH Single Antenna Port Performance for CA (3DL CA)	subframes are independent	1	To pass the test case all applicable components in the test vector must pass
8.2.2.3.1_A.1 TDD PDSCH Open Loop Spatial Multiplexing 2x2 for CA (2DL CA)	subframes are independent	1	To pass the test case all applicable components in the test vector must pass
8.2.2.3.1_A.2 TDD PDSCH Open Loop Spatial Multiplexing 2x2 for CA (3DL CA)	subframes are independent	1	To pass the test case all applicable components in the test vector must pass
8.2.2.3.1A_A.1 TDD PDSCH Soft buffer management test (2 DL CA)	subframes are independent	1	To pass the test case all applicable components in the test vector must pass
8.2.2.4.2_A.1 TDD PDSCH Closed Loop Multi Layer Spatial Multiplexing 4x2 for CA (2DL CA)	subframes are independent	1	To pass the test case all applicable components in the test vector must pass
8.2.2.4.2_A.2 TDD PDSCH Closed Loop	subframes are independent	1	To pass the test case all applicable components in the test vector must

Multi Layer Spatial Multiplexing 4x2 for CA (3DL CA)			pass
8.7.1.1_A.1 FDD Sustained data rate performance for CA (2DL CA)	subframes are independent	1	To pass the test case all applicable components in the test vector must pass
8.7.1.1_A.2 FDD Sustained data rate performance for CA (3DL CA)	subframes are independent	1	To pass the test case all applicable components in the test vector must pass
8.7.2.1_A.1 TDD Sustained data rate performance for CA (2DL CA)	subframes are independent	1	To pass the test case all applicable components in the test vector must pass
8.7.2.1_A.2 TDD Sustained data rate performance for CA (3DL CA)	subframes are independent	1	To pass the test case all applicable components in the test vector must pass

## G.4 Statistical testing of Performance Requirements with probability of misdetection

### G.4.1 General

The test of receiver performance characteristics is two fold.

1. A signal or a combination of signals is offered to the RX port(s) of the receiver.
2. The ability of the receiver to demodulate /decode this signal is verified by analyzing the reaction of the UE to this signal.

In (2) is the statistical aspect of the test and is treated here.

The minimum requirement for those receiver performance tests are 1% or 0.1% misdetection probability

All receiver performance tests are performed in fading conditions. In addition to the statistical considerations, this requires the definition of a minimum test time.

NOTE: All demodulation performance tests (state from version 9.5.0) require a minimum test time, which exceeds the maximum test time in tables G.4.4. Under this circumstances only the test limit at the end of tables G.4.4.-1 resp. G.4.4.-2 is applicable.

### G.4.2 Mapping the UE reaction to error ratio

The UE can not indicate the detection or misdetection of the physical channel under test directly. Indirect methods are described in the procedure of the applicable test.

### G.4.3 Design of the test

G.2.3 applies, exception:

Limit ER = 0.01 and ER = 0.001

## G.4.4 Numerical definition of the pass fail limits

Table G.4.4-1: pass fail limits for ER = 0.01

ne	ns <sub>p</sub>	ns <sub>f</sub>	ne	ns <sub>p</sub>	ns <sub>f</sub>	ne	ns <sub>p</sub>	ns <sub>f</sub>	ne	ns <sub>p</sub>	ns <sub>f</sub>
0	344	NA	40	3929	2553	80	7033	5874	120	10036	9354
1	485	NA	41	4009	2632	81	7109	5960	121	10110	9442
2	607	10	42	4089	2712	82	7185	6046	122	10184	9530
3	719	33	43	4168	2792	83	7261	6131	123	10259	9619
4	826	66	44	4247	2873	84	7336	6217	124	10333	9707
5	929	107	45	4327	2953	85	7412	6303	125	10407	9796
6	1029	152	46	4406	3034	86	7488	6389	126	10481	9884
7	1127	202	47	4484	3115	87	7564	6475	127	10555	9972
8	1223	255	48	4563	3196	88	7639	6561	128	10629	10061
9	1317	311	49	4642	3278	89	7715	6648	129	10703	10150
10	1409	370	50	4720	3359	90	7790	6734	130	10777	10238
11	1501	430	51	4799	3441	91	7866	6820	131	10851	10327
12	1592	492	52	4877	3523	92	7941	6907	132	10925	10416
13	1681	555	53	4955	3605	93	8017	6993	133	10999	10504
14	1770	620	54	5033	3688	94	8092	7080	134	11073	10593
15	1858	686	55	5111	3770	95	8167	7167	135	11147	10682
16	1946	754	56	5189	3853	96	8242	7253	136	11221	10771
17	2032	822	57	5267	3935	97	8317	7340	137	11295	10860
18	2119	891	58	5344	4018	98	8393	7427	138	11369	10949
19	2204	961	59	5422	4101	99	8468	7514	139	11442	11038
20	2290	1032	60	5499	4185	100	8543	7601	140	11516	11127
21	2374	1103	61	5577	4268	101	8618	7688	141	11590	11216
22	2459	1175	62	5654	4352	102	8693	7775	142	11664	11305
23	2543	1248	63	5731	4435	103	8768	7863	143	11737	11394
24	2627	1321	64	5809	4519	104	8843	7950	144	11811	11483
25	2710	1395	65	5886	4603	105	8917	8037	145	11885	11573
26	2793	1470	66	5963	4687	106	8992	8125	146	11958	11662
27	2876	1544	67	6039	4771	107	9067	8212	147	12032	11751
28	2958	1620	68	6116	4855	108	9142	8300	148	12105	11840
29	3040	1696	69	6193	4940	109	9216	8387	149	12179	11930
30	3122	1772	70	6270	5024	110	9291	8475	150	12252	12019
31	3204	1848	71	6346	5109	111	9366	8562	151	12326	12109
32	3285	1925	72	6423	5193	112	9440	8650	152	12399	12198
33	3366	2003	73	6499	5278	113	9515	8738	153	12473	12288
34	3447	2080	74	6576	5363	114	9589	8826	154	12546	12377
35	3528	2158	75	6652	5448	115	9664	8914	155	12620	12467
36	3609	2237	76	6728	5533	116	9738	9002	156	12693	12556
37	3689	2315	77	6805	5618	117	9813	9090	157	12767	12646
38	3769	2394	78	6881	5704	118	9887	9178	158	12840	12736
39	3850	2473	79	6957	5789	119	9962	9266	159	12913	12826
									160	NA	12915
									Test limit = 1.2352E-2		



Table G.4.4-2: pass fail limits for ER = 0.001

ne	ns <sub>p</sub>	ns <sub>f</sub>	ne	ns <sub>p</sub>	ns <sub>f</sub>	ne	ns <sub>p</sub>	ns <sub>f</sub>	ne	ns <sub>p</sub>	ns <sub>f</sub>
0	3463	NA	41	40174	26265	82	71961	60368	123	102723	96075
1	4874	4	42	40971	27063	83	72720	61225	124	103465	96958
2	6096	99	43	41766	27863	84	73479	62083	125	104208	97842
3	7226	329	44	42559	28666	85	74237	62941	126	104949	98726
4	8298	658	45	43352	29471	86	74995	63801	127	105691	99610
5	9330	1059	46	44142	30279	87	75752	64661	128	106432	100495
6	10332	1513	47	44932	31088	88	76509	65522	129	107173	101380
7	11310	2009	48	45720	31899	89	77265	66383	130	107914	102266
8	12269	2539	49	46507	32713	90	78020	67246	131	108655	103152
9	13212	3096	50	47293	33528	91	78776	68109	132	109395	104039
10	14141	3677	51	48078	34345	92	79530	68973	133	110135	104926
11	15058	4278	52	48861	35164	93	80285	69838	134	110875	105813
12	15965	4896	53	49644	35984	94	81038	70704	135	111614	106701
13	16863	5530	54	50425	36807	95	81792	71570	136	112353	107589
14	17753	6177	55	51205	37631	96	82544	72437	137	113092	108478
15	18635	6836	56	51985	38456	97	83297	73305	138	113830	109367
16	19511	7507	57	52763	39283	98	84049	74173	139	114569	110257
17	20380	8188	58	53541	40112	99	84800	75042	140	115307	111146
18	21244	8878	59	54317	40942	100	85551	75911	141	116045	112037
19	22103	9576	60	55092	41773	101	86302	76782	142	116782	112927
20	22957	10282	61	55867	42606	102	87052	77653	143	117520	113818
21	23806	10995	62	56641	43440	103	87802	78524	144	118257	114710
22	24652	11715	63	57414	44276	104	88552	79396	145	118994	115602
23	25493	12441	64	58186	45113	105	89301	80269	146	119730	116494
24	26331	13173	65	58957	45951	106	90050	81143	147	120466	117386
25	27166	13911	66	59728	46790	107	90798	82017	148	121203	118279
26	27997	14654	67	60497	47631	108	91546	82891	149	121939	119173
27	28826	15401	68	61266	48472	109	92293	83766	150	122674	120066
28	29651	16154	69	62035	49315	110	93041	84642	151	123410	120960
29	30474	16910	70	62802	50159	111	93787	85518	152	124145	121855
30	31294	17671	71	63569	51004	112	94534	86395	153	124880	122749
31	32111	18436	72	64335	51851	113	95280	87273	154	125615	123644
32	32927	19204	73	65100	52698	114	96026	88151	155	126349	124540
33	33740	19976	74	65865	53546	115	96771	89029	156	127083	125435
34	34551	20752	75	66629	54396	116	97516	89908	157	127818	126332
35	35360	21531	76	67393	55246	117	98261	90788	158	128551	127228
36	36166	22312	77	68156	56097	118	99005	91668	159	129285	128125
37	36971	23097	78	68918	56950	119	99750	92548	160	130019	129022
38	37775	23885	79	69679	57803	120	100493	93429	161	130752	129919
39	38576	24676	80	70440	58657	121	101237	94311	162	NA	130817
40	39376	25469	81	71201	59512	122	101980	95193	Test limit = 1.2345E-3		

NOTE 1: The first column is the number of errors (ne = number of misdetections)

NOTE 2: The second column is the number of samples for the pass limit (ns<sub>p</sub>, ns=Number of Samples= number misdetections + number of detections)

NOTE 3: The third column is the number of samples for the fail limit (ns<sub>f</sub>)

NOTE 4: The test limit at the end of the table is applicable, when the minimum test time in clause 3.5 governs the test. Pass the test for ER ≤ Test limit, otherwise fail.

## G.4.5 Pass fail decision rules

G.2.5 applies

NOTE: For ER=0.01 an ideal DUT passes after 344 samples. The maximum test time is 12913 samples. For ER=0.001 an ideal DUT passes after 3463 samples. The maximum test time is 130752 samples.

## G.4.6 Minimum Test time

**Table G.4.6-1: Minimum Test time for Demodulation of PCFICH/PDCCH**

Test No	Demod. Scenario	Demodulation scenario (info only)	MNAS (Simulation)	MNS (Calculation)		MNSF (Min No Sub Frames, mandatory)	
				FDD	TDD	FDD	TDD
1	[8.1]	R.15 (10 MHz, 8CCE, full, QPSK 1/3) (1x2 Low) ETU70	200 000	222 222	400 000	224 000	401 000
1	[8.2]	R.16 (1.4MHz, 2CCE, full, QPSK 1/3) (2x2 Low) EPA5	200 000	222 222	400 000	224 000	401 000
1 Rel-9 ...	[ ]	R.16_1 (10MHz, 4CCE, full, QPSK 1/3) (2x2 Low) EVA70	200 000	222 222	400 000	224 000	401 000
1	[8.3]	R.17 (10MHz, 4CCE, full, QPSK 1/3) (4x2 Medium) EVA5	200 000	222 222	400 000	224 000	401 000
1 Rel-9 ...	[ ]	R.17_1 (5MHz, 2CCE, full, QPSK 1/3) (4x2 Medium) EPA5	200 000	222 222	400 000	224 000	401 000
Note: Simulation method to derive MNAS is based on finite test time and its effect on test system uncertainty specified in clause F.1.4.							

**Table G.4.6-1a: Minimum Test time for Demodulation of PCFICH/PDCCH for eICIC**

Test No	Demod. Scenario	Demodulation scenario (info only)	MNAS (Simulation)	MNS (Calculation)		MNSF (Min No Sub Frames, mandatory)	
				FDD	TDD	FDD	TDD
1	[ ]	R.15-1 (10 MHz, 8CCE, full, QPSK 1/3) (2x2 Low) EVA5	200 000 (MNAS is not simulated, but estimated based on similar scenario in Table G.4.6-1 Test1)	2 000 000	2 000 000	2 001 000	2 001 000
Note: Simulation method to derive MNAS is based on finite test time and its effect on test system uncertainty specified in clause F.1.4.							

Table G.4.6-1b: Minimum Test time for Demodulation of PCFICH/PDCCH for feICIC

Test No	Demod. Scenario	Demodulation scenario (info only)	MNAS (Simulation)	MNS (Calculation)		MNSF (Min No Sub Frames, mandatory)	
				FDD	TDD	FDD	TDD
1	[ ]	R.15-2 (10 MHz, 8CCE, full, QPSK 1/3) (2x2 Low) EVA5	200 000 (MNAS is not simulated, but estimated based on similar scenario in Table G.4.6-1 Test1)	2 000 000	2 000 000	2 001 000	2 001 000
Note: Simulation method to derive MNAS is based on finite test time and its effect on test system uncertainty specified in clause F.1.4.							

Table G.4.6-2: Minimum Test time for Demodulation of PHICH

Test No	Demod. scenario	Demodulation scenario (info only)	MNAS (Simulation)	MNS (Calculation)		MNSF (Min No Sub Frames, mandatory)	
				FDD	TDD	FDD	TDD
1	[9.1]	R.18 (10 MHz, full, QPSK 1/3) (1x2 Low) ETU70	200 000	200 000	500 000	200 000	500 000
2	[9.4]	R.24 (10MHz, full, 16QAM ½) (1x2 Low) ETU70	200 000	200 000	500 000	200 000	500 000
1	[9.2]	R.19 (1.4MHz, full, 64QAM ¾) (2x2 Low) EPA5	200 000	200 000	500 000	200 000	500 000
1 Rel-9...	[ ]	R.19_1 (10MHz, full, 64QAM ¾) (2x2 Low) EVA70	200 000	200 000	500 000	200 000	500 000
1A		R.19-1 (5MHz, full, 64QAM ¾) (2x2 Low) EVA70	200 000	200 000	500 000	200 000	500 000
1	[9.3]	R.20 (10MHz, 1PRB, 16QAM ½) (4x2 Medium) EVA5	200 000	200 000	500 000	200 000	500 000
1 Rel-9...	[ ]	R.20_1 (5MHz, 1PRB, 16QAM ½) (4x2 Medium) EPA5	200 000	200 000	500 000	200 000	500 000
Note: Simulation method to derive MNAS is based on finite test time and its effect on test system uncertainty specified in clause F.1.4.							

**Table G.4.6-2a: Minimum Test time for Demodulation of PHICH for eICIC**

Test No	Demod. scenario	Demodulation scenario (info only)	MNAS (Simulation)	MNS (Calculation)		MNSF (Min No Sub Frames, mandatory)	
				FDD	TDD	FDD	TDD
1	[ ]	R.19_1 (10MHz, full, 64QAM 3/4) (2x2 Low) EPA5	200 000 (MNAS is not simulated, but estimated based on similar scenario in Table G.4.6-2 Test1)	1 600 000	2 000 000	1 600 000	2 000 000
Note: Simulation method to derive MNAS is based on finite test time and its effect on test system uncertainty specified in clause F.1.4.							

**Table G.4.6-2b: Minimum Test time for Demodulation of PHICH for feICIC**

Test No	Demod. scenario	Demodulation scenario (info only)	MNAS (Simulation)	MNS (Calculation)		MNSF (Min No Sub Frames, mandatory)	
				FDD	TDD	FDD	TDD
1	[ ]	R.19_1 (10MHz, full, 64QAM 3/4) (2x2 Low) EPA5	200 000 (MNAS is not simulated, but estimated based on similar scenario in Table G.4.6-2 Test1)	1 600 000	2 000 000	1 600 000	2 000 000
Note: Simulation method to derive MNAS is based on finite test time and its effect on test system uncertainty specified in clause F.1.4.							

## G.4.7 Test conditions for receiver performance tests

**Table G.4.7: Test conditions for receiver performance tests**

<b>Test</b>	<b>Statistical independence</b>	<b>Number of components in the test vector, as specified in the test requirements and initial conditions of the applicable test</b>	<b>Over all Pass/Fail condition Restrictions and extensions see Table G.3.6-1</b>
8.4.1.1 FDD PCFICH/PDCCH Single-antenna Port Performance	A misdetection is an independent event	1	NA
8.4.1.2 FDD PCFICH/PDCCH Transmit Diversity Performance	A misdetection is an independent event	2	To pass 8.4.1.2 each component in the test vector must pass
8.4.2.1 TDD PCFICH/PDCCH Single-antenna Port Performance	A misdetection is an independent event	1	NA
8.4.2.2 TDD PCFICH/PDCCH Transmit Diversity Performance	A misdetection is an independent event	2	To pass 8.4.2.2 each component in the test vector must pass
8.5.1.1 FDD PHICH Single-antenna Port Performance	A misdetection is an independent event	2	To pass 8.5.1.1 each component in the test vector must pass
8.5.1.2 FDD PHICH Transmit Diversity Performance	A misdetection is an independent event	2	To pass 8.5.1.2 each component in the test vector must pass
8.5.2.1 TDD PHICH Single- antenna Port Performance	A misdetection is an independent event	2	To pass 8.5.2.1 each component in the test vector must pass
8.5.2.2 TDD PHICH Transmit Diversity Performance	A misdetection is an independent event	2	To pass 8.5.2.2 each component in the test vector must pass

## G.5 Measuring throughput ratio

### G.5.1 General

Annex G.5 is applicable for clauses 9.3, 9.4 and 9.5. Common to those clauses is, that a throughput ratio  $\gamma$  is measured. These clauses are tested exclusively with “slow” multipath fading profiles. Hence the test time is governed by test time due to fading, and number of samples due to statistical significance is not applicable.

The test requirements in clause 9.4 are a ratio of 2 throughput tests according to  $\gamma = \frac{t_{ue}}{t_{rnd}}$ . The denominator must be established by an approach, resulting in the denominator throughput  $t_{rnd}$  and the reference  $SNR_{rnd}$ , the latter is reused to measure the nominator throughput.

The test requirements in clauses 9.3 and 9.5 are a ratio of 2 throughput tests according to  $\gamma = \frac{t_{subband}}{t_{median}}$ ,  $\gamma = \frac{t_{reported}}{t_{fix}}$  etc.

Nominator and denominator are ordinary throughput tests

$t_{ue}$ ,  $t_{rnd}$ ,  $t_{reported}$ ,  $t_{fix}$ ,  $t_{subband}$ ,  $t_{median}$ ,  $t_{wideband}$  are throughputs, derived under different conditions and are defined in clauses 9.3, 9.4 and 9.5.

$SNR_{rnd}$  is the signal noise ratio, derived together with  $t_{rnd}$  and is defined in clause 9.4.

### G.5.2 Establishing $t_{rnd}$

Adjust SNR such that the measured throughput is  $58\% \leq t_{rnd} \leq 62\%$ .

The resulting SNR is declared  $SNR_{rnd}$

To achieve statistical significance the final throughput measurement must be done with MNS samples, given table G.5.4-1

The approach, leading to  $t_{rnd}$  and  $SNR_{rnd}$  is not specified.

### G.5.3 Measuring T-put

To achieve statistical significance the final throughput measurement must be done with MNS samples, given in table.G.5.4 -1. Number of samples due to statistical significance is not applicable.

For measuring  $t_{subband}$ ,  $t_{wideband}$ ,  $t_{reported}$  and  $t_{fix}$ , the SS collects ACK, NACK and statDTX from the UE and records the time, elapsed from the beginning of the test. The payload size, received by the UE and acknowledged towards the SS, may vary within a test versus time (e.g. due to subband changes upon a UE report) Throughput is calculated in the SS by summing up the payload, associated to each ACK, from the start of the test and dividing the accumulated payload in kilobits by the time in seconds, elapsed from the beginning of the test. This is similar but not same as in G.2.2. (Main difference in bullet d, where the payload size is constant).

For measuring  $t_{median}$ ,  $t_{ue}$ , and  $t_{rnd}$ , the SS collects ACK, NACK and statDTX from the UE and records the time, elapsed from the beginning of the test. The payload size, received by the UE and acknowledged towards the SS, is constant. Throughput can be calculated in the SS by multiplying the payload size with the number of ACKs and dividing the accumulated payload in kilobits by the time in seconds, elapsed from the beginning of the test, being associated to the following ratio:  $ACK / (ACK + NACK + DTX)$ .

### G.5.4 Number of samples for throughput ratios

TT for  $\gamma$  and MNS are based on theoretical estimations.

Table G.5.4-1: Test time for testing throughput ratios

Test	Demodulation scenario:  RMC (Bandwidth, allocated RBs, modulation, coding) [Antenna configuration, correlation] Propagation condition, Doppler	$\Gamma$	Minimum Number of Subframes (MNS)		$\Gamma$ including TT	BLER
			FDD	TDD		
9.3.1.1.1 9.3.1.1.2	(10 MHz, 6, variable modulation and coding) [1x2, full] Special propagation according to clause B.2.4, 5Hz	1.1	100000 For denominator- and nominator-measurement each	170000 For denominator- and nominator-measurement each	$\gamma = 1.09$	BLER=0.05, no TT No of samples: subset of ACKs and NACKs in the MNS for throughput.
9.3.1.2.1 _D	(10 MHz, 6, variable modulation and coding) [2x2, full] Special propagation according to clause B.2.4, 5Hz	1.1	100000 For denominator- and nominator-measurement each	NA	$\gamma = 1.09$	BLER=0.05, no TT No of samples: subset of ACKs and NACKs in the MNS for throughput.
9.3.1.2.2 _D	(10 MHz, 6, variable modulation and coding) [2x2, full] Special propagation according to clause B.2.4, 5Hz	1.1	NA	170000 For denominator- and nominator-measurement each	$\gamma = 1.09$	BLER=0.05, no TT No of samples: subset of ACKs and NACKs in the MNS for throughput.
9.3.1.3.1 _E	(10 MHz, 6, variable modulation and coding) [1x2, full] Special propagation according to clause B.2.4, 5Hz	1.1	200000 For denominator- and nominator-measurement each	NA	$\gamma = 1.09$	BLER=0.01, no TT No of samples: subset of ACKs and NACKs in the MNS for throughput.
9.3.1.3.2 _E	(10 MHz, 6, variable modulation and coding) [1x2, full] Special propagation according to clause B.2.4, 5Hz	1.1	NA	170000 For denominator- and nominator-measurement each	$\gamma = 1.09$	BLER=0.01, no TT No of samples: subset of ACKs and NACKs in the MNS for throughput.
9.3.2.1.1	(10 MHz or	1.05	100000	170000	$\gamma = 1.04$	BLER=0.02, no TT

9.3.2.1.2	5MHz according to test, full, variable modulation and coding) [1x2, high] EPA5		For denominator- and nominator-measurement each	For denominator- and nominator-measurement each		No of samples for FDD: subset of ACKs and NACKs in the MNS for throughput. No of samples for TDD: subset of <i>filtered</i> ACKs and NACKs in the MNS for throughput.
9.3.2.1.1 9.3.2.1.2 _1	(10 MHz or 5MHz according to test, partial, variable modulation and coding) [1x2, high] EPA5	1.05	100000 For denominator- and nominator-measurement each	170000 For denominator- and nominator-measurement each	$\gamma = 1.04$	BLER=0.02, no TT No of samples for FDD: subset of ACKs and NACKs in the MNS for throughput. No of samples for TDD: subset of <i>filtered</i> ACKs and NACKs in the MNS for throughput.
9.3.2.2.1 _D	(10 MHz, full, variable modulation and coding) [4x2, high] EPA5	1.05	100000 For denominator- and nominator-measurement each	NA	$\gamma = 1.04$	BLER=0.02, no TT No of samples for FDD: subset of ACKs and NACKs in the MNS for throughput.
9.3.2.2.2 _D	(10 MHz, full, variable modulation and coding) [8x2, high] EPA5	1.05	NA	170000 For denominator- and nominator-measurement each	$\gamma = 1.04$	BLER=0.02, no TT No of samples for TDD: subset of <i>filtered</i> ACKs and NACKs in the MNS for throughput.
9.3.3.1.1 9.3.3.1.2	10 MHz, full (however unequal SNR), variable modulation and coding) [1x2, full] Special: propagation according to clause B.2.4, 5Hz	1.6	100000 For denominator- and nominator-measurement each	170000 For denominator- and nominator-measurement each	1.50	
9.3.4.1.1 9.3.4.1.2	Same as 9.3.3	1.2	100000	170000	1.19	
9.3.4.2.1 9.3.4.2.2	Same as 9.3.3	1.15	100000	170000	1.14	
9.3.5.1.1 9.3.5.1.2	variable modulation and coding, 1x2 Low, EPA5	1.8	100000	170000	1.79	
9.3.5.2.1 9.3.5.2.2	variable modulation and coding, 2x2 Low, EPA5	1.8	100000	170000	1.79	
9.4.1.1.1 9.4.1.1.2	R.10 (10 MHz, full, QPSK, 1/3) [2x2, Low] EVA5	1.1	100000	170000	$\gamma = 1.09$	
9.4.1.2.1 9.4.1.2.2	R.14-1 (10 MHz, partial, 16QAM, 1/2) [4x2, Low]	1.2	100000	170000	1.19	



	EVA5					
9.4.2.1.1 9.4.2.1.2	R.30 (20 MHz, full, 16QAM, 1/2) [2x2, Low] EPA5	1.2	100000	170000	$\gamma = 1.19$	
9.4.2.1.1 _1 9.4.2.1.2 _1	R.11-3 or R.11 (10 MHz, partial or full, 16QAM, 1/2) [2x2, Low] EPA5	1.2	100000	170000	$\gamma = 1.19$	
9.4.2.2.1	R.14-2 FDD (10MHz, 3, 16 QAM, 1/2) [4x2, low] EVA5	1.2	100000	NA	1.19	
9.4.2.2.2	R.14-2 TDD (10MHz, 3, 16QAM, 1/2) [4x2, low] EVA5	1.15	NA	170000	1.14	
9.4.1.3.1 _D	R.44 (10 MHz, partial, QPSK, 1/3) [4x2, Low] EPA5	1.2	100000	NA	$\gamma = 1.19$	
9.4.1.3.2 _D	R.45-1 or R.45 (10 MHz, partial or full, 16QAM, 1/2) [8x2, High] EVA5	1.2	NA	170000	$\gamma = 1.19$	
9.4.2.3.1 _D	R.45-1 or R.45 (10 MHz, partial or full, 16QAM, 1/2) [4x2, Low] EVA5	1.3	100000	NA	$\gamma = 1.29$	
9.4.2.3.2 _D	R.45-1 or R.45 (10 MHz, partial or full, 16QAM, 1/2) [8x2, High] EVA5	3.5	NA	170000	$\gamma = 3.49$	
9.5.1.1 9.5.1.2	(10MHz, full, variable modulation and coding) [2x2, low or high according to test] EPA5	Test 2 $\gamma_1=1$ .05 Test 1 $\gamma_2=1$ Test 3 $\gamma_2=1$ .1	100000	170000	Test2 $\gamma_1=$ 1.04 Test1 $\gamma_2=$ 0.99 Test3 $\gamma_2=$ 1.09	
9.5.1.1_ 1 9.5.1.2_ 1	(10MHz, full, variable modulation and coding) [2x2, low or high according to test] EPA5	Test 2 $\gamma_1=1$ .05 Test 1 $\gamma_2=1$ Test 3: $\gamma_1=0.$ 90 $\gamma_2=1.$	100000	170000	Test2 $\gamma_1=$ 1.04 Test1 $\gamma_2=$ 0.99 Test3: $\gamma_1=0.89$ $\gamma_2=1.09$	

		10				
9.5.1.1_ 2	(10MHz, full, variable modulation and coding)	Test 2 $\gamma_1=1.05$	100000	170000	Test2 $\gamma_1=1.04$	
9.5.1.2_ 2	[2x2, low or high according to test] EPA5	Test 1 $\gamma_2=1$ Test 3: $\gamma_1=0.90$			Test1 $\gamma_2=0.99$ Test3: $\gamma_1=0.89$	
9.5.2.1_ D	(10MHz, full, variable modulation and coding)	Test 2 $\gamma_1=1.05$	100000	170000	Test2 $\gamma_1=1.04$	
9.5.2.2_ D	[2x2, low or high according to test] EPA5	Test 3 $\gamma_1=0.9$ Test 1 $\gamma_2=1.00$			Test3 $\gamma_1=0.89$ Test1 $\gamma_2=0.99$	
9.5.3.1_ C.1	(10MHz, full, variable modulation and coding)	Test 1 $\gamma_1=0.9$	800000	340000	Test1 $\gamma_1=0.89$	
9.5.3.2_ C.1	[2x2, low according to test] EPA5	Test 2 $\gamma_1=1.05$			Test2 $\gamma_1=1.04$	
9.5.4.1_ E	(10MHz, full, variable modulation and coding)	Test 2 $\gamma_1=1.05$	100000	170000	Test2 $\gamma_1=1.04$	
9.5.4.2_ E	[2x2, low or high according to test] EPA5	Test 3 $\gamma_1=0.9$ Test 1 $\gamma_2=1.00$			Test3 $\gamma_1=0.89$ Test1 $\gamma_2=0.99$	
9.5.5.1_ F.2	(10MHz, full, variable modulation and coding)	Test 2 $\gamma_1=1.00$	100000	170000	Test2 $\gamma_1=0.99$	
9.5.5.2_ F.2	[2x2, low or high according to test] EPA5					

## G.6 Statistical testing of MBMS Performance

### G.6.1 General

The system simulator sends MBMS packets to the UE under test. The number of packets, the SS sends, is predefined by the test time in G.6.4. The UE under tests demodulates the MBMS packets and counts the successfully received number of MBMS packets into the UE internal MBMS packet counter. The SS reads out the counter and issues a pass fail decision.

### G.6.2 Mapping of MBMS Packet ratio to BLER

The minimum requirements are designed in terms of BLER = 1%. 10 MBMS packets are included in one Transport block, constant throughout the test. The ratio of correct received MBMS packets ( $M_{ok}$ ) to transmitted packets ( $M_{tot}$ ) is

assumed to be equal to the ratio of correct received transport blocks to transmitted transport blocks. This assumption ignores the unlikely case that payload and CRC for a transport block are consistent but wrong.

### G.6.3 Design of the test

The minimum requirement for all MBMS tests is BLER = 1%. All MBMS tests are performed under a fading scenario: MBSFN channel model (Table B.2.6-1). It is obvious, that this fading scenario requires a minimum test time, greater than the time, required for statistical significance. In addition the test design with the MBMS packet counter in the UE suggest a fixed test time. Without simulation the test time is set to 200 000 active subframes (Transport blocks), leading to 333 333 subframes (333sec) for FDD and 400 000 subframes (400sec) for TDD. In order to avoid the fail of a good DUT due to statistical uncertainty the minimum requirement of BLER = 1% leads to a

Test limit = 1.2352 %. (refer Table G.4.4-1)

This means a DUT actually on the limit (1%) is measured and passed with a confidence level of greater than 95%.

### G.6.4 Test time for MBMS performance tests

**Table G.6.4-1: Minimum Test time for MBMS**

Test No	Demodulation scenario (info only)	Min No of Sub Frames	
		FDD (6 of 10 subframes are active)	TDD (5 of 10 subframes are active)
1	R.37 (10 MHz, full, QPSK 1/3) (1x2 Low) MBSFN channel model	333 333	400 000
2	R.38 (10MHz, full, 16QAM 1/2) (1x2 Low) MBSFN channel model	333 333	400 000
3	R.39 (10 MHz, full, 64QAM 2/3) (1x2 Low) MBSFN channel model	333 333	400 000
3	R.39-1 (5 MHz, full, 64QAM 2/3) (1x2 Low) MBSFN channel model	333 333	400 000
4	R.40 (1.4 MHz, full, QPSK 1/3) (1x2 Low) MBSFN channel model	333 333	400 000

---

## G.X Theory to derive the numbers in Table G.2.4-1 (Informative)

**Editor's note:** This clause of the Annex G is for information only and it described the background theory and information to derive the entries in the table G.2.4-1.

## G.X.1 Error Ratio (ER)

The Error Ratio (ER) is defined as the ratio of number of errors (ne) to all results, number of samples (ns).  
(1-ER is the success ratio).

## G.X.2 Test Design

A statistical test is characterised by:

Test-time, Selectivity and Confidence level.

## G.X.3 Confidence level

The outcome of a statistical test is a decision. This decision may be correct or in-correct. The Confidence Level CL describes the probability that the decision is a correct one. The complement is the wrong decision probability (risk)  $D = 1 - CL$

## G.X.4 Introduction: Supplier Risk versus Customer Risk

There are two targets of decision:

- (a) A measurement on the pass-limit shows, that the DUT has the specified quality or is better with probability CL (CL e.g.95%) This shall lead to a "pass decision"

The pass-limit is on the good side of the specified DUT-quality. A more stringent CL (CL e.g.99%) shifts the pass-limit farther into the good direction. Given the quality of the DUTs is distributed, a greater CL passes less and better DUTs.

A measurement on the bad side of the pass-limit is simply "not pass" (undecided or artificial fail).

- (aa) Complementary:

A measurement on the fail-limit shows, that the DUT is worse than the specified quality with probability CL.

The fail-limit is on the bad side of the specified DUT-quality. A more stringent CL shifts the fail-limit farther into the bad direction. Given the quality of the DUTs is distributed, a greater CL fails less and worse DUTs.

A measurement on the good side of the fail-limit is simply "not fail".

- (b) A DUT, known to have the specified quality, shall be measured and decided pass with probability CL. This leads to the test limit.

For CL e.g. 95%, the test limit is on the bad side of the specified DUT-quality. CL e.g.99% shifts the pass-limit farther into the bad direction. Given the DUT-quality is distributed, a greater CL passes more and worse DUTs.

- (bb) A DUT, known to be an ( $\epsilon \rightarrow 0$ ) beyond the specified quality, shall be measured and decided fail with probability CL.

For CL e.g.95%, the test limit is on the good side of the specified DUT-quality.

NOTE 1: The different sense for CL in (a), (aa) versus (b), (bb).

NOTE 2: For constant CL in all 4 bullets (a) is equivalent to (bb) and (aa) is equivalent to (b).

## G.X.5 Supplier Risk versus Customer Risk

The table below summarizes the different targets of decision.

**Table G.X.5-1: Equivalent statements**

	<b>Equivalent statements, using different cause-to-effect directions, and assuming CL = constant &gt;1/2</b>	
cause-to-effect-directions	Known measurement result → estimation of the DUT's quality	Known DUT's quality → estimation of the measurement's outcome
Supplier Risk	A measurement on the pass-limit shows, that the DUT has the specified quality or is better (a)	A DUT, known to have an ( $\epsilon \rightarrow 0$ ) beyond the specified DUT-quality, shall be measured and decided fail (bb)
Customer Risk	A measurement on the fail-limit shall shows, that the DUT is worse than the specified quality (aa)	A DUT, known to have the specified quality, shall be measured and decided pass (b)

The shaded area shown the direct interpretation of Supplier Risk and Customer Risk.

The same statements can be based on other DUT-quality-definitions.

### G.X.6 Introduction: Standard test versus early decision concept

In standard statistical tests, a certain number of results (ns) is predefined in advance to the test. After ns results the number of bad results (ne) is counted and the error ratio (ER) is calculated by ne/ns.

Applying statistical theory, a decision limit can be designed, against which the calculated ER is compared to derive the decision. Such a limit is one decision point and is characterised by:

- D: the wrong decision probability (a predefined parameter)
- ns: the number of results (a fixed predefined parameter)
- ne: the number of bad results (the limit based on just ns)

In the formula for the limit, D and ns can be understood as variable parameter and variable. However the standard test execution requires fixed ns and D. The property of such a test is: It discriminate between two states only, depending on the test design:

- pass (with CL) / undecided (undecided in the sense: finally undecided)
- fail (with CL) / undecided (undecided in the sense: finally undecided)
- pass(with CL) / fail (with CL) (however against two limits).

In contrast to the standard statistical tests, the early decision concept predefines a set of (ne,ns) co-ordinates, representing the limit-curve for decision. After each result a preliminary ER is calculated and compared against the limit-curve. After each result one may make the decision or not (undecided for later decision) The parameters and variables in the limit-curve for the early decision concept have a similar but not equal meaning:

- D: the wrong decision probability (a predefined parameter)
- ns: the number of results (a variable parameter)
- ne: the number of bad results (the limit. It varies together with ns)

To avoid a “final undecided” in the standard test, a second limit must be introduced and the single decision co-ordinate (ne,ns) needs a high ne, leading to a fixed (high) test time. In the early decision concept, having the same selectivity and the same confidence level an “undecided” need not to be avoided, as it can be decided later. A perfect DUT will hit the decision coordinate (ne,ns) with ne=0. This test time is short.

## G.X.7 Standard test versus early decision concept

For Supplier Risk:

The wrong decision probability  $D$  in the standard test is the probability, to decide a DUT in-correct in the single decision point. In the early decision concept there is a probability of in-correct decisions  $d$  at each point of the limit-curve. The sum of all those wrong decision probabilities accumulate to  $D$ . Hence  $d < D$

For Customer Risk:

The correct decision probability  $CL$  in the standard test is the probability, to decide a DUT correct in the single decision point. In the early decision concept there is a probability of correct decisions  $cl$  at each point of the limit-curve. The sum of all those correct decision probabilities accumulate to  $CL$ . Hence  $cl < CL$  or  $d > D$

## G.X.8 Selectivity

There is no statistical test which can discriminate between a limit DUT and a DUT which is an  $(\epsilon \rightarrow 0)$  apart from the limit in finite time and high confidence level  $CL$ . Either the test discriminates against one limit with the results pass (with  $CL$ )/undecided or fail (with  $CL$ )/undecided, or the test ends in a result pass (with  $CL$ )/fail (with  $CL$ ) but this requires a second limit.

For  $CL > 1/2$ , a (measurement-result = specified-DUT-quality), generates undecided in test “supplier risk against pass limit” (a, from above) and also in the test “customer risk against the fail limit” (aa)

For  $CL > 1/2$ , a DUT, known to be on the limit, will be decided pass for the test “customer risk against pass limit” (b) and also “supplier risk against fail limit” (bb).

This overlap or undecided area is not a fault or a contradiction, however it can be avoided by introducing a Bad or a Good DUT quality according to:

- Bad DUT quality: specified DUT-quality \*  $M$  ( $M > 1$ )
- Good DUT quality: specified DUT-quality \*  $m$  ( $m < 1$ )

Using e.g.  $M > 1$  and  $CL = 95\%$  the test for different DUT qualities yield different pass probabilities:

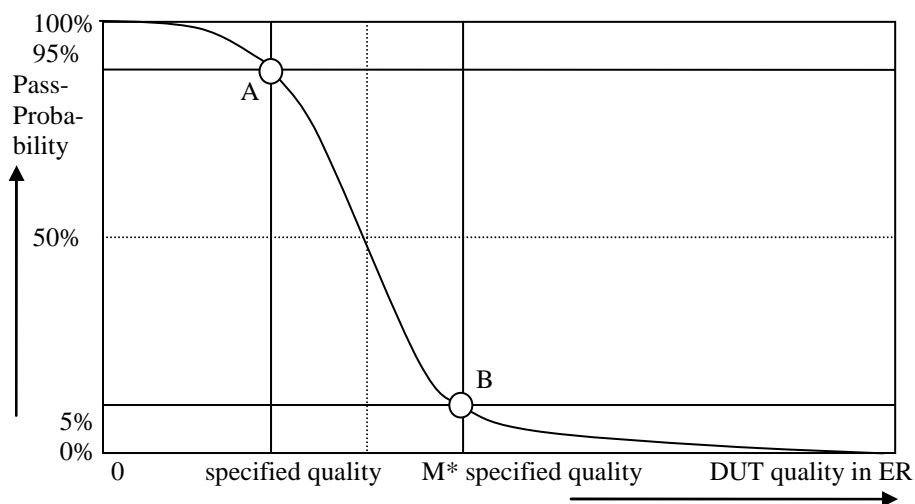

Figure G.X.8-1: Pass probability versus DUT quality

## G.X.9 Design of the test

The receiver characteristic test are defined by the following design principles:

1. The early decision concept is applied.
2. A second limit is introduced: Bad DUT factor  $M > 1$
3. To decide the test pass:
  - Supplier risk is applied based on the Bad DUT quality
  - To decide the test fail
  - Customer Risk is applied based on the specified DUT quality

The receiver characteristic test are defined by the following parameters:

1. Limit  $ER = 0.05$
2. Bad DUT factor  $M = 1.5$  (selectivity)
3. Confidence level  $CL = 95\%$  (for specified DUT and Bad DUT-quality)

This has the following consequences:

1. A measurement on the fail limit is connected with 2 equivalent statements:

A measurement on the fail-limit shows, that the DUT is worse than the specified DUT-quality	A DUT, known have the specified quality, shall be measured and decided pass
---------------------------------------------------------------------------------------------	-----------------------------------------------------------------------------

2. A measurement on the pass limit is connected with the complementary statements:

A measurement on the pass limit shows, that the DUT is better than the Bad DUT-quality.	A DUT, known to have the Bad DUT quality, shall be measured and decided fail
-----------------------------------------------------------------------------------------	------------------------------------------------------------------------------

The left column is used to decide the measurement.

The right column is used to verify the design of the test by simulation.

The simulation is based on the two fulcrums A and B only in Figure G.x.8-1

3. Test time

The minimum and maximum test time is fixed.

The average test time is a function of the DUT's quality.

The individual test time is not predictable.

4. The number of decision co-ordinates ( $n_e, n_s$ ) in the early decision concept is responsible for the selectivity of the test and the maximum test time. Having fixed the number of decision co-ordinates there is still freedom to select the individual decision co-ordinates in many combinations, all leading to the same confidence level.

## G.X.10 Simulation to derive the pass fail limits in Table G.2.4-1

There is freedom to design the decision co-ordinates ( $n_e, n_s$ ).

The binomial distribution and its inverse is used to design the pass and fail limits. Note that this method is not unique and that other methods exist.

$$\text{fail}(ne, d_f) := \frac{ne}{(ne + \text{qnbinom}(d_f, ne, ER))}$$

$$\text{pass}(ne, cl_p, M) := \frac{ne}{(ne + \text{qnbinom}(cl_p, ne, ER \cdot M))}$$

Where

- fail(..) is the error ratio for the fail limit
- pass(..) is the error ratio for the pass limit
- ER is the specified error ratio 0.05
- ne is the number of bad results. This is the variable in both equations
- M is the Bad DUT factor M=1.5
- $d_f$  is the wrong decision probability of a single (ne,ns) co-ordinate for the fail limit.  
It is found by simulation to be  $d_f = 0.004$
- $cl_p$  is the confidence level of a single (ne,ns) co-ordinate for the pass limit.  
It is found by simulation to be  $cl_p = 0.9975$
- $\text{qnbinom}(\cdot)$ : The inverse cumulative function of the negative binomial distribution

The simulation works as follows:

- A large population of limit DUTs with true ER = 0.05 is decided against the pass and fail limits.
- $cl_p$  and  $d_f$  are tuned such that CL (95%) of the population passes and D (5%) of the population fails.
- A population of Bad DUTs with true ER = M\*0.05 is decided against the same pass and fail limits.
- $cl_p$  and  $d_f$  are tuned such that CL (95%) of the population fails and D (5%) of the population passes.
- This procedure and the relationship to the measurement is justified in clause G.x.9. The number of DUTs decrease during the simulation, as the decided DUTs leave the population. That number decreases with an approximately exponential characteristics. After 169 bad results all DUTs of the population are decided.

NOTE: The exponential decrease of the population is an optimal design goal for the decision co-ordinates (ne,ns), which can be achieved with other formulas or methods as well.



# Annex H (normative): Uplink Physical Channels

## H.0 Uplink Signal Levels

Uplink signal power is a UE figure, which is configured by the Test System by means of:

RRC messages (IE-s), such as:

- UplinkPowerControlCommon (-v1020, SCell-r10),
- UplinkPowerControlDedicated (-v1020, SCell-r10),
- Other IE-s affecting directly or indirectly the uplink power,

and L1/2 Power control commands (TPC).

The uplink power settings are specified in the test case.

Otherwise, the uplink power settings result from the default RRC messages described in 3GPP TS 36.508 [7], and appropriate TPC-s, which are sent to the UE to transmit with an UL power level necessary for maintaining the call during the test.

## H.1 General

This annex specifies the uplink physical channels that are needed for setting a connection and channels that are needed during a connection. Table H.1-1 describes the mapping of uplink physical channels and signals to physical resources for FDD. Table H.1-2 describes the mapping of uplink physical channels and signals to physical resources for TDD.

**Table H.1-1: Mapping of uplink physical channels and signals to physical resources for FDD**

Physical channel	Time Domain Location	Frequency Domain Location	Note
PRACH	Allowed for the parameter <i>prach-Configuration Index</i> provided by higher layers	Allowed for the parameter <i>prach-FrequencyOffset</i> provided by higher layers	Mapping rule is specified in TS 36.211 [8] Section 5.7.1
DMRS	For PUCCH: Symbols 2 to 4 of each slot (PUCCH format: 1, 1a, 1b)  Symbol 1 and 5 of each slot (PUCCH format: 2, 2a, 2b)  For PUSCH: Symbol 3 of each slot	Uplink system bandwidth dependent.	Mapping rule of DMRS for PUCCH is specified in TS 36.211 [8] 5.5.2.2.2  Mapping rule of DMRS for PUSCH is specified in TS 36.211 [8] 5.5.2.1.2
PUCCH	Slot 0 and 1 of each subframe	Each 12 subcarriers of both ends of the bandwidth	Mapping rule is specified in TS 36.211 [8] Section 5.4.3
PUSCH	All remaining SC-FDMA symbols of each subframe not allocated to DMRS	RBs allocated according to Reference Measurement channel in Annex A.2	Mapping rule is specified in TS 36.211 [8] Section 5.4.2
SRS	Allowed for the cell-specific parameter <i>srs-BandwidthConfig</i> and the UE-specific parameter <i>srs-Bandwidth</i> provided by higher layers	Allowed for the cell-specific parameter <i>srsMaxUpPt</i> and the UE-specific parameter <i>transmissionComb</i> or <i>transmissionComb-ap</i> provided by higher layers	Mapping rule is specified in TS 36.211 [8] Section 5.5.3.2

**Table H.1-2: Mapping of uplink physical channels and signals to physical resources for TDD**

Physical channel	Time Domain Location	Frequency Domain Location	Note
PRACH	Allowed for the parameters $(t_{RA}^0, t_{RA}^1, t_{RA}^2)$ in <i>prach-Configuration Index</i> provided by higher layers	For format 0-3, the frequency location allowed is by <i>prach-FrequencyOffset</i> and $(f_{RA})$ in <i>prach-Configuration Index</i> provided by higher layers. Preamble format 4 is mapped only on UpPTS, where the frequency location allowed is only by $(f_{RA})$ in <i>prach-Configuration Index</i> provided by higher layers.	Mapping rule is specified in TS 36.211 [8] Section 5.7.1
DMRS	For PUCCH: Symbols 2 to 4 of each slot (PUCCH format: 1, 1a, 1b)  Symbol 1 and 5 of each slot (PUCCH format: 2, 2a, 2b)  For PUSCH: Symbol 3 of each slot	Uplink system bandwidth dependent.	Mapping rule of DMRS for PUCCH is specified in TS 36.211 [8] 5.5.2.2.2  Mapping rule of DMRS for PUSCH is specified in TS 36.211 [8] 5.5.2.1.2
PUCCH	Slot 0 and 1 of each subframe	Each 12 subcarriers of both ends of the bandwidth	Mapping rule is specified in TS 36.211 [8] Section 5.4.3
PUSCH	All remaining SC-FDMA symbols of each subframe not allocated to DMRS	RBs allocated according to Reference Measurement channel in Annex A.2	Mapping rule is specified in TS 36.211 [8] Section 5.4.2
SRS	Allowed for the cell-specific parameter <i>srs-BandwidthConfig</i> and the UE-specific parameter <i>srs-Bandwidth</i> provided by higher layers	Allowed for the cell-specific parameter <i>srsMaxUpPt</i> and the UE-specific parameter <i>transmissionComb</i> or <i>transmissionComb-ap</i> provided by higher layers	Mapping rule is specified in TS 36.211 [8] Section 5.5.3.2

NOTE: PUSCH, PUCCH, DMRS are not present in UpPTS for TDD.

## H.2 Set-up

Table H.2-1 describes the uplink physical channels that are required for connection set up.

**Table H.2-1: Uplink Physical Channels required for connection set-up**

Physical Channel
PRACH
DMRS
PUCCH
PUSCH

## H.3 Connection

The following clauses describes the uplink physical channels that are transmitted during a connection i.e., when measurements are done.

### H.3.0 Measurement of Transmitter Characteristics

As specified in the test case. Otherwise:

- PUSCH + DMRS for PUSCH (and DMRS) measurements.
- PUCCH + DMRS for PUCCH (and DMRS) measurements.
- PRACH for PRACH measurements.

SRS for SRS measurements.

### H.3.1 Measurement of Receiver Characteristics

As specified in the test case. Otherwise:

- PUSCH + DMRS for measurements with uplink interference configured.
- PUCCH + DMRS for measurements without uplink interference configured.

### H.3.2 Measurement of Performance Requirements

As specified in the test case. Otherwise:

- PUCCH + DMRS for measurements without CSI feedback, or with CSI feedback in PUCCH mode.
- PUSCH + DMRS for measurements with CSI feedback in PUSCH mode.

---

# Annex I (informative): Handling requirements and tests for different releases and UE capabilities

This annex gives guidance on how minimum requirements in different releases of 3GPP TS 36.101 [2] and different UE capabilities are handled in the specification 3GPP TS 36.521-1.

---

## I.1 General Considerations

Conformance tests in TS 36.521-1 are derived and specified by RAN WG5 based on minimum requirements in TS 36.101 [2] defined by RAN WG4. The actual practice of RAN WG5 is to specify conformance tests only in a single release of TS 36.521-1, capturing requirements defined by RAN WG4 in all releases of TS 36.101 [2].

- 1) In general the structure of TS 36.521-1 follows the structure of TS 36.101 [2].
- 2) In general for minimum requirements specified in a single clause in TS 36.101 [2], a corresponding conformance test is specified in a single clause in TS 36.521-1.
- 3) Exceptions to rule 2) occur in the following cases:
  - a) Coverage of minimum requirements is too wide, in term of different test environments required for verifying all of them.
  - b) Coverage of minimum requirements is too wide, in term of different features which need to be tested for verifying all of them.
  - c) Coverage of minimum requirements is too wide, in term of different UE capabilities required for verifying all of them.

A set of conformance tests is generated in TS 36.521-1 based on the same clause with minimum requirements in TS 36.101 [2]. This "test group" consists in several "individual tests".

- 4) Exceptions to rule 2) occur also in the case when minimum requirements (including test conditions, test points etc.) are not the same in different releases of TS 36.101 [2]. More in details the differences may consist in:
  - a) Different requirement values / test conditions for the same test points.
  - b) Exclusion / Replacement / Addition of test points without introduction of new features
  - c) Addition of test points introducing new features.

A set of conformance tests is generated in TS 36.521-1 based on the same clause with minimum requirements in TS 36.101 [2]. This set consists in one "original test" and one or several "additional tests".

- 5) The clause-number and the title of the "test group" / "original test" is derived based on the number and title of the corresponding minimum requirements in TS 36.101 [2], while the clause-numbers and titles of the "individual tests" / "additional tests" are derived based on those of the "test group" / "original test". In any case it should be avoided to have in TS 36.521-1 specification tests with the same title, even though they have different clause-numbers.
- 6) In case of high similarity between "individual tests", or between "additional tests" and "original test", in order to reduce the standardization and maintenance work the content of clauses for "individual tests" / "additional tests" may be reduced to a minimum by referencing to the analogue clauses of other "individual tests" / the "original test" and specifying the exceptions (requirement-tables, test parameter tables etc). This method should be applied very carefully considering differences in core functionalities of different E-UTRAN releases.

Details how to apply the above principles to concrete scenarios are defined in Annex I.2.

## 1.2 Concrete scenarios

### 1.2.1 Tests for minimum requirements varying between releases, without introduction of new features

Different minimum requirement between different releases of 3GPP TS 36.101 [2] without introduction of new features represent scenarios according to Annex I.1 bullets 4) a) and b).

In TS 36.521-1 are specified one "original test" and several "additional tests" respectively applicable to the appropriate releases. This is shown graphically in Figure I.2.1-1.

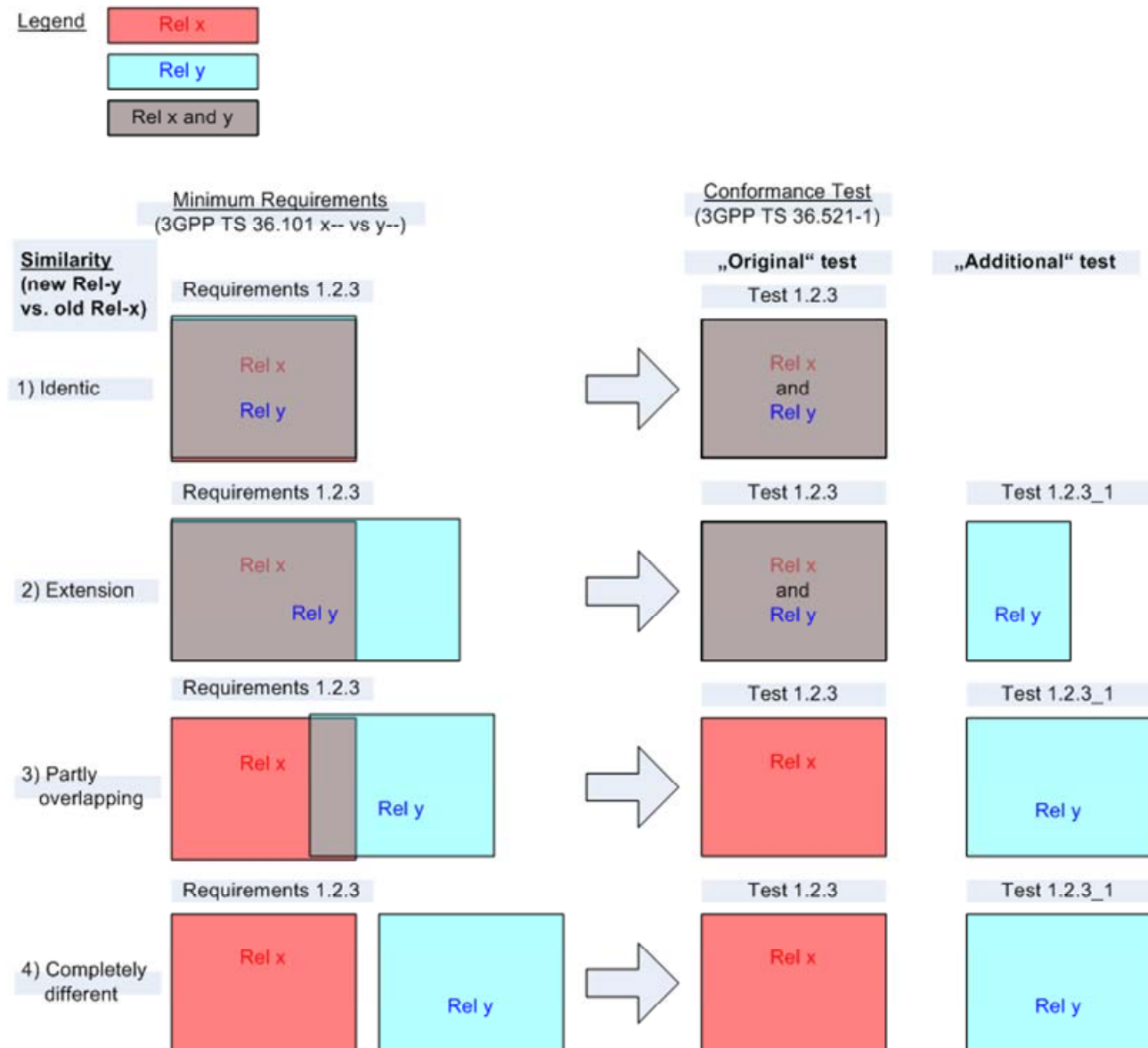

Figure I.2.1-1: Mapping of minimum requirements to conformance tests, when minimum requirements are specified in multiple releases

**Rule:**

Following tests and clauses are specified in TS 36.521-1:

*Original tests:*

<x.x.x>            <Test>

*Additional tests:*

<x.x.x>\_<y>       <Test> (<Release> <UE capability>)

**where:**

<x.x.x>            = number of the original test

<y>                = incrementing clause number (Arabic numeral)

<Test>            = title of the original test

<Release>        = optional identifier showing the release applicability of the test. To be included only when there is already a test with the same title for earlier releases.

<UE capability> = optional identifier showing the UE capability, which leads to additional test. To be included only when there is already a test with the same title for the same release.

**Examples:**

1.2.3        Virtual test

1.2.3\_1     Virtual test (Rel-9 and forward)

1.2.3\_2     Virtual test (Rel-10 and forward)

## 1.2.2 Tests for CA (Carrier aggregation)

### 1.2.2.1 CA Tx tests (Chapter 6)

CA Transmitter minimum requirements in 3GPP TS 36.101 [2] are already specified in separate clauses from the legacy requirements, bearing the suffix "A" in the number and "for CA" in the title. However minimum requirements have a wide coverage in terms of Annex I.1 bullet 3).

In TS 36.521-1 are specified several separate "individual tests" for different CA scenarios and UE capabilities.

**Rule:**

Following tests and clauses are specified in TS 36.521-1:

*Test group clause:*

<x.x.x>A           <Test> for CA

*Individual tests:*

<x.x.x>A.<y>       <Test> for CA (<CA type> <DL/UL support> <BW Class> <Release>)

**where:**

<x.x.x>            = number of the corresponding legacy test (if available), or number derived from TS 36.101 without potential suffix "A" (if no legacy test available)

<y>                = incrementing clause number (Arabic numeral)

<Test>            = title of the corresponding legacy test (if available), or title derived from TS 36.101 without potential suffix "for CA" (if no legacy test available)

- <CA type> = mandatory identifier {intra-band contiguous; intra-band non-contiguous; inter-band}
- <DL/UL support>= mandatory identifier {DL CA without UL CA; DL CA and UL CA}
- <BW Class> = optional identifier showing UE CA Bandwidth class {Class B; Class C}. To be included only for intra-band contiguous scenarios, if there is already a test with the same title.
- <Release> = optional identifier showing the release applicability of the test. To be included only when there is already a test with the same title for earlier releases.

**Examples:**

- 1.2.3 Virtual test
- 1.2.3A Virtual test for CA
- 1.2.3A.1 Virtual test for CA (intra-band contiguous DL CA and UL CA)
- 1.2.3A.2 Virtual test for CA (inter-band DL CA without UL CA)
- 1.2.3A.3 Virtual test for CA (intra-band contiguous DL CA and UL CA Class B)

### 1.2.2.2 CA Rx tests (Chapter 7)

Same as for Transmitter tests (Chapter 6) in Annex I.2.2.1.

### 1.2.2.3 CA Performance tests (Chapter 8)

CA Performance minimum requirements in 3GPP TS 36.101 [2] are specified mostly in the same clause with the legacy requirements, as additional test points marked with CA capability identifiers. CA introduces a new feature in terms of Annex I.1 bullet 4) c). Furthermore the set of CA test points has a wide coverage in terms of Annex I.1 bullet 3).

In TS 36.521-1 are specified several separate "individual tests" for different CA scenarios and UE capabilities.

**Rule:**

Following tests and clauses are specified in TS 36.521-1:

*Test group clause:*

<x.x.x>\_A <Test> for CA

*Individual tests:*

<x.x.x>\_A.<y> <Test> for CA (<CA type > <DL/UL support> <Release>)

where:

<x.x.x> = number of the corresponding legacy test (if available), or number derived from TS 36.101 without potential suffix "A" (if no legacy test available)

<y> = incrementing clause number (Arabic numeral)

<Test> = title of the corresponding legacy test (if available), or title derived from TS 36.101 without potential "for CA" (if no legacy test available)

<CA type> = mandatory identifier {intra-band contiguous; intra-band non-contiguous; inter-band}

<DL/UL support> = mandatory identifier {DL CA}

<Release> = optional identifier showing the release applicability of the test. To be included only when there is already a test with the same title for earlier releases.

**Examples:**

1.2.3	Virtual test
1.2.3_A	Virtual test for CA
1.2.3_A.1	Virtual test for CA (intra-band contiguous DL CA)
1.2.3_A.2	Virtual test for CA (inter-band DL CA)
1.2.3_A.3	Virtual test for CA (intra-band non-contiguous)
1.2.3_A.4	Virtual test for CA (intra-band contiguous DL CA Rel-11 and forward)

## 1.2.3 Tests for UL-MIMO (Uplink Multiple Antenna Transmission)

### 1.2.3.1 UL-MIMO Tx tests (Chapter 6)

UL-MIMO Transmitter minimum requirements in 3GPP TS 36.101 [2] are already specified in separate clauses from the legacy requirements, bearing the suffix "B" in the number and "for UL-MIMO" in the title.

**Rule:**

Following tests and clauses are specified in TS 36.521-1:

*Test group clause:*

<x.x.x>B      <Test> for UL-MIMO

*Individual tests:*

<x.x.x>B.<y>      <Test> for UL-MIMO (<Release>)

where:

<x.x.x>      = number of the corresponding legacy test (if available), or number derived from TS 36.101 without potential suffix "B" (if no legacy test available)

<y>      = incrementing clause number (Arabic numeral)

<Test>      = title of the corresponding legacy test (if available), or title derived from TS 36.101 without potential suffix "for UL-MIMO" (if no legacy test available)

<Release>      = optional identifier showing the release applicability of the test. To be included only when there is already a test with the same title for earlier releases.

**Examples:**

1.2.3	Virtual test
1.2.3B	Virtual test for UL-MIMO

### 1.2.3.2 UL-MIMO Rx tests (Chapter 7)

Same as for Transmitter tests (Chapter 6) in Annex I.2.3.1.



## 1.2.4 Tests for eDL-MIMO (Enhanced Downlink Multiple Antenna Transmission)

### 1.2.4.1 eDL MIMO Performance tests (Chapter 8)

eDL MIMO Performance minimum requirements in 3GPP TS 36.101 [2] are specified in separate clauses from the legacy requirements. In some cases the minimum requirements have a wide coverage in terms of Annex I.1 bullet 3) a) with respect of the presence of a simultaneous interfering transmission a) with respect of the presence of a simultaneous interfering transmission.

In TS 36.521-1 are specified several separate "individual tests" for eDL-MIMO.

#### Rule:

Following tests and clauses are specified in TS 36.521-1:

*Test group clause:*

<x.x.x>\_D      <Test> for eDL-MIMO

*Individual tests:*

<x.x.x>\_D.<y>   <Test> for eDL-MIMO (<Release>)

where:

<x.x.x>            = number of the corresponding legacy test (if available), or number derived from TS 36.101 without potential suffix (if no legacy test available).

<y>                = optional incrementing clause number (Arabic numeral) (if many individual tests).

<Test>            = title of the corresponding legacy test (if available), or title derived from TS 36.101 without potential suffix (if no legacy test available).

<Release>        = optional identifier showing the release applicability of the test. To be included only when there is already a test with the same title for earlier releases.

#### Examples:

1.2.4             Virtual test

1.2.4\_D          Virtual test for eDL-MIMO

### 1.2.4.2 eDL MIMO CSI tests (Chapter 9)

eDL MIMO CSI minimum requirements in 3GPP TS 36.101 [2] are specified in separate clauses from legacy requirements.

#### Rule:

Following tests and clauses are specified in TS 36.521-1:

*Test group clause:*

<x.x.x>\_D      <Test> for eDL-MIMO

*Individual tests:*

<x.x.x>\_D.<y>   <Test> for eDL-MIMO (<Release>)

where:

<x.x.x>            = number of the corresponding legacy test (if available), or number derived from TS 36.101 without potential suffix (if no legacy test available).

- <y> = optional incrementing clause number (Arabic numeral) (if many individual tests).
- <Test> = title of the corresponding legacy test (if available), or title derived from TS 36.101 without potential suffix (if no legacy test available).
- <Release> = optional identifier showing the release applicability of the test. To be included only when there is already a test with the same title for earlier releases.

**Examples:**

- 1.2.4 Virtual test
- 1.2.4\_D Virtual test for eDL-MIMO

## 1.2.5 Tests for eICIC (Enhanced Inter-carrier Interference Cancellation / Coordination)

### 1.2.5.1 eICIC Performance tests (Chapter 8)

eICIC Performance minimum requirements in 3GPP TS 36.101 [2] are specified in separate clauses from the legacy requirements. The set of eICIC test points have a wide coverage in terms of Annex I.1 bullet 3)a) with respect of the ABS type (Non-MBSFN / MBSFN). In TS 36.521-1 are specified several separate "individual tests" for eICIC.

**Rule:**

Following tests and clauses are specified in TS 36.521-1:

*Test group clause:*

<x.x.x>\_C <Test> for eICIC

*Individual tests:*

<x.x.x>\_C.<y> <Test> for eICIC (<ABS-type> <Release>)

where:

- <x.x.x> = number of the corresponding legacy test (if available), or number derived from TS 36.101 without potential suffix (if no legacy test available).
- <y> = optional incrementing clause number (Arabic numeral) (if many individual tests).
- <Test> = title of the corresponding legacy test (if available), or title derived from TS 36.101 without potential suffix (if no legacy test available).
- <ABS-Type> = mandatory identifier {non-MBSFN ABS, MBSFN ABS}
- <Release> = optional identifier showing the release applicability of the test. To be included only when there is already a test with the same title for earlier releases.

**Examples:**

- 1.2.4 Virtual test
- 1.2.4\_C Virtual test for eICIC
- 1.2.4\_C.1 Virtual test for eICIC (non-MBSFN ABS)
- 1.2.4\_C.2 Virtual test for eICIC (MBSFN ABS)

### 1.2.5.2 eICIC CSI tests (Chapter 9)

Same as for Performance tests (Chapter 8) in Annex I.2.5.1.

## 1.2.6 Tests for feICIC (Further Enhanced Non CA-based ICIC for LTE)

### 1.2.6.1 feICIC Performance tests (Chapter 8)

feICIC Performance minimum requirements in 3GPP TS 36.101 [2] are specified in separate clauses from the legacy requirements. The set of feICIC test points have a wide coverage in terms of Annex I.1 bullet 3)a) with respect of the ABS type (Non-MBSFN / MBSFN). In TS 36.521-1 are specified several separate "individual tests" for feICIC.

Rule:

Following tests and clauses are specified in TS 36.521-1:

*Test group clause:*

<x.x.x>\_E<Test> for feICIC

*Individual tests:*

<x.x.x>\_E.<y> <Test> for feICIC (<ABS-type> <Release>)

where:

<x.x.x> = number of the corresponding legacy test (if available), or number derived from TS 36.101 without potential suffix (if no legacy test available).

<y> = optional incrementing clause number (Arabic numeral) (if many individual tests).

<Test> = title of the corresponding legacy test (if available), or title derived from TS 36.101 without potential suffix (if no legacy test available).

<ABS-Type> = mandatory identifier {non-MBSFN ABS, MBSFN ABS}

<Release> = optional identifier showing the release applicability of the test. To be included only when there is already a test with the same title for earlier releases.

Examples:

1.2.6	Virtual test
1.2.6_E	Virtual test for feICIC
1.2.6_E.1	Virtual test for feICIC (non-MBSFN ABS)
1.2.6_E.2	Virtual test for eICIC (MBSFN ABS)

### 1.2.6.2 feICIC CSI tests (Chapter 9)

Same as for Performance tests (Chapter 8) in Annex I.2.6.1.

## 1.2.7 Tests for DL CoMP (Downlink Coordinated Multipoint Transmission)

### 1.2.7.1 CoMP Performance tests (Chapter 8)

CoMP Performance minimum requirements in 3GPP TS 36.101 [2] are specified in separate clauses from the legacy requirements. The set of CoMP test points may have a wide coverage in terms of Annex I.1 bullet 3)a) with respect of the number of CSI processes (Single / Multiple CSI process) etc. In such cases in TS 36.521-1 are specified several separate "individual tests" for CoMP.

**Rule:**

Following tests and clauses are specified in TS 36.521-1:

*Test (group) clause:*

<x.x.x>\_F <Test> for CoMP

*Individual tests:*

<x.x.x>\_F.<y> <Test> < CSI Process number > for CoMP (<Release>)

where:

<x.x.x> = number derived from TS 36.101.

<y> = optional incrementing clause number (Arabic numeral) (if many individual tests).

<Test> = title derived from TS 36.101.

<CSI Process number> = optional identifier { with Single CSI process, with Multiple CSI processes } (if many individual tests)

<Release> = optional identifier showing the release applicability of the test. To be included only when there is already a test with the same title for earlier releases.

**Examples:**

1.2.3	Virtual test
1.2.3_F	Virtual test for CoMP
1.2.3_F.1	Virtual test with Single CSI process for CoMP
1.2.3_F.2	Virtual test with Multiple CSI processes for CoMP

## 1.2.7.2 CoMP CSI tests (Chapter 9)

Same as for Performance tests (Chapter 8) in Annex I.2.7.1.

## 1.2.8 Tests for Further eDL-MIMO (Enhanced Downlink Multiple Antenna Transmission) Enhancement for LTE-A

### 1.2.8.1 eDL MIMO Enhancement CSI tests (Chapter 9)

Further eDL MIMO Enhancement for LTE-A CSI minimum requirements in 3GPP TS 36.101 [2] are specified in separate clauses from the legacy requirements.

**Rule:**

Following tests and clauses are specified in TS 36.521-1:

*Test group clause:*

<x.x.x>\_G <Test> for eDL-MIMO Enhancement

*Individual tests:*

<x.x.x>\_G.<y> <Test> for eDL-MIMO Enhancement (<Release>)

where:

<x.x.x> = number of the corresponding legacy test (if available), or number derived from TS 36.101 without potential suffix (if no legacy test available).

- <y> = optional incrementing clause number (Arabic numeral) (if many individual tests).
- <Test> = title of the corresponding legacy test (if available), or title derived from TS 36.101 without potential suffix (if no legacy test available).
- <Release> = optional identifier showing the release applicability of the test. To be included only when there is already a test with the same title for earlier releases.

**Examples:**

- 1.2.8 Virtual test
- 1.2.8\_G Virtual test for eDL-MIMO Enhancement

## 1.2.9 Tests for UE category 0

### 1.2.9.1 UE category 0 Tx tests (Chapter 6)

UE category 0 specific Transmitter minimum requirements in 3GPP TS 36.101 [2] are specified in separate clauses from the legacy requirements, bearing the suffix "E" in the number and "for UE category 0" in the title. In other cases where no category 0 specific requirements exist, the legacy requirements apply. To maintain consistency all test cases for UE category 0 to be specified in TS 36.521-1 are handled similarly.

**Rule:**

Following tests and clauses are specified in TS 36.521-1:

- <x.x.x>E <Test> for UE category 0
- <x.x.x>E<\_y> <Test> for UE category 0 (<Release>)

where:

- <x.x.x> = number of the corresponding legacy test (if available), or number derived from TS 36.101 without potential suffix "E" (if no legacy test available)
- <\_y> = optional incrementing clause number (Arabic numeral) with preceding underscore. To be applied only when there is already a test with the same title for earlier releases.
- <Test> = title of the corresponding legacy test (if available), or title derived from TS 36.101 without potential "for UE category 0" (if no legacy test available)
- <Release> = optional identifier showing the release applicability of the test. To be included only when there is already a test with the same title for earlier releases.

**Examples:**

- 1.2.3 Virtual test
- 1.2.3E Virtual test for UE category 0
- 1.2.3E\_1 Virtual test for UE category 0 (Rel-13 and forward)

### 1.2.9.2 UE category 0 Rx tests (Chapter 7)

Same as for Transmitter tests (Chapter 6) in Annex I.2.9.1.

### 1.2.9.3 UE category 0 Performance tests (Chapter 8)

UE category 0 Performance minimum requirements in 3GPP TS 36.101 [2] are already specified in separate clauses from the legacy requirements.

**Rule:**

Following tests and clauses are specified in TS 36.521-1:

<x.x.x>            <Test> for UE category 0

<x.x.x><\_y>       <Test> for UE category 0 (<Release>)

where:

<x.x.x>            = number derived from the corresponding requirement clause in TS 36.101

<\_y>               = optional incrementing clause number (Arabic numeral) with preceding underscore. To be applied only when there is already a test with the same title for earlier releases.

<Test>             = title derived from the corresponding requirement clause in TS 36.101

<Release>         = optional identifier showing the release applicability of the test. To be included only when there is already a test with the same title for earlier releases.

**Examples:**

1.2.3              Virtual test for UE category 0

1.2.3\_1           Virtual test for UE category 0 (Rel-13 and forward)

**1.2.9.4 UE category 0 CSI tests (Chapter 9)**

Same as for Performance tests (Chapter 8) in Annex I.2.9.3.

**1.2.10 Tests for SCE-L1 (Small Cell Enhancements-Physical layer)****1.2.10.1 SCE-L1 Receiver tests (Chapter 7)**

The set of 256QAM test points may have a wide coverage in terms of Annex I.1 bullet 3)c) with respect of the different UE capabilities (UE category 11-16), modulation mode and coding rate required and Annex I.1 bullet 4)a)etc with the addition of new requirements and new defined RMC for SCE-L1. In such cases in TS 36.521-1 are specified several separate "individual tests" for SCE-L1.

**Rule:**

Following tests and clauses are specified in TS 36.521-1:

*Test (group) clause:*

<x.x.x>\_H       <Test> for SCE-L1

*Individual tests:*

<x.x.x>\_H.<y>   <Test> for SCE-L1 (<Release>)

where:

<x.x.x>            = number derived from TS 36.101.

<y>                 = optional incrementing clause number (Arabic numeral) (if many individual tests).

<Test>             = title derived from TS 36.101.

<Release>         = optional identifier showing the release applicability of the test. To be included only when there is already a test with the same title for earlier releases.

Examples:

1.2.3	Virtual test
1.2.3_H	Virtual test for SCE-L1

## I.2.10.2 SCE-L1 Performance tests (Chapter 8)

The set of 256QAM test points may have a wide coverage in terms of Annex I.1 bullet 3)c) with respect of the different UE capabilities (UE category 11-16) and demodulation mode required and Annex I.1 bullet 4)c)etc with the addition of new test points introducing new features of 256QAM for SCE-L1. In such cases in TS 36.521-1 are specified several separate "individual tests" for SCE-L1.

Rule:

Following tests and clauses are specified in TS 36.521-1:

*Test (group) clause:*

<x.x.x>\_H <Test> for SCE-L1

*Individual tests:*

<x.x.x>\_H.<y> <Test> for SCE-L1 (<Release>)

where:

<x.x.x>	= number derived from TS 36.101.
<y>	= optional incrementing clause number (Arabic numeral) (if many individual tests).
<Test>	= title derived from TS 36.101.
<Release>	= optional identifier showing the release applicability of the test. To be included only when there is already a test with the same title for earlier releases.

Examples:

1.2.3	Virtual test
1.2.3_H	Virtual test for SCE-L1
1.2.3_H.1	Virtual test for SCE-L1(Single Carrier)
1.2.3_H.2	Virtual test for SCE-L1(2DL CA)
1.2.3_H.3	Virtual test for SCE-L1(3DL CA)

## I.2.10.3 SCE-L1 CSI tests (Chapter 9)

SCE-L1 Performance minimum requirements in 3GPP TS 36.101 [2] are specified in separate clauses from the legacy requirements. The set of SCE-L1 test points may have a wide coverage in terms of Annex I.1 bullet 3)b) and c) etc. In such cases in TS 36.521-1 are specified several separate "individual tests" for SCE-L1.

Rule:

Following tests and clauses are specified in TS 36.521-1:

*Test (group) clause:*

<x.x.x>\_H <Test> for SCE-L1

*Individual tests:*

<x.x.x>\_H.<y> <Test> for SCE-L1 (<Release>)

where:

- <x.x.x> = number derived from TS 36.101.
- <y> = optional incrementing clause number (Arabic numeral) (if many individual tests).
- <Test> = title derived from TS 36.101.
- <Release> = optional identifier showing the release applicability of the test. To be included only when there is already a test with the same title for earlier releases.

Examples:

- 1.2.3 Virtual test
- 1.2.3\_H Virtual test for SCE-L1



## Annex J (informative): Change history

Change history								
Date	TSG #	TSG Doc.	CR	R ev	Subject/Comment	Old	New	
2007-08	RAN5 #36	R5-072185			Skeleton proposed for RAN5#36Athens		0.0.1	
2007-08	RAN5 #36	R5-072419			Update the skeleton base on R4-071234_TR36.803.0.4.0.doc	0.0.1	0.0.2	
2007-08	RAN5 #36	R5-072424			Update with editorial changes	0.0.2	0.0.3	
2007-11	RAN5 #37	R5-073043			Update document with some info as following: Section 5: Frequency band information Section 6.2: Maximum output power Section 6.5: Output RF spectrum emissions Section 6.5.1: Occupied bandwidth Section 6.5.2: Out of band emission Section 6.5.3: Spurious emissions	0.0.3	0.0.4	
2007-11	RAN5 #37	R5-073360			Editorial change to split MOP and UE Power classes	0.0.4	0.0.5	
2008-03	RAN5 #38	R5-080069			Editorial changes to sync up with 36.101 v1.0.0 as much as feasible for the moment: Update definitions, symbols and abbreviations Update frequency bands, channel bandwidth, channel numbers information. Restructure document to move "frequency error" sub-section inside Transmit signal quality. Add "additional spectrum Emission Mask" sub-test (mask A,B,C) section to address the regulatory requirements that are not met with the general mask (OOB and spurious emission). Add "Additional ACLR requirements" to address additional requirements that the network might indicate to the UE via signalling for a specific deployment scenario (in terms of additional requirements for UTRA/ACLR2 Restructure "Spurious Emission" to indicate we need to have 3 test cases to address: "E-UTRA Spurious Emission" requirements, "Spurious Emission band UE co-existence" requirements, and "Additional spurious emissions" requirements Separate wide band and narrow band intermodulation in the intermodulation characteristics	0.0.5	0.0.6	
2008-03	RAN5 #38	R5-080408			LTE Reference Sensitivity test Text proposal		0.0.7	
2008-03	RAN5 #38	R5-080409			LTE Maximum Rx input level test Text proposal		0.0.7	
2008-03	RAN5 #38	R5-080410			LTE Adjacent Channel Selectivity test Text proposal		0.0.7	
2008-03	RAN5 #38	R5-080064			LTE RF Receiver tests, General section Text proposal		0.0.7	
2008-03	RAN5 #38	R5-080412			LTE RF: transmission modulation initial EVM test proposal		0.0.7	
2008-03	RAN5 Workshop-UE LTE Test (9-11 April)	R5w0800027			Modify styles and formats of tables and others according to drafting rules. Add some definitions and abbreviations Modified section 6.2 structure to be aligned with 36.101 v8.1.0 Modify tables of requirements to remove 1.6 MHz and 3.2MHz channel bandwidth according to new requirements 36.101 v8.1.0		0.0.9	
2008-03	RAN5 Workshop-UE LTE Test (9-11 April)	R5w0800028			Following TPs have been included: R5w080013r1 R5w080014r1 R5w080008r2 R5w080009r2 R5w080040r1 R5w080015r1 R5w080016r1 R5w080017r1 R5w080018r2	0.0.9	0.1.0	
2008-05	RAN5#39	R5-081046			36-521-1 alignment of measurement state for test cases	0.1.0	0.1.1	

2008-05	RAN5#39	R5-081042		<p>Following approved TPs have been included:</p> <p>R5-081040 36.521-1 after April LTE-RF workshop</p> <p>R5-081415 36-521-1 alignment of measurement state for test cases – also the measurement state for each test cases has been updated according to R5-081404</p> <p>R5-081416 Cover for LTE E-UTRAN RRC_IDLE State Mobility text proposal</p> <p>R5-081417 Cover for LTE E-UTRAN RRC_CONNECTED State Mobility text proposal</p> <p>R5-081404 LTE Rx Intermodulation test case text proposal</p> <p>R5-081409 Annex structure for Measurement uncertainty &amp; Test Tools</p> <p>R5-081405 Text Proposal for TS 36.521-1 TC7.6 Blocking Characteristics</p> <p>R5-081406 Text Proposal for TS 36.521-1 TC7.7 Spurious Response</p> <p>R5-081403 Text Proposal for TS 36.521-1 TC7.9 Spurious Emissions</p> <p>R5-081410 Uncertainties and Test Tools for subset of UE tests</p> <p>R5-081331 Clarification of diversity characteristics section for multiple UE antennas</p> <p>R5-081335 36-521-1 update of nominal and additional channel bandwidths</p>	0.1.1	0.2.0
2008-06	RAN5 #39bis	R5-082029		<p>Following approved TPs have been included:</p> <p>R5-082129: Restructure of TS 36.521-1 and RRM proposal (Split of RRM from 36.521-1 v0.2.0 in its own specification 36.521-3.)</p> <p>R5-082166: Text Proposal for Annex C Downlink Physical Channels</p> <p>R5-082130: Text Proposal for Chan bandwidths in TS 36.521-1</p> <p>R5-082155: Text Proposal for LTE Tx Minimum Output Power</p> <p>R5-082027: Text Proposal for Occupied bandwidth in TS 36.521-1</p> <p>R5-082171: Text Proposal for LTE Adjacent Channel Leakage power Ratio</p> <p>R5-082134: Text Proposal for LTE Tx Spurious Emissions</p> <p>R5-082135: Text Proposal for LTE UE Maximum Output Power</p> <p>R5-082136: Text Proposal for LTE Spectrum Emission Mask</p> <p>R5-082138: UE Spurious Emissions Measurement uncertainty &amp; Test Tolerances</p> <p>R5-082169: LTE Spectrum Emission Mask test uncertainties and TTs</p> <p>R5-082151: LTE UE Max Power and ACLR tests uncertainties and TTs</p> <p>R5-082152: Text proposal for LTE Transmit OFF Power</p> <p>R5-082153: LTE UE Max Rx Input and ACS test cases update</p> <p>R5-082082: LTE Rx Intermodulation test case uncertainties and TTs</p> <p>R5-082093: Text Proposal for TS 36.521-1 TC7.6 Blocking Characteristics</p> <p>R5-082154: Text Proposal for TS 36.521-1 TC7.7 Spurious Response</p> <p>R5-082167: OBW Measurement uncertainty &amp; Test Tolerances</p> <p>R5-082158: Cover for LTE Performance Requirement text proposal</p> <p>R5-082159: Text Proposal for LTE Demodulation of PCFICH/PDCCH and PHICH</p> <p>R5-082156: Text proposal for LTE Tx Minimum Output Power Uncertainty</p> <p>R5-082157: Text proposal for LTE Tx Minimum Output Power Tolerance</p> <p>R5-082164: Statistical testing of receiver characteristics</p> <p>R5-082170: Cover for LTE Propagation Conditions Text Proposal</p> <p>Editorial changes to align tables and figures numbering with R5-082025</p>	0.2.0	0.3.0

2008-08	RAN5 #40	R5-083163		<p>Following approved TPs have been included:</p> <p>R5-083804: LTE Demodulation Performance text proposal</p> <p>R5-083159: LTE-RF Occupied bandwidth test case / measurement uncertainty and TT text proposal</p> <p>R5-083160: Transmission OFF power: TP, measurement uncertainty and test tolerances proposal</p> <p>R5-083805: Frequency Error test case / measurement uncertainty and TT test proposal</p> <p>R5-083162: Propagation conditions correction text proposal</p> <p>R5-083220: Text Proposal for LTE Tx Minimum Output Power</p> <p>R5-083806: TP of section 8 for E-UTRAN TDD in 36.521-1</p> <p>R5-083344: Test Tolerance and System uncertainty for OBW test</p> <p>R5-083848: Test Tolerance and System uncertainty for Reference sensitivity test</p> <p>R5-083840: Test Tolerances for Spectrum Emission Mask</p> <p>R5-083808: Reference Measurement Channel for LTE UE Receiver tests</p> <p>R5-083350: Test Tolerance and System uncertainty for Blocking and Spurious response</p> <p>R5-083366: Text Proposal for LTE Reporting of CQI/PMI</p> <p>R5-083810: LTE PBCH Demodulation Performance Requirements</p> <p>R5-083482: LTE-RF TP for Test Case 7.6 Blocking Characteristics</p> <p>R5-083809: LTE-RF TP for Test Case 7.7 Spurious Response</p> <p>R5-083484: LTE-RF TP for Test Case 7.9 Spurious Emissions</p> <p>R5-083811: Annex E Global In-Channel TX-Test</p> <p>R5-083163: TS 36.521-1 after RAN5#40</p>	0.3.0	1.0.0
2008-10	RAN5 #40Bis	R5-084072		<p>Following approved TPs have been included:</p> <p>R5-084072 TS 36.521-1 after RAN5#40Bis</p> <p>R5-084300 LTE-RF TP for Definitions Symbols and Abbreviations</p> <p>R5-084304 LTE-RF-TP for general section</p> <p>R5-084036 Test Tolerances for additional SEM</p> <p>R5-084303 LTE-RF TP for Channel bandwidths and frequency range</p> <p>R5-084305 LTE-RF TP for new Absolute Power Tolerance test case</p> <p>R5-084067 LTE-RF TP for Transmission OFF test case</p> <p>R5-084318 LTE-RF TP for Transmission Modulation test cases</p> <p>R5-084069 LTE-RF Investigation of E-UTRA-TDD Frequency Error test case applicability</p> <p>R5-084319 LTE-RF TP for Frequency Error test case</p> <p>R5-084309 Text Proposal for LTE Tx Spurious Emissions</p> <p>R5-084111 Text Proposal for LTE Adjacent Channel Leakage power Ratio</p> <p>R5-084320 Text Proposal for LTE Additional Spectrum Emission Mask</p> <p>R5-084310 Test Tolerances for additional spurious emission</p> <p>R5-084311 Text Proposal for Occupied bandwidth</p> <p>R5-084321 Text Proposal for LTE Spectrum Emission Mask</p> <p>R5-084060 Modification to section 7.2 Diversity characteristics</p> <p>R5-084312 References in 36.521-1 tests initial conditions</p> <p>R5-084148 Update of Reference Measurement Channel for LTE UE Rx tests</p> <p>R5-084167 LTE-RF TP for TC7.9 Spurious Emissions</p> <p>R5-084075 LTE DL Reference Measurement Channel for PDSCH (FDD) text proposal</p> <p>R5-084077 LTE Measurement of Performance Requirements text proposal</p> <p>R5-084313 LTE Demodulation of PDSCH Test Requirements text proposal</p> <p>R5-084147 Specification of DL propagation conditions for LTE UE tests</p> <p>R5-084315 Text Proposal for LTE Demodulation of PCFICH/PDCCH</p> <p>R5-084323 Text Proposal for Annex E Global In-Channel</p>	1.0.0	1.1.0
2008-12	RAN#42	RP-080863		Approval of version 2.0.0 at RAN#42, then put to version 8.0.0.	2.0.0	8.0.0
2008-01				Editorial corrections.	8.0.0	8.0.1
2009-03	RAN#43	R5-086011	0001	- TP for In-band emissions	8.0.1	8.1.0
2009-03	RAN#43	R5-086012	0002	- TP for Spectrum flatness	8.0.1	8.1.0
2009-03	RAN#43	R5-086013	0003	- TP for IQ-component	8.0.1	8.1.0
2009-03	RAN#43	R5-086064	0004	- LTE-RF: UE max output power	8.0.1	8.1.0

2009-03	RAN#43	R5-086093	0005	-	Clarification of measurement period in minimum output power test procedure	8.0.1	8.1.0
2009-03	RAN#43	R5-086094	0006	-	Clarification of measurement period in transmit OFF power test procedure	8.0.1	8.1.0
2009-03	RAN#43	R5-086120	0007	-	Update of Max.input level test	8.0.1	8.1.0
2009-03	RAN#43	R5-086125	0008	-	Addition of UL Reference Measurement Channels in Annex A2	8.0.1	8.1.0
2009-03	RAN#43	R5-086160	0009	-	correction for Maximum Power Reduction (MPR)	8.0.1	8.1.0
2009-03	RAN#43	R5-086167	0010	-	LTE-RF: TDD applicability and CR for Blocking Characteristics and Spurious Response	8.0.1	8.1.0
2009-03	RAN#43	R5-086168	0011	-	LTE-RF: TDD applicability and CR for Spurious Emissions	8.0.1	8.1.0
2009-03	RAN#43	R5-086239	0012	-	Update of Symbols	8.0.1	8.1.0
2009-03	RAN#43	R5-086401	0013	-	LTE-RF: TX-RX channel freq separation	8.0.1	8.1.0
2009-03	RAN#43	R5-086405	0014	-	Update of 6.7 Transmit intermodulation test	8.0.1	8.1.0
2009-03	RAN#43	R5-086406	0015	-	Update of initial conditions for Tx and Rx test cases	8.0.1	8.1.0
2009-03	RAN#43	R5-086408	0016	-	Update of Adjacent Channel Leakage power Ratio	8.0.1	8.1.0
2009-03	RAN#43	R5-086409	0017	-	Removal of [ ] from Clause 7 Receiver Characteristics	8.0.1	8.1.0
2009-03	RAN#43	R5-086413	0018	-	Updates to Demodulation of PCFICH/PDCCH test case	8.0.1	8.1.0
2009-03	RAN#43	R5-086414	0019	-	Text proposal for Reporting of Channel State Information	8.0.1	8.1.0
2009-03	RAN#43	R5-086415	0020	-	Correction of RS_EPRE powers for default DL signal levels	8.0.1	8.1.0
2009-03	RAN#43	R5-086416	0021	-	Update of DL Reference Measurement Channels in Annex A3	8.0.1	8.1.0
2009-03	RAN#43	R5-086417	0022	-	Update to Annex E	8.0.1	8.1.0
2009-03	RAN#43	R5-086425	0023	-	Update of General text in clause 6	8.0.1	8.1.0
2009-03	RAN#43	R5-086426	0024	-	Clarification of measurement bandwidth in spectrum emission mask test	8.0.1	8.1.0
2009-03	RAN#43	R5-086428	0025	-	Demodulation of TDD PHICH test requirements text proposal	8.0.1	8.1.0
2009-03	RAN#43	R5-086429	0026	-	Demodulation of TDD PCFICH/PDCCH test requirements text proposal	8.0.1	8.1.0
2009-03	RAN#43	R5-090306	0027	-	New Annex H for Uplink Physical Channels	8.0.1	8.1.0
2009-03	RAN#43	R5-090308	0028	-	Text proposal for Reporting of Channel State Information	8.0.1	8.1.0
2009-03	RAN#43	R5-090403	0029	-	CR to 36.521-1: Update of Spurious Emissions test cases	8.0.1	8.1.0
2009-03	RAN#43	R5-090404	0030	-	CR to 36.521-1: Update of ACLR test case	8.0.1	8.1.0
2009-03	RAN#43	R5-090443	0031	-	LTE-RF: Correction to 36.521-1 Frequency error test case	8.0.1	8.1.0
2009-03	RAN#43	R5-090488	0032	-	LTE TDD applicability for Transmit intermodulation test case	8.0.1	8.1.0
2009-03	RAN#43	R5-091002	0033	-	LTE Demodulation of PDSCH Test Requirements text proposal	8.0.1	8.1.0
2009-03	RAN#43	R5-091004	0034	-	LTE-RF: CR for UE max power test case	8.0.1	8.1.0
2009-03	RAN#43	R5-091007	0035	-	LTE-RF: TDD Applicability and CR for Spectrum Emission Mask and Additional Spectrum Emission Mask	8.0.1	8.1.0
2009-03	RAN#43	R5-091008	0036	-	LTE-RF Investigation of E-UTRA-TDD for Occupied bandwidth test case applicability	8.0.1	8.1.0
2009-03	RAN#43	R5-091009	0037	-	LTE-RF: Investigation of E-UTRA-TDD for Adjacent Channel Leakage power Ratio test case applicability	8.0.1	8.1.0
2009-03	RAN#43	R5-091011	0038	-	LTE-RF: TDD applicability and CR for Maximum Input Level	8.0.1	8.1.0
2009-03	RAN#43	R5-091012	0039	-	LTE-RF: TDD applicability and CR for Adjacent Channel Selectivity (ACS)	8.0.1	8.1.0
2009-03	RAN#43	R5-091017	0040	-	Removal of Rx Narrowband Intermod 7.8.2	8.0.1	8.1.0
2009-03	RAN#43	R5-091019	0041	-	Relocation of 36.521-1 Annex C DL mapping	8.0.1	8.1.0
2009-03	RAN#43	R5-091020	0042	-	Removal of "Out-of-synchronization handling of output power" heading	8.0.1	8.1.0
2009-03	RAN#43	R5-091023	0043	-	Test requirements of TDD PDSCH demodulation performance with user-specific reference symbols	8.0.1	8.1.0
2009-03	RAN#43	R5-091024	0044	-	CR to 36.521-1: Update of Annex F.3.2 Measurement of transmitter	8.0.1	8.1.0
2009-03	RAN#43	R5-091025	0045	-	CR to 36.521-1: Update of SEM and Additional SEM test cases	8.0.1	8.1.0
2009-03	RAN#43	R5-091077	0046	-	CR to 36.521-1: Addition of test combinations for test cases with MPR application	8.0.1	8.1.0
2009-03	RAN#43	R5-091082	0047	-	Spurious emission requirements on PHS band including the future plan in Japan	8.0.1	8.1.0
2009-03	RAN#43	R5-091101	0048	-	LTE-RF: CR for MPR test case	8.0.1	8.1.0
2009-03	RAN#43	R5-091106	0049	-	Update of Reference sensitivity test in 7.3	8.0.1	8.1.0
2009-03	RAN#43	R5-091111	0050	1	Update of initial conditions for Rx tests	8.0.1	8.1.0
2009-05	RAN#44	R5-092144	0051	-	LTE-RF: Resubmission of R5-086424 UE output power dynamics 36.521-1 v8.1.0 (re-submit no changes)	8.1.0	8.2.0
2009-05	RAN#44	R5-092146	0052	-	LTE-RF: CR for UE configured UE transmitted output power test case (re-submit no changes)	8.1.0	8.2.0
2009-05	RAN#44	R5-092147	0053	-	LTE-RF: CR for UE minimum output power test case (re-submit no change)	8.1.0	8.2.0
2009-05	RAN#44	R5-092149	0054	-	LTE-RF: CR for Power Control Absolute power tolerance test case (re-submit no changes)	8.1.0	8.2.0
2009-05	RAN#44	R5-092150	0055	-	LTE-RF: CR for Power Control Relative power tolerance test case (re-submit no changes)	8.1.0	8.2.0

2009-05	RAN#44	R5-092151	0056	-	LTE-RF: New test case for Aggregate power control tolerance (re-submit no changes)	8.1.0	8.2.0
2009-05	RAN#44	R5-092263	0057	-	Text proposal for Reporting of Channel State Information	8.1.0	8.2.0
2009-05	RAN#44	R5-092264	0058	-	Propagation conditions for CQI tests	8.1.0	8.2.0
2009-05	RAN#44	R5-092265	0059	-	Correction to Demodulation of PDCCH/PCFICH test cases	8.1.0	8.2.0
2009-05	RAN#44	R5-092273	0060	-	Mapping of downlink physical channels for TDD	8.1.0	8.2.0
2009-05	RAN#44	R5-092277	0061	-	Annex A RMC updates	8.1.0	8.2.0
2009-05	RAN#44	R5-092369	0062	-	Update of A.3.4.3 for RMC with UE-specific RS	8.1.0	8.2.0
2009-05	RAN#44	R5-092372	0063	-	Maintenance on Initial configurations for Perf TCs	8.1.0	8.2.0
2009-05	RAN#44	R5-092436	0064	-	CR to 36.521-1: Update of ACLR test case	8.1.0	8.2.0
2009-05	RAN#44	R5-092442	0065	-	CR to 36.521-1: Update of Spurious Emissions test case	8.1.0	8.2.0
2009-05	RAN#44	R5-092467	0066	-	LTE-RF: Transmit OFF Power update	8.1.0	8.2.0
2009-05	RAN#44	R5-092473	0067	-	LTE_RF - Update on TC 7.7 Spurious Response (re-submit with no changes)	8.1.0	8.2.0
2009-05	RAN#44	R5-092474	0068	-	LTE_RF - Update on TC 7.9 Spurious Emissions (re-submit with no changes)	8.1.0	8.2.0
2009-05	RAN#44	R5-092527	0069	-	Update of TDD PDSCH test cases	8.1.0	8.2.0
2009-05	RAN#44	R5-092602	0070	-	LTE-RF: CR for Maximum Power Reduction test case (re-submit no changes)	8.1.0	8.2.0
2009-05	RAN#44	R5-092603	0071	-	TP for Demodulation of TDD PDCCH/PCFICH	8.1.0	8.2.0
2009-05	RAN#44	R5-092605	0072	-	Mapping of uplink physical channels for FDD	8.1.0	8.2.0
2009-05	RAN#44	R5-092606	0073	-	Update of Annex C	8.1.0	8.2.0
2009-05	RAN#44	R5-092607	0074	-	CR to 36.521-1: Update of test parameters for Demodulation of PDSCH (FDD) tests	8.1.0	8.2.0
2009-05	RAN#44	R5-092614	0075	-	Update of SEM test case	8.1.0	8.2.0
2009-05	RAN#44	R5-092642	0076	-	Update of transmit quality test cases	8.1.0	8.2.0
2009-05	RAN#44	R5-092643	0077	-	Text proposal for TDD part of CQI Reporting under Fading conditions	8.1.0	8.2.0
2009-05	RAN#44	R5-092644	0078	-	Text proposal for TDD part of CQI Reporting under AWGN conditions	8.1.0	8.2.0
2009-05	RAN#44	R5-092645	0079	-	LTE-RF: Update of Additional Spectrum Emission mask Test case with TDD Uplink Test configuration	8.1.0	8.2.0
2009-05	RAN#44	R5-092649	0080	-	LTE-RF: CR for TDD DL RMC to be used in TX test cases	8.1.0	8.2.0
2009-05	RAN#44	R5-092653	0081	-	LTE-RF: CR for Additional Maximum Power Reduction test case	8.1.0	8.2.0
2009-05	RAN#44	R5-092661	0082	-	RMC update for PDCCH/PCFICH performance requirement	8.1.0	8.2.0
2009-05	RAN#44	RP-090444	1161	-	Test frequencies for Additional Spurious Emission test case	8.6.0	8.7.0
2009-05	RAN#44	R5-092366	0084	-	Update of 7.3.1	8.1.0	8.2.0
2009-05	RAN#44	R5-092440	0085	-	LTE-RF: CR for UE max output power test case	8.1.0	8.2.0
2009-05	RAN#44	R5-092472	0086	-	LTE_RF - Update on TC 7.6 Blocking Characteristics (re-submit with changes)	8.1.0	8.2.0
2009-05	RAN#44	R5-092636	0087	-	CR to 36.521-1 Addition of frequencies for band 18 and band 19	8.1.0	8.2.0
2009-05	RAN#44	R5-092652	0088	2	Improved stability of TC 7.8.5 Power Control in the DL from F-DPCH to HSDPA TC 5.2D and 5.13.2B	8.1.0	8.2.0
-	-	-	-	-	Editorial corrections	8.2.0	8.2.1
2009-09	RAN#45	R5-094032	0089	-	Correction CR to 36.521-1: Update of Requirements for Demodulation of PDSCH (FDD) tests	8.2.1	8.3.0
2009-09	RAN#45	R5-094034	0090	-	Correction CR to 36.521-1: Update of General Requirements for Demodulation tests	8.2.1	8.3.0
2009-09	RAN#45	R5-094214	0091	-	Update of In-band emissions	8.2.1	8.3.0
2009-09	RAN#45	R5-094215	0092	-	TDD Initial downlink channel setting	8.2.1	8.3.0
2009-09	RAN#45	R5-094216	0093	-	Correction to Annex B	8.2.1	8.3.0
2009-09	RAN#45	R5-094248	0094	-	CR to 36.521-1: Update to ACLR test case	8.2.1	8.3.0
2009-09	RAN#45	R5-094250	0095	-	CR to 36.521-1: Update to UE max output power test case	8.2.1	8.3.0
2009-09	RAN#45	R5-094281	0096	-	Mapping of uplink physical channels for TDD	8.2.1	8.3.0
2009-09	RAN#45	R5-094282	0097	-	LTE-RF: CR for notes in TDD DL RMC to be used in TX test cases	8.2.1	8.3.0
2009-09	RAN#45	R5-094283	0098	-	LTE-RF: message update to keep Tx power constant for some Rx test cases	8.2.1	8.3.0
2009-09	RAN#45	R5-094313	0099	-	LTE-RF: CR to test case for Aggregate power control tolerance	8.2.1	8.3.0
2009-09	RAN#45	R5-094317	0100	-	LTE-RF: CR for UE minimum output power test case for TDD	8.2.1	8.3.0
2009-09	RAN#45	R5-094318	0101	-	LTE-RF: CR for Power Control Relative power tolerance test case	8.2.1	8.3.0
2009-09	RAN#45	R5-094319	0102	-	In band emission for non-allocated RB	8.2.1	8.3.0
2009-09	RAN#45	R5-094320	0103	-	LTE RF: correction for subclause 6.6.2.2.5 (A-SEM) supported band list	8.2.1	8.3.0
2009-09	RAN#45	R5-094362	0104	-	Correction of RMCs (36.521 Annex A)	8.2.1	8.3.0
2009-09	RAN#45	R5-094363	0105	-	Usage of the Global In-Channels TX-Test across different Signal Quality tests.	8.2.1	8.3.0
2009-09	RAN#45	R5-094365	0106	-	LTE TX: 1to2 RX antenna	8.2.1	8.3.0
2009-09	RAN#45	R5-094367	0107	-	Correction to 6.6.2.2 Additional Spectrum Emission Mask	8.2.1	8.3.0

2009-09	RAN#45	R5-094370	0108	-	Correction to 6.6.2.3 ACLR	8.2.1	8.3.0
2009-09	RAN#45	R5-094371	0109	-	Correction to 6.7 TX Intermodulation	8.2.1	8.3.0
2009-09	RAN#45	R5-094374	0110	-	Correction to 7.6.1 In-Band Blocking	8.2.1	8.3.0
2009-09	RAN#45	R5-094375	0111	-	UE category (36.521 clause 8)	8.2.1	8.3.0
2009-09	RAN#45	R5-094378	0112	-	Completion of Global in-Channel TX-Test (36.521 Annex E)	8.2.1	8.3.0
2009-09	RAN#45	R5-094379	0113	-	Completion of Global in-Channel TX-Test with PRACH (36.521 Annex E)	8.2.1	8.3.0
2009-09	RAN#45	R5-094380	0114	-	Completion of Statistical testing (36.521 Annex G)	8.2.1	8.3.0
2009-09	RAN#45	R5-094385	0115	-	Correction to Annex D.2 Interference signals	8.2.1	8.3.0
2009-09	RAN#45	R5-094439	0116	-	Update for ACS	8.2.1	8.3.0
2009-09	RAN#45	R5-094661	0117	-	LTE RF - Core update on TC7.6.2 Out-of-band Blocking	8.2.1	8.3.0
2009-09	RAN#45	R5-094663	0118	-	LTE RF - Symbols Update on UL transmission configurations	8.2.1	8.3.0
2009-09	RAN#45	R5-094665	0119	-	LTE RF - Clarification for Test Configurations in General Section	8.2.1	8.3.0
2009-09	RAN#45	R5-094668	0120	-	LTE RF - Applicability of 6.2.3 MPR	8.2.1	8.3.0
2009-09	RAN#45	R5-094671	0121	-	LTE RF - Verification of UE Output Power in Out of Band Emission tests	8.2.1	8.3.0
2009-09	RAN#45	R5-094684	0122	-	CR to 36.521-1: Update to UE max output power test case	8.2.1	8.3.0
2009-09	RAN#45	R5-094686	0123	-	LTE-RF CR to 36.521-1: Update the E-UTRA channel numbers	8.2.1	8.3.0
2009-09	RAN#45	R5-094687	0124	-	LTE-RF: CR for UE maximum power reduction(MPR) test case	8.2.1	8.3.0
2009-09	RAN#45	R5-094699	0125	-	Update to SEM and spurious emissions TC	8.2.1	8.3.0
2009-09	RAN#45	R5-094706	0126	-	Resubmission-Update to the Requirements for frequency-selective fading test	8.2.1	8.3.0
2009-09	RAN#45	R5-094717	0127	-	Update of SEM	8.2.1	8.3.0
2009-09	RAN#45	R5-094718	0128	-	Update of initial conditions with Annex references	8.2.1	8.3.0
2009-09	RAN#45	R5-094721	0129	-	Update of 6.7 Tx Inter Mod	8.2.1	8.3.0
2009-09	RAN#45	R5-094725	0130	-	Correction to E-UTRA channel numbers for Band 2	8.2.1	8.3.0
2009-09	RAN#45	R5-094726	0131	-	Correction to Tx spurious emissions	8.2.1	8.3.0
2009-09	RAN#45	R5-094757	0132	-	Update of TDD PHICH test cases	8.2.1	8.3.0
2009-09	RAN#45	R5-094874	0133	-	Correction to Demodulation of PDCCH/PCFICH test cases	8.2.1	8.3.0
2009-09	RAN#45	R5-094902	0134	-	Addition of 15 MHz and 20 MHz bandwidths and corresponding sensitivity requirements into band 38	8.2.1	8.3.0
2009-09	RAN#45	R5-094903	0135	-	Correction CR to 36.521-1: Update of Transmitter tests network signalled parameter value	8.2.1	8.3.0
2009-09	RAN#45	R5-094905	0136	-	Update of TDD PDSCH test cases	8.2.1	8.3.0
2009-09	RAN#45	R5-094908	0137	-	LTE-RF: CR for Power Control Absolute power tolerance test case	8.2.1	8.3.0
2009-09	RAN#45	R5-094909	0138	-	Update to Output Power dynamics test cases	8.2.1	8.3.0
2009-09	RAN#45	R5-094913	0139	-	Clarification for downlink signal setting in RX tests	8.2.1	8.3.0
2009-09	RAN#45	R5-094914	0140	-	UL RB allocation for receiver tests	8.2.1	8.3.0
2009-09	RAN#45	R5-094915	0141	-	Update of TDD PCFICH/PDCCH test cases	8.2.1	8.3.0
2009-09	RAN#45	R5-094921	0142	-	Correction to CQI performance test case	8.2.1	8.3.0
2009-09	RAN#45	R5-094922	0143	-	Test description for CQI test cases under AWGN conditions	8.2.1	8.3.0
2009-09	RAN#45	R5-094923	0144	-	Resubmission - Requirements for PMI reporting ( Single and Multiple PMI)	8.2.1	8.3.0
2009-09	RAN#45	R5-094966	0145	-	CR to 36.521-1: Addition of A-MPR for band 19	8.2.1	8.3.0
2009-09	RAN#45	R5-094976	0146	-	Without loop back: 6.2.2 UE maximum output power	8.2.1	8.3.0
2009-09	RAN#45	R5-094977	0147	-	Without loop back: 6.3.2 Minimum output power	8.2.1	8.3.0
2009-09	RAN#45	R5-094979	0148	-	LTE-RF: CR for UE configured UE transmitted output power test case	8.2.1	8.3.0
2009-09	RAN#45	R5-094980	0149	-	CR to 36.521-1: Definition of Maximum Power state in TX/RX test cases	8.2.1	8.3.0
2009-09	RAN#45	R5-094982	0150	1	Correction of Tx general description	8.2.1	8.3.0
2009-09	RAN#45	R5-094986	0151	-	Update of 6.6.1 OOBW	8.2.1	8.3.0
2009-09	RAN#45	R5-094989	0152	-	Correction to 1PRB tests in Demodulation of PDSCH	8.2.1	8.3.0
2009-09	RAN#45	R5-094995	0153	-	Correction CR to 36.521-1: Update of Requirements for Additional Maximum Power Reduction (A-MPR) test	8.2.1	8.3.0
2009-09	RAN#45	R5-094996	0154	-	Correction to Demodulation of PHICH test cases	8.2.1	8.3.0
2009-09	RAN#45	R5-094997	0155	-	EVM TC update	8.2.1	8.3.0
2009-09	RAN#45	R5-095300	0156	-	LTE-RF: test description update	8.2.1	8.3.0
2009-09	RAN#45	R5-095301	0157	-	Correction CR to 36.521-1: Addition of measurement uncertainty and test tolerances for A-MPR	8.2.1	8.3.0
2009-09	RAN#45	R5-095304	0158	-	Sorting out Demodulation of PDSCH for FDD	8.2.1	8.3.0
2009-09	-	-	-	-	TOC update and Annexes' titles formatings	8.3.0	8.3.1
2009-12	RAN#46	R5-095515	0159	-	Correction CR to 36.521-1: Additional Spectrum Emission Mask test need to be updated to include the network signalled value "NS_07ø message contents exceptions	8.3.1	8.4.0
2009-12	RAN#46	R5-095589	0160	-	Update for test period description in the general section	8.3.1	8.4.0
2009-12	RAN#46	R5-095657	0161	-	LTE-RF: CR for Power Control Absolute power tolerance test case	8.3.1	8.4.0
2009-12	RAN#46	R5-095661	0162	-	LTE-RF: CR for UE minimum output power test case	8.3.1	8.4.0

2009-12	RAN#46	R5-095735	0163	-	Corrections to Annex A.4	8.3.1	8.4.0
2009-12	RAN#46	R5-095766	0164	-	LTE-RF: CR for In band emission for non-allocated RB	8.3.1	8.4.0
2009-12	RAN#46	R5-095790	0165	-	Completion of Statistical testing (36.521 Annex G)	8.3.1	8.4.0
2009-12	RAN#46	R5-095791	0166	-	Corrections to Annex E	8.3.1	8.4.0
2009-12	RAN#46	R5-096058	0167	-	Removal of [ ] from 7.6.1, 7.8.1, and 7.5 of Annex F3.3	8.3.1	8.4.0
2009-12	RAN#46	R5-096096	0168	-	Update on 8.2.1	8.3.1	8.4.0
2009-12	RAN#46	R5-096105	0169	-	LTE RF: Symbols Update on Configured UE Transmitted Power	8.3.1	8.4.0
2009-12	RAN#46	R5-096204	0170	-	LTE-RF: CR to Transmission signal quality	8.3.1	8.4.0
2009-12	RAN#46	R5-096208	0171	-	LTE-RF: CR for Power Control Relative power tolerance test case	8.3.1	8.4.0
2009-12	RAN#46	R5-096210	0172	-	LTE-RF: CR to ON/OFF Time mask test cases	8.3.1	8.4.0
2009-12	RAN#46	R5-096211	0173	-	Measurement period for TX-Tests	8.3.1	8.4.0
2009-12	RAN#46	R5-096213	0174	-	CR to 36.521-1: Update to Spurious Emissions test cases	8.3.1	8.4.0
2009-12	RAN#46	R5-096214	0175	-	CR to 36.521-1: Update to ACLR test case	8.3.1	8.4.0
2009-12	RAN#46	R5-096219	0176	-	LTE-RF: CR for UE configured UE transmitted output power test case	8.3.1	8.4.0
2009-12	RAN#46	R5-096222	0177	-	Test description for CQI test cases under AWGN conditions	8.3.1	8.4.0
2009-12	RAN#46	R5-096223	0178	-	LTE RF: Blocking Characteristics update	8.3.1	8.4.0
2009-12	RAN#46	R5-096224	0179	-	LTE RF: Spurious Response Update	8.3.1	8.4.0
2009-12	RAN#46	R5-096228	0180	-	LTE-RF: CR for MPR test case	8.3.1	8.4.0
2009-12	RAN#46	R5-096229	0204	2	CR to 36.521-1: Update to A-MPR test case	8.3.1	8.4.0
2009-12	RAN#46	R5-096230	0181	-	LTE RF: Applicability of 6.2.4 A-MPR	8.3.1	8.4.0
2009-12	RAN#46	R5-096231	0182	-	Correction to Demodulation of PHICH test cases	8.3.1	8.4.0
2009-12	RAN#46	R5-096235	0183	-	Introduction of CQI reporting test with frequency-selective interference	8.3.1	8.4.0
2009-12	RAN#46	R5-096239	0184	-	Update to the test procedure and message contents of TDD PMI reporting test cases	8.3.1	8.4.0
2009-12	RAN#46	R5-096240	0205	-	CR to 36.521-1: Update to Derivation of Test Requirements for A-MPR	8.3.1	8.4.0
2009-12	RAN#46	R5-096241	0185	-	Measurement uncertainties and Test Tolerances for transmit quality test cases	8.3.1	8.4.0
2009-12	RAN#46	R5-096242	0186	-	Update for 36.521-1 Annex A	8.3.1	8.4.0
2009-12	RAN#46	R5-096289	0187	-	CR on 36.521-1, 'Introduction of clause 8.2.1.1 test case uncertainties and Test Tolerances'	8.3.1	8.4.0
2009-12	RAN#46	R5-096306	0188	-	Update to the test procedure of SEM test cases of 36.521-1	8.3.1	8.4.0
2009-12	RAN#46	R5-096311	0189	-	Update of 6.6.1 OBW	8.3.1	8.4.0
2009-12	RAN#46	R5-096312	0190	-	Correction to SEM	8.3.1	8.4.0
2009-12	RAN#46	R5-096313	0191	-	Update of 6.7 Transmit intermodulation	8.3.1	8.4.0
2009-12	RAN#46	R5-096315	0192	-	CR to 36.521-1: Update to UE max output power test case	8.3.1	8.4.0
2009-12	RAN#46	R5-096316	0193	-	CR to 36.521-1: Update to Additional Spurious Emissions test case	8.3.1	8.4.0
2009-12	RAN#46	R5-096317	0194	-	CR to TDD PHICH demodulation test cases	8.3.1	8.4.0
2009-12	RAN#46	R5-096318	0195	-	Correction to FDD PMI reporting test cases	8.3.1	8.4.0
2009-12	RAN#46	R5-096320	0196	-	Tx power range and core update for Receiver tests	8.3.1	8.4.0
2009-12	RAN#46	R5-096322	0197	-	Update on 7.4, 7.5, and 7.8.1	8.3.1	8.4.0
2009-12	RAN#46	R5-096323	0198	-	Introduction of RI reporting test	8.3.1	8.4.0
2009-12	RAN#46	R5-096333	0199	-	Update to 6.5 Transmit signal quality test cases	8.3.1	8.4.0
2009-12	RAN#46	R5-096334	0200	-	LTE-RF: CR for Aggregate power control tolerance test case	8.3.1	8.4.0
2009-12	RAN#46	R5-096335	0201	-	Correction CR to 36.521-1: Update for Demodulation of PDSCH (FDD) tests to correct CR merges results from RAN5#44	8.3.1	8.4.0
2009-12	RAN#46	R5-096336	0206	1	Update TDD PDSCH test cases	8.3.1	8.4.0
2009-12	RAN#46	R5-096338	0202	-	Number of used HARQ processes in DL Performance tests	8.3.1	8.4.0
2009-12	RAN#46	R5-096342	0207	2	Minimum test time for performance tests	8.3.1	8.4.0
2009-12	RAN#46	R5-096718	0203	-	LTE RF: A-SEM update and A-MPR verification	8.3.1	8.4.0
2010-03	RAN#47	R5-100353	0208	-	LTE-RF CR to 36.521-1: TIME MASK test case updated	8.4.0	8.5.0
2010-03	RAN#47	R5-100354	0209	-	LTE-RF: CR for A-MPR notation in NS_07	8.4.0	8.5.0
2010-03	RAN#47	R5-100403	0210	-	LTE-RF: CR for Tx Intermodulation test case	8.4.0	8.5.0
2010-03	RAN#47	R5-100404	0211	-	LTE-RF: CR for OBW measurement period alignment	8.4.0	8.5.0
2010-03	RAN#47	R5-100408	0212	-	Reporting mode, Reporting Interval and Editorial corrections for demodulation	8.4.0	8.5.0
2010-03	RAN#47	R5-100456	0213	-	Misc update on MAC padding in Rx and performance sections	8.4.0	8.5.0
2010-03	RAN#47	R5-100566	0214	-	Missing Test limits in 36.521-1 Annex G	8.4.0	8.5.0
2010-03	RAN#47	R5-100567	0215	-	Wrong references from 36.521-1 clauses 8.4 and 8.5 into Annex G	8.4.0	8.5.0
2010-03	RAN#47	R5-100569	0216	-	Typos in 36.521-1, Annex E	8.4.0	8.5.0
2010-03	RAN#47	R5-100571	0217	-	Minimum test time for performance tests	8.4.0	8.5.0
2010-03	RAN#47	R5-100572	0218	-	Correction to 6.6.3.3 Additional spurious emissions	8.4.0	8.5.0
2010-03	RAN#47	R5-100790	0219	-	DL-RMC-s for transmitter tests: Corrections	8.4.0	8.5.0
2010-03	RAN#47	R5-100800	0220	-	Update of Test environment for RF test	8.4.0	8.5.0
2010-03	RAN#47	R5-100803	0221	-	Spectrum emission mask: Correction to uplink configuration	8.4.0	8.5.0

2010-03	RAN#47	R5-100807	0222	-	Performance tests: Scheduling of retransmissions	8.4.0	8.5.0
2010-03	RAN#47	R5-100810	0223	-	UL-RMC-s: Corrections and completion	8.4.0	8.5.0
2010-03	RAN#47	R5-100814	0224	-	Corrections to CI 5.4.2.1 of TS 36.521-1	8.4.0	8.5.0
2010-03	RAN#47	R5-100815	0225	-	LTE-RF: CR for UE configured UE transmitted output power test case	8.4.0	8.5.0
2010-03	RAN#47	R5-100816	0226	-	LTE-RF: CR for Power Control Relative power tolerance test case	8.4.0	8.5.0
2010-03	RAN#47	R5-100822	0227	-	CR to 36.521-1: Update to Maximum output power	8.4.0	8.5.0
2010-03	RAN#47	R5-100823	0228	-	CR to 36.521-1: Update to ACLR test case	8.4.0	8.5.0
2010-03	RAN#47	R5-100825	0229	-	CR to 36.521-1: Update to Additional Tx spurious emissions test case	8.4.0	8.5.0
2010-03	RAN#47	R5-100826	0230	-	RMC-s and OCNG patterns: Update according 36.101 8.8.0	8.4.0	8.5.0
2010-03	RAN#47	R5-100827	0231	-	Receiver and performance tests: Update use of OCNG according 36.101 8.8.0	8.4.0	8.5.0
2010-03	RAN#47	R5-100828	0232	-	Update of PDSCH Demodulation Tests	8.4.0	8.5.0
2010-03	RAN#47	R5-100831	0233	-	Introduction of clause 8.2.1.2, 8.2.1.3, 8.2.1.4 test case uncertainties and Test Tolerances	8.4.0	8.5.0
2010-03	RAN#47	R5-100832	0234	-	Clarifications on DRS performance test case	8.4.0	8.5.0
2010-03	RAN#47	R5-100833	0235	-	Misc update on MAC padding in PDCCH, CSI test	8.4.0	8.5.0
2010-03	RAN#47	R5-100834	0236	-	Updates to the TDD portion of CQI reporting test cases under AWGN	8.4.0	8.5.0
2010-03	RAN#47	R5-100838	0237	-	Editorial Correction to 8.2.1.3	8.4.0	8.5.0
2010-03	RAN#47	R5-100839	0238	-	Update on Annex C for 36.521-1	8.4.0	8.5.0
2010-03	RAN#47	R5-100840	0239	-	Update on MAC padding in TDD PMI test case 9.4 of 36.521-1.	8.4.0	8.5.0
2010-03	RAN#47	R5-100841	0240	-	Correction to CQI test cases under AWGN conditions	8.4.0	8.5.0
2010-03	RAN#47	R5-100842	0241	-	Correction to CQI test cases under fading conditions	8.4.0	8.5.0
2010-03	RAN#47	R5-100843	0242	-	Correction to PMI reporting test cases	8.4.0	8.5.0
2010-03	RAN#47	R5-100845	0243	-	CSI: Corrections to tests titles and RI clause structure	8.4.0	8.5.0
2010-03	RAN#47	R5-100848	0244	-	CR to 36.521-1: Update LTE RF test cases with test requirements for extended LTE1500MHz	8.4.0	8.5.0
2010-03	RAN#47	R5-100886	0245	-	Transmitter characteristics: UE Categories and other corrections	8.4.0	8.5.0
2010-03	RAN#47	R5-100887	0246	-	CR to 36.521-1: Update to Tx spurious emissions and Spurious emission band UE co-existence	8.4.0	8.5.0
2010-03	RAN#47	R5-100888	0247	-	Clarification on notes in Max Power	8.4.0	8.5.0
2010-03	RAN#47	R5-100889	0248	-	Maximum input level: Corrections w.r.t. UE categories	8.4.0	8.5.0
2010-03	RAN#47	R5-100891	0249	-	Correction to PDCCH demodulation test cases	8.4.0	8.5.0
2010-03	RAN#47	R5-100892	0250	-	Correction to PHICH demodulation test cases	8.4.0	8.5.0
2010-03	RAN#47	R5-100907	0251	-	Update of RI reporting test case	8.4.0	8.5.0
2010-03	RAN#47	R5-100909	0252	-	Correction to set UL power in Rx TCs	8.4.0	8.5.0
2010-03	RAN#47	-	-	-	Moved to v9.0.0 with no change	8.5.0	9.0.0
2010-06	RAN#48	R5-103102	0253	-	CR to 36.521-1: Update of EARFCN for band 21	9.0.0	9.1.0
2010-06	RAN#48	R5-103103	0254	-	CR to 36.521-1: Update of A-MPR test case with band 21	9.0.0	9.1.0
2010-06	RAN#48	R5-103104	0255	-	CR to 36.521-1: Update of Additional Spurious test case with band 21	9.0.0	9.1.0
2010-06	RAN#48	R5-103106	0256	-	CR to 36.521-1: Update to ACLR test case	9.0.0	9.1.0
2010-06	RAN#48	R5-103108	0257	-	CR to 36.521-1: Update of Reference sensitivity level test case	9.0.0	9.1.0
2010-06	RAN#48	R5-103226	0258	-	CR to 36.521-1: Update of UE RF requirements for LTE, Band 20	9.0.0	9.1.0
2010-06	RAN#48	R5-103263	0259	-	LTE-RF: Updates of PDCCH demodulation test cases (FDD and TDD)	9.0.0	9.1.0
2010-06	RAN#48	R5-103265	0260	-	LTE-RF:CR for TDD ACK/NACK feedback mode in CQI BLER test cases	9.0.0	9.1.0
2010-06	RAN#48	R5-103288	0261	-	PDCCH Aggregation level for RF tests	9.0.0	9.1.0
2010-06	RAN#48	R5-103291	0262	-	Update and correction to UE maximum output power requirements	9.0.0	9.1.0
2010-06	RAN#48	R5-103293	0263	-	Editorial correction in In-band blocking test	9.0.0	9.1.0
2010-06	RAN#48	R5-103296	0264	-	Correction to additional spectrum emission mask test configuration	9.0.0	9.1.0
2010-06	RAN#48	R5-103300	0265	-	Corrections to Uplink RMC-s	9.0.0	9.1.0
2010-06	RAN#48	R5-103450	0266	-	LTE-RF: editorial CR for TC 7.6.2 and 7.7	9.0.0	9.1.0
2010-06	RAN#48	R5-103471	0267	-	Minimum test time for performance tests	9.0.0	9.1.0
2010-06	RAN#48	R5-103476	0268	-	EVM with exclusion period (annex)	9.0.0	9.1.0
2010-06	RAN#48	R5-103521	0269	-	CR on 36.521-1 for updating the "Reporting of Channel State Information"	9.0.0	9.1.0
2010-06	RAN#48	R5-103525	0270	-	CR on 36.521-1 for corrections in UE RF requirements	9.0.0	9.1.0
2010-06	RAN#48	R5-103598	0271	-	Correction to notes in Max Power	9.0.0	9.1.0
2010-06	RAN#48	R5-103602	0272	-	Clarification of measurement conditions for Rx spurious emission	9.0.0	9.1.0
2010-06	RAN#48	R5-103726	0273	-	CR to 36.521-1: Update of Spurious emission band UE co-existence test case	9.0.0	9.1.0
2010-06	RAN#48	R5-103727	0274	-	LTE-RF: CR for Prach time mask test case	9.0.0	9.1.0



2010-06	RAN#48	R5-103728	0275	-	LTE-RF: CR for General ON/OFF time mask test case	9.0.0	9.1.0
2010-06	RAN#48	R5-103729	0276	-	LTE-RF: Update to spectrum flatness test case and relevant annexes	9.0.0	9.1.0
2010-06	RAN#48	R5-103730	0277	-	LTE-RF:CR for test case of In-band emissions	9.0.0	9.1.0
2010-06	RAN#48	R5-103731	0278	-	EVM with exclusion period (test)	9.0.0	9.1.0
2010-06	RAN#48	R5-103732	0279	-	CR to 36.521-1 on Correction to Demodulation Requirements for PDSCH	9.0.0	9.1.0
2010-06	RAN#48	R5-103733	0280	-	CR to 36.521-1: Update PDCCH DCI Formats for Open Loop and Closed Loop Spatial Multiplexing Test Cases	9.0.0	9.1.0
2010-06	RAN#48	R5-103751	0281	-	Misc update in CSI tests	9.0.0	9.1.0
2010-06	RAN#48	R5-103752	0282	-	Correction of the statistical part in PMI and RI tests	9.0.0	9.1.0
2010-06	RAN#48	R5-103753	0283	-	LTE-RF:CR to downlink RMCs for TX characteristics	9.0.0	9.1.0
2010-06	RAN#48	R5-103754	0284	-	LTE-RF: Update of annex C	9.0.0	9.1.0
2010-06	RAN#48	R5-103756	0285	-	Measuring throughput ratios (Annex G)	9.0.0	9.1.0
2010-06	RAN#48	R5-103763	0286	-	LTE-RF: CR for Minimum output power test case	9.0.0	9.1.0
2010-06	RAN#48	R5-103764	0287	-	Performance, CSI reporting and uncertainties for UEs with multiple Rx antennas	9.0.0	9.1.0
2010-06	RAN#48	R5-103771	0288	-	Introduction of clause 8.4.1 and 8.5.1 test case uncertainties and Test Tolerances	9.0.0	9.1.0
2010-06	RAN#48	R5-103778	0291	-	Uplink power for receiver tests	9.0.0	9.1.0
2010-06	RAN#48	R5-103780	0292	1	Addition of the exceptional message for In-band emissions	9.0.0	9.1.0
2010-06	RAN#48	R5-103781	0289	-	Correction to 6.5.2.1 EVM	9.0.0	9.1.0
2010-06	RAN#48	R5-103782	0290	-	Correction to CQI reporting	9.0.0	9.1.0
2010-09	RAN#49	R5-104090	0294	-	Corrections to Spectrum emission mask test regarding UE category	9.1.0	9.2.0
2010-09	RAN#49	R5-104091	0295	-	Missing note in Additional spurious emission test with NS_07	9.1.0	9.2.0
2010-09	RAN#49	R5-104095	0296	-	PDCCH Aggregation level for CSI tests	9.1.0	9.2.0
2010-09	RAN#49	R5-104096	0297	-	Default initial and connection Uplink power for RF tests	9.1.0	9.2.0
2010-09	RAN#49	R5-104212	0298	-	Limits on Uplink power for Receiver tests	9.1.0	9.2.0
2010-09	RAN#49	R5-104244	0299	-	Correction to Demodulation Requirements	9.1.0	9.2.0
2010-09	RAN#49	R5-104461	0300	-	CR to 36.521-1: Editorial Corrections for Closed Loop Spatial Multiplexing Test Cases	9.1.0	9.2.0
2010-09	RAN#49	R5-104478	0301	-	Correction to Test requirements in 6.5.2.2	9.1.0	9.2.0
2010-09	RAN#49	R5-104482	0302	-	Correction to 8.2.1.1	9.1.0	9.2.0
2010-09	RAN#49	R5-104520	0303	-	36521-1 General update of sections 00 to 08: missing Introduction references formatting	9.1.0	9.2.0
2010-09	RAN#49	R5-104583	0304	-	No necessity to apply - consecutive time slots for EVM	9.1.0	9.2.0
2010-09	RAN#49	R5-104584	0305	-	Correction to E.4.4 EVM equalizer spectrum flatness	9.1.0	9.2.0
2010-09	RAN#49	R5-104630	0306	-	Correction of table reference in In-band emissions test	9.1.0	9.2.0
2010-09	RAN#49	R5-104808	0307	-	CR to 36.521-1: Update to Additional Spectrum Emission Mask test case	9.1.0	9.2.0
2010-09	RAN#49	R5-104809	0308	-	CR to 36.521-1: Update to Spurious emission band UE co-existence test case	9.1.0	9.2.0
2010-09	RAN#49	R5-104810	0309	-	LTE-RF: CR for Max Output Power	9.1.0	9.2.0
2010-09	RAN#49	R5-104811	0310	-	LTE-RF: CR for Freq Error	9.1.0	9.2.0
2010-09	RAN#49	R5-104812	0311	-	Introduction of exclusion period for PUCCH-EVM test in clause 6.5.3	9.1.0	9.2.0
2010-09	RAN#49	R5-104813	0312	-	Correction to Demodulation UE-Specific Reference Symbols	9.1.0	9.2.0
2010-09	RAN#49	R5-104814	0313	-	Uncertainties and Test Tolerances for CSI Test cases 9.2.1.1 and 9.2.1.2	9.1.0	9.2.0
2010-09	RAN#49	R5-104815	0314	-	Uncertainties and Test Tolerances for CSI Test cases 9.2.2.1 and 9.2.2.2	9.1.0	9.2.0
2010-09	RAN#49	R5-104816	0315	-	UE applicability for CSI test cases	9.1.0	9.2.0
2010-09	RAN#49	R5-104817	0316	-	Update of CQI reporting TCs under fading conditions	9.1.0	9.2.0
2010-09	RAN#49	R5-104818	0317	-	Update of Reporting of Precoding Matrix Indicator TCs	9.1.0	9.2.0
2010-09	RAN#49	R5-104819	0318	-	Correction of the statistical part 9.3.1.1.1 (CQI Reporting under fading conditions)	9.1.0	9.2.0
2010-09	RAN#49	R5-104820	0319	-	Correction of the statistical part 9.3.3.1.1 (CQI Reporting under fading conditions)	9.1.0	9.2.0
2010-09	RAN#49	R5-104821	0320	-	Correction of the statistical part 9.3.2.1.1 (CQI Reporting under fading conditions)	9.1.0	9.2.0
2010-09	RAN#49	R5-104822	0321	-	Update and new RMC-s for CQI tests	9.1.0	9.2.0
2010-09	RAN#49	R5-104823	0322	-	Correction of EVM calculation in annex	9.1.0	9.2.0
2010-09	RAN#49	R5-104824	0323	-	Introduction of exclusion period for PUCCH-EVM test in Annex E	9.1.0	9.2.0
2010-09	RAN#49	R5-104844	0324	-	Pcmx changes to Configured UE Transmitted Output Power	9.1.0	9.2.0
2010-09	RAN#49	R5-104845	0325	-	Clarification on the frequency range with net work signal in 6.6.3.2	9.1.0	9.2.0
2010-09	RAN#49	R5-104846	0326	-	Update of editor's notes	9.1.0	9.2.0
2010-09	RAN#49	R5-104847	0327	-	Removal of Extreme Conditions in 6.2.3	9.1.0	9.2.0
2010-09	RAN#49	R5-104850	0328	-	Corrections to Test procedure loop in CSI tests	9.1.0	9.2.0
2010-09	RAN#49	R5-104851	0329	-	Introduction of TDD CQI Reporting under fading conditions and frequency-selective interference test case	9.1.0	9.2.0

2010-09	RAN#49	R5-104852	0330	-	Introduction of TDD RI Reporting test case	9.1.0	9.2.0
2010-09	RAN#49	R5-104853	0331	-	Update of CQI reporting TCs under AWGN conditions	9.1.0	9.2.0
2010-09	RAN#49	R5-104854	0332	-	Update of FDD RI Reporting TC	9.1.0	9.2.0
2010-09	RAN#49	R5-104857	0333	-	CR to 36.521-1 LTE UE Tx_RX test cases band 20	9.1.0	9.2.0
2010-09	RAN#49	R5-104861	0334	-	Corrections to Test requirements for MPR test	9.1.0	9.2.0
2010-09	RAN#49	R5-104863	0335	-	Clarification on notes in Max Power	9.1.0	9.2.0
2010-09	RAN#49	R5-104872	0336	-	Correction to 6.3.5.2	9.1.0	9.2.0
2010-09	RAN#49	R5-104873	0337	-	Numbering and alignment of TDD PHICH demod test cases	9.1.0	9.2.0
2010-09	RAN#49	R5-104874	0338	-	Correction to test numbering for exceptional messages in 8.2.x.x	9.1.0	9.2.0
2010-09	RAN#49	R5-104875	0339	-	Correction to 9.2.2	9.1.0	9.2.0
2010-09	RAN#49	R5-104876	0340	-	Correction to the test procedures of 9.3.x	9.1.0	9.2.0
2010-09	RAN#49	R5-104877	0341	-	Correction to 9.4.x	9.1.0	9.2.0
2010-09	RAN#49	R5-104878	0342	-	The new reference of connection diagram for 9.3.3	9.1.0	9.2.0
2010-09	RAN#49	R5-104879	0343	-	Correction to 6.3.4.1 and 6.3.5.1	9.1.0	9.2.0
2010-09	RAN#49	R5-104888	0344	-	Update of Annex C.2 for AG level	9.1.0	9.2.0
2010-09	RAN#49	R5-105055	0345	-	Introduction of a new RF test case (8.7) to verify downlink sustained data rate performance	9.1.0	9.2.0
2010-09	RAN#49	R5-105061	0347	-	CR to 36.521-1: Modification to Additional Maximum Power Reduction Test Case	9.1.0	9.2.0
2010-09	RAN#49	R5-105062	0348	-	Modification to Additional Spectrum Emission Mask	9.1.0	9.2.0
2010-09	RAN#49	R5-105063	0349	-	Modification to Additional Spurious Emissions	9.1.0	9.2.0
2010-09	RAN#49	R5-105064	0350	-	Modification to Maximum Power Reduction	9.1.0	9.2.0
2010-09	RAN#49	R5-105065	0351	-	Modification to Adjacent Channel Leakage Power Ratio	9.1.0	9.2.0
2010-09	RAN#49	RP-100987	0352	-	Correction of status for RF performance test case	9.1.0	9.2.0
2010-12	RAN#50	R5-106073	0353	-	Corrections to receiver spurious emissions test	9.2.0	9.3.0
2010-12	RAN#50	R5-106074	0354	-	Update of downlink power for receiver tests	9.2.0	9.3.0
2010-12	RAN#50	R5-106076	0355	-	CQI: Side condition when CQI median equals min or max CQI-values	9.2.0	9.3.0
2010-12	RAN#50	R5-106077	0356	-	Update of the throughput-definition for multi-data stream transmission	9.2.0	9.3.0
2010-12	RAN#50	R5-106078	0357	-	Update of RF OCNG patterns	9.2.0	9.3.0
2010-12	RAN#50	R5-106092	0358	-	Correction of DCI format used in PDSCH performance test 8.2.1.4.2	9.2.0	9.3.0
2010-12	RAN#50	R5-106249	0359	-	CR to 36.521-1: Correction to Spurious emission band UE co-existence test case	9.2.0	9.3.0
2010-12	RAN#50	R5-106250	0360	-	CR to 36.521-1: Correction to Additional Tx spurious emissions test case	9.2.0	9.3.0
2010-12	RAN#50	R5-106374	0361	-	Correction of FDD CQI reporting test under AWGN - PUCCH 1-1	9.2.0	9.3.0
2010-12	RAN#50	R5-106394	0362	-	Correction of clause 9.3.1 and 9.3.3	9.2.0	9.3.0
2010-12	RAN#50	R5-106399	0363	-	"Correction of G.2.5 Pass fail decision rules"	9.2.0	9.3.0
2010-12	RAN#50	R5-106420	0364	-	Introduction of test uncertainties and tolerances for TDD PDSCH DRS test cases	9.2.0	9.3.0
2010-12	RAN#50	R5-106440	0365	-	Correction to unsigned numbers in Annex F.1.2	9.2.0	9.3.0
2010-12	RAN#50	R5-106443	0366	-	Correction to the exceptional messages in 9.4 Reporting of PMI TCs	9.2.0	9.3.0
2010-12	RAN#50	R5-106491	0367	-	CR to 36.521-1: Correction to Table Numbering Error in TDD PDSCH Closed Loop Single/Multi Layer Spatial Multiplexing 2x2	9.2.0	9.3.0
2010-12	RAN#50	R5-106512	0368	-	Transport format table clarification in CSI test cases	9.2.0	9.3.0
2010-12	RAN#50	R5-106801	0369	-	HARQ scheduling in TDD performance tests using special subframes	9.2.0	9.3.0
2010-12	RAN#50	R5-106803	0370	-	Correction to Fading Profiles in TCs 8.4 and 8.5	9.2.0	9.3.0
2010-12	RAN#50	R5-106816	0372	-	CR to 36.521-1: Modification to Spectrum Emissions Mask	9.2.0	9.3.0
2010-12	RAN#50	R5-106817	0373	-	Introduction of test uncertainties and tolerances for TDD PCFICH/PDCCH and PHICH test cases	9.2.0	9.3.0
2010-12	RAN#50	R5-106818	0374	-	Update of TDD PDSCH CRS Demodulation test cases	9.2.0	9.3.0
2010-12	RAN#50	R5-106821	0375	-	PUSCH-EVM with exclusion period	9.2.0	9.3.0
2010-12	RAN#50	R5-106822	0376	-	Maintenance of Band 20 for receiver tests	9.2.0	9.3.0
2010-12	RAN#50	R5-106823	0377	-	Completion of clause 9.3.1 and 9.3.2	9.2.0	9.3.0
2010-12	RAN#50	R5-106824	0378	-	Update of FDD RI Reporting TC	9.2.0	9.3.0
2010-12	RAN#50	R5-106825	0379	-	Correction to 9.2.2 CQI TCs	9.2.0	9.3.0
2010-12	RAN#50	R5-106826	0380	-	G.3.5 on PDCCH&PHICH Minimum Test Times	9.2.0	9.3.0
2010-12	RAN#50	R5-106827	0381	-	Completion of test time and $\frac{T}{T}$ -TT for clauses 9.3 to 9.5	9.2.0	9.3.0
2010-12	RAN#50	R5-106828	0382	-	EVM window length for PRACH	9.2.0	9.3.0
2010-12	RAN#50	R5-106842	0383	-	Modification of TC 8.3.2.1 - TDD PDSCH Single-layer SM Performance (UE-Specific Reference Symbols)	9.2.0	9.3.0
2010-12	RAN#50	R5-106843	0384	-	Power control relative power tolerance: Missing band edge relaxation	9.2.0	9.3.0
2010-12	RAN#50	R5-106844	0385	-	SRS time mask test procedure update	9.2.0	9.3.0
2010-12	RAN#50	R5-106845	0386	-	Correction of TC General ON/OFF time mask	9.2.0	9.3.0

2010-12	RAN#50	R5-106846	0387	-	Update of TDD CQI reporting test under frequency selective interference conditions	9.2.0	9.3.0
2010-12	RAN#50	R5-106847	0388	-	Update of TDD RI reporting test	9.2.0	9.3.0
2010-12	RAN#50	R5-106848	0389	-	lot setting in CQI test clarification	9.2.0	9.3.0
2010-12	RAN#50	R5-106850	0390	-	Correction of Test Uncertainties and Test Tolerances for Reference Sensitivity-Band 4	9.2.0	9.3.0
2010-12	RAN#50	R5-106855	0391	-	Correction to DL and UL RMC configurations in 6.5.1 Frequency Error	9.2.0	9.3.0
2010-12	RAN#50	R5-106858	0392	-	CR to 36.521-1: Update LTE RF test cases with test requirements for EUTRA TDD LTE band 41.	9.2.0	9.3.0
2011-03	RAN#51	R5-110138	0393	-	Spurious emission band co-existence test: Remaining old test requirement table	9.3.0	9.4.0
2011-03	RAN#51	R5-110139	0394	-	Transmit intermodulation test: Interferer offset for Band 20, Bandwidth 20 MHz	9.3.0	9.4.0
2011-03	RAN#51	R5-110141	0395	-	PMI Performance tests: Corrections to test settings	9.3.0	9.4.0
2011-03	RAN#51	R5-110143	0396	-	PDCCH Performance test: Correction to TDD DL RMC-s	9.3.0	9.4.0
2011-03	RAN#51	R5-110144	0397	-	OCNG for RF tests: Updates	9.3.0	9.4.0
2011-03	RAN#51	R5-110158	0398	-	CQI Performance tests: Clarification on subbands used in the test	9.3.0	9.4.0
2011-03	RAN#51	R5-110302	0399	-	LTE RF: PCFICH/PDCCH Transmit Diversity Performance	9.3.0	9.4.0
2011-03	RAN#51	R5-110349	0401	-	Correction of OFF power measurements in 6.3.4 ON/OFF time mask	9.3.0	9.4.0
2011-03	RAN#51	R5-110354	0402	-	Correction of Annex E (Global In-Channel TX-Test)	9.3.0	9.4.0
2011-03	RAN#51	R5-110506	0403	-	Addition of 3500 MHz TDD bands into chapter 5 of 36.521-1	9.3.0	9.4.0
2011-03	RAN#51	R5-110747	0404	-	Updates to section 8.7 DL sustained data rate test case	9.3.0	9.4.0
2011-03	RAN#51	R5-110850	0405	-	Sustained data rate: Definition of UL RMC-s	9.3.0	9.4.0
2011-03	RAN#51	R5-110860	0400	-	Update measurement period from test procedure of 6.2.2	9.3.0	9.4.0
2011-03	RAN#51	R5-110861	0428	-	A-MPR Test requirement update	9.3.0	9.4.0
2011-03	RAN#51	R5-110862	0437	-	Measuring throughput with different payload size.	9.3.0	9.4.0
2011-03	RAN#51	R5-110900	0406	-	Correction to SNR reference in FDD PCFICH/PDCCH Single Antenna Port Performance Test	9.3.0	9.4.0
2011-03	RAN#51	R5-110901	0407	-	CR to 36.521-1: Correction of Additional Maximum Power Reduction (A-MPR) test case	9.3.0	9.4.0
2011-03	RAN#51	R5-110915	0408	-	Uncertainties and Test Tolerances for CSI Test cases 9.3.1.1.x and 9.3.2.1.x	9.3.0	9.4.0
2011-03	RAN#51	R5-110916	0409	-	Uncertainties and Test Tolerances for CSI Test cases 9.3.3.1.x	9.3.0	9.4.0
2011-03	RAN#51	R5-110917	0410	-	Uncertainties and Test Tolerances for CSI Test cases 9.4.1.1.x and 9.4.2.1.x	9.3.0	9.4.0
2011-03	RAN#51	R5-110918	0411	-	Uncertainties and Test Tolerances for CSI Test cases 9.5.1.x	9.3.0	9.4.0
2011-03	RAN#51	R5-110919	0412	-	Editorial errors in CSI test cases 9.2.1.x Test procedure	9.3.0	9.4.0
2011-03	RAN#51	R5-110933	0413	-	Handling of different releases in RAN5 LTE RF specification	9.3.0	9.4.0
2011-03	RAN#51	R5-110938	0414	-	PRACH Time mask and EVM tests: TDD Special subframe configuration	9.3.0	9.4.0
2011-03	RAN#51	R5-110939	0415	-	Update on PRACH time mask for TDD	9.3.0	9.4.0
2011-03	RAN#51	R5-110940	0416	-	Correction of the connection diagram reference in the initial conditions for Transmitter Characteristics	9.3.0	9.4.0
2011-03	RAN#51	R5-110941	0417	-	Update of the reference sensitivity requirement for the 1.4MHz and 3MHz bandwidths and note correction for Band 3 and Band 9	9.3.0	9.4.0
2011-03	RAN#51	R5-110942	0418	-	CR Removing brackets of band 41 reference sensitivity in 36.521-1	9.3.0	9.4.0
2011-03	RAN#51	R5-110949	0419	-	PDCCH and PHICH performance tests: Updates and corrections	9.3.0	9.4.0
2011-03	RAN#51	R5-110950	0420	-	Addition of CodeBookSubsetRestriction bitmap for Multi-Layer Spatial Multiplexing	9.3.0	9.4.0
2011-03	RAN#51	R5-110951	0421	-	Addition of exceptional message in 8.4.1.2.2	9.3.0	9.4.0
2011-03	RAN#51	R5-110952	0422	-	CQI test 9.2.2.2: Update acc TS 36.101	9.3.0	9.4.0
2011-03	RAN#51	R5-110953	0423	-	Maximum input level test: Correction to DL-RMC	9.3.0	9.4.0
2011-03	RAN#51	R5-110954	0424	-	Correction of E.7, EVM with exclusion period	9.3.0	9.4.0
2011-03	RAN#51	R5-110967	0425	-	Updates to Additional Spurious emissions and Spurious emission band UE co-existence test	9.3.0	9.4.0
2011-03	RAN#51	R5-110970	0426	-	LTE RF: references to state 3A in 36.521-1	9.3.0	9.4.0
2011-03	RAN#51	R5-110973	0429	-	RI Performance tests: Corrections	9.3.0	9.4.0
2011-03	RAN#51	R5-110975	0430	-	Completion of annex G.3.5 (Minimum test time, performance tests)	9.3.0	9.4.0
2011-03	RAN#51	R5-110978	0431	-	Correction to Band 12 frequency range	9.3.0	9.4.0
2011-03	RAN#51	R5-110979	0432	-	Additional in-band blocking requirement for Band 12	9.3.0	9.4.0
2011-03	RAN#51	R5-110989	0433	-	Completion of annex G.3.6 (test conditions, performance tests)	9.3.0	9.4.0
2011-03	RAN#51	R5-110990	0434	-	Addition of test cases of TDD PDSCH Single-layer and Dual-layer Spatial Multiplexing Performance	9.3.0	9.4.0
2011-03	RAN#51	R5-110991	0435	-	Correction to Times Mask and Power Control tests	9.3.0	9.4.0

2011-03	RAN#51	R5-110992	0436	-	Add requirement of QPSK with partial RB allocation into test requirement of 6.2.3	9.3.0	9.4.0
2011-04	-	-	-	-	Added approved R5-110967 which was missing.	9.4.0	9.4.1
2011-06	RAN#52	R5-112148	0438	-	ON/OFF time mask for PRACH: PRACH configuration index	9.4.1	9.5.0
2011-06	RAN#52	R5-112149	0439	-	CQI tests with frequency selective scheduling mode: Random selection of Sub-Bands	9.4.1	9.5.0
2011-06	RAN#52	R5-112150	0440	-	DL-RMC for receiver tests: Obsolete editors note	9.4.1	9.5.0
2011-06	RAN#52	R5-112211	0441	-	Adding Band 24 to TS 36.521-1	9.4.1	9.5.0
2011-06	RAN#52	R5-112311	0442	-	Correction to the sustained data rate tests	9.4.1	9.5.0
2011-06	RAN#52	R5-112312	0443	-	Correction to the multi-antenna transmission tests	9.4.1	9.5.0
2011-06	RAN#52	R5-112349	0444	-	Update Annex G.3.6 for spatial multiplexing test cases	9.4.1	9.5.0
2011-06	RAN#52	R5-112412	0445	-	Correction to DL RMC for Max input for UE category 2	9.4.1	9.5.0
2011-06	RAN#52	R5-112459	0446	-	EVM window length for PRACH	9.4.1	9.5.0
2011-06	RAN#52	R5-112460	0447	-	Removal of square brackets in Annex G.5.4	9.4.1	9.5.0
2011-06	RAN#52	R5-112462	0448	-	Test tolerances for EVM with exclusion period	9.4.1	9.5.0
2011-06	RAN#52	R5-112808	0449	-	LTE RF - UEs Demodulation and CSI Band applicability	9.4.1	9.5.0
2011-06	RAN#52	R5-112810	0450	-	Correction on test requirement of test case 6.5.2.3	9.4.1	9.5.0
2011-06	RAN#52	R5-112811	0451	-	LTE RF - TC6.3.5.2 Change in Minimum Requirements	9.4.1	9.5.0
2011-06	RAN#52	R5-112812	0452	-	Removal of NS values for TDD	9.4.1	9.5.0
2011-06	RAN#52	R5-112813	0453	-	Correction on initial condition for test cases of 9.3.3	9.4.1	9.5.0
2011-06	RAN#52	R5-112814	0454	-	Correction to 9.4 PMI test cases	9.4.1	9.5.0
2011-06	RAN#52	R5-112816	0455	-	Test procedure change on Tx spurious emissions test cases	9.4.1	9.5.0
2011-06	RAN#52	R5-112850	0456	-	Update of Initial conditions according to table 7.3.3-2 for the 5MHz and 10MHz bandwidths	9.4.1	9.5.0
2011-06	RAN#52	R5-112851	0457	-	lot modelling in frequency-selective interference CQI tests	9.4.1	9.5.0
2011-06	RAN#52	R5-112852	0458	-	Correction to test procedure in 9.5.1	9.4.1	9.5.0
2011-06	RAN#52	R5-112859	0459	-	Introduction of additional PDCCH test cases for Rel-9	9.4.1	9.5.0
2011-06	RAN#52	R5-112860	0460	-	Introduction of additional PHICH test cases for Rel-9	9.4.1	9.5.0
2011-06	RAN#52	R5-112861	0461	-	Introducing UE-selected subband CQI tests for Rel-9	9.4.1	9.5.0
2011-06	RAN#52	R5-112862	0462	-	Introduction of new PMI test cases for UE-selected sub-band reporting for Rel-9	9.4.1	9.5.0
2011-06	RAN#52	R5-112863	0463	-	Addition of a new TC for FDD MBMS performance	9.4.1	9.5.0
2011-06	RAN#52	R5-112864	0464	-	Addition of a new TC for TDD MBMS performance	9.4.1	9.5.0
2011-06	RAN#52	R5-112866	0465	-	Addition of UE category 1 coverage for single-layer spatial multiplexing transmission on antenna port 7 or 8	9.4.1	9.5.0
2011-06	RAN#52	R5-112870	0466	-	Removal of square brackets in annex G.3.5 (Minimum test time, performance tests)	9.4.1	9.5.0
2011-06	RAN#52	R5-112871	0467	-	Update minimum requirements and test requirements for spatial multiplexing test cases	9.4.1	9.5.0
2011-06	RAN#52	R5-112873	0468	-	Test procedure change on few Rx test cases	9.4.1	9.5.0
2011-09	RAN#53	R5-113178	0506	-	RF TC 8.7.2: Correction of the ACK/NACK feedback mode	9.5.0	9.6.0
2011-09	RAN#53	R5-113179	0469	-	RF TC-s 9.3.4: Updates to minimum requirements and corrections to test procedures	9.5.0	9.6.0
2011-09	RAN#53	R5-113180	0470	-	RF: New UL RMC for 10 MHz 15RB-s	9.5.0	9.6.0
2011-09	RAN#53	R5-113181	0471	-	RF: Use of State 3A-RF	9.5.0	9.6.0
2011-09	RAN#53	R5-113233	0472	-	LTE RF: EVM Annex E correction	9.5.0	9.6.0
2011-09	RAN#53	R5-113238	0473	-	RF TC 6.3.4.2.2: Correction to CSI configuration	9.5.0	9.6.0
2011-09	RAN#53	R5-113368	0474	-	Correction in test cases of 8.2.2.1.2 and 8.5.1	9.5.0	9.6.0
2011-09	RAN#53	R5-113369	0475	-	Correction in test cases of 9.5	9.5.0	9.6.0
2011-09	RAN#53	R5-113380	0476	-	Update of minimum test time for PCFICH/PDCCH and PHICH tests	9.5.0	9.6.0
2011-09	RAN#53	R5-113383	0477	-	Correction of Table G.3.5-1 (minimum test time)	9.5.0	9.6.0
2011-09	RAN#53	R5-113419	0478	-	Correction for spurious emission band UE co-existence limits of Band 3	9.5.0	9.6.0
2011-09	RAN#53	R5-113454	0479	-	Correction to test procedure in 6.5.1	9.5.0	9.6.0
2011-09	RAN#53	R5-113455	0480	-	Correction to Minimum requirement in 6.6.2.2	9.5.0	9.6.0
2011-09	RAN#53	R5-113456	0481	-	Correction to RMC for PDCCH/PCFICH performance requirements	9.5.0	9.6.0
2011-09	RAN#53	R5-113458	0482	-	Correction to CSI TCs	9.5.0	9.6.0
2011-09	RAN#53	R5-113541	0483	-	Introduction of Expanded 1900MHz Band (Band 25) into section 5 of 36.521-1	9.5.0	9.6.0
2011-09	RAN#53	R5-113596	0506	-	Abbreviation update and Editorial corrections in TS 36.521-1	9.5.0	9.6.0
2011-09	RAN#53	R5-114000	0484	-	Correction in 6.3.5.2 Power Control Relative power tolerance	9.5.0	9.6.0
2011-09	RAN#53	R5-114001	0485	-	Correction in 6.3.4.2.2 SRS time mask	9.5.0	9.6.0
2011-09	RAN#53	R5-114002	0486	-	Addition of PDSCH TDD performance tests for Low UE categories	9.5.0	9.6.0
2011-09	RAN#53	R5-114003	0487	-	Additional FDD scenarios	9.5.0	9.6.0
2011-09	RAN#53	R5-114004	0488	-	Addition of RMC-s for PDSCH performance tests for low UE categories	9.5.0	9.6.0
2011-09	RAN#53	R5-114032	0489	-	Introduction of Expanded 1900MHz Band (Band 25) into section 6 of 36.521-1	9.5.0	9.6.0

2011-09	RAN#53	R5-114033	0490	-	Correction on TDD MBMS performance requirements for 64QAM mode	9.5.0	9.6.0
2011-09	RAN#53	R5-114034	0491	-	Correction on FDD MDMS performance requirements for 64QAM mode	9.5.0	9.6.0
2011-09	RAN#53	R5-114038	0492	-	RF TC 6.3.5.2: Consideration of band edge relaxation in test requirements	9.5.0	9.6.0
2011-09	RAN#53	R5-114039	0493	-	Band 19 A-MPR refinement	9.5.0	9.6.0
2011-09	RAN#53	R5-114040	0494	-	Test system uncertainty and TT for 6.6.3.3 additional spurious emissions NS_07	9.5.0	9.6.0
2011-09	RAN#53	R5-114041	0495	-	Correction to Additional Maximum Power Reduction	9.5.0	9.6.0
2011-09	RAN#53	R5-114042	0496	-	Correction to 6.3.4.2.1 PRACH time mask	9.5.0	9.6.0
2011-09	RAN#53	R5-114043	0497	-	Correction to Receiver Characteristics Minimum Requirements	9.5.0	9.6.0
2011-09	RAN#53	R5-114044	0498	-	Addition of PDSCH FDD performance tests for Low UE categories	9.5.0	9.6.0
2011-09	RAN#53	R5-114045	0499	-	Additional Rel-9 TDD scenarios	9.5.0	9.6.0
2011-09	RAN#53	R5-114046	0500	-	Update of CQI/PMI test cases	9.5.0	9.6.0
2011-09	RAN#53	R5-114047	0501	-	Update of RI test cases	9.5.0	9.6.0
2011-09	RAN#53	R5-114048	0502	-	Release dependent RMCs in PCFICH/PDCCH and PHICH tests	9.5.0	9.6.0
2011-09	RAN#53	R5-114049	0503	-	Addition of tests scenarios in Annex	9.5.0	9.6.0
2011-09	RAN#53	R5-114073	0504	-	Introduction of Expanded 1900MHz Band (Band 25) into section 7 of 36.521-1	9.5.0	9.6.0
2011-09	RAN#53	R5-114091	0505	-	Correction to test cases 10.1 and 10.2	9.5.0	9.6.0
2011-12	RAN#54	R5-115112	0507	-	RF: Coverage of MPR and A-MPR requirements in emissions tests	9.6.0	9.7.0
2011-12	RAN#54	R5-115113	0508	-	RF: Update to names of some RMC-s used in different releases	9.6.0	9.7.0
2011-12	RAN#54	R5-115114	0509	-	RF TC 6.2.4, 6.6.2.2, 6.6.3.3: Corrections to A-MPR related tests	9.6.0	9.7.0
2011-12	RAN#54	R5-115115	0510	-	RF TC-s 9: Corrections to UL allocation for some CQI tests	9.6.0	9.7.0
2011-12	RAN#54	R5-115116	0511	-	RF TC 6.3.5.2: Missing extreme conditions in test requirements	9.6.0	9.7.0
2011-12	RAN#54	R5-115117	0512	-	RF TC 6.2.3: Missing test requirements for band 25	9.6.0	9.7.0
2011-12	RAN#54	R5-115118	0513	-	RF TC 6.5.2.1: Redundant conflicting IE-s in message contents	9.6.0	9.7.0
2011-12	RAN#54	R5-115119	0514	-	RF TC 6.6.3.1: Correction of reference to the connection diagram	9.6.0	9.7.0
2011-12	RAN#54	R5-115324	0517	-	LTE RF: CSI test case update	9.6.0	9.7.0
2011-12	RAN#54	R5-115472	0518	-	Corrections to the dual-layer beamforming demodulation requirements	9.6.0	9.7.0
2011-12	RAN#54	R5-115475	0519	-	Correction to Code Block Numbers	9.6.0	9.7.0
2011-12	RAN#54	R5-115800	0522	-	Delete note in PUSCH-EVM	9.6.0	9.7.0
2011-12	RAN#54	R5-115812	0526	-	RF: Corrections to tests with release dependent requirements	9.6.0	9.7.0
2011-12	RAN#54	R5-115815	0527	-	Test Frequency for Relative Power Tolerance	9.6.0	9.7.0
2011-12	RAN#54	R5-115821	0531	-	RF: General review of the reference measurement channels	9.6.0	9.7.0
2011-12	RAN#54	R5-115822	0532	-	Correction for codebook subset restriction in single-layer closed loop spatial multiplexing test	9.6.0	9.7.0
2011-12	RAN#54	R5-115830	0533	-	Uncertainties and Test Tolerances for 3000MHz to 4200MHz, Tx Test cases	9.6.0	9.7.0
2011-12	RAN#54	R5-115831	0534	-	Uncertainties and Test Tolerances for 3000MHz to 4200MHz, Rx Test cases	9.6.0	9.7.0
2011-12	RAN#54	R5-115832	0535	-	Support for band 22, 42 and 43	9.6.0	9.7.0
2011-12	RAN#54	R5-115837	0536	-	Update LTE RF test cases with test requirements for FDD LTE Band 23 in 36.521-1	9.6.0	9.7.0
2011-12	RAN#54	R5-115875	0537	-	Correction on FDD and TDD MBMS conformance requirements	9.6.0	9.7.0
2011-12	RAN#54	R5-115877	0538	-	Introduction of test system uncertainties and TT to new TCs in clauses 9.3.4 to 9.4.2.2.2	9.6.0	9.7.0
2011-12	RAN#54	R5-115879	0539	-	Uncertainties and Test Tolerances for Sustained data rate test cases	9.6.0	9.7.0
2011-12	RAN#54	R5-115891	0540	-	Requirement change in UE spurious emissions for Band 7 and 38 co-existence (Rel-8 only)	9.6.0	9.7.0
2011-12	RAN#54	R5-115162	0515	-	Definitions, symbols and abbreviations for CA RF	9.7.0	10.0.0
2011-12	RAN#54	R5-115565	0520	-	In-band blocking for CA (New)	9.7.0	10.0.0
2011-12	RAN#54	R5-115568	0521	-	Spurious Response for CA (New)	9.7.0	10.0.0
2011-12	RAN#54	R5-115801	0523	-	Out-of-Band blocking for CA (new)	9.7.0	10.0.0
2011-12	RAN#54	R5-115802	0524	-	Narrow band blocking for CA (new)	9.7.0	10.0.0
2011-12	RAN#54	R5-115803	0525	-	Addition of new RMCs for CA feature related Chapter8 test cases	9.7.0	10.0.0
2011-12	RAN#54	R5-115816	0528	-	General Section for CA RF	9.7.0	10.0.0
2011-12	RAN#54	R5-115817	0529	-	Frequency Band and Channel Assignments for CA RF	9.7.0	10.0.0
2011-12	RAN#54	R5-115818	0530	-	UE Maximum Output Power for intra-band contiguous CA (new)	9.7.0	10.0.0

2012-03	RAN#55	R5-120080	0587	-	Removal of technical content in 36.521-1 v9.7.0 and substitution with pointer to the next Release	10.0.0	10.1.0
2012-03	RAN#55	R5-120134	0541	-	RF: General clarification on the count of ACK / NACKs in throughput calculation in CQI tests	10.0.0	10.1.0
2012-03	RAN#55	R5-120137	0542	-	RF: Corrections to message contents in some MIMO demodulation performance tests	10.0.0	10.1.0
2012-03	RAN#55	R5-120138	0543	-	RF: Updates to handling requirements and tests for different releases	10.0.0	10.1.0
2012-03	RAN#55	R5-120140	0544	-	RF: Coverage of MPR and A-MPR requirements in Tx emissions tests	10.0.0	10.1.0
2012-03	RAN#55	R5-120243	0545	-	Tx Test cases Uplink power limit window for 3000MHz to 4200MHz	10.0.0	10.1.0
2012-03	RAN#55	R5-120244	0546	-	Rx Test cases Uplink power limit window for 3000MHz to 4200MHz	10.0.0	10.1.0
2012-03	RAN#55	R5-120252	0547	-	Global in-channel TX-test, delete note	10.0.0	10.1.0
2012-03	RAN#55	R5-120288	0548	-	LTE RF - Update of abbreviations and addition of RBstart	10.0.0	10.1.0
2012-03	RAN#55	R5-120314	0549	-	Clarification for the starting point of RB in 6.3.5.2 Relative Power test	10.0.0	10.1.0
2012-03	RAN#55	R5-120338	0550	-	Correction to MCS value in Table A.4-3	10.0.0	10.1.0
2012-03	RAN#55	R5-120343	0551	-	Introduction of new maximum input level test case for CA	10.0.0	10.1.0
2012-03	RAN#55	R5-120351	0552	-	CA RF - Changes in aggregated CC configurations	10.0.0	10.1.0
2012-03	RAN#55	R5-120355	0553	-	CA RF - updates to 7.7A Spurious response for CA	10.0.0	10.1.0
2012-03	RAN#55	R5-120370	0554	-	Test Tolerance for 6.6.3.3 additional spurious emissions NS_07	10.0.0	10.1.0
2012-03	RAN#55	R5-120426	0555	-	Correction to Frequency Range for Spurious Emission Requirements	10.0.0	10.1.0
2012-03	RAN#55	R5-120521	0556	-	Introduction to Maximum Power Reduction for CA	10.0.0	10.1.0
2012-03	RAN#55	R5-120524	0557	-	Introduction to Maximum Power Reduction for CA in Annex	10.0.0	10.1.0
2012-03	RAN#55	R5-120526	0558	-	Introduction to Adjacent Channel Leakage power Ratio (ACLR) for CA in Annex	10.0.0	10.1.0
2012-03	RAN#55	R5-120801	0559	-	Correction of TC 6.5.2.1 Error Vector Magnitude (EVM) for Test requirement	10.0.0	10.1.0
2012-03	RAN#55	R5-120802	0560	-	Correction of TC 8.2.1.3.1 FDD PDSCH Open Loop Spatial Multiplexing 2x2 for 8.2.1.3.1.4.1 Initial conditions	10.0.0	10.1.0
2012-03	RAN#55	R5-120803	0561	-	Correction of TC8.2.1.3.2 FDD PDSCH Open Loop Spatial Multiplexing 4x2 for 8.2.1.3.2.4.1 Initial conditions	10.0.0	10.1.0
2012-03	RAN#55	R5-120804	0562	-	Correction of TC 8.2.2.3.1 TDD PDSCH Open Loop Spatial Multiplexing 2x2 for 8.2.2.3.1.4.1 Initial conditions	10.0.0	10.1.0
2012-03	RAN#55	R5-120805	0563	-	Correction of TC 8.2.2.3.2 TDD PDSCH Open Loop Spatial Multiplexing 4x2 for 8.2.2.3.2.4.1 Initial conditions	10.0.0	10.1.0
2012-03	RAN#55	R5-120816	0564	-	Addition of frequency band and channel assignments for UL MIMO	10.0.0	10.1.0
2012-03	RAN#55	R5-120825	0565	-	Introduction of Chapter8 Single antenna port and Open loop spatial Multiplexing test cases for CA capable UE's.	10.0.0	10.1.0
2012-03	RAN#55	R5-120828	0566	-	LTE RF - UE Co-ex test point clarification for bands 7 and 38	10.0.0	10.1.0
2012-03	RAN#55	R5-120833	0567	-	Addition of receiver image section 7.10	10.0.0	10.1.0
2012-03	RAN#55	R5-120835	0568	-	Correction to Reporting of Rank Indicator (RI) FDD Test	10.0.0	10.1.0
2012-03	RAN#55	R5-120837	0569	-	Introduction to Adjacent Channel Leakage power Ratio (ACLR) for CA	10.0.0	10.1.0
2012-03	RAN#55	R5-120839	0570	-	Addition of a new TC 6.2.2B for UE Maximum Output Power for UL-MIMO	10.0.0	10.1.0
2012-03	RAN#55	R5-120842	0571	-	Harmonic exceptions in LTE UE to UE co-existence tests	10.0.0	10.1.0
2012-03	RAN#55	R5-120843	0572	-	Clarification for upper and lower interferers in 7.6.3 Narrow Band Blocking	10.0.0	10.1.0
2012-03	RAN#55	R5-120844	0573	-	RF: Correction of frequency range for out of band blocking test	10.0.0	10.1.0
2012-03	RAN#55	R5-120845	0574	-	Correction and completion to clause 10 MBMS performance	10.0.0	10.1.0
2012-03	RAN#55	R5-120874	0575	-	RF: New RMC-s and updates to the RMC-s overview tables	10.0.0	10.1.0
2012-03	RAN#55	R5-120875	0576	-	RF: Test frequencies for UE co-existence emissions under Note 13	10.0.0	10.1.0
2012-03	RAN#55	R5-120877	0577	-	UE Transmit OFF power for CA	10.0.0	10.1.0
2012-03	RAN#55	R5-120878	0578	-	Frequency error for Intraband CA	10.0.0	10.1.0
2012-03	RAN#55	R5-120879	0579	-	Occupied bandwidth for intra-band contiguous CA	10.0.0	10.1.0
2012-03	RAN#55	R5-120880	0580	-	Transmitter Spurious emissions for CA	10.0.0	10.1.0
2012-03	RAN#55	R5-120881	0581	-	Reference sensitivity level for CA	10.0.0	10.1.0
2012-03	RAN#55	R5-120882	0582	-	CA RF - Addition of test description to 6.2.2A MOP for intra-band CA	10.0.0	10.1.0
2012-03	RAN#55	R5-120884	0583	-	CA RF - updates to 7.6.2A OOB blocking for CA	10.0.0	10.1.0
2012-03	RAN#55	R5-120885	0584	-	CA RF - updates to 7.6.3A Narrow-band blocking for CA	10.0.0	10.1.0
2012-03	RAN#55	R5-120899	0585	-	CA RF - updates to 7.6.1A In-band Blocking for CA	10.0.0	10.1.0
2012-03	RAN#55	R5-120900	0586	-	Correction to UE Spurious Emissions	10.0.0	10.1.0
2012-06	RAN#56	R5-121138	0588	-	Correction of TC 6.3.5.2 Power Control Relative power tolerance	10.1.0	10.2.0
2012-06	RAN#56	R5-121155	0589	-	Correction in test configuration table of sections 7.4 and 7.5	10.1.0	10.2.0

2012-06	RAN#56	R5-121206	0590	-	Correction of test procedure for intermodulation	10.1.0	10.2.0
2012-06	RAN#56	R5-121208	0591	-	Correction of test procedure for out-of-band blocking	10.1.0	10.2.0
2012-06	RAN#56	R5-121221	0592	-	Relative frequency error for CA performance tests	10.1.0	10.2.0
2012-06	RAN#56	R5-121241	0593	-	RF: Corrections to derivation of test requirements for some test points of TC 6.2.4	10.1.0	10.2.0
2012-06	RAN#56	R5-121242	0594	-	RF: Updates to Annex I (Handling of different releases)	10.1.0	10.2.0
2012-06	RAN#56	R5-121253	0595	-	RF: Clarification of test frequencies for UE co-existence emissions under Note 13	10.1.0	10.2.0
2012-06	RAN#56	R5-121254	0596	-	RF: Minor correction to RMC reference in minimum test time annex for TC 8.3.2.1.3	10.1.0	10.2.0
2012-06	RAN#56	R5-121305	0597	-	Removal of test description from Transmit off power for CA and introducing ON/OFF time mask for CA	10.1.0	10.2.0
2012-06	RAN#56	R5-121322	0598	-	Update of 6.3.4.2.2	10.1.0	10.2.0
2012-06	RAN#56	R5-121337	0599	-	Clarifications to Maximum Power Reduction for CA	10.1.0	10.2.0
2012-06	RAN#56	R5-121438	0600	-	Modification to Configured UE transmitted Output Power	10.1.0	10.2.0
2012-06	RAN#56	R5-121451	0601	-	Correction of the Band 23 for UE coexistence requirements	10.1.0	10.2.0
2012-06	RAN#56	R5-121459	0602	-	Correction of RF Test case: 8.7.2.1 TDD sustained data rate performance	10.1.0	10.2.0
2012-06	RAN#56	R5-121463	0603	-	Introduction of Adjacent Channel Selectivity (ACS) for CA	10.1.0	10.2.0
2012-06	RAN#56	R5-121475	0604	-	LTE CA general updates to sections 3 - 5	10.1.0	10.2.0
2012-06	RAN#56	R5-121479	0605	-	CA RF - TC 6.2.2A MOP updates	10.1.0	10.2.0
2012-06	RAN#56	R5-121482	0606	-	CA RF - 7.6.1A In-band blocking updates	10.1.0	10.2.0
2012-06	RAN#56	R5-121483	0607	-	CA RF - 7.6.2A Out-of-band blocking updates	10.1.0	10.2.0
2012-06	RAN#56	R5-121484	0608	-	CA RF - 7.6.3A Narrow-band blocking updates	10.1.0	10.2.0
2012-06	RAN#56	R5-121485	0609	-	CA RF - 7.7A Spurious response updates	10.1.0	10.2.0
2012-06	RAN#56	R5-121488	0610	-	LTE RF - TC 6.6.3.2 UE co-existence requirements correction	10.1.0	10.2.0
2012-06	RAN#56	R5-121523	0611	-	Correction to downlink RB allocation in 7.5.4	10.1.0	10.2.0
2012-06	RAN#56	R5-121525	0612	-	Correction to test requirement in 9.2.2.2	10.1.0	10.2.0
2012-06	RAN#56	R5-121678	0613	-	TS 36.521-1: Spurious emission band UE co-existence alignment	10.1.0	10.2.0
2012-06	RAN#56	R5-121680	0614	-	TS 36.521-1: Applicability correction for 9.3.2.1.1 and 9.3.2.1.2	10.1.0	10.2.0
2012-06	RAN#56	R5-121700	0615	-	Suffix definition of Clause 5 for CA, UL-MIMO, and DL-MIMO for 36.521-1 R-10	10.1.0	10.2.0
2012-06	RAN#56	R5-121903	0616	-	Update of Band 41 RF requirements to align with recent core specification changes	10.1.0	10.2.0
2012-06	RAN#56	R5-121906	0617	-	TS 36.521-1: Introduction of Band 26/XXVI in section 5	10.1.0	10.2.0
2012-06	RAN#56	R5-121907	0618	-	TS 36.521-1: Band 26 Test points for A-MPR test	10.1.0	10.2.0
2012-06	RAN#56	R5-121909	0619	-	CA RF - Adding contents to TC 6.2.4A A-MPR for CA	10.1.0	10.2.0
2012-06	RAN#56	R5-121918	0620	-	TS 36.521-1: Introduction of Band 26/XXVI in section 6	10.1.0	10.2.0
2012-06	RAN#56	R5-121920	0621	-	Corrections of test parameters and test procedure for ACS	10.1.0	10.2.0
2012-06	RAN#56	R5-121921	0622	-	TS 36.521-1: Introduction of Band 26/XXVI in section 7	10.1.0	10.2.0
2012-06	RAN#56	R5-121925	0623	-	CA RF - addition of test case 8.7.2.1A TDD sustained data rate performance for CA	10.1.0	10.2.0
2012-06	RAN#56	R5-121937	0624	-	A-MPR: Band 20, NS_10 not tested	10.1.0	10.2.0
2012-06	RAN#56	R5-121938	0625	-	RF: Several corrections to sustained data rate TC-s 8.7.1 and 8.7.2	10.1.0	10.2.0
2012-06	RAN#56	R5-121939	0626	-	RF: Corrections to CSI tests	10.1.0	10.2.0
2012-06	RAN#56	R5-121944	0627	-	Addition of a new TC 6.3.3B	10.1.0	10.2.0
2012-06	RAN#56	R5-121945	0628	-	Addition of a new TC 6.3.2B for Minimum Output Power for UL-MIMO	10.1.0	10.2.0
2012-06	RAN#56	R5-121946	0629	-	Addition of a new TC 6.3.4B	10.1.0	10.2.0
2012-06	RAN#56	R5-121947	0630	-	Addition of a new TC 6.5.1B for Frequency Error for UL-MIMO	10.1.0	10.2.0
2012-06	RAN#56	R5-121948	0631	-	Addition of a new TC 6.6.1B	10.1.0	10.2.0
2012-06	RAN#56	R5-121949	0632	-	Addition of a new TC 6.7B	10.1.0	10.2.0
2012-06	RAN#56	R5-121950	0633	-	Addition of a new TC for Configured transmitted power for UL-MIMO	10.1.0	10.2.0
2012-06	RAN#56	R5-121951	0634	-	Addition of a new TC for Power Control Absolute Power Tolerance for UL-MIMO	10.1.0	10.2.0
2012-06	RAN#56	R5-121955	0635	-	SEM for CA	10.1.0	10.2.0
2012-06	RAN#56	R5-121956	0636	-	Addition of a new TC for Carrier leakage for UL-MIMO	10.1.0	10.2.0
2012-06	RAN#56	R5-121957	0637	-	Addition of a new TC for In-band emissions for non allocated RB for UL-MIMO	10.1.0	10.2.0
2012-06	RAN#56	R5-121958	0638	-	Addition of a new TC for EVM equalizer spectrum flatness for UL-MIMO	10.1.0	10.2.0
2012-06	RAN#56	R5-121959	0639	-	Addition of a new TC for Reference sensitivity level for UL-MIMO	10.1.0	10.2.0
2012-06	RAN#56	R5-121960	0640	-	Addition of a new TC for Maximum input level for UL-MIMO	10.1.0	10.2.0
2012-06	RAN#56	R5-121961	0641	-	Addition of a new TC for Adjacent Channel Selectivity (ACS) for UL-MIMO	10.1.0	10.2.0
2012-06	RAN#56	R5-121962	0642	-	Addition of a new TC for In-band blocking for UL-MIMO	10.1.0	10.2.0
2012-06	RAN#56	R5-121963	0643	-	Addition of a new TC for Narrow band blocking for UL-MIMO	10.1.0	10.2.0
2012-06	RAN#56	R5-121964	0644	-	Addition of a new TC for Wide band Intermodulation for UL-MIMO	10.1.0	10.2.0

2012-06	RAN#56	R5-121983	0645	-	Introduction of Chapter8 Single antenna port and Open loop spatial Multiplexing TDD test cases for CA capable UEs	10.1.0	10.2.0
2012-06	RAN#56	R5-121984	0646	-	EVM and Global In-Channel TX-Test for intra band CA	10.1.0	10.2.0
2012-06	RAN#56	R5-121985	0647	-	RF: Corrections to applicability of some CA tests	10.1.0	10.2.0
2012-06	RAN#56	R5-121986	0648	-	Addition of test description to Occupied bandwidth for CA	10.1.0	10.2.0
2012-06	RAN#56	R5-121987	0649	-	Addition of test description to ACLR for CA	10.1.0	10.2.0
2012-06	RAN#56	R5-121988	0650	-	Addition of test description to Transmitter Spurious emissions for CA	10.1.0	10.2.0
2012-06	RAN#56	R5-121989	0651	-	Addition of test description to Reference sensitivity level for CA	10.1.0	10.2.0
2012-06	RAN#56	R5-121994	0652	-	Addition of Codebook Subset Restriction in 8.3.2.x	10.1.0	10.2.0
2012-06	RAN#56	R5-121995	0653	-	Update of 6.3.5.2	10.1.0	10.2.0
2012-06	RAN#56	R5-121996	0654	-	TS 36.521-1: 9.4.1.2.1 and 9.4.1.2.2.1 test procedure correction	10.1.0	10.2.0
2012-06	RAN#56	R5-121997	0655	-	TS 36.521-1: Minimum conformance requirements alignments for section 9	10.1.0	10.2.0
2012-06	RAN#56	R5-122003	0656	-	Addition of a new TC for Out-of-band blocking for UL-MIMO	10.1.0	10.2.0
2012-06	RAN#56	R5-122004	0657	-	Addition of a new TC for Spurious response for UL-MIMO	10.1.0	10.2.0
2012-06	RAN#56	R5-122006	0658	-	Addition of a new TC for Error Vector Magnitude for UL-MIMO	10.1.0	10.2.0
2012-09	RAN#57	R5-123136	0659	-	Correction of TC 6.3.5.2	10.2.0	10.3.0
2012-09	RAN#57	R5-123146	0660	-	Corrections to Transmitter Characteristics Requirements	10.2.0	10.3.0
2012-09	RAN#57	R5-123148	0661	-	Correction to SNR definition	10.2.0	10.3.0
2012-09	RAN#57	R5-123150	0662	-	RF: Several editorial corrections	10.2.0	10.3.0
2012-09	RAN#57	R5-123161	0663	-	RF: PDCCH Padding in Rx spurious emissions test	10.2.0	10.3.0
2012-09	RAN#57	R5-123179	0664	-	Introduction of eDL-MIMO to Propagation Conditions	10.2.0	10.3.0
2012-09	RAN#57	R5-123209	0665	-	RF: Alignment of RMC references in test procedure of CSI tests	10.2.0	10.3.0
2012-09	RAN#57	R5-123234	0666	-	LTE RF - Correction to 7.4 and 7.5 UL allocations	10.2.0	10.3.0
2012-09	RAN#57	R5-123239	0667	-	Addition of test description to CA Maximum input level test case	10.2.0	10.3.0
2012-09	RAN#57	R5-123267	0668	-	Correction to Occupied bandwidth for CA	10.2.0	10.3.0
2012-09	RAN#57	R5-123268	0669	-	Correction to Reference sensitivity level for CA	10.2.0	10.3.0
2012-09	RAN#57	R5-123324	0670	-	New Annex for: Statistical testing of receiver performance with throughput for CA	10.2.0	10.3.0
2012-09	RAN#57	R5-123330	0671	-	Correction to test parameters in 6.6.3.2	10.2.0	10.3.0
2012-09	RAN#57	R5-123332	0672	-	Update of section 8 uncertainties and Test Tolerances for Rel-9 Tests	10.2.0	10.3.0
2012-09	RAN#57	R5-123333	0673	-	Clarification of RB allocation for DRS demodulation tests	10.2.0	10.3.0
2012-09	RAN#57	R5-123334	0674	-	Correction to uplink reference measurement channel	10.2.0	10.3.0
2012-09	RAN#57	R5-123386	0675	-	Addition of a new TC for power control relative power tolerance for UL-MIMO	10.2.0	10.3.0
2012-09	RAN#57	R5-123387	0676	-	Addition of a new TC for aggregate power control tolerance for UL-MIMO	10.2.0	10.3.0
2012-09	RAN#57	R5-123392	0677	-	Update carrier frequency and EARFCN	10.2.0	10.3.0
2012-09	RAN#57	R5-123394	0678	-	Update test case of UE maximum output power for UL-MIMO	10.2.0	10.3.0
2012-09	RAN#57	R5-123395	0679	-	Update test case of configured UE transmitted output power for UL-MIMO	10.2.0	10.3.0
2012-09	RAN#57	R5-123397	0680	-	Update test case of power control absolute power tolerance for UL-MIMO	10.2.0	10.3.0
2012-09	RAN#57	R5-123507	0681	-	Editorial corrections to blocking characteristics for CA	10.2.0	10.3.0
2012-09	RAN#57	R5-123510	0682	-	ACLR for UL-MIMO	10.2.0	10.3.0
2012-09	RAN#57	R5-123521	0683	-	TS 36.521-1: A-MPR and additional spurious corrections	10.2.0	10.3.0
2012-09	RAN#57	R5-123522	0684	-	TS 36.521-1: UL allocation clarification in PUSCH-EVM with exclusion period test	10.2.0	10.3.0
2012-09	RAN#57	R5-123523	0685	-	TS 36.521-1: Section 9 applicability revision (UE categories)	10.2.0	10.3.0
2012-09	RAN#57	R5-123534	0687	-	TS 36.521-1:A-MPR Test tolerances update for NS_12, NS_13, NS_14, NS_15	10.2.0	10.3.0
2012-09	RAN#57	R5-123547	0688	-	Correction to the content of reference table number for TC 7.8.1	10.2.0	10.3.0
2012-09	RAN#57	R5-123783	0689	-	Corrections to EVM and global in channel test for Intra-Band CA	10.2.0	10.3.0
2012-09	RAN#57	R5-123850	0690	-	Correction to ONOFF time mask for CA	10.2.0	10.3.0
2012-09	RAN#57	R5-123851	0691	-	Correction to Transmitter Spurious emissions for CA	10.2.0	10.3.0
2012-09	RAN#57	R5-123852	0692	-	New Annex for: Statistical testing of receiver characteristics with CA	10.2.0	10.3.0
2012-09	RAN#57	R5-123853	0693	-	Introduction of eDL-MIMO to measurement of performance requirements	10.2.0	10.3.0
2012-09	RAN#57	R5-123854	0694	-	Addition of a new TC for additional maximum power reduction (A-MPR) for UL-MIMO	10.2.0	10.3.0
2012-09	RAN#57	R5-123855	0695	-	Additional texts for Note2 in Spurious emission test	10.2.0	10.3.0
2012-09	RAN#57	R5-123857	0696	-	Additions to test requirements for Maximum Power Reduction for CA	10.2.0	10.3.0
2012-09	RAN#57	R5-123859	0697	-	Addition of a new TC for time alignment between transmitter branches for UL-MIMO	10.2.0	10.3.0



2012-09	RAN#57	R5-123900	0698	-	Changes associated with PHS band operation change for LTE	10.2.0	10.3.0
2012-09	RAN#57	R5-123901	0699	-	TS 36.521-1: PDSCH RMC for Rel-9 PCFICH test cases	10.2.0	10.3.0
2012-09	RAN#57	R5-123902	0700	-	TS 36.521-1: Adding missing UL RMCs for test 9.4.1.2.2	10.2.0	10.3.0
2012-09	RAN#57	R5-123910	0701	-	MPR for UL-MIMO	10.2.0	10.3.0
2012-09	RAN#57	R5-123911	0702	-	SEM for UL-MIMO	10.2.0	10.3.0
2012-09	RAN#57	R5-123912	0703	-	ADDITIONAL SEM for UL-MIMO	10.2.0	10.3.0
2012-09	RAN#57	R5-123915	0704	-	RF: Update of Annex I	10.2.0	10.3.0
2012-09	RAN#57	R5-123917	0705	-	Correction of test procedure for 36.521-1 chapter 8 CA test cases	10.2.0	10.3.0
2012-09	RAN#57	R5-123919	0706	-	TS 36.521-1: New test cases for CQI reporting under fading conditions - PUCCH 1-0	10.2.0	10.3.0
2012-09	RAN#57	R5-123932	0707	-	RF: Updates to transmission mode 8 test cases	10.2.0	10.3.0
2012-09	RAN#57	R5-123933	0708	-	RF: Several corrections to MBMS performance tests	10.2.0	10.3.0
2012-09	RAN#57	R5-123934	0709	-	Addition of RF Test case: 8.7.2.1_1 TDD sustained data rate performance (Rel-10 and forward)	10.2.0	10.3.0
2012-09	RAN#57	R5-123943	0710	-	Introduction of FDD PMI Reporting - PUSCH 1-2 (Multiple PMI) for eDL-MIMO	10.2.0	10.3.0
2012-09	RAN#57	R5-123944	0711	-	Introduction of TDD PMI Reporting - PUSCH 1-2 (Multiple PMI) for eDL-MIMO	10.2.0	10.3.0
2012-09	RAN#57	R5-123945	0712	-	FDD RI Reporting for eDL-MIMO	10.2.0	10.3.0
2012-09	RAN#57	R5-123946	0713	-	TDD RI Reporting for eDL-MIMO	10.2.0	10.3.0
2012-09	RAN#57	R5-123947	0714	-	Introduction of eDL-MIMO to CSI Reference Measurement Channels	10.2.0	10.3.0
2012-09	RAN#57	R5-123948	0715	-	Introduction of eDL-MIMO to structure of subclauses	10.2.0	10.3.0
2012-09	RAN#57	R5-123950	0716	-	RF-CA: Introduction of new specification structure for Tx tests for CA	10.2.0	10.3.0
2012-09	RAN#57	R5-123951	0717	-	CA RF - TC 6.2.2A update	10.2.0	10.3.0
2012-09	RAN#57	R5-123952	0718	-	CA RF - Updates to Blocking Test Cases	10.2.0	10.3.0
2012-09	RAN#57	R5-123953	0719	-	CA RF - TC 7.7A Spurious Response update	10.2.0	10.3.0
2012-09	RAN#57	R5-123954	0720	-	New RF TC for 36.521-1 _ 6.3.5A.1 Power Control Absolute power tolerance for CA	10.2.0	10.3.0
2012-09	RAN#57	R5-123955	0721	-	New RF TC for 36.521-1 _ 6.3.5A.2 Power Control Relative power tolerance for CA	10.2.0	10.3.0
2012-09	RAN#57	R5-123956	0722	-	Correction to Transmit OFF power for CA	10.2.0	10.3.0
2012-09	RAN#57	R5-123957	0723	-	Adjusting test procedure and test requirements to new Annex G.3A	10.2.0	10.3.0
2012-09	RAN#57	R5-123958	0724	-	Update of Test case 8.7.2.1A TDD sustained data rate performance for CA	10.2.0	10.3.0
2012-09	RAN#57	R5-123961	0725	-	Corrections to A-MPR for CA	10.2.0	10.3.0
2012-09	RAN#57	R5-123962	0726	-	Additions to test description for Adjacent Channel Selectivity (ACS) for CA	10.2.0	10.3.0
2012-09	RAN#57	R5-123963	0727	-	Introduction to UE configured transmitted output power for CA	10.2.0	10.3.0
2012-09	RAN#57	R5-123964	0728	-	Introduction of ACS and UE configured Tx output power for CA in Annex	10.2.0	10.3.0
2012-09	RAN#57	R5-123969	0729	-	Introduction Single-Layer Spatial Multiplexing for eDL-MIMO	10.2.0	10.3.0
2012-09	RAN#57	R5-123970	0730	-	updates to 6.6.2.1A SEM for CA	10.2.0	10.3.0
2012-09	RAN#57	R5-123977	0731	-	Addition of a new TC6.6.3B.1 for Transmitter Spurious emissions for UL-MIMO	10.2.0	10.3.0
2012-09	RAN#57	R5-123978	0732	-	Addition of a new TC6.6.3B.2 for Spurious emission band UE co-existence for UL-MIMO	10.2.0	10.3.0
2012-09	RAN#57	R5-123979	0733	-	Addition of a new TC6.6.3B.3 for Additional spurious emissions for UL-MIMO	10.2.0	10.3.0
2012-09	RAN#57	R5-123980	0734	-	Addition of a new TC for narrow band blocking for UL-MIMO	10.2.0	10.3.0
2012-09	RAN#57	R5-123981	0735	-	Update test case of general ON OFF time mask for UL-MIMO	10.2.0	10.3.0
2012-09	RAN#57	R5-123982	0736	-	Update test case of frequency error for UL-MIMO	10.2.0	10.3.0
2012-09	RAN#57	R5-123983	0737	-	Update test case of Error Vector Magnitude (EVM) for UL-MIMO	10.2.0	10.3.0
2012-09	RAN#57	R5-123984	0738	-	Update test case of carrier leakage for UL-MIMO	10.2.0	10.3.0
2012-09	RAN#57	R5-123985	0739	-	Update test case of in-band emissions for non allocated RB for UL-MIMO	10.2.0	10.3.0
2012-09	RAN#57	R5-123986	0740	-	Update test case of EVM equalizer spectrum flatness for UL-MIMO	10.2.0	10.3.0
2012-09	RAN#57	R5-123987	0741	-	Update test case of reference sensitivity level for UL-MIMO	10.2.0	10.3.0
2012-09	RAN#57	R5-123988	0742	-	Update test case of maximum input level for UL-MIMO	10.2.0	10.3.0
2012-09	RAN#57	R5-123989	0743	-	Update test case of in-band blocking for UL-MIMO	10.2.0	10.3.0
2012-09	RAN#57	R5-123990	0744	-	Update test case of out-of-band blocking for UL-MIMO	10.2.0	10.3.0
2012-09	RAN#57	R5-123991	0745	-	Update test case of spurious response for UL-MIMO	10.2.0	10.3.0
2012-09	RAN#57	R5-123992	0746	-	Update test case of wide band Intermodulation for UL-MIMO	10.2.0	10.3.0
2012-09	RAN#57	R5-123994	0747	-	Update test case of Adjacent Channel Selectivity (ACS) for UL-MIMO	10.2.0	10.3.0
2012-12	RAN#58	R5-125109	0749	-	Update of TC6.6.3B.2 for Spurious emissions band UE co-existence for UL-MIMO	10.3.0	10.4.0

2012-12	RAN#58	R5-125110	0750	-	Update of TC6.6.3B.3 for Additional spurious emissions for UL-MIMO	10.3.0	10.4.0
2012-12	RAN#58	R5-125146	0751	-	Corrections to Test Procedure of TC 6.6.2.3 ACLR	10.3.0	10.4.0
2012-12	RAN#58	R5-125147	0752	-	Updates for TC 6.2.3B MPR for UL-MIMO	10.3.0	10.4.0
2012-12	RAN#58	R5-125148	0753	-	Updates for TC 6.6.2.1B SEM for UL-MIMO	10.3.0	10.4.0
2012-12	RAN#58	R5-125149	0754	-	Updates for TC 6.6.2.2B A-SEM for UL-MIMO	10.3.0	10.4.0
2012-12	RAN#58	R5-125150	0755	-	Updates for TC 6.6.2.3B ACLR for UL-MIMO	10.3.0	10.4.0
2012-12	RAN#58	R5-125215	0756	-	Correction of TC 6.6.2.1	10.3.0	10.4.0
2012-12	RAN#58	R5-125252	0757	-	Adding normative reference for core requirements in TC 6.2.4	10.3.0	10.4.0
2012-12	RAN#58	R5-125253	0758	-	Adding normative reference for core requirements for many section 9 tests	10.3.0	10.4.0
2012-12	RAN#58	R5-125254	0759	-	Correction of table references in sub clause G.X	10.3.0	10.4.0
2012-12	RAN#58	R5-125260	0760	-	CR to TC 7.4A: Splitting the CA Maximum input level test case	10.3.0	10.4.0
2012-12	RAN#58	R5-125263	0761	-	RF CI G.3A: General corrections and completion of Annex G.3A with TDD tests	10.3.0	10.4.0
2012-12	RAN#58	R5-125304	0762	-	Updates for Minimum requirements of 6.2.5 Configured UE transmitted Output Power	10.3.0	10.4.0
2012-12	RAN#58	R5-125309	0763	-	Addition of Band 28 definition to Chap.5	10.3.0	10.4.0
2012-12	RAN#58	R5-125311	0764	-	Addition of Band 28 to 6.2.2 MOP	10.3.0	10.4.0
2012-12	RAN#58	R5-125314	0765	-	Addition of Band 28 to 7.3 Refsens	10.3.0	10.4.0
2012-12	RAN#58	R5-125321	0766	-	Updates for TC6.6.1A: Occupied bandwidth for CA	10.3.0	10.4.0
2012-12	RAN#58	R5-125322	0767	-	Updates for TC6.6.2.3A: ACLR for CA	10.3.0	10.4.0
2012-12	RAN#58	R5-125323	0768	-	Updates for TC6.6.3.1A: Transmitter Spurious emissions for CA	10.3.0	10.4.0
2012-12	RAN#58	R5-125346	0769	-	TC 6.2.4A.1 A-MPR for CA updates	10.3.0	10.4.0
2012-12	RAN#58	R5-125351	0770	-	Correction to LTE Rx TCs UL allocation location	10.3.0	10.4.0
2012-12	RAN#58	R5-125365	0771	-	Uncertainties and Test Tolerances for Rel-9 CQI Reporting under fading conditions, PUCCH 1-0 Tests	10.3.0	10.4.0
2012-12	RAN#58	R5-125374	0772	-	Clean up of Tx tests	10.3.0	10.4.0
2012-12	RAN#58	R5-125405	0773	-	Addition of 15MHz and 20MHz Bandwidths for Band 23	10.3.0	10.4.0
2012-12	RAN#58	R5-125407	0774	-	RF TC 6.6.3.2: Clarification and corrections	10.3.0	10.4.0
2012-12	RAN#58	R5-125417	0775	-	Additions to test description for TC 7.5A.1 Adjacent Channel Selectivity (ACS) for CA (intra-band contiguous DL CA and UL CA)	10.3.0	10.4.0
2012-12	RAN#58	R5-125422	0776	-	Introduction to CA_1 & CA_40 TC 7.5A.2 Adjacent Channel Selectivity (ACS) for CA (intra-band contiguous DL CA without UL CA)	10.3.0	10.4.0
2012-12	RAN#58	R5-125443	0777	-	Corrections of RMC for receiver characteristics	10.3.0	10.4.0
2012-12	RAN#58	R5-125445	0778	-	Corrections of FRC subframe allocations for performance requirements	10.3.0	10.4.0
2012-12	RAN#58	R5-125450	0779	-	Introduction of TC 9.2.2.1_D FDD CQI Reporting under AWGN conditions - PUCCH 1-1 for eDL-MIMO	10.3.0	10.4.0
2012-12	RAN#58	R5-125451	0780	-	Introduction of TC 9.2.2.2_D TDD CQI Reporting under AWGN conditions - PUCCH 1-1 for eDL-MIMO	10.3.0	10.4.0

2012-12	RAN#58	R5-125452	0781	-	Introduction of TC 9.3.2.2.1_D FDD CQI Reporting under fading conditions - PUCCH 1-1 for eDL-MIMO	10.3.0	10.4.0
2012-12	RAN#58	R5-125453	0782	-	Introduction of TC 9.3.2.2.2_D TDD CQI Reporting under fading conditions - PUCCH 1-1 for eDL-MIMO	10.3.0	10.4.0
2012-12	RAN#58	R5-125454	0783	-	Additions of eDL-MIMO to Annex A	10.3.0	10.4.0
2012-12	RAN#58	R5-125455	0784	-	Additions of eDL-MIMO to Annex B Propagation Conditions for eDL-MIMO	10.3.0	10.4.0
2012-12	RAN#58	R5-125456	0785	-	Additions of eDL-MIMO to Annex F	10.3.0	10.4.0
2012-12	RAN#58	R5-125463	0786	-	Additions to TC 9.4.2.1.1_D FDD PMI Reporting - PUSCH 1-2 (Multiple PMI) for eDL-MIMO	10.3.0	10.4.0
2012-12	RAN#58	R5-125464	0787	-	Additions to TC 9.4.2.1.2_D TDD PMI Reporting - PUSCH 1-2 (Multiple PMI) for eDL-MIMO	10.3.0	10.4.0
2012-12	RAN#58	R5-125465	0788	-	Additions to TC 9.5.1.1_D FDD RI Reporting for eDL-MIMO	10.3.0	10.4.0
2012-12	RAN#58	R5-125466	0789	-	Additions to TC 9.5.1.2_D TDD RI Reporting for eDL-MIMO	10.3.0	10.4.0
2012-12	RAN#58	R5-125593	0790	-	RF TC 6.2.4: Minor correction to test points for NS_15	10.3.0	10.4.0
2012-12	RAN#58	R5-125594	0791	-	RF TC 6.2.4B: Minor correction to test points for NS_15	10.3.0	10.4.0
2012-12	RAN#58	R5-125610	0792	-	TS 36-521-1: MPR correction for band 26	10.3.0	10.4.0
2012-12	RAN#58	R5-125801	0793	-	Updates of 6.3.3A UE Transmit OFF power for CA	10.3.0	10.4.0
2012-12	RAN#58	R5-125802	0794	-	Update of Annex F in 36.521-1	10.3.0	10.4.0
2012-12	RAN#58	R5-125803	0795	-	Updates for 6.3.4A ON/OFF time mask for CA	10.3.0	10.4.0
2012-12	RAN#58	R5-125804	0796	-	Addition of Transmitter test case - Transmit intermodulation for CA	10.3.0	10.4.0
2012-12	RAN#58	R5-125835	0797	-	Update of TC6.6.3B.1 for Transmitter Spurious emissions for UL-MIMO	10.3.0	10.4.0
2012-12	RAN#58	R5-125851	0798	-	Introduction of TC 8.3.1.2.1_D FDD PDSCH Dual-layer Spatial Multiplexing for eDL-MIMO	10.3.0	10.4.0
2012-12	RAN#58	R5-125852	0799	-	Introduction of TC 8.3.2.2.1_D TDD PDSCH Dual-layer Spatial Multiplexing for eDL-MIMO	10.3.0	10.4.0
2012-12	RAN#58	R5-125853	0800	-	Additions to Annex G for eDL-MIMO	10.3.0	10.4.0
2012-12	RAN#58	R5-125854	0801	-	Corrections to Annex H for eDL-MIMO	10.3.0	10.4.0
2012-12	RAN#58	R5-125855	0802	-	Additions to TC 8.3.2.1.2_D TDD Single-Layer Spatial Multiplexing on antenna ports without a simultaneous transmission for eDL-MIMO	10.3.0	10.4.0
2012-12	RAN#58	R5-125856	0803	-	Additions to TC 8.3.2.1.3_D TDD Single-Layer Spatial Multiplexing on antenna ports with a simultaneous transmission for eDL-MIMO	10.3.0	10.4.0
2012-12	RAN#58	R5-125857	0804	-	Introduction of Band 27 to TS 36.521-1	10.3.0	10.4.0
2012-12	RAN#58	R5-125858	0805	-	Updates to TC 8.2.2.3.1_A.1 for CA	10.3.0	10.4.0
2012-12	RAN#58	R5-125859	0806	-	Addition of new test case 8.2.1.4.2_A.1 for CA	10.3.0	10.4.0
2012-12	RAN#58	R5-125860	0807	-	Addition of new test case 8.2.2.4.2_A.1 for CA	10.3.0	10.4.0
2012-12	RAN#58	R5-125861	0808	-	Addition of sustained downlink data rate TC 8.7.1.1_A.1 for CA	10.3.0	10.4.0
2012-12	RAN#58	R5-125862	0809	-	Addition of sustained downlink data rate TC 8.7.1.1_A.2 for CA	10.3.0	10.4.0
2012-12	RAN#58	R5-125866	0810	-	Update of RF TC for 36.521-1 _ 6.3.5A.2.1 Power Control Relative power tolerance for CA	10.3.0	10.4.0

2012-12	RAN#58	R5-125867	0811	-	Update TC 6.6.3.2_1 Spurious emission band UE co-existence(Release 9 and forward)	10.3.0	10.4.0
2012-12	RAN#58	R5-125868	0812	-	Correction to test applicability in 6.2.4 A-MPR test case	10.3.0	10.4.0
2012-12	RAN#58	R5-125869	0813	-	Correction to test parameter in Perf 8.2.1 of 36.521-1	10.3.0	10.4.0
2012-12	RAN#58	R5-125870	0814	-	Clarification of AG level for 8.7 sustained data rate test of 36.521-1	10.3.0	10.4.0
2012-12	RAN#58	R5-125871	0815	-	Correction to SNR test points in test procedure	10.3.0	10.4.0
2012-12	RAN#58	R5-125872	0816	-	Clarification of random precoding granularity	10.3.0	10.4.0
2012-12	RAN#58	R5-125873	0817	-	Update of General sections for CA	10.3.0	10.4.0
2012-12	RAN#58	R5-125874	0818	-	Introduction to CA_1-5 TC 7.5A.3 Adjacent Channel Selectivity (ACS) for CA (inter-band DL CA without UL CA)	10.3.0	10.4.0
2012-12	RAN#58	R5-125875	0819	-	Addition of a new TC 6.3.5A.3.1 Aggregate power control tolerance for CA(intra-band contiguous DL CA and UL CA)	10.3.0	10.4.0
2012-12	RAN#58	R5-125876	0820	-	Addition of a new TC 6.6.3.2A.1 Spurious emission band UE co-existence for CA(intra-band contiguous DL CA and UL CA)	10.3.0	10.4.0
2012-12	RAN#58	R5-125890	0821	-	Addition of Band 28 to 6.6.3.2 Spurious emission band UE co-existence	10.3.0	10.4.0
2012-12	RAN#58	R5-125891	0822	-	Addition of Band 28 to 6.6.3.3 Additional spurious emissions	10.3.0	10.4.0
2012-12	RAN#58	R5-125892	0823	-	UE output power definition for UL-MIMO	10.3.0	10.4.0
2012-12	RAN#58	R5-125893	0824	-	Update TC 6.2.4B Additional maximum power reduction (A-MPR) for UL-MIMO	10.3.0	10.4.0
2012-12	RAN#58	R5-125894	0825	-	Update TC 6.5.2B.1 Error vector magnitude (EVM) for UL-MIMO	10.3.0	10.4.0
2012-12	RAN#58	R5-125895	0826	-	Update TC 6.2.5B Configured transmitted output power for UL-MIMO	10.3.0	10.4.0
2012-12	RAN#58	R5-125896	0827	-	Update TC 7.3B Reference sensitivity level for UL-MIMO	10.3.0	10.4.0
2012-12	RAN#58	R5-125897	0828	-	Update TC 7.4B Maximum input level for UL-MIMO	10.3.0	10.4.0
2012-12	RAN#58	R5-125898	0829	-	Update TC 7.5B Adjacent Channel Selectivity (ACS) for UL-MIMO	10.3.0	10.4.0
2012-12	RAN#58	R5-125899	0830	-	Update TC 7.6.1B In-band blocking for UL-MIMO	10.3.0	10.4.0
2012-12	RAN#58	R5-125900	0831	-	Update TC 7.6.2B Out-of-band blocking for UL-MIMO	10.3.0	10.4.0
2012-12	RAN#58	R5-125901	0832	-	Update TC 7.6.3B Narrow band blocking for UL-MIMO	10.3.0	10.4.0
2012-12	RAN#58	R5-125902	0833	-	Update TC 7.7B Spurious response for UL-MIMO	10.3.0	10.4.0
2012-12	RAN#58	R5-125903	0834	-	Update TC 7.8.1B Wide band intermodulation for UL-MIMO	10.3.0	10.4.0
2012-12	RAN#58	R5-125906	0835	-	New RF TC for 36.521-1_8.2.1.2.3_Enhanced ICIC for LTE	10.3.0	10.4.0
2012-12	RAN#58	R5-125907	0836	-	New RF TC for 36.521-1_8.4.1.2.3_Enhanced ICIC for LTE	10.3.0	10.4.0
2012-12	RAN#58	R5-125908	0837	-	TDD CQI Reporting under AWGN conditions-PUCCH 1-0-Demod subframe overlaps with aggressor cell ABS (eICIC)	10.3.0	10.4.0
2012-12	RAN#58	R5-125909	0838	-	TDD PHICH Transmit Diversity 2x2-Demod subframe overlaps with aggressor cell ABS (eICIC)	10.3.0	10.4.0
2012-12	RAN#58	R5-125910	0839	-	TDD PDSCH Open Loop Spatial Multiplexing 2x2 Demod subframe overlaps with aggressor cell ABS (eICIC)	10.3.0	10.4.0
2012-12	RAN#58	R5-125924	0841	-	CR to 8.2.1.1.1_A: Correction to an average throughput measurement	10.3.0	10.4.0

2012-12	RAN#58	R5-125925	0842	-	CR to 8.2.1.3.1_A: Correction to an average throughput measurement	10.3.0	10.4.0
2012-12	RAN#58	R5-125931	0844	-	Additions to test description TC 6.2.5A.1 and 6.2.5A.2 including CA_1A-19A and CA_1A-21A updates	10.3.0	10.4.0
2012-12	RAN#58	R5-125932	0845	-	Updates for TC7.3A: Reference sensitivity level for CA including CA_41C, CA_1-19 and CA_1-21	10.3.0	10.4.0
2012-12	RAN#58	R5-125934	0846	-	Update of RF TC for 36.521-1_6.3.5A.1.1 Power Control Absolute power tolerance for CA	10.3.0	10.4.0
2012-12	RAN#58	R5-125935	0847	-	Updates for TC6.5.1A: Frequency error for CA	10.3.0	10.4.0
2012-12	RAN#58	R5-126043	0849	-	Updates for 5.2A operating bands for CA_7, CA_38, CA_41, CA_1-18, CA_1-19, CA_1-21, CA_2-17, CA_3-5, CA_3-7, CA_3-8, CA_3-20, CA_4-12, CA_4-13, CA_4-17, CA_4-20	10.3.0	10.4.0
2012-12	RAN#58	R5-126044	0850	-	Updates for 5.4.2A channel bandwidth for CA_7, CA_38, CA_41, CA_1-18, CA_1-19, CA_1-21, CA_2-17, CA_3-5, CA_3-7, CA_3-8, CA_3-20, CA_4-12, CA_4-13, CA_4-17, CA_4-20	10.3.0	10.4.0
2012-12	RAN#58	R5-126063	0840	-	Update of Perf 8.7.1.1 and 8.7.2.1 of 36.521-1	10.3.0	10.4.0
2012-12	RAN#58	R5-126065	0843	-	Clarification of RB position in 9.4.1 and 9.4.2	10.3.0	10.4.0
2012-12	RAN#58	R5-126066	0848	-	Update of minimum test time in Annex G.3.5	10.3.0	10.4.0
2012-12	RAN#58	R5-124010	0851	-	RF CI 8.1.1: Update of the CA capability table	10.3.0	10.4.0
2012-12	RAN#58	R5-124013	0852	-	RF CI 8.7.2.1A: Update of test structure according to the work plan	10.3.0	10.4.0
2012-12	RAN#58	R5-124082	0853	-	Correction to TC 7.5.1 Adjacent Channel Selectivity (ACS)	10.3.0	10.4.0
2012-12	RAN#58	R5-124116	0854	-	Addition to test description for SEM for CA	10.3.0	10.4.0
2012-12	RAN#58	R5-124123	0855	-	Addition to minimum requirement for TC 6.5.2A.3.1 in-band emissions for non allocated RB for CA	10.3.0	10.4.0
2012-12	RAN#58	R5-124125	0856	-	TC 6.2.2A.1 UE MOP for CA updates	10.3.0	10.4.0
2012-12	RAN#58	R5-124126	0857	-	CR to Annex G.3A.5: Minimum number of samples for CA performance tests	10.3.0	10.4.0
2012-12	RAN#58	R5-124131	0858	-	Additions to test case for TC 6.2.3A.1 Maximum Power Reduction (MPR) for CA (intra-band contiguous DL CA and UL CA)	10.3.0	10.4.0
2012-12	RAN#58	R5-124133	0859	-	Introduction to TC 6.6.3.3A.1 Additional spurious emissions for CA (intra-band contiguous DL CA and UL CA)	10.3.0	10.4.0
2012-12	RAN#58	R5-124139	0860	-	TC 6.3.2A.1 Minimum Output Power for CA introduction	10.3.0	10.4.0
2012-12	RAN#58	R5-124149	0861	-	RF TC 8.2.2.1.1_A: Adjusting test procedure and requirements to completed Annex G.3A	10.3.0	10.4.0
2012-12	RAN#58	R5-124160	0862	-	TC 7.6.1A.x In-band blocking for CA introduction	10.3.0	10.4.0
2012-12	RAN#58	R5-124163	0863	-	TC 7.6.2A.x Out-of-band blocking for CA introduction	10.3.0	10.4.0
2012-12	RAN#58	R5-124164	0864	-	TC 7.6.3A.x Narrow-band blocking for CA introduction	10.3.0	10.4.0
2012-12	RAN#58	R5-124165	0865	-	TC 7.7A.x Spurious response for CA introduction	10.3.0	10.4.0
2012-12	RAN#58	R5-124166	0866	-	Addition of Receiver test case - Wideband intermodulation for CA	10.3.0	10.4.0
2012-12	RAN#58	R5-124186	0867	-	RF: Addition of references to connection diagrams in CA tests	10.3.0	10.4.0
2013-03	RAN#59	R5-130092	0851	-	Updates of 6.6.3.3 - Addition of Low-channel Band 1 coexistence with PHS condition	10.4.0	10.5.0

2013-03	RAN#59	R5-130105	0854	-	Update of TC6.6.3B.2 for Spurious emissions band UE co-existence for UL-MIMO	10.4.0	10.5.0
2013-03	RAN#59	R5-130125	0856	-	Update of TC6.6.3B.3 for Additional spurious emissions for UL-MIMO	10.4.0	10.5.0
2013-03	RAN#59	R5-130128	0857	-	Update TC 6.2.4B Additional Maximum Power Reduction (AMPR) for UL-MIMO	10.4.0	10.5.0
2013-03	RAN#59	R5-130129	0858	-	Update TC 6.3.5B.1 Power control absolute power tolerance for UL-MIMO	10.4.0	10.5.0
2013-03	RAN#59	R5-130130	0859	-	Update TC 6.3.5B.2 Power Control Relative power tolerance for UL-MIMO	10.4.0	10.5.0
2013-03	RAN#59	R5-130131	0860	-	Update TC 6.3.5B.3 Aggregate power control tolerance for UL-MIMO	10.4.0	10.5.0
2013-03	RAN#59	R5-130132	0861	-	Update TC 6.5.2B.2 Carrier leakage for UL-MIMO	10.4.0	10.5.0
2013-03	RAN#59	R5-130133	0862	-	Update TC 6.3.2B Minimum Output Power for UL-MIMO	10.4.0	10.5.0
2013-03	RAN#59	R5-130134	0863	-	Update TC 6.6.1B Occupied bandwidth for UL-MIMO	10.4.0	10.5.0
2013-03	RAN#59	R5-130135	0864	-	Update TC 6.7B Transmit intermodulation for UL-MIMO	10.4.0	10.5.0
2013-03	RAN#59	R5-130176	0869	-	Introduction of new rel-10 Reporting of RI test cases into annexes	10.4.0	10.5.0
2013-03	RAN#59	R5-130182	0870	-	CA RF: Correction to Annex I	10.4.0	10.5.0
2013-03	RAN#59	R5-130183	0871	-	UL-MIMO RF: Correction to Annex I	10.4.0	10.5.0
2013-03	RAN#59	R5-130184	0872	-	eICIC RF: Correction to Annex I	10.4.0	10.5.0
2013-03	RAN#59	R5-130185	0873	-	eDL-MIMO RF: Correction to Annex I	10.4.0	10.5.0
2013-03	RAN#59	R5-130188	0874	-	RF: Correction to TC 8.2.1.1.1 - Frequency range for partial allocation	10.4.0	10.5.0
2013-03	RAN#59	R5-130245	0877	-	Additions to TC 6.6.2.3A.1 Adjacent Channel Leakage power Ratio for CA (intra-band contiguous DL CA and UL CA)	10.4.0	10.5.0
2013-03	RAN#59	R5-130273	0880	-	Corrections to Annex A DL Reference Measurement and PMI Accuracy Measurements	10.4.0	10.5.0
2013-03	RAN#59	R5-130285	0881	-	Correction to TC 8.3.2.1.3 TDD PDSCH Single-layer Spatial Multiplexing on antenna port 7 or 8 with a simultaneous transmission	10.4.0	10.5.0
2013-03	RAN#59	R5-130288	0882	-	Addition to TC 9.2.2.2_D TDD CQI Reporting under AWGN conditions - PUCCH 1-1 for eDL-MIMO	10.4.0	10.5.0
2013-03	RAN#59	R5-130291	0883	-	Addition to TC 9.3.2.2.2_D TDD CQI Reporting under fading conditions " PUCCH 1-1 for eDL-MIMO	10.4.0	10.5.0
2013-03	RAN#59	R5-130292	0884	-	Additions to TC 9.4.2.1.1_D FDD PMI Reporting - PUSCH 1-2 (Multiple PMI) for eDL-MIMO	10.4.0	10.5.0
2013-03	RAN#59	R5-130293	0885	-	Additions to TC 9.4.2.1.2_D TDD PMI Reporting - PUSCH 1-2 (Multiple PMI) for eDL-MIMO	10.4.0	10.5.0
2013-03	RAN#59	R5-130298	0886	-	CA RF: Correction to TC 7.6.1A	10.4.0	10.5.0
2013-03	RAN#59	R5-130299	0887	-	Uncertainties and Test Tolerances for Test case 7.4A	10.4.0	10.5.0
2013-03	RAN#59	R5-130308	0888	-	Corrections to test procedure of TC 6.2.2 UE Maximum Output Power	10.4.0	10.5.0
2013-03	RAN#59	R5-130309	0889	-	Corrections to test purpose of TC 6.2.3 Maximum Power Reduction (MPR)	10.4.0	10.5.0
2013-03	RAN#59	R5-130310	0890	-	Correction to test procedure of TC 6.7A.1 Transmit Intermodulation for CA	10.4.0	10.5.0

2013-03	RAN#59	R5-130407	0894	-	Correction to test requirement of 6.2.4A	10.4.0	10.5.0
2013-03	RAN#59	R5-130408	0895	-	Correction to test procedure in 6.3.5A.1	10.4.0	10.5.0
2013-03	RAN#59	R5-130411	0896	-	Correction to test procedure in 6.6.2.3A	10.4.0	10.5.0
2013-03	RAN#59	R5-130413	0897	-	Correction to 7.6.3A.3 test procedure	10.4.0	10.5.0
2013-03	RAN#59	R5-130415	0898	-	Correction to 6.6.3.2A and 6.6.3.3A	10.4.0	10.5.0
2013-03	RAN#59	R5-130416	0899	-	Correction to 6.6.3B.2 and 6.6.3B.3	10.4.0	10.5.0
2013-03	RAN#59	R5-130419	0900	-	Correction to 9.3.4 UE-selected subband CQI	10.4.0	10.5.0
2013-03	RAN#59	R5-130421	0901	-	Correction to wideband CQI-samples	10.4.0	10.5.0
2013-03	RAN#59	R5-130427	0902	-	Update of minimum test time in Annex G.5.4	10.4.0	10.5.0
2013-03	RAN#59	R5-130471	0905	-	Update of spurious emission test cases for introduction of Japanese Regulatory Requirements for LTE Band 8	10.4.0	10.5.0
2013-03	RAN#59	R5-130779	0875	1	CA RF: Clarification on Cell ID	10.4.0	10.5.0
2013-03	RAN#59	R5-130780	0903	1	Correction to 941 and 942	10.4.0	10.5.0
2013-03	RAN#59	R5-130801	0908	-	Additions of CA RF test cases to Annex F	10.4.0	10.5.0
2013-03	RAN#59	R5-130804	0909	-	Correction to 6.6.3.2 and 6.6.3.3	10.4.0	10.5.0
2013-03	RAN#59	R5-130806	0911	-	Update TC 6.6.3.2 Spurious emission band UE co-existence	10.4.0	10.5.0
2013-03	RAN#59	R5-130808	0912	-	CA RF - SCC configuration references	10.4.0	10.5.0
2013-03	RAN#59	R5-130809	0913	-	CA RF Rx - Update of blocking characteristics	10.4.0	10.5.0
2013-03	RAN#59	R5-130811	0915	-	LTE RF - Correction to LTE Rx TCs UL allocation location	10.4.0	10.5.0
2013-03	RAN#59	R5-130901	0916	-	Update of TC 8.7.2.1_A.1 TDD sustained data rate performance for CA (intra-band contiguous DL CA)	10.4.0	10.5.0
2013-03	RAN#59	R5-130902	0917	-	Editorial correction for ON/OFF time mask for CA	10.4.0	10.5.0
2013-03	RAN#59	R5-130903	0918	-	Correction to Band 12 frequency for CA_4-12	10.4.0	10.5.0
2013-03	RAN#59	R5-130908	0920	-	Additions of eDL-MIMO to Annex A.4 CQI Reference Measurement Channels	10.4.0	10.5.0
2013-03	RAN#59	R5-130909	0921	-	Introduction of TC 8.3.1.1.1_D FDD Single-Layer Spatial Multiplexing on antenna ports without a simultaneous transmission for eDL-MIMO	10.4.0	10.5.0
2013-03	RAN#59	R5-130910	0922	-	Introduction of FDD TC 8.3.1.1.2_D FDD Single-Layer Spatial Multiplexing on antenna ports with a simultaneous transmission for eDL-MIMO	10.4.0	10.5.0
2013-03	RAN#59	R5-130911	0923	-	Additions to TC 8.3.1.2.1_D FDD PDSCH Dual-layer Spatial Multiplexing for eDL-MIMO	10.4.0	10.5.0
2013-03	RAN#59	R5-130912	0924	-	Additions to TC 8.3.2.1_D TDD PDSCH Dual-layer Spatial Multiplexing for eDL-MIMO	10.4.0	10.5.0
2013-03	RAN#59	R5-130913	0925	-	Additions to TC 8.3.2.1.2_D TDD Single-Layer Spatial Multiplexing on antenna ports without a simultaneous transmission for eDL-MIMO	10.4.0	10.5.0
2013-03	RAN#59	R5-130914	0926	-	Additions to TC 8.3.2.1.3_D TDD Single-Layer Spatial Multiplexing on antenna ports with a simultaneous transmission for eDL-MIMO	10.4.0	10.5.0
2013-03	RAN#59	R5-130924	0934	-	Update RF TC for 36.521-1_8.2.1.2.3_C FDD PDSCH Transmit div 2x2 Enhanced ICIC for LTE	10.4.0	10.5.0
2013-03	RAN#59	R5-130925	0935	-	Update RF TC for 36.521-1_8.4.1.2.3_C FDD PCFICH PDCCH Transmit div 2x2 Enhanced ICIC for LTE	10.4.0	10.5.0

2013-03	RAN#59	R5-130935	0937	-	SNR uncertainty	10.4.0	10.5.0
2013-03	RAN#59	R5-130936	0938	-	Introduction of new rel-10 Reporting of RI test cases	10.4.0	10.5.0
2013-03	RAN#59	R5-130937	0939	-	RF: Corrections to Annex H - Default uplink settings	10.4.0	10.5.0
2013-03	RAN#59	R5-130938	0940	-	Update of TC 8.7.2.1_1 TDD sustained data rate performance (Rel-10 and forward)	10.4.0	10.5.0
2013-03	RAN#59	R5-130939	0941	-	Clarification to Soft Channel Bit size used by SS and UE	10.4.0	10.5.0
2013-03	RAN#59	R5-130940	0942	-	Correction to sustained data rate performance test	10.4.0	10.5.0
2013-03	RAN#59	R5-130941	0943	-	Clean up on performance tests	10.4.0	10.5.0
2013-03	RAN#59	R5-130944	0944	-	Update TC 6.3.5A.3.1 Aggregate power control tolerance for CA (intra-band contiguous DL CA and UL CA)	10.4.0	10.5.0
2013-03	RAN#59	R5-130945	0945	-	Update TC 6.6.3.2A.1 Spurious emission band UE co-existence for CA (intra-band contiguous DL CA and UL CA)	10.4.0	10.5.0
2013-03	RAN#59	R5-130946	0946	-	Additions to TC 6.2.5A.1 Configured UE transmitted Power for CA (intra-band contiguous DL CA and UL CA)	10.4.0	10.5.0
2013-03	RAN#59	R5-130947	0947	-	Additions to TC 6.6.3.3A.1 Additional spurious emissions for CA (intra-band contiguous DL CA and UL CA)	10.4.0	10.5.0
2013-03	RAN#59	R5-130948	0948	-	Additions to TC 7.5A.1 Adjacent Channel Selectivity (ACS) for CA (intra-band contiguous DL CA and UL CA)	10.4.0	10.5.0
2013-03	RAN#59	R5-130949	0949	-	Additions to TC 7.5A.2 Adjacent Channel Selectivity (ACS) for CA (intra-band contiguous DL CA without UL CA)	10.4.0	10.5.0
2013-03	RAN#59	R5-130950	0950	-	Additions to TC 7.5A.3 Adjacent Channel Selectivity (ACS) for CA (inter-band contiguous DL CA without UL CA)	10.4.0	10.5.0
2013-03	RAN#59	R5-130951	0951	-	Correction to test point of Frequency Error for CA and addition of TC for intra-band contiguous DL CA without UL CA	10.4.0	10.5.0
2013-03	RAN#59	R5-130961	0955	-	Channel matrix impairments for eDL-MIMO CSI tests	10.4.0	10.5.0
2013-03	RAN#59	R5-130965	0957	-	TC 9.4.1.1.1_D FDD Reporting of PMI - PUSCH 3-1 (Single PMI) for eDL-MIMO	10.4.0	10.5.0
2013-03	RAN#59	R5-130966	0958	-	TC 9.4.1.1.2_D TDD Reporting of PMI -PUSCH 3-1 (Single PMI) for eDL-MIMO	10.4.0	10.5.0
2013-03	RAN#59	R5-130967	0959	-	Additions of eDL-MIMO to Annex C Measurement of Performance Requirements	10.4.0	10.5.0
2013-03	RAN#59	R5-130968	0960	-	Additions of eDL-MIMO test cases to Annex F	10.4.0	10.5.0
2013-03	RAN#59	R5-130969	0961	-	Additions to Annex G for eDL-MIMO	10.4.0	10.5.0
2013-03	RAN#59	R5-130970	0962	-	Addition to TC 9.2.2.1_D FDD CQI Reporting under AWGN conditions - PUCCH 1-1 for eDL-MIMO	10.4.0	10.5.0
2013-03	RAN#59	R5-130971	0963	-	Addition to TC 9.3.2.2.1_D FDD CQI Reporting under fading conditions - PUCCH 1-1 for eDL-MIMO	10.4.0	10.5.0
2013-03	RAN#59	R5-130972	0964	-	Additions to TC 9.5.1.1_D FDD RI Reporting for eDL-MIMO	10.4.0	10.5.0
2013-03	RAN#59	R5-130973	0965	-	Additions to TC 9.5.1.2_D TDD RI Reporting for eDL-MIMO	10.4.0	10.5.0
2013-03	RAN#59	R5-130978	0966	-	Correcting TS 36.521-1 to reflect changes in 36.101	10.4.0	10.5.0
2013-03	RAN#59	R5-130979	0967	-	Correction of RF conformance Test case: 8.2.1.3.3	10.4.0	10.5.0
2013-03	RAN#59	R5-130980	0968	-	Addition new TC 8.2.2.3.3 TDD PDSCH Open Loop Spatial Multiplexing 2x2-Demod subframe overlaps with aggressor cell ABS (eICIC)	10.4.0	10.5.0
2013-03	RAN#59	R5-130994	0969	-	Corrections to 7.8.1A Wideband intermodulation for CA	10.4.0	10.5.0



2013-03	RAN#59	R5-130998	0970	-	TC 9.3.1.2.1_D FDD CQI Reporting under fading conditions - PUSCH 3-1 for eDL-MIMO	10.4.0	10.5.0
2013-03	RAN#59	R5-130999	0971	-	TC 9.3.1.2.2_D TDD CQI Reporting under fading conditions - PUSCH 3-1 for eDL-MIMO	10.4.0	10.5.0
2013-03	RAN#59	R5-130093	0852	-	Updates of 5.2A Operating bands for CA_11-18	10.5.0	11.0.0
2013-03	RAN#59	R5-130094	0853	-	Updates of 5.4.2A Channel bandwidth combination for CA_11-18	10.5.0	11.0.0
2013-03	RAN#59	R5-130124	0855	-	Additions to the inter-band relaxation term for CA 3A-8A in Table 6.2.5A.1.3-3	10.5.0	11.0.0
2013-03	RAN#59	R5-130140	0865	-	Update TC 7.3A.3 Reference sensitivity level for CA_3-7 and CA_7-20 (inter-band DL CA without UL CA)	10.5.0	11.0.0
2013-03	RAN#59	R5-130141	0866	-	Update TC 7.6.2A.1 Out-of-band blocking for CA_38 (intra-band contiguous DL CA and UL CA)	10.5.0	11.0.0
2013-03	RAN#59	R5-130142	0867	-	Update TC 6.2.2A.1 UE Maximum Output Power for CA_38 (intra-band contiguous DL CA and UL CA)	10.5.0	11.0.0
2013-03	RAN#59	R5-130144	0868	-	Update TC 6.2.4A.1 Additional Maximum Power Reduction (A-MPR) for CA_38 (intra-band contiguous DL CA and UL CA)	10.5.0	11.0.0
2013-03	RAN#59	R5-130239	0876	-	Updates of 6.2.5A - inter-band relaxation term for CA_1A-18A and CA_11A-18A	10.5.0	11.0.0
2013-03	RAN#59	R5-130257	0878	-	Addition of TDD operating band 44 in receiver characteristic test cases	10.5.0	11.0.0
2013-03	RAN#59	R5-130258	0879	-	Addition of TDD operating band 44 in transmitter characteristic test cases	10.5.0	11.0.0
2013-03	RAN#59	R5-130329	0891	-	Updates for 7.6.1A.1 in-band blocking for CA_7 and CA_41	10.5.0	11.0.0
2013-03	RAN#59	R5-130330	0892	-	Updates for 7.6.2A.1 Out-of-band blocking for CA_7 and CA_41	10.5.0	11.0.0
2013-03	RAN#59	R5-130348	0972	-	Correction to Spurious emission band UE co-existence and Additional spurious emissions for Band 28	10.5.0	11.0.0
2013-03	RAN#59	R5-130349	0893	-	Addition of Band 28 to MPR and A-MPR	10.5.0	11.0.0
2013-03	RAN#59	R5-130769	0907	-	Updates of Refsens for inter-band CA test points for CA_1A-19A and CA_1A-21A	10.5.0	11.0.0
2013-03	RAN#59	R5-130783	0906	-	Update TC 6.2.3A.1 Maximum Power Reduction (MPR) for CA_38 (intra-band contiguous DL CA and UL CA)	10.5.0	11.0.0
2013-03	RAN#59	R5-130805	0910	-	Update TC 7.3A.1 Reference sensitivity level for CA_38, CA_3-7 and CA_7-20 (intra-band contiguous DL CA and UL CA)	10.5.0	11.0.0
2013-03	RAN#59	R5-130810	0914	-	CA_2-17 and CA_4-17 addition to 36.521-1 Rx characteristics	10.5.0	11.0.0
2013-03	RAN#59	R5-130905	0919	-	Addition of TDD operating band 44 in chapter 5	10.5.0	11.0.0
2013-03	RAN#59	R5-130915	0927	-	Addition of band 38 and band 41 in intra-band contiguous CA transmitter test cases	10.5.0	11.0.0
2013-03	RAN#59	R5-130916	0928	-	Update TC 7.6.1A.1 In-band blocking for CA_38 (intra-band contiguous DL CA and UL CA)	10.5.0	11.0.0
2013-03	RAN#59	R5-130917	0929	-	Addition of Inter Band CA combo CA_2A-29A	10.5.0	11.0.0
2013-03	RAN#59	R5-130918	0930	-	Update of 6.2.5A Configured transmitted power for CA	10.5.0	11.0.0
2013-03	RAN#59	R5-130919	0931	-	CA_2-17 and CA_4-17 addition to 36.521-1 Tx characteristics	10.5.0	11.0.0
2013-03	RAN#59	R5-130920	0932	-	Adding transmit power relaxation value for inter-band CA configurations CA_4A-5A and CA_4A-13A	10.5.0	11.0.0

2013-03	RAN#59	R5-130921	0933	-	Adding refsens relaxation value for inter-band CA configurations CA_4A-5A and CA_4A-13A	10.5.0	11.0.0
2013-03	RAN#59	R5-130926	0936	-	Updates for 6.6.2.1A Spectrum emission mask for CA for CA_7 and CA_41	10.5.0	11.0.0
2013-03	RAN#59	R5-130956	0952	-	Updates for 7.3A.1 Reference sensitivity level for CA_7C	10.5.0	11.0.0
2013-03	RAN#59	R5-130957	0953	-	Updates for 6.2.2A UE Maximum Output Power for CA_7 and CA_41	10.5.0	11.0.0
2013-03	RAN#59	R5-130958	0954	-	Updates of 7.3A - Reference sensitivity level for CA_11A-18A	10.5.0	11.0.0
2013-03	RAN#59	R5-130964	0956	-	Adding Band 27 to TS 36.521-1	10.5.0	11.0.0
2013-03	RAN#59	-	-	-	Correction of missing small changes of R5-130806 in Table 6.6.3.2.3-1, 6.6.3.2.5-1, 6.6.3.2_1.3-1 and 6.6.3.2_1.5-1.	11.0.0	11.0.1
2013-06	RAN#60	R5-131085	0973	-	Removal of technical content in 36.521-1 v10.5.0 and substitution with pointer to the next Release	11.0.1	11.1.0
2013-06	RAN#60	R5-131147	0974	-	Updates to Chapter7 for Inter Band CA combo CA_2A-29A	11.0.1	11.1.0
2013-06	RAN#60	R5-131149	0975	-	New chap8 TDD TC 8.2.2.2.3_C for eICIC	11.0.1	11.1.0
2013-06	RAN#60	R5-131150	0976	-	New chap 8 TDD TC 8.4.2.2.3_C for eICIC	11.0.1	11.1.0
2013-06	RAN#60	R5-131153	0977	-	Introduction of new rel-11 Reporting of RI test cases	11.0.1	11.1.0
2013-06	RAN#60	R5-131154	0978	-	Introduction of new rel-11 Reporting of RI test cases into annexes	11.0.1	11.1.0
2013-06	RAN#60	R5-131156	0979	-	Correction to TC 8.4.1.1 test procedure	11.0.1	11.1.0
2013-06	RAN#60	R5-131158	0980	-	Introduction of Maximum Input Level test case for CA (inter-band DL CA without UL CA) into annexes	11.0.1	11.1.0
2013-06	RAN#60	R5-131210	0981	-	Correction of test applicability for TC 8.2.1.1.1_1: TC 8.2.1.2.1_1 and TC 8.3.2.1.1_1 in 36.521-1	11.0.1	11.1.0
2013-06	RAN#60	R5-131222	0982	-	Update of TC6.6.3B.1 for Transmitter Spurious emissions for UL-MIMO	11.0.1	11.1.0
2013-06	RAN#60	R5-131226	0983	-	Clarification to test procedure on applying timing offset between CCs for Chap8 inter-band CA test cases	11.0.1	11.1.0
2013-06	RAN#60	R5-131238	0984	-	Update TC 6.2.4A.1 Additional Maximum Power Reduction (A-MPR) for CA_38C (intra-band contiguous DL CA and UL CA)	11.0.1	11.1.0
2013-06	RAN#60	R5-131241	0985	-	Update TC 7.3A.1 Reference sensitivity level for CA_4A-12A (intra-band contiguous DL CA and UL CA)	11.0.1	11.1.0
2013-06	RAN#60	R5-131242	0986	-	Update TC 7.3A.3 Reference sensitivity level for CA_4A-12A (inter-band DL CA without UL CA)	11.0.1	11.1.0
2013-06	RAN#60	R5-131245	0987	-	Update TT of 6.3.5A.3.1 Aggregate power control tolerance for CA (intra-band contiguous DL CA and UL CA)	11.0.1	11.1.0
2013-06	RAN#60	R5-131289	0988	-	Uncertainties and Test Tolerances for CA spectrum emission mask	11.0.1	11.1.0
2013-06	RAN#60	R5-131358	0989	-	RF: Corrections to RMC-s for sustained data rate test	11.0.1	11.1.0
2013-06	RAN#60	R5-131379	0990	-	CA RF - Corrections to 6.2.4A.1 requirements	11.0.1	11.1.0
2013-06	RAN#60	R5-131381	0991	-	LTE RF - Editorial correction to 8.2.2.4.2_1	11.0.1	11.1.0
2013-06	RAN#60	R5-131415	0992	-	Updates for 6.6.1A Occupied bandwidth for CA_41C	11.0.1	11.1.0
2013-06	RAN#60	R5-131450	0993	-	Addition of band44 in MPR for UL-MIMO	11.0.1	11.1.0
2013-06	RAN#60	R5-131473	0994	-	References to wrong section in TS 36.508	11.0.1	11.1.0
2013-06	RAN#60	R5-131518	0995	-	Corrections to Common Test Parameters User-Specific	11.0.1	11.1.0

2013-06	RAN#60	R5-131519	0996	-	Corrections to Beamforming Model Parameters	11.0.1	11.1.0
2013-06	RAN#60	R5-131521	0997	-	Corrections to Reporting of Channel State Requirements	11.0.1	11.1.0
2013-06	RAN#60	R5-131522	0998	-	Corrections to Reporting of Precoding Matrix Indicator Requirements	11.0.1	11.1.0
2013-06	RAN#60	R5-131527	0999	-	Additions to Annex G for eDL-MIMO	11.0.1	11.1.0
2013-06	RAN#60	R5-131528	1000	-	Additions of eDL-MIMO test cases to Annex F	11.0.1	11.1.0
2013-06	RAN#60	R5-131539	1001	-	LTE RF: Minor changes to test case 7.5A.3	11.0.1	11.1.0
2013-06	RAN#60	R5-131540	1002	-	LTE-RF: Clarification to 7.6.1A.3 test procedure	11.0.1	11.1.0
2013-06	RAN#60	R5-131541	1003	-	Corrections to TC 6.6.2.3A.1 Adjacent Channel Leakage power Ratio for CA (intra-band contiguous DL CA and UL CA)	11.0.1	11.1.0
2013-06	RAN#60	R5-131545	1004	-	Additions to TC 9.2.3.1_D for FDD CQI reporting under AWGN conditions - PUCCH 1-1 for eDL-MIMO	11.0.1	11.1.0
2013-06	RAN#60	R5-131546	1005	-	LTE-RF: Corrections to CA Open Loop Spatial Multiplexing Performance test cases	11.0.1	11.1.0
2013-06	RAN#60	R5-131553	1006	-	Additions to TC 9.2.3.2_D for TDD CQI reporting under AWGN conditions - PUCCH 1-1 for eDL-MIMO	11.0.1	11.1.0
2013-06	RAN#60	R5-131555	1007	-	Additions to TC 9.3.1.2.2_D for TDD CQI reporting under fading conditions - PUSCH 3-1 for eDL-MIMO	11.0.1	11.1.0
2013-06	RAN#60	R5-131559	1008	-	Additions to TC 9.3.2.2.2_D for TDD CQI reporting under fading conditions - PUCCH 1-1 for eDL-MIMO	11.0.1	11.1.0
2013-06	RAN#60	R5-131561	1009	-	Update of 6.2.5A - Delta TIB for CA_11A-18A	11.0.1	11.1.0
2013-06	RAN#60	R5-131562	1010	-	Additions to TC 9.4.1.3.2_D for TDD reporting of PMI-PUSCH 3-1 (Single PMI) for eDL-MIMO	11.0.1	11.1.0
2013-06	RAN#60	R5-131563	1011	-	Update of 7.3A - Delta RIB for CA_11A-18A	11.0.1	11.1.0
2013-06	RAN#60	R5-131567	1012	-	Additions to TC 9.4.2.3.2_D for TDD PMI reporting - PUSCH 1-2 (Multiple PMI) for eDL-MIMO	11.0.1	11.1.0
2013-06	RAN#60	R5-131569	1013	-	Additions to TC 9.5.2.2_D for TDD RI reporting - PUCCH 1-1 for eDL-MIMO	11.0.1	11.1.0
2013-06	RAN#60	R5-131634	1014	-	Removal of Spurious emission UE co-existence test case 6.6.3.2_1 from annex F	11.0.1	11.1.0
2013-06	RAN#60	R5-131649	1015	-	Adding Band28 in some Receiver test cases in section 7	11.0.1	11.1.0
2013-06	RAN#60	R5-131677	1016	-	Correction to the contents of the chapter 5.	11.0.1	11.1.0
2013-06	RAN#60	R5-131711	1017	-	Corrections to test procedure of TC 7.5B Adjacent Channel Selectivity (ACS) for UL-MIMO	11.0.1	11.1.0
2013-06	RAN#60	R5-131900	1018	-	RF: Correction of Imcs for CQI index 10 (15 RBs)	11.0.1	11.1.0
2013-06	RAN#60	R5-131901	1019	-	Corrections to Frequency non-selective scheduling mode	11.0.1	11.1.0
2013-06	RAN#60	R5-131902	1020	-	Correction to the missing title of Rel-9 close loop tests	11.0.1	11.1.0
2013-06	RAN#60	R5-131903	1021	-	Correction to the references of connection diagrams	11.0.1	11.1.0
2013-06	RAN#60	R5-131904	1022	-	Maintenance of Band 23 additional regulatory requirements	11.0.1	11.1.0
2013-06	RAN#60	R5-131905	1023	-	Realignment of A-MPR Configuration Tables for Band 27 in TS 36.521-1	11.0.1	11.1.0
2013-06	RAN#60	R5-131906	1024	-	Update on General section of Tx and Rx for Cell IDs	11.0.1	11.1.0
2013-06	RAN#60	R5-131907	1025	-	LTE RF: Initial conditions update for test 6.2.5A.2	11.0.1	11.1.0

2013-06	RAN#60	R5-131908	1026	-	CA RF: Alignment for inter-band Rx tests with DL tested only as S-Cell	11.0.1	11.1.0
2013-06	RAN#60	R5-131909	1027	-	36.521-1: Inter-band CA operating bands update	11.0.1	11.1.0
2013-06	RAN#60	R5-131911	1028	-	Updates for 7.7A.1 Spurious response for CA	11.0.1	11.1.0
2013-06	RAN#60	R5-131915	1029	-	Additions to TC 9.3.1.2.1_D for FDD CQI reporting under fading conditions - PUSCH 3-1 for eDL-MIMO	11.0.1	11.1.0
2013-06	RAN#60	R5-131916	1030	-	Additions to TC 9.3.2.2.1_D for FDD CQI reporting under fading conditions - PUCCH 1-1 for eDL-MIMO	11.0.1	11.1.0
2013-06	RAN#60	R5-131917	1031	-	Additions to TC 9.4.1.3.1_D for FDD reporting of PMI - PUSCH 3-1 (Single PMI) for eDL-MIMO	11.0.1	11.1.0
2013-06	RAN#60	R5-131918	1032	-	Additions to TC 9.4.2.3.1_D for FDD PMI reporting - PUSCH 1-2 (Multiple PMI) for eDL-MIMO	11.0.1	11.1.0
2013-06	RAN#60	R5-131919	1033	-	Additions to TC 9.5.2.1_D for FDD RI reporting - PUCCH 1-1 for eDL-MIMO	11.0.1	11.1.0
2013-06	RAN#60	R5-131920	1034	-	Adding Band28 in some Transmitter test cases in section 6	11.0.1	11.1.0
2013-06	RAN#60	R5-131921	1035	-	New RF TC for 36.521-1_8.5.1.2.3_C.1_Enhanced ICIC for LTE	11.0.1	11.1.0
2013-06	RAN#60	R5-131929	1036	-	Update TT of 6.2.2B_6.2.3B_6.2.4B and 6.2.5B for UL-MIMO	11.0.1	11.1.0
2013-06	RAN#60	R5-131930	1037	-	Update TT of 6.3.2B_6.3.3B and 6.3.4B for UL-MIMO	11.0.1	11.1.0
2013-06	RAN#60	R5-131931	1038	-	Update TT of 6.3.5B.1_6.3.5B.2 and 6.3.5B.3 for UL- MIMO	11.0.1	11.1.0
2013-06	RAN#60	R5-131932	1039	-	Update TT of 6.5.1B_6.5.2B.1_6.5.2B.2_6.5.2B.3_6.5.2B.4 for UL-MIMO	11.0.1	11.1.0
2013-06	RAN#60	R5-131933	1040	-	Update TT of 6.6.1B Occupied bandwidth for UL-MIMO	11.0.1	11.1.0
2013-06	RAN#60	R5-131934	1041	-	Update TT of 6.6.2.1B_6.6.2.2B and 6.6.2.3B for UL- MIMO	11.0.1	11.1.0
2013-06	RAN#60	R5-131935	1042	-	Update TT of 6.7B Transmit intermodulation for UL-MIMO	11.0.1	11.1.0
2013-06	RAN#60	R5-131936	1043	-	Update TT of 6.8B Time alignment error for UL-MIMO	11.0.1	11.1.0
2013-06	RAN#60	R5-131937	1044	-	Update TT of 7.3B Reference sensitivity level for UL-MIMO	11.0.1	11.1.0
2013-06	RAN#60	R5-131952	1045	-	Corrections to TC 6.2.5A.1 Configured UE transmitted Power for CA (intra-band contiguous DL CA and UL CA)	11.0.1	11.1.0
2013-06	RAN#60	R5-131954	1046	-	Maintenance of Band 23 Spurious Emissions Requirements	11.0.1	11.1.0
2013-06	RAN#60	R5-131955	1047	-	Corrections to Demodulation Requirements	11.0.1	11.1.0
2013-06	RAN#60	R5-131956	1048	-	Updates to sustained data rate test case	11.0.1	11.1.0
2013-06	RAN#60	R5-131957	1049	-	New RF TC for 36.521-1_9.2.1.3_C.1_Enhanced ICIC for LTE	11.0.1	11.1.0
2013-06	RAN#60	R5-131958	1050	-	RF: Structure clean-up for chapter 9 (including eICIC and eDL-MIMO tests)	11.0.1	11.1.0
2013-06	RAN#60	R5-131959	1051	-	Update TT of 7.4B_7.5B_7.6.1B_7.6.2B_7.6.3B_7.7B and 7.8.1B for UL-MIMO	11.0.1	11.1.0
2013-06	RAN#60	R5-131960	1052	-	Update of TC6.6.3B.3 for Additional spurious emissions for UL-MIMO	11.0.1	11.1.0
2013-06	RAN#60	R5-131961	1053	-	Update of TC6.6.3B.2 for Spurious emissions band UE co-existence for UL-MIMO	11.0.1	11.1.0
2013-06	RAN#60	R5-131962	1054	-	Updates of 6.2.2.3 - maximum output power for UE that supports both Band 18 and 26	11.0.1	11.1.0
2013-06	RAN#60	R5-131963	1055	-	Update of 6.2.4 Test points for A-MPR when NS_05 is signalled	11.0.1	11.1.0

2013-06	RAN#60	R5-131964	1056	-	Updates of 7.3.3 - Refsens for UE that supports both Band 18 and Band 26	11.0.1	11.1.0
2013-06	RAN#60	R5-131969	1057	-	CA RF: Alignment for tests with PCC and SCC switching	11.0.1	11.1.0
2013-06	RAN#60	R5-131971	1059	-	Introduction of Maximum Input Level test case for CA (inter-band DL CA without UL CA)	11.0.1	11.1.0
2013-06	RAN#60	R5-131972	1060	-	Addition of Maximum input level for inter-band CA and updates to test configuration for some Rx TCs	11.0.1	11.1.0
2013-06	RAN#60	R5-131973	1061	-	Updates to FDD sustained data rate test case for CA	11.0.1	11.1.0
2013-06	RAN#60	R5-131974	1062	-	Clarification on Time offset between cells	11.0.1	11.1.0
2013-06	RAN#60	R5-131975	1063	-	Update TC 6.2.3A.1 Maximum Power Reduction (MPR) for CA (intra-band contiguous DL CA and UL CA)	11.0.1	11.1.0
2013-06	RAN#60	R5-131976	1064	-	Update of UE co-existence requirement for CA	11.0.1	11.1.0
2013-06	RAN#60	R5-131977	1065	-	Update TC 6.2.5A.1 Configured UE transmitted Output Power for CA_3A-7A, CA_4A-12A and CA_7A-20A (intra-band contiguous DL CA and UL CA)	11.0.1	11.1.0
2013-06	RAN#60	R5-131978	1066	-	Updates for 6.2.4A A-MPR for CA_41C	11.0.1	11.1.0
2013-06	RAN#60	R5-131979	1067	-	Updates for 7.5A.1 Adjacent Channel Selectivity (ACS) for CA_41C	11.0.1	11.1.0
2013-06	RAN#60	R5-131980	1068	-	Updates for 7.6.1A.1 in-band blocking for CA_41C	11.0.1	11.1.0
2013-06	RAN#60	R5-131981	1069	-	Updates for 7.6.2A.1 Out-of-band blocking for CA_41C	11.0.1	11.1.0
2013-06	RAN#60	R5-131982	1070	-	Updates for 7.6.3A.1 Narrow band blocking for CA_41C	11.0.1	11.1.0
2013-06	RAN#60	R5-131983	1071	-	Updates for 7.8.1A.1 Wideband intermodulation for CA_41C	11.0.1	11.1.0
2013-06	RAN#60	R5-131985	1072	-	Update of CA refsens test 7.3A for inter-band CA configurations CA_4A-5A and CA_4A-13A	11.0.1	11.1.0
2013-06	RAN#60	R5-131987	1073	-	Addition of band 44 in MPR	11.0.1	11.1.0
2013-06	RAN#60	R5-131990	1074	-	CA_1A-18A, CA_2A-17A, CA_3A-8A, CA_4A-5A, CA_4A-13A, CA_4A-17A, CA_11A-18A addition and corrections to Reference Sensitivity TC 7.3A	11.0.1	11.1.0
2013-06	RAN#60	R5-132079	1058	-	Corrections to TC 6.6.3.3A.1 Additional spurious emissions for CA (intra-band contiguous DL CA and UL CA)	11.0.1	11.1.0
2013-06	RAN#60	R5-132080	1075	-	CA RF - Corrections to Blocking Characteristics in 7.6	11.0.1	11.1.0
2013-06	RAN#60	R5-132103	1076	-	Change Spurious emission UE co-existence test cases to align with release independence rule	11.0.1	11.1.0
2013-06	RAN#60	R5-132105	1077	-	CA RF: Corrections to message contents with regard to transmission mode	11.0.1	11.1.0
2013-06	RAN#60	R5-132110	1078	-	Updated test points test case 6.2.3 A-MPR for NS_15 band26	11.0.1	11.1.0
2013-06	RAN#60	R5-132113	1079	-	New test cases for LTE B14 public safety high power UE	11.0.1	11.1.0
2013-09	RAN#61	R5-133070	1080	-	Correction to test points in Additional Spurious Emissions Coexistence test case	11.1.0	11.2.0
2013-09	RAN#61	R5-133073	1081	-	LTE Type A performance requirements - Changes to clause 3	11.1.0	11.2.0
2013-09	RAN#61	R5-133074	1082	-	LTE Type A performance requirements - Changes to clause 8.1.1	11.1.0	11.2.0
2013-09	RAN#61	R5-133075	1083	-	LTE Type A performance requirements - Changes to Annex A	11.1.0	11.2.0
2013-09	RAN#61	R5-133076	1084	-	LTE Type A performance requirements - Introduction of Annex B.5	11.1.0	11.2.0

2013-09	RAN#61	R5-133077	1085	-	LTE Type A performance requirements - Introduction of the new test case 9.3.5.1.1.	11.1.0	11.2.0
2013-09	RAN#61	R5-133232	1086	-	Corrections to CA TC 6.5.2A.3	11.1.0	11.2.0
2013-09	RAN#61	R5-133247	1087	-	Addition of Band 31 to 36.521-1 General s05	11.1.0	11.2.0
2013-09	RAN#61	R5-133248	1088	-	Addition of Band 31 to 36.521-1 RX s07	11.1.0	11.2.0
2013-09	RAN#61	R5-133249	1089	-	Addition of Band 31 to 36.521-1 TX s06	11.1.0	11.2.0
2013-09	RAN#61	R5-133252	1090	-	RF: Minor correction to test points for spurious emissions UE co-existence	11.1.0	11.2.0
2013-09	RAN#61	R5-133258	1091	-	Update TC 7.3A.3 Reference sensitivity level for CA_5A-12A (inter-band DL CA without UL CA)	11.1.0	11.2.0
2013-09	RAN#61	R5-133261	1092	-	Update the minimum requirements of TCs 7.6.3A.1, 7.7A.1 and 7.8.1A.1 for CA	11.1.0	11.2.0
2013-09	RAN#61	R5-133262	1093	-	Update TC 6.6.3B.2 of Spurious emission band UE co-existence for UL-MIMO	11.1.0	11.2.0
2013-09	RAN#61	R5-133263	1094	-	Update TCs 6.2.2B and 6.2.5B for UL-MIMO	11.1.0	11.2.0
2013-09	RAN#61	R5-133265	1095	-	RF: Addition of missing UL-RMC-s for Tx testing	11.1.0	11.2.0
2013-09	RAN#61	R5-133266	1096	-	Correction of TCs 7.3 and 7.3B Reference sensitivity level for Band 27	11.1.0	11.2.0
2013-09	RAN#61	R5-133268	1097	-	CA RF: Addition of new CQI tests for CA	11.1.0	11.2.0
2013-09	RAN#61	R5-133298	1098	-	Correction to Spurious emission band UE co-existence	11.1.0	11.2.0
2013-09	RAN#61	R5-133415	1099	-	Correction to the repeat steps in 7.6.1A, 7.6.3A and 7.8.1A	11.1.0	11.2.0
2013-09	RAN#61	R5-133418	1100	-	Correction to CA sustained data rate performance test	11.1.0	11.2.0
2013-09	RAN#61	R5-133423	1101	-	Correction to eICIC Performance test cases	11.1.0	11.2.0
2013-09	RAN#61	R5-133425	1102	-	Correction to UE category in Tx test cases	11.1.0	11.2.0
2013-09	RAN#61	R5-133426	1103	-	Correction to Spurious emission band UE co-existence	11.1.0	11.2.0
2013-09	RAN#61	R5-133431	1104	-	Correction to MBMS Performance test cases	11.1.0	11.2.0
2013-09	RAN#61	R5-133474	1105	-	Update TC of 8.7.2.1_A.1 TDD sustained data rate performance for CA (intra-band contiguous DL CA)	11.1.0	11.2.0
2013-09	RAN#61	R5-133517	1106	-	Adding the minimum channel spacing for intra-band non-contiguous CA	11.1.0	11.2.0
2013-09	RAN#61	R5-133522	1107	-	Corrections to Annex F for Maintenance of Band 23	11.1.0	11.2.0
2013-09	RAN#61	R5-133523	1108	-	Corrections to description for definition of MIMO Correlation Matrices using cross polarized antennas	11.1.0	11.2.0
2013-09	RAN#61	R5-133524	1109	-	Corrections to UE maximum output power for CA	11.1.0	11.2.0
2013-09	RAN#61	R5-133525	1110	-	Corrections to General Maintenance of Operating Bands and Channel Arrangements	11.1.0	11.2.0
2013-09	RAN#61	R5-133532	1111	-	Introduction of eICIC_enh_LTE to Annex C	11.1.0	11.2.0
2013-09	RAN#61	R5-133534	1112	-	Corrections to TC 6.6.2.3A.1 Adjacent Channel Leakage power Ratio for CA (intra-band contiguous DL CA and UL CA)	11.1.0	11.2.0
2013-09	RAN#61	R5-133535	1113	-	Corrections to TC 7.5A.1 Adjacent Channel Selectivity (ACS) for CA (intra-band contiguous DL CA and UL CA)	11.1.0	11.2.0
2013-09	RAN#61	R5-133800	1114	-	Correction to test frequency in Additional Spurious Emissions test cases for NS_15	11.1.0	11.2.0
2013-09	RAN#61	R5-133801	1115	-	Update applicability of test cases 9.4.2.2.1 and 9.4.2.2.2	11.1.0	11.2.0

2013-09	RAN#61	R5-133802	1116	-	Correction to applicability for TDD-TM8 test cases	11.1.0	11.2.0
2013-09	RAN#61	R5-133803	1117	-	Editorial correction to 6.6.3.3 Additional spurious emissions	11.1.0	11.2.0
2013-09	RAN#61	R5-133804	1118	-	Correction the Minimum conformance requirements for test case 6.2.2B	11.1.0	11.2.0
2013-09	RAN#61	R5-133805	1119	-	CA RF: Adding missing DL-RMC-s	11.1.0	11.2.0
2013-09	RAN#61	R5-133806	1120	-	Update TC of 8.2.1.1 FDD PDSCH Single Antenna Port Performance (Cell-Specific Reference Symbols) for CA	11.1.0	11.2.0
2013-09	RAN#61	R5-133807	1121	-	Update TC of 8.2.1.4 FDD PDSCH Closed Loop Spatial Multiplexing Performance (Cell-Specific Reference Symbols) for CA	11.1.0	11.2.0
2013-09	RAN#61	R5-133808	1122	-	Addition of new TC 8.2.1.4.2_A.2 for FDD PDSCH Closed Loop Multi Layer Spatial Multiplexing 4x2 for CA (inter band DL CA)	11.1.0	11.2.0
2013-09	RAN#61	R5-133811	1123	-	Update of CA TC 7.3A.1	11.1.0	11.2.0
2013-09	RAN#61	R5-133812	1124	-	Update of CA TC 7.4A.1	11.1.0	11.2.0
2013-09	RAN#61	R5-133819	1125	-	Correction of applicability for FDD RF TCs 9.3.4.1.1, 9.3.4.2.1 & 9.4.1.2.1 and TDD RF TCs 9.3.4.1.2, 9.3.4.2.2 & 9.4.1.2.2	11.1.0	11.2.0
2013-09	RAN#61	R5-133823	1126	-	Introduction of eICIC_enh_LTE to Annex A to reference measurement channels for PDCCH/PCFICH	11.1.0	11.2.0
2013-09	RAN#61	R5-133824	1127	-	Introduction of eICIC_enh_LTE to Annex A DL reference measurement channels	11.1.0	11.2.0
2013-09	RAN#61	R5-133828	1128	-	Corrections to 6.2.4 A-MPR for Maintenance of Band 23	11.1.0	11.2.0
2013-09	RAN#61	R5-133829	1129	-	Corrections to Transmitter Characteristics Maintenance	11.1.0	11.2.0
2013-09	RAN#61	R5-133830	1130	-	Alignment of test configuration tables (test frequencies) in Additional Spurious Emissions tests cases	11.1.0	11.2.0
2013-09	RAN#61	R5-133831	1131	-	Corrections to Receiver Characteristics Maintenance	11.1.0	11.2.0
2013-09	RAN#61	R5-133832	1132	-	Corrections to 6.6.2.2 Additional Spectrum Emission Mask for Maintenance of Band 23	11.1.0	11.2.0
2013-09	RAN#61	R5-133833	1133	-	Updates to Chapter7 for Inter Band CA combo CA_4A-29A	11.1.0	11.2.0
2013-09	RAN#61	R5-133838	1134	-	Update Minimum Requirements of TCs 6.2.4 and 6.2.5	11.1.0	11.2.0
2013-09	RAN#61	R5-133845	1135	-	Correction to Configured UE transmitted output power for CA	11.1.0	11.2.0
2013-09	RAN#61	R5-133846	1136	-	Corrections to TC 6.2.5A.2 Configured UE transmitted Power for CA (inter-band DL CA without UL CA)	11.1.0	11.2.0
2013-09	RAN#61	R5-133847	1137	-	Updates to Wideband intermodulation for CA test cases	11.1.0	11.2.0
2013-09	RAN#61	R5-133850	1138	-	Correction to measurement target of CA Rx test cases	11.1.0	11.2.0
2013-09	RAN#61	R5-133851	1139	-	Corrections to TC 7.5A.2 Adjacent Channel Selectivity (ACS) for CA (intra-band contiguous DL CA without UL CA)	11.1.0	11.2.0
2013-09	RAN#61	R5-133852	1140	-	Update TC of 8.7.1.1_A.1 FDD Sustained data rate performance for CA (intra band contiguous DL CA)	11.1.0	11.2.0
2013-09	RAN#61	R5-133853	1141	-	Update TC of 8.7.1.1_A.2 FDD Sustained data rate performance for CA (inter band DL CA)	11.1.0	11.2.0
2013-09	RAN#61	R5-133854	1142	-	Updates of Annex for CA test cases	11.1.0	11.2.0
2013-09	RAN#61	R5-133863	1143	-	Clarification on Bandwidth Combination Set for Carrier Aggregation Transmitter tests	11.1.0	11.2.0
2013-09	RAN#61	R5-133865	1144	-	Update TC 6.2.5A.1 Configured UE transmitted Output Power for CA_5A-12A (intra-band contiguous DL CA and UL CA)	11.1.0	11.2.0

2013-09	RAN#61	R5-133866	1145	-	Update the minimum requirements of TCs 7.5A.1, 7.6.1A.1 and 7.6.2A.1 for CA	11.1.0	11.2.0
2013-09	RAN#61	R5-133867	1146	-	Update TC 7.3A.1 Reference sensitivity level for CA (intra-band contiguous DL CA and UL CA)	11.1.0	11.2.0
2013-09	RAN#61	R5-133869	1147	-	Addition of Refsens for intra-band non-contiguous CA	11.1.0	11.2.0
2013-09	RAN#61	R5-133870	1148	-	Update TC 7.3A.3 reference sensitivity level for CA_3-8 (inter-band DL CA without UL CA)	11.1.0	11.2.0
2013-09	RAN#61	R5-133871	1149	-	Test cases and test system uncertainty for LTE B14 public safety highpower UE	11.1.0	11.2.0
2013-09	RAN#61	R5-133873	1150	-	Addition of new TC 8.3.1.1.3 for FDD PDSCH Single-layer Spatial Multiplexing on antenna ports 7 or 8 with TM9 Interference Model	11.1.0	11.2.0
2013-09	RAN#61	R5-133874	1151	-	Addition of new TC 8.3.2.1.4 for TDD PDSCH Single-layer Spatial Multiplexing on antenna ports 7 or 8 with TM9 Interference Model	11.1.0	11.2.0
2013-09	RAN#61	R5-133886	1152	-	eICIC RF: Addition of new RI tests and OCNG patterns for eICIC	11.1.0	11.2.0
2013-09	RAN#61	R5-133887	1153	-	Update of CA TC 6.2.3A and TC 6.2.4A	11.1.0	11.2.0
2013-09	RAN#61	R5-133888	1154	-	CA RF: Corrections to reference sensitivity requirements for CA	11.1.0	11.2.0
2013-09	RAN#61	R5-133889	1155	-	Correction to Test Requirement in 7.3A.3	11.1.0	11.2.0
2013-09	RAN#61	R5-133890	1156	-	Update TC of 8.2.1.3 FDD PDSCH Open Loop Spatial Multiplexing Performance (Cell-Specific Reference Symbols)for CA	11.1.0	11.2.0
2013-09	RAN#61	R5-133898	1157	-	Clarification on Bandwidth Combination Set for Carrier Aggregation Receiver tests	11.1.0	11.2.0
2013-09	RAN#61	R5-133899	1158	-	Addition of CA TC 6.6.2.2A	11.1.0	11.2.0
2013-12	RAN#62	R5-134130	1159	-	RF: Corrections to the notes in the band UE co-existence requirements table	11.2.0	11.3.0
2013-12	RAN#62	R5-134131	1160	-	RF: Corrections to sustained data rate test case	11.2.0	11.3.0
2013-12	RAN#62	R5-134132	1161	-	RF: Clean-up of uplink reference measurement channels	11.2.0	11.3.0
2013-12	RAN#62	R5-134139	1162	-	eICIC RF: Corrections to PHICH demodulation test	11.2.0	11.3.0
2013-12	RAN#62	R5-134161	1163	-	Corrections to Transmitter Requirements for Intra-band Non-contiguous CA	11.2.0	11.3.0
2013-12	RAN#62	R5-134169	1164	-	Introduction of I.2.6 Tests for feICIC (Further Enhanced Non CA- based ICIC for LTE)	11.2.0	11.3.0
2013-12	RAN#62	R5-134170	1165	-	Introduction of TC 8.2.1.2.3_E.1 FDD PDSCH Transmit diversity 2x2 for feICIC (non-MBSFN ABS)	11.2.0	11.3.0
2013-12	RAN#62	R5-134171	1166	-	Introduction of TC 8.2.2.2.3_E.1 TDD PDSCH Transmit diversity 2x2 for feICIC (non-MBSFN ABS)	11.2.0	11.3.0
2013-12	RAN#62	R5-134172	1167	-	Introduction of TC 8.2.1.4.1_E.1 FDD PDSCH Closed Loop Single Layer Spatial Multiplexing 2x2 for feICIC (non-MBSFN ABS)	11.2.0	11.3.0
2013-12	RAN#62	R5-134173	1168	-	Introduction of TC 8.2.2.4.1_E.1 TDD PDSCH Closed Loop Single Layer Spatial Multiplexing 2x2 for feICIC (non-MBSFN ABS)	11.2.0	11.3.0
2013-12	RAN#62	R5-134174	1169	-	Introduction of TC 8.4.1.2.3_E.1 FDD PCFICH/PDCCH Transmit Diversity 2x2 for feICIC (non-MBSFN ABS)	11.2.0	11.3.0
2013-12	RAN#62	R5-134175	1170	-	Introduction of TC 8.4.1.2.3_E.2 FDD PCFICH/PDCCH Transmit Diversity 2x2 for feICIC (MBSFN ABS)	11.2.0	11.3.0



2013-12	RAN#62	R5-134176	1171	-	Introduction of TC 8.4.2.2.3_E.1 TDD PCFICH/PDCCH Transmit Diversity 2x2 for felCIC (non-MBSFN ABS)	11.2.0	11.3.0
2013-12	RAN#62	R5-134177	1172	-	Introduction of TC 8.4.2.2.3_E.2 TDD PCFICH/PDCCH Transmit Diversity 2x2 for felCIC (MBSFN ABS)	11.2.0	11.3.0
2013-12	RAN#62	R5-134178	1173	-	Introduction of Demodulation felCIC Test Cases to Annex F	11.2.0	11.3.0
2013-12	RAN#62	R5-134179	1174	-	Introduction of TC 9.2.1.5_E.1 FDD CQI Reporting under AWGN conditions - PUCCH 1-0 for felCIC (non-MBSFN ABS)	11.2.0	11.3.0
2013-12	RAN#62	R5-134180	1175	-	Introduction of TC 9.2.1.6_E.1 TDD CQI Reporting under AWGN conditions - PUCCH 1-0 for felCIC (non-MBSFN ABS)	11.2.0	11.3.0
2013-12	RAN#62	R5-134181	1176	-	Introduction of TC 9.3.1.3.1_E.1 FDD CQI Reporting under fading conditions - PUSCH 3-0 for felCIC (non-MBSFN ABS)	11.2.0	11.3.0
2013-12	RAN#62	R5-134182	1177	-	Introduction of TC 9.3.1.3.2_E.1 TDD CQI Reporting under fading conditions - PUSCH 3-0 for felCIC (non-MBSFN ABS)	11.2.0	11.3.0
2013-12	RAN#62	R5-134183	1178	-	Introduction of TC 9.5.4.1_E FDD RI Reporting - PUCCH 1-0 for felCIC (non-MBSFN ABS)	11.2.0	11.3.0
2013-12	RAN#62	R5-134184	1179	-	Introduction of TC 9.5.4.2_E TDD RI Reporting - PUCCH 1-0 for felCIC (non-MBSFN ABS)	11.2.0	11.3.0
2013-12	RAN#62	R5-134185	1180	-	Introduction of Reporting of Channel State Information felCIC Test Cases to Annex F	11.2.0	11.3.0
2013-12	RAN#62	R5-134196	1181	-	Corrections to 7.5A.3 Adjacent Channel Selectivity (ACS) for CA (inter-band DL CA without UL CA)	11.2.0	11.3.0
2013-12	RAN#62	R5-134199	1182	-	Corrections to MPR for intra-band non-contiguous CA	11.2.0	11.3.0
2013-12	RAN#62	R5-134234	1183	-	CA RF: Corrections to requirements for In-Band blocking for Inter-Band without UL-CA	11.2.0	11.3.0
2013-12	RAN#62	R5-134247	1184	-	RF: Corrections to requirements for NS_11 (Band 23)	11.2.0	11.3.0
2013-12	RAN#62	R5-134250	1185	-	RF: Band edge relaxation for UE-s supporting Band 18 and Band 26	11.2.0	11.3.0
2013-12	RAN#62	R5-134289	1187	-	Correction to Maximum Power Reduction (MPR) for CA Test Procedure	11.2.0	11.3.0
2013-12	RAN#62	R5-134413	1189	-	Update TT of TC 8.2.1.4.2_A.2 FDD PDSCH Closed Loop Multi Layer 4x2 for CA	11.2.0	11.3.0
2013-12	RAN#62	R5-134414	1190	-	Correction of TC 6.2.4A Test Requirements for CA_38C	11.2.0	11.3.0
2013-12	RAN#62	R5-134421	1191	-	The addition of Beamforming model for EPDCCH localized transmission	11.2.0	11.3.0
2013-12	RAN#62	R5-134423	1192	-	The addition of Beamforming model for EPDCCH distributed transmission	11.2.0	11.3.0
2013-12	RAN#62	R5-134424	1193	-	The addition of Downlink physical setup for EPDCCH	11.2.0	11.3.0
2013-12	RAN#62	R5-134431	1194	-	LTE Type A performance requirements - Introduction of the new test case 8.2.1.2.4	11.2.0	11.3.0
2013-12	RAN#62	R5-134432	1195	-	LTE Type A performance requirements - adding TC 8.2.1.2.4 and 9.3.5.1.1 to Annex E and G	11.2.0	11.3.0
2013-12	RAN#62	R5-134445	1196	-	TU and TT for 36.521-1 eICIC FDD PCFICH/PDCCH and PHICH demodulation tests	11.2.0	11.3.0
2013-12	RAN#62	R5-134477	1197	-	Correction to CA Sustained data rate tests	11.2.0	11.3.0
2013-12	RAN#62	R5-134478	1198	-	Correction to CQI-ReportConfig-DEFAULT for CA performance tests	11.2.0	11.3.0
2013-12	RAN#62	R5-134485	1199	-	Clarification of UL resource blocks for CA_4A-17A in 7.3A.3	11.2.0	11.3.0

2013-12	RAN#62	R5-134488	1200	-	Correction to test requirement in 6.2.4	11.2.0	11.3.0
2013-12	RAN#62	R5-134489	1201	-	Correction to test requirement in 6.6.3.2	11.2.0	11.3.0
2013-12	RAN#62	R5-134490	1202	-	Additional exception message for SIB3 in MBMS performance test	11.2.0	11.3.0
2013-12	RAN#62	R5-134800	1204	-	Introduction of UE TM3 Demodulation Performance under High Speed to Annex F	11.2.0	11.3.0
2013-12	RAN#62	R5-134801	1205	-	Introduction of UE TM3 Demodulation Performance under High Speed	11.2.0	11.3.0
2013-12	RAN#62	R5-134802	1206	-	Corrections to eDL-MIMO Channel State Information Test	11.2.0	11.3.0
2013-12	RAN#62	R5-134805	1207	-	Update Minimum Requirements of TCs 6.6.3.2 and 6.6.3.2A Spurious emission band UE co-existence	11.2.0	11.3.0
2013-12	RAN#62	R5-134806	1208	-	Change Spurious emission UE co-existence test case for LTE CA to align with release independence rule	11.2.0	11.3.0
2013-12	RAN#62	R5-134807	1209	-	Clarification of applicability of additional relaxation RIB,c on Reference Sensitivity Test Cases	11.2.0	11.3.0
2013-12	RAN#62	R5-134816	1215	-	Addition of new Test Case PUCCH 1-1 for Interference rejection	11.2.0	11.3.0
2013-12	RAN#62	R5-134817	1216	-	Addition of interference rejection test cases TC 8.2.2.2.4 and TC 8.2.2.4.3	11.2.0	11.3.0
2013-12	RAN#62	R5-134828	1217	-	Clarification of multi-cluster transmission terminology	11.2.0	11.3.0
2013-12	RAN#62	R5-134829	1218	-	Corrections to P <sub>cm</sub>	11.2.0	11.3.0
2013-12	RAN#62	R5-134830	1219	-	Corrections to test descriptions reference tables for Transmitter Characteristics test cases	11.2.0	11.3.0
2013-12	RAN#62	R5-134832	1220	-	Corrections to definition of 5+20 MHz for spectrum emission mask for CA in Annex F	11.2.0	11.3.0
2013-12	RAN#62	R5-134857	1223	-	Update TC 6.2.4 A-MPR for NS_19	11.2.0	11.3.0
2013-12	RAN#62	R5-134858	1224	-	Update TC 6.6.3.3 Additional Spurious Emissions for NS_19	11.2.0	11.3.0
2013-12	RAN#62	R5-134859	1225	-	Simplification of test points in Additional Spurious Emissions Coexistence test case	11.2.0	11.3.0
2013-12	RAN#62	R5-134861	1227	-	Addition of Sustained data rate test(FDD) for category 6 and 7 UEs	11.2.0	11.3.0
2013-12	RAN#62	R5-134865	1228	-	CA RF: Power alignment between uplink component carriers	11.2.0	11.3.0
2013-12	RAN#62	R5-134866	1229	-	Completion of test case 6.7A Transmit intermodulation for CA	11.2.0	11.3.0
2013-12	RAN#62	R5-134867	1230	-	Update Minimum Requirements of TCs 7.3 and 7.3.1A Reference sensitivity power level	11.2.0	11.3.0
2013-12	RAN#62	R5-134868	1231	-	Clean-up of CA Rx test cases	11.2.0	11.3.0
2013-12	RAN#62	R5-134871	1232	-	Update Minimum Requirements and TT of TC 8.2.1.3.1_A	11.2.0	11.3.0
2013-12	RAN#62	R5-134875	1233	-	Addition of Inter Band CA combo CA_3A-5A, CA_3A-20A	11.2.0	11.3.0
2013-12	RAN#62	R5-134876	1234	-	Addition of Inter Band CA combo CA_4A-7A	11.2.0	11.3.0
2013-12	RAN#62	R5-134878	1235	-	Correction and applicability clarification to multi-cluster allocations for UL CA TCs 6.2.3A, 6.2.4A, 6.6.2.1A, 6.6.2.2A, 6.6.2.3A and 6.6.3.3A	11.2.0	11.3.0
2013-12	RAN#62	R5-134879	1236	-	Clarification of CA Reference sensitivity level	11.2.0	11.3.0
2013-12	RAN#62	R5-134880	1237	-	Correction to blocking requirements and use of delta RIB	11.2.0	11.3.0

2013-12	RAN#62	R5-134881	1238	-	Addition of new TC 7.4A.4 Maximum input level for CA (intra band non-contiguous DL CA without UL CA)	11.2.0	11.3.0
2013-12	RAN#62	R5-134882	1239	-	Addition of new TC 7.5A.4 Adjacent Channel Selectivity (ACS) for CA(intra band non-contiguous DL CA without UL CA)	11.2.0	11.3.0
2013-12	RAN#62	R5-134889	1244	-	Uncertainties and Test Tolerances for eICIC PDSCH demodulation tests	11.2.0	11.3.0
2013-12	RAN#62	R5-134893	1247	-	Addition of applicabilities of LTE Type A performance requirements	11.2.0	11.3.0
2013-12	RAN#62	R5-134894	1248	-	Test Procedure, uncerts and TT for Rx Test cases with intra-band contiguous UL CA	11.2.0	11.3.0
2013-12	RAN#62	R5-134976	1251	-	Update TT of TC 8.2.1.4.2_A.1 FDD PDSCH Closed Loop Multi Layer 4x2 for CA	11.2.0	11.3.0
2013-12	RAN#62	R5-134977	1252	-	Update of CA CSI tests	11.2.0	11.3.0
2013-12	RAN#62	R5-134978	1253	-	Update of eICIC Performance test cases	11.2.0	11.3.0
2013-12	RAN#62	R5-134985	1254	-	LTE Type A performance requirements - Changes to TC 9.3.5.1.1	11.2.0	11.3.0
2013-12	RAN#62	R5-134987	1255	-	RF: Corrections to requirements for NS_15 (Band 26)	11.2.0	11.3.0
2013-12	RAN#62	R5-134988	1256	-	Corrections to Band 23 NS_11 and NS_20 Test Points	11.2.0	11.3.0
2013-12	RAN#62	R5-134995	1259	-	Update on MPR and A-MPR test requirements	11.2.0	11.3.0
2013-12	RAN#62	R5-135012	1261	-	Clarification in regard to 36.521-1 tests not included in 36.521-2 Applicability table	11.2.0	11.3.0
2013-12	RAN#62	R5-135031	1222	-	RF TC Update for 36.521-1_9.2.1.3_C1 eICIC	11.2.0	11.3.0
2013-12	RAN#62	R5-135046	1226	-	RF: Updates to the downlink reference measurement channels	11.2.0	11.3.0
2013-12	RAN#62	R5-134277	1186	-	Addition of Rel-12 CA band combinations(CA_3-19 and CA_19-21) to Chap. 5	11.3.0	12.0.0
2013-12	RAN#62	R5-134339	1188	-	Updates to TC 6.2.2A.1 for CA_3C	11.3.0	12.0.0
2013-12	RAN#62	R5-134540	1203	-	Applicability statement of new 5MHz BB tests for Band 31 in TS 36.521-1	11.3.0	12.0.0
2013-12	RAN#62	R5-134808	1210	-	Updates of 5.4.2A Channel bandwidth for CA_1A-18A	11.3.0	12.0.0
2013-12	RAN#62	R5-134809	1211	-	Updates of 5.2A Operating bands for CA_1A-26A	11.3.0	12.0.0
2013-12	RAN#62	R5-134810	1212	-	Updates of 5.4.2A Channel bandwidth for CA_1A-26A	11.3.0	12.0.0
2013-12	RAN#62	R5-134811	1213	-	Updates of 6.2.5A Delta TIB for CA_1A-26A	11.3.0	12.0.0
2013-12	RAN#62	R5-134812	1214	-	Updates of 7.3A Delta RIB for CA_1A-26A	11.3.0	12.0.0
2013-12	RAN#62	R5-134833	1221	-	Correction to Tx TCs for lower tolerance relaxation, removal of 6.2.5A.2 and addition of Rel-12 CA band combinations(CA_3-19 and CA_19-21) to 6.2.5	11.3.0	12.0.0
2013-12	RAN#62	R5-134884	1240	-	Addition of Rel-12 CA band combination(CA_3-19 and CA_19-21) to Refsens	11.3.0	12.0.0
2013-12	RAN#62	R5-134886	1241	-	Updates for 5.2A operating bands and 5.4.2A channel bandwidth for CA_3C	11.3.0	12.0.0
2013-12	RAN#62	R5-134887	1242	-	Updates to TC 6.2.3A.1 for CA_3C	11.3.0	12.0.0
2013-12	RAN#62	R5-134888	1243	-	Updates to TC 6.6.2.1A.1 for CA_3C	11.3.0	12.0.0
2013-12	RAN#62	R5-134891	1245	-	Updates to FDD PDSCH Single Antenna and Transmit Diversity 2x2 performance test cases for 5MHz BW	11.3.0	12.0.0

2013-12	RAN#62	R5-134892	1246	-	Updates to 8.2.1.3.1 for FDD PDSCH Open Loop Spatial Multiplexing 2x2 for 5MHz BW	11.3.0	12.0.0
2013-12	RAN#62	R5-134896	1249	-	Updates to TC 9.2.1.1 FDD CQI reporting under AWGN conditions - PUCCH 1-0 test case for 5MHz BW	11.3.0	12.0.0
2013-12	RAN#62	R5-134897	1250	-	Updates to TC 9.3.2.1.1 and 9.3.2.1.1_1 FDD CQI Reporting under fading conditions - PUCCH 1-0 test case for 5MHz BW	11.3.0	12.0.0
2013-12	RAN#62	R5-134989	1257	-	Corrections to definition of 5+20 MHz for spectrum emission mask for CA	11.3.0	12.0.0
2013-12	RAN#62	R5-134992	1258	-	Updates to 8.5.1.2 FDD PHICH Transmit Diversity Performance tests	11.3.0	12.0.0
2013-12	RAN#62	R5-135068	1262	-	Updates to 8.2.1.4 FDD PDSCH Closed Loop Single/Multiple layer Spatial Multiplexing 2x2 for 5MHz BW	11.3.0	12.0.0
2014-03	RAN#63	R5-140228	1264	-	Uncertainties for eICIC 9.x CSI Test Cases	12.0.0	12.1.0
2014-03	RAN#63	R5-140245	1265	-	eDL-MIMO RF: Corrections to 8x2 MIMO tests	12.0.0	12.1.0
2014-03	RAN#63	R5-140247	1266	-	CA RF: Corrections to sustained data rate tests	12.0.0	12.1.0
2014-03	RAN#63	R5-140248	1267	-	RF: Corrections to OCNG pattern for PMI tests	12.0.0	12.1.0
2014-03	RAN#63	R5-140249	1268	-	RF: Corrections to cross references between tests	12.0.0	12.1.0
2014-03	RAN#63	R5-140250	1269	-	feICIC RF: Corrections to some subclause-titles	12.0.0	12.1.0
2014-03	RAN#63	R5-140261	1270	-	CoMP RF: Introduction of CoMP section in Annex I	12.0.0	12.1.0
2014-03	RAN#63	R5-140388	1272	-	LTE Type A performance requirements - Introduction of the new test case 9.3.5.1.2	12.0.0	12.1.0
2014-03	RAN#63	R5-140444	1273	-	Updates of 6.2.5 Delta TIB for CA_1A-26A	12.0.0	12.1.0
2014-03	RAN#63	R5-140446	1274	-	Updates of 7.3 Delta RIB for CA_1A-26A	12.0.0	12.1.0
2014-03	RAN#63	R5-140448	1275	-	Updates of 6.6.3.2 Spurious emission band UE co-existence for B41	12.0.0	12.1.0
2014-03	RAN#63	R5-140499	1276	-	Update of eICIC Performance tests	12.0.0	12.1.0
2014-03	RAN#63	R5-140505	1277	-	Correction to test configuration parameter in Tx	12.0.0	12.1.0
2014-03	RAN#63	R5-140508	1278	-	Update of CA FDD and TDD performance tests	12.0.0	12.1.0
2014-03	RAN#63	R5-140509	1279	-	Addition of CQI configuration in CA closed loop performance tests	12.0.0	12.1.0
2014-03	RAN#63	R5-140511	1280	-	Addition of SCC activation and CQI configuration in CA CQI Reporting tests	12.0.0	12.1.0
2014-03	RAN#63	R5-140561	1281	-	Removal of [ ]s in Annex G.6	12.0.0	12.1.0
2014-03	RAN#63	R5-140800	1282	-	Corrections to NS signalling for CA refsens	12.0.0	12.1.0
2014-03	RAN#63	R5-140801	1283	-	Correction to statistical testing for Inter-band CA Rx tests	12.0.0	12.1.0
2014-03	RAN#63	R5-140802	1284	-	Additions to combinations of channel model parameters	12.0.0	12.1.0
2014-03	RAN#63	R5-140803	1285	-	Addition of a Fixed Reference Channel two antenna ports	12.0.0	12.1.0
2014-03	RAN#63	R5-140804	1286	-	Corrections to TDD eDL-MIMO test cases	12.0.0	12.1.0
2014-03	RAN#63	R5-140805	1287	-	Correction the category information of Table 8.2.1.1.2.3-2 and Table 8.2.1.1.2.5-1 in test case 8.2.1.1.2	12.0.0	12.1.0
2014-03	RAN#63	R5-140806	1288	-	Correction the category information in Table 8.2.1.2.1.3-2 and Table 8.2.1.2.1.3-2 for Test case 8.2.1.2.1	12.0.0	12.1.0
2014-03	RAN#63	R5-140807	1289	-	Correction the test case applicability of test case 8.2.1.3.2	12.0.0	12.1.0

2014-03	RAN#63	R5-140811	1290	-	Addition of A.3.9.4 TDD SDR Reference Channel for EPDCCH	12.0.0	12.1.0
2014-03	RAN#63	R5-140812	1291	-	Addition of A.3.9.3 FDD SDR Reference Channel for EPDCCH	12.0.0	12.1.0
2014-03	RAN#63	R5-140813	1292	-	Addition of OCNG Pattern for EPDCCH TDD performance requirements	12.0.0	12.1.0
2014-03	RAN#63	R5-140814	1293	-	Addition of OCNG Pattern for EPDCCH FDD performance requirements	12.0.0	12.1.0
2014-03	RAN#63	R5-140815	1294	-	Addition of Reference Measurement Channels for EPDCCH performance requirements	12.0.0	12.1.0
2014-03	RAN#63	R5-140816	1295	-	Introduction of RMCs and power levels for CoMP in annex	12.0.0	12.1.0
2014-03	RAN#63	R5-140818	1296	-	Addition of CA_1A-8A to 36.521-1 Chapter 5	12.0.0	12.1.0
2014-03	RAN#63	R5-140819	1297	-	Addition of CA_1A-8A to 36.521-1 Chapter 6	12.0.0	12.1.0
2014-03	RAN#63	R5-140820	1298	-	Addition of CA_1A-8A to 36.521-1 Chapter 7	12.0.0	12.1.0
2014-03	RAN#63	R5-140823	1300	-	Corrections to definition of 20 MHz and 5MHz for transmit intermodulation for CA in 6.7A	12.0.0	12.1.0
2014-03	RAN#63	R5-140824	1301	-	Updates to TC 7.4A.1 for CA_3C	12.0.0	12.1.0
2014-03	RAN#63	R5-140825	1302	-	Updates to TC 6.6.3.2A for CA_3C	12.0.0	12.1.0
2014-03	RAN#63	R5-140826	1303	-	Corrections to definition of 20 MHz and 5MHz for occupied bandwidth for CA in 6.6.1A	12.0.0	12.1.0
2014-03	RAN#63	R5-140827	1304	-	Updates to TC 7.3A.1 for CA_3C	12.0.0	12.1.0
2014-03	RAN#63	R5-140828	1305	-	Updates to TC 7.3A.2 for CA_3C	12.0.0	12.1.0
2014-03	RAN#63	R5-140831	1306	-	Additions to TC 8.2.2.2.3_E.1 TDD PDSCH Transmit diversity 2x2 for feICIC (non-MBSFN ABS)	12.0.0	12.1.0
2014-03	RAN#63	R5-140832	1307	-	Additions to TC 8.2.1.4.1_E.1 FDD PDSCH Closed Loop Single Layer Spatial Multiplexing 2x2 for feICIC (non-MBSFN ABS)	12.0.0	12.1.0
2014-03	RAN#63	R5-140833	1308	-	Additions to TC 8.2.2.4.1_E.1 TDD PDSCH Closed Loop Single Layer Spatial Multiplexing 2x2 for feICIC (non-MBSFN ABS)	12.0.0	12.1.0
2014-03	RAN#63	R5-140834	1309	-	Additions to TC 8.4.1.2.3_E.1 FDD PCFICH/PDCCH Transmit Diversity 2x2 for feICIC (non-MBSFN ABS)	12.0.0	12.1.0
2014-03	RAN#63	R5-140835	1310	-	Additions to TC 8.4.2.2.3_E.1 TDD PCFICH/PDCCH Transmit Diversity 2x2 for feICIC (non-MBSFN ABS)	12.0.0	12.1.0
2014-03	RAN#63	R5-140836	1311	-	Additions to TC 8.4.1.2.3_E.2 FDD PCFICH/PDCCH Transmit Diversity 2x2 for feICIC (MBSFN ABS)	12.0.0	12.1.0
2014-03	RAN#63	R5-140837	1312	-	Additions to TC 8.4.2.2.3_E.2 TDD PCFICH/PDCCH Transmit Diversity 2x2 for feICIC (MBSFN ABS)	12.0.0	12.1.0
2014-03	RAN#63	R5-140838	1313	-	Additions to TC 9.2.1.5_E.1 FDD CQI Reporting under AWGN conditions - PUCCH 1-0 for feICIC (non-MBSFN ABS)	12.0.0	12.1.0
2014-03	RAN#63	R5-140839	1314	-	Additions to TC 9.2.1.6_E.1 TDD CQI Reporting under AWGN conditions - PUCCH 1-0 for feICIC (non-MBSFN ABS)	12.0.0	12.1.0
2014-03	RAN#63	R5-140840	1315	-	Additions to TC 9.3.1.3.1_E.1 FDD CQI Reporting under fading conditions - PUSCH 3-0 for feICIC (non-MBSFN ABS)	12.0.0	12.1.0
2014-03	RAN#63	R5-140841	1316	-	Additions to TC 9.3.1.3.2_E.1 TDD CQI Reporting under fading conditions - PUSCH 3-0 for feICIC (non-MBSFN ABS)	12.0.0	12.1.0
2014-03	RAN#63	R5-140842	1317	-	Additions to TC 9.5.4.1_E FDD RI Reporting - PUCCH 1-0 for feICIC (non-MBSFN ABS)	12.0.0	12.1.0

2014-03	RAN#63	R5-140843	1318	-	Additions to TC 9.5.4.2_E TDD RI Reporting - PUCCH 1-0 for feICIC (non-MBSFN ABS)	12.0.0	12.1.0
2014-03	RAN#63	R5-140844	1319	-	Introduction of feICIC to Annex G	12.0.0	12.1.0
2014-03	RAN#63	R5-140845	1361	-	Addition of PHICH demod requirements for feICIC	12.0.0	12.1.0
2014-03	RAN#63	R5-140846	1320	-	Addition to TC 8.2.2.3.3_E.1 TDD PDSCH Open Loop Spatial Multiplexing 2x2 for feICIC (non-MBSFN ABS)	12.0.0	12.1.0
2014-03	RAN#63	R5-140847	1321	-	Corrections to test configuration notes of CA soft buffer	12.0.0	12.1.0
2014-03	RAN#63	R5-140856	1322	-	Additions to TC 8.2.1.2.3_E.1 FDD PDSCH Transmit diversity 2x2 for feICIC (non-MBFSN ABS)	12.0.0	12.1.0
2014-03	RAN#63	R5-140868	1323	-	Uncertainties and Test Tolerances for Interf_Rej Test case 8.2.1.2.4	12.0.0	12.1.0
2014-03	RAN#63	R5-140877	1324	-	Introduction of TC 9.5.5.1_F.1 FDD RI Reporting with Single CSI process	12.0.0	12.1.0
2014-03	RAN#63	R5-140878	1325	-	Introduction of TC 9.5.5.2_F.1 TDD RI Reporting with Single CSI process	12.0.0	12.1.0
2014-03	RAN#63	R5-140881	1326	-	Addition to TC 8.2.1.3.3_E.1 FDD FDD PDSCH Open Loop Spatial Multiplexing 2x2 for feICIC (non-MBSFN ABS)	12.0.0	12.1.0
2014-03	RAN#63	R5-140887	1327	-	Correction to eICIC CQI Reporting tests	12.0.0	12.1.0
2014-03	RAN#63	R5-140888	1328	-	eICIC RF: Corrections to requirements, procedure and UL-RMCs for CQI tests	12.0.0	12.1.0
2014-03	RAN#63	R5-140889	1329	-	Addition of TC 8.7.3.1 FDD sustained data rate performance for EPDCCH scheduling	12.0.0	12.1.0
2014-03	RAN#63	R5-140890	1330	-	Addition of TC 8.8.1.1.1 FDD distributed EPDCCH performance	12.0.0	12.1.0
2014-03	RAN#63	R5-140891	1331	-	Addition of TC 8.7.4.1 TDD sustained data rate performance for EPDCCH scheduling	12.0.0	12.1.0
2014-03	RAN#63	R5-140892	1332	-	Addition of TC 8.8.1.2.1 TDD distributed EPDCCH performance	12.0.0	12.1.0
2014-03	RAN#63	R5-140893	1333	-	Addition of TC 8.8.2.1.1 FDD localized EPDCCH performance	12.0.0	12.1.0
2014-03	RAN#63	R5-140894	1334	-	Addition of TC 8.8.2.1.2 FDD EPDCCH localized transmission with TM10 quasi co-location Type-B	12.0.0	12.1.0
2014-03	RAN#63	R5-140895	1335	-	Addition of TC 8.8.2.2.1 TDD localized EPDCCH performance	12.0.0	12.1.0
2014-03	RAN#63	R5-140896	1336	-	Addition of TC 8.8.2.2.2 TDD EPDCCH localized transmission with TM10 quasi co-location Type-B	12.0.0	12.1.0
2014-03	RAN#63	R5-140922	1337	-	Modify Applicability for LTE B14 public safety high power UE test cases	12.0.0	12.1.0
2014-03	RAN#63	R5-141003	1338	-	Addition of FDD CQI Reporting under AWGN conditions - Single CSI Process TC 9.2.4.1	12.0.0	12.1.0
2014-03	RAN#63	R5-141004	1339	-	Addition of TDD CQI Reporting under AWGN conditions - Single CSI Process TC 9.2.4.2	12.0.0	12.1.0
2014-03	RAN#63	R5-141006	1340	-	Addition of TC 8.2.1.7 FDD Carrier Aggregation with power imbalance	12.0.0	12.1.0
2014-03	RAN#63	R5-141007	1341	-	Updates to TC 7.4A.2 for CA_3C	12.0.0	12.1.0
2014-03	RAN#63	R5-141008	1342	-	Addition of TC 9.3.6.1_F FDD CQI Reporting under fading conditions multiple CSI processes for CoMP	12.0.0	12.1.0
2014-03	RAN#63	R5-141009	1343	-	Addition of TC 9.3.6.2_F TDD CQI Reporting under fading conditions multiple CSI processes for CoMP	12.0.0	12.1.0

2014-03	RAN#63	R5-141011	1345	-	Corrections to definition of 20 MHz and 5MHz for minimum output power for CA in 6.3.2A	12.0.0	12.1.0
2014-03	RAN#63	R5-141012	1346	-	Addition of Intra NC CA to chap. 5 and related symbol to chap. 3	12.0.0	12.1.0
2014-03	RAN#63	R5-141016	1347	-	Correction and proposed resolution to TBDs UL CA TCs 6.2.4A and 6.6.3.3A	12.0.0	12.1.0
2014-03	RAN#63	R5-141017	1348	-	Update for CA Rx TCs	12.0.0	12.1.0
2014-03	RAN#63	R5-141018	1349	-	PCC/SCC switching in inter-band CA Rx test cases	12.0.0	12.1.0
2014-03	RAN#63	R5-141026	1350	-	Introduction of new TC 8.3.1.3.2_F FDD PDSCH Performance with DCI format 2D, non Quasi Co-located Antenna Ports, Same Cell ID and multiple NZP CSI-RS resources for CoMP	12.0.0	12.1.0
2014-03	RAN#63	R5-141027	1351	-	Introduction of TC 8.3.1.3.3_F FDD PDSCH Performance with DCI format 2D, non Quasi Co-located Antenna Ports, Different Cell ID, Colliding CRS and single NZP CSI-RS for CoMP	12.0.0	12.1.0
2014-03	RAN#63	R5-141028	1352	-	Addition of new demod scenario for DL COMP - Same Cell ID and single NZP CSI-RS resource	12.0.0	12.1.0
2014-03	RAN#63	R5-141029	1353	-	Corrections to TM9 test to verify correct SNR estimation	12.0.0	12.1.0
2014-03	RAN#63	R5-141038	1354	-	Correction to sustained downlink data rate tests	12.0.0	12.1.0
2014-03	RAN#63	R5-141040	1355	-	Changes to test frequencies in Tx test cases for Band 28	12.0.0	12.1.0
2014-03	RAN#63	R5-141041	1356	-	Updates of Reference sensitivity for Intra-band non-contiguous CA	12.0.0	12.1.0
2014-03	RAN#63	R5-141042	1357	-	Update TC of 7.4A.4 Maximum input level for CA (intra band non-contiguous DL CA without UL CA)	12.0.0	12.1.0
2014-03	RAN#63	R5-141043	1358	-	Update TC of 7.5A.4 Adjacent Channel Selectivity (ACS) for CA (intra band non-contiguous DL CA without UL CA)	12.0.0	12.1.0
2014-03	RAN#63	R5-141044	1359	-	Corrections to maximum output power for multiple transmissions in a subframe	12.0.0	12.1.0
2014-03	RAN#63	R5-141045	1360	-	Correction to test configuration of Maximum input for CA	12.0.0	12.1.0
2014-03	RAN#63	R5-141047	1271	-	eICIC RF: Corrections to TDD PHICH test	12.0.0	12.1.0
2014-06	RAN#64	R5-142069	1362	-	LTE Type A performance requirements - adding TC 8.2.1.4.3 into annex F and G	12.1.0	12.2.0
2014-06	RAN#64	R5-142071	1363	-	Addition of connection diagram references to LTE Type A performance tests	12.1.0	12.2.0
2014-06	RAN#64	R5-142072	1364	-	Addition of connection diagram references to LTE Type A CSI tests	12.1.0	12.2.0
2014-06	RAN#64	R5-142111	1365	-	Addition of CA 3A-28A to 36.521-1 Chapter 6	12.1.0	12.2.0
2014-06	RAN#64	R5-142112	1366	-	Addition of CA 3A-28A to 36.521-1 Chapter 7	12.1.0	12.2.0
2014-06	RAN#64	R5-142172	1367	-	Addition of TC 6.2.2A.1 for CA_39C	12.1.0	12.2.0
2014-06	RAN#64	R5-142176	1368	-	Corrections to configured transmitted power for CA	12.1.0	12.2.0
2014-06	RAN#64	R5-142177	1369	-	Corrections to OCN pattern	12.1.0	12.2.0
2014-06	RAN#64	R5-142295	1370	-	Updates of 6.2.5 Delta TIB for CA_3A-26A and CA_3A-27A	12.1.0	12.2.0
2014-06	RAN#64	R5-142296	1371	-	Updates of 7.3.3 Delta RIB for CA_3A-26A and CA_3A-27A	12.1.0	12.2.0
2014-06	RAN#64	R5-142307	1372	-	RF: Corrections to spurious emission requirements with NS different than NS_01	12.1.0	12.2.0
2014-06	RAN#64	R5-142309	1373	-	RF: Editorial corrections to the annexes	12.1.0	12.2.0

2014-06	RAN#64	R5-142312	1374	-	CA RF: Several corrections to some Tx tests	12.1.0	12.2.0
2014-06	RAN#64	R5-142317	1375	-	eICIC RF: Corrections to RI performance tests	12.1.0	12.2.0
2014-06	RAN#64	R5-142343	1376	-	Addition of LTE CA_39A-41A into Table 6.2.5.3-2	12.1.0	12.2.0
2014-06	RAN#64	R5-142366	1377	-	Update of TC 8.7.4.1 TDD sustained data rate performance for EPDCCH scheduling	12.1.0	12.2.0
2014-06	RAN#64	R5-142372	1378	-	Update of TC 8.8.2.1.2 FDD EPDCCH localized transmission with TM10 quasi co-location Type-B	12.1.0	12.2.0
2014-06	RAN#64	R5-142376	1379	-	Update of TC 8.8.2.2.2 TDD EPDCCH localized transmission with TM10 quasi co-location Type-B	12.1.0	12.2.0
2014-06	RAN#64	R5-142384	1380	-	Update of TC 9.3.6.1_F FDD CQI Reporting under fading conditions multiple CSI processes for CoMP	12.1.0	12.2.0
2014-06	RAN#64	R5-142387	1381	-	Update overview of DL reference measurement channels for EPDCCH	12.1.0	12.2.0
2014-06	RAN#64	R5-142391	1382	-	Uncertainties and Test Tolerances for Enhanced Performance Requirement Type A 9.3.5.1.1 and 9.3.5.1.2 CQI Test cases	12.1.0	12.2.0
2014-06	RAN#64	R5-142393	1383	-	Test Tolerances for eICIC 9.2.x CQI Test cases	12.1.0	12.2.0
2014-06	RAN#64	R5-142394	1384	-	Correction of the test cases 8.2.1.2.2 and 8.2.1.2.2_1	12.1.0	12.2.0
2014-06	RAN#64	R5-142420	1386	-	Corrections to Annex G.5.4	12.1.0	12.2.0
2014-06	RAN#64	R5-142444	1387	-	Introduction of transmission mode 10 in precoder update granularity in FDD and TDD common test parameters	12.1.0	12.2.0
2014-06	RAN#64	R5-142446	1388	-	Introduction of new TC 8.3.2.4.2_F TDD PDSCH Performance with DCI format 2D, non Quasi Co-located Antenna Ports, Same Cell ID and multiple NZP CSI-RS resources for CoMP	12.1.0	12.2.0
2014-06	RAN#64	R5-142449	1389	-	Introduction of TC 8.3.2.4.3_F TDD PDSCH Performance with DCI format 2D, non Quasi Co-located Antenna Ports, Different Cell ID, Colliding CRS and single NZP CSI-RS for CoMP	12.1.0	12.2.0
2014-06	RAN#64	R5-142515	1390	-	Corrections to MBMS performance test cases	12.1.0	12.2.0
2014-06	RAN#64	R5-142576	1391	-	Update UE Transmit OFF power for CA_39C (intra-band contiguous DL CA and UL CA)	12.1.0	12.2.0
2014-06	RAN#64	R5-142588	1392	-	Remove the square bracket in TC 8.3.1.3.2_F and TC 8.3.1.3.3_F	12.1.0	12.2.0
2014-06	RAN#64	R5-142590	1393	-	Uncertainties and Test Tolerances for eICIC PDCCH/PCFICH and PHICH demodulation tests	12.1.0	12.2.0
2014-06	RAN#64	R5-142596	1394	-	Addition of message exception for PHICH duration	12.1.0	12.2.0
2014-06	RAN#64	R5-142597	1515	-	Correction to eICIC CSI tests	12.1.0	12.2.0
2014-06	RAN#64	R5-142601	1395	-	Correction to title in eICIC PDSCH demodulation tests	12.1.0	12.2.0
2014-06	RAN#64	R5-142605	1396	-	Correction to measurement bandwidth in 6.6.2.1A.1	12.1.0	12.2.0
2014-06	RAN#64	R5-142616	1399	-	Correction to MBMS performance	12.1.0	12.2.0
2014-06	RAN#64	R5-142672	1400	-	Correction to in-band blocking requirements	12.1.0	12.2.0
2014-06	RAN#64	R5-142676	1401	-	Correction to 6.6.2.1A test environment	12.1.0	12.2.0
2014-06	RAN#64	R5-142692	1402	-	Correction to 8.2.2.1.1_1 and 8.2.2.2.1_1 applicability	12.1.0	12.2.0
2014-06	RAN#64	R5-142697	1403	-	36.521-1: Corrections to section 7.3A	12.1.0	12.2.0
2014-06	RAN#64	R5-142701	1404	-	Introduction of NC CA TC 7.7A.4	12.1.0	12.2.0
2014-06	RAN#64	R5-142703	1405	-	Uncertainties and Derivation of Test Requirements for TCs 7.6.xA.4 and 7.7A.4	12.1.0	12.2.0



2014-06	RAN#64	R5-142710	1406	-	36-521-1: Clarification on Averaged EVM for PRACH	12.1.0	12.2.0
2014-06	RAN#64	R5-142749	1407	-	Correction to CA band combo CA_3A-5A	12.1.0	12.2.0
2014-06	RAN#64	R5-142750	1408	-	Verification of exceptions of REFSSENS requirements for carrier aggregation	12.1.0	12.2.0
2014-06	RAN#64	R5-142771	1409	-	Addition of CA_2A-4A and CA_5A-7A to 36.521-1 Chapter 7	12.1.0	12.2.0
2014-06	RAN#64	R5-143003	1410	-	36.521-1: Editorial correction on 6.6.3.3 Initial conditions for NS_19	12.1.0	12.2.0
2014-06	RAN#64	R5-143004	1411	-	36.521-1: Editorial correction on 6.6.2.2B test requirements for NS_06 or NS_07	12.1.0	12.2.0
2014-06	RAN#64	R5-143005	1412	-	Correction for CA_4A-12A uplink configuration in inter-band CA reference sensitivity	12.1.0	12.2.0
2014-06	RAN#64	R5-143006	1413	-	CA RF: Clarification of test parameters and requirements for Inter-band CA Rx tests	12.1.0	12.2.0
2014-06	RAN#64	R5-143007	1414	-	Corrections to SNR test for TM9 minimum requirements	12.1.0	12.2.0
2014-06	RAN#64	R5-143008	1415	-	Correction to ACK NAK Reporting mode for TDD CA test cases	12.1.0	12.2.0
2014-06	RAN#64	R5-143009	1416	-	Addition of TC 8.2.1.1.1_2 and 8.2.2.1.1_2	12.1.0	12.2.0
2014-06	RAN#64	R5-143010	1417	-	Correction of FDD PDSCH Open Loop Spatial Multiplexing 2x2 for CA test cases of TCs 8.2.1.3.1_A.2 and 8.2.1.3.1_A.2_1	12.1.0	12.2.0
2014-06	RAN#64	R5-143011	1418	-	Updates to 8.2.1.3 FDD PDSCH Open Loop Spatial Multiplexing 2x2 related test cases	12.1.0	12.2.0
2014-06	RAN#64	R5-143012	1419	-	Updates to 8.2.2.3 TDD PDSCH Open Loop Spatial Multiplexing 2x2 related test cases	12.1.0	12.2.0
2014-06	RAN#64	R5-143013	1420	-	36.521-1: Editorial correction on 8.2.1.4.2_A.2 message contents	12.1.0	12.2.0
2014-06	RAN#64	R5-143014	1421	-	Clarification the minimum conformance requirement and test parameter for 8.2.1.3.3_C1 and 8.2.1.3.3_C2 test cases	12.1.0	12.2.0
2014-06	RAN#64	R5-143015	1422	-	Correction to minimum test time for eICIC tests	12.1.0	12.2.0
2014-06	RAN#64	R5-143025	1423	-	LTE Type A performance requirements - Introduction of the new test case 8.2.1.4.3	12.1.0	12.2.0
2014-06	RAN#64	R5-143026	1424	-	Test Tolerances for eICIC 9.5.x RI Test cases	12.1.0	12.2.0
2014-06	RAN#64	R5-143027	1425	-	Uncerainties and Test Tolerances for EPDCCH 8.8.1.x demodulation Test cases	12.1.0	12.2.0
2014-06	RAN#64	R5-143031	1426	-	Update to operating bands for CA	12.1.0	12.2.0
2014-06	RAN#64	R5-143032	1427	-	Update to channel bandwidths for CA	12.1.0	12.2.0
2014-06	RAN#64	R5-143033	1428	-	Update to TC 6.3.2A.1 for CA_39C	12.1.0	12.2.0
2014-06	RAN#64	R5-143034	1429	-	Updates of 7.3A.3 Refsens for CA_3A-26A and CA_3A-27A	12.1.0	12.2.0
2014-06	RAN#64	R5-143035	1430	-	Addition of CA band Combo CA_2A-13A	12.1.0	12.2.0
2014-06	RAN#64	R5-143036	1431	-	Addition of CA_39A-41A to Refsens in chap.7	12.1.0	12.2.0
2014-06	RAN#64	R5-143037	1432	-	Updates to Chap.5 for CA_27B	12.1.0	12.2.0
2014-06	RAN#64	R5-143038	1433	-	Addition of CA_2A-4A and CA_5A-7A to 36.521-1 Clause 6	12.1.0	12.2.0
2014-06	RAN#64	R5-143039	1434	-	TC 8.2.1.3.3_E.1 FDD PDSCH Open Loop Spatial Multiplexing 2x2 for feICIC (non-MBSFN ABS)	12.1.0	12.2.0

2014-06	RAN#64	R5-143040	1435	-	TC 8.2.2.3.3_E.1 TDD PDSCH Open Loop Spatial Multiplexing 2x2 for feICIC (non-MBSFN ABS)	12.1.0	12.2.0
2014-06	RAN#64	R5-143041	1436	-	Corrections applicability statement including UE category for feICIC	12.1.0	12.2.0
2014-06	RAN#64	R5-143042	1437	-	Additions to TC 8.2.1.2.3_E.1 FDD PDSCH Transmit diversity 2x2 for feICIC (non-MBSFN ABS)	12.1.0	12.2.0
2014-06	RAN#64	R5-143043	1438	-	Additions to TC 8.2.2.2.3_E.1 TDD PDSCH Transmit diversity 2x2 for feICIC (non-MBSFN ABS)	12.1.0	12.2.0
2014-06	RAN#64	R5-143044	1439	-	Additions to TC 8.2.1.4.1_E.1 FDD PDSCH Closed Loop Single Layer Spatial Multiplexing 2x2 for feICIC (non-MBSFN ABS)	12.1.0	12.2.0
2014-06	RAN#64	R5-143045	1440	-	Additions to TC 8.2.2.4.1_E.1 TDD PDSCH Closed Loop Single Layer Spatial Multiplexing 2x2 for feICIC (non-MBSFN ABS)	12.1.0	12.2.0
2014-06	RAN#64	R5-143046	1441	-	Additions to TC 9.2.1.5_E.1 FDD CQI Reporting under AWGN conditions - PUCCH 1-0 for feICIC (non-MBSFN ABS)	12.1.0	12.2.0
2014-06	RAN#64	R5-143047	1442	-	Additions to TC 9.2.1.6_E.1 TDD CQI Reporting under AWGN conditions - PUCCH 1-0 for feICIC (non-MBSFN ABS)	12.1.0	12.2.0
2014-06	RAN#64	R5-143048	1443	-	Additions to TC 9.3.1.3.1_E.1 FDD CQI Reporting under fading conditions - PUSCH 3-0 for feICIC (non-MBSFN ABS)	12.1.0	12.2.0
2014-06	RAN#64	R5-143049	1444	-	Additions to TC 9.3.1.3.2_E.1 TDD CQI Reporting under fading conditions - PUSCH 3-0 for feICIC (non-MBSFN ABS)	12.1.0	12.2.0
2014-06	RAN#64	R5-143050	1445	-	Additions to TC 9.5.4.1_E.1 FDD RI Reporting - PUCCH 1-0 for feICIC (non-MBSFN ABS)	12.1.0	12.2.0
2014-06	RAN#64	R5-143051	1446	-	Additions to TC 9.5.4.2_E.1 TDD RI Reporting - PUCCH 1-0 for feICIC (non-MBSFN ABS)	12.1.0	12.2.0
2014-06	RAN#64	R5-143052	1447	-	Additions to Reporting of Channel State Information feICIC Test Cases to Annex F	12.1.0	12.2.0
2014-06	RAN#64	R5-143076	1448	-	Update of TC 9.3.6.2_F TDD CQI Reporting under fading conditions multiple CSI processes for CoMP	12.1.0	12.2.0
2014-06	RAN#64	R5-143077	1449	-	Correction parameter and reference table number in test case 8.3.2.4.1_F	12.1.0	12.2.0
2014-06	RAN#64	R5-143079	1450	-	Update of TC 8.7.3.1 FDD sustained data rate performance for EPDCCH scheduling	12.1.0	12.2.0
2014-06	RAN#64	R5-143080	1451	-	Addition of TC 8.8.3.1 FDD Localized transmission with TM10 Type B quasi co-location type	12.1.0	12.2.0
2014-06	RAN#64	R5-143081	1452	-	Addition of TC 8.8.3.2 TDD Localized transmission with TM10 Type B quasi co-location type	12.1.0	12.2.0
2014-06	RAN#64	R5-143082	1453	-	Update initial condition and test requirement in test case 8.7.1.1_A.2_1 for two 15MHz CCs	12.1.0	12.2.0
2014-06	RAN#64	R5-143097	1454	-	Addition of message content exception in eICIC performance tests with MBSFN ABS	12.1.0	12.2.0
2014-06	RAN#64	R5-143098	1455	-	Additions to TC 8.4.1.2.3_E.1 FDD PCFICH/PDCCH Transmit Diversity 2x2 for feICIC (non-MBSFN ABS)	12.1.0	12.2.0
2014-06	RAN#64	R5-143099	1456	-	Additions to TC 8.4.2.2.3_E.1 TDD PCFICH/PDCCH Transmit Diversity 2x2 for feICIC (non-MBSFN ABS)	12.1.0	12.2.0
2014-06	RAN#64	R5-143100	1457	-	Additions to TC 8.4.2.2.3_E.2 TDD PCFICH/PDCCH Transmit Diversity 2x2 for feICIC (MBSFN ABS)	12.1.0	12.2.0
2014-06	RAN#64	R5-143101	1458	-	Additions to Demodulation feICIC Test Cases to Annex F	12.1.0	12.2.0
2014-06	RAN#64	R5-143104	1459	-	Introduction of TC 8.2.2.4.2_A.3 TDD PDSCH Closed Loop Multi Layer Spatial Multiplexing 4 x 2 for CA	12.1.0	12.2.0

2014-06	RAN#64	R5-143105	1460	-	Updates to Refsens for Intra-band non-contiguous CA	12.1.0	12.2.0
2014-06	RAN#64	R5-143106	1461	-	Correction of interference rejection test cases TC 8.2.2.4.3	12.1.0	12.2.0
2014-06	RAN#64	R5-143107	1462	-	Correction to eICIC PDSCH demodulation tests	12.1.0	12.2.0
2014-06	RAN#64	R5-143113	1463	-	Introduction of TC 8.2.2.1.1_A.3 TDD PDSCH Signle Antenna Port Performance for CA	12.1.0	12.2.0
2014-06	RAN#64	R5-143114	1464	-	Additions to TC 8.4.1.2.3_E.2 FDD PCFICH/PDCCH Transmit Diversity 2x2 for feICIC (MBSFN ABS)	12.1.0	12.2.0
2014-06	RAN#64	R5-143115	1465	-	Uplate of TC 8.8.1.1 FDD distributed EPDCCH performance	12.1.0	12.2.0
2014-06	RAN#64	R5-143116	1466	-	Uplate of TC 8.8.2.1 FDD localized transmission with TM9	12.1.0	12.2.0
2014-06	RAN#64	R5-143117	1467	-	Uplate of TC 8.8.2.2 TDD localized transmission with TM9	12.1.0	12.2.0
2014-06	RAN#64	R5-143118	1468	-	Uplate sections of A.3.9 and A.3.10 reference channel for EPDCCH test	12.1.0	12.2.0
2014-06	RAN#64	R5-143129	1469	-	Addition of FDD CQI Reporting under AWGN conditions - PUCCH 1-0 for CA (intra band non-contiguous DL CA) TC 9.6.1.1_A.3	12.1.0	12.2.0
2014-06	RAN#64	R5-143130	1470	-	Addition of TDD CQI Reporting under AWGN conditions - PUCCH 1-0 for CA (intra band non-contiguous DL CA) TC 9.6.1.2_A.3	12.1.0	12.2.0
2014-06	RAN#64	R5-143131	1471	-	Addition of TC 6.2.4A.1 for CA_39C	12.1.0	12.2.0
2014-06	RAN#64	R5-143133	1472	-	Update additional spurious emissions for CA_38C (intra-band contiguous DL CA and UL CA)	12.1.0	12.2.0
2014-06	RAN#64	R5-143134	1473	-	Update In-band blocking for CA_39C (intra-band contiguous DL CA and UL CA)	12.1.0	12.2.0
2014-06	RAN#64	R5-143135	1474	-	Update Out-of-band blocking for CA_39C (intra-band contiguous DL CA and UL CA)	12.1.0	12.2.0
2014-06	RAN#64	R5-143136	1475	-	Update Reference sensitivity level for CA_39C (intra-band contiguous DL CA and UL CA)	12.1.0	12.2.0
2014-06	RAN#64	R5-143137	1476	-	RF: Corrections to CSI RMCs	12.1.0	12.2.0
2014-06	RAN#64	R5-143138	1477	-	CA RF: Corrections to CQI performance tests	12.1.0	12.2.0
2014-06	RAN#64	R5-143140	1478	-	CA RF: Corrections to performance test with power imbalance (Class C)	12.1.0	12.2.0
2014-06	RAN#64	R5-143141	1479	-	Correction of test case 8.2.1.1.1_1	12.1.0	12.2.0
2014-06	RAN#64	R5-143142	1480	-	Correction of the test applicability for test cases 8.2.1.1.1_A.2, 8.2.1.3.1_A.1, 8.2.1.3.1_A.2 and 8.2.1.4.2_A.2	12.1.0	12.2.0
2014-06	RAN#64	R5-143143	1481	-	Correction of the test applicability of the test cases 8.2.1.1.1_A.1, 8.2.1.4.2_A.1, 8.2.2.1.1_A.1 and 8.2.2.4.2_A.1	12.1.0	12.2.0
2014-06	RAN#64	R5-143144	1482	-	Correction of the applicability for the test case 8.7.1.1	12.1.0	12.2.0
2014-06	RAN#64	R5-143146	1483	-	Addition of TC 9.5.5.1_F.2 FDD RI Reporting with Multiple CSI processes for CoMP	12.1.0	12.2.0
2014-06	RAN#64	R5-143147	1484	-	Addition of TC 9.5.5.2_F.2 TDD RI Reporting with Multiple CSI processes for CoMP	12.1.0	12.2.0
2014-06	RAN#64	R5-143148	1485	-	Clarification of test parameters for eICIC PDCCH performance tests	12.1.0	12.2.0
2014-06	RAN#64	R5-143149	1486	-	Correction to Intra-band CA uplink configuration for reference sensitivity	12.1.0	12.2.0
2014-06	RAN#64	R5-143151	1487	-	Correction to CQI reference measurement channels	12.1.0	12.2.0

2014-06	RAN#64	R5-143154	1488	-	Introduction of NC CA TC 7.6.1A.4	12.1.0	12.2.0
2014-06	RAN#64	R5-143155	1489	-	Introduction of NC CA TC 7.6.2A.4	12.1.0	12.2.0
2014-06	RAN#64	R5-143156	1490	-	Introduction of NC CA TC 7.6.3A.4	12.1.0	12.2.0
2014-06	RAN#64	R5-143161	1491	-	Update Spurious emission band UE co-existence for CA_39C (intra-band contiguous DL CA and UL CA)	12.1.0	12.2.0
2014-06	RAN#64	R5-143162	1492	-	Update additional spurious emissions for CA_39C (intra-band contiguous DL CA and UL CA)	12.1.0	12.2.0
2014-06	RAN#64	R5-143163	1493	-	Updates to TC 7.3A.2 Reference sensitivity level for CA_27B	12.1.0	12.2.0
2014-06	RAN#64	R5-143164	1494	-	Updates to TC 7.4A.2 maximum input level for intra-band contiguous CA for CA_27B	12.1.0	12.2.0
2014-06	RAN#64	R5-143165	1495	-	Updates to TC 7.5A.2 ACS for CA_27B	12.1.0	12.2.0
2014-06	RAN#64	R5-143166	1496	-	Updates to 7.6.1A.2 IBB for CA of CA_27B	12.1.0	12.2.0
2014-06	RAN#64	R5-143167	1497	-	Updates to TC 7.6.2A.2 OOB for CA of CA_27B	12.1.0	12.2.0
2014-06	RAN#64	R5-143168	1498	-	Updates to TC 7.6.3A.2 Narrow band blocking for CA_27B	12.1.0	12.2.0
2014-06	RAN#64	R5-143169	1499	-	Updates to TC 7.7A.2 Spurious response for CA_27B	12.1.0	12.2.0
2014-06	RAN#64	R5-143170	1500	-	Updates to TC 7.8.1A.2 Wideband intermodulation for CA_27B	12.1.0	12.2.0
2014-06	RAN#64	R5-143175	1502	-	Updates to 8.7.2.1 TDD sustained data rate performance related test cases	12.1.0	12.2.0
2014-06	RAN#64	R5-143178	1504	-	Additions to TC 9.5.5.1_F.1 FDD RI Reporting with Single CSI process	12.1.0	12.2.0
2014-06	RAN#64	R5-143179	1505	-	Additions to TC 9.5.5.2_F.1 TDD RI Reporting with Single CSI process	12.1.0	12.2.0
2014-06	RAN#64	R5-143181	1506	-	Splitting of FDD CA TM3 and soft buffer management tests	12.1.0	12.2.0
2014-06	RAN#64	R5-143182	1507	-	Removal of soft buffer test points from FDD TM3 test cases in 8.2.1.3.1 and move to new soft buffer test cases in section 8.2.1.3.1A	12.1.0	12.2.0
2014-06	RAN#64	R5-143183	1508	-	Splitting of TDD CA TM3 and soft buffer management tests	12.1.0	12.2.0
2014-06	RAN#64	R5-143184	1509	-	Removal of soft buffer test points from TDD TM3 test cases in 8.2.2.3.1 and move to new soft buffer test case in section 8.2.2.3.1A	12.1.0	12.2.0
2014-06	RAN#64	R5-143188	1512	-	Addition of TC 8.2.2.7 TDD Carrier Aggregation with power imbalance	12.1.0	12.2.0
2014-06	RAN#64	R5-143189	1513	-	Corrections to test case 8.2.1.4.2_1, 8.2.2.4.1_1, and 8.2.2.4.2_1	12.1.0	12.2.0
2014-06	RAN#64	R5-143190	1514	-	Uncertainties and Test Tolerances for CoMP Test case 8.3.1.3.2_F	12.1.0	12.2.0
2014-06	RAN#64	R5-143203	1385	-	Throughput calculation for eCIC demodulation requirements	12.1.0	12.2.0
2014-06	RAN#64	R5-143204	1503	-	Correction to eCIC TDD RI requirements	12.1.0	12.2.0
2014-06	RAN#64	R5-143205	1510	-	Updates to 8.7.1.1_A FDD sustained data rate performance for CA related test cases	12.1.0	12.2.0
2014-06	RAN#64	R5-143206	1511	-	Updates to 8.7.2.1_A TDD sustained data rate performance for CA related test cases	12.1.0	12.2.0
2014-06	RAN#64	R5-143207	1397	-	Correction to CA Rx test cases	12.1.0	12.2.0
2014-06	RAN#64	R5-143208	1398	-	Correction to call setup in 8.7.1 and 8.7.2	12.1.0	12.2.0

2014-06	RAN#64	R5-143216	1501	-	Updates to 8.7.1.1 FDD sustained data rate performance related test cases	12.1.0	12.2.0
2014-09	RAN#65	R5-144068	1516	-	Uncertainties and test tolerances for test case 8.2.2.2.4	12.2.0	12.3.0
2014-09	RAN#65	R5-144072	1517	-	Uncertainties and test tolerances for test case 8.3.1.1.3	12.2.0	12.3.0
2014-09	RAN#65	R5-144074	1518	-	Uncertainties and test tolerances for test case 8.3.2.1.4	12.2.0	12.3.0
2014-09	RAN#65	R5-144086	1519	-	Corrections to TC 8.2.2.1.1_A.3 TDD PDSCH Single Antenna Port Performance for CA	12.2.0	12.3.0
2014-09	RAN#65	R5-144087	1520	-	Corrections to TC 8.2.2.4.2_A.3 TDD PDSCH Closed Loop Multi Layer Spatial Multiplexing 4 x 2 for CA	12.2.0	12.3.0
2014-09	RAN#65	R5-144088	1521	-	Test Tolerances to Annex F for TC 8.2.2.1.1_A.3 and TC 8.2.2.4.2_A.3	12.2.0	12.3.0
2014-09	RAN#65	R5-144093	1522	-	Test Tolerances for TC 9.5.5.1_F.1 FDD RI Reporting with Single CSI process	12.2.0	12.3.0
2014-09	RAN#65	R5-144094	1523	-	Test Tolerances for TC 9.5.5.2_F.1 TDD RI Reporting with Single CSI process	12.2.0	12.3.0
2014-09	RAN#65	R5-144095	1524	-	Addition of OCNG pattern for TM10	12.2.0	12.3.0
2014-09	RAN#65	R5-144096	1525	-	Uncertainties and Test Tolerances for TC 9.5.5.1_F.1+9.5.5.2_F.1 in Annex F	12.2.0	12.3.0
2014-09	RAN#65	R5-144098	1526	-	Test Tolerances for TC 8.2.1.4.1_E.1 FDD PDSCH Closed Loop Single Layer Spatial Multiplexing 2x2 for felCIC (non-MBSFN ABS)	12.2.0	12.3.0
2014-09	RAN#65	R5-144099	1527	-	Test Tolerances for TC 8.2.2.4.1_E.1 TDD PDSCH Closed Loop Single Layer Spatial Multiplexing 2x2 for felCIC (non-MBSFN ABS)	12.2.0	12.3.0
2014-09	RAN#65	R5-144101	1528	-	Test Tolerances for TC 8.4.1.2.3_E.1 FDD PCFICH/PDCCH Transmit Diversity 2x2 for felCIC (non-MBSFN ABS)	12.2.0	12.3.0
2014-09	RAN#65	R5-144102	1529	-	Test Tolerances for TC 8.4.2.2.3_E.1 TDD PCFICH/PDCCH Transmit Diversity 2x2 for felCIC (non-MBSFN ABS)	12.2.0	12.3.0
2014-09	RAN#65	R5-144104	1530	-	Test Tolerances for TC 8.4.1.2.3_E.2 FDD PCFICH/PDCCH Transmit Diversity 2x2 for felCIC (MBSFN ABS)	12.2.0	12.3.0
2014-09	RAN#65	R5-144105	1531	-	Test Tolerances for TC 8.4.2.2.3_E.2 TDD PCFICH/PDCCH Transmit Diversity 2x2 for felCIC (MBSFN ABS)	12.2.0	12.3.0
2014-09	RAN#65	R5-144107	1532	-	Uncertainties and Test Tolerances to Annex F for Demodulation felCIC	12.2.0	12.3.0
2014-09	RAN#65	R5-144111	1533	-	Test Tolerances for TC 9.2.1.5_E.1 FDD CQI Reporting under AWGN conditions - PUCCH 1-0 for felCIC (non-MBSFN ABS)	12.2.0	12.3.0
2014-09	RAN#65	R5-144112	1534	-	Test Tolerances for TC 9.2.1.6_E.1 TDD CQI Reporting under AWGN conditions - PUCCH 1-0 for felCIC (non-MBSFN ABS)	12.2.0	12.3.0
2014-09	RAN#65	R5-144114	1535	-	Test Tolerances for TC 9.3.1.3.1_E.1 FDD CQI Reporting under fading conditions - PUSCH 3-0 for felCIC (non-MBSFN ABS)	12.2.0	12.3.0
2014-09	RAN#65	R5-144115	1536	-	Test Tolerances for TC 9.3.1.3.2_E.1 TDD CQI Reporting under fading conditions - PUSCH 3-0 for felCIC (non-MBSFN ABS)	12.2.0	12.3.0
2014-09	RAN#65	R5-144117	1537	-	Test Tolerances for TC 9.5.4.1_E.1 FDD RI Reporting - PUCCH 1-0 for felCIC (non-MBSFN ABS)	12.2.0	12.3.0
2014-09	RAN#65	R5-144118	1538	-	Test Tolerances for TC 9.5.4.2_E.1 TDD RI Reporting - PUCCH 1-0 for felCIC (non-MBSFN ABS)	12.2.0	12.3.0
2014-09	RAN#65	R5-144120	1539	-	Uncertainties and Test Tolerances to Annex F for Reporting of Channel State Information felCIC	12.2.0	12.3.0

2014-09	RAN#65	R5-144122	1540	-	Message contents updates for CSI feICIC test cases	12.2.0	12.3.0
2014-09	RAN#65	R5-144123	1541	-	Corrections to Annex G for feICIC	12.2.0	12.3.0
2014-09	RAN#65	R5-144173	1542	-	RF: Corrections to spurious emission band co-existence test	12.2.0	12.3.0
2014-09	RAN#65	R5-144174	1543	-	RF: Missing test coverage for Band 31	12.2.0	12.3.0
2014-09	RAN#65	R5-144176	1544	-	IR RF: Correction to TCs 8.3.1.1.3 and 8.3.2.1.4	12.2.0	12.3.0
2014-09	RAN#65	R5-144244	1545	-	Correction of clause 6.2.4.5 in 36.521-1	12.2.0	12.3.0
2014-09	RAN#65	R5-144248	1546	-	Addition of operating band 30 to TS 36.521-1, clause 5	12.2.0	12.3.0
2014-09	RAN#65	R5-144283	1547	-	Add static propagation condition matrix for 1 x 2	12.2.0	12.3.0
2014-09	RAN#65	R5-144299	1548	-	Update of TC 8.3.1.3.2_F CoMP	12.2.0	12.3.0
2014-09	RAN#65	R5-144300	1549	-	Update of TC 8.3.1.3.3_F CoMP	12.2.0	12.3.0
2014-09	RAN#65	R5-144301	1550	-	Update of TC 8.3.2.4.2_F CoMP	12.2.0	12.3.0
2014-09	RAN#65	R5-144302	1551	-	Update of TC 8.3.2.4.3_F CoMP	12.2.0	12.3.0
2014-09	RAN#65	R5-144310	1552	-	Update minimum requirements and test tolerance for TC 8.7.3.1	12.2.0	12.3.0
2014-09	RAN#65	R5-144311	1553	-	Update minimum requirements and test tolerance for TC 8.7.4.1	12.2.0	12.3.0
2014-09	RAN#65	R5-144312	1554	-	Update minimum requirements and test tolerance for TC 8.8.2.1	12.2.0	12.3.0
2014-09	RAN#65	R5-144313	1555	-	Update minimum requirements and test tolerance for TC 8.8.2.2	12.2.0	12.3.0
2014-09	RAN#65	R5-144347	1556	-	Correction to Inter-band CA operating bands	12.2.0	12.3.0
2014-09	RAN#65	R5-144352	1557	-	Correction to eICIC performance test cases	12.2.0	12.3.0
2014-09	RAN#65	R5-144353	1558	-	Correction to UL/DL configuration in CQI requirements	12.2.0	12.3.0
2014-09	RAN#65	R5-144393	1559	-	RF: Corrections to A-MPR test requirements	12.2.0	12.3.0
2014-09	RAN#65	R5-144416	1560	-	Update configurations of CA_39C in A-MPR for CA	12.2.0	12.3.0
2014-09	RAN#65	R5-144420	1561	-	Update configurations of CA_39C in Additional spurious emissions for CA	12.2.0	12.3.0
2014-09	RAN#65	R5-144436	1562	-	Update of test applicabilities for TDD PDSCH Transmit Diversity	12.2.0	12.3.0
2014-09	RAN#65	R5-144439	1563	-	Update of test applicability for TDD PDSCH Transmit Diversity 4x2	12.2.0	12.3.0
2014-09	RAN#65	R5-144441	1564	-	Update test applicabilities for TDD interference rejection test cases	12.2.0	12.3.0
2014-09	RAN#65	R5-144474	1565	-	Updates to TC 8.7.2.1 and 8.7.2.1_1 for TDD SDR	12.2.0	12.3.0
2014-09	RAN#65	R5-144766	1567	-	Correction to CA Rx Blocking TCs	12.2.0	12.3.0
2014-09	RAN#65	R5-144775	1568	-	Correction of the ePDCCH TCs for applying default parameter	12.2.0	12.3.0
2014-09	RAN#65	R5-144787	1566	-	Addition of new TC 8.2.1.3.1_A.3 FDD PDSCH Open Loop Spatial Multiplexing 2x2 for intra-band NC DL CA	12.2.0	12.3.0
2014-09	RAN#65	R5-144801	1569	-	Removal of TBDs in Clause 6.2.4A.1 (A-MPR for UL intra-band cont. CA), CA_NS_02 and 03, correction of Test Requirements	12.2.0	12.3.0
2014-09	RAN#65	R5-144802	1570	-	Correction to in-band blocking for CA requirements	12.2.0	12.3.0
2014-09	RAN#65	R5-144803	1571	-	Corrections to TM9 SNR requirements for eDL-MIMO	12.2.0	12.3.0

2014-09	RAN#65	R5-144804	1572	-	Addition of exception message for TDD MBMS	12.2.0	12.3.0
2014-09	RAN#65	R5-144805	1573	-	RF: Corrections to sustained data rate tests	12.2.0	12.3.0
2014-09	RAN#65	R5-144806	1574	-	Correction of TDD CQI Reporting under AWGN conditions - PUCCH 1-0 for CA (intra band contiguous DL CA) TC 9.6.1.2_A.1	12.2.0	12.3.0
2014-09	RAN#65	R5-144807	1575	-	Correction of TDD CQI Reporting under AWGN conditions - PUCCH 1-0 for CA (intra band non-contiguous DL CA) TC 9.6.1.2_A.3	12.2.0	12.3.0
2014-09	RAN#65	R5-144808	1576	-	Correction to the test cases 8.3.2.1.1, 8.3.2.1.2, 8.3.2.1.3 and 8.3.2.2.1	12.2.0	12.3.0
2014-09	RAN#65	R5-144809	1577	-	Correction to RF General section on CA configurations	12.2.0	12.3.0
2014-09	RAN#65	R5-144814	1578	-	Update TC 9.3.6.1_F FDD CQI Reporting under fading conditions multiple CSI processes for CoMP	12.2.0	12.3.0
2014-09	RAN#65	R5-144815	1579	-	Update TC 9.3.6.2_F TDD CQI Reporting under fading conditions multiple CSI processes for CoMP	12.2.0	12.3.0
2014-09	RAN#65	R5-144817	1580	-	Addition of CoMP AWGN CQI Tests to Test Requirements Derivation in Annex F	12.2.0	12.3.0
2014-09	RAN#65	R5-144818	1581	-	Update minimum requirements and test tolerance for TC 8.8.3.1	12.2.0	12.3.0
2014-09	RAN#65	R5-144819	1582	-	Update minimum requirements and test tolerance for TC 8.8.3.2	12.2.0	12.3.0
2014-09	RAN#65	R5-144820	1583	-	Uncertainties and test tolerances for test cases 8.2.1.3.3_E.1 and 8.2.2.3.3_E.1	12.2.0	12.3.0
2014-09	RAN#65	R5-144821	1584	-	Uncertainties and Test Tolerances for felCIC Test cases 8.2.1.2.3_E.1 and 8.2.2.2.3_E.1.	12.2.0	12.3.0
2014-09	RAN#65	R5-144822	1585	-	Uncertainties and test tolerances for test case 8.2.2.4.3	12.2.0	12.3.0
2014-09	RAN#65	R5-144824	1586	-	Uncertainties and test tolerances for test cases 9.3.5.2.1 and 9.3.5.2.2	12.2.0	12.3.0
2014-09	RAN#65	R5-144826	1587	-	eICIC Test Tolerance references to TS 36.904	12.2.0	12.3.0
2014-09	RAN#65	R5-144827	1588	-	Addition of CA aQI Tests to Test Requirements Derivation in Annex F	12.2.0	12.3.0
2014-09	RAN#65	R5-144828	1589	-	ePDCCH RF: Corrections to sustained data rate tests	12.2.0	12.3.0
2014-09	RAN#65	R5-144836	1590	-	Update to CoMP test case 9.5.5.1_F.2 and 9.5.5.2_F.2	12.2.0	12.3.0
2014-09	RAN#65	R5-144839	1591	-	New CA band combination CA_NC_42 and CA_4-27-Update to 36.521-1 Chapter 6	12.2.0	12.3.0
2014-09	RAN#65	R5-144840	1592	-	New CA band combination CA_NC_42 and CA_4-27-Update to 36.521-1 Chapter 7	12.2.0	12.3.0
2014-09	RAN#65	R5-144841	1593	-	Addition of CA band Combo CA_7A-28A	12.2.0	12.3.0
2014-09	RAN#65	R5-144842	1594	-	Addition of CA_2A-2A to 36.521-1	12.2.0	12.3.0
2014-09	RAN#65	R5-144844	1595	-	Existing CA band combination CA_3A-28A update to 36.521-1 7.3	12.2.0	12.3.0
2014-09	RAN#65	R5-144845	1596	-	Addition of new CA band combo CA_2A-5A to 36.521-1	12.2.0	12.3.0
2014-09	RAN#65	R5-144859	1597	-	New TC: TDD CQI Reporting under AWGN conditions - PUCCH 1-0 for CA (inter band DL CA)	12.2.0	12.3.0
2014-09	RAN#65	R5-144873	1599	-	Correction of clause 6.3.4.1.4 in 36.521-1	12.2.0	12.3.0
2014-09	RAN#65	R5-144874	1600	-	Removal of transition period for Band 28 test frequency definition	12.2.0	12.3.0

2014-09	RAN#65	R5-144875	1601	-	Clarification of tables used in TDD Intra band non-contiguous DL CA TCs	12.2.0	12.3.0
2014-09	RAN#65	R5-144876	1602	-	Introduction of new Wideband Intermodulation test for Intra-band NC CA	12.2.0	12.3.0
2014-09	RAN#65	R5-144879	1603	-	New CA band combination CA_NC_42 and CA_4-27-Update to 36.521-1 Chapter 5	12.2.0	12.3.0
2014-09	RAN#65	R5-144880	1604	-	Update reference sensitivity level for CA (intra-band contiguous DL CA without UL CA)	12.2.0	12.3.0
2014-09	RAN#65	R5-144881	1605	-	Update In-band blocking for CA (intra-band contiguous DL CA without UL CA)	12.2.0	12.3.0
2014-09	RAN#65	R5-144891	1606	-	CA RF: Adopting test frequencies selection to the new structure proposed for TS 36.508	12.2.0	12.3.0
2014-09	RAN#65	R5-144894	1607	-	Corrections to 8.3.1.2.1_D_1 FDD PDSCH Dual-layer Spatial Multiplexing for eDL-MIMO (Release 11 and forward)	12.2.0	12.3.0
2014-09	RAN#65	R5-144895	1608	-	Corrections to 8.3.2.2.1_D_1 TDD PDSCH Dual-layer Spatial Multiplexing for eDL-MIMO (Release 11 and forward)	12.2.0	12.3.0
2014-09	RAN#65	R5-144896	1609	-	Correct errors in TDD PDSCH Single Antenna Port Performance test case	12.2.0	12.3.0
2014-09	RAN#65	R5-144897	1610	-	Separation of minimum requirements for CA UE PDSCH demodulation from single carrier	12.2.0	12.3.0
2014-09	RAN#65	R5-144898	1611	-	Introduction of FDD CQI Reporting under AWGN conditions - PUCCH 1-0 for CA (intra band contiguous DL CA) TC 9.6.1.1_A.1	12.2.0	12.3.0
2014-09	RAN#65	R5-144899	1612	-	Correction of FDD CQI Reporting under AWGN conditions - PUCCH 1-0 for CA (inter band DL CA) TC 9.6.1.1_A.2	12.2.0	12.3.0
2014-09	RAN#65	R5-144900	1613	-	Correction of FDD CQI Reporting under AWGN conditions - PUCCH 1-0 for CA (intra band non-contiguous DL CA) TC 9.6.1.1_A.3	12.2.0	12.3.0
2014-09	RAN#65	R5-144901	1614	-	Updates to 8.2.1.4.2_A.1/A.2 FDD PDSCH Closed Loop Multi Layer Spatial Multiplexing 4x2 for CA related test cases	12.2.0	12.3.0
2014-09	RAN#65	R5-144902	1615	-	Updates to 8.2.2.3.1_A TDD PDSCH Open Loop Spatial Multiplexing 2x2 for CA	12.2.0	12.3.0
2014-09	RAN#65	R5-144903	1616	-	Updates to 8.2.2.4.2_A TDD PDSCH Closed Loop Multi Layer Spatial Multiplexing 4x2 for CA	12.2.0	12.3.0
2014-09	RAN#65	R5-144904	1617	-	Updates to 8.2.2.3.1 TDD PDSCH Open Loop Spatial Multiplexing 2x2	12.2.0	12.3.0
2014-09	RAN#65	R5-144905	1618	-	Updates to 8.2.2.3.2 TDD PDSCH Open Loop Spatial Multiplexing 4x2	12.2.0	12.3.0
2014-09	RAN#65	R5-144906	1619	-	Updates to 8.2.2.4 TDD PDSCH Closed Loop Single/Multi Layer Spatial Multiplexing 2x2 and 4x2	12.2.0	12.3.0
2014-09	RAN#65	R5-144907	1620	-	Updates to 9.2.x CQI Reporting under AWGN conditions	12.2.0	12.3.0
2014-09	RAN#65	R5-144916	1621	-	Message contents updates for TC 9.5.5.1_F.1+9.5.5.2_F.1 CoMP	12.2.0	12.3.0
2014-09	RAN#65	R5-144917	1622	-	FDD CQI Reporting under AWGN conditions - Single CSI Process TC 9.2.4.1_F - Editor Notes Resolution	12.2.0	12.3.0
2014-09	RAN#65	R5-144918	1623	-	TDD CQI Reporting under AWGN conditions - Single CSI Process TC 9.2.4.2_F - Editor Notes Resolution	12.2.0	12.3.0
2014-09	RAN#65	R5-144920	1624	-	Addition of SDR test case 8.7.1.1_A.3 for intra-band NC DL CA	12.2.0	12.3.0
2014-09	RAN#65	R5-144922	1625	-	New TC: TDD PDSCH Closed Loop Multi Layer Spatial Multiplexing 4x2 for CA (inter band DL CA)	12.2.0	12.3.0



2014-09	RAN#65	R5-144923	1626	-	New TC: TDD PDSCH Single Antenna Port Performance for CA (inter-band DL CA)	12.2.0	12.3.0
2014-09	RAN#65	R5-144924	1627	-	New TC: TDD PDSCH Open Loop Spatial Multiplexing 2x2 for CA (inter-band DL CA)	12.2.0	12.3.0
2014-09	RAN#65	R5-144925	1628	-	New TC: TDD sustained data rate performance for CA (inter-band DL CA)	12.2.0	12.3.0
2014-09	RAN#65	R5-144926	1629	-	Update Out-of-band blocking for CA (intra-band contiguous DL CA without UL CA)	12.2.0	12.3.0
2014-09	RAN#65	R5-144928	1630	-	Message contents updates for Demod feICIC test cases	12.2.0	12.3.0
2014-09	RAN#65	R5-144930	1631	-	Addition of new TC 8.2.2.3.1A_A.3 TDD Soft buffer management test for intra-band NC DL CA	12.2.0	12.3.0
2014-09	RAN#65	R5-144931	1632	-	Addition of new TC 8.2.1.4.2_A.3 FDD PDSCH Closed Loop Multi Layer Spatial Multiplexing 4x2 for CA (intra band NC DL CA)	12.2.0	12.3.0
2014-09	RAN#65	R5-144932	1633	-	Updates to TCs 8.2.1.3.1_A.1/A.2 for FDD PDSCH Open Loop Spatial Multiplexing 2x2 for CA	12.2.0	12.3.0
2014-09	RAN#65	R5-144933	1634	-	Updates to 8.7.1.1_A FDD SDR for CA related test cases	12.2.0	12.3.0
2014-09	RAN#65	R5-144934	1635	-	Addition of new TC 8.2.2.3.1A_A.2 TDD Soft buffer management test for inter-band DL CA	12.2.0	12.3.0
2014-09	RAN#65	R5-144936	1636	-	Updates of Annex F.1.4 and F.3.4 for newly added performance test cases	12.2.0	12.3.0
2014-09	RAN#65	R5-144938	1637	-	Updates to TC 8.2.2.1 TDD PDSCH Single Antenna Port Performance (Cell-Specific Reference Symbols) related test cases	12.2.0	12.3.0
2014-09	RAN#65	R5-144939	1638	-	Updates to 8.2.2.2 TDD PDSCH Transmit Diversity Performance (Cell-Specific Reference Symbols)	12.2.0	12.3.0
2014-09	RAN#65	R5-144942	1640	-	Updates to TC 9.6.1.1_A.2 FDD CQI Reporting under AWGN conditions – PUCCH 1-0 for CA (inter band DL CA)	12.2.0	12.3.0
2014-12	RAN#66	R5-145014	1641	-	Corrections to CA Blocking TCs minimum requirements	12.3.0	12.4.0
2014-12	RAN#66	R5-145015	1642	-	Correction to CA Spurious Response TC minimum requirements	12.3.0	12.4.0
2014-12	RAN#66	R5-145125	1645	-	RF: Review of definition of CSI measurement channels with dynamic coding rate	12.3.0	12.4.0
2014-12	RAN#66	R5-145128	1646	-	RF: Review of references to CSI measurement channels with dynamic coding rate	12.3.0	12.4.0
2014-12	RAN#66	R5-145175	1647	-	New CA band combination CA_1A-3A - Updates of 5.2A Operating bands	12.3.0	12.4.0
2014-12	RAN#66	R5-145176	1648	-	New CA band combination CA_1A-3A - Updates of 5.4.2A Channel Bandwidth	12.3.0	12.4.0
2014-12	RAN#66	R5-145177	1649	-	New CA band combination CA_1A-3A - Updates of 6.2.5 Delta TIB	12.3.0	12.4.0
2014-12	RAN#66	R5-145178	1650	-	New CA band combination CA_1A-3A - Updates of 7.3.3 Delta RIB	12.3.0	12.4.0
2014-12	RAN#66	R5-145189	1651	-	elCIC-RF: Corrections to PDCCH performance tests	12.3.0	12.4.0
2014-12	RAN#66	R5-145196	1652	-	RF: Corrections to RMC-s tables	12.3.0	12.4.0
2014-12	RAN#66	R5-145210	1653	-	CA-RF: Correction to OBW requirement	12.3.0	12.4.0
2014-12	RAN#66	R5-145222	1654	-	Introduction of UE maximum output power for CA_42C	12.3.0	12.4.0

2014-12	RAN#66	R5-145223	1655	-	Introduction of Spurious emission band UE co-existence for CA_42C	12.3.0	12.4.0
2014-12	RAN#66	R5-145229	1656	-	Update the minimum requirement and test requirements of TC 8.8.3 localized transmission with TM10	12.3.0	12.4.0
2014-12	RAN#66	R5-145232	1657	-	Existing CA band combination CA_4A-27A and new CA band combination CA_41A-42A update to 36.521-1 section 5.4.2A.1	12.3.0	12.4.0
2014-12	RAN#66	R5-145234	1658	-	New CA band combination CA_41A-42A update to 36.521-1 section 5.2A	12.3.0	12.4.0
2014-12	RAN#66	R5-145235	1659	-	New CA band combination CA_41A-42A update to 36.521-1 section 6.2.5	12.3.0	12.4.0
2014-12	RAN#66	R5-145236	1660	-	New CA band combination CA_41A-42A update to 36.521-1 section 7.3.3	12.3.0	12.4.0
2014-12	RAN#66	R5-145291	1661	-	CQI reporting in AWGN and in fading: CQI indices in set	12.3.0	12.4.0
2014-12	RAN#66	R5-145311	1662	-	Clarification for CA ACS and Wideband Intermodulation testcases	12.3.0	12.4.0
2014-12	RAN#66	R5-145374	1663	-	New CA band combination CA_18A-28A - Updates of 5.2A Operating bands	12.3.0	12.4.0
2014-12	RAN#66	R5-145375	1664	-	New CA band combination CA_18A-28A - Updates of 5.4.2A Channel bandwidth	12.3.0	12.4.0
2014-12	RAN#66	R5-145376	1665	-	New CA band combination CA_18A-28A - Updates of 6.2.5.3 Delta TIB	12.3.0	12.4.0
2014-12	RAN#66	R5-145377	1666	-	New CA band combination CA_18A-28A - Updates of 7.3A Delta RIB	12.3.0	12.4.0
2014-12	RAN#66	R5-145407	1667	-	Alignment with 36.521-2 on UE categories for COMP	12.3.0	12.4.0
2014-12	RAN#66	R5-145425	1668	-	Removal of Non-contiguous Allocation within a Component Carrier Testpoints from UL CA MPR, Spectrum Emissions and ACLR Tests	12.3.0	12.4.0
2014-12	RAN#66	R5-145431	1669	-	Correction on parameters for high speed train scenario	12.3.0	12.4.0
2014-12	RAN#66	R5-145436	1670	-	Update TC 9.3.6 CQI Reporting under fading conditions Multiple CSI processes for CoMP	12.3.0	12.4.0
2014-12	RAN#66	R5-145437	1671	-	New CA band combination 1+11 and 8+11 û Introduction of 1+11 and 8+11 to 36.521-1 chapter 5	12.3.0	12.4.0
2014-12	RAN#66	R5-145438	1672	-	New CA band combination 1+11 and 8+11 û Introduction of 1+11 and 8+11 to 36.521-1 chapter 6	12.3.0	12.4.0
2014-12	RAN#66	R5-145439	1673	-	New CA band combination 1+11 and 8+11 û Introduction of 1+11 and 8+11 to 36.521-1 chapter 7	12.3.0	12.4.0
2014-12	RAN#66	R5-145465	1674	-	Correction to TC 8.2.1.1.1_A.1 FDD PDSCH Single Antenna Port Performance for CA	12.3.0	12.4.0
2014-12	RAN#66	R5-145479	1675	-	Corrections to throughput calculation for feICIC demodulation minimum requirements	12.3.0	12.4.0
2014-12	RAN#66	R5-145480	1676	-	Test Tolerances for TC 8.5.1.2.3_E.1 FDD PHICH Transmit Diversity 2x2 for feICIC (non-MBSFN ABS)	12.3.0	12.4.0
2014-12	RAN#66	R5-145481	1677	-	Test Tolerances for TC 8.5.2.2.3_E.1 TDD PHICH Transmit Diversity 2x2 for feICIC (non-MBSFN ABS)	12.3.0	12.4.0
2014-12	RAN#66	R5-145486	1678	-	Uncertainties and Test Tolerances to Annex F for PHICH feICIC	12.3.0	12.4.0
2014-12	RAN#66	R5-145487	1679	-	Corrections to Annex G for minimum test time for demodulation for feICIC	12.3.0	12.4.0
2014-12	RAN#66	R5-145505	1680	-	Updates to TDD SDR CA test cases	12.3.0	12.4.0

2014-12	RAN#66	R5-145532	1681	-	Addition of missing bandwidth combination sets for inter-band CA	12.3.0	12.4.0
2014-12	RAN#66	R5-145536	1682	-	Additions to CoMP Demod test cases 8.3.1.3.1_F and 8.3.2.4.1_F	12.3.0	12.4.0
2014-12	RAN#66	R5-145539	1683	-	Addition of Band 30 in Max output power test cases	12.3.0	12.4.0
2014-12	RAN#66	R5-145540	1684	-	Addition of Band 30 in Max power reduction test cases	12.3.0	12.4.0
2014-12	RAN#66	R5-145543	1685	-	Addition of Band 30 in Spurious emission UE co-existence test cases	12.3.0	12.4.0
2014-12	RAN#66	R5-145559	1686	-	Correction to 6.3.5A.1.1	12.3.0	12.4.0
2014-12	RAN#66	R5-145638	1687	-	Correction to HPUE Applicability statements in TS 36.521-1	12.3.0	12.4.0
2014-12	RAN#66	R5-145800	1688	-	RF: Modification of test description to refer to State 2A-RF	12.3.0	12.4.0
2014-12	RAN#66	R5-145803	1689	-	Removal of Non-contiguous Allocation within a Component Carrier Testpoints from UL CA A-MPR and Additional Spectrum/Spurious Emissions Tests	12.3.0	12.4.0
2014-12	RAN#66	R5-145804	1690	-	Addition of RF requirements in later releases	12.3.0	12.4.0
2014-12	RAN#66	R5-145805	1691	-	eDL-MIMO RF: Correction to TC 8.3.1.1.1_D	12.3.0	12.4.0
2014-12	RAN#66	R5-145808	1692	-	Correction on support of a bandwidth combination set	12.3.0	12.4.0
2014-12	RAN#66	R5-145809	1693	-	Correction to TC 8.7.1.1_A FDD sustained data rate performance for CA	12.3.0	12.4.0
2014-12	RAN#66	R5-145810	1694	-	Correction to TC 8.2.2.1.1_A.1 TDD PDSCH Single Antenna Port Performance for CA	12.3.0	12.4.0
2014-12	RAN#66	R5-145811	1695	-	Corrections to TC 8.2.2.1.1_A.3 TDD PDSCH Single Antenna Port Performance for CA	12.3.0	12.4.0
2014-12	RAN#66	R5-145812	1696	-	Corrections to TC 8.2.2.4.2_A.3 TDD PDSCH Closed Loop Multi Layer Spatial Multiplexing 4 x 2 for CA	12.3.0	12.4.0
2014-12	RAN#66	R5-145813	1697	-	Corrections to Annex G for CA Enhancements	12.3.0	12.4.0
2014-12	RAN#66	R5-145825	1698	-	Uncertainties and TT for CoMP test case 9.5.5.1_F.2 and 9.5.5.2_F.2	12.3.0	12.4.0
2014-12	RAN#66	R5-145835	1699	-	Update Uncertainties for RI Test cases 9.5.x	12.3.0	12.4.0
2014-12	RAN#66	R5-145839	1700	-	Update of Demodulation of PDSCH CoMP TCs	12.3.0	12.4.0
2014-12	RAN#66	R5-145840	1701	-	Uncertainties and Test Tolerances for CoMP Test cases 8.3.1.3.3_F, 8.3.2.4.2_F, 8.3.2.4.3_F	12.3.0	12.4.0
2014-12	RAN#66	R5-145841	1702	-	Correction to CoMP TDD RI test case	12.3.0	12.4.0
2014-12	RAN#66	R5-145846	1703	-	Introduction of CA_42C in section 5 of TS 36.521-1	12.3.0	12.4.0
2014-12	RAN#66	R5-145847	1704	-	New CA band combination CA_4A-27A and CA_41A-42A update to 36.521-1 section 7.3A.3	12.3.0	12.4.0
2014-12	RAN#66	R5-145848	1705	-	Introduction of receiver requirements for CA_42C into TS 36.521-1	12.3.0	12.4.0
2014-12	RAN#66	R5-145851	1706	-	Addition of operating band 30 to TS 36.521-1 Clause 7 for receiver tests	12.3.0	12.4.0
2014-12	RAN#66	R5-145853	1707	-	Sections 3 and 4 update on 3DL CA WI	12.3.0	12.4.0
2014-12	RAN#66	R5-145854	1708	-	Addition of new 2DL(CA_1A-42A and CA_19A-42A) and 3DL CA band combinations(CA_1A-3A-19A, CA_1A-19A-21A, CA_1A-42C and CA_19A-42C)	12.3.0	12.4.0
2014-12	RAN#66	R5-145855	1709	-	New CA band combination CA_18A-28A - Updates of 7.3A Refsens	12.3.0	12.4.0

2014-12	RAN#66	R5-145856	1710	-	Update of CA Maximum input level Test cases	12.3.0	12.4.0
2014-12	RAN#66	R5-145857	1711	-	Update of CA ACS Test cases	12.3.0	12.4.0
2014-12	RAN#66	R5-145858	1712	-	Update of CA Blocking and Spurious Response Test cases	12.3.0	12.4.0
2014-12	RAN#66	R5-145859	1713	-	Update of CA Rx Intermodulation Test cases	12.3.0	12.4.0
2014-12	RAN#66	R5-145872	1714	-	Update to applicability for TM9 test cases	12.3.0	12.4.0
2014-12	RAN#66	R5-145874	1715	-	RF: Correction to A-MPR requirements with NS_20	12.3.0	12.4.0
2014-12	RAN#66	R5-145876	1716	-	Applicability of CSI requirements for CA capability	12.3.0	12.4.0
2014-12	RAN#66	R5-145880	1717	-	Addition of Band 30 in Additional Max power reduction test cases	12.3.0	12.4.0
2014-12	RAN#66	R5-145881	1718	-	Addition of Band 30 in Additional SEM test cases	12.3.0	12.4.0
2014-12	RAN#66	R5-145882	1719	-	Addition of Band 30 in Additional Spurious emission test cases	12.3.0	12.4.0
2014-12	RAN#66	R5-145883	1720	-	Update the minimum requirement and test requirements of TC 8.8.2 localized transmission with TM9	12.3.0	12.4.0
2014-12	RAN#66	R5-145884	1721	-	New CA band combination CA_1A-3A - Updates of 7.3A Refsens	12.3.0	12.4.0
2014-12	RAN#66	R5-145885	1722	-	New CA band combination CA_NC_41A and CA_NC_42A update to 36.521-1 section 7.4A.4 and 7.5A.4	12.3.0	12.4.0
2014-12	RAN#66	R5-145886	1723	-	New CA band combination CA_NC_41A and CA_NC_42A update to 36.521-1 section 7.6.1A.4, 7.6.2A.4 and 7.6.3A.4	12.3.0	12.4.0
2014-12	RAN#66	R5-145887	1724	-	New CA band combination CA_NC_41A and CA_NC_42A update to 36.521-1 section 7.8.1A.4	12.3.0	12.4.0
2014-12	RAN#66	R5-145888	1725	-	Existing CA band combination CA_39C: update bandwidth combination to CQI test	12.3.0	12.4.0
2014-12	RAN#66	R5-145889	1726	-	Existing CA band combination CA_39C: update bandwidth combination to PDSCH TM1 test	12.3.0	12.4.0
2014-12	RAN#66	R5-145890	1727	-	Existing CA band combination CA_39C: update bandwidth combination to PDSCH TM3 test	12.3.0	12.4.0
2014-12	RAN#66	R5-145891	1728	-	Existing CA band combination CA_39C: update bandwidth combination to PDSCH TM4 test	12.3.0	12.4.0
2014-12	RAN#66	R5-145893	1729	-	7A-7A NC CA RX RF Tests Testpoint Correction	12.3.0	12.4.0
2014-12	RAN#66	R5-145896	1730	-	CA-RF: Correction to ACLR test points	12.3.0	12.4.0
2014-12	RAN#66	R5-145898	1731	-	Intraband Contiguous CA RF Tests Testpoint Choice Clarification	12.3.0	12.4.0
2014-12	RAN#66	R5-145899	1732	-	Updates to Spurious emission band UE co-existence test cases 6.6.3.2 and 6.6.3.2A.1	12.3.0	12.4.0
2014-12	RAN#66	R5-145900	1733	-	Chapter 7 RX RF Tests Intra-band contiguous Test Configuration Tables Cleanup	12.3.0	12.4.0
2014-12	RAN#66	R5-145901	1734	-	Updates to FDD and TDD PDSCH Soft buffer management test (inter-band DL CA)	12.3.0	12.4.0
2014-12	RAN#66	R5-145902	1735	-	Updates to TM3 CA demodulation tests for release independence	12.3.0	12.4.0
2014-12	RAN#66	R5-145917	1736	-	Addition of CRS assistance data in message contents for feICIC demodulation test cases	12.3.0	12.4.0
2014-12	RAN#66	R5-145922	1737	-	Introduction of TC 8.2.1.1.1_A.3 FDD PDSCH Single Antenna Port Performance for CA	12.3.0	12.4.0

2014-12	RAN#66	R5-145926	1739	-	New CA band combination CA_NC_41A and CA_NC_42A update to 36.521-1 section 7.3A.4	12.3.0	12.4.0
2014-12	RAN#66	R5-145933	1740	-	Existing CA band combination CA_39C: update annex tables for 20+15MHz	12.3.0	12.4.0
2014-12	RAN#66	R5-145934	1741	-	Reconstruction of FDD SDR test cases based on Release independent rule	12.3.0	12.4.0
2014-12	RAN#66	R5-145935	1742	-	RF: Cleanup of sustained data rate test cases	12.3.0	12.4.0
2014-12	RAN#66	R5-145936	1743	-	Applicability of Demodulation requirements for CA capability	12.3.0	12.4.0
2014-12	RAN#66	R5-145975	1643	-	CA-RF: Review of test frequencies clause 8	12.3.0	12.4.0
2014-12	RAN#66	R5-145976	1644	-	CA-RF: Review of test frequencies clause 9	12.3.0	12.4.0
2015-03	RAN#67	R5-150112	1744	-	Addition of CA_2-30 to Clause 5.2A of TS 36.521-1.	12.4.0	12.5.0
2015-03	RAN#67	R5-150135	1745	-	Addition of CA_5-30 to Clause 5.2A of TS 36.521-1.	12.4.0	12.5.0
2015-03	RAN#67	R5-150136	1746	-	Addition of CA_5A-30A to Clause 5.4.2A of TS 36.521-1.	12.4.0	12.5.0
2015-03	RAN#67	R5-150169	1747	-	Addition of CA_4A-5A-30A to Clause 5.4.2A of TS 36.521-1.	12.4.0	12.5.0
2015-03	RAN#67	R5-150181	1748	-	Addition of new TC 9.3.6.1_F.2 FDD CQI Reporting under fading conditions with Three CSI processes for CoMP	12.4.0	12.5.0
2015-03	RAN#67	R5-150184	1749	-	Addition of new TC 9.3.6.2_F.2 TDD CQI Reporting under fading conditions with Three CSI processes for CoMP	12.4.0	12.5.0
2015-03	RAN#67	R5-150186	1840	-	Addition of TT for new TCs 9.3.6.1_F.1, 9.3.6.1_F.2, 9.3.6.1_F.3, 9.3.6.2_F.1, 9.3.6.2_F.2 and 9.3.6.2_F.3	12.4.0	12.5.0
2015-03	RAN#67	R5-150209	1750	-	Corrections to 1 PRB allocation performance in presence of MBSF	12.4.0	12.5.0
2015-03	RAN#67	R5-150210	1751	-	Corrections to the Common Test Parameters for User-specific Reference Symbols	12.4.0	12.5.0
2015-03	RAN#67	R5-150214	1752	-	Test Tolerances for 8.3.1.2.1_D_1 FDD PDSCH Dual-layer Spatial Multiplexing for eDL-MIMO Rel-11	12.4.0	12.5.0
2015-03	RAN#67	R5-150215	1753	-	Test Tolerances for 8.3.2.2.1_D_1 TDD PDSCH Dual-layer Spatial Multiplexing for eDL-MIMO Rel-11	12.4.0	12.5.0
2015-03	RAN#67	R5-150216	1754	-	Uncertainties and Test Tolerances to Annex F for PDSCH for eDL-MIMO Rel-11	12.4.0	12.5.0
2015-03	RAN#67	R5-150234	1755	-	CA RF: Corrections to power imbalance test	12.4.0	12.5.0
2015-03	RAN#67	R5-150252	1756	-	Update of non-contiguous CA Rx Test Cases	12.4.0	12.5.0
2015-03	RAN#67	R5-150364	1757	-	ePDCCH RF: Corrections to sustained data rate test	12.4.0	12.5.0
2015-03	RAN#67	R5-150373	1758	-	Introduction of new CA band combinations 5+25 and 12+25 for Transmitter Characteristics	12.4.0	12.5.0
2015-03	RAN#67	R5-150409	1759	-	Correction in cl.3 of 36.521-1	12.4.0	12.5.0
2015-03	RAN#67	R5-150415	1760	-	Correction to message exceptions for eICIC performance test cases	12.4.0	12.5.0
2015-03	RAN#67	R5-150416	1761	-	Clean up on Performance and CSI test cases for eICIC and feICIC	12.4.0	12.5.0
2015-03	RAN#67	R5-150417	1762	-	Correction to test procedure in CQI Reporting under AWGN for feICIC	12.4.0	12.5.0
2015-03	RAN#67	R5-150420	1763	-	Correction to minimum test time for feICIC performance tests in G.3A.5	12.4.0	12.5.0
2015-03	RAN#67	R5-150437	1764	-	New CA band combination CA_1A-28A - Updates of 5.2A Operating bands	12.4.0	12.5.0

2015-03	RAN#67	R5-150438	1765	-	New CA band combination CA_1A-28A - Updates of 5.4.2A Channel bandwidth	12.4.0	12.5.0
2015-03	RAN#67	R5-150440	1766	-	New CA band combination CA_1A-28A - Updates of 6.2.5.3 Delta TIB	12.4.0	12.5.0
2015-03	RAN#67	R5-150441	1767	-	New CA band combination CA_1A-28A - Updates of 7.3.3 Delta RIB	12.4.0	12.5.0
2015-03	RAN#67	R5-150452	1768	-	New CA band combination CA_1A-18A-28A - Updates of 5.4.2A Channel bandwidth	12.4.0	12.5.0
2015-03	RAN#67	R5-150453	1769	-	New CA band combinations (CA_1A-41A, CA_1A-41C) - Updates of 5.2A Operating bands	12.4.0	12.5.0
2015-03	RAN#67	R5-150455	1770	-	New CA band combinations (CA_26A-41A, CA_26A-41C) - Updates of 5.2A Operating bands	12.4.0	12.5.0
2015-03	RAN#67	R5-150456	1771	-	New CA band combination CA_1A-18A-28A - Updates of 5.2A Operating bands	12.4.0	12.5.0
2015-03	RAN#67	R5-150460	1772	-	Correction to the description of duplex mode related to CA_18A-28A	12.4.0	12.5.0
2015-03	RAN#67	R5-150461	1773	-	Correction to the test frequencies and test CC combinations for CA_18A-28A	12.4.0	12.5.0
2015-03	RAN#67	R5-150472	1774	-	Correction to requirements for test case 7.6.2A.1 and 7.6.2A.2	12.4.0	12.5.0
2015-03	RAN#67	R5-150476	1775	-	Removal of Note 1 in requirements of TC 6.2.2A	12.4.0	12.5.0
2015-03	RAN#67	R5-150478	1776	-	Addition of &#916;RIB,c to requirements of blocking and spurious response test cases	12.4.0	12.5.0
2015-03	RAN#67	R5-150479	1777	-	Correction to PUSCH configuration details for 36.521-1 4x2 CA test cases	12.4.0	12.5.0
2015-03	RAN#67	R5-150505	1778	-	Added TT in annex for TDD inter band CA performance tests	12.4.0	12.5.0
2015-03	RAN#67	R5-150506	1779	-	Updated TT in TDD inter band CA performance tests	12.4.0	12.5.0
2015-03	RAN#67	R5-150522	1780	-	Addition of CA_1A-20A to TS 36.521-1	12.4.0	12.5.0
2015-03	RAN#67	R5-150543	1781	-	Addition of 2A-12A and 5A-13A 2DL Interband CA to 36.521-1	12.4.0	12.5.0
2015-03	RAN#67	R5-150606	1782	-	Clarification on bandwidth to be tested	12.4.0	12.5.0
2015-03	RAN#67	R5-150800	1783	-	Correction to 6.6.3.2 of Tx Spurious	12.4.0	12.5.0
2015-03	RAN#67	R5-150801	1784	-	Correction in 6.2.5A and 6.5.1A of 36.521-1	12.4.0	12.5.0
2015-03	RAN#67	R5-150802	1785	-	Fixing numbering in Table 6.6.2.3A.1.4.1-1	12.4.0	12.5.0
2015-03	RAN#67	R5-150803	1786	-	Change of test points for A-MPR in band 26	12.4.0	12.5.0
2015-03	RAN#67	R5-150809	1787	-	Addition of BCS1 to 25A-25A CA	12.4.0	12.5.0
2015-03	RAN#67	R5-150810	1788	-	Introduction of CA_1A-7A to TS 36.521-1	12.4.0	12.5.0
2015-03	RAN#67	R5-150811	1789	-	Correction to test points for intra-band contiguous receiver test cases	12.4.0	12.5.0
2015-03	RAN#67	R5-150816	1790	-	Addition of CA_2A-30A to Clause 7.3.3 of TS 36.521-1.	12.4.0	12.5.0
2015-03	RAN#67	R5-150817	1791	-	Addition of CA_2A-30A to Clause 6.2.5 of TS 36.521-1.	12.4.0	12.5.0
2015-03	RAN#67	R5-150818	1792	-	Addition of CA_2A-30A to Clause 5.4.2A of TS 36.521-1.	12.4.0	12.5.0
2015-03	RAN#67	R5-150819	1793	-	Addition of CA_4A-30A to Clause 7.3.3 of TS 36.521-1.	12.4.0	12.5.0
2015-03	RAN#67	R5-150820	1794	-	Addition of CA_4A-30A to Clause 6.2.5 of TS 36.521-1.	12.4.0	12.5.0
2015-03	RAN#67	R5-150821	1795	-	Addition of CA_4-30 to Clause 5.2A of TS 36.521-1.	12.4.0	12.5.0

2015-03	RAN#67	R5-150822	1796	-	Addition of CA_4A-30A to Clause 5.4.2A of TS 36.521-1.	12.4.0	12.5.0
2015-03	RAN#67	R5-150823	1797	-	Addition of CA_5A-30A to Clause 7.3.3 of TS 36.521-1.	12.4.0	12.5.0
2015-03	RAN#67	R5-150824	1798	-	Addition of CA_5A-30A to Clause 6.2.5 of TS 36.521-1.	12.4.0	12.5.0
2015-03	RAN#67	R5-150825	1799	-	Addition of CA_4-5-30 to Clause 5.2A of TS 36.521-1.	12.4.0	12.5.0
2015-03	RAN#67	R5-150826	1800	-	Addition of new TC FDD PDSCH Single Antenna Port Performance for CA (3DL CA)	12.4.0	12.5.0
2015-03	RAN#67	R5-150827	1801	-	Addition of CA_2A-2A-13A to TS 36.521-1	12.4.0	12.5.0
2015-03	RAN#67	R5-150828	1802	-	Addition of 40D,41D,41C-41A and 25A-25A BCS1 to Channel BW for CA tables	12.4.0	12.5.0
2015-03	RAN#67	R5-150829	1803	-	Addition of multiple interband 3DL CA Combinations to Channel BW for CA tables	12.4.0	12.5.0
2015-03	RAN#67	R5-150848	1804	-	Addition of new TC 9.3.6.1_F.1 FDD CQI Reporting under fading conditions with Single CSI process for CoMP	12.4.0	12.5.0
2015-03	RAN#67	R5-150849	1805	-	Addition of new TC 9.3.6.1_F.3 FDD CQI Reporting under fading conditions with Four CSI processes for CoMP	12.4.0	12.5.0
2015-03	RAN#67	R5-150850	1806	-	Addition of new TC 9.3.6.2_F.1 TDD CQI Reporting under fading conditions with Single CSI process for CoMP	12.4.0	12.5.0
2015-03	RAN#67	R5-150851	1807	-	Addition of new TC 9.3.6.2_F.3 TDD CQI Reporting under fading conditions with Four CSI processes for CoMP	12.4.0	12.5.0
2015-03	RAN#67	R5-150860	1808	-	Introduction of new CA band combinations 5+25 and 12+25 for Receiver Characteristics	12.4.0	12.5.0
2015-03	RAN#67	R5-150861	1809	-	Addition of CA_1A-7A-20A to TS 36.521-1	12.4.0	12.5.0
2015-03	RAN#67	R5-150862	1810	-	Update of minimum requirements for TC 6.2.5 Configured UE transmitted Output Power	12.4.0	12.5.0
2015-03	RAN#67	R5-150863	1811	-	Updates of minimum requirement to reference sensitivity for CA	12.4.0	12.5.0
2015-03	RAN#67	R5-150865	1812	-	Addition of new TC TDD PDSCH Single Antenna Port Performance for CA (3DL CA)	12.4.0	12.5.0
2015-03	RAN#67	R5-150866	1813	-	Addition of new TC FDD Sustained data rate performance for CA (3DL CA)	12.4.0	12.5.0
2015-03	RAN#67	R5-150867	1814	-	Addition of new TC TDD Sustained data rate performance for CA (3DL CA)	12.4.0	12.5.0
2015-03	RAN#67	R5-150869	1839	-	Addition of Cell IDs for 3DL CA Rx tests	12.4.0	12.5.0
2015-03	RAN#67	R5-150870	1815	-	New CA band combinations (CA_1A-41A, CA_1A-41C) - Updates of 5.4.2A Channel bandwidth	12.4.0	12.5.0
2015-03	RAN#67	R5-150871	1816	-	New CA band combinations (CA_26A-41A, CA_26A-41C) - Updates of 5.4.2A Channel bandwidth	12.4.0	12.5.0
2015-03	RAN#67	R5-150935	1817	-	Change in UE co-existence 6.6.3.2 harmonic emissions exceptions	12.4.0	12.5.0
2015-03	RAN#67	R5-150874	1818	-	CA RF: Updates to in-band emissions requirements	12.4.0	12.5.0
2015-03	RAN#67	R5-150875	1819	-	Correction to test procedure of TC 7.6.1A.4	12.4.0	12.5.0
2015-03	RAN#67	R5-150880	1820	-	Update of CA sustained data rate tests	12.4.0	12.5.0
2015-03	RAN#67	R5-150881	1821	-	Aligning Bandwidth Combination Sets with latest core specification	12.4.0	12.5.0
2015-03	RAN#67	R5-150892	1822	-	Update to TC 7.5A.4 Adjacent Channel Selectivity (ACS) for CA (intra-band non-contiguous DL CA without UL CA)	12.4.0	12.5.0

2015-03	RAN#67	R5-150897	1823	-	New CA band combination CA_1A-28A - Updates of 7.3A Refsens	12.4.0	12.5.0
2015-03	RAN#67	R5-150928	1824	-	Updates to Spurious emission band UE co-existence test case 6.6.3.2	12.4.0	12.5.0
2015-03	RAN#67	R5-150906	1825	-	Updates to FDD and TDD RI Reporting test cases for CoMP	12.4.0	12.5.0
2015-03	RAN#67	R5-150929	1827	-	Addition of CA capability in Rx tests	12.4.0	12.5.0
2015-03	RAN#67	R5-150913	1828	-	Addition of Multi-Cluster PUSCH with One Uplink Carrier test cases to 36.521-1	12.4.0	12.5.0
2015-03	RAN#67	R5-150915	1829	-	Addition of CA capability and applicability changes to Section 8 36.521-1 FDD TM3 CA test cases	12.4.0	12.5.0
2015-03	RAN#67	R5-150916	1830	-	Changes to Annex F of 36.521-1 related to CA capability and applicability changes to FDD CA test cases	12.4.0	12.5.0
2015-03	RAN#67	R5-150917	1831	-	Correction to CA applicability and test rules	12.4.0	12.5.0
2015-03	RAN#67	R5-150918	1832	-	Addition of CA capability and applicability changes to 36.521-1 FDD TM1 CA test cases	12.4.0	12.5.0
2015-03	RAN#67	R5-150919	1833	-	Update to LTE CA Sustained Data rate test cases	12.4.0	12.5.0
2015-03	RAN#67	R5-150920	1834	-	CA demod Soft Buffer test case variants merge	12.4.0	12.5.0
2015-03	RAN#67	R5-150921	1835	-	Addition of CA capability and applicability changes to Section 8 36.521-1 FDD TM4 CA test cases	12.4.0	12.5.0
2015-03	RAN#67	R5-150922	1836	-	Addition of CA capability and applicability changes to FDD chap9 CA test cases	12.4.0	12.5.0
2015-03	RAN#67	R5-150925	1837	-	Introduction of Test Case for Maximum input level for 3DL CA	12.4.0	12.5.0
2015-03	RAN#67	R5-150926	1838	-	Addition of new TC of reference sensitivity for 3DL CA	12.4.0	12.5.0
2015-06	RAN#68	R5-151067	1841	-	Removal of Extreme Conditions from TC 6.6.2.1A test environment	12.5.0	12.6.0
2015-06	RAN#68	R5-151114	1843	-	RF: Missing power class information	12.5.0	12.6.0
2015-06	RAN#68	R5-151116	1845	-	CA RF: Clarification of PHICH configuration	12.5.0	12.6.0
2015-06	RAN#68	R5-151117	1846	-	RF: Corrections to CSI RMCs references	12.5.0	12.6.0
2015-06	RAN#68	R5-151121	1850	-	ePDCCH RF: Corrections to sustained data rate test	12.5.0	12.6.0
2015-06	RAN#68	R5-151122	1851	-	feICIC RF: Updates to TC 9.2.1.6_E.1	12.5.0	12.6.0
2015-06	RAN#68	R5-151123	1852	-	feICIC RF: Corrections to CSI TCs	12.5.0	12.6.0
2015-06	RAN#68	R5-151151	1853	-	Correction to the requirements of test case 6.6.2.1A	12.5.0	12.6.0
2015-06	RAN#68	R5-151152	1854	-	Addition of Rx parameter for test case 7.6.2A.1 and 7.6.2A.2	12.5.0	12.6.0
2015-06	RAN#68	R5-151181	1855	-	CA RF: Corrections to the applicability clause	12.5.0	12.6.0
2015-06	RAN#68	R5-151195	1857	-	Corrections to CSI Reference Measurement Channel	12.5.0	12.6.0
2015-06	RAN#68	R5-151213	1871	-	Updating Annex A relevant for the introduced of eDL MIMO enhancement Tests	12.5.0	12.6.0
2015-06	RAN#68	R5-151214	1872	-	Updating Annex B Beam steering approach for eDL MIMO enhancement Tests	12.5.0	12.6.0
2015-06	RAN#68	R5-151215	1873	-	Updating Annex I relevant for the introduced of eDL MIMO enhancement Tests	12.5.0	12.6.0
2015-06	RAN#68	R5-151231	1874	-	CoMP TCs applicability update section 8	12.5.0	12.6.0
2015-06	RAN#68	R5-151237	1876	-	Update of CoMP TCs 9.2.4.1_F and 9.2.4.2_F	12.5.0	12.6.0



2015-06	RAN#68	R5-151238	1877	-	Update of CoMP TCs in sections 9.3.6.1_F and 9.3.6.2_F	12.5.0	12.6.0
2015-06	RAN#68	R5-151256	1884	-	Update of CoMP TCs in section 8	12.5.0	12.6.0
2015-06	RAN#68	R5-151257	1885	-	Update of CoMP TCs 9.5.5.1_F.1 and 9.5.5.2_F.1	12.5.0	12.6.0
2015-06	RAN#68	R5-151329	1902	-	Addition of band 32 to clause 6 in 36.521-1	12.5.0	12.6.0
2015-06	RAN#68	R5-151366	1912	-	Removal of double table 7.6.1B.5-2	12.5.0	12.6.0
2015-06	RAN#68	R5-151367	1913	-	Corrections to UL CA Test Cases	12.5.0	12.6.0
2015-06	RAN#68	R5-151369	1915	-	Editorial corrections to TC 6.6.1	12.5.0	12.6.0
2015-06	RAN#68	R5-151425	1940	-	Addition of Band 32 in Receiver test cases	12.5.0	12.6.0
2015-06	RAN#68	R5-151487	1955	-	Introduction of new test case 8.9.1.1.1 MTC	12.5.0	12.6.0
2015-06	RAN#68	R5-151515	1962	-	Correction to test case 6.3.3A.1: UE Transmit OFF power for CA (intra-band contiguous DL CA and UL CA)	12.5.0	12.6.0
2015-06	RAN#68	R5-151561	1963	-	Update to TX test case 6.6.3.3 Additional spurious emissions	12.5.0	12.6.0
2015-06	RAN#68	R5-151591	1976	-	36.521-1: CA Soft buffering corrections	12.5.0	12.6.0
2015-06	RAN#68	R5-151616	1978	-	Introduction of new test case 9.7.1.1 MTC	12.5.0	12.6.0
2015-06	RAN#68	R5-151639	1980	-	Test points correction in test case 7.3A.2 for CA_23B in 36.521-1	12.5.0	12.6.0
2015-06	RAN#68	R5-151802	1875	1	CoMP TCs applicability update section 9	12.5.0	12.6.0
2015-06	RAN#68	R5-151805	1904	1	Clarification to spurious emission requirement for the edge of spurious domain	12.5.0	12.6.0
2015-06	RAN#68	R5-151806	1842	1	Missing NS Value for Band 30 Reference Sensitivity Testing and Missing Message Content Exceptions	12.5.0	12.6.0
2015-06	RAN#68	R5-151807	1891	1	Correction of UL RB Allocation in Interband DL CA Testcases	12.5.0	12.6.0
2015-06	RAN#68	R5-151808	1898	1	Correction of CA_25A-25A wrong allocation in Chapter 7 Table 7.3A.4.4.1-1	12.5.0	12.6.0
2015-06	RAN#68	R5-151809	1914	1	Updates for interferer placement in non-contiguous CA	12.5.0	12.6.0
2015-06	RAN#68	R5-151811	1903	1	Correction of UEs category for TDD sustained data rate performance	12.5.0	12.6.0
2015-06	RAN#68	R5-151812	1952	1	Updates to 36.521-1 Annex F and G	12.5.0	12.6.0
2015-06	RAN#68	R5-151813	1916	1	Clean up of PDSCH performance test cases	12.5.0	12.6.0
2015-06	RAN#68	R5-151814	1924	1	Clean up of eDL-MIMO test cases	12.5.0	12.6.0
2015-06	RAN#68	R5-151815	1925	1	Clean up of TM9 interference model test cases	12.5.0	12.6.0
2015-06	RAN#68	R5-151816	1926	1	Correction to eCIC performance test cases	12.5.0	12.6.0
2015-06	RAN#68	R5-151817	1927	1	Correction to CQI and RI reporting test in feCIC	12.5.0	12.6.0
2015-06	RAN#68	R5-151818	1928	1	Correction to PDSCH demodulation test in feCIC	12.5.0	12.6.0
2015-06	RAN#68	R5-151819	1929	1	Clean up on PCFICH/PDCCH demodulation test in feCIC	12.5.0	12.6.0
2015-06	RAN#68	R5-151820	1930	1	Clean up on PHICH demodulation test in feCIC	12.5.0	12.6.0
2015-06	RAN#68	R5-151821	1932	1	Correction of PMI test cases in the section 9.4.1 and 9.4.2	12.5.0	12.6.0
2015-06	RAN#68	R5-151822	1966	1	Removal of the correlation matrix of HST propagation conditions	12.5.0	12.6.0
2015-06	RAN#68	R5-151825	1979	1	Updates to CoMP test cases 9.5.5.x	12.5.0	12.6.0

2015-06	RAN#68	R5-151854	1909	1	Addition of new TC FDD PDSCH 2x2 Open Loop Performance for 3DL CA	12.5.0	12.6.0
2015-06	RAN#68	R5-151855	1910	1	Addition of new TC FDD PDSCH 4x2 Closed Loop Performance for 3DL CA	12.5.0	12.6.0
2015-06	RAN#68	R5-151856	1967	1	Introduction of TC TDD PDSCH Closed Loop Multi Layer Spatial Multiplexing 4X2 for CA (3DL CA)	12.5.0	12.6.0
2015-06	RAN#68	R5-151857	1968	1	Introduction of TC TDD PDSCH Open Loop Spatial Multiplexing 2X2 for CA (3DL CA)	12.5.0	12.6.0
2015-06	RAN#68	R5-151858	1969	1	New CA band combination CA_1A-41A and CA_26A-41A - Updates of 6.2.5.3 Delta TIB	12.5.0	12.6.0
2015-06	RAN#68	R5-151859	1970	1	New CA band combination CA_1A-41A and CA_26A-41A - Updates of 7.3.3 Delta RIB	12.5.0	12.6.0
2015-06	RAN#68	R5-151884	1878	1	New TCs: FDD PMI Reporting with 4Tx enhanced codebook - PUSCH 1-2 (Multiple PMI) for eDL-MIMO Enhancement	12.5.0	12.6.0
2015-06	RAN#68	R5-151885	1879	1	New TCs: TDD PMI Reporting with 4Tx enhanced codebook - PUSCH 1-2 (Multiple PMI) for eDL-MIMO Enhancement	12.5.0	12.6.0
2015-06	RAN#68	R5-151891	1901	1	Addition of band 32 to clause 5 in 36.521-1	12.5.0	12.6.0
2015-06	RAN#68	R5-151894	1941	1	Addition of test case 6.2.2E - UE Maximum Output Power for UE category 0	12.5.0	12.6.0
2015-06	RAN#68	R5-151895	1943	1	Introduction of UE category 0 in section 4 of 36.521-1	12.5.0	12.6.0
2015-06	RAN#68	R5-151896	1954	1	Update of SNR definition in clause 8.1.1	12.5.0	12.6.0
2015-06	RAN#68	R5-151897	1859	1	Introduction of TC 6.3.5A.1.2 Power Control Absolute Power Tolerance for CA	12.5.0	12.6.0
2015-06	RAN#68	R5-151899	1860	1	Introduction of TC 6.3.5A.1.3 Power Control Absolute Power Tolerance for CA	12.5.0	12.6.0
2015-06	RAN#68	R5-151900	1883	1	New CA 2UL Tx test case 6.2.2A.3	12.5.0	12.6.0
2015-06	RAN#68	R5-151901	1861	1	Introduction of TC 6.3.5A.2.3 Power Control Relative Power Tolerance for CA	12.5.0	12.6.0
2015-06	RAN#68	R5-151902	1862	1	Introduction of TC 6.3.5A.2.2 Power Control Relative Power Tolerance for CA	12.5.0	12.6.0
2015-06	RAN#68	R5-151903	1863	1	Introduction of TC 6.7A.2 Transmit intermodulation for CA	12.5.0	12.6.0
2015-06	RAN#68	R5-151921	1886	1	Updates of minimum requirement for reference sensitivity for CA	12.5.0	12.6.0
2015-06	RAN#68	R5-151922	1887	1	Addition of test points and test requirements for 3DL inter-band CA	12.5.0	12.6.0
2015-06	RAN#68	R5-151926	1977	1	Update of 7.6.1A.1	12.5.0	12.6.0
2015-06	RAN#68	R5-151928	1918	1	Correction to CQI reference measurement channels	12.5.0	12.6.0
2015-06	RAN#68	R5-151929	1849	1	CA RF: Corrections to sustained data rate test	12.5.0	12.6.0
2015-06	RAN#68	R5-151930	1946	1	Update two band and three band information in test case 7.3	12.5.0	12.6.0
2015-06	RAN#68	R5-151931	1888	1	Update of Maximum input level for CA (3DL CA without UL CA)	12.5.0	12.6.0
2015-06	RAN#68	R5-151932	1950	1	Introduction of TDD FDD CA with TDD as Pcell for PDSCH Single Antenna Port Performance	12.5.0	12.6.0
2015-06	RAN#68	R5-151933	1951	1	Introduction of TDD FDD CA with FDD as Pcell for PDSCH Single Antenna Port Performance	12.5.0	12.6.0
2015-06	RAN#68	R5-151934	1956	1	Introduction to test case 9.6.1.1_A.2: FDD CQI Reporting under AWGN conditions – PUCCH 1-0 (3DL CA)	12.5.0	12.6.0

2015-06	RAN#68	R5-151935	1957	1	Introduction to test case 9.6.1.2_A.2: TDD CQI Reporting under AWGN conditions – PUCCH 1-0 (3DL CA)	12.5.0	12.6.0
2015-06	RAN#68	R5-151936	1965	1	Addition of CA capability and applicability for 3 DL CCs in Chapter 8	12.5.0	12.6.0
2015-06	RAN#68	R5-151937	1971	1	New CA band combination CA_1A-41A and CA_26A-41A - Updates of 7.3A Refsens	12.5.0	12.6.0
2015-06	RAN#68	R5-151938	1972	1	New CA band combination CA_1A-18A-28A - Updates of 7.3.3 Delta RIB and 7.3A Refsens	12.5.0	12.6.0
2015-06	RAN#68	R5-151940	1958	1	Introduction to test case 6.3.3A.3: UE Transmit OFF power for CA (intra-band non-contiguous DL CA and UL CA)	12.5.0	12.6.0
2015-06	RAN#68	R5-151941	1959	1	Introduction to test case 6.3.4A.1.3: General ON/OFF time mask for CA (intra-band non-contiguous DL CA and UL CA)	12.5.0	12.6.0
2015-06	RAN#68	R5-151942	1960	1	Introduction to test case 6.6.1A.3: UE Occupied bandwidth for CA (intra-band non-contiguous DL CA and UL CA)	12.5.0	12.6.0
2015-06	RAN#68	R5-151943	1961	1	Introduction to test case 6.6.2.1A.3: Spectrum Emission Mask for CA (intra-band non-contiguous DL CA and UL CA)	12.5.0	12.6.0
2015-06	RAN#68	R5-151944	1893	1	Merge of TDD CQI Reporting under AWGN conditions – PUCCH 1-0 for CA cases	12.5.0	12.6.0
2015-06	RAN#68	R5-151945	1936	1	Introduction of TC 7.6.2A.5 Out-of-band blocking for CA (3DL CA without UL CA)	12.5.0	12.6.0
2015-06	RAN#68	R5-151946	1983	1	Introduction of TC 7.6.3A.5 Narrow-band blocking for CA (3DL CA without UL CA)	12.5.0	12.6.0
2015-06	RAN#68	R5-151947	1937	1	Introduction of TC 7.7A.5 Spurious response for CA (3DL CA without UL CA)	12.5.0	12.6.0
2015-06	RAN#68	R5-151948	1935	1	Introduction of TC 7.6.1A.5 In-band blocking for CA (3DL CA without UL CA)	12.5.0	12.6.0
2015-06	RAN#68	R5-151950	1844	1	CA RF: PCC/SCC mapping onto physical CC-s definition cleanup	12.5.0	12.6.0
2015-06	RAN#68	R5-152000	1848	1	CA RF: Corrections to power imbalance test	12.5.0	12.6.0
2015-06	RAN#68	R5-152001	1953	1	Correction to 9.3.1.3.1_E.1 FDD CQI Reporting test	12.5.0	12.6.0
2015-06	RAN#68	R5-152002	1858	1	Corrections to Reference Measurement Channel	12.5.0	12.6.0
2015-06	RAN#68	R5-152003	1911	1	Update of DL RMCs for PDSCH performance requirements	12.5.0	12.6.0
2015-06	RAN#68	R5-152004	1947	1	Addition of CA capability, applicability changes and core spec updates to Section 8 36.521-1 TDD TM1 CA test cases	12.5.0	12.6.0
2015-06	RAN#68	R5-152005	1948	1	Addition of CA capability, applicability changes and core spec updates to Section 8 36.521-1 TDD TM3 CA test cases	12.5.0	12.6.0
2015-06	RAN#68	R5-152006	1949	1	Addition of CA capability, applicability changes and core spec updates to Section 8 36.521-1 TDD TM4 CA test cases	12.5.0	12.6.0
2015-06	RAN#68	R5-152007	1974	1	Editorial correction to 8.2.1.1.1_A.1 and 8.2.1.3.1_A.1	12.5.0	12.6.0
2015-06	RAN#68	R5-152013	1856	1	Addition of Chapter 7 3DL CA Test Configuration Tables	12.5.0	12.6.0
2015-06	RAN#68	R5-152017	1938	1	Introduction of test case 7.8.1A.5 Wideband intermodulation for CA (3DL CA without UL CA)	12.5.0	12.6.0
2015-06	RAN#68	R5-152018	1942	1	Addition of test case 7.3E - Reference sensitivity level for UE category 0	12.5.0	12.6.0
2015-06	RAN#68	R5-152020	1882	1	New CA 2UL Tx test case 6.2.2A.2	12.5.0	12.6.0
2015-06	RAN#68	R5-152021	1944	1	Introduction of test case Maximum Power Reduction (MPR) for CA (inter-band DL CA and UL CA)	12.5.0	12.6.0

2015-06	RAN#68	R5-152022	1945	1	Introduction of test case Maximum Power Reduction (MPR) for CA (intra-band non-contiguous DL CA and UL CA)	12.5.0	12.6.0
2015-06	RAN#68	R5-152025	1922	1	Corrections to spurious emission band co-existence limit tables in clause 6	12.5.0	12.6.0
2015-06	RAN#68	R5-152027	1896	1	Update Reference Channel and Minimum test time for TDD CA power imbalance demodulation test	12.5.0	12.6.0
2015-06	RAN#68	R5-152028	1897	1	Update TDD CA BW combination to power imbalance test	12.5.0	12.6.0
2015-06	RAN#68	R5-152031	1908	1	Update of TC8.2.1.1.1_A.2:FDD PDSCH Single Antenna Performance for 3DL CA	12.5.0	12.6.0
2015-06	RAN#68	R5-152032	1900	1	Addition of Multiple 3DL CA Combinations to Chapter 7 Delta RIB and REFSENS Exceptions Tables	12.5.0	12.6.0
2015-06	RAN#68	R5-152033	1906	1	Clarification of the power of interferer with deltaRIBc	12.5.0	12.6.0
2015-06	RAN#68	R5-152038	1889	1	Introduction of ACS Test Case for 3DL CA without UL CA	12.5.0	12.6.0
2015-06	RAN#68	R5-152043	1923	2	Addition and alignment of all Rel-12 CA configurations in Section 5	12.5.0	12.6.0
2015-06	RAN#68	R5-152133	1939	2	NS value for intra-band contiguous CA configurations not allowed A-MPR	12.5.0	12.6.0
2015-06	RAN#68	R5-152136	1981	2	36.521-1: DL Sustained Data Rate clarifications	12.5.0	12.6.0
2015-06	RAN#68	-	-	-	section 8.2.1.4.3 which was deleted by mistake due to a wrong implementation of R5-150921 was restored	12.5.0	12.6.0
2015-09	RAN#69	R5-153100	1991	-	Corrections to EVM and Carrier leakage CA test cases	12.6.0	12.7.0
2015-09	RAN#69	R5-153101	1992	-	Update of EVM minimum requirements	12.6.0	12.7.0
2015-09	RAN#69	R5-153243	2017	-	CA RF: Minor corrections	12.6.0	12.7.0
2015-09	RAN#69	R5-153244	2018	-	eDL-MIMO RF: Minor corrections	12.6.0	12.7.0
2015-09	RAN#69	R5-153245	2019	-	CA RF: Correction to applicability of SDR test	12.6.0	12.7.0
2015-09	RAN#69	R5-153247	2021	-	eICIC and feICIC RF: Corrections to PDSCH RMCs used for PDCCH performance	12.6.0	12.7.0
2015-09	RAN#69	R5-153300	2029	-	Addition of new TC of Frequency error for inter-band CA	12.6.0	12.7.0
2015-09	RAN#69	R5-153305	2033	-	Addition of new TC of Reference sensitivity level for 2UL inter-band CA	12.6.0	12.7.0
2015-09	RAN#69	R5-153317	2037	-	CA RF: Addition of missing requirements for CA_4A-12A	12.6.0	12.7.0
2015-09	RAN#69	R5-153318	2038	-	RF: Clarifications for TC 6.6.3.2	12.6.0	12.7.0
2015-09	RAN#69	R5-153322	2042	-	RF: Correction to TC 6.6.3.3A	12.6.0	12.7.0
2015-09	RAN#69	R5-153362	2053	-	Clean up for Tx test cases	12.6.0	12.7.0
2015-09	RAN#69	R5-153364	2055	-	Correction to DL parameters in CA Rx tests	12.6.0	12.7.0
2015-09	RAN#69	R5-153365	2056	-	Correction to 7.6.1A.4 In-band blocking for non-contiguous CA	12.6.0	12.7.0
2015-09	RAN#69	R5-153367	2058	-	Removable of PCFICH_RA in 8.4 and 8.5	12.6.0	12.7.0
2015-09	RAN#69	R5-153371	2062	-	Correction to CQI reporting under AWGN for eDL-MIMO	12.6.0	12.7.0
2015-09	RAN#69	R5-153372	2063	-	Correction to CQI reporting under fading(PUSCH3-1) for eDL-MIMO	12.6.0	12.7.0
2015-09	RAN#69	R5-153373	2064	-	Correction to CQI reporting under fading(PUCCH1-1) for eDL-MIMO	12.6.0	12.7.0
2015-09	RAN#69	R5-153375	2066	-	Correction to RI reporting test for eDL-MIMO	12.6.0	12.7.0

2015-09	RAN#69	R5-153377	2068	-	Correction to CQI reporting test for TM9	12.6.0	12.7.0
2015-09	RAN#69	R5-153378	2069	-	Correction to feICIC CQI reporting test procedure in 9.2.1.5_E.1	12.6.0	12.7.0
2015-09	RAN#69	R5-153423	2075	-	Updates of ?TIB,c values to TC 6.2.5	12.6.0	12.7.0
2015-09	RAN#69	R5-153460	2091	-	Correction of 1A-3A-5A CA REFSSENS DL Allocation	12.6.0	12.7.0
2015-09	RAN#69	R5-153462	2092	-	Addition of several definitions to chapter 3	12.6.0	12.7.0
2015-09	RAN#69	R5-153474	2095	-	Applicability Update of Intra-Band DL-only CA testcases in Chapter 7	12.6.0	12.7.0
2015-09	RAN#69	R5-153613	2122	-	Introduction of Receiver Spurious emissions test case for Carrier Aggregation in DL-only bands	12.6.0	12.7.0
2015-09	RAN#69	R5-153624	2126	-	New CA 2UL Tx test case 6.6.2.3A.2 Adjacent Channel Leakage power Ratio for CA (inter-band DL CA and UL CA)	12.6.0	12.7.0
2015-09	RAN#69	R5-153629	2127	-	Test Tolerances for test case 6.3.4A.1.3 General ON/OFF time mask for CA (intra-band contiguous DL CA and UL CA)	12.6.0	12.7.0
2015-09	RAN#69	R5-153630	2128	-	Test Tolerances for test case 6.3.4A.1.1 General ON/OFF time mask for CA (intra-band contiguous DL CA and UL CA)	12.6.0	12.7.0
2015-09	RAN#69	R5-153633	2130	-	Test Tolerances for test case 6.6.1A.3 Occupied bandwidth for CA (intra-band non-contiguous DL CA and UL CA)	12.6.0	12.7.0
2015-09	RAN#69	R5-153634	2131	-	Test Tolerances for test case 6.6.2.1A.3 Spectrum emission mask for CA (intra-band non-contiguous DL CA and UL CA)	12.6.0	12.7.0
2015-09	RAN#69	R5-153646	2135	-	36.521-1_Reference corrections in test 6.6.3.2	12.6.0	12.7.0
2015-09	RAN#69	R5-153671	2145	-	Resubmission: CA RF: Clarification of PHICH configuration	12.6.0	12.7.0
2015-09	RAN#69	R5-153800	2070	1	Correction to applicability of feICIC demod test cases	12.6.0	12.7.0
2015-09	RAN#69	R5-153801	2057	1	Correction to test procedure in 7.8.1A.4 Wideband intermodulation for non-contiguous CA	12.6.0	12.7.0
2015-09	RAN#69	R5-153802	2090	1	Correction to Testpoint Selection in Chapter 7 NC CA Testcases	12.6.0	12.7.0
2015-09	RAN#69	R5-153803	2048	1	Correction to title of table A 3.2-3 and A 3.2-4 in annex A.3.2	12.6.0	12.7.0
2015-09	RAN#69	R5-153804	2061	1	Correction to message exceptions in performance test(User-Specific RS) for eDL-MIMO	12.6.0	12.7.0
2015-09	RAN#69	R5-153805	2065	1	Correction to PMI reporting test for eDL-MIMO	12.6.0	12.7.0
2015-09	RAN#69	R5-153806	2067	1	Correction to TM9 interference model test cases	12.6.0	12.7.0
2015-09	RAN#69	R5-153807	2078	1	Updates to 8.7.2.1.A_1 TDD Sustained data rate performance for CA (2DL CA)	12.6.0	12.7.0
2015-09	RAN#69	R5-153810	2087	1	Correction to test point selection table for all chap8/9 FDD and TDD 2DLCA cases	12.6.0	12.7.0
2015-09	RAN#69	R5-153821	2012	1	Update to FDD PDSCH Closed Loop Multi Layer Spatial Multiplexing 4x2 for CA (3DL CA)	12.6.0	12.7.0
2015-09	RAN#69	R5-153822	2024	1	Addition of annex F for Reference sensitivity for 3DL CA	12.6.0	12.7.0
2015-09	RAN#69	R5-153823	2039	1	CA RF: Update of test points for CA_12B	12.6.0	12.7.0
2015-09	RAN#69	R5-153827	2094	1	Addition of 3DL CA default XB-YA configuration to REFSSENS test configuration table	12.6.0	12.7.0
2015-09	RAN#69	R5-153836	1999	1	Introduction of SUMIMO for LTE Type C performance TC 8.2.2.3.1B	12.6.0	12.7.0
2015-09	RAN#69	R5-153837	2111	1	Addition of Reference measurement channel and overview reference for multi-cell test in Annex	12.6.0	12.7.0

2015-09	RAN#69	R5-153838	2112	1	Introduction of FDD TM3 test case for LTE Type C performance requirements (8.2.1.3.1B)	12.6.0	12.7.0
2015-09	RAN#69	R5-153839	2113	1	Introduction of FDD TM3 multi-cell test case with TM1 interference for LTE Type C performance requirements (8.2.1.3.1C)	12.6.0	12.7.0
2015-09	RAN#69	R5-153840	2114	1	Introduction of TDD TM3 multi-cell test case with TM1 interference for LTE Type C performance requirements (8.2.2.3.1C)	12.6.0	12.7.0
2015-09	RAN#69	R5-153841	2115	1	Introduction of FDD TM4 test case for LTE Type C performance requirements (8.2.1.4.2A)	12.6.0	12.7.0
2015-09	RAN#69	R5-153842	2116	1	Introduction of TDD TM4 test case for LTE Type C performance requirements (8.2.2.4.2A)	12.6.0	12.7.0
2015-09	RAN#69	R5-153843	2117	1	Introduction of TDD TM8 test case for LTE Type C performance requirements (8.3.2.2.2)	12.6.0	12.7.0
2015-09	RAN#69	R5-153844	2118	1	Introduction of FDD TM9 test case for LTE Type C performance requirements (8.3.1.2.2)	12.6.0	12.7.0
2015-09	RAN#69	R5-153845	2119	1	Addition of Enhanced performance requirements Type C definition	12.6.0	12.7.0
2015-09	RAN#69	R5-153848	1997	1	Update of eDL MIMO enhancement TC 9.4.2.3.3_G	12.6.0	12.7.0
2015-09	RAN#69	R5-153849	1998	1	Update of eDL MIMO enhancement TC 9.4.2.3.4_G	12.6.0	12.7.0
2015-09	RAN#69	R5-153851	2000	1	New TC: 9.7.1.2 TDD CQI reporting definition under AWGN conditions for UE category 0	12.6.0	12.7.0
2015-09	RAN#69	R5-153852	2125	1	RMC definitions for UE category 0	12.6.0	12.7.0
2015-09	RAN#69	R5-153853	2123	1	Additions to test case 6.2.2E - UE Maximum Output Power for UE category 0	12.6.0	12.7.0
2015-09	RAN#69	R5-153854	2124	1	Changes to test case 7.3E - Reference sensitivity level for UE category 0	12.6.0	12.7.0
2015-09	RAN#69	R5-153855	2026	1	Addition of new TC of Transmit off power for inter-band CA	12.6.0	12.7.0
2015-09	RAN#69	R5-153856	2034	1	Addition of annex F for 2UL CA test cases	12.6.0	12.7.0
2015-09	RAN#69	R5-153858	2045	1	Introduction to test case 6.2.4A.3: Additional Maximum Power Reduction (A-MPR) for CA (intra-band non-contiguous DL CA and UL CA)	12.6.0	12.7.0
2015-09	RAN#69	R5-153859	2088	1	EVM for Intra-band contiguous UL CA for non-equal Channel BWs	12.6.0	12.7.0
2015-09	RAN#69	R5-153867	2150	-	Adding missing subclauses in Annex A.2	12.6.0	12.7.0
2015-09	RAN#69	R5-153868	2008	1	Align Test Procedure and Test requirements for 7.5A.5 ACS 3DL CA	12.6.0	12.7.0
2015-09	RAN#69	R5-153869	2010	1	Align Test requirements for 7.4A.5 Max Input 3DL CA	12.6.0	12.7.0
2015-09	RAN#69	R5-153870	2132	1	Completion to Test cases 9.6.1.1_A.2 and 9.6.1.2_A.2: FDD/TDD CQI Reporting under AWGN conditions – PUCCH 1-0 (3DL CA)	12.6.0	12.7.0
2015-09	RAN#69	R5-153873	2035	1	Updates of minimum requirements of Spurious emission band UE co-existence	12.6.0	12.7.0
2015-09	RAN#69	R5-153874	2001	1	New CA band combination CA_1A-5A-7A - Updates of 7.3.3 Delta RIB and 7.3A Refsens Test Configuration	12.6.0	12.7.0
2015-09	RAN#69	R5-153879	2036	1	CA RF: Update of intraband contiguous blocking requirements	12.6.0	12.7.0
2015-09	RAN#69	R5-153880	2096	1	Update of Reference sensitivity for CA_39A-41C and CA_39C-41A	12.6.0	12.7.0

2015-09	RAN#69	R5-153881	2121	1	Updates to test case 7.8.1A.5 Wideband intermodulation for CA (3DL CA without UL CA)	12.6.0	12.7.0
2015-09	RAN#69	R5-153882	2148	-	New CA band combinations (CA_1A-41C, CA_26A_41C) - Updates of 7.3.3 Delta RIB	12.6.0	12.7.0
2015-09	RAN#69	R5-153884	2147	-	Addition of Multiple Inter-band CA Configurations to 7.3A.4	12.6.0	12.7.0
2015-09	RAN#69	R5-153885	2011	1	Update to FDD PDSCH Open Loop Spatial Multiplexing 2x2 for CA (3DL CA)	12.6.0	12.7.0
2015-09	RAN#69	R5-153886	2013	1	Update to TDD PDSCH Open Loop Spatial Multiplexing 2x2 for CA (3DL CA)	12.6.0	12.7.0
2015-09	RAN#69	R5-153887	2014	1	Update to TDD PDSCH Closed Loop Multi Layer Spatial Multiplexing 4x2 for CA (3DL CA)	12.6.0	12.7.0
2015-09	RAN#69	R5-153888	2076	1	Updates to 8.2.2.1.1_A.2 TDD PDSCH Single Antenna Port Performance for CA (3DL CA)	12.6.0	12.7.0
2015-09	RAN#69	R5-153889	2077	1	Updates to 8.7.1.1.A_2 FDD Sustained data rate performance for CA (3DL CA)	12.6.0	12.7.0
2015-09	RAN#69	R5-153890	2079	1	Updates to 8.7.2.1.A_2 TDD Sustained data rate performance for CA (3DL CA)	12.6.0	12.7.0
2015-09	RAN#69	R5-153891	2086	1	Updates to TDD FDD CA test cases for PDSCH Single Antenna Port Performance	12.6.0	12.7.0
2015-09	RAN#69	R5-153892	2105	1	Update of FDD PDSCH Single Antenna Port Performance for CA (3DL CA)	12.6.0	12.7.0
2015-09	RAN#69	R5-153893	2106	1	TDD FDD CA PDSCH Closed Loop Multi Layer Spatial Multiplexing 4x2 for TDD PCell (2DL CA)	12.6.0	12.7.0
2015-09	RAN#69	R5-153894	2107	1	TDD FDD CA PDSCH Closed Loop Multi Layer Spatial Multiplexing 4x2 for TDD PCell (3DL CA)	12.6.0	12.7.0
2015-09	RAN#69	R5-153895	2149	1	New CA band combinations (CA_1A-41C, CA_26A-41C) - Updates of 7.3A Refsens	12.6.0	12.7.0
2015-09	RAN#69	R5-153902	1993	1	Introduction of eDL MIMO enhancement TC 9.3.7.1_G	12.6.0	12.7.0
2015-09	RAN#69	R5-153903	1994	1	Introduction of eDL MIMO enhancement TC 9.3.7.2_G	12.6.0	12.7.0
2015-09	RAN#69	R5-153904	1995	1	Introduction of eDL MIMO enhancement TC 9.4.1.4.1_G	12.6.0	12.7.0
2015-09	RAN#69	R5-153905	1996	1	Introduction of eDL MIMO enhancement TC 9.4.1.4.2_G	12.6.0	12.7.0
2015-09	RAN#69	R5-153906	2016	1	UE Cat 0 RF: Addition to Annex I	12.6.0	12.7.0
2015-09	RAN#69	R5-153907	2097	1	Addition of test case 7.4E - Maximum input level for UE category 0	12.6.0	12.7.0
2015-09	RAN#69	R5-153908	2120	1	Additions to test case 6.2.3E - Maximum Power Reduction (MPR) for UE category 0	12.6.0	12.7.0
2015-09	RAN#69	R5-153909	2144	1	Additions to test case 6.2.4E – Additional Maximum Power Reduction (A-MPR) for UE category 0	12.6.0	12.7.0
2015-09	RAN#69	R5-153912	2027	1	Addition of new TC of ON/OFF time mask for inter-band CA	12.6.0	12.7.0
2015-09	RAN#69	R5-153913	2028	1	Addition of new TC of Occupied bandwidth for inter-band CA	12.6.0	12.7.0
2015-09	RAN#69	R5-153914	2030	1	Addition of new TC of Spectrum emission mask for inter-band CA	12.6.0	12.7.0
2015-09	RAN#69	R5-153915	2031	1	Addition of new TC of Transmitter Spurious emissions for inter-band CA	12.6.0	12.7.0
2015-09	RAN#69	R5-153916	2032	1	Addition of new TC of Spurious emission band UE co-existence for inter-band CA	12.6.0	12.7.0

2015-09	RAN#69	R5-153917	2046	1	Introduction to test case 6.2.5A.2: Configured UE transmitted Output Power for CA (inter-band DL CA and UL CA)	12.6.0	12.7.0
2015-09	RAN#69	R5-153918	2047	1	Introduction to test case 6.2.5A.3: Configured UE transmitted Output Power for CA (intra-band non-contiguous DL CA and UL CA)	12.6.0	12.7.0
2015-09	RAN#69	R5-153920	2007	1	Update of 6.2.3_2 MPR for Multi-Cluster PUSCH	12.6.0	12.7.0
2015-09	RAN#69	R5-153921	2054	1	Correction to lower tolerances for CA_NS_05 in A-MPR	12.6.0	12.7.0
2015-09	RAN#69	R5-153922	2129	1	Corrections to test case 6.6.1A.1 Occupied bandwidth for CA (intra-band contiguous DL CA and UL CA)	12.6.0	12.7.0
2015-09	RAN#69	R5-153923	2043	1	CA RF: Clean Up of UL resource allocation for interband 2DL CA	12.6.0	12.7.0
2015-09	RAN#69	R5-153924	2002	1	Correction of minimum requirements and test procedures for 8.2.2.1.1_A.1	12.6.0	12.7.0
2015-09	RAN#69	R5-153925	2003	1	Corrections to 8.2.2.3.1_A.1	12.6.0	12.7.0
2015-09	RAN#69	R5-153926	2059	1	Correction to the title in 2DL CA performance test cases	12.6.0	12.7.0
2015-09	RAN#69	R5-153927	2060	1	Correction to FDD soft buffer test for CA	12.6.0	12.7.0
2015-09	RAN#69	R5-153928	2134	1	36.521-1_CA power imbalance test updates	12.6.0	12.7.0
2015-09	RAN#69	R5-153944	2022	2	Updates of minimum requirements of reference sensitivity for 3DL CA	12.6.0	12.7.0
2015-09	RAN#69	R5-153945	2023	2	Updates of Reference sensitivity for 3DL CA	12.6.0	12.7.0
2015-09	RAN#69	R5-153947	2146	1	UE Category Corrections to test case 8.2.1.4.2_A.1 from 36.521-1	12.6.0	12.7.0
2015-09	RAN#69	R5-153949	1985	1	Correction to RC.2 TDD Nr. HARQ Proc.	12.6.0	12.7.0
2015-09	RAN#69	R5-154002	1986	1	Introduction of TC 9.6.1.3.1 TDD FDD CA CQI Reporting – PUCCH 1-0 for FDD PCell (2DL CA)	12.6.0	12.7.0
2015-09	RAN#69	R5-154003	1987	1	Introduction of TC 9.6.1.3.2 TDD FDD CA CQI Reporting – PUCCH 1-0 for FDD PCell (3DL CA)	12.6.0	12.7.0
2015-09	RAN#69	R5-154004	1988	1	Introduction of TC 9.6.1.4.1 TDD FDD CA CQI Reporting – PUCCH 1-0 for TDD PCell (2DL CA)	12.6.0	12.7.0
2015-09	RAN#69	R5-154005	1989	1	Introduction of TC 9.6.1.4.2 TDD FDD CA CQI Reporting – PUCCH 1-0 for TDD PCell (3DL CA)	12.6.0	12.7.0
2015-09	RAN#69	R5-154006	2098	1	Addition of test case 7.5E - Adjacent Channel Selectivity (ACS) for UE category 0	12.6.0	12.7.0
2015-09	RAN#69	R5-154007	2099	1	Addition of test case 7.6.1E - In-band blocking for UE category 0	12.6.0	12.7.0
2015-09	RAN#69	R5-154008	2100	1	Addition of test case 7.6.2E - Out-of-band blocking for UE category 0	12.6.0	12.7.0
2015-09	RAN#69	R5-154009	2101	1	Addition of test case 7.6.3E - Narrow band blocking for UE category 0	12.6.0	12.7.0
2015-09	RAN#69	R5-154010	2102	1	Addition of test case 7.7E - Spurious response for UE category 0	12.6.0	12.7.0
2015-09	RAN#69	R5-154011	2103	1	Addition of test case 7.8.1E - Wide band Intermodulation for UE category 0	12.6.0	12.7.0
2015-09	RAN#69	R5-154012	2104	1	Addition of test case 7.9E - Spurious emissions for UE category 0	12.6.0	12.7.0
2015-09	RAN#69	R5-154014	2136	1	36.521-1_Test requirements correction in test 6.3.5.2	12.6.0	12.7.0



2015-09	RAN#69	R5-154015	2080	1	Addition of 8.7.5.1.1 TDD FDD CA Sustained data rate performance for FDD PCell (2DL CA)	12.6.0	12.7.0
2015-09	RAN#69	R5-154016	2081	1	Addition of 8.7.5.1.2 TDD FDD CA Sustained data rate performance for FDD PCell (3DL CA)	12.6.0	12.7.0
2015-09	RAN#69	R5-154017	2082	1	Addition of 8.7.5.2.1 TDD FDD CA Sustained data rate performance for TDD PCell (2DL CA)	12.6.0	12.7.0
2015-09	RAN#69	R5-154018	2083	1	Addition of 8.7.5.2.2 TDD FDD CA Sustained data rate performance for TDD PCell (3DL CA)	12.6.0	12.7.0
2015-09	RAN#69	R5-154019	2049	1	Update to TC 7.6.1A.5 In-band blocking for CA (3DL CA without UL CA)	12.6.0	12.7.0
2015-09	RAN#69	R5-154022	2050	1	Update to TC 7.6.2A.5 Out-of-band blocking for CA (3DL CA without UL CA)	12.6.0	12.7.0
2015-09	RAN#69	R5-154023	2051	1	Update to TC 7.6.3A.5 Narrow band blocking for CA (3DL CA without UL CA)	12.6.0	12.7.0
2015-09	RAN#69	R5-154024	2052	1	Update to TC 7.7A.5 Spurious response for CA (3DL CA without UL CA)	12.6.0	12.7.0
2015-09	RAN#69	R5-154026	2084	2	Addition of SCE-L1 clause numbering principle in Annex I	12.6.0	12.7.0
2015-09	RAN#69	R5-154030	2009	1	Revise Power Control Relative power tolerance for 2 UL CA test case 6.3.5A.2.1	12.6.0	12.7.0
2015-09	RAN#69	R5-154031	2020	1	RF: Applicability of CSI requirements to UE Category 1 (for 36.521-1)	12.6.0	12.7.0
2015-09	RAN#69	-	-	-	update of the "non-specific references" in section 2 according to the approved R5-153582 and an action point on ETSI MCC	12.6.0	12.7.0

---

# History

<b>Document history</b>		
V12.3.0	November 2014	Publication
V12.4.0	March 2015	Publication
V12.5.0	May 2015	Publication
V12.6.0	September 2015	Publication
V12.7.0	October 2015	Publication