



Technical Specification

**LTE;
Evolved Universal Terrestrial Radio Access (E-UTRA);
User Equipment (UE) conformance specification;
Radio transmission and reception;
Part 1: Conformance testing
(3GPP TS 36.521-1 version 9.5.0 Release 9)**



ReferenceRTS/TSGR-0536521-1v950

Keywords

LTE

ETSI

650 Route des Lucioles
F-06921 Sophia Antipolis Cedex - FRANCE

Tel.: +33 4 92 94 42 00 Fax: +33 4 93 65 47 16

Siret N° 348 623 562 00017 - NAF 742 C
Association à but non lucratif enregistrée à la
Sous-Préfecture de Grasse (06) N° 7803/88

Important notice

Individual copies of the present document can be downloaded from:

<http://www.etsi.org>

The present document may be made available in more than one electronic version or in print. In any case of existing or perceived difference in contents between such versions, the reference version is the Portable Document Format (PDF). In case of dispute, the reference shall be the printing on ETSI printers of the PDF version kept on a specific network drive within ETSI Secretariat.

Users of the present document should be aware that the document may be subject to revision or change of status. Information on the current status of this and other ETSI documents is available at <http://portal.etsi.org/tb/status/status.asp>

If you find errors in the present document, please send your comment to one of the following services:

http://portal.etsi.org/chaicor/ETSI_support.asp

Copyright Notification

No part may be reproduced except as authorized by written permission.
The copyright and the foregoing restriction extend to reproduction in all media.

© European Telecommunications Standards Institute 2011.
All rights reserved.

DECT™, **PLUGTESTS™**, **UMTS™** and the ETSI logo are Trade Marks of ETSI registered for the benefit of its Members.
3GPP™ and **LTE™** are Trade Marks of ETSI registered for the benefit of its Members and
of the 3GPP Organizational Partners.
GSM® and the GSM logo are Trade Marks registered and owned by the GSM Association.

Intellectual Property Rights

IPRs essential or potentially essential to the present document may have been declared to ETSI. The information pertaining to these essential IPRs, if any, is publicly available for **ETSI members and non-members**, and can be found in ETSI SR 000 314: *"Intellectual Property Rights (IPRs); Essential, or potentially Essential, IPRs notified to ETSI in respect of ETSI standards"*, which is available from the ETSI Secretariat. Latest updates are available on the ETSI Web server (<http://ipr.etsi.org>).

Pursuant to the ETSI IPR Policy, no investigation, including IPR searches, has been carried out by ETSI. No guarantee can be given as to the existence of other IPRs not referenced in ETSI SR 000 314 (or the updates on the ETSI Web server) which are, or may be, or may become, essential to the present document.

Foreword

This Technical Specification (TS) has been produced by ETSI 3rd Generation Partnership Project (3GPP).

The present document may refer to technical specifications or reports using their 3GPP identities, UMTS identities or GSM identities. These should be interpreted as being references to the corresponding ETSI deliverables.

The cross reference between GSM, UMTS, 3GPP and ETSI identities can be found under <http://webapp.etsi.org/key/queryform.asp>.

Contents

Intellectual Property Rights	2
Foreword.....	2
Foreword.....	17
Introduction	17
1 Scope	18
2 References	19
3 Definitions, symbols and abbreviations	20
3.1 Definitions	20
3.2 Symbols.....	20
3.3 Abbreviations	21
4 General	23
5 Frequency bands and channel arrangement.....	24
5.1 General	24
5.2 Operating bands.....	24
5.3 TX–RX frequency separation.....	25
5.4 Channel arrangement.....	25
5.4.1 Channel spacing.....	25
5.4.2 Channel bandwidth	25
5.4.2.1 Channel bandwidths per operating band	26
5.4.3 Channel raster	27
5.4.4 Carrier frequency and EARFCN.....	27
6 Transmitter Characteristics.....	29
6.1 General	29
6.2 Transmit power	29
6.2.1 Void	29
6.2.2 UE Maximum Output Power	29
6.2.2.1 Test purpose	29
6.2.2.2 Test applicability.....	29
6.2.2.3 Minimum conformance requirements	29
6.2.2.4 Test description	30
6.2.2.4.1 Initial condition	30
6.2.2.4.2 Test procedure	31
6.2.2.4.3 Message contents.....	32
6.2.2.5 Test requirements.....	32
6.2.3 Maximum Power Reduction (MPR)	33
6.2.3.1 Test purpose	33
6.2.3.2 Test applicability.....	33
6.2.3.3 Minimum conformance requirements	33
6.2.3.4 Test description	33
6.2.3.4.1 Initial condition	33
6.2.3.4.2 Test procedure	34
6.2.3.4.3 Message contents.....	35
6.2.3.5 Test requirements.....	35
6.2.4 Additional Maximum Power Reduction (A-MPR).....	37
6.2.4.1 Test purpose	37
6.2.4.2 Test applicability.....	37
6.2.4.3 Minimum conformance requirements	37
6.2.4.4 Test description	38
6.2.4.4.1 Initial condition	38
6.2.4.4.2 Test procedure	45
6.2.4.4.3 Message contents.....	46

6.2.4.5	Test requirements	48
6.2.5	Configured UE transmitted Output Power	58
6.2.5.1	Test purpose	58
6.2.5.2	Test applicability	58
6.2.5.3	Minimum conformance requirements	58
6.2.5.4	Test description	59
6.2.5.4.1	Initial conditions	59
6.2.5.4.2	Test procedure	60
6.2.5.4.3	Message contents	60
6.2.5.5	Test requirement	60
6.3	Output Power Dynamics	61
6.3.1	Void	61
6.3.2	Minimum Output Power	61
6.3.2.1	Test purpose	61
6.3.2.2	Test applicability	61
6.3.2.3	Minimum conformance requirements	61
6.3.2.4	Test description	62
6.3.2.4.1	Initial conditions	62
6.3.2.4.2	Test procedure	62
6.3.2.4.3	Message contents	63
6.3.2.5	Test requirement	63
6.3.3	Transmit OFF power	63
6.3.3.1	Test purpose	63
6.3.3.2	Test applicability	63
6.3.3.3	Minimum conformance requirement	63
6.3.3.4	Test description	64
6.3.3.5	Test requirement	64
6.3.4	ON/OFF time mask	64
6.3.4.1	General ON/OFF time mask	64
6.3.4.1.1	Test purpose	64
6.3.4.1.2	Test applicability	64
6.3.4.1.3	Minimum conformance requirement	64
6.3.4.1.4	Test description	65
6.3.4.1.4.1	Initial conditions	65
6.3.4.1.4.2	Test procedure	66
6.3.4.1.4.3	Message contents	66
6.3.4.1.5	Test requirement	67
6.3.4.2	PRACH and SRS time mask	67
6.3.4.2.1	PRACH time mask	67
6.3.4.2.2	SRS time mask	70
6.3.5	Power Control	74
6.3.5.1	Power Control Absolute power tolerance	75
6.3.5.1.1	Test purpose	75
6.3.5.1.2	Minimum conformance requirement	75
6.3.5.1.3	Test applicability	75
6.3.5.1.4	Test description	75
6.3.5.1.5	Test requirement	77
6.3.5.2	Power Control Relative power tolerance	78
6.3.5.2.1	Test purpose	78
6.3.5.2.2	Test applicability	78
6.3.5.2.3	Minimum conformance requirement	78
6.3.5.2.4	Test description	79
6.3.5.2.5	Test requirement	86
6.3.5.3	Aggregate power control tolerance	93
6.3.5.3.1	Test purpose	93
6.3.5.3.2	Test applicability	93
6.3.5.3.3	Minimum conformance requirement	93
6.3.5.3.4	Test description	94
6.3.5.3.5	Test requirement	96
6.4	Void	96
6.5	Transmit signal quality	96
6.5.1	Frequency Error	97

6.5.1.1	Test purpose	97
6.5.1.2	Test applicability	97
6.5.1.3	Minimum conformance requirements	97
6.5.1.4	Test description	97
6.5.1.4.1	Initial condition	97
6.5.1.4.2	Test procedure	98
6.5.1.4.3	Message contents	99
6.5.1.5	Test requirement	99
6.5.2	Transmit modulation	99
6.5.2.1	Error Vector Magnitude (EVM)	99
6.5.2.1.1	Test Purpose	99
6.5.2.1.2	Test applicability	99
6.5.2.1.3	Minimum conformance requirements	99
6.5.2.1.4	Test description	100
6.5.2.1.5	Test requirement	104
6.5.2.1A	PUSCH-EVM with exclusion period	104
6.5.2.1A.1	Test purpose	104
6.5.2.1A.2	Test applicability	105
6.5.2.1A.3	Minimum conformance requirement	105
6.5.2.1A.4	Test description	105
6.5.2.1A.5	Test requirement	106
6.5.2.2	Carrier leakage	107
6.5.2.2.1	Test Purpose	107
6.5.2.2.2	Test applicability	107
6.5.2.2.3	Minimum conformance requirements	107
6.5.2.2.4	Test description	107
6.5.2.2.5	Test requirement	109
6.5.2.3	In-band emissions for non allocated RB	109
6.5.2.3.1	Test Purpose	109
6.5.2.3.2	Test applicability	109
6.5.2.3.3	Minimum conformance requirements	109
6.5.2.3.4	Test description	110
6.5.2.3.5	Test requirement	112
6.5.2.4	EVM equalizer spectrum flatness	113
6.5.2.4.1	Test Purpose	113
6.5.2.4.2	Test applicability	113
6.5.2.4.3	Minimum conformance requirements	113
6.5.2.4.4	Test description	115
6.5.2.4.5	Test requirement	116
6.6	Output RF spectrum emissions	117
6.6.1	Occupied bandwidth	117
6.6.1.1	Test purpose	117
6.6.1.2	Test applicability	117
6.6.1.2	Minimum conformance requirements	117
6.6.1.4	Test description	118
6.6.1.4.1	Initial conditions	118
6.6.1.4.2	Test procedure	119
6.6.1.4.3	Message contents	119
6.6.1.5	Test requirement	119
6.6.2	Out of band emission	119
6.6.2.1	Spectrum Emission Mask	119
6.6.2.1.1	Test purpose	119
6.6.2.1.2	Test applicability	119
6.6.2.1.3	Minimum conformance requirements	120
6.6.2.1.4	Test description	120
6.6.2.1.5	Test requirements	122
6.6.2.2	Additional Spectrum Emission Mask	122
6.6.2.2.1	Test purpose	122
6.6.2.2.2	Test applicability	123
6.6.2.2.3	Minimum conformance requirements	123
6.6.2.2.4	Test description	124
6.6.2.2.5	Test requirements	130

6.6.2.3	Adjacent Channel Leakage power Ratio	132
6.6.2.3.1	Test purpose	132
6.6.2.3.2	Test applicability	132
6.6.2.3.3	Minimum conformance requirements.....	132
6.6.2.3.4	Test description	134
6.6.2.3.5	Test requirement	136
6.6.2.4	Void.....	137
6.6.3	Spurious emissions	137
6.6.3.1	Transmitter Spurious emissions	137
6.6.3.1.1	Test purpose	137
6.6.3.1.2	Test applicability	137
6.6.3.1.3	Minimum conformance requirements.....	137
6.6.3.1.4	Test description	138
6.6.3.1.5	Test requirement	139
6.6.3.2	Spurious emission band UE co-existence	140
6.6.3.2.1	Test purpose	140
6.6.3.2.2	Test applicability	140
6.6.3.2.3	Minimum conformance requirements.....	140
6.6.3.2.4	Test description	143
6.6.3.2.5	Test requirement	144
6.6.3.3	Additional spurious emissions	147
6.6.3.3.1	Test purpose	147
6.6.3.3.2	Test applicability	147
6.6.3.3.3	Minimum conformance requirements.....	147
6.6.3.3.3.4	Minimum requirement (network signalled value “NS_09”).....	148
6.6.3.3.4	Test description	149
6.6.3.3.5	Test requirement	154
6.7	Transmit intermodulation	156
6.7.1	Test purpose.....	156
6.7.2	Test applicability	156
6.7.3	Minimum conformance requirements	156
6.7.4	Test description.....	156
6.7.4.1	Initial conditions	156
6.7.4.3	Test procedure.....	157
6.7.4.3	Message contents	158
6.7.5	Test requirement	158
7	Receiver Characteristics	159
7.1	General	159
7.2	Diversity characteristics	159
7.3	Reference sensitivity level.....	159
7.3.1	Test purpose.....	159
7.3.2	Test applicability	159
7.3.3	Minimum conformance requirements	160
7.3.4	Test description.....	162
7.3.4.1	Initial conditions	162
7.3.4.2	Test procedure.....	163
7.3.4.3	Message contents	164
7.3.5	Test requirement	164
7.4	Maximum input level	166
7.4.1	Test purpose.....	166
7.4.2	Test applicability	167
7.4.3	Minimum conformance requirements	167
7.4.4	Test description.....	167
7.4.4.1	Initial conditions	167
7.4.4.2	Test procedure.....	168
7.4.4.3	Message contents	168
7.4.5	Test requirement	169
7.5	Adjacent Channel Selectivity (ACS)	169
7.5.1	Test purpose.....	169
7.5.2	Test applicability	169
7.5.3	Minimum conformance requirements	169

7.5.4	Test description.....	170
7.5.4.1	Initial conditions	170
7.5.4.2	Test procedure.....	171
7.5.4.3	Message contents	172
7.5.5	Test requirement	172
7.6	Blocking characteristics	173
7.6.1	In-band blocking.....	173
7.6.1.1	Test Purpose	173
7.6.1.2	Test Applicability.....	173
7.6.1.3	Minimum Conformance Requirements	174
7.6.1.4	Test Description	174
7.6.1.4.1	Initial Conditions	174
7.6.1.4.2	Test Procedure.....	175
7.6.1.4.3	Message Contents	176
7.6.1.5	Test Requirement	176
7.6.2	Out-of-band blocking.....	177
7.6.2.1	Test Purpose	177
7.6.2.2	Test Applicability.....	177
7.6.2.3	Minimum Conformance Requirements	178
7.6.2.4	Test Description	178
7.6.2.4.1	Initial Conditions	178
7.6.2.4.2	Test Procedure.....	179
7.6.2.4.3	Message Contents	180
7.6.2.5	Test Requirement	180
7.6.3	Narrow band blocking	181
7.6.3.1	Test Purpose.....	181
7.6.3.2	Test Applicability.....	181
7.6.3.3	Minimum Conformance Requirements	181
7.6.3.4	Test Description	181
7.6.3.4.1	Initial Conditions	181
7.6.3.4.2	Test Procedure.....	182
7.6.3.4.3	Message Contents	183
7.6.3.5	Test Requirement	183
7.7	Spurious response.....	184
7.7.1	Test Purpose.....	184
7.7.2	Test Applicability	184
7.7.3	Minimum Conformance Requirements.....	184
7.7.4	Test Description.....	184
7.7.4.1	Initial Conditions.....	184
7.7.4.2	Test Procedure.....	184
7.7.4.3	Message Contents	185
7.7.5	Test Requirement.....	185
7.8	Intermodulation characteristics	186
7.8.1	Wide band Intermodulation	186
7.8.1.1	Test purpose	186
7.8.1.2	Test applicability.....	186
7.8.1.3	Minimum conformance requirements	186
7.8.1.4	Test description	187
7.8.1.4.1	Initial condition	187
7.8.1.4.2	Test procedure	188
7.8.1.4.3	Message contents.....	188
7.8.1.5	Test requirements.....	188
7.8.2	Void.....	189
7.9	Spurious emissions	189
7.9.1	Test Purpose.....	189
7.9.2	Test Applicability	189
7.9.3	Minimum Conformance Requirements.....	189
7.9.4	Test Description.....	190
7.9.4.1	Initial Conditions.....	190
7.9.4.2	Test Procedure.....	190
7.9.4.3	Message Contents	190
7.9.5	Test Requirement.....	190

8	Performance Requirement	192
8.1	General	192
8.1.1	Dual-antenna receiver capability	192
8.1.1.1	Simultaneous unicast and MBMS operations.....	192
8.1.1.2	Dual-antenna receiver capability in idle mode.....	192
8.2	Demodulation of PDSCH (Cell-Specific Reference Symbols)	192
8.2.1	FDD (Fixed Reference Channel)	192
8.2.1.1	FDD PDSCH Single Antenna Port Performance (Cell-Specific Reference Symbols).....	193
8.2.1.1.1	FDD PDSCH Single Antenna Port Performance	193
8.2.1.1.2	FDD PDSCH Single Antenna Port Performance with 1 PRB in presence of MBSFN	196
8.2.1.2	FDD PDSCH Transmit Diversity Performance (Cell-Specific Reference Symbols).....	198
8.2.1.2.2	FDD PDSCH Transmit Diversity 4x2	200
8.2.1.3	FDD PDSCH Open Loop Spatial Multiplexing Performance (Cell-Specific Reference Symbols)	202
8.2.1.3.1	FDD PDSCH Open Loop Spatial Multiplexing 2x2.....	202
8.2.1.3.2	FDD PDSCH Open Loop Spatial Multiplexing 4x2.....	204
8.2.1.4	FDD PDSCH Closed Loop Spatial Multiplexing Performance (Cell-Specific Reference Symbols) ..	207
8.2.1.4.1	FDD PDSCH Closed Loop Single/Multi Layer Spatial Multiplexing 2x2.....	207
8.2.1.4.2	FDD PDSCH Closed Loop Single/Multi Layer Spatial Multiplexing 4x2.....	210
8.2.2	TDD (Fixed Reference Channel)	215
8.2.2.1	TDD PDSCH Single Antenna Port Performance (Cell-Specific Reference Symbols).....	216
8.2.2.1.1	TDD PDSCH Single Antenna Port Performance	216
8.2.2.1.2	TDD PDSCH Single Antenna Port Performance with 1 PRB in the presence of MBSFN	219
8.2.2.2	TDD PDSCH Transmit Diversity Performance (Cell-Specific Reference Symbols).....	222
8.2.2.2.1	TDD PDSCH Transmit Diversity 2x2	222
8.2.2.2.2	TDD PDSCH Transmit Diversity 4x2	223
8.2.2.3	TDD PDSCH Open Loop Spatial Multiplexing Performance (Cell-Specific Reference Symbols)	225
8.2.2.3.2	TDD PDSCH Open Loop Spatial Multiplexing 4x2	228
8.2.2.4	TDD PDSCH Closed Loop Spatial Multiplexing Performance (Cell-Specific Reference Symbols)	230
8.2.2.4.1	TDD PDSCH Closed Loop Single/Multi Layer Spatial Multiplexing 2x2.....	230
8.2.2.4.2	TDD PDSCH Closed Loop Single/Multi Layer Spatial Multiplexing 4x2.....	234
8.3	Demodulation of PDSCH (User-Specific Reference Symbols).....	238
8.3.1	FDD	238
8.3.2	TDD	238
8.3.2.1	TDD PDSCH Single-layer Spatial Multiplexing Performance (UE-Specific Reference Symbols)	239
8.3.2.1.1	TDD PDSCH Single-layer Spatial Multiplexing on antenna port 5 (Release 8 and forward)	239
8.3.2.1.1.1	Test purpose	239
8.3.2.1.1.2	Test applicability.....	239
8.3.2.1.1.3	Minimum conformance requirements	240
8.3.2.1.1.4	Test description.....	240
8.3.2.1.1.4.2	Test procedure.....	241
8.3.2.1.1.4.3	Message contents.....	241
8.3.2.1.1.5	Test requirement.....	241
8.3.2.1.1_1	TDD PDSCH Single-layer Spatial Multiplexing on antenna port 5 (Release 9 and forward)	242
8.3.2.1.1_1.1	Test purpose	242
8.3.2.1.1_1.2	Test applicability.....	242
8.3.2.1.1_1.3	Minimum conformance requirements	242
8.3.2.1.1_1.4	Test description.....	243
8.3.2.1.1_1.5	Test requirement	243
8.3.2.1.2	TDD PDSCH Single-layer Spatial Multiplexing on antenna port 7 or 8 without a simultaneous transmission.....	244
8.3.2.1.2.1	Test purpose	244
8.3.2.1.2.2	Test applicability.....	244
8.3.2.1.2.3	Minimum conformance requirements	244
8.3.2.1.2.4	Test description.....	245
8.3.2.1.2.4.1	Initial conditions.....	245
8.3.2.1.2.4.2	Test procedure.....	245
8.3.2.1.2.4.3	Message contents.....	246
8.3.2.1.2.5	Test requirement	246
8.3.2.1.3	TDD PDSCH Single-layer Spatial Multiplexing on antenna port 7 or 8 with a simultaneous transmission.....	246
8.3.2.1.3.1	Test purpose.....	246

8.3.2.1.3.2	Test applicability.....	246
8.3.2.1.3.3	Minimum conformance requirements	247
8.3.2.1.3.4	Test description.....	247
8.3.2.1.3.4.1	Initial conditions.....	247
8.3.2.1.3.4.2	Test procedure.....	248
8.3.2.1.3.4.3	Message contents.....	248
8.3.2.1.3.5	Test requirement	248
8.3.2.2	TDD PDSCH Dual-layer Spatial Multiplexing Performance (UE-Specific Reference Symbols)	249
8.3.2.2.1	TDD PDSCH Dual-layer Spatial Multiplexing	249
8.3.2.2.1.1	Test purpose	249
8.3.2.2.1.2	Test applicability.....	249
8.3.2.2.1.3	Minimum conformance requirements	249
8.3.2.2.1.4	Test description.....	250
8.3.2.2.1.4.1	Initial conditions.....	250
8.3.2.2.1.4.2	Test procedure.....	250
8.3.2.1.2.4.3	Message contents.....	250
8.3.2.2.1.5	Test requirement	251
8.4	Demodulation of PCFICH/PDCCH.....	251
8.4.1	FDD	251
8.4.1.1	FDD PCFICH/PDCCH Single-antenna Port Performance.....	251
8.4.1.1.1	Test purpose	251
8.4.1.1.2	Test applicability	251
8.4.1.1.3	Minimum conformance requirements.....	251
8.4.1.1.4	Test description	252
8.4.1.1.5	Test requirement	253
8.4.1.2	FDD PCFICH/PDCCH Transmit Diversity Performance	253
8.4.1.2.1	FDD PCFICH/PDCCH Transmit Diversity 2x2.....	253
8.4.1.2.1.1	Test purpose	253
8.4.1.2.1.2	Test applicability	253
8.4.1.2.1.3	Minimum conformance requirements.....	253
8.4.1.2.1.4	Test description	254
8.4.1.2.1_1	FDD PCFICH/PDCCH Transmit Diversity 2x2.....	255
8.4.1.2.1_1.1	Test purpose	256
8.4.1.2.1_1.2	Test applicability	256
8.4.1.2.1_1.3	Minimum conformance requirements.....	256
8.4.1.2.1_1.4	Test description	256
8.4.1.2.2	FDD PCFICH/PDCCH Transmit Diversity 4x2.....	258
8.4.1.2.2.1	Test purpose.....	258
8.4.1.2.2.2	Test applicability.....	258
8.4.1.2.2.3	Minimum conformance requirements	258
8.4.1.2.2.4	Test description.....	259
8.4.1.2.2.5	Test requirement	260
8.4.1.2.2_1	FDD PCFICH/PDCCH Transmit Diversity 4x2.....	260
8.4.1.2.2_1.1	Test purpose	260
8.4.1.2.2_1.2	Test applicability.....	260
8.4.1.2.2_1.3	Minimum conformance requirements	260
8.4.1.2.2_1.4	Test description.....	261
8.4.1.2.2_1.5	Test requirement	262
8.4.2	TDD.....	263
8.4.2.1	TDD PCFICH/PDCCH Single-antenna Port Performance	263
8.4.2.1.1	Test purpose	263
8.4.2.1.2	Test applicability	263
8.4.2.1.3	Minimum conformance requirements.....	263
8.4.2.1.4	Test description	264
8.4.2.1.5	Test requirement	265
8.4.2.2	TDD PCFICH/PDCCH Transmit Diversity Performance.....	265
8.4.2.2.1	TDD PCFICH/PDCCH Transmit Diversity 2x2	265
8.4.2.2.1.1	Test purpose	265
8.4.2.2.1.2	Test applicability	265
8.4.2.2.1.3	Minimum conformance requirements.....	265
8.4.2.2.1.4	Test description	266
8.4.2.2.1.5	Test requirement	267

8.4.2.2.1_1	TDD PCFICH/PDCCH Transmit Diversity 2x2	268
8.4.2.2.1_1.1	Test purpose	268
8.4.2.2.1_1.2	Test applicability	268
8.4.2.2.1_1.3	Minimum conformance requirements	268
8.4.2.2.1_1.4	Test description	269
8.4.2.2.1_1.5	Test requirement	270
8.4.2.2.2	TDD PCFICH/PDCCH Transmit Diversity 4x2	270
8.4.2.2.2.1	Test purpose	270
8.4.2.2.2.2	Test applicability	270
8.4.2.2.2.3	Minimum conformance requirements	270
8.4.2.2.2.4	Test description	271
8.4.2.2.2.4.1	Initial conditions	271
8.4.2.2.2.4.2	Test procedure	272
8.4.2.2.2.4.3	Message contents	272
8.4.2.2.2.5	Test requirement	272
8.4.2.2.2_1	TDD PCFICH/PDCCH Transmit Diversity 4x2	273
8.4.2.2.2_1.1	Test purpose	273
8.4.2.2.2_1.2	Test applicability	273
8.4.2.2.2_1.3	Minimum conformance requirements	273
8.4.2.2.2_1.4	Test description	274
8.4.2.2.2_1.4.1	Initial conditions	274
8.4.2.2.2_1.4.2	Test procedure	274
8.4.2.2.2_1.4.3	Message contents	274
8.4.2.2.2.5	Test requirement	275
8.5	Demodulation of PHICH	275
8.5.1	FDD	275
8.5.1.1	FDD PHICH Single-antenna Port Performance	275
8.5.1.1.1	Test purpose	275
8.5.1.1.2	Test applicability	275
8.5.1.1.3	Minimum conformance requirements	276
8.5.1.1.4	Test description	276
8.5.1.1.5	Test requirement	278
8.5.1.2	FDD PHICH Transmit Diversity Performance	278
8.5.1.2.1	FDD PHICH Transmit Diversity 2x2	278
8.5.1.2.1_1	FDD PHICH Transmit Diversity 2x2	281
8.5.1.2.2	FDD PHICH Transmit Diversity 4x2	283
8.5.1.2.2.1	Test purpose	283
8.5.1.2.2.2	Test applicability	283
8.5.1.2.2.3	Minimum conformance requirements	283
8.5.1.2.2.4	Test description	284
8.5.1.2.2.5	Test requirement	285
8.5.1.2.2_1	FDD PHICH Transmit Diversity 4x2	286
8.5.1.2.2_1.1	Test purpose	286
8.5.1.2.2_1.2	Test applicability	286
8.5.1.2.2_1.3	Minimum conformance requirements	286
8.5.1.2.2_1.4	Test description	287
8.5.1.2.2_1.5	Test requirement	288
8.5.2	TDD	288
8.5.2.1	TDD PHICH Single-antenna Port Performance	288
8.5.2.1.1	Test purpose	288
8.5.2.1.2	Test applicability	288
8.5.2.1.3	Minimum conformance requirements	288
8.5.2.1.4	Test description	289
8.5.2.1.5	Test requirement	291
8.5.2.2	TDD PHICH Transmit Diversity Performance	291
8.5.2.2.1	TDD PHICH Transmit Diversity 2x2	291
8.5.2.2.1_1	TDD PHICH Transmit Diversity 2x2	294
8.5.2.2.2	TDD PHICH Transmit Diversity 4x2	297
8.5.2.2.2_1	TDD PHICH Transmit Diversity 4x2	300
8.6	Demodulation of PBCH	303
8.7	Sustained downlink data rate provided by lower layers	303
8.7.1	FDD	303

8.7.1.1	FDD sustained data rate performance	303
8.7.1.1.1	Test purpose	303
8.7.1.1.2	Test applicability	303
8.7.1.1.3	Minimum requirements	303
8.7.1.1.4	Test description	305
8.7.1.1.5	Test requirement	307
8.7.2	TDD	308
8.7.2.1	TDD sustained data rate performance	308
8.7.2.1.1	Test purpose	308
8.7.2.1.2	Test applicability	308
8.7.2.1.3	Minimum requirements	308
8.7.2.1.4	Test description	310
8.7.2.1.5	Test requirement	312
9	Reporting of Channel State Information	314
9.1	General	314
9.2	CQI Reporting under AWGN conditions	314
9.2.1	CQI Reporting under AWGN conditions - PUCCH 1-0	314
9.2.1.1	FDD CQI Reporting under AWGN conditions – PUCCH 1-0	314
9.2.1.1.1	Test purpose	314
9.2.1.1.2	Test applicability	314
9.2.1.1.3	Minimum conformance requirements	314
9.2.1.1.4	Test description	315
9.2.1.1.5	Test requirement	317
9.2.1.2	TDD CQI Reporting under AWGN conditions – PUCCH 1-0	317
9.2.1.2.1	Test purpose	317
9.2.1.2.2	Test applicability	317
9.2.1.2.3	Minimum conformance requirements	317
9.2.1.2.4	Test description	318
9.2.1.2.5	Test requirement	320
9.2.2	CQI Reporting under AWGN conditions - PUCCH 1-1	321
9.2.2.1	FDD CQI Reporting under AWGN conditions – PUCCH 1-1	321
9.2.2.1.1	Test purpose	321
9.2.2.1.2	Test applicability	321
9.2.2.1.3	Minimum conformance requirements	321
9.2.2.1.4	Test description	322
9.2.2.1.5	Test requirement	324
9.2.2.2	TDD CQI Reporting under AWGN conditions – PUCCH 1-1	325
9.2.2.2.1	Test purpose	325
9.2.2.2.2	Test applicability	325
9.2.2.2.3	Minimum conformance requirements	325
9.2.2.2.4	Test description	326
9.2.2.2.5	Test requirement	329
9.3	CQI Reporting under fading conditions	329
9.3.1	Frequency-selective scheduling mode	329
9.3.1.1	CQI Reporting under fading conditions – PUSCH 3-0	329
9.3.1.1.1	FDD CQI Reporting under fading conditions – PUSCH 3-0	329
9.3.1.1.2	TDD CQI Reporting under fading conditions – PUSCH 3-0	332
9.3.2	Frequency non-selective scheduling mode	336
9.3.2.1	CQI Reporting under fading conditions – PUCCH 1-0	336
9.3.2.1.1	FDD CQI Reporting under fading conditions – PUCCH 1-0	336
9.3.2.1.2	TDD CQI Reporting under fading conditions – PUCCH 1-0	339
9.3.3	Frequency-selective interference	343
9.3.3.1	CQI Reporting under fading conditions and frequency-selective interference – PUSCH 3-0	343
9.3.3.1.1	FDD CQI Reporting under fading conditions and frequency-selective interference – PUSCH 3-0	343
9.3.3.1.2	TDD CQI Reporting under fading conditions and frequency-selective interference – PUSCH 3-0	346
9.3.4	UE-selected subband CQI	349
9.3.4.1	CQI Reporting under fading conditions – PUSCH 2-0	349
9.3.4.1.1	FDD CQI Reporting under fading conditions – PUSCH 2-0	349
9.3.4.1.2	TDD CQI Reporting under fading conditions – PUSCH 2-0	352

9.3.4.2	CQI Reporting under fading conditions – PUCCH 2-0.....	355
9.3.4.2.1	FDD CQI Reporting under fading conditions – PUCCH 2-0	355
9.3.4.2.2	TDD CQI Reporting under fading conditions – PUCCH 2-0.....	358
9.4	Reporting of Precoding Matrix Indicator (PMI).....	362
9.4.1	Single PMI.....	363
9.4.1.1	PMI Reporting – PUSCH 3-1 (Single PMI).....	363
9.4.1.1.1	FDD PMI Reporting – PUSCH 3-1 (Single PMI)	363
9.4.1.1.2	TDD PMI Reporting – PUSCH 3-1 (Single PMI).....	366
9.4.1.2	PMI Reporting – PUCCH 2-1 (Single PMI)	369
9.4.1.2.1	FDD PMI Reporting – PUCCH 2-1 (Single PMI).....	369
9.4.2	Multiple PMI	376
9.4.2.1	PMI Reporting – PUSCH 1-2 (Multiple PMI)	376
9.4.2.1.1	FDD PMI Reporting – PUSCH 1-2 (Multiple PMI).....	376
9.4.2.1.1_1	FDD PMI Reporting – PUSCH 1-2 (Multiple PMI).....	378
9.4.2.1.2	TDD PMI Reporting – PUSCH 1-2 (Multiple PMI)	381
9.4.2.1.2_1	TDD PMI Reporting – PUSCH 1-2 (Multiple PMI)	384
9.4.2.2	PMI Reporting – PUSCH 2-2 (Multiple PMI)	387
9.4.2.2.1	FDD PMI Reporting – PUSCH 2-2 (Multiple PMI).....	387
9.4.2.2.2	TDD PMI Reporting – PUSCH 2-2 (Multiple PMI)	390
9.5	Reporting of Rank Indicator (RI)	393
9.5.1	RI Reporting	393
9.5.1.1	FDD RI Reporting– PUCCH 1-1	393
9.5.1.1.1	Test purpose	393
9.5.1.1.2	Test applicability	393
9.5.1.1.3	Minimum conformance requirements.....	393
9.5.1.1.4	Test description	394
9.5.1.1.5	Test requirement.....	397
9.5.1.2	TDD RI Reporting – PUSCH 3-1	397
9.5.1.2.1	Test purpose	397
9.5.1.2.2	Test applicability	397
9.5.1.2.3	Minimum conformance requirements.....	397
9.5.1.2.4	Test description	398
9.5.1.2.5	Test requirement.....	401
10	MBMS Performance.....	401
10.1	FDD MBMS performance (Fixed Reference Channel).....	401
10.1.1	Test purpose	401
10.1.2	Test applicability	401
10.1.3	Minimum conformance requirements.....	401
10.1.4	Test description	402
10.1.5	Test requirement	403
10.2	TDD MBMS performance (Fixed Reference Channel)	403
10.2.1	Test purpose	403
10.2.2	Test applicability	404
10.2.3	Minimum conformance requirements.....	404
10.2.4	Test description	405
10.2.5	Test requirement	406
Annex A (normative): Measurement Channels.....		407
A.1	General	407
A.2	UL reference measurement channels	407
A.2.1	General	407
A.2.1.1	Applicability and common parameters	407
A.2.1.2	Determination of payload size	408
A.2.2	Reference measurement channels for FDD	409
A.2.2.1	Full RB allocation.....	409
A.2.2.1.1	QPSK	409
A.2.2.1.2	16-QAM.....	409
A.2.2.2	Partial RB allocation.....	409
A.2.2.2.1	QPSK	410
A.2.2.2.2	16-QAM.....	414
A.2.2.3	Reference measurement channels for sustained downlink data rate provided by lower layers.....	416

A.2.3	Reference measurement channels for TDD	416
A.2.3.1	Full RB allocation	416
A.2.3.1.1	QPSK	416
A.2.3.1.2	16-QAM	417
A.2.3.2	Partial RB allocation	417
A.2.3.2.1	QPSK	417
A.2.3.2.2	16-QAM	423
A.2.3.3	Reference measurement channels for sustained downlink data rate provided by lower layers	426
A.3	DL reference measurement channels	427
A.3.1	General	427
A.3.2	Reference measurement channel for receiver characteristics	427
A.3.2A	Downlink Reference measurement channel for TX characteristics	434
A.3.3	Reference measurement channel for PDSCH performance requirements (FDD)	437
A.3.3.1	Single-antenna transmission (Common Reference Symbols)	437
A.3.3.2	Multi-antenna transmission (Common Reference Symbols)	440
A.3.3.2.1	Two antenna ports	440
A.3.3.2.2	Four antenna ports	441
A.3.4	Reference measurement channel for PDSCH performance requirements (TDD)	442
A.3.4.1	Single-antenna transmission (Common Reference Symbols)	442
A.3.4.2	Multi-antenna transmission (Common Reference Symbols)	447
A.3.4.2.1	Two antenna ports	447
A.3.4.2.2	Four antenna ports	448
A.3.4.3	Reference Measurement Channels for UE-Specific Reference Symbols	448
A.3.5	Reference measurement channels for PDCCH/PCFICH performance requirements	450
A.3.5.1	FDD	450
A.3.5.2	TDD	451
A.3.6	Reference measurement channels for PHICH performance requirements	452
A.3.7	[FFS]	453
A.3.8	Reference measurement channels for MBMS performance requirements	453
A.3.8.1	FDD	453
A.3.8.2	TDD	454
A.3.9	Reference measurement channels for sustained downlink data rate provided by lower layers	456
A.3.9.1	FDD	456
A.3.9.2	TDD	457
A.4	CQI reference measurement channels	457
A.5	OFDMA Channel Noise Generator (OCNG)	464
A.5.1	OCNG Patterns for FDD	464
A.5.1.1	OCNG FDD pattern 1: One sided dynamic OCNG FDD pattern	464
A.5.1.2	OCNG FDD pattern 2: Two sided dynamic OCNG FDD pattern	465
A.5.1.3	OCNG FDD pattern 3: 49 RB OCNG allocation with MBSFN in 10 MHz	466
A.5.2	OCNG Patterns for TDD	466
A.5.2.1	OCNG TDD pattern 1: One sided dynamic OCNG TDD pattern	467
A.5.2.2	OCNG TDD pattern 2: Two sided dynamic OCNG TDD pattern	467
A.5.2.3	OCNG TDD pattern 3: 49 RB OCNG allocation with MBSFN in 10 MHz	468
Annex B (normative):	Propagation Conditions	469
B.0	No interference	469
B.1	Static propagation condition	469
B.1.1	Definition of Additive White Gaussian Noise (AWGN) Interferer	469
B.2	Multi-path fading Propagation Conditions	469
B.2.1	Delay profiles	469
B.2.2	Combinations of channel model parameters	470
B.2.3	MIMO Channel Correlation Matrices	471
B.2.3.1	Definition of MIMO Correlation Matrices	471
B.2.3.2	MIMO Correlation Matrices at High, Medium and Low Level	472
B.2.4	Propagation conditions for CQI tests	474
B.2.5	FFS	475
B.2.6	MBSFN Propagation Channel Profile	475

B.3	High speed train scenario	475
B.4	Beamforming Model	476
B.4.1	Single-layer beamforming (Antenna port 5, 7 or 8)	476
Annex C (normative):	Downlink Physical Channels.....	478
C.0	Downlink signal levels	478
C.1	General	478
C.2	Set-up	481
C.3	Connection	482
C.3.0	Measurement of Transmitter Characteristics	482
C.3.1	Measurement of Receiver Characteristics	483
C.3.2	Measurement of Performance requirements	484
Annex D (normative):	Characteristics of the Interfering Signal	486
D.1	General	486
D.2	Interference signals.....	486
Annex E (normative):	Global In-Channel TX-Test	487
E.1	General	487
E.2	Signals and results	487
E.2.1	Basic principle.....	487
E.2.2	Output signal of the TX under test	487
E.2.3	Reference signal	488
E.2.4	Measurement results.....	488
E.2.5	Measurement points	488
E.3	Signal processing.....	489
E.3.1	Pre FFT minimization process.....	489
E.3.2	Timing of the FFT window	489
E.3.3	Post FFT equalisation.....	490
E.4	Derivation of the results	491
E.4.1	EVM.....	491
E.4.2	Averaged EVM	492
E.4.3	In-band emissions measurement.....	492
E.4.4	EVM equalizer spectrum flatness.....	494
E.4.5	Frequency error and Carrier leakage	494
E.4.6	EVM of Demodulation reference symbols (EVM _{DMRS})	495
E.4.6.1	1 st average for EVM _{DMRS}	495
E.4.6.2	Final average for EVM _{DMRS}	496
E.5	EVM and inband emissions for PUCCH.....	496
E.5.1	Basic principle.....	496
E.5.2	Output signal of the TX under test	496
E.5.3	Reference signal	496
E.5.4	Measurement results.....	496
E.5.5	Measurement points	496
E.5.6	Pre FFT minimization process.....	497
E.5.7	Timing of the FFT window	497
E.5.8	Post FFT equalisation.....	497
E.5.9	Derivation of the results	498
E.5.9.1	EVM _{PUCCH}	498
E.5.9.2	Averaged EVM _{PUCCH}	498
E.5.9.3	In-band emissions measurement	499
E.6	EVM for PRACH	500
E.6.1	Basic principle.....	500
E.6.2	Output signal of the TX under test	500

E.6.3	Reference signal	500
E.6.4	Measurement results	501
E.6.5	Measurement points	501
E.6.6	Pre FFT minimization process	501
E.6.7	Timing of the FFT window	501
E.6.8	Post FFT equalisation	502
E.6.9	Derivation of the results	502
E.6.9.1	EVM _{PRACH}	502
E.6.9.2	Averaged EVM _{PRACH}	503
E.7	EVM with exclusion period	503
E.7.1	General	503
E.7.2	The model	503
E.7.3	Illustration	504
E.7.4	Formula	507
Annex F (normative): Measurement uncertainties and Test Tolerances		509
F.1	Acceptable uncertainty of Test System (normative)	509
F.1.1	Measurement of test environments	509
F.1.2	Measurement of transmitter	510
F.1.3	Measurement of receiver	512
F.1.4	Measurement of performance requirements	515
F.1.5	Measurement of Channel State Information reporting	527
F.2	Interpretation of measurement results (normative)	529
F.3	Test Tolerance and Derivation of Test Requirements (informative)	530
F.3.1	Measurement of test environments	530
F.3.2	Measurement of transmitter	531
F.3.3	Measurement of receiver	539
F.3.4	Measurement of performance requirements	542
F.3.5	Measurement of Channel State Information reporting	545
Annex G (normative): Statistical Testing		547
G.1	General	547
G.2	Statistical testing of receiver characteristics	547
G.2.1	General	547
G.2.2	Mapping throughput to error ratio	547
G.2.3	Design of the test	548
G.2.4	Numerical definition of the pass fail limits	548
G.2.5	Pass fail decision rules	549
G.2.6	Test conditions for receiver tests	550
G.3	Statistical testing of Performance Requirements with throughput	550
G.3.1	General	550
G.3.2	Mapping throughput to error ratio	551
G.3.3	Design of the test	551
G.3.4	Pass Fail limit	551
G.3.5	Minimum Test time	552
G.3.6	Test conditions for receiver performance tests	559
G.4	Statistical testing of Performance Requirements with probability of misdetection	564
G.4.1	General	564
G.4.2	Mapping the UE reaction to error ratio	564
G.4.3	Design of the test	564
G.4.4	Numerical definition of the pass fail limits	565
G.4.5	Pass fail decision rules	566
G.4.6	Minimum Test time	567
G.4.7	Test conditions for receiver performance tests	567
G.5	Measuring throughput ratio	568
G.5.1	General	568

G.5.2	Establishing t_{md}	568
G.5.3	Measuring T-put	568
G.5.4	Number of samples for throughput ratios	568
G.X	Theory to derive the numbers in Table G.2.1.3-1 (Informative)	570
G.X.1	Error Ratio (ER)	570
G.X.2	Test Design	570
G.X.3	Confidence level	570
G.X.4	Introduction: Supplier Risk versus Customer Risk	570
G.X.5	Supplier Risk versus Customer Risk	571
G.X.6	Introduction: Standard test versus early decision concept	571
G.X.7	Standard test versus early decision concept	572
G.X.8	Selectivity	572
G.X.9	Design of the test	573
G.X.10	Simulation to derive the pass fail limits in Table G.2.1.3-1	574
Annex H (normative): Uplink Physical Channels		576
H.0	Uplink Signal Levels	576
H.1	General	576
H.2	Set-up	577
H.3	Connection	577
H.3.0	Measurement of Transmitter Characteristics	577
H.3.1	Measurement of Receiver Characteristics	578
H.3.2	Measurement of Performance Requirements	578
Annex I (informative): Handling of different releases		579
I.1	Mapping of minimum requirements to conformance tests	579
I.2	Structure and numbering of subclauses	580
I.3	Specification of the additional tests	581
Annex J (informative): Change history		582
History	594

Foreword

This Technical Specification has been produced by the 3rd Generation Partnership Project (3GPP).

The contents of the present document are subject to continuing work within the TSG and may change following formal TSG approval. Should the TSG modify the contents of the present document, it will be re-released by the TSG with an identifying change of release date and an increase in version number as follows:

Version x.y.z

where:

- x the first digit:
 - 1 presented to TSG for information;
 - 2 presented to TSG for approval;
 - 3 or greater indicates TSG approved document under change control.
- y the second digit is incremented for all changes of substance, i.e. technical enhancements, corrections, updates, etc.
- z the third digit is incremented when editorial only changes have been incorporated in the document.

Introduction

The present document is part 1 of a multi-parts TS:

3GPP TS 36.521-1: Evolved Universal Terrestrial Radio Access (E-UTRA); User Equipment (UE) conformance specification Radio transmission and reception; Part 1: Conformance Testing.

3GPP TS 36.521-2 [11]: Evolved Universal Terrestrial Radio Access (E-UTRA); User Equipment (UE) conformance specification Radio transmission and reception; Part 2: Implementation Conformance Statement (ICS).

- 3GPP TS 36.521-3 [12]: Evolved Universal Terrestrial Radio Access (E-UTRA); User Equipment (UE) conformance specification Radio transmission and reception; Part 3: Radio Resource Management (RRM) conformance testing.

1 Scope

The present document specifies the measurement procedures for the conformance test of the user equipment (UE) that contain transmitting characteristics, receiving characteristics and performance requirements as part of the 3G Long Term Evolution (3G LTE). Conformance test for the support of RRM (Radio Resource Management) are specified in TS 36.521-3 [12].

The requirements are listed in different clauses only if the corresponding parameters deviate. More generally, tests are only applicable to those mobiles that are intended to support the appropriate functionality. To indicate the circumstances in which tests apply, this is noted in the “*definition and applicability*” part of the test.

For example only Release 8 and later UE declared to support LTE shall be tested for this functionality. In the event that for some tests different conditions apply for different releases, this is indicated within the text of the test itself.

2 References

The following documents contain provisions which, through reference in this text, constitute provisions of the present document.

- References are either specific (identified by date of publication, edition number, version number, etc.) or non-specific.
- For a specific reference, subsequent revisions do not apply.
- For a non-specific reference, the latest version applies. In the case of a reference to a 3GPP document (including a GSM document), a non-specific reference implicitly refers to the latest version of that document *in the same Release as the present document*.

- [1] 3GPP TR 21.905: "Vocabulary for 3GPP Specifications".
- [2] 3GPP TS 36.101: "E-UTRA UE radio transmission and reception".
- [3] ITU-R Recommendation SM.329-10, "Unwanted emissions in the spurious domain"
- [4] 3GPP TS 36.133: "E-UTRA requirements for support of radio resource management".
- [5] 3GPP TS 36.331: "E-UTRA Radio Resource Control (RRC): protocol specification".
- [6] 3GPP TS 36.304: "E-UTRA UE procedures in idle mode".
- [7] 3GPP TS 36.508: "Common test environments for User Equipment (UE)".
- [8] 3GPP TS 36.211: "Physical Channels and Modulation".
- [9] 3GPP TS 36.212: "E-UTRA Multiplexing and channel coding".
- [10] 3GPP TS 36.213: "E-UTRA Physical layer procedures".
- [11] 3GPP TS 36.521-2: "Evolved Universal Terrestrial Radio Access (E-UTRA); User Equipment (UE) conformance specification; Radio transmission and reception; Part 2: Implementation Conformance Statement (ICS)".
- [12] 3GPP TS 36.521-3: "Evolved Universal Terrestrial Radio Access (E-UTRA); User Equipment (UE) conformance specification; Radio transmission and reception; Part 3: Radio Resource Management (RRM) conformance testing".

3 Definitions, symbols and abbreviations

3.1 Definitions

For the purposes of the present document, the terms and definitions given in TR 21.905 [1] and the following apply. A term defined in the present document takes precedence over the definition of the same term, if any, in TR 21.905 [1].

Channel edge: The lowest and highest frequency of the carrier, separated by the channel bandwidth.

Channel bandwidth: The RF bandwidth supporting a single E-UTRA RF carrier with the transmission bandwidth configured in the uplink or downlink of a cell. The channel bandwidth is measured in MHz and is used as a reference for transmitter and receiver RF requirements.

Maximum Output Power: The mean power level per carrier of UE measured at the antenna connector in a specified reference condition.

Mean power: When applied to E-UTRA transmission this is the power measured in the operating system bandwidth of the carrier. The period of measurement shall be at least one subframe (1ms) unless otherwise stated.

Occupied bandwidth: The width of a frequency band such that, below the lower and above the upper frequency limits, the mean powers emitted are each equal to a specified percentage $\beta/2$ of the total mean power of a given emission.

Output power: The mean power of one carrier of the UE, delivered to a load with resistance equal to the nominal load impedance of the transmitter.

PMI delay: The rate in basic time unit at which PMI is updated.

Reference bandwidth: The bandwidth in which an emission level is specified.

Transmission bandwidth: Bandwidth of an instantaneous transmission from a UE or BS, measured in Resource Block units.

Transmission bandwidth configuration: The highest transmission bandwidth allowed for uplink or downlink in a given channel bandwidth, measured in Resource Block units.

Transmit Diversity: Transmit diversity is based on space-frequency block coding techniques complemented with frequency-shift time diversity when four transmit antennas is used.

3.2 Symbols

For the purposes of the present document, the following symbols apply:

BW_{Channel}	Channel bandwidth
E_{RS}	Transmitted energy per RE for reference symbols during the useful part of the symbol, i.e. excluding the cyclic prefix, (average power normalized to the subcarrier spacing) at the eNode B transmit antenna connector
\hat{E}_s	The received energy per RE of the wanted signal during the useful part of the symbol, i.e. excluding the cyclic prefix, averaged across the allocated RB(s) (average power within the allocated RB(s), divided by the number of RE within this allocation, and normalized to the subcarrier spacing) at the UE antenna connector
F	Frequency
$F_{\text{Interferer (offset)}}$	Frequency offset of the interferer
$F_{\text{Interferer}}$	Frequency of the interferer
F_C	Frequency of the carrier centre frequency
$F_{\text{DL_low}}$	The lowest frequency of the downlink operating band
$F_{\text{DL_high}}$	The highest frequency of the downlink operating band
$F_{\text{UL_low}}$	The lowest frequency of the uplink operating band
$F_{\text{UL_high}}$	The highest frequency of the uplink operating band

Editor's note: one of the two following definitions for I_o will be used (TBD in RAN4)

I_o	The power spectral density of the total input signal (power averaged over the useful part of the symbols within the transmission bandwidth configuration, divided by the total number of RE for this configuration and normalised to the subcarrier spacing) at the UE antenna connector, including the own-cell downlink signal
I_o	The power spectral density of the total input signal at the UE antenna connector (power averaged over the useful part of the symbols within a given bandwidth and normalised to the said bandwidth), including the own-cell downlink signal
I_{or}	The total transmitted power spectral density of the own-cell downlink signal (power averaged over the useful part of the symbols within the transmission bandwidth configuration, divided by the total number of RE for this configuration and normalised to the subcarrier spacing) at the eNode B transmit antenna connector
\hat{I}_{or}	The total received power spectral density of the own-cell downlink signal (power averaged over the useful part of the symbols within the transmission bandwidth configuration, divided by the total number of RE for this configuration and normalised to the subcarrier spacing) at the UE antenna connector
I_{ot}	The received power spectral density of the total noise and interference for a certain RE (average power obtained within the RE and normalized to the subcarrier spacing) as measured at the UE antenna connector
L_{CRBs}	The number of resource blocks allocated in the uplink transmission bandwidth.
N_{cp}	Cyclic prefix length
N_{DL}	Downlink EARFCN
N_{oc}	The power spectral density of a white noise source (average power per RE normalised to the subcarrier spacing), simulating interference from cells that are not defined in a test procedure, as measured at the UE antenna connector
$N_{Offis-DL}$	Offset used for calculating downlink EARFCN
$N_{Offis-UL}$	Offset used for calculating uplink EARFCN
N_{otx}	The power spectral density of a white noise source (average power per RE normalised to the subcarrier spacing) simulating eNode B transmitter impairments as at the eNode B transmit antenna connector
N_{RB}	Transmission bandwidth configuration, expressed in units of resource blocks
N_{UL}	Uplink EARFCN
P	Number of cell-specific antenna ports
p	Antenna port number
P_{CMAX}	The measured configured maximum UE output power..
P_{EMAX}	Maximum allowed UE output power signalled by higher layers. Same as IE <i>P-Max</i> , defined in [5].
$P_{PowerClass}$	$P_{PowerClass}$ is the nominal UE power (i.e., no tolerance).
P_{UMAX}	Maximum UE Power with possible power reduction due to modulation type, network signalling values and location near the edge of the band; it equals P_{CMAX} when the IE <i>P-Max</i> , defined in [5], is not signalled.
R_{av}	Minimum average throughput per RB
$P_{Interferer}$	Modulated mean power of the interferer
ΔF_{OOB}	Δ Frequency of Out Of Band emission
RB #	Position of the RB in the channel bandwidth.

3.3 Abbreviations

For the purposes of the present document, the abbreviations given in TR 21.905 [1] and the following apply. An abbreviation defined in the present document takes precedence over the definition of the same abbreviation, if any, in TR 21.905 [1].

ACLR	Adjacent Channel Leakage Ratio
ACS	Adjacent Channel Selectivity
A-MPR	Additional Maximum Power Reduction
AWGN	Additive White Gaussian Noise
BS	Base Station
CP	Cyclic Prefix

CW	Continuous Wave
DCI	Downlink Control Information
DL	Downlink
EARFCN	E-UTRA Absolute Radio Frequency Channel Number
EPRE	Energy Per Resource Element
E-UTRA	Evolved UMTS Terrestrial Radio Access
EUTRAN	Evolved UMTS Terrestrial Radio Access Network
EVM	Error Vector Magnitude
FDD	Frequency Division Duplex
FRC	Fixed Reference Channel
FSTD	Frequency-Shift Time Diversity
HARQ	Hybrid ARQ
HD-FDD	Half- Duplex FDD
MCS	Modulation and Coding Scheme
MOP	Maximum Output Power
MPR	Maximum Power Reduction
MSR	Maximum Sensitivity Reduction
OCNG	OFDMA Channel Noise Generator
OFDMA	Orthogonal Frequency Division Multiple Access
OOB	Out-of-band
PA	Power Amplifier
PCFICH	Physical Control Format Indicator Channel
PDCCH	Physical Downlink Control Channel
PDSCH	Physical Downlink Shared Channel
PRB	Physical Resource Block
PMI	Precoding Matrix Indicator
PSS	Primary Synchronization Signal
PSS_RA	PSS-to-EPRE ratio for the channel PSS
PUCCH	Physical Uplink Control Channel
RE	Resource Element
REFSENS	Reference Sensitivity power level
r.m.s	Root Mean Square
RS	Reference Signal
SFBC	Space-Frequency Block Coding
SNR	Signal-to-Noise Ratio
SSS	Secondary Synchronization Signal
SSS_RA	SSS-to-RS EPRE ratio for the channel SSS
TDD	Time Division Duplex
TPC	Transmit Power Control
TPMI	Transmitted Precoding Matrix Indicator
UE	User Equipment
UL	Uplink
UMTS	Universal Mobile Telecommunications System
UTRA	UMTS Terrestrial Radio Access
UTRAN	UMTS Terrestrial Radio Access Network
xCH_RA	xCH-to-RS EPRE ratio for the channel xCH in all transmitted OFDM symbols not containing RS
xCH_RB	xCH-to-RS EPRE ratio for the channel xCH in all transmitted OFDM symbols containing RS

4 General

Unless otherwise stated, the following reference conditions used by all test cases in this document are specified in TS 36.508 [7]:

- Connection Diagrams,
- Test Frequencies,
- Cell Settings,
- Reference Environments,
- Environmental Conditions,
- Generic Connection Setup Procedures,
- System Information (SI),
- Message Contents.

Where a test requires one of the above reference conditions that are different, this will be specified within the test itself.

The Minimum Requirements defined in each test make no allowance for Measurement Uncertainty. Therefore, Test Tolerances are used to relax the Minimum Requirements. If the Test Requirement differs from the Minimum Requirement then the Test Tolerance applied for that test is non-zero. For each test the Test Tolerances are individually calculated to create the Test Requirements. The Test Tolerance for each test and the explanation of how the Minimum Requirement has been relaxed by the Test Tolerance is given in Annex F.3.

Downlink and Uplink transmissions are organized into radio frames with $T_f = 307200 \times T_s = 10$ ms duration. Two radio frame structures are supported in this document:

- Type 1, applicable to FDD,
- Type 2, applicable to TDD.

In clauses 6 and 7 TX and RX test cases for FDD/TDD test cases are defined. FDD and TDD test scenarios/requirements are included within the same test case. For test cases with any difference between the FDD and TDD branches the test description part of the test case has been separated in two sections to cover the two technologies. The applicability for the FDD and TDD branches are specified in TS 36-521-2.

In clause 8 the performance requirement test cases are defined. FDD and TDD performance requirement test cases are defined in different clauses accordingly to the requirements specified in TS 36.101.

Unless otherwise stated, each test case is tested for every operating band supported by the UE and repeated with the applicable test configurations (i.e. test environment, test frequencies, test channel bandwidths, channel bandwidth parameters) indicated in each test case. For test cases in clauses 6, 7, 8 the initial conditions of the downlink physical channels signal levels and downlink physical channels required are specified in Annex C.0, Annex C.1 and Annex C.2.

For test cases in clauses 6 and 7 that require measurements with maximum output power, the UE shall transmit at its maximum output power state with output power level of P_{UMAX} level. This range of maximum output power shall not be modified for any further additional relaxation.

For test cases in clauses 6 and 7, the partial RB allocations refer to any RB allocation less than full RB allocation except 1 RB allocation.

5 Frequency bands and channel arrangement

5.1 General

The channel arrangements presented in this clause are based on the frequency bands and channel bandwidths defined in the present release of specifications.

NOTE: Other operating bands and channel bandwidths may be considered in future releases.

5.2 Operating bands

E-UTRA is designed to operate in the operating bands defined in Table 5.2-1.

Table 5.2-1 E-UTRA operating bands

E-UTRA Operating Band	Uplink (UL) eNode B receive UE transmit		Downlink (DL) eNode B transmit UE receive		Duplex Mode
	F _{UL_low}	F _{UL_high}	F _{DL_low}	F _{DL_high}	
1	1920 MHz	1980 MHz	2110 MHz	2170 MHz	FDD
2	1850 MHz	1910 MHz	1930 MHz	1990 MHz	FDD
3	1710 MHz	1785 MHz	1805 MHz	1880 MHz	FDD
4	1710 MHz	1755 MHz	2110 MHz	2155 MHz	FDD
5	824 MHz	849 MHz	869 MHz	894 MHz	FDD
6	830 MHz	840 MHz	875 MHz	885 MHz	FDD
7	2500 MHz	2570 MHz	2620 MHz	2690 MHz	FDD
8	880 MHz	915 MHz	925 MHz	960 MHz	FDD
9	1749.9 MHz	1784.9 MHz	1844.9 MHz	1879.9 MHz	FDD
10	1710 MHz	1770 MHz	2110 MHz	2170 MHz	FDD
11	1427.9 MHz	1447.9 MHz	1475.9 MHz	1495.9 MHz	FDD
12	699 MHz	716 MHz	729 MHz	746 MHz	FDD
13	777 MHz	787 MHz	746 MHz	756 MHz	FDD
14	788 MHz	798 MHz	758 MHz	768 MHz	FDD
15	Reserved		Reserved		FDD
16	Reserved		Reserved		FDD
17	704 MHz	716 MHz	734 MHz	746 MHz	FDD
18	815 MHz	830 MHz	860 MHz	875 MHz	FDD
19	830 MHz	845 MHz	875 MHz	890 MHz	FDD
20	832 MHz	862 MHz	791 MHz	821 MHz	FDD
21	1447.9 MHz	1462.9 MHz	1495.9 MHz	1510.9 MHz	FDD
...					
24	1626.5 MHz	1660.5 MHz	1525 MHz	1559 MHz	FDD
...					
33	1900 MHz	1920 MHz	1900 MHz	1920 MHz	TDD
34	2010 MHz	2025 MHz	2010 MHz	2025 MHz	TDD
35	1850 MHz	1910 MHz	1850 MHz	1910 MHz	TDD
36	1930 MHz	1990 MHz	1930 MHz	1990 MHz	TDD
37	1910 MHz	1930 MHz	1910 MHz	1930 MHz	TDD
38	2570 MHz	2620 MHz	2570 MHz	2620 MHz	TDD
39	1880 MHz	1920 MHz	1880 MHz	1920 MHz	TDD
40	2300 MHz	2400 MHz	2300 MHz	2400 MHz	TDD
41	2496 MHz	2690 MHz	2496 MHz	2690 MHz	TDD
42	3400 MHz	3600 MHz	3400 MHz	3600 MHz	TDD
43	3600 MHz	3800 MHz	3600 MHz	3800 MHz	TDD

Note: Band 6 is not applicable.

5.3 TX–RX frequency separation

a) The default EUTRA TX channel (carrier centre frequency) to RX channel (carrier centre frequency) separation is specified in Table 5.3-1 for the TX and RX channel bandwidths defined in Table 5.4.2.1-1

Table 5.3-1: Default UE TX-RX frequency separation

E-UTRA Operating Band	TX - RX carrier centre frequency separation
1	190 MHz
2	80 MHz
3	95 MHz
4	400 MHz
5	45 MHz
6	45 MHz
7	120 MHz
8	45 MHz
9	95 MHz
10	400 MHz
11	48 MHz
12	30 MHz
13	-31 MHz
14	-30 MHz
17	30 MHz
18	45 MHz
19	45 MHz
20	-41 MHz
21	48 MHz
...	
24	-101.5 MHz

b) The use of other TX channel to RX channel carrier centre frequency separation is not precluded and is intended to form part of a later release.

5.4 Channel arrangement

5.4.1 Channel spacing

The spacing between carriers will depend on the deployment scenario, the size of the frequency block available and the channel bandwidths. The nominal channel spacing between two adjacent E-UTRA carriers is defined as following:

$$\text{Nominal Channel spacing} = (\text{BW}_{\text{Channel}(1)} + \text{BW}_{\text{Channel}(2)})/2$$

where $\text{BW}_{\text{Channel}(1)}$ and $\text{BW}_{\text{Channel}(2)}$ are the channel bandwidths of the two respective E-UTRA carriers. The channel spacing can be adjusted to optimize performance in a particular deployment scenario.

5.4.2 Channel bandwidth

Requirements in present document are specified for the channel bandwidths listed in Table 5.4.2-1

Table 5.4.2-1 Transmission bandwidth configuration N_{RB} in E-UTRA channel bandwidths

Channel bandwidth $\text{BW}_{\text{Channel}}$ [MHz]	1.4	3	5	10	15	20
Transmission bandwidth configuration N_{RB}	6	15	25	50	75	100

Figure 5.4.2-1 shows the relation between the Channel bandwidth (BW_{Channel}) and the Transmission bandwidth configuration (N_{RB}). The channel edges are defined as the lowest and highest frequencies of the carrier separated by the channel bandwidth, i.e. at $F_C \pm BW_{\text{Channel}}/2$.

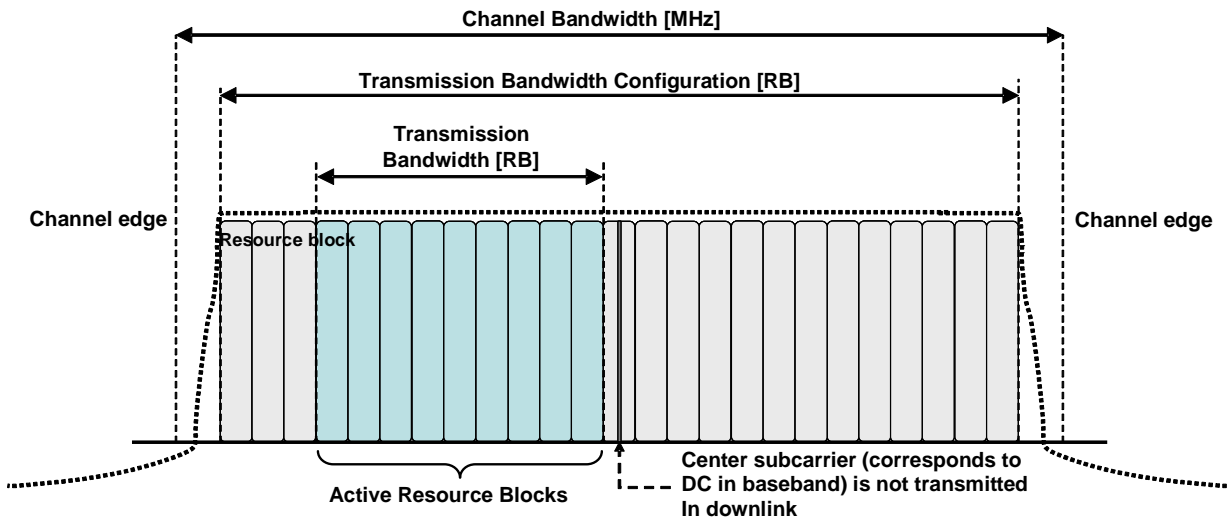

Figure 5.4.2-1 Definition of Channel Bandwidth and Transmission Bandwidth Configuration for one E-UTRA carrier.

5.4.2.1 Channel bandwidths per operating band

a) The requirements in this specification apply to the combination of channel bandwidths and operating bands shown in Table 5.4.2.1-1. The transmission bandwidth configuration in Table 5.4.2-1 shall be supported for each of the specified supported channel bandwidths. The same (symmetrical) channel bandwidth is specified for both the TX and RX path.

Table 5.4.2.1-1: E-UTRA channel bandwidth

E-UTRA Band	E-UTRA band / channel bandwidth					
	1.4 MHz	3 MHz	5 MHz	10 MHz	15 MHz	20 MHz
1			Yes	Yes	Yes	Yes
2	Yes	Yes	Yes	Yes	Yes ^[1]	Yes ^[1]
3	Yes	Yes	Yes	Yes	Yes ^[1]	Yes ^[1]
4	Yes	Yes	Yes	Yes	Yes	Yes
5	Yes	Yes	Yes	Yes ^[1]		
6			Yes	Yes ^[1]		
7			Yes	Yes	Yes	Yes ^[1]
8	Yes	Yes	Yes	Yes ^[1]		
9			Yes	Yes	Yes ^[1]	Yes ^[1]
10			Yes	Yes	Yes	Yes
11			Yes	Yes ^[1]		
12	Yes	Yes	Yes ^[1]	Yes ^[1]		
13			Yes ^[1]	Yes ^[1]		
14			Yes ^[1]	Yes ^[1]		
...						
17			Yes ^[1]	Yes ^[1]		
18			Yes	Yes ^[1]	Yes ^[1]	
19			Yes	Yes ^[1]	Yes ^[1]	
20			Yes	Yes ^[1]	Yes ^[1]	Yes ^[1]
21			Yes	Yes ^[1]	Yes ^[1]	
...						
24			Yes	Yes		
...						
33			Yes	Yes	Yes	Yes
34			Yes	Yes	Yes	
35	Yes	Yes	Yes	Yes	Yes	Yes
36	Yes	Yes	Yes	Yes	Yes	Yes
37			Yes	Yes	Yes	Yes
38			Yes	Yes	Yes	Yes
39			Yes	Yes	Yes	Yes
40			Yes	Yes	Yes	Yes
41			Yes	Yes	Yes	Yes
42			Yes	Yes	Yes	Yes
43			Yes	Yes	Yes	Yes

Note 1: bandwidth for which a relaxation of the specified UE receiver sensitivity requirement (Clause 7.3) is allowed.

b) The use of different (asymmetrical) channel bandwidth for the TX and RX is not precluded and is intended to form part of a later release.

5.4.3 Channel raster

The channel raster is 100 kHz for all bands, which means that the carrier centre frequency must be an integer multiple of 100 kHz.

5.4.4 Carrier frequency and EARFCN

The carrier frequency in the uplink and downlink is designated by the E-UTRA Absolute Radio Frequency Channel Number (EARFCN) in the range 0 - 65535. The relation between EARFCN and the carrier frequency in MHz for the downlink is given by the following equation, where F_{DL_low} and $N_{Offs-DL}$ are given in table 5.4.4-1 and N_{DL} is the downlink EARFCN.

$$F_{DL} = F_{DL_low} + 0.1(N_{DL} - N_{Offs-DL})$$

The relation between EARFCN and the carrier frequency in MHz for the uplink is given by the following equation where F_{UL_low} and $N_{Offs-UL}$ are given in table 5.4.4-1 and N_{UL} is the uplink EARFCN.

$$F_{UL} = F_{UL_low} + 0.1(N_{UL} - N_{Offs-UL})$$

Table 5.4.4-1 E-UTRA channel numbers

Band	Downlink			Uplink		
	F _{DL_low} (MHz)	N _{Offs-DL}	Range of N _{DL}	F _{UL_low} (MHz)	N _{Offs-UL}	Range of N _{UL}
1	2110	0	0 – 599	1920	18000	18000 – 18599
2	1930	600	600 – 1199	1850	18600	18600 – 19199
3	1805	1200	1200 – 1949	1710	19200	19200 – 19949
4	2110	1950	1950 – 2399	1710	19950	19950 – 20399
5	869	2400	2400 – 2649	824	20400	20400 – 20649
6	875	2650	2650 – 2749	830	20650	20650 – 20749
7	2620	2750	2750 – 3449	2500	20750	20750 – 20449
8	925	3450	3450 – 3799	880	21450	21450 – 21799
9	1844.9	3800	3800 – 4149	1749.9	21800	21800 – 22149
10	2110	4150	4150 – 4749	1710	22150	22150 – 22749
11	1475.9	4750	4750 – 4949	1427.9	22750	22750 – 22949
12	729	5010	5010 – 5179	699	23010	23010 – 23179
13	746	5180	5180 – 5279	777	23180	23180 – 23279
14	758	5280	5280 – 5379	788	23280	23280 – 23379
...						
17	734	5730	5730 – 5849	704	23730	23730 – 23849
18	860	5850	5850 – 5999	815	23850	23850 – 23999
19	875	6000	6000 – 6149	830	24000	24000 – 24149
20	791	6150	6150 – 6449	832	24150	24150 – 24449
21	1495.9	6450	6450 – 6599	1447.9	24450	24450 – 24599
...						
24	1525	7700	7700 - 8039	1626.5	25700	25700 – 26039
...						
33	1900	36000	36000 – 36199	1900	36000	36000 – 36199
34	2010	36200	36200 – 36349	2010	36200	36200 – 36349
35	1850	36350	36350 – 36949	1850	36350	36350 – 36949
36	1930	36950	36950 – 37549	1930	36950	36950 – 37549
37	1910	37550	37550 – 37749	1910	37550	37550 – 37749
38	2570	37750	37750 – 38249	2570	37750	37750 – 38249
39	1880	38250	38250 – 38649	1880	38250	38250 – 38649
40	2300	38650	38650 – 39649	2300	38650	38650 – 39649
41	2496	39650	39650 - 41589	2496	39650	39650 - 41589
42	3400	41590	41590 – 43589	3400	41590	41590 – 43589
43	3600	43590	43590 – 45589	3600	43590	43590 – 45589
Note:	The channel numbers that designate carrier frequencies so close to the operating band edges that the carrier extends beyond the operating band edge shall not be used. This implies that the first 7, 15, 25, 50, 75 and 100 channel numbers at the lower operating band edge and the last 6, 14, 24, 49, 74 and 99 channel numbers at the upper operating band edge shall not be used for channel bandwidths of 1.4, 3, 5, 10, 15 and 20 MHz respectively.					

6 Transmitter Characteristics

6.1 General

Unless otherwise stated, the transmitter characteristics are specified at the antenna connector of the UE with a single transmit antenna. For UE with integral antenna only, a reference antenna with a gain of 0 dBi is assumed.

The transient periods due to power steps, OFF/ON and ON/OFF transitions could occur at slot or symbol boundary with transients, on one or both sides of the boundary. The measurement period and whether to exclude the transient periods are specified in the respective sections below.

Unless otherwise stated, the Test Equipment shall be synchronised to the Uplink signal for measurement of TDD transmitter characteristics.

6.2 Transmit power

6.2.1 Void

Editor's note: this "void" section was introduced because TS 36.101 v8.1.0 also contains a "void" sub-clause with in the transmit power clause 6.2, and there is a strong desire in RAN5 to keep the test cases clauses numbering matching their specific core requirements as much as possible.

6.2.2 UE Maximum Output Power

6.2.2.1 Test purpose

To verify that the error of the UE maximum output power does not exceed the range prescribed by the specified nominal maximum output power and tolerance.

An excess maximum output power has the possibility to interfere to other channels or other systems. A small maximum output power decreases the coverage area.

6.2.2.2 Test applicability

This test case applies to all types of E-UTRA UE release 8 and forward.

6.2.2.3 Minimum conformance requirements

The following UE Power Classes defines the maximum output power for any transmission bandwidth within the channel bandwidth. The period of measurement shall be at least one sub frame (1ms).

Table 6.2.2.3-1: UE Power Class

EUTRA band	Class 1 (dBm)	Tolerance (dB)	Class 2 (dBm)	Tolerance (dB)	Class 3 (dBm)	Tolerance (dB)	Class 4 (dBm)	Tolerance (dB)
1					23	±2		
2					23	±2 ²		
3					23	±2 ²		
4					23	±2		
5					23	±2		
6					23	±2		
7					23	±2 ²		
8					23	±2 ²		
9					23	±2		
10					23	±2		
11					23	±2		
12					23	±2 ²		
13					23	±2		
14					23	±2		
...								
17					23	±2		
18					23	±2		
19					23	±2		
20					23	±2 ²		
21					23	±2		
...								
24					23	±2		
...								
33					23	±2		
34					23	±2		
35					23	±2		
36					23	±2		
37					23	±2		
38					23	±2		
39					23	±2		
40					23	±2		
41					23	±2		
...								
Note 1:	The above tolerances are applicable for UE(s) that support up to 4 E-UTRA operating bands. For UE(s) that support 5 or more E-UTRA bands the maximum output power is expected to decrease with each additional band and is FFS							
Note 2:	For transmission bandwidths (Figure 5.4.2-1) confined within F_{UL_low} and $F_{UL_low} + 4$ MHz or $F_{UL_high} - 4$ MHz and F_{UL_high} , the maximum output power requirement is relaxed by reducing the lower tolerance limit by 1.5 dB							
Note 3:	$P_{PowerClass}$ is the maximum UE power specified without taking into account the tolerance							
Note 4:	For the UE which supports both Band 11 and Band 21 operating frequencies, the tolerance is FFS.							

The normative reference for this requirement is TS 36.101 clause 6.2.2.

6.2.2.4 Test description

6.2.2.4.1 Initial condition

Initial conditions are a set of test configurations the UE needs to be tested in and the steps for the SS to take with the UE to reach the correct measurement state.

The initial test configurations consist of environmental conditions, test frequencies, and channel bandwidths based on E-UTRA operating bands specified in table 5.4.2.1-1. All of these configurations shall be tested with applicable test parameters for each channel bandwidth, and are shown in table 6.2.2.4.1-1. The details of the uplink reference measurement channels (RMCs) are specified in Annex A.2. Configurations of PDSCH and PDCCH before measurement are specified in Annex C.2.

Table 6.2.2.4.1-1: Test Configuration Table

Initial Conditions					
Test Environment as specified in TS 36.508[7] subclause 4.1	Normal, TL/VL, TL/VH, TH/VL, TH/VH				
Test Frequencies as specified in TS36.508 [7] subclause 4.3.1	Low range, Mid range, High range				
Test Channel Bandwidths as specified in TS 36.508 [7] subclause 4.3.1	Lowest, 5MHz, Highest				
Test Parameters for Channel Bandwidths					
Ch BW	Downlink Configuration		Uplink Configuration		
	N/A for Max UE output power testing		Mod'n	RB allocation	
			FDD	TDD	
1.4MHz			QPSK	1	1
1.4MHz			QPSK	5	5
3MHz			QPSK	1	1
3MHz			QPSK	4	4
5MHz			QPSK	1	1
5MHz			QPSK	8	8
10MHz			QPSK	1	1
10MHz			QPSK	12	12
15MHz			QPSK	1	1
15MHz			QPSK	16	16
20MHz			QPSK	1	1
20MHz			QPSK	18	18
Note 1: Test Channel Bandwidths are checked separately for each E-UTRA band, the applicable channel bandwidths are specified in Table 5.4.2.1-1.					
Note 2: For E-UTRA bands not applied with Note 2 in Table 6.2.2.3-1:					
- The 1 RB allocation shall be tested at RB#0 for low and mid range, RB #max for high range test frequency.					
- The starting resource block of non-1RB allocation shall be RB #0 for low and mid range, RB# (max +1 - RB allocation) for high range test frequency.					
Note 3: For E-UTRA bands applied with Note 2 in Table 6.2.2.3-1:					
- If the test channel bandwidth is larger than 4MHz, then the 1 RB allocation shall be tested at both RB #0 and RB #max.					
- If the test channel bandwidth is smaller or equal to 4MHz, then the 1 RB allocation shall be tested at RB #0.					
- If the test channel bandwidth = $(F_{UL_high} - F_{UL_low})$ specified by the operating band, then only one frequency range shall be tested and the 1 RB allocation shall be tested at RB #0, RB # $\lceil N_{RB}^{UL} / 2 \rceil$ and RB #max.					
- For non-1RB allocation, test frequency is middle range, and the starting resource block shall be RB #0.					

1. Connect the SS to the UE antenna connectors as shown in TS 36.508[7] Annex A Figure A.3.
2. The parameter settings for the cell are set up according to TS 36.508 [7] subclause 4.4.3.
3. Downlink signals are initially set up according to Annex C.0, C.1, and C.3.0, and uplink signals according to Annex H.1 and H.3.0.
4. The UL Reference Measurement channel is set according to Table 6.2.2.4.1-1.
5. Propagation conditions are set according to Annex B.0.
6. Ensure the UE is in State 3A or 3A-RF according to TS 36.508 [7] clause 4.5.3A or 5.2A.2. Message contents are defined in clause 6.2.2.4.3.

6.2.2.4.2 Test procedure

1. SS sends uplink scheduling information for each UL HARQ process via PDCCH DCI format 0 for C_RNTI to schedule the UL RMC according to Table 6.2.2.1.4.1-1. Since the UE has no payload and no loopback data to send the UE sends uplink MAC padding bits on the UL RMC.
2. Send continuously uplink power control “up” commands in every uplink scheduling information to the UE; allow at least 200ms for the UE to reach P_{UMAX} level.

3. Measure the mean power of the UE in the channel bandwidth of the radio access mode. The period of measurement shall be at least the continuous duration of one sub-frame (1ms). For TDD slots with transient periods are not under test.

6.2.2.4.3 Message contents

Message contents are according to TS 36.508 [7] subclause 4.6.

6.2.2.5 Test requirements

The maximum output power, derived in step 3 shall be within the range prescribed by the nominal maximum output power and tolerance in Table 6.2.2.5-1.

Table 6.2.2.5-1: UE Power Class test requirements

EUTRA band	Class 1 (dBm)	Tolerance (dB)	Class 2 (dBm)	Tolerance (dB)	Class 3 (dBm)	Tolerance (dB)	Class 4 (dBm)	Tolerance (dB)
1					23	±2.7		
2					23	±2.7 ²		
3					23	±2.7 ²		
4					23	±2.7		
5					23	±2.7		
6					23	±2.7		
7					23	±2.7 ²		
8					23	±2.7 ²		
9					23	±2.7		
10					23	±2.7		
11					23	±2.7		
12					23	±2.7 ²		
13					23	±2.7		
14					23	±2.7		
...								
17					23	±2.7		
18					23	±2.7		
19					23	±2.7		
20					23	±2.7 ²		
21					23	±2.7		
...								
24					23	±2.7		
...								
33					23	±2.7		
34					23	±2.7		
35					23	±2.7		
36					23	±2.7		
37					23	±2.7		
38					23	±2.7		
39					23	±2.7		
40					23	±2.7		
41					23	±2.7		
...								
Note 1:	The above tolerances are applicable for UE(s) that support up to 4 E-UTRA operating bands. For UE(s) that support 5 or more E-UTRA bands the maximum output power is expected to decrease with each additional band and is FFS							
Note 2:	For transmission bandwidths (Figure 5.4.2-1, Table 5.4.4-1) confined within F_{UL_low} and $F_{UL_low} + 4$ MHz or $F_{UL_high} - 4$ MHz and F_{UL_high} , the maximum output power requirement is relaxed by reducing the lower tolerance limit by 1.5 dB (Tolerance = +2.7 / -4.2)							
Note 3:	For the UE which supports both Band 11 and Band 21 operating frequencies, the tolerance is FFS.							

6.2.3 Maximum Power Reduction (MPR)

6.2.3.1 Test purpose

The number of RB identified in Table 6.2.2.3-1 is based on meeting the requirements for adjacent channel leakage ratio and the maximum power reduction (MPR) due to Cubic Metric (CM).

Simple scaling can be used to derive the requirement for other bandwidth based on the previously agreed value for 5MHz channel bandwidth.

6.2.3.2 Test applicability

The requirements of this test apply in test cases 6.6.2.3 Adjacent Channel Leakage power Ratio to all types of E-UTRA UE release 8 and forward.

6.2.3.3 Minimum conformance requirements

For UE Power Class 3, the allowed Maximum Power Reduction (MPR) for the maximum output power in Table 6.2.2.3-1 due to higher order modulation and transmit bandwidth configuration (resource blocks) is specified in Table 6.2.3.3-1.

Table 6.2.3.3-1: Maximum Power Reduction (MPR) for Power Class 3

Modulation	Channel bandwidth / Transmission bandwidth configuration [RB]						MPR (dB)
	1.4 MHz	3.0 MHz	5 MHz	10 MHz	15 MHz	20 MHz	
QPSK	> 5	> 4	> 8	> 12	> 16	> 18	≤ 1
16 QAM	≤ 5	≤ 4	≤ 8	≤ 12	≤ 16	≤ 18	≤ 1
16 QAM	> 5	> 4	> 8	> 12	> 16	> 18	≤ 2

For the UE maximum output power modified by MPR, the power limits specified in subclause 6.2.5.3 apply.

The normative reference for this requirement is TS 36.101 clause 6.2.3.

6.2.3.4 Test description

6.2.3.4.1 Initial condition

Initial conditions are a set of test configurations the UE needs to be tested in and the steps for the SS to take with the UE to reach the correct measurement state.

The initial test configurations consist of environmental conditions, test frequencies, and channel bandwidths based on E-UTRA operating bands specified in table 5.4.2.1-1. All of these configurations shall be tested with applicable test parameters for each channel bandwidth, and are shown in table 6.2.3.4.1-1. The details of the uplink reference measurement channels (RMCs) are specified in Annexes A.2. Configurations of PDSCH and PDCCH before measurement are specified in Annex C.2.

Table 6.2.3.4.1-1: Test Configuration Table

Initial Conditions				
Test Environment as specified in TS 36.508[7] subclause 4.1	Normal, TL/VL, TL/VH, TH/VL, TH/VH			
Test Frequencies as specified in TS36.508 [7] subclause 4.3.1	Low range, Mid range, High range			
Test Channel Bandwidths as specified in TS 36.508 [7] subclause 4.3.1	Lowest, 5MHz, 10MHz, Highest			
Test Parameters for Channel Bandwidths				
Ch BW	Downlink Configuration	Uplink Configuration		
	N/A for Maximum Power Reduction (MPR) test case	Mod'n	RB allocation	
		FDD	TDD	
1.4MHz		QPSK	5	5
1.4MHz		QPSK	6	6
1.4MHz		16QAM	5	5
1.4MHz		16QAM	6	6
3.0MHz		QPSK	4	4
3.0MHz		QPSK	15	15
3.0MHz		16QAM	4	4
3.0MHz		16QAM	15	15
5MHz		QPSK	8	8
5MHz		QPSK	25	25
5MHz		16QAM	8	8
5MHz		16QAM	25	25
10MHz		QPSK	12	12
10MHz		QPSK	50	50
10MHz		16QAM	12	12
10MHz		16QAM	50 (Note 3)	50 (Note 3)
15MHz		QPSK	16	16
15MHz		QPSK	75	75
15MHz	16QAM	16	16	
15MHz	16QAM	75 (Note 3)	75 (Note 3)	
20MHz	QPSK	18	18	
20MHz	QPSK	100	100	
20MHz	16QAM	18	18	
20MHz	16QAM	100 (Note 3)	100 (Note 3)	
Note 1: Test Channel Bandwidths are checked separately for each E-UTRA band, the applicable channel bandwidths are specified in Table 5.4.2.1-1. Note 2: The starting resource block of partial RB allocation shall be RB#0 and RB# (max + 1 - RB allocation) of the channel bandwidth. Note 3: Applies only for UE-Categories 2-5				

1. Connect the SS and interfering sources to the UE antenna connectors as shown in TS 36.508[7] Annex A Figure A.3.
2. The parameter settings for the cell are set up according to TS 36.508 [7] subclause 4.4.3.
3. Downlink signals are initially set up according to Annex C.0, C.1, and C.3.0, and uplink signals according to Annex H.1 and H.3.0.
4. The UL Reference Measurement channels are set according to Table 6.2.3.4.1-1.
5. Ensure the UE is in State 3A or 3A-RF according to TS 36.508 [7] clause 4.5.3A or 5.2A.2. Message contents are defined in clause 6.2.2.4.3.

6.2.3.4.2 Test procedure

- a) 1. SS sends uplink scheduling information for each UL HARQ process via PDCCH DCI format 0 for C_RNTI to schedule the UL RMC according to Table 6.2.3.4.1-1. Since the UE has no payload and no loopback data to send the UE sends uplink MAC padding bits on the UL RMC

- b) 2. Send continuously uplink power control “up” commands in the uplink scheduling information to the UE to ensure that the UE transmits at P_{UMAX} level.
- c) 3. Measure the mean power of the UE in the channel bandwidth of the radio access mode. The period of measurement shall be at least the continuous duration one sub-frame (1ms). For TDD slots with transient periods are not under test.

6.2.3.4.3 Message contents

Message contents are according to TS 36.508 [7] subclause 4.6.

6.2.3.5 Test requirements

The maximum output power, derived in step 2 shall be within the range prescribed by the nominal maximum output power and tolerance in Table 6.2.3.5-1.

Table 6.2.3.5-1: UE Power Class test requirements

E-UTRA Band	Class 1 (dBm)	Tol. (Db)	Class 2 (dBm)	Tol. (dB)	Class 3 (dBm)	QPSK partial RB allocation Tol. (dB)	QPSK full RB allocation Tol. (dB)	16QAM partial RB allocation Tol. (dB)	16QAM full RB allocation Tol. (dB)
1					23	±2.7	+2.7 / -3.7	+2.7 / -3.7	+2.7 / -4.7
2					23	±2.7 ¹	+2.7 / ^{1,2} -3.7	+2.7 / ^{1,2} -3.7	+2.7 / ^{1,2} -4.7
3					23	±2.7 ¹	+2.7 / ^{1,2} -3.7	+2.7 / ^{1,2} -3.7	+2.7 / ^{1,2} -4.7
4					23	±2.7	+2.7 / -3.7	+2.7 / -3.7	+2.7 / -4.7
5					23	±2.7	+2.7 / -3.7	+2.7 / -3.7	+2.7 / -4.7
6					23	±2.7	+2.7 / -3.7	+2.7 / -3.7	+2.7 / -4.7
7					23	±2.7 ¹	+2.7 / ^{1,2} -3.7	+2.7 / ^{1,2} -3.7	+2.7 / ^{1,2} -4.7
8					23	±2.7 ¹	+2.7 / ^{1,2} -3.7	+2.7 / ^{1,2} -3.7	+2.7 / ^{1,2} -4.7
9					23	±2.7	+2.7 / -3.7	+2.7 / -3.7	+2.7 / -4.7
10					23	±2.7	+2.7 / -3.7	+2.7 / -3.7	+2.7 / -4.7
11					23	±2.7	+2.7 / -3.7	+2.7 / -3.7	+2.7 / -4.7
12					23	±2.7 ¹	+2.7 / ^{1,2} -3.7	+2.7 / ^{1,2} -3.7	+2.7 / ^{1,2} -4.7
13					23	±2.7	+2.7 / -3.7	+2.7 / -3.7	+2.7 / -4.7
14					23	±2.7	+2.7 / -3.7	+2.7 / -3.7	+2.7 / -4.7
...									
17					23	±2.7	+2.7 / -3.7	+2.7 / -3.7	+2.7 / -4.7
18					23	±2.7	+2.7 / -3.7	+2.7 / -3.7	+2.7 / -4.7
19					23	±2.7	+2.7 / -3.7	+2.7 / -3.7	+2.7 / -4.7
20					23	±2.7 ¹	+2.7 / ^{1,2} -3.7	+2.7 / ^{1,2} -3.7	+2.7 / ^{1,2} -4.7
21					23	±2.7	+2.7 / -3.7	+2.7 / -3.7	+2.7 / -4.7
...									
24					23	±2.7	+2.7 / -3.7	+2.7 / -3.7	+2.7 / -4.7
...									
33					23	±2.7	+2.7 / -3.7	+2.7 / -3.7	+2.7 / -4.7
34					23	±2.7	+2.7 / -3.7	+2.7 / -3.7	+2.7 / -4.7
35					23	±2.7	+2.7 / -3.7	+2.7 / -3.7	+2.7 / -4.7
36					23	±2.7	+2.7 / -3.7	+2.7 / -3.7	+2.7 / -4.7
37					23	±2.7	+2.7 / -3.7	+2.7 / -3.7	+2.7 / -4.7
38					23	±2.7	+2.7 / -3.7	+2.7 / -3.7	+2.7 / -4.7
39					23	±2.7	+2.7 / -3.7	+2.7 / -3.7	+2.7 / -4.7
40					23	±2.7	+2.7 / -3.7	+2.7 / -3.7	+2.7 / -4.7

41					23	± 2.7	+2.7 / -3.7	+2.7 / -3.7	+2.7 / -4.7
Note 1:	For transmission configurations (Figure 5.4.2-1) confined within FUL_low and FUL_low + 4 MHz or FUL_high – 4 MHz and FUL_high, the maximum output power requirement is relaxed by reducing the lower tolerance limit by 1.5 dB.								
Note 2:	For the UE maximum output power modified by MPR, the power limits specified in Table 6.2.5.3-1 apply								

6.2.4 Additional Maximum Power Reduction (A-MPR)

6.2.4.1 Test purpose

Additional ACLR and spectrum emission requirements can be signalled by the network to indicate that the UE shall also meet additional requirements in a specific deployment scenario. To meet these additional requirements, Additional Maximum Power Reduction A-MPR is allowed for the output power as specified in Table 6.2.2.3-1. Unless stated otherwise, an A-MPR of 0 dB shall be used.

6.2.4.2 Test applicability

The requirements of this test apply in test case 6.6.2.2 Additional Spectrum Emission Mask for network signalled values NS_03, NS_04, NS_06 and NS_07 to all types of E-UTRA UE release 8 and forward.

The requirements of this test apply in test case 6.6.3.3 Additional Spurious Emissions for network signalled values NS_05, NS_07 and NS_08, NS_09 to all types of E-UTRA UE release 8 and forward.

6.2.4.3 Minimum conformance requirements

For UE Power Class 3 the specific requirements and identified sub-clauses are specified in Table 6.2.4.3-1 along with the allowed A-MPR values that may be used to meet these requirements. The allowed A-MPR values specified below in Table 6.2.4.3.-1 and 6.2.4.3-2 are in addition to the allowed MPR requirements specified in clause 6.2.3. For the UE maximum output power modified by A-MPR, the power limits specified in clause 6.2.5 apply.

Table 6.2.4.3-1: Additional Maximum Power Reduction (A-MPR) / Spectrum Emission requirements

Network Signalling value	Requirements (sub-clause)	E-UTRA Band	Channel bandwidth (MHz)	Resources Blocks (N_{RB})	A-MPR (dB)
NS_01	6.6.2.1.1	Table 5.2-1	1.4,3,5,10,15,20	Table 5.4.2-1	NA
NS_03	6.6.2.2.3.1	2,4,10,35,36	3	>5	≤ 1
			5	>6	≤ 1
			10	>6	≤ 1
			15	>8	≤ 1
			20	>10	≤ 1
NS_04	6.6.2.2.3.2	41	5	>6	≤ 1
			10, 15, 20	See Table 6.2.4.3-4	
NS_05	6.6.3.3.3.1	1	10,15,20	≥ 50	≤ 1
NS_06	6.6.2.2.3.3	12, 13, 14, 17	1.4, 3, 5, 10	Table 5.4.2-1	n/a
NS_07	6.6.2.2.3.3 6.6.3.3.3.2	13	10	Table 6.2.4.3-2	Table 6.2.4.3-2
				> 29	≤ 1
NS_08	6.6.3.3.3.3	19	10, 15	> 39	≤ 2
				> 44	≤ 3
				> 40	≤ 1
NS_09	6.6.3.3.3.4	21	10, 15	> 55	≤ 2
				Table 6.2.4.3-3	Table 6.2.4.3-3
..					
NS_32	-	-	-	-	-

Table 6.2.4.3-2: A-MPR for “NS_07”

RB_start ¹	Region A		Region B				Region C	
	0 – 12		13 – 18		19 – 42		43 – 49	
L_CRB ² [RBs]	6 – 8	1 to 5 and 9-50	<8	≥8	<18	≥18	≤2	>2
A-MPR [dB]	≤8	≤12	0	≤12	0	≤6	≤3	0

Note 1: RB_start indicates the lowest RB index of transmitted resource blocks
Note 2: L_CRB is the length of a contiguous resource block allocation
Note 3: For intra-subframe frequency hopping between two regions, notes 1 and 2 apply on a per slot basis.
Note 4: For intra-subframe frequency hopping between two regions, the larger A-MPR value of the two regions may be applied for both slots in the subframe.

Table 6.2.4.3-3: A-MPR for “NS_10”

RB_start ¹	Region A	Region B
		[0 – 15]
L_CRB ² [RBs]	[1-25]	[1-23]
A-MPR [dB]	≤[5]	≤[5]

Note 1: RB_start indicates the lowest RB index of transmitted resource blocks
Note 2: L_CRB is the length of a contiguous resource block allocation
Note 3: For intra-subframe frequency hopping between two regions, notes 1 and 2 apply on a per slot basis.
Note 4: For intra-subframe frequency hopping between two regions, the larger A-MPR value of the two regions may be applied for both slots in the subframe.

Table 6.2.4.3-4 A-MPR for NS_04 for bandwidths > 5MHz

Channel BW	Parameters	Region A	Region B	Region C	
10	RB_start ¹	0 – 12	13 – 36		37 – 49
	RB_start ¹ + L_CRB ² [RBs]	NA (Note 3)	14 - 37	>37	NA (Note 3)
	A-MPR [dB]	≤3dB	0	≤2dB	≤3dB
15	RB_start ¹	0 – 18	19 – 55		56 – 74
	RB_start ¹ + L_CRB ² [RBs]	NA (Note 3)	20 - 56	>56	NA (Note 3)
	A-MPR [dB]	≤3dB	0	≤2dB	≤3dB
20	RB_start ¹	0 – 24	25 – 74		75 – 99
	RB_start ¹ + L_CRB ² [RBs]	NA (Note 3)	26 - 75	>75	NA (Note 3)
	A-MPR [dB]	≤3dB	0	≤2dB	≤3dB

Note 1: RB_start indicates the lowest RB index of transmitted resource blocks
Note 2: L_CRB is the length of a contiguous resource block allocation
Note 3: Any RB allocation that starts in Region A or C is allowed the specified A-MPR
Note 4: For intra-subframe frequency hopping which intersects regions, notes 1 and 2 apply on a per slot basis
Note 5: For intra-subframe frequency hopping which intersects regions, the larger A-MPR value may be applied for both slots in the subframe

6.2.4.4 Test description

6.2.4.4.1 Initial condition

Initial conditions are a set of test configurations the UE needs to be tested in and the steps for the SS to take with the UE to reach the correct measurement state.

The initial test configurations consist of environmental conditions, test frequencies, and channel bandwidths based on E-UTRA operating bands specified in table 5.4.2.1-1. All of these configurations shall be tested with applicable test parameters for each channel bandwidth, and are shown in tables 6.2.4.4.1-1 through table 6.2.4.4.1-6. The details of the uplink reference measurement channels (RMCs) are specified in Annex A.2. Configurations of PDSCH and PDCCH before measurement are specified in Annex C.2.

Table 6.2.4.4.1-1: Test Configuration Table (network signalled value "NS_03")

Initial Conditions							
Test Environment (as specified in TS 36.508 [7] subclause 4.1)					NC		
Test Frequencies (as specified in TS36.508 [7] subclause 4.3.1)					Low range, Mid range, High range		
Test Channel Bandwidths (as specified in TS 36.508 [7] subclause 4.3.1)					Lowest, 5MHz, 10MHz, Highest		
Test Parameters for NS_03 A-MPR							
Configuration ID	Ch BW	Downlink Configuration			Uplink Configuration		
		Mod'n	RB allocation		Mod'n	RB allocation	
			FDD	TDD		FDD	TDD
1	1.4MHz	N/A for A-MPR testing.			QPSK	6	6
2	1.4MHz				QPSK	5	5
3	1.4MHz				16QAM	5	5
4	3MHz				QPSK	15	15
5	3MHz				QPSK	4	4
6	3MHz				16QAM	15	15
7	3MHz				16QAM	4	4
8	5MHz				QPSK	25	25
9	5MHz				QPSK	8	8
10	5MHz				QPSK	6	6
11	5MHz				16QAM	25	25
12	5MHz				16QAM	8	8
13	10MHz				QPSK	50	50
14	10MHz				QPSK	12	12
15	10MHz				QPSK	6	6
16	10MHz				16QAM	50 (Note 4)	50 (Note 4)
17	10MHz				16QAM	12	12
18	15MHz				QPSK	75	75
19	15MHz				QPSK	16	16
20	15MHz				QPSK	8	8
21	15MHz				16QAM	75 (Note 4)	75 (Note 4)
22	15MHz				16QAM	16	16
23	20MHz				QPSK	100	100
24	20MHz				QPSK	18	18
25	20MHz				QPSK	10	10
26	20MHz				16QAM	100 (Note 4)	100 (Note 4)
27	20MHz				16QAM	18	18

Note 1: Test Channel Bandwidths are checked separately for each E-UTRA band, the applicable channel bandwidths are specified in Table 5.4.2.1-1.

Note 2: The Configuration ID will be used to map the applicable Test Configuration to the corresponding Test Requirement in subclause 6.2.4.5 as not all combinations are necessarily required based on the applicability of the UE.

Note 3: The starting resource block of partial RB allocation shall be RB# 0 and RB# (max +1 - RB allocation) of the channel bandwidth.

Note 4: Applies only for UE-Categories 2-5

Table 6.2.4.4.1-2: Test Configuration Table for 5, 10, 15, 20MHz (network signalled value "NS_04")

Initial Conditions						
Test Environment (as specified in TS 36.508 [7] subclause 4.1)			NC			
Test Frequencies (as specified in TS36.508 [7] subclause 4.3.1)			Low range, Mid range, High range			
Test Channel Bandwidths (as specified in TS 36.508 [7] subclause 4.3.1)			5MHz, 10 MHz, 15 MHz, 20MHz			
Test Parameters for NS_04 A-MPR						
Configuration ID	Ch BW	Downlink Configuration		Uplink Configuration		
		Mod'n	RB allocation TDD	Mod'n	RB allocation TDD	RB_start TDD
1	5MHz	N/A for A-MPR testing		QPSK	25	Note 3
2	5MHz			QPSK	8	Note 3
3	5MHz			QPSK	6	Note 3
4	5MHz			16QAM	25	Note 3
5	5MHz			16QAM	8	Note 3
6	10MHz			QPSK	1	0
7	10MHz			QPSK	12	0
8	10MHz			QPSK	50	0
9	10MHz			16QAM	50 (Note 4)	0
10	10MHz			QPSK	24	13
11	10MHz			16QAM	24	13
12	10MHz			QPSK	36 (Note 4)	13
13	10MHz			QPSK	12	37
14	10MHz			QPSK	1	49
15	15MHz			QPSK	1	0
16	15MHz			QPSK	16	0
17	15MHz			QPSK	75	0
18	15MHz			16QAM	75 (Note 4)	0
19	15MHz			QPSK	36	19
20	15MHz			16QAM	36	19
21	15MHz			QPSK	50	19
22	15MHz			QPSK	18	56
23	15MHz			QPSK	1	74
24	20MHz			QPSK	1	0
25	20MHz			QPSK	18	0
26	20MHz			QPSK	100	0
27	20MHz			16QAM	100 (Note 4)	0
28	20MHz			QPSK	50	25
29	20MHz			16QAM	50	25
30	20MHz			QPSK	75 (Note 4)	25
31	20MHz			QPSK	25	75
32	20MHz			QPSK	1	99
<p>Note 1: Test Channel Bandwidths are checked separately for E-UTRA band, the applicable channel bandwidths are specified in Table 5.4.2.1-1.</p> <p>Note 2: The configuration ID will be used to map the applicable Test Configuration to be corresponding Test Requirement in subclause 6.2.4 as not all combinations are necessarily required based on the applicability of the UE.</p> <p>Note 3: The starting resource block of partial RB allocation shall be RB# 0 and RB# (max +1 - RB allocation) of the channel bandwidth.</p> <p>Note 4: Applies only for UE-Categories 2-5</p>						

Table 6.2.4.4.1-2: Test Configuration Table (network signalled value "NS_04")

FFS

Table 6.2.4.4.1-3: Test Configuration Table (network signalled value "NS_05")

Initial Conditions					
Test Environment (as specified in TS 36.508 [7] subclause 4.1)			Normal		
Test Frequencies (as specified in TS36.508 [7] subclause 4.3.1)			Low range, Mid range In case of Low range: <ul style="list-style-type: none"> - For 5MHz channel bandwidth: UL 1927.2MHz (N_UL = 18072), DL 2117.2MHz (N_DL = 72) and UL 1931.1MHz (N_UL = 18111) DL 2121.1 MHz (N_DL = 111) - For 10MHz: UL 1934.7MHz (N_UL = 18147), DL 2124.7MHz (N_DL = 147) - For 20MHz channel bandwidth: Not available 		
Test Channel Bandwidths (as specified in TS 36.508 [7] subclause 4.3.1)			5MHz, 10MHz, 15MHz, 20MHz		
Test Parameters for NS_05 A-MPR					
Configuration ID	Ch BW	Downlink Configuration		Uplink Configuration	
		Mod'n	RB allocation FDD	Mod'n	RB allocation FDD
1	5MHz	N/A for A-MPR testing		QPSK	1
2	5MHz			QPSK	25
3	10MHz			QPSK	1
4	10MHz			QPSK	12
5	10MHz			QPSK	48
6	10MHz			QPSK	50
7	10MHz		16QAM	50	
8	15MHz		QPSK	1	
9	15MHz		QPSK	16	
10	15MHz		QPSK	48	
11	15MHz		QPSK	75	
12	15MHz		16QAM	75	
13	20MHz		QPSK	1	
14	20MHz		QPSK	18	
15	20MHz		QPSK	48	
16	20MHz		QPSK	100	
17	20MHz		16QAM	100	
Note 1. The 1 RB allocation shall be tested at both RB #0 and RB #max. Note 2. The starting resource block of partial RB allocation shall be RB# 0 and RB# (max +1 - RB allocation) of the channel bandwidth. Note 3: The Configuration ID will be used to map the applicable Test Configuration to the corresponding Test Requirement in subclause 6.2.4.5 as not all combinations are necessarily required based on the applicability of the UE. Note 4: Low range frequencies for 5MHz channel bandwidth in case of network signalled "NS_05" shall be reviewed after June 2012 because of PHS band operation change.					

Table 6.2.4.4.1-4: Test Configuration Table (network signalled value "NS_06")

Initial Conditions					
Test Environment (as specified in TS 36.508 [7] subclause 4.1)			Normal		
Test Frequencies (as specified in TS36.508 [7] subclause 4.3.1)			Low range, Mid range, High range		
Test Channel Bandwidths (as specified in TS 36.508 [7] subclause 4.3.1)			Lowest, 5MHz, 10MHz, Highest		
Test Parameters for NS_06 A-MPR					
Configuration ID	Ch BW	Downlink Configuration		Uplink Configuration	
		Mod'n	RB allocation FDD	Mod'n	RB allocation FDD
1	1.4MHz	N/A for A-MPR testing		QPSK	6
2	1.4MHz			QPSK	5
3	1.4MHz			16QAM	5
4	3MHz			QPSK	15
5	3MHz			QPSK	4
6	3MHz			16QAM	4
7	5MHz			QPSK	25
8	5MHz			QPSK	8
9	5MHz			16QAM	8
10	10MHz			QPSK	50
11	10MHz			QPSK	12
12	10MHz			16QAM	12
13	15MHz			QPSK	75
14	15MHz			QPSK	16
15	15MHz			16QAM	16
16	20MHz			QPSK	100
17	20MHz			QPSK	18
18	20MHz			16QAM	18
Note 1:	Test Channel Bandwidths are checked separately for each E-UTRA band, the applicable channel bandwidths are specified in Table 5.4.2.1-1.				
Note 2:	The Configuration ID will be used to map the applicable Test Configuration to the corresponding Test Requirement in subclause 6.2.4.5 as not all combinations are necessarily required based on the applicability of the UE.				
Note 3:	The starting resource block of partial RB allocation shall be RB# 0 and RB# (max +1 - RB allocation) of the channel bandwidth.				

Table 6.2.4.4.1-5: Test Configuration Table (network signalled value "NS_07")

Initial Conditions						
Test Environment (as specified in TS 36.508 [7] subclause 4.1)				NC		
Test Frequencies (as specified in TS36.508 [7] subclause 4.3.1)				Mid range		
Test Channel Bandwidths (as specified in TS 36.508 [7] subclause 4.3.1)				10MHz		
Test Parameters for NS_07 A-MPR						
Configuration ID	Ch BW	Downlink Configuration		Uplink Configuration		
		Mod'n	RB allocation FDD	Mod'n	RB allocation FDD	RB_start FDD
1	10MHz	N/A for A-MPR testing		QPSK	1	0
2	10MHz			QPSK	8	0
3	10MHz			QPSK	6	13
4	10MHz			QPSK	20	13
5	10MHz			QPSK	12	13
6	10MHz			16QAM	36 (Note 2)	13
7	10MHz			QPSK	16	19
8	10MHz			QPSK	12	19
9	10MHz			16QAM	16	19
10	10MHz			QPSK	30	19
11	10MHz			16QAM	30 (Note 2)	19
12	10MHz			QPSK	6	43
13	10MHz			QPSK	2	48
14	10MHz			QPSK	50	0
15	10MHz			QPSK	12	0
16	10MHz			16QAM	50	0
Note 1:	The Configuration ID will be used to map the applicable Test Configuration to the corresponding Test Requirement in subclause 6.2.4.5 as not all combinations are necessarily required based on the applicability of the UE.					
Note 2:	Applies only for UE-Categories 2-5					

Table 6.2.4.4.1-6: Test Configuration Table (network signalled value "NS_08")

Initial Conditions					
Test Environment (as specified in TS 36.508 [7] subclause 4.1)			Normal		
Test Frequencies (as specified in TS36.508 [7] subclause 4.3.1)			High range		
Test Channel Bandwidths (as specified in TS 36.508 [7] subclause 4.3.1)			5MHz, 10MHz, 15MHz		
Test Parameters for NS_08 A-MPR					
Configuration ID	Ch BW	Downlink Configuration		Uplink Configuration	
		Mod'n	RB allocation FDD	Mod'n	RB allocation FDD
1	5MHz	N/A for A-MPR testing		QPSK	1
2	5MHz			QPSK	8
3	5MHz			QPSK	25
4	10MHz			QPSK	1
5	10MHz			QPSK	12
6	10MHz			QPSK	27
7	10MHz			QPSK	36
8	10MHz			QPSK	40
9	10MHz			QPSK	50
10	10MHz			16QAM	50 (Note 4)
11	15MHz			QPSK	1
12	15MHz			QPSK	16
13	15MHz			QPSK	27
14	15MHz			QPSK	36
15	15MHz			QPSK	40
16	15MHz			QPSK	75
17	15MHz			16QAM	75 (Note 4)
<p>Note 1: The Configuration ID will be used to map the applicable Test Configuration to the corresponding Test Requirement in subclause 6.2.4.5 as not all combinations are necessarily required based on the applicability of the UE.</p> <p>Note 2: The 1 RB allocation shall be tested at both RB #0 and RB #max.</p> <p>Note 3: The starting resource block of partial RB allocation shall be RB# 0 and RB# (max + 1 - RB allocation) of the channel bandwidth</p> <p>Note 4: Applies only for UE-Categories 2-5</p>					

Table 6.2.4.4.1-7: Test Configuration Table (network signalled value “NS_09”)

Initial Conditions					
Test Environment (as specified in TS 36.508 [7] subclause 4.1)			Normal		
Test Frequencies (as specified in TS36.508 [7] subclause 4.3.1)			High range		
Test Channel Bandwidths (as specified in TS 36.508 [7] subclause 4.3.1)			5MHz, 10MHz, 15MHz		
Test Parameters for Channel Bandwidths					
Configuration ID	Ch BW	Downlink Configuration		Uplink Configuration	
		Mod'n	RB allocation FDD	Mod'n	RB allocation FDD
1	5MHz	N/A for A-MPR testing		QPSK	1
2	5MHz			QPSK	8
3	5MHz			QPSK	25
4	10MHz			QPSK	1
5	10MHz			QPSK	12
6	10MHz			QPSK	40
7	10MHz			QPSK	50
8	10MHz			16QAM	50 (Note 4)
9	15MHz			QPSK	1
10	15MHz			QPSK	16
11	15MHz			QPSK	40
12	15MHz			QPSK	54
13	15MHz			QPSK	75
14	15MHz			16QAM	75 (Note 4)
<p>Note 1: The Configuration ID will be used to map the applicable Test Configuration to the corresponding Test Requirement in subclause 6.2.4.5 as not all combinations are necessarily required based on the applicability of the UE.</p> <p>Note 2: The 1 RB allocation shall be tested at both RB #0 and RB #max.</p> <p>Note 3: The starting resource block of partial RB allocation shall be RB# 0 and RB# (max + 1 - RB allocation) of the channel bandwidth</p> <p>Note 4: Applies only for UE-Categories 2-5</p>					

Table 6.2.4.4.1-8: Test Configuration Table (network signalled value “NS_10”)

Editor's note: no requirements are specified in the core specification for the table above

1. Connect the SS to the UE antenna connectors as shown in Figure TS 36.508 [7] Annex A, Figure A.3.
2. The parameter settings for the cell are set up according to TS 36.508 [7] subclause 4.4.3.
3. Downlink signals are initially set up according to Annex C.0, C.1, and C.3.0, and uplink signals according to Annex H.1 and H.3.0.
4. The UL Reference Measurement channels are set according to the applicable table from Table 6.2.4.4.1-1 to Table 6.2.4.4.1-6.
5. Propagation conditions are set according to Annex B.0.
6. Ensure the UE is in State 3A or 3A-RF according to TS 36.508 [7] clause 4.5.3A or 5.2A.2. Message contents are defined in clause 6.2.4.4.3.

6.2.4.4.2 Test procedure

1. SS sends uplink scheduling information for each UL HARQ process via PDCCH DCI format 0 for C_RNTI to schedule the UL RMC according to the applicable table from Table 6.2.4.4.1-1 to Table 6.2.4.4.1-6. Since the UE has no payload data to send, the UE transmits uplink MAC padding bits on the UL RMC.
2. Send continuously uplink power control “up” commands in the uplink scheduling information to the UE until the UE transmits at P_{UMAX} level.

3. Measure the mean power of the UE in the channel bandwidth of the radio access mode. The period of measurement shall be at least the continuous duration one sub-frame (1ms). For TDD slots with transient periods are not under test.

6.2.4.4.3 Message contents

Message contents are according to TS 36.508 [7] subclause 4.6, with the following exceptions for each network signalled value.

6.2.4.4.3.1 Message contents exceptions (network signalled value "NS_03")

1. Information element `additionalSpectrumEmission` is set to NS_03. This can be set in the *SystemInformationBlockType2* as part of the cell broadcast message. This exception indicates that the UE shall meet the additional spurious emission requirement for a specific deployment scenario.

Table 6.2.4.4.3.1-1: *SystemInformationBlockType2* :Additional spurious emissions test requirement for "NS_03"

Derivation Path: TS 36.508 [7] clause 4.4.3.3, Table 4.4.3.3-1			
Information Element	Value/remark	Comment	Condition
<code>additionalSpectrumEmission</code>	3 (NS_03)		

6.2.4.4.3.2 Message contents exceptions (network signalled value "NS_04")

1. Information element `additionalSpectrumEmission` is set to NS_04. This can be set in the *SystemInformationBlockType2* as part of the cell broadcast message. This exception indicates that the UE shall meet the additional spurious emission requirement for a specific deployment scenario.

Table 6.2.4.4.3.2-1: *SystemInformationBlockType2* :Additional spurious emissions test requirement for "NS_04"

Derivation Path: TS 36.508 [7] clause 4.4.3.3, Table 4.4.3.3-1			
Information Element	Value/remark	Comment	Condition
<code>additionalSpectrumEmission</code>	4 (NS_04)		

6.2.4.4.3.3 Message contents exceptions (network signalled value "NS_05")

1. Information element `additionalSpectrumEmission` is set to NS_05. This can be set in the *SystemInformationBlockType2* as part of the cell broadcast message. This exception indicates that the UE shall meet the additional spurious emission requirement for a specific deployment scenario.

Table 6.2.4.4.3.3-1: *SystemInformationBlockType2* :Additional spurious emissions test requirement for "NS_05"

Derivation Path: TS 36.508 [7] clause 4.4.3.3, Table 4.4.3.3-1			
Information Element	Value/remark	Comment	Condition
<code>additionalSpectrumEmission</code>	5 (NS_05)		

6.2.4.4.3.4 Message contents exceptions (network signalled value "NS_06")

1. Information element `additionalSpectrumEmission` is set to NS_06. This can be set in the *SystemInformationBlockType2* as part of the cell broadcast message. This exception indicates that the UE shall meet the additional spurious emission requirement for a specific deployment scenario.

Table 6.2.4.4.3.4-1: SystemInformationBlockType2 :Additional spurious emissions test requirement for “NS_06”

Derivation Path: TS 36.508 [7] clause 4.4.3.3, Table 4.4.3.3-1			
Information Element	Value/remark	Comment	Condition
additionalSpectrumEmission	6 (NS_06)		

6.2.4.4.3.5 Message contents exceptions (network signalled value “NS_07”)

- Information element additionalSpectrumEmission is set to NS_07. This can be set in the *SystemInformationblockType2* as part of the cell broadcast message. This exception indicates that the UE shall meet the additional spurious emission requirement for a specific deployment scenario.

Table 6.2.4.4.3.5-1: SystemInformationBlockType2 :Additional spurious emissions test requirement for “NS_07”

Derivation Path: TS 36.508 [7] clause 4.4.3.3, Table 4.4.3.3-1			
Information Element	Value/remark	Comment	Condition
additionalSpectrumEmission	7 (NS_07)		

6.2.4.4.3.6 Message contents exceptions (network signalled value “NS_08”)

- Information element additionalSpectrumEmission is set to NS_08. This can be set in the *SystemInformationblockType2* as part of the cell broadcast message. This exception indicates that the UE shall meet the additional spurious emission requirement for a specific deployment scenario.

Table 6.2.4.4.3.6-1: SystemInformationBlockType2 :Additional spurious emissions test requirement for “NS_08”

Derivation Path: TS 36.508 [7] clause 4.4.3.3, Table 4.4.3.3-1			
Information Element	Value/remark	Comment	Condition
additionalSpectrumEmission	8 (NS_08)		

6.2.4.4.3.7 Message contents exceptions (network signalled value “NS_09”)

- Information element additionalSpectrumEmission is set to NS_09. This can be set in the *SystemInformationblockType2* as part of the cell broadcast message. This exception indicates that the UE shall meet the additional spurious emission requirement for a specific deployment scenario.

Table 6.2.4.4.3.7-1: SystemInformationBlockType2 :Additional spurious emissions test requirement for “NS_09”

Derivation Path: TS 36.508 [7] clause 4.4.3.3, Table 4.4.3.3-1			
Information Element	Value/remark	Comment	Condition
additionalSpectrumEmission	9 (NS_09)		

6.2.4.4.3.8 Message contents exceptions (network signalled value “NS_10”)

- Information element additionalSpectrumEmission is set to NS_10. This can be set in the *SystemInformationblockType2* as part of the cell broadcast message. This exception indicates that the UE shall meet the additional spurious emission requirement for a specific deployment scenario.

Table 6.2.4.4.3.8-1: SystemInformationBlockType2 :Additional spurious emissions test requirement for “NS_10”

Derivation Path: TS 36.508 [7] clause 4.4.3.3, Table 4.4.3.3-1			
Information Element	Value/remark	Comment	Condition
additionalSpectrumEmission	10 (NS_10)		

6.2.4.5 Test requirements

The maximum output power, derived in step 2 shall be within the range prescribed by the nominal maximum output power and tolerance in the applicable table from Table 6.2.4.5-1 to Table 6.2.4.5-8. The allowed A-MPR values specified in Table 6.2.4.3-1 are in addition to the allowed MPR requirements specified in clause 6.2.3. For the UE maximum output power modified by MPR and/or A-MPR, the power limits specified in Table 6.2.5.3-1 apply.

Table 6.2.4.5-1: UE Power Class test requirements (network signalled value "NS_03" for Bands 4, 10, 35, and 36)

Configuration ID	EUTRA band	Class 1 (dBm)	Tol. (dB)	Class 2 (dBm)	Tol. (dB)	Class 3 (dBm)	Tol. (dB)
1	4,10,35,36					23	+2.7 / -3.7
2	4,10,35,36					23	+2.7 / -2.7
3	4,10,35,36					23	+2.7 / -3.7
4	4,10,35,36					23	+2.7 / -4.7
5	4,10,35,36					23	+2.7 / -2.7
6	4,10,35,36					23	+2.7 / -6.2
7	4,10,35,36					23	+2.7 / -3.7
8	4,10,35,36					23	+2.7 / -4.7
9	4,10,35,36					23	+2.7 / -3.7
10	4,10,35,36					23	+2.7 / -2.7
11	4,10,35,36					23	+2.7 / -6.2
12	4,10,35,36					23	+2.7 / -4.7
13	4,10,35,36					23	+2.7 / -4.7
14	4,10,35,36					23	+2.7 / -3.7
15	4,10,35,36					23	+2.7 / -2.7
16	4,10,35,36					23	+2.7 / -6.2
17	4,10,35,36					23	+2.7 / -4.7
18	4,10,35,36					23	+2.7 / -4.7
19	4,10,35,36					23	+2.7 / -3.7
20	4,10,35,36					23	+2.7 / -2.7
21	4,10,35,36					23	+2.7 / -6.2
22	4,10,35,36					23	+2.7 / -4.7
23	4,10,35,36					23	+2.7 / -4.7
24	4,10,35,36					23	+2.7 / -3.7
25	4,10,35,36					23	+2.7 / -2.7
26	4,10,35,36					23	+2.7 / -6.2
27	4,10,35,36					23	+2.7 / -4.7

Table 6.2.4.5-2: UE Power Class test requirements (network signalled value "NS_03" for Band 2)

Configuration ID	EUTRA band	Test Freq.	Class 1 (dBm)	Tol. (dB)	Class 2 (dBm)	Tol. (dB)	Class 3 (dBm)	Tol. (dB)
1	2	Mid					23	+2.7 / -3.7
1	2	Low, High					23	+2.7 / -5.7
2	2	Mid					23	+2.7 / -2.7
2	2	Low, High					23	+2.7 / -4.2
3	2	Mid					23	+2.7 / -3.7
3	2	Low, High					23	+2.7 / -5.7
4	2	Mid					23	+2.7 / -4.7
4	2	Low, High					23	+2.7 / -7.7
5	2	Mid					23	+2.7 / -2.7
5	2	Low, High					23	+2.7 / -4.2
6	2	Mid					23	+2.7 / -6.2
6	2	Low, High					23	+2.7 / -9.2
7	2	Mid					23	+2.7 / -3.7
7	2	Low, High					23	+2.7 / -5.7
8	2	All					23	+2.7 / -4.7
9	2	Low @ RB#(max+1-RB allocation), Mid, High @ RB#0					23	+2.7 / -3.7
9	2	Low @ RB#0, High @ RB#(max+1-RB allocation)					23	+2.7 / -5.7
10	2	Low @ RB#(max+1-RB allocation), Mid, High @ RB#0					23	+2.7 / -2.7
10	2	Low @ RB#0, High @ RB#(max+1-RB allocation)					23	+2.7 / -4.2
11	2	All					23	+2.7 / -6.2
12	2	Low @ RB#(max+1-RB allocation), Mid, High @ RB#0					23	+2.7 / -4.7
12	2	Low @ RB#0, High @ RB#(max+1-RB allocation)					23	+2.7 / -7.7
13	2	All					23	+2.7 / -4.7
14	2	Low @ RB#(max+1-RB allocation), Mid, High @ RB#0					23	+2.7 / -3.7
14	2	Low @ RB#0, High @ RB#(max+1-RB allocation)					23	+2.7 / -5.7

15	2	Low @ RB#(max+1-RB allocation), Mid, High @ RB#0					23	+2.7 / -2.7
15	2	Low @ RB#0, High @ RB#(max+1-RB allocation)					23	+2.7 / -4.2
16	2	All					23	+2.7 / -6.2
17	2	Low @ RB#(max+1-RB allocation), Mid, High @ RB#0					23	+2.7 / -4.7
17	2	Low @ RB#0, High @ RB#(max+1-RB allocation)					23	+2.7 / -7.7
18	2	All					23	+2.7 / -4.7
19	2	Low @ RB#(max+1-RB allocation), Mid, High @ RB#0					23	+2.7 / -3.7
19	2	Low @ RB#0, High @ RB#(max+1-RB allocation)					23	+2.7 / -5.7
20	2	Low @ RB#(max+1-RB allocation), Mid, High @ RB#0					23	+2.7 / -2.7
20	2	Low @ RB#0, High @ RB#(max+1-RB allocation)					23	+2.7 / -4.2
21	2	All					23	+2.7 / -6.2
22	2	Low @ RB#(max+1-RB allocation), Mid, High @ RB#0					23	+2.7 / -4.7
22	2	Low @ RB#0, High @ RB#(max+1-RB allocation)					23	+2.7 / -7.7
23	2	All					23	+2.7 / -4.7
24	2	All					23	+2.7 / -3.7
25	2	Low @ RB#(max+1-RB allocation), Mid, High @ RB#0					23	+2.7 / -2.7
25	2	Low @ RB#0, High @ RB#(max+1-RB allocation)					23	+2.7 / -4.2
26	2	All					23	+2.7 / -6.2
27	2	All					23	+2.7 / -4.7

Table 6.2.4.5-3: UE Power Class test requirements (network signalled value "NS_04")

Configuration ID	EUTRA band	Bandwidth (MHz)	Class 3 (dBm)	Tol. (dB)
1	41	5 MHz	23	+2.7 / -4.7
2	41	5 MHz	23	+2.7 / -3.7
3	41	5 MHz	23	+2.7 / -2.7
4	41	5 MHz	23	+2.7 / -6.2
5	41	5 MHz	23	+2.7 / -4.7
6	41	10MHz	23	+2.7 / -6.2
7	41	10MHz	23	+2.7 / -6.2
8	41	10MHz	23	+2.7 / -8.2
9	41	10MHz	23	+2.7 / -9.7
10	41	10MHz	23	+2.7 / -3.7
11	41	10MHz	23	+2.7 / -4.7
12	41	10MHz	23	+2.7 / -6.2
13	41	10MHz	23	+2.7 / -8.2
14	41	10MHz	23	+2.7 / -6.2
15	41	15MHz	23	+2.7 / -6.2
16	41	15MHz	23	+2.7 / -6.2
17	41	15MHz	23	+2.7 / -8.2
18	41	15MHz	23	+2.7 / -9.7
19	41	15MHz	23	+2.7 / -3.7
20	41	15MHz	23	+2.7 / -4.7
21	41	15MHz	23	+2.7 / -6.2
22	41	15MHz	23	+2.7 / -8.2
23	41	15MHz	23	+2.7 / -6.2
24	41	20MHz	23	+2.7 / -6.2
25	41	20MHz	23	+2.7 / -6.2
26	41	20MHz	23	+2.7 / -8.2
27	41	20MHz	23	+2.7 / -9.7
28	41	20MHz	23	+2.7 / -3.7
29	41	20MHz	23	+2.7 / -4.7
30	41	20MHz	23	+2.7 / -6.2
31	41	20MHz	23	+2.7 / -8.2
32	41	20MHz	23	+2.7 /

				-6.2
--	--	--	--	------

Table 6.2.4.5-4: UE Power Class test requirements (network signalled value "NS_05")

Configuration ID	EUTRA band	Class 1 (dBm)	Tol. (dB)	Class 2 (dBm)	Tol. (dB)	Class 3 (dBm)	Tol. (dB)
1	1					23	+2.7 / -2.7
2	1					23	+2.7 / -3.7
3	1					23	+2.7 / -2.7
4	1					23	+2.7 / -2.7
5	1					23	+2.7 / -3.7
6	1					23	+2.7 / -4.7
7	1					23	+2.7 / -6.2
8	1					23	+2.7 / -2.7
9	1					23	+2.7 / -2.7
10	1					23	+2.7 / -3.7
11	1					23	+2.7 / -4.7
12	1					23	+2.7 / -6.2
13	1					23	+2.7 / -2.7
14	1					23	+2.7 / -2.7
15	1					23	+2.7 / -3.7
16	1					23	+2.7 / -4.7
17	1					23	+2.7 / -6.2

Table 6.2.4.5-5: UE Power Class test requirements (network signalled value "NS_06" for Bands 13, 14, and 17)

Configuration ID	EUTRA band	Class 1 (dBm)	Tol. (dB)	Class 2 (dBm)	Tol. (dB)	Class 3 (dBm)	Tol. (dB)
1	13,14,17					23	+2.7 / -3.7
2	13,14,17					23	+2.7 / -2.7
3	13,14,17					23	+2.7 / -2.7
4	13,14,17					23	+2.7 / -3.7
5	13,14,17					23	+2.7 / -2.7
6	13,14,17					23	+2.7 / -3.7
7	13,14,17					23	+2.7 / -3.7
8	13,14,17					23	+2.7 / -2.7
9	13,14,17					23	+2.7 / -3.7
10	13,14,17					23	+2.7 / -3.7
11	13,14,17					23	+2.7 / -2.7
12	13,14,17					23	+2.7 / -3.7
13	13,14,17					23	+2.7 / -3.7
14	13,14,17					23	+2.7 / -2.7
15	13,14,17					23	+2.7 / -3.7
16	13,14,17					23	+2.7 / -3.7
17	13,14,17					23	+2.7 / -2.7
18	13,14,17					23	+2.7 / -3.7

Table 6.2.4.5-6: UE Power Class test requirements (network signalled value "NS_06" for Band 12)

Configuration ID	EUTRA band	Test Freq.	Class 1 (dBm)	Tol. (dB)	Class 2 (dBm)	Tol. (dB)	Class 3 (dBm)	Tol. (dB)
1	12	Mid					23	+2.7 / -3.7
1	12	Low, High					23	+2.7 / -5.7
2	12	Mid					23	+2.7 / -2.7
2	12	Low, High					23	+2.7 / -4.2
3	12	Mid					23	+2.7 / -2.7
3	12	Low, High					23	+2.7 / -4.2
4	12	Mid					23	+2.7 / -3.7
4	12	Low, High					23	+2.7 / -5.7
5	12	Mid					23	+2.7 / -2.7
5	12	Low, High					23	+2.7 / -4.2
6	12	Mid					23	+2.7 / -3.7
6	12	Low, High					23	+2.7 / -5.7
7	12	All					23	+2.7 / -3.7
8	12	Low @ RB#(max+1-RB allocation), Mid, High @ RB#0					23	+2.7 / -2.7
8	12	Low @ RB#0, High @ RB#(max+1-RB allocation)					23	+2.7 / -4.2
9	12	Low @ RB#(max+1-RB allocation), Mid, High @ RB#0					23	+2.7 / -3.7
9	12	Low @ RB#0, High @ RB#(max+1-RB allocation)					23	+2.7 / -5.7
10	12	All					23	+2.7 / -3.7
11	12	Low @ RB#(max+1-RB allocation), Mid, High @ RB#0					23	+2.7 / -2.7
11	12	Low @ RB#0, High @ RB#(max+1-RB allocation)					23	+2.7 / -4.2
12	12	Low @ RB#(max+1-RB allocation), Mid, High @ RB#0					23	+2.7 / -3.7
12	12	Low @ RB#0, High @ RB#(max+1-RB allocation)					23	+2.7 / -5.7

Table 6.2.4.5-7: UE Power Class test requirements (network signalled value "NS_07")

Configuration ID	EUTRA band	Class 1 (dBm)	Tol. (dB)	Class 2 (dBm)	Tol. (dB)	Class 3 (dBm)	Tol. (dB)
1	13					23	+2.7 / -18.7
2	13					23	+2.7 / -13.7
3	13					23	+2.7 / -2.7
4	13					23	+2.7 / -19.7
5	13					23	+2.7 / -18.7
6	13					23	+2.7 / -20.7
7	13					23	+2.7 / -3.7
8	13					23	+2.7 / -2.7
9	13					23	+2.7 / -4.7
10	13					23	+2.7 / -12.7
11	13					23	+2.7 / -13.7
12	13					23	+2.7 / -2.7
13	13					23	+2.7 / -6.2
14	13					23	+2.7 / -19.7
15	13					23	+2.7 / -18.7
16	13					23	+2.7 / -20.7

Table 6.2.4.5-8: UE Power Class test requirements (network signalled value "NS_08")

Configuration ID	EUTRA band	Class 1 (dBm)	Tol. (dB)	Class 2 (dBm)	Tol. (dB)	Class 3 (dBm)	Tol. (dB)
1	19					23	+2.7 / -2.7
2	19					23	+2.7 / -2.7
3	19					23	+2.7 / -3.7
4	19					23	+2.7 / -2.7
5	19					23	+2.7 / -2.7
6	19					23	+2.7 / -3.7
7	19					23	+2.7 / -4.7
8	19					23	+2.7 / -6.2
9	19					23	+2.7 / -8.2
10	19					23	+2.7 / -9.7
11	19					23	+2.7 / -2.7
12	19					23	+2.7 / -2.7
13	19					23	+2.7 / -3.7
14	19					23	+2.7 / -4.7
15	19					23	+2.7 / -6.2
16	19					23	+2.7 / -8.2
17	19					23	+2.7 / -9.7

Table 6.2.4.5-9: UE Power Class test requirements (network signalled value "NS_09")

Configuration ID	EUTRA band	Class 1 (dBm)	Tol. (dB)	Class 2 (dBm)	Tol. (dB)	Class 3 (dBm)	Tol. (dB)
1	21					23	+2.7 / -2.7
2	21					23	+2.7 / -2.7
3	21					23	+2.7 / -3.7
4	21					23	+2.7 / -2.7
5	21					23	+2.7 / -2.7
6	21					23	+2.7 / -3.7
7	21					23	+2.7 / -4.7
8	21					23	+2.7 / -6.2
9	21					23	+2.7 / -2.7
19	21					23	+2.7 / -2.7
11	21					23	+2.7 / -3.7
12	21					23	+2.7 / -4.7
13	21					23	+2.7 / -6.2
14	21					23	+2.7 / -8.2

Table 6.2.4.5-10: UE Power Class test requirements (network signalled value "NS_10 for Band 20")

- *Editor's note:* no requirements are specified in the core specification for the table above

6.2.5 Configured UE transmitted Output Power

6.2.5.1 Test purpose

To verify the UE does not exceed the minimum between the P_{EMAX} maximum allowed UL TX Power signalled by the E-UTRAN and the P_{UMAX} maximum UE power for the UE power class.

6.2.5.2 Test applicability

This test applies to all types of E-UTRA UE release 8 and forward.

6.2.5.3 Minimum conformance requirements

The UE is allowed to set its configured maximum output power P_{CMAX} . The configured maximum output power P_{CMAX} is set within the following bounds:

$$P_{CMAX_L} \leq P_{CMAX} \leq P_{CMAX_H}$$

Where

- $P_{CMAX_L} = \text{MIN} \{ P_{EMAX} - \Delta T_C, P_{PowerClass} - MPR - A-MPR - \Delta T_C \}$
- $P_{CMAX_H} = \text{MIN} \{ P_{EMAX}, P_{PowerClass} \}$
- P_{EMAX} is the value given to IE *P-Max*, defined in [5]
- $P_{PowerClass}$ is the maximum UE power specified in Table 6.2.2.3-1 without taking into account the tolerance specified in the Table 6.2.2.3-1

- MRP and A-MRP are specified in Section 6.2.3 and Section 6.2.4, respectively
- $\Delta T_C = 1.5$ dB when Note 2 in Table 6.2.2.3-1 applies
- $\Delta T_C = 0$ dB when Note 2 in Table 6.2.2.3-1 does not apply

The measured maximum output power P_{CMAX} shall be within the following bounds:

$$P_{\text{CMAX}_L} - T(P_{\text{CMAX}_L}) \leq P_{\text{CMAX}} \leq P_{\text{CMAX}_H} + T(P_{\text{CMAX}_H})$$

Where

$T(P_{\text{CMAX}})$ is defined by the tolerance table below and applies to P_{CMAX_L} and P_{CMAX_H} separately.

Table 6.2.5-1: P_{CMAX} tolerance

P_{CMAX} (dBm)	Tolerance $T(P_{\text{CMAX}})$ (dB)
$21 \leq P_{\text{CMAX}} \leq 23$	2.0
$20 \leq P_{\text{CMAX}} < 21$	2.5
$19 \leq P_{\text{CMAX}} < 20$	3.5
$18 \leq P_{\text{CMAX}} < 19$	4.0
$13 \leq P_{\text{CMAX}} < 18$	5.0
$8 \leq P_{\text{CMAX}} < 13$	6.0
$-40 \leq P_{\text{CMAX}} < 8$	7.0

The normative reference for this requirement is TS 36.101 [2] clause 6.2.5.

6.2.5.4 Test description

6.2.5.4.1 Initial conditions

Initial conditions are a set of test configurations the UE needs to be tested in and the steps for the SS to take with the UE to reach the correct measurement state.

The initial test configurations consist of environmental conditions, test frequencies, and channel bandwidths based on E-UTRA operating bands specified in table 5.4.2.1-1. All of these configurations shall be tested with applicable test parameters for each channel bandwidth, and are shown in table 6.2.5.4.1-1. The details of the uplink reference measurement channels (RMCs) are specified in Annex A.2. Configurations of PDSCH and PDCCH before measurement are specified in Annex C.2.

Table 6.2.5.4.1-1: Test Configuration Table

Initial Conditions				
Test Environment as specified in TS 36.508[7] subclause 4.1	Normal, TL/VL, TL/VH, TH/VL, TH/VH			
Test Frequencies as specified in TS36.508 [7] subclause 4.3.1	Mid range			
Test Channel Bandwidths as specified in TS 36.508 [7] subclause 4.3.1	Lowest, 5MHz, Highest			
Test Parameters for Channel Bandwidths				
Ch BW	Downlink Configuration	Uplink Configuration		
		Mod'n	RB allocation	
	N/A for Configured UE transmitted Output Power test case		FDD	TDD
1.4MHz		QPSK	5	5
3MHz		QPSK	4	4
5MHz		QPSK	8	8
10MHz		QPSK	12	12
15MHz		QPSK	16	16
20MHz		QPSK	18	18
Note 1: Test Channel Bandwidths are checked separately for each E-UTRA band, the applicable channel bandwidths are specified in Table 5.4.2.1-1.				
Note 2: For the uplink RB allocation the starting resource block shall be RB #0.				

1. Connect the SS to the UE antenna connectors as shown in TS 36.508 [7] Annex A, in Figure A.3.
2. The parameter settings for the cell are set up according to TS 36.508 [7] subclause 4.4.3.
3. Downlink signals are initially set up according to Annex C.0, C.1, and C.3.0, and uplink signals according to Annex H.1 and H.3.0.
4. The UL Reference Measurement channel is set according to Table 6.2.5.4.1-1
5. Propagation conditions are set according to Annex B.0.
6. Ensure the UE is in State 3A or 3A-RF according to TS 36.508 [7] clause 4.5.3A or 5.2A.2. Message contents are defined in clause 6.2.5.4.3.

6.2.5.4.2 Test procedure

1. SS sends uplink scheduling information for each UL HARQ process via PDCCH DCI format 0 for C_RNTI to schedule the UL RMC according to Table 6.2.5.4.1-1. Since the UE has no payload and no loopback data to send the UE sends uplink MAC padding bits on the UL RMC.
2. Send transmit uplink power control “up” commands in every uplink scheduling information to the UE; allow at least 200ms for the UE to reach the P_{max} level of the test point.
3. Measure the mean power of the UE in the channel bandwidth for each test point in table 6.2.5.5-1 according to the test configuration from Table 6.2.5.4.1-1. The period of measurement shall be at least continuous duration of one sub-frame (1ms). For TDD slots with transient periods are not under test.

6.2.5.4.3 Message contents

Message contents are according to TS 36.508 [7] subclause 4.6 with the following exceptions:

Table 6.2.5.4.3-1: SystemInformationBlockType1: Test point 1

Derivation Path: TS 36.508 [7] clause 4.4.3.2, Table 4.4.3.2-3 SystemInformationBlockType1			
Information Element	Value/remark	Comment	Condition
p-Max	-10		

Table 6.2.5.4.3-2: SystemInformationBlockType1: Test point 2

Derivation Path: TS 36.508 [7] clause 4.4.3.2, Table 4.4.3.2-3 SystemInformationBlockType1			
Information Element	Value/remark	Comment	Condition
p-Max	10		

Table 6.2.5.4.3-3: SystemInformationBlockType1: Test point 3

Derivation Path: TS 36.508 [7] clause 4.4.3.2, Table 4.4.3.2-3 SystemInformationBlockType1			
Information Element	Value/remark	Comment	Condition
p-Max	15		

6.2.5.5 Test requirement

The maximum output power measured shall not exceed the values specified in Table 6.2.5.5-1.

Table 6.2.5.5-1: P_{C_{MAX}} configured UE output power

	Channel bandwidth / maximum output power					
	1.4 MHz	3.0 MHz	5 MHz	10 MHz	15 MHz	20 MHz
Measured UE output power test point 1	-10 dBm ± 7.7					
Measured UE output power test point 2	10 dBm ± 6.7					
Measured UE output power test point 3	15 dBm ± 5.7					
Note:	In addition note 2 in Table 6.2.2.3-1 shall apply to the tolerances.					

6.3 Output Power Dynamics

6.3.1 Void

6.3.2 Minimum Output Power

6.3.2.1 Test purpose

To verify the UE's ability to transmit with a broadband output power below the value specified in the test requirement when the power is set to a minimum value.

6.3.2.2 Test applicability

This test applies to all types of E-UTRA UE release 8 and forward.

6.3.2.3 Minimum conformance requirements

The minimum output power is defined as the mean power in one sub-frame (1ms). The minimum output power shall not exceed the values specified in Table 6.3.2.3-1.

Table 6.3.2.3-1: Minimum output power

	Channel bandwidth / minimum output power / measurement bandwidth					
	1.4 MHz	3.0 MHz	5 MHz	10 MHz	15 MHz	20 MHz
Minimum output power	-40 dBm					
Measurement bandwidth	1.08 MHz	2.7 MHz	4.5 MHz	9.0 MHz	13.5 MHz	18 MHz

The normative reference for this requirement is TS 36.101 [2] clause 6.3.2.1.

Minimum output power test verifies the UE's ability to transmit with a broadband output power below the specified limit when the power is set to a minimum value. The broadband output power is defined as the power in the channel bandwidth, for all transmit bandwidth configurations (resource blocks).

An excess minimum output power potentially increases the Rise Over Thermal (RoT) and therefore reduces the cell coverage area for other UEs.

6.3.2.4 Test description

6.3.2.4.1 Initial conditions

Initial conditions are a set of test configurations the UE needs to be tested in and the steps for the SS to take with the UE to reach the correct measurement state.

The initial test configurations consist of environmental conditions, test frequencies, and channel bandwidths based on E-UTRA operating bands specified in table 5.4.2.1-1. All of these configurations shall be tested with applicable test parameters for each channel bandwidth, and are shown in table 6.3.2.4.1-1. The details of the uplink reference measurement channels (RMCs) are specified in Annexes A.2. Configurations of PDSCH and PDCCH before measurement are specified in Annex C.2.

Table 6.3.2.4.1-1: Test Configuration Table

Initial Conditions				
Test Environment as specified in TS 36.508 [7] subclause 4.1		Normal, TL/VL, TL/VH, TH/VL, TH/VH		
Test Frequencies as specified in TS36.508 [7] subclause 4.3.1		Low range, Mid range, High range		
Test Channel Bandwidths as specified in TS 36.508 [7] subclause 4.3.1		Lowest, 5MHz, Highest		
Test Parameters for Channel Bandwidths				
Ch BW	Downlink Configuration	Mod'n	Uplink Configuration	
			FDD	TDD
	N/A for min output power test			
1.4MHz		QPSK	6	6
3MHz		QPSK	15	15
5MHz		QPSK	25	25
10MHz		QPSK	50	50
15MHz		QPSK	75	75
20MHz		QPSK	100	100
Note 1: Test Channel Bandwidths are checked separately for each E-UTRA band, the applicable channel bandwidths are specified in Table 5.4.2.1-1.				

1. Connect the SS to the UE antenna connectors as shown in TS 36.508 [7] Annex A, in Figure A.3.
2. The parameter settings for the cell are set up according to TS 36.508 [7] subclause 4.4.3.
3. Downlink signals are initially set up according to Annex C.0, C.1, and C.3.0, and uplink signals according to Annex H.1 and H.3.0.
4. The UL Reference Measurement channel is set according to Table 6.3.2.4.1-1.
5. Propagation conditions are set according to Annex B.0.
6. Ensure the UE is in State 3A or 3A-RF according to TS 36.508 [7] clause 4.5.3.A or 5.2A.2. Message contents are defined in clause 6.3.2.4.3.

6.3.2.4.2 Test procedure

1. SS sends uplink scheduling information for each UL HARQ process via PDCCH DCI format 0 for C_RNTI to schedule the UL RMC according to Table 6.3.2.1.4.1-1. Since the UE has no payload and no loopback data to send the UE sends uplink MAC padding bits on the UL RMC
2. Send continuous uplink power control “down” commands in the uplink scheduling information to the UE to ensure that the UE transmits at its minimum output power.
3. Measure the mean power of the UE in the associated measurement bandwidth specified in Table 6.3.2.5-1 for the specific channel bandwidth under test. The period of measurement shall be the continuous duration of one sub-frame (1ms). For TDD slots with transient periods are not under test.

6.3.2.4.3 Message contents

Message contents are according to TS 36.508 [7] subclause 4.6.

6.3.2.5 Test requirement

The minimum output power measured shall not exceed the values specified in Table 6.3.2.5-1.

Table 6.3.2.5-1: Minimum output power

	Channel bandwidth / minimum output power / measurement bandwidth					
	1.4 MHz	3.0 MHz	5 MHz	10 MHz	15 MHz	20 MHz
Minimum output power	-39 dBm					
Measurement bandwidth (Note 1)	1.08 MHz	2.7 MHz	4.5 MHz	9.0 MHz	13.5 MHz	18 MHz
Note 1: Different implementations such as FFT or spectrum analyzer approach are allowed. For spectrum analyzer approach the measurement bandwidth is defined as an equivalent noise bandwidth.						

6.3.3 Transmit OFF power

6.3.3.1 Test purpose

To verify that the UE transmit OFF power is lower than the value specified in the test requirement.

6.3.3.2 Test applicability

The requirements of this test apply in test cases 6.3.4.1 General ON/OFF time mask and 6.3.4.2 PRACH and SRS time mask to all types of E-UTRA UE release 8 and forward.

6.3.3.3 Minimum conformance requirement

The transmit OFF power is defined as the mean power in a duration of at least one sub-frame (1ms) excluding any transient periods. The requirement for the transmit OFF power shall not exceed the values specified in Table 6.3.3.3-1.

Table 6.3.3.3-1: Transmit OFF power

	Channel bandwidth / Transmit OFF power / measurement bandwidth					
	1.4 MHz	3.0 MHz	5 MHz	10 MHz	15 MHz	20 MHz
Transmit OFF power	-50 dBm					
Measurement bandwidth	1.08 MHz	2.7 MHz	4.5 MHz	9.0 MHz	13.5 MHz	18 MHz

The normative reference for this requirement is TS 36.101 [2] clause 6.3.3.

Transmit OFF power is defined as the mean power when the transmitter is OFF. The transmitter is considered to be OFF when the UE is not allowed to transmit or during periods when the UE is not transmitting a sub-frame. During DTX and measurements gaps, the UE is not considered to be OFF.

An excess transmit OFF power potentially increases the Rise Over Thermal (RoT) and therefore reduces the cell coverage area for other UEs

6.3.3.4 Test description

This test is covered by clause 6.3.4.1 General ON/OFF time mask and 6.3.4.2 PRACH and SRS time mask.

6.3.3.5 Test requirement

The requirement for the transmit OFF power shall not exceed the values specified in Table 6.3.3.5-1.

Table 6.3.3.5-1: Transmit OFF power

	Channel bandwidth / Transmit OFF power / measurement bandwidth					
	1.4 MHz	3.0 MHz	5 MHz	10 MHz	15 MHz	20 MHz
Transmit OFF power	-48.5 dBm					
Measurement bandwidth	1.08 MHz	2.7 MHz	4.5 MHz	9.0 MHz	13.5 MHz	18 MHz

6.3.4 ON/OFF time mask

6.3.4.1 General ON/OFF time mask

Editor's note: The measurement period in the minimum requirement is defined to be 1 subframe (14 symbols). Due to practical reasons the TDD measurement period for off power prior the PUSCH is 10 symbols. It is FFS, if this deviation is acceptable.

6.3.4.1.1 Test purpose

To verify that the general ON/OFF time mask meets the requirements given in 6.3.4.1.5.

The time mask for transmit ON/OFF defines the ramping time allowed for the UE between transmit OFF power and transmit ON power.

Transmission of the wrong power increases interference to other channels, or increases transmission errors in the uplink channel.

6.3.4.1.2 Test applicability

This test applies to all types of E-UTRA UE release 8 and forward.

6.3.4.1.3 Minimum conformance requirement

The General ON/OFF time mask defines the observation period between Transmit OFF and ON power and between Transmit ON and OFF power. ON/OFF scenarios include; the beginning or end of DTX, measurement gap, contiguous, and non contiguous transmission

The OFF power measurement period is defined in a duration of at least one sub-frame excluding any transient periods. The ON power is defined as the mean power over one sub-frame excluding any transient period.

There are no additional requirements on UE transmit power beyond that which is required in clause 6.2.2 and clause 6.6.2.3.

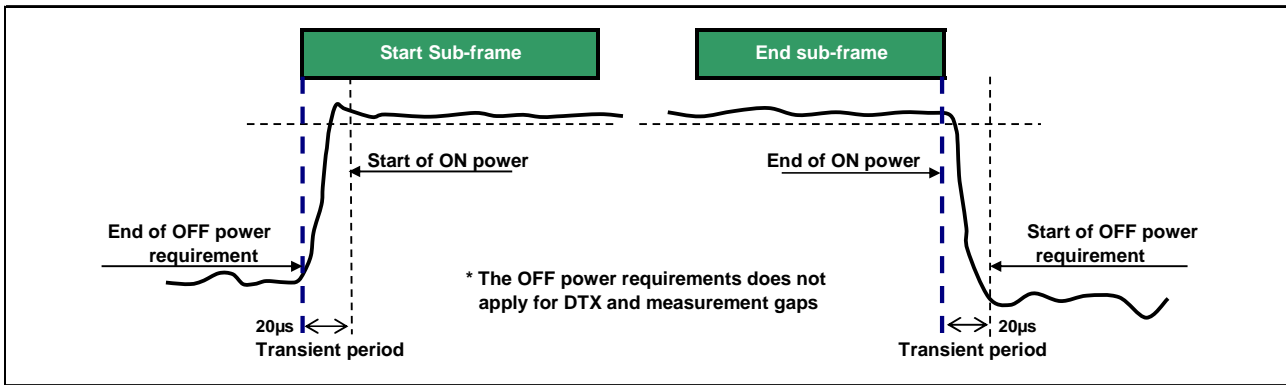

Figure 6.3.4.1.3-1: General ON/OFF time mask

The normative reference for this requirement is TS 36.101 [2] clause 6.3.4.1.

6.3.4.1.4 Test description

6.3.4.1.4.1 Initial conditions

Initial conditions are a set of test configurations the UE needs to be tested in and the steps for the SS to take with the UE to reach the correct measurement state.

The initial test configurations consist of environmental conditions, test frequencies, and channel bandwidths based on E-UTRA operating bands specified in table 5.4.2.1-1. All of these configurations shall be tested with applicable test parameters for each channel bandwidth, and are shown in table 6.3.4.1.4.1-1. The details of the uplink reference measurement channels (RMCs) are specified in Annexes A.2. Configurations of PDSCH and PDCCH before measurement are specified in Annex C.2

Table 6.3.4.1.4.1-1: Test Configuration Table

Initial Conditions				
Test Environment as specified in TS 36.508[7] subclause 4.1		Normal, TL/VL, TL/VH, TH/VL, TH/VH		
Test Frequencies as specified in TS36.508 [7] subclause 4.3.1		Low range, Mid range, High range		
Test Channel Bandwidths as specified in TS 36.508 [7] subclause 4.3.1		Lowest, 5MHz, Highest		
Test Parameters for Channel Bandwidths				
Ch BW	Downlink Configuration	Uplink Configuration		
		Mod'n	RB allocation	
	N/A for General On/Off Time Mask test case	FDD	TDD	
1.4MHz		QPSK	6	6
3MHz		QPSK	15	15
5MHz		QPSK	25	25
10MHz		QPSK	50	50
15MHz		QPSK	75	75
20MHz		QPSK	100	100
Note 1: Test Channel Bandwidths are checked separately for each E-UTRA band, the applicable channel bandwidths are specified in Table 5.4.2.1-1.				

1. Connect the SS to the UE antenna connectors as shown in TS 36.508 [7] Annex A, Figure A.3.
2. The parameter settings for the cell are set up according to TS 36.508 [7] subclause 4.4.3.
3. Downlink signals are initially set up according to Annex C.0, C.1 and C.3.0, and uplink signals according to Annex H.1 and H.3.0.
4. The UL and DL Reference Measurement channels are set according to Table 6.3.4.1.4.1-1.

5. Propagation conditions are set according to Annex B.0.
6. Ensure the UE is in State 3A or 3A-RF according to TS 36.508 [7] clause 4.5.3A or 5.2A.2. Message contents are defined in clause 6.3.4.1.4.3. Note that PDCCH DCI format 0 sent after resetting uplink power with RRC Connection Reconfiguration, should have TPC command 0dB.

6.3.4.1.4.2 Test procedure

1. SS sends uplink scheduling information via PDCCH DCI format 0 with TPC command 0dB for C_RNTI to schedule the UL RMC according to Table 6.3.4.1.4.1-1. Since the UE has no payload and no loopback data to send the UE sends uplink MAC padding bits on the UL RMC. The UL assignment is such that the UE transmits on UL sub-frame 2 of every radio frame.
2. For FDD: Measure the UE transmission OFF power during the sub-frame prior to the PUSCH subframe. For TDD: Measure the UE transmission OFF power during the 10 SCFDMA symbols prior to the PUSCH subframe.
3. Measure the output power of the UE PUSCH transmission during one sub-frame, excluding a transient period of 20 μ s at the beginning of the subframe.
4. Measure the UE transmission OFF power during one sub-frame following the PUSCH subframe, excluding a transient period of 20 μ s at the beginning of the subframe.

6.3.4.1.4.3 Message contents

Message contents are according to TS 36.508 [7] subclause 4.6 with the following exceptions:

Table 6.3.4.1.4.3-1: UplinkPowerControlCommon: Test point 1

Derivation Path: TS 36.508 [7] clause 4.6.3, Table 4.6.3-25 UplinkPowerControlCommon-DEFAULT			
Information Element	Value/remark	Comment	Condition
UplinkPowerControlCommon-DEFAULT ::= SEQUENCE { p0-NominalPUSCH	-105	Test point 1 to verify a UE relative low initial power transmission	

Table 6.3.4.1.4.3-2: PhysicalConfigDedicated

Derivation Path: TS 36.508 [7] clause 5.5.1.2, Table 5.5.1.2.1 PhysicalConfigDedicated-DEFAULT			
Information Element	Value/remark	Comment	Condition
PhysicalConfigDedicated-DEFAULT ::= SEQUENCE { UplinkPowerControlDedicated	UplinkPowerControlDedicated-DEFAULT	See subclause 4.6.3	SRB1
	UplinkPowerControlDedicated-DEFAULT	See subclause 4.6.3	RBC

Table 6.3.4.1.4.3-3: UplinkPowerControlDedicated

Derivation Path: TS 36.508 [7] clause 4.6.3, Table 4.6.3-26 UplinkPowerControlDedicated-DEFAULT			
Information Element	Value/remark	Comment	Condition
UplinkPowerControlDedicated-DEFAULT ::= SEQUENCE { p0-UE-PUSCH	1		SRB1
	0		RBC
}			

Table 6.3.4.1.3-4: TDD-Config-DEFAULT: On/OFF time mask measurement

Derivation Path: 36.508 clause 5.3.1 Table 5.3.1-1 (<i>SystemInformationBlockType1</i>)			
Information Element	Value/remark	Comment	Condition
TDD-Config-DEFAULT ::= SEQUENCE {			
subframeAssignment	sa1		
specialSubframePatterns	ssp5	To enable two symbol UpPTS, and to have 9 symbols GP.	
}			

6.3.4.1.5 Test requirement

The requirement for the power measured in steps (2), (3) and (4) of the test procedure shall not exceed the values specified in Table 6.3.4.1.5-1.

Table 6.3.4.1.5-1: General ON/OFF time mask

	Channel bandwidth / minimum output power / measurement bandwidth					
	1.4 MHz	3.0 MHz	5 MHz	10 MHz	15 MHz	20 MHz
Transmit OFF power	-48.5 dBm					
Transmission OFF Measurement bandwidth	1.08 MHz	2.7 MHz	4.5 MHz	9.0 MHz	13.5 MHz	18 MHz
Expected Transmission ON Measured power	-14.8 ± 7.5	-10.8 ± 7.5	-8.6 ± 7.5	-5.6 ± 7.5	-3.9 ± 7.5	-2.6 ± 7.5

6.3.4.2 PRACH and SRS time mask

6.3.4.2.1 PRACH time mask

6.3.4.2.1.1 Test purpose

To verify that the PRACH time mask meets the requirements given in 6.3.4.2.1.5.

The time mask for PRACH time mask defines the ramping time allowed for the UE between transmit OFF power and transmit ON power when transmitting the PRACH.

Transmission of the wrong power increases interference to other channels, or increases transmission errors in the uplink channel.

6.3.4.2.1.2 Test applicability

This test applies to all types of E-UTRA UE release 8 and forward.

6.3.4.2.1.3 Minimum conformance requirement

For the PRACH Power / Time mask defines the observation period for PRACH transmissions. The PRACH ON power is specified as the mean power over the PRACH measurement period excluding any transient periods. The measurement period for different PRACH preamble format is specified in Table 6.3.4.2.1.3-1.

There are no additional requirements on UE transmit power beyond that which is required in clause 6.2.2 and clause 6.6.2.3

Table 6.3.4.2.1.3-1: PRACH ON power measurement period

PRACH preamble format	Measurement period (ms)
0	0.9031
1	1.4844
2	1.8031
3	2.2844
4	0.1479

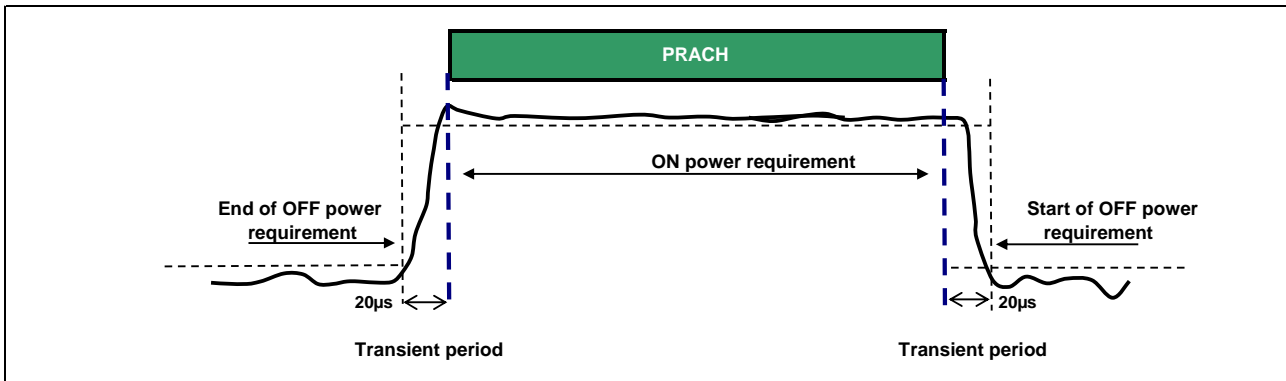

Figure 6.3.4.2.1.3-1: PRACH ON/OFF time mask

The normative reference for this requirement is TS 36.101 [2] clause 6.3.4.2.1.

6.3.4.2.1.4 Test description

6.3.4.2.1.4.1 Initial conditions

Initial conditions are a set of test configurations the UE needs to be tested in and the steps for the SS to take with the UE to reach the correct measurement state.

The initial test configurations consist of environmental conditions, test frequencies, and channel bandwidths based on E-UTRA operating bands specified in table 5.4.2.1-1. All of these configurations shall be tested with applicable test parameters for each channel bandwidth, and are shown in table 6.3.4.2.1.4.1-1. The details of the uplink and downlink reference measurement channels (RMCs) are specified in Annexes A.2 and A.3.

Table 6.3.4.2.1.4.1-1: Test Configuration Table

Initial Conditions		
Test Environment (as specified in TS 36.508 [7] subclause 4.1)	Normal, TL/VL, TL/VH, TH/VL, TH/VH	
Test Frequencies (as specified in TS36.508 [7] subclause 4.3.1)	Mid range	
Test Channel Bandwidths (as specified in TS 36.508 [7] subclause 4.3.1)	Lowest, 5MHz, Highest	
PRACH preamble format		
	FDD	TDD
PRACH Configuration Index	3	51

1. Connect the SS to the UE antenna connectors as shown in TS 36.508 [7] Annex A, Figure A3.
2. The parameter settings for the cell are set up according to TS 36.508 [7] subclause 4.4.3.
3. Downlink signals are initially set up according to Annex C.0, C.1 and C.3.0, and uplink signals according to Annex H.1 and H.3.0.

4. Propagation conditions are set according to Annex B.0.
5. Ensure the UE is in State 3A or 3A-RF according to TS 36.508 [7] clause 4.5.3A or 5.2A.2. Message contents are defined in clause 6.3.4.2.1.4.3.

6.3.4.2.1.4.2 Test procedure

1. The SS shall signal a Random Access Preamble ID via a PDCCH order to the UE and initiate a Non-contention based Random Access procedure.
2. The UE shall send the signalled preamble to the SS.
3. For FDD UE, the SS measure the UE transmission OFF power during the sub-frame preceding the PRACH preamble excluding a transient period of 20 μ s according to Figure 6.3.4.2.1.3-1. For TDD UE, the SS measure the UE transmission OFF power starting (20 μ s+the duration of 8 OFDM symbols) before the PRACH starts, and ending 20 μ s before PRACH starts. Note, the nominal PRACH timing for TDD is not aligned with the sub frame and symbol raster.
4. Measure the output power of the transmitted PRACH preamble according to Figure 6.3.4.2.1.3-1.
5. Measure the UE transmission OFF power, starting 20 μ s after the PRACH preamble ends for a measurement period of 980 μ s..

6.3.4.2.1.4.3 Message contents

Message contents are according to TS 36.508 [7] subclause 4.6 with the following exceptions:

Table 6.3.4.2.1.4.3-1: RACH-ConfigCommon-DEFAULT: PRACH measurement

Derivation Path: TS 36.508 [7] clause 4.6.3, Table 4.6.3-12 RACH-ConfigCommon-DEFAULT			
Information Element	Value/remark	Comment	Condition
RACH-ConfigCommon-DEFAULT ::= SEQUENCE {			
powerRampingParameters SEQUENCE {			
powerRampingStep	db0		

Table 6.3.4.2.1.4.3-2: PRACH-Config-DEFAULT: PRACH measurement for TDD

Derivation Path: TS 36.508 [7] clause 5.3.1, Table 5.3.1-3: PRACH-Config-DEFAULT			
Information Element	Value/remark	Comment	Condition
PRACH-Config-DEFAULT ::= SEQUENCE {			
prach-ConfigIndex	51		TDD
}			

Table 6.3.4.2.1.4.3-3: TDD-Config-DEFAULT: PRACH measurement for TDD

Derivation Path: TS 36.508 [7] clause 5.3.1, Table 5.3.1-1: TDD-Config-DEFAULT			
Information Element	Value/remark	Comment	Condition
TDD-Config-DEFAULT ::= SEQUENCE {			
subframeAssignment	sa1		
specialSubframePatterns	ssp5	To enable two symbol UpPTS, and to have 9 symbols GP.	
}			

6.3.4.2.1.5 Test requirement

The requirement for the power measured in steps (3), (4) and (5) of the test procedure shall not exceed the values specified in Table 6.3.4.2.1.5-1.

Table 6.3.4.2.1.5-1: PRACH time mask

	Channel bandwidth / Output Power [dBm] / measurement bandwidth					
	1.4 MHz	3.0 MHz	5 MHz	10 MHz	15 MHz	20 MHz
Transmit OFF power	≤ -48.5 dBm					
Transmission OFF Measurement bandwidth	1.08 MHz	2.7 MHz	4.5 MHz	9.0 MHz	13.5 MHz	18 MHz
Expected PRACH Transmission ON Measured power	-1 ± 7.5	-1 ± 7.5	-1 ± 7.5	-1 ± 7.5	-1 ± 7.5	-1 ± 7.5

6.3.4.2.2 SRS time mask

6.3.4.2.2.1 Test purpose

To verify that the SRS time mask meets the requirements given in 6.3.4.2.2.5.

The time mask for SRS time mask defines the ramping time allowed for the UE between transmit OFF power and transmit ON power when transmitting the SRS.

Transmission of the wrong power increases interference to other channels, or increases transmission errors in the uplink channel.

6.3.4.2.2.2 Test applicability

This test applies to all types of E-UTRA UE release 8 and forward.

6.3.4.2.2.3 Minimum conformance requirement

In the case a single SRS transmission, the ON power is defined as the mean power for each symbol duration excluding any transient period. Figure 6.3.4.2.2.3-1.

In the case a dual SRS transmission, the ON power is defined as the mean power for each symbol duration excluding any transient period. Figure 6.3.4.2.2.3-2.

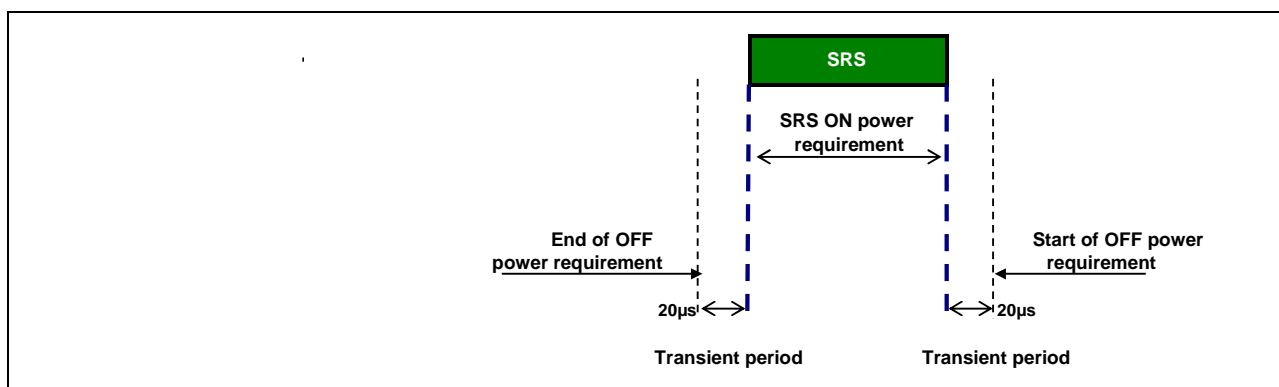

Figure 6.3.4.2.2.3-1: Single SRS time mask

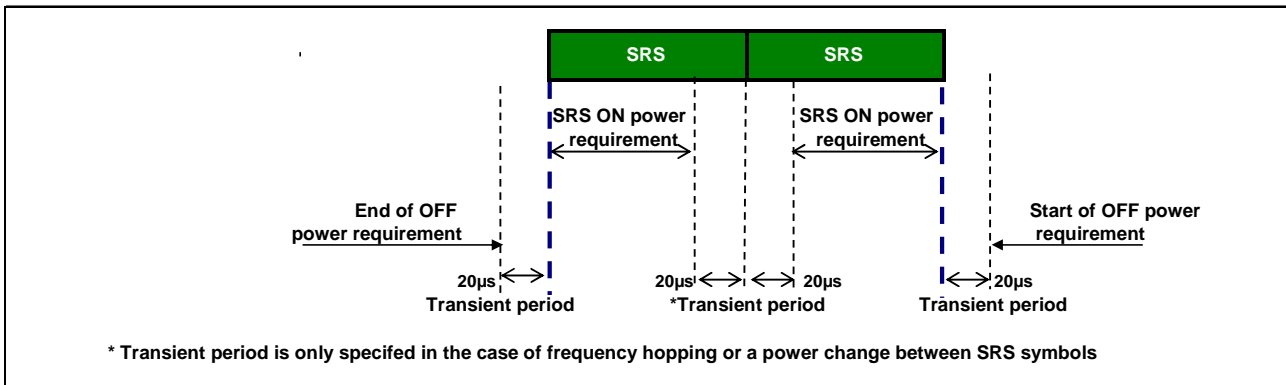

Figure 6.3.4.2.2.3-2: Dual SRS time mask for the case of UpPTS transmissions

6.3.4.2.2.4 Test description

6.3.4.2.2.4.1 Initial conditions

Initial conditions are a set of test configurations the UE needs to be tested in and the steps for the SS to take with the UE to reach the correct measurement state.

The initial test configurations consist of environmental conditions, test frequencies, and channel bandwidths based on E-UTRA operating bands specified in table 5.4.2.1-1. All of these configurations shall be tested with applicable test parameters for each channel bandwidth, and are shown in table 6.3.4.2.2.4.1-1. The details of the uplink and downlink reference measurement channels (RMCs) are specified in Annexes A.2 and A.3.

Table 6.3.4.2.2.4.1-1: Test Configuration Table

Initial Conditions		
Test Environment (as specified in TS 36.508 [7] subclause 4.1)	Normal, TL/VL, TL/VH, TH/VL, TH/VH	
Test Frequencies (as specified in TS36.508 [7] subclause 4.3.1)	Mid range	
Test Channel Bandwidths (as specified in TS 36.508 [7] subclause 4.3.1)	Lowest, 5MHz, Highest	
SRS configuration		
	FDD	TDD
srs-BandwidthConfig	bw7	bw0
srs-SubframeConfig	sc3	sc0
ackNackSRS-SimultaneousTransmission	FALSE	FALSE
srsMaxUpPts	N/A	N/A
srs-Bandwidth	bw3	bw3
srs-HoppingBandwidth	hbw3	hbw0
freqDomainPosition	0	0
Duration	TRUE	TRUE
srs-ConfigIndex	7	0
transmissionComb	0	0
cyclicShift	cs0	cs0

1. Connect the SS to the UE antenna connectors as shown in TS 36.508 [7] Annex A, Figure A.3.
2. The parameter settings for the cell are set up according to TS 36.508 [7] subclause 4.4.3.
3. Downlink signals are initially set up according to Annex C.0, C.1 and C.3.0, and uplink signals according to Annex H.1 and H.3.0.
4. Propagation conditions are set according to Annex B.0.

5. Ensure the UE is in State 3A or 3A-RF according to TS 36.508 [7] clause 4.5.3A or 5.2A.2. Message contents are defined in clause 6.3.4.2.2.4.3. Note that PDCCH DCI format 0 sent after resetting uplink power with RRC Connection Reconfiguration, should have TPC command 0dB.

6.3.4.2.2.4.2 Test procedure

1. For FDD UE, the SS measure the UE transmission OFF power during the 13 symbols preceding the SRS symbol excluding a transient period of 20 μ s according to Figure 6.3.4.2.1.3-1. For TDD UE, the SS measure the UE transmission OFF power during the 8 symbols preceding the two SRS symbols excluding a transient period of 20 μ s according to Figure 6.3.4.2.1.3-2.
2. Measure the output power of the transmitted SRS according to Figure 6.3.4.2.2.3-1 for FDD UE and according to Figure 6.3.4.2.1.3-2 for TDD UE, The transient periods are excluded from measurement accordingly.
3. Measure the UE transmission OFF power during the sub-frame following the SRS under test, excluding a transient period of 20 μ s according to Figure 6.3.4.2.2.3-1 for FDD UE and according to Figure 6.3.4.2.1.3-2 for TDD UE.

6.3.4.2.2.4.3 Message contents

Message contents are according to TS 36.508 [7] subclause 4.6 with the following exceptions:

Table 6.3.4.2.2.4.3-1: RadioResourceConfigCommonSIB-DEFAULT: SRS measurement

Derivation Path: 36.508 clause 5.3.1 Table 5.3.1-2 RadioResourceConfigCommonSIB-DEFAULT			
Information Element	Value/remark	Comment	Condition
RadioResourceConfigCommon-DEFAULT ::= SEQUENCE {			
rach-ConfigCommon	RACH-ConfigCommon-DEFAULT		
bcch-Config	BCCH-Config-DEFAULT		
pcch-Config	PCCH-Config-DEFAULT		
prach-Config	PRACH-ConfigSIB-DEFAULT		
pdsch-ConfigCommon	Not present		
pusch-ConfigCommon	PUSCH-ConfigCommon-DEFAULT		
pucch-ConfigCommon	PUCCH-ConfigCommon-DEFAULT		
soundingRSUL-ConfigCommon	<i>SoundingRS-UL-ConfigCommon-DEFAULT</i>		
uplinkPowerControlCommon	UplinkPowerControlCommon-DEFAULT		
ul-CyclicPrefixLength	len1		
}			

Table 6.3.4.2.2.4.3-2: SoundingRS-UL-ConfigCommon-DEFAULT: SRS time mask measurement

Derivation Path: TS 36.508 [7] clause 4.6.3, Table 4.6.3-21 SoundingRS-UL-ConfigCommon-DEFAULT			
Information Element	Value/remark	Comment	Condition
SoundingRS-UL-ConfigCommon-DEFAULT ::= SEQUENCE {			
setup SEQUENCE {			
srs-BandwidthConfig	bw7		FDD
	bw0		TDD
srs-SubframeConfig	sc3	Periodicity of 5ms, with offset of 0.	FDD
	sc0	Periodicity of 5ms, with offset of 1.	TDD
ackNackSRS-SimultaneousTransmission	FALSE		
srsMaxUpPts	Not present		
}			
}			

Table 6.3.4.2.2.4.3-3: PhysicalConfigDedicated-DEFAULT: SRS time mask measurement

Derivation Path: 36.508 clause 5.5.1 Table 5.5.1.2-1: PhysicalConfigDedicated-DEFAULT			
Information Element	Value/remark	Comment	Condition
PhysicalConfigDedicated-DEFAULT ::= SEQUENCE {			
cqi-ReportConfig	Not present		
soundingRS-UL-ConfigDedicated	<i>SoundingRSUL-ConfigDedicated-DEFAULT</i>		
}			

Table 6.3.4.2.2.4.3-4: SoundingRSUL-ConfigDedicated-DEFAULT: SRS time mask measurement

Derivation Path: TS 36.508 [7] clause 4.6.3, Table 4.6.3-22 SoundingRS-UL-ConfigDedicated-DEFAULT			
Information Element	Value/remark	Comment	Condition
SoundingRS-UL-ConfigDedicated-DEFAULT ::= CHOICE {			
setup SEQUENCE {			
srs-Bandwidth	bw3	bw3 used to ensure that the bandwidth is constantly 4 RBs irrespective of channel bandwidth.	
srs-HoppingBandwidth	hbw3	This is selected so that hopping is disabled	FDD
	hbw0	This is selected so that hopping is enabled	TDD
freqDomainPosition	0		
Duration	TRUE	Indefinite duration	
srs-ConfigIndex	7	SRS periodicity of 10ms, Toffset=0.	FDD
	0	SRS periodicity of 2ms, Ksrs=0,1, this is two symbols UpPTS in first half subframe.	TDD
transmissionComb	0		
cyclicShift	cs0	No cyclic shift	
}			
}			

Table 6.3.4.2.2.4.3-5: TDD-Config-DEFAULT: SRS time mask measurement

Derivation Path: 36.508 331 clause 65.3.21 Table 5.3.1-1 (<i>SystemInformationBlockType1</i>)			
Information Element	Value/remark	Comment	Condition
TDD-Config-DEFAULT ::= SEQUENCE {			
subframeAssignment	sa1		
specialSubframePatterns	ssp5	To enable two symbol UpPTS, and to have 9 symbols GP.	
}			

Table 6.3.4.2.2.4.3-6: PhysicalConfigDedicated

Derivation Path: TS 36.508 [7] clause 5.5.1.2, Table 5.5.1.2.1 PhysicalConfigDedicated-DEFAULT			
Information Element	Value/remark	Comment	Condition
PhysicalConfigDedicated-DEFAULT ::= SEQUENCE {			
uplinkPowerControlDedicated	UplinkPowerControlDedicated-DEFAULT	See subclause 4.6.3	SRB1
	UplinkPowerControlDedicated-DEFAULT	See subclause 4.6.3	RBC

Table 6.3.4.2.2.4.3-7: UplinkPowerControlDedicated

Derivation Path: TS 36.508 [7] clause 4.6.3, Table 4.6.3-26 UplinkPowerControlDedicated-DEFAULT			
Information Element	Value/remark	Comment	Condition
UplinkPowerControlDedicated-DEFAULT ::= SEQUENCE {			
p0-UE-PUSCH	1		SRB1
	0		RBC
}			

Condition	Explanation
FDD	FDD cell environment
TDD	TDD cell environment

6.3.4.2.2.5 Test requirement

The requirement for the power measured in steps (1), (2) and (3) of the test procedure shall not exceed the values specified in Table 6.3.4.2.2.5-1.

Table 6.3.4.2.2.5-1: SRS time mask

	Channel bandwidth / Output Power [dBm] / measurement bandwidth					
	1.4 MHz	3.0 MHz	5 MHz	10 MHz	15 MHz	20 MHz
Transmit OFF power	≤ -48.5 dBm					
Transmission OFF Measurement bandwidth	1.08 MHz	2.7 MHz	4.5 MHz	9.0 MHz	13.5 MHz	18 MHz
Expected SRS Transmission ON Measured power	-2.6± 7.5	-2.6 ± 7.5	-2.6 ± 7.5	-2.6 ± 7.5	-2.6 ± 7.5	-2.6 ± 7.5

6.3.5 Power Control

Power control is used to limit the interference level and compensate the channel fading. The UE power is defined as the mean power in a subframe or ON power duration, whichever is available.

The UE transmission can be in two contiguity modes, i.e. contiguous transmission and non-contiguous transmission. The former has a transmission gap of 0 and the later has a transmission gap larger than 0. The transmission gap is the time interval between the end of the last UE transmission subframe and the beginning of the next UE transmission subframe or the UpPTS (for TDD).

6.3.5.1 Power Control Absolute power tolerance

6.3.5.1.1 Test purpose

To verify the ability of the UE transmitter to set its initial output power to a specific value at the start of a contiguous transmission or non-contiguous transmission with a long transmission gap, i.e. transmission gap is larger than 20 ms.

6.3.5.1.2 Minimum conformance requirement

Absolute power tolerance is the ability of the UE transmitter to set its initial output power to a specific value for the first sub-frame at the start of a contiguous transmission or non-contiguous transmission with a transmission gap larger than 20ms.

The minimum requirement on absolute power tolerance is given in Table 6.3.5.1.2-1 over the power range bounded by the Maximum output power as defined in sub-clause 6.2.2 and the Minimum output power as defined in sub clause 6.3.2.

For operating bands under Note 2 in Table 6.2.2.3-1, the absolute power tolerance as specified in Table 6.3.5.1.2-1 is relaxed by reducing the lower limit by 1.5 dB when the transmission bandwidth is confined within F_{UL_low} and $F_{UL_low} + 4$ MHz or $F_{UL_high} - 4$ MHz and F_{UL_high} .

Table 6.3.5.1.2-1: Absolute power tolerance

Conditions	Tolerance
Normal conditions	± 9.0 dB
Extreme conditions	± 12.0 dB

The normative reference for this requirement is TS 36.101 [2] clause 6.3.5.1.1.

6.3.5.1.3 Test applicability

This test applies to all types of E-UTRA UE release 8 and forward.

6.3.5.1.4 Test description

6.3.5.1.4.1 Initial conditions

Initial conditions are a set of test configurations the UE needs to be tested in and the steps for the SS to take with the UE to reach the correct measurement state.

The initial test configurations consist of environmental conditions, test frequencies, and channel bandwidths based on E-UTRA operating bands specified in table 5.4.2.1-1. All of these configurations shall be tested with applicable test parameters for each channel bandwidth, and are shown in table 6.3.5.1.4.1-1. The details of the uplink reference measurement channel (RMCs) are specified in Annexes A.2. Configurations of PDSCH and PDCCH before measurement are specified in Annex C.2.

Table 6.3.5.1.4.1-1: Test Configuration Table

Initial Conditions					
Test Environment as specified in TS 36.508[7] subclause 4.1		Normal, TL/VL, TL/VH, TH/VL, TH/VH			
Test Frequencies as specified in TS36.508 [7] subclause 4.3.1		Mid range			
Test Channel Bandwidths as specified in TS 36.508 [7] subclause 4.3.1		Lowest, 5MHz, Highest			
Test Parameters for Channel Bandwidths					
Ch BW	Downlink Configuration		Uplink Configuration		
	N/A for Power Control Absolute power tolerance test case		Mod'n	RB allocation	
1.4MHz				FDD	TDD
3MHz			QPSK	6	6
5MHz			QPSK	15	15
10MHz			QPSK	25	25
15MHz			QPSK	50	50
20MHz			QPSK	75	75
20MHz			QPSK	100	100
Note 1: Test Channel Bandwidths are checked separately for each E-UTRA band, the applicable channel bandwidths are specified in Table 5.4.2.1-1.					

1. Connect the SS to the UE antenna connectors as shown in TS 36.508 [7] Annex A, Figure A.3.
2. The parameter settings for the cell are set up according to TS 36.508 [7] subclause 4.4.3.
3. Downlink signals are initially set up according to Annex C.0, C.1 and C.3.0, and uplink signals according to Annex H.1 and H.3.0.
4. The UL Reference Measurement channel is set according to Table 6.3.5.1.4.1-1.
5. Ensure the UE is in State 3A or 3A-RF according to TS 36.508 [7] clause 4.5.3A or 5.2A.2. Message contents are defined in clause 6.3.5.1.4.3. Note that PDCCH DCI format 0 sent after resetting uplink power with RRC Connection Reconfiguration, should have TPC command 0dB.

6.3.5.1.4.2 Test procedure

1. SS sends uplink scheduling information via PDCCH DCI format 0 with TPC command 0dB for C_RNTI to schedule the UL RMC according to Table 6.3.5.1.4.1-1. Since the UE has no payload and no loopback data to send the UE sends uplink MAC padding bits on the UL RMC.
2. Measure the initial output power of the first subframe of UE PUSCH first transmission. The transient periods of 20us are excluded.
3. Repeat for the two test points as indicated in section 6.3.5.1.4.3. The timing of the execution between the two test points shall be larger than 20ms.

6.3.5.1.4.3 Message contents

Message contents are according to TS 36.508 [7] subclause 4.6 with the following exceptions:

Table 6.3.5.1.4.3-1: UplinkPowerControlCommon: Test point 1

Derivation Path: TS 36.508 [7] clause 4.6.3, Table 4.6.3-25 UplinkPowerControlCommon-DEFAULT			
Information Element	Value/remark	Comment	Condition
UplinkPowerControlCommon-DEFAULT ::= SEQUENCE { p0-NominalPUSCH	-105	Test point 1 to verify a UE relative low initial power transmission	

Table 6.3.5.1.4.3-2: UplinkPowerControlCommon: Test point 2

Derivation Path: TS 36.508 [7] clause 4.6.3, Table 4.6.3-25 UplinkPowerControlCommon-DEFAULT			
Information Element	Value/remark	Comment	Condition
UplinkPowerControlCommon-DEFAULT ::= SEQUENCE { p0-NominalPUSCH	-93	Test point 2 to verify a UE relative high initial power transmission	

Table 6.3.5.1.4.3-3: PhysicalConfigDedicated

Derivation Path: TS 36.508 [7] clause 5.5.1.2, Table 5.5.1.2.1 PhysicalConfigDedicated-DEFAULT			
Information Element	Value/remark	Comment	Condition
PhysicalConfigDedicated-DEFAULT ::= SEQUENCE {			
uplinkPowerControlDedicated	UplinkPowerControlDedicated-DEFAULT	See subclause 4.6.3	SRB1
	UplinkPowerControlDedicated-DEFAULT	See subclause 4.6.3	RBC

Table 6.3.5.1.4.3-4: UplinkPowerControlDedicated

Derivation Path: TS 36.508 [7] clause 4.6.3, Table 4.6.3-26 UplinkPowerControlDedicated-DEFAULT			
Information Element	Value/remark	Comment	Condition
UplinkPowerControlDedicated-DEFAULT ::= SEQUENCE {			
p0-UE-PUSCH	1		SRB1
	0		RBC
}			

6.3.5.1.5 Test requirement

The requirement for the power measured in step (2) of the test procedure is not to exceed the values specified in Table 6.3.5.1.5-1 and 6.3.5.1.5-2.

Table 6.3.5.1.5-1: Absolute power tolerance: test point 1

	Channel bandwidth / expected output power (dBm)					
	1.4 MHz	3.0 MHz	5 MHz	10 MHz	15 MHz	20 MHz
Expected Measured power Normal conditions	-14.8 ± 10.0	-10.8 ± 10.0	-8.6 ± 10.0	-5.6 ± 10.0	-3.9 ± 10.0	-2.6 ± 10.0
Expected Measured power Extreme conditions	-14.8 ± 13.0	-10.8 ± 13.0	-8.6 ± 13.0	-5.6 ± 13.0	-3.9 ± 13.0	-2.6 ± 13.0
Note 1: The lower power limit shall not exceed the minimum output power requirements defined in sub-clause 6.3.2.3						

Table 6.3.5.1.5-2: Absolute power tolerance: test point 2

	Channel bandwidth / expected output power (dBm)					
	1.4 MHz	3.0 MHz	5 MHz	10 MHz	15 MHz	20 MHz
Expected Measured power Normal conditions	-2.8 ± 10.0	1.2 ± 10.0	3.4 ± 10.0	6.4 ± 10.0	8.2 ± 10.0	9.4 ± 10.0
Expected Measured power Extreme conditions	-2.8 ± 13.0	1.2 ± 13.0	3.4 ± 13.0	6.4 ± 13.0	8.2 ± 13.0	9.4 ± 13.0
Note 1: The upper power limit shall not exceed the maximum output power requirements defined by the power class in sub-clause 6.2.2.3						

6.3.5.2 Power Control Relative power tolerance

Editor's note: The test requirements do not take the impact of note 2 in Table 6.3.5.2.3-1 into account.

6.3.5.2.1 Test purpose

To verify the ability of the UE transmitter to set its output power relatively to the power in a target sub-frame relatively to the power of the most recently transmitted reference sub-frame if the transmission gap between these sub-frames is ≤ 20 ms.

6.3.5.2.2 Test applicability

This test applies to all types of E-UTRA UE release 8 and forward.

6.3.5.2.3 Minimum conformance requirement

The UE shall meet the requirements specified in Table 6.3.5.2.3-1.

To account for RF Power amplifier mode changes 2 exceptions are allowed for each of two test patterns. The test patterns are a monotonically increasing power sweep and a monotonically decreasing power sweep over a range bounded by the requirements of minimum power and maximum power specified in clauses 6.3.2.3 and 6.2.2.3. For these exceptions the power tolerance limit is a maximum of ±6.0 dB in Table 6.3.5.2.3-1.

Table 6.3.5.2.3-1 Relative Power Tolerance for Transmission (normal conditions)

Power step ΔP (Up or down) [dB]	All combinations of PUSCH and PUCCH transitions [dB]	All combinations of PUSCH/PUCCH and SRS transitions between sub- frames [dB]	PRACH [dB]
$\Delta P < 2$	± 2.5 (Note 3)	± 3.0	± 2.5
$2 \leq \Delta P < 3$	± 3.0	± 4.0	± 3.0
$3 \leq \Delta P < 4$	± 3.5	± 5.0	± 3.5
$4 \leq \Delta P \leq 10$	± 4.0	± 6.0	± 4.0
$10 \leq \Delta P < 15$	± 5.0	± 8.0	± 5.0
$15 \leq \Delta P$	± 6.0	± 9.0	± 6.0
<p>Note 1: For extreme conditions an additional ± 2.0 dB relaxation is allowed</p> <p>Note 2: For operating bands under Note 2 in Table 6.2.2-1, the relative power tolerance is relaxed by increasing the upper limit by 1.5 dB if the transmission bandwidth of the reference sub-frames is confined within F_{UL_low} and $F_{UL_low} + 4$ MHz or $F_{UL_high} - 4$ MHz and F_{UL_high} and the target sub-frame is not confined within any one of these frequency ranges; if the transmission bandwidth of the target sub-frame is confined within F_{UL_low} and $F_{UL_low} + 4$ MHz or $F_{UL_high} - 4$ MHz and F_{UL_high} and the reference sub-frame is not confined within any one of these frequency ranges, then the tolerance is relaxed by reducing the lower limit by 1.5 dB.</p> <p>Note 3: For PUSCH to PUSCH transitions with the allocated resource blocks fixed in frequency and no transmission gaps other than those generated by downlink subframes, DwPTS fields or Guard Periods for TDD: for a power step $\Delta P \leq 1$ dB, the relative power tolerance for transmission is ± 1.0 dB.</p>			

The power step (ΔP) is defined as the difference in the calculated setting of the UE Transmit power between the target and reference sub-frames with the power setting according to Clause 5.1 of TS 36.213. The error is the difference between ΔP and the power change measured at the UE antenna port with the power of the cell-specific reference signals kept constant. The error shall be less than the relative power tolerance specified in Table 6.3.5.2.3-1.

The normative reference for this requirement is TS 36.101 clause 6.3.5.2.

6.3.5.2.4 Test description

6.3.5.2.4.1 Initial conditions

Initial conditions are a set of test configurations the UE needs to be tested in and the steps for the SS to take with the UE to reach the correct measurement state.

The initial test configurations consist of environmental conditions, test frequencies, and channel bandwidths based on E-UTRA operating bands specified in table 5.4.2.1-1. All of these configurations shall be tested with applicable test parameters for each channel bandwidth, and are shown in table 6.3.5.4.2.1-1. The details of the uplink reference measurement channels (RMCs) are specified in Annexes A.2. Configurations of PDSCH and PDCCH before measurement are specified in Annex C.2.

Table 6.3.5.2.4.1-1: Test Configuration Table

Initial Conditions				
Test Environment as specified in TS 36.508[7] subclause 4.1		Normal, TL/VL, TL/VH, TH/VL, TH/VH		
Test Frequencies as specified in TS36.508 [7] subclause 4.3.1		Mid range		
Test Channel Bandwidths as specified in TS 36.508 [7] subclause 4.3.1		Lowest, 5MHz, Highest		
Test Parameters for Channel Bandwidths				
Ch BW	Downlink Configuration		Uplink Configuration	
	N/A for Power Control Relative power tolerance test case		Mod'n	RB allocation
			FDD	TDD
1.4MHz		QPSK	See table 6.3.5.2.5-1 6.3.5.2.5-2 6.3.5.2.5-13	See table 6.3.5.2.5-1 6.3.5.2.5-2 6.3.5.2.5-13
3MHz		QPSK	See table 6.3.5.2.5-3 6.3.5.2.5-4 6.3.5.2.5-13	See table 6.3.5.2.5-3 6.3.5.2.5-4 6.3.5.2.5-13
5MHz		QPSK	See table 6.3.5.2.5-5 6.3.5.2.5-6 6.3.5.2.5-13	See table 6.3.5.2.5-5 6.3.5.2.5-6 6.3.5.2.5-13
10MHz		QPSK	See table 6.3.5.2.5-7 6.3.5.2.5-8 6.3.5.2.5-13	See table 6.3.5.2.5-7 6.3.5.2.5-8 6.3.5.2.5-13
15MHz		QPSK	See table 6.3.5.2.5-9 6.3.5.2.5-10 6.3.5.2.5-13	See table 6.3.5.2.5-9 6.3.5.2.5-10 6.3.5.2.5-13
20MHz		QPSK	See table 6.3.5.2.5-11 6.3.5.2.5-12 6.3.5.2.5-13	See table 6.3.5.2.5-11 6.3.5.2.5-12 6.3.5.2.5-13
Note 1: Test Channel Bandwidths are checked separately for each E-UTRA band, the applicable channel bandwidths are specified in Table 5.4.2.1-1				

1. Connect the SS to the UE antenna connectors as shown in TS 36.508 [7] Annex A, Figure A.3.
2. The parameter settings for the cell are set up according to TS 36.508 [7] subclause 4.4.3.
3. Downlink signals are initially set up according to Annex C.0, C.1 and C.3.0, and uplink signals according to Annex H.1 and H.3.0.
4. The UL Reference Measurement channel is set according to table 6.3.5.4.2.1-1
5. Propagation conditions are set according to Annex B.0.
6. Ensure the UE is in State 3A or 3A-RF according to TS 36.508 [7] clause 4.5.3A or 5.2A.2. Message contents are defined in clause 6.3.5.2.4.3.

6.3.5.2.4.2 Test procedure

The procedure is separated in various subtests to verify different aspects of relative power control. The power patterns of the subtests are described in figure 6.3.5.2.4.2-1.

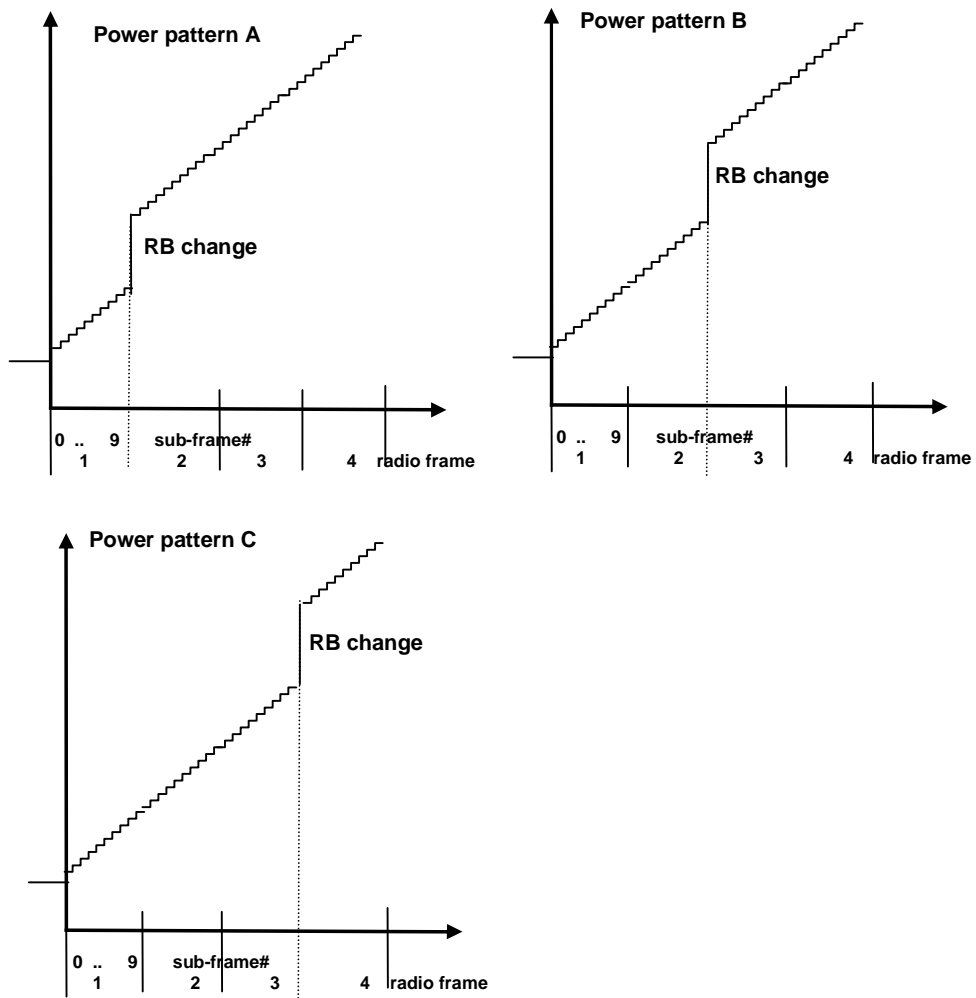

Figure 6.3.5.2.4.2-1: FDD ramping up test power patterns

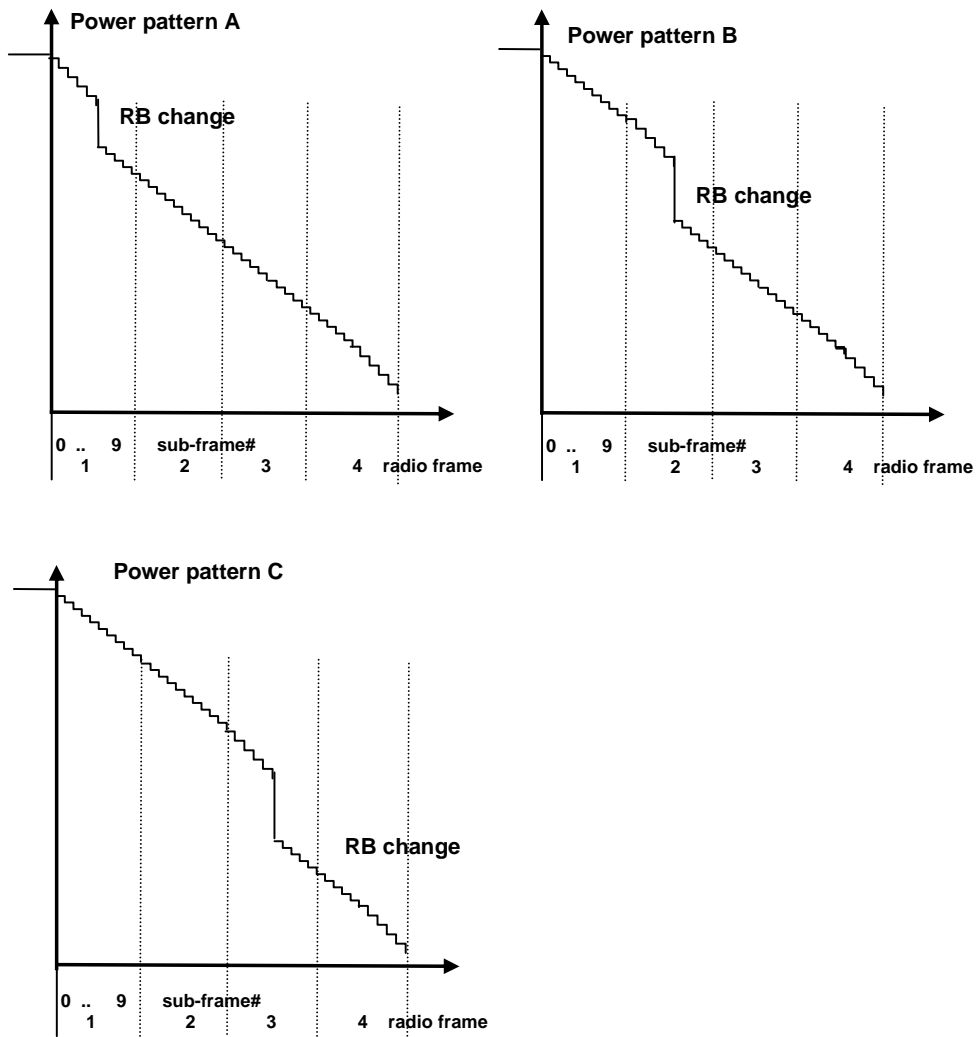

Figure 6.3.5.2.4.2-2: FDD ramping down test power patterns

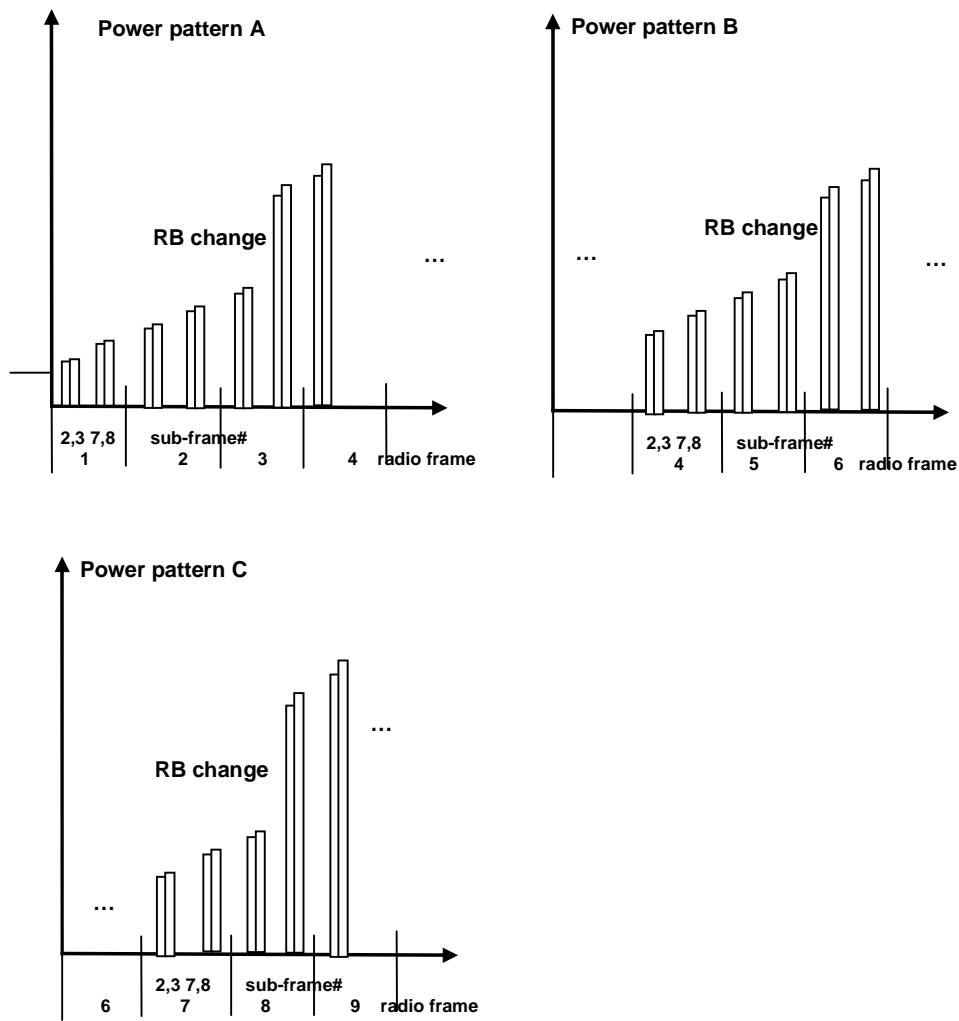

Figure 6.3.5.2.4.2-3: TDD ramping up test power patterns

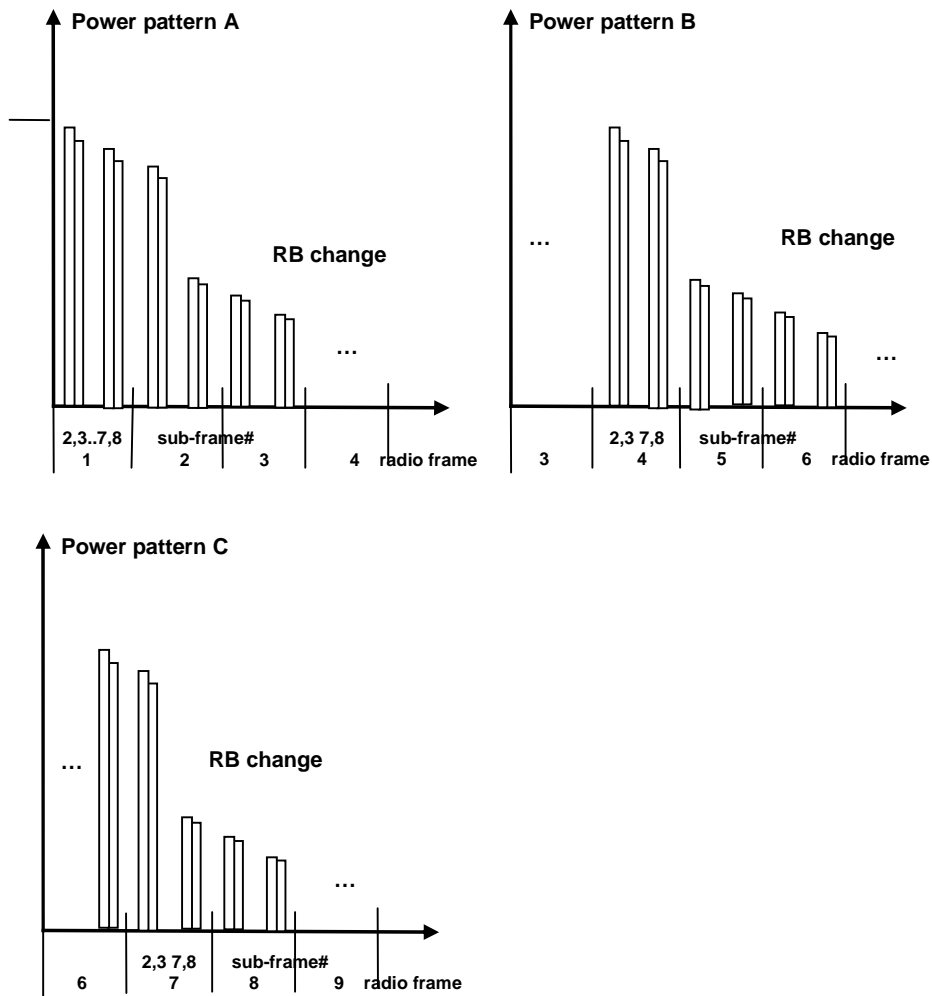

Figure 6.3.5.2.4.2-4: TDD ramping down test power patterns

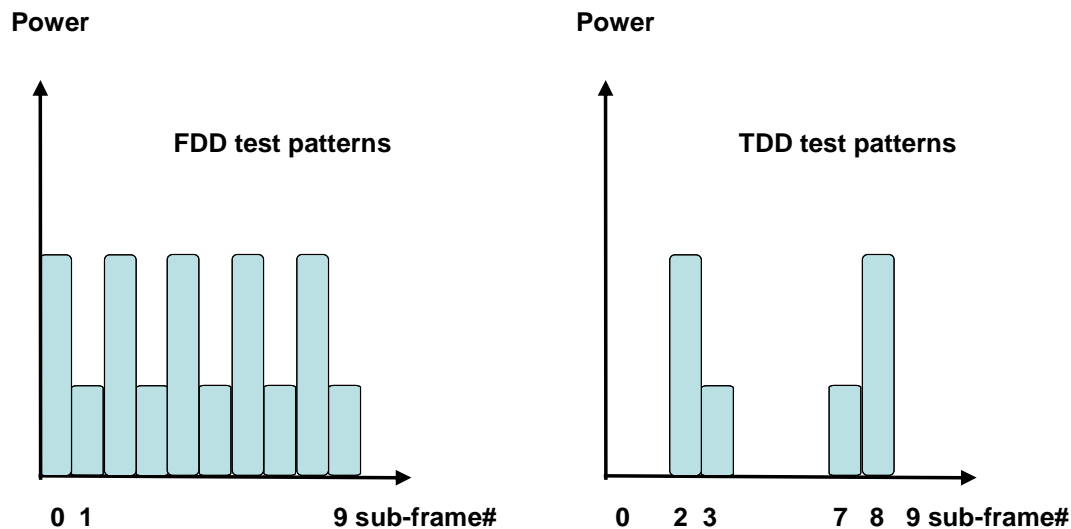

Figure 6.3.5.2.4.2-5: Alternating Test Power patterns

1. Sub test: ramping up pattern

- 1.1. SS sends uplink scheduling information for each UL HARQ process via PDCCH DCI format 0 for C_RNTI to schedule the PUSCH. Since the UE has no payload and no loopback data to send the UE sends uplink MAC padding bits on the UL RMC. Send the appropriate TPC commands for PUSCH to the UE to ensure that the UE transmits PUSCH at $-36.8\text{dBm} \pm 3.2\text{ dB}$.
- 1.2. Schedule the UE's PUSCH data transmission as described in Figure 6.3.5.2.4.2-1 (FDD pattern A: sub-test is divided in 4 arbitrary radio frames with 10 active uplink sub-frames per radio frame) and Figure 6.3.5.2.4.2-3 (TDD pattern A: sub-test is divided in 10 arbitrary radio frames with 4 active uplink sub-frames per radio frame) with an uplink RB allocation as defined in tables 6.3.5.2.5-1 thru 6.3.5.2.5-12 depending on channel bandwidth. On the PDCCH format 0 for the scheduling of the PUSCH the SS will transmit a +1dB TPC command. Note that the measurement need not be done continuously, provided that interruptions are whole numbers of frames, and TPC commands of 0dB are sent during the interruption.
- 1.3. Measure the power of PUSCH transmissions to verify the UE relative power control meet test requirements 6.3.5.2.5. For power transients between subframes, transient periods of 40us between subframes are excluded. For ON/OFF or OFF/ON transients, transient periods of 20 us at the beginning of the subframe are excluded.
- 1.4. Repeat the subtest different pattern B, C to move the RB allocation change at different points in the pattern as described in Table 6.3.5.2.5-1 thru Table 6.3.5.2.5-12 to force bigger UE power steps at various points in the power range.

2. Sub test: ramping down pattern

- 2.1. SS sends uplink scheduling information for each UL HARQ process via PDCCH DCI format 0 for C_RNTI to schedule the PUSCH. Since the UE has no payload and no loopback data to send the UE sends uplink MAC padding bits on the UL RMC. Send the appropriate TPC commands for PUSCH to the UE to ensure that the UE transmits PUSCH at $+18.0\text{dBm} \pm 3.2\text{ dB}$.
- 2.2. Schedule the UE's PUSCH data transmission as described in Figure 6.3.5.2.4.2-3 (FDD pattern A: sub-test is divided in 4 arbitrary radio frames with 10 active uplink sub-frames per radio frame) and Figure 6.3.5.2.4.2-4 (TDD pattern A: sub-test is divided in 10 arbitrary radio frames with 4 active uplink sub-frames per radio frame) with an uplink RB allocation as defined in tables 6.3.5.2.5-1 thru 6.3.5.2.5-12 depending on channel bandwidth. On the PDCCH format 0 for the scheduling of the PUSCH the SS will transmit a -1dB TPC command. Note that the measurement need not be done continuously, provided that interruptions are whole numbers of frames, and TPC commands of 0dB are sent during the interruption.

2.3. Measure the power of PUSCH transmissions to verify the UE relative power control meet test requirements 6.3.5.2.5. For power transients between subframes, transient periods of 40us between subframes are excluded. For ON/OFF or OFF/OFF transients, transient periods of 20 us at the beginning of the subframe are excluded.

2.4. Repeat the subtest different pattern B, C to move the RB allocation change at different points in the pattern as described in Table 6.3.5.2.5-1 thru Table 6.3.5.2.5-12 to force bigger UE power steps at various points in the power range.

3. Sub test: alternating pattern

3.1 SS sends uplink scheduling information for each UL HARQ process via PDCCH DCI format 0 for C_RNTI to schedule the PUSCH. Since the UE has no payload and no loopback data to send the UE sends uplink MAC padding bits on the UL RMC. Send the appropriate TPC commands for PUSCH to the UE to ensure that the UE transmits PUSCH at -10dBm +/- 3.2 dB. The initial uplink RB allocation is defined as the smaller uplink RB allocation value specified in tables 6.3.5.2.5-13. The power level and RB allocation are reset for each sub-test.

3.2. Schedule the UE’s PUSCH data transmission as described in Figure 6.3.5.2.4.2-3for 10 sub-frames with an uplink RB allocation alternating pattern as defined in table 6.3.5.2.5-13 while transmitting 0dB TPC command for PUSCH via the PDCCH.

3.3. Measure the power of PUSCH transmissions to verify the UE relative power control meet test requirements specified in clause 6.3.5.2.5. For power transients between subframes, transient periods of 40us between subframes are excluded. For ON/OFF or OFF/OFF transients, transient periods of 20 us at the beginning of the subframe are excluded.

6.3.5.2.4.3 Message contents

Message contents are according to TS 36.508 [7] subclause 4.6.

6.3.5.2.5 Test requirement

Each UE power step measured in the test procedure 6.3.5.2.4.2 should satisfy the test requirements specified in Table 6.3.5.2.5-1, thru 6.3.5.2.5-13 for normal conditions; for extreme conditions an additional ± 2.0 dB relaxation is allowed.

To account for RF Power amplifier mode changes 2 exceptions are allowed for each of ramping up and ramping down test patterns. For these exceptions the power tolerance limit is a maximum of ±6.7 dB. If there is an exception in the power step caused by the RB change for all test patterns (A, B, C) then fail the UE.

Table 6.3.5.2.5-1: Test Requirements Relative Power Tolerance for Transmission (normal conditions) channel bandwidth 1.4MHz (ramping up)

Sub-test (ramp up)	Uplink RB allocation	TPC command	Expected power step size (Up) ΔP [dB]	Power step size range (Up) ΔP [dB]	PUSCH [dB]
Subframes before RB change	Fixed = 1	TPC=+1dB	1	ΔP < 2	1 ± (1.7)
RB change	Change from 1 to 6 RBs	TPC=+1dB	8.78	4 ≤ ΔP < 10	8.78 ± (4.7)
Subframes after RB change	Fixed = 6	TPC=+1dB	1	ΔP < 2	1 ± (1.7)
Note 1: Position of RB change: Pattern A the position of RB uplink allocation change is after 10 active uplink subframes Pattern B the position of RB uplink allocation change is after 20 active uplink subframes Pattern C the position of RB uplink allocation change is after 30 active uplink subframes					

Table 6.3.5.2.5-2: Test Requirements Relative Power Tolerance for Transmission (normal conditions) channel bandwidth 1.4MHz (ramping down)

Sub-test (ramp down)	Uplink RB allocation	TPC command	Expected power step size (down) ΔP [dB]	Power step size range (down) ΔP [dB]	PUSCH [dB]
Subframes before RB change	Fixed = 5	TPC=-1dB	1	$\Delta P < 2$	$1 \pm (1.7)$
RB change	Change from 5 to 1 RBs	TPC=-1dB	7.99	$4 \leq \Delta P < 1$	$7.99 \pm (4.7)$
Subframes after RB change	Fixed = 1	TPC=-1dB	1	$\Delta P < 2$	$1 \pm (1.7)$
Note 1:	Position of RB change: Pattern A the position of RB uplink allocation change is after 6 active uplink subframes Pattern B the position of RB uplink allocation change is after 16 active uplink subframes Pattern C the position of RB uplink allocation change is after 26 active uplink subframes				

Table 6.3.5.2.5-3: Test Requirements Relative Power Tolerance for Transmission (normal conditions) channel bandwidth 3MHz (ramping up)

Sub-test (ramp up)	Uplink RB allocation	TPC command	Expected power step size (Up) ΔP [dB]	Power step size range (Up) ΔP [dB]	PUSCH [dB]
Subframes before RB change	Fixed = 1	TPC=+1dB	1	$\Delta P < 2$	$1 \pm (1.7)$
RB change	Change from 1 to 4 RBs	TPC=+1dB	7.02	$4 \leq \Delta P < 10$	$7.02 \pm (4.7)$
Subframes after RB change	Fixed =4	TPC=+1dB	1	$\Delta P < 2$	$1 \pm (1.7)$
Note 1:	Position of RB change: Pattern A the position of RB uplink allocation change is after 10 active uplink subframes Pattern B the position of RB uplink allocation change is after 20 active uplink subframes Pattern C the position of RB uplink allocation change is after 30 active uplink subframes				

Table 6.3.5.2.5-4: Test Requirements Relative Power Tolerance for Transmission (normal conditions) channel bandwidth 3MHz (ramping down)

Sub-test (ramp down)	Uplink RB allocation	TPC command	Expected power step size (down) ΔP [dB]	Power step size range (down) ΔP [dB]	PUSCH [dB]
Subframes before RB change	Fixed = 15	TPC=-1dB	1	$\Delta P < 2$	$1 \pm (1.7)$
RB change	Change from 15 to 1 RBs	TPC=-1dB	12.76	$10 \leq \Delta P < 15$	$12.76 \pm (5.7)$
Subframes after RB change	Fixed =1	TPC=-1dB	1	$\Delta P < 2$	$1 \pm (1.7)$
Note 1:	Position of RB change: Pattern A the position of RB uplink allocation change is after 6 active uplink subframes Pattern A the position of RB uplink allocation change is after 16 active uplink subframes Pattern C the position of RB uplink allocation change is after 26 active uplink subframes				

Table 6.3.5.2.5-5: Test Requirements Relative Power Tolerance for Transmission (normal conditions) channel bandwidth 5MHz (ramping up)

Sub-test (ramp up)	Uplink RB allocation	TPC command	Expected power step size (Up) ΔP [dB]	Power step size range (Up) ΔP [dB]	PUSCH [dB]
Subframes before RB change	Fixed = 1	TPC=+1dB	1	$\Delta P < 2$	$1 \pm (1.7)$
RB change	Change from 1 to 20	TPC=+1dB	14.01	$10 \leq \Delta P < 15$	$14.01 \pm (5.7)$
Subframes after RB change	Fixed = 20	TPC=+1dB	1	$\Delta P < 2$	$1 \pm (1.7)$
Note 1:	Position of RB change: Pattern A the position of RB uplink allocation change is after 10 active uplink subframes Pattern B the position of RB uplink allocation change is after 20 active uplink subframes Pattern C the position of RB uplink allocation change is after 30 active uplink subframes				

Table 6.3.5.2.5-6: Test Requirements Relative Power Tolerance for Transmission (normal conditions) channel bandwidth 5MHz (ramping down)

Sub-test (ramp down)	Uplink RB allocation	TPC command	Expected power step size (down) ΔP [dB]	Power step size range (down) ΔP [dB]	PUSCH [dB]
Subframes before RB change	Fixed = 25	TPC=-1dB	1	$\Delta P < 2$	$1 \pm (1.7)$
RB change	Change from 25 to 1	TPC=-1dB	14.98	$10 \leq \Delta P < 15$	$14.98 \pm (5.7)$
Subframes after RB change	Fixed = 1	TPC=-1dB	1	$\Delta P < 2$	$1 \pm (1.7)$
Note 1:	Position of RB change: Pattern A the position of RB uplink allocation change is after 6 active uplink subframes Pattern B the position of RB uplink allocation change is after 16 active uplink subframes Pattern C the position of RB uplink allocation change is after 26 active uplink subframes				

Table 6.3.5.2.5-7: Test Requirements Relative Power Tolerance for Transmission (normal conditions) channel bandwidth 10MHz (ramping up)

Sub-test (ramp up)	Uplink RB allocation	TPC command	Expected power step size (Up) ΔP [dB]	Power step size range (Up) ΔP [dB]	PUSCH [dB]
Subframes before RB change	Fixed = 1	TPC=+1dB	1	$\Delta P < 2$	$1 \pm (1.7)$
RB change	Change from 1 to 25	TPC=+1dB	14.98	$10 \leq \Delta P < 15$	$14.98 \pm (5.7)$
Subframes after RB change	Fixed = 25	TPC=+1dB	1	$\Delta P < 2$	$1 \pm (1.7)$
Note 1:	Position of RB change: Pattern A the position of RB uplink allocation change is after 10 active uplink subframes Pattern B the position of RB uplink allocation change is after 20 active uplink subframes Pattern C the position of RB uplink allocation change is after 30 active uplink subframes				

Table 6.3.5.2.5-8: Test Requirements Relative Power Tolerance for Transmission (normal conditions) channel bandwidth 10MHz (ramping down)

Sub-test (ramp down)	Uplink RB allocation	TPC command	Expected power step size (down) ΔP [dB]	Power step size range (down) ΔP [dB]	PUSCH [dB]
Subframes before RB change	Fixed = 50 (UE Cat 2-5) Fixed = 48 (UE Cat 1)	TPC=-1dB	1	$\Delta P < 2$	$1 \pm (1.7)$
RB change	Change from 50 to 1 (UE cat 2-5) Change from 48 to 1 (UE cat 1)	TPC=-1dB	17.99 17.81	$15 \leq \Delta$	$17.99 \pm (6.7)$ $17.81 \pm (6.7)$
Subframes after RB change	Fixed = 1	TPC=-1dB	1	$\Delta P < 2$	$1 \pm (1.7)$
Note 1:	Position of RB change: Pattern A the position of RB uplink allocation change is after 6 active uplink subframes Pattern B the position of RB uplink allocation change is after 16 active uplink subframes Pattern C the position of RB uplink allocation change is after 26 active uplink subframes				

Table 6.3.5.2.5-9: Test Requirements Relative Power Tolerance for Transmission (normal conditions) channel bandwidth 15MHz (ramping up)

Sub-test (ramp up)	Uplink RB allocation	TPC command	Expected power step size (Up) ΔP [dB]	Power step size range (Up) ΔP [dB]	PUSCH [dB]
Subframes before RB change	Fixed = 1	TPC=+1dB	1	$\Delta P < 2$	$1 \pm (1.7)$
RB change	Change from 1 to 50	TPC=+1dB	17.99	$15 \leq \Delta P$	$17.99 \pm (6.7)$
Subframes after RB change	Fixed = 50	TPC=+1dB	1	$\Delta P < 2$	$1 \pm (1.7)$
Note 1:	Position of RB change: Pattern A the position of RB uplink allocation change is after 10 active uplink subframes Pattern B the position of RB uplink allocation change is after 20 active uplink subframes Pattern C the position of RB uplink allocation change is after 30 active uplink subframes				

Table 6.3.5.2.5-10: Test Requirements Relative Power Tolerance for Transmission (normal conditions) channel bandwidth 15MHz (ramping down)

Sub-test (ramp down)	Uplink RB allocation	TPC command	Expected power step size (down) ΔP [dB]	Power step size range (down) ΔP [dB]	PUSCH [dB]
Subframes before RB change	Fixed = 75 (UE Cat 2-5) Fixed = 50 (UE Cat 1)	TPC=-1dB	1	$\Delta P < 2$	$1 \pm (1.7)$
RB change	Change from 75 to 1 (UE Cat 2-5) Change from 50 to 1 (UE Cat 1)	TPC=-1dB	19.75 17.99	$15 \leq \Delta P$	$19.75 \pm (6.7)$ $17.99 \pm (6.7)$
Subframes after RB change	Fixed = 1	TPC=-1dB	1	$\Delta P < 2$	$1 \pm (1.7)$
Note 1:	Position of RB change: Pattern A the position of RB uplink allocation change is after 6 active uplink subframes Pattern B the position of RB uplink allocation change is after 16 active uplink subframes Pattern C the position of RB uplink allocation change is after 26 active uplink subframes				

Table 6.3.5.2.5-11: Test Requirements Relative Power Tolerance for Transmission (normal conditions) channel bandwidth 20MHz (ramping up)

Sub-test (ramp up)	Uplink RB allocation	TPC command	Expected power step size (Up) ΔP [dB]	Power step size range (Up) ΔP [dB]	PUSCH [dB]
Subframes before RB change	Fixed = 1	TPC=+1dB	1	$\Delta P < 2$	$1 \pm (1.7)$
RB change	Change from 1 to 75	TPC=+1dB	19.75	$15 \leq \Delta P$	$19.75 \pm (6.7)$
Subframes after RB change	Fixed = 75	TPC=+1dB	1	$\Delta P < 2$	$1 \pm (1.7)$
Note 1:	Position of RB change: Pattern A the position of RB uplink allocation change is after 10 active uplink subframes Pattern B the position of RB uplink allocation change is after 20 active uplink subframes Pattern C the position of RB uplink allocation change is after 30 active uplink subframes				

Table 6.3.5.2.5-12: Test Requirements Relative Power Tolerance for Transmission (normal conditions) channel bandwidth 20MHz (ramping down)

Sub-test (ramp down)	Uplink RB allocation	TPC command	Expected power step size (down) ΔP [dB]	Power step size range (down) ΔP [dB]	PUSCH [dB]
Subframes before RB change	Fixed = 100 (UE Cat 2-5) Fixed = 75 (UE Cat 1)	TPC=-1dB	1	$\Delta P < 2$	$1 \pm (1.7)$
RB change	Change from 100 to 1 (UE Cat 2-5) Change from 75 to 1 (UE Cat 1)	TPC=-1dB	21.0 19.75	$15 \leq \Delta P$	$21.0 \pm (6.7)$ $19.75 \pm (6.7)$
Subframes after RB change	Fixed = 1	TPC=-1dB	1	$\Delta P < 2$	$1 \pm (1.7)$
Note 1:	Position of RB change: Pattern A the position of RB uplink allocation change is after 6 active uplink subframes Pattern B the position of RB uplink allocation change is after 16 active uplink subframes Pattern C the position of RB uplink allocation change is after 26 active uplink subframes				

Table 6.3.5.2.5-13: Test Requirements Relative Power Tolerance for Transmission (normal conditions) (Alternating pattern)

Sub-test	Uplink RB allocation	TPC command	Expected power step size (Up or down) ΔP [dB]	Power step size range (Up or down) ΔP [dB]	PUSCH [dB]
1.4 MHz	Alternating 1 and 6	TPC=0dB	7.78	$4 \leq \Delta P < 10$	$7.78 \pm (6.7)$ (note 1)
3 MHz	Alternating 1 and 15	TPC=0dB	11.76	$10 \leq \Delta P < 15$	$11.76 \pm (6.7)$ (note 1)
5 MHz	Alternating 1 and 25	TPC=0dB	13.98	$10 \leq \Delta P < 15$	$13.98 \pm (6.7)$ (note 1)
10 MHz	Alternating 1 and 50 (UE Cat 2-5)	TPC=0dB	16.99	$15 \leq \Delta P$	$16.99 \pm (6.7)$
	Alternating 1 and 48 (UE Cat 1)		16,81		$16.81 \pm (6.7)$
15 MHz	Alternating 1 and 75 (UE Cat 2-5)	TPC=0dB	18.75	$15 \leq \Delta P$	$18.75 \pm (6.7)$
	Alternating 1 and 50 (UE Cat 1)		16.99		$16.99 \pm (6.7)$
20 MHz	Alternating 1 and 100 (UE Cat 2-5)	TPC=0dB	20.00	$15 \leq \Delta P$	$20.00 \pm (6.7)$
	Alternating 1 and 75 (UE Cat 1)		18.75		$18.75 \pm (6.7)$
Note 1: test tolerance +/- 6.7 dB was selected to allow PA switch possible exceptions to occur					

6.3.5.3 Aggregate power control tolerance

6.3.5.3.1 Test purpose

To verify the ability of the UE to maintain its power level in non-contiguous transmission within 21 ms in response to 0 dB TPC commands with respect to the first UE transmission, when the power control parameters specified in TS 36.213 are constant.

6.3.5.3.2 Test applicability

This test applies to all types of E-UTRA UE release 8 and forward.

6.3.5.3.3 Minimum conformance requirement

The UE shall meet the requirements specified in Table 6.3.5.3.3-1 for relative power control over the power range bounded by the minimum output power as defined in sub clause 6.3.2 and the maximum output power in sub-clause 6.2.2.

Table 6.3.5.3.3-1: Power control tolerance

TPC command	UL channel	Aggregate power tolerance within 21 ms
0 dB	PUCCH	± 2.5 dB
0 dB	PUSCH	± 3.5 dB
Note: 1: The UE transmission gap is 4 ms. TPC command is transmitted via PDCCH 4 subframes preceding each PUCCH/PUSCH transmission.		

The normative reference for this requirement is TS 36.101 [2] clause 6.3.5.3.1.

6.3.5.3.4 Test description

6.3.5.3.4.1 Initial conditions

Initial conditions are a set of test configurations the UE needs to be tested in and the steps for the SS to take with the UE to reach the correct measurement state.

The initial test configurations consist of environmental conditions, test frequencies, and channel bandwidths based on E-UTRA operating bands specified in table 5.4.2.1-1. All of these configurations shall be tested with applicable test parameters for each channel bandwidth, and are shown in table 6.3.5.3.4.1-1. The details of the uplink and downlink reference measurement channels (RMCs) are specified in Annexes A.2 and A.3. Configurations of PDSCH and PDCCH before measurement are specified in Annex C.2.

Table 6.3.5.3.4.1-1: Test Configuration Table: PUCCH sub-test

Initial Conditions			
Test Environment as specified in TS 36.508[7] subclause 4.1		Normal	
Test Frequencies as specified in TS36.508 [7] subclause 4.3.1		Mid range	
Test Channel Bandwidths as specified in TS 36.508 [7] subclause 4.3.1		Lowest, 5MHz, Highest	
Test Parameters for Channel Bandwidths			
Ch BW	Downlink Configuration		Uplink Configuration
	Mod'n	RB allocation	
		FDD	TDD
1.4MHz	QPSK	3	3
3MHz	QPSK	4	4
5MHz	QPSK	8	8
10MHz	QPSK	16	16
15MHz	QPSK	25	25
20MHz	QPSK	30	30
Note 1: Test Channel Bandwidths are checked separately for each E-UTRA band, the applicable channel bandwidths are specified in Table 5.4.2.1-1.			

Table 6.3.5.3.4.1-2: Test Configuration Table: PUSCH sub-test

Initial Conditions				
Test Environment as specified in TS 36.508[7] subclause 4.1		Normal		
Test Frequencies as specified in TS36.508 [7] subclause 4.3.1		Mid range		
Test Channel Bandwidths as specified in TS 36.508 [7] subclause 4.3.1		Lowest, 5MHz, Highest		
Test Parameters for Channel Bandwidths				
Ch BW	Downlink Configuration		Uplink Configuration	
	N/A for PUSCH sub-test		Mod'n	RB allocation
			FDD	TDD
1.4MHz		QPSK	1	1
3MHz		QPSK	4	4
5MHz		QPSK	8	8
10MHz		QPSK	12	12
15MHz		QPSK	16	16
20MHz		QPSK	18	18
Note 1: Test Channel Bandwidths are checked separately for each E-UTRA band, the applicable channel bandwidths are specified in Table 5.4.2.1-1.				

1. Connect the SS to the UE antenna connectors as shown in TS 36.508 [7] Annex A, Figure A.3.
2. The parameter settings for the cell are set up according to TS 36.508 [7] subclause 4.4.3.
3. Downlink signals are initially set up according to Annex C0, C.1 and C.3.0, and uplink signals according to Annex H.1 and H.3.0.
4. The UL and DL Reference Measurement channels are set according to Table 6.3.5.3.4.1-1 (PUCCH sub-test) and Table 6.3.5.3.4.1-2 (PUSCH sub-test).
5. Ensure the UE is in State 3A or 3A-RF according to TS 36.508 [7] clause 4.5.3A or 5.2A.2. Message contents are defined in clause 6.3.5.3.4.3.

6.3.5.3.4.2 Test procedure

The procedure is separated in two subtests to verify PUCCH and PUSCH aggregate power control tolerance respectively. The uplink transmission patterns are described in figure 6.3.5.3.4.2-1.

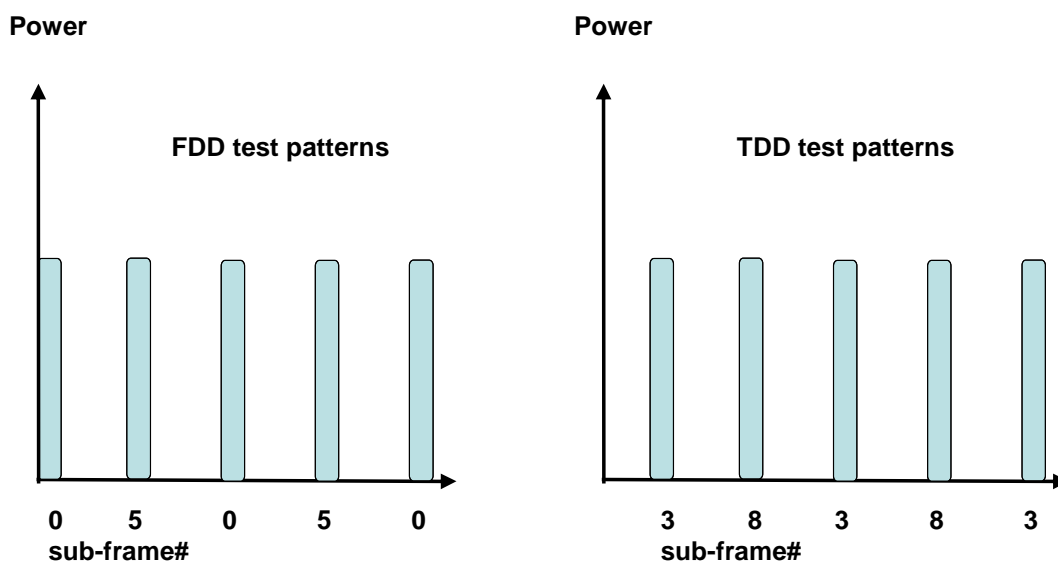

Figure 6.3.5.3.4.2-1 Test uplink transmission

1. PUCCH sub test:

- 1.1 The SS transmits PDSCH via PDCCH DCI format 1A for C_RNTI to transmit the DL RMC according to Table 6.3.5.3.4.1-1. The SS sends downlink MAC padding bits on the DL RMC. The transmission of PDSCH will make the UE send uplink ACK/NACK using PUCCH. Send the appropriate TPC commands for PUCCH to the UE to ensure that the UE transmits PUCCH at 0dBm +/- 3.2 dB.
- 1.2. Every 5 subframes transmit to the UE downlink PDSCH MAC padding bits as well as 0 dB TPC command for PUCCH via the PDCCH to make the UE transmit ACK/NACK on the PUCCH with transmission gap of 4 subframes. The downlink transmission is scheduled in the appropriate sub-frames to make the UE transmit PUCCH as described in figure 6.3.5.3.4.2-1.
- 1.3. Measure the power of 5 consecutive PUCCH transmissions to verify the UE transmitted PUCCH power is maintained within 21 ms. The transient periods of 20us are excluded from the power measurement.

2. PUSCH sub test:

- 2.1. The SS sends uplink scheduling information via PDCCH DCI format 0 for C_RNTI to schedule the PUSCH. Since the UE has no payload and no loopback data to send the UE sends uplink MAC padding bits on the UL RMC. Send the appropriate TPC commands for PUSCH to the UE to ensure that the UE transmits PUSCH at 0dBm +/- 3.2dB
- 2.2. Every 5 subframes schedule the UE's PUSCH data transmission and transmit 0 dB TPC command for PUSCH via the PDCCH to make the UE transmit PUSCH with 4 subframes gap. The uplink transmission patterns are described in figure 6.3.5.3.4.2-1.
- 2.3. Measure the power of 5 consecutive PUSCH transmissions to verify the UE transmitted PUSCH power is maintained within 21 ms. The transient periods of 20us are excluded from the power measurement.

6.3.5.3.4.3 Message contents

Message contents are according to TS 36.508 [7] subclause 4.6.

6.3.5.3.5 Test requirement

The requirement for the power measurements made in step (1.3) and (2.3) of the test procedure shall not exceed the values specified in Table 6.3.5.3.5-1. The power measurement period shall be 1 sub-frame excluding transient periods.

Table 6.3.5.3.5-1: Power control tolerance

TPC command	UL channel	Test requirement measured power
0 dB	PUCCH	Given 5 power measurements in the pattern, the 2 nd , 3 rd , 4 th , and 5 th measurements shall be within ± 3.2 dB of the 1 st measurement.
0 dB	PUSCH	Given 5 power measurements in the pattern, the 2 nd , 3 rd , 4 th , and 5 th measurements shall be within ± 4.2 dB of the 1 st measurement.
Note 1: The UE transmission gap is 4 ms. TPC command is transmitted via PDCCH 4 subframes preceding each PUCCH/PUSCH transmission.		

6.4 Void

6.5 Transmit signal quality

Editor's note:

The test cases for transmit signal quality : frequency error, EVM, carrier leakage, IBE, EVM equalizer spectrum flatness are complete, except the following aspect is not determined:

- *Reference signal EVM and PRACH EVM minimum requirements from the core specification are still in brackets*

In this clause a multitude of results are derived, all using one common algorithm returning these results: Global In-Channels TX-Test (Annex E). Each sub clause of this clause contains a procedure and test requirements described for a specific measurement. If all relevant test parameters in different sub clauses are the same, then the results, returned by the Global In-Channel TX-Test, may be used across the applicable sub clauses.

6.5.1 Frequency Error

6.5.1.1 Test purpose

This test verifies the ability of both, the receiver and the transmitter, to process frequency correctly.

Receiver: to extract the correct frequency from the stimulus signal, offered by the System simulator, under ideal propagation conditions and low level.

Transmitter: to derive the correct modulated carrier frequency from the results, gained by the receiver.

6.5.1.2 Test applicability

This test case applies to all types of E-UTRA UE release 8 and forward.

6.5.1.3 Minimum conformance requirements

The UE modulated carrier frequency shall be accurate to within ± 0.1 PPM observed over a period of one time slot (0.5ms) compared to the carrier frequency received from the E-UTRA Node B.

The normative reference for this requirement is TS 36.101 clause 6.5.1

6.5.1.4 Test description

6.5.1.4.1 Initial condition

Initial conditions are a set of test configurations the UE needs to be tested in and the steps for the SS to take with the UE to reach the correct measurement state.

The initial test configurations consist of environmental conditions, test frequencies, and channel bandwidths based on E-UTRA bands specified in table 5.4.2.1-1. All of these configurations shall be tested with applicable test parameters for each channel bandwidth, and are shown in table 6.5.1.4.1-1. The details of the uplink and downlink reference measurement channels (RMCs) are specified in Annexes A.2 and A.3. Configurations of PDSCH and PDCCH before measurement are specified in Annex C.2.

Table 6.5.1.4.1-1: Test Configuration Table

Initial Conditions						
Test Environment as specified in TS 36.508[7] subclause 4.1			NC, TL/VL, TL/VH, TH/VL, TH/VH			
Test Frequencies as specified in TS36.508 [7] subclause 4.3.1			Low range, Mid range, High range			
Test Channel Bandwidths as specified in TS 36.508 [7] subclause 4.3.1			Lowest, 5MHz, Highest			
Test Parameters for Channel Bandwidths						
Ch BW	Downlink Configuration			Uplink Configuration		
	Mod'n	RB allocation		Mod'n	RB allocation	
		FDD	TDD		FDD	TDD
1.4MHz	QPSK	6	6	QPSK	6	6
3MHz	QPSK	15	15	QPSK	15	15
5MHz	QPSK	25	25	QPSK	25	25
5MHz	QPSK	25	N/A	QPSK	20	N/A
5MHz	QPSK	25	N/A	QPSK	15	N/A
10MHz	QPSK	50	50	QPSK	50	50
10MHz	QPSK	50	N/A	QPSK	25	N/A
10MHz	QPSK	50	N/A	QPSK	20	N/A
10MHz	QPSK	50	N/A	QPSK	15	N/A
15MHz	QPSK	75	75	QPSK	75	75
15MHz	QPSK	75	N/A	QPSK	50	N/A
15MHz	QPSK	75	N/A	QPSK	25	N/A
15MHz	QPSK	75	N/A	QPSK	20	N/A
20MHz	QPSK	100	100	QPSK	100	100
20MHz	QPSK	100	N/A	QPSK	75	N/A
20MHz	QPSK	100	N/A	QPSK	50	N/A
20MHz	QPSK	100	N/A	QPSK	25	N/A
20MHz	QPSK	100	N/A	QPSK	20	N/A
Note 1: Test Channel Bandwidths are checked separately for each E-UTRA band, which applicable channel bandwidths are specified in Table 5.4.2.1-1.						
Note 2. Depending on E-UTRA band, only the appropriate Uplink RB allocation value according to table 7.3.3-2 is tested per Test Channel Bandwidth.						

1. Connect the SS to the UE to the UE antenna connectors as shown in TS 36.508 [7] Annex A, Figure A.3.
2. The parameter settings for the cell are set up according to TS 36.508[7] subclause 4.4.3.
3. Downlink signals are initially set up according to Annex C0, C.1 and C.3.0, and uplink signals according to Annex H.1 and H.3.0.
4. The UL and DL Reference Measurement channels are set according to Table 6.5.1.4.1-1.
5. Propagation conditions are set according to Annex B.0
6. Ensure the UE is in State 3A or 3A-RF according to TS 36.508 [7] clause 4.5.3A or 5.2A.2. Message contents are defined in clause 6.5.1.4.3.

6.5.1.4.2 Test procedure

1. SS transmits PDSCH via PDCCH DCI format 1A for C_RNTI to transmit the DL RMC according to Table 6.5.1.4.1-1. The SS sends downlink MAC padding bits on the DL RMC.
2. SS sends uplink scheduling information for each UL HARQ process via PDCCH DCI format 0 for C_RNTI to schedule the UL RMC according to Table 6.5.1.4.1-1, since the UE has no payload data to send, the UE transmit uplink MAC padding bits on the UL RMC
3. Send continuously uplink power control “up” commands to the UE in every uplink scheduling information to the UE so that the UE transmits at P_{UMAX} level for the duration of the test.
4. Set the Downlink signal level to the appropriate REFSENS value defined in Table 7.3.5-1.

5. Measure the Frequency Error using Global In-Channel Tx-Test (Annex E). For TDD slots with transient periods are not under test.

6.5.1.4.3 Message contents

Message contents are according to TS 36.508 [7] subclause 4.6 with the exceptions in [subclause 7.3.4.3](#) and [Table 7.3.3-3](#).

6.5.1.5 Test requirement

The 20 frequency error Δf results must fulfil the test requirement:

$$|\Delta f| \leq (0.1 \text{ PPM} + 15 \text{ Hz})$$

6.5.2 Transmit modulation

Transmit modulation defines the modulation quality for expected in-channel RF transmissions from the UE. This transmit modulation limit is specified in terms of:

- Error Vector Magnitude (EVM) for the allocated resources blocks (RB),
- EVM equalizer spectrum flatness derived from the equalizer coefficients generated by the EVM measurement process
- Carrier leakage (caused by IQ offset)

In-band emissions for the non-allocated RB

6.5.2.1 Error Vector Magnitude (EVM)

6.5.2.1.1 Test Purpose

The Error Vector Magnitude is a measure of the difference between the reference waveform and the measured waveform. This difference is called the error vector. Before calculating the EVM the measured waveform is corrected by the sample timing offset and RF frequency offset. Then the IQ origin offset shall be removed from the measured waveform before calculating the EVM.

The measured waveform is further modified by selecting the absolute phase and absolute amplitude of the Tx chain. The EVM result is defined after the front-end IDFT as the square root of the ratio of the mean error vector power to the mean reference power expressed as a %.

The basic EVM measurement interval in the time domain is one preamble sequence for the PRACH and is one slot for the PUCCH and PUSCH in the time domain. When the PUSCH or PUCCH transmission slot is shortened due to multiplexing with SRS, the EVM measurement interval is reduced by one symbol, accordingly. The PUSCH or PUCCH EVM measurement interval is also reduced when the mean power, modulation or allocation between slots is expected to change. In the case of PUSCH transmission, the measurement interval is reduced by a time interval equal to the sum of 5 μs and the applicable exclusion period defined in subclause 6.3.4, adjacent to the boundary where the power change is expected to occur. The PUSCH exclusion period is applied to the signal obtained after the front-end IDFT. In the case of PUCCH transmission, the PUCCH EVM measurement interval is reduced by one symbol adjacent to the slot boundary.

6.5.2.1.2 Test applicability

This test case applies to all types of E-UTRA UE release 8 and forward.

6.5.2.1.3 Minimum conformance requirements

EVM measurements are evaluated for 10 uplink sub-frames excluding any transient period for the average EVM case, and 60 subframes excluding any transient period for the reference signal EVM case, the different modulations schemes shall not exceed the values specified in Table 6.5.2.1.3-1 for the parameters defined in Table 6.5.2.1.3-2. For EVM

evaluation purposes, [all PRACH preamble formats 0-4 and] all PUCCH formats 1, 1a, 1b, 2, 2a and 2b are considered to have the same EVM requirement as QPSK modulated.

Table 6.5.2.1.3-1: Minimum requirements for Error Vector Magnitude

Parameter	Unit	Average EVM Level	Reference Signal EVM Level
QPSK or BPSK	%	17.5	[17.5]
16QAM	%	12.5	[12.5]

Table 6.5.2.1.3-2: Parameters for Error Vector Magnitude

Parameter	Unit	Level
UE Output Power	dBm	≥ -40
Operating conditions		Normal conditions

The normative reference for this requirement is TS 36.101 [2] clause 6.5.2.1.1.

6.5.2.1.4 Test description

6.5.2.1.4.1 Initial conditions

Initial conditions are a set of test configurations the UE needs to be tested in and the steps for the SS to take with the UE to reach the correct measurement state.

The initial test configurations consist of environmental conditions, test frequencies, and channel bandwidths based on E-UTRA bands specified in table 5.4.2.1-1. All of these configurations shall be tested with applicable test parameters for each channel bandwidth, and are shown in table 6.5.2.1.4.1-1. The details of the uplink reference measurement channels (RMCs) are specified in Annex A.2. Configurations of PDSCH and PDCCH before measurement are specified in Annex C.2.

Table 6.5.2.1.4.1-1: Test Configuration Table for PUSCH

Initial Conditions			
Test Environment (as specified in TS 36.508 [7] subclause 4.1)		NC	
Test Frequencies (as specified in TS36.508 [7] subclause 4.3.1)		See Table 6.5.1.4.1-1	
Test Channel Bandwidths (as specified in TS 36.508 [7] subclause 4.3.1)		See Table 6.5.1.4.1-1	
Test Parameters for Channel Bandwidths			
Ch BW	Downlink Configuration	Uplink Configuration	
		Mod'n	RB allocation
	N/A for PUSCH EVM testing	FDD	TDD
1.4MHz		QPSK	6
1.4MHz		QPSK	1
1.4MHz		16QAM	6
1.4MHz		16QAM	1
3MHz		QPSK	15
3MHz		QPSK	4
3MHz		16QAM	15
3MHz		16QAM	4
5MHz		QPSK	25
5MHz		QPSK	8
5MHz		16QAM	25
5MHz		16QAM	8
10MHz		QPSK	50
10MHz		QPSK	12
10MHz		16QAM	50
		(Note 3)	(Note 3)
10MHz		16QAM	12
15MHz		QPSK	75
15MHz		QPSK	16
15MHz		16QAM	75
		(Note 3)	(Note 3)
15MHz		16QAM	16
20MHz		QPSK	100
20MHz		QPSK	18
20MHz		16QAM	100
		(Note 3)	(Note 3)
20MHz		16QAM	18
Note 1: Test Channel Bandwidths are checked separately for each E-UTRA band, which applicable channel bandwidths are specified in Table 5.4.2.1-1. Note 2: For partial RB allocation, the starting resource block shall be RB #0 and RB# (max+1 - RB allocation) of the channel bandwidth. Note 3: Applies only for UE-Categories 2-5			

Table 6.5.2.1.4.1-2: Test Configuration Table for PUCCH

Initial Conditions			
Test Environment as specified in TS 36.508[7] subclause 4.1			NC
Test Frequencies as specified in TS36.508 [7] subclause 4.3.1			See Table 6.5.1.4.1-1
Test Channel Bandwidths as specified in TS 36.508 [7] subclause 4.3.1			See Table 6.5.1.4.1-1
Test Parameters for Channel Bandwidths			
Ch BW	Downlink Configuration		Uplink Configuration
	Mod'n	RB allocation	
		FDD	TDD
1.4MHz	QPSK	3	3
3MHz	QPSK	4	4
5MHz	QPSK	8	8
10MHz	QPSK	16	16
15MHz	QPSK	25	25
20MHz	QPSK	30	30
Note 1: Test Channel Bandwidths are checked separately for each E-UTRA band, the applicable channel bandwidths are specified in Table 5.4.2.1-1.			

Table 6.5.2.1.4.1-3: Test Configuration for PRACH

Initial Conditions		
Test Environment (as specified in TS 36.508 [7] subclause 4.1)		NC
Test Frequencies (as specified in TS36.508 [7] subclause 4.3.1)		See Table 6.5.1.4.1-1
Test Channel Bandwidths (as specified in TS 36.508 [7] subclause 4.3.1)		See Table 6.5.1.4.1-1
PRACH preamble format		
	FDD	TDD
PRACH Configuration Index	4	53
RS EPRE setting for test point 1 (dBm/15kHz)	-71	-63
RS EPRE setting for test point 2 (dBm/15kHz)	-86	-78

1. Connect the SS to the UE to the UE antenna connectors as shown in TS 36.508 [7] Annex A, Figure A.3.
2. The parameter settings for the cell are set up according to TS 36.508[7] subclause 4.4.3.
3. Downlink signals are initially set up according to Annex C0, C.1 and C.3.0, and uplink signals according to Annex H.1 and H.3.0.
4. The UL Reference Measurement channels are set according to in Table 6.5.2.1.4.1-1.
5. Propagation conditions are set according to Annex B.0
6. Ensure the UE is in State 3A or 3A-RF according to TS 36.508 [7] clause 4.5.3A or 5.2A.2. Message contents are defined in clause 6.5.2.1.4.3.

6.5.2.1.4.2 Test procedure

Test procedure for PUSCH:

- 1.1. SS sends uplink scheduling information for each UL HARQ process via PDCCH DCI format 0 for C_RNTI to schedule the UL RMC according to Table 6.5.2.1.4.1-1. Since the UE has no payload data to send, the UE transmits uplink MAC padding bits on the UL RMC.
- 1.2 Send continuously uplink power control “up” commands in the uplink scheduling information to the UE until the UE transmits at P_{UMAX} level.
- 1.3 Measure the EVM and \overline{EVM}_{DMRS} using Global In-Channel Tx-Test (Annex E).

1.4 Send power control “down” commands in the uplink scheduling information to the UE until UE output power is -36.8dBm, with ±3.2dB tolerance.

1.5 Measure the EVM and \overline{EVM}_{DMRS} using Global In-Channel Tx-Test (Annex E).

Test procedure for PUCCH:

2.1. PUCCH are set according to Table 6.5.2.1.4.1-2.

2.2. SS transmits PDSCH via PDCCH DCI format 1A for C_RNTI to transmit the DL RMC according to Table 6.5.2.1.4.1-2. The SS sends downlink MAC padding bits on the DL RMC. The transmission of PDSCH will make the UE send uplink ACK/NACK using PUCCH. There is no PUSCH transmission.

2.3. SS send appropriate TPC commands for PUCCH to the UE until the UE transmit PUCCH at P_{UMAX} level.

2.4. Measure PUCCH EVM using Global In-Channel Tx-Test (Annex E).

2.5. SS send appropriate TPC commands for PUCCH to the UE until the UE transmits PUCCH at -36.8dbm, with ±3.2dB tolerance. 2.6. Measure PUCCH EVM using Global In-Channel Tx-Test (Annex E).

Test procedure for PRACH:

3.1. The SS shall set RS EPRE according to Table 6.5.2.1.4.1-3.

3.2. PRACH is set according to Table 6.5.2.1.4.1-3.

3.3. The SS shall signal a Random Access Preamble ID via a PDCCH order to the UE and initiate a Non-contention based Random Access procedure

3.4. The UE shall send the signalled preamble to the SS.

3.5. In response to the preamble, the SS shall transmit a random access response not corresponding to the transmitted random access preamble, or send no response.

3.6. The UE shall consider the random access response reception not successful then re-transmit the preamble with the calculated PRACH transmission power.

3.7. Repeat step 5 and 6 until the SS collect enough PRACH preambles (2 preambles for format 0 and 10 preambles for format 4). Measure the EVM in PRACH channel using Global In-Channel Tx-Test (Annex E).

6.5.2.1.4.3 Message contents

Message contents are according to TS 36.508 [7] subclause 4.6 with the following exceptions:

Table 6.5.2.1.4.3-1: PRACH-ConfCommonDEFAULT: PRACH EVM measurement for FDD

Derivation Path: TS 36.508 [7] clause 4.6.3, Table 4.6.3-7 PRACH-ConfCommonDEFAULT			
Information Element	Value/remark	Comment	Condition
PRACH-ConfigInfo SEQUENCE {			
prach-ConfigIndex	4		

Table 6.5.2.1.4.3-2: PRACH-ConfCommonDEFAULT: PRACH EVM measurement for TDD

Derivation Path: TS 36.508 [7] clause 5.3.1, Table 5.3.1-1 PRACH-ConfCommonDEFAULT			
Information Element	Value/remark	Comment	Condition
PRACH-ConfigInfo SEQUENCE {			
prach-ConfigIndex	53		

Table 6.5.2.1.4.3-4: RACH-ConfigCommon-DEFAULT: PRACH EVM measurement

Derivation Path: TS 36.508 [7] clause 4.6.3, Table 4.6.3-12 RACH-ConfigCommon-DEFAULT			
Information Element	Value/remark	Comment	Condition
RACH-ConfigCommon-DEFAULT ::= SEQUENCE {			
preambleInfo SEQUENCE {			
numberOfRA-Preambles	n52		
preamblesGroupAConfig SEQUENCE {}	Not present		
}			
powerRampingParameters SEQUENCE {			
powerRampingStep	db0		
preambleInitialReceivedTargetPower	dBm-120 Test point 1 dBm-90 Test point 2		
}			
ra-SupervisionInfo SEQUENCE {			
preambleTransMax	n10 n20		FDD TDD
ra-ResponseWindowSize	Sf10		
mac-ContentionResolutionTimer	sf48		
}			
ra-SupervisionInfo SEQUENCE {			

Table 6.5.2.1.4.3-5: TDD-Config-DEFAULT: PRACH EVM measurement for TDD

Derivation Path: TS 36.508 [7] clause 5.3.1, Table 5.3.1-1: TDD-Config-DEFAULT			
Information Element	Value/remark	Comment	Condition
TDD-Config-DEFAULT ::= SEQUENCE {			
subframeAssignment	sa1		
specialSubframePatterns	ssp5	To enable two symbol UpPTS, and to have 9 symbols GP.	
}			

6.5.2.1.5 Test requirement

The PUSCH EVM derived in E.4.2 shall not exceed 17,5 % for QPSK and BPSK, 12,5% for 16 QAM.

The PUSCH \overline{EVM}_{DMRS} derived in E.4.8.2 shall not exceed [17,5 %] when embedded with data symbols of QPSK and BPSK, [12,5%] for 16 QAM.

The PUCCH EVM and derived in E.5.9.2 shall not exceed 17,5 %.

The PRACH EVM derived in FFS shall not exceed 17.5%.

6.5.2.1A PUSCH-EVM with exclusion period

Editor's note:

- Test Tolerances in Annex F.3.2 are defined to be zero and are applicable to clause 6.5.2.1 (EVM). It is FFS, if the same test tolerances are applicable for this test as well.

6.5.2.1A.1 Test purpose

To verify the ability of the UE transmitter to keep the EVM minimum requirements, even in the presence of transients according to subclause 6.5.2.1.1 third paragraph:

.....In the case of PUSCH transmission, the measurement interval is reduced by a time interval equal to the sum of 5 μ s and the applicable exclusion period defined in subclause 6.3.4, adjacent to the boundary where the power change is expected to occur. The PUSCH exclusion period is applied to the signal obtained after the front-end IDFT.

6.5.2.1A.2 Test applicability

This test applies to all types of E-UTRA UE release 8 and forward.

6.5.2.1A.3 Minimum conformance requirement

EVM measurements are evaluated for 10 uplink sub-frames in a reduced time interval due to exclusion periods for the average EVM. The different modulations schemes shall not exceed the values specified in Table 6.5.2.1.3-1 for the parameters defined in Table 6.5.2.1.3-2.

6.5.2.1A.4 Test description

6.5.2.1A.4.1 Initial conditions

Initial conditions are a set of test configurations the UE needs to be tested in and the steps for the SS to take with the UE to reach the correct measurement state.

The initial test configurations consist of environmental conditions, test frequencies, and channel bandwidths based on E-UTRA operating bands specified in table 5.4.2.1-1. All of these configurations shall be tested with applicable test parameters for each channel bandwidth, and are shown in table 6.5.2.1A.4.1-1. The details of the uplink reference measurement channels (RMCs) are specified in Annexes A.2. Configurations of PDSCH and PDCCH before measurement are specified in Annex C.2.

Table 6.5.2.1A.4.1-1: Test Configuration Table

Initial Conditions				
Test Environment as specified in TS 36.508[7] subclause 4.1		Normal Conditions		
Test Frequencies as specified in TS36.508 [7] subclause 4.3.1		Low range		
Test Channel Bandwidths as specified in TS 36.508 [7] subclause 4.3.1		10 MHz		
Test Parameters for Channel Bandwidths				
Ch BW	Downlink Configuration	Uplink Configuration		
		Mod'n	RB allocation	
	N/A		FDD	TDD
10MHz		QPSK	Alternating 12 and 1	Alternating 12 and 1
10MHz		16 QAM	Alternating 12 and 1	Alternating 12 and 1

1. Connect the SS to the UE antenna connectors as shown in TS 36.508 [7] Annex A, Figure A.3.
2. The parameter settings for the cell are set up according to TS 36.508 [7] subclause 4.4.3.
3. Downlink signals are initially set up according to Annex C.0, C.1 and C.3.0, and uplink signals according to Annex H.1 and H.3.0.
4. The UL Reference Measurement channel is set according to table 6.5.2.1A.4.1-1
5. Propagation conditions are set according to Annex B.0.
6. Ensure the UE is in State 3A or 3A-RF according to TS 36.508 [7] clause 4.5.3A or 5.2A.2. Message contents are defined in clause 6.3.5.2.4.3.

6.5.2.1A.4.2 Test procedure

The test pattern is illustrated in figure 6.5.2.1A.4.2-1.

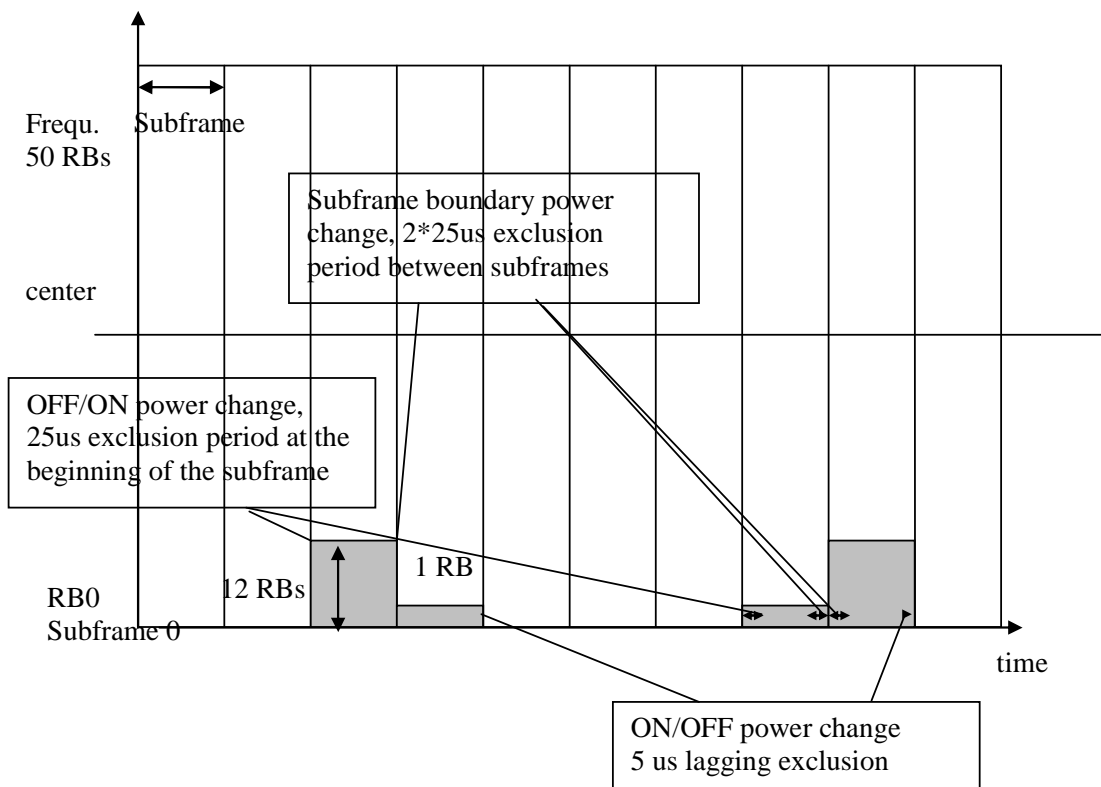

Figure 6.5.2.1A.4.2-1: Test pattern

NOTE 1: In TDD the free subframes are special subframes or DL, in FDD the free subframes are OFF.

1. SS sends uplink scheduling information for each UL HARQ process via PDCCH DCI format 0 for C_RNTI to schedule the PUSCH... Since the UE has no payload data to send, the UE transmits uplink MAC padding bits on the UL RMC. The initial uplink RB allocation is 12 as specified in Table 6.3.5.2A.1.4.1. Send appropriate TPC commands for PUSCH to the UE to ensure UE transmit PUSCH at 0dB with ± 3.2 dB tolerance.
2. Schedule the UE's PUSCH data transmission as described in Figure 6.5.2.1A.4.2-1 for 16¹⁾ active time slots with an uplink RB allocation alternating pattern as described in table 6.5.2.1A.4.1-1 while transmitting 0dB TPC command for PUSCH via the PDCCH.
3. Measure the EVM using Global In-Channel Tx-Test. The averaging across 16¹⁾ timeslots is done across mixed RB allocations, as illustrated in Figure 6.5.2.1A.4.2-1

NOTE 1: Averaging across 16 timeslots is used to represent each type of transition equally in the average.

6.5.2.1A.5 Test requirement

The PUSCH EVM derived in Annex E.4.2 taking into account Annex E.7 shall not exceed 17,5 % for QPSK and 12,5% for 16 QAM. The test requirements shall be fulfilled for early and late EVM window.

6.5.2.2 Carrier leakage

6.5.2.2.1 Test Purpose

Carrier leakage (the I/Q origin offset) is an interference caused by crosstalk or DC offset and expresses itself as unmodulated sine wave with the carrier frequency. It is an interference of approximately constant amplitude and independent of the amplitude of the wanted signal. I/Q origin offset interferes with the centre sub carriers of the UE under test (if allocated), especially, when their amplitude is small. The measurement interval is defined over one slot in the time domain.

The purpose of this test is to exercise the UE transmitter to verify its modulation quality in terms of carrier leakage.

6.5.2.2.2 Test applicability

This test case applies to all types of E-UTRA UE release 8 and forward.

6.5.2.2.3 Minimum conformance requirements

The relative carrier leakage power (IQ origin offset power) is a power ratio of the additive sinusoid waveform and the modulated waveform. The relative carrier leakage power shall not exceed the values specified in Table 6.5.2.2.3-1.

Table 6.5.2.2.3-1: Minimum requirements for Relative Carrier Leakage Power

LO Leakage	Parameters	Relative Limit (dBc)
	Output power >0 dBm	-25
	-30 dBm ≤ Output power ≤ 0 dBm	-20
	-40 dBm ≤ Output power < -30 dBm	-10

The normative reference for this requirement is TS 36.101 clause 6.5.2.2.1

6.5.2.2.4 Test description

6.5.2.2.4.1 Initial conditions

Initial conditions are a set of test configurations the UE needs to be tested in and the steps for the SS to take with the UE to reach the correct measurement state.

The initial test configurations consist of environmental conditions, test frequencies, and channel bandwidths based on E-UTRA bands specified in table 5.4.2.1-1. All of these configurations shall be tested with applicable test parameters for each channel bandwidth, and are shown in table 6.5.2.2.4.1-1. The details of the uplink reference measurement channels (RMCs) are specified in Annexes A.2. Configurations of PDSCH and PDCCH before measurement are specified in Annex C.2.

Table 6.5.2.2.4.1-1: Test Configuration Table

Initial Conditions				
Test Environment (as specified in TS 36.508 [7] subclause 4.1)		See Table 6.5.1.4.1-1		
Test Frequencies (as specified in TS36.508 [7] subclause 4.3.1)		See Table 6.5.1.4.1-1		
Test Channel Bandwidths (as specified in TS 36.508 [7] subclause 4.3.1)		See Table 6.5.1.4.1-1		
Test Parameters for Channel Bandwidths				
Ch BW	Downlink Configuration	Uplink Configuration		
	N/A for carrier leakage testing	Mod'n	RB allocation	
		FDD	TDD	
1.4MHz		QPSK	1	1
3MHz		QPSK	4	4
5MHz		QPSK	8	8
10MHz		QPSK	12	12
15MHz		QPSK	16	16
20MHz		QPSK	18	18
Note 1: Test Channel Bandwidths are checked separately for each E-UTRA band, which applicable channel bandwidths are specified in Table 5.4.2.1-1.				
Note 2: For partial RB allocation, the starting resource block shall be RB #0 and RB# (max +1-RB allocation) of the channel bandwidth.				

1. Connect the SS to the UE to the UE antenna connectors as shown in TS 36.508 [7] Annex A, Figure A.3.
2. The parameter settings for the cell are set up according to TS 36.508[7] subclause 4.4.3.
3. Downlink signals are initially set up according to Annex C0, C.1 and C.3.0, and uplink signals according to Annex H.1 and H.3.0.
4. The UL Reference Measurement channels are set according to in Table 6.5.2.2.4.1-1.
5. Propagation conditions are set according to Annex B.0
6. Ensure the UE is in State 3A or 3A-RF according to TS 36.508 [7] clause 4.5.3A or 5.2A.2. Message contents are defined in clause 6.5.2.2.4.3.

6.5.2.2.4.2 Test procedure

1. SS sends uplink scheduling information for each UL HARQ process via PDCCH DCI format 0 for C_RNTI to schedule the UL RMC according to Table 6.5.2.2.4.1-1. Since the UE has no payload and no loopback data to send the UE sends uplink MAC padding bits on the UL RMC
2. Send the appropriate TPC commands in the uplink scheduling information to the UE until UE output power is 3.2 dBm, with ± 3.2 dB tolerance.
3. Measure carrier leakage using Global In-Channel Tx-Test (Annex E). For TDD slots with transient periods are not under test.
4. Send the appropriate TPC commands in the uplink scheduling information to the UE until UE output power is -26.8 dBm, with ± 3.2 dB tolerance.
5. Measure carrier leakage using Global In-Channel Tx-Test (Annex E). For TDD slots with transient periods are not under test
6. Send the appropriate TPC commands in the uplink scheduling information to the UE until UE output power is -36.8dBm, with ± 3.2 dB tolerance.
7. Measure carrier leakage using Global In-Channel Tx-Test (Annex E). For TDD slots with transient periods are not under test

6.5.2.2.4.3 Message contents

Message contents are according to TS 36.508 [7] subclause 4.6.

6.5.2.2.5 Test requirement

Each of the 20 IQ offset results, derived in Annex E.3.1, shall not exceed the values in table 6.5.2.2.5-1

Table 6.5.2.2.5-1: Test requirements for Relative Carrier Leakage Power

LO Leakage	Parameters	Relative Limit (dBc)
	3.2 dBm \pm 3.2dB	-24.2
	-26.8 dBm \pm 3.2dB	-19.2
	-36.8dBm \pm 3.2dB	-9.2

6.5.2.3 In-band emissions for non allocated RB

6.5.2.3.1 Test Purpose

The in-band emissions are a measure of the interference falling into the non-allocated resources blocks

The in-band emission is defined as the average across 12 sub-carrier and as a function of the RB offset from the edge of the allocated UL transmission bandwidth. The in-band emission is measured as the ratio of the UE output power in a non-allocated RB to the UE output power in an allocated RB. The basic in-band emissions measurement interval is defined over one slot in the time domain. When the PUSCH or PUCCH transmission slot is shortened due to multiplexing with SRS, the in-band emissions measurement interval is reduced by one SC-FDMA symbol, accordingly.

6.5.2.3.2 Test applicability

This test case applies to all types of E-UTRA UE release 8 and forward.

6.5.2.3.3 Minimum conformance requirements

The relative in-band emission shall not exceed the values specified in Table 6.5.2.3.3-1.

Table 6.5.2.3.3-1: Minimum requirements for in-band emissions

Parameter Description	Unit	Limit (Note 1)		Applicable Frequencies
General	dB	$\max \left\{ -25 - 10 \cdot \log_{10} (N_{RB} / L_{CRBs}), \right.$ $20 \cdot \log_{10} EVM - 3 - 5 \cdot (\Delta_{RB} - 1) / L_{CRBs},$ $\left. -57 \text{ dBm} / 180 \text{ kHz} - P_{RB} \right\}$		Any non-allocated (Note 2)
IQ Image	dB	-25		Image frequencies (Notes 2, 3)
Carrier leakage	dBc	-25	Output power > 0 dBm	LO frequency (Notes 4, 5)
		-20	-30 dBm ≤ Output power ≤ 0 dBm	
		-10	-40 dBm ≤ Output power < -30 dBm	
<p>Note 1: An in-band emissions combined limit is evaluated in each non-allocated RB. For each such RB, the minimum requirement is calculated as the higher of $P_{RB} - 30$ dB and the power sum of all limit values (General, IQ Image or Carrier leakage) that apply. P_{RB} is defined in Note 10.</p> <p>Note 2: The measurement bandwidth is 1 RB and the limit is expressed as a ratio of measured power in one non-allocated RB to the measured average power per allocated RB, where the averaging is done across all allocated RBs.</p> <p>Note 3: The applicable frequencies for this limit are those that are enclosed in the reflection of the allocated bandwidth, based on symmetry with respect to the centre carrier frequency, but excluding any allocated RBs.</p> <p>Note 4: The measurement bandwidth is 1 RB and the limit is expressed as a ratio of measured power in one non-allocated RB to the measured total power in all allocated RBs.</p> <p>Note 5: The applicable frequencies for this limit are those that are enclosed in the RBs containing the DC frequency if N_{RB} is odd, or in the two RBs immediately adjacent to the DC frequency if N_{RB} is even, but excluding any allocated RB.</p> <p>Note 6: L_{CRBs} is the Transmission Bandwidth (see Figure 5.4.2-1).</p> <p>Note 7: N_{RB} is the Transmission Bandwidth Configuration (see Figure 5.4.2-1).</p> <p>Note 8: EVM is the limit specified in Table 6.5.2.1.1-1 for the modulation format used in the allocated RBs.</p> <p>Note 9: Δ_{RB} is the starting frequency offset between the allocated RB and the measured non-allocated RB (e.g. $\Delta_{RB} = 1$ or $\Delta_{RB} = -1$ for the first adjacent RB outside of the allocated bandwidth).</p> <p>Note 10: P_{RB} is the transmitted power per 180 kHz in allocated RBs, measured in dBm.</p>				

The normative reference for this requirement is TS 36.101 [2] clause 6.5.2.3.1.

The in-band emission is defined as the average across 12 sub-carrier and as a function of the RB offset from the edge of the allocated UL transmission bandwidth. The in-band emission is measured as the ratio of the UE output power in a non-allocated RB to the UE output power in an allocated RB. The basic in-band emissions measurement interval is defined over one slot in the time domain.

6.5.2.3.4 Test description

6.5.2.3.4.1 Initial conditions

Initial conditions are a set of test configurations the UE needs to be tested in and the steps for the SS to take with the UE to reach the correct measurement state.

The initial test configurations consist of environmental conditions, test frequencies, and channel bandwidths based on E-UTRA bands specified in table 5.4.2.1-1. All of these configurations shall be tested with applicable test parameters for each channel bandwidth, and are shown in table 6.5.2.3.4.1-1. The details of the uplink reference measurement channels (RMCs) are specified in Annexes A.2. Configurations of PDSCH and PDCCH before measurement are specified in Annex C.2.

Table 6.5.2.3.4.1-1: Test Configuration Table for PUSCH

Initial Conditions					
Test Environment (as specified in TS 36.508 [7] subclause 4.1)		See Table 6.5.1.4.1-1			
Test Frequencies (as specified in TS36.508 [7] subclause 4.3.1)		See Table 6.5.1.4.1-1			
Test Channel Bandwidths (as specified in TS 36.508 [7] subclause 4.3.1)		See Table 6.5.1.4.1-1			
Test Parameters for Channel Bandwidths					
Ch BW	Downlink Configuration		Uplink Configuration		
	N/A for in-band emissions testing		Mod'n	RB allocation	
1.4MHz				FDD	TDD
3MHz			QPSK	1	1
5MHz			QPSK	4	4
10MHz			QPSK	8	8
15MHz			QPSK	12	12
20MHz			QPSK	16	16
20MHz			QPSK	18	18
Note 1. Test Channel Bandwidths are checked separately for each E-UTRA band, which applicable channel bandwidths are specified in Table 5.4.2.1-1.					
Note 2. For partial RB allocation, the starting resource block shall be RB #0 and RB# (max+1 - RB allocation) of the channel bandwidth.					

Table 6.5.2.3.4.1-2: Test Configuration Table for PUCCH

Initial Conditions				
Test Environment as specified in TS 36.508[7] subclause 4.1		See Table 6.5.1.4.1-1		
Test Frequencies as specified in TS36.508 [7] subclause 4.3.1		See Table 6.5.1.4.1-1		
Test Channel Bandwidths as specified in TS 36.508 [7] subclause 4.3.1		See Table 6.5.1.4.1-1		
Test Parameters for Channel Bandwidths				
Ch BW	Downlink Configuration		Uplink Configuration	
	Mod'n	RB allocation		FDD: PUCCH format = Format 1a TDD: PUCCH format = Format 1a / 1b
		FDD	TDD	
1.4MHz	QPSK	3	3	
3MHz	QPSK	4	4	
5MHz	QPSK	8	8	
10MHz	QPSK	16	16	
15MHz	QPSK	25	25	
20MHz	QPSK	30	30	
Note 1: Test Channel Bandwidths are checked separately for each E-UTRA band, the applicable channel bandwidths are specified in Table 5.4.2.1-1.				

1. Connect the SS to the UE antenna connectors as shown in TS 36.508 [7] Figure A.3.
2. The parameter settings for the cell are set up according to TS 36.508 [7] subclause 4.4.3.
3. Downlink signals are initially set up according to Annex C.0, C.1, and C.3.0, and uplink signals according to Annex H.1 and H.3.0.
4. The UL Reference Measurement channels are set according to in Table 6.5.2.3.4.1-1.
5. Propagation conditions are set according to Annex B.0
6. Ensure the UE is in State 3A or 3A-RF according to TS 36.508 [7] clause 4.5.3A or 5.2A.2. Message contents are defined in clause 6.5.2.3.4.3.

6.5.2.3.4.2 Test procedure

Test procedure for PUSCH:

- 1.1 SS sends uplink scheduling information for each UL HARQ process via PDCCH DCI format 0 for C_RNTI to schedule the UL RMC according to Table 6.5.2.3.4.1-1. Since the UE has no payload and no loopback data to send the UE sends uplink MAC padding bits on the UL RMC

- 1.2 Send the appropriate TPC commands in the uplink scheduling information to the UE until UE output power is 3.2 dBm, with ± 3.2 dB tolerance.
- 1.3 Measure In-band emission using Global In-Channel Tx-Test (Annex E)
- 1.4 Send the appropriate TPC commands in the uplink scheduling information to the UE until UE output power is -26.8 dBm, with ± 3.2 dB tolerance.
- 1.5 Measure In-band emission using Global In-Channel Tx-Test (Annex E). For TDD slots with transient periods are not under test
- 1.6 Send the appropriate TPC commands in the uplink scheduling information to the UE until UE output power is to -36.8 dBm, with ± 3.2 dB tolerance.
- 1.7 Measure In-band emission using Global In-Channel Tx-Test (Annex E). For TDD slots with transient periods are not under test

Test procedure for PUCCH:

- 2.1 PUCCH is set according to Table 6.5.2.3.4.1-2. SS transmits PDSCH via PDCCH DCI format 1A for C_RNTI to transmit the DL RMC according to Table 6.5.2.3.4.1-2. The SS sends downlink MAC padding bits on the DL RMC. The transmission of PDSCH will make the UE send uplink ACK/NACK using PUCCH.
- 2.2 Send the appropriate TPC commands in the uplink scheduling information for PUCCH to the UE until UE output power is 3.2 dBm, with ± 3.2 dB tolerance.
- 2.3 Measure In-band emission using Global In-Channel Tx-Test (Annex E)
- 2.4 Send the appropriate TPC commands for PUCCH in the uplink scheduling information to the UE until UE output power is -26.8 dBm, with ± 3.2 dB tolerance.
- 2.5 Measure In-band emission using Global In-Channel Tx-Test (Annex E)
- 2.6 Send the appropriate TPC commands for PUCCH in the uplink scheduling information to the UE until UE output power is to -36.8 dBm, with ± 3.2 dB tolerance.
- 2.7 Measure In-band emission using Global In-Channel Tx-Test (Annex E)

6.5.2.3.4.3 Message contents

Message contents are according to TS 36.508 [7] subclause 4.6 with the following exceptions:

Table 4.6.3-8: PUCCH-ConfigCommon: PUCCH in-band emissions measurement

Derivation Path: 36.331 clause 6.3.2, Table 4.6.3-8: PUCCH-ConfigCommon-DEFAULT			
Information Element	Value/remark	Comment	Condition
PUCCH-ConfigCommon-DEFAULT ::= SEQUENCE {			
nRB-CQI	0		
}			

6.5.2.3.5 Test requirement

Each of the 20 In-band emissions results, derived in Annex E.4.3 shall not exceed the corresponding values in Table 6.5.2.3.5-1

Table 6.5.2.3.5-1: Test requirements for in-band emissions

Parameter Description	Unit	Limit (Note 1)		Applicable Frequencies
General	dB	$\max \left\{ -25 - 10 \cdot \log_{10} (N_{RB} / L_{CRBs}), \right.$ $20 \cdot \log_{10} EVM - 3 - 5 \cdot (\Delta_{RB} - 1) / L_{CRBs}, \quad +0.8$ $\left. - 57 \text{ dBm} / 180 \text{ kHz} - P_{RB} \right\}$		Any non-allocated (Note 2)
IQ Image	dB	-24.2		Image frequencies (Notes 2, 3)
DC	dBc	-24.2	Output power = 3.2dBm \pm 3.2dB	LO frequency (Notes 4, 5)
		-19.2	Output power = -26.8 dBm \pm 3.2dB	
		-9.2	Output power = -36.8 dBm \pm 3.2dB	
<p>Note 1: An in-band emissions combined limit is evaluated in each non-allocated RB. For each such RB, the test requirement is calculated as the higher of $P_{RB} - 29.2$ dB and the power sum of all limit values (General, IQ Image or Carrier leakage) that apply. P_{RB} is defined in Note 10.</p> <p>Note 2: The measurement bandwidth is 1 RB and the limit is expressed as a ratio of measured power in one non-allocated RB to the measured average power per allocated RB, where the averaging is done across all allocated RBs.</p> <p>Note 3: The applicable frequencies for this limit are those that are enclosed in the reflection of the allocated bandwidth, based on symmetry with respect to the centre carrier frequency, but excluding any allocated RBs.</p> <p>Note 4: The measurement bandwidth is 1 RB and the limit is expressed as a ratio of measured power in one non-allocated RB to the measured total power in all allocated RBs.</p> <p>Note 5: The applicable frequencies for this limit are those that are enclosed in the RBs containing the DC frequency if N_{RB} is odd, or in the two RBs immediately adjacent to the DC frequency if N_{RB} is even, but excluding any allocated RB.</p> <p>Note 6: L_{CRBs} is the Transmission Bandwidth (see Figure 5.4.2-1).</p> <p>Note 7: N_{RB} is the Transmission Bandwidth Configuration (see Figure 5.4.2-1).</p> <p>Note 8: EVM is the limit specified in Table 6.5.2.1.1-1 for the modulation format used in the allocated RBs.</p> <p>Note 9: Δ_{RB} is the starting frequency offset between the allocated RB and the measured non-allocated RB (e.g. $\Delta_{RB} = 1$ or $\Delta_{RB} = -1$ for the first adjacent RB outside of the allocated bandwidth).</p> <p>Note 10: P_{RB} is the transmitted power per 180 kHz in allocated RBs, measured in dBm.</p>				

6.5.2.4 EVM equalizer spectrum flatness

6.5.2.4.1 Test Purpose

The zero-forcing equalizer correction applied in the EVM measurement process (as described in Annex E) must meet a spectrum flatness requirement for the EVM measurement to be valid. The EVM equalizer spectrum flatness is defined in terms of the maximum peak-to-peak ripple of the equalizer coefficients (dB) across the allocated uplink block variation in dB of the equalizer coefficients generated by the EVM measurement process. The EVM equalizer spectrum flatness requirement does not limit the correction applied to the signal in the EVM measurement process but for the EVM result to be valid, the equalizer correction that was applied must meet the EVM equalizer spectrum flatness minimum requirements. The basic measurement interval is the same as for EVM.

6.5.2.4.2 Test applicability

This test case applies to all types of E-UTRA UE release 8 and forward.

6.5.2.4.3 Minimum conformance requirements

The peak-to-peak variation of the EVM equalizer coefficients contained within the frequency range of the uplink allocation shall not exceed the maximum ripple. The EVM equalizer spectrum flatness shall not exceed the values specified in Table 6.5.2.4.3-1 for normal conditions. For uplink allocations contained within both Range 1 and Range 2, the coefficients evaluated within each of these frequency ranges shall meet the corresponding ripple requirement and the following additional requirement: the relative difference between the maximum coefficient in Range 1 and the

minimum coefficient in Range 2 must not be larger than 5 dB, and the relative difference between the maximum coefficient in Range 2 and the minimum coefficient in Range 1 must not be larger than 7 dB (see Figure 6.5.2.4.3-1).

The EVM equalizer spectrum flatness shall not exceed the values specified in Table 6.5.2.4.3-2 for extreme conditions. For uplink allocations contained within both Range 1 and Range 2, the coefficients evaluated within each of these frequency ranges shall meet the corresponding ripple requirement and the following additional requirement: the relative difference between the maximum coefficient in Range 1 and the minimum coefficient in Range 2 must not be larger than 6 dB, and the relative difference between the maximum coefficient in Range 2 and the minimum coefficient in Range 1 must not be larger than 10 dB (see Figure 6.5.2.4.3-1).

Table 6.5.2.4.3-1: Minimum requirements for EVM equalizer spectrum flatness (normal conditions)

Frequency Range	Maximum Ripple [dB]
$F_{UL_Meas} - F_{UL_Low} \geq 3$ MHz and $F_{UL_High} - F_{UL_Meas} \geq 3$ MHz (Range 1)	4 (p-p)
$F_{UL_Meas} - F_{UL_Low} < 3$ MHz or $F_{UL_High} - F_{UL_Meas} < 3$ MHz (Range 2)	8 (p-p)
Note 1: F_{UL_Meas} refers to the sub-carrier frequency for which the equalizer coefficient is evaluated	
Note 2: F_{UL_Low} and F_{UL_High} refer to each E-UTRA frequency band specified in Table 5.2-1	

Table 6.5.2.4.3-2: Minimum requirements for EVM equalizer spectrum flatness (extreme conditions)

$F_{UL_Meas} - F_{UL_Low} \geq 5$ MHz and $F_{UL_High} - F_{UL_Meas} \geq 5$ MHz (Range 1)	4 (p-p)
$F_{UL_Meas} - F_{UL_Low} < 5$ MHz or $F_{UL_High} - F_{UL_Meas} < 5$ MHz (Range 2)	12 (p-p)
Note 1: F_{UL_Meas} refers to the sub-carrier frequency for which the equalizer coefficient is evaluated	
Note 2: F_{UL_Low} and F_{UL_High} refer to each E-UTRA frequency band specified in Table 5.2-1	

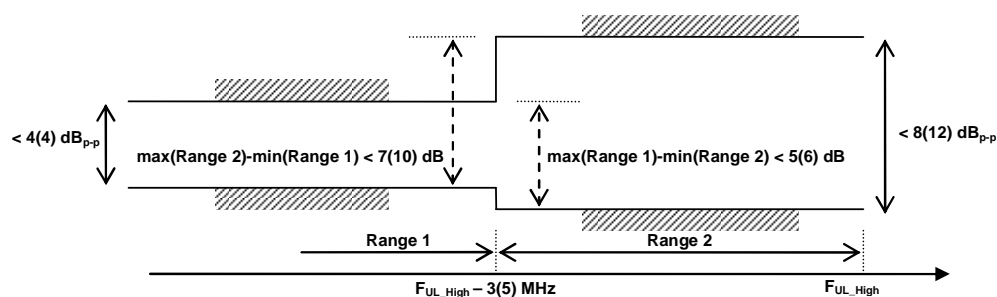

Figure 6.5.2.4.3-1: The limits for EVM equalizer spectrum flatness with the maximum allowed variation of the coefficients indicated (the ETC minimum requirement within brackets).

The normative reference for this requirement is TS 36.101 clause 6.5.2.4.1.

6.5.2.4.4 Test description

6.5.2.4.4.1 Initial conditions

Initial conditions are a set of test configurations the UE needs to be tested in and the steps for the SS to take with the UE to reach the correct measurement state.

The initial test configurations consist of environmental conditions, test frequencies, and channel bandwidths based on E-UTRA bands specified in table 5.4.2.1-1. All of these configurations shall be tested with applicable test parameters for each channel bandwidth, and are shown in table 6.4.2.4.4.1-1. The details of the uplink reference measurement channels (RMCs) are specified in A.2. Configurations of PDSCH and PDCCH before measurement are specified in Annex C.2.

Table 6.5.2.4.4.1-1: Test Configuration Table

Initial Conditions				
Test Environment (as specified in TS 36.508 [7] subclause 4.1)		See Table 6.5.1.4.1-1		
Test Frequencies (as specified in TS36.508 [7] subclause 4.3.1)		See Table 6.5.1.4.1-1		
Test Channel Bandwidths (as specified in TS 36.508 [7] subclause 4.3.1)		See Table 6.5.1.4.1-1		
Test Parameters for Channel Bandwidths				
Ch BW	Downlink Configuration	Uplink Configuration		
		Mod'n	RB allocation	
	N/A for EVM equalizer spectrum flatness testing		FDD	TDD
1.4MHz		QPSK	6	6
3MHz		QPSK	15	15
5MHz		QPSK	25	25
10MHz		QPSK	50	50
15MHz		QPSK	75	75
20MHz		QPSK	100	100
Note 1: Test Channel Bandwidths are checked separately for each E-UTRA band, which applicable channel bandwidths are specified in Table 5.4.2.1-1.				

1. Connect the SS to the UE antenna connectors as shown in TS 36.508 [7] Figure A.3.
2. The parameter settings for the cell are set up according to TS 36.508 [7] subclause 4.4.3.
3. Downlink signals are initially set up according to Annex C0, C.1 and C.3.0, and uplink signals according to Annex H.1 and H.3.0.
4. The UL Reference Measurement channels are set according to in Table 6.5.2.4.4.1-1.
5. Propagation conditions are set according to Annex B.0
6. Ensure the UE is in State 3A or 3A-RF according to TS 36.508 [7] clause 4.5.3A or 5.2A.2. Message contents are defined in clause 6.5.2.4.4.3.

6.5.2.4.4.2 Test procedure

1. SS sends uplink scheduling information for each UL HARQ process via PDCCH DCI format 0 for C_RNTI to schedule the UL RMC according to Table 6.5.2.4.4.1-1. Since the UE has no payload and no loopback data to send the UE sends uplink MAC padding bits on the UL RMC
2. Send continuously uplink power control “up” commands in the uplink scheduling information to the UE until the UE transmits at P_{UMAX} level.
3. Measure spectrum flatness using Global In-Channel Tx-Test (Annex E). For TDD slots with transient periods are not under test.

6.5.2.4.4.3 Message contents

Message contents are according to TS 36.508 [7] subclause 4.6.

6.5.2.4.5 Test requirement

Each of the 20 spectrum flatness functions, shall derive four ripple results in Annex E.4.4, The derived results shall not exceed the values in Figure 6.5.2.4.5-1:

For normal conditions, the maximum ripple in Range 1 and Range 2 shall not exceed the values specified in Table 6.5.2.4.5-1 and the following additional requirement: the relative difference between the maximum coefficient in Range 1 and the minimum coefficient in Range 2 must not be larger than 6.4 dB, and the relative difference between the maximum coefficient in Range 2 and the minimum coefficient in Range 1 must not be larger than 8.4 dB (see Figure 6.5.2.4.5-1).

For extreme conditions, the maximum ripple in Range 1 and Range 2 shall not exceed the values specified in Table 6.5.2.4.5-2 and the following additional requirement: the relative difference between the maximum coefficient in Range 1 and the minimum coefficient in Range 2 must not be larger than 7.4 dB, and the relative difference between the maximum coefficient in Range 2 and the minimum coefficient in Range 1 must not be larger than 11.4 dB (see Figure 6.5.2.4.5-1).

Table 6.5.2.4.5-1: Test requirements for EVM equalizer spectrum flatness (normal conditions)

Frequency Range	Maximum Ripple [dB]
$F_{UL_Meas} - F_{UL_Low} \geq 3 \text{ MHz}$ and $F_{UL_High} - F_{UL_Meas} \geq 3 \text{ MHz}$ (Range 1)	5.4 (p-p)
$F_{UL_Meas} - F_{UL_Low} < 3 \text{ MHz}$ or $F_{UL_High} - F_{UL_Meas} < 3 \text{ MHz}$ (Range 2)	9.4 (p-p)
Note 1: F_{UL_Meas} refers to the sub-carrier frequency for which the equalizer coefficient is evaluated	
Note 2: F_{UL_Low} and F_{UL_High} refer to each E-UTRA frequency band specified in Table 5.2-1	

Table 6.5.2.4.5-2: Test requirements for spectrum flatness (extreme conditions)

Frequency Range	Maximum Ripple [dB]
$F_{UL_Meas} - F_{UL_Low} \geq 5 \text{ MHz}$ and $F_{UL_High} - F_{UL_Meas} \geq 5 \text{ MHz}$ (Range 1)	5.4 (p-p)
$F_{UL_Meas} - F_{UL_Low} < 5 \text{ MHz}$ or $F_{UL_High} - F_{UL_Meas} < 5 \text{ MHz}$ (Range 2)	13.4 (p-p)
Note 1: F_{UL_Meas} refers to the sub-carrier frequency for which the equalizer coefficient is evaluated	
Note 2: F_{UL_Low} and F_{UL_High} refer to each E-UTRA frequency band specified in Table 5.2-1	

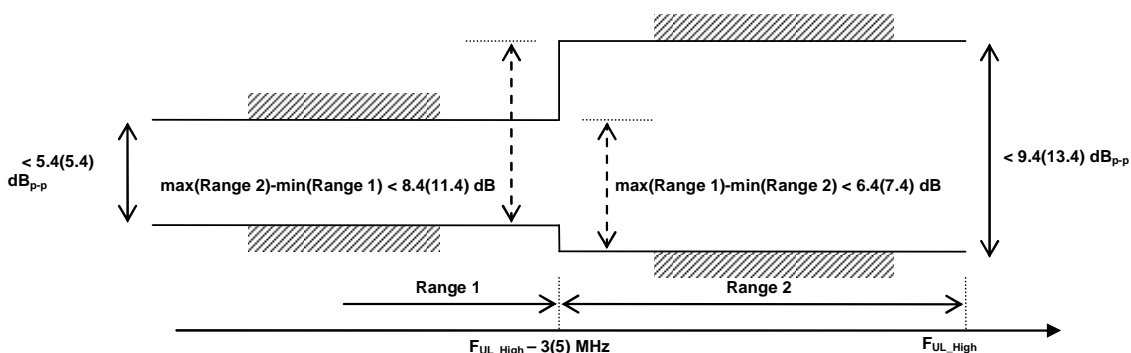

Figure 6.5.2.4.5-1: The limits for EVM equalizer spectrum flatness with the maximum allowed variation of the coefficients indicated (the ETC minimum requirement within brackets).

6.6 Output RF spectrum emissions

Unwanted emissions are divided into “Out-of-band emission” and “Spurious emissions” in 3GPP RF specifications. This notation is in line with ITU-R recommendations such as SM.329 [2] and the Radio Regulations [3].

ITU defines:

Out-of-band emission = Emission on a frequency or frequencies immediately outside the necessary bandwidth which results from the modulation process, but excluding spurious emissions.

Spurious emission = Emission on a frequency, or frequencies, which are outside the necessary bandwidth and the level of which may be reduced without affecting the corresponding transmission of information. Spurious emissions include harmonic emissions, parasitic emissions, intermodulation products and frequency conversion products but exclude out-of-band emissions.

Unwanted emissions = Consist of spurious emissions and out-of-band emissions.

The UE transmitter spectrum emission consists of the three components; the occupied bandwidth (channel bandwidth), the Out Of Band (OOB) emissions and the far out spurious emission domain.

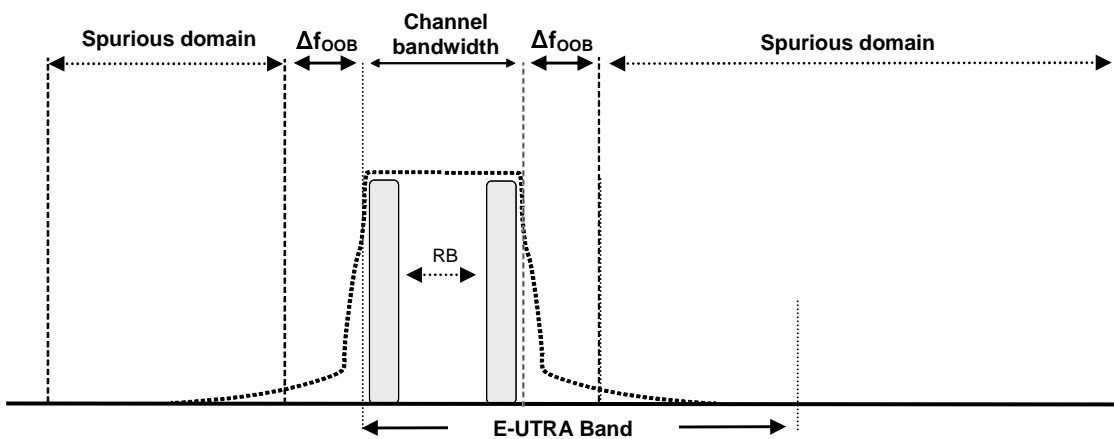

Figure 6.6-1: Transmitter RF spectrum

6.6.1 Occupied bandwidth

6.6.1.1 Test purpose

To verify that the UE occupied bandwidth for all transmission bandwidth configurations supported by the UE are less than their specific limits

6.6.1.2 Test applicability

This test applies to all types of E-UTRA UE release 8 and forward.

6.6.1.2 Minimum conformance requirements

Occupied bandwidth is a measure of the bandwidth containing 99 % of the total integrated mean power of the transmitted spectrum on the assigned channel. The occupied channel bandwidth for all transmission bandwidth configurations (Resources Blocks) should be less than the channel bandwidth specified in Table 6.6.1.2-1

Table 6.6.1.2-1: Occupied channel bandwidth

	Occupied channel bandwidth / channel bandwidth					
	1.4 MHz	3.0 MHz	5 MHz	10 MHz	15 MHz	20 MHz
Channel bandwidth [MHz]	1.4	3	5	10	15	20

The normative reference for this requirement is TS 36.101 [2] clause 6.6.1.

6.6.1.4 Test description

6.6.1.4.1 Initial conditions

Initial conditions are a set of test configurations the UE needs to be tested in and the steps for the SS to take with the UE to reach the correct measurement state.

The initial test configurations consist of environmental conditions, test frequencies, and channel bandwidths based on E-UTRA operating bands specified in table 5.4.2.1-1. All of these configurations shall be tested with applicable test parameters for each channel bandwidth, and are shown in table 6.6.1.4.1-1. The details of the uplink reference measurement channels (RMCs) are specified in Annexes A.2. Configurations of PDSCH and PDCCH before measurement are specified in Annex C.2.

Table 6.6.1.4.1-1: Test Configuration Table

Initial Conditions					
Test Environment as specified in TS 36.508[7] subclause 4.1	Normal				
Test Frequencies as specified in TS36.508 [7] subclause 4.3.1	Mid range				
Test Channel Bandwidths as specified in TS 36.508 [7] subclause 4.3.1	All				
Test Parameters for Channel Bandwidths					
Ch BW	Downlink Configuration		Uplink Configuration		
	N/A for Occupied bandwidth		Mod'n	RB allocation	
				FDD	TDD
1.4MHz			QPSK	6	6
3MHz			QPSK	15	15
5MHz			QPSK	25	25
10MHz			QPSK	50	50
15MHz			QPSK	75	75
20MHz			QPSK	100	100
Note 1: Test Channel Bandwidths are checked separately for each E-UTRA band, the applicable channel bandwidths are specified in Table 5.4.2.1-1.					

1. Connect the SS to the UE antenna connectors as shown in TS 36.508 [7] Annex A, Figure A.3.
2. The parameter settings for the cell are set up according to TS 36.508 [7] subclause 4.4.3.
3. Downlink signals are initially set up according to Annex C0, C.1 and C.3.0, and uplink signals according to Annex H.1 and H.3.0.
4. The UL Reference Measurement channels are set according to Table 6.6.1.4.1-1.
5. Propagation conditions are set according to Annex B.0
6. Ensure the UE is in State 3A or 3A-RF according to TS 36.508 [7] clause 4.5.3A or 5.2A.2. Message contents are defined in clause 6.6.1.4.3

6.6.1.4.2 Test procedure

1. SS sends uplink scheduling information for each UL HARQ process via PDCCH DCI format 0 for C_RNTI to schedule the UL RMC according to Table 6.6.1.4.1-1. Since the UE has no payload and no loopback data to send the UE sends uplink MAC padding bits on the UL RMC.
2. Send continuously power control “up” commands to the UE until the UE transmits at P_{UMAX} level.
3. Measure the power spectrum distribution within two times or more range over the requirement for Occupied Bandwidth specification centring on the current carrier frequency. The characteristic of the filter shall be approximately Gaussian (typical spectrum analyzer filter). Other methods to measure the power spectrum distribution are allowed. The measuring duration is one active uplink subframe. For TDD slots with transient periods are not under test.
4. Calculate the total power within the range of all frequencies measured in '3)' and save this value as "Total Power".
5. Sum up the power upward from the lower boundary of the measured frequency range in '3)' and seek the limit frequency point by which this sum becomes 0,5 % of "Total Power" and save this point as "Lower Frequency".
6. Sum up the power downward from the upper boundary of the measured frequency range in '3)' and seek the limit frequency point by which this sum becomes 0,5 % of "Total Power" and save this point as "Upper Frequency".
7. Calculate the difference ("Upper Frequency" – "Lower Frequency" = "Occupied Bandwidth") between two limit frequencies obtained in '5)' and '6)'.

6.6.1.4.3 Message contents

Message contents are according to TS 36.508 [7] subclause 4.6

6.6.1.5 Test requirement

The measured Occupied Bandwidth shall not exceed values in Table 6.6.1.5-1.

Table 6.6.1.5-1: Occupied channel bandwidth

	Occupied channel bandwidth / channel bandwidth					
	1.4 MHz	3.0 MHz	5 MHz	10 MHz	15 MHz	20 MHz
Channel bandwidth [MHz]	1.4	3	5	10	15	20

6.6.2 Out of band emission

Out of band emissions are unwanted emissions immediately outside the nominal channel resulting from the modulation process and non-linearity in the transmitter but excluding spurious emissions. This out of band emission limit is specified in terms of a Spectrum Emission Mask and Adjacent Channel Leakage power Ratio.

6.6.2.1 Spectrum Emission Mask

6.6.2.1.1 Test purpose

To verify that the power of any UE emission shall not exceed specified level for the specified channel bandwidth.

6.6.2.1.2 Test applicability

This test case applies to all types of E-UTRA FDD UE release 8 and forward.

6.6.2.1.3 Minimum conformance requirements

The spectrum emission mask of the UE applies to frequencies (Δf_{OoB}) starting from the edge of the assigned E-UTRA channel bandwidth. For frequencies greater than (Δf_{OoB}) as specified in Table 6.6.2.1.3-1 the spurious requirements in clause 6.6.3 are applicable.

The power of any UE emission shall not exceed the levels specified in Table 6.6.2.1.3-1 for the specified channel bandwidth.

Table 6.6.2.1.3-1: General E-UTRA spectrum emission mask

Spectrum emission limit (dBm)/ Channel bandwidth							
Δf_{OoB} (MHz)	1.4 MHz	3.0 MHz	5 MHz	10 MHz	15 MHz	20 MHz	Measurement bandwidth
$\pm 0-1$	-10	-13	-15	-18	-20	-21	30 kHz
$\pm 1-2.5$	-10	-10	-10	-10	-10	-10	1 MHz
$\pm 2.5-2.8$	-25	-10	-10	-10	-10	-10	1 MHz
$\pm 2.8-5$		-10	-10	-10	-10	-10	1 MHz
$\pm 5-6$		-25	-13	-13	-13	-13	1 MHz
$\pm 6-10$			-25	-13	-13	-13	1 MHz
$\pm 10-15$				-25	-13	-13	1 MHz
$\pm 15-20$					-25	-13	1 MHz
$\pm 20-25$						-25	1 MHz

NOTE: As a general rule, the resolution bandwidth of the measuring equipment should be equal to the measurement bandwidth. However, to improve measurement accuracy, sensitivity and efficiency, the resolution bandwidth may be smaller than the measurement bandwidth. When the resolution bandwidth is smaller than the measurement bandwidth, the result should be integrated over the measurement bandwidth in order to obtain the equivalent noise bandwidth of the measurement bandwidth.

The normative reference for this requirement is TS 36.101 [2] clause 6.6.2.1.

6.6.2.1.4 Test description

6.6.2.1.4.1 Initial conditions

Initial conditions are a set of test configurations the UE needs to be tested in and the steps for the SS to take with the UE to reach the correct measurement state.

The initial test configurations consist of environmental conditions, test frequencies, and channel bandwidths based on E-UTRA bands specified in table 5.4.2.1-1. All of these configurations shall be tested with applicable test parameters for each channel bandwidth, and are shown in table 6.6.2.1.4.1-1. The details of the uplink reference measurement channels (RMCs) are specified in Annexes A.2 respectively. Configurations of PDSCH and PDCCH before measurement are specified in Annex C.2.

Table 6.6.2.1.4.1-1: Test Configuration Table

Initial Conditions				
Test Environment (as specified in TS 36.508 [7] subclause 4.1)		NC		
Test Frequencies (as specified in TS36.508 [7] subclause 4.3.1)		Low range, Mid range, High range		
Test Channel Bandwidths (as specified in TS 36.508 [7] subclause 4.3.1)		Lowest, 5MHz, 10MHz, Highest		
Test Parameters for Channel Bandwidths				
Ch BW	Downlink Configuration	Uplink Configuration		
	N/A for SEM testing	Mod'n	RB allocation	
			FDD	TDD
1.4MHz		QPSK	6	6
1.4MHz		QPSK	5	5
1.4MHz		16QAM	5	5
1.4MHz		16QAM	6	6
3MHz		QPSK	15	15
3MHz		QPSK	4	4
3MHz		16QAM	4	4
3MHz		16QAM	15	15
5MHz		QPSK	25	25
5MHz		QPSK	8	8
5MHz		16QAM	8	8
5MHz		16QAM	25	25
10MHz		QPSK	50	50
10MHz		QPSK	12	12
10MHz		16QAM	12	12
10MHz		16QAM	50 (Note 4)	50 (Note 4)
15MHz		QPSK	75	75
15MHz		QPSK	16	16
15MHz		16QAM	16	16
15MHz		16QAM	75 (Note 4)	75 (Note 4)
20MHz		QPSK	100	100
20MHz		QPSK	18	18
20MHz		16QAM	18	18
20MHz		16QAM	100 (Note 4)	100 (Note 4)
Note 1: Test Channel Bandwidths are checked separately for each E-UTRA band, which applicable channel bandwidths are specified in Table 5.4.2.1-1. Note 2: The allowed MPR for maximum output power UE might apply is described in clause 6.2.3.3. Note 3: The starting resource block of partial RB allocation shall be RB#0 and RB# (max+1 - RB allocation) of the channel bandwidth. Note 4: Applies only for UE-Categories 2-5				

1. Connect the SS to the UE antenna connectors as shown in Figure TS 36.508 [7] Annex A, Figure A.3.
2. The parameter settings for the cell are set up according to TS 36.508 [7] subclause 4.4.3.
3. Downlink signals are initially set up according to Annex C0, C.1 and C.3.0, and uplink signals according to Annex H.1 and H.3.0.
4. The UL Reference Measurement channels are set according to Table 6.6.2.1.4.1-1.
5. Propagation conditions are set according to Annex B.0.
6. Ensure the UE is in State 3A or 3A-RF according to TS 36.508 [7] clause 4.5.3A or 5.2A.2. Message contents are defined in clause 6.6.2.1.4.3.

6.6.2.1.4.2 Test procedure

1. SS sends uplink scheduling information via PDCCH DCI format 0 for C_RNTI to schedule the UL RMC according to Table 6.6.2.1.4.1-1. Since the UE has no payload data to send, the UE transmits uplink MAC padding bits on the UL RMC.
2. Send continuously uplink power control “up” commands in the uplink scheduling information to the UE until the UE transmits at P_{UMAX} level.
3. Measure the mean power of the UE in the channel bandwidth of the radio access mode according to the test configuration, which shall meet the requirements described in Tables 6.2.2.5-1 and 6.2.3.5-1. The period of the measurement shall be at least the continuous duration of one sub-frame (1ms). For TDD slots with transient periods are not under test.
4. Measure the power of the transmitted signal with a measurement filter of bandwidths according to table 6.6.2.1.5-1. The centre frequency of the filter shall be stepped in continuous steps according to table 6.6.2.1.5-1. The measured power shall be recorded for each step. The measurement period shall capture the active TSs.

6.6.2.1.4.3 Message contents

Message contents are according to TS 36.508 [7] subclause 4.6.

6.6.2.1.5 Test requirements

The power of any UE emission shall fulfil requirements in Table.6.6.2.1.5-1.

Table 6.6.2.1.5-1: General E-UTRA spectrum emission mask

Δf_{OOB} (MHz)	Spectrum emission limit (dBm)/ Channel bandwidth						Measurement bandwidth
	1.4 MHz	3.0 MHz	5 MHz	10 MHz	15 MHz	20 MHz	
0-1	-8.5	-11.5	-13.5	-16.5	-18.5	-19.5	30 kHz
1-2.5	-8.5	-8.5	-8.5	-8.5	-8.5	-8.5	1 MHz
2.5-2.8	-23.5						1 MHz
2.8-5							1 MHz
5-6		-23.5	-11.5	-11.5	-11.5	-11.5	1 MHz
6-10			-23.5				1 MHz
10-15				-23.5			1 MHz
15-20					-23.5		1 MHz
20-25						-23.5	1 MHz
Note 1:	The first and last measurement position with a 30 kHz filter is at Δf_{OOB} equals to 0.015 MHz and 0.985 MHz.						
Note 2:	At the boundary of spectrum emission limit, the first and last measurement position with a 1 MHz filter is the inside of +0.5MHz and -0.5MHz, respectively.						
Note 3:	The measurements are to be performed above the upper edge of the channel and below the lower edge of the channel						
Note 4:	For the 2.5-2.8 MHz offset range with 1.4 MHz channel bandwidth, the measurement position is at Δf_{OOB} equals to 3 MHz.						

NOTE: As a general rule, the resolution bandwidth of the measuring equipment should be equal to the measurement bandwidth. However, to improve measurement accuracy, sensitivity and efficiency, the resolution bandwidth may be smaller than the measurement bandwidth. When the resolution bandwidth is smaller than the measurement bandwidth, the result should be integrated over the measurement bandwidth in order to obtain the equivalent noise bandwidth of the measurement bandwidth.

6.6.2.2 Additional Spectrum Emission Mask

6.6.2.2.1 Test purpose

To verify that the power of any UE emission shall not exceed specified level for the specified channel bandwidth under the deployment scenarios where additional requirements are specified.

6.6.2.2.2 Test applicability

This test case applies to all types of E-UTRA UE release 8 and forward.

6.6.2.2.3 Minimum conformance requirements

6.6.2.2.3.1 Minimum requirement (network signalled value "NS_03")

When "NS_03" is indicated in the cell, the power of any UE emission shall not exceed the levels specified in Table 6.6.2.2.3.1-1.

Table 6.6.2.2.3.1-1: Additional requirements (network signalled value "NS_03")

Δf_{OoB} (MHz)	Spectrum emission limit (dBm)/ Channel bandwidth						Measurement bandwidth
	1.4 MHz	3.0 MHz	5 MHz	10 MHz	15 MHz	20 MHz	
$\pm 0-1$	-10	-13	-15	-18	-20	-21	30 kHz
$\pm 1-2.5$	-13	-13	-13	-13	-13	-13	1 MHz
$\pm 2.5-2.8$	-25	-13	-13	-13	-13	-13	1 MHz
$\pm 2.8-5$		-13	-13	-13	-13	-13	1 MHz
$\pm 5-6$		-25	-13	-13	-13	-13	1 MHz
$\pm 6-10$			-25	-13	-13	-13	1 MHz
$\pm 10-15$				-25	-13	-13	1 MHz
$\pm 15-20$					-25	-13	1 MHz
$\pm 20-25$						-25	1 MHz

NOTE: As a general rule, the resolution bandwidth of the measuring equipment should be equal to the measurement bandwidth. However, to improve measurement accuracy, sensitivity and efficiency, the resolution bandwidth may be smaller than the measurement bandwidth. When the resolution bandwidth is smaller than the measurement bandwidth, the result should be integrated over the measurement bandwidth in order to obtain the equivalent noise bandwidth of the measurement bandwidth.

The normative reference for this requirement is TS 36.101 [2] clause 6.6.2.2.1.

6.6.2.2.3.2 Minimum requirement (network signalled value "NS_04")

When "NS_04" is indicated in the cell, the power of any UE emission shall not exceed the levels specified in Table 6.6.2.2.3.2-1.

Table 6.6.2.2.3.2-1: Additional requirements (network signalled value "NS_04")

Δf_{OoB} (MHz)	Spectrum emission limit (dBm)/ Channel bandwidth						Measurement bandwidth
	1.4 MHz	3.0 MHz	5 MHz	10 MHz	15 MHz	20 MHz	
$\pm 0-1$	-10	-13	-15	-18	-20	-21	30 kHz
$\pm 1-2.5$	-13	-13	-13	-13	-13	-13	1 MHz
$\pm 2.5-2.8$	-25	-13	-13	-13	-13	-13	1 MHz
$\pm 2.8-5.5$		-13	-13	-13	-13	-13	1 MHz
$\pm 5.5-6$		-25	-25	-25	-25	-25	1 MHz
$\pm 6-10$			-25	-25	-25	-25	1 MHz
$\pm 10-15$				-25	-25	-25	1 MHz
$\pm 15-20$					-25	-25	1 MHz
$\pm 20-25$						-25	1 MHz

NOTE: As a general rule, the resolution bandwidth of the measuring equipment should be equal to the measurement bandwidth. However, to improve measurement accuracy, sensitivity and efficiency, the resolution bandwidth may be smaller than the measurement bandwidth. When the resolution bandwidth is smaller than the measurement bandwidth, the result should be integrated over the measurement bandwidth in order to obtain the equivalent noise bandwidth of the measurement bandwidth.

The normative reference for this requirement is TS 36.101 [2] clause 6.6.2.2.2.

6.6.2.2.3.3 Minimum requirement (network signalled value "NS_06" or NS_07)

When "NS_06" or "NS_07" is indicated in the cell, the power of any UE emission shall not exceed the levels specified in Table 6.6.2.2.3.3-1.

Table 6.6.2.2.3.3-1: Additional requirements (network signalled value "NS_06" or "NS_07")

Δf_{OOB} (MHz)	Spectrum emission limit (dBm)/ Channel bandwidth				
	1.4 MHz	3.0 MHz	5 MHz	10 MHz	Measurement bandwidth
$\pm 0-0.1$	-13	-13	-15	-18	30 kHz
$\pm 0.1-1$	-13	-13	-13	-13	100 kHz
$\pm 1-2.5$	-13	-13	-13	-13	1 MHz
$\pm 2.5-2.8$	-25	-13	-13	-13	1 MHz
$\pm 2.8-5$		-13	-13	-13	1 MHz
$\pm 5-6$		-25	-13	-13	1 MHz
$\pm 6-10$			-25	-13	1 MHz
$\pm 10-15$				-25	1 MHz

NOTE: As a general rule, the resolution bandwidth of the measuring equipment should be equal to the measurement bandwidth. However, to improve measurement accuracy, sensitivity and efficiency, the resolution bandwidth may be smaller than the measurement bandwidth. When the resolution bandwidth is smaller than the measurement bandwidth, the result should be integrated over the measurement bandwidth in order to obtain the equivalent noise bandwidth of the measurement bandwidth.

The normative reference for this requirement is TS 36.101 [2] clause 6.6.2.2.3.

6.6.2.2.4 Test description

6.6.2.2.4.1 Initial conditions

Initial conditions are a set of test configurations the UE needs to be tested in and the steps for the SS to take with the UE to reach the correct measurement state.

The initial test configurations consist of environmental conditions, test frequencies, and channel bandwidths based on E-UTRA bands specified in table 5.4.2.1-1. All of these configurations shall be tested with applicable test parameters for each channel bandwidth, and are shown in tables 6.6.2.2.4.1-1, 6.6.2.2.4.1-2, and 6.6.2.2.4.1-3. The details of the uplink reference measurement channels (RMCs) are specified in Annex A.2 respectively. Configurations of PDSCH and PDCCH before measurement are specified in Annex C.2.

Table 6.6.2.4.1-1: Test Configuration Table (network signalled value “NS_03”)

Initial Conditions						
Test Environment (as specified in TS 36.508 [7] subclause 4.1)				NC		
Test Frequencies (as specified in TS36.508 [7] subclause 4.3.1)				Low range, Mid range, High range		
Test Channel Bandwidths (as specified in TS 36.508 [7] subclause 4.3.1)				Lowest, 5MHz, 10MHz, Highest		
Test Parameters for Channel Bandwidths						
Ch BW	Downlink Configuration			Uplink Configuration		
	Mod'n	RB allocation		Mod'n	RB allocation	
		FDD	TDD		FDD	TDD
1.4MHz	N/A for Additional Spectrum Emission Mask testing.			QPSK	6	6
1.4MHz				QPSK	5	5
1.4MHz				16QAM	5	5
3MHz				QPSK	15	15
3MHz				QPSK	4	4
3MHz				16QAM	15	15
3MHz				16QAM	4	4
5MHz				QPSK	25	25
5MHz				QPSK	8	8
5MHz				QPSK	6	6
5MHz				16QAM	25	25
5MHz				16QAM	8	8
10MHz				QPSK	50	50
10MHz				QPSK	12	12
10MHz				QPSK	6	6
10MHz				16QAM	50 (Note 3)	50 (Note 3)
10MHz				16QAM	12	12
15MHz				QPSK	75	75
15MHz				QPSK	16	16
15MHz				QPSK	8	8
15MHz			16QAM	75 (Note 3)	75 (Note 3)	
15MHz			16QAM	16	16	
20MHz			QPSK	100	100	
20MHz			QPSK	18	18	
20MHz			QPSK	10	10	
20MHz			16QAM	100 (Note 3)	100 (Note 3)	
20MHz			16QAM	18	18	

Note 1: Test Channel Bandwidths are checked separately for each E-UTRA band, the applicable channel bandwidths are specified in Table 5.4.2.1-1.

Note 2: The starting resource block of partial RB allocation shall be RB# 0 and RB# (max +1 - RB allocation) of the channel bandwidth.

Note 3: Applies only for UE-Categories 2-5

Table 6.6.2.4.1-2: Test Configuration Table (network signalled value “NS_06”)

Initial Conditions						
Test Environment (as specified in TS 36.508 [7] subclause 4.1)				NC		
Test Frequencies (as specified in TS36.508 [7] subclause 4.3.1)				Low range, Mid range, High range		
Test Channel Bandwidths (as specified in TS 36.508 [7] subclause 4.3.1)				Lowest, 5MHz, 10MHz, Highest		
Test Parameters for Channel Bandwidths						
Ch BW	Downlink Configuration			Uplink Configuration		
	Mod'n	RB allocation		Mod'n	RB allocation	
		FDD	TDD		FDD	TDD
1.4MHz	N/A for Additional Spectrum Emission Mask testing.			QPSK	6	NA
1.4MHz				QPSK	5	
1.4MHz				16QAM	5	
3MHz				QPSK	15	
3MHz				QPSK	4	
3MHz				16QAM	4	
5MHz				QPSK	25	
5MHz				QPSK	8	
5MHz				16QAM	8	
10MHz				QPSK	50	
10MHz				QPSK	12	
10MHz				16QAM	12	
15MHz				QPSK	75	
15MHz				QPSK	16	
15MHz				16QAM	16	
20MHz				QPSK	100	
20MHz				QPSK	18	
20MHz			16QAM	18		
Note 1: Test Channel Bandwidths are checked separately for each E-UTRA band, the applicable channel bandwidths are specified in Table 5.4.2.1-1.						
Note 2: The starting resource block of partial RB allocation shall be RB# 0 and RB# (max +1 - RB allocation) of the channel bandwidth.						

Table 6.6.2.4.1-3: Test Configuration Table (network signalled value "NS_07")

Initial Conditions						
Test Environment (as specified in TS 36.508 [7] subclause 4.1)				NC		
Test Frequencies (as specified in TS36.508 [7] subclause 4.3.1)				Mid range		
Test Channel Bandwidths (as specified in TS 36.508 [7] subclause 4.3.1)				10MHz		
Test Parameters for Channel Bandwidths						
Test Number	Ch BW	Downlink Configuration		Uplink Configuration		
		Mod'n	RB allocation FDD	Mod'n	RB allocation FDD	RB_start
1	10MHz	N/A for Additional Spectrum Emission Mask testing.		QPSK	1	0
2	10MHz			QPSK	8	0
3	10MHz			QPSK	6	13
4	10MHz			QPSK	20	13
5	10MHz			QPSK	12	13
6	10MHz			16QAM	36 (Note 1)	13
7	10MHz			QPSK	16	19
8	10MHz			QPSK	12	19
9	10MHz			16QAM	16	19
10	10MHz			QPSK	30	19
11	10MHz			16QAM	30 (Note 1)	19
12	10MHz			QPSK	6	43
13	10MHz			QPSK	2	48
14	10MHz			QPSK	50	0
15	10MHz			QPSK	12	0
16	10MHz			16QAM	50 (Note 1)	0
Note 1: Applies only for UE-Categories 2-5						

Table 6.6.2.4.1-4: Test Configuration Table (network signalled value "NS_04")

Initial Conditions						
Test Environment (as specified in TS 36.508 [7] subclause 4.1)				NC		
Test Frequencies (as specified in TS36.508 [7] subclause 4.3.1)				Low range, Mid range, High range		
Test Channel Bandwidths (as specified in TS 36.508 [7] subclause 4.3.1)				5MHz, 10 MHz, 15 MHz, 20MHz		
Test Parameters for NS_04 A-MPR						
Configuration ID	Ch BW	Downlink Configuration		Uplink Configuration		
		Mod'n	RB allocation TDD	Mod'n	RB allocation TDD	RB_start TDD
1	5MHz	N/A for Additional Spectrum Emission Mask testing.		QPSK	25	Note 2
2	5MHz			QPSK	8	Note 2
3	5MHz			QPSK	6	Note 2
4	5MHz			16QAM	25	Note 2
5	5MHz			16QAM	8	Note 2
6	10MHz			QPSK	1	0
7	10MHz			QPSK	12	0
8	10MHz			QPSK	50	0
9	10MHz			16QAM	50 (Note 3)	0
10	10MHz			QPSK	24	13
11	10MHz			16QAM	24	13
12	10MHz			QPSK	36 (Note 3)	13
13	10MHz			QPSK	12	37
14	10MHz			QPSK	1	49
15	15MHz			QPSK	1	0
16	15MHz			QPSK	16	0
17	15MHz			QPSK	75	0
18	15MHz			16QAM	75 (Note 3)	0
19	15MHz			QPSK	36	19
20	15MHz			16QAM	36	19
21	15MHz			QPSK	50	19
22	15MHz			QPSK	18	56
23	15MHz			QPSK	1	74
24	20MHz			QPSK	1	0
25	20MHz			QPSK	18	0
26	20MHz			QPSK	100	0
27	20MHz			16QAM	100 (Note 3)	0
28	20MHz			QPSK	50	25
29	20MHz			16QAM	50	25
30	20MHz			QPSK	75 (Note 3)	25
31	20MHz			QPSK	25	75
32	20MHz			QPSK	1	99
Note 1: Test Channel Bandwidths are checked separately for E-UTRA band, the applicable channel bandwidths are specified in Table 5.4.2.1-1.						
Note 2: The starting resource block of partial RB allocation shall be RB# 0 and RB# (max +1 - RB allocation) of the channel bandwidth.						
Note 3: Applies only for UE-Categories 2-5						

1. Connect the SS to the UE antenna connectors as shown in TS 36.508 [7] Annex A, Figure A.3.
2. The parameter settings for the cell are set up according to TS 36.508 [7] subclause 4.4.3.
3. Downlink signals are initially set up according to Annex C0, C.1 and C.3.0, and uplink signals according to Annex H.1 and H.3.0.
4. The DL Reference Measurement channels are set according to Tables 6.6.2.4.1-1, 6.6.2.4.1-2, 6.6.2.4.1-3 and 6.6.2.4.1-4.

5. Propagation conditions are set according to Annex B.0.
6. Ensure the UE is in State 3A or 3A-RF according to TS 36.508 [7] clause 4.5.3A or 5.2A.2. Message contents are defined in clause 6.6.2.2.4.3.

6.6.2.2.4.2 Test procedure

1. SS sends uplink scheduling information for each UL HARQ process via PDCCH DCI format 0 for C_RNTI to schedule the UL RMC according to the corresponding Table 6.6.2.2.4.1-1, 6.6.2.2.4.1-2, 6.6.2.2.4.1-3 or 6.6.2.2.4.1-4. Since the UE has no payload data to send, the UE transmits uplink MAC padding bits on the UL RMC.
- a) 2. Send continuously uplink power control “up” commands in the uplink scheduling information to the UE until the UE transmits at P_{UMAX} level.
3. Measure the mean power of the UE in the channel bandwidth of the radio access mode according to the test configuration, which shall meet the requirements described in Tables 6.2.2.5-1, 6.2.3.5-1, 6.2.4.5-1, and 6.2.4.5-2. The period of the measurement shall be at least one sub-frame (1ms).4. Measure the power of the transmitted signal with a measurement filter of bandwidths according to table 6.6.2.2.5.1-1, 6.6.2.2.5.2-1, 6.6.2.2.5.3-1. The centre frequency of the filter shall be stepped in continuous steps according to table 6.6.2.2.5.1-1, 6.6.2.2.5.2-1, 6.6.2.2.5.3-1. The measured power shall be recorded for each step. The measurement period shall capture the active TSs.

6.6.2.2.4.3 Message contents

Message contents are according to TS 36.508 [7] subclause 4.6, with the following exceptions for each network signalled value.

6.6.2.2.4.3.1 Message contents exceptions (network signalled value "NS_03")

1. Information element `additionalSpectrumEmission` is set to NS_03. This can be set in the *SystemInformationBlockType2* as part of the cell broadcast message. This exception indicates that the UE shall meet the additional spurious emission requirement for a specific deployment scenario.

Table 6.6.2.2.4.3.1-1: SystemInformationBlockType2 :Additional spurious emissions requirement

Derivation Path: TS 36.508 [7] clause 4.4.3.3, Table 4.4.3.3-1			
Information Element	Value/remark	Comment	Condition
<code>additionalSpectrumEmission</code>	3 (NS_03)		

6.6.2.2.4.3.2 Message contents exceptions (network signalled value "NS_04")

1. Information element `additionalSpectrumEmission` is set to NS_04. This can be set in the *SystemInformationBlockType2* as part of the cell broadcast message. This exception indicates that the UE shall meet the additional spurious emission requirement for a specific deployment scenario.

Table 6.6.2.2.4.3.2-1: SystemInformationBlockType2 :Additional spurious emissions requirement

Derivation Path: TS 36.508 [7] clause 4.4.3.3, Table 4.4.3.3-1			
Information Element	Value/remark	Comment	Condition
<code>additionalSpectrumEmission</code>	4 (NS_04)		

6.6.2.2.4.3.3 Message contents exceptions (network signalled value "NS_06")

1. Information element `additionalSpectrumEmission` is set to NS_06. This can be set in the *SystemInformationBlockType2* as part of the cell broadcast message. This exception indicates that the UE shall meet the additional spurious emission requirement for a specific deployment scenario.

Table 6.6.2.2.4.3.3-1: SystemInformationBlockType2 :Additional spurious emissions requirement

Derivation Path: TS 36.508 [7] clause 4.4.3.3, Table 4.4.3.3-1			
Information Element	Value/remark	Comment	Condition
additionalSpectrumEmission	6 (NS_06)		

6.6.2.2.4.3.4 Message contents exceptions (network signalled value "NS_07")

- a) 1. Information element additionalSpectrumEmission is set to NS_07. This can be set in the SystemInformationblockType2 as part of the cell broadcast message. This exception indicates that the UE shall meet the additional spurious emission requirement for a specific deployment scenario.

Table 6.6.2.2.4.3.4-1: SystemInformationBlockType2 :Additional spurious emissions requirement

Derivation Path: TS 36.508 [7] clause 4.4.3.3, Table 4.4.3.3-1			
Information Element	Value/remark	Comment	Condition
additionalSpectrumEmission	7 (NS_07)		

6.6.2.2.5 Test requirements

6.6.2.2.5.1 Test requirements (network signalled value "NS_03")

When "NS_03" is indicated in the cell, the power of any UE emission shall fulfil requirements in Table 6.6.2.2.5.1-1.

Table 6.6.2.2.5.1-1: Additional requirements (network signalled value "NS_03")

Δf_{OOB} (MHz)	Spectrum emission limit (dBm)/ Channel bandwidth						Measurement bandwidth
	1.4 MHz	3.0 MHz	5 MHz	10 MHz	15 MHz	20 MHz	
0-1	-8.5	-11.5	-13.5	-16.5	-18.5	-19.5	30 kHz
1-2.5	-11.5	-11.5	-11.5	-11.5	-11.5	-11.5	1 MHz
2.5-2.8	-23.5						1 MHz
2.8-5		-23.5	-23.5	-23.5	-23.5	-23.5	1 MHz
5-6							1 MHz
6-10							1 MHz
10-15							1 MHz
15-20					-23.5		1 MHz
20-25						-23.5	1 MHz
Note 1: The first and last measurement position with a 30 kHz filter is at Δf_{OOB} equals to 0.015 MHz and 0.985 MHz. Note 2: At the boundary of spectrum emission limit, the first and last measurement position with a 1 MHz filter is the inside of +0.5MHz and -0.5MHz, respectively. Note 3: The measurements are to be performed above the upper edge of the channel and below the lower edge of the channel Note 4: Above SEM requirement applies to bands corresponding to network signalling value NS_03 as defined in TS 36.101 [2] subclause 6.2.4 Table 6.2.4-1. Note 5: For the 2.5-2.8 MHz offset range with 1.4 MHz channel bandwidth, the measurement position is at Δf_{OOB} equals to 3 MHz.							

NOTE: As a general rule, the resolution bandwidth of the measuring equipment should be equal to the measurement bandwidth. However, to improve measurement accuracy, sensitivity and efficiency, the resolution bandwidth may be smaller than the measurement bandwidth. When the resolution bandwidth is smaller than the measurement bandwidth, the result should be integrated over the measurement bandwidth in order to obtain the equivalent noise bandwidth of the measurement bandwidth.

6.6.2.2.5.2 Test requirements (network signalled value "NS_04")

When "NS_04" is indicated in the cell, the power of any UE emission shall fulfil requirements in Table 6.6.2.2.5.2-1.

Table 6.6.2.2.5.2-1: Additional requirements (network signalled value "NS_04")

Δf_{OOB} (MHz)	Spectrum emission limit (dBm)/ Channel bandwidth						Measurement bandwidth
	1.4 MHz	3.0 MHz	5 MHz	10 MHz	15 MHz	20 MHz	
0-1	-8.5	-11.5	-13.5	-16.5	-18.5	-19.5	30 kHz
1-2.5	-11.5	-11.5	-11.5	-11.5	-11.5	-11.5	1 MHz
2.5-2.8	-23.5						1 MHz
2.8-5							1 MHz
5-6		-23.5	-23.5	-23.5	-23.5	-23.5	1 MHz
6-10							1 MHz
10-15							1 MHz
15-20							1 MHz
20-25							1 MHz
Note 1:	The first and last measurement position with a 30 kHz filter is at Δf_{OOB} equals to 0.015 MHz and 0.985 MHz.						
Note 2:	At the boundary of spectrum emission limit, the first and last measurement position with a 1 MHz filter is the inside of +0.5MHz and -0.5MHz, respectively.						
Note 3:	The measurements are to be performed above the upper edge of the channel and below the lower edge of the channel						
Note 4:	Above SEM requirement applies to bands corresponding to network signalling value NS_04 as defined in TS 36.101 [2] subclause 6.2.4 Table 6.2.4-1.						
Note 5:	For the 2.5-2.8 MHz offset range with 1.4 MHz channel bandwidth, the measurement position is at Δf_{OOB} equals to 3 MHz.						

NOTE: As a general rule, the resolution bandwidth of the measuring equipment should be equal to the measurement bandwidth. However, to improve measurement accuracy, sensitivity and efficiency, the resolution bandwidth may be smaller than the measurement bandwidth. When the resolution bandwidth is smaller than the measurement bandwidth, the result should be integrated over the measurement bandwidth in order to obtain the equivalent noise bandwidth of the measurement bandwidth.

6.6.2.2.5.3 Test requirements (network signalled value "NS_06" or "NS_07")

When "NS_06" or "NS_07" is indicated in the cell, the power of any UE emission shall fulfil requirements in Table 6.6.2.2.5.3-1.

Table 6.6.2.2.5.3-1: Additional requirements (network signalled value "NS_06" or "NS_07")

Δf_{OOB} (MHz)	Spectrum emission limit (dBm)/ Channel bandwidth				Measurement bandwidth
	1.4 MHz	3.0 MHz	5 MHz	10 MHz	
0-0.1	-11.5	-11.5	-13.5	-16.5	30 kHz
0.1-1	-11.5	-11.5	-11.5	-11.5	100 kHz
1-2.5	-11.5	-11.5	-11.5	-11.5	1 MHz
2.5-2.8	-23.5				1 MHz
2.8-5					1 MHz
5-6		-23.5			1 MHz
6-10			-23.5		1 MHz
10-15				-23.5	1 MHz
Note 1:	The first and last measurement position with a 30 kHz filter is at Δf_{OOB} equals to 0.015 MHz and 0.085 MHz. The first and last measurement position with a 100 kHz filter is at Δf_{OOB} equals to 0.15 MHz and 0.95 MHz.				
Note 2:	At the boundary of spectrum emission limit, the first and last measurement position with a 1 MHz filter is the inside of +0.5MHz and -0.5MHz, respectively.				
Note 3:	The measurements are to be performed above the upper edge of the channel and below the lower edge of the channel				
Note 4:	Above SEM requirement applies to bands corresponding to network signalling value NS_06 and NS_07 as defined in TS 36.101 [2] subclause 6.2.4 Table 6.2.4-1.				
Note 5:	For the 2.5-2.8 MHz offset range with 1.4 MHz channel bandwidth, the measurement position is at Δf_{OOB} equals to 3 MHz.				

NOTE: As a general rule, the resolution bandwidth of the measuring equipment should be equal to the measurement bandwidth. However, to improve measurement accuracy, sensitivity and efficiency, the resolution bandwidth may be smaller than the measurement bandwidth. When the resolution bandwidth is smaller than the measurement bandwidth, the result should be integrated over the measurement bandwidth in order to obtain the equivalent noise bandwidth of the measurement bandwidth.

6.6.2.3 Adjacent Channel Leakage power Ratio

6.6.2.3.1 Test purpose

To verify that UE transmitter does not cause unacceptable interference to adjacent channels in terms of Adjacent Channel Leakage power Ratio (ACLR).

6.6.2.3.2 Test applicability

This test case applies to all types of E-UTRA UE release 8 and forward.

6.6.2.3.3 Minimum conformance requirements

ACLR requirements are specified for two scenarios for an adjacent E-UTRA_{ACLR} and UTRA_{ACLR1/2} as shown in Figure 6.6.2.3.3-1.

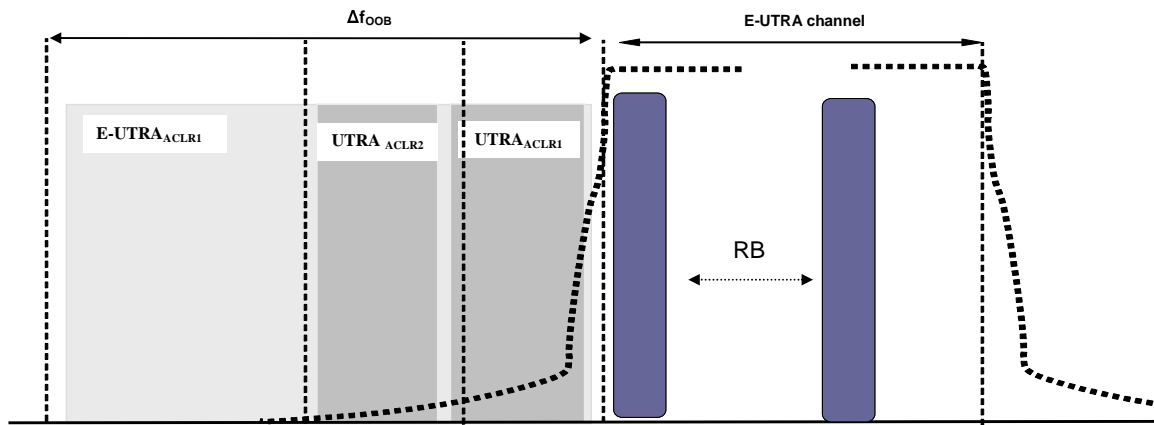

Figure 6.6.2.3.3-1: Adjacent Channel Leakage Power Ratio requirements

6.6.2.3.3.1 Minimum conformance requirements for E-UTRA

E-UTRA ACLR ($E-UTRA_{ACLR}$) is the ratio of the filtered mean power centred on the assigned channel frequency to the filtered mean power centred on an adjacent channel frequency at nominal channel spacing. The assigned E-UTRA channel power and adjacent E-UTRA channel power are measured with rectangular filters with measurement bandwidth specified in Table 6.6.2.3.3.1-1.

If the measured adjacent channel power is greater than -50dBm then the $E-UTRA_{ACLR}$ shall be higher than the valued specified in Table 6.6.2.3.3.1-1.

Table 6.6.2.3.3.1-1: General requirements for $E-UTRA_{ACLR}$

	Channel bandwidth / $E-UTRA_{ACLR1}$ / measurement bandwidth					
	1.4 MHz	3.0 MHz	5 MHz	10 MHz	15 MHz	20 MHz
$E-UTRA_{ACLR1}$	30 dB	30 dB	30 dB	30 dB	30 dB	30 dB
E-UTRA channel Measurement bandwidth	1.08 MHz	2.7 MHz	4.5 MHz	9.0 MHz	13.5 MHz	18 MHz

The normative reference for this requirement is TS 36.101 [2] subclause 6.6.2.3.1.

6.6.2.3.3.2 Minimum conformance requirements for UTRA

UTRA ACLR ($UTRA_{ACLR}$) is the ratio of the filtered mean power centred on the assigned E-UTRA channel frequency to the filtered mean power centred on an adjacent UTRA channel frequency.

UTRA ACLR is specified for both the first UTRA adjacent channel ($UTRA_{ACLR1}$) and the 2nd UTRA adjacent channel ($UTRA_{ACLR2}$). The UTRA channel power is measured with a RRC bandwidth filter with roll-off factor $\alpha = 0.22$. The assigned E-UTRA channel power is measured with a rectangular filter with measurement bandwidth specified in Table 6.6.2.3.3.2-1.

If the measured UTRA channel power is greater than -50dBm then the $UTRA_{ACLR1}$, and $UTRA_{ACLR2}$ shall be higher than the valued specified in Table 6.6.2.3.3.2-1.

Table 6.6.2.3.3.2-1: General requirements for $UTRA_{ACLR1/2}$

	Channel bandwidth / $UTRA_{ACLR1/2}$ / measurement bandwidth					
	1.4 MHz	3.0 MHz	5 MHz	10 MHz	15 MHz	20 MHz

UTRA_{ACL}R1	33 dB	33 dB	33 dB	33 dB	33 dB	33 dB
Adjacent channel centre frequency offset (in MHz)	$0.7+BW_U$ $TR_A/2$ / $-0.7-$ $BW_{UTRA}/2$	$1.5+BW_U$ $TR_A/2$ / $-1.5-$ $BW_{UTRA}/2$	$2.5+BW_U$ $TR_A/2$ / $-2.5-$ $BW_{UTRA}/2$	$5+BW_{UTR}$ $A/2$ / $-5-$ $BW_{UTRA}/2$	$7.5+BW_U$ $TR_A/2$ / $-7.5-$ $BW_{UTRA}/2$	$10+BW_{UT}$ $RA/2$ / $-10-$ $BW_{UTRA}/2$
UTRA_{ACL}R2	-	-	36 dB	36 dB	36 dB	36 dB
Adjacent channel centre frequency offset (in MHz)	-	-	$2.5+3*B$ $W_{UTRA}/2$ / $-2.5-$ $3*BW_{UTR}$ $A/2$	$5+3*BW_U$ $TR_A/2$ / $-5-$ $3*BW_{UTR}$ $A/2$	$7.5+3*B$ $W_{UTRA}/2$ / $-7.5-$ $3*BW_{UTR}$ $A/2$	$10+3*BW$ $UTRA/2$ / $-10-$ $3*BW_{UTR}$ $A/2$
E-UTRA channel Measurement bandwidth	1.08 MHz	2.7 MHz	4.5 MHz	9.0 MHz	13.5 MHz	18 MHz
UTRA 5MHz channel Measurement bandwidth¹	3.84 MHz	3.84 MHz	3.84 MHz	3.84 MHz	3.84 MHz	3.84 MHz
UTRA 1.6MHz channel measurement bandwidth²	1.28 MHz	1.28 MHz	1.28 MHz	1.28 MHz	1.28 MHz	1.28 MHz
Note 1: Applicable for E-UTRA FDD co-existence with UTRA FDD in paired spectrum. Note 2: Applicable for E-UTRA TDD co-existence with UTRA TDD in unpaired spectrum.						

The normative reference for this requirement is TS 36.101 subclause 6.6.2.3.2.

6.6.2.3.4 Test description

6.6.2.3.4.1 Initial conditions

Initial conditions are a set of test configurations the UE needs to be tested in and the steps for the SS to take with the UE to reach the correct measurement state.

The initial test configurations consist of environmental conditions, test frequencies, and channel bandwidths based on E-UTRA bands specified in table 5.4.2.1-1. All of these configurations shall be tested with applicable test parameters for each channel bandwidth, and are shown in table 6.6.2.3.4.1-1. The details of the uplink reference measurement channels (RMCs) are specified in Annex A.2. Configurations of PDSCH and PDCCH before measurement are specified in Annex C.2.

Table 6.6.2.3.4.1-1: Test Configuration Table

Initial Conditions						
Test Environment (as specified in TS 36.508 [7] subclause 4.1)				NC, TL/VL, TL/VH, TH/VL, TH/VH		
Test Frequencies (as specified in TS36.508 [7] subclause 4.3.1)				Low range, Mid range, High range		
Test Channel Bandwidths (as specified in TS 36.508 [7] subclause 4.3.1)				Lowest, 5MHz, 10MHz, Highest		
Test Parameters for Channel Bandwidths						
Ch BW	Downlink Configuration			Uplink Configuration		
	Mod'n	RB allocation		Mod'n	RB allocation	
		FDD	TDD		FDD	TDD
1.4MHz	N/A for ACLR testing			QPSK	6	6
1.4MHz				QPSK	5	5
1.4MHz				16QAM	6	6
1.4MHz				16QAM	5	5
3MHz				QPSK	15	15
3MHz				QPSK	4	4
3MHz				16QAM	15	15
3MHz				16QAM	4	4
5MHz				QPSK	25	25
5MHz				QPSK	8	8
5MHz				16QAM	25	25
5MHz				16QAM	8	8
10MHz				QPSK	50	50
10MHz				QPSK	12	12
10MHz				16QAM	50 (Note 3)	50 (Note 3)
10MHz				16QAM	12	12
15MHz				QPSK	75	75
15MHz				QPSK	16	16
15MHz				16QAM	75 (Note 3)	75 (Note 3)
15MHz				16QAM	16	16
20MHz				QPSK	100	100
20MHz				QPSK	18	18
20MHz				16QAM	100 (Note 3)	100 (Note 3)
20MHz				16QAM	18	18
Note 1: Test Channel Bandwidths are checked separately for each E-UTRA band, which applicable channel bandwidths are specified in Table 5.4.2.1-1. Note 2: The starting resource block of partial RB allocation shall be RB#0 and RB# (max + 1 - RB allocation) of the channel bandwidth. Note 3: Applies only for UE-Categories 2-5						

1. Connect the SS to the UE antenna connectors as shown in Figure TS 36.508 [7] Annex A, Figure A.3.
2. The parameter settings for the cell are set up according to TS 36.508 [7] subclause 4.4.3.
3. Downlink signals are initially set up according to Annex C0, C.1 and C.3.0, and uplink signals according to Annex H.1 and H.3.0.
4. The UL Reference Measurement channels are set according to Table 6.6.2.3.4.1-1.
5. Propagation conditions are set according to Annex B.0.
6. Ensure the UE is in State 3A or 3A-RF according to TS 36.508 [7] clause 4.5.3A or 5.2A.2. Message contents are defined in clause 6.6.2.3.4.3.

6.6.2.3.4.2 Test procedure

1. SS sends uplink scheduling information for each UL HARQ process via PDCCH DCI format 0 for C_RNTI to schedule the UL RMC according to Table 6.6.2.3.4.1-1. Since the UE has no payload data to send, the UE transmits uplink MAC padding bits on the UL RMC.

2. Send continuously uplink power control “up” commands in the uplink scheduling information to the UE until the UE transmits at P_{UMAX} level.
3. Measure the mean power of the UE in the channel bandwidth of the radio access mode according to the test configuration, which shall meet the requirements described in Tables 6.2.2.5-1 and 6.2.3.5-1. The period of the measurement shall be at least the continuous duration of one sub-frame (1ms). For TDD slots with transient periods are not under test.
4. Measure the rectangular filtered mean power for E-UTRA.
5. Measure the rectangular filtered mean power of the first E-UTRA adjacent channel.
6. Measure the RRC filtered mean power of the first and the second UTRA adjacent channel.
7. Calculate the ratio of the power between the values measured in step 4 over step 5 for $E-UTRA_{ACLR}$.
8. Calculated the ratio of the power between the values measured in step 4 over step 6 for $UTRA_{ACLR1}$, $UTRA_{ACLR2}$.

6.6.2.3.4.3 Message contents

Message contents are according to TS 36.508 [7] subclause 4.6.

6.6.2.3.5 Test requirement

6.6.2.3.5.1 Test requirements E-UTRA

If the measured adjacent channel power is greater than -50 dBm then the measured $E-UTRA_{ACLR}$, derived in step 7, shall be higher than the limits in table 6.6.2.3.5.1-1.

Table 6.6.2.3.5.1-1: E-UTRA UE ACLR

	Channel bandwidth / $E-UTRA_{ACLR1}$ / measurement bandwidth					
	1.4 MHz	3.0 MHz	5 MHz	10 MHz	15 MHz	20 MHz
$E-UTRA_{ACLR1}$	29.2 dB	29.2 dB	29.2 dB	29.2 dB	29.2 dB	29.2 dB
E-UTRA channel Measurement bandwidth	1.08 MHz	2.7 MHz	4.5 MHz	9.0 MHz	13.5 MHz	18 MHz
UE channel	+1.4 MHz or -1.4 MHz	+3 MHz or -3 MHz	+5MHz or -5MHz	+10MHz or -10MHz	+15MHz or -15MHz	+20MHz or -20MHz

6.6.2.3.5.2 Test requirements UTRA

If the measured UTRA channel power is greater than -50 dBm then the measured $UTRA_{ACLR1}$, $UTRA_{ACLR2}$, derived in step 8, shall be higher than the limits in table 6.6.2.3.5.2-1.

Table 6.6.2.3.5.2-1: UTRA UE ACLR

	Channel bandwidth / $UTRA_{ACLR1/2}$ / measurement bandwidth					
	1.4 MHz	3.0 MHz	5 MHz	10 MHz	15 MHz	20 MHz

UTRA_{ACL}R1	32.2 dB	32.2 dB	32.2 dB	32.2 dB	32.2 dB	32.2 dB
Adjacent channel centre frequency offset (in MHz)	$0.7+BW_{UTR}$ $A/2$ / -0.7- $BW_{UTR}/2$	$1.5+BW_{UTR}$ $A/2$ / -1.5- $BW_{UTR}/2$	$2.5+BW_{UTR}$ $A/2$ / -2.5- $BW_{UTR}/2$	$5+BW_{UTR}$ 2 / -5- $BW_{UTR}/2$	$7.5+BW_{UTR}$ $A/2$ / -7.5- $BW_{UTR}/2$	$10+BW_{UTR}$ /2 / -10- $BW_{UTR}/2$
UTRA_{ACL}R2	-	-	35.2 dB	35.2 dB	35.2 dB	35.2 dB
Adjacent channel centre frequency offset (in MHz)	-	-	$2.5+3*BW_U$ $TR_A/2$ / -2.5- $3*BW_{UTR}/2$	$5+3*BW_{UTR}$ $A/2$ / -5- $3*BW_{UTR}/2$	$7.5+3*BW_U$ $TR_A/2$ / -7.5- $3*BW_{UTR}/2$	$10+3*BW_{UT}$ $RA/2$ / -10- $3*BW_{UTR}/2$
E-UTRA channel Measurement bandwidth	1.08 MHz	2.7 MHz	4.5 MHz	9.0 MHz	13.5 MHz	18 MHz
UTRA 5MHz channel Measurement bandwidth¹	3.84 MHz	3.84 MHz	3.84 MHz	3.84 MHz	3.84 MHz	3.84 MHz
UTRA 1.6MHz channel measurement bandwidth²	1.28 MHz	1.28 MHz	1.28 MHz	1.28 MHz	1.28 MHz	1.28 MHz
Note 1: Applicable for E-UTRA FDD co-existence with UTRA FDD in paired spectrum.						
Note 2: Applicable for E-UTRA TDD co-existence with UTRA TDD in unpaired spectrum.						
Note 3: BW_{UTR} for UTRA FDD is 5MHz and for UTRA TDD is 1.6MHz.						

6.6.2.4 Void

6.6.3 Spurious emissions

Spurious emissions are emissions which are caused by unwanted transmitter effects such as harmonics emission, parasitic emissions, intermodulation products and frequency conversion products, but exclude out of band emissions. The spurious emission limits are specified in terms of general requirements inline with SM.329 [3] and E-UTRA operating band requirement to address UE co-existence.

Unless otherwise stated, the spurious emission limits apply for the frequency ranges that are more than Δf_{OOB} (MHz) in Table 6.6.3.1.3-1 from the edge of the channel bandwidth. To improve measurement accuracy, sensitivity and efficiency, the resolution bandwidth may be smaller than the measurement bandwidth. When the resolution bandwidth is smaller than the measurement bandwidth, the result should be integrated over the measurement bandwidth in order to obtain the equivalent noise bandwidth of the measurement bandwidth.

6.6.3.1 Transmitter Spurious emissions

6.6.3.1.1 Test purpose

To verify that UE transmitter does not cause unacceptable interference to other channels or other systems in terms of transmitter spurious emissions.

6.6.3.1.2 Test applicability

This test case applies to all types of E-UTRA UE release 8 and forward.

6.6.3.1.3 Minimum conformance requirements

The spurious emission limits apply for the frequency ranges that are more than Δf_{OOB} (MHz) from the edge of the channel bandwidth.

Table 6.6.3.1.3-1: Δf_{OOB} boundary between E-UTRA channel and spurious emission domain

Channel bandwidth	1.4 MHz	3.0 MHz	5 MHz	10 MHz	15 MHz	20 MHz
Δf_{OOB} (MHz)	2.8	6	10	15	20	25

The spurious emission limits in Table 6.6.3.1.3-2 apply for all transmitter band configurations (RB) and channel bandwidths.

NOTE: In order that the measurement of spurious emissions falls within the frequency ranges that are more than Δf_{OOB} (MHz) from the edge of the channel bandwidth, the minimum offset of the measurement frequency from each edge of the channel should be $\Delta f_{\text{OOB}} + \text{MBW}/2$. MBW denotes the measurement bandwidth defined in Table 6.6.3.1.3-2.

Table 6.6.3.1.3-2: Spurious emissions limits

Frequency Range	Maximum Level	Measurement Bandwidth
$9 \text{ kHz} \leq f < 150 \text{ kHz}$	-36 dBm	1 kHz
$150 \text{ kHz} \leq f < 30 \text{ MHz}$	-36 dBm	10 kHz
$30 \text{ MHz} \leq f < 1000 \text{ MHz}$	-36 dBm	100 kHz
$1 \text{ GHz} \leq f < 12.75 \text{ GHz}$	-30 dBm	1 MHz

The normative reference for this requirement is TS 36.101 [2] subclause 6.6.3.1.

6.6.3.1.4 Test description

6.6.3.1.4.1 Initial conditions

Initial conditions are a set of test configurations the UE needs to be tested in and the steps for the SS to take with the UE to reach the correct measurement state.

The initial test configurations consist of environmental conditions, test frequencies, and channel bandwidths based on E-UTRA bands specified in Table 5.4.2.1-1. All of these configurations shall be tested with applicable test parameters for each channel bandwidth, and are shown in Table 6.6.3.1.4.1-1. The details of the uplink reference measurement channels (RMCs) are specified in Annex A.2. Configurations of PDSCH and PDCCH before measurement are specified in Annex C.2.

Table 6.6.3.1.4.1-1: Test Configuration Table

Initial Conditions						
Test Environment (as specified in TS 36.508 [7] subclause 4.1)			NC			
Test Frequencies (as specified in TS36.508 [7] subclause 4.3.1)			Low range, Mid range, High range			
Test Channel Bandwidths (as specified in TS 36.508 [7] subclause 4.3.1)			Lowest, 5MHz, Highest			
Test Parameters for Channel Bandwidths						
Ch BW	Downlink Configuration			Uplink Configuration		
	Mod'n	RB allocation		Mod'n	RB allocation	
		FDD	TDD		FDD	TDD
1.4MHz	N/A for Spurious Emissions testing			QPSK	6	6
1.4MHz				QPSK	1	1
3MHz				QPSK	15	15
3MHz				QPSK	1	1
5MHz				QPSK	25	25
5MHz				QPSK	1	1
10MHz				QPSK	50	50
10MHz				QPSK	1	1
15MHz				QPSK	75	75
15MHz				QPSK	1	1
20MHz				QPSK	100	100
20MHz				QPSK	1	1
Note 1: Test Channel Bandwidths are checked separately for each E-UTRA band, which applicable channel bandwidths are specified in Table 5.4.2.1-1.						
Note 2: The 1 RB allocation shall be tested at both RB #0 and RB #max.						

1. Connect the SS to the UE to the UE antenna connectors as shown in Figure TS 36.508 [7] Annex A, Figure A.3.
2. The parameter settings for the cell are set up according to TS 36.508 [7] subclause 4.4.3.
3. Downlink signals are initially set up according to Annex C0, C.1 and C.3.0, and uplink signals according to Annex H.1 and H.3.0.
4. The UL Reference Measurement channels are set according to Table 6.6.3.1.4.1-1.
5. Propagation conditions are set according to Annex B.0.
6. Ensure the UE is in State 3A or 3A-RF according to TS 36.508 [7] clause 4.5.3A or 5.2A.2. Message contents are defined in clause 6.6.3.1.4.3.

6.6.3.1.4.2 Test procedure

1. SS sends uplink scheduling information for each UL HARQ process via PDCCH DCI format 0 for C_RNTI to schedule the UL RMC according to Table 6.6.3.1.4.1-1. Since the UE has no payload data to send, the UE transmits uplink MAC padding bits on the UL RMC.
2. Send continuously uplink power control “up” commands in the uplink scheduling information to the UE until the UE transmits at P_{UMAX} level.
3. Measure the power of the transmitted signal with a measurement filter of bandwidths according to table 6.6.3.1.5-1. The centre frequency of the filter shall be stepped in contiguous steps according to table 6.6.3.1.5-1. The measured power shall be verified for each step. The measurement period shall capture the active time slots.

6.6.3.1.4.3 Message contents

Message contents are according to TS 36.508 [7] subclause 4.6.

6.6.3.1.5 Test requirement

The measured average power of spurious emission, derived in step 3, shall not exceed the described value in tables 6.6.3.1.5-1.

The spurious emission limits apply for the frequency ranges that are more than Δf_{OOB} (MHz) from the edge of the channel bandwidth shown in Table 6.6.3.1.3-1.

Table 6.6.3.1.5-1: General spurious emissions test requirements

Frequency Range	Maximum Level	Measurement Bandwidth
$9 \text{ kHz} \leq f < 150 \text{ kHz}$	-36 dBm	1 kHz
$150 \text{ kHz} \leq f < 30 \text{ MHz}$	-36 dBm	10 kHz
$30 \text{ MHz} \leq f < 1000 \text{ MHz}$	-36 dBm	100 kHz
$1 \text{ GHz} \leq f < 12.75 \text{ GHz}$	-30 dBm	1 MHz

NOTE: In order that the measurement of spurious emissions falls within the frequency ranges that are more than Δf_{OOB} (MHz) from the edge of the channel bandwidth, the minimum offset of the measurement frequency from each edge of the channel should be $\Delta f_{\text{OOB}} + \text{MBW}/2$. MBW denotes the measurement bandwidth defined in Table 6.6.3.1.3-2.

6.6.3.2 Spurious emission band UE co-existence

6.6.3.2.1 Test purpose

To verify that UE transmitter does not cause unacceptable interference to co-existing systems for the specified bands which has specific requirements in terms of transmitter spurious emissions.

6.6.3.2.2 Test applicability

This test case applies to all types of E-UTRA UE release 8 and forward.

6.6.3.2.3 Minimum conformance requirements

This clause specifies the requirements for the specified E-UTRA band for coexistence with protected bands as indicated in Table 6.6.3.2.3-1.

NOTE: For measurement conditions at the edge of each frequency range, the lowest frequency of the measurement position in each frequency range should be set at the lowest boundary of the frequency range plus $\text{MBW}/2$. The highest frequency of the measurement position in each frequency range should be set at the highest boundary of the frequency range minus $\text{MBW}/2$. MBW denotes the measurement bandwidth defined for the protected band.

Table 6.6.3.2.3-1: Spurious emission band UE co-existence limits

E-UTRA Band	Spurious emission						
	Protected band	Frequency range (MHz)		Maximum Level (dBm)	MBW (MHz)	Comment	
1	E-UTRA Band 1, 3, 7, 8, 9, 11, 20, 21, 34, 38, 40	FDL_low	-	FDL_high	-50	1	
	E-UTRA band 33	FDL_low	-	FDL_high	-50	1	Note ³
	E-UTRA band 39	FDL_low	-	FDL_high	-50	1	Note ³
	Frequency range	860	-	895	-50	1	
	Frequency range	1884.5	-	1919.6	-41	0.3	Note ^{6,7}
	1884.5	-	1915.7	Note ^{6,8}			
2	E-UTRA Band 2, 4, 5, 10, 12, 13, 14, 17, 24, 41	FDL_low	-	FDL_high	-50	1	
3	E-UTRA Band 1, 3, 7, 8, 20, 33, 34, 38	FDL_low	-	FDL_high	-50	1	
4	E-UTRA Band 2, 4, 5, 10, 12, 13, 14, 17, 24, 41	FDL_low	-	FDL_high	-50	1	
5	E-UTRA Band 2, 4, 5, 10, 12, 13, 14, 17, 24	FDL_low	-	FDL_high	-50	1	
	E-UTRA Band 41	FDL_low	-	FDL_high	-50	1	Note ²
6	E-UTRA Band 1, 9, 11, 34	FDL_low	-	FDL_high	-50	1	
	Frequency range	860	-	875	-37	1	
	Frequency range	875	-	895	-50	1	
	Frequency range	1884.5	-	1919.6	-41	0.3	Note ⁷
	1884.5	-	1915.7	Note ⁸			
7	E-UTRA Band 1, 3, 7, 8, 20, 33, 34	FDL_low	-	FDL_high	-50	1	
	E-UTRA Band 38	FDL_low	-	FDL_low	-50	1	Note ³
8	E-UTRA Band 1, 8, 20, 33, 34, 38, 39, 40	FDL_low	-	FDL_high	-50	1	
	E-UTRA band 3	FDL_low	-	FDL_high	-50	1	Note ²
	E-UTRA band 7	FDL_low	-	FDL_high	-50	1	Note ²
9	E-UTRA Band 1, 9, 11, 21, 34	FDL_low	-	FDL_high	-50	1	
	Frequency range	860	-	895	-50	1	
	Frequency range	1884.5	-	1919.6	-41	0.3	Note ⁷
	1884.5	-	1915.7	Note ⁸			
10	E-UTRA Band 2, 4, 5, 10, 12, 13, 14, 17, 24, 41	FDL_low	-	FDL_high	-50	1	
11	E-UTRA Band 1, 9, 11, 21, 34	FDL_low	-	FDL_high	-50	1	
	Frequency range	860	-	895	-50	1	
	Frequency range	1884.5	-	1919.6	-41	0.3	Note ⁷
	1884.5	-	1915.7	Note ⁸			
12	E-UTRA Band 2, 5, 12, 13, 14, 17, 24, 41	FDL_low	-	FDL_high	-50	1	
	E-UTRA Band 4, 10	FDL_low	-	FDL_high	-50	1	Note ²
13	E-UTRA Band 2, 4, 5, 10, 12, 13, 14, 17, 41	FDL_low	-	FDL_high	-50	1	
	Frequency range	769	-	775	-35	0.00625	
	Frequency range	799	-	805	-35	0.00625	Note ¹¹
	E-UTRA Band 24	FDL_low	-	FDL_high	-50	1	Note ²

14	E-UTRA Band 2, 4, 5, 10, 12, 13, 14, 17, 24, 41	FDL_low	-	FDL_high	-50	1	
	Frequency range	763	-	775	-35	0.00625	Note ¹²
	Frequency range	799		805	-35	0.00625	Note ¹¹ Note ¹²
17	E-UTRA Band 2, 5, 12, 13, 14, 17, 24, 41	FDL_low	-	FDL_high	-50	1	
	E-UTRA Band 4, 10	FDL_low	-	FDL_high	-50	1	Note ²
18	E-UTRA Band 1, 9, 11, 21, 34	FDL_low	-	FDL_high	-50	1	
	Frequency range	860	-	895	-40	1	
	Frequency range	1884.5	-	1919.6	-41	0.3	Note ⁷
		1884.5	-	1915.7			Note ⁸
19	E-UTRA Band 1, 9, 11, 21, 34	FDL_low	-	FDL_high	-50	1	
	Frequency range	860	-	895	-40	1	Note ⁹
	Frequency range	1884.5	-	1919.6	-41	0.3	Note ⁷
		1884.5	-	1915.7			Note ⁸
20	E-UTRA Band 1, 3, 7, 8, 20, 33, 34	FDL_low	-	FDL_high	-50	1	
	Frequency range 38	FDL_low	-	FDL_high	-50	1	Note ²
21	E-UTRA Band 11, 21	FDL_low	-	FDL_high	-35	1	Note ¹⁰
	E-UTRA Band 1, 9, 34	FDL_low	-	FDL_high	-50	1	
	Frequency range	860	-	895	-50	1	
	Frequency range	1884.5	-	1919.6	-41	0.3	Note ⁷
		1884.5	-	1915.7			Note ⁸
...							
24	E-UTRA Band 2, 4, 5, 10, 12, 13, 14, 17, 24, 41	FDL_low	-	FDL_high	-50	1	
...							
33	E-UTRA Band 1, 3, 7, 8, 20, 34, 38, 39, 40	FDL_low	-	FDL_high	-50	1	Note ⁵
34	E-UTRA Band 1, 3, 7, 8, 9, 11, 20, 21, 33, 38, 39, 40	FDL_low	-	FDL_high	-50	1	Note ⁵
	Frequency range	860	-	895	-50	1	
	Frequency range	1884.5	-	1919.6	-41	0.3	Note ⁷
1884.5		-	1915.7	Note ⁸			
35							
36							
37			-				
38	E-UTRA Band 1, 3, 8, 33, 34	FDL_low	-	FDL_high	-50	1	
	E-UTRA Band 7	FDL_low	-	FDL_high	-50	1	Note ³
39	E-UTRA Band 34, 40	FDL_low	-	FDL_high	-50	1	
40	E-UTRA Band 1, 3, 33, 34, 39	FDL_low	-	FDL_high	-50	1	
41	E-UTRA Band 2, 4, 5, 10, 12, 13, 14, 17, 24	FDL_low	-	FDL_high	-50	1	

Note 1: FDL_low and FDL_high refer to each E-UTRA frequency band specified in Table 5.2-1

Note 2: As exceptions, measurements with a level up to the applicable requirements defined in Table 6.6.3.1.3-2 are permitted for each assigned E-UTRA carrier used in the measurement due to 2nd or 3rd harmonic spurious emissions. An exception is allowed if there is at least one individual RE within the transmission bandwidth (see Figure 5.4.2-1) for which the 2nd or 3rd harmonic, i.e. the frequency equal to two or three times the frequency of that RE, is within the measurement bandwidth (MBW).

Note 3: To meet these requirements some restriction will be needed for either the operating band or protected band

Note 4: N/A

Note 5: For non synchronised TDD operation to meet these requirements some restriction will be needed for either the operating band or protected band

Note 6: Applicable when NS_05 in section 6.6.3.3.3.1 is signalled by the network.

Note 7: Applicable when co-existence with PHS system operating in 1884.5 -1919.6MHz.

Note 8: Applicable when co-existence with PHS system operating in 1884.5 -1915.7MHz.

Note 9: Applicable when NS_08 in section 6.6.3.3.3.3 is signalled by the network

Note 10: Applicable when NS_09 in section 6.6.3.3.4 is signalled by the network

Note 11: Whether the applicable frequency range should be 793-805MHz instead of 799-805MHz is TBD

Note 12: The emissions measurement shall be sufficiently power averaged to ensure a standard deviation < 0.5 dB

NOTE: Bands 1,6,9,11,34 in the tables shall be reviewed after June 2012 because of PHS band operation change

The normative reference for this requirement is TS 36.101 [2] subclause 6.6.3.2.

6.6.3.2.4 Test description

6.6.3.2.4.1 Initial conditions

Initial conditions are a set of test configurations the UE needs to be tested in and the steps for the SS to take with the UE to reach the correct measurement state.

The initial test configurations consist of environmental conditions, test frequencies, and channel bandwidths based on E-UTRA bands specified in Table 5.4.2.1-1. All of these configurations shall be tested with applicable test parameters for each channel bandwidth, and are shown in Table 6.6.3.2.4.1-1. The details of the uplink reference measurement channels (RMCs) are specified in Annex A.2. Configurations of PDSCH and PDCCH before measurement are specified in Annex C.2.

Table 6.6.3.2.4.1-1: Test Configuration Table

Initial Conditions						
Test Environment (as specified in TS 36.508 [7] subclause 4.1)			NC			
Test Frequencies (as specified in TS36.508 [7] subclause 4.3.1)			Low range, Mid range, High range			
Test Channel Bandwidths (as specified in TS 36.508 [7] subclause 4.3.1)			Lowest, 5MHz, Highest			
Test Parameters for Channel Bandwidths						
Ch BW	Downlink Configuration			Uplink Configuration		
	Mod'n	RB allocation		Mod'n	RB allocation	
		FDD	TDD		FDD	TDD
1.4MHz	N/A for Spurious Emissions testing			QPSK	6	6
1.4MHz				QPSK	1	1
3MHz				QPSK	15	15
3MHz				QPSK	1	1
5MHz				QPSK	25	25
5MHz				QPSK	1	1
10MHz				QPSK	50	50
10MHz				QPSK	1	1
15MHz				QPSK	75	75
15MHz				QPSK	1	1
20MHz				QPSK	100	100
20MHz				QPSK	1	1
Note 1: Test Channel Bandwidths are checked separately for each E-UTRA band, which applicable channel bandwidths are specified in Table 5.4.2.1-1.						
Note 2: The 1 RB allocation shall be tested at both RB #0 and RB #max.						

1. Connect the SS to the UE to the UE antenna connectors as shown in Figure TS 36.508 [7] Annex A, Figure A.3.
2. The parameter settings for the cell are set up according to TS 36.508 [7] subclause 4.4.3.
3. Downlink signals are initially set up according to Annex C0, C.1 and C.3.0, and uplink signals according to Annex H.1 and H.3.0.
4. The UL Reference Measurement channels are set according to Table 6.6.3.2.4.1-1.
5. Propagation conditions are set according to Annex B.0.
6. Ensure the UE is in State 3A or 3A-RF according to TS 36.508 [7] clause 4.5.3A or 5.2A.2. Message contents are defined in clause 6.6.3.2.4.3.

6.6.3.2.4.2 Test procedure

1. SS sends uplink scheduling information for each UL HARQ process via PDCCH DCI format 0 for C_RNTI to schedule the UL RMC according to Table 6.6.3.2.4.1-1. Since the UE has no payload data to send, the UE transmits uplink MAC padding bits on the UL RMC.

2. Send continuously uplink power control “up” commands in the uplink scheduling information to the UE until the UE transmits at P_{UMAX} level.
3. Measure the power of the transmitted signal with a measurement filter of bandwidths according to table 6.6.3.2.5- For band 14 measurements made in a bandwidth of 6.25kHz, measurement parameter settings defined in table 6.6.3.2.4.2-1 shall be used. 1. The centre frequency of the filter shall be stepped in contiguous steps according to table 6.6.3.2.5-1. The measured power shall be verified for each step. The measurement period shall capture the active time slots.

Table 6.6.3.2.4.2-1: Measurement setup for band 14

	Option 1: Measurement with No RMS VBW available	Option2 Measurement with VBW Filtering on Power scale
VBW	≥ 62.5 kHz (10 times or more the RBW)	≤ 43 Hz
RBW	≤ 6.25 kHz	≤ 6.25 kHz
Detector type	Averages signal envelope during each measurement point, such as “RMS detector”	Peak
Averaging mode (Trace averaging)	Power (RMS voltage)	Power (RMS voltage), as controlled by “Average Type”
Average Type (applies to detector)	Power (RMS voltage) (automatically occurs with “RMS detector”)	Not applicable
Average Type (applies to VBW filter)	Not applicable	Power (RMS voltage)
Number of averages	30, to reduce variance as required, or use an even longer sweep time	1 or use an even narrower VBW filter, thus a longer sweep time
Sweep time	[Don't specify]	Sweep rate (span divided by sweep time) $\leq 0.8 * RBW * VBW$

6.6.3.2.4.3 Message contents

Message contents are according to TS 36.508 [7] subclause 4.6.

6.6.3.2.5 Test requirement

The measured average power of spurious emission, derived in step 3, shall not exceed the described value in tables 6.6.3.2.5-1.

Table 6.6.3.2.5-1: Spurious emission band UE co-existence limits

E-UTRA Band	Spurious emission						
	Protected band	Frequency range (MHz)		Maximum Level (dBm)	MBW (MHz)	Comment	
1	E-UTRA Band 1, 3, 7, 8, 9, 11, 20, 21, 34, 38, 40	FDL_low	-	FDL_high	-50	1	
	E-UTRA band 33	FDL_low	-	FDL_high	-50	1	Note ³
	E-UTRA band 39	FDL_low	-	FDL_high	-50	1	Note ³
	Frequency range	860	-	895	-50	1	
	Frequency range	1884.5	-	1919.6	-41	0.3	Note ^{6,7}
	1884.5	-	1915.7	Note ^{6,8}			
2	E-UTRA Band 2, 4, 5, 10, 12, 13, 14, 17, 24, 41	FDL_low	-	FDL_high	-50	1	
3	E-UTRA Band 1, 3, 7, 8, 20, 33, 34, 38	FDL_low	-	FDL_high	-50	1	
4	E-UTRA Band 2, 4, 5, 10, 12, 13, 14, 17, 24, 41	FDL_low	-	FDL_high	-50	1	
5	E-UTRA Band 2, 4, 5, 10, 12, 13, 14, 17, 24	FDL_low	-	FDL_high	-50	1	
	E-UTRA Band 41	FDL_low	-	FDL_high	-50	1	Note ²
6	E-UTRA Band 1, 9, 11, 34	FDL_low	-	FDL_high	-50	1	
	Frequency range	860	-	875	-37	1	
	Frequency range	875	-	895	-50	1	
	Frequency range	1884.5	-	1919.6	-41	0.3	Note ⁷
	1884.5	-	1915.7	Note ⁸			
7	E-UTRA Band 1, 3, 7, 8, 20, 33, 34	FDL_low	-	FDL_high	-50	1	
	E-UTRA Band 38	FDL_low	-	FDL_low	-50	1	Note ³
8	E-UTRA Band 1, 8, 20, 33, 34, 38, 39, 40	FDL_low	-	FDL_high	-50	1	
	E-UTRA band 3	FDL_low	-	FDL_high	-50	1	Note ²
	E-UTRA band 7	FDL_low	-	FDL_high	-50	1	Note ²
9	E-UTRA Band 1, 9, 11, 21, 34	FDL_low	-	FDL_high	-50	1	
	Frequency range	860	-	895	-50	1	
	Frequency range	1884.5	-	1919.6	-41	0.3	Note ⁷
	1884.5	-	1915.7	Note ⁸			
10	E-UTRA Band 2, 4, 5, 10, 12, 13, 14, 17, 24, 41	FDL_low	-	FDL_high	-50	1	
11	E-UTRA Band 1, 9, 11, 21, 34	FDL_low	-	FDL_high	-50	1	
	Frequency range	860	-	895	-50	1	
	Frequency range	1884.5	-	1919.6	-41	0.3	Note ⁷
	1884.5	-	1915.7	Note ⁸			
12	E-UTRA Band 2, 5, 12, 13, 14, 17, 24, 41	FDL_low	-	FDL_high	-50	1	
	E-UTRA Band 4, 10	FDL_low	-	FDL_high	-50	1	Note ²
13	E-UTRA Band 2, 4, 5, 10, 12, 13, 14, 17, 41	FDL_low	-	FDL_high	-50	1	
	Frequency range	769	-	775	-35	0.00625	
	Frequency range	799	-	805	-35	0.00625	Note ¹¹
	E-UTRA Band 24	FDL_low	-	FDL_high	-50	1	Note ²
14	E-UTRA Band 2, 4, 5, 10, 12, 13, 14, 17, 24, 41	FDL_low	-	FDL_high	-50	1	
	Frequency range	763	-	775	-35	0.00625	Note ¹²
	Frequency range	799	-	805	-35	0.00625	Note ¹¹ Note ¹²
17	E-UTRA Band 2, 5, 12, 13, 14, 17, 24, 41	FDL_low	-	FDL_high	-50	1	
	E-UTRA Band 4, 10	FDL_low	-	FDL_high	-50	1	Note ²
18	E-UTRA Band 1, 9, 11, 21, 34	FDL_low	-	FDL_high	-50	1	
	Frequency range	860	-	895	-40	1	
	Frequency range	1884.5	-	1919.6	-41	0.3	Note ⁷
	1884.5	-	1915.7	Note ⁸			
19	E-UTRA Band 1, 9, 11, 21, 34	FDL_low	-	FDL_high	-50	1	
	Frequency range	860	-	895	-40	1	Note ⁹
	Frequency range	1884.5	-	1919.6	-41	0.3	Note ⁷

		1884.5	-	1915.7			Note ⁸
20	E-UTRA Band 1, 3, 7, 8, 20, 33, 34	FDL_low	-	FDL_high	-50	1	
	Frequency range 38	FDL_low	-	FDL_high	-50	1	Note ²
21	E-UTRA Band 11, 21	FDL_low	-	FDL_high	-35	1	Note ¹⁰
	E-UTRA Band 1, 9, 34	FDL_low	-	FDL_high	-50	1	
	Frequency range	860	-	895	-50	1	
	Frequency range	1884.5	-	1919.6	-41	0.3	Note ⁷
	1884.5	-	1915.7	Note ⁸			
...							
24	E-UTRA Band 2, 4, 5, 10, 12, 13, 14, 17, 24, 41	FDL_low	-	FDL_high	-50	1	
...							
33	E-UTRA Band 1, 3, 7, 8, 20, 34, 38, 39, 40	FDL_low	-	FDL_high	-50	1	Note ⁵
34	E-UTRA Band 1, 3, 7, 8, 9, 11, 20, 21, 33, 38,39, 40	FDL_low	-	FDL_high	-50	1	Note ⁵
	Frequency range	860	-	895	-50	1	
	Frequency range	1884.5	-	1919.6	-41	0.3	Note ⁷
	1884.5	-	1915.7	Note ⁸			
35							
36							
37			-				
38	E-UTRA Band 1,3, 8, 33, 34	FDL_low	-	FDL_high	-50	1	
	E-UTRA Band 7	FDL_low	-	FDL_high	-50	1	Note ³
39	E-UTRA Band 34, 40	FDL_low	-	FDL_high	-50	1	
40	E-UTRA Band 1, 3, 33, 34, 39	FDL_low	-	FDL_high	-50	1	
41	E-UTRA Band 2, 4, 5, 10, 12, 13, 14, 17, 24	FDL_low	-	FDL_high	-50	1	
<p>Note 1: FDL_low and FDL_high refer to each E-UTRA frequency band specified in Table 5.2-1</p> <p>Note 2: As exceptions, measurements with a level up to the applicable requirements defined in Table 6.6.3.1.3-2 are permitted for each assigned E-UTRA carrier used in the measurement due to 2nd or 3rd harmonic spurious emissions. An exception is allowed if there is at least one individual RE within the transmission bandwidth (see Figure 5.4.2-1) for which the 2nd or 3rd harmonic, i.e. the frequency equal to two or three times the frequency of that RE, is within the measurement bandwidth (MBW).</p> <p>Note 3: To meet these requirements some restriction will be needed for either the operating band or protected band</p> <p>Note 4: N/A</p> <p>Note 5: For non synchronised TDD operation to meet these requirements some restriction will be needed for either the operating band or protected band</p> <p>Note 6: Applicable when NS_05 in section 6.6.3.3.3.1 is signalled by the network.</p> <p>Note 7: Applicable when co-existence with PHS system operating in 1884.5 -1919.6MHz.</p> <p>Note 8: Applicable when co-existence with PHS system operating in 1884.5 -1915.7MHz.</p> <p>Note 9: Applicable when NS_08 in section 6.6.3.3.3.3 is signalled by the network</p> <p>Note 10: Applicable when NS_09 in section 6.6.3.3.4 is signalled by the network</p> <p>Note 11: Whether the applicable frequency range should be 793-805MHz instead of 799-805MHz is TBD</p> <p>Note 12: The emissions measurement shall be sufficiently power averaged to ensure a standard deviation < 0.5 dB,</p>							

NOTE 1: Bands 1,6,9,11,34 in the tables shall be reviewed after June 2012 because of PHS band operation change

NOTE 2: For measurement conditions at the edge of each frequency range, the lowest frequency of the measurement position in each frequency range should be set at the lowest boundary of the frequency range plus MBW/2. The highest frequency of the measurement position in each frequency range should be set at the highest boundary of the frequency range minus MBW/2. MBW denotes the measurement bandwidth defined for the protected band.

NOTE 3: The frequency range applicable with network signalled values of NS_05, NS_08, and NS_09 are covered in 6.6.3.3 Additional Spurious Emissions.

6.6.3.3 Additional spurious emissions

6.6.3.3.1 Test purpose

To verify that UE transmitter does not cause unacceptable interference to other channels or other systems in terms of transmitter spurious emissions under the deployment scenarios where additional requirements are specified.

6.6.3.3.2 Test applicability

This test case applies to all types of E-UTRA UE release 8 and forward.

6.6.3.3.3 Minimum conformance requirements

6.6.3.3.3.1 Minimum conformance requirements (network signalled value "NS_05")

When "NS_05" is indicated in the cell, the power of any UE emission shall not exceed the levels specified in Table 6.6.3.3.3.1-1. This requirement also applies for the frequency ranges that are less than Δf_{OoB} (MHz) in Table 6.6.3.1.3-1 from the edge of the channel bandwidth.

Table 6.6.3.3.3.1-1: Additional requirements (PHS)

Frequency band (MHz)	Channel bandwidth / Spectrum emission limit (dBm)				Measurement bandwidth
	5 MHz	10 MHz	15 MHz	20 MHz	
$1884.5 \leq f \leq 1919.6^{*1}$	-41	-41	-41	-41	300 KHz
$1884.5 \leq f \leq 1915.7^{*2}$	-41	-41	-41	-41	300 KHz
Note 1: Applicable when the lower edge of the assigned E-UTRA UL channel bandwidth frequency is larger than or equal to the upper edge of PHS band (1919.6 MHz) + 4 MHz + the Channel BW assigned, where Channel BW is as defined in sub-clause 5.4.2. Operations below this point are for further study. Note 2: Applicable when the lower edge of the assigned E-UTRA UL channel bandwidth frequency is larger than or equal to the upper edge of PHS band (1915.7 MHz) + 4 MHz + the Channel BW assigned, where Channel BW is as defined in sub-clause 5.4.2. Operations below this point are for further study.					

NOTE 1: For measurement conditions at the edge of each frequency range, the lowest frequency of the measurement position in each frequency range should be set at the lowest boundary of the frequency range plus MBW/2. The highest frequency of the measurement position in each frequency range should be set at the highest boundary of the frequency range minus MBW/2. MBW denotes the measurement bandwidth (300 kHz).

NOTE 2: Notes in the tables shall be reviewed after June 2012 because of PHS band operation change

The normative reference for this requirement is TS 36.101[2] subclause 6.6.3.3.1.

6.6.3.3.3.2 Minimum conformance requirements (network signalled value "NS_07")

When "NS_07" is indicated in the cell, the power of any UE emission shall not exceed the levels specified in Table 6.6.3.3.3.2-1.

Table 6.6.3.3.2-1: Additional requirements

Frequency band (MHz)	Channel bandwidth / Spectrum emission limit (dBm)		Measurement bandwidth
	10 MHz		
$769 \leq f \leq 775$	-57		6.25 kHz
Note: The emissions measurement shall be sufficiently power averaged to ensure a standard deviation < 0.5 dB.			

NOTE: For measurement conditions at the edge of each frequency range, the lowest frequency of the measurement position in each frequency range should be set at the lowest boundary of the frequency range plus MBW/2. The highest frequency of the measurement position in each frequency range should be set at the highest boundary of the frequency range minus MBW/2. MBW denotes the measurement bandwidth (6.25 kHz).

The normative reference for this requirement is TS 36.101[2] subclause 6.6.3.3.2.

6.6.3.3.3.3 Minimum requirement (network signalled value "NS_08")

When "NS_08" is indicated in the cell, the power of any UE emission shall not exceed the levels specified in Table 6.6.3.3.3-1. This requirement also applies for the frequency ranges that are less than Δf_{OoB} (MHz) in Table 6.6.3.1.3-1 from the edge of the channel bandwidth.

Table 6.6.3.3.3-1 Additional requirement

Frequency band (MHz)	Channel bandwidth / Spectrum emission limit (dBm)			Measurement bandwidth
	5MHz	10MHz	15MHz	
$860 \leq f \leq 895$	-40	-40	-40	1 MHz

NOTE: For measurement conditions at the edge of each frequency range, the lowest frequency of the measurement position in each frequency range should be set at the lowest boundary of the frequency range plus MBW/2. The highest frequency of the measurement position in each frequency range should be set at the highest boundary of the frequency range minus MBW/2. MBW denotes the measurement bandwidth (1 MHz).

6.6.3.3.3.4 Minimum requirement (network signalled value "NS_09")

When "NS_09" is indicated in the cell, the power of any UE emission shall not exceed the levels specified in Table 6.6.3.3.3.4-1. This requirement also applies for the frequency ranges that are less than Δf_{OoB} (MHz) in Table 6.6.3.1.3-1 from the edge of the channel bandwidth.

Table 6.6.3.3.3.4-1 Additional requirement

Frequency band (MHz)	Channel bandwidth / Spectrum emission limit (dBm)			Measurement bandwidth
	5MHz	10MHz	15MHz	
$1475.9 \leq f \leq 1510.9$	-35	-35	-35	1 MHz

NOTE 1: For measurement conditions at the edge of each frequency range, the lowest frequency of the measurement position in each frequency range should be set at the lowest boundary of the frequency range plus MBW/2. The highest frequency of the measurement position in each frequency range should be set at the highest boundary of the frequency range minus MBW/2. MBW denotes the measurement bandwidth (1 MHz).

NOTE 2: To improve measurement accuracy, A-MPR values for NS_09 specified in Table 6.2.4.3-1 in sub-clause 6.2.4 are derived based on both the above NOTE 1 and 100 kHz RBW.

6.6.3.3.4 Test description

6.6.3.3.4.1 Initial conditions

Initial conditions are a set of test configurations the UE needs to be tested in and the steps for the SS to take with the UE to reach the correct measurement state.

The initial test configurations consist of environmental conditions, test frequencies, and channel bandwidths based on E-UTRA operating bands specified in table 5.4.2.1-1. All of these configurations shall be tested with applicable test parameters for each channel bandwidth, and are shown in table 6.6.3.3.4.1-1, 6.6.3.3.4.1-2, and 6.6.3.3.4.1-3. The details of the uplink reference measurement channels (RMCs) are specified in Annexes A.2. Configurations of PDSCH and PDCCH before measurement are specified in Annex C.2.

Table 6.6.3.3.4.1-1: Test Configuration Table (network signalled value “NS_05”)

Initial Conditions						
Test Environment as specified in TS 36.508[7] subclause 4.1			Normal			
Test Frequencies as specified in TS36.508 [7] subclause 4.3.1			Low range, Mid range In case of Low range: - For 5MHz channel bandwidth: UL 1927.2MHz (N_UL = 18072), DL 2117.2MHz (N_DL = 72) and UL 1931.1MHz (N_UL = 18111) DL 2121.1 MHz (N_DL = 111) - For 10MHz: UL 1934.7MHz (N_UL = 18147), DL 2124.7MHz (N_DL = 147) - For 20MHz channel bandwidth: Not available			
Test Channel Bandwidths as specified in TS 36.508 [7] subclause 4.3.1			5MHz, 10MHz, 20MHz			
Test Parameters for Channel Bandwidths						
Ch BW	Downlink Configuration			Uplink Configuration		
	Mod'n	RB allocation		Mod'n	RB allocation	
		FDD	TDD		FDD	TDD
5MHz	N/A for Additional Spurious Emissions testing			QPSK	1	N/A
5MHz				QPSK	25	
10MHz				QPSK	1	
10MHz				QPSK	12	
10MHz				QPSK	48	
10MHz				QPSK	50	
10MHz				16QAM	50	
15MHz				QPSK	1	
15MHz				QPSK	16	
15MHz				QPSK	48	
15MHz				QPSK	75	
15MHz				16QAM	75	
20MHz				QPSK	1	
20MHz				QPSK	18	
20MHz				QPSK	48	
20MHz				QPSK	100	
20MHz			16QAM	100		
Note 1. The 1 RB allocation shall be tested at both RB #0 and RB #max. Note 2. The starting resource block of partial RB allocation shall be RB# 0 and RB# (max +1 - RB allocation) of the channel bandwidth. Note 3: Low range frequencies for 5MHz and 10MHz channel bandwidth in case of network signalled “NS_05” shall be reviewed after June 2012 because of PHS band operation change.						

Table 6.6.3.3.4.1-2: Test Configuration Table (network signalled value "NS_07")

Initial Conditions						
Test Environment (as specified in TS 36.508 [7] subclause 4.1)				NC		
Test Frequencies (as specified in TS36.508 [7] subclause 4.3.1)				Mid range		
Test Channel Bandwidths (as specified in TS 36.508 [7] subclause 4.3.1)				10MHz		
Test Parameters for Channel Bandwidths						
Test Number	Ch BW	Downlink Configuration		Uplink Configuration		
		Mod'n	RB allocation	Mod'n	RB allocation	RB_start
1	10MHz	N/A for Additional Spurious Emissions testing.		QPSK	1	0
2	10MHz			QPSK	8	0
3	10MHz			QPSK	6	13
4	10MHz			QPSK	20	13
5	10MHz			QPSK	12	13
6	10MHz			16QAM	36 (Note 1)	13
7	10MHz			QPSK	16	19
8	10MHz			QPSK	12	19
9	10MHz			16QAM	16	19
10	10MHz			QPSK	30	19
11	10MHz			16QAM	30 (Note 1)	19
12	10MHz			QPSK	6	43
13	10MHz			QPSK	2	48
14	10MHz			QPSK	50	0
15	10MHz			QPSK	12	0
16	10MHz			16QAM	50 (Note 1)	0
Note 1: Applies only for UE-Categories 2-5						

Table 6.6.3.3.4.1-3: Test Configuration Table (network signalled value “NS_08”)

Initial Conditions						
Test Environment as specified in TS 36.508[7] subclause 4.1			Normal			
Test Frequencies as specified in TS36.508 [7] subclause 4.3.1			High range			
Test Channel Bandwidths as specified in TS 36.508 [7] subclause 4.3.1			5MHz, 10MHz, 15MHz			
Test Parameters for Channel Bandwidths						
Ch BW	Downlink Configuration			Uplink Configuration		
	Mod'n	RB allocation		Mod'n	RB allocation	
		FDD	TDD		FDD	TDD
5MHz	N/A for Additional Spurious Emissions testing			QPSK	1	N/A
5MHz				QPSK	8	
5MHz				QPSK	25	
10MHz				QPSK	1	
10MHz				QPSK	12	
10MHz				QPSK	27	
10MHz				QPSK	36	
10MHz				QPSK	40	
10MHz				QPSK	50	
10MHz				16QAM	50 (Note 3)	
15MHz				QPSK	1	
15MHz				QPSK	16	
15MHz				QPSK	27	
15MHz				QPSK	36	
15MHz				QPSK	40	
15MHz				QPSK	75	
15MHz				16QAM	75 (Note 3)	
Note 1: The 1 RB allocation shall be tested at both RB #0 and RB #max. Note 2: The starting resource block of partial RB allocation shall be RB#0 and RB# (max + 1 - RB allocation) of the channel bandwidth Note 3: Applies only for UE-Categories 2-5						

Table 6.6.3.3.4.1-4: Test Configuration Table (network signalled value “NS_09”)

Initial Conditions						
Test Environment as specified in TS 36.508[7] subclause 4.1			Normal			
Test Frequencies as specified in TS36.508 [7] subclause 4.3.1			High range			
Test Channel Bandwidths as specified in TS 36.508 [7] subclause 4.3.1			5MHz, 10MHz, 15MHz			
Test Parameters for Channel Bandwidths						
Ch BW	Downlink Configuration			Uplink Configuration		
	Mod'n	RB allocation		Mod'n	RB allocation	
		FDD	TDD		FDD	TDD
5MHz	N/A for Additional Spurious Emissions testing			QPSK	1	N/A
5MHz				QPSK	8	
5MHz				QPSK	25	
10MHz				QPSK	1	
10MHz				QPSK	12	
10MHz				QPSK	40	
10MHz				QPSK	50	
10MHz				16QAM	50 (Note 3)	
15MHz				QPSK	1	
15MHz				QPSK	16	
15MHz				QPSK	40	
15MHz				QPSK	54	
15MHz				QPSK	75	
15MHz				16QAM	75 (Note 3)	
Note 1: The 1 RB allocation shall be tested at both RB #0 and RB #max. Note 2: The starting resource block of partial RB allocation shall be RB#0 and RB# (max + 1 - RB allocation) of the channel bandwidth Note 3: Applies only for UE-Categories 2-5						

1. Connect the SS to the UE to the UE antenna connectors as shown in Figure TS 36.508 [7] Annex A, Figure A.3.
2. The parameter settings for the cell are set up according to TS 36.508 [7] subclause 4.4.3.
3. Downlink signals are initially set up according to Annex C0, C.1 and C.3.0, and uplink signals according to Annex H.1 and H.3.0.
4. The UL Reference Measurement channels are set according to Table 6.6.3.3.4.1-1, Table 6.6.3.3.4.1-2 or Table 6.6.3.3.4.1-3 depending on network signal value.
5. Propagation conditions are set according to Annex B.0.
6. Ensure the UE is in State 3A or 3A-RF according to TS 36.508 [7] clause 4.5.3A or 5.2A.2. Message contents are defined in clause 6.6.3.3.4.3.

6.6.3.3.4.2 Test procedure

1. SS sends uplink scheduling information for each UL HARQ process via PDCCH DCI format 0 for C_RNTI to schedule the UL RMC according to Table 6.6.3.3.4.1-1 and Table 6.6.3.3.4.1-2. Since the UE has no payload and no loopback data to send the UE sends uplink MAC padding bits on the UL RMC.
2. Send continuously uplink power control “up” commands in the uplink scheduling information to the UE until the UE transmits at P_{UMAX} level.
3. Measure the mean power of the UE in the channel bandwidth of the radio access mode according to the test configuration, which shall meet the requirements described in Tables 6.2.2.5-1, 6.2.3.5-1, 6.2.4.5-1, 6.2.4.5-2, and 6.2.4.5-3. The period of the measurement shall be at least one sub-frame (1ms).
4. Measure the power of the transmitted signal with a measurement filter of bandwidths according to table 6.6.3.3.5.1-1, 6.6.3.3.5.2-1 and 6.6.3.3.5.3-1. For NS_07 measurements made in a bandwidth of 6.25kHz, measurement parameter settings defined in table 6.6.3.3.4.2-1 shall be used. The centre frequency of the filter

shall be stepped in contiguous steps according to table 6.6.3.3.5.1-1, 6.6.3.3.5.2-1 and 6.6.3.3.5.3-1. The measured power shall be verified for each step. The measurement period shall capture the active time slots.

Table 6.6.3.3.4.2-1: Measurement setup for NS_07

	Option 1: Measurement with No RMS VBW available	Option2 Measurement with VBW Filtering on Power scale
VBW	>=62.5 kHz (10 times or more the RBW)	<=43Hz
RBW	<=6.25kHz	<=6.25kHz
Detector type	Averages signal envelope during each measurement point, such as "RMS detector"	Peak
Averaging mode (Trace averaging)	Power (RMS voltage)	Power (RMS voltage), as controlled by "Average Type"
Average Type (applies to detector)	Power (RMS voltage) (automatically occurs with "RMS detector")	Not applicable
Average Type (applies to VBW filter)	Not applicable	Power (RMS voltage)
Number of averages	30, to reduce variance as required, or use an even longer sweep time	1 or use an even narrower VBW filter, thus a longer sweep time
Sweep time	[Don't specify]	Sweep rate (span divided by sweep time) <= 0.8 * RBW*VBW

6.6.3.3.4.3 Message contents

6.6.3.3.4.3.1 Message contents (network signalled value "NS_05")

Message contents are according to TS 36.508 [7] subclause 4.6, with the following exceptions:

1. Information element `additionalSpectrumEmission` is set to NS_05. This can be set in the *SystemInformationBlockType2* as part of the cell broadcast message. This exception indicates that the UE shall meet the additional spurious emission requirement for a specific deployment scenario.

Table 6.6.3.3.4.3.1-1: SystemInformationBlockType2 :Additional spurious emissions requirement

Derivation Path: TS 36.508 [7] clause 4.4.3.3, Table 4.4.3.3-1			
Information Element	Value/remark	Comment	Condition
<code>additionalSpectrumEmission</code>	5 (NS_05)		

6.6.3.3.4.3.2 Message contents (network signalled value "NS_07")

Message contents are according to TS 36.508 [7] subclause 4.6, with the following exceptions:

1. Information element `additionalSpectrumEmission` is set to NS_07. This can be set in the *SystemInformationBlockType2* as part of the cell broadcast message. This exception indicates that the UE shall meet the additional spurious emission requirement for a specific deployment scenario.

Table 6.6.3.3.4.3.2-1: SystemInformationBlockType2 :Additional spurious emissions requirement

Derivation Path: TS 36.508 [7] clause 4.4.3.3, Table 4.4.3.3-1			
Information Element	Value/remark	Comment	Condition
<code>additionalSpectrumEmission</code>	7 (NS_07)		

6.6.3.3.4.3.3 Message contents (network signalled value "NS_08")

Message contents are according to TS 36.508 [7] subclause 4.6, with the following exceptions:

1. Information element additionalSpectrumEmission is set to NS_08. This can be set in the *SystemInformationBlockType2* as part of the cell broadcast message. This exception indicates that the UE shall meet the additional spurious emission requirement for a specific deployment scenario.

Table 6.6.3.3.4.3.3-1: SystemInformationBlockType2 :Additional spurious emissions requirement

Derivation Path: TS 36.508 [7] clause 4.4.3.3, Table 4.4.3.3-1			
Information Element	Value/remark	Comment	Condition
additionalSpectrumEmission	8 (NS_08)		

6.6.3.3.4.3.4 Message contents (network signalled value "NS_09")

Message contents are according to TS 36.508 [7] subclause 4.6, with the following exceptions:

1. Information element additionalSpectrumEmission is set to NS_09. This can be set in the *SystemInformationBlockType2* as part of the cell broadcast message. This exception indicates that the UE shall meet the additional spurious emission requirement for a specific deployment scenario.

Table 6.6.3.3.4.3.4-1: SystemInformationBlockType2 :Additional spurious emissions requirement

Derivation Path: TS 36.508 [7] clause 4.4.3.3, Table 4.4.3.3-1			
Information Element	Value/remark	Comment	Condition
additionalSpectrumEmission	9 (NS_09)		

6.6.3.3.5 Test requirement

6.6.3.3.5.1 Test requirement (network signalled value "NS_05")

The measured average power of spurious emission, derived in step 2, shall not exceed the described value in tables 6.6.3.3.5.1-1. This requirement also applies for the frequency ranges that are less than Δf_{OOB} (MHz) in Table 6.6.3.1.3-1 from the edge of the channel bandwidth.

Table 6.6.3.3.5.1-1: Additional requirements (PHS) test requirements

Frequency band (MHz)	Channel bandwidth / Spectrum emission limit (dBm)				Measurement bandwidth
	5 MHz	10 MHz	15 MHz	20 MHz	
$1884.5 \leq f \leq 1919.6$ ^{*1}	-41	-41	-41	-41	300 KHz
$1884.5 \leq f \leq 1915.7$ ^{*2}	-41	-41	-41	-41	300 KHz
Note 1:	Applicable when the lower edge of the assigned E-UTRA UL channel bandwidth frequency is larger than or equal to the upper edge of PHS band (1919.6 MHz) + 4 MHz + the Channel BW assigned, where Channel BW is as defined in sub-clause 5.4.2. Operations below this point are for further study.				
Note 2:	Applicable when the lower edge of the assigned E-UTRA UL channel bandwidth frequency is larger than or equal to the upper edge of PHS band (1915.7 MHz) + 4 MHz + the Channel BW assigned, where Channel BW is as defined in sub-clause 5.4.2. Operations below this point are for further study.				

NOTE 1: Notes in the tables shall be reviewed after June 2012 because of PHS band operation change

NOTE 2: For measurement conditions at the edge of each frequency range, the lowest frequency of the measurement position in each frequency range should be set at the lowest boundary of the frequency range plus MBW/2. The highest frequency of the measurement position in each frequency range should be set at the highest boundary of the frequency range minus MBW/2. MBW denotes the measurement bandwidth (300 kHz).

6.6.3.3.5.2 Test requirement (network signalled value "NS_07")

The measured average power of spurious emission, derived in step 4, shall not exceed the described value in tables 6.6.3.3.5.2-1.

Table 6.6.3.3.5.2-1: Additional requirements (network signalled value "NS_07")

Frequency band (MHz)	Channel bandwidth / Spectrum emission limit (dBm)		Measurement bandwidth
	10 MHz		
$769 \leq f \leq 775$	-57+TT		6.25 kHz
Note: The emissions measurement shall be sufficiently power averaged to ensure a standard deviation < 0.5 dB,			

NOTE: For measurement conditions at the edge of each frequency range, the lowest frequency of the measurement position in each frequency range should be set at the lowest boundary of the frequency range plus MBW/2. The highest frequency of the measurement position in each frequency range should be set at the highest boundary of the frequency range minus MBW/2. MBW denotes the measurement bandwidth (6.25 kHz).

6.6.3.3.5.3 Test requirement (network signalled value "NS_08")

The measured average power of spurious emission, derived in step 4, shall not exceed the described value in tables 6.6.3.3.5.3-1. This requirement also applies for the frequency ranges that are less than Δf_{OOB} (MHz) in Table 6.6.3.1.3-1 from the edge of the channel bandwidth.

Table 6.6.3.3.5.3-1: Additional requirements (network signalled value "NS_08")

Frequency band (MHz)	Channel bandwidth / Spectrum emission limit (dBm)			Measurement bandwidth
	5MHz	10MHz	15MHz	
$860 \leq f \leq 895$	-40	-40	-40	1 MHz

NOTE: For measurement conditions at the edge of each frequency range, the lowest frequency of the measurement position in each frequency range should be set at the lowest boundary of the frequency range plus MBW/2. The highest frequency of the measurement position in each frequency range should be set at the highest boundary of the frequency range minus MBW/2. MBW denotes the measurement bandwidth (1 MHz).

6.6.3.3.5.4 Test requirement (network signalled value "NS_09")

The measured average power of spurious emission, derived in step 4, shall not exceed the described value in table 6.6.3.3.5.4-1. This requirement also applies for the frequency ranges that are less than Δf_{OOB} (MHz) in Table 6.6.3.1.3-1 from the edge of the channel bandwidth.

Table 6.6.3.3.5.4-1: Additional requirements (network signalled value "NS_09")

Frequency band (MHz)	Channel bandwidth / Spectrum emission limit (dBm)			Measurement bandwidth
	5MHz	10MHz	15MHz	
$1475.9 \leq f \leq 1510.9$	-35	-35	-35	1 MHz

NOTE 1: For measurement conditions at the edge of each frequency range, the lowest frequency of the measurement position in each frequency range should be set at the lowest boundary of the frequency range plus MBW/2. The highest frequency of the measurement position in each frequency range should be set at the highest boundary of the frequency range minus MBW/2. MBW denotes the measurement bandwidth (1 MHz).

NOTE 2: To improve measurement accuracy, A-MPR values for NS_09 specified in Table 6.2.4.3-1 in sub-clause 6.2.4 are derived based on both the above NOTE 1 and 100 kHz RBW.

6.7 Transmit intermodulation

6.7.1 Test purpose

To verify that the UE transmit intermodulation does not exceed the described value in the test requirement.

The transmit intermodulation performance is a measure of the capability of the transmitter to inhibit the generation of signals in its non linear elements caused by presence of the wanted signal and an interfering signal reaching the transmitter via the antenna.

6.7.2 Test applicability

This test applies to all types of E-UTRA UE release 8 and forward.

6.7.3 Minimum conformance requirements

User Equipment(s) transmitting in close vicinity of each other can produce intermodulation products, which can fall into the UE, or eNode B receive band as an unwanted interfering signal. The UE intermodulation attenuation is defined by the ratio of the mean power of the wanted signal to the mean power of the intermodulation product when an interfering CW signal is added at a level below the wanted signal at each of the transmitter antenna port with the other antenna port(s) if any is terminated. Both the wanted signal power and the intermodulation product power are measured through E-UTRA rectangular filter with measurement bandwidth shown in Table 6.7.3-1.

The requirement of transmitting intermodulation is prescribed in Table 6.7.3-1.

Table 6.7.3-1: Transmit Intermodulation

BWChannel (UL)	5MHz		10MHz		15MHz		20MHz	
Interference Signal Frequency Offset	5MHz	10MHz	10MHz	20MHz	15MHz	30MHz	20MHz	40MHz
Interference CW Signal Level	-40dBc							
Intermodulation Product	-29dBc	-35dBc	-29dBc	-35dBc	-29dBc	-35dBc	-29dBc	-35dBc
Measurement bandwidth	4.5MHz	4.5MHz	9.0MHz	9.0MHz	13.5MHz	13.5MHz	18MHz	18MHz

The normative reference for this requirement is TS 36.101 [2] clause 6.7.1.

6.7.4 Test description

6.7.4.1 Initial conditions

Initial conditions are a set of test configurations the UE needs to be tested in and the steps for the SS to take with the UE to reach the correct measurement state.

The initial test configurations consist of environmental conditions, test frequencies, and channel bandwidths based on E-UTRA operating bands specified in table 5.4.2.1-1. All of these configurations shall be tested with applicable test parameters for each channel bandwidth, and are shown in table 6.7.4.1-1. The details of the uplink reference

measurement channels (RMCs) are specified in Annexes A.2. Configurations of PDSCH and PDCCH before measurement are specified in Annex C.2.

Table 6.7.4.1-1: Test Configuration Table

Initial Conditions				
Test Environment as specified in TS 36.508[7] subclause 4.1		Normal		
Test Frequencies as specified in TS36.508 [7] subclause 4.3.1		Mid range		
Test Channel Bandwidths as specified in TS 36.508 [7] subclause 4.3.1		5MHz and Highest		
Test Parameters for Channel Bandwidths				
Ch BW	Downlink Configuration	Uplink Configuration		
		Mod'n	RB allocation	
	N/A for Transmit Intermodulation	FDD	TDD	
5MHz		QPSK	8	8
10MHz		QPSK	12	12
15MHz		QPSK	16	16
20MHz		QPSK	18	18
Note 1: Test Channel Bandwidths are checked separately for each E-UTRA band, the applicable channel bandwidths are specified in Table 5.4.2.1-1.				

1. Connect the SS to the UE antenna connectors as shown in TS 36.508 [7] Annex A, Figure A.2.
2. The parameter settings for the cell are set up according to TS 36.508 [7] subclause 4.4.3.
3. Downlink signals are initially set up according to Annex C.0, C.1, and C.3.0, and uplink signals according to Annex H.1 and H.3.0.
4. The UL Reference Measurement channels are set according to Table 6.7.4.1-1.
5. Propagation conditions are set according to Annex B.0.
6. Ensure the UE is in State 3A or 3A-RF according to TS 36.508 [7] clause 4.5.3A or 5.2A.2. Message contents are defined in clause 6.7.4.3.

6.7.4.3 Test procedure

1. SS sends uplink scheduling information for each UL HARQ process via PDCCH DCI format 0 for C_RNTI to schedule the UL RMC according to Table 6.7.4.1-1. Since the UE has no payload and no loopback data to send the UE sends uplink MAC padding bits on the UL RMC.
2. Send continuously uplink power control “up” commands to the UE until the UE transmits at its P_{UMAX} level.
3. Measure the rectangular filtered mean power of the UE. For TDD slots with transient periods are not under test for the wanted signal and for the intermodulation product.
4. Set the interference signal frequency below the UL carrier frequency using the first offset in table 6.7.5-1.
5. Set the interference CW signal level according to table 6.7.5-1.
6. Search the intermodulation product signals below and above the UL carrier frequency, then measure the rectangular filtered mean power of transmitting intermodulation for both signals, and calculate the ratios with the power measured in step 3.
7. Set the interference signal frequency above the UL carrier frequency using the first offset in table 6.7.5-1.
8. Search the intermodulation product signals below and above the UL carrier frequency, then measure the rectangular filtered mean power of transmitting intermodulation for both signals, and calculate the ratios with the power measured in step 3.
9. Repeat the measurement using the second offset in table 6.7.5-1.

6.7.4.3 Message contents

Message contents are according to TS 36.508 [7] subclause 4.6.

6.7.5 Test requirement

The ratio derived in step 5 and 7, shall not exceed the described value in table 6.7.5-1

Table 6.7.5-1: Transmit Intermodulation

BWChannel (UL)	5MHz		10MHz		15MHz		20MHz	
Interference Signal Frequency Offset	5MHz	10MHz	10MHz	20MHz	15MHz	30MHz	20MHz	40MHz (Note 1)
Interference CW Signal Level	-40dBc							
Intermodulation Product	-29dBc	-35dBc	-29dBc	-35dBc	-29dBc	-35dBc	-29dBc	-35dBc
Measurement bandwidth	4.5MHz	4.5MHz	9.0MHz	9.0MHz	13.5MHz	13.5MHz	18MHz	18MHz
Note 1: For Band 20, only applicable for interference signal frequency above the UL carrier frequency.								

7 Receiver Characteristics

7.1 General

Unless otherwise stated the receiver characteristics are specified at the antenna connector(s) of the UE. For UE(s) with an integral antenna only, a reference antenna(s) with a gain of 0 dBi is assumed for each antenna port(s). UE with an integral antenna(s) may be taken into account by converting these power levels into field strength requirements, assuming a 0 dBi gain antenna. For UEs with more than one receiver antenna connector, identical interfering signals shall be applied to each receiver antenna port if more than one of these is used (diversity).

Unless otherwise stated, the test signal levels are defined at each antenna port, and specified in the respective sections below. Any specific test conditions are defined in the paragraph for each test. Unless stated otherwise, power control of the Downlink is OFF.

In general, the UE is set into the correct state in the “Initial conditions” part of the test, using normal SS signalling procedures over the air interface under easy radio conditions to ensure reliable message exchange. In the “Test procedure” part of the test, specific radio conditions are applied according to the test requirement and the desired measurement is made or the desired response is tested.

The ACS, blocking, spurious emissions and intermodulation requirements in sections 7.5, 7.6, 7.7 and 7.8 are defined for full band width signals i.e. for signals where all resource blocks are allocated for a specific user.

With the exception of Clause 7.3, the requirements shall be verified with the network signalling value NS_01 configured (Table 6.2.4.3-1).

All the parameters in clause 7 are defined using the UL reference measurement channels specified in Annexes A.2.2 and A.2.3, the DL reference measurement channels specified in Annex A.3.2 and using the set-up specified in Annex C.3.1

7.2 Diversity characteristics

The requirements in Section 7 assume that the receiver is equipped with two Rx port as a baseline. Requirements for 4 ports are FFS. With the exception of clause 7.9, All requirements shall be verified by using both (all) antenna ports simultaneously.

7.3 Reference sensitivity level

Editor’s note: FDD/TDD aspects missing or not yet determined:

- **The Maximum Sensitivity Degradation figures for large transmission configurations are not finalised in the core specification.**

7.3.1 Test purpose

To verify the UE’s ability to receive data with a given average throughput for a specified reference measurement channel, under conditions of low signal level, ideal propagation and no added noise.

A UE unable to meet the throughput requirement under these conditions will decrease the effective coverage area of an e-NodeB.

7.3.2 Test applicability

This test applies to all types of E-UTRA UE release 8 and forward.

7.3.3 Minimum conformance requirements

The throughput shall be $\geq 95\%$ of the maximum throughput of the reference measurement channels as specified in Annexes A.2.2, A.2.3 and A.3.2 (with one sided dynamic OCNG Pattern OP.1 FDD/TDD for the DL-signal as described in Annex A.5.1.1/A.5.2.1) with parameters specified in Table 7.3.3-1, Table 7.3.3-2 and Table 7.3.3-3.

Table 7.3.3-1: Reference sensitivity QPSK P_{REFSENS}

E-UTRA Band	Channel bandwidth						Duplex Mode
	1.4 MHz (dBm)	3 MHz (dBm)	5 MHz (dBm)	10 MHz (dBm)	15 MHz (dBm)	20 MHz (dBm)	
1	-	-	-100	-97	-95.2	-94	FDD
2	-102.7	-99.7	-98	-95	-93.2	-92	FDD
3	-101.7	-98.7	-97	-94	-92.2	-91	FDD
4	-104.7	-101.7	-100	-97	-95.2	-94	FDD
5	-103.2	-100.2	-98	-95			FDD
6	-	-	-100	-97			FDD
7	-	-	-98	-95	-93.2	-92	FDD
8	-102.2	-99.2	-97	-94			FDD
9	-	-	-99	-96	-94.2	-93	FDD
10	-	-	-100	-97	-95.2	-94	FDD
11	-	-	-100	-97			FDD
12	-101.7	-98.7	-97	-94			FDD
13			-97	-94			FDD
14		-99.2	-97	-94			FDD
...							
17	-102.2	-99.2	-97	-94			FDD
18	-	-	-100	-97	-95.2	-	FDD
19	-	-	-100	-97	-95.2	-	FDD
20			-97	-94	-91.2	-90	FDD
21			-100	-97	-95.2		FDD
...							
24			-100	-97			FDD
...							
33	-	-	-100	-97	-95.2	-94	TDD
34	-	-	-100	-97	-95.2	-94	TDD
35	-106.2	-102.2	-100	-97	-95.2	-94	TDD
36	-106.2	-102.2	-100	-97	-95.2	-94	TDD
37	-	-	-100	-97	-95.2	-94	TDD
38	-	-	-100	-97	-95.2	-94	TDD
39	-	-	-100	-97	-95.2	-94	TDD
40	-	-	-100	-97	-95.2	-94	TDD
41	-	-	-99	-96	-94.2	-93	TDD
Note 1:	The transmitter shall be set to P_{UMAX} as defined in clause 6.2.5						
Note 2:	The reference measurement channel is specified in A.3.2 with one sided dynamic OCNG Pattern OP.1 FDD/TDD as described in Annex A.5.1.1/A.5.2.1						
Note 3:	The signal power is specified per port						
Note 4:	For the UE which supports both Band 3 and Band 9 the reference sensitivity level is FFS.						
Note 5:	For the UE which supports both Band 11 and Band 21 the reference sensitivity level is FFS.						

The reference receive sensitivity (REFSENS) requirement specified in Table 7.3.3-1 shall be met for an uplink transmission bandwidth less than or equal to that specified in Table 7.3.3-2.

NOTE: Table 7.3.3-2 does not necessarily reflect the operational conditions of the network, where the number of uplink and downlink allocated resource blocks will be practically constrained by other factors.

Table 7.3.3-2: Uplink configuration for reference sensitivity

E-UTRA Band / Channel bandwidth / N_{RB} / Duplex mode							
E-UTRA Band	1.4 MHz	3 MHz	5 MHz	10 MHz	15 MHz	20 MHz	Duplex Mode
1	-	-	25	50	75	100	FDD
2	6	15	25	50	50 ¹	50 ¹	FDD
3	6	15	25	50	50 ¹	50 ¹	FDD
4	6	15	25	50	75	100	FDD
5	6	15	25	25 ¹	-	-	FDD
6	-	-	25	25 ¹	-	-	FDD
7	-	-	25	50	75 ¹	75 ¹	FDD
8	6	15	25	25 ¹	-	-	FDD
9	-	-	25	50	50 ¹	50 ¹	FDD
10	-	-	25	50	75	100	FDD
11	-	-	25	25 ¹			FDD
12	6	15	20 ¹	20 ¹			FDD
13			20 ¹	20 ¹			FDD
14		15	15 ¹	15 ¹			FDD
...							
17	6	15	20 ¹	20 ¹			FDD
18	-	-	25	25 ¹	25 ¹	-	FDD
19	-	-	25	25 ¹	25 ¹	-	FDD
20			25	20 ¹	20 ³	20 ³	FDD
21			25	25 ¹	25 ¹		FDD
...							
24			25	50			FDD
...							
33	-	-	25	50	75	100	TDD
34	-	-	25	50	75	-	TDD
35	6	15	25	50	75	100	TDD
36	6	15	25	50	75	100	TDD
37	-	-	25	50	75	100	TDD
38	-	-	25	50	75	100	TDD
39			25	50	75	100	TDD
40			25	50	75	100	TDD
41			25	50	75	100	TDD
Note 1:	The UL resource blocks shall be located as close as possible to the downlink operating band but confined within the transmission bandwidth configuration for the channel bandwidth (Table 5.4.2-1).						
Note 2:	For the UE which supports both Band 11 and Band 21 the uplink configuration for reference sensitivity is FFS.						
Note 3:	For Band 20; in the case of 15MHz channel bandwidth, the UL resource blocks shall be located at RBstart_11 and in the case of 20MHz channel bandwidth, the UL resource blocks shall be located at RBstart_16						

Unless given by Table 7.3.3-3, the minimum requirements specified in Tables 7.3.3-1 and 7.3.3-2 shall be verified with the network signalling value NS_01 (Table 6.2.4.3-1) configured.

Table 7.3.3-3: Network Signalling Value for reference sensitivity

E-UTRA Band	Network Signalling value
2	NS_03
4	NS_03
10	NS_03
12	NS_06
13	NS_06
14	NS_06
17	NS_06
19	NS_08
21	NS_09

The normative reference for this requirement is TS 36.101 [2] clause 7.3.1.

7.3.4 Test description

7.3.4.1 Initial conditions

Initial conditions are a set of test configurations the UE needs to be tested in and the steps for the SS to take with the UE to reach the correct measurement state.

The initial test configurations consist of environmental conditions, test frequencies, and channel bandwidths based on E-UTRA bands specified in table 5.4.2.1-1. All of these configurations shall be tested with applicable test parameters for each channel bandwidth, and are shown in table 7.3.4.1-1. The details of the downlink and uplink reference measurement channels (RMCs) are specified in Annexes A.2 and A.3. The details of the OCNG patterns used are specified in Annex A.5. Configurations of PDSCH and PDCCH before measurement are specified in Annex C.2.

Table 7.3.4.1-1: Test Configuration Table

Initial Conditions						
Test Environment as specified in TS 36.508[7] subclause 4.1			NC, TL/VL, TL/VH, TH/VL, TH/VH			
Test Frequencies as specified in TS36.508 [7] subclause 4.3.1			Low range, Mid range, High range			
Test Channel Bandwidths as specified in TS 36.508 [7] subclause 4.3.1			Lowest, 5MHz, Highest			
Test Parameters for Channel Bandwidths						
Ch BW	Downlink Configuration			Uplink Configuration		
	Mod'n	RB allocation		Mod'n	RB allocation	
		FDD	TDD		FDD	TDD
1.4MHz	QPSK	6	6	QPSK	6	6
3MHz	QPSK	15	15	QPSK	15	15
5MHz	QPSK	25	25	QPSK	25	25
5MHz	QPSK	25	N/A	QPSK	20	N/A
5MHz	QPSK	25	N/A	QPSK	15	N/A
10MHz	QPSK	50	50	QPSK	50	50
10MHz	QPSK	50	N/A	QPSK	25	N/A
10MHz	QPSK	50	N/A	QPSK	20	N/A
10MHz	QPSK	50	N/A	QPSK	15	N/A
15MHz	QPSK	75	75	QPSK	75	75
15MHz	QPSK	75	N/A	QPSK	50	N/A
15MHz	QPSK	75	N/A	QPSK	25	N/A
15MHz	QPSK	75	N/A	QPSK	20	N/A
20MHz	QPSK	100	100	QPSK	100	100
20MHz	QPSK	100	N/A	QPSK	75	N/A
20MHz	QPSK	100	N/A	QPSK	50	N/A
20MHz	QPSK	100	N/A	QPSK	25	N/A
20MHz	QPSK	100	N/A	QPSK	20	N/A
Note 1: Test Channel Bandwidths are checked separately for each E-UTRA band, which applicable channel bandwidths are specified in Table 5.4.2.1-1. Note 2: Depending on E-UTRA band, only the appropriate Uplink RB allocation value according to table 7.3.3-2 is tested per Test Channel Bandwidth. Note 3: For the DL signal one sided dynamic OCNG Pattern OP.1 FDD/TDD is used.						

1. Connect the SS to the UE antenna connectors as shown in TS 36.508 [7] Annex A, Figure A.3.
2. The parameter settings for the cell are set up according to TS 36.508 [7] subclause 4.4.3.
3. Downlink signals are initially set up according to Annex C0, C.1 and C.3.1, and uplink signals according to Annex H.1 and H.3.1.
4. The UL and DL Reference Measurement channels are set according to Table 7.3.4.1-1.
5. Propagation conditions are set according to Annex B.0.
6. Ensure the UE is in State 3A or 3A-RF according to TS 36.508 [7] clause 4.5.3A or 5.2A.2. Message contents are defined in clause 7.3.4.3.

7.3.4.2 Test procedure

1. SS transmits PDSCH via PDCCH DCI format 1A for C_RNTI to transmit the DL RMC according to Table 7.3.4.1-1. The SS sends downlink MAC padding bits on the DL RMC.
2. SS sends uplink scheduling information for each UL HARQ process via PDCCH DCI format 0 for C_RNTI to schedule the UL RMC according to Table 7.3.4.1-1. Since the UE has no payload data to send, the UE transmits uplink MAC padding bits on the UL RMC.
3. Set the Downlink signal level to the appropriate REFSENS value defined in Table 7.3.5-1. Send continuously uplink power control "up" commands in the uplink scheduling information to the UE to ensure the UE transmits P_{UMAX} level for at least the duration of the Throughput measurement.

4. Measure the average throughput for a duration sufficient to achieve statistical significance according to Annex G.2.

7.3.4.3 Message contents

Message contents are according to TS 36.508 [7] subclause 4.6 with the following exceptions.

7.3.4.3.1 Message contents exceptions (network signalled value "NS_01")

Message contents according to TS 36.508 [7] subclause 4.6 can be used without exceptions.

7.3.4.3.2 Message contents exceptions (network signalled value "NS_03")

1. Information element `additionalSpectrumEmission` is set to NS_03. This can be set in the *SystemInformationBlockType2* as part of the cell broadcast message. This exception indicates that the UE shall meet the additional spurious emission requirement for a specific deployment scenario.

Table 7.3.4.3.2-1: *SystemInformationBlockType2* :Additional spurious emissions test requirement for "NS_03"

Derivation Path: TS 36.508 [7] clause 4.4.3.3, Table 4.4.3.3-1			
Information Element	Value/remark	Comment	Condition
<code>additionalSpectrumEmission</code>	3 (NS_03)		

7.3.4.3.3 Message contents exceptions (network signalled value "NS_06")

1. Information element `additionalSpectrumEmission` is set to NS_06. This can be set in the *SystemInformationBlockType2* as part of the cell broadcast message. This exception indicates that the UE shall meet the additional spurious emission requirement for a specific deployment scenario.

Table 7.3.4.3.3-1: *SystemInformationBlockType2* :Additional spurious emissions test requirement for "NS_06"

Derivation Path: TS 36.508 [7] clause 4.4.3.3, Table 4.4.3.3-1			
Information Element	Value/remark	Comment	Condition
<code>additionalSpectrumEmission</code>	6 (NS_06)		

7.3.4.3.4 Message contents exceptions (network signalled value "NS_[09]")

1. Information element `additionalSpectrumEmission` is set to NS_[09]. This can be set in the *SystemInformationBlockType2* as part of the cell broadcast message. This exception indicates that the UE shall meet the additional spurious emission requirement for a specific deployment scenario.

Table 7.3.4.3.4-1: *SystemInformationBlockType2* :Additional spurious emissions test requirement for "NS_[09]"

Derivation Path: TS 36.508 [7] clause 4.4.3.3, Table 4.4.3.3-1			
Information Element	Value/remark	Comment	Condition
<code>additionalSpectrumEmission</code>	TBD		

7.3.5 Test requirement

The throughput shall be $\geq 95\%$ of the maximum throughput of the reference measurement channels as specified in Annex A.3.2 with parameters specified in Tables 7.3.5-1 and Table 7.3.5-2.

Table 7.3.5-1: Reference sensitivity QPSK $P_{REFSENS}$

Channel bandwidth							
E-UTRA Band	1.4 MHz (dBm)	3 MHz (dBm)	5 MHz (dBm)	10 MHz (dBm)	15 MHz (dBm)	20 MHz (dBm)	Duplex Mode
1	-	-	-99.3	-96.3	-94.5	-93.3	FDD
2	-102.0	-99.0	-97.3	-94.3	-92.5	-91.3	FDD
3	-101.0	-98.0	-96.3	-93.3	-91.5	-90.3	FDD
4	-104.0	-101	-99.3	-96.3	-94.5	-93.3	FDD
5	-102.5	-99.5	-97.3	-94.3			FDD
6	-	-	-99.3	-96.3			FDD
7	-	-	-97.3	-94.3	-92.5	-91.3	FDD
8	-101.5	-98.5	-96.3	-93.3			FDD
9	-	-	-98.3	-95.3	-93.5	-92.3	FDD
10	-	-	-99.3	-96.3	-94.5	-93.3	FDD
11	-	-	-99.3	-96.3			FDD
12	-101.0	-98.0	-96.3	-93.3			FDD
13			-96.3	-93.3			FDD
14		-98.5	-96.3	-93.3			FDD
...							
17	-101.5	-98.5	-96.3	-93.3			FDD
18	-	-	-99,3	-96.3	-94.5	-	FDD
19	-	-	-99,3	-96.3	-94.5	-	FDD
20			-96.3	-93.3	-90.5	-89.3	FDD
21			-99.3	-96.3	-94.5		FDD
...							
24			-99.3	-96.3			FDD
...							
33	-	-	-99,3	-96.3	-94.5	-93.3	TDD
34	-	-	-99.3	-96.3	-94.5	-93.3	TDD
35	-105.5	-101.5	-99.3	-96.3	-94.5	-93.3	TDD
36	-105.5	-101.5	-99.3	-96.3	-94.5	-93.3	TDD
37	-	-	-99.3	-96.3	-94.5	-93.3	TDD
38	-	-	-99.3	-96.3	-94.5	-93.3	TDD
39	-	-	-99.3	-96.3	-94.5	-93.3	TDD
40	-	-	-99.3	-96.3	-94.5	-93.3	TDD
41	-	-	-98.3	-95.3	-93.5	-92.3	TDD
Note 1:	The transmitter shall be set to maximum output power level (Table 7.3.5-2)						
Note 2:	The reference measurement channel is specified in A.3.2 with one sided dynamic OCNG Pattern OP.1 FDD/TDD as described in Annex A.5.1.1/A.5.2.1						
Note 3:	The signal power is specified per port						
Note 4:	For the UE which supports both Band 3 and Band 9 the reference sensitivity level is FFS.						
Note 5:	For the UE which supports both Band 11 and Band 21 the reference sensitivity level is FFS.						

NOTE: The relation to the received PSD is $\langle \text{REF} \hat{I}_{or} \rangle = P_{REFSENS} (N_{sc}^{RB} N_{RB} \Delta f)^{-1}$ with N_{RB} is the maximum transmission configuration according to Table 5.4.2-1.

The reference receive sensitivity (REFSENS) requirement specified in Table 7.3.5-1 shall be met for an uplink transmission bandwidth less than or equal to that specified in Table 7.3.5-2.

NOTE: Table 7.3.5-2 does not necessarily reflect the operational conditions of the network, where the number of uplink and downlink allocated resource blocks will be practically constrained by other factors.

Table 7.3.5-2: Uplink configuration for reference sensitivity

E-UTRA Band / Channel bandwidth / N_{RB} / Duplex mode							
E-UTRA Band	1.4 MHz	3 MHz	5 MHz	10 MHz	15 MHz	20 MHz	Duplex Mode
1	-	-	25	50	75	100	FDD
2	6	15	25	50	50 ¹	50 ¹	FDD
3	6	15	25	50	50 ¹	50 ¹	FDD
4	6	15	25	50	75	100	FDD
5	6	15	25	25 ¹	-	-	FDD
6	-	-	25	25 ¹	-	-	FDD
7	-	-	25	50	75 ¹	75 ¹	FDD
8	6	15	25	25 ¹	-	-	FDD
9	-	-	25	50	50 ¹	50 ¹	FDD
10	-	-	25	50	75	100	FDD
11	-	-	25	25 ¹			FDD
12	6	15	20 ¹	20 ¹			FDD
13			20 ¹	20 ¹			FDD
14		15	15 ¹	15 ¹			FDD
...							
17	6	15	20 ¹	20 ¹			FDD
18	-	-	25	25 ¹	25 ¹	-	FDD
19	-	-	25	25 ¹	25 ¹	-	FDD
20			25	20 ¹	20 ³	20 ³	FDD
21			25	25 ¹	25 ¹		FDD
...							
24			25	50			FDD
...							
33	-	-	25	50	75	100	TDD
34	-	-	25	50	75	-	TDD
35	6	15	25	50	75	100	TDD
36	6	15	25	50	75	100	TDD
37	-	-	25	50	75	100	TDD
38	-	-	25	50	75	100	TDD
39			25	50	75	100	TDD
40			25	50	75	100	TDD
41			25	50	75	100	TDD
Note 1:	The UL resource blocks shall be located as close as possible to the downlink operating band but confined within the transmission bandwidth configuration for the channel bandwidth (Table 5.4.2-1).						
Note 2:	For the UE which supports both Band 11 and Band 21 the uplink configuration for reference sensitivity is FFS.						
Note 3:	For Band 20; in the case of 15MHz channel bandwidth, the UL resource blocks shall be located at RBstart_11 and in the case of 20MHz channel bandwidth, the UL resource blocks shall be located at RBstart_16						

7.4 Maximum input level

7.4.1 Test purpose

Maximum input level tests the UE's ability to receive data with a given average throughput for a specified reference measurement channel, under conditions of high signal level, ideal propagation and no added noise.

A UE unable to meet the throughput requirement under these conditions will decrease the coverage area near to an e-NodeB.

7.4.2 Test applicability

This test applies to all types of E-UTRA UE release 8 and forward.

7.4.3 Minimum conformance requirements

The throughput shall be $\geq 95\%$ of the maximum throughput of the reference measurement channels as specified in Annexes A.2.2, A.2.3 and A.3.2 (with one sided dynamic OCNG Pattern OP.1 FDD/TDD as described in Annex A.5.1.1/A.5.2.1) with parameters specified in Table 7.4.3-1.

Table 7.4.3-1: Maximum input level

Rx Parameter	Units	Channel bandwidth					
		1.4 MHz	3 MHz	5 MHz	10 MHz	15 MHz	20 MHz
Power in Transmission Bandwidth Configuration	dBm	-25					
Note 1:	The transmitter shall be set to 4dB below $P_{\text{CMAX,L}}$ at the minimum uplink configuration specified in Table 7.3.3-2 with $P_{\text{CMAX,L}}$ as defined in clause 6.2.5.						
Note 2:	Reference measurement channel is Annex A.3.2 64QAM R=3/4 variant with one sided dynamic OCNG Pattern OP.1 FDD/TDD as described in Annex A.5.1.1/A.5.2.1.						

The normative reference for this requirement is TS 36.101 [2] clause 7.4.1.

7.4.4 Test description

7.4.4.1 Initial conditions

Initial conditions are a set of test configurations the UE needs to be tested in and the steps for the SS to take with the UE to reach the correct measurement state.

The initial test configurations consist of environmental conditions, test frequencies, and channel bandwidths based on E-UTRA bands specified in table 5.4.2.1-1. All of these configurations shall be tested with applicable test parameters for each channel bandwidth, and are shown in table 7.4.4.1-1. The details of the uplink and downlink reference measurement channels (RMCs) are specified in Annexes A.2 and A.3 respectively. The details of the OCNG patterns used are specified in Annex A.5. Configurations of PDSCH and PDCCH before measurement are specified in Annex C.2.

Table 7.4.4.1-1: Test Configuration Table

Initial Conditions							
Test Environment as specified in TS 36.508[7] subclause 4.1				NC			
Test Frequencies as specified in TS36.508 [7] subclause 4.3.1				Mid range			
Test Channel Bandwidths as specified in TS 36.508 [7] subclause 4.3.1				Lowest, 5MHz, Highest			
Test Parameters for Channel Bandwidths							
Ch BW	Downlink Configuration			Uplink Configuration			UE Category
	Mod'n	RB allocation		Mod'n	RB allocation		
		FDD	TDD		FDD	TDD	
1.4MHz	64-QAM	6	6	QPSK	5	5	1-5
3MHz	64-QAM	15	15	QPSK	4	4	1-5
5MHz	64-QAM	25	25	QPSK	8	8	2-5
5MHz	64-QAM	18	18	QPSK	8	8	1
10MHz	64-QAM	50	50	QPSK	12	12	2-5
10MHz	64-QAM	17	17	QPSK	12	12	1
15MHz	64-QAM	75	75	QPSK	16	16	2-5
15MHz	64-QAM	17	17	QPSK	16	16	1
20MHz	64-QAM	100	100	QPSK	18	18	3-5
20MHz	64-QAM	83	83	QPSK	18	18	2
20MHz	64-QAM	17	17	QPSK	18	18	1
Note 1: Test Channel Bandwidths are checked separately for each E-UTRA band. The applicable channel bandwidths are specified in Table 7.3.3-2.							
Note 2: For the DL signal one sided dynamic OCN Pattern OP.1 FDD/TDD is used							

1. Connect the SS to the UE antenna connectors as shown in TS 36.508 [7] Figure A.3.
2. The parameter settings for the cell are set up according to TS 36.508 [7] subclause 4.4.3.
3. Downlink signals are initially set up according to Annex C0, C.1 and C.3.1, and uplink signals according to Annex H.1 and H.3.1.
4. The UL and DL Reference Measurement channels are set according to Table 7.4.4.1-1.
5. Propagation conditions are set according to Annex B.0.
6. Ensure the UE is in State 3A or 3A-RF according to TS 36.508 [7] clause 4.5.3A or 5.2A.2. Message contents are defined in clause 7.4.4.3.

7.4.4.2 Test procedure

1. SS transmits PDSCH via PDCCH DCI format 1A for C_RNTI to transmit the DL RMC according to Table 7.4.4.1-1. The SS sends downlink MAC padding bits on the DL RMC.
2. SS sends uplink scheduling information for each UL HARQ process via PDCCH DCI format 0 for C_RNTI to schedule the UL RMC according to Table 7.4.4.1-1. Since the UE has no payload data to send, the UE transmits uplink MAC padding bits on the UL RMC.
3. Set the Downlink signal level to the value defined in Table 7.4.5-1. Send Uplink power control commands to the UE (less or equal to 1dB step size should be used), to ensure that the UE output power is within +0, - 3.4 dB of the target level in Table 7.4.5-1 for at least the duration of the Throughput measurement.
4. Measure the average throughput for a duration sufficient to achieve statistical significance according to Annex G.2.

7.4.4.3 Message contents

Message contents are according to TS 36.508 [7] subclause 4.6 with the following exception.

Table 7.4.4.3-1: UplinkPowerControlDedicated

Derivation Path: 36.331 clause 6.3.2			
Information Element	Value/remark	Comment	Condition
UplinkPowerControlDedicated-DEFAULT ::= SEQUENCE {			
p0-UePUSCH	0		
deltaMCS-Enabled	en0		
accumulationEnabled	TRUE		
p0-uePUCCH	0		
pSRS-Offset	3 (-6 dB)		
filterCoefficient	fc8	larger filter length is used to reduce the RSRP measurement variation	
}			

7.4.5 Test requirement

The throughput shall be $\geq 95\%$ of the maximum throughput of the reference measurement channels as specified in Annex A.3.2 with parameters specified in Table 7.4.5-1.

Table 7.4.5-1: Maximum input level

Rx Parameter	Units	Channel bandwidth					
		1.4 MHz	3 MHz	5 MHz	10 MHz	15 MHz	20 MHz
Power in Transmission Bandwidth Configuration	dBm	-25.7					
Note 1:	The transmitter shall be set to 4dB below P_{CMAX_L} with P_{CMAX_L} as defined in clause 6.2.5.						
Note 2:	Reference measurement channel is Annex A.3.2 64QAM R=3/4 variant with one sided dynamic OCNG Pattern OP.1 FDD/TDD as described in Annex A.5.1.1/A.5.2.1.						

7.5 Adjacent Channel Selectivity (ACS)

7.5.1 Test purpose

Adjacent channel selectivity tests the UE's ability to receive data with a given average throughput for a specified reference measurement channel, in the presence of an adjacent channel signal at a given frequency offset from the centre frequency of the assigned channel, under conditions of ideal propagation and no added noise.

A UE unable to meet the throughput requirement under these conditions will decrease the coverage area when other e-NodeB transmitters exist in the adjacent channel.

7.5.2 Test applicability

This test applies to all types of E-UTRA UE release 8 and forward.

7.5.3 Minimum conformance requirements

Adjacent Channel Selectivity (ACS) is a measure of a receiver's ability to receive an E-UTRA signal at its assigned channel frequency in the presence of an adjacent channel signal at a given frequency offset from the centre frequency of the assigned channel. ACS is the ratio of the receive filter attenuation on the assigned channel frequency to the receive filter attenuation on the adjacent channel(s).

The UE shall fulfil the minimum requirement specified in Table 7.5.3-1 for all values of an adjacent channel interferer up to -25 dBm. However it is not possible to directly measure the ACS, instead the lower and upper range of test parameters are chosen in Table 7.5.3-2 and Table 7.5.3-3 where the throughput R_{av} shall be $\geq 95\%$ of the maximum throughput of the reference measurement channels as specified in Annexes A.2.2, A.2.3 and A.3.2 (with one sided dynamic OCNG Pattern OP.1 FDD/TDD for the DL-signal as described in Annex A.5.1.1/A.5.2.1).

Table 7.5.3-1: Adjacent channel selectivity

Rx Parameter	Units	Channel bandwidth					
		1.4 MHz	3 MHz	5 MHz	10 MHz	15 MHz	20 MHz
ACS	dB	33.0	33.0	33.0	33.0	30	27

Table 7.5.3-2: Test parameters for Adjacent channel selectivity, Case 1

Rx Parameter	Units	Channel bandwidth					
		1.4 MHz	3 MHz	5 MHz	10 MHz	15 MHz	20 MHz
Power in Transmission Bandwidth Configuration	dBm	REFSENS + 14 dB					
$P_{\text{Interferer}}$	dBm	REFSENS +45.5dB	REFSENS +45.5dB	REFSENS +45.5dB*	REFSENS +45.5dB	REFSENS +42.5dB	REFSENS +39.5dB
$BW_{\text{Interferer}}$	MHz	1.4	3	5	5	5	5
$F_{\text{Interferer}}$ (offset)	MHz	1.4+0.0025	3+0.0075	5+0.0025	7.5+0.0075	10+0.0125	12.5+0.0025
Note 1: The transmitter shall be set to 4dB below $P_{\text{CMAX_L}}$ at the minimum uplink configuration specified in Table 7.3.3-2 with $P_{\text{CMAX_L}}$ as defined in clause 6.2.5.							
Note 2: The interferer consists of the Reference measurement channel specified in Annex A.3.2 with one sided dynamic OCNG Pattern OP.1 FDD/TDD as described in Annex A.5.1.1/A.5.2.1 and set-up according to Annex C.3.1.							

Table 7.5.3-3: Test parameters for Adjacent channel selectivity, Case 2

Rx Parameter	Units	Channel bandwidth					
		1.4 MHz	3 MHz	5 MHz	10 MHz	15 MHz	20 MHz
Power in Transmission Bandwidth Configuration	dBm	-56.5	-56.5	-56.5	-56.5	-53.5	-50.5
$P_{\text{Interferer}}$	dBm	-25					
$BW_{\text{Interferer}}$	MHz	1.4	3	5	5	5	5
$F_{\text{Interferer}}$ (offset)	MHz	1.4+0.0025	3+0.0075	5+0.0025	7.5+0.0075	10+0.0125	12.5+0.0025
Note 1: The transmitter shall be set to 24dB below $P_{\text{CMAX_L}}$ at the minimum uplink configuration specified in Table 7.3.3-2 with $P_{\text{CMAX_L}}$ as defined in clause 6.2.5.							
Note 2: The interferer consists of the Reference measurement channel specified in Annex A.3.2 with one sided dynamic OCNG Pattern OP.1 FDD/TDD as described in Annex A.5.1.1/A.5.2.1 and set-up according to Annex C.3.1.							

The normative reference for this requirement is TS 36.101 [2] clause 7.5.1.

7.5.4 Test description

7.5.4.1 Initial conditions

Initial conditions are a set of test configurations the UE needs to be tested in and the steps for the SS to take with the UE to reach the correct measurement state.

The initial test configurations consist of environmental conditions, test frequencies, and channel bandwidths based on E-UTRA bands specified in table 5.4.2.1-1. All of these configurations shall be tested with applicable test parameters for each channel bandwidth, and are shown in table 7.5.4.1-1. The details of the uplink and downlink reference measurement channels (RMCs) are specified in Annexes A.2 and A.3 respectively. The details of the OCN patterns used are specified in Annex A.5. Configurations of PDSCH and PDCCH before measurement are specified in Annex C.2.

Table 7.5.4.1-1: Test Configuration Table

Initial Conditions						
Test Environment as specified in TS 36.508[7] subclause 4.1			NC			
Test Frequencies as specified in TS36.508 [7] subclause 4.3.1			Mid range			
Test Channel Bandwidths as specified in TS 36.508 [7] subclause 4.3.1			Lowest, 5MHz, Highest			
Test Parameters for Channel Bandwidths						
Downlink Configuration				Uplink Configuration		
Ch BW	Mod'n	RB allocation		Mod'n	RB allocation	
		FDD	TDD		FDD	TDD
1.4MHz	QPSK	Full	Full	QPSK	5	5
3MHz	QPSK	Full	Full	QPSK	4	4
5MHz	QPSK	Full	Full	QPSK	8	8
10MHz	QPSK	Full	Full	QPSK	12	12
15MHz	QPSK	Full	Full	QPSK	16	16
20MHz	QPSK	Full	Full	QPSK	18	18
Note 1: Test Channel Bandwidths are checked separately for each E-UTRA band. The applicable channel bandwidths are specified in Table 7.3.3-2.						
Note 2: For the DL signal one sided dynamic OCN Pattern OP.1 FDD/TDD is used.						

1. Connect the SS and interfering source to the UE antenna connectors as shown in TS 36.508 [7] Figure A.4.
2. The parameter settings for the cell are set up according to TS 36.508 [7] subclause 4.4.3.
3. Downlink signals are initially set up according to Annex C0, C.1 and C.3.1, and uplink signals according to Annex H.1 and H.3.1.
4. The UL and DL Reference Measurement channels are set according to Table 7.5.4.1-1.
5. Propagation conditions are set according to Annex B.0.
6. Ensure the UE is in State 3A or 3A-RF according to TS 36.508 [7] clause 4.5.3A or 5.2A.2. Message contents are defined in clause 7.5.4.3.

7.5.4.2 Test procedure

1. SS transmits PDSCH via PDCCH DCI format 1A for C_RNTI to transmit the DL RMC according to Table 7.5.4.1-1. The SS sends downlink MAC padding bits on the DL RMC.
2. SS sends uplink scheduling information for each UL HARQ process via PDCCH DCI format 0 for C_RNTI to schedule the UL RMC according to Table 7.5.4.1-1. Since the UE has no payload data to send, the UE transmits uplink MAC padding bits on the UL RMC.
3. Set the Downlink signal level to the value as defined in Table 7.5.5-2 (Case 1). Send Uplink power control commands to the UE (less or equal to 1dB step size should be used), to ensure that the UE output power is within +0, - 3.4 dB of the target level in Table 7.5.5-2 (Case 1) for at least the duration of the Throughput measurement.
4. Set the Interferer signal level to the value as defined in Table 7.5.5-2 (Case 1), using a modulated interferer bandwidth as defined in Annex D of the present document.
5. Measure the average throughput for a duration sufficient to achieve statistical significance according to Annex G.2.

6. Set the Downlink signal level to the value as defined in Table 7.5.5-3 (Case 2). Send Uplink power control commands to the UE (less or equal to 1dB step size should be used), to ensure that the UE output power is within +0, - 3.4 dB of the target level in Table 7.5.5-3 (Case 2) for at least the duration of the Throughput measurement.
7. Set the Interferer signal level to the value as defined in Table 7.5.5-3 (Case 2), using a modulated interferer bandwidth as defined in Annex D of the present document.
8. Measure the average throughput for a duration sufficient to achieve statistical significance according to Annex G.2.
9. Repeat for applicable channel bandwidths and operating band combinations in both Case 1 and Case 2.

7.5.4.3 Message contents

Message contents are according to TS 36.508 [7] subclause 4.6 with the following exception

Table 7.5.4.3-1: UplinkPowerControlDedicated

Derivation Path: 36.331 clause 6.3.2			
Information Element	Value/remark	Comment	Condition
UplinkPowerControlDedicated-DEFAULT ::= SEQUENCE {			
p0-UePUSCH	0		
deltaMCS-Enabled	en0		
accumulationEnabled	TRUE		
p0-uePUCCH	0		
pSRS-Offset	3 (-6 dB)		
filterCoefficient	fc8	larger filter length is used to reduce the RSRP measurement variation	
}			

7.5.5 Test requirement

The throughput R_{av} shall be $\geq 95\%$ of the maximum throughput of the reference measurement channels as specified in Annex A.3.2 under the conditions specified in table 7.5.5-2, and also under the conditions specified in table 7.5.5-3.

Table 7.5.5-1: Adjacent channel selectivity

Rx Parameter	Units	Channel bandwidth					
		1.4 MHz	3 MHz	5 MHz	10 MHz	15 MHz	20 MHz
ACS	dB	33.0	33.0	33.0	33.0	30	27

Table 7.5.5-2: Test parameters for Adjacent channel selectivity, Case 1

Rx Parameter	Units	Channel bandwidth					
		1.4 MHz	3 MHz	5 MHz	10 MHz	15 MHz	20 MHz
Power in Transmission Bandwidth Configuration	dBm	REFSENS + 14 dB					
$P_{\text{Interferer}}$	dBm	REFSENS +45.5dB	REFSENS +45.5dB	REFSENS +45.5dB*	REFSENS +45.5dB	REFSENS +42.5dB	REFSENS +39.5dB
$BW_{\text{Interferer}}$	MHz	1.4	3	5	5	5	5
$F_{\text{Interferer}}$ (offset)	MHz	1.4+0.0025	3+0.0075	5+0.0025	7.5+0.0075	10+0.0125	12.5+0.0025
Note 1: The transmitter shall be set to 4dB below $P_{\text{CMAX,L}}$ with $P_{\text{CMAX,L}}$ as defined in clause 6.2.5. Note 2: The interferer consists of the Reference measurement channel specified in Annex A.3.2 with one sided dynamic OCNG Pattern OP.1 FDD/TDD as described in Annex A.5.1.1/A.5.2.1 and set-up according to Annex C.3.1.							

Table 7.5.5-3: Test parameters for Adjacent channel selectivity, Case 2

Rx Parameter	Units	Channel bandwidth					
		1.4 MHz	3 MHz	5 MHz	10 MHz	15 MHz	20 MHz
Power in Transmission Bandwidth Configuration	dBm	-56.5	-56.5	-56.5	-56.5	-53.5	-50.5
$P_{\text{Interferer}}$	dBm	-25					
$BW_{\text{Interferer}}$	MHz	1.4	3	5	5	5	5
$F_{\text{Interferer}}$ (offset)	MHz	1.4+0.0025	3+0.0075	5+0.0025	7.5+0.0075	10+0.0125	12.5+0.0025
Note 1: The transmitter shall be set to 24dB below $P_{\text{CMAX,L}}$ with $P_{\text{CMAX,L}}$ as defined in clause 6.2.5. Note 2: The interferer consists of the Reference measurement channel specified in Annex A.3.2 with one sided dynamic OCNG Pattern OP.1 FDD/TDD as described in Annex A.5.1.1/A.5.2.1 and set-up according to Annex C.3.1.							

7.6 Blocking characteristics

The blocking characteristic is a measure of the receiver's ability to receive a wanted signal at its assigned channel frequency in the presence of an unwanted interferer on frequencies other than those of the spurious response or the adjacent channels, without this unwanted input signal causing a degradation of the performance of the receiver beyond a specified limit. The blocking performance shall apply at all frequencies except those at which a spurious response occur.

7.6.1 In-band blocking

7.6.1.1 Test Purpose

In-band blocking is defined for an unwanted interfering signal falling into the range from 15MHz below to 15MHz above the UE receive band, at which the relative throughput shall meet or exceed the requirement for the specified measurement channels.

The lack of in-band blocking ability will decrease the coverage area when other e-NodeB transmitters exist (except in the adjacent channels and spurious response).

7.6.1.2 Test Applicability

This test applies to all types of E-UTRA UE release 8 and forward..

7.6.1.3 Minimum Conformance Requirements

The throughput shall be $\geq 95\%$ of the maximum throughput of the reference measurement channels as specified in Annexes A.2.2, A.2.3 and A.3.2 (with one sided dynamic OCNG Pattern OP.1 FDD/TDD for the DL-signal as described in Annex A.5.1.1/A.5.2.1) with parameters specified in Tables 7.6.1.3-1 and 7.6.1.3-2.

Table 7.6.1.3-1: In band blocking parameters

Rx Parameter	Units	Channel bandwidth					
		1.4 MHz	3 MHz	5 MHz	10 MHz	15 MHz	20 MHz
Power in Transmission Bandwidth Configuration	dBm	REFSENS + channel bandwidth specific value below					
		6	6	6	6	7	9
BW _{Interferer}	MHz	1.4	3	5	5	5	5
F _{offset, case 1}	MHz	2.1+0.0125	4.5+0.0075	7.5+0.0125	7.5+0.0025	7.5+0.0075	7.5+0.0125
F _{offset, case 2}	MHz	3.5+0.0075	7.5+0.0075	12.5+0.0075	12.5+0.012	12.5+0.002	12.5+0.007
					5	5	5
Note 1: The transmitter shall be set to 4dB below P _{CMAX,L} at the minimum uplink configuration specified in Table 7.3.3-2 with P _{CMAX,L} as defined in clause 6.2.5. Note 2: The interferer consists of the Reference measurement channel specified in Annex A.3.2 with one sided dynamic OCNG Pattern OP.1 FDD/TDD as described in Annex A.5.1.1/A.5.2.1 and set-up according to Annex C.3.1.							

Table 7.6.1.3-2: In-band blocking

E-UTRA band	Parameter	Unit	Case 1	Case 2	Case 3	Case 4
	P _{Interferer}	dBm	-56	-44	-30	[-30]
	F _{Interferer (offset)}	MHz	=-BW/2 - F _{offset, case 1} & =+BW/2 - F _{offset, case 1}	\leq -BW/2 - F _{offset, case 2} & \geq +BW/2 - F _{offset, case 2}	-BW/2 - 15 & -BW/2 - 9	-BW/2 - 10
1, 2, 3, 4, 5, 6, 7, 8, 9, 10, 11, 13, 18, 19, 20, 21,33,34,35, 36,37,38,39, 40, 41	F _{Interferer}	MHz	(Note 2)	F _{DL_low} - 15 to F _{DL_high} + 15		
12	F _{Interferer}	MHz	(Note 2)	F _{DL_low} - 10 to F _{DL_high} + 15		F _{DL_low} - 10
17	F _{Interferer}	MHz	(Note 2)	F _{DL_low} - 9 to F _{DL_high} + 15	F _{DL_low} - 15 and F _{DL_low} - 9	
Note 1: For certain bands, the unwanted modulated interfering signal may not fall inside the UE receive band, but within the first 15 MHz below or above the UE receive band Note 2: For each carrier frequency the requirement is valid for two frequencies: a. the carrier frequency -BW/2 - F _{offset, case 1} and b. the carrier frequency +BW/2 + F _{offset, case 1} Note 3: F _{Interferer} range values for unwanted modulated interfering signal are interferer centre frequencies Note 4: Case 3 and Case 4 only apply to assigned UE channel bandwidth of 5 MHz						

The normative reference for this requirement is TS 36.101 [2] clause 7.6.1.

7.6.1.4 Test Description

7.6.1.4.1 Initial Conditions

Initial conditions are a set of test configurations the UE needs to be tested in and the steps for the SS to take with the UE to reach the correct measurement state.

The initial test configurations consist of environmental conditions, test frequencies, and channel bandwidths based on E-UTRA bands specified in table 5.4.2.1-1. All of these configurations shall be tested with applicable test parameters for each channel bandwidth, and are shown in table 7.6.1.4.1-1. The details of the uplink and downlink reference measurement channels (RMCs) are specified in Annexes A.2 and A.3 respectively. The details of the OCNG patterns

used are specified in Annex A.5. Configurations of PDSCH and PDCCH before measurement are specified in Annex C.2.

Table 7.6.1.4.1-1: Test Configuration Table

Initial Conditions						
Test Environment as specified in TS 36.508[7] subclause 4.1			NC			
Test Frequencies as specified in TS36.508 [7] subclause 4.3.1			Mid range			
Test Channel Bandwidths as specified in TS 36.508 [7] subclause 4.3.1			Lowest, 5MHz, Highest			
Test Parameters for Channel Bandwidths						
Ch BW	Downlink Configuration			Uplink Configuration		
	Mod'n	RB allocation		Mod'n	RB allocation	
		FDD	TDD		FDD	TDD
1.4MHz	QPSK	6	6	QPSK	6	6
3MHz	QPSK	15	15	QPSK	15	15
5MHz	QPSK	25	25	QPSK	25	25
5MHz	QPSK	25	N/A	QPSK	20	N/A
5MHz	QPSK	25	N/A	QPSK	15	N/A
10MHz	QPSK	50	50	QPSK	50	50
10MHz	QPSK	50	N/A	QPSK	25	N/A
10MHz	QPSK	50	N/A	QPSK	20	N/A
10MHz	QPSK	50	N/A	QPSK	15	N/A
15MHz	QPSK	75	75	QPSK	75	75
15MHz	QPSK	75	N/A	QPSK	50	N/A
15MHz	QPSK	75	N/A	QPSK	25	N/A
15MHz	QPSK	75	N/A	QPSK	20	N/A
20MHz	QPSK	100	100	QPSK	100	100
20MHz	QPSK	100	N/A	QPSK	75	N/A
20MHz	QPSK	100	N/A	QPSK	50	N/A
20MHz	QPSK	100	N/A	QPSK	25	N/A
20MHz	QPSK	100	N/A	QPSK	20	N/A

Note 1: Test Channel Bandwidths are checked separately for each E-UTRA band, which applicable channel bandwidths are specified in Table 5.4.2.1-1.

Note 2: Depending on E-UTRA band, only the appropriate Uplink RB allocation value according to table 7.3.3-2 is tested per Test Channel Bandwidth.

Note 3: For the DL signal one sided dynamic OCNB Pattern OP.1 FDD/TDD is used.

1. Connect the SS to the UE antenna connectors as shown in TS 36.508 [7] Annex A, in Figure A.4.
2. The parameter settings for the cell are set up according to TS 36.508 [7] subclause 4.4.3.
3. Downlink signals are initially set up according to Annex C0, C.1 and C.3.1, and uplink signals according to Annex H.1 and H.3.1.
4. The UL and DL Reference Measurement channels are set according to in Table 7.6.1.4.1-1.
5. Propagation conditions are set according to Annex B.0.
6. Ensure the UE is in State 3A or 3A-RF according to TS 36.508 [7] clause 4.5.3A or 5.2A.2. Message contents are defined in clause 7.6.1.4.3.

7.6.1.4.2 Test Procedure

1. SS transmits PDSCH via PDCCH DCI format 1A for C_RNTI to transmit the DL RMC according to Table 7.6.1.4.1-1. The SS sends downlink MAC padding bits on the DL RMC.
2. SS sends uplink scheduling information for each UL HARQ process via PDCCH DCI format 0 for C_RNTI to schedule the UL RMC according to Table 7.6.1.4.1-1. Since the UE has no payload data to send, the UE transmits uplink MAC padding bits on the UL RMC.
3. Set the parameters of the signal generator for an interfering signal below the wanted signal in Case 1 according to Tables 7.6.1.5-1 and 7.6.1.5-2.

4. Set the downlink signal level according to the table 7.6.1.5-1. Send uplink power control commands to the UE (less or equal to 1 dB step size should be used), to ensure that the UE output power is within +0, - 3.4 dB of the target level in table 7.6.1.5-1 for at least the duration of the throughput measurement.
5. Measure the average throughput for a duration sufficient to achieve statistical significance according to Annex G.2.
6. Repeat steps from 3 to 5, using an interfering signal above the wanted signal in Case 1 at step 3.
7. Repeat steps from 3 to 6, using interfering signals in Case 2 at step 3 and 6. The ranges of case 2 are covered in steps equal to the interferer bandwidth. The test frequencies are chosen in analogy to table 7.6.1.4.2-1.
8. Repeat steps from 3 to 5, using successively all interfering signals in Case 3 and Case 4 at step 3.

Table 7.6.1.4.2-1: Example for interferer frequencies

	Lower frequency	Upper frequency
Band 1 DL	2110 MHz	2170 MHz
Band 1 Midrange	2140 MHz	
Receive band wanted signal (BW 5MHz)	2137.5 MHz	2142.5 MHz
Interferer case 1	2129.9875 MHz	2150.0125 MHz
Interferer case 2 (inner frequency)	2124.9925 MHz	2155.0075 MHz
Interferer case 2 (outer frequency)	2099.9925 MHz	2180.0075 MHz
Outer limit for inband blocking	2095 MHz	2185 MHz
Number of test frequencies case 2	6	6
Number of test frequencies for Band 17 (asymmetric!), BW 5MHz, case 2	0	2

7.6.1.4.3 Message Contents

Message contents are according to TS 36.508 [7] subclause 4.6 with the following exception

Table 7.6.1.4.3-1: UplinkPowerControlDedicated

Derivation Path: 36.331 clause 6.3.2			
Information Element	Value/remark	Comment	Condition
UplinkPowerControlDedicated-DEFAULT ::= SEQUENCE {			
p0-UePUSCH	0		
deltaMCS-Enabled	en0		
accumulationEnabled	TRUE		
p0-uePUCCH	0		
pSRS-Offset	3 (-6 dB)		
filterCoefficient	fc8	larger filter length is used to reduce the RSRP measurement variation	
}			

7.6.1.5 Test Requirement

The throughput measurement derived in test procedure shall be $\geq 95\%$ of the maximum throughput of the reference measurement channels as specified in Annex A.3.2 with parameters specified in Tables 7.6.1.5-1 and 7.6.1.5-2.

Table 7.6.1.5-1: In band blocking parameters

Rx Parameter	Units	Channel bandwidth					
		1.4 MHz	3 MHz	5 MHz	10 MHz	15 MHz	20 MHz
Power in Transmission Bandwidth Configuration	dBm	REFSENS + channel bandwidth specific value below					
		6	6	6	6	7	9
$BW_{\text{Interferer}}$	MHz	1.4	3	5	5	5	5
$F_{\text{offset, case 1}}$	MHz	2.1+0.0125	4.5+0.0075	7.5+0.0125	7.5+0.0025	7.5+0.0075	7.5+0.0125
$F_{\text{offset, case 2}}$	MHz	3.5+0.0075	7.5+0.0075	12.5+0.0075	12.5+0.012	12.5+0.002	12.5+0.007
Note 1:		The transmitter shall be set to 4dB below $P_{\text{CMAX_L}}$ with $P_{\text{CMAX_L}}$ as defined in clause 6.2.5.					
Note 2:		The interferer consists of the Reference measurement channel specified in Annex A.3.2 with one sided dynamic OCNG Pattern OP.1 FDD/TDD as described in Annex A.5.1.1/A.5.2.1 and set-up according to Annex C.3.1.					

Table 7.6.1.5-2: In-band blocking

E-UTRA band	Parameter	Unit	Case 1	Case 2	Case 3	Case 4
	$P_{\text{Interferer}}$	dBm	-56	-44	-30	[-30]
	$F_{\text{Interferer}}$ (offset)	MHz	$=-BW/2 - F_{\text{offset, case 1}}$ & $=+BW/2 - F_{\text{offset, case 1}}$	$\leq -BW/2 - F_{\text{offset, case 2}}$ & $\geq +BW/2 - F_{\text{offset, case 2}}$	$-BW/2 - 15$ & $-BW/2 - 9$	$-BW/2 - 10$
1, 2, 3, 4, 5, 6, 7, 8, 9, 10, 11, 13, 18, 19, 20, 21, 33, 34, 35, 36, 37, 38, 39, 40, 41	$F_{\text{Interferer}}$	MHz	(Note 2)	$F_{\text{DL_low}} - 15$ to $F_{\text{DL_high}} + 15$		
12	$F_{\text{Interferer}}$	MHz	(Note 2)	$F_{\text{DL_low}} - 10$ to $F_{\text{DL_high}} + 15$		$F_{\text{DL_low}} - 10$
17	$F_{\text{Interferer}}$	MHz	(Note 2)	$F_{\text{DL_low}} - 9$ to $F_{\text{DL_high}} + 15$	$F_{\text{DL_low}} - 15$ and $F_{\text{DL_low}} - 9$	
Note 1: For certain bands, the unwanted modulated interfering signal may not fall inside the UE receive band, but within the first 15 MHz below or above the UE receive band						
Note 2: For each carrier frequency the requirement is valid for two frequencies: a. the carrier frequency $-BW/2 - F_{\text{offset, case 1}}$ and b. the carrier frequency $+BW/2 + F_{\text{offset, case 1}}$						
Note 3: $F_{\text{Interferer}}$ range values for unwanted modulated interfering signal are interferer centre frequencies						
Note 4: Case 3 and Case 4 only apply to assigned UE channel bandwidth of 5 MHz						

7.6.2 Out-of-band blocking

7.6.2.1 Test Purpose

Out-of-band band blocking is defined for an unwanted CW interfering signal falling more than 15 MHz below or above the UE receive band, at which a given average throughput shall meet or exceed the requirement for the specified measurement channels.

For the first 15 MHz below or above the UE receive band the appropriate in-band blocking or adjacent channel selectivity in sub-clause 7.5.1 and sub-clause 7.6.1 shall be applied.

The lack of out-of-band blocking ability will decrease the coverage area when other e-NodeB transmitters exist (except in the adjacent channels and spurious response).

7.6.2.2 Test Applicability

This test applies to all types of E-UTRA UE release 8 and forward.

7.6.2.3 Minimum Conformance Requirements

The throughput shall be $\geq 95\%$ of the maximum throughput of the reference measurement channels as specified in Annexes A.2.2, A.2.3 and A.3.2 (with one sided dynamic OCNNG Pattern OP.1 FDD/TDD for the DL-signal as described in Annex A.5.1.1/A.5.2.1) with parameters specified in Tables 7.6.2.3-1 and 7.6.2.3-2.

For Table 7.6.2.3-2 in frequency range 1, 2 and 3, up to $\max(24, 6 \cdot \lceil N_{RB} / 6 \rceil)$ exceptions are allowed for spurious response frequencies in each assigned frequency channel when measured using a 1MHz step size, where N_{RB} is the number of resource blocks in the downlink transmission bandwidth configuration (see Figure 5.4.2-1). For these exceptions the requirements of clause 7.7 Spurious Response are applicable.

For Table 7.6.2.3-2 in frequency range 4, up to $\max(8, \lceil (N_{RB} + 2 \cdot L_{CRBs}) / 8 \rceil)$ exceptions are allowed for spurious response frequencies in each assigned frequency channel when measured using a 1MHz step size, where N_{RB} is the number of resource blocks in the downlink transmission bandwidth configurations (see Figure 5.4.2-1) and L_{CRBs} is the number of resource blocks allocated in the uplink. For these exceptions the requirements of clause 7.7 Spurious Response are applicable.

Table 7.6.2.3-1: Out-of-band blocking parameters

Rx Parameter	Units	Channel bandwidth					
		1.4 MHz	3 MHz	5 MHz	10 MHz	15 MHz	20 MHz
Power in Transmission Bandwidth Configuration	dBm	REFSENS + channel bandwidth specific value below					
		6	6	6	6	7	9
Note 1: The transmitter shall be set to 4dB below P_{CMAX_L} at the minimum uplink configuration specified in Table 7.3.3-2 with P_{CMAX_L} as defined in clause 6.2.5. Note 2: The reference measurement channel is specified in Annex A.3.2 with one sided dynamic OCNNG Pattern OP.1 FDD/TDD as described in Annex A.5.1.1/A.5.2.1.							

Table 7.6.2.3-2: Out of band blocking

E-UTRA band	Parameter	Units	Frequency			
			range 1	range 2	range 3	range 4
	$P_{Interferer}$	dBm	-44	-30	-15	-15
1, 2, 3, 4, 5, 6, 7, 8, 9, 10, 11, 12, 13, 17, 18, 19, 20, 21, 24, 33,34,35,36,37,38,39,40, 41	$F_{Interferer}$ (CW)	MHz	$F_{DL_low} -15$ to $F_{DL_low} -60$	$F_{DL_low} -60$ to $F_{DL_low} -85$	$F_{DL_low} -85$ to 1 MHz	-
			$F_{DL_high} +15$ to $F_{DL_high} +60$	$F_{DL_high} +60$ to $F_{DL_high} +85$	$F_{DL_high} +85$ to +12750 MHz	-
2, 5, 12, 17	$F_{Interferer}$	MHz	-	-	-	$F_{UL_low} - F_{UL_high}$
Note: For the UE which supports both Band 11 and Band 21 the out of blocking is FFS.						

The normative reference for this requirement is TS 36.101 [2] clause 7.6.2.

7.6.2.4 Test Description

7.6.2.4.1 Initial Conditions

Initial conditions are a set of test configurations the UE needs to be tested in and the steps for the SS to take with the UE to reach the correct measurement state.

The initial test configurations consist of environmental conditions, test frequencies, and channel bandwidths based on E-UTRA bands specified in table 5.4.2.1-1. All of these configurations shall be tested with applicable test parameters for each channel bandwidth, and are shown in table 7.6.2.4.1-1. The details of the uplink and downlink reference measurement channels (RMCs) are specified in Annexes A.2 and A.3 respectively. The details of the OCNNG patterns

used are specified in Annex A.5. Configurations of PDSCH and PDCCH before measurement are specified in Annex C.2.

Table 7.6.2.4.1-1: Test Configuration Table

Initial Conditions						
Test Environment as specified in TS 36.508[7] subclause 4.1			NC			
Test Frequencies as specified in TS36.508 [7] subclause 4.3.1			Low range for $F_{\text{Interferer}}$ below $F_{\text{DL_low}}$ High range for $F_{\text{Interferer}}$ above $F_{\text{DL_high}}$			
Test Channel Bandwidths as specified in TS 36.508 [7] subclause 4.3.1			Lowest, 5MHz, Highest			
Test Parameters for Channel Bandwidths						
Ch BW	Downlink Configuration			Uplink Configuration		
	Mod'n	RB allocation		Mod'n	RB allocation	
		FDD	TDD		FDD	TDD
1.4MHz	QPSK	6	6	QPSK	6	6
3MHz	QPSK	15	15	QPSK	15	15
5MHz	QPSK	25	25	QPSK	25	25
5MHz	QPSK	25	N/A	QPSK	20	N/A
5MHz	QPSK	25	N/A	QPSK	15	N/A
10MHz	QPSK	50	50	QPSK	50	50
10MHz	QPSK	50	N/A	QPSK	25	N/A
10MHz	QPSK	50	N/A	QPSK	20	N/A
10MHz	QPSK	50	N/A	QPSK	15	N/A
15MHz	QPSK	75	75	QPSK	75	75
15MHz	QPSK	75	N/A	QPSK	50	N/A
15MHz	QPSK	75	N/A	QPSK	25	N/A
15MHz	QPSK	75	N/A	QPSK	20	N/A
20MHz	QPSK	100	100	QPSK	100	100
20MHz	QPSK	100	N/A	QPSK	75	N/A
20MHz	QPSK	100	N/A	QPSK	50	N/A
20MHz	QPSK	100	N/A	QPSK	25	N/A
20MHz	QPSK	100	N/A	QPSK	20	N/A
Note 1: Test Channel Bandwidths are checked separately for each E-UTRA band, which applicable channel bandwidths are specified in Table 5.4.2.1-1. Note 2: Depending on E-UTRA band, only the appropriate Uplink RB allocation value according to table 7.3.3-2 is tested per Test Channel Bandwidth. Note 3: For the DL signal one sided dynamic OCN Pattern OP.1 FDD/TDD is used.						

1. Connect the SS to the UE antenna connectors as shown in TS 36.508 [7] Annex A, in Figure A.5.
2. The parameter settings for the cell are set up according to TS 36.508 [7] subclause 4.4.3.
3. Downlink signals are initially set up according to Annex C0, C.1 and C.3.1, and uplink signals according to Annex H.1 and H.3.1.
4. The UL and DL Reference Measurement channels are set according to Table 7.6.2.4.1-1.
5. Propagation conditions are set according to Annex B.0.
6. Ensure the UE is in State 3A or 3A-RF according to TS 36.508 [7] clause 4.5.3A or 5.2A.2. Message contents are defined in clause 7.6.2.4.3.

7.6.2.4.2 Test Procedure

1. SS transmits PDSCH via PDCCH DCI format 1A for C_{RNTI} to transmit the DL RMC according to Table 7.6.2.4.1-1. The SS sends downlink MAC padding bits on the DL RMC.
2. SS sends uplink scheduling information for each UL HARQ process via PDCCH DCI format 0 for C_{RNTI} to schedule the UL RMC according to Table 7.6.2.4.1-1. Since the UE has no payload data to send, the UE transmits uplink MAC padding bits on the UL RMC.
3. Set the parameters of the CW signal generator for an interfering signal according to Table 7.6.2.5-2. The frequency step size is 1MHz.

4. Set the downlink signal level according to the table 7.6.2.5-1. Send uplink power control commands to the UE (less or equal to 1dB step size should be used), to ensure that the UE output power is within +0, - 3.4 dB of the target level in table 7.6.2.5-1 for at least the duration of the throughput measurement.
5. Measure the average throughput for a duration sufficient to achieve statistical significance according to Annex G.2.
6. Record the frequencies for which the throughput doesn't meet the requirements.

7.6.2.4.3 Message Contents

Message contents are according to TS 36.508 [7] subclause 4.6 with the following exception.

Table 7.6.2.4.3-1: UplinkPowerControlDedicated

Derivation Path: 36.331 clause 6.3.2			
Information Element	Value/remark	Comment	Condition
UplinkPowerControlDedicated-DEFAULT ::= SEQUENCE {			
p0-UePUSCH	0		
deltaMCS-Enabled	en0		
accumulationEnabled	TRUE		
p0-uePUCCH	0		
pSRS-Offset	3 (-6 dB)		
filterCoefficient	fc8	larger filter length is used to reduce the RSRP measurement variation	
}			

7.6.2.5 Test Requirement

Except for the spurious response frequencies recorded at the final step of test procedure, the throughput measurement derived in test procedure shall be $\geq 95\%$ of the maximum throughput of the reference measurement channels as specified in Annex A.3.2 with parameters specified in Tables 7.6.2.5-1 and 7.6.2.5-2.

For frequency range 1, 2, and 3, the number of spurious response frequencies recorded in the final step of test procedure shall not exceed $\max(24, 6 \cdot \lceil N_{RB} / 6 \rceil)$ in each assigned frequency channel when measured using a 1MHz step size. For these exceptions the requirements of clause 7.7 Spurious Response are applicable.

For frequency range 4, the number of spurious response frequencies recorded in the final step of test procedure shall not exceed $\max(8, \lceil (N_{RB} + 2 \cdot L_{CRBs}) / 8 \rceil)$ in each assigned frequency channel when measured using a 1MHz step size. For these exceptions the requirements of clause 7.7 Spurious Response are applicable.

Table 7.6.2.5-1: Out-of-band blocking parameters

Rx Parameter	Units	Channel bandwidth					
		1.4 MHz	3 MHz	5 MHz	10 MHz	15 MHz	20 MHz
Power in Transmission Bandwidth Configuration	dBm	REFSENS + channel bandwidth specific value below					
		6	6	6	6	7	9
Note 1:	The transmitter shall be set to 4dB below P_{CMAX_L} with P_{CMAX_L} as defined in clause 6.2.5.						
Note 2:	The reference measurement channel is specified in Annex A.3.2 with one sided dynamic OCNG Pattern OP.1 FDD/TDD as described in Annex A.5.1.1/A.5.2.1.						

Table 7.6.2.5-2: Out of band blocking

E-UTRA band	Parameter	Units	Frequency			
			range 1	range 2	range 3	range 4
	$P_{\text{Interferer}}$	dBm	-44	-30	-15	-15
1, 2, 3, 4, 5, 6, 7, 8, 9, 10, 11, 12, 13, 17, 18, 19, 20, 21, 24 33,34,35,36,37 ,38,39,40, 41	$F_{\text{Interferer}}$ (CW)	MHz	$F_{\text{DL_low}}$ -15 to $F_{\text{DL_low}}$ -60	$F_{\text{DL_low}}$ -60 to $F_{\text{DL_low}}$ -85	$F_{\text{DL_low}}$ -85 to 1 MHz	-
			$F_{\text{DL_high}}$ +15 to $F_{\text{DL_high}}$ + 60	$F_{\text{DL_high}}$ +60 to $F_{\text{DL_high}}$ +85	$F_{\text{DL_high}}$ +85 to +12750 MHz	-
2, 5, 12, 17	$F_{\text{Interferer}}$	MHz	-	-	-	$F_{\text{UL_low}} - F_{\text{UL_high}}$
Note 1: Range 3 shall be tested only with the highest channel bandwidth.						
Note 2: For the UE which supports both Band 11 and Band 21 the out of blocking is FFS.						

7.6.3 Narrow band blocking

7.6.3.1 Test Purpose

Verifies a receiver's ability to receive an E-UTRA signal at its assigned channel frequency in the presence of an unwanted narrow band CW interferer at a frequency, which is less than the nominal channel spacing.

The lack of narrow-band blocking ability will decrease the coverage area when other e-NodeB transmitters exist (except in the adjacent channels and spurious response).

7.6.3.2 Test Applicability

This test applies to all types of E-UTRA UE release 8 and forward.

7.6.3.3 Minimum Conformance Requirements

The relative throughput shall be $\geq 95\%$ of the maximum throughput of the reference measurement channels as specified in Annexes A.2.2, A.2.3 and A.3.2 (with one sided dynamic OCNG Pattern OP.1 FDD/TDD for the DL-signal as described in Annex A.5.1.1/A.5.2.1) with parameters specified in Table 7.6.3.3-1.

Table 7.6.3.3-1: Narrow-band blocking

Parameter	Unit	Channel Bandwidth					
		1.4 MHz	3 MHz	5 MHz	10 MHz	15 MHz	20 MHz
P_w	dBm	P_{REFSENS} + channel-bandwidth specific value below					
		22	18	16	13	14	16
P_{UW} (CW)	dBm	-55	-55	-55	-55	-55	-55
F_{UW} (offset for $\Delta f = 15$ kHz)	MHz	0.9075	1.7025	2.7075	5.2125	7.7025	10.2075
F_{UW} (offset for $\Delta f = 7.5$ kHz)	MHz						
Note 1: The transmitter shall be set a 4 dB below $P_{\text{CMAX_L}}$ at the minimum uplink configuration specified in Table 7.3.3-2 with $P_{\text{CMAX_L}}$ as defined in clause 6.2.5.							
Note 2: The reference measurement channel is specified in Annex A.3.2 with one sided dynamic OCNG Pattern OP.1 FDD/TDD as described in Annex A.5.1.1/A.5.2.1.							

The normative reference for this requirement is TS 36.101 [2] clause 7.6.3.

7.6.3.4 Test Description

7.6.3.4.1 Initial Conditions

Initial conditions are a set of test configurations the UE needs to be tested in and the steps for the SS to take with the UE to reach the correct measurement state.

The initial test configurations consist of environmental conditions, test frequencies, and channel bandwidths based on E-UTRA bands specified in table 5.4.2.1-1. All of these configurations shall be tested with applicable test parameters for each channel bandwidth, and are shown in table 7.6.3.4.1-1. The details of the uplink and downlink reference measurement channels (RMCs) are specified in Annexes A.2 and A.3 respectively. The details of the OCN patterns used are specified in Annex A.5. Configurations of PDSCH and PDCCH before measurement are specified in Annex C.2.

Table 7.6.3.4.1-1: Test Configuration Table

Initial Conditions						
Test Environment as specified in TS 36.508[7] subclause 4.1			NC			
Test Frequencies as specified in TS36.508 [7] subclause 4.3.1			Mid range			
Test Channel Bandwidths as specified in TS 36.508 [7] subclause 4.3.1			Lowest, 5MHz, Highest			
Test Parameters for Channel Bandwidths						
Ch BW	Downlink Configuration			Uplink Configuration		
	Mod'n	RB allocation		Mod'n	RB allocation	
		FDD	TDD		FDD	TDD
1.4MHz	QPSK	6	6	QPSK	6	6
3MHz	QPSK	15	15	QPSK	15	15
5MHz	QPSK	25	25	QPSK	25	25
5MHz	QPSK	25	N/A	QPSK	20	N/A
5MHz	QPSK	25	N/A	QPSK	15	N/A
10MHz	QPSK	50	50	QPSK	50	50
10MHz	QPSK	50	N/A	QPSK	25	N/A
10MHz	QPSK	50	N/A	QPSK	20	N/A
10MHz	QPSK	50	N/A	QPSK	15	N/A
15MHz	QPSK	75	75	QPSK	75	75
15MHz	QPSK	75	N/A	QPSK	50	N/A
15MHz	QPSK	75	N/A	QPSK	25	N/A
15MHz	QPSK	75	N/A	QPSK	20	N/A
20MHz	QPSK	100	100	QPSK	100	100
20MHz	QPSK	100	N/A	QPSK	75	N/A
20MHz	QPSK	100	N/A	QPSK	50	N/A
20MHz	QPSK	100	N/A	QPSK	25	N/A
20MHz	QPSK	100	N/A	QPSK	20	N/A
Note 1: Test Channel Bandwidths are checked separately for each E-UTRA band, which applicable channel bandwidths are specified in Table 5.4.2.1-1. Note 2: Depending on E-UTRA band, only the appropriate Uplink RB allocation value according to table 7.3.3-2 is tested per Test Channel Bandwidth. Note 3: For the DL signal one sided dynamic OCN Pattern OP.1 FDD/TDD is used.						

1. Connect the SS to the UE antenna connectors as shown in TS 36.508 [7] Annex A, Figure A.5.
2. The parameter settings for the cell are set up according to TS 36.508 [7] subclause 4.4.3.
3. Downlink signals are initially set up according to Annex C0, C.1 and C.3.1, and uplink signals according to Annex H.1 and H.3.1
4. The UL and DL Reference Measurement channels are set according to Table 7.6.3.4.1-1.
5. Propagation conditions are set according to Annex B.0.
6. Ensure the UE is in State 3A or 3A-RF according to TS 36.508 [7] clause 4.5.3A or 5.2A.2. Message contents are defined in clause 7.6.3.4.3.

7.6.3.4.2 Test Procedure

1. SS transmits PDSCH via PDCCH DCI format 1A for C_RNTI to transmit the DL RMC according to Table 7.6.3.4.1-1. The SS sends downlink MAC padding bits on the DL RMC.

2. SS sends uplink scheduling information for each UL HARQ process via PDCCH DCI format 0 for C_RNTI to schedule the UL RMC according to Table 7.6.3.4.1-1. Since the UE has no payload data to send, the UE transmits uplink MAC padding bits on the UL RMC.
3. Set the parameters of the CW signal generator for an interfering signal according to Table 7.6.3.5-1.
4. Set the downlink signal level according to the table 7.6.3.5-1. Send uplink power control commands to the UE (less or equal to 1dB step size should be used), to ensure that the UE output power is within +0, - 3.4 dB of the target level in table 7.6.3.5-1 for at least the duration of the throughput measurement.
5. Measure the average throughput for a duration sufficient to achieve statistical significance according to Annex G.2.

7.6.3.4.3 Message Contents

Message contents are according to TS 36.508 [7] subclause 4.6 with the following exception.

Table 7.6.3.4.3-1: UplinkPowerControlDedicated

Derivation Path: 36.331 clause 6.3.2			
Information Element	Value/remark	Comment	Condition
UplinkPowerControlDedicated-DEFAULT ::= SEQUENCE {			
p0-UePUSCH	0		
deltaMCS-Enabled	en0		
accumulationEnabled	TRUE		
p0-uePUCCH	0		
pSRS-Offset	3 (-6 dB)		
filterCoefficient	fc8	larger filter length is used to reduce the RSRP measurement variation	
}			

7.6.3.5 Test Requirement

The throughput measurement derived in test procedure shall be $\geq 95\%$ of the maximum throughput of the reference measurement channels as specified in Annex A.3.2 with parameters specified in Table 7.6.3.5-1.

Table 7.6.3.5-1: Narrow-band blocking

Parameter	Unit	Channel Bandwidth					
		1.4 MHz	3 MHz	5 MHz	10 MHz	15 MHz	20 MHz
P_w	dBm	P_{REFSENS} + channel-bandwidth specific value below					
		22	18	16	13	14	16
P_{uw} (CW)	dBm	-55	-55	-55	-55	-55	-55
F_{uw} (offset for $\Delta f = 15$ kHz)	MHz	0.9075	1.7025	2.7075	5.2125	7.7025	10.2075
F_{uw} (offset for $\Delta f = 7.5$ kHz)	MHz						
Note 1: The transmitter shall be set a 4 dB below P_{CMAX_L} with P_{CMAX_L} as defined in clause 6.2.5.							
Note 2: The reference measurement channel is specified in Annex A.3.2 with one sided dynamic OCNG Pattern OP.1 FDD/TDD as described in Annex A.5.1.1/A.5.2.1.							

7.7 Spurious response

7.7.1 Test Purpose

Spurious response verifies the receiver's ability to receive a wanted signal on its assigned channel frequency without exceeding a given degradation due to the presence of an unwanted CW interfering signal at any other frequency at which a response is obtained i.e. for which the out of band blocking limit as specified in sub-clause 7.6.2 is not met.

The lack of the spurious response ability decreases the coverage area when other unwanted interfering signal exists at any other frequency.

7.7.2 Test Applicability

This test applies to all types of E-UTRA UE release 8 and forward.

7.7.3 Minimum Conformance Requirements

The throughput shall be $\geq 95\%$ of the maximum throughput of the reference measurement channels as specified in Annexes A.2.2, A.2.3 and A.3.2 (with one sided dynamic OCNB Pattern OP.1 FDD/TDD for the DL-signal as described in Annex A.5.1.1/A.5.2.1) with parameters specified in Tables 7.7.3-1 and 7.7.3-2.

Table 7.7.3-1: Spurious response parameters

Rx Parameter	Units	Channel bandwidth					
		1.4 MHz	3 MHz	5 MHz	10 MHz	15 MHz	20 MHz
Power in Transmission Bandwidth Configuration	dBm	REFSENS + channel bandwidth specific value below					
		6	6	6	6	7	9
Note 1: The transmitter shall be set to 4dB below $P_{\text{CMAX_L}}$ at the minimum uplink configuration specified in Table 7.3.3-2 with $P_{\text{CMAX_L}}$ as defined in clause 6.2.5. Note 2: The reference measurement channel is specified in Annex A.3.2 with one sided dynamic OCNB Pattern OP.1 FDD/TDD as described in Annex A.5.1.1/A.5.2.1.							

Table 7.7.3-2: Spurious Response

Parameter	Unit	Level
$P_{\text{Interferer}}$ (CW)	dBm	-44
$F_{\text{Interferer}}$	MHz	Spurious response frequencies

The normative reference for this requirement is TS 36.101 [2] clause 7.7.

7.7.4 Test Description

7.7.4.1 Initial Conditions

The initial conditions shall be the same as in clause 7.6.2.4.1 in order to test spurious responses obtained in clause 7.6.2 under the same conditions.

7.7.4.2 Test Procedure

1. SS transmits PDSCH via PDCCH DCI format 1A for C_{RNTI} to transmit the DL RMC according to Table 7.6.2.4.1-1. The SS sends downlink MAC padding bits on the DL RMC.
2. SS sends uplink scheduling information for each UL HARQ process via PDCCH DCI format 0 for C_{RNTI} to schedule the UL RMC according to Table 7.6.2.4.1-1. Since the UE has no payload data to send, the UE transmits uplink MAC padding bits on the UL RMC.

3. Set the parameters of the CW signal generator for an interfering signal according to Table 7.7.5-2. The spurious frequencies are taken from records in the final step of test procedures in clause 7.6.2.4.2.
4. Set the downlink signal level according to the table 7.7.5-1. Send uplink power control commands to the UE (less or equal to 1dB step size should be used), to ensure that the UE output power is within +0, - 3.4 dB of the target level in table 7.7.5-1 for at least the duration of the throughput measurement.
5. For the spurious frequency, measure the average throughput for a duration sufficient to achieve statistical significance according to Annex G.2.

7.7.4.3 Message Contents

Message contents are according to TS 36.508 [7] subclause 4.6 with the following exception.

Table 7.7.4.3-1: UplinkPowerControlDedicated

Derivation Path: 36.331 clause 6.3.2			
Information Element	Value/remark	Comment	Condition
UplinkPowerControlDedicated-DEFAULT ::= SEQUENCE {			
p0-UePUSCH	0		
deltaMCS-Enabled	en0		
accumulationEnabled	TRUE		
p0-uePUCCH	0		
pSRS-Offset	3 (-6 dB)		
filterCoefficient	fc8	larger filter length is used to reduce the RSRP measurement variation	
}			

7.7.5 Test Requirement

The throughput measurement derived in test procedure shall be $\geq 95\%$ of the maximum throughput of the reference measurement channels as specified in Annex A.3.2 with parameters specified in Tables 7.7.5-1 and 7.7.5-2.

Table 7.7.5-1: Spurious response parameters

Rx Parameter	Units	Channel bandwidth					
		1.4 MHz	3 MHz	5 MHz	10 MHz	15 MHz	20 MHz
Power in Transmission Bandwidth Configuration	dBm	REFSENS + channel bandwidth specific value below					
		6	6	6	6	7	9
Note 1: The transmitter shall be set to 4dB below P_{CMAX_L} with P_{CMAX_L} as defined in clause 6.2.5.							
Note 2: The reference measurement channel is specified in Annex A.3.2 with one sided dynamic OCNG Pattern OP.1 FDD/TDD as described in Annex A.5.1.1/A.5.2.1.							

Table 7.7.5-2: Spurious Response

Parameter	Unit	Level
$P_{Interferer}$ (CW)	dBm	-44
$F_{Interferer}$	MHz	Spurious response frequencies

7.8 Intermodulation characteristics

7.8.1 Wide band Intermodulation

7.8.1.1 Test purpose

Intermodulation response tests the UE's ability to receive data with a given average throughput for a specified reference measurement channel, in the presence of two or more interfering signals which have a specific frequency relationship to the wanted signal, under conditions of ideal propagation and no added noise.

A UE unable to meet the throughput requirement under these conditions will decrease the coverage area when two or more interfering signals exist which have a specific frequency relationship to the wanted signal.

7.8.1.2 Test applicability

This test applies to all types of E-UTRA UE release 8 and forward.

7.8.1.3 Minimum conformance requirements

Intermodulation response rejection is a measure of the capability of the receiver to receive a wanted signal on its assigned channel frequency in the presence of two or more interfering signals which have a specific frequency relationship to the wanted signal.

The throughput shall be $\geq 95\%$ of the maximum throughput of the reference measurement channels as specified in Annexes A.2.2, A.2.3 and A.3.2 (with one sided dynamic OCNG Pattern OP.1 FDD/TDD for the DL-signal as described in Annex A.5.1.1/A.5.2.1) with parameters specified in Table 7.8.1.3-1 for the specified wanted signal mean power in the presence of two interfering signals.

Table 7.8.1.3-1: Wide band intermodulation

Rx Parameter	Units	Channel bandwidth					
		1.4 MHz	3 MHz	5 MHz	10 MHz	15 MHz	20 MHz
Power in Transmission Bandwidth Configuration	dBm	REFSENS + channel bandwidth specific value below					
		12	8	6	6	7	9
$P_{\text{Interferer 1}}$ (CW)	dBm	-46					
$P_{\text{Interferer 2}}$ (Modulated)	dBm	-46					
$BW_{\text{Interferer 2}}$		1.4	3	5			
$F_{\text{Interferer 1}}$ (Offset)	MHz	-BW/2 -2.1 / +BW/2+ 2.1	-BW/2 -4.5 / +BW/2 + 4.5	-BW/2 - 7.5 / +BW/2 + 7.5			
$F_{\text{Interferer 2}}$ (Offset)	MHz	$2 \cdot F_{\text{Interferer 1}}$					
Note 1:	The transmitter shall be set to 4dB below $P_{\text{CMAX_L}}$ at the minimum uplink configuration specified in Table 7.3.3-2 with $P_{\text{CMAX_L}}$ as defined in clause 6.2.5.						
Note 2:	The reference measurement channel is specified in Annex A.3.2 with one sided dynamic OCNG Pattern OP.1 FDD/TDD as described in Annex A.5.1.1/A.5.2.1.						
Note 3:	The modulated interferer consists of the Reference measurement channel specified in Annex A.3.2 with one sided dynamic OCNG Pattern OP.1 FDD/TDD as described in Annex A.5.1.1/A.5.2.1 with set-up according to Annex C.3.1. The interfering modulated signal is 5MHz E-UTRA signal as described in Annex D for channel bandwidth $\geq 5\text{MHz}$						

The normative reference for this requirement is TS 36.101 [2] clause 7.8.1 and TS 36.101 [2] Annexes A and D.

[FFS: Although it is not explicitly stated in TS 36.101 [2] whether the modulated interferer defined in 36.101 Annex D applies to wanted channel bandwidths of less than 5MHz, this test specification has assumed that the modulated interferer definition applies to all channel bandwidths. The content of TS 36.101 [2] Annex D.2 has been copied into Annex FFS of the present document]

7.8.1.4 Test description

7.8.1.4.1 Initial condition

Initial conditions are a set of test configurations the UE needs to be tested in and the steps for the SS to take with the UE to reach the correct measurement state.

The initial test configurations consist of environmental conditions, test frequencies, and channel bandwidths based on E-UTRA bands specified in table 5.4.2.1-1. All of these configurations shall be tested with applicable test parameters for each channel bandwidth, and are shown in table 7.8.4.1-1. The details of the uplink and downlink reference measurement channels (RMCs) are specified in Annexes A.2 and A.3 respectively. The details of the OCNG patterns used are specified in Annex A.5. Configurations of PDSCH and PDCCH before measurement are specified in Annex C.2.

Table 7.8.1.4.1-1: Test Configuration Table

Initial Conditions						
Test Environment as specified in TS 36.508[7] subclause 4.1			NC			
Test Frequencies as specified in TS36.508 [7] subclause 4.3.1			Mid range			
Test Channel Bandwidths as specified in TS 36.508 [7] subclause 4.3.1			Lowest, 5MHz, Highest			
Test Parameters for Channel Bandwidths						
Ch BW	Downlink Configuration			Uplink Configuration		
	Mod'n	RB allocation		Mod'n	RB allocation	
		FDD	TDD		FDD	TDD
1.4MHz	QPSK	6	6	QPSK	6	6
3MHz	QPSK	15	15	QPSK	15	15
5MHz	QPSK	25	25	QPSK	25	25
5MHz	QPSK	25	N/A	QPSK	20	N/A
5MHz	QPSK	25	N/A	QPSK	15	N/A
10MHz	QPSK	50	50	QPSK	50	50
10MHz	QPSK	50	N/A	QPSK	25	N/A
10MHz	QPSK	50	N/A	QPSK	20	N/A
10MHz	QPSK	50	N/A	QPSK	15	N/A
15MHz	QPSK	75	75	QPSK	75	75
15MHz	QPSK	75	N/A	QPSK	50	N/A
15MHz	QPSK	75	N/A	QPSK	25	N/A
15MHz	QPSK	75	N/A	QPSK	20	N/A
20MHz	QPSK	100	100	QPSK	100	100
20MHz	QPSK	100	N/A	QPSK	75	N/A
20MHz	QPSK	100	N/A	QPSK	50	N/A
20MHz	QPSK	100	N/A	QPSK	25	N/A
20MHz	QPSK	100	N/A	QPSK	20	N/A
Note 1: Test Channel Bandwidths are checked separately for each E-UTRA band, which applicable channel bandwidths are specified in Table 5.4.2.1-1.						
Note 2: Depending on E-UTRA band, only the appropriate Uplink RB allocation value according to table 7.3.3-2 is tested per Test Channel Bandwidth.						
Note 3: For the DL signal one sided dynamic OCNG Pattern OP.1 FDD/TDD is used.						

1. Connect the SS and interfering sources to the UE antenna connectors as shown in TS 36.508 [7] Figure A.6.
2. The parameter settings for the cell are set up according to TS 36.508 [7] subclause 4.4.3.
3. Downlink signals are initially set up according to Annex C0, C.1 and C.3.1, and uplink signals according to Annex H.1 and H.3.1.
4. The UL and DL Reference Measurement channels are set according to Table 7.8.4.1-1.
5. Propagation conditions are set according to Annex B.0.
6. Ensure the UE is in State 3A or 3A-RF according to TS 36.508 [7] clause 4.5.3A or 5.2A.2. Message contents are defined in clause 7.8.1.4.3.

7.8.1.4.2 Test procedure

1. SS transmits PDSCH via PDCCH DCI format 1A for C_RNTI to transmit the DL RMC according to Table 7.8.1.4.1-1. The SS sends downlink MAC padding bits on the DL RMC.
2. SS sends uplink scheduling information for each UL HARQ process via PDCCH DCI format 0 for C_RNTI to schedule the UL RMC according to Table 7.8.1.4.1-1. Since the UE has no payload data to send, the UE transmits uplink MAC padding bits on the UL RMC.
3. Set the Downlink signal level to the value as defined in Table 7.8.1.5-1. Send Uplink power control commands to the UE (less or equal to 1dB step size should be used), to ensure that the UE output power is within +0, - 3.4 dB of the target level in Table 7.8.1.5-1 for at least the duration of the Throughput measurement.
4. Set the Interfering signal levels to the values as defined in Table 7.8.1.5-1, using a modulated interferer bandwidth as defined in Annex D of the present document.
5. Measure the average throughput for a duration sufficient to achieve statistical significance according to Annex G.2.

7.8.1.4.3 Message contents

Message contents are according to TS 36.508 [7] subclause 4.6 with the following exception.

Table 7.8.1.4.3-1: UplinkPowerControlDedicated

Derivation Path: 36.331 clause 6.3.2			
Information Element	Value/remark	Comment	Condition
UplinkPowerControlDedicated-DEFAULT ::= SEQUENCE {			
p0-UePUSCH	0		
deltaMCS-Enabled	en0		
accumulationEnabled	TRUE		
p0-uePUCCH	0		
pSRS-Offset	3 (-6 dB)		
filterCoefficient	fc8	larger filter length is used to reduce the RSRP measurement variation	
}			

7.8.1.5 Test requirements

The throughput shall be $\geq 95\%$ of the maximum throughput of the reference measurement channels as specified in Annex A.3.2 with parameters specified in Table 7.8.1.5-1 for the specified wanted signal mean power in the presence of two interfering signals.

Table 7.8.1.5-1: Test parameters for Wide band intermodulation

Rx Parameter	Units	Channel bandwidth					
		1.4 MHz	3 MHz	5 MHz	10 MHz	15 MHz	20 MHz
Power in Transmission Bandwidth Configuration	dBm	REFSENS + channel bandwidth specific value below					
		12	8	6	6	7	9
$P_{\text{Interferer 1 (CW)}}$	dBm	-46					
$P_{\text{Interferer 2 (Modulated)}}$	dBm	-46					
$BW_{\text{Interferer 2}}$		1.4	3	5			
$F_{\text{Interferer 1 (Offset)}}$	MHz	-BW/2 -2.1 / +BW/2+ 2.1	-BW/2 -4.5 / +BW/2 + 4.5	-BW/2 - 7.5 / +BW/2 + 7.5			
$F_{\text{Interferer 2 (Offset)}}$	MHz	$2 \cdot F_{\text{Interferer 1}}$					
Note 1: The transmitter shall be set to 4dB below $P_{\text{C}_{\text{MAX_L}}}$ with $P_{\text{C}_{\text{MAX_L}}}$ as defined in clause 6.2.5.							
Note 2: The reference measurement channel is specified in Annex A.3.2 with one sided dynamic OCNG Pattern OP.1 FDD/TDD as described in Annex A.5.1.1/A.5.2.1.							
Note 3: The modulated interferer consists of the Reference measurement channel specified in Annex A.3.2 with one sided dynamic OCNG Pattern OP.1 FDD/TDD as described in Annex A.5.1.1/A.5.2.1 and set-up according to Annex C.3.1. The interfering modulated signal is 5MHz E-UTRA signal as described in Annex D for channel bandwidth $\geq 5\text{MHz}$							

7.8.2 Void

7.9 Spurious emissions

The spurious emissions power is the power of emissions generated or amplified in a receiver that appear at the UE antenna connector.

7.9.1 Test Purpose

Test verifies the UE's spurious emissions meet the requirements described in clause 7.9.3.

Excess spurious emissions increase the interference to other systems.

7.9.2 Test Applicability

This test applies to all types of E-UTRA UE release 8 and forward.

7.9.3 Minimum Conformance Requirements

The power of any narrow band CW spurious emission shall not exceed the maximum level specified in Table 7.9.3-1

Table 7.9.3-1: General receiver spurious emission requirements

Frequency Band	Measurement Bandwidth	Maximum level	Note
$30\text{MHz} \leq f < 1\text{GHz}$	100 kHz	-57 dBm	
$1\text{GHz} \leq f \leq 12.75\text{GHz}$	1 MHz	-47 dBm	

The normative reference for this requirement is TS 36.101 [2] clause 7.9.

7.9.4 Test Description

7.9.4.1 Initial Conditions

Initial conditions are a set of test configurations the UE needs to be tested in and the steps for the SS to take with the UE to reach the correct measurement state.

The initial test configurations consist of environmental conditions, test frequencies, and channel bandwidths based on E-UTRA bands specified in table 5.4.2.1-1. All of these configurations shall be tested with applicable test parameters for each channel bandwidth, and are shown in table 7.9.4.1-1. The details of the downlink and uplink reference measurement channels (RMCs) are specified in Annexes A.3 and A.2 respectively.

Table 7.9.4.1-1: Test Configuration Table

Initial Conditions						
Test Environment as specified in TS 36.508[7] subclause 4.1			NC			
Test Frequencies as specified in TS36.508 [7] subclause 4.3.1			Low range, Mid range, High range			
Test Channel Bandwidths as specified in TS 36.508 [7] subclause 4.3.1			Highest			
Test Parameters for Channel Bandwidths						
Ch BW	Downlink Configuration			Uplink Configuration		
	Mod'n	RB allocation		Mod'n	RB allocation	
		FDD	TDD		FDD	TDD
1.4MHz	QPSK	0	0	QPSK	0	0
3MHz	QPSK	0	0	QPSK	0	0
5MHz	QPSK	0	0	QPSK	0	0
10MHz	QPSK	0	0	QPSK	0	0
15MHz	QPSK	0	0	QPSK	0	0
20MHz	QPSK	0	0	QPSK	0	0
Note 1: Test Channel Bandwidths are checked separately for each E-UTRA band. The applicable channel bandwidths are specified in Table 7.3.3-2.						

1. Connect a spectrum analyzer (or other suitable test equipment) to the UE antenna connectors as shown in TS 36.508 [7] Annex A, Figure A.8.
2. The parameter settings for the cell are set up according to TS 36.508 [7] subclause 4.4.3.
3. Downlink signals are initially set up according to Annex C0, C.1 and C.3.1.
4. The DL Reference Measurement channels are set according to Table 7.9.4.1-1.
5. Propagation conditions are set according to Annex B.0.
6. Ensure the UE is in State 3A or 3A-RF according to TS 36.508 [7] clause 4.5.3A or 5.2A.2. Message contents are defined in clause 7.9.4.3.

7.9.4.2 Test Procedure

1. Sweep the spectrum analyzer (or equivalent equipment) over a frequency range and measure the average power of spurious emission.
2. Repeat step 1 for all E-UTRA Rx antennas of the UE.

7.9.4.3 Message Contents

Message contents are according to TS 36.508 [7] subclause 4.6.

7.9.5 Test Requirement

The measured spurious emissions derived in step 1), shall not exceed the maximum level specified in Table 7.9.5-1

Table 7.9.5-1: General receiver spurious emission requirements

Frequency Band	Measurement Bandwidth	Maximum level	Note
$30\text{MHz} \leq f < 1\text{GHz}$	100 kHz	-57 dBm	
$1\text{GHz} \leq f \leq 12.75\text{GHz}$	1 MHz	-47 dBm	

8 Performance Requirement

8.1 General

The performance requirements for the physical channels specified in TS 36.211 [8] clause 6 (for downlink physical channels) shall be as defined in the respective sections below.

The requirements for the UE in this clause are specified for the downlink reference measurement channels specified in Annex A, the propagation conditions specified in Annex B and the downlink physical channels specified in Annex C.

Unless otherwise stated the throughput measurements in clause 8 shall be performed according to the general rules for statistical testing in Annex G clause G.3.

The requirement for a UE that support E-UTRA in downlink shall be tested according to the declared UE PDSCH category.

The fading of the signals and the AWGN signals applied to each receiver antenna connector shall be uncorrelated. The levels of the test signal applied to each of the antenna connectors shall be as defined in the respective test cases.

The UE performance in this section is considered to be operating band independent. Therefore, the required performance in the respective test cases can be verified in one of the operating bands supported by the UE under test. All the test points supported by the bands of the multiband UE (based on channel bandwidth, DL and UL configuration) need to be tested.

8.1.1 Dual-antenna receiver capability

The performance requirements are based on UE(s) that utilize a dual-antenna receiver.

For all test cases, the SNR is defined as:

$$SNR = \frac{\hat{E}_s^{(1)} + \hat{E}_s^{(2)}}{N_{oc}^{(1)} + N_{oc}^{(2)}}$$

where the superscript indicates the receiver antenna connector. The SNR requirement applies for the UE categories given for each test.

The normative reference for this requirement is TS 36.101 [2] clause 8.1.1.

8.1.1.1 Simultaneous unicast and MBMS operations

8.1.1.2 Dual-antenna receiver capability in idle mode

8.2 Demodulation of PDSCH (Cell-Specific Reference Symbols)

8.2.1 FDD (Fixed Reference Channel)

The parameters specified in Table 8.2.1-1 are valid for all FDD tests unless otherwise stated.

Table 8.2.1-1: Common Test Parameters (FDD)

Parameter	Unit	Value	Comments
Inter-TTI Distance		1	
Number of HARQ processes	Processes	8	For FDD, 8 HARQ processes in the DL, as specified in TS 36.213 [10] clause 7. All 8 HARQ processes are used.
Scheduling of retransmissions			1. Retransmissions use the same Transport Block Size (TBS) as the initial transmission. 2. HARQ processes are scheduled consecutively, independent of the fact, whether retransmissions (for negatively acknowledged HARQ processes) or new transmissions (for positively acknowledged HARQ processes) occur.
Maximum number of HARQ transmission		4	It is always 4 for FDD, as specified in TS 36.213 [10] clause 8
Redundancy version coding sequence		{0,1,2,3} for QPSK and 16QAM {0,0,1,2} for 64QAM	
Number of OFDM symbols for PDCCH	OFDM symbols	4 for 1.4 MHz bandwidth, 3 for 3 MHz and 5 MHz bandwidths, 2 for 10 MHz, 15 MHz and 20 MHz bandwidths	The PCFICH carries information about the number of OFDM symbols used for transmission of PDCCHs in a subframe, as specified in TS 36.211 [8] clause 6.7
Cyclic Prefix		Normal	CP consist of the following physical resource blocks (RBs) parameters: 12 consecutive subcarriers at a 15 kHz spacing and 7 OFDM symbols, as specified in TS 36.211 [8] clause 6.2.3
Cell ID		0	The Cell ID is uniquely defined by a number in the range of 0 to 503, representing the physical-layer cell identity, as specified in TS 36.211 [8] clause 6.11.

The normative reference for this requirement is TS 36.101 [2] clause 8.2.1.

8.2.1.1 FDD PDSCH Single Antenna Port Performance (Cell-Specific Reference Symbols)

8.2.1.1.1 FDD PDSCH Single Antenna Port Performance

8.2.1.1.1.1 Test purpose

To verify the UE's ability to receive a predefined test signal, representing a multi-path fading channel that is determined by the SNR with a percentage of the information bit throughput for a specified downlink Reference Measurement Channel (RMC) not falling below a specified value for transmission on a single-antenna port with different channel models and MCS.

8.2.1.1.1.2 Test applicability

This test applies to all types of E-UTRA FDD UE release 8 and forward.

8.2.1.1.1.3 Minimum conformance requirements

The requirements are specified in terms of the percentage of information bit throughput for the downlink reference measurement channels specified in Annex A clause A.3.3.1, with the addition of the relevant parameters in Tables 8.2.1-1, 8.2.1.1.3-1 and the downlink physical channel setup according to Table C.3.2-1 in Annex C.

Using this configuration the fraction of maximum throughput percentage shall meet or exceed the minimum requirements specified in Table 8.2.1.1.1.3-2 for the specified SNR. For QPSK and 64QAM performance the bandwidths specified in Table 5.4.2.1-1 are verified.

Table 8.2.1.1.1.3-1: Test Parameters for Testing

Parameter		Unit	Test 1- 5	Test 6- 8	Test 9- 15	Test 16- 18
Downlink power allocation	ρ_A	dB	0	0	0	0
	ρ_B	dB	0 (Note 1)	0 (Note 1)	0 (Note 1)	0 (Note 1)
N_{oc} at antenna port		dBm/15kHz	-98	-98	-98	-98
Symbols for unused PRBs			OCNG (Note 2)	OCNG (Note 2)	OCNG (Note 2)	OCNG (Note 2)
Modulation			QPSK	16QAM	64QAM	16QAM
Note 1: $P_B = 0$						
Note 2: These physical resource blocks are assigned to an arbitrary number of virtual UEs with one PDSCH per virtual UE; the data transmitted over the OCNG PDSCHs shall be uncorrelated pseudo random data, which is QPSK modulated.						

Table 8.2.1.1.1.3-2: Minimum performance (FRC)

Test number	Bandwidth	Reference Channel	OCNG Pattern	Propagation Condition	Correlation Matrix and Antenna Configuration	Reference value		UE Category
						Fraction of Maximum Throughput (%)	SNR (dB)	
1	10 MHz	R.2 FDD	OP.1 FDD	EVA5	1x2 Low	70	-1.0	1-5
2	10 MHz	R.2 FDD	OP.1 FDD	ETU70	1x2 Low	70	-0.4	1-5
3	10 MHz	R.2 FDD	OP.1 FDD	ETU300	1x2 Low	70	0.0	1-5
4	10 MHz	R.2 FDD	OP.1 FDD	HST	1x2 Low	70	-2.4	1-5
5	1.4 MHz	R.4 FDD	OP.1 FDD	EVA5	1x2 Low	70	0.0	1-5
6	10 MHz	R.3 FDD	OP.1 FDD	EVA5	1x2 Low	70	6.7	2-5
7	10 MHz	R.3 FDD	OP.1 FDD	ETU70	1x2 Low	30	1.4	2-5
8	10 MHz	R.3 FDD	OP.1 FDD	ETU300	1x2 High	70	9.4	2-5
9	3 MHz	R.5 FDD	OP.1 FDD	EVA5	1x2 Low	70	17.6	1-5
10	5 MHz	R.6 FDD	OP.1 FDD	EVA5	1x2 Low	70	17.4	2-5
11	10 MHz	R.7 FDD	OP.1 FDD	EVA5	1x2 Low	70	17.7	2-5
12	10 MHz	R.7 FDD	OP.1 FDD	ETU70	1x2 Low	70	19.0	2-5
13	10 MHz	R.7 FDD	OP.1 FDD	EVA5	1x2 High	70	19.1	2-5
14	15 MHz	R.8 FDD	OP.1 FDD	EVA5	1x2 Low	70	17.7	2-5
15	20 MHz	R.9 FDD	OP.1 FDD	EVA5	1x2 Low	70	17.6	3-5
16	3 MHz	R.0 FDD	OP.1 FDD	ETU70	1x2 Low	30	1.9	1-5
17	10 MHz	R.1 FDD	OP.1 FDD	ETU70	1x2 Low	30	1.9	1-5
18	20 MHz	R.1 FDD	OP.1 FDD	ETU70	1x2 Low	30	1.9	1-5

The normative reference for this requirement is TS 36.101 [2] clause 8.2.1.1.

8.2.1.1.1.4 Test description

8.2.1.1.1.4.1 Initial conditions

Initial conditions are a set of test configurations the UE needs to be tested in and the steps for the SS to take with the UE to reach the correct measurement state.

Configurations of PDSCH and PDCCH before measurement are specified in Annex C.2.

Test Environment: Normal, as defined in TS 36.508 [7] clause 4.1.

Frequencies to be tested for full allocation: Mid Range, as defined in TS 36.508 [7] clause 4.3.1.1.

Frequencies to be tested for 1PRB allocation: Low Range, as defined in TS 36.508 [7] clause 4.3.1.1.

Channel Bandwidths to be tested: As specified per test number in Table 8.2.1.1.1.3-2 as defined in TS 36.508 [7] clause 4.3.1.1

1. Connect the SS, the faders and AWGN noise source to the UE antenna connectors as shown in TS 36.508 [7] Annex A, Figure A.9.
2. The parameter settings for the cell are set up according to Table 8.2.1-1 and 8.2.1.1.1.3-1 as appropriate.
3. Downlink signals are initially set up according to Annex C0, C.1 and Annex C.3.2 and uplink signals according to Annex H.1 and H.3.2.
4. Propagation conditions are set according to Annex B.0.
5. Ensure the UE is in State 3A or 3A-RF according to TS 36.508 [7] clause 4.5.3A or 5.2A.2. Message contents are defined in clause 8.2.1.1.1.4.3.

8.2.1.1.1.4.2 Test procedure

1. SS transmits PDSCH via PDCCH DCI format 1A for C_RNTI to transmit the DL RMC according to Tables 8.2.1.1.1.3-1 and 8.2.1.1.1.3-2. The SS sends downlink MAC padding bits on the DL RMC.
2. Set the parameters of the bandwidth, MCS, reference channel, the propagation condition, the correlation matrix and the SNR according to Tables 8.2.1.1.1.5-1 as appropriate.
3. Measure the average throughput for a duration sufficient to achieve statistical significance according to Annex G clause G.3. Count the number of NACKs, ACKs and statDTXs on the UL during each subtest and decide pass or fail according to Tables G.3.5 and G.3.6 in Annex G clause G.3.
4. Repeat steps from 1 to 3 for each subtest in Table 8.2.1.1.1.5-1 as appropriate.

8.2.1.1.1.4.3 Message contents

Message contents are according to TS 36.508 [7] clause 4.6.

8.2.1.1.1.5 Test requirement

Table 8.2.1.1.1.3-1 defines the primary level settings.

The fraction of maximum throughput percentage for the downlink reference measurement channels specified in Annex A clause A.3.3.1 for each throughput test shall meet or exceed the specified value in Table 8.2.1.1.1.5-1 for the specified SNR including test tolerances for all throughput tests.

Table 8.2.1.1.1.5-1: Test requirement (FRC)

Test number	Bandwidth	Reference Channel	OCNG Pattern	Propagation Condition	Correlation Matrix and Antenna Configuration	Reference value		UE Category
						Fraction of Maximum Throughput (%)	SNR (dB)	
1	10 MHz	R.2 FDD	OP.1 FDD	EVA5	1x2 Low	70	-0.2	1-5
2	10 MHz	R.2 FDD	OP.1 FDD	ETU70	1x2 Low	70	+0.4	1-5
3	10 MHz	R.2 FDD	OP.1 FDD	ETU300	1x2 Low	70	+0.8	1-5
4	10 MHz	R.2 FDD	OP.1 FDD	HST	1x2 Low	70	-1.8	1-5
5	1.4 MHz	R.4 FDD	OP.1 FDD	EVA5	1x2 Low	70	+0.8	1-5
6	10 MHz	R.3 FDD	OP.1 FDD	EVA5	1x2 Low	70	+7.5	2-5
7	10 MHz	R.3 FDD	OP.1 FDD	ETU70	1x2 Low	30	+2.2	2-5
8	10 MHz	R.3 FDD	OP.1 FDD	ETU300	1x2 High	70	+10.2	2-5
9	3 MHz	R.5 FDD	OP.1 FDD	EVA5	1x2 Low	70	+18.4 1	1-5
10	5 MHz	R.6 FDD	OP.1 FDD	EVA5	1x2 Low	70	+18.2	2-5
11	10 MHz	R.7 FDD	OP.1 FDD	EVA5	1x2 Low	70	+18.5	2-5
12	10 MHz	R.7 FDD	OP.1 FDD	ETU70	1x2 Low	70	+19.8	2-5
13	10 MHz	R.7 FDD	OP.1 FDD	EVA5	1x2 High	70	+19.9	2-5
14	15 MHz	R.8 FDD	OP.1 FDD	EVA5	1x2 Low	70	+18.5	2-5
15	20 MHz	R.9 FDD	OP.1 FDD	EVA5	1x2 Low	70	+18.4	3-5
16	3 MHz	R.0 FDD	OP.1 FDD	ETU70	1x2 Low	30	+2.7	1-5
17	10 MHz	R.1 FDD	OP.1 FDD	ETU70	1x2 Low	30	+2.7	1-5
18	20 MHz	R.1 FDD	OP.1 FDD	ETU70	1x2 Low	30	+2.7	1-5

8.2.1.1.2 FDD PDSCH Single Antenna Port Performance with 1 PRB in presence of MBSFN

8.2.1.1.2.1 Test purpose

To verify the UE's ability to receive a predefined test signal, representing a multi-path fading channel that is determined by the SNR with a percentage of the information bit throughput for a specified downlink Reference Measurement Channel (RMC) not falling below a specified value for transmission on a single-antenna port with different channel models and MCS for 1 PRB allocation in presence of MBSFN.

8.2.1.1.2.2 Test applicability

This test applies to all types of E-UTRA FDD UE release 8 and forward.

8.2.1.1.2.3 Minimum conformance requirements

The requirements are specified in terms of the percentage of information bit throughput for the downlink reference measurement channels specified in Annex A clause A.3.3.1, with the addition of the relevant parameters in Tables 8.2.1-1, 8.2.1.1.2.3-1, and the downlink physical channel setup according to Table C.3.2-1 in Annex C.

Using this configuration the fraction of maximum throughput percentage shall meet or exceed the minimum requirements specified in Tables 8.2.1.1.2.3-2, for the specified SNR.

Table 8.2.1.1.2.3-1: Test Parameters for Testing 1 PRB allocation

Parameter		Unit	Test 1
Downlink power allocation	ρ_A	dB	0
	ρ_B	dB	0 (Note 1)
N_{oc} at antenna port		dBm/15kHz	-98
Symbols for MBSFN portion of MBSFN subframes (Note 2)			OCNG (Note 3)
Note 1: $P_B = 0$ Note 2: The MBSFN portion of an MBSFN subframe comprises the whole MBSFN subframe except the first two symbols in the first slot. Note 3: The MBSFN portion of the MBSFN subframes shall contain QPSK modulated data. Cell-specific reference signals are not inserted in the MBSFN portion of the MBSFN subframes, QPSK modulated MBSFN data is used instead.			

Table 8.2.1.1.2.3-2: Minimum performance 1 PRB allocation (FRC)

Test number	Bandwidth	Reference Channel	OCNG Pattern	Propagation Condition	Correlation Matrix and Antenna Configuration	Reference value		UE Category
						Fraction of Maximum Throughput (%)	SNR (dB)	
1	10 MHz	R.29 FDD	OP.3 FDD	ETU70	1x2 Low	30	2.0	1-5

The normative reference for this requirement is TS 36.101 [2] clause 8.2.1.1.

8.2.1.1.2.4 Test description

8.2.1.1.2.4.1 Initial conditions

Initial conditions are a set of test configurations the UE needs to be tested in and the steps for the SS to take with the UE to reach the correct measurement state.

Configurations of PDSCH and PDCCH before measurement are specified in Annex C.2.

Test Environment: Normal, as defined in TS 36.508 [7] clause 4.1.

Frequencies to be tested: Low Range, as defined in TS 36.508 [7] clause 4.3.1.1.

Channel Bandwidths to be tested: As specified per test number in Tables 8.2.1.1.2.3-2as defined in TS 36.508 [7] clause 4.3.1.1

1. Connect the SS, the faders and AWGN noise source to the UE antenna connectors as shown in TS 36.508 [7] Annex A, Figure A.9.
2. The parameter settings for the cell are set up according to Tables 8.2.1-1, 8.2.1.1.2.3-1as appropriate.
3. Downlink signals are initially set up according to Annex C.1 and Annex C.3.2 and uplink signals according to Annex H.1 and H.3.2.
4. Propagation conditions are set according to Annex B.0.
5. Ensure the UE is in State 3A or 3A-RF according to TS 36.508 [7] clause 4.5.3A or 5.2A.2. Message contents are defined in clause 8.2.1.1.2.4.3.

8.2.1.1.2.4.2 Test procedure

1. SS transmits PDSCH via PDCCH DCI format 1A for C_RNTI to transmit the DL RMC according to Tables 8.2.1.1.2.3-1 and 8.2.1.1.2.3-2. The SS sends downlink MAC padding bits on the DL RMC.
2. Set the parameters of the bandwidth, MCS, reference channel, the propagation condition, the correlation matrix and the SNR according to Table 8.2.1.1.2.5-1 as appropriate.
3. Measure the average throughput for a duration sufficient to achieve statistical significance according to Annex G clause G.3. Count the number of NACKs, ACKs and statDTXs on the UL during each subtest and decide pass or fail according to Tables G.3.5 and G.3.6 in Annex G clause G.3.

8.2.1.1.2.4.3 Message contents

Message contents are according to TS 36.508 [7] clause 4.6 with the following exceptions:

Table 8.2.1.1.2.4.3-1: SystemInformationBlockType2: Additional FDD PDSCH Single Antenna Port Performance for 1 PRB allocation with MBSFN subframes test point 1 requirement

Derivation Path: TS 36.508 [7] clause 4.4.3.3, Table 4.4.3.3-1 SystemInformationBlockType2			
Information Element	Value/remark	Comment	Condition
SystemInformationBlockType2 ::= SEQUENCE {			
mbsfn-SubframeConfig ::= SEQUENCE {			
radioframeAllocationPeriod	n1	Every radio frame is with MBSFN subframe	
radioframeAllocationOffset	0		
subframeAllocation CHOICE {			
oneFrame	111111	Subframe 1, 2, 3, 6, 7, 8 is used for MBSFN	FDD
}			
}			
}			

8.2.1.1.2.5 Test requirement

Table 8.2.1.1.2.3-1 defines the primary level settings.

The fraction of maximum throughput percentage for the downlink reference measurement channels specified in Annex A clause A.3.3.1 for each throughput test shall meet or exceed the specified value in Tables 8.2.1.1.2.5-1 for the specified SNR including test tolerances for all throughput tests.

Table 8.2.1.1.2.5-1: Test requirement 1 PRB allocation with MBSFN subframes (FRC)

Test number	Bandwidth	Reference Channel	OCNG Pattern	Propagation Condition	Correlation Matrix and Antenna Configuration	Reference value		UE Category
						Fraction of Maximum Throughput (%)	SNR (dB)	
1	10 MHz	R.29 FDD	OP.3 FDD	ETU70	1x2 Low	30	+2.8	1-5

8.2.1.2 FDD PDSCH Transmit Diversity Performance (Cell-Specific Reference Symbols)

8.2.1.2.1 FDD PDSCH Transmit Diversity 2x2

8.2.1.2.1.1 Test purpose

To verify the UE's ability to receive a predefined test signal, representing a multi-path fading channel that is determined by the SNR with a percentage of the information bit throughput for a specified downlink Reference Measurement

Channel (RMC) not falling below a specified value for transmission on two antenna ports using transmit diversity (SFBC).

8.2.1.2.1.2 Test applicability

This test applies to all types of E-UTRA FDD UE release 8 and forward.

8.2.1.2.1.3 Minimum conformance requirements

The requirements are specified in terms of the percentage of information bit throughput for the downlink reference measurement channels specified in Annex A clause A.3.3.2, with the addition of the relevant parameters in Tables 8.2.1-1 and 8.2.1.2.1.3-1 and the downlink physical channel setup according to Table C.3.2-1 in Annex C.3.2.

Using this configuration the fraction of maximum throughput percentage shall meet or exceed the minimum requirements specified in Table 8.2.1.2.1.3-2 for the specified SNR. For transmit diversity (SFBC) performance with 2 transmitter antennas as specified.

Table 8.2.1.2.1.3-1: Test Parameters for Testing Transmit Diversity Performance

Parameter		Unit	Test 1-2
Downlink power allocation	ρ_A	dB	-3
	ρ_B	dB	-3 (Note 1)
N_{oc} at antenna port		dBm/15kHz	-98
Note 1: $P_B = 1$			

Table 8.2.1.2.1.3-2: Minimum performance Transmit Diversity (FRC)

Test number	Bandwidth	Reference Channel	OCNG Pattern	Propagation Condition	Correlation Matrix and Antenna Configuration	Reference value		UE Category
						Fraction of Maximum Throughput (%)	SNR (dB)	
1	10 MHz	R.11 FDD	OP.1 FDD	EVA5	2x2 Medium	70	6.8	2-5
2	10 MHz	R.10 FDD	OP.1 FDD	HST	2x2 Low	70	-2.3	1-5

The normative reference for this requirement is TS 36.101 [2] clause 8.2.1.2.

8.2.1.2.1.4 Test description

8.2.1.2.1.4.1 Initial conditions

Initial conditions are a set of test configurations the UE needs to be tested in and the steps for the SS to take with the UE to reach the correct measurement state.

Configurations of PDSCH and PDCCH before measurement are specified in Annex C.2.

Test Environment: Normal, as defined in TS 36.508 [7] clause 4.1.

Frequencies to be tested: Mid Range, as defined in TS 36.508 [7] clause 4.3.1.1.

Channel Bandwidths to be tested: As specified per test number in Table 8.2.1.2.1.3-2 as defined in TS 36.508 [7] clause 4.3.1.1.

1. Connect the SS, the faders and AWGN noise sources to the UE antenna connectors as shown in TS 36.508 [7] Annex A, Figure A.10 for antenna configuration 2x2.
2. The parameter settings for the cell are set up according to Tables 8.2.1-1 and 8.2.1.2.1.3-1 as appropriate.
3. Downlink signals are initially set up according to Annex C0, C.1 and Annex C.3.2 and uplink signals according to Annex H.1 and H.3.2.

4. Propagation conditions are set according to Annex B.0.
5. Ensure the UE is in State 3A or 3A-RF according to TS 36.508 [7] clause 4.5.3A or 5.2A.2. Message contents are defined in clause 8.2.1.2.1.4.3.

8.2.1.2.1.4.2 Test procedure

1. SS transmits PDSCH via PDCCH DCI format 1A for C_RNTI to transmit the DL RMC according to Tables 8.2.1.2.1.3-1 and 8.2.1.2.1.3-2. The SS sends downlink MAC padding bits on the DL RMC.
2. Set the parameters of the bandwidth, MCS, reference channel, the propagation condition, the correlation matrix, antenna configuration and the SNR according to Tables 8.2.1.2.1.5-1 as appropriate.
3. Measure the average throughput for a duration sufficient to achieve statistical significance according to Annex G clause G.3. Count the number of NACKs, ACKs and statDTXs on the UL during the test interval and decide pass or fail according to Tables G.3.5 and G.3.6 in Annex G clause G.3.
4. Repeat steps from 1 to 3 for each test interval in Table 8.2.1.2.1.5-1 as appropriate.

8.2.1.2.1.4.3 Message contents

Message contents are according to TS 36.508 [7] clause 4.6.

8.2.1.2.1.5 Test requirement

Table 8.2.1.2.1.3-1 defines the primary level settings.

The fraction of maximum throughput percentage for the downlink reference measurement channels specified in Annex A clause A.3.3.2 for each throughput test shall meet or exceed the specified value in Table 8.2.1.2.1.5-1 for the specified SNR including test tolerances for all throughput tests.

Table 8.2.1.2.1.5-1: Test requirement Transmit Diversity (FRC)

Test number	Bandwidth	Reference Channel	OCNG Pattern	Propagation Condition	Correlation Matrix and Antenna Configuration	Reference value		UE Category
						Fraction of Maximum Throughput (%)	SNR (dB)	
1	10 MHz	R.11 FDD	OP.1 FDD	EVA5	2x2 Medium	70	7.7	2-5
2	10 MHz	R.10 FDD	OP.1 FDD	HST	2x2 Low	70	-1.7	1-5

8.2.1.2.2 FDD PDSCH Transmit Diversity 4x2

8.2.1.2.2.1 Test purpose

To verify the UE's ability to receive a predefined test signal, representing a multi-path fading channel that is determined by the SNR with a percentage of the information bit throughput for a specified downlink Reference Measurement Channel (RMC) not falling below a specified value for transmission on two antenna ports using transmit diversity (SFBC-FSTD).

8.2.1.2.2.2 Test applicability

This test applies to all types of E-UTRA FDD UE release 8 and forward.

8.2.1.2.2.3 Minimum conformance requirements

The requirements are specified in terms of the percentage of information bit throughput for the downlink reference measurement channels specified in Annex A clause A.3.3.2, with the addition of the relevant parameters in Tables 8.2.1-1 and 8.2.1.2.2.3-1 and the downlink physical channel setup according to Table C.3.2-1 in Annex C.3.2.

Using this configuration the fraction of maximum throughput percentage shall meet or exceed the minimum requirements specified in Table 8.2.1.2.2.3-2 for the specified SNR. For transmit diversity (SFBC) performance with 4 transmitter antennas as specified.

Table 8.2.1.2.2.3-1: Test Parameters for Testing Transmit Diversity Performance

Parameter		Unit	Test 1
Downlink power allocation	ρ_A	dB	-3
	ρ_B	dB	-3 (Note 1)
N_{oc} at antenna port		dBm/15kHz	-98
Note 1: $P_B = 1$			

Table 8.2.1.2.2.3-2: Minimum performance Transmit Diversity (FRC)

Test number	Band-width	Reference Channel	OCNG Pattern	Propagation Condition	Correlation Matrix and Antenna Configuration	Reference value		UE Category
						Fraction of Maximum Throughput (%)	SNR (dB)	
1	1.4 MHz	R.12 FDD	OP.1 FDD	EPA5	4x2 Medium	70	0.6	1-5

The normative reference for this requirement is TS 36.101 [2] clause 8.2.1.2.

8.2.1.2.2.4 Test description

8.2.1.2.2.4.1 Initial conditions

Initial conditions are a set of test configurations the UE needs to be tested in and the steps for the SS to take with the UE to reach the correct measurement state.

Configurations of PDSCH and PDCCH before measurement are specified in Annex C.2.

Test Environment: Normal, as defined in TS 36.508 [7] clause 4.1.

Frequencies to be tested: Mid Range, as defined in TS 36.508 [7] clause 4.3.1.1.

Channel Bandwidths to be tested: As specified per test number in Table 8.2.1.2.2.3-2 as defined in TS 36.508 [7] clause 4.3.1.1.

1. Connect the SS, the faders and AWGN noise sources to the UE antenna connectors as shown in TS 36.508 [7] Annex A, Figure A.11 for antenna configuration 4x2.
2. The parameter settings for the cell are set up according to Tables 8.2.1-1 and 8.2.1.2.2.3-1 as appropriate.
3. Downlink signals are initially set up according to Annex C.1 and Annex C.3.2 and uplink signals according to Annex H.1 and H.3.2.
4. Propagation conditions are set according to Annex B.0.
5. Ensure the UE is in State 3A or 3A-RF according to TS 36.508 [7] clause 4.5.3A or 5.2A.2. Message contents are defined in clause 8.2.1.2.2.4.3.

8.2.1.2.2.4.2 Test procedure

1. SS transmits PDSCH via PDCCH DCI format 1A for C_RNTI to transmit the DL RMC according to Tables 8.2.1.2.2.3-1 and 8.2.1.2.2.3-2. The SS sends downlink MAC padding bits on the DL RMC.
2. Set the parameters of the bandwidth, MCS, reference channel, the propagation condition, the correlation matrix, antenna configuration and the SNR according to Tables 8.2.1.2.2.5-1 as appropriate.

3. Measure the average throughput for a duration sufficient to achieve statistical significance according to Annex G clause G.3. Count the number of NACKs, ACKs and statDTXs on the UL during the test interval and decide pass or fail according to Tables G.3.5 and G.3.6 in Annex G clause G.3.

8.2.1.2.2.4.3 Message contents

Message contents are according to TS 36.508 [7] clause 4.6 with the following exceptions:

Table 8.2.1.2.2.4.3-1: PDSCH-ConfigDedicated-DEFAULT: Additional FDD PDSCH transmit diversity performance downlink power allocation test point 1 requirement

Derivation Path: 36.331 clause 6.3.2			
Information Element	Value/remark	Comment	Condition
PDSCH-ConfigDedicated-DEFAULT ::= SEQUENCE {			
p-a	dB-3		
}			

8.2.1.2.2.5 Test requirement

Table 8.2.1.2.2.3-1 defines the primary level settings.

The fraction of maximum throughput percentage for the downlink reference measurement channels specified in Annex A clause A.3.3.2 for each throughput test shall meet or exceed the specified value in Table 8.2.1.2.2.5-1 for the specified SNR including test tolerances for all throughput tests.

Table 8.2.1.2.2.5-1: Test requirement Transmit Diversity (FRC)

Test number	Band-width	Reference Channel	OCNG Pattern	Propagation Condition	Correlation Matrix and Antenna Configuration	Reference value		UE Category
						Fraction of Maximum Throughput (%)	SNR (dB)	
1	1.4 MHz	R.12 FDD	OP.1 FDD	EPA5	4x2 Medium	70	1.5	1-5

8.2.1.3 FDD PDSCH Open Loop Spatial Multiplexing Performance (Cell-Specific Reference Symbols)

8.2.1.3.1 FDD PDSCH Open Loop Spatial Multiplexing 2x2

8.2.1.3.1.1 Test purpose

To verify the UE's ability to receive a predefined test signal, representing a multi-path fading channel that is determined by the SNR with a percentage of the information bit throughput for a specified downlink Reference Measurement Channel (RMC) not falling below a specified value for transmission on two antenna ports using large delay CDD.

8.2.1.3.1.2 Test applicability

This test applies to all types of E-UTRA FDD UE release 8 and forward.

8.2.1.3.1.3 Minimum conformance requirements

The requirements are specified in terms of the percentage of information bit throughput for the downlink reference measurement channels specified in Annex A clause A.3.3.2, with the addition of the relevant parameters in Tables 8.2.1-1 and 8.2.1.3.1.3-1 and the downlink physical channel setup according to Table C.3.2-1 in Annex C.

Using this configuration the fraction of maximum throughput percentage shall meet or exceed the minimum requirements specified in Table 8.2.1.3.1.3-1 for the specified SNR. For open-loop spatial multiplexing performance with large delay CDD is specified.

Table 8.2.1.3.1.3-1: Test Parameters for Large Delay CDD (FRC)

Parameter		Unit	Test 1
Downlink power allocation	ρ_A	dB	-3
	ρ_B	dB	-3 (Note 1)
N_{oc} at antenna port		dBm/15kHz	-98
Note 1: $P_B = 1$			

Table 8.2.1.3.1.3-2: Minimum performance Large Delay CDD (FRC)

Test number	Band-width	Reference Channel	OCNG Pattern	Propagation Condition	Correlation Matrix and Antenna Configuration	Reference value		UE Category
						Fraction of Maximum Throughput (%)	SNR (dB)	
1	10 MHz	R.11 FDD	OP.1 FDD	EVA70	2x2 Low	70	13.0	2-5

The normative reference for this requirement is TS 36.101 [2] clause 8.2.1.3.

8.2.1.3.1.4 Test description

8.2.1.3.1.4.1 Initial conditions

Initial conditions are a set of test configurations the UE needs to be tested in and the steps for the SS to take with the UE to reach the correct measurement state.

Configurations of PDSCH and PDCCH before measurement are specified in Annex C.2.

Test Environment: Normal, as defined in TS 36.508 [7] clause 4.1.

Frequencies to be tested: Mid Range, as defined in TS 36.508 [7] clause 4.3.1.1.

Channel Bandwidths to be tested: As specified per test number in Table 8.2.1.3.1.3-1, as defined in TS 36.508 [7] clause 4.3.1.1

1. Connect the SS, the faders and AWGN noise sources to the UE antenna connectors as shown in TS 36.508 [7] Annex A, Figure A.10 for antenna configuration 2x2.
2. The parameter settings for the cell are set up according to Tables 8.2.1-1 and 8.2.1.3.1.3-1 as appropriate.
3. Downlink signals are initially set up according to Annex C0, C.1 and Annex C.3.2 and uplink signals according to Annex H.1 and H.3.2.
4. Propagation conditions are set according to Annex B.0.
5. Ensure the UE is in State 3A or 3A-RF according to TS 36.508 [7] clause 4.5.3A or 5.2A.2. Message contents are defined in clause 8.2.1.3.1.4.3.

8.2.1.3.1.4.2 Test procedure

1. SS transmits PDSCH via PDCCH DCI format 2A for C_RNTI to transmit the DL RMC according to Tables 8.2.1.3.1.3-1 and 8.2.1.3.1.3-2. The SS sends downlink MAC padding bits on the DL RMC.
2. Set the parameters of the reference channel, the propagation condition, the correlation matrix and the SNR according to Table 8.2.1.3.1.5-1 as appropriate.
3. Measure the average throughput for a duration sufficient to achieve statistical significance according to Annex G clause G.3. Count the number of NACKs, ACKs and statDTXs on the UL during the test interval and decide pass or fail according to Tables G.3.5 and G.3.6 in Annex G clause G.3.

8.2.1.3.1.4.3 Message contents

Message contents are according to TS 36.508 [7] clause 4.6 with the following exceptions:

Table 8.2.1.3.1.4.3-1: *PhysicalConfigDedicated-DEFAULT*: Additional FDD PDSCH open loop spatial multiplexing performance downlink power allocation for Test number 1

Derivation Path: 36.331 clause 6.3.2			
Information Element	Value/remark	Comment	Condition
PhysicalConfigDedicated-DEFAULT ::= SEQUENCE {			
antennaInfo CHOICE {			
antennaInfoDedicated ::= SEQUENCE {			
transmissionMode	tm3		
codebookSubsetRestriction CHOICE {			
n2TxAntenna-tm3	11		
}			
ue-TransmitAntennaSelection CHOICE {			
release	NULL		
}			
}			
}			

8.2.1.3.1.5 Test requirement

Table 8.2.1.3.1.3-1 defines the primary level settings.

The fraction of maximum throughput percentage for the downlink reference measurement channels specified in Annex A clause A.3.3.2 for each throughput test shall meet or exceed the specified value in Tables 8.2.1.3.1.5-1 for the specified SNR including test tolerances for all throughput tests.

Table 8.2.1.3.1.5-1: Test Requirement Large Delay CDD (FRC)

Test number	Band-width	Reference Channel	OCNG Pattern	Propagation Condition	Correlation Matrix and Antenna Configuration	Reference value		UE Category
						Fraction of Maximum Throughput (%)	SNR (dB)	
1	10 MHz	R.11 FDD	OP.1 FDD	EVA70	2x2 Low	70	13.9	2-5

8.2.1.3.2 FDD PDSCH Open Loop Spatial Multiplexing 4x2

8.2.1.3.2.1 Test purpose

To verify the UE's ability to receive a predefined test signal, representing a multi-path fading channel that is determined by the SNR with a percentage of the information bit throughput for a specified downlink Reference Measurement Channel (RMC) not falling below a specified value for transmission on two antenna ports using large delay CDD.

8.2.1.3.2.2 Test applicability

This test applies to all types of E-UTRA FDD UE release 8 and forward.

8.2.1.3.2.3 Minimum conformance requirements

The requirements are specified in terms of the percentage of information bit throughput for the downlink reference measurement channels specified in Annex A clause A.3.3.2, with the addition of the relevant parameters in Tables 8.2.1-1 and 8.2.1.3.2.3-1 and the downlink physical channel setup according to Table C.3.2-1 in Annex C.

Using this configuration the fraction of maximum throughput percentage shall meet or exceed the minimum requirements specified in Table 8.2.1.3.2.3-1 for the specified SNR. For open-loop spatial multiplexing performance with large delay CDD is specified.

Table 8.2.1.3.2.3-1: Test Parameters for Large Delay CDD (FRC)

Parameter		Unit	Test 1
Downlink power allocation	ρ_A	dB	-6
	ρ_B	dB	-6 (Note 1)
N_{oc} at antenna port		dBm/15kHz	-98
Note 1: $P_B = 1$			

Table 8.2.1.3.2.3-2: Minimum performance Large Delay CDD (FRC)

Test number	Band-width	Reference Channel	OCNG Pattern	Propagation Condition	Correlation Matrix and Antenna Configuration	Reference value		UE Category
						Fraction of Maximum Throughput (%)	SNR (dB)	
1	10 MHz	R.14 FDD	OP.1 FDD	EVA70	4x2 Low	70	14.3	2-5

The normative reference for this requirement is TS 36.101 [2] clause 8.2.1.3.

8.2.1.3.2.4 Test description

8.2.1.3.2.4.1 Initial conditions

Initial conditions are a set of test configurations the UE needs to be tested in and the steps for the SS to take with the UE to reach the correct measurement state.

Configurations of PDSCH and PDCCH before measurement are specified in Annex C.2.

Test Environment: Normal, as defined in TS 36.508 [7] clause 4.1.

Frequencies to be tested: Mid Range, as defined in TS 36.508 [7] clause 4.3.1.1.

Channel Bandwidths to be tested: As specified per test number in Table 8.2.1.3.1.3-1, as defined in TS 36.508 [7] clause 4.3.1.1

1. Connect the SS, the faders and AWGN noise sources to the UE antenna connectors as shown in TS 36.508 [7] Annex A, Figure A.11 for antenna configuration 4x2.
2. The parameter settings for the cell are set up according to Tables 8.2.1-1 and 8.2.1.3.2.3-1 as appropriate.
3. Downlink signals are initially set up according to Annex C.1 and Annex C.3.2 and uplink signals according to Annex H.1 and H.3.2.
4. Propagation conditions are set according to Annex B.0.
5. Ensure the UE is in State 3A or 3A-RF according to TS 36.508 [7] clause 4.5.3A or 5.2A.2. Message contents are defined in clause 8.2.1.3.2.4.3.

8.2.1.3.2.4.2 Test procedure

1. SS transmits PDSCH via PDCCH DCI format 2A for C_RNTI to transmit the DL RMC according to Tables 8.2.1.3.2.3-1 and 8.2.1.3.2.3-2. The SS sends downlink MAC padding bits on the DL RMC.
2. Set the parameters of the reference channel, the propagation condition, the correlation matrix and the SNR according to Table 8.2.1.3.2.5-1 as appropriate.

3. Measure the average throughput for a duration sufficient to achieve statistical significance according to Annex G clause G.3. Count the number of NACKs, ACKs and statDTXs on the UL during the test interval and decide pass or fail according to Tables G.3.5 and G.3.6 in Annex G clause G.3.

8.2.1.3.2.4.3 Message contents

Message contents are according to TS 36.508 [7] clause 4.6 with the following exceptions:

Table 8.2.1.3.2.4.3-1: PDSCH-ConfigDedicated-DEFAULT: Additional FDD PDSCH open loop spatial multiplexing performance downlink power allocation for Test number 1

Derivation Path: 36.331 clause 6.3.2			
Information Element	Value/remark	Comment	Condition
PDSCH-ConfigDedicated-DEFAULT ::= SEQUENCE {			
p-a	dB-6		
}			

Table 8.2.1.3.2.4.3-2: PhysicalConfigDedicated-DEFAULT: Additional FDD PDSCH open loop spatial multiplexing performance downlink power allocation for Test number 1

Derivation Path: 36.331 clause 6.3.2			
Information Element	Value/remark	Comment	Condition
PhysicalConfigDedicated-DEFAULT ::= SEQUENCE {			
antennaInfo CHOICE {			
antennaInfoDedicated ::= SEQUENCE {			
transmissionMode	tm3		
codebookSubsetRestriction CHOICE {			
n4TxAntenna-tm3	1111		
}			
ue-TransmitAntennaSelection CHOICE {			
release	NULL		
}			
}			
}			

8.2.1.3.2.5 Test requirement

Table 8.2.1.3.2.3-1 defines the primary level settings.

The fraction of maximum throughput percentage for the downlink reference measurement channels specified in Annex A clause A.3.3.2 for each throughput test shall meet or exceed the specified value in Tables 8.2.1.3.2.5-1 for the specified SNR including test tolerances for all throughput tests.

Table 8.2.1.3.2.5-1: Test Requirement Large Delay CDD (FRC)

Test number	Band-width	Reference Channel	OCNG Pattern	Propagation Condition	Correlation Matrix and Antenna Configuration	Reference value		UE Category
						Fraction of Maximum Throughput (%)	SNR (dB)	
1	10 MHz	R.14 FDD	OP.1 FDD	EVA70	4x2 Low	70	15.2	2-5

8.2.1.4 FDD PDSCH Closed Loop Spatial Multiplexing Performance (Cell-Specific Reference Symbols)

8.2.1.4.1 FDD PDSCH Closed Loop Single/Multi Layer Spatial Multiplexing 2x2

8.2.1.4.1.1 Test purpose

To verify the UE's ability to receive a predefined test signal, representing a multi-path fading channel that is determined by the SNR with a percentage of the information bit throughput for a specified downlink Reference Measurement Channel (RMC) not falling below a specified value for transmission on two antenna ports using closed-loop spatial multiplexing.

8.2.1.4.1.2 Test applicability

This test applies to all types of E-UTRA FDD UE release 8 and forward.

8.2.1.4.1.3 Minimum conformance requirements

The requirements are specified in terms of the percentage of information bit throughput for the downlink reference measurement channels specified in Annex A clause A.3.3.2, with the addition of the relevant parameters in Tables 8.2.1-1, 8.2.1.4.1.3-1 and 8.2.1.4.1.3-3 and the downlink physical channel setup according to Table C.3.2-1 in Annex C.

Using this configuration the fraction of maximum throughput percentage shall meet or exceed the minimum requirements specified in Tables 8.2.1.4.1.3-2 and 8.2.1.4.1.3-4 for the specified SNR. For single-layer spatial multiplexing closed loop rank-one performance with wideband and frequency selective precoding is specified. For multi-layer spatial multiplexing closed loop rank-two performance with wideband and frequency selective precoding is specified.

Table 8.2.1.4.1.3-1: Test Parameters for Testing Single-Layer Spatial Multiplexing (FRC)

Parameter		Unit	Test 1	Test 2
Downlink power allocation	ρ_A	dB	-3	-3
	ρ_B	dB	-3 (Note 1)	-3 (Note 1)
N_{oc} at antenna port		dBm/15kHz	-98	-98
Precoding granularity		PRB	6	50
PMI delay (Note 2)		ms	8	8
Reporting interval		ms	1	1
Reporting mode			PUSCH 1-2	PUSCH 3-1
Note 1: $P_B = 1$				
Note 2: If the UE reports in an available uplink reporting instance at subframe SF#n based on PMI estimation at a downlink SF not later than SF#(n-4), this reported PMI cannot be applied at the eNB downlink before SF#(n+4)				

Table 8.2.1.4.1.3-2: Minimum performance Single-Layer Spatial Multiplexing (FRC)

Test number	Band-width	Reference Channel	OCNG Pattern	Propagation Condition	Correlation Matrix and Antenna Configuration	Reference value		UE Category
						Fraction of Maximum Throughput (%)	SNR (dB)	
1	10 MHz	R.10 FDD	OP.1 FDD	EVA5	2x2 Low	70	-2.5	1-5
2	10 MHz	R.10 FDD	OP.1 FDD	EPA5	2x2 High	70	-2.3	1-5

Table 8.2.1.4.1.3-3: Test Parameters for Testing Multi-Layer Spatial Multiplexing

Parameter		Unit	Test 3	Test 4
Downlink power allocation	ρ_A	dB	-3	-3
	ρ_B	dB	-3 (Note 1)	-3 (Note 1)
N_{oc} at antenna port		dBm/15kHz	-98	-98
Precoding granularity		PRB	50	50
PMI delay (Note 2)		ms	8	8
Reporting interval		ms	1	1
Reporting mode			PUSCH 3-1	PUSCH 3-1
CodeBookSubsetRestriction bitmap			110000	110000
Note 1: $P_B = 1$				
Note 2: If the UE reports in an available uplink reporting instance at subframe SF#n based on PMI estimation at a downlink SF not later than SF#(n-4), this reported PMI cannot be applied at the eNB downlink before SF#(n+4)				

Table 8.2.1.4.1.3-4: Minimum performance Multi-Layer Spatial Multiplexing (FRC)

Test number	Band-width	Reference Channel	OCNG Pattern	Propagation Condition	Correlation Matrix and Antenna Configuration	Reference value		UE Category
						Fraction of Maximum Throughput (%)	SNR (dB)	
3	10 MHz	R.11 FDD	OP.1 FDD	EVA5	2x2 Low	70	12.9	2-5
4	10 MHz	R.11 FDD	OP.1 FDD	ETU70	2x2 Low	70	14.3	2-5

The normative reference for this requirement is TS 36.101 [2] clause 8.2.1.4.

8.2.1.4.1.4 Test description

8.2.1.4.1.4.1 Initial conditions

Initial conditions are a set of test configurations the UE needs to be tested in and the steps for the SS to take with the UE to reach the correct measurement state.

Configurations of PDSCH and PDCCH before measurement are specified in Annex C.2.

Test Environment: Normal, as defined in TS 36.508 [7] clause 4.1.

Frequencies to be tested: Mid Range, as defined in TS 36.508 [7] clause 4.3.1.1.

Channel Bandwidths to be tested: As specified per test number in Tables 8.2.1.4.1.3-2 and 8.2.1.4.1.3-4 as defined in TS 36.508 [7] clause 4.3.1.1.

1. Connect the SS, the faders and AWGN noise sources to the UE antenna connectors as shown in TS 36.508 [7] Annex A, Figure A.10 for antenna configuration 2x2.
2. The parameter settings for the cell are set up according to Tables 8.2.1-1, 8.2.1.4.1.3-1 and 8.2.1.4.1.3-3 as appropriate.
3. Downlink signals are initially set up according to Annex C0, C.1 and Annex C.3.2 and uplink signals according to Annex H.1 and H.3.2.
4. Propagation conditions are set according to Annex B.0.
5. Ensure the UE is in State 3A or 3A-RF according to TS 36.508 [7] clause 4.5.3A or 5.2A.2. Message contents are defined in clause 8.2.1.4.1.4.3.

8.2.1.4.1.4.2 Test procedure

1. For single-layer spatial multiplexing, SS transmits PDSCH via PDCCH DCI format 1B for C_RNTI to transmit the DL RMC according to Tables 8.2.1.4.1.3-1 and 8.2.1.4.1.3-2. For multi-layer spatial multiplexing, SS transmits PDSCH via PDCCH DCI format 2 for C_RNTI to transmit the DL RMC according to Tables 8.2.1.4.1.3-3 and 8.2.1.4.1.3-4. The SS sends downlink MAC padding bits on the DL RMC.
2. SS schedules the UL transmission to carry the PUSCH CQI feedback via PDCCH DCI format 0 with CQI request bit set to 1 and I_MCS=29 and N_PRB allocated to be less or equal to 4.
3. Set the parameters of the bandwidth, MCS, reference channel, the propagation condition, the correlation matrix, antenna configuration and the SNR according to Tables 8.2.1.4.1.5-1 and 8.2.1.4.1.5-2 as appropriate.
4. Measure the average throughput for a duration sufficient to achieve statistical significance according to Annex G clause G.3. Count the number of NACKs, ACKs and statDTXs on the UL during the test interval and decide pass or fail according to Tables G.3.5 and G.3.6 in Annex G clause G.3.
5. Repeat steps from 1 to 4 for each test interval in Tables 8.2.1.4.1.5-1 and 8.2.1.4.1.5-2 as appropriate.

8.2.1.4.1.4.3 Message contents

Message contents are according to TS 36.508 [7] clause 4.6 with the following exceptions:

Table 8.2.1.4.1.4.3-1: *PhysicalConfigDedicated-DEFAULT*: Additional FDD PDSCH closed loop single-layer spatial multiplexing performance downlink power allocation for Test number 1, 2

Derivation Path: 36.331 clause 6.3.2			
Information Element	Value/remark	Comment	Condition
PhysicalConfigDedicated-DEFAULT ::= SEQUENCE {			
antennaInfo CHOICE {			
antennaInfoDedicated ::= SEQUENCE {			
transmissionMode	tm6		
codebookSubsetRestriction CHOICE {			
n2TxAntenna-tm6	1111		
}			
ue-TransmitAntennaSelection CHOICE {			
release	NULL		
}			
}			
}			

Table 8.2.1.4.1.4.3-2: *PhysicalConfigDedicated-DEFAULT*: Additional FDD PDSCH closed loop multi-layer spatial multiplexing performance downlink power allocation for Test number 3, 4

Derivation Path: 36.331 clause 6.3.2			
Information Element	Value/remark	Comment	Condition
PhysicalConfigDedicated-DEFAULT ::= SEQUENCE {			
antennaInfo CHOICE {			
antennaInfoDedicated ::= SEQUENCE {			
transmissionMode	tm4		
codebookSubsetRestriction CHOICE {			
n2TxAntenna-tm4	110000		
}			
ue-TransmitAntennaSelection CHOICE {			
release	NULL		
}			
}			
}			

Table 8.2.1.4.1.4.3-3: CQI-ReportConfig-DEFAULT: Additional FDD PDSCH closed loop single -layer spatial multiplexing performance downlink power allocation for Test number 1

Derivation Path: 36.331 clause 6.3.2			
Information Element	Value/remark	Comment	Condition
CQI-ReportConfig-DEFAULT ::= SEQUENCE {			
cqi-ReportModeAperiodic	rm12		
nomPDSCH-RS-EPRE-Offset	0		
cqi-ReportPeriodic	Not present		
}			

Table 8.2.1.4.1.4.3-4: CQI-ReportConfig-DEFAULT: Additional FDD PDSCH closed loop single/multi-layer spatial multiplexing performance downlink power allocation for Test number 2, 3, 4

Derivation Path: 36.331 clause 6.3.2			
Information Element	Value/remark	Comment	Condition
CQI-ReportConfig-DEFAULT ::= SEQUENCE {			
cqi-ReportModeAperiodic	rm31		
nomPDSCH-RS-EPRE-Offset	0		
cqi-ReportPeriodic	Not present		
}			

8.2.1.4.1.5 Test requirement

Tables 8.2.1.4.3-1 and 8.2.1.4.3-3 define the primary level settings.

The fraction of maximum throughput percentage for the downlink reference measurement channels specified in Annex A clause A.3.3.2 for each throughput test shall meet or exceed the specified value in Tables 8.2.1.4.1.5-1 and 8.2.1.4.1.5-2 for the specified SNR including test tolerances for all throughput tests.

Table 8.2.1.4.1.5-1: Test requirement Single-Layer Spatial Multiplexing (FRC)

Test number	Band-width	Reference Channel	OCNG Pattern	Propagation Condition	Correlation Matrix and Antenna Configuration	Reference value		UE Category
						Fraction of Maximum Throughput (%)	SNR (dB)	
1	10 MHz	R.10 FDD	OP.1 FDD	EVA5	2x2 Low	70	-1.6	1-5
2	10 MHz	R.10 FDD	OP.1 FDD	EPA5	2x2 High	70	-1.4	1-5

Table 8.2.1.4.1.5-2: Test requirement Multi-Layer Spatial Multiplexing (FRC)

Test number	Band-width	Reference Channel	OCNG Pattern	Propagation Condition	Correlation Matrix and Antenna Configuration	Reference value		UE Category
						Fraction of Maximum Throughput (%)	SNR (dB)	
3	10 MHz	R.11 FDD	OP.1 FDD	EVA5	2x2 Low	70	13.8	2-5
4	10 MHz	R.11 FDD	OP.1 FDD	ETU70	2x2 Low	70	15.2	2-5

8.2.1.4.2 FDD PDSCH Closed Loop Single/Multi Layer Spatial Multiplexing 4x2

8.2.1.4.2.1 Test purpose

To verify the UE's ability to receive a predefined test signal, representing a multi-path fading channel that is determined by the SNR with a percentage of the information bit throughput for a specified downlink Reference Measurement Channel (RMC) not falling below a specified value for transmission on two antenna ports using closed-loop spatial multiplexing.

8.2.1.4.2.2 Test applicability

This test applies to all types of E-UTRA FDD UE release 8 and forward.

8.2.1.4.2.3 Minimum conformance requirements

The requirements are specified in terms of the percentage of information bit throughput for the downlink reference measurement channels specified in Annex A clause A.3.3.2, with the addition of the relevant parameters in Tables 8.2.1-1, 8.2.1.4.2.3-1 and 8.2.1.4.2.3-3 and the downlink physical channel setup according to Table C.3.2-1 in Annex C.

Using this configuration the fraction of maximum throughput percentage shall meet or exceed the minimum requirements specified in Tables 8.2.1.4.2.3-2 and 8.2.1.4.2.3-4 for the specified SNR. For single-layer spatial multiplexing closed loop rank-one performance with wideband and frequency selective precoding is specified. For multi-layer spatial multiplexing closed loop rank-two performance with wideband and frequency selective precoding is specified.

Table 8.2.1.4.2.3-1: Test Parameters for Testing Single-Layer Spatial Multiplexing

Parameter		Unit	Test 1
Downlink power allocation	ρ_A	dB	-6
	ρ_B	dB	-6 (Note 1)
N_{oc} at antenna port		dBm/15kHz	-98
Precoding granularity		PRB	6
PMI delay (Note 2)		ms	8
Reporting interval		ms	1
Reporting mode			PUSCH 1-2
Note 1: $P_B = 1$			
Note 2: If the UE reports in an available uplink reporting instance at subframe SF#n based on PMI estimation at a downlink SF not later than SF#(n-4), this reported PMI cannot be applied at the eNB downlink before SF#(n+4)			

Table 8.2.1.4.2.3-2: Minimum performance Single-Layer Spatial Multiplexing (FRC)

Test number	Band-width	Reference Channel	OCNG Pattern	Propagation Condition	Correlation Matrix and Antenna Configuration	Reference value		UE Category
						Fraction of Maximum Throughput (%)	SNR (dB)	
1	10 MHz	R.13 FDD	OP.1 FDD	EVA5	4x2 Low	70	-3.2	1-5

Table 8.2.1.4.2.3-3: Test Parameters for Testing Multi-Layer Spatial Multiplexing

Parameter		Unit	Test 2
Downlink power allocation	ρ_A	dB	-6
	ρ_B	dB	-6 (Note 1)
N_{oc} at antenna port		dBm/15kHz	-98
Precoding granularity		PRB	6
PMI delay (Note 2)		ms	8
Reporting interval		ms	1
Reporting mode			PUSCH 1-2
CodeBookSubsetRestriction bitmap			0000000000000000 0000000000000000 0000111111111111 1111110000000000 00000000
Note 1: $P_B = 1$			
Note 2: If the UE reports in an available uplink reporting instance at subframe SF#n based on PMI estimation at a downlink SF not later than SF#(n-4), this reported PMI cannot be applied at the eNB downlink before SF#(n+4)			

Table 8.2.1.4.2.3-4: Minimum performance Multi-Layer Spatial Multiplexing (FRC)

Test number	Band-width	Reference Channel	OCNG Pattern	Propagation Condition	Correlation Matrix and Antenna Configuration	Reference value		UE Category
						Fraction of Maximum Throughput (%)	SNR (dB)	
2	10 MHz	R.14 FDD	OP.1 FDD	EVA5	4x2 Low	70	10.5	2-5

The normative reference for this requirement is TS 36.101 [2] clause 8.2.1.4.

8.2.1.4.2.4 Test description

8.2.1.4.2.4.1 Initial conditions

Initial conditions are a set of test configurations the UE needs to be tested in and the steps for the SS to take with the UE to reach the correct measurement state.

Configurations of PDSCH and PDCCH before measurement are specified in Annex C.2.

Test Environment: Normal, as defined in TS 36.508 [7] clause 4.1.

Frequencies to be tested: Mid Range, as defined in TS 36.508 [7] clause 4.3.1.1.

Channel Bandwidths to be tested: As specified per test number in Tables 8.2.1.4.2.3-2 and 8.2.1.4.2.3-4 as defined in TS 36.508 [7] clause 4.3.1.1.

1. Connect the SS, the faders and AWGN noise sources to the UE antenna connectors as shown in TS 36.508 [7] Annex A, Figure A.11 for antenna configuration 4x2.
2. The parameter settings for the cell are set up according to Tables 8.2.1-1, 8.2.1.4.2.3-1 and 8.2.1.4.2.3-3 as appropriate.
3. Downlink signals are initially set up according to Annex C.1 and Annex C.3.2 and uplink signals according to Annex H.1 and H.3.2.
4. Propagation conditions are set according to Annex B.0.
5. Ensure the UE is in State 3A or 3A-RF according to TS 36.508 [7] clause 4.5.3A or 5.2A.2. Message contents are defined in clause 8.2.1.4.2.4.3.

8.2.1.4.2.4.2 Test procedure

1. For single-layer spatial multiplexing, SS transmits PDSCH via PDCCH DCI format 1B for C_RNTI to transmit the DL RMC according to Tables 8.2.1.4.2.3-1 and 8.2.1.4.2.3-2. For multi-layer spatial multiplexing, SS transmits PDSCH via PDCCH DCI format 2 for C_RNTI to transmit the DL RMC according to Tables 8.2.1.4.2.3-3 and 8.2.1.4.2.3-4. The SS sends downlink MAC padding bits on the DL RMC.
2. SS schedules the UL transmission to carry the PUSCH CQI feedback via PDCCH DCI format 0 with CQI request bit set to 1 and I_MCS=29 and N_PRB allocated to be less or equal to 4.
3. Set the parameters of the bandwidth, MCS, reference channel, the propagation condition, the correlation matrix, antenna configuration and the SNR according to Tables 8.2.1.4.2.5-1 and 8.2.1.4.2.5-2 as appropriate.
4. Measure the average throughput for a duration sufficient to achieve statistical significance according to Annex G clause G.3. Count the number of NACKs, ACKs and statDTXs on the UL during the test interval and decide pass or fail according to Tables G.3.5 and G.3.6 in Annex G clause G.3.
5. Repeat steps from 1 to 4 for each test interval in Tables 8.2.1.4.2.5-1 and 8.2.1.4.2.5-2 as appropriate.

8.2.1.4.2.4.3 Message contents

Message contents are according to TS 36.508 [7] clause 4.6 with the following exceptions:

Table 8.2.1.4.2.4.3-1: PDSCH-ConfigDedicated-DEFAULT: Additional FDD PDSCH closed loop spatial multiplexing performance downlink power allocation for Test numbers 1, 2

Derivation Path: TS 36.508 [7] clause 4.6.3, Table 4.6.3-6 PDSCH-ConfigDedicated-DEFAULT			
Information Element	Value/remark	Comment	Condition
PDSCH-ConfigDedicated-DEFAULT ::= SEQUENCE {			
p-a	dB-6		
}			

Table 8.2.1.4.2.4.3-2: PhysicalConfigDedicated-DEFAULT: Additional FDD PDSCH closed loop single-layer spatial multiplexing performance downlink power for Test number 1

Derivation Path: 36.331 clause 6.3.2			
Information Element	Value/remark	Comment	Condition
PhysicalConfigDedicated-DEFAULT ::= SEQUENCE {			
antennaInfo CHOICE {			
antennaInfoDedicated ::= SEQUENCE {			
transmissionMode	tm6		
codebookSubsetRestriction CHOICE {			
n4TxAntenna-tm6	1111111111111111		
}			
ue-TransmitAntennaSelection CHOICE {			
release	NULL		
}			
}			
}			

Table 8.2.1.4.2.4.3-3: PhysicalConfigDedicated-DEFAULT: Additional FDD PDSCH closed loop multi-layer spatial multiplexing performance downlink power allocation Test number 2

Derivation Path: 36.331 clause 6.3.2			
Information Element	Value/remark	Comment	Condition
PhysicalConfigDedicated-DEFAULT ::= SEQUENCE {			
antennaInfo CHOICE {			
antennaInfoDedicated ::= SEQUENCE {			
transmissionMode	tm4		
codebookSubsetRestriction CHOICE {			
n4TxAntenna-tm4	00000000000000000000 00000000000011111111 11111111000000000000 0000		
}			
ue-TransmitAntennaSelection CHOICE {			
release	NULL		
}			
}			

Table 8.2.1.4.2.4.3-4: CQI-ReportConfig-DEFAULT: Additional FDD PDSCH closed loop single/multi-layer spatial multiplexing performance downlink power allocation Test number 1, 2

Derivation Path: 36.331 clause 6.3.2			
Information Element	Value/remark	Comment	Condition
CQI-ReportConfig-DEFAULT ::= SEQUENCE {			
cqi-ReportModeAperiodic	rm12		
nomPDSCH-RS-EPRE-Offset	0		
cqi-ReportPeriodic	Not present		
}			

8.2.1.4.2.5 Test requirement

Tables 8.2.1.4.2.3-1 and 8.2.1.4.2.3-3 define the primary level settings.

The fraction of maximum throughput percentage for the downlink reference measurement channels specified in Annex A clause A.3.3.2 for each throughput test shall meet or exceed the specified value in Tables 8.2.1.4.2.5-1 and 8.2.1.4.2.5-2 for the specified SNR including test tolerances for all throughput tests.

Table 8.2.1.4.2.5-1: Test requirement Single-Layer Spatial Multiplexing (FRC)

Test number	Band-width	Reference Channel	OCNG Pattern	Propagation Condition	Correlation Matrix and Antenna Configuration	Reference value		UE Category
						Fraction of Maximum Throughput (%)	SNR (dB)	
1	10 MHz	R.13 FDD	OP.1 FDD	EVA5	4x2 Low	70	-2.3	1-5

Table 8.2.1.4.2.5-2: Test requirement Multi-Layer Spatial Multiplexing (FRC)

Test number	Band-width	Reference Channel	OCNG Pattern	Propagation Condition	Correlation Matrix and Antenna Configuration	Reference value		UE Category
						Fraction of Maximum Throughput (%)	SNR (dB)	
2	10 MHz	R.14 FDD	OP.1 FDD	EVA5	4x2 Low	70	11.4	2-5

8.2.2 TDD (Fixed Reference Channel)

The parameters specified in Table 8.2.2-1 are valid for all TDD tests unless otherwise stated.

Table 8.2.2-1: Common Test Parameters (TDD)

Parameter	Unit	Value	Comments
Uplink downlink configuration (Note 1)		1	
Special subframe configuration (Note 2)		4	
Inter-TTI Distance		1	
Number of HARQ processes	Processes	7	For TDD, 7 HARQ processes in the DL, as specified in TS 36.213 [10] clause 7. All 7 HARQ processes are used.
Scheduling of retransmissions			1. Retransmissions use the same Transport Block Size (TBS) as the initial transmission. 2. HARQ processes are scheduled consecutively, independent of the fact, whether retransmissions (for negatively acknowledged HARQ processes) or new transmissions (for positively acknowledged HARQ processes) occur. 3. In case when the initial transmission and the retransmissions are scheduled in subframes with a different N_{PRB} (in terms of TS 36.213 [10] subclause 7.1.7) $29 \leq I_{MCS} \leq 31$ according to TS 36.213 [10] subclause 7.1.7.2 and the appropriate modulation is used.
Maximum number of HARQ transmission		4	It is always 4 for TDD, as specified in TS 36.213 [10] clause 8
Redundancy version coding sequence		{0,1,2,3} for QPSK and 16QAM {0,0,1,2} for 64QAM	
Number of OFDM symbols for PDCCH	OFDM symbols	4 for 1.4 MHz bandwidth, 3 for 3 MHz and 5 MHz bandwidths, 2 for 10 MHz, 15 MHz and 20 MHz bandwidths	The PCFICH carries information about the number of OFDM symbols used for transmission of PDCCHs in a subframe, as specified in TS 36.211 [8] clause 6.7
Cyclic Prefix		Normal	CP consist of the following physical resource blocks (RBs) parameters: 12 consecutive subcarriers at a 15 kHz spacing and 7 OFDM symbols, as specified in TS 36.211 [8] clause 6.2.3
Cell ID		0	The Cell ID is uniquely defined by a number in the range of 0 to 503, representing the physical-layer cell identity, as specified in TS 36.211 [8] clause 6.11.
Note 1: as specified in Table 4.2-2 in TS 36.211 [8]			
Note 2: as specified in Table 4.2-1 in TS 36.211 [8]			

The normative reference for this requirement is TS 36.101 [2] clause 8.2.2.

8.2.2.1 TDD PDSCH Single Antenna Port Performance (Cell-Specific Reference Symbols)

8.2.2.1.1 TDD PDSCH Single Antenna Port Performance

8.2.2.1.1.1 Test purpose

To verify the UE's ability to receive a predefined test signal, representing a multi-path fading channel that is determined by the SNR with a percentage of the information bit throughput for a specified downlink Reference Measurement Channel (RMC) not falling below a specified value for transmission on a single-antenna port with different channel models and MCS and also for the transmission on a single-antenna port with full RB allocation.

8.2.2.1.1.2 Test applicability

This test applies to all types of E-UTRA TDD UE release 8 and forward.

8.2.2.1.1.3 Minimum conformance requirements

The requirements are specified in terms of the percentage of information bit throughput for the downlink reference measurement channels specified in Annex A clause A.3.4.1, with the addition of the relevant parameters in Tables 8.2.2-1, 8.2.2.1.1.3-1 and the downlink physical channel setup according to table C.3.2-1 in Annex C.

Using this configuration the fraction of maximum throughput percentage shall meet or exceed the minimum requirements specified in Tables 8.2.2.1.1.3-2 for the specified SNR.

Table 8.2.2.1.1.3-1: Test Parameters

Parameter		Unit	Test 1- 5	Test 6- 8	Test 9- 15	Test 16- 18
Downlink power allocation	ρ_A	dB	0	0	0	0
	ρ_B	dB	0 (Note 1)	0 (Note 1)	0 (Note 1)	0 (Note 1)
N_{oc} at antenna port		dBm/15kHz	-98	-98	-98	-98
Symbols for unused PRBs			OCNG (Note 2)	OCNG (Note 2)	OCNG (Note 2)	OCNG (Note 2)
Modulation			QPSK	16QAM	64QAM	16QAM
ACK/NACK feedback mode			Multiplexing	Multiplexing	Multiplexing	Multiplexing
Note 1: $P_B = 0$						
Note 2: These physical resource blocks are assigned to an arbitrary number of virtual UEs with one PDSCH per virtual UE; the data transmitted over the OCNG PDSCHs shall be uncorrelated pseudo random data, which is QPSK modulated.						

Table 8.2.2.1.1.3-2: Minimum performance (FRC)

Test number	Bandwidth	Reference Channel	OCNG Pattern	Propagation Condition	Correlation Matrix and Antenna Configuration	Reference value		UE Category
						Fraction of Maximum Throughput (%)	SNR (dB)	
1	10 MHz	R.2 TDD	OP.1 TDD	EVA5	1x2 Low	70	-1.2	1-5
2	10 MHz	R.2 TDD	OP.1 TDD	ETU70	1x2 Low	70	-0.6	1-5
3	10 MHz	R.2 TDD	OP.1 TDD	ETU300	1x2 Low	70	-0.2	1-5
4	10 MHz	R.2 TDD	OP.1 TDD	HST	1x2 Low	70	-2.6	1-5
5	1.4 MHz	R.4 TDD	OP.1 TDD	EVA5	1x2 Low	70	0.0	1-5
6	10 MHz	R.3 TDD	OP.1 TDD	EVA5	1x2 Low	70	6.7	2-5
7	10 MHz	R.3 TDD	OP.1 TDD	ETU70	1x2 Low	30	1.4	2-5
8	10 MHz	R.3 TDD	OP.1 TDD	ETU300	1x2 High	70	9.3	2-5
9	3 MHz	R.5 TDD	OP.1 TDD	EVA5	1x2 Low	70	17.6	1-5
10	5 MHz	R.6 TDD	OP.1 TDD	EVA5	1x2 Low	70	17.6	2-5
11	10 MHz	R.7 TDD	OP.1 TDD	EVA5	1x2 Low	70	17.6	2-5
12	10 MHz	R.7 TDD	OP.1 TDD	ETU70	1x2 Low	70	19.1	2-5
13	10 MHz	R.7 TDD	OP.1 TDD	EVA5	1x2 High	70	19.1	2-5
14	15 MHz	R.8 TDD	OP.1 TDD	EVA5	1x2 Low	70	17.8	2-5
15	20 MHz	R.9 TDD	OP.1 TDD	EVA5	1x2 Low	70	17.7	3-5
16	3 MHz	R.0 TDD	OP.1 TDD	ETU70	1x2 Low	30	2.1	1-5
17	10 MHz	R.1 TDD	OP.1 TDD	ETU70	1x2 Low	30	2.0	1-5
18	20 MHz	R.1 TDD	OP.1 TDD	ETU70	1x2 Low	30	2.1	1-5

The normative reference for this requirement is TS 36.101 [2] clause 8.2.2.

8.2.2.1.1.4 Test description

8.2.2.1.1.4.1 Initial conditions

Initial conditions are a set of test configurations the UE needs to be tested in and the steps for the SS to take with the UE to reach the correct measurement state.

Configurations of PDSCH and PDCCH before measurement are specified in Annex C.2.

Test Environment: Normal, as defined in TS 36.508 [7] clause 4.1.

Frequencies to be tested: Mid Range, as defined in TS 36.508 [7] clause 4.3.1.2.

Frequencies to be tested for 1PRB allocation: Low Range, as defined in TS 36.508 [7] clause 4.3.1.1.

Bandwidths to be tested: As specified per test number in Tables 8.2.2.1.1.3-2 as defined in TS 36.508 [7] clause 4.3.1.2.

1. Connect the SS, the faders and AWGN noise sources to the UE antenna connectors as shown in TS 36.508 [7] Annex A, Figure A.9.

2. The parameter settings for the cell are set up according to Tables 8.2.2-1, 8.2.2.1.1.3-1 as appropriate.
3. Downlink signals are initially set up according to Annex C.0, C.1 and Annex C.3.2 and uplink signals according to Annex H.1 and H.3.2.
4. Propagation conditions are set according to Annex B.0.
5. Ensure the UE is in State 3A or 3A-RF according to TS 36.508 [7] clause 4.5.3A or 5.2A.2. Message contents are defined in clause 8.2.2.1.1.4.3.

8.2.2.1.1.4.2 Test procedure

1. SS transmits PDSCH via PDCCH DCI format 1A for C_RNTI to transmit the DL RMC according to Tables 8.2.2.1.1.3-1 and 8.2.2.1.1.3-2. The SS sends downlink MAC padding bits on the DL RMC.
2. Set the parameters of the reference channel, MCS, reference channel, the propagation condition, the correlation matrix and the SNR according to Tables 8.2.2.1.1.5-1 as appropriate.
3. Measure the average throughput for a duration sufficient to achieve statistical significance according to Annex G clause G.3. Count the number of NACKs, ACKs and statDTXs on the UL during each subtest interval and decide pass or fail according to Tables G.3.5 and G.3.6 in Annex G clause G.3.
4. Repeat steps from 1 to 3 for each subtest in Tables 8.2.2.1.1.5-1 as appropriate.

8.2.2.1.1.4.3 Message contents

Message contents are according to TS 36.508 [7] clause 4.6.

8.2.2.1.1.5 Test requirement

Table 8.2.2.1.1.3-1 defines the primary level settings including test tolerances for all throughput tests.

The fraction of maximum throughput percentage for the downlink reference measurement channels specified in Annex A for each throughput test shall meet or exceed the specified value in Tables 8.2.2.1.1.5-1 for the specified SNR including test tolerances for all throughput tests.

Table 8.2.2.1.1.5-1: Test Requirement (FRC)

Test number	Bandwidth	Reference Channel	OCNG Pattern	Propagation Condition	Correlation Matrix and Antenna Configuration	Reference value		UE Category
						Fraction of Maximum Throughput (%)	SNR (dB)	
1	10 MHz	R.2 TDD	OP.1 TDD	EVA5	1x2 Low	70	-0.4	1-5
2	10 MHz	R.2 TDD	OP.1 TDD	ETU70	1x2 Low	70	0.2	1-5
3	10 MHz	R.2 TDD	OP.1 TDD	ETU300	1x2 Low	70	0.6	1-5
4	10 MHz	R.2 TDD	OP.1 TDD	HST	1x2 Low	70	-2.0	1-5
5	1.4 MHz	R.4 TDD	OP.1 TDD	EVA5	1x2 Low	70	0.8	1-5
6	10 MHz	R.3 TDD	OP.1 TDD	EVA5	1x2 Low	70	7.5	2-5
7	10 MHz	R.3 TDD	OP.1 TDD	ETU70	1x2 Low	30	2.2	2-5
8	10 MHz	R.3 TDD	OP.1 TDD	ETU300	1x2 High	70	10.1	2-5
9	3 MHz	R.5 TDD	OP.1 TDD	EVA5	1x2 Low	70	18.4	1-5
10	5 MHz	R.6 TDD	OP.1 TDD	EVA5	1x2 Low	70	18.4	2-5
11	10 MHz	R.7 TDD	OP.1 TDD	EVA5	1x2 Low	70	18.4	2-5
12	10 MHz	R.7 TDD	OP.1 TDD	ETU70	1x2 Low	70	19.9	2-5
13	10 MHz	R.7 TDD	OP.1 TDD	EVA5	1x2 High	70	19.9	2-5
14	15 MHz	R.8 TDD	OP.1 TDD	EVA5	1x2 Low	70	18.6	2-5
15	20 MHz	R.9 TDD	OP.1 TDD	EVA5	1x2 Low	70	18.5	3-5
16	3 MHz	R.0 TDD	OP.1 TDD	ETU70	1x2 Low	30	2.9	1-5
17	10 MHz	R.1 TDD	OP.1 TDD	ETU70	1x2 Low	30	2.8	1-5
18	20 MHz	R.1 TDD	OP.1 TDD	ETU70	1x2 Low	30	2.9	1-5

8.2.2.1.2 TDD PDSCH Single Antenna Port Performance with 1 PRB in the presence of MBSFN

8.2.2.1.2.1 Test purpose

To verify the UE's ability to receive a predefined test signal, representing a multi-path fading channel that is determined by the SNR with a percentage of the information bit throughput for a specified downlink Reference Measurement Channel (RMC) not falling below a specified value for transmission on a single-antenna port with different channel models and MCS and also for the transmission on a single-antenna port with single RB allocation in the presence of MBSFN.

8.2.2.1.2.2 Test applicability

This test applies to all types of E-UTRA TDD UE release 8 and forward.

8.2.2.1.2.3 Minimum conformance requirements

The requirements are specified in terms of the percentage of information bit throughput for the downlink reference measurement channels specified in Annex A clause A.3.4.1, with the addition of the relevant parameters in Tables 8.2.2-1, 8.2.2.1.2.3-1 and the downlink physical channel setup according to table C.3.2-1 in Annex C.

Using this configuration the fraction of maximum throughput percentage shall meet or exceed the minimum requirements specified in Tables 8.2.2.1.2.3-2 for the specified SNR.

Table 8.2.2.1.2.3-1: Test Parameters for Testing 1 PRB allocation

Parameter		Unit	Test 1
Downlink power allocation	ρ_A	dB	0
	ρ_B	dB	0 (Note 1)
N_{oc} at antenna port		dBm/15kHz	-98
Symbols for MBSFN portion of MBSFN subframes (Note 2)			OCNG (Note 3)
ACK/NACK feedback mode			Multiplexing
Note 1: $P_B = 0$ Note 2: The MBSFN portion of an MBSFN subframe comprises the whole MBSFN subframe except the first two symbols in the first slot. Note 3: The MBSFN portion of the MBSFN subframes shall contain QPSK modulated data. Cell-specific reference signals are not inserted in the MBSFN portion of the MBSFN subframes, QPSK modulated MBSFN data is used instead.			

Table 8.2.2.1.2.3-2: Minimum performance 1 PRB allocation (FRC)

Test number	Bandwidth	Reference Channel	OCNG Pattern	Propagation Condition	Correlation Matrix and Antenna Configuration	Reference value		UE Category
						Fraction of Maximum Throughput (%)	SNR (dB)	
1	10 MHz	R.29 TDD	OP.3 TDD	ETU70	1x2 Low	30	2.0	1-5

The normative reference for this requirement is TS 36.101 [2] clause 8.2.2.

8.2.2.1.2.4 Test description

8.2.2.1.2.4.1 Initial conditions

Initial conditions are a set of test configurations the UE needs to be tested in and the steps for the SS to take with the UE to reach the correct measurement state.

Configurations of PDSCH and PDCCH before measurement are specified in Annex C.2.

Test Environment: Normal, as defined in TS 36.508 [7] clause 4.1.

Frequencies to be tested: Low Range, as defined in TS 36.508 [7] clause 4.3.1.1.

Bandwidths to be tested: As specified per test number in Tables 8.2.2.1.2.3-2 as defined in TS 36.508 [7] clause 4.3.1.2.

1. Connect the SS, the faders and AWGN noise sources to the UE antenna connectors as shown in TS 36.508 [7] Annex A, Figure A.9.
2. The parameter settings for the cell are set up according to Tables 8.2.2-1, 8.2.2.1.2.3-1 as appropriate.
3. Downlink signals are initially set up according to Annex C.0, C.1 and Annex C.3.2 and uplink signals according to Annex H.1 and H.3.2.

4. Propagation conditions are set according to Annex B.0.
5. Ensure the UE is in State 3A or 3A-RF according to TS 36.508 [7] clause 4.5.3A or 5.2A.2 and receiving payload data from the SS. Message contents are defined in clause 8.2.2.1.2.4.3.

8.2.2.1.2.4.2 Test procedure

1. SS transmits PDSCH via PDCCH DCI format 1A for C_RNTI to transmit the DL RMC according to Tables 8.2.2.1.2.3-1 and 8.2.2.1.2.3-2. The SS sends downlink MAC padding bits on the DL RMC.
2. Set the parameters of the reference channel, MCS, reference channel, the propagation condition, the correlation matrix and the SNR according to Tables 8.2.2.1.1.2.5-1 as appropriate.
3. Measure the average throughput for a duration sufficient to achieve statistical significance according to Annex G clause G.3. Count the number of NACKs, ACKs and statDTXs on the UL during each subtest interval and decide pass or fail according to Tables G.3.5 and G.3.6 in Annex G clause G.3.

8.2.2.1.2.4.3 Message contents

Message contents are according to TS 36.508 [7] clause 4.6 with the following exceptions.

Table 8.2.2.1.2.4.3-1: SystemInformationBlockType2: Additional TDD PDSCH Single Antenna Port Performance for 1 PRB allocation with MBSFN subframes test point 1 requirement

Derivation Path: TS 36.508 [7] clause 4.4.3.3, Table 4.4.3.3-1 SystemInformationBlockType2			
Information Element	Value/remark	Comment	Condition
SystemInformationBlockType2 ::= SEQUENCE {			
mbsfn-SubframeConfig ::= SEQUENCE {			
radioframeAllocationPeriod	n1	Every radio frame is with MBSFN subframe	
radioframeAllocationOffset	0		
subframeAllocation CHOICE {			
oneFrame	01001x	subframe 4 and 9 is used for MBSFN.	TDD
}			
}			
}			

8.2.2.1.2.5 Test requirement

Table 8.2.2.1.2.3-1 defines the primary level settings including test tolerances for all throughput tests.

The fraction of maximum throughput percentage for the downlink reference measurement channels specified in Annex A for each throughput test shall meet or exceed the specified value in Tables 8.2.2.1.2.5-1 for the specified SNR including test tolerances for all throughput tests.

Table 8.2.2.1.2.5-1: Test Requirement 1PRB with MBSFN subframes (FRC)

Test number	Bandwidth	Reference Channel	OCNG Pattern	Propagation Condition	Correlation Matrix and Antenna Configuration	Reference value		UE Category
						Fraction of Maximum Throughput (%)	SNR (dB)	
1	10 MHz	R.29 TDD	OP.3 TDD	ETU70	1x2 Low	30	2.8	1-5

8.2.2.2 TDD PDSCH Transmit Diversity Performance (Cell-Specific Reference Symbols)

8.2.2.2.1 TDD PDSCH Transmit Diversity 2x2

8.2.2.2.1.1 Test purpose

To verify the UE's ability to receive a predefined test signal, representing a multi-path fading channel that is determined by the SNR with a percentage of the information bit throughput for a specified downlink Reference Measurement Channel (RMC) not falling below a specified value for transmission on two antenna ports using transmit diversity (SFBC).

8.2.2.2.1.2 Test applicability

This test applies to all types of E-UTRA TDD UE release 8 and forward.

8.2.2.2.1.3 Minimum conformance requirements

The requirements are specified in terms of the percentage of information bit throughput for the downlink reference measurement channels specified in Annex A clause A.3.4.2, with the addition of the relevant parameters in Tables 8.2.2-1 and 8.2.2.2.1.3-1 and the downlink physical channel setup according to Table C.3.2-1 in Annex C.3.2.

Using this configuration the fraction of maximum throughput percentage shall meet or exceed the minimum requirements specified in Table 8.2.2.2.1.3-2 for the specified SNR. For transmit diversity (SFBC) performance with 2 and 4 transmitter antennas as specified.

Table 8.2.2.2.1.3-1: Test Parameters for Testing Transmit Diversity Performance (FRC)

Parameter		Unit	Test 1-2
Downlink power allocation	ρ_A	dB	-3
	ρ_B	dB	-3 (Note 1)
N_{oc} at antenna port		dBm/15kHz	-98
ACK/NACK feedback mode			Multiplexing
Note 1: $P_B = 1$			

Table 8.2.2.2.1.3-2: Minimum performance Transmit Diversity (FRC)

Test number	Bandwidth	Reference Channel	OCNG Pattern	Propagation Condition	Correlation Matrix and Antenna Configuration	Reference value		UE Category
						Fraction of Maximum Throughput (%)	SNR (dB)	
1	10 MHz	R.11 TDD	OP.1 TDD	EVA5	2x2 Medium	70	6.8	2-5
2	10 MHz	R.10 TDD	OP.1 TDD	HST	2x2 Low	70	-2.3	1-5

The normative reference for this requirement is TS 36.101 [2] clause 8.2.2.2.

8.2.2.2.1.4 Test description

8.2.2.2.1.4.1 Initial conditions

Initial conditions are a set of test configurations the UE needs to be tested in and the steps for the SS to take with the UE to reach the correct measurement state.

Configurations of PDSCH and PDCCH before measurement are specified in Annex C.2.

Test Environment: Normal, as defined in TS 36.508 [7] clause 4.1.

Frequencies to be tested: Mid Range, as defined in TS 36.508 [7] clause 4.3.1.2.

Bandwidths to be tested: As specified per test number in Table 8.2.2.2.1.3-2 as defined in TS 36.508 [7] clause 4.3.1.2

1. Connect the SS, the faders and AWGN noise sources to the UE antenna connectors as shown in TS 36.508 [7] Annex A, Figure A.10 for antenna configuration 2x2.
2. The parameter settings for the cell are set up according to Tables 8.2.2-1 and 8.2.2.2.1.3-1 as appropriate.
3. Downlink signals are initially set up according to Annex C.0, C.1 and Annex C.3.2 and uplink signals according to Annex H.1 and H.3.2.
4. Propagation conditions are set according to Annex B.0.
5. Ensure the UE is in State 3A or 3A-RF according to TS 36.508 [7] clause 4.5.3A or 5.2A.2. Message contents are defined in clause 8.2.2.2.1.4.3.

8.2.2.2.1.4.2 Test procedure

1. SS transmits PDSCH via PDCCH DCI format 1A for C_RNTI to transmit the DL RMC according to Tables 8.2.2.2.1.3-1 and 8.2.2.2.1.3-2. The SS sends downlink MAC padding bits on the DL RMC.
2. Set the parameters of the bandwidth, MCS, reference channel, the propagation condition, the correlation matrix, antenna configuration and the SNR according to Table 8.2.2.2.1.5-1 as appropriate.
3. Measure the average throughput for a duration sufficient to achieve statistical significance according to Annex G clause G.3. Count the number of NACKs, ACKs and statDTXs on the UL during each test interval and decide pass or fail according to Tables G.3.5 and G.3.6 in Annex G clause G.3.
4. Repeat steps from 1 to 3 for each test interval in Table 8.2.2.2.1.5-1 as appropriate.

8.2.2.2.1.4.3 Message contents

Message contents are according to TS 36.508 [7] clause 4.6.

8.2.2.2.1.5 Test requirement

Table 8.2.2.2.1.3-1 defines the primary level settings.

The fraction of maximum throughput percentage for the downlink reference measurement channels specified in Annex A clause A.3.4.2, for each throughput test shall meet or exceed the specified value in Table 8.2.2.2.1.5-1 for the specified SNR including test tolerances for all throughput tests.

Table 8.2.2.2.1.5-1: Test requirement Transmit Diversity (FRC)

Test number	Bandwidth	Reference Channel	OCNG Pattern	Propagation Condition	Correlation Matrix and Antenna Configuration	Reference value		UE Category
						Fraction of Maximum Throughput (%)	SNR (dB)	
1	10 MHz	R.11 TDD	OP.1 TDD	EVA5	2x2 Medium	70	7.7	2-5
2	10 MHz	R.10 TDD	OP.1 TDD	HST	2x2 Low	70	-1.7	1-5

8.2.2.2.2 TDD PDSCH Transmit Diversity 4x2

8.2.2.2.2.1 Test purpose

To verify the UE's ability to receive a predefined test signal, representing a multi-path fading channel that is determined by the SNR with a percentage of the information bit throughput for a specified downlink Reference Measurement Channel (RMC) not falling below a specified value for transmission on four antenna ports using transmit diversity (SFBC-FSTD).

8.2.2.2.2.2 Test applicability

This test applies to all types of E-UTRA TDD UE release 8 and forward.

8.2.2.2.2.3 Minimum conformance requirements

The requirements are specified in terms of the percentage of information bit throughput for the downlink reference measurement channels specified in Annex A clause A.3.4.2, with the addition of the relevant parameters in Tables 8.2.2-1 and 8.2.2.2.3-1 and the downlink physical channel setup according to Table C.3.2-1 in Annex C.3.2.

Using this configuration the fraction of maximum throughput percentage shall meet or exceed the minimum requirements specified in Table 8.2.2.2.3-2 for the specified SNR. For transmit diversity (SFBC) performance with 2 and 4 transmitter antennas as specified.

Table 8.2.2.2.3-1: Test Parameters for Testing Transmit Diversity Performance (FRC)

Parameter		Unit	Test 1
Downlink power allocation	ρ_A	dB	-3
	ρ_B	dB	-3 (Note 1)
N_{oc} at antenna port		dBm/15kHz	-98
ACK/NACK feedback mode			Multiplexing
Note 1: $P_B = 1$			

Table 8.2.2.2.3-2: Minimum performance Transmit Diversity (FRC)

Test number	Bandwidth	Reference Channel	OCNG Pattern	Propagation Condition	Correlation Matrix and Antenna Configuration	Reference value		UE Category
						Fraction of Maximum Throughput (%)	SNR (dB)	
1	1.4 MHz	R.12 TDD	OP.1 TDD	EPA5	4x2 Medium	70	0.2	1-5

The normative reference for this requirement is TS 36.101 [2] clause 8.2.2.2.

8.2.2.2.2.4 Test description

8.2.2.2.2.4.1 Initial conditions

Initial conditions are a set of test configurations the UE needs to be tested in and the steps for the SS to take with the UE to reach the correct measurement state.

Configurations of PDSCH and PDCCH before measurement are specified in Annex C.2.

Test Environment: Normal, as defined in TS 36.508 [7] clause 4.1.

Frequencies to be tested: Mid Range, as defined in TS 36.508 [7] clause 4.3.1.2.

Bandwidths to be tested: As specified per test number in Table 8.2.2.2.3-2 as defined in TS 36.508 [7] clause 4.3.1.2

1. Connect the SS, the faders and AWGN noise sources to the UE antenna connectors as shown in TS 36.508 [7] Annex A, Figure A.11 for antenna configuration 4x2.
2. The parameter settings for the cell are set up according to Tables 8.2.2-1 and 8.2.2.2.3-1 as appropriate.
3. Downlink signals are initially set up according to Annex C.0, C.1 and Annex C.3.2 and uplink signals according to Annex H.1 and H.3.2.
4. Propagation conditions are set according to Annex B.0.

5. Ensure the UE is in State 3A or 3A-RF according to TS 36.508 [7] clause 4.5.3A or 5.2A.2. Message contents are defined in clause 8.2.2.2.2.4.3.

8.2.2.2.2.4.2 Test procedure

1. SS transmits PDSCH via PDCCH DCI format 1A for C_RNTI to transmit the DL RMC according to Tables 8.2.2.2.2.3-1 and 8.2.2.2.2.3-2. The SS sends downlink MAC padding bits on the DL RMC.
2. Set the parameters of the bandwidth, MCS, reference channel, the propagation condition, the correlation matrix, antenna configuration and the SNR according to Table 8.2.2.2.2.5-1 as appropriate.
3. Measure the average throughput for a duration sufficient to achieve statistical significance according to Annex G clause G.3. Count the number of NACKs, ACKs and statDTXs on the UL during each test interval and decide pass or fail according to Tables G.3.5 and G.3.6 in Annex G clause G.3.

8.2.2.2.2.4.3 Message contents

Message contents are according to TS 36.508 [7] clause 4.6 with the following exceptions.

Table 8.2.2.2.2.4.3-1: PDSCH-ConfigDedicated-DEFAULT: Additional TDD PDSCH transmit diversity performance downlink power allocation test point 1 requirement

Derivation Path: 36.508 clause 4.6.3			
Information Element	Value/remark	Comment	Condition
PDSCH-ConfigDedicated-DEFAULT ::= SEQUENCE {			
p-a	dB-3		
}			

8.2.2.2.2.5 Test requirement

Table 8.2.2.2.2.3-1 defines the primary level settings.

The fraction of maximum throughput percentage for the downlink reference measurement channels specified in Annex A clause A.3.4.2, for each throughput test shall meet or exceed the specified value in Table 8.2.2.2.2.5-1 for the specified SNR including test tolerances for all throughput tests.

Table 8.2.2.2.2.5-1: Test requirement Transmit Diversity (FRC)

Test number	Bandwidth	Reference Channel	OCNG Pattern	Propagation Condition	Correlation Matrix and Antenna Configuration	Reference value		UE Category
						Fraction of Maximum Throughput (%)	SNR (dB)	
1	1.4 MHz	R.12 TDD	OP.1 TDD	EPA5	4x2 Medium	70	1.1	1-5

8.2.2.3 TDD PDSCH Open Loop Spatial Multiplexing Performance (Cell-Specific Reference Symbols)

8.2.2.3.1 TDD PDSCH Open Loop Spatial Multiplexing 2x2

8.2.2.3.1.1 Test purpose

To verify the UE's ability to receive a predefined test signal, representing a multi-path fading channel that is determined by the SNR with a percentage of the information bit throughput for a specified downlink Reference Measurement Channel (RMC) not falling below a specified value for transmission on two antenna ports using large delay CDD.

8.2.2.3.1.2 Test applicability

This test applies to all types of E-UTRA TDD UE release 8 and forward.

8.2.2.3.1.3 Minimum conformance requirements

The requirements are specified in terms of the percentage of information bit throughput for the downlink reference measurement channels specified in Annex A clause A.3.4.2, with the addition of the relevant parameters in Tables 8.2.2-1 and 8.2.2.3.1.3-1 and the downlink physical channel setup according to Table C.3.2-1 in Annex C.

Using this configuration the fraction of maximum throughput percentage shall meet or exceed the minimum requirements specified in Tables 8.2.2.3.1.3-2 for the specified SNR. For open-loop spatial multiplexing performance with large delay CDD is specified.

Table 8.2.2.3.1.3-1: Test Parameters for Large Delay CDD (FRC)

Parameter	Unit	Test 1
Downlink power allocation	ρ_A	-3
	ρ_B	-3 (Note 1)
N_{oc} at antenna port	dBm/15kHz	-98
ACK/NACK feedback mode		Bundling
Note 1: $P_B = 1$		

Table 8.2.2.3.1.3-2: Minimum performance Large Delay CDD (FRC)

Test number	Bandwidth	Reference Channel	OCNG Pattern	Propagation Condition	Correlation Matrix and Antenna Configuration	Reference value		UE Category
						Fraction of Maximum Throughput (%)	SNR (dB)	
1	10 MHz	R.11-1 TDD	OP.1 TDD	EVA70	2x2 Low	70	13.1	2-5

The normative reference for this requirement is TS 36.101 [2] clause 8.2.2.3.

8.2.2.3.1.4 Test description

8.2.2.3.1.4.1 Initial conditions

Initial conditions are a set of test configurations the UE needs to be tested in and the steps for the SS to take with the UE to reach the correct measurement state.

Configurations of PDSCH and PDCCH before measurement are specified in Annex C.2.

Test Environment: Normal, as defined in TS 36.508 [7] clause 4.1.

Frequencies to be tested: Mid Range, as defined in TS 36.508 [7] clause 4.3.1.2.

Bandwidths to be tested: As specified per test number in Table 8.2.2.3.1.3-1 as defined in TS 36.508 [7] clause 4.3.1.2.

1. Connect the SS, the faders and AWGN noise sources to the UE antenna connectors as shown in TS 36.508 [7] Annex A, Figure A.10 for antenna configuration 2x2.
2. The parameter settings for the cell are set up according to Tables 8.2.2-1 and 8.2.2.3.1.3-1 as appropriate.
3. Downlink signals are initially set up according to Annex C.0, C.1 and Annex C.3.2 and uplink signals according to Annex H.1 and H.3.2.
4. Propagation conditions are set according to Annex B.0.

5. Ensure the UE is in State 3A or 3A-RF according to TS 36.508 [7] clause 4.5.3A or 5.2A.2. Message contents are defined in clause 8.2.2.3.1.4.3.

8.2.2.3.1.4.2 Test procedure

1. SS transmits PDSCH via PDCCH DCI format 2A for C_RNTI to transmit the DL RMC according to Tables 8.2.2.3.1.3-1 and 8.2.2.3.1.3-2. The SS sends downlink MAC padding bits on the DL RMC.
2. Set the parameters of the bandwidth, MCS, reference channel, the propagation condition, the correlation matrix, antenna configuration and the SNR according to Table 8.2.2.3.1.5-1 as appropriate.
3. Measure the average throughput for a duration sufficient to achieve statistical significance according to Annex G clause G.3. Count the number of NACKs, ACKs and statDTXs on the UL during each test interval and decide pass or fail according to Tables G.3.5 and G.3.6 in Annex G clause G.3.

8.2.2.3.1.4.3 Message contents

Message contents are according to TS 36.508 [7] clause 4.6 with the following exceptions.

Table 8.2.2.3.1.4.3-1: PhysicalConfigDedicated-DEFAULT: Additional TDD PDSCH open loop spatial multiplexing performance downlink power allocation for Test number 1

Derivation Path: 36.331 clause 6.3.2			
Information Element	Value/remark	Comment	Condition
PhysicalConfigDedicated-DEFAULT ::= SEQUENCE {			
antennaInfo CHOICE {			
antennaInfoDedicated ::= SEQUENCE {			
transmissionMode	tm3		
codebookSubsetRestriction CHOICE {			
n2TxAntenna-tm3	11		
}			
ue-TransmitAntennaSelection CHOICE {			
release	NULL		
}			
}			
}			

8.2.2.3.1.5 Test requirement

Table 8.2.2.3.1.3-1 defines the primary level settings.

The fraction of maximum throughput percentage for the downlink reference measurement channels specified in Annex A clause A.3.4.2, for each throughput test shall meet or exceed the specified value in Tables 8.2.2.3.1.5-1 for the specified SNR including test tolerances for all throughput tests.

Table 8.2.2.3.5-1: Test requirement Large Delay CDD (FRC)

Test number	Bandwidth	Reference Channel	OCNG Pattern	Propagation Condition	Correlation Matrix and Antenna Configuration	Reference value		UE Category
						Fraction of Maximum Throughput (%)	SNR (dB)	
1	10 MHz	R.11-1 TDD	OP.1 TDD	EVA70	2x2 Low	70	14.0	2-5

8.2.2.3.2 TDD PDSCH Open Loop Spatial Multiplexing 4x2

8.2.2.3.2.1 Test purpose

To verify the UE's ability to receive a predefined test signal, representing a multi-path fading channel that is determined by the SNR with a percentage of the information bit throughput for a specified downlink Reference Measurement Channel (RMC) not falling below a specified value for transmission on four antenna ports using large delay CDD.

8.2.2.3.2.2 Test applicability

This test applies to all types of E-UTRA TDD UE release 8 and forward.

8.2.2.3.2.3 Minimum conformance requirements

The requirements are specified in terms of the percentage of information bit throughput for the downlink reference measurement channels specified in Annex A clause A.3.4.2, with the addition of the relevant parameters in Tables 8.2.2-1 and 8.2.2.3.2.3-1 and the downlink physical channel setup according to Table C.3.2-1 in Annex C.

Using this configuration the fraction of maximum throughput percentage shall meet or exceed the minimum requirements specified in Tables 8.2.2.3.2.3-2 for the specified SNR. For open-loop spatial multiplexing performance with large delay CDD is specified.

Table 8.2.2.3.2.3-1: Test Parameters for Large Delay CDD (FRC)

Parameter	Unit	Test 1
Downlink power allocation	ρ_A	dB
	ρ_B	dB
N_{oc} at antenna port	dBm/15kHz	-98
ACK/NACK feedback mode		Bundling
Note 1: $P_B = 1$		

Table 8.2.2.3.2.3-2: Minimum performance Large Delay CDD (FRC)

Test number	Bandwidth	Reference Channel	OCNG Pattern	Propagation Condition	Correlation Matrix and Antenna Configuration	Reference value		UE Category
						Fraction of Maximum Throughput (%)	SNR (dB)	
1	10 MHz	R.14 TDD	OP.1 TDD	EVA70	4x2 Low	70	14.2	2-5

The normative reference for this requirement is TS 36.101 [2] clause 8.2.2.3.

8.2.2.3.2.4 Test description

8.2.2.3.2.4.1 Initial conditions

Initial conditions are a set of test configurations the UE needs to be tested in and the steps for the SS to take with the UE to reach the correct measurement state.

Configurations of PDSCH and PDCCH before measurement are specified in Annex C.2.

Test Environment: Normal, as defined in TS 36.508 [7] clause 4.1.

Frequencies to be tested: Mid Range, as defined in TS 36.508 [7] clause 4.3.1.2.

Bandwidths to be tested: As specified per test number in Table 8.2.2.3.2.3-1 as defined in TS 36.508 [7] clause 4.3.1.2.

1. Connect the SS, the faders and AWGN noise sources to the UE antenna connectors as shown in TS 36.508 [7] Annex A, Figure A.11 for antenna configuration 4x2.

2. The parameter settings for the cell are set up according to Tables 8.2.2-1 and 8.2.2.3.2.3-1 as appropriate.
3. Downlink signals are initially set up according to Annex C.0, C.1 and Annex C.3.2 and uplink signals according to Annex H.1 and H.3.2.
4. Propagation conditions are set according to Annex B.0.
5. Ensure the UE is in State 3A or 3A-RF according to TS 36.508 [7] clause 4.5.3A or 5.2A.2. Message contents are defined in clause 8.2.2.3.2.4.3.

8.2.2.3.2.4.2 Test procedure

1. SS transmits PDSCH via PDCCH DCI format 2A for C_RNTI to transmit the DL RMC according to Tables 8.2.2.3.2.3-1 and 8.2.2.3.2.3-2. The SS sends downlink MAC padding bits on the DL RMC.
2. Set the parameters of the bandwidth, MCS, reference channel, the propagation condition, the correlation matrix, antenna configuration and the SNR according to Table 8.2.2.3.2.5-1 as appropriate.
3. Measure the average throughput for a duration sufficient to achieve statistical significance according to Annex G clause G.3. Count the number of NACKs, ACKs and statDTXs on the UL during each test interval and decide pass or fail according to Tables G.3.5 and G.3.6 in Annex G clause G.3.

8.2.2.3.2.4.3 Message contents

Message contents are according to TS 36.508 [7] clause 4.6 with the following exceptions.

Table 8.2.2.3.2.4.3-1: PDSCH-ConfigDedicated-DEFAULT: Additional TDD PDSCH open loop spatial multiplexing performance downlink power allocation for Test number 1

Derivation Path: 36.508 clause 4.6.3			
Information Element	Value/remark	Comment	Condition
PDSCH-ConfigDedicated-DEFAULT ::= SEQUENCE {			
p-a	dB-6		
}			

Table 8.2.2.3.2.4.3-2: PhysicalConfigDedicated-DEFAULT: Additional TDD PDSCH open loop spatial multiplexing performance downlink power for Test number 1

Derivation Path: 36.331 clause 6.3.2			
Information Element	Value/remark	Comment	Condition
PhysicalConfigDedicated-DEFAULT ::= SEQUENCE {			
antennaInfo CHOICE {			
antennaInfoDedicated ::= SEQUENCE {			
transmissionMode	tm3		
codebookSubsetRestriction CHOICE {			
n4TxAntenna-tm3	1111		
}			
ue-TransmitAntennaSelection CHOICE {			
release	NULL		
}			
}			
}			

8.2.2.3.2.5 Test requirement

Table 8.2.2.3.2.3-1 defines the primary level settings.

The fraction of maximum throughput percentage for the downlink reference measurement channels specified in Annex A clause A.3.4.2, for each throughput test shall meet or exceed the specified value in Tables 8.2.2.3.2.5-1 for the specified SNR including test tolerances for all throughput tests.

Table 8.2.2.3.2.5-1: Test requirement Large Delay CDD (FRC)

Test number	Bandwidth	Reference Channel	OCNG Pattern	Propagation Condition	Correlation Matrix and Antenna Configuration	Reference value		UE Category
						Fraction of Maximum Throughput (%)	SNR (dB)	
1	10 MHz	R.14 TDD	OP.1 TDD	EVA70	4x2 Low	70	15.1	2-5

8.2.2.4 TDD PDSCH Closed Loop Spatial Multiplexing Performance (Cell-Specific Reference Symbols)

8.2.2.4.1 TDD PDSCH Closed Loop Single/Multi Layer Spatial Multiplexing 2x2

8.2.2.4.1.1 Test purpose

To verify the UE's ability to receive a predefined test signal, representing a multi-path fading channel that is determined by the SNR with a percentage of the information bit throughput for a specified downlink Reference Measurement Channel (RMC) not falling below a specified value for transmission on two antenna ports using closed loop spatial multiplexing with wideband and frequency selective precoding.

8.2.2.4.1.2 Test applicability

This test applies to all types of E-UTRA TDD UE release 8 and forward.

8.2.2.4.1.3 Minimum conformance requirements

The requirements are specified in terms of the percentage of information bit throughput for the downlink reference measurement channels specified in Annex A clause A.3.4.2, with the addition of the relevant parameters in Tables 8.2.2-1, 8.2.2.4.1.3-1 and 8.2.2.4.1.3-3 and the downlink physical channel setup according to Table C.3.2-1 in Annex C.

Using this configuration the fraction of maximum throughput percentage shall meet or exceed the minimum requirements specified in Tables 8.2.2.4.1.3-2 and 8.2.2.4.1.3-4 for the specified SNR. For single-layer spatial multiplexing closed loop rank-one performance with wideband and frequency selective precoding is specified. For multi-layer spatial multiplexing closed loop rank-two performance with wideband and frequency selective precoding is specified.

Table 8.2.2.4.1.3-1: Test Parameters for Testing Single-Layer Spatial Multiplexing (FRC)

Parameter		Unit	Test 1	Test 2
Downlink power allocation	ρ_A	dB	-3	-3
	ρ_B	dB	-3 (Note 1)	-3 (Note 1)
N_{oc} at antenna port		dBm/15kHz	-98	-98
Precoding granularity		PRB	6	50
PMI delay (Note 2)		ms	10 or 11	10 or 11
Reporting interval		ms	1 or 4 (Note 3)	1 or 4 (Note 3)
Reporting mode			PUSCH 1-2	PUSCH 3-1
ACK/NACK feedback mode			Multiplexing	Multiplexing
Note 1: $P_B = 1$				
Note 2: If the UE reports in an available uplink reporting instance at SF#n based on PMI estimation at a downlink SF not later than SF#(n-4), this reported PMI cannot be applied at the eNB downlink before SF#(n+4)				
Note 3: For Uplink - downlink configuration 1 the reporting interval will alternate between 1ms and 4ms				

Table 8.2.2.4.1.3-2: Minimum performance Single-Layer Spatial Multiplexing (FRC)

Test number	Bandwidth	Reference Channel	OCNG Pattern	Propagation Condition	Correlation Matrix and Antenna Configuration	Reference value		UE Category
						Fraction of Maximum Throughput (%)	SNR (dB)	
1	10 MHz	R.10 TDD	OP.1 TDD	EVA5	2x2 Low	70	-3.1	1-5
2	10 MHz	R.10 TDD	OP.1 TDD	EPA5	2x2 High	70	-2.8	1-5

Table 8.2.2.4.1.3-3: Test Parameters for Testing Multi-Layer Spatial Multiplexing

Parameter		Unit	Test 3	Test 4
Downlink power allocation	ρ_A	dB	-3	-3
	ρ_B	dB	-3 (Note 1)	-3 (Note 1)
N_{oc} at antenna port		dBm/15kHz	-98	-98
Precoding granularity		PRB	50	50
PMI delay (Note 2)		ms	10 or 11	10 or 11
Reporting interval		ms	1 or 4 (Note 3)	1 or 4 (Note 3)
Reporting mode			PUSCH 3-1	PUSCH 3-1
ACK/NACK feedback mode			Bundling	Bundling
CodeBookSubsetRestriction bitmap			110000	110000
Note 1: $P_B = 1$				
Note 2: If the UE reports in an available uplink reporting instance at subframe SF#n based on PMI estimation at a downlink SF not later than SF#(n-4), this reported PMI cannot be applied at the eNB downlink before SF#(n+4)				
Note 3: For Uplink - downlink configuration 1 the reporting interval will alternate between 1ms and 4ms				

Table 8.2.2.4.1.3-4: Minimum performance Multi-Layer Spatial Multiplexing (FRC)

Test number	Bandwidth	Reference Channel	OCNG Pattern	Propagation Condition	Correlation Matrix and Antenna Configuration	Reference value		UE Category
						Fraction of Maximum Throughput (%)	SNR (dB)	
3	10 MHz	R.11-1 TDD	OP.1 TDD	EVA5	2x2 Low	70	12.8	2-5
4	10 MHz	R.11-1 TDD	OP.1 TDD	ETU70	2x2 Low	70	13.9	2-5

The normative reference for this requirement is TS 36.101 [2] clause 8.2.2.4.

8.2.2.4.1.4 Test description

8.2.2.4.1.4.1 Initial conditions

Initial conditions are a set of test configurations the UE needs to be tested in and the steps for the SS to take with the UE to reach the correct measurement state.

Configurations of PDSCH and PDCCH before measurement are specified in Annex C.2.

Test Environment: Normal, as defined in TS 36.508 [7] clause 4.1.

Frequencies to be tested: Mid Range, as defined in TS 36.508 [7] clause 4.3.1.2.

Bandwidths to be tested: As specified per test number in Tables 8.2.2.4.1.3-2 and 8.2.2.4.1.3-4 as defined in TS 36.508 [7] clause 4.3.1.2.

1. Connect the SS, the faders and AWGN noise sources to the UE antenna connectors as shown in TS 36.508 [7] Annex A, Figure A.10 for antenna configuration 2x2.
2. The parameter settings for the cell are set up according to Tables 8.2.2-1, 8.2.2.4.1.3-1 and 8.2.2.4.1.3-3 as appropriate.
3. Downlink signals are initially set up according to Annex C.0, C.1 and Annex C.3.2 and uplink signals according to Annex H.1 and H.3.2.
4. Propagation conditions are set according to Annex B.0.
5. Ensure the UE is in State 3A or 3A-RF according to TS 36.508 [7] clause 4.5.3A or 5.2A.2. Message contents are defined in clause 8.2.2.4.1.4.3.

8.2.2.4.1.4.2 Test procedure

1. For single-layer spatial multiplexing, SS transmits PDSCH via PDCCH DCI format 1B for C_RNTI to transmit the DL RMC according to Tables 8.2.2.4.1.3-1 and 8.2.2.4.1.3-2. For multi-layer spatial multiplexing, SS transmits PDSCH via PDCCH DCI format 2 for C_RNTI to transmit the DL RMC according to Tables 8.2.2.4.1.3-3 and 8.2.2.4.1.3-4. The SS sends downlink MAC padding bits on the DL RMC.
2. SS schedules the UL transmission to carry the PUSCH CQI feedback via PDCCH DCI format 0 with CQI request bit set to 1 and I_MCS=29 and N_PRB allocated to be less or equal to 4.
3. Set the parameters of the bandwidth, MCS, reference channel, the propagation condition, the correlation matrix, antenna configuration and the SNR according to Tables 8.2.2.4.1.5-1 and 8.2.2.4.1.5-2 as appropriate.
4. Measure the average throughput for a duration sufficient to achieve statistical significance according to Annex G clause G.3. Count the number of NACKs, ACKs and statDTXs on the UL during each test interval and decide pass or fail according to Tables G.3.5 and G.3.6 in Annex G clause G.3.
5. Repeat steps from 1 to 4 for each test interval in Tables 8.2.2.4.1.5-1 and 8.2.2.4.1.5-2 as appropriate.

8.2.2.4.1.4.3 Message contents

Message contents are according to TS 36.508 [7] clause 4.6 with the following exceptions.

Table 8.2.2.4.1.4.3-1: *PhysicalConfigDedicated-DEFAULT*: Additional TDD PDSCH closed loop single-layer spatial multiplexing performance downlink power allocation for Test number 1,2

Derivation Path: 36.331 clause 6.3.2			
Information Element	Value/remark	Comment	Condition
PhysicalConfigDedicated-DEFAULT ::= SEQUENCE {			
antennaInfo CHOICE {			
antennaInfoDedicated ::= SEQUENCE {			
transmissionMode	tm6		
codebookSubsetRestriction CHOICE {			
n2TxAntenna-tm6	1111		
}			
ue-TransmitAntennaSelection CHOICE {			
release	NULL		
}			
}			
}			

Table 8.2.2.4.1.4.3-2: *PhysicalConfigDedicated-DEFAULT*: Additional TDD PDSCH closed loop multi-layer spatial multiplexing performance downlink power allocation for Test number 3,4

Derivation Path: 36.331 clause 6.3.2			
Information Element	Value/remark	Comment	Condition
PhysicalConfigDedicated-DEFAULT ::= SEQUENCE {			
antennaInfo CHOICE {			
antennaInfoDedicated ::= SEQUENCE {			
transmissionMode	tm4		
codebookSubsetRestriction CHOICE {			
n2TxAntenna-tm4	110000		
}			
ue-TransmitAntennaSelection CHOICE {			
release	NULL		
}			
}			
}			

Table 8.2.2.4.1.4.3-3: *CQI-ReportConfig-DEFAULT*: Additional TDD PDSCH closed loop single -layer spatial multiplexing performance downlink power allocation for Test number 1

Derivation Path: 36.331 clause 6.3.2			
Information Element	Value/remark	Comment	Condition
CQI-ReportConfig-DEFAULT ::= SEQUENCE {			
cqi-ReportModeAperiodic	rm12		
nomPDSCH-RS-EPRE-Offset	0		
cqi-ReportPeriodic	Not present		
}			

Table 8.2.2.4.1.4.3-4: *CQI-ReportConfig-DEFAULT*: Additional TDD PDSCH closed loop single/multi-layer spatial multiplexing performance downlink power allocation for Test number 2, 3, 4

Derivation Path: 36.331 clause 6.3.2			
Information Element	Value/remark	Comment	Condition
CQI-ReportConfig-DEFAULT ::= SEQUENCE {			
cqi-ReportModeAperiodic	rm31		
nomPDSCH-RS-EPRE-Offset	0		
cqi-ReportPeriodic	Not present		
}			

8.2.2.4.1.5 Test requirement

Tables 8.2.2.4.1.3-1 and 8.2.2.4.1.3-3 defines the primary level settings.

The fraction of maximum throughput percentage for the downlink reference measurement channels specified in Annex A clause A.3.4.2, for each throughput test shall meet or exceed the specified value in Tables 8.2.2.4.1.5-1 and 8.2.2.4.1.5-2 for the specified SNR including test tolerances for all throughput tests.

Table 8.2.2.4.1.5-1: Test requirement Single-Layer Spatial Multiplexing (FRC)

Test number	Bandwidth	Reference Channel	OCNG Pattern	Propagation Condition	Correlation Matrix and Antenna Configuration	Reference value		UE Category
						Fraction of Maximum Throughput (%)	SNR (dB)	
1	10 MHz	R.10 TDD	OP.1 TDD	EVA5	2x2 Low	70	-2.2	1-5
2	10 MHz	R.10 TDD	OP.1 TDD	EPA5	2x2 High	70	-2.0	1-5

Table 8.2.2.4.1.5-2: Test requirement Multi-Layer Spatial Multiplexing (FRC)

Test number	Bandwidth	Reference Channel	OCNG Pattern	Propagation Condition	Correlation Matrix and Antenna Configuration	Reference value		UE Category
						Fraction of Maximum Throughput (%)	SNR (dB)	
3	10 MHz	R.11-1 TDD	OP.1 TDD	EVA5	2x2 Low	70	13.7	2-5
4	10 MHz	R.11-1 TDD	OP.1 TDD	ETU70	2x2 Low	70	14.8	2-5

8.2.2.4.2 TDD PDSCH Closed Loop Single/Multi Layer Spatial Multiplexing 4x2

8.2.2.4.2.1 Test purpose

To verify the UE's ability to receive a predefined test signal, representing a multi-path fading channel that is determined by the SNR with a percentage of the information bit throughput for a specified downlink Reference Measurement Channel (RMC) not falling below a specified value for transmission on four antenna ports using closed loop spatial multiplexing with wideband and frequency selective precoding.

8.2.2.4.2.2 Test applicability

This test applies to all types of E-UTRA TDD UE release 8 and forward.

8.2.2.4.2.3 Minimum conformance requirements

The requirements are specified in terms of the percentage of information bit throughput for the downlink reference measurement channels specified in Annex A clause A.3.4.2, with the addition of the relevant parameters in Tables 8.2.2-1, 8.2.2.4.2.3-1 and 8.2.2.4.2.3-3 and the downlink physical channel setup according to Table C.3.2-1 in Annex C.

Using this configuration the fraction of maximum throughput percentage shall meet or exceed the minimum requirements specified in Tables 8.2.2.4.3-2 and 8.2.2.4.2.3-4 for the specified SNR. For single-layer spatial multiplexing closed loop rank-one performance with wideband and frequency selective precoding is specified. For multi-layer spatial multiplexing closed loop rank-two performance with wideband and frequency selective precoding is specified.

Table 8.2.2.4.2.3-1: Test Parameters for Testing Single-Layer Spatial Multiplexing (FRC)

Parameter		Unit	Test 1
Downlink power allocation	ρ_A	dB	-6
	ρ_B	dB	-6 (Note 1)
N_{oc} at antenna port		dBm/15kHz	-98
Precoding granularity		PRB	6
PMI delay (Note 2)		ms	10 or 11
Reporting interval		ms	1 or 4 (Note 3)
Reporting mode			PUSCH 1-2
ACK/NACK feedback mode			Multiplexing
Note 1: $P_B = 1$ Note 2: If the UE reports in an available uplink reporting instance at subframe SF#n based on PMI estimation at a downlink SF not later than SF#(n-4), this reported PMI cannot be applied at the eNB downlink before SF#(n+4) Note 3: For Uplink - downlink configuration 1 the reporting interval will alternate between 1ms and 4ms			

Table 8.2.2.4.2.3-2: Minimum performance Single-Layer Spatial Multiplexing (FRC)

Test number	Bandwidth	Reference Channel	OCNG Pattern	Propagation Condition	Correlation Matrix and Antenna Configuration	Reference value		UE Category
						Fraction of Maximum Throughput (%)	SNR (dB)	
1	10 MHz	R.13 TDD	OP.1 TDD	EVA5	4x2 Low	70	-3.5	1-5

Table 8.2.2.4.2.3-3: Test Parameters for Testing Multi-Layer Spatial Multiplexing

Parameter		Unit	Test 2
Downlink power allocation	ρ_A	dB	-6
	ρ_B	dB	-6 (Note 1)
N_{oc} at antenna port		dBm/15kHz	-98
Precoding granularity		PRB	6
PMI delay (Note 2)		ms	10 or 11
Reporting interval		ms	1 or 4 (Note 3)
Reporting mode			PUSCH 1-2
ACK/NACK feedback mode			Bundling
CodeBookSubsetRestriction bitmap			000000000000 000000000000 000000111111 111111111000 000000000000
Note 1: $P_B = 1$ Note 2: If the UE reports in an available uplink reporting instance at subframe SF#n based on PMI estimation at a downlink SF not later than SF#(n-4), this reported PMI cannot be applied at the eNB downlink before SF#(n+4) Note 3: For Uplink - downlink configuration 1 the reporting interval will alternate between 1ms and 4ms			

Table 8.2.2.4.2.3-4: Minimum performance Multi-Layer Spatial Multiplexing (FRC)

Test number	Bandwidth	Reference Channel	OCNG Pattern	Propagation Condition	Correlation Matrix and Antenna Configuration	Reference value		UE Category
						Fraction of Maximum Throughput (%)	SNR (dB)	
2	10 MHz	R.14 TDD	OP.1 TDD	EVA5	4x2 Low	70	10.7	2-5

The normative reference for this requirement is TS 36.101 [2] clause 8.2.2.4.

8.2.2.4.2.4 Test description

8.2.2.4.2.4.1 Initial conditions

Initial conditions are a set of test configurations the UE needs to be tested in and the steps for the SS to take with the UE to reach the correct measurement state.

Configurations of PDSCH and PDCCH before measurement are specified in Annex C.2.

Test Environment: Normal, as defined in TS 36.508 [7] clause 4.1.

Frequencies to be tested: Mid Range, as defined in TS 36.508 [7] clause 4.3.1.2.

Bandwidths to be tested: As specified per test number in Tables 8.2.2.4.2.3-2 and 8.2.2.4.2.3-4 as defined in TS 36.508 [7] clause 4.3.1.2.

1. Connect the SS, the faders and AWGN noise sources to the UE antenna connectors as shown in TS 36.508 [7] Annex A, Figure A.10 Figure A.11 for antenna configuration 4x2.
2. The parameter settings for the cell are set up according to Tables 8.2.2-1, 8.2.2.4.2.3-1 and 8.2.2.4.2.3-3 as appropriate.
3. Downlink signals are initially set up according to Annex C.0, C.1 and Annex C.3.2 and uplink signals according to Annex H.1 and H.3.2.
4. Propagation conditions are set according to Annex B.0.
5. Ensure the UE is in State 3A or 3A-RF according to TS 36.508 [7] clause 4.5.3A or 5.2A.2. Message contents are defined in clause 8.2.2.4.2.4.3.

8.2.2.4.2.4.2 Test procedure

1. For single-layer spatial multiplexing, SS transmits PDSCH via PDCCH DCI format 1B for C_RNTI to transmit the DL RMC according to Tables 8.2.2.4.2.3-1 and 8.2.2.4.2.3-2. For multi-layer spatial multiplexing, SS transmits PDSCH via PDCCH DCI format 2 for C_RNTI to transmit the DL RMC according to Tables 8.2.2.4.2.3-3 and 8.2.2.4.2.3-4. The SS sends downlink MAC padding bits on the DL RMC.
2. SS schedules the UL transmission to carry the PUSCH CQI feedback via PDCCH DCI format 0 with CQI request bit set to 1 and I_MCS=29 and N_PRB allocated to be less or equal to 4.
3. Set the parameters of the bandwidth, MCS, reference channel, the propagation condition, the correlation matrix, antenna configuration and the SNR according to Tables 8.2.2.4.2.5-1 and 8.2.2.4.2.5-2 as appropriate.
4. Measure the average throughput for a duration sufficient to achieve statistical significance according to Annex G clause G.3. Count the number of NACKs, ACKs and statDTXs on the UL during each test interval and decide pass or fail according to Tables G.3.5 and G.3.6 in Annex G clause G.3.
5. Repeat steps from 1 to 4 for each test interval in Tables 8.2.2.4.2.5-1 and 8.2.2.4.2.5-2 as appropriate.

8.2.2.4.2.4.3 Message contents

Message contents are according to TS 36.508 [7] clause 4.6 with the following exceptions.

Table 8.2.2.4.2.4.3-1: PDSCH-ConfigDedicated-DEFAULT: Additional TDD PDSCH closed loop spatial multiplexing performance downlink power allocation for Test numbers 1,2

Derivation Path: 36.508 clause 4.6.3			
Information Element	Value/remark	Comment	Condition
PDSCH-ConfigDedicated-DEFAULT ::= SEQUENCE {			
p-a	dB-6		
}			

Table 8.2.2.4.2.4.3-2: PhysicalConfigDedicated-DEFAULT: Additional TDD PDSCH closed loop single-layer spatial multiplexing performance downlink power allocation for Test number 1

Derivation Path: 36.331 clause 6.3.2			
Information Element	Value/remark	Comment	Condition
PhysicalConfigDedicated-DEFAULT ::= SEQUENCE {			
antennaInfo CHOICE {			
antennaInfoDedicated ::= SEQUENCE {			
transmissionMode	tm6		
codebookSubsetRestriction CHOICE {			
n4TxAntenna-tm6	1111111111111111		
}			
ue-TransmitAntennaSelection CHOICE {			
release	NULL		
}			
}			
}			

Table 8.2.2.4.2.4.3-3: PhysicalConfigDedicated-DEFAULT: Additional TDD PDSCH closed loop multi-layer spatial multiplexing performance downlink power allocation for Test number 2

Derivation Path: 36.331 clause 6.3.2			
Information Element	Value/remark	Comment	Condition
PhysicalConfigDedicated-DEFAULT ::= SEQUENCE {			
antennaInfo CHOICE {			
antennaInfoDedicated ::= SEQUENCE {			
transmissionMode	tm4		
codebookSubsetRestriction CHOICE {			
n4TxAntenna-tm4	00000000000000000000 00000000000011111111 11111111000000000000 0000		
}			
ue-TransmitAntennaSelection CHOICE {			
release	NULL		
}			
}			
}			

Table 8.2.2.4.2.4.3-4: CQI-ReportConfig-DEFAULT: Additional TDD PDSCH closed loop single/multi-layer spatial multiplexing performance downlink power allocation for Test number 1, 2

Derivation Path: 36.331 clause 6.3.2			
Information Element	Value/remark	Comment	Condition
CQI-ReportConfig-DEFAULT ::= SEQUENCE {			
cqi-ReportModeAperiodic	rm12		
nomPDSCH-RS-EPRE-Offset	0		
cqi-ReportPeriodic	Not present		
}			

8.2.2.4.2.5 Test requirement

Tables 8.2.2.4.2.3-1 and 8.2.2.4.2.3-3 defines the primary level settings.

The fraction of maximum throughput percentage for the downlink reference measurement channels specified in Annex A clause A.3.4.2, for each throughput test shall meet or exceed the specified value in Tables 8.2.2.4.2.5-1 and 8.2.2.4.2.5-2 for the specified SNR including test tolerances for all throughput tests.

Table 8.2.2.4.2.5-1: Test requirement Single-Layer Spatial Multiplexing (FRC)

Test number	Bandwidth	Reference Channel	OCNG Pattern	Propagation Condition	Correlation Matrix and Antenna Configuration	Reference value		UE Category
						Fraction of Maximum Throughput (%)	SNR (dB)	
1	10 MHz	R.13 TDD	OP.1 TDD	EVA5	4x2 Low	70	-2.6	1-5

Table 8.2.2.4.2.5-2: Test requirement Multi-Layer Spatial Multiplexing (FRC)

Test number	Bandwidth	Reference Channel	OCNG Pattern	Propagation Condition	Correlation Matrix and Antenna Configuration	Reference value		UE Category
						Fraction of Maximum Throughput (%)	SNR (dB)	
2	10 MHz	R.14 TDD	OP.1 TDD	EVA5	4x2 Low	70	11.6	2-5

8.3 Demodulation of PDSCH (User-Specific Reference Symbols)

8.3.1 FDD

[FFS]

8.3.2 TDD

The parameters specified in Table 8.3.2-1 are valid for TDD unless otherwise stated.

Table 8.3.2-1: Common Test Parameters for User-specific Reference Symbols

Parameter	Unit	Value
Uplink downlink configuration (Note 1)		1
Special subframe configuration (Note 2)		4
Cyclic prefix		Normal
Cell ID		0
Inter-TTI Distance		1
Number of HARQ processes. All these HARQ processes are used.	Processes	7
Maximum number of HARQ transmission		4
Redundancy version coding sequence		{0,1,2,3} for QPSK and 16QAM {0,0,1,2} for 64QAM
Number of OFDM symbols for PDCCH	OFDM symbols	2
Beamforming Model		As specified in Section B.4
Precoder update granularity		Frequency domain: 1 PRB Time domain: 1 ms
ACK/NACK feedback mode		Multiplexing
Note 1: as specified in Table 4.2-2 in TS 36.211 [8]		
Note 2: as specified in Table 4.2-1 in TS 36.211 [8]		

For all test cases, the SNR is defined as:

$$SNR = \frac{\hat{E}_s^{(1)} + \hat{E}_s^{(2)}}{N_{oc}^{(1)} + N_{oc}^{(2)}}$$

where the superscript indicates the receiver antenna connector. The SNR requirement applies for the UE categories given for each test.

The normative reference for this requirement is TS 36.101 [2] clause 8.3.2.

8.3.2.1 TDD PDSCH Single-layer Spatial Multiplexing Performance (UE-Specific Reference Symbols)

8.3.2.1.1 TDD PDSCH Single-layer Spatial Multiplexing on antenna port 5 (Release 8 and forward)

8.3.2.1.1.1 Test purpose

To verify the UE's ability to receive a predefined test signal, representing a multi-path fading channel that is determined by the SNR with a percentage of the information bit throughput for a specified downlink Reference Measurement Channel (RMC) not falling below a specified value for single-layer transmission on antenna port 5 using user-specific reference signals with full RB or single RB allocation.

8.3.2.1.1.2 Test applicability

This test applies to all types of E-UTRA TDD UE release 8 and forward.

8.3.2.1.1.3 Minimum conformance requirements

The requirements are specified in terms of the percentage of information bit throughput for the downlink reference measurement channels specified in Annex A clause A.3.4.3.1, with the addition of the relevant parameters in Tables 8.3.2-1, 8.3.2.1. 1.3-1, and the downlink physical channel setup according to Table C.3.2-1 in Annex C.

Using this configuration the fraction of maximum throughput percentage shall meet or exceed the minimum requirements specified in Tables 8.3.2.1. 1.3-2 for the specified SNR.

Table 8.3.2.1.1.3-1: Test Parameters for Testing DRS

parameter		Unit	Test 1	Test 2	Test 3	Test 4
Downlink power allocation	ρ_A	dB	0	0	0	0
	ρ_B	dB	0 (Note 1)	0 (Note 1)	0 (Note 1)	0 (Note 1)
Cell-specific reference signals		Antenna port 0				
N_{oc} at antenna port		dBm/15kHz	-98	-98	-98	-98
Symbols for unused PRBs			OCNG (Note 2)	OCNG (Note 2)	OCNG (Note 2)	OCNG (Note 2)
Number of allocated resource blocks		PRB	50	50	50	1 (Note 2)
Note 1: $P_B = 0$						
Note 2: These physical resource blocks are assigned to an arbitrary number of virtual UEs with one PDSCH per virtual UE; the data transmitted over the OCNG PDSCHs shall be uncorrelated pseudo random data, which is QPSK modulated.						

Table 8.3.2.1.1.3-2: Minimum performance DRS (FRC)

Test number	Bandwidth and MCS	Reference Channel	OCNG Pattern	Propagation Condition	Correlation Matrix and Antenna Configuration	Reference value		UE Category
						Fraction of Maximum Throughput (%)	SNR (dB)	
1	10 MHz QPSK 1/3	R.25 TDD	OP.1 TDD	EPA5	2x2 Low	70	-0.8	1-5
2	10 MHz 16QAM 1/2	R.26 TDD	OP.1 TDD	EPA5	2x2 Low	70	7.0	2-5
3	10 MHz 64QAM 3/4	R.27 TDD	OP.1 TDD	EPA5	2x2 Low	70	17.0	2-5
4	10 MHz 16QAM 1/2	R.28 TDD	OP.1 TDD	EPA5	2x2 Low	30	1.7	1-5

The normative reference for this requirement is TS 36.101 [2] clause 8.3.2.

8.3.2.1.1.4 Test description

8.3.2.1.1.4.1 Initial conditions

Initial conditions are a set of test configurations the UE needs to be tested in and the steps for the SS to take with the UE to reach the correct measurement state.

Configurations of PDSCH and PDCCH before measurement are specified in Annex C.2.

Test Environment: Normal, as defined in TS 36.508 [7] clause 4.1.

Frequencies to be tested: Mid Range, as defined in TS 36.508 [7] clause 4.3.1.2.

Bandwidths to be tested: 10MHz, as defined in TS 36.508 [7] clause 4.3.1.2.

1. Connect the SS, the faders and AWGN noise sources to the UE antenna connectors as shown in TS 36.508 [7] Annex A, Figure A.10 for antenna configuration 2x2.

2. The parameter settings for the cell are set up according to Tables 8.3.2-1 and 8.3.2.1. 1.3-1 as appropriate.
3. Downlink signals are initially set up according to Annex C0, C.1 and Annex C.3.2 and uplink signals according to Annex H.1 and H.3.2.
4. Propagation conditions are set according to Annex B.0.
5. Ensure the UE is in State 3A or 3A-RF according to TS 36.508 [7] clause 4.5.3A or 5.2A.2. Message contents are defined in clause 8.3.2.1.1.4.3.

8.3.2.1.1.4.2 Test procedure

1. SS transmits PDSCH via PDCCH DCI format 1 for C_RNTI to transmit the DL RMC according to Tables 8.3.2.1.1.3-1, 8.3.2.1.1.3-2. The SS sends downlink MAC padding bits on the DL RMC.
2. Set the parameters of the bandwidth, MCS, reference channel, the propagation condition, the correlation matrix and the SNR according to Table 8.3.2.1.1.5-1 as appropriate.

BCH/CRS/PDCCH/PCFICH are sent on antenna port 0 using one Tx antenna, while DRS/Dedicated data for the test UE are sent on antenna port 5 using two Tx antennas with beam-forming model as specified in Annex B.4.1 and precoder update granularity specified in Table 8.3.2-1.

3. Measure the average throughput for a duration sufficient to achieve statistical significance according to Annex G clause G.3. Count the number of NACKs, ACKs and statDTXs on the UL during each test interval and decide pass or fail according to Tables G.3.5 and G.3.6 in Annex G clause G.3.
4. Repeat steps from 1 to 3 for each test interval in Tables 8.3.2.1.1.5-1 as appropriate.

8.3.2.1.1.4.3 Message contents

Message contents are according to TS 36.508 [7] clause 4.6 with the following exceptions.

Table 8.3.2.1.1.4.3-1: PhysicalConfigDedicated-DEFAULT: Additional TDD PDSCH DRS performance downlink power allocation test point 1 requirement for Test number 1 - 4

Derivation Path: 36.331 clause 6.3.2			
Information Element	Value/remark	Comment	Condition
PhysicalConfigDedicated-DEFAULT ::= SEQUENCE {			
antennaInfo CHOICE {			
antennaInfoDedicated ::= SEQUENCE {			
transmissionMode	tm7		
ue-TransmitAntennaSelection CHOICE {			
Release	NULL		
}			
}			
}			
}			

8.3.2.1.1.5 Test requirement

Table 8.3.2.1.1.3-1 defines the primary level settings.

The fraction of maximum throughput percentage for the downlink reference measurement channels specified in Annex A clause A.3.4.3.1 for each throughput test shall meet or exceed the specified value in Table 8.3.2.1.1.5-1 for the specified SNR including test tolerances for all throughput tests.

Table 8.3.2.1.1.5-1: Test requirement DRS

Test number	Bandwidth and MCS	Reference Channel	OCNG Pattern	Propagation Condition	Correlation Matrix and Antenna Configuration	Reference value		UE Category
						Fraction of Maximum Throughput (%)	SNR (dB)	
1	10 MHz QPSK 1/3	R.25 TDD	OP.1 TDD	EPA5	2x2 Low	70	0.1	1-5
2	10 MHz 16QAM 1/2	R.26 TDD	OP.1 TDD	EPA5	2x2 Low	70	7.9	2-5
3	10 MHz 64QAM 3/4	R.27 TDD	OP.1 TDD	EPA5	2x2 Low	70	17.9	2-5
4	10 MHz 16QAM 1/2	R.28 TDD	OP.1 TDD	EPA5	2x2 Low	30	2.6	1-5

8.3.2.1.1_1 TDD PDSCH Single-layer Spatial Multiplexing on antenna port 5 (Release 9 and forward)

8.3.2.1.1_1.1 Test purpose

Same test purpose as in clause 8.3.2.1.1.1.

8.3.2.1.1_1.2 Test applicability

This test applies to all types of E-UTRA TDD UE release 9 and forward.

8.3.2.1.1_1.3 Minimum conformance requirements

Same minimum conformance requirements as in clause 8.3.2.1.1.3 with the following exceptions:

- Instead of Table 8.3.2.1.1.3-1 → use Table 8.3.2.1.1_1.3-1.
- Instead of Table 8.3.2.1.1.3-2 → use Table 8.3.2.1.1_1.3-2.

Table 8.3.2.1.1_1.3-1: Test Parameters for Testing DRS (Antenna port 5)

Parameter		Unit	Test 1 (Note 4)	Test 2	Test 3	Test 4 (Note 4)
Downlink power allocation	ρ_A	dB	N/A	0	0	NA
	ρ_B	dB		0 (Note 1)	0 (Note 1)	
Cell-specific reference signals		Antenna port 0				
N_{oc} at antenna port		dBm/15kHz	N/A	-98	-98	NA
Symbols for unused PRBs				OCNG (Note 2)	OCNG (Note 2)	
Number of allocated resource blocks		PRB		50	50	
Note 1: $P_B = 0$ Note 2: These physical resource blocks are assigned to an arbitrary number of virtual UEs with one PDSCH per virtual UE; the data transmitted over the OCNG PDSCHs shall be uncorrelated pseudo random data, which is QPSK modulated. Note 3: The modulation symbols of the signal under test are mapped onto antenna port 5. Note 4: This tests are covered in subclause 8.3.2.1.1						

Table 8.3.2.1.1_1.3-2: Minimum performance DRS (FRC) (Antenna port 5)

Test number	Bandwidth and MCS	Reference Channel	OCNG Pattern	Propagation Condition	Correlation Matrix and Antenna Configuration	Reference value		UE Category
						Fraction of Maximum Throughput (%)	SNR (dB)	
1 (Note 1)	N/A							
2	5MHz 16QAM 1/2	R.26-1 TDD	OP.1 TDD	EPA5	2x2 Low	70	7.0	1
3	10 MHz 64QAM 3/4	R.27-1 TDD	OP.1 TDD	EPA5	2x2 Low	70	17.0	1
4 (Note 1)	N/A							
Note 1:	These tests are covered in subclause 8.3.2.1.1							

The normative reference for this requirement is TS 36.101 [2] clause 8.3.2.

8.3.2.1.1_1.4 Test description

Same test description as in clause 8.3.2.1.1.4 with the following exceptions:

- Instead of Table 8.3.2.1.1.3-1 → use Table 8.3.2.1.1_1.3-1.
- Instead of Table 8.3.2.1.1.3-2 → use Table 8.3.2.1.1_1.3-2.
- Instead of Table 8.3.2.1.1.5-1 → use Table 8.3.2.1.1_1.5-1.

8.3.2.1.1_1.5 Test requirement

Same test requirement as in clause 8.3.2.1.1.5 with the following exceptions:

- Instead of Table 8.3.2.1.1.3-1 → use Table 8.3.2.1.1_1.3-1.
- Instead of Table 8.3.2.1.1.5-1 → use Table 8.3.2.1.1_1.5-1.

Table 8.3.2.1.1_1.5-1: Test requirement DRS (FRC) (Antenna port 5)

Test number	Bandwidth and MCS	Reference Channel	OCNG Pattern	Propagation Condition	Correlation Matrix and Antenna Configuration	Reference value		UE Category
						Fraction of Maximum Throughput (%)	SNR (dB)	
1 (Note 1)	N/A							
2	5MHz 16QAM 1/2	R.26-1 TDD	OP.1 TDD	EPA5	2x2 Low	70	7.9	1
3	10 MHz 64QAM 3/4	R.27-1 TDD	OP.1 TDD	EPA5	2x2 Low	70	17.9	1
4 (Note 1)	N/A							
Note 1:	These tests are covered in subclause 8.3.2.1.1							

8.3.2.1.2 TDD PDSCH Single-layer Spatial Multiplexing on antenna port 7 or 8 without a simultaneous transmission

8.3.2.1.2.1 Test purpose

To verify the UE's ability to receive a predefined test signal, representing a multi-path fading channel that is determined by the SNR with a percentage of the information bit throughput for a specified downlink Reference Measurement Channel (RMC) not falling below a specified value for single-layer transmission on antenna port 7 or 8 without a simultaneous transmission on the other antenna port using DM-RS with full RB allocation.

8.3.2.1.2.2 Test applicability

This test applies to all types of E-UTRA TDD UE release 9 and forward.

8.3.2.1.2.3 Minimum conformance requirements

The requirements are specified in terms of the percentage of information bit throughput for the downlink reference measurement channels specified in Annex A clause A.3.4.3.1, with the addition of the relevant parameters in Tables 8.3.2-1, 8.3.2.1.2.3-1, and the downlink physical channel setup according to Table C.3.2-1 in Annex C.

Using this configuration the fraction of maximum throughput percentage shall meet or exceed the minimum requirements specified in Tables 8.3.2.1.2.3-2 for the specified SNR.

Table 8.3.2.1.2.3-1: Test Parameters for Testing CDM-multiplexed DM RS (single layer)

parameter		Unit	Test 1	Test 2	Test 3	Test 4 (Note 3)	Test 5 (Note 3)
Downlink power allocation	ρ_A	dB	0	0	0	N/A	N/A
	ρ_B	dB	0 (Note 1)	0 (Note 1)	0 (Note 1)	N/A	N/A
Cell-specific reference signals			Antenna port 0 and antenna port 1				
N_{oc} at antenna port		dBm/15kHz	-98	-98	-98	N/A	N/A
Symbols for unused PRBs			OCNG (Note 4,5)	OCNG (Note 4,5)	OCNG (Note 4,5)	N/A	N/A
Number of allocated resource blocks (Note 2)		PRB	50	50	50	N/A	N/A
Simultaneous transmission			No	No	No	N/A	N/A
Note 1: $P_B = 1$ Note 2: The modulation symbols of the signal under test are mapped onto antenna port 7 or 8. Note 3: Test 4 and Test 5 are covered in subclause 8.3.2.1.3. Note 4: These physical resource blocks are assigned to an arbitrary number of virtual UEs with one PDSCH per virtual UE; the data transmitted over the OCNG PDSCHs shall be uncorrelated pseudo random data, which is QPSK modulated. Note 5: $OCNG_RA = \rho_A - 3$ dB, $OCNG_RB = \rho_B - 3$ dB in order to have the same PDSCH and OCNG power pro subcarrier at the receiver.							

Table 8.3.2.1.2.3-2: Minimum performance for CDM-multiplexed DM RS without simultaneous transmission (FRC)

Test number	Bandwidth and MCS	Reference Channel	OCNG Pattern	Propagation Condition	Correlation Matrix and Antenna Configuration	Reference value		UE Category
						Fraction of Maximum Throughput (%)	SNR (dB)	
1	10 MHz QPSK 1/3	R.31 TDD	OP.1 TDD	EVA5	2x2 Low	70	-1.0	1-5
2	10 MHz 16QAM 1/2	R.32 TDD	OP.1 TDD	EPA5	2x2 Medium	70	7.7	2-5
	5MHz 16QAM 1/2	R.32-1 TDD	OP.1 TDD	EPA5	2x2 Medium	70	[7.7]	1
3	10 MHz 64QAM 3/4	R.33 TDD	OP.1 TDD	EPA5	2x2 Low	70	17.7	2-5
	10 MHz 64QAM 3/4	R.33-1 TDD	OP.1 TDD	EPA5	2x2 Low	70	[17.7]	1

The normative reference for this requirement is TS 36.101 [2] clause 8.3.2.

8.3.2.1.2.4 Test description

8.3.2.1.2.4.1 Initial conditions

Initial conditions are a set of test configurations the UE needs to be tested in and the steps for the SS to take with the UE to reach the correct measurement state.

Configurations of PDSCH and PDCCH before measurement are specified in Annex C.2.

Test Environment: Normal, as defined in TS 36.508 [7] clause 4.1.

Frequencies to be tested: Mid Range, as defined in TS 36.508 [7] clause 4.3.1.2.

Bandwidths to be tested: 10MHz, as defined in TS 36.508 [7] clause 4.3.1.2.

1. Connect the SS, the faders and AWGN noise sources to the UE antenna connectors as shown in TS 36.508 [7] Annex A, Figure A.10.
2. The parameter settings for the cell are set up according to Tables 8.3.2-1 and 8.3.2.1.2.3-1 as appropriate.
3. Downlink signals are initially set up according to Annex C0, C.1 and Annex C.3.2 and uplink signals according to Annex H.1 and H.3.2.
4. Propagation conditions are set according to Annex B.0.
5. Ensure the UE is in State 3A or State 3A-RF according to TS 36.508 [7] clause 4.5.3A or 5.2A.2. Message contents are defined in clause 8.3.2.1.2.4.3.

8.3.2.1.2.4.2 Test procedure

1. SS transmits PDSCH via PDCCH DCI format 2B for C_RNTI to transmit the DL RMC according to Tables 8.3.2.1.2.3-1, 8.3.2.1.2.3-2. The SS sends downlink MAC padding bits on the DL RMC.
2. Set the parameters of the bandwidth, MCS, reference channel, the propagation condition, the correlation matrix and the SNR according to Table 8.3.2.1.2.5-1 as appropriate. BCH/CRS/PDCCH/PCFICH are sent on antenna ports 0 and 1 using two Tx antennas, while DRS/Dedicated data for the test UE are sent on antenna port 7 (or 8) using two Tx antennas with beam-forming model as specified in Annex B.4.1 and precoder update granularity specified in Table 8.3.2-1.
3. Measure the average throughput for a duration sufficient to achieve statistical significance according to Annex G clause G.3. Count the number of NACKs, ACKs and statDTXs on the UL during each test interval and decide pass or fail according to Tables G.3.5 and G.3.6 in Annex G clause G.3.

4. Repeat steps from 1 to 3 for each test interval in Tables 8.3.2.1.2.5-1 as appropriate.

8.3.2.1.2.4.3 Message contents

Message contents are according to TS 36.508 [7] clause 4.6 with the following exceptions .

Table 8.3.2.1.2.4.3-1: PhysicalConfigDedicated-DEFAULT

Derivation Path: 36.331 clause 6.3.2			
Information Element	Value/remark	Comment	Condition
PhysicalConfigDedicated-DEFAULT ::= SEQUENCE {			
antennaInfo CHOICE {			
antennaInfoDedicated ::= SEQUENCE {			
transmissionMode	tm8		
}			
}			
}			

8.3.2.1.2.5 Test requirement

Table 8.3.2.1.2.3-1 defines the primary level settings.

The fraction of maximum throughput percentage for the downlink reference measurement channels specified in Annex A clause A.3.4.3.1 for each throughput test shall meet or exceed the specified value in Table 8.3.2.1.2.5-1 for the specified SNR including test tolerances for all throughput tests.

Table 8.3.2.1.2.5-1: Test requirement for CDM-multiplexed DM RS without simultaneous transmission (FRC)

Test number	Bandwidth and MCS	Reference Channel	OCNG Pattern	Propagation Condition	Correlation Matrix and Antenna Configuration	Reference value		UE Category
						Fraction of Maximum Throughput (%)	SNR (dB)	
1	10 MHz QPSK 1/3	R.31 TDD	OP.1 TDD	EVA5	2x2 Low	70	-0.1	1-5
2	10 MHz 16QAM 1/2	R.32 TDD	OP.1 TDD	EPA5	2x2 Medium	70	8.6	2-5
	5 MHz 16QAM 1/2	R.32-1 TDD	OP.1 TDD	EPA5	2x2 Medium	70	[8.6]	1
3	10 MHz 64QAM 3/4	R.33 TDD	OP.1 TDD	EPA5	2x2 Low	70	18.6	2-5
	10 MHz 64QAM 3/4	R.33-1 TDD	OP.1 TDD	EPA5	2x2 Low	70	[18.6]	1

8.3.2.1.3 TDD PDSCH Single-layer Spatial Multiplexing on antenna port 7 or 8 with a simultaneous transmission

8.3.2.1.3.1 Test purpose

To verify the UE’s ability to receive a predefined test signal, representing a multi-path fading channel that is determined by the SNR with a percentage of the information bit throughput for a specified downlink Reference Measurement Channel (RMC) not falling below a specified value for single-layer transmission on antenna port 7 or 8 with a simultaneous transmission on the other antenna port using DM-RS with full RB allocation.

8.3.2.1.3.2 Test applicability

This test applies to all types of E-UTRA TDD UE release 9 and forward.

8.3.2.1.3.3 Minimum conformance requirements

The requirements are specified in terms of the percentage of information bit throughput for the downlink reference measurement channels specified in Annex A clause A.3.4.3.1, with the addition of the relevant parameters in Tables 8.3.2-1, 8.3.2.1.3.3-1, and the downlink physical channel setup according to Table C.3.2-1 in Annex C.

Using this configuration the fraction of maximum throughput percentage shall meet or exceed the minimum requirements specified in Tables 8.3.2.1.3.3-2 for the specified SNR.

Table 8.3.2.1.3.3-1: Test Parameters for Testing CDM-multiplexed DM RS (single layer)

parameter	Unit	Test 1 (Note 6)	Test 2 (Note 6)	Test 3 (Note 6)	Test 4	Test 5	
Downlink power allocation	ρ_A	dB	N/A	N/A	N/A	0	0
	ρ_B	dB	N/A	N/A	N/A	0 (Note 1)	0 (Note 1)
Cell-specific reference signals		Antenna port 0 and antenna port 1					
N_{oc} at antenna port	dBm/15kHz	N/A	N/A	N/A	-98	-98	
Symbols for unused PRBs		N/A	N/A	N/A	OCNG (Note 4,5)	OCNG (Note 4,5)	
Number of allocated resource blocks (Note 2)	PRB	N/A	N/A	N/A	50	50	
Simultaneous transmission		N/A	N/A	N/A	Yes (Note 3)	Yes (Note 3)	
Note 1: $P_B = 1$ Note 2: The modulation symbols of the signal under test are mapped onto antenna port 7 or 8. Note 3: Modulation symbols of an interference signal is mapped onto the antenna port (7 or 8) not used for the input signal under test. Note 4: These physical resource blocks are assigned to an arbitrary number of virtual UEs with one PDSCH per virtual UE; the data transmitted over the OCNG PDSCHs shall be uncorrelated pseudo random data, which is QPSK modulated. Note 5: $OCNG_RA = \rho_A - 3$ dB, $OCNG_RB = \rho_B - 3$ dB in order to have the same PDSCH and OCNG power pro subcarrier at the receiver. Note 6: Test 1, Test 2 and Test 3 are covered in subclause 8.3.2.1.2.							

Table 8.3.2.1.3.3-2: Minimum performance for CDM-multiplexed DM RS with interfering simultaneous transmission (FRC)

Test number	Bandwidth and MCS	Reference Channel	OCNG Pattern	Propagation Condition	Correlation Matrix and Antenna Configuration	Reference value		UE Category
						Fraction of Maximum Throughput (%)	SNR (dB)	
4	10 MHz 16QAM 1/2	R.32 TDD (Note 1)	OP.1 TDD	EPA5	2x2 Medium	70	21.9	2-5
5	10 MHz 64QAM 1/2	R.34 TDD (Note 1)	OP.1 TDD	EPA5	2x2 Low	70	22.0	2-5
Note 1: The reference channel applies to both the input signal under test and the interfering signal.								

The normative reference for this requirement is TS 36.101 [2] clause 8.3.2.

8.3.2.1.3.4 Test description

8.3.2.1.3.4.1 Initial conditions

Initial conditions are a set of test configurations the UE needs to be tested in and the steps for the SS to take with the UE to reach the correct measurement state.

Configurations of PDSCH and PDCCH before measurement are specified in Annex C.2.

Test Environment: Normal, as defined in TS 36.508 [7] clause 4.1.

Frequencies to be tested: Mid Range, as defined in TS 36.508 [7] clause 4.3.1.2.

Bandwidths to be tested: 10MHz, as defined in TS 36.508 [7] clause 4.3.1.2.

1. Connect the SS, the faders and AWGN noise sources to the UE antenna connectors as shown in TS 36.508 [7] Annex A, Figure A.10.
2. The parameter settings for the cell are set up according to Tables 8.3.2-1 and 8.3.2.1.3.3-1 as appropriate.
3. Downlink signals are initially set up according to Annex C0, C.1 and Annex C.3.2 and uplink signals according to Annex H.1 and H.3.2.
4. Propagation conditions are set according to Annex B.0.
5. Ensure the UE is in State 3A or State 3A-RF according to TS 36.508 [7] clause 4.5.3A or 5.2A.2. Message contents are defined in clause 8.3.2.1.3.4.3.

8.3.2.1.3.4.2 Test procedure

1. SS transmits PDSCH via PDCCH DCI format 2B for C_RNTI to transmit the DL RMC according to Tables 8.3.2.1.3.3-1, 8.3.2.1.3.3-2. The SS sends downlink MAC padding bits on the DL RMC.
2. Set the parameters of the bandwidth, MCS, reference channel, the propagation condition, the correlation matrix and the SNR according to Table 8.3.2.1.3.5-1 as appropriate. BCH/CRS/PDCCH/PCFICH are sent on antenna ports 0 and 1 using two Tx antennas, while DRS/Dedicated data for the test UE are sent on antenna port 7 (or 8) and another simultaneous transmission of DRS/Dedicated data not for the test UE is sent on antenna port 8 (or 7). The DRS/Dedicated data transmissions use two Tx antennas with different beam-forming model as specified in Annex B.4.1 and precoder update granularity specified in Table 8.3.2-1.
3. Measure the average throughput for a duration sufficient to achieve statistical significance according to Annex G clause G.3. Count the number of NACKs, ACKs and statDTXs on the UL during each test interval and decide pass or fail according to Tables G.3.5 and G.3.6 in Annex G clause G.3.
4. Repeat steps from 1 to 3 for each test interval in Tables 8.3.2.1.3.5-1 as appropriate.

8.3.2.1.3.4.3 Message contents

Message contents are according to TS 36.508 [7] clause 4.6 with the following exceptions.

Table 8.3.2.1.3.4.3-1: PhysicalConfigDedicated-DEFAULT

Derivation Path: 36.331 clause 6.3.2			
Information Element	Value/remark	Comment	Condition
PhysicalConfigDedicated-DEFAULT ::= SEQUENCE {			
antennaInfo CHOICE {			
antennaInfoDedicated ::= SEQUENCE {			
transmissionMode	tm8		
}			
}			
}			

8.3.2.1.3.5 Test requirement

Table 8.3.2.1.3.3-1 defines the primary level settings.

The fraction of maximum throughput percentage for the downlink reference measurement channels specified in Annex A clause A.3.4.3.1 for each throughput test shall meet or exceed the specified value in Table 8.3.2.1.3.5-1 for the specified SNR including test tolerances for all throughput tests.

Table 8.3.2.1.3.5-1: Test requirement for CDM-multiplexed DM RS with interfering simultaneous transmission (FRC)

Test number	Bandwidth and MCS	Reference Channel	OCNG Pattern	Propagation Condition	Correlation Matrix and Antenna Configuration	Reference value		UE Category
						Fraction of Maximum Throughput (%)	SNR (dB)	
4	10 MHz 16QAM 1/2	R.32 TDD (Note 1)	OP.1 TDD	EPA5	2x2 Medium	70	22.8	2-5
5	10 MHz 64QAM 1/2	R.34 TDD (Note 1)	OP.1 TDD	EPA5	2x2 Low	70	22.9	2-5

Note 1: The reference channel applies to both the input signal under test and the interfering signal.

8.3.2.2 TDD PDSCH Dual-layer Spatial Multiplexing Performance (UE-Specific Reference Symbols)

8.3.2.2.1 TDD PDSCH Dual-layer Spatial Multiplexing

8.3.2.2.1.1 Test purpose

To verify the UE's rank-2 performance and ability to receive a predefined test signal, representing a multi-path fading channel that is determined by the SNR with a percentage of the information bit throughput for a specified downlink Reference Measurement Channel (RMC) not falling below a specified value for dual-layer transmission on antenna ports 7 and 8 using DM-RS with full RB allocation.

8.3.2.2.1.2 Test applicability

This test applies to all types of E-UTRA TDD UE release 9 and forward.

8.3.2.2.1.3 Minimum conformance requirements

The requirements are specified in terms of the percentage of information bit throughput for the downlink reference measurement channels specified in Annex A clause A.3.4.3.2, with the addition of the relevant parameters in Tables 8.3.2-1, 8.3.2.2.1.3-1, and the downlink physical channel setup according to Table C.3.2-1 in Annex C.

Using this configuration the fraction of maximum throughput percentage shall meet or exceed the minimum requirements specified in Tables 8.3.2.2.1.3-2 for the specified SNR.

Table 8.3.2.2.1.3-1: Test Parameters for Testing CDM-multiplexed DM RS (dual layer)

Parameter		Unit	Test 1	Test 2
Downlink power allocation	ρ_A	dB	-3	-3
	ρ_B	dB	-3 (Note 1)	-3 (Note 1)
Cell-specific reference symbols			Antenna port 0 and antenna port 1	
N_{oc} at antenna port		dBm/15kHz	-98	-98
Symbols for unused PRBs			OCNG (Note 2)	OCNG (Note 2)
Number of allocated resource blocks		PRB	50	50
Note 1: $P_B = 1$				
Note 2: These physical resource blocks are assigned to an arbitrary number of virtual UEs with one PDSCH per virtual UE; the data transmitted over the OCNG PDSCHs shall be uncorrelated pseudo random data, which is QPSK modulated.				

Table 8.3.2.2.1.3-2: Minimum performance for CDM-multiplexed DM RS (FRC)

Test number	Bandwidth and MCS	Reference Channel	OCNG Pattern	Propagation Condition	Correlation Matrix and Antenna Configuration	Reference value		UE Category
						Fraction of Maximum Throughput (%)	SNR (dB)	
1	10 MHz QPSK 1/3	R.31 TDD	OP.1 TDD	EVA5	2x2 Low	70	4.5	2-5
2	10 MHz 16QAM 1/2	R.32 TDD	OP.1 TDD	EPA5	2x2 Medium	70	21.7	2-5

The normative reference for this requirement is TS 36.101 [2] clause 8.3.2.

8.3.2.2.1.4 Test description

8.3.2.2.1.4.1 Initial conditions

Initial conditions are a set of test configurations the UE needs to be tested in and the steps for the SS to take with the UE to reach the correct measurement state.

Configurations of PDSCH and PDCCH before measurement are specified in Annex C.2.

Test Environment: Normal, as defined in TS 36.508 [7] clause 4.1.

Frequencies to be tested: Mid Range, as defined in TS 36.508 [7] clause 4.3.1.2.

Bandwidths to be tested: 10MHz, as defined in TS 36.508 [7] clause 4.3.1.2.

1. Connect the SS, the faders and AWGN noise sources to the UE antenna connectors as shown in TS 36.508 [7] Annex A, Figure A.10.
2. The parameter settings for the cell are set up according to Tables 8.3.2-1 and 8.3.2.2.1.3-1 as appropriate.
3. Downlink signals are initially set up according to Annex C0, C.1 and Annex C.3.2 and uplink signals according to Annex H.1 and H.3.2.
4. Propagation conditions are set according to Annex B.0.
5. Ensure the UE is in State 3A or State 3A-RF according to TS 36.508 [7] clause 4.5.3A or 5.2A.2. Message contents are defined in clause 8.3.2.2.1.4.3.

8.3.2.2.1.4.2 Test procedure

1. SS transmits PDSCH via PDCCH DCI format 2B for C_RNTI to transmit the DL RMC according to Tables 8.3.2.2.1.3-1, 8.3.2.2.1.3-2. The SS sends downlink MAC padding bits on the DL RMC.
2. Set the parameters of the bandwidth, MCS, reference channel, the propagation condition, the correlation matrix and the SNR according to Table 8.3.2.2.1.5-1 as appropriate.
BCH/CRS/PDCCH/PCFICH are sent on antenna ports 0 and 1 using two Tx antennas, while DRS/Dedicated data for test UE are sent on antenna ports 7 and 8 using two Tx antennas with beam-forming model as specified in Annex B.4.2 and precoder update granularity specified in Table 8.3.2-1.
3. Measure the average throughput for a duration sufficient to achieve statistical significance according to Annex G clause G.3. Count the number of NACKs, ACKs and statDTXs on the UL during each test interval and decide pass or fail according to Tables G.3.5 and G.3.6 in Annex G clause G.3.
4. Repeat steps from 1 to 3 for each test interval in Tables 8.3.2.2.1.5-1 as appropriate.

8.3.2.2.1.4.3 Message contents

Message contents are according to TS 36.508 [7] clause 4.6 with the following exceptions .

Table 8.3.2.2.1.4.3-1: PhysicalConfigDedicated-DEFAULT

Derivation Path: 36.331 clause 6.3.2			
Information Element	Value/remark	Comment	Condition
PhysicalConfigDedicated-DEFAULT ::= SEQUENCE {			
antennaInfo CHOICE {			
antennaInfoDedicated ::= SEQUENCE {			
transmissionMode	tm8		
}			
}			
}			

8.3.2.2.1.5 Test requirement

Table 8.3.2.2.1.3-1 defines the primary level settings.

The fraction of maximum throughput percentage for the downlink reference measurement channels specified in Annex A clause A.3.4.3.2 for each throughput test shall meet or exceed the specified value in Table 8.3.2.2.1.5-1 for the specified SNR including test tolerances for all throughput tests.

Table 8.3.2.2.1.5-1: Test requirement for CDM-multiplexed DM RS (FRC)

Test number	Bandwidth and MCS	Reference Channel	OCNG Pattern	Propagation Condition	Correlation Matrix and Antenna Configuration	Reference value		UE Category
						Fraction of Maximum Throughput (%)	SNR (dB)	
1	10 MHz QPSK 1/3	R.31 TDD	OP.1 TDD	EVA5	2x2 Low	70	5.4	2-5
2	10 MHz 16QAM 1/2	R.32 TDD	OP.1 TDD	EPA5	2x2 Medium	70	22.6	2-5

8.4 Demodulation of PCFICH/PDCCH

8.4.1 FDD

8.4.1.1 FDD PCFICH/PDCCH Single-antenna Port Performance

8.4.1.1.1 Test purpose

This test verifies the demodulation performance of PCFICH/PDCCH for a single-antenna port with a given SNR for which the average probability of miss-detection of the Downlink Scheduling Grant, tested jointly on PDCCH and PCFICH of the specified reference measurement channels in A.3.5.1 remains below a given reference value.

8.4.1.1.2 Test applicability

This test applies to all types of E-UTRA FDD UE release 8 and forward.

8.4.1.1.3 Minimum conformance requirements

The receiver characteristics of the PDCCH/PCFICH are determined by the probability of miss-detection of the Downlink Scheduling Grant (Pm-dsg). PDCCH and PCFICH are tested jointly, i.e. a miss detection of PCFICH implies a miss detection of PDCCH.

Table 8.4.1.1.3-1: Test Parameters for PDCCH/PCFICH

Parameter		Unit	Single antenna port
Number of PDCCH symbols		symbols	2
Number of PHICH groups (N_g)			1
PHICH duration			Normal
Unused RE-s and PRB-s			OCNG
Cell ID			0
Downlink power allocation	PCFICH_RA PDCCH_RA PHICH_RA OCNG_RA	dB	0
	PCFICH_RB PDCCH_RB PHICH_RB OCNG_RB	dB	0
N_{oc} at antenna port		dBm/15kHz	-98
Cyclic prefix			Normal
Note: PHICH power setting refer to PHICH group power, i.e. the total power of all active PHICH sequences within a PHICH group.			

For the parameters specified in Table 8.4.1.1.3-1 the average probability of a missed downlink scheduling grant (P_{m-dsg}) shall be below the specified value in Table 8.4.1.1.3-2.

Table 8.4.1.1.3-2: Minimum performance PDCCH/PCFICH

Test number	Bandwidth	Aggregation level	Reference Channel	OCNG Pattern	Propagation Condition	Antenna configuration and Correlation Matrix	Reference value	
							P_{m-dsg} (%)	SNR (dB)
1	10 MHz	8 CCE	R.15 FDD	OP.1 FDD	ETU70	1x2 Low	1	-1.7

The normative reference for this requirement is TS 36.101 [2] clause 8.4.1.

8.4.1.1.4 Test description

8.4.1.1.4.1 Initial conditions

Initial conditions are a set of test configurations the UE needs to be tested in and the steps for the SS to take with the UE to reach the correct measurement state.

Configurations of PDSCH and PDCCH before measurement are specified in Annex C.2.

Test Environment: Normal, as defined in TS 36.508 [7] clause 4.1.

Frequencies to be tested: Mid Range, as defined in TS 36.508 [7] clause 4.3.1.1.

Channel Bandwidths to be tested: 10MHz, as defined in TS 36.508 [7] clause 4.3.1.1

1. Connect the SS, the faders and AWGN noise source to the UE antenna connector (s) as shown in TS 36.508 [7] Annex A, Figure A.9.
2. The parameter settings for the cell are set up according to Table 8.4.1.1.3-1.
3. The downlink signals are initially set up according to Annex C.1 and Annex C.3.2 and uplink signals according to Annex H.1 and H.3.2.
4. Propagation conditions are set according to Annex B clause B.0.
5. Ensure the UE is in State 3A or 3A-RF according to TS 36.508 [7] clause 4.5.3A or 5.2A.2. Message contents are defined in clause 8.4.1.1.4.3.

8.4.1.1.4.2 Test procedure

1. SS transmits PDSCH via PDCCH DCI format 1 for C_RNTI to transmit the DL RMC according to Table 8.4.1.1.3-2. The details of PDCCH and PDSCH are specified in Table A.3.5.1-1 and Table A.3.5.1-2 respectively. The SS sends downlink MAC padding bits on the DL RMC.
2. Set the parameters of the propagation condition, antenna configuration, the correlation matrix and the SNR according to Table 8.4.1.1.5-1 as appropriate.
3. Measure the Pm-dsg for a duration sufficient to achieve statistical significance according to Annex G clause G.4. Count the number of NACKs, ACKs and statDTXs on the UL PUCCH during each subtest interval. Pm-dsg is the ratio (statDTX)/(NACK+ACK+statDTX). If Pm-dsg is less than the value specified in table 8.4.1.1.5-1, pass the UE. Otherwise fail the UE.
If Pm-dsg is less than the value specified in table 8.4.1.1.5-1, pass the UE. Otherwise fail the UE.

8.4.1.1.4.3 Message contents

Message contents are according to TS 36.508 [7] clause 4.6.

8.4.1.1.5 Test requirement

For the parameters specified in Table 8.4.1.1.3-1 the average probability of a missed downlink scheduling grant (Pm-dsg) shall be below the specified value in Table 8.4.1.1.5-1.

Table 8.4.1.1.5-1: Test requirement PDCCH/PCFICH

Test number	Bandwidth	Aggregation level	Reference Channel	OCNG Pattern	Propagation Condition	Antenna configuration and correlation Matrix	Reference value	
							Pm-dsg (%)	SNR (dB)
1	10 MHz	8 CCE	R.15 FDD	OP.1 FDD	ETU70	1x2 Low	1	-0.9

8.4.1.2 FDD PCFICH/PDCCH Transmit Diversity Performance

8.4.1.2.1 FDD PCFICH/PDCCH Transmit Diversity 2x2

8.4.1.2.1.1 Test purpose

This test verifies the demodulation performance of PCFICH/PDCCH for transmit diversity with a given SNR for which the average probability of miss-detection of the Downlink Scheduling Grant, tested jointly on PDCCH and PCFICH of the specified reference measurement channels in A.3.5.1 remains below a given reference value.

8.4.1.2.1.2 Test applicability

This test applies to all types of E-UTRA FDD UE release 8.

8.4.1.2.1.3 Minimum conformance requirements

The receiver characteristics of the PDCCH/PCFICH are determined by the probability of miss-detection of the Downlink Scheduling Grant (Pm-dsg). PDCCH and PCFICH are tested jointly, i.e. a miss detection of PCFICH implies a miss detection of PDCCH.

Table 8.4.1.2.1.3-1: Test Parameters for PDCCH/PCFICH

Parameter		Unit	Transmit diversity
Number of PDCCH symbols		symbols	2
Number of PHICH groups (N_g)			1
PHICH duration			Normal
Unused RE-s and PRB-s			OCNG
Cell ID			0
Downlink power allocation	PCFICH_RA PDCCH_RA PHICH_RA OCNG_RA	dB	-3
	PCFICH_RB PDCCH_RB PHICH_RB OCNG_RB	dB	-3
N_{oc} at antenna port		dBm/15kHz	-98
Cyclic prefix			Normal
Note: PHICH power setting refer to PHICH group power, i.e. the total power of all active PHICH sequences within a PHICH group.			

For the parameters specified in Table 8.4.1.2.1.3-1 the average probability of a missed downlink scheduling grant (P_{m-dsg}) shall be below the specified value in Table 8.4.1.2.1.3-2.

Table 8.4.1.2.1.3-2: Minimum performance PDCCH/PCFICH 2 Tx Antenna Port

Test number	Bandwidth	Aggregation level	Reference Channel	OCNG Pattern	Propagation Condition	Antenna configuration and correlation Matrix	Reference value	
							P_{m-dsg} (%)	SNR (dB)
1	1.4 MHz	2 CCE	R.16 FDD	OP.1 FDD	EPA5	2 x 2 Low	1	4.3

The normative reference for this requirement is TS 36.101 [2] clause 8.4.1.

8.4.1.2.1.4 Test description

8.4.1.2.1.4.1 Initial conditions

Initial conditions are a set of test configurations the UE needs to be tested in and the steps for the SS to take with the UE to reach the correct measurement state.

Configurations of PDSCH and PDCCH before measurement are specified in Annex C.2.

Test Environment: Normal, as defined in TS 36.508 [7] clause 4.1.

Frequencies to be tested: Mid Range, as defined in TS 36.508 [7] clause 4.3.1.1.

Channel Bandwidths to be tested: 1.4MHz, as defined in TS 36.508 [7] clause 4.3.1.1

1. Connect the SS, the faders and AWGN noise sources to the UE antenna connector (s) as shown in TS 36.508 [7] Annex A, Figure A.10.
2. The parameter settings for the cell are set up according to Table 8.4.1.2.1.3-1.
3. The downlink signals are initially set up according to Annex C.1 and C.3.2 and uplink signals according to Annex H.1 and H.3.2.
4. Propagation conditions are set according to Annex B clauses B.0.

5. Ensure the UE is in State 3A or 3A-RF according to TS 36.508 [7] clause 4.5.3A or 5.2A.2. Message contents are defined in clause 8.4.1.2.1.4.3.

8.4.1.2.1.4.2 Test procedure

1. SS transmits PDSCH via PDCCH DCI format 2 for C_RNTI to transmit the DL RMC according to Table 8.4.1.2.1.3-2. The details of PDCCH and PDSCH are specified in Table A.3.5.1-1 and Table A.3.5.1-2 respectively. The SS sends downlink MAC padding bits on the DL RMC. Transmission scheme for the PDSCH shall be transmit diversity.
2. Set the parameters of the propagation condition, antenna configuration, the correlation matrix and the SNR according to Table 8.4.1.2.1.5-1.
3. Measure the Pm-dsg for a duration sufficient to achieve statistical significance according to Annex G clause G.4. Count the number of NACKs, ACKs and statDTXs on the UL PUCCH during each subtest interval. Pm-dsg is the ratio (statDTX)/(NACK+ACK+statDTX).
If Pm-dsg is less than the value specified in table 8.4.1.2.1.5-1, pass the UE. Otherwise fail the UE.

8.4.1.2.1.4.3 Message contents

Message contents are according to TS 36.508 [7] clause 4.6 with the following exceptions:

Table 8.4.1.2.1.4.3-1: PhysicalConfigDedicated-DEFAULT

Derivation Path: 36.331 clause 6.3.2			
Information Element	Value/remark	Comment	Condition
PhysicalConfigDedicated-DEFAULT ::= SEQUENCE {			
antennaInfo CHOICE {			
antennaInfoDedicated ::= SEQUENCE {			
transmissionMode	tm4		
codebookSubsetRestriction CHOICE {			
n2TxAntenna-tm4	111111		
}			
ue-TransmitAntennaSelection CHOICE {			
release	NULL		
}			
}			

8.4.1.2.1.5 Test requirement

For the parameters specified in Table 8.4.1.2.1.3-1 the average probability of a missed downlink scheduling grant (Pm-dsg) shall be below the specified value in Table 8.4.1.2.1.5-1.

Table 8.4.1.2.1.5-1: Test requirement PDCCH/PCFICH 2 Tx Antenna Port

Test number	Bandwidth	Aggregation level	Reference Channel	OCNG Pattern	Propagation Condition	Antenna configuration and correlation Matrix	Reference value	
							Pm-dsg (%)	SNR (dB)
1	1.4 MHz	2 CCE	R.16 FDD	OP.1 FDD	EPA5	2 x 2 Low	1	5.3

8.4.1.2.1_1 FDD PCFICH/PDCCH Transmit Diversity 2x2

Editor's note: This clause is incomplete. The following aspects are either missing or not yet determined:

- Test tolerance is undefined

8.4.1.2.1_1.1 Test purpose

This test verifies the demodulation performance of PCFICH/PDCCH for transmit diversity with a given SNR for which the average probability of miss-detection of the Downlink Scheduling Grant, tested jointly on PDCCH and PCFICH of the specified reference measurement channels in A.3.5.1 remains below a given reference value.

8.4.1.2.1_1.2 Test applicability

This test applies to all types of E-UTRA FDD UE release 9 and forward.

8.4.1.2.1_1.3 Minimum conformance requirements

The receiver characteristics of the PDCCH/PCFICH are determined by the probability of miss-detection of the Downlink Scheduling Grant (Pm-dsg). PDCCH and PCFICH are tested jointly, i.e. a miss detection of PCFICH implies a miss detection of PDCCH.

Table 8.4.1.2.1_1.3-1: Test Parameters for PDCCH/PCFICH

Parameter		Unit	Transmit diversity
Number of PDCCH symbols		symbols	2
Number of PHICH groups (Ng)			1
PHICH duration			Normal
Unused RE-s and PRB-s			OCNG
Cell ID			0
Downlink power allocation	PCFICH_RA PDCCH_RA PHICH_RA OCNG_RA	dB	-3
	PCFICH_RB PDCCH_RB PHICH_RB OCNG_RB	dB	-3
N_{oc} at antenna port		dBm/15kHz	-98
Cyclic prefix			Normal
Note: PHICH power setting refer to PHICH group power, i.e. the total power of all active PHICH sequences within a PHICH group.			

For the parameters specified in Table 8.4.1.2.1_1.3-1 the average probability of a missed downlink scheduling grant (Pm-dsg) shall be below the specified value in Table 8.4.1.2.1_1.3-2.

Table 8.4.1.2.1_1.3-2: Minimum performance PDCCH/PCFICH 2 Tx Antenna Port

Test number	Bandwidth	Aggregation level	Reference Channel	OCNG Pattern	Propagation Condition	Antenna configuration and correlation Matrix	Reference value	
							Pm-dsg (%)	SNR (dB)
1	10 MHz	4 CCE	R.16 FDD	OP.1 FDD	EVA70	2 x 2 Low	1	-0.6

The normative reference for this requirement is TS 36.101 [2] clause 8.4.1

8.4.1.2.1_1.4 Test description

8.4.1.2.1_1.4.1 Initial conditions

Initial conditions are a set of test configurations the UE needs to be tested in and the steps for the SS to take with the UE to reach the correct measurement state.

Configurations of PDSCH and PDCCH before measurement are specified in Annex C.2.

Test Environment: Normal, as defined in TS 36.508 [7] clause 4.1.

Frequencies to be tested: Mid Range, as defined in TS 36.508 [7] clause 4.3.1.1.

Channel Bandwidths to be tested: 10MHz, as defined in TS 36.508 [7] clause 4.3.1.1

1. Connect the SS, the faders and AWGN noise sources to the UE antenna connector (s) as shown in TS 36.508 [7] Annex A, Figure A.10.
2. The parameter settings for the cell are set up according to Table 8.4.1.2.1_1.3-1.
3. The downlink signals are initially set up according to Annex C.1 and C.3.2 and uplink signals according to Annex H.1 and H.3.2.
4. Propagation conditions are set according to Annex B clauses B.0.
5. Ensure the UE is in State 3A or 3A-RF according to TS 36.508 [7] clause 4.5.3A or 5.2A.2. Message contents are defined in clause 8.4.1.2.1_1.4.3.

8.4.1.2.1_1.4.2 Test procedure

1. SS transmits PDSCH via PDCCH DCI format 2 for C_RNTI to transmit the DL RMC according to Table 8.4.1.2.1_1.3-2. The details of PDCCH and PDSCH are specified in Table A.3.5.1-1 and Table A.3.5.1-2 respectively. The SS sends downlink MAC padding bits on the DL RMC. Transmission scheme for the PDSCH shall be transmit diversity.
2. Set the parameters of the propagation condition, antenna configuration, the correlation matrix and the SNR according to Table 8.4.1.2.1_1.5-1.
3. Measure the Pm-dsg for a duration sufficient to achieve statistical significance according to Annex G clause G.4. Count the number of NACKs, ACKs and statDTXs on the UL PUCCH during each subtest interval. Pm-dsg is the ratio (statDTX)/(NACK+ACK+statDTX).
If Pm-dsg is less than the value specified in table 8.4.1.2.1_1.5-1, pass the UE. Otherwise fail the UE.

8.4.1.2.1_1.4.3 Message contents

Message contents are according to TS 36.508 [7] clause 4.6 with the following exceptions:

Table 8.4.1.2.1_1.4.3-1: PhysicalConfigDedicated-DEFAULT

Derivation Path: 36.331 clause 6.3.2			
Information Element	Value/remark	Comment	Condition
PhysicalConfigDedicated-DEFAULT ::= SEQUENCE {			
antennaInfo CHOICE {			
antennaInfoDedicated ::= SEQUENCE {			
transmissionMode	tm4		
codebookSubsetRestriction CHOICE {			
n2TxAntenna-tm4	111111		
}			
ue-TransmitAntennaSelection CHOICE {			
release	NULL		
}			
}			
}			

8.4.1.2.1_1.5 Test requirement

For the parameters specified in Table 8.4.1.2.1_1.3-1 the average probability of a missed downlink scheduling grant (Pm-dsg) shall be below the specified value in Table 8.4.1.2.1_1.5-1.

Table 8.4.1.2.1_1.5-1: Test requirement PDCCH/PCFICH 2 Tx Antenna Port

Test number	Bandwidth	Aggregation level	Reference Channel	OCNG Pattern	Propagation Condition	Antenna configuration and correlation Matrix	Reference value	
							Pm-dsg (%)	SNR (dB)
1	10 MHz	4 CCE	R.16 FDD	OP.1 FDD	EVA70	2 x 2 Low	1	-0.6+TT

8.4.1.2.2 FDD PCFICH/PDCCH Transmit Diversity 4x2

8.4.1.2.2.1 Test purpose

This test verifies the demodulation performance of PCFICH/PDCCH for transmit diversity with a given SNR for which the average probability of miss-detection of the Downlink Scheduling Grant, tested jointly on PDCCH and PCFICH of the specified reference measurement channels in A.3.5.1 remains below a given reference value.

8.4.1.2.2.2 Test applicability

This test applies to all types of E-UTRA FDD UE release 8.

8.4.1.2.2.3 Minimum conformance requirements

The receiver characteristics of the PDCCH/PCFICH are determined by the probability of miss-detection of the Downlink Scheduling Grant (Pm-dsg). PDCCH and PCFICH are tested jointly, i.e. a miss detection of PCFICH implies a miss detection of PDCCH.

Table 8.4.1.2.2.3-1: Test Parameters for PDCCH/PCFICH

Parameter		Unit	Transmit diversity
Number of PDCCH symbols		symbols	2
Number of PHICH groups (N_g)			1
PHICH duration			Normal
Unused RE-s and PRB-s			OCNG
Cell ID			0
Downlink power allocation	PCFICH_RA PDCCH_RA PHICH_RA OCNG_RA	dB	-3
	PCFICH_RB PDCCH_RB PHICH_RB OCNG_RB	dB	-3
N_{oc} at antenna port		dBm/15kHz	-98
Cyclic prefix			Normal
Note: PHICH power setting refer to PHICH group power, i.e. the total power of all active PHICH sequences within a PHICH group.			

For the parameters specified in Table 8.4.1.2.2.3-1 the average probability of a missed downlink scheduling grant (Pm-dsg) shall be below the specified value in Table 8.4.1.2.2.3-2.

Table 8.4.1.2.2.3-2: Minimum performance PDCCH/PCFICH 4 Tx Antenna Port

Test number	Bandwidth	Aggregation level	Reference Channel	OCNG Pattern	Propagation Condition	Antenna configuration and correlation Matrix	Reference value	
							Pm-dsg (%)	SNR (dB)
1	10 MHz	4 CCE	R.17 FDD	OP.1 FDD	EVA5	4 x 2 Medium	1	0.9

The normative reference for this requirement is TS 36.101 [2] clause 8.4.1.

8.4.1.2.2.4 Test description

8.4.1.2.2.4.1 Initial conditions

Initial conditions are a set of test configurations the UE needs to be tested in and the steps for the SS to take with the UE to reach the correct measurement state.

Configurations of PDSCH and PDCCH before measurement are specified in Annex C.2.

Test Environment: Normal, as defined in TS 36.508 [7] clause 4.1.

Frequencies to be tested: Mid Range, as defined in TS 36.508 [7] clause 4.3.1.1.

Channel Bandwidths to be tested: 10MHz, as defined in TS 36.508 [7] clause 4.3.1.1

1. Connect the SS, the faders and AWGN noise sources to the UE antenna connector (s) as shown in TS 36.508 [7] Annex A, Figure A.11.
2. The parameter settings for the cell are set up according to Table 8.4.1.2.2.3-1.
3. The downlink signals are initially set up according to Annex C.1 and C.3.2 and uplink signals according to Annex H.1 and H.3.2.
4. Propagation conditions are set according to Annex B clauses B.0.
5. Ensure the UE is in State 3A or 3A-RF according to TS 36.508 [7] clause 4.5.3A or 5.2A.2. Message contents are defined in clause 8.4.1.2.2.4.3.

8.4.1.2.2.4.2 Test procedure

1. SS transmits PDSCH via PDCCH DCI format 2 for C_RNTI to transmit the DL RMC according to Table 8.4.1.2.2.3-2. The details of PDCCH and PDSCH are specified in Table A.3.5.1-1 and Table A.3.5.1-2 respectively. The SS sends downlink MAC padding bits on the DL RMC. Transmission scheme for the PDSCH shall be transmit diversity.
2. Set the parameters of the propagation condition, antenna configuration, the correlation matrix and the SNR according to Table 8.4.1.2.2.5-1.
3. Measure the Pm-dsg for a duration sufficient to achieve statistical significance according to Annex G clause G.3. Count the number of NACKs, ACKs and statDTXs on the UL PUCCH during each subtest interval. Pm-dsg is the ratio (statDTX)/(NACK+ACK+statDTX). If Pm-dsg is less than the value specified in table 8.4.1.2.2.5-1, pass the UE. Otherwise fail the UE.

8.4.1.2.2.4.3 Message contents

Message contents are according to TS 36.508 [7] clause 4.6 with the following exceptions:

Table 8.4.1.2.2.4.3-1: PhysicalConfigDedicated-DEFAULT

Derivation Path: 36.331 clause 6.3.2			
Information Element	Value/remark	Comment	Condition
PhysicalConfigDedicated-DEFAULT ::= SEQUENCE {			
antennaInfo CHOICE {			
antennaInfoDedicated ::= SEQUENCE {			
transmissionMode	tm4		
codebookSubsetRestriction CHOICE {			
n2TxAntenna-tm4	111111		
}			
ue-TransmitAntennaSelection CHOICE {			
release	NULL		
}			
}			
}			

8.4.1.2.2.5 Test requirement

For the parameters specified in Table 8.4.1.2.2.3-1 the average probability of a missed downlink scheduling grant (Pm-dsg) shall be below the specified value in Table 8.4.1.2.2.5-1.

Table 8.4.1.2.2.5-1: Test requirement PDCCH/PCFICH 4 Tx Antenna Port

Test number	Bandwidth	Aggregation level	Reference Channel	OCNG Pattern	Propagation Condition	Antenna configuration and correlation Matrix	Reference value	
							Pm-dsg (%)	SNR (dB)
1	10 MHz	4 CCE	R.17 FDD	OP.1 FDD	EVA5	4 x 2 Medium	1	1.9

8.4.1.2.2_1 FDD PCFICH/PDCCH Transmit Diversity 4x2

Editor's note: This clause is incomplete. The following aspects are either missing or not yet determined:

- Test tolerance is undefined

8.4.1.2.2_1.1 Test purpose

This test verifies the demodulation performance of PCFICH/PDCCH for transmit diversity with a given SNR for which the average probability of miss-detection of the Downlink Scheduling Grant, tested jointly on PDCCH and PCFICH of the specified reference measurement channels in A.3.5.1 remains below a given reference value.

8.4.1.2.2_1.2 Test applicability

This test applies to all types of E-UTRA FDD UE release 9 and forward.

8.4.1.2.2_1.3 Minimum conformance requirements

The receiver characteristics of the PDCCH/PCFICH are determined by the probability of miss-detection of the Downlink Scheduling Grant (Pm-dsg). PDCCH and PCFICH are tested jointly, i.e. a miss detection of PCFICH implies a miss detection of PDCCH.

Table 8.4.1.2.2_1.3-1: Test Parameters for PDCCH/PCFICH

Parameter		Unit	Transmit diversity
Number of PDCCH symbols		symbols	2
Number of PHICH groups (N_g)			1
PHICH duration			Normal
Unused RE-s and PRB-s			OCNG
Cell ID			0
Downlink power allocation	PCFICH_RA PDCCH_RA PHICH_RA OCNG_RA	dB	-3
	PCFICH_RB PDCCH_RB PHICH_RB OCNG_RB	dB	-3
N_{oc} at antenna port		dBm/15kHz	-98
Cyclic prefix			Normal
Note: PHICH power setting refer to PHICH group power, i.e. the total power of all active PHICH sequences within a PHICH group.			

For the parameters specified in Table 8.4.1.2.2_1.3-1 the average probability of a missed downlink scheduling grant (P_m -dsg) shall be below the specified value in Table 8.4.1.2.2_1.3-2.

Table 8.4.1.2.2_1.3-2: Minimum performance PDCCH/PCFICH 4 Tx Antenna Port

Test number	Bandwidth	Aggregation level	Reference Channel	OCNG Pattern	Propagation Condition	Antenna configuration and correlation Matrix	Reference value	
							Pm-dsg (%)	SNR (dB)
1	5 MHz	2 CCE	R.17 FDD	OP.1 FDD	EPA5	4 x 2 Medium	1	6.3

The normative reference for this requirement is TS 36.101 [2] clause 8.4.1.

8.4.1.2.2_1.4 Test description

8.4.1.2.2_1.4.1 Initial conditions

Initial conditions are a set of test configurations the UE needs to be tested in and the steps for the SS to take with the UE to reach the correct measurement state.

Configurations of PDSCH and PDCCH before measurement are specified in Annex C.2.

Test Environment: Normal, as defined in TS 36.508 [7] clause 4.1.

Frequencies to be tested: Mid Range, as defined in TS 36.508 [7] clause 4.3.1.1.

Channel Bandwidths to be tested: 5MHz, as defined in TS 36.508 [7] clause 4.3.1.1

1. Connect the SS, the faders and AWGN noise sources to the UE antenna connector (s) as shown in TS 36.508 [7] Annex A, Figure A.11.
2. The parameter settings for the cell are set up according to Table 8.4.1.2.2_1.3-1.
3. The downlink signals are initially set up according to Annex C.1 and C.3.2 and uplink signals according to Annex H.1 and H.3.2.
4. Propagation conditions are set according to Annex B clauses B.0.

5. Ensure the UE is in State 3A or 3A-RF according to TS 36.508 [7] clause 4.5.3A or 5.2A.2. Message contents are defined in clause 8.4.1.2.2_1.4.3.

8.4.1.2.2_1.4.2 Test procedure

1. SS transmits PDSCH via PDCCH DCI format 2 for C_RNTI to transmit the DL RMC according to Table 8.4.1.2.2_1.3-2. The details of PDCCH and PDSCH are specified in Table A.3.5.1-1 and Table A.3.5.1-2 respectively. The SS sends downlink MAC padding bits on the DL RMC. Transmission scheme for the PDSCH shall be transmit diversity.
2. Set the parameters of the propagation condition, antenna configuration, the correlation matrix and the SNR according to Table 8.4.1.2.2_1.5-1.
3. Measure the Pm-dsg for a duration sufficient to achieve statistical significance according to Annex G clause G.3. Count the number of NACKs, ACKs and statDTXs on the UL PUCCH during each subtest interval. Pm-dsg is the ratio (statDTX)/(NACK+ACK+statDTX). If Pm-dsg is less than the value specified in table 8.4.1.2.2_1.5-1, pass the UE. Otherwise fail the UE.

8.4.1.2.2_1.4.3 Message contents

Message contents are according to TS 36.508 [7] clause 4.6 with the following exceptions:

Table 8.4.1.2.2_1.4.3-1: PhysicalConfigDedicated-DEFAULT

Derivation Path: 36.331 clause 6.3.2			
Information Element	Value/remark	Comment	Condition
PhysicalConfigDedicated-DEFAULT ::= SEQUENCE {			
antennaInfo CHOICE {			
antennaInfoDedicated ::= SEQUENCE {			
transmissionMode	tm4		
codebookSubsetRestriction CHOICE {			
n2TxAntenna-tm4	111111		
}			
ue-TransmitAntennaSelection CHOICE {			
release	NULL		
}			
}			

8.4.1.2.2_1.5 Test requirement

For the parameters specified in Table 8.4.1.2.2_1.3-1 the average probability of a missed downlink scheduling grant (Pm-dsg) shall be below the specified value in Table 8.4.1.2.2_1.5-1.

Table 8.4.1.2.2_1.5-1: Test requirement PDCCH/PCFICH 4 Tx Antenna Port

Test number	Bandwidth	Aggregation level	Reference Channel	OCNG Pattern	Propagation Condition	Antenna configuration and correlation Matrix	Reference value	
							Pm-dsg (%)	SNR (dB)
1	5 MHz	2 CCE	R.17 FDD	OP.1 FDD	EPA5	4 x 2 Medium	1	6.3+TT

8.4.2 TDD

8.4.2.1 TDD PCFICH/PDCCH Single-antenna Port Performance

8.4.2.1.1 Test purpose

This test verifies the demodulation performance of PCFICH/PDCCH for a single-antenna port with a given SNR for which the average probability of miss-detection of the Downlink Scheduling Grant, tested jointly on PDCCH and PCFICH of the specified reference measurement channels in A.3.5.2 remains below a given reference value.

8.4.2.1.2 Test applicability

This test applies to all types of E-UTRA TDD UE release 8 and forward.

8.4.2.1.3 Minimum conformance requirements

The receiver characteristics of the PDCCH/PCFICH are determined by the probability of miss-detection of the Downlink Scheduling Grant (P_{m-dsg}). PDCCH and PCFICH are tested jointly, i.e. a miss detection of PCFICH implies a miss detection of PDCCH.

Table 8.4.2.1.3-1: Test Parameters for PDCCH/PCFICH

Parameter		Unit	Single antenna port
Uplink downlink configuration (Note 1)			0
Special subframe configuration (Note 2)			4
Number of PDCCH symbols		symbols	2
Number of PHICH groups (N_g)			1
PHICH duration			Normal
Unused RE-s and PRB-s			OCNG
Cell ID			0
Downlink power allocation	PCFICH_RA PDCCH_RA PHICH_RA OCNG_RA	dB	0
	PCFICH_RB PDCCH_RB PHICH_R B OCNG_RB	dB	0
N_{oc} at antenna port		dBm/15kHz	-98
Cyclic prefix			Normal
ACK/NACK feedback mode			Multiplexing
Note 1: as specified in Table 4.2-2 in TS 36.211 [8]			
Note 2: as specified in Table 4.2-1 in TS 36.211 [8]			
Note 3: PHICH power setting refer to PHICH group power, i.e. the total power of all active PHICH sequences within a PHICH group.			

For the parameters specified in Table 8.4.2.1.3-1 the average probability of a missed downlink scheduling grant (P_{m-dsg}) shall be below the specified value in Table 8.4.2.1.3-2.

Table 8.4.2.1.3-2: Minimum performance PDCCH/PCFICH

Test number	Bandwidth	Aggregation level	Reference Channel	OCNG Pattern	Propagation Condition	Antenna configuration and correlation Matrix	Reference value	
							Pm-dsg (%)	SNR (dB)
1	10 MHz	8 CCE	R.15 TDD	OP.1 TDD	ETU70	1x2Low	1	-1.6

The normative reference for this requirement is TS 36.101 [2] clause 8.4.2.

8.4.2.1.4 Test description

8.4.2.1.4.1 Initial conditions

Initial conditions are a set of test configurations the UE needs to be tested in and the steps for the SS to take with the UE to reach the correct measurement state.

Configurations of PDSCH and PDCCH before measurement are specified in Annex C.2.

Test Environment: Normal, as defined in TS 36.508 [7] clause 4.1.

Frequencies to be tested: Mid Range, as defined in TS 36.508 [7] clause 4.3.1.2.

Channel Bandwidths to be tested: 10MHz, as defined in TS 36.508 [7] clause 4.3.1.2.

1. Connect the SS, the faders and AWGN noise source to the UE antenna connector (s) as shown in TS 36.508 [7] Annex A, Figure A.9.
2. The parameter settings for the cell are set up according to 8.4.2.1.3-1.
3. Downlink signals are initially set up according to Annex C0, C.1 and Annex C.3.2 and uplink signals according to Annex H.1 and H.3.2.
4. Propagation conditions are set according to Annex B.0.
5. Ensure the UE is in State 3A or 3A-RF according to TS 36.508 [7] clause 4.5.3A or 5.2A.2. Message contents are defined in clause 8.4.2.1.4.3.

8.4.2.1.4.2 Test procedure

1. SS transmits PDSCH via PDCCH DCI format 1 for C_RNTI to transmit the DL RMC according to Table 8.4.2.1.3-2. The details of PDCCH and PDSCH are specified in Table A.3.5.2-1 and Table A.3.5.2-2 respectively. The SS sends downlink MAC padding bits on the DL RMC.
2. Set the parameters of the propagation condition, the correlation matrix, antenna configuration and the SNR according to Tables 8.4.2.1.5-1 as appropriate.
3. Measure the Pm-dsg for a duration sufficient to achieve statistical significance according to Annex G clause G.4. Count the number of NACKs, ACKs and statDTXs on the UL PUCCH during each subtest interval. Pm-dsg is the ratio (statDTX)/(NACK +ACK+statDTX). If Pm-dsg is less than the value specified in table 8.4.2.1.5-1, pass the UE. Otherwise fail the UE.

8.4.2.1.4.3 Message contents

Message contents are according to TS 36.508 [7] clause 4.6 with the following exception:.

Table 8.4.2.1.4.3-1: TDD-Configuration-DEFAULT

Derivation Path: 36.508 clause 4.6.4			
Information Element	Value/remark	Comment	Condition
TDD-Configuration-DEFAULT ::= SEQUENCE {			
subframeAssignment	sa0		
specialSubframePatterns	Ssp4		
}			

8.4.2.1.5 Test requirement

For the parameters specified in Table 8.4.2.1.3-1 the average probability of a missed downlink scheduling grant (Pm-dsg) shall be below the specified value in Table 8.4.2.1.5-1.

Table 8.4.2.1.5-1: Test requirement PDCCH/PCFICH

Test number	Bandwidth	Aggregation level	Reference Channel	OCNG Pattern	Propagation Condition	Antenna configuration and correlation Matrix	Reference value	
							Pm-dsg (%)	SNR (dB)
1	10 MHz	8 CCE	R.15 TDD	OP.1 TDD	ETU70	1x2Low	1	-0.8

8.4.2.2 TDD PCFICH/PDCCH Transmit Diversity Performance

8.4.2.2.1 TDD PCFICH/PDCCH Transmit Diversity 2x2

8.4.2.2.1.1 Test purpose

This test verifies the demodulation performance of PCFICH/PDCCH for transmit diversity with a given SNR for which the average probability of miss-detection of the Downlink Scheduling Grant, tested jointly on PDCCH and PCFICH of the specified reference measurement channels in A.3.5.2 remains below a given reference value.

8.4.2.2.1.2 Test applicability

This test applies to all types of E-UTRA TDD UE release 8.

8.4.2.2.1.3 Minimum conformance requirements

The receiver characteristics of the PDCCH/PCFICH are determined by the probability of miss-detection of the Downlink Scheduling Grant (Pm-dsg). PDCCH and PCFICH are tested jointly, i.e. a miss detection of PCFICH implies a miss detection of PDCCH.

Table 8.4.2.2.1.3-1: Test Parameters for PDCCH/PCFICH

Parameter		Unit	Transmit diversity
Uplink downlink configuration (Note 1)			0
Special subframe configuration (Note 2)			4
Number of PDCCH symbols		symbols	2
Number of PHICH groups (N_g)			1
PHICH duration			Normal
Unused RE-s and PRB-s			OCNG
Cell ID			0
Downlink power allocation	PCFICH_RA PDCCH_RA PHICH_RA OCNG_RA	dB	-3
	PCFICH_RB PDCCH_RB PHICH_RB OCNG_RB	dB	-3
N_{oc} at antenna port		dBm/15kHz	-98
Cyclic prefix			Normal
ACK/NACK feedback mode			Multiplexing
Note 1: as specified in Table 4.2-2 in TS 36.211 [8]			
Note 2: as specified in Table 4.2-1 in TS 36.211 [8]			
Note 3: PHICH power setting refer to PHICH group power, i.e. the total power of all active PHICH sequences within a PHICH group			

For the parameters specified in Table 8.4.2.2.1.3-1 the average probability of a missed downlink scheduling grant (P_{m-dsg}) shall be below the specified value in Table 8.4.2.2.1.3-2.

Table 8.4.2.2.1.3-2: Minimum performance PDCCH/PCFICH 2 Tx Antenna Port

Test number	Bandwidth	Aggregation level	Reference Channel	OCNG Pattern	Propagation Condition	Antenna configuration and correlation Matrix	Reference value	
							Pm-dsg (%)	SNR (dB)
1	1.4 MHz	2 CCE	R.16 TDD	OP.1 TDD	EPA5	2 x 2 Low	1	4.2

The normative reference for this requirement is TS 36.101 [2] clause 8.4.2.

8.4.2.2.1.4 Test description

8.4.2.2.1.4.1 Initial conditions

Initial conditions are a set of test configurations the UE needs to be tested in and the steps for the SS to take with the UE to reach the correct measurement state.

Configurations of PDSCH and PDCCH before measurement are specified in Annex C.2.

Test Environment: Normal, as defined in TS 36.508 [7] clause 4.1.

Frequencies to be tested: Mid Range, as defined in TS 36.508 [7] clause 4.3.1.1.

Channel Bandwidths to be tested: 1.4MHz, as defined in TS 36.508 [7] clause 4.3.1.1

1. Connect the SS, the faders and AWGN noise sources to the UE antenna connectors as shown in TS 36.508 [7] Annex A, Figure A.10.
2. The parameter settings for the cell are set up according to 8.4.2.2.1.3-1.

3. Downlink signals are initially set up according to Annex C0, C.1 and C.3.2 and uplink signals according to Annex H.1 and H.3.2.
4. Propagation conditions are set according to Annex B.0.
5. Ensure the UE is in State 3A or 3A-RF according to TS 36.508 [7] clause 4.5.3A or 5.2A.2. Message contents are defined in clause 8.4.2.2.1.4.3.

8.4.2.2.1.4.2 Test procedure

1. SS transmits PDSCH via PDCCH DCI format 2 for C_RNTI to transmit the DL RMC according to Table 8.4.2.2.1.3-2. The details of PDCCH and PDSCH are specified in Table A.3.5.2-1 and Table A.3.5.2-2 respectively. The SS sends downlink MAC padding bits on the DL RMC. Transmission scheme for the PDSCH shall be transmit diversity.
2. Set the parameters of the propagation condition, the correlation matrix, antenna configuration and the SNR according to Tables 8.4.2.2.1.5-1 as appropriate.
3. Measure the Pm-dsg for a duration sufficient to achieve statistical significance according to Annex G clause G.4. Count the number of NACKs, ACKs and statDTXs on the UL PUCCH during each subtest interval. Pm-dsg is the ratio (statDTX)/(NACK +ACK+statDTX). If Pm-dsg is less than the value specified in table 8.4.2.2.1.5-1, pass the UE. Otherwise fail the UE

8.4.2.2.1.4.3 Message contents

Message contents are according to TS 36.508 [7] clause 4.6 with the following exception:

Table 8.4.2.2.1.4.3-1: TDD-Configuration-DEFAULT

Derivation Path: 36.508 clause 4.6.4			
Information Element	Value/remark	Comment	Condition
TDD-Configuration-DEFAULT ::= SEQUENCE {			
subframeAssignment	Sa0		
specialSubframePatterns	Ssp4		
}			

Table 8.4.2.2.1.4.3-2: PhysicalConfigDedicated-DEFAULT

Derivation Path: 36.331 clause 6.3.2			
Information Element	Value/remark	Comment	Condition
PhysicalConfigDedicated-DEFAULT ::= SEQUENCE {			
antennaInfo CHOICE {			
antennaInfoDedicated ::= SEQUENCE {			
transmissionMode	tm4		
codebookSubsetRestriction CHOICE {			
n2TxAntenna-tm4	111111		
}			
ue-TransmitAntennaSelection CHOICE {			
release	NULL		
}			
}			
}			
}			

8.4.2.2.1.5 Test requirement

For the parameters specified in Table 8.4.2.2.1.3-1 the average probability of a missed downlink scheduling grant (Pm-dsg) shall be below the specified value in Table 8.4.2.2.1.5-1.

Table 8.4.2.2.1.5-1: Test requirement PDCCH/PCFICH 2 Tx Antenna Port

Test number	Bandwidth	Aggregation level	Reference Channel	OCNG Pattern	Propagation Condition	Antenna configuration and correlation Matrix	Reference value	
							Pm-dsg (%)	SNR (dB)
1	1.4 MHz	2 CCE	[R.16 TDD]	OP.1 TDD	EPA5	2 x 2 Low	1	5.2

8.4.2.2.1_1 TDD PCFICH/PDCCH Transmit Diversity 2x2

Editor's note: This clause is incomplete. The following aspects are either missing or not yet determined:

- Test tolerance is undefined

8.4.2.2.1_1.1 Test purpose

This test verifies the demodulation performance of PCFICH/PDCCH for transmit diversity with a given SNR for which the average probability of miss-detection of the Downlink Scheduling Grant, tested jointly on PDCCH and PCFICH of the specified reference measurement channels in A.3.5.2 remains below a given reference value.

8.4.2.2.1_1.2 Test applicability

This test applies to all types of E-UTRA TDD UE release 9 and forward.

8.4.2.2.1_1.3 Minimum conformance requirements

The receiver characteristics of the PDCCH/PCFICH are determined by the probability of miss-detection of the Downlink Scheduling Grant (Pm-dsg). PDCCH and PCFICH are tested jointly, i.e. a miss detection of PCFICH implies a miss detection of PDCCH.

Table 8.4.2.2.1_1.3-1: Test Parameters for PDCCH/PCFICH

Parameter		Unit	Transmit diversity
Uplink downlink configuration (Note 1)			0
Special subframe configuration (Note 2)			4
Number of PDCCH symbols		symbols	2
Number of PHICH groups (N_g)			1
PHICH duration			Normal
Unused RE-s and PRB-s			OCNG
Cell ID			0
Downlink power allocation	PCFICH_RA PDCCH_RA PHICH_RA OCNG_RA	dB	-3
	PCFICH_RB PDCCH_RB PHICH_RB OCNG_RB	dB	-3
N_{oc} at antenna port		dBm/15kHz	-98
Cyclic prefix			Normal
ACK/NACK feedback mode			Multiplexing
Note 1: as specified in Table 4.2-2 in TS 36.211 [8] Note 2: as specified in Table 4.2-1 in TS 36.211 [8] Note 3: PHICH power setting refer to PHICH group power, i.e. the total power of all active PHICH sequences within a PHICH group			

For the parameters specified in Table 8.4.2.2.1_1.3-1 the average probability of a missed downlink scheduling grant (Pm-dsg) shall be below the specified value in Table 8.4.2.2.1_1.3-2.

Table 8.4.2.2.1_1.3-2: Minimum performance PDCCH/PCFICH 2 Tx Antenna Port

Test number	Bandwidth	Aggregation level	Reference Channel	OCNG Pattern	Propagation Condition	Antenna configuration and correlation Matrix	Reference value	
							Pm-dsg (%)	SNR (dB)
1	10 MHz	4 CCE	R.16 TDD	OP.1 TDD	EVA70	2 x 2 Low	1	0.1

The normative reference for this requirement is TS 36.101 [2] clause 8.4.2.

8.4.2.2.1_1.4 Test description

8.4.2.2.1_1.4.1 Initial conditions

Initial conditions are a set of test configurations the UE needs to be tested in and the steps for the SS to take with the UE to reach the correct measurement state.

Configurations of PDSCH and PDCCH before measurement are specified in Annex C.2.

Test Environment: Normal, as defined in TS 36.508 [7] clause 4.1.

Frequencies to be tested: Mid Range, as defined in TS 36.508 [7] clause 4.3.1.1.

Channel Bandwidths to be tested: 10MHz, as defined in TS 36.508 [7] clause 4.3.1.1

1. Connect the SS, the faders and AWGN noise sources to the UE antenna connectors as shown in TS 36.508 [7] Annex A, Figure A.10.
2. The parameter settings for the cell are set up according to 8.4.2.2.1_1.3-1.
3. Downlink signals are initially set up according to Annex C0, C.1 and C.3.2 and uplink signals according to Annex H.1 and H.3.2.
4. Propagation conditions are set according to Annex B.0.
5. Ensure the UE is in State 3A or 3A-RF according to TS 36.508 [7] clause 4.5.3A or 5.2A.2. Message contents are defined in clause 8.4.2.2.1_1.4.3.

8.4.2.2.1_1.4.2 Test procedure

1. SS transmits PDSCH via PDCCH DCI format 2 for C_RNTI to transmit the DL RMC according to Table 8.4.2.2.1_1.3-2. The details of PDCCH and PDSCH are specified in Table A.3.5.2-1 and Table A.3.5.2-2 respectively. The SS sends downlink MAC padding bits on the DL RMC. Transmission scheme for the PDSCH shall be transmit diversity.
2. Set the parameters of the propagation condition, the correlation matrix, antenna configuration and the SNR according to Tables 8.4.2.2.1_1.5-1 as appropriate.
3. Measure the Pm-dsg for a duration sufficient to achieve statistical significance according to Annex G clause G.4. Count the number of NACKs, ACKs and statDTXs on the UL PUCCH during each subtest interval. Pm-dsg is the ratio (statDTX)/(NACK +ACK+statDTX). If Pm-dsg is less than the value specified in table 8.4.2.2.1_1.5-1, pass the UE. Otherwise fail the UE

8.4.2.2.1_1.4.3 Message contents

Message contents are according to TS 36.508 [7] clause 4.6 with the following exception:.

Table 8.4.2.2.1_1.4.3-1: TDD-Configuration-DEFAULT

Derivation Path: 36.508 clause 4.6.4			
Information Element	Value/remark	Comment	Condition
TDD-Configuration-DEFAULT ::= SEQUENCE {			
subframeAssignment	Sa0		
specialSubframePatterns	Ssp4		
}			

Table 8.4.2.2.1_1.4.3-2: PhysicalConfigDedicated-DEFAULT

Derivation Path: 36.331 clause 6.3.2			
Information Element	Value/remark	Comment	Condition
PhysicalConfigDedicated-DEFAULT ::= SEQUENCE {			
antennaInfo CHOICE {			
antennaInfoDedicated ::= SEQUENCE {			
transmissionMode	tm4		
codebookSubsetRestriction CHOICE {			
n2TxAntenna-tm4	111111		
}			
ue-TransmitAntennaSelection CHOICE {			
release	NULL		
}			
}			
}			

8.4.2.2.1_1.5 Test requirement

For the parameters specified in Table 8.4.2.2.1_1.3-1 the average probability of a missed downlink scheduling grant (Pm-dsg) shall be below the specified value in Table 8.4.2.2.1_1.5-1.

Table 8.4.2.2.1_1.5-1: Test requirement PDCCH/PCFICH 2 Tx Antenna Port

Test number	Bandwidth	Aggregation level	Reference Channel	OCNG Pattern	Propagation Condition	Antenna configuration and correlation Matrix	Reference value	
							Pm-dsg (%)	SNR (dB)
1	10 MHz	4 CCE	R.16 TDD	OP.1 TDD	EVA70	2 x 2 Low	1	0.1+TT

8.4.2.2.2 TDD PCFICH/PDCCH Transmit Diversity 4x2

8.4.2.2.2.1 Test purpose

This test verifies the demodulation performance of PCFICH/PDCCH for transmit diversity with a given SNR for which the average probability of miss-detection of the Downlink Scheduling Grant, tested jointly on PDCCH and PCFICH of the specified reference measurement channels in A.3.5.2 remains below a given reference value.

8.4.2.2.2.2 Test applicability

This test applies to all types of E-UTRA TDD UE release 8.

8.4.2.2.2.3 Minimum conformance requirements

The receiver characteristics of the PDCCH/PCFICH are determined by the probability of miss-detection of the Downlink Scheduling Grant (Pm-dsg). PDCCH and PCFICH are tested jointly, i.e. a miss detection of PCFICH implies a miss detection of PDCCH.

Table 8.4.2.2.3-1: Test Parameters for PDCCH/PCFICH

Parameter		Unit	Transmit diversity
Uplink downlink configuration (Note 1)			0
Special subframe configuration (Note 2)			4
Number of PDCCH symbols		symbols	2
Number of PHICH groups (N_g)			1
PHICH duration			Normal
Unused RE-s and PRB-s			OCNG
Cell ID			0
Downlink power allocation	PCFICH_RA PDCCH_RA PHICH_RA OCNG_RA	dB	-3
	PCFICH_RB PDCCH_RB PHICH_RB OCNG_RB	dB	-3
N_{oc} at antenna port		dBm/15kHz	-98
Cyclic prefix			Normal
ACK/NACK feedback mode			Multiplexing
Note 1: as specified in Table 4.2-2 in TS 36.211 [8]			
Note 2: as specified in Table 4.2-1 in TS 36.211 [8]			
Note 3: PHICH power setting refer to PHICH group power, i.e. the total power of all active PHICH sequences within a PHICH group.			

For the parameters specified in Table 8.4.2.2.3-1 the average probability of a missed downlink scheduling grant (P_{m-dsg}) shall be below the specified value in Table 8.4.2.2.3-2.

Table 8.4.2.2.3-2: Minimum performance PDCCH/PCFICH 2 Tx Antenna Port

Test number	Bandwidth	Aggregation level	Reference Channel	OCNG Pattern	Propagation Condition	Antenna configuration and correlation Matrix	Reference value	
							Pm-dsg (%)	SNR (dB)
1	10 MHz	4 CCE	R.17 TDD	OP.1 TDD	EVA5	4 x 2 Medium	1	1.2

The normative reference for this requirement is TS 36.101 [2] clause 8.4.2.

8.4.2.2.2.4 Test description

8.4.2.2.2.4.1 Initial conditions

Initial conditions are a set of test configurations the UE needs to be tested in and the steps for the SS to take with the UE to reach the correct measurement state.

Configurations of PDSCH and PDCCH before measurement are specified in Annex C.2.

Test Environment: Normal, as defined in TS 36.508 [7] clause 4.1.

Frequencies to be tested: Mid Range, as defined in TS 36.508 [7] clause 4.3.1.1.

Channel Bandwidths to be tested: 10 MHz, as defined in TS 36.508 [7] clause 4.3.1.1

1. Connect the SS, the faders and AWGN noise sources to the UE antenna connectors as shown in TS 36.508 [7] Annex A, Figure A.11.

2. The parameter settings for the cell are set up according to 8.4.2.2.3-1.
3. Downlink signals are initially set up according to Annex C0, C.1 and C.3.2 and uplink signals according to Annex H.1 and H.3.2.
4. Propagation conditions are set according to Annex B.0.
5. Ensure the UE is in State 3A or 3A-RF according to TS 36.508 [7] clause 4.5.3A or 5.2A.2. Message contents are defined in clause 8.4.2.2.4.3.

8.4.2.2.4.2 Test procedure

1. SS transmits PDSCH via PDCCH DCI format 2 for C_RNTI to transmit the DL RMC according to Table 8.4.2.2.3-2. The details of PDCCH and PDSCH are specified in Table A.3.5.2-1 and Table A.3.5.2-2 respectively. The SS sends downlink MAC padding bits on the DL RMC. Transmission scheme for the PDSCH shall be transmit diversity.
2. Set the parameters of the propagation condition, the correlation matrix, antenna configuration and the SNR according to Tables 8.4.2.2.5-1 as appropriate.
3. Measure the Pm-dsg for a duration sufficient to achieve statistical significance according to Annex G clause G.4. Count the number of NACKs, ACKs and statDTXs on the UL PUCCH during each subtest interval. Pm-dsg is the ratio (statDTX)/(NACK + ACK + statDTX). If Pm-dsg is less than the value specified in table 8.4.2.2.5-1, pass the UE. Otherwise fail the UE

8.4.2.2.4.3 Message contents

Message contents are according to TS 36.508 [7] clause 4.6 with the following exception..

Table 8.4.2.2.4.3-1: TDD-Configuration-DEFAULT

Derivation Path: 36.508 clause 4.6.4			
Information Element	Value/remark	Comment	Condition
TDD-Configuration-DEFAULT ::= SEQUENCE {			
subframeAssignment	Sa0		
specialSubframePatterns	Ssp4		
}			

Table 8.4.2.2.4.3-2: PhysicalConfigDedicated-DEFAULT

Derivation Path: 36.331 clause 6.3.2			
Information Element	Value/remark	Comment	Condition
PhysicalConfigDedicated-DEFAULT ::= SEQUENCE {			
antennaInfo CHOICE {			
antennaInfoDedicated ::= SEQUENCE {			
transmissionMode	tm4		
codebookSubsetRestriction CHOICE {			
n2TxAntenna-tm4	111111		
}			
ue-TransmitAntennaSelection CHOICE {			
release	NULL		
}			
}			
}			

8.4.2.2.5 Test requirement

For the parameters specified in Table 8.4.2.2.3-1 the average probability of a missed downlink scheduling grant (Pm-dsg) shall be below the specified value in Table 8.4.2.2.5-1.

Table 8.4.2.2.5-1: Test requirement PDCCH/PCFICH 2 Tx Antenna Port

Test number	Bandwidth	Aggregation level	Reference Channel	OCNG Pattern	Propagation Condition	Antenna configuration and correlation Matrix	Reference value	
							Pm-dsg (%)	SNR (dB)
1	10 MHz	4 CCE	R.17 TDD	OP.1 TDD	EVA5	4 x 2 Medium	1	2.2

8.4.2.2.2_1 TDD PCFICH/PDCCH Transmit Diversity 4x2

Editor's note: This clause is incomplete. The following aspects are either missing or not yet determined:

- Test tolerance is undefined

8.4.2.2.2_1.1 Test purpose

This test verifies the demodulation performance of PCFICH/PDCCH for transmit diversity with a given SNR for which the average probability of miss-detection of the Downlink Scheduling Grant, tested jointly on PDCCH and PCFICH of the specified reference measurement channels in A.3.5.2 remains below a given reference value.

8.4.2.2.2_1.2 Test applicability

This test applies to all types of E-UTRA TDD UE release 9 and forward.

8.4.2.2.2_1.3 Minimum conformance requirements

The receiver characteristics of the PDCCH/PCFICH are determined by the probability of miss-detection of the Downlink Scheduling Grant (Pm-dsg). PDCCH and PCFICH are tested jointly, i.e. a miss detection of PCFICH implies a miss detection of PDCCH.

Table 8.4.2.2.2_1.3-1: Test Parameters for PDCCH/PCFICH

Parameter		Unit	Transmit diversity
Uplink downlink configuration (Note 1)			0
Special subframe configuration (Note 2)			4
Number of PDCCH symbols		symbols	2
Number of PHICH groups (N_g)			1
PHICH duration			Normal
Unused RE-s and PRB-s			OCNG
Cell ID			0
Downlink power allocation	PCFICH_RA PDCCH_RA PHICH_RA OCNG_RA	dB	-3
	PCFICH_RB PDCCH_RB PHICH_RB OCNG_RB	dB	-3
N_{oc} at antenna port		dBm/15kHz	-98
Cyclic prefix			Normal
ACK/NACK feedback mode			Multiplexing
Note 1: as specified in Table 4.2-2 in TS 36.211 [8] Note 2: as specified in Table 4.2-1 in TS 36.211 [8] Note 3: PHICH power setting refer to PHICH group power, i.e. the total power of all active PHICH sequences within a PHICH group.			

For the parameters specified in Table 8.4.2.2.2_1.3-1 the average probability of a missed downlink scheduling grant (Pm-dsg) shall be below the specified value in Table 8.4.2.2.2_1.3-2.

Table 8.4.2.2.2_1.3-2: Minimum performance PDCCH/PCFICH 2 Tx Antenna Port

Test number	Bandwidth	Aggregation level	Reference Channel	OCNG Pattern	Propagation Condition	Antenna configuration and correlation Matrix	Reference value	
							Pm-dsg (%)	SNR (dB)
1	5 MHz	2 CCE	R.17 TDD	OP.1 TDD	EPA5	4 x 2 Medium	1	6.5

The normative reference for this requirement is TS 36.101 [2] clause 8.4.2.

8.4.2.2.2_1.4 Test description

8.4.2.2.2_1.4.1 Initial conditions

Initial conditions are a set of test configurations the UE needs to be tested in and the steps for the SS to take with the UE to reach the correct measurement state.

Configurations of PDSCH and PDCCH before measurement are specified in Annex C.2.

Test Environment: Normal, as defined in TS 36.508 [7] clause 4.1.

Frequencies to be tested: Mid Range, as defined in TS 36.508 [7] clause 4.3.1.1.

Channel Bandwidths to be tested: 5 MHz, as defined in TS 36.508 [7] clause 4.3.1.1

1. Connect the SS, the faders and AWGN noise sources to the UE antenna connectors as shown in TS 36.508 [7] Annex A, Figure A.11.
2. The parameter settings for the cell are set up according to 8.4.2.2.2_1.3-1.
3. Downlink signals are initially set up according to Annex C0, C.1 and C.3.2 and uplink signals according to Annex H.1 and H.3.2.
4. Propagation conditions are set according to Annex B.0.
5. Ensure the UE is in State 3A or 3A-RF according to TS 36.508 [7] clause 4.5.3A or 5.2A.2. Message contents are defined in clause 8.4.2.2.2_1.4.3.

8.4.2.2.2_1.4.2 Test procedure

1. SS transmits PDSCH via PDCCH DCI format 2 for C_RNTI to transmit the DL RMC according to Table 8.4.2.2.2.3-2. The details of PDCCH and PDSCH are specified in Table A.3.5.2-1 and Table A.3.5.2-2 respectively. The SS sends downlink MAC padding bits on the DL RMC. Transmission scheme for the PDSCH shall be transmit diversity.
2. Set the parameters of the propagation condition, the correlation matrix, antenna configuration and the SNR according to Tables 8.4.2.2.2_1.5-1 as appropriate.
3. Measure the Pm-dsg for a duration sufficient to achieve statistical significance according to Annex G clause G.4. Count the number of NACKs, ACKs and statDTXs on the UL PUCCH during each subtest interval. Pm-dsg is the radio (statDTX)/(NACK + ACK + statDTX). If Pm-dsg is less than the value specified in table 8.4.2.2.2_1.5-1, pass the UE. Otherwise fail the UE

8.4.2.2.2_1.4.3 Message contents

Message contents are according to TS 36.508 [7] clause 4.6 with the following exception:.

Table 8.4.2.2.2_1.4.3-1: TDD-Configuration-DEFAULT

Derivation Path: 36.508 clause 4.6.4			
Information Element	Value/remark	Comment	Condition
TDD-Configuration-DEFAULT ::= SEQUENCE {			
subframeAssignment	Sa0		
specialSubframePatterns	Ssp4		
}			

Table 8.4.2.2.2_1.4.3-2: PhysicalConfigDedicated-DEFAULT

Derivation Path: 36.331 clause 6.3.2			
Information Element	Value/remark	Comment	Condition
PhysicalConfigDedicated-DEFAULT ::= SEQUENCE {			
antennaInfo CHOICE {			
antennaInfoDedicated ::= SEQUENCE {			
transmissionMode	tm4		
codebookSubsetRestriction CHOICE {			
n2TxAntenna-tm4	111111		
}			
ue-TransmitAntennaSelection CHOICE {			
release	NULL		
}			
}			
}			

8.4.2.2.2.5 Test requirement

For the parameters specified in Table 8.4.2.2.2.3-1 the average probability of a missed downlink scheduling grant (P_{m-dsg}) shall be below the specified value in Table 8.4.2.2.2_1.5-1.

Table 8.4.2.2.2_1.5-1: Test requirement PDCCH/PCFICH 2 Tx Antenna Port

Test number	Bandwidth	Aggregation level	Reference Channel	OCNG Pattern	Propagation Condition	Antenna configuration and correlation Matrix	Reference value	
							P _{m-dsg} (%)	SNR (dB)
1	5 MHz	2 CCE	R.17 TDD	OP.1 TDD	EPA5	4 x 2 Medium	1	6.5+TT

8.5 Demodulation of PHICH

8.5.1 FDD

8.5.1.1 FDD PHICH Single-antenna Port Performance

8.5.1.1.1 Test purpose

This test verifies the demodulation performance of PHICH for a single antenna port with a given SNR for which the average probability of miss detection of Hybrid Indicator (“ACK to NACK”) of the specified reference measurement channels remains below a specified value.

8.5.1.1.2 Test applicability

This test applies to all types of E-UTRA FDD UE release 8 and forward.

8.5.1.1.3 Minimum conformance requirements

The receiver characteristics of the PHICH are determined by the probability of miss-detecting an ACK for a NACK (P_{m-an}). It is assumed that there is no bias applied to the detection of ACK and NACK (zero-threshold detection).

Table 8.5.1.1.3-1: Test Parameters for PHICH

Parameter		Unit	Single antenna port
Downlink power allocation	PCFICH_RA PDCCH_RA PHICH_RA OCNG_RA	dB	0
	PCFICH_RB PDCCH_RB PHICH_RB OCNG_RB	dB	0
PHICH duration			Normal
Number of PHICH groups (Note 1)			$N_g = 1$
PDCCH Content		UL Grant should be included with the proper information aligned with A.3.6.	
Unused RE-s and PRB-s			OCNG
Cell ID			0
N_{oc} at antenna port		dBm/15kHz	-98
Cyclic prefix			Normal
Note 1:		according to Clause 6.9 in TS 36.211 [8]	
Note 2:		PHICH power settings refer to PHICH group power, i.e. the total power of all active PHICH sequences within a PHICH group.	

For the parameters specified in Table 8.5.1.1.3-1 the average probability of a miss-detecting an ACK for a NACK (P_{m-an}) shall be below the specified value in Table 8.5.1.1.3-2.

Table 8.5.1.1.3-2: Minimum performance PHICH

Test number	Bandwidth	Reference Channel	OCNG Pattern	Propagation Condition	Antenna configuration and correlation Matrix	Reference value	
						P_{m-an} (%)	SNR (dB)
1	10 MHz	R.18	OP.1 FDD	ETU70	1 x 2 Low	0.1	5.5
2	10 MHz	R.24	OP.1 FDD	ETU70	1 x 2 Low	0.1	0.6

The normative reference for this requirement is TS 36.101 [2] clause 8.5.

8.5.1.1.4 Test description

8.5.1.1.4.1 Initial conditions

Initial conditions are a set of test configurations the UE needs to be tested in and the steps for the SS to take with the UE to reach the correct measurement state.

Configurations of PDSCH and PDCCH before measurement are specified in Annex C.2.

Test Environment: Normal as defined in TS 36.508 [7] clause 4.1.

Frequencies to be tested: Mid Range as defined in TS 36.508 [7] clause 4.3.1.1.

Channel Bandwidths to be tested: 10 MHz, as defined in TS 36.508 [7] clause 4.3.1.1

1. Connect the SS, the faders and AWGN noise sources to the UE antenna connector (s) as shown in TS 36.508 [7] Annex A, Figure A.9.
2. The parameter settings for the cell are set up according to Table 8.5.1.1.3-1.
3. Downlink signals are initially set up according to Annex C0, C.1 and Annex C.3.2 and uplink signals according to Annex H.1 and H.3.2.
4. Propagation conditions are set according to Annex B.0.
5. Ensure the UE is in State 3A or 3A-RF according to TS 36.508 [7] clause 4.5.3A or 5.2A.2 and receiving payload data from the SS. Message contents are defined in clause 8.5.1.1.4.3.

8.5.1.1.4.2 Test procedure

1. Set the parameters of bandwidth, reference Channel, the propagation condition, antenna configuration, the correlation matrix and the SNR according to Table 8.5.1.1.5-1 Test 1 as appropriate.
2. SS shall schedule PUSCH transmissions according to Annex A.2.2.1.1 Table A.2.2.1.1-1 to happen during 8 consecutive uplink TTIs via PDCCH DCI format 0 with new data indicator set to true. Since the UE has no payload, the UE shall send uplink MAC padding bits in PUSCH. SS upon receiving the PUSCH transmissions will transmit the associated ACKs. PHICH is set according to Annex 3.6 Table A.3.6-1. SS will only transmit PDCCH to schedule PUSCH transmission in the appropriate sub-frames. Table 8.5.1.1.4.2-1 indicates the transmissions for one cycle.

Table 8.5.1.1.4.2-1: PHICH test pattern

TTI	1-4	5-8	9-12	13-16	17-20	21-24
PDCCH	S	S	-	-	S	S
PHICH	-	-	A	A	-	-
PUSCH		T	T	R	R	T
UL HARQ Process	1-4	5-8	1-4	5-8	1-4	5-8
Note 1: This table gives an example test pattern for HARQ process for FDD PHICH test Note 2: Following notation is used: S: represents sending PDCCH DCI format 0 to schedule a future PUSCH transmission A: represents the ACK transmission on PHICH T: represents a scheduled PUSCH transmission R: represents a potential PUSCH re-transmission due to a missed ACK						

3. SS will only monitor for uplink retransmissions due to ACK missed-detections. Such re-transmissions (if they occur) will potentially happen in TTI 13 to 20. DTXs on TTI 13 to 20 are counted as successful ACK receptions while any transmission on these TTIs is counted as NACKs.
4. Repeat steps 1 – 3 for a duration sufficient to achieve statistical significance according to Annex G clause G.4 and measure Pm-an. Pm-an is (NACK) / (ACK + NACK).
If Pm-an is less than the value specified in table 8.5.1.1.5-1, pass the UE. Otherwise fail the UE.
5. Repeat the same procedure (steps 1 to 3) with test conditions according to the Table 8.5.1.1.5-1 for Test 2.

8.5.1.1.4.3 Message contents

Message contents are according to TS 36.508 [7] clause 4.6, with the following exceptions

Table 8.5.1.1.4.3-1: MAC-MainConfig-RBC

Derivation Path: TS 36.508 [7] clause 4.8.2.1.5, Table 4.8.2.1.5-1			
Information Element	Value/remark	Comment	Condition
MAC-MainConfig-RBC ::= SEQUENCE {			
dl-SCH-Config SEQUENCE {}	Not present		
ul-SCH-Config SEQUENCE {			
maxHARQ-Tx	n2	Only one retransmission per UL HARQ	
...			

8.5.1.1.5 Test requirement

For the parameters specified in Table 8.5.1.1.3-1 the average probability of a miss-detecting ACK for NACK (P_{m-dsg}) shall be below the specified value in Table 8.5.1.1.5-1.

Table 8.5.1.1.5-1: Test requirement PHICH

Test number	Bandwidth	Reference Channel	OCNG Pattern	Propagation Condition	Antenna configuration and correlation Matrix	Reference value	
						P_{m-an} (%)	SNR (dB)
1	10 MHz	R.18	OP.1 FDD	ETU70	1 x 2 Low	0.1	6.4
2	10 MHz	R.24	OP.1 FDD	ETU70	1 x 2 Low	0.1	1.5

8.5.1.2 FDD PHICH Transmit Diversity Performance

8.5.1.2.1 FDD PHICH Transmit Diversity 2x2

8.5.1.2.1.1 Test purpose

This test verifies the demodulation performance of PHICH for transmit diversity with a given SNR for which the average probability of miss detection of Hybrid Indicator (“ACK to NACK”) of the specified reference measurement channels remains below a specified value.

8.5.1.2.1.2 Test applicability

This test applies to all types of E-UTRA FDD UE release 8.

8.5.1.2.1.3 Minimum conformance requirements

The receiver characteristics of the PHICH are determined by the probability of miss-detecting an ACK for a NACK (P_{m-an}). It is assumed that there is no bias applied to the detection of ACK and NACK (zero-threshold detection).

Table 8.5.1.2.1.3-1: Test Parameters for PHICH

Parameter		Unit	Transmit diversity
Downlink power allocation	PCFICH_RA PDCCH_RA PHICH_RA OCNG_RA	dB	-3
	PCFICH_RB PDCCH_RB PHICH_RB OCNG_RB	dB	-3
PHICH duration			Normal
Number of PHICH groups (Note 1)			Ng = 1
PDCCH Content		UL Grant should be included with the proper information aligned with A.3.6.	
Unused RE-s and PRB-s			OCNG
Cell ID			0
N_{oc} at antenna port		dBm/15kHz	-98
Cyclic prefix			Normal
Note 1: according to Clause 6.9 in TS 36.211 [8]			
Note 2: PHICH power settings refer to PHICH group power, i.e. the total power of all active PHICH sequences within a PHICH group.			

For the parameters specified in Table 8.5.1.2.1.3-1 the average probability of a miss-detecting an ACK for a NACK (P_{m-an}) shall be below the specified value in Table 8.5.1.2.1.3-2

Table 8.5.1.2.1.3-2: Minimum performance PHICH 2 Tx Antenna Port

Test number	Bandwidth	Reference Channel	OCNG Pattern	Propagation Condition	Antenna configuration and correlation Matrix	Reference value	
						P_{m-an} (%)	SNR (dB)
1	1.4 MHz	R.19	OP.1 FDD	EPA5	2 x 2 Low	0.1	5.6

The normative reference for this requirement is TS 36.101 [2] clause 8.5.1.

8.5.1.2.1.4 Test description

8.5.1.2.1.4.1 Initial conditions

Test Environment: Normal as defined in TS 36.508 [7] clause 4.1.

Frequencies to be tested: Mid Range as defined in TS 36.508 [7] clause 4.3.1.1.

Channel Bandwidths to be tested: 1.4 MHz, as defined in TS 36.508 [7] clause 4.3.1.1

1. Connect the SS, the faders and AWGN noise sources to the UE antenna connector (s) as shown in TS 36.508 [7] Annex A, Figure A.10.
2. The parameter settings for the cell are set up according to Table 8.5.1.2.1.3-1.
3. Downlink signals are initially set up according to Annex C.1 and C.3.2 and uplink signals according to Annex H.1 and H.3.2.
4. Propagation conditions are set according to Annex B clauses B.0.
5. Ensure the UE is in State 3A or 3A-RF according to TS 36.508 [7] clause 4.5.3A or 5.2A.2 and receiving payload data from the SS. Message contents are defined in clause 8.5.1.2.1.4.3.

8.5.1.2.1.4.2 Test procedure

1. Set the parameters of bandwidth, reference Channel, the propagation condition, antenna configuration, the correlation matrix and the SNR according to Table 8.5.1.2.1.5-1.
2. SS shall schedule PUSCH transmissions according to Annex A.2.2.1.1 Table A.2.2.1.1-1 to happen during 8 consecutive uplink TTIs via PDCCH DCI format 0 with new data indicator set to true. Since the UE has no payload, the UE shall send uplink MAC padding bits in PUSCH. SS upon receiving the PUSCH transmissions will transmit the associated ACKs. PHICH is set according to Annex 3.6 Table A.3.6-1. SS will only transmit PDCCH to schedule PUSCH transmission in the appropriate sub-frames. Table 8.5.1.2.1.4.2-1 indicates the transmissions for one cycle.

Table 8.5.1.2.1.4.2-1: PHICH test pattern

TTI	1-4	5-8	9-12	13-16	17-20	21-24
PDCCH	S	S	-	-	S	S
PHICH	-	-	A	A	-	-
PUSCH		T	T	R	R	T
UL HARQ Process	1-4	5-8	1-4	5-8	1-4	5-8
Note 1: This table gives an example test pattern for HARQ process for FDD PHICH test Note 2: Following notation is used: S: represents sending PDCCH DCI format 0 to schedule a future PUSCH transmission A: represents the ACK transmission on PHICH T: represents a scheduled PUSCH transmission R: represents a potential PUSCH re-transmission due to a missed ACK						

3. SS will only monitor for uplink retransmissions due to ACK missed-detections. Such re-transmissions (if they occur) will potentially happen in TTI 13 to 20. DTXs on TTI 13 to 20 are counted as successful ACK receptions while any transmission on these TTIs is counted as NACKs.
4. Repeat steps 1 – 3 for a duration sufficient to achieve statistical significance according to Annex G clause G.4 and measure Pm-an. Pm-an is (NACK) / (ACK + NACK).
If Pm-an is less than the value specified in table 8.5.1.2.1.5-1, pass the UE. Otherwise fail the UE.

8.5.1.2.1.4.3 Message contents

Message contents are according to TS 36.508 [7] clause 4.6 with the following exceptions

Table 8.5.1.2.1.4.3-1: MAC-MainConfig-RBC

Derivation Path: TS 36.508 [7] clause 4.8.2.1.5, Table 4.8.2.1.5-1			
Information Element	Value/remark	Comment	Condition
MAC-MainConfig-RBC ::= SEQUENCE {			
dl-SCH-Config SEQUENCE {}	Not present		
ul-SCH-Config SEQUENCE {			
maxHARQ-Tx	n2	Only one retransmission per UL HARQ	
...			

8.5.1.2.1.5 Test requirement

For the parameters specified in Table 8.5.1.2.1.3-1 the average probability of a miss-detecting ACK for NACK (Pm-dsg) shall be below the specified value in Table 8.5.1.2.1.5-1.

Table 8.5.1.2.1.5-1: Test requirement PHICH 2 Tx Antenna Port

Test number	Bandwidth	Reference Channel	OCNG Pattern	Propagation Condition	Antenna configuration and correlation Matrix	Reference value	
						Pm-an (%)	SNR (dB)
1	1.4 MHz	R.19	OP.1 FDD	EPA5	2 x 2 Low	0.1	6.7

8.5.1.2.1_1 FDD PHICH Transmit Diversity 2x2

Editor's note: This clause is incomplete. The following aspects are either missing or not yet determined:

- Test tolerance is undefined

8.5.1.2.1_1.1 Test purpose

This test verifies the demodulation performance of PHICH for transmit diversity with a given SNR for which the average probability of miss detection of Hybrid Indicator ("ACK to NACK") of the specified reference measurement channels remains below a specified value.

8.5.1.2.1_1.2 Test applicability

This test applies to all types of E-UTRA FDD UE release 9 and forward.

8.5.1.2.1_1.3 Minimum conformance requirements

The receiver characteristics of the PHICH are determined by the probability of miss-detecting an ACK for a NACK (Pm-an). It is assumed that there is no bias applied to the detection of ACK and NACK (zero-threshold detection).

Table 8.5.1.2.1_1.3-1: Test Parameters for PHICH

Parameter		Unit	Transmit diversity
Downlink power allocation	PCFICH_RA PDCCH_RA PHICH_RA OCNG_RA	dB	-3
	PCFICH_RB PDCCH_RB PHICH_RB OCNG_RB	dB	-3
PHICH duration			Normal
Number of PHICH groups (Note 1)			Ng = 1
PDCCH Content		UL Grant should be included with the proper information aligned with A.3.6.	
Unused RE-s and PRB-s		OCNG	
Cell ID			0
N_{oc} at antenna port		dBm/15kHz	-98
Cyclic prefix			Normal
Note 1: according to Clause 6.9 in TS 36.211 [8] Note 2: PHICH power settings refer to PHICH group power, i.e. the total power of all active PHICH sequences within a PHICH group.			

For the parameters specified in Table 8.5.1.2.1_1.3-1 the average probability of a miss-detecting an ACK for a NACK (Pm-an) shall be below the specified value in Table 8.5.1.2.1_1.3-2

Table 8.5.1.2.1_1.3-2: Minimum performance PHICH 2 Tx Antenna Port

Test number	Bandwidth	Reference Channel	OCNG Pattern	Propagation Condition	Antenna configuration and correlation Matrix	Reference value	
						Pm-an (%)	SNR (dB)
1	10 MHz	R.19	OP.1 FDD	EVA70	2 x 2 Low	0.1	4.4

The normative reference for this requirement is TS 36.101 [2] clause 8.5.1.

8.5.1.2.1_1.4 Test description

8.5.1.2.1_1.4.1 Initial conditions

Test Environment: Normal as defined in TS 36.508 [7] clause 4.1.

Frequencies to be tested: Mid Range as defined in TS 36.508 [7] clause 4.3.1.1.

Channel Bandwidths to be tested: 10 MHz, as defined in TS 36.508 [7] clause 4.3.1.1

1. Connect the SS, the faders and AWGN noise sources to the UE antenna connector (s) as shown in TS 36.508 [7] Annex A, Figure A.10.
2. The parameter settings for the cell are set up according to Table 8.5.1.2.1_1.3-1.
3. Downlink signals are initially set up according to Annex C.1 and C.3.2 and uplink signals according to Annex H.1 and H.3.2.
4. Propagation conditions are set according to Annex B clauses B.0.
5. Ensure the UE is in State 3A or 3A-RF according to TS 36.508 [7] clause 4.5.3A or 5.2A.2 and receiving payload data from the SS. Message contents are defined in clause 8.5.1.2.1_1.4.3.

8.5.1.2.1_1.4.2 Test procedure

1. Set the parameters of bandwidth, reference Channel, the propagation condition, antenna configuration, the correlation matrix and the SNR according to Table 8.5.1.2.1_1.5-1.
2. SS shall schedule PUSCH transmissions according to Annex A.2.2.1.1 Table A.2.2.1.1-1 to happen during 8 consecutive uplink TTIs via PDCCH DCI format 0 with new data indicator set to true. Since the UE has no payload, the UE shall send uplink MAC padding bits in PUSCH. SS upon receiving the PUSCH transmissions will transmit the associated ACKs. PHICH is set according to Annex 3.6 Table A.3.6-1. SS will only transmit PDCCH to schedule PUSCH transmission in the appropriate sub-frames. Table 8.5.1.2.1_1.4.2-1 indicates the transmissions for one cycle.

Table 8.5.1.2.1_1.4.2-1: PHICH test pattern

TTI	1-4	5-8	9-12	13-16	17-20	21-24
PDCCH	S	S	-	-	S	S
PHICH	-	-	A	A	-	-
PUSCH		T	T	R	R	T
UL HARQ Process	1-4	5-8	1-4	5-8	1-4	5-8
Note 1: This table gives an example test pattern for HARQ process for FDD PHICH test Note 2: Following notation is used: S: represents sending PDCCH DCI format 0 to schedule a future PUSCH transmission A: represents the ACK transmission on PHICH T: represents a scheduled PUSCH transmission R: represents a potential PUSCH re-transmission due to a missed ACK						

3. SS will only monitor for uplink retransmissions due to ACK missed-detections. Such re-transmissions (if they occur) will potentially happen in TTI 13 to 20. DTXs on TTI 13 to 20 are counted as successful ACK receptions while any transmission on these TTIs is counted as NACKs.

4. Repeat steps 1 – 3 for a duration sufficient to achieve statistical significance according to Annex G clause G.4 and measure Pm-an. Pm-an is (NACK) / (ACK + NACK).
If Pm-an is less than the value specified in table 8.5.1.2.1_1.5-1, pass the UE. Otherwise fail the UE.

8.5.1.2.1_1.4.3 Message contents

Message contents are according to TS 36.508 [7] clause 4.6 with the following exceptions

Table 8.5.1.2.1_1.4.3-1: MAC-MainConfig-RBC

Derivation Path: TS 36.508 [7] clause 4.8.2.1.5, Table 4.8.2.1.5-1			
Information Element	Value/remark	Comment	Condition
MAC-MainConfig-RBC ::= SEQUENCE {			
dl-SCH-Config SEQUENCE {	Not present		
ul-SCH-Config SEQUENCE {			
maxHARQ-Tx	n2	Only one retransmission per UL HARQ	
...			

8.5.1.2.1_1.5 Test requirement

For the parameters specified in Table 8.5.1.2.1_1.3-1 the average probability of a miss-detecting ACK for NACK (Pm-dsg) shall be below the specified value in Table 8.5.1.2.1_1.5-1.

Table 8.5.1.2.1_1.5-1: Test requirement PHICH 2 Tx Antenna Port

Test number	Bandwidth	Reference Channel	OCNG Pattern	Propagation Condition	Antenna configuration and correlation Matrix	Reference value	
						Pm-an (%)	SNR (dB)
1	10 MHz	R.19	OP.1 FDD	EVA70	2 x 2 Low	0.1	4.4+TT

8.5.1.2.2 FDD PHICH Transmit Diversity 4x2

8.5.1.2.2.1 Test purpose

This test verifies the demodulation performance of PHICH for transmit diversity with a given SNR for which the average probability of miss detection of Hybrid Indicator (“ACK to NACK”) of the specified reference measurement channels remains below a specified value.

8.5.1.2.2.2 Test applicability

This test applies to all types of E-UTRA FDD UE release 8.

8.5.1.2.2.3 Minimum conformance requirements

The receiver characteristics of the PHICH are determined by the probability of miss-detecting an ACK for a NACK (Pm-an). It is assumed that there is no bias applied to the detection of ACK and NACK (zero-threshold detection).

Table 8.5.1.2.2.3-1: Test Parameters for PHICH

Parameter		Unit	Transmit diversity
Downlink power allocation	PCFICH_RA PDCCH_RA PHICH_RA OCNG_RA	dB	-3
	PCFICH_RB PDCCH_RB PHICH_RB OCNG_RB	dB	-3
PHICH duration			Normal
Number of PHICH groups (Note 1)			Ng = 1
PDCCH Content		UL Grant should be included with the proper information aligned with A.3.6.	
Unused RE-s and PRB-s			OCNG
Cell ID			0
N_{oc} at antenna port		dBm/15kHz	-98
Cyclic prefix			Normal
Note 1: according to Clause 6.9 in TS 36.211 [8]			
Note 2: PHICH power settings refer to PHICH group power, i.e. the total power of all active PHICH sequences within a PHICH group.			

For the parameters specified in Table 8.5.1.2.2.3-1 the average probability of a miss-detecting an ACK for a NACK (P_{m-an}) shall be below the specified value in Table 8.5.1.2.2.3-2.

Table 8.5.1.2.2.3-2: Minimum performance PHICH 4 Tx Antenna Port

Test number	Bandwidth	Reference Channel	OCNG Pattern	Propagation Condition	Antenna configuration and correlation Matrix	Reference value	
						P_{m-an} (%)	SNR (dB)
1	10 MHz	R.20	OP.1 FDD	EVA5	4 x 2 Medium	0.1	6.0

The normative reference for this requirement is TS 36.101 [2] clause 8.5.1.

8.5.1.2.2.4 Test description

8.5.1.2.2.4.1 Initial conditions

Test Environment: Normal as defined in TS 36.508 [7] clause 4.1.

Frequencies to be tested: Mid Range as defined in TS 36.508 [7] clause 4.3.1.1.

Channel Bandwidths to be tested: 10 MHz, as defined in TS 36.508 [7] clause 4.3.1.1

1. Connect the SS, the faders and AWGN noise sources to the UE antenna connector (s) as shown in TS 36.508 [7] Annex A, Figure A.11.
2. The parameter settings for the cell are set up according to Table 8.5.1.2.2.3-1.
3. Downlink signals are initially set up according to Annex C.1 and C.3.2 and uplink signals according to Annex H.1 and H.3.2.
4. Propagation conditions are set according to Annex B clauses B.0.
5. Ensure the UE is in State 3A or 3A-RF according to TS 36.508 [7] clause 4.5.3A or 5.2A.2 and receiving payload data from the SS. Message contents are defined in clause 8.5.1.2.2.4.3.

8.5.1.2.2.4.2 Test procedure

1. Set the parameters of bandwidth, reference Channel, the propagation condition, antenna configuration, the correlation matrix and the SNR according to Table 8.5.1.2.2.5-1.
2. SS shall schedule PUSCH transmissions according to Annex A.2.2.1.1 Table A.2.2.1.1-1 to happen during 8 consecutive uplink TTIs via PDCCH DCI format 0 with new data indicator set to true. Since the UE has no payload, the UE shall send uplink MAC padding bits in PUSCH. SS upon receiving the PUSCH transmissions will transmit the associated ACKs. PHICH is set according to Annex 3.6 Table A.3.6-1. SS will only transmit PDCCH to schedule PUSCH transmission in the appropriate sub-frames. Table 8.5.1.2.2.4.2-1 indicates the transmissions for one cycle.

Table 8.5.1.2.2.4.2-1: PHICH test pattern

TTI	1-4	5-8	9-12	13-16	17-20	21-24
PDCCH	S	S	-	-	S	S
PHICH	-	-	A	A	-	-
PUSCH		T	T	R	R	T
UL HARQ Process	1-4	5-8	1-4	5-8	1-4	5-8
Note 1: This table gives an example test pattern for HARQ process for FDD PHICH test Note 2: Following notation is used: S: represents sending PDCCH DCI format 0 to schedule a future PUSCH transmission A: represents the ACK transmission on PHICH T: represents a scheduled PUSCH transmission R: represents a potential PUSCH re-transmission due to a missed ACK						

3. SS will only monitor for uplink retransmissions due to ACK missed-detections. Such re-transmissions (if they occur) will potentially happen in TTI 13 to 20. DTXs on TTI 13 to 20 are counted as successful ACK receptions while any transmission on these TTIs is counted as NACKs.
4. Repeat steps 1 – 3 for a duration sufficient to achieve statistical significance according to Annex G clause G.3 and measure P_{m-an} . P_{m-an} is $(NACK) / (ACK + NACK)$. If P_{m-an} is less than the value specified in table 8.5.1.2.2.5-1, pass the UE. Otherwise fail the UE.

8.5.1.2.2.4.3 Message contents

Message contents are according to TS 36.508 [7] clause 4.6 with the following exceptions

Table 8.5.1.2.2.4.3-1: MAC-MainConfig-RBC

Derivation Path: TS 36.508 [7] clause 4.8.2.1.5, Table 4.8.2.1.5-1			
Information Element	Value/remark	Comment	Condition
MAC-MainConfig-RBC ::= SEQUENCE {			
dl-SCH-Config SEQUENCE {	Not present		
ul-SCH-Config SEQUENCE {			
maxHARQ-Tx	n2	Only one retransmission per UL HARQ	
...			

8.5.1.2.2.5 Test requirement

For the parameters specified in Table 8.5.1.2.2.3-1 the average probability of a miss-detecting ACK for NACK (P_{m-dsg}) shall be below the specified value in Table 8.5.1.2.2.5-1.

Table 8.5.1.2.2.5-1: Test requirement PHICH 4 Tx Antenna Port

Test number	Bandwidth	Reference Channel	OCNG Pattern	Propagation Condition	Antenna configuration and correlation Matrix	Reference value	
						Pm-an (%)	SNR (dB)
1	10 MHz	R.20	OP.1 FDD	EVA5	4 x 2 Medium	0.1	7.0

8.5.1.2.2_1 FDD PHICH Transmit Diversity 4x2

Editor's note: This clause is incomplete. The following aspects are either missing or not yet determined:

- Test tolerance is undefined

8.5.1.2.2_1.1 Test purpose

This test verifies the demodulation performance of PHICH for transmit diversity with a given SNR for which the average probability of miss detection of Hybrid Indicator ("ACK to NACK") of the specified reference measurement channels remains below a specified value.

8.5.1.2.2_1.2 Test applicability

This test applies to all types of E-UTRA FDD UE release 9 and forward.

8.5.1.2.2_1.3 Minimum conformance requirements

The receiver characteristics of the PHICH are determined by the probability of miss-detecting an ACK for a NACK (Pm-an). It is assumed that there is no bias applied to the detection of ACK and NACK (zero-threshold detection).

Table 8.5.1.2.2_1.3-1: Test Parameters for PHICH

Parameter		Unit	Transmit diversity
Downlink power allocation	PCFICH_RA PDCCH_RA PHICH_RA OCNG_RA	dB	-3
	PCFICH_RB PDCCH_RB PHICH_RB OCNG_RB	dB	-3
PHICH duration			Normal
Number of PHICH groups (Note 1)			Ng = 1
PDCCH Content		UL Grant should be included with the proper information aligned with A.3.6.	
Unused RE-s and PRB-s		OCNG	
Cell ID			0
N_{oc} at antenna port		dBm/15kHz	-98
Cyclic prefix			Normal
Note 1: according to Clause 6.9 in TS 36.211 [8] Note 2: PHICH power settings refer to PHICH group power, i.e. the total power of all active PHICH sequences within a PHICH group.			

For the parameters specified in Table 8.5.1.2.2_1.3-1 the average probability of a miss-detecting an ACK for a NACK (Pm-an) shall be below the specified value in Table 8.5.1.2.2_1.3-2.

Table 8.5.1.2.2_1.3-2: Minimum performance PHICH 4 Tx Antenna Port

Test number	Bandwidth	Reference Channel	OCNG Pattern	Propagation Condition	Antenna configuration and correlation Matrix	Reference value	
						Pm-an (%)	SNR (dB)
1	5 MHz	R.20	OP.1 FDD	EPA5	4 x 2 Medium	0.1	6.1

The normative reference for this requirement is TS 36.101 [2] clause 8.5.1.

8.5.1.2.2_1.4 Test description

8.5.1.2.2_1.4.1 Initial conditions

Test Environment: Normal as defined in TS 36.508 [7] clause 4.1.

Frequencies to be tested: Mid Range as defined in TS 36.508 [7] clause 4.3.1.1.

Channel Bandwidths to be tested: 5 MHz, as defined in TS 36.508 [7] clause 4.3.1.1

1. Connect the SS, the faders and AWGN noise sources to the UE antenna connector (s) as shown in TS 36.508 [7] Annex A, Figure A.11.
2. The parameter settings for the cell are set up according to Table 8.5.1.2.2_1.3-1.
3. Downlink signals are initially set up according to Annex C.1 and C.3.2 and uplink signals according to Annex H.1 and H.3.2.
4. Propagation conditions are set according to Annex B clauses B.0.
5. Ensure the UE is in State 3A or 3A-RF according to TS 36.508 [7] clause 4.5.3A or 5.2A.2 and receiving payload data from the SS. Message contents are defined in clause 8.5.1.2.2_1.4.3.

8.5.1.2.2_1.4.2 Test procedure

1. Set the parameters of bandwidth, reference Channel, the propagation condition, antenna configuration, the correlation matrix and the SNR according to Table 8.5.1.2.2_1.5-1.
2. SS shall schedule PUSCH transmissions according to Annex A.2.2.1.1 Table A.2.2.1.1-1 to happen during 8 consecutive uplink TTIs via PDCCH DCI format 0 with new data indicator set to true. Since the UE has no payload, the UE shall send uplink MAC padding bits in PUSCH. SS upon receiving the PUSCH transmissions will transmit the associated ACKs. PHICH is set according to Annex 3.6 Table A.3.6-1. SS will only transmit PDCCH to schedule PUSCH transmission in the appropriate sub-frames. Table 8.5.1.2.2_1.4.2-1 indicates the transmissions for one cycle.

Table 8.5.1.2.2_1.4.2-1: PHICH test pattern

TTI	1-4	5-8	9-12	13-16	17-20	21-24
PDCCH	S	S	-	-	S	S
PHICH	-	-	A	A	-	-
PUSCH		T	T	R	R	T
UL HARQ Process	1-4	5-8	1-4	5-8	1-4	5-8
Note 1: This table gives an example test pattern for HARQ process for FDD PHICH test Note 2: Following notation is used: S: represents sending PDCCH DCI format 0 to schedule a future PUSCH transmission A: represents the ACK transmission on PHICH T: represents a scheduled PUSCH transmission R: represents a potential PUSCH re-transmission due to a missed ACK						

3. SS will only monitor for uplink retransmissions due to ACK missed-detections. Such re-transmissions (if they occur) will potentially happen in TTI 13 to 20. DTXs on TTI 13 to 20 are counted as successful ACK receptions while any transmission on these TTIs is counted as NACKs.

4. Repeat steps 1 – 3 for a duration sufficient to achieve statistical significance according to Annex G clause G.3 and measure Pm-an. Pm-an is (NACK) / (ACK + NACK). If Pm-an is less than the value specified in table 8.5.1.2.2_1.5-1, pass the UE. Otherwise fail the UE.

8.5.1.2.2_1.4.3 Message contents

Message contents are according to TS 36.508 [7] clause 4.6 with the following exceptions

Table 8.5.1.2.2_1.4.3-1: MAC-MainConfig-RBC

Derivation Path: TS 36.508 [7] clause 4.8.2.1.5, Table 4.8.2.1.5-1			
Information Element	Value/remark	Comment	Condition
MAC-MainConfig-RBC ::= SEQUENCE {			
dl-SCH-Config SEQUENCE {	Not present		
ul-SCH-Config SEQUENCE {			
maxHARQ-Tx	n2	Only one retransmission per UL HARQ	
...			

8.5.1.2.2_1.5 Test requirement

For the parameters specified in Table 8.5.1.2.2_1.3-1 the average probability of a miss-detecting ACK for NACK (Pm-dsg) shall be below the specified value in Table 8.5.1.2.2_1.5-1.

Table 8.5.1.2.2_1.5-1: Test requirement PHICH 4 Tx Antenna Port

Test number	Bandwidth	Reference Channel	OCNG Pattern	Propagation Condition	Antenna configuration and correlation Matrix	Reference value	
						Pm-an (%)	SNR (dB)
1	5 MHz	R.20	OP.1 FDD	EPA5	4 x 2 Medium	0.1	6.1+TT

8.5.2 TDD

8.5.2.1 TDD PHICH Single-antenna Port Performance

8.5.2.1.1 Test purpose

This test verifies the demodulation performance of PHICH for a single antenna port with a given SNR for which a certain Hybrid Indicator detection error rate (i.e. missed detection of “NACK to ACK” and “ACK to NACK”) of the specified reference measurement channels is achieved.

8.5.2.1.2 Test applicability

This test applies to all types of E-UTRA TDD UE release 8 and forward.

8.5.2.1.3 Minimum conformance requirements

The receiver characteristics of the PHICH are determined by the probability of miss-detecting an ACK for a NACK (Pm-an). It is assumed that there is no bias applied to the detection of ACK and NACK (zero-threshold detection).

Table 8.5.2.1.3-1: Test Parameters for PHICH

Parameter		Unit	Single antenna port
Uplink downlink configuration (Note 1)			1
Special subframe configuration (Note 2)			4
Downlink power allocation	PCFICH_RA PDCCH_RA PHICH_RA OCNG_RA	dB	0
	PCFICH_RB PDCCH_RB PHICH_RB OCNG_RB	dB	0
PHICH duration			Normal
Number of PHICH groups (Note 3)			$N_g = 1$
Cell ID			0
PDCCH Content		UL Grant should be included with the proper information aligned with A.3.6.	
Unused RE-s and PRB-s			OCNG
N_{oc} at antenna port		dBm/15kHz	-98
Cyclic prefix			Normal
ACK/NACK feedback mode			Multiplexing
Note 1: as specified in Table 4.2-2 in TS 36.211 [8] Note 2: as specified in Table 4.2-1 in TS 36.211 [8] Note 3: according to Clause 6.9 in TS 36.211 [8] Note 4: PHICH power settings refer to PHICH group power, i.e. the total power of all active PHICH sequences within a PHICH group.			

For the parameters specified in Table 8.5.2.1.3-1 the average probability of a miss-detecting ACK for NACK (P_{m-an}) shall be below the specified value in Table 8.5.2.1.3-2.

Table 8.5.2.1.3-2: Minimum performance of PHICH

Test number	Bandwidth	Reference Channel	OCNG Pattern	Propagation Condition	Antenna configuration and correlation Matrix	Reference value	
						P_{m-an} (%)	SNR (dB)
1	10 MHz	R.18	OP.1 TDD	ETU70	1 x 2 Low	0.1	5.8
2	10 MHz	R.24	OP.1 TDD	ETU70	1 x 2 Low	0.1	1.3

The normative reference for this requirement is TS 36.101 [2] clause 8.5.2.

8.5.2.1.4 Test description

8.5.2.1.4.1 Initial conditions

Initial conditions are a set of test configurations the UE needs to be tested in and the steps for the SS to take with the UE to reach the correct measurement state.

Configurations of PDSCH and PDCCH before measurement are specified in Annex C.2.

Test Environment: Normal, as defined in TS 36.508 [7] clause 4.1

Frequencies to be tested: Mid Range, as defined in TS 36.508 [7] clause 4.3.1.1

Bandwidths to be tested: As specified per test number in Tables 8.5.2.1.3-2 as defined in TS 36.508 [7] clause 4.3.1.2.

1. Connect the SS, the faders and AWGN noise source to the UE antenna connector (s) as shown in TS 36.508 [7] Annex a, Figure A.9.
2. The parameter settings for the cell are set up according to 8.5.2.1.3-1.
3. Downlink signals are initially set up according to Annex C0, C.1 and Annex C.3.2 and uplink signals according to Annex H.1 and H.3.2.
4. Propagation conditions are set according to Annex B.0.
5. Ensure the UE is in State 3A or 3A-RF according to TS 36.508 [7] clause 4.5.3A or 5.2A.2. Message contents are defined in clause 8.5.2.1.4.3.

8.5.2.1.4.2 Test procedure

1. Set the parameters of bandwidth, reference Channel, the propagation condition, antenna configuration, the correlation matrix and the SNR according to Table 8.5.2.1.5-1 Test 1 as appropriate.
2. In Each HARQ process (4 HARQ processes for UL/DL configuration 1); SS shall schedule PUSCH transmissions according to Annex A.2.3.1.1 Table A.2.3.1.1-1 via PDCCH DCI format 0 with new data indicator set to true. Since the UE has no payload, the UE shall send uplink MAC padding bits in PUSCH. SS upon receiving the PUSCH transmissions shall transmit the associated ACKs. PHICH is set according to Annex 3.6 Table A.3.6-1. SS will only transmit PDCCH to schedule PUSCH transmission in the appropriate sub-frames. Table 8.5.2.1.4.2-1 indicates the transmissions for one cycle.
3. SS will only monitor for uplink retransmissions due to ACK missed-detections. DTX from the UE side is counted as successful ACK reception, while any transmission on these subframes is counted as NACKs.

Table 8.5.2.1.4.2-1: PHICH test pattern

Subframe Index	0	1	2	3	4	5	6	7	8	9	0	1	2	3	4	5	6	7	8	9
PDCCH		S			S		S			S										
PHICH												A			A		A			A
PUSCH			R?	R?				T	T				T	T					R?	R?
HARQ process		1	3	4	2		3	1	2	4		1	3	4	2		3	1	2	4

Note 1: This table gives an example test pattern for HARQ process for TDD PHICH test
 Note 2: Following notation is used:
 S: represents sending PDCCH DCI format 0 to schedule a future PUSCH transmission
 A: represents the ACK transmission on PHICH
 T: represents a scheduled PUSCH transmission
 R: represents a potential PUSCH re-transmission due to a missed ACK
 Note 3: TDD UL/DL configuration 1 is used here, special subframe is denoted as blue

4. Repeat steps 1 – 3 for a duration sufficient to achieve statistical significance according to Annex G clause G.4 and measure Pm-an. Pm-an is (NACK) / (ACK + NACK).
 If Pm-an is less than the value specified in table 8.5.2.1.5-1, pass the UE. Otherwise fail the UE.
5. Repeat the same procedure (steps 1 to 4) with test conditions according to the Table 8.5.2.1.5-1 for Test 2.

8.5.2.1.4.3 Message contents

Message contents are according to TS 36.508 [7] clause 4.6, with the following exceptions

Table 8.5.1.1.4.3-1: MAC-MainConfig-RBC

Derivation Path: TS 36.508 [7] clause 4.8.2.1.5, Table 4.8.2.1.5-1			
Information Element	Value/remark	Comment	Condition
MAC-MainConfig-RBC ::= SEQUENCE {			
dl-SCH-Config SEQUENCE {}	Not present		
ul-SCH-Config SEQUENCE {			
maxHARQ-Tx	n2	Only one retransmission per UL HARQ	
...			

8.5.2.1.5 Test requirement

For the parameters specified in Table 8.5.2.1.3-1 the average probability of a miss-detecting ACK for NACK (P_{m-an}) shall be below the specified value in Table 8.5.2.1.5-1.

Table 8.5.2.1.5-1: Test requirement of PHICH

Test number	Bandwidth	Reference Channel	OCNG Pattern	Propagation Condition	Antenna configuration and correlation Matrix	Reference value	
						P_{m-an} (%)	SNR (dB)
1	10 MHz	R.18	OP.1 TDD	ETU70	1 x 2 Low	0.1	6.7
2	10 MHz	R.24	OP.1 TDD	ETU70	1 x 2 Low	0.1	2.2

8.5.2.2 TDD PHICH Transmit Diversity Performance

8.5.2.2.1 TDD PHICH Transmit Diversity 2x2

8.5.2.2.1.1 Test purpose

This test verifies the demodulation performance of PHICH for transmit diversity with a given SNR for which a certain Hybrid Indicator detection error rate (i.e. missed detection of “NACK to ACK” and “ACK to NACK”) of the specified reference measurement channels is achieved.

8.5.2.2.1.2 Test applicability

This test applies to all types of E-UTRA TDD UE release 8.

8.5.2.2.1.3 Minimum conformance requirements

The receiver characteristics of the PHICH are determined by the probability of miss-detecting an ACK for a NACK (P_{m-an}). It is assumed that there is no bias applied to the detection of ACK and NACK (zero-threshold detection).

Table 8.5.2.2.1.3-1: Test Parameters for PHICH

Parameter		Unit	Transmit diversity
Uplink downlink configuration (Note 1)			1
Special subframe configuration (Note 2)			4
Downlink power allocation	PCFICH_RA PDCCH_RA PHICH_RA OCNG_RA	dB	-3
	PCFICH_RB PDCCH_RB PHICH_RB OCNG_RB	dB	-3
PHICH duration			Normal
Number of PHICH groups (Note 3)			$N_g = 1$
Cell ID			0
PDCCH Content		UL Grant should be included with the proper information aligned with A.3.6.	
Unused RE-s and PRB-s			OCNG
N_{oc} at antenna port		dBm/15kHz	-98
Cyclic prefix			Normal
ACK/NACK feedback mode			Multiplexing
Note 1: as specified in Table 4.2-2 in TS 36.211 [8] Note 2: as specified in Table 4.2-1 in TS 36.211 [8] Note 3: according to Clause 6.9 in TS 36.211 [8] Note 4: PHICH power settings refer to PHICH group power, i.e. the total power of all active PHICH sequences within a PHICH group.			

For the parameters specified in Table 8.5.2.2.1.3-1 the average probability of a miss-detecting ACK for NACK (P_{m-an}) shall be below the specified value in Table 8.5.2.2.1.3-2.

Table 8.5.2.2.1.3-2: Minimum performance of PHICH 2 Tx Antenna Port

Test number	Bandwidth	Reference Channel	OCNG Pattern	Propagation Condition	Antenna configuration and correlation Matrix	Reference value	
						P_{m-an} (%)	SNR (dB)
1	1.4 MHz	R.19	OP.1 TDD	EPA5	2 x 2 Low	0.1	5.3

The normative reference for this requirement is TS 36.101 [2] clause 8.5.2.

8.5.2.2.1.4 Test description

8.5.2.2.1.4.1 Initial conditions

Test Environment: Normal, as defined in TS 36.508 [7] clause 4.1

Frequencies to be tested: Mid Range, as defined in TS 36.508 [7] clause 4.3.1.2

Bandwidths to be tested: 1.4 MHz, as defined in TS 36.508 [7] clause 4.3.1.2.

1. Connect the SS, the faders and AWGN noise sources to the UE antenna connector (s) as shown in TS 36.508 [7] Annex A Figure A.10.
2. The parameter settings for the cell are set up according to Table 8.5.2.2.1.3-1.

3. Downlink signals are initially set up according to Annex C.1 and Annex C.3.2 and uplink signals according to Annex H.1 and H.3.2.
4. Propagation conditions are set according to Annex B clause B.0.
5. Ensure the UE is in State 3A or 3A-RF according to TS 36.508 [7] clause 4.5.3A or 5.2A.2. Message contents are defined in clause 8.5.2.2.1.4.3.

8.5.2.2.1.4.2 Test procedure

1. Set the parameters of bandwidth, reference Channel, the propagation condition, antenna configuration, the correlation matrix and the SNR according to Table 8.5.2.2.1.5-1.
2. In Each HARQ process (4 HARQ processes for UL/DL configuration 1), SS shall schedule PUSCH transmissions according to Annex A.2.3.1.1 Table A.2.3.1.1-1 via PDCCH DCI format 0 with new data indicator set to true. Since the UE has no payload, the UE shall send uplink MAC padding bits in PUSCH. SS upon receiving the PUSCH transmissions shall transmit the associated ACKs. PHICH is set according to Annex 3.6 Table A.3.6-1. SS will only transmit PDCCH to schedule PUSCH transmission in the appropriate sub-frames. Table 8.5.2.2.1.4.2-1 indicates the transmissions for one cycle.
3. SS will only monitor for uplink retransmissions due to ACK missed-detections. DTX from the UE side is counted as successful ACK reception, while any transmission on these subframes is counted as NACKs.
4. Repeat steps 1 – 3 for a duration sufficient to achieve statistical significance according to Annex G clause G.4 and measure Pm-an. Pm-an is (NACK) / (ACK + NACK).

If Pm-an is less than the value specified in table 8.5.2.2.1.5-1, pass the UE. Otherwise fail the UE.

Table 8.5.2.2.1.4.2-1: PHICH test pattern

Subframe Index	0	1	2	3	4	5	6	7	8	9	0	1	2	3	4	5	6	7	8	9
PDCCH		S			S		S			S										
PHICH												A			A		A			A
PUSCH			R?	R?				T	T				T	T					R?	R?
HARQ process		1	3	4	2		3	1	2	4		1	3	4	2		3	1	2	4

Note 1: This table gives an example test pattern for HARQ process for TDD PHICH test
 Note 2: Following notation is used:
 S: represents sending PDCCH DCI format 0 to schedule a future PUSCH transmission
 A: represents the ACK transmission on PHICH
 T: represents a scheduled PUSCH transmission
 R: represents a potential PUSCH re-transmission due to a missed ACK
 Note 3: TDD UL/DL configuration 1 is used here, special subframe is denoted as blue

8.5.2.2.1.4.3 Message contents

Message contents are according to TS 36.508 [7] clause 4.6, with the following exceptions:

Table 8.5.2.2.1.4.3-1: MAC-MainConfig-RBC

Derivation Path: TS 36.508 [7] clause 4.8.2.1.5, Table 4.8.2.1.5-1			
Information Element	Value/remark	Comment	Condition
MAC-MainConfig-RBC ::= SEQUENCE {			
dl-SCH-Config SEQUENCE {	Not present		
ul-SCH-Config SEQUENCE {			
maxHARQ-Tx	n2	Only one retransmission per UL HARQ	
...			

8.5.2.2.1.5 Test requirement

For the parameters specified in Table 8.5.2.2.1.3-1 the average probability of a miss-detecting ACK for NACK (Pm-an) shall be below the specified value in Table 8.5.2.2.1.5-1.

Table 8.5.2.2.1.5-1: Test requirement of PHICH 2 Tx Antenna Port

Test number	Bandwidth	Reference Channel	OCNG Pattern	Propagation Condition	Antenna configuration and correlation Matrix	Reference value	
						Pm-an (%)	SNR (dB)
1	1.4 MHz	R.19	OP.1 TDD	EPA5	2 x 2 Low	0.1	6.4

8.5.2.2.1_1 TDD PHICH Transmit Diversity 2x2

Editor's note: This clause is incomplete. The following aspects are either missing or not yet determined:

- Test tolerance is undefined

8.5.2.2.1_1.1 Test purpose

This test verifies the demodulation performance of PHICH for transmit diversity with a given SNR for which a certain Hybrid Indicator detection error rate (i.e. missed detection of "NACK to ACK" and "ACK to NACK") of the specified reference measurement channels is achieved.

8.5.2.2.1_1.2 Test applicability

This test applies to all types of E-UTRA TDD UE release 9 and forward.

8.5.2.2.1_1.3 Minimum conformance requirements

The receiver characteristics of the PHICH are determined by the probability of miss-detecting an ACK for a NACK (Pm-an). It is assumed that there is no bias applied to the detection of ACK and NACK (zero-threshold detection).

Table 8.5.2.2.1_1.3-1: Test Parameters for PHICH

Parameter		Unit	Transmit diversity
Uplink downlink configuration (Note 1)			1
Special subframe configuration (Note 2)			4
Downlink power allocation	PCFICH_RA PDCCH_RA PHICH_RA OCNG_RA	dB	-3
	PCFICH_RB PDCCH_RB PHICH_RB OCNG_RB	dB	-3
PHICH duration			Normal
Number of PHICH groups (Note 3)			$N_g = 1$
Cell ID			0
PDCCH Content		UL Grant should be included with the proper information aligned with A.3.6.	
Unused RE-s and PRB-s		OCNG	
N_{oc} at antenna port		dBm/15kHz	-98
Cyclic prefix			Normal
ACK/NACK feedback mode			Multiplexing
Note 1: as specified in Table 4.2-2 in TS 36.211 [8] Note 2: as specified in Table 4.2-1 in TS 36.211 [8] Note 3: according to Clause 6.9 in TS 36.211 [8] Note 4: PHICH power settings refer to PHICH group power, i.e. the total power of all active PHICH sequences within a PHICH group.			

For the parameters specified in Table 8.5.2.2.1_1.3-1 the average probability of a miss-detecting ACK for NACK (P_{m-an}) shall be below the specified value in Table 8.5.2.2.1_1.3-2.

Table 8.5.2.2.1_1.3-2: Minimum performance of PHICH 2 Tx Antenna Port

Test number	Bandwidth	Reference Channel	OCNG Pattern	Propagation Condition	Antenna configuration and correlation Matrix	Reference value	
						P_{m-an} (%)	SNR (dB)
1	10 MHz	R.19	OP.1 TDD	EVA70	2 x 2 Low	0.1	4.2

The normative reference for this requirement is TS 36.101 [2] clause 8.5.2.

8.5.2.2.1_1.4 Test description

8.5.2.2.1_1.4.1 Initial conditions

Test Environment: Normal, as defined in TS 36.508 [7] clause 4.1

Frequencies to be tested: Mid Range, as defined in TS 36.508 [7] clause 4.3.1.2

Bandwidths to be tested: 10 MHz, as defined in TS 36.508 [7] clause 4.3.1.2.

1. Connect the SS, the faders and AWGN noise sources to the UE antenna connector (s) as shown in TS 36.508 [7] Annex A Figure A.10.
2. The parameter settings for the cell are set up according to Table 8.5.2.2.1_1.3-1.

3. Downlink signals are initially set up according to Annex C.1 and Annex C.3.2 and uplink signals according to Annex H.1 and H.3.2.
4. Propagation conditions are set according to Annex B clause B.0.
5. Ensure the UE is in State 3A or 3A-RF according to TS 36.508 [7] clause 4.5.3A or 5.2A.2. Message contents are defined in clause 8.5.2.2.1_1.4.3.

8.5.2.2.1_1.4.2 Test procedure

1. Set the parameters of bandwidth, reference Channel, the propagation condition, antenna configuration, the correlation matrix and the SNR according to Table 8.5.2.2.1_1.5-1.
2. In Each HARQ process (4 HARQ processes for UL/DL configuration 1), SS shall schedule PUSCH transmissions according to Annex A.2.3.1.1 Table A.2.3.1.1-1 via PDCCH DCI format 0 with new data indicator set to true. Since the UE has no payload, the UE shall send uplink MAC padding bits in PUSCH. SS upon receiving the PUSCH transmissions shall transmit the associated ACKs. PHICH is set according to Annex 3.6 Table A.3.6-1. SS will only transmit PDCCH to schedule PUSCH transmission in the appropriate sub-frames. Table 8.5.2.2.1_1.4.2-1 indicates the transmissions for one cycle.
3. SS will only monitor for uplink retransmissions due to ACK missed-detections. DTX from the UE side is counted as successful ACK reception, while any transmission on these subframes is counted as NACKs.
4. Repeat steps 1 – 3 for a duration sufficient to achieve statistical significance according to Annex G clause G.4 and measure Pm-an. Pm-an is (NACK) / (ACK + NACK).

If Pm-an is less than the value specified in table 8.5.2.2.1_1.5-1, pass the UE. Otherwise fail the UE.

Table 8.5.2.2.1_1.4.2-1: PHICH test pattern

Subframe Index	0	1	2	3	4	5	6	7	8	9	0	1	2	3	4	5	6	7	8	9
PDCCH		S			S		S			S										
PHICH												A			A		A			A
PUSCH			R?	R?				T	T				T	T					R?	R?
HARQ process		1	3	4	2		3	1	2	4		1	3	4	2		3	1	2	4

Note 1: This table gives an example test pattern for HARQ process for TDD PHICH test
 Note 2: Following notation is used:
 S: represents sending PDCCH DCI format 0 to schedule a future PUSCH transmission
 A: represents the ACK transmission on PHICH
 T: represents a scheduled PUSCH transmission
 R: represents a potential PUSCH re-transmission due to a missed ACK
 Note 3: TDD UL/DL configuration 1 is used here, special subframe is denoted as blue

8.5.2.2.1_1.4.3 Message contents

Message contents are according to TS 36.508 [7] clause 4.6, with the following exceptions:

Table 8.5.2.2.1_1.4.3-1: MAC-MainConfig-RBC

Derivation Path: TS 36.508 [7] clause 4.8.2.1.5, Table 4.8.2.1.5-1			
Information Element	Value/remark	Comment	Condition
MAC-MainConfig-RBC ::= SEQUENCE {			
dl-SCH-Config SEQUENCE {	Not present		
ul-SCH-Config SEQUENCE {			
maxHARQ-Tx	n2	Only one retransmission per UL HARQ	
...			

8.5.2.2.1_1.5 Test requirement

For the parameters specified in Table 8.5.2.2.1_1.3-1 the average probability of a miss-detecting ACK for NACK (Pm-an) shall be below the specified value in Table 8.5.2.2.1_1.5-1.

Table 8.5.2.2.1.5-1: Test requirement of PHICH 2 Tx Antenna Port

Test number	Bandwidth	Reference Channel	OCNG Pattern	Propagation Condition	Antenna configuration and correlation Matrix	Reference value	
						Pm-an (%)	SNR (dB)
1	10 MHz	R.19	OP.1 TDD	EVA70	2 x 2 Low	0.1	4.2+TT

8.5.2.2.2 TDD PHICH Transmit Diversity 4x2

8.5.2.2.2.1 Test purpose

This test verifies the demodulation performance of PHICH for transmit diversity with a given SNR for which a certain Hybrid Indicator detection error rate (i.e. missed detection of “NACK to ACK” and “ACK to NACK”) of the specified reference measurement channels is achieved.

8.5.2.2.2.2 Test applicability

This test applies to all types of E-UTRA TDD UE release 8.

8.5.2.2.2.3 Minimum conformance requirements

The receiver characteristics of the PHICH are determined by the probability of miss-detecting an ACK for a NACK (Pm-an). It is assumed that there is no bias applied to the detection of ACK and NACK (zero-threshold detection).

Table 8.5.2.2.3-1: Test Parameters for PHICH

Parameter		Unit	Transmit diversity
Uplink downlink configuration (Note 1)			1
Special subframe configuration (Note 2)			4
Downlink power allocation	PCFICH_RA PDCCH_RA PHICH_RA OCNG_RA	dB	-3
	PCFICH_RB PDCCH_RB PHICH_RB OCNG_RB	dB	-3
PHICH duration			Normal
Number of PHICH groups (Note 3)			$N_g = 1$
Cell ID			0
PDCCH Content		UL Grant should be included with the proper information aligned with A.3.6.	
Unused RE-s and PRB-s			OCNG
N_{oc} at antenna port		dBm/15kHz	-98
Cyclic prefix			Normal
ACK/NACK feedback mode			Multiplexing
Note 1: as specified in Table 4.2-2 in TS 36.211 [8] Note 2: as specified in Table 4.2-1 in TS 36.211 [8] Note 3: according to Clause 6.9 in TS 36.211 [8] Note 4: PHICH power settings refer to PHICH group power, i.e. the total power of all active PHICH sequences within a PHICH group.			

For the parameters specified in Table 8.5.2.2.3-1 the average probability of a miss-detecting ACK for NACK (P_{m-an}) shall be below the specified value in Table 8.5.2.2.3-2.

Table 8.5.2.2.3-2: Minimum performance of PHICH 4 Tx Antenna port

Test number	Bandwidth	Reference Channel	OCNG Pattern	Propagation Condition	Antenna configuration and correlation Matrix	Reference value	
						P_{m-an} (%)	SNR (dB)
1	10 MHz	R.20	OP.1 TDD	EVA5	4 x 2 Medium	0.1	6.1

The normative reference for this requirement is TS 36.101 [2] clause 8.5.2.

8.5.2.2.2.4 Test description

8.5.2.2.2.4.1 Initial conditions

Test Environment: Normal, as defined in TS 36.508 [7] clause 4.1

Frequencies to be tested: Mid Range, as defined in TS 36.508 [7] clause 4.3.1.2

Channel Bandwidths to be tested: 10 MHz, as defined in TS 36.508 [7] clause 4.3.1.2.

1. Connect the SS, the faders and AWGN noise sources to the UE antenna connector (s) as shown in TS 36.508 [7] Annex A, Figure A.11.
2. The parameter settings for the cell are set up according to Table 8.5.2.2.3-1.

3. Downlink signals are initially set up according to Annex C.1 and Annex C.3.2 and uplink signals according to Annex H.1 and H.3.2.
4. Propagation conditions are set according to Annex B clause B.0.
5. Ensure the UE is in State 3A or 3A-RF according to TS 36.508 [7] clause 4.5.3A or 5.2A.2. Message contents are defined in clause 8.5.2.2.4.3.

8.5.2.2.4.2 Test procedure

1. Set the parameters of bandwidth, reference Channel, the propagation condition, antenna configuration, the correlation matrix and the SNR according to Table 8.5.2.2.5-1.
2. In Each HARQ process (4 HARQ processes for UL/DL configuration 1), SS shall schedule PUSCH transmissions according to Annex A.2.3.1.1 Table A.2.3.1.1-1 via PDCCH DCI format 0 with new data indicator set to true. Since the UE has no payload, the UE shall send uplink MAC padding bits in PUSCH. SS upon receiving the PUSCH transmissions shall transmit the associated ACKs. PHICH is set according to Annex 3.6 Table A.3.6-1. SS will only transmit PDCCH to schedule PUSCH transmission in the appropriate sub-frames. Table 8.5.2.2.4.2-1 indicates the transmissions for one cycle.
3. SS will only monitor for uplink retransmissions due to ACK missed-detections. DTX from the UE side is counted as successful ACK reception, while any transmission on these subframes is counted as NACKs.
4. Repeat steps 1 – 3 for a duration sufficient to achieve statistical significance according to Annex G clause G.4 and measure Pm-an. Pm-an is (NACK) / (ACK + NACK).

If Pm-an is less than the value specified in table 8.5.2.2.5-1, pass the UE. Otherwise fail the UE.

Table 8.5.2.2.4.2-1: PHICH test pattern

Subframe Index	0	1	2	3	4	5	6	7	8	9	0	1	2	3	4	5	6	7	8	9
PDCCH		S			S		S			S										
PHICH												A			A		A			A
PUSCH			R?	R?				T	T				T	T					R?	R?
HARQ process		1	3	4	2		3	1	2	4		1	3	4	2		3	1	2	4
Note 1:	This table gives an example test pattern for HARQ process for TDD PHICH test																			
Note 2:	Following notation is used: S: represents sending PDCCH DCI format 0 to schedule a future PUSCH transmission A: represents the ACK transmission on PHICH T: represents a scheduled PUSCH transmission R: represents a potential PUSCH re-transmission due to a missed ACK																			
Note 3:	TDD UL/DL configuration 1 is used here, special subframe is denoted as blue																			

8.5.2.2.4.3 Message contents

Message contents are according to TS 36.508 [7] clause 4.6, with the following exceptions:

Table 8.5.2.2.4.3-1: MAC-MainConfig-RBC

Derivation Path: TS 36.508 [7] clause 4.8.2.1.5, Table 4.8.2.1.5-1			
Information Element	Value/remark	Comment	Condition
MAC-MainConfig-RBC ::= SEQUENCE {			
dl-SCH-Config SEQUENCE {	Not present		
ul-SCH-Config SEQUENCE {			
maxHARQ-Tx	n2	Only one retransmission per UL HARQ	
...			

8.5.2.2.2.5 Test requirement

For the parameters specified in Table 8.5.2.2.2.3-1 the average probability of a miss-detecting ACK for NACK (P_{m-an}) shall be below the specified value in Table 8.5.2.2.2.5-1.

Table 8.5.2.2.2.5-1: Test requirement of PHICH 4 Tx Antenna Port

Test number	Bandwidth	Reference Channel	OCNG Pattern	Propagation Condition	Antenna configuration and correlation Matrix	Reference value	
						P_{m-an} (%)	SNR (dB)
1	10 MHz	R.20	OP.1 TDD	EVA5	4 x 2 Medium	0.1	7.1

8.5.2.2.2_1 TDD PHICH Transmit Diversity 4x2

Editor's note: This clause is incomplete. The following aspects are either missing or not yet determined:

- Test tolerance is undefined

8.5.2.2.2_1.1 Test purpose

This test verifies the demodulation performance of PHICH for transmit diversity with a given SNR for which a certain Hybrid Indicator detection error rate (i.e. missed detection of "NACK to ACK" and "ACK to NACK") of the specified reference measurement channels is achieved.

8.5.2.2.2_1.2 Test applicability

This test applies to all types of E-UTRA TDD UE release 9 and forward.

8.5.2.2.2_1.3 Minimum conformance requirements

The receiver characteristics of the PHICH are determined by the probability of miss-detecting an ACK for a NACK (P_{m-an}). It is assumed that there is no bias applied to the detection of ACK and NACK (zero-threshold detection).

Table 8.5.2.2.2_1.3-1: Test Parameters for PHICH

Parameter		Unit	Transmit diversity
Uplink downlink configuration (Note 1)			1
Special subframe configuration (Note 2)			4
Downlink power allocation	PCFICH_RA PDCCH_RA PHICH_RA OCNG_RA	dB	-3
	PCFICH_RB PDCCH_RB PHICH_RB OCNG_RB	dB	-3
PHICH duration			Normal
Number of PHICH groups (Note 3)			$N_g = 1$
Cell ID			0
PDCCH Content		UL Grant should be included with the proper information aligned with A.3.6, other PDCCH resource shall be occupied by non-zero data.	
Unused RE-s and PRB-s		OCNG	
N_{oc} at antenna port		dBm/15kHz	-98
Cyclic prefix			Normal
ACK/NACK feedback mode			Multiplexing
Note 1: as specified in Table 4.2-2 in TS 36.211 [8] Note 2: as specified in Table 4.2-1 in TS 36.211 [8] Note 3: according to Clause 6.9 in TS 36.211 [8] Note 4: PHICH power settings refer to PHICH group power, i.e. the total power of all active PHICH sequences within a PHICH group.			

For the parameters specified in Table 8.5.2.2.2_1.3-1 the average probability of a miss-detecting ACK for NACK (P_{m-an}) shall be below the specified value in Table 8.5.2.2.2_1.3-2.

Table 8.5.2.2.2_1.3-2: Minimum performance of PHICH 4 Tx Antenna port

Test number	Bandwidth	Reference Channel	OCNG Pattern	Propagation Condition	Antenna configuration and correlation Matrix	Reference value	
						P_{m-an} (%)	SNR (dB)
1	5 MHz	R.20	OP.1 TDD	EPA5	4 x 2 Medium	0.1	6.2

The normative reference for this requirement is TS 36.101 [2] clause 8.5.2.

8.5.2.2.2_1.4 Test description

8.5.2.2.2_1.4.1 Initial conditions

Test Environment: Normal, as defined in TS 36.508 [7] clause 4.1

Frequencies to be tested: Mid Range, as defined in TS 36.508 [7] clause 4.3.1.2

Channel Bandwidths to be tested: 5 MHz, as defined in TS 36.508 [7] clause 4.3.1.2.

1. Connect the SS, the faders and AWGN noise sources to the UE antenna connector (s) as shown in TS 36.508 [7] Annex A, Figure A.11.
2. The parameter settings for the cell are set up according to Table 8.5.2.2.2_1.3-1.

3. Downlink signals are initially set up according to Annex C.1 and Annex C.3.2 and uplink signals according to Annex H.1 and H.3.2.
4. Propagation conditions are set according to Annex B clause B.0.
5. Ensure the UE is in State 3A or 3A-RF according to TS 36.508 [7] clause 4.5.3A or 5.2A.2. Message contents are defined in clause 8.5.2.2.2_1.4.3.

8.5.2.2.2_1.4.2 Test procedure

1. Set the parameters of bandwidth, reference Channel, the propagation condition, antenna configuration, the correlation matrix and the SNR according to Table 8.5.2.2.2_1.5-1.
2. In Each HARQ process (4 HARQ processes for UL/DL configuration 1), SS shall schedule PUSCH transmissions according to Annex A.2.3.1.1 Table A.2.3.1.1-1 via PDCCH DCI format 0 with new data indicator set to true. Since the UE has no payload, the UE shall send uplink MAC padding bits in PUSCH. SS upon receiving the PUSCH transmissions shall transmit the associated ACKs. PHICH is set according to Annex 3.6 Table A.3.6-1. SS will only transmit PDCCH to schedule PUSCH transmission in the appropriate sub-frames. Table 8.5.2.2.2_1.4.2-1 indicates the transmissions for one cycle.
3. SS will only monitor for uplink retransmissions due to ACK missed-detections. DTX from the UE side is counted as successful ACK reception, while any transmission on these subframes is counted as NACKs.
4. Repeat steps 1 – 3 for a duration sufficient to achieve statistical significance according to Annex G clause G.4 and measure Pm-an. Pm-an is (NACK) / (ACK + NACK).

If Pm-an is less than the value specified in table 8.5.2.2.2_1.5-1, pass the UE. Otherwise fail the UE.

Table 8.5.2.2.2_1.4.2-1: PHICH test pattern

Subframe Index	0	1	2	3	4	5	6	7	8	9	0	1	2	3	4	5	6	7	8	9
PDCCH		S			S		S			S										
PHICH												A			A		A			A
PUSCH			R?	R?				T	T				T	T					R?	R?
HARQ process		1	3	4	2		3	1	2	4		1	3	4	2		3	1	2	4

Note 1: This table gives an example test pattern for HARQ process for TDD PHICH test
 Note 2: Following notation is used:
 S: represents sending PDCCH DCI format 0 to schedule a future PUSCH transmission
 A: represents the ACK transmission on PHICH
 T: represents a scheduled PUSCH transmission
 R: represents a potential PUSCH re-transmission due to a missed ACK
 Note 3: TDD UL/DL configuration 1 is used here, special subframe is denoted as blue

8.5.2.2.2_1.4.3 Message contents

Message contents are according to TS 36.508 [7] clause 4.6, with the following exceptions:

Table 8.5.2.2.2_1.4.3-1: MAC-MainConfig-RBC

Derivation Path: TS 36.508 [7] clause 4.8.2.1.5, Table 4.8.2.1.5-1			
Information Element	Value/remark	Comment	Condition
MAC-MainConfig-RBC ::= SEQUENCE {			
dl-SCH-Config SEQUENCE {}	Not present		
ul-SCH-Config SEQUENCE {			
maxHARQ-Tx	n2	Only one retransmission per UL HARQ	
...			

8.5.2.2.2_1.5 Test requirement

For the parameters specified in Table 8.5.2.2.2_1.3-1 the average probability of a miss-detecting ACK for NACK (Pm-an) shall be below the specified value in Table 8.5.2.2.2_1.5-1.

Table 8.5.2.2.2_1.5-1: Test requirement of PHICH 4 Tx Antenna Port

Test number	Bandwidth	Reference Channel	OCNG Pattern	Propagation Condition	Antenna configuration and correlation Matrix	Reference value	
						Pm-an (%)	SNR (dB)
1	5 MHz	R.20	OP.1 TDD	EPA5	4 x 2 Medium	0.1	6.2+TT

8.6 Demodulation of PBCH

RAN4 will specify the PBCH performance requirements and has recommended that these requirements do not need to be tested.

8.7 Sustained downlink data rate provided by lower layers

Editor's note: This clause is incomplete. The following aspects are either missing or not yet determined:

- Test tolerances are undefined
- The minimum requirements are not confirmed and within []
- ACK/NACK Multiplexing is not supported for TDD UL/DL configuration 5 (according to TS 36.213 [10] (Subclause 7.3)), hence 8.7.2 Test 1 will be unimplementable, until the ACK/NACK feedback mode is corrected in TS 36.101[2].

8.7.1 FDD

8.7.1.1 FDD sustained data rate performance

8.7.1.1.1 Test purpose

The purpose of the test is to verify that the Layer 1 and Layer 2 correctly process in a sustained manner the received packets corresponding to the maximum number of DL-SCH transport block bits received within a TTI for the UE category indicated. The sustained downlink data rate shall be verified in terms of the success rate of delivered PDCP SDU(s) by Layer 2. The test case below specifies the RF conditions and the required success rate of delivered TB by Layer 1 to meet the sustained data rate requirement. The size of the TB per TTI corresponds to the largest possible DL-SCH transport block for each UE category using the maximum number of layers for spatial multiplexing. Transmission modes 1 and 3 are used with radio conditions resembling a scenario where sustained maximum data rates are available.

8.7.1.1.2 Test applicability

This test applies to all types of E-UTRA FDD UE Release 9 and forward.

8.7.1.1.3 Minimum requirements

The parameters specified in Table 8.7.1.1.3-1 are valid for all FDD tests unless otherwise stated.

Table 8.7.1.1.3-1: Common Test Parameters (FDD)

Parameter	Unit	Value
Cyclic prefix		Normal
Cell ID		0
Inter-TTI Distance		1
Number of HARQ processes	Processes	Downlink: 8 Uplink: 8
Maximum number of HARQ transmission		Downlink: 4 Uplink: 1
Redundancy version coding sequence		{0,0,1,2} for 64QAM
Number of OFDM symbols for PDCCH	OFDM symbols	1

The requirements are specified in Table 8.7.1.1.3-3, with the addition of the parameters in Table 8.7.1.1.3-2 and the downlink physical channel setup according to Annex C.3.2. The PDCP SDU success rate shall be sustained during at least 300 frames.

Table 8.7.1.1.3-2: Test Parameters for sustained downlink data rate (FDD)

Parameter	Unit	Test 1	Test 2	Test 3,4	Test 3A	
Bandwidth	MHz	10	10	20	10	
Transmission mode		1	3	3	3	
Antenna configuration		1 x 2	2 x 2	2 x 2	2 x 2	
Propagation condition		Static propagation condition (Note 1)				
CodeBookSubsetRestriction bitmap		n/a	10	10	10	
Downlink power allocation	ρ_A	dB	0	-3	-3	-3
	ρ_B	dB	0	-3	-3	-3
\hat{E}_s at antenna port	dBm/15kHz	-85	-85	-85	-85	
Symbols for unused PRBs		[OCNG]	[OCNG]	[OCNG]	[OCNG]	

Note 1: No external noise sources are applied

Table 8.7.1.1.3-3: Minimum Requirement (FDD)

Test	UE Category	Number of bits of a DL-SCH transport block received within a TTI	Measurement channel	Reference value TB success rate [%]
1	Category 1	10296	R31-1 FDD	95
2	Category 2	25456	R31-2 FDD	95
3	Category 3 (Note 1)	51024	R31-3 FDD	95
3A	Category 3 (Note 2)	36696 (Note 4)	R31-3A FDD	85
4	Category 4	75376 (Note 5)	R31-4 FDD	85
5	Category 5	FFS	FFS	FFS

Note 1: If the operating band under test does not support 20 MHz channel bandwidth, then test is executed according to Test 3A.
Note 2: Applicable to operating bands supporting up to 10 MHz channel bandwidths.
Note 3: For 2 layer transmissions, 2 transport blocks are received within a TTI
Note 4: 35160 bits for sub-frame 5
Note 5: 71112 bits for sub-frame 5
Note 6: The TB success rate is defined as TB success rate = 100% * $N_{DL_correct_rx} / (N_{DL_newtx} + N_{DL_retx})$, where N_{DL_newtx} is the number of newly transmitted DL transport blocks, N_{DL_retx} is the number of retransmitted DL transport blocks, and $N_{DL_correct_rx}$ is the number of correctly received DL transport blocks.

The normative reference for this requirement is TS 36.101[2] clause 8.7.1

8.7.1.1.4 Test description

8.7.1.1.4.1 Initial conditions

Table 8.7.1.1.4.1-1: Applicable test and Transport Block Size for different UE categories

UE Category	Applicable test	DL Measurement channel	UL Measurement channel	TB _{size} per Codeword	Number of PDCP SDU per Codeword	PDCP SDU size [bits] Note 3
1	Test 1	[R31-1 FDD]	R.1-1 FDD	10296	1	$8 * \text{FLOOR}((\text{TB}_{\text{size}} - 96)/8)$
2	Test 2	[R31-2 FDD]	R.1-2 FDD	25456	3	$8 * \text{FLOOR}((\text{TB}_{\text{size}} - 152)/24)$
3	Test 3 (Note 1)	[R31-3 FDD]	R.1-3 FDD	51024	5	$8 * \text{FLOOR}((\text{TB}_{\text{size}} - 208)/40)$
3	Test 3A (Note 2)	[R31-3A FDD]	R.1-3A FDD	36696 (Note 5)	4	$8 * \text{FLOOR}((\text{TB}_{\text{size}} - 184)/32)$
4	Test 4 (Note 2)	[R31-4 FDD]	R.1-4 FDD	75376 (Note 6)	7	$8 * \text{FLOOR}((\text{TB}_{\text{size}} - 264)/56)$
5	FFS	FFS	TBD	FFS	FFS	FFS

Note 1: If the operating band under test does not support 20 MHz channel bandwidth, then test is executed according to Test 3A.

Note 2: Applicable to operating bands supporting up to 10 MHz channel bandwidths.

Note 3: Transport block size under test according to applicable Fixed Reference Channel for sustained data-rate test in annex A.3.9.

Note 4: Each PDCP SDU is limited to 1500 octets (to keep below maximum SDU size of ESM as specified in TS 24.301 clause 9.9.4.12).

The PDCP SDU size of each PDCP SDU is:

$$\text{PDCP SDU size} = (\text{TB}_{\text{size}} - N * \text{PDCP header size} - \text{AMD PDU header size} - \text{MAC header size} - \text{Size of RLC STATUS PDU}) / N,$$

where PDCP header size is 16 bits for the RLC AM and 12-bit SN case; AMD PDU header size is $\text{CEIL}[(16+(N-1)*12)/8]$ bytes which includes 16 bit standard AM header and (N-1) Length indicators; and MAC header size = R/R/E/LCID/F/L MAC subheader (24 bits for MAC SDU for RLC STATUS PDU with 15 bit LI) + R/R/E/LCID MAC subheader (8 bits for MAC SDU for RLC Data PDU) = 32 bits. The size of RLC STATUS PDU including one ACK_SN field and one NACK_SN field is 32 bits (if no STATUS PDU is sent or if the size of the STATUS PDU is less than 32 bits then padding will be used to fill the 32 bits). This gives: PDCP SDU size = $8 * \text{FLOOR}((\text{TB}_{\text{size}} - N * 16 - 8 * \text{CEIL}[(16+(N-1)*12)/8] - 64)/(8 * N))$ bits.

The calculation of PDCP SDU sizes does not consider timing advance MAC CE as timing advance is not transmitted by SS for RF test cases.

Note 5: 35160 bits for sub-frame 5

Note 6: 71112 bits for sub-frame 5

Initial conditions are a set of test configurations the UE needs to be tested in and the steps for the SS to take with the UE to reach the correct measurement state.

Configurations of PDSCH and PDCCH before measurement are specified in Annex C.2.

Test Environment: Normal as defined in TS 36.508 [7] clause 4.1.

Frequencies to be tested: Mid Range as defined in TS 36.508 [7] clause 4.3.1.1.

Channel Bandwidths to be tested: According to table 8.7.1.1.3-2.

1. Connect the SS to the UE antenna connector(s) as shown in TS 36.508 [7] Annex A, Figure A.3 for test 1 and Figure A.10 for tests 2-5 (without using faders and AWGN generators).
2. The parameter settings for the cell are set up according to Table 8.7.1.1.5-1 and Table 8.7.1.1.5-2.
3. Downlink signals are initially set up according to Annex C0, C.1 and Annex C.3.2 and uplink signals according to Annex H.1 and H.3.2.
4. Propagation conditions are set according to Annex B.0.

5. Ensure the UE is in State 4 (Loopback activated) according to TS 36.508 [7] clause 4.5.4. Message contents are defined in clause 8.7.1.1.4.3.

8.7.1.1.4.2 Test procedure

1. The SS looks up TB_{size} in table 8.7.1.1.4.1-1 according to the UE category under test.
2. SS sets the counters N_{DL_newtx} , N_{DL_retx} , N_{UL_PDCP} , and N_{DL_PDCP} to 0.
3. If PHY requests a new DL HARQ transmission this TTI, the SS creates one or more PDCP SDUs to fill up the TB [Note 1], depending on TB_{size} , in accordance with Table 8.7.1.1.4.1-1. and cipher the PDCP SDUs. The SS then concatenates the resultant PDCP PDUs to form an RLC PDU and then a MAC PDU. The SS then transmits the MAC PDU. The SS then increments the transmitted DL subframe (N_{DL_newtx}) by one and N_{DL_PDCP} by the number of PDCP SDUs included in the MAC PDU.
4. If PHY requests a DL HARQ retransmission in this TTI, the SS performs a HARQ retransmission and increments the retransmitted subframe (N_{DL_retx}) by one. [Note 2]
5. Steps 3 to 4 are repeated at every TTI for at least [300] frames or until statistical significance is fulfilled according to [Annex G FFS] and the SS waits for [300ms] to let any HARQ retransmissions and RLC retransmissions to finish.
6. For each PDCP SDU received at the SS, if the content of the data matches that of the truncated version of the original PDCP SDU generated at the SS, the SS increments N_{UL_PDCP} by one
7. The SS calculates the TB success rate as $A = 100\% * N_{DL_newtx} / (N_{DL_newtx} + N_{DL_retx})$
8. The SS calculates the PDCP SDU loss as $B = N_{DL_PDCP} - N_{UL_PDCP}$
9. The UE passes the test if $A \geq$ “corresponding TB success rate according to Table 8.7.1.1.3-3” and $B = 0$.

NOTE 1: if there is RLC PDU retransmission in this TTI, the SS forms as many number of new PDCP SDUs to fill the rest of the TB.

NOTE 2: the SS should prioritize the HARQ retransmissions over new HARQ transmissions. This is to minimize the RLC buffering/processing load at the UE in case of HARQ transmission error.

8.7.1.1.4.3 Message contents

Message contents are according to TS 36.508 [7] clause 4.6 and 4.7A, with the following exceptions:

Table 8.7.1.1.4.3-1: CLOSE UE TEST LOOP (in the preamble)

Derivation Path: 36.509 clause 6.1			
Information Element	Value/remark	Comment	Condition
Protocol discriminator	1 1 1 1		
Skip indicator	0 0 0 0		
Message type	1 0 0 0 0 0 0 0		
UE test loop mode	0 0 0 0 0 0 0 0	UE test loop mode A	
UE test loop mode A LB setup			
Length of UE test loop mode A LB setup list in bytes	0 0 0 0 0 0 1 1	Length of one LB setup DRB (3 bytes)	
LB setup DRB	0 0 0 0 0 0 0 0, 0 0 1 0 1 0 0 0, 0 0 0 Q4 Q3 Q2 Q1 Q0	UL PDCP SDU size = 40 bits (5 bytes) Q4..Q0 = Data Radio Bearer identity number for the default radio bearer. See 36.509 clause 6.1	
UE test loop mode B LB setup	Not present		

Table 8.7.1.1.4.3-2: SecurityModeCommand (in the preamble)

Derivation Path: TS36.508 clause 4.6.1 table 4.6.1-19			
Information Element	Value/remark	Comment	Condition
SecurityModeCommand ::= SEQUENCE {			
criticalExtensions CHOICE {			
c1 CHOICE{			
securityModeCommand-r8 SEQUENCE {			
securityConfiguration SEQUENCE {			
cipheringAlgorithm	eea2		
nextHopChainingCount	Not present		
}			
nonCriticalExtension SEQUENCE {}	Not present		
}			
}			
}			

8.7.1.1.5 Test requirement

The requirements are specified in Table 8.7.1.1.5-1. The PDCP SDU success rate shall be sustained during at least [100] frames.

Table 8.7.1.1.5-1: Test requirements for sustained downlink data rate (FDD)

Test	UE Category	Number of bits of a DL-SCH transport block received within a TTI per Codeword	Measurement channel	Number of PDCP SDU per Codeword	PDCP SDU size [Octets]	Reference value
						TB success rate [%]
1	Category 1	10296	R31-1 FDD	1	1275	95
2	Category 2	25456	R31-2 FDD	3	1054	95
3	Category 3 (Note 1)	51024	R31-3 FDD	5	1270	95
3A	Category 3 (Note 2)	36696 (Note4)	R31-3A FDD	4	1141	85
4	Category 4	75376 (Note5)	R31-4 FDD	7	1341	85
Note 1: If the operating band under test does not support 20 MHz channel bandwidth, then test is executed according to Test 3A. Note 2: Applicable to operating bands supporting up to 10 MHz channel bandwidths Note 3: For 2 layer transmissions, 2 transport blocks are received within a TTI Note 4: 35160 bits for sub-frame 5 Note 5: 71112 bits for sub-frame 5 Note 6: The TB success rate is defined as TB success rate = $100\% \cdot N_{DL_correct_rx} / (N_{DL_newtx} + N_{DL_retx})$, where N_{DL_newtx} is the number of newly transmitted DL transport blocks, N_{DL_retx} is the number of retransmitted DL transport blocks, and $N_{DL_correct_rx}$ is the number of correctly received DL transport blocks.						

Table 8.7.1.1.5-2: Test Parameters for sustained downlink data rate (FDD)

Parameter		Unit	Test 1	Test 2	Test 3,4	Test 3A
Bandwidth		MHz	10	10	20	10
Transmission mode			1	3	3	3
Antenna configuration			1 x 2	2 x 2	2 x 2	2 x 2
Propagation condition			Static propagation condition (Note 1)			
CodeBookSubsetRestriction bitmap			n/a	10	10	10
Downlink power allocation	ρ_A	dB	0	-3	-3	-3
	ρ_B	dB	0	-3	-3	-3
\hat{E}_s at antenna port		dBm/15kHz	-85+TT	-85 +TT	-85 +TT	-85 +TT
Symbols for unused PRBs			[OCNG]	[OCNG]	[OCNG]	[OCNG]
Note 1: No external noise sources are applied						

8.7.2 TDD

8.7.2.1 TDD sustained data rate performance

8.7.2.1.1 Test purpose

The purpose of the test is to verify that the Layer 1 and Layer 2 correctly process in a sustained manner the received packets corresponding to the maximum number of DL-SCH transport block bits received within a TTI for the UE category indicated. The sustained downlink data rate shall be verified in terms of the success rate of delivered PDCP SDU(s) by Layer 2. The test case below specifies the RF conditions and the required success rate of delivered TB by Layer 1 to meet the sustained data rate requirement. The size of the TB per TTI corresponds to the largest possible DL-SCH transport block for each UE category using the maximum number of layers for spatial multiplexing. Transmission modes 1 and 3 are used with radio conditions resembling a scenario where sustained maximum data rates are available.

8.7.2.1.2 Test applicability

This test applies to all types of E-UTRA TDD UE release 9 and forward.

8.7.2.1.3 Minimum requirements

The parameters specified in Table 8.7.1.1.3-1 are valid for all TDD tests unless otherwise stated.

Table 8.7.2.1.3-1: Common Test Parameters (TDD)

Parameter	Unit	Value
Uplink downlink configuration (Note 1)		5
Special subframe configuration (Note 2)		4
Cyclic prefix		Normal
Cell ID		0
Inter-TTI Distance		1
Number of HARQ processes	Processes	Downlink: 7 Uplink: 1
Maximum number of HARQ transmission		Downlink: 4 Uplink: 1
Redundancy version coding sequence		{0,0,1,2} for 64QAM
Number of OFDM symbols for PDCCH	OFDM symbols	1
Note 1: as specified in Table 4.2-2 in TS 36.211 [4]		
Note 2: as specified in Table 4.2-1 in TS 36.211 [4]		

The requirements are specified in Table 8.7.2.1.3-3, with the addition of the parameters in Table 8.7.2.1.3-2 and the downlink physical channel setup according to Annex C.3.2. The PDCP SDU success rate shall be sustained during at least 300 frames.

Table 8.7.2.1.3-2: test parameters for sustained downlink data rate (TDD)

Parameter		Unit	Test 1	Test 2	Test 3,4	Test 3B
Bandwidth		MHz	10	10	20	15
Transmission mode			1	3	3	3
Antenna configuration			1 x 2	2 x 2	2 x 2	2 x 2
Propagation condition			Static propagation condition (Note 1)			
CodeBookSubsetRestriction bitmap			n/a	10	10	10
Downlink power allocation	ρ_A	dB	0	-3	-3	-3
	ρ_B	dB	0	-3	-3	-3
\hat{E}_s at antenna port		dBm/15kHz	-85	-85	-85	-85
Symbols for unused PRBs			[OCNG]	[OCNG]	[OCNG]	[OCNG]
ACK/NACK feedback mode			Multiplexing	Bundling	Bundling	Bundling

Note 1: No external noise sources are applied

Table 8.7.2.1.3-3: Minimum requirement (TDD)

Test	UE Category	Number of bits of a DL-SCH transport block received within a TTI for normal/special sub-frame	Measurement channel	Reference value
				TB success rate [%]
1	Category 1	10296/0	R31-1 TDD	95
2	Category 2	25456/0	R31-2 TDD	95
3	Category 3 (Note 1)	51024/0	R31-3 TDD	95
3B	Category 3 (Note 2)	51024/0	R31-3B TDD	85
4	Category 4	75376/0 (Note 4)	R31-4 TDD	90
5	Category 5	FFS	FFS	FFS

Note 1: If the operating band under test does not support 20 MHz channel bandwidth, then test is executed according to Test 3B.
Note 2: Applicable to operating bands supporting up to 15 MHz channel bandwidths.
Note 3: For 2 layer transmissions, 2 transport blocks are received within a TTI
Note 4: 71112 bits for sub-frame 5
Note 5: The TB success rate is defined as TB success rate = $100\% \cdot N_{DL_correct_rx} / (N_{DL_newtx} + N_{DL_retx})$, where N_{DL_newtx} is the number of newly transmitted DL transport blocks, N_{DL_retx} is the number of retransmitted DL transport blocks, and $N_{DL_correct_rx}$ is the number of correctly received DL transport blocks.

The normative reference for this requirement is TS 36.101[2] clause 8.7.2

8.7.2.1.4 Test description

8.7.2.1.4.1 Initial conditions

Table 8.7.2.1.4.1-1: Applicable test and Transport Block Size for different UE categories

UE Category	Applicable test	DL Measurement channel	UL Measurement Channel	TB _{size} per Codeword	Number of PDCP SDU per Codeword for normal/special sub-frame	PDCP SDU size [bits] Note 3
1	Test 1	R31-1 TDD	R.1-1 TDD	10296	1/0	$8 \cdot \text{FLOOR}((\text{TB}_{\text{size}} - 96)/8)$
2	Test 2	R31-2 TDD	R.1-2 TDD	25456	3/0	$8 \cdot \text{FLOOR}((\text{TB}_{\text{size}} - 152)/24)$
3	Test 3 (Note 1)	R31-3 TDD	R.1-3 TDD	51024	5/0	$8 \cdot \text{FLOOR}((\text{TB}_{\text{size}} - 208)/40)$
3	Test 3B (Note 2)	R31-3B TDD	R.1-3B TDD	TBD	4/0	$8 \cdot \text{FLOOR}((\text{TB}_{\text{size}} - 184)/32)$
4	Test 4 (Note 2)	R31-4 TDD	R.1-4 TDD	75376 (Note 5)	7/0	$8 \cdot \text{FLOOR}((\text{TB}_{\text{size}} - 264)/56)$
5	FFS	FFS	FFS	FFS	FFS	FFS
<p>Note 1: If the operating band under test does not support 20 MHz channel bandwidth, then test is executed according to Test 3B.</p> <p>Note 2: Applicable to operating bands supporting up to 15 MHz channel bandwidths</p> <p>Note 3: Transport block size under test according to applicable Fixed Reference Channel for sustained data-rate test in annex A.3.9.</p> <p>Note 4: Each PDCP SDU is limited to 1500 octets (to keep below maximum SDU size of ESM as specified in TS 24.301 clause 9.9.4.12).</p> <p>The PDCP SDU size of each PDCP SDU is:</p> $\text{PDCP SDU size} = (\text{TB}_{\text{size}} - N \cdot \text{PDCP header size} - \text{AMD PDU header size} - \text{MAC header size} - \text{Size of Timing Advance} - \text{Size of RLC STATUS PDU}) / N,$ <p>where PDCP header size is 16 bits for the RLC AM and 12-bit SN case; AMD PDU header size is $\text{CEIL}[(16+(N-1) \cdot 12)/8]$ bytes which includes 16 bit standard AM header and (N-1) Length indicators; and MAC header size = R/R/E/LCID/F/L MAC subheader (24 bits for MAC SDU for RLC STATUS PDU with 15 bit LI) + R/R/E/LCID MAC subheader (8 bits for MAC SDU for RLC data PDU) = 32 bits. The size of RLC STATUS PDU including one ACK_SN field and one NACK_SN field is 32 bits (if no STATUS PDU is sent or if the size of the STATUS PDU is less than 32 bits then padding will be used to fill the 32 bits). This gives: $\text{PDCP SDU size} = 8 \cdot \text{FLOOR}((\text{TB}_{\text{size}} - N \cdot 16 - 8 \cdot \text{CEIL}[(16+(N-1) \cdot 12)/8] - 64)/(8 \cdot N))$ bits.</p> <p>The calculation of PDCP SDU sizes does not consider timing advance MAC CE as timing advance is not transmitted by SS for RF test cases.</p> <p>Note 5: 71112 bits for sub-frame 5</p>						

Initial conditions are a set of test configurations the UE needs to be tested in and the steps for the SS to take with the UE to reach the correct measurement state.

Configurations of PDSCH and PDCCH before measurement are specified in Annex C.2.

Test Environment: Normal as defined in TS 36.508 [7] clause 4.1.

Frequencies to be tested: Mid Range as defined in TS 36.508 [7] clause 4.3.1.1.

Channel Bandwidths to be tested: According to table 8.7.2.1.3-2.

1. Connect the SS, to the UE antenna connector(s) as shown in TS 36.508 [7] Annex A, Figure A.3 for test 1 and Figure A.10 for tests 2-5 (without using faders and AWGN generators).
2. The parameter settings for the cell are set up according to Table 8.7.2.1.5-1 and Table 8.7.2.1.5-2.
3. Downlink signals are initially set up according to Annex C0, C.1 and Annex C.3.2 and uplink signals according to Annex H.1 and H.3.2.

4. Propagation conditions are set according to Annex B.0.
5. Ensure the UE is in State 4 (Loopback activated) according to TS 36.508 [7] clause 4.5.4. Message contents are defined in clause 8.7.2.1.4.3.

8.7.2.1.4.2 Test procedure

1. The SS looks up TB_{size} in table 8.7.2.1.4.1-1 according to the UE category under test.
2. SS sets the counters N_{DL_newtx} , N_{DL_retx} , N_{UL_PDCP} , and N_{DL_PDCP} to 0.
3. If PHY requests a new DL HARQ transmission this TTI, the SS creates one or more PDCP SDUs to fill up the TB [Note 1], depending on TB_{size} , in accordance with Table 8.7.2.1.4.1-1. and cipher the PDCP SDUs. The SS then concatenates the resultant PDCP PDUs to form an RLC PDU and then a MAC PDU. The SS then transmits the MAC PDU. The SS then increments the transmitted DL subframe (N_{DL_newtx}) by one and N_{DL_PDCP} by the number of PDCP SDUs included in the MAC PDU.
4. If PHY requests a DL HARQ retransmission in this TTI, the SS performs a HARQ retransmission and increments the retransmitted subframe (N_{DL_retx}) by one. [Note 2]
5. Steps 3 to 4 are repeated at every TTI for at least [300] frames or until statistical significance is fulfilled according to [Annex G FFS] and the SS waits for [300ms] to let any HARQ retransmissions and RLC retransmissions to finish.
6. For each PDCP SDU received at the SS, if the content of the data matches that of the truncated version of the original PDCP SDU generated at the SS, the SS increments N_{UL_PDCP} by one.
7. The SS calculates the TB success rate as $A = 100\% * N_{DL_newtx} / (N_{DL_newtx} + N_{DL_retx})$
8. The SS calculates the PDCP SDU loss as $B = N_{DL_PDCP} - N_{UL_PDCP}$
9. The UE passes the test if $A \geq$ “corresponding TB success rate according to Table 8.7.2.1.3-3” and $B = 0$

NOTE 1: if there is RLC PDU retransmission in this TTI, the SS forms as many number of new PDCP SDUs to fill the rest of the TB.

NOTE 2: the SS should prioritize the HARQ retransmissions over new HARQ transmissions. This is to minimize the RLC buffering/processing load at the UE in case of HARQ transmission error.

8.7.2.1.4.3 Message contents

Message contents are according to TS 36.508 [7] clause 4.6 and 4.7A, with the following exceptions:

Table 8.7.2.1.4.3-1: CLOSE UE TEST LOOP (in the preamble)

Derivation Path: 36.509 clause 6.1			
Information Element	Value/remark	Comment	Condition
Protocol discriminator	1 1 1 1		
Skip indicator	0 0 0 0		
Message type	1 0 0 0 0 0 0		
UE test loop mode	0 0 0 0 0 0 0	UE test loop mode A	
UE test loop mode A LB setup			
Length of UE test loop mode A LB setup list in bytes	0 0 0 0 0 1 1	Length of one LB setup DRB (3 bytes)	
LB setup DRB	0 0 0 0 0 0 0, 0 0 101 0 0 0, 0 0 0 Q4 Q3 Q2 Q1 Q0	UL PDCP SDU size = 40 bits (5 bytes) Q4..Q0 = Data Radio Bearer identity number for the default radio bearer. See 36.509 clause 6.1.	
UE test loop mode B LB setup	Not present		

Table 8.7.2.1.4.3-2: SecurityModeCommand (in the preamble)

Derivation Path: TS36.508 clause 4.6.1 table 4.6.1-19			
Information Element	Value/remark	Comment	Condition
SecurityModeCommand ::= SEQUENCE {			
criticalExtensions CHOICE {			
c1 CHOICE{			
securityModeCommand-r8 SEQUENCE {			
securityConfiguration SEQUENCE {			
cipheringAlgorithm	eea2		
nextHopChainingCount	Not present		
}			
nonCriticalExtension SEQUENCE {}	Not present		
}			
}			
}			

8.7.2.1.5 Test requirement

The requirements are specified in Table 8.7.2.1.5-1. The PDCP SDU success rate shall be sustained during at least [100] frames.

Table 8.7.2.1.5-1: Test requirements for sustained downlink data rate (TDD)

Test	UE Category	Number of bits of a DL-SCH transport block received within a TTI per codeword for normal/special sub-frame	Measurement channel	Number of PDCP SDU per TTI per codeword for normal/special sub-frame	PDCP SDU size for normal/special sub-frame [Octets]	Reference value
						TB success rate [%]
1	Category 1	10296/0	R31-1 TDD	1/0	1275/0	95
2	Category 2	25456/0	R31-2 TDD	3/0	1054/0	95
3	Category 3 (Note 1)	51024/0	R31-3 TDD	5/0	1270/0	95
3B	Category 3 (Note 2)	51024	R31-3B TDD	4/0	1588	85
4	Category 4	75376/0	R31-4 TDD	7/0	1341/0	85
5	Category 5	FFS	FFS	FFS	FFS	FFS
<p>Note 1: If the operating band under test does not support 20 MHz channel bandwidth, then test is executed according to Test 3B.</p> <p>Note 2: Applicable to operating bands supporting up to 15 MHz channel bandwidths.</p> <p>Note 3: For 2 layer transmissions, 2 transport blocks are received within a TTI</p> <p>Note 4: 71112 bits for sub-frame 5</p> <p>Note 5: The TB success rate is defined as $TB\ success\ rate = 100\% \cdot N_{DL_correct_rx} / (N_{DL_newtx} + N_{DL_retx})$, where N_{DL_newtx} is the number of newly transmitted DL transport blocks, N_{DL_retx} is the number of retransmitted DL transport blocks, and $N_{DL_correct_rx}$ is the number of correctly received DL transport blocks.</p>						

Table 8.7.2.1.5-2: test parameters for sustained downlink data rate (TDD)

Parameter		Unit	Test 1	Test 2	Test 3,4	Test 3B
Bandwidth		MHz	10	10	20	15
Transmission mode			1	3	3	3
Antenna configuration			1 x 2	2 x 2	2 x 2	2 x 2
Propagation condition			Static propagation condition (Note 1)			
CodeBookSubsetRestriction bitmap			n/a	10	10	10
Downlink power allocation	ρ_A	dB	0	-3	-3	-3
	ρ_B	dB	0	-3	-3	-3
\hat{E}_s at antenna port		dBm/15kHz	-85+TT	-85+TT	-85+TT	-85+TT
Symbols for unused PRBs			[OCNG]	[OCNG]	[OCNG]	[OCNG]
Note 1: No external noise sources are applied						

9 Reporting of Channel State Information

9.1 General

For the cases in this clause it is expected that the UE will not always detect the PDCCH, resulting in a statDTX for the uplink ACK/NACK transmission. The downlink configuration for evaluating CQI performance does not use retransmission. Therefore any BLER calculations must exclude any packets where the UE may have attempted to combine data from more than one transmission due to missed new data indicators from lost PDCCH transmissions

This section includes requirements for the reporting of channel state information (CSI).

The fading of the signals and the AWGN signals applied to each receiver antenna connector shall be uncorrelated. The levels of the test signal applied to each of the antenna connectors shall be as defined in the respective test cases.

The UE performance in this section is considered to be operating band independent. Therefore, the required performance in the respective test cases can be verified in one of the operating bands supported by the UE under test. All the test points supported by the bands of the multiband UE (based on channel bandwidth, DL and UL configuration) need to be tested.

9.2 CQI Reporting under AWGN conditions

The reporting accuracy of the channel quality indicator (CQI) under frequency non-selective conditions is determined by the reporting variance and the BLER performance using the transport format indicated by the reported CQI median. The purpose is to verify that the reported CQI values are in accordance with the CQI definition given in TS 36.213[10] clause 7.2. To account for sensitivity of the input SNR the reporting definition is considered to be verified if the reporting accuracy is met for at least one of two SNR levels separated by an offset of 1 dB.

9.2.1 CQI Reporting under AWGN conditions - PUCCH 1-0

9.2.1.1 FDD CQI Reporting under AWGN conditions – PUCCH 1-0

9.2.1.1.1 Test purpose

To verify the variance of the wideband CQI reports is within the limits defined and a PDSCH BLER of 10% falls between the transport format based median CQI-1 and median CQI or the transport format based median CQI and median CQI +1.

9.2.1.1.2 Test applicability

This test applies to E-UTRA FDD UE release 8 and forward of UE category 2-5.

9.2.1.1.3 Minimum conformance requirements

For the parameters specified in Table 9.2.1.1.3-1, and using the downlink physical channels specified in tables C.3.2-1 and C.3.2-2, the reported CQI value according to Table A.4-1 shall be in the range of ± 1 of the reported median more than 90% of the time. If the PDSCH BLER using the transport format indicated by median CQI is less than or equal to 0.1, the BLER using the transport format indicated by the (median CQI +1) shall be greater than 0.1. If the PDSCH BLER using the transport format indicated by the median CQI is greater than 0.1, the BLER using transport format indicated by (median CQI –1) shall be less than or equal to 0.1

Table 9.2.1.1.3-1: PUCCH 1-0 static test

Parameter		Unit	Test 1		Test 2	
Bandwidth		MHz			10	
PDSCH transmission mode					1	
Downlink power allocation	ρ_A	dB			0	
	ρ_B	dB			0	
Propagation condition and antenna configuration			AWGN (1 x 2)			
SNR (Note 2)		dB	0	1	6	7
$\hat{I}_{or}^{(j)}$		dB[mW/15kHz]	-98	-97	-92	-91
$N_{oc}^{(j)}$		dB[mW/15kHz]	-98		-98	
Max number of HARQ transmissions			1			
Physical channel for CQI reporting			PUCCH Format 2			
PUCCH Report Type			4			
Reporting periodicity		ms	$N_P = 5$			
<i>cqi-pmi-ConfigurationIndex</i>			6			
Note 1: Reference measurement channel according to Table A.4-1 with one sided dynamic OCNG Pattern OP.1 FDD as described in Annex A.5.1.1.						
Note 2: For each test, the minimum requirements shall be fulfilled for at least one of the two SNR(s) and the respective wanted signal input level.						

9.2.1.1.4 Test description

9.2.1.1.4.1 Initial conditions

Initial conditions are a set of test configurations the UE needs to be tested in and the steps for the SS to take with the UE to reach the correct measurement state.

Configurations of PDSCH and PDCCH before measurement are specified in Annex C.2.

Test Environment: Normal as defined in TS 36.508 [7] clause 4.1.

Frequencies to be tested: Mid Range as defined in TS 36.508 [7] clause 4.3.1.1.

Channel Bandwidths to be tested: 10MHz, as defined in TS 36.508 [7] clause 4.3.1.1

1. Connect the SS, faders and AWGN noise source to the UE antenna connector (s) as shown in TS 36.508 [7] Annex A, Figure A.9.
2. The parameter settings for the cell are set up according to Table 9.2.1.1.3-1.
3. Downlink signals are initially set up according to Annex C0, C.1 and Annex C.3.2 and uplink signals according to Annex H.1 and H.3.2.
4. Propagation conditions are set according to Annex B.0.
5. Ensure the UE is in State 3A or 3A-RF according to TS 36.508 [7] clause 4.5.3A or 5.2A.2. Message contents are defined in clause 9.2.1.1.4.3.

9.2.1.1.4.2 Test procedure

1. Set the parameters of bandwidth, reference Channel, the propagation condition, antenna configuration and the SNR according to Table 9.2.1.1.3-1 as appropriate.
2. The SS shall transmit PDSCH via PDCCH DCI format 1A for C_RNTI to transmit the DL RMC according to CQI value 8 of Annex A.4 Table A.4-3 and keep it regardless of the wideband CQI value sent by the UE. The SS sends downlink MAC padding bits on the DL RMC. Continue transmission of the PDSCH until 2000

wideband CQI reports have been gathered. In this process the SS collects wideband CQI reports every 5 ms and also cases where UE transmits nothing in its CQI timing are also counted as wideband CQI reports.

3. Set up a relative frequency distribution for the reported wideband CQI-values, Calculate the median value (wideband Median CQI is the wideband CQI that is at or crosses 50% distribution from the lower wideband CQI side). This CQI-value is declared as wideband Median CQI value.
4. If Median CQI is not equal to 1 or 15 and 1800 or more of the wideband CQI values are in the range $(\text{Median CQI} - 1) \leq \text{Median CQI} \leq (\text{Median CQI} + 1)$ then continue with step 5, otherwise go to step 8.
5. The SS shall transmit PDSCH via PDCCH DCI format 1A for C_{RNTI} to transmit the DL RMC according to the wideband median-CQI value and shall not react to the UE's wideband CQI reports. The SS sends downlink MAC padding bits on the DL RMC. For any PDSCH transmitted by the SS, record the associated ACK, NACK and statDTX responses. The responses are then filtered as follows: for the sequence of responses for each HARQ process, discard all the statDTX responses. If the number of consecutive discarded statDTX for any one process is an odd number including one, also discard the next response for that HARQ process regardless whether it is an ACK or NACK. Continue to gather data until the number of filtered ACK+NACK responses reaches 1000.

For the filtered ACK and NACK responses if the ratio $(\text{NACK} / \text{ACK} + \text{NACK}) \leq 0.1$ then go to step 6, otherwise go to step 7.

6. The SS shall transmit PDSCH via PDCCH DCI format 1A for C_{RNTI} to transmit the DL RMC according to the wideband median-CQI+1 value and shall not react to the UE's wideband CQI reports. The SS sends downlink MAC padding bits on the DL RMC. For any PDSCH, transmitted by the SS, record and filter the ACK, NACK and statDTX responses as in step 5 until 1000 filtered ACK+NACK responses are gathered.

If the ratio $(\text{NACK} / \text{ACK} + \text{NACK}) > 0.1$

then pass the UE for this test and go to step 9, otherwise go to step 8.

7. The SS shall transmit PDSCH via PDCCH DCI format 1A for C_{RNTI} to transmit the DL RMC according to the wideband median-CQI-1 value and shall not react to the UE's wideband CQI reports. The SS sends downlink MAC padding bits on the DL RMC. For any PDSCH, transmitted by the SS, record and filter the ACK, NACK and statDTX responses as in step 5 until 1000 filtered ACK+NACK responses are gathered.

If the ratio $(\text{NACK} / \text{ACK} + \text{NACK}) \leq 0.1$

then pass the UE for this test and go to step 9, otherwise go to step 8.

8. If both SNR points of the test have not been tested, then repeat the same procedure (steps 1 to 7) for the other SNR point as appropriate. Otherwise fail the UE.
9. If both tests have not been done, then repeat the same procedure (steps 1 to 8) with test conditions according to the table 9.2.1.1.3-1 for the other Test as appropriate. Otherwise pass the UE.

9.2.1.1.4.3 Message contents

Message contents are according to TS 36.508 [7] clause 4.6 with the following exceptions:

Table 9.2.1.1.4.3-1: PhysicalConfigDedicated-DEFAULT

Derivation Path: 36.508 clause 5.5.1.2			
Information Element	Value/remark	Comment	Condition
PhysicalConfigDedicated-DEFAULT ::= SEQUENCE {			
cqi-ReportConfig	CQI-ReportConfig-DEFAULT		
}			

Table 9.2.1.1.4.3-2: CQI-ReportConfig-DEFAULT

Derivation Path: 36.508 clause 4.6.3			
Information Element	Value/remark	Comment	Condition
CQI-ReportConfig-DEFAULT ::= SEQUENCE {			
cqi-ReportModeAperiodic	Not present		
nomPDSCH-RS-EPRE-Offset	0		
cqi-ReportPeriodic CHOICE {			
setup SEQUENCE {			
cqi-PUCCH-ResourceIndex	0		
cqi-pmi-ConfigIndex	6	(see Table 7.2.2-1A in TS 36.213)	
cqi-FormatIndicatorPeriodic CHOICE {			
widebandCQI	NULL		
}			
ri-ConfigIndex	NULL	(see Table 7.2.2-1B in TS 36.213)	
simultaneousAckNackAndCQI	FALSE		
}			
}			
}			
}			

9.2.1.1.5 Test requirement

The pass fail decision is as specified in the test procedure in clause 9.2.1.1.4.2.

There are no parameters in the test setup or measurement process whose variation impacts the results so there are no applicable test tolerances for this test.

9.2.1.2 TDD CQI Reporting under AWGN conditions – PUCCH 1-0

9.2.1.2.1 Test purpose

To verify the variance of the wideband CQI reports is within the limits defined and a PDSCH BLER of 10% falls between the transport format based on wideband median CQI-1 and wideband median CQI or the transport format based on wideband median CQI and wideband median CQI +1.

9.2.1.2.2 Test applicability

This test applies to E-UTRA TDD UE release 8 and forward of UE category 2-5.

9.2.1.2.3 Minimum conformance requirements

For the parameters specified in Table 9.2.1.2.3-1, and using the downlink physical channels specified in tables C.3.2-1 and C.3.2-2, the reported CQI value according to Table A.4-2 shall be in the range of ± 1 of the reported median more than 90% of the time. If the PDSCH BLER using the transport format indicated by median CQI is less than or equal to 0.1, the BLER using the transport format indicated by the (median CQI +1) shall be greater than 0.1. If the PDSCH BLER using the transport format indicated by the median CQI is greater than 0.1, the BLER using transport format indicated by (median CQI –1) shall be less than or equal to 0.1.

Table 9.2.1.2.3-1: PUCCH 1-0 static test (TDD)

Parameter		Unit	Test 1		Test 2	
Bandwidth		MHz			10	
PDSCH transmission mode					1	
Uplink downlink configuration					2	
Special subframe configuration					4	
Downlink power allocation	ρ_A	dB			0	
	ρ_B	dB			0	
Propagation condition and antenna configuration			AWGN (1 x 2)			
SNR (Note 2)		dB	0	1	6	7
$\hat{I}_{or}^{(j)}$		dB[mW/15kHz]	-98	-97	-92	-91
$N_{oc}^{(j)}$		dB[mW/15kHz]	-98		-98	
Maximum number of HARQ transmissions			1			
Physical channel for CQI reporting			PUSCH (Note 3)			
PUCCH Report Type			4			
Reporting periodicity		ms	$N_p = 5$			
<i>cqi-pmi-ConfigurationIndex</i>			3			
ACK/NACK feedback mode			Multiplexing			
<p>Note 1: Reference measurement channel according to clause A.4-2 with one sided dynamic OCNB Pattern OP.1 TDD as described in Annex A.5.2.1</p> <p>Note 2: For each test, the minimum requirements shall be fulfilled for at least one of the two SNR(s) and the respective wanted signal input level.</p> <p>Note 3: To avoid collisions between CQI reports and HARQ-ACK it is necessary to report both on PUSCH instead of PUCCH. PDCCH DCI format 0 shall be transmitted in downlink SF#3 and #8 to allow periodic CQI to multiplex with the HARQ-ACK on PUSCH in uplink subframe SF#7 and #2.</p>						

9.2.1.2.4 Test description

9.2.1.2.4.1 Initial conditions

Initial conditions are a set of test configurations the UE needs to be tested in and the steps for the SS to take with the UE to reach the correct measurement state.

Configurations of PDSCH and PDCCH before measurement are specified in Annex C.2.

Test Environment: Normal as defined in TS 36.508 [7] clause 4.1.

Frequencies to be tested: Mid Range as defined in TS 36.508 [7] clause 4.3.1.2.

Channel Bandwidths to be tested: 10MHz, as defined in TS 36.508 [7] clause 4.3.1.2

1. Connect the SS, faders and AWGN noise source to the UE antenna connector (s) as shown in TS 36.508 [7] Annex A, Figure A.9.
2. The parameter settings for the cell are set up according to Table 9.2.1.2.3-1.
3. Downlink signals are initially set up according to Annex C0, C.1 and Annex C.3.2 and uplink signals according to Annex H.1 and H.3.2.
4. Propagation conditions are set according to Annex B.0
5. Ensure the UE is in State 3A or 3A-RF according to TS 36.508 [7] clause 4.5.3A or 5.2A.2. Message contents are defined in clause 9.2.1.2.4.3.

9.2.1.2.4.2 Test procedure

1. Set the parameters of bandwidth, reference Channel, the propagation condition, antenna configuration and the SNR according to Table 9.2.1.2.3-1 as appropriate.
2. The SS shall transmit PDSCH via PDCCH DCI format 1A for C_RNTI to transmit the DL RMC according to CQI value 8 of Annex A.4 Table A.4-3 and keep it regardless of the wideband CQI value sent by the UE. The SS sends downlink MAC padding bits on the DL RMC. The SS sends uplink scheduling information via PDCCH DCI format 0 with CQI request bit set to 0 to schedule UL RMC in subframe #2 and subframe #7 according to Annex A.4-11. The UE will send ACK/NACK and periodic CQI report using PUSCH. Continue transmission of the PDSCH until 2000 wideband CQI reports have been gathered. In this process the SS collects wideband CQI reports every 5 ms and also cases where UE transmits nothing in its CQI timing are counted as wideband CQI reports.
3. Set up a relative frequency distribution for the reported wideband CQI-values, Calculate the median value (wideband Median CQI is the CQI that is at or crosses 50% distribution from the lower wideband CQI side). This CQI-value is declared as wideband Median CQI value.
4. If Median CQI is not equal to 1 or 15 and 1800 or more of the wideband CQI values are in the range $(\text{Median CQI} - 1) \leq \text{Median CQI} \leq (\text{Median CQI} + 1)$ then continue with step 5, otherwise go to step 8.
5. The SS shall transmit PDSCH via PDCCH DCI format 1A for C_RNTI to transmit the DL RMC according to the wideband median-CQI value and shall not react to the UE's wideband CQI reports. The SS sends downlink MAC padding bits on the DL RMC. The SS sends uplink scheduling information via PDCCH DCI format 0 with CQI request bit set to 0 to schedule UL RMC in subframe #2 and subframe #7 according to Annex A.4-11. The UE will send ACK/NACK and periodic CQI report using PUSCH. For any PDSCH transmitted by the SS, record the associated ACK, NACK and statDTX responses. *In case statDTX can not be differentiated from NACK due to multiplexing effect, evaluate the feedback as a NACK* The responses are then filtered as follows: for the sequence of responses for each HARQ process, discard all the statDTX responses. If the number of consecutive discarded statDTX for any one process is an odd number including one, also discard the next response for that HARQ process regardless whether it is an ACK or NACK. Continue to gather data until the number of filtered ACK+NACK responses reaches 1000.

For the filtered ACK and NACK responses if the ratio $(\text{NACK} / \text{ACK} + \text{NACK}) \leq 0.1$ then go to step 6, otherwise go to step 7.

6. The SS shall transmit PDSCH via PDCCH DCI format 1A for C_RNTI to transmit the DL RMC according to the wideband median-CQI+1 value and shall not react to the UE's wideband CQI reports. The SS sends downlink MAC padding bits on the DL RMC. The SS sends uplink scheduling information via PDCCH DCI format 0 with CQI request bit set to 0 to schedule UL RMC in subframe #2 and subframe #7 according to Annex A.4-11. The UE will send ACK/NACK and periodic CQI report using PUSCH. For any PDSCH, transmitted by the SS, record and filter the ACK, NACK and statDTX responses as in step 5 until 1000 filtered ACK+NACK responses are gathered. *In case statDTX can not be differentiated from NACK due to multiplexing effect, evaluate the feedback as a NACK*

If the ratio $(\text{NACK} / \text{ACK} + \text{NACK}) > 0.1$

then pass the UE for this test and go to step 9, otherwise go to step 8.

7. The SS shall transmit PDSCH via PDCCH DCI format 1A for C_RNTI to transmit the DL RMC according to the wideband median-CQI-1 value and shall not react to the UE's wideband CQI reports. The SS sends downlink MAC padding bits on the DL RMC. The SS sends uplink scheduling information via PDCCH DCI format 0 with CQI request bit set to 0 to schedule UL RMC in subframe #2 and subframe #7 according to Annex A.4-11. The UE will send ACK/NACK and periodic CQI report using PUSCH. For any PDSCH, transmitted by the SS, record and filter the ACK, NACK and statDTX responses as in step 5 until 1000 filtered ACK+NACK responses are gathered. *In case statDTX can not be differentiated from NACK due to multiplexing effect, evaluate the feedback as a NACK*

If the ratio $(\text{NACK} / \text{ACK} + \text{NACK}) \leq 0.1$

then pass the UE for this test and go to step 9, otherwise go to step 8.

8. If both SNR points of the test have not been tested, then repeat the same procedure (steps 1 to 7) for the other SNR point as appropriate. Otherwise fail the UE.

9. If both tests have not been done, then repeat the same procedure (steps 1 to 8) with test conditions according to the table 9.2.1.2.3-1 for the other Test as appropriate. Otherwise pass the UE.

9.2.1.2.4.3 Message contents

Message contents are according to TS 36.508 [7] clause 4.6 with the following exceptions:

Table 9.2.1.2.4.3-1: PhysicalConfigDedicated-DEFAULT

Derivation Path: 36.508 clause 5.5.1.2			
Information Element	Value/remark	Comment	Condition
PhysicalConfigDedicated-DEFAULT ::= SEQUENCE {			
cqi-ReportConfig	<i>CQI-ReportConfig-DEFAULT</i>		
}			

Table 9.2.1.2.4.3-2: CQI-ReportConfig-DEFAULT

Derivation Path: 36.508 clause 4.6.3			
Information Element	Value/remark	Comment	Condition
CQI-ReportConfig-DEFAULT ::= SEQUENCE {			
cqi-ReportModeAperiodic	Not present		
nomPDSCH-RS-EPRE-Offset	0		
cqi-ReportPeriodic CHOICE {			
setup SEQUENCE {			
cqi-PUCCH-ResourceIndex	0		
cqi-pmi-ConfigIndex	3		
cqi-FormatIndicatorPeriodic CHOICE {			
widebandCQI	NULL		
}			
ri-ConfigIndex	NULL		
simultaneousAckNackAndCQI	FALSE		
}			
}			

Table 9.2.1.2.4.3-3: TDD-Config-DEFAULT

Derivation Path: 36.508 clause 4.6.3			
Information Element	Value/remark	Comment	Condition
TDD-Config-DEFAULT ::= SEQUENCE {			
subframeAssignment	sa2		
specialSubframePatterns	ssp4		
}			

9.2.1.2.5 Test requirement

The pass fail decision is as specified in the test procedure in clause 9.2.1.2.4.2.

There are no parameters in the test setup or measurement process whose variation impacts the results so there are no applicable test tolerances for this test.

9.2.2 CQI Reporting under AWGN conditions - PUCCH 1-1

9.2.2.1 FDD CQI Reporting under AWGN conditions – PUCCH 1-1

9.2.2.1.1 Test purpose

To verify the variance of the wideband spatial differential CQI between codeword #0 and codeword #1 are within the limits defined and for both codeword #0 and codeword #1, the PDSCH BLER using the transport format indicated by the respective median $CQI_0 - 1$ and median $CQI_1 - 1$ shall be less than or equal to 0.1 and the PDSCH BLER using the transport format indicated by the respective median $CQI_0 + 1$ and median $CQI_1 + 1$ shall be greater than or equal to 0.1.

9.2.2.1.2 Test applicability

This test applies to E-UTRA FDD UE release 8 and forward of UE category 2-5.

9.2.2.1.3 Minimum conformance requirements

The minimum requirements for dual codeword transmission are defined in terms of a reporting spread of the wideband CQI value for codeword #1, and their BLER performance using the transport format indicated by the reported CQI median of codeword #0 and codeword #1. The precoding used at the transmitter is a fixed precoding matrix specified by the bitmap parameter *codebookSubsetRestriction*. The propagation condition assumed for the minimum performance requirement is defined in subclause B.1.

For the parameters specified in table 9.2.2.1.3-1, and using the downlink physical channels specified in tables C.3.2-1 and C.3.2-2, the reported offset level of the wideband spatial differential CQI for codeword #1 (Table 7.2.2 in TS 36.213[10]) shall be used to determine the wideband CQI index for codeword #1 as

$$\text{wideband } CQI_1 = \text{wideband } CQI_0 - \text{Codeword 1 offset level}$$

The wideband CQI_1 shall be within the set $\{\text{median } CQI_1 - 1, \text{median } CQI_1 + 1\}$ for more than 90% of the time, where the resulting wideband values CQI_1 shall be used to determine the median CQI values for codeword #1. For both codewords #0 and #1, the PDSCH BLER using the transport format indicated by the respective median $CQI_0 - 1$ and median $CQI_1 - 1$ shall be less than or equal to 0.1. Furthermore, for both codewords #0 and #1, the PDSCH BLER using the transport format indicated by the respective median $CQI_0 + 1$ and median $CQI_1 + 1$ shall be greater than or equal to 0.1.

Table 9.2.2.1.3-1: PUCCH 1-1 static test (FDD)

Parameter		Unit	Test 1		Test 2	
Bandwidth		MHz	10			
PDSCH transmission mode			4			
Downlink power allocation	ρ_A	dB	-3			
	ρ_B	dB	-3			
Propagation condition and antenna configuration			Clause B.1 (2 x 2)			
CodeBookSubsetRestriction bitmap			010000			
SNR (Note 2)		dB	10	11	16	17
$\hat{I}_{or}^{(j)}$		dB[mW/15kHz]	-88	-87	-82	-81
$N_{oc}^{(j)}$		dB[mW/15kHz]	-98		-98	
Max number of HARQ transmissions			1			
Physical channel for CQI/PMI reporting			PUCCH Format 2			
PUCCH Report Type for CQI/PMI			2			
PUCCH Report Type for RI			3			
Reporting periodicity		ms	$N_P = 5$			
<i>cqi-pmi-ConfigurationIndex</i>			6			
<i>ri-ConfigIndex</i>			1 (Note 3)			
Note 1:		Reference measurement channel according to Table A.4-1 with one sided dynamic OCNG Pattern OP.1 FDD as described in Annex A.5.1.1				
Note 2:		For each test, the minimum requirements shall be fulfilled for at least one of the two SNR(s) and the respective wanted signal input level.				
Note 3:		It is intended to have UL collisions between RI reports and HARQ-ACK, since the RI reports shall not be used by the eNB in this test.				

9.2.2.1.4 Test description

9.2.2.1.4.1 Initial conditions

Initial conditions are a set of test configurations the UE needs to be tested in and the steps for the SS to take with the UE to reach the correct measurement state.

Configurations of PDSCH and PDCCH before measurement are specified in Annex C.2.

Test Environment: Normal as defined in TS 36.508 [7] clause 4.1.

Frequencies to be tested: Mid Range as defined in TS 36.508 [7] clause 4.3.1.1.

Channel Bandwidths to be tested: 10MHz, as defined in TS 36.508 [7] clause 4.3.1.1

1. Connect the SS, faders and AWGN noise source to the UE antenna connector (s) as shown in TS 36.508 [7] Annex A, Figure A.10.
2. The parameter settings for the cell are set up according to Table 9.2.2.1.3-1.
3. Downlink signals are initially set up according to Annex C0, C.1 and Annex C.3.2 and uplink signals according to Annex H.1 and H.3.2.
4. Propagation conditions are set according to Annex B.0.
5. Ensure the UE is in State 3A or 3A-RF according to TS 36.508 [7] clause 4.5.3A or 5.2A.2. Message contents are defined in clause 9.2.2.1.4.3.

9.2.2.1.4.2 Test procedure

1. Set the parameters of bandwidth, reference Channel, the propagation condition, antenna configuration and the SNR according to Table 9.2.2.1.3-1 as appropriate.
2. The SS shall transmit PDSCH via PDCCH DCI format 2 for C_RNTI to transmit the DL RMC including two codewords with spatial multiplexing both using the transport format according to CQI value 8 of Annex A.4 Table A.4-3a and keep them regardless of the wideband CQI value sent by the UE. The SS sends downlink MAC padding bits on the DL RMC. The SS shall use a fixed precoding matrix specified by the bitmap parameter *codebookSubsetRestriction*. Continue transmission of the PDSCH until 2000 wideband and wideband spatial differential CQI reports have been gathered. In this process the SS collects wideband and wideband spatial differential CQI reports every 5 ms and also cases where UE transmits nothing in its CQI timing are also counted as wideband and wideband spatial differential CQI reports respectively.
3. From each wideband CQI report, wideband CQI₀ is defined as Wideband CQI of codeword #0 and wideband CQI₁ is calculated according to clause 9.2.2.1.3. Codeword 1 offset level is selected from {0,1,2,3,-4,-3,-2,-1}. Set up a relative frequency distribution for the wideband CQI-values, reported. Calculate the median value (wideband Median CQI is the CQI that is at or crosses 50% distribution from the lower wideband CQI side) for each codewords. Wideband Median CQI₀ is based on the wideband CQI₀ and wideband median CQI₁ is based on the wideband CQI₁.
4. If Median CQI is not equal to 1 or 15 and 1800 or more of the wideband CQI₁ values are in the range (Median CQI₁ - 1) ≤ Median CQI ≤ (Median CQI₁ + 1) then continue with step 5, otherwise go to step 7.
5. The SS shall transmit PDSCH via PDCCH DCI format 2 for C_RNTI to transmit the DL RMC including two codewords with spatial multiplexing where the transport format of codeword #0 is according to the wideband median-CQI₀- 1 and the transport format of codeword #1 is according to the wideband median CQI₁- 1. The SS sends downlink MAC padding bits on the DL RMC. The SS shall not react to the any wideband CQI reports from UE and shall use a fixed precoding matrix specified by the bitmap parameter *codebookSubsetRestriction*. For any PDSCH transmitted by the SS, record the associated ACK, NACK and statDTX responses for each codewords respectively. The responses are then filtered as follows: for the sequence of responses for each HARQ process, discard all the statDTX responses. If the number of consecutive discarded statDTX for any one process is an odd number including one, also discard the next response for that HARQ process regardless whether it is an ACK or NACK. Continue to gather data until the number of filtered ACK+NACK responses for each codewords reaches 1000.

If the ratio (NACK /ACK + NACK) ≤ 0.1 for both codeword #0 and codeword #1

then and go to step 6, otherwise go to step 7.

6. The SS shall transmit PDSCH via PDCCH DCI format 2 for C_RNTI to transmit the DL RMC including two codewords with spatial multiplexing where the transport format of codeword #0 is according to the wideband median-CQI₀ + 1 and the transport format of codeword #1 is according to the wideband median-CQI₁ + 1. The SS sends downlink MAC padding bits on the DL RMC. The SS shall not react to the any wideband CQI reports from UE and shall use a fixed precoding matrix specified by the bitmap parameter *codebookSubsetRestriction*. For any PDSCH transmitted by the SS, record the associated ACK, NACK and statDTX responses for each codewords respectively. The responses are then filtered as follows: for the sequence of responses for each HARQ process, discard all the statDTX responses. If the number of consecutive discarded statDTX for any one process is an odd number including one, also discard the next response for that HARQ process regardless whether it is an ACK or NACK. Continue to gather data until the number of filtered ACK+NACK responses for each codewords reaches 1000.

If the ratio (NACK /ACK + NACK) ≥ 0.1 for both codeword #0 and codeword #1

then pass the UE for this test and go to step 8, otherwise go to step 7.

7. If both SNR points of the test have not been tested, then repeat the same procedure (steps 1 to 6) for the other SNR point as appropriate. Otherwise fail the UE.
8. If both tests have not been done, then repeat the same procedure (steps 1 to 7) with test conditions according to the table 9.2.2.1.3-1 for the other Test as appropriate. Otherwise pass the UE.

9.2.2.1.4.3 Message contents

Message contents are according to TS 36.508 [7] clause 4.6 with the following exceptions:

Table 9.2.2.1.4.3-1: PhysicalConfigDedicated-DEFAULT

Derivation Path: 36.508 clause 5.5.1.2			
Information Element	Value/remark	Comment	Condition
PhysicalConfigDedicated-DEFAULT ::= SEQUENCE {			
cqi-ReportConfig	<i>CQI-ReportConfig-DEFAULT</i>		
antennaInfo CHOICE {			
antennaInfoDedicated ::= SEQUENCE {			
transmissionMode	tm4		
}			
codebookSubsetRestriction CHOICE {			
n2TxAntenna-tm4	010000		
ue-TransmitAntennaSelection CHOICE {			
release	NULL		
}			
}			

Table 9.2.2.1.4.3-2: PDSCH-ConfigDedicated-DEFAULT

Derivation Path: 36.508 clause 4.6.3			
Information Element	Value/remark	Comment	Condition
PDSCH-ConfigDedicated-DEFAULT ::= SEQUENCE {			
p-a	dB-3		
}			

Table 9.2.2.1.4.3-3: CQI-ReportConfig-DEFAULT

Derivation Path: 36.508 clause 4.6.3			
Information Element	Value/remark	Comment	Condition
CQI-ReportConfig-DEFAULT ::= SEQUENCE {			
cqi-ReportModeAperiodic	Not present		
nomPDSCH-RS-EPRE-Offset	0		
cqi-ReportPeriodic CHOICE {			
setup SEQUENCE {			
cqi-PUCCH-ResourceIndex	0		
cqi-pmi-ConfigIndex	6	(see Table 7.2.2-1A in TS 36.213)	
cqi-FormatIndicatorPeriodic CHOICE {			
widebandCQI	NULL		
}			
ri-ConfigIndex	1	(see Table 7.2.2-1B in TS 36.213)	
simultaneousAckNackAndCQI	FALSE		
}			
}			

9.2.2.1.5 Test requirement

The pass fail decision is as specified in the test procedure in clause 9.2.2.1.4.2.

There are no parameters in the test setup or measurement process whose variation impacts the results so there are no applicable test tolerances for this test.

9.2.2.2 TDD CQI Reporting under AWGN conditions – PUCCH 1-1

9.2.2.2.1 Test purpose

To verify the variance of the wideband spatial differential CQI between codeword #0 and codeword #1 are within the limits defined and for both codeword #0 and codeword #1, the PDSCH BLER using the transport format indicated by the respective wideband median $CQI_0 - 1$ and wideband median $CQI_1 - 1$ shall be less than or equal to 0.1 and the PDSCH BLER using the transport format indicated by the respective wideband median $CQI_0 + 1$ and wideband median $CQI_1 + 1$ shall be greater than or equal to 0.1.

9.2.2.2.2 Test applicability

This test applies to E-UTRA TDD UE release 8 and forward of UE category 2-5.

9.2.2.2.3 Minimum conformance requirements

For the parameters specified in table 9.2.2.2.3-1, and using the downlink physical channels specified in tables C.3.2-1 and C.3.2-2, the reported offset level of the wideband spatial differential CQI for codeword #1 (Table 7.2.2 in TS 36.213[10]) shall be used to determine the wideband CQI index for codeword #1 as

$$\text{wideband } CQI_1 = \text{wideband } CQI_0 - \text{Codeword 1 offset level}$$

The wideband CQI_1 shall be within the set $\{\text{median } CQI_1 - 1, \text{median } CQI_1 + 1\}$ for more than 90% of the time, where the resulting wideband values CQI_1 shall be used to determine the median CQI values for codeword #1. For both codewords #0 and #1, the PDSCH BLER using the transport format indicated by the respective median $CQI_0 - 1$ and median $CQI_1 - 1$ shall be less than or equal to 0.1. Furthermore, for both codewords #0 and #1, the PDSCH BLER using the transport format indicated by the respective median $CQI_0 + 1$ and median $CQI_1 + 1$ shall be greater than or equal to 0.1.

Table 9.2.2.3-1: PUCCH 1-1 static test (TDD)

Parameter		Unit	Test 1		Test 2	
Bandwidth		MHz			10	
PDSCH transmission mode					4	
Uplink downlink configuration					2	
Special subframe configuration					4	
Downlink power allocation	ρ_A	dB			-3	
	ρ_B	dB			-3	
Propagation condition and antenna configuration			Clause B.1 (2 x 2)			
CodeBookSubsetRestriction bitmap			010000			
SNR (Note 2)		dB	10	11	16	17
$\hat{I}_{or}^{(j)}$		dB[mW/15kHz]	-88	-87	-82	-81
$N_{oc}^{(j)}$		dB[mW/15kHz]	-98		-98	
Maximum number of HARQ transmissions			1			
Physical channel for CQI/PMI reporting			PUSCH (Note 3)			
PUCCH Report Type			2			
Reporting periodicity		ms	$N_P = 5$			
<i>cqi-pmi-ConfigurationIndex</i>			3			
<i>ri-ConfigIndex</i>			805 (Note 4)			
ACK/NACK feedback mode			Multiplexing			
<p>Note 1: Reference measurement channel according to Table A.4-2 with one sided dynamic OCNG Pattern OP.1 TDD as described in Annex A.5.2.1</p> <p>Note 2: For each test, the minimum requirements shall be fulfilled for at least one of the two SNR(s) and the respective wanted signal input level.</p> <p>Note 3: To avoid collisions between CQI/PMI reports and HARQ-ACK it is necessary to report both on PUSCH instead of PUCCH. PDCCH DCI format 0 shall be transmitted in downlink SF#3 and #8 to allow periodic CQI/PMI to multiplex with the HARQ-ACK on PUSCH in uplink subframe SF#7 and #2.</p> <p>Note 4: RI reporting interval is set to the maximum allowable length of 160ms to minimise collisions between RI, CQI/PMI and HARQ-ACK reports. In the case when all three reports collide, it is expected that CQI/PMI reports will be dropped, while RI and HARQ-ACK will be multiplexed. At eNB, CQI report collection shall be skipped every 160ms during performance verification.</p>						

9.2.2.2.4 Test description

9.2.2.2.4.1 Initial conditions

Initial conditions are a set of test configurations the UE needs to be tested in and the steps for the SS to take with the UE to reach the correct measurement state.

Configurations of PDSCH and PDCCH before measurement are specified in Annex C.2.

Test Environment: Normal as defined in TS 36.508 [7] clause 4.1.

Frequencies to be tested: Mid Range as defined in TS 36.508 [7] clause 4.3.1.2.

Channel Bandwidths to be tested: 10MHz, as defined in TS 36.508 [7] clause 4.3.1.2

1. Connect the SS, faders and AWGN noise source to the UE antenna connector (s) as shown in TS 36.508 [7] Annex A, Figure A.10.
2. The parameter settings for the cell are set up according to Table 9.2.2.3-1.
3. Downlink signals are initially set up according to Annex C0, C.1 and Annex C.3.2 and uplink signals according to Annex H1 and H.3.2.

4. Propagation conditions are set according to Annex B.0.
5. Ensure the UE is in State 3A or 3A-RF according to TS 36.508 [7] clause 4.5.3A or 5.2A.2. Message contents are defined in clause 9.2.2.2.4.3.

9.2.2.2.4.2 Test procedure

1. Set the parameters of bandwidth, reference Channel, the propagation condition, antenna configuration and the SNR according to Table 9.2.2.2.3-1 as appropriate.
2. The SS shall transmit PDSCH via PDCCH DCI format 2 for C_RNTI to transmit the DL RMC including two codewords with spatial multiplexing both using the transport format according to CQI value 8 of Annex A.4 Table A.4-3a and keep them regardless of the wideband CQI value sent by the UE. The SS sends downlink MAC padding bits on the DL RMC. The SS shall use a fixed precoding matrix specified by the bitmap parameter *codebookSubsetRestriction*. The SS sends uplink scheduling information via PDCCH DCI format 0 with CQI request bit set to 0 to schedule UL RMC in subframe #2 and subframe #7 according to Annex A.4-11. The UE will send ACK/NACK and periodic CQI report using PUSCH. Continue transmission of the PDSCH until 2000 wideband and wideband spatial differential CQI reports have been gathered. In this process the SS collects wideband and wideband spatial differential CQI reports every 5 ms and also cases where UE transmits nothing in its CQI timing are counted as wideband and wideband spatial differential CQI reports respectively.
3. From each wideband CQI report, wideband CQI₀ is defined as Wideband CQI of codeword #0 and wideband CQI₁ is calculated according to clause 9.2.2.2.3. Codeword 1 offset level is selected from {0,1,2,3,-4,-3,-2,-1}. Set up a relative frequency distribution for the wideband CQI-values, reported. Calculate the median value (wideband Median CQI is the CQI that is at or crosses 50% distribution from the lower wideband CQI side) for each codewords. Wideband Median CQI₀ is based on the wideband CQI₀ and wideband median CQI₁ is based on the wideband CQI₁.
4. If Median CQI is not equal to 1 or 15 and 1800 or more of the wideband CQI₁ values are in the range (Median CQI₁ - 1) ≤ Median CQI ≤ (Median CQI₁ + 1) then continue with step 5, otherwise go to step 7.
5. The SS shall transmit PDSCH via PDCCH DCI format 2 for C_RNTI to transmit the DL RMC including two codewords with spatial multiplexing where the transport format of codeword #0 is according to the wideband median- CQI₀- 1 and the transport format of codeword #1 is according to the wideband median CQI₁- 1. The SS sends downlink MAC padding bits on the DL RMC. The SS shall not react to the any wideband CQI reports from UE and shall use a fixed precoding matrix specified by the bitmap parameter *codebookSubsetRestriction*. The SS sends uplink scheduling information via PDCCH DCI format 0 with CQI request bit set to 0 to schedule UL RMC in subframe #2 and subframe #7 according to Annex A.4-11. The UE will send ACK/NACK and periodic CQI report using PUSCH. For any PDSCH transmitted by the SS, record the associated ACK, NACK and statDTX responses for each codewords respectively. *In case statDTX can not be differentiated from NACK due to multiplexing effect, evaluate the feedback as a NACK* The responses are then filtered as follows: for the sequence of responses for each HARQ process, discard all the statDTX responses. If the number of consecutive discarded statDTX for any one process is an odd number including one, also discard the next response for that HARQ process regardless whether it is an ACK or NACK. Continue to gather data until the number of filtered ACK+NACK responses for each codewords reaches 1000.

If the ratio (NACK /ACK + NACK) ≤ 0.1

then, and go to step 6, otherwise go to step 7.

6. The SS shall transmit PDSCH via PDCCH DCI format 2 for C_RNTI to transmit the DL RMC including two codewords with spatial multiplexing where the transport format of codeword #0 is according to the wideband median-CQI₀ + 1 and the transport format of codeword #1 is according to the wideband median-CQI₁ + 1. The SS sends downlink MAC padding bits on the DL RMC. The SS shall not react to the any wideband CQI reports from UE and shall use a fixed precoding matrix specified by the bitmap parameter *codebookSubsetRestriction*. The SS sends uplink scheduling information via PDCCH DCI format 0 with CQI request bit set to 0 to schedule UL RMC in subframe #2 and subframe #7 according to Annex A.4-11. The UE will send ACK/NACK and periodic CQI report using PUSCH. For any PDSCH transmitted by the SS, record the associated ACK, NACK and statDTX responses for each codewords respectively. *In case statDTX can not be differentiated from NACK due to multiplexing effect, evaluate the feedback as a NACK* The responses are then filtered as follows: for the sequence of responses for each HARQ process, discard all the statDTX responses. If the number of consecutive discarded statDTX for any one process is an odd number including

one, also discard the next response for that HARQ process regardless whether it is an ACK or NACK. Continue to gather data until the number of filtered ACK+NACK responses for each codewords reaches 1000.

If the ratio $(NACK / (ACK + NACK)) \geq 0.1$

then pass the UE for this test and go to step 8, otherwise go to step 7.

7. If both SNR points of the test have not been tested, then repeat the same procedure (steps 1 to 6) for the other SNR point as appropriate. Otherwise fail the UE.
8. If both tests have not been done, then repeat the same procedure (steps 1 to 7) with test conditions according to the table 9.2.2.2.3-1 for the other Test as appropriate. Otherwise pass the UE.

9.2.2.2.4.3 Message contents

Message contents are according to TS 36.508 [7] clause 4.6 with the following exceptions:

Table 9.2.2.2.4.3-1: PhysicalConfigDedicated-DEFAULT

Derivation Path: 36.508 clause 5.5.1.2			
Information Element	Value/remark	Comment	Condition
PhysicalConfigDedicated-DEFAULT ::= SEQUENCE {			
cqi-ReportConfig	<i>CQI-ReportConfig-DEFAULT</i>		
antennaInfo CHOICE {			
antennaInfoDedicated ::= SEQUENCE {			
transmissionMode	tm4		
}			
codebookSubsetRestriction CHOICE {			
n2TxAntenna-tm4	010000		
ue-TransmitAntennaSelection CHOICE {			
release	NULL		
}			
}			

Table 9.2.2.2.4.3-2: PDSCH-ConfigDedicated-DEFAULT

Derivation Path: TS 36.508 [7] clause 4.6.3, Table 4.6.3-6 PDSCH-ConfigDedicated-DEFAULT			
Information Element	Value/remark	Comment	Condition
PDSCH-ConfigDedicated-DEFAULT ::= SEQUENCE {			
p-a	dB-3		
}			

Table 9.2.2.4.3-3: CQI-ReportConfig-DEFAULT

Derivation Path: 36.508 clause 4.6.3			
Information Element	Value/remark	Comment	Condition
CQI-ReportConfig-DEFAULT ::= SEQUENCE {			
cqi-ReportModeAperiodic	Not present		
nomPDSCH-RS-EPRE-Offset	0		
cqi-ReportPeriodic CHOICE {			
setup SEQUENCE {			
cqi-PUCCH-ResourceIndex	0		
cqi-pmi-ConfigIndex	3		
cqi-FormatIndicatorPeriodic CHOICE {			
widebandCQI	NULL		
}			
ri-ConfigIndex	805		
simultaneousAckNackAndCQI	FALSE		
}			
}			

Table 9.2.2.4.3-4: TDD-Config-DEFAULT

Derivation Path: 36.508 clause 4.6.3			
Information Element	Value/remark	Comment	Condition
TDD-Config-DEFAULT ::= SEQUENCE {			
subframeAssignment	Sa2		
specialSubframePatterns	Ssp4		
}			

9.2.2.2.5 Test requirement

The pass fail decision is as specified in the test procedure in clause 9.2.1.2.4.2.

There are no parameters in the test setup or measurement process whose variation impacts the results so there are no applicable test tolerances for this test.

9.3 CQI Reporting under fading conditions

9.3.1 Frequency-selective scheduling mode

The accuracy of sub-band channel quality indicator (CQI) reporting under frequency selective fading conditions is determined by a double-sided percentile of the reported differential CQI offset level 0 per sub-band, and the relative increase of the throughput obtained when transmitting on any one of the sub-bands with the highest reported differential CQI offset level the corresponding transport format compared to the case for which a fixed format is transmitted on any sub-band in set of TS 36.213[10]. To account for sensitivity of the input SNR the sub-band CQI reporting under frequency selective fading conditions is considered to be verified if the reporting accuracy is met for at least one of two SNR levels separated by an offset of 1 dB.

9.3.1.1 CQI Reporting under fading conditions – PUSCH 3-0

9.3.1.1.1 FDD CQI Reporting under fading conditions – PUSCH 3-0

9.3.1.1.1.1 Test purpose

To verify that preferred sub-bands can be used for frequently-selective scheduling.

9.3.1.1.1.2 Test applicability

This test applies to all types of E-UTRA FDD UE release 8 and forward.

9.3.1.1.1.3 Minimum conformance requirements

For the parameters specified in Table 9.3.1.1.1.3-1, and using the downlink physical channels specified in Annex C, the minimum requirements are specified in Table 9.3.1.1.1.3-2 and by the following

- a sub-band differential CQI offset level of 0 shall be reported at least $\alpha\%$ of the time but less than $\beta\%$ for each sub-band;
- the ratio of the throughput obtained when transmitting a randomly selected sub-band among the sub-bands with the highest differential CQI offset level the corresponding TBS and that obtained when transmitting the TBS indicated by the reported wideband CQI median on a randomly selected sub-band in set S shall be $\geq \gamma$;
- when transmitting a randomly selected sub-band among the sub-bands with the highest differential CQI offset level the corresponding TBS, the average BLER for the indicated transport formats shall be greater or equal to 0.05.

The requirements only apply for sub-bands of full size and the random scheduling across the sub-bands is done by selecting a new sub-band in each TTI. The transport block size TBS(wideband CQI median) is that resulting from the code rate which is closest to that indicated by the wideband CQI median and the N_{PRB} entry in Table 7.1.7.2.1-1 of TS 36.213[10] that corresponds to the sub-band size.

Table 9.3.1.1.1.3-1: Sub-band test for single antenna transmission (FDD)

Parameter	Unit	Test 1		Test 2	
Bandwidth	MHz	10 MHz			
Transmission mode		1 (port 0)			
SNR (Note 3)	dB	9	10	14	15
$\hat{I}_{or}^{(j)}$	dB[mW/15kHz]	-89	-88	-84	-83
$N_{oc}^{(j)}$	dB[mW/15kHz]	-98		-98	
Propagation channel		Clause B.2.4 with $\tau_d = 0.45 \mu\text{s}$, $a = 1$, $f_D = 5 \text{ Hz}$			
Correlation		Full			
Reporting interval	ms	5			
CQI delay	ms	8			
Reporting mode		PUSCH 3-0			
Max number of HARQ transmissions		1			
Note 1: If the UE reports in an available uplink reporting instance at subframe SF#n based on CQI estimation at a downlink subframe not later than SF#(n-4), this reported subband or wideband CQI cannot be applied at the eNB downlink before SF#(n+4) Note 2: Reference measurement channel according to Table A.4-4 with one/two sided dynamic OCNG Pattern OP.1/2 FDD as described in Annex A.5.1.1/2 Note 3: For each test, the minimum requirements shall be fulfilled for at least one of the two SNR(s) and the respective wanted signal input level.					

Table 9.3.1.1.1.3-2: Minimum requirement (FDD)

Parameter	Test 1	Test 2
α [%]	2	2
β [%]	55	55
γ	1.1	1.1
UE Category	1-5	1-5

9.3.1.1.1.4 Test description

9.3.1.1.1.4.1 Initial conditions

Initial conditions are a set of test configurations the UE needs to be tested in and the steps for the SS to take with the UE to reach the correct measurement state.

Configurations of PDSCH and PDCCH before measurement are specified in Annex C.2.

Test Environment: Normal as defined in TS 36.508 [7] clause 4.1.

Frequencies to be tested: Mid Range as defined in TS 36.508 [7] clause 4.3.1.1.

Channel Bandwidths to be tested: 10MHz, as defined in TS 36.508 [7] clause 4.3.1.1

1. Connect the SS, faders and AWGN noise source to the UE antenna connector (s) as shown in TS 36.508 [7] Annex A, Figure A.9.
2. The parameter settings for the cell are set up according to Table 9.3.1.1.1.3-1.
3. Downlink signals are initially set up according to Annex C0, C.1 and Annex C.3.2, and uplink signals according to Annex H.1 and H.3.2.
4. Propagation conditions are set according to Annex B.0.
5. Ensure the UE is in State 3A or 3A-RF according to TS 36.508 [7] clause 4.5.3A or 5.2A.2. Message contents are defined in clause 9.3.1.1.1.4.3.

9.3.1.1.1.4.2 Test procedure

1. Set the parameters of bandwidth, reference Channel, the propagation condition, antenna configuration and the SNR according to Table 9.3.1.1.1.3-1 as appropriate.
2. The SS shall transmit PDSCH via PDCCH DCI format 1A for C_RNTI to transmit the DL RMC according to CQI value 8 of Annex A.4 Table A.4-3 and keep it regardless of the wideband and subband CQI value sent by the UE. Continue transmission of the PDSCH until 2000 wideband CQI reports and full-size subband CQI reports for each full-size subband have been gathered. The SS sends downlink MAC padding bits on the DL RMC. SS schedules the UL transmission every 5 ms to carry the PUSCH CQI feedback via PDCCH DCI format 0 with CQI request bit set to 1 and I_MCS=29 and N_PRB allocated to be less or equal to 4. In this process the SS collects wideband CQI reports every 5 ms and also cases where UE transmits nothing in its CQI timing are counted as wideband CQI and full-size subband CQI reports.
3. Set up a relative frequency distribution for the reported wideband CQI-values, Calculate the median value (wideband Median CQI is the CQI that is at or crosses 50% distribution from the lower wideband CQI side). This CQI-value is declared as wideband Median CQI value.
4. Check if " $2000 * \alpha \% / 100 \leq \text{number of CQI reports with index 0 for each full-size subband} \leq 2000 * \beta \% / 100$ ". (2000= No of full-size subband reports, 100 because of %) If yes, continue with step5, otherwise goto step 7.
5. The SS shall transmit PDSCH via PDCCH DCI format 1A for C_RNTI to transmit the DL RMC according to the wideband median-CQI value in an each TTI randomly selected full-size subband regardless of UE wideband and full-size subband CQI report. Note that each full-size subband is selected in equal probability. The SS sends downlink MAC padding bits on the DL RMC. The transport format to be used is defined in Annex A.4 Table A.4-6. SS schedules the UL transmission every 5 ms to carry the PUSCH CQI feedback via PDCCH DCI format 0 with CQI request bit set to 1 and I_MCS=29 and N_PRB allocated to be less or equal to 4. Measure the average throughput according to Annex G.5.3. Declare the throughput as t_{median} .
6. The SS shall transmit PDSCH via PDCCH DCI format 1A for C_RNTI to transmit the DL RMC according to the highest UE reported full-size subband CQI value in one full-size subband selected among the subbands in which UE reports the highest full-size subband CQI. Subband differential CQI offset level is selected from {0, 1, 2, -1}. Note that the SS shall send PDSCH in the same full-size subband until next UE report is available. In case when same full-size subbands are reported subsequently as subbands with highest full-size subband CQI, the SS shall select for transmission a different subband with respect to the last selection. The SS sends downlink MAC padding bits on the DL RMC. The transport format to be used is defined in Annex A.4 Table

A.4-6. SS schedules the UL transmission every 5 ms to carry the PUSCH CQI feedback via PDCCH DCI format 0 with CQI request bit set to 1 and I_MCS=29 and N_PRB allocated to be less or equal to 4. Measure the average throughput and $(\text{NACK} / (\text{ACK} + \text{NACK}))$ according to Annex G.5.3. Declare the throughput as t_{subband} . If the ratio $(t_{\text{subband}} / t_{\text{median}}) \geq \gamma$ and $(\text{NACK} / (\text{ACK} + \text{NACK})) \geq 0.05$, pass the UE for this test and go to step 8. Otherwise, go to step 7.

7. If both SNR points of the test have not been tested, then repeat the same procedure (steps 1 to 6) for the other SNR point as appropriate. Otherwise fail the UE.
8. If both tests have not been done, then repeat the same procedure (steps 1 to 7) with test conditions according to the table 9.3.1.1.1.3-1 for the other Test as appropriate. Otherwise pass the UE.

9.3.1.1.1.4.3 Message contents

Message contents are according to TS 36.508 [7] clause 4.6 with the following exceptions:

Table 9.3.1.1.1.4.3-1: PhysicalConfigDedicated-DEFAULT

Derivation Path: 36.508 clause 5.5.1.2			
Information Element	Value/remark	Comment	Condition
PhysicalConfigDedicated-DEFAULT ::= SEQUENCE {			
cqi-ReportConfig	CQI-ReportConfig-DEFAULT		
}			

Table 9.3.1.1.1.4.3-2: CQI-ReportConfig-DEFAULT

Derivation Path: 36.508 clause 4.6.3			
Information Element	Value/remark	Comment	Condition
CQI-ReportConfig-DEFAULT ::= SEQUENCE {			
cqi-ReportModeAperiodic	rm30		
nomPDSCH-RS-EPRE-Offset	0		
cqi-ReportPeriodic	Not present		
}			

9.3.1.1.1.5 Test requirement

Table 9.3.1.1.1.5-1: Test requirement (FDD)

Parameter	Test 1	Test 2
α [%]	2	2
β [%]	55	55
γ	1.09	1.09
BLER	0.05	0.05

To pass the test, α and β and γ and BLER must be fulfilled.

To pass the test, Test 1 and Test 2 must be passed.

To pass the test, one **or** the other SNR point within one test must be fulfilled.

9.3.1.1.2 TDD CQI Reporting under fading conditions – PUSCH 3-0

9.3.1.1.2.1 Test purpose

To verify that preferred sub-bands can be used for frequently-selective scheduling.

9.3.1.1.2.2 Test applicability

This test applies to all types of E-UTRA TDD UE release 8 and forward.

9.3.1.1.2.3 Minimum conformance requirements

For the parameters specified in Table 9.3.1.1.2.3-1, and using the downlink physical channels specified in Annex C, the minimum requirements are specified in Table 9.3.1.1.2.3-2 and by the following

- a sub-band differential CQI offset level of 0 shall be reported at least $\alpha\%$ of the time but less than $\beta\%$ for each sub-band;
- the ratio of the throughput obtained when transmitting on a randomly selected sub-band among the sub-bands with the highest differential CQI offset level the corresponding TBS and that obtained when transmitting the TBS indicated by the reported wideband CQI median on a randomly selected sub-band in set S shall be $\geq \gamma$;
- when transmitting on a randomly selected sub-band among the sub-bands with the highest differential CQI offset level the corresponding TBS, the average BLER for the indicated transport formats shall be greater or equal to 0.05.

The requirements only apply for sub-bands of full size and the random scheduling across the sub-bands is done by selecting a new sub-band in each available downlink transmission instance]. The transport block size TBS(wideband CQI median) is that resulting from the code rate which is closest to that indicated by the wideband CQI median and the N_{PRB} entry in Table 7.1.7.2.1-1 of TS 36.213[10] that corresponds to the sub-band size.

Table 9.3.1.1.2.3-1: Sub-band test for single antenna transmission (TDD)

Parameter	Unit	Test 1		Test 2	
Bandwidth	MHz	10 MHz			
Transmission mode		1 (port 0)			
Uplink downlink configuration		2			
Special subframe configuration		4			
SNR	dB	9	10	14	15
$N_{oc}^{(j)}$	dB[mW/15kHz]	-98		-98	
$\hat{I}_{or}^{(j)}$	dB[mW/15kHz]	-89	-88	-84	-83
Propagation channel		Clause B.2.4 with $\tau_d = 0.45 \mu s$ $a = 1, f_D = 5 \text{ Hz}$			
Correlation		Full			
Reporting interval	ms	5			
Minimum CQI delay	ms	10 or 11			
Reporting mode		PUSCH 3-0			
Max number of HARQ transmissions		1			
ACK/NACK feedback mode		Multiplexing			
Note 1:	If the UE reports in an available uplink reporting instance at subframe SF#n based on CQI estimation at a downlink subframe not later than SF#(n-4), this reported subband or wideband CQI cannot be applied at the eNB downlink before SF#(n+4)				
Note 2:	Reference measurement channel according to Table A.4-5 with one/two sided dynamic OCNG Pattern OP.1/2 TDD as described in Annex A.5.2.1/2.				
Note 3:	For each test, the minimum requirements shall be fulfilled for at least one of the two SNR(s) and the respective wanted signal input level.				

Table 9.3.1.1.2.3-2: Minimum requirement (TDD)

Parameter	Test 1	Test 2
α [%]	2	2
β [%]	55	55
γ	1.1	1.1
UE Category	1-5	1-5

9.3.1.1.2.4 Test description

9.3.1.1.2.4.1 Initial conditions

Initial conditions are a set of test configurations the UE needs to be tested in and the steps for the SS to take with the UE to reach the correct measurement state.

Configurations of PDSCH and PDCCH before measurement are specified in Annex C.2.

Test Environment: Normal as defined in TS 36.508 [7] clause 4.1.

Frequencies to be tested: Mid Range as defined in TS 36.508 [7] clause 4.3.1.2.

Channel Bandwidths to be tested: 10MHz, as defined in TS 36.508 [7] clause 4.3.1.2

1. Connect the SS to the UE antenna connector (s) as shown in TS 36.508 [7] Annex A, Figure [FFS].
2. The parameter settings for the cell are set up according to Table 9.3.1.1.2.3-1.
3. Downlink signals are initially set up according to Annex C0, C.1 and Annex C.3.2, and uplink signals according to Annex H.1 and H.3.2.
4. Propagation conditions are set according to Annex B.0
5. Ensure the UE is in State 3A or 3A-RF according to TS 36.508 [7] clause 4.5.3A or 5.2A.2. Message contents are defined in clause 9.3.1.1.2.4.3.

9.3.1.1.2.4.2 Test procedure

1. Set the parameters of bandwidth, reference Channel, the propagation condition, antenna configuration and the SNR according to Table 9.3.1.1.2.3-1 as appropriate.
2. The SS shall transmit PDSCH via PDCCH DCI format 1A for C_RNTI to transmit the DL RMC according to CQI value 8 of Annex A.4 Table A.4-3 and keep it regardless of the wideband and full-size subband CQI value sent by the UE. Continue transmission of the PDSCH until 2000 wideband CQI reports and full-size subband CQI report for each full-size subband have been gathered. The SS sends downlink MAC padding bits on the DL RMC. SS schedules the UL transmission in subframe #2 and subframe #7 to carry the PUSCH CQI feedback via PDCCH DCI format 0 with CQI request bit set to 1 and I_MCS=29 and N_PRB allocated to be less or equal to 4. In this process the SS collects wideband CQI reports every 5 ms and also cases where UE transmits nothing in its CQI timing are counted as wideband CQI and full-size subband CQI reports.
3. Set up a relative frequency distribution for the reported wideband CQI-values, Calculate the median value (wideband Median CQI is the CQI that is at or crosses 50% distribution from the lower wideband CQI side). This CQI-value is declared as wideband Median CQI value.
4. For each subband, if subband CQI of index 0 is reported, at least α % but less than β % of 2000 full-size subband CQI report, then continue to step 5, otherwise, go to step 7.
5. The SS shall send PDSCH via PDCCH DCI format 1A for C_RNTI to transmit the DL RMC according to the wideband median-CQI value in an each available downlink transmission instance randomly selected full-size subband regardless of UE wideband and subband CQI report. Note that each full-size subband is selected in equal probability. The SS sends downlink MAC padding bits on the DL RMC. The transport format to be used is defined in Annex A.4 Table A.4-6. SS schedules the UL transmission in subframe #2 and subframe #7 to carry the PUSCH CQI feedback via PDCCH DCI format 0 with CQI request bit set to 1 and I_MCS=29 and

N_PRB allocated to be less or equal to 4. Measure the average throughput according to Annex G.5.3 Declare the throughput as t_{median} .

6. The SS shall transmit PDSCH via PDCCH DCI format 1A for C_RNTI to transmit the DL RMC according to the highest UE reported full-size subband CQI value in one full-size subband selected among the sub-bands in which UE report the highest full-size subband CQI. Subband differential CQI offset level is selected from {0, 1, 2, -1}. Note that the SS shall send PDSCH in the same full-size subband until next UE report is available. In case when same full-size subbands are reported subsequently as subbands with highest full-size subband CQI, the SS shall select for transmission a different subband with respect to the last selection. The SS sends downlink MAC padding bits on the DL RMC. The transport format to be used is defined in Annex A.4 Table A.4-6. SS schedules the UL transmission in subframe #2 and subframe #7 to carry the PUSCH CQI feedback via PDCCH DCI format 0 with CQI request bit set to 1 and I_MCS=29 and N_PRB allocated to be less or equal to 4. Measure the average throughput and (NACK / (ACK + NACK)) according to Annex G.5.3. Declare the throughput as $t_{subband}$. If the ratio $(t_{subband} / t_{median}) \geq \gamma$ and (NACK / (ACK + NACK)) ≥ 0.05 , pass the UE and go to step 8. Otherwise, go to step 7.
7. If both SNR points of the test have not been tested, then repeat the same procedure (steps 1 to 6) for the other SNR point as appropriate. Otherwise fail the UE.
8. If both tests have not been done, then repeat the same procedure (steps 1 to 7) with test conditions according to the table 9.3.1.1.2.3-1 for the other test as appropriate.

9.3.1.1.2.4.3 Message contents

Message contents are according to TS 36.508 [7] clause 4.6 with the following exceptions:

Table 9.3.1.1.2.4.3-1: PhysicalConfigDedicated-DEFAULT

Derivation Path: 36.508 clause 5.5.1.2			
Information Element	Value/remark	Comment	Condition
PhysicalConfigDedicated-DEFAULT ::= SEQUENCE {			
cqi-ReportConfig	CQI-ReportConfig-DEFAULT		
}			

Table 9.3.1.1.2.4.3-2: CQI-ReportConfig-DEFAULT

Derivation Path: 36.508 clause 4.6.3			
Information Element	Value/remark	Comment	Condition
CQI-ReportConfig-DEFAULT ::= SEQUENCE {			
cqi-ReportModeAperiodic	rm30		
nomPDSCH-RS-EPRE-Offset	0		
cqi-ReportPeriodic	Not present		
}			

Table 9.3.1.1.2.4.3-3: TDD-Config-DEFAULT

Derivation Path: 36.508 clause 4.6.3			
Information Element	Value/remark	Comment	Condition
TDD-Config-DEFAULT ::= SEQUENCE {			
subframeAssignment	Sa2		
specialSubframePatterns	Ssp4		
}			

9.3.1.1.2.5 Test requirement

Table 9.3.1.1.2.5-1: Test requirement (TDD)

Parameter	Test 1	Test 2
α [%]	2	2
β [%]	55	55
γ	1.09	1.09
BLER	0.05	0.05

To pass the test, α and β and γ and BLER must be fulfilled.

To pass the test, Test 1 and Test 2 must be passed.

To pass the test, one **or** the other SNR point within one test must be fulfilled.

9.3.2 Frequency non-selective scheduling mode

The reporting accuracy of the channel quality indicator (CQI) under frequency non-selective fading conditions is determined by a double-sided percentile of the reported CQI, and the relative increase of the throughput obtained when the transport format transmitted is that indicated by the reported CQI compared to the case for which a fixed transport format configured according to the reported median CQI is transmitted. In addition, the reporting accuracy is determined by a minimum BLER using the transport formats indicated by the reported CQI. To account for sensitivity of the input SNR the CQI reporting under frequency non-selective fading conditions is considered to be verified if the reporting accuracy is met for at least one of two SNR levels separated by an offset of 1 dB.

9.3.2.1 CQI Reporting under fading conditions – PUCCH 1-0

9.3.2.1.1 FDD CQI Reporting under fading conditions – PUCCH 1-0

9.3.2.1.1.1 Test purpose

To verify that the UE is tracking the channel variations and selecting the largest transport format possible according to the prevailing channel state for frequently non-selective scheduling

9.3.2.1.1.2 Test applicability

This test applies to E-UTRA FDD UE release 8 of UE category 2-5.

9.3.2.1.1.3 Minimum conformance requirements

For the parameters specified in Table 9.3.2.1.1.3-1, and using the downlink physical channels specified in Annex C, the minimum requirements are specified in Table 9.3.2.1.1.3-2 and by the following

- CQI index not in the set {median CQI -1, median CQI +1} shall be reported at least $\alpha\%$ of the time;
- the ratio of the throughput obtained when transmitting the transport format indicated by each reported wideband CQI index and that obtained when transmitting a fixed transport format configured according to the wideband CQI median shall be $\geq \gamma$;
- when transmitting the transport format indicated by each reported wideband CQI index, the average BLER for the indicated transport formats shall be greater or equal to 0.02

The transport block size TBS(wideband CQI median) is that resulting from the code rate which is closest to that indicated by the wideband CQI median and the N_{PRB} entry in Table 7.1.7.2.1-1 of 36.213 [10] that corresponds to the maximum transmission configuration (Table 5.6-1).

Table 9.3.2.1.1.3-1 Fading test for single antenna (FDD)

Parameter	Unit	Test 1		Test 2	
Bandwidth	MHz	10 MHz			
Transmission mode		1 (port 0)			
SNR (Note 3)	dB	6	7	12	13
$\hat{I}_{or}^{(j)}$	dB[mW/15kHz]	-92	-91	-86	-85
$N_{oc}^{(j)}$	dB[mW/15kHz]	-98		-98	
Propagation channel		EPA5			
Correlation		High			
Reporting mode		PUCCH 1-0			
Reporting periodicity	ms	$N_p = 2$			
CQI delay	ms	8			
Physical channel for CQI reporting		PUSCH (Note 4)			
PUCCH Report Type		4			
<i>cqi-pmi-ConfigurationIndex</i>		1			
Max number of HARQ transmissions		1			
Note 1:	If the UE reports in an available uplink reporting instance at subframe SF#n based on CQI estimation at a downlink SF not later than SF#(n-4), this reported wideband CQI cannot be applied at the eNB downlink before SF#(n+4)				
Note 2:	Reference measurement channel according to Table A.4-1 with one sided dynamic OCNG Pattern OP.1 FDD as described in Annex A.5.1.1				
Note 3:	For each test, the minimum requirements shall be fulfilled for at least one of the two SNR(s) and the respective wanted signal input level.				
Note 4:	To avoid collisions between CQI reports and HARQ-ACK it is necessary to report both on PUSCH instead of PUCCH. PDCCH DCI format 0 shall be transmitted in downlink SF#1, #3, #7 and #9 to allow periodic CQI to multiplex with the HARQ-ACK on PUSCH in uplink subframe SF#5, #7, #1 and #3.				

Table 9.3.2.1.1.3-2 Minimum requirement (FDD)

Parameter	Test 1	Test 2
α [%]	20	20
γ	1.05	1.05
UE Category	2-5	2-5

9.3.2.1.1.4 Test description

9.3.2.1.1.4.1 Initial conditions

Initial conditions are a set of test configurations the UE needs to be tested in and the steps for the SS to take with the UE to reach the correct measurement state.

Configurations of PDSCH and PDCCH before measurement are specified in Annex C.2.

Test Environment: Normal as defined in TS 36.508 [7] clause 4.1.

Frequencies to be tested: Mid Range as defined in TS 36.508 [7] clause 4.3.1.1.

Channel Bandwidths to be tested: 10MHz, as defined in TS 36.508 [7] clause 4.3.1.1

1. Connect the SS, faders and AWGN noise source to the UE antenna connector (s) as shown in TS 36.508 [7] Annex A, Figure A.9.
2. The parameter settings for the cell are set up according to Table 9.3.2.1.1.3-1.

3. Downlink signals are initially set up according to Annex C0, C.1 and Annex C.3.2, and uplink signals according to Annex H.3.2.
4. Propagation conditions are set according to Annex B.0.
5. Ensure the UE is in State 3A or 3A-RF according to TS 36.508 [7] clause 4.5.3A or 5.2A.2. Message contents are defined in clause 9.3.2.1.1.4.3.

9.3.2.1.1.4.2 Test procedure

1. Set the parameters of bandwidth, the propagation condition, antenna configuration and measurement channel according to Table 9.3.2.1.1.3-1 as appropriate.
2. The SS shall transmit PDSCH via PDCCH DCI format 1A for C_RNTI to transmit the DL RMC according to CQI value 8 of Annex A.4 Table A.4-3 and keep it regardless of the wideband CQI value sent by the UE. The SS sends downlink MAC padding bits on the DL RMC. The SS sends uplink scheduling information via PDCCH DCI format 0 with CQI request bit set to 0 to schedule UL RMC in subframe #1,#3,#5 and subframe #7 according to Annex A.4-10. The UE will send ACK/NACK and periodic CQI report using PUSCH. Continue transmission of the PDSCH until 2000 wideband CQI reports have been gathered. In this process the SS collects wideband CQI reports every 2 ms and also cases where UE transmits nothing in its CQI timing are counted as wideband CQI reports.
3. Set up a relative frequency distribution for the reported wideband CQI-values, reported. Calculate the median value (wideband Median CQI is the wideband CQI that is at or crosses 50% distribution from the lower wideband CQI side). This CQI-value is declared as wideband Median CQI value.
4. If less than $(100-\alpha)/100 \cdot 2000$ of the wideband CQI values are in the range $(\text{Median CQI} - 1) \leq \text{Median CQI} \leq (\text{Median CQI} + 1)$ then continue with step 5, otherwise go to step 7.
5. The SS shall transmit PDSCH via PDCCH DCI format 1A for C_RNTI to transmit the DL RMC according to the wideband median-CQI value regardless of UE wideband CQI report. The SS sends downlink MAC padding bits on the DL RMC. The SS sends uplink scheduling information via PDCCH DCI format 0 with CQI request bit set to 0 to schedule UL RMC in subframe #1,#3,#5 and subframe #7 according to Annex A.4-10. The UE will send ACK/NACK and periodic CQI report using PUSCH. Measure the average throughput according to Annex G.5.3. Declare the throughput as t_{median} .
6. The SS shall transmit PDSCH via PDCCH DCI format 1A for C_RNTI to transmit the DL RMC according to the wideband CQI value reported from UE. The SS sends downlink MAC padding bits on the DL RMC. The SS sends uplink scheduling information via PDCCH DCI format 0 with CQI request bit set to 0 to schedule UL RMC in subframe #1,#3,#5 and subframe #7 according to Annex A.4-10. The UE will send ACK/NACK and periodic CQI report using PUSCH. Measure the average throughput according to Annex G.5.3. Declare the throughput as $t_{wideband}$. For any PDSCH transmitted by the SS, record the associated ACK, NACK and statDTX responses. The responses are then filtered as follows: for the sequence of responses for each HARQ process, discard all the statDTX responses. If the number of consecutive discarded statDTX for any one process is an odd number including one, also discard the next response for that HARQ process regardless whether it is an ACK or NACK.
If the ratio $(t_{wideband} / t_{median}) \geq \gamma$ and ratio $(\text{NACK} / (\text{ACK} + \text{NACK}))$ is greater or equal to 0.02, then pass the UE for this test and go to step 8. Otherwise go to step 7.
7. If both SNR points of the test have not been tested, then repeat the same procedure (steps 1 to 6) for the other SNR point as appropriate. Otherwise fail the UE.
8. If both tests have not been done, then repeat the same procedure (steps 1 to 7) with test conditions according to the table 9.3.2.1.1.3-1 for the other Test as appropriate. Otherwise pass the UE.

9.3.2.1.1.4.3 Message contents

Message contents are according to TS 36.508 [7] clause 4.6 with the following exceptions:

Table 9.3.2.1.1.4.3-1: PhysicalConfigDedicated-DEFAULT

Derivation Path: 36.508 clause 5.5.1.2			
Information Element	Value/remark	Comment	Condition
PhysicalConfigDedicated-DEFAULT ::= SEQUENCE {			
cqi-ReportConfig	CQI-ReportConfig-DEFAULT		
}			

Table 9.3.2.1.1.4.3-2: CQI-ReportConfig-DEFAULT

Derivation Path: 36.508 clause 4.6.3			
Information Element	Value/remark	Comment	Condition
CQI-ReportConfig-DEFAULT ::= SEQUENCE {			
cqi-ReportModeAperiodic	Not present		
nomPDSCH-RS-EPRE-Offset	0		
cqi-ReportPeriodic CHOICE {			
setup SEQUENCE {			
cqi-PUCCH-ResourceIndex	0		
cqi-pmi-ConfigIndex	1	(see Table 7.2.2-1A in TS 36.213)	
cqi-FormatIndicatorPeriodic CHOICE {			
widebandCQI	NULL		
}			
ri-ConfigIndex	NULL	(see Table 7.2.2-1B in TS 36.213)	
simultaneousAckNackAndCQI	FALSE		
}			
}			

9.3.2.1.1.5 Test requirement

Table 9.3.2.1.1.5-1 Test requirement (FDD)

Parameter	Test 1	Test 2
α [%]	20	20
γ	1.04	1.04
BLER	0.02	0.02

To pass the test, α and γ and BLER must be fulfilled.

To pass the test, Test 1 and Test 2 must be passed.

To pass the test, one **or** the other SNR point within one test must be fulfilled.

9.3.2.1.2 TDD CQI Reporting under fading conditions – PUCCH 1-0

9.3.2.1.2.1 Test purpose

To verify that the UE is tracking the channel variations and selecting the transport format according to the prevailing channel state for frequently non-selective scheduling

9.3.2.1.2.2 Test applicability

This test applies to E-UTRA TDD UE release 8 .of UE category 2-5.

9.3.2.1.2.3 Minimum conformance requirements

For the parameters specified in Table 9.3.2.1.2.3-1, and using the downlink physical channels specified in Annex C, the minimum requirements are specified in Table 9.3.2.1.2.3-2 and by the following

- a CQI index not in the set {median CQI -1, median CQI +1} shall be reported at least α % of the time;
- the ratio of the throughput obtained when transmitting the transport format indicated by each reported wideband CQI index and that obtained when transmitting a fixed transport format configured according to the wideband CQI median shall be $\geq \gamma$;
- when transmitting the transport format indicated by each reported wideband CQI index, the average BLER for the indicated transport formats shall be greater or equal to 0.02

The transport block size TBS(wideband CQI median) is that resulting from the code rate which is closest to that indicated by the wideband CQI median and the N_{PRB} entry in Table 7.1.7.2.1-1 of 36.213[10] that corresponds to the maximum transmission configuration (Table 5.6-1).

Table 9.3.2.1.2.3-1: Fading test for single antenna (TDD)

Parameter	Unit	Test 1		Test 2	
Bandwidth	MHz	10 MHz			
Transmission mode		1 (port 0)			
Uplink downlink configuration		2			
Special subframe configuration		4			
SNR	dB	6	7	12	13
$N_{oc}^{(j)}$	dB[mW/15kHz]	-98		-98	
$\hat{I}_{or}^{(j)}$	dB[mW/15kHz]	-92	-91	-86	-85
Propagation channel		EPA5			
Correlation		High			
Reporting mode		PUCCH 1-0			
Reporting periodicity	ms	$N_P = 5$			
CQI delay	ms	10 or 11			
Physical channel for CQI reporting		PUSCH (Note 4)			
PUCCH Report Type		4			
<i>cqi-pmi-ConfigurationIndex</i>		3			
Max number of HARQ transmissions		1			
ACK/NACK feedback mode		Multiplexing			
Note 1:	If the UE reports in an available uplink reporting instance at subframe SF#n based on CQI estimation at a downlink SF not later than SF#(n-4), this reported wideband CQI cannot be applied at the eNB downlink before SF#(n+4)				
Note 2:	Reference measurement channel according to Table A.4-2 with one sided dynamic OCNG Pattern OP.1 TDD as described in Annex A.5.2.1.				
Note 3:	For each test, the minimum requirements shall be fulfilled for at least one of the two SNR(s) and the respective wanted signal input level.				
Note 4:	To avoid collisions between CQI reports and HARQ-ACK it is necessary to report both on PUSCH instead of PUCCH. PDCCH DCI format 0 shall be transmitted in downlink SF#3 and #8 to allow periodic CQI to multiplex with the HARQ-ACK on PUSCH in uplink subframe SF#7 and #2.				

Table 9.3.2.1.2.3-2: Minimum requirement (TDD)

Parameter	Test 1	Test 2
α [%]	20	20
γ	1.05	1.05
UE Category	2-5	2-5

9.3.2.1.2.4 Test description

9.3.2.1.2.4.1 Initial conditions

Initial conditions are a set of test configurations the UE needs to be tested in and the steps for the SS to take with the UE to reach the correct measurement state.

Configurations of PDSCH and PDCCH before measurement are specified in Annex C.2.

Test Environment: Normal as defined in TS 36.508 [7] clause 4.1.

Frequencies to be tested: Mid Range as defined in TS 36.508 [7] clause 4.3.1.2.

Channel Bandwidths to be tested: 10MHz, as defined in TS 36.508 [7] clause 4.3.1.2

1. Connect the SS to the UE antenna connector (s) as shown in TS 36.508 [7] Annex A, Figure [FFS].
2. The parameter settings for the cell are set up according to Table 9.3.2.1.2.3-1.
3. Downlink signals are initially set up according to Annex C0, C.1 and Annex C.3.2, and uplink signals according to Annex H.3.2.
4. Propagation conditions are set according to Annex B.0.
5. Ensure the UE is in State 3A or 3A-RF according to TS 36.508 [7] clause 4.5.3A or 5.2A.2. Message contents are defined in clause 9.3.2.1.2.4.3.

9.3.2.1.2.4.2 Test procedure

1. Set the parameters of bandwidth, the propagation condition, antenna configuration and measurement channel according to Table 9.3.2.1.2.3-1 as appropriate.
2. The SS shall transmit PDSCH via PDCCH DCI format 1A for C_{RNTI} to transmit the DL RMC according to CQI value 8 of Annex A.4 Table A.4-3 and keep it regardless of the wideband CQI value sent by the UE. The SS sends downlink MAC padding bits on the DL RMC. The SS sends uplink scheduling information via PDCCH DCI format 0 with CQI request bit set to 0 to schedule UL RMC in subframe #2 and subframe #7 according to Annex A.4-11. The UE will send ACK/NACK and periodic CQI report using PUSCH Continue transmission of the PDSCH until 2000 wideband CQI reports have been gathered. In this process the SS collects wideband CQI reports every 5 ms and also cases where UE transmits nothing in its CQI timing are counted as wideband CQI reports.
3. Set up a relative frequency distribution for the reported wideband CQI-values, reported. Calculate the median value (wideband Median CQI is the wideband CQI that is at or crosses 50% distribution from the lower wideband CQI side). This CQI-value is declared as wideband Median CQI value.
4. If less than $(100-\alpha)/100 \cdot 2000$ of the wideband CQI values are in the range $(\text{Median CQI} - 1) \leq \text{Median CQI} \leq (\text{Median CQI} + 1)$ then continue with step 5, otherwise go to step 7.
5. The SS shall transmit PDSCH via PDCCH DCI format 1A for C_{RNTI} to transmit the DL RMC according to the wideband median-CQI value regardless of UE wideband CQI report. The SS sends downlink MAC padding bits on the DL RMC. The SS sends uplink scheduling information via PDCCH DCI format 0 with CQI request bit set to 0 to schedule UL RMC in subframe #2 and subframe #7 according to Annex A.4-11. The UE will send ACK/NACK and periodic CQI report using PUSCH. Measure the average throughput for a duration sufficient to achieve statistical significance according to Annex G clause G.3. Declare the throughput as t_{median} .

6. The SS shall transmit PDSCH via PDCCH DCI format 1A for C_RNTI to transmit the DL RMC according to the wideband CQI value reported from UE. The SS sends downlink MAC padding bits on the DL RMC. The SS sends uplink scheduling information via PDCCH DCI format 0 with CQI request bit set to 0 to schedule UL RMC in subframe #2 and subframe #7 according to Annex A.4-11. The UE will send ACK/NACK and periodic CQI report using PUSCH Measure the average throughput for a duration sufficient to achieve statistical significance according to Annex G clause G.3. Declare the throughput as $t_{wideband}$. For any PDSCH transmitted by the SS, record the associated ACK, NACK and statDTX responses. The responses are then filtered as follows: for the sequence of responses for each HARQ process, discard all the statDTX responses. If the number of consecutive discarded statDTX for any one process is an odd number including one, also discard the next response for that HARQ process regardless whether it is an ACK or NACK. If the ratio $(t_{wideband} / t_{median}) \geq \gamma$ and ratio $(NACK / (ACK + NACK))$ is greater or equal to 0.02, then pass the UE and go to step 8. Otherwise go to step 7.
7. If both SNR points of the test have not been tested, then repeat the same procedure (steps 1 to 6) for the other SNR point as appropriate. Otherwise fail the UE.
8. If both tests have not been done, repeat the same procedure (steps 1 to 7) with test conditions according to the table 9.3.2.1.2.3-1 for the other test as appropriate.

9.3.2.1.2.4.3 Message contents

Message contents are according to TS 36.508 [7] clause 4.6 with the following exceptions:

Table 9.3.2.1.2.4.3-1: PhysicalConfigDedicated-DEFAULT

Derivation Path: 36.508 clause 5.5.1.2			
Information Element	Value/remark	Comment	Condition
PhysicalConfigDedicated-DEFAULT ::= SEQUENCE {			
cqi-ReportConfig	CQI-ReportConfig-DEFAULT		
}			

Table 9.3.2.1.2.4.3-2: CQI-ReportConfig-DEFAULT

Derivation Path: 36.508 clause 4.6.3			
Information Element	Value/remark	Comment	Condition
CQI-ReportConfig-DEFAULT ::= SEQUENCE {			
cqi-ReportModeAperiodic	Not present		
nomPDSCH-RS-EPRE-Offset	0		
cqi-ReportPeriodic CHOICE {			
setup SEQUENCE {			
cqi-PUCCH-ResourceIndex	0		
cqi-pmi-ConfigIndex	3	(see Table 7.2.2-1C in TS 36.213)	
cqi-FormatIndicatorPeriodic CHOICE {			
widebandCQI	NULL		
}			
ri-ConfigIndex	NULL	(see Table 7.2.2-1B in TS 36.213)	
simultaneousAckNackAndCQI	FALSE		
}			
}			
}			

Table 9.3.2.1.2.4.3-3: TDD-Config-DEFAULT

Derivation Path: 36.508 clause 4.6.3			
Information Element	Value/remark	Comment	Condition
TDD-Config-DEFAULT ::= SEQUENCE {			
subframeAssignment	Sa2		
specialSubframePatterns	Ssp4		
}			

9.3.2.1.2.5 Test requirement

Table 9.3.2.1.1.5-1 Test requirement (TDD)

Parameter	Test 1	Test 2
α [%]	20	20
γ	1.04	1.04
BLER	0.02	0.02

To pass the test, α and γ and BLER must be fulfilled.

To pass the test, Test 1 and Test 2 must be passed.

To pass the test, one **or** the other SNR point within one test must be fulfilled.

9.3.3 Frequency-selective interference

The accuracy of sub-band channel quality indicator (CQI) reporting under frequency selective interference conditions is determined by a double-sided percentile of the reported differential CQI offset level +2 for a preferred sub-band, and the relative increase of the throughput obtained when transmitting on any one of the sub-bands with the highest reported differential CQI offset level the corresponding transport format compared to the case for which a fixed format is transmitted on any sub-band in set of TS 36.213[10]. The purpose is to verify that preferred sub-bands are used for frequently-selective scheduling under frequency-selective interference conditions.

9.3.3.1 CQI Reporting under fading conditions and frequency-selective interference – PUSCH 3-0

9.3.3.1.1 FDD CQI Reporting under fading conditions and frequency-selective interference – PUSCH 3-0

9.3.3.1.1.1 Test purpose

To verify that preferred sub-bands can be used for frequently-selective scheduling with frequency-selective interference situation.

9.3.3.1.1.2 Test applicability

This test applies to all types of E-UTRA FDD UE release 8 and forward.

9.3.3.1.1.3 Minimum conformance requirements

For the parameters specified in Table 9.3.3.1.1.3-1, and using the downlink physical channels specified in Annex C, the minimum requirements are specified in Table 9.3.3.1.1.3-2 and by the following:

- a sub-band differential CQI offset level of +2 shall be reported at least α % for at least one of the sub-bands of full size at the channel edges;
- the ratio of the throughput obtained when transmitting on a randomly selected sub-band among the sub-bands with the highest differential CQI offset level the corresponding TBS and that obtained when transmitting the TBS indicated by the reported wideband CQI median on a randomly selected sub-band in set S shall be $\geq \gamma$;

The requirements only apply for sub-bands of full size and the random scheduling across the sub-bands is done by selecting a new sub-band in each TTI for FDD, each available downlink transmission instance for TDD. Sub-bands of a size smaller than full size are excluded from the test. The transport block size TBS(wideband CQI median) is that resulting from the code rate which is closest to that indicated by the wideband CQI median and the N_{PRB} entry in Table 7.1.7.2.1-1 of TS 36.213 [10] that corresponds to the sub-band size.

Table 9.3.3.1.1.3-1 Sub-band test for single antenna transmission (FDD)

Parameter	Unit	Test 1	Test 2
Bandwidth	MHz	10 MHz	10 MHz
Transmission mode		1 (port 0)	1 (port 0)
$I_{ot}^{(j)}$ for RB 0...5 Note 3	dB[mW/15kHz]	-102	-93
$I_{ot}^{(j)}$ for RB 6...41 Note 3	dB[mW/15kHz]	-93	-93
$I_{ot}^{(j)}$ for RB 42...49 Note 3	dB[mW/15kHz]	-93	-102
$\hat{I}_{or}^{(j)}$	dB[mW/15kHz]	-94	-94
Propagation channel		Clause B.2.4 with $\tau_d = 0.45 \mu\text{s}$, $a = 1$, $f_D = 5 \text{ Hz}$	
Correlation		Full	
Reporting interval	ms	5	
Minimum CQI delay	ms	8	
Reporting mode		PUSCH 3-0	
Sub-band size	RB	6 (full size)	
<p>Note 1: If the UE reports in an available uplink reporting instance at subframe SF#n based on CQI estimation at a downlink subframe not later than SF#(n-4), this reported subband or wideband CQI cannot be applied at the eNB downlink before SF#(n+4)</p> <p>Note 2: Reference measurement channel according to Table A.4-4.with one/two sided dynamic OCNG Pattern OP.1/2 FDD as described in Annex A.5.1.1/2</p> <p>Note 3: lot shall be modelled as connecting Gaussian distributed uncorrelated interference source for each UE receive antenna port. The received power spectral density of the interfering signal as measured at the UE antenna connector is to be scaled accordingly for different RB groups.</p>			

Table 9.3.3.1.1.3-2: Minimum requirement (FDD)

Parameter	Test 1	Test 2
α [%]	60	60
γ	1.6	1.6
UE Category	1-5	1-5

9.3.3.1.1.4 Test description

9.3.3.1.1.4.1 Initial conditions

Initial conditions are a set of test configurations the UE needs to be tested in and the steps for the SS to take with the UE to reach the correct measurement state.

Configurations of PDSCH and PDCCH before measurement are specified in Annex C.2.

Test Environment: Normal as defined in TS 36.508 [7] clause 4.1.

Frequencies to be tested: Mid Range as defined in TS 36.508 [7] clause 4.3.1.1.

Channel Bandwidths to be tested: 10MHz, as defined in TS 36.508 [7] clause 4.3.1.1

1. Connect the SS, interfering source and faders to the UE antenna connector (s) as shown in TS 36.508 [7] Annex A, Figure A.21.
2. The parameter settings for the cell are set up according to Table 9.3.3.1.1.3-1.
3. Downlink signals are initially set up according to Annex C.1 and Annex C.3.2, and uplink signals according to Annex H.1 and H.3.2.
4. Propagation conditions are set according to Annex B.0.
5. Ensure the UE is in State 3A or 3A-RF according to TS 36.508 [7] clause 4.5.3A or 5.2A.2. Message contents are defined in clause 9.3.3.1.1.4.3.

9.3.3.1.1.4.2 Test procedure

1. Set the parameters of bandwidth, the propagation condition, antenna configuration and measurement channel according to Table 9.3.3.1.1.3-1 as appropriate.
2. The SS shall transmit PDSCH via PDCCH DCI format 1A for C_RNTI to transmit the DL RMC according to CQI value 8 of Annex A.4 Table A.4-3 and keep it regardless of the wideband and subband CQI value sent by the UE. Continue transmission of the PDSCH until 2000 wideband CQI reports and full-size subband CQI reports for each full-size subband have been gathered. The SS sends downlink MAC padding bits on the DL RMC. SS schedules the UL transmission every 5 ms to carry the PUSCH CQI feedback via PDCCH DCI format 0 with CQI request bit set to 1 and I_MCS=29 and N_PRB allocated to be less or equal to 4. In this process the SS collects wideband CQI reports every 5 ms and also cases where UE transmits nothing in its CQI timing are counted as wideband CQI and full-size subband CQI reports.
3. Set up a relative frequency distribution for the reported wideband CQI-values, Calculate the median value (wideband Median CQI is the CQI that is at or crosses 50% distribution from the lower wideband CQI side). This CQI-value is declared as wideband Median CQI value.
4. If for at least one of the full-size subbands at the channel edges, a subband differential CQI offset level of +2 is reported in $\alpha\%$ or more of 2000 reports, then continue with step 5, otherwise fail the UE.
5. The SS shall transmit PDSCH via PDCCH DCI format 1A for C_RNTI to transmit the DL RMC on an each TTI randomly selected full-size subband using the transport format according to the wideband median-CQI value regardless of UE wideband or subband CQI report. Note that each full-size subband shall be selected in the equal probability The SS sends downlink MAC padding bits on the DL RMC. The transport format to be used is defined in Annex A.4 Table A.4-6. SS schedules the UL transmission every 5 ms to carry the PUSCH CQI feedback via PDCCH DCI format 0 with CQI request bit set to 1 and I_MCS=29 and N_PRB allocated to be less or equal to 4. Measure the average throughput according to Annex G.5.3. Declare the throughput as t_{median} .
6. The SS shall transmit PDSCH via PDCCH DCI format 1A for C_RNTI to transmit the DL RMC according to the highest UE reported full-size subband CQI value in one full-size subband selected among the sub-bands in which UE reports the highest full-size subband CQI. Subband differential CQI offset level is selected from {0, 1, 2, -1}. Note that the SS shall send PDSCH in the same full-size subband until next UE report is available. In case when same full-size subbands are reported subsequently as subbands with highest full-size subband CQI, the SS shall select for transmission a different subband with respect to the last selection. The SS sends downlink MAC padding bits on the DL RMC. The transport format to be used is defined in Annex A.4 Table A.4-6. SS schedules the UL transmission every 5 ms to carry the PUSCH CQI feedback via PDCCH DCI format 0 with CQI request bit set to 1 and I_MCS=29 and N_PRB allocated to be less or equal to 4. Measure the average throughput according to Annex G.5.3. Declare the throughput as $t_{subband}$. Count the number of NACKs, ACKs and statDTXs on the UL during the test interval.
If $t_{subband} / t_{median} \geq \gamma$, then pass the UE for this test and go to step 7. Otherwise fail the UE.
7. If both tests have not been done, then repeat the same procedure (steps 1 to 6) with test conditions according to the table 9.3.3.1.1.3-1 for the other Test as appropriate. Otherwise pass the UE.

9.3.3.1.1.4.3 Message contents

Table 9.3.3.1.1.4.3-1: PhysicalConfigDedicated-DEFAULT

Derivation Path: 36.508 clause 5.5.1.2			
Information Element	Value/remark	Comment	Condition
PhysicalConfigDedicated-DEFAULT ::= SEQUENCE {			
cqi-ReportConfig	<i>CQI-ReportConfig-DEFAULT</i>		
}			

Table 9.3.3.1.1.4.3-2: CQI-ReportConfig-DEFAULT

Derivation Path: 36.508 clause 4.6.3			
Information Element	Value/remark	Comment	Condition
CQI-ReportConfig-DEFAULT ::= SEQUENCE {			
cqi-ReportModeAperiodic	rm30		
nomPDSCH-RS-EPRE-Offset	0		
cqi-ReportPeriodic CHOICE {	Not present		
}			
}			

9.3.3.1.1.5 Test requirement

Table 9.3.3.1.1.5-1: Test requirement (FDD)

Parameter	Test 1	Test 2
α [%]	40	40
γ	1.50	1.50

9.3.3.1.2 TDD CQI Reporting under fading conditions and frequency-selective interference – PUSCH 3-0

9.3.3.1.2.1 Test purpose

To verify that preferred sub-bands can be used for frequently-selective scheduling with frequency-selective interference situation.

9.3.3.1.2.2 Test applicability

This test applies to all types of E-UTRA TDD UE release 8 and forward.

9.3.3.1.2.3 Minimum conformance requirements

For the parameters specified in Table 9.3.3.1.1.3-1, and using the downlink physical channels specified in Annex C, the minimum requirements are specified in Table 9.3.3.1.1.3-2 and by the following:

- a sub-band differential CQI offset level of +2 shall be reported at least α % for at least one of the sub-bands of full size at the channel edges;
- the ratio of the throughput obtained when transmitting on any one of the sub-bands with the highest differential CQI offset level the corresponding TBS and that obtained when transmitting the TBS indicated by the reported wideband CQI median on a randomly selected sub-band in set S shall be $\geq \gamma$;

The requirements only apply for sub-bands of full size and the random scheduling across the sub-bands is done by selecting a new sub-band in each TTI for FDD, each available downlink transmission instance for TDD. Sub-bands of a size smaller than full size are excluded from the test. The transport block size TBS(wideband CQI median) is that resulting from the code rate which is closest to that indicated by the wideband CQI median and the N_{PRB} entry in Table 7.1.7.2.1-1 of TS 36.213 [10] that corresponds to the sub-band size.

Table 9.3.3.1.2.3-1: Sub-band test for single antenna transmission (TDD)

Parameter	Unit	Test 1	Test 2
Bandwidth	MHz	10 MHz	10 MHz
Transmission mode		1 (port 0)	1 (port 0)
Uplink downlink configuration		2	
Special subframe configuration		4	
$I_{ot}^{(j)}$ for RB 0...[5] Note 3	dB[mW/15kHz]	-102	-93
$I_{ot}^{(j)}$ for RB 6...[41] Note 3	dB[mW/15kHz]	-93	-93
$I_{ot}^{(j)}$ for RB [42]...49 Note 3	dB[mW/15kHz]	-93	-102
$\hat{I}_{or}^{(j)}$	dB[mW/15kHz]	-94	-94
Max number of HARQ transmissions		1	
Propagation channel		Clause B.2.4 with $\tau_d = 0.45 \mu\text{s}$, $a = 1$, $f_D = 5 \text{ Hz}$	
Correlation		Full	
Reporting interval	ms	5	
CQI delay	ms	10 or 11	
Reporting mode		PUSCH 3-0	
Sub-band size	RB	6 (full size)	
ACK/NACK feedback mode		Multiplexing	
<p>Note 1: If the UE reports in an available uplink reporting instance at subframe SF#n based on CQI estimation at a downlink subframe not later than SF#(n-4), this reported subband or wideband CQI cannot be applied at the eNB downlink before SF#(n+4)</p> <p>Note 2: Reference measurement channel according to table A.4-5 with one/two sided dynamic OCNG Pattern OP.1/2 TDD as described in Annex A.5.2.1/2.</p> <p>Note 3: Iot shall be modelled as connecting Gaussian distributed uncorrelated interference source for each UE receive antenna port. The received power spectral density of the interfering signal as measured at the UE antenna connector is to be scaled accordingly for different RB groups.</p>			

Table 9.3.3.1.2.3-2: Minimum requirement (TDD)

Parameter	Test 1	Test 2
α [%]	60	60
γ	1.6	1.6
UE Category	1-5	1-5

9.3.3.1.2.4 Test description

9.3.3.1.2.4.1 Initial conditions

Initial conditions are a set of test configurations the UE needs to be tested in and the steps for the SS to take with the UE to reach the correct measurement state.

Configurations of PDSCH and PDCCH before measurement are specified in Annex C.2.

Test Environment: Normal as defined in TS 36.508 [7] clause 4.1.

Frequencies to be tested: Mid Range as defined in TS 36.508 [7] clause 4.3.1.1.

Channel Bandwidths to be tested: 10MHz, as defined in TS 36.508 [7] clause 4.3.1.1

1. Connect the SS, faders and interfering source to the UE antenna connector (s) as shown in TS 36.508 [7] Annex A, Figure A.21.
2. The parameter settings for the cell are set up according to Table 9.3.1.2.1.3-1.
3. Downlink signals are initially set up according to Annex C.1 and Annex C.3.2, and uplink signals according to Annex H.1 and H.3.2.
4. Propagation conditions are set according to Annex B.0.
5. Ensure the UE is in State 3A or 3A-RF according to TS 36.508 [7] clause 4.5.3A or 5.2A.2. Message contents are defined in clause 9.3.3.1.2.4.3.

9.3.3.1.2.4.2 Test procedure

1. Set the parameters of bandwidth, the propagation condition, antenna configuration and measurement channel according to Table 9.3.3.1.2.3-1 as appropriate.
2. The SS shall transmit PDSCH via PDCCH DCI format 1A for C_RNTI to transmit the DL RMC according to CQI value 8 of Annex A.4 Table A.4-3 and keep it regardless of the wideband and subband CQI value sent by the UE. Continue transmission of the PDSCH until 2000 wideband CQI reports and full-size subband CQI reports for each full-size subband have been gathered. The SS sends downlink MAC padding bits on the DL RMC. SS schedules the UL transmission every 5 ms to carry the PUSCH CQI feedback via PDCCH DCI format 0 with CQI request bit set to 1 and I_MCS=29 and N_PRB allocated to be less or equal to 4. In this process the SS collects wideband CQI reports every 5 ms and also cases where UE transmits nothing in its CQI timing are counted as wideband CQI and full-size subband CQI reports.
3. Set up a relative frequency distribution for the reported wideband CQI-values, Calculate the median value (wideband Median CQI is the CQI that is at or crosses 50% distribution from the lower wideband CQI side). This CQI-value is declared as wideband Median CQI value.
4. If for at least one of the full-size subbands at the channel edges, a subband differential CQI offset level of +2 is reported in $\alpha\%$ or more of 2000 reports, then continue with step 5, otherwise fail the UE.
5. The SS shall transmit PDSCH via PDCCH DCI format 1A for C_RNTI to transmit the DL RMC in an each available downlink transmission instance randomly selected full-size subband using the transport format according to the wideband median-CQI value regardless of UE wideband or subband CQI report. Note that each full-size subband shall be selected in the equal probability. The SS sends downlink MAC padding bits on the DL RMC. SS schedules the UL transmission every 5 ms to carry the PUSCH CQI feedback via PDCCH DCI format 0 with CQI request bit set to 1 and I_MCS=29 and N_PRB allocated to be less or equal to 4. Measure the average throughput according to Annex G.5.3. Declare the throughput as t_{median} .
6. The SS shall transmit PDSCH via PDCCH DCI format 1A for C_RNTI to transmit the DL RMC according to the highest UE reported full-size subband CQI value in one full-size subband selected among the sub-bands in which UE reports the highest full-size subband CQI. Subband differential CQI offset level is selected from {0, 1, 2, -1}. Note that the SS shall send PDSCH in the same full-size subband until next UE report is available. In case when same full-size subbands are reported subsequently as subbands with highest full-size subband CQI, the SS shall select for transmission a different subband with respect to the last selection. The SS sends downlink MAC padding bits on the DL RMC. SS schedules the UL transmission every 5 ms to carry the PUSCH CQI feedback via PDCCH DCI format 0 with CQI request bit set to 1 and I_MCS=29 and N_PRB allocated to be less or equal to 4. Measure the average throughput according to Annex G.5.3. Declare the throughput as $t_{subband}$. Count the number of NACKs, ACKs and statDTXs on the UL during the test interval. If $t_{subband} / t_{median} \geq \gamma$, then pass the UE for this test and go to step 7. Otherwise fail the UE.
7. If both tests have not been done, then repeat the same procedure (steps 1 to 6) with test conditions according to the table 9.3.3.1.2.3-1 for the other Test as appropriate. Otherwise pass the UE.

9.3.3.1.2.4.3 Message contents

Message contents are according to TS 36.508 [7] clause 4.6 with the following exceptions:

Table 9.3.3.1.2.4.3-1: PhysicalConfigDedicated-DEFAULT

Derivation Path: 36.508 clause 5.5.1.2			
Information Element	Value/remark	Comment	Condition
PhysicalConfigDedicated-DEFAULT ::= SEQUENCE {			
cqi-ReportConfig	CQI-ReportConfig-DEFAULT		
}			

Table 9.3.3.1.2.4.3-2: CQI-ReportConfig-DEFAULT

Derivation Path: 36.508 clause 4.6.3			
Information Element	Value/remark	Comment	Condition
CQI-ReportConfig-DEFAULT ::= SEQUENCE {			
cqi-ReportModeAperiodic	rm30		
nomPDSCH-RS-EPRE-Offset	0		
cqi-ReportPeriodic CHOICE {	Not present		
}			

Table 9.3.3.1.2.4.3-3: TDD-Config-DEFAULT

Derivation Path: 36.508 clause 4.6.3			
Information Element	Value/remark	Comment	Condition
TDD-Config-DEFAULT ::= SEQUENCE {			
subframeAssignment	Sa2		
specialSubframePatterns	Ssp4		
}			

9.3.3.1.2.5 Test requirement

Table 9.3.3.1.2.5-1: Test requirement (TDD)

Parameter	Test 1	Test 2
α [%]	40	40
γ	1.50	1.50

9.3.4 UE-selected subband CQI

The accuracy of UE-selected subband channel quality indicator (CQI) reporting under frequency-selective fading conditions is determined by the relative increase of the throughput obtained when transmitting on the UE-selected subbands with the corresponding transport format compared to the case for which a fixed format is transmitted on any subband in set S of TS 36.213 [10]. The purpose is to verify that correct subbands are accurately reported for frequency-selective scheduling. To account for sensitivity of the input SNR the subband CQI reporting under frequency-selective fading conditions is considered to be verified if the reporting accuracy is met for at least one of two SNR levels separated by an offset of 1 dB.

9.3.4.1 CQI Reporting under fading conditions – PUSCH 2-0

9.3.4.1.1 FDD CQI Reporting under fading conditions – PUSCH 2-0

Editor's note: This clause is incomplete. The following aspects are either missing or not yet determined:

- Test tolerances are undefined

9.3.4.1.1.1 Test purpose

To verify that UE-selected sub-bands can be used for frequently-selective scheduling.

9.3.4.1.1.2 Test applicability

This test applies to all types of E-UTRA FDD UE release 9 and forward.

9.3.4.1.1.3 Minimum conformance requirements

For the parameters specified in Table 9.3.4.1.1.3-1, and using the downlink physical channels specified in Annex C, the minimum requirements are specified in Table 9.3.4.1.1.3-2 and by the following:

- a) the ratio of the throughput obtained when transmitting on a randomly selected subband among the best M subbands reported by the UE the corresponding TBS and that obtained when transmitting the TBS indicated by the reported wideband CQI median on a randomly selected subband in set S shall be $\geq \gamma$;

The requirements only apply for subbands of full size and the random scheduling across the subbands is done by selecting a new subband in each TTI for FDD. The transport block size TBS (wideband CQI median) is that resulting from the code rate which is closest to that indicated by the wideband CQI median and the N_{PRB} entry in Table 7.1.7.2.1-1 of TS 36.213 [10] that corresponds to the subband size.

Table 9.3.4.1.1.3-1: Subband test for single antenna transmission (FDD)

Parameter	Unit	Test 1		Test 2	
Bandwidth	MHz	10 MHz			
Transmission mode		1 (port 0)			
SNR (Note 3)	dB	9	10	14	15
$\hat{I}_{or}^{(j)}$	dB[mW/15kHz]	-89	-88	-84	-83
$N_{oc}^{(j)}$	dB[mW/15kHz]	-98		-98	
Propagation channel		Clause B.2.4 with $\tau_d = 0.45 \mu\text{s}$, $a = 1$, $f_D = 5 \text{ Hz}$			
Reporting interval	ms	5			
CQI delay	ms	8			
Reporting mode		PUSCH 2-0			
Max number of HARQ transmissions		1			
Subband size (k)	RBs	3 (full size)			
Number of preferred subbands (M)		5			
Note 1: If the UE reports in an available uplink reporting instance at subframe SF# n based on CQI estimation at a downlink subframe not later than SF#(n-4), this reported subband or wideband CQI cannot be applied at the eNB downlink before SF#(n+4) Note 2: Reference measurement channel according to Table A.4-11 with one/two sided dynamic OCNG Pattern OP.1/2 FDD as described in Annex A.5.1.1/2. Note 3: For each test, the minimum requirements shall be fulfilled for at least one of the two SNR(s) and the respective wanted signal input level.					

Table 9.3.4.1.1.3-2: Minimum requirement (FDD)

	Test 1	Test 2
γ	[1,2]	[1,2]
UE Category	1-5	1-5

The normative reference for this requirement is TS 36.101 [2] clause 9.3.4.1.1.

9.3.4.1.1.4 Test description

9.3.4.1.1.4.1 Initial conditions

Initial conditions are a set of test configurations the UE needs to be tested in and the steps for the SS to take with the UE to reach the correct measurement state.

Configurations of PDSCH and PDCCH before measurement are specified in Annex C.2.

Test Environment: Normal as defined in TS 36.508 [7] clause 4.1.

Frequencies to be tested: Mid Range as defined in TS 36.508 [7] clause 4.3.1.1.

Channel Bandwidths to be tested: 10MHz, as defined in TS 36.508 [7] clause 4.3.1.1

1. Connect the SS and faders to the UE antenna connector (s) as shown in TS 36.508 [7] Annex A, Figure A.21.
2. The parameter settings for the cell are set up according to Table 9.3.4.1.1.3-1.
3. Downlink signals are initially set up according to Annex C.1 and Annex C.3.2, and uplink signals according to Annex H.1 and H.3.2.
4. Propagation conditions are set according to Annex B.0.
5. Ensure the UE is in State 3A or 3A-RF according to TS 36.508 [7] clause 4.5.3A or 5.2A.2. Message contents are defined in clause 9.3.4.1.1.4.3.

9.3.4.1.1.4.2 Test procedure

1. Set the parameters of bandwidth, the propagation condition, antenna configuration and measurement channel according to Table 9.3.4.1.1.3-1 as appropriate.
2. The SS shall transmit PDSCH via PDCCH DCI format 1A for C_RNTI to transmit the DL RMC according to CQI value 8 of Annex A.4 Table A.4-3 and keep it regardless of the wideband and subband CQI value sent by the UE. Continue transmission of the PDSCH until 2000 wideband CQI reports and full-size subband CQI reports for each full-size subband have been gathered. The SS sends downlink MAC padding bits on the DL RMC. SS schedules the UL transmission every 5 ms to carry the PUSCH CQI feedback via PDCCH DCI format 0 with CQI request bit set to 1 and I_MCS=29 and N_PRB allocated to be less or equal to 4. In this process the SS collects wideband CQI reports every 5 ms and also cases where UE transmits nothing in its CQI timing are counted as wideband CQI and full-size subband CQI reports.
3. Set up a relative frequency distribution for the reported wideband CQI-values, Calculate the median value (wideband Median CQI is the CQI that is at or crosses 50% distribution from the lower wideband CQI side). This CQI-value is declared as wideband Median CQI value.
4. The SS shall transmit PDSCH via PDCCH DCI format 1A for C_RNTI to transmit the DL RMC on a randomly selected full-size subband using the transport format according to the wideband median-CQI value regardless of UE wideband or subband CQI report. Note that each full-size subband shall be selected in the equal probability The SS sends downlink MAC padding bits on the DL RMC. The transport format to be used is defined in Annex A.4 Table A.4-6. SS schedules the UL transmission every 5 ms to carry the PUSCH CQI feedback via PDCCH DCI format 0 with CQI request bit set to 1 and I_MCS=29 and N_PRB allocated to be less or equal to 4. Measure the average throughput according to Annex G.5.3. Declare the throughput as t_{median} .
5. The SS shall transmit PDSCH via PDCCH DCI format 1A for C_RNTI to transmit the DL RMC on a randomly selected subband among the best M subbands reported by the UE the corresponding TBS. Note that the SS shall send PDSCH among the same best M subband until next UE report is available. The SS sends downlink MAC padding bits on the DL RMC. The transport format to be used is defined in Annex A.4 Table A.4-6. SS schedules the UL transmission every 5 ms to carry the PUSCH CQI feedback via PDCCH DCI format 0 with CQI request bit set to 1 and I_MCS=29 and N_PRB allocated to be less or equal to 4. Measure the average throughput according to Annex G.5.3. Declare the throughput as $t_{subband}$. Count the number of NACKs, ACKs and statDTXs on the UL during the test interval.
If $t_{subband} / t_{median} \geq \gamma$, then pass the UE for this test and go to step 6. Otherwise fail the UE.

6. If both tests have not been done, then repeat the same procedure (steps 1 to 5) with test conditions according to the table 9.3.4.1.1.3-1 for the other Test as appropriate. Otherwise pass the UE.

9.3.4.1.1.4.3 Message contents

Table 9.3.4.1.1.4.3-1: PhysicalConfigDedicated-DEFAULT

Derivation Path: 36.508 clause 5.5.1.2			
Information Element	Value/remark	Comment	Condition
PhysicalConfigDedicated-DEFAULT ::= SEQUENCE {			
cqi-ReportConfig	CQI-ReportConfig-DEFAULT		
}			

Table 9.3.4.1.1.4.3-2: CQI-ReportConfig-DEFAULT

Derivation Path: 36.508 clause 4.6.3			
Information Element	Value/remark	Comment	Condition
CQI-ReportConfig-DEFAULT ::= SEQUENCE {			
cqi-ReportModeAperiodic	rm20		
nomPDSCH-RS-EPRE-Offset	0		
cqi-ReportPeriodic CHOICE {	Not present		
}			
}			

9.3.4.1.1.5 Test requirement

Table 9.3.4.1.1.5-1: Test requirement (FDD)

	Test 1	Test 2
γ	[1.2+TT]	[1.2+TT]
UE Category	1-5	1-5

9.3.4.1.2 TDD CQI Reporting under fading conditions – PUSCH 2-0

Editor's note: This clause is incomplete. The following aspects are either missing or not yet determined:

- Test tolerances are undefined

9.3.4.1.2.1 Test purpose

To verify that UE-selected sub-bands can be used for frequently-selective scheduling.

9.3.4.1.2.2 Test applicability

This test applies to all types of E-UTRA TDD UE release 9 and forward.

9.3.4.1.2.3 Minimum conformance requirements

For the parameters specified in Table 9.3.4.1.2.3-1, and using the downlink physical channels specified in Annex C, the minimum requirements are specified in Table 9.3.4.1.2.3-2 and by the following:

- the ratio of the throughput obtained when transmitting on a randomly selected subband among the best M subbands reported by the UE the corresponding TBS and that obtained when transmitting the TBS indicated by the reported wideband CQI median on a randomly selected subband in set S shall be $\geq \gamma$;

The requirements only apply for subbands of full size and the random scheduling across the subbands is done by selecting a new subband in each available downlink transmission instance for TDD. The transport block size TBS

(wideband CQI median) is that resulting from the code rate which is closest to that indicated by the wideband CQI median and the N_{PRB} entry in Table 7.1.7.2.1-1 of TS 36.213 [10] that corresponds to the subband size.

Table 9.3.4.1.2.3-1: Sub-band test for single antenna transmission (TDD)

Parameter	Unit	Test 1		Test 2	
Bandwidth	MHz	10 MHz			
Transmission mode		1 (port 0)			
Uplink downlink configuration		2			
Special subframe configuration		4			
SNR (Note 3)	dB	9	10	14	15
$\hat{I}_{or}^{(j)}$	dB[mW/15kHz]	-89	-88	-84	-83
$N_{oc}^{(j)}$	dB[mW/15kHz]	-98		-98	
Propagation channel		Clause B.2.4 with $\tau_d = 0.45 \mu s$, $a = 1$, $f_D = 5$ Hz			
Reporting interval	ms	5			
CQI delay	ms	10 or 11			
Reporting mode		PUSCH 2-0			
Max number of HARQ transmissions		1			
Subband size (k)	RBs	3 (full size)			
Number of preferred subbands (M)		5			
ACK/NACK feedback mode		Multiplexing			
Note 1:	If the UE reports in an available uplink reporting instance at subframe SF# n based on CQI estimation at a downlink subframe not later than SF#($n-4$), this reported subband or wideband CQI cannot be applied at the eNB downlink before SF#($n+4$)				
Note 2:	Reference measurement channel according to Table A.4-12 with one/two sided dynamic OCNG Pattern OP.1/2 TDD as described in Annex A.5.2.1/2.				
Note 3:	For each test, the minimum requirements shall be fulfilled for at least one of the two SNR(s) and the respective wanted signal input level.				

Table 9.3.4.1.2.3-2: Minimum requirement (TDD)

	Test 1	Test 2
γ	[1.2]	[1.2]
UE Category	1-5	1-5

The normative reference for this requirement is TS 36.101 [2] clause 9.3.4.1.2.

9.3.4.1.2.4 Test description

9.3.4.1.2.4.1 Initial conditions

Initial conditions are a set of test configurations the UE needs to be tested in and the steps for the SS to take with the UE to reach the correct measurement state.

Configurations of PDSCH and PDCCH before measurement are specified in Annex C.2.

Test Environment: Normal as defined in TS 36.508 [7] clause 4.1.

Frequencies to be tested: Mid Range as defined in TS 36.508 [7] clause 4.3.1.1.

Channel Bandwidths to be tested: 10MHz, as defined in TS 36.508 [7] clause 4.3.1.1

1. Connect the SS, faders and AWGN noise source to the UE antenna connector (s) as shown in TS 36.508 [7] Annex A, Figure A.9.
2. The parameter settings for the cell are set up according to Table 9.3.4.1.2.3-1.
3. Downlink signals are initially set up according to Annex C.1 and Annex C.3.2, and uplink signals according to Annex H.1 and H.3.2.
4. Propagation conditions are set according to Annex B.0.
5. Ensure the UE is in State 3A or 3A-RF according to TS 36.508 [7] clause 4.5.3A or 5.2A.2. Message contents are defined in clause 9.3.4.1.2.4.3.

9.3.4.1.2.4.2 Test procedure

1. Set the parameters of bandwidth, the propagation condition, antenna configuration and measurement channel according to Table 9.3.4.1.2.3-1 as appropriate.
2. The SS shall transmit PDSCH via PDCCH DCI format 1A for C_RNTI to transmit the DL RMC according to CQI value 8 of Annex A.4 Table A.4-3 and keep it regardless of the wideband and subband CQI value sent by the UE. Continue transmission of the PDSCH until 2000 wideband CQI reports and full-size subband CQI reports for each full-size subband have been gathered. The SS sends downlink MAC padding bits on the DL RMC. SS schedules the UL transmission every 5 ms to carry the PUSCH CQI feedback via PDCCH DCI format 0 with CQI request bit set to 1 and I_MCS=29 and N_PRB allocated to be less or equal to 4. In this process the SS collects wideband CQI reports every 5 ms and also cases where UE transmits nothing in its CQI timing are counted as wideband CQI and full-size subband CQI reports.
3. Set up a relative frequency distribution for the reported wideband CQI-values, Calculate the median value (wideband Median CQI is the CQI that is at or crosses 50% distribution from the lower wideband CQI side). This CQI-value is declared as wideband Median CQI value.
4. The SS shall transmit PDSCH via PDCCH DCI format 1A for C_RNTI to transmit the DL RMC on a randomly selected full-size subband using the transport format according to the wideband median-CQI value regardless of UE wideband or subband CQI report. Note that each full-size subband shall be selected in the equal probability. The SS sends downlink MAC padding bits on the DL RMC. SS schedules the UL transmission every 5 ms to carry the PUSCH CQI feedback via PDCCH DCI format 0 with CQI request bit set to 1 and I_MCS=29 and N_PRB allocated to be less or equal to 4. Measure the average throughput according to Annex G.5.3. Declare the throughput as t_{median} .
5. The SS shall transmit PDSCH via PDCCH DCI format 1A for C_RNTI to transmit the DL RMC on a randomly selected subband among the best M subbands reported by the UE the corresponding TBS. Note that the SS shall send PDSCH among the same best M subband until next UE report is available. The SS sends downlink MAC padding bits on the DL RMC. SS schedules the UL transmission every 5 ms to carry the PUSCH CQI feedback via PDCCH DCI format 0 with CQI request bit set to 1 and I_MCS=29 and N_PRB allocated to be less or equal to 4. Measure the average throughput according to Annex G.5.3. Declare the throughput as $t_{subband}$. Count the number of NACKs, ACKs and statDTXs on the UL during the test interval.
If $t_{subband} / t_{median} \geq \gamma$, then pass the UE for this test and go to step 6. Otherwise fail the UE.
6. If both tests have not been done, then repeat the same procedure (steps 1 to 5) with test conditions according to the table 9.3.4.1.2.3-1 for the other Test as appropriate. Otherwise pass the UE.

9.3.4.1.2.4.3 Message contents

Message contents are according to TS 36.508 [7] clause 4.6 with the following exceptions:

Table 9.3.4.1.2.4.3-1: PhysicalConfigDedicated-DEFAULT

Derivation Path: 36.508 clause 5.5.1.2			
Information Element	Value/remark	Comment	Condition
PhysicalConfigDedicated-DEFAULT ::= SEQUENCE {			
cqi-ReportConfig	CQI-ReportConfig-DEFAULT		
}			

Table 9.3.4.1.2.4.3-2: CQI-ReportConfig-DEFAULT

Derivation Path: 36.508 clause 4.6.3			
Information Element	Value/remark	Comment	Condition
CQI-ReportConfig-DEFAULT ::= SEQUENCE {			
cqi-ReportModeAperiodic	rm20		
nomPDSCH-RS-EPRE-Offset	0		
cqi-ReportPeriodic CHOICE {	Not present		
}			

Table 9.3.4.1.2.4.3-3: TDD-Config-DEFAULT

Derivation Path: 36.508 clause 4.6.3			
Information Element	Value/remark	Comment	Condition
TDD-Config-DEFAULT ::= SEQUENCE {			
subframeAssignment	Sa2		
specialSubframePatterns	Ssp4		
}			

9.3.4.1.2.5 Test requirement

Table 9.3.4.1.2.5-1: Test requirement (TDD)

	Test 1	Test 2
γ	[1.2+TT]	[1.2+TT]
UE Category	1-5	1-5

9.3.4.2 CQI Reporting under fading conditions – PUCCH 2-0

9.3.4.2.1 FDD CQI Reporting under fading conditions – PUCCH 2-0

Editor's note: This clause is incomplete. The following aspects are either missing or not yet determined:

- Test tolerances are undefined

9.3.4.2.1.1 Test purpose

To verify that UE-selected sub-bands can be used for frequently-selective scheduling.

9.3.4.2.1.2 Test applicability

This test applies to all types of E-UTRA FDD UE release 9 and forward.

9.3.4.2.1.3 Minimum conformance requirements

For the parameters specified in Table 9.3.4.2.1.3-1, and using the downlink physical channels specified in Annex C, the minimum requirements are specified in Table 9.3.4.2.1.3-2 and by the following

- a) the ratio of the throughput obtained when transmitting on subbands reported by the UE the corresponding TBS and that obtained when transmitting the TBS indicated by the reported wideband CQI median on a randomly selected subband in set S shall be $\geq \gamma$;

The requirements only apply for subbands of full size and the random scheduling across the subbands is done by selecting a new subband in each TTI for FDD. The transport block size TBS (wideband CQI median) is that resulting from the code rate which is closest to that indicated by the wideband CQI median and the N_{PRB} entry in Table 7.1.7.2.1-1 of TS 36.213 [10] that corresponds to the subband size.

Table 9.3.4.2.1.3-1: Subband test for single antenna transmission (FDD)

Parameter	Unit	Test 1		Test 2	
Bandwidth	MHz	10 MHz			
Transmission mode		1 (port 0)			
SNR (Note 3)	dB	[8]	[9]	[13]	[14]
$\hat{I}_{or}^{(j)}$	dB[mW/15kHz]	[-90]	[-89]	[-85]	[-84]
$N_{oc}^{(j)}$	dB[mW/15kHz]	[-98]		[-98]	
Propagation channel		[Clause B.2.4 with $\tau_d = 0.45 \mu s$, $a = 1$, $f_D = 5$ Hz]			
Reporting periodicity	ms	$N_p = 2$			
CQI delay	ms	8			
Physical channel for CQI reporting		PUSCH (Note 4)			
PUCCH Report Type for wideband CQI		4			
PUCCH Report Type for subband CQI		1			
Max number of HARQ transmissions		1			
Subband size (k)	RBs	6 (full size)			
Number of bandwidth parts (J)		3			
K		1			
<i>cqi-pmi-ConfigIndex</i>		1			
Note 1:	If the UE reports in an available uplink reporting instance at subframe SF#n based on CQI estimation at a downlink subframe not later than SF#(n-4), this reported subband or wideband CQI cannot be applied at the eNB downlink before SF#(n+4)				
Note 2:	Reference measurement channel according to Table A.4-4 with one/two sided dynamic OCNG Pattern OP.1/2 FDD as described in Annex A.5.1.1/2.				
Note 3:	For each test, the minimum requirements shall be fulfilled for at least one of the two SNR(s) and the respective wanted signal input level.				
Note 4:	To avoid collisions between CQI reports and HARQ-ACK it is necessary to report both on PUSCH instead of PUCCH. PDCCH DCI format 0 shall be transmitted in downlink SF#1, #3, #7 and #9 to allow periodic CQI to multiplex with the HARQ-ACK on PUSCH in uplink subframe SF#5, #7, #1 and #3.				
Note 5:	CQI reports for the short subband (having 2RBs in the last bandwidth part) are to be disregarded and data scheduling according to the most recent subband CQI report for bandwidth part with $j=1$.				
Note 6:	In the case where wideband CQI is reported, data is to be scheduled according to the most recently used subband CQI report.				

Table 9.3.4.2.1.3-2: Minimum requirement (FDD)

	Test 1	Test 2
γ	TBD	TBD
UE Category	1-5	1-5

The normative reference for this requirement is TS 36.101 [2] clause 9.3.4.2.1.

9.3.4.2.1.4 Test description

9.3.4.2.1.4.1 Initial conditions

Initial conditions are a set of test configurations the UE needs to be tested in and the steps for the SS to take with the UE to reach the correct measurement state.

Configurations of PDSCH and PDCCH before measurement are specified in Annex C.2.

Test Environment: Normal as defined in TS 36.508 [7] clause 4.1.

Frequencies to be tested: Mid Range as defined in TS 36.508 [7] clause 4.3.1.1.

Channel Bandwidths to be tested: 10MHz, as defined in TS 36.508 [7] clause 4.3.1.1

1. Connect the SS and faders to the UE antenna connector (s) as shown in TS 36.508 [7] Annex A, Figure A.21.
2. The parameter settings for the cell are set up according to Table 9.3.4.2.1.3-1.
3. Downlink signals are initially set up according to Annex C.1 and Annex C.3.2, and uplink signals according to Annex H.1 and H.3.2.
4. Propagation conditions are set according to Annex B.0.
5. Ensure the UE is in State 3A or 3A-RF according to TS 36.508 [7] clause 4.5.3A or 5.2A.2. Message contents are defined in clause 9.3.4.2.1.4.3.

9.3.4.2.1.4.2 Test procedure

1. Set the parameters of bandwidth, the propagation condition, antenna configuration and measurement channel according to Table 9.3.4.2.1.3-1 as appropriate.
2. The SS shall transmit PDSCH via PDCCH DCI format 1A for C_RNTI to transmit the DL RMC according to CQI value 8 of Annex A.4 Table A.4-3 and keep it regardless of the wideband and subband CQI value sent by the UE. Continue transmission of the PDSCH until 2000 wideband CQI reports and full-size subband CQI reports for each full-size subband have been gathered. The SS sends downlink MAC padding bits on the DL RMC. SS schedules the UL transmission in subframe #1, #3, #5 and #7 to carry the both ACK and CQI feedback via PDCCH DCI format 0 with CQI request bit set to 1 and I_MCS=29 and N_PRB allocated to be less or equal to 4. In this process the SS collects wideband CQI reports and also cases where UE transmits nothing in its wideband CQI timing are counted as wideband CQI reports.
3. Set up a relative frequency distribution for the reported wideband CQI-values, Calculate the median value (wideband Median CQI is the CQI that is at or crosses 50% distribution from the lower wideband CQI side). This CQI-value is declared as wideband Median CQI value.
4. The SS shall transmit PDSCH via PDCCH DCI format 1A for C_RNTI to transmit the DL RMC on a randomly selected full-size subband using the transport format according to the wideband median-CQI value regardless of UE wideband or subband CQI report. Note that each full-size subband shall be selected in the equal probability The SS sends downlink MAC padding bits on the DL RMC. The transport format to be used is defined in Annex A.4 Table A.4-6. Measure the average throughput according to Annex G.5.3. Declare the throughput as t_{median} .
5. The SS shall transmit PDSCH via PDCCH DCI format 1A for C_RNTI to transmit the DL RMC on a randomly selected subband among the best M subbands reported by the UE the corresponding TBS. Note that the SS shall send PDSCH among the same best M subband until next UE report is available. The SS sends

downlink MAC padding bits on the DL RMC. The transport format to be used is defined in Annex A.4 Table A.4-6. Measure the average throughput according to Annex G.5.3. Declare the throughput as $t_{subband}$. Count the number of NACKs, ACKs and statDTXs on the UL during the test interval.

If $t_{subband} / t_{median} \geq \gamma$, then pass the UE for this test and go to step 6. Otherwise fail the UE.

6. If both tests have not been done, then repeat the same procedure (steps 1 to 5) with test conditions according to the table 9.3.4.2.1.3-1 for the other Test as appropriate. Otherwise pass the UE.

9.3.4.1.1.4.3 Message contents

Table 9.3.4.2.1.4.3-1: PhysicalConfigDedicated-DEFAULT

Derivation Path: 36.508 clause 5.5.1.2			
Information Element	Value/remark	Comment	Condition
PhysicalConfigDedicated-DEFAULT ::= SEQUENCE {			
cqi-ReportConfig	CQI-ReportConfig-DEFAULT		
}			

Table 9.3.4.2.1.4.3-2: CQI-ReportConfig-DEFAULT

Derivation Path: 36.508 clause 4.6.3			
Information Element	Value/remark	Comment	Condition
CQI-ReportConfig-DEFAULT ::= SEQUENCE {			
cqi-ReportModeAperiodic	Not present		
nomPDSCH-RS-EPRE-Offset	0		
cqi-ReportPeriodic CHOICE {			
setup SEQUENCE {			
cqi-PUCCH-ResourceIndex	0		
cqi-pmi-ConfigIndex	1	(see Table 7.2.2-1A in TS 36.213)	
cqi-FormatIndicatorPeriodic CHOICE {			
subbandCQI	1		
}			
ri-ConfigIndex	483	(see Table 7.2.2-1B in TS 36.213)	
simultaneousAckNackAndCQI	FALSE		
}			
}			

9.3.4.2.1.5 Test requirement

Table 9.3.4.2.1.5-1: Test requirement (FDD)

	Test 1	Test 2
γ	TBD+TT	TBD+TT
UE Category	1-5	1-5

9.3.4.2.2 TDD CQI Reporting under fading conditions – PUCCH 2-0

Editor’s note: This clause is incomplete. The following aspects are either missing or not yet determined:

- Test tolerances are undefined

9.3.4.2.2.1 Test purpose

To verify that UE-selected sub-bands can be used for frequently-selective scheduling.

9.3.4.2.2.2 Test applicability

This test applies to all types of E-UTRA TDD UE release 9 and forward.

9.3.4.2.2.3 Minimum conformance requirements

For the parameters specified in Table 9.3.4.2.2.3-1, and using the downlink physical channels specified in Annex C, the minimum requirements are specified in Table 9.3.4.2.2.3-2 and by the following:

- a) the ratio of the throughput obtained when transmitting on subbands reported by the UE the corresponding TBS and that obtained when transmitting the TBS indicated by the reported wideband CQI median on a randomly selected subband in set S shall be $\geq \gamma$;

The requirements only apply for subbands of full size and the random scheduling across the subbands is done by selecting a new subband in each available downlink transmission instance for TDD. The transport block size TBS (wideband CQI median) is that resulting from the code rate which is closest to that indicated by the wideband CQI median and the N_{PRB} entry in Table 7.1.7.2.1-1 of TS 36.213 [10] that corresponds to the subband size.

Table 9.3.4.2.2.3-1: Sub-band test for single antenna transmission (TDD)

Parameter	Unit	Test 1		Test 2	
Bandwidth	MHz	10 MHz			
Transmission mode		1 (port 0)			
Uplink downlink configuration		2			
Special subframe configuration		4			
SNR (Note 3)	dB	[8]	[9]	[13]	[14]
$\hat{I}_{or}^{(j)}$	dB[mW/15kHz]	[-90]	[-89]	[-85]	[-84]
$N_{oc}^{(j)}$	dB[mW/15kHz]	[-98]		[-98]	
Propagation channel		Clause B.2.4 with $\tau_d = 0.45 \mu\text{s}$, $a = 1$, $f_D = 5 \text{ Hz}$			
Reporting periodicity	ms	$N_P = 5$			
CQI delay	ms	10 or 11			
Physical channel for CQI reporting		PUSCH (Note 4)			
PUCCH Report Type for wideband CQI		4			
PUCCH Report Type for subband CQI		1			
Max number of HARQ transmissions		1			
Subband size (k)	RBs	6 (full size)			
Number of bandwidth parts (J)		3			
K		1			
<i>cqi-pmi-ConfigIndex</i>		3			
ACK/NACK feedback mode		Multiplexing			
Note 1:	If the UE reports in an available uplink reporting instance at subframe SF# n based on CQI estimation at a downlink subframe not later than SF#(n-4), this reported subband or wideband CQI cannot be applied at the eNB downlink before SF#(n+4)				
Note 2:	Reference measurement channel according to Table A.4-5 with one/two sided dynamic OCNG Pattern OP.1/2 TDD as described in Annex A.5.2.1/2.				
Note 3:	For each test, the minimum requirements shall be fulfilled for at least one of the two SNR(s) and the respective wanted signal input level.				
Note 4:	To avoid collisions between CQI reports and HARQ-ACK it is necessary to report both on PUSCH instead of PUCCH. PDCCH DCI format 0 shall be transmitted in downlink SF#3 and #8 to allow periodic CQI to multiplex with the HARQ-ACK on PUSCH in uplink subframe SF#7 and #2.				
Note 5:	CQI reports for the short subband (having 2RBs in the last bandwidth part) are to be disregarded and data scheduling according to the most recent subband CQI report for bandwidth part with $j=1$.				
Note 6:	In the case where wideband CQI is reported, data is to be scheduled according to the most recently used subband CQI report.				

Table 9.3.4.2.2.3-2: Minimum requirement (TDD)

	Test 1	Test 2
γ	TBD	TBD
UE Category	1-5	1-5

The normative reference for this requirement is TS 36.101 [2] clause 9.3.4.2.1.

9.3.4.2.2.4 Test description

9.3.4.2.2.4.1 Initial conditions

Initial conditions are a set of test configurations the UE needs to be tested in and the steps for the SS to take with the UE to reach the correct measurement state.

Configurations of PDSCH and PDCCH before measurement are specified in Annex C.2.

Test Environment: Normal as defined in TS 36.508 [7] clause 4.1.

Frequencies to be tested: Mid Range as defined in TS 36.508 [7] clause 4.3.1.1.

Channel Bandwidths to be tested: 10MHz, as defined in TS 36.508 [7] clause 4.3.1.1

1. Connect the SS, faders and AWGN noise source to the UE antenna connector (s) as shown in TS 36.508 [7] Annex A, Figure A.9.
2. The parameter settings for the cell are set up according to Table 9.3.4.2.2.3-1.
3. Downlink signals are initially set up according to Annex C.1 and Annex C.3.2, and uplink signals according to Annex H.1 and H.3.2.
4. Propagation conditions are set according to Annex B.0.
5. Ensure the UE is in State 3A or 3A-RF according to TS 36.508 [7] clause 4.5.3A or 5.2A.2. Message contents are defined in clause 9.3.4.2.2.4.3.

9.3.4.2.2.4.2 Test procedure

1. Set the parameters of bandwidth, the propagation condition, antenna configuration and measurement channel according to Table 9.3.4.2.2.3-1 as appropriate.
2. The SS shall transmit PDSCH via PDCCH DCI format 1A for C_RNTI to transmit the DL RMC according to CQI value 8 of Annex A.4 Table A.4-3 and keep it regardless of the wideband and subband CQI value sent by the UE. Continue transmission of the PDSCH until 2000 wideband CQI reports and full-size subband CQI reports for each full-size subband have been gathered. The SS sends downlink MAC padding bits on the DL RMC. SS schedules the UL transmission in subframe #1, #3, #5 and #7 to carry the both ACK and CQI feedback via PDCCH DCI format 0 with CQI request bit set to 1 and I_MCS=29 and N_PRB allocated to be less or equal to 4. In this process the SS collects wideband CQI reports and also cases where UE transmits nothing in its wideband CQI timing are counted as wideband CQI reports.
3. Set up a relative frequency distribution for the reported wideband CQI-values, Calculate the median value (wideband Median CQI is the CQI that is at or crosses 50% distribution from the lower wideband CQI side). This CQI-value is declared as wideband Median CQI value.
4. The SS shall transmit PDSCH via PDCCH DCI format 1A for C_RNTI to transmit the DL RMC on a randomly selected full-size subband using the transport format according to the wideband median-CQI value regardless of UE wideband or subband CQI report. Note that each full-size subband shall be selected in the equal probability. The SS sends downlink MAC padding bits on the DL RMC. SS schedules the UL transmission in subframe #1, #3, #5 and #7 to carry the both ACK and CQI feedback via PDCCH DCI format 0 with CQI request bit set to 1 and I_MCS=29 and N_PRB allocated to be less or equal to 4. Measure the average throughput according to Annex G.5.3. Declare the throughput as t_{median} .
5. The SS shall transmit PDSCH via PDCCH DCI format 1A for C_RNTI to transmit the DL RMC on a randomly selected subband among the best M subbands reported by the UE the corresponding TBS. Note that the SS shall send PDSCH among the same best M subband until next UE report is available. The SS sends downlink MAC padding bits on the DL RMC. SS schedules the UL transmission in subframe #1, #3, #5 and #7 to carry the both ACK and CQI feedback via PDCCH DCI format 0 with CQI request bit set to 1 and I_MCS=29 and N_PRB allocated to be less or equal to 4. Measure the average throughput according to Annex G.5.3. Declare the throughput as $t_{subband}$. Count the number of NACKs, ACKs and statDTXs on the UL during the test interval.

If $t_{subband} / t_{median} \geq \gamma$, then pass the UE for this test and go to step 6. Otherwise fail the UE.

6. If both tests have not been done, then repeat the same procedure (steps 1 to 5) with test conditions according to the table 9.3.4.2.2.3-1 for the other Test as appropriate. Otherwise pass the UE.

9.3.4.2.2.4.3 Message contents

Message contents are according to TS 36.508 [7] clause 4.6 with the following exceptions:

Table 9.3.4.2.2.4.3-1: PhysicalConfigDedicated-DEFAULT

Derivation Path: 36.508 clause 5.5.1.2			
Information Element	Value/remark	Comment	Condition
PhysicalConfigDedicated-DEFAULT ::= SEQUENCE {			
cqi-ReportConfig	<i>CQI-ReportConfig-DEFAULT</i>		
}			

Table 9.3.4.2.2.4.3-2: CQI-ReportConfig-DEFAULT

Derivation Path: 36.508 clause 4.6.3			
Information Element	Value/remark	Comment	Condition
CQI-ReportConfig-DEFAULT ::= SEQUENCE {			
cqi-ReportModeAperiodic	Not present		
nomPDSCH-RS-EPRE-Offset	0		
cqi-ReportPeriodic CHOICE {			
setup SEQUENCE {			
cqi-PUCCH-ResourceIndex	0		
cqi-pmi-ConfigIndex	1	(see Table 7.2.2-1A in TS 36.213)	
cqi-FormatIndicatorPeriodic CHOICE {			
subbandCQI	1		
}			
ri-ConfigIndex	484	(see Table 7.2.2-1B in TS 36.213)	
simultaneousAckNackAndCQI	FALSE		
}			
}			

Table 9.3.4.2.2.4.3-3: TDD-Config-DEFAULT

Derivation Path: 36.508 clause 4.6.3			
Information Element	Value/remark	Comment	Condition
TDD-Config-DEFAULT ::= SEQUENCE {			
subframeAssignment	Sa2		
specialSubframePatterns	Ssp4		
}			

9.3.4.2.2.5 Test requirement

Table 9.3.4.2.2.5-1: Test requirement (TDD)

	Test 1	Test 2
γ	TBD+TT	TBD+TT
UE Category	1-5	1-5

9.4 Reporting of Precoding Matrix Indicator (PMI)

The minimum performance requirements of PMI reporting are defined based on the precoding gain, expressed as the relative increase in throughput when the transmitter is configured according to the UE reports compared to the case

when the transmitter is using random precoding. Transmission mode 6 is used with a fixed transport format (FRC) configured. The requirements are specified in terms of the ratio $\gamma = \frac{t_{ue}}{t_{rnd}}$

In the definition of γ , for PUSCH 3-1 single PMI and PUSCH 1-2 multiple PMI requirements, t_{rnd} is 60% of the maximum throughput obtained at SNR_{rnd} using random precoding, and t_{ue} the throughput measured at SNR_{rnd} with precoders configured according to the UE reports.

For the PUCCH 2-1 single PMI requirement, t_{rnd} is [TBD]% of the maximum throughput obtained at SNR_{rnd} using random precoding on a randomly selected full-size subband in set S subbands, and t_{ue} the throughput measured at SNR_{rnd} with both the precoder and the preferred full-size subband applied according to the UE reports;

For PUSCH 2-2 multiple PMI requirements, t_{rnd} is [TBD]% of the maximum throughput obtained at SNR_{rnd} using random precoding on a randomly selected full-size subband in set S subbands, and t_{ue} the throughput measured at SNR_{rnd} with both the subband precoder and a randomly selected full-size subband (within the preferred subbands) applied according to the UE reports.

9.4.1 Single PMI

9.4.1.1 PMI Reporting – PUSCH 3-1 (Single PMI)

9.4.1.1.1 FDD PMI Reporting – PUSCH 3-1 (Single PMI)

9.4.1.1.1.1 Test purpose

To test the accuracy of the Precoding Matrix Indicator (PMI) reporting such that the system throughput is maximized based on the precoders configured according to the UE reports.

9.4.1.1.1.2 Test applicability

This test applies to all types of E-UTRA FDD UE release 8 and forward.

9.4.1.1.1.3 Minimum conformance requirements

For the parameters specified in Table 9.4.1.1.1.3-1, and using the downlink physical channels specified in Annex C, the minimum requirements are specified in Table 9.4.1.1.1.3-2.

Table 9.4.1.1.1.3-1: PMI test for single-layer (FDD)

Parameter		Unit	Test 1
Bandwidth		MHz	10
Transmission mode			6
Propagation channel			EVA5
Precoding granularity		PRB	50
Correlation and antenna configuration			Low 2 x 2
Downlink power allocation	ρ_A	dB	-3
	ρ_B	dB	-3
$N_{oc}^{(j)}$		dB[mW/15kHz]	-98
Reporting mode			PUSCH 3-1
Reporting interval		ms	1
PMI delay (Note 2)		ms	8
Measurement channel			R.10 FDD
OCNG Pattern			OP.1 FDD
Max number of HARQ transmissions			4
Redundancy version coding sequence			{0,1,2,3}
Note 1: For random precoder selection, the precoder shall be updated in each TTI (1 ms granularity)			
Note 2: If the UE reports in an available uplink reporting instance at subframe SF#n based on PMI estimation at a downlink SF not later than SF#(n-4), this reported PMI cannot be applied at the eNB downlink before SF#(n+4).			

Table 9.4.1.1.1.3-2: Minimum requirement (FDD)

Parameter	Test 1
γ	1.1
UE Category	1-5

9.4.1.1.1.4 Test description

9.4.1.1.1.4.1 Initial conditions

Initial conditions are a set of test configurations the UE needs to be tested in and the steps for the SS to take with the UE to reach the correct measurement state.

Configurations of PDSCH and PDCCH before measurement are specified in Annex C.2.

Test Environment: Normal as defined in TS 36.508 [7] clause 4.1.

Frequencies to be tested: Mid Range as defined in TS 36.508 [7] clause 4.3.1.1.

Channel Bandwidths to be tested: 10MHz, as defined in TS 36.508 [7] clause 4.3.1.1

1. Connect the SS to the UE antenna connector (s) as shown in TS 36.508 [7] Annex A, Figure A.10.
2. The parameter settings for the cell are set up according to Table 9.4.1.1.1.3-1.
3. Downlink signals are initially set up according to Annex C.1 and Annex C.3.2, and uplink signals according to Annex H.1 and H.3.2.
4. Propagation conditions are set according to Annex B clause B.0
5. Ensure the UE is in State 3A or 3A-RF according to TS 36.508 [7] clause 4.5.3A 5.2A.2. Message contents are defined in clause 9.4.1.1.1.4.3.

9.4.1.1.1.4.2 Test procedure

1. Set the parameters of bandwidth, the propagation condition, antenna configuration and measurement channel according to Table 9.4.1.1.1.3-1 as appropriate.
2. The SS shall transmit PDSCH via PDCCH DCI format 1B for C_RNTI to transmit the DL RMC with randomly selected precoding matrix from codebook (Table 6.3.4.2.3-1 in TS 36.211 [8]) every subframe regardless of PMI reports from the UE. Note that each precoding matrix shall be selected in equal probabilities. The SS sends downlink MAC padding bits on the DL RMC. SS schedules the UL transmission to carry the PUSCH CQI feedback via PDCCH DCI format 0 with CQI request bit set to 1 and I_MCS=29 and N_PRB allocated to be less or equal to 4. Establish t_{rnd} and SNR_{rnd} according to annex G.5.2
3. Set SNR to SNR_{rnd} . The SS shall transmit PDCCH with DCI format 0 in which CQI request bit is set to true [every subframe]. Then the SS shall transmit PDSCH with precoding matrix according to PMI report from the UE. The SS sends downlink MAC padding bits on the DL RMC. SS schedules the UL transmission to carry the PUSCH CQI feedback via PDCCH DCI format 0 with CQI request bit set to 1 and I_MCS=29 and N_PRB allocated to be less or equal to 4. Measure t_{ue} according to Annex G.5.3
4. Calculate $\gamma = \frac{t_{ue}}{t_{rnd}}$. If the ratio (throughput / t_{rnd}) $\geq \gamma$ which is specified in table 9.4.1.1.1.5-1, then the test is pass. Otherwise, the test is fail.

9.4.1.1.1.4.3 Message contents

Message contents are according to TS 36.508 [7] clause 4.6 with the following exceptions:

Table 9.4.1.1.1.4.3-1: PhysicalConfigDedicated-DEFAULT

Derivation Path: 36.508 clause 5.5.1.2			
Information Element	Value/remark	Comment	Condition
PhysicalConfigDedicated-DEFAULT ::= SEQUENCE {			
cqi-ReportConfig	CQI-ReportConfig-DEFAULT		
antennaInfo CHOICE {			
explicitValue	AntennaInfoDedicated		
}			
}			

Table 9.4.1.1.1.4.3-2: AntennaInfoDedicated

Derivation Path: 36.331 clause 6.3.2			
Information Element	Value/remark	Comment	Condition
AntennaInfoDedicated ::= SEQUENCE {			
transmissionMode	tm6		
codebookSubsetRestriction CHOICE{			
n2TxAntenna-tm6	1111		
}			
ue-TransmitAntennaSelection CHOICE{			
release	NULL		
}			

Table 9.4.1.1.1.4.3-3: CQI-ReportConfig-DEFAULT

Derivation Path: 36.508 clause 4.6.3			
Information Element	Value/remark	Comment	Condition
CQI-ReportConfig-DEFAULT ::= SEQUENCE {			
cqi-ReportModeAperiodic	rm31		
nomPDSCH-RS-EPRE-Offset	0		
cqi-ReportPeriodic	Not present		
}			

9.4.1.1.1.5 Test requirement

Table 9.4.1.1.1.5-1: Test requirement (FDD)

Parameter	Test 1
γ	1.09

The ratio of throughput using precoding matrix of PMI reports from the UE to using random precoding matrix shall equal or exceed the value specified in table 9.4.1.1.1.5.

9.4.1.1.2 TDD PMI Reporting – PUSCH 3-1 (Single PMI)

9.4.1.1.2.1 Test purpose

To test the accuracy of the Precoding Matrix Indicator (PMI) reporting such that the system throughput is maximized based on the precoders configured according to the UE reports.

9.4.1.1.2.2 Test applicability

This test applies to all types of E-UTRA TDD UE release 8 and forward.

9.4.1.1.2.3 Minimum conformance requirements

For the parameters specified in Table 9.4.1.1.2.3-1, and using the downlink physical channels specified in Annex C, the minimum requirements are specified in 9.4.1.1.2.3-2.

Table 9.4.1.1.2.3-1: PMI test for single-layer (TDD)

Parameter	Unit	Test 1	
Bandwidth	MHz	10	
Transmission mode		6	
Uplink downlink configuration		1	
Special subframe configuration		4	
Propagation channel		EVA5	
Precoding granularity	PRB	50	
Correlation and antenna configuration		Low 2 x 2	
Downlink power allocation	ρ_A	dB	-3
	ρ_B	dB	-3
$N_{oc}^{(j)}$	dB[mW/15kHz]	-98	
Reporting mode		PUSCH 3-1	
Reporting interval	ms	1	
Minimum PMIdelay (Node-2)	ms	10 or 11	
Measurement channel		R.10 TDD	
OCNG Pattern		OP.1 TDD	
Max number of HARQ transmissions		4	
Redundancy version coding sequence		{0,1,2,3}	
ACK/NACK feedback mode		Multiplexing	
Note 1: For random precoder selection, the precoder shall be updated in each available downlink transmission instance Note 2: If the UE reports in an available uplink reporting instance at subframe SF#n based on PMI estimation at a downlink SF not later than SF#(n-4), this reported PMI cannot be applied at the eNB downlink before SF#(n+4)			

Table 9.4.1.1.2.3-2: Minimum requirement (TDD)

Parameter	Test 1
γ	1.1
UE Category	1-5

9.4.1.1.2.4 Test description

9.4.1.1.2.4.1 Initial conditions

Initial conditions are a set of test configurations the UE needs to be tested in and the steps for the SS to take with the UE to reach the correct measurement state.

Configurations of PDSCH and PDCCH before measurement are specified in Annex C.2.

Test Environment: Normal as defined in TS 36.508 [7] clause 4.1.

Frequencies to be tested: Mid Range as defined in TS 36.508 [7] clause 4.3.1.2.

Channel Bandwidths to be tested: 10MHz, as defined in TS 36.508 [7] clause 4.3.1.2

1. Connect the SS to the UE antenna connector (s) as shown in TS 36.508 [7] Annex A, Figure A.10.
2. The parameter settings for the cell are set up according to Table 9.4.1.1.2.3-1.

3. Downlink signals are initially set up according to Annex C.1 and Annex C.3.2, and uplink signals according to Annex H.1 and H.3.2.
4. Propagation conditions are set according to Annex B clause B.0
5. Ensure the UE is in State 3A or 3A-RF according to TS 36.508 [7] clause 4.5.3.A or 5.2A.2. Message contents are defined in clause 9.4.1.1.2.4.3.

9.4.1.1.2.4.2 Test procedure

1. Set the bandwidth, propagation condition, antenna configuration and measurement channel parameters according to Table 9.4.1.1.2.3-1 as appropriate.
2. The SS shall transmit PDSCH via PDCCH DCI format 1B for C_RNTI to transmit the DL RMC with randomly selected precoding matrix from codebook (Table 6.3.4.2.3-1 in TS 36.211 [8]) every subframe regardless of PMI reports from the UE. Note that each precoding matrix shall be selected in equal probabilities. The SS sends downlink MAC padding bits on the DL RMC. SS schedules the UL transmission to carry the PUSCH CQI feedback via PDCCH DCI format 0 with CQI request bit set to 1 and I_MCS=29 and N_PRB allocated to be less or equal to 4. Establish t_{md} and SNR_{md} according to annex G.5.2.
3. Set SNR to SNR_{md} . The SS shall transmit PDSCH with precoding matrix according to PMI report from the UE. The SS sends downlink MAC padding bits on the DL RMC. SS schedules the UL transmission to carry the PUSCH CQI feedback via PDCCH DCI format 0 with CQI request bit set to 1 and I_MCS=29 and N_PRB allocated to be less or equal to 4. Measure t_{ue} according to Annex G.5.3
4. Calculate $\gamma = \frac{t_{ue}}{t_{md}}$

9.4.1.1.2.4.3 Message contents

Message contents are according to TS 36.508 [7] clause 4.6 with the following exceptions:

Table 9.4.1.1.2.4.3-1: PhysicalConfigDedicated-DEFAULT

Derivation Path: 36.508 clause 5.5.1.2			
Information Element	Value/remark	Comment	Condition
PhysicalConfigDedicated-DEFAULT ::= SEQUENCE {			
cqi-ReportConfig	CQI-ReportConfig-DEFAULT		
antennaInfo CHOICE {			
explicitValue	AntennaInfoDedicated		
}			
}			

Table 9.4.1.1.2.4.3-2: AntennaInfoDedicated

Derivation Path: 36.331 clause 6.3.2			
Information Element	Value/remark	Comment	Condition
AntennaInfoDedicated ::= SEQUENCE {			
transmissionMode	tm6		
codebookSubsetRestriction CHOICE{			
n2TxAntenna-tm6	1111		
}			
ue-TransmitAntennaSelection CHOICE{			
release	NULL		
}			

Table 9.4.1.1.2.4.3-3: CQI-ReportConfig-DEFAULT

Derivation Path: 36.508 clause 4.6.3			
Information Element	Value/remark	Comment	Condition
CQI-ReportConfig-DEFAULT ::= SEQUENCE {			
cqi-ReportModeAperiodic	rm31		
nomPDSCH-RS-EPRE-Offset	0		
cqi-ReportPeriodic	Not present		
}			

9.4.1.1.2.5 Test requirement

Table 9.4.1.1.2.5-1: Test requirement (TDD)

Parameter	Test 1
γ	1.09

9.4.1.2 PMI Reporting – PUCCH 2-1 (Single PMI)

9.4.1.2.1 FDD PMI Reporting – PUCCH 2-1 (Single PMI)

Editor's note: This clause is incomplete. The following aspects are either missing or not yet determined:

- Throughput ratio and test tolerance are undefined

9.4.1.2.1.1 Test purpose

To test the accuracy of the Precoding Matrix Indicator (PMI) reporting such that the system throughput is maximized based on the precoders configured according to the UE reports.

9.4.1.2.1.2 Test applicability

This test applies to all types of E-UTRA FDD UE release 9 and forward.

9.4.1.2.1.3 Minimum conformance requirements

For the parameters specified in Table 9.4.1.2.1.3-1, and using the downlink physical channels specified in Annex C, the minimum requirements are specified in Table 9.4.1.2.1.3-2.

Table 9.4.1.2.1.3-1: PMI test for single-layer (FDD)

Parameter	Unit	Test 1
Bandwidth	MHz	10
Transmission mode		6
Propagation channel		[EVA5]
Correlation and antenna configuration		Low 4 x 2
$N_{oc}^{(j)}$	dB[mW/15kHz]	-98
PMI delay	ms	8
Reporting mode		PUCCH 2-1
Reporting periodicity	ms	$N_p = 2$
Physical channel for CQI reporting		PUSCH (Note 3)
PUCCH Report Type for wideband CQI/PMI		2
PUCCH Report Type for subband CQI		1
Measurement channel		[R.14-1 FDD]
OCNG Pattern		[OP.1/2 FDD]
Precoding granularity	PRB	6 (full size)
Number of bandwidth parts (J)		3
K		1
<i>cqi-pmi-ConfigIndex</i>		1
Max number of HARQ transmissions		4
Redundancy version coding sequence		{0,1,2,3}
Note 1:	For random precoder selection, the precoder shall be updated every two TTI (2 ms granularity)	
Note 2:	If the UE reports in an available uplink reporting instance at subframe SF#n based on PMI estimation at a downlink SF not later than SF#(n-4), this reported PMI cannot be applied at the eNB downlink before SF#(n+4).	
Note 3:	To avoid collisions between HARQ-ACK and wideband CQI/PMI or subband CQI, it is necessary to report both on PUSCH instead of PUCCH. PDCCH DCI format 0 shall be transmitted in downlink SF#1, #3, #7 and #9 to allow periodic CQI to multiplex with the HARQ-ACK on PUSCH in uplink subframe SF#5, #7, #1 and #3.	
Note 4:	Reports for the short subband (having 2RBs in the last bandwidth part) are to be disregarded and instead data is to be transmitted on the most recently used subband for bandwidth part with j=1.	
Note 5:	In the case where wideband PMI is reported, data is to be transmitted on the most recently used subband.	

Table 9.4.1.2.1.3-2: Minimum requirement (FDD)

	Test 1
γ	TBD
UE Category	1-5

The normative reference for this requirement is TS 36.101 [2] clause 9.4.1.2.1.

9.4.1.2.1.4 Test description

9.4.1.2.1.4.1 Initial conditions

Initial conditions are a set of test configurations the UE needs to be tested in and the steps for the SS to take with the UE to reach the correct measurement state.

Configurations of PDSCH and PDCCH before measurement are specified in Annex C.2.

Test Environment: Normal as defined in TS 36.508 [7] clause 4.1.

Frequencies to be tested: Mid Range as defined in TS 36.508 [7] clause 4.3.1.1.

Channel Bandwidths to be tested: 10MHz, as defined in TS 36.508 [7] clause 4.3.1.1

1. Connect the SS to the UE antenna connector (s) as shown in TS 36.508 [7] Annex A, Figure A.10.
2. The parameter settings for the cell are set up according to Table 9.4.1.2.1.3-1.
3. Downlink signals are initially set up according to Annex C.1 and Annex C.3.2, and uplink signals according to Annex H.1 and H.3.2.
4. Propagation conditions are set according to Annex B clause B.0
5. Ensure the UE is in State 3A or 3A-RF according to TS 36.508 [7] clause 4.5.3A 5.2A.2. Message contents are defined in clause 9.4.1.2.1.4.3.

9.4.1.2.1.4.2 Test procedure

1. Set the parameters of bandwidth, the propagation condition, antenna configuration and measurement channel according to Table 9.4.1.2.1.3-1 as appropriate.
2. The SS shall transmit PDSCH via PDCCH DCI format 1B for C_RNTI to transmit the DL RMC with randomly selected precoding matrix from codebook (Table 6.3.4.2.3-1 in TS 36.211 [8]) every subframe regardless of PMI reports from the UE. Note that each precoding matrix shall be selected in equal probabilities. The SS sends downlink MAC padding bits on the DL RMC. SS schedules the UL transmission in subframe #1, #3, #5 and #7 to carry the both ACK and CQI feedback via PDCCH DCI format 0 with CQI request bit set to 1 and I_MCS=29 and N_PRB allocated to be less or equal to 4. Establish t_{rnd} and SNR_{rnd} according to annex G.5.2
3. Set SNR to SNR_{rnd} . The SS shall transmit PDCCH with DCI format 0 in which CQI request bit is set to true [every subframe]. Then the SS shall transmit PDSCH with precoding matrix according to PMI report from the UE. The SS sends downlink MAC padding bits on the DL RMC. SS schedules the UL transmission in subframe #1, #3, #5 and #7 to carry the both ACK and CQI feedback via PDCCH DCI format 0 with CQI request bit set to 1 and I_MCS=29 and N_PRB allocated to be less or equal to 4. Measure t_{ue} according to Annex G.5.3
4. Calculate $\gamma = \frac{t_{ue}}{t_{rnd}}$. If the ratio (throughput / t_{rnd}) $\geq \gamma$ which is specified in table 9.4.1.2.2.5-1, then the test is pass. Otherwise, the test is fail.

9.4.1.2.1.4.3 Message contents

Message contents are according to TS 36.508 [7] clause 4.6 with the following exceptions:

Table 9.4.1.2.1.4.3-1: PhysicalConfigDedicated-DEFAULT

Derivation Path: 36.508 clause 5.5.1.2			
Information Element	Value/remark	Comment	Condition
PhysicalConfigDedicated-DEFAULT ::= SEQUENCE {			
cqi-ReportConfig	CQI-ReportConfig-DEFAULT		
antennaInfo CHOICE {			
explicitValue	AntennaInfoDedicated		
}			
}			

Table 9.4.1.2.1.4.3-2: AntennaInfoDedicated

Derivation Path: 36.331 clause 6.3.2			
Information Element	Value/remark	Comment	Condition
AntennaInfoDedicated ::= SEQUENCE {			
transmissionMode	tm6		
codebookSubsetRestriction CHOICE{			
n4TxAntenna-tm6	1111111111111111		
}			
ue-TransmitAntennaSelection CHOICE{			
release	NULL		
}			
}			

Table 9.4.1.2.1.4.3-3: CQI-ReportConfig-DEFAULT

Derivation Path: 36.508 clause 4.6.3			
Information Element	Value/remark	Comment	Condition
CQI-ReportConfig-DEFAULT ::= SEQUENCE {			
cqi-ReportModeAperiodic	Not present		
nomPDSCH-RS-EPRE-Offset	0		
cqi-ReportPeriodic CHOICE {			
setup SEQUENCE {			
cqi-PUCCH-ResourceIndex	0		
cqi-pmi-ConfigIndex	1	(see Table 7.2.2-1A in TS 36.213)	
cqi-FormatIndicatorPeriodic CHOICE {			
subbandCQI	1		
}			
ri-ConfigIndex	483	(see Table 7.2.2-1B in TS 36.213)	
simultaneousAckNackAndCQI	FALSE		
}			
}			

9.4.1.2.1.5 Test requirement

Table 9.4.1.2.1.5-1: Test requirement (FDD)

	Test 1
γ	TBD+TT
UE Category	1-5

The ratio of throughput using precoding matrix of PMI reports from the UE to using random precoding matrix shall equal or exceed the value specified in table 9.4.1.2.1.5.9.4.1.2.2TDD PMI Reporting – PUCCH 2-1 (Single PMI)

Editor’s note: This clause is incomplete. The following aspects are either missing or not yet determined:

- Throughput ratio and test tolerance are undefined

9.4.1.2.2.1 Test purpose

To test the accuracy of the Precoding Matrix Indicator (PMI) reporting such that the system throughput is maximized based on the precoders configured according to the UE reports.

9.4.1.2.2.2 Test applicability

This test applies to all types of E-UTRA TDD UE release 9 and forward.

9.4.1.2.2.3 Minimum conformance requirements

For the parameters specified in Table 9.4.1.2.2.3-1, and using the downlink physical channels specified in Annex C, the minimum requirements are specified in 9.4.1.2.2.3-2.

Table 9.4.1.2.2.3-1: PMI test for single-layer (TDD)

Parameter	Unit	Test 1
Bandwidth	MHz	10
Transmission mode		6
Uplink downlink configuration		1
Special subframe configuration		4
Propagation channel		[EVA5]
Correlation and antenna configuration		Low 4 x 2
$N_{oc}^{(j)}$	dB[mW/15kHz]	-98
PMI delay	ms	[10 or 11]
Reporting mode		PUCCH 2-1
Reporting periodicity	ms	$N_P = 5$
Physical channel for CQI reporting		PUSCH (Note 3)
PUCCH Report Type for wideband CQI/PMI		2
PUCCH Report Type for subband CQI		1
Measurement channel		[R.14-1 TDD]
OCNG Pattern		[OP.1/2 TDD]
Precoding granularity	PRB	6 (full size)
Number of bandwidth parts (J)		3
K		1
<i>cqi-pmi-ConfigIndex</i>		0
Max number of HARQ transmissions		4
Redundancy version coding sequence		{0,1,2,3}
ACK/NACK feedback mode		Multiplexing
Note 1:	For random precoder selection, the precoder shall be updated in each available downlink transmission instance	
Note 2:	If the UE reports in an available uplink reporting instance at subframe SF#n based on PMI estimation at a downlink SF not later than SF#(n-4), this reported PMI cannot be applied at the eNB downlink before SF#(n+4)	
Note 3:	To avoid collisions between HARQ-ACK and wideband CQI/PMI or subband CQI it is necessary to report both on PUSCH instead of PUCCH. PDCCH DCI format 0 shall be transmitted in downlink SF#4 and #9 to allow periodic CQI to multiplex with the HARQ-ACK on PUSCH in uplink subframe SF#8 and #3.	
Note 4:	Reports for the short subband (having 2RBs in the last bandwidth part) are to be disregarded and instead data is to be transmitted on the most recently used subband for bandwidth part with j=1.	
Note 5:	In the case where wideband PMI is reported, data is to be transmitted on the most recently used subband.	

Table 9.4.1.2.2.3-2: Minimum requirement (TDD)

Parameter	Test 1
γ	1.1
UE Category	1-5

The normative reference for this requirement is TS 36.101 [2] clause 9.4.1.2.2.

9.4.1.2.2.4 Test description

9.4.1.2.2.4.1 Initial conditions

Initial conditions are a set of test configurations the UE needs to be tested in and the steps for the SS to take with the UE to reach the correct measurement state.

Configurations of PDSCH and PDCCH before measurement are specified in Annex C.2.

Test Environment: Normal as defined in TS 36.508 [7] clause 4.1.

Frequencies to be tested: Mid Range as defined in TS 36.508 [7] clause 4.3.1.2.

Channel Bandwidths to be tested: 10MHz, as defined in TS 36.508 [7] clause 4.3.1.2

1. Connect the SS to the UE antenna connector (s) as shown in TS 36.508 [7] Annex A, Figure A.10.
2. The parameter settings for the cell are set up according to Table 9.4.1.2.2.3-1.
3. Downlink signals are initially set up according to Annex C.1 and Annex C.3.2, and uplink signals according to Annex H.1 and H.3.2.
4. Propagation conditions are set according to Annex B clause B.0
5. Ensure the UE is in State 3A or 3A-RF according to TS 36.508 [7] clause 4.5.3.A or 5.2A.2. Message contents are defined in clause 9.4.1.2.2.4.3.

9.4.1.2.2.4.2 Test procedure

1. Set the bandwidth, propagation condition, antenna configuration and measurement channel parameters according to Table 9.4.1.2.2.3-1 as appropriate.
2. The SS shall transmit PDSCH via PDCCH DCI format 1B for C_RNTI to transmit the DL RMC with randomly selected precoding matrix from codebook (Table 6.3.4.2.3-1 in TS 36.211 [8]) every subframe regardless of PMI reports from the UE. Note that each precoding matrix shall be selected in equal probabilities. The SS sends downlink MAC padding bits on the DL RMC. SS schedules the UL transmission in subframe #3 and #8 to carry the both ACK and CQI feedback via PDCCH DCI format 0 with CQI request bit set to 1 and I_MCS=29 and N_PRB allocated to be less or equal to 4. Establish t_{rnd} and SNR_{rnd} according to annex G.5.2
3. Set SNR to SNR_{rnd} . The SS shall transmit PDCCH with DCI format 0 in which CQI request bit is set to true [every subframe]. Then the SS shall transmit PDSCH with precoding matrix according to PMI report from the UE. The SS sends downlink MAC padding bits on the DL RMC. SS schedules the UL transmission in subframe #3 and #8 to carry the both ACK and CQI feedback via PDCCH DCI format 0 with CQI request bit set to 1 and I_MCS=29 and N_PRB allocated to be less or equal to 4. Measure t_{ue} according to Annex G.5.3
4. Calculate $\gamma = \frac{t_{ue}}{t_{rnd}}$. If the ratio (throughput / t_{rnd}) $\geq \gamma$ which is specified in table 9.4.1.2.2.5-1, then the test is pass. Otherwise, the test is fail.

9.4.1.2.2.4.3 Message contents

Message contents are according to TS 36.508 [7] clause 4.6 with the following exceptions:

Table 9.4.1.2.2.4.3-1: PhysicalConfigDedicated-DEFAULT

Derivation Path: 36.508 clause 5.5.1.2			
Information Element	Value/remark	Comment	Condition
PhysicalConfigDedicated-DEFAULT ::= SEQUENCE {			
cqi-ReportConfig	CQI-ReportConfig-DEFAULT		
antennaInfo CHOICE {			
explicitValue	AntennaInfoDedicated		
}			
}			

Table 9.4.1.2.2.4.3-2: AntennaInfoDedicated

Derivation Path: 36.331 clause 6.3.2			
Information Element	Value/remark	Comment	Condition
AntennaInfoDedicated ::= SEQUENCE {			
transmissionMode	tm6		
codebookSubsetRestriction CHOICE{			
n4TxAntenna-tm6	1111111111111111		
}			
ue-TransmitAntennaSelection CHOICE{			
release	NULL		
}			
}			

Table 9.4.1.2.2.4.3-3: CQI-ReportConfig-DEFAULT

Derivation Path: 36.508 clause 4.6.3			
Information Element	Value/remark	Comment	Condition
CQI-ReportConfig-DEFAULT ::= SEQUENCE {			
cqi-ReportModeAperiodic	Not present		
nomPDSCH-RS-EPRE-Offset	0		
cqi-ReportPeriodic CHOICE {			
setup SEQUENCE {			
cqi-PUCCH-ResourceIndex	0		
cqi-pmi-ConfigIndex	1	(see Table 7.2.2-1A in TS 36.213)	
cqi-FormatIndicatorPeriodic CHOICE {			
subbandCQI	1		
}			
ri-ConfigIndex	484	(see Table 7.2.2-1B in TS 36.213)	
simultaneousAckNackAndCQI	FALSE		
}			
}			

9.4.1.2.2.5

Test requirement

Table 9.4.1.2.2.5-1: Test requirement (TDD)

Parameter	Test 1
γ	TBD +TT
UE Category	1-5

9.4.2 Multiple PMI

9.4.2.1 PMI Reporting – PUSCH 1-2 (Multiple PMI)

9.4.2.1.1 FDD PMI Reporting – PUSCH 1-2 (Multiple PMI)

9.4.2.1.1.1 Test purpose

To test the accuracy of the Precoding Matrix Indicator (PMI) reporting such that the system throughput is maximized based on the precoders configured according to the UE reports.

9.4.2.1.1.2 Test applicability

This test applies to E-UTRA FDD UE release 8 of UE category 2-5.

9.4.2.1.1.3 Minimum conformance requirements

For the parameters specified in Table 9.4.2.1.1.3-1, and using the downlink physical channels specified in Annex C, the minimum requirements are specified in Table 9.4.2.1.1.3-2.

Table 9.4.2.1.1.3-1 PMI test for single-layer (FDD)

Parameter		Unit	Test 1
Bandwidth		MHz	20
Transmission mode			6
Propagation channel			EPA5
Precoding granularity (only for reporting and following PMI)		PRB	8
Correlation and antenna configuration			Low 2 x 2
Downlink power allocation	ρ_A	dB	-3
	ρ_B	dB	-3
$N_{oc}^{(j)}$		dB[mW/15kHz]	-98
Reporting mode			PUSCH 1-2
Reporting interval		ms	1
PMI delay		ms	8
Measurement channel			R.30 FDD
OCNG Pattern			OP.1 FDD
Max number of HARQ transmissions			4
Redundancy version coding sequence			{0,1,2,3}
Note 1: For random precoder selection, the precoders shall be updated in each TTI (1 ms granularity) Note 2: If the UE reports in an available uplink reporting instance at subframe SF#n based on PMI estimation at a downlink SF not later than SF#(n-4), this reported PMI cannot be applied at the eNB downlink before SF#(n+4)			

Table 9.4.2.1.1.3-2: Minimum requirement (FDD)

Parameter	Test 1
γ	1,2
UE Category	2-5

The normative reference for this requirement is TS 36.101 [2] clause 9.4.2.1.1.

9.4.2.1.1.4 Test description

9.4.2.1.1.4.1 Initial conditions

Initial conditions are a set of test configurations the UE needs to be tested in and the steps for the SS to take with the UE to reach the correct measurement state.

Configurations of PDSCH and PDCCH before measurement are specified in Annex C.2.

Test Environment: Normal as defined in TS 36.508 [7] clause 4.1.

Frequencies to be tested: Mid Range as defined in TS 36.508 [7] clause 4.3.1.1.

Channel Bandwidths to be tested: 20MHz, as defined in TS 36.508 [7] clause 4.3.1.1

1. Connect the SS to the UE antenna connector (s) as shown in TS 36.508 [7] Annex A, Figure A.10.
2. The parameter settings for the cell are set up according to Table 9.4.2.1.1.3-1.
3. Downlink signals are initially set up according to Annex C.1 and Annex C.3.2, and uplink signals according to Annex H.1 and H.3.2.
4. Propagation conditions are set according to Annex B clause B.0
5. Ensure the UE is in State 3A or 3A-RF according to TS 36.508 [7] clause 4.5.3A or 5.2A.2. Message contents are defined in clause 9.4.2.1.1.4.3.

9.4.2.1.1.4.2 Test procedure

1. Set the parameters of bandwidth, the propagation condition, antenna configuration and measurement channel according to Table 9.4.2.1.1.3-1 as appropriate.
2. The SS shall transmit PDSCH via PDCCH DCI format 1B for C_RNTI to transmit the DL RMC with randomly selected precoding matrix from codebook (Table 6.3.4.2.3-1 in TS 36.211 [8]) every subframe regardless of PMI reports from the UE. Note that each precoding matrix shall be selected in equal probabilities. The SS sends downlink MAC padding bits on the DL RMC SS schedules the UL transmission to carry the PUSCH CQI feedback via PDCCH DCI format 0 with CQI request bit set to 1 and I_MCS=29 and N_PRB allocated to be less or equal to 4. Establish t_{rd} and SNR_{rd} according to annex G.5.2
3. Set SNR to SNR_{rd} . The SS shall transmit PDCCH with DCI format 0 in which CQI request bit is set to true [every subframe]. Then the SS shall transmit PDSCH with precoding matrix according to PMI report from the UE. The SS sends downlink MAC padding bits on the DL RMC SS schedules the UL transmission to carry the PUSCH CQI feedback via PDCCH DCI format 0 with CQI request bit set to 1 and I_MCS=29 and N_PRB allocated to be less or equal to 4. . Measure the average throughput. Measure t_{ue} according to Annex G.5.3
4. Calculate $\gamma = \frac{t_{ue}}{t_{rd}}$

9.4.2.1.1.4.3 Message contents

Message contents are according to TS 36.508 [7] clause 4.6 with the following exceptions:

Table 9.4.2.1.1.4.3-1: PhysicalConfigDedicated-DEFAULT

Derivation Path: 36.508 clause 5.5.1.2			
Information Element	Value/remark	Comment	Condition
PhysicalConfigDedicated-DEFAULT ::= SEQUENCE {			
cqi-ReportConfig	CQI-ReportConfig-DEFAULT		
antennaInfo CHOICE {			
explicitValue	AntennaInfoDedicated		
}			
}			

Table 9.4.2.1.1.4.3-2: AntennaInfoDedicated

Derivation Path: 36.331 clause 6.3.2			
Information Element	Value/remark	Comment	Condition
AntennaInfoDedicated ::= SEQUENCE {			
transmissionMode	tm6		
codebookSubsetRestriction CHOICE{			
n2TxAntenna-tm6	1111		
}			
ue-TransmitAntennaSelection CHOICE{			
release	NULL		
}			
}			

Table 9.4.2.1.1.4.3-3: CQI-ReportConfig-DEFAULT

Derivation Path: 36.508 clause 4.6.3			
Information Element	Value/remark	Comment	Condition
CQI-ReportConfig-DEFAULT ::= SEQUENCE {			
cqi-ReportModeAperiodic	rm12		
nomPDSCH-RS-EPRE-Offset	0		
cqi-ReportPeriodic	Not present		
}			

9.4.2.1.1.5 Test requirement

Table 9.4.2.1.1.5-1: Test requirement (FDD)

Parameter	Test 1
γ	1.19
UE Category	2-5

9.4.2.1.1_1 FDD PMI Reporting – PUSCH 1-2 (Multiple PMI)

Editor's note: This clause is incomplete. The following aspects are either missing or not yet determined:

- Test tolerance are undefined

9.4.2.1.1_1.1 Test purpose

To test the accuracy of the Precoding Matrix Indicator (PMI) reporting such that the system throughput is maximized based on the precoders configured according to the UE reports.

9.4.2.1.1_1.2 Test applicability

This test applies to all types of E-UTRA FDD UE release 9 and forward.

9.4.2.1.1_1.3 Minimum conformance requirements

For the parameters specified in Table 9.4.2.1.1_1.3-1, and using the downlink physical channels specified in Annex C, the minimum requirements are specified in Table 9.4.2.1.1_1.3-2.

Table 9.4.2.1.1_1.3-1: PMI test for single-layer (FDD)

Parameter	Unit	Test 1	
Bandwidth	MHz	10	
Transmission mode		6	
Propagation channel		EPA5	
Precoding granularity (only for reporting and following PMI)	PRB	6	
Correlation and antenna configuration		Low 2 x 2	
Downlink power allocation	ρ_A	dB	-3
	ρ_B	dB	-3
$N_{oc}^{(j)}$	dB[mW/15kHz]	-98	
Reporting mode		PUSCH 1-2	
Reporting interval	ms	1	
PMI delay	ms	8	
Measurement channel		R.11-3 FDD for UE Category 1, R.11 FDD for UE Category 2-5	
OCNG Pattern		OP.1 FDD	
Max number of HARQ transmissions		4	
Redundancy version coding sequence		{0,1,2,3}	
Note 1:	For random precoder selection, the precoders shall be updated in each TTI (1 ms granularity)		
Note 2:	If the UE reports in an available uplink reporting instance at subframe SF#n based on PMI estimation at a downlink SF not later than SF#(n-4), this reported PMI cannot be applied at the eNB downlink before SF#(n+4)		
Note 3:	One/two sided dynamic OCNG Pattern OP.1/2 FDD as described in Annex A.5.1.1/2 shall be used.		

Table 9.4.2.1.1_1.3-2: Minimum requirement (FDD)

Parameter	Test 1
γ	1.2
UE Category	1-5

The normative reference for this requirement is TS 36.101 [2] clause 9.4.2.1.1.

9.4.2.1.1_1.4 Test description

9.4.2.1.1_1.4.1 Initial conditions

Initial conditions are a set of test configurations the UE needs to be tested in and the steps for the SS to take with the UE to reach the correct measurement state.

Configurations of PDSCH and PDCCH before measurement are specified in Annex C.2.

Test Environment: Normal as defined in TS 36.508 [7] clause 4.1.

Frequencies to be tested: Mid Range as defined in TS 36.508 [7] clause 4.3.1.1.

Channel Bandwidths to be tested: 10MHz, as defined in TS 36.508 [7] clause 4.3.1.1

1. Connect the SS to the UE antenna connector (s) as shown in TS 36.508 [7] Annex A, Figure A.10.
2. The parameter settings for the cell are set up according to Table 9.4.2.1.1_1.3-1.
3. Downlink signals are initially set up according to Annex C.1 and Annex C.3.2, and uplink signals according to Annex H.1 and H.3.2.
4. Propagation conditions are set according to Annex B clause B.0
5. Ensure the UE is in State 3A or 3A-RF according to TS 36.508 [7] clause 4.5.3A or 5.2A.2. Message contents are defined in clause 9.4.2.1.1_1.4.3.

9.4.2.1.1_1.4.2 Test procedure

1. Set the parameters of bandwidth, the propagation condition, antenna configuration and measurement channel according to Table 9.4.2.1.1_1.3-1 as appropriate.
2. The SS shall transmit PDSCH via PDCCH DCI format 1B for C_RNTI to transmit the DL RMC with randomly selected precoding matrix from codebook (Table 6.3.4.2.3-1 in TS 36.211 [8]) every subframe regardless of PMI reports from the UE. Note that each precoding matrix shall be selected in equal probabilities. The SS sends downlink MAC padding bits on the DL RMC SS schedules the UL transmission to carry the PUSCH CQI feedback via PDCCH DCI format 0 with CQI request bit set to 1 and I_MCS=29 and N_PRB allocated to be less or equal to 4. Establish t_{rd} and SNR_{rd} according to annex G.5.2
3. Set SNR to SNR_{rd} . The SS shall transmit PDCCH with DCI format 0 in which CQI request bit is set to true [every subframe]. Then the SS shall transmit PDSCH with precoding matrix according to PMI report from the UE. The SS sends downlink MAC padding bits on the DL RMC SS schedules the UL transmission to carry the PUSCH CQI feedback via PDCCH DCI format 0 with CQI request bit set to 1 and I_MCS=29 and N_PRB allocated to be less or equal to 4. . Measure the average throughput. Measure t_{ue} according to Annex G.5.3
4. Calculate $\gamma = \frac{t_{ue}}{t_{rd}}$

9.4.2.1.1_1.4.3 Message contents

Message contents are according to TS 36.508 [7] clause 4.6 with the following exceptions:

Table 9.4.2.1.1_1.4.3-1: PhysicalConfigDedicated-DEFAULT

Derivation Path: 36.508 clause 5.5.1.2			
Information Element	Value/remark	Comment	Condition
PhysicalConfigDedicated-DEFAULT ::= SEQUENCE {			
cqi-ReportConfig	CQI-ReportConfig-DEFAULT		
antennaInfo CHOICE {			
explicitValue	AntennaInfoDedicated		
}			
}			

Table 9.4.2.1.1_1.4.3-2: AntennaInfoDedicated

Derivation Path: 36.331 clause 6.3.2			
Information Element	Value/remark	Comment	Condition
AntennaInfoDedicated ::= SEQUENCE {			
transmissionMode	Tm6		
codebookSubsetRestriction CHOICE{			
n2TxAntenna-tm6	1111		
}			
ue-TransmitAntennaSelection CHOICE{			
release	NULL		
}			
}			

Table 9.4.2.1.1_1.4.3-3: CQI-ReportConfig-DEFAULT

Derivation Path: 36.508 clause 4.6.3			
Information Element	Value/remark	Comment	Condition
CQI-ReportConfig-DEFAULT ::= SEQUENCE {			
cqi-ReportModeAperiodic	Rm12		
nomPDSCH-RS-EPRE-Offset	0		
cqi-ReportPeriodic	Not present		
}			

9.4.2.1.1_1.5 Test requirement

Table 9.4.2.1.1_1.5-1: Test requirement (FDD)

Parameter	Test 1
γ	1.19+[TT]
UE Category	1-5

9.4.2.1.2 TDD PMI Reporting – PUSCH 1-2 (Multiple PMI)

9.4.2.1.2.1 Test purpose

To test the accuracy of the Precoding Matrix Indicator (PMI) reporting such that the system throughput is maximized based on the precoders configured according to the UE reports.

9.4.2.1.2.2 Test applicability

This test applies to E-UTRA TDD UE release 8 of UE category 2-5.

9.4.2.1.2.3 Minimum conformance requirements

For the parameters specified in Table 9.4.2.1.2.3-1, and using the downlink physical channels specified in Annex C, the minimum requirements are specified in Table 9.4.2.1.2.3-2.

Table 9.4.2.1.2.3-1: PMI test for single-layer (TDD)

Parameter		Unit	Test 1
Bandwidth		MHz	20
Transmission mode			6
Uplink downlink configuration			1
Special subframe configuration			4
Propagation channel			EPA5
Precoding granularity (only for reporting and following PMI)		PRB	8
Correlation and antenna configuration			Low 2 x 2
Downlink power allocation	ρ_A	dB	-3
	ρ_B	dB	-3
$N_{oc}^{(j)}$		dB[mW/15kHz]	-98
Reporting mode			PUSCH 1-2
Reporting interval		ms	1
Minimum PMI delay		ms	10 or 11
Measurement channel			R.30 TDD
OCNG Pattern			OP.1 TDD
Max number of HARQ transmissions			4
Redundancy version coding sequence			{0,1,2,3}
ACK/NACK feedback mode			Multiplexing
Note 1: For random precoder selection, the precoders shall be updated in each available downlink transmission instance			
Note 2: If the UE reports in an available uplink reporting instance at subframe SF#n based on PMI estimation at a downlink SF not later than SF#(n-4), this reported PMI cannot be applied at the eNB downlink before SF#(n+4)			

Table 9.4.2.1.2.3-2: Minimum requirement (TDD)

Parameter	Test 1
γ	1,2
UE Category	2-5

The normative reference for this requirement is TS 36.101 [2] clause 9.4.2.1.2.

9.4.2.1.2.4 Test description

9.4.2.1.2.4.1 Initial conditions

Initial conditions are a set of test configurations the UE needs to be tested in and the steps for the SS to take with the UE to reach the correct measurement state.

Configurations of PDSCH and PDCCH before measurement are specified in Annex C.2.

Test Environment: Normal as defined in TS 36.508 [7] clause 4.1.

Frequencies to be tested: Mid Range as defined in TS 36.508 [7] clause 4.3.1.2.

Channel Bandwidths to be tested: 20MHz, as defined in TS 36.508 [7] clause 4.3.1.2

1. Connect the SS to the UE antenna connector (s) as shown in TS 36.508 [7] Annex A, Figure A.10.

2. The parameter settings for the cell are set up according to Table 9.4.2.1.2.3-1.
3. Downlink signals are initially set up according to Annex C.1 and Annex C.3.2, and uplink signals according to Annex H.1 and H.3.2.
4. Propagation conditions are set according to Annex B clause B.0
5. Ensure the UE is in State 3A or 3A-RF according to TS 36.508 [7] clause 4.5.3A or 5.2A.2. Message contents are defined in clause 9.4.2.1.2.4.3.

9.4.2.1.2.4.2 Test procedure

1. Set the bandwidth, propagation condition, antenna configuration and measurement channel parameters according to Table 9.4.2.1.2.3-1 as appropriate.
2. The SS shall transmit PDSCH via PDCCH DCI format 1B for C_RNTI to transmit the DL RMC with randomly selected precoding matrix from codebook (Table 6.3.4.2.3-1 in TS 36.211 [8]) every subframe regardless of PMI reports from the UE. Note that each precoding matrix shall be selected in equal probabilities. The SS sends downlink MAC padding bits on the DL RMC. SS schedules the UL transmission to carry the PUSCH CQI feedback via PDCCH DCI format 0 with CQI request bit set to 1 and I_MCS=29 and N_PRB allocated to be less or equal to 4. Establish t_{rnd} and SNR_{rnd} according to annex G.5.2
3. Set SNR to SNR_{rnd} . The SS shall transmit PDSCH with precoding matrix according to PMI report from the UE. The SS sends downlink MAC padding bits on the DL RMC. SS schedules the UL transmission to carry the PUSCH CQI feedback via PDCCH DCI format 0 with CQI request bit set to 1 and I_MCS=29 and N_PRB allocated to be less or equal to 4. Measure t_{ue} according to Annex G.5.3
4. Calculate $\gamma = \frac{t_{ue}}{t_{rnd}}$

9.4.2.1.2.4.3 Message contents

Message contents are according to TS 36.508 [7] clause 4.6 with the following exceptions:

Table 9.4.2.1.2.4.3-1: PhysicalConfigDedicated-DEFAULT

Derivation Path: 36.508 clause 5.5.1.2			
Information Element	Value/remark	Comment	Condition
PhysicalConfigDedicated-DEFAULT ::= SEQUENCE {			
cqi-ReportConfig	CQI-ReportConfig-DEFAULT		
antennaInfo CHOICE {			
explicitValue	AntennaInfoDedicated		
}			
}			

Table 9.4.2.1.2.4.3-2: AntennaInfoDedicated

Derivation Path: 36.331 clause 6.3.2			
Information Element	Value/remark	Comment	Condition
AntennaInfoDedicated ::= SEQUENCE {			
transmissionMode	tm6		
codebookSubsetRestriction CHOICE{			
n2TxAntenna-tm6	1111		
}			
ue-TransmitAntennaSelection CHOICE{			
release	NULL		
}			

Table 9.4.2.1.2.4.3-3: CQI-ReportConfig-DEFAULT

Derivation Path: 36.508 clause 4.6.3			
Information Element	Value/remark	Comment	Condition
CQI-ReportConfig-DEFAULT ::= SEQUENCE {			
cqi-ReportModeAperiodic	rm12		
nomPDSCH-RS-EPRE-Offset	0		
cqi-ReportPeriodic	Not present		
}			

9.4.2.1.2.5 Test requirement

Table 9.4.2.1.2.5-1: Test requirement (TDD)

Parameter	Test 1
γ	1.19
UE Category	2-5

9.4.2.1.2_1 TDD PMI Reporting – PUSCH 1-2 (Multiple PMI)

Editor's note: This clause is incomplete. The following aspects are either missing or not yet determined:

- Test tolerance is undefined

9.4.2.1.2_1.1 Test purpose

To test the accuracy of the Precoding Matrix Indicator (PMI) reporting such that the system throughput is maximized based on the precoders configured according to the UE reports.

9.4.2.1.2_1.2 Test applicability

This test applies to all types of E-UTRA TDD UE release 9 and forward.

9.4.2.1.2_1.3 Minimum conformance requirements

For the parameters specified in Table 9.4.2.1.2_1.3-1, and using the downlink physical channels specified in Annex C, the minimum requirements are specified in Table 9.4.2.1.2_1.3-2.

Table 9.4.2.1.2_1.3-1: PMI test for single-layer (TDD)

Parameter	Unit	Test 1	
Bandwidth	MHz	10	
Transmission mode		6	
Uplink downlink configuration		1	
Special subframe configuration		4	
Propagation channel		EPA5	
Precoding granularity (only for reporting and following PMI)	PRB	6	
Correlation and antenna configuration		Low 2 x 2	
Downlink power allocation	ρ_A	dB	-3
	ρ_B	dB	-3
$N_{oc}^{(j)}$	dB[mW/15kHz]	-98	
Reporting mode		PUSCH 1-2	
Reporting interval	ms	1	
PMI delay	ms	10 or 11	
Measurement channel		R.11-3 TDD for UE Category 1 R.11 TDD for UE Category 2-5	
OCNG Pattern		OP.1 TDD	
Max number of HARQ transmissions		4	
Redundancy version coding sequence		{0,1,2,3}	
ACK/NACK feedback mode		Multiplexing	
Note 1:	For random precoder selection, the precoders shall be updated in each available downlink transmission instance		
Note 2:	If the UE reports in an available uplink reporting instance at subframe SF#n based on PMI estimation at a downlink SF not later than SF#(n-4), this reported PMI cannot be applied at the eNB downlink before SF#(n+4)		
Note 3:	One/two sided dynamic OCNG Pattern OP.1/2 TDD as described in Annex A.5.2.1/2 shall be used.		

Table 9.4.2.1.2_1.3-2: Minimum requirement (TDD)

Parameter	Test 1
γ	1-2
UE Category	1-5

The normative reference for this requirement is TS 36.101 [2] clause 9.4.2.1.2.

9.4.2.1.2_1.4 Test description

9.4.2.1.2_1.4.1 Initial conditions

Initial conditions are a set of test configurations the UE needs to be tested in and the steps for the SS to take with the UE to reach the correct measurement state.

Configurations of PDSCH and PDCCH before measurement are specified in Annex C.2.

Test Environment: Normal as defined in TS 36.508 [7] clause 4.1.

Frequencies to be tested: Mid Range as defined in TS 36.508 [7] clause 4.3.1.2.

Channel Bandwidths to be tested: 10MHz, as defined in TS 36.508 [7] clause 4.3.1.2

1. Connect the SS to the UE antenna connector (s) as shown in TS 36.508 [7] Annex A, Figure A.10.
2. The parameter settings for the cell are set up according to Table 9.4.2.1.2_1.3-1.
3. Downlink signals are initially set up according to Annex C.1 and Annex C.3.2, and uplink signals according to Annex H.1 and H.3.2.
4. Propagation conditions are set according to Annex B clause B.0
5. Ensure the UE is in State 3A or 3A-RF according to TS 36.508 [7] clause 4.5.3A or 5.2A.2. Message contents are defined in clause 9.4.2.1.2_1.4.3.

9.4.2.1.2_1.4.2 Test procedure

1. Set the bandwidth, propagation condition, antenna configuration and measurement channel parameters according to Table 9.4.2.1.2_1.3-1 as appropriate.
2. The SS shall transmit PDSCH via PDCCH DCI format 1B for C_RNTI to transmit the DL RMC with randomly selected precoding matrix from codebook (Table 6.3.4.2.3-1 in TS 36.211 [8]) every subframe regardless of PMI reports from the UE. Note that each precoding matrix shall be selected in equal probabilities. The SS sends downlink MAC padding bits on the DL RMC. SS schedules the UL transmission to carry the PUSCH CQI feedback via PDCCH DCI format 0 with CQI request bit set to 1 and I_MCS=29 and N_PRB allocated to be less or equal to 4. Establish t_{rnd} and SNR_{rnd} according to annex G.5.2
3. Set SNR to SNR_{rnd} . The SS shall transmit PDSCH with precoding matrix according to PMI report from the UE. The SS sends downlink MAC padding bits on the DL RMC. SS schedules the UL transmission to carry the PUSCH CQI feedback via PDCCH DCI format 0 with CQI request bit set to 1 and I_MCS=29 and N_PRB allocated to be less or equal to 4. Measure t_{ue} according to Annex G.5.3
4. Calculate $\gamma = \frac{t_{ue}}{t_{rnd}}$

9.4.2.1.2_1.4.3 Message contents

Message contents are according to TS 36.508 [7] clause 4.6 with the following exceptions:

Table 9.4.2.1.2_1.4.3-1: PhysicalConfigDedicated-DEFAULT

Derivation Path: 36.508 clause 5.5.1.2			
Information Element	Value/remark	Comment	Condition
PhysicalConfigDedicated-DEFAULT ::= SEQUENCE {			
cqi-ReportConfig	CQI-ReportConfig-DEFAULT		
antennaInfo CHOICE {			
explicitValue	AntennaInfoDedicated		
}			
}			

Table 9.4.2.1.2_1.4.3-2: AntennaInfoDedicated

Derivation Path: 36.331 clause 6.3.2			
Information Element	Value/remark	Comment	Condition
AntennaInfoDedicated ::= SEQUENCE {			
transmissionMode	tm6		
codebookSubsetRestriction CHOICE{			
n2TxAntenna-tm6	1111		
}			
ue-TransmitAntennaSelection CHOICE{			
release	NULL		
}			
}			

Table 9.4.2.1.2_1.4.3-3: CQI-ReportConfig-DEFAULT

Derivation Path: 36.508 clause 4.6.3			
Information Element	Value/remark	Comment	Condition
CQI-ReportConfig-DEFAULT ::= SEQUENCE {			
cqi-ReportModeAperiodic	rm12		
nomPDSCH-RS-EPRE-Offset	0		
cqi-ReportPeriodic	Not present		
}			

9.4.2.1.2_1.5 Test requirement

Table 9.4.2.1.2_1.5-1: Test requirement (TDD)

Parameter	Test 1
γ	1.19+TT
UE Category	1-5

9.4.2.2 PMI Reporting – PUSCH 2-2 (Multiple PMI)

9.4.2.2.1 FDD PMI Reporting – PUSCH 2-2 (Multiple PMI)

Editor's note: This clause is incomplete. The following aspects are either missing or not yet determined:

- Throughput ratio and test tolerance are undefined

9.4.2.2.1.1 Test purpose

To test the accuracy of the Precoding Matrix Indicator (PMI) reporting such that the system throughput is maximized based on the precoders configured according to the UE reports.

9.4.2.2.1.2 Test applicability

This test applies to all types of E-UTRA FDD UE release 9 and forward.

9.4.2.2.1.3 Minimum conformance requirements

For the parameters specified in Table 9.4.2.2.1.3-1, and using the downlink physical channels specified in Annex C, the minimum requirements are specified in Table 9.4.2.2.1.3-2.

Table 9.4.2.2.1.3-1: PMI test for single-layer (FDD)

Parameter	Unit	Test 1
Bandwidth	MHz	10
Transmission mode		6
Propagation channel		[EVA5]
Correlation and antenna configuration		Low 4 x 2
$N_{oc}^{(j)}$	dB[mW/15kHz]	-98
PMI delay	ms	8
Reporting mode		PUSCH 2-2
Reporting interval	ms	1
Measurement channel		[R.14-2 FDD]
OCNG Pattern		[OP.1/2 FDD]
Subband size (k)	RBs	3 (full size)
Number of preferred subbands (M)		5
Max number of HARQ transmissions		4
Redundancy version coding sequence		{0,1,2,3}
Note 1:	For random precoder selection, the precoder shall be updated in each TTI (1 ms granularity)	
Note 2:	If the UE reports in an available uplink reporting instance at subframe SF# n based on PMI estimation at a downlink SF not later than SF#(n-4), this reported PMI cannot be applied at the eNB downlink before SF#(n+4)	

Table 9.4.2.2.1.3-2: Minimum requirement (FDD)

	Test 1
γ	TBD
UE Category	[1-5]

The normative reference for this requirement is TS 36.101 [2] clause 9.4.2.2.1.

9.4.2.2.1.4 Test description

9.4.2.2.1.4.1 Initial conditions

Initial conditions are a set of test configurations the UE needs to be tested in and the steps for the SS to take with the UE to reach the correct measurement state.

Configurations of PDSCH and PDCCH before measurement are specified in Annex C.2.

Test Environment: Normal as defined in TS 36.508 [7] clause 4.1.

Frequencies to be tested: Mid Range as defined in TS 36.508 [7] clause 4.3.1.1.

Channel Bandwidths to be tested: 10MHz, as defined in TS 36.508 [7] clause 4.3.1.1

1. Connect the SS to the UE antenna connector (s) as shown in TS 36.508 [7] Annex A, Figure A.10.
2. The parameter settings for the cell are set up according to Table 9.4.2.2.1.3-1.
3. Downlink signals are initially set up according to Annex C.1 and Annex C.3.2, and uplink signals according to Annex H.1 and H.3.2.
4. Propagation conditions are set according to Annex B clause B.0
5. Ensure the UE is in State 3A or 3A-RF according to TS 36.508 [7] clause 4.5.3A or 5.2A.2. Message contents are defined in clause 9.4.2.2.1.4.3.

9.4.2.2.1.4.2 Test procedure

1. Set the parameters of bandwidth, the propagation condition, antenna configuration and measurement channel according to Table 9.4.2.2.1.3-1 as appropriate.
2. The SS shall transmit PDSCH via PDCCH DCI format 1B for C_RNTI to transmit the DL RMC with randomly selected precoding matrix from codebook (Table 6.3.4.2.3-1 in TS 36.211 [8]) every subframe regardless of PMI reports from the UE. Note that each precoding matrix shall be selected in equal probabilities. The SS sends downlink MAC padding bits on the DL RMC SS schedules the UL transmission to carry the PUSCH CQI feedback via PDCCH DCI format 0 with CQI request bit set to 1 and I_MCS=29 and N_PRB allocated to be less or equal to 4. Establish t_{md} and SNR_{md} according to annex G.5.2
3. Set SNR to SNR_{md} . The SS shall PDCCH with DCI format 0 in which CQI request bit is set to true [every subframe]. Then the SS shall transmit PDSCH with precoding matrix according to PMI report from the UE. The SS sends downlink MAC padding bits on the DL RMC SS schedules the UL transmission to carry the PUSCH CQI feedback via PDCCH DCI format 0 with CQI request bit set to 1 and I_MCS=29 and N_PRB allocated to be less or equal to 4. Measure the average throughput. Measure t_{ue} according to Annex G.5.3
4. Calculate $\gamma = \frac{t_{ue}}{t_{md}}$

9.4.2.2.1.4.3 Message contents

Message contents are according to TS 36.508 [7] clause 4.6 with the following exceptions:

Table 9.4.2.2.1.4.3-1: PhysicalConfigDedicated-DEFAULT

Derivation Path: 36.508 clause 5.5.1.2			
Information Element	Value/remark	Comment	Condition
PhysicalConfigDedicated-DEFAULT ::= SEQUENCE {			
cqi-ReportConfig	CQI-ReportConfig-DEFAULT		
antennaInfo CHOICE {			
explicitValue	AntennaInfoDedicated		
}			
}			

Table 9.4.2.2.1.4.3-2: AntennaInfoDedicated

Derivation Path: 36.331 clause 6.3.2			
Information Element	Value/remark	Comment	Condition
AntennaInfoDedicated ::= SEQUENCE {			
transmissionMode	tm6		
codebookSubsetRestriction CHOICE{			
n4TxAntenna-tm6	1111111111111111		
}			
ue-TransmitAntennaSelection CHOICE{			
release	NULL		
}			
}			

Table 9.4.2.2.1.4.3-3: CQI-ReportConfig-DEFAULT

Derivation Path: 36.508 clause 4.6.3			
Information Element	Value/remark	Comment	Condition
CQI-ReportConfig-DEFAULT ::= SEQUENCE {			
cqi-ReportModeAperiodic	rm22		
nomPDSCH-RS-EPRE-Offset	0		
cqi-ReportPeriodic	Not present		
}			

9.4.2.2.1.5 Test requirement

Table 9.4.2.2.1.5-1: Test requirement (FDD)

	Test 1
γ	TBD+TT
UE Category	[1-5]

9.4.2.2.2 TDD PMI Reporting – PUSCH 2-2 (Multiple PMI)

Editor's note: This clause is incomplete. The following aspects are either missing or not yet determined:

- Throughput ratio and test tolerance are undefined

9.4.2.2.2.1 Test purpose

To test the accuracy of the Precoding Matrix Indicator (PMI) reporting such that the system throughput is maximized based on the precoders configured according to the UE reports.

9.4.2.2.2.2 Test applicability

This test applies to all types of E-UTRA TDD UE release 9 and forward.

9.4.2.2.2.3 Minimum conformance requirements

For the parameters specified in Table 9.4.2.2.2.3-1, and using the downlink physical channels specified in Annex C, the minimum requirements are specified in Table 9.4.2.2.2.3-2.

Table 9.4.2.2.2.3-1: PMI test for single-layer (TDD)

Parameter	Unit	Test 1
Bandwidth	MHz	10
Transmission mode		6
Uplink downlink configuration		1
Special subframe configuration		4

Propagation channel		[EVA5]
Correlation and antenna configuration		Low 4 x 2
$N_{oc}^{(j)}$	dB[mW/15kHz]	-98
PMI delay	ms	[10 or 11]
Reporting mode		PUSCH 2-2
Reporting interval	ms	1
Measurement channel		[R.14-2 TDD]
OCNG Pattern		[OP.1/2 FDD]
Subband size (k)	RBs	3 (full size)
Number of preferred subbands (M)		5
Max number of HARQ transmissions		4
Redundancy version coding sequence		{0,1,2,3}
ACK/NACK feedback mode		Multiplexing
<p>Note 1: For random precoder selection, the precoders shall be updated in each available downlink transmission instance</p> <p>Note 2: If the UE reports in an available uplink reporting instance at subframe SF#n based on PMI estimation at a downlink SF not later than SF#(n-4), this reported PMI cannot be applied at the eNB downlink before SF#(n+4)</p>		

Table 9.4.2.2.3-2: Minimum requirement (TDD)

	Test 1
γ	TBD
UE Category	[1-5]

The normative reference for this requirement is TS 36.101 [2] clause 9.4.2.2.2.

9.4.2.2.2.4 Test description

9.4.2.2.2.4.1 Initial conditions

Initial conditions are a set of test configurations the UE needs to be tested in and the steps for the SS to take with the UE to reach the correct measurement state.

Configurations of PDSCH and PDCCH before measurement are specified in Annex C.2.

Test Environment: Normal as defined in TS 36.508 [7] clause 4.1.

Frequencies to be tested: Mid Range as defined in TS 36.508 [7] clause 4.3.1.2.

Channel Bandwidths to be tested: 10MHz, as defined in TS 36.508 [7] clause 4.3.1.2

1. Connect the SS to the UE antenna connector (s) as shown in TS 36.508 [7] Annex A, Figure A.10.
2. The parameter settings for the cell are set up according to Table 9.4.2.2.3-1.
3. Downlink signals are initially set up according to Annex C.1 and Annex C.3.2, and uplink signals according to Annex H.1 and H.3.2.
4. Propagation conditions are set according to Annex B clause B.0
5. Ensure the UE is in State 3A or 3A-RF according to TS 36.508 [7] clause 4.5.3A or 5.2A.2. Message contents are defined in clause 9.4.2.2.2.4.3.

9.4.2.2.2.4.2 Test procedure

1. Set the bandwidth, propagation condition, antenna configuration and measurement channel parameters according to Table 9.4.2.2.2.3-1 as appropriate.
2. The SS shall transmit PDSCH via PDCCH DCI format 1B for C_RNTI to transmit the DL RMC with randomly selected precoding matrix from codebook (Table 6.3.4.2.3-1 in TS 36.211 [8]) every subframe regardless of PMI reports from the UE. Note that each precoding matrix shall be selected in equal probabilities. The SS sends downlink MAC padding bits on the DL RMC. SS schedules the UL transmission to carry the PUSCH CQI feedback via PDCCH DCI format 0 with CQI request bit set to 1 and I_MCS=29 and N_PRB allocated to be less or equal to 4. Establish t_{rnd} and SNR_{rnd} according to annex G.5.2
3. Set SNR to SNR_{rnd} . The SS shall transmit PDSCH with precoding matrix according to PMI report from the UE. The SS sends downlink MAC padding bits on the DL RMC. SS schedules the UL transmission to carry the PUSCH CQI feedback via PDCCH DCI format 0 with CQI request bit set to 1 and I_MCS=29 and N_PRB allocated to be less or equal to 4. Measure t_{ue} according to Annex G.5.3
4. Calculate $\gamma = \frac{t_{ue}}{t_{rnd}}$

9.4.2.2.2.4.3 Message contents

Message contents are according to TS 36.508 [7] clause 4.6 with the following exceptions:

Table 9.4.2.2.2.4.3-1: PhysicalConfigDedicated-DEFAULT

Derivation Path: 36.508 clause 5.5.1.2			
Information Element	Value/remark	Comment	Condition
PhysicalConfigDedicated-DEFAULT ::= SEQUENCE {			
cqi-ReportConfig	CQI-ReportConfig-DEFAULT		
antennaInfo CHOICE {			
explicitValue	AntennaInfoDedicated		
}			
}			

Table 9.4.2.2.2.4.3-2: AntennaInfoDedicated

Derivation Path: 36.331 clause 6.3.2			
Information Element	Value/remark	Comment	Condition
AntennaInfoDedicated ::= SEQUENCE {			
transmissionMode	tm6		
codebookSubsetRestriction CHOICE{			
n4TxAntenna-tm6	1111111111111111		
}			
ue-TransmitAntennaSelection CHOICE{			
release	NULL		
}			
}			

Table 9.4.2.2.2.4.3-3: CQI-ReportConfig-DEFAULT

Derivation Path: 36.508 clause 4.6.3			
Information Element	Value/remark	Comment	Condition
CQI-ReportConfig-DEFAULT ::= SEQUENCE {			
cqi-ReportModeAperiodic	rm22		
nomPDSCH-RS-EPRE-Offset	0		
cqi-ReportPeriodic	Not present		
}			

9.4.2.2.2.5 Test requirement

Table 9.4.2.2.2.5-1: Test requirement (TDD)

	Test 1
γ	TBD+TT
UE Category	[1-5]

9.5 Reporting of Rank Indicator (RI)

The purpose of this test is to verify that the reported rank indicator accurately represents the channel rank. The accuracy of RI (CQI) reporting is determined by the relative increase of the throughput obtained when transmitting based on the reported rank compared to the case for which a fixed rank is used for transmission. Transmission mode 4 is used with the specified CodebookSubSetRestriction.

For fixed rank 1 transmission, the RI and PMI reporting is restricted to two single-layer precoders, For fixed rank 2 transmission, the RI and PMI reporting is restricted to one two-layer precoder, For follow RI transmission, the RI and PMI reporting is restricted to select the union of these precoders. Channels with low and high correlation are used to ensure that RI reporting reflects the channel condition.

9.5.1 RI Reporting

9.5.1.1 FDD RI Reporting– PUCCH 1-1

9.5.1.1.1 Test purpose

To verify that the reported rank indicator accurately represents the channel rank.

9.5.1.1.2 Test applicability

This test applies to E-UTRA FDD UE release 8 and forward of UE category 2-5.

9.5.1.1.3 Minimum conformance requirements

The minimum performance requirement in Table 9.5.1.1.3-2 is defined as

- The ratio of the throughput obtained when transmitting based on UE reported RI and that obtained when transmitting with fixed rank 1 shall be $\geq \gamma_1$;
- The ratio of the throughput obtained when transmitting based on UE reported RI and that obtained when transmitting with fixed rank 2 shall be $\geq \gamma_2$;

TBS selection is based on the UE wideband CQI feedback. The transport block size TBS is that resulting from the code rate which is closest to that indicated by $M = \text{wideband CQI}$ and the N_{PRB} entry in Table 7.1.7.2.1-1 of TS36.213 [10] that corresponds to the transmission bandwidth configuration in Table 5.6-1 of TS36.101 [2].

For the parameters specified in Table 9.5.1.1.3-1, and using the downlink physical channels specified in Annex C, the minimum requirements are specified in Table 9.5.1.1.3-2.

Table 9.5.1.1.3-1: RI Test (FDD)

Parameter	Unit	Test 1	Test 2	Test 3
Bandwidth	MHz		10	
PDSCH transmission mode			4	
Downlink power allocation	ρ_A	dB	-3	
	ρ_B	dB	-3	
CodeBookSubsetRestriction bitmap		000011 for fixed RI = 1 010000 for fixed RI = 2 010011 for UE reported RI		
Propagation condition and antenna configuration		2 x 2 EPA5		
Antenna correlation		Low	Low	High
RI configuration		Fixed RI=2 and follow RI	Fixed RI=1 and follow RI	Fixed RI=2 and follow RI
SNR	dB	0	20	20
$N_{oc}^{(j)}$	dB[mW/15kHz]	-98	-98	-98
$\hat{I}_{or}^{(j)}$	dB[mW/15kHz]	-98	-78	-78
Maximum number of HARQ transmissions		1		
Reporting mode		PUCCH 1-1		
Physical channel for CQI/PMI reporting		PUCCH Format 2		
PUCCH Report Type for CQI/PMI		2		
Physical channel for RI reporting		PUSCH (Note 3)		
PUCCH Report Type for RI		3		
Reporting periodicity	ms	$N_p = 5$		
PMI and CQI delay	ms	8		
<i>cqi-pmi-ConfigurationIndex</i>		6		
<i>ri-ConfigurationInd</i>		1		
<p>Note 1: If the UE reports in an available uplink reporting instance at subframe SF#n based on PMI and CQI estimation at a downlink subframe not later than SF#(n-4), this reported PMI and wideband CQI cannot be applied at the eNB downlink before SF#(n+4).</p> <p>Note 2: Reference measurement channel according to Table A.4-1 with one sided dynamic OCNG Pattern OP.1 FDD as described in Annex A.5.1.1.</p> <p>Note 3: To avoid collisions between RI reports and HARQ-ACK it is necessary to report both on PUSCH instead of PUCCH. PDCCH DCI format 0 shall be transmitted in downlink SF#4 and #9 to allow periodic RI to multiplex with the HARQ-ACK on PUSCH in uplink subframe SF#8 and #3.</p>				

Table 9.5.1.1.3-2: Minimum requirement (FDD)

Parameter	Test 1	Test 2	Test 3
γ_1	N/A	1.05	N/A
γ_2	1	N/A	1.1
UE Category	2-5	2-5	2-5

9.5.1.1.4 Test description

9.5.1.1.4.1 Initial conditions

Initial conditions are a set of test configurations the UE needs to be tested in and the steps for the SS to take with the UE to reach the correct measurement state.

Configurations of PDSCH and PDCCH before measurement are specified in Annex C.2.

Test Environment: Normal as defined in TS 36.508 [7] clause 4.1.

Frequencies to be tested: Mid Range as defined in TS 36.508 [7] clause 4.3.1.1.

Channel Bandwidths to be tested: 10MHz, as defined in TS 36.508 [7] clause 4.3.1.1

1. Connect the SS, faders and AWGN noise source to the UE antenna connector (s) as shown in TS 36.508 [7] Annex A, Figure A.9.
2. The parameter settings for the cell are set up according to Table 9.5.1.1.3-1.
3. Downlink signals are initially set up according to Annex C.1 and Annex C.3.2, and uplink signals according to Annex H.1 and H.3.2.
4. Propagation conditions are set according to Annex B.0.
5. Ensure the UE is in State 3A or 3A-RF according to TS 36.508 [7] clause 4.5.3A or 5.2A.2. Message contents are defined in clause 9.5.1.1.4.3.

9.5.1.1.4.2 Test procedure

1. Set the parameters of bandwidth, reference Channel, the propagation condition, antenna configuration, antenna correlation, CodeBookSubsetRestriction for fixed Rank and the SNR according to Table 9.5.1.1.3-1 as appropriate.
2. The SS shall send PDSCH via PDCCH DCI format 2 for C_RNTI to transmit the DL RMC according to the UE reported CQI, PMI and RI. In case of CQI reports for two codewords (codeword #0 and #1), the CQI offset level for codeword #1 is selected from {0,1,2,3,-4,-3,-2,-1}. The SS sends downlink MAC padding bits on the DL RMC. The transport format to be used is defined in Annex A.4 Table A.4-3a. The SS sends uplink scheduling information via PDCCH DCI format 0 with CQI request bit set to 0 to schedule UL RMC in subframe #3 and #8 according to Annex A.4-10. Measure the t_{fix} according to annex G.5.3.
3. Propagation conditions are set according to Annex B.1.
4. The SS sends uplink scheduling information via PDCCH DCI format 0 to schedule UL RMC in every subframe according to Annex A.4-10.
5. The SS shall transmit an RRC Connection Reconfiguration message to set codebookSubsetRestriction as for UE reported RI according to Table 9.5.1.1.3-1.
6. The UE shall transmit RRC Connection Reconfiguration Complete message.
7. Propagation conditions are set according to Table 9.5.1.1.3-1.
8. The SS shall send PDSCH via PDCCH DCI format 2 for C_RNTI to transmit the DL RMC according to the UE reported CQI, PMI and RI. In case of CQI reports for two codewords (codeword #0 and #1), the CQI offset level for codeword #1 is selected from {0,1,2,3,-4,-3,-2,-1}. The SS sends downlink MAC padding bits on the DL RMC. The transport format to be used is defined in Annex A.4 Table A.4-3a. The SS sends uplink scheduling information via PDCCH DCI format 0 with CQI request bit set to 0 to schedule UL RMC in subframe #3 and #8 according to Annex A.4-10. Measure $t_{reported}$ according to Annex G.5.3
If the ratio ($t_{reported} / t_{fix}$) satisfies the requirement in Table 9.5.1.1.5-1, then pass the UE for this test and go to step 9. Otherwise, fail the UE.
9. If all tests have not been done, then repeat the same procedure (steps 1 to 8) with test conditions according to the Table 9.5.1.1.3-2 for the other Tests as appropriate. Otherwise pass the UE.

9.5.1.1.4.3 Message contents

Message contents are according to TS 36.508 [7] clause 4.6 with the following exceptions:

Table 9.5.1.1.4.3-1: PhysicalConfigDedicated-DEFAULT

Derivation Path: 36.508 clause 4.6.3			
Information Element	Value/remark	Comment	Condition
RadioResourceConfigDedicated-SRB2-DRB(n, m) ::= SEQUENCE {			
physicalConfigDedicated	PhysicalConfigDedicated - DEFAULT using condition RBC		
}			

Table 9.5.1.1.4.3-2: PhysicalConfigDedicated-DEFAULT

Derivation Path: 36.508 clause 5.5.1.2			
Information Element	Value/remark	Comment	Condition
PhysicalConfigDedicated-DEFAULT ::= SEQUENCE {			
cqi-ReportConfig	<i>CQI-ReportConfig-DEFAULT</i>		RBC
antennaInfo CHOICE {			
antennaInfoDedicated ::= SEQUENCE {			
transmissionMode	tm4		
}			
codebookSubsetRestriction CHOICE {			
N2TxAntenna-tm4	According to each test		
ue-TransmitAntennaSelection CHOICE {			
release	NULL		
}			
}			

Table 9.5.1.1.4.3-3: PDSCH-ConfigDedicated-DEFAULT

Derivation Path: 36.331 clause 6.3.2			
Information Element	Value/remark	Comment	Condition
PDSCH-ConfigDedicated-DEFAULT ::= SEQUENCE {			
p-a	dB-3		
}			

Table 9.5.1.1.4.3-4: CQI-ReportConfig-DEFAULT

Derivation Path: 36.508 clause 4.6.3			
Information Element	Value/remark	Comment	Condition
CQI-ReportConfig-DEFAULT ::= SEQUENCE {			
cqi-ReportModeAperiodic	Not present		
nomPDSCH-RS-EPRE-Offset	0		
cqi-ReportPeriodic CHOICE {			
setup SEQUENCE {			
cqi-PUCCH-ResourceIndex	0		
cqi-pmi-ConfigIndex	6	(see Table 7.2.2-1A in TS 36.213)	
cqi-FormatIndicatorPeriodic CHOICE {			
widebandCQI	NULL		
}			
ri-ConfigIndex	1	(see Table 7.2.2-1B in TS 36.213)	
simultaneousAckNackAndCQI	FALSE		
}			
}			
}			
}			

9.5.1.1.5 Test requirement

Table 9.5.1.1.5-1: Test requirement (FDD)

Parameter	Test 1	Test 2	Test 3
γ_1	N/A	1.04	N/A
γ_2	0.99	N/A	1.09
UE Category	2-5	2-5	2-5

9.5.1.2 TDD RI Reporting – PUSCH 3-1

9.5.1.2.1 Test purpose

To verify that the reported rank indicator accurately represents the channel rank.

9.5.1.2.2 Test applicability

This test applies to E-UTRA TDD UE release 8 and forward, which support UE Category 2-5.

9.5.1.2.3 Minimum conformance requirements

The minimum performance requirement in Table 9.5.1.2.3-2 is defined as

- The ratio of the throughput obtained when transmitting based on UE reported RI and that obtained when transmitting with fixed rank 1 shall be $\geq \gamma_1$;
- The ratio of the throughput obtained when transmitting based on UE reported RI and that obtained when transmitting with fixed rank 2 shall be $\geq \gamma_2$;

TBS selection is based on the UE wideband CQI feedback. The transport block size TBS is that resulting from the code rate which is closest to that indicated by $M = \text{wideband CQI}$ and the N_{PRB} entry in Table 7.1.7.2.1-1 of TS36.213 [10] that corresponds to the transmission bandwidth configuration in Table 5.6-1 of TS36.101 [2].

For the parameters specified in Table 9.5.1.2.3-1, and using the downlink physical channels specified in Annex C, the minimum requirements are specified in Table 9.5.1.2.3-2.

Table 9.5.1.2.3-1: RI Test (TDD)

Parameter	Unit	Test 1	Test 2	Test 3
Bandwidth	MHz		10	
PDSCH transmission mode			4	
Downlink power allocation	ρ_A	dB	-3	
	ρ_B	dB	-3	
Uplink downlink configuration			2	
Special subframe configuration			4	
Propagation condition and antenna configuration			2 x 2 EPA5	
CodeBookSubsetRestriction bitmap			000011 for fixed RI = 1 010000 for fixed RI = 2 010011 for UE reported RI	
Antenna correlation		Low	Low	High
RI configuration		Fixed RI=2 and follow RI	Fixed RI=1 and follow RI	Fixed RI=2 and follow RI
SNR	dB	0	20	20
$N_{oc}^{(j)}$	dB[mW/15kHz]	-98	-98	-98
$\hat{I}_{or}^{(j)}$	dB[mW/15kHz]	-98	-78	-78
Maximum number of HARQ transmissions		1		
Reporting mode		PUSCH 3-1 (Note 3)		
Reporting interval	ms	5		
PMI and CQI delay	ms	10 or 11		
ACK/NACK feedback mode		Bundling		
Note 1:	If the UE reports in an available uplink reporting instance at subframe SF#n based on PMI and CQI estimation at a downlink subframe not later than SF#(n-4), this reported PMI and wideband CQI cannot be applied at the eNB downlink before SF#(n+4).			
Note 2:	Reference measurement channel according to Table A.4-2 with one sided dynamic OCNG Pattern OP.1 TDD as described in Annex A.5.2.1.			
Note 3:	Reported wideband CQI and PMI are used and sub-band CQI is discarded.			

Table 9.5.1.2.3-2: Minimum requirement (TDD)

Parameter	Test 1	Test 2	Test 3
γ_1	N/A	1.05	N/A
γ_2	1	N/A	1.1
UE Category	2-5	2-5	2-5

9.5.1.2.4 Test description

9.5.1.2.4.1 Initial conditions

Initial conditions are a set of test configurations the UE needs to be tested in and the steps for the SS to take with the UE to reach the correct measurement state.

Configurations of PDSCH and PDCCH before measurement are specified in Annex C.2.

Test Environment: Normal as defined in TS 36.508 [7] clause 4.1.

Frequencies to be tested: Mid Range as defined in TS 36.508 [7] clause 4.3.1.2.

Channel Bandwidths to be tested: 10MHz, as defined in TS 36.508 [7] clause 4.3.1.2

1. Connect the SS, faders and AWGN noise source to the UE antenna connector (s) as shown in TS 36.508 [7] Annex A, Figure A.9.
2. The parameter settings for the cell are set up according to Table 9.5.1.2.3-1.

3. Downlink signals are initially set up according to Annex C.1 and Annex C.3.2, and uplink signals according to Annex H.1 and H.3.2.
4. Propagation conditions are set according to Annex B.0.
5. Ensure the UE is in State 3A or 3A-RF according to TS 36.508 [7] clause 4.5.3A or 5.2A.2. Message contents are defined in clause 9.5.1.2.4.3.

9.5.1.2.4.2 Test procedure

1. Set the parameters of bandwidth, reference Channel, the propagation condition, antenna configuration, antenna correlation, CodeBookSubsetRestriction for fixed Rank and the SNR according to Table 9.5.1.2.3-1 as appropriate.
2. The SS shall send PDSCH via PDCCH DCI format 2 for C_RNTI to transmit the DL RMC according to the UE reported CQI (wideband CQI), PMI and RI. The SS sends downlink MAC padding bits on the DL RMC. The transport format to be used is defined in Annex A.4 Table A.4-3a. The SS schedules the UL transmission to carry the PUSCH CQI feedback via PDCCH DCI format 0 with CQI request bit set to 1 and I_MCS=29 and N_PRB allocated to be less or equal to 4. Measure the t_{fix} according to annex G.5.3
3. Propagation conditions are set according to Annex B.1.
4. The SS sends uplink scheduling information via PDCCH DCI format 0 with CQI request bit to 0 to schedule UL RMC in subframe#2 and #7 according to Annex A.4-11.
5. The SS shall transmit an RRC Connection Reconfiguration message to set codebookSubsetRestriction as for UE reported RI according to Table 9.5.1.2.3-1.
6. The UE shall transmit RRC Connection Reconfiguration Complete message.
7. Propagation conditions are set according to Table 9.5.1.2.3-1.
8. The SS shall send PDSCH via PDCCH DCI format 2 for C_RNTI to transmit the DL RMC according to the UE reported CQI (wideband CQI), PMI and RI. The SS sends downlink MAC padding bits on the DL RMC. The transport format to be used is defined in Annex A.4 Table A.4-3a. The SS schedules the UL transmission to carry the PUSCH CQI feedback via PDCCH DCI format 0 with CQI request bit set to 1 and I_MCS=29 and N_PRB allocated to be less or equal to 4. Measure $t_{reported}$ according to Annex G.5.3
If the ratio ($t_{reported} / t_{fix}$) satisfies the requirement in Table 9.5.1.2.5-1, then pass the UE for this test and go to step 9. Otherwise, fail the UE.
9. If all tests have not been done, then repeat the same procedure (steps 1 to 8) with test conditions according to the Table 9.5.1.2.3-2 for the other Tests as appropriate. Otherwise pass the UE.

9.5.1.2.4.3 Message contents

Message contents are according to TS 36.508 [7] clause 4.6 with the following exceptions:

Table 9.5.1.2.4.3-1: PhysicalConfigDedicated-DEFAULT

Derivation Path: 36.508 clause 5.5.1.2			
Information Element	Value/remark	Comment	Condition
PhysicalConfigDedicated-DEFAULT ::= SEQUENCE {			
cqi-ReportConfig	<i>CQI-ReportConfig-DEFAULT</i>		
antennaInfo CHOICE {			
antennaInfoDedicated ::= SEQUENCE {			
transmissionMode	tm4		
}			
codebookSubsetRestriction CHOICE {			
N2TxAntenna-tm4	According to each test		
ue-TransmitAntennaSelection CHOICE {			
release	NULL		
}			
}			

Table 9.5.1.2.4.3-2: PDSCH-ConfigDedicated-DEFAULT

Derivation Path: 36.331 clause 6.3.2			
Information Element	Value/remark	Comment	Condition
PDSCH-ConfigDedicated-DEFAULT ::= SEQUENCE {			
p-a	dB-3		
}			

Table 9.5.1.2.4.3-3: CQI-ReportConfig-DEFAULT

Derivation Path: 36.508 clause 4.6.3			
Information Element	Value/remark	Comment	Condition
CQI-ReportConfig-DEFAULT ::= SEQUENCE {			
cqi-ReportModeAperiodic	rm31		
nomPDSCH-RS-EPRE-Offset	0		
cqi-ReportPeriodic CHOICE {	Not Present		
}			
}			

Table 9.5.1.2.4.3-4: PUCCH-ConfigDedicated-DEFAULT

Derivation Path: 36.331 clause 6.3.2			
Information Element	Value/remark	Comment	Condition
PUCCH-ConfigDedicated-DEFAULT ::= SEQUENCE {			
ackNackRepetition CHOICE {			
release	NULL		
}			
tddAckNackFeedbackMode	Bundling	Multiplexing is selected as default to align with RAN4's assumptions in RF tests.	TDD
}			

9.5.1.2.5 Test requirement

Table 9.5.1.2.5-1: Test requirement (TDD)

Parameter	Test 1	Test 2	Test 3
γ_1	N/A	1.04	N/A
γ_2	0.99	N/A	1.09
UE Category	2-5	2-5	2-5

10 MBMS Performance

10.1 FDD MBMS performance (Fixed Reference Channel)

Editor's note: This section is incomplete. The following aspects are either missing or not yet determined:

- The Test system uncertainties applicable to this test are undefined
- The Test tolerances applicable to this test are undefined

10.1.1 Test purpose

This test verifies the performance of FDD MBMS with a given SNR for which the average BLER remains below a given reference value.

10.1.2 Test applicability

This test applies to all types of E-UTRA FDD UE supporting MBMS release 9 and forward.

10.1.3 Minimum conformance requirements

The parameters specified in Table 10.1.3-1 are valid for all FDD tests unless otherwise stated.

Table 10.1.3-1: Common Test Parameters (FDD)

Parameter	Unit	Value
Number of HARQ processes	Processes	None
Subcarrier spacing	kHz	15 kHz
Allocated subframes per Radio Frame (Note 1)		6 subframes
Number of OFDM symbols for PDCCH (Note 2)		2 symbols in the case of 3 PHICH symbols or 4 RS Ports; 1 or 2 symbols for other scenarios.
Cyclic Prefix		Extended
Note1: For FDD mode, up to 6 subframes (#1/2/3/6/7/8) are available for MBMS, in line with TS 36.331.		
Note2: 2 OFDM symbols are reserved for PDCCH in this subclause.		

The receive characteristic of MBMS is determined by the BLER. The requirement is valid for all RRC states for which the UE has capabilities for MBMS.

For the parameters specified in Table 10.1.3-1 and Table 10.1.3-2 and Annex A.3.8.1, the average downlink SNR shall be below the specified value for the BLER shown in Table 10.1.3-3.

Table 10.1.3-2: Test Parameters for Testing

Parameter		Unit	Test 1-4
Downlink power allocation	ρ_A	dB	0
	ρ_B	dB	0 (Note 1)
N_{oc} at antenna port		dBm/15kHz	-98
Note 1: $P_B = 0$			

Table 10.1.3-3: Minimum performance

Test number	Bandwidth	Reference Channel	OCNG Pattern	Propagation condition	Correlation Matrix and antenna	Reference value		MBMS UE Category
						BLER (%)	SNR(dB)	
1	10 MHz	R.37 FDD	OP.4 FDD	MBSFN channel model (Table B.2.6-1)	1x2 low	1	4.1	1-5
2	10 MHz	R.38 FDD	OP.4 FDD				11.0	1-5
3	10 MHz	R.39 FDD	OP.4 FDD				[24.2]	2-5
	[5.0MHz]	TBD	[OP.4 FDD]				TBD	1
4	1.4 MHz	R.40 FDD	OP.4 FDD			6.6	1-5	

The normative reference for this requirement is TS 36.101 [2] clause 10.1.

10.1.4 Test description

10.1.4.1 Initial conditions

Test Environment: Normal, as defined in TS 36.508 [7] clause 4.1.

Frequencies to be tested: Mid Range, as defined in TS 36.508 [7] clause 4.3.1.

Channel Bandwidths to be tested: As specified per test number in Table 10.1.3-3 as defined in TS 36.508 [7] clause 4.3.1.

1. Connect the SS, the faders and AWGN noise source to the UE antenna connector (s) as shown in TS 36.508 [7] Annex A, Figure A.9.
2. The parameter settings for the cell are set up according to Table 10.1.3-1.
3. The downlink signals are initially set up according to Annex C.1 and Annex C.3.2 and uplink signals according to Annex H.1 and H.3.2.
4. Propagation conditions are set according to Annex B clause B.0.
5. SS configures 10 MBMS packets are included in one TB.
6. Ensure the UE is in State 3A or 3A-RF according to TS 36.508 [7] clause 4.5.3A or 5.2A.2. Message contents are defined in clause 10.1.4.3.

10.1.4.2 Test procedure

1. Initiate the variables M_{tot} to 0. Propagation conditions are set according to Annex B clause B.2.6
2. SS shall start the test by sending MBMS Packets on the MTCH radio bearer for [164] seconds ([10] seconds in the second or later iteration). SS stores the count of transmitted MBMS Packets on the MTCH in the variable M_{tot} .

3. SS shall send a “UE TEST LOOP MODE C MBMS PACKET COUNTER REQUEST” message and wait for the UE to respond with a “UE TEST LOOP MODE C MBMS PACKET COUNTER RESPONSE” reporting the received RLC SDU counter value. Store this counter in the variable M_{ok} .
4. SS shall compute the BLER as the following:
 The BLER = $(M_{tot} - M_{ok}) / M_{tot}$
 SS controls the number of MBMS packets used per transport block. The formula for BLER would be:
 $BLER = (N_{tot} - N_{ok}) / N_{tot} = ((M_{tot} / M_{mp}) - (M_{ok} / M_{mp})) / (M_{tot} / M_{mp}) = (M_{tot} - M_{ok}) / M_{tot}$, where,
 M_{mp} = Number of MBMS packets used by the SS per MCH transport block (on the observed MTCH)
 M_{tot} = Total number of MBMS packets transmitted by the SS on the observed MTCH
 M_{ok} = The UE counted successfully received MBMS packets on the observed MTCH
5. If BLER is not greater than the value for the BLER as specified in Table 10.1.5-1 then the number of successful tests is increased by one. Otherwise, the number of failure tests is increased by one.
6. Repeat steps 2 to 5 until the statistical significance according to Annex to G.4 is achieved.
7. Repeat steps from 1 to 6 for each subtest in Table 10.1.5-1 as appropriate.

10.1.4.3 Message contents

Message contents are according to TS 36.508 [7] clause 4.6.

10.1.5 Test requirement

For the parameters specified in Table 10.1-1 and Table 10.1.1-1 and Annex A.3.8.1, the average downlink SNR shall be below the specified value for the BLER shown in Table 10.1.5-1.

Table 10.1.5-1: Test requirement

Test number	Bandwidth	Reference Channel	OCNG Pattern	Propagation condition	Correlation Matrix and antenna	Reference value		MBMS UE Category
						BLER (%)	SNR(dB)	
1	10 MHz	R.37 FDD	OP.4 FDD	MBSFN channel model (Table B.2.6-1)	1x2 low	1	4.1+TT	1-5
2	10 MHz	R.38 FDD	OP.4 FDD				11.0+TT	1-5
3	10 MHz	R.39 FDD	OP.4 FDD				[24.2] +TT	2-5
	[5.0MHz]	TBD	[OP.4 FDD]				TBD	1
4	1.4 MHz	R.40 FDD	OP.4 FDD			6.6+TT	1-5	

10.2 TDD MBMS performance (Fixed Reference Channel)

Editor’s note: This section is incomplete. The following aspects are either missing or not yet determined:

- The Test system uncertainties applicable to this test are undefined
- The Test tolerances applicable to this test are undefined

10.2.1 Test purpose

This test verifies the performance of TDD MBMS with a given SNR for which the average BLER remains below a given reference value.

10.2.2 Test applicability

This test applies to all types of E-UTRA TDD UE supporting MBMS release 9 and forward.

10.2.3 Minimum conformance requirements

The parameters specified in Table 10.2.3-1 are valid for all TDD tests unless otherwise stated.

Table 10.2.3-1: Common Test Parameters (TDD)

Parameter	Unit	Value
Number of HARQ processes	Processes	None
Subcarrier spacing	kHz	15 kHz
Allocated subframes per Radio Frame (Note 1)		5 subframes
Number of OFDM symbols for PDCCH (Note 2)		2 symbols in the case of 3 PHICH symbols or 4 RS Ports; 1 or 2 symbols for other scenarios.
Cyclic Prefix		Extended
Note1: For TDD mode, in line with TS 36.331, Uplink-Downlink Configuration 5 is proposed, up to 5 subframes (#3/4/7/8/9) are available for MBMS.		
Note2: 2 OFDM symbols are reserved for PDCCH in this subclause.		

The receive characteristic of MBMS is determined by the BLER. The requirement is valid for all RRC states for which the UE has capabilities for MBMS.

For the parameters specified in Table 10.2.3-1 and Table 10.2.3-2 and Annex A.3.8.2, the average downlink SNR shall be below the specified value for the BLER shown in Table 10.2.3-3.

Table 10.2.3-2: Test Parameters for Testing

Parameter	Unit	Test 1-4
Downlink power allocation	ρ_A	dB
	ρ_B	dB
N_{oc} at antenna port	dBm/15kHz	-98
Note 1: $P_B = 0$		

Table 10.2.3-3: Minimum performance

Test number	Bandwidth	Reference Channel	OCNG Pattern	Propagation condition	Correlation Matrix and antenna	Reference value		MBMS UE Category
						BLER (%)	SNR(dB)	
1	10 MHz	R.37 TDD	OP.4 TDD	MBSFN channel model (Table B.2.6-1)	1x2 low	1	3.4	1-5
2	10 MHz	R.38 TDD	OP.4 TDD				11.1	1-5
3	10 MHz	R.39 TDD	OP.4 TDD				[24.2]	2-5
	[5MHz]	TBD	[OP.4 TDD]				TBD	1
4	1.4 MHz	R.40 TDD	OP.4 TDD			5.8	1-5	

The normative reference for this requirement is TS 36.101 [2] clause 10.2.

10.2.4 Test description

10.2.4.1 Initial conditions

Test Environment: Normal, as defined in TS 36.508 [7] clause 4.1.

Frequencies to be tested: Mid Range, as defined in TS 36.508 [7] clause 4.3.1.

Channel Bandwidths to be tested: As specified per test number in Table 10.2.3-3 as defined in TS 36.508 [7] clause 4.3.1.

1. Connect the SS, the faders and AWGN noise source to the UE antenna connector (s) as shown in TS 36.508 [7] Annex A, Figure A.9.
2. The parameter settings for the cell are set up according to Table 10.2.3-1.
3. The downlink signals are initially set up according to Annex C.1 and Annex C.3.2 and uplink signals according to Annex H.1 and H.3.2.
4. Propagation conditions are set according to Annex B clause B.0.
5. SS configures 10 MBMS packets are included in one TB.
6. Ensure the UE is in State 3A or 3A-RF according to TS 36.508 [7] clause 4.5.3A or 5.2A.2. Message contents are defined in clause 10.2.4.3.

10.2.4.2 Test procedure

1. Initiate the variables M_{tot} to 0. Propagation conditions are set according to Annex B clause B.2.6
2. SS shall start the test by sending MBMS Packets on the MTCH radio bearer for [164] seconds ([10] seconds in the second or later iteration). SS stores the count of transmitted MBMS Packets on the MTCH in the variable M_{tot} .
3. SS shall send a "UE TEST LOOP MODE C MBMS PACKET COUNTER REQUEST" message and wait for the UE to respond with a "UE TEST LOOP MODE C MBMS PACKET COUNTER RESPONSE" reporting the received MBMS Packet counter value. Store this counter in the variable M_{ok} .
4. SS shall compute the BLER as the following:

$$\text{The BLER} = (M_{tot} - M_{ok}) / M_{tot}$$

SS controls the number of MBMS packets used per transport block. The formula for BLER would be:

$$\text{BLER} = (N_{tot} - N_{ok}) / N_{tot} = ((M_{tot} / M_{mp}) - (M_{ok} / M_{mp})) / (M_{tot} / M_{mp}) = (M_{tot} - M_{ok}) / M_{tot}, \text{ where,}$$

M_{mp} = Number of MBMS packets used by the SS per MCH transport block (on the observed MTCH)

M_{tot} = Total number of MBMS packets transmitted by the SS on the observed MTCH

M_{ok} = The UE counted successfully received MBMS packets on the observed MTCH

5. If BLER is not greater than the value for the BLER as specified in Table 10.2.5-1 then the number of successful tests is increased by one. Otherwise, the number of failure tests is increased by one.
6. Repeat steps 2 to 5 until the statistical significance according to Annex to G.4 is achieved.
7. Repeat steps from 1 to 6 for each subtest in Table 10.2.5-1 as appropriate.

10.2.4.3 Message contents

Message contents are according to TS 36.508 [7] clause 4.6.

10.2.5 Test requirement

For the parameters specified in Table 10.2-1 and Table 10.2.1-1 and Annex A.3.8.1, the average downlink SNR shall be below the specified value for the BLER shown in Table 10.2.5-1.

Table 10.2.5-1: Test

Test number	Bandwidth	Reference Channel	OCNG Pattern	Propagation condition	Correlation Matrix and antenna	Reference value		MBMS UE Category
						BLER (%)	SNR(dB)	
1	10 MHz	R.37 TDD	OP.4 TDD	MBSFN channel model (Table B.2.6-1)	1x2 low	1	3.4+TT	1-5
2	10 MHz	R.38 TDD	OP.4 TDD				11.1+TT	1-5
3	10 MHz	R.39 TDD	OP.4 TDD				[24.2] +TT	2-5
	[5MHz]	TBD	[OP.4 TDD]				TBD	1
4	1.4 MHz	R.40 TDD	OP.4 TDD				5.8+TT	1-5

Annex A (normative): Measurement Channels

A.1 General

A schematic overview of the encoding process for the reference measurement channels is provided in Figure A-1.

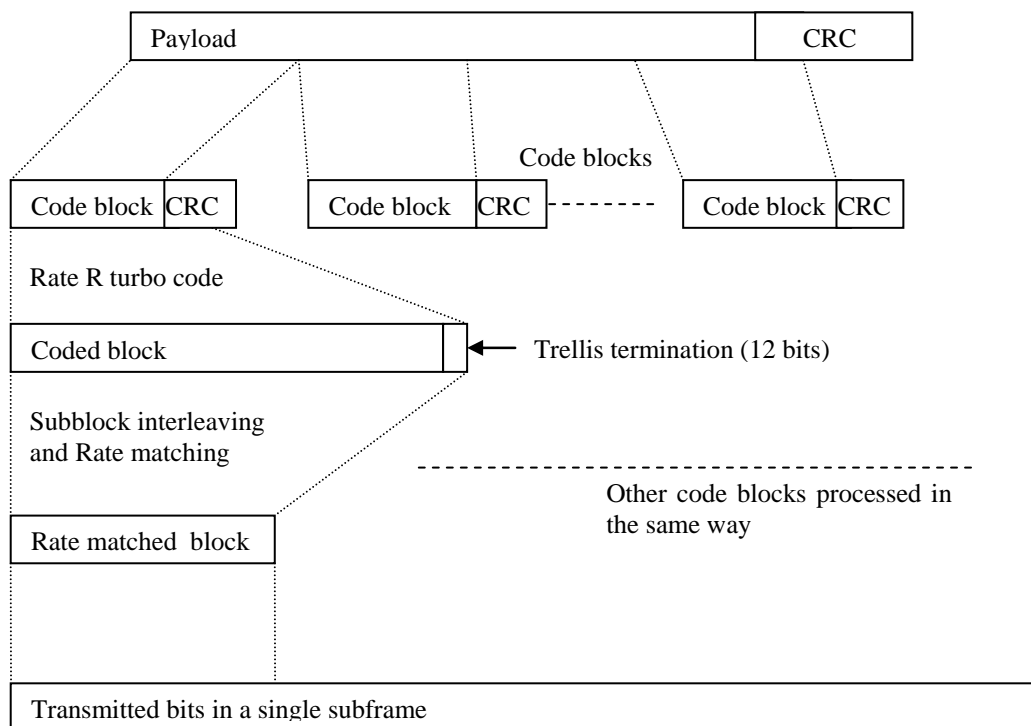

Figure A-1: Schematic overview of the encoding process

The throughput values defined in the measurement channels specified in Annex A, are calculated and are valid per data stream (codeword). For multi-stream (more than one codeword) transmissions, the throughput referenced in the minimum requirements is the sum of throughputs of all data streams (codewords).

A.2 UL reference measurement channels

A.2.1 General

A.2.1.1 Applicability and common parameters

The following sections define the UL signal applicable to the Transmitter Characteristics (clause 6) and for the Receiver Characteristics (clause 7) where the UL signal is relevant.

The Reference channels in this section assume transmission of PUSCH and Demodulation Reference signal only. The following conditions apply:

- 1 HARQ transmission
- Cyclic Prefix normal
- PUSCH hopping off
- Link adaptation off
- Demodulation Reference signal as per TS 36.211 [8] subclause 5.5.2.1.2.

Where ACK/NACK is transmitted, it is assumed to be multiplexed on PUSCH as per TS 36.212 [9] subclause 5.2.2.6.

- ACK/NACK 1 bit
- ACK/NACK mapping adjacent to Demodulation Reference symbol
- ACK/NACK resources punctured into data
- Max number of resources for ACK/NACK: 4 SC-FDMA symbols per subframe
- No CQI transmitted, no RI transmitted

A.2.1.2 Determination of payload size

The algorithm for determining the payload size A is as follows; given a desired coding rate R and radio block allocation N_{RB}

1. Calculate the number of channel bits N_{ch} that can be transmitted during the first transmission of a given sub-frame.
2. Find A such that the resulting coding rate is as close to R as possible, that is,

$$\min \left| R - (A + 24) / N_{ch} \right|,$$

subject to

- a) A is a valid TB size according to clause 7.1.7 of TS 36.213 [10] assuming an allocation of N_{RB} resource blocks.
 - b) Segmentation is not included in this formula, but should be considered in the TBS calculation.
 - c) For RMC-s, which at the nominal target coding rate do not cover all the possible UE categories for the given modulation, reduce the target coding rate gradually (within the same modulation), until the maximal possible number of UE categories is covered.
3. If there is more than one A that minimises the equation above, then the larger value is chosen per default.

A.2.2 Reference measurement channels for FDD

A.2.2.1 Full RB allocation

A.2.2.1.1 QPSK

Table A.2.2.1.1-1: Reference Channels for QPSK with full RB allocation

Parameter	Unit	Value					
		1.4	3	5	10	15	20
Channel bandwidth	MHz	1.4	3	5	10	15	20
Allocated resource blocks		6	15	25	50	75	100
DFT-OFDM Symbols per Sub-Frame		12	12	12	12	12	12
Modulation		QPSK	QPSK	QPSK	QPSK	QPSK	QPSK
Target Coding rate		1/3	1/3	1/3	1/3	1/5	1/6
Payload size	Bits	600	1544	2216	5160	4392	4584
Transport block CRC	Bits	24	24	24	24	24	24
Number of code blocks per Sub-Frame (Note 1)		1	1	1	1	1	1
Total number of bits per Sub-Frame (Note 1)	Bits	1728	4320	7200	14400	21600	28800
Total symbols per Sub-Frame		864	2160	3600	7200	10800	14400
UE Category		1-5	1-5	1-5	1-5	1-5	1-5
Note 1: If more than one Code Block is present, an additional CRC sequence of L = 24 Bits is attached to each Code Block (otherwise L = 0 Bit)							

A.2.2.1.2 16-QAM

Table A.2.2.1.2-1: Reference Channels for 16-QAM with full RB allocation

Parameter	Unit	Value					
		1.4	3	5	10	15	20
Channel bandwidth	MHz	1.4	3	5	10	15	20
Allocated resource blocks		6	15	25	50	75	100
DFT-OFDM Symbols per Sub-Frame		12	12	12	12	12	12
Modulation		16QAM	16QAM	16QAM	16QAM	16QAM	16QAM
Target Coding rate		3/4	1/2	1/3	3/4	1/2	1/3
Payload size	Bits	2600	4264	4968	21384	21384	19848
Transport block CRC	Bits	24	24	24	24	24	24
Number of code blocks per Sub-Frame (Note 1)		1	1	1	4	4	4
Total number of bits per Sub-Frame	Bits	3456	8640	14400	28800	43200	57600
Total symbols per Sub-Frame		864	2160	3600	7200	10800	14400
UE Category		1-5	1-5	1-5	2-5	2-5	2-5
Note 1: If more than one Code Block is present, an additional CRC sequence of L = 24 Bits is attached to each Code Block (otherwise L = 0 Bit)							

A.2.2.2 Partial RB allocation

For each channel bandwidth, various partial RB allocations are specified. The number of allocated RBs is chosen according to values specified in the Tx and Rx requirements. The single allocated RB case is included.

The allocated RBs are contiguous and start from one end of the channel bandwidth. A single allocated RB is at one end of the channel bandwidth.

A.2.2.2.1 QPSK

Table A.2.2.1-1: Reference Channels for 1.4MHz QPSK with partial RB allocation

Parameter	Unit	Value	Value	Value	Value	Value
Channel bandwidth	MHz	1.4	1.4	1.4	1.4	1.4
Allocated resource blocks		1	2	3	4	5
DFT-OFDM Symbols per Sub-Frame		12	12	12	12	12
Modulation		QPSK	QPSK	QPSK	QPSK	QPSK
Target Coding rate		1/3	1/3	1/3	1/3	1/3
Payload size	Bits	72	176	256	392	424
Transport block CRC	Bits	24	24	24	24	24
Number of code blocks per Sub-Frame (Note 1)		1	1	1	1	1
Total number of bits per Sub-Frame	Bits	288	576	864	1152	1440
Total symbols per Sub-Frame		144	288	432	576	720
UE Category		1-5	1-5	1-5	1-5	1-5
Note 1: If more than one Code Block is present, an additional CRC sequence of L = 24 Bits is attached to each Code Block (otherwise L = 0 Bit)						

Table A.2.2.1-2: Reference Channels for 3MHz QPSK with partial RB allocation

Parameter	Unit	Value	Value	Value	Value	Value	Value	Value
Channel bandwidth	MHz	3	3	3	3	3	3	3
Allocated resource blocks		1	2	3	4	5	6	10
DFT-OFDM Symbols per Sub-Frame		12	12	12	12	12	12	12
Modulation		QPSK	QPSK	QPSK	QPSK	QPSK	QPSK	QPSK
Target Coding rate		1/3	1/3	1/3	1/3	1/3	1/3	1/3
Payload size	Bits	72	176	256	392	424	600	872
Transport block CRC	Bits	24	24	24	24	24	24	24
Number of code blocks per Sub-Frame (Note 1)		1	1	1	1	1	1	1
Total number of bits per Sub-Frame	Bits	288	576	864	1152	1440	1728	2880
Total symbols per Sub-Frame		144	288	432	576	720	864	1440
UE Category		1-5	1-5	1-5	1-5	1-5	1-5	1-5
Note 1: If more than one Code Block is present, an additional CRC sequence of L = 24 Bits is attached to each Code Block (otherwise L = 0 Bit)								

Table A.2.2.1-3: Reference Channels for 5MHz QPSK with partial RB allocation

Parameter	Unit	Value	Value	Value	Value	Value
Channel bandwidth	MHz	5	5	5	5	5
Allocated resource blocks		1	2	5	6	8
DFT-OFDM Symbols per Sub-Frame		12	12	12	12	12
Modulation		QPSK	QPSK	QPSK	QPSK	QPSK
Target Coding rate		1/3	1/3	1/3	1/3	1/3
Payload size	Bits	72	176	424	600	808
Transport block CRC	Bits	24	24	24	24	24
Number of code blocks per Sub-Frame (Note 1)		1	1	1	1	1
Total number of bits per Sub-Frame	Bits	288	576	1440	1728	2304
Total symbols per Sub-Frame		144	288	720	864	1152
UE Category		1-5	1-5	1-5	1-5	1-5
Note 1: If more than one Code Block is present, an additional CRC sequence of L = 24 Bits is attached to each Code Block (otherwise L = 0 Bit)						

Table A.2.2.2.1-3a: Reference Channels for 5MHz QPSK with partial RB allocation

Parameter	Unit	Value	Value	Value	Value	Value
Channel bandwidth	MHz	5	5	5	5	5
Allocated resource blocks		10	15	18	20	24
DFT-OFDM Symbols per Sub-Frame		12	12	12	12	12
Modulation		QPSK	QPSK	QPSK	QPSK	QPSK
Target Coding rate		1/3	1/3	1/3	1/3	1/3
Payload size	Bits	872	1320	1864	1736	2472
Transport block CRC	Bits	24	24	24	24	24
Number of code blocks per Sub-Frame (Note 1)		1	1	1	1	1
Total number of bits per Sub-Frame	Bits	2880	4320	5184	5760	6912
Total symbols per Sub-Frame		1440	2160	2592	2880	3456
UE Category		1-5	1-5	1-5	1-5	1-5
Note 1: If more than one Code Block is present, an additional CRC sequence of L = 24 Bits is attached to each Code Block (otherwise L = 0 Bit)						

Table A.2.2.2.1-4: Reference Channels for 10MHz QPSK with partial RB allocation

Parameter	Unit	Value	Value	Value	Value	Value	Value
Channel bandwidth	MHz	10	10	10	10	10	10
Allocated resource blocks		1	2	5	6	8	10
DFT-OFDM Symbols per Sub-Frame		12	12	12	12	12	12
Modulation		QPSK	QPSK	QPSK	QPSK	QPSK	QPSK
Target Coding rate		1/3	1/3	1/3	1/3	1/3	1/3
Payload size	Bits	72	176	424	600	808	872
Transport block CRC	Bits	24	24	24	24	24	24
Number of code blocks per Sub-Frame (Note 1)		1	1	1	1	1	1
Total number of bits per Sub-Frame	Bits	288	576	1440	1728	2304	2880
Total symbols per Sub-Frame		144	288	720	864	1152	1440
UE Category		1-5	1-5	1-5	1-5	1-5	1-5
Note 1: If more than one Code Block is present, an additional CRC sequence of L = 24 Bits is attached to each Code Block (otherwise L = 0 Bit)							

Table A.2.2.2.1-4a: Reference Channels for 10MHz QPSK with partial RB allocation

Parameter	Unit	Value	Value	Value	Value	Value	Value
Channel bandwidth	MHz	10	10	10	10	10	10
Allocated resource blocks		12	16	18	20	24	25
DFT-OFDM Symbols per Sub-Frame		12	12	12	12	12	12
Modulation		QPSK	QPSK	QPSK	QPSK	QPSK	QPSK
Target Coding rate		1/3	1/3	1/3	1/3	1/3	1/3
Payload size	Bits	1224	1384	1864	1736	2472	2216
Transport block CRC	Bits	24	24	24	24	24	24
Number of code blocks per Sub-Frame (Note 1)		1	1	1	1	1	1
Total number of bits per Sub-Frame	Bits	3456	4608	5184	5760	6912	7200
Total symbols per Sub-Frame		1728	2304	2592	2880	3456	3600
UE Category		1-5	1-5	1-5	1-5	1-5	1-5
Note 1: If more than one Code Block is present, an additional CRC sequence of L = 24 Bits is attached to each Code Block (otherwise L = 0 Bit)							

Table A.2.2.2.1-4b: Reference Channels for 10MHz QPSK with partial RB allocation

Parameter	Unit	Value	Value	Value	Value	Value
Channel bandwidth	MHz	10	10	10	10	10
Allocated resource blocks		27	30	36	40	48
DFT-OFDM Symbols per Sub-Frame		12	12	12	12	12
Modulation		QPSK	QPSK	QPSK	QPSK	QPSK
Target Coding rate		1/3	1/3	1/3	1/3	1/3
Payload size	Bits	2792	2664	3752	4136	4264
Transport block CRC	Bits	24	24	24	24	24
Number of code blocks per Sub-Frame (Note 1)		1	1	1	1	1
Total number of bits per Sub-Frame	Bits	7776	8640	10368	11520	13824
Total symbols per Sub-Frame		3888	4320	5184	5760	6912
UE Category		1-5	1-5	1-5	1-5	1-5
Note 1: If more than one Code Block is present, an additional CRC sequence of L = 24 Bits is attached to each Code Block (otherwise L = 0 Bit)						

Table A.2.2.2.1-5: Reference Channels for 15MHz QPSK with partial RB allocation

Parameter	Unit	Value	Value	Value	Value	Value	Value
Channel bandwidth	MHz	15	15	15	15	15	15
Allocated resource blocks		1	2	5	6	8	10
DFT-OFDM Symbols per Sub-Frame		12	12	12	12	12	12
Modulation		QPSK	QPSK	QPSK	QPSK	QPSK	QPSK
Target Coding rate		1/3	1/3	1/3	1/3	1/3	1/3
Payload size	Bits	72	176	424	600	808	872
Transport block CRC	Bits	24	24	24	24	24	24
Number of code blocks per Sub-Frame (Note 1)		1	1	1	1	1	1
Total number of bits per Sub-Frame	Bits	288	576	1440	1728	2304	2880
Total symbols per Sub-Frame		144	288	720	864	1152	1440
UE Category		1-5	1-5	1-5	1-5	1-5	1-5
Note 1: If more than one Code Block is present, an additional CRC sequence of L = 24 Bits is attached to each Code Block (otherwise L = 0 Bit)							

Table A.2.2.2.1-5a: Reference Channels for 15MHz QPSK with partial RB allocation

Parameter	Unit	Value	Value	Value	Value	Value	Value	Value
Channel bandwidth	MHz	15	15	15	15	15	15	15
Allocated resource blocks		16	18	20	24	25	27	36
DFT-OFDM Symbols per Sub-Frame		12	12	12	12	12	12	12
Modulation		QPSK	QPSK	QPSK	QPSK	QPSK	QPSK	QPSK
Target Coding rate		1/3	1/3	1/3	1/3	1/3	1/3	1/3
Payload size	Bits	1384	1864	1736	2472	2216	2792	3752
Transport block CRC	Bits	24	24	24	24	24	24	24
Number of code blocks per Sub-Frame (Note 1)		1	1	1	1	1	1	1
Total number of bits per Sub-Frame	Bits	4608	5184	5760	6912	7200	7776	10368
Total symbols per Sub-Frame		2304	2592	2880	3456	3600	3888	5184
UE Category		1-5	1-5	1-5	1-5	1-5	1-5	1-5
Note 1: If more than one Code Block is present, an additional CRC sequence of L = 24 Bits is attached to each Code Block (otherwise L = 0 Bit)								

Table A.2.2.2.1-5b: Reference Channels for 15MHz QPSK with partial RB allocation

Parameter	Unit	Value	Value	Value
Channel bandwidth	MHz	15	15	15
Allocated resource blocks		40	48	50
DFT-OFDM Symbols per Sub-Frame		12	12	12
Modulation		QPSK	QPSK	QPSK
Target Coding rate		1/3	1/3	1/3
Payload size	Bits	4136	4264	5160
Transport block CRC	Bits	24	24	24
Number of code blocks per Sub-Frame (Note 1)		1	1	1
Total number of bits per Sub-Frame	Bits	11520	13824	14400
Total symbols per Sub-Frame		5760	6912	7200
UE Category		1-5	1-5	1-5
Note 1: If more than one Code Block is present, an additional CRC sequence of L = 24 Bits is attached to each Code Block (otherwise L = 0 Bit)				

Table A.2.2.2.1-6: Reference Channels for 20MHz QPSK with partial RB allocation

Parameter	Unit	Value	Value	Value	Value	Value	Value
Channel bandwidth	MHz	20	20	20	20	20	20
Allocated resource blocks		1	2	5	6	8	10
DFT-OFDM Symbols per Sub-Frame		12	12	12	12	12	12
Modulation		QPSK	QPSK	QPSK	QPSK	QPSK	QPSK
Target Coding rate		1/3	1/3	1/3	1/3	1/3	1/3
Payload size	Bits	72	176	424	600	808	872
Transport block CRC	Bits	24	24	24	24	24	24
Number of code blocks per Sub-Frame (Note 1)		1	1	1	1	1	1
Total number of bits per Sub-Frame	Bits	288	576	1440	1728	2304	2880
Total symbols per Sub-Frame		144	288	720	864	1152	1440
UE Category		1-5	1-5	1-5	1-5	1-5	1-5
Note 1: If more than one Code Block is present, an additional CRC sequence of L = 24 Bits is attached to each Code Block (otherwise L = 0 Bit)							

Table A.2.2.2.1-6a: Reference Channels for 20MHz QPSK with partial RB allocation

Parameter	Unit	Value	Value	Value	Value	Value	Value	Value
Channel bandwidth	MHz	20	20	20	20	20	20	20
Allocated resource blocks		18	20	24	25	48	50	75
DFT-OFDM Symbols per Sub-Frame		12	12	12	12	12	12	12
Modulation		QPSK	QPSK	QPSK	QPSK	QPSK	QPSK	QPSK
Target Coding rate		1/3	1/3	1/3	1/3	1/3	1/3	1/5
Payload size	Bits	1864	1736	2472	2216	4264	5160	4392
Transport block CRC	Bits	24	24	24	24	24	24	24
Number of code blocks per Sub-Frame (Note 1)		1	1	1	1	1	1	1
Total number of bits per Sub-Frame	Bits	5184	5760	6912	7200	13824	14400	21600
Total symbols per Sub-Frame		2592	2880	3456	3600	6912	7200	10800
UE Category		1-5	1-5	1-5	1-5	1-5	1-5	1-5
Note 1: If more than one Code Block is present, an additional CRC sequence of L = 24 Bits is attached to each Code Block (otherwise L = 0 Bit)								

A.2.2.2.2 16-QAM

Table A.2.2.2.2-1: Reference Channels for 1.4MHz 16-QAM with partial RB allocation

Parameter	Unit	Value	Value
Channel bandwidth	MHz	1.4	1.4
Allocated resource blocks		1	5
DFT-OFDM Symbols per Sub-Frame		12	12
Modulation		16QAM	16QAM
Target Coding rate		3/4	3/4
Payload size	Bits	408	2152
Transport block CRC	Bits	24	24
Number of code blocks per Sub-Frame (Note 1)		1	1
Total number of bits per Sub-Frame	Bits	576	2880
Total symbols per Sub-Frame		144	720
UE Category		1-5	1-5
Note 1: If more than one Code Block is present, an additional CRC sequence of L = 24 Bits is attached to each Code Block (otherwise L = 0 Bit)			

Table A.2.2.2.2-2: Reference Channels for 3MHz 16-QAM with partial RB allocation

Parameter	Unit	Value	Value
Channel bandwidth	MHz	3	3
Allocated resource blocks		1	4
DFT-OFDM Symbols per Sub-Frame		12	12
Modulation		16QAM	16QAM
Target Coding rate		3/4	3/4
Payload size	Bits	408	1736
Transport block CRC	Bits	24	24
Number of code blocks per Sub-Frame (Note 1)		1	1
Total number of bits per Sub-Frame	Bits	576	2304
Total symbols per Sub-Frame		144	576
UE Category		1-5	1-5
Note 1: If more than one Code Block is present, an additional CRC sequence of L = 24 Bits is attached to each Code Block (otherwise L = 0 Bit)			

Table A.2.2.2.2-3: Reference Channels for 5MHz 16-QAM with partial RB allocation

Parameter	Unit	Value	Value
Channel bandwidth	MHz	5	5
Allocated resource blocks		1	8
DFT-OFDM Symbols per Sub-Frame		12	12
Modulation		16QAM	16QAM
Target Coding rate		3/4	3/4
Payload size	Bits	408	3496
Transport block CRC	Bits	24	24
Number of code blocks per Sub-Frame (Note 1)		1	1
Total number of bits per Sub-Frame	Bits	576	4608
Total symbols per Sub-Frame		144	1152
UE Category		1-5	1-5
Note 1: If more than one Code Block is present, an additional CRC sequence of L = 24 Bits is attached to each Code Block (otherwise L = 0 Bit)			

Table A.2.2.2-4: Reference Channels for 10MHz 16-QAM with partial RB allocation

Parameter	Unit	Value	Value	Value	Value	Value
Channel bandwidth	MHz	10	10	10	10	10
Allocated resource blocks		1	12	16	30	36
DFT-OFDM Symbols per Sub-Frame		12	12	12	12	12
Modulation		16QAM	16QAM	16QAM	16QAM	16QAM
Target Coding rate		3/4	3/4	1/2	3/4	3/4
Payload size	Bits	408	5160	4584	12960	15264
Transport block CRC	Bits	24	24	24	24	24
Number of code blocks per Sub-Frame (Note 1)		1	1	1	3	3
Total number of bits per Sub-Frame	Bits	576	6912	9216	17280	20736
Total symbols per Sub-Frame		144	1728	2304	4320	5184
UE Category		1-5	1-5	1-5	2-5	2-5
Note 1: If more than one Code Block is present, an additional CRC sequence of L = 24 Bits is attached to each Code Block (otherwise L = 0 Bit)						

Table A.2.2.2-5: Reference Channels for 15MHz 16-QAM with partial RB allocation

Parameter	Unit	Value	Value
Channel bandwidth	MHz	15	15
Allocated resource blocks		1	16
DFT-OFDM Symbols per Sub-Frame		12	12
Modulation		16QAM	16QAM
Target Coding rate		3/4	1/2
Payload size	Bits	408	4584
Transport block CRC	Bits	24	24
Number of code blocks per Sub-Frame (Note 1)		1	1
Total number of bits per Sub-Frame	Bits	576	9216
Total symbols per Sub-Frame		144	2304
UE Category		1-5	1-5
Note 1: If more than one Code Block is present, an additional CRC sequence of L = 24 Bits is attached to each Code Block (otherwise L = 0 Bit)			

Table A.2.2.2-6: Reference Channels for 20MHz 16-QAM with partial RB allocation

Parameter	Unit	Value	Value	Value
Channel bandwidth	MHz	20	20	20
Allocated resource blocks		1	18	75
DFT-OFDM Symbols per Sub-Frame		12	12	12
Modulation		16QAM	16QAM	16QAM
Target Coding rate		3/4	1/2	1/2
Payload size	Bits	408	5160	21384
Transport block CRC	Bits	24	24	24
Number of code blocks per Sub-Frame (Note 1)		1	1	4
Total number of bits per Sub-Frame	Bits	576	10368	43200
Total symbols per Sub-Frame		144	2592	10800
UE Category		1-5	1-5	2-5
Note 1: If more than one Code Block is present, an additional CRC sequence of L = 24 Bits is attached to each Code Block (otherwise L = 0 Bit)				

A.2.2.3 Reference measurement channels for sustained downlink data rate provided by lower layers

Table A.2.2.3-1: Uplink Reference Channels for sustained data-rate test (FDD)

Parameter	Unit	Value					
		R.1-1 FDD	R.1-2 FDD	R.1-3 FDD	R.1-3A FDD	R.1-4 FDD	FFS
Reference Channel							
Channel Bandwidth	MHz	10	10	20	10	20	
Allocated Resource Blocks		40 (Note 2)	40 (Note 2)	90 (Note 3)	40 (Note 2)	90 (Note 3)	
Allocated Sub-Frames per Radio-Frame		10	10	10	10	10	
DFT-OFDM Symbols per Sub-Frame		12	12	12	12	12	
Modulation		QPSK	QPSK	QPSK	QPSK	QPSK	
Coding Rate		0.31	0.31	0.31	0.31	0.31	
Information Bit Payload per Sub-Frame	Bits	3496	3496	7992	3496	7992	
Number of Code Blocks per Sub-Frame (Note 1)		1	1	2	1	2	
Modulation Symbols per Sub-Frame		5760	5760	12960	5760	12960	
Binary Channel Bits per Sub-Frame		11520	11520	25920	11520	25920	
Max Throughput over 1 Radio-Frame	Mbps	3.496	3.496	7.992	3.496	7.992	
UE Category		1	2	3	3	4	
Note 1: If more than one Code Block is present, an additional CRC sequence of L = 24 Bits is attached to each Code Block (otherwise L = 0 Bit)							
Note 2: RB-s 5-44 allocated with PUSCH.							
Note 3: RB-s 5-94 allocated with PUSCH.							

A.2.3 Reference measurement channels for TDD

For TDD the measurement channel is based on DL/UL configuration ratio of 2DL:2UL.

A.2.3.1 Full RB allocation

A.2.3.1.1 QPSK

Table A.2.3.1.1-1: Reference Channels for QPSK with full RB allocation

Parameter	Unit	Value					
		1.4	3	5	10	15	20
Channel bandwidth	MHz						
Allocated resource blocks		6	15	25	50	75	100
Uplink-Downlink Configuration (Note 2)		1	1	1	1	1	1
DFT-OFDM Symbols per Sub-Frame		12	12	12	12	12	12
Modulation		QPSK	QPSK	QPSK	QPSK	QPSK	QPSK
Target Coding rate		1/3	1/3	1/3	1/3	1/5	1/6
Payload size							
For Sub-Frame 2,3,7,8	Bits	600	1544	2216	5160	4392	4584
Transport block CRC	Bits	24	24	24	24	24	24
Number of code blocks per Sub-Frame (Note 1)		1	1	1	1	1	1
Total number of bits per Sub-Frame							
For Sub-Frame 2,3,7,8	Bits	1728	4320	7200	14400	21600	28800
Total symbols per Sub-Frame							
For Sub-Frame 2,3,7,8		864	2160	3600	7200	10800	14400
UE Category		1-5	1-5	1-5	1-5	1-5	1-5
Note 1: If more than one Code Block is present, an additional CRC sequence of L = 24 Bits is attached to each Code Block (otherwise L = 0 Bit)							
Note 2: As per Table 4.2-2 in TS 36.211 [8]							

A.2.3.1.2 16-QAM

Table A.2.3.1.2-1: Reference Channels for 16-QAM with full RB allocation

Parameter	Unit	Value					
		1.4	3	5	10	15	20
Channel bandwidth	MHz	1.4	3	5	10	15	20
Allocated resource blocks		6	15	25	50	75	100
Uplink-Downlink Configuration (Note 2)		1	1	1	1	1	1
DFT-OFDM Symbols per Sub-Frame		12	12	12	12	12	12
Modulation		16QAM	16QAM	16QAM	16QAM	16QAM	16QAM
Target Coding rate		3/4	1/2	1/3	3/4	1/2	1/3
Payload size							
For Sub-Frame 2,3,7,8	Bits	2600	4264	4968	21384	21384	19848
Transport block CRC	Bits	24	24	24	24	24	24
Number of code blocks - C		1	1	1	4	4	4
Total number of bits per Sub-Frame							
For Sub-Frame 2,3,7,8	Bits	3456	8640	14400	28800	43200	57600
Total symbols per Sub-Frame							
For Sub-Frame 2,3,7,8		864	2160	3600	7200	10800	14400
UE Category		1-5	1-5	1-5	2-5	2-5	2-5
Note 1: If more than one Code Block is present, an additional CRC sequence of L = 24 Bits is attached to each Code Block (otherwise L = 0 Bit)							
Note 2: As per Table 4.2-2 in TS 36.211 [8]							

A.2.3.2 Partial RB allocation

For each channel bandwidth, various partial RB allocations are specified. The number of allocated RBs is chosen according to values specified in the Tx and Rx requirements. The single allocated RB case is included.

The allocated RBs are contiguous and start from one end of the channel bandwidth. A single allocated RB is at one end of the channel bandwidth.

A.2.3.2.1 QPSK

Table A.2.3.2.1-1: Reference Channels for 1.4MHz QPSK with partial RB allocation

Parameter	Unit	Value	Value	Value	Value	Value
Channel bandwidth	MHz	1.4	1.4	1.4	1.4	1.4
Allocated resource blocks		1	2	3	4	5
Uplink-Downlink Configuration (Note 2)		1	1	1	1	1
DFT-OFDM Symbols per Sub-Frame		12	12	12	12	12
Modulation		QPSK	QPSK	QPSK	QPSK	QPSK
Target Coding rate		1/3	1/3	1/3	1/3	1/3
Payload size						
For Sub-Frame 2,3,7,8	Bits	72	176	256	392	424
Transport block CRC	Bits	24	24	24	24	24
Number of code blocks per Sub-Frame (Note 1)		1	1	1	1	1
Total number of bits per Sub-Frame						
For Sub-Frame 2,3,7,8	Bits	288	576	864	1152	1440
Total symbols per Sub-Frame						
For Sub-Frame 2,3,7,8		144	288	432	576	720
UE Category		1-5	1-5	1-5	1-5	1-5
Note 1: If more than one Code Block is present, an additional CRC sequence of L = 24 Bits is attached to each Code Block (otherwise L = 0 Bit)						
Note 2: As per Table 4.2-2 in TS 36.211 [8]						

Table A.2.3.2.1-2: Reference Channels for 3MHz QPSK with partial RB allocation

Parameter	Unit	Value	Value	Value	Value	Value	Value	Value
Channel bandwidth	MHz	3	3	3	3	3	3	3
Allocated resource blocks		1	2	3	4	5	6	10
Uplink-Downlink Configuration (Note 2)		1	1	1	1	1	1	1
DFT-OFDM Symbols per Sub-Frame		12	12	12	12	12	12	12
Modulation		QPSK	QPSK	QPSK	QPSK	QPSK	QPSK	QPSK
Target Coding rate		1/3	1/3	1/3	1/3	1/3	1/3	1/3
Payload size								
For Sub-Frame 2,3,7,8	Bits	72	176	256	392	424	600	872
Transport block CRC	Bits	24	24	24	24	24	24	24
Number of code blocks per Sub-Frame (Note 1)		1	1	1	1	1	1	1
Total number of bits per Sub-Frame								
For Sub-Frame 2,3,7,8	Bits	288	576	864	1152	1440	1728	2880
Total symbols per Sub-Frame								
For Sub-Frame 2,3,7,8		144	288	432	576	720	864	1440
UE Category		1-5	1-5	1-5	1-5	1-5	1-5	1-5
Note 1: If more than one Code Block is present, an additional CRC sequence of L = 24 Bits is attached to each Code Block (otherwise L = 0 Bit)								
Note 2: As per Table 4.2-2 in TS 36.211 [8]								

Table A.2.3.2.1-3: Reference Channels for 5MHz QPSK with partial RB allocation

Parameter	Unit	Value	Value	Value	Value	Value
Channel bandwidth	MHz	5	5	5	5	5
Allocated resource blocks		1	2	5	6	8
Uplink-Downlink Configuration (Note 2)		1	1	1	1	1
DFT-OFDM Symbols per Sub-Frame		12	12	12	12	12
Modulation		QPSK	QPSK	QPSK	QPSK	QPSK
Target Coding rate		1/3	1/3	1/3	1/3	1/3
Payload size						
For Sub-Frame 2,3,7,8	Bits	72	176	424	600	808
Transport block CRC	Bits	24	24	24	24	24
Number of code blocks per Sub-Frame (Note 1)		1	1	1	1	1
Total number of bits per Sub-Frame	Bits					
For Sub-Frame 2,3,7,8		288	576	1440	1728	2304
Total symbols per Sub-Frame						
For Sub-Frame 2,3,7,8		144	288	720	864	1152
UE Category		1-5	1-5	1-5	1-5	1-5
Note 1: If more than one Code Block is present, an additional CRC sequence of L = 24 Bits is attached to each Code Block (otherwise L = 0 Bit)						
Note 2: As per Table 4.2-2 in TS 36.211 [8]						

Table A.2.3.2.1-3a: Reference Channels for 5MHz QPSK with partial RB allocation

Parameter	Unit	Value	Value	Value	Value	Value
Channel bandwidth	MHz	5	5	5	5	5
Allocated resource blocks		10	15	18	20	24
Uplink-Downlink Configuration (Note 2)		1	1	1	1	1
DFT-OFDM Symbols per Sub-Frame		12	12	12	12	12
Modulation		QPSK	QPSK	QPSK	QPSK	QPSK
Target Coding rate		1/3	1/3	1/3	1/3	1/3
Payload size						
For Sub-Frame 2,3,7,8	Bits	872	1320	1864	1736	2472
Transport block CRC	Bits	24	24	24	24	24
Number of code blocks per Sub-Frame (Note 1)		1	1	1	1	1
Total number of bits per Sub-Frame	Bits					
For Sub-Frame 2,3,7,8		2880	4320	5184	5760	6912
Total symbols per Sub-Frame						
For Sub-Frame 2,3,7,8		1440	2160	2592	2880	3456
UE Category		1-5	1-5	1-5	1-5	1-5
Note 1: If more than one Code Block is present, an additional CRC sequence of L = 24 Bits is attached to each Code Block (otherwise L = 0 Bit)						
Note 2: As per Table 4.2-2 in TS 36.211 [8]						

Table A.2.3.2.1-4: Reference Channels for 10MHz QPSK with partial RB allocation

Parameter	Unit	Value	Value	Value	Value	Value	Value
Channel bandwidth	MHz	10	10	10	10	10	10
Allocated resource blocks		1	2	5	6	8	10
Uplink-Downlink Configuration		1	1	1	1	1	1
DFT-OFDM Symbols per Sub-Frame		12	12	12	12	12	12
Modulation		QPSK	QPSK	QPSK	QPSK	QPSK	QPSK
Target Coding rate		1/3	1/3	1/3	1/3	1/3	1/3
Payload size							
For Sub-Frame 2,3,7,8	Bits	72	176	424	600	808	872
Transport block CRC	Bits	24	24	24	24	24	24
Number of code blocks per Sub-Frame (Note 1)		1	1	1	1	1	1
Total number of bits per Sub-Frame							
For Sub-Frame 2,3,7,8	Bits	288	576	1440	1728	2304	2880
Total symbols per Sub-Frame							
For Sub-Frame 2,3,7,8		144	288	720	864	1152	1440
UE Category		1-5	1-5	1-5	1-5	1-5	1-5
Note 1: If more than one Code Block is present, an additional CRC sequence of L = 24 Bits is attached to each Code Block (otherwise L = 0 Bit)							
Note 2: As per Table 4.2-2 in TS 36.211 [8]							

Table A.2.3.2.1-4a: Reference Channels for 10MHz QPSK with partial RB allocation

Parameter	Unit	Value	Value	Value	Value	Value	Value
Channel bandwidth	MHz	10	10	10	10	10	10
Allocated resource blocks		12	16	18	20	24	25
Uplink-Downlink Configuration		1	1	1	1	1	1
DFT-OFDM Symbols per Sub-Frame		12	12	12	12	12	12
Modulation		QPSK	QPSK	QPSK	QPSK	QPSK	QPSK
Target Coding rate		1/3	1/3	1/3	1/3	1/3	1/3
Payload size							
For Sub-Frame 2,3,7,8	Bits	1224	1384	1864	1736	2472	2216
Transport block CRC	Bits	24	24	24	24	24	24
Number of code blocks per Sub-Frame (Note 1)		1	1	1	1	1	1
Total number of bits per Sub-Frame							
For Sub-Frame 2,3,7,8	Bits	3456	4608	5184	5760	6912	7200
Total symbols per Sub-Frame							
For Sub-Frame 2,3,7,8		1728	2304	2592	2880	3456	3600
UE Category		1-5	1-5	1-5	1-5	1-5	1-5
Note 1: If more than one Code Block is present, an additional CRC sequence of L = 24 Bits is attached to each Code Block (otherwise L = 0 Bit)							
Note 2: As per Table 4.2-2 in TS 36.211 [8]							

Table A.2.3.2.1-4b: Reference Channels for 10MHz QPSK with partial RB allocation

Parameter	Unit	Value	Value	Value	Value	Value
Channel bandwidth	MHz	10	10	10	10	10
Allocated resource blocks		27	30	36	40	48
Uplink-Downlink Configuration		1	1	1	1	1
DFT-OFDM Symbols per Sub-Frame		12	12	12	12	12
Modulation		QPSK	QPSK	QPSK	QPSK	QPSK
Target Coding rate		1/3	1/3	1/3	1/3	1/3
Payload size						
For Sub-Frame 2,3,7,8	Bits	2792	2664	3752	4136	4264
Transport block CRC	Bits	24	24	24	24	24
Number of code blocks per Sub-Frame (Note 1)		1	1	1	1	1
Total number of bits per Sub-Frame						
For Sub-Frame 2,3,7,8	Bits	7776	8640	10368	11520	13824
Total symbols per Sub-Frame						
For Sub-Frame 2,3,7,8		3888	4320	5184	5760	6912
UE Category		1-5	1-5	1-5	1-5	1-5
Note 1: If more than one Code Block is present, an additional CRC sequence of L = 24 Bits is attached to each Code Block (otherwise L = 0 Bit)						
Note 2: As per Table 4.2-2 in TS 36.211 [8]						

Table A.2.3.2.1-5: Reference Channels for 15MHz QPSK with partial RB allocation

Parameter	Unit	Value	Value	Value	Value	Value	Value
Channel bandwidth	MHz	15	15	15	15	15	15
Allocated resource blocks		1	2	5	6	8	10
Uplink-Downlink Configuration		1	1	1	1	1	1
DFT-OFDM Symbols per Sub-Frame		12	12	12	12	12	12
Modulation		QPSK	QPSK	QPSK	QPSK	QPSK	QPSK
Target Coding rate		1/3	1/3	1/3	1/3	1/3	1/3
Payload size							
For Sub-Frame 2,3,7,8	Bits	72	176	424	600	808	872
Transport block CRC	Bits	24	24	24	24	24	24
Number of code blocks per Sub-Frame (Note 1)		1	1	1	1	1	1
Total number of bits per Sub-Frame							
For Sub-Frame 2,3,7,8	Bits	288	576	1440	1728	2304	2880
Total symbols per Sub-Frame							
For Sub-Frame 2,3,7,8		144	288	720	864	1152	1440
UE Category		1-5	1-5	1-5	1-5	1-5	1-5
Note 1: If more than one Code Block is present, an additional CRC sequence of L = 24 Bits is attached to each Code Block (otherwise L = 0 Bit)							
Note 2: As per Table 4.2-2 in TS 36.211 [8]							

Table A.2.3.2.1-5a: Reference Channels for 15MHz QPSK with partial RB allocation

Parameter	Unit	Value	Value	Value	Value	Value	Value	Value
Channel bandwidth	MHz	15	15	15	15	15	15	15
Allocated resource blocks		16	18	20	24	25	27	36
Uplink-Downlink Configuration		1	1	1	1	1	1	1
DFT-OFDM Symbols per Sub-Frame		12	12	12	12	12	12	12
Modulation		QPSK	QPSK	QPSK	QPSK	QPSK	QPSK	QPSK
Target Coding rate		1/3	1/3	1/3	1/3	1/3	1/3	1/3
Payload size								
For Sub-Frame 2,3,7,8	Bits	1384	1864	1736	2472	2216	2792	3752
Transport block CRC	Bits	24	24	24	24	24	24	24
Number of code blocks per Sub-Frame (Note 1)		1	1	1	1	1	1	1
Total number of bits per Sub-Frame								
For Sub-Frame 2,3,7,8	Bits	4608	5184	5760	6912	7200	7776	10368
Total symbols per Sub-Frame								
For Sub-Frame 2,3,7,8		2304	2592	2880	3456	3600	3888	5184
UE Category		1-5	1-5	1-5	1-5	1-5	1-5	1-5
Note 1: If more than one Code Block is present, an additional CRC sequence of L = 24 Bits is attached to each Code Block (otherwise L = 0 Bit)								
Note 2: As per Table 4.2-2 in TS 36.211 [8]								

Table A.2.3.2.1-5b: Reference Channels for 15MHz QPSK with partial RB allocation

Parameter	Unit	Value	Value	Value
Channel bandwidth	MHz	15	15	15
Allocated resource blocks		40	48	50
Uplink-Downlink Configuration		1	1	1
DFT-OFDM Symbols per Sub-Frame		12	12	12
Modulation		QPSK	QPSK	QPSK
Target Coding rate		1/3	1/3	1/3
Payload size				
For Sub-Frame 2,3,7,8	Bits	4136	4264	5160
Transport block CRC	Bits	24	24	24
Number of code blocks per Sub-Frame (Note 1)		1	1	1
Total number of bits per Sub-Frame				
For Sub-Frame 2,3,7,8	Bits	11520	13824	14400
Total symbols per Sub-Frame				
For Sub-Frame 2,3,7,8		5760	6912	7200
UE Category		1-5	1-5	1-5
Note 1: If more than one Code Block is present, an additional CRC sequence of L = 24 Bits is attached to each Code Block (otherwise L = 0 Bit)				
Note 2: As per Table 4.2-2 in TS 36.211 [8]				

Table A.2.3.2.1-6: Reference Channels for 20MHz QPSK with partial RB allocation

Parameter	Unit	Value	Value	Value	Value	Value	Value
Channel bandwidth	MHz	20	20	20	20	20	20
Allocated resource blocks		1	2	5	6	8	10
Uplink-Downlink Configuration (Note 2)		1	1	1	1	1	1
DFT-OFDM Symbols per Sub-Frame		12	12	12	12	12	12
Modulation		QPSK	QPSK	QPSK	QPSK	QPSK	QPSK
Target Coding rate		1/3	1/3	1/3	1/3	1/3	1/3
Payload size							
For Sub-Frame 2,3,7,8	Bits	72	176	424	600	808	872
Transport block CRC	Bits	24	24	24	24	24	24
Number of code blocks per Sub-Frame (Note 1)		1	1	1	1	1	1
Total number of bits per Sub-Frame							
For Sub-Frame 2,3,7,8	Bits	288	576	1440	1728	2304	2880
Total symbols per Sub-Frame							
For Sub-Frame 2,3,7,8		144	288	720	864	1152	1440
UE Category		1-5	1-5	1-5	1-5	1-5	1-5
Note 1: If more than one Code Block is present, an additional CRC sequence of L = 24 Bits is attached to each Code Block (otherwise L = 0 Bit)							
Note 2: As per Table 4.2-2 in TS 36.211 [

Table A.2.3.2.1-6a: Reference Channels for 20MHz QPSK with partial RB allocation

Parameter	Unit	Value	Value	Value	Value	Value	Value	Value
Channel bandwidth	MHz	20	20	20	20	20	20	20
Allocated resource blocks		18	20	24	25	48	50	75
Uplink-Downlink Configuration (Note 2)		1	1	1	1	1	1	1
DFT-OFDM Symbols per Sub-Frame		12	12	12	12	12	12	12
Modulation		QPSK	QPSK	QPSK	QPSK	QPSK	QPSK	QPSK
Target Coding rate		1/3	1/3	1/3	1/3	1/3	1/3	1/5
Payload size								
For Sub-Frame 2,3,7,8	Bits	1864	1736	2472	2216	4264	5160	4392
Transport block CRC	Bits	24	24	24	24	24	24	24
Number of code blocks per Sub-Frame (Note 1)		1	1	1	1	1	1	1
Total number of bits per Sub-Frame								
For Sub-Frame 2,3,7,8	Bits	5184	5760	6912	7200	13824	14400	21600
Total symbols per Sub-Frame								
For Sub-Frame 2,3,7,8		2592	2880	3456	3600	6912	7200	10800
UE Category		1-5	1-5	1-5	1-5	1-5	1-5	1-5
Note 1: If more than one Code Block is present, an additional CRC sequence of L = 24 Bits is attached to each Code Block (otherwise L = 0 Bit)								
Note 2: As per Table 4.2-2 in TS 36.211								

A.2.3.2.2 16-QAM

Table A.2.3.2.2-1: Reference Channels for 1.4MHz 16-QAM with partial RB allocation

Parameter	Unit	Value	Value
Channel bandwidth	MHz	1.4	1.4
Allocated resource blocks		1	5
Uplink-Downlink Configuration (Note 2)		1	1
DFT-OFDM Symbols per Sub-Frame		12	12
Modulation		16QAM	16QAM
Target Coding rate		3/4	3/4
Payload size			
For Sub-Frame 2,3,7,8	Bits	408	2152
Transport block CRC	Bits	24	24
Number of code blocks per Sub-Frame (Note 1)		1	1
Total number of bits per Sub-Frame			
For Sub-Frame 2,3,7,8	Bits	576	2880
Total symbols per Sub-Frame			
For Sub-Frame 2,3,7,8		144	720
UE Category		1-5	1-5
Note 1: If more than one Code Block is present, an additional CRC sequence of L = 24 Bits is attached to each Code Block (otherwise L = 0 Bit)			
Note 2: As per Table 4.2-2 in TS 36.211 [8]			

Table A.2.3.2.2-2: Reference Channels for 3MHz 16-QAM with partial RB allocation

Parameter	Unit	Value	Value
Channel bandwidth	MHz	3	3
Allocated resource blocks		1	4
Uplink-Downlink Configuration (Note 2)		1	1
DFT-OFDM Symbols per Sub-Frame		12	12
Modulation		16QAM	16QAM
Target Coding rate		3/4	3/4
Payload size			
For Sub-Frame 2,3,7,8	Bits	408	1736
Transport block CRC	Bits	24	24
Number of code blocks per Sub-Frame (Note 1)		1	1
Total number of bits per Sub-Frame			
For Sub-Frame 2,3,7,8	Bits	576	2304
Total symbols per Sub-Frame			
For Sub-Frame 2,3,7,8		144	576
UE Category		1-5	1-5
Note 1: If more than one Code Block is present, an additional CRC sequence of L = 24 Bits is attached to each Code Block (otherwise L = 0 Bit)			
Note 2: As per Table 4.2-2 in TS 36.211 [8]			

Table A.2.3.2.2-3: Reference Channels for 5MHz 16-QAM with partial RB allocation

Parameter	Unit	Value	Value
Channel bandwidth	MHz	5	5
Allocated resource blocks		1	8
Uplink-Downlink Configuration (Note 2)		1	1
DFT-OFDM Symbols per Sub-Frame		12	12
Modulation		16QAM	16QAM
Target Coding rate		3/4	3/4
Payload size			
For Sub-Frame 2,3,7,8	Bits	408	3496
Transport block CRC	Bits	24	24
Number of code blocks per Sub-Frame (Note 1)		1	1
Total number of bits per Sub-Frame			
For Sub-Frame 2,3,7,8	Bits	576	4608
Total symbols per Sub-Frame			
For Sub-Frame 2,3,7,8		144	1152
UE Category		1-5	1-5
Note 1: If more than one Code Block is present, an additional CRC sequence of L = 24 Bits is attached to each Code Block (otherwise L = 0 Bit)			
Note 2: As per Table 4.2-2 in TS 36.211 [8]			

Table A.2.3.2.2-4: Reference Channels for 10MHz 16-QAM with partial RB allocation

Parameter	Unit	Value	Value	Value	Value	Value
Channel bandwidth	MHz	10	10	10	10	10
Allocated resource blocks		1	12	16	30	36
Uplink-Downlink Configuration (Note 2)		1	1	1	1	1
DFT-OFDM Symbols per Sub-Frame		12	12	12	12	12
Modulation		16QAM	16QAM	16QAM	16QAM	16QAM
Target Coding rate		3/4	3/4	1/2	3/4	3/4
Payload size						
For Sub-Frame 2,3,7,8	Bits	408	5160	4584	12960	15264
Transport block CRC	Bits	24	24	24	24	24
Number of code blocks per Sub-Frame (Note 1)		1	1	1	3	3
Total number of bits per Sub-Frame						
For Sub-Frame 2,3,7,8	Bits	576	6912	9216	17280	20736
Total symbols per Sub-Frame						
For Sub-Frame 2,3,7,8		144	1728	2304	4320	5184
UE Category		1-5	1-5	1-5	2-5	2-5
Note 1: If more than one Code Block is present, an additional CRC sequence of L = 24 Bits is attached to each Code Block (otherwise L = 0 Bit)						
Note 2: As per Table 4.2-2 in TS 36.211 [8]						

Table A.2.3.2.2-5: Reference Channels for 15MHz 16-QAM with partial RB allocation

Parameter	Unit	Value	Value
Channel bandwidth	MHz	15	15
Allocated resource blocks		1	16
Uplink-Downlink Configuration(Note 2)		1	1
DFT-OFDM Symbols per Sub-Frame		12	12
Modulation		16QAM	16QAM
Target Coding rate		3/4	1/2
Payload size			
For Sub-Frame 2,3,7,8	Bits	408	4584
Transport block CRC	Bits	24	24
Number of code blocks per Sub-Frame (Note 1)		1	1
Total number of bits per Sub-Frame			
For Sub-Frame 2,3,7,8	Bits	576	9216
Total symbols per Sub-Frame			
For Sub-Frame 2,3,7,8		144	2304
UE Category		1-5	1-5
Note 1: If more than one Code Block is present, an additional CRC sequence of L = 24 Bits is attached to each Code Block (otherwise L = 0 Bit)			
Note 2: As per Table 4.2-2 in TS 36.211 [8]			

Table A.2.3.2-6: Reference Channels for 20MHz 16-QAM with partial RB allocation

Parameter	Unit	Value	Value	Value
Channel bandwidth	MHz	20	20	20
Allocated resource blocks		1	18	75
Uplink-Downlink Configuration (Note 2)		1	1	1
DFT-OFDM Symbols per Sub-Frame		12	12	12
Modulation		16QAM	16QAM	16QAM
Target Coding rate		3/4	1/2	1/2
Payload size				
For Sub-Frame 2,3,7,8	Bits	408	5160	21384
Transport block CRC	Bits	24	24	24
Number of code blocks per Sub-Frame (Note 1)		1	1	4
Total number of bits per Sub-Frame				
For Sub-Frame 2,3,7,8	Bits	576	10368	43200
Total symbols per Sub-Frame				
For Sub-Frame 2,3,7,8		144	2592	10800
UE Category		1-5	1-5	2-5
Note 1: If more than one Code Block is present, an additional CRC sequence of L = 24 Bits is attached to each Code Block (otherwise L = 0 Bit)				
Note 2: As per Table 4.2-2 in TS 36.211 [8]				

A.2.3.3 Reference measurement channels for sustained downlink data rate provided by lower layers

Table A.2.3.3-1: Uplink Reference Channels for sustained data-rate test (TDD)

Parameter	Unit	Value					
		R.1-1 TDD	R.1-2 TDD	R.1-3 TDD	R.1-3B TDD	R.1-4 TDD	FFS
Reference Channel							
Channel Bandwidth	MHz	10	10	20	15	20	
Uplink-Downlink Configuration (Note 2)		5	5	5	5	5	
Allocated Resource Blocks		40 (Note 3)	40 (Note 3)	90 (Note 5)	60 (Note 4)	90 (Note 5)	
Allocated Sub-Frames per Radio-Frame		1	1	1	1	1	
DFT-OFDM Symbols per Sub-Frame		12	12	12	12	12	
Modulation		QPSK	QPSK	QPSK	QPSK	QPSK	
Coding Rate							
For Sub-Frame 2		0.43	0.61	0.49	0.42	0.49	
Information Bit Payload per Sub-Frame	Bits						
For Sub-Frame 2		4968	6968	12576	7224	12576	
Number of Code Blocks per Sub-Frame (Note 1)							
For Sub-Frame 2		1	2	3	2	3	
Modulation Symbols per Sub-Frame							
For Sub-Frame 2		5760	5760	12960	8640	10240	
Binary Channel Bits per Sub-Frame							
For Sub-Frame 2		11520	11520	25920	17280	25920	
Max Throughput over 1 Radio-Frame	Mbps	0.4968	0.6968	1.2576	0.7224	1.2576	
UE Category		1	2	3	3	4	
Note 1: If more than one Code Block is present, an additional CRC sequence of L = 24 Bits is attached to each Code Block (otherwise L = 0 Bit)							
Note 2: As per Table 4.2-2 in TS 36.211 [8]							
Note 3: RB-s 5-44 allocated with PUSCH.							
Note 4: RB-s 7-66 allocated with PUSCH.							
Note 5: RB-s 5-94 allocated with PUSCH.							

A.3 DL reference measurement channels

A.3.1 General

The number of available channel bits varies across the sub-frames due to PBCH and PSS/SSS overhead. The payload size per sub-frame is varied in order to keep the code rate constant throughout a frame.

No user data is scheduled on subframes #5 in order to facilitate the transmission of system information blocks (SIB).

The algorithm for determining the payload size A is as follows; given a desired coding rate R and radio block allocation N_{RB}

1. Calculate the number of channel bits N_{ch} that can be transmitted during the first transmission of a given sub-frame.
2. Find A such that the resulting coding rate is as close to R as possible, that is,

$$\min |R - (A + 24) / N_{ch}|,$$

subject to

- a) A is a valid TB size (according to TS 36.213 [10] clause 7.1.7) assuming an allocation of N_{RB} resource blocks
- b) Segmentation is not included in this formula, but should be considered in the TBS calculation
3. If there is more than one A that minimizes the equation above, then the larger value is chosen per default.
4. For TDD, the measurement channel is based on DL/UL configuration ratio of 2DL+DwPTS (12 OFDM symbol): 2UL

A.3.2 Reference measurement channel for receiver characteristics

Tables A.3.2-1 and A.3.2-2 are applicable for measurements on the Receiver Characteristics (clause 7) with the exception of sub-clause 7.4 (Maximum input level).

Tables A.3.2-3, A.3.2-3a, A.3.2-3b, A.3.2-4, A.3.2-4a and A.3.2-4b are applicable for sub-clause 7.4 (Maximum input level).

Tables A.3.2-1 and A.3.2-2 also apply for the modulated interferer used in Clauses 7.5, 7.6 and 7.8 with test specific bandwidths.

Table A.3.2-1: Fixed Reference Channel for Receiver Requirements (FDD)

Parameter	Unit	Value					
		1.4	3	5	10	15	20
Channel bandwidth	MHz	1.4	3	5	10	15	20
Allocated resource blocks		6	15	25	50	75	100
Subcarriers per resource block		12	12	12	12	12	12
Allocated subframes per Radio Frame		10	10	10	10	10	10
Modulation		QPSK	QPSK	QPSK	QPSK	QPSK	QPSK
Target Coding Rate		1/3	1/3	1/3	1/3	1/3	1/3
Number of HARQ Processes	Processes	8	8	8	8	8	8
Maximum number of HARQ transmissions		1	1	1	1	1	1
Information Bit Payload per Sub-Frame							
For Sub-Frames 1,2,3,4,6,7,8,9	Bits	408	1320	2216	4392	6712	8760
For Sub-Frame 5	Bits	n/a	n/a	n/a	n/a	n/a	n/a
For Sub-Frame 0	Bits	152	872	1800	4392	6712	8760
Transport block CRC	Bits	24	24	24	24	24	24
Number of Code Blocks per Sub-Frame (Note 3)							
For Sub-Frames 1,2,3,4,6,7,8,9	Bits	1	1	1	1	2	2
For Sub-Frame 5	Bits	n/a	n/a	n/a	n/a	n/a	n/a
For Sub-Frame 0	Bits	1	1	1	1	2	2
Binary Channel Bits Per Sub-Frame							
For Sub-Frames 1,2,3,4,6,7,8,9	Bits	1368	3780	6300	13800	20700	27600
For Sub-Frame 5	Bits	n/a	n/a	n/a	n/a	n/a	n/a
For Sub-Frame 0	Bits	528	2940	5460	12960	19860	26760
Max. Throughput averaged over 1 frame	kbps	341.6	1143. 2	1952. 8	3952. 8	6040. 8	7884
UE Category		1-5	1-5	1-5	1-5	1-5	1-5
Note 1:	2 symbols allocated to PDCCH for 20 MHz, 15 MHz and 10MHz channel BW. 3 symbols allocated to PDCCH for 5 MHz and 3 MHz. 4 symbols allocated to PDCCH for 1.4 MHz						
Note 2:	Reference signal, Synchronization signals and PBCH allocated as per TS 36.211 [8]						
Note 3:	If more than one Code Block is present, an additional CRC sequence of L = 24 Bits is attached to each Code Block (otherwise L = 0 Bit)						

Table A.3.2-2: Fixed Reference Channel for Receiver Requirements (TDD)

Parameter	Unit	Value					
		1.4	3	5	10	15	20
Channel Bandwidth	MHz	1.4	3	5	10	15	20
Allocated resource blocks		6	15	25	50	75	100
Uplink-Downlink Configuration (Note 6)		1	1	1	1	1	1
Allocated subframes per Radio Frame (D+S)		4	4+2	4+2	4+2	4+2	4+2
Number of HARQ Processes	Processes	7	7	7	7	7	7
Maximum number of HARQ transmission		1	1	1	1	1	1
Modulation		QPSK	QPSK	QPSK	QPSK	QPSK	QPSK
Target coding rate		1/3	1/3	1/3	1/3	1/3	1/3
Information Bit Payload per Sub-Frame	Bits						
For Sub-Frame 4, 9		408	1320	2216	4392	6712	8760
For Sub-Frame 1, 6		n/a	968	1544	3240	4968	6712
For Sub-Frame 5		n/a	n/a	n/a	n/a	n/a	n/a
For Sub-Frame 0		208	1064	1800	4392	6712	8760
Transport block CRC	Bits	24	24	24	24	24	24
Number of Code Blocks per Sub-Frame (Note 4)							
For Sub-Frame 4, 9		1	1	1	1	2	2
For Sub-Frame 1, 6		n/a	1	1	1	1	2
For Sub-Frame 5		n/a	n/a	n/a	n/a	n/a	n/a
For Sub-Frame 0		1	1	1	1	2	2
Binary Channel Bits Per Sub-Frame	Bits						
For Sub-Frame 4, 9		1368	3780	6300	13800	20700	27600
For Sub-Frame 1, 6		n/a	3276	5556	11256	16956	22656
For Sub-Frame 5		n/a	n/a	n/a	n/a	n/a	n/a
For Sub-Frame 0		672	3084	5604	13104	20004	26904
Max. Throughput averaged over 1 frame	kbps	102.4	564	932	1965.6	3007.2	3970.4
UE Category		1-5	1-5	1-5	1-5	1-5	1-5
Note 1:	For normal subframes(0,4,5,9), 2 symbols allocated to PDCCH for 20 MHz, 15 MHz and 10 MHz channel BW; 3 symbols allocated to PDCCH for 5 MHz and 3 MHz; 4 symbols allocated to PDCCH for 1.4 MHz. For special subframe (1&6), only 2 OFDM symbols are allocated to PDCCH for all BWs.						
Note 2:	For 1.4MHz, no data shall be scheduled on special subframes (1&6) to avoid problems with insufficient PDCCH performance						
Note 3:	Reference signal, Synchronization signals and PBCH allocated as per TS 36.211 [8]						
Note 4:	If more than one Code Block is present, an additional CRC sequence of L = 24 Bits is attached to each Code Block (otherwise L = 0 Bit).						
Note 5:	As per Table 4.2-2 in TS 36.211 [8]						

Table A.3.2-3: Fixed Reference Channel for Maximum input level for UE Categories 3-5 (FDD)

Parameter	Unit	Value					
		1.4	3	5	10	15	20
Channel bandwidth	MHz	1.4	3	5	10	15	20
Allocated resource blocks		6	15	25	50	75	100
Subcarriers per resource block		12	12	12	12	12	12
Allocated subframes per Radio Frame		10	10	10	10	10	10
Modulation		64QAM	64QAM	64QAM	64QAM	64QAM	64QAM
Target Coding Rate		3/4	3/4	3/4	3/4	3/4	3/4
Number of HARQ Processes	Processes	8	8	8	8	8	8
Maximum number of HARQ transmissions		1	1	1	1	1	1
Information Bit Payload per Sub-Frame							
For Sub-Frames 1,2,3,4,6,7,8,9	Bits	2984	8504	14112	30576	46888	61664
For Sub-Frame 5	Bits	n/a	n/a	n/a	n/a	n/a	n/a
For Sub-Frame 0	Bits	n/a	6456	12576	28336	45352	61664
Transport block CRC	Bits	24	24	24	24	24	24
Number of Code Blocks per Sub-Frame (Note 3)							
For Sub-Frames 1,2,3,4,6,7,8,9		1	2	3	5	8	11
For Sub-Frame 5		n/a	n/a	n/a	n/a	n/a	n/a
For Sub-Frame 0		n/a	2	3	5	8	11
Binary Channel Bits Per Sub-Frame							
For Sub-Frames 1,2,3,4,6,7,8,9	Bits	4104	11340	18900	41400	62100	82800
For Sub-Frame 5	Bits	n/a	n/a	n/a	n/a	n/a	n/a
For Sub-Frame 0	Bits	n/a	8820	16380	38880	59580	80280
Max. Throughput averaged over 1 frame	kbps	2387.2	7448.8	12547	27294	42046	55498
Note 1:	2 symbols allocated to PDCCH for 20 MHz, 15 MHz and 10 MHz channel BW. 3 symbols allocated to PDCCH for 5 MHz and 3 MHz. 4 symbols allocated to PDCCH for 1.4 MHz						
Note 2:	Reference signal, Synchronization signals and PBCH allocated as per TS 36.211 [8]						
Note 3:	If more than one Code Block is present, an additional CRC sequence of L = 24 Bits is attached to each Code Block (otherwise L = 0 Bit)						

Table A.3.2-3a: Fixed Reference Channel for Maximum input level for UE Category 1 (FDD)

Parameter	Unit	Value					
		1.4	3	5	10	15	20
Channel bandwidth	MHz	1.4	3	5	10	15	20
Allocated resource blocks		6	15	18	17	17	17
Subcarriers per resource block		12	12	12	12	12	12
Allocated subframes per Radio Frame		10	10	10	10	10	10
Modulation		64QAM	64QAM	64QAM	64QAM	64QAM	64QAM
Target Coding Rate		3/4	3/4	3/4	3/4	3/4	3/4
Number of HARQ Processes	Processes	8	8	8	8	8	8
Maximum number of HARQ transmissions		1	1	1	1	1	1
Information Bit Payload							
For Sub-Frames 1,2,3,4,6,7,8,9	Bits	2984	8504	10296	10296	10296	10296
For Sub-Frame 5	Bits	n/a	n/a	n/a	n/a	n/a	n/a
For Sub-Frame 0	Bits	n/a	6456	8248	10296	10296	10296
Transport block CRC	Bits	24	24	24	24	24	24
Number of Code Blocks per Sub-Frame (Note 3)							
For Sub-Frames 1,2,3,4,6,7,8,9		1	2	2	2	2	2
For Sub-Frame 5		n/a	n/a	n/a	n/a	n/a	n/a
For Sub-Frame 0		n/a	2	2	2	2	2
Binary Channel Bits Per Sub-Frame							
For Sub-Frames 1,2,3,4,6,7,8,9	Bits	4104	11340	13608	14076	14076	14076
For Sub-Frame 5	Bits	n/a	n/a	n/a	n/a	n/a	n/a
For Sub-Frame 0	Bits	n/a	8820	11088	14076	14076	14076
Max. Throughput averaged over 1 frame	kbps	2387.2	7448.8	9079.6	9266.4	9266.4	9266.4
Note 1:	2 symbols allocated to PDCCH for 20 MHz, 15 MHz and 10 MHz channel BW. 3 symbols allocated to PDCCH for 5 MHz and 3 MHz. 4 symbols allocated to PDCCH for 1.4 MHz						
Note 2:	Reference signal, Synchronization signals and PBCH allocated as per TS 36.211 [8]						
Note 3:	If more than one Code Block is present, an additional CRC sequence of L = 24 Bits is attached to each Code Block (otherwise L = 0 Bit)						

Table A.3.2-3b: Fixed Reference Channel for Maximum input level for UE Category 2 (FDD)

Parameter	Unit	Value					
		1.4	3	5	10	15	20
Channel bandwidth	MHz	1.4	3	5	10	15	20
Allocated resource blocks		6	15	25	50	75	83
Subcarriers per resource block		12	12	12	12	12	12
Allocated subframes per Radio Frame		10	10	10	10	10	10
Modulation		64QAM	64QAM	64QAM	64QAM	64QAM	64QAM
Target Coding Rate		3/4	3/4	3/4	3/4	3/4	3/4
Number of HARQ Processes	Processes	8	8	8	8	8	8
Maximum number of HARQ transmissions		1	1	1	1	1	1
Information Bit Payload							
For Sub-Frames 1,2,3,4,6,7,8,9	Bits	2984	8504	14112	30576	46888	51024
For Sub-Frame 5	Bits	n/a	n/a	n/a	n/a	n/a	n/a
For Sub-Frame 0	Bits	n/a	6456	12576	28336	45352	51024
Transport block CRC	Bits	24	24	24	24	24	24
Number of Code Blocks per Sub-Frame (Note 3)							
For Sub-Frames 1,2,3,4,6,7,8,9		1	2	3	5	8	9
For Sub-Frame 5		n/a	n/a	n/a	n/a	n/a	n/a
For Sub-Frame 0		n/a	2	3	5	8	9
Binary Channel Bits Per Sub-Frame							
For Sub-Frames 1,2,3,4,6,7,8,9	Bits	4104	11340	18900	41400	62100	68724
For Sub-Frame 5	Bits	n/a	n/a	n/a	n/a	n/a	n/a
For Sub-Frame 0	Bits	n/a	8820	16380	38880	59580	66204
Max. Throughput averaged over 1 frame	kbps	2387.2	7448.8	12547	27294	42046	45922
Note 1:	2 symbols allocated to PDCCH for 20 MHz, 15 MHz and 10 MHz channel BW. 3 symbols allocated to PDCCH for 5 MHz and 3 MHz. 4 symbols allocated to PDCCH for 1.4 MHz						
Note 2:	Reference signal, Synchronization signals and PBCH allocated as per TS 36.211 [8]						
Note 3:	If more than one Code Block is present, an additional CRC sequence of L = 24 Bits is attached to each Code Block (otherwise L = 0 Bit)						

Table A.3.2-4: Fixed Reference Channel for Maximum input level for UE Categories 3-5 (TDD)

Parameter	Unit	Value					
		1.4	3	5	10	15	20
Channel bandwidth	MHz	1.4	3	5	10	15	20
Allocated resource blocks		6	15	25	50	75	100
Subcarriers per resource block		12	12	12	12	12	12
Uplink-Downlink Configuration (Note 6)		1	1	1	1	1	1
Allocated subframes per Radio Frame		4	4+2	4+2	4+2	4+2	4+2
Modulation		64QAM	64QAM	64QAM	64QAM	64QAM	64QAM
Target Coding Rate		3/4	3/4	3/4	3/4	3/4	3/4
Number of HARQ Processes	Processes	7	7	7	7	7	7
Maximum number of HARQ transmissions		1	1	1	1	1	1
Information Bit Payload per Sub-Frame							
For Sub-Frames 4,9	Bits	2984	8504	14112	30576	46888	61664
For Sub-Frames 1,6	Bits	n/a	6968	11448	23688	35160	46888
For Sub-Frame 5	Bits	n/a	n/a	n/a	n/a	n/a	n/a
For Sub-Frame 0	Bits	n/a	6968	12576	30576	45352	61664
Transport block CRC	Bits	24	24	24	24	24	24
Number of Code Blocks per Sub-Frame (Note 4)							
For Sub-Frames 4,9		1	2	3	5	8	11
For Sub-Frames 1,6		n/a	2	3	5	7	9
For Sub-Frame 5		n/a	n/a	n/a	n/a	n/a	n/a
For Sub-Frame 0		n/a	2	3	5	8	11
Binary Channel Bits per Sub-Frame							
For Sub-Frames 4,9	Bits	4104	11340	18900	41400	62100	82800
For Sub-Frames 1,6		n/a	9828	16668	33768	50868	67968
For Sub-Frame 5	Bits	n/a	n/a	n/a	n/a	n/a	n/a
For Sub-Frame 0	Bits	n/a	9252	16812	39312	60012	80712
Max. Throughput averaged over 1 frame	kbps	596.8	3791.2	6369.6	13910	20945	27877
Note 1:	For normal subframes(0,4,5,9), 2 symbols allocated to PDCCH for 20 MHz, 15 MHz and 10 MHz channel BW; 3 symbols allocated to PDCCH for 5 MHz and 3 MHz; 4 symbols allocated to PDCCH for 1.4 MHz. For special subframe (1&6), only 2 OFDM symbols are allocated to PDCCH for all BWs.						
Note 2:	For 1.4MHz, no data shall be scheduled on special subframes(1&6) to avoid problems with insufficient PDCCH performance						
Note 3:	Reference signal, Synchronization signals and PBCH allocated as per TS 36.211 [8]						
Note 4:	If more than one Code Block is present, an additional CRC sequence of L = 24 Bits is attached to each Code Block (otherwise L = 0 Bit).						
Note 5:	As per Table 4.2-2 in TS 36.211 [8]						

Table A.3.2-4a: Fixed Reference Channel for Maximum input level for UE Category 1 (TDD)

Parameter	Unit	Value					
		1.4	3	5	10	15	20
Channel bandwidth	MHz	1.4	3	5	10	15	20
Allocated resource blocks		6	15	18	17	17	17
Subcarriers per resource block		12	12	12	12	12	12
Uplink-Downlink Configuration (Note 5)		1	1	1	1	1	1
Allocated subframes per Radio Frame		4	4+2	4+2	4+2	4+2	4+2
Modulation		64QAM	64QAM	64QAM	64QAM	64QAM	64QAM
Target Coding Rate		3/4	3/4	3/4	3/4	3/4	3/4
Number of HARQ Processes	Processes	7	7	7	7	7	7
Maximum number of HARQ transmissions		1	1	1	1	1	1
Information Bit Payload per Sub-Frame							
For Sub-Frames 4,9	Bits	2984	8504	10296	10296	10296	10296
For Sub-Frames 1,6	Bits	n/a	6968	8248	7480	7480	7480
For Sub-Frame 5	Bits	n/a	n/a	n/a	n/a	n/a	n/a
For Sub-Frame 0	Bits	n/a	6968	8248	10296	10296	10296
Transport block CRC	Bits	24	24	24	24	24	24
Number of Code Blocks per Sub-Frame (Note 4)							
For Sub-Frames 4,9		1	2	2	2	2	2
For Sub-Frames 1,6		n/a	2	2	2	2	2
For Sub-Frame 5		n/a	n/a	n/a	n/a	n/a	n/a
For Sub-Frame 0		n/a	2	2	2	2	2
Binary Channel Bits per Sub-Frame							
For Sub-Frames 4,9	Bits	4104	11340	13608	14076	14076	14076
For Sub-Frames 1,6		n/a	9828	11880	11628	11628	11628
For Sub-Frame 5	Bits	n/a	n/a	n/a	n/a	n/a	n/a
For Sub-Frame 0	Bits	n/a	9252	11520	14076	14076	14076
Max. Throughput averaged over 1 frame	kbps	596.8	3791.2	4533.6	4584.8	4584.8	4584.8
Note 1:	For normal subframes(0,4,5,9), 2 symbols allocated to PDCCH for 20 MHz, 15 MHz and 10 MHz channel BW; 3 symbols allocated to PDCCH for 5 MHz and 3 MHz; 4 symbols allocated to PDCCH for 1.4 MHz. For special subframe (1&6), only 2 OFDM symbols are allocated to PDCCH for all BWs.						
Note 2:	For 1.4MHz, no data shall be scheduled on special subframes(1&6) to avoid problems with insufficient PDCCH performance						
Note 3:	Reference signal, Synchronization signals and PBCH allocated as per TS 36.211 [8]						
Note 4:	If more than one Code Block is present, an additional CRC sequence of L = 24 Bits is attached to each Code Block (otherwise L = 0 Bit)						
Note 5:	As per Table 4.2-2 in TS 36.211 [8]						

Table A.3.2-4b: Fixed Reference Channel for Maximum input level for UE Category 2 (TDD)

Parameter	Unit	Value					
		1.4	3	5	10	15	20
Channel bandwidth	MHz	1.4	3	5	10	15	20
Allocated resource blocks		6	15	25	50	75	83
Subcarriers per resource block		12	12	12	12	12	12
Uplink-Downlink Configuration (Note 5)		1	1	1	1	1	1
Allocated subframes per Radio Frame		4	4+2	4+2	4+2	4+2	4+2
Modulation		64QAM	64QAM	64QAM	64QAM	64QAM	64QAM
Target Coding Rate		3/4	3/4	3/4	3/4	3/4	3/4
Number of HARQ Processes	Processes	7	7	7	7	7	7
Maximum number of HARQ transmissions		1	1	1	1	1	1
Information Bit Payload per Sub-Frame							
For Sub-Frames 4,9	Bits	2984	8504	14112	30576	46888	51024
For Sub-Frames 1,6	Bits	n/a	6968	11448	23688	35160	39232
For Sub-Frame 5	Bits	n/a	n/a	n/a	n/a	n/a	n/a
For Sub-Frame 0	Bits	n/a	6968	12576	30576	45352	51024
Transport block CRC	Bits	24	24	24	24	24	24
Number of Code Blocks per Sub-Frame (Note 4)							
For Sub-Frames 4,9		1	2	3	5	8	9
For Sub-Frames 1,6		n/a	2	3	5	7	7
For Sub-Frame 5		n/a	n/a	n/a	n/a	n/a	n/a
For Sub-Frame 0		n/a	2	3	5	8	9
Binary Channel Bits per Sub-Frame							
For Sub-Frames 4,9	Bits	4104	11340	18900	41400	62100	68724
For Sub-Frames 1,6		n/a	9828	16668	33768	50868	56340
For Sub-Frame 5	Bits	n/a	n/a	n/a	n/a	n/a	n/a
For Sub-Frame 0	Bits	n/a	9252	16380	39312	60012	66636
Max. Throughput averaged over 1 frame	kbps	596.8	3791.2	6369.6	13910	20945	23154
Note 1:	For normal subframes(0,4,5,9), 2 symbols allocated to PDCCH for 20 MHz, 15 MHz and 10 MHz channel BW; 3 symbols allocated to PDCCH for 5 MHz and 3 MHz; 4 symbols allocated to PDCCH for 1.4 MHz. For special subframe (1&6), only 2 OFDM symbols are allocated to PDCCH for all BWs.						
Note 2:	For 1.4MHz, no data shall be scheduled on special subframes(1&6) to avoid problems with insufficient PDCCH performance						
Note 3:	Reference signal, Synchronization signals and PBCH allocated as per TS 36.211 [8]						
Note 4:	If more than one Code Block is present, an additional CRC sequence of L = 24 Bits is attached to each Code Block (otherwise L = 0 Bit)						
Note 5:	As per Table 4.2-2 in TS 36.211 [8]						

A.3.2A Downlink Reference measurement channel for TX characteristics

Tables A.3.2A-1 and A.3.2A-2 describes the reference measurement channels to be used on the downlink during Transmitter Characteristics (clause 6) for FDD and TDD respectively. The number of allocated resource blocks have been defined (partial allocation) to allow the transmission of PBCH, PSS/SSS and system information mapped on PDSCH.

Table A.3.2A-1: Fixed DL PDSCH Dedicated Reference Channel for TX Requirements (FDD)

Parameter	Unit	Value					
		1.4	3	5	10	15	20
Channel bandwidth	MHz	1.4	3	5	10	15	20
Allocated resource blocks		3	4	8	16	25	30
Subcarriers per resource block		12	12	12	12	12	12
Allocated subframes per Radio Frame		10	10	10	10	10	10
Modulation		QPSK	QPSK	QPSK	QPSK	QPSK	QPSK
Target Coding Rate		(Note 4)	1/3	1/3	1/3	1/3	1/3
Number of HARQ Processes	Processes	8	8	8	8	8	8
Maximum number of HARQ transmissions		1	1	1	1	1	1
Information Bit Payload							
For Sub-Frames 0, 1, 2, 3, 4, 5, 6, 7, 8, 9	Bits	88	328	680	1384	2216	2664
Transport block CRC	Bits	24	24	24	24	24	24
Number of Code Blocks per Sub-Frame		1	1	1	1	1	1
Code block CRC size	Bits	0	0	0	0	0	0
Binary Channel Bits Per Sub-Frame							
For Sub-Frames 1, 2, 3, 4, 6, 7, 8, 9	Bits	684	1008	2016	4416	6900	8280
For Sub-Frames 5		540	1008	2016	4416	6900	8280
For Sub-Frames 0		264	1008	2016	4416	6900	8280
Max. Throughput averaged over 1 frame	kbps	88	328	680	1384	2216	2664
UE-Category		1-5	1-5	1-5	1-5	1-5	1-5
Note 1:	2 symbols allocated to PDCCH for 20 MHz, 15 MHz and 10MHz channel BW. 3 symbols allocated to PDCCH for 5 MHz and 3 MHz. 4 symbols allocated to PDCCH for 1.4 MHz						
Note 2:	Reference signal, Synchronization signals and PBCH allocated as per TS 36.211 [8]						
Note 3:	The PDSCH shall be assigned to the UE under test with a set of allocated localized virtual resource blocks starting from one end of the channel.						
Note 4:	To ensure constant transport block size in 1.4MHz, the code rate for subframes varies approx. within {1/8-1/3}						

Table A.3.2A-2: Fixed DL PDSCH Dedicated Reference Channel for TX Requirements (TDD)

Parameter	Unit	Value					
		1.4	3	5	10	15	20
Channel Bandwidth	MHz	1.4	3	5	10	15	20
Allocated resource blocks		3	4	8	16	25	30
Uplink-Downlink Configuration (Note 6)		1	1	1	1	1	1
Allocated subframes per Radio Frame (D+S)		4	4	4	4	4	4
Number of HARQ Processes	Processes	7	7	7	7	7	7
Maximum number of HARQ transmission		1	1	1	1	1	1
Modulation		QPSK	QPSK	QPSK	QPSK	QPSK	QPSK
Target coding rate		(Note 5)	1/3	1/3	1/3	1/3	1/3
Information Bit Payload per Sub-Frame	Bits						
For Sub-Frame 1, 6		n/a	n/a	n/a	n/a	n/a	n/a
For Sub-Frame 0, 4, 5, 9		88	328	680	1384	2216	2664
Transport block CRC	Bits	24	24	24	24	24	24
Number of Code Blocks		1	1	1	1	1	1
Code block CRC size		0	0	0	0	0	0
Binary Channel Bits Per Sub-Frame	Bits						
For Sub-Frame 1, 6		n/a	n/a	n/a	n/a	n/a	n/a
For Sub-Frame 4, 9		684	1008	2016	4416	6900	8280
For Sub-Frame 0		336	1008	2016	4416	6900	8280
For Sub-Frame 5		612	1008	2016	4416	6900	8280
Max. Throughput averaged over one frame	kbps	35.2	131.2	272	553.6	886.4	1065.6
UE-Category		1-5	1-5	1-5	1-5	1-5	1-5
Note 1:	For normal subframes (0,4,5,9), 2 symbols allocated to PDCCH for 20 MHz, 15 MHz and 10 MHz channel BW; 3 symbols allocated to PDCCH for 5 MHz and 3 MHz; 4 symbols allocated to PDCCH for 1.4 MHz. For special subframe (1&6), only 2 OFDM symbols are allocated to PDCCH for all BWs.						
Note 2:	For simplicity, no data shall be scheduled on special subframes (1&6).						
Note 3:	Reference signal, Synchronization signals and PBCH allocated as per TS 36.211 [8]						
Note 4:	The PDSCH shall be assigned to the UE under test with a set of allocated localized virtual resource blocks starting from one end of the channel.						
Note 5:	To ensure constant transport block size in 1.4MHz, the code rate for subframes varies approx. within {1/8-1/3}.						
Note 6:	As per Table 4.2-2 in TS 36.211 [8]						

A.3.3 Reference measurement channel for PDSCH performance requirements (FDD)

A.3.3.1 Single-antenna transmission (Common Reference Symbols)

Table A.3.3.1-1: Fixed Reference Channel QPSK R=1/3

Parameter	Unit	Value					
		R.4 FDD			R.2 FDD		
Reference channel							
Channel bandwidth	MHz	1.4	3	5	10	15	20
Allocated resource blocks		6			50		
Allocated subframes per Radio Frame		10			10		
Modulation		QPSK			QPSK		
Target Coding Rate		1/3			1/3		
Information Bit Payload							
For Sub-Frames 1,2,3,4,6,7,8,9	Bits	408			4392		
For Sub-Frame 5	Bits	n/a			n/a		
For Sub-Frame 0	Bits	152			4392		
Number of Code Blocks per Sub-Frame (see Note 3)		1			1		
Binary Channel Bits Per Sub-Frame							
For Sub-Frames 1,2,3,4,6,7,8,9	Bits	1368			13800		
For Sub-Frame 5	Bits	n/a			n/a		
For Sub-Frame 0	Bits	528			12960		
Max. Throughput averaged over 1 frame	Mbps	0.342			3.953		
UE Category		1-5			1-5		
Note 1: 2 symbols allocated to PDCCH for 20 MHz, 15 MHz and 10 MHz channel BW; 3 symbols allocated to PDCCH for 5 MHz and 3 MHz; 4 symbols allocated to PDCCH for 1.4 MHz Note 2: Reference signal, synchronization signals and PBCH allocated as per TS 36.211 [8] Note 3: If more than one Code Block is present, an additional CRC sequence of L = 24 Bits is attached to each Code Block (otherwise L = 0 Bit)							

Table A.3.3.1-2: Fixed Reference Channel 16QAM R=1/2

Parameter	Unit	Value					
					R.3 FDD		
Reference channel							
Channel bandwidth	MHz	1.4	3	5	10	15	20
Allocated resource blocks					50		
Allocated subframes per Radio Frame					10		
Modulation					16QAM		
Target Coding Rate					1/2		
Information Bit Payload							
For Sub-Frames 1,2,3,4,6,7,8,9	Bits				14112		
For Sub-Frame 5	Bits				n/a		
For Sub-Frame 0	Bits				12960		
Number of Code Blocks per Sub-Frame (see Note 3)							
For Sub-Frames 1,2,3,4,6,7,8,9					3		
For Sub-Frame 5					n/a		
For Sub-Frame 0					3		
Binary Channel Bits Per Sub-Frame							
For Sub-Frames 1,2,3,4,6,7,8,9	Bits				27600		
For Sub-Frame 5	Bits				n/a		
For Sub-Frame 0	Bits				25920		
Max. Throughput averaged over 1 frame	Mbps				12.586		
UE Category							2-5
Note 1: 2 symbols allocated to PDCCH for 20 MHz, 15 MHz and 10 MHz channel BW; 3 symbols allocated to PDCCH for 5 MHz and 3 MHz; 4 symbols allocated to PDCCH for 1.4 MHz							
Note 2: Reference signal, synchronization signals and PBCH allocated as per TS 36.211 [8]							
Note 3: If more than one Code Block is present, an additional CRC sequence of L = 24 Bits is attached to each Code Block (otherwise L = 0 Bit)							

Table A.3.3.1-3: Fixed Reference Channel 64QAM R=3/4

Parameter	Unit	Value					
			R.5 FDD	R.6 FDD	R.7 FDD	R.8 FDD	R.9 FDD
Reference channel							
Channel bandwidth	MHz	1.4	3	5	10	15	20
Allocated resource blocks			15	25	50	75	100
Allocated subframes per Radio Frame			10	10	10	10	10
Modulation		64QAM	64QAM	64QAM	64QAM	64QAM	64QAM
Target Coding Rate		3/4	3/4	3/4	3/4	3/4	3/4
Information Bit Payload							
For Sub-Frames 1,2,3,4,6,7,8,9	Bits		8504	14112	30576	46888	61664
For Sub-Frame 5	Bits		n/a	n/a	n/a	n/a	n/a
For Sub-Frame 0	Bits		6456	12576	28336	45352	61664
Number of Code Blocks per Sub-Frame (see Note 3)			2	3	5	8	11
Binary Channel Bits Per Sub-Frame							
For Sub-Frames 1,2,3,4,6,7,8,9	Bits		11340	18900	41400	62100	82800
For Sub-Frame 5	Bits		n/a	n/a	n/a	n/a	n/a
For Sub-Frame 0	Bits		8820	16380	38880	59580	80280
Max. Throughput averaged over 1 frame	Mbps		7.449	12.547	27.294	42.046	55.498
UE Category			1-5	2-5	2-5	2-5	3-5
Note 1: 2 symbols allocated to PDCCH for 20 MHz, 15 MHz and 10 MHz channel BW; 3 symbols allocated to PDCCH for 5 MHz and 3 MHz; 4 symbols allocated to PDCCH for 1.4 MHz							
Note 2: Reference signal, synchronization signals and PBCH allocated as per TS 36.211 [8]							
Note 3: If more than one Code Block is present, an additional CRC sequence of L = 24 Bits is attached to each Code Block (otherwise L = 0 Bit)							

Table A.3.3.1-4: Fixed Reference Channel Single PRB (Channel Edge)

Parameter	Unit	Value					
			R.0 FDD		R.1 FDD		
Reference channel							
Channel bandwidth	MHz	1.4	3	5	10/20	15	20
Allocated resource blocks			1		1		
Allocated subframes per Radio Frame			10		10		
Modulation			16QAM		16QAM		
Target Coding Rate			1/2		1/2		
Information Bit Payload							
For Sub-Frames 1,2,3,4,6,7,8,9	Bits		224		256		
For Sub-Frame 5	Bits		n/a		n/a		
For Sub-Frame 0	Bits		224		256		
Number of Code Blocks per Sub-Frame (see Note 3)			1		1		
Binary Channel Bits Per Sub-Frame							
For Sub-Frames 1,2,3,4,6,7,8,9	Bits		504		552		
For Sub-Frame 5	Bits		n/a		n/a		
For Sub-Frame 0	Bits		504		552		
Max. Throughput averaged over 1 frame	Mbps		0.202		0.230		
UE Category			1-5		1-5		
Note 1:	2 symbols allocated to PDCCH for 20 MHz, 15 MHz and 10 MHz channel BW; 3 symbols allocated to PDCCH for 5 MHz and 3 MHz; 4 symbols allocated to PDCCH for 1.4 MHz						
Note 2:	Reference signal, synchronization signals and PBCH allocated as per TS 36.211 [8]						
Note 3:	If more than one Code Block is present, an additional CRC sequence of L = 24 Bits is attached to each Code Block (otherwise L = 0 Bit)						

Table A.3.3.1-5: Fixed Reference Channel Single PRB (MBSFN Configuration)

Parameter	Unit	Value
Reference channel		R.29 FDD (MBSFN)
Channel bandwidth	MHz	10
Allocated resource blocks		1
MBSFN Configuration		TBD
Allocated subframes per Radio Frame		4
Modulation		16QAM
Target Coding Rate		1/2
Information Bit Payload		
For Sub-Frames 4,9	Bits	256
For Sub-Frame 5	Bits	n/a
For Sub-Frame 0	Bits	256
For Sub-Frame 1,2,3,6,7,8	Bits	0 (MBSFN)
Number of Code Blocks per Sub-Frame (see Note 3)		1
For Sub-Frames 4,9		1
For Sub-Frame 5		n/a
For Sub-Frame 0		1
For Sub-Frame 1,2,3,6,7,8		0 (MBSFN)
Binary Channel Bits Per Sub-Frame		
For Sub-Frames 4,9	Bits	552
For Sub-Frame 5	Bits	n/a
For Sub-Frame 0	Bits	552
For Sub-Frame 1,2,3,6,7,8	Bits	0 (MBSFN)
Max. Throughput averaged over 1 frame	kbps	76.8
UE Category		1-5
Note 1:	2 symbols allocated to PDCCH	
Note 2:	Reference signal, synchronization signals and PBCH allocated as per TS 36.211 [8]	
Note 3:	If more than one Code Block is present, an additional CRC sequence of L = 24 Bits is attached to each Code Block (otherwise L = 0 Bit)	

A.3.3.2 Multi-antenna transmission (Common Reference Symbols)

A.3.3.2.1 Two antenna ports

Table A.3.3.2.1-1: Fixed Reference Channel two antenna ports

Parameter	Unit	Value				
		R.10 FDD	R.11 FDD	R.11-2 FDD	R.11-3 FDD	R.30 FDD
Reference channel						
Channel bandwidth	MHz	10	10	5	10	20
Allocated resource blocks		50	50	25	40	100
Allocated subframes per Radio Frame		10	10	10	10	10
Modulation		QPSK	16QAM	16QAM	16QAM	16QAM
Target Coding Rate		1/3	1/2	1/2	1/2	1/2
Information Bit Payload						
For Sub-Frames 1,2,3,4,6,7,8,9	Bits	4392	12960	5736	10296	25456
For Sub-Frame 5	Bits	n/a	n/a	n/a	n/a	n/a
For Sub-Frame 0	Bits	4392	12960	4968	10296	25456
Number of Code Blocks per Sub-Frame (Note 3)						
For Sub-Frames 1,2,3,4,6,7,8,9	Bits	1	3	1	2	5
For Sub-Frame 5	Bits	n/a	n/a	n/a	n/a	n/a
For Sub-Frame 0	Bits	1	3	1	2	5
Binary Channel Bits Per Sub-Frame						
For Sub-Frames 1,2,3,4,6,7,8,9	Bits	13200	26400	12000	21120	52800
For Sub-Frame 5	Bits	n/a	n/a	n/a	n/a	n/a
For Sub-Frame 0	Bits	12384	24768	10368	19488	51168
Max. Throughput averaged over 1 frame	Mbps	3.953	11.664	5.086	9.266	22.910
UE Category		1-5	2-5	1-5	1-5	2-5
Note 1:	2 symbols allocated to PDCCH for 20 MHz, 15 MHz and 10 MHz channel BW; 3 symbols allocated to PDCCH for 5 MHz and 3 MHz; 4 symbols allocated to PDCCH for 1.4 MHz					
Note 2:	Reference signal, synchronization signals and PBCH allocated as per TS 36.211 8					
Note 3:	If more than one Code Block is present, an additional CRC sequence of L = 24 Bits is attached to each Code Block (otherwise L = 0 Bit)					

A.3.3.2.2 Four antenna ports

Table A.3.3.2.2-1: Fixed Reference Channel four antenna ports

Parameter	Unit	Value		
		R.12 FDD	R.13 FDD	R.14 FDD
Reference channel				
Channel bandwidth	MHz	1.4	10	10
Allocated resource blocks		6	50	50
Allocated subframes per Radio Frame		10	10	10
Modulation		QPSK	QPSK	16QAM
Target Coding Rate		1/3	1/3	1/2
Information Bit Payload				
For Sub-Frames 1,2,3,4,6,7,8,9	Bits	408	4392	12960
For Sub-Frame 5	Bits	n/a	n/a	n/a
For Sub-Frame 0	Bits	152	3624	11448
Number of Code Blocks per Sub-Frame (see Note 3)				
For Sub-Frames 1,2,3,4,6,7,8,9		1	1	3
For Sub-Frame 5		n/a	n/a	n/a
For Sub-Frame 0		1	1	2
Binary Channel Bits Per Sub-Frame				
For Sub-Frames 1,2,3,4,6,7,8,9	Bits	1248	12800	25600
For Sub-Frame 5	Bits	n/a	n/a	n/a
For Sub-Frame 0	Bits	480	12032	24064
Max. Throughput averaged over 1 frame	Mbps	0.342	3.876	11.513
UE Category		1-5	1-5	2-5
Note 1:	2 symbols allocated to PDCCH for 20 MHz, 15 MHz and 10 MHz channel BW; 3 symbols allocated to PDCCH for 5 MHz and 3 MHz; 4 symbols allocated to PDCCH for 1.4 MHz			
Note 2:	Reference signal, synchronization signals and PBCH allocated as per TS 36.211 8			
Note 3:	If more than one Code Block is present, an additional CRC sequence of L = 24 Bits is attached to each Code Block (otherwise L = 0 Bit)			

A.3.4 Reference measurement channel for PDSCH performance requirements (TDD)

A.3.4.1 Single-antenna transmission (Common Reference Symbols)

Table A.3.4.1-1: Fixed Reference Channel QPSK R=1/3

Parameter	Unit	Value					
		R.4 TDD			R.2 TDD		
Reference channel							
Channel bandwidth	MHz	1.4	3	5	10	15	20
Allocated resource blocks		6			50		
Uplink-Downlink Configuration (Note 4)		1			1		
Allocated subframes per Radio Frame (D+S)		4+2			4+2		
Modulation		QPSK			QPSK		
Target Coding Rate		1/3			1/3		
Information Bit Payload							
For Sub-Frames 4,9	Bits	408			4392		
For Sub-Frames 1,6	Bits	n/a			3240		
For Sub-Frame 5	Bits	n/a			n/a		
For Sub-Frame 0	Bits	208			4392		
Number of Code Blocks per Sub-Frame (Note 5)							
For Sub-Frames 4,9		1			1		
For Sub-Frames 1,6		n/a			1		
For Sub-Frame 5		n/a			n/a		
For Sub-Frame 0		1			1		
Binary Channel Bits Per Sub-Frame							
For Sub-Frames 4,9	Bits	1368			13800		
For Sub-Frames 1,6	Bits	n/a			11256		
For Sub-Frame 5	Bits	n/a			n/a		
For Sub-Frame 0	Bits	672			13104		
Max. Throughput averaged over 1 frame	Mbps	0.102			1.966		
UE Category		1-5			1-5		
Note 1:	2 symbols allocated to PDCCH for 20 MHz, 15 MHz and 10 MHz channel BW; 3 symbols allocated to PDCCH for 5 MHz and 3 MHz; 4 symbols allocated to PDCCH for 1.4 MHz. For subframe 1&6, only 2 OFDM symbols are allocated to PDCCH.						
Note 2:	For BW=1.4 MHz, the information bit payloads of special subframes are set to zero (no scheduling) to avoid problems with insufficient PDCCH performance at the test point.						
Note 3:	Reference signal, synchronization signals and PBCH allocated as per TS 36.211 8						
Note 4:	As per Table 4.2-2 in TS 36.211 [8]						
Note 5:	If more than one Code Block is present, an additional CRC sequence of L = 24 Bits is attached to each Code Block (otherwise L = 0 Bit)						

Table A.3.4.1-2: Fixed Reference Channel 16QAM R=1/2

Parameter	Unit	Value					
Reference channel					R.3 TDD		
Channel bandwidth	MHz	1.4	3	5	10	15	20
Allocated resource blocks					50		
Uplink-Downlink Configuration (Note 3)					1		
Allocated subframes per Radio Frame (D+S)					4+2		
Modulation					16QAM		
Target Coding Rate					1/2		
Information Bit Payload							
For Sub-Frames 4,9	Bits				14112		
For Sub-Frames 1,6	Bits				11448		
For Sub-Frame 5	Bits				n/a		
For Sub-Frame 0	Bits				12960		
Number of Code Blocks per Sub-Frame (see Note 4)							
For Sub-Frames 4,9					3		
For Sub-Frames 1,6					2		
For Sub-Frame 5					n/a		
For Sub-Frame 0					3		
Binary Channel Bits Per Sub-Frame							
For Sub-Frames 4,9	Bits				27600		
For Sub-Frames 1,6	Bits				22512		
For Sub-Frame 5	Bits				n/a		
For Sub-Frame 0	Bits				26208		
Max. Throughput averaged over 1 frame	Mbps				6.408		
UE Category					2-5		
Note 1:	2 symbols allocated to PDCCH for 20 MHz, 15 MHz and 10 MHz channel BW; 3 symbols allocated to PDCCH for 5 MHz and 3 MHz; 4 symbols allocated to PDCCH for 1.4 MHz. For subframe 1&6, only 2 OFDM symbols are allocated to PDCCH.						
Note 2:	Reference signal, synchronization signals and PBCH allocated as per TS 36.211 [8]						
Note 3:	As per Table 4.2-2 in TS 36.211 [8]						
Note 4:	If more than one Code Block is present, an additional CRC sequence of L = 24 Bits is attached to each Code Block (otherwise L = 0 Bit)						

Table A.3.4.1-3: Fixed Reference Channel 64QAM R=3/4

Parameter	Unit	Value					
			R.5 TDD	R.6 TDD	R.7 TDD	R.8 TDD	R.9 TDD
Reference channel							
Channel bandwidth	MHz	1.4	3	5	10	15	20
Allocated resource blocks			15	25	50	75	100
Uplink-Downlink Configuration (Note 3)			1	1	1	1	1
Allocated subframes per Radio Frame (D+S)			4+2	4+2	4+2	4+2	4+2
Modulation		64QAM	64QAM	64QAM	64QAM	64QAM	64QAM
Target Coding Rate			3/4	3/4	3/4	3/4	3/4
Information Bit Payload							
For Sub-Frames 4,9	Bits		8504	14112	30576	46888	61664
For Sub-Frames 1,6	Bits		6968	11448	23688	35160	46888
For Sub-Frame 5	Bits		n/a	n/a	n/a	n/a	n/a
For Sub-Frame 0	Bits		6968	12576	30576	45352	61664
Number of Code Blocks per Sub-Frame (see Note 4)							
For Sub-Frames 4,9			2	3	5	8	11
For Sub-Frames 1,6			2	2	4	6	8
For Sub-Frame 5			n/a	n/a	n/a	n/a	n/a
For Sub-Frame 0			2	3	5	8	11
Binary Channel Bits Per Sub-Frame							
For Sub-Frames 4,9	Bits		11340	18900	41400	62100	82800
For Sub-Frames 1,6	Bits		9828	16668	33768	50868	67968
For Sub-Frame 5	Bits		n/a	n/a	n/a	n/a	n/a
For Sub-Frame 0	Bits		9252	16812	39312	60012	80712
Max. Throughput averaged over 1 frame	Mbps		3.791	6.370	13.910	20.945	27.877
UE Category			1-5	2-5	2-5	2-5	3-5
Note 1:	2 symbols allocated to PDCCH for 20 MHz, 15 MHz and 10 MHz channel BW; 3 symbols allocated to PDCCH for 5 MHz and 3 MHz; 4 symbols allocated to PDCCH for 1.4 MHz. For subframe 1&6, only 2 OFDM symbols are allocated to PDCCH.						
Note 2:	Reference signal, synchronization signals and PBCH allocated as per TS 36.211 [8]						
Note 3:	As per Table 4.2-2 TS 36.211 [8]						
Note 4:	If more than one Code Block is present, an additional CRC sequence of L = 24 Bits is attached to each Code Block (otherwise L = 0 Bit)						

Table A.3.4.1-4: Fixed Reference Channel Single PRB

Parameter	Unit	Value					
			R.0 TDD		R.1 TDD		
Reference channel							
Channel bandwidth	MHz	1.4	3	5	10/20	15	20
Allocated resource blocks			1		1		
Uplink-Downlink Configuration (Note 3)			1		1		
Allocated subframes per Radio Frame (D+S)			4+2		4+2		
Modulation			16QAM		16QAM		
Target Coding Rate			1/2		1/2		
Information Bit Payload							
For Sub-Frames 4,9	Bits		224		256		
For Sub-Frames 1,6	Bits		208		208		
For Sub-Frame 5	Bits		n/a		n/a		
For Sub-Frame 0	Bits		224		256		
Number of Code Blocks per Sub-Frame (Note 4)							
For Sub-Frames 4,9			1		1		
For Sub-Frames 1,6			1		1		
For Sub-Frame 5			n/a		n/a		
For Sub-Frame 0			1		1		
Binary Channel Bits Per Sub-Frame							
For Sub-Frames 4,9	Bits		504		552		
For Sub-Frames 1,6	Bits		456		456		
For Sub-Frame 5	Bits		n/a		n/a		
For Sub-Frame 0	Bits		504		552		
Max. Throughput averaged over 1 frame	Mbps		0.109		0.118		
UE Category			1-5		1-5		
Note 1:	2 symbols allocated to PDCCH for 20 MHz, 15 MHz and 10 MHz channel BW; 3 symbols allocated to PDCCH for 5 MHz and 3 MHz; 4 symbols allocated to PDCCH for 1.4 MHz. For subframe 1&6, only 2 OFDM symbols are allocated to PDCCH.						
Note 2:	Reference signal, synchronization signals and PBCH allocated as per TS 36.211 [8]						
Note 3:	As per Table 4.2-2 in TS 36.211 [8]						
Note 4:	If more than one Code Block is present, an additional CRC sequence of L = 24 Bits is attached to each Code Block (otherwise L = 0 Bit)						

Table A.3.4.1-5: Fixed Reference Channel Single PRB (MBSFN Configuration)

Parameter	Unit	Value
Reference channel		R.29 TDD (MBSFN)
Channel bandwidth	MHz	10
Allocated resource blocks		1
MBSFN Configuration		[TBD]
Uplink-Downlink Configuration (Note 3)		1
Allocated subframes per Radio Frame (D+S)		2+2
Modulation		16QAM
Target Coding Rate		1/2
Information Bit Payload		
For Sub-Frames 4,9	Bits	0 (MBSFN)
For Sub-Frames 1,6	Bits	208
For Sub-Frame 5	Bits	n/a
For Sub-Frame 0	Bits	256
Number of Code Blocks per Sub-Frame (Note 4)		
For Sub-Frames 4,9	Bits	0 (MBSFN)
For Sub-Frames 1,6	Bits	1
For Sub-Frame 5	Bits	n/a
Binary Channel Bits Per Sub-Frame		
For Sub-Frames 4,9	Bits	0 (MBSFN)
For Sub-Frames 1,6	Bits	456
For Sub-Frame 5	Bits	n/a
For Sub-Frame 0	Bits	552
Max. Throughput averaged over 1 frame	kbps	67.2
UE Category		1-5
Note 1:	2 symbols allocated to PDCCH	
Note 2:	Reference signal, synchronization signals and PBCH allocated as per TS 36.211 [8]	
Note 3:	as per Table 4.2-2 in TS 36.211 [8]	
Note 4:	If more than one Code Block is present, an additional CRC sequence of L = 24 Bits is attached to each Code Block (otherwise L = 0 Bit)	

A.3.4.2 Multi-antenna transmission (Common Reference Symbols)

A.3.4.2.1 Two antenna ports

Table A.3.4.2.1-1: Fixed Reference Channel two antenna ports

Parameter	Unit	Value					
		R.10 TDD	R.11 TDD	R.11-1 TDD	R.11-2 TDD	R.11-3 TDD	R.30 TDD
Reference channel							
Channel bandwidth	MHz	10	10	10	5	10	20
Allocated resource blocks		50	50	50	25	40	100
Uplink-Downlink Configuration (Note 3)		1	1	1	1	1	1
Allocated subframes per Radio Frame (D+S)		4+2	4+2	4+2	4+2	4+2	4+2
Modulation		QPSK	16QAM	16QAM	16QAM	16QAM	16QAM
Target Coding Rate		1/3	1/2	1/2	1/2	1/2	1/2
Information Bit Payload							
For Sub-Frames 4,9	Bits	4392	12960	12960	5736	10296	25456
For Sub-Frames 1,6		3240	9528	9528	5160	9144	22920
For Sub-Frame 5	Bits	n/a	n/a	n/a	n/a		n/a
For Sub-Frame 0	Bits	4392	12960	n/a	4968	10296	25456
Number of Code Blocks per Sub-Frame (Note 4)							
For Sub-Frames 4,9		1	3	3	1	2	5
For Sub-Frames 1,6		1	2	2	1	2	4
For Sub-Frame 5		n/a	n/a	n/a	n/a	n/a	n/a
For Sub-Frame 0		1	3	n/a	1	2	5
Binary Channel Bits Per Sub-Frame							
For Sub-Frames 4,9	Bits	13200	26400	26400	12000	21120	52800
For Sub-Frames 1,6		10656	21312	21312	10512	16992	42912
For Sub-Frame 5	Bits	n/a	n/a	n/a	n/a	n/a	n/a
For Sub-Frame 0	Bits	12528	25056	n/a	10656	19776	51456
Max. Throughput averaged over 1 frame	Mbps	1.966	5.794	4.498	2.676	4.918	12.221
UE Category		1-5	2-5	2-5	1-5	1-5	2-5
Note 1:	2 symbols allocated to PDCCH for 20 MHz, 15 MHz and 10 MHz channel BW; 3 symbols allocated to PDCCH for 5 MHz and 3 MHz; 4 symbols allocated to PDCCH for 1.4 MHz. For subframe 1&6, only 2 OFDM symbols are allocated to PDCCH.						
Note 2:	Reference signal, synchronization signals and PBCH allocated as per TS 36.211 [8]						
Note 3:	As per Table 4.2-2 in TS 36.211 [8]						
Note 4:	If more than one Code Block is present, an additional CRC sequence of L = 24 Bits is attached to each Code Block (otherwise L = 0 Bit)						

A.3.4.2.2 Four antenna ports

Table A.3.4.2.2-1: Fixed Reference Channel four antenna ports

Parameter	Unit	Value		
		R.12 TDD	R.13 TDD	R.14 TDD
Reference channel				
Channel bandwidth	MHz	1.4	10	10
Allocated resource blocks		6	50	50
Uplink-Downlink Configuration (Note 4)		1	1	1
Allocated subframes per Radio Frame (D+S)		4+2	4+2	4+2
Modulation		QPSK	QPSK	16QAM
Target Coding Rate		1/3	1/3	1/2
Information Bit Payload				
For Sub-Frames 4,9	Bits	408	4392	12960
For Sub-Frames 1,6	Bits	n/a	3240	9528
For Sub-Frame 5	Bits	n/a	n/a	n/a
For Sub-Frame 0	Bits	208	4392	n/a
Number of Code Blocks per Sub-Frame (Note 5)				
For Sub-Frames 4,9		1	1	3
For Sub-Frames 1,6		n/a	1	2
For Sub-Frame 5		n/a	n/a	n/a
For Sub-Frame 0		1	1	n/a
Binary Channel Bits Per Sub-Frame				
For Sub-Frames 4,9	Bits	1248	12800	25600
For Sub-Frames 1,6		n/a	10256	20512
For Sub-Frame 5	Bits	n/a	n/a	n/a
For Sub-Frame 0	Bits	624	12176	n/a
Max. Throughput averaged over 1 frame	Mbps	0.102	1.966	4.498
UE Category		1-5	1-5	2-5
Note 1:	2 symbols allocated to PDCCH for 20 MHz, 15 MHz and 10 MHz channel BW; 3 symbols allocated to PDCCH for 5 MHz and 3 MHz; 4 symbols allocated to PDCCH for 1.4 MHz. For subframe 1&6, only 2 OFDM symbols are allocated to PDCCH.			
Note 2:	For BW=1.4 MHz, the information bit payloads of special subframes are set to zero (no scheduling) to avoid problems with insufficient PDCCH performance at the test point.			
Note 3:	Reference signal, synchronization signals and PBCH allocated as per TS 36.211 [8]			
Note 4:	As per Table 4.2-2 in TS 36.211 [8]			
Note 5:	If more than one Code Block is present, an additional CRC sequence of L = 24 Bits is attached to each Code Block (otherwise L = 0 Bit)			

A.3.4.3 Reference Measurement Channels for UE-Specific Reference Symbols

A.3.4.3.1 Single antenna port (Cell Specific)

The reference measurement channels in Table A.3.4.3.1-1 apply for verifying demodulation performance for UE-specific reference symbols with one cell-specific antenna port.

Table A.3.4.3.1-1: Fixed Reference Channel for DRS

Parameter	Unit	Value					
		R.25 TDD	R.26 TDD	R.26-1 TDD	R.27 TDD	R.27-1 TDD	R.28 TDD
Reference channel							
Channel bandwidth	MHz	10	10	5	10	10	10
Allocated resource blocks		50 ⁴	50 ⁴	25 ⁴	50 ⁴	18 ⁶	1
Uplink-Downlink Configuration (Note 3)		1	1	1	1	1	1
Allocated subframes per Radio Frame (D+S)		4+2	4+2	4+2	4+2	4+2	4+2
Modulation		QPSK	16QAM	16QAM	64QAM	64QAM	16QAM
Target Coding Rate		1/3	1/2	1/2	3/4	3/4	1/2
Information Bit Payload							
For Sub-Frames 4,9	Bits	4392	12960	5736	28336	10296	224
For Sub-Frames 1,6	Bits	3240	9528	4584	22920	8248	176
For Sub-Frame 5	Bits	n/a	n/a	n/a	n/a	n/a	n/a
For Sub-Frame 0	Bits	2984	9528	3880	22152	10296	224
Number of Code Blocks per Sub-Frame (see Note 5)							
For Sub-Frames 4,9		1	3	1	5	2	1
For Sub-Frames 1,6		1	2	1	4	2	1
For Sub-Frame 5		n/a	n/a	n/a	n/a	n/a	n/a
For Sub-Frame 0		1	2	1	4	2	1
Binary Channel Bits Per Sub-Frame							
For Sub-Frames 4,9	Bits	12600	25200	11400	37800	13608	504
For Sub-Frames 1,6	Bits	10356	20712	10212	31068	11340	420
For Sub-Frame 5	Bits	n/a	n/a	n/a	n/a	n/a	n/a
For Sub-Frame 0	Bits	10332	20664	7752	30996	13608	504
Max. Throughput averaged over 1 frame	Mbps	1.825	5.450	2.452	12.466	4.738	0.102
UE Category		1-5	2-5	1	2-5	1	1-5
Note 1:	2 symbols allocated to PDCCH for 20 MHz, 15 MHz and 10 MHz channel BW; 3 symbols allocated to PDCCH for 5 MHz and 3 MHz; 4 symbols allocated to PDCCH for 1.4 MHz. For subframe 1&6, only 2 OFDM symbols are allocated to PDCCH.						
Note 2:	Reference signal, synchronization signals and PBCH allocated as per TS 36.211 [8].						
Note 3:	as per Table 4.2-2 in TS 36.211 [8].						
Note 4:	For R.25, R.26 and R.27, 50 resource blocks are allocated in sub-frames 1–9 and 41 resource blocks (RB0–RB20 and RB30–RB49) are allocated in sub-frame 0. For R.26-1, 25 resource blocks are allocated in sub-frames 1–9 and 17 resource blocks (RB0–RB7 and RB16–RB24) are allocated in sub-frame 0.						
Note 5:	If more than one Code Block is present, an additional CRC sequence of L = 24 Bits is attached to each Code Block (otherwise L = 0 Bit).						
Note 6:	Localized allocation started from RB #0 is applied.						

A.3.4.3.2 Two antenna ports (Cell Specific)

The reference measurement channels in Table A.3.4.3.2-1 apply for verifying demodulation performance for CDM-multiplexed UE specific reference symbols with two cell-specific antenna ports.

Table A.3.4.3.2-1: Fixed Reference Channel for CDM-multiplexed DM RS

Parameter	Unit	Value					
		R.31 TDD	R.32 TDD	R.32-1 TDD	R.33 TDD	R.33-1 TDD	R.34 TDD
Reference channel							
Channel bandwidth	MHz	10	10	5	10	10	10
Allocated resource blocks		50 ^a	50 ^a	[25 ^a]	50 ^a	[18] ^b	50 ^a
Uplink-Downlink Configuration (Note 3)		1	1	1	1	1	1
Allocated subframes per Radio Frame (D+S)		4+2	4+2	4+2	4+2	4+2	4+2
Modulation		QPSK	16QAM	16QAM	64QAM	64QAM	64QAM
Target Coding Rate		1/3	1/2	1/2	3/4	3/4	1/2
Information Bit Payload							
For Sub-Frames 4,9	Bits	3624	11448	[5736]	27376	[9528]	18336
For Sub-Frames 1,6		2664	7736	[3112]	16992	[7480]	11832
For Sub-Frame 5	Bits	n/a	n/a	n/a	n/a	n/a	n/a
For Sub-Frame 0	Bits	2984	9528	[3496]	22152	[9528]	14688
Number of Code Blocks per Sub-Frame (Note 4)							
For Sub-Frames 4,9		1	2	1	5	2	3
For Sub-Frames 1,6		1	2	1	3	2	2
For Sub-Frame 5		n/a	n/a	n/a	n/a	n/a	n/a
For Sub-Frame 0		1	2	1	4	2	3
Binary Channel Bits Per Sub-Frame							
For Sub-Frames 4,9	Bits	12000	24000	[10800]	36000	[12960]	36000
For Sub-Frames 1,6		7872	15744	[6528]	23616	[10368]	23616
For Sub-Frame 5	Bits	n/a	n/a	n/a	n/a	n/a	n/a
For Sub-Frame 0	Bits	9840	19680	[7344]	29520	[12960]	29520
Max. Throughput averaged over 1 frame	Mbps	1.556	4.79	[2.119]	11.089	[4.354]	7.502
UE Category		1-5	2-5	1	2-5	1	2-5
Note 1:	2 symbols allocated to PDCCH for 20 MHz, 15 MHz and 10 MHz channel BW; 3 symbols allocated to PDCCH for 5 MHz and 3 MHz; 4 symbols allocated to PDCCH for 1.4 MHz. For subframe 1&6, only 2 OFDM symbols are allocated to PDCCH.						
Note 2:	Reference signal, synchronization signals and PBCH allocated as per TS 36.211 [8].						
Note 3:	as per Table 4.2-2 in TS 36.211 [8].						
Note 4:	For R.31, R.32, R.33 and R.34, 50 resource blocks are allocated in sub-frames 4,9 and 41 resource blocks (RB0–RB20 and RB30–RB49) are allocated in sub-frame 0 and the DwPTS portion of sub-frames 1,6 . For R.32-1, 25 resource blocks are allocated in sub-frames 4, 9 and 17 resource blocks (RB0–RB7 and RB16–RB24) are allocated in sub-frame 0 and the DwPTS portion of sub-frames 1, 6.						
Note 5:	If more than one Code Block is present, an additional CRC sequence of L = 24 Bits is attached to each Code Block (otherwise L = 0 Bit).						
Note 6:	Localized allocation started from RB#0 is applied.						

A.3.5 Reference measurement channels for PDCCH/PCFICH performance requirements

A.3.5.1 FDD

Table A.3.5.1-1: Reference Channel FDD

Parameter	Unit	Value		
		R.15 FDD	R.16 FDD	R.17 FDD
Reference channel				
Number of transmitter antennas		1	2	4
Channel bandwidth	MHz	10	1.4	10
Number of OFDM symbols for PDCCH	symbols	2	2	2
Aggregation level	CCE	8	2	4
DCI Format		Format 1	Format 2	Format 2
Cell ID		0	0	0
Payload (without CRC)	Bits	31	31	46

Table A.3.5.1-2: Additional PDSCH Reference Channel FDD

Parameter	Unit	Value		
		1	2	4
Number of transmitter antennas		1	2	4
Channel bandwidth	MHz	10	1.4	10
Allocated Resource Blocks		50	6	50
Modulation		QPSK	QPSK	QPSK
Target Coding Rate		1/3	1/3	1/3
Information Bit Payload				
For Sub-Frames 1,2,3,4,6,7,8,9	Bits	4392	504	4392
For Sub-Frame 5		n/a	n/a	n/a
For Sub-Frame 0	Bits	4392	256	3624
Number of Code Blocks per Sub-Frame				
For Sub-Frames 1,2,3,4,6,7,8,9		1	1	1
For Sub-Frame 5		n/a	n/a	n/a
For Sub-Frame 0		1	1	1
Binary Channel Bits Per Sub-Frame				
For Sub-Frames 1,2,3,4,6,7,8,9	Bits	13800	1584	12800
For Sub-Frame 5	Bits	n/a	n/a	n/a
For Sub-Frame 0		12960	768	12032
Max. Throughput averaged over 1 frame	Mbps	3.953	0.429	3.876
UE Category		1-5	1-5	1-5
Note 1: 2 symbols allocated to PDCCH for all BW.				

A.3.5.2 TDD

Table A.3.5.2-1: Reference Channel TDD

Parameter	Unit	Value		
		R.15 TDD	R.16 TDD	R.17 TDD
Reference channel		R.15 TDD	R.16 TDD	R.17 TDD
Number of transmitter antennas		1	2	4
Channel bandwidth	MHz	10	1.4	10
Number of OFDM symbols for PDCCH	symbols	2	2	2
Aggregation level	CCE	8	2	4
DCI Format		Format 1	Format 2	Format 2
Cell ID		0	0	0
Payload (without CRC)	Bits	34	34	49

Table A.3.5.2-2: Additional PDSCH Reference Channel TDD

Parameter	Unit	Value		
		1	2	4
Number of transmitter antennas		1	2	4
Channel bandwidth	MHz	10	1.4	10
Uplink-Downlink Configuration (Note 2)		0	0	0
Allocated Resource Blocks		50	6	50
Modulation		QPSK	QPSK	QPSK
Target Coding Rate		1/3	1/3	1/3
Information Bit Payload				
For Sub-Frame 1,6	Bits	3240	328	3624
For Sub-Frame 5	Bits	n/a	n/a	n/a
For Sub-Frame 0	Bits	4392	256	4392
Number of Code Blocks per Sub-Frame				
For Sub-Frame 1,6		1	1	1
For Sub-Frame 5	Bits	n/a	n/a	n/a
For Sub-Frame 0		1	1	1
Binary Channel Bits Per Sub-Frame				
For Sub-Frame 1,6	Bits	11256	1152	10256
For Sub-Frame 5	Bits	n/a	n/a	n/a
For Sub-Frame 0	Bits	13104	936	12176
Max. Throughput averaged over 1 frame	Mbps	1.087	0.091	1.164
UE Category		1-5	1-5	1-5
Note 1: 2 symbols allocated to PDCCH for all BW.				
Note 2: As per Table 4.2-2 in TS 36.211 [8]				

A.3.6 Reference measurement channels for PHICH performance requirements

Table A.3.6-1: Reference Channel FDD/TDD

Parameter	Unit	Value			
		R.18	R.19	R.20	R.24
Reference channel		R.18	R.19	R.20	R.24
Number of transmitter antennas		1	2	4	1
Channel bandwidth	MHz	10	1.4	10	10
User roles (Note 1)		[W I1 I2]	[W I1 I2]	[W I1 I2]	[W I1]
Resource allocation (Note 2)		[(0,0) (0,1) (0,4)]	[(0,0) (0,1) (0,4)]	[(0,0) (0,1) (0,4)]	[(0,0) (0,1)]
Power offsets (Note 3)	dB	[-4 0 -3]	[-4 0 -3]	[-4 0 -3]	[+3 0]
Payload (Note 4)		[A R R]	[A R R]	[A R R]	[A R]
Note 1: W=wanted user, I1=interfering user 1, I2=interfering user 2.					
Note 2: The resource allocation per user is given as (N_group_PHICH, N_seq_PHICH).					
Note 3: The power offsets (per user) represent the difference of the power of BPSK modulated symbol per PHICH relative to the first interfering user.					
Note 4: A=fixed ACK, R=random ACK/NACK.					

A.3.7 [FFS]

A.3.8 Reference measurement channels for MBMS performance requirements

A.3.8.1 FDD

Table A.3.8.1-1: Fixed Reference Channel QPSK R=1/3

Parameter	PMCH						
	Unit	Value					
Reference channel		R.40 FDD			R.37 FDD		
Channel bandwidth	MHz	1.4	3	5	10	15	20
Allocated resource blocks		6			50		
Allocated subframes per Radio Frame (Note 1)		6			6		
Modulation		QPSK			QPSK		
Target Coding Rate		1/3			1/3		
Information Bit Payload (Note 2)							
For Sub-Frames 1,2,3,6,7,8	Bits	408			3624		
For Sub-Frames 0,4,5,9	Bits	n/a			n/a		
Number of Code Blocks per Subframe (Note 3)		1			1		
Binary Channel Bits Per Subframe							
For Sub-Frames 1,2,3,6,7,8	Bits	1224			10200		
For Sub-Frames 0,4,5,9	Bits	n/a			n/a		
MBMS UE Category		1-5			1-5		
Note 1: For FDD mode, up to 6 subframes (#1/2/3/6/7/8) are available for MBMS, in line with TS 36.331.							
Note 2: 2 OFDM symbols are reserved for PDCCH; and reference signal allocated as per TS 36.211.							
Note 3: If more than one Code Block is present, an additional CRC sequence of L = 24 Bits is attached to each Code Block (otherwise L = 0 Bit).							

Table A.3.8.1-2: Fixed Reference Channel 16QAM R=1/2

Parameter	PMCH						
	Unit	Value					
Reference channel					R.38 FDD		
Channel bandwidth	MHz	1.4	3	5	10	15	20
Allocated resource blocks					50		
Allocated subframes per Radio Frame (Note 1)					6		
Modulation					16QAM		
Target Coding Rate					1/2		
Information Bit Payload (Note 2)							
For Sub-Frames 1,2,3,6,7,8	Bits				9912		
For Sub-Frames 0,4,5,9	Bits				n/a		
Number of Code Blocks per Subframe (Note 3)					2		
Binary Channel Bits Per Subframe							
For Sub-Frames 1,2,3,6,7,8	Bits				20400		
For Sub-Frames 0,4,5,9	Bits				n/a		
MBMS UE Category					1-5		
Note 1: For FDD mode, up to 6 subframes (#1/2/3/6/7/8) are available for MBMS, in line with TS 36.331.							
Note 2: 2 OFDM symbols are reserved for PDCCH; and reference signal allocated as per TS 36.211.							
Note 3: If more than one Code Block is present, an additional CRC sequence of L = 24 Bits is attached to each Code Block (otherwise L = 0 Bit).							

Table A.3.8.1-3: Fixed Reference Channel 64QAM R=3/4

Parameter	PMCH
-----------	------

	Unit	Value					
Reference channel					R.39 FDD		
Channel bandwidth	MHz	1.4	3	5	10	15	20
Allocated resource blocks					50		
Allocated subframes per Radio Frame(Note1)					6		
Modulation					64QAM		
Target Coding Rate					3/4		
Information Bit Payload (Note 2)							
For Sub-Frames 1,2,3,6,7,8	Bits				[22920]		
For Sub-Frames 0,4,5,9	Bits				n/a		
Number of Code Blocks per Sub-Frame (Note 3)					4		
Binary Channel Bits Per Subframe							
For Sub-Frames 1,2,3,6,7,8	Bits				30600		
For Sub-Frames 0,4,5,9	Bits				n/a		
MBMS UE Category					2-5		
Note 1: For FDD mode, up to 6 subframes (#1/2/3/6/7/8) are available for MBMS, in line with TS 36.331.							
Note 2: 2 OFDM symbols are reserved for PDCCH; and reference signal allocated as per TS 36.211.							
Note 3: If more than one Code Block is present, an additional CRC sequence of L = 24 Bits is attached to each Code Block (otherwise L = 0 Bit).							

A.3.8.2 TDD

Table A.3.8.2-1: Fixed Reference Channel QPSK R=1/3

Parameter	PMCH						
	Unit	Value					
Reference channel		R.40 TDD			R.37 TDD		
Channel bandwidth	MHz	1.4	3	5	10	15	20
Allocated resource blocks		6			50		
Uplink-Downlink Configuration(Note 1)		5			5		
Allocated subframes per Radio Frame		5			5		
Modulation		QPSK			QPSK		
Target Coding Rate		1/3			1/3		
Information Bit Payload (Note 2)							
For Sub-Frames 3,4,7,8,9	Bits	408			3624		
For Sub-Frames 0,1,2,5,6	Bits	n/a			n/a		
Number of Code Blocks per Subframe (Note 3)		1			1		
Binary Channel Bits Per Subframe							
For Sub-Frames 3,4,7,8,9	Bits	1224			10200		
For Sub-Frames 0,1,2,5,6	Bits	n/a			n/a		
MBMS UE Category		1-5			1-5		
Note 1: For TDD mode, in line with TS 36.331, Uplink-Downlink Configuration 5 is proposed, up to 5 subframes (#3/4/7/8/9) are available for MBMS.							
Note 2: 2 OFDM symbols are reserved for PDCCH; reference signal allocated as per TS 36.211.							
Note 3: If more than one Code Block is present, an additional CRC sequence of L = 24 Bits is attached to each Code Block (otherwise L = 0 Bit).							

Table A.3.8.2-2: Fixed Reference Channel 16QAM R=1/2

Parameter	PMCH						
	Unit	Value					
Reference channel					R.38 TDD		
Channel bandwidth	MHz	1.4	3	5	10	15	20
Allocated resource blocks					50		
Uplink-Downlink Configuration(Note 1)					5		
Allocated subframes per Radio Frame					5		
Modulation					16QAM		
Target Coding Rate					1/2		
Information Bit Payload (Note 2)							
For Sub-Frames 3,4,7,8,9	Bits				9912		
For Sub-Frames 0,1,2,5,6	Bits				n/a		
Number of Code Blocks per Subframe (Note 3)					2		
Binary Channel Bits Per Subframe							
For Sub-Frames 3,4,7,8,9	Bits				20400		
For Sub-Frames 0,1,2,5,6	Bits				n/a		
MBMS UE Category					1-5		
<p>Note 1: For TDD mode, in line with TS 36.331, Uplink-Downlink Configuration 5 is proposed, up to 5 subframes (#3/4/7/8/9) are available for MBMS.</p> <p>Note 2: 2 OFDM symbols are reserved for PDCCH; reference signal allocated as per TS 36.211.</p> <p>Note 3: If more than one Code Block is present, an additional CRC sequence of L = 24 Bits is attached to each Code Block (otherwise L = 0 Bit).</p>							

Table A.3.8.2-3: Fixed Reference Channel 64QAM R=3/4

Parameter	PMCH						
	Unit	Value					
Reference channel					R.39 TDD		
Channel bandwidth	MHz	1.4	3	5	10	15	20
Allocated resource blocks					50		
Uplink-Downlink Configuration(Note 1)					5		
Allocated subframes per Radio Frame					5		
Modulation					64QAM		
Target Coding Rate					3/4		
Information Bit Payload (Note 2)							
For Sub-Frames 3,4,7,8,9	Bits				22920		
For Sub-Frames 0,1,2,5,6	Bits				n/a		
Number of Code Blocks per Sub-Frame (Note 3)					4		
Binary Channel Bits Per Subframe							
For Sub-Frames 3,4,7,8,9	Bits				30600		
For Sub-Frames 0,1,2,5,6	Bits				n/a		
MBMS UE Category					2-5		
<p>Note 1: For TDD mode, in line with TS 36.331, Uplink-Downlink Configuration 5 is proposed, up to 5 subframes (#3/4/7/8/9) are available for MBMS.</p> <p>Note 2: 2 OFDM symbols are reserved for PDCCH; reference signal allocated as per TS 36.211.</p> <p>Note 3: If more than one Code Block is present, an additional CRC sequence of L = 24 Bits is attached to each Code Block (otherwise L = 0 Bit).</p>							

A.3.9 Reference measurement channels for sustained downlink data rate provided by lower layers

A.3.9.1 FDD

Table A.3.9.1-1: Fixed Reference Channel for sustained data-rate test (FDD)

Parameter	Unit	Value				
		R.31-1 FDD	R.31-2 FDD	R.31-3 FDD	R.31-3A FDD	R.31-4 FDD
Reference channel						
Channel bandwidth	MHz	10	10	20	10	20
Allocated resource blocks		Note 5	Note 6	Note 7	Note 6	Note 7
Allocated subframes per Radio Frame		10	10	10	10	10
Modulation		64QAM	64QAM	64QAM	64QAM	64QAM
Coding Rate						
For Sub-Frame 1,2,3,4,6,7,8,9,		0.40	0.59	0.59	0.85	0.88
For Sub-Frame 5		0.40	0.64	0.62	0.89	0.87
For Sub-Frame 0		0.40	0.63	0.61	0.90	0.90
Information Bit Payload						
For Sub-Frames 1,2,3,4,6,7,8,9	Bits	10296	25456	51024	36696	75376
For Sub-Frame 5	Bits	10296	25456	51024	35160	71112
For Sub-Frame 0	Bits	10296	25456	51024	36696	75376
Number of Code Blocks per Sub-Frame (Note 3)						
For Sub-Frames 1,2,3,4,6,7,8,9	Bits	2	5	9	6	13
For Sub-Frame 5		2	5	9	6	12
For Sub-Frame 0	Bits	2	5	9	6	13
Binary Channel Bits Per Sub-Frame						
For Sub-Frames 1,2,3,4,6,7,8,9	Bits	26100	43200	86400	43200	86400
For Sub-Frame 5		26100	39744	82080	39744	82080
For Sub-Frame 0	Bits	26100	40752	83952	40752	83952
Number of layers		1	2	2	2	2
Max. Throughput averaged over 1 frame	Mbps	10.296	25.456	51.024	36.542	74.950
UE Category		1	2	3	3	4
Note 1:	1 symbol allocated to PDCCH for all tests					
Note 2:	Reference signal, synchronization signals and PBCH allocated as per TS 36.211 [4]					
Note 3:	If more than one Code Block is present, an additional CRC sequence of L = 24 Bits is attached to each Code Block (otherwise L = 0 Bit)					
Note 4:	Resource blocks $n_{PRB} = 0..2$ are allocated for SIB transmissions in sub-frame 5 for all bandwidths					
Note 5:	Resource blocks $n_{PRB} = 6..14,30..49$ are allocated for the user data in all sub-frames					
Note 6:	Resource blocks $n_{PRB} = 3..49$ are allocated for the user data in sub-frame 5, and resource blocks $n_{PRB} = 0..49$ in sub-frames 0,1,2,3,4,6,7,8,9					
Note 7:	Resource blocks $n_{PRB} = 4..99$ are allocated for the user data in sub-frame 5, and resource blocks $n_{PRB} = 0..99$ in sub-frames 0,1,2,3,4,6,7,8,9					

A.3.9.2 TDD

Table A.3.9.2-1: Fixed Reference Channel for sustained data-rate test (TDD)

Parameter	Unit	Value				
		R.31-1 TDD	R.31-2 TDD	R.31-3 TDD	R.31-3B TDD	R.31-4 TDD
Reference channel						
Channel bandwidth	MHz	10	10	20	15	20
Allocated resource blocks		Note 6	Note 7	Note 8	Note 9	Note 8
Uplink-Downlink Configuration (Note 3)		5	5	5	5	5
Allocated subframes per Radio Frame (D+S)		8+1	8+1	8+1	8+1	8+1
Modulation		64QAM	64QAM	64QAM	64QAM	64QAM
Coding Rate						
For Sub-Frames 3,4,7,8,9		0.40	0.59	0.59	0.87	0.88
For Sub-Frame 1		n/a	n/a	n/a	n/a	n/a
For Sub-Frame 5		0.40	0.64	0.62	0.88	0.87
For Sub-Frame 6		0.40	0.60	0.60	0.88	0.88
For Sub-Frame 0		0.40	0.62	0.61	0.90	0.90
Information Bit Payload						
For Sub-Frames 3,4,6,7,8,9	Bits	10296	25456	51024	[51024]	75376
For Sub-Frame 1	Bits	0	0	0	0	0
For Sub-Frame 5	Bits	10296	25456	51024	[51024]	71112
For Sub-Frame 0	Bits	10296	25456	51024	[51024]	75376
Number of Code Blocks per Sub-Frame (Note 4)						
For Sub-Frames 3,4,6,7,8,9		2	5	9	9	13
For Sub-Frame 1		n/a	n/a	n/a	n/a	n/a
For Sub-Frame 5		2	5	9	9	12
For Sub-Frame 0		2	5	9	9	13
Binary Channel Bits Per Sub-Frame						
For Sub-Frames 3,4,7,8,9	Bits	26100	43200	86400	[58752]	86400
For Sub-Frame 1	Bits	n/a	n/a	n/a	n/a	n/a
For Sub-Frame 5	Bits	26100	40176	82512	[58320]	82512
For Sub-Frame 6	Bits	26100	42768	85968	[58320]	85968
For Sub-Frame 0	Bits	26100	41184	84384	[56736]	84384
Number of layers		1	2	2	2	2
Max. Throughput averaged over 1 frame	Mbps	8.237	20.365	40.819	40.819	59.874
UE Category		1	2	3	3	4
Note 1: 1 symbol allocated to PDCCH for all tests Note 2: Reference signal, synchronization signals and PBCH allocated as per TS 36.211 [4] Note 3: As per Table 4.2-2 in TS 36.211 [4] Note 4: If more than one Code Block is present, an additional CRC sequence of L = 24 Bits is attached to each Code Block (otherwise L = 0 Bit) Note 5: Resource blocks $n_{PRB} = 0..2$ are allocated for SIB transmissions in sub-frame 5 for all bandwidths Note 6: Resource blocks $n_{PRB} = 6..14,30..49$ are allocated for the user data in all subframes Note 7: Resource blocks $n_{PRB} = 3..49$ are allocated for the user data in sub-frame 5, and resource blocks $n_{PRB} = 0..49$ in sub-frames 0,3,4,6,7,8,9 Note 8: Resource blocks $n_{PRB} = 4..99$ are allocated for the user data in sub-frame 5, and resource blocks $n_{PRB} = 0..99$ in sub-frames 0,3,4,6,7,8,9 Note 9: Resource blocks $n_{PRB} = 4..71$ are allocated for the user data in all sub-frames						

A.4 CQI reference measurement channels

This section defines the DL signal applicable to the reporting of channel quality information (Clause 9.2 and 9.3).

The reference channels in Table A.4-1, A.4-2, A.4-4 and A.4-5 comply with the CQI definition specified in Sec. 7.2.3 of TS 36.213 [10]. Table A.4-3 and A.4-6 specify the transport format corresponding to each CQI for single antenna transmission. Table A.4-3a specifies the transport format corresponding to each CQI for dual antenna transmission.

Table A.4-1: Reference channel for CQI requirements (FDD) full PRB allocation

Parameter	Unit	Value					
		1.4	3	5	10	15	20
Channel bandwidth	MHz	1.4	3	5	10	15	20
Allocated resource blocks		6	15	25	50	75	100
Subcarriers per resource block		12	12	12	12	12	12
Allocated subframes per Radio Frame		8	8	8	8	8	8
Modulation					Table A.4-3	Table A.4-3a	
Target coding rate					Table A.4-3	Table A.4-3a	
Number of HARQ Processes	Processes	8	8	8	8	8	8
Maximum number of HARQ transmissions		1	1	1	1	1	1
Note 1: 3 symbols allocated to PDCCH							
Note 2: Only subframes 1,2,3,4,6,7,8, and 9 are allocated to avoid PBCH and synchronization signal overhead							

Table A.4-2: Reference channel for CQI requirements (TDD) full PRB allocation

Parameter	Unit	Value					
		1.4	3	5	10	15	20
Channel bandwidth	MHz	1.4	3	5	10	15	20
Allocated resource blocks		6	15	25	50	75	100
Subcarriers per resource block		12	12	12	12	12	12
Allocated subframes per Radio Frame		4	4	4	4	4	4
Modulation					Table A.4-3	Table A.4-3a	
Target coding rate					Table A.4-3	Table A.4-3a	
Number of HARQ Processes	Processes	10	10	10	10	10	10
Maximum number of HARQ transmissions		1	1	1	1	1	1
Note 1: 3 symbols allocated to PDCCH							
Note 2: UL-DL configuration 2 is used and only subframes 3, 4, 8, and 9 are allocated to avoid PBCH and synchronization signal overhead							

Table A.4-3: Transport format corresponding to each CQI index for 50 PRB allocation single antenna transmission

CQI index	Modulation	Target code rate	Imcs	Information Bit Payload (Subframes 1,2,3,4,6,7,8,9)	Binary Channel Bits Per Sub-Frame (Subframes 1,2,3,4,6,7,8,9)	Actual Code rate
0	out of range	out of range	DTX	-	-	-
1	QPSK	0.0762	0	1384	12600	0.1117
2	QPSK	0.1172	0	1384	12600	0.1117
3	QPSK	0.1885	2	2216	12600	0.1778
4	QPSK	0.3008	4	3624	12600	0.2895
5	QPSK	0.4385	6	5160	12600	0.4114
6	QPSK	0.5879	8	6968	12600	0.5549
7	16QAM	0.3691	11	8760	25200	0.3486
8	16QAM	0.4785	13	11448	25200	0.4552
9	16QAM	0.6016	16	15264	25200	0.6067
10	64QAM	0.4551	18	16416	37800	0.4349
11	64QAM	0.5537	21	21384	37800	0.5663
12	64QAM	0.6504	23	25456	37800	0.6741
13	64QAM	0.7539	25	28336	37800	0.7503
14	64QAM	0.8525	27	31704	37800	0.8394
15	64QAM	0.9258	28	31704	37800	0.8394

Note1: Sub-frame#0 and #5 are not used for the corresponding requirement.

Table A.4-3a: Transport format corresponding to each CQI index for 50 PRB allocation dual antenna transmission

CQI index	Modulation	Target code rate	Imcs	Information Bit Payload (Subframes 1,2,3,4,6,7,8,9)	Binary Channel Bits Per Sub-Frame (Subframes 1,2,3,4,6,7,8,9)	Actual Code rate
0	out of range	out of range	DTX	-	-	-
1	QPSK	0.0762	0	1384	12000	0.1173
2	QPSK	0.1172	0	1384	12000	0.1173
3	QPSK	0.1885	2	2216	12000	0.1867
4	QPSK	0.3008	4	3624	12000	0.3040
5	QPSK	0.4385	6	5160	12000	0.4320
6	QPSK	0.5879	8	6968	12000	0.5827
7	16QAM	0.3691	11	8760	24000	0.3660
8	16QAM	0.4785	13	11448	24000	0.4780
9	16QAM	0.6016	15	14112	24000	0.5890
10	64QAM	0.4551	18	16416	36000	0.4567
11	64QAM	0.5537	20	19848	36000	0.5520
12	64QAM	0.6504	22	22920	36000	0.6373
13	64QAM	0.7539	24	27376	36000	0.7611
14	64QAM	0.8525	26	30576	36000	0.8500
15	64QAM	0.9258	27	31704	36000	0.8813

Note1: Sub-frame#0 and #5 are not used for the corresponding requirement. The next subframe (i.e. sub-frame#1 or #6) shall be used for the retransmission.

Table A.4-4: Reference channel for CQI requirements (FDD) 6 PRB allocation

Parameter	Unit	Value					
		1.4	3	5	10	15	20
Channel bandwidth	MHz	1.4	3	5	10	15	20
Allocated resource blocks		6	6	6	6	6	6
Subcarriers per resource block		12	12	12	12	12	12
Allocated subframes per Radio Frame		8	8	8	8	8	8
Modulation					Table A.4-6		
Target coding rate					Table A.4-6		
Number of HARQ Processes	Processes	8	8	8	8	8	8
Maximum number of HARQ transmissions		1	1	1	1	1	1
Note 1: 3 symbols allocated to PDCCH							
Note 2: Only subframes 1,2,3,4,6,7,8, and 9 are allocated to avoid PBCH and synchronization signal overhead							

Table A.4-5: Reference channel for CQI requirements (TDD) 6 PRB allocation

Parameter	Unit	Value					
		1.4	3	5	10	15	20
Channel bandwidth	MHz	1.4	3	5	10	15	20
Allocated resource blocks		6	6	6	6	6	6
Subcarriers per resource block		12	12	12	12	12	12
Allocated subframes per Radio Frame		4	4	4	4	4	4
Modulation					Table A.4-6		
Target coding rate					Table A.4-6		
Number of HARQ Processes	Processes	10	10	10	10	10	10
Maximum number of HARQ transmissions		1	1	1	1	1	1
Note 1: 3 symbols allocated to PDCCH							
Note 2: UL-DL configuration 2 is used and only subframes 3, 4, 8, and 9 are allocated to avoid PBCH and synchronization signal overhead							

Table A.4-6: Transport format corresponding to each CQI index for 6 PRB allocation

CQI index	Modulation	Target code rate	Imcs	Information Bit Payload (Subframes 1,2,3,4,6,7,8,9)	Binary Channel Bits Per Sub-Frame (Subframes 1,2,3,4,6,7,8,9)	Actual Code rate
0	out of range	out of range	DTX	-	-	-
1	QPSK	0.0762	0	152	1512	0.1005
2	QPSK	0.1172	0	152	1512	0.1005
3	QPSK	0.1885	2	256	1512	0.1693
4	QPSK	0.3008	4	408	1512	0.2698
5	QPSK	0.4385	6	600	1512	0.3968
6	QPSK	0.5879	8	808	1512	0.5344
7	16QAM	0.3691	11	1032	3024	0.3413
8	16QAM	0.4785	13	1352	3024	0.4471
9	16QAM	0.6016	16	1800	3024	0.5952
10	64QAM	0.4551	19	2152	4536	0.4744
11	64QAM	0.5537	21	2600	4536	0.5732
12	64QAM	0.6504	23	2984	4536	0.6578
13	64QAM	0.7539	25	3496	4536	0.7707
14	64QAM	0.8525	27	3752	4536	0.8272
15	64QAM	0.9258	27	3752	4536	0.8272
Note1: Sub-frame#0 and #5 are not used for the corresponding requirement.						

Table A.4-7: Reference channel for CQI requirements (FDD) partial PRB allocation

Parameter	Unit	Value				
		3	5	10	15	20
Channel bandwidth	MHz	3	5	10	15	20
Allocated resource blocks				15 (Note 3)		
Subcarriers per resource block				12		
Allocated subframes per Radio Frame				8		
Modulation		Table A.4-9				
Target coding rate		Table A.4-9				
Number of HARQ processes				8		
Maximum number of HARQ transmissions				1		
Note 1: 3 symbols allocated to PDCCH						
Note 2: Only subframes 1,2,3,4,6,7,8, and 9 are allocated to avoid PBCH and synchronization signal overhead						
Note 3: Centered within the Transmission Bandwidth Configuration (Figure 5.6-1)						

Table A.4-8: Reference channel for CQI requirements (TDD) partial PRB allocation

Parameter	Unit	Value				
		3	5	10	15	20
Channel bandwidth	MHz	3	5	10	15	20
Allocated resource blocks				15 (Note 3)		
Subcarriers per resource block				12		
Allocated subframes per Radio Frame				4		
Modulation		Table A.4-9				
Target coding rate		Table A.4-9				
Number of HARQ processes				10		
Maximum number of HARQ transmissions				1		
Note 1: 3 symbols allocated to PDCCH						
Note 2: UL-DL configuration 2 is used and only subframes 3, 4, 8, and 9 are allocated to avoid PBCH and synchronization signal overhead						
Note 3: Centered within the Transmission Bandwidth Configuration (Figure 5.6-1)						

Table A.4-9: Transport format corresponding to each CQI index for 15 PRB allocation

CQI index	Modulation	Target code rate	Imcs	Information Bit Payload (Subframes 1,2,3,4,6,7,8,9)	Binary Channel Bits Per Sub-Frame (Subframes 1,2,3,4,6,7,8,9)	Actual Code rate
0	out of range	out of range	DTX	-	-	-
1	QPSK	0.0762	0	392	3780	0.1037
2	QPSK	0.1172	0	392	3780	0.1037
3	QPSK	0.1885	2	648	3780	0.1714
4	QPSK	0.3008	4	1064	3780	0.2815
5	QPSK	0.4385	6	1544	3780	0.4085
6	QPSK	0.5879	8	2088	3780	0.5524
7	16QAM	0.3691	11	2664	7560	0.3524
8	16QAM	0.4785	13	3368	7560	0.4455
9	16QAM	0.6016	16	4584	7560	0.6063
10	64QAM	0.4551	19	4968	11340	0.4381
11	64QAM	0.5537	21	6456	11340	0.5693
12	64QAM	0.6504	23	7480	11340	0.6596
13	64QAM	0.7539	25	8504	11340	0.7499
14	64QAM	0.8525	27	9528	11340	0.8402
15	64QAM	0.9258	27	9528	11340	0.8402

Note1: Sub-frame#0 and #5 are not used for the corresponding requirement.

Table A.4-10: Uplink reference channels for transmitting CSI reports on PUSCH, when being in a PUCCH reporting mode (FDD)

Parameter	Unit	Value				
Channel bandwidth	MHz	10	10	10		
Allocated resource blocks		6	6	6		
DFT-OFDM Symbols per Sub-Frame		12	12	12		
Modulation		QPSK	QPSK	QPSK		
Target Coding rate		1/3	1/3	1/3		
Allocated Sub-Frames (Note 1)		1, 3, 5, 7	3, 8	0, 1, 2, 3, 4, 5, 6, 7, 8, 9		
Payload size	Bits	600	600	600		
Transport block CRC	Bits	24	24	24		
Number of code blocks per Sub-Frame (Note 2)		1	1	1		
Total number of bits per Sub-Frame	Bits	1728	1728	1728		
Total symbols per Sub-Frame		864	864	864		
UE Category		1-5	1-5	1-5		
Note 1: The remaining subframes are not allocated with data. All the allocation details specified in the reference channel are valid only for the allocated subframes.						
Note 2: If more than one Code Block is present, an additional CRC sequence of L = 24 Bits is attached to each Code Block (otherwise L = 0 Bit)						

Table A.4-11: Uplink reference channels for transmitting CSI reports on PUSCH, when being in a PUCCH reporting mode (TDD)

Parameter	Unit	Value					
Channel bandwidth	MHz	10					
Allocated resource blocks		6					
Uplink-Downlink Configuration (Note 1)		2					
DFT-OFDM Symbols per Sub-Frame		12					
Modulation		QPSK					
Target Coding rate		1/3					
Allocated Sub-Frames (Note 2)		2, 7					
Payload size	Bits	600					
Transport block CRC	Bits	24					
Number of code blocks per Sub-Frame (Note 3)		1					
Total number of bits per Sub-Frame	Bits	1728					
Total symbols per Sub-Frame		864					
UE Category		1-5					
Note 1: As per Table 4.2-2 in TS 36.211 [4]							
Note 2: The remaining subframes are not allocated with data. All the allocation details specified in the reference channel are valid only for the allocated subframes.							
Note 3: If more than one Code Block is present, an additional CRC sequence of L = 24 Bits is attached to each Code Block (otherwise L = 0 Bit)							

Table A.4-12: Reference channel for CQI requirements (FDD) 3 PRB allocation

Parameter	Unit	Value					
Channel bandwidth	MHz	1.4	3	5	10	15	20
Allocated resource blocks		3	3	3	3	3	3
Subcarriers per resource block		12	12	12	12	12	12
Allocated subframes per Radio Frame		8	8	8	8	8	8
Modulation					Table A.4-12		
Target coding rate					Table A.4-12		
Number of HARQ Processes	Processes	8	8	8	8	8	8
Maximum number of HARQ transmissions		1	1	1	1	1	1
Note 1: 3 symbols allocated to PDCCH							
Note 2: Only subframes 1,2,3,4,6,7,8, and 9 are allocated to avoid PBCH and synchronization signal overhead							

Table A.4-13: Reference channel for CQI requirements (TDD) 3 PRB allocation

Parameter	Unit	Value					
Channel bandwidth	MHz	1.4	3	5	10	15	20
Allocated resource blocks		3	3	3	3	3	3
Subcarriers per resource block		12	12	12	12	12	12
Allocated subframes per Radio Frame		4	4	4	4	4	4
Modulation					Table A.4-12		
Target coding rate					Table A.4-12		
Number of HARQ Processes	Processes	10	10	10	10	10	10
Maximum number of HARQ transmissions		1	1	1	1	1	1
Note 1: 3 symbols allocated to PDCCH.							
Note 2: UL-DL configuration 2 is used and only subframes 3, 4, 8, and 9 are allocated to avoid PBCH and synchronization signal overhead.							

Table A.4-14: Transport format corresponding to each CQI index for 3 PRB allocation

CQI index	Modulation	Target code rate	Imcs	Information Bit Payload (Subframes 1,2,3,4,6,7,8,9)	Binary Channel Bits Per Sub-Frame (Subframes 1,2,3,4,6,7,8,9)	Actual Code rate
0	out of range	out of range	DTX	-	-	-
1	QPSK	0.0762	0	56	756	0.0741
2	QPSK	0.1172	1	88	756	0.1164
3	QPSK	0.1885	2	144	756	0.1905
4	QPSK	0.3008	5	224	756	0.2963
5	QPSK	0.4385	7	328	756	0.4339
6	QPSK	0.5879	9	456	756	0.6032
7	16QAM	0.3691	12	584	1512	0.3862
8	16QAM	0.4785	13	744	1512	0.4921
9	16QAM	0.6016	16	904	1512	0.5979
10	64QAM	0.4551	19	1064	2268	0.4691
11	64QAM	0.5537	21	1288	2268	0.5679
12	64QAM	0.6504	23	1480	2268	0.6526
13	64QAM	0.7539	25	1736	2268	0.7654
14	64QAM	0.8525	27	1864	2268	0.8219
15	64QAM	0.9258	27	1864	2268	0.8219

Note1: Sub-frame#0 and #5 are not used for the corresponding requirement.

A.5 OFDMA Channel Noise Generator (OCNG)

A.5.1 OCNG Patterns for FDD

The following OCNG patterns are used for modelling allocations to virtual UEs (which are not under test). The OCNG pattern for each sub frame specifies the allocations that shall be filled with OCNG, and furthermore, the relative power level of each such allocation.

In each test case the OCNG is expressed by parameters OCNG_RA and OCNG_RB which together with a relative power level (γ) specifies the PDSCH EPRE-to-RS EPRE ratios in OFDM symbols with and without reference symbols, respectively. The relative power, which is used for modelling boosting per virtual UE allocation, is expressed by:

$$\gamma_i = PDSCH_{i_RA} / OCNG_RA = PDSCH_{i_RB} / OCNG_RB,$$

where γ_i denotes the relative power level of the i :th virtual UE. The parameter settings of OCNG_RA, OCNG_RB, and the set of relative power levels γ are chosen such that when also taking allocations to the UE under test into account, as given by a PDSCH reference channel, a transmitted power spectral density that is constant on an OFDM symbol basis is targeted.

Moreover the OCNG pattern is accompanied by a PCFICH/PDCCH/PHICH reference channel which specifies the control region. For any aggregation and PHICH allocation, the PDCCH and any unused PHICH groups are padded with resource element groups with a power level given respectively by PDCCH_RA/RB and PHICH_RA/RB as specified in the test case such that a total power spectral density in the control region that is constant on an OFDM symbol basis is targeted.

A.5.1.1 OCNG FDD pattern 1: One sided dynamic OCNG FDD pattern

This OCNG Pattern fills with OCNG all empty PRB-s (PRB-s with no allocation of data or system information) of the DL sub-frames, when the unallocated area is continuous in frequency domain (one sided).

Table A.5.1.1-1: OP.1 FDD: One sided dynamic OCNG FDD Pattern

Relative power level γ_{PRB} [dB]			PDSCH Data
Subframe			
0	5	1 – 4, 6 – 9	
Allocation			
First unallocated PRB – Last unallocated PRB	First unallocated PRB – Last unallocated PRB	First unallocated PRB – Last unallocated PRB	
0	0	0	Note 1
<p>Note 1: These physical resource blocks are assigned to an arbitrary number of virtual UEs with one PDSCH per virtual UE; the data transmitted over the OCNG PDSCHs shall be uncorrelated pseudo random data, which is QPSK modulated. The parameter γ_{PRB} is used to scale the power of PDSCH.</p> <p>Note 2: If two or more transmit antennas with CRS are used in the test, the OCNG shall be transmitted to the virtual users by all the transmit antennas with CRS according to transmission mode 2. The parameter γ_{PRB} applies to each antenna port separately, so the transmit power is equal between all the transmit antennas with CRS used in the test. The antenna transmission modes are specified in section 7.1 in 3GPP TS 36.213.</p>			

A.5.1.2 OCNG FDD pattern 2: Two sided dynamic OCNG FDD pattern

This OCNG Pattern fills with OCNG all empty PRB-s (PRB-s with no allocation of data or system information) of the DL sub-frames, when the unallocated area is discontinuous in frequency domain (divided in two parts by the allocated area – two sided), starts with PRB 0 and ends with PRB $N_{RB} - 1$.

Table A.5.1.2-1: OP.2 FDD: Two sided dynamic OCNG FDD Pattern

Relative power level γ_{PRB} [dB]			PDSCH Data
Subframe			
0	5	1 – 4, 6 – 9	
Allocation			
0 – (First allocated PRB-1) and (Last allocated PRB+1) – ($N_{RB} - 1$)	0 – (First allocated PRB-1) and (Last allocated PRB+1) – ($N_{RB} - 1$)	0 – (First allocated PRB-1) and (Last allocated PRB+1) – ($N_{RB} - 1$)	
0	0	0	Note 1
<p>Note 1: These physical resource blocks are assigned to an arbitrary number of virtual UEs with one PDSCH per virtual UE; the data transmitted over the OCNG PDSCHs shall be uncorrelated pseudo random data, which is QPSK modulated. The parameter γ_{PRB} is used to scale the power of PDSCH.</p> <p>Note 2: If two or more transmit antennas with CRS are used in the test, the OCNG shall be transmitted to the virtual users by all the transmit antennas with CRS according to transmission mode 2. The parameter γ_{PRB} applies to each antenna port separately, so the transmit power is equal between all the transmit antennas with CRS used in the test. The antenna transmission modes are specified in section 7.1 in 3GPP TS 36.213.</p>			

A.5.1.3 OCNG FDD pattern 3: 49 RB OCNG allocation with MBSFN in 10 MHz

Table A.5.1.3-1: OP.3 FDD: OCNG FDD Pattern 3

Allocation n_{PRB}	Relative power level γ_{PRB} [dB]				PDSCH Data	PMCH Data
	Subframe					
	0	5	4, 9	1 – 3, 6 – 8		
1 – 49	0	0 (Allocation: all empty PRB-s)	0	N/A	Note 1	N/A
0 – 49	N/A	N/A	N/A	0	N/A	Note 2

Note 1: These physical resource blocks are assigned to an arbitrary number of virtual UEs with one PDSCH per virtual UE; the data transmitted over the OCNG PDSCHs shall be uncorrelated pseudo random data, which is QPSK modulated. The parameter γ_{PRB} is used to scale the power of PDSCH.

Note 2: Each physical resource block (PRB) is assigned to MBSFN transmission. The data in each PRB shall be uncorrelated with data in other PRBs over the period of any measurement. The MBSFN data shall be QPSK modulated. PMCH subframes shall contain cell-specific Reference Signals only in the first symbol of the first time slot. The parameter γ_{PRB} is used to scale the power of PMCH.

Note 3: If two or more transmit antennas are used in the test, the OCNG shall be transmitted to the virtual users by all the transmit antennas according to transmission mode 2. The transmit power shall be equally split between all the transmit antennas used in the test. The antenna transmission modes are specified in section 7.1 in 3GPP TS 36.213.

N/A: Not Applicable

A.5.2 OCNG Patterns for TDD

The following OCNG patterns are used for modelling allocations to virtual UEs (which are not under test). The OCNG pattern for each sub frame specifies the allocations that shall be filled with OCNG, and furthermore, the relative power level of each such allocation.

In each test case the OCNG is expressed by parameters OCNG_RA and OCNG_RB which together with a relative power level (γ) specifies the PDSCH EPRE-to-RS EPRE ratios in OFDM symbols with and without reference symbols, respectively. The relative power, which is used for modelling boosting per virtual UE allocation, is expressed by:

$$\gamma_i = PDSCH_i_RA / OCNG_RA = PDSCH_i_RB / OCNG_RB,$$

where γ_i denotes the relative power level of the i :th virtual UE. The parameter settings of OCNG_RA, OCNG_RB, and the set of relative power levels γ are chosen such that when also taking allocations to the UE under test into account, as given by a PDSCH reference channel, a transmitted power spectral density that is constant on an OFDM symbol basis is targeted.

Moreover the OCNG pattern is accompanied by a PCFICH/PDCCH/PHICH reference channel which specifies the control region. For any aggregation and PHICH allocation, the PDCCH and any unused PHICH groups are padded with resource element groups with a power level given respectively by PDCCH_RA/RB and PHICH_RA/RB as specified in the test case such that a total power spectral density in the control region that is constant on an OFDM symbol basis is targeted.

A.5.2.1 OCNG TDD pattern 1: One sided dynamic OCNG TDD pattern

This OCNG Pattern fills with OCNG all empty PRB-s (PRB-s with no allocation of data or system information) of the subframes available for DL transmission (depending on TDD UL/DL configuration), when the unallocated area is continuous in frequency domain (one sided).

Table A.5.2.1-1: OP.1 TDD: One sided dynamic OCNG TDD Pattern

Relative power level γ_{PRB} [dB]				PDSCH Data
Subframe (only if available for DL)				
0	5	3, 4, 7, 8, 9 and 6 (as normal subframe) ^{Note 2}	1 and 6 (as special subframe) ^{Note 2}	
Allocation				
First unallocated PRB – Last unallocated PRB	First unallocated PRB – Last unallocated PRB	First unallocated PRB – Last unallocated PRB	First unallocated PRB – Last unallocated PRB	
0	0	0	0	Note 1
<p>Note 1: These physical resource blocks are assigned to an arbitrary number of virtual UEs with one PDSCH per virtual UE; the data transmitted over the OCNG PDSCHs shall be uncorrelated pseudo random data, which is QPSK modulated. The parameter γ_{PRB} is used to scale the power of PDSCH.</p> <p>Note 2: Subframes available for DL transmission depends on the Uplink-Downlink configuration in Table 4.2-2 in 3GPP TS 36.211.</p> <p>Note 3: If two or more transmit antennas with CRS are used in the test, the OCNG shall be transmitted to the virtual users by all the transmit antennas with CRS according to transmission mode 2. The parameter γ_{PRB} applies to each antenna port separately, so the transmit power is equal between all the transmit antennas with CRS used in the test. The antenna transmission modes are specified in section 7.1 in 3GPP TS 36.213.</p>				

A.5.2.2 OCNG TDD pattern 2: Two sided dynamic OCNG TDD pattern

This OCNG Pattern fills with OCNG all empty PRB-s (PRB-s with no allocation of data or system information) of the subframes available for DL transmission (depending on TDD UL/DL configuration), when the unallocated area is discontinuous in frequency domain (divided in two parts by the allocated area – two sided), starts with PRB 0 and ends with PRB $N_{RB} - 1$.

Table A.5.2.2-1: OP.2 TDD: Two sided dynamic OCNG TDD Pattern

Relative power level γ_{PRB} [dB]				PDSCH Data
Subframe (only if available for DL)				
0	5	3, 4, 6, 7, 8, 9 (6 as normal subframe) ^{Note 2}	1,6 (6 as special subframe) ^{Note 2}	
Allocation				
0 – (First allocated PRB-1) and (Last allocated PRB+1) – ($N_{RB} - 1$)	0 – (First allocated PRB-1) and (Last allocated PRB+1) – ($N_{RB} - 1$)	0 – (First allocated PRB-1) and (Last allocated PRB+1) – ($N_{RB} - 1$)	0 – (First allocated PRB-1) and (Last allocated PRB+1) – ($N_{RB} - 1$)	
[0]	[0]	[0]	[0]	Note 1
<p>Note 1: These physical resource blocks are assigned to an arbitrary number of virtual UEs with one PDSCH per virtual UE; the data transmitted over the OCNG PDSCHs shall be uncorrelated pseudo random data, which is QPSK modulated. The parameter γ_{PRB} is used to scale the power of PDSCH.</p> <p>Note 2: Subframes available for DL transmission depends on the Uplink-Downlink configuration in Table 4.2-2 in 3GPP TS 36.211.</p> <p>Note 3: If two or more transmit antennas with CRS are used in the test, the OCNG shall be transmitted to the virtual users by all the transmit antennas with CRS according to transmission mode 2. The parameter γ_{PRB} applies to each antenna port separately, so the transmit power is equal between all the transmit antennas with CRS used in the test. The antenna transmission modes are specified in section 7.1 in 3GPP TS 36.213.</p>				

A.5.2.3 OCNG TDD pattern 3: 49 RB OCNG allocation with MBSFN in 10 MHz

Table A.5.2. 3-1: OP.3 TDD: OCNG TDD Pattern 3 for 5ms downlink-to-uplink switch-point periodicity

Allocation n_{PRB}	Relative power level γ_{PRB} [dB]				PDSCH Data	PMCH Data
	Subframe					
	0	5	4, 9 ^{Note 2}	1, 6		
1 – 49	0	0 (Allocation: all empty PRB-s)	N/A	0	Note 1	N/A
0 – 49	N/A	N/A	0	N/A	N/A	Note 3
<p>Note 1: These physical resource blocks are assigned to an arbitrary number of virtual UEs with one PDSCH per virtual UE; the data transmitted over the OCNG PDSCHs shall be uncorrelated pseudo random data, which is QPSK modulated. The parameter γ_{PRB} is used to scale the power of PDSCH.</p> <p>Note 2: Subframes available for DL transmission depends on the Uplink-Downlink configuration in Table 4.2-2 in 3GPP TS 36.211.</p> <p>Note 3: Each physical resource block (PRB) is assigned to MBSFN transmission. The data in each PRB shall be uncorrelated with data in other PRBs over the period of any measurement. The MBSFN data shall be QPSK modulated. PMCH symbols shall not contain cell-specific Reference Signals</p> <p>Note 4: If two or more transmit antennas are used in the test, the OCNG shall be transmitted to the virtual users by all the transmit antennas according to transmission mode 2. The transmit power shall be equally split between all the transmit antennas used in the test. The antenna transmission modes are specified in section 7.1 in 3GPP TS 36.213.</p>						
N/A: Not Applicable						

Annex B (normative): Propagation Conditions

The propagation conditions and channel models for various environments are specified. For each environment a propagation model is used to evaluate the propagation pathloss due to the distance. Channel models are formed by combining delay profiles with a Doppler spectrum, with the addition of correlation properties in the case of a multi-antenna scenario.

B.0 No interference

The downlink connection between the System Simulator and the UE is without Additive White Gaussian Noise, and has no fading or multipath effects.

B.1 Static propagation condition

The downlink connection between the System Simulator and the UE is an Additive White Gaussian Noise (AWGN) environment with no fading or multipath effects.

For 2 port transmission the channel matrix is defined in the frequency domain by

$$\mathbf{H} = \begin{pmatrix} 1 & j \\ 1 & -j \end{pmatrix}$$

B.1.1 Definition of Additive White Gaussian Noise (AWGN) Interferer

Note that the AWGN interferer can be used in static propagation conditions, or in conjunction with multi-path fading.

The acceptable uncertainties of the AWGN interferer are defined in Annex F.

B.2 Multi-path fading Propagation Conditions

The multipath propagation conditions consist of several parts:

- A delay profile in the form of a "tapped delay-line", characterized by a number of taps at fixed positions on a sampling grid. The profile can be further characterized by the r.m.s. delay spread and the maximum delay spanned by the taps.
- A combination of channel model parameters that include the Delay profile and the Doppler spectrum, that is characterized by a classical spectrum shape and a maximum Doppler frequency
- A set of correlation matrices defining the correlation between the UE and eNodeB antennas in case of multi-antenna systems.

B.2.1 Delay profiles

The delay profiles are selected to be representative of low, medium and high delay spread environments. The resulting model parameters are defined in Table B.2.1-1 and the tapped delay line models are defined in Tables B.2.1-2, B.2.1-3 and B.2.1-4.

Table B.2.1-1: Delay profiles for E-UTRA channel models

Model	Number of channel taps	Delay spread (r.m.s.)	Maximum excess tap delay (span)
Extended Pedestrian A (EPA)	7	45 ns	410 ns
Extended Vehicular A model (EVA)	9	357 ns	2510 ns
Extended Typical Urban model (ETU)	9	991 ns	5000 ns

Table B.2.1-2: Extended Pedestrian A model (EPA)

Excess tap delay [ns]	Relative power [dB]
0	0.0
30	-1.0
70	-2.0
90	-3.0
110	-8.0
190	-17.2
410	-20.8

Table B.2.1-3: Extended Vehicular A model (EVA)

Excess tap delay [ns]	Relative power [dB]
0	0.0
30	-1.5
150	-1.4
310	-3.6
370	-0.6
710	-9.1
1090	-7.0
1730	-12.0
2510	-16.9

Table B.2.1-4: Extended Typical Urban model (ETU)

Excess tap delay [ns]	Relative power [dB]
0	-1.0
50	-1.0
120	-1.0
200	0.0
230	0.0
500	0.0
1600	-3.0
2300	-5.0
5000	-7.0

B.2.2 Combinations of channel model parameters

Table B.2.2-1 shows propagation conditions that are used for the performance measurements in multi-path fading environment for low, medium and high Doppler frequencies

Table B.2.2-1: Channel model parameters

Model	Maximum Doppler frequency
EPA 5Hz	5 Hz
EVA 5Hz	5 Hz
EVA 70Hz	70 Hz
ETU 70Hz	70 Hz
ETU 300Hz	300 Hz

B.2.3 MIMO Channel Correlation Matrices

B.2.3.1 Definition of MIMO Correlation Matrices

Table B.2.3.1-1 defines the correlation matrix for the eNodeB

Table B.2.3.1-1: eNodeB correlation matrix

	One antenna	Two antennas	Four antennas
eNode B Correlation	$R_{eNB} = 1$	$R_{eNB} = \begin{pmatrix} 1 & \alpha \\ \alpha^* & \mathbf{1} \end{pmatrix}$	$R_{eNB} = \begin{pmatrix} 1 & \alpha^{1/9} & \alpha^{4/9} & \alpha \\ \alpha^{1/9*} & 1 & \alpha^{1/9} & \alpha^{4/9} \\ \alpha^{4/9*} & \alpha^{1/9*} & 1 & \alpha^{1/9} \\ \alpha^* & \alpha^{4/9*} & \alpha^{1/9*} & 1 \end{pmatrix}$

Table B.2.3.1-2 defines the correlation matrix for the UE:

Table B.2.3.1-2: UE correlation matrix

	One antenna	Two antennas	Four antennas
UE Correlation	$R_{UE} = 1$	$R_{UE} = \begin{pmatrix} 1 & \beta \\ \beta^* & \mathbf{1} \end{pmatrix}$	$R_{UE} = \begin{pmatrix} 1 & \beta^{1/9} & \beta^{4/9} & \beta \\ \beta^{1/9*} & 1 & \beta^{1/9} & \beta^{4/9} \\ \beta^{4/9*} & \beta^{1/9*} & 1 & \beta^{1/9} \\ \beta^* & \beta^{4/9*} & \beta^{1/9*} & 1 \end{pmatrix}$

Table B.2.3.1-3 defines the channel spatial correlation matrix R_{spat} . The parameters, α and β in Table B.2.3.1-3 defines the spatial correlation between the antennas at the eNodeB and UE.

Table B.2.3.1-3: R_{spat} correlation matrices

1x2 case	$R_{spat} = R_{UE} = \begin{bmatrix} 1 & \beta \\ \beta^* & 1 \end{bmatrix}$
2x2 case	$R_{spat} = R_{eNB} \otimes R_{UE} = \begin{bmatrix} 1 & \alpha \\ \alpha^* & 1 \end{bmatrix} \otimes \begin{bmatrix} 1 & \beta \\ \beta^* & 1 \end{bmatrix} = \begin{bmatrix} 1 & \beta & \alpha & \alpha\beta \\ \beta^* & 1 & \alpha\beta^* & \alpha \\ \alpha^* & \alpha^*\beta & 1 & \beta \\ \alpha^*\beta^* & \alpha^* & \beta^* & 1 \end{bmatrix}$
4x2 case	$R_{spat} = R_{eNB} \otimes R_{UE} = \begin{bmatrix} 1 & \alpha^{1/9} & \alpha^{4/9} & \alpha \\ \alpha^{1/9*} & 1 & \alpha^{1/9} & \alpha^{4/9} \\ \alpha^{4/9*} & \alpha^{1/9*} & 1 & \alpha^{1/9} \\ \alpha^* & \alpha^{4/9*} & \alpha^{1/9*} & 1 \end{bmatrix} \otimes \begin{bmatrix} 1 & \beta \\ \beta^* & 1 \end{bmatrix}$
4x4 case	$R_{spat} = R_{eNB} \otimes R_{UE} = \begin{bmatrix} 1 & \alpha^{1/9} & \alpha^{4/9} & \alpha \\ \alpha^{1/9*} & 1 & \alpha^{1/9} & \alpha^{4/9} \\ \alpha^{4/9*} & \alpha^{1/9*} & 1 & \alpha^{1/9} \\ \alpha^* & \alpha^{4/9*} & \alpha^{1/9*} & 1 \end{bmatrix} \otimes \begin{bmatrix} 1 & \beta^{1/9} & \beta^{4/9} & \beta \\ \beta^{1/9*} & 1 & \beta^{1/9} & \beta^{4/9} \\ \beta^{4/9*} & \beta^{1/9*} & 1 & \beta^{1/9} \\ \beta^* & \beta^{4/9*} & \beta^{1/9*} & 1 \end{bmatrix}$

For cases with more antennas at either eNodeB or UE or both, the channel spatial correlation matrix can still be expressed as the Kronecker product of R_{eNB} and R_{UE} according to $R_{spat} = R_{eNB} \otimes R_{UE}$.

B.2.3.2 MIMO Correlation Matrices at High, Medium and Low Level

The α and β for different correlation types are given in Table B.2.3.2-1.

Table B.2.3.2-1

Low correlation		Medium Correlation		High Correlation	
α	β	α	β	α	β
0	0	0.3	0.9	0.9	0.9

The correlation matrices for high, medium and low correlation are defined in Table B.2.3.2-2, B.2.3.2-3 and B.2.3.2-4, as below.

The values in the Table B.2.3.2-2 table have been adjusted for the 4x2 and 4x4 high correlation cases to insure the correlation matrix is positive semi-definite after round-off to 4 digit precision. This is done using the equation:

$$\mathbf{R}_{high} = [\mathbf{R}_{spatial} + a\mathbf{I}_n] / (1 + a)$$

Where the value “a” is a scaling factor such that the smallest value is used to obtain a positive semi-definite result. For the 4x2 high correlation case, a=0.00010. For the 4x4 high correlation case, a=0.00012.

The same method is used to adjust the 4x4 medium correlation matrix in Table B.2.3.2-3 to insure the correlation matrix is positive semi-definite after round-off to 4 digit precision with a = 0.00012.

Table B.2.3.2-2: MIMO correlation matrices for high correlation

1x2 case	$R_{high} = \begin{pmatrix} 1 & 0.9 \\ 0.9 & 1 \end{pmatrix}$																																																																																																																																																																																																																																																																												
2x2 case	$R_{high} = \begin{pmatrix} 1 & 0.9 & 0.9 & 0.81 \\ 0.9 & 1 & 0.81 & 0.9 \\ 0.9 & 0.81 & 1 & 0.9 \\ 0.81 & 0.9 & 0.9 & 1 \end{pmatrix}$																																																																																																																																																																																																																																																																												
4x2 case	$R_{high} =$	<table border="1" style="width: 100%; border-collapse: collapse; text-align: center;"> <tr><td>1.0000</td><td>0.8999</td><td>0.9883</td><td>0.8894</td><td>0.9542</td><td>0.8587</td><td>0.8999</td><td>0.8099</td></tr> <tr><td>0.8999</td><td>1.0000</td><td>0.8894</td><td>0.9883</td><td>0.8587</td><td>0.9542</td><td>0.8099</td><td>0.8999</td></tr> <tr><td>0.9883</td><td>0.8894</td><td>1.0000</td><td>0.8999</td><td>0.9883</td><td>0.8894</td><td>0.9542</td><td>0.8587</td></tr> <tr><td>0.8894</td><td>0.9883</td><td>0.8999</td><td>1.0000</td><td>0.8894</td><td>0.9883</td><td>0.8587</td><td>0.9542</td></tr> <tr><td>0.9542</td><td>0.8587</td><td>0.9883</td><td>0.8894</td><td>1.0000</td><td>0.8999</td><td>0.9883</td><td>0.8894</td></tr> <tr><td>0.8587</td><td>0.9542</td><td>0.8894</td><td>0.9883</td><td>0.8999</td><td>1.0000</td><td>0.8894</td><td>0.9883</td></tr> <tr><td>0.8999</td><td>0.8099</td><td>0.9542</td><td>0.8587</td><td>0.9883</td><td>0.8894</td><td>1.0000</td><td>0.8999</td></tr> <tr><td>0.8099</td><td>0.8999</td><td>0.8587</td><td>0.9542</td><td>0.8894</td><td>0.9883</td><td>0.8999</td><td>1.0000</td></tr> </table>								1.0000	0.8999	0.9883	0.8894	0.9542	0.8587	0.8999	0.8099	0.8999	1.0000	0.8894	0.9883	0.8587	0.9542	0.8099	0.8999	0.9883	0.8894	1.0000	0.8999	0.9883	0.8894	0.9542	0.8587	0.8894	0.9883	0.8999	1.0000	0.8894	0.9883	0.8587	0.9542	0.9542	0.8587	0.9883	0.8894	1.0000	0.8999	0.9883	0.8894	0.8587	0.9542	0.8894	0.9883	0.8999	1.0000	0.8894	0.9883	0.8999	0.8099	0.9542	0.8587	0.9883	0.8894	1.0000	0.8999	0.8099	0.8999	0.8587	0.9542	0.8894	0.9883	0.8999	1.0000																																																																																																																																																																																																				
1.0000	0.8999	0.9883	0.8894	0.9542	0.8587	0.8999	0.8099																																																																																																																																																																																																																																																																						
0.8999	1.0000	0.8894	0.9883	0.8587	0.9542	0.8099	0.8999																																																																																																																																																																																																																																																																						
0.9883	0.8894	1.0000	0.8999	0.9883	0.8894	0.9542	0.8587																																																																																																																																																																																																																																																																						
0.8894	0.9883	0.8999	1.0000	0.8894	0.9883	0.8587	0.9542																																																																																																																																																																																																																																																																						
0.9542	0.8587	0.9883	0.8894	1.0000	0.8999	0.9883	0.8894																																																																																																																																																																																																																																																																						
0.8587	0.9542	0.8894	0.9883	0.8999	1.0000	0.8894	0.9883																																																																																																																																																																																																																																																																						
0.8999	0.8099	0.9542	0.8587	0.9883	0.8894	1.0000	0.8999																																																																																																																																																																																																																																																																						
0.8099	0.8999	0.8587	0.9542	0.8894	0.9883	0.8999	1.0000																																																																																																																																																																																																																																																																						
4x4 case	$R_{high} =$	<table border="1" style="width: 100%; border-collapse: collapse; text-align: center;"> <tr><td>1.0000</td><td>0.9882</td><td>0.9541</td><td>0.8999</td><td>0.9882</td><td>0.9767</td><td>0.9430</td><td>0.8894</td><td>0.9541</td><td>0.9430</td><td>0.9105</td><td>0.8587</td><td>0.8999</td><td>0.8894</td><td>0.8587</td><td>0.8099</td></tr> <tr><td>0.9882</td><td>1.0000</td><td>0.9882</td><td>0.9541</td><td>0.9767</td><td>0.9882</td><td>0.9767</td><td>0.9430</td><td>0.9430</td><td>0.9541</td><td>0.9430</td><td>0.9105</td><td>0.8894</td><td>0.8999</td><td>0.8894</td><td>0.8587</td></tr> <tr><td>0.9541</td><td>0.9882</td><td>1.0000</td><td>0.9882</td><td>0.9430</td><td>0.9767</td><td>0.9882</td><td>0.9767</td><td>0.9105</td><td>0.9430</td><td>0.9541</td><td>0.9430</td><td>0.8587</td><td>0.8894</td><td>0.8999</td><td>0.8894</td></tr> <tr><td>0.8999</td><td>0.9541</td><td>0.9882</td><td>1.0000</td><td>0.8894</td><td>0.9430</td><td>0.9767</td><td>0.9882</td><td>0.8587</td><td>0.9105</td><td>0.9430</td><td>0.9541</td><td>0.8099</td><td>0.8587</td><td>0.8894</td><td>0.8999</td></tr> <tr><td>0.9882</td><td>0.9767</td><td>0.9430</td><td>0.8894</td><td>1.0000</td><td>0.9882</td><td>0.9541</td><td>0.8999</td><td>0.9882</td><td>0.9767</td><td>0.9430</td><td>0.8894</td><td>0.9541</td><td>0.9430</td><td>0.9105</td><td>0.8587</td></tr> <tr><td>0.9767</td><td>0.9882</td><td>0.9767</td><td>0.9430</td><td>0.9882</td><td>1.0000</td><td>0.9882</td><td>0.9541</td><td>0.9767</td><td>0.9882</td><td>0.9767</td><td>0.9430</td><td>0.9430</td><td>0.9541</td><td>0.9430</td><td>0.9105</td></tr> <tr><td>0.9430</td><td>0.9767</td><td>0.9882</td><td>0.9767</td><td>0.9541</td><td>0.9882</td><td>1.0000</td><td>0.9882</td><td>0.9430</td><td>0.9767</td><td>0.9882</td><td>0.9767</td><td>0.9105</td><td>0.9430</td><td>0.9541</td><td>0.9430</td></tr> <tr><td>0.8894</td><td>0.9430</td><td>0.9767</td><td>0.9882</td><td>0.8999</td><td>0.9541</td><td>0.9882</td><td>1.0000</td><td>0.8894</td><td>0.9430</td><td>0.9767</td><td>0.9882</td><td>0.8587</td><td>0.9105</td><td>0.9430</td><td>0.9541</td></tr> <tr><td>0.9541</td><td>0.9430</td><td>0.9105</td><td>0.8587</td><td>0.9882</td><td>0.9767</td><td>0.9430</td><td>0.8894</td><td>1.0000</td><td>0.9882</td><td>0.9541</td><td>0.8999</td><td>0.9882</td><td>0.9767</td><td>0.9430</td><td>0.8894</td></tr> <tr><td>0.9430</td><td>0.9541</td><td>0.9430</td><td>0.9105</td><td>0.9767</td><td>0.9882</td><td>0.9767</td><td>0.9430</td><td>0.9882</td><td>1.0000</td><td>0.9882</td><td>0.9541</td><td>0.9767</td><td>0.9882</td><td>0.9767</td><td>0.9430</td></tr> <tr><td>0.9105</td><td>0.9430</td><td>0.9541</td><td>0.9430</td><td>0.9430</td><td>0.9767</td><td>0.9882</td><td>0.9767</td><td>0.9541</td><td>0.9882</td><td>1.0000</td><td>0.9882</td><td>0.9430</td><td>0.9767</td><td>0.9882</td><td>0.9767</td></tr> <tr><td>0.8587</td><td>0.9105</td><td>0.9430</td><td>0.9541</td><td>0.8894</td><td>0.9430</td><td>0.9767</td><td>0.9882</td><td>0.8999</td><td>0.9541</td><td>0.9882</td><td>1.0000</td><td>0.8894</td><td>0.9430</td><td>0.9767</td><td>0.9882</td></tr> <tr><td>0.8999</td><td>0.8894</td><td>0.8587</td><td>0.8099</td><td>0.9541</td><td>0.9430</td><td>0.9105</td><td>0.8587</td><td>0.9882</td><td>0.9767</td><td>0.9430</td><td>0.8894</td><td>1.0000</td><td>0.9882</td><td>0.9541</td><td>0.8999</td></tr> <tr><td>0.8894</td><td>0.8999</td><td>0.8894</td><td>0.8587</td><td>0.9430</td><td>0.9541</td><td>0.9430</td><td>0.9105</td><td>0.9767</td><td>0.9882</td><td>0.9767</td><td>0.9430</td><td>0.9882</td><td>1.0000</td><td>0.9882</td><td>0.9541</td></tr> <tr><td>0.8587</td><td>0.8894</td><td>0.8999</td><td>0.8894</td><td>0.9105</td><td>0.9430</td><td>0.9541</td><td>0.9430</td><td>0.9430</td><td>0.9767</td><td>0.9882</td><td>0.9767</td><td>0.9541</td><td>0.9882</td><td>1.0000</td><td>0.9882</td></tr> <tr><td>0.8099</td><td>0.8587</td><td>0.8894</td><td>0.8999</td><td>0.8587</td><td>0.9105</td><td>0.9430</td><td>0.9541</td><td>0.8894</td><td>0.9430</td><td>0.9767</td><td>0.9882</td><td>0.8999</td><td>0.9541</td><td>0.9882</td><td>1.0000</td></tr> </table>												1.0000	0.9882	0.9541	0.8999	0.9882	0.9767	0.9430	0.8894	0.9541	0.9430	0.9105	0.8587	0.8999	0.8894	0.8587	0.8099	0.9882	1.0000	0.9882	0.9541	0.9767	0.9882	0.9767	0.9430	0.9430	0.9541	0.9430	0.9105	0.8894	0.8999	0.8894	0.8587	0.9541	0.9882	1.0000	0.9882	0.9430	0.9767	0.9882	0.9767	0.9105	0.9430	0.9541	0.9430	0.8587	0.8894	0.8999	0.8894	0.8999	0.9541	0.9882	1.0000	0.8894	0.9430	0.9767	0.9882	0.8587	0.9105	0.9430	0.9541	0.8099	0.8587	0.8894	0.8999	0.9882	0.9767	0.9430	0.8894	1.0000	0.9882	0.9541	0.8999	0.9882	0.9767	0.9430	0.8894	0.9541	0.9430	0.9105	0.8587	0.9767	0.9882	0.9767	0.9430	0.9882	1.0000	0.9882	0.9541	0.9767	0.9882	0.9767	0.9430	0.9430	0.9541	0.9430	0.9105	0.9430	0.9767	0.9882	0.9767	0.9541	0.9882	1.0000	0.9882	0.9430	0.9767	0.9882	0.9767	0.9105	0.9430	0.9541	0.9430	0.8894	0.9430	0.9767	0.9882	0.8999	0.9541	0.9882	1.0000	0.8894	0.9430	0.9767	0.9882	0.8587	0.9105	0.9430	0.9541	0.9541	0.9430	0.9105	0.8587	0.9882	0.9767	0.9430	0.8894	1.0000	0.9882	0.9541	0.8999	0.9882	0.9767	0.9430	0.8894	0.9430	0.9541	0.9430	0.9105	0.9767	0.9882	0.9767	0.9430	0.9882	1.0000	0.9882	0.9541	0.9767	0.9882	0.9767	0.9430	0.9105	0.9430	0.9541	0.9430	0.9430	0.9767	0.9882	0.9767	0.9541	0.9882	1.0000	0.9882	0.9430	0.9767	0.9882	0.9767	0.8587	0.9105	0.9430	0.9541	0.8894	0.9430	0.9767	0.9882	0.8999	0.9541	0.9882	1.0000	0.8894	0.9430	0.9767	0.9882	0.8999	0.8894	0.8587	0.8099	0.9541	0.9430	0.9105	0.8587	0.9882	0.9767	0.9430	0.8894	1.0000	0.9882	0.9541	0.8999	0.8894	0.8999	0.8894	0.8587	0.9430	0.9541	0.9430	0.9105	0.9767	0.9882	0.9767	0.9430	0.9882	1.0000	0.9882	0.9541	0.8587	0.8894	0.8999	0.8894	0.9105	0.9430	0.9541	0.9430	0.9430	0.9767	0.9882	0.9767	0.9541	0.9882	1.0000	0.9882	0.8099	0.8587	0.8894	0.8999	0.8587	0.9105	0.9430	0.9541	0.8894	0.9430	0.9767	0.9882	0.8999	0.9541	0.9882	1.0000
1.0000	0.9882	0.9541	0.8999	0.9882	0.9767	0.9430	0.8894	0.9541	0.9430	0.9105	0.8587	0.8999	0.8894	0.8587	0.8099																																																																																																																																																																																																																																																														
0.9882	1.0000	0.9882	0.9541	0.9767	0.9882	0.9767	0.9430	0.9430	0.9541	0.9430	0.9105	0.8894	0.8999	0.8894	0.8587																																																																																																																																																																																																																																																														
0.9541	0.9882	1.0000	0.9882	0.9430	0.9767	0.9882	0.9767	0.9105	0.9430	0.9541	0.9430	0.8587	0.8894	0.8999	0.8894																																																																																																																																																																																																																																																														
0.8999	0.9541	0.9882	1.0000	0.8894	0.9430	0.9767	0.9882	0.8587	0.9105	0.9430	0.9541	0.8099	0.8587	0.8894	0.8999																																																																																																																																																																																																																																																														
0.9882	0.9767	0.9430	0.8894	1.0000	0.9882	0.9541	0.8999	0.9882	0.9767	0.9430	0.8894	0.9541	0.9430	0.9105	0.8587																																																																																																																																																																																																																																																														
0.9767	0.9882	0.9767	0.9430	0.9882	1.0000	0.9882	0.9541	0.9767	0.9882	0.9767	0.9430	0.9430	0.9541	0.9430	0.9105																																																																																																																																																																																																																																																														
0.9430	0.9767	0.9882	0.9767	0.9541	0.9882	1.0000	0.9882	0.9430	0.9767	0.9882	0.9767	0.9105	0.9430	0.9541	0.9430																																																																																																																																																																																																																																																														
0.8894	0.9430	0.9767	0.9882	0.8999	0.9541	0.9882	1.0000	0.8894	0.9430	0.9767	0.9882	0.8587	0.9105	0.9430	0.9541																																																																																																																																																																																																																																																														
0.9541	0.9430	0.9105	0.8587	0.9882	0.9767	0.9430	0.8894	1.0000	0.9882	0.9541	0.8999	0.9882	0.9767	0.9430	0.8894																																																																																																																																																																																																																																																														
0.9430	0.9541	0.9430	0.9105	0.9767	0.9882	0.9767	0.9430	0.9882	1.0000	0.9882	0.9541	0.9767	0.9882	0.9767	0.9430																																																																																																																																																																																																																																																														
0.9105	0.9430	0.9541	0.9430	0.9430	0.9767	0.9882	0.9767	0.9541	0.9882	1.0000	0.9882	0.9430	0.9767	0.9882	0.9767																																																																																																																																																																																																																																																														
0.8587	0.9105	0.9430	0.9541	0.8894	0.9430	0.9767	0.9882	0.8999	0.9541	0.9882	1.0000	0.8894	0.9430	0.9767	0.9882																																																																																																																																																																																																																																																														
0.8999	0.8894	0.8587	0.8099	0.9541	0.9430	0.9105	0.8587	0.9882	0.9767	0.9430	0.8894	1.0000	0.9882	0.9541	0.8999																																																																																																																																																																																																																																																														
0.8894	0.8999	0.8894	0.8587	0.9430	0.9541	0.9430	0.9105	0.9767	0.9882	0.9767	0.9430	0.9882	1.0000	0.9882	0.9541																																																																																																																																																																																																																																																														
0.8587	0.8894	0.8999	0.8894	0.9105	0.9430	0.9541	0.9430	0.9430	0.9767	0.9882	0.9767	0.9541	0.9882	1.0000	0.9882																																																																																																																																																																																																																																																														
0.8099	0.8587	0.8894	0.8999	0.8587	0.9105	0.9430	0.9541	0.8894	0.9430	0.9767	0.9882	0.8999	0.9541	0.9882	1.0000																																																																																																																																																																																																																																																														

Table B.2.3.2-3: MIMO correlation matrices for medium correlation

1x2 case	N/A
2x2 case	$R_{medium} = \begin{pmatrix} 1 & 0.9 & 0.3 & 0.27 \\ 0.9 & 1 & 0.27 & 0.3 \\ 0.3 & 0.27 & 1 & 0.9 \\ 0.27 & 0.3 & 0.9 & 1 \end{pmatrix}$
4x2 case	$R_{medium} = \begin{pmatrix} 1.0000 & 0.9000 & 0.8748 & 0.7873 & 0.5856 & 0.5271 & 0.3000 & 0.2700 \\ 0.9000 & 1.0000 & 0.7873 & 0.8748 & 0.5271 & 0.5856 & 0.2700 & 0.3000 \\ 0.8748 & 0.7873 & 1.0000 & 0.9000 & 0.8748 & 0.7873 & 0.5856 & 0.5271 \\ 0.7873 & 0.8748 & 0.9000 & 1.0000 & 0.7873 & 0.8748 & 0.5271 & 0.5856 \\ 0.5856 & 0.5271 & 0.8748 & 0.7873 & 1.0000 & 0.9000 & 0.8748 & 0.7873 \\ 0.5271 & 0.5856 & 0.7873 & 0.8748 & 0.9000 & 1.0000 & 0.7873 & 0.8748 \\ 0.3000 & 0.2700 & 0.5856 & 0.5271 & 0.8748 & 0.7873 & 1.0000 & 0.9000 \\ 0.2700 & 0.3000 & 0.5271 & 0.5856 & 0.7873 & 0.8748 & 0.9000 & 1.0000 \end{pmatrix}$
4x4 case	$R_{medium} = \begin{pmatrix} 1.0000 & 0.9882 & 0.9541 & 0.8999 & 0.8747 & 0.8645 & 0.8347 & 0.7872 & 0.5855 & 0.5787 & 0.5588 & 0.5270 & 0.3000 & 0.2965 & 0.2862 & 0.2700 \\ 0.9882 & 1.0000 & 0.9882 & 0.9541 & 0.8645 & 0.8747 & 0.8645 & 0.8347 & 0.5787 & 0.5855 & 0.5787 & 0.5588 & 0.2965 & 0.3000 & 0.2965 & 0.2862 \\ 0.9541 & 0.9882 & 1.0000 & 0.9882 & 0.8347 & 0.8645 & 0.8747 & 0.8645 & 0.5588 & 0.5787 & 0.5855 & 0.5787 & 0.2862 & 0.2965 & 0.3000 & 0.2965 \\ 0.8999 & 0.9541 & 0.9882 & 1.0000 & 0.7872 & 0.8347 & 0.8645 & 0.8747 & 0.5270 & 0.5588 & 0.5787 & 0.5855 & 0.2700 & 0.2862 & 0.2965 & 0.3000 \\ 0.8747 & 0.8645 & 0.8347 & 0.7872 & 1.0000 & 0.9882 & 0.9541 & 0.8999 & 0.8747 & 0.8645 & 0.8347 & 0.7872 & 0.5855 & 0.5787 & 0.5588 & 0.5270 \\ 0.8645 & 0.8747 & 0.8645 & 0.8347 & 0.9882 & 1.0000 & 0.9882 & 0.9541 & 0.8645 & 0.8747 & 0.8645 & 0.8347 & 0.5787 & 0.5855 & 0.5787 & 0.5588 \\ 0.8347 & 0.8645 & 0.8747 & 0.8645 & 0.9541 & 0.9882 & 1.0000 & 0.9882 & 0.8347 & 0.8645 & 0.8747 & 0.8645 & 0.5588 & 0.5787 & 0.5855 & 0.5787 \\ 0.7872 & 0.8347 & 0.8645 & 0.8747 & 0.8999 & 0.9541 & 0.9882 & 1.0000 & 0.7872 & 0.8347 & 0.8645 & 0.8747 & 0.5270 & 0.5588 & 0.5787 & 0.5855 \\ 0.5855 & 0.5787 & 0.5588 & 0.5270 & 0.8747 & 0.8645 & 0.8347 & 0.7872 & 1.0000 & 0.9882 & 0.9541 & 0.8999 & 0.8747 & 0.8645 & 0.8347 & 0.7872 \\ 0.5787 & 0.5855 & 0.5787 & 0.5588 & 0.8645 & 0.8747 & 0.8645 & 0.8347 & 0.9882 & 1.0000 & 0.9882 & 0.9541 & 0.8645 & 0.8747 & 0.8645 & 0.8347 \\ 0.5588 & 0.5787 & 0.5855 & 0.5787 & 0.8347 & 0.8645 & 0.8747 & 0.8645 & 0.9541 & 0.9882 & 1.0000 & 0.9882 & 0.8347 & 0.8645 & 0.8747 & 0.8645 \\ 0.5270 & 0.5588 & 0.5787 & 0.5855 & 0.7872 & 0.8347 & 0.8645 & 0.8747 & 0.8999 & 0.9541 & 0.9882 & 1.0000 & 0.7872 & 0.8347 & 0.8645 & 0.8747 \\ 0.3000 & 0.2965 & 0.2862 & 0.2700 & 0.5855 & 0.5787 & 0.5588 & 0.5270 & 0.8747 & 0.8645 & 0.8347 & 0.7872 & 1.0000 & 0.9882 & 0.9541 & 0.8999 \\ 0.2965 & 0.3000 & 0.2965 & 0.2862 & 0.5787 & 0.5855 & 0.5787 & 0.5588 & 0.8645 & 0.8747 & 0.8645 & 0.8347 & 0.9882 & 1.0000 & 0.9882 & 0.9541 \\ 0.2862 & 0.2965 & 0.3000 & 0.2965 & 0.5588 & 0.5787 & 0.5855 & 0.5787 & 0.8347 & 0.8645 & 0.8747 & 0.8645 & 0.9541 & 0.9882 & 1.0000 & 0.9882 \\ 0.2700 & 0.2862 & 0.2965 & 0.3000 & 0.5270 & 0.5588 & 0.5787 & 0.5855 & 0.7872 & 0.8347 & 0.8645 & 0.8747 & 0.8999 & 0.9541 & 0.9882 & 1.0000 \end{pmatrix}$

Table B.2.3.2-4: MIMO correlation matrices for low correlation

1x2 case	$R_{low} = \mathbf{I}_2$
2x2 case	$R_{low} = \mathbf{I}_4$
4x2 case	$R_{low} = \mathbf{I}_8$
4x4 case	$R_{low} = \mathbf{I}_{16}$

In Table B.2.3.2-4, \mathbf{I}_d is the $d \times d$ identity matrix.

B.2.4 Propagation conditions for CQI tests

[For Channel Quality Indication (CQI) tests, the following additional multi-path profile is used:

$$h(t, \tau) = \delta(\tau) + a \exp(-i2\pi f_D t) \delta(\tau - \tau_d)$$

in continuous time (t, τ) representation, with τ_d the delay, a a constant and f_D the Doppler frequency.]

B.2.5 FFS

B.2.6 MBSFN Propagation Channel Profile

Table B.2.6-1 shows propagation conditions that are used for the MBSFN performance requirements in multi-path fading environment in an extended delay spread environment.

Table B.2.6-1: Propagation Conditions for Multi-Path Fading Environments for MBSFN Performance Requirements in an extended delay spread environment

Extended Delay Spread	
Maximum Doppler frequency [5Hz]	
Relative Delay [ns]	Relative Mean Power [dB]
0	0
30	-1.5
150	-1.4
310	-3.6
370	-0.6
1090	-7.0
12490	-10
12520	-11.5
12640	-11.4
12800	-13.6
12860	-10.6
13580	-17.0
27490	-20
27520	-21.5
27640	-21.4
27800	-23.6
27860	-20.6
28580	-27.0

B.3 High speed train scenario

The high speed train condition for the test of the baseband performance is a non fading propagation channel with one tap. Doppler shift is given by

$$f_s(t) = f_d \cos \theta(t) \quad (\text{B.3.1})$$

where $f_s(t)$ is the Doppler shift and f_d is the maximum Doppler frequency. The cosine of angle $\theta(t)$ is given by

$$\cos \theta(t) = \frac{D_s/2 - vt}{\sqrt{D_{\min}^2 + (D_s/2 - vt)^2}}, \quad 0 \leq t \leq D_s/v \quad (\text{B.3.2})$$

$$\cos \theta(t) = \frac{-1.5D_s + vt}{\sqrt{D_{\min}^2 + (-1.5D_s + vt)^2}}, \quad D_s/v < t \leq 2D_s/v \quad (\text{B.3.3})$$

$$\cos \theta(t) = \cos \theta(t \bmod (2D_s/v)), \quad t > 2D_s/v \quad (\text{B.3.4})$$

where $D_s/2$ is the initial distance of the train from eNodeB, and D_{\min} is eNodeB Railway track distance, both in meters; v is the velocity of the train in m/s, t is time in seconds.

Doppler shift and cosine angle are given by equation B.3.1 and B.3.2-B.3.4 respectively, where the required input parameters listed in table B.3-1 and the resulting Doppler shift is shown in Figure B.3-1 are applied for all frequency bands.

Table B.3-1: High speed train scenario

Parameter	Value
D_s	300 m
D_{\min}	2 m
v	300 km/h
f_d	750 Hz

NOTE 1: Parameters for HST conditions in table B.3-1 including f_d and Doppler shift trajectories presented on figure B.3-1 were derived for Band7.

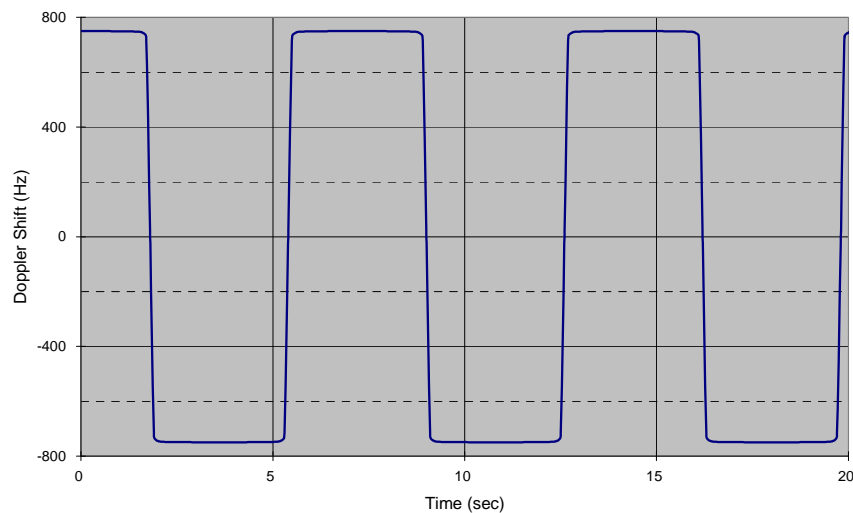

Figure B.3-1: Doppler shift trajectory

B.4 Beamforming Model

B.4.1 Single-layer beamforming (Antenna port 5, 7 or 8)

Single-layer transmission on antenna port 5 or on antenna port 7 or 8 without a simultaneous transmission on the other antenna port, is defined by using a precoder vector $W(i)$ of size 2×1 randomly selected with the number of layers $\nu = 1$ from Table 6.3.4.2.3-1 in TS 36.211 [8] as beamforming weights. This precoder takes as an input the

signal $y^{(p)}(i)$, $i = 0, 1, \dots, M_{\text{symp}}^{\text{ap}} - 1$, for antenna port $p \in \{5, 7, 8\}$, with $M_{\text{symp}}^{\text{ap}}$ the number of modulation symbols including the user-specific reference symbols (DRS), and generates a block of signals $y_{\text{bf}}(i) = [y_{\text{bf}}(i) \ \tilde{y}_{\text{bf}}(i)]^T$ the elements of which are to be mapped onto the same physical RE but transmitted on different antenna elements:

$$\begin{bmatrix} y_{\text{bf}}(i) \\ \tilde{y}_{\text{bf}}(i) \end{bmatrix} = W(i)y^{(p)}(i)$$

Single-layer transmission on antenna port 7 or 8 with a simultaneous transmission on the other antenna port, is defined by using a pair of precoder vectors $W_1(i)$ and $W_2(i)$ each of size 2×1 , which are not identical and randomly selected with the number of layers $\nu = 1$ from Table 6.3.4.2.3-1 in TS 36.211 [8], as beamforming weights, and normalizing the transmit power as follows:

$$\begin{bmatrix} y_{\text{bf}}(i) \\ \tilde{y}_{\text{bf}}(i) \end{bmatrix} = \frac{1}{\sqrt{2}} (W_1(i)y^{(7)}(i) + W_2(i)y^{(8)}(i))$$

The precoder update granularity is according to Table 8.3.2-1.

B.4.2 Dual-layer beamforming (antenna ports 7 and 8)

Dual-layer transmission on antenna ports 7 and 8 is defined by using a precoder matrix $W(i)$ of size 2×2 randomly selected with the number of layers $\nu = 2$ from Table 6.3.4.2.3-1 in TS 36.211 [8] as beamforming weights. This precoder takes as an input a block of signals for antenna ports 7 and 8, $y(i) = [y^{(7)}(i) \ y^{(8)}(i)]^T$, $i = 0, 1, \dots, M_{\text{symp}}^{\text{ap}} - 1$, with $M_{\text{symp}}^{\text{ap}}$ being the number of modulation symbols per antenna port including the user-specific reference symbols, and generates a block of signals $y_{\text{bf}}(i) = [y_{\text{bf}}(i) \ \tilde{y}_{\text{bf}}(i)]^T$ the elements of which are to be mapped onto the same physical RE but transmitted on different antenna elements:

$$\begin{bmatrix} y_{\text{bf}}(i) \\ \tilde{y}_{\text{bf}}(i) \end{bmatrix} = W(i) \begin{bmatrix} y^{(7)}(i) \\ y^{(8)}(i) \end{bmatrix},$$

The precoder update granularity is according to Table 8.3.2-1.

Annex C (normative): Downlink Physical Channels

This annex specifies the downlink physical channels that are needed for setting a connection and channels that are needed during a connection.

C.0 Downlink signal levels

The downlink power settings in Table C.0-1 are used unless otherwise specified in a test case.

If the UE has two Rx antennas, the downlink signal is applied to each one. Both UE Rx antennas shall be connected.

If the UE has one Rx antenna, the downlink signal is applied to it.

Table C.0-1: Default Downlink power levels

	Unit	Channel bandwidth					
		1.4 MHz	3 MHz	5 MHz	10 MHz	15 MHz	20 MHz
Number of RBs		6	15	25	50	75	100
Channel BW Power	dBm	-66	-62	-60	-57	-55	-54
RS EPRE	dBm/15kHz	-85	-85	-85	-85	-85	-85
Note 1: The channel bandwidth powers and RB allocations are informative, based on -85dBm/15kHz RS_EPRES, then scaled according to the number of RBs and rounded to the nearest integer dBm value. Full RE allocation with no boost or deboost is assumed in this calculation, but allocation may vary during setup.							
Note 2: The power level is specified at each UE Rx antenna.							

The default signal level uncertainty is +/-3dB at each test port, for any level specified. If the uncertainty value is critical for the test purpose, a tighter uncertainty is specified for the related test case in Annex F.

C.1 General

Table C.1-1 describes the mapping of downlink physical channels and signals to physical resources for FDD.

Table C.1-2 describes the mapping of downlink physical channels and signals to physical resources for TDD.

Table C.1-1: Mapping of downlink physical channels and signals to physical resources for FDD

Physical channel	Time Domain Location	Frequency Domain Location	Note
RS	Symbols 0, 4 of each subframe for antenna port 0 & 1 Symbol 1 of each subframe for antenna port 2 & 3	Downlink system bandwidth dependent.	Mapping rule is specified in TS36.211 6.10.1.2 - CELL_ID = 0
PBCH	Symbols 0 to 3 of slot 1 of subframe 0 of each radio frame	Occupies 72 subcarriers centered on the DC subcarrier	Mapping rule is specified in TS36.211 Section 6.6.4 (Note 2)
PSS	Symbol 6 of slot 0 and 10 of each radio frame	Occupies 62 subcarriers centered on the DC subcarrier. Additional 10 subcarriers (5 on each side) adjacent to the centered 62 subcarriers are reserved.	Mapping rule is specified in TS36.211 Section 6.11.1.2
SSS	Symbol 5 of slots 0 and 10 of each radio frame	Occupies 62 subcarriers centered on the DC subcarrier. Additional 10 subcarriers (5 on each side) adjacent to the centered 62 subcarriers are reserved.	Mapping rule is specified in TS36.211 Section 6.11.2.2
PCFICH	Symbol 0 of each subframe	Downlink system bandwidth dependent. Maps into 4 REGs uniformly spread in the frequency domain over the whole system bandwidth.	Mapping rule is specified in TS36.211 Section 6.7.4 (Note 1) - CELL_ID = 0
PHICH	Symbol 0 of each subframe	Downlink system bandwidth dependent. Each PHICH group maps into 3 REGs in the frequency domain on the REGs not assigned to PCFICH over the whole system bandwidth,	Mapping rule is specified in TS36.211 Section 6.9.3 (Note 1) - CELL_ID = 0 - Ng = 1 - Normal PHICH duration - Number of PHICH groups = 1(BW=1.4MHz)/2(BW=3MHz)/4(BW=5MHz)/7(BW=10MHz)/10(BW=15MHz)/13(BW=20MHz)
PDCCH	Symbols 0, 1, 2, 3 of each subframe for 1.4 MHz Symbols 0, 1, 2, of each subframe for 3 and 5 MHz Symbols 0, 1 of each subframe for 10, 15 and 20 MHz	The remaining REGs not allocated to both PCFICH and PHICH are used for PDCCH	Mapping rule is specified in TS36.211 Section 6.8.5 (Note 1)
PDSCH	All remaining OFDM symbols of each subframe not allocated to PDCCH	For Subframe 0, REs not allocated to RS, PSS, SSS and PBCH, is allocated to PDSCH For Subframe 5, REs not allocated to RS, PSS and SSS, is allocated to PDSCH For other subframes, REs not allocated to RS, is allocated to PDSCH	Note that there are reserved REs that are not used for transmission of any physical channels (Note 3) & (Note 4) which need to be taken into account when allocating REs to PDSCH

Note 1: In case a single cell-specific RS is configured, cell-specific RS shall be assumed to be present on antenna ports 0 and 1 for the purpose of mapping a symbol-quadruplet to a REG (resource-element group). (See TS 36.211 Section 6.2.4).

Note 2: PBCH is mapped into RE assuming RS from 4 antennas are used at the eNB transmitter, irrespective of the actual number of Tx antenna. Resource elements assumed to be reserved for RS but not used for transmission of RS shall not be used for transmission of any physical channel. (See TS 36.211 Section 6.6.4).

Note 3: In slot 0 and slot 10 of each radioframe, there are reserved REs for PSS and SSS that are not used for transmission of any physical channels. (See TS 36.211 Section 6.11.1.2 & 6.11.2.2).

Note 4: REs used for RS transmission on any of the antenna ports in a slot shall not be used for any transmission on any other antenna port in the same slot and set to zero. (See TS 36.211 Section 6.10.1.2).

Table C.1-2: Mapping of downlink physical channels and signals to physical resources for TDD

Physical channel	Time Domain Location	Frequency Domain Location	Note
RS	Symbols 0, 4 of each subframe for antenna port 0 & 1 Symbol 1 of each subframe for antenna port 2 & 3	Downlink system bandwidth dependent.	Mapping rule is specified in TS36.211[8] 6.10.1.2 - CELL_ID = 0
PBCH	Symbols 0 to 3 of slot 1 of subframe 0 of each radio frame	Occupies 72 subcarriers centered on the DC subcarrier	Mapping rule is specified in TS36.211[8] Section 6.6.4 (Note 3)
PSS	Symbol 2 of slot 2 and 12 of each radio frame	Occupies 62 subcarriers centered on the DC subcarrier. Additional 10 subcarriers (5 on each side) adjacent to the centered 62 subcarriers are reserved.	Mapping rule is specified in TS36.211[8] Section 6.11.1.2
SSS	Symbol 6 of slots 1 and 11 of each radio frame	Occupies 62 subcarriers centered on the DC subcarrier. Additional 10 subcarriers (5 on each side) adjacent to the centered 62 subcarriers are reserved.	Mapping rule is specified in TS36.211[8] Section 6.11.2.2
PCFICH	Symbol 0 of each subframe and special subframe	Downlink system bandwidth dependent. Maps into 4 REGs uniformly spread in the frequency domain over the whole system bandwidth.	Mapping rule is specified in TS36.211[8] Section 6.7.4 (Note 2) - CELL_ID = 0
PHICH	Symbol 0 of each subframe and special subframe	Downlink system bandwidth dependent. Each PHICH group maps into 3 REGs in the frequency domain on the REGs not assigned to PCFICH over the whole system bandwidth,	Mapping rule is specified in TS36.211[8] Section 6.9.3 (Note 2) - CELL_ID = 0 - Ng = 1 - Normal PHICH duration - Number of PHICH groups = 1(BW=1.4MHz)/2(BW=3MHz)/4(BW=5MHz)/7(BW=10MHz)/10(BW=15MHz)/13(BW=20MHz)
PDCCH	For normal subframes(0,4,5,9) Symbols 0, 1, 2, 3 of each subframe for 1.4 MHz Symbols 0, 1, 2, of each subframe for 3 and 5 MHz Symbols 0, 1 of each subframe for 10, 15 and 20 MHz For special subframe (1&6) Symbols 0, 1 of each subframe for all BWs	The remaining REGs not allocated to both PCFICH and PHICH are used for PDCCH	Mapping rule is specified in TS36.211[8] Section 6.8.5 (Note 2)
PDSCH	,All remaining OFDM symbols of each subframe not allocated to PDCCH with the following exception: For 1.4MHz,no data shall be scheduled on special subframes (1&6) to avoid problems with insufficient PDCCH performance	For Subframe 0, REs not allocated to RS, SSS and PBCH, is allocated to PDSCH For Subframe 5, REs not allocated to RS and SSS, is allocated to PDSCH For Subframe 1 and 6, REs not allocated to RS, PSS, GP and UpPTS is allocated to PDSCH For other downlink subframes, REs not allocated to RS is allocated to PDSCH	Note that there are reserved REs that are not used for transmission of any physical channels (Note 4) & (Note 5) which need to be taken into account when allocating REs to PDSCH
Note 1: The mapping is based on the default TDD configuration for subframe assignment and special subframe patterns (see 36.508 [7]subclause 4.6.3)			
Note 2: In case a single cell-specific RS is configured, cell-specific RS shall be assume to be present on antenna ports 0 and 1 for the purpose of mapping a symbol-quadruplet to a REG (resource-element group). (See TS			

36.211[8] Section 6.2.4).

Note 3: PBCH is mapped into RE assuming RS from 4 antennas are used at the eNB transmitter, irrespective of the actual number of Tx antenna. Resource elements assumed to be reserved for RS but not used for transmission of RS shall not be used for transmission of any physical channel. (See TS 36.211[8] Section 6.6.4).

Note 4: In slot 1,2,11 and 12 of each radio frame, there are reserved REs for PSS and SSS that are not used for transmission of any physical channels. (See TS 36.211[8] Section 6.11.1.2 & 6.11.2.2).

Note 5: REs used for RS transmission on any of the antenna ports in a slot shall not be used for any transmission on any other antenna port in the same slot and set to zero. (See TS 36.211[8] Section 6.10.1.2).

C.2 Set-up

Table C.2-1 describes the downlink Physical Channels that are required for connection set up.

Table C.2-1: Downlink Physical Channels required for connection set-up

Physical Channel	EPRE Ratio	Note
PBCH	PBCH_RA = 0 dB	
	PBCH_RB = 0 dB	
PSS	PSS_RA = 0 dB	
SSS	SSS_RA = 0 dB	
PCFICH	PCFICH_RB = 0 dB	
PDCCH	PDCCH_RA = 0 dB	
	PDCCH_RB = 0 dB	
PDSCH	PDSCH_RA = 0 dB	
	PDSCH_RB = 0 dB	
PHICH	PHICH_RA = 0 dB	Note 2
	PHICH_RB = 0 dB	
Note 1: No boosting is applied.		
Note 2: PHICH group power, i.e. the total power of all active PHICH sequences within a PHICH group.		

Table C.2-2 describes the configuration of PDSCH and PDCCH before measurement for FDD and Table C.2-3 for TDD.

Table C.2-2: PDSCH and PDCCH configuration for FDD

Parameter	Unit	Value	Comments
Allocated resource blocks		6	
MCS Index		-	TB Size with transmitting message in 1TTI
Number of HARQ processes	Processes	8	
Maximum number of HARQ transmission		5	
Aggregation level	CCE	2	Note 4
DCI Format for PDSCH		Format 1A	
DCI Format for PUSCH		Format 0	
Note 1: 2 symbols allocated to PDCCH for 20 MHz, 15 MHz and 10 MHz channel BW. 3 symbols allocated to PDCCH for 5 MHz and 3 MHz. 4 symbols allocated to PDCCH for 1.4 MHz.			
Note 2: Reference signal, Synchronization signals and PBCH allocated as per TS 36.211 [8].			
Note 3: The PDSCH shall be occupied 6 resource blocks centered on the DC subcarrier.			
Note 4: For PDCCH using SI-RNTI, Aggregation level:			
a) Tables C.3.0-3, C.3.1-3, and C.3.2-3 for RF tests			
b) Table A.2.1-1 of 36.521-3 for RRM tests.			

Table C.2-3: PDSCH and PDCCH configuration for TDD

Parameter	Unit	Value	Comments
Allocated resource blocks		6	
MCS Index		0	TB Size with transmitting message in 1TTI
Number of HARQ processes (Note 1)	Processes	7	
Maximum number of HARQ transmission		4	
Aggregation level	CCE	2	Note 5
DCI Format for PDSCH		Format 1A	
DCI Format for PUSCH		Format 0	
Note 1:	Number of HARQ processes shall be determined by UL/DL configuration, for configuration other than 1, the process number shall be set per TS 36.213 [10] Table 8-1.		
Note 2:	For normal downlink subframes, 2 symbols allocated to PDCCH for 20 MHz, 15 MHz and 10 MHz channel BW. 3 symbols allocated to PDCCH for 5 MHz and 3 MHz. 4 symbols allocated to PDCCH for 1.4 MHz. For special subframe (1&6), only 2 OFDM symbols are allocated to PDCCH for all BWs.		
Note 3:	Reference signal, Synchronization signals and PBCH allocated as per TS 36.211 [8].		
Note 4:	The PDSCH shall be occupied 6 resource blocks centered on the DC subcarrier.		
Note 5:	For PDCCH using SI-RNTI, Aggregation level: a) Tables C.3.0-3, C.3.1-3, and C.3.2-3 for RF tests b) Table A.2.2-1 of 36.521-3 for RRM tests		

C.3 Connection

The following clauses describes the downlink Physical Channels that are transmitted during a connection i.e., when measurements are done.

C.3.0 Measurement of Transmitter Characteristics

Table C.3.0-1 is applicable for measurements on the Transmitter Characteristics (clause 6).

Table C.3.0-1: Downlink Physical Channels transmitted during a connection (FDD and TDD)

Physical Channel	EPRE Ratio	Note
PBCH	PBCH_RA = 0 dB	
	PBCH_RB = 0 dB	
PSS	PSS_RA = 0 dB	
SSS	SSS_RA = 0 dB	
PCFICH	PCFICH_RB = 0 dB	
PDCCH	PDCCH_RA = 0 dB	
	PDCCH_RB = 0 dB	
PDSCH	PDSCH_RA = 0 dB	
	PDSCH_RB = 0 dB	
PHICH	PHICH_RB = 0 dB	Note 1
Note 1: PHICH group power, i.e. the total power of all active PHICH sequences within a PHICH group.		

NOTE 1: No boosting is applied.

Table C.3.0-2: Power allocation for OFDM symbols and reference signals

Parameter	Unit	Value	Note
Transmitted power spectral density I_{or}	dBm/15 kHz	Test specific	1. I_{or} shall be kept constant throughout all OFDM symbols
Cell-specific reference signal power ratio E_{RS} / I_{or}		0 dB	

Table C.3.0-3: PDCCH Aggregation Level (in CCE-s)

Bandwidth	DCI for DL (SI-RNTI)	DCI for DL (C-RNTI)	DCI for UL (C-RNTI)	Notes
1.4 MHz	4	1	1	Note 1
3 MHz	4	4	4	Note 1
5 MHz	4	4	4	Note 1
10 MHz	8	8	8	Note 1
15 MHz	8	8	8	Note 1
20 MHz	8	8	8	Note 1

Note 1: No DL data allocated on TDD special subframes

C.3.1 Measurement of Receiver Characteristics

Table C.3.1-1 is applicable for measurements on the Receiver Characteristics (clause 7).

Table C.3.1-1: Downlink Physical Channels transmitted during a connection (FDD and TDD)

Physical Channel	EPRE Ratio	Note
PBCH	PBCH_RA = 0 dB	
	PBCH_RB = 0 dB	
PSS	PSS_RA = 0 dB	
SSS	SSS_RA = 0 dB	
PCFICH	PCFICH_RB = 0 dB	
PDCCH	PDCCH_RA = 0 dB	
	PDCCH_RB = 0 dB	
PDSCH	PDSCH_RA = 0 dB	
	PDSCH_RB = 0 dB	
PHICH	PHICH_RB = 0 dB	Note 1
OCNG	OCNG_RA = 0 dB	
	OCNG_RB = 0 dB	

Note 1: PHICH group power, i.e. the total power of all active PHICH sequences within a PHICH group.

NOTE 1: No boosting is applied.

Table C.3.1-2: Power allocation for OFDM symbols and reference signals

Parameter	Unit	Value	Note
Transmitted power spectral density I_{or}	dBm/15 kHz	Test specific	1. I_{or} shall be kept constant throughout all OFDM symbols
Cell-specific reference signal power ratio E_{RS} / I_{or}		0 dB	

Table C.3.1-3: PDCCH Aggregation Level (in CCE-s)

Bandwidth	DCI for DL (SI-RNTI)	DCI for DL (C-RNTI)	DCI for UL (C-RNTI)	Notes
1.4 MHz	4	4	2	Note 1, 2
3 MHz	4	4	2	Note 2
5 MHz	8	8	4	Note 2
10 MHz	8	8	8	Note 2
15 MHz	8	8	8	Note 2
20 MHz	8	8	8	Note 2

Note 1: No DL data allocated on TDD special subframes
Note 2: No DL data allocated on subframe 5

C.3.2 Measurement of Performance requirements

Table C.3.2-1 is applicable for measurements in which uniform RS-to-EPRE boosting for all downlink physical channels.

Table C.3.2-1: Downlink Physical Channels transmitted during a connection (FDD and TDD)

Physical Channel	EPRE Ratio	Note
PBCH	PBCH_RA = ρ_A	
	PBCH_RB = ρ_B	
PSS	PSS_RA = ρ_A	
SSS	SSS_RA = ρ_A	
PCFICH	PCFICH_RB = ρ_B	
PDCCH	PDCCH_RA = ρ_A	
	PDCCH_RB = ρ_B	
PDSCH	PDSCH_RA = ρ_A	
	PDSCH_RB = ρ_B	
PHICH	PHICH_RB = ρ_B	Note 1
OCNG	OCNG_RA = ρ_A	
	OCNG_RB = ρ_B	
Note 1: PHICH group power, i.e. the total power of all active PHICH sequences within a PHICH group.		

NOTE 1: $\rho_A = \rho_B = 0$ dB means no RS boosting.

NOTE 2: ρ_A denotes the ratio of PDSCH EPRE to cell-specific RS EPRE among PDSCH REs in all the OFDM symbols not containing cell-specific RS. ρ_B denotes the ratio of PDSCH EPRE to cell-specific RS EPRE among PDSCH REs in all the OFDM symbols containing cell-specific RS.

Table C.3.2-2: Power allocation for OFDM symbols and reference signals

Parameter	Unit	Value	Note
Total transmitted power spectral density I_{or}	dBm/15 kHz	Test specific	1. I_{or} shall be kept constant throughout all OFDM symbols
Cell-specific reference signal power ratio E_{RS} / I_{or}		Test specific	1. Applies for antenna port p

Table C.3.2-3: PDCCH Aggregation Level (in CCE-s) for PDSCH demodulation and PMI performance tests

Bandwidth	DCI for DL (SI-RNTI)	DCI for DL (C-RNTI)	DCI for UL (C-RNTI)	Notes
1.4 MHz	4	4	2	Note 1, 2
3 MHz	4	4	2	Note 2
5 MHz	8	8	4	Note 2
10 MHz	8	8	8	Note 2
15 MHz	8	8	8	Note 2
20 MHz	8	8	8	Note 2
Note 1: No DL data allocated on TDD special subframes				
Note 2: No DL data allocated on subframe 5				

Table C.3.2-4: PDCCH Aggregation Level for CQI and RI performance tests (in CCE-s)

Bandwidth	DCI for DL (SI-RNTI)	DCI for DL (C-RNTI)	DCI for UL (C-RNTI)	Notes
1.4 MHz				
3 MHz				
5 MHz				
10 MHz	8	8	8	Note 1,2
15 MHz				
20 MHz				
Note 1: 3 symbols allocated to PDCCH				
Note 2: No DL data allocated on subframes 0 and 5 for FDD and 0, 1, 5 and 6 for TDD				

Annex D (normative): Characteristics of the Interfering Signal

D.1 General

Some RF performance requirements for the E-UTRA UE receiver are defined with interfering signals present in addition to the wanted signal. When the wanted channel band width is wider than or equal to 5MHz, a modulated 5MHz full band width E-UTRA down link signal, and in some cases an additional CW signal, are used. For wanted channel band widths below 5MHz, the band width of the modulated interferer should be equal to the channel band width of the wanted signal.

D.2 Interference signals

Table D.2-1 describes the modulated interferer for different channel band width options.

Table D.2-1: Description of modulated E-UTRA interferer

	Channel bandwidth					
	1.4 MHz	3 MHz	5 MHz	10 MHz	15 MHz	20 MHz
RB	6	15	25	25	25	25
BW _{Interferer}	1.4 MHz	3 MHz	5 MHz	5 MHz	5 MHz	5 MHz

Annex E (normative): Global In-Channel TX-Test

Editor's note: This annex is incomplete. The following aspects are either missing or not yet determined:

- *An average EVM, comprising 20 individual values, is defined and compared against the test limit. The other sub-results of the Global In channel TX-Test deliver one value per slot, hence 20 values. It is tbd, how to compare this individual values against the test limit.*

Clauses E.2.2 to E.5.9.3 are descriptions, which exclude any transients due to power on/off or power change.

When the test runs with exclusions periods, Clause E.7 is applicable

E.1 General

The global in-channel TX test enables the measurement of all relevant parameters that describe the in-channel quality of the output signal of the TX under test in a single measurement process.

The parameters describing the in-channel quality of a transmitter, however, are not necessarily independent. The algorithm chosen for description inside this annex places particular emphasis on the exclusion of all interdependencies among the parameters.

E.2 Signals and results

E.2.1 Basic principle

The process is based on the comparison of the actual **output signal of the TX under test**, received by an ideal receiver, with a **reference signal**, that is generated by the measuring equipment and represents an ideal error free received signal. All signals are represented as equivalent (generally complex) baseband signals.

The description below uses numbers as examples. These numbers are taken from frame structure 1 with normal CP length and 20 MHz bandwidth. The application of the text below, however, is not restricted to this frame structure and bandwidth.

E.2.2 Output signal of the TX under test

The output signal of the TX under test is acquired by the measuring equipment and stored for further processing. It is sampled at a sampling rate of 30.72 Msps. In the time domain it comprises at least 10 uplink subframes. The measurement period is derived by concatenating the correct number of individual uplink slots until the correct measurement period is reached. The output signal is named $z(v)$. Each slot is modelled as a signal with the following parameters: demodulated data content, carrier frequency, amplitude and phase for each subcarrier, timing, carrier leakage.

NOTE 1: TDD

For frame structure type 2, subframes with special fields (UpPTS) do not undergo any evaluation. Since the uplink subframes are not continuous, the 20 slots should be extracted from more than 1 continuous radio frame:

Figure E.2.2-1 is an example for uplink-downlink configuration 1 (DSUUDDSUUD) as specified in TS 36.211 [8] Table 4.2-2, assuming all uplink subframes are active.

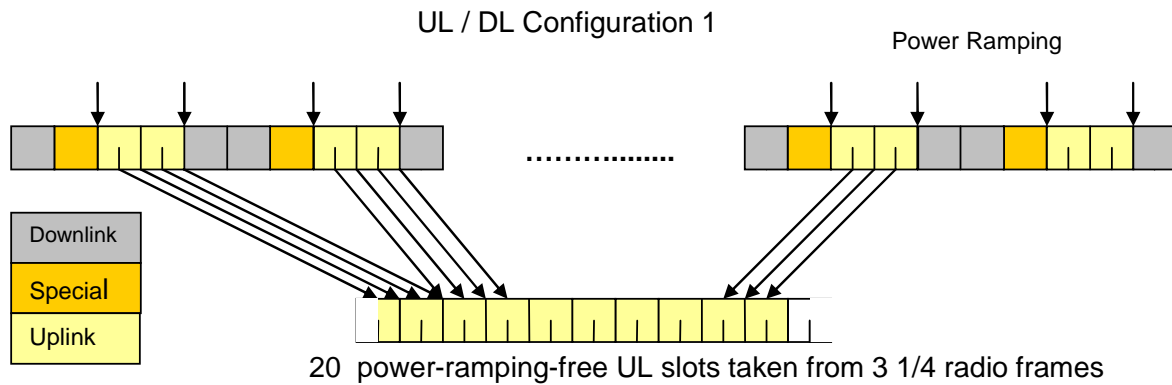

Figure E.2.2-1: Example of uplink – downlink configuration 1

E.2.3 Reference signal

Two types of reference signal are defined:

The reference signal $i_1(v)$ is constructed by the measuring equipment according to the relevant TX specifications, using the following parameters: demodulated data content, nominal carrier frequency, nominal amplitude and phase for each subcarrier, nominal timing, no carrier leakage. It is represented as a sequence of samples at a sampling rate of 30.72 Msps in the time domain.

The reference signal $i_2(v)$ is constructed by the measuring equipment according to the relevant TX specifications, using the following parameters: restricted data content: nominal reference symbols, (all modulation symbols for user data symbols are set to 0V), nominal carrier frequency, nominal amplitude and phase for each applicable subcarrier, nominal timing, no carrier leakage. It is represented as a sequence of samples at a sampling rate of 30.72 Msps in the time domain.

NOTE: The PUCCH is off during the time under test.

E.2.4 Measurement results

The measurement results, achieved by the global in channel TX test are the following:

- Carrier Frequency error
- EVM (Error Vector Magnitude)
- Carrier leakage
- Unwanted emissions, falling into non allocated resource blocks.
- EVM equalizer spectrum flatness

E.2.5 Measurement points

The unwanted emission falling into non-allocated RB(s) is calculated directly after the FFT as described below. In contrast to this, the EVM for the allocated RB(s) is calculated after the IDFT. The samples after the TX-RX chain equalizer are used to calculate EVM equalizer spectrum flatness. Carrier frequency error and carrier leakage is calculated in the block “RF correction”.

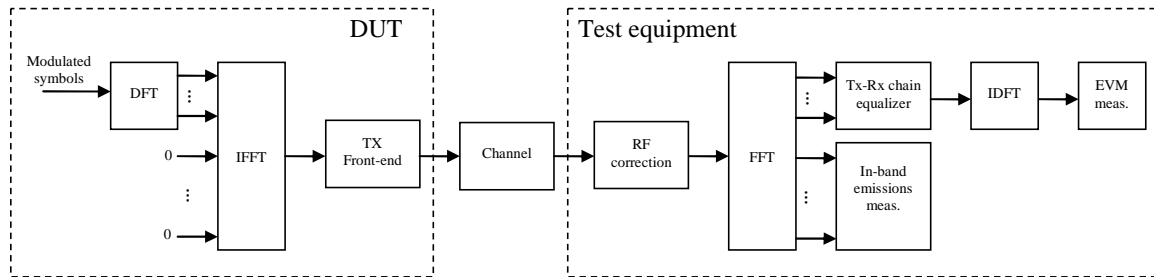

Figure E.2.5-1: EVM measurement points

E.3 Signal processing

E.3.1 Pre FFT minimization process

Before applying the pre-FFT minimization process, $z(v)$ and $i(v)$ are portioned into 20 pieces, comprising one slot each. Each slot is processed separately. Sample timing, Carrier frequency and baseband-I/Q offset (corresponding carrier leakage in RF) in $z(v)$ are jointly varied in order to minimise the difference between $z(v)$ and $i(v)$. Best fit (minimum difference) is achieved when the RMS difference value between $z(v)$ and $i(v)$ is an absolute minimum.

The carrier frequency variation and the IQ variation are the measurement results: Carrier Frequency Error and Carrier leakage.

From the acquired samples 20 carrier frequencies and 20 carrier leakages can be derived.

NOTE 1: The minimisation process, to derive carrier leakage and RF error can be supported by Post FFT operations. However the minimisation process defined in the pre FFT domain comprises all acquired samples (i.e. it does not exclude the samples in between the FFT widths and it does not exclude the bandwidth outside the transmission bandwidth configuration)

NOTE 2: The algorithm would allow to derive Carrier Frequency error and Sample Frequency error of the TX under test separately. However there are no requirements for Sample Frequency error. Hence the algorithm models the RF and the sample frequency commonly (not independently). It returns one error and does not distinguish between both.

After this process the samples $z(v)$ are called $z^0(v)$.

E.3.2 Timing of the FFT window

The FFT window length is 2048 samples per OFDM symbol. 7 FFTs (14336 samples) cover less than the acquired number of samples (15360 samples) The position in time for FFT must be determined.

In an ideal signal, the FFT may start at any instant within the cyclic prefix without causing an error. The TX filter, however, reduces the window. The EVM requirements shall be met within a window $W < CP$. There are three different instants for FFT:

Centre of the reduced window, called $\Delta\tilde{c}$, $\Delta\tilde{c} - W/2$ and $\Delta\tilde{c} + W/2$.

The timing of the measured signal is determined in the pre FFT domain as follows, using $z^0(v)$ and $i_2(v)$:

1. The measured signal is delay spread by the TX filter. Hence the distinct borders between the OFDM symbols and between Data and CP are also spread and the timing is not obvious.
2. In the Reference Signal $i_2(v)$ the timing is known.
3. Correlation between (1.) and (2.) will result in a correlation peak. The meaning of the correlation peak is approx. the "impulse response" of the TX filter. The meaning of "impulse response" assumes that the

autocorrelation of the reference signal $i_2(v)$ is a Dirac peak and that the correlation between the reference signal $i_2(v)$ and the data in the measured signal is 0. The correlation peak, (the highest, or in case of more than one, the earliest) indicates the timing in the measured signal.

From the acquired samples 20 timings can be derived.

For all calculations, except EVM, the number of samples in $z^0(v)$ is reduced to 7 blocks of samples, comprising 2048 samples (FFT width) and starting with $\Delta\tilde{c}$ in each OFDM symbol including the demodulation reference signal.

For the EVM calculation the output signal under test is reduced to 14 blocks of samples, comprising 2048 samples (FFT width) and starting with $\Delta\tilde{c} -W/2$ and $\Delta\tilde{c} +W/2$ in each OFDM symbol including the demodulation reference signal.

The number of samples, used for FFT is reduced compared to $z^0(v)$. This subset of samples is called $z'(v)$.

The timing of the centre $\Delta\tilde{c}$ with respect to the different CP length in a slot is as follows: (Frame structure 1, normal CP length)

$\Delta\tilde{c}$ is on $T_f=72$ within the CP of length 144 (in OFDM symbol 1 to 6)

$\Delta\tilde{c}$ is on $T_f=88$ (=160-72) within the CP of length 160 (in OFDM symbol 0)

E.3.3 Post FFT equalisation

Perform 7 FFTs on $z'(v)$, one for each OFDM symbol in a slot using the timing $\Delta\tilde{c}$, including the demodulation reference symbol. The result is an array of samples, 7 in the time axis t times 2048 in the frequency axis f . The samples represent the DFT coded data symbols (in OFDM-symbol 0,1,2,4,5 and 6 in each slot) and demodulation reference symbols (OFDM symbol 3 in each slot) in the allocated RBs and inband emissions in the non allocated RBs within the transmission BW.

Only the allocated resource blocks in the frequency domain are used for equalisation.

The nominal demodulation reference symbols and nominal DFT coded data symbols are used to equalize the measured data symbols. (Location for equalization see Figure E.2.5-1)

NOTE: The nomenclature inside this note is local and not valid outside.

The nominal DFT coded data symbols are created by a demodulation process. The location to gain the demodulated data symbols is "EVM" in Figure E.2.5-1. A demodulation process as follows is recommended:

1. Equalize the measured DFT coded data symbols using the reference symbols for equalisation. Result: Equalized DFT coded data symbols
2. iDFT transform the equalized DFT coded data symbols: Result: Equalized data symbols
3. Decide for the nearest constellation point: Result: Nominal data symbols
4. DFT transform the nominal data symbols: Result: Nominal DFT coded data symbols

At this stage we have an array of M Measured DFT coded data-Symbols and reference-Symbols ($MS(f,t)$)

versus an array of Nominal DFT coded data-Symbols and reference Symbols ($NS(f,t)$)

(complex, the arrays comprise 6 DFT coded data symbols and 1 demodulation reference symbol in the time axis and the number of allocated subcarriers in the frequency axis.)

$MS(f,t)$ and $NS(f,t)$ are processed with a least square (LS) estimator, to derive one equalizer coefficient per time slot and per allocated subcarrier. $EC(f)$

$$EC(f) = \frac{\sum_{t=0}^6 NS(f,t)^* NS(f,t)}{\sum_{t=0}^6 MS(f,t)^* NS(f,t)}$$

With * denoting complex conjugation.

EC(f) are used to equalize the DFT-coded data symbols. The measured DFT-coded data and the references symbols are equalized by:

$$Z'(f,t) = MS(f,t) \cdot EC(f)$$

With · denoting multiplication.

Z'(f,t), restricted to the data symbol (excluding t=3) is used to calculate EVM, as described in E.4.1.

EC(f) is used in E.4.4 to calculate EVM equalizer spectral flatness.

NOTE: although an exclusion period for EVM may be applicable in E.7, the post FFT minimisation process is done over 7 symbols (6 DFT-coded data symbols and 1 reference symbol).

The samples of the non allocated resource blocks within the transmission bandwidth configuration in the post FFT domain are called Y(f,t) (f covering the non allocated subcarriers within the transmission bandwidth configuration, t covering the OFDM symbols during 1 slot).

E.4 Derivation of the results

E.4.1 EVM

For EVM create two sets of Z'(f,t), according to the timing " $\Delta\tilde{c} -W/2$ and $\Delta\tilde{c} +W/2$ " using the equalizer coefficients from E.3.3.

Perform the iDFTs on Z'(f,t). The IDFT-decoding preserves the meaning of t but transforms the variable f (representing the allocated sub carriers) into an another variable g, covering the same count and representing the demodulated symbols. The samples in the post IDFT domain are called $iZ'(g, t)$. The equivalent ideal samples are called $iI(g,t)$. Those samples of Z'(f,t), carrying the reference symbols (=symbol 3) are not iDFT processed.

The EVM is the difference between the ideal waveform and the measured and equalized waveform for the allocated RB(s)

$$EVM = \sqrt{\frac{\sum_{t \in T} \sum_{g \in G} |iZ'(g, t) - iI(g, t)|^2}{|G| \cdot |T| \cdot P_0}},$$

where

t covers the count of demodulated symbols with the considered modulation scheme being active within the measurement period, (i.e. symbol 0,1,2,4,5 and 6 in each slot, $\Rightarrow |T|=6$)

g covers the count of demodulated symbols with the considered modulation scheme being active within the allocated bandwidth. ($|G|=12 \cdot L_{CRBs}$ (with L_{CRBs} : number of allocated resource blocks)).

$iZ'(g, t)$ are the samples of the signal evaluated for the EVM.

$iI(g, t)$ is the ideal signal reconstructed by the measurement equipment, and

P_0 is the average power of the ideal signal. For normalized modulation symbols P_0 is equal to 1.

From the acquired samples 40 EVM value can be derived, 20 values for the timing $\Delta\tilde{c} -W/2$ and 20 values for the timing $\Delta\tilde{c} +W/2$

E.4.2 Averaged EVM

EVM is averaged over all basic EVM measurements.

The averaging comprises 20 UL slots (for frame structure 2: excluding special fields(UpPTS))

$$\overline{EVM} = \sqrt{\frac{1}{20} \sum_{i=1}^{20} EVM_i^2}$$

The averaging is done separately for timing! $\Delta\tilde{c} -W/2$ and $\Delta\tilde{c} +W/2$ leading to \overline{EVM}_l and \overline{EVM}_h

$EVM_{\text{final}} = \max(\overline{EVM}_l, \overline{EVM}_h)$ is compared against the test requirements.

E.4.3 In-band emissions measurement

The in-band emissions are a measure of the interference falling into the non-allocated resources blocks.

Explanatory Note:

The inband emission measurement is only meaningful with allocated RBs next to non allocated RB. The allocated RBs are necessary but not under test. The non allocated RBs are under test. The RB allocation for this test is as follows: The allocated RBs are at one end of the channel BW, leaving the other end unallocated. The number of allocated RBs is smaller than half of the number of RBs, available in the channel BW. This means that the vicinity of the carrier in the centre is unallocated.

There are 3 types of inband emissions:

1. General
2. IQ image
3. Carrier leakage

Carrier leakage are inband emissions next to the carrier.

IQ image are inband emissions symmetrically (with respect to the carrier) on the other side of the allocated RBs.

General are applied to all unallocated RBs.

For each evaluated RB, the minimum requirement is calculated as the higher of $P_{RB} - 30$ dB and the power sum of all limit values (General, IQ Image or Carrier leakage) that apply.

In specific the following combinations:

- Power (General)
- Power (General + Carrier leakage)
- Power (General + IQ Image)

1 and 2 is expressed in terms of power in one non allocated RB under test, normalized to the average power of an allocated RB (unit dB).

3 is expressed in terms of power in one non allocated RB, normalized to the power of all allocated RBs. (unit dBc).

This is the reason for two formulas *Emissions_{relative}*

Create one set of $Y(t,f)$ per slot according to the timing “ $\Delta\tilde{c}$ ”

For the non-allocated RBs below the in-band emissions are calculated as follows

$$Emissions_{absolute}(\Delta_{RB}) = \begin{cases} \frac{1}{|T_s|} \sum_{t \in T_s} \sum_{c_l + (12 \cdot \Delta_{RB} + 1) \cdot \Delta f}^{c_l + (12 \cdot \Delta_{RB} + 11) \cdot \Delta f} |Y(t, f)|^2, \Delta_{RB} < 0 \\ \frac{1}{|T_s|} \sum_{t \in T_s} \sum_{c_h + (12 \cdot \Delta_{RB} - 11) \cdot \Delta f}^{\min(f_{\max}, (c_h + 12 \cdot \Delta_{RB} \cdot \Delta f))} |Y(t, f)|^2, \Delta_{RB} > 0 \end{cases}$$

where

the upper formula represents the in band emissions below the allocated frequency block and the lower one the in band emissions above the allocated frequency block.

T_s is a set of $|T_s|$ SC-FDMA symbols with the considered modulation scheme being active within the measurement period,

Δ_{RB} is the starting frequency offset between the allocated RB and the measured non-allocated RB (e.g. $\Delta_{RB} = 1$ for the first upper or $\Delta_{RB} = -1$ for the first lower adjacent RB),

f_{\min} and f_{\max} are the lower and upper edge of the UL transmission BW configuration,

c_l and c_h are the lower and upper edge of the allocated BW,

Δf is 15kHz, and

$Y(t, f)$ is the frequency domain signal evaluated for in-band emissions as defined in the subsection E.3.3

The allocated RB power per RB and the total allocated RB power are given by:

$$P_{RB} = \frac{1}{|T_s| \cdot L_{CRBs}} \sum_{t \in T_s} \sum_{c_1}^{c_1 + (12 \cdot L_{CRBs} - 1) \cdot \Delta f} |MS(t, f)|^2 \text{ [dBm/180 kHz]}$$

$$P_{All-RBs} = \frac{1}{|T_s|} \sum_{t \in T_s} \sum_{c_1}^{c_1 + (12 \cdot L_{CRBs} - 1) \cdot \Delta f} |MS(t, f)|^2 \text{ [dBm]}$$

The relative in-band emissions, applicable for General and IQ image, are given by:

$$Emissions_{relative}(\Delta_{RB}) = 10 \cdot \log_{10} \left(\frac{Emissions_{absolute}(\Delta_{RB})}{\frac{1}{|T_s| \cdot L_{CRBs}} \sum_{t \in T_s} \sum_{c_1}^{c_1 + (12 \cdot L_{CRBs} - 1) \cdot \Delta f} |MS(t, f)|^2} \right) \text{ [dB]}$$

$$= Emissions_{absolute}(\Delta_{RB}) \text{ [dBm/180 kHz]} - P_{RB} \text{ [dBm/180 kHz]}$$

where

L_{CRBs} is the number of allocated resource blocks,

and

$MS(t, f)$ is the frequency domain samples for the allocated bandwidth, as defined in the subsection E.3.3.

The relative in-band emissions, applicable for carrier leakage, is given by:

$$\begin{aligned}
 Emissions_{relative} &= 10 \cdot \log_{10} \left(\frac{Emissions_{absolute}(RBnextDC)}{\frac{1}{|T_s|} \sum_{t \in T_s} \sum_{c_1}^{c_1+(12 \cdot L_{CRBS}-1) \cdot \Delta f} |MS(t, f)|^2} \right) [\text{dBc}] \\
 &= Emissions_{absolute}(RBnextDC) [\text{dBm}/180\text{kHz}] - P_{All-RBs} [\text{dBm}]
 \end{aligned}$$

where RBnextDC means: Resource Block next to the carrier.

This is one RB, namely the central one in case of an odd number of RBs in the channel BW.

This is one pair of RBs, namely the immediately adjacent RBs to the carrier in case of an even number of RBs in the channel BW.

Although an exclusion period may be applicable in the time domain, when evaluating EVM (clause E.7), the inband emissions measurement interval is defined over one complete slot in the time domain.

From the acquired samples 20 functions for general in band emissions and IQ image inband emissions can be derived. 20 values or 20 pairs of carrier leakage inband emissions can be derived. They are compared against different limits.

E.4.4 EVM equalizer spectrum flatness

For EVM equalizer spectrum flatness use EC(f) as defined in E.3.3. Note, EC(f) represents equalizer coefficient

$f \in F$ \square f is the allocated subcarriers within the transmission bandwidth ($(|F|=12 \cdot L_{CRBS})$)

From the acquired samples 20 functions EC(f) can be derived.

EC(f) is broken down to 2 functions:

$EC_1(f), f \in \text{Range } 1$

$EC_2(f), f \in \text{Range } 2$

Where Range 1 and Range 2 are as defined in Table 6.5.2.4.5-1 for normal condition and Table 6.5.2.4.5-2 for extreme condition

The following peak to peak ripple is calculated:

$RP_1 = 20 \cdot \log (\max (| EC_1 (f) |) / \min (| EC_1 (f) |))$,which denote the maximum ripple in Range 1

$RP_2 = 20 \cdot \log (\max (| EC_2 (f) |) / \min (| EC_2 (f) |))$,which denote the maximum ripple in Range 2

$RP_{12} = 20 \cdot \log (\max (| EC_1 (f) |) / \min (| EC_2 (f) |))$,which denote the maximum ripple between the upper side of Range 1 and lower side of Range 2

$RP_{21} = 20 \cdot \log (\max (| EC_2 (f) |) / \min (| EC_1 (f) |))$,which denote the maximum ripple between the upper side of Range 2 and lower side of Range 1

E.4.5 Frequency error and Carrier leakage

See E.3.1.

E.4.6 EVM of Demodulation reference symbols (EVM_{DMRS})

For the purpose of EVM_{DMRS}, the steps E.2.2 to E.4.2 are repeated 6 times, constituting 6 EVM_{DMRS} sub-periods. The only purpose of the repetition is to cover the longer gross measurement period of EVM_{DMRS} (120 time slots) and to derive the FFT window timing per sub-period.

The bigger of the EVM results in one 20 TS period corresponding to the timing! $\Delta\tilde{c} -W/2$ or $\Delta\tilde{c} +W/2$ is compared against the limit. (Clause E.4.2) This timing is re-used for EVM_{DMRS} in the equivalent EVM_{DMRS} sub-period.

For EVM the demodulation reference symbols are excluded, while the data symbols are used. For EVM_{DMRS} the data symbols are excluded, while the demodulation references symbols are used. This is illustrated in figure E.4.6-1

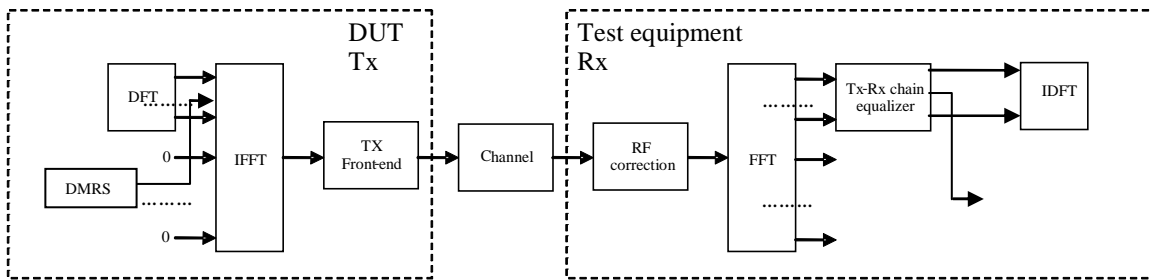

Figure E.4.6-1: EVM_{DMRS} measurement points

Re-use the following formula from E.3.3:

$$Z'(f,t) = MS(f,t) \cdot EC(f)$$

To calculate EVM_{DMRS}, the data symbol (t=0,1,2,4,5,6) in Z'(f,t) are excluded and only the reference symbol (t=3) is used.

The EVM_{DMRS} is the difference between the ideal waveform and the measured and equalized waveform for the allocated RB(s)

$$EVM_{DMRS} = \sqrt{\frac{\sum_{t \in T} \sum_{f \in F} |Z'(f,t) - I(f,t)|^2}{|T| \cdot P_0 \cdot |F|}},$$

where

t covers the count of demodulation reference symbols (i.e. only symbol 3 in each slot, so count =1)

f covers the count of demodulation reference symbols within the allocated bandwidth. (|F|=12* L_{CRBs} (with L_{CRBs} : number of allocated resource blocks)).

Z'(f,t) are the samples of the signal evaluated for the EVM_{DMRS}

I(f,t) is the ideal signal reconstructed by the measurement equipment, and

P₀ is the average power of the ideal signal. For normalized modulation symbols P₀ is equal to 1.

20 such results are generated per measurement sub-period.

E.4.6.1 1st average for EVM_{DMRS}

EVM_{DMRS} is averaged over all basic EVM_{DMRS} measurements in one sub-period

The averaging comprises 20 UL slots (for frame structure 2: excluding special fields(UpPTS))

$$1stEVM_{DMRS} = \sqrt{\frac{1}{20} \sum_{i=1}^{20} EVM_{DMRS_i}^2}$$

The timing is taken from the EVM for the data. 6 of those results are achieved from the samples. In general the timing is not the same for each result.

E.4.6.2 Final average for EVM_{DMRS}

$$finalEVM_{DMRS} = \sqrt{\frac{1}{6} \sum_{i=1}^6 1stEVM_{DMRS_i}^2}$$

E.5 EVM and inband emissions for PUCCH

For the purpose of worst case testing, the PUCCH shall be located on the edges of the Transmission Bandwidth Configuration (6,15,25,50,75,100 RBs).

The EVM for PUCCH (EVM_{PUCCH}) is averaged over 20 slots. At least 20 TSs shall be transmitted by the UE without power change. SRS multiplexing shall be avoided during this period. The following transition periods are applicable: One OFDM symbol on each side of the slot border (instant of band edge alternation).

The description below is generic in the sense that all 6 PUCCH formats are covered. Although the number of OFDM symbols in one slot is 6 or 7 (depending on the cyclic prefix length), the text below uses 7 without excluding 6.

E.5.1 Basic principle

The basis principle is the same as described in E.2.1

E.5.2 Output signal of the TX under test

The output signal of the TX under test is processed same as described in E.2.2

E.5.3 Reference signal

The reference signal is defined same as in E.2.3. Same as in E.2.3, $i_1(v)$ is the ideal reference for EVM_{PUCCH} and $i_2(v)$ is used to estimate the FFT window timing.

Note PUSCH is off during the PUCCH measurement period.

E.5.4 Measurement results

The measurement results are:

- EVM_{PUCCH}
- Inband emissions with the sub-results: General in-band emission, IQ image (according to: 36.101. Annex F.4, Clause starting with: "At this stage the")

E.5.5 Measurement points

The measurement points are illustrated in the figure below:

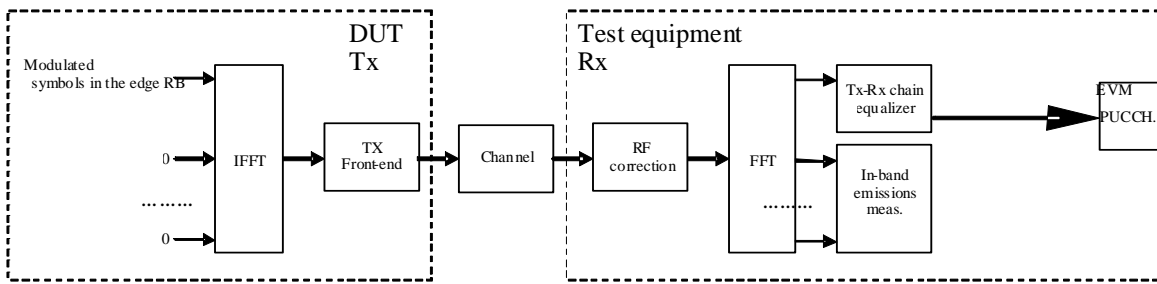

Figure E.5.5-1

E.5.6 Pre FFT minimization process

The pre FFT minimisation process is the same as describes in clause E.3.1.

NOTE: although an exclusion period for EVM_{PUCCH} is applicable in E.5.9.1, the pre FFT minimisation process is done over the complete slot.

RF error, and carrier leakage are necessary for best fit of the measured signal towards the ideal signal in the pre FFT domain. However they are not used to compare them against the limits.

E.5.7 Timing of the FFT window

Timing of the FFT window is estimated with the same method as described in E.3.2.

E.5.8 Post FFT equalisation

The post FFT equalisation is described separately without reference to E.3.3:

Perform 7 FFTs on $z'(v)$, one for each OFDM symbol in a slot using the timing $\Delta\tilde{c}$, including the demodulation reference symbol. The result is an array of samples, 7 in the time axis t times 2048 in the frequency axis f . The samples represent the OFDM symbols (data and reference symbols) in the allocated RBs and inband emissions in the non allocated RBs within the transmission BW.

Only the allocated resource blocks in the frequency domain are used for equalisation.

The nominal reference symbols and **nominal** OFDM data symbols are used to equalize the measured data symbols.

Note: (The nomenclature inside this note is local and not valid outside)

The nominal OFDM data symbols are created by a demodulation process. A demodulation process as follows is recommended:

1. Equalize the measured OFDM data symbols using the reference symbols for equalisation. Result: Equalized OFDM data symbols
2. Decide for the nearest constellation point, however not independent for each subcarrier in the RB. 12 constellation points are decided dependent, using the applicable CAZAC sequence. Result: Nominal OFDM data symbols

At this stage we have an array of Measured data-Symbols and reference-Symbols ($MS(f,t)$)

versus an array of Nominal data-Symbols and reference Symbols ($NS(f,t)$)

The arrays comprise in sum 7 data and reference symols, depending on the PUCCH format, in the time axis and the number of allocated sub-carriers in the frequency axis.

$MS(f,t)$ and $NS(f,t)$ are processed with a least square (LS) estimator, to derive one equalizer coefficient per time slot and per allocated subcarrier. $EC(f)$

$$EC(f) = \frac{\sum_{t=0}^6 NS(f,t)^* NS(f,t)}{\sum_{t=0}^6 MS(f,t)^* NS(f,t)}$$

With * denoting complex conjugation.

EC(f) are used to equalize the OFDM data together with the demodulation reference symbols by:

$$Z'(f,t) = MS(f,t) \cdot EC(f)$$

With · denoting multiplication.

Z'(f,t) is used to calculate EVM_{PUCCH} , as described in E.5.9.1

NOTE: although an exclusion period for EVM_{PUCCH} is applicable in E.5.9.1, the post FFT minimisation process is done over 7 OFDM symbols.

The samples of the non allocated resource blocks within the transmission bandwidth configuration in the post FFT domain are called Y(f,t) (f covering the non allocated subcarriers within the transmission bandwidth configuration, t covering the OFDM symbols during 1 slot).

E.5.9 Derivation of the results

E.5.9.1 EVM_{PUCCH}

For EVM_{PUCCH} create two sets of Z'(f,t), according to the timing " $\Delta\tilde{c} -W/2$ and $\Delta\tilde{c} +W/2$ " using the equalizer coefficients from E.5.8

The EVM_{PUCCH} is the difference between the ideal waveform and the measured and equalized waveform for the allocated RB(s)

$$EVM_{PUCCH} = \sqrt{\frac{\sum_{t \in T} \sum_{f \in F} |Z'(f,t) - I(f,t)|^2}{|T| \cdot P_0 \cdot |F|}},$$

where

the OFDM symbols next to slot borders (instant of band edge alternation) are excluded:

t covers less than the count of demodulated symbols in the slot (|T|= 5)

f covers the count of subcarriers within the allocated bandwidth. (|F|=12)

Z'(f,t) are the samples of the signal evaluated for the EVM_{PUCCH}

I(f,t) is the ideal signal reconstructed by the measurement equipment, and

P_0 is the average power of the ideal signal. For normalized modulation symbols P_0 is equal to 1.

From the acquired samples 40 EVM_{PUCCH} value can be derived, 20 values for the timing $\Delta\tilde{c} -W/2$ and 20 values for the timing $\Delta\tilde{c} +W/2$

E.5.9.2 Averaged EVM_{PUCCH}

EVM_{PUCCH} is averaged over all basic EVM_{PUCCH} measurements

The averaging comprises 20 UL slots (for frame structure 2: excluding special fields(UpPTS))

$$\overline{EVM}_{PUCCH} = \sqrt{\frac{1}{20} \sum_{i=1}^{20} EVM_{PUCCH_i}^2}$$

The averaging is done separately for timing! $\Delta\tilde{c} -W/2$ and $\Delta\tilde{c} +W/2$ leading to $\overline{EVM}_{PUCCH,low}$ and $\overline{EVM}_{PUCCH,high}$

$EVM_{PUCCH,final} = \max(\overline{EVM}_{PUCCH,low}, \overline{EVM}_{PUCCH,high})$ is compared against the test requirements.

E.5.9.3 In-band emissions measurement

The in-band emissions are a measure of the interference falling into the non-allocated resources blocks

Create one set of $Y(t,f)$ per slot according to the timing “ $\Delta\tilde{c}$ ”

For the non-allocated RBs the in-band emissions are calculated as follows

$$Emissions_{absolute}(\Delta_{RB}) = \begin{cases} \frac{1}{|T_s|} \sum_{t \in T_s} \sum_{c_l + (12 \cdot \Delta_{RB} + 1) \cdot \Delta f}^{c_l + (12 \cdot \Delta_{RB} + 1) \cdot \Delta f} |Y(t, f)|^2, \Delta_{RB} < 0 \\ \frac{1}{|T_s|} \sum_{t \in T_s} \sum_{c_h + (12 \cdot \Delta_{RB} - 1) \cdot \Delta f}^{c_h + (12 \cdot \Delta_{RB} - 1) \cdot \Delta f} |Y(t, f)|^2, \Delta_{RB} > 0 \end{cases}$$

where

the upper formula represents the inband emissions below the allocated frequency block and the lower one the inband emissions above the allocated frequency block.

T_s is a set of $|T_s|$ OFDM symbols in the measurement period,

Δ_{RB} is the starting frequency offset between the allocated RB and the measured non-allocated RB (e.g. $\Delta_{RB} = 1$ for the first upper or $\Delta_{RB} = -1$ for the first lower adjacent RB),

f_{min} and f_{max} are the lower and upper edge of the UL system BW,

c_l and c_h are the lower and upper edge of the allocated BW,

Δf is 15kHz, and

$Y(t, f)$ is the frequency domain signal evaluated for in-band emissions as defined in the subsection E.5.8

The relative in-band emissions are, given by

$$Emissions_{relative}(\Delta_{RB}) = 10 * \log_{10} \frac{Emissions_{absolute}(\Delta_{RB})}{\frac{1}{|T_s|} \cdot L_{CRBs} \sum_{t \in T_s} \sum_{c_1}^{c_1 + (12 \cdot L_{CRBs} - 1) \cdot \Delta f} |MS(t, f)|^2} [dB]$$

where

L_{CRBs} is the number of allocated RBs, which is always 1 in case of PUCCH

and $MS(t, f)$ is the frequency domain samples for the allocated bandwidth, as defined in the subsection E.5.8

Although an exclusion period for EVM is applicable in E.5.9.1, the inband emissions measurement interval is defined over one complete slot in the time domain.

From the acquired samples 20 functions for inband emissions can be derived.

Since the PUCCH allocation is always on the upper or lower band-edge, the opposite to the allocated one represents the IQ image, and the remaining inner RBs represent the general inband emissions. They are compared against different limits.

E.6 EVM for PRACH

The description below is generic in the sense that all 5 PRACH formats are covered. The numbers, used in the text below are taken from PRACH format#0 without excluding the other formats. The sampling rate for the PUSCH, 30.72 Msps in the time domain, is re-used for the PRACH. The carrier spacing of the PUSCH is 12 (format 0 to 3) and 2 (format 4) times of the PRACH. This results in an oversampling factor of 12 (format 0 to 3) and 2 (format 4), when acquiring the time samples for the PRACH. The pre-FFT algorithms (clauses E.6.6 and E.6.7) use all time samples, although oversampled. For the FFT the time samples are decimated by the factor of 12 (format 0 to 3) and 2 (format 4), resulting in the same FFT size as for the other transmit modulation tests (2048). Decimation requires a decision, which samples are used and which ones are rejected. The algorithm in E.6.6, Timing of the FFT window, can also be used to decide about the used samples.

E.6.1 Basic principle

The basic principle is the same as described in E.2.1

E.6.2 Output signal of the TX under test

The output signal of the TX under test is processed same as described in E.2.2

The measurement period is different:

- 2 PRACH preambles are recorded for format 0 and 1,
- 1 PRACH preamble is recorded for format 2 and 3, each containing 1 CP and 2 preamble sequences
- 10 RPRACH preambles are recorded for format 4.

E.6.3 Reference signal

The test description in 6.5.2.1.4.1A is based on non contention based access:

- PRACH configuration index (responsible for Preamble format, System frame number and subframe number)
- Preamble ID
- Preamble power

signalled to the UE, defines the reference signal unambiguously, such that no demodulation process is necessary to gain the reference signal.

The reference signal $i(v)$ is constructed by the measuring equipment according to the relevant TX specifications, using the following parameters: the applicable Zadoff Chu sequence, nominal carrier frequency, nominal amplitude and phase for each subcarrier, nominal timing, no carrier leakage. It is represented as a sequence of samples at a sampling rate of 30.72 Msps in the time domain.

E.6.4 Measurement results

The measurement result is:

- EVM_{PRACH}

E.6.5 Measurement points

The measurement points are illustrated in the figure below:

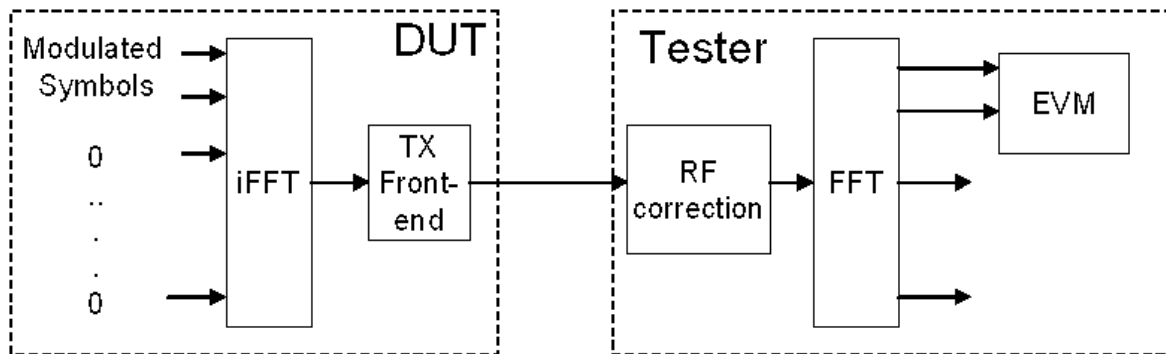

Figure E.6.5-1

E.6.6 Pre FFT minimization process

The pre-FFT minimization process is applied to each PRACH preamble separately. The time period for the pre-FFT minimisation process includes the complete CP and Zadoff-Chu sequence (in other words, the power transition period is per definition outside of this time period) Sample timing, Carrier frequency and I/Q offset in $z(v)$ are jointly varied in order to minimise the difference between $z(v)$ and $i(v)$. Best fit (minimum difference) is achieved when the RMS difference value between $z(v)$ and $i(v)$ is an absolute minimum.

After this process the samples $z(v)$ are called $z^0(v)$.

RF error, and carrier leakage are necessary for best fit of the measured signal towards the ideal signal in the pre FFT domain. However they are not used to compare them against the limits.

E.6.7 Timing of the FFT window

The FFT window length is 24576 samples for preamble format 0, however in the measurement period is at least 27744 samples are taken. The position in time for FFT must be determined.

In an ideal signal, the FFT may start at any instant within the cyclic prefix without causing an error. The TX filter, however, reduces the window. The EVM requirements shall be met within a window $W < CP$.

The reference instant for the FFT start is the centre of the reduced window, called $\Delta\tilde{c}$,

EVM is measured at the following two instants: $\Delta\tilde{c} - W/2$ and $\Delta\tilde{c} + W/2$.

The timing of the measured signal $z^0(v)$ with respect to the ideal signal $i(v)$ is determined in the pre FFT domain as follows:

Correlation between $z^0(v)$ and $i(v)$ will result in a correlation peak. The meaning of the correlation peak is approx. the “impulse response” of the TX filter. The correlation peak, (the highest, or in case of more than one, the earliest) indicates the timing in the measured signal with respect to the ideal signal.

W is different for different preamble formats and shown in Table E.6.7-1.

Table E.6.7-1EVM window length for PRACH

Preamble format	Cyclic prefix length ¹ N_{cp}	Nominal FFT size ²	EVM window length W in FFT samples	Ratio of W to CP ³
0	3168	24576	3072	96.7%
1	21024	24576	20928	99.5%
2	6240	49152	6144	98.5%
3	21024	49152	20928	99.5%
4	448	4096	432	96.4%
Note 1: The unit is number of samples, sampling rate of 30.72MHz is assumed				
Note 2: Decimation of time samples by 12(format 0 to 3) and factor 2 (format 4) is assumed, leading to a uniform FFT size of 2048 for all formats.				
Note 3: These percentages are informative				

The number of samples, used for FFT is reduced compared to $z^0(v)$. This subset of samples is called $z'(v)$.

The sample frequency 30.72 MHz is oversampled with respect to the PRACH-subcarrier spacing of 1.25kHz (format 0 to 3) and 7.5kHz (format 4). EVM is based on 2048 samples per PRACH preamble and requires decimation of the time samples by the factor of 12 (format 0 to 3) and factor 2 (format 4). The final number of samples per PRACH preamble, used for FFT is reduced compared to $z''(v)$ by the factor of 12 (format 0 to 3) and factor 2 (format 4). This subset of samples is called $z'(v)$.

E.6.8 Post FFT equalisation

Equalisation is not applicable for the PRACH.

E.6.9 Derivation of the results

E.6.9.1 EVM_{PRACH}

Perform FFT on $z'(v)$ and $i(v)$ using the FFT timing $\Delta\tilde{c} - W/2$ and $\Delta\tilde{c} + W/2$.

For format 2 and 3 the first and the repeated preamble sequence are FFT-converted separately, using the standard FFT length of 2048

The EVM_{PRACH} is the difference between the ideal waveform and the measured and equalized waveform for the allocated RB(s).

$$EVM_{PRACH} = \sqrt{\frac{\sum_{f \in F} |Z'(f) - I(f)|^2}{N_{ZC} \cdot P_0}},$$

where

f covers the count of demodulated symbols within the allocated bandwidth.

$Z'(f)$ are the samples of the signal evaluated for the EVM_{PRACH}

$I(f)$ is the ideal signal reconstructed by the measurement equipment, and

P_0 is the average power of the ideal signal. For normalized modulation symbols P_0 is equal to 1.

N_{ZC} is random access preamble sequence length.

From the acquired samples 4 EVM_{PRACH} value can be derived, 2 values for the timing $\Delta\tilde{c} -W/2$ and 2 values for the timing $\Delta\tilde{c} +W/2$ (4 and 2 applies for format 0,1,2,3. 20 and 10 applies for format 4).

E.6.9.2 Averaged EVM_{PRACH}

EVM_{PRACH} is averaged over all basic EVM_{PRACH} measurements

$$\overline{EVM}_{PRACH} = \sqrt{\frac{1}{2} \sum_{i=1}^2 EVM_{PRACH_i}^2}$$

(i= 2 applies for format 0,1,2,3. i= 10 applies for format 4)

The averaging is done separately for timing! $\Delta\tilde{c} -W/2$ and $\Delta\tilde{c} +W/2$ leading to $\overline{EVM}_{PRACH,low}$ and $\overline{EVM}_{PRACH,high}$

$EVM_{PRACH,final} = \max(\overline{EVM}_{PRACH,low}, \overline{EVM}_{PRACH,high})$ is compared against the test requirements.

E.7 EVM with exclusion period

E.7.1 General

EVM with exclusion periods is defined in clause 6.5.2.1.1, third paragraph. For PUCCH entire symbols are excluded, if applicable. For PUSCH fractions of symbols are excluded, if applicable. The exclusion period for PUSCH is defined at the air interface, leading to exclusion periods in the EVM domain. The necessary mapping is described in this clause.

E.7.2 The model

The exclusion period in the time domain has corresponding periods in the quasi time domains (Table E.7.2). The mapping of corresponding periods needs only scaling and cyclic shifting.

The algorithm below uses a sampling frequency 30.72 MHz and FFT-width 2048 for all bandwidths. Bandwidth-adapted sampling frequencies and FFT-widths are not excluded. Only normal cyclic prefix is mentioned in the model without excluding the extended CP.

Table. E.7.2: Model for mapping exclusion period in the time domain

Operation	TX			Channel	EVM meter					
		D F T			i F F T		F F T		iD F T	
Meaning	Modulation symbols		Precoded symbols		BB samples	BB samples		Precoded symbols		demodulated symbols
No of samples	allocated Sub Carriers		allocated subcarriers + unallocated subcarriers = 2048		allocated subcarriers + unallocated subcarriers + CP samples	2048, position depending on EVM window		allocated sub carriers		allocated sub carriers
Domain	Quasi time domain		Frequency domain		Time domain	Time domain		Frequency domain		Quasi time domain
text below		1	2	3	4	7	7	8	9	11

1. A sequence of complex valued modulation symbols are Transform-Precoded (DFT) according to 36.211 clause 5.3.3. The size of this transformation is the number of allocated subcarriers.
2. The outcome of (1) is supplemented by 0 for the non allocated subcarriers. In sum 2048 subcarriers.
3. The baseband time signal (without CP) is then calculated by a iFFT according to 36.211 clause 5.6
4. (3) is then supplemented by a cyclic prefix (144 or 160 samples) leading to 2192 or 2208 samples. (144 CP samples = 144 tail samples from the data field)
5. (4) is transmitted over the channel and sampled by the EVM meter.
6. In case of an exclusion period those samples of (5) are marked, where the exclusion applies. The exclusion period is an unbroken leading or lagging exclusion period next to a subframe or timeslot boarder.
7. Depending on early or late EVM-window a subset of 2048 samples (out of 2192 or 2208 samples) are the input for the subsequent FFT . These samples may or may not comprise marked samples. The result are 2048 frequency domain samples.
8. The non allocated subcarriers are removed from the 2048 samples.
9. (8) is then iDFT transformed. The result are demodulated complex valued symbols in the same domain as (1)
10. Step 7, 8 and 9 are modified by an equalizer algorithm.
For the purpose of this clause, the equalizer partly re-does step 4 (CP insertion):
The equalizer algorithm cuts that subset of CP samples, covered by the FFT, from the head and copies it to the tail of the data field.
11. The result of (10) is: complex valued symbols in the same sequence as in (1) They are compared with (1) symbol by symbol for EVM. Due to exclusion in the time domain (6) we have marked corresponding symbols, which are disregarded for EVM.
12. From step 1 to 4 the number of samples is expanded. A subset of expanded samples is marked as excluded. Form step 6 to step 9 the number of samples is compressed, leading to a non integer number of samples, marked as excluded. The number of marked samples in this domain is rounded up at the expense of the EVM samples

E.7.3 Illustration

The figures below illustrate the cyclic shift due to the equalizer and scaling.

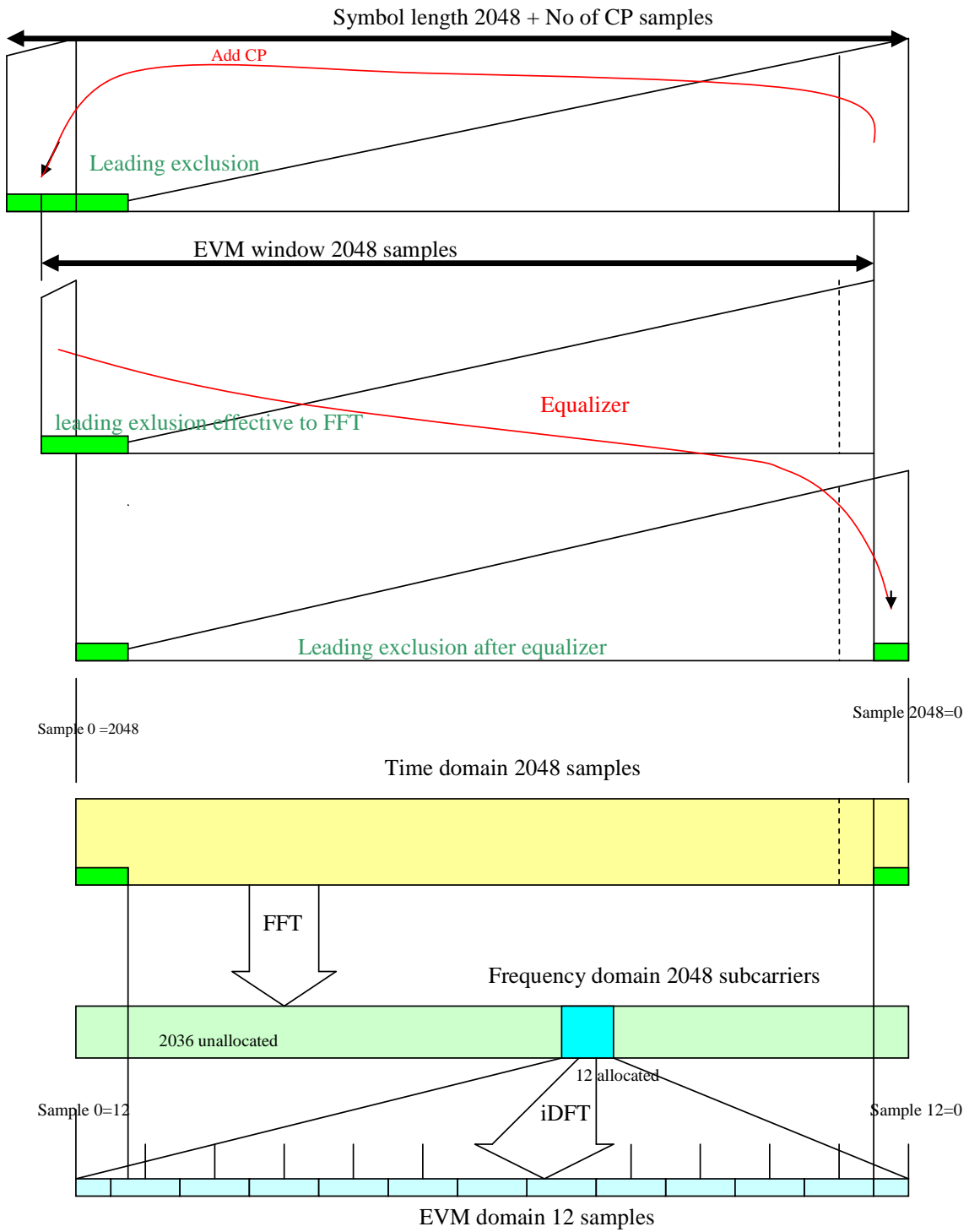

Figure E.7.3-1: leading exclusion period (when number of RBs=1)

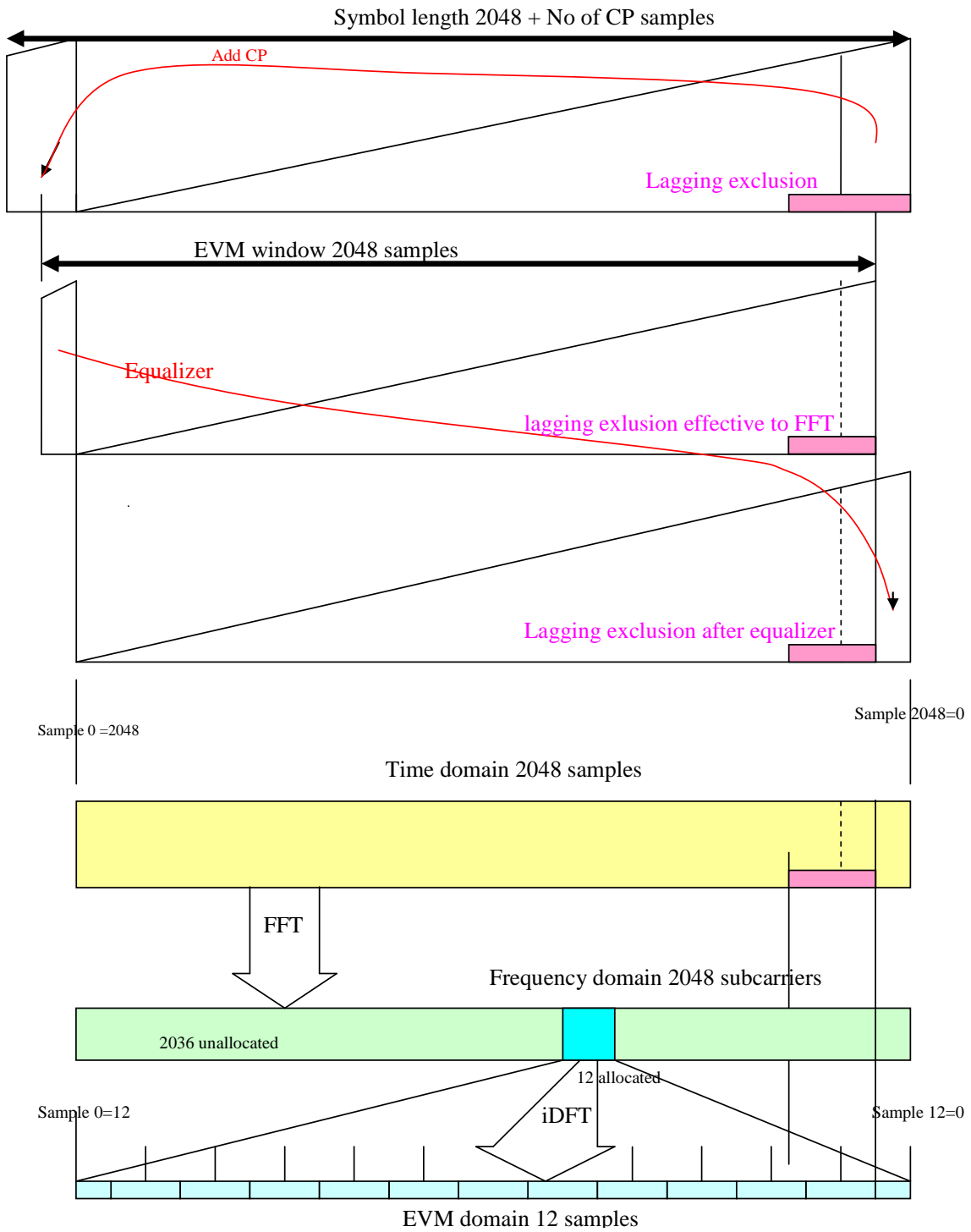

Figure E.7.3-2: lagging exclusion period (when number of RBs=1)

Legend to figure E.7.3-1

The figure contains 6 related subfigures.

The upper 3 triangles illustrate the cyclic shift due to EVM windowing and equalizer.

The lower 3 boxes illustrate the mapping from the time domain, where the exclusion period is defined, into the EVM domain, where EVM samples are actually excluded.

Cyclic shift

The leading exclusion period covers the entire CP and a part of the data field. The EVM window masks a part of the exclusion period. For the purpose of this annex, the equalizer re-arranges the time domain samples into the original order, splitting the exclusion period into two parts.

Mapping

The split exclusion period (after cyclic shift) is copied from above. The frequency domain is derived by Fast Fourier Transformation from the time domain and represent the frequency domain with 2048 subcarriers, 12 of them are allocated, the rest is unallocated. The 12 allocated subcarriers are iDFT transformed into the EVM domain comprising 12 samples. Note that all 3 domains are displayed cyclically: the leftmost sample is identical to the rightmost sample.

The two transformations map the time domain into the EVM domain, carrying out a compression of samples 12/2048. In spite of the compression, there is a correspondence of ranges in the time domain and in the EVM domain. One sample in the EVM domain comprises a range, which is influenced from (and only from) the equivalent samples in the time domain vertically above. Note that this correspondence holds irrespective of the position of the 12 allocated samples in the frequency domain.

Example leading exclusion (figure E.7.3-1)

Sample No in the EVM domain	Influence(exclusion) from the time domain	EVM exclusion
12=0	full	excluded
1	partly	excluded
2 to 11	none	counted

Example lagging exclusion example (figure E.7.3-2)

Sample No in the EVM domain	Influence(exclusion) from the time domain	EVM exclusion
12=0	none	counted
1 to 9	none	counted
10	partly	excluded
11	full	excluded

E.7.4 Formula

The exclusion period is defined in μs at the air interface.

Convert the μs 's into No of samples in the time domain.

No of exclusion samples (before EVM windowing and equalizer) is calculated from:

No of exclusion sample = $\text{ceil}(30.72 * \text{Exclusion } \mu\text{s})$

then, EVM windowing and equalizer is applied by 2048 samples based cyclic shift process.

(the upper 3 triangles illustrate in fig. E.7.3-1 and -2.)

Determine the indices \mathbf{k} , to be excluded in the time domain, according to fig. E.7.3-1 and -2
(after application of EVM windowing and equaliser, original sample order,

\mathbf{k} = subset from the set (0 to 2047))

The indices \mathbf{l} in the EVM domain, to be excluded, are:

$$\mathbf{l} = [\text{round} (\mathbf{k} * 12 * L_{\text{CRBs}} / 2048)] \bmod (12 * L_{\text{CRBs}})$$

with L_{CRBs} number of allocated resource blocks

Annex F (normative): Measurement uncertainties and Test Tolerances

F.1 Acceptable uncertainty of Test System (normative)

The maximum acceptable uncertainty of the Test System is specified below for each test, where appropriate. The Test System shall enable the stimulus signals in the test case to be adjusted to within the specified range, and the equipment under test to be measured with an uncertainty not exceeding the specified values. All ranges and uncertainties are absolute values, and are valid for a confidence level of 95 %, unless otherwise stated.

A confidence level of 95 % is the measurement uncertainty tolerance interval for a specific measurement that contains 95 % of the performance of a population of test equipment.

For RF tests it should be noted that the uncertainties in clause F.1 apply to the Test System operating into a nominal 50 ohm load and do not include system effects due to mismatch between the DUT and the Test System.

The downlink signal uncertainties apply at each receiver antenna connector.

F.1.1 Measurement of test environments

The measurement accuracy of the UE test environments defined in TS 36.508 subclause 4.1, Test environments shall be.

- Pressure ± 5 kPa.
- Temperature ± 2 degrees.
- Relative Humidity ± 5 %.
- DC Voltage $\pm 1,0$ %.
- AC Voltage $\pm 1,5$ %.
- Vibration 10 %.
- Vibration frequency 0,1 Hz.

The above values shall apply unless the test environment is otherwise controlled and the specification for the control of the test environment specifies the uncertainty for the parameter.

F.1.2 Measurement of transmitter

Table F.1.2-1: Maximum Test System Uncertainty for transmitter tests

Subclause	Maximum Test System Uncertainty	Derivation of Test System Uncertainty
6.2.2. UE Maximum Output Power	± 0.7 dB	
6.2.3 Maximum Power Reduction	± 0.7 dB	
6.2.4 UE Maximum Output Power with additional requirements	± 0.7 dB	
6.2.5 Configured UE transmitted Output Power	± 0.7 dB	
6.3.2 Minimum Output Power	± 1.0 dB	
6.3.3 Transmission ON/OFF Power	Transmission OFF Power: ± 1.5 dB	
6.3.4.1 General ON/OFF time mask	Transmission ON/OFF Power: ± 1.5 dB	
6.3.4.2 PRACH and SRS time mask	Transmission ON/OFF Power: ± 1.5 dB	
6.3.5.1 Power Control Absolute power tolerance	± 1.0 dB	
6.3.5.2 Power Control Relative power tolerance	± 0.7 dB	
6.3.5.3 Aggregate power control tolerance	± 0.7 dB	
6.5.1 Frequency Error	± 15 Hz DL Signal level: ± 0.7 dB	
6.5.2.1 Error Vector Magnitude	PUSCH : $\pm 2.5\%$ PUCCH: $\pm 2.5\%$ PRACH: $\pm 2.5\%$	
6.5.2.1A PUSCH-EVM with exclusion period	PUSCH : $\pm 2.5\%$	

6.5.2.2 Carrier leakage	±0.8dB	
6.5.2.3 In-band emissions for non allocated RB	±0.8dB	
6.5.2.4 EVM equalizer Spectrum flatness	±1.4dB	
6.6.1 Occupied bandwidth	1.4MHz, 3MHz: 30kHz 5MHz, 10MHz: 100kHz 15MHz, 20MHz: 300kHz	
6.6.2.1 Spectrum Emission Mask	±1.5 dB	
6.6.2.2 Additional Spectrum Emission Mask	±1.5 dB	
6.6.2.3 Adjacent Channel Leakage power Ratio	±0.8 dB	
6.6.2.4 Additional ACLR requirements	±0.8 dB	
6.6.3.1 Transmitter Spurious emissions	9kHz < f ≤ 4 GHz: ± 2.0 dB 4 GHz < f ≤ 12.75 GHz: ± 4.0 dB	
6.6.3.2 Spurious emission band UE co-existence	± 2.0 dB for results > -60 dBm ± 3.0 dB for results ≤ -60 dBm	
6.6.3.3 Additional spurious emissions	9kHz < f ≤ 4 GHz: ± 2.0 dB	
6.7 Transmit intermodulation	± 2.6 dB	<p>Overall system uncertainty comprises four quantities:</p> <ol style="list-style-type: none"> 1. Wanted signal setting error 2. CW Interferer level error 3. Wanted signal meas. error 4. Intermodulation product measurement error <p>The relative level of the wanted signal and the CW interferer has 2 x effect on the intermodulation product.</p> <p>Items 1, 2, 3 and 4 are assumed to be uncorrelated so can be root sum squared to provide the combined effect.</p> <p>Test System uncertainty = $\text{SQRT} [(2 \times \text{SQRT} (\text{Wanted_setting_error}^2 + \text{CW_level_error}^2))^2 + \text{Wanted_level_meas_error}^2 + \text{Intermodulation_product_measurement_error}^2]$</p> <p>Wanted signal setting ± 0.7dB CW Interferer level ± 1.0dB Wanted signal meas ± 0.7dB Intermodulation product measurement error ± 0.7dB</p>

F.1.3 Measurement of receiver

Table F.1.3-1: Maximum Test System Uncertainty for receiver tests

Subclause	Maximum Test System Uncertainty ¹	Derivation of Test System Uncertainty
7.3.1 Reference sensitivity power level; Minimum requirements (QPSK)	Downlink power ±0.7 dB	
7.4 Maximum input level	Downlink power ±0.7 dB Uplink power measurement ±0.7 dB	
7.5 Adjacent Channel Selectivity (ACS)	ACS value ±1.1 dB Uplink power measurement ±0.7 dB	<p>Overall ACS uncertainty comprises three quantities:</p> <ol style="list-style-type: none"> 1. Wanted signal level error 2. Interferer signal level error 3. Additional impact of interferer ACLR <p>Items 1 and 2 are assumed to be uncorrelated so can be root sum squared to provide the ratio error of the two signals. The interferer ACLR effect is systematic, and is added arithmetically.</p> <p>Test System uncertainty = [SQRT (wanted_level_error² + interferer_level_error²)] + ACLR effect.</p> <p>Wanted signal level ± 0.7dB Interferer signal level ± 0.7dB Impact of interferer ACLR 0.1dB</p>
7.6.1 In-band blocking	Blocking ±1.4 dB Uplink power measurement ±0.7 dB	<p>Overall blocking uncertainty can have these contributions:</p> <ol style="list-style-type: none"> 1. Wanted signal level error 2. Interferer signal level error 3. Interferer ACLR 4. Interferer broadband noise <p>Items 1 and 2 are assumed to be uncorrelated so can be root sum squared to provide the ratio error of the two signals. The Interferer ACLR or Broadband noise effect is systematic, and is added arithmetically.</p> <p>Test System uncertainty = [SQRT (wanted_level_error² + interferer_level_error²)] + ACLR effect + Broadband noise effect.</p> <p><u>In-band blocking, using modulated interferer:</u> Wanted signal level ± 0.7dB Interferer signal level: ± 0.7dB Interferer ACLR 0.4dB Broadband noise not applicable</p>

7.6.2 Out of-band blocking	Blocking, $1\text{MHz} < f_{\text{interferer}} \leq 3\text{GHz}$: $\pm 1.3\text{ dB}$ Blocking, $3\text{GHz} < f_{\text{interferer}} \leq 12.75\text{GHz}$: $\pm 3.2\text{ dB}$ Uplink power measurement $\pm 0.7\text{ dB}$	<u>Out of band blocking, using CW interferer:</u> Wanted signal level $\pm 0.7\text{dB}$ Interferer signal level: $\pm 1.0\text{dB}$ up to 3GHz $\pm 3.0\text{dB}$ up to 12.75GHz Interferer ACLR not applicable Impact of interferer Broadband noise 0.1dB Figures are combined to give Test System uncertainty, using formula given for 7.6.1
7.6.3 Narrow band blocking	Blocking $\pm 1.3\text{ dB}$ Uplink power measurement $\pm 0.7\text{ dB}$	<u>Narrow band blocking, using CW interferer:</u> Wanted signal level $\pm 0.7\text{dB}$ Interferer signal level: $\pm 1.0\text{dB}$ Interferer ACLR not applicable Impact of interferer Broadband noise 0.1dB Figures are combined to give Test System uncertainty, using formula given for 7.6.1
7.7 Spurious response	Spurious response, $1\text{MHz} < f_{\text{interferer}} \leq 3\text{GHz}$: $\pm 1.3\text{ dB}$ Spurious response, $3\text{GHz} < f_{\text{interferer}} \leq 12.75\text{GHz}$: $\pm 3.2\text{ dB}$ Uplink power measurement $\pm 0.7\text{ dB}$	<u>Spurious response, using CW interferer:</u> Wanted signal level $\pm 0.7\text{dB}$ Interferer signal level: $\pm 1.0\text{dB}$ up to 3GHz $\pm 3.0\text{dB}$ up to 12.75GHz Interferer ACLR not applicable Impact of interferer Broadband noise 0.1dB Figures are combined to give Test System uncertainty, using formula given for 7.6.1

7.8.1 Wide band intermodulation	Intermodulation ± 1.4 dB Uplink power measurement ± 0.7 dB	<p>Overall intermodulation uncertainty comprises three quantities:</p> <ol style="list-style-type: none"> 1. Wanted signal level error 2. CW Interferer level error 3. Modulated Interferer level error <p>Effect of interferer ACLR has not been included as modulated interferer has larger frequency offset</p> <p>The effect of the closer CW signal has twice the effect.</p> <p>Items 1, 2 and 3 are assumed to be uncorrelated so can be root sum squared to provide the combined effect of the three signals.</p> <p>Test System uncertainty = $\text{SQRT} [(2 \times \text{CW_level_error})^2 + (\text{mod interferer_level_error})^2 + (\text{wanted signal_level_error})^2]$</p> <p>Wanted signal level ± 0.7dB CW Interferer level ± 0.5dB Mod Interferer level ± 0.7dB</p>
7.9 Spurious emissions	$30\text{MHz} \leq f \leq 4.0\text{GHz}: \pm 2.0$ dB $4\text{ GHz} < f \leq 12.75\text{ GHz}: \pm 4.0$ dB	
<p>Note 1: Unless otherwise noted, only the Test System stimulus error is considered here. The effect of errors in the throughput measurements due to finite test duration is not considered.</p>		

F.1.4 Measurement of performance requirements

Table F.1.4-1: Maximum Test System Uncertainty for Performance Requirements

Subclause	Maximum Test System Uncertainty ¹	Derivation of Test System Uncertainty
8.2.1.1.1 Multiple PRBs - Propagation Condition EVA5 - Propagation Condition ETU70 - Propagation Condition ETU300	± 0.8 dB	Overall system uncertainty for fading conditions comprises three quantities: 1. Signal-to-noise ratio uncertainty 2. Fading profile power uncertainty 3. Effect of AWGN flatness and signal flatness Items 1, 2 and 3 are assumed to be uncorrelated so can be root sum squared: AWGN flatness and signal flatness has x 0.25 effect on the required SNR, so use sensitivity factor of x 0.25 for the uncertainty contribution. Test System uncertainty = $\text{SQRT}(\text{Signal-to-noise ratio uncertainty}^2 + \text{Fading profile power uncertainty}^2 + (0.25 \times \text{AWGN flatness and signal flatness})^2)$ Signal-to-noise ratio uncertainty ± 0.3 dB Fading profile power uncertainty ± 0.5 dB for single Tx AWGN flatness and signal flatness ± 2.0 dB
8.2.1.1.1 Multiple PRBs - Propagation Condition HST	± 0.6 dB	Overall system uncertainty for HST condition comprises two quantities: 1. Signal-to-noise ratio uncertainty 2. Effect of AWGN flatness and signal flatness Items 1 and 2 are assumed to be uncorrelated so can be root sum squared: AWGN flatness and signal flatness has x 0.25 effect on the required SNR, so use sensitivity factor of x 0.25 for the uncertainty contribution. Test System uncertainty = $\text{SQRT}(\text{Signal-to-noise ratio uncertainty}^2 + (0.25 \times \text{AWGN flatness and signal flatness})^2)$ Signal-to-noise ratio uncertainty ± 0.3 dB AWGN flatness and signal flatness ± 2.0 dB

8.2.1.1.1 Single PRB - Propagation Condition ETU70	± 0.8 dB	<p>Overall system uncertainty for fading condition comprises three quantities:</p> <ol style="list-style-type: none"> 1. Average Signal-to-noise ratio uncertainty 2. Signal-to noise ratio variation for single PRB 3. Fading profile power uncertainty <p>Items 1, 2 and 3 are assumed to be uncorrelated so can be root sum squared:</p> <p>Test System uncertainty = $\text{SQRT}(\text{Average signal-to-noise ratio uncertainty}^2 + \text{Signal-to-noise ratio variation}^2 + \text{Fading profile power uncertainty}^2)$</p> <p>Signal-to-noise ratio uncertainty ±0.3 dB Signal-to-noise ratio variation ±0.5 dB Fading profile power uncertainty ±0.5 dB for single Tx</p>
8.2.1.1.2 Single PRB	± 0.8 dB	Same as 8.2.1.1.1 Single PRB
8.2.1.2.1 - Propagation Condition EVA5	± 0.9 dB	<p>Overall system uncertainty for fading conditions comprises three quantities:</p> <ol style="list-style-type: none"> 1. Signal-to-noise ratio uncertainty 2. Fading profile power uncertainty 3. Effect of AWGN flatness and signal flatness <p>Items 1, 2 and 3 are assumed to be uncorrelated so can be root sum squared:</p> <p>AWGN flatness and signal flatness has x 0.25 effect on the required SNR, so use sensitivity factor of x 0.25 for the uncertainty contribution.</p> <p>Test System uncertainty = $\text{SQRT}(\text{Signal-to-noise ratio uncertainty}^2 + \text{Fading profile power uncertainty}^2 + (0.25 \times \text{AWGN flatness and signal flatness})^2)$</p> <p>Signal-to-noise ratio uncertainty ±0.3 dB Fading profile power uncertainty ±0.7 dB for Tx Diversity AWGN flatness and signal flatness ±2.0 dB</p>
8.2.1.2.1 - Propagation Condition HST	± 0.6 dB	<p>Overall system uncertainty for HST condition comprises two quantities:</p> <ol style="list-style-type: none"> 1. Signal-to-noise ratio uncertainty 2. Effect of AWGN flatness and signal flatness <p>Items 1 and 2 are assumed to be uncorrelated so can be root sum squared:</p> <p>AWGN flatness and signal flatness has x 0.25 effect on the required SNR, so use sensitivity factor of x 0.25 for the uncertainty contribution.</p> <p>Test System uncertainty = $\text{SQRT}(\text{Signal-to-noise ratio uncertainty}^2 + (0.25 \times \text{AWGN flatness and signal flatness})^2)$</p> <p>Signal-to-noise ratio uncertainty ±0.3 dB AWGN flatness and signal flatness ±2.0 dB</p>
8.2.1.2.2	± 0.9 dB	Same as 8.2.1.2.1 Propagation Condition EVA5

8.2.1.3.1	± 0.9 dB	<p>Overall system uncertainty for fading conditions comprises three quantities:</p> <ol style="list-style-type: none"> 1. Signal-to-noise ratio uncertainty 2. Fading profile power uncertainty 3. Effect of AWGN flatness and signal flatness <p>Items 1, 2 and 3 are assumed to be uncorrelated so can be root sum squared:</p> <p>AWGN flatness and signal flatness has x 0.25 effect on the required SNR, so use sensitivity factor of x 0.25 for the uncertainty contribution.</p> <p>Test System uncertainty = $\text{SQRT}(\text{Signal-to-noise ratio uncertainty}^2 + \text{Fading profile power uncertainty}^2 + (0.25 \times \text{AWGN flatness and signal flatness})^2)$</p> <p>Signal-to-noise ratio uncertainty ±0.3 dB Fading profile power uncertainty ±0.7 dB for MIMO AWGN flatness and signal flatness ±2.0 dB</p>
8.2.1.3.2	± 0.9 dB	Same as 8.2.1.3.1
8.2.1.4.1	± 0.9 dB	Same as 8.2.1.3.1
8.2.1.4.2	± 0.9 dB	Same as 8.2.1.3.1
8.2.2.1.1 Multiple PRBs - Propagation Condition EVA5 - Propagation Condition ETU70 - Propagation Condition ETU300	± 0.8 dB	<p>Overall system uncertainty for fading conditions comprises three quantities:</p> <ol style="list-style-type: none"> 1. Signal-to-noise ratio uncertainty 2. Fading profile power uncertainty 3. Effect of AWGN flatness and signal flatness <p>Items 1, 2 and 3 are assumed to be uncorrelated so can be root sum squared:</p> <p>AWGN flatness and signal flatness has x 0.25 effect on the required SNR, so use sensitivity factor of x 0.25 for the uncertainty contribution.</p> <p>Test System uncertainty = $\text{SQRT}(\text{Signal-to-noise ratio uncertainty}^2 + \text{Fading profile power uncertainty}^2 + (0.25 \times \text{AWGN flatness and signal flatness})^2)$</p> <p>Signal-to-noise ratio uncertainty ±0.3 dB Fading profile power uncertainty ±0.5 dB for single Tx AWGN flatness and signal flatness ±2.0 dB</p>

<p>8.2.2.1.1 Multiple PRBs - Propagation Condition HST</p>	<p>± 0.6 dB</p>	<p>Overall system uncertainty for HST condition comprises two quantities:</p> <ol style="list-style-type: none"> 1. Signal-to-noise ratio uncertainty 2. Effect of AWGN flatness and signal flatness <p>Items 1 and 2 are assumed to be uncorrelated so can be root sum squared:</p> <p>AWGN flatness and signal flatness has x 0.25 effect on the required SNR, so use sensitivity factor of x 0.25 for the uncertainty contribution.</p> <p>Test System uncertainty = $\text{SQRT}(\text{Signal-to-noise ratio uncertainty}^2 + (0.25 \times \text{AWGN flatness and signal flatness})^2)$</p> <p>Signal-to-noise ratio uncertainty ±0.3 dB AWGN flatness and signal flatness ±2.0 dB</p>
<p>8.2.2.1.1 Single PRB - Propagation Condition ETU70</p>	<p>± 0.8 dB</p>	<p>Overall system uncertainty for fading condition comprises three quantities:</p> <ol style="list-style-type: none"> 1. Average Signal-to-noise ratio uncertainty 2. Signal-to noise ratio variation for single PRB 3. Fading profile power uncertainty <p>Items 1, 2 and 3 are assumed to be uncorrelated so can be root sum squared:</p> <p>Test System uncertainty = $\text{SQRT}(\text{Average signal-to-noise ratio uncertainty}^2 + \text{Signal-to-noise ratio variation}^2 + \text{Fading profile power uncertainty}^2)$</p> <p>Signal-to-noise ratio uncertainty ±0.3 dB Signal-to-noise ratio variation ±0.5 dB Fading profile power uncertainty ±0.5 dB for single Tx</p>
<p>8.2.2.1.2 Single PRB</p>	<p>± 0.8 dB</p>	<p>Same as 8.2.2.1.1 Single PRB</p>
<p>8.2.2.2.1 - Propagation Condition EVA5</p>	<p>± 0.9 dB</p>	<p>Overall system uncertainty for fading conditions comprises three quantities:</p> <ol style="list-style-type: none"> 1. Signal-to-noise ratio uncertainty 2. Fading profile power uncertainty 3. Effect of AWGN flatness and signal flatness <p>Items 1, 2 and 3 are assumed to be uncorrelated so can be root sum squared:</p> <p>AWGN flatness and signal flatness has x 0.25 effect on the required SNR, so use sensitivity factor of x 0.25 for the uncertainty contribution.</p> <p>Test System uncertainty = $\text{SQRT}(\text{Signal-to-noise ratio uncertainty}^2 + \text{Fading profile power uncertainty}^2 + (0.25 \times \text{AWGN flatness and signal flatness})^2)$</p> <p>Signal-to-noise ratio uncertainty ±0.3 dB Fading profile power uncertainty ±0.7 dB for Tx Diversity AWGN flatness and signal flatness ±2.0 dB</p>

8.2.2.2.1 - Propagation Condition HST	± 0.6 dB	<p>Overall system uncertainty for HST condition comprises two quantities:</p> <ol style="list-style-type: none"> 1. Signal-to-noise ratio uncertainty 2. Effect of AWGN flatness and signal flatness <p>Items 1 and 2 are assumed to be uncorrelated so can be root sum squared:</p> <p>AWGN flatness and signal flatness has x 0.25 effect on the required SNR, so use sensitivity factor of x 0.25 for the uncertainty contribution.</p> <p>Test System uncertainty = $\text{SQRT}(\text{Signal-to-noise ratio uncertainty}^2 + (0.25 \times \text{AWGN flatness and signal flatness})^2)$</p> <p>Signal-to-noise ratio uncertainty ±0.3 dB AWGN flatness and signal flatness ±2.0 dB</p>
8.2.2.2.2	± 0.9 dB	Same as 8.2.2.2.1 Propagation Condition EVA5
8.2.2.3.1	± 0.9 dB	<p>Overall system uncertainty for fading conditions comprises three quantities:</p> <ol style="list-style-type: none"> 1. Signal-to-noise ratio uncertainty 2. Fading profile power uncertainty 3. Effect of AWGN flatness and signal flatness <p>Items 1, 2 and 3 are assumed to be uncorrelated so can be root sum squared:</p> <p>AWGN flatness and signal flatness has x 0.25 effect on the required SNR, so use sensitivity factor of x 0.25 for the uncertainty contribution.</p> <p>Test System uncertainty = $\text{SQRT}(\text{Signal-to-noise ratio uncertainty}^2 + \text{Fading profile power uncertainty}^2 + (0.25 \times \text{AWGN flatness and signal flatness})^2)$</p> <p>Signal-to-noise ratio uncertainty ±0.3 dB Fading profile power uncertainty ±0.7 dB for MIMO AWGN flatness and signal flatness ±2.0 dB</p>
8.2.2.3.2	± 0.9 dB	Same as 8.2.2.3.1
8.2.2.4.1	± 0.9 dB	Same as 8.2.2.3.1
8.2.2.4.2	± 0.9 dB	Same as 8.2.2.3.1

8.3.2.1.1	± 0.9 dB	<p>Overall system uncertainty for fading conditions comprises three quantities:</p> <ol style="list-style-type: none"> 1. Signal-to-noise ratio uncertainty 2. Fading profile power uncertainty 3. Effect of AWGN flatness and signal flatness <p>Items 1, 2 and 3 are assumed to be uncorrelated so can be root sum squared:</p> <p>AWGN flatness and signal flatness has x 0.25 effect on the required SNR, so use sensitivity factor of x 0.25 for the uncertainty contribution.</p> <p>Test System uncertainty = $\text{SQRT}(\text{Signal-to-noise ratio uncertainty}^2 + \text{Fading profile power uncertainty}^2 + (0.25 \times \text{AWGN flatness and signal flatness})^2)$</p> <p>Signal-to-noise ratio uncertainty ±0.3 dB Fading profile power uncertainty ±0.7 dB for Tx Diversity AWGN flatness and signal flatness ±2.0 dB</p>
8.3.2.1.1_1	± 0.9 dB	Same as 8.3.2.1.1
8.3.2.1.2	± 0.9 dB	Same as 8.2.2.3.1
8.3.2.1.3	± 0.9 dB	Same as 8.2.2.3.1
8.3.2.2.1	± 0.9 dB	Same as 8.2.2.3.1
8.4.1.1	± 0.8 dB	<p>Overall system uncertainty for fading conditions comprises four quantities:</p> <ol style="list-style-type: none"> 1. Signal-to-noise ratio uncertainty 2. Fading profile power uncertainty 3. Effect of AWGN flatness and signal flatness 4. Result variation due to finite test time <p>Items 1, 2, 3 and 4 are assumed to be uncorrelated so can be root sum squared:</p> <p>AWGN flatness and signal flatness has x 0.25 effect on the required SNR, so use sensitivity factor of x 0.25 for the uncertainty contribution.</p> <p>Test System uncertainty = $\text{SQRT}(\text{Signal-to-noise ratio uncertainty}^2 + \text{Fading profile power uncertainty}^2 + (0.25 \times \text{AWGN flatness and signal flatness})^2 + \text{variation due to finite test time}^2)$</p> <p>Signal-to-noise ratio uncertainty ±0.3 dB Fading profile power uncertainty ±0.5 dB for single Tx AWGN flatness and signal flatness ±2.0 dB Result variation due to finite test time ±0.2 dB</p>

8.4.1.2.1	± 1.0 dB	<p>Overall system uncertainty for fading conditions comprises four quantities:</p> <ol style="list-style-type: none"> 1. Signal-to-noise ratio uncertainty 2. Fading profile power uncertainty 3. Effect of AWGN flatness and signal flatness 4. Result variation due to finite test time <p>Items 1, 2, 3 and 4 are assumed to be uncorrelated so can be root sum squared:</p> <p>AWGN flatness and signal flatness has x 0.25 effect on the required SNR, so use sensitivity factor of x 0.25 for the uncertainty contribution.</p> <p>Test System uncertainty = SQRT (Signal-to-noise ratio uncertainty² + Fading profile power uncertainty² + (0.25 x AWGN flatness and signal flatness)² + variation due to finite test time²)</p> <p>Signal-to-noise ratio uncertainty ±0.3 dB Fading profile power uncertainty ±0.7 dB for Tx Diversity AWGN flatness and signal flatness ±2.0 dB Result variation due to finite test time ±0.4 dB</p>
8.4.1.2.2	± 1.0 dB	<p>Overall system uncertainty for fading conditions comprises four quantities:</p> <ol style="list-style-type: none"> 1. Signal-to-noise ratio uncertainty 2. Fading profile power uncertainty 3. Effect of AWGN flatness and signal flatness 4. Result variation due to finite test time <p>Items 1, 2, 3 and 4 are assumed to be uncorrelated so can be root sum squared:</p> <p>AWGN flatness and signal flatness has x 0.25 effect on the required SNR, so use sensitivity factor of x 0.25 for the uncertainty contribution.</p> <p>Test System uncertainty = SQRT (Signal-to-noise ratio uncertainty² + Fading profile power uncertainty² + (0.25 x AWGN flatness and signal flatness)² + variation due to finite test time²)</p> <p>Signal-to-noise ratio uncertainty ±0.3 dB Fading profile power uncertainty ±0.7 dB for MIMO AWGN flatness and signal flatness ±2.0 dB Result variation due to finite test time ±0.4 dB</p>

8.4.2.1	± 0.8 dB	<p>Overall system uncertainty for fading conditions comprises four quantities:</p> <ol style="list-style-type: none"> 1. Signal-to-noise ratio uncertainty 2. Fading profile power uncertainty 3. Effect of AWGN flatness and signal flatness 4. Result variation due to finite test time <p>Items 1, 2, 3 and 4 are assumed to be uncorrelated so can be root sum squared:</p> <p>AWGN flatness and signal flatness has x 0.25 effect on the required SNR, so use sensitivity factor of x 0.25 for the uncertainty contribution.</p> <p>Test System uncertainty = SQRT (Signal-to-noise ratio uncertainty² + Fading profile power uncertainty² + (0.25 x AWGN flatness and signal flatness)² + variation due to finite test time²)</p> <p>Signal-to-noise ratio uncertainty ±0.3 dB Fading profile power uncertainty ±0.5 dB for single Tx AWGN flatness and signal flatness ±2.0 dB Result variation due to finite test time ±0.2 dB</p>
8.4.2.2.1	± 1.0 dB	<p>Overall system uncertainty for fading conditions comprises four quantities:</p> <ol style="list-style-type: none"> 1. Signal-to-noise ratio uncertainty 2. Fading profile power uncertainty 3. Effect of AWGN flatness and signal flatness 4. Result variation due to finite test time <p>Items 1, 2, 3 and 4 are assumed to be uncorrelated so can be root sum squared:</p> <p>AWGN flatness and signal flatness has x 0.25 effect on the required SNR, so use sensitivity factor of x 0.25 for the uncertainty contribution.</p> <p>Test System uncertainty = SQRT (Signal-to-noise ratio uncertainty² + Fading profile power uncertainty² + (0.25 x AWGN flatness and signal flatness)² + variation due to finite test time²)</p> <p>Signal-to-noise ratio uncertainty ±0.3 dB Fading profile power uncertainty ±0.7 dB for Tx Diversity AWGN flatness and signal flatness ±2.0 dB Result variation due to finite test time ±0.4 dB</p>

<p>8.4.2.2.2</p>	<p>± 1.0 dB</p>	<p>Overall system uncertainty for fading conditions comprises four quantities:</p> <ol style="list-style-type: none"> 1. Signal-to-noise ratio uncertainty 2. Fading profile power uncertainty 3. Effect of AWGN flatness and signal flatness 4. Result variation due to finite test time <p>Items 1, 2, 3 and 4 are assumed to be uncorrelated so can be root sum squared:</p> <p>AWGN flatness and signal flatness has x 0.25 effect on the required SNR, so use sensitivity factor of x 0.25 for the uncertainty contribution.</p> <p>Test System uncertainty = SQRT (Signal-to-noise ratio uncertainty² + Fading profile power uncertainty² + (0.25 x AWGN flatness and signal flatness)² + variation due to finite test time²)</p> <p>Signal-to-noise ratio uncertainty ±0.3 dB Fading profile power uncertainty ±0.7 dB for MIMO AWGN flatness and signal flatness ±2.0 dB Result variation due to finite test time ±0.4 dB</p>
<p>8.5.1.1</p>	<p>± 0.9 dB</p>	<p>Overall system uncertainty for fading conditions comprises four quantities:</p> <ol style="list-style-type: none"> 1. Signal-to-noise ratio uncertainty 2. Fading profile power uncertainty 3. Effect of AWGN flatness and signal flatness 4. Result variation due to finite test time <p>Items 1, 2, 3 and 4 are assumed to be uncorrelated so can be root sum squared:</p> <p>AWGN flatness and signal flatness has x 0.25 effect on the required SNR, so use sensitivity factor of x 0.25 for the uncertainty contribution.</p> <p>Test System uncertainty = SQRT (Signal-to-noise ratio uncertainty² + Fading profile power uncertainty² + (0.25 x AWGN flatness and signal flatness)² + variation due to finite test time²)</p> <p>Signal-to-noise ratio uncertainty ±0.3 dB Fading profile power uncertainty ±0.5 dB for single Tx AWGN flatness and signal flatness ±2.0 dB Result variation due to finite test time ±0.4 dB</p>

8.5.1.2.1	± 1.1 dB	<p>Overall system uncertainty for fading conditions comprises four quantities:</p> <ol style="list-style-type: none"> 1. Signal-to-noise ratio uncertainty 2. Fading profile power uncertainty 3. Effect of AWGN flatness and signal flatness 4. Result variation due to finite test time <p>Items 1, 2, 3 and 4 are assumed to be uncorrelated so can be root sum squared:</p> <p>AWGN flatness and signal flatness has x 0.25 effect on the required SNR, so use sensitivity factor of x 0.25 for the uncertainty contribution.</p> <p>Test System uncertainty = SQRT (Signal-to-noise ratio uncertainty² + Fading profile power uncertainty² + (0.25 x AWGN flatness and signal flatness)² + variation due to finite test time²)</p> <p>Signal-to-noise ratio uncertainty ±0.3 dB Fading profile power uncertainty ±0.7 dB for Tx Diversity AWGN flatness and signal flatness ±2.0 dB Result variation due to finite test time ±0.6 dB</p>
8.5.1.2.2	± 1.0 dB	<p>Overall system uncertainty for fading conditions comprises four quantities:</p> <ol style="list-style-type: none"> 1. Signal-to-noise ratio uncertainty 2. Fading profile power uncertainty 3. Effect of AWGN flatness and signal flatness 4. Result variation due to finite test time <p>Items 1, 2, 3 and 4 are assumed to be uncorrelated so can be root sum squared:</p> <p>AWGN flatness and signal flatness has x 0.25 effect on the required SNR, so use sensitivity factor of x 0.25 for the uncertainty contribution.</p> <p>Test System uncertainty = SQRT (Signal-to-noise ratio uncertainty² + Fading profile power uncertainty² + (0.25 x AWGN flatness and signal flatness)² + variation due to finite test time²)</p> <p>Signal-to-noise ratio uncertainty ±0.3 dB Fading profile power uncertainty ±0.7 dB for MIMO AWGN flatness and signal flatness ±2.0 dB Result variation due to finite test time ±0.4 dB</p>

8.5.2.1	± 0.9 dB	<p>Overall system uncertainty for fading conditions comprises four quantities:</p> <ol style="list-style-type: none"> 1. Signal-to-noise ratio uncertainty 2. Fading profile power uncertainty 3. Effect of AWGN flatness and signal flatness 4. Result variation due to finite test time <p>Items 1, 2, 3 and 4 are assumed to be uncorrelated so can be root sum squared:</p> <p>AWGN flatness and signal flatness has x 0.25 effect on the required SNR, so use sensitivity factor of x 0.25 for the uncertainty contribution.</p> <p>Test System uncertainty = SQRT (Signal-to-noise ratio uncertainty² + Fading profile power uncertainty² + (0.25 x AWGN flatness and signal flatness)² + variation due to finite test time²)</p> <p>Signal-to-noise ratio uncertainty ±0.3 dB Fading profile power uncertainty ±0.5 dB for single Tx AWGN flatness and signal flatness ±2.0 dB Result variation due to finite test time ±0.4 dB</p>
8.5.2.2.1	± 1.1 dB	<p>Overall system uncertainty for fading conditions comprises four quantities:</p> <ol style="list-style-type: none"> 1. Signal-to-noise ratio uncertainty 2. Fading profile power uncertainty 3. Effect of AWGN flatness and signal flatness 4. Result variation due to finite test time <p>Items 1, 2, 3 and 4 are assumed to be uncorrelated so can be root sum squared:</p> <p>AWGN flatness and signal flatness has x 0.25 effect on the required SNR, so use sensitivity factor of x 0.25 for the uncertainty contribution.</p> <p>Test System uncertainty = SQRT (Signal-to-noise ratio uncertainty² + Fading profile power uncertainty² + (0.25 x AWGN flatness and signal flatness)² + variation due to finite test time²)</p> <p>Signal-to-noise ratio uncertainty ±0.3 dB Fading profile power uncertainty ±0.7 dB for Tx Diversity AWGN flatness and signal flatness ±2.0 dB Result variation due to finite test time ±0.6 dB</p>

8.5.2.2.2	± 1.0 dB	<p>Overall system uncertainty for fading conditions comprises four quantities:</p> <ol style="list-style-type: none"> 1. Signal-to-noise ratio uncertainty 2. Fading profile power uncertainty 3. Effect of AWGN flatness and signal flatness 4. Result variation due to finite test time <p>Items 1, 2, 3 and 4 are assumed to be uncorrelated so can be root sum squared:</p> <p>AWGN flatness and signal flatness has x 0.25 effect on the required SNR, so use sensitivity factor of x 0.25 for the uncertainty contribution.</p> <p>Test System uncertainty = SQRT (Signal-to-noise ratio uncertainty² + Fading profile power uncertainty² + (0.25 x AWGN flatness and signal flatness)² + variation due to finite test time²)</p> <p>Signal-to-noise ratio uncertainty ± 0.3 dB Fading profile power uncertainty ± 0.7 dB for MIMO AWGN flatness and signal flatness ± 2.0 dB Result variation due to finite test time ± 0.4 dB</p>
[Other tests FFS]		
In addition, the following Test System uncertainties and related constraints apply:		
AWGN Bandwidth	≥ 1.08 MHz, 2.7MHz, 4.5MHz, 9MHz, 13.5MHz, 18MHz; $N_{RB} \times 180$ kHz according to BW_{Config}	
AWGN absolute power uncertainty, averaged over BW_{Config}	± 3 dB	
AWGN flatness and signal flatness, max deviation for any Resource Block, relative to average over BW_{Config}	± 2 dB	
AWGN peak to average ratio	≥ 10 dB @0.001%	
Signal-to noise ratio uncertainty, averaged over downlink transmission Bandwidth	± 0.3 dB	
Signal-to noise ratio variation for any resource block, relative to average over downlink transmission Bandwidth	± 0.5 dB	
Fading profile power uncertainty	Test-specific	
Fading profile delay uncertainty, relative to frame timing	± 5 ns (excludes absolute errors related to baseband timing)	
Note 1: Only the overall stimulus error is considered here. The effect of errors in the throughput measurements due to finite test duration is not considered.		

F.1.5 Measurement of Channel State Information reporting

Table F.1.5-1: Maximum Test System Uncertainty for Channel State Information reporting

Subclause	Maximum Test System Uncertainty ¹	Derivation of Test System Uncertainty
9.2.1.1 FDD CQI Reporting under AWGN conditions – PUCCH 1-0	± 0.3 dB	Signal-to-noise ratio uncertainty ±0.3 dB <i>AWGN flatness and signal flatness ±2.0 dB not expected to have any significant effect</i> <i>AWGN absolute power uncertainty ±3.0 dB not expected to have any significant effect</i>
9.2.1.2 TDD CQI Reporting under AWGN conditions – PUCCH 1-0	± 0.3 dB	Same as 9.2.1.1
9.2.2.1 FDD CQI Reporting under AWGN conditions – PUCCH 1-1	± 0.3 dB	Signal-to-noise ratio uncertainty ±0.3 dB <i>AWGN flatness and signal flatness ±2.0 dB not expected to have any significant effect</i> <i>AWGN absolute power uncertainty ±3.0 dB not expected to have any significant effect</i>
9.2.2.2 TDD CQI Reporting under AWGN conditions – PUCCH 1-1	± 0.3 dB	Same as 9.2.1.1
9.3.1.1.1 FDD CQI Reporting under fading conditions – PUSCH 3-0	± 0.6 dB	Overall system uncertainty for fading conditions comprises two quantities: 1. Signal-to-noise ratio uncertainty ±0.3 dB 2. Fading profile power uncertainty ±0.5 dB Items 1 and 2 are assumed to be uncorrelated so can be root sum squared: Test System uncertainty = SQRT (Signal-to-noise ratio uncertainty ² + Fading profile power uncertainty ²) <i>AWGN flatness and signal flatness ±2.0 dB not expected to have any significant effect</i> <i>AWGN absolute power uncertainty ±3.0 dB not expected to have any significant effect</i>
9.3.1.1.2 TDD CQI Reporting under fading conditions – PUSCH 3-0	± 0.6 dB	Same as 9.3.1.1.1
9.3.2.1.1 FDD CQI Reporting under fading conditions – PUCCH 1-0	± 0.6 dB	Overall system uncertainty for fading conditions comprises two quantities: 1. Signal-to-noise ratio uncertainty ±0.3 dB 2. Fading profile power uncertainty ±0.5 dB Items 1 and 2 are assumed to be uncorrelated so can be root sum squared: Test System uncertainty = SQRT (Signal-to-noise ratio uncertainty ² + Fading profile power uncertainty ²) <i>AWGN flatness and signal flatness ±2.0 dB not expected to have any significant effect</i> <i>AWGN absolute power uncertainty ±3.0 dB not expected to have any significant effect</i>
9.3.2.1.2 TDD CQI Reporting under fading conditions – PUCCH 1-0	± 0.6 dB	Same as 9.3.2.1.1

9.3.3.1.1 FDD CQI Reporting under fading conditions and frequency-selective interference – PUSCH 3-0	± 1.2 dB	<p>Overall system uncertainty for fading conditions comprises two quantities:</p> <ol style="list-style-type: none"> 1. Ior/Iot ratio uncertainty ± 1.0 dB 2. Fading profile power uncertainty ± 0.5 dB <p>Items 1 and 2 are assumed to be uncorrelated so can be root sum squared:</p> <p>Test System uncertainty = SQRT (Ior/Iot ratio uncertainty² + Fading profile power uncertainty²)</p> <p><i>Ior absolute power uncertainty ± 3.0 dB not expected to have any significant effect</i></p>
9.3.3.1.2 TDD CQI Reporting under fading conditions and frequency-selective interference – PUSCH 3-0	± 1.2 dB	Same as 9.3.3.1.1
9.4.1.1.1 FDD PMI Reporting – PUSCH 3-1 (Single PMI)	± 0.6 dB	<p>Overall system uncertainty for fading conditions comprises two quantities:</p> <ol style="list-style-type: none"> 1. Signal-to-noise ratio uncertainty ± 0.3 dB 2. Fading profile power uncertainty ± 0.5 dB <p>Items 1 and 2 are assumed to be uncorrelated so can be root sum squared:</p> <p>Test System uncertainty = SQRT (Signal-to-noise ratio uncertainty² + Fading profile power uncertainty²)</p> <p><i>AWGN flatness and signal flatness ± 2.0 dB not expected to have any significant effect</i></p> <p><i>AWGN absolute power uncertainty ± 3.0 dB not expected to have any significant effect</i></p>
9.4.1.1.2 TDD PMI Reporting – PUSCH 3-1 (Single PMI)	± 0.6 dB	Same as 9.4.1.1.1
9.4.2.1.1 FDD PMI Reporting – PUSCH 1-2 (Multiple PMI)	± 0.6 dB	<p>Overall system uncertainty for fading conditions comprises two quantities:</p> <ol style="list-style-type: none"> 1. Signal-to-noise ratio uncertainty ± 0.3 dB 2. Fading profile power uncertainty ± 0.5 dB <p>Items 1 and 2 are assumed to be uncorrelated so can be root sum squared:</p> <p>Test System uncertainty = SQRT (Signal-to-noise ratio uncertainty² + Fading profile power uncertainty²)</p> <p><i>AWGN flatness and signal flatness ± 2.0 dB not expected to have any significant effect</i></p> <p><i>AWGN absolute power uncertainty ± 3.0 dB not expected to have any significant effect</i></p>
9.4.2.1.2 TDD PMI Reporting – PUSCH 1-2 (Multiple PMI)	± 0.6 dB	Same as 9.4.2.1.1

9.5.1.1 FDD RI Reporting– PUCCH 1-1	± 0.6 dB	Overall system uncertainty for fading conditions comprises two quantities: 1. Signal-to-noise ratio uncertainty ± 0.3 dB 2. Fading profile power uncertainty ± 0.5 dB Items 1 and 2 are assumed to be uncorrelated so can be root sum squared: Test System uncertainty = SQRT (Signal-to-noise ratio uncertainty ² + Fading profile power uncertainty ²) <i>AWGN flatness and signal flatness ± 2.0 dB not expected to have any significant effect</i> <i>AWGN absolute power uncertainty ± 3.0 dB not expected to have any significant effect</i>
9.5.1.2 TDD RI Reporting– PUSCH 3-1	± 0.6 dB	Same as 9.5.1.1
In addition, the following Test System uncertainties and related constraints apply:		
AWGN Bandwidth		≥ 1.08 MHz, 2.7MHz, 4.5MHz, 9MHz, 13.5MHz, 18MHz; $N_{RB} \times 180$ kHz according to BW_{Config}
AWGN absolute power uncertainty, averaged over BW_{Config}		± 3 dB
AWGN flatness and signal flatness, max deviation for any Resource Block, relative to average over BW_{Config}		± 2 dB
AWGN peak to average ratio		≥ 10 dB @0.001%
Signal-to noise ratio uncertainty, averaged over downlink transmission Bandwidth		± 0.3 dB
Signal-to noise ratio variation for any resource block, relative to average over downlink transmission Bandwidth		± 0.5 dB
Fading profile power uncertainty		Test-specific
Fading profile delay uncertainty, relative to frame timing		± 5 ns (excludes absolute errors related to baseband timing)
Note 1:	Only the overall stimulus error is considered here. The effect of errors in the throughput measurements due to finite test duration is not considered.	
Note 2:	The AWGN parameters apply to all test cases except 9.3.3.1.1 and 9.3.3.1.2. The fading parameters apply to test cases using fading	

F.2 Interpretation of measurement results (normative)

The measurement results returned by the Test System are compared – without any modification – against the Test Requirements as defined by the shared risk principle.

The Shared Risk principle is defined in ETR 273-1-2 clause 6.5.

The actual measurement uncertainty of the Test System for the measurement of each parameter shall be included in the test report.

The recorded value for the Test System uncertainty shall be, for each measurement, equal to or lower than the appropriate figure in clause F.1 of the present document.

If the Test System for a test is known to have a measurement uncertainty greater than that specified in clause F.1, it is still permitted to use this apparatus provided that an adjustment is made value as follows:

Any additional uncertainty in the Test System over and above that specified in clause F.1 shall be used to tighten the Test Requirement, making the test harder to pass. For some tests, for example receiver tests, this may require modification of stimulus signals. This procedure will ensure that a Test System not compliant with clause F.1 does not increase the chance of passing a device under test where that device would otherwise have failed the test if a Test System compliant with clause F.1 had been used.

F.3 Test Tolerance and Derivation of Test Requirements (informative)

The Test Requirements in the present document have been calculated by relaxing the Minimum Requirements of the core specification using the Test Tolerances defined in this clause. When the Test Tolerance is zero, the Test Requirement will be the same as the Minimum Requirement. When the Test Tolerance is non-zero, the Test Requirements will differ from the Minimum Requirements, and the formula used for the relaxation is given in this clause.

The Test Tolerances are derived from Test System uncertainties, regulatory requirements and criticality to system performance. As a result, the Test Tolerances may sometimes be set to zero.

The test tolerances should not be modified for any reason e.g. to take account of commonly known test system errors (such as mismatch, cable loss, etc.).

The downlink Test Tolerances apply at each receiver antenna connector.

F.3.1 Measurement of test environments

The UE test environments are set to the values defined in TS 36.508 subclause 4.1, without any relaxation. The applied Test Tolerance is therefore zero.

F.3.2 Measurement of transmitter

Table F.3.2-1: Derivation of Test Requirements (Transmitter tests)

Test	Minimum Requirement in TS 36.101	Test Tolerance (TT)	Test Requirement in TS 36.521-1
6.2.2 UE Maximum Output Power	Power class 1: [FFS] Power class 2: [FFS] Power class 3: 23dBm \pm 2 dB Power class 4: [FFS]	0.7 dB 0.7 dB 0.7 dB 0.7 dB	Formula: Upper limit + TT, Lower limit - TT Power class 1: [FFS] Power class 2: [FFS] Power class 3: 23dBm \pm 2.7 dB Power class 4: [FFS]
6.2.3 Maximum Power Reduction	Power class 3: QPSK: MPR \leq 1dB 16QAM: Depending on the number RB allocated: 16QAM: MPR \leq 1dB 16QAM: MPR \leq 2dB	0.7 dB	Formula: Upper limit + TT, Lower limit – MPR – TT Power class 3: QPSK: 23dBm +2.7 / - 3.7dB 16QAM: 23dBm +2.7 / - 3.7dB 23dBm +2.7 / - 4.7dB

<p>6.2.4 UE Maximum Output Power with additional requirements</p>	<p>For the UE maximum output power modified by MPR and A-MPR, the power limits specified in TS 36.101 [2] clause 6.2.5 apply.</p> <p>For transmission configurations (Figure 5.4.2-1) confined within FUL_{low} and FUL_{low} + 4 MHz or FUL_{high} – 4 MHz and FUL_{high}, the power requirement is relaxed by reducing the lower tolerance limit by 1.5 dB.</p> <p>Power class 3:</p> <p>QPSK: $MPR \leq 1\text{ dB}$</p> <p>16QAM: Depending on the number RB allocated: 16QAM: $MPR \leq 1\text{ dB}$ 16QAM: $MPR \leq 2\text{ dB}$</p> <p>For network signalled value NS₀₃ , NS₀₄ (5MHz only), NS₀₅, to NS₀₆: A-MPR $\leq 1\text{ dB}$</p> <p>For network signalled value NS-04; Depending on the RB_{start} and RB allocation (10MHz, 15MHz and 20MHz):</p> <p>For 10MHz Region A with RB_{start}=0 – 12: A-MPR $\leq 3\text{ dB}$.</p> <p>Region B with RB_{start}=13 – 36 : A-MPR $\leq 2\text{ dB}$.</p> <p>Region C with RB_{start}=37 – 49 : A-MPR $\leq 3\text{ dB}$.</p> <p>For 15MHz</p> <p>Region A with RB_{start}=0 – 18: A-MPR $\leq 3\text{ dB}$.</p> <p>Region B with RB_{start}=19 – 55 : A-MPR $\leq 2\text{ dB}$.</p> <p>Region C with RB_{start}=56 – 74 : A-MPR $\leq 3\text{ dB}$.</p> <p>For 20MHz Region A with RB_{start}=0 – 24: A-MPR $\leq 3\text{ dB}$.</p> <p>Region B with RB_{start}=25 – 74 : A-MPR $\leq 2\text{ dB}$.</p> <p>Region C with RB_{start}=75 – 99 : A-MPR $\leq 3\text{ dB}$.</p>	<p>0.7 dB</p>	<p>Formula: Upper limit + TT, A: Lower limit – TT, B: (UE Maximum Output Power from 6.2.2) - T(P_{C_{MAX}}) – MPR – TT, C: (UE Maximum Output Power from 6.2.2) - T(P_{C_{MAX}}) – A-MPR – TT, D: (UE Maximum Output Power from 6.2.2) - T(P_{C_{MAX}}) – A-MPR – MPR – TT</p> <p>Power class 3:</p> <p>Test Requirement Configuration ID versus Formula Above</p> <p>Network signalled value NS₀₃:</p> <p>[A]:2, 5, 10, 15, 20, 25 [B]:1, 3, 7 [C]:9, 14, 19, 24 [D]:4, 6, 8, 11, 12, 13, 16, 17, 18, 21, 22, 23, 26, 27</p> <p>Network signalled value NS₀₄ (5, 10, 15, 20MHz):</p> <p>[A] 3 [B] 10, 11, 19, 20, 28, 29 [C] 2, 6, 7, 14, 15, 16, 23, 24, 25, 32 [D] 1, 4, 5, 8, 9, 12, 13, 17, 18, 21, 22, 26, 27, 30, 31</p> <p>Network signalled value NS₀₅:</p> <p>[A]:1, 3, 4, 7, 8, 11, 12 [B]:2, 5, 9, 13 [C]:None [D]:6, 10, 14</p> <p>Network signalled value NS₀₆:</p> <p>[A]:2, 5, 8, 11, 14, 17 [B]:1, 3, 4, 6, 7, 9, 10, 12, 13, 15, 16, 18 [C]:None [D]:None</p> <p>Network signalled value NS₀₇:</p> <p>[A]:3, 8, 12 [B]:7, 9 [C]:1, 2, 5, 13, 15 [D]:4, 6, 10, 11, 14, 16</p> <p>Network signalled value NS₀₈:</p> <p>[A]:1, 2, 4, 5, 11, 12 [B]:3, 6, 13 [C]:None [D]:7, 8, 9, 10, 14, 15, 16, 17</p>
---	---	---------------	--

6.2.5 Configured UE transmitted Output Power	TS 36.101 [2] clause 6.2.5 PCMAX normal conditions: 23 ± 2.0 22 ± 2.5 21 ± 3.0 20 ± 3.5 19 ± 4.0 18 ± 4.5 13 ≤ PCMAX < 18 ± 5.0 □ 8 ≤ PCMAX < 13 ± 6.0 □ -40 ≤ PCMAX < 8 ± 7.0	0.7 dB	Formula: Upper limit + TT, Lower limit – TT PCMAX normal conditions: 23 ± 2.7 22 ± 3.2 21 ± 3.7 20 ± 4.2 19 ± 4.7 18 ± 5.2 13 ≤ PCMAX < 18 ± 5.7 □ 8 ≤ PCMAX < 13 ± 6.7 □ -40 ≤ PCMAX < 8 ± 7.7
6.3.2 Minimum Output Power	-40 dBm	1 dB	Formula: Minimum Requirement + TT UE minimum output power = –39 dBm
6.3.3 Transmission ON/OFF Power	Transmission OFF Power ≤ -50 dBm	1.5 dB	Transmission OFF power formula: Transmission OFF power Minimum Requirement + TT Transmission OFF Power = –48.5 dBm
6.3.4.1 General ON/OFF time mask	Transmission OFF Power ≤ -50 dBm Transmission ON Power value depends on the test parameters. In the particular test case parameters the ON power measurement has minimum requirements of ±6.0 dB.	1.5 dB	Transmission OFF power formula: Transmission OFF power Minimum Requirement + TT Transmission OFF Power ≤ –48.5 dBm Transmission ON power formula: Transmission ON Power = specific test value ± 7.5 dBm
6.3.4.2 Prach and SRS time mask	Transmission OFF Power ≤ -50 dBm Transmission ON Power value depends on the test parameters. In the particular test case parameters the ON power measurement has minimum requirements of ±6.0 dB.	1.5 dB	Transmission OFF power formula: Transmission OFF power Minimum Requirement + TT Transmission OFF Power ≤ –48.5 dBm Transmission ON power formula: Transmission ON Power = specific test value ± 7.5 dBm
6.3.5.1 Power Control Absolute power tolerance	Normal conditions ± 9.0 dB Extreme conditions ± 12.0 dB	1.0 dB	Formula: Upper limit + TT, Lower limit - TT Normal conditions ± 10.0 dB Extreme conditions ± 13.0 dB
6.3.5.1 Power Control Relative power tolerance	TS 36.101 [2] clause 6.3.5.1 All combinations of PUSCH and PUCCH transitions: ΔP < 2; ±2.5 dB 2 ≤ ΔP < 3; ±3.0 dB 3 ≤ ΔP < 4; ±3.5 dB 4 ≤ ΔP ≤ 10; ±4.0 dB 10 ≤ ΔP < 15; ±5.0 dB 15 ≤ ΔP; ±6.0 dB	0.7 dB	Formula: Upper limit + TT, Lower limit – TT All combinations of PUSCH and PUCCH transitions: ΔP < 2; ±3.2 dB 2 ≤ ΔP < 3; ±3.7 dB 3 ≤ ΔP < 4; ±4.2 dB 4 ≤ ΔP < 10; ±4.7 dB 10 ≤ ΔP < 15; ±5.7 dB 15 ≤ ΔP; ±6.7 dB

6.3.5.1 Aggregate power control tolerance	Aggregate power control tolerance within 21 ms: PUCCH = ± 2.5 dB PUSCH = ± 3.5 dB	0.7 dB	Formula: Upper limit + TT, Lower limit - TT PUCCH = ± 3.2 dB PUSCH = ± 4.2 dB
6.5.1 Frequency Error	The UE modulated carrier frequency shall be accurate to within ± 0.1 ppm compared to the carrier frequency received from the E-UTRA Node B.	15 Hz	Formula: modulated carrier frequency error + TT modulated carrier frequency error = $\pm(0.1 \text{ ppm} + 15 \text{ Hz})$.
6.5.2.1 Error Vector Magnitude	EVM limit: BPSK : 17.5 % QPSK: 17.5 % 16QAM: 12.5 %	0%	Formula: Minimum Requirement + TT
6.5.2.1A PUSCH-EVM with exclusion period	EVM limit: QPSK: 17.5 % 16QAM: 12.5 %	0%	Formula: Minimum Requirement + TT
6.5.2.2 Carrier leakage	For Output power >0 dBm -25dBc For $-30 \text{ dBm} \leq \text{Output power} \leq 0 \text{ dBm}$ -20dBc For $-40 \text{ dBm} \leq \text{Output power} < -30 \text{ dBm}$ -10dBc	0.8dB	Formula: Minimum Requirement + TT
6.5.2.3 In-band emissions for non allocated RB	For general emissions: $\max \left\{ -25 - 10 \cdot \log_{10} (N_{RB} / L_{CRF}) \right.$ $20 \cdot \log_{10} EVM - 3 - 5 \cdot (\Delta_{RB} - 1)$ $\left. - 57 \text{ dBm} / 180 \text{ kHz} - P_{RB} \right\}$ For IQ image: -25dB For Carrier leakage: Output power >0 dBm -25dBc -30 dBm \leq Output power \leq 0 dBm -20dBc -40 dBm \leq Output power < -30 dBm -10dBc For each evaluated RB, the test requirement is calculated as the higher of $P_{RB} - 30$ dB and the power sum of all limit values (General, IQ Image or Carrier leakage)	0.8dB	Formula: Minimum Requirement + TT

<p>6.5.2.4 EVM equalizer Spectrum flatness</p>	<p>Normal conditions.</p> <p>If (F-FUL_low ≥ [3MHz]) & (FUL_high-F ≥ [3MHz]) 4 dB else 8 dB</p> <p>maximum coefficient in Range 1 - the minimum coefficient in Range 2 5 dB the maximum coefficient in Range 2 - the minimum coefficient in Range 7 dB</p> <p>Extreme conditions:</p> <p>If (F-FUL_low ≥ [5MHz]) & (FUL_high-F ≥ [5MHz]) 4 dB else 12 dB</p> <p>maximum coefficient in Range 1 - the minimum coefficient in Range 2 6 dB the maximum coefficient in Range 2 - the minimum coefficient in Range 10 dB</p>	<p>1.4dB</p>	<p>Formula: Minimum Requirement + TT</p>
<p>6.6.1 Occupied bandwidth</p>	<p>For 1.4 MHz channel bandwidth: Occupied channel bandwidth = 1.4 MHz</p> <p>For 3.0 MHz channel bandwidth: Occupied channel bandwidth = 3.0 MHz</p> <p>For 5 MHz channel bandwidth: Occupied channel bandwidth = 5 MHz</p> <p>For 10 MHz channel bandwidth: Occupied channel bandwidth = 10 MHz</p> <p>For 15 MHz channel bandwidth: Occupied channel bandwidth = 15 MHz</p> <p>For 20 MHz channel bandwidth: Occupied channel bandwidth = 20 MHz</p>	<p>0kHz</p>	<p>Formula: Minimum Requirement + TT</p>

<p>6.6.2.1 Spectrum Emission Mask</p>	<p>For 1.4 MHz BW: -10 dBm / 30kHz -25dBm to -10dBm / 1MHz</p> <p>For 3 MHz BW: -10 dBm / 30kHz -25dBm to -10dBm / 1MHz</p> <p>For 5 MHz BW: -15dBm / 30kHz -25dBm to -10dBm / 1MHz</p> <p>For 10 MHz BW: -18dBm / 30kHz -25dBm to -10dBm / 1MHz</p> <p>For 15 MHz BW: -20dBm / 30kHz -25dBm to -10dBm / 1MHz</p> <p>For 20 MHz BW: -21dBm / 30kHz -25dBm to -10dBm / 1MHz</p>	<p>1.5dB ($\Delta f_{OOB} < 2 \times$ Channel Bandwidth)</p> <p>0dB ($\Delta f_{OOB} \geq 2 \times$ Channel Bandwidth)</p> <p>1.5dB</p> <p>1.5dB</p> <p>1.5dB</p> <p>1.5dB</p> <p>1.5dB</p> <p>1.5dB</p>	<p>Formula: Minimum Requirement + TT</p>
---------------------------------------	--	---	---

<p>6.6.2.2 Additional Spectrum Emission Mask</p>	<p>For 1.4 MHz BW: NS_03, NS_04 -10 dBm / 30 kHz -25 dBm to -13 dBm / 1MHz</p> <p>NS_06 or NS_07 -13 dBm / 30 kHz -13 dBm / 100 kHz -25 dBm to -13 dBm / 1MHz</p> <p>For 3 MHz BW: NS_03, NS_04 -13 dBm / 30 kHz -25 dBm to -13 dBm / 1 MHz</p> <p>NS_06 or NS_07 -13 dBm / 30 kHz -13 dBm / 100kHz -25 dBm to -13 dBm / 1 MHz</p> <p>For 5 MHz BW: NS_03, NS_04 -15 dBm / 30 kHz -25 dBm to -13 dBm / 1 MHz</p> <p>NS_06 or NS_07 -15 dBm / 30 kHz -13 dBm / 100 kHz -25 dBm to -13 dBm / 1 MHz</p> <p>For 10 MHz BW: NS_03, NS_04, -18 dBm / 30 kHz -25 dBm to -13dBm / 1 MHz</p> <p>NS_06 or NS_07 -18 dBm / 30 kHz -13 dBm / 100 kHz -25 dBm to -13dBm / 1 MHz</p> <p>For 15 MHz BW: NS_03, NS_04 -20 dBm / 30kHz -25 dBm to -13 dBm / 1 MHz</p> <p>For 20 MHz BW: NS_03, NS_04 -21 dBm / 30 kHz -25 dBm to -13 dBm / 1 MHz</p>	<p>1.5dB ($\Delta f_{OOB} < 2 \times$ Channel Bandwidth)</p> <p>0dB ($\Delta f_{OOB} \geq 2 \times$ Channel Bandwidth)</p> <p>1.5dB</p> <p>1.5dB</p> <p>1.5dB</p> <p>1.5dB</p> <p>1.5dB</p> <p>1.5dB</p> <p>1.5dB</p>	<p>Formula: Minimum Requirement + TT</p>
<p>6.6.2.3 Adjacent Channel Leakage power Ratio</p>	<p>If the adjacent channel power is greater than -50 dBm then the ACLR shall be higher than the values specified below.</p> <p>E-UTRA ACLR: 30 dB</p> <p>UTRA ACLR: 33 dB for UTRA ACLR 1 36 dB for UTRA ACLR 2</p>	<p>0 dB</p> <p>0.8 dB</p> <p>0.8 dB</p> <p>0.8 dB</p>	<p>Formula: ACLR Minimum Requirement + TT</p> <p>Formula: ACLR Minimum Requirement - TT</p> <p>E-UTRA ACLR: 29.2 dB</p> <p>UTRA ACLR: 32.2 dB for UTRA ACLR 1 35.2 dB for UTRA ACLR 2</p>

6.6.2.4 Additional ACLR requirements	If the adjacent channel power is greater than -50 dBm then the ACLR shall be higher than the values specified below. E-UTRA ACLR: 43 dB for UTRA ACLR 2	0 dB 0.8 dB	Formula: ACLR Minimum Requirement + TT Formula: ACLR Minimum Requirement – TT E-UTRA ACLR: 42.2 dB for UTRA ACLR 2
6.6.3.1 Transmitter Spurious emissions	9 kHz $\leq f < 150$ kHz: -36dBm / 1kHz 150 kHz $\leq f < 30$ MHz: -36dBm / 10kHz 30 MHz $\leq f < 1$ GHz: -36dBm / 100kHz 1 GHz $\leq f < 12.75$ GHz: -30dBm / 1MHz	0 dB	Formula: Minimum Requirement + TT
6.6.3.2 Spurious emission band UE co-existence	-35 dBm / 6.25kHz -36 dBm / 100kHz -41 dBm / 300kHz -37 dBm / 1MHz -40 dBm / 1MHz -50 dBm / 1MHz Frequencies as detailed in core requirement	0 dB	Formula: Minimum Requirement + TT
6.6.3.3 Additional spurious emissions	NS_05 1884.5MHz $\leq f \leq 1919.6$ MHz: -41dBm / 300kHz 1884.5MHz $\leq f \leq 1915.7$ MHz: -41dBm / 300kHz NS_07 769MHz $\leq f \leq 775$ MHz -57dBm / 6.25kHz NS_08 860MHz $\leq f \leq 895$ MHz -40dBm / 1MHz NS_09 1475.9MHz $\leq f \leq 1510.9$ MHz -35dBm / 1MHz	0 dB 0 dB TT 0 dB 0 dB	Formula: Minimum Requirement + TT -41dBm / 300kHz -41dBm / 300kHz -57+TTdBm / 6.25kHz -40dBm / 1MHz -35dBm / 1MHz
6.7 Transmit intermodulation	Intermodulation Product 5MHz -29 dBc 10MHz -35 dBc CW Interferer level = -40 dBc	0 dB	Formula: CW interferer Minimum Requirement– TT Intermod Products limits remain unchanged. CW interferer level = -40 dBc

NOTE: Section 6.6.3.3 in the table shall be reviewed after June 2012 because of PHS band operation change

F.3.3 Measurement of receiver

Table F.3.3-1: Derivation of Test Requirements (Receiver tests)

Test	Minimum Requirement in TS 36.101	Test Tolerance (TT)	Test Requirement in TS 36.521-1
7.3.1 Reference sensitivity power level; Minimum requirements (QPSK)	<p>Reference sensitivity power level:</p> <p>For 1.4MHz -102.2dBm -103.2dBm -105.2dBm -106.2dBm</p> <p>For 3MHz -99.2dBm -100.2dBm -102.2dBm</p> <p>For 5MHz -97dBm -98dBm -99dBm -100dBm -96.5dBm Band 9 with Multi band</p> <p>For 10MHz -94dBm -95dBm -96dBm -97dBm -93.5dBm Band 9 with Multi band</p> <p>For 15MHz -92.2dBm -93.2dBm -94.2dBm -95.2dBm -91.7dBm Band 9 with Multi band</p> <p>For 20MHz -91dBm -92dBm -93dBm -94dBm -90.5dBm Band 9 with Multi band</p> <p>T-put limit = 95% of maximum for the Ref Meas channel</p>	0.7dB	<p>Formula: Reference sensitivity power level + TT</p> <p>T-put limit unchanged</p>
7.4 Maximum input level	<p>Signal level -25dBm</p> <p>T-put limit = 95% of maximum for the Ref Meas channel</p> <p>Uplink power</p>	<p>0.7 dB</p> <p>0dB, -3.4dB</p>	<p>Formula: Maximum input level - TT</p> <p>Signal level -25.7 dBm</p> <p>T-put limit unchanged</p> <p>Uplink power measurement window comprises four quantities:</p> <ol style="list-style-type: none"> 1. UE power step size 1dB 2. UE Power step tolerance ± 1dB 3. Test system power measurement at top of window ± 0.7 dB

			<p>3. Test system power measurement at bottom of window ± 0.7 dB</p> <p>Items 1 to 4 are added arithmetically: Overall UL power window size = (1dB+1dB+0.7dB+0.7dB) =3.4dB</p> <p>Top of window is aligned to UL power requirement, hence +0dB, -3.4dB</p>
7.5 Adjacent Channel Selectivity (ACS)	<p><u>Case 1:</u> Wanted signal power, all BWs: (REFSENS + 14 dB)</p> <p>Interferer signal power For 1.4 MHz, 3 MHz, 5 MHz, 10 MHz BW: (REFSENS + 45.5 dB) For 15 MHz BW: (REFSENS + 42.5 dB) For 20 MHz BW: (REFSENS + 39.5 dB)</p> <p><u>Case 2:</u> Wanted signal power For 1.4 MHz, 3 MHz, 5 MHz, 10 MHz BW: -56.5 dBm For 15 MHz BW: -53.5 dBm For 20 MHz BW: -50.5 dBm</p> <p>Interferer signal power, all BWs: -25 dBm</p> <p>T-put limit = 95% of maximum for the Ref Meas channel</p> <p>Uplink power</p>	0 dB	<p>Formula: Wanted signal power + TT</p> <p>Interferer signal power unchanged</p> <p>T-put limit unchanged</p> <p>Uplink power measurement window same as 7.4</p>
7.6.1 In-band blocking	<p>Wanted signal power: (REFSENS + BW dependent value)</p> <p>Interferer signal power: -56dBm or -44dBm</p> <p>T-put limit = 95% of maximum for the Ref Meas channel</p> <p>Uplink power</p>	0 dB	<p>Formula: Wanted signal power + TT</p> <p>Interferer signal power unchanged</p> <p>T-put limit unchanged</p> <p>Uplink power measurement window same as 7.4</p>
7.6.2 Out of-band blocking	<p>Wanted signal power: (REFSENS + BW dependent value)</p> <p>Interferer signal power: -44dBm, -30dBm or -15dBm</p> <p>T-put limit = 95% of maximum for the Ref Meas channel</p> <p>Uplink power</p>	0 dB	<p>Formula: Wanted signal power + TT</p> <p>Interferer signal power unchanged</p> <p>T-put limit unchanged</p> <p>Uplink power measurement window same as 7.4</p>
7.6.3 Narrow band blocking	<p>Wanted signal power, : (REFSENS + BW dependent value)</p> <p>Interferer signal power: -55dBm</p> <p>T-put limit = 95% of maximum for the Ref Meas channel</p> <p>Uplink power</p>	0 dB	<p>Formula: Wanted signal power + TT</p> <p>Interferer signal power unchanged</p> <p>T-put limit unchanged</p> <p>Uplink power measurement window same as 7.4</p>

F.3.4 Measurement of performance requirements

Table F.3.4-1: Derivation of Test Requirements (performance tests)

Test	Minimum Requirement in TS 36.133	Test Tolerance (TT)	Test Requirement in TS 36.521-1
8.2.1.1.1 Multiple PRBs - Prop'n Condition EVA5 - Prop'n Condition ETU70 - Prop'n Condition ETU300	SNRs as specified	0.8dB	Formula: SNR + TT T-put limit unchanged
8.2.1.1.1 Multiple PRBs - Prop'n Condition HST	SNR as specified	0.6dB	Formula: SNR + TT T-put limit unchanged
8.2.1.1.1 Single PRB - Prop'n Condition ETU70	SNRs as specified	0.8dB	Formula: SNR + TT T-put limit unchanged
8.2.1.1.2 Single PRB	SNR as specified	0.8dB	Formula: SNR + TT T-put limit unchanged
8.2.1.2.1 - Prop'n Condition EVA5	SNR as specified	0.9 dB	Formula: SNR + TT T-put limit unchanged
8.2.1.2.1 - Prop'n Condition HST	SNR as specified	0.6 dB	Formula: SNR + TT T-put limit unchanged
8.2.1.2.2	SNR as specified	0.9 dB	Formula: SNR + TT T-put limit unchanged
8.2.1.3.1	SNR as specified	0.9 dB	Formula: SNR + TT T-put limit unchanged
8.2.1.3.2	SNR as specified	0.9 dB	Formula: SNR + TT T-put limit unchanged
8.2.1.4.1	SNRs as specified	0.9 dB	Formula: SNR + TT T-put limit unchanged
8.2.1.4.2	SNRs as specified	0.9 dB	Formula: SNR + TT T-put limit unchanged
8.2.2.1.1 Multiple PRBs - Prop'n Condition EVA5 - Prop'n Condition ETU70 - Prop'n Condition ETU300	SNRs as specified	0.8dB	Formula: SNR + TT T-put limit unchanged
8.2.2.1.1 Multiple PRBs - Prop'n Condition HST	SNR as specified	0.6dB	Formula: SNR + TT T-put limit unchanged
8.2.2.1.1 Single PRB - Prop'n Condition ETU70	SNRs as specified	0.8dB	Formula: SNR + TT T-put limit unchanged
8.2.2.1.2 Single PRB	SNR as specified	0.8dB	Formula: SNR + TT T-put limit unchanged
8.2.2.2.1 - Prop'n Condition EVA5	SNR as specified	0.9 dB	Formula: SNR + TT T-put limit unchanged
8.2.2.2.1 - Prop'n Condition HST	SNR as specified	0.6 dB	Formula: SNR + TT T-put limit unchanged
8.2.2.2.2	SNR as specified	0.9 dB	Formula: SNR + TT T-put limit unchanged

8.2.2.3.1	SNR as specified	0.9 dB	Formula: SNR + TT T-put limit unchanged
8.2.2.3.2	SNR as specified	0.9 dB	Formula: SNR + TT T-put limit unchanged
8.2.2.4.1	SNRs as specified	0.9 dB	Formula: SNR + TT T-put limit unchanged
8.2.2.4.2	SNRs as specified	0.9 dB	Formula: SNR + TT T-put limit unchanged
8.3.2.1.1	SNRs as specified	0.9 dB	Formula: SNR + TT T-put limit unchanged
8.3.2.1.1_1	SNRs as specified	0.9 dB	Formula: SNR + TT T-put limit unchanged
8.3.2.1.2	SNRs as specified	0.9 dB	Formula: SNR + TT T-put limit unchanged
8.3.2.1.3	SNRs as specified	0.9 dB	Formula: SNR + TT T-put limit unchanged
8.3.2.2.1	SNRs as specified	0.9 dB	Formula: SNR + TT T-put limit unchanged
8.4.1.1	SNR as specified	0.8 dB	Formula: SNR + TT T-put limit unchanged
8.4.1.2.1	SNR as specified	1.0 dB	Formula: SNR + TT T-put limit unchanged
8.4.1.2.2	SNR as specified	1.0 dB	Formula: SNR + TT T-put limit unchanged
8.4.2.1	SNR as specified	0.8 dB	Formula: SNR + TT T-put limit unchanged
8.4.2.2.1	SNR as specified	1.0 dB	Formula: SNR + TT T-put limit unchanged
8.4.2.2.2	SNR as specified	1.0 dB	Formula: SNR + TT T-put limit unchanged
8.5.1.1	SNRs as specified	0.9 dB	Formula: SNR + TT T-put limit unchanged
8.5.1.2.1	SNR as specified	1.1 dB	Formula: SNR + TT T-put limit unchanged
8.5.1.2.2	SNR as specified	1.0 dB	Formula: SNR + TT T-put limit unchanged
8.5.2.1	SNRs as specified	0.9 dB	Formula: SNR + TT T-put limit unchanged
8.5.2.2.1	SNR as specified	1.1 dB	Formula: SNR + TT T-put limit unchanged
8.5.2.2.2	SNR as specified	1.0 dB	Formula: SNR + TT T-put limit unchanged
[Other tests FFS]			

F.3.5 Measurement of Channel State Information reporting

Table F.3.5-1: Derivation of Test Requirements (Channel State Information reporting tests)

Test	Minimum Requirement in TS 36.101	Test Tolerance (TT)	Test Requirement in TS 36.521-1
9.2.1.1 FDD CQI Reporting under AWGN conditions – PUCCH 1-0	SNRs as specified Limits as in the Test Procedure	No test tolerances applied	SNR and limits unchanged
9.2.1.2 TDD CQI Reporting under AWGN conditions – PUCCH 1-0	SNRs as specified Limits as in the Test Procedure	No test tolerances applied	SNR and limits unchanged
9.2.2.1 FDD CQI Reporting under AWGN conditions – PUCCH 1-1	SNRs as specified Limits as in the Test Procedure	No test tolerances applied	SNR and limits unchanged
9.2.2.2 TDD CQI Reporting under AWGN conditions – PUCCH 1-1	SNRs as specified Limits as in the Test Procedure	No test tolerances applied	SNR and limits unchanged
9.3.1.1.1 FDD CQI Reporting under fading conditions – PUSCH 3-0	SNRs as specified α 2% β 55% γ 1.10 BLER 0.05	SNR 0dB α 0% β 0% γ 0.01 BLER 0	SNR unchanged α limit unchanged β limit unchanged γ 1.09 as per Table G.5.4-1 BLER limit unchanged
9.3.1.1.2 TDD CQI Reporting under fading conditions – PUSCH 3-0	Same as 9.3.1.1.1	Same as 9.3.1.1.1	Same as 9.3.1.1.1
9.3.2.1.1 FDD CQI Reporting under fading conditions – PUCCH 1-0	SNRs as specified α 20% γ 1.05 BLER 0.02	SNR 0dB α 0% γ 0.01 BLER 0	SNR and α , BLER limits unchanged α limit unchanged γ 1.04 as per Table G.5.4-1 BLER limit unchanged
9.3.2.1.2 TDD CQI Reporting under fading conditions – PUCCH 1-0	Same as 9.3.2.1.1	Same as 9.3.2.1.1	Same as 9.3.2.1.1
9.3.3.1.1 FDD CQI Reporting under fading conditions and frequency-selective interference – PUSCH 3-0	lor and lot as specified α 60% γ 1.60	lor, lot 0dB α 20% γ 0.10	lor and lot unchanged α 40%, Formula: Min Req't – Test Tol γ 1.50, Formula: Min Req't – Test Tol The effect of AWGN flatness and signal flatness on the α requirement was derived by simulation. AWGN flatness / signal flatness and the statistical effect of a finite test time both affect the T-put result. The Test Tolerance comprises two quantities: 1. Effect of AWGN flatness and signal flatness, derived by simulation 2. Statistical effect as per Table G.5.4-1 Items 1 and 2 are assumed to be uncorrelated so can be root sum squared T-put requirement Test Tol = SQRT (AWGN flatness and signal flatness effect ² + Statistical effect ²) AWGN flatness and signal flatness effect 0.1, Statistical effect 0.01, giving overall effect 0.10

9.3.3.1.2 TDD CQI Reporting under fading conditions and frequency-selective interference – PUSCH 3-0	Same as 9.3.3.1.1	Same as 9.3.3.1.1	Same as 9.3.3.1.1
9.4.1.1.1 FDD PMI Reporting – PUSCH 3-1 (Single PMI)	γ 1.10	γ 0.01	γ 1.09 as per Table G.5.4-1
9.4.1.1.2 TDD PMI Reporting – PUSCH 3-1 (Single PMI)	Same as 9.4.1.1.1	Same as 9.4.1.1.1	Same as 9.4.1.1.1
9.4.2.1.1 FDD PMI Reporting – PUSCH 1-2 (Multiple PMI)	γ 1.20	γ 0.01	γ 1.19 as per Table G.5.4-1
9.4.2.1.2 TDD PMI Reporting – PUSCH 1-2 (Multiple PMI)	Same as 9.4.2.1.1	Same as 9.4.2.1.1	Same as 9.4.2.1.1
9.5.1.1 FDD RI Reporting– PUCCH 1-1	SNRs as specified Test 1: γ_2 1.00 Test 2: γ_1 1.05 Test 3: γ_2 1.10	SNR 0dB γ_2 0.01 γ_1 0.01 γ_2 0.01	SNR unchanged γ_2 0.99 as per Table G.5.4-1 γ_1 1.04 as per Table G.5.4-1 γ_2 1.09 as per Table G.5.4-1
9.5.1.2 TDD RI Reporting– PUSCH 3-1	Same as 9.5.1.1	Same as 9.5.1.1	Same as 9.5.1.1

Annex G (normative): Statistical Testing

G.1 General

FFS.

G.2 Statistical testing of receiver characteristics

G.2.1 General

The test of receiver characteristics is two fold.

1. A signal or a combination of signals is offered to the RX port(s) of the receiver.
2. The ability of the receiver to demodulate /decode this signal is verified by measuring the throughput.

In (2) is the statistical aspect of the test and is treated here.

The minimum requirement for all receiver tests is >95% of the maximum throughput.

All receiver tests are performed in static propagation conditions. No fading conditions are applied.

G.2.2 Mapping throughput to error ratio

- a) The measured information bit throughput R is defined as the sum (in kilobits) of the information bit payloads successfully received during the test interval, divided by the duration of the test interval (in seconds).
- b) In measurement practice the UE indicates successfully received information bit payload by signalling an ACK to the SS.
If payload is received, but damaged and cannot be decoded, the UE signals a NACK.
- c) Only the ACK and NACK signals, not the data bits received, are accessible to the SS.
The number of bits is known in the SS from knowledge of what payload was sent.
- d) For the reference measurement channel, applied for testing, the number of bits is different in different subframes, however in a radio frame it is fixed during one test.
- e) The time in the measurement interval is composed of successfully received subframes (ACK), unsuccessfully received subframes (NACK) and no reception at all (DTX-subframes).
- f) DTX-subframes may occur regularly according the applicable reference measurement channel (regDTX).
In real live networks this is the time when other UEs are served. In TDD these are the UL and special subframes.
regDTX vary from test to test but are fixed within the test.
- g) Additional DTX-subframes occur statistically when the UE is not responding ACK or NACK where it should. (statDTX)
This may happen when the UE was not expecting data or decided that the data were not intended for it.

The pass / fail decision is done by observing the:

- number of NACKs
- number of ACKs and
- number of statDTXs (regDTX is implicitly known to the SS)

The ratio $(NACK + statDTX) / (NACK + statDTX + ACK)$ is the Error Ratio (ER). Taking into account the time consumed by the ACK, NACK, and DTX-TTIs (regular and statistical), ER can be mapped unambiguously to throughput for any single reference measurement channel test.

G.2.3 Design of the test

The test is defined by the following design principles (see clause G.x, Theory....):

1. The early decision concept is applied.
2. A second limit is introduced: Bad DUT factor $M > 1$
3. To decide the test pass:

Supplier risk is applied based on the Bad DUT quality

To decide the test fail

Customer Risk is applied based on the specified DUT quality

The test is defined by the following parameters:

1. Limit ER = 0.05 (Throughput limit = 95%)
2. Bad DUT factor $M = 1.5$ (selectivity)
3. Confidence level CL = 95% (for specified DUT and Bad DUT-quality)

G.2.4 Numerical definition of the pass fail limits

Table G.2.4-1: pass fail limits

ne	ns _p	ns _f	ne	ns _p	ns _f	ne	ns _p	ns _f	ne	ns _p	ns _f
0	67	NA	39	763	500	78	1366	1148	117	1951	1828
1	95	NA	40	778	516	79	1381	1166	118	1965	1845
2	119	2	41	794	532	80	1396	1183	119	1980	1863
3	141	7	42	810	548	81	1412	1200	120	1995	1881
4	162	14	43	826	564	82	1427	1217	121	2010	1899
5	183	22	44	842	580	83	1442	1234	122	2025	1916
6	202	32	45	858	596	84	1457	1252	123	2039	1934
7	222	42	46	873	612	85	1472	1269	124	2054	1952
8	241	53	47	889	629	86	1487	1286	125	2069	1969
9	259	64	48	905	645	87	1502	1303	126	2084	1987
10	278	76	49	920	661	88	1517	1321	127	2099	2005
11	296	88	50	936	678	89	1532	1338	128	2113	2023
12	314	100	51	952	694	90	1547	1355	129	2128	2040
13	332	113	52	967	711	91	1562	1373	130	2143	2058
14	349	126	53	983	727	92	1577	1390	131	2158	2076
15	367	140	54	998	744	93	1592	1407	132	2172	2094
16	384	153	55	1014	760	94	1607	1425	133	2187	2111
17	401	167	56	1029	777	95	1623	1442	134	2202	2129
18	418	181	57	1045	793	96	1637	1459	135	2217	2147
19	435	195	58	1060	810	97	1652	1477	136	2231	2165
20	452	209	59	1076	827	98	1667	1494	137	2246	2183
21	469	224	60	1091	844	99	1682	1512	138	2261	2201
22	486	238	61	1106	860	100	1697	1529	139	2275	2218
23	503	253	62	1122	877	101	1712	1547	140	2290	2236
24	519	268	63	1137	894	102	1727	1564	141	2305	2254

25	536	283	64	1153	911	103	1742	1582	142	2320	2272
26	552	298	65	1168	928	104	1757	1599	143	2334	2290
27	569	313	66	1183	944	105	1772	1617	144	2349	2308
28	585	328	67	1199	961	106	1787	1634	145	2364	2326
29	602	343	68	1214	978	107	1802	1652	146	2378	2344
30	618	359	69	1229	995	108	1817	1669	147	2393	2361
31	634	374	70	1244	1012	109	1832	1687	148	2408	2379
32	650	389	71	1260	1029	110	1847	1704	149	2422	2397
33	667	405	72	1275	1046	111	1861	1722	150	2437	2415
34	683	421	73	1290	1063	112	1876	1740	151	2452	2433
35	699	436	74	1305	1080	113	1891	1757	152	2466	2451
36	715	452	75	1321	1097	114	1906	1775	153*)	NA	2469
37	731	468	76	1336	1114	115	1921	1793			
38	747	484	77	1351	1131	116	1936	1810	*) note 2 in G.2.5		

NOTE 1: The first column is the number of errors (ne = number of NACK + statDTX)

NOTE 2: The second column is the number of samples for the pass limit (ns_p, ns=Number of Samples= number of NACK + statDTX + ACK)

NOTE 3: The third column is the number of samples for the fail limit (ns_f)

G.2.5 Pass fail decision rules

The pass fail decision rules apply for a single test, comprising one component in the test vector. The over all Pass /Fail conditions are defined in clause G.2.1.5.

Having observed 0 errors, pass the test at 67+ samples, otherwise continue

Having observed 1 error, pass the test at 95+ otherwise continue

Having observed 2 errors, pass the test at 119+ samples, fail the test at 2- samples, otherwise continue

Etc. etc.

Having observed 151 errors, pass the test at 2452+ samples, fail the test at 2433- samples, otherwise continue

Having observed 152 errors, pass the test at 2466+ samples, fail the test at 2451- samples.

Where x+ means: x or more, x- means x or less

NOTE 1: an ideal DUT passes after 67 samples. The maximum test time is 2466 samples.

NOTE 2: It is allowed to deviate from the early decision concept by postponing the decision (pass/fail or continue). Postponing the decision to or beyond the end of table Table G.2.4-1 requires a pass fail decision against the test limit: pass the DUT for ER<0.0618, otherwise fail.

G.2.6 Test conditions for receiver tests

Table G.2.6-1: Test conditions for receiver tests

Test	Statistical independence	Number of components in the test vector, as specified in the test requirements and initial conditions of the applicable test	Over all Pass/Fail condition
7.3 Reference sensitivity level	Yes: the inherent receiver noise is assumed to be AWGN	tbd	To pass 7.3 each component in the test vector must pass
7.4 Maximum input level	Unclear: in case, clipping causes errors, errors are data dependent. Statistical independence is assumed.	tbd	To pass 7.4 each component in the test vector must pass
7.5 Adjacent Channel Selectivity (ACS)	Unclear: errors are data dependent on the interferers data. Statistical independence is assumed.	tbd	To pass 7.5 each component in the test vector must pass
7.6.1 In-band blocking	Unclear: errors are data dependent on the interferers data. Statistical independence is assumed.	tbd	To pass 7.6.1 each component in the test vector must pass
7.6.2 Out of-band blocking	yes: it is assumed that the CW interferer causes errors, which are independent and time invariant.	tbd	To pass 7.6.2, all except [tbd] components in the test vector must pass
7.6.3 Narrow band blocking	yes: it is assumed that the CW interferer causes errors, which are independent and time invariant.	tbd	To pass 7.6.3 each component in the test vector must pass
7.7 Spurious response	yes: it is assumed that the CW interferer causes errors, which are independent and time invariant.	tbd	To pass 7.7 each component in the test vector must pass
7.8.1 Wide band Intermodulation	Unclear: errors are dependent on the data content of the interferer. Statistical independence is assumed.	tbd	To pass 7.8.1 each component in the test vector must pass

G.3 Statistical testing of Performance Requirements with throughput

G.3.1 General

The test of receiver performance characteristics is two fold.

1. A signal or a combination of signals is offered to the RX port(s) of the receiver.
2. The ability of the receiver to demodulate /decode this signal is verified by measuring the throughput.

In (2) is the statistical aspect of the test and is treated here.

The minimum requirement for all receiver performance tests is either 70% or 30% of the maximum throughput.

All receiver performance tests are performed in fading conditions. In addition to the statistical considerations, this requires the definition of a minimum test time.

G.3.2 Mapping throughput to error ratio

G.2.2 applies

G.3.3 Design of the test

The test is defined by the following design principles (see clause G.x, Theory...):

1. The standard concept is applied. (not the early decision concept)
2. A second limit is introduced: The second limit is different, whether 30% or 70% throughput is tested.
3. To decide the test pass:
 - Supplier risk is applied based on the Bad DUT quality
 - To decide the test fail:
 - Customer Risk is applied based on the specified DUT quality

The test is defined by the following parameters:

- 1a) Limit Error Ratio = 0.3 (in case 70% Throughput is tested) or
- 1b) Limit Throughput = 0.3 (in case 30% Throughput is tested)
- 2a) Bad DUT factor $M=1.378$ (selectivity)
- 2b) Bad DUT factor $m=0.692$ (selectivity)
 - justification see: TS 34.121 Clause F.6.3.3
- 3) Confidence level $CL = 95\%$ (for specified DUT and Bad DUT-quality)

G.3.4 Pass Fail limit

Testing Throughput = 30%, then the test limit is

Number of successes (ACK) / number of samples $\geq 59 / 233$

Testing Throughput = 70% then the test limit is

Number of fails (NACK and statDTX) / number of samples $\leq 66 / 184$

We have to distinguish 3 cases:

- a) The duration for the number of samples (233 or 184) is greater than the minimum test time:
 - Then the number of samples (233 or 184) is predefined and the decision is done according to the number of events (59 successes or 66 fails)
- b) Since subframe 0 and 5 contain less bits than the remaining subframes, it is allowed to predefine a number of samples contained in an integer number of frames. In this case test-limit-ratio applies.
- c) The minimum test time is greater than the duration for the number of samples:
 - The minimum testtime is predefined and the decision is done comparing the measured ratio at that instant against the test-limit-ratio.

NOTE: The test time for most of the tests is governed by the Minimum Test Time

G.3.5 Minimum Test time

If a pass fail decision in G.3.4 can be achieved earlier than the minimum test time, then the test shall not be decided, but continued until the minimum test time is elapsed.

The tables below contain the minimum number of subframes for FDD and TDD.

By simulations the minimum number of active subframes (carrying DL payload) was derived (MNAS),

then adding inactive subframes to the active ones (e.g. subframe 5 contains no DL payload. For TDD additional subframes contain no DL payload)

then rounding up to full thousand and

then adding a bias of 1000 (BMNSF).

Simulation method to derive minimum test time:

With a level, corresponding a throughput at the test limit (here 30% or 70% of the max. throughput) the preliminary throughput versus time converges towards the final throughput. The allowance of ± 0.2 dB around the above mentioned level is predefined by RAN5 to find the minimum test time. The allowance of ± 0.2 dB maps through the function “final throughput versus level” into a throughput corridor. The minimum test time is achieved when the preliminary throughput escapes the corridor the last time. The two functions “final throughput versus level” and “preliminary throughput versus time” are simulation results, which are done individual for each demodulation scenario. HST-scenarios and scenarios with $MNAS \geq 50000$ are derived differently.

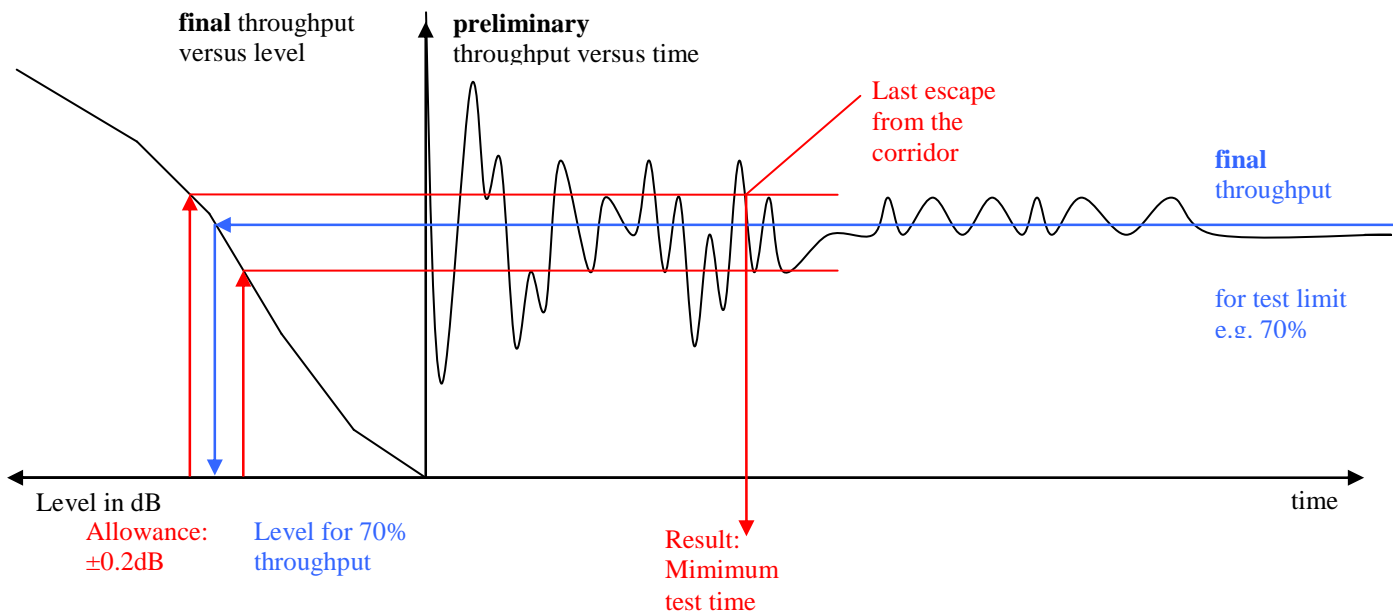

Fig. G.3.5-1: Simulation method to derive minimum test time

Table G.3.5-1: Minimum Test time for PDSCH Single Antenna Port Performance

Test No	Demod. scenario	Demodulation scenario plain text: RMC (Bandwidth, allocated RBs, modulation, coding) Antenna (configuration, correlation) Propagation condition, Doppler [additional parameters, if applicable] (info only)	Minimum Number of Active Subframes (MNAS) to reach the corridor (Simulation, info only)	Minimum Number of Subframes (MNS) to reach the corridor (MNS = active and inactive subframes) (Calculation, info only)		Biased Minimum Number of SubFrames (BMNSF) $BMNSF = 1000 * \left\lceil \frac{MNS}{1000} \right\rceil + 1000$ (mandatory)	
				FDD	TDD	FDD	TDD
				1	[1.1]	R.2 (10 MHz, full, QPSK, 1/3) (1x2 Low) EVA,5	38 764
2	[1.2]	R.2 (10 MHz, full, QPSK, 1/3) (1x2 Low) ETU,70	2 764	3 072	5 528	5 000	7 000
3	[1.3]	R.2 (10 MHz, full, QPSK, 1/3) (1x2 Low) ETU,300	1 424	1 583	2 848	3 000	4 000
4	[1.4]	R.2 (10 MHz, full, QPSK, 1/3) (1x2 Low) HST	28 800	NA	NA	28 800	57 600
5	[2.1]	R.4 (1.4 MHz, full, QPSK, 1/3) (1x2 Low) EVA,5	44 354	49 283	147 847	51 000	149 000
6	[1.5]	R.3 (10 MHz, full, 16QAM, 1/2) (1x2 Low) EVA,5	39 020	43 356	78 040	45 000	80 000
7	[1.6]	R.3 (10 MHz, full, 16QAM, 1/2) (1x2 Low) ETU,70	1 366	1 518	2 732	3 000	4 000
8	[1.7]	R.3 (10 MHz, full, 64QAM, 1/2) (1x2 High) ETU,300	3 189	3 544	6 378	5 000	8 000
9	[2.2]	R.5 (3 MHz, full, 64QAM, 3/4) (1x2 Low) EVA,5	50 000	55 556	100 000	57 000	101 000
10	[2.3]	R.6 (5 MHz, full, 64QAM, 3/4) (1x2 Low) EVA,5	48 847	54 275	97 694	56 000	99 000
11	[1.8]	R.7 (10 MHz, full, 64QAM, 3/4) (1x2 Low) EVA,5	46 524	51 694	93 048	53 000	95 000
12	[1.9]	R.7 (10 MHz, full, 64QAM, 3/4) (1x2 Low) ETU,70	4 722	5 247	9 444	7 000	11 000
13	[1.10]	R.7 (10 MHz, full, 64 QAM, 3/4) (1x2High) EVA,5	100 000	111 112	200 000	113 000	201 000

14	[2.4]	R.8 (15 MHz, full, 64QAM, 3/4) (1x2 Low) EVA,5	48 434	53 816	96 868	55 000	98 000
15	[2.5]	R.9 (20 MHz, full, 64QAM,3/4) (1x2 Low) EVA,5	100 000	111 112	200 000	113 000	201 000
16	[3.1]	R.0 (3 MHz, 1PRB,16QAM,1/2) (1x2 Low) ETU,70	5 710	6 345	11 420	8 000	13 000
17	[3.2]	R.1 (10MHz,1PRB,16QAM,1/2) (1x2 Low) ETU,70	9 234	10 260	18 468	12 000	20 000
18	[3.3]	R.1 (20MHz,1PRB,16QAM,1/2) (1x2 Low) ETU,70	13 373	14 859	26 746	16 000	28 000

Table G.3.5-2: Minimum Test time for PDSCH Single Antenna Port Performance with 1 PRB

Test No	Demod. scenario	Demodulation scenario (info only)	MNAS (Simulation)	MNS (Calculation)		MNSF (Min No Sub Frames, mandatory)	
				FDD	TDD	FDD	TDD
1	[3.4]	R.29 (10MHz,1PRB,16QAM,1/2) (1x2 Low) ETU,70 [MBFSN]	5 246	17 487	17 487	19 000	19 000

Table G.3.5-3: Minimum Test time for PDSCH Transmit diversity 2x2

Test No	Demod. scenario	Demodulation scenario (info only)	MNAS (Simulation)	MNS (Calculation)		MNSF (Min No Sub Frames, mandatory)	
				FDD	TDD	FDD	TDD
1	[7.1]	R11 (10MHz, full, 16QAM 1/2) (2x2 Med) EVA,5 [SFBC, Space Frequency Block Code]	50 000	55 556	100 000	57 000	101 000
2	[7.2]	R.10 (10MHz, Full, QPSK, 1/3) (2x2 low) HST [SFBC]	28 800	NA	NA	28 800	57 600

Table G.3.5-4: Minimum Test time for PDSCH Transmit diversity 4x2

Test No	Demod. scenario	Demodulation scenario (info only)	MNAS (Simulation)	MNS (Calculation)		MNSF (Min No Sub Frames, mandatory)	
				FDD	TDD	FDD	TDD
1	[7.3]	R.12 (1.4MHz, full, QPSK 1/3) (4x2 med) EPA,5 [SFBC-FSTD, SFBC-Frequency Shifted Transmit Diversity]	150 000	166 667	300 000	168 000	301 000

Table G.3.5-5: Minimum Test time for PDSCH Open Loop Spatial Multiplexing 2x2

Test No	Demod. scenario	Demodulation scenario (info only)	MNAS (Simulation)	MNS (Calculation)		MNSF (Min No Sub Frames, mandatory)	
				FDD	TDD	FDD	TDD
1	[6.1]	R.11 (10MHz, Full, 16QAM, ½) (2x2 Low) EVA,70 [LD-CDD, Large Delay-Cyclic Delay Diversity]	7 600	8 445	19 000	10 000	20 000

Table G.3.5-6: Minimum Test time for PDSCH Open Loop Spatial Multiplexing 4x2

Test No	Demod. scenario	Demodulation scenario (info only)	MNAS (Simulation)	MNS (Calculation)		MNSF (Min No Sub Frames, mandatory)	
				FDD	TDD	FDD	TDD
1	[6.2]	R.14 (10MHz, full, 16 QAM, ½) (4x2 low) EVA,70 [LD-CDD]	4 860	5 400	12 150	7 000	14 000

Table G.3.5-7: Minimum Test time for PDSCH Closed Loop Single/Multilayer Spatial Multiplexing 2x2

Test No	Demod. scenario	Demodulation scenario (info only)	MNAS (Simulation)	MNS (Calculation)		MNSF (Min No Sub Frames, mandatory)	
				FDD	TDD	FDD	TDD
1	[4.1]	R.10 (10MHz, 6PRB, QPSK, 1/3) (2x2 Low) EVA,5 [SCW, Single CodeWord]	49 140	54 600	98 280	56 000	100 000
2	[4.2]	R.10 (10MHz, Full, QPSK, 1/3) (2x2 High) EPA,5 [SCW]	50 000	55 556	100 000	57 000	101 000
3	[5.1]	R.11 (10MHz, full, 16QAM ½) (2x2Low) EVA,5 [MCW, Multiple Code Word]	34 266	38 074	85 665	40 000	87 000
4	[5.2]	R.11 (10MHz, full, 16QAM ½) (2x2Low) ETU,70 [MCW]	2 736	3 040	6 840	5 000	8 000

Table G.3.5-8: Minimum Test time for PDSCH Closed Loop Single/Multilayer Spatial Multiplexing 4x2

Test No	Demod. scenario	Demodulation scenario (info only)	MNAS (Simulation)	MNS (Calculation)		MNSF (Min No Sub Frames, mandatory)	
				FDD	TDD	FDD	TDD
1	[4.3]	R.13 (10 MHz, 6PRB, QPSK 1/3) (4x2 Low) EVA, 5 [SCW]	[26 528]	29 476	53 056	31 000	55 000
2	[5.3]	R.14 (10MHz, 6PRB, 16QAM 1/2) (4x2low) EVA5 [MCW]	26 066	28 963	65 165	30 000	67 000

Table G.3.5-9: Minimum Test time for PDSCH Single-layer Spatial Multiplexing on antenna port 5 (Release 8 and forward)

Test No	Demod. scenario	Demodulation scenario (info only)	MNAS (Simulation)	MNS (Calculation)		MNSF (Min No Sub Frames, mandatory)	
				FDD	TDD	FDD	TDD
1	[11.1]	R.25 (10 MHz, full, QPSK 1/3) (1x2 Low) EPA, 5	38 879	43 199	77 758	45 000	79 000
2	[11.2]	R.26 (10MHz, full, 16QAM 1/2) (1x2 Low) EPA5	47 781	53 090	95 562	55 000	97 000
3	[11.3]	R.27 (10MHz, full, 64QAM 3/4) (1x2 Low) EPA, 5	48 685	54 095	97 370	56 000	99 000
4	[11.4]	R.28 (10MHz, 1PRB, 16QAM 1/2) (1x2 Low) EPA, 5	100 000	111 112	200 000	113 000	201 000

Table G.3.5-10: Minimum Test time for PDSCH Single-layer Spatial Multiplexing on antenna port 5 (Release 9 and forward)

Test No	Demod. scenario	Demodulation scenario (info only)	MNAS (Simulation)	MNSF (Min No Sub Frames, mandatory)	
				FDD	TDD
1 NA					
2	[.]	R.26 (5MHz, full, 16QAM ½) (2x2 Low) EPA5	Note: MNAS is not simulated. Because of same demodulation scenario except for antenna configuration, MNSF is reused from Table G.3.5-9, Test 2	55 000	97 000
3	[.]	R.27 (10MHz, part, 64QAM 3/4) (2x2 Low) EPA,5	Note: MNAS is not simulated. Because of same demodulation scenario except for antenna configuration, MNSF is reused from Table G.3.5-9, Test 3	56 000	99 000
4 NA					

Table G.3.5-11: Minimum Test time for PDSCH Single-layer Spatial Multiplexing on antenna port 7 or 8 without simultaneous transmission

Test No	Demod. scenario	Demodulation scenario (info only)	MNAS (Simulation)	MNSF (Min No Sub Frames, mandatory)	
				FDD	TDD
1	[.]	R.31 (10 MHz, full, QPSK 1/3) (2x2 Low) EVA,5	Note: MNAS is not simulated. Because of same demodulation scenario except for RMC, antenna configuration, MNSF is reused from Table G.3.5-9, Test 1	45 000	79 000
2	[.]	R.32 (10MHz, full, 16QAM ½) (2x2 Medium) EPA5	Note: MNAS is not simulated. Because of same demodulation scenario except for RMC, antenna configuration, MNSF is reused from Table G.3.5-9, Test 2	55 000	97 000
		R.32-1 (5MHz, full, 16QAM ½) (2x2 Medium) EPA5	Note: MNAS is not simulated. Because of same demodulation scenario except for RMC, channel BW, antenna configuration, MNSF is reused from Table G.3.5-9, Test 2		
3	[.]	R.33 (10MHz, full, 64QAM 3/4) (2x2 Low) EPA,5	Note: MNAS is not simulated. Because of same demodulation scenario except for RMC, antenna configuration, MNSF is reused from Table G.3.5-9, Test 3	56 000	99 000
		R.33-1 (10MHz, part, 64QAM 3/4) (2x2 Low) EPA5	Note: MNAS is not simulated. Because of same demodulation scenario except for RMC, allocation, antenna configuration, MNSF is reused from Table G.3.5-9, Test 3		

Table G.3.5-12: Minimum Test time for PDSCH Single-layer Spatial Multiplexing on antenna port 7 or 8 with a simultaneous transmission

Test No	Demod. scenario	Demodulation scenario (info only)	MNAS (Simulation)	MNSF (Min No Sub Frames, mandatory)	
				FDD	TDD
4	[.]	R.32 (10MHz, full, 16QAM ½) (2x2 Medium) EPA,5	Note: MNAS is not simulated. Because of same demodulation scenario except for RMC, antenna configuration, MNSF is reused from Table G.3.5-9, Test 2	55 000	97 000
5		R.33 (10MHz, full, 64QAM 1/2) (2x2 Low) EPA,5	Note: MNAS is not simulated. Because of same demodulation scenario except for RMC, antenna configuration, MNSF is reused from Table G.3.5-9, Test 3	56 000	99 000

Table G.3.5-13: Minimum Test time for PDSCH Dual-layer Spatial Multiplexing

Test No	Demod. scenario	Demodulation scenario (info only)	MNAS (Simulation)	MNSF (Min No Sub Frames, mandatory)	
				FDD	TDD
1	[.]	R.31 (10 MHz, full, QPSK 1/3) (2x2 Low) EVA,5	Note: MNAS is not simulated. Because of same demodulation scenario except for RMC, antenna configuration, MNSF is reused from Table G.3.5-9, Test 1	[45 000]	[79 000]
2	[.]	R.32 (10MHz, full, 16QAM ½) (2x2 Medium) EPA5	Note: MNAS is not simulated. Because of same demodulation scenario except for RMC, antenna configuration, MNSF is reused from Table G.3.5-9, Test 2	[55 000]	[97 000]

Table G.3.5-14: Minimum Test time for Demodulation of PCFICH/PDCCH

Test No	Demod. Scenario	Demodulation scenario (info only)	MNAS (Simulation)	MNS (Calculation)		MNSF (Min No Sub Frames, mandatory)	
				FDD	TDD	FDD	TDD
1	[8.1]	R.15 (10 MHz, 8CCE, full, QPSK 1/3) (1x2 Low) ETU70	200 000	222 222	400 000	224 000	401 000
1	[8.2]	R.16 (1.4MHz, 2CCE, full, QPSK 1/3) (2x2 Low) EVA70	200 000	222 222	400 000	224 000	401 000
1	[8.3]	R.17 (10MHz, 4CCE, full, QPSK 1/3) (4x2 Medium) EPA5	200 000	222 222	400 000	224 000	401 000
Note: Simulation method to derive MNAS is based on finite test time and its effect on test system uncertainty specified in clause F.1.4.							

Table G.3.5-15: Minimum Test time for Demodulation of PHICH

Test No	Demod. scenario	Demodulation scenario (info only)	MNAS (Simulation)	MNS (Calculation)		MNSF (Min No Sub Frames, mandatory)	
				FDD	TDD	FDD	TDD
1	[9.1]	R.18 (10 MHz, full, QPSK 1/3) (1x2 Low) ETU70	200 000	200 000	500 000	200 000	500 000
2	[9.4]	R.24 (10MHz, full, 16QAM ½) (1x2 Low) ETU70	200 000	200 000	500 000	200 000	500 000
1	[9.2]	R.19 (1.4MHz, full, 64QAM 3/4) (2x2 Low) EVA70	200 000	200 000	500 000	200 000	500 000
1	[9.3]	R.20 (10MHz, 1PRB, 16QAM ½) (4x2 Medium) EPA5	200 000	200 000	500 000	200 000	500 000
Note: Simulation method to derive MNAS is based on finite test time and its effect on test system uncertainty specified in clause F.1.4.							

G.3.6 Test conditions for receiver performance tests

Table G.3.6: Test conditions for receiver performance tests

Table G.3.6-1: Single Antenna Port Performance (Cell-specific Reference Symbols) for test case 8.2.1.1 and 8.2.2.1 demodulation of PDSCH

Test	Statistical independence	Number of components in the test vector, as specified in the test requirements and initial conditions of the applicable test				Over all Pass/Fail condition
8.2.1.1 FDD PDSCH Single Antenna Port Performance (Cell- Specific Reference Symbols)	subframes are independent	CAT	1	2	3-5	To pass 8.2.1.1 and 8.2.2.1 each component in the test vector must pass For UEs, supporting multiple E_UTRA-bands (number of bands =B), the number of repetitions must be multiplied by B.
		QPSK	5	5	5	
		16QAM	0	3	3	
8.2.1.2 TDD PDSCH Single Antenna Port Performance (Cell- Specific Reference Symbols)	subframes are independent	64 QAM	1	6	7	If a test is defined over a BW>(BW of the E_UTRA band), the test is not applicable and reduces the number of repetitions. If a test is defined over a BW, which is not supported in the E_UTRAN band, the test is not applicable and reduces the number of repetitions.
		1PRB	4	4	4	
		Σ	10	18	19	

Table G.3.6-2: Transmit Diversity Performance (Cell-specific Reference Symbols) for test case 8.2.1.2 and 8.2.2.2 demodulation of PDSCH

Test	Statistical independence	Number of components in the test vector, as specified in the test requirements and initial conditions of the applicable test				Over all Pass/Fail condition
8.2.1.2 FDD PDSCH Transmit Diversity Performance (Cell-Specific Reference Symbols)	subframes are independent	CAT	1	2	3-5	To pass 8.2.1.2 and 8.2.2.2 each component in the test vector must pass For UEs, supporting multiple E_UTRA-bands (number of bands =B), the number of repetitions must be multiplied by B.
		QPSK	2	2	2	
8.2.2.2 TDD PDSCH Transmit Diversity Performance (Cell-Specific Reference Symbols)	subframes are independent	16QAM	0	1	1	If a test is defined over a BW, which is not supported in the E_UTRAN band, the test is not applicable and reduces the number of repetitions.
		Σ	2	3	3	

Table G.3.6-3: Open Loop Spatial Multiplexing Performance (Cell-specific Reference Symbols) for test case 8.2.1.3 and 8.2.2.3 demodulation of PDSCH

Test	Statistical independence	Number of components in the test vector, as specified in the test requirements and initial conditions of the applicable test				Over all Pass/Fail condition
8.2.1.3 FDD PDSCH Open Loop Spatial Multiplexing Performance (Cell-Specific Reference Symbols)	subframes are independent	CAT	1	2	3-5	To pass 8.2.1.3 and 8.2.2.3 each component in the test vector must pass
		16QAM	0	2	2	
8.2.2.3 TDD PDSCH Open Loop Spatial Multiplexing Performance (Cell-Specific Reference Symbols)	subframes are independent	Σ	0	2	2	

Table G.3.6-4: Closed Loop Spatial Multiplexing Performance (Cell-specific Reference Symbols) for test case 8.2.1.4 and 8.2.2.4 demodulation of PDSCH

Test	Statistical independence	Number of components in the test vector, as specified in the test requirements and initial conditions of the applicable test				Over all Pass/Fail condition
8.2.1.4 FDD PDSCH Closed Loop Spatial Multiplexing Performance (Cell- Specific Reference Symbols)	subframes are independent	CAT	1	2	3-5	To pass 8.2.1.4 and 8.2.2.4 each component in the test vector must pass
		Single layer QPSK	3	3	3	
8.2.2.4 TDD PDSCH Closed Loop Spatial Multiplexing Performance (Cell- Specific Reference Symbols)	subframes are independent	Multi layer 16QAM	0	3	3	
		Σ	3	6	6	

Table G.3.6-5: TDD PDSCH Single-layer Spatial Multiplexing on antenna port 5 (Release 8 and forward)

Test	Statistical independence	Number of components in the test vector, as specified in the test requirements and initial conditions of the applicable test				Over all Pass/Fail condition
8.3.2.1.1 TDD PDSCH Single-layer Spatial Multiplexing on antenna port 5 (Release 8 and forward)	subframes are independent	CAT	1	2	3-5	To pass 8.3.2.1 each component in the test vector must pass
		QPSK	1	1	1	
		16QAM	1	2	2	
		64 QAM	0	1	1	
		Σ	2	4	4	

Table G.3.6-6: TDD PDSCH Single-layer Spatial Multiplexing on antenna port 5 (Release 9 and forward)

Test	Statistical independence	Number of components in the test vector, as specified in the test requirements and initial conditions of the applicable test				Over all Pass/Fail condition
		CAT	1	2	3-5	
8.3.2.1.1_1 TDD PDSCH Single-layer Spatial Multiplexing on antenna port 5 (Release 9 and forward)	subframes are independent	16QAM	1	0	0	To pass 8.3.2.1.1_1 each component in the test vector must pass
		64 QAM	1	0	0	
		Σ	2	0	0	

Table G.3.6-7: TDD PDSCH Single-layer Spatial Multiplexing on antenna port 7 or 8 without a simultaneous transmission

Test	Statistical independence	Number of components in the test vector, as specified in the test requirements and initial conditions of the applicable test				Over all Pass/Fail condition
		CAT	1	2-5		
8.3.2.1.2 TDD PDSCH Single-layer Spatial Multiplexing on antenna port 7 or 8 without a simultaneous transmission	subframes are independent	QPSK	1	1		To pass 8.3.2.1.2 each component in the test vector must pass
		16QAM	1	1		
		64 QAM	1	1		
		Σ	3	3		

Table G.3.6-8: TDD PDSCH Single-layer Spatial Multiplexing on antenna port 7 or 8 with a simultaneous transmission

Test	Statistical independence	Number of components in the test vector, as specified in the test requirements and initial conditions of the applicable test				Over all Pass/Fail condition
		CAT	1	2-5		
8.3.2.1.3 TDD PDSCH Single-layer Spatial Multiplexing on antenna port 7 or 8 with a simultaneous transmission	subframes are independent	16QAM	0	1		To pass 8.3.2.1.3 each component in the test vector must pass
		64 QAM	0	1		
		Σ	0	2		

Table G.3.6-9: TDD PDSCH Dual-layer Spatial Multiplexing

Test	Statistical independence	Number of components in the test vector, as specified in the test requirements and initial conditions of the applicable test				Over all Pass/Fail condition
		CAT	1	2	3-5	
8.3.2.2.1 TDD PDSCH Dual-layer Spatial Multiplexing	subframes are independent	QPSK	1	1	1	To pass 8.3.2.2.1 each component in the test vector must pass
		16QAM	1	2	2	
		64 QAM	0	1	1	
		Σ	2	4	4	

G.4 Statistical testing of Performance Requirements with probability of misdetection

G.4.1 General

The test of receiver performance characteristics is two fold.

1. A signal or a combination of signals is offered to the RX port(s) of the receiver.
2. The ability of the receiver to demodulate /decode this signal is verified by analyzing the reaction of the UE to this signal.

In (2) is the statistical aspect of the test and is treated here.

The minimum requirement for those receiver performance tests are 1% or 0.1% misdetection probability

All receiver performance tests are performed in fading conditions. In addition to the statistical considerations, this requires the definition of a minimum test time.

G.4.2 Mapping the UE reaction to error ratio

The UE can not indicate the detection or misdetection of the physical channel under test directly. Indirect methods are described in the procedure of the applicable test.

G.4.3 Design of the test

G.2.3 applies, exception:

Limit ER = 0.01 and ER = 0.001

G.4.4 Numerical definition of the pass fail limits

Table G.4.4-1 pass fail limits for ER = 0.01

ne	ns _p	ns _f	ne	ns _p	ns _f	ne	ns _p	ns _f	ne	ns _p	ns _f
0	344	NA	40	3929	2553	80	7033	5874	120	10036	9354
1	485	NA	41	4009	2632	81	7109	5960	121	10110	9442
2	607	10	42	4089	2712	82	7185	6046	122	10184	9530
3	719	33	43	4168	2792	83	7261	6131	123	10259	9619
4	826	66	44	4247	2873	84	7336	6217	124	10333	9707
5	929	107	45	4327	2953	85	7412	6303	125	10407	9796
6	1029	152	46	4406	3034	86	7488	6389	126	10481	9884
7	1127	202	47	4484	3115	87	7564	6475	127	10555	9972
8	1223	255	48	4563	3196	88	7639	6561	128	10629	10061
9	1317	311	49	4642	3278	89	7715	6648	129	10703	10150
10	1409	370	50	4720	3359	90	7790	6734	130	10777	10238
11	1501	430	51	4799	3441	91	7866	6820	131	10851	10327
12	1592	492	52	4877	3523	92	7941	6907	132	10925	10416
13	1681	555	53	4955	3605	93	8017	6993	133	10999	10504
14	1770	620	54	5033	3688	94	8092	7080	134	11073	10593
15	1858	686	55	5111	3770	95	8167	7167	135	11147	10682
16	1946	754	56	5189	3853	96	8242	7253	136	11221	10771
17	2032	822	57	5267	3935	97	8317	7340	137	11295	10860
18	2119	891	58	5344	4018	98	8393	7427	138	11369	10949
19	2204	961	59	5422	4101	99	8468	7514	139	11442	11038
20	2290	1032	60	5499	4185	100	8543	7601	140	11516	11127
21	2374	1103	61	5577	4268	101	8618	7688	141	11590	11216
22	2459	1175	62	5654	4352	102	8693	7775	142	11664	11305
23	2543	1248	63	5731	4435	103	8768	7863	143	11737	11394
24	2627	1321	64	5809	4519	104	8843	7950	144	11811	11483
25	2710	1395	65	5886	4603	105	8917	8037	145	11885	11573
26	2793	1470	66	5963	4687	106	8992	8125	146	11958	11662
27	2876	1544	67	6039	4771	107	9067	8212	147	12032	11751
28	2958	1620	68	6116	4855	108	9142	8300	148	12105	11840
29	3040	1696	69	6193	4940	109	9216	8387	149	12179	11930
30	3122	1772	70	6270	5024	110	9291	8475	150	12252	12019
31	3204	1848	71	6346	5109	111	9366	8562	151	12326	12109
32	3285	1925	72	6423	5193	112	9440	8650	152	12399	12198
33	3366	2003	73	6499	5278	113	9515	8738	153	12473	12288
34	3447	2080	74	6576	5363	114	9589	8826	154	12546	12377
35	3528	2158	75	6652	5448	115	9664	8914	155	12620	12467
36	3609	2237	76	6728	5533	116	9738	9002	156	12693	12556
37	3689	2315	77	6805	5618	117	9813	9090	157	12767	12646
38	3769	2394	78	6881	5704	118	9887	9178	158	12840	12736
39	3850	2473	79	6957	5789	119	9962	9266	159	12913	12826
									160	NA	12915
									Test limit = 1.2352E-2		

Table G.4.4-2 pass fail limits for ER = 0.001

ne	ns _p	ns _f	ne	ns _p	ns _f	ne	ns _p	ns _f	ne	ns _p	ns _f
0	3463	NA	41	40174	26265	82	71961	60368	123	102723	96075
1	4874	4	42	40971	27063	83	72720	61225	124	103465	96958
2	6096	99	43	41766	27863	84	73479	62083	125	104208	97842
3	7226	329	44	42559	28666	85	74237	62941	126	104949	98726
4	8298	658	45	43352	29471	86	74995	63801	127	105691	99610
5	9330	1059	46	44142	30279	87	75752	64661	128	106432	100495
6	10332	1513	47	44932	31088	88	76509	65522	129	107173	101380
7	11310	2009	48	45720	31899	89	77265	66383	130	107914	102266
8	12269	2539	49	46507	32713	90	78020	67246	131	108655	103152
9	13212	3096	50	47293	33528	91	78776	68109	132	109395	104039
10	14141	3677	51	48078	34345	92	79530	68973	133	110135	104926
11	15058	4278	52	48861	35164	93	80285	69838	134	110875	105813
12	15965	4896	53	49644	35984	94	81038	70704	135	111614	106701
13	16863	5530	54	50425	36807	95	81792	71570	136	112353	107589
14	17753	6177	55	51205	37631	96	82544	72437	137	113092	108478
15	18635	6836	56	51985	38456	97	83297	73305	138	113830	109367
16	19511	7507	57	52763	39283	98	84049	74173	139	114569	110257
17	20380	8188	58	53541	40112	99	84800	75042	140	115307	111146
18	21244	8878	59	54317	40942	100	85551	75911	141	116045	112037
19	22103	9576	60	55092	41773	101	86302	76782	142	116782	112927
20	22957	10282	61	55867	42606	102	87052	77653	143	117520	113818
21	23806	10995	62	56641	43440	103	87802	78524	144	118257	114710
22	24652	11715	63	57414	44276	104	88552	79396	145	118994	115602
23	25493	12441	64	58186	45113	105	89301	80269	146	119730	116494
24	26331	13173	65	58957	45951	106	90050	81143	147	120466	117386
25	27166	13911	66	59728	46790	107	90798	82017	148	121203	118279
26	27997	14654	67	60497	47631	108	91546	82891	149	121939	119173
27	28826	15401	68	61266	48472	109	92293	83766	150	122674	120066
28	29651	16154	69	62035	49315	110	93041	84642	151	123410	120960
29	30474	16910	70	62802	50159	111	93787	85518	152	124145	121855
30	31294	17671	71	63569	51004	112	94534	86395	153	124880	122749
31	32111	18436	72	64335	51851	113	95280	87273	154	125615	123644
32	32927	19204	73	65100	52698	114	96026	88151	155	126349	124540
33	33740	19976	74	65865	53546	115	96771	89029	156	127083	125435
34	34551	20752	75	66629	54396	116	97516	89908	157	127818	126332
35	35360	21531	76	67393	55246	117	98261	90788	158	128551	127228
36	36166	22312	77	68156	56097	118	99005	91668	159	129285	128125
37	36971	23097	78	68918	56950	119	99750	92548	160	130019	129022
38	37775	23885	79	69679	57803	120	100493	93429	161	130752	129919
39	38576	24676	80	70440	58657	121	101237	94311	162	NA	130817
40	39376	25469	81	71201	59512	122	101980	95193	Test limit = 1.2345E-3		

NOTE 1: The first column is the number of errors (ne = number of misdetections)

NOTE 2: The second column is the number of samples for the pass limit (ns_p, ns=Number of Samples= number misdetections + number of detections)

NOTE 3: The third column is the number of samples for the fail limit (ns_f)

NOTE 4: The test limit at the end of the table is applicable, when the minimum test time in clause 3.5 governs the test. Pass the test for ER ≤ Test limit, otherwise fail.

G.4.5 Pass fail decision rules

G.2.5 applies

NOTE: For ER=0.01 an ideal DUT passes after 344 samples. The maximum test time is 12913 samples. For ER=0.001 an ideal DUT passes after 3463 samples. The maximum test time is 130752 samples.

G.4.6 Minimum Test time

G.3.5 applies

G.4.7 Test conditions for receiver performance tests

Table G.4.7: Test conditions for receiver performance tests

Test	Statistical independence	Number of components in the test vector, as specified in the test requirements and initial conditions of the applicable test	Over all Pass/Fail condition Restrictions and extensions see Table G.3.6-1
8.4.1.1 FDD PCFICH/PDCCH Single-antenna Port Performance	A misdetection is an independent event	1	NA
8.4.1.2 FDD PCFICH/PDCCH Transmit Diversity Performance	A misdetection is an independent event	2	To pass 8.4.1.2 each component in the test vector must pass
8.4.2.1 TDD PCFICH/PDCCH Single-antenna Port Performance	A misdetection is an independent event	1	NA
8.4.2.2 TDD PCFICH/PDCCH Transmit Diversity Performance	A misdetection is an independent event	2	To pass 8.4.2.2 each component in the test vector must pass
8.5.1.1 FDD PHICH Single-antenna Port Performance	A misdetection is an independent event	2	To pass 8.5.1.1 each component in the test vector must pass
8.5.1.2 FDD PHICH Transmit Diversity Performance	A misdetection is an independent event	2	To pass 8.5.1.2 each component in the test vector must pass
8.5.2.1 TDD PHICH Single- antenna Port Performance	A misdetection is an independent event	2	To pass 8.5.2.1 each component in the test vector must pass
8.5.2.2 TDD PHICH Transmit Diversity Performance	A misdetection is an independent event	2	To pass 8.5.2.2 each component in the test vector must pass

G.5 Measuring throughput ratio

G.5.1 General

Annex G.5 is applicable for clauses 9.3, 9.4 and 9.5. Common to those clauses is, that a throughput ratio γ is measured. These clauses are tested exclusively with “slow” multipath fading profiles. Hence the test time is governed by test time due to fading, and number of samples due to statistical significance is not applicable.

The test requirements in clause 9.4 are a ratio of 2 throughput tests according to $\gamma = \frac{t_{ue}}{t_{rnd}}$. The denominator must be established by an approach, resulting in the denominator throughput t_{rnd} and the reference SNR_{rnd} , the latter is reused to measure the nominator throughput.

The test requirements in clauses 9.3 and 9.5 are a ratio of 2 throughput tests according to $\gamma = \frac{t_{subband}}{t_{median}}$, $\gamma = \frac{t_{reported}}{t_{fix}}$ etc.

Nominator and denominator are ordinary throughput tests

t_{ue} , t_{rnd} , $t_{reported}$, t_{fix} , $t_{subband}$, t_{median} , $t_{wideband}$ are throughputs, derived under different conditions and are defined in clause 9.3, 9.4 and 9.5.

SNR_{rnd} is the signal noise ratio, derived together with t_{rnd} and is defined in clause 9.4.

G.5.2 Establishing t_{rnd}

Adjust SNR such that the measured throughput is $58\% \leq t_{rnd} \leq 62\%$.

The resulting SNR is declared SNR_{rnd}

To achieve statistical significance the final throughput measurement must be done with MNS samples, given table G.5.4-1

The approach, leading to t_{rnd} and SNR_{rnd} is not specified.

G.5.3 Measuring T-put

To achieve statistical significance the final throughput measurement must be done with MNS samples, given in table.G.5.4 -1. Number of samples due to statistical significance is not applicable.

For measuring $t_{subband}$, $t_{wideband}$, $t_{reported}$ and t_{fix} , the SS collects ACK, NACK and statDTX from the UE and records the time, elapsed from the beginning of the test. The payload size, received by the UE and acknowledged towards the SS, may vary within a test versus time (e.g. due to subband changes upon a UE report) Throughput is calculated in the SS by summing up the payload, associated to each ACK, from the start of the test and dividing the accumulated payload in kilobits by the time in seconds, elapsed from the beginning of the test. This is similar but not same as in G.2.2. (Main difference in bullet d, where the payload size is constant).

For measuring t_{median} , t_{ue} , and t_{rnd} , the SS collects ACK, NACK and statDTX from the UE and records the time, elapsed from the beginning of the test. The payload size, received by the UE and acknowledged towards the SS, is constant. Throughput can be calculated in the SS by multiplying the payload size with the number of ACKs and dividing the accumulated payload in kilobits by the time in seconds, elapsed from the beginning of the test, being associated to the following ratio: $ACK / (ACK + NACK + DTX)$.

G.5.4 Number of samples for throughput ratios

TT for γ and MNS are based on theoretical estimations.

Table G.5.4-1: Test time for testing throughput ratios

Test	Demodulation scenario: RMC (Bandwidth, allocated RBs, modulation, coding) [Antenna configuration, correlation] Propagation condition, Doppler	Γ	Minimum Number of Subframes (MNS)		Γ including TT	BLER
			FDD	TDD		
9.3.1.1.1 9.3.1.1.2	(10 MHz, 6, variable modulation and coding) [1x2, full] Special propagation according to clause B.4.2, 5Hz	1.1	100000 For denominator- and nominator-measurement each	170000 For denominator- and nominator-measurement each	$\gamma = 1.09$	BLER=0.05, no TT No of samples: subset of ACKs and NACKs in the MNS for throughput.
9.3.2.1.1 9.3.2.1.2	(10 MHz, full, variable modulation and coding) [1x2, high] EPA5	1.05	100000 For denominator- and nominator-measurement each	170000 For denominator- and nominator-measurement each	$\gamma = 1.04$	BLER=0.02, no TT No of samples for FDD: subset of ACKs and NACKs in the MNS for throughput. No of samples for TDD: subset of <i>filtered</i> ACKs and NACKs in the MNS for throughput.
9.3.3.1.1 9.3.3.1.2	10 MHz, full(however unequal SNR), variable modulation and coding) [1x2, full] Special: propagation according to clause B.4.2, 5Hz	1.6	100000 For denominator- and nominator-measurement each	170000 For denominator- and nominator-measurement each	1.59	
9.4.1.1.1 9.4.1.1.2	R.2 (10 MHz, full, QPSK, 1/3) (1x2 Low) EVA,5	1.1	100000	170000	$\gamma = 1.09$	
9.4.2.1.1 9.4.2.1.2	R.30 (20 MHz, full, 16QAM, 1/2) (2x2 Low) EPA5	1.2	100000	170000	$\gamma = 1.19$	
9.5.1.1	(10MHz, full,	Test	100000	170000	Test $\gamma_1 =$	

9.5.1.2	variable modulation and coding) (2x2, low or high according to test) (2x2, EPA5)	2 $\gamma_1=1$.05 Test 1 $\gamma_2=1$ Test 3 $\gamma_2=1$.1			1.04 Test1 $\gamma_2=$ 0.99 Test3 $\gamma_2=$ 1.09	
---------	--	---	--	--	--	--

G.X Theory to derive the numbers in Table G.2.1.3-1 (Informative)

Editor's note: this section of the Annex G is for information only and it described the background theory and information to derive the entries in the table G.2.1.3-1.

G.X.1 Error Ratio (ER)

The Error Ratio (ER) is defined as the ratio of number of errors (ne) to all results, number of samples (ns).

(1-ER is the success ratio).

G.X.2 Test Design

A statistical test is characterised by:

Test-time, Selectivity and Confidence level.

G.X.3 Confidence level

The outcome of a statistical test is a decision. This decision may be correct or in-correct. The Confidence Level CL describes the probability that the decision is a correct one. The complement is the wrong decision probability (risk) D = 1-CL

G.X.4 Introduction: Supplier Risk versus Customer Risk

There are two targets of decision:

1. (a) A measurement on the pass-limit shows, that the DUT has the specified quality or is better with probability CL (CL e.g.95%) This shall lead to a "pass decision"

The pass-limit is on the good side of the specified DUT-quality. A more stringent CL (CL e.g.99%) shifts the pass-limit farther into the good direction. Given the quality of the DUTs is distributed, a greater CL passes less and better DUTs.

A measurement on the bad side of the pass-limit is simply "not pass" (undecided or artificial fail).

(aa) Complementary:

A measurement on the fail-limit shows, that the DUT is worse than the specified quality with probability CL.

The fail-limit is on the bad side of the specified DUT-quality. A more stringent CL shifts the fail-limit farther into the bad direction. Given the quality of the DUTs is distributed, a greater CL fails less and worse DUTs.

A measurement on the good side of the fail-limit is simply "not fail".

- 2. (b) A DUT, known to have the specified quality, shall be measured and decided pass with probability CL. This leads to the test limit.

For CL e.g. 95%, the test limit is on the bad side of the specified DUT-quality. CL e.g.99% shifts the pass-limit farer into the the bad direction. Given the DUT-quality is distributed, a greater CL passes more and worse DUTs.

(bb) A DUT, known to be an ($\epsilon \rightarrow 0$) beyond the specified quality, shall be measured and decided fail with probability CL.

For CL e.g.95%, the test limit is on the good side of the specified DUT-quality.

NOTE 1: the different sense for CL in (a), (aa) versus (b), (bb)

NOTE 2: for constant CL in all 4 bullets (a) is equivalent to (bb) and (aa) is equivalent to (b)

G.X.5 Supplier Risk versus Customer Risk

The table below summarizes the different targets of decision.

Table G.X.5-1 Equivalent statements

	Equivalent statements, using different cause-to-effect-directions, and assuming CL = constant >1/2	
cause-to-effect-directions	Known measurement result \rightarrow estimation of the DUT's quality	Known DUT's quality \rightarrow estimation of the measurement's outcome
Supplier Risk	A measurement on the pass-limit shows, that the DUT has the specified quality or is better (a)	A DUT, known to have an ($\epsilon \rightarrow 0$) beyond the specified DUT-quality, shall be measured and decided fail (bb)
Customer Risk	A measurement on the fail-limit shall shows, that the DUT is worse than the specified quality (aa)	A DUT, known to have the specified quality, shall be measured and decided pass (b)

The shaded area shown the direct interpretation of Supplier Risk and Customer Risk.

The same statements can be based on other DUT-quality-definitions.

G.X.6 Introduction: Standard test versus early decision concept

In standard statistical tests, a certain number of results (ns) is predefined in advance to the test. After ns results the number of bad results (ne) is counted and the error ratio (ER) is calculated by ne/ns.

Applying statistical theory, a decision limit can be designed, against which the calculated ER is compared to derive the decision. Such a limit is one decision point and is characterised by:

- D: the wrong decision probability (a predefined parameter)
- ns: the number of results (a fixed predefined parameter)
- ne: the number of bad results (the limit based on just ns)

In the formula for the limit, D and ns can be understood as variable parameter and variable. However the standard test execution requires fixed ns and D. The property of such a test is: It discriminate between two states only, depending on the test design:

- pass (with CL) / undecided (undecided in the sense: finally undecided)
- fail (with CL) / undecided (undecided in the sense: finally undecided)

- pass(with CL) / fail (with CL) (however against two limits).

In contrast to the standard statistical tests, the early decision concept predefines a set of (ne,ns) co-ordinates, representing the limit-curve for decision. After each result a preliminary ER is calculated and compared against the limit-curve. After each result one may make the decision or not (undecided for later decision) The parameters and variables in the limit-curve for the early decision concept have a similar but not equal meaning:

- D: the wrong decision probability (a predefined parameter)
- ns: the number of results (a variable parameter)
- ne: the number of bad results (the limit. It varies together with ns)

To avoid a “final undecided” in the standard test, a second limit must be introduced and the single decision co-ordinate (ne,ns) needs a high ne, leading to a fixed (high) test time. In the early decision concept, having the same selectivity and the same confidence level an “undecided” need not to be avoided, as it can be decided later. A perfect DUT will hit the decision coordinate (ne,ns) with ne=0. This test time is short.

G.X.7 Standard test versus early decision concept

For Supplier Risk:

The wrong decision probability D in the standard test is the probability, to decide a DUT in-correct in the single decision point. In the early decision concept there is a probability of in-correct decisions d at each point of the limit-curve. The sum of all those wrong decision probabilities accumulate to D. Hence $d < D$

For Customer Risk:

The correct decision probability CL in the standard test is the probability, to decide a DUT correct in the single decision point. In the early decision concept there is a probability of correct decisions cl at each point of the limit-curve. The sum of all those correct decision probabilities accumulate to CL. Hence $cl < CL$ or $d > D$

G.X.8 Selectivity

There is no statistical test which can discriminate between a limit DUT and a DUT which is an ($\epsilon \rightarrow 0$) apart from the limit in finite time and high confidence level CL. Either the test discriminates against one limit with the results pass (with CL)/undecided or fail (with CL)/undecided, or the test ends in a result pass (with CL)/fail (with CL) but this requires a second limit.

For $CL > 1/2$, a (measurement-result = specified-DUT-quality), generates undecided in test “supplier risk against pass limit” (a, from above) and also in the test “customer risk against the fail limit “ (aa)

For $CL > 1/2$, a DUT, known to be on the limit, will be decided pass for the test “customer risk against pass limit” (b) and also “supplier risk against fail limit” (bb).

This overlap or undecided area is not a fault or a contradiction, however it can be avoided by introducing a Bad or a Good DUT quality according to:

- Bad DUT quality: specified DUT-quality * M ($M > 1$)
- Good DUT quality: specified DUT-quality * m ($m < 1$)

Using e.g $M > 1$ and $CL = 95\%$ the test for different DUT qualities yield different pass probabilities:

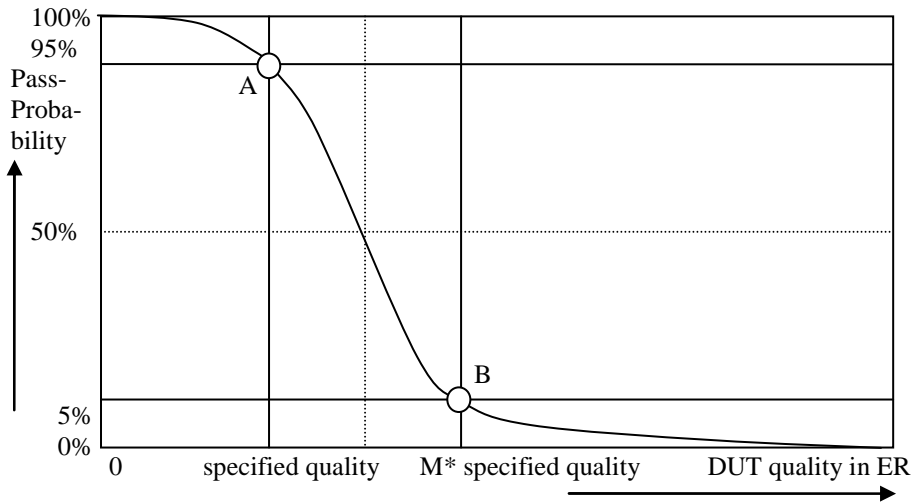

Figure G.X.8-1: Pass probability versus DUT quality

G.X.9 Design of the test

The receiver characteristic test are defined by the following design principles:

1. The early decision concept is applied.
2. A second limit is introduced: Bad DUT factor $M > 1$
3. To decide the test pass:
Supplier risk is applied based on the Bad DUT quality
- To decide the test fail
Customer Risk is applied based on the specified DUT quality

The receiver characteristic test are defined by the following parameters:

1. Limit ER = 0.05
2. Bad DUT factor $M = 1.5$ (selectivity)
3. Confidence level CL = 95% (for specified DUT and Bad DUT-quality)

This has the following consequences:

1. A measurement on the fail limit is connected with 2 equivalent statements:

A measurement on the fail-limit shows, that the DUT is worse than the specified DUT-quality	A DUT, known have the specified quality, shall be measured and decided pass
---	---

2. A measurement on the pass limit is connected with the complementary statements:

A measurement on the pass limit shows, that the DUT is better than the Bad DUT-quality.	A DUT, known to have the Bad DUT quality, shall be measured and decided fail
---	--

The left column is used to decide the measurement.

The right column is used to verify the design of the test by simulation.

The simulation is based on the two fulcrums A and B only in Figure G.x.8-1

3. Test time

The minimum and maximum test time is fixed.

The average test time is a function of the DUT's quality.

The individual test time is not predictable.

4. The number of decision co-ordinates (n_e, n_s) in the early decision concept is responsible for the selectivity of the test and the maximum test time. Having fixed the number of decision co-ordinates there is still freedom to select the individual decision co-ordinates in many combinations, all leading to the same confidence level.

G.X.10 Simulation to derive the pass fail limits in Table G.2.1.3-1

There is freedom to design the decision co-ordinates (n_e, n_s).

The binomial distribution and its inverse is used to design the pass and fail limits. Note that this method is not unique and that other methods exist.

$$\text{fail}(n_e, d_f) := \frac{n_e}{(n_e + \text{qnbinom}(d_f, n_e, ER))}$$

$$\text{pass}(n_e, cl_p, M) := \frac{n_e}{(n_e + \text{qnbinom}(cl_p, n_e, ER \cdot M))}$$

Where

- fail(..) is the error ratio for the fail limit
- pass(..) is the error ratio for the pass limit
- ER is the specified error ratio 0.05
- n_e is the number of bad results. This is the variable in both equations
- M is the Bad DUT factor $M=1.5$
- d_f is the wrong decision probability of a single (n_e, n_s) co-ordinate for the fail limit. It is found by simulation to be $d_f = 0.004$
- cl_p is the confidence level of a single (n_e, n_s) co-ordinate for the pass limit. It is found by simulation to be $cl_p = 0.9975$
- $\text{qnbinom}(\cdot)$: The inverse cumulative function of the negative binomial distribution

The simulation works as follows:

- A large population of limit DUTs with true $ER = 0.05$ is decided against the pass and fail limits.
- cl_p and d_f are tuned such that CL (95%) of the population passes and D (5%) of the population fails.
- A population of Bad DUTs with true $ER = M \cdot 0.05$ is decided against the same pass and fail limits.
- cl_p and d_f are tuned such that CL (95%) of the population fails and D (5%) of the population passes.
- This procedure and the relationship to the measurement is justified in clause G.x.9. The number of DUTs decrease during the simulation, as the decided DUTs leave the population. That number decreases with an approximately exponential characteristics. After 169 bad results all DUTs of the population are decided.

NOTE: The exponential decrease of the population is an optimal design goal for the decision co-ordinates (n_e, n_s), which can be achieved with other formulas or methods as well.

Annex H (normative): Uplink Physical Channels

H.0 Uplink Signal Levels

Editor's note: The configuration of SRS is FFS

Unless otherwise specified in the test case, the uplink power settings result from the default configuration of the UE described in 3GPP TS 36.508 [7].

H.1 General

This annex specifies the uplink physical channels that are needed for setting a connection and channels that are needed during a connection. Table H.1-1 describes the mapping of uplink physical channels and signals to physical resources for FDD. Table H.1-2 describes the mapping of uplink physical channels and signals to physical resources for TDD.

Table H.1-1: Mapping of uplink physical channels and signals to physical resources for FDD

Physical channel	Time Domain Location	Frequency Domain Location	Note
PRACH	Allowed for the parameter <i>prach-Configuration Index</i> provided by higher layers	[Allowed for the parameter <i>prach-FrequencyOffset</i> provided by higher layers]	Mapping rule is specified in TS36.211 Section 5.7.1
DMRS	For PUCCH: Symbols 2 to 4 of each slot (PUCCH format: 1, 1a, 1b) Symbol 1 and 5 of each slot (PUCCH format: 2, 2a, 2b) For PUSCH: Symbol 3 of each slot	Uplink system bandwidth dependent.	Mapping rule of DMRS for PUCCH is specified in TS36.211 5.5.2.2.2 Mapping rule of DMRS for PUSCH is specified in TS36.211 5.5.2.1.2
PUCCH	Slot 0 and 1 of each subframe	[Each 12 subcarriers of both ends of the bandwidth]	Mapping rule is specified in TS36.211 Section 5.4.3
PUSCH	All remaining SC-FDMA symbols of each subframe not allocated to DMRS	RBs allocated according to Reference Measurement channel in Annex A.2	Mapping rule is specified in TS36.211 Section 5.4.2

Table H.1-2: Mapping of uplink physical channels and signals to physical resources for TDD

Physical channel	Time Domain Location	Frequency Domain Location	Note
PRACH	Allowed for the parameters $(t_{RA}^0, t_{RA}^1, t_{RA}^2)$ in <i>prach-Configuration Index</i> provided by higher layers	For format 0-3, the frequency location allowed is by <i>prach-FrequencyOffset</i> and (f_{RA}) in <i>prach-Configuration Index</i> provided by higher layers. Preamble format 4 is mapped only on UpPTS, where the frequency location allowed is only by (f_{RA}) in <i>prach-Configuration Index</i> provided by higher layers.	Mapping rule is specified in TS36.211 Section 5.7.1
DMRS	For PUCCH: Symbols 2 to 4 of each slot (PUCCH format: 1, 1a, 1b) Symbol 1 and 5 of each slot (PUCCH format: 2, 2a, 2b) For PUSCH: Symbol 3 of each slot	Uplink system bandwidth dependent.	Mapping rule of DMRS for PUCCH is specified in TS36.211 5.5.2.2.2 Mapping rule of DMRS for PUSCH is specified in TS36.211 5.5.2.1.2
PUCCH	Slot 0 and 1 of each subframe	[Each 12 subcarriers of both ends of the bandwidth]	Mapping rule is specified in TS36.211 Section 5.4.3
PUSCH	All remaining SC-FDMA symbols of each subframe not allocated to DMRS	RBs allocated according to Reference Measurement channel in Annex A.2	Mapping rule is specified in TS36.211 Section 5.4.2

NOTE: PUSCH, PUCCH, DMRS are not present in UpPTS for TDD.

H.2 Set-up

Table H.2-1 describes the uplink physical channels that are required for connection set up.

Table H.2-1: Uplink Physical Channels required for connection set-up

Physical Channel
PRACH
DMRS
PUCCH
PUSCH

H.3 Connection

The following clauses describes the uplink physical channels that are transmitted during a connection i.e., when measurements are done.

Table H.3-1: Uplink Physical Channels required during a connection

[Table contents FFS]

H.3.0 Measurement of Transmitter Characteristics

[FFS]

H.3.1 Measurement of Receiver Characteristics

[FFS]

H.3.2 Measurement of Performance Requirements

[FFS]

Annex I (informative): Handling of different releases

This annex gives guidance on how different minimum requirements between releases in 3GPP TS 36.101 [2] are handled in specification 3GPP TS 36.521-1.

I.1 Mapping of minimum requirements to conformance tests

Basic principles of deriving and specifying conformance tests in 3GPP TS 36.521-1 from minimum requirements in 3GPP TS 36.101 [2]:

- a. reuse as far as possible the already specified tests even for later releases (if applicable)
- b. avoid repeating and redundant test standardization
- c. minimize the maintenance work

The application of these principles results in the following conformance test drafting strategy:

- d. if minimum requirements are specified only in one release of 3GPP TS 36.101 [2], then also the equivalent test in 3GPP TS 36.521-1 is specified only for that release.
- e. if minimum requirements are specified in multiple releases of 3GPP TS 36.101 [2], then the specification structure for the derived tests in 3GPP TS 36.521-1, depends on the similarity (intersection) of the minimum requirements set between different releases of 3GPP TS 36.101 [2].

This is described graphically in the following figure:

Figure I.1-1: Mapping of minimum requirements to conformance tests, when minimum requirements are specified in multiple releases

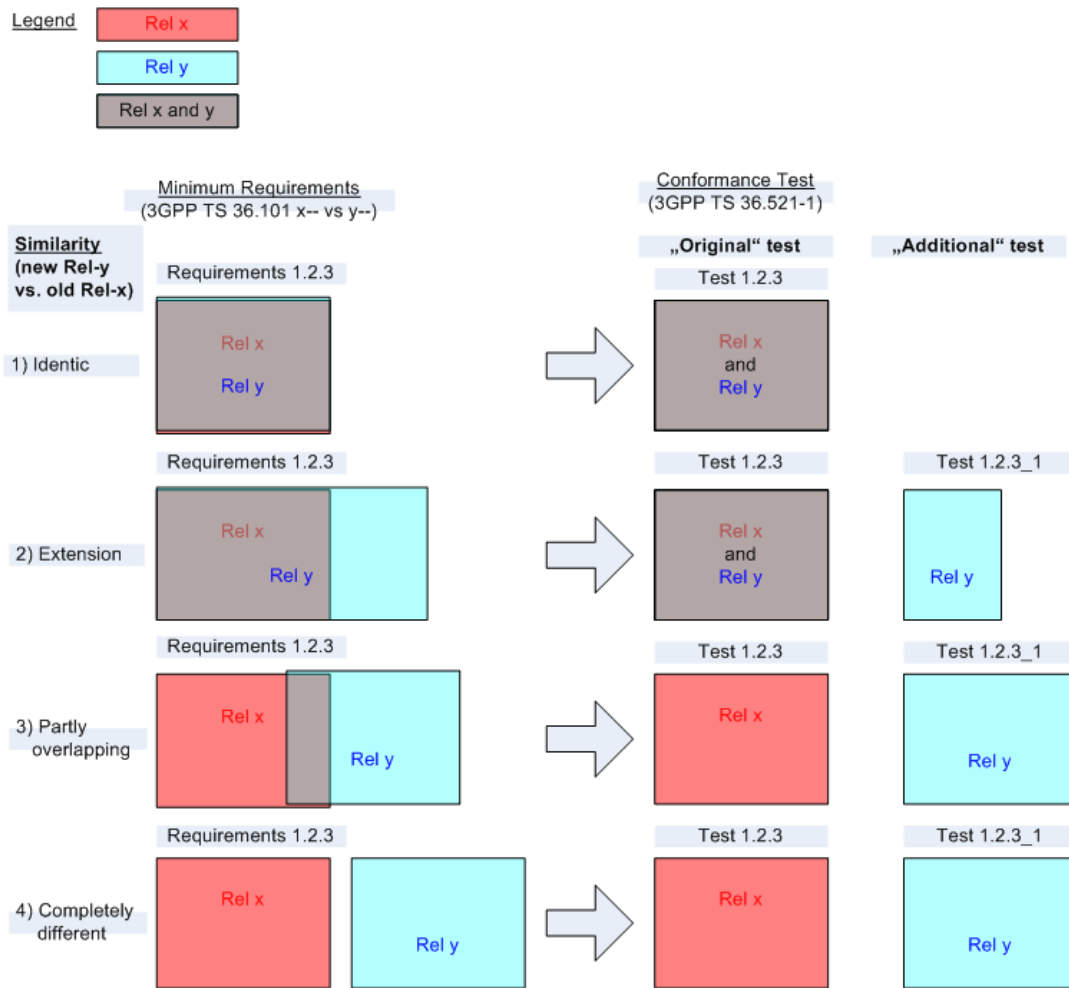

I.2 Structure and numbering of subclauses

- The general effort is to keep the numbering and structure of conformance tests in 3GPP TS 36.521-1 as similar as possible with the corresponding minimum requirements in 3GPP TS 36.101 [2].
- In case of multiple conformance tests due to difference of minimum requirements between releases (as per Figure X.1-1), the "additional" inserted tests are numbered using the number of the "original" test extended by an Arabic numeral preceded by an underscore ("_"). Using an underscore instead of a full-stop keeps the subclause level of the "additional" test the same as of the "original" test.

Example:

Minimum requirements in 3GPP TS 36.101[2]: 1.2.3,
1.2.3A,
1.2.4

Conformance tests in 3GPP TS 36.521-1: 1.2.3, 1.2.3_1, 1.2.3_2, ...
1.2.3A, 1.2.3A_1, 1.2.3A_2, ...
1.2.4, 1.2.4_1, 1.2.4_2, ...

I.3 Specification of the additional tests

In case when the additional conformance tests are procedurally very similar to the original tests, in order to reduce the standardization and maintenance work (as per Annex I.1), the content of subclauses of the additional tests may be reduced to a minimum by referencing to the analogue subclauses of the original tests (provided they are similar), and specifying the exceptions (requirement-tables, test parameter tables etc). This method is to apply very carefully, in order to make sure that possible differences in the core functionality of different E-UTRAN releases remain considered.

Annex J (informative): Change history

Change history							
Date	TSG #	TSG Doc.	CR	R ev	Subject/Comment	Old	New
2007-08	RAN5 #36	R5-072185			Skeleton proposed for RAN5#36Athens		0.0.1
2007-08	RAN5 #36	R5-072419			Update the skeleton base on R4-071234_TR36.803.0.4.0.doc	0.0.1	0.0.2
2007-08	RAN5 #36	R5-072424			Update with editorial changes	0.0.2	0.0.3
2007-11	RAN5 #37	R5-073043			Update document with some info as following: Section 5: Frequency band information Section 6.2: Maximum output power Section 6.5: Output RF spectrum emissions Section 6.5.1: Occupied bandwidth Section 6.5.2: Out of band emission Section 6.5.3: Spurious emissions	0.0.3	0.0.4
2007-11	RAN5 #37	R5-073360			Editorial change to split MOP and UE Power classes	0.0.4	0.0.5
2008-03	RAN5 #38	R5-080069			Editorial changes to sync up with 36.101 v1.0.0 as much as feasible for the moment: Update definitions, symbols and abbreviations Update frequency bands, channel bandwidth, channel numbers information. Restructure document to move "frequency error" sub-section inside Transmit signal quality. Add "additional spectrum Emission Mask" sub-test (mask A,B,C) section to address the regulatory requirements that are not met with the general mask (OOB and spurious emission). Add "Additional ACLR requirements" to address additional requirements that the network might indicate to the UE via signalling for a specific deployment scenario (in terms of additional requirements for UTRA/ACLR2 Restructure "Spurious Emission" to indicate we need to have 3 test cases to address: "E-UTRA Spurious Emission" requirements, "Spurious Emission band UE co-existence" requirements, and "Additional spurious emissions" requirements Separate wide band and narrow band intermodulation in the intermodulation characteristics	0.0.5	0.0.6
2008-03	RAN5 #38	R5-080408			LTE Reference Sensitivity test Text proposal		0.0.7
2008-03	RAN5 #38	R5-080409			LTE Maximum Rx input level test Text proposal		0.0.7
2008-03	RAN5 #38	R5-080410			LTE Adjacent Channel Selectivity test Text proposal		0.0.7
2008-03	RAN5 #38	R5-080064			LTE RF Receiver tests, General section Text proposal		0.0.7
2008-03	RAN5 #38	R5-080412			LTE RF: transmission modulation initial EVM test proposal		0.0.7
2008-03	RAN5 Workshop-UE LTE Test (9-11 April)	R5w0800027			Modify styles and formats of tables and others according to drafting rules. Add some definitions and abbreviations Modified section 6.2 structure to be aligned with 36.101 v8.1.0 Modify tables of requirements to remove 1.6 MHz and 3.2MHz channel bandwidth according to new requirements 36.101 v8.1.0		0.0.9
2008-03	RAN5 Workshop-UE LTE Test (9-11 April)	R5w0800028			Following TPs have been included: R5w080013r1 R5w080014r1 R5w080008r2 R5w080009r2 R5w080040r1 R5w080015r1 R5w080016r1 R5w080017r1 R5w080018r2	0.0.9	0.1.0
2008-05	RAN5#39	R5-081046			36-521-1 alignment of measurement state for test cases	0.1.0	0.1.1
2008-05	RAN5#39	R5-081042			Following approved TPs have been included: R5-081040 36.521-1 after April LTE-RF workshop R5-081415 36-521-1 alignment of measurement state for test cases – also the measurement state for each test cases has been updated according to R5-081404 R5-081416 Cover for LTE E-UTRAN RRC_IDLE State Mobility text proposal R5-081417 Cover for LTE E-UTRAN RRC_CONNECTED State Mobility text proposal R5-081404 LTE Rx Intermodulation test case text proposal	0.1.1	0.2.0

				<p>R5-081409 Annex structure for Measurement uncertainty & Test Tools</p> <p>R5-081405 Text Proposal for TS36.521-1 TC7.6 Blocking Characteristics</p> <p>R5-081406 Text Proposal for TS36.521-1 TC7.7 Spurious Response</p> <p>R5-081403 Text Proposal for TS36.521-1 TC7.9 Spurious Emissions</p> <p>R5-081410 Uncertainties and Test Tools for subset of UE tests</p> <p>R5-081331 Clarification of diversity characteristics section for multiple UE antennas</p> <p>R5-081335 36-521-1 update of nominal and additional channel bandwidths</p>		
2008-06	RAN5 #39bis	R5-082029		<p>Following approved TPs have been included:</p> <p>R5-082129: Restructure of TS 36.521-1 and RRM proposal (Split of RRM from 36.521-1 v0.2.0 in its own specification 36.521-3.)</p> <p>R5-082166: Text Proposal for Annex C Downlink Physical Channels</p> <p>R5-082130: Text Proposal for Chan bandwidths in TS 36.521-1</p> <p>R5-082155: Text Proposal for LTE Tx Minimum Output Power</p> <p>R5-082027: Text Proposal for Occupied bandwidth in TS 36.521-1</p> <p>R5-082171: Text Proposal for LTE Adjacent Channel Leakage power Ratio</p> <p>R5-082134: Text Proposal for LTE Tx Spurious Emissions</p> <p>R5-082135: Text Proposal for LTE UE Maximum Output Power</p> <p>R5-082136: Text Proposal for LTE Spectrum Emission Mask</p> <p>R5-082138: UE Spurious Emissions Measurement uncertainty & Test Tolerances</p> <p>R5-082169: LTE Spectrum Emission Mask test uncertainties and TTs</p> <p>R5-082151: LTE UE Max Power and ACLR tests uncertainties and TTs</p> <p>R5-082152: Text proposal for LTE Transmit OFF Power</p> <p>R5-082153: LTE UE Max Rx Input and ACS test cases update</p> <p>R5-082082: LTE Rx Intermodulation test case uncertainties and TTs</p> <p>R5-082093: Text Proposal for TS36.521-1 TC7.6 Blocking Characteristics</p> <p>R5-082154: Text Proposal for TS36.521-1 TC7.7 Spurious Response</p> <p>R5-082167: OBW Measurement uncertainty & Test Tolerances</p> <p>R5-082158: Cover for LTE Performance Requirement text proposal</p> <p>R5-082159: Text Proposal for LTE Demodulation of PCFICH/PDCCH and PHICH</p> <p>R5-082156: Text proposal for LTE Tx Minimum Output Power Uncertainty</p> <p>R5-082157: Text proposal for LTE Tx Minimum Output Power Tolerance</p> <p>R5-082164: Statistical testing of receiver characteristics</p> <p>R5-082170: Cover for LTE Propagation Conditions Text Proposal</p> <p>Editorial changes to align tables and figures numbering with R5-082025</p>	0.2.0	0.3.0
2008-08	RAN5 #40	R5-083163		<p>Following approved TPs have been included:</p> <p>R5-083804: LTE Demodulation Performance text proposal</p> <p>R5-083159: LTE-RF Occupied bandwidth test case / measurement uncertainty and TT text proposal</p> <p>R5-083160: Transmission OFF power: TP, measurement uncertainty and test tolerances proposal</p> <p>R5-083805: Frequency Error test case / measurement uncertainty and TT test proposal</p> <p>R5-083162: Propagation conditions correction text proposal</p> <p>R5-083220:Text Proposal for LTE Tx Minimum Output Power</p> <p>R5-083806: TP of section 8 for E-UTRAN TDD in 36.521-1</p> <p>R5-083344: Test Tolerance and System uncertainty for OBW test</p> <p>R5-083848:Test Tolerance and System uncertainty for Reference sensitivity test</p> <p>R5-083840: Test Tolerances for Spectrum Emission Mask</p> <p>R5-083808: Reference Measurement Channel for LTE UE</p>	0.3.0	1.0.0

				Receiver tests R5-083350: Test Tolerance and System uncertainty for Blocking and Spurious response R5-083366: Text Proposal for LTE Reporting of CQI/PMI R5-083810: LTE PBCH Demodulation Performance Requirements R5-083482: LTE-RF TP for Test Case 7.6 Blocking Characteristics R5-083809: LTE-RF TP for Test Case 7.7 Spurious Response R5-083484: LTE-RF TP for Test Case 7.9 Spurious Emissions R5-083811: Annex E Global In-Channel TX-Test R5-083163: TS 36.521-1 after RAN5#40		
2008-10	RAN5 #40Bis	R5-084072		Following approved TPs have been included: R5-084072 TS 36.521-1 after RAN5#40Bis R5-084300 LTE-RF TP for Definitions Symbols and Abbreviations R5-084304 LTE-RF-TP for general section R5-084036 Test Tolerances for additional SEM R5-084303 LTE-RF TP for Channel bandwidths and frequency range R5-084305 LTE-RF TP for new Absolute Power Tolerance test case R5-084067 LTE-RF TP for Transmission OFF test case R5-084318 LTE-RF TP for Transmission Modulation test cases R5-084069 LTE-RF Investigation of E-UTRA-TDD Frequency Error test case applicability R5-084319 LTE-RF TP for Frequency Error test case R5-084309 Text Proposal for LTE Tx Spurious Emissions R5-084111 Text Proposal for LTE Adjacent Channel Leakage power Ratio R5-084320 Text Proposal for LTE Additional Spectrum Emission Mask R5-084310 Test Tolerances for additional spurious emission R5-084311 Text Proposal for Occupied bandwidth R5-084321 Text Proposal for LTE Spectrum Emission Mask R5-084060 Modification to section 7.2 Diversity characteristics R5-084312 References in 36.521-1 tests initial conditions R5-084148 Update of Reference Measurement Channel for LTE UE Rx tests R5-084167 LTE-RF TP for TC7.9 Spurious Emissions R5-084075 LTE DL Reference Measurement Channel for PDSCH (FDD) text proposal R5-084077 LTE Measurement of Performance Requirements text proposal R5-084313 LTE Demodulation of PDSCH Test Requirements text proposal R5-084147 Specification of DL propagation conditions for LTE UE tests R5-084315 Text Proposal for LTE Demodulation of PCFICH/PDCCH R5-084323 Text Proposal for Annex E Global In-Channel	1.0.0	1.1.0
2008-12	RAN#42	RP-080863		Approval of version 2.0.0 at RAN#42, then put to version 8.0.0.	2.0.0	8.0.0
2008-01				Editorial corrections.	8.0.0	8.0.1
2009-03	RAN#43	R5-086011	0001	- TP for In-band emissions	8.0.1	8.1.0
2009-03	RAN#43	R5-086012	0002	- TP for Spectrum flatness	8.0.1	8.1.0
2009-03	RAN#43	R5-086013	0003	- TP for IQ-component	8.0.1	8.1.0
2009-03	RAN#43	R5-086064	0004	- LTE-RF: UE max output power	8.0.1	8.1.0
2009-03	RAN#43	R5-086093	0005	- Clarification of measurement period in minimum output power test procedure	8.0.1	8.1.0
2009-03	RAN#43	R5-086094	0006	- Clarification of measurement period in transmit OFF power test procedure	8.0.1	8.1.0
2009-03	RAN#43	R5-086120	0007	- Update of Max.input level test	8.0.1	8.1.0
2009-03	RAN#43	R5-086125	0008	- Addition of UL Reference Measurement Channels in Annex A2	8.0.1	8.1.0
2009-03	RAN#43	R5-086160	0009	- correction for Maximum Power Reduction (MPR)	8.0.1	8.1.0
2009-03	RAN#43	R5-086167	0010	- LTE-RF: TDD applicability and CR for Blocking Characteristics and Spurious Response	8.0.1	8.1.0
2009-03	RAN#43	R5-086168	0011	- LTE-RF: TDD applicability and CR for Spurious Emissions	8.0.1	8.1.0
2009-03	RAN#43	R5-086239	0012	- Update of Symbols	8.0.1	8.1.0
2009-03	RAN#43	R5-086401	0013	- LTE-RF: TX-RX channel freq separation	8.0.1	8.1.0
2009-03	RAN#43	R5-086405	0014	- Update of 6.7 Transmit intermodulation test	8.0.1	8.1.0
2009-03	RAN#43	R5-086406	0015	- Update of initial conditions for Tx and Rx test cases	8.0.1	8.1.0
2009-03	RAN#43	R5-086408	0016	- Update of Adjacent Channel Leakage power Ratio	8.0.1	8.1.0
2009-03	RAN#43	R5-086409	0017	- Removal of [] from Clause 7 Receiver Characteristics	8.0.1	8.1.0
2009-03	RAN#43	R5-086413	0018	- Updates to Demodulation of PCFICH/PDCCH test case	8.0.1	8.1.0

2009-03	RAN#43	R5-086414	0019	-	Text proposal for Reporting of Channel State Information	8.0.1	8.1.0
2009-03	RAN#43	R5-086415	0020	-	Correction of RS_EPRES powers for default DL signal levels	8.0.1	8.1.0
2009-03	RAN#43	R5-086416	0021	-	Update of DL Reference Measurement Channels in Annex A3	8.0.1	8.1.0
2009-03	RAN#43	R5-086417	0022	-	Update to Annex E	8.0.1	8.1.0
2009-03	RAN#43	R5-086425	0023	-	Update of General text in clause 6	8.0.1	8.1.0
2009-03	RAN#43	R5-086426	0024	-	Clarification of measurement bandwidth in spectrum emission mask test	8.0.1	8.1.0
2009-03	RAN#43	R5-086428	0025	-	Demodulation of TDD PHICH test requirements text proposal	8.0.1	8.1.0
2009-03	RAN#43	R5-086429	0026	-	Demodulation of TDD PCFICH/PDCCH test requirements text proposal	8.0.1	8.1.0
2009-03	RAN#43	R5-090306	0027	-	New Annex H for Uplink Physical Channels	8.0.1	8.1.0
2009-03	RAN#43	R5-090308	0028	-	Text proposal for Reporting of Channel State Information	8.0.1	8.1.0
2009-03	RAN#43	R5-090403	0029	-	CR to 36.521-1: Update of Spurious Emissions test cases	8.0.1	8.1.0
2009-03	RAN#43	R5-090404	0030	-	CR to 36.521-1: Update of ACLR test case	8.0.1	8.1.0
2009-03	RAN#43	R5-090443	0031	-	LTE-RF: Correction to 36.521-1 Frequency error test case	8.0.1	8.1.0
2009-03	RAN#43	R5-090488	0032	-	LTE TDD applicability for Transmit intermodulation test case	8.0.1	8.1.0
2009-03	RAN#43	R5-091002	0033	-	LTE Demodulation of PDSCH Test Requirements text proposal	8.0.1	8.1.0
2009-03	RAN#43	R5-091004	0034	-	LTE-RF: CR for UE max power test case	8.0.1	8.1.0
2009-03	RAN#43	R5-091007	0035	-	LTE-RF: TDD Applicability and CR for Spectrum Emission Mask and Additional Spectrum Emission Mask	8.0.1	8.1.0
2009-03	RAN#43	R5-091008	0036	-	LTE-RF Investigation of E-UTRA-TDD for Occupied bandwidth test case applicability	8.0.1	8.1.0
2009-03	RAN#43	R5-091009	0037	-	LTE-RF: Investigation of E-UTRA-TDD for Adjacent Channel Leakage power Ratio test case applicability	8.0.1	8.1.0
2009-03	RAN#43	R5-091011	0038	-	LTE-RF: TDD applicability and CR for Maximum Input Level	8.0.1	8.1.0
2009-03	RAN#43	R5-091012	0039	-	LTE-RF: TDD applicability and CR for Adjacent Channel Selectivity (ACS)	8.0.1	8.1.0
2009-03	RAN#43	R5-091017	0040	-	Removal of Rx Narrowband Intermod 7.8.2	8.0.1	8.1.0
2009-03	RAN#43	R5-091019	0041	-	Relocation of 36.521-1 Annex C DL mapping	8.0.1	8.1.0
2009-03	RAN#43	R5-091020	0042	-	Removal of "Out-of-synchronization handling of output power" heading	8.0.1	8.1.0
2009-03	RAN#43	R5-091023	0043	-	Test requirements of TDD PDSCH demodulation performance with user-specific reference symbols	8.0.1	8.1.0
2009-03	RAN#43	R5-091024	0044	-	CR to 36.521-1: Update of Annex F.3.2 Measurement of transmitter	8.0.1	8.1.0
2009-03	RAN#43	R5-091025	0045	-	CR to 36.521-1: Update of SEM and Additional SEM test cases	8.0.1	8.1.0
2009-03	RAN#43	R5-091077	0046	-	CR to 36.521-1: Addition of test combinations for test cases with MPR application	8.0.1	8.1.0
2009-03	RAN#43	R5-091082	0047	-	Spurious emission requirements on PHS band including the future plan in Japan	8.0.1	8.1.0
2009-03	RAN#43	R5-091101	0048	-	LTE-RF: CR for MPR test case	8.0.1	8.1.0
2009-03	RAN#43	R5-091106	0049	-	Update of Reference sensitivity test in 7.3	8.0.1	8.1.0
2009-03	RAN#43	R5-091111	0050	1	Update of initial conditions for Rx tests	8.0.1	8.1.0
2009-05	RAN#44	R5-092144	0051	-	LTE-RF: Resubmission of R5-086424 UE output power dynamics 36.521-1 v8.1.0 (re-submit no changes)	8.1.0	8.2.0
2009-05	RAN#44	R5-092146	0052	-	LTE-RF: CR for UE configured UE transmitted output power test case (re-submit no changes)	8.1.0	8.2.0
2009-05	RAN#44	R5-092147	0053	-	LTE-RF: CR for UE minimum output power test case (re-submit no change)	8.1.0	8.2.0
2009-05	RAN#44	R5-092149	0054	-	LTE-RF: CR for Power Control Absolute power tolerance test case (re-submit no changes)	8.1.0	8.2.0
2009-05	RAN#44	R5-092150	0055	-	LTE-RF: CR for Power Control Relative power tolerance test case (re-submit no changes)	8.1.0	8.2.0
2009-05	RAN#44	R5-092151	0056	-	LTE-RF: New test case for Aggregate power control tolerance (re-submit no changes)	8.1.0	8.2.0
2009-05	RAN#44	R5-092263	0057	-	Text proposal for Reporting of Channel State Information	8.1.0	8.2.0
2009-05	RAN#44	R5-092264	0058	-	Propagation conditions for CQI tests	8.1.0	8.2.0
2009-05	RAN#44	R5-092265	0059	-	Correction to Demodulation of PDCCH/PCFICH test cases	8.1.0	8.2.0
2009-05	RAN#44	R5-092273	0060	-	Mapping of downlink physical channels for TDD	8.1.0	8.2.0
2009-05	RAN#44	R5-092277	0061	-	Annex A RMC updates	8.1.0	8.2.0
2009-05	RAN#44	R5-092369	0062	-	Update of A.3.4.3 for RMC with UE-specific RS	8.1.0	8.2.0
2009-05	RAN#44	R5-092372	0063	-	Maintenance on Initial configurations for Perf TCs	8.1.0	8.2.0
2009-05	RAN#44	R5-092436	0064	-	CR to 36.521-1: Update of ACLR test case	8.1.0	8.2.0
2009-05	RAN#44	R5-092442	0065	-	CR to 36.521-1: Update of Spurious Emissions test case	8.1.0	8.2.0
2009-05	RAN#44	R5-092467	0066	-	LTE-RF: Transmit OFF Power update	8.1.0	8.2.0
2009-05	RAN#44	R5-092473	0067	-	LTE_RF - Update on TC 7.7 Spurious Response (re-submit with no changes)	8.1.0	8.2.0
2009-05	RAN#44	R5-092474	0068	-	LTE_RF - Update on TC 7.9 Spurious Emissions (re-submit with no changes)	8.1.0	8.2.0
2009-05	RAN#44	R5-092527	0069	-	Update of TDD PDSCH test cases	8.1.0	8.2.0
2009-05	RAN#44	R5-092602	0070	-	LTE-RF: CR for Maximum Power Reduction test case (re-	8.1.0	8.2.0

					submit no changes)		
2009-05	RAN#44	R5-092603	0071	-	TP for Demodulation of TDD PDCCH/PCFICH	8.1.0	8.2.0
2009-05	RAN#44	R5-092605	0072	-	Mapping of uplink physical channels for FDD	8.1.0	8.2.0
2009-05	RAN#44	R5-092606	0073	-	Update of Annex C	8.1.0	8.2.0
2009-05	RAN#44	R5-092607	0074	-	CR to 36.521-1: Update of test parameters for Demodulation of PDSCH (FDD) tests	8.1.0	8.2.0
2009-05	RAN#44	R5-092614	0075	-	Update of SEM test case	8.1.0	8.2.0
2009-05	RAN#44	R5-092642	0076	-	Update of transmit quality test cases	8.1.0	8.2.0
2009-05	RAN#44	R5-092643	0077	-	Text proposal for TDD part of CQI Reporting under Fading conditions	8.1.0	8.2.0
2009-05	RAN#44	R5-092644	0078	-	Text proposal for TDD part of CQI Reporting under AWGN conditions	8.1.0	8.2.0
2009-05	RAN#44	R5-092645	0079	-	LTE-RF: Update of Additional Spectrum Emission mask Test case with TDD Uplink Test configuration	8.1.0	8.2.0
2009-05	RAN#44	R5-092649	0080	-	LTE-RF: CR for TDD DL RMC to be used in TX test cases	8.1.0	8.2.0
2009-05	RAN#44	R5-092653	0081	-	LTE-RF: CR for Additional Maximum Power Reduction test case	8.1.0	8.2.0
2009-05	RAN#44	R5-092661	0082	-	RMC update for PDCCH/PCFICH performance requirement	8.1.0	8.2.0
2009-05	RAN#44	RP-090444	1161	-	Test frequencies for Additional Spurious Emission test case	8.6.0	8.7.0
2009-05	RAN#44	R5-092366	0084	-	Update of 7.3.1	8.1.0	8.2.0
2009-05	RAN#44	R5-092440	0085	-	LTE-RF: CR for UE max output power test case	8.1.0	8.2.0
2009-05	RAN#44	R5-092472	0086	-	LTE_RF - Update on TC 7.6 Blocking Characteristics (re-submit with changes)	8.1.0	8.2.0
2009-05	RAN#44	R5-092636	0087	-	CR to 36.521-1 Addition of frequencies for band 18 and band 19	8.1.0	8.2.0
2009-05	RAN#44	R5-092652	0088	2	Improved stability of TC 7.8.5 Power Control in the DL fro F-DPCH to HSUPA TC 5.2D and 5.13.2B	8.1.0	8.2.0
-	-	-	-	-	Editorial corrections	8.2.0	8.2.1
2009-09	RAN#45	R5-094032	0089	-	Correction CR to 36.521-1: Update of Requirements for Demodulation of PDSCH (FDD) tests	8.2.1	8.3.0
2009-09	RAN#45	R5-094034	0090	-	Correction CR to 36.521-1: Update of General Requirements for Demodulation tests	8.2.1	8.3.0
2009-09	RAN#45	R5-094214	0091	-	Update of In-band emissions	8.2.1	8.3.0
2009-09	RAN#45	R5-094215	0092	-	TDD Initial downlink channel setting	8.2.1	8.3.0
2009-09	RAN#45	R5-094216	0093	-	Correction to Annex B	8.2.1	8.3.0
2009-09	RAN#45	R5-094248	0094	-	CR to 36.521-1: Update to ACLR test case	8.2.1	8.3.0
2009-09	RAN#45	R5-094250	0095	-	CR to 36.521-1: Update to UE max output power test case	8.2.1	8.3.0
2009-09	RAN#45	R5-094281	0096	-	Mapping of uplink physical channels for TDD	8.2.1	8.3.0
2009-09	RAN#45	R5-094282	0097	-	LTE-RF: CR for notes in TDD DL RMC to be used in TX test cases	8.2.1	8.3.0
2009-09	RAN#45	R5-094283	0098	-	LTE-RF: message update to keep Tx power constant for some Rx test cases	8.2.1	8.3.0
2009-09	RAN#45	R5-094313	0099	-	LTE-RF: CR to test case for Aggregate power control tolerance	8.2.1	8.3.0
2009-09	RAN#45	R5-094317	0100	-	LTE-RF: CR for UE minimum output power test case for TDD	8.2.1	8.3.0
2009-09	RAN#45	R5-094318	0101	-	LTE-RF: CR for Power Control Relative power tolerance test case	8.2.1	8.3.0
2009-09	RAN#45	R5-094319	0102	-	In band emission for non-allocated RB	8.2.1	8.3.0
2009-09	RAN#45	R5-094320	0103	-	LTE RF: correction for subclause 6.6.2.2.5 (A-SEM) supported band list	8.2.1	8.3.0
2009-09	RAN#45	R5-094362	0104	-	Correction of RMCs (36.521 Annex A)	8.2.1	8.3.0
2009-09	RAN#45	R5-094363	0105	-	Usage of the Global In-Channels TX-Test across different Signal Quality tests.	8.2.1	8.3.0
2009-09	RAN#45	R5-094365	0106	-	LTE TX: 1to2 RX antenna	8.2.1	8.3.0
2009-09	RAN#45	R5-094367	0107	-	Correction to 6.6.2.2 Additional Spectrum Emission Mask	8.2.1	8.3.0
2009-09	RAN#45	R5-094370	0108	-	Correction to 6.6.2.3 ACLR	8.2.1	8.3.0
2009-09	RAN#45	R5-094371	0109	-	Correction to 6.7 TX Intermodulation	8.2.1	8.3.0
2009-09	RAN#45	R5-094374	0110	-	Correction to 7.6.1 In-Band Blocking	8.2.1	8.3.0
2009-09	RAN#45	R5-094375	0111	-	UE category (36.521 clause 8)	8.2.1	8.3.0
2009-09	RAN#45	R5-094378	0112	-	Completion of Global in-Channel TX-Test (36.521 Annex E)	8.2.1	8.3.0
2009-09	RAN#45	R5-094379	0113	-	Completion of Global in-Channel TX-Test with PRACH (36.521 Annex E)	8.2.1	8.3.0
2009-09	RAN#45	R5-094380	0114	-	Completion of Statistical testing (36.521 Annex G)	8.2.1	8.3.0
2009-09	RAN#45	R5-094385	0115	-	Correction to Annex D.2 Interference signals	8.2.1	8.3.0
2009-09	RAN#45	R5-094439	0116	-	Update for ACS	8.2.1	8.3.0
2009-09	RAN#45	R5-094661	0117	-	LTE RF - Core update on TC7.6.2 Out-of-band Blocking	8.2.1	8.3.0
2009-09	RAN#45	R5-094663	0118	-	LTE RF - Symbols Update on UL transmission configurations	8.2.1	8.3.0
2009-09	RAN#45	R5-094665	0119	-	LTE RF - Clarification for Test Configurations in General Section	8.2.1	8.3.0
2009-09	RAN#45	R5-094668	0120	-	LTE RF - Applicability of 6.2.3 MPR	8.2.1	8.3.0
2009-09	RAN#45	R5-094671	0121	-	LTE RF - Verification of UE Output Power in Out of Band Emission tests	8.2.1	8.3.0
2009-09	RAN#45	R5-094684	0122	-	CR to 36.521-1: Update to UE max output power test case	8.2.1	8.3.0

2009-09	RAN#45	R5-094686	0123	-	LTE-RF CR to 36.521-1: Update the E-UTRA channel numbers	8.2.1	8.3.0
2009-09	RAN#45	R5-094687	0124	-	LTE-RF: CR for UE maximum power reduction(MPR) test case	8.2.1	8.3.0
2009-09	RAN#45	R5-094699	0125	-	Update to SEM and spurious emissions TC	8.2.1	8.3.0
2009-09	RAN#45	R5-094706	0126	-	Resubmission-Update to the Requirements for frequency-selective fading test	8.2.1	8.3.0
2009-09	RAN#45	R5-094717	0127	-	Update of SEM	8.2.1	8.3.0
2009-09	RAN#45	R5-094718	0128	-	Update of initial conditions with Annex references	8.2.1	8.3.0
2009-09	RAN#45	R5-094721	0129	-	Update of 6.7 Tx Inter Mod	8.2.1	8.3.0
2009-09	RAN#45	R5-094725	0130	-	Correction to E-UTRA channel numbers for Band 2	8.2.1	8.3.0
2009-09	RAN#45	R5-094726	0131	-	Correction to Tx spurious emissions	8.2.1	8.3.0
2009-09	RAN#45	R5-094757	0132	-	Update of TDD PHICH test cases	8.2.1	8.3.0
2009-09	RAN#45	R5-094874	0133	-	Correction to Demodulation of PDCCH/PCFICH test cases	8.2.1	8.3.0
2009-09	RAN#45	R5-094902	0134	-	Addition of 15 MHz and 20 MHz bandwidths and corresponding sensitivity requirements into band 38	8.2.1	8.3.0
2009-09	RAN#45	R5-094903	0135	-	Correction CR to 36.521-1: Update of Transmitter tests network signalled parameter value	8.2.1	8.3.0
2009-09	RAN#45	R5-094905	0136	-	Update of TDD PDSCH test cases	8.2.1	8.3.0
2009-09	RAN#45	R5-094908	0137	-	LTE-RF: CR for Power Control Absolute power tolerance test case	8.2.1	8.3.0
2009-09	RAN#45	R5-094909	0138	-	Update to Output Power dynamics test cases	8.2.1	8.3.0
2009-09	RAN#45	R5-094913	0139	-	Clarification for downlink signal setting in RX tests	8.2.1	8.3.0
2009-09	RAN#45	R5-094914	0140	-	UL RB allocation for receiver tests	8.2.1	8.3.0
2009-09	RAN#45	R5-094915	0141	-	Update of TDD PCFICH/PDCCH test cases	8.2.1	8.3.0
2009-09	RAN#45	R5-094921	0142	-	Correction to CQI performance test case	8.2.1	8.3.0
2009-09	RAN#45	R5-094922	0143	-	Test description for CQI test cases under AWGN conditions	8.2.1	8.3.0
2009-09	RAN#45	R5-094923	0144	-	Resubmission - Requirements for PMI reporting (Single and Multiple PMI)	8.2.1	8.3.0
2009-09	RAN#45	R5-094966	0145	-	CR to 36.521-1: Addition of A-MPR for band 19	8.2.1	8.3.0
2009-09	RAN#45	R5-094976	0146	-	Without loop back: 6.2.2 UE maximum output power	8.2.1	8.3.0
2009-09	RAN#45	R5-094977	0147	-	Without loop back: 6.3.2 Minimum output power	8.2.1	8.3.0
2009-09	RAN#45	R5-094979	0148	-	LTE-RF: CR for UE configured UE transmitted output power test case	8.2.1	8.3.0
2009-09	RAN#45	R5-094980	0149	-	CR to 36.521-1: Definition of Maximum Power state in TX/RX test cases	8.2.1	8.3.0
2009-09	RAN#45	R5-094982	0150	1	Correction of Tx general description	8.2.1	8.3.0
2009-09	RAN#45	R5-094986	0151	-	Update of 6.6.1OBW	8.2.1	8.3.0
2009-09	RAN#45	R5-094989	0152	-	Correction to 1PRB tests in Demodulation of PDSCH	8.2.1	8.3.0
2009-09	RAN#45	R5-094995	0153	-	Correction CR to 36.521-1: Update of Requirements for Additional Maximum Power Reduction (A-MPR) test	8.2.1	8.3.0
2009-09	RAN#45	R5-094996	0154	-	Correction to Demodulation of PHICH test cases	8.2.1	8.3.0
2009-09	RAN#45	R5-094997	0155	-	EVM TC update	8.2.1	8.3.0
2009-09	RAN#45	R5-095300	0156	-	LTE-RF: test description update	8.2.1	8.3.0
2009-09	RAN#45	R5-095301	0157	-	Correction CR to 36.521-1: Addition of measurement uncertainty and test tolerances for A-MPR	8.2.1	8.3.0
2009-09	RAN#45	R5-095304	0158	-	Sorting out Demodulation of PDSCH for FDD	8.2.1	8.3.0
2009-09	-	-	-	-	TOC update and Annexes' titles formatings	8.3.0	8.3.1
2009-12	RAN#46	R5-095515	0159	-	Correction CR to 36.521-1: Additional Spectrum Emission Mask test need to be updated to include the network signalled value "NS_07ö message contents exceptions	8.3.1	8.4.0
2009-12	RAN#46	R5-095589	0160	-	Update for test period description in the general section	8.3.1	8.4.0
2009-12	RAN#46	R5-095657	0161	-	LTE-RF: CR for Power Control Absolute power tolerance test case	8.3.1	8.4.0
2009-12	RAN#46	R5-095661	0162	-	LTE-RF: CR for UE minimum output power test case	8.3.1	8.4.0
2009-12	RAN#46	R5-095735	0163	-	Corrections to Annex A.4	8.3.1	8.4.0
2009-12	RAN#46	R5-095766	0164	-	LTE-RF: CR for In band emission for non-allocated RB	8.3.1	8.4.0
2009-12	RAN#46	R5-095790	0165	-	Completion of Statistical testing (36.521 Annex G)	8.3.1	8.4.0
2009-12	RAN#46	R5-095791	0166	-	Corrections to Annex E	8.3.1	8.4.0
2009-12	RAN#46	R5-096058	0167	-	Removal of [] from 7.6.1, 7.8.1, and 7.5 of Annex F3.3	8.3.1	8.4.0
2009-12	RAN#46	R5-096096	0168	-	Update on 8.2.1	8.3.1	8.4.0
2009-12	RAN#46	R5-096105	0169	-	LTE RF: Symbols Update on Configured UE Transmitted Power	8.3.1	8.4.0
2009-12	RAN#46	R5-096204	0170	-	LTE-RF: CR to Transmission signal quality	8.3.1	8.4.0
2009-12	RAN#46	R5-096208	0171	-	LTE-RF: CR for Power Control Relative power tolerance test case	8.3.1	8.4.0
2009-12	RAN#46	R5-096210	0172	-	LTE-RF: CR to ON/OFF Time mask test cases	8.3.1	8.4.0
2009-12	RAN#46	R5-096211	0173	-	Measurement period for TX-Tests	8.3.1	8.4.0
2009-12	RAN#46	R5-096213	0174	-	CR to 36.521-1: Update to Spurious Emissions test cases	8.3.1	8.4.0
2009-12	RAN#46	R5-096214	0175	-	CR to 36.521-1: Update to ACLR test case	8.3.1	8.4.0
2009-12	RAN#46	R5-096219	0176	-	LTE-RF: CR for UE configured UE transmitted output power test case	8.3.1	8.4.0
2009-12	RAN#46	R5-096222	0177	-	Test description for CQI test cases under AWGN conditions	8.3.1	8.4.0

2009-12	RAN#46	R5-096223	0178	-	LTE RF: Blocking Characteristics update	8.3.1	8.4.0
2009-12	RAN#46	R5-096224	0179	-	LTE RF: Spurious Response Update	8.3.1	8.4.0
2009-12	RAN#46	R5-096228	0180	-	LTE-RF: CR for MPR test case	8.3.1	8.4.0
2009-12	RAN#46	R5-096229	0204	2	CR to 36.521-1: Update to A-MPR test case	8.3.1	8.4.0
2009-12	RAN#46	R5-096230	0181	-	LTE RF: Applicability of 6.2.4 A-MPR	8.3.1	8.4.0
2009-12	RAN#46	R5-096231	0182	-	Correction to Demodulation of PHICH test cases	8.3.1	8.4.0
2009-12	RAN#46	R5-096235	0183	-	Introduction of CQI reporting test with frequency-selective interference	8.3.1	8.4.0
2009-12	RAN#46	R5-096239	0184	-	Update to the test procedure and message contents of TDD PMI reporting test cases	8.3.1	8.4.0
2009-12	RAN#46	R5-096240	0205	-	CR to 36.521-1: Update to Derivation of Test Requirements for A-MPR	8.3.1	8.4.0
2009-12	RAN#46	R5-096241	0185	-	Measurement uncertainties and Test Tolerances for transmit quality test cases	8.3.1	8.4.0
2009-12	RAN#46	R5-096242	0186	-	Update for 36.521-1 Annex A	8.3.1	8.4.0
2009-12	RAN#46	R5-096289	0187	-	CR on 36.521-1, 'Introduction of clause 8.2.1.1 test case uncertainties and Test Tolerances'	8.3.1	8.4.0
2009-12	RAN#46	R5-096306	0188	-	Update to the test procedure of SEM test cases of 36.521-1	8.3.1	8.4.0
2009-12	RAN#46	R5-096311	0189	-	Update of 6.6.1 OBW	8.3.1	8.4.0
2009-12	RAN#46	R5-096312	0190	-	Correction to SEM	8.3.1	8.4.0
2009-12	RAN#46	R5-096313	0191	-	Update of 6.7 Transmit intermodulation	8.3.1	8.4.0
2009-12	RAN#46	R5-096315	0192	-	CR to 36.521-1: Update to UE max output power test case	8.3.1	8.4.0
2009-12	RAN#46	R5-096316	0193	-	CR to 36.521-1: Update to Additional Spurious Emissions test case	8.3.1	8.4.0
2009-12	RAN#46	R5-096317	0194	-	CR to TDD PHICH demodulation test cases	8.3.1	8.4.0
2009-12	RAN#46	R5-096318	0195	-	Correction to FDD PMI reporting test cases	8.3.1	8.4.0
2009-12	RAN#46	R5-096320	0196	-	Tx power range and core update for Receiver tests	8.3.1	8.4.0
2009-12	RAN#46	R5-096322	0197	-	Update on 7.4, 7.5, and 7.8.1	8.3.1	8.4.0
2009-12	RAN#46	R5-096323	0198	-	Introduction of RI reporting test	8.3.1	8.4.0
2009-12	RAN#46	R5-096333	0199	-	Update to 6.5 Transmit signal quality test cases	8.3.1	8.4.0
2009-12	RAN#46	R5-096334	0200	-	LTE-RF: CR for Aggregate power control tolerance test case	8.3.1	8.4.0
2009-12	RAN#46	R5-096335	0201	-	Correction CR to 36.521-1: Update for Demodulation of PDSCH (FDD) tests to correct CR merges results from RAN5#44	8.3.1	8.4.0
2009-12	RAN#46	R5-096336	0206	1	Update TDD PDSCH test cases	8.3.1	8.4.0
2009-12	RAN#46	R5-096338	0202	-	Number of used HARQ processes in DL Performance tests	8.3.1	8.4.0
2009-12	RAN#46	R5-096342	0207	2	Minimum test time for performance tests	8.3.1	8.4.0
2009-12	RAN#46	R5-096718	0203	-	LTE RF: A-SEM update and A-MPR verification	8.3.1	8.4.0
2010-03	RAN#47	R5-100353	0208	-	LTE-RF CR to 36.521-1: TIME MASK test case updated	8.4.0	8.5.0
2010-03	RAN#47	R5-100354	0209	-	LTE-RF: CR for A-MPR notation in NS_07	8.4.0	8.5.0
2010-03	RAN#47	R5-100403	0210	-	LTE-RF: CR for Tx Intermodulation test case	8.4.0	8.5.0
2010-03	RAN#47	R5-100404	0211	-	LTE-RF: CR for OBW measurement period alignment	8.4.0	8.5.0
2010-03	RAN#47	R5-100408	0212	-	Reporting mode, Reporting Interval and Editorial corrections for demodulation	8.4.0	8.5.0
2010-03	RAN#47	R5-100456	0213	-	Misc update on MAC padding in Rx and performance sections	8.4.0	8.5.0
2010-03	RAN#47	R5-100566	0214	-	Missing Test limits in 36.521-1 Annex G	8.4.0	8.5.0
2010-03	RAN#47	R5-100567	0215	-	Wrong references from 36.521-1 clauses 8.4 and 8.5 into Annex G	8.4.0	8.5.0
2010-03	RAN#47	R5-100569	0216	-	Typos in 36.521-1, Annex E	8.4.0	8.5.0
2010-03	RAN#47	R5-100571	0217	-	Minimum test time for performance tests	8.4.0	8.5.0
2010-03	RAN#47	R5-100572	0218	-	Correction to 6.6.3.3 Additional spurious emissions	8.4.0	8.5.0
2010-03	RAN#47	R5-100790	0219	-	DL-RMC-s for transmitter tests: Corrections	8.4.0	8.5.0
2010-03	RAN#47	R5-100800	0220	-	Update of Test environment for RF test	8.4.0	8.5.0
2010-03	RAN#47	R5-100803	0221	-	Spectrum emission mask: Correction to uplink configuration	8.4.0	8.5.0
2010-03	RAN#47	R5-100807	0222	-	Performance tests: Scheduling of retransmissions	8.4.0	8.5.0
2010-03	RAN#47	R5-100810	0223	-	UL-RMC-s: Corrections and completion	8.4.0	8.5.0
2010-03	RAN#47	R5-100814	0224	-	Corrections to Cl 5.4.2.1 of TS 36.521-1	8.4.0	8.5.0
2010-03	RAN#47	R5-100815	0225	-	LTE-RF: CR for UE configured UE transmitted output power test case	8.4.0	8.5.0
2010-03	RAN#47	R5-100816	0226	-	LTE-RF: CR for Power Control Relative power tolerance test case	8.4.0	8.5.0
2010-03	RAN#47	R5-100822	0227	-	CR to 36.521-1: Update to Maximum output power	8.4.0	8.5.0
2010-03	RAN#47	R5-100823	0228	-	CR to 36.521-1: Update to ACLR test case	8.4.0	8.5.0
2010-03	RAN#47	R5-100825	0229	-	CR to 36.521-1: Update to Additional Tx spurious emissions test case	8.4.0	8.5.0
2010-03	RAN#47	R5-100826	0230	-	RMC-s and OCNG patterns: Update according 36.101 8.8.0	8.4.0	8.5.0
2010-03	RAN#47	R5-100827	0231	-	Receiver and performance tests: Update use of OCNG according 36.101 8.8.0	8.4.0	8.5.0
2010-03	RAN#47	R5-100828	0232	-	Update of PDSCH Demodulation Tests	8.4.0	8.5.0
2010-03	RAN#47	R5-100831	0233	-	Introduction of clause 8.2.1.2, 8.2.1.3, 8.2.1.4 test case uncertainties and Test Tolerances	8.4.0	8.5.0
2010-03	RAN#47	R5-100832	0234	-	Clarifications on DRS performance test case	8.4.0	8.5.0

2010-03	RAN#47	R5-100833	0235	-	Misc update on MAC padding in PDCCH, CSI test	8.4.0	8.5.0
2010-03	RAN#47	R5-100834	0236	-	Updates to the TDD portion of CQI reporting test cases under AWGN	8.4.0	8.5.0
2010-03	RAN#47	R5-100838	0237	-	Editorial Correction to 8.2.1.3	8.4.0	8.5.0
2010-03	RAN#47	R5-100839	0238	-	Update on Annex C for 36.521-1	8.4.0	8.5.0
2010-03	RAN#47	R5-100840	0239	-	Update on MAC padding in TDD PMI test case 9.4 of 36.521-1.	8.4.0	8.5.0
2010-03	RAN#47	R5-100841	0240	-	Correction to CQI test cases under AWGN conditions	8.4.0	8.5.0
2010-03	RAN#47	R5-100842	0241	-	Correction to CQI test cases under fading conditions	8.4.0	8.5.0
2010-03	RAN#47	R5-100843	0242	-	Correction to PMI reporting test cases	8.4.0	8.5.0
2010-03	RAN#47	R5-100845	0243	-	CSI: Corrections to tests titles and RI clause structure	8.4.0	8.5.0
2010-03	RAN#47	R5-100848	0244	-	CR to 36.521-1: Update LTE RF test cases with test requirements for extended LTE1500MHz	8.4.0	8.5.0
2010-03	RAN#47	R5-100886	0245	-	Transmitter characteristics: UE Categories and other corrections	8.4.0	8.5.0
2010-03	RAN#47	R5-100887	0246	-	CR to 36.521-1: Update to Tx spurious emissions and Spurious emission band UE co-existence	8.4.0	8.5.0
2010-03	RAN#47	R5-100888	0247	-	Clarification on notes in Max Power	8.4.0	8.5.0
2010-03	RAN#47	R5-100889	0248	-	Maximum input level: Corrections w.r.t. UE categories	8.4.0	8.5.0
2010-03	RAN#47	R5-100891	0249	-	Correction to PDCCH demodulation test cases	8.4.0	8.5.0
2010-03	RAN#47	R5-100892	0250	-	Correction to PHICH demodulation test cases	8.4.0	8.5.0
2010-03	RAN#47	R5-100907	0251	-	Update of RI reporting test case	8.4.0	8.5.0
2010-03	RAN#47	R5-100909	0252	-	Correction to set UL power in Rx TCs	8.4.0	8.5.0
2010-03	RAN#47	-	-	-	Moved to v9.0.0 with no change	8.5.0	9.0.0
2010-06	RAN#48	R5-103102	0253	-	CR to 36.521-1: Update of EARFCN for band 21	9.0.0	9.1.0
2010-06	RAN#48	R5-103103	0254	-	CR to 36.521-1: Update of A-MPR test case with band 21	9.0.0	9.1.0
2010-06	RAN#48	R5-103104	0255	-	CR to 36.521-1: Update of Additional Spurious test case with band 21	9.0.0	9.1.0
2010-06	RAN#48	R5-103106	0256	-	CR to 36.521-1: Update to ACLR test case	9.0.0	9.1.0
2010-06	RAN#48	R5-103108	0257	-	CR to 36.521-1: Update of Reference sensitivity level test case	9.0.0	9.1.0
2010-06	RAN#48	R5-103226	0258	-	CR to 36.521-1: Update of UE RF requirements for LTE, Band 20	9.0.0	9.1.0
2010-06	RAN#48	R5-103263	0259	-	LTE-RF:Updates of PDCCH demodulation test cases (FDD and TDD)	9.0.0	9.1.0
2010-06	RAN#48	R5-103265	0260	-	LTE-RF:CR for TDD ACK/NACK feedback mode in CQI BLER test cases	9.0.0	9.1.0
2010-06	RAN#48	R5-103288	0261	-	PDCCH Aggregation level for RF tests	9.0.0	9.1.0
2010-06	RAN#48	R5-103291	0262	-	Update and correction to UE maximum output power requirements	9.0.0	9.1.0
2010-06	RAN#48	R5-103293	0263	-	Editorial correction in In-band blocking test	9.0.0	9.1.0
2010-06	RAN#48	R5-103296	0264	-	Correction to additional spectrum emission mask test configuration	9.0.0	9.1.0
2010-06	RAN#48	R5-103300	0265	-	Corrections to Uplink RMC-s	9.0.0	9.1.0
2010-06	RAN#48	R5-103450	0266	-	LTE-RF: editorial CR for TC 7.6.2 and 7.7	9.0.0	9.1.0
2010-06	RAN#48	R5-103471	0267	-	Minimum test time for performance tests	9.0.0	9.1.0
2010-06	RAN#48	R5-103476	0268	-	EVM with exclusion period (annex)	9.0.0	9.1.0
2010-06	RAN#48	R5-103521	0269	-	CR on 36.521-1 for updating the "Reporting of Channel State Information"	9.0.0	9.1.0
2010-06	RAN#48	R5-103525	0270	-	CR on 36.521-1 for corrections in UE RF requirements	9.0.0	9.1.0
2010-06	RAN#48	R5-103598	0271	-	Correction to notes in Max Power	9.0.0	9.1.0
2010-06	RAN#48	R5-103602	0272	-	Clarification of measurement conditions for Rx spurious emission	9.0.0	9.1.0
2010-06	RAN#48	R5-103726	0273	-	CR to 36.521-1: Update of Spurious emission band UE co-existence test case	9.0.0	9.1.0
2010-06	RAN#48	R5-103727	0274	-	LTE-RF: CR for Prach time mask test case	9.0.0	9.1.0
2010-06	RAN#48	R5-103728	0275	-	LTE-RF: CR for General ON/OFF time mask test case	9.0.0	9.1.0
2010-06	RAN#48	R5-103729	0276	-	LTE-RF: Update to spectrum flatness test case and relevant annexes	9.0.0	9.1.0
2010-06	RAN#48	R5-103730	0277	-	LTE-RF:CR for test case of In-band emissions	9.0.0	9.1.0
2010-06	RAN#48	R5-103731	0278	-	EVM with exclusion period (test)	9.0.0	9.1.0
2010-06	RAN#48	R5-103732	0279	-	CR to 36.521-1 on Correction to Demodulation Requirements for PDSCH	9.0.0	9.1.0
2010-06	RAN#48	R5-103733	0280	-	CR to 36.521-1: Update PDCCH DCI Formats for Open Loop and Closed Loop Spatial Multiplexing Test Cases	9.0.0	9.1.0
2010-06	RAN#48	R5-103751	0281	-	Misc update in CSI tests	9.0.0	9.1.0
2010-06	RAN#48	R5-103752	0282	-	Correction of the statistical part in PMI and RI tests	9.0.0	9.1.0
2010-06	RAN#48	R5-103753	0283	-	LTE-RF:CR to downlink RMCs for TX characteristics	9.0.0	9.1.0
2010-06	RAN#48	R5-103754	0284	-	LTE-RF: Update of annex C	9.0.0	9.1.0
2010-06	RAN#48	R5-103756	0285	-	Measuring throughput ratios (Annex G)	9.0.0	9.1.0
2010-06	RAN#48	R5-103763	0286	-	LTE-RF: CR for Minimum output power test case	9.0.0	9.1.0
2010-06	RAN#48	R5-103764	0287	-	Performance, CSI reporting and uncertainties for UEs with multiple Rx antennas	9.0.0	9.1.0
2010-06	RAN#48	R5-103771	0288	-	Introduction of clause 8.4.1 and 8.5.1 test case uncertainties	9.0.0	9.1.0

					and Test Tolerances		
2010-06	RAN#48	R5-103778	0291	-	Uplink power for receiver tests	9.0.0	9.1.0
2010-06	RAN#48	R5-103780	0292	1	Addition of the exceptional message for In-band emissions	9.0.0	9.1.0
2010-06	RAN#48	R5-103781	0289	-	Correction to 6.5.2.1 EVM	9.0.0	9.1.0
2010-06	RAN#48	R5-103782	0290	-	Correction to CQI reporting	9.0.0	9.1.0
2010-09	RAN#49	R5-104090	0294	-	Corrections to Spectrum emission mask test regarding UE category	9.1.0	9.2.0
2010-09	RAN#49	R5-104091	0295	-	Missing note in Additional spurious emission test with NS_07	9.1.0	9.2.0
2010-09	RAN#49	R5-104095	0296	-	PDCCH Aggregation level for CSI tests	9.1.0	9.2.0
2010-09	RAN#49	R5-104096	0297	-	Default initial and connection Uplink power for RF tests	9.1.0	9.2.0
2010-09	RAN#49	R5-104212	0298	-	Limits on Uplink power for Receiver tests	9.1.0	9.2.0
2010-09	RAN#49	R5-104244	0299	-	Correction to Demodulation Requirements	9.1.0	9.2.0
2010-09	RAN#49	R5-104461	0300	-	CR to 36.521-1: Editorial Corrections for Closed Loop Spatial Multiplexing Test Cases	9.1.0	9.2.0
2010-09	RAN#49	R5-104478	0301	-	Correction to Test requirements in 6.5.2.2	9.1.0	9.2.0
2010-09	RAN#49	R5-104482	0302	-	Correction to 8.2.1.1	9.1.0	9.2.0
2010-09	RAN#49	R5-104520	0303	-	36521-1 General update of sections 00 to 08: missing Introduction references formatting	9.1.0	9.2.0
2010-09	RAN#49	R5-104583	0304	-	No necessity to apply - consecutive time slots for EVM	9.1.0	9.2.0
2010-09	RAN#49	R5-104584	0305	-	Correction to E.4.4 EVM equalizer spectrum flatness	9.1.0	9.2.0
2010-09	RAN#49	R5-104630	0306	-	Correction of table reference in In-band emissions test	9.1.0	9.2.0
2010-09	RAN#49	R5-104808	0307	-	CR to 36.521-1: Update to Additional Spectrum Emission Mask test case	9.1.0	9.2.0
2010-09	RAN#49	R5-104809	0308	-	CR to 36.521-1: Update to Spurious emission band UE co-existence test case	9.1.0	9.2.0
2010-09	RAN#49	R5-104810	0309	-	LTE-RF: CR for Max Output Power	9.1.0	9.2.0
2010-09	RAN#49	R5-104811	0310	-	LTE-RF: CR for Freq Error	9.1.0	9.2.0
2010-09	RAN#49	R5-104812	0311	-	Introduction of exclusion period for PUCCH-EVM test in clause 6.5.3	9.1.0	9.2.0
2010-09	RAN#49	R5-104813	0312	-	Correction to Demodulation UE-Specific Reference Symbols	9.1.0	9.2.0
2010-09	RAN#49	R5-104814	0313	-	Uncertainties and Test Tolerances for CSI Test cases 9.2.1.1 and 9.2.1.2	9.1.0	9.2.0
2010-09	RAN#49	R5-104815	0314	-	Uncertainties and Test Tolerances for CSI Test cases 9.2.2.1 and 9.2.2.2	9.1.0	9.2.0
2010-09	RAN#49	R5-104816	0315	-	UE applicability for CSI test cases	9.1.0	9.2.0
2010-09	RAN#49	R5-104817	0316	-	Update of CQI reporting TCs under fading conditions	9.1.0	9.2.0
2010-09	RAN#49	R5-104818	0317	-	Update of Reporting of Precoding Matrix Indicator TCs	9.1.0	9.2.0
2010-09	RAN#49	R5-104819	0318	-	Correction of the statistical part 9.3.1.1.1 (CQI Reporting under fading conditions)	9.1.0	9.2.0
2010-09	RAN#49	R5-104820	0319	-	Correction of the statistical part 9.3.3.1.1 (CQI Reporting under fading conditions)	9.1.0	9.2.0
2010-09	RAN#49	R5-104821	0320	-	Correction of the statistical part 9.3.2.1.1 (CQI Reporting under fading conditions)	9.1.0	9.2.0
2010-09	RAN#49	R5-104822	0321	-	Update and new RMC-s for CQI tests	9.1.0	9.2.0
2010-09	RAN#49	R5-104823	0322	-	Correction of EVM calculation in annex	9.1.0	9.2.0
2010-09	RAN#49	R5-104824	0323	-	Introduction of exclusion period for PUCCH-EVM test in Annex E	9.1.0	9.2.0
2010-09	RAN#49	R5-104844	0324	-	Pcmx changes to Configured UE Transmitted Output Power	9.1.0	9.2.0
2010-09	RAN#49	R5-104845	0325	-	Clarification on the frequency range with net work signal in 6.6.3.2	9.1.0	9.2.0
2010-09	RAN#49	R5-104846	0326	-	Update of editor's notes	9.1.0	9.2.0
2010-09	RAN#49	R5-104847	0327	-	Removal of Extreme Conditions in 6.2.3	9.1.0	9.2.0
2010-09	RAN#49	R5-104850	0328	-	Corrections to Test procedure loop in CSI tests	9.1.0	9.2.0
2010-09	RAN#49	R5-104851	0329	-	Introduction of TDD CQI Reporting under fading conditions and frequency-selective interference test case	9.1.0	9.2.0
2010-09	RAN#49	R5-104852	0330	-	Introduction of TDD RI Reporting test case	9.1.0	9.2.0
2010-09	RAN#49	R5-104853	0331	-	Update of CQI reporting TCs under AWGN conditions	9.1.0	9.2.0
2010-09	RAN#49	R5-104854	0332	-	Update of FDD RI Reporting TC	9.1.0	9.2.0
2010-09	RAN#49	R5-104857	0333	-	CR to 36.521-1 LTE UE Tx_RX test cases band 20	9.1.0	9.2.0
2010-09	RAN#49	R5-104861	0334	-	Corrections to Test requirements for MPR test	9.1.0	9.2.0
2010-09	RAN#49	R5-104863	0335	-	Clarification on notes in Max Power	9.1.0	9.2.0
2010-09	RAN#49	R5-104872	0336	-	Correction to 6.3.5.2	9.1.0	9.2.0
2010-09	RAN#49	R5-104873	0337	-	Numbering and alignment of TDD PHICH demod test cases	9.1.0	9.2.0
2010-09	RAN#49	R5-104874	0338	-	Correction to test numbering for exceptional messages in 8.2.x.x	9.1.0	9.2.0
2010-09	RAN#49	R5-104875	0339	-	Correction to 9.2.2	9.1.0	9.2.0
2010-09	RAN#49	R5-104876	0340	-	Correction to the test procedures of 9.3.x	9.1.0	9.2.0
2010-09	RAN#49	R5-104877	0341	-	Correction to 9.4.x	9.1.0	9.2.0
2010-09	RAN#49	R5-104878	0342	-	The new reference of connection diagram for 9.3.3	9.1.0	9.2.0
2010-09	RAN#49	R5-104879	0343	-	Correction to 6.3.4.1 and 6.3.5.1	9.1.0	9.2.0
2010-09	RAN#49	R5-104888	0344	-	Update of Annex C.2 for AG level	9.1.0	9.2.0
2010-09	RAN#49	R5-105055	0345	-	Introduction of a new RF test case (8.7) to verify downlink	9.1.0	9.2.0

					sustained data rate performance		
2010-09	RAN#49	R5-105061	0347	-	CR to 36.521-1: Modification to Additional Maximum Power Reduction Test Case	9.1.0	9.2.0
2010-09	RAN#49	R5-105062	0348	-	Modification to Additional Spectrum Emission Mask	9.1.0	9.2.0
2010-09	RAN#49	R5-105063	0349	-	Modification to Additional Spurious Emissions	9.1.0	9.2.0
2010-09	RAN#49	R5-105064	0350	-	Modification to Maximum Power Reduction	9.1.0	9.2.0
2010-09	RAN#49	R5-105065	0351	-	Modification to Adjacent Channel Leakage Power Ratio	9.1.0	9.2.0
2010-09	RAN#49	RP-100987	0352	-	Correction of status for RF performance test case	9.1.0	9.2.0
2010-12	RAN#50	R5-106073	0353	-	Corrections to receiver spurious emissions test	9.2.0	9.3.0
2010-12	RAN#50	R5-106074	0354	-	Update of downlink power for receiver tests	9.2.0	9.3.0
2010-12	RAN#50	R5-106076	0355	-	CQI: Side condition when CQI median equals min or max CQI-values	9.2.0	9.3.0
2010-12	RAN#50	R5-106077	0356	-	Update of the throughput-definition for multi-data stream transmission	9.2.0	9.3.0
2010-12	RAN#50	R5-106078	0357	-	Update of RF OCNG patterns	9.2.0	9.3.0
2010-12	RAN#50	R5-106092	0358	-	Correction of DCI format used in PDSCH performance test 8.2.1.4.2	9.2.0	9.3.0
2010-12	RAN#50	R5-106249	0359	-	CR to 36.521-1: Correction to Spurious emission band UE co-existence test case	9.2.0	9.3.0
2010-12	RAN#50	R5-106250	0360	-	CR to 36.521-1: Correction to Additional Tx spurious emissions test case	9.2.0	9.3.0
2010-12	RAN#50	R5-106374	0361	-	Correction of FDD CQI reporting test under AWGN - PUCCH 1-1	9.2.0	9.3.0
2010-12	RAN#50	R5-106394	0362	-	Correction of clause 9.3.1 and 9.3.3	9.2.0	9.3.0
2010-12	RAN#50	R5-106399	0363	-	"Correction of G.2.5 Pass fail decision rules"	9.2.0	9.3.0
2010-12	RAN#50	R5-106420	0364	-	Introduction of test uncertainties and tolerances for TDD PDSCH DRS test cases	9.2.0	9.3.0
2010-12	RAN#50	R5-106440	0365	-	Correction to unsigned numbers in Annex F.1.2	9.2.0	9.3.0
2010-12	RAN#50	R5-106443	0366	-	Correction to the exceptional messages in 9.4 Reporting of PMI TCs	9.2.0	9.3.0
2010-12	RAN#50	R5-106491	0367	-	CR to 36.521-1: Correction to Table Numbering Error in TDD PDSCH Closed Loop Single/Multi Layer Spatial Multiplexing 2x2	9.2.0	9.3.0
2010-12	RAN#50	R5-106512	0368	-	Transport format table clarification in CSI test cases	9.2.0	9.3.0
2010-12	RAN#50	R5-106801	0369	-	HARQ scheduling in TDD performance tests using special subframes	9.2.0	9.3.0
2010-12	RAN#50	R5-106803	0370	-	Correction to Fading Profiles in TCs 8.4 and 8.5	9.2.0	9.3.0
2010-12	RAN#50	R5-106816	0372	-	CR to 36.521-1: Modification to Spectrum Emissions Mask	9.2.0	9.3.0
2010-12	RAN#50	R5-106817	0373	-	Introduction of test uncertainties and tolerances for TDD PCFICH/PDCCH and PHICH test cases	9.2.0	9.3.0
2010-12	RAN#50	R5-106818	0374	-	Update of TDD PDSCH CRS Demodulation test cases	9.2.0	9.3.0
2010-12	RAN#50	R5-106821	0375	-	PUSCH-EVM with exclusion period	9.2.0	9.3.0
2010-12	RAN#50	R5-106822	0376	-	Maintenance of Band 20 for receiver tests	9.2.0	9.3.0
2010-12	RAN#50	R5-106823	0377	-	Completion of clause 9.3.1 and 9.3.2	9.2.0	9.3.0
2010-12	RAN#50	R5-106824	0378	-	Update of FDD RI Reporting TC	9.2.0	9.3.0
2010-12	RAN#50	R5-106825	0379	-	Correction to 9.2.2 CQI TCs	9.2.0	9.3.0
2010-12	RAN#50	R5-106826	0380	-	G.3.5 on PDCCH&PHICH Minimum Test Times	9.2.0	9.3.0
2010-12	RAN#50	R5-106827	0381	-	Completion of test time and $\frac{1}{T}$ -TT for clauses 9.3 to 9.5	9.2.0	9.3.0
2010-12	RAN#50	R5-106828	0382	-	EVM window length for PRACH	9.2.0	9.3.0
2010-12	RAN#50	R5-106842	0383	-	Modification of TC 8.3.2.1 - TDD PDSCH Single-layer SM Performance (UE-Specific Reference Symbols)	9.2.0	9.3.0
2010-12	RAN#50	R5-106843	0384	-	Power control relative power tolerance: Missing band edge relaxation	9.2.0	9.3.0
2010-12	RAN#50	R5-106844	0385	-	SRS time mask test procedure update	9.2.0	9.3.0
2010-12	RAN#50	R5-106845	0386	-	Correction of TC General ON/OFF time mask	9.2.0	9.3.0
2010-12	RAN#50	R5-106846	0387	-	Update of TDD CQI reporting test under frequency selective interference conditions	9.2.0	9.3.0
2010-12	RAN#50	R5-106847	0388	-	Update of TDD RI reporting test	9.2.0	9.3.0
2010-12	RAN#50	R5-106848	0389	-	lot setting in CQI test clarification	9.2.0	9.3.0
2010-12	RAN#50	R5-106850	0390	-	Correction of Test Uncertainties and Test Tolerances for Reference Sensitivity-Band 4	9.2.0	9.3.0
2010-12	RAN#50	R5-106855	0391	-	Correction to DL and UL RMC configurations in 6.5.1 Frequency Error	9.2.0	9.3.0
2010-12	RAN#50	R5-106858	0392	-	CR to 36.521-1: Update LTE RF test cases with test requirements for EUTRA TDD LTE band 41.	9.2.0	9.3.0
2011-03	RAN#51	R5-110138	0393	-	Spurious emission band co-existence test: Remaining old test requirement table	9.3.0	9.4.0
2011-03	RAN#51	R5-110139	0394	-	Transmit intermodulation test: Interferer offset for Band 20, Bandwidth 20 MHz	9.3.0	9.4.0
2011-03	RAN#51	R5-110141	0395	-	PMI Performance tests: Corrections to test settings	9.3.0	9.4.0
2011-03	RAN#51	R5-110143	0396	-	PDCCH Performance test: Correction to TDD DL RMC-s	9.3.0	9.4.0
2011-03	RAN#51	R5-110144	0397	-	OCNG for RF tests: Updates	9.3.0	9.4.0
2011-03	RAN#51	R5-110158	0398	-	CQI Performance tests: Clarification on subbands used in the	9.3.0	9.4.0

				test		
2011-03	RAN#51	R5-110302	0399	- LTE RF: PCFICH/PDCCH Transmit Diversity Performance	9.3.0	9.4.0
2011-03	RAN#51	R5-110349	0401	- Correction of OFF power measurements in 6.3.4 ON/OFF time mask	9.3.0	9.4.0
2011-03	RAN#51	R5-110354	0402	- Correction of Annex E (Global In-Channel TX-Test)	9.3.0	9.4.0
2011-03	RAN#51	R5-110506	0403	- Addition of 3500 MHz TDD bands into chapter 5 of 36.521-1	9.3.0	9.4.0
2011-03	RAN#51	R5-110747	0404	- Updates to section 8.7 DL sustained data rate test case	9.3.0	9.4.0
2011-03	RAN#51	R5-110850	0405	- Sustained data rate: Definition of UL RMC-s	9.3.0	9.4.0
2011-03	RAN#51	R5-110860	0400	- Update measurement period from test procedure of 6.2.2	9.3.0	9.4.0
2011-03	RAN#51	R5-110861	0428	- A-MPR Test requirement update	9.3.0	9.4.0
2011-03	RAN#51	R5-110862	0437	- Measuring throughput with different payload size.	9.3.0	9.4.0
2011-03	RAN#51	R5-110900	0406	- Correction to SNR reference in FDD PCFICH/PDCCH Single Antenna Port Performance Test	9.3.0	9.4.0
2011-03	RAN#51	R5-110901	0407	- CR to 36.521-1: Correction of Additional Maximum Power Reduction (A-MPR) test case	9.3.0	9.4.0
2011-03	RAN#51	R5-110915	0408	- Uncertainties and Test Tolerances for CSI Test cases 9.3.1.1.x and 9.3.2.1.x	9.3.0	9.4.0
2011-03	RAN#51	R5-110916	0409	- Uncertainties and Test Tolerances for CSI Test cases 9.3.3.1.x	9.3.0	9.4.0
2011-03	RAN#51	R5-110917	0410	- Uncertainties and Test Tolerances for CSI Test cases 9.4.1.1.x and 9.4.2.1.x	9.3.0	9.4.0
2011-03	RAN#51	R5-110918	0411	- Uncertainties and Test Tolerances for CSI Test cases 9.5.1.x	9.3.0	9.4.0
2011-03	RAN#51	R5-110919	0412	- Editorial errors in CSI test cases 9.2.1.x Test procedure	9.3.0	9.4.0
2011-03	RAN#51	R5-110933	0413	- Handling of different releases in RAN5 LTE RF specification	9.3.0	9.4.0
2011-03	RAN#51	R5-110938	0414	- PRACH Time mask and EVM tests: TDD Special subframe configuration	9.3.0	9.4.0
2011-03	RAN#51	R5-110939	0415	- Update on PRACH time mask for TDD	9.3.0	9.4.0
2011-03	RAN#51	R5-110940	0416	- Correction of the connection diagram reference in the initial conditions for Transmitter Characteristics	9.3.0	9.4.0
2011-03	RAN#51	R5-110941	0417	- Update of the reference sensitivity requirement for the 1.4MHz and 3MHz bandwidths and note correction for Band 3 and Band 9	9.3.0	9.4.0
2011-03	RAN#51	R5-110942	0418	- CR Removing brackets of band 41 reference sensitivity in 36.521-1	9.3.0	9.4.0
2011-03	RAN#51	R5-110949	0419	- PDCCH and PHICH performance tests: Updates and corrections	9.3.0	9.4.0
2011-03	RAN#51	R5-110950	0420	- Addition of CodeBookSubsetRestriction bitmap for Multi-Layer Spatial Multiplexing	9.3.0	9.4.0
2011-03	RAN#51	R5-110951	0421	- Addition of exceptional message in 8.4.1.2.2	9.3.0	9.4.0
2011-03	RAN#51	R5-110952	0422	- CQI test 9.2.2.2: Update acc TS 36.101	9.3.0	9.4.0
2011-03	RAN#51	R5-110953	0423	- Maximum input level test: Correction to DL-RMC	9.3.0	9.4.0
2011-03	RAN#51	R5-110954	0424	- Correction of E.7, EVM with exclusion period	9.3.0	9.4.0
2011-03	RAN#51	R5-110967	0425	- Updates to Additional Spurious emissions and Spurious emission band UE co-existence test	9.3.0	9.4.0
2011-03	RAN#51	R5-110970	0426	- LTE RF: references to state 3A in 36.521-1	9.3.0	9.4.0
2011-03	RAN#51	R5-110973	0429	- RI Performance tests: Corrections	9.3.0	9.4.0
2011-03	RAN#51	R5-110975	0430	- Completion of annex G.3.5 (Minimum test time, performance tests)	9.3.0	9.4.0
2011-03	RAN#51	R5-110978	0431	- Correction to Band 12 frequency range	9.3.0	9.4.0
2011-03	RAN#51	R5-110979	0432	- Additional in-band blocking requirement for Band 12	9.3.0	9.4.0
2011-03	RAN#51	R5-110989	0433	- Completion of annex G.3.6 (test conditions, performance tests)	9.3.0	9.4.0
2011-03	RAN#51	R5-110990	0434	- Addition of test cases of TDD PDSCH Single-layer and Dual-layer Spatial Multiplexing Performance	9.3.0	9.4.0
2011-03	RAN#51	R5-110991	0435	- Correction to Times Mask and Power Control tests	9.3.0	9.4.0
2011-03	RAN#51	R5-110992	0436	- Add requirement of QPSK with partial RB allocation into test requirement of 6.2.3	9.3.0	9.4.0
2011-04	-	-	-	- Added approved R5-110967 which was missing.	9.4.0	9.4.1
2011-06	RAN#52	R5-112148	0438	- ON/OFF time mask for PRACH: PRACH configuration index	9.4.1	9.5.0
2011-06	RAN#52	R5-112149	0439	- CQI tests with frequency selective scheduling mode: Random selection of Sub-Bands	9.4.1	9.5.0
2011-06	RAN#52	R5-112150	0440	- DL-RMC for receiver tests: Obsolete editors note	9.4.1	9.5.0
2011-06	RAN#52	R5-112211	0441	- Adding Band 24 to TS 36.521-1	9.4.1	9.5.0
2011-06	RAN#52	R5-112311	0442	- Correction to the sustained data rate tests	9.4.1	9.5.0
2011-06	RAN#52	R5-112312	0443	- Correction to the multi-antenna transmission tests	9.4.1	9.5.0
2011-06	RAN#52	R5-112349	0444	- Update Annex G.3.6 for spatial multiplexing test cases	9.4.1	9.5.0
2011-06	RAN#52	R5-112412	0445	- Correction to DL RMC for Max input for UE category 2	9.4.1	9.5.0
2011-06	RAN#52	R5-112459	0446	- EVM window length for PRACH	9.4.1	9.5.0
2011-06	RAN#52	R5-112460	0447	- Removal of square brackets in Annex G.5.4	9.4.1	9.5.0
2011-06	RAN#52	R5-112462	0448	- Test tolerances for EVM with exclusion period	9.4.1	9.5.0
2011-06	RAN#52	R5-112808	0449	- LTE RF - UEs Demodulation and CSI Band applicability	9.4.1	9.5.0
2011-06	RAN#52	R5-112810	0450	- Correction on test requirement of test case 6.5.2.3	9.4.1	9.5.0
2011-06	RAN#52	R5-112811	0451	- LTE RF - TC6.3.5.2 Change in Minimum Requirements	9.4.1	9.5.0
2011-06	RAN#52	R5-112812	0452	- Removable of NS values for TDD	9.4.1	9.5.0

2011-06	RAN#52	R5-112813	0453	-	Correction on initial condition for test cases of 9.3.3	9.4.1	9.5.0
2011-06	RAN#52	R5-112814	0454	-	Correction to 9.4 PMI test cases	9.4.1	9.5.0
2011-06	RAN#52	R5-112816	0455	-	Test procedure change on Tx spurious emissions test cases	9.4.1	9.5.0
2011-06	RAN#52	R5-112850	0456	-	Update of Initial conditions according to table 7.3.3-2 for the 5MHz and 10MHz bandwidths	9.4.1	9.5.0
2011-06	RAN#52	R5-112851	0457	-	lot modelling in frequency-selective interference CQI tests	9.4.1	9.5.0
2011-06	RAN#52	R5-112852	0458	-	Correction to test procedure in 9.5.1	9.4.1	9.5.0
2011-06	RAN#52	R5-112859	0459	-	Introduction of additional PDCCH test cases for Rel-9	9.4.1	9.5.0
2011-06	RAN#52	R5-112860	0460	-	Introduction of additional PHICH test cases for Rel-9	9.4.1	9.5.0
2011-06	RAN#52	R5-112861	0461	-	Introducing UE-selected subband CQI tests for Rel-9	9.4.1	9.5.0
2011-06	RAN#52	R5-112862	0462	-	Introduction of new PMI test cases for UE-selected sub-band reporting for Rel-9	9.4.1	9.5.0
2011-06	RAN#52	R5-112863	0463	-	Addition of a new TC for FDD MBMS performance	9.4.1	9.5.0
2011-06	RAN#52	R5-112864	0464	-	Addition of a new TC for TDD MBMS performance	9.4.1	9.5.0
2011-06	RAN#52	R5-112866	0465	-	Addition of UE category 1 coverage for single-layer spatial multiplexing transmission on antenna port 7 or 8	9.4.1	9.5.0
2011-06	RAN#52	R5-112870	0466	-	Removal of square brackets in annex G.3.5 (Minimum test time, performance tests)	9.4.1	9.5.0
2011-06	RAN#52	R5-112871	0467	-	Update minimum requirements and test requirements for spatial multiplexing test cases	9.4.1	9.5.0
2011-06	RAN#52	R5-112873	0468	-	Test procedure change on few Rx test cases	9.4.1	9.5.0

History

Document history		
V9.0.0	June 2010	Publication
V9.1.0	June 2010	Publication
V9.2.0	November 2010	Publication
V9.3.0	January 2011	Publication
V9.4.1	July 2011	Publication
V9.5.0	September 2011	Publication