

ETSI TS 136 355 V13.2.0 (2016-10)



**LTE;
Evolved Universal Terrestrial Radio Access (E-UTRA);
LTE Positioning Protocol (LPP)
(3GPP TS 36.355 version 13.2.0 Release 13)**



Reference

RTS/TSGR-0236355vd20

Keywords

LTE

ETSI

650 Route des Lucioles
F-06921 Sophia Antipolis Cedex - FRANCE

Tel.: +33 4 92 94 42 00 Fax: +33 4 93 65 47 16

Siret N° 348 623 562 00017 - NAF 742 C
Association à but non lucratif enregistrée à la
Sous-Préfecture de Grasse (06) N° 7803/88

Important notice

The present document can be downloaded from:
<http://www.etsi.org/standards-search>

The present document may be made available in electronic versions and/or in print. The content of any electronic and/or print versions of the present document shall not be modified without the prior written authorization of ETSI. In case of any existing or perceived difference in contents between such versions and/or in print, the only prevailing document is the print of the Portable Document Format (PDF) version kept on a specific network drive within ETSI Secretariat.

Users of the present document should be aware that the document may be subject to revision or change of status. Information on the current status of this and other ETSI documents is available at
<https://portal.etsi.org/TB/ETSIDeliverableStatus.aspx>

If you find errors in the present document, please send your comment to one of the following services:
<https://portal.etsi.org/People/CommiteeSupportStaff.aspx>

Copyright Notification

No part may be reproduced or utilized in any form or by any means, electronic or mechanical, including photocopying and microfilm except as authorized by written permission of ETSI.

The content of the PDF version shall not be modified without the written authorization of ETSI.
The copyright and the foregoing restriction extend to reproduction in all media.

© European Telecommunications Standards Institute 2016.
All rights reserved.

DECT™, PLUGTESTS™, UMTS™ and the ETSI logo are Trade Marks of ETSI registered for the benefit of its Members.
3GPP™ and LTE™ are Trade Marks of ETSI registered for the benefit of its Members and of the 3GPP Organizational Partners.
GSM® and the GSM logo are Trade Marks registered and owned by the GSM Association.

Intellectual Property Rights

IPRs essential or potentially essential to the present document may have been declared to ETSI. The information pertaining to these essential IPRs, if any, is publicly available for **ETSI members and non-members**, and can be found in ETSI SR 000 314: *"Intellectual Property Rights (IPRs); Essential, or potentially Essential, IPRs notified to ETSI in respect of ETSI standards"*, which is available from the ETSI Secretariat. Latest updates are available on the ETSI Web server (<https://ipr.etsi.org>).

Pursuant to the ETSI IPR Policy, no investigation, including IPR searches, has been carried out by ETSI. No guarantee can be given as to the existence of other IPRs not referenced in ETSI SR 000 314 (or the updates on the ETSI Web server) which are, or may be, or may become, essential to the present document.

Foreword

This Technical Specification (TS) has been produced by ETSI 3rd Generation Partnership Project (3GPP).

The present document may refer to technical specifications or reports using their 3GPP identities, UMTS identities or GSM identities. These should be interpreted as being references to the corresponding ETSI deliverables.

The cross reference between GSM, UMTS, 3GPP and ETSI identities can be found under <http://webapp.etsi.org/key/queryform.asp>.

Modal verbs terminology

In the present document "**shall**", "**shall not**", "**should**", "**should not**", "**may**", "**need not**", "**will**", "**will not**", "**can**" and "**cannot**" are to be interpreted as described in clause 3.2 of the [ETSI Drafting Rules](#) (Verbal forms for the expression of provisions).

"**must**" and "**must not**" are **NOT** allowed in ETSI deliverables except when used in direct citation.

Contents

Intellectual Property Rights	2
Foreword.....	2
Modal verbs terminology.....	2
Foreword.....	9
1 Scope	10
2 References	10
3 Definitions and Abbreviations.....	11
3.1 Definitions	11
3.2 Abbreviations	11
4 Functionality of Protocol.....	13
4.1 General	13
4.1.1 LPP Configuration	13
4.1.2 LPP Sessions and Transactions.....	13
4.1.3 LPP Position Methods	14
4.1.4 LPP Messages	14
4.2 Common LPP Session Procedure	14
4.3 LPP Transport	15
4.3.1 Transport Layer Requirements	15
4.3.2 LPP Duplicate Detection	15
4.3.3 LPP Acknowledgement	16
4.3.3.1 General	16
4.3.3.2 Procedure related to Acknowledgement.....	16
4.3.4 LPP Retransmission.....	17
4.3.4.1 General	17
4.3.4.2 Procedure related to Retransmission	17
5 LPP Procedures	18
5.1 Procedures related to capability transfer	18
5.1.1 Capability Transfer procedure.....	18
5.1.2 Capability Indication procedure	18
5.1.3 Reception of LPP Request Capabilities.....	19
5.1.4 Transmission of LPP Provide Capabilities	19
5.2 Procedures related to Assistance Data Transfer.....	19
5.2.1 Assistance Data Transfer procedure	19
5.2.2 Assistance Data Delivery procedure	20
5.2.3 Transmission of LPP Request Assistance Data	20
5.2.4 Reception of LPP Provide Assistance Data	20
5.3 Procedures related to Location Information Transfer	20
5.3.1 Location Information Transfer procedure	21
5.3.2 Location Information Delivery procedure.....	21
5.3.3 Reception of Request Location Information	22
5.3.4 Transmission of Provide Location Information	22
5.4 Error Handling Procedures	22
5.4.1 General.....	22
5.4.2 Procedures related to Error Indication	22
5.4.3 LPP Error Detection.....	23
5.4.4 Reception of an LPP Error Message	23
5.5 Abort Procedure	23
5.5.1 General.....	23
5.5.2 Procedures related to Abort	24
5.5.3 Reception of an LPP Abort Message	24
6 Information Element Abstract Syntax Definition.....	24

6.1	General	24
6.2	LPP PDU Structure	25
-	LPP-PDU-Definitions	25
-	LPP-Message	25
-	LPP-MessageBody	26
-	LPP-TransactionID	26
6.3	Message Body IEs	27
-	RequestCapabilities	27
-	ProvideCapabilities	27
-	RequestAssistanceData	28
-	ProvideAssistanceData	28
-	RequestLocationInformation	29
-	ProvideLocationInformation	29
-	Abort	30
-	Error	30
6.4	Common IEs	30
6.4.1	Common Lower-Level IEs	31
-	AccessTypes	31
-	ARFCN-ValueEUTRA	31
-	ARFCN-ValueUTRA	31
-	CellGlobalIdEUTRA-AndUTRA	31
-	CellGlobalIdGERAN	32
-	ECGI	32
-	Ellipsoid-Point	32
-	Ellipsoid-PointWithUncertaintyCircle	33
-	EllipsoidPointWithUncertaintyEllipse	33
-	EllipsoidPointWithAltitude	33
-	EllipsoidPointWithAltitudeAndUncertaintyEllipsoid	33
-	EllipsoidArc	34
-	EPDU-Sequence	34
-	HorizontalVelocity	35
-	HorizontalWithVerticalVelocity	35
-	HorizontalVelocityWithUncertainty	35
-	HorizontalWithVerticalVelocityAndUncertainty	36
-	LocationCoordinateTypes	36
-	Polygon	36
-	PositioningModes	36
-	VelocityTypes	37
6.4.2	Common Positioning	37
-	CommonIEsRequestCapabilities	37
-	CommonIEsProvideCapabilities	37
-	CommonIEsRequestAssistanceData	37
-	CommonIEsProvideAssistanceData	38
-	CommonIEsRequestLocationInformation	38
-	CommonIEsProvideLocationInformation	41
-	CommonIEsAbort	42
-	CommonIEsError	42
6.5	Positioning Method IEs	43
6.5.1	OTDOA Positioning	43
6.5.1.1	OTDOA Assistance Data	43
-	OTDOA-ProvideAssistanceData	43
6.5.1.2	OTDOA Assistance Data Elements	43
-	OTDOA-ReferenceCellInfo	43
-	PRS-Info	44
-	OTDOA-NeighbourCellInfoList	45
6.5.1.3	OTDOA Assistance Data Request	47
-	OTDOA-RequestAssistanceData	47
6.5.1.4	OTDOA Location Information	48
-	OTDOA-ProvideLocationInformation	48
6.5.1.5	OTDOA Location Information Elements	48
-	OTDOA-SignalMeasurementInformation	48
-	OTDOA-MeasQuality	49

6.5.1.6	OTDOA Location Information Request.....	50
-	OTDOA-RequestLocationInformation	50
6.5.1.7	OTDOA Capability Information	50
-	OTDOA-ProvideCapabilities	50
6.5.1.8	OTDOA Capability Information Request	51
-	OTDOA-RequestCapabilities.....	51
6.5.1.9	OTDOA Error Elements	51
-	OTDOA-Error.....	51
-	OTDOA-LocationServerErrorCauses	52
-	OTDOA-TargetDeviceErrorCauses	52
6.5.2	A-GNSS Positioning.....	52
6.5.2.1	GNSS Assistance Data.....	52
-	A-GNSS-ProvideAssistanceData	52
-	GNSS-CommonAssistData	53
-	GNSS-GenericAssistData	53
6.5.2.2	GNSS Assistance Data Elements	53
-	GNSS-ReferenceTime.....	53
-	GNSS-SystemTime	55
-	GPS-TOW-Assist.....	55
-	NetworkTime	56
-	GNSS-ReferenceLocation	57
-	GNSS-IonosphericModel	58
-	KlobucharModelParameter	58
-	NeQuickModelParameter.....	59
-	GNSS-EarthOrientationParameters.....	59
-	GNSS-TimeModelList	60
-	GNSS-DifferentialCorrections	61
-	GNSS-NavigationModel	63
-	StandardClockModelList	65
-	NAV-ClockModel.....	66
-	CNAV-ClockModel	66
-	GLONASS-ClockModel	67
-	SBAS-ClockModel	68
-	BDS-ClockModel.....	68
-	NavModelKeplerianSet.....	69
-	NavModelNAV-KeplerianSet.....	70
-	NavModelCNAV-KeplerianSet	71
-	NavModel-GLONASS-ECEF.....	73
-	NavModel-SBAS-ECEF	74
-	NavModel-BDS-KeplerianSet	75
-	GNSS-RealTimeIntegrity.....	76
-	GNSS-DataBitAssistance.....	77
-	GNSS-AcquisitionAssistance.....	78
-	GNSS-Almanac.....	81
-	AlmanacKeplerianSet	82
-	AlmanacNAV-KeplerianSet.....	83
-	AlmanacReducedKeplerianSet.....	84
-	AlmanacMidiAlmanacSet	85
-	AlmanacGLONASS-AlmanacSet	86
-	AlmanacECEF-SBAS-AlmanacSet.....	87
-	AlmanacBDS-AlmanacSet.....	88
-	GNSS-UTC-Model	89
-	UTC-ModelSet1	89
-	UTC-ModelSet2.....	90
-	UTC-ModelSet3	91
-	UTC-ModelSet4.....	91
-	UTC-ModelSet5.....	92
-	GNSS-AuxiliaryInformation	93
-	BDS-DifferentialCorrections	94
-	BDS-GridModelParameter.....	95
6.5.2.3	GNSS Assistance Data Request	95
-	A-GNSS-RequestAssistanceData.....	95

–	GNSS-CommonAssistDataReq.....	96
–	GNSS-GenericAssistDataReq.....	96
6.5.2.4	GNSS Assistance Data Request Elements	97
–	GNSS-ReferenceTimeReq.....	97
–	GNSS-ReferenceLocationReq.....	97
–	GNSS-IonosphericModelReq.....	98
–	GNSS-EarthOrientationParametersReq.....	98
–	GNSS-TimeModelListReq.....	98
–	GNSS-DifferentialCorrectionsReq.....	99
–	GNSS-NavigationModelReq.....	99
–	GNSS-RealTimeIntegrityReq.....	101
–	GNSS-DataBitAssistanceReq.....	101
–	GNSS-AcquisitionAssistanceReq.....	102
–	GNSS-AlmanacReq.....	102
–	GNSS-UTC-ModelReq.....	102
–	GNSS-AuxiliaryInformationReq.....	103
–	BDS-DifferentialCorrectionsReq.....	103
–	BDS-GridModelReq.....	103
6.5.2.5	GNSS Location Information	104
–	A-GNSS-ProvideLocationInformation.....	104
6.5.2.6	GNSS Location Information Elements.....	104
–	GNSS-SignalMeasurementInformation.....	104
–	MeasurementReferenceTime.....	104
–	GNSS-MeasurementList.....	106
–	GNSS-LocationInformation.....	109
6.5.2.7	GNSS Location Information Request.....	110
–	A-GNSS-RequestLocationInformation.....	110
6.5.2.8	GNSS Location Information Request Elements.....	110
–	GNSS-PositioningInstructions.....	110
6.5.2.9	GNSS Capability Information.....	111
–	A-GNSS-ProvideCapabilities.....	111
6.5.2.10	GNSS Capability Information Elements.....	112
–	GNSS-CommonAssistanceDataSupport.....	112
–	GNSS-ReferenceTimeSupport.....	113
–	GNSS-ReferenceLocationSupport.....	113
–	GNSS-IonosphericModelSupport.....	113
–	GNSS-EarthOrientationParametersSupport.....	113
–	GNSS-GenericAssistanceDataSupport.....	114
–	GNSS-TimeModelListSupport.....	115
–	GNSS-DifferentialCorrectionSupport.....	115
–	GNSS-NavigationModelSupport.....	115
–	GNSS-RealTimeIntegritySupport.....	116
–	GNSS-DataBitAssistanceSupport.....	116
–	GNSS-AcquisitionAssistanceSupport.....	116
–	GNSS-AlmanacSupport.....	117
–	GNSS-UTC-ModelSupport.....	117
–	GNSS-AuxiliaryInformationSupport.....	117
–	BDS-DifferentialCorrectionsSupport.....	118
–	BDS-GridModelSupport.....	118
6.5.2.11	GNSS Capability Information Request.....	118
–	A-GNSS-RequestCapabilities.....	118
6.5.2.12	GNSS Error Elements.....	119
–	A-GNSS-Error.....	119
–	GNSS-LocationServerErrorCauses.....	119
–	GNSS-TargetDeviceErrorCauses.....	119
6.5.2.13	Common GNSS Information Elements.....	120
–	GNSS-ID.....	120
–	GNSS-ID-Bitmap.....	120
–	GNSS-SignalID.....	120
–	GNSS-SignalIDs.....	121
–	SBAS-ID.....	122
–	SBAS-IDs.....	122

–	SV-ID	122
6.5.3	Enhanced Cell ID Positioning	123
6.5.3.1	E-CID Location Information	123
–	ECID-ProvideLocationInformation	123
6.5.3.2	E-CID Location Information Elements	123
–	ECID-SignalMeasurementInformation	123
6.5.3.3	E-CID Location Information Request	124
–	ECID-RequestLocationInformation	124
6.5.3.4	E-CID Capability Information	125
–	ECID-ProvideCapabilities	125
6.5.3.5	E-CID Capability Information Request	125
–	ECID-RequestCapabilities	125
6.5.3.6	E-CID Error Elements	125
–	ECID-Error	125
–	ECID-LocationServerErrorCauses	126
–	ECID-TargetDeviceErrorCauses	126
6.5.4	Terrestrial Beacon System Positioning	126
6.5.4.1	TBS Location Information	126
–	TBS-ProvideLocationInformation	126
6.5.4.2	TBS Location Information Elements	127
–	TBS-MeasurementInformation	127
–	MBS-BeaconMeasList	127
6.5.4.3	TBS Location Information Request	128
–	TBS-RequestLocationInformation	128
6.5.4.4	TBS Capability Information	128
–	TBS-ProvideCapabilities	128
6.5.4.5	TBS Capability Information Request	128
–	TBS-RequestCapabilities	128
6.5.4.6	TBS Error Elements	129
–	TBS-Error	129
–	TBS-LocationServerErrorCauses	129
–	TBS-TargetDeviceErrorCauses	129
6.5.5	Sensor based Positioning	130
6.5.5.1	Sensor Location Information	130
–	Sensor-ProvideLocationInformation	130
6.5.5.2	Sensor Location Information Elements	130
–	Sensor-MeasurementInformation	130
6.5.5.3	Sensor Location Information Request	130
–	Sensor-RequestLocationInformation	130
6.5.5.4	Sensor Capability Information	131
–	Sensor-ProvideCapabilities	131
6.5.5.5	Sensor Capability Information Request	131
–	Sensor-RequestCapabilities	131
6.5.5.6	Sensor Error Elements	131
–	Sensor-Error	131
–	Sensor-LocationServerErrorCauses	132
–	Sensor-TargetDeviceErrorCauses	132
6.5.6	WLAN-based Positioning	132
6.5.6.1	WLAN Location Information	132
–	WLAN-ProvideLocationInformation	132
6.5.6.2	WLAN Location Information Elements	132
–	WLAN-MeasurementInformation	132
6.5.6.3	WLAN Location Information Request	134
–	WLAN-RequestLocationInformation	134
6.5.6.4	WLAN Capability Information	134
–	WLAN-ProvideCapabilities	134
6.5.6.5	WLAN Capability Information Request	135
–	WLAN-RequestCapabilities	135
6.5.6.6	WLAN Error Elements	135
–	WLAN-Error	135
–	WLAN-LocationServerErrorCauses	135
–	WLAN-TargetDeviceErrorCauses	135

6.5.7	Bluetooth-based Positioning	136
6.5.7.1	Bluetooth Location Information	136
–	BT-ProvideLocationInformation	136
6.5.7.2	BT Location Information Elements	136
–	BT-MeasurementInformation	136
6.5.7.3	Bluetooth Location Information Request	137
–	BT-RequestLocationInformation	137
6.5.7.4	Bluetooth Capability Information	137
–	BT-ProvideCapabilities	137
6.5.7.5	Bluetooth Capability Information Request	137
–	BT-RequestCapabilities	137
6.5.7.6	BT Error Elements	138
–	BT-Error	138
–	BT-LocationServerErrorCauses	138
–	BT-TargetDeviceErrorCauses	138
–	End of LPP-PDU-Definitions	139
Annex A (informative): Change History		140
History		142

Foreword

This Technical Specification has been produced by the 3rd Generation Partnership Project (3GPP).

The contents of the present document are subject to continuing work within the TSG and may change following formal TSG approval. Should the TSG modify the contents of the present document, it will be re-released by the TSG with an identifying change of release date and an increase in version number as follows:

Version x.y.z

where:

- x the first digit:
 - 1 presented to TSG for information;
 - 2 presented to TSG for approval;
 - 3 or greater indicates TSG approved document under change control.
- y the second digit is incremented for all changes of substance, i.e. technical enhancements, corrections, updates, etc.
- z the third digit is incremented when editorial only changes have been incorporated in the document.

1 Scope

The present document contains the definition of the LTE Positioning Protocol (LPP).

2 References

The following documents contain provisions which, through reference in this text, constitute provisions of the present document.

- References are either specific (identified by date of publication, edition number, version number, etc.) or non-specific.
- For a specific reference, subsequent revisions do not apply.
- For a non-specific reference, the latest version applies. In the case of a reference to a 3GPP document (including a GSM document), a non-specific reference implicitly refers to the latest version of that document *in the same Release as the present document*.

- [1] 3GPP TR 21.905: "Vocabulary for 3GPP Specifications".
- [2] 3GPP TS 36.305: "Stage 2 functional specification of User Equipment (UE) positioning in E-UTRAN".
- [3] 3GPP TS 23.271: "Functional stage 2 description of Location Services (LCS)".
- [4] IS-GPS-200, Revision D, Navstar GPS Space Segment/Navigation User Interfaces, March 7th, 2006.
- [5] IS-GPS-705, Navstar GPS Space Segment/User Segment L5 Interfaces, September 22, 2005.
- [6] IS-GPS-800, Navstar GPS Space Segment/User Segment L1C Interfaces, September 4, 2008.
- [7] IS-QZSS, Quasi Zenith Satellite System Navigation Service Interface Specifications for QZSS, Ver.1.1, July 31, 2009.
- [8] Galileo OS Signal in Space ICD (OS SIS ICD), Issue 1.2, February 2014, European Union.
- [9] Global Navigation Satellite System GLONASS Interface Control Document, Version 5.1, 2008.
- [10] Specification for the Wide Area Augmentation System (WAAS), US Department of Transportation, Federal Aviation Administration, DTFA01-96-C-00025, 2001.
- [11] RTCM-SC104, RTCM Recommended Standards for Differential GNSS Service (v.2.3), August 20, 2001.
- [12] 3GPP TS 36.331: "Evolved Universal Terrestrial Radio Access (E-UTRA); Radio Resource Control (RRC); Protocol specification".
- [13] 3GPP TS 25.331: "Radio Resource Control (RRC); Protocol Specification".
- [14] 3GPP TS 44.031: "Location Services (LCS); Mobile Station (MS) - Serving Mobile Location Centre (SMLC) Radio Resource LCS Protocol (RRLP)".
- [15] 3GPP TS 23.032: "Universal Geographical Area Description (GAD)".
- [16] 3GPP TS 36.211: "Evolved Universal Terrestrial Radio Access (E-UTRA); Physical Channels and Modulation".
- [17] 3GPP TS 36.214: "Evolved Universal Terrestrial Radio Access (E-UTRA); Physical layer – Measurements".

- [18] 3GPP TS 36.133: "Evolved Universal Terrestrial Radio Access (E-UTRA); Requirements for support of radio resource management".
- [19] 3GPP TS 23.003: "Numbering, addressing and identification".
- [20] OMA-TS-LPPe-V1_0, LPP Extensions Specification, Open Mobile Alliance.
- [21] 3GPP TS 36.101: "Evolved Universal Terrestrial Radio Access (E-UTRA); User Equipment (UE) radio transmission and reception".
- [22] ITU-T Recommendation X.691 (07/2002) "Information technology - ASN.1 encoding rules: Specification of Packed Encoding Rules (PER)" (Same as the ISO/IEC International Standard 8825-2).
- [23] BDS-SIS-ICD-2.0: "BeiDou Navigation Satellite System Signal In Space Interface Control Document Open Service Signal (Version 2.0)", December 2013.
- [24] ATIS-0500027: "Recommendations for Establishing Wide Scale Indoor Location Performance", May 2015.
- [25] Bluetooth Special Interest Group: "Bluetooth Core Specification v4.2", December 2014.
- [26] IEEE 802.11, Part 11: "Wireless LAN Medium Access Control (MAC) and Physical Layer (PHY) Specifications".

3 Definitions and Abbreviations

3.1 Definitions

For the purposes of the present document, the terms and definitions given in [1], [2] and [3] apply. Other definitions are provided below.

Location Server: a physical or logical entity (e.g., E-SMLC or SUPL SLP) that manages positioning for a target device by obtaining measurements and other location information from one or more positioning units and providing assistance data to positioning units to help determine this. A Location Server may also compute or verify the final location estimate.

Reference Source: a physical entity or part of a physical entity that provides signals (e.g., RF, acoustic, infra-red) that can be measured (e.g., by a Target Device) in order to obtain the location of a Target Device.

Target Device: the device that is being positioned (e.g., UE or SUPL SET).

Observed Time Difference Of Arrival (OTDOA): The time interval that is observed by a target device between the reception of downlink signals from two different cells. If a signal from cell 1 is received at the moment t_1 , and a signal from cell 2 is received at the moment t_2 , the OTDOA is $t_2 - t_1$.

3.2 Abbreviations

For the purposes of the present document, the following abbreviations apply.

ADR	Accumulated Delta-Range
A-GNSS	Assisted-GNSS
AP	Access Point
ARFCN	Absolute Radio Frequency Channel Number
BDS	BeiDou Navigation Satellite System
BTS	Base Transceiver Station (GERAN)
CID	Cell-ID (positioning method)
CNAV	Civil Navigation
CRS	Cell-specific Reference Signals

ECEF	Earth-Centered, Earth-Fixed
ECGI	Evolved Cell Global Identifier
ECI	Earth-Centered-Inertial
E-CID	Enhanced Cell-ID (positioning method)
EGNOS	European Geostationary Navigation Overlay Service
E-SMLC	Enhanced Serving Mobile Location Centre
E-UTRAN	Evolved Universal Terrestrial Radio Access Network
EOP	Earth Orientation Parameters
EPDU	External Protocol Data Unit
FDMA	Frequency Division Multiple Access
FEC	Forward Error Correction
FTA	Fine Time Assistance
GAGAN	GPS Aided Geo Augmented Navigation
GLONASS	GLOBAL'naya NAVigatsionnaya Sputnikovaya Sistema (Engl.: Global Navigation Satellite System)
GNSS	Global Navigation Satellite System
GPS	Global Positioning System
ICD	Interface Control Document
IOD	Issue of Data
IS	Interface Specification
LPP	LTE Positioning Protocol
LPPa	LTE Positioning Protocol Annex
LSB	Least Significant Bit
MBS	Metropolitan Beacon System
MO-LR	Mobile Originated Location Request
MSAS	Multi-functional Satellite Augmentation System
MSB	Most Significant Bit
msd	mean solar day
MT-LR	Mobile Terminated Location Request
NAV	Navigation
NICT	National Institute of Information and Communications Technology
NI-LR	Network Induced Location Request
NTSC	National Time Service Center of Chinese Academy of Sciences
OTDOA	Observed Time Difference Of Arrival
PDU	Protocol Data Unit
PRC	Pseudo-Range Correction
PRS	Positioning Reference Signals
PZ-90	Parametry Zemli 1990 Goda – Parameters of the Earth Year 1990
QZS	Quasi Zenith Satellite
QZSS	Quasi-Zenith Satellite System
QZST	Quasi-Zenith System Time
RF	Radio Frequency
RRC	Range-Rate Correction Radio Resource Control
RSRP	Reference Signal Received Power
RSRQ	Reference Signal Received Quality
RSTD	Reference Signal Time Difference
RU	Russia
SBAS	Space Based Augmentation System
SET	SUPL Enabled Terminal
SFN	System Frame Number
SLP	SUPL Location Platform
SUPL	Secure User Plane Location
SV	Space Vehicle
TBS	Terrestrial Beacon System
TLM	Telemetry
TOD	Time Of Day
TOW	Time Of Week
UDRE	User Differential Range Error
ULP	User Plane Location Protocol
USNO	US Naval Observatory
UT1	Universal Time No.1
UTC	Coordinated Universal Time

WAAS	Wide Area Augmentation System
WGS-84	World Geodetic System 1984
WLAN	Wireless Local Area Network

4 Functionality of Protocol

4.1 General

4.1.1 LPP Configuration

LPP is used point-to-point between a location server (E-SMLC or SLP) and a target device (UE or SET) in order to position the target device using position-related measurements obtained by one or more reference sources. Figure 4.1.1-1 shows the configuration as applied to the control- and user-plane location solutions for E-UTRAN (as defined in [2] and [3]).

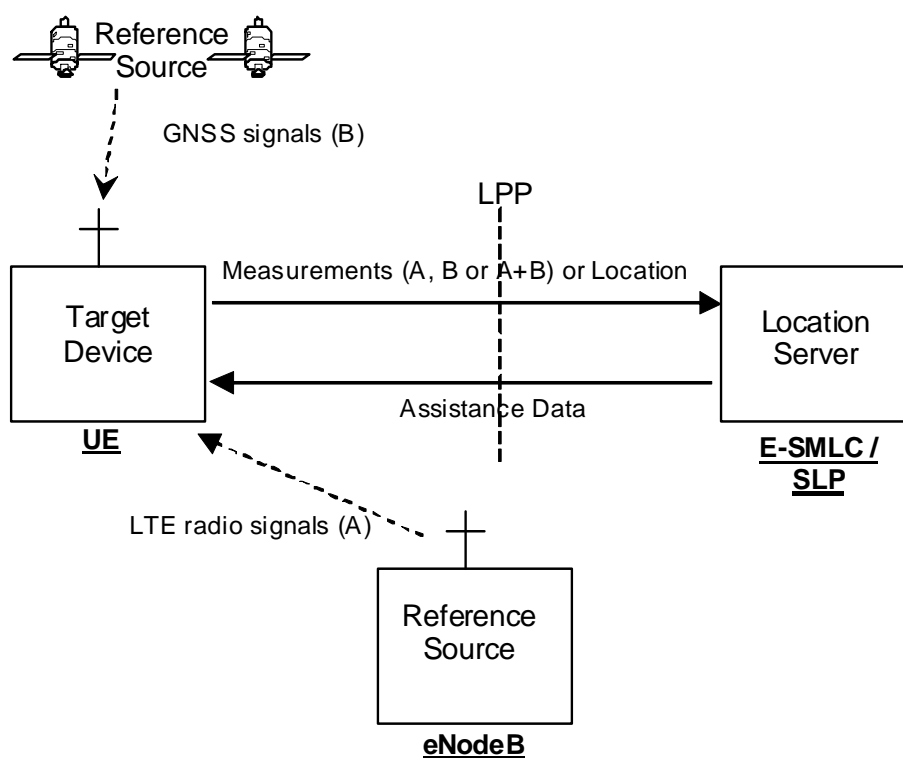

Figure 4.1.1-1: LPP Configuration for Control- and User-Plane Positioning in E-UTRAN

4.1.2 LPP Sessions and Transactions

An LPP session is used between a Location Server and the target device in order to obtain location related measurements or a location estimate or to transfer assistance data. A single LPP session is used to support a single location request (e.g., for a single MT-LR, MO-LR or NI-LR). Multiple LPP sessions can be used between the same endpoints to support multiple different location requests (as required by [3]). Each LPP session comprises one or more LPP transactions, with each LPP transaction performing a single operation (capability exchange, assistance data transfer, or location information transfer). In E-UTRAN the LPP transactions are realized as LPP procedures. The instigator of an LPP session will always instigate the first LPP transaction, but subsequent transactions may be instigated by either end. LPP transactions within a session may occur serially or in parallel. LPP transactions are indicated at the LPP protocol level with a transaction ID in order to associate messages with one another (e.g., request and response).

Messages within a transaction are linked by a common transaction identifier.

4.1.3 LPP Position Methods

Internal LPP positioning methods and associated signalling content are defined in this specification.

This version of the specification defines OTDOA, A-GNSS, E-CID, Barometric Sensor, TBS, WLAN, and Bluetooth positioning methods.

Editor's Note: Value ranges may need confirmation with RAN4.

4.1.4 LPP Messages

Each LPP transaction involves the exchange of one or more LPP messages between the location server and the target device. The general format of an LPP message consists of a set of common fields followed by a body. The body (which may be empty) contains information specific to a particular message type. Each message type contains information specific to one or more positioning methods and/or information common to all positioning methods.

The common fields are as follows:

Field	Role
Transaction ID	Identify messages belonging to the same transaction
Transaction End Flag	Indicate when a transaction (e.g. one with periodic responses) has ended
Sequence Number	Enable detection of a duplicate LPP message at a receiver
Acknowledgement	Enable an acknowledgement to be requested and/or returned for any LPP message

NOTE: Use of the Transaction ID and Transaction End fields conform to the procedures in clause 5 and are independent of the means used to transport LPP messages (e.g., whether using a NAS MO-LR Request, NAS Generic Transport or user-plane solution).

The following message types are defined:

- Request Capabilities;
- Provide Capabilities;
- Request Assistance Data;
- Provide Assistance Data;
- Request Location Information;
- Provide Location Information;
- Abort;
- Error.

4.2 Common LPP Session Procedure

The purpose of this procedure is to support an LPP session comprising a sequence of LPP transactions. The procedure is described in Figure 4.2-1.

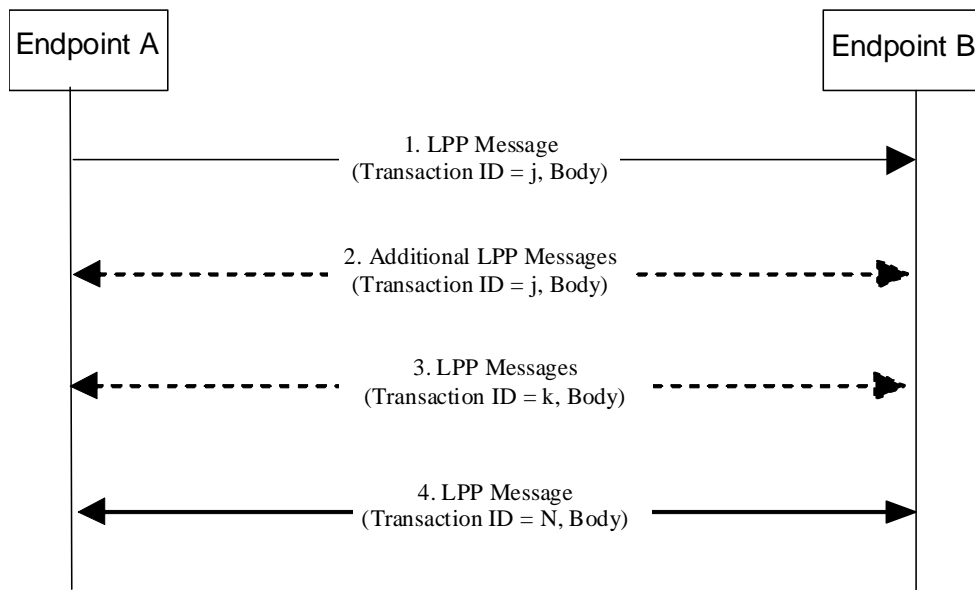

Figure 4.2-1 LPP Session Procedure

1. Endpoint A, which may be either the target or the server, initiates an LPP session by sending an LPP message for an initial LPP transaction j to the other endpoint B (which has an opposite role to A).
2. Endpoints A and B may exchange further messages to continue the transaction started in step 1.
3. Either endpoint may instigate further transactions by sending additional LPP messages.
4. A session is terminated by a final transaction N in which LPP messages will be exchanged between the two endpoints.

Within each transaction, all constituent messages shall contain the same transaction identifier. The last message sent in each transaction shall have the IE *endTransaction* set to TRUE. Transactions that occur in parallel shall use different transaction IDs; transaction IDs for completed transactions may be reused at any time after the final message of the previous transaction with the same ID is known to have been received.

4.3 LPP Transport

4.3.1 Transport Layer Requirements

LPP requires reliable, in-sequence delivery of LPP messages from the underlying transport layers. This section describes the transport capabilities that are available within LPP. A UE implementing LPP for the control-plane solution shall support LPP reliable transport (including all three of duplicate detection, acknowledgement, and retransmission).

LPP reliable transport functionality is not used in the user-plane solution.

The following requirements in subclauses 4.3.2, 4.3.3, and 4.3.4 for LPP reliable transport apply only when the capability is supported.

4.3.2 LPP Duplicate Detection

A sender shall include a sequence number in all LPP messages sent for a particular location session. The sequence number shall be distinct for different LPP messages sent in the same direction in the same location session (e.g., may start at zero in the first LPP message and increase monotonically in each succeeding LPP message). Sequence numbers used in the uplink and downlink are independent (e.g., can be the same).

A receiver shall record the most recent received sequence number for each location session. If a message is received carrying the same sequence number as that last received for the associated location session, it shall be discarded. Otherwise (i.e., if the sequence number is different or if no sequence number was previously received or if no sequence number is included), the message shall be processed.

Sending and receiving sequence numbers shall be deleted in a server when the associated location session is terminated and shall be deleted in a target device when there has been no activity for a particular location session for 10 minutes.

NOTE: For LPP control-plane use, a target device can be aware of a location session from information provided at the NAS level for downlink transport of an LPP message.

4.3.3 LPP Acknowledgement

4.3.3.1 General

Each LPP message may carry an acknowledgement request and/or an acknowledgement indicator. A LPP message including an acknowledgement request (i.e., that include the IE *ackRequested* set to TRUE) shall also include a sequence number. Upon reception of an LPP message which includes the IE *ackRequested* set to TRUE, a receiver returns an LPP message with an acknowledgement response (i.e., that includes the *ackIndicator* IE set to the same sequence number of the message being acknowledged). An acknowledgement response may contain no LPP message body (in which case only the sequence number being acknowledged is significant); alternatively, the acknowledgement may be sent in an LPP message along with an LPP message body. An acknowledgement is returned for each received LPP message that requested an acknowledgement including any duplicate(s). Once a sender receives an acknowledgement for an LPP message, and provided any included sequence number is matching, it is permitted to send the next LPP message. No message reordering is needed at the receiver since this stop-and-wait method of sending ensures that messages normally arrive in the correct order.

When an LPP message is transported via a NAS MO-LR request, the message does not request an acknowledgement.

4.3.3.2 Procedure related to Acknowledgement

Figure 4.3.3.2-1 shows the procedure related to acknowledgement.

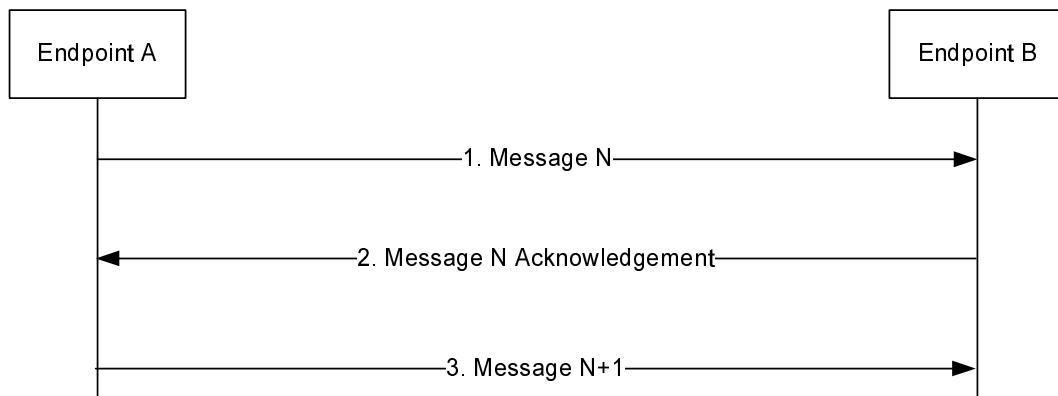

Figure 4.3.3.2-1: LPP Acknowledgement procedure

1. Endpoint A sends an LPP message *N* to Endpoint B which includes the IE *ackRequested* set to TRUE and a sequence number.
2. If LPP message *N* is received and Endpoint B is able to decode the *ackRequested* value and sequence number, Endpoint B shall return an acknowledgement for message *N*. The acknowledgement shall contain the IE *ackIndicator* set to the same sequence number as that in message *N*.
3. When the acknowledgement for LPP message *N* is received and provided the included *ackIndicator* IE matches the sequence number sent in message *N*, Endpoint A sends the next LPP message *N+1* to Endpoint B when this message is available.

4.3.4 LPP Retransmission

4.3.4.1 General

This capability builds on the acknowledgement and duplicate detection capabilities. When an LPP message which requires acknowledgement is sent and not acknowledged, it is resent by the sender following a timeout period up to three times. If still unacknowledged after that, the sender aborts all LPP activity for the associated session. The timeout period is determined by the sender implementation but shall not be less than a minimum value of 250ms.

4.3.4.2 Procedure related to Retransmission

Figure 4.3.4.2-1 shows the procedure related to retransmission when combined with acknowledgement and duplicate detection.

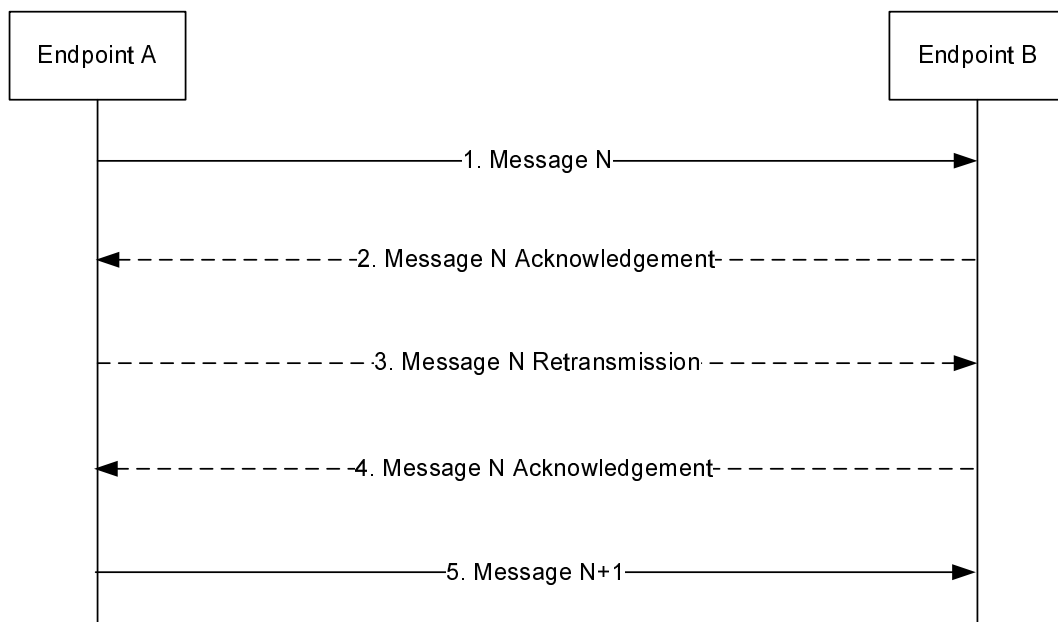

Figure 4.3.4.2-1: LPP Retransmission procedure

1. Endpoint A sends an LPP message N to Endpoint B for a particular location session and includes a request for acknowledgement along with a sequence number.
2. If LPP message N is received and Endpoint B is able to decode the *ackRequested* value and sequence number (regardless of whether the message body can be correctly decoded), Endpoint B shall return an acknowledgement for message N . If the acknowledgement is received by Endpoint A (such that the acknowledged message can be identified and sequence numbers are matching), Endpoint A skips steps 3 and 4.
3. If the acknowledgement in step 2 is not received after a timeout period, Endpoint A shall retransmit LPP message N and shall include the same sequence number as in step 1.
4. If LPP message N in step 3 is received and Endpoint B is able to decode the *ackRequested* value and sequence number (regardless of whether the message body can be correctly decoded and whether or not the message is considered a duplicate), Endpoint B shall return an acknowledgement. Steps 3 may be repeated one or more times if the acknowledgement in step 4 is not received after a timeout period by Endpoint A. If the acknowledgement in step 4 is still not received after sending three retransmissions, Endpoint A shall abort all procedures and activity associated with LPP support for the particular location session.
5. Once an acknowledgement in step 2 or step 4 is received, Endpoint A sends the next LPP message $N+1$ for the location session to Endpoint B when this message is available.

5 LPP Procedures

5.1 Procedures related to capability transfer

The purpose of the procedures that are grouped together in this section is to enable the transfer of capabilities from the target device to the server. Capabilities in this context refer to positioning and protocol capabilities related to LPP and the positioning methods supported by LPP.

These procedures instantiate the Capability Transfer transaction from 3GPP TS 36.305 [2].

5.1.1 Capability Transfer procedure

The Capability Transfer procedure is shown in Figure 5.1.1-1.

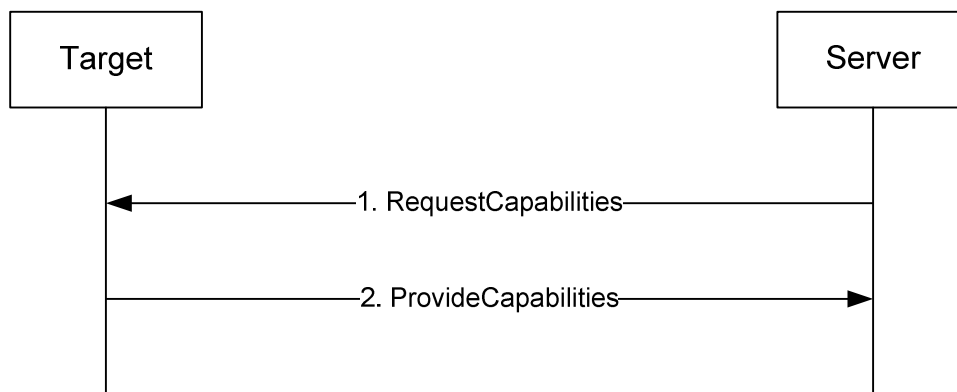

Figure 5.1.1-1: LPP Capability Transfer procedure

1. The server sends a *RequestCapabilities* message to the target. The server may indicate the types of capability needed.
2. The target responds with a *ProvideCapabilities* message to the server. The capabilities shall correspond to any capability types specified in step 1. This message shall include the *endTransaction* IE set to TRUE.

5.1.2 Capability Indication procedure

The Capability Indication procedure allows the target to provide unsolicited capabilities to the server and is shown in Figure 5.1.2-1.

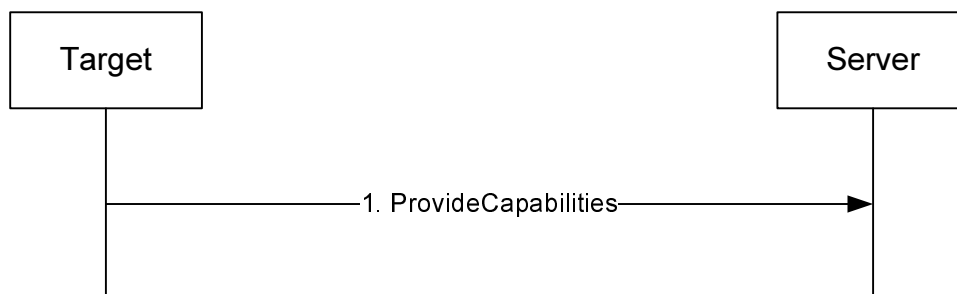

Figure 5.1.2-1: LPP Capability Indication procedure

1. The target sends a *ProvideCapabilities* message to the server. This message shall include the *endTransaction* IE set to TRUE.

5.1.3 Reception of LPP Request Capabilities

Upon receiving a *RequestCapabilities* message, the target device shall generate a *ProvideCapabilities* message as a response.

The target device shall:

- 1> for each positioning method for which a request for capabilities is included in the message:
 - 2> if the target device supports this positioning method:
 - 3> include the capabilities of the device for that supported positioning method in the response message;
- 1> set the IE *LPP-TransactionID* in the response message to the same value as the IE *LPP-TransactionID* in the received message;
- 1> deliver the response message to lower layers for transmission.

5.1.4 Transmission of LPP Provide Capabilities

When triggered to transmit a *ProvideCapabilities* message, the target device shall:

- 1> for each positioning method whose capabilities are to be indicated:
 - 2> set the corresponding IE to include the device"s capabilities;
 - 2> if OTDOA capabilities are to be indicated:
 - 3> include the IE *supportedBandListEUTRA*;
- 1> deliver the response to lower layers for transmission.

5.2 Procedures related to Assistance Data Transfer

The purpose of the procedures in this section is to enable the target to request assistance data from the server to assist in positioning, and to enable the server to transfer assistance data to the target in the absence of a request.

These procedures instantiate the Assistance Data Transfer transaction from 3GPP TS 36.305 [2].

5.2.1 Assistance Data Transfer procedure

The Assistance Data Transfer procedure is shown in Figure 5.2.1-1.

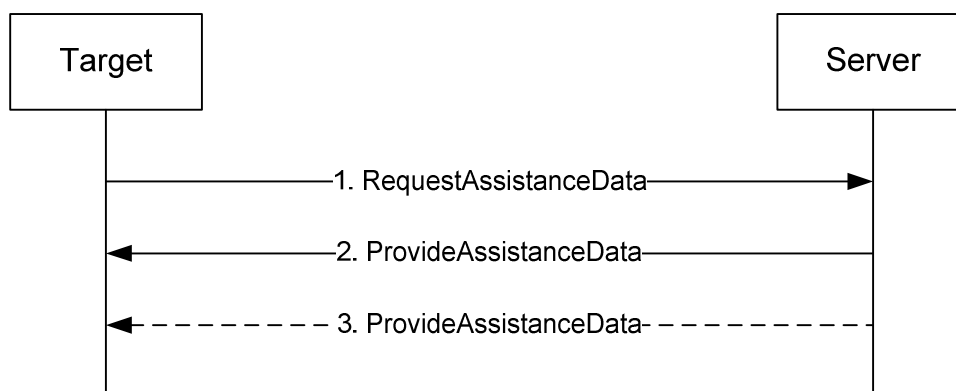

Figure 5.2.1-1: LPP Assistance data transfer procedure

1. The target sends a *RequestAssistanceData* message to the server.
2. The server responds with a *ProvideAssistanceData* message to the target containing assistance data. The transferred assistance data should match or be a subset of the assistance data requested in step 1. The server may

also provide any not requested information that it considers useful to the target . If step 3 does not occur, this message shall set the *endTransaction* IE to TRUE.

3. The server may transmit one or more additional *ProvideAssistanceData* messages to the target containing further assistance data. The transferred assistance data should match or be a subset of the assistance data requested in step 1. The server may also provide any not requested information that it considers useful to the target. The last message shall include the *endTransaction* IE set to TRUE.

5.2.2 Assistance Data Delivery procedure

The Assistance Data Delivery procedure allows the server to provide unsolicited assistance data to the target and is shown in Figure 5.2.2-1.

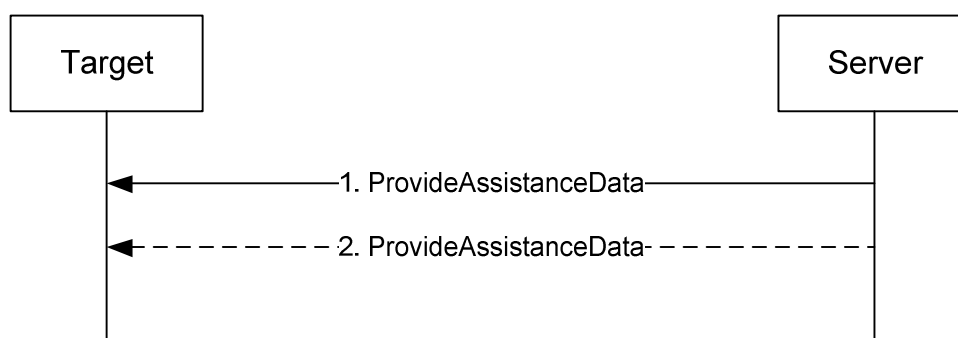

Figure 5.2.2-1: LPP Assistance data transfer procedure

1. The server sends a *ProvideAssistanceData* message to the target containing assistance data. If step 2 does not occur, this message shall set the *endTransaction* IE to TRUE.
2. The server may transmit one or more additional *ProvideAssistanceData* messages to the target containing additional assistance data. The last message shall include the *endTransaction* IE set to TRUE.

5.2.3 Transmission of LPP Request Assistance Data

When triggered to transmit a *RequestAssistanceData* message, the target device shall:

- 1> set the IEs for the positioning-method-specific request for assistance data to request the data indicated by upper layers.

5.2.4 Reception of LPP Provide Assistance Data

Upon receiving a *ProvideAssistanceData* message, the target device shall:

- 1> for each positioning method contained in the message:
 - 2> deliver the related assistance data to upper layers.

5.3 Procedures related to Location Information Transfer

The purpose of the procedures in this section is to enable the server to request location measurement data and/or a location estimate from the target, and to enable the target to transfer location measurement data and/or a location estimate to a server in the absence of a request.

These procedures instantiate the Location Information Transfer transaction in 3GPP TS 36.305 [2].

NOTE: The service layer (e.g. NAS or OMA SUPL ULP) would be used to transfer information associated with a location request from a target to a server (MO-LR).

5.3.1 Location Information Transfer procedure

The Location Information Transfer procedure is shown in Figure 5.3.1-1.

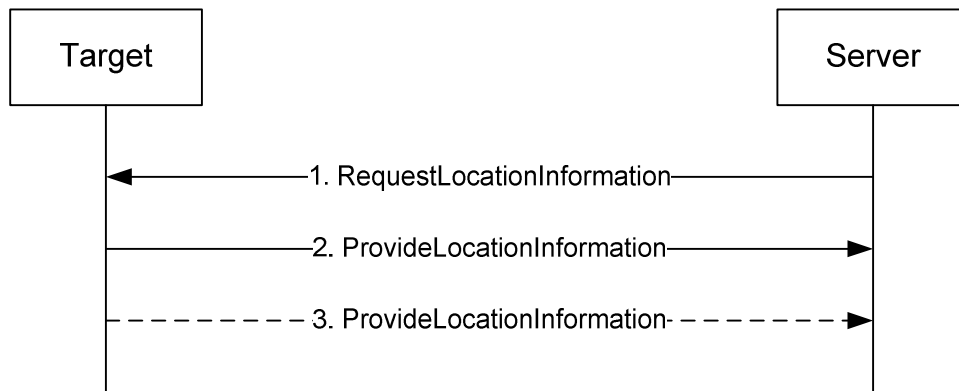

Figure 5.3.1-1: LPP Location Information transfer procedure

1. The server sends a *RequestLocationInformation* message to the target to request location information, indicating the type of location information needed and potentially the associated QoS.
2. The target sends a *ProvideLocationInformation* message to the server to transfer location information. The location information transferred should match or be a subset of the location information requested in step 1 unless the server explicitly allows additional location information. If step 3 does not occur, this message shall set the *endTransaction* IE to TRUE.
3. If requested in step 1, the target sends additional *ProvideLocationInformation* messages to the server to transfer location information. The location information transferred should match or be a subset of the location information requested in step 1 unless the server explicitly allows additional location information. The last message shall include the *endTransaction* IE set to TRUE.

5.3.2 Location Information Delivery procedure

The Location Information Delivery allows the target to provide unsolicited location information to the server. The procedure is shown in Figure 5.3.2-1.

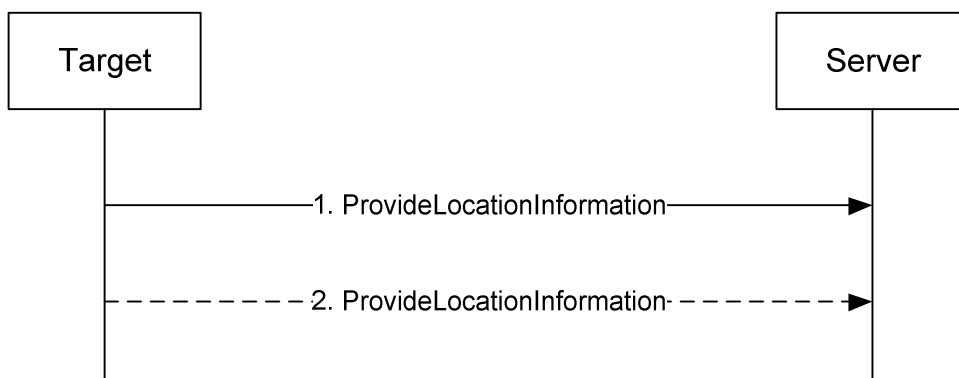

Figure 5.3.2-1: LPP Location Information Delivery procedure

1. The target sends a *ProvideLocationInformation* message to the server to transfer location information. If step 2 does not occur, this message shall set the *endTransaction* IE to TRUE.

2. The target may send one or more additional *ProvideLocationInformation* messages to the server containing additional location information data. The last message shall include the *endTransaction* IE set to TRUE.

5.3.3 Reception of Request Location Information

Upon receiving a *RequestLocationInformation* message, the target device shall:

- 1> if the requested information is compatible with the target device capabilities and configuration:
 - 2> include the requested information in a *ProvideLocationInformation* message;
 - 2> set the IE *LPP-TransactionID* in the response to the same value as the IE *LPP-TransactionID* in the received message;
 - 2> deliver the *ProvideLocationInformation* message to lower layers for transmission.
- 1> otherwise:
 - 2> if one or more positioning methods are included that the target device does not support:
 - 3> continue to process the message as if it contained only information for the supported positioning methods;
 - 3> handle the signaling content of the unsupported positioning methods by LPP error detection as in 5.4.3.

5.3.4 Transmission of Provide Location Information

When triggered to transmit *ProvideLocationInformation* message, the target device shall:

- 1> for each positioning method contained in the message:
 - 2> set the corresponding IE to include the available location information;
- 1> deliver the response to lower layers for transmission.

5.4 Error Handling Procedures

5.4.1 General

This sub-clause describes how a receiving entity (target device or location server) behaves in cases when it receives erroneous or unexpected data or detects that certain data are missing.

5.4.2 Procedures related to Error Indication

Figure 5.4.2-1 shows the Error indication procedure.

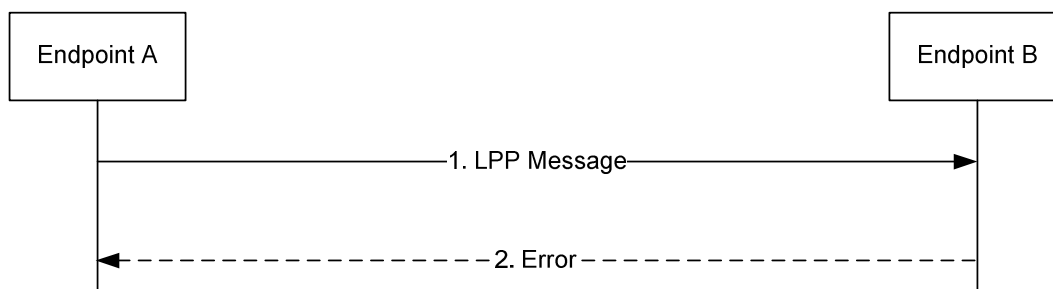

Figure 5.4.2-1: LPP Error Indication procedure

1. Endpoint A sends an LPP message to Endpoint B.

2. Endpoint B determines that the LPP message in step 1 contains an error. Endpoint B returns an *Error* message to Endpoint A indicating the error or errors and discards the message in step 1. If Endpoint B is able to determine that the erroneous LPP message in step 1 is an LPP Error or Abort Message, Endpoint B discards the message in step 1 without returning an *Error* message to Endpoint A.

5.4.3 LPP Error Detection

Upon receiving any LPP message, the receiving entity shall attempt to decode the message and verify the presence of any errors and:

- 1> if decoding errors are encountered:
 - 2> if the receiver can not determine that the received message is an LPP *Error* or *Abort* message:
 - 3> return an LPP *Error* message to the sender and include the received *LPP-TransactionID*, if this was decoded, and type of error;
 - 3> discard the received message and stop the error detection procedure;
- 1> if the message is a duplicate of a previously received message:
 - 2> discard the message and stop the error detection procedure;
- 1> if the *LPP-TransactionID* matches the *LPP-TransactionID* for a procedure that is still ongoing for the same session and the message type is invalid for the current state of the procedure:
 - 2> abort the ongoing procedure;
 - 2> return an LPP *Error* message to the sender and include the received transaction ID and type of error;
 - 2> discard the message and stop the error detection procedure;
- 1> if the message type is an LPP *RequestCapabilities* and some of the requested information is not supported:
 - 2> return any information that can be provided in a normal response.
- 1> if the message type is an LPP *RequestAssistanceData* or *RequestLocationInformation* and some or all of the requested information is not supported:
 - 2> return any information that can be provided in a normal response, which includes indications on other information that is not supported.

5.4.4 Reception of an LPP Error Message

Upon receiving an *Error* message, a device shall:

- 1> abort any ongoing procedure associated with the *LPP-TransactionID* if included in the received message.

The device may:

- 1> restart the aborted procedure taking into consideration the returned error information.

5.5 Abort Procedure

5.5.1 General

The purpose of the abort procedure is to allow the target device or location server to abort an ongoing procedure due to some unexpected event (e.g., cancellation of a location request by an LCS client). It can also be used to stop an ongoing procedure (e.g., periodic location reporting from the target device).

5.5.2 Procedures related to Abort

Figure 5.5.2-1 shows the Abort procedure.

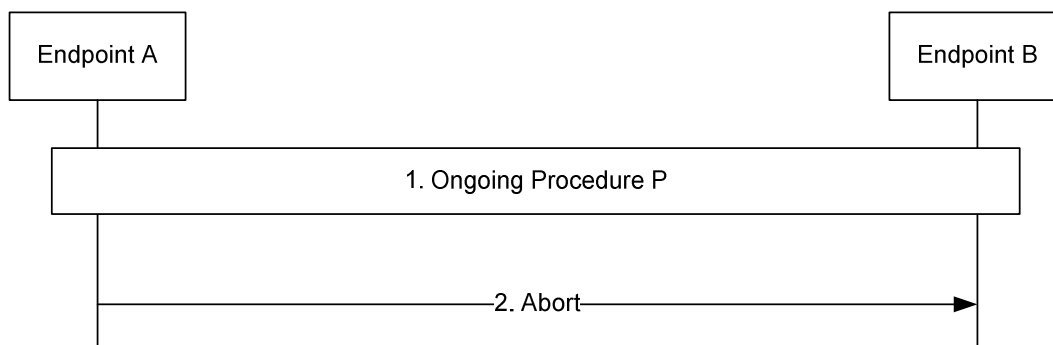

Figure 5.5.2-1: LPP Abort procedure

1. A procedure P is ongoing between endpoints A and B.
2. Endpoint A determines that the procedure must be aborted and sends an *Abort* message to Endpoint B carrying the transaction ID for procedure P. Endpoint B aborts procedure P.

5.5.3 Reception of an LPP Abort Message

Upon receiving an *Abort* message, a device shall:

- 1> abort any ongoing procedure associated with the transaction ID indicated in the message.

6 Information Element Abstract Syntax Definition

6.1 General

The contents of each LPP message is specified in sub-clause 6.2 using ASN.1 to specify the message syntax and using tables when needed to provide further detailed information about the fields specified in the message syntax.

The ASN.1 in this section uses the same format and coding conventions as described in Annex A of [12].

Transfer syntax for LPP messages is derived from their ASN.1 definitions by use of Basic Packed Encoding Rules (BASIC-PER), Unaligned Variant, as specified in ITU-T Rec. X.691 [22]. The encoded LPP message always contains a multiple of 8 bits.

Transfer syntax for LPP IEs is derived from their ASN.1 definitions by use of Basic Packed Encoding Rules (BASIC-PER), Unaligned Variant, as specified in ITU-T Rec. X.691 [22]. The encoded LPP IE always contains a multiple of 8 bits. This applies when a single LPP IE is encoded as the basic production, i.e. for other purposes than encoding the LPP IE within an LPP message.

The need for fields to be present in a message or an abstract type, i.e., the ASN.1 fields that are specified as OPTIONAL in the abstract notation (ASN.1), is specified by means of comment text tags attached to the OPTIONAL statement in the abstract syntax. The meaning of each tag is specified in table 6.1-1. These tags are used in the downlink (server to target) direction only.

Table 6.1-1: Meaning of abbreviations used to specify the need for fields to be present

Abbreviation	Meaning
--------------	---------

Abbreviation	Meaning
Cond <i>conditionTag</i>	<i>Conditionally present</i> A field for which the need is specified by means of conditions. For each <i>conditionTag</i> , the need is specified in a tabular form following the ASN.1 segment. In case, according to the conditions, a field is not present, the target takes no action and where applicable shall continue to use the existing value (and/or the associated functionality) unless explicitly stated otherwise in the description of the field itself.
Need OP	<i>Optionally present</i> A field that is optional to signal. For downlink messages, the target is not required to take any special action on absence of the field beyond what is specified in the procedural text or the field description table following the ASN.1 segment. The target behaviour on absence should be captured either in the procedural text or in the field description.
Need ON	<i>Optionally present, No action</i> A field that is optional to signal. If the message is received by the target, and in case the field is absent, the target takes no action and where applicable shall continue to use the existing value (and/or the associated functionality).
Need OR	<i>Optionally present, Release</i> A field that is optional to signal. If the message is received by the target, and in case the field is absent, the target shall discontinue/ stop using/ delete any existing value (and/ or the associated functionality).

When specifying information elements which are to be represented by BIT STRINGS, if not otherwise specifically stated in the field description of the concerned IE or elsewhere, the following principle applies with regards to the ordering of bits:

- The first bit (leftmost bit) contains the most significant bit (MSB);
- the last bit (rightmost bit) contains the least significant bit (LSB).

6.2 LPP PDU Structure

– LPP-PDU-Definitions

This ASN.1 segment is the start of the LPP PDU definitions.

```
-- ASN1START

LPP-PDU-Definitions {
itu-t (0) identified-organization (4) etsi (0) mobileDomain (0)
eps-Access (21) modules (3) lpp (7) version1 (1) lpp-PDU-Definitions (1) }

DEFINITIONS AUTOMATIC TAGS ::=

BEGIN

-- ASN1STOP
```

– LPP-Message

The *LPP-Message* provides the complete set of information for an invocation or response pertaining to an LPP transaction.

```
-- ASN1START

LPP-Message ::= SEQUENCE {
  transactionID      LPP-TransactionID  OPTIONAL,  -- Need ON
  endTransaction     BOOLEAN,
  sequenceNumber     SequenceNumber     OPTIONAL,  -- Need ON
  acknowledgement    Acknowledgement    OPTIONAL,  -- Need ON
  lpp-MessageBody    LPP-MessageBody    OPTIONAL  -- Need ON
}

SequenceNumber ::= INTEGER (0..255)

Acknowledgement ::= SEQUENCE {
  ackRequested       BOOLEAN,
```

```

    ackIndicator      SequenceNumber      OPTIONAL
  }
-- ASN1STOP

```

LPP-Message field descriptions

transactionID	This field is omitted if an <i>lpp-MessageBody</i> is not present (i.e. in an LPP message sent only to acknowledge a previously received message) or if it is not available to the transmitting entity (e.g., in an <i>LPP-Error</i> message triggered by a message that could not be parsed). If present, this field shall be ignored at a receiver in an LPP message for which the <i>lpp-MessageBody</i> is not present.
endTransaction	This field indicates whether an LPP message is the last message carrying an <i>lpp-MessageBody</i> in a transaction (TRUE) or not last (FALSE).
sequenceNumber	This field may be included when LPP operates over the control plane and an <i>lpp-MessageBody</i> is included but shall be omitted otherwise.
acknowledgement	This field is included in an LPP acknowledgement and in any LPP message requesting an acknowledgement when LPP operates over the control plane and is omitted otherwise
ackRequested	This field indicates whether an LPP acknowledgement is requested (TRUE) or not (FALSE). A value of TRUE may only be included when an <i>lpp-MessageBody</i> is included.
ackIndicator	This field indicates the sequence number of the message being acknowledged.
lpp-MessageBody	This field may be omitted in case the message is sent only to acknowledge a previously received message.

– LPP-MessageBody

The *LPP-MessageBody* identifies the type of an LPP message and contains all LPP information specifically associated with that type.

```

-- ASN1START
LPP-MessageBody ::= CHOICE {
  c1 CHOICE {
    requestCapabilities      RequestCapabilities,
    provideCapabilities      ProvideCapabilities,
    requestAssistanceData    RequestAssistanceData,
    provideAssistanceData    ProvideAssistanceData,
    requestLocationInformation RequestLocationInformation,
    provideLocationInformation ProvideLocationInformation,
    abort                    Abort,
    error                    Error,
    spare7 NULL, spare6 NULL, spare5 NULL, spare4 NULL,
    spare3 NULL, spare2 NULL, spare1 NULL, spare0 NULL
  },
  messageClassExtension SEQUENCE {}
}
-- ASN1STOP

```

– LPP-TransactionID

The *LPP-TransactionID* identifies a particular LPP transaction and the initiator of the transaction.

```

-- ASN1START
LPP-TransactionID ::= SEQUENCE {
  initiator      Initiator,
  transactionNumber TransactionNumber,
  ...
}

Initiator ::= ENUMERATED {
  locationServer,
  targetDevice,

```

```

}
...
TransactionNumber ::= INTEGER (0..255)
-- ASN1STOP

```

6.3 Message Body IEs

– RequestCapabilities

The *RequestCapabilities* message body in a LPP message is used by the location server to request the target device capability information for LPP and the supported individual positioning methods.

```

-- ASN1START
RequestCapabilities ::= SEQUENCE {
    criticalExtensions      CHOICE {
        c1                  CHOICE {
            requestCapabilities-r9      RequestCapabilities-r9-IEs,
            spare3 NULL, spare2 NULL, spare1 NULL
        },
        criticalExtensionsFuture      SEQUENCE {}
    }
}

RequestCapabilities-r9-IEs ::= SEQUENCE {
    commonIEsRequestCapabilities      CommonIEsRequestCapabilities      OPTIONAL, -- Need ON
    a-gnss-RequestCapabilities        A-GNSS-RequestCapabilities        OPTIONAL, -- Need ON
    otdoa-RequestCapabilities          OTDOA-RequestCapabilities          OPTIONAL, -- Need ON
    ecid-RequestCapabilities           ECID-RequestCapabilities           OPTIONAL, -- Need ON
    epdu-RequestCapabilities           EPDU-Sequence                   OPTIONAL, -- Need ON
    ...
    [[ sensor-RequestCapabilities-r13  Sensor-RequestCapabilities-r13    OPTIONAL, -- Need ON
      tbs-RequestCapabilities-r13      TBS-RequestCapabilities-r13      OPTIONAL, -- Need ON
      wlan-RequestCapabilities-r13     WLAN-RequestCapabilities-r13     OPTIONAL, -- Need ON
      bt-RequestCapabilities-r13       BT-RequestCapabilities-r13       OPTIONAL, -- Need ON
    ]]
}
-- ASN1STOP

```

RequestCapabilities field descriptions

commonIEsRequestCapabilities

This IE is provided for future extensibility and should not be included in this version of the protocol.

– ProvideCapabilities

The *ProvideCapabilities* message body in a LPP message indicates the LPP capabilities of the target device to the location server.

```

-- ASN1START
ProvideCapabilities ::= SEQUENCE {
    criticalExtensions      CHOICE {
        c1                  CHOICE {
            provideCapabilities-r9      ProvideCapabilities-r9-IEs,
            spare3 NULL, spare2 NULL, spare1 NULL
        },
        criticalExtensionsFuture      SEQUENCE {}
    }
}

ProvideCapabilities-r9-IEs ::= SEQUENCE {
    commonIEsProvideCapabilities      CommonIEsProvideCapabilities      OPTIONAL,
    a-gnss-ProvideCapabilities        A-GNSS-ProvideCapabilities        OPTIONAL,
    otdoa-ProvideCapabilities          OTDOA-ProvideCapabilities          OPTIONAL,
    ecid-ProvideCapabilities           ECID-ProvideCapabilities           OPTIONAL,
    epdu-ProvideCapabilities           EPDU-Sequence                   OPTIONAL,

```

```

    ...,
    [[ sensor-ProvideCapabilities-r13  Sensor-ProvideCapabilities-r13  OPTIONAL,
       tbs-ProvideCapabilities-r13   TBS-ProvideCapabilities-r13  OPTIONAL,
       wlan-ProvideCapabilities-r13  WLAN-ProvideCapabilities-r13  OPTIONAL,
       bt-ProvideCapabilities-r13    BT-ProvideCapabilities-r13   OPTIONAL
    ]]
}
-- ASN1STOP

```

ProvideCapabilities field descriptions

commonIEsProvideCapabilities

This IE is provided for future extensibility and should not be included in this version of the protocol.

– RequestAssistanceData

The *RequestAssistanceData* message body in a LPP message is used by the target device to request assistance data from the location server.

```

-- ASN1START
RequestAssistanceData ::= SEQUENCE {
    criticalExtensions    CHOICE {
        c1                CHOICE {
            requestAssistanceData-r9  RequestAssistanceData-r9-IEs,
            spare3 NULL, spare2 NULL, spare1 NULL
        },
        criticalExtensionsFuture    SEQUENCE {}
    }
}

RequestAssistanceData-r9-IEs ::= SEQUENCE {
    commonIEsRequestAssistanceData    CommonIEsRequestAssistanceData    OPTIONAL,
    a-gnss-RequestAssistanceData      A-GNSS-RequestAssistanceData      OPTIONAL,
    otdoa-RequestAssistanceData       OTDOA-RequestAssistanceData       OPTIONAL,
    epdu-RequestAssistanceData        EPDU-Sequence                     OPTIONAL,
    ...
}
-- ASN1STOP

```

– ProvideAssistanceData

The *ProvideAssistanceData* message body in a LPP message is used by the location server to provide assistance data to the target device either in response to a request from the target device or in an unsolicited manner.

```

-- ASN1START
ProvideAssistanceData ::= SEQUENCE {
    criticalExtensions    CHOICE {
        c1                CHOICE {
            provideAssistanceData-r9  ProvideAssistanceData-r9-IEs,
            spare3 NULL, spare2 NULL, spare1 NULL
        },
        criticalExtensionsFuture    SEQUENCE {}
    }
}

ProvideAssistanceData-r9-IEs ::= SEQUENCE {
    commonIEsProvideAssistanceData    CommonIEsProvideAssistanceData    OPTIONAL,  -- Need ON
    a-gnss-ProvideAssistanceData      A-GNSS-ProvideAssistanceData      OPTIONAL,  -- Need ON
    otdoa-ProvideAssistanceData       OTDOA-ProvideAssistanceData       OPTIONAL,  -- Need ON
    epdu-Provide-Assistance-Data      EPDU-Sequence                     OPTIONAL,  -- Need ON
    ...
}
-- ASN1STOP

```

ProvideAssistanceData field descriptions**commonIEsProvideAssistanceData**

This IE is provided for future extensibility and should not be included in this version of the protocol.

RequestLocationInformation

The *RequestLocationInformation* message body in a LPP message is used by the location server to request positioning measurements or a position estimate from the target device.

```
-- ASN1START
RequestLocationInformation ::= SEQUENCE {
    criticalExtensions      CHOICE {
        c1                  CHOICE {
            requestLocationInformation-r9  RequestLocationInformation-r9-IEs,
            spare3 NULL, spare2 NULL, spare1 NULL
        },
        criticalExtensionsFuture  SEQUENCE {}
    }
}

RequestLocationInformation-r9-IEs ::= SEQUENCE {
    commonIEsRequestLocationInformation
        CommonIEsRequestLocationInformation  OPTIONAL, -- Need ON
    a-gnss-RequestLocationInformation  A-GNSS-RequestLocationInformation  OPTIONAL, -- Need ON
    otdoa-RequestLocationInformation  OTDOA-RequestLocationInformation  OPTIONAL, -- Need ON
    ecid-RequestLocationInformation  ECID-RequestLocationInformation  OPTIONAL, -- Need ON
    epdu-RequestLocationInformation  EPDU-Sequence  OPTIONAL, -- Need ON
    ...,
    [[
    sensor-RequestLocationInformation-r13
        Sensor-RequestLocationInformation-r13  OPTIONAL, -- Need ON
    tbs-RequestLocationInformation-r13  TBS-RequestLocationInformation-r13  OPTIONAL, -- Need ON
    wlan-RequestLocationInformation-r13  WLAN-RequestLocationInformation-r13  OPTIONAL, -- Need ON
    bt-RequestLocationInformation-r13  BT-RequestLocationInformation-r13  OPTIONAL, -- Need ON
    ]]
}
-- ASN1STOP
```

RequestLocationInformation field descriptions**commonIEsRequestLocationInformation**

This field specifies the location information type requested by the location server and optionally other configuration information associated with the requested location information. This field should always be included in this version of the protocol.

ProvideLocationInformation

The *ProvideLocationInformation* message body in a LPP message is used by the target device to provide positioning measurements or position estimates to the location server.

```
-- ASN1START
ProvideLocationInformation ::= SEQUENCE {
    criticalExtensions      CHOICE {
        c1                  CHOICE {
            provideLocationInformation-r9  ProvideLocationInformation-r9-IEs,
            spare3 NULL, spare2 NULL, spare1 NULL
        },
        criticalExtensionsFuture  SEQUENCE {}
    }
}

ProvideLocationInformation-r9-IEs ::= SEQUENCE {
    commonIEsProvideLocationInformation
        CommonIEsProvideLocationInformation  OPTIONAL,
    a-gnss-ProvideLocationInformation  A-GNSS-ProvideLocationInformation  OPTIONAL,
    otdoa-ProvideLocationInformation  OTDOA-ProvideLocationInformation  OPTIONAL,
    ecid-ProvideLocationInformation  ECID-ProvideLocationInformation  OPTIONAL,
```

```

epdu-ProvideLocationInformation    EPDU-Sequence                OPTIONAL,
...,
[[
sensor-ProvideLocationInformation-r13
                                Sensor-ProvideLocationInformation-r13
                                OPTIONAL,
tbs-ProvideLocationInformation-r13 TBS-ProvideLocationInformation-r13 OPTIONAL,
wlan-ProvideLocationInformation-r13 WLAN-ProvideLocationInformation-r13 OPTIONAL,
bt-ProvideLocationInformation-r13  BT-ProvideLocationInformation-r13  OPTIONAL
]]
}
-- ASN1STOP

```

– Abort

The *Abort* message body in a LPP message carries a request to abort an ongoing LPP procedure.

```

-- ASN1START
Abort ::= SEQUENCE {
    criticalExtensions    CHOICE {
        c1                CHOICE {
            abort-r9      Abort-r9-IEs,
            spare3 NULL, spare2 NULL, spare1 NULL
        },
        criticalExtensionsFuture SEQUENCE {}
    }
}
Abort-r9-IEs ::= SEQUENCE {
    commonIEsAbort      CommonIEsAbort      OPTIONAL, -- Need ON
    ...,
    epdu-Abort          EPDU-Sequence        OPTIONAL -- Need ON
}
-- ASN1STOP

```

– Error

The *Error* message body in a LPP message carries information concerning a LPP message that was received with errors.

```

-- ASN1START
Error ::= CHOICE {
    error-r9              Error-r9-IEs,
    criticalExtensionsFuture SEQUENCE {}
}
Error-r9-IEs ::= SEQUENCE {
    commonIEsError      CommonIEsError      OPTIONAL, -- Need ON
    ...,
    epdu-Error          EPDU-Sequence        OPTIONAL -- Need ON
}
-- ASN1STOP

```

6.4 Common IEs

Common IEs comprise IEs that are applicable to more than one LPP positioning method.

6.4.1 Common Lower-Level IEs

– AccessTypes

The IE *AccessTypes* is used to indicate several cellular access types using a bit map.

```
-- ASN1START
AccessTypes ::= SEQUENCE {
    accessTypes    BIT STRING {
        eutra      (0),
        utra       (1),
        gsm        (2) } (SIZE (1..8)),
    ...
}
-- ASN1STOP
```

AccessTypes field descriptions

accessTypes

This field specifies the cellular access type(s). This is represented by a bit string, with a one-value at the bit position means the particular access type is addressed; a zero-value means not addressed.

– ARFCN-ValueEUTRA

The IEs *ARFCN-ValueEUTRA* and *ARFCN-ValueEUTRA-v9a0* are used to indicate the ARFCN of the E-UTRA carrier frequency, as defined in [12].

```
-- ASN1START
ARFCN-ValueEUTRA ::= INTEGER (0..maxEARFCN)
ARFCN-ValueEUTRA-v9a0 ::= INTEGER (maxEARFCN-Plus1..maxEARFCN2)
maxEARFCN          INTEGER ::= 65535    -- Maximum value of EUTRA carrier frequency
maxEARFCN-Plus1    INTEGER ::= 65536    -- Lowest value extended EARFCN range
maxEARFCN2         INTEGER ::= 262143   -- Highest value extended EARFCN range
-- ASN1STOP
```

NOTE: For fields using the original value range, as defined by IE *ARFCN-ValueEUTRA* i.e. without suffix, value *maxEARFCN* indicates that the E-UTRA carrier frequency is indicated by means of an extension.

– ARFCN-ValueUTRA

The IE *ARFCN-ValueUTRA* is used to indicate the ARFCN of the UTRA carrier frequency, as defined in [13].

```
-- ASN1START
ARFCN-ValueUTRA ::= INTEGER (0..16383)
-- ASN1STOP
```

– CellGlobalIdEUTRA-AndUTRA

The IE *CellGlobalIdEUTRA-AndUTRA* specifies the global Cell Identifier for E-UTRA or UTRA, the globally unique identity of a cell in E-UTRA or UTRA.

```
-- ASN1START
CellGlobalIdEUTRA-AndUTRA ::= SEQUENCE {
    plmn-Identity    SEQUENCE {
        mcc          SEQUENCE (SIZE (3)) OF INTEGER (0..9),
        mnc          SEQUENCE (SIZE (2..3)) OF INTEGER (0..9)
    }
}
-- ASN1STOP
```



```

    },
    cellIdentity CHOICE {
        eutra BIT STRING (SIZE (28)),
        utra BIT STRING (SIZE (32))
    },
    ...
}
-- ASN1STOP

```

CellGlobaldEUTRA-AndUTRA field descriptions

plmn-Identity

This field identifies the PLMN of the cell as defined in [12].

cellIdentity

This field defines the identity of the cell within the context of the PLMN as defined in [12] and [13]. The size of the bit string allows for the 32-bit extended UTRAN cell ID; in case the cell ID is shorter, the first bits of the string are set to 0.

– CellGlobaldGERAN

The IE *CellGlobaldGERAN* specifies the global Cell Identifier for GERAN, the globally unique identity of a cell in GERAN.

```

-- ASN1START
CellGlobaldGERAN ::= SEQUENCE {
    plmn-Identity SEQUENCE {
        mcc SEQUENCE (SIZE (3)) OF INTEGER (0..9),
        mnc SEQUENCE (SIZE (2..3)) OF INTEGER (0..9)
    },
    locationAreaCode BIT STRING (SIZE (16)),
    cellIdentity BIT STRING (SIZE (16)),
    ...
}
-- ASN1STOP

```

CellGlobaldGERAN field descriptions

plmn-Identity

This field identifies the PLMN of the cell.

locationAreaCode

This field is a fixed length code identifying the location area within a PLMN.

cellIdentity

This field specifies the cell Identifier which is unique within the context of the GERAN location area.

– ECGI

The IE *ECGI* specifies the Evolved Cell Global Identifier (ECGI), the globally unique identity of a cell in E-UTRA [12].

```

-- ASN1START
ECGI ::= SEQUENCE {
    mcc SEQUENCE (SIZE (3)) OF INTEGER (0..9),
    mnc SEQUENCE (SIZE (2..3)) OF INTEGER (0..9),
    cellidentity BIT STRING (SIZE (28))
}
-- ASN1STOP

```

– Ellipsoid-Point

The IE *Ellipsoid-Point* is used to describe a geographic shape as defined in 3GPP TS 23.032 [15].

```

-- ASN1START

```

```

Ellipsoid-Point ::= SEQUENCE {
    latitudeSign          ENUMERATED {north, south},
    degreesLatitude      INTEGER (0..8388607),          -- 23 bit field
    degreesLongitude     INTEGER (-8388608..8388607)   -- 24 bit field
}
-- ASN1STOP

```

– Ellipsoid-PointWithUncertaintyCircle

The IE *Ellipsoid-PointWithUncertaintyCircle* is used to describe a geographic shape as defined in 3GPP TS 23.032 [15].

```

-- ASN1START
Ellipsoid-PointWithUncertaintyCircle ::= SEQUENCE {
    latitudeSign          ENUMERATED {north, south},
    degreesLatitude      INTEGER (0..8388607),          -- 23 bit field
    degreesLongitude     INTEGER (-8388608..8388607),   -- 24 bit field
    uncertainty          INTEGER (0..127)
}
-- ASN1STOP

```

– EllipsoidPointWithUncertaintyEllipse

The IE *EllipsoidPointWithUncertaintyEllipse* is used to describe a geographic shape as defined in 3GPP TS 23.032 [15].

```

-- ASN1START
EllipsoidPointWithUncertaintyEllipse ::= SEQUENCE {
    latitudeSign          ENUMERATED {north, south},
    degreesLatitude      INTEGER (0..8388607),          -- 23 bit field
    degreesLongitude     INTEGER (-8388608..8388607),   -- 24 bit field
    uncertaintySemiMajor INTEGER (0..127),
    uncertaintySemiMinor INTEGER (0..127),
    orientationMajorAxis INTEGER (0..179),
    confidence           INTEGER (0..100)
}
-- ASN1STOP

```

– EllipsoidPointWithAltitude

The IE *EllipsoidPointWithAltitude* is used to describe a geographic shape as defined in 3GPP TS 23.032 [15].

```

-- ASN1START
EllipsoidPointWithAltitude ::= SEQUENCE {
    latitudeSign          ENUMERATED {north, south},
    degreesLatitude      INTEGER (0..8388607),          -- 23 bit field
    degreesLongitude     INTEGER (-8388608..8388607),   -- 24 bit field
    altitudeDirection    ENUMERATED {height, depth},
    altitude             INTEGER (0..32767)              -- 15 bit field
}
-- ASN1STOP

```

– EllipsoidPointWithAltitudeAndUncertaintyEllipsoid

The IE *EllipsoidPointWithAltitudeAndUncertaintyEllipsoid* is used to describe a geographic shape as defined in 3GPP TS 23.032 [15].

```

-- ASN1START
EllipsoidPointWithAltitudeAndUncertaintyEllipsoid ::= SEQUENCE {

```

```

latitudeSign          ENUMERATED {north, south},
degreesLatitude      INTEGER (0..8388607),           -- 23 bit field
degreesLongitude     INTEGER (-8388608..8388607), -- 24 bit field
altitudeDirection    ENUMERATED {height, depth},
altitude             INTEGER (0..32767),         -- 15 bit field
uncertaintySemiMajor INTEGER (0..127),
uncertaintySemiMinor INTEGER (0..127),
orientationMajorAxis INTEGER (0..179),
uncertaintyAltitude  INTEGER (0..127),
confidence           INTEGER (0..100)
}
-- ASN1STOP

```

– EllipsoidArc

The IE *EllipsoidArc* is used to describe a geographic shape as defined in 3GPP TS 23.032 [15].

```

-- ASN1START
EllipsoidArc ::= SEQUENCE {
  latitudeSign          ENUMERATED {north, south},
  degreesLatitude      INTEGER (0..8388607),           -- 23 bit field
  degreesLongitude     INTEGER (-8388608..8388607), -- 24 bit field
  innerRadius          INTEGER (0..65535),             -- 16 bit field,
  uncertaintyRadius    INTEGER (0..127),
  offsetAngle         INTEGER (0..179),
  includedAngle       INTEGER (0..179),
  confidence           INTEGER (0..100)
}
-- ASN1STOP

```

– EPDU-Sequence

The *EPDU-Sequence* contains IEs that are defined externally to LPP by other organizations.

```

-- ASN1START
EPDU-Sequence ::= SEQUENCE (SIZE (1..maxEPDU)) OF EPDU
maxEPDU INTEGER ::= 16
EPDU ::= SEQUENCE {
  ePDU-Identifier      EPDU-Identifier,
  ePDU-Body            EPDU-Body
}
EPDU-Identifier ::= SEQUENCE {
  ePDU-ID              EPDU-ID,
  ePDU-Name            EPDU-Name      OPTIONAL,
  ...
}
EPDU-ID ::= INTEGER (1..256)
EPDU-Name ::= VisibleString (SIZE (1..32))
EPDU-Body ::= OCTET STRING
-- ASN1STOP

```

EPDU-Sequence field descriptions**EPDU-ID**

This field provides a unique integer ID for the externally defined positioning method. Its value is assigned to the external entity that defines the EPDU. See table External PDU Identifier Definition for a list of external PDU identifiers defined in this version of the specification.

EPDU-Name

This field provides an optional character encoding which can be used to provide a quasi-unique name for an external PDU – e.g., by containing the name of the defining organization and/or the name of the associated public or proprietary standard for the EPDU.

EPDU-Body

The content and encoding of this field are defined externally to LPP.

External PDU Identifier Definition

EPDU-ID	EPDU Defining entity	Method name	Reference
1	OMA LOC	OMA LPP extensions (LPPe)	OMA-TS-LPPe-V1_0 [20]

HorizontalVelocity

The IE *HorizontalVelocity* is used to describe a velocity shape as defined in 3GPP TS 23.032 [15].

```
-- ASN1START
HorizontalVelocity ::= SEQUENCE {
    bearing          INTEGER(0..359),
    horizontalSpeed  INTEGER(0..2047)
}
-- ASN1STOP
```

HorizontalWithVerticalVelocity

The IE *HorizontalWithVerticalVelocity* is used to describe a velocity shape as defined in 3GPP TS 23.032 [15].

```
-- ASN1START
HorizontalWithVerticalVelocity ::= SEQUENCE {
    bearing          INTEGER(0..359),
    horizontalSpeed  INTEGER(0..2047),
    verticalDirection ENUMERATED{upward, downward},
    verticalSpeed    INTEGER(0..255)
}
-- ASN1STOP
```

HorizontalVelocityWithUncertainty

The IE *HorizontalVelocityWithUncertainty* is used to describe a velocity shape as defined in 3GPP TS 23.032 [15].

```
-- ASN1START
HorizontalVelocityWithUncertainty ::= SEQUENCE {
    bearing          INTEGER(0..359),
    horizontalSpeed  INTEGER(0..2047),
    uncertaintySpeed INTEGER(0..255)
}
-- ASN1STOP
```

– HorizontalWithVerticalVelocityAndUncertainty

The IE *HorizontalWithVerticalVelocityAndUncertainty* is used to describe a velocity shape as defined in 3GPP TS 23.032 [15].

```
-- ASN1START
HorizontalWithVerticalVelocityAndUncertainty ::= SEQUENCE {
    bearing                INTEGER(0..359),
    horizontalSpeed        INTEGER(0..2047),
    verticalDirection      ENUMERATED{upward, downward},
    verticalSpeed          INTEGER(0..255),
    horizontalUncertaintySpeed  INTEGER(0..255),
    verticalUncertaintySpeed  INTEGER(0..255)
}
-- ASN1STOP
```

– LocationCoordinateTypes

The IE *LocationCoordinateTypes* defines a list of possible geographic shapes as defined in 3GPP TS 23.032 [15].

```
-- ASN1START
LocationCoordinateTypes ::= SEQUENCE {
    ellipsoidPoint                BOOLEAN,
    ellipsoidPointWithUncertaintyCircle  BOOLEAN,
    ellipsoidPointWithUncertaintyEllipse  BOOLEAN,
    polygon                       BOOLEAN,
    ellipsoidPointWithAltitude      BOOLEAN,
    ellipsoidPointWithAltitudeAndUncertaintyEllipse  BOOLEAN,
    ellipsoidArc                   BOOLEAN,
    ...
}
-- ASN1STOP
```

– Polygon

The IE *Polygon* is used to describe a geographic shape as defined in 3GPP TS 23.032 [15].

```
-- ASN1START
Polygon ::= SEQUENCE (SIZE (3..15)) OF PolygonPoints
PolygonPoints ::= SEQUENCE {
    latitudeSign      ENUMERATED {north, south},
    degreesLatitude   INTEGER (0..8388607),           -- 23 bit field
    degreesLongitude  INTEGER (-8388608..8388607)     -- 24 bit field
}
-- ASN1STOP
```

– PositioningModes

The IE *PositioningModes* is used to indicate several positioning modes using a bit map.

```
-- ASN1START
PositioningModes ::= SEQUENCE {
    posModes          BIT STRING {
        standalone (0),
        ue-based (1),
        ue-assisted (2) } (SIZE (1..8)),
    ...
}
-- ASN1STOP
```

PositioningModes field descriptions**posModes**

This field specifies the positioning mode(s). This is represented by a bit string, with a one-value at the bit position means the particular positioning mode is addressed; a zero-value means not addressed.

– VelocityTypes

The IE *VelocityTypes* defines a list of possible velocity shapes as defined in 3GPP TS 23.032 [15].

```
-- ASN1START
VelocityTypes ::= SEQUENCE {
    horizontalVelocity                BOOLEAN,
    horizontalWithVerticalVelocity    BOOLEAN,
    horizontalVelocityWithUncertainty BOOLEAN,
    horizontalWithVerticalVelocityAndUncertainty  BOOLEAN,
    ...
}
-- ASN1STOP
```

6.4.2 Common Positioning

– CommonIEsRequestCapabilities

The *CommonIEsRequestCapabilities* carries common IEs for a Request Capabilities LPP message Type.

```
-- ASN1START
CommonIEsRequestCapabilities ::= SEQUENCE {
    ...
}
-- ASN1STOP
```

– CommonIEsProvideCapabilities

The *CommonIEsProvideCapabilities* carries common IEs for a Provide Capabilities LPP message Type.

```
-- ASN1START
CommonIEsProvideCapabilities ::= SEQUENCE {
    ...
}
-- ASN1STOP
```

– CommonIEsRequestAssistanceData

The *CommonIEsRequestAssistanceData* carries common IEs for a Request Assistance Data LPP message Type.

```
-- ASN1START
CommonIEsRequestAssistanceData ::= SEQUENCE {
    primaryCellID      ECGI      OPTIONAL,  -- Cond EUTRA
    ...
}
-- ASN1STOP
```

Conditional presence	Explanation
EUTRA	The field is mandatory present for E-UTRA access. The field shall be omitted for non-EUTRA user plane support.

CommonEsRequestAssistanceData field descriptions

primaryCellID

This parameter identifies the current primary cell for the target device.

– CommonEsProvideAssistanceData

The *CommonEsProvideAssistanceData* carries common IEs for a Provide Assistance Data LPP message Type.

```
-- ASN1START
CommonEsProvideAssistanceData ::= SEQUENCE {
    ...
}
-- ASN1STOP
```

– CommonEsRequestLocationInformation

The *CommonEsRequestLocationInformation* carries common IEs for a Request Location Information LPP message Type.

```
-- ASN1START
CommonEsRequestLocationInformation ::= SEQUENCE {
    locationInformationType      LocationInformationType,
    triggeredReporting           TriggeredReportingCriteria OPTIONAL, -- Cond ECID
    periodicalReporting         PeriodicalReportingCriteria OPTIONAL, -- Need ON
    additionalInformation       AdditionalInformation OPTIONAL, -- Need ON
    qos                         QoS OPTIONAL, -- Need ON
    environment                 Environment OPTIONAL, -- Need ON
    locationCoordinateTypes     LocationCoordinateTypes OPTIONAL, -- Need ON
    velocityTypes              VelocityTypes OPTIONAL, -- Need ON
    ...
}

LocationInformationType ::= ENUMERATED {
    locationEstimateRequired,
    locationMeasurementsRequired,
    locationEstimatePreferred,
    locationMeasurementsPreferred,
    ...
}

PeriodicalReportingCriteria ::= SEQUENCE {
    reportingAmount             ENUMERATED {
        ra1, ra2, ra4, ra8, ra16, ra32,
        ra64, ra-Infinity
    } DEFAULT ra-Infinity,
    reportingInterval           ENUMERATED {
        noPeriodicalReporting, ri0-25,
        ri0-5, ri1, ri2, ri4, ri8, ri16, ri32, ri64
    }
}

TriggeredReportingCriteria ::= SEQUENCE {
    cellChange                 BOOLEAN,
    reportingDuration           ReportingDuration,
    ...
}

ReportingDuration ::= INTEGER (0..255)

AdditionalInformation ::= ENUMERATED {
    onlyReturnInformationRequested,
    mayReturnAdditionalInformation,
    ...
}
```

```

}

QoS ::= SEQUENCE {
    horizontalAccuracy      HorizontalAccuracy      OPTIONAL,    -- Need ON
    verticalCoordinateRequest  BOOLEAN,
    verticalAccuracy        VerticalAccuracy        OPTIONAL,    -- Need ON
    responseTime            ResponseTime            OPTIONAL,    -- Need ON
    velocityRequest         BOOLEAN,
    ...
}

HorizontalAccuracy ::= SEQUENCE {
    accuracy      INTEGER(0..127),
    confidence    INTEGER(0..100),
    ...
}

VerticalAccuracy ::= SEQUENCE {
    accuracy      INTEGER(0..127),
    confidence    INTEGER(0..100),
    ...
}

ResponseTime ::= SEQUENCE {
    time          INTEGER (1..128),
    ...
    [[ responseTimeEarlyFix-r12    INTEGER (1..128)    OPTIONAL    -- Need ON
    ]]
}

Environment ::= ENUMERATED {
    badArea,
    notBadArea,
    mixedArea,
    ...
}

-- ASN1STOP

```

Conditional presence	Explanation
ECID	The field is optionally present, need ON, if ECID is requested. Otherwise it is not present.

CommonEsRequestLocationInformation field descriptions

locationInformationType

This IE indicates whether the server requires a location estimate or measurements. For "*locationEstimateRequired*", the target device shall return a location estimate if possible, or indicate a location error if not possible. For "*locationMeasurementsRequired*", the target device shall return measurements if possible, or indicate a location error if not possible. For "*locationEstimatePreferred*", the target device shall return a location estimate if possible, but may also or instead return measurements for any requested position methods for which a location estimate is not possible. For "*locationMeasurementsPreferred*", the target device shall return location measurements if possible, but may also or instead return a location estimate for any requested position methods for which return of location measurements is not possible.

triggeredReporting

This IE indicates that triggered reporting is requested and comprises the following subfields:

- **cellChange:** If this field is set to TRUE, the target device provides requested location information each time the primary cell has changed.
- **reportingDuration:** Maximum duration of triggered reporting in seconds. A value of zero is interpreted to mean an unlimited (i.e. "infinite") duration. The target device should continue triggered reporting for the *reportingDuration* or until an LPP *Abort* or LPP *Error* message is received.

The *triggeredReporting* field should not be included by the location server and shall be ignored by the target device if the *periodicalReporting* IE or *responseTime* IE is included in *CommonEsRequestLocationInformation*.

CommonEsRequestLocationInformation field descriptions**periodicalReporting**

This IE indicates that periodic reporting is requested and comprises the following subfields:

- **reportingAmount** indicates the number of periodic location information reports requested. Enumerated values correspond to 1, 2, 4, 8, 16, 32, 64, or infinite/indefinite number of reports. If the *reportingAmount* is "infinite/indefinite", the target device should continue periodic reporting until an LPP *Abort* message is received. The value "ra1" shall not be used by a sender.
- **reportingInterval** indicates the interval between location information reports and the response time requirement for the first location information report. Enumerated values ri0-25, ri0-5, ri1, ri2, ri4, ri8, ri16, ri32, ri64 correspond to reporting intervals of 1, 2, 4, 8, 10, 16, 20, 32, and 64 seconds, respectively. Measurement reports containing no measurements or no location estimate are required when a *reportingInterval* expires before a target device is able to obtain new measurements or obtain a new location estimate. The value "noPeriodicalReporting" shall not be used by a sender.

additionalInformation

This IE indicates whether a target device is allowed to return additional information to that requested. If this IE indicates "onlyReturnInformationRequested" then the target device shall not return any additional information to that requested by the server. If this IE indicates "mayReturnAdditionalInformation" then the target device may return additional information to that requested by the server. If a location estimate is returned, any additional information is restricted to that associated with a location estimate (e.g. might include velocity if velocity was not requested but cannot include measurements). If measurements are returned, any additional information is restricted to additional measurements (e.g. might include E-CID measurements if A-GNSS measurements were requested but not E-CID measurements).

qos

This IE indicates the quality of service and comprises a number of sub-fields. In the case of measurements, some of the sub-fields apply to the location estimate that could be obtained by the server from the measurements provided by the target device assuming that the measurements are the only sources of error. Fields are as follows:

- **horizontalAccuracy** indicates the maximum horizontal error in the location estimate at an indicated confidence level. The "accuracy" corresponds to the encoded uncertainty as defined in 3GPP TS 23.032 [15] and "confidence" corresponds to confidence as defined in 3GPP TS 23.032 [15].
- **verticalCoordinateRequest** indicates whether a vertical coordinate is required (TRUE) or not (FALSE)
- **verticalAccuracy** indicates the maximum vertical error in the location estimate at an indicated confidence level and is only applicable when a vertical coordinate is requested. The "accuracy" corresponds to the encoded uncertainty altitude as defined in 3GPP TS 23.032 [15] and "confidence" corresponds to confidence as defined in 3GPP TS 23.032 [15].
- **responseTime**
 - **time** indicates the maximum response time as measured between receipt of the *RequestLocationInformation* and transmission of a *ProvideLocationInformation*. This is given as an integer number of seconds between 1 and 128. If the *periodicalReporting* IE is included in *CommonEsRequestLocationInformation*, this field should not be included by the location server and shall be ignored by the target device (if included).
 - **responseTimeEarlyFix** indicates the maximum response time as measured between receipt of the *RequestLocationInformation* and transmission of a *ProvideLocationInformation* containing early location measurements or an early location estimate. This is given as an integer number of seconds between 1 and 128. When this IE is included, a target should send a *ProvideLocationInformation* (or more than one *ProvideLocationInformation* if location information will not fit into a single message) containing early location information according to the *responseTimeEarlyFix* IE and a subsequent *ProvideLocationInformation* (or more than one *ProvideLocationInformation* if location information will not fit into a single message) containing final location information according to the *time* IE. A target shall omit sending a *ProvideLocationInformation* if the early location information is not available at the expiration of the time value in the *responseTimeEarlyFix* IE. A server should set the *responseTimeEarlyFix* IE to a value less than that for the *time* IE. A target shall ignore the *responseTimeEarlyFix* IE if its value is not less than that for the *time* IE.
- **velocityRequest** indicates whether velocity (or measurements related to velocity) is requested (TRUE) or not (FALSE).

All QoS requirements shall be obtained by the target device to the degree possible but it is permitted to return a response that does not fulfill all QoS requirements if some were not attainable. The single exception is *time* which shall always be fulfilled – even if that means not fulfilling other QoS requirements.

environment

This field provides the target device with information about expected multipath and non line of sight (NLOS) in the current area. The following values are defined:

- **badArea**: possibly heavy multipath and NLOS conditions (e.g. bad urban or urban).
- **notBadArea**: no or light multipath and usually LOS conditions (e.g. suburban or rural).
- **mixedArea**: environment that is mixed or not defined.

If this field is absent, a default value of "mixedArea" applies.

locationCoordinateTypes

This field provides a list of the types of location estimate that the target device may return when a location estimate is obtained by the target.

CommonIEsRequestLocationInformation field descriptions**velocityTypes**

This fields provides a list of the types of velocity estimate that the target device may return when a velocity estimate is obtained by the target.

– CommonIEsProvideLocationInformation

The *CommonIEsProvideLocationInformation* carries common IEs for a Provide Location Information LPP message Type.

```
-- ASN1START

CommonIEsProvideLocationInformation ::= SEQUENCE {
    locationEstimate          LocationCoordinates    OPTIONAL,
    velocityEstimate          Velocity                OPTIONAL,
    locationError             LocationError           OPTIONAL,
    ...,
    [[ earlyFixReport-r12     EarlyFixReport-r12    OPTIONAL
    ]],
    [[ locationSource-r13    LocationSource-r13    OPTIONAL,
    locationTimestamp-r13   UTCTime                OPTIONAL
    ]]
}

LocationCoordinates ::= CHOICE {
    ellipsoidPoint                Ellipsoid-Point,
    ellipsoidPointWithUncertaintyCircle Ellipsoid-PointWithUncertaintyCircle,
    ellipsoidPointWithUncertaintyEllipse EllipsoidPointWithUncertaintyEllipse,
    polygon                       Polygon,
    ellipsoidPointWithAltitude     EllipsoidPointWithAltitude,
    ellipsoidPointWithAltitudeAndUncertaintyEllipsoid EllipsoidPointWithAltitudeAndUncertaintyEllipsoid,
    ellipsoidArc                  EllipsoidArc,
    ...
}

Velocity ::= CHOICE {
    horizontalVelocity            HorizontalVelocity,
    horizontalWithVerticalVelocity HorizontalWithVerticalVelocity,
    horizontalVelocityWithUncertainty HorizontalVelocityWithUncertainty,
    horizontalWithVerticalVelocityAndUncertainty HorizontalWithVerticalVelocityAndUncertainty,
    ...
}

LocationError ::= SEQUENCE {
    locationFailureCause          LocationFailureCause,
    ...
}

LocationFailureCause ::= ENUMERATED {
    undefined,
    requestedMethodNotSupported,
    positionMethodFailure,
    periodicLocationMeasurementsNotAvailable,
    ...
}

EarlyFixReport-r12 ::= ENUMERATED {
    noMoreMessages,
    moreMessagesOnTheWay
}

LocationSource-r13 ::= BIT STRING { a-gnss          (0),
                                     wlan             (1),
                                     bt                (2),
                                     tbs              (3),
                                     sensor            (4) } (SIZE(1..16))

-- ASN1STOP
```

CommonEsProvideLocationInformation field descriptions
<p>locationEstimate This field provides a location estimate using one of the geographic shapes defined in 3GPP TS 23.032 [15]. Coding of the values of the various fields internal to each geographic shape follow the rules in [15]. The conditions for including this field are defined for the <i>locationInformationType</i> field in a Request Location Information message.</p>
<p>velocityEstimate This field provides a velocity estimate using one of the velocity shapes defined in 3GPP TS 23.032 [15]. Coding of the values of the various fields internal to each velocity shape follow the rules in [15].</p>
<p>locationError This field shall be included if and only if a location estimate and measurements are not included in the LPP PDU. The field includes information concerning the reason for the lack of location information. The <i>LocationFailureCause</i> "periodicLocationMeasurementsNotAvailable" shall be used by the target device if periodic location reporting was requested, but no measurements or location estimate are available when <i>the reportingInterval</i> expired.</p>
<p>earlyFixReport This field shall be included if and only if the <i>ProvideLocationInformation</i> message contains early location measurements or an early location estimate. The target device shall set the values of this field as follows:</p> <ul style="list-style-type: none"> • noMoreMessages: This is the only or last <i>ProvideLocationInformation</i> message used to deliver the entire set of early location information. • moreMessagesOnTheWay: This is one of multiple <i>ProvideLocationInformation</i> messages used to deliver the entire set of early location information (if early location information will not fit into a single message).
<p>locationSource This field provides the source positioning technology for the location estimate.</p>
<p>locationTimestamp This field provides the UTC time when the location estimate is valid and should take the form of <i>YYMMDDhhmmssZ</i>.</p>

– CommonEsAbort

The *CommonEsAbort* carries common IEs for an Abort LPP message Type.

```
-- ASN1START
CommonEsAbort ::= SEQUENCE {
    abortCause      ENUMERATED {
        undefined,
        stopPeriodicReporting,
        targetDeviceAbort,
        networkAbort,
        ...
    }
}
-- ASN1STOP
```

CommonEsAbort field descriptions
<p>abortCause This IE defines the request to abort an ongoing procedure. The abort cause "stopPeriodicReporting" should be used by the location server to stop any ongoing location reporting configured as <i>periodicalReporting</i> or <i>triggeredReporting</i> in the <i>CommonEsRequestLocationInformation</i>.</p>

– CommonEsError

The *CommonEsError* carries common IEs for an Error LPP message Type.

```
-- ASN1START
CommonEsError ::= SEQUENCE {
    errorCause      ENUMERATED {
        undefined,
        lppMessageHeaderError,
        lppMessageBodyError,
        epduError,
        incorrectDataValue,
        ...
    }
}
```

```

}
}
-- ASN1STOP

```

CommonIEsError field descriptions

errorCause

This IE defines the cause for an error. "*lppMessageHeaderError*", "*lppMessageBodyError*" and "*epduError*" is used if a receiver is able to detect a coding error in the LPP header (i.e., in the common fields), LPP message body or in an EPDU, respectively.

6.5 Positioning Method IEs

6.5.1 OTDOA Positioning

6.5.1.1 OTDOA Assistance Data

– OTDOA-ProvideAssistanceData

The IE *OTDOA-ProvideAssistanceData* is used by the location server to provide assistance data to enable UE-assisted downlink OTDOA. It may also be used to provide OTDOA positioning specific error reason.

Throughout Section 6.5.1, "assistance data reference cell" refers to the cell defined by the IE *OTDOA-ReferenceCellInfo* (see section 6.5.1.2). "RSTD reference cell" applies only in Section 6.5.1.5.

NOTE: The location server should include at least one cell for which the SFN can be obtained by the target device, e.g. the serving cell, in the assistance data, either as the assistance data reference cell or in the neighbour cell list. Otherwise the target device will be unable to perform the OTDOA measurement and the positioning operation will fail.

```

-- ASN1START
OTDOA-ProvideAssistanceData ::= SEQUENCE {
    otdoa-ReferenceCellInfo      OTDOA-ReferenceCellInfo      OPTIONAL, -- Need ON
    otdoa-NeighbourCellInfo     OTDOA-NeighbourCellInfoList OPTIONAL, -- Need ON
    otdoa-Error                 OTDOA-Error                 OPTIONAL, -- Need ON
    ...
}
-- ASN1STOP

```

6.5.1.2 OTDOA Assistance Data Elements

– OTDOA-ReferenceCellInfo

The IE *OTDOA-ReferenceCellInfo* is used by the location server to provide assistance data reference cell information for OTDOA assistance data. The slot number offsets and expected RSTDs in *OTDOA-NeighbourCellInfoList* are provided relative to the cell defined by this IE. If *earfcnRef* of this assistance data reference cell is different from that of the serving cell, the LPP layer shall inform lower layers to start performing inter-frequency RSTD measurements with this cell and provide to lower layers the information about this assistance data reference cell, e.g. EARFCN and PRS positioning occasion information.

NOTE: The location server should always include the PRS configuration of the assistance data reference and neighbour cells. Otherwise the UE may not meet the accuracy requirements as defined in [18].

```

-- ASN1START
OTDOA-ReferenceCellInfo ::= SEQUENCE {
    physCellId      INTEGER (0..503),

```

```

cellGlobalId          ECGI                OPTIONAL,          -- Need ON
earfcnRef              ARFCN-ValueEUTRA     OPTIONAL,          -- Cond NotSameAsServ0
antennaPortConfig     ENUMERATED {ports1-or-2, ports4, ... } OPTIONAL,          -- Cond NotSameAsServ1
cpLength              ENUMERATED { normal, extended, ... },
prsInfo               PRS-Info             OPTIONAL,          -- Cond PRS
...
[[ earfcnRef-v9a0      ARFCN-ValueEUTRA-v9a0     OPTIONAL          -- Cond NotSameAsServ2
]]
}
-- ASN1STOP

```

Conditional presence	Explanation
<i>NotSameAsServ0</i>	This field is absent if <i>earfcnRef-v9a0</i> is present. Otherwise, the field is mandatory present if the EARFCN of the OTDOA assistance data reference cell is not the same as the EARFCN of the target devices's current primary cell.
<i>NotSameAsServ1</i>	The field is mandatory present if the antenna port configuration of the OTDOA assistance data reference cell is not the same as the antenna port configuration of the target devices's current primary cell.
<i>NotSameAsServ2</i>	The field is absent if <i>earfcnRef</i> is present. Otherwise, the field is mandatory present if the EARFCN of the OTDOA assistance data reference cell is not the same as the EARFCN of the target devices's current primary cell.
<i>PRS</i>	The field is mandatory present if positioning reference signals are available in the assistance data reference cell [16]; otherwise it is not present.

OTDOA-ReferenceCellInfo field descriptions

physCellId	This field specifies the physical cell identity of the assistance data reference cell, as defined in [12].
cellGlobalId	This field specifies the ECGI, the globally unique identity of a cell in E-UTRA, of the assistance data reference cell, as defined in [12]. The server should include this field if it considers that it is needed to resolve ambiguity in the cell indicated by <i>physCellId</i> .
earfcnRef	This field specifies the EARFCN of the assistance data reference cell.
antennaPortConfig	This field specifies whether 1 (or 2) antenna port(s) or 4 antenna ports for cell specific reference signals (CRS) are used in the assistance data reference cell.
cpLength	This field specifies the cyclic prefix length of the assistance data reference cell PRS if the <i>prsInfo</i> field is present, otherwise this field specifies the cyclic prefix length of the assistance data reference cell CRS.
prsInfo	This field specifies the PRS configuration of the assistance data reference cell.

– PRS-Info

The IE *PRS-Info* provides the information related to the configuration of PRS in a cell.

```

-- ASN1START
PRS-Info ::= SEQUENCE {
  prs-Bandwidth          ENUMERATED { n6, n15, n25, n50, n75, n100, ... },
  prs-ConfigurationIndex INTEGER (0..4095),
  numDL-Frames           ENUMERATED {sf-1, sf-2, sf-4, sf-6, ...},
  ...,
  prs-MutingInfo-r9     CHOICE {
    po2-r9              BIT STRING (SIZE(2)),
    po4-r9              BIT STRING (SIZE(4)),
    po8-r9              BIT STRING (SIZE(8)),
    po16-r9             BIT STRING (SIZE(16)),
    ...
  }
}
-- ASN1STOP

```

PRS-Info field descriptions

PRS-Info field descriptions
<p>prs-Bandwidth This field specifies the bandwidth that is used to configure the positioning reference signals on. Enumerated values are specified in number of resource blocks (n6 corresponds to 6 resource blocks, n15 to 15 resource blocks and so on) and define 1.4, 3, 5, 10, 15 and 20 MHz bandwidth.</p>
<p>prs-ConfigurationIndex This field specifies the positioning reference signals configuration index I_{PRS} as defined in [16].</p>
<p>numDL-Frames This field specifies the number of consecutive downlink subframes N_{PRS} with positioning reference signals, as defined in [16]. Enumerated values define 1, 2, 4, or 6 consecutive subframes.</p>
<p>prs-MutingInfo This field specifies the PRS muting configuration of the cell. The PRS muting configuration is defined by a periodic PRS muting sequence with periodicity T_{REP} where T_{REP}, counted in the number of PRS positioning occasions [18], can be 2, 4, 8, or 16 which is also the length of the selected bit string that represents this PRS muting sequence. If a bit in the PRS muting sequence is set to "0", then the PRS is muted in the corresponding PRS positioning occasion. A PRS positioning occasion comprises of N_{PRS} downlink positioning subframes as defined in [16]. The first bit of the PRS muting sequence corresponds to the first PRS positioning occasion that starts after the beginning of the assistance data reference cell SFN=0. The sequence is valid for all subframes after the target device has received the <i>prs-MutingInfo</i>. If this field is not present the target device may assume that the PRS muting is not in use for the cell.</p> <p>When the SFN of the assistance data reference cell is not known to the UE and <i>prs-MutingInfo</i> is provided for a cell in the <i>OTDOA-NeighbourCellInfoList</i> IE, the UE may assume no PRS is transmitted by that cell.</p> <p>When the UE receives a 16-bit muting pattern (po16-r9) and PRS periodicity T_{PRS} of 1280 subframes for the same cell, the UE shall assume an 8-bit muting pattern (po8-r9) based on the first half of the 16-bit muting pattern.</p>

– OTDOA-NeighbourCellInfoList

The IE *OTDOA-NeighbourCellInfoList* is used by the location server to provide neighbour cell information for OTDOA assistance data. If the target device is not capable of supporting additional neighbour cells (as indicated by the absence of the IE *additionalNeighbourCellInfoList* in *OTDOA-ProvideCapabilities*), the set of cells in the *OTDOA-NeighbourCellInfoList* is grouped per frequency layer and in the decreasing order of priority for measurement to be performed by the target device, with the first cell in the list being the highest priority for measurement and with the same *earfcn* not appearing in more than one instance of *OTDOA-NeighbourFreqInfo*.

If the target device is capable of supporting additional neighbour cells (as indicated by the presence of the IE *additionalNeighbourCellInfoList* in *OTDOA-ProvideCapabilities*), the list may contain all cells (up to 3x24 cells) belonging to the same frequency layer or cells from different frequency layers with the first cell in the list still being the highest priority for measurement.

The prioritization of the cells in the list is left to server implementation. The target device should provide the available measurements in the same order as provided by the server.

If inter-frequency neighbour cells are included in *OTDOA-NeighbourCellInfoList*, where an inter-frequency is a E-UTRA frequency which is different from the E-UTRA serving cell frequency, the LPP layer shall inform lower layers to start performing inter-frequency RSTD measurements for these neighbour cells and also provide to lower layers the information about these neighbour cells, e.g. EARFCN and PRS positioning occasion information.

```
-- ASN1START
OTDOA-NeighbourCellInfoList ::= SEQUENCE (SIZE (1..maxFreqLayers)) OF OTDOA-NeighbourFreqInfo
OTDOA-NeighbourFreqInfo ::= SEQUENCE (SIZE (1..24)) OF OTDOA-NeighbourCellInfoElement

OTDOA-NeighbourCellInfoElement ::= SEQUENCE {
    physCellId          INTEGER (0..503),
    cellGlobalId        ECGI                               OPTIONAL,      -- Need ON
    earfcn               ARFCN-ValueEUTRA                 OPTIONAL,      -- Cond NotSameAsRef0
    cpLength            ENUMERATED {normal, extended, ...} OPTIONAL,
    prsInfo              PRS-Info                         OPTIONAL,      -- Cond NotSameAsRef1
    antennaPortConfig   ENUMERATED {ports-1-or-2, ports-4, ...} OPTIONAL,      -- Cond NotSameAsRef2
    slotNumberOffset    INTEGER (0..19)                   OPTIONAL,      -- Cond NotsameAsRef3
    prs-SubframeOffset  INTEGER (0..1279)                 OPTIONAL,      -- Cond NotSameAsRef4
    expectedRSTD        INTEGER (0..16383),
    expectedRSTD-Uncertainty INTEGER (0..1023),
    ...
    [[ earfcn-v9a0      ARFCN-ValueEUTRA-v9a0             OPTIONAL      -- Cond NotSameAsRef5
```

```

    ]]
}
maxFreqLayers    INTEGER ::= 3
-- ASN1STOP

```

Conditional presence	Explanation
<i>NotsameAsRef0</i>	The field is absent if <i>earfcn-v9a0</i> is present. If <i>earfcn-v9a0</i> is not present, the field is mandatory present if the EARFCN is not the same as for the assistance data reference cell; otherwise it is not present.
<i>NotsameAsRef1</i>	The field is mandatory present if the cyclic prefix length is not the same as for the assistance data reference cell; otherwise it is not present.
<i>NotsameAsRef2</i>	The field is mandatory present if the PRS configuration is not the same as for the assistance data reference cell; otherwise it is not present.
<i>NotsameAsRef3</i>	The field is mandatory present if the antenna port configuration is not the same as for the assistance data reference cell; otherwise it is not present.
<i>NotsameAsRef4</i>	The field is mandatory present if the slot timing is not the same as for the assistance data reference cell; otherwise it is not present.
<i>NotSameAsRef5</i>	The field is absent if <i>earfcn</i> is present. If <i>earfcn</i> is not present, the field is mandatory present if the EARFCN is not the same as for the assistance data reference cell; otherwise it is not present.
<i>InterFreq</i>	The field is optionally present, need OP, if the EARFCN is not the same as for the assistance data reference cell; otherwise it is not present.

OTDOA-NeighbourCellInfoList field descriptions
<p><i>physCellId</i> This field specifies the physical cell identity of the neighbour cell, as defined in [12].</p>
<p><i>cellGlobalId</i> This field specifies the ECGI, the globally unique identity of a cell in E-UTRA, of the neighbour cell, as defined in [12]. The server should provide this field if it considers that it is needed to resolve any ambiguity in the cell identified by <i>physCellId</i>.</p>
<p><i>earfcn</i> This field specifies the EARFCN of the neighbour cell.</p>
<p><i>cpLength</i> This field specifies the cyclic prefix length of the neighbour cell PRS if PRS are present in this neighbour cell, otherwise this field specifies the cyclic prefix length of CRS in this neighbour cell.</p>
<p><i>prsInfo</i> This field specifies the PRS configuration of the neighbour cell. When the EARFCN of the neighbour cell is the same as for the assistance data reference cell, the target device may assume that each PRS positioning occasion in the neighbour cell at least partially overlaps with a PRS positioning occasion in the assistance data reference cell where the maximum offset between the transmitted PRS positioning occasions may be assumed to not exceed half a subframe. When the EARFCN of the neighbour cell is the same as for the assistance data reference cell, the target may assume that this cell has the same PRS periodicity (Tprs) as the assistance data reference cell.</p>
<p><i>antennaPortConfig</i> This field specifies whether 1 (or 2) antenna port(s) or 4 antenna ports for cell specific reference signals are used.</p>
<p><i>slotNumberOffset</i> This field specifies the slot number offset at the transmitter between this cell and the assistance data reference cell. The <i>slotNumberOffset</i> together with the current slot number of the assistance data reference cell may be used to calculate the current slot number of this cell which may further be used to generate the CRS sequence by the target device. The offset corresponds to the number of full slots counted from the beginning of a radio frame of the assistance data reference cell to the beginning of the closest subsequent radio frame of this cell. If this field is absent, the slot timing is the same as for the assistance data reference cell.</p>
<p><i>prs-SubframeOffset</i> This field specifies the offset between the first PRS subframe in the assistance data reference cell on the reference carrier frequency layer and the first PRS subframe in the closest subsequent PRS positioning occasion of this cell on the other carrier frequency layer. The value is given in number of full sub-frames. If the EARFCN is not the same as for the assistance data reference cell and the field is not present but PRS are available on this cell, the receiver shall consider the PRS subframe offset for this cell to be 0.</p>

OTDOA-NeighbourCellInfoList field descriptions**expectedRSTD**

If PRS is transmitted:

This field indicates the RSTD value that the target device is expected to measure between this cell and the assistance data reference cell. The *expectedRSTD* field takes into account the expected propagation time difference as well as transmit time difference of PRS positioning occasions between the two cells. The RSTD value can be negative and is calculated as (*expectedRSTD*-8192). The resolution is $3 \times T_s$, with $T_s = 1/(15000 \times 2048)$ seconds.

If PRS is not transmitted:

This field indicates the RSTD value that the target device is expected to measure between this cell and the assistance data reference cell. The *expectedRSTD* field takes into account the expected propagation time difference as well as transmit time difference between the two cells. The RSTD value can be negative and is calculated as (*expectedRSTD*-8192). The resolution is $3 T_s$, with $T_s = 1/(15000 \times 2048)$ seconds.

expectedRSTD-Uncertainty

If PRS is transmitted:

This field indicates the uncertainty in *expectedRSTD* value. The uncertainty is related to the location server's a-priori estimation of the target device location. The *expectedRSTD* and *expectedRSTD-Uncertainty* together define the search window for the target device.

The scale factor of the *expectedRSTD-Uncertainty* field is $3 \times T_s$, with $T_s = 1/(15000 \times 2048)$ seconds.

The target device may assume that the beginning of the PRS positioning occasion of the neighbour cell is received within the search window of size $[- \text{expectedRSTD-Uncertainty} \times 3 \times T_s, \text{expectedRSTD-Uncertainty} \times 3 \times T_s]$ centered at $T_{\text{REF}} + 1 \text{ millisecond} \times N + (\text{expectedRSTD} - 8192) \times 3 \times T_s$, where T_{REF} is the reception time of the beginning of the PRS positioning occasion of the assistance data reference cell at the target device antenna connector, $N = 0$ when the EARFCN of the neighbour cell is equal to that of the assistance data reference cell, and $N = \text{prs-SubframeOffset}$ otherwise.

If PRS is not transmitted:

This field indicates the uncertainty in *expectedRSTD* value. The uncertainty is related to the location server's a-priori estimation of the target device location. The *expectedRSTD* and *expectedRSTD-Uncertainty* together define the search window for the target device. The scale factor of the *expectedRSTD-Uncertainty* field is $3 \times T_s$, with $T_s = 1/(15000 \times 2048)$ seconds.

If T_x is the reception time of the beginning of the subframe X of the assistance data reference cell at the target device antenna connector, the target device may assume that the beginning of the closest subframe of this neighbour cell to subframe X is received within the search window of size $[- \text{expectedRSTD-Uncertainty} \times 3 \times T_s, \text{expectedRSTD-Uncertainty} \times 3 \times T_s]$ centered at $T_x + (\text{expectedRSTD} - 8192) \times 3 \times T_s$.

6.5.1.3 OTDOA Assistance Data Request

– OTDOA-RequestAssistanceData

The IE *OTDOA-RequestAssistanceData* is used by the target device to request assistance data from a location server.

```
-- ASN1START
OTDOA-RequestAssistanceData ::= SEQUENCE {
    physCellId      INTEGER (0..503),
    ...
}
-- ASN1STOP
```

OTDOA-RequestAssistanceData field descriptions**physCellId**

This field specifies the physical cell identity of the current primary cell of the target device.

6.5.1.4 OTDOA Location Information

– OTDOA-ProvideLocationInformation

The IE *OTDOA-ProvideLocationInformation* is used by the target device to provide OTDOA location measurements to the location server. It may also be used to provide OTDOA positioning specific error reason.

```
-- ASN1START
OTDOA-ProvideLocationInformation ::= SEQUENCE {
    otdoaSignalMeasurementInformation  OTDOA-SignalMeasurementInformation  OPTIONAL,
    otdoa-Error                        OTDOA-Error                        OPTIONAL,
    ...
}
-- ASN1STOP
```

6.5.1.5 OTDOA Location Information Elements

– OTDOA-SignalMeasurementInformation

The IE *OTDOA-SignalMeasurementInformation* is used by the target device to provide RSTD measurements to the location server. The RSTD measurements are provided for a neighbour cell and the RSTD reference cell, both of which are provided in the IE *OTDOA-ProvideAssistanceData*. The RSTD reference cell may or may not be the same as the assistance data reference cell provided in *OTDOA-ReferenceCellInfo*. If the target device stops reporting inter-frequency RSTD measurements, where the inter-frequency RSTD measurement is an OTDOA RSTD measurement with at least one cell on a frequency different from the serving cell frequency, the LPP layer shall inform lower layers that inter-frequency RSTD measurements are stopped.

NOTE: If there are more than 24 *NeighbourMeasurementElement* to be sent, the target device may send them in multiple *ProvideLocationInformation* messages, as described under sub-clause 5.3.

```
-- ASN1START
OTDOA-SignalMeasurementInformation ::= SEQUENCE {
    systemFrameNumber      BIT STRING (SIZE (10)),
    physCellIdRef          INTEGER (0..503),
    cellGlobalIdRef        ECGI                OPTIONAL,
    earfcnRef              ARFCN-ValueEUTRA    OPTIONAL,        -- Cond NotSameAsRef0
    referenceQuality       OTDOA-MeasQuality  OPTIONAL,
    neighbourMeasurementList NeighbourMeasurementList,
    ...,
    [[ earfcnRef-v9a0      ARFCN-ValueEUTRA-v9a0  OPTIONAL        -- Cond NotSameAsRef1
    ]]
}

NeighbourMeasurementList ::= SEQUENCE (SIZE(1..24)) OF NeighbourMeasurementElement

NeighbourMeasurementElement ::= SEQUENCE {
    physCellIdNeighbour    INTEGER (0..503),
    cellGlobalIdNeighbour ECGI                OPTIONAL,
    earfcnNeighbour        ARFCN-ValueEUTRA    OPTIONAL,        -- Cond NotSameAsRef2
    rstd                   INTEGER (0..12711),
    rstd-Quality           OTDOA-MeasQuality,
    ...,
    [[ earfcnNeighbour-v9a0 ARFCN-ValueEUTRA-v9a0  OPTIONAL        -- Cond NotSameAsRef3
    ]]
}
-- ASN1STOP
```

Conditional presence	Explanation
<i>NotSameAsRef0</i>	The field is absent if the corresponding <i>earfcnRef-v9a0</i> is present. Otherwise, the target device shall include this field if the EARFCN of the RSTD reference cell is not the same as the EARFCN of the assistance data reference cell provided in the OTDOA assistance data.
<i>NotSameAsRef1</i>	The field is absent if the corresponding <i>earfcnRef</i> is present. Otherwise, the target device shall include this field if the EARFCN of the RSTD reference cell is not the same as the EARFCN of the assistance data reference cell provided in the OTDOA assistance data.
<i>NotSameAsRef2</i>	The field is absent if the corresponding <i>earfcnNeighbour-v9a0</i> is present. Otherwise, the target device shall include this field if the EARFCN of this neighbour cell is not the same as the <i>earfcnRef</i> for the RSTD reference cell.
<i>NotSameAsRef3</i>	The field is absent if the corresponding <i>earfcnNeighbour</i> is present. Otherwise, the target device shall include this field if the EARFCN of this neighbour cell is not the same as the <i>earfcnRef</i> for the RSTD reference cell.

OTDOA-SignalMeasurementInformation field descriptions
<p>systemFrameNumber This field specifies the SFN of the RSTD reference cell containing the starting subframe of the PRS positioning occasion if PRS are available on the RSTD reference cell, or subframe of the CRS for RSTD measurements if PRS are not available on the RSTD reference cell during which the most recent neighbour cell RSTD measurement was performed.</p>
<p>physCellIdRef This field specifies the physical cell identity of the RSTD reference cell.</p>
<p>cellGlobalIdRef This field specifies the ECGI, the globally unique identity of a cell in E-UTRA, of the RSTD reference cell. The target shall provide this IE if it knows the ECGI of the RSTD reference cell.</p>
<p>earfcnRef This field specifies the EARFCN of the RSTD reference cell.</p>
<p>referenceQuality This field specifies the target device's best estimate of the quality of the TOA measurement from the RSTD reference cell, $T_{\text{SubframeRxRef}}$, where $T_{\text{SubframeRxRef}}$ is the time of arrival of the signal from the RSTD reference cell.</p>
<p>neighbourMeasurementList This list contains the measured RSTD values for neighbour cells together with the RSTD reference cell, along with quality for each measurement.</p>
<p>physCellIdNeighbour This field specifies the physical cell identity of the neighbour cell for which the RSTDs are provided.</p>
<p>cellGlobalIdNeighbour This field specifies the ECGI, the globally unique identity of a cell in E-UTRA, of the neighbour cell for which the RSTDs are provided. The target device shall provide this IE if it was able to determine the ECGI of the neighbour cell at the time of measurement.</p>
<p>earfcnNeighbour This field specifies the EARFCN of the neighbour cell used for the RSTD measurements.</p>
<p>rstd This field specifies the relative timing difference between this neighbour cell and the RSTD reference cell, as defined in [17]. Mapping of the measured quantity is defined as in [18] subclause 9.1.10.3.</p>
<p>rstd-Quality This field specifies the target device's best estimate of the quality of the measured <i>rstd</i>.</p>

– OTDOA-MeasQuality

```

-- ASN1START
OTDOA-MeasQuality ::= SEQUENCE {
    error-Resolution      BIT STRING (SIZE (2)),
    error-Value          BIT STRING (SIZE (5)),
    error-NumSamples     BIT STRING (SIZE (3))          OPTIONAL,
    ...
}
-- ASN1STOP

```

OTDOA-MeasQuality field descriptions

OTDOA-MeasQuality field descriptions																					
error-Resolution	<p>This field specifies the resolution R used in <i>error-Value</i> field. The encoding on two bits is as follows:</p> <table> <tr><td>'00'</td><td>5 meters</td></tr> <tr><td>'01'</td><td>10 meters</td></tr> <tr><td>'10'</td><td>20 meters</td></tr> <tr><td>'11'</td><td>30 meters.</td></tr> </table>	'00'	5 meters	'01'	10 meters	'10'	20 meters	'11'	30 meters.												
'00'	5 meters																				
'01'	10 meters																				
'10'	20 meters																				
'11'	30 meters.																				
error-Value	<p>This field specifies the target device"s best estimate of the uncertainty of the OTDOA (or TOA) measurement. The encoding on five bits is as follows:</p> <table> <tr><td>'00000'</td><td>0</td><td>to</td><td>(R*1-1) meters</td></tr> <tr><td>'00001'</td><td>R*1</td><td>to</td><td>(R*2-1) meters</td></tr> <tr><td>'00010'</td><td>R*2</td><td>to</td><td>(R*3-1) meters</td></tr> <tr><td>...</td><td></td><td></td><td></td></tr> <tr><td>'11111'</td><td>R*31</td><td></td><td>meters or more;</td></tr> </table> <p>where R is the resolution defined by <i>error-Resolution</i> field. E.g. , R=20 m corresponds to 0-19 m, 20-39 m, ..., 620+ m.</p>	'00000'	0	to	(R*1-1) meters	'00001'	R*1	to	(R*2-1) meters	'00010'	R*2	to	(R*3-1) meters	...				'11111'	R*31		meters or more;
'00000'	0	to	(R*1-1) meters																		
'00001'	R*1	to	(R*2-1) meters																		
'00010'	R*2	to	(R*3-1) meters																		
...																					
'11111'	R*31		meters or more;																		
error-NumSamples	<p>If the <i>error-Value</i> field provides the sample uncertainty of the OTDOA (or TOA) measurement, this field specifies how many measurements have been used by the target device to determine this (i.e., sample size). Following 3 bit encoding is used:</p> <table> <tr><td>"000"</td><td>Not the baseline metric</td></tr> <tr><td>'001'</td><td>5-9</td></tr> <tr><td>'010'</td><td>10-14</td></tr> <tr><td>'011'</td><td>15-24</td></tr> <tr><td>'100'</td><td>25-34</td></tr> <tr><td>'101'</td><td>35-44</td></tr> <tr><td>'110'</td><td>45-54</td></tr> <tr><td>'111'</td><td>55 or more.</td></tr> </table> <p>In case of the value "000", the <i>error-Value</i> field contains the target device"s best estimate of the uncertainty of the OTDOA (or TOA) measurement not based on the baseline metric. E.g., other measurements such as signal-to-noise-ratio or signal strength can be utilized to estimate the <i>error-Value</i>. If this field is absent, the value of this field is "000".</p>	"000"	Not the baseline metric	'001'	5-9	'010'	10-14	'011'	15-24	'100'	25-34	'101'	35-44	'110'	45-54	'111'	55 or more.				
"000"	Not the baseline metric																				
'001'	5-9																				
'010'	10-14																				
'011'	15-24																				
'100'	25-34																				
'101'	35-44																				
'110'	45-54																				
'111'	55 or more.																				

6.5.1.6 OTDOA Location Information Request

– OTDOA-RequestLocationInformation

The IE *OTDOA-RequestLocationInformation* is used by the location server to request OTDOA location measurements from a target device. Details of the required measurements (e.g. details of assistance data reference cell and neighbour cells) are conveyed in the *OTDOA-ProvideAssistanceData* IE in a separate Provide Assistance Data message.

```
-- ASN1START
OTDOA-RequestLocationInformation ::= SEQUENCE {
    assistanceAvailability    BOOLEAN,
    ...
}
-- ASN1STOP
```

OTDOA-RequestLocationInformation field descriptions	
assistanceAvailability	<p>This field indicates whether the target device may request additional OTDOA assistance data from the server. TRUE means allowed and FALSE means not allowed.</p>

6.5.1.7 OTDOA Capability Information

– OTDOA-ProvideCapabilities

The IE *OTDOA-ProvideCapabilities* is used by the target device to indicate its capability to support OTDOA and to provide its OTDOA positioning capabilities to the location server.

```

-- ASN1START
OTDOA-ProvideCapabilities ::= SEQUENCE {
    otdoa-Mode          BIT STRING { ue-assisted (0) } (SIZE (1..8)),
    . . . ,
    supportedBandListEUTRA SEQUENCE (SIZE (1..maxBands)) OF SupportedBandEUTRA OPTIONAL,
    supportedBandListEUTRA-v9a0 SEQUENCE (SIZE (1..maxBands)) OF SupportedBandEUTRA-v9a0 OPTIONAL,
    interFreqRSTDmeasurement-r10 ENUMERATED { supported } OPTIONAL,
    additionalNeighbourCellInfoList-r10 ENUMERATED { supported } OPTIONAL
}

maxBands INTEGER ::= 64

SupportedBandEUTRA ::= SEQUENCE {
    bandEUTRA          INTEGER (1..maxFBI)
}

SupportedBandEUTRA-v9a0 ::= SEQUENCE {
    bandEUTRA-v9a0    INTEGER (maxFBI-Plus1..maxFBI2) OPTIONAL
}

maxFBI          INTEGER ::= 64 -- Maximum value of frequency band indicator
maxFBI-Plus1    INTEGER ::= 65 -- lowest value extended FBI range
maxFBI2         INTEGER ::= 256 -- highest value extended FBI range

-- ASN1STOP

```

OTDOA-ProvideCapabilities field descriptions

otdoa-Mode

This field specifies the OTDOA mode(s) supported by the target device. This is represented by a bit string, with a one-value at the bit position means the particular OTDOA mode is supported; a zero-value means not supported. A zero-value in all bit positions in the bit string means OTDOA positioning method is not supported by the target device.

SupportedBandEUTRA

This field specifies the frequency bands for which the target device supports RSTD measurements. One entry corresponding to each supported E-UTRA band as defined in TS 36.101 [21]. In case the target device includes *bandEUTRA-v9a0*, the target device shall set the corresponding entry of *bandEUTRA* (i.e. without suffix) to *maxFBI*.

interFreqRSTDmeasurement

This field, if present, indicates that the target device supports inter-frequency RSTD measurements within and between the frequency bands indicated in *SupportedBandEUTRA*.

additionalNeighbourCellInfoList

This field, if present, indicates that the target device supports up to 3x24 *OTDOA-NeighbourCellInfoElement* in *OTDOA-NeighbourCellInfoList* in *OTDOA-ProvideAssistanceData* without any restriction for the *earfcn* in each *OTDOA-NeighbourCellInfoElement* as specified in subclause 6.5.1.2.

6.5.1.8 OTDOA Capability Information Request

– OTDOA-RequestCapabilities

The IE *OTDOA-RequestCapabilities* is used by the location server to request the capability of the target device to support OTDOA and to request OTDOA positioning capabilities from a target device.

```

-- ASN1START

OTDOA-RequestCapabilities ::= SEQUENCE {
    . . .
}

-- ASN1STOP

```

6.5.1.9 OTDOA Error Elements

– OTDOA-Error

The IE *OTDOA-Error* is used by the location server or target device to provide OTDOA error reasons to the target device or location server, respectively.

```

-- ASN1START
OTDOA-Error ::= CHOICE {
    locationServerErrorCauses      OTDOA-LocationServerErrorCauses,
    targetDeviceErrorCauses       OTDOA-TargetDeviceErrorCauses,
    ...
}
-- ASN1STOP

```

– OTDOA-LocationServerErrorCauses

The IE *OTDOA-LocationServerErrorCauses* is used by the location server to provide OTDOA error reasons to the target device.

```

-- ASN1START
OTDOA-LocationServerErrorCauses ::= SEQUENCE {
    cause      ENUMERATED { undefined,
                           assistanceDataNotSupportedByServer,
                           assistanceDataSupportedButCurrentlyNotAvailableByServer,
                           ...
    },
    ...
}
-- ASN1STOP

```

– OTDOA-TargetDeviceErrorCauses

The IE *OTDOA-TargetDeviceErrorCauses* is used by the target device to provide OTDOA error reasons to the location server.

```

-- ASN1START
OTDOA-TargetDeviceErrorCauses ::= SEQUENCE {
    cause      ENUMERATED { undefined,
                           assistance-data-missing,
                           unableToMeasureReferenceCell,
                           unableToMeasureAnyNeighbourCell,
                           attemptedButUnableToMeasureSomeNeighbourCells,
                           ...
    },
    ...
}
-- ASN1STOP

```

6.5.2 A-GNSS Positioning

6.5.2.1 GNSS Assistance Data

– A-GNSS-ProvideAssistanceData

The IE *A-GNSS-ProvideAssistanceData* is used by the location server to provide assistance data to enable UE-based and UE-assisted A-GNSS. It may also be used to provide GNSS positioning specific error reasons.

```

-- ASN1START
A-GNSS-ProvideAssistanceData ::= SEQUENCE {
    gnss-CommonAssistData      GNSS-CommonAssistData          OPTIONAL, -- Need ON
    gnss-GenericAssistData     GNSS-GenericAssistData          OPTIONAL, -- Need ON
    gnss-Error                 A-GNSS-Error                    OPTIONAL, -- Need ON
    ...
}
-- ASN1STOP

```

– GNSS-CommonAssistData

The IE *GNSS-CommonAssistData* is used by the location server to provide assistance data which can be used for any GNSS (e.g., GPS, Galileo, GLONASS, BDS, etc.).

```
-- ASN1START
GNSS-CommonAssistData ::= SEQUENCE {
  gnss-ReferenceTime          GNSS-ReferenceTime          OPTIONAL, -- Need ON
  gnss-ReferenceLocation     GNSS-ReferenceLocation     OPTIONAL, -- Need ON
  gnss-IonosphericModel     GNSS-IonosphericModel     OPTIONAL, -- Need ON
  gnss-EarthOrientationParameters GNSS-EarthOrientationParameters OPTIONAL, -- Need ON
  ...
}
-- ASN1STOP
```

– GNSS-GenericAssistData

The IE *GNSS-GenericAssistData* is used by the location server to provide assistance data for a specific GNSS (e.g., GPS, Galileo, GLONASS, BDS, etc.). The specific GNSS for which the provided assistance data are applicable is indicated by the IE *GNSS-ID* and (if applicable) by the IE *SBAS-ID*. Assistance for up to 16 GNSSs can be provided.

```
-- ASN1START
GNSS-GenericAssistData ::= SEQUENCE (SIZE (1..16)) OF GNSS-GenericAssistDataElement
GNSS-GenericAssistDataElement ::= SEQUENCE {
  gnss-ID          GNSS-ID,
  sbas-ID          SBAS-ID          OPTIONAL, -- Cond GNSS-ID-SBAS
  gnss-TimeModels  GNSS-TimeModelList OPTIONAL, -- Need ON
  gnss-DifferentialCorrections GNSS-DifferentialCorrections OPTIONAL, -- Need ON
  gnss-NavigationModel GNSS-NavigationModel OPTIONAL, -- Need ON
  gnss-RealTimeIntegrity GNSS-RealTimeIntegrity OPTIONAL, -- Need ON
  gnss-DataBitAssistance GNSS-DataBitAssistance OPTIONAL, -- Need ON
  gnss-AcquisitionAssistance GNSS-AcquisitionAssistance OPTIONAL, -- Need ON
  gnss-Almanac      GNSS-Almanac      OPTIONAL, -- Need ON
  gnss-UTC-Model    GNSS-UTC-Model    OPTIONAL, -- Need ON
  gnss-AuxiliaryInformation GNSS-AuxiliaryInformation OPTIONAL, -- Need ON
  ...
  [[
    bds-DifferentialCorrections-r12          BDS-DifferentialCorrections-r12 OPTIONAL, -- Cond GNSS-ID-BDS
    bds-GridModel-r12                       BDS-GridModelParameter-r12   OPTIONAL, -- Cond GNSS-ID-BDS
  ]]
}
-- ASN1STOP
```

Conditional presence	Explanation
<i>GNSS-ID-SBAS</i>	The field is mandatory present if the <i>GNSS-ID</i> = <i>sbas</i> ; otherwise it is not present.
<i>GNSS-ID-BDS</i>	The field may be present if the <i>GNSS-ID</i> = <i>bds</i> ; otherwise it is not present.

6.5.2.2 GNSS Assistance Data Elements

– GNSS-ReferenceTime

The IE *GNSS-ReferenceTime* is used by the location server to provide the GNSS specific system time with uncertainty and the relationship between GNSS system time and network air-interface timing of the eNodeB/NodeB/BTS transmission in the reference cell.

If the IE *networkTime* is present, the IEs *gnss-SystemTime* and *networkTime* provide a valid relationship between GNSS system time and air-interface network time, as seen at the approximate location of the target device, i.e. the propagation delay from the the eNodeB/NodeB/BTS to the target device shall be compensated for by the location server. Depending on implementation, the relation between GNSS system time and air-interface network time may have varying accuracy. The uncertainty of this timing relation is provided in the IE *referenceTimeUnc*. If the propagation delay from the eNodeB/NodeB/BTS to the target device is not accurately known, the location server shall use the best available approximation of the propagation delay and take the corresponding delay uncertainty into account in the calculation of the IE *referenceTimeUnc*.

If the IE *networkTime* is not present, the IE *gnssSystemTime* is an estimate of current GNSS system time at time of reception of the IE *GNSS-ReferenceTime* by the target device. The location server should achieve an accuracy of +/- 3 seconds for this estimate including allowing for the transmission delay between the location server and the target device. Note that the target device should further compensate *gnss-SystemTime* for the time between the reception of *GNSS-ReferenceTime* and the time when the *gnss-SystemTime* is used.

The location server shall provide a value for the *gnss-TimeID* only for GNSSs supported by the target device.

The IE *GNSS-ReferenceTimeForOneCell* can be provided multiple times (up to 16) to provide fine time assistance for several (neighbour) cells.

```

-- ASN1START

GNSS-ReferenceTime ::= SEQUENCE {
    gnss-SystemTime      GNSS-SystemTime,
    referenceTimeUnc     INTEGER (0..127)           OPTIONAL,  -- Cond noFTA
    gnss-ReferenceTimeForCells SEQUENCE (SIZE (1..16)) OF
                        GNSS-ReferenceTimeForOneCell  OPTIONAL,  -- Need ON
    ...
}

GNSS-ReferenceTimeForOneCell ::= SEQUENCE {
    networkTime          NetworkTime,
    referenceTimeUnc     INTEGER (0..127),
    bsAlign              ENUMERATED {true}  OPTIONAL,
    ...
}

-- ASN1STOP
    
```

Conditional presence	Explanation
<i>noFTA</i>	The field may be present if <i>gnss-ReferenceTimeForCells</i> is absent; otherwise it is not present.

GNSS-ReferenceTime field descriptions	
gnss-SystemTime	This field provides the specific GNSS system time.
networkTime	This field specifies the cellular network time at the epoch corresponding to <i>gnss-SystemTime</i> .
referenceTimeUnc	<p>This field provides the accuracy of the relation between <i>gnssSystemTime</i> and <i>networkTime</i> time if IE <i>networkTime</i> is provided. When IE <i>networkTime</i> is not provided, this field can be included to provide the accuracy of the provided <i>gnssSystemTime</i>.</p> <p>If GNSS TOD is the given GNSS time, then the true GNSS time, corresponding to the provided network time as observed at the target device location, lies in the interval [GNSS TOD - <i>referenceTimeUnc</i>, GNSS TOD + <i>referenceTimeUnc</i>].</p> <p>The uncertainty <i>r</i>, expressed in microseconds, is mapped to a number <i>K</i>, with the following formula:</p> $r = C * (((1+x)^K) - 1)$ <p>with <i>C</i> = 0.5 and <i>x</i> = 0.14. To encode any higher value of uncertainty than that corresponding in the above formula to <i>K</i>=127, the same value, <i>K</i>=127, shall also be used. The uncertainty is then coded on 7 bits, as the binary encoding of <i>K</i>. Example values for the <i>referenceTimeUnc</i> Format: see table K to uncertainty relation below.</p>
bsAlign	<p>This flag, if present, indicates that the transmission timings of all cells sharing, depending on the RAT, the same carrier frequency and Tracking Area/Location Area/ Routing Area as the cell indicated, are frame aligned. This information allows the target device to derive the GNSS - cellular time relation for any of these cells based on the timing relation information provided in GNSS-ReferenceTime. The flag should be set consistently in all these cells. This flag does not guarantee SFN alignment.</p>

K to uncertainty relation

Value of K	Value of uncertainty
0	0 nanoseconds
1	70 nanoseconds
2	149.8 nanoseconds
-	-
50	349.62 microseconds
-	-
127	≥ 8.43 seconds

GNSS-SystemTime

```
-- ASN1START
GNSS-SystemTime ::= SEQUENCE {
    gnss-TimeID          GNSS-ID,
    gnss-DayNumber       INTEGER (0..32767),
    gnss-TimeOfDay       INTEGER (0..86399),
    gnss-TimeOfDayFrac-msec INTEGER (0..999)    OPTIONAL, -- Need ON
    notificationOfLeapSecond BIT STRING (SIZE(2)) OPTIONAL, -- Cond gnss-TimeID=glonass
    gps-TOW-Assist       GPS-TOW-Assist        OPTIONAL, -- Cond gnss-TimeID=gps
    ...
}
-- ASN1STOP
```

Conditional presence	Explanation
<i>gnss-TimeID=glonass</i>	The field may be present if <i>gnss-TimeID=glonass</i> ; otherwise it is not present.
<i>gnss-TimeID=gps</i>	The field may be present if <i>gnss-TimeID=gps</i> ; otherwise it is not present.

GNSS-SystemTime field descriptions

<p>gnss-TimeID This field specifies the GNSS for which the <i>GNSS-SystemTime</i> is provided.</p>
<p>gnss-DayNumber This field specifies the sequential number of days (with day count starting at 0) from the origin of the GNSS System Time as follows: GPS, QZSS, SBAS – Days from January 6th 1980 00:00:00 UTC (USNO); Galileo – Days from Galileo System Time (GST) start epoch, defined as 13 seconds before midnight between 21st August and 22nd August 1999; i.e., GST was equal to 13 seconds at August 22nd 1999 00:00:00 UTC; GLONASS – Days from December 31st 1995 21:00:00 UTC (SU), which is local UTC Moscow January 1st 1996 00:00:00, defined as UTC(SU) + 3 hours in [9]; BDS – Days from January 1st 2006 00:00:00 UTC (NTSC).</p>
<p>gnss-TimeOfDay This field specifies the integer number of seconds from the GNSS day change.</p>
<p>gnss-TimeOfDayFrac-msec This field specifies the fractional part of the <i>gnssTimeOfDay</i> field in 1-milli-seconds resolution. The total GNSS TOD is <i>gnss-TimeOfDay</i> + <i>gnssTimeOfDayFrac-msec</i>.</p>
<p>notificationOfLeapSecond This field specifies the notification of forthcoming leap second correction, as defined by parameter KP in [9, Table 4.7].</p>
<p>gps-TOW-Assist This field contains several fields in the Telemetry (TLM) Word and Handover Word (HOW) that are currently being broadcast by the respective GPS satellites. Combining this information with GPS TOW enables the target device to know the entire 1.2-second (60-bit) pattern of TLM and HOW that is transmitted at the start of each six-second NAV subframe by the particular GPS satellite.</p>

GPS-TOW-Assist

```
-- ASN1START
GPS-TOW-Assist ::= SEQUENCE (SIZE(1..64)) OF GPS-TOW-AssistElement
GPS-TOW-AssistElement ::= SEQUENCE {
    satelliteID    INTEGER (1..64),
```



```

    tlmWord      INTEGER (0..16383),
    antiSpoof    INTEGER (0..1),
    alert        INTEGER (0..1),
    tlmRsvdBits  INTEGER (0..3),
    ...
}
-- ASN1STOP

```

GPS-TOW-Assist field descriptions

satelliteID	This field identifies the satellite for which the <i>GPS-TOW-Assist</i> is applicable. This field is identical to the GPS PRN Signal No. defined in [4].
tlmWord	This field contains a 14-bit value representing the Telemetry Message (TLM) being broadcast by the GPS satellite identified by the particular <i>satelliteID</i> , with the MSB occurring first in the satellite transmission, as defined in [4].
antiSpoof	This field contains the Anti-Spoof flag that is being broadcast by the GPS satellite identified by <i>satelliteID</i> , as defined in [4].
alert	This field contains the Alert flag that is being broadcast by the GPS satellite identified by <i>satelliteID</i> , as defined in [4].
tlmRsvdBits	This field contains the two reserved bits in the TLM Word being broadcast by the GPS satellite identified by <i>satelliteID</i> , with the MSB occurring first in the satellite transmission, as defined in [4].

NetworkTime

```

-- ASN1START
NetworkTime ::= SEQUENCE {
    secondsFromFrameStructureStart      INTEGER(0..12533),
    fractionalSecondsFromFrameStructureStart  INTEGER(0..3999999),
    frameDrift                          INTEGER (-64..63)  OPTIONAL,  -- Cond GNSSsynch
    cellID                               CHOICE {
        eUTRA                            SEQUENCE {
            physCellId                   INTEGER (0..503),
            cellGlobalIdEUTRA            CellGlobalIdEUTRA-AndUTRA  OPTIONAL,  -- Need ON
            earfcn                        ARFCN-ValueEUTRA,
            ...
            [[ earfcn-v9a0                ARFCN-ValueEUTRA-v9a0  OPTIONAL  -- Cond EARFCN-max
            ]],
        },
        uTRA                              SEQUENCE {
            mode                          CHOICE {
                fdd                       SEQUENCE {
                    primary-CPICH-Info   INTEGER (0..511),
                    ...
                },
                tdd                       SEQUENCE {
                    cellParameters       INTEGER (0..127),
                    ...
                }
            },
            cellGlobalIdUTRA              CellGlobalIdEUTRA-AndUTRA  OPTIONAL,  -- Need ON
            uarfcn                        ARFCN-ValueUTRA,
            ...
        },
        gSM                               SEQUENCE {
            bchCarrier                    INTEGER (0..1023),
            bsic                          INTEGER (0..63),
            cellGlobalIdGERAN             CellGlobalIdGERAN          OPTIONAL,  -- Need ON
            ...
        },
        ...
    },
    ...
}
-- ASN1STOP

```

Conditional presence	Explanation
<i>EARFCN-max</i>	The field is mandatory present if the corresponding <i>earfcn</i> (i.e. without suffix) is set to <i>maxEARFCN</i> . Otherwise the field is not present.
<i>GNSSsynch</i>	The field is present and set to 0 if <i>NetworkTime</i> is synchronized to <i>gnss-SystemTime</i> ; otherwise the field is optionally present, need OR.

<i>NetworkTime</i> field descriptions
<p><i>secondsFromFrameStructureStart</i> This field specifies the number of seconds from the beginning of the longest frame structure in the corresponding air interface. In case of E-UTRA, the SFN cycle length is 10.24 seconds. In case of UTRA, the SFN cycle length is 40.96 seconds. In case of GSM, the hyperframe length is 12533.76 seconds.</p>
<p><i>fractionalSecondsFromFrameStructureStart</i> This field specifies the fractional part of the <i>secondsFromFrameStructureStart</i> in 250 ns resolution. The total time since the particular frame structure start is <i>secondsFromFrameStructureStart</i> + <i>fractionalSecondsFromFrameStructureStart</i></p>
<p><i>frameDrift</i> This field specifies the drift rate of the GNSS-network time relation with scale factor 2^{-30} seconds/second, in the range from $-5.9605e-8$ to $+5.8673e-8$ sec/sec.</p>
<p><i>cellID</i> This field specifies the cell for which the GNSS-network time relation is provided.</p>
<p><i>physCellId</i> This field specifies the physical cell identity of the reference cell (E-UTRA), as defined in [12], for which the GNSS network time relation is provided.</p>
<p><i>cellGlobalIdEUTRA</i> This field specifies the Evolved Cell Global Identifier (ECGI), the globally unique identity of a cell in E-UTRA, of the reference cell for the GNSS-network time relation, as defined in [12].</p>
<p><i>earfcn</i> This field specifies E-ARFCN of the reference cell for the GNSS-network time relation (E-UTRA). In case the server includes <i>earfcn-v9a0</i>, the server shall set the corresponding <i>earfcn</i> (i.e. without suffix) to <i>maxEARFCN</i>.</p>
<p><i>primary-CPICH-Info</i> This field specifies the physical cell identity of the reference cell (UTRA) for the GNSS-network time relation, as defined in [13].</p>
<p><i>cellParameters</i> This field specifies the physical cell identity of the reference cell (UTRA) for the GNSS-network time relation, as defined in [13].</p>
<p><i>cellGlobalIdUTRA</i> The field specifies the global UTRAN Cell Identifier, the globally unique identity of a cell in UTRA, of the reference cell for the GNSS-network time relation, as defined in [13].</p>
<p><i>uarfcn</i> This field specifies ARFCN of the reference cell for the GNSS-network time relation (UTRA).</p>
<p><i>bcchCarrier</i> This field specifies the absolute GSM RF channel number of the BCCH of the reference base station (GERAN) for the GNSS-network time relation, as defined in [14].</p>
<p><i>bsic</i> This field specifies the Base Station Identity Code of the reference base station (GERAN) for the GNSS-network time relation, as defined in [14].</p>
<p><i>cellGlobalIdGERAN</i> This field specifies the Cell Global Identification (CGI), the globally unique identity of a cell in GERAN, of the reference base station for the GNSS-network time relation.</p>

– GNSS-ReferenceLocation

The IE *GNSS-ReferenceLocation* is used by the location server to provide the target device with a-priori knowledge of its location in order to improve GNSS receiver performance. The IE *GNSS-ReferenceLocation* is provided in WGS-84 reference system.

```
-- ASN1START
GNSS-ReferenceLocation ::= SEQUENCE {
    threeDlocation      EllipsoidPointWithAltitudeAndUncertaintyEllipsoid,
    ...
}
-- ASN1STOP
```

– GNSS-IonosphericModel

The IE *GNSS-IonosphericModel* is used by the location server to provide parameters to model the propagation delay of the GNSS signals through the ionosphere. Proper use of these fields allows a single-frequency GNSS receiver to remove parts of the ionospheric delay from the pseudorange measurements. Two Ionospheric Models are supported: The Klobuchar model as defined in [4], and the NeQuick model as defined in [8].

```
-- ASN1START
GNSS-IonosphericModel ::= SEQUENCE {
    klobucharModel      KlobucharModelParameter      OPTIONAL,    -- Need ON
    neQuickModel        NeQuickModelParameter        OPTIONAL,    -- Need ON
    ...
}
-- ASN1STOP
```

– KlobucharModelParameter

```
-- ASN1START
KlobucharModelParameter ::= SEQUENCE {
    dataID              BIT STRING (SIZE (2)),
    alfa0               INTEGER (-128..127),
    alfa1               INTEGER (-128..127),
    alfa2               INTEGER (-128..127),
    alfa3               INTEGER (-128..127),
    beta0               INTEGER (-128..127),
    beta1               INTEGER (-128..127),
    beta2               INTEGER (-128..127),
    beta3               INTEGER (-128..127),
    ...
}
-- ASN1STOP
```

***KlobucharModelParameter* field descriptions**

dataID

When *dataID* has the value "11" it indicates that the parameters have been generated by QZSS, and the parameters have been specialized and are applicable within the area defined in [7]. When *dataID* has the value "01" it indicates that the parameters have been generated by BDS, and UE shall use these parameters according to the description given in 5.2.4.7 in [23]. When *dataID* has the value "00" it indicates the parameters are applicable worldwide [4,7]. All other values for *dataID* are reserved.

alpha0

This field specifies the α_0 parameter of the Klobuchar model, as specified in [4], [23].
Scale factor 2^{-30} seconds.

alpha1

This field specifies the α_1 parameter of the Klobuchar model, as specified in [4], [23].
Scale factor 2^{27} seconds/semi-circle.

alpha2

This field specifies the α_2 parameter of the Klobuchar model, as specified in [4], [23].
Scale factor 2^{-24} seconds/semi-circle².

alpha3

This field specifies the α_3 parameter of the Klobuchar model, as specified in [4], [23].
Scale factor 2^{-24} seconds/semi-circle³.

beta0

This field specifies the β_0 parameter of the Klobuchar model, as specified in [4], [23].
Scale factor 2^{11} seconds.

beta1

This field specifies the β_1 parameter of the Klobuchar model, as specified in [4], [23].
Scale factor 2^{14} seconds/semi-circle.

beta2

This field specifies the β_2 parameter of the Klobuchar model, as specified in [4], [23].
Scale factor 2^{16} seconds/semi-circle².

KlobucharModelParamater field descriptions**beta3**

This field specifies the β_3 parameter of the Klobuchar model, as specified in [4], [23].
Scale factor 2^{16} seconds/semi-circle³.

– **NeQuickModelParameter**

```
-- ASN1START
NeQuickModelParameter ::= SEQUENCE {
    ai0          INTEGER (0..2047),
    ai1          INTEGER (-1024..1023),
    ai2          INTEGER (-8192..8191),
    ionoStormFlag1  INTEGER (0..1)    OPTIONAL,  -- Need OP
    ionoStormFlag2  INTEGER (0..1)    OPTIONAL,  -- Need OP
    ionoStormFlag3  INTEGER (0..1)    OPTIONAL,  -- Need OP
    ionoStormFlag4  INTEGER (0..1)    OPTIONAL,  -- Need OP
    ionoStormFlag5  INTEGER (0..1)    OPTIONAL,  -- Need OP
    ...
}
-- ASN1STOP
```

NeQuickModelParameter field descriptions**ai0**

Effective Ionisation Level 1st order parameter.
Scale factor 2^2 Solar Flux Units (SFUs), [8] section 5.1.6.

ai1

Effective Ionisation Level 2nd order parameter.
Scale factor 2^8 Solar Flux Units/degree, [8] section 5.1.6.

ai2

Effective Ionisation Level 3rd order parameter.
Scale factor 2^{15} Solar Flux Units/degree², [8] section 5.1.6.

ionoStormFlag1, ionoStormFlag2, ionoStormFlag3, ionoStormFlag4, ionoStormFlag5

These fields specify the ionosphere disturbance flags (1,...,5) for five different regions as described in [8], section 5.1.6. If the ionosphere disturbance flag for a region is not present the target device shall treat the ionosphere disturbance condition as unknown.

– **GNSS-EarthOrientationParameters**

The IE *GNSS-EarthOrientationParameters* is used by the location server to provide parameters to construct the ECEF and ECI coordinate transformation as defined in [4]. The IE *GNSS-EarthOrientationParameters* indicates the relationship between the Earth's rotational axis and WGS-84 reference system.

```
-- ASN1START
GNSS-EarthOrientationParameters ::= SEQUENCE {
    teop          INTEGER (0..65535),
    pmX           INTEGER (-1048576..1048575),
    pmXdot        INTEGER (-16384..16383),
    pmY           INTEGER (-1048576..1048575),
    pmYdot        INTEGER (-16384..16383),
    deltaUT1      INTEGER (-1073741824..1073741823),
    deltaUT1dot   INTEGER (-262144..262143),
    ...
}
-- ASN1STOP
```

GNSS-EarthOrientationParameters field descriptions**teop**

This field specifies the EOP data reference time in seconds, as specified in [4].
Scale factor 2^4 seconds.

pmX

This field specifies the X-axis polar motion value at reference time in arc-seconds, as specified in [4].
Scale factor 2^{20} arc-seconds.

GNSS-EarthOrientationParameters field descriptions
<p>pmXdot This field specifies the X-axis polar motion drift at reference time in arc-seconds/day, as specified in [4]. Scale factor 2^{21} arc-seconds/day.</p>
<p>pmY This field specifies the Y-axis polar motion value at reference time in arc-seconds, as specified in [4]. Scale factor 2^{20} arc-seconds.</p>
<p>pmYdot This field specifies the Y-axis polar motion drift at reference time in arc-seconds/day, as specified in [4]. Scale factor 2^{21} arc-seconds/day.</p>
<p>deltaUT1 This field specifies the UT1-UTC difference at reference time in seconds, as specified in [4]. Scale factor 2^{24} seconds.</p>
<p>deltaUT1dot This field specifies the Rate of UT1-UTC difference at reference time in seconds/day, as specified in [4]. Scale factor 2^{25} seconds/day.</p>

– GNSS-TimeModelList

The IE *GNSS-TimeModelList* is used by the location server to provide the GNSS-GNSS system time offset between the GNSS system time indicated by IE *GNSS-ID* in IE *GNSS-GenericAssistDataElement* to the GNSS system time indicated by IE *gnss-TO-ID*. Several *GNSS-TimeModelElement* IEs can be included with different *gnss-TO-ID* fields.

```
-- ASN1START
GNSS-TimeModelList ::= SEQUENCE (SIZE (1..15)) OF GNSS-TimeModelElement

GNSS-TimeModelElement ::= SEQUENCE {
    gnss-TimeModelRefTime      INTEGER (0..65535),
    tA0                        INTEGER (-67108864..67108863),
    tA1                        INTEGER (-4096..4095)                OPTIONAL,    -- Need ON
    tA2                        INTEGER (-64..63)                    OPTIONAL,    -- Need ON
    gnss-TO-ID                 INTEGER (1..15),
    weekNumber                 INTEGER (0..8191)                   OPTIONAL,    -- Need ON
    deltaT                     INTEGER (-128..127)                OPTIONAL,    -- Need ON
    ...
}
-- ASN1STOP
```

GNSS-TimeModelElement field descriptions
<p>gnss-TimeModelRefTime This field specifies the reference time of week for <i>GNSS-TimeModelElement</i> and it is given in GNSS specific system time. Scale factor 2^4 seconds.</p>
<p>tA0 This field specifies the bias coefficient of the <i>GNSS-TimeModelElement</i>. Scale factor 2^{35} seconds.</p>
<p>tA1 This field specifies the drift coefficient of the <i>GNSS-TimeModelElement</i>. Scale factor of 2^{51} seconds/second.</p>
<p>tA2 This field specifies the drift rate correction coefficient of the <i>GNSS-TimeModelElement</i>. Scale factor of 2^{68} seconds/second².</p>
<p>gnss-TO-ID This field specifies the GNSS system time of the GNSS for which the <i>GNSS-TimeModelElement</i> is applicable. <i>GNSS-TimeModelElement</i> contains parameters to convert GNSS system time from the system indicated by <i>GNSS-ID</i> to GNSS system time indicated by <i>gnss-TO-ID</i>. The conversion is defined in [4,5,6]. See table of <i>gnss-TO-ID</i> to Indication relation below.</p>
<p>weekNumber This field specifies the reference week of the <i>GNSS-TimeModelElement</i> given in GNSS specific system time. Scale factor 1 week.</p>
<p>deltaT This field specifies the integer number of seconds of the GNSS-GNSS time offset provided in the <i>GNSS-TimeModelElement</i>. Scale factor 1 second.</p>

gnss-TO-ID to Indication relation

Value of <i>gnss-TO-ID</i>	Indication
1	GPS
2	Galileo
3	QZSS
4	GLONASS
5	BDS
6-15	reserved

– **GNSS-DifferentialCorrections**

The IE *GNSS-DifferentialCorrections* is used by the location server to provide differential GNSS corrections to the target device for a specific GNSS. Differential corrections can be provided for up to 3 signals per GNSS.

```
-- ASN1START
GNSS-DifferentialCorrections ::= SEQUENCE {
    dgnss-RefTime      INTEGER (0..3599),
    dgnss-SgnTypeList  DGNSS-SgnTypeList,
    ...
}

DGNSS-SgnTypeList ::= SEQUENCE (SIZE (1..3)) OF DGNSS-SgnTypeElement

DGNSS-SgnTypeElement ::= SEQUENCE {
    gnss-SignalID      GNSS-SignalID,
    gnss-StatusHealth  INTEGER (0..7),
    dgnss-SatList      DGNSS-SatList,
    ...
}

DGNSS-SatList ::= SEQUENCE (SIZE (1..64)) OF DGNSS-CorrectionsElement

DGNSS-CorrectionsElement ::= SEQUENCE {
    svID               SV-ID,
    iod                BIT STRING (SIZE(11)),
    udre               INTEGER (0..3),
    pseudoRangeCor     INTEGER (-2047..2047),
    rangeRateCor       INTEGER (-127..127),
    udreGrowthRate     INTEGER (0..7)          OPTIONAL,  -- Need ON
    udreValidityTime   INTEGER (0..7)          OPTIONAL,  -- Need ON
    ...
}
-- ASN1STOP
```

GNSS-DifferentialCorrections field descriptions***dgnss-RefTime***

This field specifies the time for which the DGNSS corrections are valid, modulo 1 hour. *dgnss-RefTime* is given in GNSS specific system time.
Scale factor 1-second.

dgnss-SgnTypeList

This list includes differential correction data for different GNSS signal types, identified by *GNSS-SignalID*.

gnss-StatusHealth

This field specifies the status of the differential corrections. The values of this field and their respective meanings are defined as in table *gnss-StatusHealth* Value to Indication relation below.

The first six values in this field indicate valid differential corrections. When using the values described below, the "UDRE Scale Factor" value is applied to the UDRE values contained in the element. The purpose is to indicate an estimate in the amount of error in the corrections.

The value "110" indicates that the source of the differential corrections (e.g., reference station or external DGNSS network) is currently not being monitored. The value "111" indicates that the corrections provided by the source are invalid, as judged by the source.

dgnss-SatList

This list includes differential correction data for different GNSS satellites, identified by *SV-ID*.

iod

This field specifies the Issue of Data field which contains the identity for the *GNSS-NavigationModel*.

GNSS-DifferentialCorrections field descriptions	
udre	<p>This field provides an estimate of the uncertainty (1-σ) in the corrections for the particular satellite. The value in this field shall be multiplied by the UDRE Scale Factor in the <i>gnss-StatusHealth</i> field to determine the final UDRE estimate for the particular satellite. The meanings of the values for this field are shown in the table <i>udre Value</i> to Indication relation below.</p>
pseudoRangeCor	<p>This field specifies the correction to the pseudorange for the particular satellite at <i>dgnss-RefTime</i>, t_0. The value of this field is given in meters and the scale factor is 0.32 meters in the range of ±655.04 meters. The method of calculating this field is described in [11].</p> <p>If the location server has received a request for GNSS assistance data from a target device which included a request for the GNSS Navigation Model and DGNSS, the location server shall determine, for each satellite, if the navigation model stored by the target device is still suitable for use with DGNSS corrections and if so and if DGNSS corrections are supported the location server should send DGNSS corrections without including the GNSS Navigation Model. The <i>iod</i> value sent for a satellite shall always be the IOD value that corresponds to the navigation model for which the pseudo-range corrections are applicable.</p> <p>The target device shall only use the <i>pseudoRangeCor</i> value when the IOD value received matches its available navigation model.</p> <p>Pseudo-range corrections are provided with respect to GNSS specific geodetic datum (e.g., PZ-90.02 if <i>GNSS-ID</i> indicates GLONASS).</p> <p>Scale factor 0.32 meters.</p>
rangeRateCor	<p>This field specifies the rate-of-change of the pseudorange correction for the particular satellite, using the satellite ephemeris and clock corrections identified by the <i>iod</i> field. The value of this field is given in meters per second and the resolution is 0.032 meters/sec in the range of ±4.064 meters/sec. For some time $t_1 > t_0$, the corrections for <i>iod</i> are estimated by</p> $PRC(t_1, IOD) = PRC(t_0, IOD) + RRC(t_0, IOD) \cdot (t_1 - t_0) ,$ <p>and the target device uses this to correct the pseudorange it measures at t_1, $PR_m(t_1, IOD)$, by</p> $PR(t_1, IOD) = PR_m(t_1, IOD) + PRC(t_1, IOD) .$ <p>The location server shall always send the RRC value that corresponds to the PRC value that it sends. The target device shall only use the RRC value when the <i>iod</i> value received matches its available navigation model.</p> <p>Scale factor 0.032 meters/second.</p>
udreGrowthRate	<p>This field provides an estimate of the growth rate of uncertainty (1-σ) in the corrections for the particular satellite identified by <i>SV-ID</i>. The estimated UDRE at time value specified in the <i>udreValidityTime</i> t_1 is calculated as follows:</p> $UDRE(t_{\sigma} + t_1) = UDRE(t_0) \times udreGrowthRate ,$ <p>where t_0 is the DGNSS Reference Time <i>dgnss-RefTime</i> for which the corrections are valid, t_1 is the <i>udreValidityTime</i> field, $UDRE(t_0)$ is the value of the <i>udre</i> field, and <i>udreGrowthRate</i> field is the factor as shown in the table Value of <i>udreGrowthRate</i> to Indication relation below.</p>
udreValidityTime	<p>This field specifies the time when the <i>udreGrowthRate</i> field applies and is included if <i>udreGrowthRate</i> is included. The meaning of the values for this field is as shown in the table Value of <i>udreValidityTime</i> to Indication relation below.</p>

gnss-StatusHealth Value to Indication relation

gnss-StatusHealth Value	Indication
000	UDRE Scale Factor = 1.0
001	UDRE Scale Factor = 0.75
010	UDRE Scale Factor = 0.5
011	UDRE Scale Factor = 0.3
100	UDRE Scale Factor = 0.2
101	UDRE Scale Factor = 0.1
110	Reference Station Transmission Not Monitored
111	Data is invalid - disregard

udre Value to Indication relation

udre Value	Indication
00	UDRE ≤ 1.0 m
01	1.0 m < UDRE ≤ 4.0 m
10	4.0 m < UDRE ≤ 8.0 m
11	8.0 m < UDRE

Value of *udreGrowthRate* to Indication relation

Value of <i>udreGrowthRate</i>	Indication
000	1.5
001	2
010	4
011	6
100	8
101	10
110	12
111	16

Value of *udreValidityTime* to Indication relation

Value of <i>udreValidityTime</i>	Indication [seconds]
000	20
001	40
010	80
011	160
100	320
101	640
110	1280
111	2560

– GNSS-*NavigationModel*

The IE *GNSS-NavigationModel* is used by the location server to provide precise navigation data to the GNSS capable target device. In response to a request from a target device for GNSS Assistance Data, the location server shall determine whether to send the navigation model for a particular satellite to a target device based upon factors like the T-Toe limit specified by the target device and any request from the target device for DGNSS (see also *GNSS-DifferentialCorrections*). GNSS Orbit Model can be given in Keplerian parameters or as state vector in Earth-Centered Earth-Fixed coordinates, dependent on the *GNSS-ID* and the target device capabilities. The meaning of these parameters is defined in relevant ICDs of the particular GNSS and GNSS specific interpretations apply. For example, GPS and QZSS use the same model parameters but some parameters have a different interpretation [7].

```
-- ASN1START

GNSS-NavigationModel ::= SEQUENCE {
    nonBroadcastIndFlag      INTEGER (0..1),
    gnss-SatelliteList      GNSS-NavModelSatelliteList,
    ...
}

GNSS-NavModelSatelliteList ::= SEQUENCE (SIZE(1..64)) OF GNSS-NavModelSatelliteElement

GNSS-NavModelSatelliteElement ::= SEQUENCE {
    svID                     SV-ID,
    svHealth                 BIT STRING (SIZE(8)),
    iod                     BIT STRING (SIZE(11)),
    gnss-ClockModel          GNSS-ClockModel,
    gnss-OrbitModel          GNSS-OrbitModel,
    ...
    [[ svHealthExt-v1240 BIT STRING (SIZE(4)) OPTIONAL -- Need ON
    ]]
}

GNSS-ClockModel ::= CHOICE {
    standardClockModelList  StandardClockModelList,      -- Model-1
    nav-ClockModel          NAV-ClockModel,              -- Model-2
    cnav-ClockModel         CNAV-ClockModel,             -- Model-3
    glonass-ClockModel      GLONASS-ClockModel,         -- Model-4
    sbas-ClockModel         SBAS-ClockModel,             -- Model-5
    ...
    bds-ClockModel-r12      BDS-ClockModel-r12          -- Model-6
}
-- ASN1END
```



```

GNSS-OrbitModel ::= CHOICE {
    keplerianSet      NavModelKeplerianSet,           -- Model-1
    nav-KeplerianSet  NavModelNAV-KeplerianSet,       -- Model-2
    cnav-KeplerianSet NavModelCNAV-KeplerianSet,      -- Model-3
    glonass-ECEF      NavModel-GLONASS-ECEF,         -- Model-4
    sbas-ECEF         NavModel-SBAS-ECEF,            -- Model-5
    . . .
    bds-KeplerianSet-r12 NavModel-BDS-KeplerianSet-r12 -- Model-6
}
-- ASN1STOP
    
```

GNSS-NavgationModel field descriptions	
nonBroadcastIndFlag	This field indicates if the <i>GNSS-NavgationModel</i> elements are not derived from satellite broadcast data or are given in a format not native to the GNSS. A value of 0 means the <i>GNSS-NavgationModel</i> data elements correspond to GNSS satellite broadcasted data; a value of 1 means the <i>GNSS-NavgationModel</i> data elements are not derived from satellite broadcast.
gnss-SatelliteList	This list provides ephemeris and clock corrections for GNSS satellites indicated by <i>SV-ID</i> .
svHealth	This field specifies the satellite's current health. The health values are GNSS system specific. The interpretation of <i>svHealth</i> depends on the <i>GNSS-ID</i> and is as shown in table GNSS to svHealth Bit String(8) relation below.
iod	This field specifies the Issue of Data and contains the identity for GNSS Navigation Model. In case of broadcasted GPS NAV ephemeris, the <i>iod</i> contains the IODC as described in [4]. In case of broadcasted Modernized GPS ephemeris, the <i>iod</i> contains the 11-bit parameter t_{oe} as defined in [4, Table 30-I] [6, Table 3.5-1]. In case of broadcasted SBAS ephemeris, the <i>iod</i> contains the 8 bits Issue of Data as defined in [10] Message Type 9. In case of broadcasted QZSS QZS-L1 ephemeris, the <i>iod</i> contains the IODC as described in [7]. In case of broadcasted QZSS QZS-L1C/L2C/L5 ephemeris, the <i>iod</i> contains the 11-bit parameter t_{oe} as defined in [7]. In case of broadcasted GLONASS ephemeris, the <i>iod</i> contains the parameter t_b as defined in [9]. In the case of broadcasted Galileo ephemeris, the <i>iod</i> contains the IOD index as described in [8]. In the case of broadcasted BDS ephemeris, the <i>iod</i> contains 11 MSB bits of the t_{oe} as defined in [23]. The interpretation of <i>iod</i> depends on the <i>GNSS-ID</i> and is as shown in table GNSS to iod Bit String(11) relation below.
svHealthExt	This field specifies the satellite's additional current health. The health values are GNSS system specific. The interpretation of <i>svHealthExt</i> depends on the <i>GNSS-ID</i> and is as shown in table GNSS to svHealthExt Bit String(4) relation below.

GNSS to svHealth Bit String(8) relation

GNSS	svHealth Bit String(8)							
	Bit 1 (MSB)	Bit 2	Bit 3	Bit 4	Bit 5	Bit 6	Bit 7	Bit 8 (LSB)
GPS L1/CA ⁽¹⁾	SV Health [4]						"0" (reserved)	"0" (reserved)
Modernized GPS ⁽²⁾	L1C Health [6]	L1 Health [4,5]	L2 Health [4,5]	L5 Health [4,5]	"0" (reserved)	"0" (reserved)	"0" (reserved)	"0" (reserved)
SBAS ⁽³⁾	Ranging On (0), Off(1) [10]	Corrections On(0), Off(1) [10]	Integrity On(0), Off(1) [10]	"0" (reserved)	"0" (reserved)	"0" (reserved)	"0" (reserved)	"0" (reserved)
QZSS ⁽⁴⁾ QZS-L1	SV Health [7]						"0" (reserved)	"0" (reserved)
QZSS ⁽⁵⁾ QZS-L1C/L2C/L5	L1C Health [7]	L1 Health [7]	L2 Health [7]	L5 Health [7]	"0" (reserved)	"0" (reserved)	"0" (reserved)	"0" (reserved)
GLONASS	B_n (MSB) [9, page 30]	F_T [9, Table 4.4]				"0" (reserved)	"0" (reserved)	"0" (reserved)
Galileo [8, section 5.1.9.3]	E5a Data Validity Status	E5b Data Validity Status	E1-B Data Validity Status	E5a Signal Health Status		"0" (reserved)	"0" (reserved)	"0" (reserved)
BDS [23]	B11 Health (SatH1) [23]	"0" (reserved)	"0" (reserved)	"0" (reserved)	"0" (reserved)	"0" (reserved)	"0" (reserved)	"0" (reserved)
Note 1:	If <i>GNSS-ID</i> indicates "gps", and GNSS Orbit Model-2 is included, this interpretation of <i>svHealth</i> applies.							
Note 2:	If <i>GNSS-ID</i> indicates "gps", and GNSS Orbit Model-3 is included, this interpretation of <i>svHealth</i> applies. If a certain signal is not supported on the satellite indicated by <i>SV-ID</i> , the corresponding health bit shall be set to "1" (i.e., signal can not be used).							
Note 3:	<i>svHealth</i> in case of <i>GNSS-ID</i> indicates "sbas" includes the 5 LSBs of the Health included in GEO Almanac Message Parameters (Type 17) [10].							

Note 4: If GNSS-ID indicates "qzss", and GNSS Orbit Model-2 is included, this interpretation of *svHealth* applies.
 Note 5: If GNSS-ID indicates "qzss", and GNSS Orbit Model-3 is included, this interpretation of *svHealth* applies.

GNSS to iod Bit String(11) relation

GNSS	iod Bit String(11)										
	Bit 1 (MSB)	Bit 2	Bit 3	Bit 4	Bit 5	Bit 6	Bit 7	Bit 8	Bit 9	Bit 10	Bit 11 (LSB)
GPS L1/CA	"0"	Issue of Data, Clock [4]									
Modernized GPS	t_{oe} (seconds, scale factor 300, range 0 – 604500) [4,5,6]										
SBAS	"0"	"0"	"0"	Issue of Data ([10], Message Type 9)							
QZSS QZS-L1	"0"	Issue of Data, Clock [7]									
QZSS QZS-L1C/L2C/L5	t_{oe} (seconds, scale factor 300, range 0 – 604500) [7]										
GLONASS	"0"	"0"	"0"	"0"	t_b (minutes, scale factor 15) [9]						
Galileo	"0"	IODnav [8]									
BDS	11 MSB bits of t_{oe} (seconds, scale factor 512, range 0 – 604672) [23]										

GNSS to svHealthExt Bit String(4) relation

GNSS	svHealthExt Bit String(4)			
	Bit 1 (MSB)	Bit 2	Bit 3	Bit 4 (LSB)
Galileo [8, section 5.1.9.3]	E5b Signal Health Status		E1-B Signal Health Status	

– **StandardClockModelList**

```
-- ASN1START
StandardClockModelList ::= SEQUENCE (SIZE(1..2)) OF StandardClockModelElement
StandardClockModelElement ::= SEQUENCE {
    stanClockToc          INTEGER (0..16383),
    stanClockAF2         INTEGER (-32..31),
    stanClockAF1         INTEGER (-1048576..1048575),
    stanClockAF0         INTEGER (-1073741824..1073741823),
    stanClockTgd         INTEGER (-512..511)           OPTIONAL, -- Need ON
    sisa                INTEGER (0..255),
    stanModelID         INTEGER (0..1)           OPTIONAL, -- Need ON
    ...
}
-- ASN1STOP
```

StandardClockModelList field descriptions
<p>standardClockModelList <i>gnss-ClockModel</i> Model-1 contains one or two clock model elements. If included, clock Model-1 shall be included once or twice depending on the target device capability. If the target device is supporting multiple Galileo signals, the location server shall include both F/Nav and I/Nav clock models in <i>gnss-ClockModel</i> if the location server assumes the target device to perform location information calculation using multiple signals.</p>
<p>stanClockToc Parameter t_{oc} defined in [8]. Scale factor 60 seconds.</p>
<p>stanClockAF2 Parameter af_2 defined in [8]. Scale factor 2^{59} seconds/second².</p>
<p>stanClockAF1 Parameter af_1 defined in [8]. Scale factor 2^{46} seconds/second.</p>
<p>stanClockAF0 Parameter af_0 defined in [8]. Scale factor 2^{-34} seconds.</p>

StandardClockModelList field descriptions
<p>stanClockTgd Parameter T_{GD}, Broadcast Group Delay (BGD), defined in [8]. Scale factor 2^{-32} seconds. This field is required if the target device supports only single frequency Galileo signal.</p>
<p>sisa Signal-In-Space Accuracy (SISA), defined in [8] section 5.1.11.</p>
<p>stanModelID This field specifies the identity of the clock model according to the table Value of stanModelID to Identity relation below. This field is required if the location server includes both F/Nav and I/Nav Galileo clock models in <i>gnss-ClockModel</i>.</p>

Value of stanModelID to Identity relation

Value of <i>stanModelID</i>	Identity
0	I/Nav (E1,E5b)
1	F/Nav (E1,E5a)

– NAV-ClockModel

```
-- ASN1START
NAV-ClockModel ::= SEQUENCE {
    navToc          INTEGER (0..37799),
    navaf2          INTEGER (-128..127),
    navaf1          INTEGER (-32768..32767),
    navaf0          INTEGER (-2097152..2097151),
    navTgd          INTEGER (-128..127),
    ...
}
-- ASN1STOP
```

NAV-ClockModel field descriptions
<p>navToc Parameter t_{oc}, time of clock (seconds) [4,7]. Scale factor 2^4 seconds.</p>
<p>navaf2 Parameter a_{f2}, clock correction polynomial coefficient (sec/sec²) [4,7]. Scale factor 2^{55} seconds/second².</p>
<p>navaf1 Parameter a_{f1}, clock correction polynomial coefficient (sec/sec) [4,7]. Scale factor 2^{43} seconds/second.</p>
<p>navaf0 Parameter a_{f0}, clock correction polynomial coefficient (seconds) [4,7]. Scale factor 2^{31} seconds.</p>
<p>navTgd Parameter T_{GD}, group delay (seconds) [4,7]. Scale factor 2^{31} seconds.</p>

– CNAV-ClockModel

```
-- ASN1START
CNAV-ClockModel ::= SEQUENCE {
    cnavToc          INTEGER (0..2015),
    cnavTop          INTEGER (0..2015),
    cnavURA0        INTEGER (-16..15),
    cnavURA1        INTEGER (0..7),
    cnavURA2        INTEGER (0..7),
    cnavAf2          INTEGER (-512..511),
    cnavAf1          INTEGER (-524288..524287),
    cnavAf0          INTEGER (-33554432..33554431),
    cnavTgd          INTEGER (-4096..4095),

```

```

cnavISCl1cp    INTEGER (-4096..4095)    OPTIONAL, -- Need ON
cnavISCl1cd    INTEGER (-4096..4095)    OPTIONAL, -- Need ON
cnavISCl1ca    INTEGER (-4096..4095)    OPTIONAL, -- Need ON
cnavISCl2c    INTEGER (-4096..4095)    OPTIONAL, -- Need ON
cnavISCl5i5    INTEGER (-4096..4095)    OPTIONAL, -- Need ON
cnavISCl5q5    INTEGER (-4096..4095)    OPTIONAL, -- Need ON
...
}
-- ASN1STOP

```

CNAV-ClockModel field descriptions

<p>cnavToc Parameter t_{oc}, clock data reference time of week (seconds) [4,5,6,7]. Scale factor 300 seconds.</p>
<p>cnavTop Parameter t_{op}, clock data predict time of week (seconds) [4,5,6,7]. Scale factor 300 seconds</p>
<p>cnavURA0 Parameter URA_{oc} Index, SV clock accuracy index (dimensionless) [4,5,6,7].</p>
<p>cnavURA1 Parameter URA_{oc1} Index, SV clock accuracy change index (dimensionless) [4,5,6,7].</p>
<p>cnavURA2 Parameter URA_{oc2} Index, SV clock accuracy change rate index (dimensionless) [4,5,6,7].</p>
<p>cnavAf2 Parameter a_{f2-n}, SV clock drift rate correction coefficient (sec/sec²) [4,5,6,7]. Scale factor 2^{60} seconds/second².</p>
<p>cnavAf1 Parameter a_{f1-n}, SV clock drift correction coefficient (sec/sec) [4,5,6,7]. Scale factor 2^{48} seconds/second.</p>
<p>cnavAf0 Parameter a_{f0-n}, SV clock bias correction coefficient (seconds) [4,5,6,7]. Scale factor 2^{35} seconds.</p>
<p>cnavTgd Parameter T_{GD}, Group delay correction (seconds) [4,5,6,7]. Scale factor 2^{35} seconds.</p>
<p>cnavISCl1cp Parameter ISC_{L1CP}, inter signal group delay correction (seconds) [6,7]. Scale factor 2^{35} seconds. The location server should include this field if the target device is GPS capable and supports the L1_C signal.</p>
<p>cnavISCl1cd Parameter ISC_{L1CD}, inter signal group delay correction (seconds) [6,7]. Scale factor 2^{35} seconds. The location server should include this field if the target device is GPS capable and supports the L1_C signal.</p>
<p>cnavISCl1ca Parameter ISC_{L1CA}, inter signal group delay correction (seconds) [4,5,7]. Scale factor 2^{35} seconds. The location server should include this field if the target device is GPS capable and supports the L1_{CA} signal.</p>
<p>cnavISCl2c Parameter ISC_{L2C}, inter signal group delay correction (seconds) [4,5,7]. Scale factor 2^{35} seconds. The location server should include this field if the target device is GPS capable and supports the L2_C signal.</p>
<p>cnavISCl5i5 Parameter ISC_{L5i5}, inter signal group delay correction (seconds) [5,7]. Scale factor 2^{35} seconds. The location server should include this field if the target device is GPS capable and supports the L5 signal.</p>
<p>cnavISCl5q5 Parameter ISC_{L5Q5}, inter signal group delay correction (seconds) [5,7]. Scale factor 2^{35} seconds. The location server should include this field if the target device is GPS capable and supports the L5 signal.</p>

GLONASS-ClockModel

```

-- ASN1START
GLONASS-ClockModel ::= SEQUENCE {
    gLoTau    INTEGER (-2097152..2097151),

```

```

    gloGamma      INTEGER (-1024..1023),
    gloDeltaTau   INTEGER (-16..15)           OPTIONAL,    -- Need ON
    ...
}
-- ASN1STOP

```

GLONASS-ClockModel field descriptions

gloTau

Parameter $\tau_n(t_b)$, satellite clock offset (seconds) [9].
Scale factor 2^{30} seconds.

gloGamma

Parameter $\gamma_n(t_b)$, relative frequency offset from nominal value (dimensionless) [9].
Scale factor 2^{40} .

gloDeltaTau

Parameter $\Delta\tau_n$, time difference between transmission in G2 and G1 (seconds) [9].
Scale factor 2^{30} seconds.

The location server should include this parameter if the target device is dual frequency GLONASS receiver capable.

– SBAS-ClockModel

```

-- ASN1START
SBAS-ClockModel ::= SEQUENCE {
    sbasTo      INTEGER (0..5399),
    sbasAgfo    INTEGER (-2048..2047),
    sbasAgf1    INTEGER (-128..127),
    ...
}
-- ASN1STOP

```

SBAS-ClockModel field descriptions

sbasTo

Parameter t_0 [10].
Scale factor 16 seconds.

sbasAgfo

Parameter a_{Gfo} [10].
Scale factor 2^{31} seconds.

sbasAgf1

Parameter a_{Gf1} [10].
Scale factor 2^{40} seconds/second.

– BDS-ClockModel

```

-- ASN1START
BDS-ClockModel-r12 ::= SEQUENCE {
    bdsAODC-r12  INTEGER (0..31),
    bdsToc-r12   INTEGER (0..131071),
    bdsA0-r12    INTEGER (-8388608..8388607),
    bdsA1-r12    INTEGER (-2097152..2097151),
    bdsA2-r12    INTEGER (-1024..1023),
    bdsTgd1-r12  INTEGER (-512..511),
    ...
}
-- ASN1STOP

```

BDS-ClockModel field descriptions
<p>bdsAODC Parameter Age of Data, Clock (AODC), see [23, Table 5-6].</p>
<p>bdsToc Parameter T_{oc}, Time of clock (seconds) [23]. Scale factor 2^3 seconds.</p>
<p>bdsA0 Parameter a_0, Clock correction polynomial coefficient (seconds) [23]. Scale factor 2^{-33} seconds.</p>
<p>bdsA1 Parameter a_1, Clock correction polynomial coefficient (sec/sec) [23]. Scale factor 2^{-50} sec/sec.</p>
<p>bdsA2 Parameter a_2, Clock correction polynomial coefficient (sec/sec²) [23]. Scale factor 2^{-66} sec/sec².</p>
<p>bdsTgd1 Parameter Equipment group delay differential T_{GD1} [23]. Scale factor is 0.1 nanosecond.</p>

NavModelKeplerianSet

```

-- ASN1START
NavModelKeplerianSet ::= SEQUENCE {
    keplerToe          INTEGER (0 .. 16383),
    keplerW            INTEGER (-2147483648 .. 2147483647),
    keplerDeltaN       INTEGER (-32768 .. 32767),
    keplerM0           INTEGER (-2147483648 .. 2147483647),
    keplerOmegaDot     INTEGER (-8388608 .. 8388607),
    keplerE            INTEGER (0 .. 4294967295),
    keplerIDot         INTEGER (-8192 .. 8191),
    keplerAPowerHalf   INTEGER (0 .. 4294967295),
    keplerI0           INTEGER (-2147483648 .. 2147483647),
    keplerOmega0       INTEGER (-2147483648 .. 2147483647),
    keplerCrS          INTEGER (-32768 .. 32767),
    keplerCis          INTEGER (-32768 .. 32767),
    keplerCus          INTEGER (-32768 .. 32767),
    keplerCrc          INTEGER (-32768 .. 32767),
    keplerCic          INTEGER (-32768 .. 32767),
    keplerCuc          INTEGER (-32768 .. 32767),
    ...
}
-- ASN1STOP

```

NavModelKeplerianSet field descriptions
<p>keplerToe Parameter t_{oe}, time-of-ephemeris in seconds [8]. Scale factor 60 seconds.</p>
<p>keplerW Parameter ω, argument of perigee (semi-circles) [8]. Scale factor 2^{-31} semi-circles.</p>
<p>keplerDeltaN Parameter Δn, mean motion difference from computed value (semi-circles/sec) [8]. Scale factor 2^{-43} semi-circles/second.</p>
<p>keplerM0 Parameter M_0, mean anomaly at reference time (semi-circles) [8]. Scale factor 2^{-31} semi-circles.</p>
<p>keplerOmegaDot Parameter Ω_{dot}, rate of change of right ascension (semi-circles/sec) [8]. Scale factor 2^{-43} semi-circles/second.</p>
<p>keplerE Parameter e, eccentricity [8]. Scale factor 2^{-33}.</p>
<p>KeplerIDot Parameter I_{dot}, rate of change of inclination angle (semi-circles/sec) [8]. Scale factor 2^{-43} semi-circles/second.</p>

NavModelKeplerianSet field descriptions
<p>keplerAPowerHalf Parameter sqrtA, square root of semi-major Axis in (meters)^{1/2} [8]. Scale factor 2⁻¹⁹ meters^{1/2}.</p>
<p>keplerI0 Parameter i₀, inclination angle at reference time (semi-circles) [8]. Scale factor 2⁻³¹ semi-circles.</p>
<p>keplerOmega0 Parameter OMEGA₀, longitude of ascending node of orbit plane at weekly epoch (semi-circles) [8]. Scale factor 2⁻³¹ semi-circles.</p>
<p>keplerCrs Parameter C_{rs}, amplitude of the sine harmonic correction term to the orbit radius (meters) [8]. Scale factor 2⁻⁵ meters.</p>
<p>keplerCis Parameter C_{is}, amplitude of the sine harmonic correction term to the angle of inclination (radians) [8]. Scale factor 2⁻²⁹ radians.</p>
<p>keplerCus Parameter C_{us}, amplitude of the sine harmonic correction term to the argument of latitude (radians) [8]. Scale factor 2⁻²⁹ radians.</p>
<p>keplerCrc Parameter C_{rc}, amplitude of the cosine harmonic correction term to the orbit radius (meters) [8]. Scale factor 2⁻⁵ meters.</p>
<p>keplerCic Parameter C_{ic}, amplitude of the cosine harmonic correction term to the angle of inclination (radians) [8]. Scale factor 2⁻²⁹ radians.</p>
<p>keplerCuc Parameter C_{uc}, amplitude of the cosine harmonic correction term to the argument of latitude (radians) [8]. Scale factor 2⁻²⁹ radians.</p>

NavModelNAV-KeplerianSet

```

-- ASN1START
NavModelNAV-KeplerianSet ::= SEQUENCE {
    navURA          INTEGER (0..15),
    navFitFlag       INTEGER (0..1),
    navToe           INTEGER (0..37799),
    navOmega         INTEGER (-2147483648..2147483647),
    navDeltaN        INTEGER (-32768..32767),
    navM0            INTEGER (-2147483648..2147483647),
    navOmegaADot     INTEGER (-8388608..8388607),
    navE             INTEGER (0..4294967295),
    navIDot          INTEGER (-8192..8191),
    navAPowerHalf    INTEGER (0..4294967295),
    navI0            INTEGER (-2147483648..2147483647),
    navOmegaA0       INTEGER (-2147483648..2147483647),
    navCrs           INTEGER (-32768..32767),
    navCis           INTEGER (-32768..32767),
    navCus           INTEGER (-32768..32767),
    navCrc           INTEGER (-32768..32767),
    navCic           INTEGER (-32768..32767),
    navCuc           INTEGER (-32768..32767),
    addNAVparam      SEQUENCE {
        ephemerCodeOnL2  INTEGER (0..3),
        ephemerL2Pflag   INTEGER (0..1),
        ephemerSF1Rsvd   SEQUENCE {
            reserved1    INTEGER (0..8388607),    -- 23-bit field
            reserved2    INTEGER (0..16777215),   -- 24-bit field
            reserved3    INTEGER (0..16777215),   -- 24-bit field
            reserved4    INTEGER (0..65535)       -- 16-bit field
        },
        ephemerAODA      INTEGER (0..31)
    } OPTIONAL, -- Need ON
    ...
}
-- ASN1STOP

```

NavModelNAV-KeplerianSet field descriptions

NavModelNAV-KeplerianSet field descriptions
<p>navURA Parameter URA Index, SV accuracy (dimensionless) [4,7].</p>
<p>navFitFlag Parameter Fit Interval Flag, fit interval indication (dimensionless) [4,7]</p>
<p>navToe Parameter t_{oe}, time of ephemeris (seconds) [4,7]. Scale factor 2^4 seconds.</p>
<p>navOmega Parameter ω, argument of perigee (semi-circles) [4,7]. Scale factor 2^{31} semi-circles.</p>
<p>navDeltaN Parameter Δn, mean motion difference from computed value (semi-circles/sec) [4,7]. Scale factor 2^{43} semi-circles/second.</p>
<p>navM0 Parameter M_0, mean anomaly at reference time (semi-circles) [4,7]. Scale factor 2^{31} semi-circles.</p>
<p>navOmegaADot Parameter $\dot{\Omega}$, rate of right ascension (semi-circles/sec) [4,7]. Scale factor 2^{43} semi-circles/second.</p>
<p>navE Parameter e, eccentricity (dimensionless) [4,7]. Scale factor 2^{33}.</p>
<p>navIDot Parameter $IDOT$, rate of inclination angle (semi-circles/sec) [4,7]. Scale factor 2^{43} semi-circles/second.</p>
<p>navAPowerHalf Parameter \sqrt{A}, square root of semi-major axis (meters^{1/2}) [4,7]. Scale factor 2^{19} meters^{1/2}.</p>
<p>navI0 Parameter i_0, inclination angle at reference time (semi-circles) [4,7]. Scale factor 2^{31} semi-circles.</p>
<p>navOmegaA0 Parameter Ω_0, longitude of ascending node of orbit plane at weekly epoch (semi-circles) [4,7]. Scale factor 2^{31} semi-circles.</p>
<p>navCrs Parameter C_{rs}, amplitude of sine harmonic correction term to the orbit radius (meters) [4,7]. Scale factor 2^5 meters.</p>
<p>navCis Parameter C_{is}, amplitude of sine harmonic correction term to the angle of inclination (radians) [4,7]. Scale factor 2^{29} radians.</p>
<p>navCus Parameter C_{us}, amplitude of sine harmonic correction term to the argument of latitude (radians) [4,7]. Scale factor 2^{29} radians.</p>
<p>navCrc Parameter C_{rc}, amplitude of cosine harmonic correction term to the orbit radius (meters) [4,7]. Scale factor 2^5 meters.</p>
<p>navCic Parameter C_{ic}, amplitude of cosine harmonic correction term to the angle of inclination (radians) [4,7]. Scale factor 2^{29} radians.</p>
<p>navCuc Parameter C_{uc}, amplitude of cosine harmonic correction term to the argument of latitude (radians) [4,7]. Scale factor 2^{29} radians.</p>
<p>addNAVparam These fields include data and reserved bits in the GPS NAV message [4,14]. These additional navigation parameters, if provided by the location server, allow the target device to perform data wipe-off similar to what is done by the target device with the <i>GNSS-DataBitAssistance</i>.</p>

NavModelCNAV-KeplerianSet

```
-- ASN1START
```

```
NavModelCNAV-KeplerianSet ::= SEQUENCE {
    cnavTop          INTEGER (0..2015),
    cnavURAindex    INTEGER (-16..15),
```



```

cnavDeltaA      INTEGER (-33554432..33554431),
cnavAdot        INTEGER (-16777216..16777215),
cnavDeltaNo     INTEGER (-65536..65535),
cnavDeltaNoDot  INTEGER (-4194304..4194303),
cnavMo          INTEGER (-4294967296..4294967295),
cnavE           INTEGER (0..8589934591),
cnavOmega       INTEGER (-4294967296..4294967295),
cnavOMEGA0      INTEGER (-4294967296..4294967295),
cnavDeltaOmegaDot  INTEGER (-65536..65535),
cnavIo          INTEGER (-4294967296..4294967295),
cnavIoDot       INTEGER (-16384..16383),
cnavCis         INTEGER (-32768..32767),
cnavCic         INTEGER (-32768..32767),
cnavCrS         INTEGER (-8388608..8388607),
cnavCrC         INTEGER (-8388608..8388607),
cnavCuS         INTEGER (-1048576..1048575),
cnavCuC         INTEGER (-1048576..1048575),
...
}
-- ASN1STOP

```

NavModelCNAV-KeplerianSet field descriptions

<p>cnavTop Parameter t_{op}, data predict time of week (seconds) [4,5,6,7]. Scale factor 300 seconds.</p>
<p>cnavURAIindex Parameter URA_{oe} Index, SV accuracy (dimensionless) [4,5,6,7].</p>
<p>cnavDeltaA Parameter ΔA, semi-major axis difference at reference time (meters) [4,5,6,7]. Scale factor 2^{-9} meters.</p>
<p>cnavAdot Parameter \dot{A}, change rate in semi-major axis (meters/sec) [4,5,6,7]. Scale factor 2^{-21} meters/sec.</p>
<p>cnavDeltaNo Parameter Δn_0, mean motion difference from computed value at reference time (semi-circles/sec) [4,5,6,7]. Scale factor 2^{-44} semi-circles/second.</p>
<p>cnavDeltaNoDot Parameter $\dot{\Delta n}_0$, rate of mean motion difference from computed value (semi-circles/sec²) [4,5,6,7]. Scale factor 2^{-57} semi-circles/second².</p>
<p>cnavMo Parameter M_{0-n}, mean anomaly at reference time (semi-circles) [4,5,6,7]. Scale factor 2^{-32} semi-circles.</p>
<p>cnavE Parameter e_n, eccentricity (dimensionless) [4,5,6,7]. Scale factor 2^{-34}.</p>
<p>cnavOmega Parameter ω_n, argument of perigee (semi-circles) [4,5,6,7]. Scale factor 2^{-32} semi-circles.</p>
<p>cnavOMEGA0 Parameter Ω_{0-n}, reference right ascension angle (semi-circles) [4,5,6,7]. Scale factor 2^{-32} semi-circles.</p>
<p>cnavDeltaOmegaDot Parameter $\dot{\Delta \Omega}$, rate of right ascension difference (semi-circles/sec) [4,5,6,7]. Scale factor 2^{-44} semi-circles/second.</p>
<p>cnavIo Parameter i_{0-n}, inclination angle at reference time (semi-circles) [4,5,6,7]. Scale factor 2^{-32} semi-circles.</p>
<p>cnavIoDot Parameter $i_{0-n-DOT}$, rate of inclination angle (semi-circles/sec) [4,5,6,7]. Scale factor 2^{-44} semi-circles/second..</p>
<p>cnavCis Parameter C_{is-n}, amplitude of sine harmonic correction term to the angle of inclination (radians) [4,5,6,7]. Scale factor 2^{-30} radians.</p>
<p>cnavCic Parameter C_{ic-n}, amplitude of cosine harmonic correction term to the angle of inclination (radians) [4,5,6,7]. Scale factor 2^{-30} radians.</p>

NavModelCNAV-KeplerianSet field descriptions
<p>cnavCrS Parameter C_{rs-n}, amplitude of sine harmonic correction term to the orbit radius (meters) [4,5,6,7]. Scale factor 2^8 meters.</p>
<p>cnavCrc Parameter C_{rc-n}, amplitude of cosine harmonic correction term to the orbit radius (meters) [4,5,6,7]. Scale factor 2^8 meters.</p>
<p>cnavCus Parameter C_{us-n}, amplitude of the sine harmonic correction term to the argument of latitude (radians) [4,5,6,7]. Scale factor 2^{30} radians.</p>
<p>cnavCuc Parameter C_{uc-n}, amplitude of cosine harmonic correction term to the argument of latitude (radians) [4,5,6,7]. Scale factor 2^{30} radians.</p>

NavModel-GLONASS-ECEF

```

-- ASN1START
NavModel-GLONASS-ECEF ::= SEQUENCE {
    gloEn          INTEGER (0..31),
    gloP1          BIT STRING (SIZE(2)),
    gloP2          BOOLEAN,
    gloM           INTEGER (0..3),
    gloX           INTEGER (-67108864..67108863),
    gloXdot        INTEGER (-8388608..8388607),
    gloXdotdot     INTEGER (-16..15),
    gloY           INTEGER (-67108864..67108863),
    gloYdot        INTEGER (-8388608..8388607),
    gloYdotdot     INTEGER (-16..15),
    gloZ           INTEGER (-67108864..67108863),
    gloZdot        INTEGER (-8388608..8388607),
    gloZdotdot     INTEGER (-16..15),
    ...
}
-- ASN1STOP

```

NavModel-GLONASS-ECEF field descriptions
<p>gloEn Parameter E_n, age of data (days) [9]. Scale factor 1 days.</p>
<p>gloP1 Parameter P1, time interval between two adjacent values of t_b (minutes) [9].</p>
<p>gloP2 Parameter P2, change of t_b flag (dimensionless) [9].</p>
<p>gloM Parameter M, type of satellite (dimensionless) [9].</p>
<p>gloX Parameter $x_n(t_b)$, x-coordinate of satellite at time t_b (kilometers) [9]. Scale factor 2^{11} kilometers.</p>
<p>gloXdot Parameter $\dot{x}_n(t_b)$, x-coordinate of satellite velocity at time t_b (kilometers/sec) [9]. Scale factor 2^{20} kilometers/second.</p>
<p>gloXdotdot Parameter $\ddot{x}_n(t_b)$, x-coordinate of satellite acceleration at time t_b (kilometers/sec²) [9]. Scale factor 2^{30} kilometers/second².</p>
<p>gloY Parameter $y_n(t_b)$, y-coordinate of satellite at time t_b (kilometers) [9]. Scale factor 2^{11} kilometers.</p>
<p>gloYdot Parameter $\dot{y}_n(t_b)$, y-coordinate of satellite velocity at time t_b (kilometers/sec) [9]. Scale factor 2^{20} kilometers/second.</p>

NavModel-GLONASS-ECEF field descriptions
<p>gloYdotdot Parameter $\ddot{y}_n(t_b)$, y-coordinate of satellite acceleration at time t_b (kilometers/sec²) [9]. Scale factor 2^{-30} kilometers/second².</p>
<p>gloZ Parameter $z_n(t_b)$, z-coordinate of satellite at time t_b (kilometers) [9]. Scale factor 2^{-11} kilometers.</p>
<p>gloZdot Parameter $\dot{z}_n(t_b)$, z-coordinate of satellite velocity at time t_b (kilometers/sec) [9]. Scale factor 2^{-20} kilometers/second.</p>
<p>gloZdotdot Parameter $\ddot{z}_n(t_b)$, z-coordinate of satellite acceleration at time t_b (kilometers/sec²) [9]. Scale factor 2^{-30} kilometers/second².</p>

– NavModel-SBAS-ECEF

```

-- ASN1START
NavModel-SBAS-ECEF ::= SEQUENCE {
    sbasTo                INTEGER (0..5399)                OPTIONAL,    -- Cond ClockModel
    sbasAccuracy          BIT STRING (SIZE(4)),
    sbasXg                INTEGER (-536870912..536870911),
    sbasYg                INTEGER (-536870912..536870911),
    sbasZg                INTEGER (-16777216..16777215),
    sbasXgDot            INTEGER (-65536..65535),
    sbasYgDot            INTEGER (-65536..65535),
    sbasZgDot            INTEGER (-131072..131071),
    sbasXgDotDot        INTEGER (-512..511),
    sbasYgDotDot        INTEGER (-512..511),
    sbasZgDotDot        INTEGER (-512..511),
    ...
}
-- ASN1STOP
    
```

Conditional presence	Explanation
<i>ClockModel</i>	This field is mandatory present if <i>gnss-ClockModel</i> Model-5 is not included; otherwise it is not present.

NavModel-SBAS-ECEF field descriptions
<p>sbasTo Parameter t_0, time of applicability (seconds) [10]. Scale factor 16 seconds.</p>
<p>sbasAccuracy Parameter Accuracy, (dimensionless) [10].</p>
<p>sbasXg Parameter X_G, (meters) [10]. Scale factor 0.08 meters.</p>
<p>sbasYg Parameter Y_G, (meters) [10]. Scale factor 0.08 meters.</p>
<p>sbasZg Parameter Z_G, (meters) [10]. Scale factor 0.4 meters.</p>
<p>sbasXgDot Parameter X_G, Rate-of-Change, (meters/sec) [10]. Scale factor 0.000625 meters/second.</p>
<p>sbasYgDot Parameter Y_G, Rate-of-Change, (meters/sec) [10]. Scale factor 0.000625 meters/second.</p>
<p>sbasZgDot Parameter Z_G, Rate-of-Change, (meters/sec) [10]. Scale factor 0.004 meters/second.</p>

<i>NavModel-SBAS-ECEF</i> field descriptions
<p><i>sbasXgDotDot</i> Parameter X_G, Acceleration, (meters/sec²) [10]. Scale factor 0.0000125 meters/second².</p>
<p><i>sbasYgDotDot</i> Parameter Y_G, Acceleration, (meters/sec²) [10]. Scale factor 0.0000125 meters/second².</p>
<p><i>sbasZgDotDot</i> Parameter Z_G Acceleration, (meters/sec²) [10]. Scale factor 0.0000625 meters/second².</p>

– NavModel-BDS-KeplerianSet

```

-- ASN1START
NavModel-BDS-KeplerianSet-r12 ::= SEQUENCE {
    bdsAODE-r12          INTEGER (0..31),
    bdsURAI-r12         INTEGER (0..15),
    bdsToe-r12          INTEGER (0..131071),
    bdsAPowerHalf-r12   INTEGER (0..4294967295),
    bdsE-r12            INTEGER (0..4294967295),
    bdsW-r12            INTEGER (-2147483648..2147483647),
    bdsDeltaN-r12       INTEGER (-32768..32767),
    bdsM0-r12           INTEGER (-2147483648..2147483647),
    bdsOmega0-r12       INTEGER (-2147483648..2147483647),
    bdsOmegaDot-r12     INTEGER (-8388608..8388607),
    bdsI0-r12           INTEGER (-2147483648..2147483647),
    bdsIDot-r12         INTEGER (-8192..8191),
    bdsCuc-r12          INTEGER (-131072..131071),
    bdsCus-r12          INTEGER (-131072..131071),
    bdsCrc-r12          INTEGER (-131072..131071),
    bdsCrs-r12          INTEGER (-131072..131071),
    bdsCic-r12          INTEGER (-131072..131071),
    bdsCis-r12          INTEGER (-131072..131071),
    ...
}
-- ASN1STOP

```

NavModel-BDS-KeplerianSet field descriptions
<p>bdsAODE Parameter Age of Data, Ephemeris (AODE), see [23, Table 5-8].</p>
<p>bdsURAI Parameter URA Index, URA is used to describe the signal-in-space accuracy in meters as defined in [23].</p>
<p>bdsToe Parameter t_{oe}, Ephemeris reference time (seconds) [23]. Scale factor 2^3 seconds.</p>
<p>bdsAPowerHalf Parameter $A^{1/2}$, Square root of semi-major axis (meters^{1/2})[23]. Scale factor 2^{-19} meters^{1/2}.</p>
<p>bdsE Parameter e, Eccentricity, dimensionless [23]. Scale factor 2^{33}.</p>
<p>bdsW Parameter ω, Argument of perigee (semi-circles) [23]. Scale factor 2^{31} semi-circles.</p>
<p>bdsDeltaN Parameter Δn, Mean motion difference from computed value (semi-circles/sec) [23]. Scale factor 2^{-43} semi-circles/sec.</p>
<p>bdsM0 Parameter M_0, Mean anomaly at reference time (semi-circles) [23]. Scale factor 2^{31} semi-circles.</p>
<p>bdsOmega0 Parameter Ω_0, Longitude of ascending node of orbital of plane computed according to reference time (semi-circles) [23]. Scale factor 2^{31} semi-circles.</p>
<p>bdsOmegaDot Parameter $\dot{\Omega}$, Rate of right ascension (semi-circles/sec) [23]. Scale factor 2^{43} semi-circles/sec.</p>
<p>bdsI0 Parameter i_0, Inclination angle at reference time (semi-circles) [23]. Scale factor 2^{31} semi-circles.</p>
<p>bdsIDot Parameter \dot{i}, Rate of inclination angle (semi-circles/sec) [23]. Scale factor 2^{43} semi-circles/sec.</p>
<p>bdsCuc Parameter C_{uc}, Amplitude of cosine harmonic correction term to the argument of latitude (radians) [23]. Scale factor 2^{31} radians.</p>
<p>bdsCus Parameter C_{us}, Amplitude of sine harmonic correction term to the argument of latitude (radians) [23]. Scale factor 2^{31} radians.</p>
<p>bdsCrc Parameter C_{rc}, Amplitude of cosine harmonic correction term to the orbit radius (meters) [23]. Scale factor 2^6 meters.</p>
<p>bdsCrs Parameter C_{rs}, Amplitude of sine harmonic correction term to the orbit radius (meters) [23]. Scale factor 2^6 meters.</p>
<p>bdsCic Parameter C_{ic}, Amplitude of cosine harmonic correction term to the angle of inclination (radians) [23]. Scale factor 2^{31} radians.</p>
<p>bdsCis Parameter C_{is}, Amplitude of sine harmonic correction term to the angle of inclination (radians) [23]. Scale factor 2^{31} radians.</p>

– GNSS-RealTimeIntegrity

The IE *GNSS-RealTimeIntegrity* is used by the location server to provide parameters that describe the real-time status of the GNSS constellations. *GNSS-RealTimeIntegrity* data communicates the health of the GNSS signals to the mobile in real-time.

The location server shall always transmit the *GNSS-RealTimeIntegrity* with the current list of unhealthy signals (i.e., not only for signals/SVs currently visible at the reference location), for any GNSS positioning attempt and whenever GNSS assistance data are sent. If the number of bad signals is zero, then the *GNSS-RealTimeIntegrity* IE shall be omitted.

```

-- ASN1START
GNSS-RealTimeIntegrity ::= SEQUENCE {
    gnss-BadSignalList  GNSS-BadSignalList,
    ...
}

GNSS-BadSignalList ::= SEQUENCE (SIZE(1..64)) OF BadSignalElement

BadSignalElement ::= SEQUENCE {
    badSVID             SV-ID,
    badSignalID         GNSS-SignalIDs  OPTIONAL,  -- Need OP
    ...
}
-- ASN1STOP

```

GNSS-RealTimeIntegrity field descriptions

gnss-BadSignalList

This field specifies a list of satellites with bad signal or signals.

badSVID

This field specifies the GNSS SV-ID of the satellite with bad signal or signals.

badSignalID

This field identifies the bad signal or signals of a satellite. This is represented by a bit string in *GNSS-SignalIDs*, with a one-value at a bit position means the particular GNSS signal type of the SV is unhealthy; a zero-value means healthy. Absence of this field means that all signals on the specific SV are bad.

GNSS-DataBitAssistance

The IE *GNSS-DataBitAssistance* is used by the location server to provide data bit assistance data for specific satellite signals for data wipe-off. The data bits included in the assistance data depends on the GNSS and its signal.

```

-- ASN1START
GNSS-DataBitAssistance ::= SEQUENCE {
    gnss-TOD             INTEGER (0..3599),
    gnss-TODfrac         INTEGER (0..999)          OPTIONAL,  -- Need ON
    gnss-DataBitsSatList GNSS-DataBitsSatList,
    ...
}

GNSS-DataBitsSatList ::= SEQUENCE (SIZE(1..64)) OF GNSS-DataBitsSatElement

GNSS-DataBitsSatElement ::= SEQUENCE {
    svID                 SV-ID,
    gnss-DataBitsSgnList GNSS-DataBitsSgnList,
    ...
}

GNSS-DataBitsSgnList ::= SEQUENCE (SIZE(1..8)) OF GNSS-DataBitsSgnElement

GNSS-DataBitsSgnElement ::= SEQUENCE {
    gnss-SignalType      GNSS-SignalID,
    gnss-DataBits        BIT STRING (SIZE (1..1024)),
    ...
}
-- ASN1STOP

```

GNSS-DataBitAssistance field descriptions

gnss-TOD

This field specifies the reference time of the first bit of the data in *GNSS-DataBitAssistance* in integer seconds in GNSS specific system time, modulo 1 hour.
Scale factor 1 second.

gnss-TODfrac

This field specifies the fractional part of the *gnss-TOD* in 1-milli-second resolution.
Scale factor 1 millisecond. The total GNSS TOD is *gnss-TOD + gnss-TODfrac*.

gnss-DataBitsSatList

This list specifies the data bits for a particular GNSS satellite SV-ID and signal *GNSS-SignalID*.

GNSS-DataBitAssistance field descriptions
<p>svID This field specifies the GNSS SV-ID of the satellite for which the <i>GNSS-DataBitAssistance</i> is given.</p>
<p>gnss-SignalType This field identifies the GNSS signal type of the <i>GNSS-DataBitAssistance</i>.</p>
<p>gnss-DataBits Data bits are contained in GNSS system and data type specific format.</p> <p>In case of GPS L1 C/A, it contains the NAV data modulation bits as defined in [4] . In case of Modernized GPS L1C, it contains the encoded and interleaved modulation symbols as defined in [6] section 3.2.3.1. In case of Modernized GPS L2C, it contains either the NAV data modulation bits, the FEC encoded NAV data modulation symbols, or the FEC encoded CNAV data modulation symbols, dependent on the current signal configuration of this satellite as defined in [4, Table 3-III]. In case of Modernized GPS L5, it contains the FEC encoded CNAV data modulation symbols as defined in [5].</p> <p>In case of SBAS, it contains the FEC encoded data modulation symbols as defined in [10].</p> <p>In case of QZSS QZS-L1, it contains the NAV data modulation bits as defined in [7] section 5.2. In case of QZSS QZS-L1C, it contains the encoded and interleaved modulation symbols as defined in [7] section 5.3. In case of QZSS QZS-L2C, it contains the encoded modulation symbols as defined in [7] section 5.5. In case of QZSS QZS-L5, it contains the encoded modulation symbols as defined in [7] section 5.6.</p> <p>In case of GLONASS, it contains the 100 sps differentially Manchester encoded modulation symbols as defined in [9] section 3.3.2.2.</p> <p>In case of Galileo, it contains the FEC encoded and interleaved modulation symbols. The logical levels 1 and 0 correspond to signal levels -1 and +1, respectively.</p> <p>In case of BDS, it contains the encoded and interleaved modulation symbols as defined in [23, section 5.1.3].</p>

– GNSS-AcquisitionAssistance

The IE *GNSS-AcquisitionAssistance* is used by the location server to provide parameters that enable fast acquisition of the GNSS signals. Essentially, these parameters describe the range and derivatives from respective satellites to the reference location at the reference time *GNSS-SystemTime* provided in IE *GNSS-ReferenceTime*.

Whenever *GNSS-AcquisitionAssistance* is provided by the location server, the IE *GNSS-ReferenceTime* shall be provided as well. E.g., even if the target device request for assistance data includes only a request for *GNSS-AcquisitionAssistance*, the location server shall also provide the corresponding IE *GNSS-ReferenceTime*.

Figure 6.5.2.2-1 illustrates the relation between some of the fields, using GPS TOW as exemplary reference.

```
-- ASN1START

GNSS-AcquisitionAssistance ::= SEQUENCE {
    gnss-SignalID          GNSS-SignalID,
    gnss-AcquisitionAssistList  GNSS-AcquisitionAssistList,
    ...,
    confidence-r10          INTEGER (0..100)    OPTIONAL    -- Need ON
}

GNSS-AcquisitionAssistList ::= SEQUENCE (SIZE(1..64)) OF GNSS-AcquisitionAssistElement

GNSS-AcquisitionAssistElement ::= SEQUENCE {
    svID                   SV-ID,
    doppler0                INTEGER (-2048..2047),
    doppler1                INTEGER (0..63),
    dopplerUncertainty      INTEGER (0..4),
    codePhase               INTEGER (0..1022),
    intCodePhase            INTEGER (0..127),
    codePhaseSearchWindow  INTEGER (0..31),
    azimuth                 INTEGER (0..511),
    elevation                INTEGER (0..127),
    ...,
    codePhase1023           BOOLEAN           OPTIONAL,    -- Need OP
    dopplerUncertaintyExt-r10  ENUMERATED {
        d60,
        d80,
        d100,
        d120,
        noInformation, ... }    OPTIONAL    -- Need ON
}
```

```
}
-- ASN1STOP
```

GNSS-AcquisitionAssistance field descriptions
<p>gnss-SignalID This field specifies the GNSS signal for which the acquisition assistance are provided.</p>
<p>gnss-AcquisitionAssistList These fields provide a list of acquisition assistance data for each GNSS satellite.</p>
<p>confidence This field specifies the confidence level of the reference location area or volume used to calculate the acquisition assistance parameters (search windows). A high percentage value (e.g., 98% or more) indicates to the target device that the provided search windows are reliable. The location server should include this field to indicate the confidence level of the provided information.</p>
<p>svID This field specifies the GNSS SV-ID of the satellite for which the <i>GNSS-AcquisitionAssistance</i> is given.</p>
<p>doppler0 This field specifies the Doppler (0th order term) value. A positive value in Doppler defines the increase in satellite signal frequency due to velocity towards the target device. A negative value in Doppler defines the decrease in satellite signal frequency due to velocity away from the target device. Doppler is given in unit of m/s by multiplying the Doppler value in Hz by the nominal wavelength of the assisted signal. Scale factor 0.5 m/s in the range from -1024 m/s to +1023.5 m/s.</p>
<p>doppler1 This field specifies the Doppler (1st order term) value. A positive value defines the rate of increase in satellite signal frequency due to acceleration towards the target device. A negative value defines the rate of decrease in satellite signal frequency due to acceleration away from the target device. Scale factor 1/210 m/s² in the range from -0.2 m/s² to +0.1 m/s². Actual value of Doppler (1st order term) is calculated as $(-42 + \text{doppler1}) * 1/210 \text{ m/s}^2$, with <i>doppler1</i> in the range of 0...63.</p>
<p>dopplerUncertainty This field specifies the Doppler uncertainty value. It is defined such that the Doppler experienced by a stationary target device is in the range [Doppler–Doppler Uncertainty] to [Doppler+Doppler Uncertainty]. Doppler Uncertainty is given in unit of m/s by multiplying the Doppler Uncertainty value in Hz by the nominal wavelength of the assisted signal. Defined values: 2.5 m/s, 5 m/s, 10 m/s, 20 m/s, 40 m/s as encoded by an integer <i>n</i> in the range 0-4 according to: $2^{-n}(40) \text{ m/s}; n = 0 - 4.$ If the <i>dopplerUncertaintyExt</i> field is present, the target device that supports the <i>dopplerUncertaintyExt</i> shall ignore this field.</p>
<p>codePhase This field together with the <i>codePhase1023</i> field specifies the code phase, in units of milli-seconds, in the range from 0 to 1 millisecond scaled by the nominal chipping rate of the GNSS signal, where increasing values of the field signify increasing predicted signal code phases, as seen by a receiver at the reference location at the reference time. The reference location would typically be an apriori estimate of the target device location. Scale factor 2^{-10} ms in the range from 0 to $(1-2^{-10}) \text{ ms}$. Note: The value $(1-2^{-10}) \text{ ms}$ is encoded using the <i>codePhase1023</i> IE.</p>
<p>intCodePhase This field contains integer code phase (expressed modulo 128 ms). The satellite integer milli-seconds code phase currently being transmitted at the reference time, as seen by a receiver at the reference location is calculated as reference time (expressed in milli-seconds) minus (<i>intCodePhase</i> + (<i>n</i>×128 ms)), as shown in Figure 6.5.2.2-1, with <i>n</i> = ...-2,-1,0,1,2... Scale factor 1 ms in the range from 0 to 127 ms.</p>
<p>codePhaseSearchWindow This field contains the code phase search window. The code phase search window accounts for the uncertainty in the estimated target device location but not any uncertainty in reference time. It is defined such that the expected code phase is in the range [Code Phase–Code Phase Search Window] to [Code Phase+Code Phase Search Window] given in units of milli-seconds. Range 0-31, mapping according to the table <i>codePhaseSearchWindow Value to Interpretation Code Phase Search Window [ms]</i> relation shown below.</p>
<p>azimuth This field specifies the azimuth angle. An angle of <i>x</i> degrees means the satellite azimuth <i>a</i> is in the range $(x \leq a < x+0.703125) \text{ degrees}$. Scale factor 0.703125 degrees.</p>
<p>elevation This field specifies the elevation angle. An angle of <i>y</i> degrees means the satellite elevation <i>e</i> is in the range $(y \leq e < y+0.703125) \text{ degrees}$. Scale factor 0.703125 degrees.</p>

GNSS-AcquisitionAssistance field descriptions**codePhase1023**

This field if set to TRUE indicates that the code phase has the value $1023 \times 2^{-10} = (1-2^{-10})$ ms. This field may only be set to TRUE if the value provided in the *codePhase* IE is 1022. If this field is set to FALSE, the code phase is the value provided in the *codePhase* IE in the range from 0 to $(1 - 2 \times 2^{-10})$ ms. If this field is not present and the *codePhase* IE has the value 1022, the target device may assume that the code phase is between $(1 - 2 \times 2^{-10})$ and $(1 - 2^{-10})$ ms.

dopplerUncertaintyExt

If this field is present, the target device that supports this field shall ignore the *dopplerUncertainty* field. The location server should include this field only if supported by the target device.

This field specifies the Doppler uncertainty value. It is defined such that the Doppler experienced by a stationary target device is in the range [Doppler–Doppler Uncertainty] to [Doppler+Doppler Uncertainty]. Doppler Uncertainty is given in unit of m/s by multiplying the Doppler Uncertainty value in Hz by the nominal wavelength of the assisted signal.

Enumerated values define 60 m/s, 80 m/s, 100 m/s, 120 m/s, and "No Information".

codePhaseSearchWindow Value to Interpretation Code Phase Search Window [ms] relation

codePhaseSearchWindow Value	Interpretation Code Phase Search Window [ms]
'00000'	No information
'00001'	0,002
'00010'	0,004
'00011'	0,008
'00100'	0,012
'00101'	0,016
'00110'	0,024
'00111'	0,032
'01000'	0,048
'01001'	0,064
'01010'	0,096
'01011'	0,128
'01100'	0,164
'01101'	0,200
'01110'	0,250
'01111'	0,300
'10000'	0,360
'10001'	0,420
'10010'	0,480
'10011'	0,540
'10100'	0,600
'10101'	0,660
'10110'	0,720
'10111'	0,780
'11000'	0,850
'11001'	1,000
'11010'	1,150
'11011'	1,300
'11100'	1,450
'11101'	1,600
'11110'	1,800
'11111'	2,000

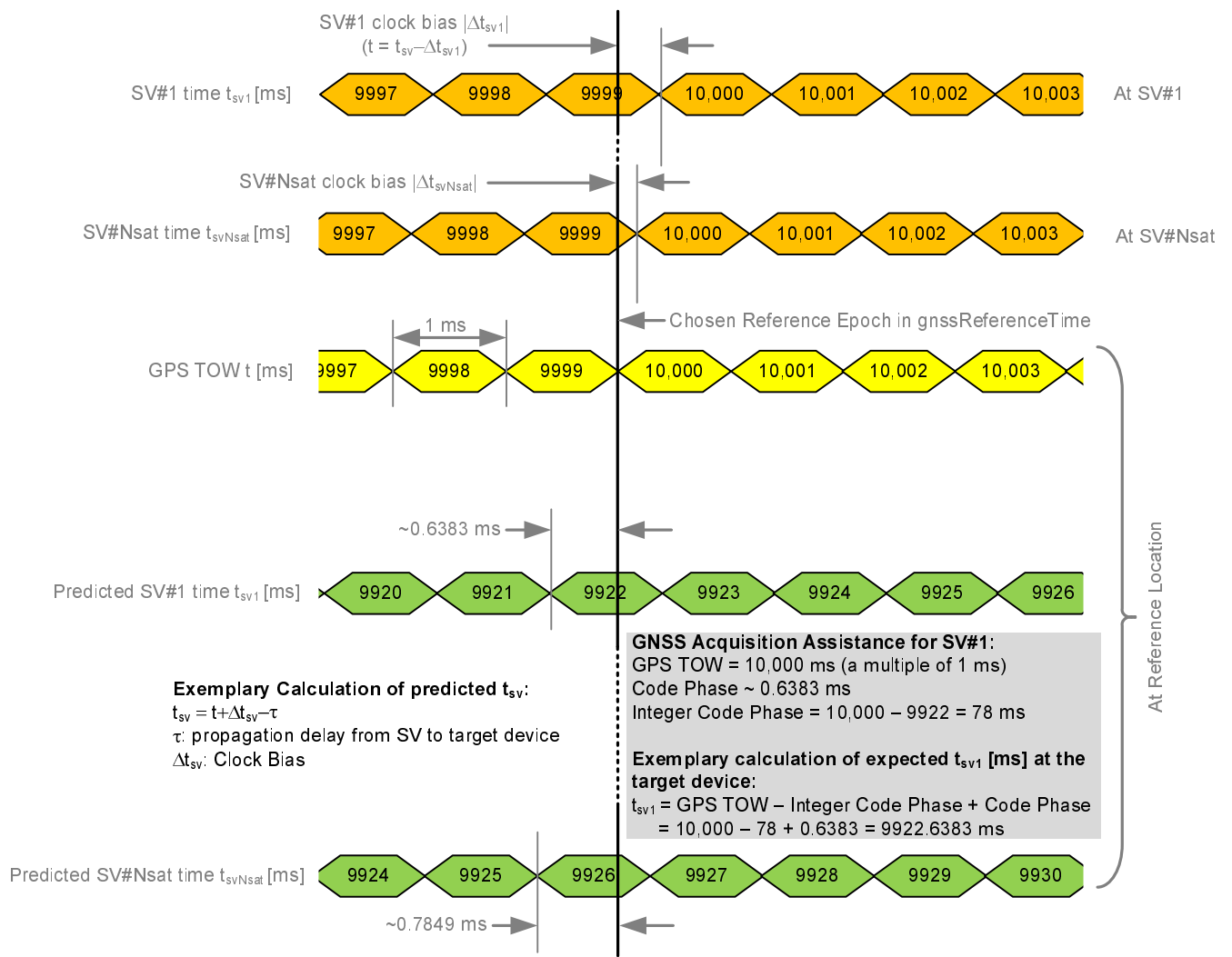

Figure 6.5.2.2-1: Exemplary calculation of some GNSS Acquisition Assistance fields.

GNSS-Almanac

The IE *GNSS-Almanac* is used by the location server to provide the coarse, long-term model of the satellite positions and clocks. The meaning of these parameters is defined in relevant ICDs of the particular GNSS and GNSS specific interpretations apply. For example, GPS and QZSS use the same model parameters but some parameters have a different interpretation [7]. *GNSS-Almanac* is useful for receiver tasks that require coarse accuracy, such as determining satellite visibility. The model is valid for up to a few weeks, typically. Since it is a long-term model, the field should be provided for all satellites available in the GNSS constellation (i.e., not only for SVs visible at the reference location and including SVs flagged as unhealthy in almanac). The *completeAlmanacProvided* field indicates whether or not the location server provided almanacs for the complete GNSS constellation.

```
-- ASN1START
GNSS-Almanac ::= SEQUENCE {
    weekNumber          INTEGER (0..255)    OPTIONAL,  -- Need ON
    toa                 INTEGER (0..255)    OPTIONAL,  -- Need ON
    ioda                INTEGER (0..3)      OPTIONAL,  -- Need ON
    completeAlmanacProvided  BOOLEAN,
    gnss-AlmanacList    GNSS-AlmanacList,
    ...,
    [[ toa-ext-v1240     INTEGER (256..1023) OPTIONAL,  -- Need ON
      ioda-ext-v1240    INTEGER (4..15)    OPTIONAL,  -- Need ON
    ]]
}

GNSS-AlmanacList ::= SEQUENCE (SIZE(1..64)) OF GNSS-AlmanacElement
```

```

GNSS-AlmanacElement ::= CHOICE {
    keplerianAlmanacSet          AlmanacKeplerianSet,          -- Model-1
    keplerianNAV-Almanac        AlmanacNAV-KeplerianSet,      -- Model-2
    keplerianReducedAlmanac     AlmanacReducedKeplerianSet,   -- Model-3
    keplerianMidiAlmanac        AlmanacMidiAlmanacSet,        -- Model-4
    keplerianGLONASS            AlmanacGLONASS-AlmanacSet,    -- Model-5
    ecef-SBAS-Almanac           AlmanacECEF-SBAS-AlmanacSet,  -- Model-6
    ...,
    keplerianBDS-Almanac-r12     AlmanacBDS-AlmanacSet-r12    -- Model-7
}
-- ASN1STOP

```

GNSS-Almanac field descriptions

weekNumber

This field specifies the almanac reference week number in GNSS specific system time to which the almanac reference time *toa* is referenced, modulo 256 weeks. This field is required for non-GLONASS GNSS.

Note, in case of Galileo, the almanac reference week number WN_a natively contains only the 2 LSB's [8, section 5.1.10].

toa, toa-ext

In case of *GNSS-ID* does not indicate Galileo, this field specifies the almanac reference time given in GNSS specific system time, in units of seconds with a scale factor of 2^{12} . *toa* is required for non-GLONASS GNSS.

In case of *GNSS-ID* does indicate Galileo, this field specifies the almanac reference time given in GNSS specific system time, in units of seconds with a scale factor of 600 seconds. Either *toa* or *toa-ext* is required for Galileo GNSS.

ioda, ioda-ext

This field specifies the issue of data. Either *ioda* or *ioda-ext* is required for Galileo GNSS.

completeAlmanacProvided

If set to TRUE, the *gnss-AlmanacList* contains almanacs for the complete GNSS constellation indicated by *GNSS-ID*.

gnss-AlmanacList

This list contains the almanac model for each GNSS satellite in the GNSS constellation.

AlmanacKeplerianSet

```

-- ASN1START
AlmanacKeplerianSet ::= SEQUENCE {
    svID                SV-ID,
    kepAlmanacE         INTEGER (0..2047),
    kepAlmanacDeltaI    INTEGER (-1024..1023),
    kepAlmanacOmegaDot  INTEGER (-1024..1023),
    kepSV-StatusINAV    BIT STRING (SIZE (4)),
    kepSV-StatusFNAV    BIT STRING (SIZE (2))          OPTIONAL,  -- Need ON
    kepAlmanacAPowerHalf INTEGER (-4096..4095),
    kepAlmanacOmega0    INTEGER (-32768..32767),
    kepAlmanacW         INTEGER (-32768..32767),
    kepAlmanacM0        INTEGER (-32768..32767),
    kepAlmanacAF0       INTEGER (-32768..32767),
    kepAlmanacAF1       INTEGER (-4096..4095),
    ...
}
-- ASN1STOP

```

AlmanacKeplerianSet field descriptions

svID

This field identifies the satellite for which the GNSS Almanac Model is given.

kepAlmanacE

Parameter *e*, eccentricity, dimensionless [8].

Scale factor 2^{-16} .

kepAlmanacDeltaI

Parameter δ_i , inclination at reference time relative to $i_0=56^\circ$; semi-circles [8].

Scale factor 2^{-14} semi-circles.

kepAlmanacOmegaDot

Parameter $\dot{\Omega}$, rate of change of right ascension (semi-circles/sec) [8].

Scale factor 2^{-33} semi-circles/seconds.

<i>AlmanacKeplerianSet</i> field descriptions
<p><i>kepSV-StatusINAV</i> This field contains the I/NAV signal health status [8, section 5.1.10] , E5b_{HS} and E1-B_{HS}, where E5b_{HS} occupies the 2 MSBs in <i>kepSV-StatusINAV</i>, and E1-B_{HS} the two LSBs.</p>
<p><i>kepSV-StatusFNAV</i> This field contains the F/NAV signal health status [8, section 5.1.10] ,E5a_{HS}. If the target device is supporting multiple Galileo signals, the location server shall include this field.</p>
<p><i>kepAlmanacAPowerHalf</i> Parameter $\Delta(a^{1/2})$, difference with respect to the square root of the nominal semi-major axis, (meters)^{1/2} [8]. Scale factor 2⁻⁹ meters^{1/2}.</p>
<p><i>kepAlmanacOmega0</i> Parameter OMEGA₀, longitude of ascending node of orbital plane at weekly epoch (semi-circles) [8]. Scale factor 2⁻¹⁵ semi-circles.</p>
<p><i>kepAlmanacW</i> Parameter ω, argument of perigee (semi-circles) [8]. Scale factor 2⁻¹⁵ semi-circles.</p>
<p><i>kepAlmanacM0</i> Parameter M₀, mean anomaly at reference time (semi-circles) [8]. Scale factor 2⁻¹⁵ semi-circles.</p>
<p><i>kepAlmanacAF0</i> Parameter af₀, satellite clock correction bias, seconds [8]. Scale factor 2⁻¹⁹ seconds.</p>
<p><i>kepAlmanacAF1</i> Parameter af₁, satellite clock correction linear, sec/sec [8]. Scale factor 2⁻³⁸ seconds/second.</p>

– AlmanacNAV-KeplerianSet

```

-- ASN1START
AlmanacNAV-KeplerianSet ::= SEQUENCE {
    svID                SV-ID,
    navAlmE              INTEGER (0..65535),
    navAlmDeltaI         INTEGER (-32768..32767),
    navAlmOMEGADOT      INTEGER (-32768..32767),
    navAlmSVHealth      INTEGER (0..255),
    navAlmSqrtA          INTEGER (0..16777215),
    navAlmOMEGAo        INTEGER (-8388608..8388607),
    navAlmOmega         INTEGER (-8388608..8388607),
    navAlmMo            INTEGER (-8388608..8388607),
    navAlmaf0           INTEGER (-1024..1023),
    navAlmaf1           INTEGER (-1024..1023),
    ...
}
-- ASN1STOP

```

<i>AlmanacNAV-KeplerianSet</i> field descriptions
svID This field identifies the satellite for which the GNSS Almanac Model is given.
navAlmE Parameter e, eccentricity, dimensionless [4,7]. Scale factor 2^{21} .
navAlmDeltaI Parameter δ_i , correction to inclination, semi-circles [4,7]. Scale factor 2^{19} semi-circles.
navAlmOMEGADOT Parameter $\dot{\Omega}$, rate of right ascension, semi-circles/sec [4,7]. Scale factor 2^{38} semi-circles/second.
navAlmSVHealth Parameter SV Health, satellite health [4,7].
navAlmSqrtA Parameter \sqrt{A} , square root of the semi-major axis, meters ^{1/2} [4,7] Scale factor 2^{11} meters ^{1/2} .
navAlmOMEGAO Parameter Ω_0 , longitude of ascending node of orbit plane at weekly epoch, semi-circles [4,7]. Scale factor 2^{23} semi-circles.
navAlmOmega Parameter ω , argument of perigee semi-circles [4,7]. Scale factor 2^{23} semi-circles.
navAlmMo Parameter M_0 , mean anomaly at reference time semi-circles [4,7]. Scale factor 2^{23} semi-circles.
navAlmaf0 Parameter a_{f0} , apparent satellite clock correction seconds [4,7]. Scale factor 2^{20} seconds.
navAlmaf1 Parameter a_{f1} , apparent satellite clock correction sec/sec [4,7]. Scale factor 2^{38} semi-circles seconds/second.

AlmanacReducedKeplerianSet

```

-- ASN1START
AlmanacReducedKeplerianSet ::= SEQUENCE {
    svID                SV-ID,
    redAlmDeltaA        INTEGER (-128..127),
    redAlmOmega0        INTEGER (-64..63),
    redAlmPhi0          INTEGER (-64..63),
    redAlmL1Health      BOOLEAN,
    redAlmL2Health      BOOLEAN,
    redAlmL5Health      BOOLEAN,
    ...
}
-- ASN1STOP

```

<i>AlmanacReducedKeplerianSet</i> field descriptions
svID This field identifies the satellite for which the GNSS Almanac Model is given.
redAlmDeltaA Parameter δ_A , meters [4,5,6,7]. Scale factor 2^{+9} meters.
redAlmOmega0 Parameter Ω_0 , semi-circles [4,5,6,7]. Scale factor 2^{-6} semi-circles.
redAlmPhi0 Parameter Φ_0 , semi-circles [4,5,6,7]. Scale factor 2^{-6} semi-circles.
redAlmL1Health Parameter L1 Health, dimensionless [4,5,6,7].
redAlmL2Health Parameter L2 Health, dimensionless [4,5,6,7].
redAlmL5Health Parameter L5 Health, dimensionless [4,5,6,7].

– AlmanacMidiAlmanacSet

```
-- ASN1START
AlmanacMidiAlmanacSet ::= SEQUENCE {
    svID                SV-ID,
    midiAlmE            INTEGER (0..2047),
    midiAlmDeltaI       INTEGER (-1024..1023),
    midiAlmOmegaDot     INTEGER (-1024..1023),
    midiAlmSqrtA        INTEGER (0..131071),
    midiAlmOmega0       INTEGER (-32768..32767),
    midiAlmOmega        INTEGER (-32768..32767),
    midiAlmMo           INTEGER (-32768..32767),
    midiAlmaf0          INTEGER (-1024..1023),
    midiAlmaf1          INTEGER (-512..511),
    midiAlmL1Health     BOOLEAN,
    midiAlmL2Health     BOOLEAN,
    midiAlmL5Health     BOOLEAN,
    ...
}
-- ASN1STOP
```

AlmanacMidiAlmanacSet field descriptions
svID This field identifies the satellite for which the GNSS Almanac Model is given.
midiAlmE Parameter e , dimensionless [4,5,6,7]. Scale factor 2^{-16} .
midiAlmDeltaI Parameter δ_i , semi-circles [4,5,6,7]. Scale factor 2^{-14} semi-circles.
midiAlmOmegaDot Parameter $\dot{\Omega}$, semi-circles/sec [4,5,6,7]. Scale factor 2^{-33} semi-circles/second.
midiAlmSqrtA Parameter \sqrt{A} , meters ^{1/2} [4,5,6,7]. Scale factor 2^{-4} meters ^{1/2} .
midiAlmOmega0 Parameter Ω_0 , semi-circles [4,5,6,7]. Scale factor 2^{-15} semi-circles.
midiAlmOmega Parameter ω , semi-circles [4,5,6,7]. Scale factor 2^{-15} semi-circles.
midiAlmMo Parameter M_0 , semi-circles [4,5,6,7]. Scale factor 2^{-15} semi-circles.
midiAlmaf0 Parameter a_{f0} , seconds [4,5,6,7]. Scale factor 2^{-20} seconds.
midiAlmaf1 Parameter a_{f1} , sec/sec [4,5,6,7]. Scale factor 2^{-37} seconds/second.
midiAlmL1Health Parameter L1 Health, dimensionless [4,5,6,7].
midiAlmL2Health Parameter L2 Health, dimensionless [4,5,6,7].
midiAlmL5Health Parameter L5 Health, dimensionless [4,5,6,7].

AlmanacGLONASS-AlmanacSet

```
-- ASN1START
AlmanacGLONASS-AlmanacSet ::= SEQUENCE {
    gloAlm-NA          INTEGER (1..1461),
    gloAlmNA          INTEGER (1..24),
    gloAlmHA          INTEGER (0..31),
    gloAlmLambdaA     INTEGER (-1048576..1048575),
    gloAlmLambdaA     INTEGER (0..2097151),
    gloAlmDeltaIa     INTEGER (-131072..131071),
    gloAlmDeltaTA     INTEGER (-2097152..2097151),
    gloAlmDeltaTdotA  INTEGER (-64..63),
    gloAlmEpsilonA    INTEGER (0..32767),
    gloAlmOmegaA      INTEGER (-32768..32767),
    gloAlmTauA        INTEGER (-512..511),
    gloAlmCA          INTEGER (0..1),
    gloAlmMA          BIT STRING (SIZE(2))          OPTIONAL, -- Need ON
    ...
}
-- ASN1STOP
```

<i>AlmanacGLONASS-AlmanacSet</i> field descriptions
<i>gloAlmNA</i> Parameter N^A , days [9]. Scale factor 1 days.
<i>gloAlmna</i> Parameter n^A , dimensionless [9].
<i>gloAlmHA</i> Parameter H_n^A , dimensionless [9].
<i>gloAlmLambdaA</i> Parameter λ_n^A , semi-circles [9]. Scale factor 2^{20} semi-circles.
<i>gloAlmlambdaA</i> Parameter $t_{\lambda_n}^A$, seconds [9]. Scale factor 2^5 seconds.
<i>gloAlmDeltala</i> Parameter Δ_n^A , semi-circles [9]. Scale factor 2^{20} semi-circles.
<i>gloAlmDeltaTA</i> Parameter ΔT_n^A , sec/orbit period [9]. Scale factor 2^9 seconds/orbit period.
<i>gloAlmDeltaTdotA</i> Parameter $\Delta T_DOT_n^A$, sec/orbit period ² [9]. Scale factor 2^{14} seconds/orbit period ² .
<i>gloAlmEpsilonA</i> Parameter ϵ_n^A , dimensionless [9]. Scale factor 2^{20} .
<i>gloAlmOmegaA</i> Parameter ω_n^A , semi-circles [9]. Scale factor 2^{15} semi-circles.
<i>gloAlmTauA</i> Parameter τ_n^A , seconds [9]. Scale factor 2^{18} seconds.
<i>gloAlmCA</i> Parameter C_n^A , dimensionless [9].
<i>gloAlmMA</i> Parameter M_n^A , dimensionless [9]. This parameter is present if its value is nonzero; otherwise it is not present.

AlmanacECEF-SBAS-AlmanacSet

```

-- ASN1START
AlmanacECEF-SBAS-AlmanacSet ::= SEQUENCE {
    sbasAlmDataID    INTEGER (0..3),
    svID             SV-ID,
    sbasAlmHealth    BIT STRING (SIZE(8)),
    sbasAlmXg        INTEGER (-16384..16383),
    sbasAlmYg        INTEGER (-16384..16383),
    sbasAlmZg        INTEGER (-256..255),
    sbasAlmXgdot     INTEGER (-4..3),
    sbasAlmYgdot     INTEGER (-4..3),
    sbasAlmZgdot     INTEGER (-8..7),
    sbasAlmTo        INTEGER (0..2047),
    ...
}
-- ASN1STOP

```

AlmanacECEF-SBAS-AlmanacSet field descriptions
sbasAlmDataID Parameter Data ID, dimensionless [10].
svID This field identifies the satellite for which the GNSS Almanac Model is given.
sbasAlmHealth Parameter Health, dimensionless [10].
sbasAlmXg Parameter X_G , meters [10]. Scale factor 2600 meters.
sbasAlmYg Parameter Y_G , meters [10]. Scale factor 2600 meters.
sbasAlmZg Parameter Z_G , meters [10]. Scale factor 26000 meters.
sbasAlmXgdot Parameter X_G Rat-of-Change, meters/sec [10]. Scale factor 10 meters/second.
sbasAlmYgDot Parameter Y_G Rate-of-Change, meters/sec [10]. Scale factor 10 meters/second.
sbasAlmZgDot Parameter Z_G Rate-of-Change, meters/sec [10]. Scale factor 40.96 meters/second.
sbasAlmTo Parameter t_0 , seconds [10]. Scale factor 64 meters/seconds.

– AlmanacBDS-AlmanacSet

```

-- ASN1START
AlmanacBDS-AlmanacSet-r12 ::= SEQUENCE {
    svID                SV-ID,
    bdsAlmToa-r12       INTEGER (0..255)                OPTIONAL,  -- Cond NotSameForAllSV
    bdsAlmSqrtA-r12     INTEGER (0..16777215),
    bdsAlmE-r12         INTEGER (0..131071),
    bdsAlmW-r12         INTEGER (-8388608..8388607),
    bdsAlmM0-r12        INTEGER (-8388608..8388607),
    bdsAlmOmega0-r12   INTEGER (-8388608..8388607),
    bdsAlmOmegaDot-r12 INTEGER (-65536..65535),
    bdsAlmDeltaI-r12   INTEGER (-32768..32767),
    bdsAlmA0-r12        INTEGER (-1024..1023),
    bdsAlmA1-r12        INTEGER (-1024..1023),
    bdsSvHealth-r12    BIT STRING (SIZE(9))           OPTIONAL,  -- Cond SV-ID
    ...
}
-- ASN1STOP

```

Conditional presence	Explanation
<i>NotSameForAllSV</i>	This field may be present if the t_{0a} is not the same for all SVs; otherwise it is not present and the t_{0a} is provided in <i>GNSS-Almanac</i> .
<i>SV-ID</i>	This field is mandatory present if <i>SV-ID</i> is between 0 and 29; otherwise it is not present.

AlmanacBDS-AlmanacSet field descriptions
svID This field identifies the satellite for which the GNSS Almanac Model is given.
bdsAlmToa Parameter t_{0a} , Almanac reference time(seconds) [23] Scale factor 2^{12} seconds.
bdsAlmSqrtA Parameter $A^{1/2}$, Square root of semi-major axis (meters ^{1/2}) [23] Scale factor 2^{11} meters ^{1/2} .
bdsAlmE Parameter e , Eccentricity, dimensionless [23] Scale factor 2^{21} .
bdsAlmW Parameter ω , Argument of Perigee (semi-circles) [23] Scale factor 2^{23} semi-circles.
bdsAlmM0 Parameter M_0 , Mean anomaly at reference time (semi-circles) [23] Scale factor 2^{23} semi-circles.
bdsAlmOmega0 Parameter Ω_0 , Longitude of ascending node of orbital plane computed according to reference time (semi-circles) [23] Scale factor 2^{23} semi-circles.
bdsAlmOmegaDot Parameter $\dot{\Omega}$, Rate of right ascension (semi-circles/sec) [23] Scale factor 2^{38} semi-circles/sec.
bdsAlmDeltai Parameter δ_i , Correction of orbit reference inclination at reference time (semi-circles) [23] Scale factor 2^{19} semi-circles.
bdsAlmA0 Parameter a_0 , Satellite clock bias (seconds) [23] Scale factor 2^{20} seconds.
bdsAlmA1 Parameter a_1 , Satellite clock rate (sec/sec) [23] Scale factor 2^{38} sec/sec.
bdsSvHealth This field indicates satellites health information as defined in [23] Table 5-15. The left most bit is the MSB.

– GNSS-UTC-Model

The IE *GNSS-UTC-Model* is used by the location server to provide several sets of parameters needed to relate GNSS system time to Universal Time Coordinate (UTC), as defined in [4], [5], [6], [7], [8], [9], [10], [23].

The UTC time standard, UTC(k), is GNSS specific. E.g., if *GNSS-ID* indicates GPS, *GNSS-UTC-Model* contains a set of parameters needed to relate GPS system time to UTC(USNO); if *GNSS-ID* indicates QZSS, *GNSS-UTC-Model* contains a set of parameters needed to relate QZST to UTC(NICT); if *GNSS-ID* indicates GLONASS, *GNSS-UTC-Model* contains a set of parameters needed to relate GLONASS system time to UTC(RU); if *GNSS-ID* indicates SBAS, *GNSS-UTC-Model* contains a set of parameters needed to relate SBAS network time for the SBAS indicated by *SBAS-ID* to the UTC standard defined by the UTC Standard ID; if *GNSS-ID* indicates BDS, *GNSS-UTC-Model* contains a set of parameters needed to relate BDS system time to UTC (NTSC).

```
-- ASN1START
GNSS-UTC-Model ::= CHOICE {
    utcModel1      UTC-ModelSet1,          -- Model-1
    utcModel2      UTC-ModelSet2,          -- Model-2
    utcModel3      UTC-ModelSet3,          -- Model-3
    utcModel4      UTC-ModelSet4,          -- Model-4
    . . .
    utcModel5-r12  UTC-ModelSet5-r12      -- Model-5
}
-- ASN1STOP
```

– UTC-ModelSet1

```
-- ASN1START
```

```

UTC-ModelSet1 ::= SEQUENCE {
    gnss-Utc-A1      INTEGER (-8388608..8388607),
    gnss-Utc-A0      INTEGER (-2147483648..2147483647),
    gnss-Utc-Tot     INTEGER (0..255),
    gnss-Utc-WNt     INTEGER (0..255),
    gnss-Utc-DeltaTls INTEGER (-128..127),
    gnss-Utc-WNlsf   INTEGER (0..255),
    gnss-Utc-DN      INTEGER (-128..127),
    gnss-Utc-DeltaTlsf INTEGER (-128..127),
    ...
}
-- ASN1STOP

```

UTC-ModelSet1 field descriptions

gnss-Utc-A1	Parameter A_1 , scale factor 2^{-50} seconds/second [4,7,8].
gnss-Utc-A0	Parameter A_0 , scale factor 2^{-30} seconds [4,7,8].
gnss-Utc-Tot	Parameter t_{ot} , scale factor 2^{12} seconds [4,7,8].
gnss-Utc-WNt	Parameter WN_t , scale factor 1 week [4,7,8].
gnss-Utc-DeltaTls	Parameter Δt_{LS} , scale factor 1 second [4,7,8].
gnss-Utc-WNlsf	Parameter WN_{LSF} , scale factor 1 week [4,7,8].
gnss-Utc-DN	Parameter DN, scale factor 1 day [4,7,8].
gnss-Utc-DeltaTlsf	Parameter Δt_{LSF} , scale factor 1 second [4,7,8].

UTC-ModelSet2

```

-- ASN1START
UTC-ModelSet2 ::= SEQUENCE {
    utcA0      INTEGER (-32768..32767),
    utcA1      INTEGER (-4096..4095),
    utcA2      INTEGER (-64..63),
    utcDeltaTls INTEGER (-128..127),
    utcTot     INTEGER (0..65535),
    utcWNt     INTEGER (0..8191),
    utcWNlsf   INTEGER (0..255),
    utcDN      BIT STRING (SIZE(4)),
    utcDeltaTlsf INTEGER (-128..127),
    ...
}
-- ASN1STOP

```

UTC-ModelSet2 field descriptions

utcA0	Parameter A_{0-n} , bias coefficient of GNSS time scale relative to UTC time scale (seconds) [4,5,6,7]. Scale factor 2^{-35} seconds.
utcA1	Parameter A_{1-n} , drift coefficient of GNSS time scale relative to UTC time scale (sec/sec) [4,5,6,7]. Scale factor 2^{-51} seconds/second.
utcA2	Parameter A_{2-n} , drift rate correction coefficient of GNSS time scale relative to UTC time scale (sec/sec ²) [4,5,6,7]. Scale factor 2^{-68} seconds/second ² .
utcDeltaTls	Parameter Δt_{LS} , current or past leap second count (seconds) [4,5,6,7]. Scale factor 1 second.
utcTot	Parameter t_{ot} , time data reference time of week (seconds) [4,5,6,7]. Scale factor 2^4 seconds.

UTC-ModelSet2 field descriptions
<p>utcWNot Parameter WN_{ot}, time data reference week number (weeks) [4,5,6,7]. Scale factor 1 week.</p>
<p>utcWNlsf Parameter WN_{LSF}, leap second reference week number (weeks) [4,5,6,7]. Scale factor 1 week.</p>
<p>utcDN Parameter DN, leap second reference day number (days) [4,5,6,7]. Scale factor 1 day.</p>
<p>utcDeltaTlsf Parameter Δt_{LSF}, current or future leap second count (seconds) [4,5,6,7]. Scale factor 1 second.</p>

– UTC-ModelSet3

```
-- ASN1START
UTC-ModelSet3 ::= SEQUENCE {
    nA                INTEGER (1..1461),
    tauC              INTEGER (-2147483648..2147483647),
    b1                INTEGER (-1024..1023)                OPTIONAL,    -- Cond GLONASS-M
    b2                INTEGER (-512..511)                  OPTIONAL,    -- Cond GLONASS-M
    kp                BIT STRING (SIZE(2))                 OPTIONAL,    -- Cond GLONASS-M
    ...
}
-- ASN1STOP
```

Conditional presence	Explanation
GLONASS-M	The field is mandatory present if GLONASS-M satellites are present in the current GLONASS constellation; otherwise it is not present.

UTC-ModelSet3 field descriptions
<p>nA Parameter N^A, calendar day number within four-year period beginning since the leap year (days) [9]. Scale factor 1 day.</p>
<p>tauC Parameter τ_c, GLONASS time scale correction to UTC(SU) (seconds) [9]. Scale factor 2^{-31} seconds.</p>
<p>b1 Parameter B1, coefficient to determine $\Delta UT1$ (seconds) [9]. Scale factor 2^{-10} seconds.</p>
<p>b2 Parameter B2, coefficient to determine $\Delta UT1$ (seconds/msd) [9]. Scale factor 2^{-16} seconds/msd.</p>
<p>kp Parameter KP, notification of expected leap second correction (dimensionless) [9].</p>

– UTC-ModelSet4

```
-- ASN1START
UTC-ModelSet4 ::= SEQUENCE {
    utcAlwnt          INTEGER (-8388608..8388607),
    utcA0wnt          INTEGER (-2147483648..2147483647),
    utcTot            INTEGER (0..255),
    utcWNt            INTEGER (0..255),
    utcDeltaTls       INTEGER (-128..127),
    utcWNlsf          INTEGER (0..255),
    utcDN             INTEGER (-128..127),
    utcDeltaTlsf      INTEGER (-128..127),
    utcStandardID     INTEGER (0..7),
    ...
}
```

-- ASN1STOP

UTC-ModelSet4 field descriptions
<p>utcA1wnt Parameter A_{1WNT}, sec/sec ([10], Message Type 12). Scale factor 2^{50} seconds/second.</p>
<p>utcA0wnt Parameter A_{0WNT}, seconds ([10], Message Type 12). Scale factor 2^{30} seconds.</p>
<p>utcTot Parameter t_{ot}, seconds ([10], Message Type 12). Scale factor 2^{12} seconds.</p>
<p>utcWNt Parameter WN_t, weeks ([10], Message Type 12). Scale factor 1 week.</p>
<p>utcDeltaTls Parameter Δt_{LS}, seconds ([10], Message Type 12). Scale factor 1 second.</p>
<p>utcWNlsf Parameter WN_{LSF}, weeks ([10], Message Type 12). Scale factor 1 week.</p>
<p>utcDN Parameter DN, days ([10], Message Type 12). Scale factor 1 day.</p>
<p>utcDeltaTlsf Parameter Δt_{LSF}, seconds ([10], Message Type 12). Scale factor 1 second.</p>
<p>utcStandardID If <i>GNSS-ID</i> indicates "sbas", this field indicates the UTC standard used for the SBAS network time indicated by <i>SBAS-ID</i> to UTC relation as defined in the table Value of UTC Standard ID to UTC Standard relation shown below ([10], Message Type 12).</p>

Value of UTC Standard ID to UTC Standard relation

Value of UTC Standard ID	UTC Standard
0	UTC as operated by the Communications Research Laboratory (CRL), Tokyo, Japan
1	UTC as operated by the National Institute of Standards and Technology (NIST)
2	UTC as operated by the U. S. Naval Observatory (USNO)
3	UTC as operated by the International Bureau of Weights and Measures (BIPM)
4-7	Reserved for future definition

– **UTC-ModelSet5**

-- ASN1START

```

UTC-ModelSet5-r12 ::= SEQUENCE {
    utcA0-r12          INTEGER (-2147483648..2147483647),
    utcA1-r12          INTEGER (-8388608..8388607),
    utcDeltaTls-r12    INTEGER (-128..127),
    utcWNlsf-r12       INTEGER (0..255),
    utcDN-r12          INTEGER (0..255),
    utcDeltaTlsf-r12   INTEGER (-128..127),
    ...
}
    
```

-- ASN1STOP

UTC-ModelSet5 field descriptions
<p>utcA0 Parameter A_{0UTC}, BDS clock bias relative to UTC, seconds [23]. Scale factor 2^{30} seconds.</p>

UTC-ModelSet5 field descriptions
<p>utcA1 Parameter A_{1UTC}, BDS clock rate relative to UTC, sec/sec [23]. Scale factor 2^{-50} sec/sec.</p>
<p>utcDeltaTls Parameter Δt_{LS}, delta time due to leap seconds before the new leap second effective, seconds [23]. Scale factor 1 second.</p>
<p>utcWNlsf Parameter WN_{LSF}, week number of the new leap second, weeks [23]. Scale factor 1 week.</p>
<p>utcDN Parameter DN, day number of week of the new leap second, days [23]. Scale factor 1 day.</p>
<p>utcDeltaTlsf Parameter Δt_{LSF}, delta time due to leap seconds after the new leap second effective, seconds [23]. Scale factor 1 second.</p>

GNSS-AuxiliaryInformation

The IE *GNSS-AuxiliaryInformation* is used by the location server to provide additional information dependent on the *GNSS-ID*. If *GNSS-AuxiliaryInformation* is provided together with other satellite dependent GNSS assistance data (i.e., any of *GNSS-DifferentialCorrections*, *GNSS-NavigationModel*, *GNSS-DataBitAssistance*, or *GNSS-AcquisitionAssistance* IEs), the *GNSS-AuxiliaryInformation* should be provided for the same satellites and in the same LPP message as the other satellite dependent GNSS assistance data.

```

-- ASN1START
GNSS-AuxiliaryInformation ::= CHOICE {
    gnss-ID-GPS      GNSS-ID-GPS,
    gnss-ID-GLONASS GNSS-ID-GLONASS,
    ...
}

GNSS-ID-GPS ::= SEQUENCE (SIZE(1..64)) OF GNSS-ID-GPS-SatElement

GNSS-ID-GPS-SatElement ::= SEQUENCE {
    svID          SV-ID,
    signalsAvailable GNSS-SignalIDs,
    ...
}

GNSS-ID-GLONASS ::= SEQUENCE (SIZE(1..64)) OF GNSS-ID-GLONASS-SatElement

GNSS-ID-GLONASS-SatElement ::= SEQUENCE {
    svID          SV-ID,
    signalsAvailable GNSS-SignalIDs,
    channelNumber INTEGER (-7..13) OPTIONAL, -- Cond FDMA
    ...
}
-- ASN1STOP
    
```

Conditional presence	Explanation
<i>FDMA</i>	The field is mandatory present if the GLONASS SV indicated by <i>svID</i> broadcasts FDMA signals; otherwise it is not present.

GNSS-AuxiliaryInformation field descriptions
<p>gnss-ID-GPS This choice may only be present if <i>GNSS-ID</i> indicates GPS.</p>
<p>gnss-ID-GLONASS This choice may only be present if <i>GNSS-ID</i> indicates GLONASS.</p>
<p>svID This field specifies the GNSS SV for which the <i>GNSS-AuxiliaryInformation</i> is given.</p>
<p>signalsAvailable This field indicates the ranging signals supported by the satellite indicated by <i>svID</i>. This field is given as a bit string as defined in <i>GNSS-SignallDs</i> for a particular GNSS. If a bit is set to "1" it indicates that the satellite identified by <i>svID</i> transmits ranging signals according to the signal correspondence in <i>GNSS-SignallDs</i>. If a bit is set to "0" it indicates that the corresponding signal is not supported on the satellite identified by <i>svID</i>.</p>
<p>channelNumber This field indicates the GLONASS carrier frequency number of the satellite identified by <i>svID</i>, as defined in [9].</p>

– BDS-DifferentialCorrections

The IE *BDS-DifferentialCorrections* is used by the location server to provide differential corrections to the target device.

```

-- ASN1START
BDS-DifferentialCorrections-r12 ::= SEQUENCE {
    dbds-RefTime-r12          INTEGER (0..3599),
    bds-SgnTypeList-r12      BDS-SgnTypeList-r12,
    ...
}
BDS-SgnTypeList-r12 ::= SEQUENCE (SIZE (1..3)) OF BDS-SgnTypeElement-r12
BDS-SgnTypeElement-r12 ::= SEQUENCE {
    gnss-SignalID            GNSS-SignalID          OPTIONAL, -- Need ON
    dbds-CorrectionList-r12 DBDS-CorrectionList-r12,
    ...
}
DBDS-CorrectionList-r12 ::= SEQUENCE (SIZE (1..64)) OF DBDS-CorrectionElement-r12
DBDS-CorrectionElement-r12 ::= SEQUENCE {
    svID                    SV-ID,
    bds-UDREI-r12           INTEGER (0..15),
    bds-RURAI-r12           INTEGER (0..15),
    bds-ECC-DeltaT-r12      INTEGER (-4096..4095),
    ...
}
-- ASN1STOP

```

BDS-DifferentialCorrections field descriptions
<p>dbds-RefTime This field <i>specifies</i> the time for which the differential corrections are valid, modulo 1 hour. <i>dbds-RefTime</i> is given in BDS system time. Scale factor 1-second.</p>
<p>bds-UDREI This field indicates user differential range error information by user differential range error index (UDREI) as defined in [23], 5.3.3.7.2.</p>
<p>bds-RURAI This field indicates Regional User Range Accuracy (RURA) information by Regional User Range Accuracy Index (UDREI) as defined in [23, 5.3.3.6].</p>
<p>bds-ECC-DeltaT This field indicates the BDS differential correction information which is expressed in equivalent clock correction (Δt). Add the value of Δt to the observed pseudo-range to correct the effect caused by the satellite clock offset and ephemeris error. Value -4096 means the Δt is not available. The scale factor is 0.1 meter.</p>

– BDS-GridModelParameter

```

-- ASN1START
BDS-GridModelParameter-r12 ::= SEQUENCE {
    bds-RefTime-r12          INTEGER (0..3599),
    gridIonList-r12         GridIonList-r12,
    ...
}

GridIonList-r12 ::= SEQUENCE (SIZE (1..320)) OF GridIonElement-r12

GridIonElement-r12 ::= SEQUENCE {
    igp-ID-r12              INTEGER (1..320),
    dt-r12                  INTEGER (0..511),
    givei-r12               INTEGER (0..15),
    ...
}
-- ASN1STOP

```

BDS-GridModelParameter field descriptions

bds-RefTime

This field specifies the time for which the grid model parameters are valid, modulo 1 hour. *bds-RefTime* is given in BDS system time.
Scale factor 1-second.

gridIonList

This list provides ionospheric grid point information for each grid point. Up to 16 instances are used in this version of the specification. The values 17 to 320 are reserved for future use.

igp-ID

This field indicates the ionospheric grid point (IGP) number as defined in [23, 5.3.3.8].

dt

This field indicates d_T as defined in [23, 5.3.3.8.1], i.e. the vertical delay at the corresponding IGP indicated by *igp-ID*. The scale factor is 0.125 meter.

givei

This field indicates the Grid Ionospheric Vertical Error Index (GIVEI) which is used to describe the delay correction accuracy at ionospheric grid point indicated by *igp-ID*, the mapping between GIVEI and GIVE is defined in [23, 5.3.3.8.2].

6.5.2.3 GNSS Assistance Data Request

– A-GNSS-RequestAssistanceData

The IE *A-GNSS-RequestAssistanceData* is used by the target device to request GNSS assistance data from a location server.

```

-- ASN1START
A-GNSS-RequestAssistanceData ::= SEQUENCE {
    gnss-CommonAssistDataReq  GNSS-CommonAssistDataReq  OPTIONAL, -- Cond CommonADReq
    gnss-GenericAssistDataReq  GNSS-GenericAssistDataReq  OPTIONAL, -- Cond GenADReq
    ...
}
-- ASN1STOP

```

Conditional presence	Explanation
<i>CommonADReq</i>	The field is mandatory present if the target device requests <i>GNSS-CommonAssistData</i> ; otherwise it is not present.
<i>GenADReq</i>	This field is mandatory present if the target device requests <i>GNSS-GenericAssistData</i> for one or more specific GNSS; otherwise it is not present.

– GNSS-CommonAssistDataReq

The IE *GNSS-CommonAssistDataReq* is used by the target device to request assistance data that are applicable to any GNSS from a location server.

```
-- ASN1START
GNSS-CommonAssistDataReq ::= SEQUENCE {
  gnss-ReferenceTimeReq          GNSS-ReferenceTimeReq
                                OPTIONAL, -- Cond RefTimeReq
  gnss-ReferenceLocationReq      GNSS-ReferenceLocationReq
                                OPTIONAL, -- Cond RefLocReq
  gnss-IonosphericModelReq       GNSS-IonosphericModelReq
                                OPTIONAL, -- Cond IonoModReq
  gnss-EarthOrientationParametersReq GNSS-EarthOrientationParametersReq
                                OPTIONAL, -- Cond EOPReq
  ...
}
-- ASN1STOP
```

Conditional presence	Explanation
<i>RefTimeReq</i>	The field is mandatory present if the target device requests <i>GNSS-ReferenceTime</i> ; otherwise it is not present.
<i>RefLocReq</i>	This field is mandatory present if the target device requests <i>GNSS-ReferenceLocation</i> ; otherwise it is not present.
<i>IonoModReq</i>	This field is mandatory present if the target device requests <i>GNSS-IonosphericModel</i> ; otherwise it is not present.
<i>EOPReq</i>	This field is mandatory present if the target device requests <i>GNSS-EarthOrientationParameters</i> ; otherwise it is not present.

– GNSS-GenericAssistDataReq

The IE *GNSS-GenericAssistDataReq* is used by the target device to request assistance data from a location server for one or more specific GNSS (e.g., GPS, Galileo, GLONASS, BDS, etc.). The specific GNSS for which the assistance data are requested is indicated by the IE *GNSS-ID* and (if applicable) by the IE *SBAS-ID*. Assistance for up to 16 GNSSs can be requested.

```
-- ASN1START
GNSS-GenericAssistDataReq ::= SEQUENCE (SIZE (1..16)) OF GNSS-GenericAssistDataReqElement
GNSS-GenericAssistDataReqElement ::= SEQUENCE {
  gnss-ID          GNSS-ID,
  sbas-ID          SBAS-ID
                  OPTIONAL, -- Cond GNSS-ID-SBAS
  gnss-TimeModelsReq GNSS-TimeModelListReq
                  OPTIONAL, -- Cond TimeModReq
  gnss-DifferentialCorrectionsReq GNSS-DifferentialCorrectionsReq
                  OPTIONAL, -- Cond DGNSS-Req
  gnss-NavigationModelReq GNSS-NavigationModelReq
                  OPTIONAL, -- Cond NavModReq
  gnss-RealTimeIntegrityReq GNSS-RealTimeIntegrityReq
                  OPTIONAL, -- Cond RTIReq
  gnss-DataBitAssistanceReq GNSS-DataBitAssistanceReq
                  OPTIONAL, -- Cond DataBitsReq
  gnss-AcquisitionAssistanceReq GNSS-AcquisitionAssistanceReq
                  OPTIONAL, -- Cond AcquAssistReq
  gnss-AlmanacReq          GNSS-AlmanacReq
                  OPTIONAL, -- Cond AlmanacReq
  gnss-UTCModelReq         GNSS-UTC-ModelReq
                  OPTIONAL, -- Cond UTCModReq
  gnss-AuxiliaryInformationReq GNSS-AuxiliaryInformationReq
                  OPTIONAL, -- Cond AuxInfoReq
  ...
  [[
    bds-DifferentialCorrectionsReq-r12
                                BDS-DifferentialCorrectionsReq-r12
                                OPTIONAL, -- Cond DBDS-Req
    bds-GridModelReq-r12        BDS-GridModelReq-r12
                                OPTIONAL, -- Cond BDS-GridModReq
  ]]
}
-- ASN1STOP
```

Conditional presence	Explanation
<i>GNSS-ID-SBAS</i>	The field is mandatory present if the <i>GNSS-ID</i> = <i>sbas</i> ; otherwise it is not present.
<i>TimeModReq</i>	The field is mandatory present if the target device requests <i>GNSS-TimeModelList</i> ; otherwise it is not present.

Conditional presence	Explanation
<i>GNSS-Req</i>	The field is mandatory present if the target device requests <i>GNSS-DifferentialCorrections</i> ; otherwise it is not present.
<i>NavModReq</i>	The field is mandatory present if the target device requests <i>GNSS-NavigationModel</i> ; otherwise it is not present.
<i>RTIReq</i>	The field is mandatory present if the target device requests <i>GNSS-RealTimeIntegrity</i> ; otherwise it is not present.
<i>DataBitsReq</i>	The field is mandatory present if the target device requests <i>GNSS-DataBitAssistance</i> ; otherwise it is not present.
<i>AcquAssistReq</i>	The field is mandatory present if the target device requests <i>GNSS-AcquisitionAssistance</i> ; otherwise it is not present.
<i>AlmanacReq</i>	The field is mandatory present if the target device requests <i>GNSS-Almanac</i> ; otherwise it is not present.
<i>UTCModReq</i>	The field is mandatory present if the target device requests <i>GNSS-UTCModel</i> ; otherwise it is not present.
<i>AuxInfoReq</i>	The field is mandatory present if the target device requests <i>GNSS-AuxiliaryInformation</i> ; otherwise it is not present.
<i>DBDS-Req</i>	The field is mandatory present if the target device requests <i>BDS-DifferentialCorrections</i> ; otherwise it is not present. This field may only be present if <i>gnss-ID</i> indicates "bds".
<i>BDS-GridModReq</i>	The field is mandatory present if the target device requests <i>BDS-GridModel</i> ; otherwise it is not present. This field may only be present if <i>gnss-ID</i> indicates "bds".

6.5.2.4 GNSS Assistance Data Request Elements

– GNSS-ReferenceTimeReq

The IE *GNSS-ReferenceTimeReq* is used by the target device to request the *GNSS-ReferenceTime* assistance from the location server.

```
-- ASN1START
GNSS-ReferenceTimeReq ::= SEQUENCE {
    gnss-TimeReqPrefList SEQUENCE (SIZE (1..8)) OF GNSS-ID,
    gps-TOW-assistReq    BOOLEAN                OPTIONAL, -- Cond gps
    notOfLeapSecReq     BOOLEAN                OPTIONAL, -- Cond glonass
    ...
}
-- ASN1STOP
```

Conditional presence	Explanation
<i>gps</i>	The field is mandatory present if <i>gnss-TimeReqPrefList</i> includes a <i>GNSS-ID</i> = "gps"; otherwise it is not present.
<i>glonass</i>	The field is mandatory present if <i>gnss-TimeReqPrefList</i> includes a <i>GNSS-ID</i> = "glonass"; otherwise it is not present.

GNSS-ReferenceTimeReq field descriptions	
<i>gnss-TimeReqPrefList</i>	This field is used by the target device to request the system time for a specific GNSS, specified by <i>GNSS-ID</i> in the order of preference. The first <i>GNSS-ID</i> in the list is the most preferred GNSS for reference time, the second <i>GNSS-ID</i> is the second most preferred, etc.
<i>gps-TOW-assistReq</i>	This field is used by the target device to request the <i>gps-TOW-Assist</i> field in <i>GNSS-SystemTime</i> . TRUE means requested.
<i>notOfLeapSecReq</i>	This field is used by the target device to request the <i>notificationOfLeapSecond</i> field in <i>GNSS-SystemTime</i> . TRUE means requested.

– GNSS-ReferenceLocationReq

The IE *GNSS-ReferenceLocationReq* is used by the target device to request the *GNSS-ReferenceLocation* assistance from the location server.

```
-- ASN1START
GNSS-ReferenceLocationReq ::= SEQUENCE {
    ...
}
-- ASN1STOP
```

– GNSS-IonosphericModelReq

The IE *GNSS-IonosphericModelReq* is used by the target device to request the *GNSS-IonosphericModel* assistance from the location server.

```
-- ASN1START
GNSS-IonosphericModelReq ::= SEQUENCE {
    klobucharModelReq BIT STRING (SIZE(2)) OPTIONAL, -- Cond klobuchar
    neQuickModelReq  NULL          OPTIONAL, -- Cond nequick
    ...
}
-- ASN1STOP
```

Conditional presence	Explanation
<i>klobuchar</i>	The field is mandatory present if the target device requests <i>klobucharModel</i> ; otherwise it is not present. The BIT STRING defines the dataID requested, defined in IE <i>KlobucharModelParameter</i> .
<i>nequick</i>	The field is mandatory present if the target device requests <i>neQuickModel</i> ; otherwise it is not present.

– GNSS-EarthOrientationParametersReq

The IE *GNSS-EarthOrientationParametersReq* is used by the target device to request the *GNSS-EarthOrientationParameters* assistance from the location server.

```
-- ASN1START
GNSS-EarthOrientationParametersReq ::= SEQUENCE {
    ...
}
-- ASN1STOP
```

– GNSS-TimeModelListReq

The IE *GNSS-TimeModelListReq* is used by the target device to request the *GNSS-TimeModelElement* assistance from the location server.

```
-- ASN1START
GNSS-TimeModelListReq ::= SEQUENCE (SIZE(1..15)) OF GNSS-TimeModelElementReq
GNSS-TimeModelElementReq ::= SEQUENCE {
    gnss-TO-IDsReq INTEGER (1..15),
    deltaTreq      BOOLEAN,
    ...
}
-- ASN1STOP
```

GNSS-TimeModelElementReq field descriptions

gnss-TO-IDsReq

This field specifies the requested *gnss-TO-ID*. The meaning and encoding is the same as the *gnss-TO-ID* field in the *GNSS-TimeModelElement* IE.

GNSS-TimeModelElementReq field descriptions**deltaTreq**

This field specifies whether or not the location server is requested to include the *deltaT* field in the *GNSS-TimeModelElement* IE. TRUE means requested.

GNSS-DifferentialCorrectionsReq

The IE *GNSS-DifferentialCorrectionsReq* is used by the target device to request the *GNSS-DifferentialCorrections* assistance from the location server.

```
-- ASN1START
GNSS-DifferentialCorrectionsReq ::= SEQUENCE {
    dgnss-SignalsReq      GNSS-SignalIDs,
    dgnss-ValidityTimeReq  BOOLEAN,
    ...
}
-- ASN1STOP
```

GNSS-DifferentialCorrectionsReq field descriptions**dgnss-SignalsReq**

This field specifies the GNSS Signal(s) for which the *GNSS-DifferentialCorrections* are requested. A one-value at a bit position means DGNSS corrections for the specific signal are requested; a zero-value means not requested. The target device shall set a maximum of three bits to value "one".

dgnss-ValidityTimeReq

This field specifies whether the *udreGrowthRate* and *udreValidityTime* in *GNSS-DifferentialCorrections* are requested or not. TRUE means requested.

GNSS-NavigationModelReq

The IE *GNSS-NavigationModelReq* is used by the target device to request the *GNSS-NavigationModel* assistance from the location server.

```
-- ASN1START
GNSS-NavigationModelReq ::= CHOICE {
    storedNavList      StoredNavListInfo,
    reqNavList         ReqNavListInfo,
    ...
}

StoredNavListInfo ::= SEQUENCE {
    gnss-WeekOrDay      INTEGER (0..4095),
    gnss-Toe             INTEGER (0..255),
    t-toeLimit          INTEGER (0..15),
    satListRelatedDataList  SatListRelatedDataList OPTIONAL,
    ...
}

SatListRelatedDataList ::= SEQUENCE (SIZE (1..64)) OF SatListRelatedDataElement

SatListRelatedDataElement ::= SEQUENCE {
    svID                SV-ID,
    iod                 BIT STRING (SIZE(11)),
    clockModelID        INTEGER (1..8) OPTIONAL,
    orbitModelID        INTEGER (1..8) OPTIONAL,
    ...
}

ReqNavListInfo ::= SEQUENCE {
    svReqList           BIT STRING (SIZE (64)),
    clockModelID-PrefList  SEQUENCE (SIZE (1..8)) OF INTEGER (1..8) OPTIONAL,
    orbitModelID-PrefList  SEQUENCE (SIZE (1..8)) OF INTEGER (1..8) OPTIONAL,
    addNavparamReq      BOOLEAN OPTIONAL, -- Cond orbitModelID-2
    ...
}
```

-- ASN1STOP

Conditional presence	Explanation
<i>orbitModelID-2</i>	The field is mandatory present if <i>orbitModelID-PrefList</i> is absent or includes a Model-ID = "2"; otherwise it is not present.

GNSS-<i>NavigationModelReq</i> field descriptions	
<i>storedNavList</i>	This list provides information to the location server about which <i>GNSS-NavigationModel</i> data the target device has currently stored for the particular GNSS indicated by <i>GNSS-ID</i> .
<i>reqNavList</i>	This list provides information to the location server which <i>GNSS-NavigationModel</i> data are requested by the target device.
<i>gnss-WeekOrDay</i>	If <i>GNSS-ID</i> does not indicate "glonass", this field defines the GNSS Week number of the assistance currently held by the target device. If <i>GNSS-ID</i> is set to "glonass", this field defines the calendar number of day within the four-year interval starting from 1 st of January in a leap year, as defined by the parameter N_T in [9] of the assistance currently held by the target device.
<i>gnss-Toe</i>	If <i>GNSS-ID</i> does not indicate "glonass", this field defines the GNSS time of ephemeris in hours of the latest ephemeris set contained by the target device. If <i>GNSS-ID</i> is set to "glonass", this field defines the time of ephemeris in units of 15 minutes of the latest ephemeris set contained by the target device (range 0 to 95 representing time values between 0 and 1425 minutes). In this case, values 96 to 255 shall not be used by the sender.
<i>t-toeLimit</i>	If <i>GNSS-ID</i> does not indicate "glonass", this IE defines the ephemeris age tolerance of the target device in units of hours. If <i>GNSS-ID</i> is set to "glonass", this IE defines the ephemeris age tolerance of the target device in units of 30 minutes.
<i>satListRelatedDataList</i>	This list defines the clock and orbit models currently held by the target device for each SV. This field is not included if the target device does not have any stored clock and orbit models for any SV.
<i>svID</i>	This field identifies the particular GNSS satellite.
<i>iod</i>	This field identifies the issue of data currently held by the target device.
<i>clockModelID, orbitModelID</i>	These fields define the clock and orbit model number currently held by the target device. If these fields are absent, the default interpretation of the table GNSS-ID to clockModelID & orbitModelID relation below applies.
<i>svReqList</i>	This field defines the SV for which the navigation model assistance is requested. Each bit position in this BIT STRING represents a <i>SV-ID</i> . Bit 0 represents <i>SV-ID</i> =0 and bit 63 represents <i>SV-ID</i> =63. A one-value at a bit position means the navigation model data for the corresponding <i>SV-ID</i> is requested, a zero-value means not requested.
<i>clockModelIDPrefList, orbitModelID-PrefList</i>	These fields define the Model-IDs of the clock and orbit models that the target device wishes to obtain in the order of preference. The first Model-ID in the list is the most preferred model, the second Model-ID the second most preferred, etc. If these fields are absent, the default interpretation of the table GNSS-ID to clockModelID-PrefList & orbitModelIDPrefList relation below applies.
<i>addNavparamReq</i>	This field specifies whether the location server is requested to include the <i>addNAVparam</i> fields in <i>GNSS-NavigationModel</i> IE (<i>NavModel-NAVKeplerianSet</i> field) or not. TRUE means requested.

GNSS-ID to clockModelID & orbitModelID relation

<i>GNSS-ID</i>	<i>clockModelID</i>	<i>orbitModelID</i>
gps	2	2
sbas	5	5
qzss	2	2
galileo	1	1
glonass	4	4
bds	6	6

GNSS-ID to clockModelID-PrefList & orbitModelID-PrefList relation

GNSS-ID	clockModelID-PrefList	orbitModelID-PrefList
gps	Model-2	Model-2
sbas	Model-5	Model-5
qzss	Model-2	Model-2
galileo	Model-1	Model-1
glonass	Model-4	Model-4
bds	Model-6	Model-6

– GNSS-RealTimeIntegrityReq

The IE *GNSS-RealTimeIntegrityReq* is used by the target device to request the *GNSS-RealTimeIntegrity* assistance from the location server.

```
-- ASN1START
GNSS-RealTimeIntegrityReq ::= SEQUENCE {
    ...
}
-- ASN1STOP
```

– GNSS-DataBitAssistanceReq

The IE *GNSS-DataBitAssistanceReq* is used by the target device to request the *GNSS-DataBitAssistance* assistance from the location server.

```
-- ASN1START
GNSS-DataBitAssistanceReq ::= SEQUENCE {
    gnss-TOD-Req          INTEGER (0..3599),
    gnss-TOD-FracReq      INTEGER (0..999)          OPTIONAL,
    dataBitInterval       INTEGER (0..15),
    gnss-SignalType       GNSS-SignalIDs,
    gnss-DataBitsReq      GNSS-DataBitsReqSatList OPTIONAL,
    ...
}
GNSS-DataBitsReqSatList ::= SEQUENCE (SIZE(1..64)) OF GNSS-DataBitsReqSatElement
GNSS-DataBitsReqSatElement ::= SEQUENCE {
    svID                  SV-ID,
    ...
}
-- ASN1STOP
```

GNSS-DataBitAssistanceReq field descriptions

gnss-TOD-Req

This field specifies the reference time for the first data bit requested in GNSS specific system time, modulo 1 hour. Scale factor 1 second.

gnss-TOD-FracReq

This field specifies the fractional part of *gnss-TOD-Req* in 1-milli-second resolution. Scale factor 1 millisecond.

dataBitInterval

This field specifies the time length for which the Data Bit Assistance is requested. The *GNSS-DataBitAssistance* shall be relative to the time interval (*gnss-TOD-Req*, *gnss-TOD-Req* + *dataBitInterval*).

The *dataBitInterval* *r*, expressed in seconds, is mapped to a binary number *K* with the following formula:

$$r = 0.1 \times 2^K$$

Value *K*=15 means that the time interval is not specified.

gnss-SignalType

This field specifies the GNSS Signal(s) for which the *GNSS-DataBitAssistance* are requested. A one-value at a bit position means *GNSS-DataBitAssistance* for the specific signal is requested; a zero-value means not requested.

gnss-DataBitsReq

This list contains the SV-IDs for which the *GNSS-DataBitAssistance* is requested.

– GNSS-AcquisitionAssistanceReq

The IE *GNSS-AcquisitionAssistanceReq* is used by the target device to request the *GNSS-AcquisitionAssistance* assistance from the location server.

```
-- ASN1START
GNSS-AcquisitionAssistanceReq ::= SEQUENCE {
    gnss-SignalID-Req      GNSS-SignalID,
    ...
}
-- ASN1STOP
```

GNSS-AcquisitionAssistanceReq field descriptions

gnss-SignalID-Req

This field specifies the GNSS signal type for which *GNSSAcquisitionAssistance* is requested.

– GNSS-AlmanacReq

The IE *GNSS-AlmanacReq* is used by the target device to request the *GNSS-Almanac* assistance from the location server.

```
-- ASN1START
GNSS-AlmanacReq ::= SEQUENCE {
    modelID                INTEGER(1..8)    OPTIONAL,
    ...
}
-- ASN1STOP
```

GNSS-AlmanacReq field descriptions

modelID

This field specifies the Almanac Model ID requested. If this field is absent, the default interpretation as in the table GNSS-ID to modelID relation below applies.

GNSS-ID to modelID relation

<i>GNSS-ID</i>	<i>modelID</i>
gps	2
sbas	6
qzss	2
galileo	1
glonass	5
bds	7

– GNSS-UTC-ModelReq

The IE *GNSS-UTC-ModelReq* is used by the target device to request the *GNSS-UTC-Model* assistance from the location server.

```
-- ASN1START
GNSS-UTC-ModelReq ::= SEQUENCE {
    modelID                INTEGER(1..8)    OPTIONAL,
    ...
}
-- ASN1STOP
```

GNSS-UTC-ModelReq field descriptions**modelID**

This field specifies the *GNSS-UTCModel* set requested. If this field is absent, the default interpretation as in the table GNSS-ID to modelID relation below applies.

GNSS-ID to modelID relation

GNSS-ID	modelID
gps	1
sbas	4
qzss	1
galileo	1
glonass	3
bds	5

– GNSS-AuxiliaryInformationReq

The IE *GNSS-AuxiliaryInformationReq* is used by the target device to request the *GNSS-AuxiliaryInformation* assistance from the location server.

```
-- ASN1START
GNSS-AuxiliaryInformationReq ::= SEQUENCE {
    ...
}
-- ASN1STOP
```

– BDS-DifferentialCorrectionsReq

The IE *BDS-DifferentialCorrectionsReq* is used by the target device to request the *BDS-DifferentialCorrections* assistance from the location server.

```
-- ASN1START
BDS-DifferentialCorrectionsReq-r12 ::= SEQUENCE {
    dgnss-SignalsReq          GNSS-SignalIDs,
    ...
}
-- ASN1STOP
```

BDS-DifferentialCorrectionsReq field descriptions**dgnss-SignalsReq**

This field specifies the BDS Signal(s) for which the *BDS-DifferentialCorrections* are requested. A one-value at a bit position means BDS differential corrections for the specific signal are requested; a zero-value means not requested. The target device shall set a maximum of three bits to value "one".

– BDS-GridModelReq

The IE *BDS-GridModelReq* is used by the target device to request the *BDS-GridModel* assistance from the location server.

```
-- ASN1START
BDS-GridModelReq-r12 ::= SEQUENCE {
    ...
}
-- ASN1STOP
```

6.5.2.5 GNSS Location Information

– A-GNSS-ProvideLocationInformation

The IE *A-GNSS-ProvideLocationInformation* is used by the target device to provide location measurements (e.g., pseudo-ranges, location estimate, velocity) to the location server, together with time information. It may also be used to provide GNSS positioning specific error reason.

```
-- ASN1START
A-GNSS-ProvideLocationInformation ::= SEQUENCE {
  gnss-SignalMeasurementInformation  GNSS-SignalMeasurementInformation  OPTIONAL,
  gnss-LocationInformation           GNSS-LocationInformation         OPTIONAL,
  gnss-Error                         A-GNSS-Error                    OPTIONAL,
  ...
}
-- ASN1STOP
```

6.5.2.6 GNSS Location Information Elements

– GNSS-SignalMeasurementInformation

The IE *GNSS-SignalMeasurementInformation* is used by the target device to provide GNSS signal measurement information to the location server and GNSS-network time association if requested by the location server. This information includes the measurements of code phase, Doppler, C/N_0 and optionally accumulated carrier phase, also called accumulated deltarange (ADR), which enable the UE-assisted GNSS method where position is computed in the location server. Figure 6.5.2.6-1 illustrates the relation between some of the fields.

```
-- ASN1START
GNSS-SignalMeasurementInformation ::= SEQUENCE {
  measurementReferenceTime  MeasurementReferenceTime,
  gnss-MeasurementList      GNSS-MeasurementList,
  ...
}
-- ASN1STOP
```

GNSS-SignalMeasurementInformation field descriptions

measurementReferenceTime

This field specifies the GNSS system time for which the information provided in *gnss-MeasurementList* is valid. It may also include network time, if requested by the location server and supported by the target device.

gnss-MeasurementList

This field provides GNSS signal measurement information for up to 16 GNSSs.

– MeasurementReferenceTime

The IE *MeasurementReferenceTime* is used to specify the time when the measurements provided in *A-GNSS-ProvideLocationInformation* are valid. It may also include GNSS-network time association, in which case reported measurements shall be valid for the cellular frame boundary defined in the network time association.

```
-- ASN1START
MeasurementReferenceTime ::= SEQUENCE {
  gnss-TOD-msec      INTEGER (0..3599999),
  gnss-TOD-frac     INTEGER (0..3999)          OPTIONAL,
  gnss-TOD-unc      INTEGER (0..127)          OPTIONAL,
  gnss-TimeID       GNSS-ID,
  networkTime       CHOICE {
    eUTRA  SEQUENCE {
      physCellId      INTEGER (0..503),
      cellGlobalId    CellGlobalIdEUTRA-AndUTRA  OPTIONAL,
      systemFrameNumber  BIT STRING (SIZE (10)),
      ...
    }
  }
}
-- ASN1STOP
```

```

    },
    uTRA SEQUENCE {
        mode CHOICE {
            fdd SEQUENCE {
                primary-CPICH-Info INTEGER (0..511),
                ...
            },
            tdd SEQUENCE {
                cellParameters INTEGER (0..127),
                ...
            }
        },
        cellGlobalId CellGlobalIdEUTRA-AndUTRA OPTIONAL,
        referenceSystemFrameNumber
            INTEGER (0..4095),
        ...
    },
    gSM SEQUENCE {
        bcchCarrier INTEGER (0..1023),
        bsic INTEGER (0..63),
        cellGlobalId CellGlobalIdGERAN OPTIONAL,
        referenceFrame SEQUENCE {
            referenceFN INTEGER (0..65535),
            referenceFNMSB INTEGER (0..63) OPTIONAL,
            ...
        },
        deltaGNSS-TOD INTEGER (0 .. 127) OPTIONAL,
        ...
    },
    ...
}
-- ASN1STOP

```

MeasurementReferenceTime field descriptions	
gnss-TOD-msec	<p>This field specifies the GNSS TOD for which the measurements and/or location estimate are valid. The 22 bits of GNSS TOD are the least significant bits. The most significant bits shall be derived by the location server to unambiguously derive the GNSS TOD.</p> <p>The value for GNSS TOD is derived from the GNSS specific system time indicated in <i>gnss-TimeID</i> rounded down to the nearest millisecond unit.</p> <p>Scale factor 1 millisecond.</p>
gnss-TOD-frac	<p>This field specifies the fractional part of the GNSS TOD in 250 ns resolution. The total GNSS TOD is given by <i>gnss-TOD-msec</i> + <i>gnss-TOD-frac</i>.</p> <p>Scale factor 250 nanoseconds.</p>
gnss-TOD-unc	<p>This field provides the accuracy of the relation GNSS-network time when GNSS-network time association is provided. When GNSS-network time association is not provided, this element can be included to provide the accuracy of the reported <i>gnss-TOD-msec</i>.</p> <p>If GNSS TOD is the given GNSS time, then the true GNSS time, corresponding to the provided network time if applicable, as observed at the target device location, lies in the interval [GNSS TOD – <i>gnss-TOD-unc</i>, GNSS TOD + <i>gnss-TOD-unc</i>].</p> <p>The uncertainty <i>r</i>, expressed in microseconds, is mapped to a number K, with the following formula:</p> $r = C * (((1+x)^K) - 1)$ <p>with C = 0.5 and x = 0.14. To encode any higher value of uncertainty than that corresponding in the above formula to K=127, the same value, K=127, shall also be used. The uncertainty is then coded on 7 bits, as the binary encoding of K. Examples of <i>gnss-TOD-unc</i> value are as in the table Value of K to Value of uncertainty relation below.</p> <p>This field shall be included if the target device provides GNSS-network time relationship.</p>
gnss-TimeID	<p>This field specifies the GNSS system time for which the <i>gnss-TOD-msec</i> (and <i>gnss-TOD-frac</i> if applicable) is provided.</p>
networkTime	<p>These fields specify the network time event which the GNSS TOD time stamps.</p> <p>This field shall be included if the target device provides GNSS-network time relationship.</p>
physCellId	<p>This field identifies the reference cell, as defined in [12], that is used for the GNSS-network time relation.</p>

MeasurementReferenceTime field descriptions
<p>cellGlobalId This field specifies the globally unique cell identifier (Evolved Cell Global Identifier (ECGI) in E-UTRA, global UTRAN Cell Identifier in UTRA, or Cell Global Identification (CGI) in GERAN) of the reference cell, as defined in [12] for E-UTRA and [13] for UTRA, for which the GNSS network time relation is provided.</p>
<p>systemFrameNumber This field specifies the system frame number in E-UTRA which the GNSS time time stamps, as defined in [12].</p>
<p>mode This field identifies the reference cell for the GNSS-network time relation, as defined in [13].</p>
<p>referenceSystemFrameNumber This field specifies the system frame number in UTRA, as defined in [13], which is used for time stamping.</p>
<p>bcchCarrier, bsic This field identifies the reference cell for the GNSS-network time relation in GERAN, as defined in [14].</p>
<p>referenceFN, referenceFNMSB These fields specify the frame number in GERAN which the GNSS time time stamps, as defined in [14]. The time of the reference frame boundary is as observed by the target device, i.e. without Timing Advance compensation. The <i>referenceFNMSB</i> field indicates the most significant bits of the frame number of the reference BTS corresponding to the <i>GNSS-MeasurementList</i>. Starting from the complete GSM frame number denoted FN, the target device calculates Reference FN MSB as</p> $\text{Reference FN MSB} = \text{floor}(\text{FN}/42432)$ <p>The complete GSM frame number FN can then be reconstructed in the location server by combining the fields <i>referenceFN</i> with <i>referenceFNMSB</i> in the following way</p> $\text{FN} = \text{referenceFNMSB} * 42432 + \text{referenceFN}$
<p>deltaGNSS-TOD This field specifies the difference in milliseconds between <i>gnss-TOD-msec</i> reported and the milli-second part of the SV time <i>tsv_1</i> of the first SV in the list reported from the target device, as defined in [14]. The <i>deltaGNSS-TOD</i> is defined as</p> $\text{deltaGNSS-TOD} = \text{gnss-TOD-msec} - \text{fix}(\text{tsv}_1)$ <p>where <i>fix()</i> denotes rounding to the nearest integer towards zero.</p>

Value of K to Value of uncertainty relation

Value of K	Value of uncertainty
0	0 microseconds
1	0.07 microseconds
2	0.1498 microseconds
-	-
50	349.62 microseconds
-	-
127	≥ 8430000 microseconds

– GNSS-MeasurementList

The IE *GNSS-MeasurementList* is used by the target device to provide measurements of code phase, Doppler, C/N_0 and optionally accumulated carrier phase, also called accumulated deltarange (ADR).

```
-- ASN1START
GNSS-MeasurementList ::= SEQUENCE (SIZE(1..16)) OF GNSS-MeasurementForOneGNSS
GNSS-MeasurementForOneGNSS ::= SEQUENCE {
    gnss-ID                GNSS-ID,
    gnss-SgnMeasList       GNSS-SgnMeasList,
    ...
}
GNSS-SgnMeasList ::= SEQUENCE (SIZE(1..8)) OF GNSS-SgnMeasElement
GNSS-SgnMeasElement ::= SEQUENCE {
    gnss-SignalID          GNSS-SignalID,
    gnss-CodePhaseAmbiguity INTEGER (0..127)    OPTIONAL,
    gnss-SatMeasList       GNSS-SatMeasList,
    ...
}
GNSS-SatMeasList ::= SEQUENCE (SIZE(1..64)) OF GNSS-SatMeasElement
```

```

GNSS-SatMeasElement ::= SEQUENCE {
    svID                SV-ID,
    cNo                 INTEGER (0..63),
    mpathDet            ENUMERATED {notMeasured (0), low (1), medium (2), high (3), ...},
    carrierQualityInd   INTEGER (0..3) OPTIONAL,
    codePhase           INTEGER (0..2097151),
    integerCodePhase    INTEGER (0..127) OPTIONAL,
    codePhaseRMSError   INTEGER (0..63),
    doppler             INTEGER (-32768..32767) OPTIONAL,
    adr                INTEGER (0..33554431) OPTIONAL,
    ...
}
-- ASN1STOP

```

GNSS-MeasurementList field descriptions

<p>gnss-ID This field identifies the GNSS constellation on which the GNSS signal measurements were measured. Measurement information for up to 16 GNSSs can be included.</p>
<p>gnss-SgnMeasList This list provides GNSS signal measurement information for up to 8 GNSS signal types per GNSS.</p>
<p>gnss-SignalID This field identifies the signal on which GNSS signal measurement parameters were measured.</p>
<p>gnss-CodePhaseAmbiguity This field provides the ambiguity of the code phase measurement. It is given in units of milli-seconds in the range between between 0 and 127 milli-seconds. The total code phase for a satellite k (Satk) is given modulo this <i>gnss-CodePhaseAmbiguity</i> and is reconstructed with: $Code_Phase_Tot(Satk) = codePhase(Satk) + integerCodePhase(Satk) + n * gnss-CodePhaseAmbiguity$, $n = 0,1,2,\dots$ If there is no code phase ambiguity, the <i>gnss-CodePhaseAmbiguity</i> shall be set to 0. The field is optional. If <i>gnss-CodePhaseAmbiguity</i> is absent, the default value is 1 milli-second.</p>
<p>gnss-SatMeasList This list provides GNSS signal measurement information for up to 64 GNSS satellites.</p>
<p>svID This field identifies the satellite on which the GNSS signal measurements were measured.</p>
<p>cNo This field provides an estimate of the carrier-to-noise ratio of the received signal from the particular satellite. The target device shall set this field to the value of the satellite C/N₀, as referenced to the antenna connector, in units of 1 dB-Hz, in the range from 0 to 63 dB-Hz. Scale factor 1 dB-Hz.</p>
<p>mpathDet This field contains the multipath indicator value, defined in the table Value of mpathDet to Multipath Indication relation below.</p>
<p>carrierQualityInd This field indicates the quality of a carrier phase measurement. The LSB indicates the data polarity, that is, if the data from a specific satellite is received inverted, this is indicated by setting the LSB value to "1". In the case the data is not inverted, the LSB is set to "0". The MSB indicates if accumulation of the carrier phase has been continuous, that is, without cycle slips since the previous measurement report. If the carrier phase accumulation has been continuous, the MSB value is set to "1X". Otherwise, the MSB is set to "0X". This field is optional but shall be included if the <i>adr</i> field is included. See table Bit toPolarity Indication relation below.</p>
<p>codePhase This field contains the whole and fractional value of the code-phase measurement made by the target device for the particular satellite signal at the time of measurement in the units of ms. GNSS specific code phase measurements (e.g. chips) are converted into unit of ms by dividing the measurements by the nominal values of the measured signal chipping rate. Scale factor 2^{-21} milli-seconds, in the range from 0 to $(1-2^{-21})$ milli-seconds.</p>
<p>integerCodePhase This field indicates the integer milli-second part of the code phase that is expressed modulo the <i>gnss-CodePhaseAmbiguity</i>. The value of the ambiguity is given in the <i>gnss-CodePhaseAmbiguity</i> field. The <i>integerCodePhase</i> is optional. If <i>integerCodePhase</i> is absent, the default value is 0 milli-second. Scale factor 1 milli-second, in the range from 0 to 127 milli-seconds.</p>
<p>codePhaseRMSError This field contains the pseudorange RMS error value. This parameter is specified according to a floating-point representation shown in the table below.</p>
<p>doppler This field contains the Doppler measured by the target device for the particular satellite signal. This information can be used to compute the 3-D velocity of the target device. Doppler measurements are converted into unit of m/s by multiplying the Doppler measurement in Hz by the nominal wavelength of the measured signal. Scale factor 0.04 meter/seconds. This field is optional, but shall be included, if the <i>velocityRequest</i> in <i>CommonIESRequestLocationInformation</i> is set to TRUE.</p>

GNSS-MeasurementList field descriptions**adr**

This field contains the ADR measurement measured by the target device for the particular satellite signal. This information can be used to compute the 3-D velocity or high-accuracy position of the target device. ADR measurements are converted into units of meter by multiplying the ADR measurement by the nominal wavelength of the measured signal.

Scale factor 2^{-10} meters, in the range from 0 to 32767.5 meters. This field is optional, but shall be included, if the *adrMeasReq* in *GNSS-PositioningInstructions* is set to TRUE and if ADR measurements are supported by the target device (i.e., *adr-Support* is set to TRUE in *A-GNSS-ProvideCapabilities*).

Value of mpathDet to Multipath Indication relation

Value of <i>mpathDet</i>	Multipath Indication
00	Not measured
01	Low, MP error < 5m
10	Medium, 5m < MP error < 43m
11	High, MP error > 43m

Bit toPolarity Indication relation

Value	Polarity Indication
0	Data Direct, carrier phase not continuous
1	Data Inverted, carrier phase not continuous
2	Data Direct, carrier phase continuous
3	Data Inverted, carrier phase continuous

floating-point representation

Index	Mantissa	Exponent	Floating-Point value, x_i	Pseudorange value, P
0	000	000	0.5	$P < 0.5$
1	001	000	0.5625	$0.5 \leq P < 0.5625$
l	x	y	$0.5 * (1 + x/8) * 2^y$	$x_{i-1} \leq P < x_i$
62	110	111	112	$104 \leq P < 112$
63	111	111	--	$112 \leq P$

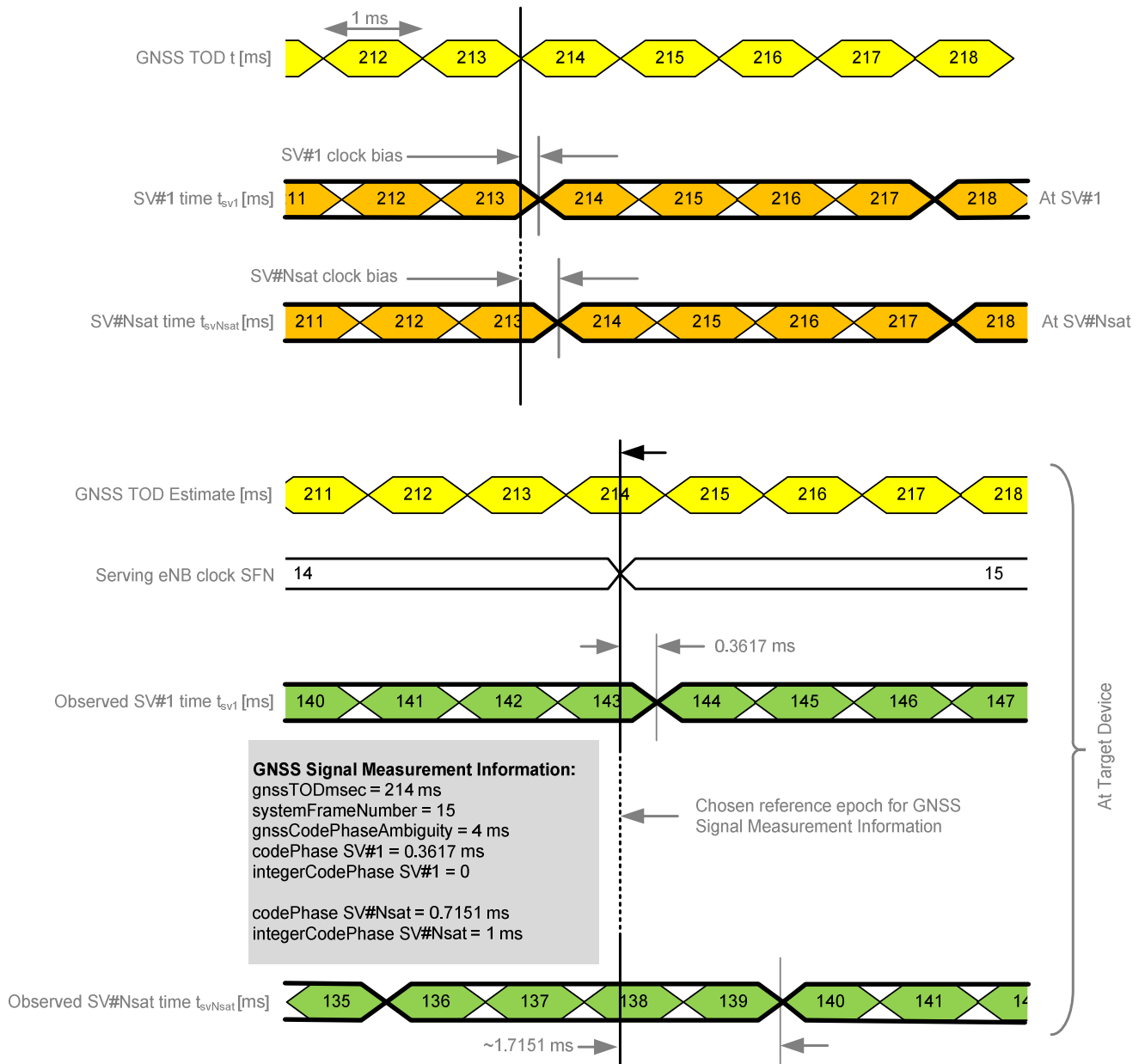

Figure 6.5.2.6-1: Exemplary calculation of some GNSS Signal Measurement Information fields.

GNSS-LocationInformation

The IE *GNSS-LocationInformation* is included by the target device when location and optionally velocity information derived using GNSS or hybrid GNSS and other measurements is provided to the location server.

```

-- ASN1START
GNSS-LocationInformation ::= SEQUENCE {
  measurementReferenceTime MeasurementReferenceTime,
  agnss-List GNSS-ID-Bitmap,
  ...
}
-- ASN1STOP
    
```

GNSS-LocationInformation field descriptions

GNSS-LocationInformation field descriptions
<p>measurementReferenceTime This field specifies the GNSS system time for which the location estimate and optionally velocity are valid. It may also include GNSS-network time relationship, if requested by the location server and supported by the target device.</p>
<p>agnss-List This field provides a list of satellite systems used by the target device to calculate the location estimate and velocity estimate, if included. This is represented by a bit string in <i>GNSS-ID-Bitmap</i>, with a one-value at the bit position means the particular method has been used; a zero-value means not used.</p>

6.5.2.7 GNSS Location Information Request

– A-GNSS-RequestLocationInformation

The IE *A-GNSS-RequestLocationInformation* is used by the location server to request location information from the target device using GNSS.

```
-- ASN1START
A-GNSS-RequestLocationInformation ::= SEQUENCE {
    gnss-PositioningInstructions    GNSS-PositioningInstructions,
    ...
}
-- ASN1STOP
```

6.5.2.8 GNSS Location Information Request Elements

– GNSS-PositioningInstructions

The IE *GNSS-PositioningInstructions* is used to provide GNSS measurement instructions.

```
-- ASN1START
GNSS-PositioningInstructions ::= SEQUENCE {
    gnss-Methods                GNSS-ID-Bitmap,
    fineTimeAssistanceMeasReq   BOOLEAN,
    adrMeasReq                  BOOLEAN,
    multiFreqMeasReq           BOOLEAN,
    assistanceAvailability      BOOLEAN,
    ...
}
-- ASN1STOP
```

GNSS-PositioningInstructions field descriptions
<p>gnssMethods This field indicates the satellite systems allowed by the location server. This is represented by a bit string in <i>GNSS-ID-Bitmap</i>, with a one-value at the bit position means the particular GNSS is allowed; a zero-value means not allowed. The target device shall not request assistance data or report or obtain measurements for systems that are not indicated in this bit map. At least one of the bits in this bit map shall be set to value one.</p>
<p>fineTimeAssistanceMeasReq This field indicates whether the target device is requested to report GNSS-network time association. TRUE means requested.</p>
<p>adrMeasReq This field indicates whether the target device is requested to include ADR measurements in <i>GNSS-MeasurementList</i> IE or not. TRUE means requested.</p>
<p>multiFreqMeasReq This field indicates whether the target device is requested to report measurements on multiple supported GNSS signal types in <i>GNSS-MeasurementList</i> IE or not. TRUE means requested.</p>
<p>assistanceAvailability This field indicates whether the target device may request additional GNSS assistance data from the server. TRUE means allowed and FALSE means not allowed.</p>

6.5.2.9 GNSS Capability Information

– A-GNSS-ProvideCapabilities

The IE *A-GNSS-Provide-Capabilities* is used by the target device to indicate its capability to support A-GNSS and to provide it's A-GNSS location capabilities (e.g., GNSSs and assistance data supported) to the location server.

```
-- ASN1START
A-GNSS-ProvideCapabilities ::= SEQUENCE {
    gnss-SupportList          GNSS-SupportList          OPTIONAL,
    assistanceDataSupportList AssistanceDataSupportList OPTIONAL,
    locationCoordinateTypes   LocationCoordinateTypes  OPTIONAL,
    velocityTypes             VelocityTypes            OPTIONAL,
    ...
}

GNSS-SupportList ::= SEQUENCE (SIZE(1..16)) OF GNSS-SupportElement

GNSS-SupportElement ::= SEQUENCE {
    gnss-ID                GNSS-ID,
    sbas-IDs                SBAS-IDs                OPTIONAL,    -- Cond GNSS-ID-SBAS
    agnss-Modes            PositioningModes,
    gnss-Signals           GNSS-SignalIDs,
    fta-MeasSupport        SEQUENCE {
        cellTime           AccessTypes,
        mode               PositioningModes,
        ...
    } OPTIONAL,    -- Cond fta
    adr-Support            BOOLEAN,
    velocityMeasurementSupport BOOLEAN,
    ...
}

AssistanceDataSupportList ::= SEQUENCE {
    gnss-CommonAssistanceDataSupport GNSS-CommonAssistanceDataSupport,
    gnss-GenericAssistanceDataSupport GNSS-GenericAssistanceDataSupport,
    ...
}

-- ASN1STOP
```

Conditional presence	Explanation
<i>GNSS-ID-SBAS</i>	The field is mandatory present if the <i>GNSS-ID = sbas</i> ; otherwise it is not present.
<i>fta</i>	The field is mandatory present if the target device supports the reporting of fine time assistance measurements; otherwise it is not present.

A-GNSS-ProvideCapabilities field descriptions

<i>gnss-SupportList</i>
This field specifies the list of GNSS supported by the target device and the target device capabilities associated with each of the supported GNSS. This field shall be present if the <i>gnss-SupportListReq</i> in the A-GNSS - <i>RequestCapabilities</i> IE is set to TRUE and if the target device supports the A-GNSS positioning method. If the IE <i>A-GNSS-Provide-Capabilities</i> is provided unsolicited, this field shall be included if the target device supports the assisted GNSS positioning method.
<i>gnss-ID</i>
This field specifies the GNSS supported by the target device for which the capabilities in <i>GNSS-SupportElement</i> are provided.
<i>sbas-IDs</i>
This field specifies the SBAS(s) supported by the target device. This is represented by a bit string, with a one-value at the bit position means the particular SBAS is supported; a zero-value means not supported.
<i>agnss-Modes</i>
This field specifies the GNSS mode(s) supported by the target device for the GNSS indicated by <i>gnss-ID</i> . This is represented by a bit string, with a one-value at the bit position means the particular GNSS mode is supported; a zero-value means not supported.
<i>gnss-Signals</i>
This field specifies the GNSS signal(s) supported by the target device for the GNSS indicated by <i>gnss-ID</i> . This is represented by a bit string, with a one-value at the bit position means the particular GNSS signal type is supported; a zero-value means not supported.

A-GNSS-ProvideCapabilities field descriptions
<p>fta-MeasSupport This field specifies that the target device is capable of performing fine time assistance measurements (i.e., GNSS-cellular time association reporting). The <i>cellTime</i> field specifies for which cellular network(s) this capability is supported. This is represented by a bit string, with a one-value at the bit position means FTA measurements for the specific cellular network time is supported; a zero-value means not supported. The <i>mode</i> field specifies for which GNSS mode(s) FTA measurements are supported by the target device. This is represented by a bit string, with a one-value at the bit position means FTA measurements for the GNSS mode is supported; a zero-value means not supported.</p>
<p>adr-Support This field specifies whether the target device supports ADR measurement reporting. TRUE means supported.</p>
<p>velocityMeasurementSupport This field specifies whether the target device supports measurement reporting related to velocity. TRUE means supported.</p>
<p>assistanceDataSupportList This list defines the assistance data and assistance data choices supported by the target device. This field shall be present if the <i>assistanceDataSupportListReq</i> in the A-GNSS-RequestCapabilities IE is set to TRUE and if the target device supports GNSS assistance data. If the IE A-GNSS-Provide-Capabilities is provided unsolicited, this field shall be included if the target device supports any GNSS assistance data.</p>
<p>locationCoordinateTypes This parameter identifies the geographical location coordinate types that a target device supports for GNSS. TRUE indicates that a location coordinate type is supported and FALSE that it is not. This field shall be present if the <i>locationVelocityTypesReq</i> in the A-GNSS-RequestCapabilities IE is set to TRUE and if the target device supports UE-based or standalone GNSS positioning method. If the IE A-GNSS-Provide-Capabilities is provided unsolicited, this field shall be included if the target device supports UE-based or standalone GNSS positioning method.</p>
<p>velocityTypes This parameter identifies the velocity types that a target device supports for GNSS. TRUE indicates that a velocity type is supported and FALSE that it is not. FALSE for all velocity types indicates that velocity reporting is not supported. This field shall be present if the <i>locationVelocityTypesReq</i> in the A-GNSS-RequestCapabilities IE is set to TRUE and if the target device supports UE-based or standalone GNSS positioning method. If the IE A-GNSS-Provide-Capabilities is provided unsolicited, this field shall be included if the target device supports UE-based or standalone GNSS positioning method.</p>

6.5.2.10 GNSS Capability Information Elements

– GNSS-CommonAssistanceDataSupport

The IE *GNSS-CommonAssistanceDataSupport* is used by the target device to provide information on supported GNSS common assistance data types to the location server.

```

-- ASN1START
GNSS-CommonAssistanceDataSupport ::= SEQUENCE {
    gnss-ReferenceTimeSupport          GNSS-ReferenceTimeSupport
                                     OPTIONAL, -- Cond RefTimeSup
    gnss-ReferenceLocationSupport      GNSS-ReferenceLocationSupport
                                     OPTIONAL, -- Cond RefLocSup
    gnss-IonosphericModelSupport       GNSS-IonosphericModelSupport
                                     OPTIONAL, -- Cond IonoModSup
    gnss-EarthOrientationParametersSupport GNSS-EarthOrientationParametersSupport
                                     OPTIONAL, -- Cond EOPSup
    ...
}
-- ASN1STOP

```

Conditional presence	Explanation
<i>RefTimeSup</i>	The field is mandatory present if the target device supports <i>GNSS-ReferenceTime</i> ; otherwise it is not present.
<i>RefLocSup</i>	This field is mandatory present if the target device supports <i>GNSS-ReferenceLocation</i> ; otherwise it is not present.
<i>IonoModSup</i>	This field is mandatory present if the target device supports <i>GNSS-IonosphericModel</i> ; otherwise it is not present.
<i>EOPSup</i>	This field is mandatory present if the target device supports <i>GNSS-EarthOrientationParameters</i> ; otherwise it is not present.

– GNSS-ReferenceTimeSupport

```
-- ASN1START
GNSS-ReferenceTimeSupport ::= SEQUENCE {
    gnss-SystemTime    GNSS-ID-Bitmap,
    fta-Support        AccessTypes                                OPTIONAL, -- Cond fta
    ...
}
-- ASN1STOP
```

Conditional presence	Explanation
<i>fta</i>	The field is mandatory present if the target device supports fine time assistance in <i>GNSSReferenceTime</i> IE; otherwise it is not present.

GNSS-ReferenceTimeSupport field descriptions

gnss-SystemTime

This field specifies the GNSS system time(s) supported by the target device. This is represented by a bit string in *GNSS-ID-Bitmap*, with a one-value at the bit position means the particular GNSS system time is supported; a zero-value means not supported.

fta-Support

This field specifies that the target device supports fine time assistance (i.e., GNSS-cellular time association) in *GNSS-ReferenceTime* IE. This is represented by a bit string in *AccessTypes*, with a one-value at the bit position means FTA for the specific cellular network time is supported; a zero-value means not supported.

– GNSS-ReferenceLocationSupport

```
-- ASN1START
GNSS-ReferenceLocationSupport ::= SEQUENCE {
    ...
}
-- ASN1STOP
```

– GNSS-IonosphericModelSupport

```
-- ASN1START
GNSS-IonosphericModelSupport ::= SEQUENCE {
    ionoModel          BIT STRING {
        klobuchar      (0),
        neQuick        (1) } (SIZE (1..8)),
    ...
}
-- ASN1STOP
```

GNSS-IonosphericModelSupport field descriptions

ionoModel

This field specifies the ionospheric model(s) supported by the target device. This is represented by a bit string, with a one-value at the bit position means the particular ionospheric model is supported; a zero-value means not supported.

– GNSS-EarthOrientationParametersSupport

```
-- ASN1START
GNSS-EarthOrientationParametersSupport ::= SEQUENCE {
    ...
}
-- ASN1STOP
```

– GNSS-GenericAssistanceDataSupport

The IE *GNSS-GenericAssistanceDataSupport* is used by the target device to provide information on supported GNSS generic assistance data types to the location server for each supported GNSS.

```

-- ASN1START
GNSS-GenericAssistanceDataSupport ::=
    SEQUENCE (SIZE (1..16)) OF GNSS-GenericAssistDataSupportElement
GNSS-GenericAssistDataSupportElement ::= SEQUENCE {
    gnss-ID                GNSS-ID,
    sbas-ID                SBAS-ID                               OPTIONAL, -- Cond GNSS-ID-SBAS
    gnss-TimeModelsSupport GNSS-TimeModelListSupport           OPTIONAL, -- Cond TimeModSup
    gnss-DifferentialCorrectionsSupport GNSS-DifferentialCorrectionsSupport
                                                                OPTIONAL, -- Cond DGNSS-Sup
    gnss-NavigationModelSupport GNSS-NavigationModelSupport
                                                                OPTIONAL, -- Cond NavModSup
    gnss-RealTimeIntegritySupport GNSS-RealTimeIntegritySupport
                                                                OPTIONAL, -- Cond RTISup
    gnss-DataBitAssistanceSupport GNSS-DataBitAssistanceSupport
                                                                OPTIONAL, -- Cond DataBitsSup
    gnss-AcquisitionAssistanceSupport GNSS-AcquisitionAssistanceSupport
                                                                OPTIONAL, -- Cond AcquAssistSup
    gnss-AlmanacSupport      GNSS-AlmanacSupport
                                                                OPTIONAL, -- Cond AlmanacSup
    gnss-UTC-ModelSupport    GNSS-UTC-ModelSupport
                                                                OPTIONAL, -- Cond UTCModSup
    gnss-AuxiliaryInformationSupport GNSS-AuxiliaryInformationSupport
                                                                OPTIONAL, -- Cond AuxInfoSup
    ...
    [
        bds-DifferentialCorrectionsSupport-r12 BDS-DifferentialCorrectionsSupport-r12
                                                                OPTIONAL, -- Cond DBDS-Sup
        bds-GridModelSupport-r12      BDS-GridModelSupport-r12
                                                                OPTIONAL -- Cond BDS-GridModSup
    ]
}
-- ASN1STOP

```

Conditional presence	Explanation
<i>GNSS-ID-SBAS</i>	The field is mandatory present if the <i>GNSS-ID</i> = <i>sbas</i> ; otherwise it is not present.
<i>TimeModSup</i>	The field is mandatory present if the target device supports <i>GNSS-TimeModelList</i> ; otherwise it is not present.
<i>DGNSS-Sup</i>	The field is mandatory present if the target device supports <i>GNSS-DifferentialCorrections</i> ; otherwise it is not present.
<i>NavModSup</i>	The field is mandatory present if the target device supports <i>GNSS-NavigationModel</i> ; otherwise it is not present.
<i>RTISup</i>	The field is mandatory present if the target device supports <i>GNSS-RealTimeIntegrity</i> ; otherwise it is not present.
<i>DataBitsSup</i>	The field is mandatory present if the target device supports <i>GNSS-DataBitAssistance</i> ; otherwise it is not present.
<i>AcquAssistSup</i>	The field is mandatory present if the target device supports <i>GNSS-AcquisitionAssistance</i> ; otherwise it is not present.
<i>AlmanacSup</i>	The field is mandatory present if the target device supports <i>GNSS-Almanac</i> ; otherwise it is not present.
<i>UTCModSup</i>	The field is mandatory present if the target device supports <i>GNSS-UTC-Model</i> ; otherwise it is not present.
<i>AuxInfoSup</i>	The field is mandatory present if the target device supports <i>GNSS-AuxiliaryInformation</i> ; otherwise it is not present.
<i>DBDS-Sup</i>	The field is mandatory present if the target device supports <i>BDS-DifferentialCorrections</i> ; otherwise it is not present. This field may only be present if <i>gnss-ID</i> indicates "bds".
<i>BDS-GridModSup</i>	The field is mandatory present if the target device supports <i>BDS-GridModel</i> ; otherwise it is not present. This field may only be present if <i>gnss-ID</i> indicates "bds".

– GNSS-TimeModelListSupport

```
-- ASN1START
GNSS-TimeModelListSupport ::= SEQUENCE {
    ...
}
-- ASN1STOP
```

– GNSS-DifferentialCorrectionSupport

```
-- ASN1START
GNSS-DifferentialCorrectionsSupport ::= SEQUENCE {
    gnssSignalIDs          GNSS-SignalIDs,
    dgnss-ValidityTimeSup  BOOLEAN,
    ...
}
-- ASN1STOP
```

GNSS-DifferentialCorrectionsSupport field descriptions

gnssSignalIDs

This field specifies the GNSS signal types for which differential corrections are supported by the target device. This is represented by a bit string in *GNSS-SignalIDs*, with a one-value at the bit position means differential corrections for the particular GNSS signal type is supported; a zero-value means not supported.

dgnss-ValidityTimeSup

This field specifies if the target device supports estimation of UDRE based on growth rate and validity time for differential corrections. TRUE means supported.

– GNSS-NavigationModelSupport

```
-- ASN1START
GNSS-NavigationModelSupport ::= SEQUENCE {
    clockModel      BIT STRING {
        model-1      (0),
        model-2      (1),
        model-3      (2),
        model-4      (3),
        model-5      (4),
        model-6      (5) } (SIZE (1..8))      OPTIONAL,
    orbitModel      BIT STRING {
        model-1      (0),
        model-2      (1),
        model-3      (2),
        model-4      (3),
        model-5      (4),
        model-6      (5) } (SIZE (1..8))      OPTIONAL,
    ...
}
-- ASN1STOP
```

GNSS-NavigationModelSupport field descriptions

GNSS-NavigationModelSupport field descriptions**clockModel**

This field specifies the *gnss-ClockModel* choice(s) in *GNSS-NavigationModel* IE supported by the target device for the GNSS indicated by *GNSS-ID*. This is represented by a bit string, with a one-value at the bit position means the particular clock model is supported; a zero-value means not supported.

If the target device supports GPS and *GNSS-NavigationModel* assistance, it shall support *clockModel* Model-2.

If the target device supports SBAS and *GNSS-NavigationModel* assistance, it shall support *clockModel* Model-5.

If the target device supports QZSS and *GNSS-NavigationModel* assistance, it shall support *clockModel* Model-2.

If the target device supports Galileo and *GNSS-NavigationModel* assistance, it shall support *clockModel* Model-1.

If the target device supports GLONASS and *GNSS-NavigationModel* assistance, it shall support *clockModel* Model-4.

If the target device supports BDS and *GNSS-NavigationModel* assistance, it shall support *clockModel* Model-6.

If this field is absent, the target device supports the mandatory (native) *clockModel* choice only as listed above for the GNSS indicated by *GNSS-ID*.

orbitModel

This field specifies the *gnss-OrbitModel* choice(s) in *GNSS-NavigationModel* IE supported by the target device for the GNSS indicated by *GNSS-ID*. This is represented by a bit string, with a one-value at the bit position means the particular orbit model is supported; a zero-value means not supported.

If the target device supports GPS and *GNSS-NavigationModel* assistance, it shall support *orbitModel* Model-2.

If the target device supports SBAS and *GNSS-NavigationModel* assistance, it shall support *orbitModel* Model-5.

If the target device supports QZSS and *GNSS-NavigationModel* assistance, it shall support *orbitModel* Model-2.

If the target device supports Galileo and *GNSS-NavigationModel* assistance, it shall support *orbitModel* Model-1.

If the target device supports GLONASS and *GNSS-NavigationModel* assistance, it shall support *orbitModel* Model-4.

If the target device supports BDS and *GNSS-NavigationModel* assistance, it shall support *orbitModel* Model-6.

If this field is absent, the target device supports the mandatory (native) *orbitModel* choice only as listed above for the GNSS indicated by *GNSS-ID*.

GNSS-RealTimeIntegritySupport

```
-- ASN1START
GNSS-RealTimeIntegritySupport ::= SEQUENCE {
    ...
}
-- ASN1STOP
```

GNSS-DataBitAssistanceSupport

```
-- ASN1START
GNSS-DataBitAssistanceSupport ::= SEQUENCE {
    ...
}
-- ASN1STOP
```

GNSS-AcquisitionAssistanceSupport

```
-- ASN1START
GNSS-AcquisitionAssistanceSupport ::= SEQUENCE {
    ...
    confidenceSupport-r10          ENUMERATED { true }    OPTIONAL,
    dopplerUncertaintyExtSupport-r10  ENUMERATED { true }    OPTIONAL
}
-- ASN1STOP
```

GNSS-AcquisitionAssistanceSupport field descriptions**confidenceSupport**

If this field is present, the target device supports the *confidence* field in *GNSS-AcquisitionAssistance*.

dopplerUncertaintyExtSupport

If this field is present, the target device supports the *dopplerUncertaintyExt* field in *GNSS-AcquisitionAssistance*.

– GNSS-AlmanacSupport

```
-- ASN1START
GNSS-AlmanacSupport ::= SEQUENCE {
    almanacModel BIT STRING {
        model-1 (0),
        model-2 (1),
        model-3 (2),
        model-4 (3),
        model-5 (4),
        model-6 (5),
        model-7 (6) } (SIZE (1..8)) OPTIONAL,
    ...
}
-- ASN1STOP
```

GNSS-AlmanacSupport field descriptions

almanacModel

This field specifies the *almanacModel* choice(s) in *GNSS-Almanac* IE supported by the target device for the GNSS indicated by *GNSS-ID*. This is represented by a bit string, with a one-value at the bit position means the particular almanac model is supported; a zero-value means not supported.

If the target device supports GPS and *GNSS-Almanac* assistance, it shall support Model-2.

If the target device supports SBAS and *GNSS-Almanac* assistance, it shall support Model-6.

If the target device supports QZSS and *GNSS-Almanac* assistance, it shall support Model-2.

If the target device supports Galileo and *GNSS-Almanac* assistance, it shall support Model-1.

If the target device supports GLONASS and *GNSS-Almanac* assistance, it shall support Model-5.

If the target device supports BDS and *GNSS-Almanac* assistance, it shall support Model-7.

If this field is absent, the target device supports the mandatory (native) *almanacModel* choice only as listed above for the GNSS indicated by *GNSS-ID*.

– GNSS-UTC-ModelSupport

```
-- ASN1START
GNSS-UTC-ModelSupport ::= SEQUENCE {
    utc-Model BIT STRING {
        model-1 (0),
        model-2 (1),
        model-3 (2),
        model-4 (3),
        model-5 (4) } (SIZE (1..8)) OPTIONAL,
    ...
}
-- ASN1STOP
```

GNSS-UTC-ModelSupport field descriptions

utc-Model

This field specifies the *GNSS-UTC-Model* choice(s) in *GNSS-UTC-Model* IE supported by the target device for the GNSS indicated by *GNSS-ID*. This is represented by a bit string, with a one-value at the bit position means the particular UTC model is supported; a zero-value means not supported.

If the target device supports GPS and *GNSS-UTC-Model* assistance, it shall support Model-1.

If the target device supports SBAS and *GNSS-UTC-Model* assistance, it shall support Model-4.

If the target device supports QZSS and *GNSS-UTC-Model* assistance, it shall support Model-1.

If the target device supports Galileo and *GNSS-UTC-Model* assistance, it shall support Model-1.

If the target device supports GLONASS and *GNSS-UTC-Model* assistance, it shall support Model-3.

If the target device supports BDS and *GNSS-UTC-Model* assistance, it shall support Model-5.

If this field is absent, the target device supports the mandatory (native) *utc-Model* choice only as listed above for the GNSS indicated by *GNSS-ID*.

– GNSS-AuxiliaryInformationSupport

```
-- ASN1START
GNSS-AuxiliaryInformationSupport ::= SEQUENCE {
    ...
}
```

```
}
-- ASN1STOP
```

– BDS-DifferentialCorrectionsSupport

```
-- ASN1START
BDS-DifferentialCorrectionsSupport-r12 ::= SEQUENCE {
    gnssSignalIDs          GNSS-SignalIDs,
    ...
}
-- ASN1STOP
```

BDS-DifferentialCorrectionsSupport field descriptions

gnssSignalIDs

This field specifies the BDS signal types for which differential corrections are supported by the target device. This is represented by a bit string in *GNSS-SignalIDs*, with a one-value at the bit position means differential corrections for the particular BDS signal type is supported; a zero-value means not supported.

– BDS-GridModelSupport

```
-- ASN1START
BDS-GridModelSupport-r12 ::= SEQUENCE {
    ...
}
-- ASN1STOP
```

6.5.2.11 GNSS Capability Information Request

– A-GNSS-RequestCapabilities

The IE *A-GNSS-Request-Capabilities* is used by the location server to request A-GNSS location capabilities (e.g., GNSSs and assistance data supported) from the target device.

```
-- ASN1START
A-GNSS-RequestCapabilities ::= SEQUENCE {
    gnss-SupportListReq          BOOLEAN,
    assistanceDataSupportListReq  BOOLEAN,
    locationVelocityTypesReq     BOOLEAN,
    ...
}
-- ASN1STOP
```

A-GNSS-RequestCapabilities field descriptions

gnss-SupportListReq

This field specifies whether the target device is requested to include the *gnss-SupportList* field in the *A-GNSS-ProvideCapabilities* IE or not. TRUE means requested.

assistanceDataSupportListReq

This field specifies whether the target device is requested to include the *assistanceDataSupportList* field in the *A-GNSS-ProvideCapabilities* IE or not. TRUE means requested.

locationVelocityTypesReq

This field specifies whether the target device is requested to include the *locationCoordinateTypes* field and *velocityTypes* field in the *A-GNSS-ProvideCapabilities* IE or not. TRUE means requested.

6.5.2.12 GNSS Error Elements

– A-GNSS-Error

The IE *A-GNSS-Error* is used by the location server or target device to provide GNSS error reasons.

```
-- ASN1START
A-GNSS-Error ::= CHOICE {
    locationServerErrorCauses      GNSS-LocationServerErrorCauses,
    targetDeviceErrorCauses       GNSS-TargetDeviceErrorCauses,
    ...
}
-- ASN1STOP
```

– GNSS-LocationServerErrorCauses

The IE *GNSS-LocationServerErrorCauses* is used by the location server to provide GNSS error reasons to the target device.

```
-- ASN1START
GNSS-LocationServerErrorCauses ::= SEQUENCE {
    cause      ENUMERATED {
        undefined,
        undeliveredAssistanceDataIsNotSupportedByServer,
        undeliveredAssistanceDataIsSupportedButCurrentlyNotAvailableByServer,
        undeliveredAssistanceDataIsPartlyNotSupportedAndPartlyNotAvailableByServer,
        ...
    },
    ...
}
-- ASN1STOP
```

– GNSS-TargetDeviceErrorCauses

The IE *GNSS-TargetDeviceErrorCauses* is used by the target device to provide GNSS error reasons to the location server.

```
-- ASN1START
GNSS-TargetDeviceErrorCauses ::= SEQUENCE {
    cause      ENUMERATED {
        undefined,
        thereWereNotEnoughSatellitesReceived,
        assistanceDataMissing,
        notAllRequestedMeasurementsPossible,
        ...
    },
    fineTimeAssistanceMeasurementsNotPossible      NULL      OPTIONAL,
    adrMeasurementsNotPossible                     NULL      OPTIONAL,
    multiFrequencyMeasurementsNotPossible          NULL      OPTIONAL,
    ...
}
-- ASN1STOP
```

GNSS-TargetDeviceErrorCauses field descriptions

cause

This field provides a GNSS specific error cause. If the cause value is "*notAllRequestedMeasurementsPossible*", the target device was not able to provide all requested GNSS measurements (but may be able to report a location estimate or location measurements). In this case, the target device should include any of the "*fineTimeAssistanceMeasurementsNotPossible*", "*adrMeasurementsNotPossible*", or "*multiFrequencyMeasurementsNotPossible*" fields, as applicable.

6.5.2.13 Common GNSS Information Elements

– GNSS-ID

The IE *GNSS-ID* is used to indicate a specific GNSS.

```
-- ASN1START
GNSS-ID ::= SEQUENCE {
    gnss-id      ENUMERATED{ gps, sbas, qzss, galileo, glonass, ..., bds },
    ...
}
-- ASN1STOP
```

– GNSS-ID-Bitmap

The IE *GNSS-ID-Bitmap* is used to indicate several GNSSs using a bit map.

```
-- ASN1START
GNSS-ID-Bitmap ::= SEQUENCE {
    gnss-ids      BIT STRING {      gps      (0),
                                   sbas      (1),
                                   qzss      (2),
                                   galileo   (3),
                                   glonass   (4),
                                   bds       (5) } (SIZE (1..16)),
    ...
}
-- ASN1STOP
```

GNSS-ID-Bitmap field descriptions

gnss-ids

This field specifies the GNSS(s). This is represented by a bit string, with a one-value at the bit position means the particular GNSS is addressed; a zero-value means not addressed.

– GNSS-SignalID

The IE *GNSS-SignalID* is used to indicate a specific GNSS signal type. The interpretation of *GNSS-SignalID* depends on the *GNSS-ID*.

```
-- ASN1START
GNSS-SignalID ::= SEQUENCE {
    gnss-SignalID INTEGER (0 .. 7),
    ...
}
-- ASN1STOP
```

GNSS-SignalID field descriptions

gnss-SignalID

This field specifies a particular GNSS signal. The interpretation of *gnss-SignalID* depends on the *GNSS-ID* and is as shown in the table System to Value & Explanation relation below.

System to Value & Explanation relation

System	Value	Explanation
GPS	0	GPS L1 C/A
	1	GPS L1C
	2	GPS L2C
	3	GPS L5
	4-7	Reserved
SBAS	0	L1
	1-7	Reserved
QZSS	0	QZS-L1
	1	QZS-L1C
	2	QZS-L2C
	3	QZS-L5
	4-7	Reserved
GLONASS	0	GLONASS G1
	1	GLONASS G2
	2	GLONASS G3
	3-7	Reserved
Galileo	0	Galileo E1
	1	Galileo E5A
	2	Galileo E5B
	3	Galileo E6
	4	Galileo E5A + E5B
	5-7	Reserved
BDS	0	B1I
	1-7	Reserved

GNSS-SignalIDs

The IE *GNSSSignal-IDs* is used to indicate several GNSS signals using a bit map. The interpretation of *GNSSSignal-IDs* depends on the *GNSS-ID*.

```

-- ASN1START
GNSS-SignalIDs ::= SEQUENCE {
    gnss-SignalIDs    BIT STRING (SIZE(8)),
    ...
}
-- ASN1STOP
    
```

GNSS-SignalIDs field descriptions

gnss-SignalIDs

This field specifies one or several GNSS signals using a bit map. A one-value at the bit position means the particular signal is addressed; a zero-value at the particular bit position means the signal is not addressed. The interpretation of the bit map in *gnssSignalIDs* depends on the *GNSS-ID* and is shown in the table below.

Unfilled table entries indicate no assignment and shall be set to zero.

interpretation of the bit map in *gnssSignalIDs*

GNSS	Bit 1 (MSB)	Bit 2	Bit 3	Bit 4	Bit 5	Bit 6	Bit 7	Bit 8 (LSB)
GPS	L1 C/A	L1C	L2C	L5				
SBAS	L1							
QZSS	QZS-L1	QZS-L1C	QZS-L2C	QZS-L5				
GLONASS	G1	G2	G3					
Galileo	E1	E5a	E5b	E6	E5a+E5b			
BDS	B1I							

– SBAS-ID

The IE *SBAS-ID* is used to indicate a specific SBAS.

```
-- ASN1START
SBAS-ID ::= SEQUENCE {
  sbas-id      ENUMERATED { waas, egnos, msas, gagan, ...},
  ...
}
-- ASN1STOP
```

– SBAS-IDs

The IE *SBAS-IDs* is used to indicate several SBASs using a bit map.

```
-- ASN1START
SBAS-IDs ::= SEQUENCE {
  sbas-IDs      BIT STRING {
    waas      (0),
    egnos     (1),
    msas      (2),
    gagan     (3) } (SIZE (1..8)),
  ...
}
-- ASN1STOP
```

SBAS-IDs field descriptions

sbas-IDs

This field specifies one or several SBAS(s) using a bit map. A one-value at the bit position means the particular SBAS is addressed; a zero-value at the particular bit position means the SBAS is not addressed.

– SV-ID

The IE *SV-ID* is used to indicate a specific GNSS satellite. The interpretation of *SV-ID* depends on the *GNSS-ID*.

```
-- ASN1START
SV-ID ::= SEQUENCE {
  satellite-id  INTEGER(0..63),
  ...
}
-- ASN1STOP
```

SV-ID field descriptions

satellite-id

This field specifies a particular satellite within a specific GNSS. The interpretation of *satellite-id* depends on the *GNSS-ID* see the table below.

interpretation of *satellite-id*

System	Value of <i>satellite-id</i>	Interpretation of <i>satellite-id</i>
GPS	"0" – "62" "63"	Satellite PRN Signal No. 1 to 63 Reserved
SBAS	"0" – "38" "39" – "63"	Satellite PRN Signal No. 120 to 158 Reserved
QZSS	"0" – "4" "5" – "63"	Satellite PRN Signal No. 193 to 197 Reserved
GLONASS	"0" – "23" "24" – "63"	Slot Number 1 to 24 Reserved
Galileo	"0" – "35" "36" – "63"	Code No. 1 to 36 Reserved
BDS	"0" – "36" "37" – "63"	Satellite ranging code number signal No.1 to 37 [23] Reserved

6.5.3 Enhanced Cell ID Positioning

6.5.3.1 E-CID Location Information

– ECID-ProvideLocationInformation

The IE *ECID-ProvideLocationInformation* is used by the target device to provide E-CID location measurements to the location server. It may also be used to provide ECID positioning specific error reason.

```
-- ASN1START
ECID-ProvideLocationInformation ::= SEQUENCE {
    ecid-SignalMeasurementInformation    ECID-SignalMeasurementInformation    OPTIONAL,
    ecid-Error                            ECID-Error                            OPTIONAL,
    ...
}
-- ASN1STOP
```

6.5.3.2 E-CID Location Information Elements

– ECID-SignalMeasurementInformation

The IE *ECID-SignalMeasurementInformation* is used by the target device to provide various UE-measurements to the location server.

```
-- ASN1START
ECID-SignalMeasurementInformation ::= SEQUENCE {
    primaryCellMeasuredResults    MeasuredResultsElement    OPTIONAL,
    measuredResultsList           MeasuredResultsList,
    ...
}

MeasuredResultsList ::= SEQUENCE (SIZE(1..32)) OF MeasuredResultsElement

MeasuredResultsElement ::= SEQUENCE {
    physCellId        INTEGER (0..503),
    cellGlobalId     CellGlobalIdEUTRA-AndUTRA    OPTIONAL,
    arfcnEUTRA       ARFCN-ValueEUTRA,
    systemFrameNumber
                        BIT STRING (SIZE (10))    OPTIONAL,
    rsrp-Result       INTEGER (0..97)             OPTIONAL,
    rsrq-Result       INTEGER (0..34)             OPTIONAL,
    ue-RxTxTimeDiff  INTEGER (0..4095)           OPTIONAL,
    ...,
    [[ arfcnEUTRA-v9a0    ARFCN-ValueEUTRA-v9a0    OPTIONAL    -- Cond EARFCN-max
    ]]
}
-- ASN1STOP
```

```
-- ASN1STOP
```

Conditional presence	Explanation
<i>EARFCN-max</i>	The field is mandatory present if the corresponding <i>arfcnEUTRA</i> (i.e. without suffix) is set to <i>maxEARFCN</i> . Otherwise the field is not present.

ECID-SignalMeasurementInformation field descriptions
<p>primaryCellMeasuredResults This field contains measurements for the primary cell, when the target device reports measurements for both primary cell and neighbour cells. This field shall be omitted when the target device reports measurements for the primary cell only, in which case the measurements the primary cell is reported in the <i>measuredResultsList</i>.</p>
<p>measuredResultsList This list contains the E-CID measurements for up to 32 cells.</p>
<p>physCellId This field specifies the physical cell identity of the measured cell.</p>
<p>cellGlobalId This field specifies cell global ID of the measured cell. The target device shall provide this field if it was able to determine the ECGI of the measured cell at the time of measurement.</p>
<p>arfcnEUTRA This field specifies the ARFCN of the measured E-UTRA carrier frequency, as defined in [12]. In case the target device includes <i>arfcnEUTRA-v9a0</i>, the target device shall set the corresponding <i>arfcnEUTRA</i> (i.e. without suffix) to <i>maxEARFCN</i>.</p>
<p>systemFrameNumber This field specifies the system frame number of the measured cell during which the measurements have been performed. The target device shall include this field if it was able to determine the SFN of the cell at the time of measurement.</p>
<p>rsrp-Result This field specifies the reference signal received power (RSRP) measurement, as defined in [12],[17].</p>
<p>rsrq-Result This field specifies the reference signal received quality (RSRQ) measurement, as defined in [12],[17].</p>
<p>ue-RxTxTimeDiff This field specifies the UE Rx-Tx time difference measurement, as defined in [17]. It is provided only for measurements on the UE's primary cell. Measurement report mapping is according to 3GPP TS 36.133 [18].</p>

6.5.3.3 E-CID Location Information Request

– ECID-RequestLocationInformation

The IE *ECID-RequestLocationInformation* is used by the location server to request E-CID location measurements from a target device.

```
-- ASN1START
ECID-RequestLocationInformation ::= SEQUENCE {
    requestedMeasurements    BIT STRING {
        rsrpReq              (0),
        rsrqReq              (1),
        ueRxTxReq            (2) } (SIZE(1..8)),
    ...
}
-- ASN1STOP
```

ECID-RequestLocationInformation field descriptions
<p>requestedMeasurements This field specifies the E-CID measurements requested. This is represented by a bit string, with a one-value at the bit position means the particular measurement is requested; a zero-value means not requested.</p>

6.5.3.4 E-CID Capability Information

– ECID-ProvideCapabilities

The IE *ECID-ProvideCapabilities* is used by the target device to indicate its capability to support E-CID and to provide its E-CID location capabilities to the location server.

```
-- ASN1START
ECID-ProvideCapabilities ::= SEQUENCE {
    ecid-MeasSupported BIT STRING {
        rsrpSup      (0),
        rsrqSup      (1),
        ueRxTxSup    (2) } (SIZE(1..8)),
    ...
    [[ ueRxTxSupTDD-r13 ENUMERATED { true } OPTIONAL
    ]]
}
-- ASN1STOP
```

ECID-Provide-Capabilities field descriptions

ecid-MeasSupported

This field specifies the E-CID measurements supported by the target device. This is represented by a bit string, with a one-value at the bit position means the particular measurement is supported; a zero-value means not supported. A zero-value in all bit positions in the bit string means only the basic Cell ID positioning method is supported by the target device.

If the UE Rx-Tx time difference measurement is supported by the target device (i.e., *ueRxTxSup* field is set to one), it means that the UE supports the UE Rx-Tx time difference measurement reporting via both LPP signaling and RRC signalling.

If a target device doesn't support LPP, the E-SMLC may assume the target device can not report the UE Rx-Tx time difference measurement results via RRC signalling.

ueRxTxSupTDD

This field, if present, indicates that any UE Rx-Tx time difference measurement reporting for TDD from the target device includes the $N_{TAoffset}$ according to [16][17] and uses the UE Rx-Tx time difference measurement report mapping for TDD as specified in 3GPP TS 36.133 [18]. This field may only be included if the *ueRxTxSup* field in *ecid-MeasSupported* is set to value one.

6.5.3.5 E-CID Capability Information Request

– ECID-RequestCapabilities

The IE *ECID-RequestCapabilities* is used by the location server to request E-CID positioning capabilities from a target device.

```
-- ASN1START
ECID-RequestCapabilities ::= SEQUENCE {
    ...
}
-- ASN1STOP
```

6.5.3.6 E-CID Error Elements

– ECID-Error

The IE *ECID-Error* is used by the location server or target device to provide E-CID error reasons to the target device or location server, respectively.

```
-- ASN1START
ECID-Error ::= CHOICE {
    locationServerErrorCauses ECID-LocationServerErrorCauses,
    targetDeviceErrorCauses  ECID-TargetDeviceErrorCauses,
}
-- ASN1STOP
```

```

...
}
-- ASN1STOP

```

– ECID-LocationServerErrorCauses

The IE *ECID-LocationServerErrorCauses* is used by the location server to provide E-CID error reasons to the target device.

```

-- ASN1START
ECID-LocationServerErrorCauses ::= SEQUENCE {
  cause          ENUMERATED {  undefined,
                               ...,
                               },
  ...
}
-- ASN1STOP

```

– ECID-TargetDeviceErrorCauses

The IE *ECID-TargetDeviceErrorCauses* is used by the target device to provide E-CID error reasons to the location server.

```

-- ASN1START
ECID-TargetDeviceErrorCauses ::= SEQUENCE {
  cause          ENUMERATED {  undefined,
                               requestedMeasurementNotAvailable,
                               notAllRequestedMeasurementsPossible,
                               ...,
                               },
  rsrpMeasurementNotPossible           NULL          OPTIONAL,
  rsrqMeasurementNotPossible           NULL          OPTIONAL,
  ueRxTxMeasurementNotPossible         NULL          OPTIONAL,
  ...
}
-- ASN1STOP

```

***ECID-TargetDeviceErrorCauses* field descriptions**

cause

This field provides a ECID specific error cause. If the cause value is "*notAllRequestedMeasurementsPossible*", the target device was not able to provide all requested ECID measurements (but may be able to provide some measurements). In this case, the target device should include any of the "*rsrpMeasurementNotPossible*", "*rsrqMeasurementNotPossible*", or "*ueRxTxMeasurementNotPossible*" fields, as applicable.

6.5.4 Terrestrial Beacon System Positioning

6.5.4.1 TBS Location Information

– TBS-ProvideLocationInformation

The IE *TBS-ProvideLocationInformation* is used by the target device to provide TBS location measurements to the location server. It may also be used to provide TBS positioning specific error reason.

```

-- ASN1START
TBS-ProvideLocationInformation-r13 ::= SEQUENCE {
  tbs-MeasurementInformation-r13      TBS-MeasurementInformation-r13  OPTIONAL,
  tbs-Error-r13                       TBS-Error-r13                OPTIONAL,
  ...
}

```

```
-- ASN1STOP
```

6.5.4.2 TBS Location Information Elements

– TBS-MeasurementInformation

The IE *TBS-MeasurementInformation* is used by the target device to provide TBS location measurements to the location server.

```
-- ASN1START
TBS-MeasurementInformation-r13 ::= SEQUENCE {
    measurementReferenceTime-r13      UTCTime                OPTIONAL,
    mbs-SgnMeasList-r13               MBS-BeaconMeasList-r13  OPTIONAL,  -- Cond MBS
    ...
}
-- ASN1STOP
```

Conditional presence	Explanation
MBS	The field is mandatory present if the <i>TBS-MeasurementInformation</i> is provided for an MBS system; otherwise it is not present.

<i>TBS-MeasurementInformation</i> field descriptions
<p>measurementReferenceTime This field provides the UTC time when the TBS measurements are performed and should take the form of <i>YYMMDDhhmmssZ</i>.</p>
<p>mbs-SgnMeasList This field provides the MBS measurements for up to 64 MBS beacons.</p>

– MBS-BeaconMeasList

The IE *MBS-BeaconMeasList* is used by the target device to provide MBS location measurements to the location server, as defined in the MBS ICD [24].

```
-- ASN1START
MBS-BeaconMeasList-r13 ::= SEQUENCE (SIZE(1..64)) OF MBS-BeaconMeasElement-r13
MBS-BeaconMeasElement-r13 ::= SEQUENCE {
    transmitterID-r13                INTEGER (0..32767),
    codePhase-r13                     INTEGER (0..2097151),
    codePhaseRMSError-r13             INTEGER (0..63),
    ...
}
-- ASN1STOP
```

<i>MBS-BeaconMeasList</i> field descriptions
<p>transmitterID This field contains the MBS transmitter identifier.</p>
<p>codePhase This field contains the value of the code-phase measurement made by the target device for the particular beacon signal at the time of measurement in the units of ms. MBS specific code phase measurements (e.g. chips) are converted into unit of ms by dividing the measurements by the nominal values of the measured signal chipping rate. Scale factor 2^{21} milli-seconds, in the range from 0 to $(1-2^{21})$ milli-seconds.</p>
<p>codePhaseRMSError This field contains the pseudorange RMS error value. This parameter is specified according to a floating-point representation shown in the table below.</p>

floating-point representation

Index	Mantissa	Exponent	Floating-Point value, x_i	Pseudorange value, P [m]
0	000	000	0.5	$P < 0.5$
1	001	000	0.5625	$0.5 \leq P < 0.5625$
i	x	y	$0.5 * (1 + x/8) * 2^y$	$x_{i-1} \leq P < x_i$
62	110	111	112	$104 \leq P < 112$
63	111	111	--	$112 \leq P$

6.5.4.3 TBS Location Information Request

– TBS-RequestLocationInformation

The IE *TBS-RequestLocationInformation* is used by the location server to request location information for TBS-based methods from the target device.

```
-- ASN1START
TBS-RequestLocationInformation-r13 ::= SEQUENCE {
    mbsSgnMeasListReq-r13          BOOLEAN,
    ...
}
-- ASN1STOP
```

TBS-RequestLocationInformation field descriptions**mbsSgnMeasListReq**

This field indicates whether the target device is requested to report MBS measurements in *TBS-MeasurementInformation* IE or not. TRUE means requested.

6.5.4.4 TBS Capability Information

– TBS-ProvideCapabilities

The IE *TBS-ProvideCapabilities* is used by the target device to indicate its capability to support TBS and to provide its TBS location capabilities to the location server.

```
-- ASN1START
TBS-ProvideCapabilities-r13 ::= SEQUENCE {
    tbs-Modes-r13          BIT STRING {
        standalone (0),
        ue-assisted (1) } (SIZE (1..8)),
    ...
}
-- ASN1STOP
```

TBS-ProvideCapabilities field descriptions**tbs-Modes**

This field specifies the TBS mode(s) supported by the target device. This is represented by a bit string, with a one-value at the bit position means the particular TBS mode is supported; a zero-value means not supported.

6.5.4.5 TBS Capability Information Request

– TBS-RequestCapabilities

The IE *TBS-RequestCapabilities* is used by the location server to request TBS positioning capabilities from a target device.

```

-- ASN1START
TBS-RequestCapabilities-r13 ::= SEQUENCE {
    ...
}
-- ASN1STOP

```

6.5.4.6 TBS Error Elements

– TBS-Error

The IE *TBS-Error* is used by the location server or target device to provide TBS error reasons to the target device or location server, respectively.

```

-- ASN1START
TBS-Error-r13 ::= CHOICE {
    locationServerErrorCauses-r13          TBS-LocationServerErrorCauses-r13,
    targetDeviceErrorCauses-r13           TBS-TargetDeviceErrorCauses-r13,
    ...
}
-- ASN1STOP

```

– TBS-LocationServerErrorCauses

The IE *TBS-LocationServerErrorCauses* is used by the location server to provide error reasons for TBS positioning to the target device.

```

-- ASN1START
TBS-LocationServerErrorCauses-r13 ::= SEQUENCE {
    cause-r13          ENUMERATED { undefined,
    ...
    },
    ...
}
-- ASN1STOP

```

– TBS-TargetDeviceErrorCauses

The IE *TBS-TargetDeviceErrorCauses* is used by the target device to provide error reasons for TBS positioning to the location server.

```

-- ASN1START
TBS-TargetDeviceErrorCauses-r13 ::= SEQUENCE {
    cause-r13          ENUMERATED { undefined,
    thereWereNotEnoughMBSBeaconsReceived,
    ...
    },
    ...
}
-- ASN1STOP

```

***TBS-TargetDeviceErrorCauses* field descriptions**

cause

This field provides a TBS specific error cause.

6.5.5 Sensor based Positioning

6.5.5.1 Sensor Location Information

– Sensor-ProvideLocationInformation

The IE *Sensor-ProvideLocationInformation* is used by the target device to provide location information for sensor-based methods to the location server. It may also be used to provide sensor specific error reason.

```
-- ASN1START
Sensor-ProvideLocationInformation-r13 ::= SEQUENCE {
    sensor-MeasurementInformation-r13      Sensor-MeasurementInformation-r13      OPTIONAL,
    sensor-Error-r13                      Sensor-Error-r13                      OPTIONAL,
    ...
}
-- ASN1STOP
```

6.5.5.2 Sensor Location Information Elements

– Sensor-MeasurementInformation

The IE *Sensor-MeasurementInformation* is used by the target device to provide UE sensor measurements to the location server.

```
-- ASN1START
Sensor-MeasurementInformation-r13 ::= SEQUENCE {
    measurementReferenceTime-r13          UTCTime                OPTIONAL,
    uncompensatedBarometricPressure-r13   INTEGER (30000..115000)  OPTIONAL,  -- Cond
    Barometer
    ...
}
-- ASN1STOP
```

Conditional presence	Explanation
<i>Barometer</i>	The field is mandatory present if the <i>Sensor-MeasurementInformation</i> is provided for barometric pressure; otherwise it is not present.

Sensor-MeasurementInformation field descriptions
<i>measurementReferenceTime</i> This field provides the UTC time when the sensor measurements are performed and should take the form of <i>YYMMDDhhmmssZ</i> .
<i>uncompensatedBarometricPressure</i> This field provides the uncompensated barometric pressure as measured by the UE sensor, in units of Pa.

6.5.5.3 Sensor Location Information Request

– Sensor-RequestLocationInformation

The IE *Sensor-RequestLocationInformation* is used by the location server to request location information for sensor-based methods from a target device.

```
-- ASN1START
Sensor-RequestLocationInformation-r13 ::= SEQUENCE {
    uncompensatedBarometricPressureReq-r13  BOOLEAN,
    ...
}
-- ASN1STOP
```

```
-- ASN1STOP
```

Sensor-RequestLocationInformation field descriptions

uncompensatedBarometricPressureReq

This field indicates whether the target device is requested to report Barometric pressure measurements in *Sensor-MeasurementInformation* IE or not. TRUE means requested.

6.5.5.4 Sensor Capability Information

– Sensor-ProvideCapabilities

The IE *Sensor-ProvideCapabilities* is used by the target device to provide capabilities for sensor-based methods from to the location server.

```
-- ASN1START
Sensor-ProvideCapabilities-r13 ::= SEQUENCE {
  sensor-Modes-r13          BIT STRING { standalone (0),
                                     ue-assisted (1) } (SIZE (1..8)),
  ...
}
-- ASN1STOP
```

Sensor-ProvideCapabilities field descriptions

sensor-Modes

This field specifies the sensor mode(s) supported by the target device. This is represented by a bit string, with a one-value at the bit position means the particular sensor mode is supported; a zero-value means not supported.

6.5.5.5 Sensor Capability Information Request

– Sensor-RequestCapabilities

The IE *Sensor-RequestCapabilities* is used by the location server to request capabilities for sensor-based methods from the target device.

```
-- ASN1START
Sensor-RequestCapabilities-r13 ::= SEQUENCE {
  ...
}
-- ASN1STOP
```

6.5.5.6 Sensor Error Elements

– Sensor-Error

The IE *Sensor-Error* is used by the location server or target device to provide Sensor Error Reasons to the target device or location server, respectively.

```
-- ASN1START
Sensor-Error-r13 ::= CHOICE {
  locationServerErrorCauses-r13      Sensor-LocationServerErrorCauses-r13,
  targetDeviceErrorCauses-r13       Sensor-TargetDeviceErrorCauses-r13,
  ...
}
-- ASN1STOP
```

– Sensor-LocationServerErrorCauses

The IE *Sensor-LocationServerErrorCauses* is used by the location server to provide error reasons for Sensor positioning to the target device.

```
-- ASN1START
Sensor-LocationServerErrorCauses-r13 ::= SEQUENCE {
  cause-r13          ENUMERATED { undefined,
                                ...
  }
  ...
}
-- ASN1STOP
```

– Sensor-TargetDeviceErrorCauses

The IE *Sensor-TargetDeviceErrorCauses* is used by the target device to provide error reasons for Sensor positioning to the location server.

```
-- ASN1START
Sensor-TargetDeviceErrorCauses-r13 ::= SEQUENCE {
  cause-r13          ENUMERATED { undefined,
                                ...
  }
  ...
}
-- ASN1STOP
```

6.5.6 WLAN-based Positioning

This section defines support for positioning using measurements related to WLAN access points.

6.5.6.1 WLAN Location Information

– WLAN-ProvideLocationInformation

The IE *WLAN-ProvideLocationInformation* is used by the target device to provide measurements for one or more WLANs to the location server. It may also be used to provide WLAN positioning specific error reason.

```
-- ASN1START
WLAN-ProvideLocationInformation-r13 ::= SEQUENCE {
  wlan-MeasurementInformation-r13  WLAN-MeasurementInformation-r13  OPTIONAL,
  wlan-Error-r13                   WLAN-Error-r13                   OPTIONAL,
  ...
}
-- ASN1STOP
```

6.5.6.2 WLAN Location Information Elements

– WLAN-MeasurementInformation

```
-- ASN1START
WLAN-MeasurementInformation-r13 ::= SEQUENCE {
  measurementReferenceTime-r13    UTCTime                        OPTIONAL,
  wlan-MeasurementList-r13        WLAN-MeasurementList-r13  OPTIONAL,
  ...
}
-- ASN1STOP
```

```

WLAN-MeasurementList-r13 ::= SEQUENCE (SIZE(1..maxWLAN-AP-r13)) OF WLAN-MeasurementElement-r13

WLAN-MeasurementElement-r13 ::= SEQUENCE {
    wlan-AP-Identifier-r13      WLAN-AP-Identifier-r13,
    rssi-r13                    INTEGER (-127..128)                OPTIONAL,
    rtt-r13                     WLAN-RTT-r13                        OPTIONAL,
    apChannelFrequency-r13     INTEGER (0..256)                    OPTIONAL,
    servingFlag-r13            BOOLEAN                            OPTIONAL,
    ...
}

WLAN-AP-Identifier-r13 ::= SEQUENCE {
    bssid-r13                   OCTET STRING (SIZE (6)),
    ssid-r13                     OCTET STRING (SIZE (1..32))        OPTIONAL,
    ...
}

WLAN-RTT-r13 ::= SEQUENCE {
    rttValue-r13                INTEGER (0..16777215),
    rttUnits-r13                ENUMERATED {
        microseconds,
        hundredsofnanoseconds,
        tensofnanoseconds,
        nanoseconds,
        tenthsofnanoseconds,
        ... },
    rttAccuracy-r13            INTEGER (0..255)                    OPTIONAL,
    ...
}

maxWLAN-AP-r13                INTEGER ::= 64

-- ASN1STOP

```

WLAN-MeasurementInformation field descriptions

measurementReferenceTime

This field provides the UTC time when the WLAN measurements are performed and should take the form of *YYMMDDhhmmssZ*.

wlan-MeasurementList

This field provides the WLAN measurements for up to 64 WLAN APs.

wlan-AP-Identifier

This field provides the BSSID and optionally the SSID of the wireless network served by the WLAN AP [26].

rssi

This field provides the AP signal strength (RSSI) of a beacon frame, probe response frame or measurement pilot frame measured at the target in dBm.

rtt

This field provides the measured round trip time between the target device and WLAN AP and optionally the accuracy expressed as the standard deviation of the delay. Units for each of these are 1000ns, 100ns, 10ns, 1ns, and 0.1ns.

apChannelFrequency

This field provides the AP channel number identification of the reported WLAN AP.

servingFlag

This parameter indicates whether a set of WLAN AP measurements were obtained for a serving WLAN AP (TRUE) or a non-serving WLAN AP (FALSE). A target device with multiple radio support may indicate more than one type of serving access for the same time instant.

rttValue

This field specifies the Round Trip Time (RTT) measurement between the target device and WLAN AP in units given by the field *rttUnits*.

rttUnits

This field specifies the Units for the fields *rttValue* and *rttAccuracy*. The available Units are 1000ns, 100ns, 10ns, 1ns, and 0.1ns.

rttAccuracy

This field provides the estimated accuracy of the provided *rttValue* expressed as the standard deviation in units given by the field *rttUnits*.

6.5.6.3 WLAN Location Information Request

– WLAN-RequestLocationInformation

The IE *WLAN-RequestLocationInformation* is used by the location server to request WLAN measurements from a target device.

```
-- ASN1START
WLAN-RequestLocationInformation-r13 ::= SEQUENCE {
  requestedMeasurements-r13  BIT STRING {
                                rssi          (0),
                                rtt           (1)} (SIZE(1..8)),
  ...
}
-- ASN1STOP
```

WLAN-RequestLocationInformation field descriptions

requestedMeasurements

This field specifies the WLAN measurements requested. This is represented by a bit string, with a one-value at the bit position means the particular measurement is requested; a zero-value means not requested. The following measurement requests can be included.

rssi: AP signal strength at the target
rtt: Round Trip Time between target and AP

6.5.6.4 WLAN Capability Information

– WLAN-ProvideCapabilities

The IE *WLAN-ProvideCapabilities* is used by the target device to provide its capabilities for WLAN positioning to the location server.

```
-- ASN1START
WLAN-ProvideCapabilities-r13 ::= SEQUENCE {
  wlan-Modes-r13          BIT STRING { standalone (0),
                                       ue-assisted (1)} (SIZE (1..8)),
  wlan-MeasSupported-r13 BIT STRING {
                                rssi-r13 (0),
                                rtt-r13 (1)} (SIZE(1..8)),
  ...
}
-- ASN1STOP
```

WLAN-ProvideCapabilities field descriptions

wlan-Modes

This field specifies the WLAN mode(s) supported by the target device. This is represented by a bit string, with a one value at the bit position means the WLAN mode is supported; a zero value means not supported.

wlan-MeasSupported

This field specifies the measurements supported by the target device when accessing a WLAN. This is represented by a bit string, with a one-value at the bit position means the particular measurement is supported; a zero-value means not supported. A zero-value in all bit positions in the bit string means only the basic WLAN positioning method is supported by the target device which is reporting of the WLAN identity. The following bits are assigned for the indicated measurements.

rssi: AP signal strength at the target
rtt: Round Trip Time between target and AP

6.5.6.5 WLAN Capability Information Request

– WLAN-RequestCapabilities

The IE *WLAN-RequestCapabilities* is used by the location server to request WLAN positioning capabilities information from a target device.

```
-- ASN1START
WLAN-RequestCapabilities-r13 ::= SEQUENCE {
    ...
}
-- ASN1STOP
```

6.5.6.6 WLAN Error Elements

– WLAN-Error

The IE *WLAN-Error* is used by the location server or target device to provide error reasons for WLAN positioning to the target device or location server, respectively.

```
-- ASN1START
WLAN-Error-r13 ::= CHOICE {
    locationServerErrorCauses-r13          WLAN-LocationServerErrorCauses-r13,
    targetDeviceErrorCauses-r13           WLAN-TargetDeviceErrorCauses-r13,
    ...
}
-- ASN1STOP
```

– WLAN-LocationServerErrorCauses

The IE *WLAN-LocationServerErrorCauses* is used by the location server to provide error reasons for WLAN positioning to the target device.

```
-- ASN1START
WLAN-LocationServerErrorCauses-r13 ::= SEQUENCE {
    cause-r13                               ENUMERATED {undefined, ...},
    ...
}
-- ASN1STOP
```

– WLAN-TargetDeviceErrorCauses

The IE *WLAN-TargetDeviceErrorCauses* is used by the target device to provide error reasons for WLAN positioning to the location server.

```
-- ASN1START
WLAN-TargetDeviceErrorCauses-r13 ::= SEQUENCE {
    cause-r13                               ENUMERATED {undefined,
                                                    requestedMeasurementsNotAvailable,
                                                    notAllRequestedMeasurementsPossible,
                                                    ...
                                                    },
    wlan-AP-RSSI-MeasurementNotPossible-r13  NULL                OPTIONAL,
    wlan-AP-RTT-MeasurementNotPossible-r13  NULL                OPTIONAL,
    ...
}
-- ASN1STOP
```

WLAN-TargetDeviceErrorCauses field descriptions**cause**

This field provides a WLAN specific error cause. If the cause value is "*notAllRequestedMeasurementsPossible*", the target device was not able to provide all requested WLAN measurements (but may be able to provide some measurements). In this case, the target device should include any of the "*wlan-AP-RSSI-MeasurementNotPossible*", "*wlan-AP-RTT-MeasurementNotPossible*" fields, as applicable.

6.5.7 Bluetooth-based Positioning

6.5.7.1 Bluetooth Location Information

– BT-ProvideLocationInformation

The IE *BT-ProvideLocationInformation* is used by the target device to provide measurements for one or more Bluetooth beacons to the location server. It may also be used to provide Bluetooth positioning specific error reason.

```
-- ASN1START
BT-ProvideLocationInformation-r13 ::= SEQUENCE {
    bt-MeasurementInformation-r13    BT-MeasurementInformation-r13    OPTIONAL,
    bt-Error-r13                    BT-Error-r13                OPTIONAL,
    ...
}
-- ASN1STOP
```

6.5.7.2 BT Location Information Elements

– BT-MeasurementInformation

```
-- ASN1START
BT-MeasurementInformation-r13 ::= SEQUENCE {
    measurementReferenceTime-r13    UTCTime                    OPTIONAL,
    bt-MeasurementList-r13          BT-MeasurementList-r13    OPTIONAL,
    ...
}
BT-MeasurementList-r13 ::= SEQUENCE (SIZE(1..maxBT-Beacon-r13)) OF BT-MeasurementElement-r13
BT-MeasurementElement-r13 ::= SEQUENCE {
    btAddr-r13                      BIT STRING (SIZE (48)),
    rssi-r13                        INTEGER (-128..127)        OPTIONAL,
    ...
}
maxBT-Beacon-r13                    INTEGER ::= 32
-- ASN1STOP
```

BT-MeasurementInformation field descriptions**measurementReferenceTime**

This field provides the UTC time when the BT measurements are performed and should take the form of *YYMMDDhhmmssZ*.

bt-MeasurementList

This field provides the BT measurements for up to 32 BT beacons.

btAddr

This field specifies the Bluetooth public address of the BT beacon [25].

rssi

This field provides the beacon received signal strength indicator (RSSI) in dBm.

6.5.7.3 Bluetooth Location Information Request

– BT-RequestLocationInformation

The IE *BT-RequestLocationInformation* is used by the location server to request Bluetooth measurements from a target device.

```
-- ASN1START
BT-RequestLocationInformation-r13 ::= SEQUENCE {
    requestedMeasurements-r13 BIT STRING {
        rssi (0) (SIZE(1..8)),
        ...
    }
}
-- ASN1STOP
```

***BT-RequestLocationInformation* field descriptions**

requestedMeasurements

This field specifies the BT measurements requested. This is represented by a bit string, with a one-value at the bit position means the particular measurement is requested; a zero-value means not requested. The following measurement requests can be included.

rssi: BT beacon signal strength at the target

6.5.7.4 Bluetooth Capability Information

– BT-ProvideCapabilities

The IE *BT-ProvideCapabilities* is used by the target device to provide its capabilities for Bluetooth positioning to the location server.

```
-- ASN1START
BT-ProvideCapabilities-r13 ::= SEQUENCE {
    bt-Modes-r13 BIT STRING {
        standalone (0),
        ue-assisted (1) (SIZE (1..8)),
    }
    bt-MeasSupported-r13 BIT STRING {
        rssi-r13 (0) (SIZE (1..8)),
        ...
    }
}
-- ASN1STOP
```

***BT-ProvideCapabilities* field descriptions**

bt-Modes

This field specifies the Bluetooth mode(s) supported by the target device. This is represented by a bit string, with a one value at the bit position means the Bluetooth mode is supported; a zero value means not supported.

bt-MeasSupported

This field specifies the BT measurements supported by the target device. This is represented by a bit string, with a one-value at the bit position means the particular measurement is supported; a zero-value means not supported. A zero-value in all bit positions in the bit string means only the basic BT positioning method is supported by the target device which is reporting of the BT beacon identity. The following bits are assigned for the indicated measurements.

rssi: BT beacon signal strength at the target device

6.5.7.5 Bluetooth Capability Information Request

– BT-RequestCapabilities

The IE *BT-RequestCapabilities* is used by the location server to request Bluetooth positioning capabilities from a target device.

```
-- ASN1START
BT-RequestCapabilities-r13 ::= SEQUENCE {
    ...
}
-- ASN1STOP
```

6.5.7.6 BT Error Elements

– BT-Error

The IE *BT-Error* is used by the location server or target device to provide error reasons for Bluetooth positioning to the target device or location server, respectively.

```
-- ASN1START
BT-Error-r13 ::= CHOICE {
    locationServerErrorCauses-r13          BT-LocationServerErrorCauses-r13,
    targetDeviceErrorCauses-r13           BT-TargetDeviceErrorCauses-r13,
    ...
}
-- ASN1STOP
```

– BT-LocationServerErrorCauses

The IE *BT-LocationServerErrorCauses* is used by the location server to provide error reasons for Bluetooth positioning to the target device.

```
-- ASN1START
BT-LocationServerErrorCauses-r13 ::= SEQUENCE {
    cause-r13                               ENUMERATED {undefined, ...},
    ...
}
-- ASN1STOP
```

– BT-TargetDeviceErrorCauses

The IE *BT-TargetDeviceErrorCauses* is used by the target device to provide error reasons for Bluetooth positioning to the location server.

```
-- ASN1START
BT-TargetDeviceErrorCauses-r13 ::= SEQUENCE {
    cause-r13                               ENUMERATED {undefined,
                                                requestedMeasurementsNotAvailable,
                                                notAllRequestedMeasurementsPossible,
                                                ...
                                                },
    bt-Beacon-rssiMeasurementNotPossible-r13  NULL          OPTIONAL,
    ...
}
-- ASN1STOP
```

***BT-TargetDeviceErrorCauses* field descriptions**

cause

This field provides a Bluetooth specific error cause. If the cause value is "*notAllRequestedMeasurementsPossible*", the target device was not able to provide all requested Bluetooth measurements (but may be able to provide some measurements). In this case, the target device should include "*bt-Beacon-rssiMeasurementNotPossible*" field.

– End of LPP-PDU-Definitions

```
-- ASN1START
```

```
END
```

```
-- ASN1STOP
```

Annex A (informative): Change History

Change history							
Date	TSG #	TSG Doc.	CR	Rev	Subject/Comment	Old	New
2009-10	RAN2 #67bis	R2-096252			RAN2 agreed TS 36.355 v0.1.0	-	0.1.0
2009-11	RAN2 #68	R2-097492			RAN2 agreed TS 36.355 v2.0.0	0.1.0	2.0.0
2009-12	RP-46	RP-091208			RAN #46 approval of TS 36.355	2.0.0	9.0.0
2010-03	RP-47	RP-100304	0001	-	Clarification on Position location	9.0.0	9.1.0
	RP-47	RP-100304	0002	-	Clarification on UE Rx-Tx time difference supporting capability	9.0.0	9.1.0
	RP-47	RP-100304	0003	2	Completion of LPP common material	9.0.0	9.1.0
	RP-47	RP-100304	0004	5	Completion of OTDOA in LPP	9.0.0	9.1.0
	RP-47	RP-100304	0006	-	Provision of Frame Drift Information in Network Time	9.0.0	9.1.0
	RP-47	RP-100304	0007	-	Clarification of measurement reference point	9.0.0	9.1.0
	RP-47	RP-100304	0010	-	GNSS-DifferentialCorrectionsSupport	9.0.0	9.1.0
	RP-47	RP-100304	0011	-	BSAlign Indication in GNSS Reference Time	9.0.0	9.1.0
	RP-47	RP-100304	0012	1	Changes to reflect LPP ASN.1 review	9.0.0	9.1.0
	RP-47	RP-100304	0013	1	Introduction of LPP reliability sublayer	9.0.0	9.1.0
	RP-47	RP-100304	0015	-	LPP error procedures and conditions	9.0.0	9.1.0
	RP-47	RP-100304	0016	-	Triggered Location Information Transfer due to Cell Change	9.0.0	9.1.0
2010-06	RP-48	RP-100558	0018	2	Addition of need codes to optional LPP information elements	9.1.0	9.2.0
	RP-48	RP-100558	0019	1	Miscellaneous corrections to LPP stage 3	9.1.0	9.2.0
	RP-48	RP-100558	0020	1	Small corrections to LPP specification	9.1.0	9.2.0
	RP-48	RP-100558	0021	-	Clarifications of OTDOA parameters	9.1.0	9.2.0
	RP-48	RP-100558	0022	1	Signalling support for PRS muting in OTDOA	9.1.0	9.2.0
	-	-	-	-	Two times capital R replaced by lower case r in "MeasuredResultsElement" (undoing not intended change)	9.2.0	9.2.1
2010-09	RP-49	RP-100852	0024	-	Addition of an EPDU to an LPP Error and LPP Abort	9.2.1	9.3.0
	RP-49	RP-100852	0026	-	Division of LPP into Separate ASN.1 Modules with a Global Identifier	9.2.1	9.3.0
	RP-49	RP-100852	0028	-	Proposed Corrections to LPP Reliable Transport	9.2.1	9.3.0
	RP-49	RP-100852	0029	-	Proposed Corrections to the PeriodicalReportingCriteria in LPP	9.2.1	9.3.0
	RP-49	RP-100852	0030	1	Various corrections and clarifications to LPP	9.2.1	9.3.0
	RP-49	RP-100852	0031	-	Support of functional components for LPP reliable transport	9.2.1	9.3.0
	RP-49	RP-100852	0032	1	Introduction of EPDU ID requested by OMA LOC	9.2.1	9.3.0
	RP-49	RP-100852	0035	1	Several corrections in LPP	9.2.1	9.3.0
	RP-49	RP-100852	0036	-	Clarification to Assistance Data Transfer Procedure	9.2.1	9.3.0
2010-12	RP-50	RP-101207	0037	-	Correction of reliable transport terminology in description of LPP-Message	9.3.0	9.4.0
	RP-50	RP-101207	0038	-	One cell with known SFN in OTDOA assistance data	9.3.0	9.4.0
	RP-50	RP-101207	0039	1	UE frequency capability for LPP	9.3.0	9.4.0
	RP-50	RP-101207	0041	-	Correction to LPP reliable transport	9.3.0	9.4.0
	RP-50	RP-101207	0042	-	Correction to LPP Error procedure	9.3.0	9.4.0
	RP-50	RP-101207	0043	-	Addition of missing reference to LPPe	9.3.0	9.4.0
	RP-50	RP-101207	0044	2	Correction to the OTDOA assistance data	9.3.0	9.4.0
	RP-50	RP-101226	0040	-	Update of 'serving cell' terminology in 36.355	9.3.0	10.0.0
2011-03	RP-51	RP-110269	0046	-	Editorial corrections to 36.355	10.0.0	10.1.0
	RP-51	RP-110269	0048	-	Removal of FFS for retransmission timer in LPP	10.0.0	10.1.0
	RP-51	RP-110269	0050	-	Correction to code phase encoding in GNSS acquisition assistance	10.0.0	10.1.0
	RP-51	RP-110269	0052	1	Clarification on SFN provided with OTDOA measurement	10.0.0	10.1.0
	RP-51	RP-110269	0053	1	Introduction of OTDOA inter-freq RSTD measurement indication procedure	10.0.0	10.1.0
	RP-51	RP-110269	0057	-	Small corrections in 36.355	10.0.0	10.1.0
	RP-51	RP-110269	0058	3	Further corrections to the OTDOA assistance data	10.0.0	10.1.0
2011-06	RP-52	RP-110830	0060	-	Clarifications to description of OTDOA positioning fields	10.1.0	10.2.0
2011-09	RP-53	RP-111279	0062	1	Various corrections to LPP	10.2.0	10.3.0
	RP-53	RP-111279	0064	-	Mandatory support of PRS for OTDOA measurements	10.2.0	10.3.0
2011-12	RP-54	RP-111709	0066	-	Clarification of packed encoding rules of LPP	10.3.0	10.4.0
	RP-54	RP-111709	0068	-	Clarification of first bit in BIT STRING definitions	10.3.0	10.4.0
2012-06	RP-56	RP-120808	0071	-	Usage of additionalInformation IE	10.4.0	10.5.0

2012-09	RP-57	RP-121424	0074	2	Corrections to GNSS Acquisition Assistance Data	10.5.0	10.6.0
	RP-57	-	-	-	Upgrade to the Release 11 - no technical change	10.6.0	11.0.0
2012-12	RP-58	RP-121931	0077	-	Correcting the referencing of QoS parameters	11.0.0	11.1.0
	RP-58	RP-121931	0080	-	Correction to missing field description in GNSS-AcquisitionAssistance IE	11.0.0	11.1.0
2013-03	RP-59	RP-130237	0083	1	Extending E-UTRA Frequency Band and EARFCN value range	11.1.0	11.2.0
	RP-59	RP-130230	0086	-	Correction to PRS Muting Configuration	11.1.0	11.2.0
2013-06	RP-60	RP-130803	0088	-	Correction for ASN.1 errors from CR0083r1	11.2.0	11.3.0
	RP-60	RP-130803	0091	-	Correction to integer code phase field description in GNSS Acquisition Assistance	11.2.0	11.3.0
	RP-60	RP-130803	0093	-	Correction to serving cell terminology	11.2.0	11.3.0
	RP-60	RP-130803	0094	-	Encoding of LPP IEs	11.2.0	11.3.0
2013-09	RP-61	RP-131314	0098	-	Correction on svReqList	11.3.0	11.4.0
2013-12	RP-62	RP-131984	0103	-	Correction to missing capability indication for inter-frequency RSTD measurements	11.4.0	11.5.0
	RP-62	RP-131984	0107	1	Correction to Galileo assistance data elements	11.4.0	11.5.0
	RP-62	RP-132000	0104	1	Stage 3 CR of TS 36.355 for introducing BDS in LTE	11.4.0	12.0.0
	RP-62	RP-131984	0108	-	Correction to Galileo assistance data elements	11.4.0	12.0.0
2014-03	RP-63	RP-140342	0112	1	Clarification to gnss-DayNumber	12.0.0	12.1.0
2014-06	RP-64	RP-140871	0119	-	Signaling of OTDOA Neighbour Cell Information and Measurements	12.1.0	12.2.0
2014-12	RP-66	RP-142114	0122	-	Correction to Galileo Assistance Data	12.2.0	12.3.0
	RP-66	RP-142114	0123	-	Addition of an Early Position Fix to LPP	12.2.0	12.3.0
	RP-66	RP-142120	0124	-	BDS update to version 2.0	12.2.0	12.3.0
2015-03	RP-67	RP-150369	0126	2	Correction of GLONASS system time	12.3.0	12.4.0
	RP-67	RP-150376	0125	1	LPP clean-up	12.3.0	12.4.0
2015-12	RP-70	RP-152055	0134	1	Correction to the definition of Need codes	12.4.0	12.5.0
2015-12	RP-70	RP-152068	0137	3	RAT-Independent positioning enhancements	12.5.0	13.0.0
2016-03	RP-71	RP-160463	0138	1	Correction to GLONASS IOD value range	13.0.0	13.1.0
	RP-71	RP-160470	0140	1	r13 Information Element correction	13.0.0	13.1.0
	RP-71	RP-160470	0141	-	WLAN AP Identifier correction	13.0.0	13.1.0
	RP-71	RP-160470	0142	1	LPP clean-up	13.0.0	13.1.0
2016-09	RP-73	RP-161750	0143	4	Correction of ECID positioning for TDD	13.1.0	13.2.0

History

Document history		
V13.0.0	January 2016	Publication
V13.1.0	April 2016	Publication
V13.2.0	October 2016	Publication