

ETSI TS 136 305 V15.0.0 (2018-07)



**LTE;
Evolved Universal Terrestrial
Radio Access Network (E-UTRAN);
Stage 2 functional specification of User Equipment (UE)
positioning in E-UTRAN
(3GPP TS 36.305 version 15.0.0 Release 15)**



ReferenceRTS/TSGR-0236305vf00

KeywordsLTE

ETSI

650 Route des Lucioles
F-06921 Sophia Antipolis Cedex - FRANCE

Tel.: +33 4 92 94 42 00 Fax: +33 4 93 65 47 16

Siret N° 348 623 562 00017 - NAF 742 C
Association à but non lucratif enregistrée à la
Sous-Préfecture de Grasse (06) N° 7803/88

Important notice

The present document can be downloaded from:

<http://www.etsi.org/standards-search>

The present document may be made available in electronic versions and/or in print. The content of any electronic and/or print versions of the present document shall not be modified without the prior written authorization of ETSI. In case of any existing or perceived difference in contents between such versions and/or in print, the only prevailing document is the print of the Portable Document Format (PDF) version kept on a specific network drive within ETSI Secretariat.

Users of the present document should be aware that the document may be subject to revision or change of status.

Information on the current status of this and other ETSI documents is available at

<https://portal.etsi.org/TB/ETSIDeliverableStatus.aspx>

If you find errors in the present document, please send your comment to one of the following services:

<https://portal.etsi.org/People/CommiteeSupportStaff.aspx>

Copyright Notification

No part may be reproduced or utilized in any form or by any means, electronic or mechanical, including photocopying and microfilm except as authorized by written permission of ETSI.

The content of the PDF version shall not be modified without the written authorization of ETSI.

The copyright and the foregoing restriction extend to reproduction in all media.

© ETSI 2018.

All rights reserved.

DECT™, **PLUGTESTS™**, **UMTS™** and the ETSI logo are trademarks of ETSI registered for the benefit of its Members.

3GPP™ and **LTE™** are trademarks of ETSI registered for the benefit of its Members and of the 3GPP Organizational Partners.

oneM2M logo is protected for the benefit of its Members.

GSM® and the GSM logo are trademarks registered and owned by the GSM Association.

Intellectual Property Rights

Essential patents

IPRs essential or potentially essential to normative deliverables may have been declared to ETSI. The information pertaining to these essential IPRs, if any, is publicly available for **ETSI members and non-members**, and can be found in ETSI SR 000 314: *"Intellectual Property Rights (IPRs); Essential, or potentially Essential, IPRs notified to ETSI in respect of ETSI standards"*, which is available from the ETSI Secretariat. Latest updates are available on the ETSI Web server (<https://ipr.etsi.org/>).

Pursuant to the ETSI IPR Policy, no investigation, including IPR searches, has been carried out by ETSI. No guarantee can be given as to the existence of other IPRs not referenced in ETSI SR 000 314 (or the updates on the ETSI Web server) which are, or may be, or may become, essential to the present document.

Trademarks

The present document may include trademarks and/or tradenames which are asserted and/or registered by their owners. ETSI claims no ownership of these except for any which are indicated as being the property of ETSI, and conveys no right to use or reproduce any trademark and/or tradename. Mention of those trademarks in the present document does not constitute an endorsement by ETSI of products, services or organizations associated with those trademarks.

Foreword

This Technical Specification (TS) has been produced by ETSI 3rd Generation Partnership Project (3GPP).

The present document may refer to technical specifications or reports using their 3GPP identities, UMTS identities or GSM identities. These should be interpreted as being references to the corresponding ETSI deliverables.

The cross reference between GSM, UMTS, 3GPP and ETSI identities can be found under <http://webapp.etsi.org/key/queryform.asp>.

Modal verbs terminology

In the present document "**shall**", "**shall not**", "**should**", "**should not**", "**may**", "**need not**", "**will**", "**will not**", "**can**" and "**cannot**" are to be interpreted as described in clause 3.2 of the [ETSI Drafting Rules](#) (Verbal forms for the expression of provisions).

"**must**" and "**must not**" are **NOT** allowed in ETSI deliverables except when used in direct citation.

Contents

Intellectual Property Rights	2
Foreword.....	2
Modal verbs terminology.....	2
Foreword.....	8
1 Scope	9
2 References	9
3 Definitions and abbreviations.....	10
3.1 Definitions	10
3.2 Abbreviations	11
4 Main concepts and requirements.....	12
4.1 Assumptions and Generalities	12
4.2 Role of UE Positioning Methods.....	13
4.3 Standard UE Positioning Methods	13
4.3.1 Network-assisted GNSS Methods.....	14
4.3.2 Downlink positioning	14
4.3.3 Enhanced Cell ID Methods.....	15
4.3.4 Uplink positioning	15
4.3.5 Barometric pressure sensor positioning	15
4.3.6 WLAN positioning	15
4.3.7 Bluetooth positioning.....	15
4.3.8 TBS positioning	15
5 E-UTRAN UE Positioning Architecture.....	16
5.1 UE Positioning Operations	16
5.2 E-UTRAN Positioning Operations.....	18
5.2.1 Downlink Position Method Support	18
5.2.2 Uplink Position Method Support	18
5.3 Functional Description of Elements Related to UE Positioning in E-UTRAN	18
5.3.1 User Equipment (UE)	18
5.3.2 eNode B	18
5.3.3 Evolved Serving Mobile Location Centre (E-SMLC)	19
5.3.4 Location Measurement Unit (LMU).....	19
6 Signalling protocols and interfaces	19
6.1 Network interfaces supporting positioning operations.....	19
6.1.1 General LCS control plane architecture.....	19
6.1.2 LTE-Uu interface.....	19
6.1.3 S1-MME interface	19
6.1.4 SLs interface	20
6.1.5 SLm interface.....	20
6.2 UE-terminated protocols	20
6.2.1 LTE Positioning Protocol (LPP).....	20
6.2.2 Radio Resource Control (RRC)	21
6.3 eNB-terminated protocols	21
6.3.1 LTE Positioning Protocol Annex (LPPa).....	21
6.3.2 S1 Application Protocol (S1-AP).....	21
6.4 Signalling between an E-SMLC and UE.....	21
6.4.1 Protocol Layering	21
6.4.2 LPP PDU Transfer	22
6.5 Signalling between an E-SMLC and eNode B	23
6.5.1 Protocol Layering	23
6.5.2 LPPa PDU Transfer for UE Positioning	23
6.5.3 LPPa PDU Transfer for Positioning Support	24
6.6 LMU-terminated protocols.....	25
6.6.1 SLm Application Protocol (SLmAP).....	25

6.7	Signalling between an E-SMLC and LMU	25
6.7.1	Protocol Layering	25
7	General E-UTRAN UE Positioning procedures	26
7.1	General LPP procedures for UE Positioning	26
7.1.1	LPP Procedures	26
7.1.2	Positioning procedures	26
7.1.2.1	Capability transfer	26
7.1.2.2	Assistance data transfer	27
7.1.2.3	Location information transfer	28
7.1.2.4	Multiple transactions	29
7.1.2.5	Sequence of Procedures	30
7.1.2.6	Error handling	30
7.1.2.7	Abort	30
7.1.3	UE positioning measurements in idle state for NB-IoT	31
7.2	General LPPa Procedures for UE Positioning	32
7.2.1	LPPa Procedures	32
7.2.2	LPPa transaction types	33
7.2.2.1	Location information transfer	33
7.3	Service Layer Support using combined LPP and LPPa Procedures	33
7.3.1	NI-LR and MT-LR Service Support	33
7.3.2	MO-LR Service Support	34
7.4	General SLmAP Procedures for UE Positioning	35
7.4.1	SLmAP Procedures	35
7.4.1.1	Measurement request	35
7.4.1.2	Measurement Update	35
7.4.1.3	Measurement Abort	36
7.5	Service Layer Support using combined SLmAP and LPPa Procedures	36
7.5.1	NI-LR and MT-LR Service Support	36
7.5.2	MO-LR Service Support	37
8	Positioning methods and Supporting Procedures	38
8.1	GNSS positioning methods	38
8.1.1	General	38
8.1.2	Information to be transferred between E-UTRAN Elements	39
8.1.2.1	Information that may be transferred from the E-SMLC to UE	39
8.1.2.1.1	Reference Time	39
8.1.2.1.2	Reference Location	40
8.1.2.1.3	Ionospheric Models	40
8.1.2.1.4	Earth Orientation Parameters	40
8.1.2.1.5	GNSS-GNSS Time Offsets	40
8.1.2.1.6	Differential GNSS Corrections	40
8.1.2.1.7	Ephemeris and Clock Models	40
8.1.2.1.8	Real-Time Integrity	40
8.1.2.1.9	Data Bit Assistance	40
8.1.2.1.10	Acquisition Assistance	40
8.1.2.1.11	Almanac	40
8.1.2.1.12	UTC Models	40
8.1.2.1.13	RTK Reference Station Information	41
8.1.2.1.14	RTK Auxiliary Station Data	41
8.1.2.1.15	RTK Observations	41
8.1.2.1.16	RTK Common Observation Information	41
8.1.2.1.17	GLONASS RTK Bias Information	41
8.1.2.1.18	RTK MAC Correction Differences	41
8.1.2.1.19	RTK Residuals	41
8.1.2.1.20	RTK FKP Gradients	42
8.1.2.1.21	SSR Orbit Corrections	42
8.1.2.1.22	SSR Clock Corrections	42
8.1.2.1.23	SSR Code Bias	42
8.1.2.1a	Recommendations for grouping of assistance data to support different RTK service levels	42
8.1.2.2	Information that may be transferred from the UE to the E-SMLC	44
8.1.2.2.1	GNSS Measurement Information	44

8.1.2.2.1.1	UE-based mode	44
8.1.2.2.1.2	UE-assisted mode	45
8.1.2.2.2	Additional Non-GNSS Related Information	45
8.1.3	Assisted-GNSS Positioning Procedures	45
8.1.3.1	Capability Transfer Procedure	45
8.1.3.1.1	Void	45
8.1.3.2	Assistance Data Transfer Procedure	45
8.1.3.2.1	E-SMLC initiated Assistance Data Delivery	45
8.1.3.2.1a	E-SMLC initiated Periodic Assistance Data Delivery	46
8.1.3.2.2	UE initiated Assistance Data Transfer	46
8.1.3.2.2a	UE initiated Periodic Assistance Data Transfer	47
8.1.3.3	Location Information Transfer Procedure	48
8.1.3.3.1	E-SMLC initiated Location Information Transfer Procedure	48
8.1.3.3.2	UE-initiated Location Information Delivery Procedure	49
8.2	Downlink positioning method	49
8.2.1	General	49
8.2.2	Transferred information	49
8.2.2.1	Assistance Data that may be transferred from the E-SMLC to UE	49
8.2.2.2	Assistance Data that may be transferred from the eNodeB to E-SMLC	49
8.2.2.3	Location Information that may be transferred from the UE to E-SMLC	50
8.2.3	Downlink Positioning Procedures	50
8.2.3.1	Capability Transfer Procedure	50
8.2.3.1.1	Void	50
8.2.3.2	Assistance Data Transfer Procedure	50
8.2.3.2.1	Assistance Data Transfer between E-SMLC and UE	50
8.2.3.2.1.1	E-SMLC-initiated assistance data delivery	50
8.2.3.2.1.2	UE-initiated assistance data transfer	51
8.2.3.2.2	Assistance Data Delivery between E-SMLC and eNodeB	51
8.2.3.2.2.1	Void	51
8.2.3.2.2.2	E-SMLC-initiated assistance data delivery to the E-SMLC	51
8.2.3.3	Location Information Transfer Procedure	52
8.2.3.3.1	E-SMLC-initiated Location Information Transfer	52
8.2.3.3.2	UE-initiated Location Information Delivery procedure	52
8.3	Enhanced cell ID positioning methods	53
8.3.1	General	53
8.3.2	Information to be transferred between E-UTRAN Elements	53
8.3.2.1	Information that may be transferred from the E-SMLC to UE	53
8.3.2.2	Information that may be transferred from the UE to E-SMLC	54
8.3.2.3	Information that may be transferred from the eNodeB to E-SMLC	54
8.3.3	Downlink E-CID Positioning Procedures	54
8.3.3.1	Capability Transfer Procedure	54
8.3.3.1.1	Void	54
8.3.3.2	Assistance Data Delivery Procedure	54
8.3.3.3	Location Information Transfer Procedure	55
8.3.3.3.1	E-SMLC-initiated Location Information Transfer	55
8.3.3.3.2	UE-initiated Location Information Delivery procedure	55
8.3.4	Uplink E-CID Positioning Procedures	55
8.3.4.1	Position Capability Transfer Procedure	56
8.3.4.2	Assistance Data Delivery Procedure	56
8.3.4.3	Position Measurement Procedure	56
8.3.4.3.1	E-SMLC-initiated Position Measurement	56
8.4	Downlink Supporting Procedures	57
8.4.1	General	57
8.4.2	Location Related Information	57
8.4.3	Location Related Information Acquisition Procedure	57
8.4.3.1	On Demand Procedure	57
8.4.3.2	Triggered Procedure	57
8.5	Uplink positioning method	58
8.5.1	General	58
8.5.2	Transferred information	58
8.5.2.1	Configuration Data that may be transferred from the eNodeB to the E-SMLC	58
8.5.2.2	Configuration Data that may be transferred from the E-SMLC to LMU	59

8.5.2.3	Location Information that may be transferred from the LMU to E-SMLC.....	59
8.5.3	Uplink Positioning Procedures	60
8.5.3.1	Uplink Information Request and Delivery Procedure	60
8.5.3.2	Uplink Positioning Information Update Procedure	61
8.6	Barometric pressure sensor positioning methods	61
8.6.1	General.....	61
8.6.2	Information to be transferred between E-UTRAN Elements.....	61
8.6.2.1	Information that may be transferred from the UE to E-SMLC	62
8.6.2.1.1	Standalone mode	62
8.6.2.1.2	UE-assisted mode	62
8.6.2.1.3	UE-based mode	62
8.6.2.2	Information that may be transferred from the E-SMLC to UE	62
8.6.2.2.1	Barometric pressure sensor assistance data	62
8.6.3	Barometric Pressure Sensor Location Information Transfer Procedures.....	62
8.6.3.1	E-SMLC initiated Location Information Transfer Procedure	63
8.6.3.2	UE-initiated Location Information Delivery Procedure.....	63
8.6.3.3	Assistance Data Transfer Procedure.....	63
8.6.3.3.1	E-SMLC initiated Assistance Data Delivery	63
8.6.3.3.2	UE initiated Assistance Data Transfer.....	64
8.7	WLAN positioning methods.....	64
8.7.1	General.....	64
8.7.2	Information to be transferred between E-UTRAN Elements.....	65
8.7.2.1	Information that may be transferred from the UE to E-SMLC	65
8.7.2.1.1	Standalone mode	65
8.7.2.1.2	UE-assisted mode	65
8.7.2.1.3	UE-based mode	66
8.7.2.2	Information that may be transferred from the E-SMLC to UE	66
8.7.2.2.1	WLAN AP BSSID.....	66
8.7.2.2.2	WLAN AP SSID	66
8.7.2.2.3	WLAN AP Type Data	66
8.7.2.2.4	WLAN AP Location.....	66
8.7.3	WLAN Positioning Procedures.....	66
8.7.3.1	Location Information Transfer Procedure	66
8.7.3.1.1	E-SMLC initiated Location Information Transfer Procedure.....	66
8.7.3.1.2	UE-initiated Location Information Delivery Procedure	67
8.7.3.2	Assistance Data Transfer Procedure.....	67
8.7.3.2.1	UE initiated Assistance Data Transfer.....	67
8.8	Bluetooth positioning methods.....	68
8.8.1	General.....	68
8.8.2	Information to be transferred between E-UTRAN Elements.....	68
8.8.2.1	Information that may be transferred from the UE to E-SMLC	68
8.8.2.1.1	Standalone mode	69
8.8.2.1.2	UE-assisted mode	69
8.8.3	Bluetooth Positioning Procedures.....	69
8.8.3.1	Location Information Transfer Procedure	69
8.8.3.1.1	E-SMLC initiated Location Information Transfer Procedure.....	69
8.8.3.1.2	UE-initiated Location Information Delivery Procedure	70
8.9	TBS positioning methods	70
8.9.1	General.....	70
8.9.2	Information to be transferred between E-UTRAN Elements.....	70
8.9.2.1	Information that may be transferred from the UE to E-SMLC	70
8.9.2.1.1	Standalone mode	71
8.9.2.1.2	UE-assisted mode	71
8.9.2.1.3	UE-based mode	71
8.9.2.2	Information that may be transferred from the E-SMLC to UE	71
8.9.2.2.1	Acquisition Assistance	71
8.9.2.2.2	Almanac.....	71
8.9.3	TBS Positioning Procedures	71
8.9.3.1	Location Information Transfer Procedure	71
8.9.3.1.1	E-SMLC initiated Location Information Transfer Procedure.....	72
8.9.3.1.2	UE-initiated Location Information Delivery Procedure	72
8.9.3.2	Assistance Data Transfer Procedure.....	72

8.9.3.2.1	E-SMLC initiated Assistance Data Delivery	72
8.9.3.2.2	UE initiated Assistance Data Transfer.....	73
Annex A (informative):	Definitions and Terms	74
Annex B (informative):	Use of LPP with SUPL.....	75
B.1	SUPL 2.0 Positioning Methods and Positioning Protocols	75
B.2	SUPL 2.0 and LTE Architecture	76
B.3	LPP session procedures using SUPL.....	77
B.4	Procedures combining C-plane and U-plane operations	78
Annex C (informative):	Change history	80
History		81

Foreword

This Technical Specification has been produced by the 3rd Generation Partnership Project (3GPP).

The contents of the present document are subject to continuing work within the TSG and may change following formal TSG approval. Should the TSG modify the contents of the present document, it will be re-released by the TSG with an identifying change of release date and an increase in version number as follows:

Version x.y.z

where:

- x the first digit:
 - 1 presented to TSG for information;
 - 2 presented to TSG for approval;
 - 3 or greater indicates TSG approved document under change control.
- y the second digit is incremented for all changes of substance, i.e. technical enhancements, corrections, updates, etc.
- z the third digit is incremented when editorial only changes have been incorporated in the document.

1 Scope

The present document specifies the stage 2 of the UE Positioning function of E-UTRAN, which provides the mechanisms to support or assist the calculation of the geographical position of a UE. UE position knowledge can be used, for example, in support of Radio Resource Management functions, as well as location-based services for operators, subscribers, and third-party service providers. The purpose of this stage 2 specification is to define the E-UTRAN UE Positioning architecture, functional entities and operations to support positioning methods. This description is confined to the E-UTRAN Access Stratum. It does not define or describe how the results of the UE position calculation can be utilised in the Core Network (e.g., LCS) or in E-UTRAN (e.g., RRM).

UE Positioning may be considered as a network-provided enabling technology consisting of standardised service capabilities that enable the provision of location applications. The application(s) may be service provider specific. The description of the numerous and varied possible location applications which are enabled by this technology is outside the scope of the present document. However, clarifying examples of how the functionality being described may be used to provide specific location services may be included.

This stage 2 specification covers the E-UTRAN positioning methods, state descriptions, and message flows to support UE Positioning.

2 References

The following documents contain provisions which, through reference in this text, constitute provisions of the present document.

- References are either specific (identified by date of publication, edition number, version number, etc.) or non-specific.
- For a specific reference, subsequent revisions do not apply.
- For a non-specific reference, the latest version applies. In the case of a reference to a 3GPP document (including a GSM document), a non-specific reference implicitly refers to the latest version of that document *in the same Release as the present document*.

- [1] 3GPP TR 21.905: "Vocabulary for 3GPP Specifications".
- [2] 3GPP TS 23.271: "Functional stage 2 description of Location Services (LCS)"
- [3] 3GPP TS 22.071: "Location Services (LCS); Service description, Stage 1".
- [4] 3GPP TS 23.032: "Universal Geographical Area Description (GAD)".
- [5] 3GPP TS 36.306: "Evolved Universal Terrestrial Radio Access (E-UTRA); "User Equipment (UE) radio access capabilities".
- [6] IS-GPS-200, Revision D, Navstar GPS Space Segment/Navigation User Interfaces, March 7th, 2006.
- [7] IS-GPS-705, Navstar GPS Space Segment/User Segment L5 Interfaces, September 22, 2005.
- [8] IS-GPS-800, Navstar GPS Space Segment/User Segment L1C Interfaces, September 4, 2008.
- [9] Galileo OS Signal in Space ICD (OS SIS ICD), Draft 0, Galileo Joint Undertaking, May 23rd, 2006.
- [10] Global Navigation Satellite System GLONASS Interface Control Document, Version 5, 2002.
- [11] IS-QZSS, Quasi Zenith Satellite System Navigation Service Interface Specifications for QZSS, Ver.1.0, June 17, 2008.
- [12] Specification for the Wide Area Augmentation System (WAAS), US Department of Transportation, Federal Aviation Administration, DTFA01-96-C-00025, 2001.
- [13] RTCM 10402.3, RTCM Recommended Standards for Differential GNSS Service (v.2.3), August 20, 2001.

- [14] 3GPP TS 36.331: "Evolved Universal Terrestrial Radio Access (E-UTRA); "Radio Resource Control (RRC); Protocol specification".
- [15] 3GPP TS 25.331: " Radio Resource Control (RRC); Protocol Specification".
- [16] 3GPP TS 44.031: "Location Services (LCS); Mobile Station (MS) - Serving Mobile Location Centre (SMLC) Radio Resource LCS Protocol (RRLP)".
- [17] OMA-AD-SUPL-V2_0: "Secure User Plane Location Architecture Approved Version 2.0".
- [18] OMA-TS-ULP-V2_0_3: "UserPlane Location Protocol Approved Version 2.0.3".
- [19] 3GPP TS 23.401: "General Packet Radio Service (GPRS) enhancements for Evolved Universal Terrestrial Radio Access Network (E-UTRAN) access".
- [20] 3GPP TS 36.214: "Evolved Universal Terrestrial Radio Access (E-UTRA); "Physical layer – Measurements".
- [21] 3GPP TS 36.302: "Evolved Universal Terrestrial Radio Access (E-UTRA); "Services provided by the physical layer ".
- [22] 3GPP TS 25.305: "Stage 2 functional specification of User Equipment (UE) positioning in UTRAN".
- [23] 3GPP TS 43.059: "Functional stage 2 description of Location Services in GERAN".
- [24] 3GPP TR 23.891: "Evaluation of LCS Control Plane Solutions for EPS".
- [25] 3GPP TS 36.355: "Evolved Universal Terrestrial Radio Access (E-UTRA); LTE Positioning Protocol (LPP)".
- [26] 3GPP TS 24.171: "Control Plane Location Services (LCS) procedures in the Evolved Packet System (EPS)".
- [27] 3GPP TS 29.171: "Location Services (LCS); LCS Application Protocol (LCS-AP) between the Mobile Management Entity (MME) and Evolved Serving Mobile Location Centre (E-SMLC); SLs interface".
- [28] BDS-SIS-ICD-2.0: "BeiDou Navigation Satellite System Signal In Space Interface Control Document Open Service Signal (Version 2.0)", December 2013.
- [29] IEEE 802.11: "Wireless LAN Medium Access Control (MAC) and Physical Layer (PHY) Specifications".
- [30] Bluetooth Special Interest Group: "Bluetooth Core Specification v4.2", December 2014.
- [31] ATIS-0500027: "Recommendations for Establishing Wide Scale Indoor Location Performance", May 2015.
- [32] 3GPP TS 36.211: "Evolved Universal Terrestrial Radio Access (E-UTRA); Physical channels and modulation".
- [33] RTCM 10403.3, RTCM Recommended Standards for Differential GNSS Services (v.3.3), October 7, 2016.

3 Definitions and abbreviations

3.1 Definitions

For the purposes of the present document, the terms and definitions given in [1] apply.

As used in this document, the suffixes "-based" and "-assisted" refer respectively to the node that is responsible for making the positioning calculation (and which may also provide measurements) and a node that provides measurements (but which does not make the positioning calculation). Thus, an operation in which measurements are provided by the

UE to the E-SMLC to be used in the computation of a position estimate is described as "UE-assisted" (and could also be called "E-SMLC-based"), while one in which the UE computes its own position is described as "UE-based".

Both standalone LMU and LMU integrated into an eNB are supported. As used in this document, LMU refers to both cases of a standalone LMU and an LMU integrated into an eNodeB unless explicitly mentioned otherwise.

State Space Representation (SSR): The state space representation provides information on the status of individual GNSS error sources. State parameter values are transmitted to UE. The user corrects his own observations of a single GNSS receiver with SSR corrections computed from these state parameters for his individual position, and performs RTK positioning with corrected observations. This contrasts with Observation Space Representation (OSR) which uses a lump-sum of distance-dependent GNSS errors instead of individual GNSS error sources. For OSR the representation of RTK network corrections in the observation space always uses GNSS observation of an actual reference station, which are then applied by the user to the conventional RTK algorithm.

Transmission Point (TP): A set of geographically co-located transmit antennas for one cell, part of one cell or one PRS-only TP. Transmission Points can include base station (eNode B) antennas, remote radio heads, a remote antenna of a base station, an antenna of a PRS-only TP, etc. One cell can be formed by one or multiple transmission points. For a homogeneous deployment, each transmission point may correspond to one cell.

PRS-only TP: A TP which only transmits PRS signals for PRS-based TBS positioning and is not associated with a cell.

3.2 Abbreviations

For the purposes of the present document, the following abbreviations apply.

ADR	Accumulated Delta Range
AoA	Angle of Arrival
AP	Access Point
ARP	Antenna Reference Point
BDS	BeiDou Navigation Satellite System
BSSID	Basic Service Set Identifier
CID	Cell-ID (positioning method)
CIoT	Cellular IoT
E-SMLC	Enhanced Serving Mobile Location Centre
E-CID	Enhanced Cell-ID (positioning method)
ECEF	Earth-Centered, Earth-Fixed
ECI	Earth-Centered-Inertial
EGNOS	European Geostationary Navigation Overlay Service
E-UTRAN	Evolved Universal Terrestrial Radio Access Network
FDMA	Frequency Division Multiple Access
FKP	Flächenkorrekturparameter (Engl: Area Correction Parameters)
GAGAN	GPS Aided Geo Augmented Navigation
GLONASS	GLObal'naya NAVigatsionnaya Sputnikovaya Sistema (Engl.: Global Navigation Satellite System)
GMLC	Gateway Mobile Location Center
GNSS	Global Navigation Satellite System
GPS	Global Positioning System
GRS80	Geodetic Reference System 1980
HESSID	Homogeneous Extended Service Set Identifier
IoT	Internet of Things
LCS	LoCation Services
LCS-AP	LCS Application Protocol
LMU	Location Measurement Unit
LPP	LTE Positioning Protocol
LPPa	LTE Positioning Protocol Annex
MAC	Master Auxiliary Concept
MBS	Metropolitan Beacon System
MO-LR	Mobile Originated Location Request
MT-LR	Mobile Terminated Location Request
NB-IoT	NarrowBand Internet of Things
NI-LR	Network Induced Location Request
N-RTK	Network – Real-Time Kinematic
OTDOA	Observed Time Difference Of Arrival
PDU	Protocol Data Unit

PPP	Precise Point Positioning
PRS	Positioning Reference Signal
QZSS	Quasi-Zenith Satellite System
RRM	Radio Resource Management
RSSI	Received Signal Strength Indicator
RTK	Real-Time Kinematic
SBAS	Space Based Augmentation System
SET	SUPL Enabled Terminal
SLP	SUPL Location Platform
SSID	Service Set Identifier
SSR	State Space Representation
SUPL	Secure User Plane Location
T _{ADV}	Timing Advance
TBS	Terrestrial Beacon System
TP	Transmission Point
UE	User Equipment
UTDOA	Uplink Time Difference of Arrival
WAAS	Wide Area Augmentation System
WGS-84	World Geodetic System 1984
WLAN	Wireless Local Area Network

4 Main concepts and requirements

4.1 Assumptions and Generalities

The stage 1 description of LCS at the service level is provided in [3]; the stage 2 LCS functional description, including the LCS system architecture and message flows, is provided in [2].

Positioning functionality provides a means to determine the geographic position and/or velocity of the UE based on measuring radio signals. The position information may be requested by and reported to a client (e.g., an application) associated with the UE, or by a client within or attached to the core network. The position information shall be reported in standard formats, such as those for cell-based or geographical co-ordinates, together with the estimated errors (uncertainty) of the position and velocity of the UE and, if available, the positioning method (or the list of the methods) used to obtain the position estimate.

Restrictions on the geographic shape encoded within the 'position information' parameter may exist for certain LCS client types. The EPS, including E-UTRAN, shall comply with any shape restrictions defined in LTE and, in a particular country, with any shape restrictions defined for a specific LCS client type in relevant national standards. For example, in the US, national standard J-STD-036-B restricts the geographic shape for an emergency services LCS client to minimally either an "ellipsoid point" or an "ellipsoid point with uncertainty circle and confidence" as defined in [4].

It shall be possible for the majority of the UEs (active or inactive) within a network to use the LCS feature without compromising the radio transmission or signalling capabilities of the E-UTRAN.

The uncertainty of the position measurement shall be network-implementation-dependent, at the choice of the network operator. The uncertainty may vary between networks as well as from one area within a network to another. The uncertainty may be hundreds of metres in some areas and only a few metres in others. In the event that a particular position measurement is provided through a UE-assisted process, the uncertainty may also depend on the capabilities of the UE. In some jurisdictions, there is a regulatory requirement for location service accuracy that is part of an emergency service. Further details of the accuracy requirements can be found in [3].

The uncertainty of the position information is dependent on the method used, the position of the UE within the coverage area and the activity of the UE. Several design options of the E-UTRAN system (e.g., size of cell, adaptive antenna technique, pathloss estimation, timing accuracy, eNode B surveys) shall allow the network operator to choose a suitable and cost-effective UE positioning method for their market.

There are many different possible uses for the positioning information. The positioning functions may be used internally by the EPS, by value-added network services, by the UE itself or through the network, and by "third party" services. The feature may also be used by an emergency service (which may be mandated or "value-added"), but the location service is not exclusively for emergencies.

The E-UTRAN is a new radio system design without a pre-existing deployment of "legacy" UEs operating according to the radio interface. This freedom from legacy equipment enables the location service feature design to make use of appropriate techniques to provide the most accurate results. The technique must also be a cost-effective total solution, must allow evolution to meet evolving service requirements, and must be able to take advantage of advances in technology over the lifetime of E-UTRAN deployments.

Design of the E-UTRAN positioning capability as documented in this specification includes position methods, protocols and procedures that are either adapted from capabilities already supported for UTRAN and GERAN, or created separately from first principles. The proportion of the latter is higher than if the UTRAN and GERAN capabilities had been designed to provide forward compatibility to other access types. In contrast to GERAN and UTRAN, the E-UTRAN positioning capabilities are intended to be forward compatible to other access types and other position methods, in an effort to reduce the amount of additional positioning support needed in the future. This goal also extends to user plane location solutions such as OMA SUPL ([17], [18]), for which E-UTRAN positioning capabilities are intended to be compatible where appropriate.

As a basis for the operation of UE Positioning in E-UTRAN, the following assumptions apply:

- both TDD and FDD will be supported;
- the provision of the UE Positioning function in E-UTRAN and EPC is optional through support of the specified method(s) in the eNode B and the E-SMLC;
- UE Positioning is applicable to any target UE, whether or not the UE supports LCS, but with restrictions on the use of certain positioning methods depending on UE capability (as defined within the LPP protocol);
- the positioning information may be used for internal system operations to improve system performance;
- the UE Positioning architecture and functions shall include the option to accommodate several techniques of measurement and processing to ensure evolution to follow changing service requirements and to take advantage of advancing technology;
- LMU aspects are left for implementation and are not standardized in this release.

4.2 Role of UE Positioning Methods

The E-UTRAN may utilise one or more positioning methods in order to determine the position of an UE.

Positioning the UE involves two main steps:

- signal measurements; and
- Position estimate and optional velocity computation based on the measurements.

The signal measurements may be made by the UE or the eNode B. The basic signals measured for terrestrial position methods are typically the E-UTRA radio transmissions; however, other methods may make use of other transmissions such as general radio navigation signals including those from Global Navigation Satellites Systems (GNSSs).

The positioning function should not be limited to a single method or measurement. That is, it should be capable of utilising other standard methods and measurements, as such methods and measurements are available and appropriate, to meet the required service needs of the location service client. This additional information could consist of readily available E-UTRAN measurements.

The position estimate computation may be made by the UE or by the E-SMLC.

4.3 Standard UE Positioning Methods

The standard positioning methods supported for E-UTRAN access are:

- network-assisted GNSS methods;
- downlink positioning;
- enhanced cell ID method;
- uplink positioning;

- barometric pressure sensor method;
- WLAN method;
- Bluetooth method;
- Terrestrial Beacon System method.

Hybrid positioning using multiple methods from the list of positioning methods above is also supported.

Standalone mode (e.g. autonomous, without network assistance) using one or more methods from the list of positioning methods above is also supported.

These positioning methods may be supported in UE-based, UE-assisted/E-SMLC-based, eNB-assisted, and LMU-assisted/E-SMLC-based versions. Table 4.3-1 indicates which of these versions are supported in this version of the specification for the standardised positioning methods.

Table 4.3-1: Supported versions of UE positioning methods

Method	UE-based	UE-assisted, E-SMLC-based	eNB-assisted	LMU-assisted/ E-SMLC-based	SUPL
A-GNSS	Yes	Yes	No	No	Yes (UE-based and UE-assisted)
Downlink <small>Note 1</small>	No	Yes	No	No	Yes (UE-assisted)
E-CID	No	Yes	Yes	No	Yes (UE-assisted)
Uplink	No	No	No	Yes	No
Barometric	Yes	Yes	No	No	No
WLAN	Yes	Yes	No	No	Yes
Bluetooth	No	Yes	No	No	No
TBS <small>Note 2</small>	Yes	Yes	No	No	Yes (MBS)
NOTE 1: This includes TBS positioning based on PRS signals.					
NOTE 2: In this version of the specification only for TBS positioning based on MBS signals.					

Barometric pressure sensor, WLAN, Bluetooth, and TBS positioning methods based on MBS signals are also supported in standalone mode, as described in the corresponding sections.

4.3.1 Network-assisted GNSS Methods

These methods make use of UEs that are equipped with radio receivers capable of receiving GNSS signals.

Examples of GNSS include GPS, Modernized GPS, Galileo, GLONASS, Space Based Augmentation Systems (SBAS), Quasi Zenith Satellite System (QZSS), and BeiDou Navigation Satellite System (BDS).

In this concept, different GNSSs (e.g. GPS, Galileo, etc.) can be used separately or in combination to determine the location of a UE.

The operation of the network-assisted GNSS methods is described in clause 8.1.

4.3.2 Downlink positioning

The downlink (OTDOA) positioning method makes use of the measured timing of downlink signals received from multiple TPs at the UE. The UE measures the timing of the received signals using assistance data received from the positioning server, and the resulting measurements are used to locate the UE in relation to the neighbouring TPs.

The operation of the downlink positioning method is described in clause 8.2.

4.3.3 Enhanced Cell ID Methods

In the Cell ID (CID) positioning method, the position of an UE is estimated with the knowledge of its serving eNode B and cell. The information about the serving eNode B and cell may be obtained by paging, tracking area update, or other methods. Enhanced Cell ID (E-CID) positioning refers to techniques which use additional UE and/or E-UTRAN radio resource and other measurements to improve the UE location estimate.

Although E-CID positioning may utilise some of the same measurements as the measurement control system in the RRC protocol, the UE generally is not expected to make additional measurements for the sole purpose of positioning; i.e., the positioning procedures do not supply a measurement configuration or measurement control message, and the UE reports the measurements that it has available rather than being required to take additional measurement actions. For NB-IoT, when the UE goes to Idle state to perform positioning measurements, the UE may be required to take additional measurement actions, as specified in section 7.1.3.

In cases with a requirement for close time coupling between UE and eNode B measurements (e.g., TADV type 1 and UE Tx-Rx time difference), the eNode B configures the appropriate RRC measurements and is responsible for maintaining the required coupling between the measurements. The operation of the Enhanced Cell ID method is described in clause 8.3.

4.3.4 Uplink positioning

The uplink (e.g., UTDOA) positioning method makes use of the measured timing at multiple LMUs of uplink signals transmitted from UE. The LMU measures the timing of the received signals using assistance data received from the positioning server, and the resulting measurements are used to estimate the location of the UE.

The operation of the Uplink positioning method is described in clause 8.5.

4.3.5 Barometric pressure sensor positioning

The barometric pressure sensor method makes use of barometric sensors to determine the vertical component of the position of the UE. The UE measures barometric pressure, optionally aided by assistance data, to calculate the vertical component of its location or to send measurements to the positioning server for position calculation.

This method should be combined with other positioning methods to determine the 3D position of the UE.

The operation of the Barometric pressure sensor positioning method is described in clause 8.6.

4.3.6 WLAN positioning

The WLAN positioning method makes use of the WLAN measurements (AP identifiers and optionally other measurements) and databases to determine the location of the UE. The UE measures received signals from WLAN [29] access points, optionally aided by assistance data, to send measurements to the positioning server for position calculation. Using the measurement results and a references database, the location of the UE is calculated.

Alternatively, the UE makes use of WLAN measurements and optionally WLAN AP assistance data provided by the positioning server, to determine its location.

The operation of the WLAN positioning method is described in clause 8.7.

4.3.7 Bluetooth positioning

The Bluetooth positioning method makes use of Bluetooth measurements (beacon identifiers and optionally other measurements) to determine the location of the UE. The UE measures received signals from Bluetooth [30] beacons. Using the measurement results and a references database, the location of the UE is calculated. The Bluetooth methods may be combined with other positioning methods (e.g. WLAN) to improve positioning accuracy of the UE.

The operation of the Bluetooth positioning method is described in clause 8.8.

4.3.8 TBS positioning

A Terrestrial Beacon System (TBS) consists of a network of ground-based transmitters, broadcasting signals only for positioning purposes. The current type of TBS positioning signals are the MBS (Metropolitan Beacon System) signals

[31] and Positioning Reference Signals (PRS) [32]. The UE measures received TBS signals, optionally aided by assistance data, to calculate its location or to send measurements to the positioning server for position calculation.

The operation of the TBS positioning method based on MBS signals is described in clause 8.9.

TBS positioning based on PRS signals is part of downlink (OTDOA) positioning and described in clause 8.2.

5 E-UTRAN UE Positioning Architecture

Figure 5-1 shows the architecture in EPS applicable to positioning of a UE with E-UTRAN access.

The MME receives a request for some location service associated with a particular target UE from another entity (e.g., GMLC or UE) or the MME itself decides to initiate some location service on behalf of a particular target UE (e.g., for an IMS emergency call from the UE) as described in [2]. The MME then sends a location services request to an E-SMLC. The E-SMLC processes the location services request which may include transferring assistance data to the target UE to assist with UE-based and/or UE-assisted positioning and/or may include positioning of the target UE. For the Uplink method, the E-SMLC processes the location services request which includes transferring configuration data to the selected LMU(s). The E-SMLC then returns the result of the location service back to the MME (e.g., a position estimate for the UE and/or an indication of any assistance data transferred to the UE). In the case of a location service requested by an entity other than the MME (e.g., UE or E-SMLC), the MME returns the location service result to this entity.

The SLP is the SUPL entity responsible for positioning over the user plane. Further details of the relationship of the user-plane positioning entities to the E-UTRAN control-plane positioning architecture are described in Annex B.

An eNodeB may control several TPs, such as remote radio heads, or PRS-only TPs for support of PRS-based TBS.

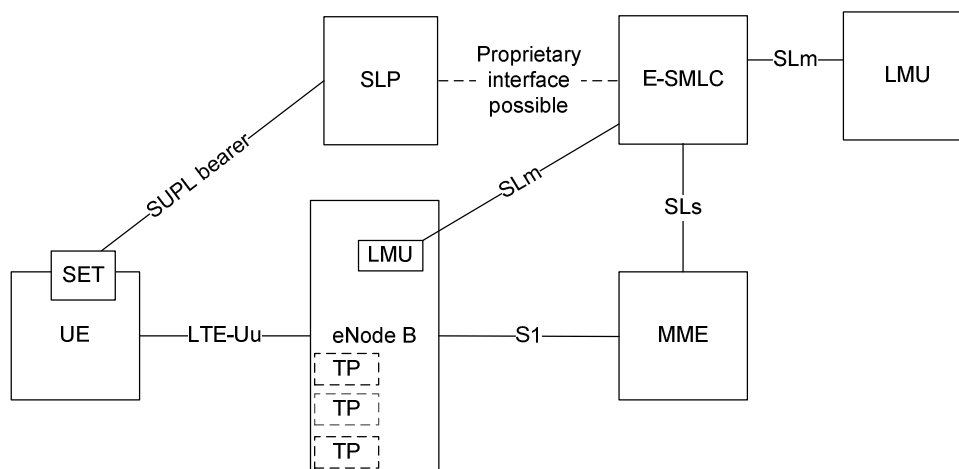

Figure 5-1: UE Positioning Architecture applicable to E-UTRAN

5.1 UE Positioning Operations

To support positioning of a target UE and delivery of location assistance data to a UE with E-UTRAN access in EPS, location related functions are distributed as shown in the architecture in Figure 5-1 and as clarified in greater detail in TS 23.271 [2]. The overall sequence of events applicable to the UE, E-UTRAN and E-SMLC for any location service is shown in Figure 5.1-1.

Note that when the MME receives Location Service Request in case of the UE is in ECM-IDLE state, the MME performs a network triggered service request as defined in TS 23.401 [19] in order to establish a signalling connection with the UE and assign a specific eNodeB. The UE is assumed to be in connected mode before the beginning of the flow shown in the Figure 5.1-1; that is, any signalling that might be required to bring the UE to connected mode prior to step 1a is not shown. The signaling connection may, however, be later released (e.g. by the eNodeB as a result of signaling and data inactivity) while positioning is still ongoing.

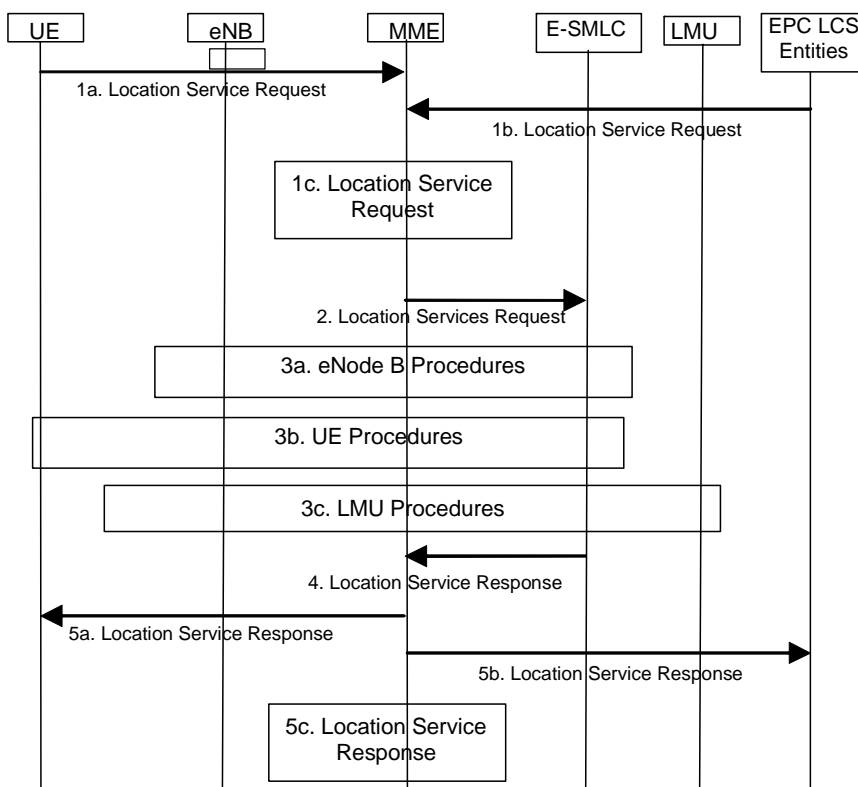

Figure 5.1-1: Location Service Support by E-UTRAN

- 1a. Either: the UE requests some location service (e.g. positioning or delivery of assistance data) to the serving MME at the NAS level.
- 1b. Or: some entity in the EPC (e.g. GMLC) requests some location service (e.g. positioning) for a target UE to the serving MME .
- 1c. Or: the serving MME for a target UE determines the need for some location service (e.g. to locate the UE for an emergency call).
2. The MME transfers the location service request to an E-SMLC.
- 3a. The E-SMLC instigates location procedures with the serving eNode B for the UE – e.g. to obtain positioning measurements or assistance data..
- 3b. In addition to step 3a or instead of step 3a, for downlink positioning the E-SMLC instigates location procedures with the UE – e.g. to obtain a location estimate or positioning measurements or to transfer location assistance data to the UE.
- 3c. For uplink positioning (e.g., UTDOA), in addition to performing step 3a, the E-SMLC instigates location procedures with multiple LMUs for the target UE – e.g. to obtain positioning measurements.
4. The E-SMLC provides a location service response to the MME and includes any needed results – e.g. success or failure indication and, if requested and obtained, a location estimate for the UE.
- 5a. If step 1a was performed, the MME returns a location service response to the UE and includes any needed results – e.g. a location estimate for the UE.
- 5b. If step 1b was performed, the MME returns a location service response to the EPC entity in step 1b and includes any needed results – e.g. a location estimate for the UE.
- 5c. If step 1c occurred, the MME uses the location service response received in step 4 to assist the service that triggered this in step 1c (e.g. may provide a location estimate associated with an emergency call to a GMLC).

Location procedures applicable to E-UTRAN occur in steps 3a, 3b and 3c in Figure 5.1-2 and are defined in greater detail in this specification. Steps 1a and 5a are also applicable to E-UTRAN support because of a capability to tunnel

signalling applicable to steps 3a and 3b. Other steps in Figure 5.1-2 are applicable only to the EPC and are described in greater detail and in TS 23.271 [2].

Steps 3a and 3b can involve the use of different position methods to obtain location related measurements for a target UE and from these compute a location estimate and possibly additional information like velocity. Positioning methods supported in this release are summarized in clause 4.3 and described in detail in clause 8.

The case that the eNode B functions as an LCS client is not supported in this version of the specification.

5.2 E-UTRAN Positioning Operations

Separately from location service support for particular UEs, an E-SMLC may interact with elements in the E-UTRAN in order to obtain measurement information to help assist one or more position methods for all UEs.

5.2.1 Downlink Position Method Support

An E-SMLC can interact with any eNodeB reachable from any of the MMEs with signaling access to the E-SMLC in order to obtain location related information to support the downlink position method, including PRS-based TBS. The information can include timing information for the TP in relation to either absolute GNSS time or timing of other TPs and information about the supported cells and TPs including PRS schedule.

Signalling access between the E-SMLC and eNodeB is via any MME with signalling access to both the E-SMLC and eNodeB.

5.2.2 Uplink Position Method Support

An E-SMLC can interact with the Serving eNodeB for the UE in order to retrieve target UE configuration information to support the uplink positioning method. The configuration information may include information required by the LMUs in order to obtain uplink time measurements; see clause 8.5.2. The E-SMLC can indicate to the serving eNodeB the need to direct the UE to transmit SRS signals (up to the maximum SRS bandwidth applicable for the carrier frequency) for uplink positioning. If the requested resources are not available, the eNB may assign other resources (or no resources e.g. if none are available) and report the resource allocation to the E-SMLC.

The E-SMLC can also request multiple LMUs to perform uplink time measurements and report the results.

5.3 Functional Description of Elements Related to UE Positioning in E-UTRAN

5.3.1 User Equipment (UE)

The UE may transmit the needed signals for uplink-based UE Positioning measurements and may make measurements of downlink signals from E-UTRAN and other sources such as different GNSS and TBS systems, WLAN access points, Bluetooth beacons, and UE barometric sensors. The measurements to be made will be determined by the chosen positioning method.

The UE may also contain LCS applications, or access an LCS application either through communication with a network accessed by the UE or through another application residing in the UE. This LCS application may include the needed measurement and calculation functions to determine the UE's position with or without network assistance. This is outside of the scope of this specification.

The UE may also, for example, contain an independent positioning function (e.g., GPS) and thus be able to report its position, independent of the E-UTRAN transmissions. The UE with an independent positioning function may also make use of assistance information obtained from the network.

5.3.2 eNode B

The eNode B is a network element of E-UTRAN that may provide measurement results for position estimation and makes measurements of radio signals for a target UE and communicates these measurements to an E-SMLC.

The eNode B makes its measurements in response to requests from the E-SMLC (on demand or periodically).

The eNode B may configure the target UE to transmit periodic SRS with multiple transmissions (see 5.2.2) during uplink positioning.

An eNode B may serve several TPs, including for example remote radio heads and PRS-only TPs for PRS-based TBS positioning.

5.3.3 Evolved Serving Mobile Location Centre (E-SMLC)

The E-SMLC manages the support of different location services for target UEs, including positioning of UEs and delivery of assistance data to UEs. The E-SMLC may interact with the serving eNode B for a target UE in order to obtain position measurements for the UE, including uplink measurements made by the eNode B and downlink measurements made by the UE that were provided to the eNode B as part of other functions such as for support of handover. The E-SMLC may also interact with the serving eNode B to indicate to the serving eNode B the need to direct the UE to transmit SRS (see 5.2.2) signals to enable the uplink positioning method and to acquire the target UE configuration data needed by the LMUs to calculate the timing of these signals.

The E-SMLC will select a set of LMUs to be used for the UTDOA positioning. The E-SMLC interacts with the selected LMUs to request timing measurements.

The E-SMLC may interact with a target UE in order to deliver assistance data if requested for a particular location service, or to obtain a location estimate if that was requested.

For positioning of a target UE, the E-SMLC decides on the position methods to be used, based on factors that may include the LCS Client type, the required QoS, UE positioning capabilities, and eNode B positioning capabilities. The E-SMLC then invokes these positioning methods in the UE and/or serving eNode B. The positioning methods may yield a location estimate for UE-based position methods and/or positioning measurements for UE-assisted and network-based position methods. The E-SMLC may combine all the received results and determine a single location estimate for the target UE (hybrid positioning). Additional information like accuracy of the location estimate and velocity may also be determined.

5.3.4 Location Measurement Unit (LMU)

The Location Measurement Unit (LMU) makes measurements and communicates these measurements to an E-SMLC. All positioning measurements obtained by an LMU are supplied to the E-SMLC that made the request.

A UE Positioning request may involve measurements by multiple LMUs.

6 Signalling protocols and interfaces

6.1 Network interfaces supporting positioning operations

6.1.1 General LCS control plane architecture

The general LCS control plane architecture in the EPS applicable to a target UE with E-UTRAN access is defined in [2].

6.1.2 LTE-Uu interface

The LTE-Uu interface, connecting the UE to the eNode B over the air, is used as one of several transport links for the LTE Positioning Protocol.

6.1.3 S1-MME interface

The S1-MME interface between the eNode B and the MME is transparent to all UE-positioning-related procedures. It is involved in these procedures only as a transport link for the LTE Positioning Protocol.

For eNode B related positioning procedures, the S1-MME interface transparently transports both positioning requests from the E-SMLC to the eNode B and positioning results from the eNode B to the E-SMLC.

6.1.4 SLs interface

The SLs interface, between the E-SMLC and the MME, is transparent to all UE related and eNode B related positioning procedures. It is then used only as a transport link for the LTE Positioning Protocols LPP and LPPa.

The SLs interface supports location sessions instigated by the MME as defined in [2]. LPP and LPPa transport are then supported as part of any location session.

6.1.5 SLm interface

The SLm interface between the E-SMLC and an LMU is used for uplink positioning. It is used to transport SLmAP protocol messages over the E-SMLC-LMU interface.

Network sharing should be supported. (Details FFS).

6.2 UE-terminated protocols

6.2.1 LTE Positioning Protocol (LPP)

The LTE Positioning Protocol (LPP) is terminated between a target device (the UE in the control-plane case or SET in the user-plane case) and a positioning server (the E-SMLC in the control-plane case or SLP in the user-plane case). It may use either the control- or user-plane protocols as underlying transport. In this specification, only control plane use of LPP is defined. User plane support of LPP is defined in [17] and [18].

LPP is a point to point positioning protocol with capabilities similar to those in UMTS RRC ([15]) and GERAN RRLP ([16]). Whereas RRLP supports positioning of a target MS accessing GERAN and RRC supports positioning of a target UE accessing UTRAN, LPP supports positioning and location related services (e.g. transfer of assistance data) for a target UE accessing E-UTRAN. To avoid creating new positioning protocols for future access types developed by 3GPP, and to enable positioning measurements for terrestrial access types other than E-UTRAN, LPP is in principle forward-compatible with other access types, even though restricted to E-UTRAN access in this specification.

LPP further supports the OMA user plane location solution SUPL 2.0, as defined in the OMA SUPL 2.0 standards ([17], [18]), and is intended to be compatible with the successor protocols of SUPL 2.0 as well.

LPP messages are carried as transparent PDUs across intermediate network interfaces using the appropriate protocols (e.g., S1-AP over the S1-MME interface, NAS/RRC over the Uu interface). The LPP protocol is intended to enable positioning for LTE using a multiplicity of different position methods, while isolating the details of any particular positioning method and the specifics of the underlying transport from one another.

The protocol operates on a transaction basis between a target device and a server, with each transaction taking place as an independent procedure. More than one such procedure may be in progress at any given moment. An LPP procedure may involve a request/response pairing of messages or one or more "unsolicited" messages. Each procedure has a single objective (e.g., transfer of assistance data, exchange of LPP related capabilities, or positioning of a target device according to some QoS and use of one or more positioning methods). Multiple procedures, in series and/or in parallel, can be used to achieve more complex objectives (e.g., positioning of a target device in association with transfer of assistance data and exchange of LPP related capabilities). Multiple procedures also enable more than one positioning attempt to be ongoing at the same time (e.g., to obtain a coarse location estimate with low delay while a more accurate location estimate is being obtained with higher delay).

An LPP session is defined between a positioning server and the target device, the details of its relation with transactions are described in section 4.1.2 of [25].

A single LPP transaction may be realised as multiple procedures; e.g., a single transaction for provision of assistance data might comprise several Provide Assistance Data messages, with each such message constituting a separate procedure (since there is no "multiple unsolicited messages" procedure type).

For the 3GPP EPS Control Plane solution defined in [2], the UE is the target device and the E-SMLC is the server. For SUPL 2.0 support, the SUPL Enabled Terminal (SET) is the target device and the SUPL Location Platform (SLP) is the server. The protocol does not preclude the possibility of future developments in control plane and user plane solutions (e.g., possible successors of SUPL 2.0, as well as possible future 3GPP control plane solutions).

All LPP operations and procedures are defined with respect to the target and server, and thus the LPP operations and procedures defined here with respect to a UE and an E-SMLC can also be viewed in this more generic context by substituting any target for the UE and any server for the E-SMLC.

LPP further supports multiple positioning methods as defined in section 4.3.

LPP supports hybrid positioning, in which two or more position methods are used concurrently to provide measurements and/or a location estimate or estimates to the server. LPP is forward compatible with the later addition of other position methods in later releases (e.g., position methods associated with other types of terrestrial access).

The operations controlled through LPP are described further in section 7.1.

6.2.2 Radio Resource Control (RRC)

The RRC protocol is terminated between the eNode B and the UE. In addition to providing transport for LPP messages over the Uu interface, it supports transfer of measurements that may be used for positioning purposes through the existing measurement systems specified in [14].

6.3 eNB-terminated protocols

6.3.1 LTE Positioning Protocol Annex (LPPa)

The LTE Positioning Protocol Annex (LPPa) carries information between the eNode B and the E-SMLC. It is used to support the following positioning functions:

- E-CID cases where assistance data or measurements are transferred from the eNode B to the E-SMLC
- data collection from eNodeBs for support of downlink OTDOA positioning
- retrieval of UE configuration data from the eNodeBs for support of uplink (e.g., UTDOA) positioning

The LPPa protocol is transparent to the MME. The MME routes the LPPa PDUs transparently based on a short Routing ID corresponding to the involved E-SMLC node over S1 interface without knowledge of the involved LPPa transaction. It carries the LPPa PDUs over S1 interface either in UE associated mode or non-UE associated mode.

6.3.2 S1 Application Protocol (S1-AP)

The S1-AP protocol, terminated between the MME and the eNode B, is used as transport for LPP and LPPa messages over the S1-MME interface. The S1-AP protocol is also used to instigate and terminate eNode B related positioning procedures.

6.4 Signalling between an E-SMLC and UE

6.4.1 Protocol Layering

Figure 6.4.1-1 shows the protocol layering used to support transfer of LPP messages between an E-SMLC and UE. The LPP PDU is carried in NAS PDU between the MME and the UE.

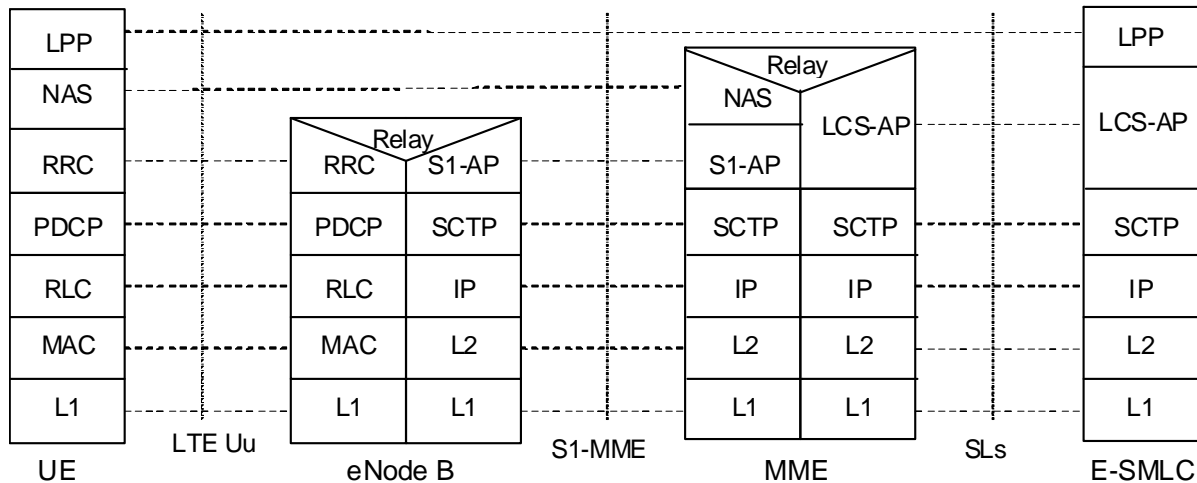

Figure 6.4.1-1: Protocol Layering for E-SMLC to UE Signalling

6.4.2 LPP PDU Transfer

Figure 6.4.2-1 shows the transfer of an LPP PDU between an E-SMLC and UE, in the network- and UE-triggered cases. These two cases may occur separately or as parts of a single more complex operation.

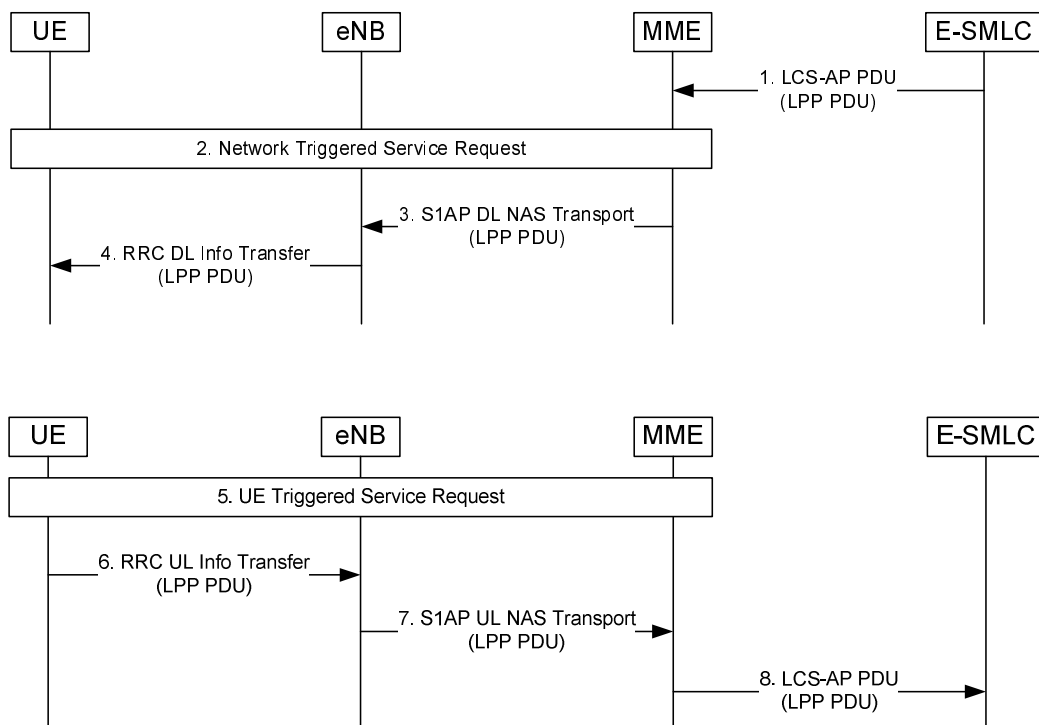

Figure 6.4.2-1: LPP PDU transfer between E-SMLC and UE (network- and UE-triggered cases)

1. Steps 1 to 4 may occur before, after, or at the same time as steps 5 to 8. Steps 1 to 4 and steps 5 to 8 may also be repeated. Steps 1 to 4 are triggered when the E-SMLC needs to send an LPP message to the UE as part of some LPP positioning activity. The E-SMLC then sends an LCS-AP PDU to the MME carrying an LPP PDU comprising the message.
2. If the UE is in ECM-IDLE state (e.g. if the S1 connection was previously released due to data and signalling inactivity), the MME performs a network triggered service request as defined in [19] in order to establish a signalling connection with the UE and assign a serving eNode B.
3. The MME includes a session identifier (a.k.a Routing identifier defined in [26]), which is associated with the positioning session between the MME and E-SMLC, and the LPP PDU in the NAS Transport Message and then forwards the NAS Transport Message to the serving eNode B in an S1AP Downlink NAS Transport message.

The MME need not retain state information for this transfer; it can treat any response in step 7 as a separate non-associated transfer.

4. The eNode B forwards the NAS Transport Message to the UE in an RRC DL Information Transfer message.
5. Steps 5 to 8 are triggered when the UE needs to send an LPP PDU to the E-SMLC as part of some LPP positioning activity. If the UE is in ECM-IDLE state, the UE instigates a UE triggered service request as defined in [19] in order to establish a signalling connection with the MME and assign a serving eNode B.
6. The UE includes the session identifier (a.k.a Routing identifier defined in [26]), which has been received in step 4, and an LPP PDU to the serving eNode B in an RRC UL Information Transfer message.
7. The eNode B forwards the NAS Transport Message to the MME in an S1AP Uplink NAS Transport message.
8. The MME forwards the LPP PDU to the E-SMLC in an LCS-AP PDU.

6.5 Signalling between an E-SMLC and eNode B

6.5.1 Protocol Layering

Figure 6.5.1-1 shows the protocol layering used to support transfer of LPPa PDUs between an E-SMLC and eNode B.

The LPPa protocol is transparent to the MME. The MME routes the LPPa PDUs transparently based on a short Routing ID which corresponds to the involved E-SMLC node over the S1 interface without knowledge of the involved LPPa transaction. It carries the LPPa PDUs over S1 interface either in UE associated mode or non-UE associated mode.

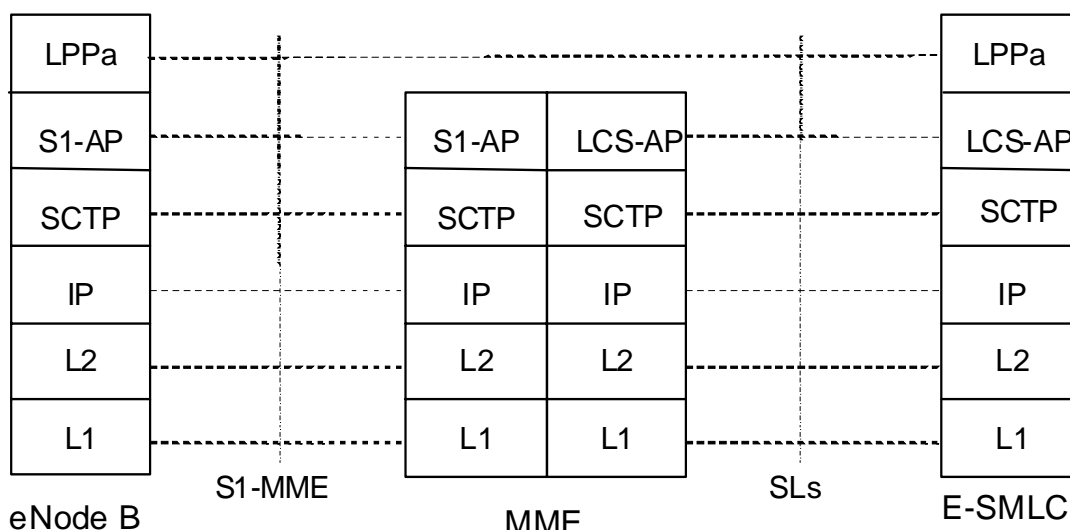

Figure 6.5.1-1: Protocol Layering for E-SMLC to eNode B Signalling

6.5.2 LPPa PDU Transfer for UE Positioning

Figure 6.5.2-1 shows LPPa PDU transfer between an E-SMLC and eNode B to support positioning of a particular UE.

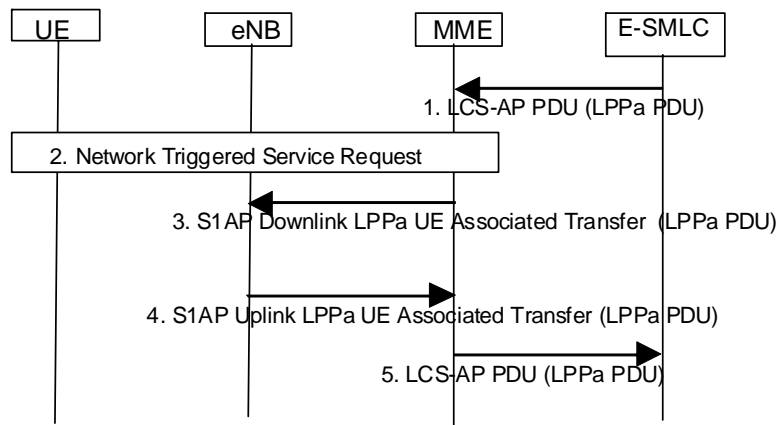

Figure 6.5.2-1: LPPa PDU Transfer between an E-SMLC and eNode B for UE Positioning

- Steps 1 to 3 are triggered when the E-SMLC needs to send an LPPa message to the serving eNode B for a target UE as part of an LPPa positioning activity. The E-SMLC then sends an LCS-AP PDU (as specified in [27]) to the MME including the Correlation ID corresponding to the UE and carrying an LPPa PDU comprising the message.
- If the UE is in ECM-IDLE state (e.g. if the S1 connection was previously released due to data and signalling inactivity), the MME performs a network triggered service request as defined in TS 23.401 [19] in order to establish a signalling connection with the UE and assign a serving eNode B.
- The MME forwards the LPPa PDU to the serving eNode B in an S1AP Downlink UE Associated LPPa Transport message over the S1 signalling connection corresponding to the UE and includes the Routing ID related to the E-SMLC. The MME need not retain state information for this transfer – e.g. can treat any response in step 4 as a separate non-associated transfer.
- Steps 4 and 5 are triggered when a serving eNode B needs to send an LPPa message to the E-SMLC for a target UE as part of an LPPa positioning activity. The eNode B then sends an LPPa PDU to the MME in an S1AP Uplink UE Associated LPPa Transport message and includes the Routing ID received in step 3.
- The MME forwards the LPPa PDU to the E-SMLC associated with the Routing ID received in step 4 in an LCS-AP PDU (as specified in [27]) including the Correlation ID corresponding to the UE. Steps 1 to 5 may be repeated.

6.5.3 LPPa PDU Transfer for Positioning Support

Figure 6.5.3-1 shows LPPa PDU transfer between an E-SMLC and eNodeB when related to gathering data from the eNodeB for positioning support for all UEs.

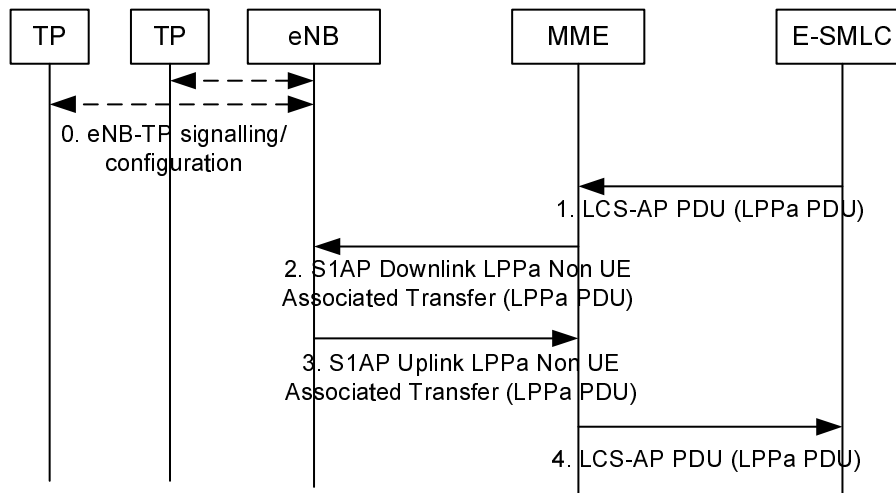

Figure 6.5.3-1: LPPa PDU Transfer between an E-SMLC and eNodeB for obtaining eNodeB Data

0. An eNodeB may communicate with several TPs (including PRS-only TPs in case of PRS-based TBS is supported) to configure TPs, obtain TP configuration information, etc.
NOTE: eNodeB-TP signalling and configuration is outside the scope of this specification.
1. Steps 1 and 2 are triggered when the E-SMLC needs to send an LPPa message to an eNodeB to obtain data related to the eNodeB, and possibly associated TPs. The E-SMLC determines an MME with access to the eNodeB and then sends an LCS-AP PDU (as specified in [27]) to the MME carrying an LPPa PDU, the global identity of the eNodeB and the identity of the E-SMLC.
2. The MME forwards the LPPa PDU to the identified eNode B in an S1AP Downlink Non UE Associated LPPa Transport message and includes the Routing ID related to the E-SMLC. The MME need not retain state information for this transfer – e.g. can treat any response in step 3 as a separate non-associated transfer.
3. Steps 3 and 4 are triggered when an eNode B needs to send an LPPa PDU to an E-SMLC containing data applicable to the eNodeB, and possibly associated TPs. The eNodeB determines an MME with access to the E-SMLC and then sends an LPPa PDU to the MME in an S1AP Uplink Non UE Associated LPPa Transport message. The eNodeB includes the Routing ID related to the E-SMLC received at step 2.
4. The MME forwards the LPPa PDU to the E-SMLC associated to the Routing ID indicated in step 3 and includes the global identity of the eNodeB and the identity of the E-SMLC in an LCS-AP PDU (as specified in [27]). Steps 1 to 4 may be repeated.

6.6 LMU-terminated protocols

6.6.1 SLm Application Protocol (SLmAP)

The SLmAP protocol, terminated between the E-SMLC and the LMU is used to support the following functions:

- delivery of target UE configuration data from the E-SMLC to the LMU
- request positioning measurements from the LMU and delivery of positioning measurements to the E-SMLC.

The SLmAP protocol is directly between the E-SMLC and the LMU.

6.7 Signalling between an E-SMLC and LMU

6.7.1 Protocol Layering

Figure 6.Y.1-1 shows the protocol layering used to support transfer of SLmAP messages between an E-SMLC and LMU.

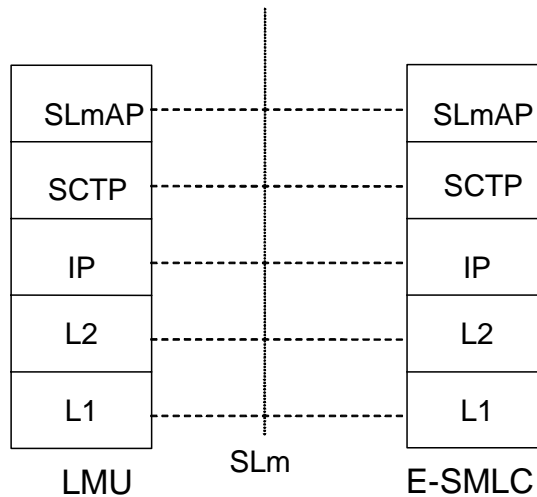

Figure 6.7.1-1: Protocol Layering for direct E-SMLC to LMU Signalling

7 General E-UTRAN UE Positioning procedures

7.1 General LPP procedures for UE Positioning

7.1.1 LPP Procedures

Positioning procedures in the E-UTRAN are modelled as transactions of the LPP protocol using the procedures defined in this specification. A procedure consists of a single operation of one of the following types:

- Exchange of positioning capabilities;
- Transfer of assistance data;
- Transfer of location information (positioning measurements and/or position estimate);
- Error handling;
- Abort.

Parallel transactions are permitted (i.e. a new LPP transaction may be initiated, while another one is outstanding).

As described in section 6.2.1, the protocol operates between a "target" and a "server". In the control-plane context, these entities are the UE and E-SMLC respectively; in the SUPL context they are the SET and the SLP. The terms "target" and "server" are used in the flows in this section to avoid redundancy between the two versions of the positioning operations. A procedure may be initiated by either the target or the server. Both target initiated and server initiated procedures are supported.

7.1.2 Positioning procedures

7.1.2.1 Capability transfer

A UE request for capability from E-SMLC or delivery of the E-SMLC capability to the UE is not supported in this version of the specification.

Capabilities in an LPP context refer to the ability of a target or server to support different position methods defined for LPP, different aspects of a particular position method (e.g. different types of assistance data for A-GNSS) and common features not specific to only one position method (e.g. ability to handle multiple LPP transactions). These capabilities are defined within the LPP protocol and transferred between the target and the server using LPP transport.

The exchange of capabilities between a target and a server may be initiated by a request or sent as "unsolicited" information. If a request is used, the server sends an LPP Request Capabilities message to the target device with a request for capability information. The target sends an LPP Provide Capabilities message.

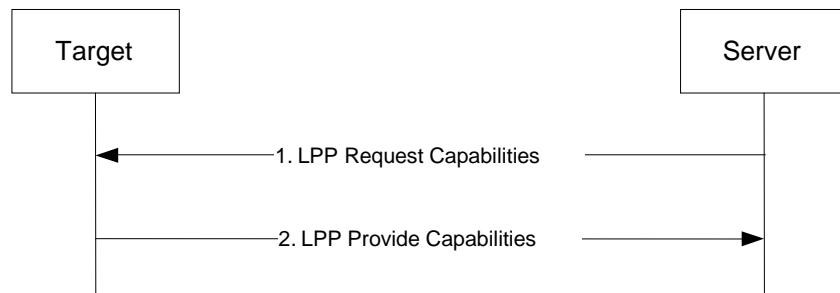

Figure 7.1.2.1-1: LPP Capability Transfer procedure

1. The server may send a request for the LPP related capabilities of the target.
2. The target transfers its LPP-related capabilities to the server. The capabilities may refer to particular position methods or may be common to multiple position methods.

LPP Capability Indication procedure is used for unsolicited capability transfer.

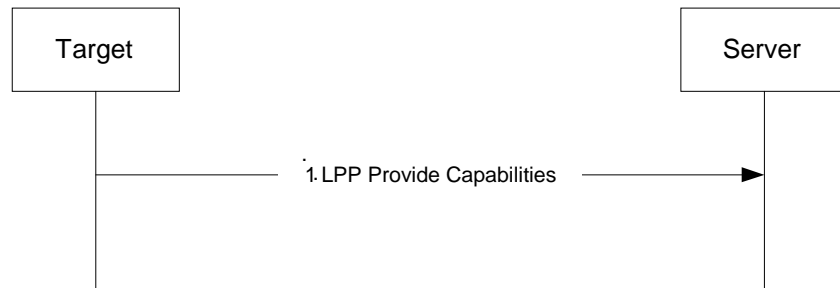

Figure 7.1.2.1-2: LPP Capability Indication procedure

7.1.2.2 Assistance data transfer

Assistance data may be transferred either by request or unsolicited. In this version of the specification, assistance data delivery is supported only via unicast transport from server to target.

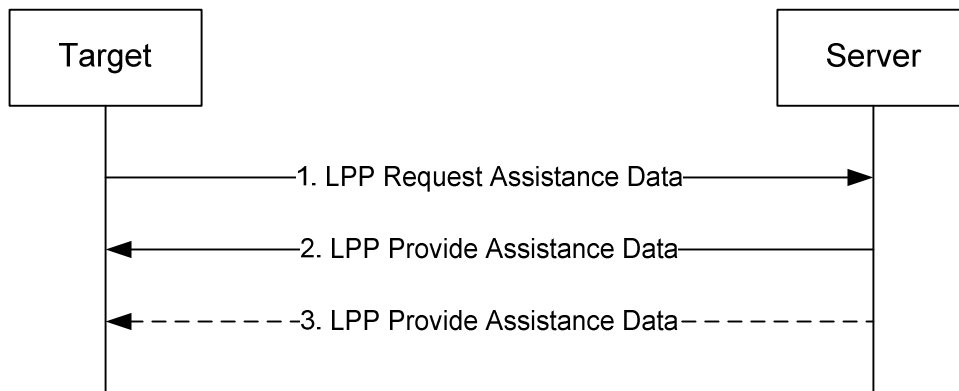

Figure 7.1.2.2-1: LPP Assistance Data Transfer procedure

1. The target may send a request to the server for assistance data and may indicate the particular assistance data needed.
2. The server transfers assistance data to the target. The transferred assistance data should match any assistance data requested in step 1.
3. Optionally, the server may transfer additional assistance data to the target in one or more additional LPP messages.

LPP Assistance Data Delivery procedure is used for unilateral assistance data transfer.

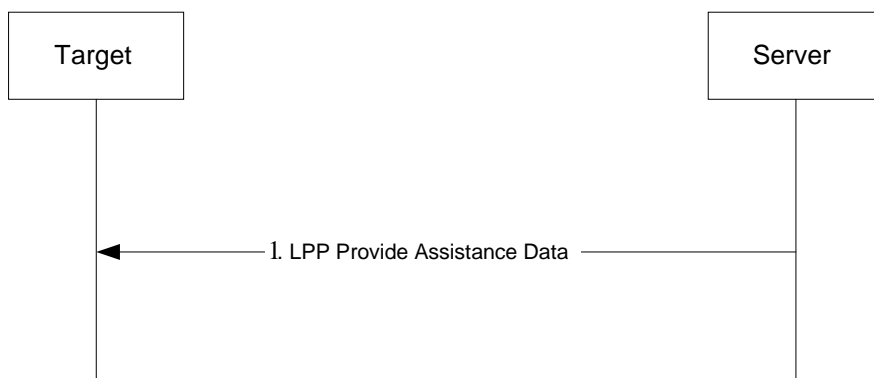

Figure 7.1.2.2-2: LPP Assistance Data Delivery procedure

This procedure is unidirectional; assistance data are always delivered from the server to the target.

7.1.2.3 Location information transfer

The term "location information" applies both to an actual position estimate and to values used in computing position (e.g., radio measurements or positioning measurements). It is delivered either in response to a request or unsolicited.

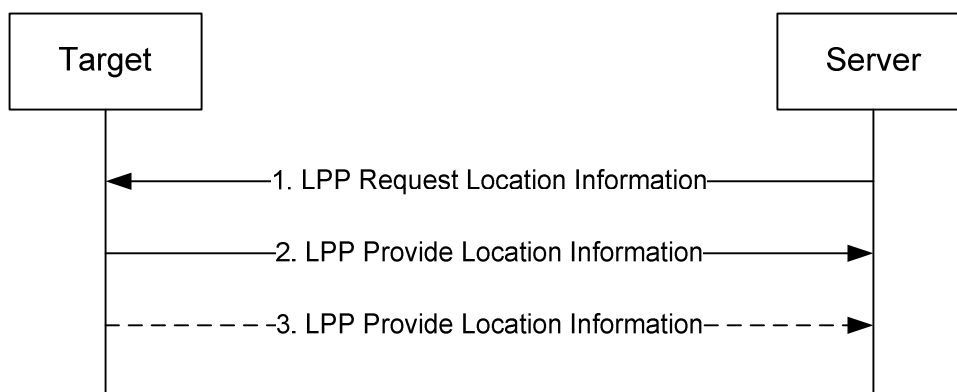

Figure 7.1.2.3-1: LPP Location Information Transfer procedure

1. The server may send a request for location information to the target, and may indicate the type of location information needed and associated QoS.
2. In response to step 1, the target transfers location information to the server. The location information transferred should match the location information requested in step 1.
3. Optionally (e.g., if requested in step 1), the target in step 2 may transfer additional location information to the server in one or more additional LPP messages.

LPP Location Information Delivery procedure is used for unilateral location information transfer.

NOTE: the LPP Location Information Delivery procedure can only be piggybacked in the MO-LR request.

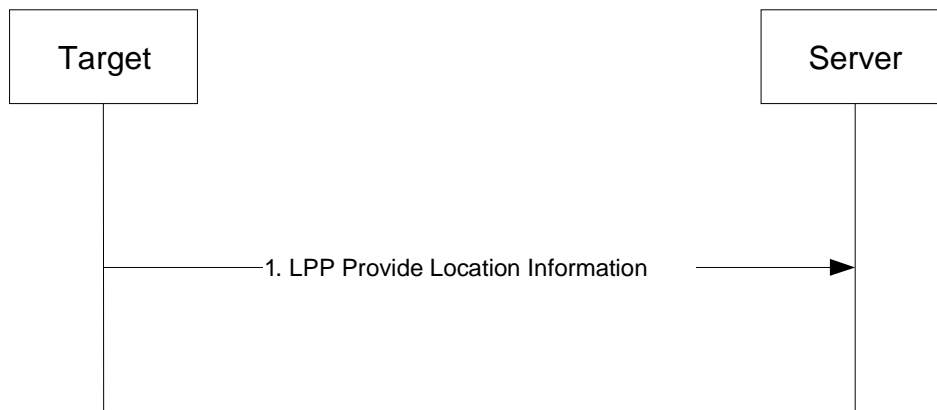

Figure 7.1.2.3-2: LPP Location Information Delivery procedure

7.1.2.4 Multiple transactions

Multiple LPP transactions may be in progress simultaneously between the same target and server nodes, to improve flexibility and efficiency. However, no more than one LPP procedure between a particular pair of target and server nodes to obtain location information shall be in progress at any time for the same position method.

In this example, the objective is to request location measurements from the target, and the server does not provide assistance data in advance, leaving the target to request any needed assistance data. A message flow is shown in Figure 7.1.2.4-1.

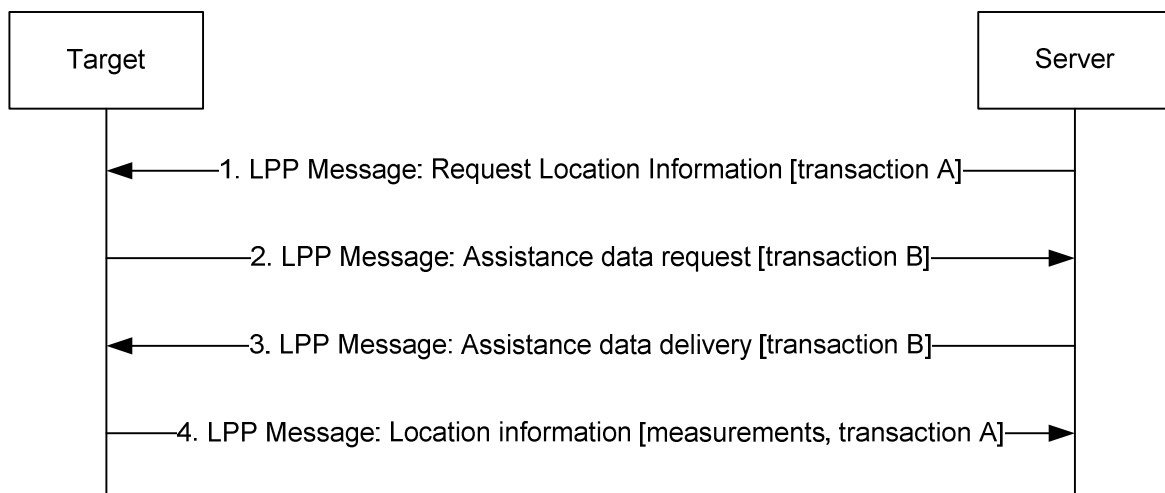

Figure 7.1.2.4-1: Example of multiple LPP procedures

1. The server sends a request to the target for positioning measurements.
2. The target sends a request for particular assistance data.
3. The server returns the assistance data requested in step 2.
4. The target obtains and returns the location information (e.g., positioning method measurements) requested in step 1.

7.1.2.5 Sequence of Procedures

LPP procedures are not required to occur in any fixed order, in order to provide greater flexibility in positioning. Thus, a UE may request assistance data at any time in order to comply with a previous request for location measurements from the E-SMLC; an E-SMLC may instigate more than one request for location information (e.g., measurements or a location estimate) in case location results from a previous request were not adequate for the requested QoS; and the target device may transfer capability information to the server at any time if not already performed.

Despite the flexibility allowed by LPP, it is expected that procedures will normally occur in the following order:

1. Capability Transfer;
2. Assistance Data Transfer;
3. Location Information Transfer (measurements and/or location estimate).

Specific examples for each positioning method are shown in clause 8.

7.1.2.6 Error handling

The procedure is used to notify the sending endpoint by the receiving endpoint that the receiving LPP message is erroneous or unexpected. This procedure is bidirectional at the LPP level; either the target or the server may take the role of either endpoint in Figure 7.1.2.6-1.

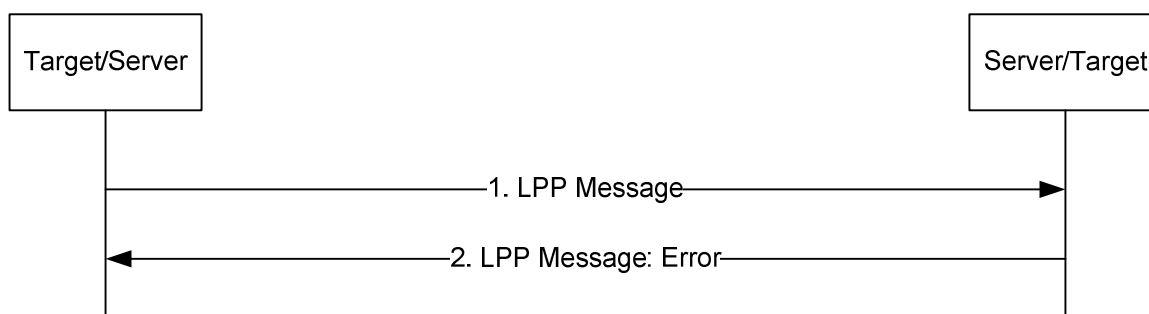

Figure 7.1.2.6-1: Error handling

1. The target or server (indicated as "Target/Server" in Figure 7.1.2.6-1) sends a LPP message to the other endpoint (indicated as "Server/Target").
2. If the server or target ("Server/Target") detects that the receiving LPP message is erroneous or unexpected, the server or target transfers error indication information to the other endpoint ("Target/Server").

7.1.2.7 Abort

The procedure is used to notify the other endpoint by one endpoint to abort an ongoing procedure between the two endpoints. This procedure is bidirectional at the LPP level; either the target or the server may take the role of either endpoint in Figure 7.1.2.7-1.

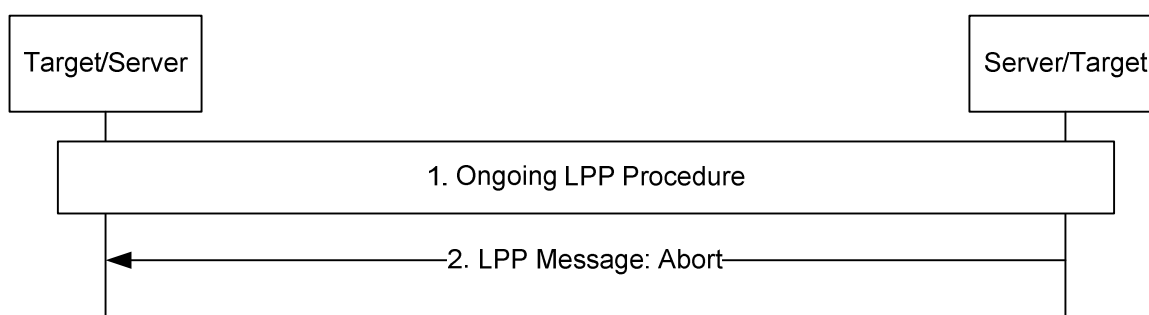

Figure 7.1.2.7-1: Abort

1. A LPP procedure is ongoing between target and server.
2. If the server or target ("Server/Target") determines that the procedure must be aborted, and then the server or target sends an LPP Abort message to the other endpoint ("Target/Server") carrying the transaction ID for the procedure.

7.1.3 UE positioning measurements in idle state for NB-IoT

NB-IoT UEs may perform measurements for some positioning methods only when in idle state.

Figure 7.1.3-1 shows the general positioning procedure where the UE performs positioning measurements in idle state.

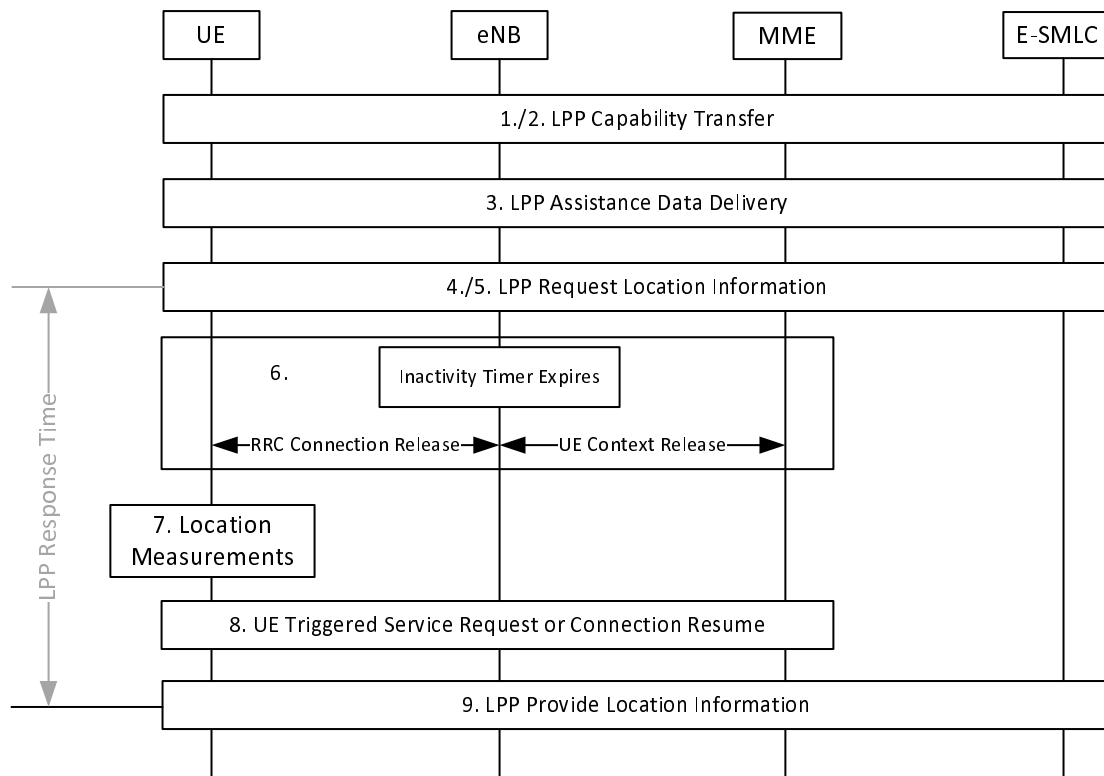

Figure 7.1.3-1: UE positioning measurements in idle state.

1. The E-SMLC is aware of the UE access type and/or coverage level if applicable from the Location Service Request message received from the MME. The E-SMLC may send a LPP Request Capabilities message to the UE to obtain the UE positioning method capabilities from the UE, as described in subclause 7.1.2.1.
2. The UE sends its positioning method capabilities to the E-SMLC in a LPP Provide Capabilities message, including an indication of position methods for which the UE needs to make measurements in idle state.
3. The E-SMLC may determine the assistance data required for the selected position method or methods, and sends them in one or more LPP Provide Assistance data messages to the UE, as described in subclause 7.1.2.2. If an LPP acknowledgement was requested, the UE sends an LPP acknowledgment for each received LPP Provide Assistance data message to the E-SMLC.
4. If the UE capabilities from step 2 indicate that idle state is required for positioning measurements, the E-SMLC may allow additional response time to the UE to obtain the location measurements, and sends one or more LPP Request Location Information messages to the UE requesting positioning measurements or a location estimate, and including the required response time, as described in subclause 7.1.2.3. For E-CID positioning method, when NRSRP/NRSRQ measurements are requested the UE is requested to provide NRSRP/NRSRQ measurements for intra-frequency neighbour cells and for inter-frequency neighbour cells. The UE may use inter-frequency information in system information of the serving cell specified in [14] to decide on which inter-frequency cells to measure.

5. The UE sends an LPP acknowledgement for each received LPP Request Location Information message to the E-SMLC, if an LPP acknowledgement was requested at step 4 but does not perform the requested measurements.
6. The UE may finish any other activities in progress (e.g., SMS or data transfer), and waits until the network releases or suspends the connection (after a certain period of inactivity). The UE will then receive an RRC connection release or suspend from the eNodeB due to the expiration of the inactivity timer.
7. When the UE has entered idle state, the UE performs the measurements requested in step 4.
8. Before the location measurements are to be sent to the E-SMLC, the UE instigates a UE triggered service request or, when User Plane CIoT EPS optimization applies, the Connection Resume procedure as defined in TS 23.401 [19], if the UE is not using Control Plane CIoT EPS Optimisation, in order to establish a signalling connection with the MME. If the UE is using Control Plane CIoT EPS Optimisation, procedures for Mobile Originated Data Transport in Control Plane CIoT EPS optimisation as defined in TS 23.401 [19] are performed by the UE to establish a signalling connection with the MME.
9. When the LPP response time received in step 4 expires (or when location measurements are available before expiry), the UE sends one or more LPP Provide Location Information messages containing the requested location measurements or location estimate obtained in step 7 to the E-SMLC.

7.2 General LPPa Procedures for UE Positioning

7.2.1 LPPa Procedures

Positioning and data acquisition transactions between an E-SMLC and eNodeB are modelled by using procedures of the LPPa protocol. There are two types of LPPa procedures:

- UE associated procedure, i.e. transfer of information for a particular UE (e.g. positioning measurements)
- Non UE associated procedure, i.e. transfer of information applicable to the eNodeB and associated TPs (e.g. eNB/TP timing differences)

Parallel transactions between the same E-SMLC and eNodeB are supported; i.e. a pair of E-SMLC and eNodeB may have more than one instance of an LPPa procedure in execution at the same time.

For possible extensibility, the protocol is considered to operate between a generic "access node" (e.g. eNodeB) and a "server" (e.g. E-SMLC). A procedure is only initiated by the server.

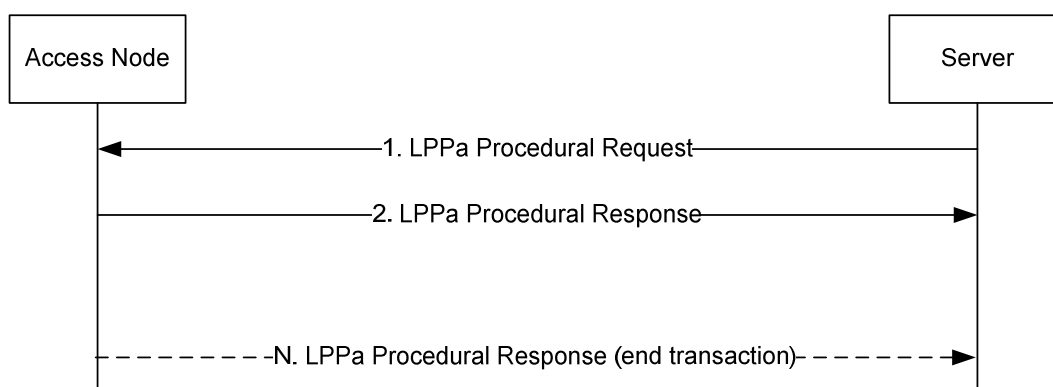

Figure 7.2.1-1: A single LPPa transaction

Figure 7.2.1.1-1 shows a single LPPa transaction. The transaction is terminated in step 2 in the case of a non UE associated procedure. For a UE associated procedure to gather information concerning the access node, additional responses may be allowed (e.g. sending of updated information periodically and/or whenever there is some significant change). In this case, the transaction may be ended after some additional responses. In the LPPa protocol, the described transaction may be realized by the execution of one procedure defined as a request and a response, followed by one or several procedures initiated by the eNB (each procedure defined as a single message) to realize the additional responses. The Correlation ID provided by the MME in the LCS-AP PDU encapsulating the LPPa PDU may be used by the E-SMLC to identify the target UE positioning session.

7.2.2 LPPa transaction types

7.2.2.1 Location information transfer

The term "location information" applies both to an actual position estimate and to values used in computing position (e.g., radio measurements or positioning measurements). It is delivered in response to a request.

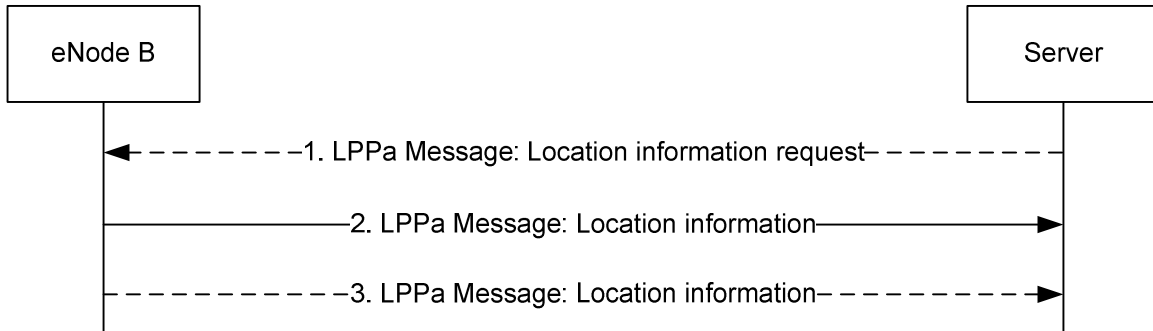

Figure 7.2.2-1: Location information transfer

1. The server sends a request for location related information to the eNodeB, and indicates the type of location information needed and associated QoS. The request may refer to a particular UE.
2. In response to step 1, the eNodeB transfers location related information to the server. The location related information transferred should match the location related information requested in step 1.
3. If requested in step 1, the eNodeB may transfer additional location related information to the server in one or more additional LPPa messages when the positioning method is E-CID.

7.3 Service Layer Support using combined LPP and LPPa Procedures

As described in [2], UE-positioning-related services can be instigated from the EPC in the case of an NI-LR or MT-LR location service, or from the UE in the case of an MO-LR location service. The complete sequence of operations in the EPC is defined in [2]. This subclause defines the overall sequences of operations that occur in the E-SMLC, E-UTRAN and UE as a result of the EPC operations.

Some flows in this scenario apply only in particular situations (e.g., only when the UE is in connected mode). The lower-layer details of such cases are not shown in the diagrams; for instance, the process of paging a UE to bring it to connected mode from idle is not explicitly indicated in these diagrams.

7.3.1 NI-LR and MT-LR Service Support

Figure 7.3.1-1 shows the sequence of operations for an NI-LR or MT-LR location service, starting at the point where the MME initiates the service in the E-SMLC.

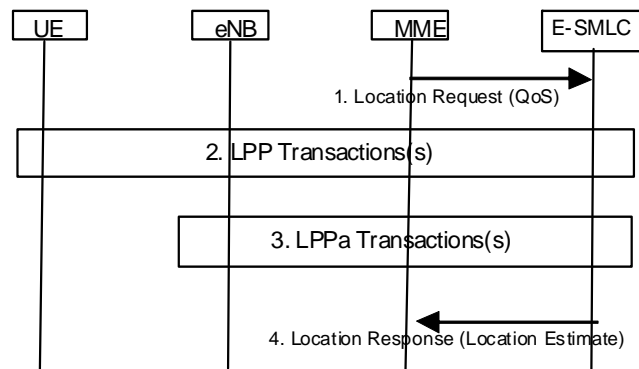

Figure 7.3.1-1: UE Positioning Operations to support an MT-LR or NI-LR

1. The MME sends a location request to the E-SMLC for a target UE and may include associated QoS.
2. The E-SMLC may obtain location related information from the UE and/or from the serving eNode B. In the former case, the E-SMLC instigates one or more LPP procedures to transfer UE positioning capabilities, provide assistance data to the UE and/or obtain location information from the UE. The UE may also instigate one or more LPP procedures after the first LPP message is received from the E-SMLC (e.g., to request assistance data from the E-SMLC).
3. If the E-SMLC needs location related information for the UE from the eNode B, the E-SMLC instigates one or more LPPa procedures. Step 3 is not necessarily serialised with step 2; if the E-SMLC and eNode B have the information to determine what procedures need to take place for the location service, step 3 could precede or overlap with step 2.
4. The E-SMLC returns a location response to the MME with any location estimate obtained as a result of steps 2 and 3.

7.3.2 MO-LR Service Support

Figure 7.3.2-1 shows the sequence of operations for an MO-LR service, starting at the point where an LCS Client in the UE or the user has requested some location service (e.g., retrieval of the UE's location or transfer of the UE's location to a third party).

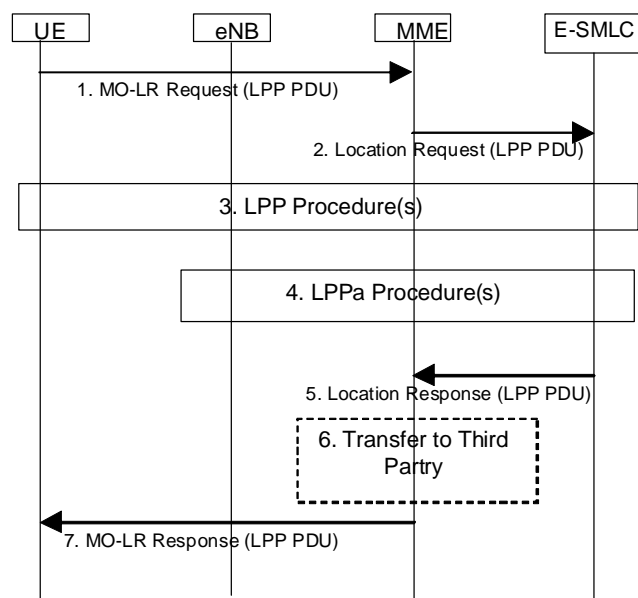

Figure 7.3.2-1: UE Positioning Operations to support an MO-LR

1. The UE sends a NAS level MO-LR request to the MME. The MO-LR request may carry an LPP PDU to instigate one or more LPP procedures to transfer capabilities, request assistance data, request location information and/or transfer location information (e.g. location measurements).
2. The MME sends a location request to the E-SMLC and includes any LPP PDU received in step 1.
3. The E-SMLC may obtain location related information from the UE and/or from the serving eNode B. In the former case or if an immediate response is needed to any LPP procedure instigated by the UE in step 1 (e.g., a request for assistance data), the E-SMLC instigates one or more LPP procedures to transfer UE positioning capabilities, provide assistance data to the UE and/or obtain location information from the UE. The UE may also instigate further LPP procedures after the first LPP message is received from the E-SMLC (e.g., to request assistance data or to request further assistance data).
4. If the E-SMLC needs location related information for the UE from the eNode B, the E-SMLC instigates one or more LPPa procedures. Step 4 may also precede step 3 or occur in parallel with it.
5. The E-SMLC returns a location response to the MME with any location estimate obtained as a result of steps 3 and 4, and/or with a final LPP message (e.g., that could provide a location estimate to the UE if requested by the UE in step 1).

6. If the UE requested location transfer to a third party the MME transfers the location received from the E-SMLC in step 5 to the third party as defined in [2].
7. The MME sends a NAS level MO-LR response to the UE, carrying any final LPP PDU that was received in step 5.

7.4 General SLmAP Procedures for UE Positioning

7.4.1 SLmAP Procedures

SLmAP includes positioning procedures, such as:

- Measurement request
- Measurement Update
- Measurement Abort

7.4.1.1 Measurement request

The measurement request procedure is used by the E-SMLC to obtain timing measurement for a particular target UE from an LMU.

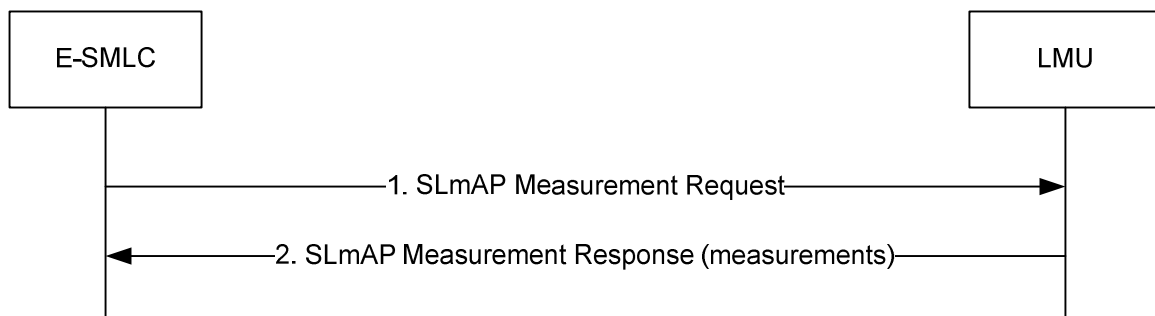

Figure 7.4.1-1: Measurement request

1. The E-SMLC sends a measurement request to the LMU. The measurement request identifies the UE to be positioned and contains the data (including SRS transmission configuration) needed to obtain the measurements.
2. In response to step 1, the LMU transfers UL RTOA measurements to the E-SMLC.

7.4.1.2 Measurement Update

The Measurement Update procedure is used by the E-SMLC to inform the LMU of a change in the UE SRS transmission configuration during an ongoing SLmAP measurement reporting transaction.

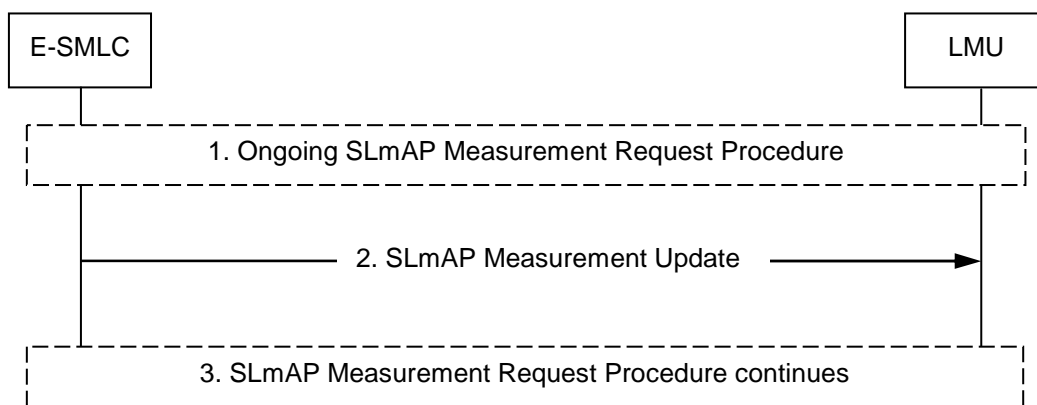

Figure 7.4.1.2-1: Measurement update

1. An SLmAP Measurement reporting transaction is ongoing between the E-SMLC and LMU.
2. The E-SMLC determines that the SRS transmission configuration data previously sent to the LMU is no longer valid. The E-SMLC sends a Measurement Update to the LMU containing the new SRS transmission configuration data. The E-SMLC shall not send a Measurement Update after receiving a Measurement Response from the LMU.
3. The LMU continues UL RTOA measurements using the updated SRS configuration.

7.4.1.3 Measurement Abort

The measurement abort procedure is used by the E-SMLC to abort an ongoing SLmAP measurement reporting transaction.

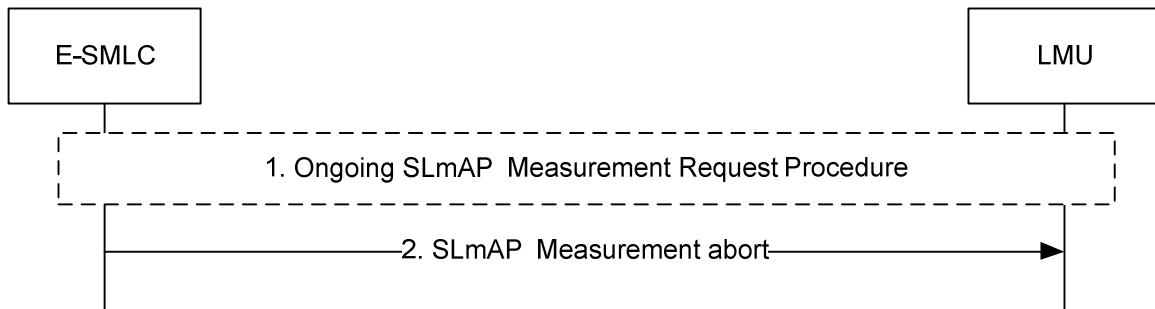

Figure 7.4.1.3-1: Measurement abort

1. An SLmAP Measurement reporting transaction is ongoing between the E-SMLC and LMU.
2. The E-SMLC determines that the transaction should be aborted (e.g. due to UE detach or inter-MME handover). The E-SMLC sends a measurement abort to the LMU and the ongoing SLmAP Measurement reporting transaction is abandoned. The E-SMLC shall not send a Measurement Abort after receiving a Measurement response from the LMU.

7.5 Service Layer Support using combined SLmAP and LPPa Procedures

7.5.1 NI-LR and MT-LR Service Support

Figure 7.5.1-1 shows the sequence of operations for an NI-LR and MT-LR, starting at the point where the MME initiates the service in the E-SMLC.

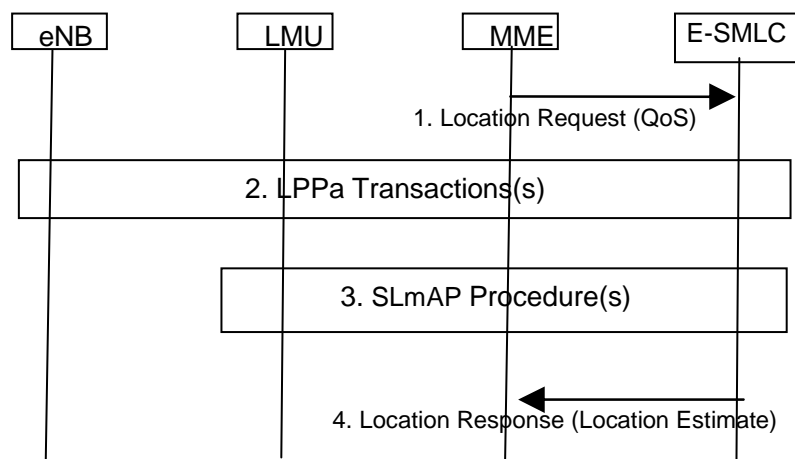

Figure 7.5.1-1: UE Positioning Operations to support NI-LR or MT-LR

1. The MME sends a location request to the E-SMLC for a target UE and may include associated QoS.
2. The E-SMLC obtains target UE configuration information from the serving eNode B.
3. If the E-SMLC needs measurement results for the UE from multiple LMUs, the E-SMLC instigates SLmAP procedures to each LMU.
4. The E-SMLC returns a location response to the MME with any location estimate obtained as a result of steps 2 and 3.

7.5.2 MO-LR Service Support

Figure 7.5.2-1 shows the sequence of operations for an MO-LR service, starting at the point where an LCS Client in the UE or the user has requested some location service (e.g., retrieval of the UE's location or transfer of the UE's location to a third party).

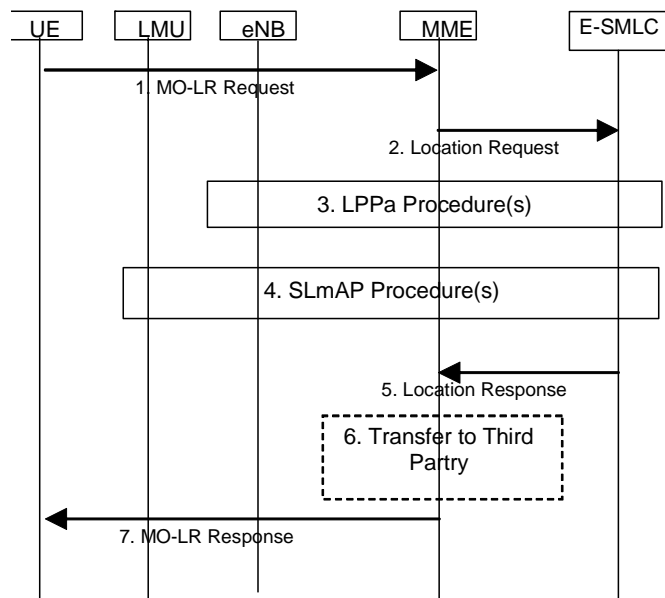

Figure 7.5.2-1: UE Positioning Operations to support an MO-LR

1. The UE sends a NAS level MO-LR request to the MME.
2. The MME sends a location request to the E-SMLC.
3. The E-SMLC obtains target UE configuration information from the serving eNode B.
4. If the E-SMLC needs measurement results for the UE from multiple LMUs, the E-SMLC instigates SLmAP procedures to each LMU.
5. The E-SMLC returns a location response to the MME with any location estimate obtained as a result of steps 2 and 3.
6. If the UE requested location transfer to a third party LCS Client, the MME transfers the location received from the E-SMLC in step 5 to the third party as defined in [2].
7. The MME sends a NAS level MO-LR response to the UE carrying any location estimate.

8 Positioning methods and Supporting Procedures

8.1 GNSS positioning methods

8.1.1 General

Global Navigation Satellite System (GNSS) is the standard generic term for satellite navigation systems that provide autonomous geo-spatial positioning with global or regional coverage. The following GNSSs are supported in this version of the specification:

- GPS and its modernization [6,7,8];
- Galileo [9];
- GLONASS [10];
- Satellite Based Augmentation Systems (SBAS), including WAAS, EGNOS, MSAS, and GAGAN [12];
- Quasi-Zenith Satellite System (QZSS) [11];
- BeiDou Navigation Satellite System (BDS) [28].

Each global GNSS can be used individually or in combination with others. When used in combination, the effective number of navigation satellite signals would be increased:

- extra satellites can improve availability (of satellites at a particular location) and results in an improved ability to work in areas where satellite signals can be obscured, such as in urban canyons;
- extra satellites and signals can improve reliability, i.e., with extra measurements the data redundancy is increased, which helps identify any measurement outlier problems;
- extra satellites and signals can improve accuracy due to improved measurement geometry and improved ranging signals from modernized satellites.

When GNSS is designed to inter-work with the E-UTRAN, the network assists the UE GNSS receiver to improve the performance in several respects. These performance improvements will:

- reduce the UE GNSS start-up and acquisition times; the search window can be limited and the measurements speed up significantly;
- increase the UE GNSS sensitivity; positioning assistance messages are obtained via E-UTRAN so the UE GNSS receiver can operate also in low SNR situations when it is unable to demodulate GNSS satellite signals;
- allow the UE to consume less handset power than with stand-alone GNSS; this is due to rapid start-up times as the GNSS receiver can be in idle mode when it is not needed;
- allow the UE to compute its position with a better accuracy; RTK corrections (for N-RTK) and GNSS physical models (for SSR/PPP) are obtained via E-UTRAN so the UE can use these assistance data, together with its own measurements, i.e., code and carrier phase measurements, to enable computation of a position with a high accuracy.

The network-assisted GNSS methods rely on signalling between UE GNSS receivers (possibly with reduced complexity) and a continuously operating GNSS reference receiver network, which has clear sky visibility of the same GNSS constellation as the assisted UEs. Two assisted modes are supported:

- *UE-Assisted*: The UE performs GNSS measurements (pseudo-ranges, pseudo Doppler, carrier phase ranges, etc.) and sends these measurements to the E-SMLC where the position calculation takes place, possibly using additional measurements from other (non GNSS) sources;
- *UE-Based*: The UE performs GNSS measurements and calculates its own position location, possibly using additional measurements from other (non GNSS) sources and assistance data from the E-SMLC.

The assistance data content may vary depending on whether the UE operates in UE-Assisted or UE-Based mode.

The assistance data signalled to the UE can be broadly classified into:

- *data assisting the measurements*: e.g. reference time, visible satellite list, satellite signal Doppler, code phase, Doppler and code phase search windows;
- *data providing means for position calculation*: e.g. reference time, reference position, satellite ephemeris, code and carrier phase measurements from a GNSS reference receiver or network of receivers;
- *data increasing the position accuracy*: e.g. satellite code biases, satellite orbit corrections, satellite clock corrections, atmospheric models. RTK residuals, gradients.

A UE with GNSS measurement capability may also operate in an autonomous (standalone) mode. In autonomous mode the UE determines its position based on signals received from GNSS without assistance from the network.

8.1.2 Information to be transferred between E-UTRAN Elements

This subclause defines the information (e.g., assistance data, measurement data) that may be transferred between E-UTRAN elements.

8.1.2.1 Information that may be transferred from the E-SMLC to UE

Table 8.1.2.1-1 lists assistance data for both UE-assisted and UE-based modes that may be sent from the E-SMLC to the UE.

NOTE: The provision of these assistance data elements and the usage of these elements by the UE depend on the E-UTRAN and UE capabilities, respectively.

Table 8.1.2.1-1: Information that may be transferred from the E-SMLC to UE

Assistance Data
Reference Time
Reference Location
Ionospheric Models
Earth Orientation Parameters
GNSS-GNSS Time Offsets
Differential GNSS Corrections
Ephemeris and Clock Models
Real-Time Integrity
Data Bit Assistance
Acquisition Assistance
Almanac
UTC Models
RTK Reference Station Information
RTK Auxiliary Station Data
RTK Observations
RTK Common Observation Information
GLONASS RTK Bias Information
RTK MAC Correction Differences
RTK Residuals
RTK FKP Gradients
SSR Orbit Corrections
SSR Clock Corrections
SSR Code Bias

8.1.2.1.1 Reference Time

Reference Time assistance provides the GNSS receiver with coarse or fine GNSS time information. The specific GNSS system times (e.g., GPS, Galileo, GLONASS, BDS system time) shall be indicated with a GNSS ID.

In case of coarse time assistance only, the Reference Time provides an estimate of the current GNSS system time (where the specific GNSS is indicated by a GNSS ID). The E-SMLC should achieve an accuracy of +/- 3 seconds for this time including allowing for the transmission delay between E-SMLC and UE.

In case of fine time assistance, the Reference Time provides the relation between GNSS system time (where the specific GNSS is indicated by a GNSS ID) and E-UTRAN air-interface timing.

8.1.2.1.2 Reference Location

Reference Location assistance provides the GNSS receiver with an a priori estimate of its location (e.g., obtained via Cell-ID, downlink positioning, etc.) together with its uncertainty.

The geodetic reference frame shall be WGS-84, as specified in [4].

8.1.2.1.3 Ionospheric Models

Ionospheric Model assistance provides the GNSS receiver with parameters to model the propagation delay of the GNSS signals through the ionosphere. Ionospheric Model parameters as specified by GPS [6], Galileo [9], QZSS [11], and BDS [28] may be provided.

8.1.2.1.4 Earth Orientation Parameters

Earth Orientation Parameters (EOP) assistance provides the GNSS receiver with parameters needed to construct the ECEF-to-ECI coordinate transformation as specified by GPS [6].

8.1.2.1.5 GNSS-GNSS Time Offsets

GNSS-GNSS Time Offsets assistance provides the GNSS receiver with parameters to correlate GNSS time (where the specific GNSS is indicated by a GNSS-1 ID) of one GNSS with other GNSS time (where the specific GNSS is indicated by a GNSS-2 ID). GNSS-GNSS Time Offsets parameters as specified by GPS [6], Galileo [9], GLONASS [10], QZSS [11], and BDS [28] may be provided.

8.1.2.1.6 Differential GNSS Corrections

Differential GNSS Corrections assistance provides the GNSS receiver with pseudo-range and pseudo-range-rate corrections to reduce biases in GNSS receiver measurements as specified in [13]. The specific GNSS for which the corrections are valid is indicated by a GNSS-ID.

8.1.2.1.7 Ephemeris and Clock Models

Ephemeris and Clock Models assistance provides the GNSS receiver with parameters to calculate the GNSS satellite position and clock offsets. The various GNSSs use different model parameters and formats, and all parameter formats as defined by the individual GNSSs are supported by the signalling.

8.1.2.1.8 Real-Time Integrity

Real-Time Integrity assistance provides the GNSS receiver with information about the health status of a GNSS constellation (where the specific GNSS is indicated by a GNSS ID).

8.1.2.1.9 Data Bit Assistance

Data Bit Assistance provides the GNSS receiver with information about data bits or symbols transmitted by a GNSS satellite at a certain time (where the specific GNSS is indicated by a GNSS ID). This information may be used by the UE for sensitivity assistance (data wipe-off) and time recovery.

8.1.2.1.10 Acquisition Assistance

Acquisition Assistance provides the GNSS receiver with information about visible satellites, reference time, expected code-phase, expected Doppler, search windows (i.e., code and Doppler uncertainty) and other information of the GNSS signals (where the specific GNSS is indicated by a GNSS ID) to enable a fast acquisition of the GNSS signals.

8.1.2.1.11 Almanac

Almanac assistance provides the GNSS receiver with parameters to calculate the coarse (long-term) GNSS satellite position and clock offsets. The various GNSSs use different model parameters and formats, and all parameter formats as defined by the individual GNSSs are supported by the signalling.

8.1.2.1.12 UTC Models

UTC Models assistance provides the GNSS receiver with parameters needed to relate GNSS system time (where the specific GNSS is indicated by a GNSS ID) to Universal Coordinated Time. The various GNSSs use different model parameters and formats, and all parameter formats as defined by the individual GNSSs are supported by the signalling.

8.1.2.1.13 RTK Reference Station Information

RTK Reference Station Information provides the GNSS receiver with the Earth-Centered, Earth-Fixed (ECEF) coordinates of the Reference Station's installed antenna's ARP, and the height of the ARP above the survey monument. Additionally, this assistance data provides information about the antenna type installed at the reference site.

NOTE: With the MAC N-RTK technique this assistance data is used to provide information regarding the Master Reference Station (see subclause 8.1.2.1a).

8.1.2.1.14 RTK Auxiliary Station Data

RTK Auxiliary Station Data provides the GNSS receiver with the location for all Auxiliary Reference Stations (see subclause 8.1.2.1a) within the assistance data. These values are expressed as relative geodetic coordinates (latitude, longitude, and height) with respect to a Master Reference Station (see subclause 8.1.2.1a) and based on the GRS80 ellipsoid. This type of assistance data is relevant only with the MAC N-RTK technique [33].

8.1.2.1.15 RTK Observations

RTK Observations provides the GNSS receiver with all primary observables (pseudo-range, phase-range, phase-range rate (Doppler), and carrier-to-noise ratio) generated at the Reference Station for each GNSS signal. The signal generation from the reference station is in compliance with [33]: as an example, the phase measurements of different signals in the same band must be phased aligned. More examples can be found in [33].

The pseudo-range is the distance between the satellite and GNSS receiver antennas, expressed in metres, equivalent to the difference of the time of reception (expressed in the time frame of the GNSS receiver) and the time of transmission (expressed in the time frame of the satellite) of a distinct satellite signal.

The phase-range measurement is a measurement of the range between a satellite and receiver expressed in units of cycles of the carrier frequency. This measurement is more precise than the pseudo-range (of the order of millimetres), but it is ambiguous by an unknown integer number of wavelengths.

The phase-range rate is the rate at which the phase-range between a satellite and a GNSS receiver changes over a particular period of time.

The carrier-to-noise ratio is the ratio of the received modulated carrier signal power to the noise power after the GNSS receiver filters.

NOTE: With the MAC N-RTK technique this assistance data is used to provide raw observables recorded at the Master Reference Station (see subclause 8.1.2.1a).

8.1.2.1.16 RTK Common Observation Information

RTK Common Observation Information provides the GNSS receiver with common information applicable to any GNSS, e.g. clock steering indicator. This assistance data is always used together GNSS RTK Observations (see subclause 8.1.2.1.15).

8.1.2.1.17 GLONASS RTK Bias Information

RTK Bias Information provides the GNSS receiver with information which is intended to compensate for the first-order inter-frequency phase-range biases introduced by the reference receiver code-phase biases. This information is applicable only for GLONASS FDMA signals. In the case that the MAC Network RTK method is used, GLONASS RTK Bias Information defines the code-phase biases related to the Master Reference Station [33].

8.1.2.1.18 RTK MAC Correction Differences

RTK MAC Correction Differences provides the GNSS receiver with information about ionospheric (dispersive) and geometric (non-dispersive) corrections generated between a Master Reference Station and its Auxiliary Reference Stations [33].

8.1.2.1.19 RTK Residuals

RTK Residuals provides the GNSS receiver with network error models generated for the interpolated corrections disseminated in Network RTK techniques. With sufficient redundancy in the RTK network, the location server process can provide an estimate for residual interpolation errors. Such quality estimates may be used by the target UE to optimize the performance of RTK solutions. The values may be considered by the target UE as a priori estimates only,

with sufficient tracking data available the target UE might be able to judge residual geometric and ionospheric errors itself. According to [33], RTK Residual error information should be transmitted every 10-60 seconds.

8.1.2.1.20 RTK FKP Gradients

RTK FKP Gradients provides the GNSS receiver with horizontal gradients for the geometric (troposphere and satellite orbits) and ionospheric signal components in the observation space. According to [33], RTK FKP gradient information should be typically transmitted every 10-60 seconds.

8.1.2.1.21 SSR Orbit Corrections

SSR Orbit Corrections provides the GNSS receiver with parameters for orbit corrections in radial, along – track and cross – track components. These orbit corrections are used to compute a satellite position correction, to be combined with satellite position calculated from broadcast ephemeris (see subclause 8.1.2.1.7).

8.1.2.1.22 SSR Clock Corrections

SSR Clock Corrections provides the GNSS receiver with parameters to compute the GNSS satellite clock correction applied to the broadcast satellite clock (see subclause 8.1.2.1.7). A polynomial of order 2 describes the clock differences for a certain time period: clock offset, drift, and drift rate.

8.1.2.1.23 SSR Code Bias

SSR Code Bias provides the GNSS receiver with the Code Biases that must be added to the pseudo range measurements of the corresponding code signal to get corrected pseudo ranges. SSR Code Bias contains absolute values, but also enables the alternative use of Differential Code Biases by setting one of the biases to zero. A UE can consistently use signals for which a code bias is transmitted. It is not reliable for a UE to use a signal without retrieving a corresponding code bias from the assistance data message.

8.1.2.1a Recommendations for grouping of assistance data to support different RTK service levels

The high-accuracy GNSS methods can be classified as:

- *Single base RTK service*: RTK is a technique that uses carrier-based ranging measurements i.e., phase-range to improve the positioning accuracy in a differential approach. The basic concept is to reduce and remove errors common to a Reference Station, with known position, and UE pair. When only pseudo ranges (code-based measurements) are used to compute the UE location, this method is known as DGNSS (Differential GNSS).

Table 8.1.2.1a-1: Single base RTK service: Specific information that may be transferred from the E-SMLC to the UE

Assistance Data
RTK Reference Station Information
RTK Observations
RTK Common Observation Information
GLONASS RTK Bias Information (if GLONASS data is transmitted)
Ephemeris and Clock (if UE did not acquire the navigation message)

- *Non-Physical Reference Station Network RTK service*: In this approach the target UE receives synthetic observations from a fictitious Reference Station. The Network RTK software at the location server is performing the error estimation and creates a virtual Reference Station close to the initial location of the target device (provided a priori to the location server). The target UE interprets and uses the data just as if it had come from a single, real Reference Station. Additionally, the target UE can also receive network information such as RTK Network Residuals (see subclause 8.1.2.1.19) or even FKP gradients (see subclause 8.1.2.1.20).

Table 8.1.2.1a-2: Non-Physical Reference Station Network RTK service: Specific information that may be transferred from the E-SMLC to the UE

Assistance Data
RTK Reference Station Information
RTK Observations
RTK Common Observation Information
GLONASS RTK Bias Information (if GLONASS data is transmitted)
RTK Residuals
RTK FKP Gradients
Ephemeris and Clock (if UE did not acquire the navigation message)

- *MAC Network RTK service:* In MAC network RTK, a group of Reference Stations are used and one of them is chosen as a Master station. The other stations are then called Auxiliary stations. In this service, the location server sends full raw observations and coordinate information for a single Reference Station, the Master Station. For all Auxiliary stations in the network (or a suitable subset of stations) the information is provided to the UE in a highly compact form: their reduced ambiguity-levelled observations, coordinate differences (to the Master Station observations and coordinates), and network residuals. Two Reference Stations are said to be on a common ambiguity level if the integer ambiguities for each phase range (satellite-receiver pair) have been removed (or adjusted) so that the integer ambiguities cancel when double-differences (involving two receivers and two satellites) are formed during processing. The maintenance of a common ambiguity level at a specific set of stations rather than across the whole GNSS network will lead to a grouping in network clusters or subnetworks of all ambiguity-levelled Reference Stations. If one network has only one subnetwork, this indicates that an ambiguity level throughout the whole network is established. When subnetworks are predefined, the assistance data can be broadcast to all UEs located in the assigned sub-network. More details on the usage of subnetworks can be found in [33].

Table 8.1.2.1a-3: MAC Network RTK service: Specific Information that may be transferred from the E-SMLC to the UE

Assistance Data
RTK Reference Station Information
RTK Auxiliary Station Data
RTK Observations
RTK Common Observation Information
GLONASS RTK Bias Information (if GLONASS data is transmitted)
RTK MAC Correction Differences
RTK Residuals
Ephemeris and Clock (if UE did not acquire the navigation message)

- *FKP Network RTK service:* With the concept of FKP, horizontal gradients of distance-dependent errors like ionosphere, troposphere and orbits are derived from a network of GNSS Reference Stations and transmitted to a target device together with raw or correction data of a corresponding Reference Station (physical or non-physical). The target UE may use the gradients to compute the effect of the distance-dependent errors for its own position.

Table 8.1.2.1a-4: FKP Network RTK service: Information that may be transferred from the E-SMLC to the UE

Assistance Data
RTK Reference Station Information
RTK Observations
RTK Common Observation Information
GLONASS RTK Bias Information (if GLONASS data is transmitted)
RTK Residuals
RTK FKP Gradients
Ephemeris and Clock (if UE did not acquire the navigation message)

- *PPP service*: This concept uses precise satellite orbit and clock parameters derived from global networks of Reference Stations as well as atmospheric models to perform single station positioning [33]. Compared to RTK and Network RTK, PPP is not a differential technique as there is no baseline limitation. When the orbits and clocks assistance data elements are provided in real-time, with no latency, the method is called Real-Time PPP.

Table 8.1.2.1a-5: SSR PPP service: Information that may be transferred from the E-SMLC to the UE

Assistance Data
SSR Orbit Corrections
SSR Clock corrections
SSR Code Bias
Ephemeris and Clock (if UE did not acquire the navigation message)

8.1.2.2 Information that may be transferred from the UE to the E-SMLC

The information that may be signalled from the UE to the E-SMLC is listed in table 8.1.2.2-1.

Table 8.1.2.2-1: Information that may be transferred from the UE to the E-SMLC

Information	UE-assisted	UE-based/ standalone
Latitude/Longitude/Altitude, together with uncertainty shape	No	Yes
Velocity, together with uncertainty shape	No	Yes
Reference Time, possibly together with GNSS-E-UTRAN time association and uncertainty	Yes	Yes
Indication of used positioning methods in the fix	No	Yes
Code phase measurements, also called pseudorange	Yes	No
Doppler measurements	Yes	No
Carrier phase measurements, also called Accumulated Delta Range (ADR)	Yes	No
Carrier-to-noise ratio of the received signal	Yes	No
Measurement quality parameters for each measurement	Yes	No
Additional, non-GNSS related measurement information	Yes	No

8.1.2.2.1 GNSS Measurement Information

The GNSS measurement information reported from the UE to the E-SMLC depends on the GNSS mode (i.e., UE-based, autonomous (standalone), or UE-assisted).

8.1.2.2.1.1 UE-based mode

In UE-based or standalone mode, the GNSS receiver reports the latitude, longitude and possibly altitude, together with an estimate of the location uncertainty, if available.

If requested by the E-SMLC and supported by the UE, the GNSS receiver may report its velocity, possibly together with an estimate of the uncertainty, if available.

If requested by the E-SMLC and supported by the UE, the GNSS receiver may report the relation between GNSS system time (where the specific GNSS is indicated by a GNSS ID; the specific GNSS system time may be selected by the UE) and E-UTRAN air-interface timing. This information may be used by the E-SMLC to assist other UEs in the network.

The UE should also report an indication of which GNSSs and possibly other location methods have been used to calculate a fix.

8.1.2.2.1.2 UE-assisted mode

In UE-assisted mode, the GNSS receiver reports the Code Phase and Doppler measurements together with associated quality estimates. These measurements enable the E-SMLC to calculate the location of the UE, possibly using other measurements and data.

If requested by the E-SMLC and supported by the UE, the GNSS receiver may report Carrier Phase measurements (also called Accumulated Delta Range), together with associated quality measurements, if available.

If requested by the E-SMLC and supported by the UE, the GNSS receiver may report the relation between GNSS system time (where the specific GNSS is indicated by a GNSS ID; the specific GNSS system time may be selected by the UE) and E-UTRAN air-interface timing. This information may be used by the E-SMLC to assist other UEs in the network.

8.1.2.2.2 Additional Non-GNSS Related Information

Additional non-GNSS measurements performed by E-UTRAN or UE may be used by the E-SMLC or UE to calculate or verify a location estimate. This information may include downlink positioning measurements, path loss and signal strength related measurements, etc.

8.1.3 Assisted-GNSS Positioning Procedures

8.1.3.1 Capability Transfer Procedure

The Capability Transfer procedure for Assisted-GNSS positioning is described in subclause 7.1.2.1.

8.1.3.1.1 Void

8.1.3.2 Assistance Data Transfer Procedure

The purpose of this procedure is to enable the E-SMLC to provide assistance data to the UE (e.g., as part of a positioning procedure) and the UE to request assistance data from the E-SMLC (e.g., as part of a positioning procedure or for autonomous self location (i.e., UE determines its own location)). In the case of high-accuracy GNSS positioning techniques (e.g., RTK), the E-SMLC can provide unsolicited periodic assistance data to the UE and the UE can request periodic assistance data from the E-SMLC.

8.1.3.2.1 E-SMLC initiated Assistance Data Delivery

Figure 8.1.3.2.1-1 shows the Assistance Data Delivery operations for the network-assisted GNSS method when the procedure is initiated by the E-SMLC.

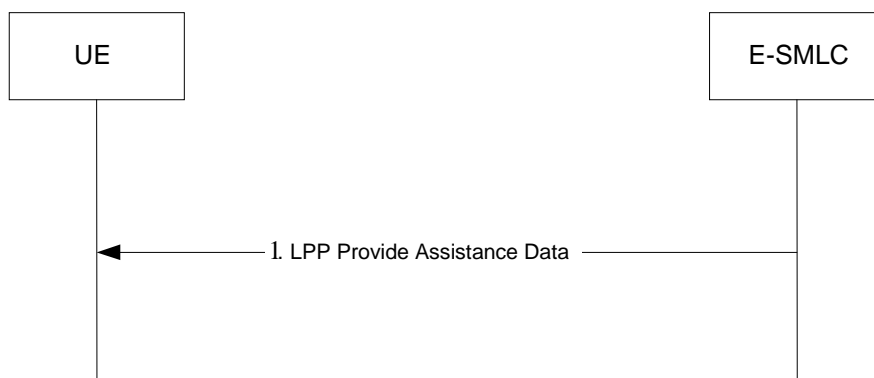

Figure 8.1.3.2.1-1: E-SMLC-initiated Assistance Data Delivery Procedure

- (1) The E-SMLC determines that assistance data needs to be provided to the UE (e.g., as part of a positioning procedure) and sends an LPP Provide Assistance Data message to the UE. This message may include any of the GNSS assistance data defined in subclause 8.1.2.1.

8.1.3.2.1a E-SMLC initiated Periodic Assistance Data Delivery

The Periodic Assistance Data Delivery procedure allows the server to provide unsolicited periodic assistance data to the target and is shown in Figure 8.1.3.2.1a-1.

NOTE: In this version of the specification, periodic assistance data delivery is supported for HA GNSS (e.g., RTK) positioning only.

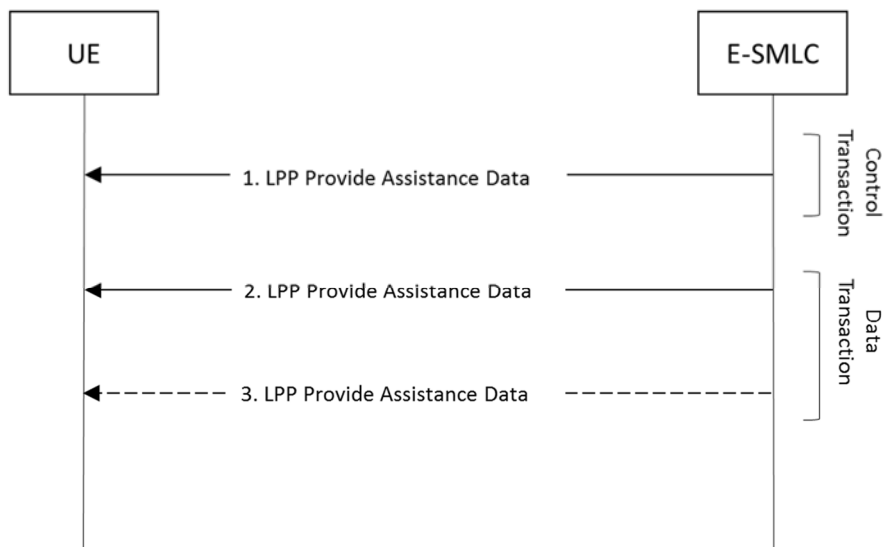

Figure 8.1.3.2.1a-1: LPP Periodic Assistance data delivery procedure

- (1) The E-SMLC determines that assistance data needs to be provided to the UE and sends an LPP Provide Assistance Data message to the UE. This message includes information to identify the type of periodic assistance data and a duration for ending the assistance data delivery.
- (2) When the first periodic message is available, the E-SMLC sends an unsolicited LPP Provide Assistance Data message to the UE containing the periodic assistance data announced in step (1).
- (3) The server may continue to send further LPP Provide Assistance Data messages to the target containing the periodic assistance data announced in step (1) when each additional periodicity condition occurs. When the duration for ending the periodic assistance data transfer occurs, the last LPP Provide Assistance Data message transferred indicates the end of transaction. Additionally, the session can be ended on request by the UE or by the E-SMLC with the help of an Abort message.

8.1.3.2.2 UE initiated Assistance Data Transfer

Figure 8.1.3.2.2-1 shows the Assistance Data Transfer operations for the network-assisted GNSS method when the procedure is initiated by the UE.

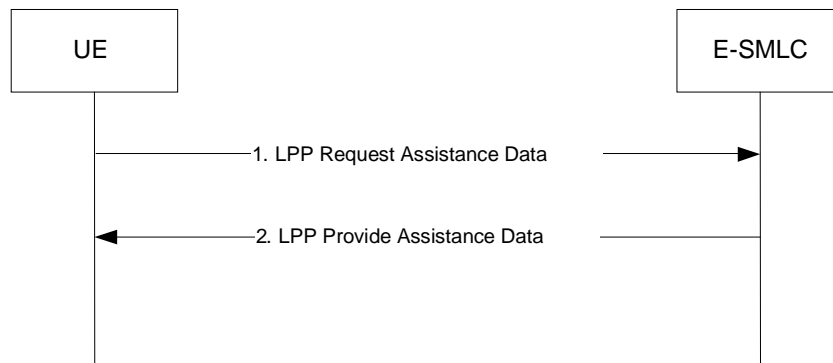

Figure 8.1.3.2.2-1: UE-initiated Assistance Data Transfer Procedure

- (1) The UE determines that certain A-GNSS assistance data are desired (e.g., in case the UE requires its own location with autonomous self location or as part of a positioning procedure when the E-SMLC provided assistance data are not sufficient for the UE to fulfill the request) and sends a LPP Request Assistance Data message to the E-SMLC. This request includes an indication of which specific A-GNSS assistance data are requested for each GNSS, possibly together with additional information (e.g., for which GNSS signal types, or satellites, or times the assistance is requested, etc.). Additional information concerning the UE's approximate location and serving and neighbour cells may also be provided in the Request Assistance Data message and/or in an accompanying Provide Location Information message to help the E-SMLC provide appropriate assistance data. This additional data may include the UE's last known location if available, the cell IDs of the UE serving eNodeB and possibly neighbour eNodeBs, as well as E-CID measurements.
- (2) The E-SMLC provides the requested assistance data in a LPP Provide Assistance Data message, if available at the E-SMLC. The entire set of assistance data may be delivered in one or several LPP messages, e.g., one message per GNSS. In this case, this step may be repeated by the E-SMLC several times. If any of the UE requested assistance data in step (1) are not provided in step 2, the UE shall assume that the requested assistance data are not supported, or currently not available at the E-SMLC. If none of the UE requested assistance data in step (1) can be provided by the E-SMLC, return any information that can be provided in an LPP message of type Provide Assistance Data which includes a cause indication for the not provided assistance data.

8.1.3.2.2a UE initiated Periodic Assistance Data Transfer

Figure 8.1.3.2.2a-1 shows the Periodic Assistance Data Transfer operations for the high-accuracy GNSS methods (e.g., RTK) when the procedure is initiated by the UE.

NOTE: In this version of the specification, periodic assistance data transfer is supported for HA GNSS (e.g., RTK) positioning only.

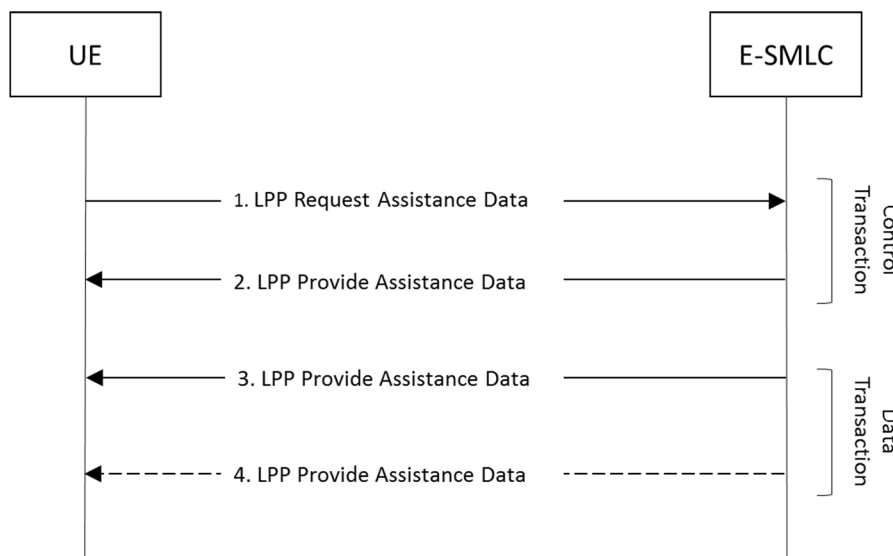

Figure 8.1.3.2.2a-1: UE-initiated Periodic Assistance Data Transfer Procedure

- (1) The UE determines that certain periodic A-GNSS assistance data, specific to one or more RTK-service levels, are desired and sends a LPP Request Assistance Data message to the E-SMLC. This request includes an indication of which specific A-GNSS assistance data are requested for each GNSS. Additional information like desired periodicity for sending the assistance data and a duration for ending the periodic session shall also be provided in the LPP Request Assistance Data message.
- (2) The E-SMLC responds with a LPP Provide Assistance Data message to the UE. If the UE request can be supported, the message contains information which may confirm or redefine the type of assistance data or periodicity parameters requested at step (1). This response indicates the end of the control transaction.
- (3) When available, the E-SMLC provides unsolicited the requested assistance data in a LPP Provide Assistance Data message to the UE. If any of the requested assistance data in step (1) or redefined in step (2) are not provided in step (3), the UE shall assume that the requested assistance data are not supported, or currently not available at the E-SMLC.
- (4) The E-SMLC may transmit one or more additional LPP Provide Assistance Data messages to the UE containing further periodic assistance data confirmed or redefined in step (2). When the duration for ending the periodic assistance data transfer occur, the last LPP Provide Assistance Data message transferred indicates the end of the transaction. Additionally, the session can be ended on request by the UE or by the E-SMLC with the help of an Abort message.

8.1.3.3 Location Information Transfer Procedure

The purpose of this procedure is to enable the E-SMLC to request position measurements or location estimate from the UE, or to enable the UE to provide location measurements to the E-SMLC for position calculation (e.g., in case of basic self location where the UE requests its own location).

8.1.3.3.1 E-SMLC initiated Location Information Transfer Procedure

Figure 8.1.3.3.1-1 shows the Location Information Transfer operations for the network-assisted GNSS method when the procedure is initiated by the E-SMLC.

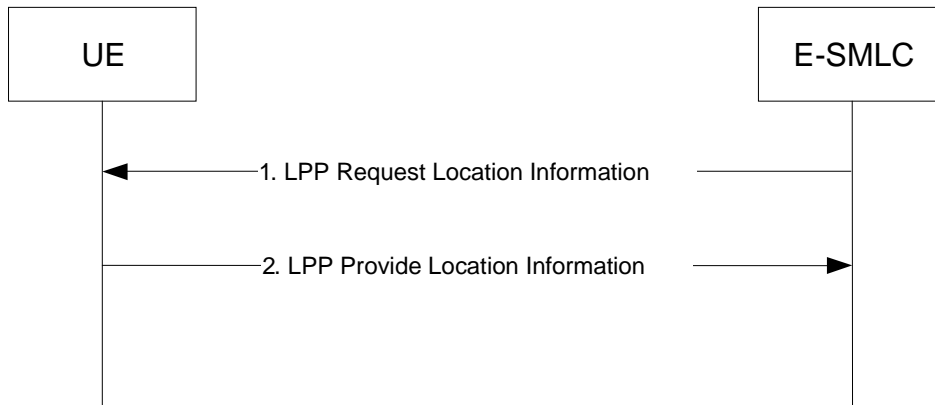

Figure 8.1.3.3.1-1: E-SMLC-initiated Location Information Transfer Procedure

- (1) The E-SMLC sends a LPP Request Location Information message to the UE for invocation of A-GNSS positioning. This request includes positioning instructions such as the GNSS mode (UE-assisted, UE-based, UE-based preferred but UE-assisted allowed, UE-assisted preferred, but UE-based allowed, standalone), positioning methods (GPS, Galileo, GLONASS, BDS, etc. and possibly non-GNSS methods, such as downlink positioning or E-CID), specific UE measurements requested if any, such as fine time assistance measurements, velocity, carrier phase, multi-frequency measurements, and quality of service parameters (accuracy, response time).
- (2) The UE performs the requested measurements and possibly calculates its own location. The UE sends an LPP Provide Location Information message to the E-SMLC before the Response Time provided in step (1) elapsed. If the UE is unable to perform the requested measurements, or if the Response Time provided in step 1 elapsed before any of the requested measurements have been obtained, the UE returns any information that can be provided in an LPP message of type Provide Location Information which includes a cause indication for the not provided location information.

8.1.3.3.2 UE-initiated Location Information Delivery Procedure

Figure 8.1.3.3.2-1 shows the Location Information delivery operations for the UE-assisted GNSS method when the procedure is initiated by the UE.

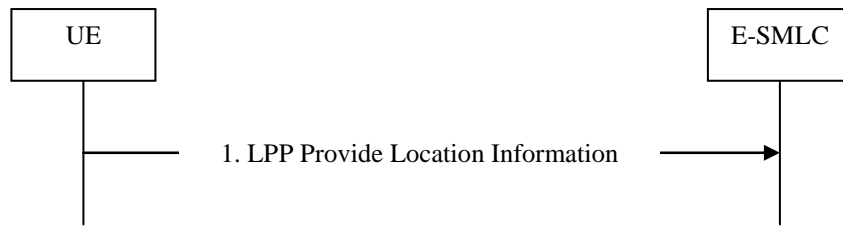

Figure 8.1.3.3.2-1: UE-initiated Location Information Delivery Procedure

- (1) The UE sends an LPP Provide Location Information message to the E-SMLC. The Provide Location Information message may include any UE measurements (GNSS pseudo-ranges, carrier phase-ranges, and other measurements) already available at the UE.

8.2 Downlink positioning method

8.2.1 General

In the downlink positioning method, the UE position is estimated based on measurements taken at the UE of downlink radio signals from multiple TPs (possibly including PRS-only TPs from a PRS-based TBS), along with knowledge of the geographical coordinates of the measured TPs and their relative downlink timing.

The specific positioning techniques used to estimate the UE's location from this information are beyond the scope of this specification.

8.2.2 Transferred information

This subclause defines the information that may be transferred between E-SMLC and UE/eNodeB.

8.2.2.1 Assistance Data that may be transferred from the E-SMLC to UE

The following assistance data may be transferred from the E-SMLC to the UE:

- Physical cell IDs (PCIs), global cell IDs (GCIs), and TP IDs of candidate TPs for measurement;
- Timing relative to the serving (reference) TP of candidate TPs;
- PRS configuration of candidate TPs.

8.2.2.2 Assistance Data that may be transferred from the eNodeB to E-SMLC

The following assistance data may be transferred from the eNodeB to the E-SMLC:

- PCI, GCI, and TP IDs of the TPs served by the eNodeB;
- Timing information of TPs served by the eNodeB;
- PRS configuration of the TPs served by the eNodeB;
- Geographical coordinates of the TPs served by the eNodeB.

An eNodeB may provide assistance data relating only to itself and served TPs via LPPa signalling, although assistance data from several eNodeBs and served TPs may be acquired through other mechanisms, see NOTE below.

NOTE: The assistance data described in this section are not necessarily transferred only from the eNodeB, and in some deployment options may not be delivered from the eNodeB at all; they may also be delivered to the E-SMLC through OA&M or other mechanisms external to the E-UTRAN. In addition, in cases where assistance data are delivered from the eNodeB, how the eNodeB acquires the data is outside the scope of this specification.

8.2.2.3 Location Information that may be transferred from the UE to E-SMLC

The information that may be signalled from UE to the E-SMLC is listed in Table 8.2.2.3-1. The individual UE measurements are defined in [20].

Table 8.2.2.3-1: Information that may be transferred from UE to the E-SMLC

Information	Measurements
Downlink Measurement Results List for EUTRA	Physical cell IDs
	Global cell IDs
	TP IDs
	Downlink timing measurements

8.2.3 Downlink Positioning Procedures

The procedures described in this subclause support downlink positioning measurements obtained by the UE and provided to the E-SMLC using LPP, or obtained by the eNode B and provided to the E-SMLC using LPPa.

In this version of the specification only the UE-assisted downlink positioning is supported.

8.2.3.1 Capability Transfer Procedure

The Capability Transfer procedure for Downlink positioning is described in subclause 7.1.2.1.

8.2.3.1.1 Void

8.2.3.2 Assistance Data Transfer Procedure

8.2.3.2.1 Assistance Data Transfer between E-SMLC and UE

The purpose of this procedure is to enable the E-SMLC to provide assistance data to the UE (e.g., as part of a positioning procedure) and the UE to request assistance data from the E-SMLC (e.g., as part of a positioning procedure or for autonomous self location (i.e., UE determines its own location)).

8.2.3.2.1.1 E-SMLC-initiated assistance data delivery

Figure 8.2.3.2.1.1-1 shows the Assistance Data Delivery operations for the downlink positioning method when the procedure is initiated by the E-SMLC.

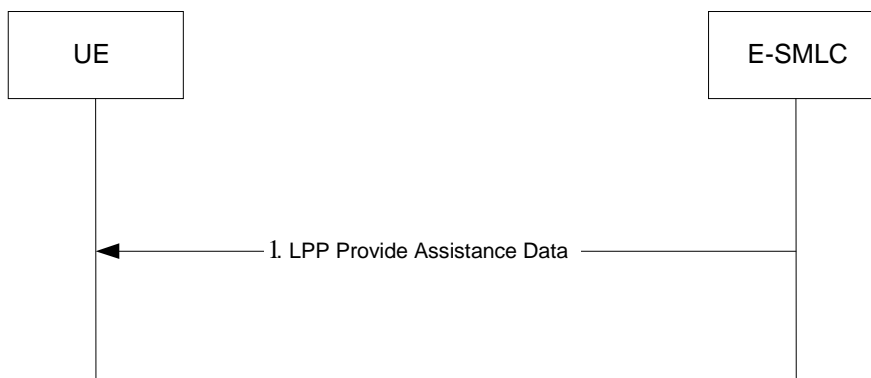

Figure 8.2.3.2.1.1-1: E-SMLC-initiated Assistance Data Delivery Procedure

- (1) The E-SMLC determines that assistance data needs to be provided to the UE (e.g., as part of a positioning procedure) and sends an LPP Provide Assistance Data message to the UE. This message may include any of the downlink positioning assistance data defined in subclause 8.2.2.1.

8.2.3.2.1.2 UE-initiated assistance data transfer

Figure 8.2.3.2.1.2-1 shows the Assistance Data Transfer operations for the downlink positioning method when the procedure is initiated by the UE.

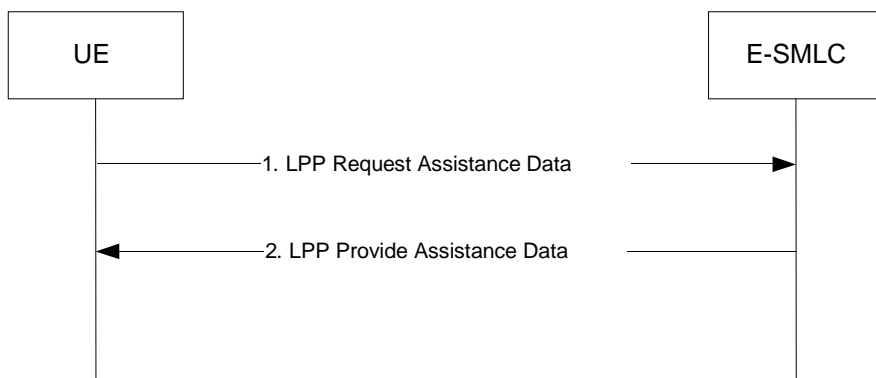

Figure 8.2.3.2.1.2-1: UE-initiated Assistance Data Transfer Procedure

- (1) The UE determines that certain downlink positioning assistance data are desired (e.g., in case the UE requires its own location with autonomous self location, or as part of a positioning procedure when the E-SMLC-provided assistance data are not sufficient for the UE to fulfill the request) and sends an LPP Request Assistance Data message to the E-SMLC. This request includes an indication of which specific downlink assistance data are requested. Additional information concerning the UE's approximate location and serving and neighbour cells may also be provided in the Request Assistance Data message and/or in an accompanying Provide Location Information message to help the E-SMLC provide appropriate assistance data. This additional data may include the UE's last known location if available, the cell IDs of the UE serving eNodeB and possibly neighbour eNodeBs, as well as E-CID measurements.
- (2) The E-SMLC provides the requested assistance in an LPP Provide Assistance Data message, if available at the E-SMLC. If any of the UE requested assistance data in step (1) are not provided in step 2, the UE shall assume that the requested assistance data are not supported, or currently not available at the E-SMLC. If none of the UE requested assistance data in step (1) can be provided by the E-SMLC, return any information that can be provided in an LPP message of type Provide Assistance Data which includes a cause indication for the not provided assistance data.

8.2.3.2.2 Assistance Data Delivery between E-SMLC and eNodeB

The purpose of this procedure is to enable the eNodeB to provide assistance data to the E-SMLC, for subsequent delivery to the UE using the procedures of sub clause 8.2.3.2.1 or for use in the calculation of positioning estimates at the E-SMLC.

8.2.3.2.2.1 Void

8.2.3.2.2.2 E-SMLC-initiated assistance data delivery to the E-SMLC

Figure 8.2.3.2.2.2-1 shows the Assistance Data Delivery operation from the eNodeB to the E-SMLC for the downlink positioning method, in the case that the procedure is initiated by the E-SMLC.

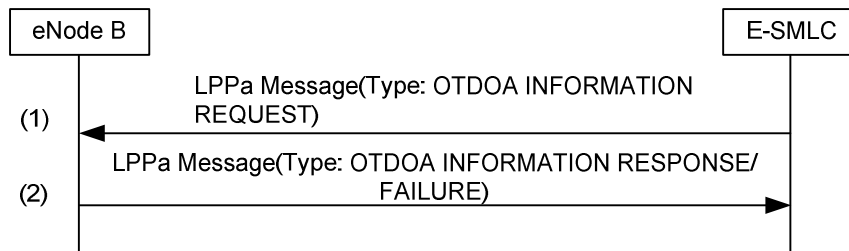

Figure 8.2.3.2.2-1: E-SMLC-initiated Assistance Data Delivery Procedure

- (1) The E-SMLC determines that certain downlink positioning assistance data are desired (e.g., as part of a periodic update or as triggered by OAM) and sends an LPPa OTDOA INFORMATION REQUEST message to the eNode B. This request includes an indication of which specific downlink assistance data are requested.
- (2) The eNode B provides the requested assistance in an LPPa OTDOA INFORMATION RESPONSE message, if available at the eNode B. If the eNode B is not able to provide any information, it returns an OTDOA INFORMATION FAILURE message indicating the cause of the failure.

8.2.3.3 Location Information Transfer Procedure

The purpose of this procedure is to enable the E-SMLC to request position measurements from the UE, or to enable the UE to provide location measurements to the E-SMLC for position calculation (e.g., in case of basic self location where the UE requests its own location).

8.2.3.3.1 E-SMLC-initiated Location Information Transfer

Figure 8.2.3.3.1-1 shows the Location Information Transfer operations for the downlink positioning method when the procedure is initiated by the E-SMLC.

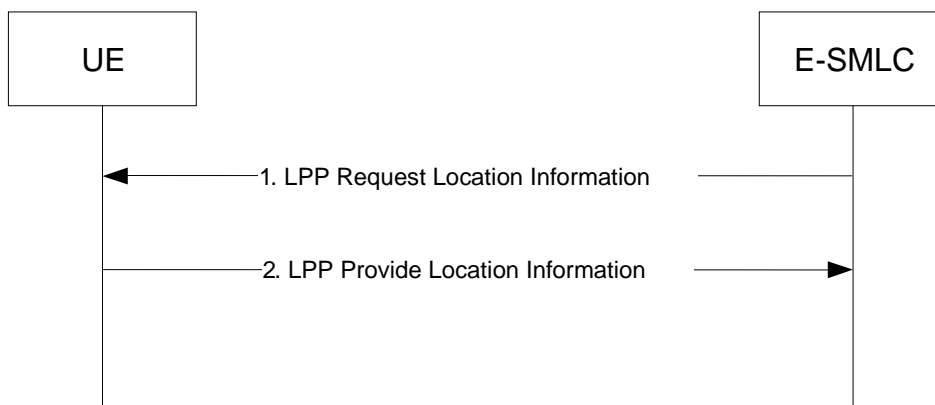

Figure 8.2.3.3.1-1: E-SMLC-initiated Location Information Transfer Procedure

- (1) The E-SMLC sends an LPP Request Location Information message to the UE. This request includes indication of downlink measurements requested, including any needed measurement configuration information, and required response time.
- (2) The UE obtains downlink measurements as requested in step 1. The UE then sends an LPP Provide Location Information message to the E-SMLC, before the Response Time provided in step (1) elapsed, and includes the obtained downlink measurements. If the UE is unable to perform the requested measurements, or the Response Time elapsed before any of the requested measurements were obtained, the UE returns any information that can be provided in an LPP message of type Provide Location Information which includes a cause indication for the not provided location information.

8.2.3.3.2 UE-initiated Location Information Delivery procedure

Figure 8.2.3.3.2-1 shows the Location Information Delivery procedure operations for the downlink positioning method when the procedure is initiated by the UE.

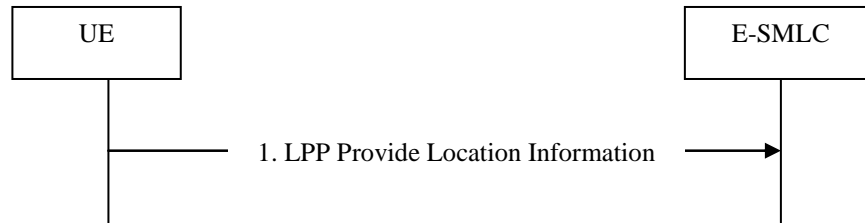

Figure 8.2.3.3.2-1: UE-initiated Location Information Delivery Procedure.

- (1) The UE sends an LPP Provide Location Information message to the E-SMLC. The Provide Location Information message may include any UE downlink measurements already available at the UE.

8.3 Enhanced cell ID positioning methods

8.3.1 General

In the Cell ID (CID)-based method, the UE position is estimated with the knowledge of the geographical coordinates of its serving eNodeB. Enhanced Cell ID (E-CID) positioning refers to techniques which use additional UE and/or E-UTRAN radio resource related measurements to improve the UE location estimate. For E-UTRAN access, these measurements may include [20, 21]:

UE measurements ([20], [21]):

- Reference signal received power (RSRP);
- Reference Signal Received Quality (RSRQ);
- UE Rx – Tx time difference;
- GERAN RSSI;
- UTRAN CPICH RSCP;
- UTRAN CPICH E_c/I_0 ;
- WLAN RSSI.

E-UTRAN measurements ([20], [21]):

- eNB Rx – Tx time difference
- Timing Advance (T_{ADV}):
 - Type1: $T_{ADV} = (\text{eNB Rx} - \text{Tx time difference}) + (\text{UE Rx} - \text{Tx time difference})$
 - Type2: $T_{ADV} = \text{eNB Rx} - \text{Tx time difference}$;
- Angle of Arrival (AoA).

Various techniques exist to use these measurements to estimate the location of the UE. The specific techniques are beyond the scope of this specification.

8.3.2 Information to be transferred between E-UTRAN Elements

This sub clause defines the information (e.g., measurement data) that may be transferred between E-UTRAN elements.

8.3.2.1 Information that may be transferred from the E-SMLC to UE

UE-assisted Enhanced Cell-ID location does not require any assistance data to be transferred from the E-SMLC to the UE.

UE-Based Enhanced Cell-ID location is not supported in this version of the specification.

8.3.2.2 Information that may be transferred from the UE to E-SMLC

The information that may be signalled from UE to the E-SMLC is listed in table 8.3.2.2-1.

Table 8.3.2.2-1: Information that may be transferred from UE to the E-SMLC

Information	UE-assisted
Evolved Cell Global Identifier (ECGI)/Physical Cell ID	Yes
Reference signal received power (RSRP)	Yes
Reference Signal Received Quality (RSRQ)	Yes
UE Rx – Tx time difference	Yes

8.3.2.3 Information that may be transferred from the eNodeB to E-SMLC

The information that may be signalled from eNodeB to the E-SMLC is listed in table 8.3.2.3-1.

Table 8.3.2.3-1: Information that may be transferred from eNB to the E-SMLC

Information
Timing Advance (T_{ADV})
Angle of Arrival (AoA)
E-UTRA Measurement Results List:
- Evolved Cell Global Identifier (ECGI)/Physical Cell ID
- Reference signal received power (RSRP)
- Reference Signal Received Quality (RSRQ)
GERAN Measurement Results List:
- Base Station Identity Code (BSIC)
- ARFCN of Base Station Control Channel (BCCH)
- Received Signal Strength Indicator (RSSI)
UTRA Measurement Results List:
- UTRAN Physical ID
- Common Pilot Channel Received Signal Code Power (RSCP)
- Common Pilot Channel E_c/I_o
WLAN Measurement Results List:
- WLAN Received Signal Strength Indicator (RSSI)
- SSID
- BSSID
- HESSID
- Operating Class
- Country Code
- WLAN Channel(s)
- WLAN Band

8.3.3 Downlink E-CID Positioning Procedures

The procedures described in this subclause support E-CID related measurements obtained by the UE and provided to the E-SMLC using LPP. The term "downlink" is intended to indicate that from the E-SMLC perspective the involved measurements are provided by the UE; this set of procedures might also be considered as "UE-assisted, E-SMLC-based E-CID".

8.3.3.1 Capability Transfer Procedure

The Capability Transfer procedure for E-CID positioning is described in subclause 7.1.2.1.

8.3.3.1.1 Void

8.3.3.2 Assistance Data Delivery Procedure

Assistance data delivery is not required for UE- or eNB-assisted forms of E-CID positioning.

8.3.3.3 Location Information Transfer Procedure

The purpose of this procedure is to enable the E-SMLC to request position measurements from the UE, or to enable the UE to provide location measurements to the E-SMLC for position calculation (e.g., in case of basic self location where the UE requests its own location).

8.3.3.3.1 E-SMLC-initiated Location Information Transfer

Figure 8.3.3.3-1 shows the Location Information Transfer operations for the E-CID method when the procedure is initiated by the E-SMLC.

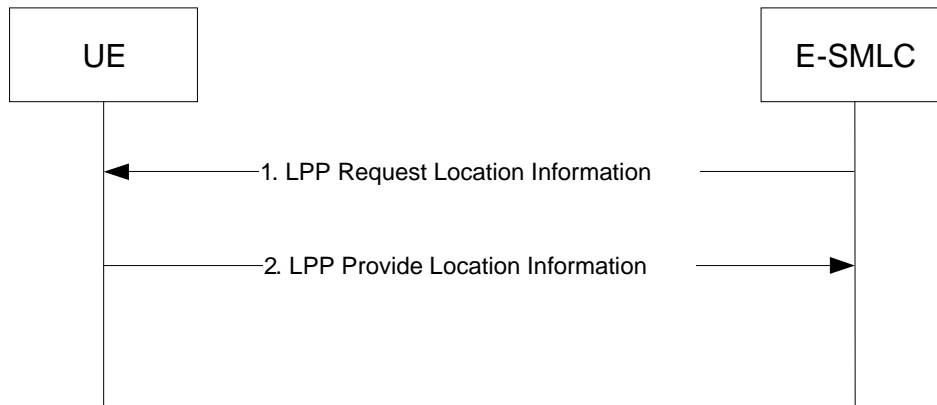

Figure 8.3.3.3-1: E-SMLC-initiated Location Information Transfer Procedure.

- (1) The E-SMLC sends a LPP Request Location Information message to the UE for invocation of E-CID positioning. This request includes the E-CID measurements requested by the E-SMLC and supported by the UE as listed in Table 8.3.2.2-1 together with a required response time.
- (2) The UE performs the requested measurements and sends an LPP Provide Location Information message to the E-SMLC before the Response Time provided in step (1) elapsed. If the UE is unable to perform the requested measurements, or if the Response Time provided in step 1 elapsed before any of the requested measurements have been obtained, the UE returns any information that can be provided in an LPP message of type Provide Location Information which includes a cause indication for the not provided location information.

8.3.3.3.2 UE-initiated Location Information Delivery procedure

Figure 8.3.3.3.2-1 shows the Location Information Delivery procedure operations for the E-CID method when the procedure is initiated by the UE.

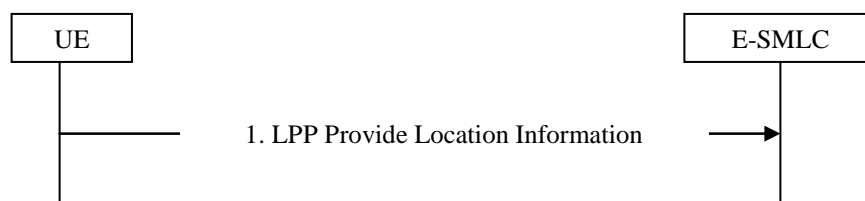

Figure 8.3.3.3.2-1: UE-initiated Location Information Delivery Procedure.

- (1) The UE sends an LPP Provide Location Information message to the E-SMLC. The Provide Location Information message may include any UE measurements already available at the UE.

8.3.4 Uplink E-CID Positioning Procedures

The procedures described in this sub clause support E-CID related measurements obtained by the eNodeB and provided to the E-SMLC using LPPa. The term "uplink" is intended to indicate that from the E-SMLC point of view, the

involved measurements are provided by the eNodeB; this set of procedures might also be considered as "eNB-assisted E-CID". An example of this uplink E-CID positioning method is AoA+T_{ADV}.

NOTE: Uplink E-CID positioning not using T_{ADV} type 1 does not require LCS support in the UE and therefore, works also with legacy UEs (assuming that any involved measurements delivered in RRC are supported by the legacy UEs).

8.3.4.1 Position Capability Transfer Procedure

The position capability transfer procedure is not applicable to uplink E-CID positioning not using T_{ADV} type 1. For uplink E-CID positioning using T_{ADV} type 1, the Capability Transfer procedure for E-CID positioning is described in subclause 7.1.2.1.

8.3.4.2 Assistance Data Delivery Procedure

The assistance data delivery procedure is not applicable to uplink E-CID positioning.

8.3.4.3 Position Measurement Procedure

The purpose of this procedure is to enable the E-SMLC to request position measurements from the eNodeB.

8.3.4.3.1 E-SMLC-initiated Position Measurement

Figure 8.3.4.3.1-1 shows the Position Measurement operations for the uplink E-CID method when the procedure is initiated by the E-SMLC.

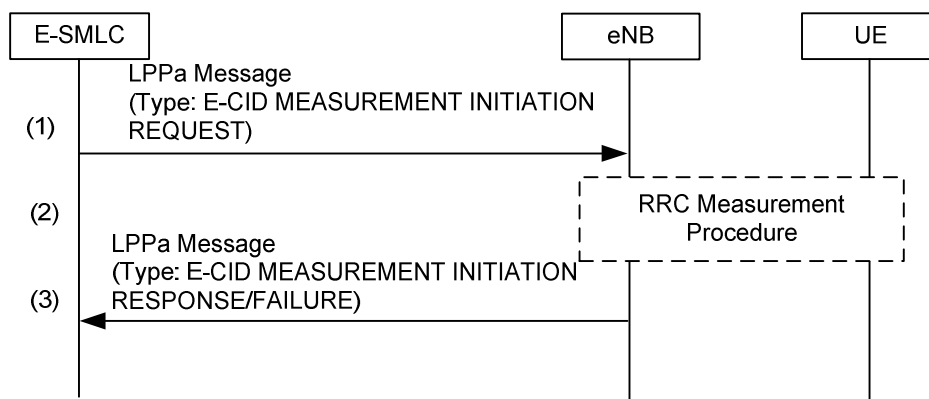

Figure 8.3.4.3.1-1: E-SMLC-initiated Position Measurement Procedure

- (1) The E-SMLC sends an LPPa E-CID MEASUREMENT INITIATION REQUEST message to the eNodeB. This request includes indication of E-CID measurements requested and whether the result is expected only once or periodically.
- (2) If the E-SMLC in step (1) requested UE measurements (i.e., RSRP, RSRQ measurements), or if the eNodeB requires UE measurements associated with the measurements requested by the E-SMLC (e.g., T_{ADV} type 1, which requires a UE Tx-Rx time difference measurement to be delivered from the UE to the eNodeB), the eNodeB may configure the UE to report the measurement information requested as specified in [14].
- (3) If the result is expected only once and the eNodeB initiates at least one of the E-CID measurements as requested, the eNodeB sends an LPPa E-CID MEASUREMENT INITIATION RESPONSE to the E-SMLC, which includes the obtained E-CID measurements. If the result is expected periodically and the eNodeB is able to initiate at least one of the E-CID measurements as requested, the eNodeB sends an LPPa E-CID MEASUREMENT INITIATION RESPONSE to the E-SMLC, which does not include any result. The eNodeB reports then the obtained measurements by initiating the E-CID Measurement Report procedure, with the requested periodicity. If the eNodeB is unable to initiate any of the requested measurements as requested from the E-SMLC, or is unable to instigate any of the required RRC procedures to obtain the requested measurements from the UE, the eNodeB sends an LPPa E-CID MEASUREMENT INITIATION FAILURE message providing the error reason. If the failure occurs during a periodic reporting, the eNodeB sends an LPPa E-CID MEASUREMENT FAILURE INDICATION message.

8.4 Downlink Supporting Procedures

8.4.1 General

An E-SMLC is enabled to request downlink location related information from the E-UTRAN in order to support downlink positioning. LPPa is employed for this between the E-SMLC and each eNodeB reachable from the E-SMLC via any of the MMEs with signalling access to the E-SMLC.

8.4.2 Location Related Information

The information that may be transferred from an eNodeB to the E-SMLC to support downlink positioning is listed in table 8.4.2-1.

Table 8.4.2-1: Information that may be transferred from an eNodeB to the E-SMLC for the Downlink Position Method Support

Information	UE-assisted
Global cell IDs (ECGIs) of eNodeB	Yes
Physical cell IDs (PCIs) of eNodeB	Yes
TP IDs	Yes
PRS Scheduling	Yes
If synchronized: SFN initialization time of TP relative to time reference	Yes

8.4.3 Location Related Information Acquisition Procedure

The purpose of this procedure is to enable an E-SMLC to request downlink location related information from an eNodeB.

8.4.3.1 On Demand Procedure

Figure 8.4.3.1-1 shows the location information acquisition operation for the downlink positioning method when information is needed on demand in real time.

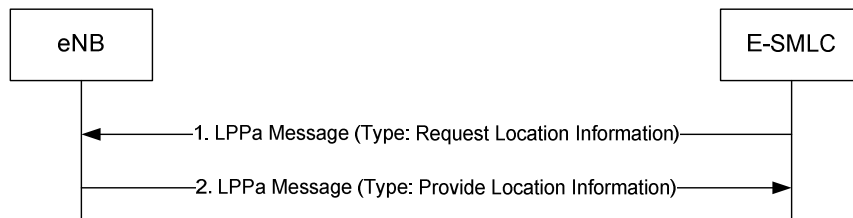

Figure 8.4.3.1-1: E-SMLC-initiated On Demand Procedure for Location Information Applicable to Downlink

- (1) The E-SMLC sends an LPPa message of type Request Location Information to the eNodeB. This request includes an indication of the downlink related information requested.
- (2) The eNodeB obtains the information requested in step 1 using previously configured or stored information and/or real time measurements in the case of a request for timing information where recent timing information is not already available. The eNodeB then sends an LPPa message of type Provide Location Information to the E-SMLC. If the eNodeB is unable to obtain any of the requested information, the eNodeB sends an LPPa failure message, providing the error reason.

8.4.3.2 Triggered Procedure

Figure 8.4.3.2-1 shows the location information acquisition operation for the downlink positioning method when information is needed on a triggered basis.

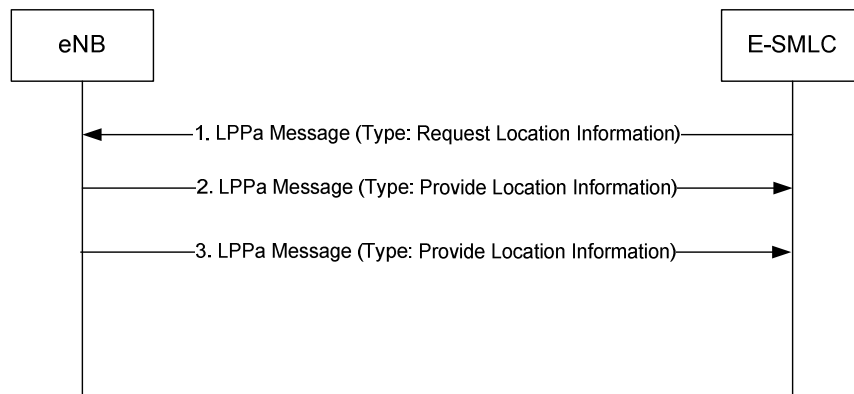

Figure 8.4.3.2-1: E-SMLC-initiated Triggered Procedure for Location Information Applicable to Downlink

- (1) The E-SMLC sends an LPPa message of type Request Location Information to the eNodeB. This request includes an indication of the downlink related information requested, triggering criteria for responses (e.g. periodic time interval).
- (2) In response to step 1, the eNodeB obtains the information requested using already available information and/or real time measurements. The eNodeB then sends an LPPa message of type Provide Location Information to the E-SMLC carrying this information. If the eNodeB is unable to obtain the requested information partly or completely, the eNodeB sends an LPPa failure message.
- (3) When the trigger criteria provided in step 1 indicate the need for a new report the eNodeB obtains the latest information. The eNodeB then sends a further LPPa message of type Provide Location Information to the E-SMLC containing this information. If the eNodeB is unable to obtain the requested information, partly or completely, the eNodeB sends an LPPa failure message.

8.5 Uplink positioning method

8.5.1 General

In the uplink positioning method, the UE position is estimated based on timing measurements of uplink radio signals taken at different LMUs, along with knowledge of the geographical coordinates of the LMUs. The time required for a signal transmitted by a UE to reach a LMU is proportional to the length of the transmission path between the UE and the LMU. A set of LMUs is tasked to sample the UE signal at the same time.

The specifics of any uplink positioning methods or techniques used to estimate the UE's location from these measurements are beyond the scope of this specification.

In order to obtain uplink measurements, the LMUs need to know the characteristics of the SRS signal transmitted by the UE for the time period required to calculate uplink measurement. These characteristics should be static over the periodic transmission of SRS during the uplink measurements. Hence, the E-SMLC will indicate to the serving eNodeB the need to direct the UE to transmit SRS (see 5.2.2) signals for uplink positioning. It is up to the eNodeB to make the final decision on resources to be assigned and to communicate this configuration information back to the E-SMLC so that E-SMLC can configure the LMUs. The eNB may decide (e.g., in case no resources are available) to configure no resources for the UE and report the empty resource configuration to the E-SMLC.

8.5.2 Transferred information

This subclause defines the information that may be transferred between E-SMLC and eNodeB/LMU.

UTDOA measurements are performed on Sounding Reference Signals (SRS), configured as periodic SRS involving multiple SRS transmissions.

NOTE: The tables in sections 8.5.2.1, 8.5.2.2, and 8.5.2.3 will be updated if needed.

8.5.2.1 Configuration Data that may be transferred from the eNodeB to the E-SMLC

The following configuration data may be transferred from the eNodeB to the E-SMLC:

Parameter Category	Parameters
General	PCI of PCell ^{Note 1} UL-EARFCN of PCell Timing advance measurement for the UE in PCell [36.214] ^{Note 3}
SRS	For each serving cell in which SRS is configured ^{Note 2} : <ul style="list-style-type: none"> - PCI - UL-EARFCN - UL cyclic prefix - UL system bandwidth of the cell - Cell-specific SRS bandwidth configuration <i>srs-BandwidthConfig</i> [36.211] - UE-specific SRS bandwidth configuration <i>srs-Bandwidth</i> [36.211] - number of antenna ports for SRS transmission <i>srs-AntennaPort</i> [36.211] - frequency domain position [36.211] - SRS frequency hopping bandwidth configuration [36.211] - SRS-Cyclic shift [36.211] - Transmission comb [36.211] - SRS configuration index [36.213] - <i>MaxUpPt</i>, used for TDD only [36.211] - <i>Group-hopping-enabled</i> [36.211] - <i>deltaSS</i>, parameter Δ_{ss} [36.211, 5.5.1.3], included when SRS sequence hopping is used [36.211, 5.5.1.4] and not included otherwise
Note 1:	Indicating PCell should not imply configuring SRS on the PCell
Note 2:	Multiple serving cells are possible for a UE configured with CA
Note 3:	Used for search window calculation

8.5.2.2 Configuration Data that may be transferred from the E-SMLC to LMU

The following configuration data may be transferred from the E-SMLC to LMU:

Parameter Category	Parameters
General	Search window parameters ^{Note 2} : <ul style="list-style-type: none"> - expected propagation delay, T, corresponding to distance between LMU and PCell, - delay uncertainty Δ
SRS	For each serving cell in which SRS is configured and to be measured by LMU ^{Note 1} : <ul style="list-style-type: none"> - PCI - UL-EARFCN - UL cyclic prefix - UL system bandwidth of the cell - Cell-specific SRS bandwidth configuration <i>srs-BandwidthConfig</i> [36.211] - UE-specific SRS bandwidth configuration <i>srs-Bandwidth</i> [36.211] - number of antenna ports for SRS transmission <i>srs-AntennaPort</i> [36.211] - frequency domain position [36.211] - SRS frequency hopping bandwidth configuration [36.211] - SRS-Cyclic shift [36.211] - Transmission comb [36.211] - SRS configuration index [36.213] - <i>MaxUpPt</i>, used for TDD only [36.211] - <i>Group-hopping-enabled</i> [36.211] - <i>deltaSS</i>, parameter Δ_{ss} [36.211, 5.5.1.3], included when SRS sequence hopping is used [36.211, 5.5.1.4] and not included otherwise
Note 1:	Multiple serving cells are possible for a UE configured with CA; SRS may be transmitted on the PCell and/or SCell(s).
Note 2:	Search window is calculated by the LMU as $[T-\Delta, T+\Delta]$, where Δ may be e.g. the timing advance measurement provided by eNodeB.

8.5.2.3 Location Information that may be transferred from the LMU to E-SMLC

The information that may be transferred from LMU to the E-SMLC is listed in Table 8.5.2.3-1. The individual measurements will be defined in [20].

Table 8.5.2.3-1: Information that may be transferred from LMU to the E-SMLC

Information	Measurements
Uplink Measurement Results List for EUTRA	UL Relative Time of Arrival
	Physical cell IDs

8.5.3 Uplink Positioning Procedures

The procedures described in this subclause support the uplink positioning method.

8.5.3.1 Uplink Information Request and Delivery Procedure

The Information Request procedure for Uplink positioning is used by the E-SMLC to obtain measurement results from the LMU which it uses to calculate a position for the UE. To do this, it needs to first indicate to the serving eNB the need to configure the UE to transmit SRS (see 5.2.2) signals and retrieve target UE configuration data from the eNodeB.

Figure 8.5.3.1-1 shows the messaging between the E-SMLC, the LMU and the serving eNodeB to perform this procedure.

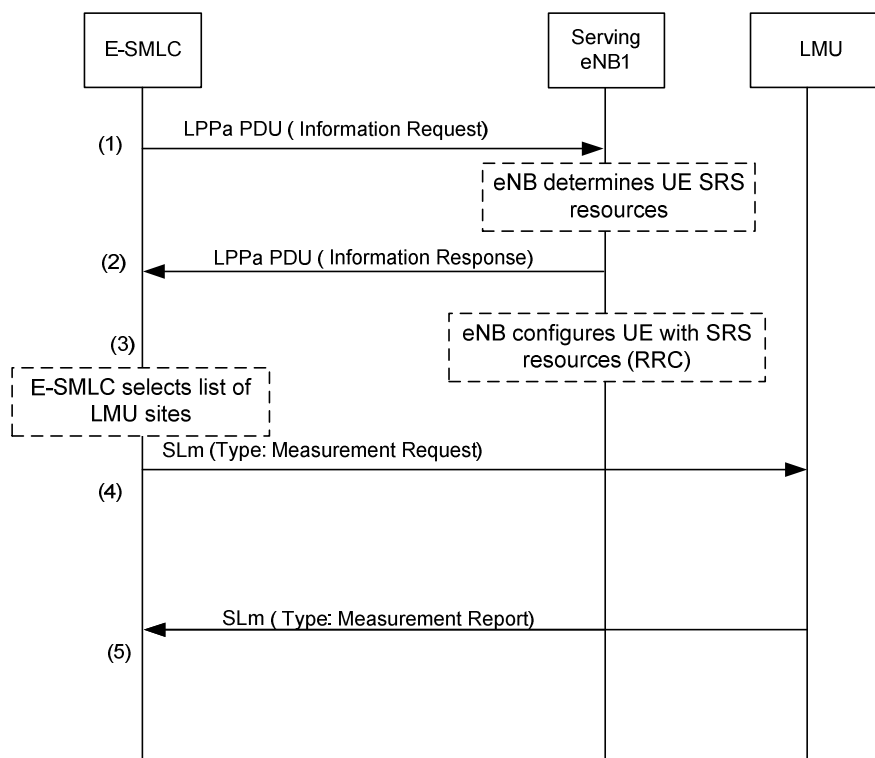

Figure 8.5.3.1-1: Uplink information request procedure

1. The E-SMLC sends an Information Request message indicating to the eNodeB the need to invoke periodic SRS (see 5.2.2) for target UE. The E-SMLC may provide the eNB with a number of SRS transmissions. The final decision of SRS transmissions to be performed and whether to take into account this information is entirely up to the eNB implementation.
2. The eNodeB determines the resources to be allocated for the UE and sends an Information Response to the E-SMLC that includes the allocated resources and the associated parameters. The eNB may decide (e.g., in case no resources are available) to configure no resources for the UE and report the empty resource configuration to the E-SMLC.
3. If in step 2 the eNodeB determines that resources will be allocated, the eNodeB then allocates the resources to the target UE.

4. The E-SMLC selects a set of LMUs to be used for the UTDOA positioning and sends a measurement request with the SRS configuration to each one of them (via SLM).
5. LMUs report back to E-SMLC the uplink measurement reports.

8.5.3.2 Uplink Positioning Information Update Procedure

This procedure is used to notify the E-SMLC of a change to the UE SRS transmission configuration for one or more cells with respect to a previously sent UTDOA INFORMATION RESPONSE message. If the configured SRS transmission for the target UE has been modified, or if a handover of the target UE has been triggered, the eNB uses the Uplink Positioning Information Update procedure to inform the E-SMLC.

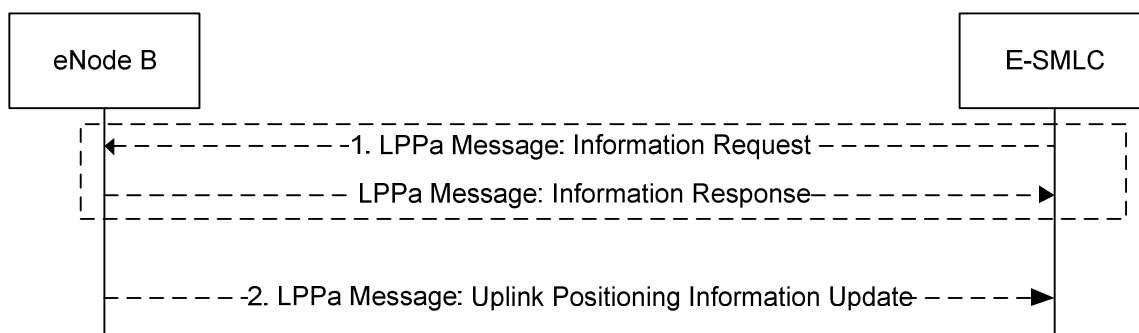

Figure 8.5.3.2-1: Uplink Positioning Information Update Procedure

1. If the SRS configuration changes or if a handover of the target UE has been triggered prior to the expected completion time of the previously communicated SRS configuration, the eNB initiates the Uplink Positioning Information Update Procedure. In the case of handover, the source eNB sends the update message after deciding to perform handover execution for the UE.
2. If the UE SRS transmission configuration has changed for one or more cells, the eNB sends an Uplink Positioning Information Update message to the E-SMLC carrying the UE SRS transmission configuration information for all cells with SRS configured.

8.6 Barometric pressure sensor positioning methods

8.6.1 General

In the barometric pressure sensor positioning method, the UE vertical component of the position is estimated by combining the measured atmospheric pressure and a reference atmospheric pressure. This is accomplished through barometric sensors measuring atmospheric pressure at the UE, and applying a height determination algorithm using the reference atmospheric pressure.

Three positioning modes are supported:

- *UE-Assisted*: The UE performs barometric pressure sensor measurements with or without assistance from the network and sends these measurements to the E-SMLC where the vertical component of the position calculation may take place, possibly using additional measurements from other sources;
- *UE-Based*: The UE performs barometric pressure sensor measurements and calculates its own vertical component of the position, possibly using additional measurements from other sources.
- *Standalone*: The UE performs barometric pressure sensor measurements and calculates its own vertical component of the position, possibly using additional measurements from other sources, without network assistance.

8.6.2 Information to be transferred between E-UTRAN Elements

This subclause defines the information (e.g., assistance data, vertical position and/or measurement data) that may be transferred between E-UTRAN elements.

8.6.2.1 Information that may be transferred from the UE to E-SMLC

The information transferred from the UE to the E-SMLC consists of capability information and location measurements or UE position. The information that may be signalled from the UE to the E-SMLC is summarized in Table 8.6.2.1-1.

Table 8.6.2.1-1: Information that may be transferred from UE to the E-SMLC

Information	UE-assisted	UE-based/ Standalone
UE position estimate with uncertainty shape	No	Yes
Indication of used positioning methods in the fix	No	Yes
Timestamp	Yes	Yes
Barometric pressure sensor measurements	Yes	No

8.6.2.1.1 Standalone mode

In Standalone mode, the UE reports the vertical component of the position, together with an estimate of the location uncertainty, if available.

The UE should also report an indication of which positioning method(s) have been used to calculate a fix.

8.6.2.1.2 UE-assisted mode

In UE-assisted mode, the UE reports the barometric pressure sensor measurements together with associated quality estimates. These measurements enable the E-SMLC to calculate the vertical component of the location of the UE, possibly using other measurements and data.

If requested by the E-SMLC and supported by the UE, the UE may report barometric pressure sensor measurements together with associated quality measurements, if available.

8.6.2.1.3 UE-based mode

In UE-based mode, the UE reports the vertical component of the position, together with an estimate of the location uncertainty, if available.

The UE should also report an indication of which positioning method(s) have been used to calculate a fix.

8.6.2.2 Information that may be transferred from the E-SMLC to UE

Table 8.6.2.2-1 lists assistance data for both UE-assisted and UE-based modes that may be sent from the E-SMLC to the UE.

NOTE: The provision of these assistance data elements and the usage of these elements by the UE depend on the E-UTRAN and UE capabilities, respectively.

Table 8.6.2.2-1: Information that may be transferred from the E-SMLC to UE

Assistance Data
Reference pressure
Additional reference data

8.6.2.2.1 Barometric pressure sensor assistance data

The barometric pressure sensor assistance data may include reference pressure, along with other reference data, such as the reference point where the reference barometric pressure is valid and reference temperature at the reference point.

8.6.3 Barometric Pressure Sensor Location Information Transfer Procedures

The purpose of this procedure is to enable the E-SMLC to request barometric pressure sensor measurements or position estimate from the UE, or to enable the UE to provide barometric pressure sensor measurements to the E-SMLC for position calculation (e.g., in case of basic self-location where the UE requests its own location).

8.6.3.1 E-SMLC initiated Location Information Transfer Procedure

Figure 8.6.3.1-1 shows the Location Information Transfer operations when the procedure is initiated by the E-SMLC.

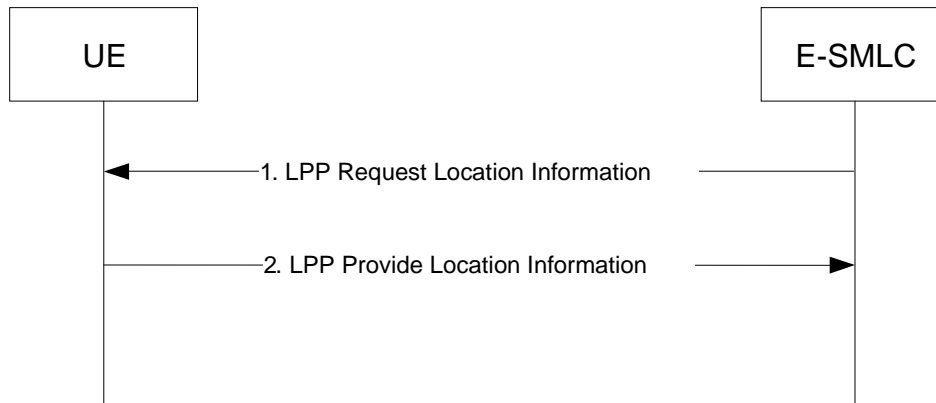

Figure 8.6.3.1-1: E-SMLC-initiated Location Information Transfer Procedure

- (1) The E-SMLC sends a LPP Request Location Information message to the UE for invocation of barometric pressure sensor positioning. This request includes positioning instructions such as the positioning mode (UE-assisted, UE-based, standalone), specific requested UE measurements if any, and quality of service parameters (accuracy, response time).
- (2) The UE performs the requested measurements and possibly calculates its own position. The UE sends an LPP Provide Location Information message to the E-SMLC before the Response Time provided in step (1) elapsed. If the UE is unable to perform the requested measurements, or if the Response Time provided in step 1 elapsed before any of the requested measurements have been obtained, the UE returns any information that can be provided in an LPP message of type Provide Location Information which includes a cause indication for the not provided location information.

8.6.3.2 UE-initiated Location Information Delivery Procedure

Figure 8.6.3.2-1 shows the Location Information delivery operations for the barometric pressure sensor method when the procedure is initiated by the UE.

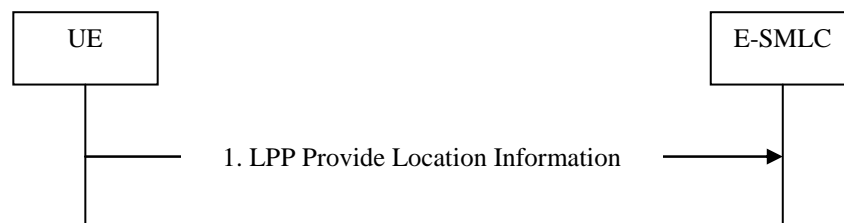

Figure 8.6.3.2-1: UE-initiated Location Information Delivery Procedure

- (1) The UE sends an LPP Provide Location Information message to the E-SMLC. The Provide Location Information message may include UE barometric pressure sensor measurements or location estimate already available at the UE.

8.6.3.3 Assistance Data Transfer Procedure

The purpose of this procedure is to enable the E-SMLC to provide assistance data to the UE (e.g., as part of a positioning procedure) and the UE to request assistance data from the E-SMLC (e.g., as part of a positioning procedure or for autonomous self location (i.e., UE determines its own location)).

8.6.3.3.1 E-SMLC initiated Assistance Data Delivery

Figure 8.6.3.3.1-1 shows the Assistance Data Delivery operations for the network-assisted barometric pressure sensor method when the procedure is initiated by the E-SMLC.

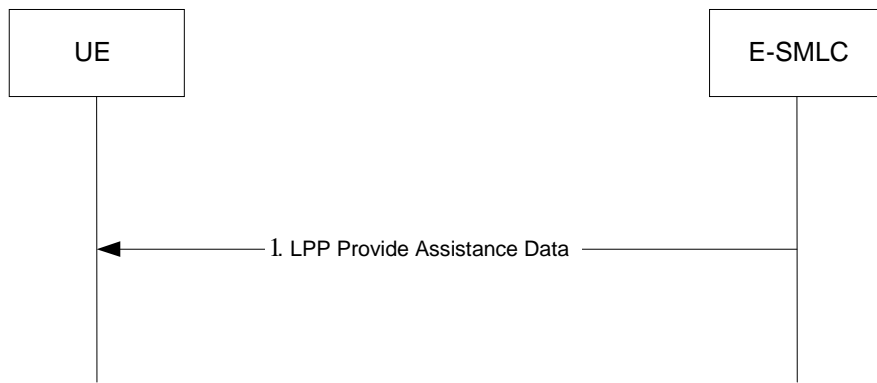

Figure 8.6.3.3.1-1: E-SMLC-initiated Assistance Data Delivery Procedure

- (1) The E-SMLC determines that assistance data needs to be provided to the UE (e.g., as part of a positioning procedure) and sends an LPP Provide Assistance Data message to the UE. This message may include any of the barometric pressure sensor assistance data defined in subclause 8.6.2.2.

8.6.3.3.2 UE initiated Assistance Data Transfer

Figure 8.6.3.3.2-1 shows the Assistance Data Transfer operations for the network-assisted Barometric pressure sensor method when the procedure is initiated by the UE.

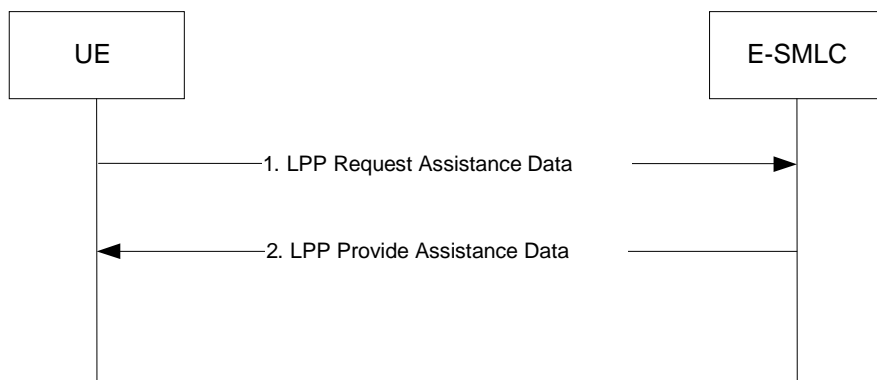

Figure 8.6.3.3.2-1: UE-initiated Assistance Data Transfer Procedure

- (1) The UE determines that certain barometric pressure sensor assistance data is desired (e.g., in case the UE requires its own location with autonomous self location or as part of a positioning procedure when the E-SMLC provided assistance data are not sufficient for the UE to fulfil the request) and sends a LPP Request Assistance Data message to the E-SMLC. This request includes an indication of which specific barometric pressure sensor assistance data is requested.
- (2) The E-SMLC provides the requested assistance data in a LPP Provide Assistance Data message, if available at the E-SMLC. The entire set of assistance data may be delivered in one or several LPP messages. In this case, this step may be repeated by the E-SMLC several times. If any of the UE requested assistance data in step (1) are not provided in step 2, the UE shall assume that the requested assistance data are not supported, or currently not available at the E-SMLC. If none of the UE requested assistance data in step (1) can be provided by the E-SMLC, return any information that can be provided in an LPP message of type Provide Assistance Data which includes a cause indication for the not provided assistance data.

8.7 WLAN positioning methods

8.7.1 General

In the WLAN positioning method, the UE position is estimated with the knowledge of geographical coordinate of reference WLAN access points. This is accomplished by collecting a certain amount of measurements from UE's

WLAN receivers, and applying a location determination algorithm using databases of the estimated position's references points.

The UE WLAN measurements may include:

- WLAN Received Signal Strength (RSSI)
- Round Trip Time (RTT) between WLAN Access Point and the UE

Three positioning modes are supported:

- *Standalone*:
The UE performs WLAN position measurements and location computation, without network assistance.
- *UE-assisted*:
The UE provides WLAN position measurements with or without assistance from the network to the E-SMLC for computation of a location estimate by the network.
- *UE-based*:
The UE performs WLAN position measurements and computation of a location estimate with network assistance.

8.7.2 Information to be transferred between E-UTRAN Elements

This subclause defines the information (e.g., assistance data, position, measurement data) that may be transferred between E-UTRAN elements.

8.7.2.1 Information that may be transferred from the UE to E-SMLC

The information transferred from the UE to the E-SMLC consists of capability information and location measurements or UE position. The information that may be signalled from the UE to the E-SMLC is summarized in Table 8.7.2.1-1.

Table 8.7.2.1-1: Information that may be transferred from the UE to the E-SMLC

Information	UE-Assisted	UE-based/ Standalone
WLAN Location Information		
BSSID	Yes	No
SSID	Yes	No
Received Signal Strength (RSSI)	Yes	No
Round Trip Time (RTT)	Yes	No
Time Stamp	Yes	No
Measurement characteristics	Yes	No
UE Location Information		
UE position estimate with uncertainty shape	No	Yes
Position Time Stamp	No	Yes
Location Source (method(s) used to compute location)	No	Yes

8.7.2.1.1 Standalone mode

In Standalone mode, the UE reports the latitude, longitude and possibly altitude, together with an estimate of the location uncertainty, if available.

The UE should also report an indication of WLAN method and possibly other positioning methods used to calculate a fix.

8.7.2.1.2 UE-assisted mode

In UE-assisted mode, the UE should report:

- The BSSID/SSID of the measured WLAN access points, and associated RSSI or RTT.

8.7.2.1.3 UE-based mode

In UE-based mode, the UE reports the latitude, longitude, and possibly altitude, together with an estimate of the location uncertainty, if available.

The UE should also report an indication that WLAN method is used and possibly other positioning methods used to calculate the fix.

8.7.2.2 Information that may be transferred from the E-SMLC to UE

Table 8.7.2.2-1 lists assistance data for both UE-assisted and UE-based modes that may be sent from the E-SMLC to the UE.

NOTE: The provision of these assistance data elements and the usage of these elements by the UE depend on the E-UTRAN and UE capabilities, respectively.

Table 8.7.2.2-1: Information that may be transferred from the E-SMLC to UE

Assistance Data
WLAN AP List
- BSSID
- SSID
- AP Type Data ⁽¹⁾
- AP Location
NOTE 1: WLAN AP Type Data may include WLAN Type (e.g., 802.11a/b/g/n/ac/ad, etc.), transmit power, antenna gain, coverage area, etc.

8.7.2.2.1 WLAN AP BSSID

This assistance data provides the BSSID of the WLAN access point [29].

8.7.2.2.2 WLAN AP SSID

This assistance data provides the SSID of the WLAN access point [29].

8.7.2.2.3 WLAN AP Type Data

This assistance data provides additional information about the access point and may include WLAN Type (e.g., 802.11a/b/g/n/ac/ad, etc.), transmit power, antenna gain, coverage area, etc. [29]

8.7.2.2.4 WLAN AP Location

This assistance data provides the location (possibly including altitude information) of the access point [29].

8.7.3 WLAN Positioning Procedures

8.7.3.1 Location Information Transfer Procedure

The purpose of this procedure is to enable the E-SMLC to request position measurements or location estimate from the UE, or to enable the UE to provide location measurements to the E-SMLC for position calculation (e.g., in case of basic self-location where the UE requests its own location).

8.7.3.1.1 E-SMLC initiated Location Information Transfer Procedure

Figure 8.7.3.1.1-1 shows the Location Information Transfer operations for the WLAN method when the procedure is initiated by the E-SMLC.

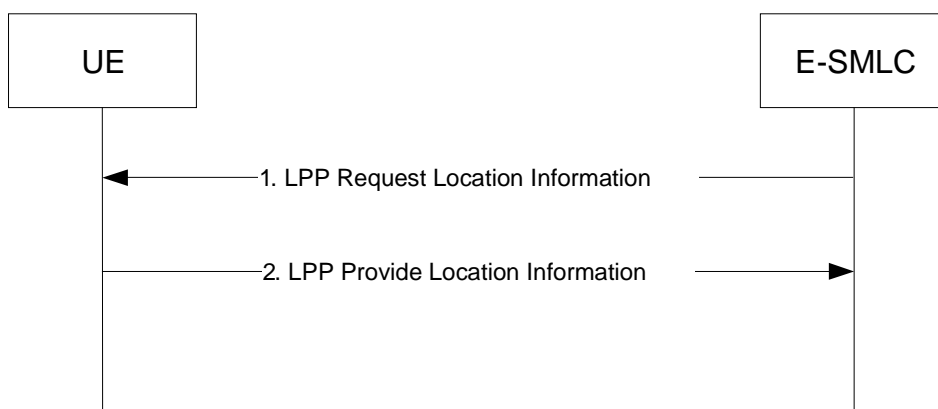

Figure 8.7.3.1.1-1: E-SMLC-initiated Location Information Transfer Procedure

- (1) The E-SMLC sends a LPP Request Location Information message to the UE for invocation of WLAN positioning. This request includes positioning instructions such as the positioning mode (UE-assisted, UE-based, Standalone), specific requested UE measurements if any, and quality of service parameters (accuracy, response time).
- (2) The UE performs the requested measurements and possibly calculates its own location. The UE sends an LPP Provide Location Information message to the E-SMLC before the Response Time provided in step (1) elapsed. If the UE is unable to perform the requested measurements, or if the Response Time provided in step 1 elapsed before any of the requested measurements have been obtained, the UE returns any information that can be provided in an LPP message of type Provide Location Information which includes a cause indication for the not provided location information.

8.7.3.1.2 UE-initiated Location Information Delivery Procedure

Figure 8.7.3.1.2-1 shows the Location Information delivery operations for the WLAN method when the procedure is initiated by the UE.

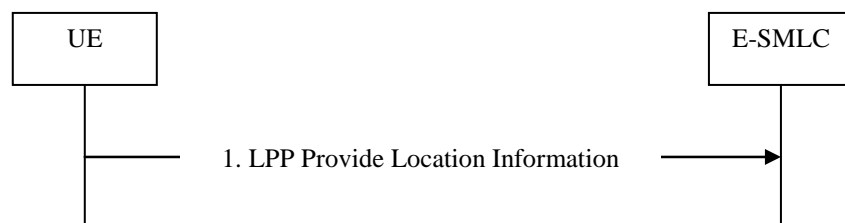

Figure 8.7.3.1.2-1: UE-initiated Location Information Delivery Procedure

- (1) The UE sends an LPP Provide Location Information message to the E-SMLC. The Provide Location Information message may include UE WLAN information or location estimate already available at the UE.

8.7.3.2 Assistance Data Transfer Procedure

The purpose of this procedure is to enable the UE to request assistance data from the E-SMLC (e.g., as part of a positioning procedure or for autonomous self location (i.e., UE determines its own location)) and the E-SMLC to provide assistance data to the UE (e.g., as part of a positioning procedure).

8.7.3.2.1 UE initiated Assistance Data Transfer

Figure 8.7.3.2.1-1 shows the Assistance Data Transfer operations for the network-assisted WLAN method when the procedure is initiated by the UE.

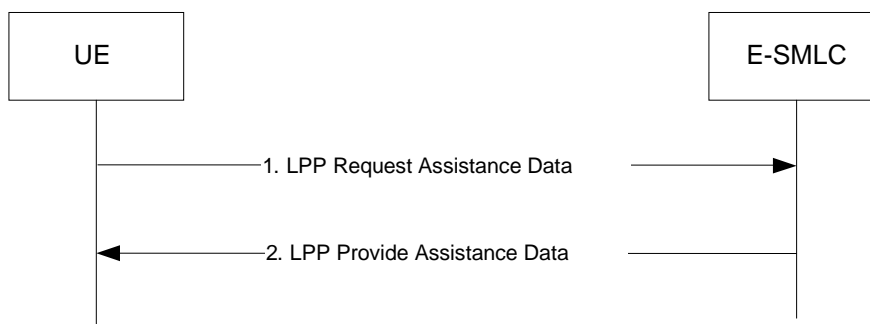

Figure 8.7.3.2.1-1: UE-initiated Assistance Data Transfer Procedure

- (1) The UE determines that certain WLAN assistance data is desired (e.g., in case the UE requires its own location with autonomous self location or as part of a positioning procedure when the E-SMLC provided assistance data are not sufficient for the UE to fulfil the request) and sends a LPP Request Assistance Data message to the E-SMLC. This request includes an indication of which specific WLAN assistance data is requested.
- (2) The E-SMLC provides the requested assistance data in a LPP Provide Assistance Data message, if available at the E-SMLC. The entire set of assistance data may be delivered in one or several LPP messages. In this case, this step may be repeated by the E-SMLC several times. If any of the UE requested assistance data in step (1) are not provided in step 2, the UE shall assume that the requested assistance data are not supported, or currently not available at the E-SMLC. If none of the UE requested assistance data in step (1) can be provided by the E-SMLC, return any information that can be provided in an LPP message of type Provide Assistance Data which includes a cause indication for the not provided assistance data.

8.8 Bluetooth positioning methods

8.8.1 General

In the Bluetooth positioning method, the UE position is estimated with the knowledge of geographical coordinate of reference Bluetooth beacons. This is accomplished by collecting a certain amount of measurements from UE's Bluetooth receiver, and applying a location determination algorithm using databases of the estimated position's references points.

The UE Bluetooth measurements may include:

- Bluetooth beacon's Received Signal Strength (RSSI)

Two positioning modes are supported:

- *Standalone*:
The UE performs Bluetooth position measurements and location computation.
- *UE-assisted*:
The UE provides Bluetooth position measurements without assistance from the network to the E-SMLC for computation of a location estimate by the network.

8.8.2 Information to be transferred between E-UTRAN Elements

This subclause defines the information (e.g., position, measurement data) that may be transferred between E-UTRAN elements.

8.8.2.1 Information that may be transferred from the UE to E-SMLC

The information transferred from the UE to the E-SMLC consists of capability information and location measurements or UE position. The information that may be signalled from the UE to the SMLC is summarized in Table 8.8.2.1-1.

Table 8.8.2.1-1: Information that may be transferred from the UE to the E-SMLC

Information	UE-Assisted	Standalone
Bluetooth Location Information		
MAC Address	Yes	No
Received Signal Strength (RSSI)	Yes	No
Time Stamp	Yes	No
Measurement characteristics	Yes	No
UE Location Information		
UE position estimate with uncertainty shape	No	Yes
Position Time Stamp	No	Yes
Location Source (method(s) used to compute location)	No	Yes

8.8.2.1.1 Standalone mode

In Standalone mode, the UE reports the latitude, longitude and possibly altitude, together with an estimate of the location uncertainty, if available.

The UE should also report an indication of Bluetooth method and possibly other location methods have been used to calculate a fix.

8.8.2.1.2 UE-assisted mode

In UE-assisted mode, the UE should report:

- The MAC addresses of the measured Bluetooth beacons and associated RSSI.

8.8.3 Bluetooth Positioning Procedures

8.8.3.1 Location Information Transfer Procedure

The purpose of this procedure is to enable the E-SMLC to request position measurements or location estimate from the UE, or to enable the UE to provide location measurements to the E-SMLC for position calculation (e.g., in case of basic self-location where the UE requests its own location).

8.8.3.1.1 E-SMLC initiated Location Information Transfer Procedure

Figure 8.8.3.1.1-1 shows the Location Information Transfer operations for the Bluetooth method when the procedure is initiated by the E-SMLC.

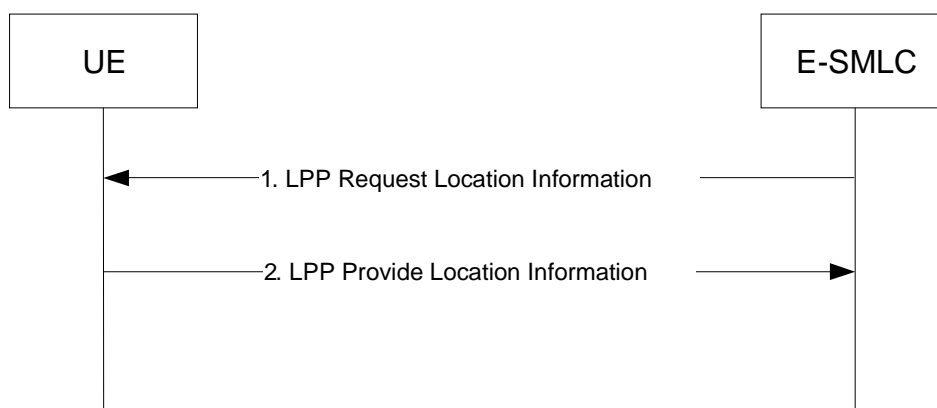
**Figure 8.8.3.1.1-1: E-SMLC-initiated Location Information Transfer Procedure**

- (1) The E-SMLC sends a LPP Request Location Information message to the UE for invocation of Bluetooth positioning. This request includes positioning instructions such as the positioning mode (UE-assisted, Standalone), specific requested UE measurements if any, and quality of service parameters (accuracy, response time).

- (2) The UE performs the requested measurements and possibly calculates its own location. The UE sends an LPP Provide Location Information message to the E-SMLC before the Response Time provided in step (1) elapsed. If the UE is unable to perform the requested measurements, or if the Response Time provided in step 1 elapsed before any of the requested measurements have been obtained, the UE returns any information that can be provided in an LPP message of type Provide Location Information which includes a cause indication for the not provided location information.

8.8.3.1.2 UE-initiated Location Information Delivery Procedure

Figure 8.8.3.1.2-1 shows the Location Information delivery operations for the Bluetooth method when the procedure is initiated by the UE.

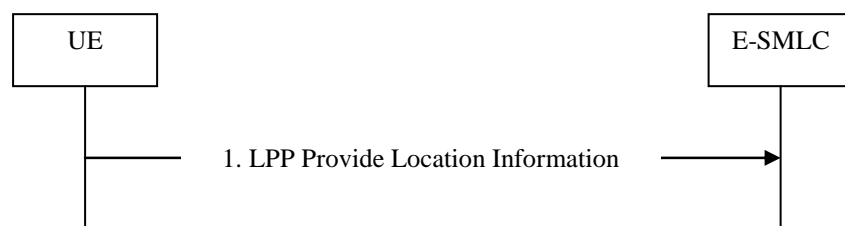

Figure 8.8.3.1.2-1: UE-initiated Location Information Delivery Procedure

- (1) The UE sends an LPP Provide Location Information message to the E-SMLC. The Provide Location Information message may include UE Bluetooth information or location estimate already available at the UE.

8.9 TBS positioning methods

8.9.1 General

Terrestrial Beacon Systems (TBS) is the standard generic term for a network of ground-based transmitters broadcasting signals for geo-spatial positioning with wide-area or regional coverage. The following TBSs are supported in this version of the specification:

- Metropolitan Beacon Systems (MBS).

NOTE: PRS-based TBS is part of downlink (OTDOA) positioning and described in subclause 8.2.

Three positioning modes are supported:

- *UE-Assisted*: The UE performs TBS measurements with or without assistance from the network, and sends these measurements to the E-SMLC where the position calculation takes place, possibly using additional measurements from other (non-TBS) sources;
- *UE-Based*: The UE performs TBS measurements and calculates its own location, possibly using additional measurements from other (non-TBS) sources.
- *Standalone*: The UE performs TBS measurements and calculates its own location, possibly using additional measurements from other (non-TBS) sources, without network assistance.

8.9.2 Information to be transferred between E-UTRAN Elements

This subclause defines the information (e.g., assistance data, position, measurement data) that may be transferred between E-UTRAN elements.

8.9.2.1 Information that may be transferred from the UE to E-SMLC

The information transferred from the UE to the E-SMLC consists of capability information and location measurements or UE position. The information that may be signalled from the UE to the E-SMLC is summarized in Table 8.9.2.1-1.

Table 8.9.2.1-1: Information that may be transferred from UE to the E-SMLC

Information	UE-assisted	UE-based/ Standalone
UE position estimate with uncertainty shape	No	Yes
Timestamp	Yes	Yes
Indication of used positioning methods in the fix	No	Yes
TBS measurements (code phase (MBS))	Yes	No
Measurement quality parameters for each measurement	Yes	No

8.9.2.1.1 Standalone mode

In Standalone mode, the UE reports the latitude, longitude and possibly altitude, together with an estimate of the location uncertainty, if available.

The UE should also report an indication that TBS method is used and possibly other positioning methods used to calculate the fix.

8.9.2.1.2 UE-assisted mode

In UE-assisted mode, the UE reports the TBS associated measurements, together with associated quality estimates. These measurements enable the E-SMLC to calculate the location of the UE, possibly using other measurements and data.

8.9.2.1.3 UE-based mode

In UE-based mode, the UE reports the latitude and longitude, together with an estimate of the location uncertainty, if available.

The UE should also report an indication that TBS method is used and possibly other positioning methods used to calculate the fix.

8.9.2.2 Information that may be transferred from the E-SMLC to UE

Table 8.9.2.2-1 lists assistance data for both UE-assisted and UE-based modes that may be sent from the E-SMLC to the UE.

NOTE: The provision of these assistance data elements and the usage of these elements by the UE depend on the E-UTRAN and UE capabilities, respectively.

Table 8.9.2.2-1: Information that may be transferred from the E-SMLC to UE

Assistance Data
Acquisition assistance
Almanac

8.9.2.2.1 Acquisition Assistance

Acquisition assistance provides the MBS receiver with information about visible beacons, PN Codes, and other information of the MBS signals to enable a fast acquisition of the MBS signals.

8.9.2.2.2 Almanac

Almanac assistance provides the MBS receiver with MBS beacon parameters that can be used to determine the UE position.

8.9.3 TBS Positioning Procedures

8.9.3.1 Location Information Transfer Procedure

The purpose of this procedure is to enable the E-SMLC to request position measurements or location estimate from the UE, or to enable the UE to provide location measurements to the E-SMLC for position calculation (e.g., in case of basic self-location where the UE requests its own location).

8.9.3.1.1 E-SMLC initiated Location Information Transfer Procedure

Figure 8.9.3.1.1-1 shows the Location Information Transfer operations for the TBS method when the procedure is initiated by the E-SMLC.

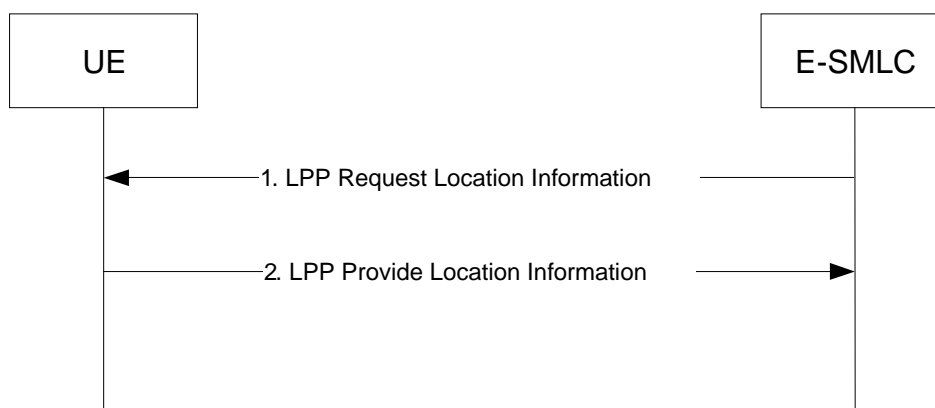

Figure 8.9.3.1.1-1: E-SMLC-initiated Location Information Transfer Procedure

- (1) The E-SMLC sends a LPP Request Location Information message to the UE for invocation of TBS positioning. This request includes positioning instructions such as the positioning mode (UE-assisted, UE-based, Standalone), specific requested UE measurements if any, and quality of service parameters (accuracy, response time).
- (2) The UE performs the requested measurements and possibly calculates its own location. The UE sends an LPP Provide Location Information message to the E-SMLC before the Response Time provided in step (1) elapsed. If the UE is unable to perform the requested measurements, or if the Response Time provided in step 1 elapsed before any of the requested measurements have been obtained, the UE returns any information that can be provided in an LPP message of type Provide Location Information which includes a cause indication for the not provided location information.

8.9.3.1.2 UE-initiated Location Information Delivery Procedure

Figure 8.9.3.1.2-1 shows the Location Information delivery operations for the TBS method when the procedure is initiated by the UE.

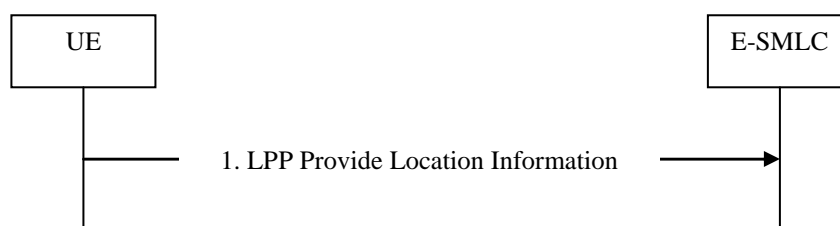

Figure 8.9.3.1.2-1: UE-initiated Location Information Delivery Procedure

- (1) The UE sends an LPP Provide Location Information message to the E-SMLC. The Provide Location Information message may include UE TBS measurements or location estimate already available at the UE.

8.9.3.2 Assistance Data Transfer Procedure

The purpose of this procedure is to enable the E-SMLC to provide assistance data to the UE (e.g., as part of a positioning procedure) and the UE to request assistance data from the E-SMLC (e.g., as part of a positioning procedure or for autonomous self location (i.e., UE determines its own location)).

8.9.3.2.1 E-SMLC initiated Assistance Data Delivery

Figure 8.9.3.2.1-1 shows the Assistance Data Delivery operations for the network-assisted TBS method when the procedure is initiated by the E-SMLC.

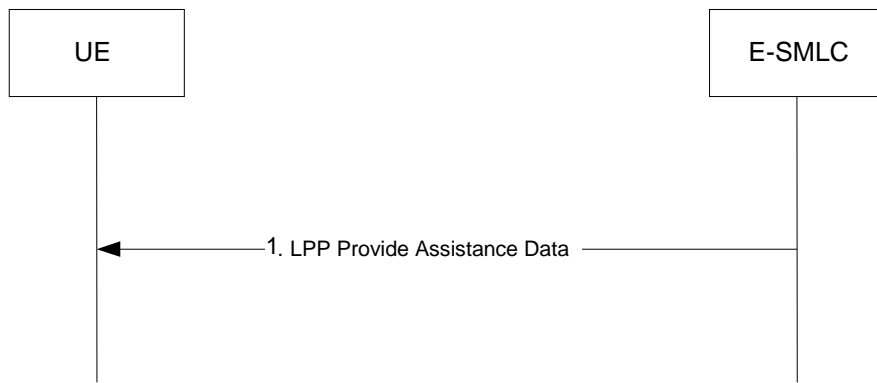

Figure 8.9.3.2.1-1: E-SMLC-initiated Assistance Data Delivery Procedure

- (1) The E-SMLC determines that assistance data needs to be provided to the UE (e.g., as part of a positioning procedure) and sends an LPP Provide Assistance Data message to the UE. This message may include any of the TBS assistance data defined in subclause 8.9.2.2.

8.9.3.2.2 UE initiated Assistance Data Transfer

Figure 8.9.3.2.2-1 shows the Assistance Data Transfer operations for the network-assisted TBS method when the procedure is initiated by the UE.

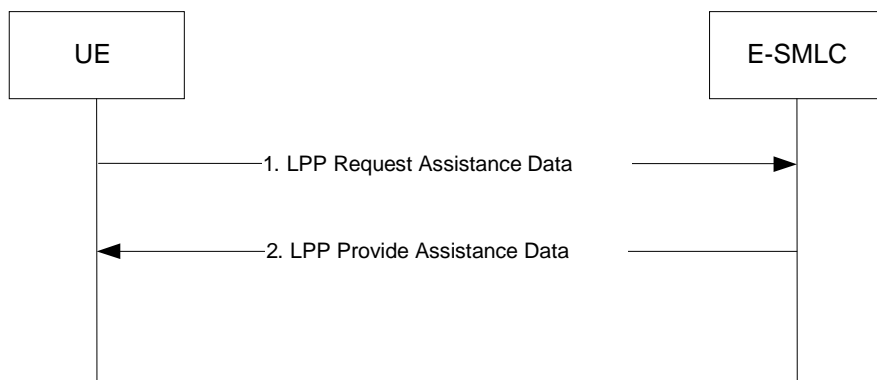

Figure 8.9.3.2.2-1: UE-initiated Assistance Data Transfer Procedure

- (1) The UE determines that certain TBS assistance data is desired (e.g., in case the UE requires its own location with autonomous self location or as part of a positioning procedure when the E-SMLC provided assistance data are not sufficient for the UE to fulfil the request) and sends a LPP Request Assistance Data message to the E-SMLC. This request includes an indication of which specific TBS assistance data is requested.
- (2) The E-SMLC provides the requested assistance data in a LPP Provide Assistance Data message, if available at the E-SMLC. The entire set of assistance data may be delivered in one or several LPP messages. In this case, this step may be repeated by the E-SMLC several times. If any of the UE requested assistance data in step (1) are not provided in step 2, the UE shall assume that the requested assistance data are not supported, or currently not available at the E-SMLC. If none of the UE requested assistance data in step (1) can be provided by the E-SMLC, return any information that can be provided in an LPP message of type Provide Assistance Data which includes a cause indication for the not provided assistance data.

Annex A (informative): Definitions and Terms

No further definitions and terms are currently described beyond those defined in clause 3.

Annex B (informative): Use of LPP with SUPL

The design goal of LPP is to enable it to be used in user plane location solutions such as OMA SUPL ([17], [18]) and this informative annex shows how LPP can be used in SUPL 2.0.

B.1 SUPL 2.0 Positioning Methods and Positioning Protocols

The following table shows how the 3GPP positioning protocols are supported in SUPL 2.0.

Table B.1-1: SUPL support of positioning methods

Positioning Protocol:	RRLP (GSM/GPRS/WCDMA/ LTE/WLAN/WiMAX)	RRC (WCDMA)	LPP (LTE)
Positioning Method:			
A-GPS (A-GANSS) SET Assisted	✓	✓	✓
A-GPS (A-GANSS) SET Based	✓	✓	✓
Autonomous GPS/GANSS	✓	✓	✓
Enhanced Cell ID	✓	✓	✓
Enhanced Observed Time Difference (E-OTD)	✓ (GSM only)	NA	NA
Observed Time Difference of Arrival (OTDOA) ^{NOTE 1}	NA	✓	✓
Barometric Pressure Sensors	NA	✓	✓
WLAN	NA	✓	✓
Bluetooth	NA	✓	✓
TBS ^{NOTE 2}	NA	✓	✓

NOTE 1: This includes TBS positioning based on PRS signals, which is only supported in LPP (LTE).
NOTE 2: TBS positioning based on MBS signals.

Note: What is referred to in the SUPL specifications as "Enhanced Cell ID is a UE-Assisted positioning mode where the neighbouring cell measurements are carried at the SUPL layer (in the SUPL_POS_INIT for example). For LTE, the ASN.1 container for this mode is defined as follows:

```
LteCellInformation ::= SEQUENCE {
    refMCC  INTEGER(0..999),          -- Mobile Country Code
    refMNC  INTEGER(0..999),          -- Mobile Network Code
    refCI   BIT STRING(SIZE (29)),    -- LTE Cell-Id including the CSG bit
    tA      INTEGER(0..255) OPTIONAL, -- Timing Advance as per 3GPP TS 36.321
    measResultListEUTRA  MeasResultListEUTRA OPTIONAL,
    ...}

MeasResultListEUTRA ::= SEQUENCE (SIZE (1..maxCellReport)) OF SEQUENCE {
    physicalCellIdentity  INTEGER(0..504),
    globalCellIdentity    BIT STRING(SIZE (29)) OPTIONAL, -- includes the CSG bit
    earfcn-DL              INTEGER(0.. 32767),             -- as per 3GPP TS 36.331
    measResultEUTRA       SEQUENCE {
        rsrpResult  INTEGER (0..97) OPTIONAL,             -- as per 3GPP TS 36.331
        rsrqResult  INTEGER (0..33) OPTIONAL,             -- as per 3GPP TS 36.331
        ...}
    ...}
}
```

The IE "MeasResultListEUTRA" mirrors the equivalent IE from the RRC specification:

```
MeasResultEUTRA ::= SEQUENCE {
```

```

physCellId          PhysCellId,
cgi-Info            SEQUENCE {
  cellGlobalId      CellGlobalIdEUTRA,
  trackingAreaCode   TrackingAreaCode,
  plmn-IdentityList PLMN-IdentityList2          OPTIONAL,
}
measResult          SEQUENCE {
  rsrpResult         RSRP-Range                OPTIONAL,
  rsrqResult         RSRQ-Range                OPTIONAL,
  ...
}
    
```

It should be noted that in addition to the container provided by SUPL itself, any E-CID positioning methods defined within LPP proper can be supported in SUPL, via tunneling LPP as shown in this annex (in the same manner that A-GNSS and OTDOA are supported).

B.2 SUPL 2.0 and LTE Architecture

This section describes interworking between the control-plane LCS architecture, as defined in the main body of this specification, and SUPL 2.0. The E-SMLC either includes or has an interface to an SPC function as defined in OMA SUPL V2.0 ([17], [18]). It can thus provide a consistent set of positioning methods for deployments utilizing both control-plane and user-plane.

The interworking does not enable use of user-plane signalling for part of a control-plane positioning session. The user plane in the interworking here is not intended as an alternative path for control-plane signalling that would be needed between UE and eNodeB for mechanisms such as A-GPS in a standalone C-plane solution.

This interworking does enable the SPC to retrieve measurements (e.g., GNSS-to-RAN time relations) from eNodeB.

The underlying architecture is shown in Figure B.2-1. Note that, for interworking between user-plane and control-plane positioning, no new interfaces need to be defined as compared to those in the figure, assuming the SPC is either integrated in the E-SMLC or attached to it with a proprietary interface.

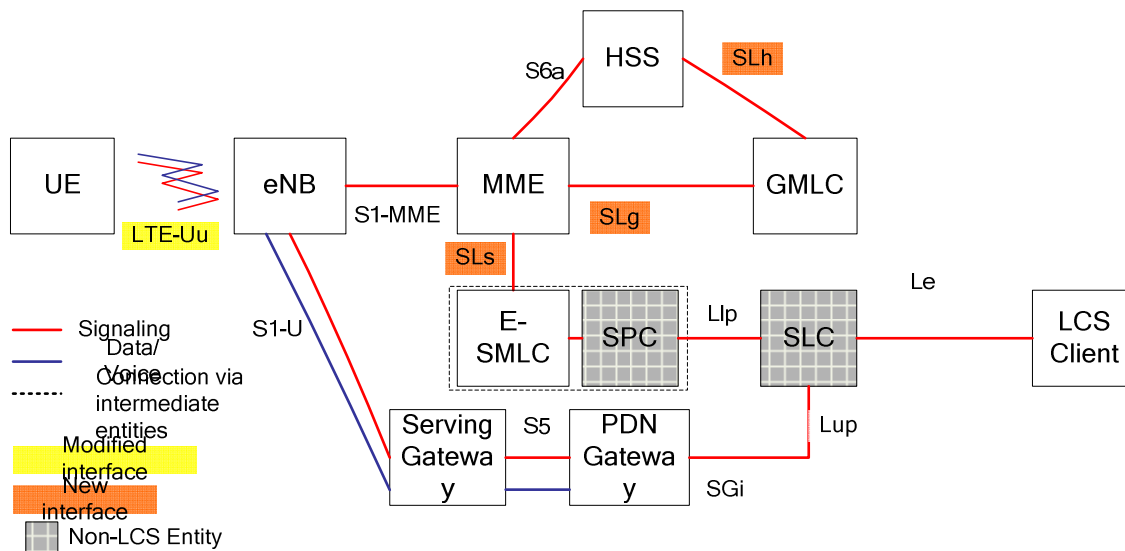

Figure B.2-1: System architecture underlying positioning

The Lup and Lp interfaces shown in this architecture are part of the user-plane solution only and are not required for control-plane positioning. The SLs interface is required for both control-plane and user-plane positioning, and needs to be capable of querying eNode Bs for information not related to a UE connection.

SUPL, including the use of LPP over SUPL, takes place as part of the general user-plane protocol stack shown in Figure B.2-2. SUPL occupies the application layer in the stack, with LPP (or another positioning protocol) transported as another layer above SUPL.

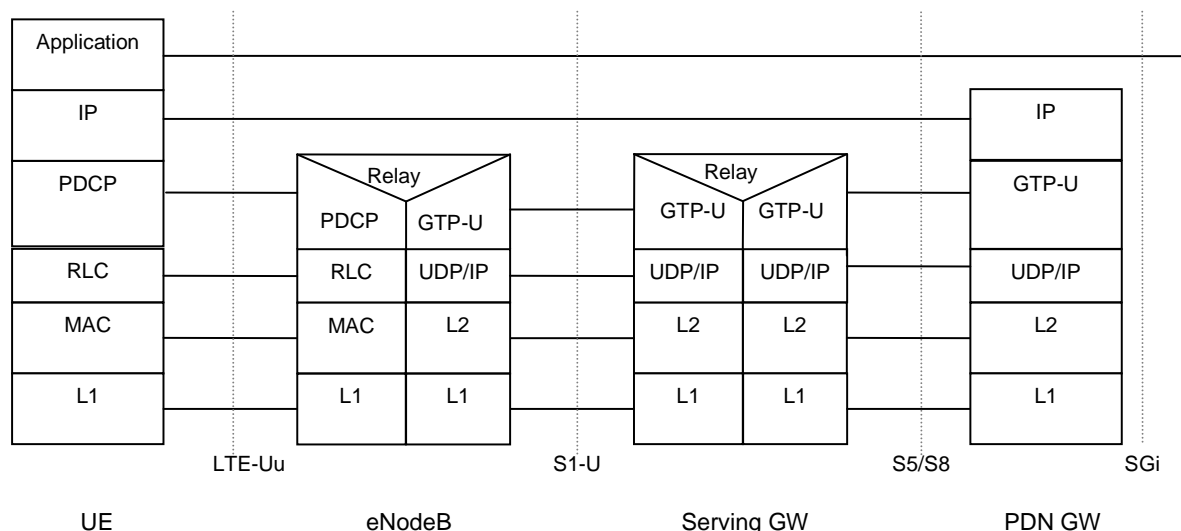

Figure B.2-2: User-plane protocol stack

B.3 LPP session procedures using SUPL

This section indicates how an LPP session relates to the SUPL structure. Figure B.3-1 shows how SUPL and LPP can be combined within a SUPL positioning session. Step 4 here is repeated to exchange multiple LPP messages between the SLP and SET.

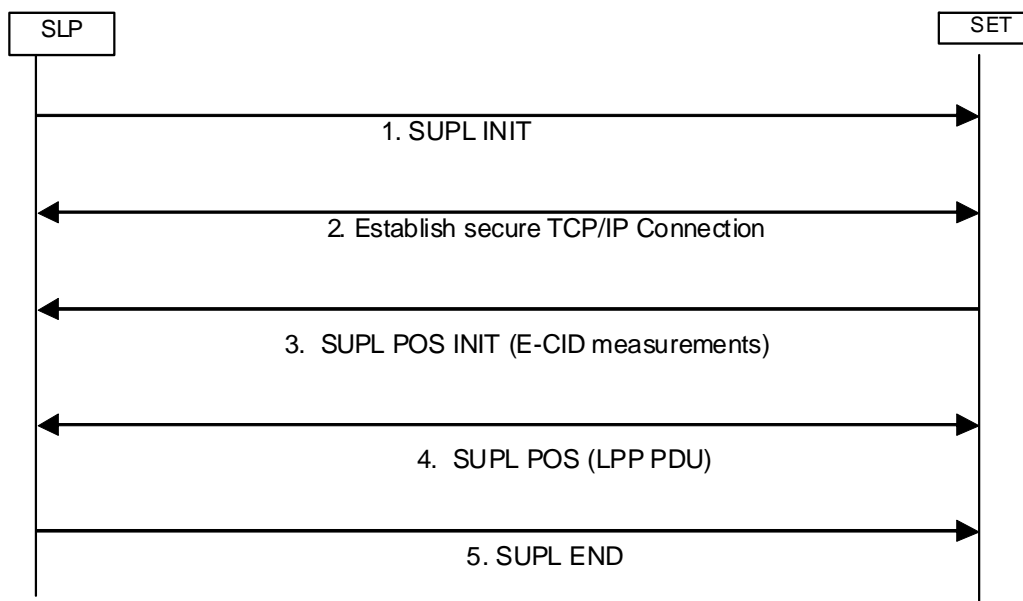

Figure B.3-1: LPP session over SUPL

For positioning operations which take place entirely within an LPP session (step 4 in Figure B.3-1), the flow of LPP messages can be the same as in the control-plane version of LPP; the role of the (LPP) target is taken by the target SET, and that of the (LPP) server by the SLP. An example LPP flow, including exchange of capabilities, request and delivery of assistance data, and request and delivery of positioning information, is shown in Figure B.3-2.

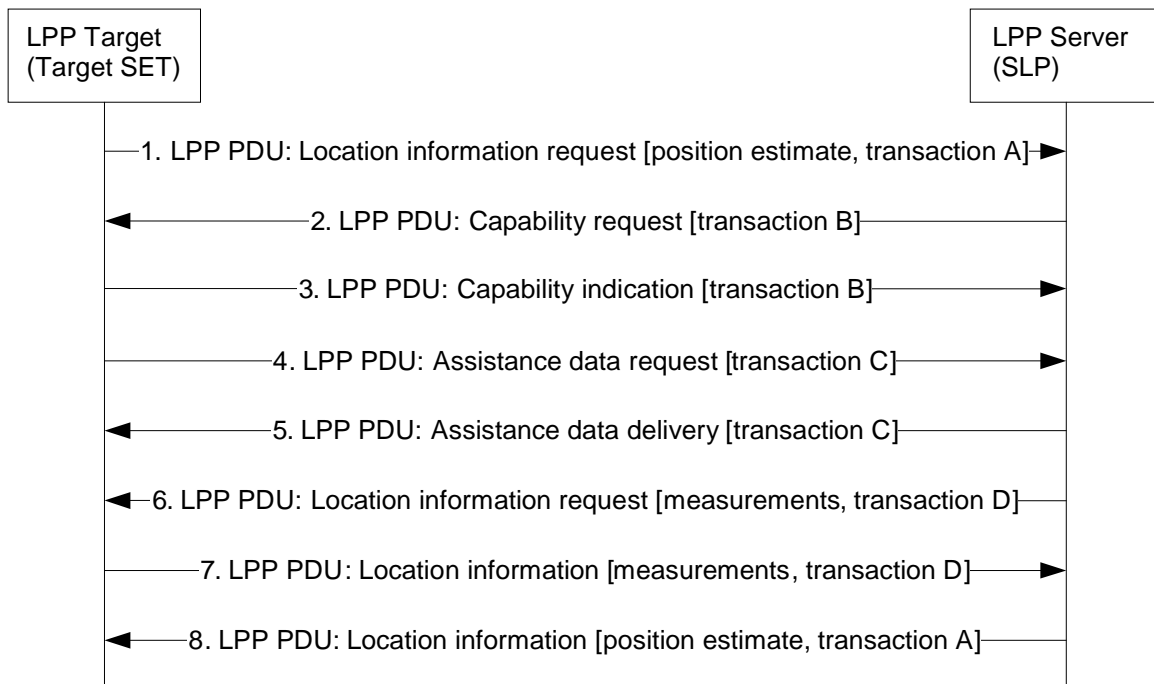

Figure B.3-2: LPP session over SUPL

B.4 Procedures combining C-plane and U-plane operations

Since SUPL is by definition carried over the user plane, it is not really applicable to operations terminating at the eNode B. Thus, in some cases where information from the eNode B and UE needs to be merged for a positioning operation, SUPL operations must take place in combination with control-plane procedures over LPPa.

This situation could arise in the case of UE-assisted OTDOA, for example, in which the SLP needs to provide the UE (in a SUPL session) with assistance data supplied by various eNode Bs. This section uses a UE-assisted OTDOA positioning operation as a running example.

Although the positioning server in this operation is of course the SLP, the existence of the Lpp interface means that the SLP can communicate freely with the E-SMLC via the SPC. In particular, this means that assistance data that were delivered to the E-SMLC via LPPa can be transferred over to the SLP for delivery to the UE via LPP over SUPL.

Several ways to realise this general behaviour are possible. In the simplest case, the E-SMLC could be supplied with the necessary assistance data in advance, so that they can be supplied to the SLP without any actual LPPa procedures taking place in real time (and possibly even before the positioning transaction begins).

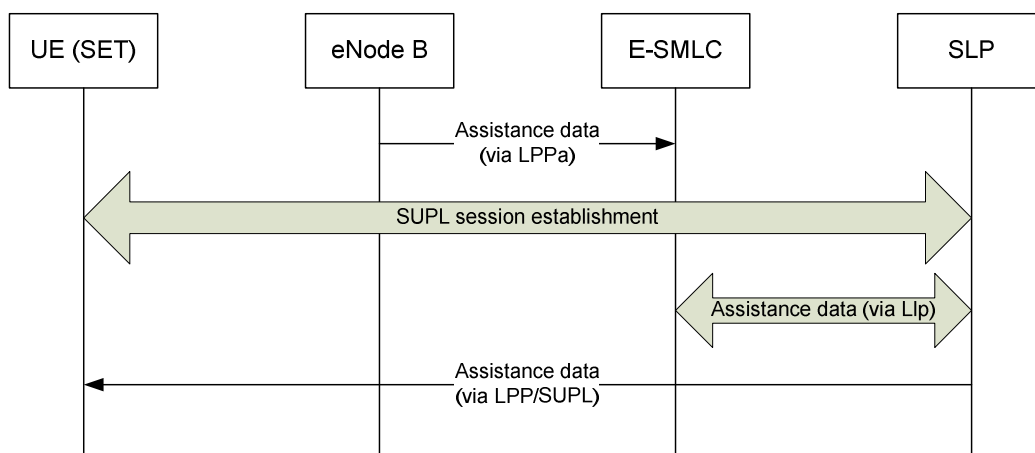

Figure B.4-1: Transfer of OTDOA assistance data to UE via SUPL

In the event that the E-SMLC does not have the required assistance data available, however, it would need to retrieve them from appropriate eNode Bs once it was made aware that they were needed.

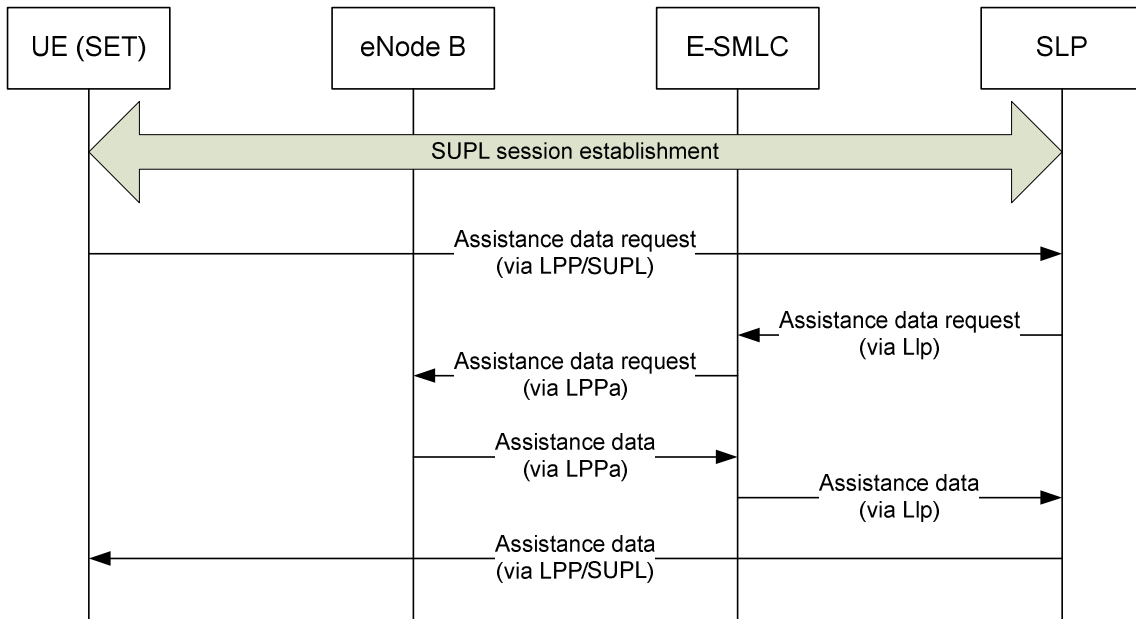

Figure B.4-2: Transfer to the UE via SUPL of OTDOA assistance data not already available at the E-SMLC

In both cases, it should be noted that the retrieval of the assistance data is transparent to the UE and to the actual SUPL session. This model is parallel to the approach used with A-GNSS, in which assistance data such as satellite ephemerides are retrieved from sources entirely external to the cellular network. For purposes of LPP over SUPL, the delivery of assistance data to the SLP can be looked on as an independent external process.

The delivery of assistance data to the UE, however, takes place through the same mechanisms as control-plane LPP, transported through SUPL.

Annex C (informative): Change history

Change history							
Date	TSG #	TSG Doc.	CR	Rev	Cat	Subject/Comment	New version
2009-05	RAN2 #66	R2-092922	-	-		Skeleton TS v0.0.0	
2009-05	RAN2 #66	R2-093522	-	-		RAN2 agreed skeleton TS v0.1.0	
2009-05	RAN2 #66	R2-093589	-	-		RAN2 agreed TS v0.2.0	
2009-09	RAN2 #67	R2-095377	-	-		RAN2 agreed TS v1.2.0	
2009-09	RAN #45	RP-090977	-	-		RAN approved TS 36.305	9.0.0
2009-12	RP-46	RP-091340	0001	1		Removal of UE-based OTDOA and ECID from LPP stage 2	9.1.0
	RP-46	RP-091340	0004	-		Removal of capability storage at MME	9.1.0
	RP-46	RP-091340	0005	-		Transfer of LPPa PDU over S1	9.1.0
2010-03	RP-47	RP-100304	0006	-		Clarification on E-CID parameters	9.2.0
	RP-47	RP-100304	0007	-		Clarification on positioning procedure	9.2.0
	RP-47	RP-100304	0008	1		Stage 2 updates to align with stage 3	9.2.0
	RP-47	RP-100304	0009	-		Updates to LPP material in stage 2	9.2.0
	RP-47	RP-100304	0010	-		Updates to LPPa material in stage 2	9.2.0
	RP-47	RP-100304	0011	-		clarification on routing id	9.2.0
	RP-47	RP-100304	0012	-		Clarification of information transfer for OTDOA	9.2.0
	RP-47	RP-100304	0013	-		Add LPP procedures to align with 36.355	9.2.0
	RP-47	RP-100304	0014	-		Clarification on Error Case Handling	9.2.0
	RP-47	RP-100304	0015	-		Transfer of LPPa PDUs over S1	9.2.0
2010-06	RP-48	RP-100558	0016	-		Miscellaneous corrections to LPP stage 2	9.3.0
	RP-48	RP-100558	0017	-		Correction on LPP session definition in LPP stage 2	9.3.0
2010-09	RP-49	RP-100852	0018	-		Corrections on LPP session identifier in Stage 2	9.4.0
	RP-49	RP-100852	0019	-		Clarifications to LPP transferred information	9.4.0
2010-12	RP-50	RP-101207	0022	-		Alignment of LPPa descriptions to stage 3	9.5.0
2010-12	RP-50	-	-	-		Upgrade to Release 10 - no technical change	10.0.0
2011-03	RP-51	RP-110269	0024	-		Alignment of LPPa descriptions to Stage 3	10.1.0
2011-06	RP-52	RP-110830	0026	-		Corrections to Align Stage2 with Stage3	10.2.0
	RP-52	RP-110830	0028	-		Corrections to the LPP protocol layering	10.2.0
2011-09	RP-53	RP-111279	0030	-		Clarification on E-CID method	10.3.0
2012-06	RP-56	RP-120820	0034	1		CR for 36.305 NBPS Support in LTE	11.0.0
2012-09	RP-57	RP-121374	0035	1		Number of SRS transmissions	11.1.0
	RP-57	RP-121394	0041	-		Clarification on the case that the eNB functions as an LCS client	11.1.0
	RP-57	RP-121374	0042	-		Correction to SRS configuration for UTDOA	11.1.0
	RP-57	RP-121374	0043	1		Network Based Positioning Support	11.1.0
2012-12	RP-58	RP-121931	0046	-		Cleanup of TS36.305	11.2.0
	RP-58	RP-121931	0049	-		Addition of Network Triggered Service Request for LPP and LPPa Positioning	11.2.0
	RP-58	RP-121931	0050	-		Correction of E-CID Measurement Initiation	11.2.0
	RP-58	RP-121931	0052	-		Correlation of LPPa class 2 procedures involved in an LPPa transaction	11.2.0
	RP-58	RP-121949	0053	-		Network Based Positioning Support SRS Update	11.2.0
	RP-58	RP-121949	0055	-		SLmAP Stage 2 Clarification	11.2.0
2013-03	RP-59	RP-130244	0056	-		Network Based Positioning Support SRS Update for intra-MME handover	11.3.0
2013-12	RP-62	RP-132000	0058	-		Introduction of BDS in LTE	12.0.0
2014-06	RP-64	RP-140890	0059	-		Addition of Inter-RAT Measurements to Stage 2 Location Specification	12.1.0
2014-12	RP-66	RP-142120	0060	-		BDS update to version 2.0	12.2.0
2015-12	RP-70	RP-152068	0061	2		RAT-Independent positioning enhancements	13.0.0
2016-12	RP-74	RP-162326	0063	1		CR for 36.305 Further Indoor positioning enhancements	14.0.0
	RP-74	RP-162326	0065	-		Reusing Available WLAN Measurements as E-CID Assistance Data	14.0.0
2017-03	RP-75	RP-170637	0066	2	B	Support of UE positioning measurements in Idle State	14.1.0
	RP-75	RP-170647	0067	-	F	Further Indoor positioning enhancements corrections	14.1.0
2017-06	RP-76	RP-171224	0069	1	F	Clarification to positioning measurement in idle state	14.2.0
2017-09	RP-77	RP-171915	0070	2	F	Clarification to positioning measurement in idle state	14.3.0
2018-07	RP-80	RP-181219	0074	1	B	RTK Stage 2 CR for 36.305	15.0.0

History

Document history		
V15.0.0	July 2018	Publication