

ETSI TS 136 211 V8.4.0 (2008-11)

Technical Specification

**LTE;
Evolved Universal Terrestrial Radio Access (E-UTRA);
Physical channels and modulation
(3GPP TS 36.211 version 8.4.0 Release 8)**



Reference

RTS/TSGR-0136211v840

Keywords

LTE

ETSI

650 Route des Lucioles
F-06921 Sophia Antipolis Cedex - FRANCE

Tel.: +33 4 92 94 42 00 Fax: +33 4 93 65 47 16

Siret N° 348 623 562 00017 - NAF 742 C
Association à but non lucratif enregistrée à la
Sous-Préfecture de Grasse (06) N° 7803/88

Important notice

Individual copies of the present document can be downloaded from:

<http://www.etsi.org>

The present document may be made available in more than one electronic version or in print. In any case of existing or perceived difference in contents between such versions, the reference version is the Portable Document Format (PDF). In case of dispute, the reference shall be the printing on ETSI printers of the PDF version kept on a specific network drive within ETSI Secretariat.

Users of the present document should be aware that the document may be subject to revision or change of status. Information on the current status of this and other ETSI documents is available at

<http://portal.etsi.org/tb/status/status.asp>

If you find errors in the present document, please send your comment to one of the following services:

http://portal.etsi.org/chaicor/ETSI_support.asp

Copyright Notification

No part may be reproduced except as authorized by written permission.
The copyright and the foregoing restriction extend to reproduction in all media.

© European Telecommunications Standards Institute 2008.
All rights reserved.

DECT™, **PLUGTESTS™**, **UMTS™**, **TIPHON™**, the TIPHON logo and the ETSI logo are Trade Marks of ETSI registered for the benefit of its Members.

3GPP™ is a Trade Mark of ETSI registered for the benefit of its Members and of the 3GPP Organizational Partners.

Intellectual Property Rights

IPRs essential or potentially essential to the present document may have been declared to ETSI. The information pertaining to these essential IPRs, if any, is publicly available for **ETSI members and non-members**, and can be found in ETSI SR 000 314: "*Intellectual Property Rights (IPRs); Essential, or potentially Essential, IPRs notified to ETSI in respect of ETSI standards*", which is available from the ETSI Secretariat. Latest updates are available on the ETSI Web server (<http://webapp.etsi.org/IPR/home.asp>).

Pursuant to the ETSI IPR Policy, no investigation, including IPR searches, has been carried out by ETSI. No guarantee can be given as to the existence of other IPRs not referenced in ETSI SR 000 314 (or the updates on the ETSI Web server) which are, or may be, or may become, essential to the present document.

Foreword

This Technical Specification (TS) has been produced by ETSI 3rd Generation Partnership Project (3GPP).

The present document may refer to technical specifications or reports using their 3GPP identities, UMTS identities or GSM identities. These should be interpreted as being references to the corresponding ETSI deliverables.

The cross reference between GSM, UMTS, 3GPP and ETSI identities can be found under <http://webapp.etsi.org/key/queryform.asp>.

Contents

| | |
|---|----|
| Intellectual Property Rights | 2 |
| Foreword..... | 2 |
| Foreword..... | 6 |
| 1 Scope | 7 |
| 2 References | 7 |
| 3 Definitions, symbols and abbreviations | 7 |
| 3.1 Symbols..... | 7 |
| 3.2 Abbreviations | 9 |
| 4 Frame structure..... | 9 |
| 4.1 Frame structure type 1 | 9 |
| 4.2 Frame structure type 2 | 10 |
| 5 Uplink..... | 11 |
| 5.1 Overview | 11 |
| 5.1.1 Physical channels..... | 11 |
| 5.1.2 Physical signals..... | 11 |
| 5.2 Slot structure and physical resources..... | 12 |
| 5.2.1 Resource grid | 12 |
| 5.2.2 Resource elements | 13 |
| 5.2.3 Resource blocks | 13 |
| 5.3 Physical uplink shared channel | 13 |
| 5.3.1 Scrambling | 14 |
| 5.3.2 Modulation..... | 14 |
| 5.3.3 Transform precoding..... | 14 |
| 5.3.4 Mapping to physical resources..... | 15 |
| 5.4 Physical uplink control channel..... | 16 |
| 5.4.1 PUCCH formats 1, 1a and 1b | 16 |
| 5.4.2 PUCCH formats 2, 2a and 2b | 19 |
| 5.4.3 Mapping to physical resources..... | 20 |
| 5.5 Reference signals..... | 21 |
| 5.5.1 Generation of the reference signal sequence..... | 21 |
| 5.5.1.1 Base sequences of length $3N_{sc}^{RB}$ or larger | 22 |
| 5.5.1.2 Base sequences of length less than $3N_{sc}^{RB}$ | 22 |
| 5.5.1.3 Group hopping | 26 |
| 5.5.1.4 Sequence hopping | 26 |
| 5.5.2 Demodulation reference signal | 27 |
| 5.5.2.1 Demodulation reference signal for PUSCH | 27 |
| 5.5.2.1.1 Reference signal sequence..... | 27 |
| 5.5.2.1.2 Mapping to physical resources | 28 |
| 5.5.2.2 Demodulation reference signal for PUCCH..... | 28 |
| 5.5.2.2.1 Reference signal sequence..... | 28 |
| 5.5.2.2.2 Mapping to physical resources | 29 |
| 5.5.3 Sounding reference signal..... | 29 |
| 5.5.3.1 Sequence generation..... | 29 |
| 5.5.3.2 Mapping to physical resources..... | 30 |
| 5.5.3.3 Sounding reference signal subframe configuration | 33 |
| 5.6 SC-FDMA baseband signal generation | 34 |
| 5.7 Physical random access channel..... | 35 |
| 5.7.1 Time and frequency structure | 35 |
| 5.7.2 Preamble sequence generation..... | 41 |
| 5.7.3 Baseband signal generation..... | 45 |
| 5.8 Modulation and upconversion | 45 |

| | | |
|-----------|--|----|
| 6 | Downlink..... | 46 |
| 6.1 | Overview..... | 46 |
| 6.1.1 | Physical channels..... | 46 |
| 6.1.2 | Physical signals..... | 46 |
| 6.2 | Slot structure and physical resource elements..... | 47 |
| 6.2.1 | Resource grid..... | 47 |
| 6.2.2 | Resource elements..... | 47 |
| 6.2.3 | Resource blocks..... | 48 |
| 6.2.3.1 | Virtual resource blocks of localized type..... | 49 |
| 6.2.3.2 | Virtual resource blocks of distributed type..... | 49 |
| 6.2.4 | Resource-element groups..... | 50 |
| 6.2.5 | Guard period for half-duplex FDD operation..... | 51 |
| 6.2.6 | Guard Period for TDD Operation..... | 51 |
| 6.3 | General structure for downlink physical channels..... | 51 |
| 6.3.1 | Scrambling..... | 52 |
| 6.3.2 | Modulation..... | 52 |
| 6.3.3 | Layer mapping..... | 52 |
| 6.3.3.1 | Layer mapping for transmission on a single antenna port..... | 52 |
| 6.3.3.2 | Layer mapping for spatial multiplexing..... | 53 |
| 6.3.3.3 | Layer mapping for transmit diversity..... | 53 |
| 6.3.4 | Precoding..... | 54 |
| 6.3.4.1 | Precoding for transmission on a single antenna port..... | 54 |
| 6.3.4.2 | Precoding for spatial multiplexing..... | 54 |
| 6.3.4.2.1 | Precoding without CDD..... | 54 |
| 6.3.4.2.2 | Precoding for large delay CDD..... | 54 |
| 6.3.4.2.3 | Codebook for precoding..... | 55 |
| 6.3.4.3 | Precoding for transmit diversity..... | 56 |
| 6.3.5 | Mapping to resource elements..... | 57 |
| 6.4 | Physical downlink shared channel..... | 57 |
| 6.5 | Physical multicast channel..... | 57 |
| 6.6 | Physical broadcast channel..... | 58 |
| 6.6.1 | Scrambling..... | 58 |
| 6.6.2 | Modulation..... | 58 |
| 6.6.3 | Layer mapping and precoding..... | 58 |
| 6.6.4 | Mapping to resource elements..... | 58 |
| 6.7 | Physical control format indicator channel..... | 59 |
| 6.7.1 | Scrambling..... | 59 |
| 6.7.2 | Modulation..... | 59 |
| 6.7.3 | Layer mapping and precoding..... | 59 |
| 6.7.4 | Mapping to resource elements..... | 60 |
| 6.8 | Physical downlink control channel..... | 60 |
| 6.8.1 | PDCCH formats..... | 60 |
| 6.8.2 | PDCCH multiplexing and scrambling..... | 60 |
| 6.8.3 | Modulation..... | 61 |
| 6.8.4 | Layer mapping and precoding..... | 61 |
| 6.8.5 | Mapping to resource elements..... | 61 |
| 6.9 | Physical hybrid ARQ indicator channel..... | 62 |
| 6.9.1 | Modulation..... | 63 |
| 6.9.2 | Resource group alignment, layer mapping and precoding..... | 64 |
| 6.9.3 | Mapping to resource elements..... | 65 |
| 6.10 | Reference signals..... | 67 |
| 6.10.1 | Cell-specific reference signals..... | 67 |
| 6.10.1.1 | Sequence generation..... | 67 |
| 6.10.1.2 | Mapping to resource elements..... | 68 |
| 6.10.2 | MBSFN reference signals..... | 70 |
| 6.10.2.1 | Sequence generation..... | 70 |
| 6.10.2.2 | Mapping to resource elements..... | 70 |
| 6.10.3 | UE-specific reference signals..... | 72 |
| 6.10.3.1 | Sequence generation..... | 72 |
| 6.10.3.2 | Mapping to resource elements..... | 73 |
| 6.11 | Synchronization signals..... | 74 |
| 6.11.1 | Primary synchronization signal..... | 75 |

| | | |
|-------------------------------|--|-----------|
| 6.11.1.1 | Sequence generation..... | 75 |
| 6.11.1.2 | Mapping to resource elements..... | 75 |
| 6.11.2 | Secondary synchronization signal..... | 75 |
| 6.11.2.1 | Sequence generation..... | 75 |
| 6.11.2.2 | Mapping to resource elements..... | 77 |
| 6.12 | OFDM baseband signal generation | 78 |
| 6.13 | Modulation and upconversion | 79 |
| 7 | Generic functions | 79 |
| 7.1 | Modulation mapper | 79 |
| 7.1.1 | BPSK..... | 79 |
| 7.1.2 | QPSK..... | 80 |
| 7.1.3 | 16QAM | 80 |
| 7.1.4 | 64QAM | 81 |
| 7.2 | Pseudo-random sequence generation..... | 83 |
| 8 | Timing | 83 |
| 8.1 | Uplink-downlink frame timing..... | 83 |
| Annex A (informative): | Change history | 84 |
| History | | 86 |

Foreword

This Technical Specification has been produced by the 3rd Generation Partnership Project (3GPP).

The contents of the present document are subject to continuing work within the TSG and may change following formal TSG approval. Should the TSG modify the contents of the present document, it will be re-released by the TSG with an identifying change of release date and an increase in version number as follows:

Version x.y.z

where:

- x the first digit:
 - 1 presented to TSG for information;
 - 2 presented to TSG for approval;
 - 3 or greater indicates TSG approved document under change control.
- y the second digit is incremented for all changes of substance, i.e. technical enhancements, corrections, updates, etc.
- z the third digit is incremented when editorial only changes have been incorporated in the document.

1 Scope

The present document describes the physical channels for evolved UTRA.

2 References

The following documents contain provisions which, through reference in this text, constitute provisions of the present document.

- References are either specific (identified by date of publication, edition number, version number, etc.) or non-specific.
- For a specific reference, subsequent revisions do not apply.
- For a non-specific reference, the latest version applies. In the case of a reference to a 3GPP document (including a GSM document), a non-specific reference implicitly refers to the latest version of that document *in the same Release as the present document*.

- [1] 3GPP TR 21.905: "Vocabulary for 3GPP Specifications".
- [2] 3GPP TS 36.201: "Evolved Universal Terrestrial Radio Access (E-UTRA); Physical Layer – General Description".
- [3] 3GPP TS 36.212: "Evolved Universal Terrestrial Radio Access (E-UTRA); Multiplexing and channel coding".
- [4] 3GPP TS 36.213: "Evolved Universal Terrestrial Radio Access (E-UTRA); Physical layer procedures".
- [5] 3GPP TS 36.214: "Evolved Universal Terrestrial Radio Access (E-UTRA); Physical layer – Measurements".
- [6] 3GPP TS 36.104: 'Evolved Universal Terrestrial Radio Access (E-UTRA); Base Station (BS) radio transmission and reception'.
-

3 Definitions, symbols and abbreviations

3.1 Symbols

For the purposes of the present document, the following symbols apply:

| | |
|------------------|---|
| (k, l) | Resource element with frequency-domain index k and time-domain index l |
| $a_{k,l}^{(p)}$ | Value of resource element (k, l) [for antenna port p] |
| D | Matrix for supporting cyclic delay diversity |
| D_{RA} | Density of random access opportunities per radio frame |
| f_0 | Carrier frequency |
| f_{RA} | PRACH resource frequency index within the considered time domain location |
| M_{sc}^{PUSCH} | Scheduled bandwidth for uplink transmission, expressed as a number of subcarriers |
| M_{RB}^{PUSCH} | Scheduled bandwidth for uplink transmission, expressed as a number of resource blocks |
| $M_{bit}^{(q)}$ | Number of coded bits to transmit on a physical channel [for code word q] |

| | |
|-------------------------------------|--|
| $M_{\text{symb}}^{(q)}$ | Number of modulation symbols to transmit on a physical channel [for code word q] |
| $M_{\text{symb}}^{\text{layer}}$ | Number of modulation symbols to transmit per layer for a physical channel |
| $M_{\text{symb}}^{\text{ap}}$ | Number of modulation symbols to transmit per antenna port for a physical channel |
| N | A constant equal to 2048 for $\Delta f = 15$ kHz and 4096 for $\Delta f = 7.5$ kHz |
| $N_{\text{CP},l}$ | Downlink cyclic prefix length for OFDM symbol l in a slot |
| $N_{\text{cs}}^{(1)}$ | Number of cyclic shifts used for PUCCH formats 1/1a/1b in a resource block with a mix of formats 1/1a/1b and 2/2a/2b |
| $N_{\text{RB}}^{(2)}$ | Bandwidth reserved for PUCCH formats 2/2a/2b, expressed in multiples of $N_{\text{sc}}^{\text{RB}}$ |
| $N_{\text{RB}}^{\text{PUCCH}}$ | Number of resource blocks in a slot used for PUCCH transmission (set by higher layers) |
| $N_{\text{ID}}^{\text{cell}}$ | Physical layer cell identity |
| $N_{\text{ID}}^{\text{MBSFN}}$ | MBSFN area identity |
| $N_{\text{RB}}^{\text{DL}}$ | Downlink bandwidth configuration, expressed in multiples of $N_{\text{sc}}^{\text{RB}}$ |
| $N_{\text{RB}}^{\text{min, DL}}$ | Smallest downlink bandwidth configuration, expressed in multiples of $N_{\text{sc}}^{\text{RB}}$ |
| $N_{\text{RB}}^{\text{max, DL}}$ | Largest downlink bandwidth configuration, expressed in multiples of $N_{\text{sc}}^{\text{RB}}$ |
| $N_{\text{RB}}^{\text{UL}}$ | Uplink bandwidth configuration, expressed in multiples of $N_{\text{sc}}^{\text{RB}}$ |
| $N_{\text{RB}}^{\text{min, UL}}$ | Smallest uplink bandwidth configuration, expressed in multiples of $N_{\text{sc}}^{\text{RB}}$ |
| $N_{\text{RB}}^{\text{max, UL}}$ | Largest uplink bandwidth configuration, expressed in multiples of $N_{\text{sc}}^{\text{RB}}$ |
| $N_{\text{symb}}^{\text{DL}}$ | Number of OFDM symbols in a downlink slot |
| $N_{\text{symb}}^{\text{UL}}$ | Number of SC-FDMA symbols in an uplink slot |
| $N_{\text{sc}}^{\text{RB}}$ | Resource block size in the frequency domain, expressed as a number of subcarriers |
| N_{SP} | Number of downlink to uplink switch points within the radio frame |
| $N_{\text{RS}}^{\text{PUCCH}}$ | Number of reference symbols per slot for PUCCH |
| N_{TA} | Timing offset between uplink and downlink radio frames at the UE, expressed in units of T_s |
| $N_{\text{TA offset}}$ | Fixed timing advance offset, expressed in units of T_s |
| $n_{\text{PUCCH}}^{(1)}$ | Resource index for PUCCH formats 1/1a/1b |
| $n_{\text{PUCCH}}^{(2)}$ | Resource index for PUCCH formats 2/2a/2b |
| n_{PDCCH} | Number of PDCCHs present in a subframe |
| n_{PRB} | Physical resource block number |
| $n_{\text{PRB}}^{\text{RA}}$ | First physical resource block occupied by PRACH resource considered |
| $n_{\text{PRB offset}}^{\text{RA}}$ | First physical resource block available for PRACH |
| n_{VRB} | Virtual resource block number |
| n_{RNTI} | Radio network temporary identifier |
| n_f | System frame number |
| n_s | Slot number within a radio frame |
| P | Number of cell-specific antenna ports |
| p | Antenna port number |
| q | Code word number |
| r_{RA} | Index for PRACH versions with same preamble format and PRACH density |
| Q_m | Modulation order: 2 for QPSK, 4 for 16QAM and 6 for 64QAM transmissions |
| $s_l^{(p)}(t)$ | Time-continuous baseband signal for antenna port p and OFDM symbol l in a slot |
| t_{RA}^0 | Radio frame indicator index of PRACH opportunity |
| t_{RA}^1 | Half frame index of PRACH opportunity within the radio frame |
| t_{RA}^2 | Uplink subframe number for start of PRACH opportunity within the half frame |

| | |
|------------------------|--|
| T_f | Radio frame duration |
| T_s | Basic time unit |
| T_{slot} | Slot duration |
| W | Precoding matrix for downlink spatial multiplexing |
| β_{PRACH} | Amplitude scaling for PRACH |
| β_{PUCCH} | Amplitude scaling for PUCCH |
| β_{PUSCH} | Amplitude scaling for PUSCH |
| β_{SRS} | Amplitude scaling for sounding reference symbols |
| Δf | Subcarrier spacing |
| Δf_{RA} | Subcarrier spacing for the random access preamble |
| ν | Number of transmission layers |

3.2 Abbreviations

For the purposes of the present document, the following abbreviations apply:

| | |
|--------|---|
| CCE | Control Channel Element |
| CDD | Cyclic Delay Diversity |
| PBCH | Physical broadcast channel |
| PCFICH | Physical control format indicator channel |
| PDCCH | Physical downlink control channel |
| PDSCH | Physical downlink shared channel |
| PHICH | Physical hybrid-ARQ indicator channel |
| PMCH | Physical multicast channel |
| PRACH | Physical random access channel |
| PUCCH | Physical uplink control channel |
| PUSCH | Physical uplink shared channel |

4 Frame structure

Throughout this specification, unless otherwise noted, the size of various fields in the time domain is expressed as a number of time units $T_s = 1/(15000 \times 2048)$ seconds.

Downlink and uplink transmissions are organized into radio frames with $T_f = 307200 \times T_s = 10$ ms duration. Two radio frame structures are supported:

- Type 1, applicable to FDD,
- Type 2, applicable to TDD.

4.1 Frame structure type 1

Frame structure type 1 is applicable to both full duplex and half duplex FDD. Each radio frame is $T_f = 307200 \cdot T_s = 10$ ms long and consists of 20 slots of length $T_{\text{slot}} = 15360 \cdot T_s = 0.5$ ms, numbered from 0 to 19. A subframe is defined as two consecutive slots where subframe i consists of slots $2i$ and $2i+1$.

For FDD, 10 subframes are available for downlink transmission and 10 subframes are available for uplink transmissions in each 10 ms interval. Uplink and downlink transmissions are separated in the frequency domain. In half-duplex FDD operation, the UE cannot transmit and receive at the same time while there are no such restrictions in full-duplex FDD.

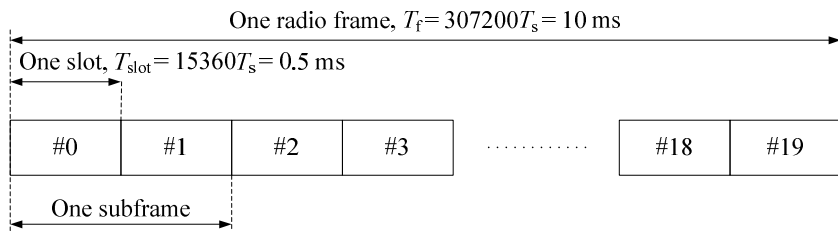

Figure 4.1-1: Frame structure type 1.

4.2 Frame structure type 2

Frame structure type 2 is applicable to TDD. Each radio frame of length $T_f = 307200 \cdot T_s = 10$ ms consists of two half-frames of length $T_f = 153600 \cdot T_s = 5$ ms each. Each half-frame consists of five subframes of length $30720 \cdot T_s = 1$ ms. The supported uplink-downlink configurations are listed in Table 4.2-2 where, for each subframe in a radio frame, 'D' denotes the subframe is reserved for downlink transmissions, 'U' denotes the subframe is reserved for uplink transmissions and 'S' denotes a special subframe with the three fields DwPTS, GP and UpPTS. The length of DwPTS and UpPTS is given by Table 4.2-1 subject to the total length of DwPTS, GP and UpPTS being equal to $30720 \cdot T_s = 1$ ms. Each subframe i is defined as two slots, $2i$ and $2i + 1$ of length $T_{slot} = 15360 \cdot T_s = 0.5$ ms in each subframe.

Uplink-downlink configurations with both 5 ms and 10 ms downlink-to-uplink switch-point periodicity are supported.

In case of 5 ms downlink-to-uplink switch-point periodicity, the special subframe exists in both half-frames.

In case of 10 ms downlink-to-uplink switch-point periodicity, the special subframe exists in the first half-frame only.

Subframes 0 and 5 and DwPTS are always reserved for downlink transmission. UpPTS and the subframe immediately following the special subframe are always reserved for uplink transmission.

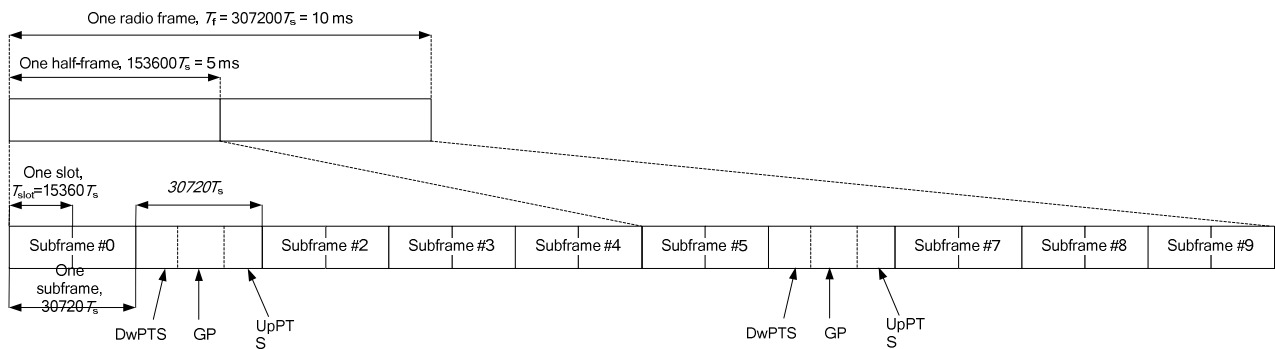

Figure 4.2-1: Frame structure type 2 (for 5 ms switch-point periodicity).

Table 4.2-1: Configuration of special subframe (lengths of DwPTS/GP/UpPTS).

| Special subframe configuration | Normal cyclic prefix | | | Extended cyclic prefix | | |
|--------------------------------|----------------------|-------------------|------------------|------------------------|-------------------|------------------|
| | DwPTS | GP | UpPTS | DwPTS | GP | UpPTS |
| 0 | $6592 \cdot T_s$ | $21936 \cdot T_s$ | | $7680 \cdot T_s$ | $20480 \cdot T_s$ | |
| 1 | $19760 \cdot T_s$ | $8768 \cdot T_s$ | | $20480 \cdot T_s$ | $7680 \cdot T_s$ | $2560 \cdot T_s$ |
| 2 | $21952 \cdot T_s$ | $6576 \cdot T_s$ | $2192 \cdot T_s$ | $23040 \cdot T_s$ | $5120 \cdot T_s$ | |
| 3 | $24144 \cdot T_s$ | $4384 \cdot T_s$ | | $25600 \cdot T_s$ | $2560 \cdot T_s$ | |
| 4 | $26336 \cdot T_s$ | $2192 \cdot T_s$ | | $7680 \cdot T_s$ | $17920 \cdot T_s$ | |
| 5 | $6592 \cdot T_s$ | $19744 \cdot T_s$ | | $20480 \cdot T_s$ | $5120 \cdot T_s$ | $5120 \cdot T_s$ |
| 6 | $19760 \cdot T_s$ | $6576 \cdot T_s$ | $4384 \cdot T_s$ | $23040 \cdot T_s$ | $2560 \cdot T_s$ | |
| 7 | $21952 \cdot T_s$ | $4384 \cdot T_s$ | | - | - | - |
| 8 | $24144 \cdot T_s$ | $2192 \cdot T_s$ | | - | - | - |

Table 4.2-2: Uplink-downlink configurations.

| Uplink-downlink configuration | Downlink-to-Uplink Switch-point periodicity | Subframe number | | | | | | | | | |
|-------------------------------|---|-----------------|----------|----------|----------|----------|----------|----------|----------|----------|----------|
| | | 0 | 1 | 2 | 3 | 4 | 5 | 6 | 7 | 8 | 9 |
| 0 | 5 ms | D | S | U | U | U | D | S | U | U | U |
| 1 | 5 ms | D | S | U | U | D | D | S | U | U | D |
| 2 | 5 ms | D | S | U | D | D | D | S | U | D | D |
| 3 | 10 ms | D | S | U | U | U | D | D | D | D | D |
| 4 | 10 ms | D | S | U | U | D | D | D | D | D | D |
| 5 | 10 ms | D | S | U | D | D | D | D | D | D | D |
| 6 | 5 ms | D | S | U | U | U | D | S | U | U | D |

5 Uplink

5.1 Overview

The smallest resource unit for uplink transmissions is denoted a resource element and is defined in section 5.2.2.

5.1.1 Physical channels

An uplink physical channel corresponds to a set of resource elements carrying information originating from higher layers and is the interface defined between 36.212 and 36.211. The following uplink physical channels are defined:

- Physical Uplink Shared Channel, PUSCH
- Physical Uplink Control Channel, PUCCH
- Physical Random Access Channel, PRACH

5.1.2 Physical signals

An uplink physical signal is used by the physical layer but does not carry information originating from higher layers. The following uplink physical signals are defined:

- Reference signal

5.2 Slot structure and physical resources

5.2.1 Resource grid

The transmitted signal in each slot is described by a resource grid of $N_{RB}^{UL} N_{sc}^{RB}$ subcarriers and N_{symbol}^{UL} SC-FDMA symbols. The resource grid is illustrated in Figure 5.2.1-1. The quantity N_{RB}^{UL} depends on the uplink transmission bandwidth configured in the cell and shall fulfil

$$N_{RB}^{min,UL} \leq N_{RB}^{UL} \leq N_{RB}^{max,UL}$$

where $N_{RB}^{min,UL} = 6$ and $N_{RB}^{max,UL} = 110$ is the smallest and largest uplink bandwidth, respectively, supported by the current version of this specification. The set of allowed values for N_{RB}^{UL} is given by [6].

The number of SC-FDMA symbols in a slot depends on the cyclic prefix length configured by higher layers and is given in Table 5.2.3-1.

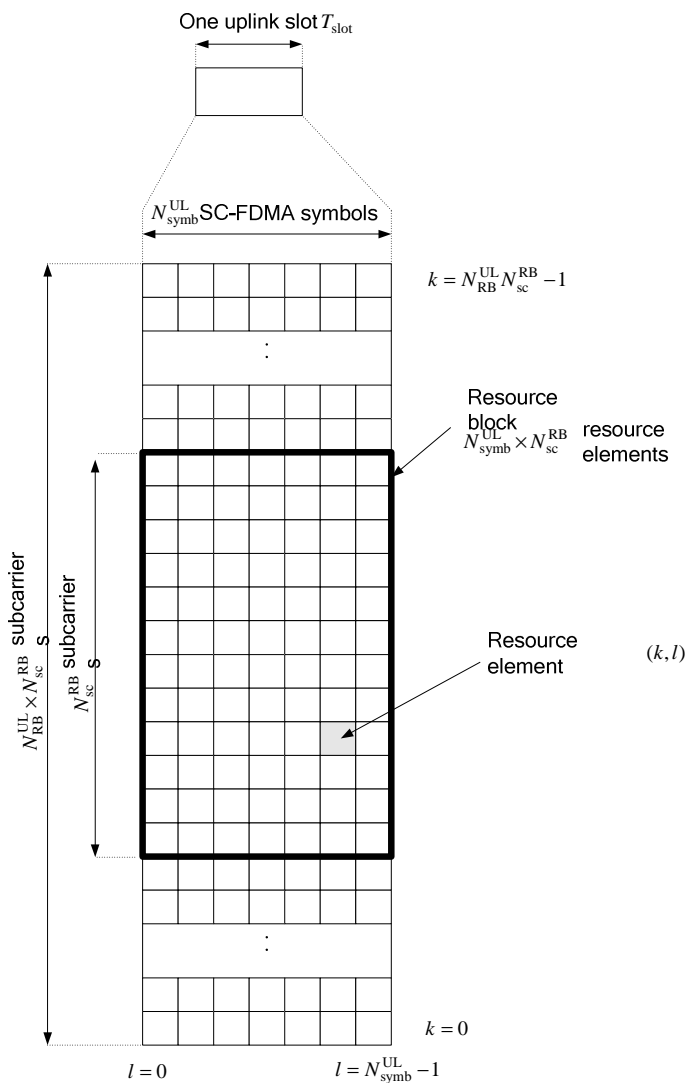

Figure 5.2.1-1: Uplink resource grid.

5.2.2 Resource elements

Each element in the resource grid is called a resource element and is uniquely defined by the index pair (k, l) in a slot where $k = 0, \dots, N_{\text{RB}}^{\text{UL}} N_{\text{sc}}^{\text{RB}} - 1$ and $l = 0, \dots, N_{\text{symb}}^{\text{UL}} - 1$ are the indices in the frequency and time domain, respectively.

Resource element (k, l) corresponds to the complex value $a_{k,l}$. Quantities $a_{k,l}$ corresponding to resource elements not used for transmission of a physical channel or a physical signal in a slot shall be set to zero.

5.2.3 Resource blocks

A physical resource block is defined as $N_{\text{symb}}^{\text{UL}}$ consecutive SC-FDMA symbols in the time domain and $N_{\text{sc}}^{\text{RB}}$ consecutive subcarriers in the frequency domain, where $N_{\text{symb}}^{\text{UL}}$ and $N_{\text{sc}}^{\text{RB}}$ are given by Table 5.2.3-1. A physical resource block in the uplink thus consists of $N_{\text{symb}}^{\text{UL}} \times N_{\text{sc}}^{\text{RB}}$ resource elements, corresponding to one slot in the time domain and 180 kHz in the frequency domain.

Table 5.2.3-1: Resource block parameters.

| Configuration | $N_{\text{sc}}^{\text{RB}}$ | $N_{\text{symb}}^{\text{UL}}$ |
|-------------------------------|-----------------------------|-------------------------------|
| Normal cyclic prefix | 12 | 7 |
| Extended cyclic prefix | 12 | 6 |

The relation between the physical resource block number n_{PRB} in the frequency domain and resource elements (k, l) in a slot is given by

$$n_{\text{PRB}} = \left\lfloor \frac{k}{N_{\text{sc}}^{\text{RB}}} \right\rfloor$$

5.3 Physical uplink shared channel

The baseband signal representing the physical uplink shared channel is defined in terms of the following steps:

- scrambling
- modulation of scrambled bits to generate complex-valued symbols
- transform precoding to generate complex-valued symbols
- mapping of complex-valued symbols to resource elements
- generation of complex-valued time-domain SC-FDMA signal for each antenna port

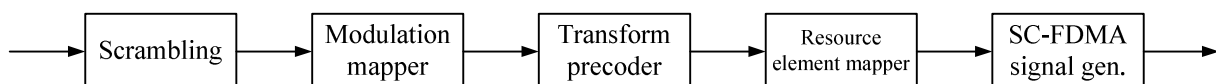

Figure 5.3-1: Overview of uplink physical channel processing.

5.3.1 Scrambling

The block of bits $b(0), \dots, b(M_{\text{bit}} - 1)$, where M_{bit} is the number of bits transmitted on the physical uplink shared channel in one subframe, shall be scrambled with a UE-specific scrambling sequence prior to modulation, resulting in a block of scrambled bits $\tilde{b}(0), \dots, \tilde{b}(M_{\text{bit}} - 1)$ according to the following pseudo code

Set $i = 0$

while $i < M_{\text{bit}}$

if $b(i) = x$ // ACK/NAK or Rank Indication placeholder bits

$\tilde{b}(i) = 1$

else

if $b(i) = y$ // ACK/NAK or Rank Indication repetition placeholder bits

$\tilde{b}(i) = \tilde{b}(i-1)$

else // Data or channel quality coded bits, Rank Indication coded bits or ACK/NAK coded bits

$\tilde{b}(i) = (b(i) + c(i)) \bmod 2$

end if

$i = i + 1$

end while

where Q_m is the number of bits per modulation symbol for the modulation scheme used for PUSCH, x and y are tags defined in [3] section 5.2.2.6 and where the scrambling sequence $c(i)$ is given by Section 7.2. The scrambling sequence generator shall be initialised with $c_{\text{init}} = n_{\text{RNTI}} \cdot 2^{14} + \lfloor n_s / 2 \rfloor \cdot 2^9 + N_{\text{ID}}^{\text{cell}}$ at the start of each subframe.

5.3.2 Modulation

The block of scrambled bits $\tilde{b}(0), \dots, \tilde{b}(M_{\text{bit}} - 1)$ shall be modulated as described in Section 7.1, resulting in a block of complex-valued symbols $d(0), \dots, d(M_{\text{symb}} - 1)$. Table 5.3.2-1 specifies the modulation mappings applicable for the physical uplink shared channel.

Table 5.3.2-1: Uplink modulation schemes

| Physical channel | Modulation schemes |
|------------------|---------------------------|
| PUSCH | QPSK, 16QAM, 64QAM |

5.3.3 Transform precoding

The block of complex-valued symbols $d(0), \dots, d(M_{\text{symb}} - 1)$ is divided into $M_{\text{symb}} / M_{\text{sc}}^{\text{PUSCH}}$ sets, each corresponding to one SC-FDMA symbol. Transform precoding shall be applied according to

$$z(l \cdot M_{\text{sc}}^{\text{PUSCH}} + k) = \frac{1}{\sqrt{M_{\text{sc}}^{\text{PUSCH}}}} \sum_{i=0}^{M_{\text{sc}}^{\text{PUSCH}} - 1} d(l \cdot M_{\text{sc}}^{\text{PUSCH}} + i) e^{-j \frac{2\pi i k}{M_{\text{sc}}^{\text{PUSCH}}}}$$

$$k = 0, \dots, M_{\text{sc}}^{\text{PUSCH}} - 1$$

$$l = 0, \dots, M_{\text{symb}} / M_{\text{sc}}^{\text{PUSCH}} - 1$$

resulting in a block of complex-valued symbols $z(0), \dots, z(M_{\text{symb}} - 1)$. The variable $M_{\text{sc}}^{\text{PUSCH}} = M_{\text{RB}}^{\text{PUSCH}} \cdot N_{\text{sc}}^{\text{RB}}$, where $M_{\text{RB}}^{\text{PUSCH}}$ represents the bandwidth of the PUSCH in terms of resource blocks, and shall fulfil

$$M_{\text{RB}}^{\text{PUSCH}} = 2^{\alpha_2} \cdot 3^{\alpha_3} \cdot 5^{\alpha_5} \leq N_{\text{RB}}^{\text{UL}}$$

where $\alpha_2, \alpha_3, \alpha_5$ is a set of non-negative integers.

5.3.4 Mapping to physical resources

The block of complex-valued symbols $z(0), \dots, z(M_{\text{symb}} - 1)$ shall be multiplied with the amplitude scaling factor β_{PUSCH} and mapped in sequence starting with $z(0)$ to physical resource blocks assigned for transmission of PUSCH. The mapping to resource elements (k, l) corresponding to the physical resource blocks assigned for transmission and not used for transmission of reference signals shall be in increasing order of first the index k , then the index l , starting with the first slot in the subframe.

If uplink frequency-hopping is disabled or the hopping is included in the uplink scheduling grant, the set of physical resource blocks to be used for transmission are given by $n_{\text{PRB}} = n_{\text{VRB}}$ where n_{VRB} is obtained from the uplink scheduling grant as described in [4].

If uplink frequency-hopping with predefined hopping pattern is enabled, the set of physical resource blocks to be used for transmission in slot n_s is given by the scheduling grant together with a predefined pattern according to

$$\begin{aligned} \tilde{n}_{\text{PRB}}(n_s) &= \left(\tilde{n}_{\text{VRB}} + f_{\text{hop}}(i) \cdot N_{\text{RB}}^{\text{sb}} + \left((N_{\text{RB}}^{\text{sb}} - 1) - 2(\tilde{n}_{\text{VRB}} \bmod N_{\text{RB}}^{\text{sb}}) \right) \cdot f_m(i) \right) \bmod N_{\text{RB}}^{\text{sb}} \cdot N_{\text{sb}} \\ i &= \begin{cases} \lfloor n_s / 2 \rfloor & \text{inter-subframe hopping} \\ n_s & \text{intra and inter-subframe hopping} \end{cases} \\ n_{\text{PRB}}(n_s) &= \begin{cases} \tilde{n}_{\text{PRB}}(n_s) & N_{\text{sb}} = 1 \\ \tilde{n}_{\text{PRB}}(n_s) + \lfloor N_{\text{RB}}^{\text{PUCCH}} / 2 \rfloor & N_{\text{sb}} > 1 \end{cases} \\ \tilde{n}_{\text{VRB}} &= \begin{cases} n_{\text{VRB}} & N_{\text{sb}} = 1 \\ n_{\text{VRB}} - \lfloor N_{\text{RB}}^{\text{PUCCH}} / 2 \rfloor & N_{\text{sb}} > 1 \end{cases} \end{aligned}$$

where n_{VRB} is obtained from the scheduling grant as described in [4]. The number of resource blocks in a slot used for PUCCH transmission, $N_{\text{RB}}^{\text{PUCCH}}$, is configured by higher layers. The size $N_{\text{RB}}^{\text{sb}}$ of each sub-band is given by,

$$N_{\text{RB}}^{\text{sb}} = \begin{cases} N_{\text{RB}}^{\text{UL}} & N_{\text{sb}} = 1 \\ \left\lfloor \left((N_{\text{RB}}^{\text{UL}} - N_{\text{RB}}^{\text{PUCCH}} - N_{\text{RB}}^{\text{PUCCH}} \bmod 2) / N_{\text{sb}} \right) \right\rfloor & N_{\text{sb}} > 1 \end{cases}$$

where the number of sub-bands N_{sb} is given by higher layers. The function $f_m(i) \in \{0, 1\}$ determines whether mirroring is used or not. The parameter *Hopping-mode* provided by higher layers determines if hopping is 'inter-subframe' or 'intra and inter-subframe'.

The hopping function $f_{\text{hop}}(i)$ and the function $f_m(i)$ are given by

$$\begin{aligned} f_{\text{hop}}(i) &= \begin{cases} 0 & N_{\text{sb}} = 1 \\ (f_{\text{hop}}(i-1) + 1) \bmod N_{\text{sb}} & N_{\text{sb}} = 2 \\ \left(f_{\text{hop}}(i-1) + \left(\sum_{k=i-10+1}^{i-10+9} c(k) \times 2^{k-(i-10+1)} \right) \right) \bmod (N_{\text{sb}} - 1) + 1 \bmod N_{\text{sb}} & N_{\text{sb}} > 2 \end{cases} \\ f_m(i) &= \begin{cases} i \bmod 2 & N_{\text{sb}} = 1 \\ c(i \cdot 10) & N_{\text{sb}} > 1 \end{cases} \end{aligned}$$

where $f_{hop}(-1) = 0$ and the scrambling sequence $c(\cdot)$ is given by section 7.2. The scrambling sequence generator shall be initialised with $c_{init} = N_{ID}^{cell}$ at the start of each frame.

5.4 Physical uplink control channel

The physical uplink control channel, PUCCH, carries uplink control information. The PUCCH is never transmitted simultaneously with the PUSCH from the same UE. For frame structure type 2, the PUCCH is not transmitted in the UpPTS field.

The physical uplink control channel supports multiple formats as shown in Table 5.4-1. Formats 2a and 2b are supported for normal cyclic prefix only.

Table 5.4-1: Supported PUCCH formats.

| PUCCH format | Modulation scheme | Number of bits per subframe, M_{bit} |
|--------------|-------------------|--|
| 1 | N/A | N/A |
| 1a | BPSK | 1 |
| 1b | QPSK | 2 |
| 2 | QPSK | 20 |
| 2a | QPSK+BPSK | 21 |
| 2b | QPSK+QPSK | 22 |

All PUCCH formats use a cyclic shift of a sequence in each symbol, where $n_{cs}^{cell}(n_s, l)$ is used to derive the cyclic shift for the different PUCCH formats. The quantity $n_{cs}^{cell}(n_s, l)$ varies with the symbol number l and the slot number n_s according to

$$n_{cs}^{cell}(n_s, l) = \sum_{i=0}^7 c(8N_{symb}^{UL} \cdot n_s + 8l + i) \cdot 2^i$$

where the pseudo-random sequence $c(i)$ is defined by section 7.2. The pseudo-random sequence generator shall be initialized with $c_{init} = N_{ID}^{cell}$ at the beginning of each radio frame.

The physical resources used for PUCCH depends on two parameters, $N_{RB}^{(2)}$ and $N_{cs}^{(1)}$, given by higher layers. The variable $N_{RB}^{(2)} \geq 0$ denotes the bandwidth in terms of resource blocks that are reserved exclusively for PUCCH formats 2/2a/2b transmission in each slot. The variable $N_{cs}^{(1)}$ denotes the number of cyclic shift used for PUCCH formats 1/1a/1b in a resource block used for a mix of formats 1/1a/1b and 2/2a/2b. The value of $N_{cs}^{(1)}$ is an integer multiple of Δ_{shift}^{PUCCH} within the range of $\{0, 1, \dots, 8\}$, where Δ_{shift}^{PUCCH} is defined in section 5.4.1. No mixed resource block is present if $N_{cs}^{(1)} = 0$. At most one resource block in each slot supports a mix of formats 1/1a/1b and 2/2a/2b. Resources used for transmission of PUCCH format 1/1a/1b and 2/2a/2b are represented by the non-negative indices $n_{PUCCH}^{(1)}$ and

$$n_{PUCCH}^{(2)} < N_{RB}^{(2)} N_{sc}^{RB} + \left\lceil \frac{N_{cs}^{(1)}}{8} \right\rceil \cdot (N_{sc}^{RB} - N_{cs}^{(1)} - 2), \text{ respectively.}$$

5.4.1 PUCCH formats 1, 1a and 1b

For PUCCH format 1, information is carried by the presence/absence of transmission of PUCCH from the UE. In the remainder of this section, $d(0) = 1$ shall be assumed for PUCCH format 1.

For PUCCH formats 1a and 1b, one or two explicit bits are transmitted, respectively. The block of bits $b(0), \dots, b(M_{bit} - 1)$ shall be modulated as described in Table 5.4.1-1, resulting in a complex-valued symbol $d(0)$. The modulation schemes for the different PUCCH formats are given by Table 5.4-1.

The complex-valued symbol $d(0)$ shall be multiplied with a cyclically shifted length $N_{\text{seq}}^{\text{PUCCH}} = 12$ sequence $r_{u,v}^{(\alpha)}(n)$ according to

$$y(n) = d(0) \cdot r_{u,v}^{(\alpha)}(n), \quad n = 0, 1, \dots, N_{\text{seq}}^{\text{PUCCH}} - 1$$

where $r_{u,v}^{(\alpha)}(n)$ is defined by section 5.5.1 with $M_{\text{sc}}^{\text{RS}} = N_{\text{seq}}^{\text{PUCCH}}$. The cyclic shift α varies between symbols and slots as defined below.

The block of complex-valued symbols $y(0), \dots, y(N_{\text{seq}}^{\text{PUCCH}} - 1)$ shall be scrambled by $S(n_s)$ and block-wise spread with the orthogonal sequence $w_{n_{\text{oc}}}(i)$ according to

$$z\left(m' \cdot N_{\text{SF}}^{\text{PUCCH}} \cdot N_{\text{seq}}^{\text{PUCCH}} + m \cdot N_{\text{seq}}^{\text{PUCCH}} + n\right) = S(n_s) \cdot w_{n_{\text{oc}}}(m) \cdot y(n)$$

where

$$\begin{aligned} m &= 0, \dots, N_{\text{SF}}^{\text{PUCCH}} - 1 \\ n &= 0, \dots, N_{\text{seq}}^{\text{PUCCH}} - 1 \\ m' &= 0, 1 \end{aligned}$$

and

$$S(n_s) = \begin{cases} 1 & \text{if } n'(n_s) \bmod 2 = 0 \\ e^{j\pi/2} & \text{otherwise} \end{cases}$$

with $N_{\text{SF}}^{\text{PUCCH}} = 4$ for both slots of PUCCH format 1 and normal PUCCH formats 1a/1b, and $N_{\text{SF}}^{\text{PUCCH}} = 4$ for the first slot and $N_{\text{SF}}^{\text{PUCCH}} = 3$ for the second slot of shortened PUCCH formats 1a/1b. The sequence $w_{n_{\text{oc}}}(i)$ is given by Table 5.4.1-2 and Table 5.4.1-3 and $n'(n_s)$ is defined below.

Resources used for transmission of PUCCH format 1, 1a and 1b are identified by a resource index $n_{\text{PUCCH}}^{(1)}$ from which the orthogonal sequence index $n_{\text{oc}}(n_s)$ and the cyclic shift $\alpha(n_s, l)$ are determined according to

$$n_{\text{oc}}(n_s) = \begin{cases} \left\lfloor \frac{n'(n_s) \cdot \Delta_{\text{shift}}^{\text{PUCCH}}}{N'} \right\rfloor & \text{for normal cyclic prefix} \\ 2 \cdot \left\lfloor \frac{n'(n_s) \cdot \Delta_{\text{shift}}^{\text{PUCCH}}}{N'} \right\rfloor & \text{for extended cyclic prefix} \end{cases}$$

$$\alpha(n_s, l) = 2\pi \cdot n_{\text{cs}}(n_s, l) / N_{\text{sc}}^{\text{RB}}$$

$$n_{\text{cs}}(n_s, l) = \begin{cases} \left\lfloor \frac{\left[n_{\text{cs}}^{\text{cell}}(n_s, l) + \left(n'(n_s) \cdot \Delta_{\text{shift}}^{\text{PUCCH}} + \delta_{\text{offset}}^{\text{PUCCH}} + (n_{\text{oc}}(n_s) \bmod \Delta_{\text{shift}}^{\text{PUCCH}}) \right) \bmod N' \right]}{N_{\text{sc}}^{\text{RB}}} \right\rfloor & \text{for normal cyclic prefix} \\ \left\lfloor \frac{\left[n_{\text{cs}}^{\text{cell}}(n_s, l) + \left(n'(n_s) \cdot \Delta_{\text{shift}}^{\text{PUCCH}} + \delta_{\text{offset}}^{\text{PUCCH}} + n_{\text{oc}}(n_s) / 2 \right) \bmod N' \right]}{N_{\text{sc}}^{\text{RB}}} \right\rfloor & \text{for extended cyclic prefix} \end{cases}$$

where

$$\begin{aligned} N' &= \begin{cases} N_{\text{cs}}^{(1)} & \text{if } n_{\text{PUCCH}}^{(1)} < c \cdot N_{\text{cs}}^{(1)} / \Delta_{\text{shift}}^{\text{PUCCH}} \\ N_{\text{sc}}^{\text{RB}} & \text{otherwise} \end{cases} \\ c &= \begin{cases} 3 & \text{normal cyclic prefix} \\ 2 & \text{extended cyclic prefix} \end{cases} \end{aligned}$$

The resource indices within the two resource blocks in the two slots of a subframe to which the PUCCH is mapped are given by

$$n'(n_s) = \begin{cases} n_{\text{PUCCH}}^{(1)} & \text{if } n_{\text{PUCCH}}^{(1)} < c \cdot N_{\text{cs}}^{(1)} / \Delta_{\text{shift}}^{\text{PUCCH}} \\ \left(n_{\text{PUCCH}}^{(1)} - c \cdot N_{\text{cs}}^{(1)} / \Delta_{\text{shift}}^{\text{PUCCH}} \right) \bmod \left(c \cdot N_{\text{sc}}^{\text{RB}} / \Delta_{\text{shift}}^{\text{PUCCH}} \right) & \text{otherwise} \end{cases}$$

for $n_s \bmod 2 = 0$ and by

$$n'(n_s) = \begin{cases} \left[\left[c(n'(n_s - 1) + 1) \right] \bmod \left(cN_{\text{sc}}^{\text{RB}} / \Delta_{\text{shift}}^{\text{PUCCH}} + 1 \right) - 1 \right] & n_{\text{PUCCH}}^{(1)} \geq c \cdot N_{\text{cs}}^{(1)} / \Delta_{\text{shift}}^{\text{PUCCH}} \\ \left[\left[h/c \right] + (h \bmod c) N' / \Delta_{\text{shift}}^{\text{PUCCH}} \right] & \text{otherwise} \end{cases}$$

for $n_s \bmod 2 = 1$, where $h = (n'(n_s - 1) + d) \bmod (cN' / \Delta_{\text{shift}}^{\text{PUCCH}})$, with $d = 2$ for normal CP and $d = 0$ for extended CP.

The quantities

$$\Delta_{\text{shift}}^{\text{PUCCH}} \in \begin{cases} \{1, 2, 3\} & \text{for normal cyclic prefix} \\ \{1, 2, 3\} & \text{for extended cyclic prefix} \end{cases}$$

$$\delta_{\text{offset}}^{\text{PUCCH}} \in \{0, 1, \dots, \Delta_{\text{shift}}^{\text{PUCCH}} - 1\}$$

are set by higher layers.

Table 5.4.1-1: Modulation symbol $d(0)$ for PUCCH formats 1a and 1b.

| PUCCH format | $b(0), \dots, b(M_{\text{bit}} - 1)$ | $d(0)$ |
|--------------|--------------------------------------|--------|
| 1a | 0 | 1 |
| | 1 | -1 |
| | 00 | 1 |
| 1b | 01 | -j |
| | 10 | j |
| | 11 | -1 |

Table 5.4.1-2: Orthogonal sequences $\left[w(0) \dots w(N_{\text{SF}}^{\text{PUCCH}} - 1) \right]$ **for** $N_{\text{SF}}^{\text{PUCCH}} = 4$.

| Sequence index $n_{\text{oc}}(n_s)$ | Orthogonal sequences $\left[w(0) \dots w(N_{\text{SF}}^{\text{PUCCH}} - 1) \right]$ |
|-------------------------------------|--|
| 0 | $[+1 \ +1 \ +1 \ +1]$ |
| 1 | $[+1 \ -1 \ +1 \ -1]$ |
| 2 | $[+1 \ -1 \ -1 \ +1]$ |

Table 5.4.1-3: Orthogonal sequences $\left[w(0) \dots w(N_{\text{SF}}^{\text{PUCCH}} - 1) \right]$ **for** $N_{\text{SF}}^{\text{PUCCH}} = 3$.

| Sequence index $n_{\text{oc}}(n_s)$ | Orthogonal sequences $\left[w(0) \dots w(N_{\text{SF}}^{\text{PUCCH}} - 1) \right]$ |
|-------------------------------------|--|
| 0 | $[1 \ 1 \ 1]$ |
| 1 | $[1 \ e^{j2\pi/3} \ e^{j4\pi/3}]$ |
| 2 | $[1 \ e^{j4\pi/3} \ e^{j2\pi/3}]$ |

5.4.2 PUCCH formats 2, 2a and 2b

The block of bits $b(0), \dots, b(M_{\text{bit}} - 1)$ shall be scrambled with a UE-specific scrambling sequence, resulting in a block of scrambled bits $\tilde{b}(0), \dots, \tilde{b}(M_{\text{bit}} - 1)$ according to

$$\tilde{b}(i) = (b(i) + c(i)) \bmod 2$$

where the scrambling sequence $c(i)$ is given by Section 7.2. The scrambling sequence generator shall be initialised with $c_{\text{init}} = (\lfloor n_s/2 \rfloor + 1) \cdot (2N_{\text{ID}}^{\text{cell}} + 1) \cdot 2^{16} + n_{\text{RNTI}}$ at the start of each subframe.

The block of scrambled bits $\tilde{b}(0), \dots, \tilde{b}(19)$ shall be QPSK modulated as described in Section 7.1, resulting in a block of complex-valued modulation symbols $d(0), \dots, d(9)$.

Each complex-valued symbol $d(0), \dots, d(9)$ shall be multiplied with a cyclically shifted length $N_{\text{seq}}^{\text{PUCCH}} = 12$ sequence $r_{u,v}^{(\alpha)}(n)$ according to

$$\begin{aligned} z(N_{\text{seq}}^{\text{PUCCH}} \cdot n + i) &= d(n) \cdot r_{u,v}^{(\alpha)}(i) \\ n &= 0, 1, \dots, 9 \\ i &= 0, 1, \dots, N_{\text{sc}}^{\text{RB}} - 1 \end{aligned}$$

where $r_{u,v}^{(\alpha)}(i)$ is defined by section 5.5.1 with $M_{\text{sc}}^{\text{RS}} = N_{\text{seq}}^{\text{PUCCH}}$.

Resources used for transmission of PUCCH formats 2/2a/2b are identified by a resource index $n_{\text{PUCCH}}^{(2)}$ from which the cyclic shift $\alpha(n_s, l)$ is determined according to

$$\alpha(n_s, l) = 2\pi \cdot n_{\text{cs}}(n_s, l) / N_{\text{sc}}^{\text{RB}}$$

where

$$n_{cs}(n_s, l) = (n_{cs}^{cell}(n_s, l) + n'(n_s)) \bmod N_{sc}^{RB}$$

and

$$n'(n_s) = \begin{cases} n_{PUCCH}^{(2)} \bmod N_{sc}^{RB} & \text{if } n_{PUCCH}^{(2)} < N_{sc}^{RB} N_{RB}^{(2)} \\ (n_{PUCCH}^{(2)} + N_{cs}^{(1)} + 1) \bmod N_{sc}^{RB} & \text{otherwise} \end{cases}$$

for $n_s \bmod 2 = 0$ and by

$$n'(n_s) = \begin{cases} \left[N_{sc}^{RB} (n'(n_s - 1) + 1) \right] \bmod (N_{sc}^{RB} + 1) - 1 & \text{if } n_{PUCCH}^{(2)} < N_{sc}^{RB} N_{RB}^{(2)} \\ (N_{sc}^{RB} - 2 - n_{PUCCH}^{(2)}) \bmod N_{sc}^{RB} & \text{otherwise} \end{cases}$$

for $n_s \bmod 2 = 1$.

For PUCCH formats 2a and 2b, supported for normal cyclic prefix only, the bit(s) $b(20), \dots, b(M_{bit} - 1)$ shall be modulated as described in Table 5.4.2-1 resulting in a single modulation symbol $d(10)$ used in the generation of the reference-signal for PUCCH format 2a and 2b as described in Section 5.5.2.2.1.

Table 5.4.2-1: Modulation symbol $d(10)$ for PUCCH formats 2a and 2b.

| PUCCH format | $b(20), \dots, b(M_{bit} - 1)$ | $d(10)$ |
|--------------|--------------------------------|---------|
| 2a | 0 | 1 |
| | 1 | -1 |
| | 00 | 1 |
| 2b | 01 | -j |
| | 10 | j |
| | 11 | -1 |

5.4.3 Mapping to physical resources

The block of complex-valued symbols $z(i)$ shall be multiplied with the amplitude scaling factor β_{PUCCH} and mapped in sequence starting with $z(0)$ to resource elements. PUCCH uses one resource block in each of the two slots in a subframe. Within the physical resource block used for transmission, the mapping of $z(i)$ to resource elements (k, l) not used for transmission of reference signals shall be in increasing order of first k , then l and finally the slot number, starting with the first slot in the subframe.

The physical resource blocks to be used for transmission of PUCCH in slot n_s is given by

$$n_{PRB} = \begin{cases} \left\lfloor \frac{m}{2} \right\rfloor & \text{if } (m + n_s \bmod 2) \bmod 2 = 0 \\ N_{RB}^{UL} - 1 - \left\lfloor \frac{m}{2} \right\rfloor & \text{if } (m + n_s \bmod 2) \bmod 2 = 1 \end{cases}$$

where the variable m depends on the PUCCH format. For formats 1, 1a and 1b

$$m = \begin{cases} N_{RB}^{(2)} & \text{if } n_{PUCCH}^{(1)} < c \cdot N_{cs}^{(1)} / \Delta_{shift}^{PUCCH} \\ \left\lfloor \frac{n_{PUCCH}^{(1)} - c \cdot N_{cs}^{(1)} / \Delta_{shift}^{PUCCH}}{c \cdot N_{sc}^{RB} / \Delta_{shift}^{PUCCH}} \right\rfloor + N_{RB}^{(2)} + \left\lceil \frac{N_{cs}^{(1)}}{8} \right\rceil & \text{otherwise} \end{cases}$$

$$c = \begin{cases} 3 & \text{normal cyclic prefix} \\ 2 & \text{extended cyclic prefix} \end{cases}$$

and for formats 2, 2a and 2b

$$m = \left\lfloor n_{PUCCH}^{(2)} / N_{sc}^{RB} \right\rfloor$$

Mapping of modulation symbols for the physical uplink control channel is illustrated in Figure 5.4.3-1.

In case of simultaneous transmission of sounding reference signal and PUCCH format 1a or 1b, one SC-FDMA symbol on PUCCH shall punctured.

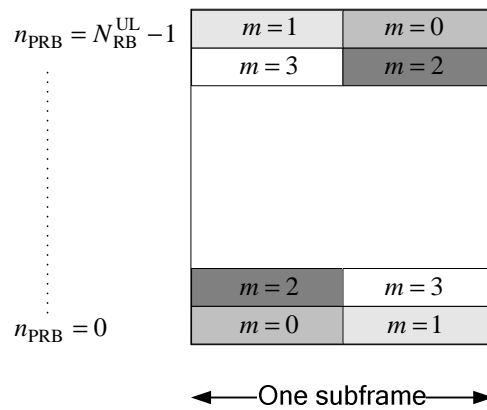

Figure 5.4.3-1: Mapping to physical resource blocks for PUCCH.

5.5 Reference signals

Two types of uplink reference signals are supported:

- Demodulation reference signal, associated with transmission of PUSCH or PUCCH
- Sounding reference signal, not associated with transmission of PUSCH or PUCCH

The same set of base sequences is used for demodulation and sounding reference signals.

5.5.1 Generation of the reference signal sequence

Reference signal sequence $r_{u,v}^{(\alpha)}(n)$ is defined by a cyclic shift α of a base sequence $\bar{r}_{u,v}(n)$ according to

$$r_{u,v}^{(\alpha)}(n) = e^{j\alpha n} \bar{r}_{u,v}(n), \quad 0 \leq n < M_{sc}^{RS}$$

where $M_{sc}^{RS} = mN_{sc}^{RB}$ is the length of the reference signal sequence and $1 \leq m \leq N_{RB}^{\max, UL}$. Multiple reference signal sequences are defined from a single base sequence through different values of α .

Base sequences $\bar{r}_{u,v}(n)$ are divided into groups, where $u \in \{0, 1, \dots, 29\}$ is the group number and v is the base sequence number within the group, such that each group contains one base sequence ($v = 0$) of each length $M_{sc}^{RS} = mN_{sc}^{RB}$, $1 \leq m \leq 5$ and two base sequences ($v = 0, 1$) of each length $M_{sc}^{RS} = mN_{sc}^{RB}$, $6 \leq m \leq N_{RB}^{\max, UL}$. The sequence group number u and the number v within the group may vary in time as described in Sections 5.5.1.3 and 5.5.1.4, respectively. The definition of the base sequence $\bar{r}_{u,v}(0), \dots, \bar{r}_{u,v}(M_{sc}^{RS} - 1)$ depends on the sequence length M_{sc}^{RS} .

5.5.1.1 Base sequences of length $3N_{sc}^{RB}$ or larger

For $M_{sc}^{RS} \geq 3N_{sc}^{RB}$, the base sequence $\bar{r}_{u,v}(0), \dots, \bar{r}_{u,v}(M_{sc}^{RS} - 1)$ is given by

$$\bar{r}_{u,v}(n) = x_q(n \bmod N_{ZC}^{RS}), \quad 0 \leq n < M_{sc}^{RS}$$

where the q^{th} root Zadoff-Chu sequence is defined by

$$x_q(m) = e^{-j \frac{\pi q m(m+1)}{N_{ZC}^{RS}}}, \quad 0 \leq m \leq N_{ZC}^{RS} - 1$$

with q given by

$$q = \lfloor \bar{q} + 1/2 \rfloor + v \cdot (-1)^{\lfloor 2\bar{q} \rfloor}$$

$$\bar{q} = N_{ZC}^{RS} \cdot (u+1)/31$$

The length N_{ZC}^{RS} of the Zadoff-Chu sequence is given by the largest prime number such that $N_{ZC}^{RS} < M_{sc}^{RS}$.

5.5.1.2 Base sequences of length less than $3N_{sc}^{RB}$

For $M_{sc}^{RS} = N_{sc}^{RB}$ and $M_{sc}^{RS} = 2N_{sc}^{RB}$, base sequence is given by

$$\bar{r}_{u,v}(n) = e^{j\varphi(n)\pi/4}, \quad 0 \leq n \leq M_{sc}^{RS} - 1$$

where the value of $\varphi(n)$ is given by Table 5.5.1.2-1 and Table 5.5.1.2-2 for $M_{sc}^{RS} = N_{sc}^{RB}$ and $M_{sc}^{RS} = 2N_{sc}^{RB}$, respectively.

Table 5.5.1.2-1: Definition of $\varphi(n)$ for $M_{sc}^{RS} = N_{sc}^{RB}$.

| u | $\varphi(0), \dots, \varphi(11)$ | | | | | | | | | | | |
|-----|----------------------------------|---|---|---|---|---|---|---|---|---|---|---|
| 0 | -1 | 1 | 3 | 3 | 3 | 3 | 1 | 1 | 3 | 1 | 3 | 3 |
| 1 | 1 | 1 | 3 | 3 | 3 | 1 | 1 | 3 | 3 | 1 | 3 | 3 |
| 2 | 1 | 1 | 3 | 3 | 3 | 1 | 3 | 3 | 1 | 3 | 1 | 1 |
| 3 | -1 | 1 | 1 | 1 | 1 | 1 | 3 | 3 | 1 | 3 | 3 | 1 |
| 4 | -1 | 3 | 1 | 1 | 1 | 1 | 3 | 1 | 1 | 1 | 1 | 3 |
| 5 | 1 | 3 | 3 | 1 | 1 | 1 | 1 | 1 | 1 | 3 | 3 | 1 |
| 6 | -1 | 3 | 3 | 3 | 3 | 3 | 1 | 1 | 3 | 3 | 3 | 1 |
| 7 | -3 | 1 | 1 | 1 | 1 | 3 | 3 | 1 | 1 | 3 | 3 | 1 |
| 8 | 1 | 3 | 3 | 1 | 1 | 1 | 1 | 1 | 1 | 3 | 1 | 1 |
| 9 | 1 | 3 | 1 | 3 | 3 | 1 | 3 | 1 | 1 | 1 | 1 | 1 |
| 10 | -1 | 3 | 1 | 1 | 1 | 3 | 3 | 1 | 3 | 3 | 3 | 1 |
| 11 | 3 | 1 | 1 | 1 | 3 | 3 | 3 | 1 | 3 | 1 | 3 | 3 |
| 12 | 1 | 3 | 1 | 1 | 3 | 1 | 1 | 1 | 3 | 3 | 3 | 1 |
| 13 | 3 | 3 | 3 | 3 | 3 | 1 | 1 | 3 | 1 | 3 | 3 | 3 |
| 14 | -3 | 1 | 1 | 3 | 1 | 3 | 1 | 3 | 3 | 3 | 1 | 1 |
| 15 | 3 | 1 | 1 | 3 | 1 | 1 | 1 | 1 | 3 | 1 | 1 | 3 |
| 16 | 1 | 3 | 1 | 1 | 1 | 3 | 3 | 3 | 1 | 1 | 3 | 1 |
| 17 | -3 | 1 | 1 | 3 | 3 | 3 | 3 | 3 | 3 | 1 | 3 | 1 |
| 18 | -3 | 3 | 1 | 1 | 3 | 1 | 3 | 3 | 1 | 1 | 1 | 3 |
| 19 | -1 | 3 | 1 | 3 | 1 | 1 | 1 | 3 | 3 | 1 | 3 | 1 |
| 20 | -1 | 3 | 1 | 1 | 1 | 1 | 3 | 1 | 1 | 1 | 3 | 1 |
| 21 | -1 | 3 | 1 | 1 | 3 | 3 | 3 | 3 | 3 | 1 | 1 | 3 |
| 22 | 1 | 1 | 3 | 3 | 3 | 3 | 1 | 3 | 3 | 1 | 3 | 3 |
| 23 | 1 | 1 | 1 | 3 | 1 | 3 | 1 | 1 | 1 | 3 | 1 | 1 |
| 24 | 1 | 1 | 3 | 1 | 3 | 3 | 1 | 1 | 1 | 3 | 3 | 1 |
| 25 | 1 | 3 | 3 | 3 | 1 | 3 | 3 | 1 | 3 | 1 | 1 | 3 |
| 26 | 1 | 3 | 3 | 3 | 3 | 3 | 1 | 1 | 1 | 3 | 1 | 3 |
| 27 | -3 | 1 | 3 | 1 | 3 | 3 | 1 | 1 | 1 | 3 | 3 | 3 |

| | | | | | | | | | | | | |
|----|----|---|---|---|---|---|---|---|---|---|---|---|
| 28 | | - | - | - | - | - | - | - | - | - | - | - |
| | -1 | 3 | 3 | 3 | 1 | 3 | 3 | 3 | 3 | 3 | 1 | 1 |
| 29 | | - | - | - | - | - | - | - | - | - | - | - |
| | 3 | 3 | 3 | 1 | 1 | 3 | 1 | 3 | 3 | 3 | 1 | 1 |

Table 5.5.1.2-2: Definition of $\varphi(n)$ for $M_{sc}^{RS} = 2N_{sc}^{RB}$.

| u | $\varphi(0), \dots, \varphi(23)$ | | | | | | | | | | | | | | | | | | | | | | | |
|-----|----------------------------------|---|---|---|---|---|---|---|---|---|---|---|---|---|---|---|---|---|---|---|---|---|---|---|
| 0 | -1 | 3 | 1 | 3 | 3 | 1 | 1 | 3 | 3 | 3 | 1 | 3 | 3 | 3 | 1 | 1 | 1 | 1 | 3 | 3 | 3 | 3 | 1 | 3 |
| 1 | -3 | 3 | 3 | 3 | 3 | 1 | 3 | 3 | 3 | 1 | 1 | 1 | 1 | 3 | 1 | 1 | 3 | 3 | 3 | 1 | 3 | 1 | 1 | 3 |
| 2 | 3 | 1 | 3 | 3 | 1 | 1 | 3 | 3 | 3 | 3 | 3 | 1 | 1 | 3 | 1 | 1 | 1 | 1 | 3 | 1 | 1 | 1 | 3 | 3 |
| 3 | -1 | 3 | 1 | 1 | 3 | 3 | 1 | 1 | 3 | 1 | 1 | 1 | 3 | 1 | 3 | 1 | 1 | 3 | 1 | 1 | 3 | 1 | 3 | 1 |
| 4 | -1 | 1 | 1 | 3 | 3 | 1 | 1 | 1 | 3 | 3 | 1 | 3 | 1 | 1 | 1 | 3 | 1 | 1 | 3 | 3 | 1 | 3 | 1 | 1 |
| 5 | -3 | 1 | 1 | 3 | 1 | 1 | 3 | 1 | 3 | 1 | 3 | 1 | 1 | 1 | 1 | 3 | 1 | 3 | 3 | 3 | 3 | 3 | 1 | 1 |
| 6 | 1 | 1 | 1 | 1 | 3 | 3 | 3 | 3 | 3 | 1 | 1 | 1 | 1 | 1 | 1 | 1 | 1 | 3 | 1 | 1 | 1 | 3 | 1 | 3 |
| 7 | -3 | 3 | 3 | 1 | 1 | 3 | 1 | 3 | 1 | 3 | 1 | 3 | 1 | 1 | 3 | 1 | 1 | 1 | 3 | 3 | 1 | 1 | 1 | 1 |
| 8 | -3 | 1 | 3 | 3 | 1 | 1 | 3 | 3 | 3 | 3 | 1 | 1 | 1 | 1 | 1 | 3 | 3 | 3 | 1 | 3 | 3 | 3 | 1 | 3 |
| 9 | 1 | 1 | 3 | 3 | 3 | 1 | 3 | 1 | 3 | 3 | 3 | 3 | 3 | 3 | 1 | 1 | 1 | 3 | 1 | 1 | 1 | 1 | 3 | 1 |
| 10 | -1 | 1 | 3 | 3 | 3 | 1 | 3 | 1 | 1 | 3 | 3 | 3 | 3 | 1 | 3 | 3 | 1 | 1 | 1 | 3 | 3 | 1 | 1 | 3 |
| 11 | 1 | 3 | 3 | 3 | 3 | 1 | 3 | 1 | 1 | 3 | 3 | 3 | 3 | 3 | 3 | 3 | 3 | 3 | 1 | 3 | 3 | 1 | 1 | 3 |
| 12 | 1 | 3 | 3 | 1 | 1 | 1 | 1 | 1 | 1 | 3 | 3 | 1 | 1 | 1 | 3 | 3 | 3 | 1 | 3 | 3 | 3 | 1 | 3 | 1 |
| 13 | 3 | 1 | 1 | 1 | 1 | 3 | 1 | 3 | 3 | 1 | 1 | 1 | 3 | 3 | 3 | 1 | 1 | 1 | 3 | 1 | 3 | 1 | 3 | 3 |
| 14 | -3 | 3 | 3 | 1 | 3 | 1 | 3 | 3 | 1 | 3 | 1 | 1 | 3 | 3 | 1 | 1 | 3 | 1 | 3 | 1 | 3 | 1 | 1 | 3 |
| 15 | -1 | 1 | 1 | 3 | 1 | 3 | 3 | 1 | 1 | 3 | 1 | 3 | 1 | 3 | 1 | 1 | 3 | 3 | 1 | 1 | 3 | 3 | 3 | 1 |
| 16 | -1 | 3 | 3 | 1 | 1 | 1 | 1 | 1 | 1 | 3 | 3 | 1 | 3 | 3 | 1 | 1 | 1 | 3 | 1 | 3 | 1 | 1 | 3 | 1 |
| 17 | 1 | 3 | 1 | 3 | 3 | 1 | 3 | 1 | 1 | 3 | 3 | 3 | 3 | 3 | 1 | 1 | 1 | 3 | 1 | 3 | 1 | 3 | 1 | 1 |
| 18 | 1 | 1 | 1 | 1 | 1 | 1 | 3 | 1 | 3 | 1 | 1 | 3 | 3 | 1 | 3 | 1 | 1 | 1 | 3 | 3 | 3 | 1 | 1 | 3 |
| 19 | 1 | 3 | 3 | 1 | 1 | 3 | 3 | 1 | 3 | 3 | 3 | 3 | 3 | 1 | 1 | 1 | 1 | 3 | 1 | 1 | 3 | 1 | 3 | 3 |
| 20 | -1 | 3 | 3 | 3 | 3 | 3 | 1 | 1 | 3 | 1 | 3 | 3 | 1 | 3 | 3 | 1 | 3 | 1 | 1 | 1 | 3 | 3 | 1 | 1 |
| 21 | -3 | 3 | 1 | 1 | 1 | 1 | 1 | 1 | 1 | 3 | 1 | 3 | 1 | 1 | 1 | 1 | 1 | 1 | 3 | 3 | 3 | 1 | 1 | 3 |
| 22 | -3 | 1 | 3 | 3 | 1 | 1 | 3 | 1 | 3 | 3 | 3 | 3 | 3 | 3 | 3 | 1 | 1 | 3 | 1 | 3 | 1 | 3 | 3 | 1 |
| 23 | -1 | 1 | 1 | 1 | 3 | 3 | 3 | 1 | 3 | 3 | 3 | 3 | 1 | 3 | 1 | 3 | 1 | 3 | 3 | 3 | 3 | 1 | 1 | 3 |
| 24 | 1 | 1 | 3 | 3 | 1 | 3 | 3 | 3 | 1 | 1 | 3 | 1 | 3 | 1 | 1 | 1 | 1 | 1 | 1 | 1 | 1 | 3 | 1 | 3 |
| 25 | 1 | 1 | 1 | 1 | 3 | 1 | 3 | 1 | 1 | 1 | 1 | 3 | 1 | 1 | 3 | 1 | 3 | 3 | 1 | 1 | 3 | 3 | 1 | 1 |
| 26 | -3 | 1 | 1 | 3 | 1 | 1 | 3 | 1 | 1 | 3 | 3 | 3 | 3 | 1 | 3 | 3 | 3 | 1 | 1 | 1 | 3 | 1 | 1 | 1 |
| 27 | -1 | 3 | 3 | 3 | 1 | 1 | 3 | 1 | 3 | 1 | 1 | 1 | 3 | 1 | 3 | 3 | 1 | 3 | 3 | 1 | 3 | 1 | 3 | 1 |

| | | | | | | | | | | | | | | | | | | | | | | | | | | | | | | | | | | |
|----|---|---|---|---|---|---|---|---|---|---|---|---|---|---|---|---|---|---|---|---|---|---|---|---|---|---|---|---|---|---|---|---|---|---|
| 28 | - | - | - | - | - | - | - | - | - | - | - | - | - | - | - | - | - | - | - | - | - | - | - | - | - | - | - | - | - | - | - | - | - | - |
| 29 | 1 | 1 | 1 | 1 | 3 | 1 | 3 | 1 | 3 | 1 | 1 | 3 | 1 | 3 | 1 | 3 | 3 | 3 | 1 | 1 | 1 | 3 | 1 | 1 | 1 | 1 | 3 | 1 | 1 | 1 | 1 | 3 | 1 | 3 |

5.5.1.3 Group hopping

The sequence-group number u in slot n_s is defined by a group hopping pattern $f_{gh}(n_s)$ and a sequence-shift pattern f_{ss} according to

$$u = (f_{gh}(n_s) + f_{ss}) \bmod 30$$

There are 17 different hopping patterns and 30 different sequence-shift patterns. Sequence-group hopping can be enabled or disabled by means of the parameter *Group-hopping-enabled* provided by higher layers. PUCCH and PUSCH have the same hopping pattern but may have different sequence-shift patterns.

The group-hopping pattern $f_{gh}(n_s)$ is the same for PUSCH and PUCCH and given by

$$f_{gh}(n_s) = \begin{cases} 0 & \text{if group hopping is disabled} \\ \left(\sum_{i=0}^7 c(8n_s + i) \cdot 2^i \right) \bmod 30 & \text{if group hopping is enabled} \end{cases}$$

where the pseudo-random sequence $c(i)$ is defined by section 7.2. The pseudo-random sequence generator shall be

initialized with $c_{init} = \left\lfloor \frac{N_{ID}^{cell}}{30} \right\rfloor$ at the beginning of each radio frame.

The sequence-shift pattern f_{ss} definition differs between PUCCH and PUSCH.

For PUCCH, the sequence-shift pattern f_{ss}^{PUCCH} is given by $f_{ss}^{PUCCH} = N_{ID}^{cell} \bmod 30$.

For PUSCH, the sequence-shift pattern f_{ss}^{PUSCH} is given by $f_{ss}^{PUSCH} = (f_{ss}^{PUCCH} + \Delta_{ss}) \bmod 30$, where $\Delta_{ss} \in \{0,1,\dots,29\}$ is configured by higher layers.

5.5.1.4 Sequence hopping

Sequence hopping only applies for reference-signals of length $M_{sc}^{RS} \geq 6N_{sc}^{RB}$.

For reference-signals of length $M_{sc}^{RS} < 6N_{sc}^{RB}$, the base sequence number ν within the base sequence group is given by $\nu = 0$.

For reference-signals of length $M_{sc}^{RS} \geq 6N_{sc}^{RB}$, the base sequence number ν within the base sequence group in slot n_s is defined by

$$\nu = \begin{cases} c(n_s) & \text{if group hopping is disabled and sequence hopping is enabled} \\ 0 & \text{otherwise} \end{cases}$$

where the pseudo-random sequence $c(i)$ is given by section 7.2. The parameter *Sequence-hopping-enabled* provided by higher layers determines if sequence hopping is enabled or not. The pseudo-random sequence generator shall be

initialized with $c_{init} = \left\lfloor \frac{N_{ID}^{cell}}{30} \right\rfloor \cdot 2^5 + f_{ss}^{PUSCH}$ at the beginning of each radio frame.

5.5.2 Demodulation reference signal

5.5.2.1 Demodulation reference signal for PUSCH

5.5.2.1.1 Reference signal sequence

The demodulation reference signal sequence $r^{\text{PUSCH}}(\cdot)$ for PUSCH is defined by

$$r^{\text{PUSCH}}(m \cdot M_{\text{sc}}^{\text{RS}} + n) = r_{u,v}^{(\alpha)}(n)$$

where

$$\begin{aligned} m &= 0,1 \\ n &= 0, \dots, M_{\text{sc}}^{\text{RS}} - 1 \end{aligned}$$

and

$$M_{\text{sc}}^{\text{RS}} = M_{\text{sc}}^{\text{PUSCH}}$$

Section 5.5.1 defines the sequence $r_{u,v}^{(\alpha)}(0), \dots, r_{u,v}^{(\alpha)}(M_{\text{sc}}^{\text{RS}} - 1)$.

The cyclic shift α in a slot is given as $\alpha = 2\pi n_{\text{cs}}/12$ with

$$n_{\text{cs}} = \left(n_{\text{DMRS}}^{(1)} + n_{\text{DMRS}}^{(2)} + n_{\text{PRS}} \right) \text{mod} 12$$

where $n_{\text{DMRS}}^{(1)}$ is a broadcasted value, $n_{\text{DMRS}}^{(2)}$ is given by the uplink scheduling assignment [3] where the values of $n_{\text{DMRS}}^{(2)}$ is given in Table 5.5.2.1.1-1 and n_{PRS} is given by

$$n_{\text{PRS}} = \sum_{i=0}^7 c(i) \cdot 2^i$$

where the pseudo-random sequence $c(i)$ is defined by section 7.2. The application of $c(i)$ is cell-specific. The pseudo-

random sequence generator shall be initialized with $c_{\text{init}} = \left\lfloor \frac{N_{\text{ID}}^{\text{cell}}}{30} \right\rfloor \cdot 2^5 + f_{\text{ss}}^{\text{PUSCH}}$ at the beginning of each radio frame.

Table 5.5.2.1.1-1: Mapping of Cyclic Shift Field in DCI format 0 to $n_{\text{DMRS}}^{(2)}$ Values.

| Cyclic Shift Field in DCI format 0 [3] | $n_{\text{DMRS}}^{(2)}$ |
|--|-------------------------|
| 000 | 0 |
| 001 | 2 |
| 010 | 3 |
| 011 | 4 |
| 100 | 6 |
| 101 | 8 |
| 110 | 9 |
| 111 | 10 |

5.5.2.1.2 Mapping to physical resources

The sequence $r^{\text{PUSCH}}(\cdot)$ shall be multiplied with the amplitude scaling factor β_{PUSCH} and mapped in sequence starting with $r^{\text{PUSCH}}(0)$ to the same set of physical resource blocks used for the corresponding PUSCH transmission defined in Section 5.3.4. The mapping to resource elements (k, l) , with $l = 3$ for normal cyclic prefix and $l = 2$ for extended cyclic prefix, in the subframe shall be in increasing order of first k , then the slot number.

5.5.2.2 Demodulation reference signal for PUCCH

5.5.2.2.1 Reference signal sequence

The demodulation reference signal sequence $r^{\text{PUCCH}}(\cdot)$ for PUCCH is defined by

$$r^{\text{PUCCH}}\left(m' N_{\text{RS}}^{\text{PUCCH}} M_{\text{sc}}^{\text{RS}} + m M_{\text{sc}}^{\text{RS}} + n\right) = \bar{w}(m) z(m) r_{u,v}^{(\alpha)}(n)$$

where

$$\begin{aligned} m &= 0, \dots, N_{\text{RS}}^{\text{PUCCH}} - 1 \\ n &= 0, \dots, M_{\text{sc}}^{\text{RS}} - 1 \\ m' &= 0, 1 \end{aligned}$$

For PUCCH format 2a and 2b, $z(m)$ equals $d(10)$ for $m = 1$, where $d(10)$ is defined in Section 5.4.2. For all other cases, $z(m) = 1$.

The sequence $r_{u,v}^{(\alpha)}(n)$ is given by Section 5.5.1 with $M_{\text{sc}}^{\text{RS}} = 12$ where the expression for the cyclic shift α is determined by the PUCCH format.

For PUCCH formats 1, 1a and 1b, $\alpha(n_s, l)$ is given by

$$\bar{n}_{\text{oc}}(n_s) = \begin{cases} \left\lfloor n'(n_s) \cdot \Delta_{\text{shift}}^{\text{PUCCH}} / N' \right\rfloor & \text{for normal cyclic prefix} \\ 2 \cdot \left\lfloor n'(n_s) \cdot \Delta_{\text{shift}}^{\text{PUCCH}} / N' \right\rfloor & \text{for extended cyclic prefix} \end{cases}$$

$$\alpha(n_s) = 2\pi \cdot \bar{n}_{\text{cs}}(n_s) / N_{\text{sc}}^{\text{RB}}$$

$$\bar{n}_{\text{cs}}(n_s) = \begin{cases} \left[n_{\text{cs}}^{\text{cell}}(n_s, l) + \left(n'(n_s) \cdot \Delta_{\text{shift}}^{\text{PUCCH}} + \delta_{\text{offset}}^{\text{PUCCH}} + \left(\bar{n}_{\text{oc}}(n_s) \bmod \Delta_{\text{shift}}^{\text{PUCCH}} \right) \right) \bmod N' \right] \bmod N_{\text{sc}}^{\text{RB}} & \text{for normal cyclic prefix} \\ \left[n_{\text{cs}}^{\text{cell}}(n_s, l) + \left(n'(n_s) \cdot \Delta_{\text{shift}}^{\text{PUCCH}} + \delta_{\text{offset}}^{\text{PUCCH}} + \bar{n}_{\text{oc}}(n_s) \right) \bmod N' \right] \bmod N_{\text{sc}}^{\text{RB}} & \text{for extended cyclic prefix} \end{cases}$$

where $n'(n_s)$, N' , $\Delta_{\text{shift}}^{\text{PUCCH}}$, $\delta_{\text{offset}}^{\text{PUCCH}}$ and $n_{\text{cs}}^{\text{cell}}(n_s, l)$ are defined by Section 5.4.1. The number of reference symbols per slot $N_{\text{RS}}^{\text{PUCCH}}$ and the sequence $\bar{w}(n)$ are given by Table 5.5.2.2.1-1 and 5.5.2.2.1-2, respectively.

For PUCCH formats 2, 2a and 2b, $\alpha(n_s, l)$ is defined by Section 5.4.2. The number of reference symbols per slot $N_{\text{RS}}^{\text{PUCCH}}$ and the sequence $\bar{w}(n)$ are given by Table 5.5.2.2.1-1 and 5.5.2.2.1-3, respectively.

Table 5.5.2.2.1-1: Number of PUCCH demodulation reference symbols per slot N_{RS}^{PUCCH} .

| PUCCH format | Normal cyclic prefix | Extended cyclic prefix |
|------------------|----------------------|------------------------|
| 1, 1a, 1b | 3 | 2 |
| 2 | 2 | 1 |
| 2a, 2b | 2 | N/A |

Table 5.5.2.2.1-2: Orthogonal sequences $[\bar{w}(0) \dots \bar{w}(N_{RS}^{PUCCH} - 1)]$ for PUCCH formats 1, 1a and 1b.

| Sequence index $\bar{n}_{oc}(n_s)$ | Normal cyclic prefix | Extended cyclic prefix |
|------------------------------------|-----------------------------------|------------------------|
| 0 | $[1 \ 1 \ 1]$ | $[1 \ 1]$ |
| 1 | $[1 \ e^{j2\pi/3} \ e^{j4\pi/3}]$ | $[1 \ -1]$ |
| 2 | $[1 \ e^{j4\pi/3} \ e^{j2\pi/3}]$ | N/A |

Table 5.5.2.2.1-3: Orthogonal sequences $[\bar{w}(0) \dots \bar{w}(N_{RS}^{PUCCH} - 1)]$ for PUCCH formats 2, 2a, 2b.

| Normal cyclic prefix | Extended cyclic prefix |
|----------------------|------------------------|
| $[1 \ 1]$ | $[1]$ |

5.5.2.2.2 Mapping to physical resources

The sequence $r^{PUCCH}(\cdot)$ shall be multiplied with the amplitude scaling factor β_{PUCCH} and mapped in sequence starting with $r^{PUCCH}(0)$ to resource elements (k, l) . The mapping shall be in increasing order of first k , then l and finally the slot number. The same set of values for k as for the corresponding PUCCH transmission shall be used. The values of the symbol index l in a slot are given by Table 5.5.2.2.2-1.

Table 5.5.2.2.2-1: Demodulation reference signal location for different PUCCH formats

| PUCCH format | Set of values for l | |
|------------------|-----------------------|------------------------|
| | Normal cyclic prefix | Extended cyclic prefix |
| 1, 1a, 1b | 2, 3, 4 | 2, 3 |
| 2 | 1, 5 | 3 |
| 2a, 2b | 1, 5 | N/A |

5.5.3 Sounding reference signal

The sounding reference signal is not transmitted simultaneously with PUCCH format 1. PUCCH format 1 takes precedence over the sounding reference signal in case their respective configurations cause an overlap in time.

5.5.3.1 Sequence generation

The sounding reference signal sequence $r^{SRS}(n) = r_{u,v}^{(\alpha)}(n)$ is defined by Section 5.5.1. The sequence index to use is derived from the PUCCH base sequence index. The cyclic shift α^{SRS} of the sounding reference signal is given as

$$\alpha = 2\pi \frac{n_{SRS}}{8},$$

where n_{SRS} is configured for each UE by higher layers and $n_{\text{SRS}} = 0, 1, 2, 3, 4, 5, 6, 7$.

5.5.3.2 Mapping to physical resources

The sequence $r^{\text{SRS}}(0), \dots, r^{\text{SRS}}(M_{\text{sc},b}^{\text{RS}} - 1)$ shall be multiplied with the amplitude scaling factor β_{SRS} and mapped in sequence starting with $r^{\text{SRS}}(0)$ to resource elements (k, l) according to

$$a_{2k+k_0,l} = \begin{cases} \beta_{\text{SRS}} r^{\text{SRS}}(k) & k = 0, 1, \dots, M_{\text{sc},b}^{\text{RS}} - 1 \\ 0 & \text{otherwise} \end{cases}$$

where k_0 is the frequency-domain starting position of the sounding reference signal and $M_{\text{sc},b}^{\text{RS}}$ is the length of the sounding reference signal sequence defined as

$$M_{\text{sc},b}^{\text{RS}} = m_{\text{SRS},b} N_{\text{sc}}^{\text{RB}} / 2$$

where $m_{\text{SRS},b}$ is given by Table 5.5.3.2-1 through Table 5.5.3.2-4 for each uplink bandwidth $N_{\text{RB}}^{\text{UL}}$. The cell-specific parameter "SRS bandwidth configuration" and the UE-specific parameter "SRS-Bandwidth" $B_{\text{SRS}} \in \{0, 1, 2, 3\}$ are given by higher layers, i.e. $b = B_{\text{SRS}}$.

The frequency-domain starting position k_0 is defined by

$$k_0 = k'_0 + \sum_{b=0}^{B_{\text{SRS}}} 2M_{\text{sc},b}^{\text{RS}} n_b$$

where $k'_0 = \left(\lfloor N_{\text{RB}}^{\text{UL}} / 2 \rfloor - m_{\text{SRS},0} / 2 \right) N_{\text{sc}}^{\text{RB}} + k_{\text{TC}}$, $k_{\text{TC}} \in \{0, 1\}$ is an offset value depending on "Transmission comb" given by higher layers for the UE, and n_b is frequency position index.

In order to configure the frequency hopping of the sounding reference signal, 'SRS hopping bandwidth' value $b_{\text{hop}} \in \{0, 1, 2, 3\}$ is given by higher layers. If frequency hopping of the sounding reference signal is not enabled (i.e., $b_{\text{hop}} \geq B_{\text{SRS}}$), the frequency position index n_b remains constant (unless re-configured) and is defined by $n_b = \lfloor 4n_{\text{RRC}} / m_{\text{SRS},b} \rfloor \bmod N_b$ where "Frequency-domain position" n_{RRC} is given by higher layers for the UE. If frequency hopping of the sounding reference signal is enabled (i.e., $b_{\text{hop}} < B_{\text{SRS}}$), the frequency position indexes n_b are defined by

$$n_b = \begin{cases} \lfloor 4n_{\text{RRC}} / m_{\text{SRS},b} \rfloor \bmod N_b & b \leq b_{\text{hop}} \\ \{F_b(n_{\text{SRS}}) + \lfloor 4n_{\text{RRC}} / m_{\text{SRS},b} \rfloor\} \bmod N_b & \text{otherwise} \end{cases}$$

where N_b is given by Table 5.5.3.2-1 through Table 5.5.3.2-4 for each uplink bandwidth $N_{\text{RB}}^{\text{UL}}$,

$$F_b(n_{\text{SRS}}) = \begin{cases} (N_b / 2) \left[\frac{n_{\text{SRS}} \bmod \prod_{b'=b_{\text{hop}}}^b N_{b'}}{\prod_{b'=b_{\text{hop}}}^{b-1} N_{b'}} \right] + \left[\frac{n_{\text{SRS}} \bmod \prod_{b'=b_{\text{hop}}}^b N_{b'}}{2 \prod_{b'=b_{\text{hop}}}^{b-1} N_{b'}} \right] & \text{if } N_b \text{ even} \\ \lfloor N_b / 2 \rfloor \lfloor n_{\text{SRS}} / \prod_{b'=b_{\text{hop}}}^{b-1} N_{b'} \rfloor & \text{if } N_b \text{ odd} \end{cases}$$

where $N_{b_{\text{hop}}} = 1$ regardless of the N_b value on Table 5.5.3.2-1 through Table 5.5.3.2-4, and

$n_{\text{SRS}} = \lfloor (n_f \times 10 + \lfloor n_s / 2 \rfloor) / T_{\text{SRS}} \rfloor$ counts the number of UE-specific SRS transmissions, where T_{SRS} is UE-specific periodicity of SRS transmission defined in section 8.2 of [4].

The sounding reference signal shall be transmitted at the last symbol of the subframe.

Table 5.5.3.2-1: $m_{\text{SRS},b}$ and N_b values for the uplink bandwidth of $6 \leq N_{\text{RB}}^{\text{UL}} \leq 40$.

| SRS bandwidth configuration | SRS-Bandwidth $b = 0$ | | SRS-Bandwidth $b = 1$ | | SRS-Bandwidth $b = 2$ | | SRS-Bandwidth $b = 3$ | |
|-----------------------------------|--------------------------|-------|--------------------------|-------|--------------------------|-------|--------------------------|-------|
| | $m_{\text{SRS},b}$ | N_b | $m_{\text{SRS},b}$ | N_b | $m_{\text{SRS},b}$ | N_b | $m_{\text{SRS},b}$ | N_b |
| 0 | 36 | 1 | 12 | 3 | 4 | 3 | 4 | 1 |
| 1 | 32 | 1 | 16 | 2 | 8 | 2 | 4 | 2 |
| 2 | 24 | 1 | 4 | 6 | 4 | 1 | 4 | 1 |
| 3 | 20 | 1 | 4 | 5 | 4 | 1 | 4 | 1 |
| 4 | 16 | 1 | 4 | 4 | 4 | 1 | 4 | 1 |
| 5 | 12 | 1 | 4 | 3 | 4 | 1 | 4 | 1 |
| 6 | 8 | 1 | 4 | 2 | 4 | 1 | 4 | 1 |
| 7 | 4 | 1 | 4 | 1 | 4 | 1 | 4 | 1 |

Table 5.5.3.2-2: $m_{\text{SRS},b}$ and N_b values for the uplink bandwidth of $40 < N_{\text{RB}}^{\text{UL}} \leq 60$.

| SRS bandwidth configuration | SRS-Bandwidth $b = 0$ | | SRS-Bandwidth $b = 1$ | | SRS-Bandwidth $b = 2$ | | SRS-Bandwidth $b = 3$ | |
|-----------------------------------|--------------------------|-------|--------------------------|-------|--------------------------|-------|--------------------------|-------|
| | $m_{\text{SRS},b}$ | N_b | $m_{\text{SRS},b}$ | N_b | $m_{\text{SRS},b}$ | N_b | $m_{\text{SRS},b}$ | N_b |
| 0 | 48 | 1 | 24 | 2 | 12 | 2 | 4 | 3 |
| 1 | 48 | 1 | 16 | 3 | 8 | 2 | 4 | 2 |
| 2 | 40 | 1 | 20 | 2 | 4 | 5 | 4 | 1 |
| 3 | 36 | 1 | 12 | 3 | 4 | 3 | 4 | 1 |
| 4 | 32 | 1 | 16 | 2 | 8 | 2 | 4 | 2 |
| 5 | 24 | 1 | 4 | 6 | 4 | 1 | 4 | 1 |
| 6 | 20 | 1 | 4 | 5 | 4 | 1 | 4 | 1 |
| 7 | 16 | 1 | 4 | 4 | 4 | 1 | 4 | 1 |

Table 5.5.3.2-3: $m_{\text{SRS},b}$ and N_b values for the uplink bandwidth of $60 < N_{\text{RB}}^{\text{UL}} \leq 80$.

| SRS bandwidth configuration | SRS-Bandwidth $b = 0$ | | SRS-Bandwidth $b = 1$ | | SRS-Bandwidth $b = 2$ | | SRS-Bandwidth $b = 3$ | |
|-----------------------------------|--------------------------|-------|--------------------------|-------|--------------------------|-------|--------------------------|-------|
| | $m_{\text{SRS},b}$ | N_b | $m_{\text{SRS},b}$ | N_b | $m_{\text{SRS},b}$ | N_b | $m_{\text{SRS},b}$ | N_b |
| 0 | 72 | 1 | 24 | 3 | 12 | 2 | 4 | 3 |
| 1 | 64 | 1 | 32 | 2 | 16 | 2 | 4 | 4 |
| 2 | 60 | 1 | 20 | 3 | 4 | 5 | 4 | 1 |
| 3 | 48 | 1 | 24 | 2 | 12 | 2 | 4 | 3 |
| 4 | 48 | 1 | 16 | 3 | 8 | 2 | 4 | 2 |
| 5 | 40 | 1 | 20 | 2 | 4 | 5 | 4 | 1 |
| 6 | 36 | 1 | 12 | 3 | 4 | 3 | 4 | 1 |
| 7 | 32 | 1 | 16 | 2 | 8 | 2 | 4 | 2 |

Table 5.5.3.2-4: $m_{\text{SRS},b}$ and N_b values for the uplink bandwidth of $80 < N_{\text{RB}}^{\text{UL}} \leq 110$.

| SRS bandwidth configuration | SRS-Bandwidth $b = 0$ | | SRS-Bandwidth $b = 1$ | | SRS-Bandwidth $b = 2$ | | SRS-Bandwidth $b = 3$ | |
|-----------------------------------|--------------------------|-------|--------------------------|-------|--------------------------|-------|--------------------------|-------|
| | $m_{\text{SRS},b}$ | N_b | $m_{\text{SRS},b}$ | N_b | $m_{\text{SRS},b}$ | N_b | $m_{\text{SRS},b}$ | N_b |
| 0 | 96 | 1 | 48 | 2 | 24 | 2 | 4 | 6 |
| 1 | 96 | 1 | 32 | 3 | 16 | 2 | 4 | 4 |
| 2 | 80 | 1 | 40 | 2 | 20 | 2 | 4 | 5 |
| 3 | 72 | 1 | 24 | 3 | 12 | 2 | 4 | 3 |
| 4 | 64 | 1 | 32 | 2 | 16 | 2 | 4 | 4 |
| 5 | 60 | 1 | 20 | 3 | 4 | 5 | 4 | 1 |
| 6 | 48 | 1 | 24 | 2 | 12 | 2 | 4 | 3 |
| 7 | 48 | 1 | 16 | 3 | 8 | 2 | 4 | 2 |

5.5.3.3 Sounding reference signal subframe configuration

The cell specific subframe configuration period and the cell specific subframe offset, relative to a frame, for the transmission of sounding reference signals are listed in Tables 5.5.3.3-1 and 5.5.3.3-2, for FDD and TDD, respectively. For TDD, sounding reference signal is transmitted only in configured UL subframes or UpPTS.

Table 5.5.3.3-1: FDD sounding reference signal subframe configuration

| Configuration | Binary | Configuration Period (subframes) | Transmission offset (subframes) |
|---------------|--------|----------------------------------|---------------------------------|
| 0 | 0000 | 1 | {0} |
| 1 | 0001 | 2 | {0} |
| 2 | 0010 | 2 | {1} |
| 3 | 0011 | 5 | {0} |
| 4 | 0100 | 5 | {1} |
| 5 | 0101 | 5 | {2} |
| 6 | 0110 | 5 | {3} |
| 7 | 0111 | 5 | {0,1} |
| 8 | 1000 | 5 | {2,3} |
| 9 | 1001 | 10 | {0} |
| 10 | 1010 | 10 | {1} |
| 11 | 1011 | 10 | {2} |
| 12 | 1100 | 10 | {3} |
| 13 | 1101 | 10 | {0,1,2,3,4,6,8} |
| 14 | 1110 | 10 | {0,1,2,3,4,5,6,8} |
| 15 | 1111 | Inf | N/A |

Table 5.5.3.3-2: TDD sounding reference signal subframe configuration

| Configuration | Binary | Configuration Period (sub-frames) | Transmission offset (sub-frames) |
|---------------|--------|-----------------------------------|----------------------------------|
| 0 | 0000 | 5 | {1} |
| 1 | 0001 | 5 | {1, 2} |
| 2 | 0010 | 5 | {1, 3} |
| 3 | 0011 | 5 | {1, 4} |
| 4 | 0100 | 5 | {1, 2, 3} |
| 5 | 0101 | 5 | {1, 2, 4} |
| 6 | 0110 | 5 | {1, 3, 4} |

| | | | |
|----|------|----------|--------------|
| 7 | 0111 | 5 | {1, 2, 3, 4} |
| 8 | 1000 | 10 | {1, 2, 6} |
| 9 | 1001 | 10 | {1, 3, 6} |
| 10 | 1010 | 10 | {1, 6, 7} |
| 11 | 1011 | 10 | {1, 2, 6, 8} |
| 12 | 1100 | 10 | {1, 3, 6, 9} |
| 13 | 1101 | 10 | {1, 4, 6, 7} |
| 14 | 1110 | Inf | N/A |
| 15 | 1111 | reserved | reserved |

5.6 SC-FDMA baseband signal generation

This section applies to all uplink physical signals and physical channels except the physical random access channel.

The time-continuous signal $s_l(t)$ in SC-FDMA symbol l in an uplink slot is defined by

$$s_l(t) = \sum_{k=-\lfloor N_{RB}^{UL} N_{sc}^{RB} / 2 \rfloor}^{\lfloor N_{RB}^{UL} N_{sc}^{RB} / 2 \rfloor - 1} a_{k^{(-)}, l} \cdot e^{j2\pi(k+1/2)\Delta f(t - N_{CP,l} T_s)}$$

for $0 \leq t < (N_{CP,l} + N) \times T_s$ where $k^{(-)} = k + \lfloor N_{RB}^{UL} N_{sc}^{RB} / 2 \rfloor$, $N = 2048$, $\Delta f = 15$ kHz and $a_{k,l}$ is the content of resource element (k, l) .

The SC-FDMA symbols in a slot shall be transmitted in increasing order of l , starting with $l = 0$, where SC-FDMA symbol $l > 0$ starts at time $\sum_{l'=0}^{l-1} (N_{CP,l'} + N) T_s$ within the slot.

Table 5.6-1 lists the values of $N_{CP,l}$ that shall be used. Note that different SC-FDMA symbols within a slot may have different cyclic prefix lengths.

Table 5.6-1: SC-FDMA parameters.

| Configuration | Cyclic prefix length $N_{CP,l}$ |
|-------------------------------|---------------------------------|
| Normal cyclic prefix | 160 for $l = 0$ |
| | 144 for $l = 1,2,\dots,6$ |
| Extended cyclic prefix | 512 for $l = 0,1,\dots,5$ |

5.7 Physical random access channel

5.7.1 Time and frequency structure

The physical layer random access preamble, illustrated in Figure 5.7.1-1, consists of a cyclic prefix of length T_{CP} and a sequence part of length T_{SEQ} . The parameter values are listed in Table 5.7.1-1 and depend on the frame structure and the random access configuration. Higher layers control the preamble format.

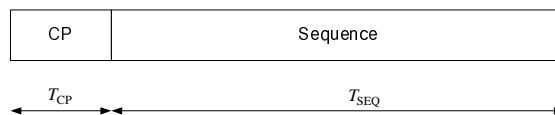
**Figure 5.7.1-1: Random access preamble format.****Table 5.7.1-1: Random access preamble parameters.**

| Preamble format | T_{CP} | T_{SEQ} |
|---|-------------------|---------------------------|
| 0 | $3168 \cdot T_s$ | $24576 \cdot T_s$ |
| 1 | $21024 \cdot T_s$ | $24576 \cdot T_s$ |
| 2 | $6240 \cdot T_s$ | $2 \cdot 24576 \cdot T_s$ |
| 3 | $21024 \cdot T_s$ | $2 \cdot 24576 \cdot T_s$ |
| 4 (frame structure type 2 only) | $448 \cdot T_s$ | $4096 \cdot T_s$ |

The transmission of a random access preamble, if triggered by the MAC layer, is restricted to certain time and frequency resources. These resources are enumerated in increasing order of the subframe number within the radio frame and the physical resource blocks in the frequency domain such that index 0 correspond to the lowest numbered physical resource block and subframe within the radio frame.

For frame structure type 1 with preamble format 0-3, there is at most one random access resource per subframe. Table 5.7.1-2 lists the preamble formats according to Table 5.7.1-1 and the subframes in which random access preamble transmission is allowed for a given configuration in frame structure type 1. *PRACH-Configuration-Index* is given by higher layers. The start of the random access preamble shall be aligned with the start of the corresponding uplink subframe at the UE assuming a timing advance of zero. For PRACH configuration 0, 1, 2, 15, 16, 17, 18, 31, 32, 33, 34, 47, 48, 49, 50 and 63 the UE may for handover purposes assume an absolute value of the relative time difference between radio frame i in the current cell and the target cell of less than $153600 \cdot T_s$. The first physical resource block

n_{PRB}^{RA} allocated to the PRACH opportunity considered for preamble format 0, 1, 2 and 3 is defined as

$n_{PRB}^{RA} = n_{PRB\ offset}^{RA}$, where the parameter *prach-FrequencyOffset* $n_{PRB\ offset}^{RA}$ is expressed as a physical resource block

number configured by higher layers and fulfilling $0 \leq n_{PRB\ offset}^{RA} \leq N_{RB}^{UL} - 6$.

Table 5.7.1-2: Frame structure type 1 random access configuration for preamble format 0-3.

| PRACH Configuration Index | Preamble Format | System frame number | Subframe number | PRACH configuration index | Preamble Format | System frame number | Subframe number |
|---------------------------|-----------------|---------------------|------------------------------|---------------------------|-----------------|---------------------|-----------------|
| 0 | 0 | Even | 1 | 32 | 2 | Even | 1 |
| 1 | 0 | Even | 4 | 33 | 2 | Even | 4 |
| 2 | 0 | Even | 7 | 34 | 2 | Even | 7 |
| 3 | 0 | Any | 1 | 35 | 2 | Any | 1 |
| 4 | 0 | Any | 4 | 36 | 2 | Any | 4 |
| 5 | 0 | Any | 7 | 37 | 2 | Any | 7 |
| 6 | 0 | Any | 1, 6 | 38 | 2 | Any | 1, 6 |
| 7 | 0 | Any | 2, 7 | 39 | 2 | Any | 2, 7 |
| 8 | 0 | Any | 3, 8 | 40 | 2 | Any | 3, 8 |
| 9 | 0 | Any | 1, 4, 7 | 41 | 2 | Any | 1, 4, 7 |
| 10 | 0 | Any | 2, 5, 8 | 42 | 2 | Any | 2, 5, 8 |
| 11 | 0 | Any | 3, 6, 9 | 43 | 2 | Any | 3, 6, 9 |
| 12 | 0 | Any | 0, 2, 4, 6, 8 | 44 | 2 | Any | 0, 2, 4, 6, 8 |
| 13 | 0 | Any | 1, 3, 5, 7, 9 | 45 | 2 | Any | 1, 3, 5, 7, 9 |
| 14 | 0 | Any | 0, 1, 2, 3, 4, 5, 6, 7, 8, 9 | 46 | N/A | N/A | N/A |
| 15 | 0 | Even | 9 | 47 | 2 | Even | 9 |
| 16 | 1 | Even | 1 | 48 | 3 | Even | 1 |
| 17 | 1 | Even | 4 | 49 | 3 | Even | 4 |
| 18 | 1 | Even | 7 | 50 | 3 | Even | 7 |
| 19 | 1 | Any | 1 | 51 | 3 | Any | 1 |
| 20 | 1 | Any | 4 | 52 | 3 | Any | 4 |
| 21 | 1 | Any | 7 | 53 | 3 | Any | 7 |
| 22 | 1 | Any | 1, 6 | 54 | 3 | Any | 1, 6 |
| 23 | 1 | Any | 2, 7 | 55 | 3 | Any | 2, 7 |
| 24 | 1 | Any | 3, 8 | 56 | 3 | Any | 3, 8 |
| 25 | 1 | Any | 1, 4, 7 | 57 | 3 | Any | 1, 4, 7 |
| 26 | 1 | Any | 2, 5, 8 | 58 | 3 | Any | 2, 5, 8 |
| 27 | 1 | Any | 3, 6, 9 | 59 | 3 | Any | 3, 6, 9 |
| 28 | 1 | Any | 0, 2, 4, 6, 8 | 60 | N/A | N/A | N/A |
| 29 | 1 | Any | 1, 3, 5, 7, 9 | 61 | N/A | N/A | N/A |
| 30 | N/A | N/A | N/A | 62 | N/A | N/A | N/A |
| 31 | 1 | Even | 9 | 63 | 3 | Even | 9 |

For frame structure type 2 with preamble format 0-4, there might be multiple random access resources in an UL subframe (or UpPTS for preamble format 4) depending on the UL/DL configuration [see table 4.2-2]. Table 5.7.1-3 lists PRACH configurations allowed for frame structure type 2 where the configuration index corresponds to a certain combination of preamble format, PRACH density value, D_{RA} , and version index, r_{RA} .

Table 5.7.1-3: Frame structure type 2 random access configurations for preamble format 0-4

| PRACH conf. Index | Preamble Format | Density Per 10 ms (D_{RA}) | Version (r_{RA}) | PRACH conf. Index | Preamble Format | Density Per 10 ms (D_{RA}) | Version (r_{RA}) |
|-------------------------|--------------------|--------------------------------------|-------------------------|-------------------------|--------------------|--------------------------------------|-------------------------|
| 0 | 0 | 0.5 | 0 | 32 | 2 | 0.5 | 2 |
| 1 | 0 | 0.5 | 1 | 33 | 2 | 1 | 0 |
| 2 | 0 | 0.5 | 2 | 34 | 2 | 1 | 1 |
| 3 | 0 | 1 | 0 | 35 | 2 | 2 | 0 |
| 4 | 0 | 1 | 1 | 36 | 2 | 3 | 0 |
| 5 | 0 | 1 | 2 | 37 | 2 | 4 | 0 |
| 6 | 0 | 2 | 0 | 38 | 2 | 5 | 0 |
| 7 | 0 | 2 | 1 | 39 | 2 | 6 | 0 |
| 8 | 0 | 2 | 2 | 40 | 3 | 0.5 | 0 |
| 9 | 0 | 3 | 0 | 41 | 3 | 0.5 | 1 |
| 10 | 0 | 3 | 1 | 42 | 3 | 0.5 | 2 |
| 11 | 0 | 3 | 2 | 43 | 3 | 1 | 0 |
| 12 | 0 | 4 | 0 | 44 | 3 | 1 | 1 |
| 13 | 0 | 4 | 1 | 45 | 3 | 2 | 0 |
| 14 | 0 | 4 | 2 | 46 | 3 | 3 | 0 |
| 15 | 0 | 5 | 0 | 47 | 3 | 4 | 0 |
| 16 | 0 | 5 | 1 | 48 | 4 | 0.5 | 0 |
| 17 | 0 | 5 | 2 | 49 | 4 | 0.5 | 1 |
| 18 | 0 | 6 | 0 | 50 | 4 | 0.5 | 2 |
| 19 | 0 | 6 | 1 | 51 | 4 | 1 | 0 |
| 20 | 1 | 0.5 | 0 | 52 | 4 | 1 | 1 |
| 21 | 1 | 0.5 | 1 | 53 | 4 | 2 | 0 |
| 22 | 1 | 0.5 | 2 | 54 | 4 | 3 | 0 |
| 23 | 1 | 1 | 0 | 55 | 4 | 4 | 0 |
| 24 | 1 | 1 | 1 | 56 | 4 | 5 | 0 |
| 25 | 1 | 2 | 0 | 57 | 4 | 6 | 0 |
| 26 | 1 | 3 | 0 | | | | |
| 27 | 1 | 4 | 0 | | | | |
| 28 | 1 | 5 | 0 | | | | |
| 29 | 1 | 6 | 0 | | | | |
| 30 | 2 | 0.5 | 0 | | | | |
| 31 | 2 | 0.5 | 1 | | | | |

Table 5.7.1-4 lists the mapping to physical resources for the different random access opportunities needed for a certain PRACH density value, D_{RA} . Each quadruple of the format $(f_{RA}, t_{RA}^0, t_{RA}^1, t_{RA}^2)$ indicates the location of a specific random access resource, where f_{RA} is a frequency resource index within the considered time instance, $t_{RA}^0 = 0,1,2$ indicates whether the resource is reoccurring in all radio frames, in even radio frames, or in odd radio frames, respectively, $t_{RA}^1 = 0,1$ indicates whether the random access resource is located in first half frame or in second half frame, respectively, and where t_{RA}^2 is the uplink subframe number where the preamble starts, counting from 0 at the first uplink subframe between 2 consecutive downlink-to-uplink switch points, with the exception of preamble format 4 which is always transmitted in UpPTS and t_{RA}^2 is denoted as (*). The start of the random access preamble formats 0-3 shall be aligned with the start of the corresponding uplink subframe at the UE assuming a timing advance of zero and the random access preamble format 4 shall start $[5158 \cdot T_s]$ before the end of the UpPTS at the UE.

The random access opportunities for each PRACH configuration shall be allocated in time first and then in frequency if and only if time multiplexing is not sufficient to hold all opportunities of a PRACH configuration needed for a certain

density value D_{RA} without overlap in time. For preamble format 0-3, the frequency multiplexing shall be done according to

$$n_{PRB}^{RA} = \begin{cases} n_{PRB\ offset}^{RA} + 6 \left\lfloor \frac{f_{RA}}{2} \right\rfloor, & \text{if } f_{RA} \bmod 2 = 0 \\ N_{RB}^{UL} - 6 - n_{PRB\ offset}^{RA} - 6 \left\lfloor \frac{f_{RA}}{2} \right\rfloor, & \text{otherwise} \end{cases}$$

where N_{RB}^{UL} is the number of uplink resource blocks, n_{PRB}^{RA} is the first physical resource block allocated to the PRACH opportunity considered and where the parameter *prach-FrequencyOffset* $n_{PRB\ offset}^{RA}$ is the first physical resource block available for PRACH expressed as a physical resource block number configured by higher layers and fulfilling $0 \leq n_{PRB\ offset}^{RA} \leq N_{RB}^{UL} - 6$.

For preamble format 4, the frequency multiplexing shall be done according to

$$n_{PRB}^{RA} = \begin{cases} 6f_{RA}, & \text{if } ((n_f \bmod 2) \times (2 - N_{SP}) + t_{RA}^1) \bmod 2 = 0 \\ N_{RB}^{UL} - 6(f_{RA} + 1), & \text{otherwise} \end{cases}$$

where n_f is the system frame number and where N_{SP} is the number of DL to UL switch points within the radio frame.

Each random access preamble occupies a bandwidth corresponding to 6 consecutive resource blocks for both frame structures.

Table 5.7.1-4: Frame structure type 2 random access preamble mapping in time and frequency.

| PRACH conf. Index (See Table 5.7.1-3) | UL/DL configuration (See Table 4.2-2) | | | | | | |
|---|---------------------------------------|-----------|-----------|-----------|-----------|-----------|-----------|
| | 0 | 1 | 2 | 3 | 4 | 5 | 6 |
| 0 | (0,1,0,2) | (0,1,0,1) | (0,1,0,0) | (0,1,0,2) | (0,1,0,1) | (0,1,0,0) | (0,1,0,2) |
| 1 | (0,2,0,2) | (0,2,0,1) | (0,2,0,0) | (0,2,0,2) | (0,2,0,1) | (0,2,0,0) | (0,2,0,2) |
| 2 | (0,1,1,2) | (0,1,1,1) | (0,1,1,0) | (0,1,0,1) | (0,1,0,0) | N/A | (0,1,1,1) |
| 3 | (0,0,0,2) | (0,0,0,1) | (0,0,0,0) | (0,0,0,2) | (0,0,0,1) | (0,0,0,0) | (0,0,0,2) |
| 4 | (0,0,1,2) | (0,0,1,1) | (0,0,1,0) | (0,0,0,1) | (0,0,0,0) | N/A | (0,0,1,1) |
| 5 | (0,0,0,1) | (0,0,0,0) | N/A | (0,0,0,0) | N/A | N/A | (0,0,0,1) |
| 6 | (0,0,0,2) | (0,0,0,1) | (0,0,0,0) | (0,0,0,2) | (0,0,0,1) | (0,0,0,0) | (0,0,0,2) |
| 7 | (0,0,1,2) | (0,0,1,1) | (0,0,1,0) | (0,0,0,1) | (0,0,0,0) | (1,0,0,0) | (0,0,1,1) |
| | (0,0,0,1) | (0,0,0,0) | N/A | (0,0,0,0) | N/A | N/A | (0,0,0,1) |
| 8 | (0,0,1,1) | (0,0,1,0) | | (0,0,0,2) | | | (0,0,1,0) |
| | (0,0,0,0) | N/A | N/A | (0,0,0,1) | N/A | N/A | (0,0,0,0) |
| 9 | (0,0,1,0) | | | (0,0,0,0) | | | (0,0,1,1) |
| | (0,0,0,2) | (0,0,0,1) | (0,0,0,0) | (0,0,0,2) | (0,0,0,1) | (0,0,0,0) | (0,0,0,2) |
| 10 | (0,0,1,2) | (0,0,1,1) | (0,0,1,0) | (0,0,0,1) | (0,0,0,0) | (1,0,0,0) | (0,0,1,1) |
| | (0,0,0,1) | (0,0,0,0) | (1,0,0,0) | (0,0,0,0) | (1,0,0,1) | (2,0,0,0) | (0,0,0,1) |
| | (0,0,1,1) | (0,0,1,0) | (0,0,1,0) | N/A | (0,0,0,0) | N/A | (0,0,1,0) |
| 11 | (0,0,0,0) | (0,0,0,1) | (0,0,0,0) | | (0,0,0,1) | | (0,0,0,0) |
| | (0,0,1,0) | (0,0,1,1) | (1,0,1,0) | | (1,0,0,0) | | (0,0,0,2) |
| | N/A | (0,0,0,0) | N/A | N/A | N/A | N/A | (0,0,1,1) |
| 12 | | (0,0,1,0) | | | | | (0,0,0,1) |
| | | (0,0,0,1) | | | | | (0,0,1,0) |
| | (0,0,0,2) | (0,0,0,1) | (0,0,0,0) | (0,0,0,2) | (0,0,0,1) | (0,0,0,0) | (0,0,0,2) |
| | (0,0,1,2) | (0,0,1,1) | (0,0,1,0) | (0,0,0,1) | (0,0,0,0) | (1,0,0,0) | (0,0,1,1) |
| 13 | (0,0,0,1) | (0,0,0,0) | (1,0,0,0) | (0,0,0,0) | (1,0,0,1) | (2,0,0,0) | (0,0,0,1) |
| | (0,0,1,1) | (0,0,1,0) | (1,0,1,0) | (1,0,0,2) | (1,0,0,0) | (3,0,0,0) | (0,0,1,0) |
| | (0,0,0,0) | N/A | N/A | (0,0,0,1) | N/A | N/A | (0,0,0,0) |
| | (0,0,1,0) | | | (0,0,0,0) | | | (0,0,0,2) |
| 14 | (0,0,0,2) | | | (0,0,0,2) | | | (0,0,1,1) |
| | (0,0,1,2) | | | (1,0,0,1) | | | (0,0,0,1) |
| | (0,0,0,1) | N/A | N/A | (0,0,0,0) | N/A | N/A | (0,0,1,0) |
| | (0,0,1,1) | | | (0,0,0,2) | | | (0,0,0,0) |
| 15 | (0,0,0,0) | | | (0,0,0,1) | | | (0,0,0,2) |
| | (0,0,1,0) | | | (1,0,0,0) | | | (0,0,1,1) |
| | (0,0,0,2) | (0,0,0,1) | (0,0,0,0) | (0,0,0,2) | (0,0,0,1) | (0,0,0,0) | (0,0,0,2) |
| | (0,0,1,2) | (0,0,1,1) | (0,0,1,0) | (0,0,0,1) | (0,0,0,0) | (1,0,0,0) | (0,0,1,1) |
| | (0,0,0,1) | (0,0,0,0) | (1,0,0,0) | (0,0,0,0) | (1,0,0,1) | (2,0,0,0) | (0,0,0,1) |
| 16 | (0,0,1,1) | (0,0,1,0) | (1,0,1,0) | (1,0,0,2) | (1,0,0,0) | (3,0,0,0) | (0,0,1,0) |
| | (0,0,0,0) | (1,0,0,1) | (2,0,0,0) | (1,0,0,1) | (2,0,0,1) | (4,0,0,0) | (0,0,0,0) |
| | (0,0,1,0) | (0,0,1,1) | (0,0,1,0) | (0,0,0,0) | (0,0,0,0) | N/A | N/A |
| | (0,0,0,2) | (0,0,0,0) | (0,0,0,0) | (0,0,0,2) | (0,0,0,1) | | |
| | (0,0,1,2) | (0,0,1,0) | (1,0,1,0) | (0,0,0,1) | (1,0,0,0) | | |
| 17 | (0,0,0,1) | (0,0,0,1) | (1,0,0,0) | (1,0,0,0) | (1,0,0,1) | | |
| | (0,0,1,1) | (1,0,1,1) | (2,0,1,0) | (1,0,0,2) | (2,0,0,0) | | |
| | (0,0,0,0) | (0,0,0,0) | N/A | (0,0,0,1) | N/A | N/A | N/A |
| | (0,0,1,0) | (0,0,1,0) | | (0,0,0,0) | | | |
| | (0,0,0,2) | (0,0,0,1) | | (0,0,0,2) | | | |
| 18 | (0,0,1,2) | (0,0,1,1) | | (1,0,0,1) | | | |
| | (0,0,0,1) | (1,0,0,0) | | (1,0,0,0) | | | |
| | (0,0,0,0) | | | (1,0,0,0) | | | |

| | | | | | | | |
|---------|-----------|-----------|-----------|-----------|-----------|-----------|-----------|
| 18 | (0,0,0,2) | (0,0,0,1) | (0,0,0,0) | (0,0,0,2) | (0,0,0,1) | (0,0,0,0) | (0,0,0,2) |
| | (0,0,1,2) | (0,0,1,1) | (0,0,1,0) | (0,0,0,1) | (0,0,0,0) | (1,0,0,0) | (0,0,1,1) |
| | (0,0,0,1) | (0,0,0,0) | (1,0,0,0) | (0,0,0,0) | (1,0,0,1) | (2,0,0,0) | (0,0,0,1) |
| | (0,0,1,1) | (0,0,1,0) | (1,0,1,0) | (1,0,0,2) | (1,0,0,0) | (3,0,0,0) | (0,0,1,0) |
| | (0,0,0,0) | (1,0,0,1) | (2,0,0,0) | (1,0,0,1) | (2,0,0,1) | (4,0,0,0) | (0,0,0,0) |
| | (0,0,1,0) | (1,0,1,1) | (2,0,1,0) | (1,0,0,0) | (2,0,0,0) | (5,0,0,0) | (1,0,0,2) |
| 19 | N/A | (0,0,0,0) | N/A | N/A | N/A | N/A | (0,0,1,1) |
| | | (0,0,1,0) | | | | | (0,0,0,1) |
| | | (0,0,0,1) | | | | | (0,0,1,0) |
| | | (0,0,1,1) | | | | | (0,0,0,0) |
| | | (1,0,0,0) | | | | | (0,0,0,2) |
| | | (1,0,1,0) | | | | | (1,0,1,1) |
| 20 / 30 | (0,1,0,1) | (0,1,0,0) | N/A | (0,1,0,1) | (0,1,0,0) | N/A | (0,1,0,1) |
| 21 / 31 | (0,2,0,1) | (0,2,0,0) | N/A | (0,2,0,1) | (0,2,0,0) | N/A | (0,2,0,1) |
| 22 / 32 | (0,1,1,1) | (0,1,1,0) | N/A | N/A | N/A | N/A | (0,1,1,0) |
| 23 / 33 | (0,0,0,1) | (0,0,0,0) | N/A | (0,0,0,1) | (0,0,0,0) | N/A | (0,0,0,1) |
| 24 / 34 | (0,0,1,1) | (0,0,1,0) | N/A | N/A | N/A | N/A | (0,0,1,0) |
| 25 / 35 | (0,0,0,1) | (0,0,0,0) | N/A | (0,0,0,1) | (0,0,0,0) | N/A | (0,0,0,1) |
| | (0,0,1,1) | (0,0,1,0) | | (1,0,0,1) | (1,0,0,0) | | (0,0,1,0) |
| | (0,0,0,1) | (0,0,0,0) | | (0,0,0,1) | (0,0,0,0) | | (0,0,0,1) |
| 26 / 36 | (0,0,1,1) | (0,0,1,0) | N/A | (1,0,0,1) | (1,0,0,0) | N/A | (0,0,1,0) |
| | (1,0,0,1) | (1,0,0,0) | | (2,0,0,1) | (2,0,0,0) | | (1,0,0,1) |
| | (0,0,0,1) | (0,0,0,0) | | (0,0,0,1) | (0,0,0,0) | | (0,0,0,1) |
| 27 / 37 | (0,0,0,1) | (0,0,0,0) | | (0,0,0,1) | (0,0,0,0) | | (0,0,0,1) |
| | (0,0,1,1) | (0,0,1,0) | N/A | (1,0,0,1) | (1,0,0,0) | N/A | (0,0,1,0) |
| | (1,0,0,1) | (1,0,0,0) | | (2,0,0,1) | (2,0,0,0) | | (1,0,0,1) |
| | (1,0,1,1) | (1,0,1,0) | | (3,0,0,1) | (3,0,0,0) | | (1,0,1,0) |
| 28 / 38 | (0,0,0,1) | (0,0,0,0) | | (0,0,0,1) | (0,0,0,0) | | (0,0,0,1) |
| | (0,0,1,1) | (0,0,1,0) | | (1,0,0,1) | (1,0,0,0) | | (0,0,1,0) |
| | (1,0,0,1) | (1,0,0,0) | N/A | (2,0,0,1) | (2,0,0,0) | N/A | (1,0,0,1) |
| | (1,0,1,1) | (1,0,1,0) | | (3,0,0,1) | (3,0,0,0) | | (1,0,1,0) |
| 29 / 39 | (2,0,0,1) | (2,0,0,0) | | (4,0,0,1) | (4,0,0,0) | | (2,0,0,1) |
| | (0,0,0,1) | (0,0,0,0) | | (0,0,0,1) | (0,0,0,0) | | (0,0,0,1) |
| | (0,0,1,1) | (0,0,1,0) | | (1,0,0,1) | (1,0,0,0) | | (0,0,1,0) |
| | (1,0,0,1) | (1,0,0,0) | N/A | (2,0,0,1) | (2,0,0,0) | N/A | (1,0,0,1) |
| | (1,0,1,1) | (1,0,1,0) | | (3,0,0,1) | (3,0,0,0) | | (1,0,1,0) |
| 40 | (0,1,0,0) | N/A | N/A | (0,1,0,0) | N/A | N/A | (0,1,0,0) |
| | (0,2,0,0) | N/A | N/A | (0,2,0,0) | N/A | N/A | (0,2,0,0) |
| 41 | (0,1,1,0) | N/A | N/A | N/A | N/A | N/A | N/A |
| 42 | (0,0,0,0) | N/A | N/A | (0,0,0,0) | N/A | N/A | (0,0,0,0) |
| 43 | (0,0,1,0) | N/A | N/A | N/A | N/A | N/A | N/A |
| 44 | (0,0,0,0) | N/A | N/A | (0,0,0,0) | N/A | N/A | (0,0,0,0) |
| | (0,0,1,0) | N/A | N/A | (1,0,0,0) | | | (1,0,0,0) |
| 45 | (0,0,0,0) | N/A | N/A | (0,0,0,0) | N/A | N/A | (0,0,0,0) |
| | (0,0,1,0) | | | (1,0,0,0) | | | (1,0,0,0) |
| 46 | (0,0,0,0) | | | (0,0,0,0) | | | (0,0,0,0) |
| | (0,0,1,0) | N/A | N/A | (1,0,0,0) | N/A | N/A | (1,0,0,0) |
| | (1,0,0,0) | | | (2,0,0,0) | | | (2,0,0,0) |
| 47 | (0,0,0,0) | | | (0,0,0,0) | | | (0,0,0,0) |
| | (0,0,1,0) | N/A | N/A | (1,0,0,0) | N/A | N/A | (1,0,0,0) |
| | (1,0,0,0) | | | (2,0,0,0) | | | (2,0,0,0) |
| 48 | (1,0,1,0) | | | (3,0,0,0) | | | (3,0,0,0) |
| | (0,1,0,*) | (0,1,0,*) | (0,1,0,*) | (0,1,0,*) | (0,1,0,*) | (0,1,0,*) | (0,1,0,*) |
| | (0,2,0,*) | (0,2,0,*) | (0,2,0,*) | (0,2,0,*) | (0,2,0,*) | (0,2,0,*) | (0,2,0,*) |

| | | | | | | | |
|----|-----------|-----------|-----------|-----------|-----------|-----------|-----------|
| 50 | (0,1,1,*) | (0,1,1,*) | (0,1,1,*) | N/A | N/A | N/A | (0,1,1,*) |
| 51 | (0,0,0,*) | (0,0,0,*) | (0,0,0,*) | (0,0,0,*) | (0,0,0,*) | (0,0,0,*) | (0,0,0,*) |
| 52 | (0,0,1,*) | (0,0,1,*) | (0,0,1,*) | N/A | N/A | N/A | (0,0,1,*) |
| 53 | (0,0,0,*) | (0,0,0,*) | (0,0,0,*) | (0,0,0,*) | (0,0,0,*) | (0,0,0,*) | (0,0,0,*) |
| | (0,0,1,*) | (0,0,1,*) | (0,0,1,*) | (1,0,0,*) | (1,0,0,*) | (1,0,0,*) | (0,0,1,*) |
| 54 | (0,0,0,*) | (0,0,0,*) | (0,0,0,*) | (0,0,0,*) | (0,0,0,*) | (0,0,0,*) | (0,0,0,*) |
| | (0,0,1,*) | (0,0,1,*) | (0,0,1,*) | (1,0,0,*) | (1,0,0,*) | (1,0,0,*) | (0,0,1,*) |
| | (1,0,0,*) | (1,0,0,*) | (1,0,0,*) | (2,0,0,*) | (2,0,0,*) | (2,0,0,*) | (1,0,0,*) |
| 55 | (0,0,0,*) | (0,0,0,*) | (0,0,0,*) | (0,0,0,*) | (0,0,0,*) | (0,0,0,*) | (0,0,0,*) |
| | (0,0,1,*) | (0,0,1,*) | (0,0,1,*) | (1,0,0,*) | (1,0,0,*) | (1,0,0,*) | (0,0,1,*) |
| | (1,0,0,*) | (1,0,0,*) | (1,0,0,*) | (2,0,0,*) | (2,0,0,*) | (2,0,0,*) | (1,0,0,*) |
| | (1,0,1,*) | (1,0,1,*) | (1,0,1,*) | (3,0,0,*) | (3,0,0,*) | (3,0,0,*) | (1,0,1,*) |
| 56 | (0,0,0,*) | (0,0,0,*) | (0,0,0,*) | (0,0,0,*) | (0,0,0,*) | (0,0,0,*) | (0,0,0,*) |
| | (0,0,1,*) | (0,0,1,*) | (0,0,1,*) | (1,0,0,*) | (1,0,0,*) | (1,0,0,*) | (0,0,1,*) |
| | (1,0,0,*) | (1,0,0,*) | (1,0,0,*) | (2,0,0,*) | (2,0,0,*) | (2,0,0,*) | (1,0,0,*) |
| | (1,0,1,*) | (1,0,1,*) | (1,0,1,*) | (3,0,0,*) | (3,0,0,*) | (3,0,0,*) | (1,0,1,*) |
| | (2,0,0,*) | (2,0,0,*) | (2,0,0,*) | (4,0,0,*) | (4,0,0,*) | (4,0,0,*) | (2,0,0,*) |
| 57 | (0,0,0,*) | (0,0,0,*) | (0,0,0,*) | (0,0,0,*) | (0,0,0,*) | (0,0,0,*) | (0,0,0,*) |
| | (0,0,1,*) | (0,0,1,*) | (0,0,1,*) | (1,0,0,*) | (1,0,0,*) | (1,0,0,*) | (0,0,1,*) |
| | (1,0,0,*) | (1,0,0,*) | (1,0,0,*) | (2,0,0,*) | (2,0,0,*) | (2,0,0,*) | (1,0,0,*) |
| | (1,0,1,*) | (1,0,1,*) | (1,0,1,*) | (3,0,0,*) | (3,0,0,*) | (3,0,0,*) | (1,0,1,*) |
| | (2,0,0,*) | (2,0,0,*) | (2,0,0,*) | (4,0,0,*) | (4,0,0,*) | (4,0,0,*) | (2,0,0,*) |
| | (2,0,1,*) | (2,0,1,*) | (2,0,1,*) | (5,0,0,*) | (5,0,0,*) | (5,0,0,*) | (2,0,1,*) |

* UpPTS

5.7.2 Preamble sequence generation

The random access preambles are generated from Zadoff-Chu sequences with zero correlation zone, generated from one or several root Zadoff-Chu sequences. The network configures the set of preamble sequences the UE is allowed to use.

There are 64 preambles available in each cell. The set of 64 preamble sequences in a cell is found by including first, in the order of increasing cyclic shift, all the available cyclic shifts of a root Zadoff-Chu sequence with the logical index RACH_ROOT_SEQUENCE, where RACH_ROOT_SEQUENCE is broadcasted as part of the System Information. Additional preamble sequences, in case 64 preambles cannot be generated from a single root Zadoff-Chu sequence, are obtained from the root sequences with the consecutive logical indexes until all the 64 sequences are found. The logical root sequence order is cyclic: the logical index 0 is consecutive to 837. The relation between a logical root sequence index and physical root sequence index u is given by Tables 5.7.2-4 and 5.7.2-5 for preamble formats 0 – 3 and 4, respectively.

The u^{th} root Zadoff-Chu sequence is defined by

$$x_u(n) = e^{-j \frac{\pi u n(n+1)}{N_{\text{ZC}}}}, \quad 0 \leq n \leq N_{\text{ZC}} - 1$$

where the length N_{ZC} of the Zadoff-Chu sequence is given by Table 5.7.2-1. From the u^{th} root Zadoff-Chu sequence, random access preambles with zero correlation zones of length $N_{\text{CS}} - 1$ are defined by cyclic shifts according to

$$x_{u,v}(n) = x_u((n + C_v) \bmod N_{\text{ZC}})$$

where the cyclic shift is given by

$$C_v = \begin{cases} vN_{CS} & v = 0, 1, \dots, \lfloor N_{ZC}/N_{CS} \rfloor - 1, N_{CS} \neq 0 & \text{for unrestricted sets} \\ 0 & N_{CS} = 0 & \text{for unrestricted sets} \\ d_{\text{start}} \lfloor v/n_{\text{shift}}^{\text{RA}} \rfloor + (v \bmod n_{\text{shift}}^{\text{RA}})N_{CS} & v = 0, 1, \dots, n_{\text{shift}}^{\text{RA}} n_{\text{group}}^{\text{RA}} + \bar{n}_{\text{shift}}^{\text{RA}} - 1 & \text{for restricted sets} \end{cases}$$

and N_{CS} is given by Tables 5.7.2-2 and 5.7.2-3 for preamble formats 0-3 and 4, respectively. The parameter *High-speed-flag* provided by higher layers determines if unrestricted set or restricted set shall be used.

The variable d_u is the cyclic shift corresponding to a Doppler shift of magnitude $1/T_{\text{SEQ}}$ and is given by

$$d_u = \begin{cases} u^{-1} \bmod N_{ZC} & 0 \leq u^{-1} \bmod N_{ZC} < N_{ZC}/2 \\ N_{ZC} - u^{-1} \bmod N_{ZC} & \text{otherwise} \end{cases}$$

The parameters for restricted sets of cyclic shifts depend on d_u . For $N_{CS} \leq d_u < N_{ZC}/3$, the parameters are given by

$$\begin{aligned} n_{\text{shift}}^{\text{RA}} &= \lfloor d_u / N_{CS} \rfloor \\ d_{\text{start}} &= 2d_u + n_{\text{shift}}^{\text{RA}} N_{CS} \\ n_{\text{group}}^{\text{RA}} &= \lfloor N_{ZC} / d_{\text{start}} \rfloor \\ \bar{n}_{\text{shift}}^{\text{RA}} &= \max\left(\lfloor (N_{ZC} - 2d_u - n_{\text{group}}^{\text{RA}} d_{\text{start}}) / N_{CS} \rfloor, 0\right) \end{aligned}$$

For $N_{ZC}/3 \leq d_u \leq (N_{ZC} - N_{CS})/2$, the parameters are given by

$$\begin{aligned} n_{\text{shift}}^{\text{RA}} &= \lfloor (N_{ZC} - 2d_u) / N_{CS} \rfloor \\ d_{\text{start}} &= N_{ZC} - 2d_u + n_{\text{shift}}^{\text{RA}} N_{CS} \\ n_{\text{group}}^{\text{RA}} &= \lfloor d_u / d_{\text{start}} \rfloor \\ \bar{n}_{\text{shift}}^{\text{RA}} &= \min\left(\max\left(\lfloor (d_u - n_{\text{group}}^{\text{RA}} d_{\text{start}}) / N_{CS} \rfloor, 0\right), n_{\text{shift}}^{\text{RA}}\right) \end{aligned}$$

For all other values of d_u , there are no cyclic shifts in the restricted set.

Table 5.7.2-1: Random access preamble sequence length.

| Preamble format | N_{ZC} |
|-----------------|------------|
| 0 – 3 | 839 |
| 4 | 139 |

Table 5.7.2-2: Cyclic shifts N_{CS} for preamble generation (preamble formats 0-3).

| N_{CS} configuration | N_{CS} value | |
|------------------------|------------------|----------------|
| | Unrestricted set | Restricted set |
| 0 | 0 | 15 |
| 1 | 13 | 18 |
| 2 | 15 | 22 |
| 3 | 18 | 26 |
| 4 | 22 | 32 |
| 5 | 26 | 38 |
| 6 | 32 | 46 |
| 7 | 38 | 55 |
| 8 | 46 | 68 |
| 9 | 59 | 82 |
| 10 | 76 | 100 |
| 11 | 93 | 128 |
| 12 | 119 | 158 |
| 13 | 167 | 202 |
| 14 | 279 | 237 |
| 15 | 419 | - |

Table 5.7.2-3: Cyclic shifts N_{CS} for preamble generation (preamble format 4).

| N_{CS} configuration | N_{CS} value |
|------------------------|----------------|
| 0 | 2 |
| 1 | 4 |
| 2 | 6 |
| 3 | 8 |
| 4 | 10 |
| 5 | 12 |
| 6 | 15 |

Table 5.7.2-4: Root Zadoff-Chu sequence order for preamble formats 0 – 3.

| Logical root sequence number | Physical root sequence number u (in increasing order of the corresponding logical sequence number) |
|------------------------------|---|
| 0–23 | 129, 710, 140, 699, 120, 719, 210, 629, 168, 671, 84, 755, 105, 734, 93, 746, 70, 769, 60, 779 2, 837, 1, 838 |
| 24–29 | 56, 783, 112, 727, 148, 691 |
| 30–35 | 80, 759, 42, 797, 40, 799 |
| 36–41 | 35, 804, 73, 766, 146, 693 |
| 42–51 | 31, 808, 28, 811, 30, 809, 27, 812, 29, 810 |
| 52–63 | 24, 815, 48, 791, 68, 771, 74, 765, 178, 661, 136, 703 |
| 64–75 | 86, 753, 78, 761, 43, 796, 39, 800, 20, 819, 21, 818 |
| 76–89 | 95, 744, 202, 637, 190, 649, 181, 658, 137, 702, 125, 714, 151, 688 |
| 90–115 | 217, 622, 128, 711, 142, 697, 122, 717, 203, 636, 118, 721, 110, 729, 89, 750, 103, 736, 61, 778, 55, 784, 15, 824, 14, 825 |
| 116–135 | 12, 827, 23, 816, 34, 805, 37, 802, 46, 793, 207, 632, 179, 660, 145, 694, 130, 709, 223, 616 |
| 136–167 | 228, 611, 227, 612, 132, 707, 133, 706, 143, 696, 135, 704, 161, 678, 201, 638, 173, 666, 106, 733, 83, 756, 91, 748, 66, 773, 53, 786, 10, 829, 9, 830 |
| 168–203 | 7, 832, 8, 831, 16, 823, 47, 792, 64, 775, 57, 782, 104, 735, 101, 738, 108, 731, 208, 631, 184, 655, 197, 642, 191, 648, 121, 718, 141, 698, 149, 690, 216, 623, 218, 621 |
| 204–263 | 152, 687, 144, 695, 134, 705, 138, 701, 199, 640, 162, 677, 176, 663, 119, 720, 158, 681, 164, 675, 174, 665, 171, 668, 170, 669, 87, 752, 169, 670, 88, 751, 107, 732, 81, 758, 82, 757, 100, 739, 98, 741, 71, 768, 59, 780, 65, 774, 50, 789, 49, 790, 26, 813, 17, 822, 13, 826, 6, 833 |
| 264–327 | 5, 834, 33, 806, 51, 788, 75, 764, 99, 740, 96, 743, 97, 742, 166, 673, 172, 667, 175, 664, 187, 652, 163, 676, 185, 654, 200, 639, 114, 725, 189, 650, 115, 724, 194, 645, 195, 644, 192, 647, 182, 657, 157, 682, 156, 683, 211, 628, 154, 685, 123, 716, 139, 700, 212, 627, 153, 686, 213, 626, 215, 624, 150, 689 |
| 328–383 | 225, 614, 224, 615, 221, 618, 220, 619, 127, 712, 147, 692, 124, 715, 193, 646, 205, 634, 206, 633, 116, 723, 160, 679, 186, 653, 167, 672, 79, 760, 85, 754, 77, 762, 92, 747, 58, 781, 62, 777, 69, 770, 54, 785, 36, 803, 32, 807, 25, 814, 18, 821, 11, 828, 4, 835 |
| 384–455 | 3, 836, 19, 820, 22, 817, 41, 798, 38, 801, 44, 795, 52, 787, 45, 794, 63, 776, 67, 772, 72 767, 76, 763, 94, 745, 102, 737, 90, 749, 109, 730, 165, 674, 111, 728, 209, 630, 204, 635, 117, 722, 188, 651, 159, 680, 198, 641, 113, 726, 183, 656, 180, 659, 177, 662, 196, 643, 155, 684, 214, 625, 126, 713, 131, 708, 219, 620, 222, 617, 226, 613 |
| 456–513 | 230, 609, 232, 607, 262, 577, 252, 587, 418, 421, 416, 423, 413, 426, 411, 428, 376, 463, 395, 444, 283, 556, 285, 554, 379, 460, 390, 449, 363, 476, 384, 455, 388, 451, 386, 453, 361, 478, 387, 452, 360, 479, 310, 529, 354, 485, 328, 511, 315, 524, 337, 502, 349, 490, 335, 504, 324, 515 |
| 514–561 | 323, 516, 320, 519, 334, 505, 359, 480, 295, 544, 385, 454, 292, 547, 291, 548, 381, 458, 399, 440, 380, 459, 397, 442, 369, 470, 377, 462, 410, 429, 407, 432, 281, 558, 414, 425, 247, 592, 277, 562, 271, 568, 272, 567, 264, 575, 259, 580 |
| 562–629 | 237, 602, 239, 600, 244, 595, 243, 596, 275, 564, 278, 561, 250, 589, 246, 593, 417, 422, 248, 591, 394, 445, 393, 446, 370, 469, 365, 474, 300, 539, 299, 540, 364, 475, 362, 477, 298, 541, 312, 527, 313, 526, 314, 525, 353, 486, 352, 487, 343, 496, 327, 512, 350, 489, 326, 513, 319, 520, 332, 507, 333, 506, 348, 491, 347, 492, 322, 517 |
| 630–659 | 330, 509, 338, 501, 341, 498, 340, 499, 342, 497, 301, 538, 366, 473, 401, 438, 371, 468, 408, 431, 375, 464, 249, 590, 269, 570, 238, 601, 234, 605 |
| 660–707 | 257, 582, 273, 566, 255, 584, 254, 585, 245, 594, 251, 588, 412, 427, 372, 467, 282, 557, 403, 436, 396, 443, 392, 447, 391, 448, 382, 457, 389, 450, 294, 545, 297, 542, 311, 528, 344, 495, 345, 494, 318, 521, 331, 508, 325, 514, 321, 518 |
| 708–729 | 346, 493, 339, 500, 351, 488, 306, 533, 289, 550, 400, 439, 378, 461, 374, 465, 415, 424, 270, 569, 241, 598 |
| 730–751 | 231, 608, 260, 579, 268, 571, 276, 563, 409, 430, 398, 441, 290, 549, 304, 535, 308, 531, 358, 481, 316, 523 |
| 752–765 | 293, 546, 288, 551, 284, 555, 368, 471, 253, 586, 256, 583, 263, 576 |
| 766–777 | 242, 597, 274, 565, 402, 437, 383, 456, 357, 482, 329, 510 |
| 778–789 | 317, 522, 307, 532, 286, 553, 287, 552, 266, 573, 261, 578 |
| 790–795 | 236, 603, 303, 536, 356, 483 |
| 796–803 | 355, 484, 405, 434, 404, 435, 406, 433 |

| | |
|---------|--|
| 804–809 | 235, 604, 267, 572, 302, 537 |
| 810–815 | 309, 530, 265, 574, 233, 606 |
| 816–819 | 367, 472, 296, 543 |
| 820–837 | 336, 503, 305, 534, 373, 466, 280, 559, 279, 560, 419, 420, 240, 599, 258, 581, 229, 610 |

Table 5.7.2-5: Root Zadoff-Chu sequence order for preamble format 4.

| Logical root sequence number | Physical root sequence number <i>u</i> (in increasing order of the corresponding logical sequence number) | | | | | | | | | | | | | | | | | | | |
|------------------------------|--|-----|-----|-----|-----|-----|-----|-----|-----|-----|-----|-----|-----|-----|-----|-----|-----|-----|-----|-----|
| | 0 – 19 | 1 | 138 | 2 | 137 | 3 | 136 | 4 | 135 | 5 | 134 | 6 | 133 | 7 | 132 | 8 | 131 | 9 | 130 | 10 |
| 20 – 39 | 11 | 128 | 12 | 127 | 13 | 126 | 14 | 125 | 15 | 124 | 16 | 123 | 17 | 122 | 18 | 121 | 19 | 120 | 20 | 119 |
| 40 – 59 | 21 | 118 | 22 | 117 | 23 | 116 | 24 | 115 | 25 | 114 | 26 | 113 | 27 | 112 | 28 | 111 | 29 | 110 | 30 | 109 |
| 60 – 79 | 31 | 108 | 32 | 107 | 33 | 106 | 34 | 105 | 35 | 104 | 36 | 103 | 37 | 102 | 38 | 101 | 39 | 100 | 40 | 99 |
| 80 – 99 | 41 | 98 | 42 | 97 | 43 | 96 | 44 | 95 | 45 | 94 | 46 | 93 | 47 | 92 | 48 | 91 | 49 | 90 | 50 | 89 |
| 100 – 119 | 51 | 88 | 52 | 87 | 53 | 86 | 54 | 85 | 55 | 84 | 56 | 83 | 57 | 82 | 58 | 81 | 59 | 80 | 60 | 79 |
| 120 – 137 | 61 | 78 | 62 | 77 | 63 | 76 | 64 | 75 | 65 | 74 | 66 | 73 | 67 | 72 | 68 | 71 | 69 | 70 | - | - |

5.7.3 Baseband signal generation

The time-continuous random access signal $s(t)$ is defined by

$$s(t) = \beta_{\text{PRACH}} \sum_{k=0}^{N_{\text{ZC}}-1} \sum_{n=0}^{N_{\text{ZC}}-1} x_{u,v}(n) \cdot e^{-j\frac{2\pi nk}{N_{\text{ZC}}}} \cdot e^{j2\pi(k+\varphi+K(k_0+\frac{1}{2}))\Delta f_{\text{RA}}(t-T_{\text{CP}})}$$

where $0 \leq t < T_{\text{SEQ}} + T_{\text{CP}}$, β_{PRACH} is an amplitude scaling factor and $k_0 = n_{\text{PRB}}^{\text{RA}} N_{\text{sc}}^{\text{RB}} - N_{\text{RB}}^{\text{UL}} N_{\text{sc}}^{\text{RB}} / 2$. The location in the frequency domain is controlled by the parameter $n_{\text{PRB}}^{\text{RA}}$ is derived from section 5.7.1. The factor $K = \Delta f / \Delta f_{\text{RA}}$ accounts for the difference in subcarrier spacing between the random access preamble and uplink data transmission. The variable Δf_{RA} , the subcarrier spacing for the random access preamble, and the variable φ , a fixed offset determining the frequency-domain location of the random access preamble within the physical resource blocks, are both given by Table 5.7.3-1.

Table 5.7.3-1: Random access baseband parameters.

| Preamble format | Δf_{RA} | φ |
|-----------------|------------------------|-----------|
| 0 – 3 | 1250 Hz | 7 |
| 4 | 7500 Hz | 2 |

5.8 Modulation and upconversion

Modulation and upconversion to the carrier frequency of the complex-valued SC-FDMA baseband signal for each antenna port is shown in Figure 5.8-1. The filtering required prior to transmission is defined by the requirements in [6].

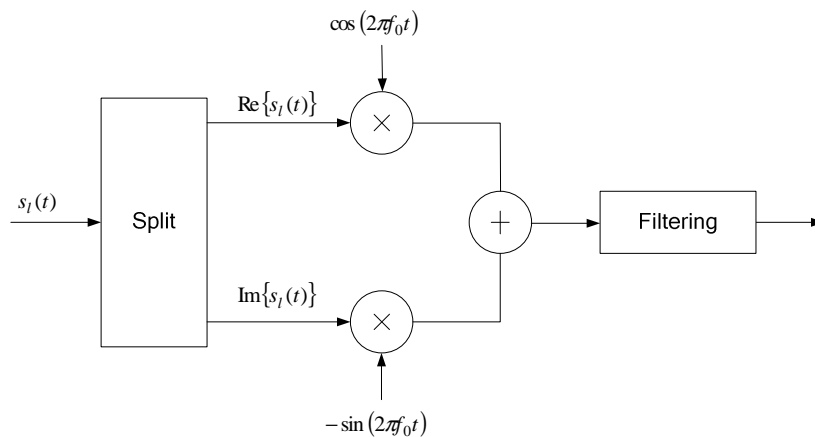

Figure 5.8-1: Uplink modulation.

6 Downlink

6.1 Overview

The smallest time-frequency unit for downlink transmission is denoted a resource element and is defined in Section 6.2.2.

6.1.1 Physical channels

A downlink physical channel corresponds to a set of resource elements carrying information originating from higher layers and is the interface defined between 36.212 and 36.211. The following downlink physical channels are defined:

- Physical Downlink Shared Channel, PDSCH
- Physical Broadcast Channel, PBCH
- Physical Multicast Channel, PMCH
- Physical Control Format Indicator Channel, PCFICH
- Physical Downlink Control Channel, PDCCH
- Physical Hybrid ARQ Indicator Channel, PHICH

6.1.2 Physical signals

A downlink signal corresponds to a set of resource elements used by the physical layer but does not carry information originating from higher layers. The following downlink physical signals are defined:

- Reference signal
- Synchronization signal

6.2 Slot structure and physical resource elements

6.2.1 Resource grid

The transmitted signal in each slot is described by a resource grid of $N_{\text{RB}}^{\text{DL}} N_{\text{sc}}^{\text{RB}}$ subcarriers and $N_{\text{symb}}^{\text{DL}}$ OFDM symbols. The resource grid structure is illustrated in Figure 6.2.2-1. The quantity $N_{\text{RB}}^{\text{DL}}$ depends on the downlink transmission bandwidth configured in the cell and shall fulfil

$$N_{\text{RB}}^{\text{min,DL}} \leq N_{\text{RB}}^{\text{DL}} \leq N_{\text{RB}}^{\text{max,DL}}$$

where $N_{\text{RB}}^{\text{min,DL}} = 6$ and $N_{\text{RB}}^{\text{max,DL}} = 110$ are the smallest and largest downlink bandwidth, respectively, supported by the current version of this specification.

The set of allowed values for $N_{\text{RB}}^{\text{DL}}$ is given by [6]. The number of OFDM symbols in a slot depends on the cyclic prefix length and subcarrier spacing configured and is given in Table 6.2.3-1.

In case of multi-antenna transmission, there is one resource grid defined per antenna port. An antenna port is defined by its associated reference signal. The set of antenna ports supported depends on the reference signal configuration in the cell:

- Cell-specific reference signals, associated with non-MBSFN transmission, support a configuration of one, two, or four antenna ports and the antenna port number p shall fulfil $p = 0$, $p \in \{0,1\}$, and $p \in \{0,1,2,3\}$, respectively.
- MBSFN reference signals, associated with MBSFN transmission, are transmitted on antenna port $p = 4$.
- UE-specific reference signals are transmitted on antenna port $p = 5$.

6.2.2 Resource elements

Each element in the resource grid for antenna port p is called a resource element and is uniquely identified by the index pair (k, l) in a slot where $k = 0, \dots, N_{\text{RB}}^{\text{DL}} N_{\text{sc}}^{\text{RB}} - 1$ and $l = 0, \dots, N_{\text{symb}}^{\text{DL}} - 1$ are the indices in the frequency and time domains, respectively. Resource element (k, l) on antenna port p corresponds to the complex value $a_{k,l}^{(p)}$. When there is no risk for confusion, or no particular antenna port is specified, the index p may be dropped.

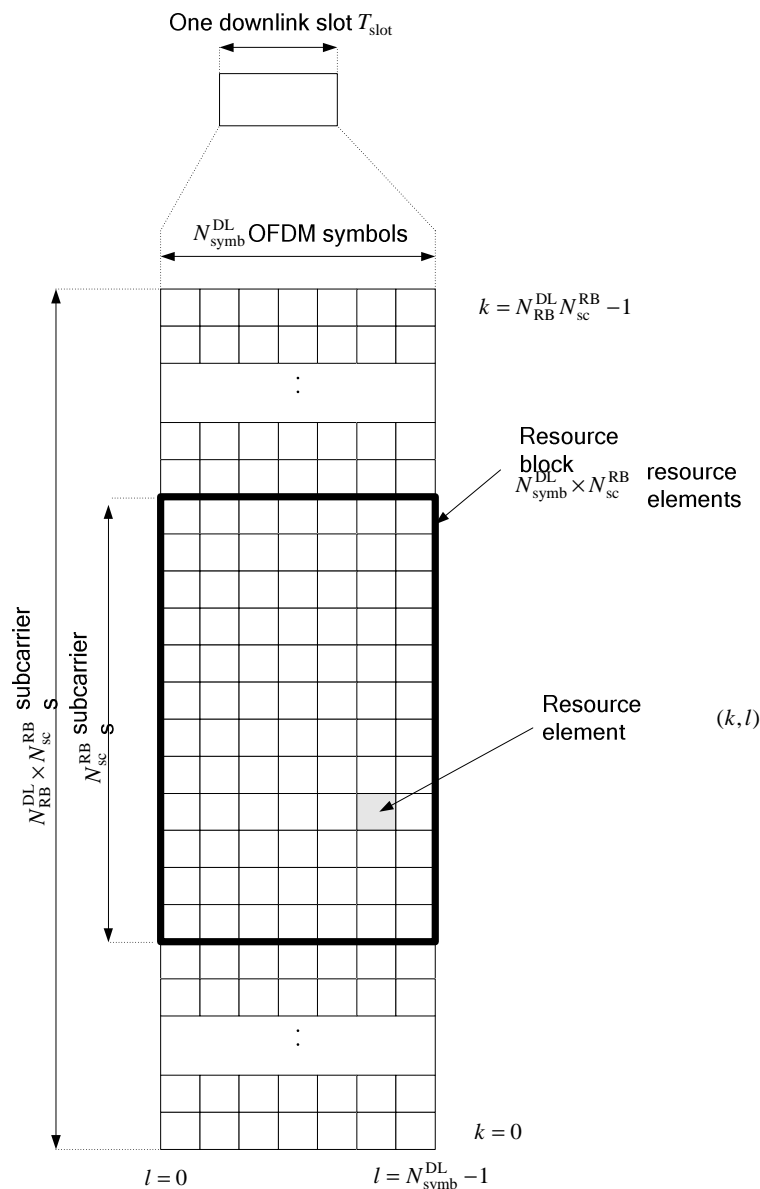

Figure 6.2.2-1: Downlink resource grid.

6.2.3 Resource blocks

Resource blocks are used to describe the mapping of certain physical channels to resource elements. Physical and virtual resource blocks are defined.

A physical resource block is defined as N_{symb}^{DL} consecutive OFDM symbols in the time domain and N_{sc}^{RB} consecutive subcarriers in the frequency domain, where N_{symb}^{DL} and N_{sc}^{RB} are given by Table 6.2.3-1. A physical resource block thus consists of $N_{symb}^{DL} \times N_{sc}^{RB}$ resource elements, corresponding to one slot in the time domain and 180 kHz in the frequency domain.

Physical resource blocks are numbered from 0 to $N_{RB}^{DL} - 1$ in the frequency domain. The relation between the physical resource block number n_{PRB} in the frequency domain and resource elements (k, l) in a slot is given by

$$n_{PRB} = \left\lfloor \frac{k}{N_{sc}^{RB}} \right\rfloor$$

Table 6.2.3-1: Physical resource blocks parameters.

| Configuration | | N_{sc}^{RB} | N_{ymb}^{DL} |
|-------------------------------|------------------------------|---------------|-----------------------|
| Normal cyclic prefix | $\Delta f = 15 \text{ kHz}$ | 12 | 7 |
| | $\Delta f = 15 \text{ kHz}$ | | 6 |
| Extended cyclic prefix | $\Delta f = 7.5 \text{ kHz}$ | 24 | 3 |

A virtual resource block is of the same size as a physical resource block. Two types of virtual resource blocks are defined:

- Virtual resource blocks of localized type
- Virtual resource blocks of distributed type

For each type of virtual resource blocks, a pair of virtual resource blocks over two slots in a subframe is assigned together by a single virtual resource block number, n_{VRB} .

6.2.3.1 Virtual resource blocks of localized type

Virtual resource blocks of localized type are mapped directly to physical resource blocks such that virtual resource block n_{VRB} corresponds to physical resource block $n_{\text{PRB}} = n_{\text{VRB}}$. Virtual resource blocks are numbered from 0 to $N_{\text{VRB}}^{DL} - 1$, where $N_{\text{VRB}}^{DL} = N_{\text{RB}}^{DL}$.

6.2.3.2 Virtual resource blocks of distributed type

Virtual resource blocks of distributed type are mapped to physical resource blocks as described below.

Table 6.2.3.2-1: RB gap values

| System BW (N_{RB}^{DL}) | Gap (N_{gap}) | |
|------------------------------------|--|--|
| | 1 st Gap ($N_{\text{gap},1}$) | 2 nd Gap ($N_{\text{gap},2}$) |
| 6-10 | $\lceil N_{\text{RB}}^{DL} / 2 \rceil$ | N/A |
| 11 | 4 | N/A |
| 12-19 | 8 | N/A |
| 20-26 | 12 | N/A |
| 27-44 | 18 | N/A |
| 45-49 | 27 | N/A |
| 50-63 | 27 | 9 |
| 64-79 | 32 | 16 |
| 80-110 | 48 | 16 |

The parameter N_{gap} is given by Table 6.2.3.2-1. For $6 \leq N_{\text{RB}}^{DL} \leq 49$, only one gap value $N_{\text{gap},1}$ is defined and $N_{\text{gap}} = N_{\text{gap},1}$. For $50 \leq N_{\text{RB}}^{DL} \leq 110$, two gap values $N_{\text{gap},1}$ and $N_{\text{gap},2}$ are defined. Whether $N_{\text{gap}} = N_{\text{gap},1}$ or $N_{\text{gap}} = N_{\text{gap},2}$ is signaled as part of the downlink scheduling assignment as described in [3].

Virtual resource blocks of distributed type are numbered from 0 to $N_{\text{VRB}}^{DL} - 1$, where

$$N_{\text{VRB}}^{DL} = N_{\text{VRB,gap1}}^{DL} = 2 \cdot \min(N_{\text{gap}}, N_{\text{RB}}^{DL} - N_{\text{gap}}) \text{ for } N_{\text{gap}} = N_{\text{gap},1} \text{ and } N_{\text{VRB}}^{DL} = N_{\text{VRB,gap2}}^{DL} = \lfloor N_{\text{RB}}^{DL} / 2N_{\text{gap}} \rfloor \cdot 2N_{\text{gap}} \text{ for } N_{\text{gap}} = N_{\text{gap},2}.$$

Consecutive $\tilde{N}_{\text{VRB}}^{\text{DL}}$ VRB numbers compose a unit of VRB number interleaving, where $\tilde{N}_{\text{VRB}}^{\text{DL}} = N_{\text{VRB}}^{\text{DL}}$ for $N_{\text{gap}} = N_{\text{gap},1}$ and $\tilde{N}_{\text{VRB}}^{\text{DL}} = 2N_{\text{gap}}$ for $N_{\text{gap}} = N_{\text{gap},2}$. Interleaving of VRB numbers of each interleaving unit is performed with 4 columns and N_{row} rows, where $N_{\text{row}} = \lceil \tilde{N}_{\text{VRB}}^{\text{DL}} / (4P) \rceil \cdot P$, and P is RBG size as described in [4]. VRB numbers are written row by row in the rectangular matrix, and read out column by column. N_{null} nulls are inserted in the last $N_{\text{null}} / 2$ rows of the 2nd and 4th column, where $N_{\text{null}} = 4N_{\text{row}} - \tilde{N}_{\text{VRB}}^{\text{DL}}$. Nulls are ignored when reading out. The VRB numbers mapping to PRB numbers including interleaving is derived as follows:

For even slot number n_s ;

$$\tilde{n}_{\text{PRB}}(n_s) = \begin{cases} \tilde{n}'_{\text{PRB}} - N_{\text{row}} & , N_{\text{null}} \neq 0 \text{ and } \tilde{n}_{\text{VRB}} \geq \tilde{N}_{\text{VRB}}^{\text{DL}} - N_{\text{null}} \text{ and } \tilde{n}_{\text{VRB}} \bmod 2 = 1 \\ \tilde{n}'_{\text{PRB}} - N_{\text{row}} + N_{\text{null}} / 2 & , N_{\text{null}} \neq 0 \text{ and } \tilde{n}_{\text{VRB}} \geq \tilde{N}_{\text{VRB}}^{\text{DL}} - N_{\text{null}} \text{ and } \tilde{n}_{\text{VRB}} \bmod 2 = 0 \\ \tilde{n}''_{\text{PRB}} - N_{\text{null}} / 2 & , N_{\text{null}} \neq 0 \text{ and } \tilde{n}_{\text{VRB}} < \tilde{N}_{\text{VRB}}^{\text{DL}} - N_{\text{null}} \text{ and } \tilde{n}_{\text{VRB}} \bmod 4 \geq 2 \\ \tilde{n}''_{\text{PRB}} & , \text{otherwise} \end{cases}$$

$$\text{where } \tilde{n}'_{\text{PRB}} = 2N_{\text{row}} \cdot (\tilde{n}_{\text{VRB}} \bmod 2) + \lfloor \tilde{n}_{\text{VRB}} / 2 \rfloor + \tilde{N}_{\text{VRB}}^{\text{DL}} \cdot \lfloor n_{\text{VRB}} / \tilde{N}_{\text{VRB}}^{\text{DL}} \rfloor,$$

$$\text{and } \tilde{n}''_{\text{PRB}} = N_{\text{row}} \cdot (\tilde{n}_{\text{VRB}} \bmod 4) + \lfloor \tilde{n}_{\text{VRB}} / 4 \rfloor + \tilde{N}_{\text{VRB}}^{\text{DL}} \cdot \lfloor n_{\text{VRB}} / \tilde{N}_{\text{VRB}}^{\text{DL}} \rfloor,$$

where $\tilde{n}_{\text{VRB}} = n_{\text{VRB}} \bmod \tilde{N}_{\text{VRB}}^{\text{DL}}$ and n_{VRB} is obtained from the downlink scheduling assignment as described in [4].

For odd slot number n_s ;

$$\tilde{n}_{\text{PRB}}(n_s) = (\tilde{n}_{\text{PRB}}(n_s - 1) + \tilde{N}_{\text{VRB}}^{\text{DL}} / 2) \bmod \tilde{N}_{\text{VRB}}^{\text{DL}} + \tilde{N}_{\text{VRB}}^{\text{DL}} \cdot \lfloor n_{\text{VRB}} / \tilde{N}_{\text{VRB}}^{\text{DL}} \rfloor$$

Then, for all n_s ;

$$n_{\text{PRB}}(n_s) = \begin{cases} \tilde{n}_{\text{PRB}}(n_s) & , \tilde{n}_{\text{PRB}}(n_s) < \tilde{N}_{\text{VRB}}^{\text{DL}} / 2 \\ \tilde{n}_{\text{PRB}}(n_s) + N_{\text{gap}} - \tilde{N}_{\text{VRB}}^{\text{DL}} / 2 & , \tilde{n}_{\text{PRB}}(n_s) \geq \tilde{N}_{\text{VRB}}^{\text{DL}} / 2 \end{cases}$$

6.2.4 Resource-element groups

Resource-element groups are used for defining the mapping of control channels to resource elements.

A resource-element group is represented by the index pair (k', l') of the resource element with the lowest index k in the group with all resource elements in the group having the same value of l . The set of resource elements (k, l) in a resource-element group depends on the number of cell-specific reference signals configured as described below with $k_0 = n_{\text{PRB}} \cdot N_{\text{sc}}^{\text{RB}}$, $0 \leq n_{\text{PRB}} < N_{\text{RB}}^{\text{DL}}$.

- In the first OFDM symbol of the first slot in a subframe the two resource-element groups in physical resource block n_{PRB} consist of resource elements $(k, l = 0)$ with $k = k_0 + 0, k_0 + 1, \dots, k_0 + 5$ and $k = k_0 + 6, k_0 + 7, \dots, k_0 + 11$, respectively.
- In the second OFDM symbol of the first slot in a subframe in case of one or two cell-specific reference signals configured, the three resource-element groups in physical resource block n_{PRB} consist of resource elements $(k, l = 1)$ with $k = k_0 + 0, k_0 + 1, \dots, k_0 + 3$, $k = k_0 + 4, k_0 + 5, \dots, k_0 + 7$ and $k = k_0 + 8, k_0 + 9, \dots, k_0 + 11$, respectively.

- In the second OFDM symbol of the first slot in a subframe in case of four cell-specific reference signals configured, the two resource-element groups in physical resource block n_{PRB} consist of resource elements $(k, l = 1)$ with $k = k_0 + 0, k_0 + 1, \dots, k_0 + 5$ and $k = k_0 + 6, k_0 + 7, \dots, k_0 + 11$, respectively.
- In the third OFDM symbol of the first slot in a subframe, the three resource-element groups in physical resource block n_{PRB} consist of resource elements $(k, l = 2)$ with $k = k_0 + 0, k_0 + 1, \dots, k_0 + 3$, $k = k_0 + 4, k_0 + 5, \dots, k_0 + 7$ and $k = k_0 + 8, k_0 + 9, \dots, k_0 + 11$, respectively.
- In the fourth OFDM symbol of the first slot in a subframe in case of normal cyclic prefix, the three resource-element groups in physical resource block n_{PRB} consist of resource elements $(k, l = 3)$ with $k = k_0 + 0, k_0 + 1, \dots, k_0 + 3$, $k = k_0 + 4, k_0 + 5, \dots, k_0 + 7$ and $k = k_0 + 8, k_0 + 9, \dots, k_0 + 11$, respectively.
- In the fourth OFDM symbol of the first slot in a subframe in case of extended cyclic prefix, the two resource-element groups in physical resource block n_{PRB} consist of resource elements $(k, l = 3)$ with $k = k_0 + 0, k_0 + 1, \dots, k_0 + 5$ and $k = k_0 + 6, k_0 + 7, \dots, k_0 + 11$, respectively.

Mapping of a symbol-quadruplet $\langle z(i), z(i+1), z(i+2), z(i+3) \rangle$ onto a resource-element group represented by resource-element (k', l') is defined such that elements $z(i)$ are mapped to resource elements (k, l) of the resource-element group not used for cell-specific reference signals in increasing order of i and k . In case a single cell-specific reference signal is configured, cell-specific reference signals shall be assumed to be present on antenna ports 0 and 1 for the purpose of mapping a symbol-quadruplet to a resource-element group, otherwise the number of cell-specific reference signals shall be assumed equal to the actual number of antenna ports used for cell-specific reference signals.

6.2.5 Guard period for half-duplex FDD operation

For half-duplex FDD operation, a guard period is created by the UE by not receiving the last part of a downlink subframe immediately preceding an uplink subframe from the same UE.

6.2.6 Guard Period for TDD Operation

For frame structure type 2, the GP field in Figure 4.2-1 serves as a guard period.

6.3 General structure for downlink physical channels

This section describes a general structure, applicable to more than one physical channel.

The baseband signal representing a downlink physical channel is defined in terms of the following steps:

- scrambling of coded bits in each of the code words to be transmitted on a physical channel
- modulation of scrambled bits to generate complex-valued modulation symbols
- mapping of the complex-valued modulation symbols onto one or several transmission layers
- precoding of the complex-valued modulation symbols on each layer for transmission on the antenna ports
- mapping of complex-valued modulation symbols for each antenna port to resource elements
- generation of complex-valued time-domain OFDM signal for each antenna port

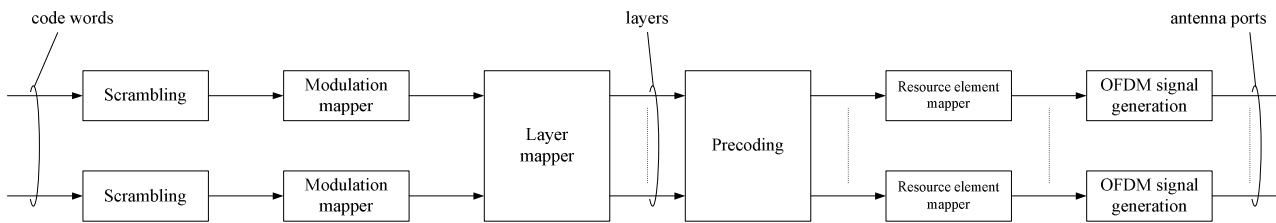

Figure 6.3-1: Overview of physical channel processing.

6.3.1 Scrambling

For each code word q , the block of bits $b^{(q)}(0), \dots, b^{(q)}(M_{\text{bit}}^{(q)} - 1)$, where $M_{\text{bit}}^{(q)}$ is the number of bits in code word q transmitted on the physical channel in one subframe, shall be scrambled prior to modulation, resulting in a block of scrambled bits $\tilde{b}^{(q)}(0), \dots, \tilde{b}^{(q)}(M_{\text{bit}}^{(q)} - 1)$ according to

$$\tilde{b}^{(q)}(i) = (b^{(q)}(i) + c^q(i)) \bmod 2$$

where the scrambling sequence $c^q(i)$ is given by Section 7.2. The scrambling sequence generator shall be initialised at the start of each subframe, where the initialisation value of c_{init} depends on the transport channel type according to

$$c_{\text{init}} = \begin{cases} n_{\text{RNTI}} \cdot 2^{14} + q \cdot 2^{13} + \lfloor n_s/2 \rfloor \cdot 2^9 + N_{\text{ID}}^{\text{cell}} & \text{for PDSCH} \\ \lfloor n_s/2 \rfloor \cdot 2^9 + N_{\text{ID}}^{\text{MBSFN}} & \text{for PMCH} \end{cases}$$

where n_{RNTI} corresponds to the identity of the UE(s) to which the PDSCH transmission is intended.

Up to two code words can be transmitted in one subframe, i.e., $q \in \{0,1\}$. In the case of single code word transmission, q is equal to zero.

6.3.2 Modulation

For each code word q , the block of scrambled bits $\tilde{b}^{(q)}(0), \dots, \tilde{b}^{(q)}(M_{\text{bit}}^{(q)} - 1)$ shall be modulated as described in Section 7.1 using one of the modulation schemes in Table 6.3.2-1, resulting in a block of complex-valued modulation symbols $d^{(q)}(0), \dots, d^{(q)}(M_{\text{symb}}^{(q)} - 1)$.

Table 6.3.2-1: Modulation schemes

| Physical channel | Modulation schemes |
|------------------|--------------------|
| PDSCH | QPSK, 16QAM, 64QAM |
| PMCH | QPSK, 16QAM, 64QAM |

6.3.3 Layer mapping

The complex-valued modulation symbols for each of the code words to be transmitted are mapped onto one or several layers. Complex-valued modulation symbols $d^{(q)}(0), \dots, d^{(q)}(M_{\text{symb}}^{(q)} - 1)$ for code word q shall be mapped onto the layers $x(i) = [x^{(0)}(i) \ \dots \ x^{(v-1)}(i)]^T$, $i = 0, 1, \dots, M_{\text{symb}}^{\text{layer}} - 1$ where v is the number of layers and $M_{\text{symb}}^{\text{layer}}$ is the number of modulation symbols per layer.

6.3.3.1 Layer mapping for transmission on a single antenna port

For transmission on a single antenna port, a single layer is used, $v = 1$, and the mapping is defined by

$$x^{(0)}(i) = d^{(0)}(i)$$

with $M_{\text{symb}}^{\text{layer}} = M_{\text{symb}}^{(0)}$.

6.3.3.2 Layer mapping for spatial multiplexing

For spatial multiplexing, the layer mapping shall be done according to Table 6.3.3.2-1. The number of layers ν is less than or equal to the number of antenna ports P used for transmission of the physical channel. The case of a single codeword mapped to two layers is only applicable when the number of antenna ports is 4.

Table 6.3.3.2-1: Codeword-to-layer mapping for spatial multiplexing

| Number of layers | Number of code words | Codeword-to-layer mapping |
|------------------|----------------------|--|
| | | $i = 0, 1, \dots, M_{\text{symb}}^{\text{layer}} - 1$ |
| 1 | 1 | $x^{(0)}(i) = d^{(0)}(i)$ $M_{\text{symb}}^{\text{layer}} = M_{\text{symb}}^{(0)}$ |
| 2 | 2 | $x^{(0)}(i) = d^{(0)}(i)$ $x^{(1)}(i) = d^{(1)}(i)$ $M_{\text{symb}}^{\text{layer}} = M_{\text{symb}}^{(0)} = M_{\text{symb}}^{(1)}$ |
| 2 | 1 | $x^{(0)}(i) = d^{(0)}(2i)$ $x^{(1)}(i) = d^{(0)}(2i+1)$ $M_{\text{symb}}^{\text{layer}} = M_{\text{symb}}^{(0)} / 2$ |
| 3 | 2 | $x^{(1)}(i) = d^{(1)}(2i)$ $x^{(2)}(i) = d^{(1)}(2i+1)$ $M_{\text{symb}}^{\text{layer}} = M_{\text{symb}}^{(0)} = M_{\text{symb}}^{(1)} / 2$ |
| 4 | 2 | $x^{(0)}(i) = d^{(0)}(2i)$ $x^{(1)}(i) = d^{(0)}(2i+1)$ $x^{(2)}(i) = d^{(1)}(2i)$ $x^{(3)}(i) = d^{(1)}(2i+1)$ $M_{\text{symb}}^{\text{layer}} = M_{\text{symb}}^{(0)} / 2 = M_{\text{symb}}^{(1)} / 2$ |

6.3.3.3 Layer mapping for transmit diversity

For transmit diversity, the layer mapping shall be done according to Table 6.3.3.3-1. There is only one codeword and the number of layers ν is equal to the number of antenna ports P used for transmission of the physical channel.

Table 6.3.3.3-1: Codeword-to-layer mapping for transmit diversity

| Number of layers | Number of code words | Codeword-to-layer mapping |
|------------------|----------------------|--|
| | | $i = 0, 1, \dots, M_{\text{symb}}^{\text{layer}} - 1$ |
| 2 | 1 | $x^{(0)}(i) = d^{(0)}(2i)$ $x^{(1)}(i) = d^{(0)}(2i+1)$ $M_{\text{symb}}^{\text{layer}} = M_{\text{symb}}^{(0)} / 2$ |
| 4 | 1 | $x^{(0)}(i) = d^{(0)}(4i)$ $x^{(1)}(i) = d^{(0)}(4i+1)$ $x^{(2)}(i) = d^{(0)}(4i+2)$ $x^{(3)}(i) = d^{(0)}(4i+3)$ $M_{\text{symb}}^{\text{layer}} = M_{\text{symb}}^{(0)} / 4$ |

6.3.4 Precoding

The precoder takes as input a block of vectors $x(i) = [x^{(0)}(i) \dots x^{(\nu-1)}(i)]^T$, $i = 0, 1, \dots, M_{\text{symp}}^{\text{layer}} - 1$ from the layer mapping and generates a block of vectors $y(i) = [y^{(p)}(i) \dots]^T$, $i = 0, 1, \dots, M_{\text{symp}}^{\text{ap}} - 1$ to be mapped onto resources on each of the antenna ports, where $y^{(p)}(i)$ represents the signal for antenna port p .

6.3.4.1 Precoding for transmission on a single antenna port

For transmission on a single antenna port, precoding is defined by

$$y^{(p)}(i) = x^{(0)}(i)$$

where $p \in \{0, 4, 5\}$ is the number of the single antenna port used for transmission of the physical channel and $i = 0, 1, \dots, M_{\text{symp}}^{\text{ap}} - 1$, $M_{\text{symp}}^{\text{ap}} = M_{\text{symp}}^{\text{layer}}$.

6.3.4.2 Precoding for spatial multiplexing

Precoding for spatial multiplexing is only used in combination with layer mapping for spatial multiplexing as described in Section 6.3.3.2. Spatial multiplexing supports two or four antenna ports and the set of antenna ports used is $p \in \{0, 1\}$ or $p \in \{0, 1, 2, 3\}$, respectively.

6.3.4.2.1 Precoding without CDD

Without cyclic delay diversity (CDD), precoding for spatial multiplexing is defined by

$$\begin{bmatrix} y^{(0)}(i) \\ \vdots \\ y^{(P-1)}(i) \end{bmatrix} = W(i) \begin{bmatrix} x^{(0)}(i) \\ \vdots \\ x^{(\nu-1)}(i) \end{bmatrix}$$

where the precoding matrix $W(i)$ is of size $P \times \nu$ and $i = 0, 1, \dots, M_{\text{symp}}^{\text{ap}} - 1$, $M_{\text{symp}}^{\text{ap}} = M_{\text{symp}}^{\text{layer}}$.

For spatial multiplexing, the values of $W(i)$ shall be selected among the precoder elements in the codebook configured in the eNodeB and the UE. The eNodeB can further confine the precoder selection in the UE to a subset of the elements in the codebook using codebook subset restrictions. The configured codebook shall be selected from Table 6.3.4.2.3-1 or 6.3.4.2.3-2.

6.3.4.2.2 Precoding for large delay CDD

For large-delay CDD, precoding for spatial multiplexing is defined by

$$\begin{bmatrix} y^{(0)}(i) \\ \vdots \\ y^{(P-1)}(i) \end{bmatrix} = W(i)D(i)U \begin{bmatrix} x^{(0)}(i) \\ \vdots \\ x^{(\nu-1)}(i) \end{bmatrix}$$

where the precoding matrix $W(i)$ is of size $P \times \nu$ and $i = 0, 1, \dots, M_{\text{symp}}^{\text{ap}} - 1$, $M_{\text{symp}}^{\text{ap}} = M_{\text{symp}}^{\text{layer}}$. The diagonal size- $\nu \times \nu$ matrix $D(i)$ supporting cyclic delay diversity and the size- $\nu \times \nu$ matrix U are both given by Table 6.3.4.2.2-1 for different numbers of layers ν .

The values of the precoding matrix $W(i)$ shall be selected among the precoder elements in the codebook configured in the eNodeB and the UE. The eNodeB can further confine the precoder selection in the UE to a subset of the elements in the codebook using codebook subset restriction. The configured codebook shall be selected from Table 6.3.4.2.3-1 or 6.3.4.2.3-2.

Table 6.3.4.2.2-1: Large-delay cyclic delay diversity

| Number of layers v | U | $D(i)$ |
|----------------------|--|---|
| 1 | $[1]$ | $[1]$ |
| 2 | $\frac{1}{\sqrt{2}} \begin{bmatrix} 1 & 1 \\ 1 & e^{-j2\pi/2} \end{bmatrix}$ | $\begin{bmatrix} 1 & 0 \\ 0 & e^{-j2\pi/2} \end{bmatrix}$ |
| 3 | $\frac{1}{\sqrt{3}} \begin{bmatrix} 1 & 1 & 1 \\ 1 & e^{-j2\pi/3} & e^{-j4\pi/3} \\ 1 & e^{-j4\pi/3} & e^{-j8\pi/3} \end{bmatrix}$ | $\begin{bmatrix} 1 & 0 & 0 \\ 0 & e^{-j2\pi/3} & 0 \\ 0 & 0 & e^{-j4\pi/3} \end{bmatrix}$ |
| 4 | $\frac{1}{2} \begin{bmatrix} 1 & 1 & 1 & 1 \\ 1 & e^{-j2\pi/4} & e^{-j4\pi/4} & e^{-j6\pi/4} \\ 1 & e^{-j4\pi/4} & e^{-j8\pi/4} & e^{-j12\pi/4} \\ 1 & e^{-j6\pi/4} & e^{-j12\pi/4} & e^{-j18\pi/4} \end{bmatrix}$ | $\begin{bmatrix} 1 & 0 & 0 & 0 \\ 0 & e^{-j2\pi/4} & 0 & 0 \\ 0 & 0 & e^{-j4\pi/4} & 0 \\ 0 & 0 & 0 & e^{-j6\pi/4} \end{bmatrix}$ |

6.3.4.2.3 Codebook for precoding

For transmission on two antenna ports, $p \in \{0,1\}$, the precoding matrix $W(i)$ shall be selected from Table 6.3.4.2.3-1 or a subset thereof. For the closed-loop spatial multiplexing transmission mode defined in [4], the codebook index 0 is not used when the number layers is $v = 2$.

Table 6.3.4.2.3-1: Codebook for transmission on antenna ports $\{0,1\}$.

| Codebook index | Number of layers v | |
|----------------|--|---|
| | 1 | 2 |
| 0 | $\frac{1}{\sqrt{2}} \begin{bmatrix} 1 \\ 1 \end{bmatrix}$ | $\frac{1}{\sqrt{2}} \begin{bmatrix} 1 & 0 \\ 0 & 1 \end{bmatrix}$ |
| 1 | $\frac{1}{\sqrt{2}} \begin{bmatrix} 1 \\ -1 \end{bmatrix}$ | $\frac{1}{2} \begin{bmatrix} 1 & 1 \\ 1 & -1 \end{bmatrix}$ |
| 2 | $\frac{1}{\sqrt{2}} \begin{bmatrix} 1 \\ j \end{bmatrix}$ | $\frac{1}{2} \begin{bmatrix} 1 & 1 \\ j & -j \end{bmatrix}$ |
| 3 | $\frac{1}{\sqrt{2}} \begin{bmatrix} 1 \\ -j \end{bmatrix}$ | - |

For transmission on four antenna ports, $p \in \{0,1,2,3\}$, the precoding matrix W shall be selected from Table 6.3.4.2.3-2 or a subset thereof. The quantity $W_n^{(s)}$ denotes the matrix defined by the columns given by the set $\{s\}$ from the expression $W_n = I - 2u_n u_n^H / u_n^H u_n$ where I is the 4×4 identity matrix and the vector u_n is given by Table 6.3.4.2.3-2.

Table 6.3.4.2.3-2: Codebook for transmission on antenna ports $\{0,1,2,3\}$.

| Codebook index | u_n | Number of layers ν | | | |
|----------------|---|------------------------|--------------------------|---------------------------|---------------------|
| | | 1 | 2 | 3 | 4 |
| 0 | $u_0 = [1 \ -1 \ -1 \ -1]^T$ | $W_0^{(1)}$ | $W_0^{(14)}/\sqrt{2}$ | $W_0^{(124)}/\sqrt{3}$ | $W_0^{(1234)}/2$ |
| 1 | $u_1 = [1 \ -j \ 1 \ j]^T$ | $W_1^{(1)}$ | $W_1^{(12)}/\sqrt{2}$ | $W_1^{(123)}/\sqrt{3}$ | $W_1^{(1234)}/2$ |
| 2 | $u_2 = [1 \ 1 \ -1 \ 1]^T$ | $W_2^{(1)}$ | $W_2^{(12)}/\sqrt{2}$ | $W_2^{(123)}/\sqrt{3}$ | $W_2^{(3214)}/2$ |
| 3 | $u_3 = [1 \ j \ 1 \ -j]^T$ | $W_3^{(1)}$ | $W_3^{(12)}/\sqrt{2}$ | $W_3^{(123)}/\sqrt{3}$ | $W_3^{(3214)}/2$ |
| 4 | $u_4 = [1 \ (-1-j)/\sqrt{2} \ -j \ (1-j)/\sqrt{2}]^T$ | $W_4^{(1)}$ | $W_4^{(14)}/\sqrt{2}$ | $W_4^{(124)}/\sqrt{3}$ | $W_4^{(1234)}/2$ |
| 5 | $u_5 = [1 \ (1-j)/\sqrt{2} \ j \ (-1-j)/\sqrt{2}]^T$ | $W_5^{(1)}$ | $W_5^{(14)}/\sqrt{2}$ | $W_5^{(124)}/\sqrt{3}$ | $W_5^{(1234)}/2$ |
| 6 | $u_6 = [1 \ (1+j)/\sqrt{2} \ -j \ (-1+j)/\sqrt{2}]^T$ | $W_6^{(1)}$ | $W_6^{(13)}/\sqrt{2}$ | $W_6^{(134)}/\sqrt{3}$ | $W_6^{(1324)}/2$ |
| 7 | $u_7 = [1 \ (-1+j)/\sqrt{2} \ j \ (1+j)/\sqrt{2}]^T$ | $W_7^{(1)}$ | $W_7^{(13)}/\sqrt{2}$ | $W_7^{(134)}/\sqrt{3}$ | $W_7^{(1324)}/2$ |
| 8 | $u_8 = [1 \ -1 \ 1 \ 1]^T$ | $W_8^{(1)}$ | $W_8^{(12)}/\sqrt{2}$ | $W_8^{(124)}/\sqrt{3}$ | $W_8^{(1234)}/2$ |
| 9 | $u_9 = [1 \ -j \ -1 \ -j]^T$ | $W_9^{(1)}$ | $W_9^{(14)}/\sqrt{2}$ | $W_9^{(134)}/\sqrt{3}$ | $W_9^{(1234)}/2$ |
| 10 | $u_{10} = [1 \ 1 \ 1 \ -1]^T$ | $W_{10}^{(1)}$ | $W_{10}^{(13)}/\sqrt{2}$ | $W_{10}^{(123)}/\sqrt{3}$ | $W_{10}^{(1324)}/2$ |
| 11 | $u_{11} = [1 \ j \ -1 \ j]^T$ | $W_{11}^{(1)}$ | $W_{11}^{(13)}/\sqrt{2}$ | $W_{11}^{(134)}/\sqrt{3}$ | $W_{11}^{(1324)}/2$ |
| 12 | $u_{12} = [1 \ -1 \ -1 \ 1]^T$ | $W_{12}^{(1)}$ | $W_{12}^{(12)}/\sqrt{2}$ | $W_{12}^{(123)}/\sqrt{3}$ | $W_{12}^{(1234)}/2$ |
| 13 | $u_{13} = [1 \ -1 \ 1 \ -1]^T$ | $W_{13}^{(1)}$ | $W_{13}^{(13)}/\sqrt{2}$ | $W_{13}^{(123)}/\sqrt{3}$ | $W_{13}^{(1324)}/2$ |
| 14 | $u_{14} = [1 \ 1 \ -1 \ -1]^T$ | $W_{14}^{(1)}$ | $W_{14}^{(13)}/\sqrt{2}$ | $W_{14}^{(123)}/\sqrt{3}$ | $W_{14}^{(3214)}/2$ |
| 15 | $u_{15} = [1 \ 1 \ 1 \ 1]^T$ | $W_{15}^{(1)}$ | $W_{15}^{(12)}/\sqrt{2}$ | $W_{15}^{(123)}/\sqrt{3}$ | $W_{15}^{(1234)}/2$ |

6.3.4.3 Precoding for transmit diversity

Precoding for transmit diversity is only used in combination with layer mapping for transmit diversity as described in Section 6.3.3.3. The precoding operation for transmit diversity is defined for two and four antenna ports.

For transmission on two antenna ports, $p \in \{0,1\}$, the output $y(i) = [y^{(0)}(i) \ y^{(1)}(i)]^T$, $i = 0,1,\dots,M_{\text{symb}}^{\text{ap}} - 1$ of the precoding operation is defined by

$$\begin{bmatrix} y^{(0)}(2i) \\ y^{(1)}(2i) \\ y^{(0)}(2i+1) \\ y^{(1)}(2i+1) \end{bmatrix} = \frac{1}{\sqrt{2}} \begin{bmatrix} 1 & 0 & j & 0 \\ 0 & -1 & 0 & j \\ 0 & 1 & 0 & j \\ 1 & 0 & -j & 0 \end{bmatrix} \begin{bmatrix} \text{Re}(x^{(0)}(i)) \\ \text{Re}(x^{(1)}(i)) \\ \text{Im}(x^{(0)}(i)) \\ \text{Im}(x^{(1)}(i)) \end{bmatrix}$$

for $i = 0,1,\dots,M_{\text{symb}}^{\text{layer}} - 1$ with $M_{\text{symb}}^{\text{ap}} = 2M_{\text{symb}}^{\text{layer}}$.

For transmission on four antenna ports, $p \in \{0,1,2,3\}$, the output $y(i) = [y^{(0)}(i) \ y^{(1)}(i) \ y^{(2)}(i) \ y^{(3)}(i)]^T$, $i = 0,1,\dots,M_{\text{symb}}^{\text{ap}} - 1$ of the precoding operation is defined by

$$\begin{bmatrix}
 y^{(0)}(4i) \\
 y^{(1)}(4i) \\
 y^{(2)}(4i) \\
 y^{(3)}(4i) \\
 y^{(0)}(4i+1) \\
 y^{(1)}(4i+1) \\
 y^{(2)}(4i+1) \\
 y^{(3)}(4i+1) \\
 y^{(0)}(4i+2) \\
 y^{(1)}(4i+2) \\
 y^{(2)}(4i+2) \\
 y^{(3)}(4i+2) \\
 y^{(0)}(4i+3) \\
 y^{(1)}(4i+3) \\
 y^{(2)}(4i+3) \\
 y^{(3)}(4i+3)
 \end{bmatrix}
 = \frac{1}{\sqrt{2}}
 \begin{bmatrix}
 1 & 0 & 0 & 0 & j & 0 & 0 & 0 \\
 0 & 0 & 0 & 0 & 0 & 0 & 0 & 0 \\
 0 & -1 & 0 & 0 & 0 & j & 0 & 0 \\
 0 & 0 & 0 & 0 & 0 & 0 & 0 & 0 \\
 0 & 1 & 0 & 0 & 0 & j & 0 & 0 \\
 0 & 0 & 0 & 0 & 0 & 0 & 0 & 0 \\
 1 & 0 & 0 & 0 & -j & 0 & 0 & 0 \\
 0 & 0 & 0 & 0 & 0 & 0 & 0 & 0 \\
 0 & 0 & 0 & 0 & 0 & 0 & 0 & 0 \\
 0 & 0 & 1 & 0 & 0 & 0 & j & 0 \\
 0 & 0 & 0 & 0 & 0 & 0 & 0 & 0 \\
 0 & 0 & 0 & -1 & 0 & 0 & 0 & j \\
 0 & 0 & 0 & 0 & 0 & 0 & 0 & 0 \\
 0 & 0 & 0 & 1 & 0 & 0 & 0 & j \\
 0 & 0 & 0 & 0 & 0 & 0 & 0 & 0 \\
 0 & 0 & 1 & 0 & 0 & 0 & -j & 0
 \end{bmatrix}
 \begin{bmatrix}
 \operatorname{Re}\{x^{(0)}(i)\} \\
 \operatorname{Re}\{x^{(1)}(i)\} \\
 \operatorname{Re}\{x^{(2)}(i)\} \\
 \operatorname{Re}\{x^{(3)}(i)\} \\
 \operatorname{Im}\{x^{(0)}(i)\} \\
 \operatorname{Im}\{x^{(1)}(i)\} \\
 \operatorname{Im}\{x^{(2)}(i)\} \\
 \operatorname{Im}\{x^{(3)}(i)\}
 \end{bmatrix}$$

for $i = 0, 1, \dots, M_{\text{symp}}^{\text{layer}} - 1$ with $M_{\text{symp}}^{\text{ap}} = 4M_{\text{symp}}^{\text{layer}}$.

6.3.5 Mapping to resource elements

For each of the antenna ports used for transmission of the physical channel, the block of complex-valued symbols $y^{(p)}(0), \dots, y^{(p)}(M_{\text{symp}}^{\text{ap}} - 1)$ shall be mapped in sequence starting with $y^{(p)}(0)$ to resource elements (k, l) in the physical resource blocks corresponding to the virtual resource blocks assigned for transmission and not used for transmission of PCFICH, PHICH, PDCCH, PBCH, synchronization signals or reference signals. The mapping to resource elements (k, l) on antenna port p not reserved for other purposes shall be in increasing order of first the index k over the assigned physical resource blocks and then the index l , starting with the first slot in a subframe.

6.4 Physical downlink shared channel

The physical downlink shared channel shall be processed and mapped to resource elements as described in Section 6.3 with the following exceptions:

- In resource blocks in which UE-specific reference signals are not transmitted, the PDSCH shall be transmitted on the same set of antenna ports as the PBCH, which is one of $\{0\}$, $\{0,1\}$, or $\{0,1,2,3\}$
- In resource blocks in which UE-specific reference signals are transmitted, the PDSCH shall be transmitted on antenna port $\{5\}$

6.5 Physical multicast channel

The physical multicast channel shall be processed and mapped to resource elements as described in Section 6.3 with the following exceptions:

- No transmit diversity scheme is specified
- Layer mapping and precoding shall be done assuming a single antenna port and the transmission shall use antenna port 4.
- In the subframes where PMCH is transmitted on a carrier supporting a mix of PDSCH and PMCH transmissions, up to two of the first OFDM symbols of a subframe can be reserved for non-MBSFN transmission and shall not be used for PMCH transmission. In a cell with 4 cell-specific antenna ports, the first two OFDM symbols of a subframe are reserved for non-MBSFN transmission in the subframes in which the PMCH is transmitted. The

non-MBSFN symbols shall use the same cyclic prefix as used for subframe #0. PMCH shall not be transmitted in subframes 0 and 5 on a carrier supporting a mix of PDSCH and PMCH transmission

6.6 Physical broadcast channel

6.6.1 Scrambling

The block of bits $b(0), \dots, b(M_{\text{bit}} - 1)$, where M_{bit} , the number of bits transmitted on the physical broadcast channel, equals 1920 for normal cyclic prefix and 1728 for extended cyclic prefix, shall be scrambled with a cell-specific sequence prior to modulation, resulting in a block of scrambled bits $\tilde{b}(0), \dots, \tilde{b}(M_{\text{bit}} - 1)$ according to

$$\tilde{b}(i) = (b(i) + c(i)) \bmod 2$$

where the scrambling sequence $c(i)$ is given by Section 7.2. The scrambling sequence shall be initialised with $c_{\text{init}} = N_{\text{ID}}^{\text{cell}}$ in each radio frame fulfilling $n_f \bmod 4 = 0$.

6.6.2 Modulation

The block of scrambled bits $\tilde{b}(0), \dots, \tilde{b}(M_{\text{bit}} - 1)$ shall be modulated as described in Section 7.1, resulting in a block of complex-valued modulation symbols $d(0), \dots, d(M_{\text{symp}} - 1)$. Table 6.6.2-1 specifies the modulation mappings applicable for the physical broadcast channel.

Table 6.6.2-1: PBCH modulation schemes

| Physical channel | Modulation schemes |
|------------------|--------------------|
| PBCH | QPSK |

6.6.3 Layer mapping and precoding

The block of modulation symbols $d(0), \dots, d(M_{\text{symp}} - 1)$ shall be mapped to layers according to one of Sections 6.3.3.1 or 6.3.3.3 with $M_{\text{symp}}^{(0)} = M_{\text{symp}}$ and precoded according to one of Sections 6.3.4.1 or 6.3.4.3, resulting in a block of vectors $y(i) = [y^{(0)}(i) \ \dots \ y^{(P-1)}(i)]^T$, $i = 0, \dots, M_{\text{symp}} - 1$, where $y^{(p)}(i)$ represents the signal for antenna port p and where $p = 0, \dots, P - 1$ and the number of antenna ports for cell-specific reference signals $P \in \{1, 2, 4\}$.

6.6.4 Mapping to resource elements

The block of complex-valued symbols $y^{(p)}(0), \dots, y^{(p)}(M_{\text{symp}} - 1)$ for each antenna port is transmitted during 4 consecutive radio frames starting in each radio frame fulfilling $n_f \bmod 4 = 0$ and shall be mapped in sequence starting with $y(0)$ to resource elements (k, l) . The mapping to resource elements (k, l) not reserved for transmission of reference signals shall be in increasing order of first the index k , then the index l in slot 1 in subframe 0 and finally the radio frame number. The resource-element indices are given by

$$k = \frac{N_{\text{RB}}^{\text{DL}} N_{\text{sc}}^{\text{RB}}}{2} - 36 + k', \quad k' = 0, 1, \dots, 71$$

$$l = 0, 1, \dots, 3$$

where resource elements reserved for reference signals shall be excluded. The mapping operation shall assume cell-specific reference signals for antenna ports 0-3 being present irrespective of the actual configuration. Resource elements assumed to be reserved for reference signals in the mapping operation above but not used for transmission of reference signal shall not be used for transmission of any physical channel.

6.7 Physical control format indicator channel

The physical control format indicator channel carries information about the number of OFDM symbols used for transmission of PDCCHs in a subframe. The set of OFDM symbols possible to use for PDCCH in a subframe is given by Table 6.7-1.

Table 6.7-1: Number of OFDM symbols used for PDCCH.

| Subframe | Number of OFDM symbols for PDCCH when $N_{RB}^{DL} > 10$ | Number of OFDM symbols for PDCCH when $N_{RB}^{DL} \leq 10$ |
|--|--|---|
| Subframe 1 and 6 for frame structure type 2 | 1, 2 | 2 |
| MBSFN subframes on a carrier supporting both PMCH and PDSCH for 1 or 2 cell specific antenna ports | 1, 2 | 2 |
| MBSFN subframes on a carrier supporting both PMCH and PDSCH for 4 cell specific antenna ports | 2 | 2 |
| MBSFN subframes on a carrier not supporting PDSCH | 0 | 0 |
| All other cases | 1, 2, 3 | 2, 3, 4 |

6.7.1 Scrambling

The block of bits $b(0), \dots, b(31)$ transmitted in one subframe shall be scrambled with a cell-specific sequence prior to modulation, resulting in a block of scrambled bits $\tilde{b}(0), \dots, \tilde{b}(31)$ according to

$$\tilde{b}(i) = (b(i) + c(i)) \bmod 2$$

where the scrambling sequence $c(i)$ is given by Section 7.2. The scrambling sequence generator shall be initialised with $c_{\text{init}} = (\lfloor n_s/2 \rfloor + 1) \cdot (2N_{ID}^{\text{cell}} + 1) \cdot 2^9 + N_{ID}^{\text{cell}}$ at the start of each subframe.

6.7.2 Modulation

The block of scrambled bits $\tilde{b}(0), \dots, \tilde{b}(31)$ shall be modulated as described in Section 7.1, resulting in a block of complex-valued modulation symbols $d(0), \dots, d(15)$. Table 6.7.2-1 specifies the modulation mappings applicable for the physical control format indicator channel.

Table 6.7.2-1: PCFICH modulation schemes

| Physical channel | Modulation schemes |
|------------------|--------------------|
| PCFICH | QPSK |

6.7.3 Layer mapping and precoding

The block of modulation symbols $d(0), \dots, d(15)$ shall be mapped to layers according to one of Sections 6.3.3.1 or 6.3.3.3 with $M_{\text{symp}}^{(0)} = 16$ and precoded according to one of Sections 6.3.4.1 or 6.3.4.3, resulting in a block of vectors

$y(i) = [y^{(0)}(i) \ \dots \ y^{(P-1)}(i)]^T$, $i = 0, \dots, 15$, where $y^{(p)}(i)$ represents the signal for antenna port p and where $p = 0, \dots, P-1$ and the number of antenna ports for cell-specific reference signals $P \in \{1, 2, 4\}$. The PCFICH shall be transmitted on the same set of antenna ports as the PBCH.

6.7.4 Mapping to resource elements

The mapping to resource elements is defined in terms of quadruplets of complex-valued symbols. Let

$z^{(p)}(i) = \langle y^{(p)}(4i), y^{(p)}(4i+1), y^{(p)}(4i+2), y^{(p)}(4i+3) \rangle$ denote symbol quadruplet i for antenna port p . For each of the antenna ports, symbol quadruplets shall be mapped in increasing order of i to the four resource-element groups in the first OFDM symbol in a downlink subframe with the representative resource-element as defined in Section 6.2.4 given by

$$\begin{aligned} z^{(p)}(0) & \text{ is mapped to the resource - element group represented by } k = \bar{k} \\ z^{(p)}(1) & \text{ is mapped to the resource - element group represented by } k = \bar{k} + \left\lfloor \frac{N_{\text{RB}}^{\text{DL}}}{2} \right\rfloor \cdot \frac{N_{\text{sc}}^{\text{RB}}}{2} \\ z^{(p)}(2) & \text{ is mapped to the resource - element group represented by } k = \bar{k} + \left\lfloor \frac{2N_{\text{RB}}^{\text{DL}}}{2} \right\rfloor \cdot \frac{N_{\text{sc}}^{\text{RB}}}{2} \\ z^{(p)}(3) & \text{ is mapped to the resource - element group represented by } k = \bar{k} + \left\lfloor \frac{3N_{\text{RB}}^{\text{DL}}}{2} \right\rfloor \cdot \frac{N_{\text{sc}}^{\text{RB}}}{2} \end{aligned}$$

where the additions are modulo $N_{\text{RB}}^{\text{DL}} N_{\text{sc}}^{\text{RB}}$,

$$\bar{k} = \left(N_{\text{sc}}^{\text{RB}} / 2 \right) \cdot \left(N_{\text{ID}}^{\text{cell}} \bmod 2N_{\text{RB}}^{\text{DL}} \right)$$

and $N_{\text{ID}}^{\text{cell}}$ is the physical-layer cell identity as given by Section 6.11.

6.8 Physical downlink control channel

6.8.1 PDCCH formats

The physical downlink control channel carries scheduling assignments and other control information. A physical control channel is transmitted on an aggregation of one or several consecutive control channel elements (CCEs), where a control channel element corresponds to 9 resource element groups. The number of resource-element groups not assigned to PCFICH or PHICH is N_{REG} . The CCEs available in the system are numbered from 0 and $N_{\text{CCE}} - 1$, where $N_{\text{CCE}} = \lfloor N_{\text{REG}} / 9 \rfloor$. The PDCCH supports multiple formats as listed in Table 6.8.1-1. A PDCCH consisting of n consecutive CCEs may only start on a CCE fulfilling $i \bmod n = 0$, where i is the CCE number.

Multiple PDCCHs can be transmitted in a subframe.

Table 6.8.1-1: Supported PDCCH formats

| PDCCH format | Number of CCEs | Number of resource-element groups | Number of PDCCH bits |
|--------------|----------------|-----------------------------------|----------------------|
| 0 | 1 | 9 | 72 |
| 1 | 2 | 18 | 144 |
| 2 | 4 | 36 | 288 |
| 3 | 8 | 72 | 576 |

6.8.2 PDCCH multiplexing and scrambling

The block of bits $b^{(i)}(0), \dots, b^{(i)}(M_{\text{bit}}^{(i)} - 1)$ on each of the control channels to be transmitted in a subframe, where $M_{\text{bit}}^{(i)}$ is the number of bits in one subframe to be transmitted on physical downlink control channel number i , shall be multiplexed, resulting in a block of

bits $b^{(0)}(0), \dots, b^{(0)}(M_{\text{bit}}^{(0)} - 1), b^{(1)}(0), \dots, b^{(1)}(M_{\text{bit}}^{(1)} - 1), \dots, b^{(n_{\text{PDCCH}} - 1)}(0), \dots, b^{(n_{\text{PDCCH}} - 1)}(M_{\text{bit}}^{(n_{\text{PDCCH}} - 1)} - 1)$, where n_{PDCCH} is the number of PDCCHs transmitted in the subframe.

The block of bits $b^{(0)}(0), \dots, b^{(0)}(M_{\text{bit}}^{(0)} - 1), b^{(1)}(0), \dots, b^{(1)}(M_{\text{bit}}^{(1)} - 1), \dots, b^{(n_{\text{PDCCH}} - 1)}(0), \dots, b^{(n_{\text{PDCCH}} - 1)}(M_{\text{bit}}^{(n_{\text{PDCCH}} - 1)} - 1)$ shall be scrambled with a cell-specific sequence prior to modulation, resulting in a block of scrambled bits $\tilde{b}(0), \dots, \tilde{b}(M_{\text{tot}} - 1)$ according to

$$\tilde{b}(i) = (b(i) + c(i)) \bmod 2$$

where the scrambling sequence $c(i)$ is given by Section 7.2. The scrambling sequence generator shall be initialised with $c_{\text{init}} = \lfloor n_s/2 \rfloor 2^9 + N_{\text{ID}}^{\text{cell}}$ at the start of each subframe.

CCE number n corresponds to bits $b(72n), b(72n+1), \dots, b(72n+71)$. If necessary, <NIL> elements shall be inserted in the block of bits prior to scrambling to ensure that the PDCCHs starts at the CCE positions as described in [4] and to ensure that the length $M_{\text{tot}} = 8N_{\text{REG}} \geq \sum_{i=0}^{n_{\text{PDCCH}} - 1} M_{\text{bit}}^{(i)}$ of the scrambled block of bits matches the amount of resource-element groups not assigned to PCFICH or PHICH.

6.8.3 Modulation

The block of scrambled bits $\tilde{b}(0), \dots, \tilde{b}(M_{\text{tot}} - 1)$ shall be modulated as described in Section 7.1, resulting in a block of complex-valued modulation symbols $d(0), \dots, d(M_{\text{symb}} - 1)$. Table 6.8.3-1 specifies the modulation mappings applicable for the physical downlink control channel.

Table 6.8.3-1: PDCCH modulation schemes

| Physical channel | Modulation schemes |
|------------------|--------------------|
| PDCCH | QPSK |

6.8.4 Layer mapping and precoding

The block of modulation symbols $d(0), \dots, d(M_{\text{symb}} - 1)$ shall be mapped to layers according to one of Sections 6.3.3.1 or 6.3.3.3 with $M_{\text{symb}}^{(0)} = M_{\text{symb}}$ and precoded according to one of Sections 6.3.4.1 or 6.3.4.3, resulting in a block of vectors $y(i) = [y^{(0)}(i) \ \dots \ y^{(P-1)}(i)]^T$, $i = 0, \dots, M_{\text{symb}} - 1$ to be mapped onto resources on the antenna ports used for transmission, where $y^{(p)}(i)$ represents the signal for antenna port p . The PDCCH shall be transmitted on the same set of antenna ports as the PBCH.

6.8.5 Mapping to resource elements

The mapping to resource elements is defined by operations on quadruplets of complex-valued symbols. Let $z^{(p)}(i) = \langle y^{(p)}(4i), y^{(p)}(4i+1), y^{(p)}(4i+2), y^{(p)}(4i+3) \rangle$ denote symbol quadruplet i for antenna port p .

The block of quadruplets $z^{(p)}(0), \dots, z^{(p)}(M_{\text{quad}} - 1)$, where $M_{\text{quad}} = M_{\text{symb}}/4$, shall be permuted resulting in $w^{(p)}(0), \dots, w^{(p)}(M_{\text{quad}} - 1)$. The permutation shall be according to the sub-block interleaver in Section 5.1.4.2.1 of [3] with the following exceptions:

- the input and output to the interleaver is defined by symbol quadruplets instead of bits
- interleaving is performed on symbol quadruplets instead of bits by substituting the terms 'bit', 'bits' and 'bit sequence' in Section 5.1.4.2.1 of [3] by 'symbol quadruplet', 'symbol quadruplets' and 'symbol-quadruplet sequence', respectively

<NULL> elements at the output of the interleaver in [3] shall be removed when forming $w^{(p)}(0), \dots, w^{(p)}(M_{\text{quad}} - 1)$. Note that the removal of <NULL> elements does not affect any <NIL> elements inserted in Section 6.8.2.

The block of quadruplets $w^{(p)}(0), \dots, w^{(p)}(M_{\text{quad}} - 1)$ shall be cyclically shifted, resulting in $\bar{w}^{(p)}(0), \dots, \bar{w}^{(p)}(M_{\text{quad}} - 1)$ where $\bar{w}^{(p)}(i) = w^{(p)}\left((i + N_{\text{ID}}^{\text{cell}}) \bmod M_{\text{quad}}\right)$.

Mapping of the block of quadruplets $\bar{w}^{(p)}(0), \dots, \bar{w}^{(p)}(M_{\text{quad}} - 1)$ is defined in terms of resource-element groups, specified in Section 6.2.4, according to steps 1–10 below:

- 1) Initialize $m' = 0$ (resource-element group number)
- 2) Initialize $k' = 0$
- 3) Initialize $l' = 0$
- 4) If the resource element (k', l') represents a resource-element group not assigned to PCFICH or PHICH then perform step 5 and 6, else go to step 7
- 5) Map symbol-quadruplet $\bar{w}^{(p)}(m')$ to the resource-element group represented by (k', l') for each antenna port p
- 6) Increase m' by 1
- 7) Increase l' by 1
- 8) Repeat from step 4 if $l' < L$, where L corresponds to the number of OFDM symbols used for PDCCH transmission as indicated by the sequence transmitted on the PCFICH
- 9) Increase k' by 1
- 10) Repeat from step 3 if $k' < N_{\text{RB}}^{\text{DL}} \cdot N_{\text{sc}}^{\text{RB}}$

6.9 Physical hybrid ARQ indicator channel

The PHICH carries the hybrid-ARQ ACK/NAK. Multiple PHICHs mapped to the same set of resource elements constitute a PHICH group, where PHICHs within the same PHICH group are separated through different orthogonal sequences. A PHICH resource is identified by the index pair $(n_{\text{PHICH}}^{\text{group}}, n_{\text{PHICH}}^{\text{seq}})$, where $n_{\text{PHICH}}^{\text{group}}$ is the PHICH group number and $n_{\text{PHICH}}^{\text{seq}}$ is the orthogonal sequence index within the group.

For frame structure type 1, the number of PHICH groups $N_{\text{PHICH}}^{\text{group}}$ is constant in all subframes and given by

$$N_{\text{PHICH}}^{\text{group}} = \begin{cases} \left\lceil N_g \left(N_{\text{RB}}^{\text{DL}} / 8 \right) \right\rceil & \text{for normal cyclic prefix} \\ 2 \cdot \left\lceil N_g \left(N_{\text{RB}}^{\text{DL}} / 8 \right) \right\rceil & \text{for extended cyclic prefix} \end{cases}$$

where $N_g \in \{1/6, 1/2, 1, 2\}$ is provided by higher layers. The index $n_{\text{PHICH}}^{\text{group}}$ ranges from 0 to $N_{\text{PHICH}}^{\text{group}} - 1$.

For frame structure type 2, the number of PHICH groups may vary between downlink subframes and is given by $m_i \cdot N_{\text{PHICH}}^{\text{group}}$ where m_i is given by Table 6.9-1 and $N_{\text{PHICH}}^{\text{group}}$ by the expression above. The index $n_{\text{PHICH}}^{\text{group}}$ in a downlink subframe with non-zero PHICH resources ranges from 0 to $m_i \cdot N_{\text{PHICH}}^{\text{group}} - 1$.

Table 6.9-1: The factor m_i for frame structure type 2.

| Uplink-downlink configuration | Subframe number i | | | | | | | | | |
|----------------------------------|---------------------|---|---|---|---|---|---|---|---|---|
| | 0 | 1 | 2 | 3 | 4 | 5 | 6 | 7 | 8 | 9 |
| 0 | 2 | 1 | - | - | - | 2 | 1 | - | - | - |
| 1 | 0 | 1 | - | - | 1 | 0 | 1 | - | - | 1 |
| 2 | 0 | 0 | - | 1 | 0 | 0 | 0 | - | 1 | 0 |
| 3 | 1 | 0 | - | - | - | 0 | 0 | 0 | 1 | 1 |
| 4 | 0 | 0 | - | - | 0 | 0 | 0 | 0 | 1 | 1 |
| 5 | 0 | 0 | - | 0 | 0 | 0 | 0 | 0 | 1 | 0 |
| 6 | 1 | 1 | - | - | - | 1 | 1 | - | - | 1 |

6.9.1 Modulation

The block of bits $b(0), \dots, b(M_{\text{bit}} - 1)$ transmitted on one PHICH in one subframe shall be modulated as described in Section 7.1, resulting in a block of complex-valued modulation symbols $z(0), \dots, z(M_s - 1)$, where $M_s = M_{\text{bit}}$. Table 6.9.1-1 specifies the modulation mappings applicable for the physical hybrid ARQ indicator channel.

Table 6.9.1-1: PHICH modulation schemes

| Physical channel | Modulation schemes |
|------------------|--------------------|
| PHICH | BPSK |

The block of modulation symbols $z(0), \dots, z(M_s - 1)$ shall be bit-wise multiplied with an orthogonal sequence, resulting in a sequence of modulation symbols $d(0), \dots, d(M_{\text{symb}} - 1)$ according to

$$d(i) = w(i \bmod N_{\text{SF}}^{\text{PHICH}}) \cdot (1 - 2c(i)) \cdot z(\lfloor i / N_{\text{SF}}^{\text{PHICH}} \rfloor)$$

where

$$i = 0, \dots, M_{\text{symb}} - 1$$

$$M_{\text{symb}} = N_{\text{SF}}^{\text{PHICH}} \cdot M_s$$

$$N_{\text{SF}}^{\text{PHICH}} = \begin{cases} 4 & \text{normal cyclic prefix} \\ 2 & \text{extended cyclic prefix} \end{cases}$$

and $c(i)$ is a cell-specific scrambling sequence generated according to Section 7.2. The scrambling sequence generator shall be initialised with $c_{\text{init}} = (\lfloor n_s / 2 \rfloor + 1) \cdot (2N_{\text{ID}}^{\text{cell}} + 1) \cdot 2^9 + N_{\text{ID}}^{\text{cell}}$ at the start of each subframe.

The sequence $[w(0) \ \dots \ w(N_{\text{SF}}^{\text{PHICH}} - 1)]$ is given by Table 6.9.1-2 where the sequence index $n_{\text{PHICH}}^{\text{seq}}$ corresponds to the PHICH number within the PHICH group.

Table 6.9.1-2: Orthogonal sequences $[w(0) \dots w(N_{SF}^{PHICH} - 1)]$ for PHICH

| Sequence index n_{PHICH}^{seq} | Orthogonal sequence | |
|-------------------------------------|----------------------|------------------------|
| | Normal cyclic prefix | Extended cyclic prefix |
| | $N_{SF}^{PHICH} = 4$ | $N_{SF}^{PHICH} = 2$ |
| 0 | [+1 +1 +1 +1] | [+1 +1] |
| 1 | [+1 -1 +1 -1] | [+1 -1] |
| 2 | [+1 +1 -1 -1] | [+j +j] |
| 3 | [+1 -1 -1 +1] | [+j -j] |
| 4 | [+j +j +j +j] | - |
| 5 | [+j -j +j -j] | - |
| 6 | [+j +j -j -j] | - |
| 7 | [+j -j -j +j] | - |

6.9.2 Resource group alignment, layer mapping and precoding

The block of symbols $d(0), \dots, d(M_{symb} - 1)$ should be first aligned with resource element group size, resulting in a block of symbols $d^{(0)}(0), \dots, d^{(0)}(c \cdot M_{symb} - 1)$, where $c=1$ for normal cyclic prefix; and $c=2$ for extended cyclic prefix.

For normal cyclic prefix, $d^{(0)}(i) = d(i)$, for $i = 0, \dots, M_{symb} - 1$.

For extended cyclic prefix,

$$\left[d^{(0)}(4i) \quad d^{(0)}(4i+1) \quad d^{(0)}(4i+2) \quad d^{(0)}(4i+3) \right]^T = \begin{cases} \left[d(2i) \quad d(2i+1) \quad 0 \quad 0 \right]^T & n_{PHICH}^{group} \bmod 2 = 0 \\ \left[0 \quad 0 \quad d(2i) \quad d(2i+1) \right]^T & n_{PHICH}^{group} \bmod 2 = 1 \end{cases}$$

, for $i = 0, \dots, (M_{symb}/2) - 1$.

The block of symbols $d^{(0)}(0), \dots, d^{(0)}(c \cdot M_{symb} - 1)$ shall be mapped to layers and precoded, resulting in a block of vectors $y(i) = [y^{(0)}(i) \quad \dots \quad y^{(P-1)}(i)]^T$, $i = 0, \dots, c \cdot M_{symb} - 1$, where $y^{(p)}(i)$ represents the signal for antenna port p , $p = 0, \dots, P-1$ and the number of antenna ports for cell-specific reference signals $P \in \{1, 2, 4\}$. The layer mapping and precoding operation depends on the cyclic prefix length and the number of antenna ports used for transmission of the PHICH. The PHICH shall be transmitted on the same set of antenna ports as the PBCH.

For transmission on a single antenna port, $P = 1$, layer mapping and precoding are defined by Sections 6.3.3.1 and 6.3.4.1, respectively, with $M_{symb}^{(0)} = c \cdot M_{symb}$.

For transmission on two antenna ports, $P = 2$, layer mapping and precoding are defined by Sections 6.3.3.3 and 6.3.4.3, respectively, with $M_{symb}^{(0)} = c \cdot M_{symb}$.

For transmission on four antenna ports, $P = 4$, layer mapping is defined by Section 6.3.3.3 with $M_{symb}^{(0)} = c \cdot M_{symb}$ and precoding by

$$\begin{bmatrix} y^{(0)}(4i) \\ y^{(1)}(4i) \\ y^{(2)}(4i) \\ y^{(3)}(4i) \\ y^{(0)}(4i+1) \\ y^{(1)}(4i+1) \\ y^{(2)}(4i+1) \\ y^{(3)}(4i+1) \\ y^{(0)}(4i+2) \\ y^{(1)}(4i+2) \\ y^{(2)}(4i+2) \\ y^{(3)}(4i+2) \\ y^{(0)}(4i+3) \\ y^{(1)}(4i+3) \\ y^{(2)}(4i+3) \\ y^{(3)}(4i+3) \end{bmatrix} = \frac{1}{\sqrt{2}} \begin{bmatrix} 1 & 0 & 0 & 0 & j & 0 & 0 & 0 \\ 0 & 0 & 0 & 0 & 0 & 0 & 0 & 0 \\ 0 & -1 & 0 & 0 & 0 & j & 0 & 0 \\ 0 & 0 & 0 & 0 & 0 & 0 & 0 & 0 \\ 0 & 1 & 0 & 0 & 0 & j & 0 & 0 \\ 0 & 0 & 0 & 0 & 0 & 0 & 0 & 0 \\ 1 & 0 & 0 & 0 & -j & 0 & 0 & 0 \\ 0 & 0 & 0 & 0 & 0 & 0 & 0 & 0 \\ 0 & 0 & 1 & 0 & 0 & 0 & j & 0 \\ 0 & 0 & 0 & 0 & 0 & 0 & 0 & 0 \\ 0 & 0 & 0 & -1 & 0 & 0 & 0 & j \\ 0 & 0 & 0 & 0 & 0 & 0 & 0 & 0 \\ 0 & 0 & 0 & 1 & 0 & 0 & 0 & j \\ 0 & 0 & 0 & 0 & 0 & 0 & 0 & 0 \\ 0 & 0 & 1 & 0 & 0 & 0 & -j & 0 \\ 0 & 0 & 0 & 0 & 0 & 0 & 0 & 0 \end{bmatrix} \begin{bmatrix} \text{Re}(x^{(0)}(i)) \\ \text{Re}(x^{(1)}(i)) \\ \text{Re}(x^{(2)}(i)) \\ \text{Re}(x^{(3)}(i)) \\ \text{Im}(x^{(0)}(i)) \\ \text{Im}(x^{(1)}(i)) \\ \text{Im}(x^{(2)}(i)) \\ \text{Im}(x^{(3)}(i)) \end{bmatrix}$$

if $(i + n_{\text{PHICH}}^{\text{group}}) \bmod 2 = 0$ for normal cyclic prefix, or $(i + \lfloor n_{\text{PHICH}}^{\text{group}} / 2 \rfloor) \bmod 2 = 0$ for extended cyclic prefix, where $n_{\text{PHICH}}^{\text{group}}$ is the PHICH group number and $i = 0,1,2$, and by

$$\begin{bmatrix} y^{(0)}(4i) \\ y^{(1)}(4i) \\ y^{(2)}(4i) \\ y^{(3)}(4i) \\ y^{(0)}(4i+1) \\ y^{(1)}(4i+1) \\ y^{(2)}(4i+1) \\ y^{(3)}(4i+1) \\ y^{(0)}(4i+2) \\ y^{(1)}(4i+2) \\ y^{(2)}(4i+2) \\ y^{(3)}(4i+2) \\ y^{(0)}(4i+3) \\ y^{(1)}(4i+3) \\ y^{(2)}(4i+3) \\ y^{(3)}(4i+3) \end{bmatrix} = \frac{1}{\sqrt{2}} \begin{bmatrix} 0 & 0 & 0 & 0 & 0 & 0 & 0 & 0 \\ 1 & 0 & 0 & 0 & j & 0 & 0 & 0 \\ 0 & 0 & 0 & 0 & 0 & 0 & 0 & 0 \\ 0 & -1 & 0 & 0 & 0 & j & 0 & 0 \\ 0 & 0 & 0 & 0 & 0 & 0 & 0 & 0 \\ 0 & 1 & 0 & 0 & 0 & j & 0 & 0 \\ 0 & 0 & 0 & 0 & 0 & 0 & 0 & 0 \\ 1 & 0 & 0 & 0 & -j & 0 & 0 & 0 \\ 0 & 0 & 0 & 0 & 0 & 0 & 0 & 0 \\ 0 & 0 & 1 & 0 & 0 & 0 & j & 0 \\ 0 & 0 & 0 & 0 & 0 & 0 & 0 & 0 \\ 0 & 0 & 0 & -1 & 0 & 0 & 0 & j \\ 0 & 0 & 0 & 0 & 0 & 0 & 0 & 0 \\ 0 & 0 & 0 & 1 & 0 & 0 & 0 & j \\ 0 & 0 & 0 & 0 & 0 & 0 & 0 & 0 \\ 0 & 0 & 1 & 0 & 0 & 0 & -j & 0 \end{bmatrix} \begin{bmatrix} \text{Re}(x^{(0)}(i)) \\ \text{Re}(x^{(1)}(i)) \\ \text{Re}(x^{(2)}(i)) \\ \text{Re}(x^{(3)}(i)) \\ \text{Im}(x^{(0)}(i)) \\ \text{Im}(x^{(1)}(i)) \\ \text{Im}(x^{(2)}(i)) \\ \text{Im}(x^{(3)}(i)) \end{bmatrix}$$

otherwise for $i = 0,1,2$.

6.9.3 Mapping to resource elements

The sequence $\bar{y}^{(p)}(0), \dots, \bar{y}^{(p)}(M_{\text{symb}}^{(0)} - 1)$ for each of the PHICH groups is defined by

$$\bar{y}^{(p)}(n) = \sum y_i^{(p)}(n)$$

where the sum is over all PHICHs in the PHICH group and $y_i^{(p)}(n)$ represents the symbol sequence from the i :th PHICH in the PHICH group.

PHICH groups are mapped to PHICH mapping units.

For normal cyclic prefix, the mapping of PHICH group m to PHICH mapping unit m' is defined by

$$\tilde{y}_{m'}^{(p)}(n) = \bar{y}_m^{(p)}(n)$$

where $m = m' = 0, 1, \dots, N_{\text{PHICH}}^{\text{group}} - 1$.

For extended cyclic prefix, the mapping of PHICH group m and $m+1$ to PHICH mapping unit m' is defined by

$$\tilde{y}_{m'}^{(p)}(n) = \bar{y}_m^{(p)}(n) + \bar{y}_{m+1}^{(p)}(n)$$

where $m' = m/2$ and $m = 0, 2, \dots, N_{\text{PHICH}}^{\text{group}} - 2$.

Let $z^{(p)}(i) = \langle \tilde{y}^{(p)}(4i), \tilde{y}^{(p)}(4i+1), \tilde{y}^{(p)}(4i+2), \tilde{y}^{(p)}(4i+3) \rangle$, $i = 0, 1, 2$ denote symbol quadruplet i for antenna port p .

Mapping to resource elements is defined in terms of symbol quadruplets according to steps 1–10 below:

- 1) For each value of I'
- 2) Let n_r denote the number of resource element groups not assigned to PCFICH in OFDM symbol I'
- 3) Number the resource-element groups not assigned to PCFICH in OFDM symbol I' from 0 to $n_r - 1$, starting from the resource-element group with the lowest frequency-domain index.
- 4) Initialize $m' = 0$ (PHICH mapping unit number)
- 5) For each value of $i = 0, 1, 2$
- 6) Symbol-quadruplet $z^{(p)}(i)$ from PHICH mapping unit m' is mapped to the resource-element group represented by $(k', l')_i$ as defined in Section 6.2.4 where the indices k'_i and l'_i are given by steps 7 and 8 below:
- 7) The time-domain index l'_i is given by

$$l'_i = \begin{cases} 0 & \text{normal PHICH duration, all subframes} \\ \left(\lfloor m'/2 \rfloor + i + 1 \right) \bmod 2 & \text{extended PHICH duration, MBSFN subframes} \\ \left(\lfloor m'/2 \rfloor + i + 1 \right) \bmod 2 & \text{extended PHICH duration, subframe 1 and 6 in frame structure type 2} \\ i & \text{otherwise} \end{cases}$$

- 8) Set the frequency-domain index k'_i to the resource-element group assigned the number \bar{n}_i in step 3 above, where \bar{n}_i is given by

$$\bar{n}_i = \begin{cases} \left(\lfloor N_{\text{ID}}^{\text{cell}} \cdot n_{l'_i} / n_1 \rfloor + m' \right) \bmod n_{l'_i} & i = 0 \\ \left(\lfloor N_{\text{ID}}^{\text{cell}} \cdot n_{l'_i} / n_1 \rfloor + m' + \lfloor n_{l'_i} / 3 \rfloor \right) \bmod n_{l'_i} & i = 1 \\ \left(\lfloor N_{\text{ID}}^{\text{cell}} \cdot n_{l'_i} / n_1 \rfloor + m' + \lfloor 2n_{l'_i} / 3 \rfloor \right) \bmod n_{l'_i} & i = 2 \end{cases}$$

in case of extended PHICH duration in MBSFN subframes, or extended PHICH duration in subframe 1 and 6 for frame structure type 2 and by

$$\bar{n}_i = \begin{cases} \left(\lfloor N_{\text{ID}}^{\text{cell}} \cdot n_{l'_i} / n_0 \rfloor + m' \right) \bmod n_{l'_i} & i = 0 \\ \left(\lfloor N_{\text{ID}}^{\text{cell}} \cdot n_{l'_i} / n_0 \rfloor + m' + \lfloor n_{l'_i} / 3 \rfloor \right) \bmod n_{l'_i} & i = 1 \\ \left(\lfloor N_{\text{ID}}^{\text{cell}} \cdot n_{l'_i} / n_0 \rfloor + m' + \lfloor 2n_{l'_i} / 3 \rfloor \right) \bmod n_{l'_i} & i = 2 \end{cases}$$

otherwise.

9) Increase m' by 1.

10) Repeat from step 5 until all PHICH mapping units have been assigned.

The PHICH duration is configurable by higher layers according to Table 6.9.3-1. The duration configured puts a lower limit on the size of the control region signalled by the PCFICH.

Table 6.9.3-1: PHICH duration in MBSFN and non-MBSFN subframes.

| PHICH duration | Non-MBSFN subframes | | MBSFN subframes |
|-----------------|---|-----------------|---|
| | Subframes 1 and 6 in case of frame structure type 2 | All other cases | On a carrier supporting both PDSCH and PMCH |
| Normal | 1 | 1 | 1 |
| Extended | 2 | 3 | 2 |

6.10 Reference signals

Three types of downlink reference signals are defined:

- Cell-specific reference signals, associated with non-MBSFN transmission
- MBSFN reference signals, associated with MBSFN transmission
- UE-specific reference signals

There is one reference signal transmitted per downlink antenna port.

6.10.1 Cell-specific reference signals

Cell-specific reference signals shall be transmitted in all downlink subframes in a cell supporting non-MBSFN transmission. In case the subframe is used for transmission with MBSFN, only the first two OFDM symbols in a subframe can be used for transmission of cell-specific reference symbols.

Cell-specific reference signals are transmitted on one or several of antenna ports 0 to 3.

Cell-specific reference signals are defined for $\Delta f = 15$ kHz only.

6.10.1.1 Sequence generation

The reference-signal sequence $r_{l,n_s}(m)$ is defined by

$$r_{l,n_s}(m) = \frac{1}{\sqrt{2}}(1 - 2 \cdot c(2m)) + j \frac{1}{\sqrt{2}}(1 - 2 \cdot c(2m+1)), \quad m = 0, 1, \dots, 2N_{RB}^{\max, DL} - 1$$

where n_s is the slot number within a radio frame and l is the OFDM symbol number within the slot. The pseudo-random sequence $c(i)$ is defined in Section 7.2. The pseudo-random sequence generator shall be initialised with $c_{\text{init}} = 2^{10} \cdot (7 \cdot (n_s + 1) + l + 1) \cdot (2 \cdot N_{ID}^{\text{cell}} + 1) + 2 \cdot N_{ID}^{\text{cell}} + N_{CP}$ at the start of each OFDM symbol where

$$N_{CP} = \begin{cases} 1 & \text{for normal CP} \\ 0 & \text{for extended CP} \end{cases}$$

6.10.1.2 Mapping to resource elements

The reference signal sequence $r_{l,n_s}(m)$ shall be mapped to complex-valued modulation symbols $a_{k,l}^{(p)}$ used as reference symbols for antenna port p in slot n_s according to

$$a_{k,l}^{(p)} = r_{l,n_s}(m')$$

where

$$\begin{aligned} k &= 6m + (v + v_{\text{shift}}) \bmod 6 \\ l &= \begin{cases} 0, N_{\text{syml}}^{\text{DL}} - 3 & \text{if } p \in \{0,1\} \\ 1 & \text{if } p \in \{2,3\} \end{cases} \\ m &= 0, 1, \dots, 2 \cdot N_{\text{RB}}^{\text{DL}} - 1 \\ m' &= m + N_{\text{RB}}^{\text{max,DL}} - N_{\text{RB}}^{\text{DL}} \end{aligned}$$

The variables v and v_{shift} define the position in the frequency domain for the different reference signals where v is given by

$$v = \begin{cases} 0 & \text{if } p = 0 \text{ and } l = 0 \\ 3 & \text{if } p = 0 \text{ and } l \neq 0 \\ 3 & \text{if } p = 1 \text{ and } l = 0 \\ 0 & \text{if } p = 1 \text{ and } l \neq 0 \\ 3(n_s \bmod 2) & \text{if } p = 2 \\ 3 + 3(n_s \bmod 2) & \text{if } p = 3 \end{cases}$$

The cell-specific frequency shift is given by $v_{\text{shift}} = N_{\text{ID}}^{\text{cell}} \bmod 6$.

Resource elements (k, l) used for reference signal transmission on any of the antenna ports in a slot shall not be used for any transmission on any other antenna port in the same slot and set to zero.

Figures 6.10.1.2-1 and 6.10.1.2-2 illustrate the resource elements used for reference signal transmission according to the above definition. The notation R_p is used to denote a resource element used for reference signal transmission on antenna port p .

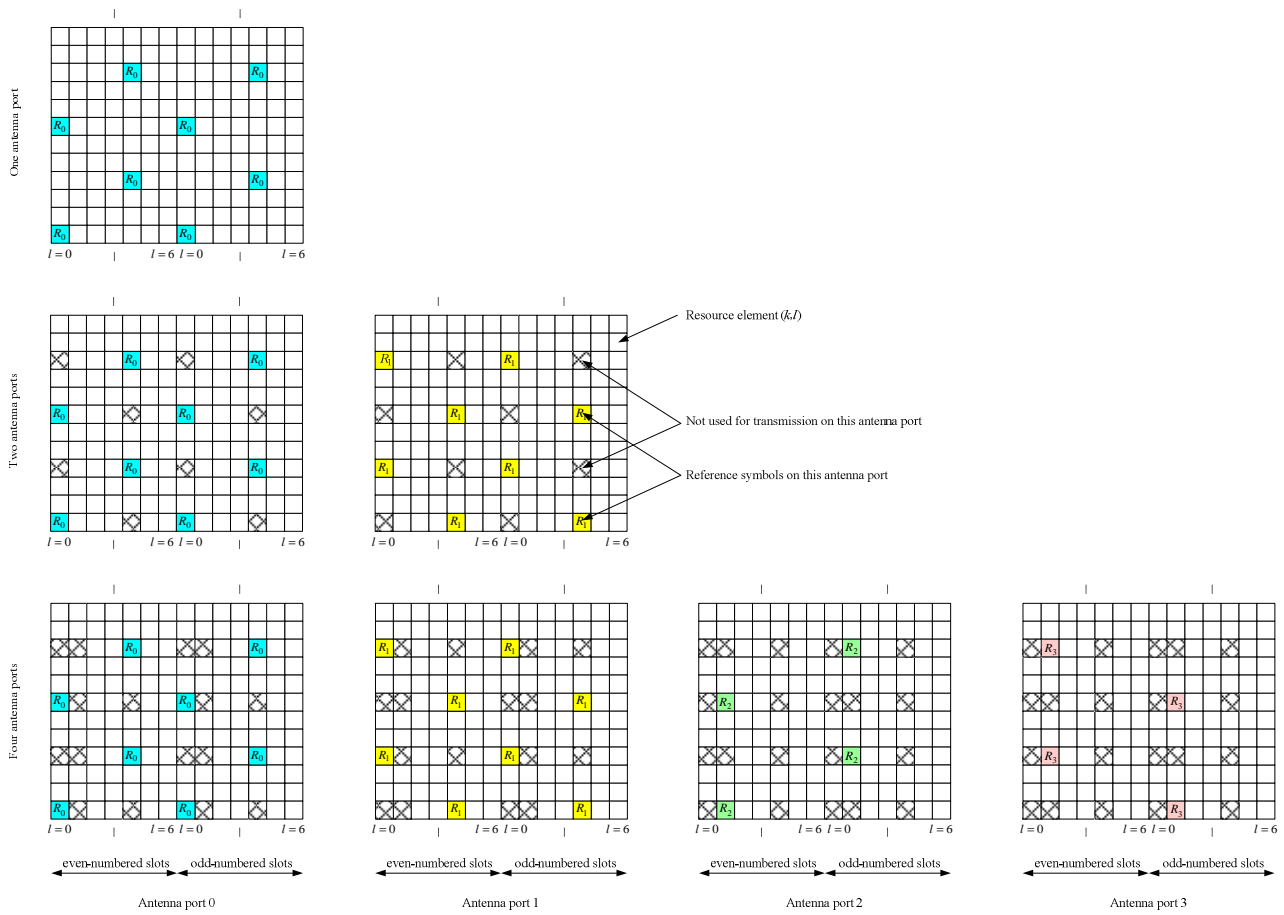

Figure 6.10.1.2-1. Mapping of downlink reference signals (normal cyclic prefix).

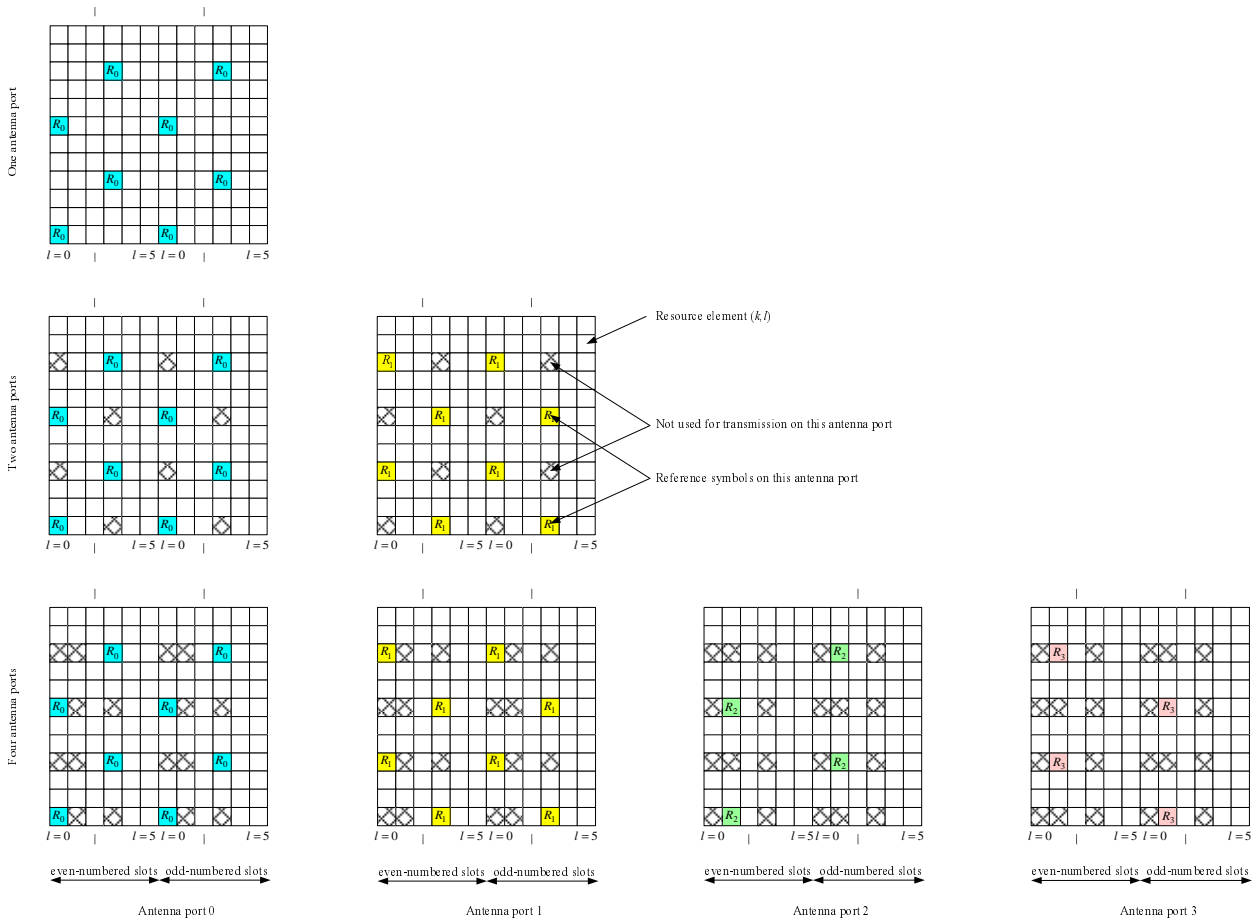

Figure 6.10.1.2-2. Mapping of downlink reference signals (extended cyclic prefix).

6.10.2 MBSFN reference signals

MBSFN reference signals shall only be transmitted in subframes allocated for MBSFN transmissions. MBSFN reference signals are transmitted on antenna port 4.

MBSFN reference signals are defined for extended cyclic prefix only.

6.10.2.1 Sequence generation

The MBSFN reference-signal sequence $r_{l,n_s}(m)$ is defined by

$$r_{l,n_s}(m) = \frac{1}{\sqrt{2}}(1 - 2 \cdot c(2m)) + j \frac{1}{\sqrt{2}}(1 - 2 \cdot c(2m + 1)), \quad m = 0, 1, \dots, 6N_{RB}^{\max, DL} - 1$$

where n_s is the slot number within a radio frame and l is the OFDM symbol number within the slot. The pseudo-random sequence $c(i)$ is defined in Section 7.2. The pseudo-random sequence generator shall be initialised with $c_{init} = 2^9 \cdot (7 \cdot (n_s + 1) + l + 1) \cdot (2 \cdot N_{ID}^{MBSFN} + 1) + N_{ID}^{MBSFN}$ at the start of each OFDM symbol.

6.10.2.2 Mapping to resource elements

The reference-signal sequence $r_{l,n_s}(m')$ in OFDM symbol l shall be mapped to complex-valued modulation symbols $a_{k,l}^{(p)}$ with $p = 4$ according to

$$a_{k,l}^{(p)} = r_{l,n_s}(m')$$

where

$$k = \begin{cases} 2m & \text{if } l \neq 0 \text{ and } \Delta f = 15 \text{ kHz} \\ 2m + 1 & \text{if } l = 0 \text{ and } \Delta f = 15 \text{ kHz} \\ 4m & \text{if } l \neq 0 \text{ and } \Delta f = 7.5 \text{ kHz} \\ 4m + 2 & \text{if } l = 0 \text{ and } \Delta f = 7.5 \text{ kHz} \end{cases}$$

$$l = \begin{cases} 2 & \text{if } n_s \bmod 2 = 0 \text{ and } \Delta f = 15 \text{ kHz} \\ 0,4 & \text{if } n_s \bmod 2 = 1 \text{ and } \Delta f = 15 \text{ kHz} \\ 1 & \text{if } n_s \bmod 2 = 0 \text{ and } \Delta f = 7.5 \text{ kHz} \\ 0,2 & \text{if } n_s \bmod 2 = 1 \text{ and } \Delta f = 7.5 \text{ kHz} \end{cases}$$

$$m = 0, 1, \dots, 6N_{RB}^{DL} - 1$$

$$m' = m + 3(N_{RB}^{max,DL} - N_{RB}^{DL})$$

Figure 6.10.2.2-1 illustrates the resource elements used for MBSFN reference signal transmission in case of $\Delta f = 15 \text{ kHz}$. In case of $\Delta f = 7.5 \text{ kHz}$ for a MBSFN-dedicated cell, the MBSFN reference signal shall be mapped to resource elements according to Figure 6.10.2.2-3. The notation R_p is used to denote a resource element used for reference signal transmission on antenna port p .

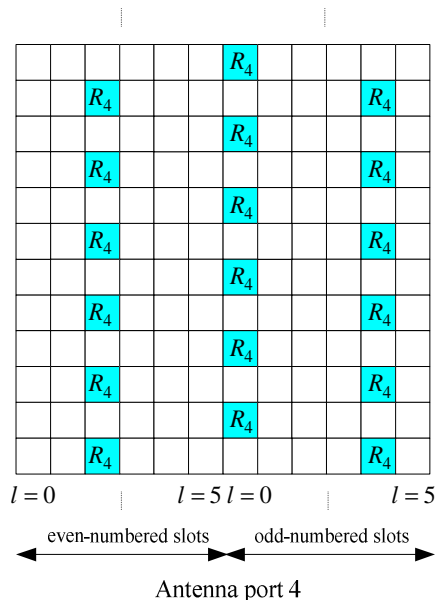

Figure 6.10.2.2-1: Mapping of MBSFN reference signals (extended cyclic prefix, $\Delta f = 15 \text{ kHz}$)

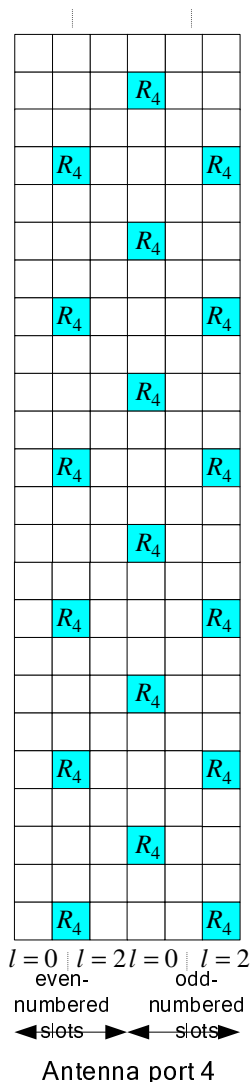

Figure 6.10.2.2-3: Mapping of MBSFN reference signals (extended cyclic prefix, $\Delta f = 7.5$ kHz)

6.10.3 UE-specific reference signals

UE-specific reference signals are supported for single-antenna-port transmission of PDSCH and are transmitted on antenna port 5. The UE is informed by higher layers whether the UE-specific reference signal is present and is a valid phase reference for PDSCH demodulation or not. UE-specific reference signals are transmitted only on the resource blocks upon which the corresponding PDSCH is mapped.

6.10.3.1 Sequence generation

The UE-specific reference-signal sequence $r(m)$ is defined by

$$r(m) = \frac{1}{\sqrt{2}}(1 - 2 \cdot c(2m)) + j \frac{1}{\sqrt{2}}(1 - 2 \cdot c(2m+1)), \quad m = 0, 1, \dots, 12N_{RB}^{PDSCH} - 1$$

where N_{RB}^{PDSCH} denotes the bandwidth in resource blocks of the corresponding PDSCH transmission. The pseudo-random sequence $c(i)$ is defined in Section 7.2. The pseudo-random sequence generator shall be initialised with $c_{init} = (\lfloor n_s/2 \rfloor + 1) \cdot (2N_{ID}^{cell} + 1) \cdot 2^{16} + n_{RNTI}$ at the start of each subframe.

6.10.3.2 Mapping to resource elements

In a physical resource block with frequency-domain index n_{PRB} assigned for the corresponding PDSCH transmission, the reference signal sequence $r(m)$ shall be mapped to complex-valued modulation symbols $a_{k,l}^{(p)}$ with $p = 5$ in a subframe according to:

Normal cyclic prefix:

$$a_{k,l}^{(p)} = r(3 \cdot l' \cdot N_{\text{RB}}^{\text{PDSCH}} + m')$$

$$k = (k') \bmod N_{\text{sc}}^{\text{RB}} + N_{\text{sc}}^{\text{RB}} \cdot n_{\text{PRB}}$$

$$k' = \begin{cases} 4m' + v_{\text{shift}} & \text{if } l \in \{2,3\} \\ 4m' + (2 + v_{\text{shift}}) \bmod 4 & \text{if } l \in \{5,6\} \end{cases}$$

$$l = \begin{cases} 3 & l' = 0 \\ 6 & l' = 1 \\ 2 & l' = 2 \\ 5 & l' = 3 \end{cases}$$

$$l' = \begin{cases} 0,1 & \text{if } n_s \bmod 2 = 0 \\ 2,3 & \text{if } n_s \bmod 2 = 1 \end{cases}$$

$$m' = 0, 1, \dots, 3N_{\text{RB}}^{\text{PDSCH}} - 1$$

Extended cyclic prefix:

$$a_{k,l}^{(p)} = r(4 \cdot l' \cdot N_{\text{RB}}^{\text{PDSCH}} + m')$$

$$k = (k') \bmod N_{\text{sc}}^{\text{RB}} + N_{\text{sc}}^{\text{RB}} \cdot n_{\text{PRB}}$$

$$k' = \begin{cases} 3m' + v_{\text{shift}} & \text{if } l = 4 \\ 3m' + (2 + v_{\text{shift}}) \bmod 3 & \text{if } l = 1 \end{cases}$$

$$l = \begin{cases} 4 & l' \in \{0,2\} \\ 1 & l' = 1 \end{cases}$$

$$l' = \begin{cases} 0 & \text{if } n_s \bmod 2 = 0 \\ 1,2 & \text{if } n_s \bmod 2 = 1 \end{cases}$$

$$m' = 0, 1, \dots, 4N_{\text{RB}}^{\text{PDSCH}} - 1$$

where m' is the counter of UE-specific reference signal resource elements within a respective OFDM symbol of the PDSCH transmission.

The cell-specific frequency shift is given by $v_{\text{shift}} = N_{\text{ID}}^{\text{cell}} \bmod 3$.

The mapping shall be in increasing order of the frequency-domain index n_{PRB} of the physical resource blocks assigned for the corresponding PDSCH transmission. The quantity $N_{\text{RB}}^{\text{PDSCH}}$ denotes the bandwidth in resource blocks of the corresponding PDSCH transmission.

Figure 6.10.3.2-1 illustrates the resource elements used for UE-specific reference signals for normal cyclic prefix.

Figure 6.10.3.2-2 illustrates the resource elements used for UE-specific reference signals for extended cyclic prefix.

The notation R_p is used to denote a resource element used for reference signal transmission on antenna port p .

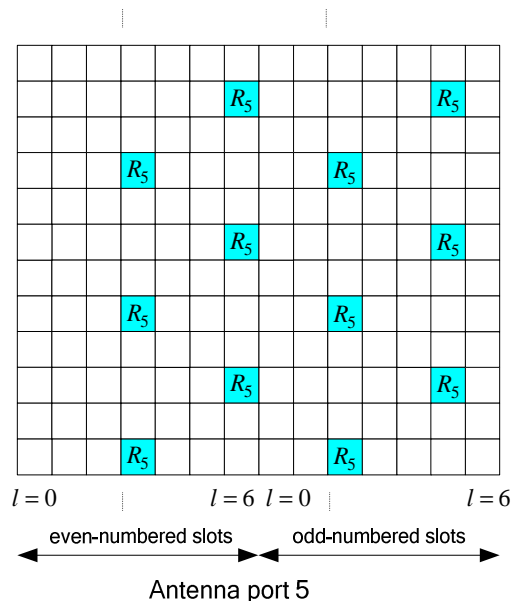

Figure 6.10.3.2-1: Mapping of UE-specific reference signals (normal cyclic prefix)

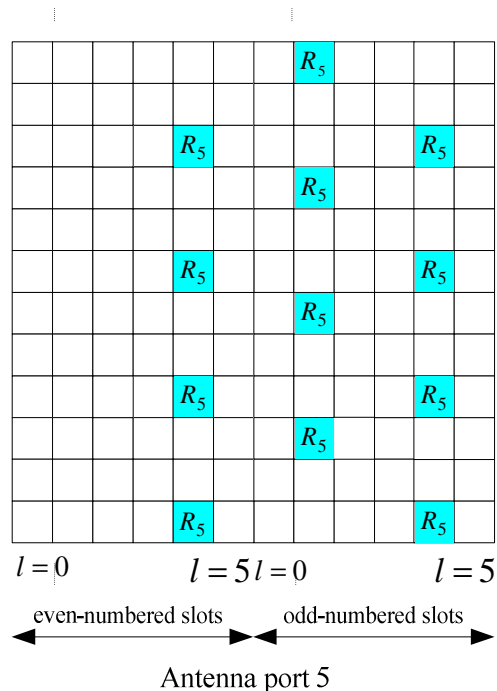

Figure 6.10.3.2-2: Mapping of UE-specific reference signals (extended cyclic prefix)

6.11 Synchronization signals

There are 504 unique physical-layer cell identities. The physical-layer cell identities are grouped into 168 unique physical-layer cell-identity groups, each group containing three unique identities. The grouping is such that each physical-layer cell identity is part of one and only one physical-layer cell-identity group. A physical-layer cell identity $N_{ID}^{cell} = 3N_{ID}^{(1)} + N_{ID}^{(2)}$ is thus uniquely defined by a number $N_{ID}^{(1)}$ in the range of 0 to 167, representing the physical-layer cell-identity group, and a number $N_{ID}^{(2)}$ in the range of 0 to 2, representing the physical-layer identity within the physical-layer cell-identity group.

6.11.1 Primary synchronization signal

6.11.1.1 Sequence generation

The sequence $d(n)$ used for the primary synchronization signal is generated from a frequency-domain Zadoff-Chu sequence according to

$$d_u(n) = \begin{cases} e^{-j\frac{\pi n(n+1)}{63}} & n = 0,1,\dots,30 \\ e^{-j\frac{\pi n(n+1)(n+2)}{63}} & n = 31,32,\dots,61 \end{cases}$$

where the Zadoff-Chu root sequence index u is given by Table 6.11.1.1-1.

Table 6.11.1.1-1: Root indices for the primary synchronization signal.

| $N_{\text{ID}}^{(2)}$ | Root index u |
|-----------------------|----------------|
| 0 | 25 |
| 1 | 29 |
| 2 | 34 |

6.11.1.2 Mapping to resource elements

The mapping of the sequence to resource elements depends on the frame structure. The UE shall not assume that the primary synchronization signal is transmitted on the same antenna port as any of the downlink reference signals. The UE shall not assume that any transmission instance of the primary synchronization signal is transmitted on the same antenna port, or ports, used for any other transmission instance of the primary synchronization signal.

The sequence $d(n)$ shall be mapped to the resource elements according to

$$a_{k,l} = d(n), \quad n = 0,\dots,61$$

$$k = n - 31 + \frac{N_{\text{RB}}^{\text{DL}} N_{\text{sc}}^{\text{RB}}}{2}$$

For frame structure type 1, the primary synchronization signal shall be mapped to the last OFDM symbol in slots 0 and 10.

For frame structure type 2, the primary synchronization signal shall be mapped to the third OFDM symbol in subframes 1 and 6. Resource elements (k, l) in the OFDM symbols used for transmission of the primary synchronization signal where

$$k = n - 31 + \frac{N_{\text{RB}}^{\text{DL}} N_{\text{sc}}^{\text{RB}}}{2}$$

$$n = -5, -4, \dots, -1, 62, 63, \dots, 66$$

are reserved and not used for transmission of the primary synchronization signal.

6.11.2 Secondary synchronization signal

6.11.2.1 Sequence generation

The sequence $d(0), \dots, d(61)$ used for the second synchronization signal is an interleaved concatenation of two length-31 binary sequences. The concatenated sequence is scrambled with a scrambling sequence given by the primary synchronization signal.

The combination of two length-31 sequences defining the secondary synchronization signal differs between subframe 0 and subframe 5 according to

$$d(2n) = \begin{cases} s_0^{(m_0)}(n)c_0(n) & \text{in subframe 0} \\ s_1^{(m_1)}(n)c_0(n) & \text{in subframe 5} \end{cases}$$

$$d(2n+1) = \begin{cases} s_1^{(m_1)}(n)c_1(n)z_1^{(m_0)}(n) & \text{in subframe 0} \\ s_0^{(m_0)}(n)c_1(n)z_1^{(m_1)}(n) & \text{in subframe 5} \end{cases}$$

where $0 \leq n \leq 30$. The indices m_0 and m_1 are derived from the physical-layer cell-identity group $N_{\text{ID}}^{(1)}$ according to

$$m_0 = m' \bmod 31$$

$$m_1 = (m_0 + \lfloor m'/31 \rfloor + 1) \bmod 31$$

$$m' = N_{\text{ID}}^{(1)} + q(q+1)/2, \quad q = \left\lfloor \frac{N_{\text{ID}}^{(1)} + q'(q'+1)/2}{30} \right\rfloor, \quad q' = \lfloor N_{\text{ID}}^{(1)}/30 \rfloor$$

where the output of the above expression is listed in Table 6.11.2.1-1.

The two sequences $s_0^{(m_0)}(n)$ and $s_1^{(m_1)}(n)$ are defined as two different cyclic shifts of the m-sequence $\tilde{s}(n)$ according to

$$s_0^{(m_0)}(n) = \tilde{s}((n + m_0) \bmod 31)$$

$$s_1^{(m_1)}(n) = \tilde{s}((n + m_1) \bmod 31)$$

where $\tilde{s}(i) = 1 - 2x(i)$, $0 \leq i \leq 30$, is defined by

$$x(\bar{i} + 5) = (x(\bar{i} + 2) + x(\bar{i})) \bmod 2, \quad 0 \leq \bar{i} \leq 25$$

with initial conditions $x(0) = 0$, $x(1) = 0$, $x(2) = 0$, $x(3) = 0$, $x(4) = 1$.

The two scrambling sequences $c_0(n)$ and $c_1(n)$ depend on the primary synchronization signal and are defined by two different cyclic shifts of the m-sequence $\tilde{c}(n)$ according to

$$c_0(n) = \tilde{c}((n + N_{\text{ID}}^{(2)}) \bmod 31)$$

$$c_1(n) = \tilde{c}((n + N_{\text{ID}}^{(2)} + 3) \bmod 31)$$

where $N_{\text{ID}}^{(2)} \in \{0,1,2\}$ is the physical-layer identity within the physical-layer cell identity group $N_{\text{ID}}^{(1)}$ and $\tilde{c}(i) = 1 - 2x(i)$, $0 \leq i \leq 30$, is defined by

$$x(\bar{i} + 5) = (x(\bar{i} + 3) + x(\bar{i})) \bmod 2, \quad 0 \leq \bar{i} \leq 25$$

with initial conditions $x(0) = 0$, $x(1) = 0$, $x(2) = 0$, $x(3) = 0$, $x(4) = 1$.

The scrambling sequences $z_1^{(m_0)}(n)$ and $z_1^{(m_1)}(n)$ are defined by a cyclic shift of the m-sequence $\tilde{z}(n)$ according to

$$z_1^{(m_0)}(n) = \tilde{z}((n + (m_0 \bmod 8)) \bmod 31)$$

$$z_1^{(m_1)}(n) = \tilde{z}((n + (m_1 \bmod 8)) \bmod 31)$$

where m_0 and m_1 are obtained from Table 6.11.2.1-1 and $\tilde{z}(i) = 1 - 2x(i)$, $0 \leq i \leq 30$, is defined by

$$x(\bar{i} + 5) = (x(\bar{i} + 4) + x(\bar{i} + 2) + x(\bar{i} + 1) + x(\bar{i})) \bmod 2, \quad 0 \leq \bar{i} \leq 25$$

with initial conditions $x(0) = 0, \quad x(1) = 0, \quad x(2) = 0, \quad x(3) = 0, \quad x(4) = 1.$

Table 6.11.2.1-1: Mapping between physical-layer cell-identity group $N_{ID}^{(1)}$ and the indices m_0 and m_1 .

| $N_{ID}^{(1)}$ | m_0 | m_1 | $N_{ID}^{(1)}$ | m_0 | m_1 | $N_{ID}^{(1)}$ | m_0 | m_1 | $N_{ID}^{(1)}$ | m_0 | m_1 | $N_{ID}^{(1)}$ | m_0 | m_1 |
|----------------|-------|-------|----------------|-------|-------|----------------|-------|-------|----------------|-------|-------|----------------|-------|-------|
| 0 | 0 | 1 | 34 | 4 | 6 | 68 | 9 | 12 | 102 | 15 | 19 | 136 | 22 | 27 |
| 1 | 1 | 2 | 35 | 5 | 7 | 69 | 10 | 13 | 103 | 16 | 20 | 137 | 23 | 28 |
| 2 | 2 | 3 | 36 | 6 | 8 | 70 | 11 | 14 | 104 | 17 | 21 | 138 | 24 | 29 |
| 3 | 3 | 4 | 37 | 7 | 9 | 71 | 12 | 15 | 105 | 18 | 22 | 139 | 25 | 30 |
| 4 | 4 | 5 | 38 | 8 | 10 | 72 | 13 | 16 | 106 | 19 | 23 | 140 | 0 | 6 |
| 5 | 5 | 6 | 39 | 9 | 11 | 73 | 14 | 17 | 107 | 20 | 24 | 141 | 1 | 7 |
| 6 | 6 | 7 | 40 | 10 | 12 | 74 | 15 | 18 | 108 | 21 | 25 | 142 | 2 | 8 |
| 7 | 7 | 8 | 41 | 11 | 13 | 75 | 16 | 19 | 109 | 22 | 26 | 143 | 3 | 9 |
| 8 | 8 | 9 | 42 | 12 | 14 | 76 | 17 | 20 | 110 | 23 | 27 | 144 | 4 | 10 |
| 9 | 9 | 10 | 43 | 13 | 15 | 77 | 18 | 21 | 111 | 24 | 28 | 145 | 5 | 11 |
| 10 | 10 | 11 | 44 | 14 | 16 | 78 | 19 | 22 | 112 | 25 | 29 | 146 | 6 | 12 |
| 11 | 11 | 12 | 45 | 15 | 17 | 79 | 20 | 23 | 113 | 26 | 30 | 147 | 7 | 13 |
| 12 | 12 | 13 | 46 | 16 | 18 | 80 | 21 | 24 | 114 | 0 | 5 | 148 | 8 | 14 |
| 13 | 13 | 14 | 47 | 17 | 19 | 81 | 22 | 25 | 115 | 1 | 6 | 149 | 9 | 15 |
| 14 | 14 | 15 | 48 | 18 | 20 | 82 | 23 | 26 | 116 | 2 | 7 | 150 | 10 | 16 |
| 15 | 15 | 16 | 49 | 19 | 21 | 83 | 24 | 27 | 117 | 3 | 8 | 151 | 11 | 17 |
| 16 | 16 | 17 | 50 | 20 | 22 | 84 | 25 | 28 | 118 | 4 | 9 | 152 | 12 | 18 |
| 17 | 17 | 18 | 51 | 21 | 23 | 85 | 26 | 29 | 119 | 5 | 10 | 153 | 13 | 19 |
| 18 | 18 | 19 | 52 | 22 | 24 | 86 | 27 | 30 | 120 | 6 | 11 | 154 | 14 | 20 |
| 19 | 19 | 20 | 53 | 23 | 25 | 87 | 0 | 4 | 121 | 7 | 12 | 155 | 15 | 21 |
| 20 | 20 | 21 | 54 | 24 | 26 | 88 | 1 | 5 | 122 | 8 | 13 | 156 | 16 | 22 |
| 21 | 21 | 22 | 55 | 25 | 27 | 89 | 2 | 6 | 123 | 9 | 14 | 157 | 17 | 23 |
| 22 | 22 | 23 | 56 | 26 | 28 | 90 | 3 | 7 | 124 | 10 | 15 | 158 | 18 | 24 |
| 23 | 23 | 24 | 57 | 27 | 29 | 91 | 4 | 8 | 125 | 11 | 16 | 159 | 19 | 25 |
| 24 | 24 | 25 | 58 | 28 | 30 | 92 | 5 | 9 | 126 | 12 | 17 | 160 | 20 | 26 |
| 25 | 25 | 26 | 59 | 0 | 3 | 93 | 6 | 10 | 127 | 13 | 18 | 161 | 21 | 27 |
| 26 | 26 | 27 | 60 | 1 | 4 | 94 | 7 | 11 | 128 | 14 | 19 | 162 | 22 | 28 |
| 27 | 27 | 28 | 61 | 2 | 5 | 95 | 8 | 12 | 129 | 15 | 20 | 163 | 23 | 29 |
| 28 | 28 | 29 | 62 | 3 | 6 | 96 | 9 | 13 | 130 | 16 | 21 | 164 | 24 | 30 |
| 29 | 29 | 30 | 63 | 4 | 7 | 97 | 10 | 14 | 131 | 17 | 22 | 165 | 0 | 7 |
| 30 | 0 | 2 | 64 | 5 | 8 | 98 | 11 | 15 | 132 | 18 | 23 | 166 | 1 | 8 |
| 31 | 1 | 3 | 65 | 6 | 9 | 99 | 12 | 16 | 133 | 19 | 24 | 167 | 2 | 9 |
| 32 | 2 | 4 | 66 | 7 | 10 | 100 | 13 | 17 | 134 | 20 | 25 | - | - | - |
| 33 | 3 | 5 | 67 | 8 | 11 | 101 | 14 | 18 | 135 | 21 | 26 | - | - | - |

6.11.2.2 Mapping to resource elements

The mapping of the sequence to resource elements depends on the frame structure. In a subframe for frame structure type 1 and in a half-frame for frame structure type 2, the same antenna port as for the primary synchronization signal shall be used for the secondary synchronization signal.

The sequence $d(n)$ shall be mapped to resource elements according to

$$\begin{aligned}
 a_{k,l} &= d(n), \quad n = 0, \dots, 61 \\
 k &= n - 31 + \frac{N_{\text{RB}}^{\text{DL}} N_{\text{sc}}^{\text{RB}}}{2} \\
 l &= \begin{cases} N_{\text{symp}}^{\text{DL}} - 2 & \text{in slots 0 and 10} & \text{for frame structure type 1} \\ N_{\text{symp}}^{\text{DL}} - 1 & \text{in slots 1 and 11} & \text{for frame structure type 2} \end{cases}
 \end{aligned}$$

Resource elements (k, l) where

$$\begin{aligned}
 k &= n - 31 + \frac{N_{\text{RB}}^{\text{DL}} N_{\text{sc}}^{\text{RB}}}{2} \\
 l &= \begin{cases} N_{\text{symp}}^{\text{DL}} - 2 & \text{in slots 0 and 10} & \text{for frame structure type 1} \\ N_{\text{symp}}^{\text{DL}} - 1 & \text{in slots 1 and 11} & \text{for frame structure type 2} \end{cases} \\
 n &= -5, -4, \dots, -1, 62, 63, \dots, 66
 \end{aligned}$$

are reserved and not used for transmission of the secondary synchronization signal.

6.12 OFDM baseband signal generation

The time-continuous signal $s_l^{(p)}(t)$ on antenna port p in OFDM symbol l in a downlink slot is defined by

$$s_l^{(p)}(t) = \sum_{k=-\lfloor N_{\text{RB}}^{\text{DL}} N_{\text{sc}}^{\text{RB}} / 2 \rfloor}^{-1} a_{k^{(-)}, l}^{(p)} \cdot e^{j2\pi k \Delta f (t - N_{\text{CP}, l} T_s)} + \sum_{k=1}^{\lfloor N_{\text{RB}}^{\text{DL}} N_{\text{sc}}^{\text{RB}} / 2 \rfloor} a_{k^{(+)}, l}^{(p)} \cdot e^{j2\pi k \Delta f (t - N_{\text{CP}, l} T_s)}$$

for $0 \leq t < (N_{\text{CP}, l} + N) \times T_s$ where $k^{(-)} = k + \lfloor N_{\text{RB}}^{\text{DL}} N_{\text{sc}}^{\text{RB}} / 2 \rfloor$ and $k^{(+)} = k + \lfloor N_{\text{RB}}^{\text{DL}} N_{\text{sc}}^{\text{RB}} / 2 \rfloor - 1$. The variable N equals 2048 for $\Delta f = 15$ kHz subcarrier spacing and 4096 for $\Delta f = 7.5$ kHz subcarrier spacing.

The OFDM symbols in a slot shall be transmitted in increasing order of l , starting with $l = 0$, where OFDM symbol $l > 0$ starts at time $\sum_{l'=0}^{l-1} (N_{\text{CP}, l'} + N) T_s$ within the slot. In case the first OFDM symbol(s) in a slot use normal cyclic prefix and the remaining OFDM symbols use extended cyclic prefix, the starting position the OFDM symbols with extended cyclic prefix shall be identical to those in a slot where all OFDM symbols use extended cyclic prefix. Thus there will be a part of the time slot between the two cyclic prefix regions where the transmitted signal is not specified.

Table 6.12-1 lists the value of $N_{\text{CP}, l}$ that shall be used. Note that different OFDM symbols within a slot in some cases have different cyclic prefix lengths.

Table 6.12-1: OFDM parameters.

| Configuration | Cyclic prefix length $N_{CP,l}$ |
|-------------------------------|---------------------------------|
| Normal cyclic prefix | 160 for $l = 0$ |
| | 144 for $l = 1, 2, \dots, 6$ |
| Extended cyclic prefix | 512 for $l = 0, 1, \dots, 5$ |
| | 1024 for $l = 0, 1, 2$ |

6.13 Modulation and upconversion

Modulation and upconversion to the carrier frequency of the complex-valued OFDM baseband signal for each antenna port is shown in Figure 6.13-1. The filtering required prior to transmission is defined by the requirements in [6].

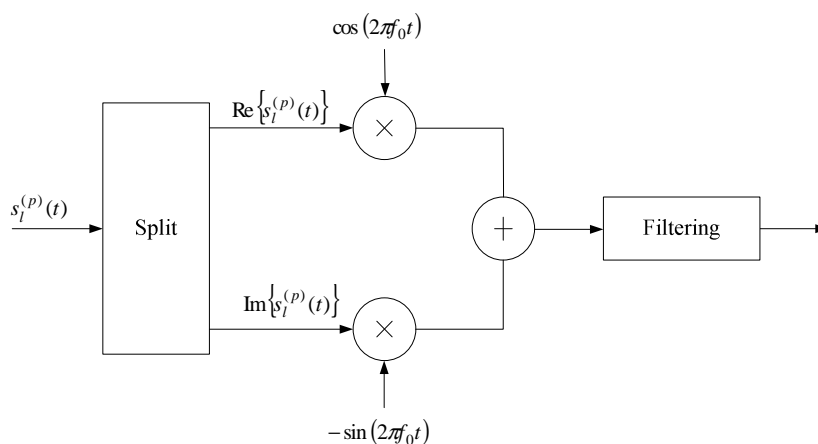

Figure 6.13-1: Downlink modulation.

7 Generic functions

7.1 Modulation mapper

The modulation mapper takes binary digits, 0 or 1, as input and produces complex-valued modulation symbols, $x=I+jQ$, as output.

7.1.1 BPSK

In case of BPSK modulation, a single bit $b(i)$, is mapped to a complex-valued modulation symbol $x=I+jQ$ according to Table 7.1.1-1.

Table 7.1.1-1: BPSK modulation mapping

| $b(i)$ | I | Q |
|--------|---------------|---------------|
| 0 | $1/\sqrt{2}$ | $1/\sqrt{2}$ |
| 1 | $-1/\sqrt{2}$ | $-1/\sqrt{2}$ |

7.1.2 QPSK

In case of QPSK modulation, pairs of bits, $b(i), b(i+1)$, are mapped to complex-valued modulation symbols $x=I+jQ$ according to Table 7.1.2-1.

Table 7.1.2-1: QPSK modulation mapping

| $b(i), b(i+1)$ | I | Q |
|----------------|---------------|---------------|
| 00 | $1/\sqrt{2}$ | $1/\sqrt{2}$ |
| 01 | $1/\sqrt{2}$ | $-1/\sqrt{2}$ |
| 10 | $-1/\sqrt{2}$ | $1/\sqrt{2}$ |
| 11 | $-1/\sqrt{2}$ | $-1/\sqrt{2}$ |

7.1.3 16QAM

In case of 16QAM modulation, quadruplets of bits, $b(i), b(i+1), b(i+2), b(i+3)$, are mapped to complex-valued modulation symbols $x=I+jQ$ according to Table 7.1.3-1.

Table 7.1.3-1: 16QAM modulation mapping

| $b(i), b(i+1), b(i+2), b(i+3)$ | I | Q |
|--------------------------------|----------------|----------------|
| 0000 | $1/\sqrt{10}$ | $1/\sqrt{10}$ |
| 0001 | $1/\sqrt{10}$ | $3/\sqrt{10}$ |
| 0010 | $3/\sqrt{10}$ | $1/\sqrt{10}$ |
| 0011 | $3/\sqrt{10}$ | $3/\sqrt{10}$ |
| 0100 | $1/\sqrt{10}$ | $-1/\sqrt{10}$ |
| 0101 | $1/\sqrt{10}$ | $-3/\sqrt{10}$ |
| 0110 | $3/\sqrt{10}$ | $-1/\sqrt{10}$ |
| 0111 | $3/\sqrt{10}$ | $-3/\sqrt{10}$ |
| 1000 | $-1/\sqrt{10}$ | $1/\sqrt{10}$ |
| 1001 | $-1/\sqrt{10}$ | $3/\sqrt{10}$ |
| 1010 | $-3/\sqrt{10}$ | $1/\sqrt{10}$ |
| 1011 | $-3/\sqrt{10}$ | $3/\sqrt{10}$ |
| 1100 | $-1/\sqrt{10}$ | $-1/\sqrt{10}$ |
| 1101 | $-1/\sqrt{10}$ | $-3/\sqrt{10}$ |
| 1110 | $-3/\sqrt{10}$ | $-1/\sqrt{10}$ |
| 1111 | $-3/\sqrt{10}$ | $-3/\sqrt{10}$ |

7.1.4 64QAM

In case of 64QAM modulation, hexuplets of bits, $b(i), b(i+1), b(i+2), b(i+3), b(i+4), b(i+5)$, are mapped to complex-valued modulation symbols $x=I+jQ$ according to Table 7.1.4-1.

Table 7.1.4-1: 64QAM modulation mapping

| $b(i), b(i+1), b(i+2), b(i+3), b(i+4), b(i+5)$ | I | Q | $b(i), b(i+1), b(i+2), b(i+3), b(i+4), b(i+5)$ | I | Q |
|--|---------------|----------------|--|----------------|----------------|
| 000000 | $3/\sqrt{42}$ | $3/\sqrt{42}$ | 100000 | $-3/\sqrt{42}$ | $3/\sqrt{42}$ |
| 000001 | $3/\sqrt{42}$ | $1/\sqrt{42}$ | 100001 | $-3/\sqrt{42}$ | $1/\sqrt{42}$ |
| 000010 | $1/\sqrt{42}$ | $3/\sqrt{42}$ | 100010 | $-1/\sqrt{42}$ | $3/\sqrt{42}$ |
| 000011 | $1/\sqrt{42}$ | $1/\sqrt{42}$ | 100011 | $-1/\sqrt{42}$ | $1/\sqrt{42}$ |
| 000100 | $3/\sqrt{42}$ | $5/\sqrt{42}$ | 100100 | $-3/\sqrt{42}$ | $5/\sqrt{42}$ |
| 000101 | $3/\sqrt{42}$ | $7/\sqrt{42}$ | 100101 | $-3/\sqrt{42}$ | $7/\sqrt{42}$ |
| 000110 | $1/\sqrt{42}$ | $5/\sqrt{42}$ | 100110 | $-1/\sqrt{42}$ | $5/\sqrt{42}$ |
| 000111 | $1/\sqrt{42}$ | $7/\sqrt{42}$ | 100111 | $-1/\sqrt{42}$ | $7/\sqrt{42}$ |
| 001000 | $5/\sqrt{42}$ | $3/\sqrt{42}$ | 101000 | $-5/\sqrt{42}$ | $3/\sqrt{42}$ |
| 001001 | $5/\sqrt{42}$ | $1/\sqrt{42}$ | 101001 | $-5/\sqrt{42}$ | $1/\sqrt{42}$ |
| 001010 | $7/\sqrt{42}$ | $3/\sqrt{42}$ | 101010 | $-7/\sqrt{42}$ | $3/\sqrt{42}$ |
| 001011 | $7/\sqrt{42}$ | $1/\sqrt{42}$ | 101011 | $-7/\sqrt{42}$ | $1/\sqrt{42}$ |
| 001100 | $5/\sqrt{42}$ | $5/\sqrt{42}$ | 101100 | $-5/\sqrt{42}$ | $5/\sqrt{42}$ |
| 001101 | $5/\sqrt{42}$ | $7/\sqrt{42}$ | 101101 | $-5/\sqrt{42}$ | $7/\sqrt{42}$ |
| 001110 | $7/\sqrt{42}$ | $5/\sqrt{42}$ | 101110 | $-7/\sqrt{42}$ | $5/\sqrt{42}$ |
| 001111 | $7/\sqrt{42}$ | $7/\sqrt{42}$ | 101111 | $-7/\sqrt{42}$ | $7/\sqrt{42}$ |
| 010000 | $3/\sqrt{42}$ | $-3/\sqrt{42}$ | 110000 | $-3/\sqrt{42}$ | $-3/\sqrt{42}$ |
| 010001 | $3/\sqrt{42}$ | $-1/\sqrt{42}$ | 110001 | $-3/\sqrt{42}$ | $-1/\sqrt{42}$ |
| 010010 | $1/\sqrt{42}$ | $-3/\sqrt{42}$ | 110010 | $-1/\sqrt{42}$ | $-3/\sqrt{42}$ |
| 010011 | $1/\sqrt{42}$ | $-1/\sqrt{42}$ | 110011 | $-1/\sqrt{42}$ | $-1/\sqrt{42}$ |
| 010100 | $3/\sqrt{42}$ | $-5/\sqrt{42}$ | 110100 | $-3/\sqrt{42}$ | $-5/\sqrt{42}$ |
| 010101 | $3/\sqrt{42}$ | $-7/\sqrt{42}$ | 110101 | $-3/\sqrt{42}$ | $-7/\sqrt{42}$ |
| 010110 | $1/\sqrt{42}$ | $-5/\sqrt{42}$ | 110110 | $-1/\sqrt{42}$ | $-5/\sqrt{42}$ |
| 010111 | $1/\sqrt{42}$ | $-7/\sqrt{42}$ | 110111 | $-1/\sqrt{42}$ | $-7/\sqrt{42}$ |
| 011000 | $5/\sqrt{42}$ | $-3/\sqrt{42}$ | 111000 | $-5/\sqrt{42}$ | $-3/\sqrt{42}$ |
| 011001 | $5/\sqrt{42}$ | $-1/\sqrt{42}$ | 111001 | $-5/\sqrt{42}$ | $-1/\sqrt{42}$ |
| 011010 | $7/\sqrt{42}$ | $-3/\sqrt{42}$ | 111010 | $-7/\sqrt{42}$ | $-3/\sqrt{42}$ |
| 011011 | $7/\sqrt{42}$ | $-1/\sqrt{42}$ | 111011 | $-7/\sqrt{42}$ | $-1/\sqrt{42}$ |
| 011100 | $5/\sqrt{42}$ | $-5/\sqrt{42}$ | 111100 | $-5/\sqrt{42}$ | $-5/\sqrt{42}$ |
| 011101 | $5/\sqrt{42}$ | $-7/\sqrt{42}$ | 111101 | $-5/\sqrt{42}$ | $-7/\sqrt{42}$ |
| 011110 | $7/\sqrt{42}$ | $-5/\sqrt{42}$ | 111110 | $-7/\sqrt{42}$ | $-5/\sqrt{42}$ |
| 011111 | $7/\sqrt{42}$ | $-7/\sqrt{42}$ | 111111 | $-7/\sqrt{42}$ | $-7/\sqrt{42}$ |

7.2 Pseudo-random sequence generation

Pseudo-random sequences are defined by a length-31 Gold sequence. The output sequence $c(n)$ of length M_{PN} , where $n = 0, 1, \dots, M_{PN} - 1$, is defined by

$$\begin{aligned}
 c(n) &= (x_1(n + N_C) + x_2(n + N_C)) \bmod 2 \\
 x_1(n + 31) &= (x_1(n + 3) + x_1(n)) \bmod 2 \\
 x_2(n + 31) &= (x_2(n + 3) + x_2(n + 2) + x_2(n + 1) + x_2(n)) \bmod 2
 \end{aligned}$$

where $N_C = 1600$ and the first m-sequence shall be initialized with $x_1(0) = 1, x_1(n) = 0, n = 1, 2, \dots, 30$. The initialization of the second m-sequence is denoted by $c_{init} = \sum_{i=0}^{30} x_2(i) \cdot 2^i$ with the value depending on the application of the sequence.

8 Timing

8.1 Uplink-downlink frame timing

Transmission of the uplink radio frame number i from the UE shall start $(N_{TA} + N_{TA\ offset}) \times T_s$ seconds before the start of the corresponding downlink radio frame at the UE, where $0 \leq N_{TA} \leq 20512$, $N_{TA\ offset} = 0$ for frame structure type 1 and $\lceil N_{TA\ offset} \rceil = 614$ for frame structure type 2. Note that not all slots in a radio frame may be transmitted. One example hereof is TDD, where only a subset of the slots in a radio frame is transmitted.

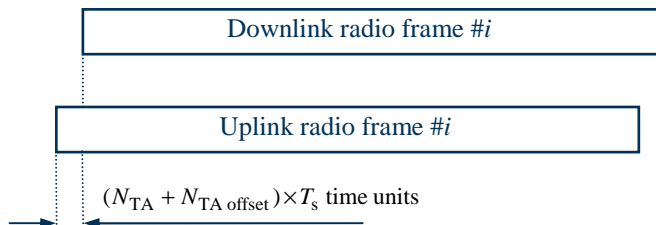

Figure 8.1-1: Uplink-downlink timing relation

Annex A (informative): Change history

| Change history | | | | | | | |
|----------------|--------|-----------|------|-----|---|-------|-------|
| Date | TSG # | TSG Doc. | CR | Rev | Subject/Comment | Old | New |
| 2006-09-24 | - | - | - | - | Draft version created | - | 0.0.0 |
| 2006-10-09 | - | - | - | - | Updated skeleton | 0.0.0 | 0.0.1 |
| 2006-10-13 | - | - | - | - | Endorsed by RAN1 | 0.0.1 | 0.1.0 |
| 2006-10-23 | - | - | - | - | Inclusion of decision from RAN1#46bis | 0.1.0 | 0.1.1 |
| 2006-11-06 | - | - | - | - | Updated editor's version | 0.1.1 | 0.1.2 |
| 2006-11-09 | - | - | - | - | Updated editor's version | 0.1.2 | 0.1.3 |
| 2006-11-10 | - | - | - | - | Endorsed by RAN1#47 | 0.1.3 | 0.2.0 |
| 2006-11-27 | - | - | - | - | Editor's version, including decisions from RAN1#47 | 0.2.0 | 0.2.1 |
| 2006-12-14 | - | - | - | - | Updated editor's version | 0.2.1 | 0.2.2 |
| 2007-01-15 | - | - | - | - | Updated editor's version | 0.2.2 | 0.2.3 |
| 2007-01-19 | - | - | - | - | Endorsed by RAN1#47bis | 0.2.3 | 0.3.0 |
| 2007-02-01 | - | - | - | - | Editor's version, including decisions from RAN1#47bis | 0.3.0 | 0.3.1 |
| 2007-02-12 | - | - | - | - | Updated editor's version | 0.3.1 | 0.3.2 |
| 2007-02-16 | - | - | - | - | Endorsed by RAN1#48 | 0.3.2 | 0.4.0 |
| 2007-02-16 | - | - | - | - | Editor's version, including decisions from RAN1#48 | 0.4.0 | 0.4.1 |
| 2007-02-21 | - | - | - | - | Updated editor's version | 0.4.1 | 0.4.2 |
| 2007-03-03 | RAN#35 | RP-070169 | - | - | For information at RAN#35 | 0.4.2 | 1.0.0 |
| 2007-04-25 | - | - | - | - | Editor's version, including decisions from RAN1#48bis and RAN1 TDD Ad Hoc | 1.0.0 | 1.0.1 |
| 2007-05-03 | - | - | - | - | Updated editor's version | 1.0.1 | 1.0.2 |
| 2007-05-08 | - | - | - | - | Updated editor's version | 1.0.2 | 1.0.3 |
| 2007-05-11 | - | - | - | - | Updated editor's version | 1.0.3 | 1.0.4 |
| 2007-05-11 | - | - | - | - | Endorsed by RAN1#49 | 1.0.4 | 1.1.0 |
| 2007-05-15 | - | - | - | - | Editor's version, including decisions from RAN1#49 | 1.1.0 | 1.1.1 |
| 2007-06-05 | - | - | - | - | Updated editor's version | 1.1.1 | 1.1.2 |
| 2007-06-25 | - | - | - | - | Endorsed by RAN1#49bis | 1.1.2 | 1.2.0 |
| 2007-07-10 | - | - | - | - | Editor's version, including decisions from RAN1#49bis | 1.2.0 | 1.2.1 |
| 2007-08-10 | - | - | - | - | Updated editor's version | 1.2.1 | 1.2.2 |
| 2007-08-20 | - | - | - | - | Updated editor's version | 1.2.2 | 1.2.3 |
| 2007-08-24 | - | - | - | - | Endorsed by RAN1#50 | 1.2.3 | 1.3.0 |
| 2007-08-27 | - | - | - | - | Editor's version, including decisions from RAN1#50 | 1.3.0 | 1.3.1 |
| 2007-09-05 | - | - | - | - | Updated editor's version | 1.3.1 | 1.3.2 |
| 2007-09-08 | RAN#37 | RP-070729 | - | - | For approval at RAN#37 | 1.3.2 | 2.0.0 |
| 12/09/07 | RAN_37 | RP-070729 | - | - | Approved version | 2.0.0 | 8.0.0 |
| 28/11/07 | RAN_38 | RP-070949 | 0001 | - | Introduction of optimized FS2 for TDD | 8.0.0 | 8.1.0 |
| 28/11/07 | RAN_38 | RP-070949 | 0002 | - | Introduction of scrambling sequences, uplink reference signal sequences, secondary synchronization sequences and control channel processing | 8.0.0 | 8.1.0 |
| 05/03/08 | RAN_39 | RP-080219 | 0003 | 1 | Update of uplink reference-signal hopping, downlink reference signals, scrambling sequences, DwPTS/UpPTS lengths for TDD and control channel processing | 8.1.0 | 8.2.0 |
| 28/05/08 | RAN_40 | RP-080432 | 0004 | - | Correction of the number of subcarriers in PUSCH transform precoding | 8.2.0 | 8.3.0 |
| 28/05/08 | RAN_40 | RP-080432 | 0005 | - | Correction of PHICH mapping | 8.2.0 | 8.3.0 |
| 28/05/08 | RAN_40 | RP-080432 | 0006 | - | Correction of PUCCH resource index for PUCCH format 2 | 8.2.0 | 8.3.0 |
| 28/05/08 | RAN_40 | RP-080432 | 0007 | 3 | Correction of the predefined hopping pattern for PUSCH | 8.2.0 | 8.3.0 |
| 28/05/08 | RAN_40 | RP-080432 | 0008 | - | Non-binary hashing functions | 8.2.0 | 8.3.0 |
| 28/05/08 | RAN_40 | RP-080432 | 0009 | 1 | PUCCH format 1 | 8.2.0 | 8.3.0 |
| 28/05/08 | RAN_40 | RP-080432 | 0010 | 1 | CR on Uplink DM RS hopping | 8.2.0 | 8.3.0 |
| 28/05/08 | RAN_40 | RP-080432 | 0012 | 1 | Correction to limitation of constellation size of ACK transmission in PUSCH | 8.2.0 | 8.3.0 |
| 28/05/08 | RAN_40 | RP-080432 | 0015 | 1 | PHICH mapping for one and two antenna ports in extended CP | 8.2.0 | 8.3.0 |
| 28/05/08 | RAN_40 | RP-080432 | 0016 | 1 | Correction of PUCCH in absent of mixed format | 8.2.0 | 8.3.0 |
| 28/05/08 | RAN_40 | RP-080432 | 0017 | - | Specification of CCE size and PHICH resource indication | 8.2.0 | 8.3.0 |
| 28/05/08 | RAN_40 | RP-080432 | 0018 | 3 | Correction of the description of frame structure type 2 | 8.2.0 | 8.3.0 |
| 28/05/08 | RAN_40 | RP-080432 | 0019 | - | On Delta ^{pucch} shift correction | 8.2.0 | 8.3.0 |
| 28/05/08 | RAN_40 | RP-080432 | 0021 | - | Corrections to Secondary Synchronization Signal Mapping | 8.2.0 | 8.3.0 |
| 28/05/08 | RAN_40 | RP-080432 | 0022 | - | Downlink VRB mapping to PRB for distributed transmission | 8.2.0 | 8.3.0 |
| 28/05/08 | RAN_40 | RP-080432 | 0023 | - | Clarification of modulation symbols to REs mapping for DVRB | 8.2.0 | 8.3.0 |
| 28/05/08 | RAN_40 | RP-080432 | 0024 | 1 | Consideration on the scrambling of PDSCH | 8.2.0 | 8.3.0 |
| 28/05/08 | RAN_40 | RP-080432 | 0025 | - | Corrections to Initialization of DL RS Scrambling | 8.2.0 | 8.3.0 |
| 28/05/08 | RAN_40 | RP-080432 | 0026 | 1 | CR on Downlink RS | 8.2.0 | 8.3.0 |
| 28/05/08 | RAN_40 | RP-080432 | 0027 | - | CR on Uplink RS | 8.2.0 | 8.3.0 |

| Change history | | | | | | | |
|----------------|--------|-----------|------|-----|--|-------|-------|
| Date | TSG # | TSG Doc. | CR | Rev | Subject/Comment | Old | New |
| 28/05/08 | RAN_40 | RP-080432 | 0028 | 1 | Fixed timing advance offset for LTE TDD and half-duplex FDD | 8.2.0 | 8.3.0 |
| 28/05/08 | RAN_40 | RP-080432 | 0029 | 1 | Timing of random access preamble format 4 | 8.2.0 | 8.3.0 |
| 28/05/08 | RAN_40 | RP-080432 | 0030 | 1 | Uplink sounding RS bandwidth configuration | 8.2.0 | 8.3.0 |
| 28/05/08 | RAN_40 | RP-080432 | 0031 | - | Use of common RS when UE-specific RS are configured | 8.2.0 | 8.3.0 |
| 28/05/08 | RAN_40 | RP-080432 | 0032 | 1 | Uplink RS Updates | 8.2.0 | 8.3.0 |
| 28/05/08 | RAN_40 | RP-080432 | 0033 | - | Orthogonal cover sequence for shortened PUCCH format 1a and 1b | 8.2.0 | 8.3.0 |
| 28/05/08 | RAN_40 | RP-080432 | 0034 | - | Clarification of PDCCH mapping | 8.2.0 | 8.3.0 |
| 28/05/08 | RAN_40 | RP-080432 | 0035 | - | TDD PRACH time/frequency mapping | 8.2.0 | 8.3.0 |
| 28/05/08 | RAN_40 | RP-080432 | 0036 | - | Cell Specific Uplink Sounding RS Subframe Configuration | 8.2.0 | 8.3.0 |
| 28/05/08 | RAN_40 | RP-080432 | 0038 | - | PDCCH length for carriers with mixed MBSFN and Unicast Traffic | 8.2.0 | 8.3.0 |
| 28/05/08 | RAN_40 | RP-080432 | 0040 | - | Correction to the scrambling sequence generation for PUCCH, PCFICH, PHICH, MBSFN RS and UE specific RS | 8.2.0 | 8.3.0 |
| 28/05/08 | RAN_40 | RP-080432 | 0041 | - | PDCCH coverage in narrow bandwidths | 8.2.0 | 8.3.0 |
| 28/05/08 | RAN_40 | RP-080432 | 0042 | - | Closed-Loop and Open-Loop Spatial Multiplexing | 8.2.0 | 8.3.0 |
| 28/05/08 | RAN_40 | RP-080432 | 0043 | - | Removal of small-delay CDD | 8.2.0 | 8.3.0 |
| 09/09/08 | RAN_41 | RP-080668 | 48 | 1 | Frequency Shifting of UE-specific RS | 8.3.0 | 8.4.0 |
| 09/09/08 | RAN_41 | RP-080668 | 49 | 1 | Correction of PHICH to RE mapping in extended CP subframe | 8.3.0 | 8.4.0 |
| 09/09/08 | RAN_41 | RP-080668 | 50 | - | Corrections to for handling remaining Res | 8.3.0 | 8.4.0 |
| 09/09/08 | RAN_41 | RP-080668 | 51 | - | PRACH configuration for frame structure type 1 | 8.3.0 | 8.4.0 |
| 09/09/08 | RAN_41 | RP-080668 | 52 | 2 | Correction of PUCCH index generation formula | 8.3.0 | 8.4.0 |
| 09/09/08 | RAN_41 | RP-080668 | 53 | - | Orthogonal cover sequence for shortened PUCCH format 1a and 1b | 8.3.0 | 8.4.0 |
| 09/09/08 | RAN_41 | RP-080668 | 54 | - | Correction of mapping of ACK/NAK to binary bit values | 8.3.0 | 8.4.0 |
| 09/09/08 | RAN_41 | RP-080668 | 56 | 2 | Remaining issues on SRS hopping | 8.3.0 | 8.4.0 |
| 09/09/08 | RAN_41 | RP-080668 | 57 | 1 | Correction of n_cs(n_s) and OC/CS remapping for PUCCH formats 1/1a/1b and 2/2a/2b | 8.3.0 | 8.4.0 |
| 09/09/08 | RAN_41 | RP-080668 | 59 | - | Corrections to Rank information scrambling in Uplink Shared Channel | 8.3.0 | 8.4.0 |
| 09/09/08 | RAN_41 | RP-080668 | 60 | - | Definition on the slot number for frame structure type 2 | 8.3.0 | 8.4.0 |
| 09/09/08 | RAN_41 | RP-080668 | 61 | - | Correction of the Npucch sequence upper limit for the formats 1/1a/1b | 8.3.0 | 8.4.0 |
| 09/09/08 | RAN_41 | RP-080668 | 62 | 1 | Clarifications for DMRS parameters | 8.3.0 | 8.4.0 |
| 09/09/08 | RAN_41 | RP-080668 | 63 | - | Correction of n_prs | 8.3.0 | 8.4.0 |
| 09/09/08 | RAN_41 | RP-080668 | 64 | 1 | Introducing missing L1 parameters to 36.211 | 8.3.0 | 8.4.0 |
| 09/09/08 | RAN_41 | RP-080668 | 65 | 3 | Clarification on reception of synchronization signals | 8.3.0 | 8.4.0 |
| 09/09/08 | RAN_41 | RP-080668 | 66 | - | Correction to the downlink/uplink timing | 8.3.0 | 8.4.0 |
| 09/09/08 | RAN_41 | RP-080668 | 67 | - | ACK/NACK Scrambling scheme on PUCCH | 8.3.0 | 8.4.0 |
| 09/09/08 | RAN_41 | RP-080668 | 68 | - | DCI format1C | 8.3.0 | 8.4.0 |
| 09/09/08 | RAN_41 | RP-080668 | 69 | - | Refinement for REG Definition for n = 4 | 8.3.0 | 8.4.0 |
| 09/09/08 | RAN_41 | RP-080668 | 71 | - | Correcting Ncs value for PRACH preamble format 0-3 | 8.3.0 | 8.4.0 |
| 09/09/08 | RAN_41 | RP-080668 | 73 | - | Correction of the half duplex timing advance offset value | 8.3.0 | 8.4.0 |
| 09/09/08 | RAN_41 | RP-080668 | 74 | - | Correction to Precoding for Transmit Diversity | 8.3.0 | 8.4.0 |
| 09/09/08 | RAN_41 | RP-080668 | 75 | - | Clarification on number of OFDM symbols used for PDCCH | 8.3.0 | 8.4.0 |
| 09/09/08 | RAN_41 | RP-080668 | 77 | - | Number of antenna ports for PDSCH | 8.3.0 | 8.4.0 |
| 09/09/08 | RAN_41 | RP-080668 | 78 | - | Correction to Type 2 PUSCH predetermined hopping for Nsb=1 operation | 8.3.0 | 8.4.0 |
| 09/09/08 | RAN_41 | RP-080668 | 79 | - | PRACH frequency location | 8.3.0 | 8.4.0 |

History

| Document history | | |
|-------------------------|---------------|-------------|
| V8.3.0 | November 2008 | Publication |
| V8.4.0 | November 2008 | Publication |
| | | |
| | | |
| | | |