



**Universal Mobile Telecommunications System (UMTS);
LTE;
5G;
Internet Protocol (IP) multimedia call control protocol based on
Session Initiation Protocol (SIP) and
Session Description Protocol (SDP);
User Equipment (UE) conformance specification;
Part 3: Abstract test suite (ATS)
(3GPP TS 34.229-3 version 17.5.0 Release 17)**



Reference

RTS/TSGR-0534229-3vh50

Keywords

5G,LTE,UMTS

ETSI

650 Route des Lucioles
F-06921 Sophia Antipolis Cedex - FRANCE

Tel.: +33 4 92 94 42 00 Fax: +33 4 93 65 47 16

Siret N° 348 623 562 00017 - APE 7112B
Association à but non lucratif enregistrée à la
Sous-Préfecture de Grasse (06) N° w061004871

Important notice

The present document can be downloaded from:

<https://www.etsi.org/standards-search>

The present document may be made available in electronic versions and/or in print. The content of any electronic and/or print versions of the present document shall not be modified without the prior written authorization of ETSI. In case of any existing or perceived difference in contents between such versions and/or in print, the prevailing version of an ETSI deliverable is the one made publicly available in PDF format at www.etsi.org/deliver.

Users of the present document should be aware that the document may be subject to revision or change of status.

Information on the current status of this and other ETSI documents is available at

<https://portal.etsi.org/TB/ETSIDeliverableStatus.aspx>

If you find errors in the present document, please send your comment to one of the following services:

<https://portal.etsi.org/People/CommitteeSupportStaff.aspx>

If you find a security vulnerability in the present document, please report it through our
Coordinated Vulnerability Disclosure Program:

<https://www.etsi.org/standards/coordinated-vulnerability-disclosure>

Notice of disclaimer & limitation of liability

The information provided in the present deliverable is directed solely to professionals who have the appropriate degree of experience to understand and interpret its content in accordance with generally accepted engineering or other professional standard and applicable regulations.

No recommendation as to products and services or vendors is made or should be implied.

No representation or warranty is made that this deliverable is technically accurate or sufficient or conforms to any law and/or governmental rule and/or regulation and further, no representation or warranty is made of merchantability or fitness for any particular purpose or against infringement of intellectual property rights.

In no event shall ETSI be held liable for loss of profits or any other incidental or consequential damages.

Any software contained in this deliverable is provided "AS IS" with no warranties, express or implied, including but not limited to, the warranties of merchantability, fitness for a particular purpose and non-infringement of intellectual property rights and ETSI shall not be held liable in any event for any damages whatsoever (including, without limitation, damages for loss of profits, business interruption, loss of information, or any other pecuniary loss) arising out of or related to the use of or inability to use the software.

Copyright Notification

No part may be reproduced or utilized in any form or by any means, electronic or mechanical, including photocopying and microfilm except as authorized by written permission of ETSI.

The content of the PDF version shall not be modified without the written authorization of ETSI.

The copyright and the foregoing restriction extend to reproduction in all media.

© ETSI 2024.
All rights reserved.

Intellectual Property Rights

Essential patents

IPRs essential or potentially essential to normative deliverables may have been declared to ETSI. The declarations pertaining to these essential IPRs, if any, are publicly available for **ETSI members and non-members**, and can be found in ETSI SR 000 314: *"Intellectual Property Rights (IPRs); Essential, or potentially Essential, IPRs notified to ETSI in respect of ETSI standards"*, which is available from the ETSI Secretariat. Latest updates are available on the ETSI Web server (<https://ipr.etsi.org/>).

Pursuant to the ETSI Directives including the ETSI IPR Policy, no investigation regarding the essentiality of IPRs, including IPR searches, has been carried out by ETSI. No guarantee can be given as to the existence of other IPRs not referenced in ETSI SR 000 314 (or the updates on the ETSI Web server) which are, or may be, or may become, essential to the present document.

Trademarks

The present document may include trademarks and/or tradenames which are asserted and/or registered by their owners. ETSI claims no ownership of these except for any which are indicated as being the property of ETSI, and conveys no right to use or reproduce any trademark and/or tradename. Mention of those trademarks in the present document does not constitute an endorsement by ETSI of products, services or organizations associated with those trademarks.

DECT™, **PLUGTESTS™**, **UMTS™** and the ETSI logo are trademarks of ETSI registered for the benefit of its Members. **3GPP™** and **LTE™** are trademarks of ETSI registered for the benefit of its Members and of the 3GPP Organizational Partners. **oneM2M™** logo is a trademark of ETSI registered for the benefit of its Members and of the oneM2M Partners. **GSM®** and the GSM logo are trademarks registered and owned by the GSM Association.

Legal Notice

This Technical Specification (TS) has been produced by ETSI 3rd Generation Partnership Project (3GPP).

The present document may refer to technical specifications or reports using their 3GPP identities. These shall be interpreted as being references to the corresponding ETSI deliverables.

The cross reference between 3GPP and ETSI identities can be found under <https://webapp.etsi.org/key/queryform.asp>.

Modal verbs terminology

In the present document "**shall**", "**shall not**", "**should**", "**should not**", "**may**", "**need not**", "**will**", "**will not**", "**can**" and "**cannot**" are to be interpreted as described in clause 3.2 of the [ETSI Drafting Rules](#) (Verbal forms for the expression of provisions).

"**must**" and "**must not**" are **NOT** allowed in ETSI deliverables except when used in direct citation.

Contents

Intellectual Property Rights	2
Legal Notice	2
Modal verbs terminology.....	2
Foreword.....	5
Introduction	5
1 Scope	6
2 References	6
3 Definitions and abbreviations.....	9
3.1 Definitions	9
3.2 Abbreviations	9
4 Requirements on the TTCN development.....	9
5 Test method and test model.....	10
5.1 Test method	10
5.2 IMS CC test model.....	10
5.2.1 Transport protocol	19
5.2.2 IMS CC test cases over IP-CAN test model	19
5.3 Upper Tester (UT).....	20
5.4 TTCN-3.....	20
5.5 Support of XCAP	20
5.5.1 XCAP Server	20
5.5.2 HTTP Signalling.....	21
5.6 Void.....	22
6 ASP definitions	22
6.1 Void.....	22
6.2 Void.....	22
6.3 Void.....	22
6.4 Void.....	22
6.5 XCAP server ASP definitions	22
7 Codec definitions for IP User Data	23
7.1 Introduction	23
7.2 General Aspects.....	23
7.3 Requirements on abstract message syntax for IMS (SIP, SDP)	24
7.3.1 Type definition - Syntax / Semantic aspects.....	24
7.3.2 Deviations of the type definition semantic	24
7.3.3 Additional requirements for codec implementations (SIP/IMS Message	25
7.3.3.1 Differences between BNF - TTCN-3 Type Mapping.....	26
7.3.3.2 URL Encoding	29
7.3.4 Additional requirements for codec implementations (Message Body).....	29
7.3.5 Additional requirements for codec implementations (SDP Body).....	29
7.3.5.1 Differences between BNF - SDP Type Mapping	29
7.3.5.2 Defined attributes.....	31
7.3.6 Additional requirements for codec implementations (HTTP).....	32
7.3.7 Additional requirements for codec implementations (XML).....	32
7.4 Requirements for codec implementations (DHCP, DNS)	32
8 Design consideration	32
8.1 Void.....	32
8.2 Void.....	32
8.3 Void.....	32
8.4 Void.....	32
8.5 Timer Tolerances.....	32
8.6 Bearer information for UTRAN	32

Annex A (normative):	Abstract Test Suites (ATS)	33
A.1	Baseline of specifications	33
A.2	IMS-CC ATS.....	33
A.2.1	Void.....	37
A.2.2	Void.....	37
A.2.3	Void.....	37
A.3	IMS_NR5GC ATS	37
Annex B (normative):	Partial IXIT proforma	42
B.0	Introduction	42
B.1	Parameter values	42
B.1.1	PIXITs	42
B.2	Void.....	43
Annex C:	Void	44
Annex D:	Void	45
Annex E (informative):	TTCN-3 style guide for 3GPP IMS ATS	46
Annex F (informative):	BNF Message Definitions	47
Annex G (Normative):	SIP Type Definitions and XSD References	48
G.0	References of XSD and SIP Type Definitions	48
G.0.1	XML Schema Definitions (XSD).....	48
G.0.2	Common TTCN-3 Libraries	49
G.1	LibSip_MessageBodyTypes.....	50
G.1.1	MIMETypes	50
G.2	References to TTCN-3	52
Annex H (informative):	TTCN-3 Definitions of Common Interfaces	53
H.1	IMS_PTC_CoordMsg	53
H.2	IMS_ASP_TypeDefs.....	56
H.3	HTTP_ASP_TypeDefs.....	60
H.3.1	HTTP_ASP_Definitions.....	60
H.3.2	HTTP_Port_Definitions	62
H.4	References to TTCN-3	63
Annex I (informative):	Change history	64
History	89

Foreword

This Technical Specification has been produced by the 3rd Generation Partnership Project (3GPP).

The contents of the present document are subject to continuing work within the TSG and may change following formal TSG approval. Should the TSG modify the contents of the present document, it will be re-released by the TSG with an identifying change of release date and an increase in version number as follows:

Version x.y.z

where:

x the first digit:

- 1 presented to TSG for information;
- 2 presented to TSG for approval;
- 3 or greater indicates TSG approved document under change control.

Y the second digit is incremented for all changes of substance, i.e. technical enhancements, corrections, updates, etc.

Z the third digit is incremented when editorial only changes have been incorporated in the document.

Introduction

The present document is 3rd part of a multi-part conformance test specification for UE and is *valid for 3GPP Release 5 and above*. The specification contains a TTCN design frame work and the detailed test specifications in TTCN for the UE conformance at the Gm reference point.

3GPP TS 34.229-1 [5] contains a conformance test description in prose for 3G and 4G.

3GPP TS 34.229-2 [6] contains a pro-forma for the UE Implementation Conformance Statement (ICS).

3GPP TS 34.229-3 the present document.

3GPP TS 34.229-5 [55] contains a conformance test description in prose for 5G.

1 Scope

The present document specifies the protocol conformance testing in TTCN for the 3GPP User Equipment (UE) at the Gm interface.

The present document is the 3rd part of a multi-part test specification, 3GPP TS 34.229. The following TTCN test specification and design considerations can be found in the present document:

- the overall test suite structure;
- the testing architecture;
- the test methods and PCO definitions;
- the test configurations;
- the design principles, assumptions, and used interfaces to the TTCN tester (System Simulator);
- TTCN styles and conventions;
- the partial PIXIT proforma;
- the TTCN files for the mentioned protocols tests.

The Abstract Test Suites designed in the document are based on the test cases specified in prose (3GPP TS 34.229-1 [5] and TS 34.229-5 [55]).

The present document is valid for UE implemented according 3GPP Releases starting from Release 5 up to the Release indicated on the cover page of the present document.

2 References

The following documents contain provisions which, through reference in this text, constitute provisions of the present document.

- References are either specific (identified by date of publication, edition number, version number, etc.) or non-specific.
- For a specific reference, subsequent revisions do not apply.
- For a non-specific reference, the latest version applies. In the case of a reference to a 3GPP document (including a GSM document), a non-specific reference implicitly refers to the latest version of that document in the same Release as the present document unless the context in which the reference is made suggests a different Release is relevant (information on the applicable release in a particular context can be found in e.g. test case title, description or applicability, message description or content).

- [1] 3GPP TR 21.905: "Vocabulary for 3GPP Specifications".
- [2] 3GPP TS 34.123-1: "User Equipment (UE) conformance specification; Part 1: Protocol conformance specification".
- [3] 3GPP TS 34.123-2: "User Equipment (UE) conformance specification; Part 2: Implementation Conformance Statement (ICS) proforma specification".
- [4] 3GPP TS 34.123-3: "User Equipment (UE) conformance specification; Part 3: Abstract Test Suites (ATS)".
- [5] 3GPP TS 34.229-1: "Internet Protocol (IP) multimedia call control protocol based on Session Initiation Protocol (SIP) and Session Description Protocol (SDP); User Equipment (UE) conformance specification; Part 1: Protocol conformance specification".

- [6] 3GPP TS 34.229-2: "Internet Protocol (IP) multimedia call control protocol based on Session Initiation Protocol (SIP) and Session Description Protocol (SDP); User Equipment (UE) conformance specification; Part 2: Implementation Conformance Statement (ICS) specification".
- [7] 3GPP TS 34.108: "Common test environments for User Equipment (UE) conformance testing".
- [8] ISO/IEC 9646-1: "Information technology - Open systems interconnection - Conformance testing methodology and framework - Part 1: General concepts".
- [9] ISO/IEC 9646-7: "Information technology - Open systems interconnection - Conformance testing methodology and framework - Part 7: Implementation Conformance Statements".
- [10] ETSI ETS 300 406 (1995): "Methods for testing and Specification (MTS); Protocol and profile conformance testing specifications; Standardization methodology".
- [11] 3GPP TS 24.229: "IP Multimedia Call Control Protocol based on Session Initiation Protocol (SIP) and Session Description Protocol (SDP); Stage 3".
- [12] ETSI ES 201 873-1: "Methods for Testing and Specification (MTS); The Testing and Test Control Notation version 3; Part 1: TTCN-3 Core Language".
- [13] IETF RFC 3320: "Signalling Compression (SigComp)".
- [14] IETF RFC 3485: "The Session Initiation Protocol (SIP) and Session Description Protocol (SDP) Static Dictionary for Signalling Compression (SigComp)".
- [15] IETF RFC 3486: "Compressing the Session Initiation Protocol (SIP)".
- [16] IETF RFC 3261: "SIP: Session Initiation Protocol".
- [17] IETF RFC 4566: "SDP: Session Description Protocol".
- [18] IETF RFC 1035: "Domain names - implementation and specification".
- [19] IETF RFC 1533: "DHCP Options and BOOTP Vendor Extensions".
- [20] IETF RFC 2131: "Dynamic Host Configuration Protocol".
- [21] IETF RFC 3315: "Dynamic Host Configuration Protocol for Ipv6 (DHCPv6)".
- [22] IETF RFC 3319: "Dynamic Host Configuration Protocol (DHCPv6) Options for Session Initiation Protocol (SIP) Servers".
- [23] IETF RFC 3361: "Dynamic Host Configuration Protocol (DHCP-for-Ipv4) Option for Session Initiation Protocol (SIP) Servers".
- [24] IETF RFC 3680: "A Session Initiation Protocol (SIP) Event Package for Registrations".
- [25] 3GPP TS 24.173: "IMS multimedia telephony communication service and supplementary services; Stage 3".
- [26] IETF RFC 4825: "The Extensible Markup Language (XML) Configuration Access Protocol (XCAP)".
- [27] IETF RFC 2616: "Hypertext Transfer Protocol – HTTP/1.1".
- [28] 3GPP TS 36.523-1: "Evolved Universal Terrestrial Radio Access (E-UTRA) and Evolved Packet Core (EPC); User Equipment (UE) conformance specification; Part 1: Protocol conformance specification".
- [29] 3GPP TS 36.523-2: "Evolved Universal Terrestrial Radio Access (E-UTRA) and Evolved Packet Core (EPC); User Equipment (UE) conformance specification; Part 2: Implementation Conformance Statement (ICS) proforma specification".
- [30] 3GPP TS 36.523-3: "Evolved Universal Terrestrial Radio Access (E-UTRA) and Evolved Packet Core (EPC); User Equipment (UE) conformance specification; Part 3: Test suites".

- [31] 3GPP TS 36.508: "Evolved Universal Terrestrial Radio Access (E-UTRA) and Evolved Packet Core (EPC); Common test environments for User Equipment (UE) conformance testing".
- [32] 3GPP TS 24.173: "IMS Multimedia telephony communication service and supplementary services; Stage 3".
- [33] 3GPP TS 24.109: "Bootstrapping interface (Ub) and network application function interface (Ua); Protocol details".
- [34] 3GPP TS 33.220: "Generic Authentication Architecture (GAA); Generic Bootstrapping Architecture".
- [35] 3GPP TS 33.222: "Generic Authentication Architecture (GAA); Access to network application functions using Hypertext Transfer Protocol over Transport Layer Security (HTTPS)".
- [36] 3GPP TS 24.623: "Extensible Markup Language (XML) Configuration Access Protocol (XCAP) over the Ut interface for Manipulating Supplementary Services".
- [37] RFC 2617: "HTTP Authentication: Basic and Digest Access Authentication".
- [38] RFC 3966: "The tel URI for Telephone Numbers".
- [39] RFC 2141: "URN Syntax".
- [40] 3GPP TS 24.604: "Communication Diversion (CDIV) using IP Multimedia (IM) Core Network (CN) subsystem; Protocol specification".
- [41] 3GPP TS 24.607: "Originating Identification Presentation (OIP) and Originating Identification Restriction (OIR) using IP Multimedia (IM) Core Network (CN) subsystem; Protocol specification".
- [42] 3GPP TS 24.608: "Terminating Identification Presentation (TIP) and Terminating Identification Restriction (TIR) using IP Multimedia (IM) Core Network (CN) subsystem; Protocol specification".
- [43] 3GPP TS 24.611: "Anonymous Communication Rejection (ACR) and Communication Barring (CB) using IP Multimedia (IM) Core Network (CN) subsystem; Protocol specification".
- [44] IETF RFC 4119 "A Presence-based GEOPRIV Location Object Format".
- [45] IETF RFC 4575: "A Session Initiation Protocol (SIP) Event Package for Conference State".
- [46] IETF RFC 5628: "Registration Event Package Extension for Session Initiation Protocol (SIP) Globally Routable User Agent URIs (GRUUs)".
- [47] IETF RFC 3863 "Presence Information Data Format (PIDF)".
- [48] IETF RFC 4745: "Common Policy: A Document Format for Expressing Privacy Preferences".
- [49] 3GPP TS 27.007: "AT command set for 3G User Equipment (UE)".
- [50] 3GPP TS 34.229-4: "User Equipment (UE) conformance specification; Part 4: Enabler for IP multimedia applications testing".
- [51] 3GPP TS 24.237: "IP Multimedia (IM) Core Network (CN) subsystem IP Multimedia Subsystem (IMS) Service Continuity".
- [52] 3GPP TS 31.121: "UICC-terminal interface; Universal Subscriber Identity Module (USIM) application test specification".
- [53] 3GPP TS 24.390: "Unstructured Supplementary Service Data (USSD) using IP Multimedia (IM) Core Network (CN) subsystem IMS".
- [54] 3GPP TS 38.523-3: "5GS; UE conformance specification; Part 3: Protocol Test Suites".

- [55] 3GPP TS 34.229-5: "Internet Protocol (IP) multimedia call control protocol based on Session Initiation Protocol (SIP) and Session Description Protocol (SDP); User Equipment (UE) conformance specification; Part 5: Protocol conformance specification using 5G System (5GS)".
- [56] 3GPP TS 38.508-1: "5GS; User Equipment (UE) conformance specification; Part 1: Common test environment".
- [57] ETSI ES 201 873-9: "Methods for Testing and Specification (MTS); The Testing and Test Control Notation version 3; Part 9: Using XML schema with TTCN-3".
- [58] IETF RFC 4479: "A Data Model for Presence".
- [59] IETF RFC 8147: "Next-Generation Pan-European eCall".

3 Definitions and abbreviations

3.1 Definitions

For the purposes of the present document, the terms and definitions given in 3GPP TR 21.905 [1], TS 34.229-1 [5] and TS 34.229-5 [55] apply.

3.2 Abbreviations

For the purposes of the present document, the abbreviations given in 3GPP TR 21.905 [1], TS 34.229-1 [5] and TS 34.229-5 [55] apply.

4 Requirements on the TTCN development

A number of requirements are identified for the development and production of TTCN specification for 3GPP UE at the Gm reference point.

1. Top-down design, following 3GPP TS 34.229-1 [5], TS 34.108 [7], TS 36.508 [31], TS 34.229-5 [55], TS 38.508-1 [56].
2. A unique testing architecture and test method for testing all protocol layers of UE.
3. Uniform TTCN style and naming conventions.
4. Improve TTCN readability.
5. Using TTCN-3 (ES 201 873-1 [12]).
6. TTCN specification feasible, implementable and compilable.
7. Test cases shall be designed in a way for easily adaptable, upwards compatible with the evolution of the 3GPP core specifications and the future Releases.
8. The test declarations, data structures and data values shall be largely reusable.
9. Modularity and modular working method.
10. Minimizing the requirements of intelligence on the emulators of the lower testers.
11. Giving enough design freedom to the test equipment manufacturers.
12. Maximizing reuse of RFC BNF definitions from the relevant IETF core specifications.

In order to fulfil these requirements and to ensure the investment of the test equipment manufacturers having a stable testing architecture for a relatively long period, a unique testing architecture and test method are applied to the 3GPP UE protocol tests.

5 Test method and test model

5.1 Test method

5.2 IMS CC test model

The test model over E-UTRA is shown in Figure 5.2-1a, the test model over UTRAN is shown in figure 5.2-1b, the test model over WLAN is shown in figure 5.2-1c, the test model over fixed access is shown in figure 5.2-1d (NOTE: the IPsec is not used by this model), and the test model over NR5GC is shown in Figure 5.2-1e.

The IMS CC test cases are executed on top of the multi-testers test model according to TS 36.523-3 [30] for E-UTRA, TS 34.123-3 [4] clause 6A for UTRAN and TS 38.523-3 [54] for NR5GC.

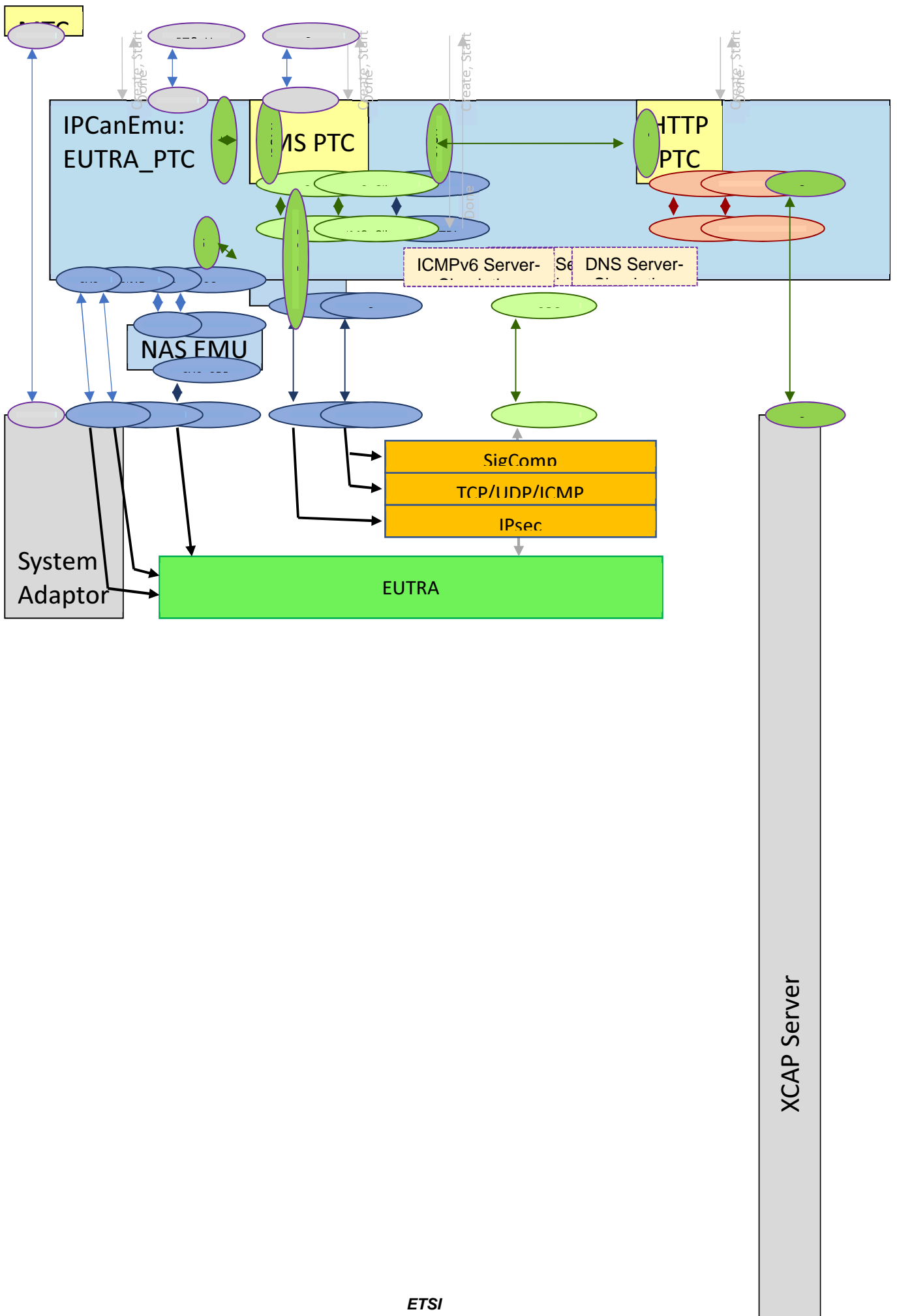

Figure 5.2-1a: Multi-TestersTest Model to support E-UTRA SS interface

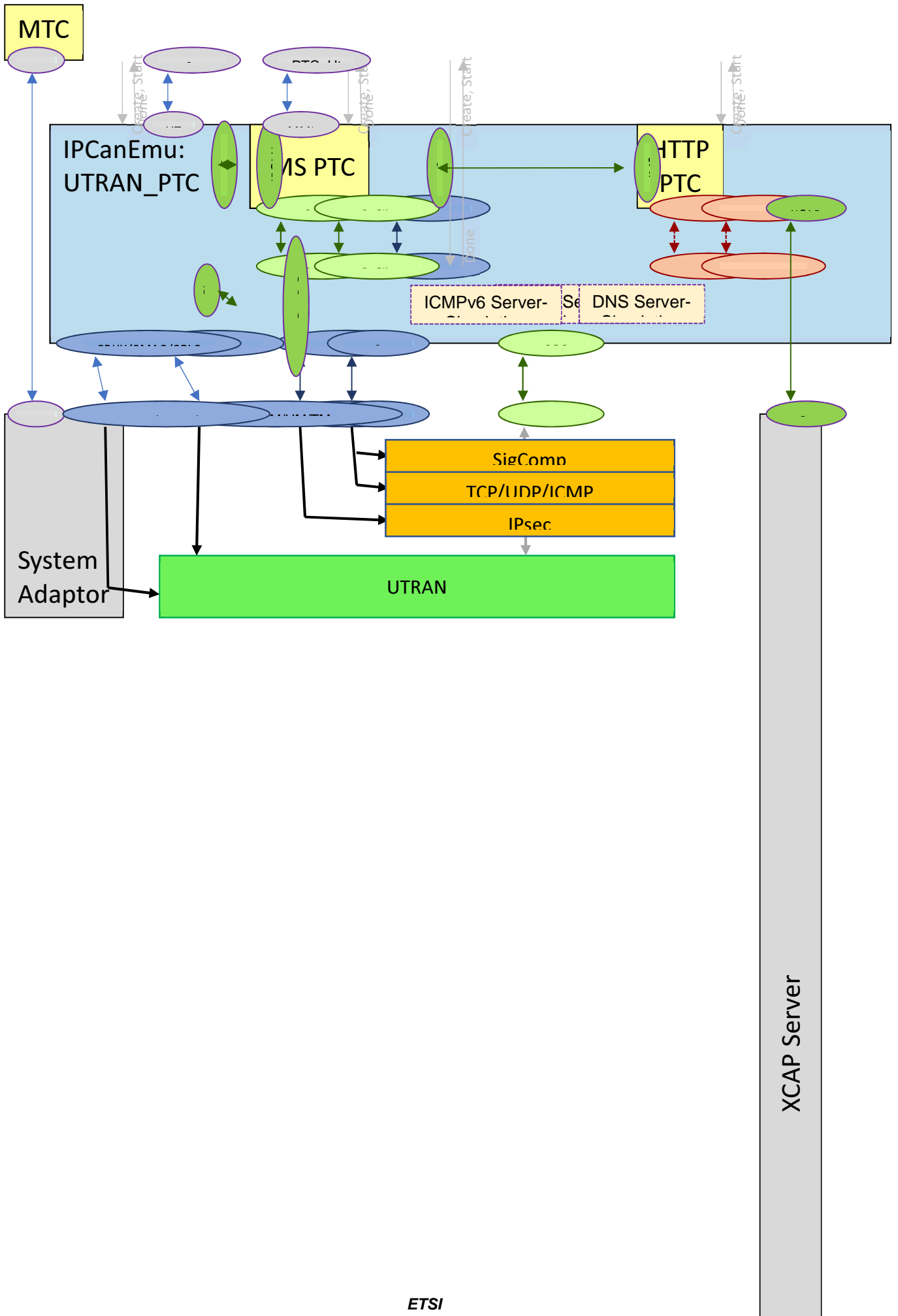

Figure 5.2-1b: Multi-Testers Test Model to support UTRAN SS interface

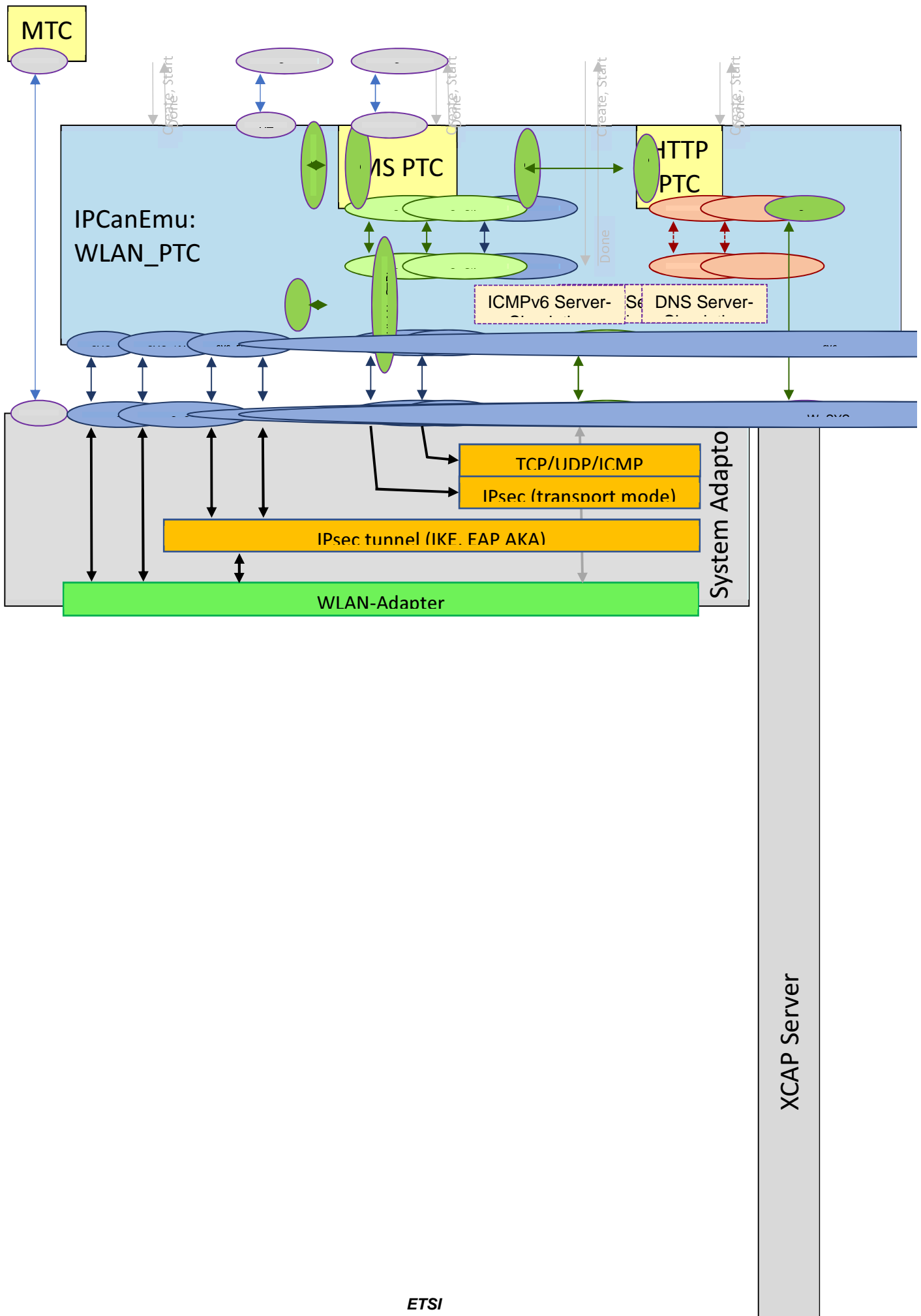

Figure 5.2-1c: Multi-Testers Test Model to support WLAN SS interface

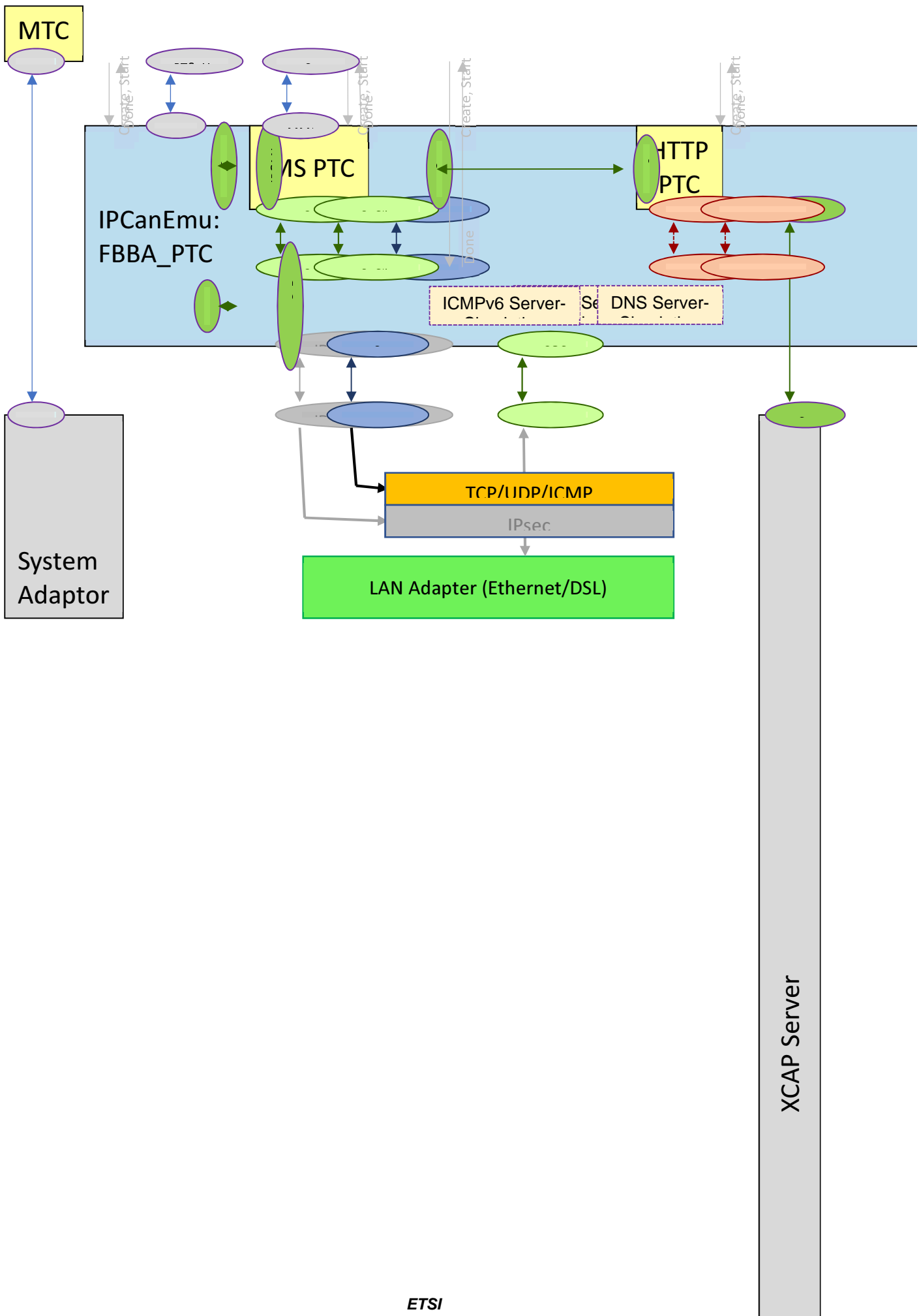

Figure 5.2-1d: Multi-Testers Test Model to support fixed access SS interface

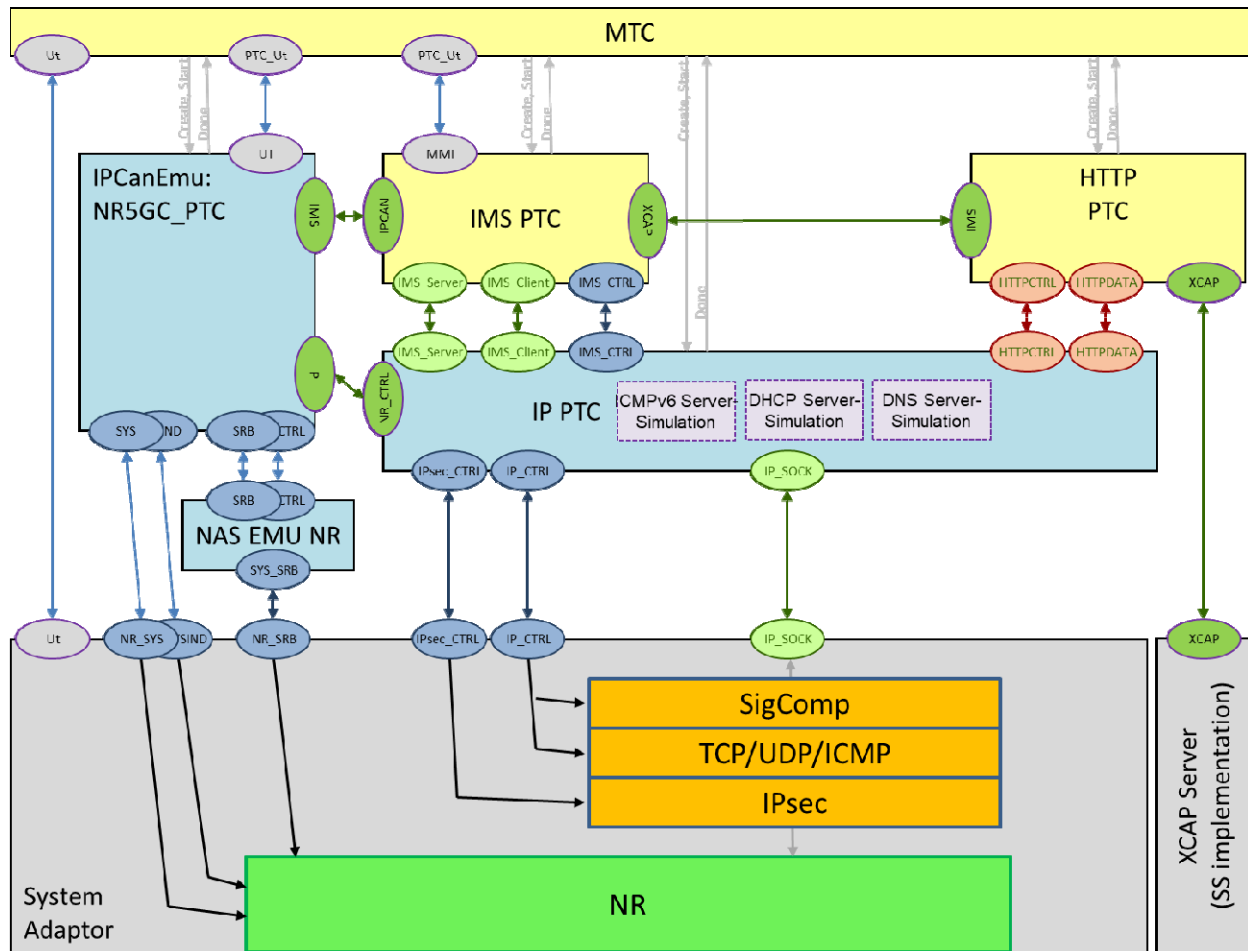

Figure 5.2-1e: Multi-Testers Test Model to support NR5GC SS interface

The IMS CC test cases run on the IMS-PTC which controls the IPCanEmu and the IP-PTC. IPCanEmu is responsible for cell setup and DRB/RAB establishment and the IP-PTC controls the IP related configurations. IPCanEmu and IP-PTC interface to the SS according to TS 36.523-3 [30] or TS 34.123-3 [4] or TS 38.523-3 [54].

Clauses 4.2.4, 4.2.5 and 4.4.1.1 of TS 36.523-3 [30] describe the common handling of IP data in the multi-testers model regarding IMS signalling. In addition to support HTTP over TLS a TCP server may be established with additional parameters for TLS which may be required for XCAP (depending on the authentication mechanism to be applied for XCAP test case).

The test model extensions for support of XCAP are shown in Figure 5.2-2. Clause 5.5 provides further information regarding support of XCAP.

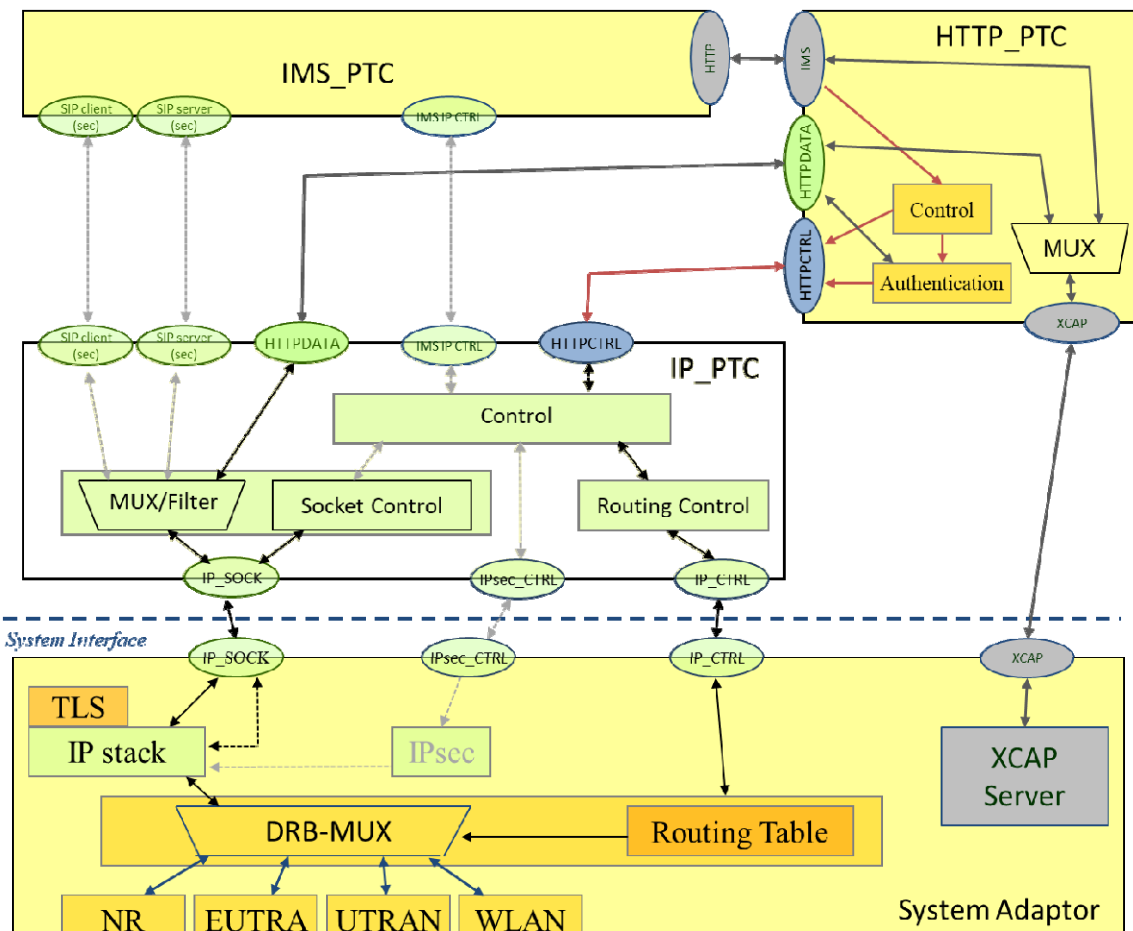

Figure 5.2-2: Extended IP model to handle HTTP/XCAP data

NOTE: Figure 5.2-2 is just an example; further details are SS implementation dependent.

5.2.1 Transport protocol

For SIP requests originated by the UE, the transport protocol in UL is selected by the UE. This information is extracted in the TTCN-3 and used in subsequent responses sent by the SS.

For SIP requests originated by the SS in DL UDP is used as transport protocol at the test. For the purpose of test coverage, TCP is used in the specific test cases as specified.

NOTE: According to RFC 3261 [16] clause 18.1.1 the server side (UE) has to be able to cope with a maximum datagram size of 65,535 bytes (independent of any guideline to restrict the maximum size of UDP packets at the client side).

5.2.2 IMS CC test cases over IP-CAN test model

The "Enabler for IP multimedia applications testing" is described in TS 34.229-4 [50]. In general IMS CC test cases can be run on this test model too as test case implementation - in general - is independent of the test model. The TTCN code for IMS and HTTP PTC is the same for TS 34.229-3 and TS 34.229-4 implementations whereas the MTC implementation is model specific. The implementation of the MTC, the IP-CAN/IP adaptor and the MMI system interface is part of TS 34.229-4 and out of scope for this document. Common interfaces are documented in annex H of this document.

5.3 Upper Tester (UT)

The AT commands of TS 36.523-3 [30] Table 5.2 are used and in addition there are IMS specific AT commands in Table 5.3-1. For all AT commands used in IMS the principles of TS 36.523-3 [30] clause 5.1 apply.

Table 5.3-1: IMS specific AT commands

Command	Reference
AT+CASIMS	TS 27.007 [49]
AT+CCMMD	TS 27.007 [49]

In addition to the common MMI commands of TS 36.523-3 [30] clause 5.2 there are IMS specific MMI commands in Table 5.3-2.

Table 5.3-2: IMS specific MMI commands

Command	Parameters	
	Name	Value
ACTIVATE_IMS_TIR	(none)	
ACTIVATE_SUPPLEMENTARY_SERVICE (NOTE 1)	"SupplementaryService"	<supplementary service> (NOTE 2)
	"Mode"	"ACTIVATE" "DEACTIVATE"
DEACTIVATE_IMS_TIR	(none)	
DEREGISTER	(none)	
IMS_INITIATE_CONFERENCE	(none)	
INVITE_TO_CONFERENCE	"Uri"	<Refer-To Uri>
LOCATION_INFO	(none)	
NO_PRECONDITIONS	(none)	
REFRESH	"HomeDomain"	<new home domain>
	"PrivateUserId"	<new private user ID>
	"PublicUserId"	<new public user ID>
TRIGGER_SMS	(none)	
NOTE 1: Used in cases where there is no AT command to activate/deactivate a particular supplementary service.		
NOTE 2: <supplementary service> = "TERMINATING IDENTIFICATION RESTRICTION" "INCOMING COMMUNICATION BARRING EXCEPT SPECIFIC USER" "OUTGOING COMMUNICATION BARRING WHILE ROAMING" "INCOMING COMMUNICATION BARRING ANONYMOUS"		

5.4 TTCN-3

TTCN is used as specification language. ES 201 873-1 [12] (TTCN-3) is applied to the notation.

5.5 Support of XCAP

MTSI supplementary services (TS 24.173[25]) like communication barring (CB) and communication diversion (CDIV) require the XCAP protocol (RFC 4825[26]) for transporting and manipulating XML documents in the network describing these services. Test cases for these services are specified in e.g. TS 34.229-1 [5] clause 15. As shown in figure 5.2-2 the SS shall provide an XCAP server to support XCAP test cases; the TTCN interface to this server is specified in clause 6.5.

5.5.1 XCAP Server

Supplementary services are managed by the XCAP server in the sirmservs documents according to TS 24.623 [36]. Test cases manipulating data related to supplementary services are specified in e.g. TS 34.229-1 [5] clause 15. For simplification of the TTCN implementation, the XCAP server functionality shall be provided by the SS i.e. it is not implemented in the TTCN. Access to the XCAP server can be distinguished into:

- HTTP based transaction between the UE and the XCAP server
- Initialisation and validation of the simservs document according to the test cases

In addition the UE may exchange HTTP messages for authentication (depending on the UE's security capabilities); see figure 5.5.1-1.

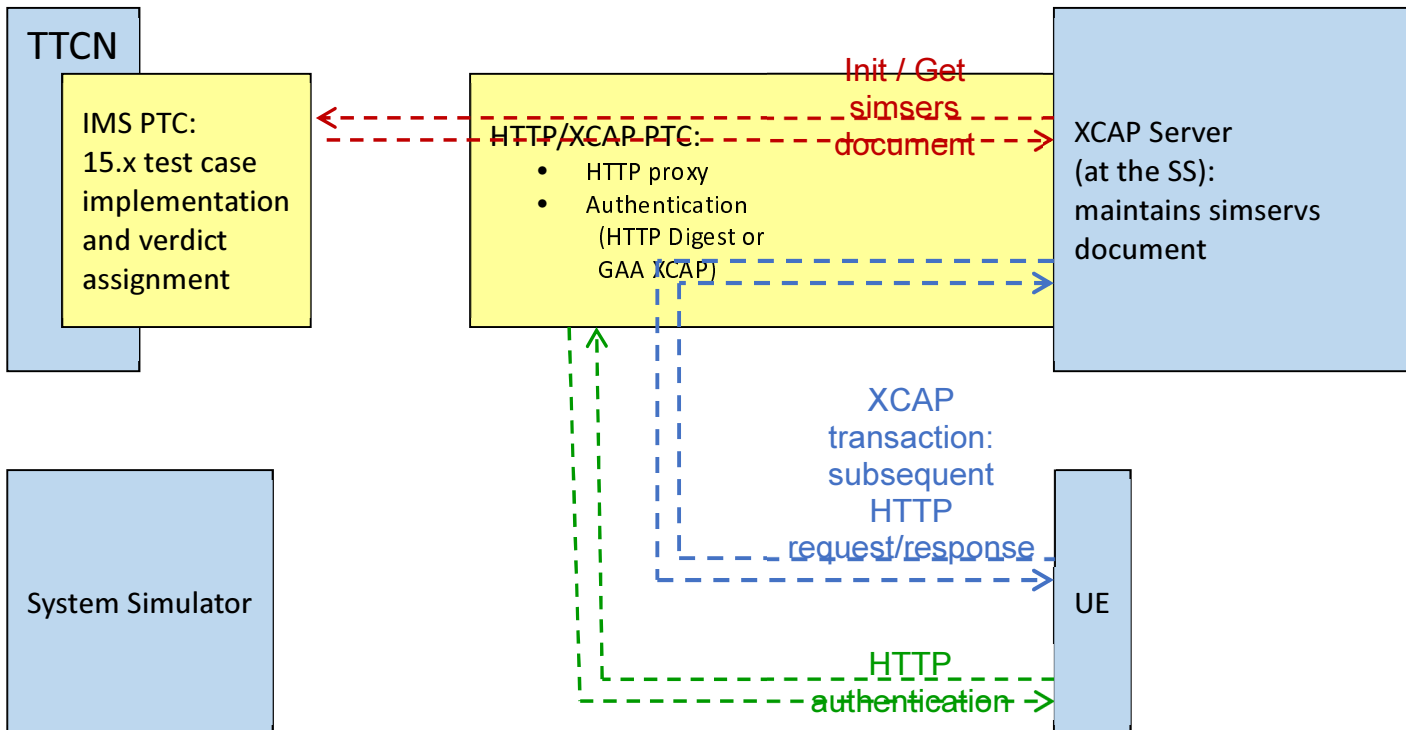

Figure 5.5.1-1: IMS CC test model

NOTE: In accordance to RFC 4825 clause 6.3 [26], the UE may use complex XPATH expressions to modify the simservs document but this shall be handled by the XCAP server; in the TTCN these expressions are not explicitly checked. Furthermore test case implementation itself does not use complex XPATH expressions to access the simservs document, but always considers the whole document.

5.5.2 HTTP Signalling

RFC 4825 [26] specifies the protocol for accessing user data in the XCAP server via HTTP requests. An HTTP request for an XCAP operation contains basically three components:

- Request line method, i.e. PUT, GET or DELETE
- Request line uri - The XCAP expression to be evaluated to access the XCAP document. The XCAP expression consists of the document selector followed by the separator “~~” followed by the node selector pointing to the user data to accessed or evaluated
- body - Describing the value (an xml fragment) referenced by the XCAP expression

Example 1

In order to set terminating-identity-presentation for user sip:ob.stf160@etsi.org, the UE sends following HTTP request:

```
PUT http://XCAP-Server/simservs.ngn.etsi.org/users/sip%3Aob.stf160%40etsi.org/simservs.xml/~/~/simservs/terminating-identity-presentation/%40active
Body: true
```

If successful, the XCAP server responds with

```
HTTP/1.1 200 OK
```

Example 2

To get the value of terminating-identity-presentation for user sip:ob.stf160@etsi.org, the UE sends following HTTP request:

```
GET
/simservs/terminating-identity-presentation/%40active
```

If successful, the XCAP server responds with

```
HTTP/1.1 200 OK
Body: true
```

In this example

```
//XCAP-server/simservs.ngn.etsi.org/users/ sip%3Aob.stf160%40etsi.org/simservs.xml/-
Document selector for user .
~~ - Document selector separator, see RFC 4825
/simservs/terminating-identity-presentation/%40active - Node selector pointing to the information in
the XCAP server to be accessed. This is an XPATH expression, see RFC 4825 section 6.3.
true - Is the xml fragment (in this case very simple) to be set as value of the XPATH expression
```

Following operations shall be implemented in the XCAP server, see RFC 4825.

GET - Returns the requested data as an XML fragment to be send to the UE

input parameters: charstring documentSelector, charstring xpathExpr
returns: XML fragment or XML document

PUT - Builds an XML subtree or sets an attribute given by the xmlFragment at the position pointed by the xpath expression

input parameters: charstring documentSelector, charstring xpathExpr, charstring xmlFragment or xmlDocument

DELETE - Deletes an XML subtree or sets an attribute given by the xmlFragment at the position pointed by the xpath expression

input parameters: charstring documentSelector, charstring xpathExpr

5.6 Void

6 ASP definitions

This clause defines abstract system primitives (ASPs) for system interfaces which are used additionally to the system interfaces defined in TS 36.523-3 [30], TS 34.123-3 [4] and TS 38.523-3 [54]. Further interfaces are documented in annex H to support the IP-CAN test model according to TS 34.229-4 [50] but these interfaces are not system interfaces in the scope of this document.

6.1 Void

6.2 Void

6.3 Void

6.4 Void

6.5 XCAP server ASP definitions

XCAP Layer ASPs are applicable to clause 5.2. and 5.6.

Name	XCAP_REQ	
Port	XCAP_PORT	
Comment	ASP type for sending a request to the external XCAP server according to RFC 4825 [26]	
Parameter Name	Parameter Type	Comment
method	charstring	GET, PUT, DELETE or RESET
xcapExpression	charstring	XCAP expression sent by the UE in its http request line
contentType	charstring	media type as contained in the HTTP content type header (optional)
xmlBody	charstring	XML fragment sent by the UE in its http body or sirmservs document initialised by the test cases (optional)

Name	XCAP_RSP	
Port	XCAP_PORT	
Comment	ASP type for sending the response to the XCAP_REQ from the XCAP server to TTCN	
Parameter Name	Parameter Type	Comment
errorInfo	charstring	string indicating a system error (optional)
contentType	charstring	media type as contained in the HTTP content type header (optional)
xmlBody	charstring	Result returned by the XCAP server (optional)

7 Codec definitions for IP User Data

7.1 Introduction

SIP is a text-based protocol, thus the message exchange between the UE and the SS are pure character strings. In the TTCN-3 ATS the messages are structured and optimized to take the advantage of TTCN-3 functionality, and to make the debugging and maintenance of the ATS easier.

7.2 General Aspects

IP user data for IMS conformance testing can be distinguished into:

1. text based: SIP (including SDP and XML messages), HTTP (see clause 7.4)
2. octetstring based: DHCP, DHCPv6, DNS (see clause 7.4)

In TTCN the following encoding information is used:

Table 7.2-1: Encoding information (NOTE 2)

Type definitions	Encoding	Encoding rule in TTCN-3
SMS_TypeDefs		
SMS_Declarations	Tabular notated (NOTE 1)	"SMS Types"
SMS_UDH_Declarations	Tabular notated (NOTE 1)	"SMS_UDH Types"
DHCPv4_TypeDefs	Tabular notated (NOTE 1)	"DHCPv4-Codec"
DNS_TypeDefs	Tabular notated (NOTE 1)	"DNS-Codec"
LibSip_SIPTypesAndValues	(see clause 7.3)	"SIPCodec"
LibSip_Common	(see clause 7.3)	"LibSip V3"
LibSip_SDPTypes	(see clause 7.3)	"SDPCodec"
HTTP_ASP_TypeDefs		
HTTP_ASP_Definitions	(see clause 7.3)	"HttpCodec"

NOTE 1: Tabular notated is performed by concatenation of all the present fields in the TTCN-3 template.

NOTE 2: Encoding information is only needed for type definitions of peer-to-peer signalling; encoding of ASPs used for system configuration or as co-ordination messages between PTCs is out of scope for this document.

7.3 Requirements on abstract message syntax for IMS (SIP, SDP)

7.3.1 Type definition - Syntax / Semantic aspects

All given defined BNF grammars (e.g. the ABNF of RFC 3261) are unique. Thus the syntax tree for each syntactically correct message derived with these grammars are unique too and the parts of a message can be uniquely identified (represented) by the terminal phrase belonging to a non terminal symbol and its derivation path in the syntax tree.

The syntax tree of all given messages can be used to uniquely identify and describe the parts of the messages. The leaves are the part of every message and the nodes from the root to the leaves represent the sequence of rules to be applied to derive that part

The IMS/SIP root message type is an ordered structured type, which is represented as a record type in TTCN-3. For each grammar rule of the ABNF a TTCN-3 record type is declared with the specific name of the rule. The following rules are applied to the fields within a record:

- A non-terminal symbol is declared as a record type for this symbol.
- The order of the symbols in the rule are represented by an equal order of the fields.
- Repetitions are declared as 'set of' or 'record of' types.
- Options are represented as optional record/set fields.
- Alternatives are declared as union types.

7.3.2 Deviations of the type definition semantic

- Most of the 'literals' of a message (for example: the string "Via" or "v" in the message header fields) are not represented.
- The TTCN-3 charstring type is used where we stop structuring even if the ABNF uses structured types. More details found in clause 8.3.3.
- Wherever possible parts are mapped to their best type representation, e.g. DIGIT based rules are mapped to integer type not to a charstring type.
- All of the following delimiters (including preceding or following whitespace) defined by the ABNF grammar to separate the parts of a message are not represented (see note).

STAR = SWS "*" SWS ; asterisk

```

SLASH   = SWS "/" SWS ; slash
EQUAL   = SWS "=" SWS ; equal
LPAREN  = SWS "(" SWS ; left parenthesis
RPAREN  = SWS ")" SWS ; right parenthesis
RAQUOT  = ">" SWS ; right angle quote
LAQUOT  = SWS "<"; left angle quote
COMMA   = SWS "," SWS ; comma
SEMI    = SWS ";" SWS ; semicolon
COLON   = SWS ":" SWS ; colon
LDQUOT  = SWS DQUOTE; open double quotation mark
RDQUOT  = DQUOTE SWS ; close double quotation mark
HCOLON  = *( SP / HTAB ) ":" SWS
SP      = single space
HTAB    = tab
SWS     = sep whitespace

```

NOTE: If they are present within a pure charstring they will be handled like a normal character and are still included.

- Messages which are not of interest to the test suite are left undecoded as a charstring and will not be further structured.

Further clarifications on the handling of delimiters are provided hereafter:

In many cases the TTCN-3 type definitions are of lower granularity than the BNF and the codec shall consider the TTCN type definitions only. Therefore as stated in the NOTE above the rules for handling of delimiters do not require delimiters to be blindly removed from strings but the codec shall only deal with the delimiters needed to encode/decode the TTCN-3 types; sub-structures of the BNF being mapped to TTCN-3 charstrings need to be handled in TTCN and are out of scope of the codec implementation.

Example 1:

According to the BNF Alert-Info is defined as

```

Alert-Info = "Alert-Info" HCOLON alert-param *(COMMA alert-param)
alert-param = LAQUOT absoluteURI RAQUOT *( SEMI generic-param )

```

The corresponding TTCN-3 type definition is

```

type record AlertInfo { FieldName fieldName (ALERT_INFO_E),
                        AlertInfoBody_List alertInfoBody optional }
type set of AlertInfoBody AlertInfoBody_List;
type record AlertInfoBody { charstring url,
                            SemicolonParam_List genericParams optional }

```

⇒ LAQUOT and RAQUOT are delimiters of the URI field which shall be removed by the codec in UL.

Example 2:

Some fields according to the BNF for SIP are defined as “(token LWS)/ quoted-string”, i.e. the field can be either a (case-insensitive) token or a quoted string. In general in TTCN this can be mapped

- a) to a charstring or
- b) to a union of two charstring (one for the token, one for the quoted string).

In case of a) the codec shall preserve the double-quotes for the quoted-string as otherwise it cannot be distinguished from a token anymore which is vital when case-sensitivity matters whereas in case of b) the double quotes shall be removed.

7.3.3 Additional requirements for codec implementations (SIP/IMS Message)

The SIP/IMS codec is based on a normalized encoding which is always produced by an encoder. Decoder implementations, however, have to handle normalization before, or when constructing the structured message value, e.g. long versus compact form, whitespace compression, delimiter removal, same header grouping, etc. All these aspects will be handled in the next clause.

7.3.3.1 Differences between BNF - TTCN-3 Type Mapping

In normal cases the mapping is straight forward. Below you find the exceptions, including potential examples.

- The root message type is not a SIP-message but directly a Request or Response type which is represented as a TTCN-3 record. All Method - Message names (INVITE, BYE, ACK etc.) and all message header field names (To, From, CallID, Cseq, Via etc.) are mapped to an enumerated type in TTCN-3 to simplify the extension of new headers. During encoding, the long-form of these message header fields is always used. The respective field in the header type is restricted to values which are allowed.

BNF rules of RFC	TTCN-3 Type Mapping
SIP-message = Request / Response	type record REGISTER_Request {...}, type record INVITE_Request {...}, type record PRACK_Request {...}, type record NOTIFY_Request {...}, type record UPDATE_Request {...}, ... type record Response {...}

Method = INVITEm / ACKm / OPTIONSm / BYEm / CANCELm / REGISTERm / ...	type enumerated Method { ACK_E, BYE_E, CANCEL_E, INVITE_E, OPTIONS_E, REGISTER_E, ...}
---	--

- The structure of the message header fields are mapped to a "set " type in TTCN-3, because the order of these header fields is not mandatory. There is an Unknown Header List given in the type system to decode unknown headers with ID and Value.

Message-header = (... / Contact / Content-Disposition ... / Via / Warning / WWW-Authenticate / extension-header) CRLF	type set MessageHeader { ... Contact contact optional, ContentDisposition contentDisposition optional, ... Via via, Warning warning optional, WwwAuthenticate wwwAuthenticate optional, UndefinedHeader_List undefinedHeader_List optional }
--	---

- The various parameter lists defined in the BNF are mapped and combined into three different TTCN-3 sets of generic-param types. These types differ only in their name: SemicolonParam_List, AmpersandParam_List, CommaParam_List to distinguish between the relevant separators.

Uri-parameters = *(";" uri-parameter)	type set of GenericParam SemicolonParam_List ;
Authentication-Info = "Authentication-Info" HCOLON ainfo *(COMMA ainfo)	type record AuthenticationInfo { FieldName fieldName(AUTHENTICATION_INFO_E), CommaParam_List ainfo }
ainfo = nextnonce / message-qop / response-auth / cnonce / nonce-count	type set of GenericParam CommaParam_List ;
Headers = "?" header *("&" header)	type set of GenericParam AmpersandParam_List ;

- Any more specific parameter rule (e.g. uri-param, user-param, lr-param , digest-cln, etc.) is simplified to the generic-param rule which will be mapped as a record structure of two charstrings (ID and paramValue). This is equivalent to a token with an optional generic value (token [EQUAL gen-value]).

Digest-cln = realm / domain / nonce / opaque / stale / algorithm / qop-options / auth-param	type record GenericParam { charstring id , charstring paramValue optional }
--	---

- In addition to the pure charstring as a base type, the TTCN-3 type system provides base integer types which are unrestricted to the model e.g. the portField, Cseq number, maxForward digit.

User = 1*(unreserved / escaped / user-unreserved) telephone-subscriber as defined in RFC 2806	charstring
password = *(unreserved / escaped / "&" / "=" / "+" / "\$" / ",") 	charstring

Port = 1*DIGIT	integer
Status-Code = Informational / Redirection / Success / Client-Error / Server-Error / Global-Failure / extension-code	integer

- Where the same header type can appear multiple times within a message, they will be decoded as a single header field, with multiple list elements. The order of appearance of the headers will be preserved within the header list value.

Contact = ("Contact" / "m") HCOLON (STAR / (contact-param *(COMMA contact-param)))	type record Contact { FieldName fieldName(CONTACT_E), ContactBody contactBody }
contact-param = (name-addr / addr-spec) *(SEMI contact-params)	type record ContactAddress { Addr_Union addressField, SemicolonParam_List contactParams optional } type union ContactBody { charstring wildcard, ContactAddress_List contactAddresses } Used in type set of ContactAddress ContactAddress_List;

- The BNF (clause 7.3.1 Header Field Format RFC 3261 [16]) specifies that several WWW or Proxy Authentication/Authorization headers should not be combined into a single header; however they will be decoded into such in the codec. If these need to be sent downlink then a new, 'raw' (pure charstring) message type will be introduced.

Authorization =	"Authorization" HCOLON credentials	type record Authorization { FieldName fieldName(AUTHORIZATION_E), Credentials body }
Credentials =	("Digest" LWS digest-response) / other-response	type union Credentials { CommaParam_List digestResponse, OtherAuth otherResponse }

- The different schemes (sip, sips, tel, fax, absoluteUri) in the SIP URI are all handled via the same type definition. The union "UriComponents" can be enhanced to support further specific URI formats. Nevertheless it is possible to use the "other" branch of "UriComponents" for any other URI format in which case the charstring shall contain the URI without the scheme and the first ":".

Request-URI =	SIP-URI / SIPS-URI / absoluteURI	type record SipUriComponents { // sip-uri acc. To RFC 3261 [16] cl. 19.1 UserInfo userInfo optional, HostPort hostPort }
with		
SIP-URI =	"sip:" [userinfo] hostport uri-parameters [headers]	type record TelUriComponents { // tel-uri acc. To RFC 3966 [38] charstring subscriber }
and		type record UrnUriComponents { // urn-uri acc. To RFC 2141 [39] charstring namespaceId, // e.g. "service" charstring namespaceSpecificString // e.g. "sos" }
SIPS-URI =	"sips:" [userinfo] hostport uri-parameters [headers]	type union UriComponents { SipUriComponents sip, // scheme: "sip" or sips" TelUriComponents tel, // scheme: "tel" UrnUriComponents urn, // scheme: "urn" charstring other }
and		
absoluteURI =	scheme ":" (hier-part / opaque-part)	type record SipUri { charstring scheme , UriComponents components, SemicolonParam_List uriParameters optional, AmpersandParam_List headers optional }

- Universal charstrings shall be supported by the codec especially for the Display name in the URI.
- For downlink messages the len field in the ContentLength header is always set to 0 by TTCN; in case of the SIP message containing a message body SS shall replace the value by the actual length of the encoded message body (see clause 7.3.4).
- According to the SIP type definitions there are many 'charstring' fields being optional in records;
⇒ in UL the decoder shall map missing information by setting the respective field to omit rather than by assigning an empty string ("").
- type union Addr_Union
As in 'NameAddr' the field 'displayName' is optional in the first place the two branches of 'Addr_Union' are equivalent when there is no 'displayName'; nevertheless in UL the decoder shall use the branch 'nameAddr' if – and only if – the address information is surrounded by '<' and '>' (what is needed at least when there is a display name followed by the address information)
- Ipv6 address in URI
When an Ipv6 address is used as hostname in a SIP URI it is typically surrounded by '[' and ']' what is matter of the codec: in DL the codec shall add '[' and ']' when needed, in UL the '[' and ']' shall be removed i.e. in the 'host' field of the SipUriComponents' hostPort there shall be no '[' or ']' at the beginning or at the end.

7.3.3.2 URL Encoding

Several fields or parameters in SIP headers require URL encoding (e.g. Contact header, Accept-Contact header). In TTCN there is no encoding rule defined for URL encoding and there is no specific type definition for URL encoded strings. For that reason URL encoding/decoding is not a matter of codec implementation but shall be done in TTCN.

7.3.4 Additional requirements for codec implementations (Message Body)

The message body of a SIP message may contain the message of other protocols (SDP, SMS, etc.) and can be represented e.g. by XML. Therefore the type definitions for these protocols can be TTCN-3 as well as XSD definitions.

As in principle the message body of a SIP message may host any XSD definition, SIP and XSD definitions are decoupled:

To avoid import of all potential XSD definitions the XML body of SIP messages is defined as a charstring. This requires a two-stage encoding and decoding: In DL an XML message needs to be encoded in TTCN first before it gets put in the message body of a SIP message, in UL the XML message contained in the message body needs to be explicitly decoded in TTCN. By defining the XML message body as a charstring the SIP definitions are independent from any XSD definitions and a specific XSD definition needs to be known only when it is really used.

An SDP message may be contained in the message body itself or in a MIME message. In both cases the SDP message is represented as charstring in the SIP message and as for XML a two-stage encoding and decoding is applied in TTCN. This allows explicit fail assignments in case of syntactically incorrect SDP messages when syntactical correctness is a test requirement.

NOTE: Test specifications (e.g. TS 34.229-1 [5]) define the criteria for syntactical correctness and codec implementations follow these criteria.

In detail the message body for SIP messages is defined as:

<pre> type charstring XmlBody; type charstring SdpBody; type union MessageBody { SdpBody sdpMessageBody XmlBody xmlBody, MIME_Message mimeMessageBody, charstring sipfrag, charstring textplain, SimpleMsgSummary simpleMsgSummary, octetstring smsMessage }; </pre>	<p>NOTE: In contrast to SIP and SDP definitions which are commonly defined by ETSI the definition of the message body is project specific i.e. other IMS test projects at ETSI may use different definitions of the message body.</p>
---	--

7.3.5 Additional requirements for codec implementations (SDP Body)

The Session Description Protocol is defined in RFC 4566.

- The 'type' fields (such as 'v' and 'o' are not represented).
- For the defined attributes, the att-field is also not represented (e.g. 'curr' is not represented in SDP_attribute_curr).
- The Messages which are not of interest to a test suite are left undecoded as a charstring and will not be further structured.

7.3.5.1 Differences between BNF - SDP Type Mapping

In normal cases the mapping is straight forward. Below are the exceptions which differ.

- The numerical fields in the origin-field, the time-field and the timezone field have been defined as charstring because they may not fit into a 32-bit signed integer.

BNF Rules of RFC 4566	TTCN 3 Type Mapping
origin = username sess-id sess-version nettype addrtype unicast-address	type record SDP_Origin { charstring username, charstring session_id, charstring session_version, charstring net_type, charstring addr_type, charstring addr }
time-fields = start-time stop-time repeat-fields [zone-adjustments]	type record SDP_time_field { charstring start_time, charstring stop_time }
zone-adjustments = time typed-time	type record SDP_timezone { charstring adjustment_time, SDP_typed_time offset }

- The zone-adjustments field in the time-fields has been included as an additional field in the top-level message definition.

BNF Rules of RFC 4566	TTCN 3 Type Mapping
session-description = proto-version origin-field session-name-field information-field uri-field email-fields phone-fields connection-field bandwidth-fields time-fields key-fields attribute-fields media-descriptions	type record SDP_Message { integer protocol_version, SDP_Origin origin, charstring session_name, charstring information optional, charstring uri optional, SDP_email_list emails optional, SDP_phone_list phone_numbers optional, SDP_connection connection optional, SDP_bandwidth_list bandwidth optional, SDP_time_list times, SDP_timezone_list timezone_adjustments optional, SDP_key key optional, SDP_attribute_list attributes optional, SDP_media_desc_list media_list optional }
time-fields = start-time stop-time repeat-fields [zone-adjustments]	type record SDP_time { SDP_time_field time_field, SDP_repeat_list time_repeat optional }

- The mappings for the email-address, phone-number and connection-address fields have been simplified.

BNF Rules of RFC 4566	TTCN 3 Type Mapping
email-address = address-and-comment / dispname-and-address / addrspec	type record SDP_contact { charstring addr_or_phone, charstring disp_name optional }
phone-number = email-safe / email-safe "<" phone ">" / phone	type record SDP_contact { charstring addr_or_phone, charstring disp_name optional }
connection-address = multicast-address / unicast-address	type record SDP_conn_addr { charstring addr, integer ttl optional, integer num_of_addr optional }

7.3.5.2 Defined attributes

The SDP_attribute type is defined as a union of the following attribute types. There is an unknown attribute given to decode undefined attributes with a name and value.

SDP Attribute	TTCN 3 Type Mapping
cat	type record SDP_attribute_cat { charstring attr_value }
charset	type record SDP_attribute_charset { charstring attr_value }
conf	type record SDP_attribute_curr { charstring preconditionType, charstring statusType, charstring direction }
curr	type record SDP_attribute_curr { charstring preconditionType, charstring statusType, charstring direction }
des	type record SDP_attribute_des { charstring preconditionType, charstring strength, charstring statusType, charstring direction }
fmtp	type record SDP_attribute_fmtp { charstring attr_value }
framerate	type record SDP_attribute_framerate { charstring attr_value }
inactive	type record SDP_attribute_inactive { }
keywds	type record SDP_attribute_keywds { charstring attr_value }
lang	type record SDP_attribute_lang { charstring attr_value }
orient	type record SDP_attribute_orient { charstring attr_value }
ptime	type record SDP_attribute_ptime { charstring attr_value }
quality	type record SDP_attribute_quality { charstring attr_value }
recvonly	type record SDP_attribute_recvonly { }
rtcp	type record SDP_attribute_rtcp { charstring attr_value }
rtppmap	type record SDP_attribute_rtpmap { charstring attr_value }
sdplang	type record SDP_attribute_sdplang { charstring attr_value }
sendrecv	type record SDP_attribute_sendrecv { }
sendonly	type record SDP_attribute_sendonly { }
Tool	type record SDP_attribute_tool { }

SDP Attribute	TTCN 3 Type Mapping
	charstring attr_value }
Type	type record SDP_attribute_type { charstring attr_value }
Unknown	type record SDP_attribute_tool { charstring name, charstring attr_value optional }

7.3.6 Additional requirements for codec implementations (HTTP)

For HTTP the same types and header are used as for SIP.

⇒ Rules and requirements are applicable as defined for SIP in clause 7.3.

7.3.7 Additional requirements for codec implementations (XML)

XML data schema is used in IMS conformance testing according to ETSI ES 201 873-9 [57]. No further requirements are necessary.

7.4 Requirements for codec implementations (DHCP, DNS)

The DHCP/DNS codec converts TTCN descriptions into/from octet streams as specified in the RFCs. The TTCN type definitions for DHCP/DNS types closely follow the data formats defined in the corresponding RFCs (RFC 1035, RFC 1533, RFC 2131, RFC 3315, RFC 3319 and RFC 3361).

8 Design consideration

8.1 Void

8.2 Void

8.3 Void

8.4 Void

8.5 Timer Tolerances

For timers used in conformance test cases according to TS 34.229-1 [5] and TS 34.229-5 [55], a tolerance of 10% shall be applied.

8.6 Bearer information for UTRAN

The Radio Access Bearer for IMS signalling is configured according to TS 34.108 [7] clause 6.10.2.4.1.26.

Annex A (normative): Abstract Test Suites (ATS)

This annex contains the approved ATSs.

The ATSs have been produced using the Testing and Test Control Notation version 3 (TTCN-3) according to ES 201 873-1 [12].

A.1 Baseline of specifications

Table A.1 lists the core specifications and the test specifications which the delivered ATSs are referred to.

Table A.1: References of the test and Core specifications

Core specifications	3GPP TS 24.229 [11]
Test specifications	3GPP TS 34.229-1 [5]
	3GPP TS 34.229-2 [6]
	3GPP TS 34.229-5 [55]
	3GPP TS 34.123-3 [2]
	3GPP TS 36.523-3 [30]

A.2 IMS-CC ATS

Table A.2 lists all approved test cases from TS 34.229-1 [5].

Table A.2: IMS-CC TTCN test cases from TS 34.229-1 [5]

Test case	Description
6.3	Dedicated PDP Context Establishment
7.1	P-CSCF Discovery via PDP Context
8.1	Initial registration
8.2	User Initiated Re-Registration
8.3	Mobile Initiated Deregistration
8.4	Invalid behaviour- 423 Interval too brief
8.15	Refresh for ISIM parameters
8.16	User initiated re-registration- 423 Interval Too Brief
9.1	Invalid Behaviour – MAC Parameter Invalid
9.2	Invalid Behaviour – SQN out of range
10.1	Invalid Behaviour – 503 Service Unavailable
11.1	Network-initiated deregistration
11.2	Network initiated re-authentication
12.2	MO Call – 503 Service Unavailable
12.2a	MO Call – 504 Server Time-out
12.12	MO MTSI Voice Call Successful with preconditions
12.13	MT MTSI speech call
12.13a	MT MTSI speech call when MO reserves resources before sending INVITE
12.18	MTSI MO speech call / SSAC / 0% access probability for MTSI MO speech call
12.19	MTSI MO video call / SSAC / 0% access probability for MTSI MO video call
12.20	Emergency call / Success / SSAC / 0% access probability for MTSI MO speech call
12.21	MO MTSI Video call
12.22	MT MTSI Video call
12.23	MO MTSI speech call / EVS
12.24	MT MTSI speech call / EVS
12.25	MO MTSI speech call / EVS / AMR-WB
12.26	MT MTSI speech call / EVS / AMR-WB IO mode
15.1	Originating Identification Presentation
15.2	Originating Identification Restriction
15.2a	Originating Identification Restriction / Signalling
15.3	Terminating Identification Presentation
15.4	Terminating Identification Restriction
15.4a	Terminating Identification Restriction / Signalling
15.5	Communication Forwarding unconditional
15.7	Communication Forwarding on non Reply: activation
15.8	Communication Forwarding on non reply: MO call initiation
15.9	Communication Forwarding on Busy
15.10	Communication Forwarding on Not logged-in
15.10a	Communication Forwarding on Not reachable
15.11	MO Call Hold without announcement
15.11a	MO Video Call Hold without announcement
15.12	MT Call Hold without announcement
15.12a	MT Video Call Hold without announcement
15.13	Incoming Communication Barring except for a specific user
15.14a	Communication barring while roaming
15.14b	Outgoing Communication Barring while roaming
15.15	Subscription to the MWI event package
15.17	Creating a conference
15.19	Inviting user to conference by sending a REFER request to the conference focus
15.19a	Inviting user to conference by sending a REFER request to the conference focus / Video
15.21a	Three way session creation
15.21c	Three way session creation / Video
15.25	MO Explicit Communication Transfer – Consultative Call Transfer
15.27	Communication Waiting and answering the call
15.28	Communication Waiting and cancelling the call
15.29	GBA authentication
16.2	Speech AMR, indicate selective codec modes
16.3	Speech AMR-WB, indicate all codec modes
16.4	Speech AMR-WB, indicate selective codec modes
17.1	MO Speech, add video remove video
17.2	MT Speech, add video remove video
18.1	Mobile Originating SMS
18.2	Mobile Terminating SMS
19.1.1	Emergency call with emergency registration / Success / Location information available

19.1.2	Emergency call with emergency registration / Success / Location information not available
19.1.3	Emergency call with emergency registration / Abnormal case / IM CN sends a 380 / UE performs emergency call via CS domain / UTRAN or GERAN
19.1.5	Emergency call with emergency registration / Emergency SIP signalling and media in parallel with an other ongoing IM CN subsystem signalling and media
19.1.6	Emergency call with emergency registration / Success / GIBA against a network with GIBA support only
19.3.1	Non-UE detectable emergency call / IM CN sends a 1xx response / UE geographical location information available
19.3.2	Non-UE detectable emergency call / IM CN sends 380 Alternative Service including emergency service URN and no emergency subservice type / Non-emergency IMS registration / UTRAN or GERAN
19.3.2b	Non-UE detectable emergency call / IM CN sends a 380 with unavailable emergency service URN / UE performs normal call via CS domain / UTRAN or GERAN
19.3.2c	Non-UE detectable emergency call / IM CN sends a 380 with available emergency service URN / UE performs CS Emergency call via CS domain / UTRAN or GERAN
19.3.3	Non-UE detectable emergency call / IM CN sends 380 Alternative Service / Emergency IMS registration
19.3.4	Non-UE detectable emergency call / IM CN sends 380 with an Alternative Service / Previous emergency IMS registration not expired
19.4.1	Emergency call without emergency registration / EPS / UE does not contain an ISIM or USIM
19.4.2	Emergency call without emergency registration / EPS / UE contains an ISIM or USIM / UE is in state EMM-REGISTERED.LIMITED-SERVICE
19.4.5	Emergency call without emergency registration / UE credentials are not accepted
19.4.6	Emergency call without emergency registration / Failure of registration / Rejected by 403(Forbidden)
19.4.7	Emergency call without emergency registration / Failure of registration / against a network with GIBA support only
19.5.1	New initial emergency registration / UE obtains from the serving IP-CAN an IP address different than the IP address used for the emergency registration
19.5.6	User-initiated emergency reregistration / UE has emergency related ongoing dialog
19.5.7	User-initiated emergency reregistration / The user initiates an emergency call
19.5.8	User-initiated emergency reregistration / Standalone transactions exist
19.5.9	In parallel emergency and non-emergency registrations
19.5.10	Deregistration upon emergency registration expiration
20.1	Mobile Originating CAT – Forking Model
21.1	eCall over IMS / Manual initiation / Normal registration / Emergency registration / Success / 200 OK with ACK
21.2	eCall over IMS / Automatic initiation / Normal registration / Emergency registration / Success / 200 OK with ACK
21.4	eCall over IMS / Manual initiation / MSD transfer and 200 OK with ACK / SIP INFO request for MSD Update / Success
21.5	eCall over IMS / Automatic initiation / MSD transfer and 200 OK with ACK / SIP INFO request for MSD Update / Success
21.6	eCall over IMS / Automatic initiation / MSD transfer and 200 OK with ACK / SIP INFO request for unsupported MSD / UE indicates unsuccessful in SIP INFO
22.1	MO Call – UE is able to refresh the session
22.2	MO Call – Remote end is refresher
22.3	MO Call – Remote end does not support Session Timer
22.4	MO Call – Remote end seems oblivious to Session Timer paramters
22.5	MT Call – Remote end does not send Session-Expires
22.6	MT Call – Remote end sends Session-Expires but does not choose refresher
22.7	MT Call – Remote end chooses UE as refresher
22.8	MT Call – Remote end does not support Session Timer
G.8.1	Initial Registration / WLAN
G.12.1	MO MTSI speech call / WLAN
G.12.2	MT MTSI speech call / WLAN
G.12.3	MO MTSI video call / WLAN
G.12.4	MT MTSI video call / WLAN
G.15.1	Originating Identification Presentation / WLAN
G.15.2	Originating Identification Restriction / WLAN
G.15.3	Terminating Identification Presentation / WLAN
G.15.4	Terminating Identification Restriction / WLAN
G.15.5	Communication Forwarding unconditional / WLAN
G.15.6	Communication Forwarding on non Reply: activation / WLAN

G.15.7	Communication Forwarding on non Reply: MO call initiation / WLAN
G.15.8	Communication Forwarding on Busy / WLAN
G.15.10	Communication Forwarding on Not Reachable / WLAN
G.15.11	MO Call Hold without announcement / WLAN
G.15.12	MT Call Hold without announcement / WLAN
G.15.13	MO video Call Hold without announcement / WLAN
G.15.14	MT video Call Hold without announcement / WLAN
G.15.15	Incoming Communication Barring while roaming / WLAN
G.15.17	Subscription to the MWI event package / WLAN
G.15.18	Inviting user to conference by sending a REFER request to the conference focus / WLAN
G.15.20	Three way session creation / WLAN
G.15.21	Inviting user to conference by sending a REFER request to the conference focus for video / WLAN
G.15.23	Three way session creation for video / WLAN
G.15.24	Communication Waiting and answering the call / WLAN
G.15.25	Communication Waiting and cancelling the call / WLAN
G.17.1	MO Speech, add video remove video / WLAN
G.17.2	MT Speech, add video remove video / WLAN
J.8.1	Initial Registration / UE category M1
J.12.1	MO MTSI speech call / UE category M1
J.12.2	MT MTSI speech call / UE category M1
J.15.1	Communication Waiting and answering the call / UE category M1
J.15.2	Communication Waiting and cancelling the call / UE category M1
J.15.3	Subscription to the MWI event package / UE category M1
J.15.4	Originating Identification Restriction / UE category M1
J.15.6	Communication forwarding on non reply: MO call initiation / UE category M1
J.18.2	Mobile Terminating SMS / UE category M1
J.19.1	Emergency call with emergency registration / Success / Location information available / UE
J.19.2	Emergency call with emergency registration / Success / Location information not available / UE category M1

The Test Suite in TTCN-3 is contained in multiple ASCII files which accompany the present document.

A.2.1 Void

A.2.2 Void

A.2.3 Void

A.3 IMS_NR5GC ATS

Table A.3 lists all approved test cases from TS 34.229-5 [55].

Table A.3: IMS_NR5GC TTCN test cases from TS 34.229-5 [55]

Test case	Description
6.1.NR5GC	Initial Registration / 5GS
6.2.NR5GC	Initial Registration Failures / 5GS
6.3.NR5GC	Re-Registration Scenarios / 5GS
6.4.NR5GC	De-Registration Scenarios / 5GS
6.6.NR5GC	Re-Registration after capability update / 5GS
6.7.NR5GC	Authentication / MAC Parameter Invalid / Only two consecutive invalid challenges / 5GS
6.8.NR5GC	Authentication / Security-Server missing / SQN out of range / 5GS
6.9.NR5GC	Subscription / 503 Service Unavailable / 5GS
7.1.NR5GC	MTSI MO Voice Call / 503 Service Unavailable / 5GS
7.2.NR5GC	MTSI MO Voice Call / 504 Server Time-out / 5GS
7.4.NR5GC	MTSI MO Voice Call with preconditions at both originating UE and terminating UE / 5GS
7.4a.NR5GC	MTSI MO Voice Call with preconditions at both originating UE and terminating UE / Default Configuration / 5GS
7.5.NR5GC	MTSI MO Voice Call without preconditions at both originating UE and terminating UE / 5GS
7.6.NR5GC	MTSI MT Voice Call with preconditions at both originating UE and terminating UE / 5GS
7.6a.NR5GC	MTSI MT Voice Call with preconditions at both originating UE and terminating UE / Default Configuration / 5GS
7.7.NR5GC	MTSI MT Voice Call without preconditions at both originating UE and terminating UE / 5GS
7.8.NR5GC	MTSI MT Voice Call without preconditions at originating UE and with preconditions at terminating UE / 5GS
7.9.NR5GC	MTSI MT Voice Call with preconditions at originating UE and without preconditions at terminating UE / 5GS
7.10.NR5GC	MTSI MT Voice call without preconditions and without SDP offer in MT INVITE / 5GS
7.11.NR5GC	MTSI MT Voice call without preconditions at terminating UE and originating UE requiring them / 5GS
7.12.NR5GC	MTSI MO Voice Call with preconditions at originating UE and without preconditions at terminating UE / 5GS
7.13.NR5GC	MTSI MT Voice Call with RTCP disabled / 5GS
7.14.NR5GC	MTSI MO Video call with preconditions at both originating UE and terminating UE / 5GS
7.15.NR5GC	MTSI MO Video call without preconditions at both originating UE and terminating UE / 5GS
7.16.NR5GC	MTSI MT Video call with preconditions at both originating UE and terminating UE / 5GS
7.17.NR5GC	MTSI MT Video call without preconditions at both originating UE and terminating UE / 5GS
7.18.NR5GC	MTSI MO Voice Call / EVS / AMR-WB / 5GS
7.19.NR5GC	MTSI MT Voice Call / EVS / AMR-WB IO mode / 5GS
7.20.NR5GC	MTSI MO Voice Call / add video and remove video / with preconditions at both originating UE and terminating UE / 5GS
7.21.NR5GC	MTSI MO Voice Call / add video and remove video / without preconditions at both originating UE and terminating UE / 5GS
7.22.NR5GC	MTSI MT Voice Call / add video and remove video / with preconditions at both originating UE and terminating UE / 5GS
7.23.NR5GC	MTSI MT Voice Call / add video and remove video / without preconditions at both originating UE and terminating UE / 5GS
7.24.NR5GC	MTSI MT Voice Call / Forking / UE receives CANCEL request for a forked MT voice call / 5GS
7.24a.NR5GC	MTSI MO Voice Call / Forking / UE receives two preliminary responses and one early dialog termination / 5GS
7.24b.NR5GC	MTSI MO Voice Call / UE receives two preliminary responses and one final response / 5GS
7.25.NR5GC	MTSI MT Voice call without SDP offer in INVITE / 5GS
7.26.NR5GC	Mobile Originating CAT / Forking Model / 5GS
7.27.NR5GC	Session Timer / MO Call / UE is able to refresh the session / 5GS
7.28.NR5GC	Session Timer / MO Call / Remote end is refresher / 5GS
7.29.NR5GC	Session Timer / MO Call / Remote end does not support Session Timer / 5GS
7.30.NR5GC	Session Timer / MO Call / Remote end supports but does not use Session Timer / 5GS
7.31.NR5GC	Session Timer / MT Call / Remote end supports but does not send Session-Expires / 5GS
7.32.NR5GC	Session Timer / MT Call / Remote end sends Session-Expires but does not choose refresher / 5GS

7.33.NR5GC	Session Timer / MT Call / Remote end chooses UE as refresher / 5GS
7.34.NR5GC	Session Timer / MT Call / Remote end does not support Session Timer / 5GS
8.1.NR5GC	Originating Identification Presentation / Configuration / 5GS
8.2.NR5GC	Originating Identification Restriction / Configuration / 5GS
8.3.NR5GC	Originating Identification Restriction / Signalling / 5GS
8.4.NR5GC	Terminating Identification Presentation / Configuration / 5GS
8.5.NR5GC	Terminating Identification Restriction / Configuration / 5GS
8.6.NR5GC	Terminating Identification Restriction / Signalling / 5GS
8.7.NR5GC	Communication Forwarding Unconditional / Configuration / 5GS
8.8.NR5GC	Communication Forwarding Unconditional / Signalling / 5GS
8.9.NR5GC	Communication Forwarding on Not Logged-in / Configuration / 5GS
8.11.NR5GC	Communication Forwarding on Busy / Configuration / 5GS
8.13.NR5GC	Communication Forwarding on Subscriber Not Reachable / Configuration / 5GS
8.15.NR5GC	Communication Forwarding on No Reply / Configuration / 5GS
8.17.NR5GC	Barring of All Incoming Calls / Configuration / 5GS
8.19.NR5GC	Barring of All Incoming Calls from anonymous users / Configuration / 5GS
8.21.NR5GC	Barring of all Outgoing Calls / Configuration / 5GS
8.22.NR5GC	Barring of Outgoing International Calls / Configuration / 5GS
8.23.NR5GC	Barring of Outgoing International Calls / ex Home Country / Configuration / 5GS
8.25.NR5GC	Barring of Incoming Calls / When Roaming / Configuration / 5GS
8.26.NR5GC	MO Call Hold without announcement / 5GS
8.27.NR5GC	MO Video Call Hold without announcement / 5GS
8.28.NR5GC	MT Call Hold without announcement / 5GS
8.29.NR5GC	MT Video Call Hold without announcement / 5GS
8.30.NR5GC	Subscription to the MWI event package / 5GS
8.31.NR5GC	Creating and leaving a conference / 5GS
8.32.NR5GC	Inviting user to conference by sending a REFER request to the conference focus / 5GS
8.33.NR5GC	Inviting user to conference by sending a REFER request to the conference focus / Video / 5GS
8.34.NR5GC	Three way session creation / 5GS
8.35.NR5GC	Three way session creation / Video / 5GS
8.36.NR5GC	MO Explicit Communication Transfer / Consultative Call Transfer / 5GS
8.37.NR5GC	Communication Waiting and answering the call / 5Gs
8.38.NR5GC	Communication Waiting and cancelling the call / 5GS
8.39.NR5GC	GBA Authentication / 5GS
8.39a.NR5GC	HTTP Digest Authentication / 5GS
8.40.NR5GC	User initiated USSI / 5GS
8.41.NR5GC	Communication Forwarding on No Reply: MO Call initiation with preconditions
9.1.NR5GC	Mobile Originating SMS / 5GS
9.2.NR5GC	Mobile Terminating SMS / 5GS
9.3.NR5GC	Mobile Originating Concatenated SMS / 5GS
9.4.NR5GC	Mobile Terminating Concatenated SMS / 5GS
9.5.NR5GC	Mobile Originating SMS / RP-ERROR / 5GS
10.1.NR5GC	Emergency Call with emergency registration / Success / Location information available / 5GS
10.2.NR5GC	Emergency Call with emergency registration / Success / Location information not available / 5GS
10.3.NR5GC	Emergency call with emergency registration / Emergency SIP signalling and media in parallel with another ongoing IM CN subsystem signalling and media / 5GS
10.4.NR5GC	Non-UE detectable emergency call / IM CN sends a 1xx response / UE geographical location information available or not / 5GS
10.6.NR5GC	Non-UE detectable emergency call / IM CN sends 380 with an Alternative Service / Previous emergency IMS registration not expired / 5GS
10.9.NR5GC	Emergency call without emergency registration / UE credentials are not accepted / 5GS
10.10.NR5GC	Emergency call without emergency registration / Failure of registration / Rejected by 403 (Forbidden) / 5GS
10.12.NR5GC	User-initiated emergency reregistration / UE has emergency related ongoing dialog / 5GS
10.13.NR5GC	User-initiated emergency reregistration / User initiates an emergency call / 5GS
10.14.NR5GC	In parallel emergency and non-emergency registrations / 5GS
11.1.NR5GC	eCall over IMS / Manual initiation / Normal registration / Emergency registration / Success / 200 OK with ACK / 5GS
11.2.NR5GC	eCall over IMS / Automatic initiation / Normal registration / Emergency registration / Success / 200 OK with ACK / 5GS

11.4.NR5GC	eCall over IMS / Manual initiation / MSD transfer and 200 OK with ACK / SIP INFO request for MSD Update / Success / 5GS
11.5.NR5GC	eCall over IMS / Automatic initiation / MSD transfer and 200 OK with ACK / SIP INFO request for MSD Update / Success / 5GS
11.6.NR5GC	eCall over IMS / Automatic initiation / MSD transfer and 200 OK with ACK / SIP INFO request for unsupported MSD / UE indicates unsuccessful in SIP INFO / 5GS

Annex B (normative): Partial IXIT proforma

Notwithstanding the provisions of the copyright related to the text of the present document, The Organizational Partners of 3GPP grant that users of the present document may freely reproduce the partial IXIT proforma in this annex so that it can be used for its intended purposes and may further publish the completed partial IXIT.

B.0 Introduction

This partial IXIT proforma contained in the present document is provided for completion, when the related Abstract Test Suite is to be used against the Implementation Under Test (IUT).

Text in *italics* is comments for guidance for the production of an IXIT, and is not to be included in the actual IXIT.

The completed partial IXIT will normally be used in conjunction with the completed ICS, as it adds precision to the information provided by the ICS.

B.1 Parameter values

B.1.1 PIXITs

Table B.1.1: PIXIT

Parameter name	Description	Type	Default value	Supported value
px_IMS_AssociatedTelUri	TEL URI for the user	charstring	"+331234567"	format shall be TEL URI
px_IMS_CalleeUri	URI of Callee, sent by the UE in INVITE (MO call establishment) to address the remote UE (NOTE 1)	charstring	"sip:User-B@3gpp.org"	
px_IMS_CalleeUri2	URI of Callee, sent by the UE in INVITE (MO call establishment) to address the remote UE (NOTE 1)	charstring	" sip:User-C@3gpp.org "	
px_IMS_CalleeContactUri	URI provided by the remote side (i.e. by SS) to be used by the UE as contact address in further SIP signalling of the dialog (NOTE 1)	charstring	"sip:User-B-Contact@3gpp.org"	
px_IMS_CalleeContactUri2	URI provided by the remote side (i.e. by SS) to be used by the UE as contact address in further SIP signalling of the dialog (NOTE 1)	charstring	"sip:User-C-Contact@3gpp.org"	
px_IMS_CiphAlgo_Def	Ciphering Algorithm; NOTE: Unless specified otherwise in the test prose „nociph“ shall not be used for verification	CiphAlgo	des_edec3_cbc	enumerated type: des_edec3_cbc, aes_cbc or nociph
px_IMS_HomeDomainName	Home Domain Name. Applicable when using an ISIM: same value as EF _{DOMAIN} . (derived from the IMSI otherwise) FBBA: value as preconfigured at the UE	charstring	As defined in TS 34.229-1 [5], Annex E	
px_IMS_HomeDomainName_Refreshed	used in 8.15	charstring	"refreshed3gpp.org"	
px_IMS_Private_UserId_Refreshed	used in 8.15	charstring	"privateuser@refreshed3gpp.org"	
px_IMS_PublicUserIdentity1_Refreshed	used in 8.15	charstring	"sip:PublicId1@refreshed3gpp.org"	
px_IMS_MessageAccountIdentity	used in 15.15	charstring	""	

Parameter name	Description	Type	Default value	Supported value
px_IMS_SPI_ValidValueList_PDN1	List of comma separated integer values that can be used as SPI values for IMS security on PDN1; each value shall be ≥ 256	charstring	""	
px_IMS_SPI_ValidValueList_PDN2	List of comma separated integer values that can be used as SPI values for IMS security on PDN2; each value shall be ≥ 256	charstring	""	
px_IMS_IPSecAlgorithm	Integrity Algorithm	IntAlgo	hmac_sha_1_96	enumerated type; hmac_md5_96, hmac_sha_1_96
px_IMS_Private_UserId	Private User Identity. Applicable when using an ISIM: same value as EF _{IMPI} . (derived from the IMSI otherwise) FBBA: username as used for authorization	charstring	As defined in TS 34.229-1 [5], Annex E	
px_IMS_PublicUserIdentity1	Public User Identity. It is set to the same value as the first record in EF _{IMPU} . FBBA: IMPU preconfigured in the UE	Charstring	As defined in TS 34.229-1 [5], Annex E	
px_IMS_PublicUserIdentity2	It is set to the same value as the second record in EF _{IMPU} .	Charstring	As defined in TS 34.229-1 [5], Annex E	
px_IMS_PublicUserIdentity3	It is set to the same value as the third record in EF _{IMPU} .	Charstring	As defined in TS 34.229-1 [5], Annex E	
px_SMS_SMSC_InternationalNumber	international number of the SMSC: Dialed number string of the TS-Service Centre Address according to clause 4.5.3.9 "EFSMSP (Short message service parameters)" in TS 31.121 [52] (TON is assumed to be "International Number").	charstring	As defined in Annex E.3.2.14 of TS 34.229-1 [5]: "112233445566778" according to TS 31.121 [52].	
px_UEwithISIM	true: UE has ISIM false: UE has USIM only	boolean	true	
px_DigestPasswordForXCAP	XCAP password	charstring	"XCAP-Password"	
px_XCAP_RootUri	XCAP Root URI according to section 6.1 of RFC 4825 [70] as configured at the UE	charstring	"/XCAP.3gpp.org"	
px_XCAP_TargetUri	Target (SIP or TEL URI) where to forward to	charstring	"sip:user@domain.com"	
px_XCAP_Username	username to be used for HTTP authentication in case of pc_XCAP_UsernameIsConfiguredInUE ==true	charstring		
NOTE 1: px_IMS_CalleeUri, px_IMS_CalleeUri2, px_IMS_CalleeContactUri and px_IMS_CalleeContactUri2 values shall be all different from each other.				

B.2 Void

Annex C: Void

Annex D: Void

Annex E (informative): TTCN-3 style guide for 3GPP IMS ATS

For IMS conformance tests, the style guide of 36.523-3[30], Annex B shall be applied.

Annex F (informative): BNF Message Definitions

The BNF definitions required for the ATS are defined in the following RFCs:

3261, 3262, 3265, 3311, 3313, 3323, 3325, 3326, 3327, 3329, 3428, 3455, 3515, 3608, 3840, 3841, 3891, 3892, 3903, 3911, 4028.

Annex G (Normative): SIP Type Definitions and XSD References

G.0 References of XSD and SIP Type Definitions

G.0.1 XML Schema Definitions (XSD)

The XSD references listed in this Annex are imported in the Test Suite.

Table G.0.1-1: Common Definitions

XML Schema	Source	Name space	Modifications
RFC3680_reginfo	RFC 3680 [24]	urn:ietf:params:xml:ns:reginfo	
RFC4575_conference-info	RFC 4575 [45]	urn:ietf:params:xml:ns:conference-info	
RFC5628_gruuinfo	RFC 5628 [46]	urn:ietf:params:xml:ns:gruuinfo	
24229_AlternativeService	TS 24.229 [11] Table 7.6.1	NoTargetNamespace	
RFC3863_pidf	RFC 3863 [47]	urn:ietf:params:xml:ns:pidf	definitions modified according to errata id 1606
RFC4119_pidf_geopriv10	RFC 4119 [44]	urn:ietf:params:xml:ns:pidf:geopriv10	NOTE: RFC's errata has no impact on definitions
RFC4119_pidf_geopriv10_basicPolicy	RFC 4119 [44]	urn:ietf:params:xml:ns:pidf:geopriv10:basicPolicy	NOTE: RFC's errata has no impact on definitions
RFC4119_pidf_geopriv10_civicLoc	RFC 4119 [44]	urn:ietf:params:xml:ns:pidf:geopriv10:civicLoc	NOTE: RFC's errata has no impact on definitions
RFC4479_pidf_data_model	RFC 4479 [58]	urn:ietf:params:xml:ns:pidf:data-model	
RFC4479_common_schema	RFC 4479 [58]	none (included by RFC4479_pidf_data_model only)	
24237_SRVCC	TS 24.237 [51] Annex D.2	NoTargetNamespace	
Xml	http://www.w3.org/2001/03/xml.xsd	http://www.w3.org/XML/1998/namespace	
RFC8147_next_generation_ecall	RFC 8147 [59]	urn:ietf:params:xml:ns:EmergencyCallData:control	
24390_ussd_data	TS 24.390 [53] clause 5.1.3.4	NoTargetNamespace	

Table G.0.1-2: XCAP specific definitions

XML Schema	Source	Name space
TS24604	TS 24.604 [40]	http://uri.etsi.org/ngn/params/xml/simservs_xcap
TS24607-OIP-OIR	TS 24.607 [41]	http://uri.etsi.org/ngn/params/xml/simservs_xcap
TS24608-TIP-TIR R2	TS 24.608 [42]	http://uri.etsi.org/ngn/params/xml/simservs_xcap
TS24611	TS 24.611 [43]	http://uri.etsi.org/ngn/params/xml/simservs_xcap
XCAP	TS 24.623 [36]	http://uri.etsi.org/ngn/params/xml/simservs_xcap
xdm_commonPolicy-V1_0	https://www.openmobilealliance.org/tech/profiles/xdm_commonPolicy-v1_0.xsd	urn_oma_xml_xdm_common_policy
RFC4745-common-policy	RFC 4745 [48]	urn_ietf_params_xml_ns_common_policy

Table G.0.1-3: GBA specific definitions

XML Schema	Source	Name space
TS24109	TS 24.109 [33]	uri_3gpp_gba

In order to avoid ambiguities and unexpected side effects due to tool specific behaviour the schemaLocation in xs:import or xs:include statements of XSD files are modified to use local references rather than references to internet locations.

The schemaLocations are shown in table G.0.1-4 and table G.0.1-5.

Table G.0.1-4: schemaLocation of imported namespaces

XML Schema	Imported name space	Original schemaLocation	Modified schemaLocation
RFC3680_reg info	http://www.w3.org/XML/1998/namespace	http://www.w3.org/2001/03/xml.xsd	../Common/IMS_XSD/xml.xsd
RFC3863_pdfif	http://www.w3.org/XML/1998/namespace	http://www.w3.org/2001/xml.xsd	../Common/IMS_XSD/xml.xsd
RFC4119_pdfif_geopriv10	http://www.w3.org/XML/1998/namespace	http://www.w3.org/2001/xml.xsd	../Common/IMS_XSD/xml.xsd
RFC4119_pdfif_geopriv10_basicPolicy	http://www.w3.org/XML/1998/namespace	http://www.w3.org/2001/xml.xsd	../Common/IMS_XSD/xml.xsd
RFC4479_common_schema	http://www.w3.org/XML/1998/namespace	http://www.w3.org/2001/xml.xsd	../Common/IMS_XSD/xml.xsd
RFC4575_conference-info	http://www.w3.org/XML/1998/namespace	http://www.w3.org/2001/03/xml.xsd	../Common/IMS_XSD/xml.xsd
TS24604	urn:ietf:params:xml:ns:common-policy	common-policy.xsd	../Common/IMS_XSD/RFC4745-common-policy.xsd
TS24604	urn:oma:xml:xdm:common-policy	xdm_commonPolicy-V1_0	(no change needed)
TS24611	urn:ietf:params:xml:ns:common-policy	common-policy.xsd	../Common/IMS_XSD/RFC4745-common-policy.xsd
TS24611	urn:oma:xml:xdm:common-policy	xdm_commonPolicy-V1_0	(no change needed)

Table G.0.1-5: schemaLocation of included namespaces

XML Schema	Original schemaLocation	Modified schemaLocation
RFC4479_pdfif_data_model	common-schema.xsd	RFC4479_common_schema.xsd

G.0.2 Common TTCN-3 Libraries

Additionally the Test Suite imports the following modules of ETSI's LibSip (ETSI SIP Library, see):

Module	Revision
LibSip_Common	LibSip v3.0.5
LibSip_SDPTypes	LibSip v3.0.5
LibSip_SimpleMsgSummaryTypes	LibSip v3.0.5
LibSip_SIPTypesAndValues	LibSip v3.0.5

The LibSip module LibSip_MessageBodyTypes (imported by LibSip_SIPTypesAndValues) contains type definitions for the message body of SIP messages which in general are project specific. For 3GPP conformance testing LibSip_MessageBodyTypes is defined as shown below.

G.1 LibSip_MessageBodyTypes

LibSip_MessageBodyTypes: Basic Type Definitions

TTCN-3 Basic Types		
XmlBody	charstring	
SdpBody	charstring	

MIME_FieldName

TTCN-3 Enumerated Type	
Name	MIME_FieldName
Comment	
MIME_CONTENT_DISPOSITION_E	
MIME_CONTENT_TYPE_E	
MIME_CONTENT_ID_E	

MessageBody

TTCN-3 Union Type		
Name	MessageBody	
Comment		
sdpMessageBody	SdpBody	to be applied when contentType is "application/sdp"
xmlBody	XmlBody	to be applied when contentType indicates an XML body, e.g. matches "application/xml", "text/xml", "application/(.*)+xml"
mimeMessageBody	MIME_Message	to be applied when contentType is "multipart/mixed"
simpleMsgSummary	SimpleMsgSummary	RFC 3842 (Message Summary and Message Waiting Indication Event Package for the Session Initiation Protocol); to be applied when contentType is "application/simple-message-summary"
smsMessage	octetstring	encoded SMS message 3GPP 23.040, 24.011; to be applied when contentType is "application/vnd.3gpp.sms"
commonText	charstring	to be applied when contentType indicates text based content other than SDP, XML or simple message summary, e.g. "application/mikey" (base64encoded), "application/json", "text/html", "application/x-www-form-urlencoded"
commonBinary	octetstring	to be applied when contentType indicates binary data other than SMS, e.g. "application/EmergencyCallData.eCall.MSD"

G.1.1 MIMETypes

MIME_ContentDisposition

TTCN-3 Record Type			
Name	MIME_ContentDisposition		
Comment	RFC 2183		
fieldName	MIME_FieldName (MIME_CONTENT_DISPOSITION_E)		
dispositionType	charstring		
dispositionParams	SemicolonParam_List	opt	

MIME_ContentType

TTCN-3 Record Type			
Name	MIME_ContentType		
Comment	RFC 2045 clause 5		
fieldName	MIME_FieldName (MIME_CONTENT_TYPE_E)		
typeAndSubtype	charstring		
typeParams	SemicolonParam_List	opt	

MIME_ContentId

TTCN-3 Record Type			
Name	MIME_ContentId		
Comment	RFC 2045 clause 7		
fieldName	MIME_FieldName (MIME_CONTENT_ID_E)		
msgId	charstring		

MIME_Part_Header

TTCN-3 Set Type			
Name	MIME_Part_Header		
Comment			
contentType	MIME_ContentType		
contentDisposition	MIME_ContentDisposition	opt	
contentId	MIME_ContentId	opt	

MIME_Part_Body

TTCN-3 Union Type			
Name	MIME_Part_Body		
Comment			
sdpMessageBody	SdpBody	to be applied when contentType is "application/sdp"	
xmlBody	XmlBody	to be applied when contentType indicates an XML body, e.g. matches "application/xml", "text/xml", "application/(.*)+xml"	
commonText	charstring	to be applied when contentType indicates text based content other than SDP or XML, e.g. "application/mikey" (base64encoded), "application/json", "text/html", "application/x-www-form-urlencoded"	
commonBinary	octetstring	to be applied when contentType indicates binary data, e.g. "application/EmergencyCallData.eCall.MSD"	

MIME_Part

TTCN-3 Record Type			
Name	MIME_Part		
Comment			
header	MIME_Part_Header		
body	MIME_Part_Body		

MIME_Message

TTCN-3 Record Type			
Name	MIME_Message		
Comment			
boundary	charstring		boundary according to RFC 2046 clause 5.1.1
mimePartList	MIME_Part_List		

MIME_Part_List

TTCN-3 Set of Type	
Name	MIME_Part_List
Comment	
set of MIME_Part	

G.2 References to TTCN-3

References to TTCN-3		
LibSip_MessageBodyTypes	IMS_LibSip/LibSip_MessageBodyTypes.ttcn	Rev 28285

Annex H (informative): TTCN-3 Definitions of Common Interfaces

The multi-testers model according to clause 5 provides interfaces which can be re-used by implementations of the IP-CAN test model according to TS 34.229-4 [50].

NOTE: Common type definitions are according to annex D of TS 36.523-3 [30].

H.1 IMS_PTC_CoordMsg

IMS_TestProcedure_Type

TTCN-3 Enumerated Type	
Name	IMS_TestProcedure_Type
Comment	
IPCAN_InitialRegistration	EUTRA/EPS signalling acc. to 36.508 cl. 4.5.2.3 without RRC Connection Release at the end of the procedure NOTE: As working assumption the UE does IMS REGISTRATION automatically after RRC/NAS registration
IPCAN_EmergencyCall_NormalService	EUTRA/EPS signalling acc. to 36.508 cl. 4.5A.4.3
IPCAN_EmergencyCall_OptionalPDNRelease	EUTRA/EPS signalling acc. to 36.508 cl. 4.5A.4.3, but with Call Release according to 34.229-1 C.32a
IPCAN_EmergencyCall_LimitedService	EUTRA/EPS signalling acc. to 36.508 cl. 4.5A.5.3
IPCAN_MO_SpeechCall	EUTRA/EPS signalling acc. to 36.508 cl. 4.5A.6.3
IPCAN_MT_SpeechCall	EUTRA/EPS signalling acc. to 36.508 cl. 4.5A.7.3
IPCAN_MO_VideoCall	EUTRA/EPS signalling acc. to 36.508 cl. 4.5A.8.3
IPCAN_MT_VideoCall	EUTRA/EPS signalling acc. to 36.508 cl. 4.5A.9.3
IPCAN_MO_AddVideo	EUTRA/EPS signalling acc. to 36.508 cl. 4.5A.11.3
IPCAN_MT_AddVideo	EUTRA/EPS signalling acc. to 36.508 cl. 4.5A.12.3
IPCAN_ReleaseVideo	EUTRA/EPS signalling acc. to 36.508 cl. 4.5A.15.3
IPCAN_MO_IMS_Signalling	EUTRA/EPS signalling acc. to 36.508 cl. 4.5.3.3 with $m = n = 0$; used e.g. for MT SMS test case 18.2
IPCAN_MT_IMS_Signalling	EUTRA/EPS signalling acc. to 36.508 cl. 4.5.3.3 Steps 3 to 9 with $m = n = 0$; used e.g. for MT SMS test case 18.1
IPCAN_XCAP_Signalling	EUTRA/EPS signalling acc. to 36.508 cl. 4.5A.14
IPCAN_MO_DataCall	for MCDData test cases
IPCAN_MT_DataCall	for MCDData test cases
IPCAN_AdditionalIPAddress	CR 213400
IPCAN_Deregistration	
IPCAN_UseVPLMN	Change cell used from Cell 1 (HPLMN) to Cell 12 (VPLMN)

IMS_TestConfiguration_Type

TTCN-3 Enumerated Type	
Name	IMS_TestConfiguration_Type
Comment	
IPCAN_SignallingOnly	EUTRA: default DRB is used only
IPCAN_SpeechCall	EUTRA: one dedicated UM bearer; for normal speech calls and emergency call for limited services
IPCAN_VideoCall	EUTRA: two dedicated UM bearers
IPCAN_EmergencyCall	EUTRA: second default bearer (AM) and one dedicated UM bearer
IPCAN_SpeechAndEmergencyCall	EUTRA: default bearer + dedicated bearer for normal speech call and another default bearer + dedicated bearer for emergency call
IPCAN_XCAP	EUTRA: second default bearer (AM) for second PDN used for XCAP signalling
IPCAN_DataCall	MCDATA: one dedicated UM bearer

IPCAN_INFO_Type

TTCN-3 Record Type			
Name	IPCAN_INFO_Type		
Comment			
RanType	IPCAN_RAN_Type	opt	
UE_Release	integer	opt	
AuthResLength	integer	opt	
NetworkSupportsVoiceOverIMS	boolean		

IMS_IPCAN_CommandName_Type

TTCN-3 Enumerated Type	
Name	IMS_IPCAN_CommandName_Type
Comment	
IPCAN_INIT	trigger the IPCAN_PTC to create a cell and do further appropriate initialisation; which RAN technology to be use is decided by the IPCAN_PTC based on PIXITs; as test procedure shall be specified which procedure is used during the test body to know which DRBs need to be pre-configured; IPCAN returns response indicating the RAN type
IPCAN_STARTPROCEDURE	trigger the IPCAN to expect (MO) or page (MT) the UE to establish an RRC connection; depending on the connection type triggers may need to be sent from IPCAN to IMS or from IMS to IPCAN to synchronise establishment of dedicated DRBs (EUTRA) or secondary PDP contexts (UTRAN)
IPCAN_ENDPROCEDURE	trigger RRC connection release by the IPCAN_PTC; as a SIP message may be sent out just before end of the procedure in general a delay of 2s shall be added before sending IPCAN_ENDPROCEDURE to IPCAN; for UTRAN it is up to IPCAN and SS implementation to cope with possible/necessary release of (secondary) PDP context; a trigger shall be sent from IPCAN to IMS to indicate when RRC connection is released
IPCAN_RELEASE	Detach UE and release cell (postamble); a trigger is shall be sent from IPCAN to IMS to indicate when IPCAN is released
IPCAN_QUERY	query information from the IPCAN PTC
IPCAN_PROVIDELOCATIONINFORMATION	trigger IPCAN to provide UELocationInformation to the UE acc. to 36.509

IMS_IPCAN_Command_Type

TTCN-3 Record Type			
Name	IMS_IPCAN_Command_Type		
Comment	Messages IMS_PTC -> IPCAN		
Name	IMS_IPCAN_CommandName_Type		
TestConfiguration	IMS_TestConfiguration_Type	opt	
TestProcedure	IMS_TestProcedure_Type	opt	

IMS_IPCAN_ResponseName_Type

TTCN-3 Enumerated Type	
Name	IMS_IPCAN_ResponseName_Type
Comment	
IPCAN_INIT	response for INIT command: carries the RAN type as used by the IPCAN PTC; the RAN type depends on PIXIT settings: part 4 model: px_RANTech part 3 model: EUTRA_FDD or EUTRA_TDD depending on px_ePrimaryFrequencyBand (px_ePrimaryFrequencyBand < 33 => FDD)
IPCAN_QUERY	

IPCAN_IMS_Response_Type

TTCN-3 Record Type			
Name	IPCAN_IMS_Response_Type		
Comment			
Name	IMS_IPCAN_ResponseName_Type		
IpcanInfo	IPCAN_INFO_Type	opt	

IPCAN_IMS_Reset_Type

TTCN-3 Enumerated Type	
Name	IPCAN_IMS_Reset_Type
Comment	
WithCNF	
WithoutCNF	

IPCAN_IMS_Control_Type

TTCN-3 Union Type		
Name	IPCAN_IMS_Control_Type	
Comment		
Reset	IPCAN_IMS_Reset_Type	to reset IMS after UE has been switched off and gets switched on again
IpcanInd	Null_Type	to indicate to IMS which IPCAN is active (at port IPCAN or at port OtherIPCAN)
ReregistrationStart	IPCAN_RAN_Type	to prepare IMS PTC for (optional) re-registration
ReregistrationStop	Null_Type	to indicate to IMS PTC that no re-registration will happen anymore
NoRegistration	Null_Type	no IMS registration shall happen (e.g. due to test loop mode being activated)

IMS_IPCAN_Coordination_MSG

TTCN-3 Union Type		
Name	IMS_IPCAN_Coordination_MSG	
Comment		
TriggerEvent	CoOrdination_Trigger_Type	any trigger of confirmation
AbortEvent	Null_Type	sent instead of TriggerEvent if procedure shall be aborted
IPCAN_IMS_Control	IPCAN_IMS_Control_Type	IMS <- IPCAN: to control IMS (default behaviour)
IMS_IPCAN_Command	IMS_IPCAN_Command_Type	IMS -> IPCAN: command from the IPCAN to control IMS (mainly for IMS default behaviour)
IPCAN_IMS_Response	IPCAN_IMS_Response_Type	IMS <- IPCAN: response for previous command
ProtocolConfigOptions	NAS_ProtocolConfigOptions_Type	IMS <-> IPCAN: PCOs to be used in NAS signalling
IPCAN_IMS_Data	charstring	IMS <- IPCAN: to send data from IPCAN to IMS
DrblInfo	IP_DrblInfo_Type	IMS <- IPCAN: to send DrblInfo for MediaControlInfo (MCX) and HTTP to MCX_IMS_PTC

IMS_IPCAN_CO_ORD_PORT

TTCN-3 Port Type		
Name	IMS_IPCAN_CO_ORD_PORT	
Comment		
out	IMS_IPCAN_Coordination_MSG	
in	IMS_IPCAN_Coordination_MSG	

CoOrdination_Trigger_Type

TTCN-3 Record Type		
Name	CoOrdination_Trigger_Type	
Comment		
Reason	charstring	

H.2 IMS_ASP_TypeDefs

IMS_ASP_TypeDefs: Basic Type Definitions

TTCN-3 Basic Types		
IMS_Request_Type	RequestUnion	Alias for "RequestUnion" as defined in LibSip_SIPTypesAndValues
IMS_Response_Type	Response	Alias for "Response" as defined in LibSip_SIPTypesAndValues
IMS_PortsAndSecurityConfigCnf_Type	Null_Type	SPIs and protected ports are fully controlled by the IMS PTC => it is not necessary anymore to return IMS_ProtectedPorts_Type, IMS_SPIs_Type to the IMS PTC

IMS_SecurityContextEnum_Type

TTCN-3 Enumerated Type	
Name	IMS_SecurityContextEnum_Type
Comment	
unprotected	
protectedContext1	
protectedContext2	

IMS_RoutingInfo_Type

TTCN-3 Record Type			
Name	IMS_RoutingInfo_Type		
Comment			
Protocol	InternetProtocol_Type		UDP or TCP
Security	IMS_SecurityContextEnum_Type	opt	protected or unprotected (in DL omit when IP PTC shall decide what to do)
UE_Address	IP_AddrInfo_Type	opt	sent by the IP PTC when there is an initial request on unprotected connection
NW_Address	IP_AddrInfo_Type	opt	sent by the IP PTC when there is an initial request on unprotected connection

IMS_DATA_REQ

TTCN-3 Record Type			
Name	IMS_DATA_REQ		
Comment			
RoutingInfo	IMS_RoutingInfo_Type		
Request	IMS_Request_Type		

IMS_DATA_RSP

TTCN-3 Record Type			
Name	IMS_DATA_RSP		
Comment			
RoutingInfo	IMS_RoutingInfo_Type		
Response	IMS_Response_Type		

IMS_ProtectedPorts_Type

TTCN-3 Record Type			
Name	IMS_ProtectedPorts_Type		
Comment			
Port_us	PortNumber_Type		UE side: Server
Port_uc	PortNumber_Type		UE side: Client
Port_ps	PortNumber_Type		network side: Server
Port_pc	PortNumber_Type		network side: Client

IMS_SPIs_Type

TTCN-3 Record Type			
Name	IMS_SPIs_Type		
Comment			
SPI_us	IPsec_SPI_Type		SPI at UE side: assigned by the UE
SPI_uc	IPsec_SPI_Type		SPI at UE side: assigned by the UE
SPI_ps	IPsec_SPI_Type	opt	SPI at network side: to be assigned by TTCN
SPI_pc	IPsec_SPI_Type	opt	SPI at network side: to be assigned by TTCN

IMS_SecurityInfo_Type

TTCN-3 Record Type			
Name	IMS_SecurityInfo_Type		
Comment			
ProtectedPorts	IMS_ProtectedPorts_Type		
SPIs	IMS_SPIs_Type		
IntegrityAlgorithm	IPsec_IntegrityAlgorithm_Type		
CipheringAlgorithm	IPsec_CipheringAlgorithm_Type		

IMS_RegistrationInfo_Type

TTCN-3 Record Type			
Name	IMS_RegistrationInfo_Type		
Comment			
NW_Address	IP_AddrInfo_Type		network address of the chosen IMS server (e.g. IPv4, IPv6)
UE_Address	IP_AddrInfo_Type		UE address as used for security protected connections
SecurityInfo	IMS_SecurityInfo_Type	opt	omit in case of GIBA

IMS_PortsAndSecurityConfigReq_Type

TTCN-3 Record Type			
Name	IMS_PortsAndSecurityConfigReq_Type		
Comment			
UnprotectedPort_us	PortNumber_Type	opt	5060 per default
RegistrationInfo	IMS_RegistrationInfo_Type	opt	

IMS_SecurityReleaseMode_Type

TTCN-3 Enumerated Type	
Name	IMS_SecurityReleaseMode_Type
Comment	
full	all protected and unprotected security contexts shall be released (e.g. at de-registration)
keepUnprotected	all protected security contexts shall be released but the unprotected security context shall be kept
oldestProtectedContextOnly	only the oldest protected security context shall be released

IMS_SecurityRelease_Type

TTCN-3 Record Type			
Name	IMS_SecurityRelease_Type		
Comment			
Mode	IMS_SecurityReleaseMode_Type		
WaitForCNF	boolean		

IMS_RestartPCSCF_Type

TTCN-3 Record Type			
Name	IMS_RestartPCSCF_Type		
Comment			
PdnIndex	PDN_Index_Type		
IPAddressIPv4	charstring		
IPAddressIPv6	charstring		

IMS_CONFIG_REQ

TTCN-3 Union Type	
Name	IMS_CONFIG_REQ
Comment	
InstallKey	IPsec_SecurityKeys_Type
PortsAndSecurityConfig	IMS_PortsAndSecurityConfigReq_Type
SecurityRelease	IMS_SecurityRelease_Type
CloseTCP	Null_Type
RestartPCSCF	IMS_RestartPCSCF_Type

IMS_CONFIG_CNF

TTCN-3 Union Type	
Name	IMS_CONFIG_CNF
Comment	
InstallKey	Null_Type
PortsAndSecurityConfig	IMS_PortsAndSecurityConfigCnf_Type
SecurityRelease	Null_Type
CloseTCP	Null_Type
RestartPCSCF	Null_Type

IMS_IP_CTRL_PORT

TTCN-3 Port Type	
Name	IMS_IP_CTRL_PORT
Comment	Control port at the IMS PTC to configure IP for IMS
out	IMS_CONFIG_REQ
in	IMS_CONFIG_CNF

IMS_IP_CLIENT_PORT

TTCN-3 Port Type	
Name	IMS_IP_CLIENT_PORT
Comment	IMS client: send requests, receive response
out	IMS_DATA_REQ
in	IMS_DATA_RSP

IMS_IP_SERVER_PORT

TTCN-3 Port Type	
Name	IMS_IP_SERVER_PORT
Comment	IMS server: send response, receive requests
out	IMS_DATA_RSP
in	IMS_DATA_REQ

H.3 HTTP_ASP_TypeDefs

H.3.1 HTTP_ASP_Definitions

HttpServerInfo_Type

TTCN-3 Record Type			
Name	HttpServerInfo_Type		
Comment			
serverAddr	IP_AddrInfo_Type		IP address of simulated server
serverPort	PortNumber_Type		Port number of simulated server
drbInfo	IP_DrbInfo_Type		DRB info as used by the IP PTC (LTE model, see TS 36.523-3 [30])
tlsConfig	TLSConfig_Type	opt	TLS parameters as used by the IP PTC (LTE model, see TS 36.523-3 [30]) (omit: no TLS)

HttpServerList_Type

TTCN-3 Record of Type	
Name	HttpServerList_Type
Comment	
record length (1 .. infinity) of HttpServerInfo_Type	

HTTP_CTRL_REQ

TTCN-3 Record Type			
Name	HTTP_CTRL_REQ		
Comment	ASP type to configure the http layer; when any of the optional fields is omitted the previous configuration of this field is kept		
httpServerList	HttpServerList_Type	opt	IP address and port of simulated HTTP servers

HTTP_CTRL_CNF

TTCN-3 Record Type			
Name	HTTP_CTRL_CNF		
Comment	ASP type to confirm HTTP_CTRL_REQ		
errorInfo	charstring	opt	string indicating a system error

HTTP_DATA_IND

TTCN-3 Record Type			
Name	HTTP_DATA_IND		
Comment	ASP type for sending a message from the http layer to TTCN; it transports relevant information of a http Request from the UE to the Tester		
routingInfo	IP_Connection_Type		TCP connection from which the request has been received; => response shall use the same
httpRequest	HttpRequest_Type		

HttpRequestBody

TTCN-3 Union Type		
Name	HttpRequestBody	
Comment		
text	charstring	
binary	octetstring	
mime	MIME_Message	

HttpRequest_Type

TTCN-3 Record Type			
Name	HttpRequest_Type		
Comment			
requestLine	HttpRequestLine_Type		RFC 2616 clause 5.1
userAgent	UserAgent	opt	User Agent according to RFC 2616 [27] clause 14.43
authorization	Authorization	opt	Authorization according to RFC 2616 [27] clause 14.8 (optional; NOTE: Same type definition as for SIP type definitions)
host	Host	opt	host according to RFC 2616 [27] clause 14.23
contentType	ContentType	opt	Content-Type according to RFC 2616 [27] clause 14.17 (optional, NOTE: Same type definition as for SIP type definitions)
cacheControl	HttpCacheControl_Type	opt	RFC 2616 clause 14.9
x3GPPIntende dIdentity	charstring	opt	3GPP TS 24.109 [33] clause G.2
messageBody	HttpRequestBody	opt	e.g. XCAP Message;

HttpResponse_Type

TTCN-3 Record Type			
Name	HttpResponse_Type		
Comment			
statusLine	HttpStatusLine_Type		Status-Line in RFC 2616 [27] clause 6.1
date	Date	opt	Date according to RFC 2616 [27] clause 14.18
eTag	SIP_ETag	opt	ETag according to RFC 2616 [27] clause 14.19
server	Server	opt	Server according to RFC 2616 [27] clause 14.38
wwwauthenticat e	WwwAuthenticate	opt	WWW-Authenticate in RFC 2616 [27] clause 14.47 (NOTE: Same type definition as for SIP type definitions)
authenticationI nfo	AuthenticationInfo	opt	Authentication-Info in RFC 2617 [37] clause 3.2.3 (NOTE: Same type definition as for SIP type definitions)
contentType	ContentType	opt	Content-Type in RFC 2616 [27] clause 14.17 (NOTE: Same type definition as for SIP type definitions)
location	HttpLocation_Type	opt	RFC 2616 clause 14.30
contentLength	ContentLength	opt	Content-Length in RFC 2616 [27] clause 14.13 (NOTE: Same type definition as for SIP type definitions)
expires	Expires	opt	Expires in RFC 2616 [27] clause 14.21 (NOTE: Same type definition as for SIP type definitions)
cacheControl	HttpCacheControl_Type	opt	Cache-Control in RFC 2616 [27] clause 14.9
pragma	HttpPragma_Type	opt	Pragma in RFC 2616 [27] clause 14.32
messageBody	HttpRequestBody	opt	e.g. XCAP Message;

HTTP_DATA_REQ

TTCN-3 Record Type			
Name	HTTP_DATA_REQ		
Comment	ASP type for sending messages from TTCN to the http layer; it transports information needed by the http layer to generate a http Response to the UE		
routingInfo	IP_Connection_Type		TCP connection to be used in DL: shall be the same as for corresponding request
httpResponse	HttpResponse_Type		

HttpRequestLine_Type

TTCN-3 Record Type			
Name	HttpRequestLine_Type		
Comment	request line according to RFC 2616 [27] clause 5.1		
method	charstring		
uri	charstring		XCAP: selection expression, RFC 4825 [26]
version	charstring		

HttpStatusLine_Type

TTCN-3 Record Type			
Name	HttpStatusLine_Type		
Comment	status line according to RFC 2616 [27] clause 5.1		
version	charstring		
code	integer		
reasonPhrase	charstring		

HttpCacheControl_Type

TTCN-3 Record Type			
Name	HttpCacheControl_Type		
Comment	RFC 2616 clause 14.9		
cacheDirective	charstring		

HttpPragma_Type

TTCN-3 Record Type			
Name	HttpPragma_Type		
Comment	RFC 2616 clause 14.32		
pragmaDirective	charstring		

HttpLocation_Type

TTCN-3 Record Type			
Name	HttpLocation_Type		
Comment	RFC 2616 clause 14.30, see also RFC 3986 section 4.3		
uri	charstring		

H.3.2 HTTP_Port_Definitions**HTTP_CTRL_PORT**

TTCN-3 Port Type			
Name	HTTP_CTRL_PORT		
Comment			
out	HTTP_CTRL_REQ		
in	HTTP_CTRL_CNF		

HTTP_DATA_PORT

TTCN-3 Port Type		
Name	HTTP_DATA_PORT	
Comment		
in	HTTP_DATA_IND	
out	HTTP_DATA_REQ	

H.4 References to TTCN-3

References to TTCN-3		
IMS_PTC_CoordMsg	IMS/IMS_PTC_CoordMsg.ttcn	Rev 35214
IMS_ASP_TypeDefs	IMS/IMS_ASP_TypeDefs.ttcn	Rev 35130
HTTP_ASP_TypeDefs	HTTP/HTTP_ASP_TypeDefs.ttcn	Rev 33197

Annex I (informative): Change history

Meeting	TSG doc	CR	Rev	Subject	Cat	Old vers	New vers	WG doc
RP-31	RP-060054	-	-	Update to version 1.0.0 and present to RAN#31 for information	-	-	1.0.0	R5-060513
RP-34	RP-060664	-	-	Present version 1.3.0 to RAN#34 for information	-	-	1.3.0	R5-063500
RP-35	RP-070010	-	-	Presented as version 2.0.0 for approval to go under revision control	-	-	2.0.0	R5-070456
-	-	-	-	Upgraded to version 5.0.0 by the 3GPP support	-	-	5.0.0	-
RP-36	RP-070352	0001	-	Addition of IMS-CC test case 8.6 to IMS_CC ATS V1.3.0	F	5.0.0	5.1.0	R5s070101
RP-36	RP-070353	0002	-	CR to 34.229-3: Add new verified and e-mail agreed TTCN test cases in the TC lists in 34.229-3 (prose), Annex A	F	5.0.0	5.1.0	-
RP-37	RP-070594	0003	-	Extension to TTCN ASP DeactivatePDPCContextReq	F	5.1.0	5.2.0	R5-072509
RP-37	RP-070594	0004	-	IMS CC / PIXIT parameter px_CellId	F	5.1.0	5.2.0	R5-072546
RP-38	RP-070870	0007		Addition of IMS-CC test case 8.5 to IMS_CC ATS V5.1.0	B	5.2.0	5.3.0	R5s070489
RP-38	RP-070870	0008		Addition of IMS-CC test case 8.7 to IMS_CC ATS V5.3.0	B	5.2.0	5.3.0	R5s070259
RP-38	RP-070870	0009		Addition of IMS-CC test case 9.1 to IMS_CC ATS V5.3.0	B	5.2.0	5.3.0	R5s070261
RP-38	RP-070889	0010		CR to 34.229-3: Add new verified and e-mail agreed TTCN test cases in the TC lists in 34.229-3 (prose), Annex A	F	5.2.0	5.3.0	-
RP-38	RP-070869	0006		Production of 34.229-3 pointer version in Rel-5 pointing to Rel-6 version	F	5.2.0	5.3.0	R5-073439
RP-38	RP-070869	0005		Addition of an MMI command	F	5.2.0	6.0.0	R5-073046
RP-39	RP-080098	0011		Update of MMI command strings	F	6.0.0	6.1.0	R5-080041
RP-39	RP-080089	0012		CR to 34.229-3: Add new verified and e-mail agreed TTCN test cases in the TC lists in 34.229-3 (prose), Annex A	F	6.0.0	6.1.0	-
RP-39	RP-080094	0013		Addition of IMS-CC test case 7.2 to IMS_CC ATS V5.3.0	B	6.0.0	6.1.0	R5s070535
RP-39	RP-080094	0014		Addition of IMS-CC test case 10.1 to IMS_CC ATS V5.1.0	B	6.0.0	6.1.0	R5s070549
RP-39	RP-080094	0015		Addition of IMS-CC test case 8.3 to IMS_CC ATS V5.1.0	B	6.0.0	6.1.0	R5s070545
RP-39	RP-080094	0016		Addition of IMS-CC test case 8.2 to IMS_CC ATS V5.1.0	B	6.0.0	6.1.0	R5s070543
RP-39	RP-080094	0017		Addition of IMS-CC test case 7.6 to IMS_CC ATS V5.1.0	B	6.0.0	6.1.0	R5s070539
RP-39	RP-080094	0018		Addition of IMS-CC test case 7.4 to IMS_CC ATS V5.1.0	B	6.0.0	6.1.0	R5s070537
RP-39	RP-080094	0019		Addition of IMS-CC test case 11.1 to IMS_CC ATS V5.1.0	B	6.0.0	6.1.0	R5s070551
RP-39	RP-080094	0020		Addition of IMS-CC test case 14.1 to IMS_CC ATS V5.1.0	B	6.0.0	6.1.0	R5s070555
RP-39	RP-080094	0021		Addition of IMS-CC test case 13.1 to IMS_CC ATS V5.1.0	B	6.0.0	6.1.0	R5s070553
RP-39	RP-080094	0022		Addition of IMS-CC test case 8.4 to IMS_CC ATS V5.1.0	B	6.0.0	6.1.0	R5s070547
RP-39	RP-080094	0023		Addition of IMS-CC test case 8.1 to IMS_CC ATS V5.1.0	B	6.0.0	6.1.0	R5s070541
RP-39	RP-080094	0024		Addition of IMS-CC test case 7.1 to IMS_CC ATS V5.1.0	B	6.0.0	6.1.0	R5s070491
RP-39	RP-080094	0025		Common corrections to IMS-CC test cases	F	6.0.0	6.1.0	R5s070534
RP-40	RP-080369	0027		Correction to regular expressions in IMS	F	6.1.0	7.0.0	R5s080036
RP-40	RP-080369	0028		IMS ATS / handling of P-Access-Network-Info header over non secure ports	F	6.1.0	7.0.0	R5s080063
RP-40	RP-080369	0029		IMS ATS / test case 9.1 / handling of authorization header in Register messages	F	6.1.0	7.0.0	R5s080085
RP-40	RP-080376	0030		Extend test model supporting XCAP test	F	6.1.0	7.0.0	R5-081036
RP-41	RP-080654	0031		CR to 34.229-3: Add new verified and e-mail agreed TTCN test cases in the TC lists in 34.229-3 (prose), Annex A	F	7.0.0	7.1.0	-
RP-41	RP-080615	0032		Addition of IMS-CC test case 9.2 to IMS_CC ATS v.7.0.0	F	7.0.0	7.1.0	R5s080115
RP-41	RP-080615	0033		Addition of IMS-CC test case 7.3 to IMS_CC ATS v.7.0.0	F	7.0.0	7.1.0	R5s080114

Meeting	TSG doc	CR	Rev	Subject	Cat	Old vers	New vers	WG doc
RP-41	RP-080615	0034		Implementation of IPCanCtl code as a parallel test component	F	7.0.0	7.1.0	R5s080138
RP-41	RP-080615	0035		Addition of IMS-CC test case 8.9 to IMS_CC ATS v.6.2.0	F	7.0.0	7.1.0	R5s080145
RP-41	RP-080615	0036		Addition of IMS-CC test case 8.8 to IMS_CC ATS v.6.2.0	F	7.0.0	7.1.0	R5s080143
RP-41	RP-080615	0037		Addition of IMS-CC test case 7.5 to IMS_CC ATS	F	7.0.0	7.1.0	R5s080151
RP-41	RP-080740	0038		Update of TS 34.229-3 from Rel-6 to Rel-7	F	7.1.0	7.2.0	R5-083065
RP-42	RP-080959	0039		Correction of HW Type and HW Length fields in DHCP response messages	F	7.1.0	7.2.0	R5s080171
RP-42	RP-080959	0040		Minor correction of Route header template in the initial Register message	F	7.1.0	7.2.0	R5s080168
RP-43	RP-090210	0041		Update of TS 34.229-3 from Rel-7 to Rel-8	F	7.2.0	8.0.0	R5-090765
RP-43	RP-090210	0042		IMS CC ATS / Improvement: Stopping test case execution once a PTC fails	F	8.0.0	8.1.0	R5s090019
RP-43	RP-090210	0043		IMS CC ATS / Handling of non-default port number in the Contact Header	F	8.0.0	8.1.0	R5s090018
RP-43	RP-090210	0044		IMS CC ATS / Handling of Contact Header	F	8.0.0	8.1.0	R5s090005
RP-43	RP-090210	0045		IMS CC / Minor corrections on test 11.2 (re-authentication)	F	8.0.0	8.1.0	R5s090004
RP-43	RP-090210	0046		IMS CC / Addition of test case 11.2 to the IMS ATS	F	8.0.0	8.1.0	R5s080313
RP-43	RP-090210	0047		IMS CC test model / Addition of new ASP to reconfigure IP Layer	F	8.0.0	8.1.0	R5-090032
RP-43	RP-090210	0048		Removal of an unused pixit and other routine updates	F	8.0.0	8.1.0	R5-090056
RP-46	RP-091156	0049	-	CR to 34.229-3 (prose) update to v820	F	8.1.0	8.2.0	-
RP-47	RP-100146	0050	-	CR to 34.229-3 (prose) update to v830	F	8.2.0	8.3.0	-
RP-47	RP-100155	0051	-	Correction of IMS test model for XCAP-based SS test	F	8.2.0	8.3.0	R5-100087
RP-47	RP-100140	0052	-	Add bearer information for E-UTRA	F	8.2.0	8.3.0	R5-100414
RP-48	RP-100514	0053	-	CR to 34.229-3 (prose) update to v840	F	8.3.0	8.4.0	-
RP-48	RP-100511	0054	-	Update IMS test model	F	8.3.0	8.4.0	R5-103382
RP-50	RP-101146	0055	-	Routine maintenance of TS 34.229-3	F	8.4.0	8.5.0	R5-106088
RP-50	RP-101150	0056	-	CR to 34.229-3 update to v850	F	8.4.0	8.5.0	-
RP-51	RP-110165	0057	-	Mapping of some PIXIT parameters to ISIM Efs – 3 IMPU	F	8.5.0	8.6.0	R5-110694
RP-51	RP-110169	0058	-	CR to 34.229-3 (prose) update to v860	F	8.5.0	8.6.0	-
RP-52	RP-110651	0059	-	Removal of technical content in 34.229-3 v8.6.0 and substitution with pointer to the next Release	F	8.6.0	8.7.0	R5-112246
RP-52	RP-110651	0060	-	Routine maintenance	F	8.6.0	9.0.0	R5-112648
RP-52	RP-110655	0061	-	CR to 34.229-3 (prose) update to v870	F	8.6.0	9.0.0	-
RP-53	RP-111160	0062	-	CR to 34.229-3 (prose) update to v910	F	9.0.0	9.1.0	-
RP-54	RP-111584	0063	-	Routine maintenance and updates for IMS ASP	F	9.1.0	9.2.0	R5-115670
RP-55	RP-120187	0064	-	CR to 34.229-3 (prose) update to v930	F	9.2.0	9.3.0	-
RP-56	RP-120649	0065	-	Routine maintenance and updates	F	9.3.0	9.4.0	R5-121090
RP-56	RP-120802	0066	-	Correction to IMS CC test cases / IPv6 address handling	F	9.3.0	9.4.0	R5s120108
RP-57	RP-121103	0067	-	34229-3: Routine maintenance and updates	F	9.4.0	9.5.0	R5-123085
RP-57	RP-121221	0068	-	TTCN IMS correction	F	9.4.0	9.5.0	R5s120530
RP-57	RP-121221	0069	-	Addition of GCF WI-031 IMS test case 8.10	F	9.4.0	9.5.0	R5s120537
RP-57	RP-121221	0070	-	Addition of GCF WI-031 IMS test case 8.12	F	9.4.0	9.5.0	R5s120539
RP-57	RP-121221	0071	-	Addition of GCF WI-031 IMS test case 8.13	F	9.4.0	9.5.0	R5s120541
RP-57	RP-121221	0072	-	Addition of GCF WI-128 IMS test case 18.1	F	9.4.0	9.5.0	R5s120543
RP-57	RP-121221	0073	-	Addition of GCF WI-128 IMS test case 18.2	F	9.4.0	9.5.0	R5s120545
RP-57	RP-121221	0074	-	Addition of GCF WI-103 IMS test case 16.1	F	9.4.0	9.5.0	R5s120547
RP-57	RP-121221	0075	-	Addition of GCF WI-103 IMS test case 16.2	F	9.4.0	9.5.0	R5s120549
RP-57	RP-121106	0076	-	CR to 34.229-3: Add new verified and e-mail agreed TTCN test cases in the TC lists in 34.229-3 (prose), Annex A	F	9.4.0	9.5.0	-
RP-58	RP-121664	0077	-	34229-3: Routine maintenance and updates	F	9.5.0	9.6.0	R5-125120
RP-58	RP-121669	0078	-	Addition of GCF WI-103 IMS test case 12.12	B	9.5.0	9.6.0	R5s120605
RP-58	RP-121669	0079	-	Addition of GCF WI-103 IMS test case 12.13	B	9.5.0	9.6.0	R5s120607
RP-58	RP-121669	0080	-	Addition of GCF WI-103 IMS test case 15.11	B	9.5.0	9.6.0	R5s120609
RP-58	RP-121669	0081	-	IMS TTCN correction	F	9.5.0	9.6.0	R5s120729
RP-58	RP-121669	0082	-	Addition of GCF WI-103 IMS test case 15.8	B	9.5.0	9.6.0	R5s120730
RP-58	RP-121669	0083	-	Addition of GCF WI-103 IMS test case 15.12	B	9.5.0	9.6.0	R5s120732
RP-58	RP-121669	0084	-	Addition of GCF WI-103 IMS test case 15.27	B	9.5.0	9.6.0	R5s120733
RP-58	RP-121669	0085	-	Addition of GCF WI-103 IMS test case 15.28	B	9.5.0	9.6.0	R5s120736
RP-58	RP-121668	0086	-	CR to 34.229-3: Add new verified and e-mail agreed TTCN test cases in the TC lists in 34.229-3 (prose), Annex A	F	9.5.0	9.6.0	-
RP-59	RP-130145	0087	-	34229-3: Routine maintenance and updates	F	9.6.0	9.7.0	R5-130198
RP-59	RP-130150	0088	-	Re-verification of IMS Registration test case 8.10 over LTE with 36.523-3 test model	F	9.6.0	9.7.0	R5s120858

Meeting	TSG doc	CR	Rev	Subject	Cat	Old vers	New vers	WG doc
RP-59	RP-130150	0089	-	Corrections for IMS test cases with 34.229-3 test model	F	9.6.0	9.7.0	R5s120907
RP-59	RP-130150	0090	-	Re-verification of IMS Registration test case 8.4 over LTE with new 34.229-3 test model	F	9.6.0	9.7.0	R5s120945
RP-59	RP-130150	0091	-	Re-verification of IMS Authentication test case 9.1 over LTE with the new 34.229-3 test model	F	9.6.0	9.7.0	R5s120947
RP-59	RP-130150	0092	-	Corrections to IMS_36523_IWD_12wk48 test suite	F	9.6.0	9.7.0	R5s130011
RP-59	RP-130150	0093	-	Corrections for IMS TC 8.1 regarding Ipv6 privacy	F	9.6.0	9.7.0	R5s130049
RP-59	RP-130149	0094	-	CR to 34.229-3 (prose) update to v970	F	9.6.0	9.7.0	-
RP-60	RP-130611	0095	-	34229-3: Routine maintenance and updates	F	9.7.0	9.8.0	R5-131140
RP-60	RP-130617	0096	-	Corrections to feature parameter in MT call invitation	F	9.7.0	9.8.0	R5s130109
RP-60	RP-130617	0097	-	Re-verification of IMS Registration (IPSec) test case 8.1 over LTE with 36.523-3 test model	F	9.7.0	9.8.0	R5s130133
RP-60	RP-130617	0098	-	Re-verification of IMS test case 8.3 over LTE with 36.523-3 test model	F	9.7.0	9.8.0	R5s130181
RP-60	RP-130617	0099	-	Re-verification of IMS SMS test case 18.2 over LTE with 36.523-3 test model	F	9.7.0	9.8.0	R5s130183
RP-60	RP-130617	0100	-	Corrections for IMS TC 8.1	F	9.7.0	9.8.0	R5s130187
RP-60	RP-130617	0101	-	Re-verification of IMS Registration test case 8.2 over LTE with 34.229-3 test model	F	9.7.0	9.8.0	R5s130233
RP-60	RP-130617	0102	-	Re-verification of IMS SMS test case 18.1 over LTE with 34.229-3 test model	F	9.7.0	9.8.0	R5s130235
RP-60	RP-130617	0103	-	Correction to SIP template cr_FromWithTag	F	9.7.0	9.8.0	R5s130256
RP-60	RP-130617	0104	-	Re-verification of IMS Authentication test case 9.2 over LTE with 34.229-3 test model	F	9.7.0	9.8.0	R5s130264
RP-60	RP-130617	0105	-	Re-verification of IMS Notification test case 11.2 over LTE with 34.229-3 test model	F	9.7.0	9.8.0	R5s130266
RP-60	RP-130617	0106	-	Corrections for IMS Registration TC 8.3 over LTE with 34.229-3 test model	F	9.7.0	9.8.0	R5s130274
RP-60	RP-130617	0107	-	Re-verification of IMS Subscription test case 10.1 over LTE with 34.229-3 test model	F	9.7.0	9.8.0	R5s130294
RP-60	RP-130617	0108	-	Re-verification of IMS Registration test case 11.1 over LTE with 34.229-3 test model	F	9.7.0	9.8.0	R5s130296
RP-60	RP-130617	0109	-	Re-verification of IMS Call Control test case 12.12 over LTE with 36.523-3 test model	F	9.7.0	9.8.0	R5s130333
RP-61	RP-131107	0111	-	Correction to EPS ATTACH procedure to enable IMS Registration via NAS signalling	F	9.8.0	9.9.0	R5s130383
RP-61	RP-131107	0112	-	Correction to IMS test cases 8.1, 8.2, 8.3 and 8.4	F	9.8.0	9.9.0	R5s130454
RP-61	RP-131107	0113	-	Correction to encoding rules to be used for Reginfo_Type	F	9.8.0	9.9.0	R5s130474
RP-61	RP-131107	0114	-	Corrections for IMS call control test case 12.12	F	9.8.0	9.9.0	R5s130497
RP-61	RP-131107	0115	-	Addition of GCF WI-154/ee1 IMS Emergency Call over EPS test case 19.1.2 (using TS 36.523-3 test model)	B	9.8.0	9.9.0	R5s130508
RP-61	RP-131107	0116	-	Re-verification for IMS TC 12.13 over LTE with 34.229-3 test model	F	9.8.0	9.9.0	R5s130510
RP-61	RP-131107	0117	-	Corrections to GCF WI-128 SMS over IMS Testcase 18.1	F	9.8.0	9.9.0	R5s130514
RP-61	RP-131107	0118	-	Correction of IMS test case 9.2 over LTE with 34.229-3 test model	F	9.8.0	9.9.0	R5s130573

Meeting	TSG doc	CR	Rev	Subject	Cat	Old vers	New vers	WG doc
RP-61	RP-131107	0119	-	Verification for IMS test case 12.2 over LTE with 34.229-1 test model	B	9.8.0	9.9.0	R5s130580
RP-61	RP-131107	0120	-	Correction of IMS test case 12.12 over LTE with 34.229-3 test model	F	9.8.0	9.9.0	R5s130586
RP-61	RP-131106	0121	-	CR to 34.229-3: Add new verified and e-mail agreed TTCN test cases in the TC lists in 34.229-3 (prose), Annex A	F	9.8.0	9.9.0	RP-131106
RP-61	RP-131100	0110	-	34229-3: Routine maintenance and updates	F	9.9.0	10.0.0	R5-133632
RP-62	RP-131875	0122	-	Splitting 34.229-3	F	10.0.0	10.1.0	R5-134070
RP-62	RP-132006	0123	-	34229-3: Routine maintenance and updates for multi-testers model	F	10.0.0	10.1.0	R5-134290
RP-62	RP-131868	0125	-	Regression CR for IMS registration procedure in ATS_13wk35	F	10.0.0	10.1.0	R5s130681
RP-62	RP-131868	0126	-	Correction of IMS test case 12.2 over LTE with 34.229-3 test model	F	10.0.0	10.1.0	R5s130684
RP-62	RP-131868	0127	-	Correction of IMS test case 12.13 over LTE with 34.229-3 test model	F	10.0.0	10.1.0	R5s130685
RP-62	RP-131868	0128	-	Correction of IMS test case 8.1 over LTE with 34.229-3 test model	F	10.0.0	10.1.0	R5s130710
RP-62	RP-131868	0129	-	Correction to usage of constant tsc_IMS_AcceptContactValue	F	10.0.0	10.1.0	R5s130738
RP-62	RP-131868	0130	-	Correction to SMS over IMS test case 18.2	F	10.0.0	10.1.0	R5s130739
RP-62	RP-131868	0131	-	Corrections to IMS codec selection test case 16.1 and 16.2	F	10.0.0	10.1.0	R5s130742
RP-62	RP-131868	0132	-	Correction to IMS Call Control test case 12.13	F	10.0.0	10.1.0	R5s130743
RP-62	RP-131868	0133	-	Correction to GCF WI-154 IMS Emergency Call over EPS test case 19.1.2	F	10.0.0	10.1.0	R5s130760
RP-62	RP-131868	0134	-	Corrections to number of channels in SDP in 34.229-3 test model	F	10.0.0	10.1.0	R5s130798
RP-62	RP-131867	0135	-	CR to 34.229-3 (prose) update to v10.1.0	F	10.0.0	10.1.0	RP-131867
RP-63	R5-140319	0136	-	Routine maintenance and updates	F	10.1.0	10.2.0	R5-140931
RP-63	RP-140313	0137	-	Addition of GCF WI-171 MTSI MO speech call / SSAC test case 12.18 (using TS 36.523-3 test model)	B	10.1.0	10.2.0	R5s130766
RP-63	RP-140313	0138	-	Addition of GCF WI-171 IMS Emergency call / SSAC test case 12.20 (using TS 36.523-3 test model)	B	10.1.0	10.2.0	R5s130768
RP-63	RP-140313	0139	-	Re-verification of MTSI MT speech call test case 12.13 (... using TS 36.523-3 test model)	F	10.1.0	10.2.0	R5s130770
RP-63	RP-140313	0140	-	Re-verification of IMS test case 16.1 over LTE with 34.229-3 test model	F	10.1.0	10.2.0	R5s130808
RP-63	RP-140313	0141	-	Re-verification of IMS test case 16.2 over LTE with 34.229-3 test model	F	10.1.0	10.2.0	R5s130810
RP-63	RP-140313	0142	-	Correction of IMS test case 12.2 over LTE with 34.229-3 test model	F	10.1.0	10.2.0	R5s130885
RP-63	RP-140313	0143	-	Correction of IMS test case 12.12 over LTE with 34.229-3 test model	F	10.1.0	10.2.0	R5s130894
RP-63	RP-140313	0144	-	Corrections for common IMS functions	F	10.1.0	10.2.0	R5s130897

Meeting	TSG doc	CR	Rev	Subject	Cat	Old vers	New vers	WG doc
RP-63	RP-140313	0145	-	Correction to GCF WI-103 IMS test case 11.2 with 36.523-3 Test Model	F	10.1.0	10.2.0	R5s130900
RP-63	RP-140313	0146	-	Correction to Postamble handling for IMS deregistration procedure	F	10.1.0	10.2.0	R5s130901
RP-63	RP-140313	0147	-	Correction to fl_EUTRA_IPCAN_ActivateDedicatedEpsBearer_SpeechCall	F	10.1.0	10.2.0	R5s130916
RP-63	RP-140313	0148	-	Correction of IMS test case 8.10 over LTE with 34.229-3 test model	F	10.1.0	10.2.0	R5s130925
RP-63	RP-140313	0149	-	Addition of GCF WI-103 IMS MTSI test case 16.3 over 36.523-3 Test Model	B	10.1.0	10.2.0	R5s130956
RP-63	RP-140313	0150	-	Addition of GCF WI-103 IMS MTSI test case 16.4 over 36.523-3 Test Model	B	10.1.0	10.2.0	R5s130958
RP-63	RP-140313	0151	-	Correction to GCF WI-154 IMS Emergency Call over EPS test case 19.1.2	F	10.1.0	10.2.0	R5s130978
RP-63	RP-140313	0152	-	Correction to GCF WI-103 IMS MTSI test case 12.13	F	10.1.0	10.2.0	R5s130985
RP-63	RP-140313	0153	-	Addition of GCF WI-154 IMS Emergency Call over EPS test case 19.4.1	B	10.1.0	10.2.0	R5s130990
RP-63	RP-140313	0154	-	Correction to GCF WI-103 IMS MTSI test case 9.2	F	10.1.0	10.2.0	R5s131004
RP-63	RP-140313	0155	-	Correction to GCF WI-103 IMS MTSI test case 11.2	F	10.1.0	10.2.0	R5s131040
RP-63	RP-140313	0156	-	Correction of common altsteps in IMS PTC for test case 11.2	F	10.1.0	10.2.0	R5s140003
RP-63	RP-140313	0157	-	Correction for IMS common function f_IMS_InviteRequest_MessageHeaderRX()	F	10.1.0	10.2.0	R5s140005
RP-63	RP-140313	0158	-	Re-verification of IMS test case 15.11 over LTE with 34.229-3 test model	F	10.1.0	10.2.0	R5s140017
RP-63	RP-140312	0159	-	CR to 34.229-3: Add new verified and e-mail agreed TTCN test cases in the TC lists in 34.229-3 (prose), Annex A	F	10.1.0	10.2.0	RP-140312
RP-64	RP-140812	0160	-	Routine maintenance and updates	F	10.2.0	10.3.0	R5-142961
RP-64	RP-140822	0161	-	Addition of GCF WI-154 IMS Emergency Call over EPS test case 19.5.6 (with TS 36.523-3 test model)	F	10.2.0	10.3.0	R5s140037
RP-64	RP-140822	0162	-	Addition of GCF WI-154 IMS Emergency Call over EPS test case 19.5.10 (with TS 36.523-3 test model)	F	10.2.0	10.3.0	R5s140039
RP-64	RP-140822	0163	-	Addition of GCF WI-103 IMS MTSI Testcase 15.28 with 36.523-3 Test Model	F	10.2.0	10.3.0	R5s140092
RP-64	RP-140822	0164	-	Re-verification of GCF WI-103 IMS MTSI Testcase 15.11 over 36.523-3 Test Model	F	10.2.0	10.3.0	R5s140121
RP-64	RP-140822	0165	-	Addition of GCF WI-154 IMS Emergency Testcase 19.4.5 with 36.523-3 Test Model	F	10.2.0	10.3.0	R5s140123
RP-64	RP-140822	0166	-	Correction of GCF WI-103 IMS MTSI Testcase 9.1	F	10.2.0	10.3.0	R5s140136
RP-64	RP-140822	0167	-	Correction to GCF WI-171 IMS SSAC testcase 12.20	F	10.2.0	10.3.0	R5s140137
RP-64	RP-140822	0168	-	Correction of P-Preferred-Service and P-Asserted-Service usage over LTE with 34.229-3 test model	F	10.2.0	10.3.0	R5s140141
RP-64	RP-140822	0169	-	Addition of GCF WI-103 IMS MO Call test case 12.2a (... with both TS 36.523-3 and TS 34.229-3 test model)	F	10.2.0	10.3.0	R5s140142
RP-64	RP-140822	0170	-	Correction to GCF WI-171 SSAC testcase 12.20	F	10.2.0	10.3.0	R5s140168

Meeting	TSG doc	CR	Rev	Subject	Cat	Old vers	New vers	WG doc
RP-64	RP-140822	0171	-	Correction to GCF WI-154 IMS Emergency Call testcase 19.1.2	F	10.2.0	10.3.0	R5s140171
RP-64	RP-140822	0172	-	Correction to GCF WI-154 IMS Emergency Call testcase 19.5.6	F	10.2.0	10.3.0	R5s140172
RP-64	RP-140822	0173	-	Correction to IMS function f_IMS_Dialog_SetRemoteTag	F	10.2.0	10.3.0	R5s140173
RP-64	RP-140822	0174	-	Correction of IMS function f_IMS_PTC_ImInfo_DialogInit	F	10.2.0	10.3.0	R5s140174
RP-64	RP-140822	0175	-	Correction to Postamble Procedure for IMS Testcases	F	10.2.0	10.3.0	R5s140175
RP-64	RP-140822	0176	-	Correction to GCF WI-103 IMS MTSI Testcases 9.1 and 9.2	F	10.2.0	10.3.0	R5s140176
RP-64	RP-140822	0177	-	Correction of GCF WI-103 IMS MTSI Testcase 15.28	F	10.2.0	10.3.0	R5s140178
RP-64	RP-140822	0178	-	Correction to IMS Route header in ACK sent by SS	F	10.2.0	10.3.0	R5s140194
RP-64	RP-140822	0179	-	Correction to 183 Session Progress Message	F	10.2.0	10.3.0	R5s140204
RP-64	RP-140822	0180	-	Correction to TCP Connection Close procedure for IMS Testcases	F	10.2.0	10.3.0	R5s140219
RP-64	RP-140822	0181	-	Correction to IMS Main PTC Function	F	10.2.0	10.3.0	R5s140243
RP-64	RP-140822	0182	-	Correction of f_IMS_AckRequest_MessageHeaderRX()	F	10.2.0	10.3.0	R5s140264
RP-64	RP-140822	0183	-	Correction of f_IPCAN_StartProcedure	F	10.2.0	10.3.0	R5s140265
RP-64	RP-140822	0184	-	spi and port values	F	10.2.0	10.3.0	R5s140266
RP-64	RP-140822	0185	-	Correction to GCF WI-103 IMS Call Control Test Case 11.2	F	10.2.0	10.3.0	R5s140303
RP-64	RP-140822	0186	-	Correction to SMS over IMS Test Case 18.1	F	10.2.0	10.3.0	R5s140304
RP-64	RP-140822	0187	-	Re-verification of IMS test case 15.27 over LTE with 34.229-3 test model	F	10.2.0	10.3.0	R5s140307
RP-64	RP-140822	0188	-	Re-verification of IMS test case 15.12 over LTE with 34.229-3 test model	F	10.2.0	10.3.0	R5s140324
RP-64	RP-140822	0189	-	Addition of GCF WI-154 IMS Emergency Call over EPS test case 19.5.9 with 36.523-3 test model	F	10.2.0	10.3.0	R5s140329
RP-64	RP-140822	0190	-	Correction to GCF WI-171 IMS SSAC Testcase 12.18	F	10.2.0	10.3.0	R5s140334
RP-64	RP-140822	0191	-	Correction to WI-103 IMS MTSI Testcase 11.1	F	10.2.0	10.3.0	R5s140342
RP-64	RP-140822	0192	-	Correction for checking of via Header in IMS response messages	F	10.2.0	10.3.0	R5s140350
RP-64	RP-140822	0193	-	Verification of IMS test case 8.11 over LTE with 34.229-3 test model	F	10.2.0	10.3.0	R5s140356
RP-64	RP-140822	0194	-	Corrections for IMS MO call setup sequence with preconditions	F	10.2.0	10.3.0	R5s140359
RP-64	RP-140822	0195	-	Corrections to de-registration procedure	F	10.2.0	10.3.0	R5s140428
RP-64	RP-140821	0196	-	CR to 34.229-3: Add new verified and e-mail agreed TTCN test cases in the TC lists in 34.229-3 (prose), Annex A	F	10.2.0	10.3.0	RP-140821
RP-65	RP-141571	0197	-	Routine maintenance and updates	F	10.3.0	10.4.0	R5-144747

Meeting	TSG doc	CR	Rev	Subject	Cat	Old vers	New vers	WG doc
RP-65	RP-141580	0217	-	CR to 34.229-3: Add new verified and e-mail agreed TTCN test cases in the TC lists in 34.229-3 (prose), Annex A	F	10.3.0	10.4.0	-
RP-65	RP-141581	0198	-	Addition of GCF WI-154 IMS Emergency Call test case 19.5.7 with TS 36.523-3 test model	B	10.3.0	10.4.0	R5s140338
RP-65	RP-141581	0199	-	Correction for IMS Codec Selection test cases 16.3 and 16.4	F	10.3.0	10.4.0	R5s140360
RP-65	RP-141581	0200	-	IMS test case 18.1 for GIBA	F	10.3.0	10.4.0	R5s140469
RP-65	RP-141581	0201	-	Addition of GCF WI-154 IMS Emergency Call test case 19.3.3 with TS 36.523-3 test model	B	10.3.0	10.4.0	R5s140490
RP-65	RP-141581	0202	-	Correction to IMS function f_IMS_MTCallSetup_SendPRACK_ReceiveOK.	F	10.3.0	10.4.0	R5s140551
RP-65	RP-141581	0203	-	Correction to GCF WI-103 IMS MTSI test case 11.2.	F	10.3.0	10.4.0	R5s140561
RP-65	RP-141581	0204	-	Regression CR for IMS modules in ATS_14wk24	F	10.3.0	10.4.0	R5s140565
RP-65	RP-141581	0205	-	Corrections for IMS Codec Selection test cases 16.3 and 16.4	F	10.3.0	10.4.0	R5s140567
RP-65	RP-141581	0206	-	Correction to GCF WI-103 IMS test case 15.12	F	10.3.0	10.4.0	R5s140571
RP-65	RP-141581	0207	-	Correction of IMS SSAC Testcases 12.18, 12.19, 12.20, 12.18a, 12.19a and 12.20a	F	10.3.0	10.4.0	R5s140577
RP-65	RP-141581	0208	-	Re-verification of GCF WI-103 IMS Codec Selecting test case 16.2 with 36.523-3 test model	F	10.3.0	10.4.0	R5s140580
RP-65	RP-141581	0209	-	Corrections to IMS test case 15.11	F	10.3.0	10.4.0	R5s140602
RP-65	RP-141581	0210	-	Correction to IMS test case 15.27	F	10.3.0	10.4.0	R5s140606
RP-65	RP-141581	0211	-	Re-verification of IMS test case 15.8 over LTE with 34.229-3 test model	F	10.3.0	10.4.0	R5s140621
RP-65	RP-141581	0212	-	Correction to IMS test case 16.2	F	10.3.0	10.4.0	R5s140646
RP-65	RP-141581	0213	-	Correction to GCF WI-154 IMS Emergency Call Testcase 19.5.7	F	10.3.0	10.4.0	R5s140647
RP-65	RP-141581	0214	-	Correction to ContactIE and UL Grant to IMS messages	F	10.3.0	10.4.0	R5s140676
RP-65	RP-141581	0215	-	Bandwidth values for TCs 16.2, 16.3, and 16.4	F	10.3.0	10.4.0	R5s140678
RP-65	RP-141581	0216	-	Correction to Socket Handling during IMS registration procedure	F	10.3.0	10.4.0	R5s140713
RP-66	RP-142054	0218	-	Routine maintenance and updates	F	10.4.0	10.5.0	R5-145191
RP-66	RP-142064	0219	-	Correction of IMS test case 8.2 over LTE	F	10.4.0	10.5.0	R5s140779
RP-66	RP-142064	0220	-	Correction of IMS test case 12.2a	F	10.4.0	10.5.0	R5s140780
RP-66	RP-142064	0221	-	Correction to IMS Emergency Call test case 19.4.5	F	10.4.0	10.5.0	R5s140786
RP-66	RP-142064	0222	-	Addition of GCF WI-154 IMS emergency call testcase 19.1.3 over 36.523-3 Test Model	F	10.4.0	10.5.0	R5s140788
RP-66	RP-142064	0223	-	Correction to IMS Emergency Call test case 19.5.7	F	10.4.0	10.5.0	R5s140791
RP-66	RP-142064	0224	-	Correction to GCF WI-103 IMS testcase 11.2	F	10.4.0	10.5.0	R5s140801
RP-66	RP-142064	0225	-	Correction to IMS test case 12.2a on branch parameter	F	10.4.0	10.5.0	R5s140802
RP-66	RP-142064	0226	-	Correction to GCF WI-103 IMS test case 12.2a	F	10.4.0	10.5.0	R5s140856

Meeting	TSG doc	CR	Rev	Subject	Cat	Old vers	New vers	WG doc
RP-66	RP-142064	0227	-	Correction to GCF WI-103 IMS test case 15.8	F	10.4.0	10.5.0	R5s140905
RP-66	RP-142064	0228	-	Correction to WI-154 IMS Emergency Call Testcases 19.5.6 and 19.5.7	F	10.4.0	10.5.0	R5s140909
RP-66	RP-142064	0229	-	Correction of IMS test case 15.11	F	10.4.0	10.5.0	R5s140919
RP-66	RP-142064	0230	-	Corrections for Ipv6 address checking in common IMS functions	F	10.4.0	10.5.0	R5s140934
RP-66	RP-142064	0231	-	Correction of IMS test case 18.1	F	10.4.0	10.5.0	R5s140968
RP-66	RP-142064	0232	-	Verification of IMS test case 15.5	F	10.4.0	10.5.0	R5s140975
RP-66	RP-142064	0233	-	Verification of IMS test case 15.7	F	10.4.0	10.5.0	R5s140976
RP-66	RP-142064	0234	-	Verification of IMS test case 15.9	F	10.4.0	10.5.0	R5s140977
RP-66	RP-142064	0235	-	Correction to IMS Emergency Call test case 19.3.3	F	10.4.0	10.5.0	R5s140997
RP-66	RP-142064	0236	-	Correction to GCF WI-103 IMS MTSI test case 15.11	F	10.4.0	10.5.0	R5s141020
RP-66	RP-142064	0237	-	Addition of GCF WI-103 IMS XCAP Supplementary Service Testcase 15.1 over 36.523-3 Test Model	F	10.4.0	10.5.0	R5s141051
RP-66	RP-142064	0238	-	Addition of GCF WI-103 XCAP supplementary service Testcase 15.3 over 36.523-3 Test Model	F	10.4.0	10.5.0	R5s141053
RP-66	RP-142064	0239	-	Addition of GCF WI-103 XCAP supplementary service Testcase 15.4 over 36.523-3 Test Model	F	10.4.0	10.5.0	R5s141055
RP-66	RP-142064	0240	-	Addition of XCAP supplementary service Testcase 15.14 over 36.523-3 Test Model	F	10.4.0	10.5.0	R5s141113
RP-66	RP-142064	0241	-	Addition of GCF WI-103 XCAP supplementary service Testcase 15.14a over 36.523-3 Test Model	F	10.4.0	10.5.0	R5s141115
RP-66	RP-142064	0242	-	Addition of IMS over UTRAN testcase 6.3 to IMS Utran testsuite	F	10.4.0	10.5.0	R5s141125
RP-66	RP-142064	0243	-	Re-Verification of IMS over UTRAN testcase 7.1 to IMS Utran testsuite	F	10.4.0	10.5.0	R5s141127
RP-66	RP-142064	0244	-	Re-verification of GCF WI-103 IMS XCAP Supplementary Service Testcase 15.5 over 36.523-3 Test Model	F	10.4.0	10.5.0	R5s141130
RP-66	RP-142064	0245	-	Re-verification of GCF WI-103 IMS XCAP Supplementary Service Testcase 15.7 over 36.523-3 Test Model	F	10.4.0	10.5.0	R5s141133
RP-66	RP-142064	0246	-	Re-verification of GCF WI-103 IMS XCAP Supplementary Service Testcase 15.9 over 36.523-3 Test Model	F	10.4.0	10.5.0	R5s141135
RP-66	RP-142064	0247	-	Changes to XML templates	F	10.4.0	10.5.0	R5s141138
RP-66	RP-142064	0248	-	Verification of IMS test case 15.2 over LTE with 34.229-4 test model	F	10.4.0	10.5.0	R5s141140
RP-66	RP-142064	0249	-	Verification of IMS test case 15.13 over LTE with 34.229-4 test model	F	10.4.0	10.5.0	R5s141142
RP-66	RP-142064	0250	-	Correction to GCF WI-103 IMS call control test case 12.2a	F	10.4.0	10.5.0	R5s141154
RP-66	RP-142064	0251	-	Addition of GCF WI-103 XCAP supplementary service Testcase 15.10a over 36.523-3 Test Model	F	10.4.0	10.5.0	R5s141162
RP-66	RP-142063	0252	-	CR to 34.229-3: Add new verified and e-mail agreed TTCN test cases in the TC lists in 34.229-3 (prose), Annex A	F	10.4.0	10.5.0	RP-142063

Meet- ing	TSG doc	CR	Rev	Subject	Cat	Old vers	New vers	WG doc
RP-67	RP-150332	0253	-	Routine maintenance for TS 34.229-3	F	10.5.0	10.6.0	R5-150355
RP-67	RP-150332	0283	-	CR to 34.229-3: Add new verified and e-mail agreed TTCN test cases in the TC lists in 34.229-3 (prose), Annex A	F	10.5.0	10.6.0	-
RP-67	RP-150333	0254	-	Addition of GCF WI-154 IMS emergency call testcase 19.3.1 over 36.523-3 Test Model	B	10.5.0	10.6.0	R5s141155
RP-67	RP-150333	0255	-	Correction of IMS test case 8.1: sip-instance	F	10.5.0	10.6.0	R5s141212
RP-67	RP-150333	0256	-	Addition of GCF WI-198 MO MTSI Video Call test case 12.21 (using 36.523-3 test model)	B	10.5.0	10.6.0	R5s141221
RP-67	RP-150333	0257	-	Correction to IMS Emergency call test case 19.4.1	F	10.5.0	10.6.0	R5s141232
RP-67	RP-150333	0258	-	Addition of GCF WI-154 Emergency Call Testcase 19.3.4 over 36.523-3 Test Model	B	10.5.0	10.6.0	R5s141237
RP-67	RP-150333	0259	-	Correction of o-lines in SDP bodies sent by SS	F	10.5.0	10.6.0	R5s141244
RP-67	RP-150333	0260	-	Correction to GCF WI-171 IMS SSAC test case 12.18	F	10.5.0	10.6.0	R5s141273
RP-67	RP-150333	0261	-	Addition of GCF WI-154 IMS Emergency Call test case 19.1.5	B	10.5.0	10.6.0	R5s141286
RP-67	RP-150333	0262	-	Correction to IMS Registration Procedure	F	10.5.0	10.6.0	R5s141322
RP-67	RP-150333	0263	-	Correction to GCF WI-103 IMS test case 11.2	F	10.5.0	10.6.0	R5s141326
RP-67	RP-150333	0264	-	Addition of GCF WI-198 MO MTSI Video Call test case 12.22 over 36.523-3 Test Model	B	10.5.0	10.6.0	R5s141329
RP-67	RP-150333	0265	-	Correction to GCF WI-154 IMS emergency test case 19.5.6 and 19.5.7	F	10.5.0	10.6.0	R5s141335
RP-67	RP-150333	0266	-	Correction to GCF WI-198 IMS MO Video Call Testcase 12.21	F	10.5.0	10.6.0	R5s141336
RP-67	RP-150333	0267	-	Correction to GCF WI-154 IMS emergency test case 19.3.4	F	10.5.0	10.6.0	R5s141337
RP-67	RP-150333	0268	-	Addition of GCF WI-103 IMS Conference Call Testcase 15.17 over 36.523-3 Test Model	B	10.5.0	10.6.0	R5s141341
RP-67	RP-150333	0269	-	Addition of GCF WI-103 IMS Conference Call Testcase 15.19 over 36.523-3 Test Model	B	10.5.0	10.6.0	R5s141343
RP-67	RP-150333	0270	-	Correction of IMS TC 15.10a: not-registered condition	F	10.5.0	10.6.0	R5s141350
RP-67	RP-150333	0271	-	Correction to GCF WI-103 IMS 15.x XCAP Testcases	F	10.5.0	10.6.0	R5s141351
RP-67	RP-150333	0272	-	Correction of XCAP TCs on usage of str2oct	F	10.5.0	10.6.0	R5s141353
RP-67	RP-150333	0273	-	Correction of IMS Emergency Call testcase 19.4.5	F	10.5.0	10.6.0	R5s141370
RP-67	RP-150333	0274	-	Correction of IMS SSAC Testcases 12.18, 12.19, 12.20, 12.18a, 12.19a and 12.20a	F	10.5.0	10.6.0	R5s141381
RP-67	RP-150333	0275	-	Correction of prefix to XCAP Root Uri	F	10.5.0	10.6.0	R5s150030
RP-67	RP-150333	0276	-	Correction to UPDATE message for IMS MT Call Testcases	F	10.5.0	10.6.0	R5s150035
RP-67	RP-150333	0277	-	Correction for record-route header in IMS MT call scenarios	F	10.5.0	10.6.0	R5s150039
RP-67	RP-150333	0278	-	Correction to cr_UE_RadioAccessCapability template for IMS UTRA test cases	F	10.5.0	10.6.0	R5s150054
RP-67	RP-150333	0279	-	Correction to IMS Multiple PDN	F	10.5.0	10.6.0	R5s150055

Meeting	TSG doc	CR	Rev	Subject	Cat	Old vers	New vers	WG doc
RP-67	RP-150333	0280	-	Correction to DNS Query procedure for IMS Testcases	F	10.5.0	10.6.0	R5s150085
RP-67	RP-150333	0281	-	Correction to SessionID in IMS signalling procedures	F	10.5.0	10.6.0	R5s150086
RP-67	RP-150333	0282	-	Addition of GCF WI-171 MO MTSI Video Call test case 12.19 (using 36.523-3 test model)	B	10.5.0	10.6.0	R5s150115
RP-68	RP-150884	0284	-	Routine maintenance for TS 34.229-3	F	10.6.0	10.7.0	R5-151102
RP-68	RP-150894	0286	-	Corrections to Emergency Services Over IMS test case 19.1.3	F	10.6.0	10.7.0	R5s150061
RP-68	RP-150894	0287	-	Corrections for Emergency Services over IMS test case 19.1.5	F	10.6.0	10.7.0	R5s150091
RP-68	RP-150894	0288	-	Correction to IMS XCAP Testcases	F	10.6.0	10.7.0	R5s150148
RP-68	RP-150894	0289	-	Correction of RR and RS modifiers	F	10.6.0	10.7.0	R5s150153
RP-68	RP-150894	0290	-	Correction to IMS Emergency Call testcase 19.4.5	F	10.6.0	10.7.0	R5s150157
RP-68	RP-150894	0291	-	Correction to IMS Emergency Call testcase 19.3.1	F	10.6.0	10.7.0	R5s150158
RP-68	RP-150894	0292	-	Correction of SPI matching error at runtime	F	10.6.0	10.7.0	R5s150174
RP-68	RP-150894	0293	-	Correction for checking of video feature tag	F	10.6.0	10.7.0	R5s150180
RP-68	RP-150894	0294	-	Correction to IMS Emergency Call testcase 19.3.1	F	10.6.0	10.7.0	R5s150193
RP-68	RP-150894	0295	-	Correction to GCF WI-154 IMS Emergency Call testcase 19.5.7	F	10.6.0	10.7.0	R5s150195
RP-68	RP-150894	0296	-	Correction regarding XCAP Root URI	F	10.6.0	10.7.0	R5s150202
RP-68	RP-150894	0297	-	Correction to Annex Procedure C.28	F	10.6.0	10.7.0	R5s150205
RP-68	RP-150894	0298	-	Correction in IMS MTSI Video call test case 12.21	F	10.6.0	10.7.0	R5s150236
RP-68	RP-150894	0299	-	Correction of Require header in 200 OK	F	10.6.0	10.7.0	R5s150237
RP-68	RP-150894	0300	-	Corrections for upper tester for IMS XCAP call forwarding test cases	F	10.6.0	10.7.0	R5s150244
RP-68	RP-150894	0301	-	Corrections for Emergency Services over IMS test case 19.5.7	F	10.6.0	10.7.0	R5s150245
RP-68	RP-150894	0302	-	Addition of GCF WI-103 MTSI Message Waiting Indication test case 15.15 (using 36.523-3 and 34.229-4 test models)	B	10.6.0	10.7.0	R5s150259
RP-68	RP-150894	0303	-	Correction of multi-PDN PCO handling	F	10.6.0	10.7.0	R5s150267
RP-68	RP-150894	0304	-	Correction for inactivity timer in IMS XCAP test cases	F	10.6.0	10.7.0	R5s150269
RP-68	RP-150894	0305	-	Corrections for TCP connection handling for IMS test cases	F	10.6.0	10.7.0	R5s150270
RP-68	RP-150894	0306	-	Correction to IMS emergency services test case 19.1.3	F	10.6.0	10.7.0	R5s150273
RP-68	RP-150894	0307	-	Correction of Require header in 200 OK - continued	F	10.6.0	10.7.0	R5s150274
RP-68	RP-150894	0308	-	Correction of IMS TC 15.19	F	10.6.0	10.7.0	R5s150276
RP-68	RP-150894	0309	-	Addition of GCF WI-103 IMS XCAP Testcase 15.10 over 36.523-3 Test Model	B	10.6.0	10.7.0	R5s150289
RP-68	RP-150894	0310	-	Addition of GCF WI-154 IMS Emergency Call test case 19.4.2 (using 36.523-3 test model)	B	10.6.0	10.7.0	R5s150327
RP-68	RP-150894	0312	-	Correction to TC 8.2 on expiration values	F	10.6.0	10.7.0	R5s150342

Meeting	TSG doc	CR	Rev	Subject	Cat	Old vers	New vers	WG doc
RP-68	RP-150894	0313	-	Addition of GCF WI-103 IMS Testcase 15.12a over 36.523-3 Test Model	B	10.6.0	10.7.0	R5s150371
RP-68	RP-150894	0314	-	Addition of GCF WI-198 IMS Testcase 15.19a over 36.523-3 Test Model	B	10.6.0	10.7.0	R5s150373
RP-68	RP-150894	0315	-	Addition of GCF WI-103 IMS Testcase 15.21a over 36.523-3 Test Model	B	10.6.0	10.7.0	R5s150382
RP-68	RP-150894	0316	-	Correction to IMS Emergency Call test case 19.3.1	F	10.6.0	10.7.0	R5s150414
RP-68	RP-150894	0317	-	Correction of IMS TC 8.1	F	10.6.0	10.7.0	R5s150446
RP-68	RP-150893	0285	-	CR to 34.229-3: Add new verified and e-mail agreed TTCN test cases in the TC lists in 34.229-3 (prose), Annex A	F	10.7.0	11.0.0	-
RP-68	RP-150894	0311	-	IMS type definition updates for rSRVCC	F	10.7.0	11.0.0	R5s150339
RP-69	RP-151409	0318	-	Routine maintenance for TS 34.229-3	F	11.0.0	11.1.0	R5-153257
RP-69	RP-151416	0319	-	CR to 34.229-3: Add new verified and e-mail agreed TTCN test cases in the TC lists in 34.229-3 (prose), Annex A	F	11.0.0	11.1.0	-
RP-69	RP-151417	0320	-	Correction to IMS emergency services test case 19.3.3 with 34.229-3 IPCAN model	F	11.0.0	11.1.0	R5s150412
RP-69	RP-151417	0321	-	Addition of IMS test case 8.16 (... using 36.523-3 test model)	F	11.0.0	11.1.0	R5s150534
RP-69	RP-151417	0322	-	Correction to IMS video conferencing test case 15.19a	F	11.0.0	11.1.0	R5s150537
RP-69	RP-151417	0323	-	Correction for IMS test cases	F	11.0.0	11.1.0	R5s150630
RP-69	RP-151417	0324	-	Correction to de-registration sequence for IMS test cases	F	11.0.0	11.1.0	R5s150647
RP-69	RP-151417	0325	-	Correction to testcase 13.4.3.26 regarding 200 OK in C.28	F	11.0.0	11.1.0	R5s150665
RP-69	RP-151417	0326	-	Correction to IMS Call forwarding testcase 15.8	F	11.0.0	11.1.0	R5s150666
RP-69	RP-151417	0327	-	Correction to GCF WI-154 IMS emergency Call testcase 19.3.1	F	11.0.0	11.1.0	R5s150667
RP-69	RP-151417	0328	-	Correction to procedure for IPv6 address comparison	F	11.0.0	11.1.0	R5s150668
RP-69	RP-151417	0329	-	Addition of IMS test case 20.1 (... using 36.523-3 test model)	F	11.0.0	11.1.0	R5s150714
RP-69	RP-151417	0330	-	Correction to XCAP Call Forwarding testcases	F	11.0.0	11.1.0	R5s150725
RP-69	RP-151417	0331	-	Addition of IMS video conference call test case 15.21c	F	11.0.0	11.1.0	R5s150775
RP-69	-	-	-	update of the "non-specific references" in section 2 according to the approved R5-153582 and an action point on ETSI MCC	-	11.0.0	11.1.0	-
RP-70	RP-151693	0333	-	Correction to IMS Emergency Call test case 19.3.1	F	11.1.0	11.2.0	R5s150692
RP-70	RP-151693	0334	-	Correction to usage of GRUU in IMS registration	F	11.1.0	11.2.0	R5s150721
RP-70	RP-151693	0335	-	Correction to GCF WI-154 IMS emergency Call testcase 19.3.1	F	11.1.0	11.2.0	R5s150739
RP-70	RP-151693	0336	-	Addition of IMS video call test case 15.11a	F	11.1.0	11.2.0	R5s150755
RP-70	RP-151693	0337	-	Correction to IMS test case 10.1	F	11.1.0	11.2.0	R5s150786
RP-70	RP-151693	0338	-	Correction to IMS emergency test case 19.5.7	F	11.1.0	11.2.0	R5s150809

Meeting	TSG doc	CR	Rev	Subject	Cat	Old vers	New vers	WG doc
RP-70	RP-151693	0339	-	Correction to initiation of Emergency Calls	F	11.1.0	11.2.0	R5s150817
RP-70	RP-151693	0340	-	Correction to IMS Emergency Call Test Case 19.1.5	F	11.1.0	11.2.0	R5s150818
RP-70	RP-151693	0341	-	Correction to IMS Registration	F	11.1.0	11.2.0	R5s150835
RP-70	RP-151693	0342	-	Correction to MTSI MO speech call procedures in AnnexC21	F	11.1.0	11.2.0	R5s150841
RP-70	RP-151693	0343	-	Correction to common IMS functions to handling IMS Dialogs	F	11.1.0	11.2.0	R5s150843
RP-70	RP-151693	0344	-	Correction to usage of Max-Forwards	F	11.1.0	11.2.0	R5s150850
RP-70	RP-151693	0345	-	Corrections to IMS emergency test case 19.3.1	F	11.1.0	11.2.0	R5s150851
RP-70	RP-151693	0346	-	Correction to number of SIP dialogs	F	11.1.0	11.2.0	R5s150854
RP-70	RP-151693	0347	-	Correction in IMS Emergency Call test case 19.5.7	F	11.1.0	11.2.0	R5s150864
RP-70	RP-151693	0348	-	Corrections to RTP and RTCP handling	F	11.1.0	11.2.0	R5s150865
RP-70	RP-151693	0349	-	Corrections to IMS Emergency call Testcase 19.1.3	F	11.1.0	11.2.0	R5s150868
RP-70	RP-151693	0350	-	Corrections to IMS authentication test cases 9.1 and 9.2	F	11.1.0	11.2.0	R5s150873
RP-70	RP-151693	0351	-	Correction to IMS registration expiry time	F	11.1.0	11.2.0	R5s150886
RP-70	RP-151693	0352	-	Correction to IMS REGISTER message	F	11.1.0	11.2.0	R5s150888
RP-70	RP-151693	0353	-	Correction to Emergency Call Normal Services in 34.229-1	F	11.1.0	11.2.0	R5s150900
RP-70	RP-151693	0354	-	Corrections to usage of GRUU	F	11.1.0	11.2.0	R5s150908
RP-70	RP-151693	0355	-	Corrections to IMS three-way session creation test cases	F	11.1.0	11.2.0	R5s150909
RP-70	RP-151693	0356	-	Correction to GCF WI-103 15.21a Three way session testcase	F	11.1.0	11.2.0	R5s150910
RP-70	RP-151693	0357	-	Correction to postamble for test cases 6.3 and 7.1	F	11.1.0	11.2.0	R5s150919
RP-70	RP-151693	0358	-	Correction to IMS emergency test case 19.5.6	F	11.1.0	11.2.0	R5s150972
RP-70	RP-151692	0359	-	CR to 34.229-3: Add new verified and e-mail agreed TTCN test cases in the TC lists in 34.229-3 (prose), Annex A	F	11.1.0	11.2.0	-
RP-71	RP-160117	0382	1	Routine maintenance for TS 34.229-3	F	11.2.0	11.3.0	R5-160912
RP-71	RP-160123	0362	-	Correction to IMS test case 15.21a regarding Route header in REFER	F	11.2.0	11.3.0	R5s160011
RP-71	RP-160123	0365	-	Corrections to IMS emergency call test case 19.4.1	F	11.2.0	11.3.0	R5s160031
RP-71	RP-160123	0366	-	Corrections to IMS IRAT Emergency Call Limited Service Functionality	F	11.2.0	11.3.0	R5s160032
RP-71	RP-160123	0367	-	Correction to IMS test case 15.21a regarding TEL URI	F	11.2.0	11.3.0	R5s160043
RP-71	RP-160123	0368	-	Correction to Unsubscribe function in IMS De-Registration procedure	F	11.2.0	11.3.0	R5s160045
RP-71	RP-160123	0369	-	Corrections to bit rate for video calls	F	11.2.0	11.3.0	R5s160046
RP-71	RP-160123	0371	-	Correction to NOTIFY for 200 OK in Conferencing test cases	B	11.2.0	11.3.0	R5s160055
RP-71	RP-160123	0373	-	Addition of test case 19.3.2b	B	11.2.0	11.3.0	R5s160070

Meeting	TSG doc	CR	Rev	Subject	Cat	Old vers	New vers	WG doc
RP-71	RP-160123	0375	-	Addition of test case 19.3.2c	F	11.2.0	11.3.0	R5s160072
RP-71	RP-160123	0377	-	Correction to IMS test case 8.16	B	11.2.0	11.3.0	R5s160075
RP-71	RP-160123	0378	-	Addition of test case 19.3.2	F	11.2.0	11.3.0	R5s160076
RP-71	RP-160123	0381	-	Correction to IMS_UTRAN_IWD_15wk50 test suite	B	11.2.0	11.3.0	R5s160090
RP-71	RP-160123	0363	1	Addition of IMS test case 15.14b	B	11.2.0	11.3.0	R5s160096
RP-71	RP-160123	0384	-	Addition of IMS test case 19.5.1	F	11.2.0	11.3.0	R5s160131
RP-71	RP-160123	0387	-	Correction to IMS test case 15.11 regarding Geolocation header	B	11.2.0	11.3.0	R5s150846
RP-71	RP-160123	0388	-	Addition of IMS test case 15.29	F	11.2.0	11.3.0	R5s150945
RP-71	RP-160123	0389	-	Correction to IMS test case 15.10	F	11.2.0	11.3.0	R5s150965
RP-71	RP-160123	0390	-	Corrections to fl_SIP_ParseURI for tel uri with phone context	F	11.2.0	11.3.0	R5s150968
RP-71	RP-160123	0391	-	Correction to f_URL_Decoding	F	11.2.0	11.3.0	R5s151006
RP-71	RP-160122	0385	-	CR to 34.229-3: Add new verified and e-mail agreed TTCN test cases in the TC lists in 34.229-3 (prose), Annex A	F	11.2.0	11.3.0	R5s160177
RP-72	RP-160845	0406	-	Routine maintenance for TS 34.229-3	F	11.3.0	11.4.0	R5-162025
RP-72	RP-160849	0400	-	Correction to GCF WI-154 IMS emergency call TC 19.5.1	F	11.3.0	11.4.0	R5s160313
RP-72	RP-160849	0401	-	Correction to host name in Temp GRUU returned in 200 OK for REGISTER	F	11.3.0	11.4.0	R5s160324
RP-72	RP-160849	0402	-	Corrections to GRUU in XML body of NOTIFY request	F	11.3.0	11.4.0	R5s160325
RP-72	RP-160849	0403	-	Correction to authentication method used in XCAP test cases	F	11.3.0	11.4.0	R5s160338
RP-72	RP-160849	0404	-	Correction to IMS emergency call test cases 19.1.3, 19.3.2, 19.3.2b	F	11.3.0	11.4.0	R5s160339
RP-72	RP-160849	0405	-	Correction to XCAP encoding rules	F	11.3.0	11.4.0	R5s160353
RP-72	RP-160849	0407	-	Corrections to Contact header of MO INVITE	F	11.3.0	11.4.0	R5s160366
RP-72	RP-160849	0410	-	Addition of IMS EVS test case 12.23	F	11.3.0	11.4.0	R5s160379
RP-72	RP-160849	0411	-	Addition of IMS EVS test case 12.25	F	11.3.0	11.4.0	R5s160381
RP-72	RP-160849	0413	-	Correction to emergency call Testcases 19.3.2, 19.3.2b and 19.3.2c	F	11.3.0	11.4.0	R5s160406
RP-72	RP-160849	0416	-	Correction to IMS emergency call test case 19.5.1	F	11.3.0	11.4.0	R5s160439
RP-72	RP-160849	0417	-	Correction to XCAP GBA authentication procedure.	F	11.3.0	11.4.0	R5s160442
RP-72	RP-160849	0383	1	Corrections to IMS-IRAT Emergency Call test case 19.4.2	F	11.3.0	11.4.0	R5s160460
RP-72	RP-160849	0392	1	Correction to IMS Emergency Call test case 19.1.5	F	11.3.0	11.4.0	R5s160472
RP-72	RP-160849	0394	1	Correction to encoding for SipUrl type	F	11.3.0	11.4.0	R5s160490
RP-72	RP-160849	0396	1	Correction for IMS video call test cases	F	11.3.0	11.4.0	R5s160502
RP-72	RP-160849	0398	1	Corrections for IMS emergency call test cases 19.1.3, 19.3.2, 19.3.2b and 19.3.2c	F	11.3.0	11.4.0	R5s160514
RP-72	RP-160849	0399	1	Correction of fl_SIP_BuildReferToUri_RX	F	11.3.0	11.4.0	R5s160516

Meeting	TSG doc	CR	Rev	Subject	Cat	Old vers	New vers	WG doc
RP-72	RP-160848	0421	-	Add new verified and e-mail agreed TTCN test cases in the TC lists in 34.229-3 (prose), Annex A	F	11.4.0	12.0.0	R5s160457
RP-73	RP-161426	0441	-	Routine maintenance for TS 34.229-3	F	12.0.0	12.1.0	R5-165259
RP-73	RP-161397	0442	-	MTSI over WLAN: Introduction of Test Model	F	12.0.0	12.1.0	R5-165261
RP-73	RP-161396	0443	-	MTSI over fixed access: Introduction of Test Model	F	12.0.0	12.1.0	R5-165262
RP-73	RP-161430	0431	-	Correction to Recv-Info header checking in MO INVITE	F	12.0.0	12.1.0	R5s160616
RP-73	RP-161430	0434	-	Correction of fl_Authorization_GBA	F	12.0.0	12.1.0	R5s160642
RP-73	RP-161430	0435	-	Correction to applicability of IMS EVS test cases	F	12.0.0	12.1.0	R5s160645
RP-73	RP-161430	0418	2	Correction of URIs used in From and To headers	F	12.0.0	12.1.0	R5s160655
RP-73	RP-161430	0420	1	Correction to XML encoding of SIP instance ID for GRUU	F	12.0.0	12.1.0	R5s160656
RP-73	RP-161430	0422	1	Correction to IMS test case 19.5.1 for Multi-PDN configured UE's	F	12.0.0	12.1.0	R5s160658
RP-73	RP-161430	0424	1	Corrections to fl_HTTP_AuthenticationMethod	F	12.0.0	12.1.0	R5s160665
RP-73	RP-161430	0426	1	Corrections to IMS Emergency Call test case 19.4.5	F	12.0.0	12.1.0	R5s160669
RP-73	RP-161430	0427	1	Correction to GCF WI-103 IMS TC 11.1	F	12.0.0	12.1.0	R5s160674
RP-73	RP-161430	0436	-	Addition of IMS Supplementary Services test case 15.2a	B	12.0.0	12.1.0	R5s160687
RP-73	RP-161430	0438	-	Corrections for GBA authentication	F	12.0.0	12.1.0	R5s160710
RP-73	RP-161430	0444	-	Correction and simplification of the release of security contexts for IMS	F	12.0.0	12.1.0	R5s160735
RP-73	RP-161430	0445	-	Correction for IMS test case initialisation	F	12.0.0	12.1.0	R5s160736
RP-73	RP-161430	0446	-	Correction for IMS test cases	F	12.0.0	12.1.0	R5s160737
RP-73	RP-161430	0448	-	Corrections to IMS IRAT emergency call test cases 19.1.3, 19.3.2, 19.3.2b, 19.3.2c	F	12.0.0	12.1.0	R5s160754
RP-73	RP-161430	0414	2	Correction to IMS test case 15.11a on assigning the value of Logical Channel Priority for DRB-AM EPS bearers	F	12.0.0	12.1.0	R5s160804
RP-73	RP-161430	0415	2	Addition of IMS test case 19.5.8	B	12.0.0	12.1.0	R5s160805
RP-73	RP-161430	0423	2	Addition of IMS test case 17.2	B	12.0.0	12.1.0	R5s160806
RP-73	RP-161430	0428	2	Correction to IMS Conference call test case 15.17	F	12.0.0	12.1.0	R5s160807
RP-73	RP-161430	0429	2	Addition of IMS test case 17.1	B	12.0.0	12.1.0	R5s160808
RP-73	RP-161429	0449	-	Add new verified and e-mail agreed TTCN test cases in the TC lists in 34.229-3 (prose), Annex A	F	12.0.0	12.1.0	R5s160803
RP-73	RP-161430	0440	-	Rel-13 baseline upgrade for IMS Test Suites	F	12.1.0	13.0.0	R5s160714
RP-74	RP-162106	0457	-	Corrections to IMS test case 17.2	F	13.0.0	13.1.0	R5s160842
RP-74	RP-162106	0458	-	Correction to IMS Mobile Originated Call test cases	F	13.0.0	13.1.0	R5s160855
RP-74	RP-162106	0459	-	Correction to GCF WI-154 IMS Emergency Call test case 19.3.2	F	13.0.0	13.1.0	R5s160856
RP-74	RP-162106	0460	-	Correcting the applicability check of IMS test case 19.5.8	F	13.0.0	13.1.0	R5s160862
RP-74	RP-162106	0461	-	Correction to CDU AT Command for IMS Video Call Establishment	F	13.0.0	13.1.0	R5s160879
RP-74	RP-162106	0450	1	Correction to GCF WI-154 IMS Emergency Call testcase 19.5.1	F	13.0.0	13.1.0	R5s160916

Meeting	TSG doc	CR	Rev	Subject	Cat	Old vers	New vers	WG doc
RP-74	RP-162106	0451	1	Correction for HTTP authentication	F	13.0.0	13.1.0	R5s160923
RP-74	RP-162106	0452	1	Correction to IP PTC altstep a_IP_IMS_Config()	F	13.0.0	13.1.0	R5s160925
RP-74	RP-162106	0453	1	Correction to cr_ReferTo template as used in IMS Conferencing test cases	F	13.0.0	13.1.0	R5s160927
RP-74	RP-162106	0455	1	Correction to postamble procedure for IMS XCAP Testcases	F	13.0.0	13.1.0	R5s160931
RP-74	RP-162106	0454	1	Correction to Authentication-Info header used in fl_AuthenticationInfo_GBA	F	13.0.0	13.1.0	R5s160962
RP-75	RP-170095	0475	-	Routine maintenance for TS 34.229-3	F	13.1.0	13.2.0	R5-170558
RP-75	RP-170099	0468	-	Correction to GCF WI-154 IMS Emergency Call test case 19.1.3	F	13.1.0	13.2.0	R5s170044
RP-75	RP-170099	0469	-	Correction for IMS conferencing test cases	F	13.1.0	13.2.0	R5s170046
RP-75	RP-170099	0470	-	Correction for IMS authentication test case 9.1 and 9.2	F	13.1.0	13.2.0	R5s170050
RP-75	RP-170099	0471	-	Correction for IMS video call test case 12.22	F	13.1.0	13.2.0	R5s170056
RP-75	RP-170099	0472	-	Addition of IMS test case 12.24	B	13.1.0	13.2.0	R5s170066
RP-75	RP-170099	0473	-	Addition of IMS test case 12.26	B	13.1.0	13.2.0	R5s170074
RP-75	RP-170099	0474	-	Addition of IMS test case 15.4a	B	13.1.0	13.2.0	R5s170078
RP-75	RP-170099	0476	-	Removing temp-gruu from Contact header for IMS emergency registration	F	13.1.0	13.2.0	R5s170098
RP-75	RP-170099	0477	-	Adding P-Access-Network-Info header to f_IMS_PrackRequest_MessageHeaderRX()	F	13.1.0	13.2.0	R5s170099
RP-75	RP-170099	0462	1	Correction for AT command used in IMS Call forwarding Supplementary Service test cases	F	13.1.0	13.2.0	R5s170108
RP-75	RP-170099	0463	1	Correction to IMS Emergency call test case 19.5.6	F	13.1.0	13.2.0	R5s170112
RP-75	RP-170099	0464	1	Correction for IMS XCAP test cases using GBA Authentication	F	13.1.0	13.2.0	R5s170122
RP-75	RP-170099	0465	1	Correction to IMS Emergency Registration test case 19.5.9	F	13.1.0	13.2.0	R5s170143
RP-75	RP-170099	0467	1	Correction to WI-198 test case 17.2	F	13.1.0	13.2.0	R5s170148
RP-75	RP-170099	0466	1	Correction to WI-198 test case 17.1	F	13.1.0	13.2.0	R5s170166
RP-75	RP-170098	0482	-	Add new verified and e-mail agreed TTCN test cases in the TC lists in 34.229-3 (prose), Annex A	F	13.1.0	13.2.0	R5s170184
RP-76	RP-171363	0494	-	Routine maintenance for TS 34.229-3	F	13.2.0	13.3.0	R5-172048
RP-76	RP-171367	0486	-	Correction to Annex C.11, C.26, C.45 and C.51	F	13.2.0	13.3.0	R5s170228
RP-76	RP-171367	0487	-	Corrections to IMS test case 12.2a	F	13.2.0	13.3.0	R5s170231
RP-76	RP-171367	0488	-	Further corrections to IMS test case 12.26	F	13.2.0	13.3.0	R5s170232
RP-76	RP-171367	0489	-	Correction for IMS authentication test cases 9.x	F	13.2.0	13.3.0	R5s170297
RP-76	RP-171367	0490	-	Correction for IMS video call test cases	F	13.2.0	13.3.0	R5s170299
RP-76	RP-171367	0491	-	Correction to SessionID in IMS signalling procedures	F	13.2.0	13.3.0	R5s170305
RP-76	RP-171367	0493	-	Correction for IMS emergency call test cases	F	13.2.0	13.3.0	R5s170327
RP-76	RP-171367	0495	-	Correction for IMS EVS test cases	F	13.2.0	13.3.0	R5s170336
RP-76	RP-171367	0496	-	Correction to GCF WI-198 IMS MTSI video Test Case 17.1	F	13.2.0	13.3.0	R5s170344
RP-76	RP-171367	0497	-	Correction to function fl_IMS_Server_SecurityContextCloseTCP	F	13.2.0	13.3.0	R5s170346
RP-76	RP-171367	0479	1	Correction to function fl_SS_CallForward	F	13.2.0	13.3.0	R5s170377
RP-76	RP-171367	0480	1	Correction to GCF WI-154 emergency call TC 19.5.8	F	13.2.0	13.3.0	R5s170378
RP-76	RP-171367	0483	1	Addition of IMS test case 8.15	B	13.2.0	13.3.0	R5s170390

Meeting	TSG doc	CR	Rev	Subject	Cat	Old vers	New vers	WG doc
RP-76	RP-171367	0484	1	Correction to Remove security context procedure	F	13.2.0	13.3.0	R5s170391
RP-76	RP-171366	0500	-	Add new verified and e-mail agreed TTCN test cases in the TC lists in 34.229-3 (prose), Annex A	F	13.2.0	13.3.0	R5s170415
RP-76	RP-171367	0481	1	Introduction of PIXIT for SPI calculation	F	13.2.0	13.3.0	R5s170417
RP-76	RP-171367	0485	1	Corrections to 180 Ringing	F	13.2.0	13.3.0	R5s170418
RP-77	RP-171688	0513	1	Routine maintenance for TS 34.229-3	F	13.3.0	13.4.0	R5-174564
RP-77	RP-171692	0507	-	Correction for UTRAN IMS test case 6.3 and 7.1	F	13.3.0	13.4.0	R5s170541
RP-77	RP-171692	0508	-	Correction to function fl_IMS_PTC_SPI_ValidValueList_Init()	F	13.3.0	13.4.0	R5s170544
RP-77	RP-171692	0509	-	Correction to IMS test cases 19.4.6 and 19.4.7	F	13.3.0	13.4.0	R5s170554
RP-77	RP-171692	0510	-	Correction to function to GCF WI-103 IMS TCs 16.2, 16.3 and 16.4	F	13.3.0	13.4.0	R5s170578
RP-77	RP-171692	0514	-	Correction to function fl_IMS_Server_GetServerAddrRx()	F	13.3.0	13.4.0	R5s170604
RP-77	RP-171692	0498	1	Addition of IMS test case 19.4.6	B	13.3.0	13.4.0	R5s170614
RP-77	RP-171692	0499	1	Addition of IMS test case 19.4.7	B	13.3.0	13.4.0	R5s170615
RP-77	RP-171692	0501	1	Correction to bandwidth used in IMS test case 12.23	F	13.3.0	13.4.0	R5s170622
RP-77	RP-171692	0502	1	Correction of f_IMS_BuildSDP_MOCallAudioVideo_Step4	F	13.3.0	13.4.0	R5s170626
RP-77	RP-171692	0503	1	Correction for IMS deregistration procedure	F	13.3.0	13.4.0	R5s170643
RP-77	RP-171692	0505	1	Correction to SPI initialization	F	13.3.0	13.4.0	R5s170645
RP-77	RP-171692	0504	1	Addition of IMS test case G.8.1	B	13.3.0	13.4.0	R5s170690
RP-77	RP-171691	0516	-	Add new verified and e-mail agreed TTCN test cases in the TC lists in 34.229-3 (prose), Annex A	F	13.3.0	13.4.0	R5s170705
RP-77	RP-171692	0512	-	Rel-14 baseline upgrade for IMS Test Suites	F	13.4.0	14.0.0	R5s170600
RP-78	RP-172217	0521	-	EIEI: Introduction of Test Model	F	14.0.0	14.1.0	R5-176171
RP-78	RP-172241	0517	-	Correction to bandwidth value in IMS test case 12.26	F	14.0.0	14.1.0	R5s170817
RP-78	RP-172241	0515	1	Correction to IMS test case 12.2a	F	14.0.0	14.1.0	R5s170836
RP-78	RP-172241	0518	-	Extending timer tolerance for 19.5.7	F	14.0.0	14.1.0	R5s170876
RP-78	RP-172241	0519	-	Correction to SRVCC feature tag handling in IMS test case 12.22	F	14.0.0	14.1.0	R5s170877
RP-78	RP-172241	0520	-	Correction to f_IMS_MTCallSetup_Common_Steps12_13	F	14.0.0	14.1.0	R5s170883
RP-78	RP-172241	0522	-	Addition of IMS test case G.12.1	F	14.0.0	14.1.0	R5s170904
RP-78	RP-172241	0523	-	Addition of IMS test case G.12.3	F	14.0.0	14.1.0	R5s170906
RP-78	RP-172241	0511	1	Addition of IMS test case 19.1.6	F	14.0.0	14.1.0	R5s170951
RP-78	RP-172240	0526	-	Add new verified and e-mail agreed TTCN test cases in the TC lists in 34.229-3 (prose), Annex A	F	14.0.0	14.1.0	R5s170959
RP-79	RP-180089	0551	-	EIEI: Test Model updates	F	14.1.0	14.2.0	R5-180613
RP-79	RP-180104	0552	-	Routine maintenance for TS 34.229-3	F	14.1.0	14.2.0	R5-180632
RP-79	RP-180112	0531	-	Correction of function f_IMS_CC_StartCall	F	14.1.0	14.2.0	R5s180023
RP-79	RP-180112	0538	-	Correction to IMS three way session creation test cases 15.21a and 15.21c	F	14.1.0	14.2.0	R5s180053
RP-79	RP-180112	0539	-	Correction for IMS UTRAN test cases 6.3 and 7.1	F	14.1.0	14.2.0	R5s180061
RP-79	RP-180112	0524	1	Clean-up and harmonisation of IMS test case implementation for EUTRA/WLAN/FBBA/CatM1	F	14.1.0	14.2.0	R5s180092
RP-79	RP-180112	0525	1	Correction of f_UTRAN_IPCAN_Release	F	14.1.0	14.2.0	R5s180093

Meeting	TSG doc	CR	Rev	Subject	Cat	Old vers	New vers	WG doc
RP-79	RP-180112	0541	-	Correction to IMS function fl_IMS_Server_RemoveSecurityContext	F	14.1.0	14.2.0	R5s180112
RP-79	RP-180112	0530	1	Addition of IMS test case G.15.17	F	14.1.0	14.2.0	R5s180116
RP-79	RP-180112	0542	-	Addition of IMS test case J.8.1 for CAT-M1 UEs	F	14.1.0	14.2.0	R5s180126
RP-79	RP-180112	0543	-	Addition of IMS test case J.12.1 for CAT-M1 UEs	F	14.1.0	14.2.0	R5s180128
RP-79	RP-180112	0544	-	Addition of IMS test case J.12.2 for CAT-M1 UEs	F	14.1.0	14.2.0	R5s180130
RP-79	RP-180112	0545	-	Addition of IMS test case J.15.1 for CAT-M1 UEs	F	14.1.0	14.2.0	R5s180132
RP-79	RP-180112	0546	-	Addition of IMS test case J.15.3 for CAT-M1 UEs	F	14.1.0	14.2.0	R5s180134
RP-79	RP-180112	0547	-	Addition of IMS test case J.15.4 for CAT-M1 UEs	F	14.1.0	14.2.0	R5s180136
RP-79	RP-180112	0548	-	Addition of IMS test case J.15.6 for CAT-M1 UEs	F	14.1.0	14.2.0	R5s180138
RP-79	RP-180112	0549	-	Addition of IMS test case J.15.2 for CAT-M1 UEs	F	14.1.0	14.2.0	R5s180142
RP-79	RP-180112	0550	-	Addition of IMS test case J.19.2 for CAT-M1 UEs	F	14.1.0	14.2.0	R5s180144
RP-79	RP-180112	0555	-	Addition of IMS test case G.12.2	F	14.1.0	14.2.0	R5s180162
RP-79	RP-180112	0527	1	Postponing activation of dedicated bearer in MT call scenarios	F	14.1.0	14.2.0	R5s180200
RP-79	RP-180111	0564	-	Add new verified and e-mail agreed TTCN test cases in the TC lists in 34.229-3 (prose), Annex A	F	14.1.0	14.2.0	R5s180209
RP-80	RP-180728	0569	-	Correction for IMS over UTRAN test cases 6.3 and 7.1	F	14.2.0	14.3.0	R5s180247
RP-80	RP-180728	0570	-	Addition of IMS test case G.17.1	F	14.2.0	14.3.0	R5s180267
RP-80	RP-180728	0571	-	Correction for IMS call control test case 12.2	F	14.2.0	14.3.0	R5s180278
RP-80	RP-180728	0574	-	Correction to IMS test case 17.2 regarding strength tag in video media	F	14.2.0	14.3.0	R5s180304
RP-80	RP-180728	0553	1	Follow-up to R5s170904 regarding IMS test case G.12.1	F	14.2.0	14.3.0	R5s180320
RP-80	RP-180728	0556	1	Addition of IMS test case G.12.4	F	14.2.0	14.3.0	R5s180323
RP-80	RP-180728	0557	1	Addition of IMS test case G.15.2	F	14.2.0	14.3.0	R5s180329
RP-80	RP-180728	0558	1	Addition of IMS test case G.15.11	F	14.2.0	14.3.0	R5s180330
RP-80	RP-180728	0559	1	Addition of IMS test case G.15.13	F	14.2.0	14.3.0	R5s180331
RP-80	RP-180728	0560	1	Addition of IMS test case G.15.18	F	14.2.0	14.3.0	R5s180332
RP-80	RP-180728	0561	1	Addition of IMS test case G.15.21	F	14.2.0	14.3.0	R5s180333
RP-80	RP-180728	0562	1	Check of codec parameters for C.44	F	14.2.0	14.3.0	R5s180342
RP-80	RP-180728	0563	1	Generic implementation of common checks for 180 and 183 responses	F	14.2.0	14.3.0	R5s180343
RP-80	RP-180728	0565	1	Addition of IMS test case G.15.20	F	14.2.0	14.3.0	R5s180357
RP-80	RP-180728	0566	1	Addition of IMS test case G.15.23	F	14.2.0	14.3.0	R5s180358
RP-80	RP-180728	0567	1	Addition of IMS test case G.15.12	F	14.2.0	14.3.0	R5s180362
RP-80	RP-180728	0568	1	Addition of IMS test case G.15.14	F	14.2.0	14.3.0	R5s180363
RP-80	RP-180727	0577	-	Add new verified and e-mail agreed TTCN test cases in the TC lists in 34.229-3 (prose), Annex A	F	14.2.0	14.3.0	R5s180396
RP-81	RP-181585	0580	-	Addition of IMS test case G.15.4	B	14.3.0	14.4.0	R5s180433
RP-81	RP-181585	0581	-	Corrections to WLAN MT calls over IMS regarding returning 180 Ringing	F	14.3.0	14.4.0	R5s180436
RP-81	RP-181585	0582	-	Corrections to IMS emergency test case 19.1.6	F	14.3.0	14.4.0	R5s180463
RP-81	RP-181585	0575	1	Correction to f_IMS_MTCallSetup_AnnexC11aC11cC26aC26b	F	14.3.0	14.4.0	R5s180483

Meeting	TSG doc	CR	Rev	Subject	Cat	Old vers	New vers	WG doc
RP-81	RP-181585	0578	1	Addition of IMS test case G.15.24	B	14.3.0	14.4.0	R5s180505
RP-81	RP-181585	0579	1	Addition of IMS test case G.15.25	B	14.3.0	14.4.0	R5s180506
RP-81	RP-181584	0584	-	Add new verified and e-mail agreed TTCN test cases in the TC lists in 34.229-3 (prose), Annex A	F	14.3.0	14.4.0	R5s180524
RP-82	RP-182288	0591	-	MCPTT: Updates to common type definitions	F	14.4.0	14.5.0	R5-187458
RP-82	RP-182291	0586	-	Addition of IMS test case 15.25	F	14.4.0	14.5.0	R5s180548
RP-82	RP-182291	0588	-	Correction to race condition in IMS test case 12.2a	F	14.4.0	14.5.0	R5s180561
RP-82	RP-182291	0589	-	Addition of IMS test case J.19.1	F	14.4.0	14.5.0	R5s180564
RP-82	RP-182291	0590	-	Corrections to IMS test case 19.4.6	F	14.4.0	14.5.0	R5s180586
RP-82	RP-182291	0583	1	Addition of IMS test case 19.1.1	F	14.4.0	14.5.0	R5s180604
RP-82	RP-182291	0585	1	Addition of IMS Testcase J.18.2	F	14.4.0	14.5.0	R5s180609
RP-82	RP-182290/ R5s180635	0592	-	Add new verified and e-mail agreed TTCN test cases in the TC lists in 34.229-3 (prose), Annex A	F	14.4.0	14.5.0	R5s180635
RP-82	RP-182291	0587	-	Rel-15 Sep'18 baseline upgrade for IMS Test Suites	F	14.5.0	15.0.0	R5s180555
RP-83	RP-190099	0594	-	Addition of IMS test case G.17.2	B	15.0.0	15.1.0	R5s190003
RP-83	RP-190099	0595	-	Correction to IMS video call test case 17.2	F	15.0.0	15.1.0	R5s190006
RP-83	RP-190098	0596	-	Add new verified and e-mail agreed TTCN test cases in the TC lists in 34.229-3 (prose), Annex A	F	15.0.0	15.1.0	R5s190125
RP-85	RP-191708	0599	-	Routine maintenance for TS 34.229-3	F	15.1.0	15.2.0	R5-195959
RP-85	RP-191713	0597	-	Addition of IMS test case 12.13a	B	15.1.0	15.2.0	R5s190458
RP-85	RP-191713	0598	-	Correction to support Geolocation information for IMS test cases.	F	15.1.0	15.2.0	R5s190580
RP-85	RP-191713	0602	-	Changes to IMS common functions to support MCX development	F	15.1.0	15.2.0	R5s190727
RP-85	RP-191712	0605	-	Add new verified and e-mail agreed TTCN test cases in the TC lists in 34.229-3 (prose), Annex A	F	15.1.0	15.2.0	R5s190818
RP-86	RP-192489	0607	-	Further changes to IMS common functions to support MCX development	F	15.2.0	15.3.0	R5s190882
RP-86	RP-192489	0608	-	Correction to generic function f_IMS_PTC_ImsInfo_GetNextBranch	F	15.2.0	15.3.0	R5s190963
RP-86	RP-192489	0609	-	Correction to IMS test case 19.3.1 for checking Geolocation information	F	15.2.0	15.3.0	R5s190985
RP-86	RP-192489	0610	-	Enhancement and improvement of TTCN function for Base64 encoding	F	15.2.0	15.3.0	R5s191000
RP-86	RP-192489	0601	1	Correction to postamble procedure for IMS XCAP Testcases	F	15.2.0	15.3.0	R5s191010
RP-86	RP-192489	0604	1	Correction to IMS Emergency Call test case 19.3.2c	F	15.2.0	15.3.0	R5s191029
RP-86	RP-192489	0603	1	Corrections to IMS emergency test cases 19.4.5, 19.4.6, and 19.4.7	F	15.2.0	15.3.0	R5s191145
RP-87	RP-200061	0616	-	IMS over NR/5GC: Initial Test Model	F	15.3.0	15.4.0	R5-200257
RP-87	RP-200077	0617	-	Routine maintenance for TS 34.229-3	F	15.3.0	15.4.0	R5-200260
RP-87	RP-200077	0614	-	Addition of IMS test case 22.2	F	15.3.0	15.4.0	R5s200206
RP-87	RP-200077	0615	-	Correction of MT re-INVITE and MT BYE for MO call	F	15.3.0	15.4.0	R5s200210
RP-87	RP-200077	0611	1	Enhancements and improvements of common IMS code	F	15.3.0	15.4.0	R5s200251
RP-87	RP-200077	0612	1	Addition of IMS test case 22.1	F	15.3.0	15.4.0	R5s200267
RP-87	RP-200077	0618	-	Addition of IMS test case 22.6	F	15.3.0	15.4.0	R5s200297
RP-87	RP-200077	0619	-	Addition of IMS test case 22.8	F	15.3.0	15.4.0	R5s200299
RP-87	RP-200077	0620	-	Addition of IMS test case 22.4	F	15.3.0	15.4.0	R5s200301
RP-87	RP-200077	0621	-	Addition of IMS test case 22.3	F	15.3.0	15.4.0	R5s200303

Meeting	TSG doc	CR	Rev	Subject	Cat	Old vers	New vers	WG doc
RP-87	RP-200077	0622	-	Addition of IMS test case 22.5	F	15.3.0	15.4.0	R5s200320
RP-87	RP-200077	0624	-	Add new verified and e-mail agreed TTCN test cases in the TC lists in 34.229-3 (prose), Annex A	F	15.3.0	15.4.0	R5s200384
RP-88	RP-200593	0625	-	Routine maintenance for TS 34.229-3	F	15.4.0	15.5.0	R5-201585
RP-88	RP-200599	0626	-	Enhancement of dialog array for support of additional event packages	F	15.4.0	15.5.0	R5s200743
RP-88	RP-200599	0623	1	Addition of IMS test case 22.7	F	15.4.0	15.5.0	R5s200840
RP-88	RP-200599	0628	-	Add new verified and e-mail agreed TTCN test cases in the TC lists in 34.229-3 (prose), Annex A	F	15.4.0	15.5.0	R5s200916
RP-89	RP-201448	0631	-	IMS over NR/5GC: Misc updates	F	15.5.0	15.6.0	R5-203544
RP-89	RP-201467	0630	-	Update of XSD.ttcn	F	15.5.0	15.6.0	R5s201014
RP-89	RP-201467	0632	-	Correction and enhancement of f.UTC_FormatDateTime	F	15.5.0	15.6.0	R5s201156
RP-89	RP-201467	0633	-	Correction of IMS PDN handling	F	15.5.0	15.6.0	R5s201177
RP-89	RP-201467	0629	1	Corrections for IMS common functions	F	15.5.0	15.6.0	R5s201273
RP-89	RP-201467	0627	1	Corrections of further XCAP test cases regarding rule elements	F	15.5.0	15.6.0	R5s201282
RP-89	-	-	-	new version to fix distorted figures for the pdf version	F	15.6.0	15.6.1	-
RP-90	RP-202249	0645	-	Addition of IMS over 5GS test case 6.8	B	15.6.1	15.7.0	R5s201378
RP-90	RP-202249	0647	-	Enhancement of IP_PTC	F	15.6.1	15.7.0	R5s201440
RP-90	RP-202249	0649	-	Correction to function f.WLAN_IPCAN_MainLoop	F	15.6.1	15.7.0	R5s201508
RP-90	RP-202249	0634	1	Enhancement of a_IMS_SUBSCRIBE_Request	F	15.6.1	15.7.0	R5s201583
RP-90	RP-202249	0635	1	Correction to IMS TCs	F	15.6.1	15.7.0	R5s201590
RP-90	RP-202249	0636	1	Correction of XCAP test cases	F	15.6.1	15.7.0	R5s201591
RP-90	RP-202249	0641	1	Addition of IMS 5GS registration test case 6.1	B	15.6.1	15.7.0	R5s201607
RP-90	RP-202249	0642	1	Addition of IMS 5GS registration test case 6.6	B	15.6.1	15.7.0	R5s201608
RP-90	RP-202249	0643	1	Addition of IMS 5GS registration test case 6.9	B	15.6.1	15.7.0	R5s201609
RP-90	RP-202249	0637	1	Addition of IMS 5GS SMS test case 9.1	B	15.6.1	15.7.0	R5s201629
RP-90	RP-202249	0638	1	Addition of IMS 5GS SMS test case 9.2	B	15.6.1	15.7.0	R5s201630
RP-90	RP-202249	0639	1	Addition of IMS 5GS SMS test case 9.4	B	15.6.1	15.7.0	R5s201631
RP-90	RP-202249	0640	1	Addition of IMS 5GS SMS test case 9.5	B	15.6.1	15.7.0	R5s201632
RP-90	RP-202249	0656	-	Add new verified and e-mail agreed TTCN test cases in the TC lists in 34.229-3 (prose), Annex A	F	15.6.1	15.7.0	R5s201647
RP-90	RP-202249	0646	-	Rel-16 Sep'20 baseline upgrade for IMS Test Suites	F	15.7.0	16.0.0	R5s201409
RP-91	RP-210166	0669	-	Routine maintenance for TS 34.229-3	F	16.0.0	16.1.0	R5-210203
RP-91	RP-210167	0661	-	Correction to Generic IMS functions	B	16.0.0	16.1.0	R5s210037
RP-91	RP-210167	0662	-	Addition of IMS over 5GS test case 7.12	B	16.0.0	16.1.0	R5s210096
RP-91	RP-210167	0663	-	Addition of IMS over 5GS test case 7.5	B	16.0.0	16.1.0	R5s210098
RP-91	RP-210167	0664	-	Addition of IMS over 5GS test case 7.2	F	16.0.0	16.1.0	R5s210100
RP-91	RP-210167	0665	-	Corrections for 5GS IMS SMS test cases	B	16.0.0	16.1.0	R5s210112
RP-91	RP-210167	0667	-	Addition of IMS 5GS call control test case 7.11	F	16.0.0	16.1.0	R5s210136
RP-91	RP-210167	0668	-	Correction to function f.IMS_UpdateRequest_MessageHeaderTX	B	16.0.0	16.1.0	R5s210144

Meeting	TSG doc	CR	Rev	Subject	Cat	Old vers	New vers	WG doc
RP-91	RP-210167	0648	1	Addition of IMS 5GS SMS test case 9.3	F	16.0.0	16.1.0	R5s210177
RP-91	RP-210167	0655	1	Improvements and common implementation of SIP over 4G/5G procedures	F	16.0.0	16.1.0	R5s210212
RP-91	RP-210167	0657	1	FBBA cleanup	B	16.0.0	16.1.0	R5s210228
RP-91	RP-210167	0658	1	Addition of IMS 5GS test case 6.7	F	16.0.0	16.1.0	R5s210247
RP-91	RP-210167	0671	-	Correction to usage of TCP in DL requests in IMS over 5GS test cases	F	16.0.0	16.1.0	R5s210268
RP-91	RP-210167	0672	-	Correction to IMS test case 9.3	B	16.0.0	16.1.0	R5s210281
RP-91	RP-210167	0654	1	Addition of IMS over 5GS test case 6.3	B	16.0.0	16.1.0	R5s210311
RP-91	RP-210167	0659	1	Addition of eCall over IMS test case 21.1	B	16.0.0	16.1.0	R5s210317
RP-91	RP-210167	0660	1	Addition of eCall over IMS test case 21.2	F	16.0.0	16.1.0	R5s210318
RP-91	RP-210167	0673	-	Add new verified and e-mail agreed TTCN test cases in the TC lists in 34.229-3 (prose), Annex A	F	16.0.0	16.1.0	R5s210320
RP-92	RP-211032	0677	-	a=sendrecv	F	16.1.0	16.2.0	R5s210392
RP-92	RP-211032	0678	-	Correction to f_IMS_MTCallSetup_NoSdpInINVITE_Step1_6	F	16.1.0	16.2.0	R5s210393
RP-92	RP-211032	0680	-	Correction for IMS common function f_IMS_MOCallSetup_NR5GC_A_4_1_Step6_7()	F	16.1.0	16.2.0	R5s210397
RP-92	RP-211032	0681	-	Correction for IMS NR5GC test case 7.10	F	16.1.0	16.2.0	R5s210413
RP-92	RP-211032	0682	-	Addition of IMS over 5GS test case 7.4	B	16.1.0	16.2.0	R5s210418
RP-92	RP-211032	0683	-	Addition of IMS over 5GS test case 7.6	B	16.1.0	16.2.0	R5s210419
RP-92	RP-211032	0684	-	Addition of IMS over 5GS test case 7.7	B	16.1.0	16.2.0	R5s210420
RP-92	RP-211032	0685	-	Addition of IMS over 5GS test case 7.9	B	16.1.0	16.2.0	R5s210421
RP-92	RP-211032	0686	-	Correction to bearer activation for no preconditions MT calls	F	16.1.0	16.2.0	R5s210423
RP-92	RP-211032	0688	-	Correction to IA5toGsm7Bit functions	F	16.1.0	16.2.0	R5s210441
RP-92	RP-211032	0689	-	Addition of IMS 5GS call control test case 7.31	B	16.1.0	16.2.0	R5s210450
RP-92	RP-211032	0692	-	Addition of IMS 5GS call control test case 7.32	B	16.1.0	16.2.0	R5s210467
RP-92	RP-211032	0693	-	Addition of IMS 5GS call control test case 7.34	B	16.1.0	16.2.0	R5s210469
RP-92	RP-211032	0697	-	Correction for IMS 5GS call control test case 7.4 applicability	F	16.1.0	16.2.0	R5s210494
RP-92	RP-211032	0698	-	Addition of IMS 5GS call control test case 7.27	B	16.1.0	16.2.0	R5s210497
RP-92	RP-211032	0699	-	Addition of IMS 5GS call control test case 7.29	B	16.1.0	16.2.0	R5s210499
RP-92	RP-211032	0700	-	Addition of IMS over 5GS test case 8.38	B	16.1.0	16.2.0	R5s210505
RP-92	RP-211032	0701	-	Addition of IMS 5GS call control test case 7.28	B	16.1.0	16.2.0	R5s210514
RP-92	RP-211032	0674	1	Addition of IMS over 5GS call control test case 7.1	B	16.1.0	16.2.0	R5s210553
RP-92	RP-211032	0675	1	Addition of IMS over 5GS call control test case 7.8	B	16.1.0	16.2.0	R5s210554
RP-92	RP-211032	0676	1	Addition of IMS over 5GS call control test case 7.10	B	16.1.0	16.2.0	R5s210555
RP-92	RP-211032	0708	-	Add new verified and e-mail agreed TTCN test cases in the TC lists in 34.229-3 (prose), Annex A	F	16.1.0	16.2.0	R5s210649
RP-93	RP-211737	0734	1	Routine maintenance for TS 34.229-3	F	16.2.0	16.3.0	R5-216341
RP-93	RP-211736	0726	-	Addition of IMS 5GS registration test case 6.2	F	16.2.0	16.3.0	R5s210720
RP-93	RP-211736	0729	-	Correction for IMS 5GS call control test cases	F	16.2.0	16.3.0	R5s210734
RP-93	RP-211736	0730	-	Addition of IMS 5GS call control test case 7.26	F	16.2.0	16.3.0	R5s210788

Meeting	TSG doc	CR	Rev	Subject	Cat	Old vers	New vers	WG doc
RP-93	RP-211736	0732	-	Correction to IMS Emergency call over EPS testcase 19.4.1	F	16.2.0	16.3.0	R5s210815
RP-93	RP-211736	0733	-	Correction of f_IMS_CommunicationWaiting_CancelCall	F	16.2.0	16.3.0	R5s210825
RP-93	RP-211736	0705	1	Correction of f_IMS_SDP_AudioMediaAttributes_InitialAnswer_TX	F	16.2.0	16.3.0	R5s210907
RP-93	RP-211736	0706	1	Improved handling of preconditions in 200 OK's Require header field	F	16.2.0	16.3.0	R5s210915
RP-93	RP-211736	0707	1	Addition of IMS 5GS supplementary services test case 8.30	F	16.2.0	16.3.0	R5s210920
RP-93	RP-211736	0711	1	Addition of IMS over 5GS test case 7.19	F	16.2.0	16.3.0	R5s210934
RP-93	RP-211736	0713	1	Correction to f_IMS_BuildSDP_InitialOfferAudio_TX	F	16.2.0	16.3.0	R5s210937
RP-93	RP-211736	0716	1	Addition of IMS over 5GS test case 7.18	F	16.2.0	16.3.0	R5s210940
RP-93	RP-211736	0717	1	Addition of IMS 5GS call control test case 7.30	F	16.2.0	16.3.0	R5s210942
RP-93	RP-211736	0718	1	Addition of IMS over 5GS test case 8.26	F	16.2.0	16.3.0	R5s210943
RP-93	RP-211736	0719	1	Addition of IMS over 5GS test case 7.13	F	16.2.0	16.3.0	R5s210944
RP-93	RP-211736	0722	1	Addition of IMS over 5GS test case 8.28	F	16.2.0	16.3.0	R5s210945
RP-93	RP-211736	0710	1	Addition of IMS over 5GS test case 6.4	F	16.2.0	16.3.0	R5s210955
RP-93	RP-211736	0712	1	Addition of IMS over 5GS test case 7.33	F	16.2.0	16.3.0	R5s210956
RP-93	RP-211736	0715	1	Addition of IMS 5GS call control test case 7.25	F	16.2.0	16.3.0	R5s210959
RP-93	RP-211736	0740	-	Add new verified and e-mail agreed TTCN test cases in the TC lists in 34.229-3 (prose), Annex A	F	16.2.0	16.3.0	R5s211176
RP-94	RP-212799	0744	-	Addition of IMS NR TC 8.41 Communication Forwarding on No Reply: MO Call initiation with preconditions	F	16.3.0	16.4.0	R5s211339
RP-94	RP-212799	0745	-	Correction for IMS emergency test case 19.4.2	F	16.3.0	16.4.0	R5s211352
RP-94	RP-212799	0738	1	Addition of IMS 5GS call control test case 7.14	F	16.3.0	16.4.0	R5s211398
RP-94	RP-212799	0739	1	Addition of IMS 5GS call control test case 7.15	F	16.3.0	16.4.0	R5s211401
RP-94	RP-212799	0743	1	Extension of f_IMS_SubscribeRequest_MessageHeaderRX	F	16.3.0	16.4.0	R5s211468
RP-94	RP-212799	0746	-	Corrections for IMS video call test cases	F	16.3.0	16.4.0	R5s211478
RP-94	RP-212799	0747	-	Corrections for IMS 5GS registration test case 6.4	F	16.3.0	16.4.0	R5s211495
RP-94	RP-212799	0749	-	Addition of IMS 5GS Supplementary Services test case 8.29	F	16.3.0	16.4.0	R5s211532
RP-94	RP-212799	0750	-	Correction to function f_IMS_MTCallSetup_BuildInviteRequestWithSdp	F	16.3.0	16.4.0	R5s211537
RP-94	RP-212799	0752	-	Addition of IMS 5GS Supplementary Services test case 8.37	F	16.3.0	16.4.0	R5s211570
RP-94	RP-212799	0753	-	Addition of IMS 5GS Supplementary Services test case 8.31	F	16.3.0	16.4.0	R5s211573
RP-94	RP-212799	0754	-	Addition of IMS 5GS Supplementary Services test case 8.27	F	16.3.0	16.4.0	R5s211582
RP-94	RP-212799	0735	1	Addition of eCall over IMS test case 21.4	F	16.3.0	16.4.0	R5s211683
RP-94	RP-212799	0736	1	Addition of eCall over IMS test case 21.5	F	16.3.0	16.4.0	R5s211684
RP-94	RP-212799	0737	1	Addition of eCall over IMS test case 21.6	F	16.3.0	16.4.0	R5s211685
RP-94	RP-212799	0742	1	Correction to TP parameter indicator template for SMS Status reporting	F	16.3.0	16.4.0	R5s211689
RP-94	RP-212799	0757	-	Add new verified and e-mail agreed TTCN test cases in the TC lists in 34.229-3 (prose), Annex A	F	16.3.0	16.4.0	R5s211694
RP-95	RP-220121	0772	-	Correction for IMS 5GS call control test cases 7.10 and 7.25	F	16.4.0	16.5.0	R5s220110
RP-95	RP-220121	0755	1	Correction of f_URL_Decoding	F	16.4.0	16.5.0	R5s220168
RP-95	RP-220121	0773	-	Addition of IMS 5GS Supplementary Services test case 7.6a	B	16.4.0	16.5.0	R5s220192

Meeting	TSG doc	CR	Rev	Subject	Cat	Old vers	New vers	WG doc
RP-95	RP-220121	0775	-	Addition of IMS 5GS Call Control test case 8.33	B	16.4.0	16.5.0	R5s220205
RP-95	RP-220121	0777	-	Addition of IMS 5GS Call Control test case 7.16	B	16.4.0	16.5.0	R5s220235
RP-95	RP-220121	0779	-	Addition of IMS 5GS Call Control test case 7.17	B	16.4.0	16.5.0	R5s220239
RP-95	RP-220121	0762	1	Addition of IMS 5GS Supplementary Services test case 8.32	B	16.4.0	16.5.0	R5s220245
RP-95	RP-220121	0763	1	Correction to IMS 5GS test case 7.18	F	16.4.0	16.5.0	R5s220251
RP-95	RP-220121	0764	1	Addition of IMS 5GS Call Control test case 7.24	B	16.4.0	16.5.0	R5s220255
RP-95	RP-220121	0765	1	Addition of IMS 5GS Call Control test case 7.4a	B	16.4.0	16.5.0	R5s220257
RP-95	RP-220121	0766	1	Correction for IMS 5GS video call test cases	F	16.4.0	16.5.0	R5s220266
RP-95	RP-220121	0781	-	Addition of IMS 5GS Supplementary Services test case 8.3	B	16.4.0	16.5.0	R5s220342
RP-95	RP-220121	0758	1	Addition of IMS 5GS Supplementary Services test case 8.36	B	16.4.0	16.5.0	R5s220406
RP-95	RP-220121	0783	1	Addition of IMS 5GS Call Control test case 8.8	B	16.4.0	16.5.0	R5s220434
RP-95	RP-220121	0801	-	Add new verified and e-mail agreed TTCN test cases in the TC lists in 34.229-3 (prose), Annex A	F	16.4.0	16.5.0	R5s220435
RP-96	RP-221113	0803	-	Checking the absence of geolocation information in INVITE request	F	16.5.0	16.6.0	R5s220485
RP-96	RP-221113	0805	-	Correction for IMS 5GS call control test cases	F	16.5.0	16.6.0	R5s220500
RP-96	RP-221113	0807	-	Correction for IMS call control test case 7.16	F	16.5.0	16.6.0	R5s220505
RP-96	RP-221113	0808	-	Correction to function f_IMS_SDP_AudioMediaAttributes_InitialAnswer5G_TX	F	16.5.0	16.6.0	R5s220510
RP-96	RP-221113	0809	-	Addition of IMS NR5GC XCAP test case 8.7	F	16.5.0	16.6.0	R5s220511
RP-96	RP-221113	0810	-	Addition of IMS NR5GC XCAP test case 8.11	F	16.5.0	16.6.0	R5s220513
RP-96	RP-221113	0811	-	Addition of IMS NR5GC XCAP test case 8.13	F	16.5.0	16.6.0	R5s220515
RP-96	RP-221113	0812	-	Addition of IMS NR5GC XCAP test case 8.15	F	16.5.0	16.6.0	R5s220517
RP-96	RP-221113	0813	-	Addition of IMS NR5GC XCAP test case 8.19	F	16.5.0	16.6.0	R5s220519
RP-96	RP-221113	0814	-	Addition of IMS NR5GC XCAP test case 8.25	F	16.5.0	16.6.0	R5s220521
RP-96	RP-221113	0815	-	Correction of f_IMS_ThreeWaySession_Creation	F	16.5.0	16.6.0	R5s220523
RP-96	RP-221113	0816	-	Addition of IMS 5GS emergency call test case 10.2	F	16.5.0	16.6.0	R5s220531
RP-96	RP-221113	0817	-	Addition of IMS 5GS Emergency Call test case 10.6	F	16.5.0	16.6.0	R5s220555
RP-96	RP-221113	0818	-	Correction to function fl_SIP_BuildReferToUri_RX	F	16.5.0	16.6.0	R5s220575
RP-96	RP-221113	0819	-	Correction for IMS 5GS selection expression	F	16.5.0	16.6.0	R5s220576
RP-96	RP-221113	0821	-	Correction to IMS NR5GC testcase 7.22	F	16.5.0	16.6.0	R5s220594
RP-96	RP-221113	0822	-	Correction to fl_NR5GC_ModifyPDUSession_RemoveIMS_Media	F	16.5.0	16.6.0	R5s220595
RP-96	RP-221113	0823	-	Addition of IMS NR5GC XCAP test case 8.17	F	16.5.0	16.6.0	R5s220601
RP-96	RP-221113	0824	-	Addition of IMS NR5GC XCAP test case 8.21	F	16.5.0	16.6.0	R5s220603
RP-96	RP-221113	0825	-	Addition of IMS NR5GC XCAP test case 8.22	F	16.5.0	16.6.0	R5s220605
RP-96	RP-221113	0826	-	Addition of IMS NR5GC XCAP test case 8.23	F	16.5.0	16.6.0	R5s220607
RP-96	RP-221113	0827	-	Addition of IMS 5GS emergency call test case 10.9	F	16.5.0	16.6.0	R5s220609
RP-96	RP-221113	0829	-	Correction to template cs_HttpResponse	F	16.5.0	16.6.0	R5s220616
RP-96	RP-221113	0830	-	Correction to IMS_NR5GC XCAP Test cases	F	16.5.0	16.6.0	R5s220617

Meeting	TSG doc	CR	Rev	Subject	Cat	Old vers	New vers	WG doc
RP-96	RP-221113	0774	1	Correction to function f_IMS_CallWithSessionTimer_CheckInviteAfter422	F	16.5.0	16.6.0	R5s220629
RP-96	RP-221113	0776	1	Addition of IMS Emergency call test case 10.3	F	16.5.0	16.6.0	R5s220632
RP-96	RP-221113	0791	1	Addition of IMS NR5GC supplementary service test case 8.6	F	16.5.0	16.6.0	R5s220648
RP-96	RP-221113	0798	1	Correction of IMS 5GS test case 8.36	F	16.5.0	16.6.0	R5s220651
RP-96	RP-221113	0778	1	Addition of IMS 5GS Call Control test case 7.24a	F	16.5.0	16.6.0	R5s220709
RP-96	RP-221113	0793	1	Addition of IMS NR5GC XCAP test case 8.4	F	16.5.0	16.6.0	R5s220710
RP-96	RP-221113	0794	1	Addition of IMS NR5GC XCAP test case 8.5	F	16.5.0	16.6.0	R5s220711
RP-96	RP-221113	0792	1	Addition of IMS NR5GC XCAP test case 8.1	F	16.5.0	16.6.0	R5s220719
RP-96	RP-221113	0797	1	Addition of IMS NR5GC call control test case 7.24b	F	16.5.0	16.6.0	R5s220720
RP-96	RP-221113	0799	1	Addition of IMS 5GS Call Control test case 7.22	F	16.5.0	16.6.0	R5s220721
RP-96	RP-221113	0832	-	Add new verified and e-mail agreed TTCN test cases in the TC lists in 34.229-3 (prose), Annex A	F	16.5.0	16.6.0	R5s220723
RP-97	RP-221995	0835	-	Addition of IMS 5GS Supplementary Services test case 8.39a	B	16.6.0	16.7.0	R5s220763
RP-97	RP-221995	0836	-	Correction to A.2.3 implementation check involving ReInvite	F	16.6.0	16.7.0	R5s220766
RP-97	RP-221995	0837	-	Correction to f_IMS_CheckGeolocationAbsent	F	16.6.0	16.7.0	R5s220767
RP-97	RP-221995	0838	-	Correction for IMS 5GS XCAP test case 8.1	F	16.6.0	16.7.0	R5s220771
RP-97	RP-221995	0839	-	Correction for IMS MO call test cases	F	16.6.0	16.7.0	R5s220772
RP-97	RP-221995	0840	-	Correction for IMS 5GS call control test case 7.33	F	16.6.0	16.7.0	R5s220782
RP-97	RP-221995	0841	-	Correction to function f_IMS_MTCallSetup_NR5GC_A_5_X_Step2_3	F	16.6.0	16.7.0	R5s220787
RP-97	RP-221995	0843	-	Correction to function f_IMS_ConferenceCreation_NR5GC_A_25_Steps1_9	F	16.6.0	16.7.0	R5s220820
RP-97	RP-221995	0844	-	Correction to function fl_IMS_Route_ReverseOrderOfRecordRouteRX	F	16.6.0	16.7.0	R5s220836
RP-97	RP-221995	0848	-	Addition of IMS 5GS Supplementary Services test case 8.2	B	16.6.0	16.7.0	R5s220855
RP-97	RP-221995	0849	-	Addition of IMS 5GS Emergency Call test case 10.12	B	16.6.0	16.7.0	R5s220860
RP-97	RP-221995	0850	-	Addition of IMS 5GS Emergency Call test case 10.13	B	16.6.0	16.7.0	R5s220862
RP-97	RP-221995	0851	-	Addition of IMS 5GS Supplementary Services test case 8.39	B	16.6.0	16.7.0	R5s220871
RP-97	RP-221995	0853	-	Correction for IMS 5GS call control test case 7.25	F	16.6.0	16.7.0	R5s220877
RP-97	RP-221995	0854	-	Addition of IMS 5GS Supplementary Services test case 8.9	B	16.6.0	16.7.0	R5s220878
RP-97	RP-221995	0780	1	Addition of IMS 5GS Call Control test case 7.23	B	16.6.0	16.7.0	R5s220886
RP-97	RP-221995	0820	1	Correction to IMS NR5GC testcase 7.23	F	16.6.0	16.7.0	R5s220889
RP-97	RP-221995	0828	1	Addition of IMS 5GS emergency call test case 10.10	B	16.6.0	16.7.0	R5s220891
RP-97	RP-221995	0831	1	Correction to f_WLAN_IPCAN_Init	F	16.6.0	16.7.0	R5s220895
RP-97	RP-221995	0833	1	Corrections of 4G/5G session timer test cases	F	16.6.0	16.7.0	R5s220922
RP-97	RP-221995	0858	-	Correction to f_IMS_CallWithSessionTimer_ReceiveUpdate function and associated tests	F	16.6.0	16.7.0	R5s220951
RP-97	RP-221995	0859	-	Correction for IMS test cases	F	16.6.0	16.7.0	R5s220959
RP-97	RP-221995	0861	-	Add new verified and e-mail agreed TTCN test cases in the TC lists in 34.229-3 (prose), Annex A	F	16.6.0	16.7.0	R5s221070
RP-98	RP-222788	0862	-	Correction to f_IMS_CC_StartCall	F	16.7.0	16.8.0	R5s221095
RP-98	RP-222788	0863	-	Correction to IMS Conference call test cases	F	16.7.0	16.8.0	R5s221098

Meeting	TSG doc	CR	Rev	Subject	Cat	Old vers	New vers	WG doc
RP-98	RP-222788	0864	-	Correction for IMS 5GS emergency call test case 10.6	F	16.7.0	16.8.0	R5s221125
RP-98	RP-222788	0865	-	Re-verification of IMS 5GS call control test case 7.21	F	16.7.0	16.8.0	R5s221127
RP-98	RP-222788	0867	-	Correction to function fl_NR5GC_ModifyPDUSession_RemoveIMS_Media	F	16.7.0	16.8.0	R5s221134
RP-98	RP-222788	0868	-	Correction to NR5GC emergency call test cases	F	16.7.0	16.8.0	R5s221136
RP-98	RP-222788	0870	-	Addition of IMS Emergency Calls testcase 10.1 in FR1	B	16.7.0	16.8.0	R5s221149
RP-98	RP-222788	0871	-	Addition of IMS Supplementary Services testcase 8.40 in FR1	B	16.7.0	16.8.0	R5s221158
RP-98	RP-222788	0872	-	Addition of IMS 5GS Supplementary Services test case 7.20	B	16.7.0	16.8.0	R5s221160
RP-98	RP-222788	0873	-	Correction to function f_MTC_IMS_CreateMapAndConnectPTCs_WLAN	F	16.7.0	16.8.0	R5s221170
RP-98	RP-222788	0874	-	Correction to EUTRA IMS conference test cases	F	16.7.0	16.8.0	R5s221176
RP-98	RP-222788	0876	-	Addition of IMS 5GS emergency call test case 10.14	B	16.7.0	16.8.0	R5s221189
RP-98	RP-222788	0878	-	Correction to IMS 5GS supplementary test case 8.36	F	16.7.0	16.8.0	R5s221215
RP-98	RP-222788	0879	-	Correction to function f_IMS_InviteRequest_MessageHeaderTX	F	16.7.0	16.8.0	R5s221221
RP-98	RP-222788	0842	1	Correction to emergency call test cases	F	16.7.0	16.8.0	R5s221266
RP-98	RP-222788	0845	1	Correction to NR XCAP test cases	F	16.7.0	16.8.0	R5s221273
RP-98	RP-222788	0847	1	Corrections for IMS 5GS supplementary services test cases 8.34 and 8.35	F	16.7.0	16.8.0	R5s221346
RP-98	RP-222788	0856	1	Addition of IMS 5GS call control test case 7.21	B	16.7.0	16.8.0	R5s221347
RP-98	RP-222788	0741	1	Addition of IMS 5GS supplementary services test case 8.34	B	16.7.0	16.8.0	R5s221357
RP-98	RP-222788	0756	1	Addition of IMS 5GS Supplementary Services test case 8.35	B	16.7.0	16.8.0	R5s221358
RP-98	RP-222788	0887	-	Add new verified and e-mail agreed TTCN test cases in the TC lists in 34.229-3 (prose), Annex A	F	16.7.0	16.8.0	R5s221359
RP-98	RP-222788	0875	-	Rel-17 Sep'22 baseline upgrade for IMS Test Suites	F	16.8.0	17.0.0	R5s221181
RP-99	RP-230241	0892	-	Correction for IMS 5GS call control test case 7.1	F	17.0.0	17.1.0	R5s230086
RP-99	RP-230241	0893	-	Correction to function f_IMS_USSD_MOCallSetup	F	17.0.0	17.1.0	R5s230107
RP-99	RP-230241	0895	-	Correction to f_IMS_InviteResponse_181_MessageHeaderTX	F	17.0.0	17.1.0	R5s230138
RP-99	RP-230241	0896	-	Correction to IMS LTE-IRAT test case 19.3.2b	F	17.0.0	17.1.0	R5s230160
RP-99	RP-230241	0883	1	Correction for IMS 5GS registration test cases 6.2 and 6.8	F	17.0.0	17.1.0	R5s230180
RP-99	RP-230241	0884	1	Correction to IMS NR5GC test case 6.2	F	17.0.0	17.1.0	R5s230191
RP-99	RP-230241	0886	1	Correction to IMS WLAN test cases	F	17.0.0	17.1.0	R5s230194
RP-99	RP-230241	0888	1	Correction to IMS WLAN test case G.17.2	F	17.0.0	17.1.0	R5s230203
RP-99	RP-230241	0889	1	Correction to f_IMS_CC_StartCall	F	17.0.0	17.1.0	R5s230207
RP-99	RP-230241	0880	1	Correction to IMS conference test case 15.21a	F	17.0.0	17.1.0	R5s230253
RP-99	RP-230241	0881	1	Correction to IMS 5GS Call Control test case 7.21	F	17.0.0	17.1.0	R5s230254
RP-99	RP-230241	0899	-	Update of TTCN type definitions, Annex H	F	17.0.0	17.1.0	R5s230257
RP-100	RP-230971	0908	-	Routine maintenance for TS 34.229-3	F	17.1.0	17.2.0	R5-232209
RP-100	RP-230968	0902	-	Corrections for IMS 5GS call control test cases	F	17.1.0	17.2.0	R5s230345
RP-100	RP-230968	0905	-	Removal of explicit encoding rule XML for alias definitions	F	17.1.0	17.2.0	R5s230374
RP-100	RP-230968	0906	-	Correction for IMS 5GS test case 10.1	F	17.1.0	17.2.0	R5s230385

Meeting	TSG doc	CR	Rev	Subject	Cat	Old vers	New vers	WG doc
RP-100	RP-230968	0897	1	Correction for IMS XCAP test case 15.10	F	17.1.0	17.2.0	R5s230401
RP-100	RP-230968	0898	1	Correction of geolocation handling	F	17.1.0	17.2.0	R5s230421
RP-101	RP-231688	0927	-	Routine maintenance for TS 34.229-3	F	17.2.0	17.3.0	R5-234302
RP-101	RP-231685	0913	-	Correction to IMS 5GS Emergency Call test case 10.4	F	17.2.0	17.3.0	R5s230520
RP-101	RP-231685	0914	-	Addition of IMS 5GS eCall over IMS testcase 11.4	B	17.2.0	17.3.0	R5s230521
RP-101	RP-231685	0915	-	Addition of IMS 5GS eCall over IMS testcase 11.5	B	17.2.0	17.3.0	R5s230523
RP-101	RP-231685	0916	-	Correction to function f_IMS_EmergencyReRegistration	F	17.2.0	17.3.0	R5s230537
RP-101	RP-231685	0900	1	Addition of IMS 5GS Emergency Call testcase 10.4	B	17.2.0	17.3.0	R5s230561
RP-101	RP-231685	0901	1	Correction for IMS test case 10.14	F	17.2.0	17.3.0	R5s230562
RP-101	RP-231685	0910	1	Correction for IMS test case 9.1	F	17.2.0	17.3.0	R5s230569
RP-101	RP-231685	0917	-	Correction for IMS 5GS conferencing test case 8.34	F	17.2.0	17.3.0	R5s230598
RP-101	RP-231685	0911	1	Addition of IMS 5GS eCall over IMS testcase 11.1	B	17.2.0	17.3.0	R5s230668
RP-101	RP-231685	0912	1	Addition of IMS 5GS eCall over IMS testcase 11.2	B	17.2.0	17.3.0	R5s230669
RP-101	RP-231685	0931	-	Add new verified and e-mail agreed TTCN test cases in the TC lists in 34.229-3 (prose), Annex A	F	17.2.0	17.3.0	R5s230670
RP-102	RP-232834	0935	-	Correction to function f_IMS_ECall_MIME_GetMSD_ContentId	F	17.3.0	17.4.0	R5s230701
RP-102	RP-232834	0936	-	Correction to function f_IMS_INVITE_ReceiveRequest_A_2_1_Optional	F	17.3.0	17.4.0	R5s230734
RP-102	RP-232834	0937	-	Corrections on selection expressions in control modules for IMS WLAN Test Suite	F	17.3.0	17.4.0	R5s230760
RP-102	RP-232834	0918	1	Correction to 11.4.x and 10.x test cases	F	17.3.0	17.4.0	R5s230826
RP-102	RP-232834	0919	1	Addition of IMS WLAN XCAP testcase G.15.1	B	17.3.0	17.4.0	R5s230827
RP-102	RP-232834	0920	1	Addition of IMS WLAN XCAP testcase G.15.3	B	17.3.0	17.4.0	R5s230828
RP-102	RP-232834	0921	1	Addition of IMS WLAN XCAP testcase G.15.5	B	17.3.0	17.4.0	R5s230829
RP-102	RP-232834	0922	1	Addition of IMS WLAN XCAP testcase G.15.6	B	17.3.0	17.4.0	R5s230830
RP-102	RP-232834	0923	1	Addition of IMS WLAN XCAP testcase G.15.7	B	17.3.0	17.4.0	R5s230831
RP-102	RP-232834	0924	1	Addition of IMS WLAN XCAP testcase G.15.8	B	17.3.0	17.4.0	R5s230832
RP-102	RP-232834	0925	1	Addition of IMS WLAN XCAP testcase G.15.10	B	17.3.0	17.4.0	R5s230833
RP-102	RP-232834	0926	1	Addition of IMS WLAN XCAP testcase G.15.15	B	17.3.0	17.4.0	R5s230834
RP-102	RP-232834	0929	1	Correction for IMS 5GS conferencing test cases	F	17.3.0	17.4.0	R5s230836
RP-102	RP-232834	0930	1	Corrections on selection expressions and applicability conditions in control modules for IMS Test Suites	F	17.3.0	17.4.0	R5s230844
RP-102	RP-232834	0932	1	Addition of IMS 5GS eCall over IMS testcase 11.6	B	17.3.0	17.4.0	R5s230849
RP-102	RP-232834	0940	-	Add new verified and e-mail agreed TTCN test cases in the TC lists in 34.229-3 (prose), Annex A	F	17.3.0	17.4.0	R5s230889
RP-102	RP-232834	0938	1	Correction to function f_IMS_MOCallHoldResume_BuildSDP_OfferRX	F	17.3.0	17.4.0	R5s230893
RP-103	RP-240219	0939	1	Correction for IMS 5GS test case 7.24a and 7.24b	F	17.4.0	17.5.0	R5s240074
RP-103	RP-240219	0941	-	Correction to IMS testcase 10.6	F	17.4.0	17.5.0	R5s240081
RP-103	RP-240219	0942	-	Correction to Voice Call Control test cases 7.5 and 7.12	F	17.4.0	17.5.0	R5s240123

History

Document history		
V17.0.0	January 2023	Publication
V17.1.0	April 2023	Publication
V17.2.0	July 2023	Publication
V17.3.0	October 2023	Publication
V17.4.0	January 2024	Publication
V17.5.0	May 2024	Publication