

# ETSI TS 134 109 V3.0.0 (2000-06)

---

*Technical Specification*

**Universal Mobile Telecommunications System (UMTS);  
Terminal logical test interface;  
Special conformance testing functions  
(3G TS 34.109 version 3.0.0 Release 1999)**

---



---

**Reference**

RTS/TSGT-0134109U

---

**Keywords**

UMTS

**ETSI**

---

650 Route des Lucioles  
F-06921 Sophia Antipolis Cedex - FRANCE

Tel.: +33 4 92 94 42 00 Fax: +33 4 93 65 47 16

Siret N° 348 623 562 00017 - NAF 742 C  
Association à but non lucratif enregistrée à la  
Sous-Préfecture de Grasse (06) N° 7803/88

---

**Important notice**

Individual copies of the present document can be downloaded from:

<http://www.etsi.org>

The present document may be made available in more than one electronic version or in print. In any case of existing or perceived difference in contents between such versions, the reference version is the Portable Document Format (PDF). In case of dispute, the reference shall be the printing on ETSI printers of the PDF version kept on a specific network drive within ETSI Secretariat.

Users of the present document should be aware that the document may be subject to revision or change of status. Information on the current status of this and other ETSI documents is available at <http://www.etsi.org/tb/status/>

If you find errors in the present document, send your comment to:  
editor@etsi.fr

---

**Copyright Notification**

No part may be reproduced except as authorized by written permission.  
The copyright and the foregoing restriction extend to reproduction in all media.

© European Telecommunications Standards Institute 2000.

All rights reserved.

---

## Intellectual Property Rights

IPRs essential or potentially essential to the present document may have been declared to ETSI. The information pertaining to these essential IPRs, if any, is publicly available for **ETSI members and non-members**, and can be found in ETSI SR 000 314: "*Intellectual Property Rights (IPRs); Essential, or potentially Essential, IPRs notified to ETSI in respect of ETSI standards*", which is available from the ETSI Secretariat. Latest updates are available on the ETSI Web server (<http://www.etsi.org/ipr>).

Pursuant to the ETSI IPR Policy, no investigation, including IPR searches, has been carried out by ETSI. No guarantee can be given as to the existence of other IPRs not referenced in ETSI SR 000 314 (or the updates on the ETSI Web server) which are, or may be, or may become, essential to the present document.

---

## Foreword

This Technical Specification (TS) has been produced by the ETSI 3<sup>rd</sup> Generation Partnership Project (3GPP).

The present document may refer to technical specifications or reports using their 3GPP identities, UMTS identities or GSM identities. These should be interpreted as being references to the corresponding ETSI deliverables.

The cross reference between GSM, UMTS, 3GPP and ETSI identities can be found under [www.etsi.org/key](http://www.etsi.org/key) .

# Contents

Foreword .....	5
1 Scope.....	6
2 References.....	6
3 Definitions and abbreviations .....	7
3.1 Definitions .....	7
3.2 Abbreviations.....	7
4 UE conformance test functions .....	7
4.1 General description.....	7
4.2 UE radio bearer test mode .....	8
4.3 UE test loop .....	8
4.4 EMMI .....	8
5 Test Control (TC) protocol procedures and test loop operation .....	9
5.1 General description.....	9
5.2 UE radio bearer test mode procedures .....	10
5.2.1 Activate UE radio bearer test mode .....	10
5.2.1.1 General .....	10
5.2.1.2 Initiation .....	10
5.2.1.3 Reception of ACTIVATE RB TEST MODE message by UE.....	11
5.2.1.4 Reception of ACTIVATE RB TEST MODE COMPLETE message by SS.....	11
5.2.1.5 TT01 timeout .....	11
5.2.2 Deactivate UE radio bearer test mode .....	11
5.2.2.1 General .....	11
5.2.2.2 Initiation .....	11
5.2.2.3 Reception of DEACTIVATE RB TEST MODE message by UE .....	12
5.2.2.4 Reception of DEACTIVATE RB TEST MODE COMPLETE message by SS .....	12
5.2.2.5 TT01 timeout .....	12
5.3 UE test loop procedures .....	12
5.3.1 General.....	12
5.3.2 Close UE test loop.....	12
5.3.2.1 General .....	13
5.3.2.2 Initiation .....	13
5.3.2.3 Reception of CLOSE UE TEST LOOP message by the UE .....	13
5.3.2.4 Reception of CLOSE UE TEST LOOP COMPLETE message by the SS .....	13
5.3.2.5 TT01 timeout.....	13
5.3.2.6 UE test loop mode 1 operation .....	13
5.3.2.6.1 Loopback of PDCP SDUs.....	13
5.3.2.6.2 Loopback of RLC SDUs.....	14
5.3.2.7 UE test loop mode 2 operation .....	15
5.3.2.7.1 Loopback of downlink transport block data and downlink CRC.....	15
5.3.2.8 Transmission of dummy messages on DCCH.....	17
5.3.2.9 Loopback delay requirement .....	17
5.3.3 Open UE test loop .....	18
5.3.3.1 General .....	18
5.3.3.2 Initiation .....	18
5.3.3.3 Reception of OPEN UE TEST LOOP message by the UE.....	18
5.3.3.4 Reception of OPEN UE TEST LOOP COMPLETE by the SS .....	19
5.3.3.5 TT01 timeout.....	19
6 Message definitions and contents .....	19
6.1 Timer values .....	19
6.2 CLOSE UE TEST LOOP .....	19
6.3 CLOSE UE TEST LOOP COMPLETE .....	21
6.4 OPEN UE TEST LOOP.....	21
6.5 OPEN UE TEST LOOP COMPLETE.....	21

6.6	ACTIVATE RB TEST MODE.....	22
6.7	ACTIVATE RB TEST MODE COMPLETE.....	22
6.8	DEACTIVATE RB TEST MODE.....	22
6.9	DEACTIVATE RB TEST MODE COMPLETE.....	23
7	Electrical Man Machine Interface (EMMI) .....	23
8	UICC/ME test interface .....	23
8.1	General description.....	23
8.2	Formal aspects .....	23
8.3	Hardware and logical aspects of the interface.....	23
8.4	Mechanical characteristics of the interface .....	23
<b>Annex A (informative): UE test loop use scenarios.....</b>		<b>24</b>
A.1	Measurement of receiver characteristics (BER) using UE test loop mode 1 and RLC TM .....	24
A.1.1	Measurement of receiver characteristics (BER) - DL reference measurement channel (12,2 kbps).....	24
A.2	Measurement of receiver performance (BLER) using UE test loop mode 1 and RLC AM .....	24
A.2.1	Measurement of receiver performance (BLER) - DL reference measurement channel (64,144,384 kbps).....	25
A.3	Measurement of receiver performance (BLER) using UE test loop mode 2 .....	25
A.3.1	Measurement of receiver performance (BLER) - DL reference measurement channel (12,2 kbps).....	26
A.3.2	Measurement of receiver performance (BLER) - DL reference measurement channel (64,144 and 384 kbps) .....	26
A.4	Measurement of transmitter characteristics .....	26
A.5	Measurement of transmitter DTX characteristics .....	26
A.6	Using UE test loop mode 1 for protocol testing.....	27
<b>Annex B (informative): Change history .....</b>		<b>29</b>

---

# Foreword

This Technical Specification (TS) has been produced by the 3<sup>rd</sup> Generation Partnership Project (3GPP).

The contents of the present document are subject to continuing work within the TSG and may change following formal TSG approval. Should the TSG modify the contents of the present document, it will be re-released by the TSG with an identifying change of release date and an increase in version number as follows:

Version x.y.z

where:

- x the first digit:
  - 1 presented to TSG for information;
  - 2 presented to TSG for approval;
  - 3 or greater indicates TSG approved document under change control.
- y the second digit is incremented for all changes of substance, i.e. technical enhancements, corrections, updates, etc.
- z the third digit is incremented when editorial only changes have been incorporated in the document.

---

# 1 Scope

The present document specifies for User Equipment (UE), for 3<sup>rd</sup> Generation WCDMA system, those ME functions which are required for conformance testing purposes.

For conformance tests, functions are activated via the radio interface. These functions shall be capable of being activated when a test USIM is present. Any USIM related features such as subsidy-related UE features should also not interfere with the functions. In the loopback state, the UE shall be able to perform all functions specified in the present document except where otherwise stated; in addition however, the conformance testing functions must be operational.

USIM, in general, is described in [7] TS 31.101. The ME recognizes the test USIM by the Administrative Data Field. Test USIM data fields are described in [10] TS 34.108.

The present document applies to the unit that includes the hardware to establish a connection across the radio interface.

---

# 2 References

The following documents contain provisions which, through reference in this text, constitute provisions of the present document.

- References are either specific (identified by date of publication, edition number, version number, etc.) or non-specific.
- For a specific reference, subsequent revisions do not apply.
- For a non-specific reference, the latest version applies.

- [1] 3G TS 24.007: "Mobile radio interface signalling layer 3; General aspects".
- [2] 3G TS 24.008: "Digital cellular telecommunications system (Phase 2+); Mobile radio interface layer 3 specification".
- [3] 3G TS 25.101: "UE Radio transmission and reception (FDD)".
- [4] 3G TS 25.102: "UE Radio transmission and reception (TDD)".
- [5] 3G TS 25.331: "Radio Resource Control; Protocol Specification".
- [6] 3G TR 21.905: "3G Vocabulary".
- [7] 3G TS 31.101: "UICC Physical and Logical Characteristics".
- [8] 3G TS 34.121: "Terminal Conformance Specification; Radio transmission and reception (FDD)".
- [9] 3G TS 34.122: "Terminal Conformance Specification; Radio transmission and reception (TDD)".
- [10] 3G TS 34.108: "Reference test environment".
- [11] 3G TS 25.211: "Physical channels and mapping of transport channels onto physical channels (FDD)".
- [12] 3G TS 25.133: "Requirements for support of RRM (FDD)".
- [13] GSM 04.14: "Individual equipment type requirements and interworking; Special conformance testing functions".
- [14] 3G TS 25.331: "RRC Protocol Specification"

## 3 Definitions and abbreviations

### 3.1 Definitions

For the purposes of the present document, the following definitions apply:

<b>UE (User Equipment)</b>	User equipment that is under test.
<b>SS (System Simulator)</b>	Test system (or equipment) which drives the test process between UE, like BS (Base Station) simulator.
<b>User</b>	Test user, who handles the test and measurement process via the logical test interface
<b>Logical Test Interface</b>	Interface which provides the logical service to interwork and to communicate between UE and System Simulator during the test of a UE.
<b>TC (Test Control)</b>	UE protocol entity used by the SS to control the UE specific testing functions.

### 3.2 Abbreviations

Abbreviation used in the present document are listed in [6] TR 21.905.

For the purposes of the present document, the following additional abbreviations apply:

LB	Loop Back
RAB	Radio Access Bearer
RB	Radio Bearer
SAPI	Service Access Point Indicator
SS	System Simulator
TC	Test Control
UICC	UMTS Integrated Circuit Card

## 4 UE conformance test functions

### 4.1 General description

The SS performs activation and deactivation of the conformance test functions in the UE by sending standard NAS Layer 3 messages. A specific protocol discriminator value has been defined in [1] TS 24.007, 11.2.3.1.1 for the UE test command messages. Figure 4.1.1 illustrates the Layer 3 protocol entity Test Control (TC) where the UE test command messages terminates.

NOTE: The protocol discriminator value used for the TC messages is the same as used in GSM for the MS specific testing functions, see [13] GSM 04.14.

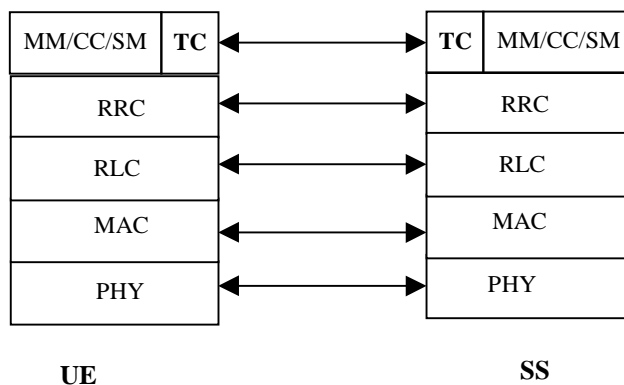

Figure 4.1.1: TC protocol termination (TC =Test Control).



Apart from sending the appropriate deactivation command to the UE the functions shall be deactivated by switching off the UE.

The following UE conformance testing functions can be activated (and deactivated):

- UE test loop function;
- UE radio bearer test mode
- Electrical Man Machine Interface (EMMI)

In addition to the conformance testing functions listed above there is a set of reference measurement channels that an UE need to support to enable RF conformance testing. The reference measurement channels are defined in [3] TS 25.101, Annex A for FDD and in [4] TS 25.102, Annex A for TDD.

Example of reference measurement channels (RMC) essential to all UEs supporting FDD are:

- UL 12.2kbps RMC (Reference Measurement Channel)
- DL 12.2kbps RMC

Example of reference measurement channels associated with UE service capabilities are:

- DL 64kbps RMC
- DL 144kbps RMC
- DL 384kbps RMC
- UL 64kbps RMC
- UL 144kbps RMC
- UL 384kbps RMC

## 4.2 UE radio bearer test mode

The UE radio bearer test mode is specified in clause 5.2.

The following TC procedures are used to control the UE radio bearer test mode:

- Activate UE radio bearer test mode
- Deactivate UE radio bearer test mode

## 4.3 UE test loop

The UE test loop function is specified in clause 5.3.

The following TC procedures are used to control the UE test loop function:

- Close UE test loop
- Open UE test loop

## 4.4 EMMI

The EMMI is specified in clause 7.

No specific TC procedures are associated with EMMI.

## 5 Test Control (TC) protocol procedures and test loop operation

### 5.1 General description

The UE test loop function provides access to isolated functions of the UE via the radio interface without introducing new physical interfaces just for the reason of conformance testing.

NOTE 1: It should be emphasised that the UE test loop function only describes the functional behaviour of the UE with respect to its external interfaces; physical implementation of the UE test loop function is completely left open to the manufacturer.

The UE test loop function is activated by transmitting the appropriate Test Control (TC) message to the UE, see clause 6.

The UE test loop function can be operated in two different loopback modes:

- UE test loop mode 1; and
- UE test loop mode 2.

Figure 5.1.1 shows a functional block diagram of UE test loop function for mode 1.

For UE test loop mode 1 the loopback point is located above Layer 2. Depending on the actual radio bearer setup loopback is performed of RLC SDUs or PDCP SDUs according to the procedure specified in clause 5.3.3.2.

The loop back point for UE test loop mode 1 has been selected above Layer 2 to separate the protocol configurations from the UE test loop function. By configuration of RLC and MAC layers other loop back points may functional be achieved. E.g. by transparent configuration of RLC and MAC layer functional loop back point at Transport channel level can be achieved to implement the reference measurement channels as specified by [3] TS 25.101, Annex A for FDD and by [4] TS 25.102, Annex A for TDD.

For UE test loop mode 2 both data and CRC are looped back. UE test loop mode 2 is intended for Blind Transport Format Detection (BTDF) testing and BLER testing of DL 12.2 kbps reference measurement channel for which loopback of downlink CRC is required. UE test loop mode 2 can also be used for BLER testing of DL 64, 144 and 384 kbps reference measurement channels if the UE supports correspondent UL reference measurement channels. Both received data and CRC bits for the DCH transport channel used for the BTDF test case is returned according to the procedure specified in clause 5.3.3.3.

A specific radio bearer test mode is specified to be used together with the UE test loop function. The purpose of the radio bearer test mode is to put the UE into a mode where: SS can set up radio bearers to be terminated in the UE test loop function without having to involve CC or SM; and to disable any control mechanisms in NAS protocols or in any UE applications that otherwise could cause the RRC connection to be released.

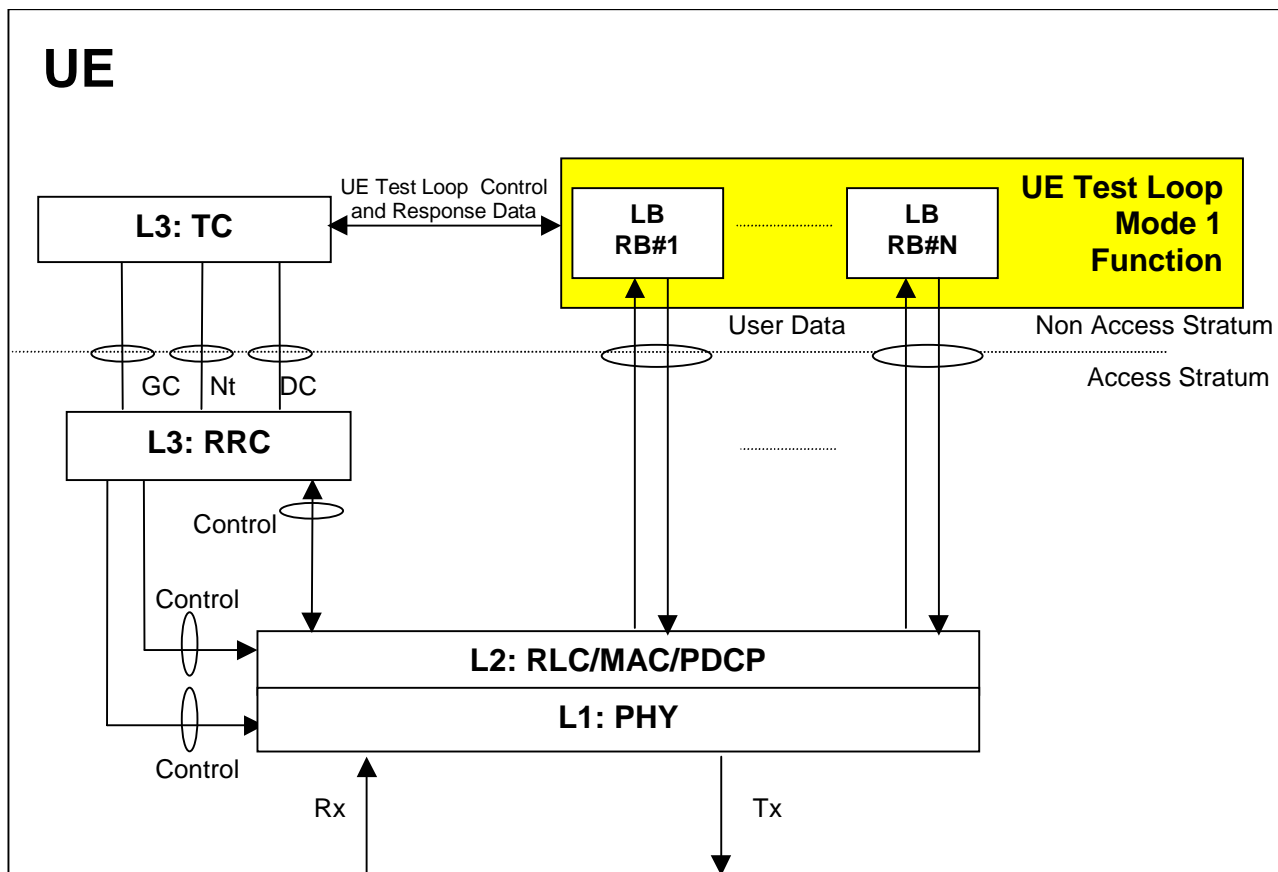

Figure 5.1.1: UE Test Loop Mode 1 function (TC =Test Control, LB = Loop Back entity)

## 5.2 UE radio bearer test mode procedures

### 5.2.1 Activate UE radio bearer test mode

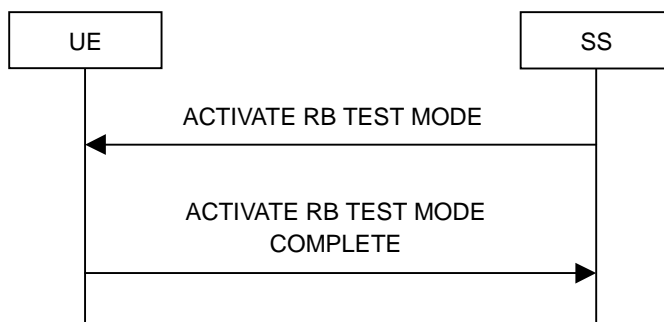

Figure 5.2.1.1: Activate UE radio bearer test mode procedure

#### 5.2.1.1 General

The SS uses the activate UE radio bearer procedure to get UE into a test mode where: SS can set up radio bearers to be terminated in the UE test loop function without having to involve CC or SM; and to disable any control mechanisms in NAS protocols (TC protocol excluded) or in any UE applications that otherwise could cause the RRC connection to be released.

#### 5.2.1.2 Initiation

The SS can initiate the UE radio bearer test mode when an RRC connection is established.

The SS requests the UE to activate the UE radio bearer test mode by transmitting an ACTIVATE RB TEST MODE message. The SS then starts timer TT01.

### 5.2.1.3 Reception of ACTIVATE RB TEST MODE message by UE

When UE receives ACTIVATE RB TEST MODE message then the radio bearer test mode shall be activated.

When the radio bearer test mode is active the UE shall:

- accept any requested radio bearer setup within the radio access capabilities of the UE;
- terminate all user plane radio bearer(s) in the UE test loop function; and
- disable any control mechanisms in NAS protocols or in any UE applications that otherwise could cause the RRC connection to be released.

When the radio bearer test mode have been activated the UE shall transmit the ACTIVATE RB TEST MODE COMPLETE message.

### 5.2.1.4 Reception of ACTIVATE RB TEST MODE COMPLETE message by SS

Upon reception of the ACTIVATE RB TEST MODE COMPLETE message the SS stops timer TT01.

The reception of the ACTIVATE RB TEST MODE COMPLETE message by SS confirms that the UE radio bearer test mode has been activated in the UE.

### 5.2.1.5 TT01 timeout

If TT01 expires, then the SS shall indicate this to the test case. The procedure is then completed.

## 5.2.2 Deactivate UE radio bearer test mode

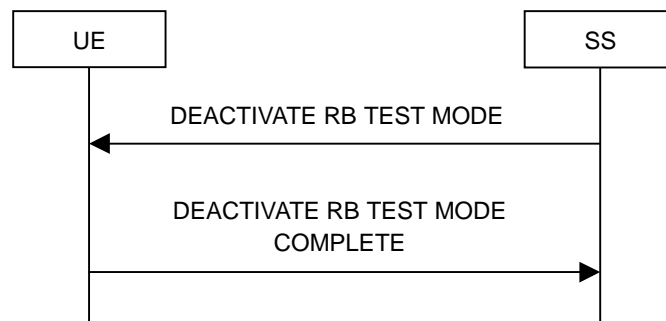

**Figure 5.2.2.1: Deactivate UE radio bearer test mode procedure**

### 5.2.2.1 General

The purpose of this procedure is to deactivate the radio bearer test mode and return UE to normal operation.

### 5.2.2.2 Initiation

The SS can deactivate the UE radio bearer test mode when an RRC connection is established and the UE radio bearer test mode is active.

The SS requests the UE to deactivate the UE radio bearer test mode by transmitting a DEACTIVATE RB TEST MODE message. The SS then starts timer TT01.

### 5.2.2.3 Reception of DEACTIVATE RB TEST MODE message by UE

When the UE receives DEACTIVATE RB TEST MODE message then the radio bearer test mode shall be deactivated and UE shall be returned to normal operation.

When the UE has deactivated the radio bearer test mode the UE shall transmit the DEACTIVATE RB TEST MODE COMPLETE message using the RRC UPLINK DIRECT TRANSFER message.

### 5.2.2.4 Reception of DEACTIVATE RB TEST MODE COMPLETE message by SS

Upon reception of the DEACTIVATE RB TEST MODE COMPLETE message the SS stops timer TT01.

The reception of DEACTIVATE RB TEST MODE COMPLETE message by SS confirms that the UE radio bearer test mode has been deactivated in the UE.

### 5.2.2.5 TT01 timeout

If TT01 expires, then the SS shall indicate this to the test case. The procedure is then completed.

## 5.3 UE test loop procedures

### 5.3.1 General

The UE test loop function is intended for:

- Testing of receiver characteristics based on BER (Bit Error Ratio) measurement. The SS calculates BER from a bit-by-bit comparison of data sent to and received from UE. BER measurement requires symmetric RAB bit-rates.
- Testing of receiver performance based on BLER (Block Error Ratio) measurement. The SS calculates BLER based on the RLC STATUS SDU received from the UE operating in RLC acknowledged mode; or the SS calculates BLER based on checking returned downlink data and downlink CRC by UE operating in UE test loop mode 2.
- Testing of UE Blind Transport Format Detection.
- Testing of UE transmitter characteristics.
- Testing of UE transmitter DTX characteristics.
- Testing of radio bearers (UE test loop function emulates terminal equipment).

### 5.3.2 Close UE test loop

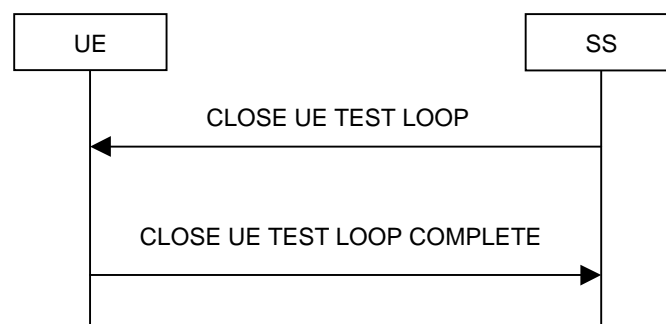

Figure 5.3.2.1: Close UE test loop procedure

### 5.3.2.1 General

The SS uses the close UE test loop procedure to start the UE Test Loop function in the UE. A prerequisite is that a RAB has been established between SS and UE. See [10] TS 34.108, clause 7 for generic setup procedures.

The UE shall provide for normal Uu layer 1, layer 2 and RRC functionality while the UE test loop function is active. This includes (but is not limited to) handover procedures and normal disconnection of the radio bearer. The loopback shall be maintained across handovers, but after RAB disconnection, the loopback shall cease to exist.

### 5.3.2.2 Initiation

The SS requests the UE to close its radio bearer test loop by transmitting a CLOSE UE TEST LOOP message. The SS then starts timer TT01.

### 5.3.2.3 Reception of CLOSE UE TEST LOOP message by the UE

If no radio bearer is established, the UE shall ignore any CLOSE UE TEST LOOP message.

If a radio bearer is established, the UE shall close the test loop and then send back to the SS a CLOSE UE TEST LOOP COMPLETE message. The loopback should be operational prior to the sending of the acknowledge.

If the test loop is already closed, the UE shall still respond as if the loop had been open, i.e the CLOSE UE TEST LOOP COMPLETE message should be sent.

If UE test mode 1 have been selected then the loop back scheme according to 5.3.2.3.1 shall be performed by the UE.

If UE test mode 2 have been selected then the loop back scheme according to 5.3.2.3.2 shall be performed by the UE.

### 5.3.2.4 Reception of CLOSE UE TEST LOOP COMPLETE message by the SS

Upon reception of the CLOSE UE TEST LOOP COMPLETE message the SS stops timer TT01.

### 5.3.2.5 TT01 timeout

If TT01 expires, then the SS shall indicate this to the test case. The procedure is then completed.

### 5.3.2.6 UE test loop mode 1 operation

If the configuration of a radio bearer includes the PDCP protocol layer then the loop back scheme according to 5.3.2.6.1 shall be performed by the UE for the actual radio bearer.

If the PDCP protocol layer is not used for a radio bearer then the loop back scheme according to 5.3.2.6.2 shall be performed by the UE for the actual radio bearer.

#### 5.3.2.6.1 Loopback of PDCP SDUs

If UE test mode 1 have been selected and the radio bearer setup includes configuration of PDCP protocol layer then the following loop back scheme shall be performed by the UE:

After the UE has closed its radio bearer test loop, every user data block received by the UE on the active radio bearer (downlink) shall be taken from the output of the PDCP service access point (SAP) and be input to the correspondent PDCP SAP and transmitted (uplink).

If uplink header compression control bit P1 of the "LB Setup RAB subflow#k" parameter associated with the actual radio bearer is set to "1" then uplink header compression shall be disabled independent on the actual configuration of PDCP. If P1=0 then uplink header compression shall be applied according to the PDCP configuration defined in the radio bearer setup. See 6.2 for description of the P1 control bit.

If downlink header compression control bit P2 of the "LB Setup RAB subflow#k" parameter associated with the actual radio bearer is set to "1" then downlink header compression shall be disabled independent on the actual configuration of PDCP. If P2=0 then downlink header compression shall be applied according to the PDCP configuration defined in the radio bearer setup. See 6.2 for description of the P2 control bit.

If no “LB Setup RAB subflow#k” parameter is associated with the actual radio bearer then the uplink and downlink header compression shall be applied according to the PDCP configuration defined in the radio bearer setup.

The PDCP loopback is illustrated in figure 5.3.2.6.1.1.

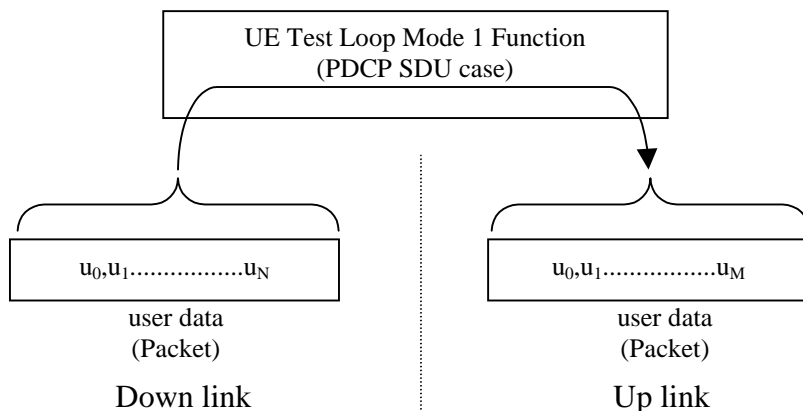

**Figure 5.3.2.6.1.1: Loop back of PDCP SDU**

**5.3.2.6.2 Loopback of RLC SDUs**

If UE test mode 1 have been selected and radio bearer setup does not include configuration of PDCP protocol layer then the following loop back scheme shall be performed by the UE:

After the UE has closed its radio bearer test loop, every user data block received by the UE on the active radio bearer (downlink) shall be taken from the output of the RLC service access point (SAP) and be input to the correspondent RLC SAP and transmitted (uplink). The UE reads the UL RLC SDU size parameter from the “LB Setup RAB subflow#k” parameter associated with the radio bearer, see 6.2.

If no “LB Setup RAB subflow#k” parameter is associated with the radio bearer then the UE shall use the same UL RLC SDU size as the received DL RLC SDU.

For the case when the “UL RLC SDU size” parameter is set to “0” no data shall be returned.

For the case when the “UL RLC SDU size” parameter is set to the same value as the down link (DL) RLC SDU block size then the complete user data block shall be returned, see figure 5.3.2.6.2.1.

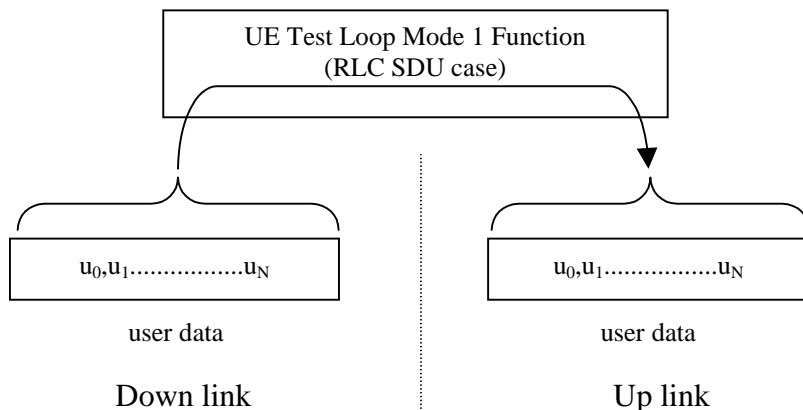

**Figure 5.3.2.6.2.1: DL and UL RLC SDU block size equal ( DL RLC SDU size = UL RLC SDU size = N+1)**

For the case when the “UL RLC SDU size” parameter is set to a value less than the down link (DL) RLC SDU block size then the UE shall return the first K bits of the received block, where K is the UL block size, see figure 5.3.2.6.2.2.

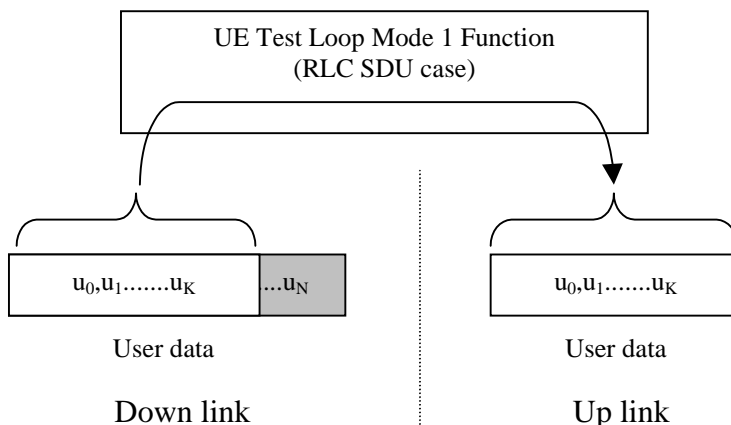

**Figure 5.3.2.6.2.2: DL > UL RLC SDU block size ( DL RLC SDU size = N+1, UL RLC SDU size = K+1)**

For the case when the “UL RLC SDU size” parameter is set to a value bigger than the down link (DL) RLC SDU block size then the UE shall pad the UL send block by repeating the received data block until the UL send block has been filled (truncating the last block if necessary), see figure 5.3.2.6.2.3.

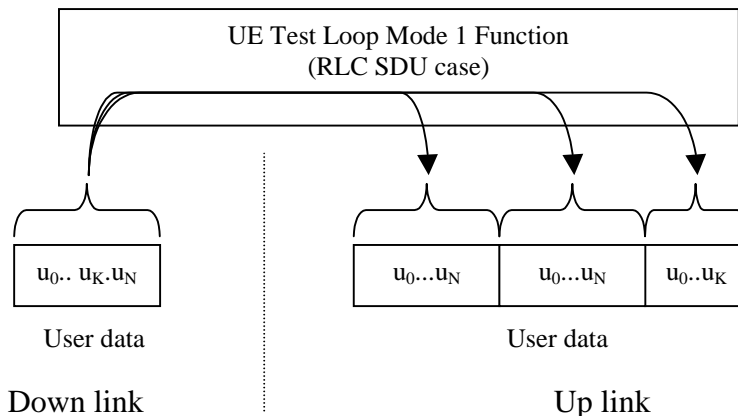

**Figure 5.3.2.6.2.3: DL < UL RLC SDU block size ( DL RLC SDU size = N+1, UL RLC SDU size = 2\*(N+1) + (K+1))**

### 5.3.2.7 UE test loop mode 2 operation

For UE test loop mode 2 to work correctly ciphering shall be disabled and the up link transport block size shall be equal or bigger than the sum of the downlink transport block size and the number of CRC bits.

#### 5.3.2.7.1 Loopback of downlink transport block data and downlink CRC

If UE test mode 2 have been selected then the following loop back scheme shall be performed by the UE:

After the UE has closed the test loop then the UE shall copy the received transport block and CRC bits to the up link transport block and transmit in the up link.

UE test mode 2 operation is illustrated for the BTFD 1.95kbps transport case in figure 5.3.2.7.1; for the 7.95kbps transport case in figure 5.3.2.7.2; and for the 12.2 kbps transport case in figure 5.3.2.7.3.

UE test mode 2 operation is illustrated for the 12.2 kbps BLER measurement case in figure 5.3.2.7.4.



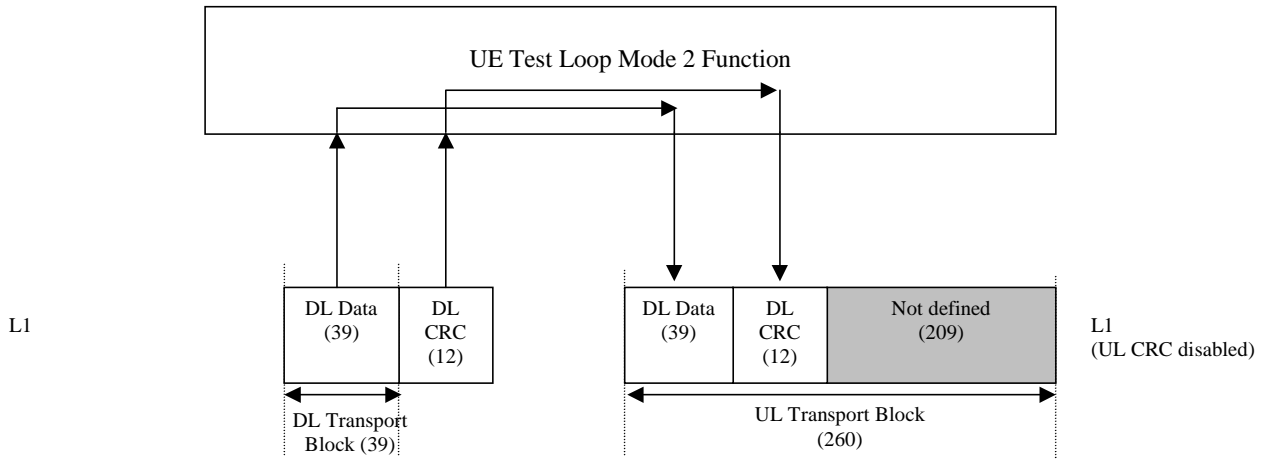

Figure 5.3.2.7.1. UE test loop mode 2 operation for the 1.95 kbps transport format case

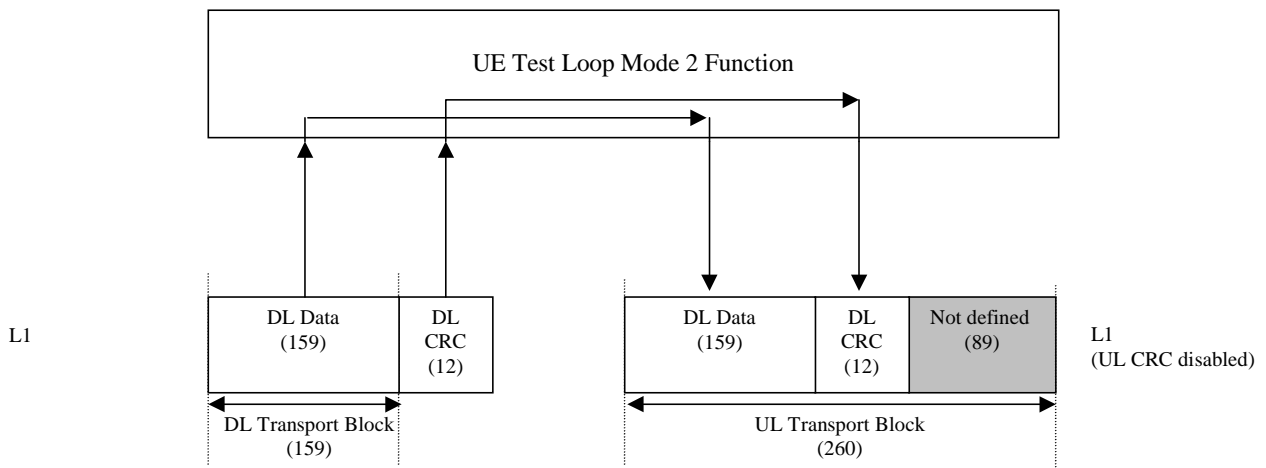

Figure 5.3.2.7.3. UE test loop mode 2 operation for the 7.95 kbps transport format case

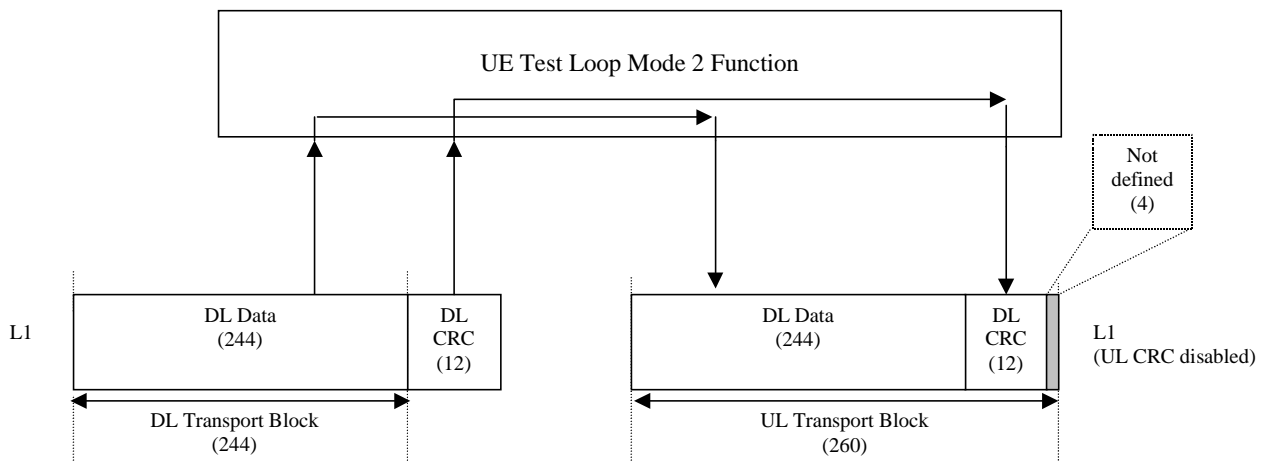

Figure 5.3.2.7.3. UE test loop mode 2 operation for the 1.95 kbps transport format case

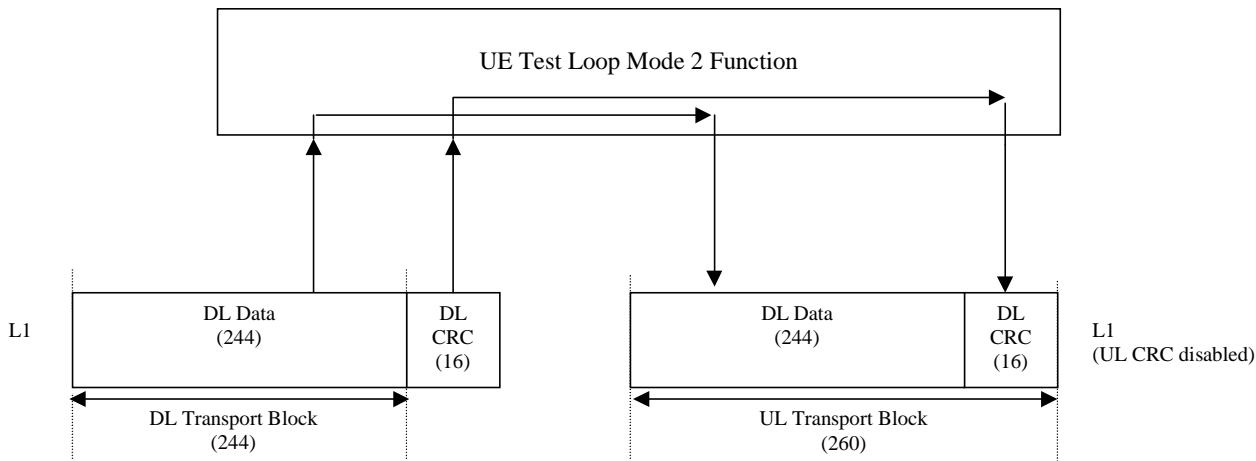

Figure 5.3.2.7.4. UE test loop mode 2 operation for the 12.2 kbps BLER measurement case

5.3.2.8 Transmission of dummy messages on DCCH

When UE test loop mode 1 or 2 is active:

If DCCH dummy mode is enabled and there is no DCCH data to be sent (i.e. there are no Layer 2/3 messages to be sent) then the UE shall set all bits in the uplink DCH transport block associated with a DCCH to 1, see figure 5.3.2.8.1.

If DCCH dummy mode is enabled the SS shall discard any received DCH transport blocks associated with a DCCH having its bits set to 1.

NOTE 1: DCCH dummy transmission is only intended for uplink RF testing for which reference radio measurement channels according to TS 25.101 Annex A are used.

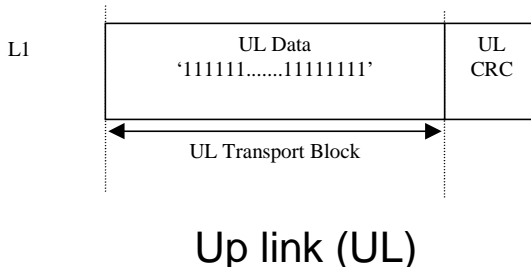

Figure 5.3.2.8.1. Bit pattern to use for DCCH dummy transmission

5.3.2.9 Loopback delay requirement

Loopback delay is specified as delay between received DL DTCH radio frames and their corresponding UL DTCH radio frames produced from the received data. The loopback delay is measured at the antenna connector of the UE and specified in the unit of radio frame(s). Timing offset between DL and UL radio frames, and timing errors are not included in the loopback delay.

While the UE test loop is closed and the radio bearer configuration is not changed, the UE shall maintain a fixed loopback delay (the loopback delay shall not vary during a test). The loopback delay shall not exceed the number of radio frames correspondent to 10 times the TTI of the actual transport channel configuration.

The loopback delay requirement is illustrated in figure 5.3.4.5.1.

See [11] TS25.211 7.6.3 for definition of the timing offset between DL and UL radio frames.

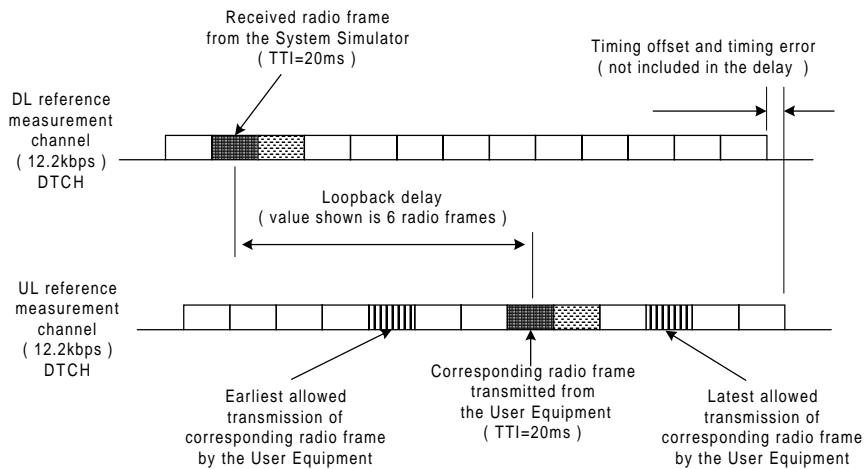

See [12] TS25.133 9.2 for definition of the timing error.

Figure 5.3.2.9.1: Loopback delay requirement

### 5.3.3 Open UE test loop

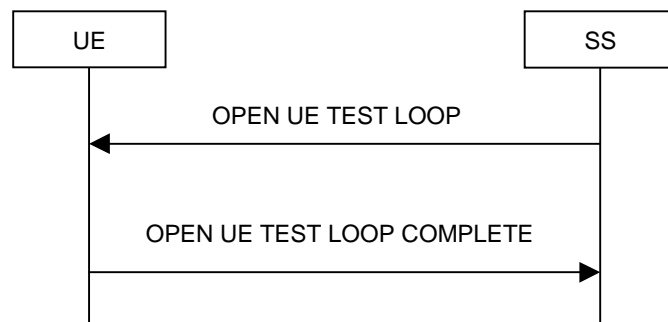

Figure 5.3.3.1: Open UE test loop procedure

#### 5.3.3.1 General

The SS uses the procedure open UE test loop to deactivate the UE test loop function in the UE.

#### 5.3.3.2 Initiation

The SS requests the UE to open its radio bearer test loop by transmitting a OPEN\_UE\_TEST\_LOOP\_CMD message. The SS then starts timer TT01.

#### 5.3.3.3 Reception of OPEN UE TEST LOOP message by the UE

If no radio bearer is established, the UE shall ignore any OPEN UE TEST LOOP message.

If a radio bearer is established, the UE shall open the test loop and send back to the SS a OPEN UE TEST LOOP COMPLETE message.

If the test loop is already open, the UE shall still respond as if the loop had been closed, i.e the OPEN\_UE\_LOOP\_ACK message should be sent prior to TT01 expiring.

### 5.3.3.4 Reception of OPEN UE TEST LOOP COMPLETE by the SS

Upon reception of the OPEN UE TEST LOOP COMPLETE message the SS stops timer TT01.

### 5.3.3.5 TT01 timeout

If TT01 expires, then the SS shall indicate this to the test case. The procedure is then completed.

## 6 Message definitions and contents

In this clause, only TC protocol messages are described. TC control messages are intended to be sent using the RRC downlink and uplink direct transfer procedures, see [14] TS 25.331 clause 8.1.9 and clause 8.1.10.

NOTE 1: A message received with skip indicator different from 0 will be ignored.

NOTE 2: For general definition of Layer 3 message format see [1] TS 24.007 subclause 11.

NOTE 3: GSM and 3G test messages uses the same protocol discriminator value ("1111"). Following message type value series are reserved for GSM testing commands as specified by [13] GSM 04.14: 0000xxxx, 0001xxxx and 0010xxxx where x represent 0 or 1. For 3G test commands the message type value series 0100xxxx is reserved.

### 6.1 Timer values

TT01: Recommended value: 2,5 seconds.

### 6.2 CLOSE UE TEST LOOP

This message is only sent in the direction SS to UE.

Information Element	Reference	Presence	Format	Length
Protocol discriminator	[1] TS 24.007, 11.2.3.1.1	M	V	1/2
Skip indicator	[1] TS 24.007, 11.2.3.1.2	M	V	1/2
Message type		M	V	1
UE test loop mode		M	V	1
UE test loop mode 1 LB setup		C	LV	1-13

where message type is:

8	7	6	5	4	3	2	1	bit no.
0	1	0	0	0	0	0	0	octet 1

where UE test loop mode is:

8	7	6	5	4	3	2	1	bit no.
0	0	0	0	0	Y1	X2	X1	octet 1

X2=0 and X1=0 then UE test loop mode 1 loop back scheme according to 5.3.2.6 shall be performed by the UE (loopback of RLC SDUs or PDCP SDUs).

X2=0 and X1=1 then UE test loop mode 2 loop back scheme according to 5.3.2.7 shall be performed by the UE (loopback of transport block data and CRC bits).

Y1 =0 then the DCCH dummy transmission according to 5.3.2.8 shall be disabled.

Y1 =1 then the DCCH dummy transmission according to 5.3.2.8 shall be enabled.

where UE test loop mode 1 LB setup is:

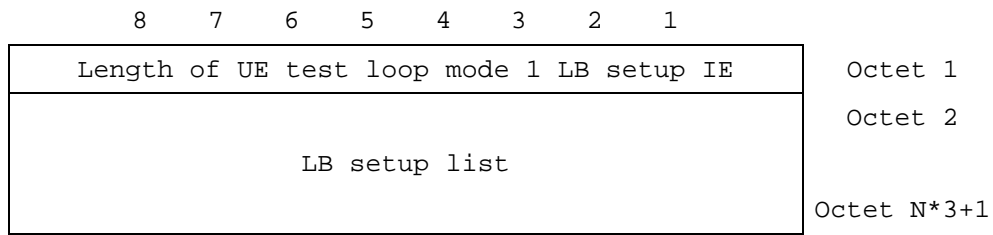

N is the number of LB entities in the LB setup list and is less than or equal to 4.

where LB setup list is:

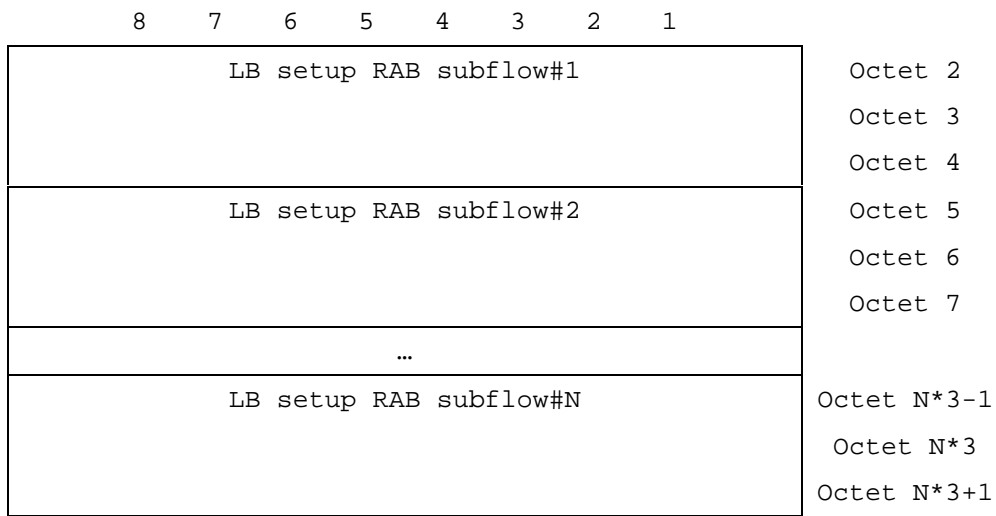

where LB Setup RAB subflow#k is:

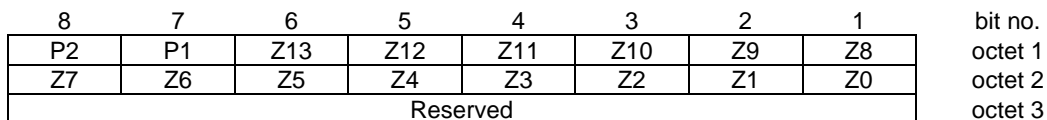

P1 =0 then uplink PDCP header compression shall be performed according to the actual radio bearer configuration, see Note 1

P1=1 then uplink PDCP header compression shall be disabled, see Note 1

P2=0 then downlink PDCP header compression shall be performed according to the actual radio bearer configuration, see Note 1

P2=1 then downlink PDCP header compression shall be disabled, see Note 1

Z13..Z0 = Uplink RLC SDU size in bits 0..16383 (binary coded, Z13 is most significant bit and Z0 least significant bit), see Note 2

NOTE 1 P1 and P2 are only valid for UE test loop mode 1 and for RAB subflows using PDCP protocol layer, see 5.3.2.6.1.

NOTE 2 The parameter UL RLC SDU size is only applicable for UE test loop mode 1 and for RAB subflows using PDCP protocol layer, see 5.3.2.6.2.

## 6.3 CLOSE UE TEST LOOP COMPLETE

This message is only sent in the direction UE to SS.

Information Element	Reference	Presence	Format	Length
Protocol discriminator	[1] TS 24.007, 11.2.3.1.1	M	V	1/2
Skip indicator	[1] TS 24.007, 11.2.3.1.2	M	V	1/2
Message type		M	V	1

where message type is:

8	7	6	5	4	3	2	1	bit no.
0	1	0	0	0	0	0	1	Octet 1

## 6.4 OPEN UE TEST LOOP

This message is only sent in the direction SS to UE

Information Element	Reference	Presence	Format	Length
Protocol discriminator	[1] TS 24.007, 11.2.3.1.1	M	V	1/2
Skip indicator	[1] TS 24.007, 11.2.3.1.2	M	V	1/2
Message type		M	V	1

where message type is:

8	7	6	5	4	3	2	1	Bit no.
0	1	0	0	0	0	1	0	Octet 1

where Acknowledge Information Element Identifier is:

8	7	6	5	4	3	2	1	Bit no.
1	0	0	0					Octet 1

and the Acknowledge Information Element contents are:

4	3	2	1	Bit no.
0	0	0	1	Octet 1
spare	spare	spare		

## 6.5 OPEN UE TEST LOOP COMPLETE

This message is only sent in the direction UE to SS.

Information Element	Reference	Presence	Format	Length
Protocol discriminator	[1] TS 24.007, 11.2.3.1.1	M	V	1/2
Skip indicator	[1] TS 24.007, 11.2.3.1.2	M	V	1/2
Message type		M	V	1

where message type is:

8	7	6	5	4	3	2	1	bit no.
0	1	0	0	0	0	1	1	Octet 1

## 6.6 ACTIVATE RB TEST MODE

This message is only sent in the direction SS to UE.

Information Element	Reference	Presence	Format	Length
Protocol discriminator	[1] TS 24.007, 11.2.3.1.1	M	V	½
Skip indicator	[1] TS 24.007, 11.2.3.1.2	M	V	½
Message type		M	V	1

where message type is:

8	7	6	5	4	3	2	1	bit no. octet 1
0	1	0	0	0	1	0	0	

## 6.7 ACTIVATE RB TEST MODE COMPLETE

This message is only sent in the direction UE to SS.

Information Element	Reference	Presence	Format	Length
Protocol discriminator	[1] TS 24.007, 11.2.3.1.1	M	V	½
Skip indicator	[1] TS 24.007, 11.2.3.1.2	M	V	½
Message type		M	V	1

where message type is:

8	7	6	5	4	3	2	1	bit no. octet 1
0	1	0	0	0	1	0	1	

## 6.8 DEACTIVATE RB TEST MODE

This message is only sent in the direction SS to UE.

Information Element	Reference	Presence	Format	Length
Protocol discriminator	[1] TS 24.007, 11.2.3.1.1	M	V	½
Skip indicator	[1] TS 24.007, 11.2.3.1.2	M	V	½
Message type		M	V	1

where message type is:

8	7	6	5	4	3	2	1	bit no. octet 1
0	1	0	0	0	1	1	0	

## 6.9 DEACTIVATE RB TEST MODE COMPLETE

This message is only sent in the direction UE to SS.

Information Element	Reference	Presence	Format	Length
Protocol discriminator	[1] TS 24.007, 11.2.3.1.1	M	V	1/2
Skip indicator	[1] TS 24.007, 11.2.3.1.2	M	V	1/2
Message type		M	V	1

where message type is:

8	7	6	5	4	3	2	1	bit no.
0	1	0	0	0	1	1	1	octet 1

---

## 7 Electrical Man Machine Interface (EMMI)

FFS

**NOTE** The EMMI is regarded as needed to provide efficient testing of 3G terminals and will be included in later revisions. EMMI will also be useful for testing of UEs not having an user interface. The support of EMMI will be optional to the UE.

---

## 8 UICC/ME test interface

### 8.1 General description

A special interface is required in order to perform the tests of the UICC/ME interface.

### 8.2 Formal aspects

It shall be possible to connect the UICC/USIM simulator to the ME. If an adapter is to be used, the manufacturer of the ME shall provide it.

When using the UICC/USIM simulator, the ME does not necessarily conform to all RF requirements.

When the UICC/USIM simulator is connected the ME shall be able to correctly send and receive on a DTCH and associated channels under ideal radio conditions.

### 8.3 Hardware and logical aspects of the interface

The signals on this interface are specified in [7] TS 31.101.

### 8.4 Mechanical characteristics of the interface

The mechanical interface is specified in [7] TS 31.101.



---

## Annex A (informative): UE test loop use scenarios

### A.1 Measurement of receiver characteristics (BER) using UE test loop mode 1 and RLC TM

SS can use the UE test loop mode 1 and RLC TM for measuring BER. For UE to be able to return all data it receives from SS it is required that the DL and UL transport block size are the same. It is also required that the UL RLC SDU size parameter of the CLOSE UE TEST LOOP message is set to the same value as the DL and UL transport block size.

#### A.1.1 Measurement of receiver characteristics (BER) - DL reference measurement channel (12,2 kbps)

For measuring BER for the DL and UL reference measurement channel 12.2 kbps according to TS 34.121 Annex A the configuration should be:

- DL and UL transport block size = 244 bits (RLC TM)
- UE test loop mode 1 parameter UL RLC SDU size = 244 bits

---

### A.2 Measurement of receiver performance (BLER) using UE test loop mode 1 and RLC AM

To measure BLER UE test loop mode 1 can be used by having the DL RLC protocol operating in acknowledged mode (AM). The SS can calculate BLER from the ratio of number of UE retransmission requests and the total number of blocks sent by the SS.

In AM the UE indicates missing protocol units (=transport blocks) in the STATUS PDU message. There are different triggers for sending the STATUS PDU message. For the purpose of SS BLER measurement a timer based trigger such as receiver timer based STATUS PDU transfer can be used (see TS 25.322 clause 9.7.2). The figure below illustrates the SS BLER measurement procedure. In the example in the figure block errors are detected by the UE of a total of N blocks. The BLER calculated by the SS is  $4 / N$ .

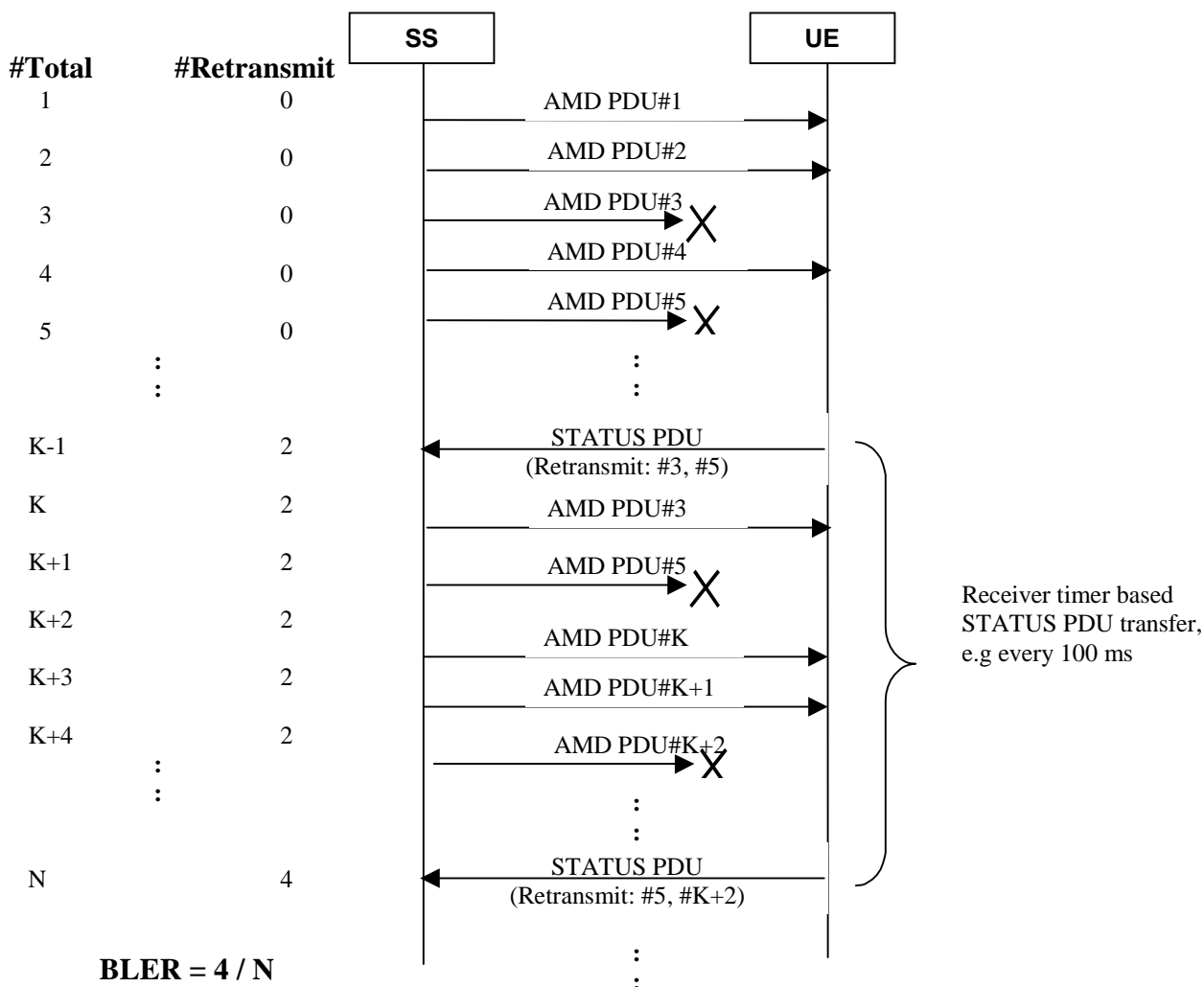

#Total = Number of sent blocks,  
 #Retransmit = Number of UE retransmission requests

Figure A.2.3 Measuring BLER using UE test loop mode 1 and DL RLC AM

### A.2.1 Measurement of receiver performance (BLER) - DL reference measurement channel (64,144,384 kbps)

By having downlink transport block size set to size of user data part according to the 64, 144 or 384 kbps reference measurement channels and using RLC acknowledge mode the UE test loop mode 1 can be used to measure BLER.

## A.3 Measurement of receiver performance (BLER) using UE test loop mode 2

In addition to the method described in A.2 UE test loop mode 2 can be used to measure BLER if the UL transport block size is bigger or equal to the sum of DL transport block size and number of DL CRC bits.

The SS can calculate BLER by checking returned data and CRC and count number of block errors and the total number of sent blocks.

### A.3.1 Measurement of receiver performance (BLER) - DL reference measurement channel (12,2 kbps)

[3] TS 25.101 A.2.1 and A.2.2 defines the DL and UL reference measurement channel 12,2 kbps.

To be able to measure BLER using UE test loop mode 2 the SS needs to configure the uplink transport block size to 260 bits to fit downlink transport block size (244 bits) and downlink CRC bits (16 bits).

### A.3.2 Measurement of receiver performance (BLER) - DL reference measurement channel (64,144 and 384 kbps)

[3] TS 25.101 A.2.1 and A.2.2 defines the DL and UL reference measurement channel for 64, 144 and 384 kbps.

If an UE supports downlink reference measurement channels for 64,144 or 384 kbps and also the correspondent uplink reference measurement channel then it is possible to use UE test loop mode 2 for measuring BLER for these reference measurement channels.

---

## A.4 Measurement of transmitter characteristics

The SS setups the radio bearer for DL and UL reference measurement channels 12,2 kbps using the generic setup procedure.

See [10] TS 34.108, clause [TBD] for specification of the generic call setup procedure.

See [3] TS 25.101 A.2.1 and A.2.2 for definition of the DL and UL reference measurement channel 12,2 kbps.

The SS orders the UE to close its UE test loop by transmitting a CLOSE UE TEST LOOP CMD message.

When the SS receives the CLOSE UE TEST LOOP COMPLETE message from the UE the SS starts transmission of data to the UE.

Perform the transmitter test.

The SS sends the OPEN UE TEST LOOP message to the UE to open the UE test loop.

---

## A.5 Measurement of transmitter DTX characteristics

The SS requests the UE to enable DTX and setups the radio bearer for DL and UL reference measurement channels 12,2 kbps using the generic setup procedure.

See [10] TS 34.108, clause [TBD] for specification of the generic setup procedure.

See [3] TS 25.101 A.2.1 and A.2.2 for definition of the DL and UL reference measurement channel 12,2 kbps.

The SS orders the UE to close its UE test loop using UE test mode 1 by transmitting a CLOSE UE TEST LOOP message.

The UE confirms that the UE test loop is closed by sending the CLOSE UE TEST LOOP COMPLETE message to the SS.

Perform the transmitter DTX testing.

The SS sends the OPEN UE TEST LOOP message to the UE to open the UE test loop.

## A.6 Using UE test loop mode 1 for protocol testing

The parameter UL RLC SDU in CLOSE UE TEST LOOP message is used to control the behaviour of the UE test function behavior regarding the uplink RLC SDU size.

In downlink the SS can control the downlink RLC SDU size by creating test data blocks of the size required for the test purpose.

The table below describes the UE test function behavior when operating in UE test loop mode 1 for different settings of DL and UL RLC SDU sizes:

UL RLC SDU size	UE test loop behaviour
= 0	Nothing is returned by UE in uplink
= DL RLC SDU size	All received data is returned by UE in uplink
< DL RLC SDU size	Received data is truncated by UE and sent in uplink
> DL RLC SDU size	Received data is repeated until UL RLC SDU block is filled and sent in uplink

Examples of different configurations are shown in figure 1 and 2 below.

Figure A.2.1 illustrates a configuration for testing of RLC reassemble and segmentation. SS sends DL RLC SDU block size > DL RLC PDU block size and have configured UL RLC SDU block size = DL RLC SDU size > UL RLC PDU block size.

NOTE. For this type of configuration the UE receiver buffer limitations need to be considered when designing the test.

Figure A.2.2 illustrates a configuration for BER measurements. SS sends DL RLC SDU block size = DL RLC PDU block size and have configured UL RLC SDU block size = UL RLC PDU block size = DL RLC PDU block size. RLC and MAC is configured for transparent mode.

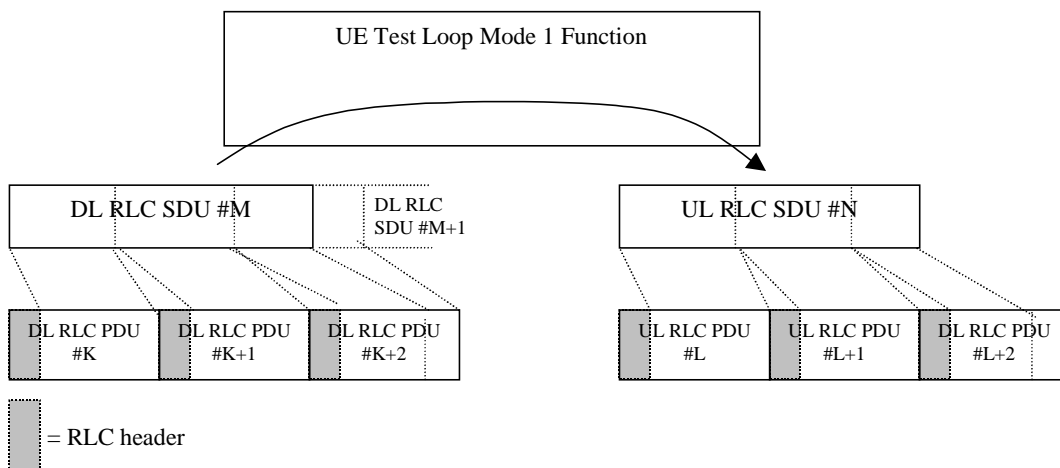

Figure A.2.1. Configuration for testing of RLC reassemble in downlink and RLC segmentation in uplink.

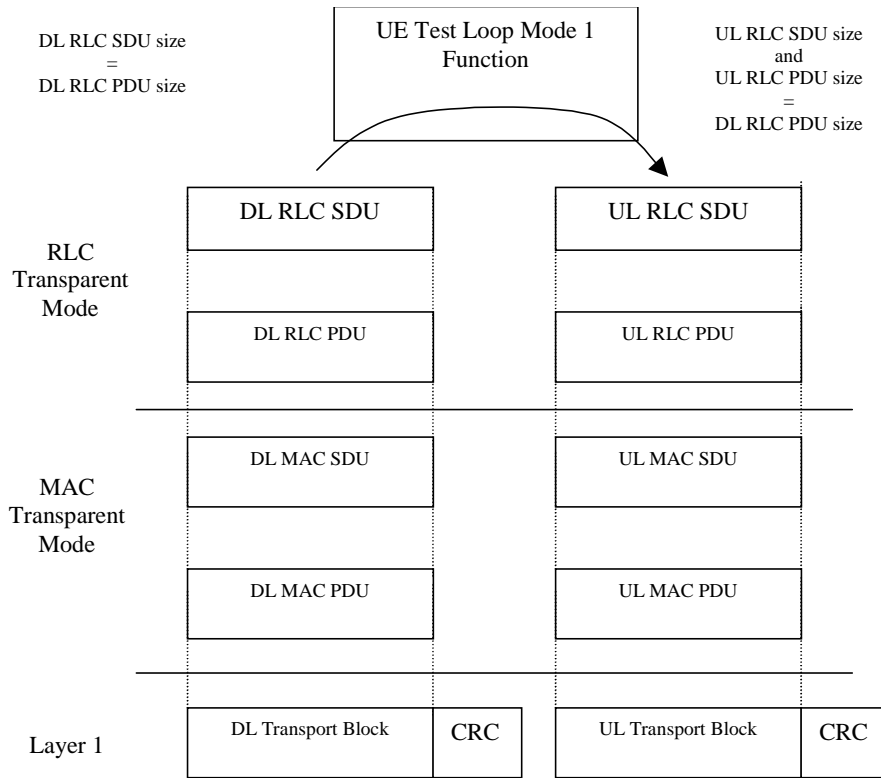

Figure A.2.2. Example of a configuration used for BER measurement

## Annex B (informative): Change history

V0.0.0	1999-02	Initial document. The contents are given from ARIB "Specification of Mobile Station for 3G Mobile System" (Ver.1.0-1.0)
V0.0.1	1999-04	Change requests agreed by TSG-T1 RF/SWG
V0.1.0	1999-04-15	Changes as agreed by TSG-T1 #2 meeting.
V0.2.0	1999-05-27	Changes as agreed by TSG-T1 RF/SWG and TSG-T1 SIG/SWG according to TSG-T1R#4(99)041 & TSG-T1S#2(99)017.
V0.2.1	1999-08-26	Change of document number from iTS-T1.001 to TS 34.109. Scope expanded to cover both FDD and TDD. Same content as v0.2.0.
V0.2.2	1999-08-27	Editorial changes in the format.
V0.3.0	1999-09-16	Changes as agreed by TSG-T1 according to TSG-T1#4(99)109.
V0.3.1	1999-09-28	Editorial changes received by T1 e-mail reflector.
V1.0.0	1999-10-21	Endorsed by TSG-T#5 as TS 34.109 V1.0.0
V1.0.1	1999-11-16	Addition of Postal address and Copyright notification
V1.0.2	1999-12-08	Changes as agreed by TSG T1 RF and SIG SWGs according to TSG-T1R#8(99)117 & TSG-T1S#6(99)058.
V1.0.3	1999-12-09	Changes as agreed by TSG T1 RF and SIG SWGs according to TSG-T1#5(99)163
V1.1.0	2000-01-27	Changes as agreed by TSG T1 RF and SIG SWGs according to TSG-T1S#8(00)0006 & TSG-T1#10(00)0017.
V1.2.0	2000-02-25	Changes as agreed at TSG T1#6
V1.2.1	2000-06-07	Changes as agreed by T1/SIG#11 and T1/RF#13 SWGs meeting 6-7 June 2000 in Harpenden UK (T1S-000108/T1R-000204)
V1.2.2	2000-06-07	Changes as agreed at joint T1/SIG#11 and T1/RF#13 SWGs meeting 7 June 2000 in Harpenden UK
V2.0.0	2000-06-21	Presented for approval to T#8
V3.0.0	2000-06-21	Approved at T#8

---

## History

<b>Document history</b>		
V3.0.0	June 2000	Publication