

# ETSI TS 132 452 V10.0.0 (2011-04)

---

*Technical Specification*

**Universal Mobile Telecommunications System (UMTS);  
LTE;  
Telecommunication management;  
Performance measurements  
Home Node B Access (HNB) network  
(3GPP TS 32.452 version 10.0.0 Release 10)**

---



---

Reference

DTS/TSGS-0532452va00

---

Keywords

LTE, UMTS

**ETSI**

650 Route des Lucioles  
F-06921 Sophia Antipolis Cedex - FRANCE

Tel.: +33 4 92 94 42 00 Fax: +33 4 93 65 47 16

Siret N° 348 623 562 00017 - NAF 742 C  
Association à but non lucratif enregistrée à la  
Sous-Préfecture de Grasse (06) N° 7803/88

---

**Important notice**

Individual copies of the present document can be downloaded from:

<http://www.etsi.org>

The present document may be made available in more than one electronic version or in print. In any case of existing or perceived difference in contents between such versions, the reference version is the Portable Document Format (PDF). In case of dispute, the reference shall be the printing on ETSI printers of the PDF version kept on a specific network drive within ETSI Secretariat.

Users of the present document should be aware that the document may be subject to revision or change of status. Information on the current status of this and other ETSI documents is available at

<http://portal.etsi.org/tb/status/status.asp>

If you find errors in the present document, please send your comment to one of the following services:

[http://portal.etsi.org/chaicor/ETSI\\_support.asp](http://portal.etsi.org/chaicor/ETSI_support.asp)

---

**Copyright Notification**

No part may be reproduced except as authorized by written permission.  
The copyright and the foregoing restriction extend to reproduction in all media.

© European Telecommunications Standards Institute 2011.  
All rights reserved.

**DECT**<sup>TM</sup>, **PLUGTESTS**<sup>TM</sup>, **UMTS**<sup>TM</sup>, **TIPHON**<sup>TM</sup>, the TIPHON logo and the ETSI logo are Trade Marks of ETSI registered for the benefit of its Members.

**3GPP**<sup>TM</sup> is a Trade Mark of ETSI registered for the benefit of its Members and of the 3GPP Organizational Partners.

**LTE**<sup>TM</sup> is a Trade Mark of ETSI currently being registered

for the benefit of its Members and of the 3GPP Organizational Partners.

**GSM**<sup>®</sup> and the GSM logo are Trade Marks registered and owned by the GSM Association.

---

## Intellectual Property Rights

IPRs essential or potentially essential to the present document may have been declared to ETSI. The information pertaining to these essential IPRs, if any, is publicly available for **ETSI members and non-members**, and can be found in ETSI SR 000 314: *"Intellectual Property Rights (IPRs); Essential, or potentially Essential, IPRs notified to ETSI in respect of ETSI standards"*, which is available from the ETSI Secretariat. Latest updates are available on the ETSI Web server (<http://webapp.etsi.org/IPR/home.asp>).

Pursuant to the ETSI IPR Policy, no investigation, including IPR searches, has been carried out by ETSI. No guarantee can be given as to the existence of other IPRs not referenced in ETSI SR 000 314 (or the updates on the ETSI Web server) which are, or may be, or may become, essential to the present document.

---

## Foreword

This Technical Specification (TS) has been produced by ETSI 3rd Generation Partnership Project (3GPP).

The present document may refer to technical specifications or reports using their 3GPP identities, UMTS identities or GSM identities. These should be interpreted as being references to the corresponding ETSI deliverables.

The cross reference between GSM, UMTS, 3GPP and ETSI identities can be found under <http://webapp.etsi.org/key/queryform.asp>.

# Contents

Intellectual Property Rights .....	2
Foreword.....	2
Foreword.....	5
Introduction .....	5
1 Scope .....	7
2 References .....	7
3 Measurement family and abbreviations.....	9
3.1 Measurement family.....	9
3.2 Abbreviations .....	9
4 Functionality related measurements .....	10
4.1 Measurements related to HNB-GW .....	10
4.1.1 UE registration/de-registration related measurements .....	10
4.1.1.1 Overview .....	10
4.1.1.2 UE registration related measurements.....	11
4.1.1.2.1 Attempted UE Registrations .....	11
4.1.1.2.2 Successful UE Registrations.....	12
4.1.1.2.3 Failed UE Registrations.....	12
4.1.1.3 UE de-registration related measurements.....	12
4.1.1.3.1 HNB Originated Successful UE De-Registrations .....	12
4.1.1.3.2 HNB GW Originated Successful UE De-Registrations.....	12
4.1.2 Signalling Plane related measurements.....	13
4.1.2.1 Numbers of incoming SCTP packets on the Iuh interface, from HNB to HNB GW .....	13
4.1.2.2 Numbers of outgoing SCTP packets on the Iuh interface, from HNB GW to HNB .....	13
4.1.2.3 Numbers of octets of incoming SCTP packets on the Iuh interface, from HNB to HNB GW.....	13
4.1.2.4 Numbers of octets of outgoing SCTP packets on the Iuh interface, from HNB GW to HNB.....	13
4.1.3 HNB registration/de-registration related measurements .....	14
4.1.3.1 Overview .....	14
4.1.3.2 HNB registration related measurements.....	15
4.1.3.2.1 Attempted HNB Registrations .....	15
4.1.3.2.2 Successful HNB Registrations.....	15
4.1.3.2.3 Failed HNB Registrations.....	15
4.1.3.3 HNB de-registration related measurements .....	16
4.1.3.3.1 HNB GW Originated Successful HNB De-Registrations.....	16
4.1.4 User plane related measurements.....	16
4.1.4.1 Numbers of incoming Iu-UP RTP packets of CS domain on Iuh interface, from HNB to HNB GW .....	16
4.1.4.2 Numbers of outgoing Iu-UP RTP packets of CS domain on Iuh interface, from HNB GW to HNB .....	16
4.1.4.3 Numbers of octets of incoming Iu-UP RTP packets of CS domain on Iuh interface, from HNB to HNB GW .....	17
4.1.4.4 Numbers of octets of outgoing Iu-UP RTP packets of CS domain on Iuh interface, from HNB GW to HNB .....	17
4.1.4.5 Numbers of incoming Iu-UP GTP-U packets of PS domain on Iuh interface, from HNB to HNB GW .....	17
4.1.4.6 Numbers of outgoing Iu-UP GTP-U packets of PS domain on Iuh interface, from HNB GW to HNB .....	17
4.1.4.7 Numbers of octets of incoming Iu-UP GTP-U packets of PS domain on Iuh interface, from HNB to HNB GW .....	18
4.1.4.8 Numbers of octets of outgoing Iu-UP GTP-U packets of PS domain on Iuh interface, from HNB GW to HNB .....	18
4.1.5 Measurements related to CSG service .....	18
4.1.5.1 Overview .....	18

4.1.5.2	Number of mean registered CSG UEs .....	19
4.1.5.3	Inbound CSG mobility measurements .....	19
4.1.5.3.1	Attempted inbound mobility for CSG UEs to CSG cells or to Hybrid Cells in connected mode .....	19
4.1.5.3.2	Successful inbound mobility for CSG UEs to CSG cells or Hybrid cells in connected mode .....	20
4.1.5.3.3	Failed inbound mobility for UEs to CSG cells or Hybrid cells in connected mode .....	20
4.2	Measurements related to HNB .....	21
4.2.1	RRC and RAB Overview .....	21
4.2.2	RRC Measurements .....	22
4.2.2.1	Attempted RRC Connection Establishment .....	22
4.2.2.2	Failed RRC connection establishment .....	22
4.2.2.3	Successful RRC connection establishment .....	23
4.2.3	RAB Measurement .....	23
4.2.3.1	Attempted RAB Establishment for PS domain .....	23
4.2.3.2	Successful RAB Establishment for PS domain .....	24
4.2.3.3	Failed RAB Establishment for PS domain .....	24
4.2.3.4	Dropped RABs for PS domain .....	24
4.2.3.5	Attempted RAB Establishment for CS domain .....	24
4.2.3.6	Failed RAB Establishment for CS domain .....	25
4.2.3.7	Successful RAB Establishment for CS domain .....	25
4.2.3.8	Dropped RABs for CS domain .....	25
4.2.4	HNB Hard Handover measurements .....	26
4.2.4.1	Successful HNB to 3G Macro Intra Frequency Hard Handovers .....	26
4.2.4.2	Successful HNB to 3G Macro Inter Frequency Hard Handovers .....	26
4.2.4.3	Attempted HNB to 3G Macro Intra Frequency Hard Handovers .....	26
4.2.4.4	Attempted HNB to 3G Macro Inter Frequency Hard Handovers .....	27
4.2.4.5	Failed HNB to 3G Macro Intra Frequency Hard Handovers .....	27
4.2.4.6	Failed HNB to 3G Macro Inter Frequency Hard Handovers .....	27
4.2.5	HNB CS handovers .....	27
4.2.5.1	Attempted 3G Macro to HNB CS Handovers .....	27
4.2.5.2	Successful 3G Macro to HNB CS Handovers .....	28
4.2.5.3	Failed 3G Macro to HNB CS Handovers .....	28
4.2.5.4	Attempted 2G Macro to HNB CS Handovers .....	28
4.2.5.5	Successful 2G Macro to HNB CS Handovers .....	28
4.2.5.6	Failed 2G Macro to HNB CS Handovers .....	28
4.2.6	Number of Uplink User Bits for PS EDCH above RLC .....	29
4.2.7	Number of Uplink User Bits for PS UL 64 kbps Data Rate .....	29
4.2.8	Number of Uplink User Bits for PS UL 128 kbps Data Rate .....	29
4.2.9	Number of Uplink User Bits for PS UL 384 kbps Data Rate .....	29
4.2.10	Number of Downlink User Bits for PS RABs related with HSDPA above RLC .....	30
4.2.11	Number of Downlink User Bits for PS DL 64 kbps Data Rate (non-HSDPA) above RLC .....	30
4.2.12	Number of Downlink User Bits for PS DL 128 kbps Data Rate (non-HSDPA) above RLC .....	30
4.2.13	Number of Downlink User Bits for PS DL 384 kbps Data Rate (non-HSDPA) above RLC .....	31
<b>Annex A:</b>	<b>Use cases for performance measurements definition .....</b>	<b>32</b>
A.1	Use case of registration and de-registration measurements .....	32
A.2	Use case of the SCTP signalling measurements .....	32
A.3	Use case of HNB registration and de-registration measurements .....	32
A.4	Use case of HNB-GW user plane measurements .....	33
A.5	RAB related performance .....	33
A.6	Faulty transport blocks related performance .....	33
A.7	CSG service related performance .....	33
<b>Annex B:</b>	<b>Change history .....</b>	<b>35</b>
History	.....	36

---

## Foreword

This Technical Report has been produced by the 3<sup>rd</sup> Generation Partnership Project (3GPP).

The contents of the present document are subject to continuing work within the TSG and may change following formal TSG approval. Should the TSG modify the contents of the present document, it will be re-released by the TSG with an identifying change of release date and an increase in version number as follows:

Version x.y.z

where:

- x the first digit:
  - 1 presented to TSG for information;
  - 2 presented to TSG for approval;
  - 3 or greater indicates TSG approved document under change control.
- y the second digit is incremented for all changes of substance, i.e. technical enhancements, corrections, updates, etc.
- z the third digit is incremented when editorial only changes have been incorporated in the document.

---

## Introduction

The present document is part of a TS-family covering the 3rd Generation Partnership Project; Technical Specification Group Services and System Aspects; Telecommunication management; as identified below:

32.401	Performance Management (PM); Concept and requirements
52.402	Performance Management (PM); Performance measurements – GSM
32.404	Performance Management (PM); Performance measurements - Definitions and template
32.405	Performance Management (PM); Performance measurements Universal Terrestrial Radio Access Network (UTRAN)
32.406	Performance Management (PM); Performance measurements Core Network (CN) Packet Switched (PS) domain
32.407	Performance Management (PM); Performance measurements Core Network (CN) Circuit Switched (CS) domain
32.408	Performance Management (PM); Performance measurements Teleservice
32.409	Performance Management (PM); Performance measurements IP Multimedia Subsystem (IMS)
<b>32.452</b>	<b>Performance Management (PM); Performance measurements Home Node B Subsystem (HNS)</b>
32.453	Performance Management (PM); Performance measurements Home enhanced Node B Subsystem (HeNS)

The present document is part of a set of specifications, which describe the requirements and information model necessary for the standardised Operation, Administration and Maintenance (OA&M) of a multi-vendor HNS.

During the lifetime of HNS, its logical and physical configuration will undergo changes of varying degrees and frequencies in order to optimise the utilisation of the network resources. These changes will be executed through network configuration management activities and/or network engineering, see 3GPP TS 32.600 [1].

Many of the activities involved in the daily operation and future network planning of HNS require data on which to base decisions. This data refers to the load carried by the network and the grade of service offered. In order to produce this data performance measurements are executed in the NEs, which comprise the network. The data can then be transferred to an external system, e.g. an Operations System (OS) in TMN terminology, for further evaluation. The purpose of the present document is to describe the mechanisms involved in the collection of the data and the definition of the data itself.

Annex B of TS 32.404 [2] helps in the definition of new performance measurements that can be submitted to 3GPP for potential adoption and inclusion in the present document. Annex B of TS 32.404 discusses a top-down performance measurement definition methodology that focuses on how the end-user of performance measurements can use the measurements.

---

# 1 Scope

The present document describes the measurements for Home Node B subsystem (HNS).

HNS [3] consists of a HNB and HNB-GW. And, it appears as an RNS to the core network and is connected by means of the Iu-CS interface to the MSC and by means of the Iu-PS interface to the SGSN.

TS 32.401 [4] describes Performance Management concepts and requirements.

The present document is valid for all measurement types provided by an implementation of a HNS.

Only measurement types that are specific to HNS are defined within the present documents. Vendor specific measurement types used in HNS are not covered. Instead, these could be applied according to manufacturer's documentation.

Measurements related to "external" technologies (such as ATM or IP) as described by "external" standards bodies (e.g. ITU-T or IETF) shall only be referenced within this specification, wherever there is a need identified for the existence of such a reference.

The definition of the standard measurements is intended to result in comparability of measurement data produced in a multi-vendor network, for those measurement types that can be standardised across all vendors' implementations.

The structure of the present document is as follows:

- Header 1: Network Element (e.g. measurements related to HNB and HNB GW);
- Header 2: Measurement function (e.g. HNB registration measurements);
- Header 3: Measurements.

---

# 2 References

The following documents contain provisions which, through reference in this text, constitute provisions of the present document.

- References are either specific (identified by date of publication, edition number, version number, etc.) or non-specific.
- For a specific reference, subsequent revisions do not apply.
- For a non-specific reference, the latest version applies. In the case of a reference to a 3GPP document (including a GSM document), a non-specific reference implicitly refers to the latest version of that document *in the same Release as the present document*.

- [1] 3GPP TS 32.600: "Telecommunication management; Configuration Management (CM); Concept and high-level requirements".
- [2] 3GPP TS 32.404: "Performance Management (PM); Performance measurements - Definitions and template".
- [3] 3GPP TS 23.060: "General Packet Radio Service (GPRS); Service description; Stage 2".
- [4] 3GPP TS 32.401: "Telecommunication management; Performance Management (PM); Concept and requirements".
- [5] 3GPP TS 25.469: "Technical Specification Group Radio Access Network; UTRAN Iuh interface Home Node B Application Part (HNBAP) signalling".
- [6] 3GPP TS 25.413: "UTRAN Iu interface Radio Access Network Application Part (RANAP) signaling".
- [7] 3GPP TS 23.107: "Quality of Service (QoS) concept and architecture".
- [8] 3GPP TS 25.993: "Typical examples of Radio Access Bearers (RABs) and Radio Bearers (RBs) supported by Universal Terrestrial Radio Access (UTRA)".



- [9] 3GPP TS 25.331: "Radio Resource Control (RRC) protocol specification".
- [10] 3GPP TS 32.403: "Telecommunication management; Performance Management (PM); Performance measurements; UMTS and combined UMTS/GSM".
- [11] 3GPP TS 25.413: "UTRAN Iu interface Radio Access Network Application Part (RANAP) signaling".
- [12] 3GPP TS 25.467: "Technical Specification Group Radio Access Network; UTRAN architecture for 3G Home Node B (HNB); Stage 2".

## 3 Measurement family and abbreviations

### 3.1 Measurement family

The measurement names defined in the present document are all beginning with a prefix containing the measurement family name (e.g. IUH.AttUeReg). This family name identifies all measurements which relate to a given functionality and it may be used for measurement administration (see 3GPP TS 32.401 [4]).

The list of families currently used in the present document is as follows:

- IUH (measurements related to Iuh interface).
- CSG (measurements related to CSG membership)

### 3.2 Abbreviations

For the purposes of the present document, the following abbreviations apply:

3G	3 <sup>rd</sup> Generation
3GPP	3G Partnership Project
CS	Circuit switched
CN	Core Network
NE	Network Element
NM	Network Manager
OA&M	Operation, Administration and Maintenance
OS	Operations System (EM, NM)
PM	Performance Management
QoS	Quality of Service
UMTS	Universal Mobile Telecommunications System

You can find below a list of abbreviations used within the measurement types for field E of the measurement template (see 3GPP TS 32.404 [2]).

Ans	Answer(ed)
Att	Attempted
Auth	Authorization
Cs	Circuit switched
DER	Discrete Event Registration
DeReg	De-Registration
Dmn	Domain
Estab	Establish(ment)
Fail	Failed(/Failure)
Fwd	Forward(ed)
Inc	Incoming
Ind	Indication
Nbr	Number
Rel	Release(s,d)
Res	Resource
Succ	Success(es,ful)

---

## 4 Functionality related measurements

The measurements defined in this clause are related to the functionality aspect performance. The detailed measurements for each function are defined in the following subclauses.

---

### 4.1 Measurements related to HNB-GW

#### 4.1.1 UE registration/de-registration related measurements

##### 4.1.1.1 Overview

The UE Registration procedure provides means for the HNB to convey UE identification data to the HNB-GW in order to perform access control for the UE in the HNB-GW. The UE Registration also establishes a UE specific context identifier to be used between HNB and HNB-GW. The procedure triggered when the UE attempts to access the HNB via an initial NAS message and there is no context in the HNB allocated for that UE. The successful UE registration rate thus poses an important impact on the QoE which accessing the HNB networks from a macro view on the OA&M basis.

The de-registration procedure may be originated by either HNB or HNB GW.

Performance Measurement definitions in this subclause are based on 3GPP TS 25.469 [5].

The following paragraphs are of interest for this purpose:

- UE REGISTER REQUEST
- UE REGISTER ACCEPT
- UE REGISTER REJECT
- UE DE-REGISTER

These paragraphs show in particular the following diagrams:

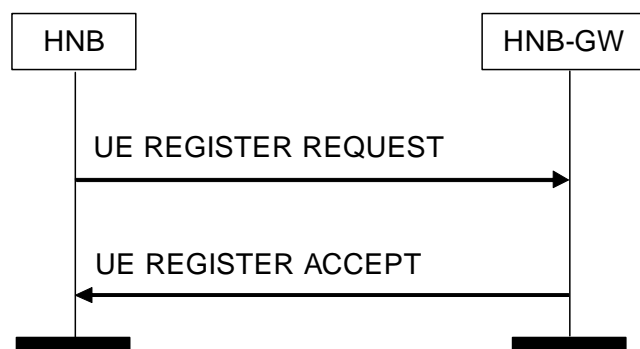

Figure 1 UE Register Procedure: Successful Operation

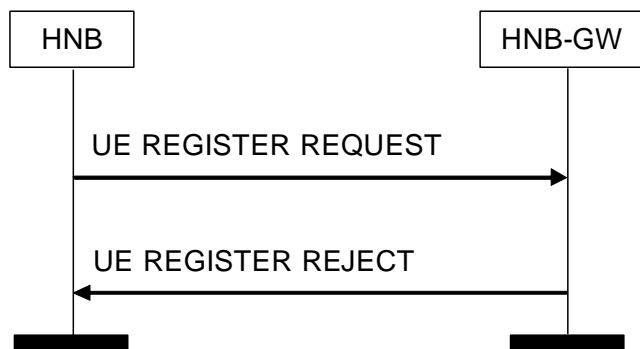

Figure 2 UE Register Procedure: Unsuccessful Operation



Figure 3 UE De-Register Procedure: HNB Originated Successful Operation



Figure 4 UE De-Register Procedure: HNB-GW Originated Successful Operation

#### 4.1.1.2 UE registration related measurements

The three measurement types defined in the clause 4.1.1.2 for HNB-GW are subject to the "2 out of 3 approach".

##### 4.1.1.2.1 Attempted UE Registrations

- a) This measurement provides the number of UE registration attempts sent from HNB.
- b) CC
- c) Receipt of an HNBAP message UE REGISTER REQUEST from HNB to HNB-GW. (3GPP TS 25.469 [5])
- d) A single integer value.
- e) IUH.AttUeReg.
- f) HNBGWFunction
- g) Valid for circuit switched and packet switched traffic.
- h) UMTS

#### 4.1.1.2.2 Successful UE Registrations

- a) This measurement provides the number of successful UE registrations sent from HNB.
- b) CC
- c) Transmission of an HNBAP message UE REGISTER ACCEPT from HNB-GW to HNB. (3GPP TS 25.469 [5])
- d) A single integer value.
- e) IUH.SuccUeReg.
- f) HNBGWFunction
- g) Valid for circuit switched and packet switched traffic.
- h) UMTS

#### 4.1.1.2.3 Failed UE Registrations

- a) This measurement provides the number of failed UE registrations sent from HNB. This measurement is then further split into subcounters per failure cause.
- b) CC
- c) Transmission of an HNBAP message UE REGISTER REJECT from HNB-GW to HNB. (3GPP TS 25.469 [5])
- d) A single integer value. The number of measurements is equal to the number of causes plus a possible sum value identified by the *.sum* suffix. (The possible cause values are defined in 3GPP TS 25.469 [5])
- e) IUH.FailUeReg.*cause*
- f) HNBGWFunction
- g) Valid for circuit switched and packet switched traffic.
- h) UMTS

#### 4.1.1.3 UE de-registration related measurements

##### 4.1.1.3.1 HNB Originated Successful UE De-Registrations

- a) This measurement provides the number of successful UE de-registrations initiated by HNB. This measurement is then further split into sub-subcounters per cause.
- b) CC
- c) Receipt of an HNBAP message UE DE-REGISTER from HNB to HNB-GW.(3GPP TS 25.469 [5])
- d) A single integer value. The number of measurements is equal to the number of causes plus a possible sum value identified by the *.sum* suffix. (The possible cause values are defined in 3GPP TS 25.469 [5])
- e) IUH.SuccUeDeRegHnb.*cause*
- f) HNBGWFunction
- g) Valid for circuit switched and packet switched traffic.
- h) UMTS

##### 4.1.1.3.2 HNB GW Originated Successful UE De-Registrations

- a) This measurement provides the number of successful UE de-registrations initiated by HNB GW. This measurement is then further split into sub-subcounters per cause.
- b) CC
- c) Transmission of an HNBAP message UE DE-REGISTER from HNB-GW to HNB.(3GPP TS 25.469 [5])
- d) A single integer value. The number of measurements is equal to the number of causes plus a possible sum value identified by the *.sum* suffix. (The possible cause values are defined in 3GPP TS 25.469 [5])
- e) IUH.SuccUeDeRegHnbGw.*cause*
- f) HNBGWFunction
- g) Valid for circuit switched and packet switched traffic.
- h) UMTS

## 4.1.2 Signalling Plane related measurements

### 4.1.2.1 Numbers of incoming SCTP packets on the Iuh interface, from HNB to HNB GW

- a) This measurement provides the number of SCTP data packets sent from HNB to HNB GW which have been accepted and processed by the SCTP protocol entity on the Iuh interface.
- b) CC.
- c) Receipt of a SCTP data PDU from HNB to HNB GW on the Iuh interface. (3GPP TS 25.469 [5])
- d) A single integer value.
- e) IUH.IncSctpPkt
- f) HNBGWFunction
- g) Valid for circuit switched and packet switched traffic
- h) UMTS

### 4.1.2.2 Numbers of outgoing SCTP packets on the Iuh interface, from HNB GW to HNB

- a) This measurement provides the number of SCTP data packets sent from HNB GW to HNB which have been generated by the SCTP protocol entity on the Iuh interface.
- b) CC.
- c) Transmission of a SCTP data PDU from HNB GW to HNB on the Iuh interface. (3GPP TS 25.469 [5])
- d) A single integer value.
- e) IUH.OutSctpPkt
- f) HNBGWFunction
- g) Valid for circuit switched and packet switched traffic
- h) UMTS

### 4.1.2.3 Numbers of octets of incoming SCTP packets on the Iuh interface, from HNB to HNB GW

- a) This measurement provides the number of octets of SCTP data packets sent from HNB to HNB GW which have been accepted and processed by the SCTP protocol entity on the Iuh interface.
- b) CC.
- c) Receipt of a SCTP data PDU from HNB to HNB GW on the Iuh interface. (3GPP TS 25.469 [5])
- d) A single integer value.
- e) IUH.IncSctpOct
- f) HNBGWFunction
- g) Valid for circuit switched and packet switched traffic
- h) UMTS

### 4.1.2.4 Numbers of octets of outgoing SCTP packets on the Iuh interface, from HNB GW to HNB

- a) This measurement provides the number of octets of SCTP data packets sent from HNB GW to HNB which have been generated by the SCTP protocol entity on the Iuh interface.
- b) CC.
- c) Transmission of a SCTP data PDU from HNB GW to HNB on the Iuh interface. (3GPP TS 25.469 [5])
- d) A single integer value.

- e) IUH.OutSctpOct
- f) HNBGWFunction
- g) Valid for circuit switched and packet switched traffic
- h) UMTS

### 4.1.3 HNB registration/de-registration related measurements

#### 4.1.3.1 Overview

The purpose of the HNB Registration Procedure is to register the HNB with the HNB-GW to enable the HNB-GW to provide service and core network connectivity for the HNB. This procedure shall be the first HNBAP procedure triggered after the SCTP association has become operational.

The de-registration procedure may be originated by either HNB or HNB GW.

Performance Measurement definitions in this subclause are based on 3PGG TS 25.469 [5].

The following paragraphs are of interest for this purpose:

- HNB REGISTER REQUEST
- HNB REGISTER ACCEPT
- HNB REGISTER REJECT
- HNB DE-REGISTER

These paragraphs show in particular the following diagrams:

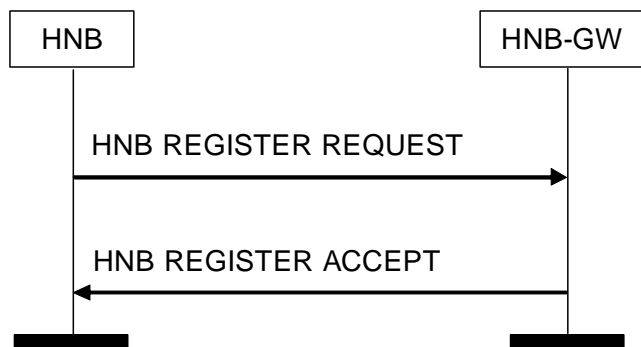

**Figure 5 HNB Register Procedure: Successful Operation**

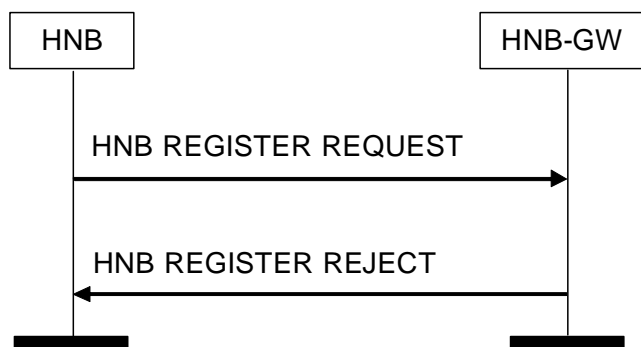

**Figure 6 HNB Register Procedure: Un-Successful Operation**



**Figure 7 HNB De-register Procedure: HNB GW Originated Successful Operation**

#### 4.1.3.2 HNB registration related measurements

The three measurement types defined in the clause 4.1.3.2 are subject to the "2 out of 3 approach".

##### 4.1.3.2.1 Attempted HNB Registrations

- This measurement provides the number of HNB registration attempts per HNB.
- CC
- Receipt of an HNBAP message HNB REGISTER REQUEST from HNB to HNB-GW. (3GPP TS 25.469 [5])
- A single integer value.
- IUH.AttHnbReg.
- HNBGWFunction
- Valid for circuit switched and packet switched traffic.
- UMTS

##### 4.1.3.2.2 Successful HNB Registrations

- This measurement provides the number of successful HNB registrations per HNB.
- CC
- Transmission of an HNBAP message HNB REGISTER ACCEPT from HNB-GW to HNB. (3GPP TS 25.469 [5])
- A single integer value.
- IUH.SuccHnbReg.
- HNBGWFunction
- Valid for circuit switched and packet switched traffic.
- UMTS

##### 4.1.3.2.3 Failed HNB Registrations

- This measurement provides the number of failed HNB registrations per HNB. This measurement is then further split into sub-subcounters per failure cause.
- CC
- Transmission of an HNB REGISTER REJECT message from HNB-GW to HNB or an expected HNB REGISTER ACCEPT message not received by HNB. Each HNB REGISTER REJECT message received is added to the relevant per cause measurement. The possible causes are included in TS 25.469 [5]. Each expected HNB REGISTER ACCEPT not received by the HNB is added to the measurement cause 'No Reply' (not specified in TS 25.469 [5]).
- Each measurement is an integer value.. The number of measurements is equal to the number of causes plus a possible sum value identified by the *.sum* suffix. (The possible cause values are defined in 3GPP TS 25.469 [5])
- IUH.FailHnbReg.*cause*  
where *Cause* identifies the Rejection Cause.



The cause *'No Reply'* is identified by the *.NoReply* suffix.

- f) HNBGWFunction
- g) Valid for circuit switched and packet switched traffic.
- h) UMTS

#### 4.1.3.3 HNB de-registration related measurements

##### 4.1.3.3.1 HNB GW Originated Successful HNB De-Registrations

- a) This measurement provides the number of successful HNB de-registrations initiated by HNB GW.
- b) CC
- c) Transmission of an HNBAP message HNB DE-REGISTER from HNB-GW to HNB.(3GPP TS 25.469 [5])
- d) A single integer value. The number of measurements is equal to the number of causes plus a possible sum value identified by the *.sum* suffix. (The possible cause values are defined in 3GPP TS 25.469 [5])
- e) IUH.AttHnbDeRegHnbGw.cause
- f) HNBGWFunction
- g) Valid for circuit switched and packet switched traffic.
- h) UMTS

#### 4.1.4 User plane related measurements

The subclauses below can NOT be applied to the use case that there is a direct GTP-U tunnel right between HNB and SGSN on the user plane of PS domain, i.e. HNB GW is skipped and there is NO GTP-U protocol entity in HNB GW, for the sake of PS bearer optimizations.

##### 4.1.4.1 Numbers of incoming Iu-UP RTP packets of CS domain on Iuh interface, from HNB to HNB GW

- a) This measurement provides the number of Iu-UP RTP data packets on the user plane of CS domain, sent from HNB to HNB GW on Iuh interface.
- b) CC.
- c) Receipt of an Iu-UP RTP data PDU from HNB to HNB GW on the user plane of CS domain on Iuh interface.
- d) A single integer value.
- e) IUH.IncIuUpCsPkt
- f) HNBGWFunction
- g) Valid for circuit switched traffic
- h) UMTS

##### 4.1.4.2 Numbers of outgoing Iu-UP RTP packets of CS domain on Iuh interface, from HNB GW to HNB

- a) This measurement provides the number of Iu-UP RTP data packets on the user plane of CS domain, sent from HNB GW to HNB on Iuh interface.
- b) CC.
- c) Transmission of an Iu-UP RTP data PDU from HNB GW to HNB on the user plane of CS domain on Iuh interface.
- d) A single integer value.
- e) IUH.OutIuUpCsPkt
- f) HNBGWFunction
- g) Valid for circuit switched traffic
- h) UMTS

#### 4.1.4.3 Numbers of octets of incoming Iu-UP RTP packets of CS domain on Iuh interface, from HNB to HNB GW

- a) This measurement provides the number of octets of Iu-UP RTP data packets on the user plane of CS domain, sent from HNB to HNB GW on Iuh interface.
- b) CC.
- c) Receipt of an Iu-UP RTP data PDU from HNB to HNB GW on the user plane of CS domain on Iuh interface.
- d) A single integer value.
- e) IUH.IncIuUpCsOct
- f) HNBGWFunction
- g) Valid for circuit switched traffic
- h) UMTS

#### 4.1.4.4 Numbers of octets of outgoing Iu-UP RTP packets of CS domain on Iuh interface, from HNB GW to HNB

- a) This measurement provides the number of octets of Iu-UP RTP data packets on the user plane of CS domain, sent from HNB GW to HNB on Iuh interface.
- b) CC.
- c) Transmission of an Iu-UP RTP data PDU from HNB GW to HNB on the user plane of CS domain on Iuh interface.
- d) A single integer value.
- e) IUH.OutIuUpCsOct
- f) HNBGWFunction
- g) Valid for circuit switched traffic
- h) UMTS

#### 4.1.4.5 Numbers of incoming Iu-UP GTP-U packets of PS domain on Iuh interface, from HNB to HNB GW

- a) This measurement provides the number of Iu-UP GTP-U data packets on the user plane of PS domain, sent from HNB to HNB GW on Iuh interface.
- b) CC.
- c) Receipt of an Iu-UP GTP-U data PDU from HNB to HNB GW on the user plane of PS domain on Iuh interface.
- d) A single integer value.
- e) IUH.IncIuUpPsPkt
- f) HNBGWFunction
- g) Valid for packet switched traffic
- h) UMTS

#### 4.1.4.6 Numbers of outgoing Iu-UP GTP-U packets of PS domain on Iuh interface, from HNB GW to HNB

- a) This measurement provides the number of Iu-UP GTP-U data packets sent on the user plane of PS domain, from HNB GW to HNB on Iuh interface.
- b) CC.
- c) Transmission of an Iu-UP GTP-U data PDU from HNB GW to HNB on the user plane of PS domain on Iuh interface.
- d) A single integer value.
- e) IUH.OutIuUpPsPkt
- f) HNBGWFunction
- g) Valid for packet switched traffic
- h) UMTS

#### 4.1.4.7 Numbers of octets of incoming Iu-UP GTP-U packets of PS domain on Iuh interface, from HNB to HNB GW

- a) This measurement provides the number of octets of Iu-UP GTP-U data packets on the user plane of PS domain, sent from HNB to HNB GW on Iuh interface.
- b) CC.
- c) Receipt of an Iu-UP GTP-U data PDU from HNB to HNB GW on the user plane of PS domain on Iuh interface.
- d) A single integer value.
- e) IUH.IncIuUpPsOct
- f) HNBGWFunction
- g) Valid for packet switched traffic
- h) UMTS

#### 4.1.4.8 Numbers of octets of outgoing Iu-UP GTP-U packets of PS domain on Iuh interface, from HNB GW to HNB

- a) This measurement provides the number of octets of Iu-UP GTP-U data packets on the user plane of PS domain, sent from HNB GW to HNB on Iuh interface.
- b) CC.
- c) Transmission of an Iu-UP GTP-U data PDU from HNB GW to HNB on the user plane of PS domain on Iuh interface.
- d) A single integer value.
- e) IUH.OutIuUpPsOct
- f) HNBGWFunction
- g) Valid for packet switched traffic
- h) UMTS

### 4.1.5 Measurements related to CSG service

#### 4.1.5.1 Overview

The CSG UE Inbound mobility procedure provides means for CSG UEs to switch from macro cells to to CSG HNBs or to Hybrid Cells in connected mode. The procedure is triggered when the HNB-GW receives a RANAP RELOCATION REQUEST message from the Core Network, including the CSG Id, Target Cell Id, etc. The successful CSG UE inbound mobility rate poses an important impact on the QoE.

The CSG UE Inbound mobility procedure is originated by Core Network.

Performance Measurement definitions in this subclause are based on 3PGG TS 25.467 [12].

The following paragraph is of interest for this purpose:

- RELOCATION REQUEST
- RELOCATION COMPLETE
- RELOCATION FAILURE

This paragraph shows in particular the following diagram:

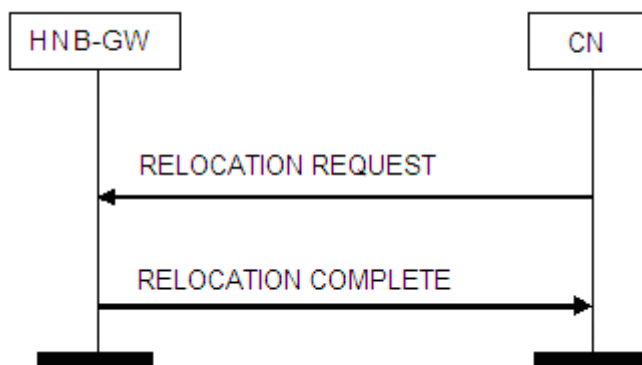

Figure 8 CSG UE Inbound Procedure: Successful Operation

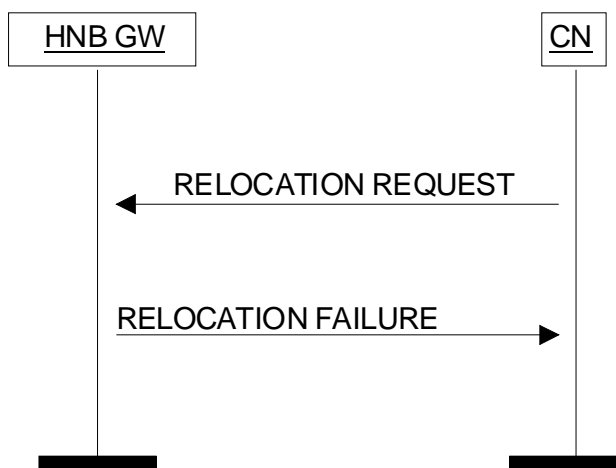

Figure 9 CSG UE Inbound Procedure: Unsuccessful Operation

#### 4.1.5.2 Number of mean registered CSG UEs

- This measurement provides the number of mean registered CSG UEs in the HNB GW.
- SI
- This measurement is obtained by sampling at a pre-defined interval the number of CSG UEs registered in the HNB GW and then taking the arithmetic mean (see TS 25.467 [12]).
- A single integer value
- CSG.MeanNbrUsr
- HNBGWFunction
- Valid for circuit and packet switched traffic
- UMTS

#### 4.1.5.3 Inbound CSG mobility measurements

The three measurement types defined in the clause 4.1.5.3 are subject to the "2 out of 3 approach".

##### 4.1.5.3.1 Attempted inbound mobility for CSG UEs to CSG cells or to Hybrid Cells in connected mode

- This measurement provides the number of attempted inbound mobility for CSG UEs to CSG cells or to Hybrid Cells in connected mode

- b) CC
- c) On receipt by the HNB GW of a RANAP message RELOCATION REQUEST from the Core Network with the “CSG id” IE, “Target Cell id” IE and “CSG Membership Status” IE for relocating to a hybrid cell (see TS 25.467 [12]).
- d) A single integer value.
- e) CSG.AttInboundMobility
- f) HNBGWFunction
- g) Valid for circuit and packet switched traffic
- h) UMTS

#### 4.1.5.3.2 Successful inbound mobility for CSG UEs to CSG cells or Hybrid cells in connected mode

- a) This measurement provides the number of successful inbound mobility for CSG UEs to CSG cells or to Hybrid cells in connected mode
- b) CC
- c) On transmission by the HNB GW of a RANAP message RELOCATION COMPLETE to the Core Network, corresponding to the receipt by the HNB GW of a RANAP message RELOCATION REQUEST from the Core Network with the “CSG id” IE, “Target Cell id” IE and “CSG Membership Status” IE for relocating to a hybrid cell the transmission of the See TS 25.467 [12].
- d) A single integer value.
- e) CSG.SuccInboundMobility
- f) HNBGWFunction
- g) Valid for circuit and packet switched traffic
- h) UMTS

#### 4.1.5.3.3 Failed inbound mobility for UEs to CSG cells or Hybrid cells in connected mode

- a) This measurement provides the number of failed successful inbound mobility for CSG UEs to CSG cells or hybrid cells in connected mode
- b) CC
- c) On transmission by the HNB GW of a RANAP message RELOCATION FAILURE to the Core Network, corresponding to the receipt by the HNB GW of a RANAP message RELOCATION REQUEST from the Core Network with the “CSG id” IE, “Target Cell id” IE and “CSG Membership Status” IE for relocating to a hybrid cell the transmission of the See TS 25.467 [12].
- d) Each measurement is an integer value. The number of measurements is equal to the number of causes supported plus a possible sum value identified by the *.sum* suffix.
- e) CSG.FailedInboundMobility. *Cause*  
where *Cause* identifies the failure cause.
- f) HNBGWFunction
- g) Valid for circuit and packet switched traffic
- h) UMTS

## 4.2 Measurements related to HNB

### 4.2.1 RRC and RAB Overview

Performance Measurement definitions in this subclause are based on 3GPP TS 25.413 [6].

The following paragraphs are of interest for this purpose:

- RAB ASSIGNMENT REQUEST;
- RAB ASSIGNMENT RESPONSE;
- RAB RELEASE REQUEST.
- IU RELEASE REQUEST;
- RRC CONNECTION REQUEST
- RRC CONNECTION SETUP COMPLETE
- RRC CONNECTION REJECT

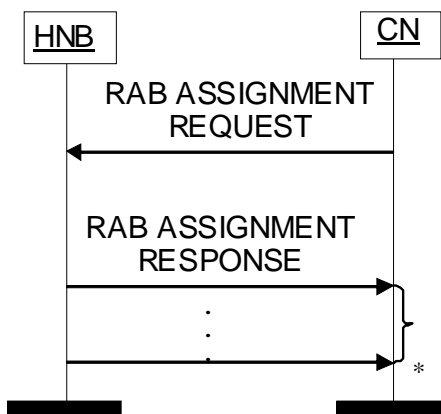

\* it can be several responses

Figure 10 RAB Assignment procedure. Successful operation

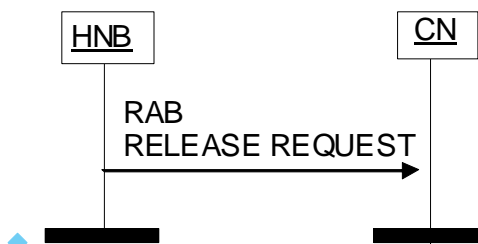

Figure 11 RAB Release Request procedure

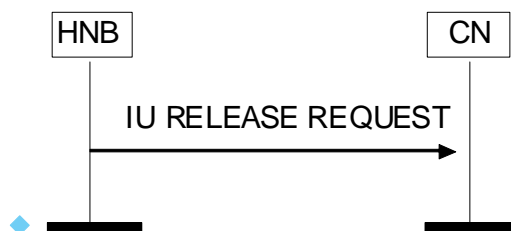

Figure 12 Iu Release Request procedure. Successful operation

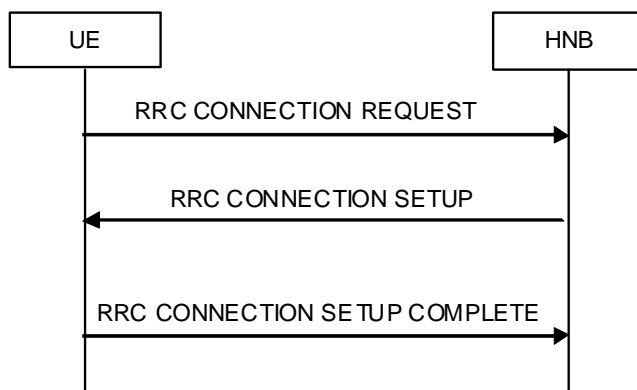

Figure 13 RRC Connection procedure, Successful operation

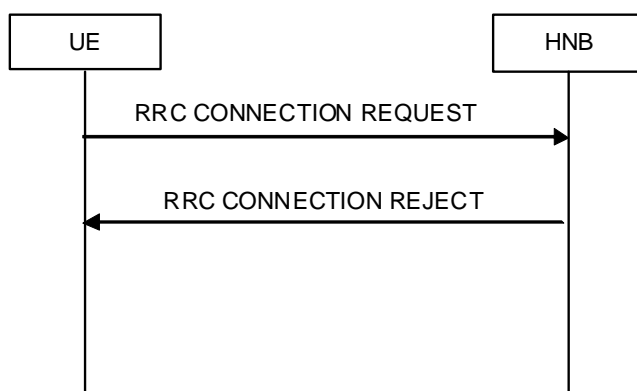

Figure 14 RRC Connection procedure, Unsuccessful operation

## 4.2.2 RRC Measurements

### 4.2.2.1 Attempted RRC Connection Establishment

- This measurement provides the number of RRC connection establishment attempts for each establishment cause.
- CC
- On Receipt of a RRC Connection Request message by the HNB from the UE. Each RRC Connection Request message received is added to the relevant per cause measurement. The possible causes are included in TS 25.331 [9]. The sum of all supported per cause measurements shall equal the total number of RRC Connection Establishment attempts. In case only a subset of per cause measurements is supported, a sum subcounter will be provided first. .
- Each measurement is an integer value.
- The measurement name has the form `RRC.AttConnEstab.Cause` where *Cause* identifies the Establishment Cause.
- HNB
- Valid for circuit switched and packet switched traffic

### 4.2.2.2 Failed RRC connection establishment

- This measurement provides the number of RRC establishment failures for each rejection cause.
- CC

- c) On transmission of RRC connection Reject message by the HNB to the UE. Each RRC Connection Reject message received is added to the relevant per cause measurement. The possible causes are included in TS 25.331 [9].

The sum of all supported per cause measurements shall equal the total number of RRC Connection Establishment Failures.

- d) Each measurement is an integer value. The number of measurements is equal to the number of causes plus a possible sum value identified by the *.sum* suffix.
- e) The measurement name has the form *RRC.FailConnEstab.Cause* where *Cause* identifies the Rejection Cause. The cause 'No Reply' is identified by the *.NoReply* suffix.
- f) HNB
- g) Valid for circuit switched and packet switched traffic

#### 4.2.2.3 Successful RRC connection establishment

- a) This measurement provides the number of successful RRC establishments for each establishment cause.
- b) CC.
- c) On Receipt by the HNB of a RRC CONNECTION SETUP COMPLETE message following a RRC establishment attempt. Each RRC Connection Setup Complete message received is added to the relevant per cause measurement. The possible causes are included in TS 25.331 [9]. The sum of all supported per cause measurements shall equal the total number of RRC Connection Establishments. In case only a subset of per cause measurements is supported, a sum subcounter will be provided first.
- d) Each measurement is an integer value. The number of measurements is equal to the number of causes plus a possible sum value identified by the *.sum* suffix.
- e) The measurement name has the form *RRC.SuccConnEstab.Cause* where *Cause* identifies the Establishment Cause.
- f) HNB.
- g) Valid for circuit switched and packet switched traffic

### 4.2.3 RAB Measurement

#### 4.2.3.1 Attempted RAB Establishment for PS domain

- a) This measurement provides the number of requested RAB in establishment attempts for PS domain. The measurement is split into subcounters per traffic class.
- b) CC
- c) Receipt of a RAB ASSIGNMENT REQUEST message from HNB for PS, each requested RAB establishment attempt is added. The counter shall be incremented for each PS RAB attempted to be established.
- d) Each measurement is an integer value.
- e) The addition is performed with the condition that the RAB has not been setup or modified successfully in a previous RANAP RAB ASSIGNMENT RESPONSE or RELOCATION REQUEST ACKNOWLEDGE. The measurement name has the form **RAB.AttEstabPS.sum**
- f) HNB
- g) Valid for packet switched traffic



#### 4.2.3.2 Successful RAB Establishment for PS domain

- a) This measurement provides the number of successfully established RABs for PS domain.
- b) CC
- c) On transmission of the RAB ASSIGNMENT RESPONSE from PS domain from the HNB. Whenever a RAB ASSIGNMENT RESPONSE message for PS is sent from HNB indicating a successfully established RAB, this counter shall be incremented.
- d) One integer value.
- e) The measurement name has the form RAB.SuccEstabPS.sum
- f) HNB
- g) Valid for packet switched traffic.

#### 4.2.3.3 Failed RAB Establishment for PS domain

- a) This measurement provides the number of RABs establishment failures for PS domain.
- b) CC
- c) On receipt of a RAB ASSIGNMENT RESPONSE message. Whenever a RAB ASSIGNMENT RESPONSE message is sent from HNB, the relevant counter according to the traffic class shall be incremented for each PS RAB that is identified in the 'RABs Failed To Setup Or Modify List'. The counter shall be incremented for each PS RAB attempted to be established.
- d) One integer value per measurement type
- e) The measurement name has the form **RAB.FailEstabPS.Sum**
- f) HNB
- g) Valid for packet switched traffic.

#### 4.2.3.4 Dropped RABs for PS domain

- a) This counter provides the total number of abnormally released PS RAB connections.
- b) CC
- c) On transmission of the RANAP Iu Release Request by the HNB. This counter shall be incremented, whenever HNB invokes RANAP Iu Release Request procedure and a RAB for service type PS Data associated with the affected Iu signalling connection is required to be dropped: Note: This counter is pegged in case of operator intervention too. The counter shall not be pegged if the RRC Connection Release was triggered by Signaling Connection Release from the UE. This counter shall not be pegged in case PS RAB was dropped due to pre-emption.
- d) One integer value per measurement type
- e) The measurement name has the form RAB.Rel.DropPS.sum
- f) HNB
- g) Valid for packet switched traffic.

#### 4.2.3.5 Attempted RAB Establishment for CS domain

- a) This measurement provides the total number of requested RABs in establishment attempts for CS conversational traffic class.
- b) CC

- c) On receipt of a RAB ASSIGNMENT REQUEST message from MSC for CS domain, this counter is incremented.
- d) One integer value
- e) The measurement name has the form RAB.AttEstabCS.
- f) HNB
- g) Valid for CS domain

#### 4.2.3.6 Failed RAB Establishment for CS domain

- a) This measurement provides the number of RABs establishment failures for CS domain.
- b) CC
- c) On transmission of a RAB ASSIGNMENT RESPONSE message from HNB to MSC, this counter shall be incremented for each CS RAB that is identified in the 'RABs Failed To Setup Or Modify List'.
- d) One integer value per measurement type
- e) The measurement name has the form RAB.FailEstabCS
- f) HNB
- g) Valid for CS domain

#### 4.2.3.7 Successful RAB Establishment for CS domain

- a) This measurement provides the number of successfully established RABs for CS domain.
- b) CC
- c) On transmission of a RAB ASSIGNMENT RESPONSE message for CS from HNB indicating a successfully established RAB this counter shall be incremented. The counter shall be incremented for each CS RAB successfully established.
- d) One integer value.
- e) The measurement name has the form RAB.SuccEstabCS.sum
- f) HNB
- g) Valid for packet switched traffic.

#### 4.2.3.8 Dropped RABs for CS domain

- a) This counter provides the total number of dropped RAB connections for service type CS Domain.
- b) CC
- c) On transmission of the RANAP Iu Release Request by the HNB. This counter shall be incremented, whenever HNB invokes RANAP Iu Release Request procedure and a RAB for service type CS Data associated with the affected Iu signalling connection is required to be dropped: Note: This counter is pegged in case of operator intervention too.
- d) One integer value
- e) The measurement name has the form RAB.Rel.DropCS.sum
- f) HNB
- g) Valid for CS domain

## 4.2.4 HNB Hard Handover measurements

### 4.2.4.1 Successful HNB to 3G Macro Intra Frequency Hard Handovers

- a) This measurement provides the number of successful HNB to UMTS macro cell intra frequency hard handovers
- b) CC
- c) On receipt of the Iu Release Command from CN. Whenever the HNB receives Iu Release Command from the core network with cause "Successful Relocation" or "Normal Release" during handover execution and the handover is a hard handover intra frequency to a UMTS macro cell.
- d) A single integer value
- e) The measurement name has the form **HHO.SuccHnbUmtsIntraFreq** (3GPP TS 32.403[10])
- f) HNB
- g) Valid for packet switched traffic and circuit switch traffic.

### 4.2.4.2 Successful HNB to 3G Macro Inter Frequency Hard Handovers

- a) This measurement provides the number of successful HNB to UMTS macro cell inter frequency hard handovers
- b) CC
- c) On receipt of the Iu Release command as part of the inter frequency hard handover. Whenever the HNB receives Iu Release Command from the core network with cause "Successful Relocation" or "Normal Release" during handover execution and the handover is a hard handover inter frequency to a UMTS macro cell.
- d) A single integer value
- e) The measurement name has the form **HHO.SuccHnbUmtsInterFreq** (3GPP TS 32.403[10])
- f) HNB
- g) Valid for packet switched traffic and circuit switch traffic.

### 4.2.4.3 Attempted HNB to 3G Macro Intra Frequency Hard Handovers

- a) This measurement provides the number of attempted HNB to UMTS macro cell intra frequency hard handovers
- b) CC
- c) When the HNB sends the last handover command to the UE in a series of intra frequency handover attempts (retries), this handover attempt is for intra frequency hard handover to a UMTS macro cell and no further handover attempt is made because, either
  - This last handover attempt was successful, or
  - This last handover attempt was not successful and no further possible target cell is available while handover would still be needed.The handover command can be one of the RRC messages. The target UMTS system selects the message that is actually used.  
Note: The HNB can determine the condition to peg the attempt counter after successful or unsuccessful outcome of the handover, only.
- d) A single integer value
- e) The measurement name has the form **HHO.AttHnbUmtsIntraFreq** (3GPP TS 32.403[10])

- f) HNB
- g) Valid for packet switched traffic and circuit switch traffic.

#### 4.2.4.4 Attempted HNB to 3G Macro Inter Frequency Hard Handovers

- a) This measurement provides the number of attempted HNB to UMTS macro cell inter frequency hard handovers
- b) CC
- c) When the HNB sends the last handover command to the UE in a series of inter frequency handover attempts (retries), this handover attempt is for inter frequency hard handover to a UMTS macro cell and no further handover attempt is made because, either
  - This last handover attempt was successful, or
  - This last handover attempt was not successful and no further possible target cell is available while handover would still be needed.

The handover command can be one of the RRC messages: The target UMTS system selects the message that is actually used.

Note: The HNB can determine the condition to peg the attempt counter after successful or unsuccessful outcome of the handover, only.

- d) A single integer value
- e) The measurement name has the form **HHO.AttHnbUmtsInterFreq** (3GPP TS 32.403[10])
- f) HNB
- g) Valid for packet switched traffic and circuit switch traffic

#### 4.2.4.5 Failed HNB to 3G Macro Intra Frequency Hard Handovers

*Editor's Note: Counter definition to be added*

#### 4.2.4.6 Failed HNB to 3G Macro Inter Frequency Hard Handovers

*Editor's Note: Counter definition to be added*

### 4.2.5 HNB CS handovers

#### 4.2.5.1 Attempted 3G Macro to HNB CS Handovers

- a) This measurement provides the number of attempted 3G Macro to HNB CS handovers
- b) CC
- c) On receipt of RANAP RelocationRequest by the HNB. When the HNB received RANAP Relocation Request with RRC container SRNS RELOCATION INFO, this counter shall be pegged. Note: The HNB can determine the condition to peg the attempt counter after successful or unsuccessful outcome of the handover.
- d) A single integer value
- e) The measurement name has the form **CSHO.Att3GMacroToHnbCSHO** (3GPP TS 32.403[10])
- f) HNB
- g) Valid for circuit switch traffic

#### 4.2.5.2 Successful 3G Macro to HNB CS Handovers

- a) This measurement provides the number of successful 3G Macro to HNB CS handovers
- b) CC
- c) The UE successfully relocates from a 3G macro with a RB reconfiguration complete and the last step of the post relocation procedures is successfully completed. The counter shall be pegged when the UTRAN Mobility Information is sent to the UE
- d) A single integer value
- e) The measurement name has the form **CSHO.Succ3GMacroToHnbCSHO** (3GPP TS 32.403[10])
- f) HNB
- g) Valid for circuit switch traffic.

#### 4.2.5.3 Failed 3G Macro to HNB CS Handovers

*Editor's Note: Counter definition to be added*

#### 4.2.5.4 Attempted 2G Macro to HNB CS Handovers

- a) This measurement provides the number of attempted 2G Macro to HNB CS handovers
- b) CC
- c) When the HNB received RANAP Relocation Request with RRC container INTER RAT HANDOVER INFO WITH INTER RAT CAPABILITIES, this counter shall be pegged. Note: The HNB can determine the condition to peg the attempt counter after successful or unsuccessful outcome of the handover
- d) A single integer value
- e) The measurement name has the form **CSHO.Att2GMacroToHnbCSHO** (3GPP TS 32.403[10])
- f) HNB
- g) Valid for circuit switch traffic.

#### 4.2.5.5 Successful 2G Macro to HNB CS Handovers

- a) This measurement provides the number of successful 2G Macro to HNB CS handovers
- b) CC
- c) The UE successfully relocates from a 2G macro with a HO to UTRAN Complete and the last step of the post relocation procedures is successfully completed.
- d) A single integer value
- e) The measurement name has the form **CSHO.Succ2GMacroToHnbCSHO** (3GPP TS 32.403[10])
- f) HNB
- g) Valid for circuit switch traffic.

#### 4.2.5.6 Failed 2G Macro to HNB CS Handovers

*Editor's Note: Counter definition to be added*

#### 4.2.6 Number of Uplink User Bits for PS EDCH above RLC

- a) Number of uplink User Bits for PS RABs related with EDCH above RLC. The average uplink data throughput on EDCH RABs can be derived from this counter.
- b) CC
- c) Whenever an RLC PDU related to a RAB UL for EDCH has been acknowledged, the number of payload bits in the RLC PDU (the number of bits that have come from a received T-PDU) is summed. The counter shall deliver per granularity period the sum of all user bits transferred on UL RAB for EDCH.
- d) One integer value (64 bits Integer)
- e) The measurement name has the form **NumUserBits.EDCH\_PS**
- f) HNB
- g) Valid for packet switched

#### 4.2.7 Number of Uplink User Bits for PS UL 64 kbps Data Rate

- a) Number of Uplink User Bits for PS RABs with UL 64 kbps data rate. The average uplink data throughput on 64 kbps RABs can be derived from this counter.
- b) CC
- c) On receipt of a RLC PDU related to a RAB with 64kbps UL data rate, the number of payload bits in the RLC PDU (the number of bits that will be transported in a T-PDU) is summed. The counter shall deliver per granularity period the sum of all user bits transferred on 64 kbps UL RAB. One integer value
- d) The measurement name has the NumUserBits.PS64UL
- e) HNB
- f) Valid for packet switched

#### 4.2.8 Number of Uplink User Bits for PS UL 128 kbps Data Rate

- a) Number of Uplink User Bits for PS RABs with UL 128 kbps data rate. The average uplink data throughput on 128 kbps RABs can be derived from this counter.
- b) CC
- c) On receipt of a RLC PDU related to a RAB with 128kbps UL data rate, the number of payload bits in the RLC PDU (the number of bits that will be transported in a T-PDU) is summed. The counter shall deliver per granularity period the sum of all user bits transferred on 128 kbps UL RAB.
- d) One integer value
- e) The measurement name has the NumUserBits.PS128UL
- f) HNB
- g) Valid for packet switched

#### 4.2.9 Number of Uplink User Bits for PS UL 384 kbps Data Rate

- a) Number of Uplink User Bits for PS RABs with UL 384 kbps data rate. The average uplink data throughput on 384 kbps RABs can be derived from this counter.
- b) CC

- c) On receipt of a RLC PDU related to a RAB with 384kbps UL data rate, the number of payload bits in the RLC PDU (the number of bits that will be transported in a T-PDU) is summed.  
The counter shall deliver per granularity period the sum of all user bits transferred on 384 kbps UL RAB.
- d) One integer value
- e) The measurement name has the NumUserBits.PS384UL
- f) HNB
- g) Valid for packet switched

#### 4.2.10 Number of Downlink User Bits for PS RABs related with HSDPA above RLC

- a) Number of Downlink User Bits for PS RABs related with HSDPA above RLC. The average downlink data throughput on HSDPA RABs can be derived from this counter.
- b) CC
- c) Whenever an RLC PDU related to a RAB DL for HSDPA has been acknowledged, the number of payload bits in the RLC PDU (the number of bits that have come from a received T-PDU) is summed. The counter shall deliver per granularity period the sum of all user bits.
- d) One integer value per measurement type (64 bits Integer)
- e) The measurement name has the form **NumUserBits.HSDPADL\_PS**
- f) HNB
- g) Valid for packet switched traffic.

#### 4.2.11 Number of Downlink User Bits for PS DL 64 kbps Data Rate (non-HSDPA) above RLC

- a) Number of Downlink User Bits for PS RABs (non-HSDPA) with DL 64 kbps data rate above RLC.  
The average downlink data throughput on 64 kbps RABs (non-HSDPA) can be derived from this counter.
- b) CC
- c) Whenever an RLC PDU related to a non-HSDPA RAB with 64kbps DL data rate has been acknowledged, the number of payload bits in the RLC PDU (the number of bits that have come from a received T-PDU) is summed. The counter shall deliver per granularity period the sum of all user bits transferred on 64 kbps DL RAB.
- d) One integer value
- e) The measurement name has the form NumUserBits.PS64DL
- f) HNB
- g) Valid for packet switched

#### 4.2.12 Number of Downlink User Bits for PS DL 128 kbps Data Rate (non-HSDPA) above RLC

- a) Number of Downlink User Bits for PS RABs (non-HSDPA) with DL 128 kbps data rate above RLC.  
The average downlink data throughput on 128 kbps RABs (non-HSDPA) can be derived from this counter.
- b) CC
- c) Whenever an RLC PDU related to a non-HSDPA RAB with 128kbps DL data rate has been acknowledged, the number of payload bits in the RLC PDU (the number of bits that have come from a received T-PDU) is

summed. The counter shall deliver per granularity period the sum of all user bits transferred on 128 kbps DL RAB.

- d) One integer value
- e) The measurement name has the NumUserBits.PS128DL
- f) HNB
- g) Valid for packet switched

#### 4.2.13 Number of Downlink User Bits for PS DL 384 kbps Data Rate (non-HSDPA) above RLC

- a) Number of Downlink User Bits for PS RABs (non-HSDPA) with DL 384 kbps data rate above RLC. The average downlink data throughput on 384 kbps RABs (non-HSDPA) can be derived from this counter.
- b) CC
- c) Whenever an RLC PDU related to a non-HSDPA RAB with 384kbps DL data rate has been acknowledged, the number of payload bits in the RLC PDU (the number of bits that have come from a received T-PDU) is summed.-The counter shall deliver per granularity period the sum of all user bits transferred on 384 kbps DL RAB.
- d) One integer value
- e) The measurement name has the NumUserBits.PS384DL
- f) HNB
- g) Valid for packet switched



---

## Annex A:

# Use cases for performance measurements definition

The present annex provides the concrete use cases for the HNS performance measurements defined in clause 4.

---

### A.1 Use case of registration and de-registration measurements

UE registration is one of most important step to start delivering services by the HNS to users.

The success or failure of a registration directly impacts the quality level for delivering the service by the networks, and also user's experience. So the success or failure of registration needs be monitored, this can be achieved by the calculation of registration setup success rate which gives a direct view to evaluate the user's access to the network and analyze the specific reason causing the failure in order to find out the problem and ascertain the solutions.

In addition, de-registration is another sort of indicator to guarantee user QoS level. In the case of radio resource and transport resource shortage, HNB or HNB-GW could initiates a de-registration requests. The collections of de-registration would help to evaluate network deployment states. Depending on these parameters meaning, network optimizations could be implemented. This can be achieved by identifying the specific reason and splitting into sub-subcounters per cause. These parameters give a direct view to evaluate network states.

---

### A.2 Use case of the SCTP signalling measurements

In order to avoid the overload of HNB-GW, SCTP signaling measurements data will be combined with HNB-GW user plane measurement data to reflect load status on HNB-GW.

In addition, the ratio of signaling to data bandwidth usage is very useful to monitor some abnormal events, such as if the ratio of them is too high, some unusual events are possible happened. Therefore, the operator could analyze whether some problems exist in the network or not, and may find out root-causes led to the bad conditions, finally resolve the problems.

---

### A.3 Use case of HNB registration and de-registration measurements

HNB registration and de-registration are most important step to start or cease delivering services by the networks to users.

The successful and failed HNB registration rate can reflect Iuh link status between HNB and HNB-GW. It could be used to evaluate an operational quality for operators. Especially, HNB uses a leased backhaul to connect to HNB-GW. A successful HNB registration rate could be treated as a key performance indicator to offer to users who signed SLA with operators. A failed HNB registration could be aroused by several causes, such network congestion, blacklisted HNB, unauthorized HNB location, etc. The monitor of failed reason could facilitate trouble-shooting. Operator can determine root-causes depending on the feedback. In addition, an operational optimization can be performed in the specific area, where HNBs using similar LAC are often failed to get service.

HNB-GW originated de-registration will be performed whenever HNB-GW needs to terminate operations with an HNB. The specific causes can be extracted from the signalling HNB DE-REGISTER, such as overload and unspecified. In the case of overload, it can accurately reflect HNB-GW load status. And, operators could implement further measures to avoid potential failures when specific HNB-GW often initiates de-registration process with the cause of overload.

---

## A.4 Use case of HNB-GW user plane measurements

HNB-GW user plane related measurements are used to measure data volume on Iuh interface including incoming and outgoing of data packets and octets for RTP and GTP-U.

Based on that, the measurements are useful to analyze data volumes and velocity from HNB-GW point-of-view. If the data volume is too high, more interface bandwidth should be deployed, or HNB-GW load balance should be considered. If data velocity is too high, the packet forwarding capacity of HNB-GW should be enhanced to avoid data congestion.

In addition, differentiating user plane statistics on PS and CS domain can allow operators to monitor respective data volume for different service type. Furthermore, it can also reflect the load status on Iucs and Iups interfaces, on which performance evaluations will benefit from distinguished data stream monitoring

Finally, HNB-GW user plane related measurements could be together with other performance measurements to analyze network performance to find out the abnormal events.

---

## A.5 RAB related performance

RAB management procedure includes RAB Assignment procedure and RAB Release Request procedure. The purpose of RAB Assignment procedure is to establish new RABs and releases of already established RABs for a given UE. If RABs are failed to be established, the involved services may fail. RAB release request can be initiated HNB when the services terminate normally or abnormally.

During daily maintenance of network, measurements regarding RAB establishment and release are useful for operators to evaluate RAB management procedures, to analyze failure reasons of RAB establishment and to analyze the causes of RAB release, especially in case RAB release abnormally.

Based on that, these measurements are useful for drawing connection rate and drop rate of Femto system for both CS and PS domain. Both rates reflect connectivity and continuity for system services, which are the direct key performance indicators of user experience. Operators can analyse these indicators and acknowledge network quality and user experience better.

---

## A.6 Faulty transport blocks related performance

This measurement family is used to measure the number of received uplink transport blocks of DCH and uplink faulty transport blocks of DCH.

Based on that, the measurements are useful to analyze uplink transport block error rate from HNB point-of-view. If the block error rate is too high, it indicates a bad channel environment, and a handover or low-level modulation may be needed. In addition, differentiating transport block error rate on PS and CS domain can allow operators to monitor respective for different service type.

Finally, faulty transport blocks related measurements could be together with other performance measurements to analyze network performance to find out the abnormal events.

---

## A.7 CSG service related performance

A Closed Subscriber Group identifies subscribers of an operator who are permitted to access one or more PLMN cells which have restricted access. It is a new added feature in HNB to facilitate the provisioning of new service.

By calculating these parameters relating to CSG service, the operator can obtain the mean number of CSG UEs and the successful rate of inbound mobility for UEs. The mean number of CSG UEs indicates how many users accessing the CSG service, which is a key performance for service utilization. The successful rate of inbound mobility for UEs performs a key indicator of CSG service accessibility. As low handover success rate will impact user experience, it is important to define measurements to capture handover success rate. Furthermore, detailed analysis of handover failures is essential to know what causes the handovers.

Based on these indicators, the operator can optimize the service coverage and enhance the user experience.

---

## Annex B: Change history

Change history							
Date	TSG #	TSG Doc.	CR	Rev	Subject/Comment	Old	New
2009-09	SP-45	SP-090547	--	--	Presentation to SA for Information	---	1.0.0
2011-03	SP-51	SP-110114	--	--	Presentation to SA for Approval	1.0.0	2.0.0
2011-03	--	--	--	--	Publication	2.0.0	10.0.0

---

## History

<b>Document history</b>		
V10.0.0	April 2011	Publication