

# ETSI TS 132 422 V10.11.0 (2013-04)



**Digital cellular telecommunications system (Phase 2+);  
Universal Mobile Telecommunications System (UMTS);  
LTE;  
Telecommunication management;  
Subscriber and equipment trace;  
Trace control and configuration management  
(3GPP TS 32.422 version 10.11.0 Release 10)**



---

**Reference**RTS/TSGS-0532422vab0

---

**Keywords**GSM,LTE,UMTS

---

**ETSI**

---

650 Route des Lucioles  
F-06921 Sophia Antipolis Cedex - FRANCE

---

Tel.: +33 4 92 94 42 00 Fax: +33 4 93 65 47 16

Siret N° 348 623 562 00017 - NAF 742 C  
Association à but non lucratif enregistrée à la  
Sous-Préfecture de Grasse (06) N° 7803/88

---

**Important notice**

---

Individual copies of the present document can be downloaded from:

<http://www.etsi.org>

The present document may be made available in more than one electronic version or in print. In any case of existing or perceived difference in contents between such versions, the reference version is the Portable Document Format (PDF). In case of dispute, the reference shall be the printing on ETSI printers of the PDF version kept on a specific network drive within ETSI Secretariat.

Users of the present document should be aware that the document may be subject to revision or change of status. Information on the current status of this and other ETSI documents is available at

<http://portal.etsi.org/tb/status/status.asp>

If you find errors in the present document, please send your comment to one of the following services:

[http://portal.etsi.org/chaicor/ETSI\\_support.asp](http://portal.etsi.org/chaicor/ETSI_support.asp)

---

**Copyright Notification**

---

No part may be reproduced except as authorized by written permission.  
The copyright and the foregoing restriction extend to reproduction in all media.

© European Telecommunications Standards Institute 2013.  
All rights reserved.

**DECT™**, **PLUGTESTS™**, **UMTS™** and the ETSI logo are Trade Marks of ETSI registered for the benefit of its Members.  
**3GPP™** and **LTE™** are Trade Marks of ETSI registered for the benefit of its Members and  
of the 3GPP Organizational Partners.  
**GSM®** and the GSM logo are Trade Marks registered and owned by the GSM Association.

---

## Intellectual Property Rights

IPRs essential or potentially essential to the present document may have been declared to ETSI. The information pertaining to these essential IPRs, if any, is publicly available for **ETSI members and non-members**, and can be found in ETSI SR 000 314: *"Intellectual Property Rights (IPRs); Essential, or potentially Essential, IPRs notified to ETSI in respect of ETSI standards"*, which is available from the ETSI Secretariat. Latest updates are available on the ETSI Web server (<http://ipr.etsi.org>).

Pursuant to the ETSI IPR Policy, no investigation, including IPR searches, has been carried out by ETSI. No guarantee can be given as to the existence of other IPRs not referenced in ETSI SR 000 314 (or the updates on the ETSI Web server) which are, or may be, or may become, essential to the present document.

---

## Foreword

This Technical Specification (TS) has been produced by ETSI 3rd Generation Partnership Project (3GPP).

The present document may refer to technical specifications or reports using their 3GPP identities, UMTS identities or GSM identities. These should be interpreted as being references to the corresponding ETSI deliverables.

The cross reference between GSM, UMTS, 3GPP and ETSI identities can be found under <http://webapp.etsi.org/key/queryform.asp>.

# Contents

Intellectual Property Rights .....	2
Foreword.....	2
Foreword.....	7
Introduction .....	7
1 Scope .....	8
2 References .....	8
3 Definitions and abbreviations.....	10
3.1 Definitions .....	10
3.2 Abbreviations .....	10
4 Trace/UE measurements activation and deactivation.....	10
4.1 Trace/UE measurements session activation / deactivation .....	10
4.1.1 Management activation.....	10
4.1.1.1 General .....	10
4.1.1.2 UTRAN activation mechanisms.....	11
4.1.1.2a UTRAN activation mechanisms for area based MDT data collections without IMSI/IMEI(SV) selection .....	12
4.1.1.3 PS Domain activation mechanisms .....	15
4.1.1.4 CS Domain activation mechanisms.....	15
4.1.1.5 IP Multimedia Subsystem activation mechanisms .....	16
4.1.1.6 E-UTRAN activation mechanisms.....	16
4.1.1.6a E-UTRAN activation mechanisms for area based MDT data collections without IMSI/IMEI(SV) selection .....	16
4.1.1.7 EPC Domain activation mechanisms .....	20
4.1.2 Signalling activation .....	20
4.1.2.1 General .....	20
4.1.2.2 Intra PLMN signalling activation.....	21
4.1.2.3 Inter PLMN Signalling Activation.....	22
4.1.2.4 UTRAN activation mechanisms.....	24
4.1.2.5 PS Domain activation mechanisms .....	24
4.1.2.6 CS Domain activation mechanisms.....	28
4.1.2.7 Void.....	29
4.1.2.8 Tracing roaming subscribers .....	29
4.1.2.9 Service Level Tracing for IMS activation mechanisms .....	29
4.1.2.9.1 General .....	29
4.1.2.9.2 Trace session activation for non-registered UE.....	31
4.1.2.9.3 Trace session activation for a registered UE .....	35
4.1.2.9.4 Trace session activation at the UE.....	36
4.1.2.10 EPC activation mechanism .....	37
4.1.2.10.1 UE attached to EPC via E-UTRAN.....	37
4.1.2.10.2 UE attached to EPC via <i>non-3GPP</i> accesses with DSMIPv6 on S2c or PMIP on S2a/S2b.....	40
4.1.2.10.3 UE attached to EPC via non-3GPP accesses with GTP on S2b interface.....	41
4.1.2.11 E-UTRAN activation mechanisms.....	43
4.1.2.12 EPC and E-UTRAN Activation mechanism for MDT.....	44
4.1.2.12.1 General .....	44
4.1.2.12.2 Activation of MDT task before UE attaches to the network.....	45
4.1.2.12.3 Activation of MDT task after UE attachment.....	47
4.1.2.12.4 Handling of various scenarios during MDT activation.....	48
4.1.2.13 PS domain activation mechanism for MDT .....	48
4.1.2.13.1 General .....	48
4.1.2.13.2 Activation of MDT task before UE attaches to the network.....	48
4.1.2.13.2a Activation of MDT task after UE attaches to the network .....	50
4.1.2.13.3 Handling of various scenarios during MDT activation.....	52
4.1.2.14 CS domain activation mechanism for MDT.....	53

4.1.2.14.1	MDT Error Handling .....	55
4.1.3	Management deactivation .....	56
4.1.3.1	UTRAN deactivation mechanisms .....	56
4.1.3.2	PS Domain deactivation mechanisms .....	56
4.1.3.3	CS Domain deactivation mechanisms .....	56
4.1.3.4	IP Multimedia Subsystem deactivation mechanisms .....	56
4.1.3.5	E-UTRAN deactivation mechanisms .....	57
4.1.3.6	EPC Domain deactivation mechanisms .....	58
4.1.3.7	E-UTRAN deactivation mechanisms for MDT .....	58
4.1.3.8	Deactivation mechanisms at UE for MDT .....	58
4.1.4	Signalling deactivation .....	59
4.1.4.1	General .....	59
4.1.4.2	UTRAN deactivation mechanisms .....	59
4.1.4.3	PS Domain deactivation mechanisms .....	62
4.1.4.4	CS Domain deactivation mechanisms .....	62
4.1.4.5	Void .....	62
4.1.4.6	Service Level Trace in IMS deactivation mechanisms .....	62
4.1.4.6.1	General .....	62
4.1.4.6.2	Trace session deactivation at an IMS NE .....	63
4.1.4.6.2.1	Trace session deactivation propagated by EM .....	63
4.1.4.6.2.2	Trace session deactivation following a Triggering event .....	63
4.1.4.6.2.3	Trace session deactivation initiated directly by an EM .....	63
4.1.4.6.3	Trace session deactivation at the UE .....	63
4.1.4.7	EPC deactivation mechanisms .....	64
4.1.4.8	E-UTRAN deactivation mechanisms .....	67
4.1.4.9	EPC deactivation mechanisms for MDT .....	67
4.1.4.10	Deactivation mechanisms at UE for MDT .....	67
4.1.5	MDT Trace selection conditions .....	67
4.2	Trace recording/UE measurements session Start / Stop triggering .....	68
4.2.1	General .....	68
4.2.2	Starting a trace recording session - management based .....	68
4.2.2.1	UTRAN starting mechanisms .....	68
4.2.2.2	PS Domain starting mechanisms .....	68
4.2.2.3	CS Domain starting mechanisms .....	68
4.2.2.4	IP Multimedia Subsystem starting mechanisms .....	69
4.2.2.5	E-UTRAN starting mechanism .....	69
4.2.2.6	EPC Domain starting mechanisms .....	71
4.2.2.7	E-UTRAN starting mechanisms for MDT .....	71
4.2.2.8	Starting mechanisms at UE for MDT .....	71
4.2.3	Starting a trace recording session - signalling based .....	72
4.2.3.1	UTRAN starting mechanisms .....	72
4.2.3.2	PS Domain starting mechanisms .....	75
4.2.3.3	CS Domain starting mechanisms .....	76
4.2.3.4	Void .....	78
4.2.3.5	Service level tracing for IMS starting mechanism .....	78
4.2.3.5.1	General .....	78
4.2.3.5.2	Starting mechanism at the UE .....	80
4.2.3.5.3	Starting mechanism at the IMS NE .....	81
4.2.3.5.4	Charging concepts for Service Level Tracing for IMS .....	81
4.2.3.6	E-UTRAN starting mechanism .....	81
4.2.3.7	EPC starting mechanisms .....	82
4.2.3.8	EPC starting mechanisms for MDT .....	83
4.2.3.9	E-UTRAN starting mechanisms for MDT .....	83
4.2.3.10	Starting mechanisms at UE for MDT .....	83
4.2.4	Stopping a trace recording session - management based .....	84
4.2.4.1	UTRAN stopping mechanisms .....	84
4.2.4.2	PS Domain stopping mechanisms .....	84
4.2.4.3	CS Domain stopping mechanisms .....	86
4.2.4.4	IP Multimedia Subsystem stopping mechanisms .....	86
4.2.4.5	E-UTRAN stopping mechanisms .....	87
4.2.4.6	EPC Domain stopping mechanisms .....	87
4.2.4.7	E-UTRAN stopping mechanisms for MDT .....	87

4.2.4.8	Stopping mechanisms at UE for MDT .....	87
4.2.5	Stopping a trace recording session - signalling based .....	88
4.2.5.1	UTRAN stopping mechanisms .....	88
4.2.5.2	PS Domain stopping mechanisms .....	88
4.2.5.3	CS Domain stopping mechanisms .....	91
4.2.5.4	Void .....	92
4.2.5.5	Service level tracing for IMS stopping mechanism .....	92
4.2.5.5.1	General .....	92
4.2.5.5.2	Stopping mechanism at the UE .....	93
4.2.5.5.3	Stopping mechanism at the IMS NE .....	93
4.2.5.6	Service level tracing Trace session deletion and trace retrieval .....	93
4.2.5.7	E-UTRAN stopping mechanisms .....	93
4.2.5.8	EPC Domain stopping mechanisms .....	93
4.2.5.9	EPC stopping mechanisms for MDT .....	94
4.2.5.10	E-UTRAN stopping mechanisms for MDT .....	94
4.2.5.11	Stopping mechanisms at UE for MDT .....	94
4.2.6	Void .....	94
4.2.7	Void .....	94
4.2.8	Void .....	94
4.2.9	Void .....	94
4.3	Void .....	94
4.4	Handling of MDT Trace sessions at handover for Immediate MDT .....	94
4.5	Handling of MDT Trace sessions at handover for Logged MDT .....	95
4.6	User consent handling in MDT .....	95
4.6.1	Signalling based MDT .....	95
4.6.2	Area based MDT .....	96
4.7	Anonymization of MDT data for area based MDT .....	98
5	Trace/UE measurement control and configuration parameters .....	99
5.1	Triggering events (M) .....	99
5.2	Service Level Tracing Start Triggering event (M) .....	103
5.3	Trace Depth (M) .....	104
5.4	List of NE types (M) .....	104
5.5	List of interfaces (O) .....	106
5.6	Trace Reference (M) .....	108
5.7	Trace Recording Session Reference (M) .....	108
5.8	Void .....	108
5.9	IP Address of Trace Collection Entity (CM, CO) .....	108
5.10	MDT specific configuration parameters (CM) .....	108
5.10.1	Job type .....	108
5.10.2	Area Scope .....	109
5.10.3	List of measurements .....	109
5.10.4	Reporting Trigger .....	110
5.10.5	Report Interval .....	110
5.10.6	Report Amount .....	111
5.10.7	Event Threshold for RSRP .....	111
5.10.7a	Event Threshold for RSRQ .....	111
5.10.8	Logging Interval .....	112
5.10.9	Logging Duration .....	112
5.10.10	Void .....	112
5.10.11	Trace Collection Entity Id .....	112
5.10.12	Anonymization of MDT data .....	112
5.10.13	Event Threshold for Event 1F .....	113
5.10.14	Event threshold for Event 1I .....	113
5.10.15	Measurement quantity .....	113
6	MDT Reporting .....	114
<b>Annex A (normative):</b>	<b>Trace failure notification file format .....</b>	<b>118</b>
A.1	Global structure .....	118
A.2	XML elements fileHeader and fileFooter .....	118

A.2.1	XML elements fileHeader .....	118
A.2.2	XML element fileFooter.....	118
A.3	Trace failure notification specific XML elements.....	118
A.4	Trace IRP XML File Name Conventions.....	118
A.5	Trace failure notification file XML schema.....	118
<b>Annex B (informative):</b>	<b>Change history .....</b>	<b>120</b>
History .....		123

---

## Foreword

This Technical Specification has been produced by the 3<sup>rd</sup> Generation Partnership Project (3GPP).

The contents of the present document are subject to continuing work within the TSG and may change following formal TSG approval. Should the TSG modify the contents of the present document, it will be re-released by the TSG with an identifying change of release date and an increase in version number as follows:

Version x.y.z

where:

- x the first digit:
  - 1 presented to TSG for information;
  - 2 presented to TSG for approval;
  - 3 or greater indicates TSG approved document under change control.
- y the second digit is incremented for all changes of substance, i.e. technical enhancements, corrections, updates, etc.
- z the third digit is incremented when editorial only changes have been incorporated in the document.

---

## Introduction

The present document is part of a TS-family covering the 3rd Generation Partnership Project; Technical Specification Group Services and System Aspects; Telecommunication management, as identified below:

- TS 32.421: "Subscriber and equipment trace: Trace concepts and requirements";
- TS 32.422: "Subscriber and equipment trace: Trace control and configuration management";**
- TS 32.423: "Subscriber and equipment trace: Trace data definition and management";

Additionally, there is a GSM only Subscriber and Equipment Trace specification: 3GPP TS 52.008 [5].

Subscriber and Equipment Trace provide very detailed information at call level on one or more specific mobile(s). This data is an additional source of information to Performance Measurements and allows going further in monitoring and optimisation operations.

Contrary to Performance Measurements, which are a permanent source of information, Trace is activated on user demand for a limited period of time for specific analysis purposes.

Trace plays a major role in activities such as determination of the root cause of a malfunctioning mobile, advanced troubleshooting, optimisation of resource usage and quality, RF coverage control and capacity improvement, dropped call analysis, Core Network, UTRAN, EPC and E-UTRAN UMTS procedure validation.

The capability to log data on any interface at call level for a specific user (e.g. IMSI) or mobile type (e.g. IMEI or IMEISV), or service initiated from a UE allows getting information which cannot be deduced from Performance Measurements such as perception of end-user QoS during his call (e.g. requested QoS vs. provided QoS), correlation between protocol messages and RF measurements, or interoperability with specific mobile vendors.

Moreover, Performance Measurements provide values aggregated on an observation period, Subscriber and Equipment Trace give instantaneous values for a specific event (e.g., call, location update, etc.).

If Performance Measurements are mandatory for daily operations, future network planning and primary trouble shooting, Subscriber and Equipment Trace is the easy way to go deeper into investigation and network optimisation.

In order to produce this data, Subscriber and Equipment Trace are carried out in the NEs, which comprise the network. The data can then be transferred to an external system (e.g. an Operations System (OS) in TMN terminology, for further evaluation).



---

# 1 Scope

The present document describes the mechanisms used for the control and configuration of the Trace functionality at the EMs, NEs and UEs. It covers the triggering events for starting/stopping of subscriber/UE activity traced over 3GPP standardized signalling interfaces, the types of trace mechanisms, configuration of a trace, level of detail available in the trace data, the generation of Trace results in the Network Elements (NEs) and User Equipment (UE) and the transfer of these results to one or more EM(s) and/or Network Manager(s) (NM(s)).

The mechanisms for Trace activation/deactivation are detailed in clause 4; clause 5 details the various Trace control and configuration parameters and the triggering events that can be set in a network. Trace concepts and requirements are covered in 3GPP TS 32.421 [2] while Trace data definition and management is covered in 3GPP TS 32.423 [3].

**Editor's note: The tracing capabilities in the UE in Service Level Trace are FFS.**

---

# 2 References

The following documents contain provisions, which, through reference in this text, constitute provisions of the present document.

- References are either specific (identified by date of publication, edition number, version number, etc.) or non-specific.
- For a specific reference, subsequent revisions do not apply.
- For a non-specific reference, the latest version applies. In the case of a reference to a 3GPP document (including a GSM document), a non-specific reference implicitly refers to the latest version of that document *in the same Release as the present document*.

NOTE: Overall management principles are defined in 3GPP TS 32.101 [1].

- [1] 3GPP TS 32.101: "Telecommunication management; Principles and high level requirements".
- [2] 3GPP TS 32.421: "Telecommunication management; Subscriber and equipment trace: Trace concepts and requirements".
- [3] 3GPP TS 32.423: "Telecommunication management; Subscriber and equipment trace: Trace data definition and management".
- [4] 3GPP TR 21.905: "Vocabulary for 3GPP Specifications".
- [5] 3GPP TS 52.008: "Telecommunication management; GSM subscriber and equipment trace".
- [6] 3GPP TS 23.060: "General Packet Radio Service (GPRS) Service description; Stage 2".
- [7] 3GPP TS 23.205: "Bearer-independent circuit-switched core network; Stage 2".
- [8] 3GPP TS 23.108: "Mobile radio interface layer 3 specification core network protocols; Stage 2 (structured procedures)".
- [9] 3GPP TS 23.246: "Multimedia Broadcast/Multicast Service (MBMS); Architecture and functional description".
- [10] 3GPP TS 29.232: "Media Gateway Controller (MGC) - Media Gateway (MGW); interface; Stage 3".
- [11] 3GPP TS 29.002: "Mobile Application Part (MAP) specification".
- [12] 3GPP TS 29.060: "General Packet Radio Service (GPRS); GPRS Tunnelling Protocol (GTP) across the Gn and Gp interface".
- [13] 3GPP TS 25.413 : "UTRAN Iu interface RANAP signalling".

- [14] 3GPP TS 23.218: "IP Multimedia (IM) session handling; IM call model; Stage 2".
- [15] 3GPP TS 23.228: "IP Multimedia Subsystem (IMS); Stage 2".
- [16] 3GPP TS 29.228: "IP Multimedia (IM) Subsystem Cx and Dx Interfaces; Signalling flows and message contents".
- [17] 3GPP TS 29.328: "IP Multimedia Subsystem (IMS) Sh interface; Signalling flows and message contents".
- [18] Enabler Release Definition for OMA Device Management Specifications, version 1.2, The Open Mobile Alliance™ ([URL:http://www.openmobilealliance.org/](http://www.openmobilealliance.org/)).
- [19] 3GPP TS 32.240: "Telecommunication management; Charging management; Charging architecture and principles".
- [20] 3GPP TS 32.260: "Telecommunication management; Charging management; IP Multimedia Subsystem (IMS) charging".
- [21] 3GPP TS 23.401: "General Packet Radio Service (GPRS) enhancements for Evolved Universal Terrestrial Radio Access Network (E-UTRAN) access".
- [22] 3GPP TS 23.402: "Architecture enhancements for non-3GPP accesses".
- [23] 3GPP TS 36.401: "Evolved Universal Terrestrial Radio Access Network (E-UTRAN); Architecture description".
- [24] 3GPP TS 32.442: "Telecommunication management; Trace management; Integration Reference Point (IRP) Information Service (IS)".
- [25] 3GPP TS 29.273: "Evolved Packet System (EPS);3GPP EPS AAA interfaces".
- [26] 3GPP TS 29.272: "Evolved Packet System (EPS); Mobility Management Entity (MME) and Serving GPRS Support Node (SGSN) related interfaces based on Diameter protocol".
- [27] 3GPP TS 32.615: "Telecommunication management; Configuration Management (CM); Bulk CM Integration Reference Point (IRP): eXtensible Markup Language (XML) definitions".
- [28] 3GPP TS 32.342: "Telecommunication management; File Transfer (FT) Integration Reference Point (IRP): Information Service (IS)".
- [29] 3GPP TS 29.212: " Policy and Charging Control over Gx reference point".
- [30] 3GPP TS 37.320: 'Universal Terrestrial Radio Access (UTRA) and Evolved Universal Terrestrial Radio Access (E-UTRA); Radio measurement collection for Minimization of Drive Tests (MDT);Overall description; Stage 2'
- [31] 3GPP TS 25.331: "Radio Resource Control (RRC); Protocol specification"
- [32] 3GPP TS 36.331: "Evolved Universal Terrestrial Radio Access (E-UTRA); Radio Resource Control (RRC); Protocol specification".
- [33] 3GPP TS 24.301: "Non-Access-Stratum (NAS) protocol for Evolved Packet System (EPS); Stage 3".
- [34] 3GPP TS 29.274: "3GPP Evolved Packet System (EPS); Evolved General Packet Radio Service (GPRS) Tunnelling Protocol for Control plane (GTPv2-C); Stage 3".
- [35] 3GPP TS 36.413 : " Evolved Universal Terrestrial Radio Access Network(E-UTRAN);S1 Application Protocol".

---

## 3 Definitions and abbreviations

### 3.1 Definitions

For the purposes of the present document, the following terms and definitions apply:

**Area based MDT:** MDT data is collected from UEs in a specified area. The area is defined as a list of cells (UTRAN or E-UTRAN) or as a list of tracking/routing/location areas. The area based MDT is an enhancement of the management based trace functionality. Area based MDT can be either a logged MDT or Immediate MDT.

**Immediate MDT:** Collection of UE measurements in connected mode.

**Logged MDT:** Collection of UE measurements in idle mode.

**Signalling based MDT:** MDT data is collected from one specific UE. The UE that is participating in the MDT data collection is specified as IMEI(SV) or as IMSI. The signalling based MDT is an enhancement of the signalling based subscriber and equipment trace. A signalling based MDT can be either a logged MDT or Immediate MDT.

### 3.2 Abbreviations

For the purposes of the present document, the abbreviations given in 3GPP TR 21.905 [4], 3GPP TS 32.101 [1] and the following apply:

AS	Application Server
BGCF	Breakout Gateway Control Function
CSCF	Call Session Control Function
I-CSCF	Interrogating-CSCF
IM CN SS	IP Multimedia Core Network Subsystem
IMEI-TAC	IMEI Type Allocation Code
MRFC	Multimedia Resource Function Controller
P-CSCF	Proxy - CSCF
S-CSCF	Serving-CSCF
TAU	Tracking Area Update

---

## 4 Trace/UE measurements activation and deactivation

### 4.1 Trace/UE measurements session activation / deactivation

#### 4.1.1 Management activation

##### 4.1.1.1 General

In Management activation, the Trace Control and Configuration parameters are sent directly to the concerned NE (by its EM). This NE shall not propagate the received data to any other NE's - whether or not it is involved in the actual recording of the call.

Once the parameters have been provided, the NE looks for the IMSI or IMEI (IMEISV) passing through it. If it does not have them, these shall be provided to the NE (that performs the trace recording) as part of traffic signalling by the CN.

The following figure represents the management based trace functionality within a PLMN. The figure represents a typical PLMN network. A dotted arrow with "Trace Parameter Configuration" represents the availability of the management based trace functionality at the EM for that domain.

NOTE: There is no propagation of trace parameters in management based trace activation.

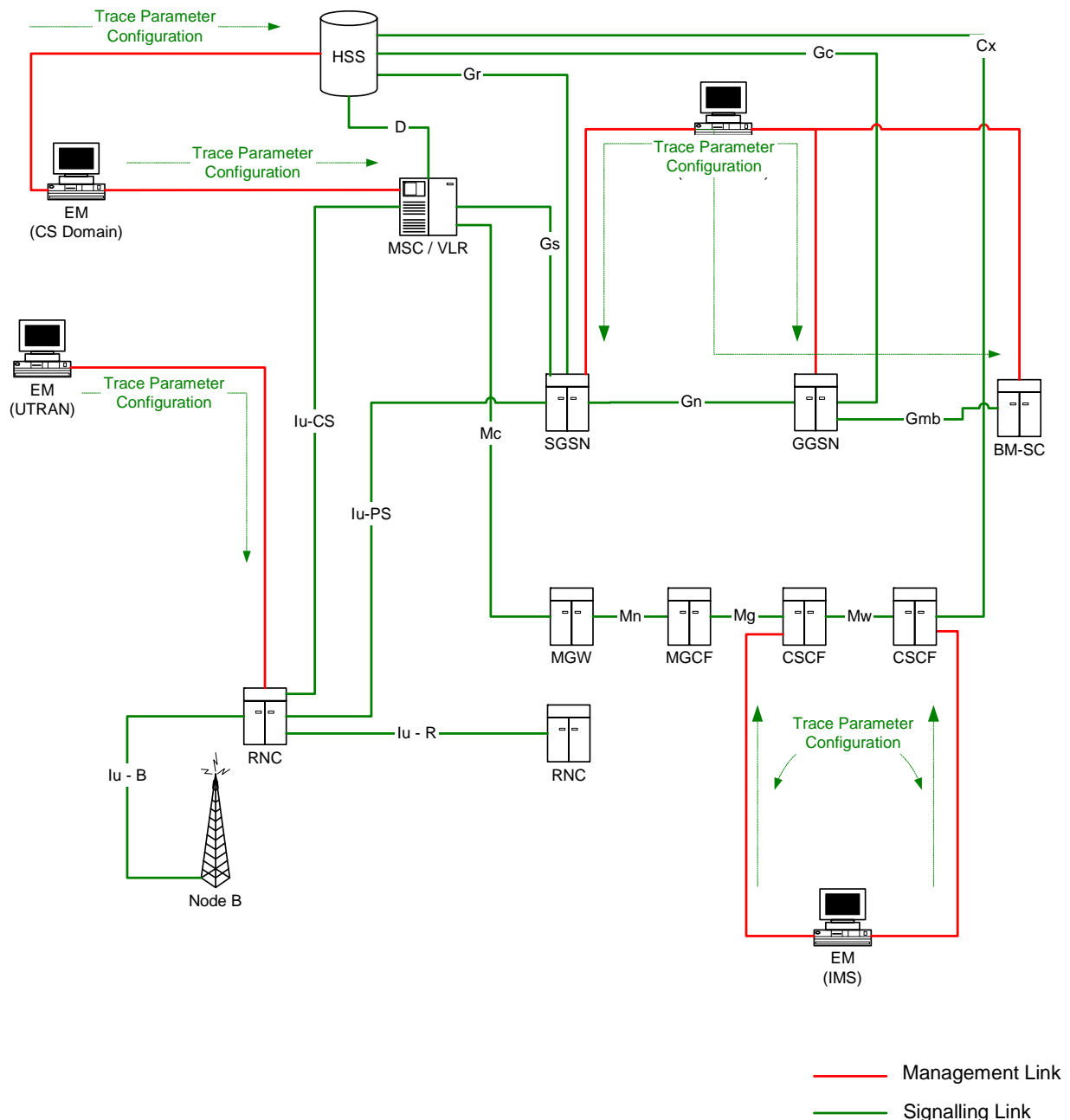

**Figure 4.1.1.1.1: Overview of management activation for an UMTS system**

If the NE failed to activate the Trace Session, a Trace failure notification shall be sent to the TCE, and the Trace failure notification has the the same parameters as the notification `notifyTraceRecordingSessionFailure` defined in 3GPP TS 32.442[24], the Trace failure notification file XML schema is defined in Annex A.

#### 4.1.1.2 UTRAN activation mechanisms

When an RNC receives Trace Session activation from the EM it shall start a Trace Session. The trace control and configuration parameters of the Trace Session are received in Trace Session activation from the EM. The RNC shall not forward these trace control and configuration parameters to other nodes. The received trace control and configuration parameters shall be saved and used to determine when and how to start a Trace Recording Session. (Starting a Trace Recording Session is described in subclause 4.2.2.1). A Trace Session may be requested for a limited geographical area.

Since a RNC has visibility of an IMSI, it can start an IMSI Trace all by itself when a Trace session is requested for an IMSI or a list of IMSI's. However, a RNC does not have visibility of the IMEI(SV). Hence, when a Trace session is requested for an IMEI(SV) or a list of IMEI(SV), the RNC shall send the requested IMEI(SV) / list of IMEI(SV)s in an 'Uplink Information Exchange Request' message to the interacting MSC Server(s) and SGSN(s). The MSC Servers and

SGSNs shall store the requested IMEI(SV)s per RNC. For each subscriber/UE activity the MSC Servers and SGSNs shall request IMEI(SV), if it is not already provided. For each subscriber/UE activity the MSC server/SGSN shall check whether a trace request is active in an RNC for the IMEI(SV). If a match is found, the MSC Server/SGSN shall inform the RNC about the IMEI(SV) in CN Invoke Trace, so that the RNC can trace the control signalling according to the trace control and configuration parameters that are received from its EM.

If an Inter-MSC SRNS Relocation or an Inter-SGSN SRNS relocation occurs, the anchor MSC Server or source SGSN shall transfer the IMSI and IMEI(SV) for the subscriber/UE activity to the non anchor MSC Server or target SGSN. The non anchor MSC Server/target SGSN shall check whether it has received a trace request from the target RNC for the transferred IMEI(SV). If a match is found on the IMEI(SV) in the non anchor MSC Server/target SGSN, the MSC Server/SGSN shall inform the RNC about the IMEI(SV) in the CN Invoke Trace. The IMSI shall be transferred from the non anchor MSC Server/target SGSN to the target RNC in Relocation Request. The RNC can then trace the subscriber/UE activity according to the trace control and configuration parameters that are received from its EM.

#### 4.1.1.2a UTRAN activation mechanisms for area based MDT data collections without IMSI/IMEI(SV) selection

In case of area based MDT data collection, the UE selection should be done in the radio network at RNC based on the input information received from OAM, like device capability information and area scope. In this case there is no IMSI, IMEI(SV) selection.

The following figure shows an example scenario how the MDT configuration is done utilising the cell traffic trace functionality:

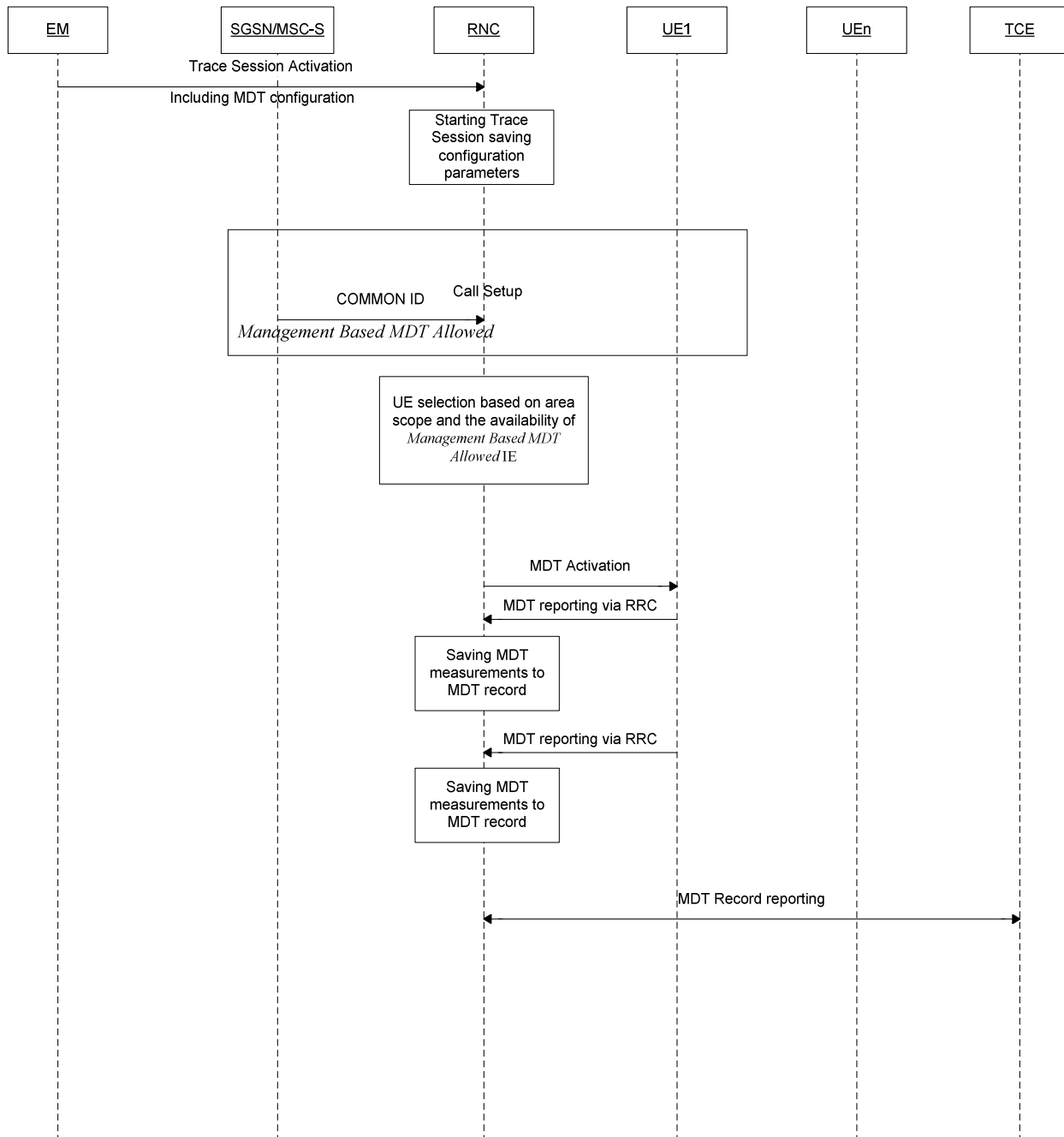

Figure 4.1.1.2a.1 Example for area based MDT activation in UTRAN

1. The EM sends a Trace Session activation request to the RNC. This request includes the parameters for configuring MDT data collection:
  - The area where the MDT data should be collected: list of UTRAN cells. Routing Area or Location Area should be converted to UTRAN cells.
  - Job type
  - List of measurements

- Reporting Trigger (only in case of Immediate MDT)
  - Report Interval (only in case of Immediate MDT)
  - Report Amount (only in case of Immediate MDT)
  - Event Threshold (Only in case of Immediate MDT)
  - Logging Interval (Only in case of Logged MDT)
  - Logging Duration (Only in case of Logged MDT)
  - Trace Reference
  - IP address of TCE
  - Anonymization of MDT data.
  - Measurement quantity parameter (only in case of Immediate MDT)
2. When RNC receives the Trace Session activation request from its EM, it shall start a Trace Session and should save the parameters associated to the Trace Session.
  3. Void.
  4. RNC shall select the suitable UEs for MDT data collection. The selection is based on the area received from the EM and the area where UE is roaming, user consent information received from the core network (As described in section in 4.6. of this document). If the user is not in the specified area or if the *Management Based MDT Allowed* IE is not received from the Core Network (which indicates lacking user consent) the UE shall not be selected by the RNC for MDT data collection. During UE selection, the RNC shall take into account also the UE capability (MDT capability) when it selects UE for logged MDT configuration. If the UE does not support logged MDT the UE shall not be selected.
  5. RNC shall activate the MDT functionality to the selected UEs. As part of this operation the RNC shall allocate a Trace Recording Session Reference and send at least the following configuration information to the UE in case of Logged MDT:
    - Trace Reference
    - Trace Recording Session Reference
    - TCE Id (The value signalled as IP address of TCE from the EM is mapped to a TCE Id, using a configured mapping in the RNC)
    - Logging Interval
    - Logging duration
    - Absolute time reference
    - The area where the MDT data should be collected: list of UTRAN cells/RA/LA.

In case of Immediate MDT only the measurements and their parameters needs to be sent to the UE:

- List of measurements
  - Reporting trigger
  - Report Interval
  - Report Amount
  - Event threshold (only if event based reporting is configured in reporting trigger)
6. When UE receives the MDT activation it shall start the MDT functionality based on the received configuration parameters. The MDT related measurements are reported to the RNC via RRC signalling. In case of Logged

MDT the MDT reporting is done when the network requests the log. The MDT log is requested if UE's rPLMN matches the PLMN where TCE used to collect MDT data resides (e.g. RNC's primary PLMN) by sending the UEInformationRequest message. The MDT log is sent by the UE in the UEInformationResponse message.

The UE should report the Trace Reference, Trace Recording Session Reference and TCE Id together with the MDT reports to the network in case of Logged MDT.

7. When RNC receives the MDT report from the UE the RNC shall compare the Trace PLMN (PLMN portion of Trace Reference) with the PLMN where TCE used to collect MDT data resides (e.g. its primary PLMN). In case of a match, for immediate MDT, it shall capture it and put the UE's serving cell CGI together with the MDT report from the UE to the trace record. In case of a match, for logged MDT, the RNC shall capture it and put it to the trace record. Otherwise it shall discard the MDT report.

NOTE: For area based Immediate MDT, TRSR may be duplicated among different RNCs when multiple cells are selected as the area scope for the same MDT job. In this case, the combination of TRSR and the UE's serving cell CGI in the MDT report can uniquely identify one trace recording session.

8. The Trace Records shall be forwarded to the Trace Collection Entity indicated in the MDT report received from the UE in case of Logged MDT. The RNC translates the TCE Id received from the UE to the TCE IP address before it forwards the measurement records to the TCE. (The address translation is done by using configured mapping in the RNC.) The RNC shall not provide the IMSI in the MDT.

The Immediate MDT measurement configuration is deleted in the UE together with the RRC context when entering idle mode.

The Logged MDT trace session is preserved in the UE until the duration time of the trace session expires, including also multiple idle periods interrupted by idle-connected-idle state transitions.

The Logged MDT trace session context of the UE is stored in the network as long as the trace session is active, including also the periods when the UE is in connected state.

EM shall validate that the MCC and MNC in the Trace reference is the same as the PLMN supported by all the RNCs specified in the area scope. If the RNC receives a request with a PLMN in the TraceReference that does not match any PLMN in its list, it shall ignore the request.

#### 4.1.1.3 PS Domain activation mechanisms

When a SGSN, GGSN or BM-SC receives Trace Session activation from the EM it shall start a Trace Session. The trace control and configuration parameters of the Trace Session are received in the Trace Session activation from the EM. The SGSN/GGSN/BM-SC shall not forward these trace control and configuration parameters to other nodes. The received trace control and configuration parameters shall be saved and used to determine when and how to start a Trace Recording Session. (Starting a Trace Recording Session is described in subclause 4.2.2.2)

#### 4.1.1.4 CS Domain activation mechanisms

When a MSC Server receives Trace Session activation from the EM it shall start a Trace Session. The trace control and configuration parameters of the Trace Session are received in the Trace Session activation from the EM. The MSC Server shall not forward these trace control and configuration parameters to other nodes. The received trace control and configuration parameters shall be saved and used to determine when and how to start a Trace Recording Session. (Starting a Trace Recording Session is described in subclause 4.2.2.3)



#### 4.1.1.5 IP Multimedia Subsystem activation mechanisms

When a S-CSCF/P-CSCF receives Trace Session activation from EM, the S-CSCF/P-CSCF shall start a Trace Session. The Trace control and configuration parameters of the Trace Session, received from EM in the Trace Session activation, shall be saved. The Trace control and configuration parameters define when the S-CSCF and P-CSCF shall start and stop a Trace Recording Session. For detailed information on starting and stopping Trace Recording Session in IMS see sub clauses 4.2.2.4 and 4.2.4.4.

The following figure illustrates the Trace Session activation in S-CSCF and in P-CSCF in case of Management based activation.

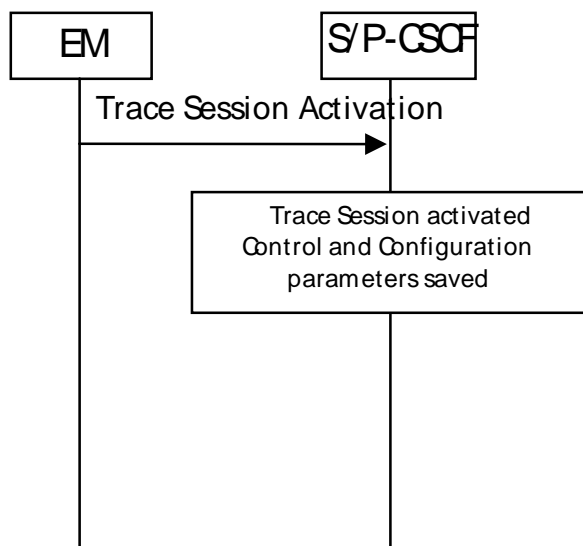

**Figure 4.1.1.5.1: Trace Session activation in IMS**

#### 4.1.1.6 E-UTRAN activation mechanisms

In E-UTRAN the Management Based Trace Activation can be fulfilled with the E-UTRAN Cell Traffic trace functionality. In this case the Trace Session Activation is done to one or a list E-UTRAN cells within one eNodeB, where Trace Session is activated.

The following trace control and configuration parameters of the Trace Session are received by eNodeB in the Trace Session activation message from the EM:

- Trace Reference
- Trace Depth
- E-UTRAN cells list
- List of interfaces for eNB
- IP address of Trace Collection Entity

When eNodeB receives the Trace Session Activation message from the EM for a given or a list of E-UTRAN cell(s) the eNodeB shall start a Trace Session for the given or list of E-UTRAN cell(s).

##### 4.1.1.6a E-UTRAN activation mechanisms for area based MDT data collections without IMSI/IMEI(SV) selection

For area based MDT data collection with no IMSI/IMEI(SV) criteria, the UE selection can be done in the radio network at eNB based on the input information received from EM and the user consent information stored in the eNB. This mechanism works for the following OAM input parameters:

- Area information only

The following figure summarizes the flow how the MDT configuration is done utilising the cell traffic trace functionality for this scenario:

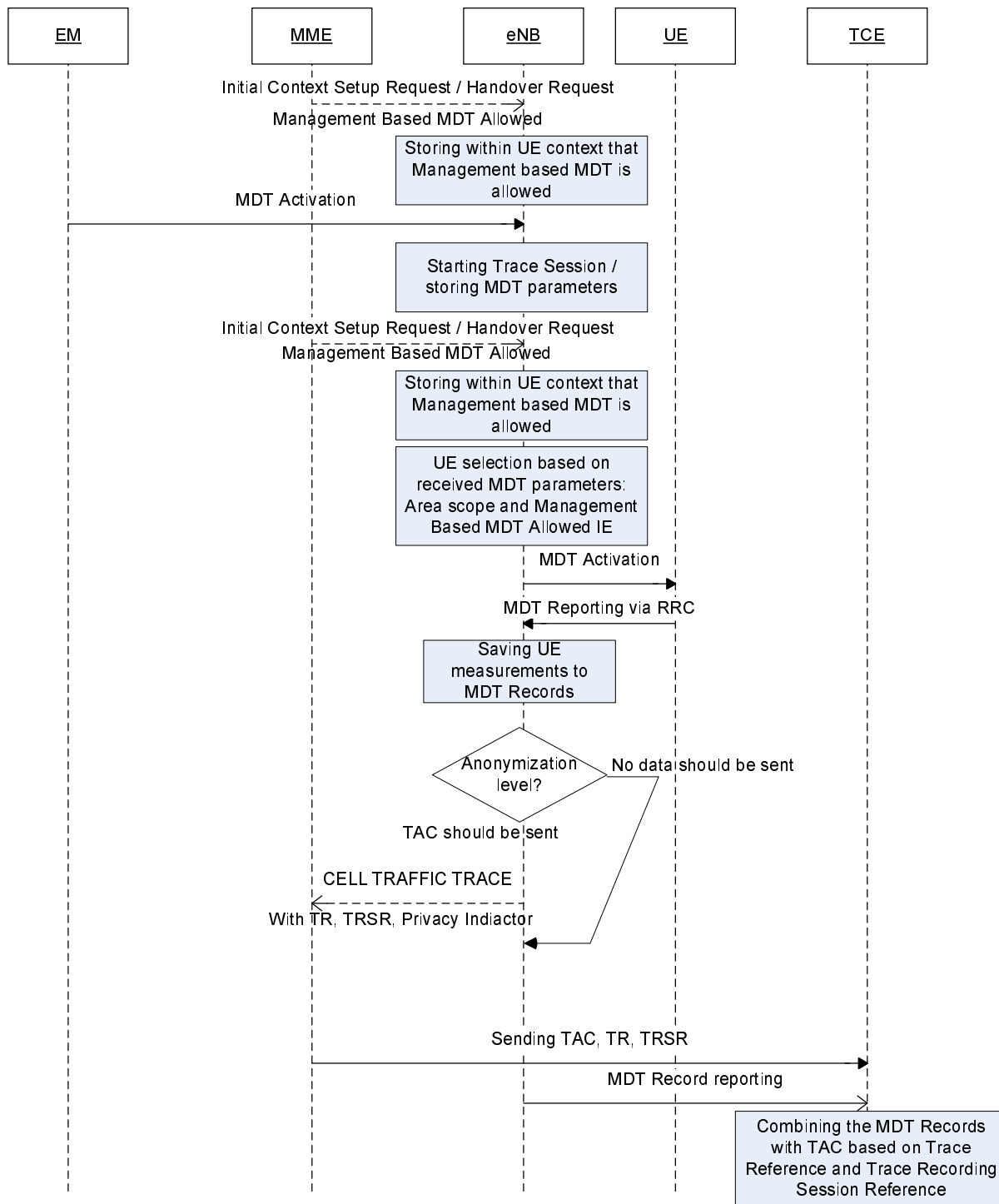

Figure 4.1.1.6a.1 Example for area based logged MDT activation in E-UTRAN

0. Whenever the eNB receives the Management based MDT allowed IE in Initial Context Setup Request or in Handover Request message, it shall save it for possible later usage.
1. The EM sends a Trace Session activation request to the eNB. This request includes the parameters for configuring UE measurements:
  - Job type

- Area scope where the UE measurements should be collected: list of E-UTRAN cells. Tracking Area should be converted to E-UTRAN cell.
- List of measurements
- Reporting Trigger
- Report Interval
- Report Amount
- Event Threshold
- Logging Interval
- Logging Duration
- Trace Reference
- IP address of TCE
- Anonymization of MDT data.

Note that at the same time not all the parameters can be present. The criteria for which parameters are present are described in clause 5 of this document.

2. When eNB receives the Trace Session activation request from its EM, it shall start a Trace Session and should save the parameters associated to the Trace Session.
3. eNB shall select the suitable UEs for MDT data collection. The selection is based on the area received from the EM and the area where UE is located, user consent information received from the core network as part of the Management Based MDT Allowed IE (As described in section 4. 6 of this document). If the user is not in the specified area or if the Management Based MDT Allowed IE is not present in the UE context, the UE shall not be selected by the eNB for MDT data collection. During UE selection, the eNB shall take into account also the UE capability (MDT capability) when it selects UE for logged MDT configuration. If the UE does not support logged MDT the UE shall not be selected.
4. eNB shall activate the MDT functionality to the selected UEs. When eNB selects a UE it shall take into account the availability of Management Based MDT Allowed IE in the user context and the area scope parameter received in MDT configuration (Trace Session activation). Detailed description about user consent handling and how it is provided to the eNB is described in section 4. 6.2. If there is noManagement Based MDT Allowed IE in the user context or the user is outside the area scope defined in the MDT configuration, the UE shall not be selected for MDT data collection. The eNB shall assign Trace Recording Session Reference corresponding to the selected UE. The eNB shall send at least the following configuration information to the UE in case of Logged MDT:
  - Trace Reference
  - Trace Recording Session Reference
  - TCE Id (The value signalled as IP address of TCE from the EM is mapped to a TCE Id, using a configured mapping in the eNB)
  - Logging Interval
  - Logging Duration
  - Absolute time reference
  - Area scope where the UE measurements should be collected: list of E-UTRAN cells/TA.

NOTE: For UEs currently being in idle mode and camping in the cell the logged MDT configuration cannot be sent. These UEs may be configured when they initiate some activity (e.g., Service Request or Tracking Area Update) at next time.

In case of Immediate MDT the following parameters shall be sent to the UE:

- List of measurements
- Reporting trigger
- Report Interval
- Report Amount
- Event Threshold

Note that at the same time not all the parameters can be present. Conditions of the parameters are described in clause 5 of this document.

5. When UE receives the MDT activation it shall start the MDT functionality based on the received configuration parameters.
6. The eNodeB shall not retrieve MDT report from the UE if UE's rPLMN does not match the PLMN where TCE used to collect MDT data resides (e.g. eNodeB's primary PLMN). When the eNodeB receives the MDT report from UE, the eNodeB shall get the Trace Recording Session Reference, Trace Reference and TCE Id from the report, and compare the Trace PLMN (PLMN portion of Trace Reference) with the PLMN where TCE used to collect MDT data resides (e.g. its primary PLMN) and discard MDT report in case of a mismatch. Otherwise if the MDT anonymization requires the IMEI-TAC in the MDT record, eNodeB shall send the Trace Recording Session Reference, Trace Reference, serving cell CGI, TCE IP address and the Privacy Indicator (that shall be set to *Logged MDT* or *Immediate MDT* depending on the configured job type) in the CELL TRAFFIC TRACE message to the MME via the S1 connection. When MME receives this S1 signalling message containing the Trace Recording Session Reference, Trace Reference and serving cell CGI, if so indicated in the privacy indicator, the MME shall look up the subscriber identities (IMEI (SV)) of the given call from its database, and send the IMEI-TAC together with the Trace Recording Session Reference and Trace Reference and for immediate MDT also the serving cell CGI to the TCE, as described in section 4.7 of the present document. For logged MDT, MME will send the IMEI-TAC together with the Trace Recording Session Reference, Trace Reference to the TCE.

NOTE: For area based Immediate MDT, TRSR may be duplicated among different eNodeBs when multiple cells are selected as the area scope for the same MDT job. In this case, the combination of TRSR and the UE's serving cell CGI in the MDT report can uniquely identify one trace recording session.

7. For Immediate MDT when the eNB receives the MDT report from the UE in the RRC message the eNB shall capture it and put the UE's serving cell CGI together with the MDT report from the UE to the trace record. A UE configured to perform Logged MDT measurements in IDLE indicates the availability of MDT measurements, by means of a one bit indicator, in *RRCConnectionSetupComplete* message during connection establishment as specified in [2]. The eNB can decide to retrieve the logged measurements based on this indication by sending the UEInformationRequest message to the UE. The UE can answer with the collected MDT logs in UEInformationResponse message.
8. The eNB shall forward the Trace Records to the Trace Collection Entity (TCE). In case of logged MDT, the TCE Id is indicated in the MDT report is translated to the actual IP address of the TCE by the eNB before it forwards the measurement records. (The address translation is using configured mapping in the eNB.) In case of immediate MDT, the IP address of the TCE is indicated for the eNB in the trace configuration.

The Immediate MDT measurement configuration is deleted in the UE together with the RRC context when entering idle mode.

The Logged MDT trace session is preserved in the UE until the duration time of the trace session expires, including also multiple idle periods interrupted by idle-connected-idle state transitions.

The Logged MDT trace session context of the UE is stored in the network as long as the trace session is active, including also the periods when the UE is in connected state.

EM shall validate that the MCC and MNC specified in the Trace reference is the same as the PLMN supported by all the cells specified in the area scope. If the eNodeB receives a request with a PLMN in the TraceReference that does not match any PLMN in its list, it shall ignore the request

#### 4.1.1.7 EPC Domain activation mechanisms

When a MME, SGW or PGW receives Trace Session activation from the EM, it shall start a Trace Session. The following trace control and configuration parameters of the Trace Session are received in the Trace Session activation from the EM:

- IMSI or IMEISV
- Trace Reference
- Triggering events for this network element
- Trace Depth
- List of Interfaces for this network element
- IP address of Trace Collection Entity

The MME, SGW or PGW shall not forward these trace control and configuration parameters to other nodes. The received trace control and configuration parameters shall be saved and used to determine when and how to start a Trace Recording Session. (Starting a Trace Recording Session is described in subclause 4.2.2.6)

### 4.1.2 Signalling activation

#### 4.1.2.1 General

In Signalling activation, the Trace Activation shall be carried out from the Core Network EM only [EM (PS), EM (CS), EM (HSS), EM (UE) and EM(EPC) are generally considered to be in the Core Network. A Core Network EM can be any of these or their combinations].

In case of home subscriber trace (i.e. in the HPLMN) the Trace Session activation shall go to the HSS / MSC Server / SGSN / MME. Instances where the home subscriber is roaming in a VPLMN, the HSS may initiate a trace in that VPLMN. The VPLMN may reject such requests.

In case of foreign subscriber trace (i.e. the HPLMN operator wishes to trace foreign subscribers roaming in his PLMN) the Trace Session activation shall go to the MSC Server/VLR, SGSN / MME. Depending on the Trace Control and Configuration parameters received, the Core Network shall propagate the activation to selected NE's in the entire network – RAN and Core Network.

If the NE failed to activate the Trace Session, a Trace failure notification shall be sent to the TCE, and the Trace failure notification has the the same parameters as the notification `notifyTraceRecordingSessionFailure` defined in 3GPP TS 32.442 [24], the Trace failure notification file XML schema is defined in Annex A.

### 4.1.2.2 Intra PLMN signalling activation

The following figure represents the signalling based trace functionality within a PLMN. The figure represents a typical PLMN network. A dotted arrow with "Trace Parameter Configuration" represents the availability of the trace functionality at the EM for that domain. E.g. you cannot invoke a Signalling Trace at the EM (UTRAN) because there is no such arrow shown in the figure. You can however do it from the EM (CS Domain). Similarly "Trace Parameter Propagation" is allowed only for the interfaces indicated in the figure. E.g. there is no parameter propagation over Iu-B.

NOTE: For tracing on the basis of IMEI(SV), the signalling based activation can be only initiated from the MSC/VLR or SGSN.

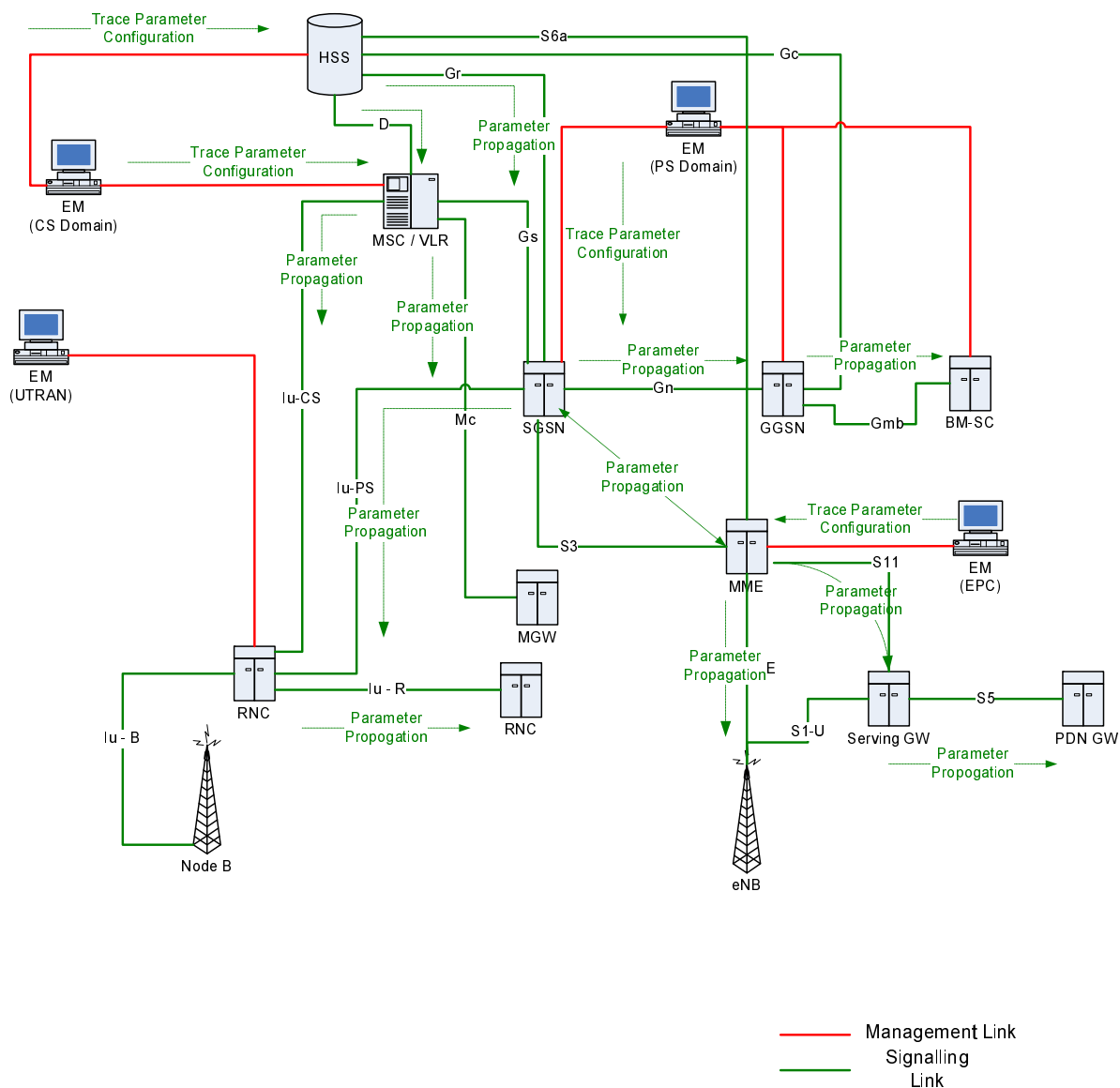

Figure 4.1.2.2.1: Overview of Intra-PLMN Signalling Activation

### 4.1.2.3 Inter PLMN Signalling Activation

The following figure represents the signalling based trace functionality between PLMNs. This is particularly useful when a roaming subscriber needs to be traced in a network. The figure represents a typical PLMN network and its connections with another PLMN's HSS. A dotted arrow with "Trace Parameter Configuration" represents the availability of the trace functionality at the EM for that domain. E.g. you cannot invoke a Signalling Trace at the EM (UTRAN) because there is no such arrow shown in the figure. You can however do it from the EM (CS Domain). Similarly "Trace Parameter Propagation" is allowed only for the interfaces indicated in the figure. E.g. there is no parameter propagation over Iu-B.

NOTE: There is no intention to allow tracing of a home subscriber roaming in a foreign network i.e. the trace function is limited to a single PLMN.

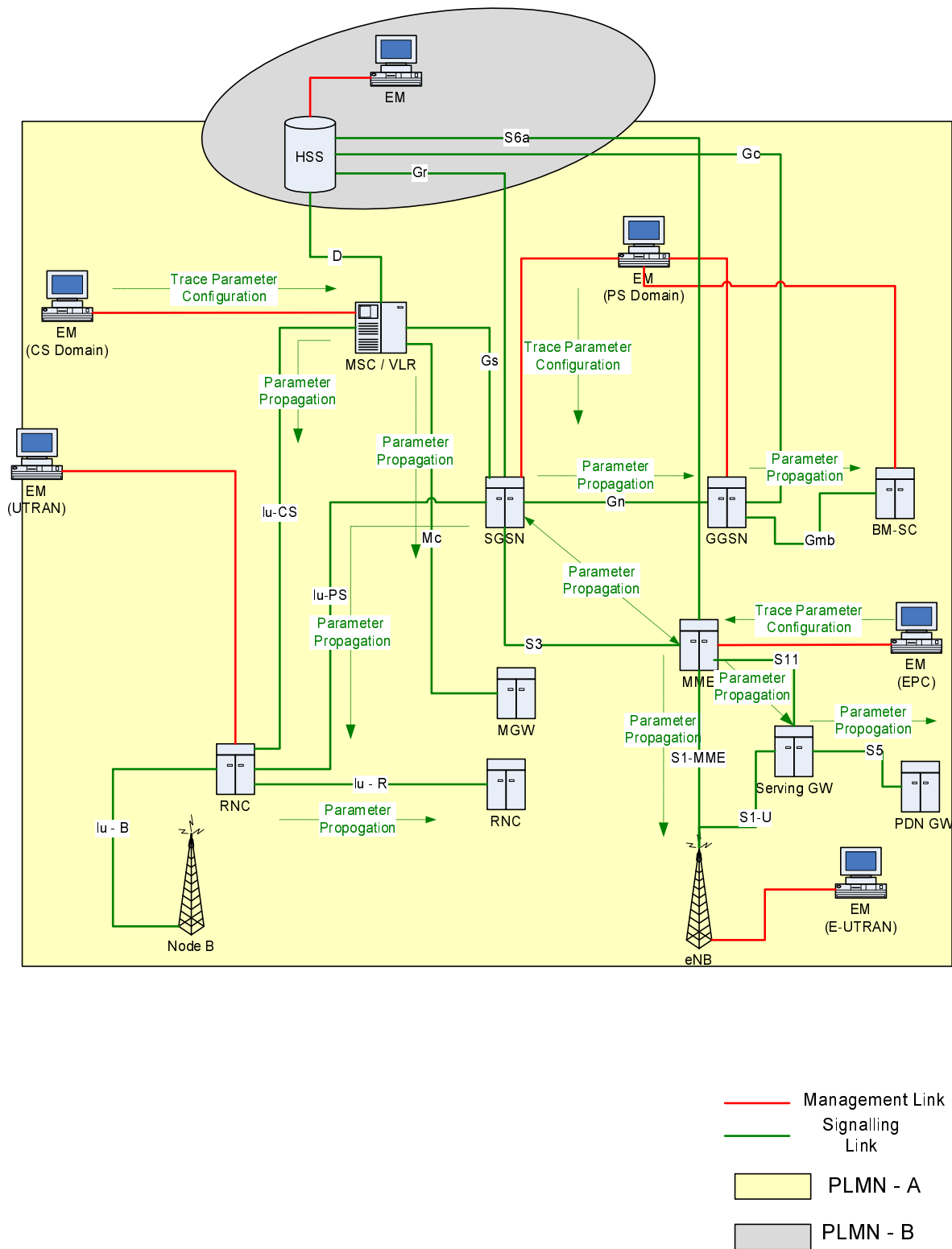

Figure 4.1.2.3.1: Overview of Inter-PLMN Signalling Activation



#### 4.1.2.4 UTRAN activation mechanisms

See subclause 4.2.3.1.

#### 4.1.2.5 PS Domain activation mechanisms

The following figure shows the Trace Session activation in the PS domain. The figure is an example of tracing PDP context.

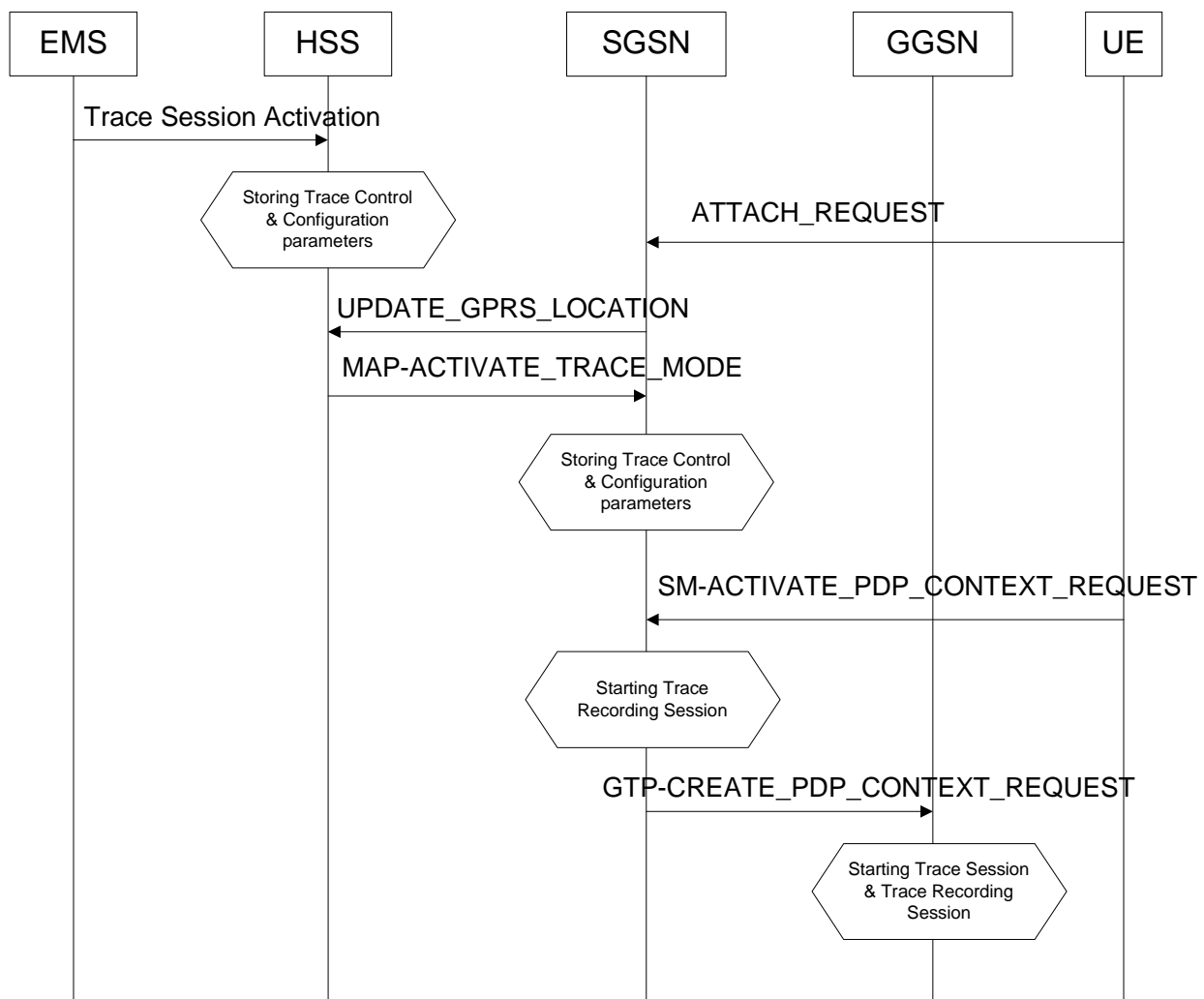

**Figure 4.1.2.5.1: Trace session activation in PS domain for PDP Context**

When a UE registers with the network by sending an ATTACH\_REQUEST message to the SGSN, it updates the location information in the HSS by sending the UPDATE\_GPRS\_LOCATION message to the HSS. The HSS checks if the UE is being traced. If it is being traced, the HSS shall propagate the trace control and configuration parameters to the SGSN by sending a MAP-ACTIVATE\_TRACE\_MODE - see 3GPP TS 29.002 [11] message to the SGSN. When an inter-SGSN routing area update occurs, HSS shall send the MAP-ACTIVATE\_TRACE\_MODE message to the new SGSN.

When SGSN receives the MAP-ACTIVATE\_TRACE\_MODE message it shall store the trace control and configuration parameters and shall start a Trace Session.

When any of the triggering events defined in the trace control and configuration parameters occur, (e.g. PS session is started (i.e. a ACTIVATE PDP CONTEXT REQUEST message is received from the UE)) the SGSN shall propagate the trace control and configuration parameters to the GGSN (by sending a GTP-CREATE\_PDP\_CONTEXT\_REQUEST message) and to the radio network (by sending a RANAP-

CN\_INVOKE\_TRACE message), if it is defined in the trace control and configuration parameters (NE types to trace). The Trace Session activation to UTRAN is described in clauses 4.1.2.4.

When HSS sends the MAP-ACTIVATE\_TRACE\_MODE message to SGSN it shall include the following parameters to the message:

- IMSI (M).
- Trace reference (M).
- Triggering events for SGSN (M) and GGSN (M).
- Trace Depth (M).
- List of NE types to trace (M).
- List of interfaces for SGSN (O), GGSN (O) and/or RNC (O).
- IP address of Trace Collection Entity (O).

When the SGSN sends the GTP-CREATE\_PDP\_CONTEXT\_REQUEST message to GGSN it shall include the following parameters to the message:

- IMSI or IMEI (SV) (M).
- Trace reference (M).
- Trace Recording Session Reference (M).
- Triggering events for GGSN (M).
- Trace Depth (M).
- List of interfaces for GGSN (O).
- IP address of Trace Collection Entity (O).

The following figure is an example of tracing for MBMS Context.

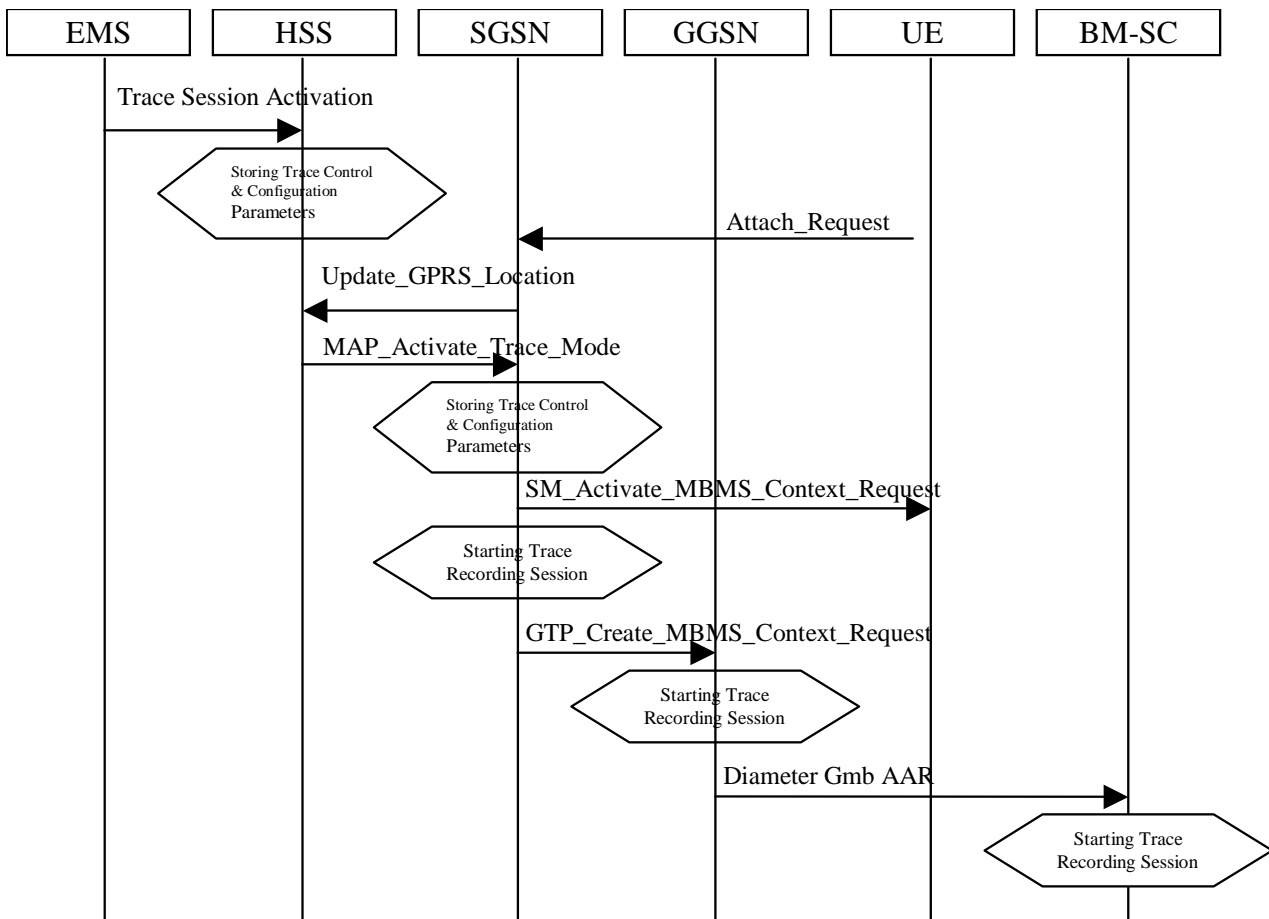

**Figure 4.1.2.5.2: Trace session activation in PS domain for MBMSContext**

When HSS receives a Trace Session activation from its EMS, it shall store the received trace control and configuration parameters. At this point a Trace Session shall be started in the HSS.

When a UE registers with the network by sending an ATTACH\_REQUEST message to the SGSN, it updates the location information in the HSS by sending the UPDATE\_GPRS\_LOCATION message to the HSS. The HSS checks if the UE is being traced. If it is being traced, the HSS shall propagate the trace control and configuration parameters to the SGSN by sending a MAP-ACTIVATE\_TRACE\_MODE message to the SGSN. When an inter-SGSN routing area update occurs, HSS shall send the MAP-ACTIVATE\_TRACE\_MODE message to the new SGSN.

When SGSN receives the MAP-ACTIVATE\_TRACE\_MODE message it shall store the trace control and configuration parameters and shall start a Trace Session.

When any of the triggering events defined in the trace control and configuration parameters occur, (i.e. an ACTIVATE MBMS CONTEXT REQUEST message is sent to the UE) the SGSN shall propagate the trace control and configuration parameters to the GGSN (by sending a GTP-CREATE\_MBMS\_CONTEXT\_REQUEST message) and to the radio network (by sending a RANAP-CN\_INVOKE\_TRACE message), if it is defined in the trace control and configuration parameters (NE types to trace). The Trace Session activation to UTRAN is described in clauses 4.1.2.4.

The GGSN shall propagate the trace control and configuration parameters to the BM-SC (by sending a Diameter Gmb AAR message) if the BM-SC is defined in the trace control and configuration parameters (NE types to trace).

When HSS sends the MAP-ACTIVATE\_TRACE\_MODE message to SGSN it shall include the following parameters in the message:

- IMSI (M).
- Trace reference (M).
- Triggering events for SGSN (M), GGSN (M) and BM-SC (M).
- Trace Depth (M).

- List of NE types to trace (M).
- List of interfaces for SGSN (O), GGSN (O), BM-SC (O) and/or RNC (O).
- IP address of Trace Collection Entity (O).

When the SGSN sends the GTP-CREATE\_MBMS\_CONTEXT\_REQUEST message to GGSN it shall include the following parameters in the message:

- IMSI or IMEI (SV) (M).
- Trace reference (M).
- Trace Recording Session Reference (M).
- Triggering events for GGSN (M) and BM-SC (M).
- Trace Depth (M).
- List of interfaces for GGSN (O) and BM-SC (O).
- IP address of Trace Collection Entity (O).

When the GGSN sends the Diameter Gmb AAR message to the BM-SC it shall include the following parameters in the message:

- IMSI or IMEI (SV) (M).
- Trace reference (M).
- Trace Recording Session Reference (M).
- Triggering events for BM-SC (M).
- Trace Depth (M).
- List of interfaces for BM-SC (O).
- IP address of Trace Collection Entity (O).

#### 4.1.2.6 CS Domain activation mechanisms

The following figure shows the Trace Session activation in the CS domain. The figure is an example of tracing Mobile Originating Call.

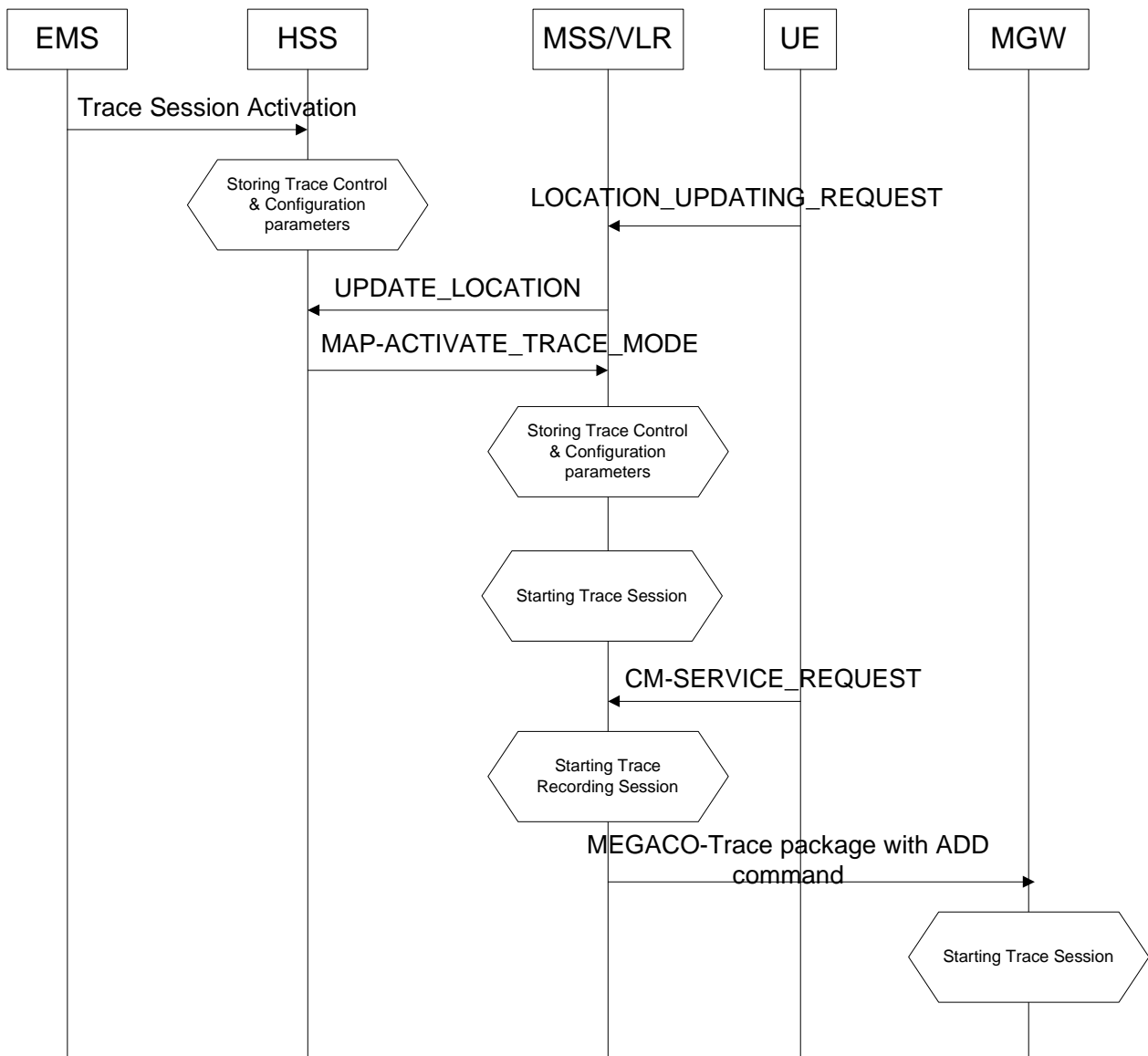

**Figure 4.1.2.6.1: Trace Session Activation in CS domain**

When HSS receives Trace Session activation from the EMS it should store the trace control and configuration parameters associated to the Trace Session.

If the UE registers to the network, by sending a LOCATION UPDATING REQUEST message to the MSC/VLR, the MSC Server/VLR updates the location information in the HSS by sending the MAP-UPDATE\_LOCATION message to the HSS. After receiving the UPDATE\_LOCATION message HSS shall propagate the trace control and configuration parameters by sending a MAP-ACTIVATE\_TRACE\_MODE message to the MSC Server/VLR.

When the MSC Server/VLR receives the MAP-ACTIVATE\_TRACE\_MODE message from the HSS, it shall store the trace control and configuration parameters.

When any of the triggering event, defined in the trace control and configuration parameters, occurs (e.g. in case of Mobile Originating Call is started (i.e. the MSC Server receives the CM\_SERVICE\_REQUEST message with service type set to originating call establishment)) the MSC Server should propagate the trace control and configuration parameters to the MGW (by sending an ADD command with a trace package - see 3GPP TS 29.232 [10]) and to the radio network if it is defined in the trace control and configuration parameters (NE types to trace). Trace Session

activation for UTRAN is described in clauses 4.1.2.4. In case of inter-MSC Server handover the MSC Server-A should propagate the trace control and configuration parameters to the MSC Server-B.

When HSS sends the MAP-ACTIVATE\_TRACE\_MODE message to MSC Server it shall include the following parameters to the message:

- IMSI (M).
- Trace reference (M).
- Triggering events for MSC Server (M) and MGW (M) .
- Trace Depth (M).
- List of NE types to trace (M).
- List of interfaces for MSC Server (O), MGW (O) and/or RNC (O).
- IP address of Trace Collection Entity (O).

When the MSC Server sends the ADD command with trace package to MGW it shall include the following parameters to the message:

- IMSI or IMEI (SV) (M).
- Trace reference (M).
- Trace Recording Session Reference (M).
- Triggering events for MGW (M).
- Trace Depth (M).
- List of interfaces for MGW (O).
- IP address of Trace Collection Entity (O).

#### 4.1.2.7 Void

#### 4.1.2.8 Tracing roaming subscribers

If a HPLMN operator activates a Trace Session for a home subscriber, while it (MS) is roaming in a VPLMN, it (HSS) may restrict the propagation of the Trace Session activation message to a MSC Server/VLR or to a SGSN located in the VPLMN.

Also, a MSC Server/VLR or a SGSN located in a VPLMN may accept any Trace Session activation message(s) coming from an HSS located in another PLMN. However, there shall be a capability to reject activations from another PLMN.

#### 4.1.2.9 Service Level Tracing for IMS activation mechanisms

##### 4.1.2.9.1 General

Figure 4.1.2.9.1.1 illustrates signalling based activation for service level tracing within a home IM CN SS and a visited IM CN SS. An arrow with "Trace Parameter Configuration" represents the availability of the trace functionality at the EM for that domain. Similarly, An arrow with "Trace Parameter Propagation" represents the ability to propagate trace parameters only for the interfaces indicated.

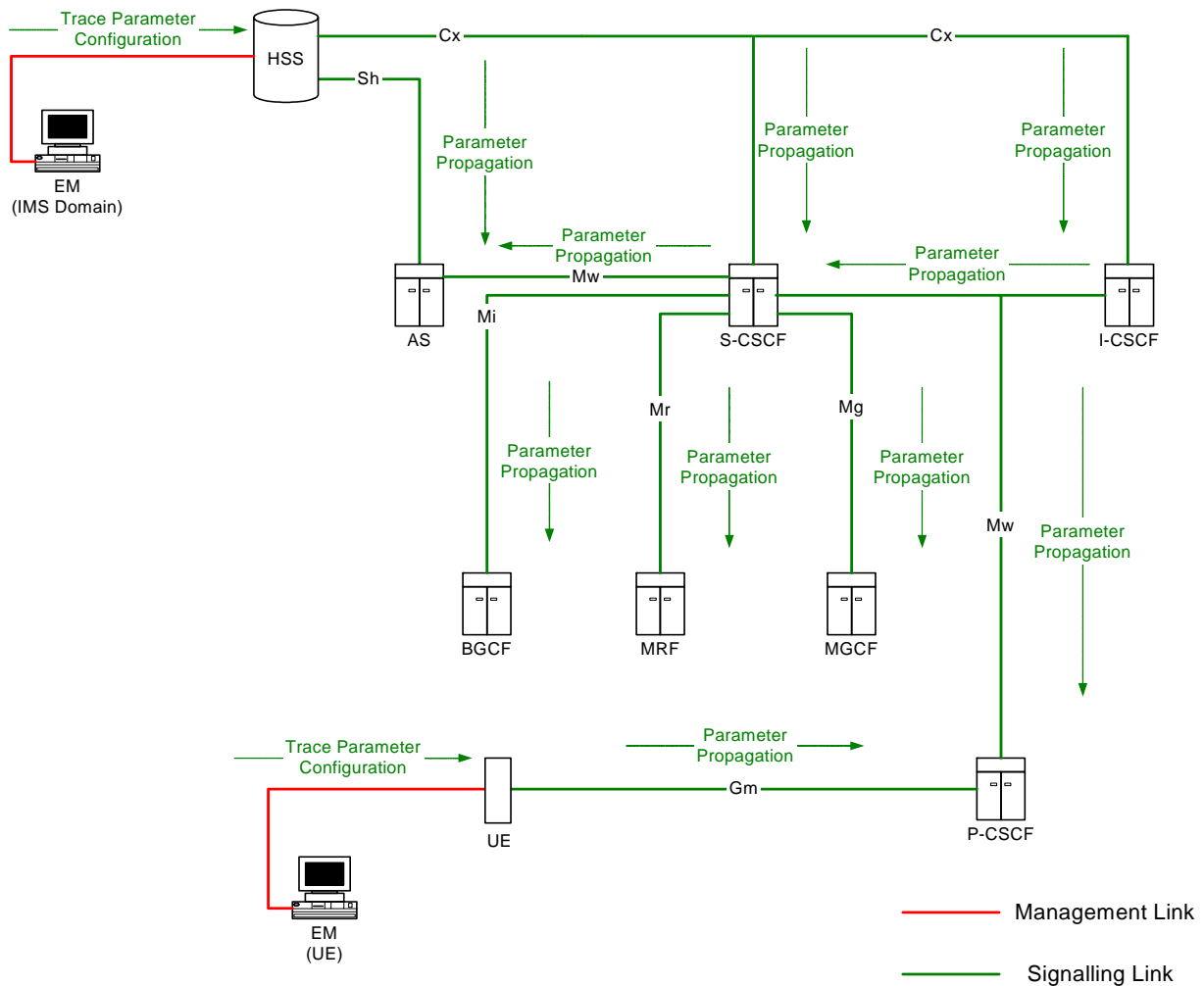

**Figure 4.1.2.9.1.1: Overview of Signalling Activation for service level tracing for IMS**

Trace Activation shall be initiated from the Core Network EM only [EM (UE), and EM (HSS)].

The EM (UE) and the interactions between the EM (UE) and the UE shall be achieved using OMA Device Management [18].

When service level tracing for IMS is required for a registered home subscriber in the home IM CN SS Trace Session activation shall go to the UE and the HSS. The HSS shall propagate the Trace Session activation to the S-CSCF, I-CSCF and the AS.

The S-CSCF and I-CSCF shall propagate the Trace Session activation to the P-CSCF. The Trace Session activation shall be propagated to the MRF, MGCF and BGCF via the S-CSCF. When an IMS NE (i.e. S/I-P-CSCF, AS, HSS, MRF, MGCF, BGCF) receives Trace Session activation it shall save the received Trace control and configuration parameters and shall start a Trace Session.

When service level tracing for IMS is required for a registered home subscriber in a visited IM CN SS Trace Session activation shall go to the UE and the HSS. The HSS shall propagate the Trace Session activation to the S-CSCF, I-CSCF and the AS. The I-CSCF may prohibit the propagation of the Trace Session activation from the home IM CN SS to the P-CSCF in the visited IM CN SS.

**Editor's Note:** The ability to send Trace session activation to the S/I-CSCF in the home IM CN SS in the situation where it is not possible to send Trace Session activation to a UE is FFS.

4.1.2.9.2 Trace session activation for non-registered UE

Figure 4.1.2.9.2.1 illustrates the sending of Trace Session activation towards the HSS, S-CSCF, I-CSCF, AS and P-CSCF during the registration of a UE with the IM CN SS.

As described in 3GPP TS 23.228 [15] for the purposes of signalling flows the user is considered always to be roaming. For a user roaming in their home network, the home network shall perform the role of the visited network elements and the home network elements.

NOTE: For detailed information of application level registration procedures for IMS see 3GPP TS 23.228 [15].

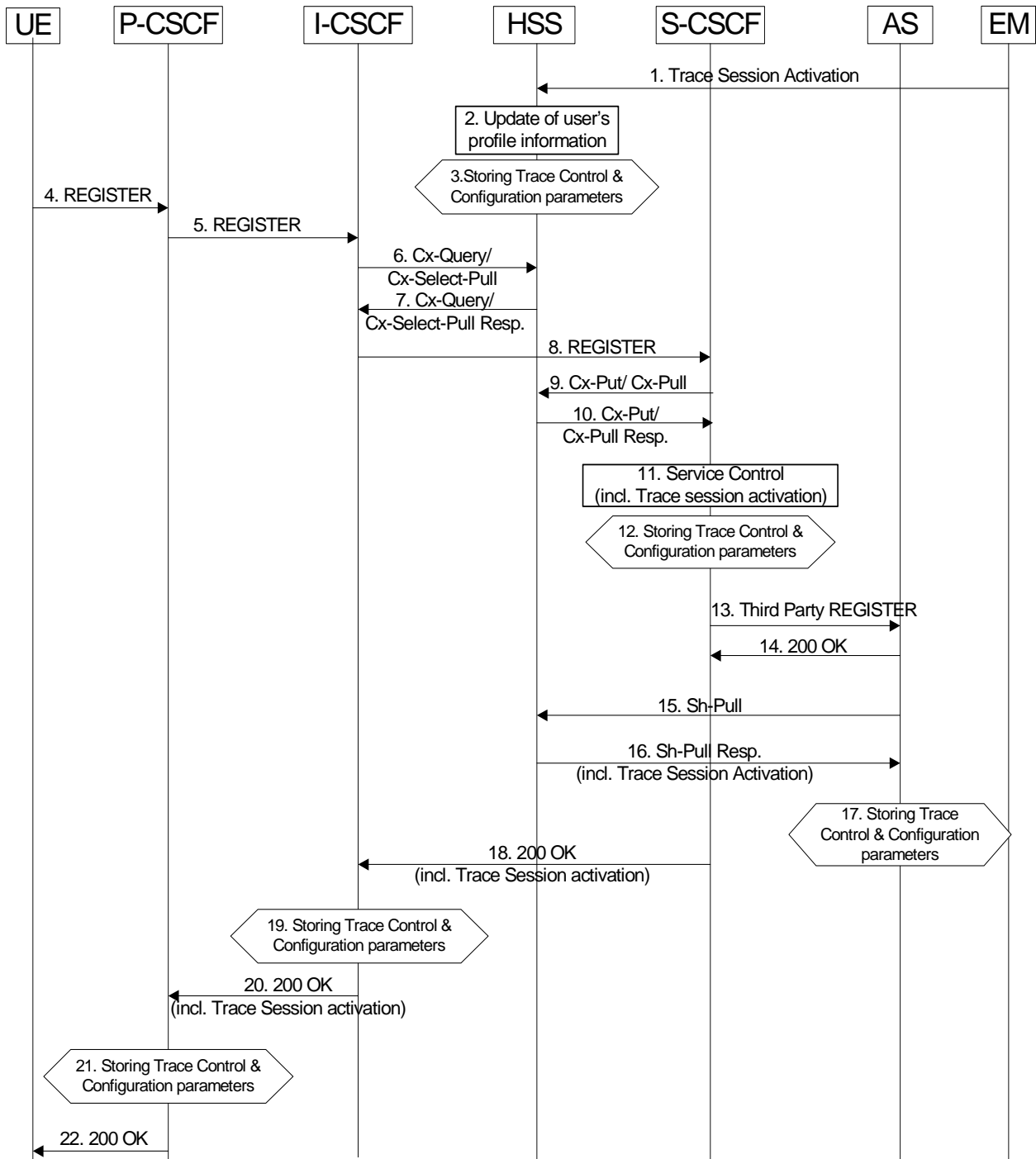

Figure 4.1.2.9.2.1: Trace Session activation for non-registered user



When HSS receives Trace Session activation from its EM (Step 1), it shall update the user information associated with the user for whom the trace is to be applied (Step 2). The HSS shall store the received trace control and configuration parameters (Step 3). At this point a Trace Session shall be started in the HSS.

When the EM sends the Trace Session activation to the HSS it shall include the following trace and configuration parameters in the message:

- Public User Identity (i.e. Identity of user initiating/terminating the service to be traced) (M)
- Service identification (M)
- Trace reference (M)
- Triggering events for HSS (M)
- Trace depth (M)
- List of NE types (M)
- Triggering events for S-CSCF (M), I-CSCF (M), P-CSCF (M), AS (M), BGCF (M), MRF (M), MGCF (M)
- Trace depth (M)

When the EM sends the Trace Session activation to the HSS it may include the following trace and configuration parameters in the message if required:

- List of interfaces for HSS (O)
- List of interfaces for S-CSCF (O), I-CSCF (O), P-CSCF (O), AS (O), BGCF (O), MRF (O), MGCF (O).

As described in 3GPP TS 23.228 [15] when a UE registers with the network by sending a REGISTER message (Steps 4 to 10), the HSS sends Service Control (user and filter information) to the S-CSCF (Steps 11). It shall also propagate trace control and configuration parameters to the S-CSCF. At this point a Trace Session shall be started in the S-CSCF (Step 12).

When the HSS sends the Cx-Put-Response operation to the S-CSCF (see 3GPP TS 29.228 [16]) it shall include the following trace and configuration parameters:

- Public User Identity (i.e. Identity of user initiating/terminating the service to be traced) (M)
- Service identification (M)
- Trace reference (M)
- Triggering events for S-CSCF (M)
- Trace depth (M)
- List of NE types (M)
- Triggering events for I-CSCF (M), P-CSCF (M), BGCF (M), MGCF (M)

When the HSS sends the Cx-Put-Response operation to the S-CSCF it may include the following trace and configuration parameters if required:

- List of interfaces for S-CSCF (O)
- List of interfaces for I-CSCF (O), P-CSCF (O), BGCF (O), MGCF (O)

**Editor's Note: The sending of trace and configuration parameters as part of the Cx-Put-Response operation is for FFS by CT4.**

As described in 3GPP TS 23.218 [14] on reception of a REGISTER request, the S-CSCF shall send a third-party REGISTER request to the Application Server if the registration request from the user matches a contained trigger as downloaded from the HSS (Step 13 and 14).

As described in 3GPP TS 29.328 [17] the Application Server shall request from the HSS information such as service and user related information. In this case, the HSS shall determine that a trace request for the user is active and shall return to the Application Server trace control and configuration parameters (Step 16). At this point a Trace Session shall be started in the AS (Step 17).

When the HSS sends the Sh-Pull-Response operation to the AS (see 3GPP TS 29.328 [17]) it shall include the following trace and configuration parameters:

- Public User Identity (i.e. Identity of user initiating/terminating the service to be traced) (M).
- Service identification (M)
- Trace reference (M)
- Triggering events for AS (M)
- Trace depth (M)
- List of NE types (M)
- Triggering events for MRF (M)

When the HSS sends the Sh-Pull-Response operation to the AS it may include the following trace and configuration parameters if required:

- List of interfaces for AS (O)
- List of interfaces for MRF (O)

**Editor's Note: The sending of trace and configuration parameters as part of the Sh-Pull-Response operation is for FFS by CT4.**

Upon successful registration the S-CSCF shall return a SIP 200 OK and shall propagate the received trace control and configuration parameters to the I-CSCF (Step 18). At this point a Trace Session shall be started in the I-CSCF (Step 19).

When the S-CSCF sends the 200 OK (Register) message to the I-CSCF (see 3GPP TS 24.228 [15]) it shall include the following trace and configuration parameters:

- Public User Identity (i.e. Identity of user initiating/terminating the service to be traced) (M).
- Service identification (M)
- Trace reference (M)
- Trace depth (M)
- Triggering events for I-CSCF (M)
- List of NE types (M)
- Triggering events for P-CSCF (M)

When the S-CSCF sends the 200 OK (Register) message to the I-CSCF it may include the following trace and configuration parameters if required:

- List of interfaces for I-CSCF (O)
- List of interfaces for P-CSCF (O)

If the P-CSCF resides in the same (i.e. home IM CN SS) network as the I-CSCF, the I-CSCF forwards the SIP 200 OK and shall propagate the retrieved trace control and configuration parameters to the P-CSCF (Step 20). At this point a Trace Session shall be started in the P-CSCF (Step 21).

When the I-CSCF sends the 200 OK (Register) message to the P-CSCF (see 3GPP TS 24.228 [15]) it shall include the following trace and configuration parameters:

- Public User Identity (i.e. Identity of user initiating/terminating the traced service) (M)
- Service identification (M)
- Trace reference (M)
- Trace depth (M)
- Triggering events for P-CSCF (M)
- List of NE types (M)

When the I-CSCF sends the 200 OK (Register) message to the P-CSCF it may include the following trace and configuration parameters if required:

- List of interfaces for P-CSCF (O).

If the P-CSCF resides in a different (i.e. visited IM CN SS) network as the I-CSCF, the I-CSCF forwards the SIP 200 OK and may propagate the retrieved trace control and configuration parameters to the P-CSCF. If the P-CSCF is in a different network than the I-CSCF and the sending of trace control and configuration parameters from the home IM CN SS to the visited IM CN SS is prohibited then the I-CSCF shall restrict the sending of the trace control and configuration parameters.

The P-CSCF shall forward the SIP 200 OK to the UE. The P-CSCF shall not send the retrieved trace control and configuration parameters.

4.1.2.9.3 Trace session activation for a registered UE

Figure 4.1.2.9.3.1 illustrates the sending of Trace Session activation towards the HSS, S-CSCF, I-CSCF, AS and P-CSCF during the re-registration of a UE with the IM CN SS.

As described in 3GPP TS 23.228 [15] periodic application level re-registration is initiated by the UE either to refresh an existing registration or in response to a change in the registration status of the UE. Re-registration follows the same process as that defined for registration of a non-registered user.

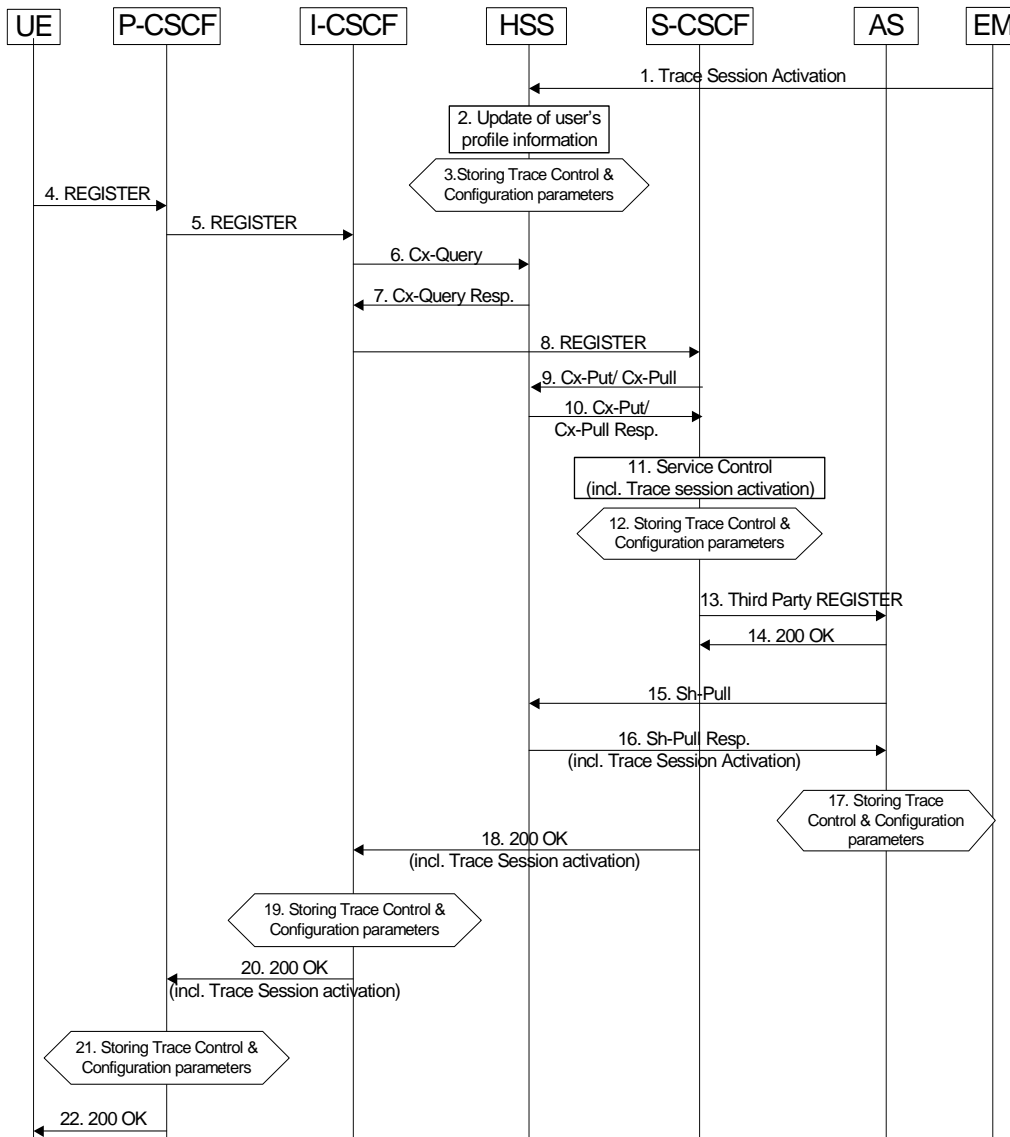

Figure 4.1.2.9.3.1: Trace Session activation for registered UE

When HSS receives Trace Session activation from its EM (Step 1), it shall update the user information associated with the user for whom the trace is to be applied (Step 2). The HSS shall store the received trace control and configuration parameters (Step 3). At this point a Trace Session shall be started in the HSS.

When the EM sends the Trace Session activation to the HSS it shall include the trace and configuration parameters as described in clause 4.1.2.9.2.

Prior to expiry of the agreed registration timer, the UE initiates a re-registration by sending a REGISTER message. The subsequent steps of re-registration of the UE as described in 3GPP TS 23.228 [15] and the signalling flow steps as described in subclause 4.1.2.9.2 apply.

The IM CN SS shall request a re-authentication of a registered UE when Trace Session activation is required before the UE performs a periodic re-registration, and when the subscription status of the registered UE is not to be affected.

Following a network initiated re-authentication, the UE shall re-register with the IM CN SS and the procedures described for Trace Session activation for a registered UE shall apply.

#### 4.1.2.9.4 Trace session activation at the UE

Figure 4.1.2.9.4.1 illustrates the sending of Trace Session activation from the Device Management Server (DMS) to a UE and the subsequent propagation of a SIP message including a start trigger event from the UE and the P-CSCF.

*Editor's note: The exact OMA Device Management enabler is FFS.*

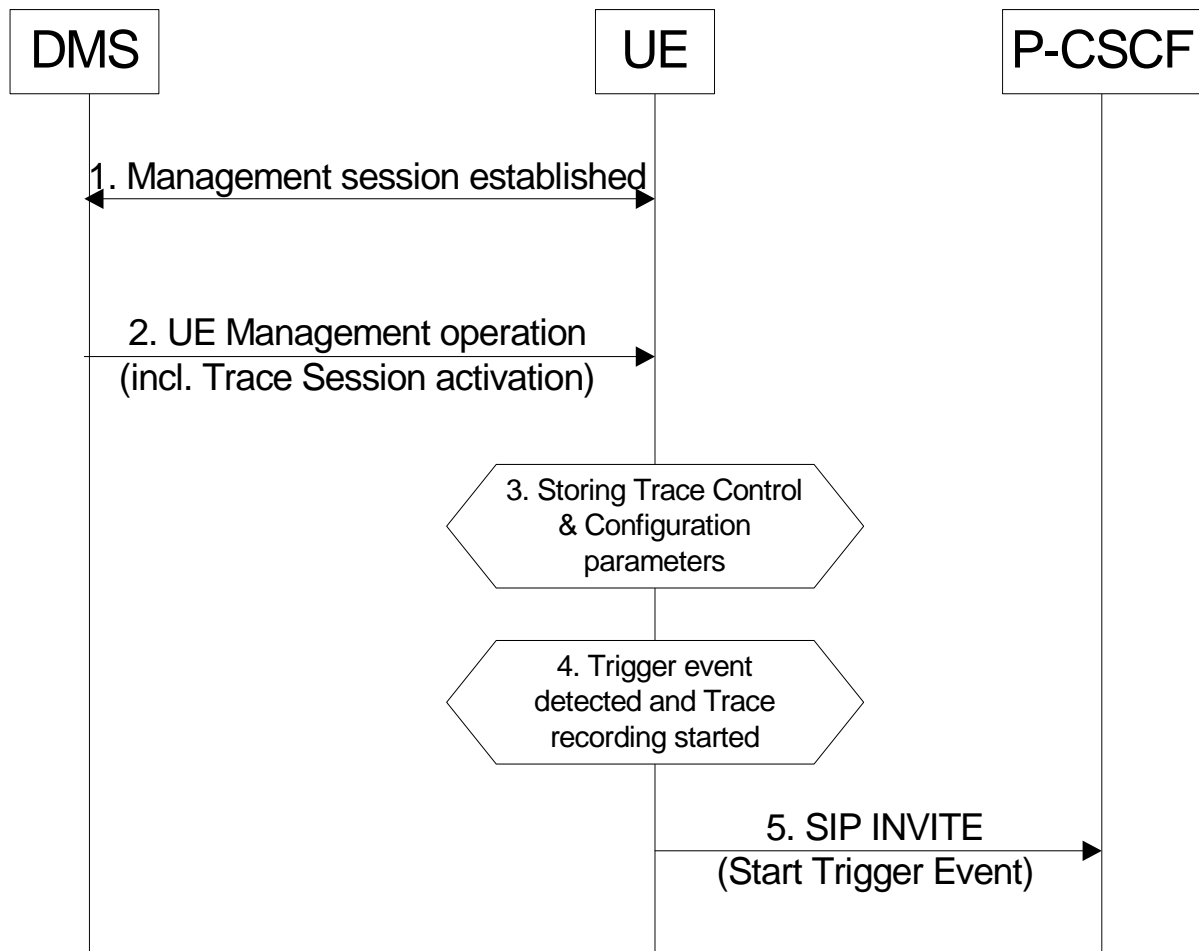

**Figure 4.1.2.9.4.1: Trace Session activation at a UE**

A management session shall be established (Step 1) in accordance with OMA Device Management [18]. When a UE receives Trace Session Activation (Step 2) as part of the received management operation it shall store the Trace Control and configuration parameters, and may (e.g. depending on Operator conditions) start a trace session (Step 3).

When any of the triggering events occur at the UE (e.g. the service to be traced from the traced UE is initiated), and when the condition(s) as defined by the trace control and configuration parameters within the received management operation occur, the UE shall start a trace recording (Step 4). As described in subclause 4.2.3.5 the UE shall include in the outgoing SIP (service) signalling message (e.g. INVITE) a Start Trigger Event (Step 5).

4.1.2.10 EPC activation mechanism

4.1.2.10.1 UE attached to EPC via E-UTRAN

Figure 4.1.2.10.1 summarizes the Trace Session activation procedure in EPC:

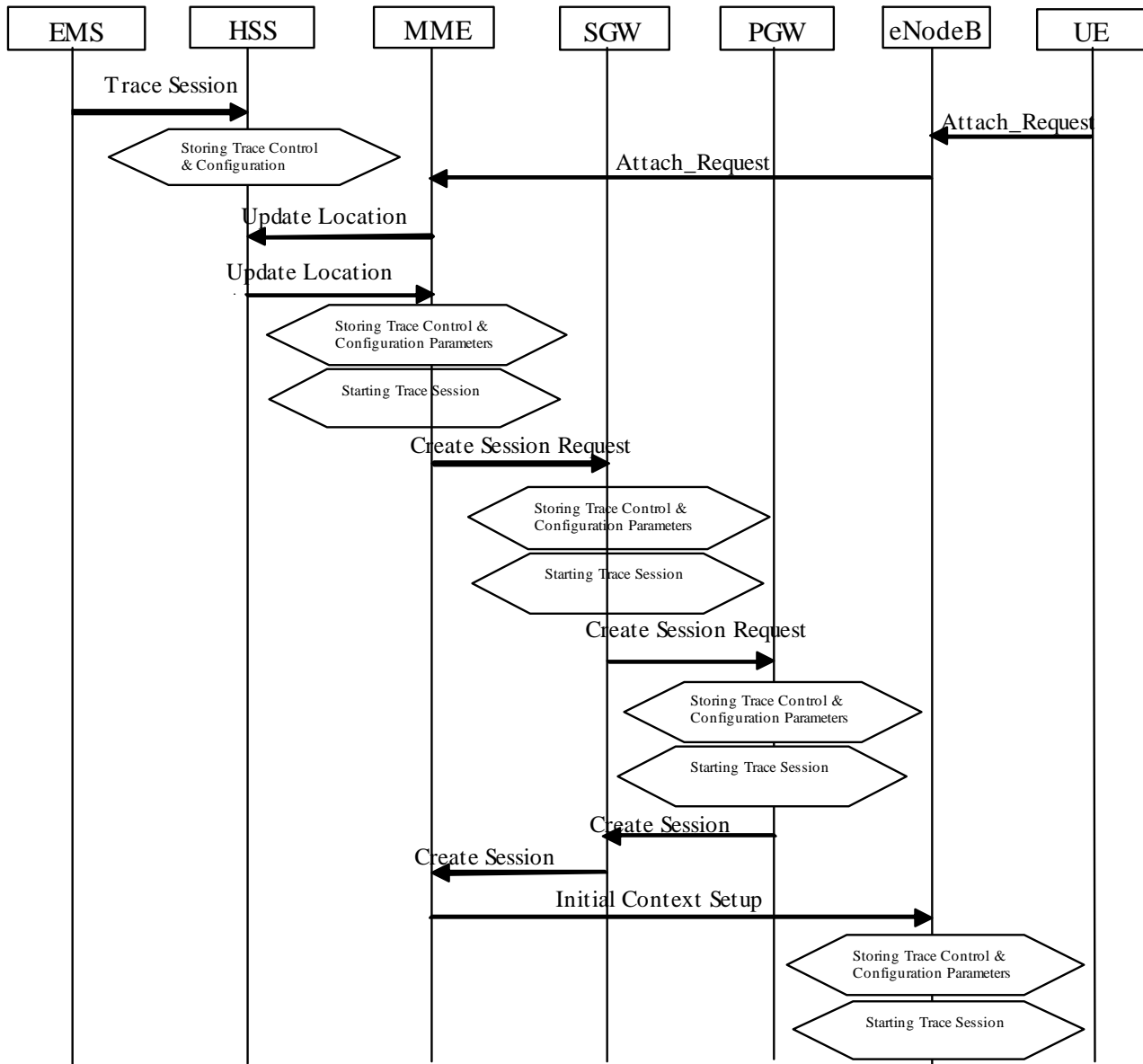

**Figure 4.1.2.10.1: Trace Session activation procedure in EPC with GTP based S5 interface:**

The Trace Session activation in MME can come for a home subscriber trace from HSS via the S6a interface or for a foreign subscriber from the EM of MME.

When the UE makes an attach request to the MME, it updates the location information in the HSS. The HSS checks if the UE is being traced. If it is being traced, the HSS shall propagate the trace control and configuration data to the MME by including the trace control and configuration parameters into the S6a-Insert subscriber data message or the S6a-Update Location Answer message. If the traced UE has already attached before receiving the Trace Session Activation from the EM/NM, the HSS shall also propagate the trace control and configuration data to the MME by either S6a-Insert subscriber data message or the S6a-Update Location Answer message. When MME receives the trace control and configuration data from the HSS it shall store the information and shall start a Trace Session.

During inter-MME TAU, the MME shall propagate the trace control and configuration parameters to the target MME within an S10- Context Response as part of inter-MME TAU procedures. During attach procedures where the context information is requested from the target MME, the MME shall propagate the trace control and configuration parameters within an S10-Identification Response message. During inter-MME handover, the MME shall propagate the trace control and configuration parameters to the target MME within an S10- Forward Relocation Request message as part of inter-MME handover procedures.

If the List of NE Types parameter specifies tracing in the SGW and/or Tracing in the PGW, MME shall propagate the trace control and configuration parameters via the S11 interface to the SGW per one of the following messages:

1. if a default bearer connection has not been established, via the S11: Create Session Request message
2. otherwise via the S11-Trace Session Activation message

The SGW upon receiving the trace control and configuration parameters shall start a trace session.

If the List of NE Types parameter specifies Tracing in the PGW, SGW shall propagate the trace control and configuration parameters via the S5 interface to the PGW per one of the following messages:

1. if a default bearer connection has not been established, via the S5: Create Session Request message
2. otherwise via the S5-Trace Session Activation message

The PGW upon receiving the trace control and configuration parameters shall start a trace session.

When a triggering events, defined in the trace control and configuration data occur (i.e. a session is started) a Trace Recording Session should be started and the trace control and configuration data should be propagated to the radio network to the eNB if the List of NE Types parameter specifies eNB tracing. However if the triggering events parameter at MME indicates that all events should be traced, Trace Recording Session shall be started only when the user specific S1 association is setup to the eNB and the Trace Recording Session is kept as long as the user specific S1 association is released or the Trace Session is deactivated. See section 4.2.3.6.

When HSS activates the trace to the MME the following trace control and configuration parameters shall be included in the message:

- IMSI or IMEISV
- Trace Reference
- Triggering events for MME, Serving GW, PDN GW
- Trace Depth
- List of NE types to trace
- List of Interfaces for MME, Serving GW, PDN GW, eNB
- IP address of Trace Collection Entity

When MME activates the trace to the SGW the following trace control and configuration parameters shall be included in the message::

- IMSI or IMEISV
- Trace Reference
- Triggering events for Serving GW, PDN GW
- Trace Depth
- List of NE types to trace
- List of Interfaces for Serving GW, PDN GW
- IP address of Trace Collection Entity

When SGW activates the trace to the PGW the following trace control and configuration parameters shall be included in the message:

- IMSI or IMEISV
- Trace Reference
- Triggering events for PDN GW
- Trace Depth
- List of Interfaces for PDN GW
- IP address of Trace Collection Entity

When MME sends the trace control and configuration parameters to the eNB the following information shall be included in the message:

- Trace Reference
- Trace Recording Session Reference
- Trace Depth
- IP Address of Trace Collection Entity

and the following information may be included in the message:

- List of Interfaces for eNB

Figure 4.1.2.10.1.A illustrates the Trace Session activation in case of PMIP based S5 interface. The figure contains only the difference compare to the GTP based S5 interface

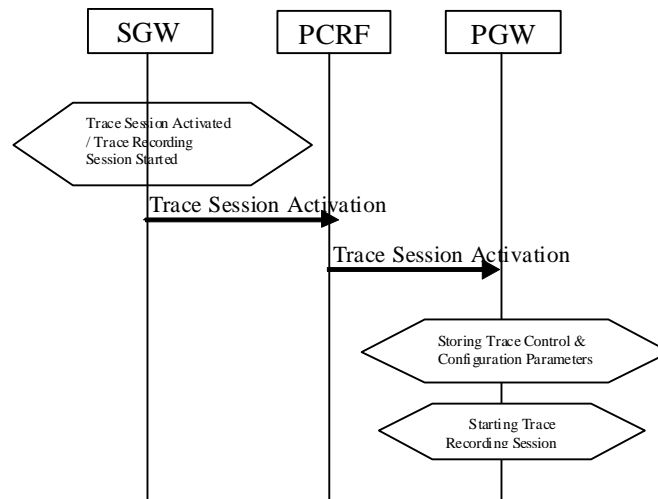

**Figure 4.1.2.10.1.A: Trace Session Activation from SWG to PGW in case of PMIP based S5 interface**

When the SGW receives the Trace Session activation message and the List of NE Type to trace parameter specifies Tracing in the PDN GW, SGW shall send Trace Session Activation to PDN GW via the PCRF. The Trace Session activation can be done as part of the IP CAN session establishment or as a standalone procedure [29].

The Trace Session Activation shall include the following information:

- IMSI or IMEISV
- Trace reference



- Trace Recording Session Reference
- Trace Depth
- Triggering events for PDN GW
- List of Interfaces for PDN GW
- IP address of Trace Collection Entity

When the PCRF receives the Trace Session Activation it shall forward the same trace control and configuration parameters to the PDN GW [29].

#### 4.1.2.10.2 UE attached to EPC via *non-3GPP* accesses with DSMIPv6 on S2c or PMIP on S2a/S2b

Figure 4.1.2.10.2 illustrates the Trace Session activation when the UE is attached from a non-3GPP access network with DSMIPv6 on S2c or PMIP on S2a or S2b interface.

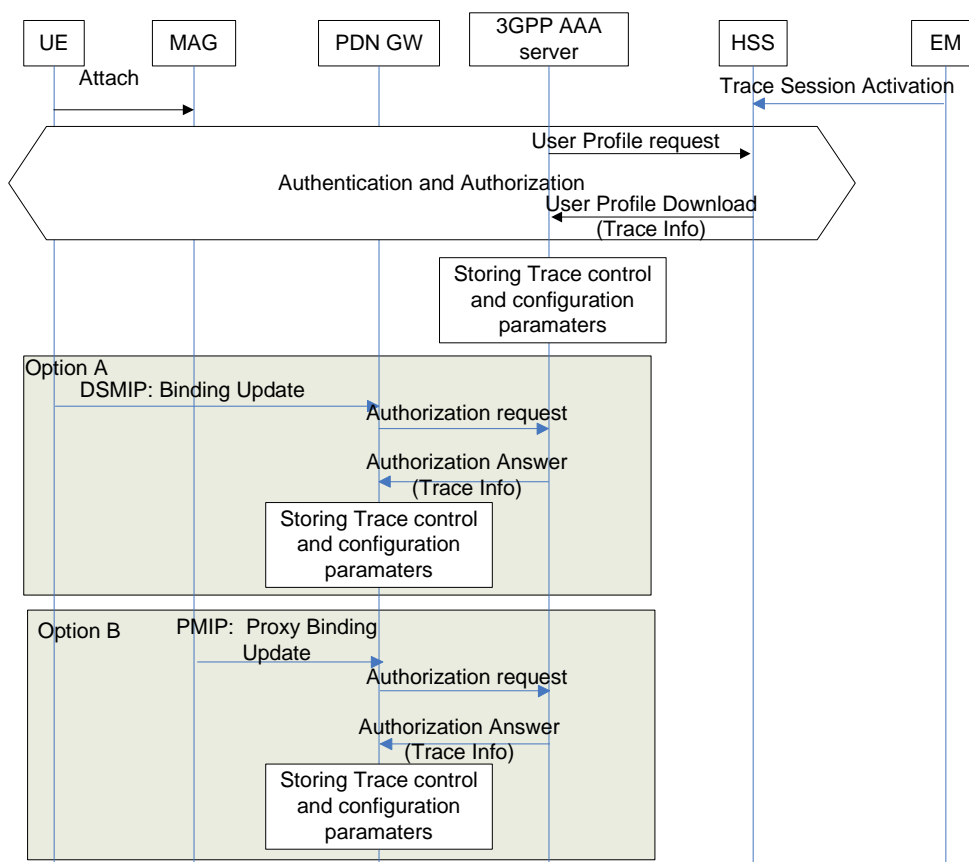

**Figure 4.1.2.10.2: Trace Session activation procedure to PGW in case of UE attaches from non-3GPP access network via DSMIPv6 on S2c or PMIP on S2a/S2b**

When the UE attaches to the EPC network via a non-3GPP access network the Trace Session activation to the PGW can be done via HSS and AAA server. Therefore when the UE attach is signalled to the HSS via non-3GPP access network, the HSS shall send the Trace control and configuration parameters to the AAA server as part of the user profile download [25]. The following information shall be included in the downloaded user data:

- IMSI, or IMEI(SV)
- Trace Reference
- Triggering event for PGW

- Trace Depth
- List of interface for PGW
- IP address of Trace Collection Entity

When the AAA server receives the user profile, which contains also the trace control and configuration parameters, it shall store the received trace control and configuration parameters. The AAA server shall forward the received trace control and configuration parameters in the authorization when it receives the authorization request from the PGW during the PDN connectivity.

The event, which triggers the authorization in the PDN GW depend on the used IP mobility protocol:

- In case of DSMIP (option A), it is a binding update received from the UE,
- In case of PMIP (Option B), it is a proxy binding update request received from the Trusted Non-3GPP GW or ePDG playing the role of the Mobile Access Gateway (MAG)

If the UE is already registered to the HSS by a AAA server via the SWx interface, Trace Session activation shall also be possible from the HSS to the PDN GW via the AAA server. In that case the HSS sends the Trace Session activation message with a push profile request.

The AAA server shall examine the received user profile and if Trace Session activation is needed in the PDN GW, it shall initiate a re-authorization procedure towards the PDN GW. The Trace Session is activated to te PDN GW using this re-authorization procedure. When PDN GW receives the Trace Session activation message, it shall save the received trace control and configuration parameters.

#### 4.1.2.10.3 UE attached to EPC via non-3GPP accesses with GTP on S2b interface

Figure 4.1.2.10.3 illustrates the Trace Session activation when the UE is attached from a non-3GPP access with GTP on the S2b interface.

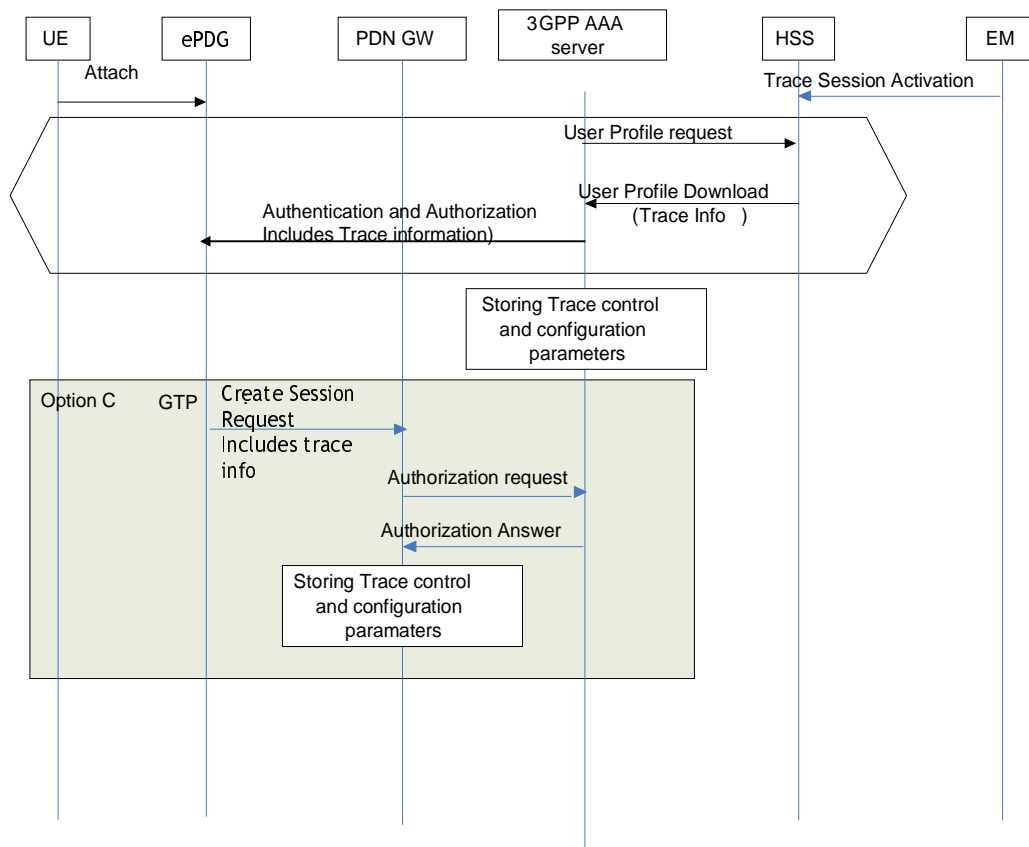

**Figure 4.1.2.10.3 : Trace Session activation procedure to PGW when the UE is attaches to EPC from a non-3GPP access with GTP based S2b**

When the UE attaches to the EPC network via a non-3GPP access network the Trace Session activation to the PGW can be done via HSS, AAA server and ePDG. Therefore when the UE attach is signalled to the HSS via non-3GPP access network, the HSS shall send the Trace control and configuration parameters to the AAA server as part of the user profile download (see [22] , [25] and [34]).

The following information shall be included in the downloaded user data:

- IMSI, or IMEI(SV)
- Trace Reference
- Triggering event for PGW
- Trace Depth
- List of interface for PGW
- IP address of Trace Collection Entity

The ePDG sends a GTPv2 Create Session Request which contains trace information message to the PGW. The RAT type indicates the non-3GPP IP access technology type.

Figure 4.1.2.10.4 illustrates the Trace Session activation when the UE is already attached from a non-3GPP access with GTP based S2b, i.e. trace session activation after a session has been created.

If the UE is already registered to the HSS by a AAA server via the SWx interface, Trace Session activation shall also be possible from the ePDG to the PDN GW. In that case the HSS sends the Trace activation message with a push profile request.

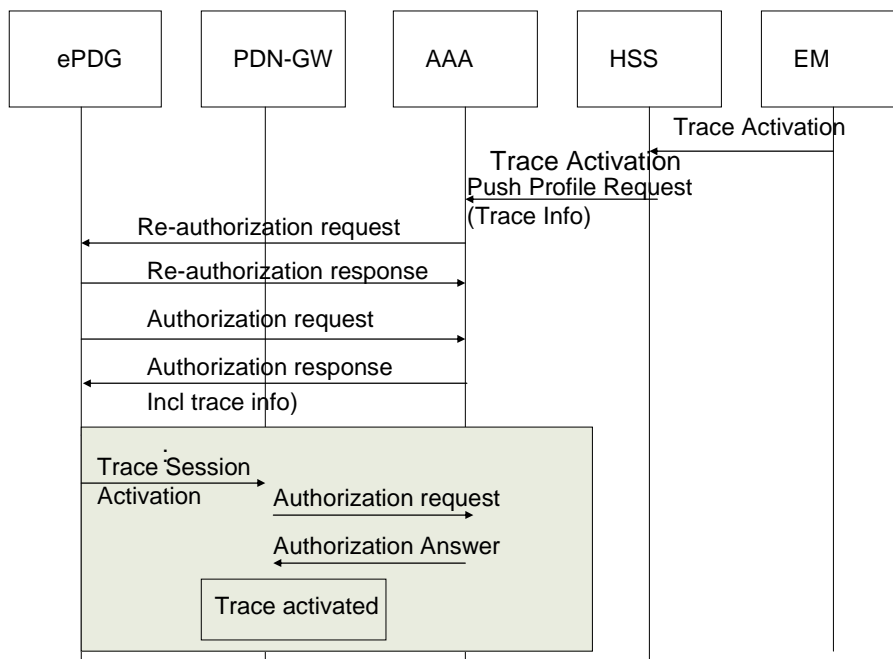

**Figure 4.1.2.10.4 : Trace Session activation procedure to PGW when the UE is already attached to EPC from a non-3GPP access with GTP based S2b**

The AAA shall examine the received information and if Trace Session activation is needed in the PDN GW, it shall initiate a reauthorization request towards the ePDG. ePDG sends a GTPv2 Trace Session Activation message to the PGW when determining from the updated profile that a trace activation is needed. When PDN GW receives the Trace Session activation message, it shall save the received trace control and configuration parameters.

#### 4.1.2.11 E-UTRAN activation mechanisms

The Trace Session should be activated in in an eNB when the eNB receives the TRACE START, INITIAL CONTEXT SETUP REQUEST or HANDOVER REQUEST message with the IE *Trace Activation* from the MME and if some activities have been started on the interfaces that have been requested to be traced.

If the subscriber or equipment which is traced makes a handover to a target eNB using the X2 interface, the source eNB should propagate the trace control and configuration parameters further to the target eNB by using the HANDOVER REQUEST message. When the target eNB receives the HANDOVER REQUEST message it should immediately start a Trace Session according to the trace control and configuration parameters received in the HANDOVER REQUEST message.

If the subscriber or equipment which is traced makes a handover to a target eNB using the S1 interface, it is the MME's responsibility to propagate the trace control and configuration parameters to the target eNB.

#### Interaction with Relocation

If the tracing shall continue also after the relocation has been performed, the CN Invoke Trace procedure shall be re-initiated from the CN towards the future eNB after the Relocation Resource Allocation procedure has been executed successfully.

The TRACE START, INITIAL CONTEXT SETUP REQUEST or HANDOVER REQUEST message that is received from the MME contains the following information:

- Trace Reference
- including Trace Recording Session Reference

- Trace Depth
- List of interfaces for eNB
- IP address of Trace Collection Entity

If the Trace Reference is the same as an existing Trace Session for the same subscriber or equipment, the eNB shall not activate a new Trace Session and the existing Trace Session will not be impacted. See clause 4.2.3.6 for the conditions on whether or not the Trace Recording Session should be started.

If the Trace Reference is the same as an existing Trace Session for different subscriber(s) or equipment(s), the eNB shall not activate a new Trace Session, and the eNB shall not start a new Trace Recording Session.

#### 4.1.2.12 EPC and E-UTRAN Activation mechanism for MDT

##### 4.1.2.12.1 General

UE measurements activation extends the EPC trace activation procedure, as described in 4.1.2.10. When a Trace Session is activated, configuration parameters of MDT are added into the message.

For IMSI/IMEI(SV) based UE selection, or IMSI/IMEI(SV) combined with geographical area based UE selection, UE performance measurements activation request is propagated to UE finally.

This mechanism works for the following input parameters:

- IMSI only or
- IMSI and area information or
- IMEI(SV) only or
- IMEI(SV) and area information or

After the IMSI or IMEISV user attached to the network, the MME shall forward the MDT configurations to the corresponding eNB which serves the IMSI or IMEISV user. If the area criterion is specified and is not satisfied, the MME shall keep the MDT configuration first and then forward it to the serving eNB only when the area criterion is satisfied.

##### **MDT criteria checking on eNB:**

- For immediate MDT, after eNB got the MDT configuration, the eNB can detect the area information and decide whether the selected IMSI/IMEISV can fit into the criteria for initiating MDT data collection. If the area information criterion is not met, the eNB keeps the MDT configuration and propagates it during handover as specified in section 4.4.
- For logged MDT, the eNB will forward the MDT configuration criteria to the selected IMSI/IMEISV. The area criteria checking will be done at UE side after UE received the MDT configuration criteria.

##### **MDT criteria checking on UE:**

- For immediate MDT, there is no need to do MDT criteria checking on UE.
- For logged MDT, The area criteria checking will be done at UE side after UE received the MDT configuration criteria.

In case of logged MDT, after UE receives from eNodeB the configuration parameters via the message RRC Connection Reconfiguration, it detects whether it stays within the specified area. If yes the UE will execute measurement job. Otherwise UE will do nothing but waiting.

In case of Immediate MDT trace (e.g., IMSI/IMEI based selection), the Immediate MDT trace session context of the UE shall be preserved in the network when the UE enters idle mode.

The Logged MDT trace session is preserved in the UE until the duration time of the trace session expires, including also multiple idle periods interrupted by idle-connected-idle state transitions.

The Logged MDT trace session context of the UE is stored in the network as long as the trace session is active, including also the periods when the UE is in connected state.

Two scenarios shall be considered according to UE status when EMS activates MDT job: before UE attachment, after UE attachment, different procedures are described in 4.1.2.12.2, 4.1.2.12.3.

4.1.2.12.2 Activation of MDT task before UE attaches to the network

As shown in figure 4.1.2.12.1, by adding configurations of MDT EMS activate the Trace Session for MDT job.

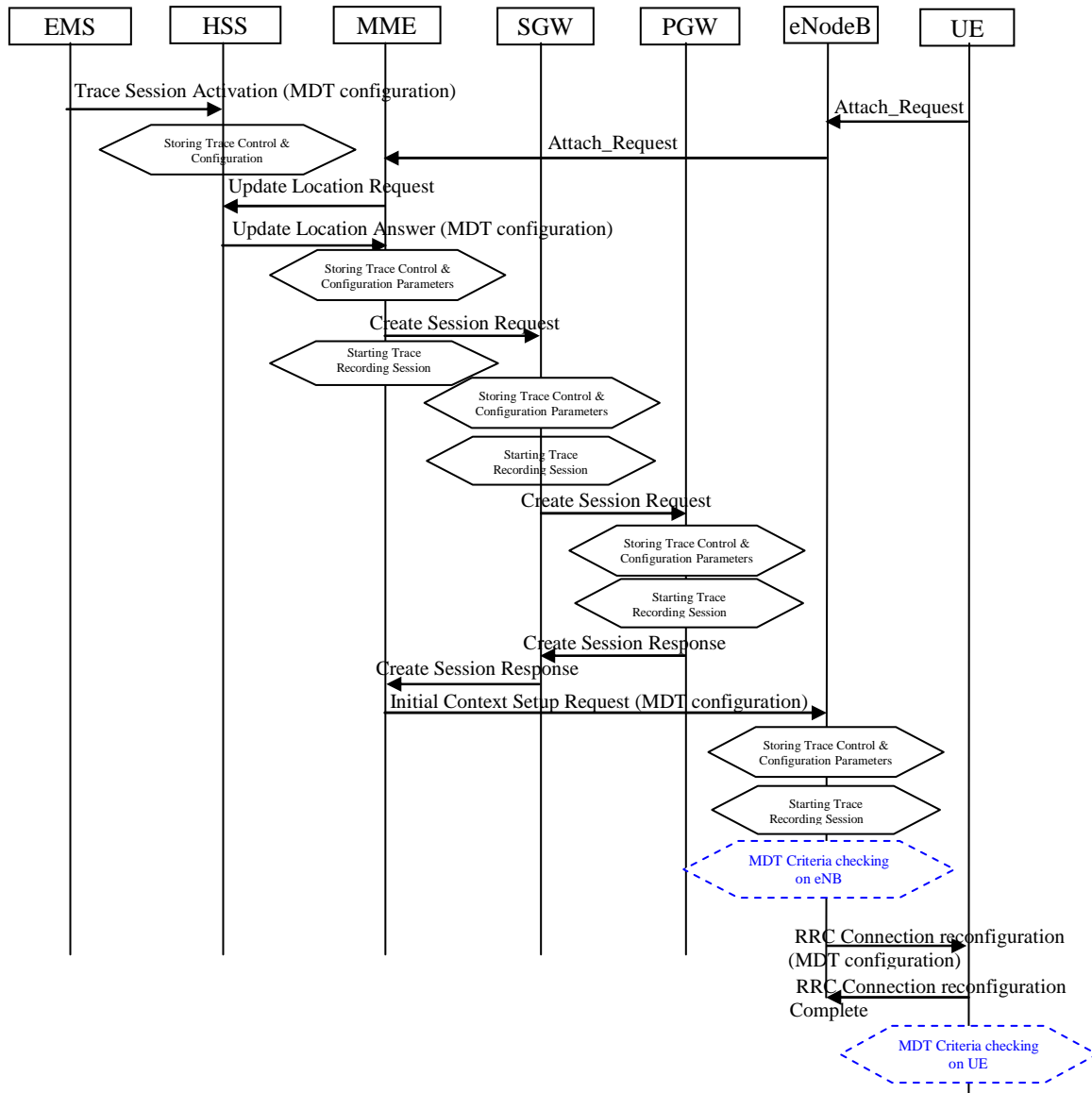

Figure 4.1.2.12.1: MDT activation procedure in EPC

When HSS activates the trace, for MDT job, to the MME the following configuration parameters shall be included in the message:

- jobType
- IMSI or IMEISV
- Area scope (e.g. TA, Cell)
- Trace Reference
- List of measurements

- Reporting Trigger
- Report Interval
- Report Amount
- Event Threshold
- Logging Interval
- Logging duration

Note that at the same time not all the parameters can be present. The conditions are described in Section 5.10 of this document.

- IP address of Trace Collection Entity

The Specified geographical area field is available when IMSI/IMEI(SV) combined with geographical area are needed for UE selection.

When MME activate MDT activation to eNodeB, the MDT configuration parameters can be included in the message in the Initial Context Setup:

- Area scope (TA, Cell)
- Trace Reference
- Trace Recording Session Reference
- List of measurements
- Reporting Trigger
- Report Amount
- Report Interval
- Event Threshold
- Logging Interval
- Logging Duration
- IP address of Trace Collection Entity

Note that at the same time not all the parameters can be present. The conditions are described in Section 5.10 of this document.

The MME receives and stores MDT user consent indication from HSS as part of subscriber information when user context is established in MME at UE attachment. The MME shall consider the MDT user consent information when activating an MDT trace session for the UE. Details on the user consent handling are described in section 4.6.

## 4.1.2.12.3 Activation of MDT task after UE attachment

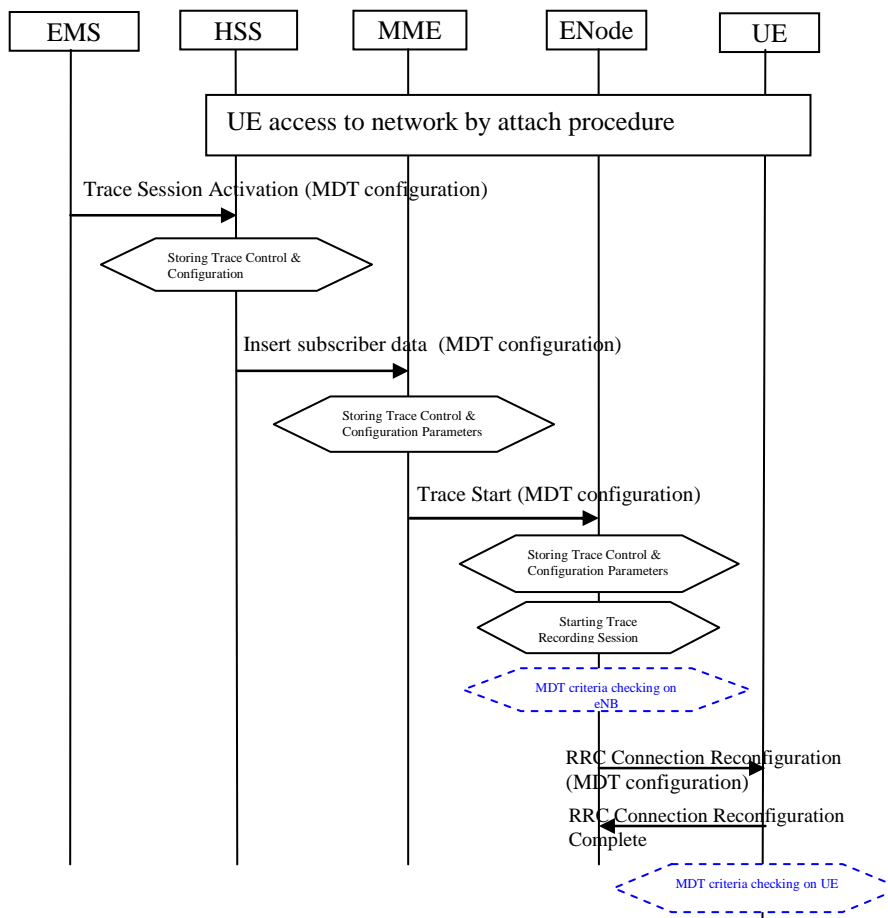

**Figure 4.1.2.12.2: MDT activation in EPC after UE attachment**

The messages propagated to HSS, MME and eNodeB are the same as described in clause 4.1.2.12.2.

When MME can send Trace Start to eNodeB, the following configuration parameters shall be included in the message:

- Area scope (TA, Cell)
- Trace Reference
- Selected UE Measurements
- IP address of Trace Collection Entity

The MME shall consider the MDT user consent information when activating an MDT trace session for the UE. Detailed procedures about user consent is described in Section 4. 6.1.

In case of logged MDT and the UE is currently being in idle mode, the MME is not required to initiate paging of the UE in order to send the configuration.

Then eNodeB initiates RRC Connection Reconfiguration Request in case of immediate MDT or the IdleMDTConfiguration RRC message in case of logged MDT toward the UE and sends the MDT measurement configuration parameters as received from the MME.

Immediate/Logged signalling based MDT criteria may consist of a cell list. MME shall validate whether the serving cell is controlled by the same eNodeB as any other cell in the cell list. If yes, the MDT activation shall be sent to the serving eNodeB.



#### 4.1.2.12.4 Handling of various scenarios during MDT activation

Handling of various scenarios for Signalling based Logged/Immediate MDT are addressed below:

1. EM initiating MDT activation shall validate that the MCC and MNC specified in the Trace reference is the same as the PLMN supported by all the cells specified in the area scope. If the eNodeB receives a request with a PLMN in the TraceReference that does not match any PLMN in its list, it shall ignore the request.
2. Void.
3. MME shall be informed with a TRACE FAILURE INDICATION message if the eNodeB could not configure the UE because it was in the middle of a handover (refer to TS 36.413[35]). MME shall try to reactivate MDT in the target cell if the target cell scope meets the MDT criteria.
4. Void.
5. When the UE re-enters PLMN (specified in trace reference) then the MME shall be responsible for restarting the Immediate MDT activation (if it is as a result of an X2 handover then one option is MME could use the path switch request as trigger). However this is best effort. There can be cases where MME may not be able to restart the MDT when the UE re-enters the PLMN (specified in area scope): for example: If the UE performs intra eNB handover where path switch is not necessarily sent, the MME may not be able to restart MDT.

#### 4.1.2.13 PS domain activation mechanism for MDT

##### 4.1.2.13.1 General

MDT activation in PS domain extends the trace activation procedure, as described in 4.1.2.5. When a Trace Session is activated, configuration parameters of MDT are added into the Trace Session Activation message(s).

For IMSI/IMEI(SV) based UE selection, or IMSI/IMEI(SV) combined with geographical area based UE selection, UE performance measurements activation request is propagated to UE finally.

Detailed behaviour of the UE when it receives the configuration parameters is described in 3GPP TS 37.320 [30].

In case of Immediate MDT trace (e.g., IMSI/IMEI based selection), the Immediate MDT trace session context of the UE shall be preserved in the network when the UE enters idle mode.

The Logged MDT trace session is preserved in the UE until the duration time of the trace session expires, including also multiple idle periods interrupted by idle-connected-idle state transitions.

The Logged MDT trace session context of the UE is stored in the network as long as the trace session is active, including also the periods when the UE is in connected state.

Two scenarios shall be considered according to UE status when the network activates MDT job: before UE attachment, after UE attachment, different procedures are described in 4.1.2.13.2 and 4.1.2.13.2a.

##### 4.1.2.13.2 Activation of MDT task before UE attaches to the network

The MDT activation procedure is shown in figure 4.1.2.13.2.1.

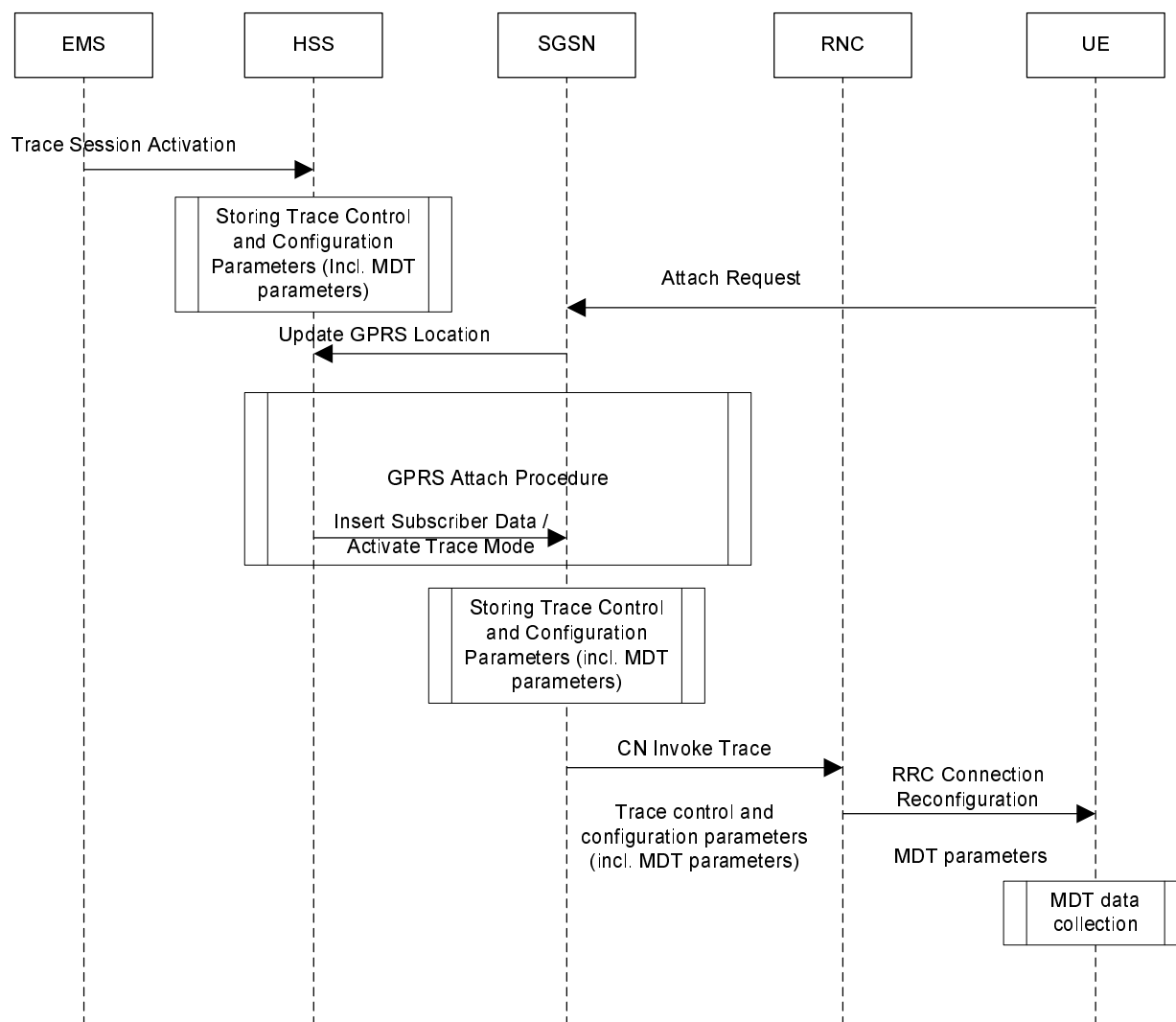

**Figure 4.1.2.13.2.1 MDT activation procedure in PS domain during attach procedure**

The Trace Session activation is started from the EMS, when it activates the Trace Session to the HSS. The HSS stores the trace control and configuration parameters in its database.

When a UE registers with the network by sending an ATTACH\_REQUEST message to the SGSN, it updates the location information in the HSS by sending the UPDATE\_GPRS\_LOCATION message to the HSS. The HSS checks if the UE is being traced. If it is being traced, the HSS shall propagate the trace control and configuration parameters to the SGSN by sending a MAP-ACTIVATE\_TRACE\_MODE - see 3GPP TS 29.002 [11] message to the SGSN (This message can be embedded also in the MAP INSERT SUBSCRIBER DATA message). The SGSN receives and stores MDT user consent indication from HSS as part of subscriber information when user context is established in SGSN at UE attachment (details are available in Section 4.6.1). When an inter-SGSN routing area update occurs, HSS shall send the MAP-ACTIVATE\_TRACE\_MODE message to the new SGSN. The Trace Session Activation from HSS to SGSN shall contain the following MDT specific parameters in addition to the existing trace parameters:

- Job type
- Area Scope
- List of measurements
- Reporting Trigger
- Report Interval

- Report Amount
- Event Threshold
- Logging Interval
- Logging Duration
- IP address of Trace Collection Entity
- Measurement quantity

Note that at the same time not all of the parameters can be present. The condition which parameters shall be present is described in clause 5 of the present document.

When SGSN receives the MAP-ACTIVATE\_TRACE\_MODE message it shall store the trace control and configuration parameters and shall start a Trace Session and shall send the CN\_INVOKE\_TRACE message to the RNC. The SGSN shall consider the MDT user consent information when activating an MDT trace session for the UE. The SGSN shall send the following parameters to the RNC beside the existing trace parameters:

- Job type
- Area Scope
- List of measurements
- Reporting Trigger
- Report Interval
- Report Amount
- Event Threshold
- Logging Interval
- Logging Duration
- IP address of Trace Collection Entity
- Measurement quantity

Note that at the same time not all of the parameters can be present. The conditions which parameters shall be present is described in clause 5 of the present document.

#### 4.1.2.13.2a Activation of MDT task after UE attaches to the network

The MDT activation procedure after UE attaches to the network is shown in figure 4.1.2.13.2a.1.

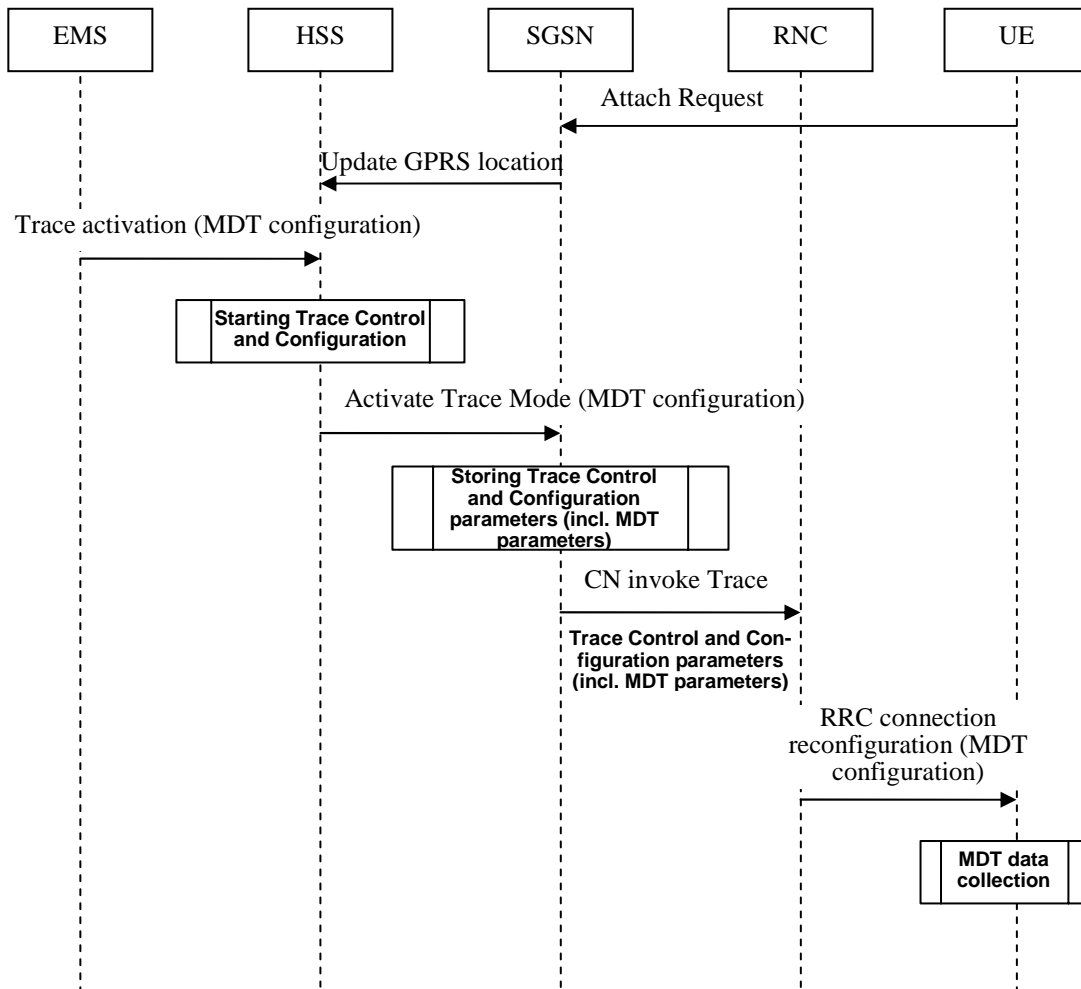

**Figure 4.1.2.13.2a.1 MDT activation procedure in PS domain after UE attaches to the network**

When a UE registers with the network by sending an ATTACH\_REQUEST message to the SGSN, it updates the location information in the HSS by sending the UPDATE\_GPRS\_LOCATION message to the HSS.

The Trace Session activation is started from the EMS, when it activates the Trace Session to the HSS. When the HSS send trace activation to the SGSN, the HSS shall propagate the trace control and configuration parameters to the SGSN by sending a MAP-ACTIVATE\_TRACE\_MODE - see 3GPP TS 29.002 [11] message to the SGSN (This message can be embedded also in the MAP INSERT SUBSCRIBER DATA message). The SGSN receives and stores MDT user consent indication from HSS as a part of subscriber information (details are available in Section 4. 6.1). When an inter-SGSN routing area update occurs, HSS shall send the MAP-ACTIVATE\_TRACE\_MODE message to the new SGSN. The Trace Session Activation from HSS to SGSN shall contain the following MDT specific parameters in addition to the existing trace parameters:

- Job type
- Area Scope
- List of measurements
- Reporting Trigger
- Report Interval
- Report Amount
- Event Threshold
- Logging Interval

- Logging Duration
- IP address of Trace Collection Entity
- Measurement quantity

Note that at the same time not all of the parameters can be present. The condition which parameters shall be present is described in clause 5 of the present document.

When SGSN receives the MAP-ACTIVATE\_TRACE\_MODE message it shall store the trace control and configuration parameters and shall start a Trace Session and shall send the CN\_INVOKE\_TRACE message to the RNC. The SGSN shall consider the MDT user consent information when activating an MDT trace session for the UE. The SGSN shall send the following parameters to the RNC beside the existing trace parameters:

- Job type
- Area Scope
- List of measurements
- Reporting Trigger
- Report Interval
- Report Amount
- Event Threshold
- Logging Interval
- Logging Duration
- IP address of Trace Collection Entity
- Measurement quantity

Note that at the same time not all of the parameters can be present. The conditions which parameters shall be present are described in clause 5 of the present document.

#### 4.1.2.13.3 Handling of various scenarios during MDT activation

Handling of various scenarios for Signalling based Logged/Immediate MDT is addressed below:

1. EM initiating MDT activation shall validate that the MCC and MNC specified in the Trace reference is the same as the PLMN supported by all the RNCs specified in the area scope. If the RNC receives a request with a PLMN in the TraceReference that does not match any PLMN in its list, it shall ignore the request.
2. SGSN shall trigger the MDT activation only when the MDT area criterion is satisfied. But if the RNC receives a request that is outside the area scope then the RNC shall store the MDT configuration and forward the request when a handover occurs (intra PLMN).
3. When the UE re-enters the PLMN (in trace reference) which matches the area scope defined in the MDT configuration then the SGSN shall be responsible for restarting the Immediate MDT activation. However, this is best effort.
4. Void.
5. SGSN shall re-initiate CN Invoke Trace procedure to reactivate MDT job after successful SRNS relocation if the RNC could not configure the UE since it was in the middle of inter-RNC handover (refer to TS 25.413 [13]). SGSN shall try to reactivate MDT in the target cell if the target cell scope meets the MDT criteria.
6. Void.
7. Area based MDT criteria may consist of a cell list. SGSN shall validate whether the UE is controlled by the same RNC as any other cell in the cell list. If yes, the MDT activation shall be sent to the serving RNC. If the RNC receives a Signalling Based MDT activation request when the UE is served by a cell that is in the RNC

but not in the MDT area scope then the RNC shall store the MDT configuration and configure the UE when the UE moves to a cell in the RNC (intra RNC handover) that satisfies the area scope in the request.

#### 4.1.2.14 CS domain activation mechanism for MDT

##### 4.1.2.14.0 Activation of MDT task before UE attaches to the network

In UMTS it is also possible to send the MDT job activation via the CS domain instead of the PS domain. The activation mechanism is shown in figure 4.1.2.14.1

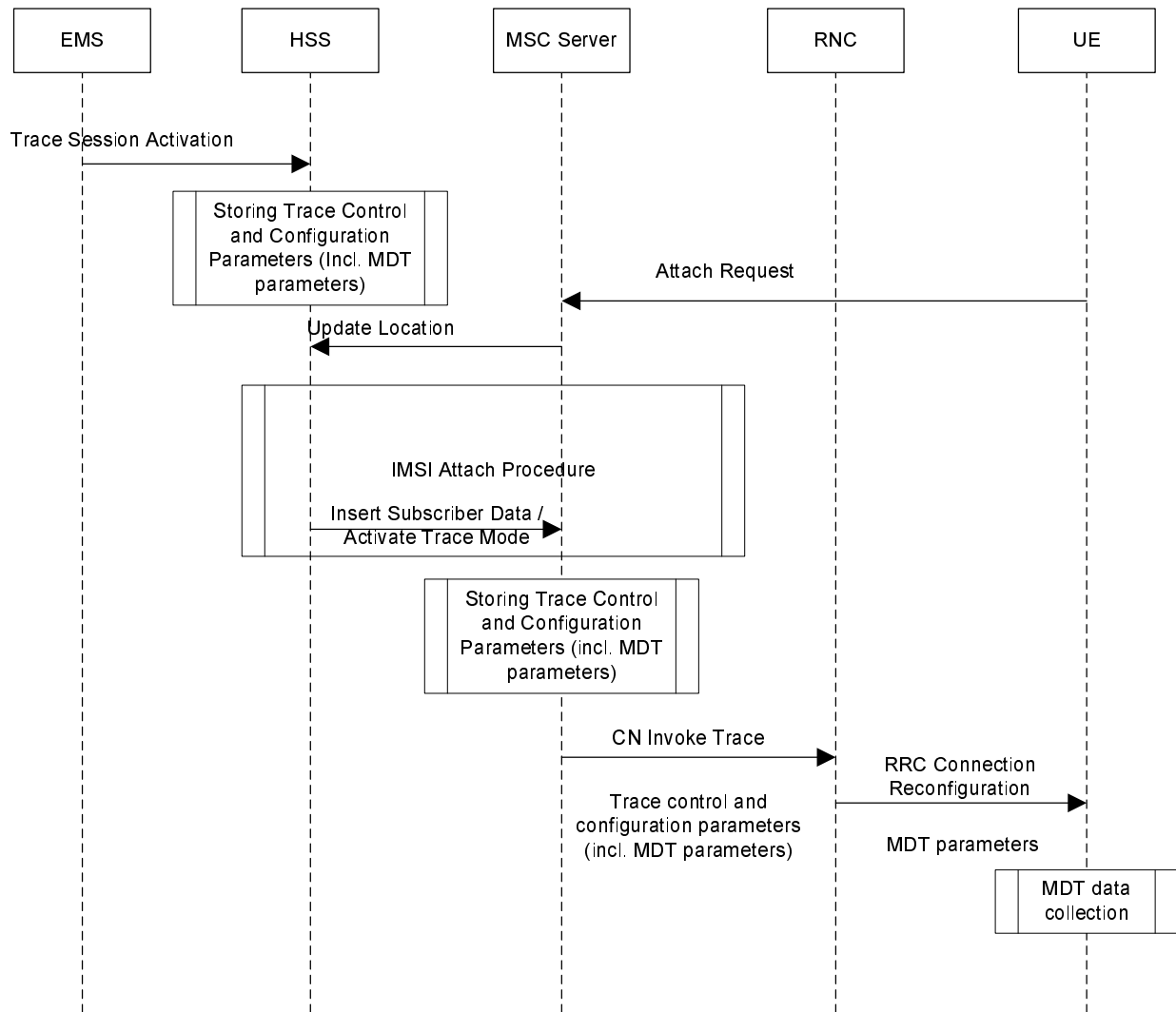

**Figure 4.1.2.14.1 MDT activation procedure in CS domain during attach procedure**

The Trace Session activation is started from the EMS, when it activates the Trace Session to the HSS. The HSS stores the trace control and configuration parameters in its database.

When a UE registers with the network by sending an ATTACH\_REQUEST message to the MSC Server, it updates the location information in the HSS by sending the UPDATE\_LOCATION message to the HSS. The HSS checks if the UE is being traced. If it is being traced, the HSS shall propagate the trace control and configuration parameters to the MSC Server by sending a MAP-ACTIVATE\_TRACE\_MODE - see 3GPP TS 29.002 [11] message to the MSC Server (This message can be embedded also in the MAP INSERT SUBSCRIBER DATA message). The MSC Server receives and stores MDT user consent indication from HSS as part of subscriber information at UE attachment (details are available in Section 4.2.8.1). When an inter-VLR Location Area update occurs, HSS shall send the MAP-

ACTIVATE\_TRACE\_MODE message to the new VLR / MSC Server. The Trace Session Activation from HSS to MSC Server shall contain the following MDT specific parameters in addition to the existing trace parameters:

- Job type
- Area Scope
- List of measurements
- Reporting Trigger
- Report Interval
- Report Amount
- Event Threshold
- Logging Interval
- Logging Duration
- IP address of Trace Collection Entity
- Measurement quantity

Note that at the same time not all of the parameters can be present. The condition under which parameters shall be present is described in clause 5 of the present document.

When MSC Server receives the MAP-ACTIVATE\_TRACE\_MODE message it shall store the trace control and configuration parameters and shall start a Trace Session and shall send the CN\_INVOKE\_TRACE message to the RNC. The MSC Server shall consider the MDT user consent information when activating an MDT trace session for the UE. The MSC Server shall send the following parameters to the RNC beside the existing trace parameters:

- Job type
- Area Scope
- List of measurements
- Reporting Trigger
- Report Interval
- Report Amount
- Event Threshold
- Logging Interval
- Logging Duration
- IP address of Trace Collection Entity
- Measurement quantity

Note that at the same time not all of the parameters can be present. The condition under which parameters shall be present is described in clause 5 of the present document.

In case of Immediate MDT trace (e.g., IMSI/IMEI based selection), the Immediate MDT trace session context of the UE shall be preserved in the network when the UE enters idle mode.

The Logged MDT trace session is preserved in the UE until the duration time of the trace session expires, including also multiple idle periods interrupted by idle-connected-idle state transitions.

The Logged MDT trace session context of the UE is stored in the network as long as the trace session is active, including also the periods when the UE is in connected state.

#### 4.1.2.14.1 MDT Error Handling

Handling of various scenarios for Signalling based Logged/Immediate MDT is addressed below:

1. EM initiating MDT activation shall validate that the MCC and MNC specified in the Trace reference is the same as the PLMN supported by all the cells specified in the area scope. If the RNC receives a request with a PLMN in the TraceReference that does not match any PLMN in its list , it shall ignore the request
2. MSC-S shall trigger the activation only when the MDT area criterion is satisfied. But if for some reason the RNC receives a request that is outside the area scope then the RNC shall store the MDT configuration and forward the request when a handover occurs (intra PLMN).
3. When the UE re-enters the PLMN (in trace reference) which matches the area scope defined in the MDT configuration then the MSC shall be responsible for restarting the Immediate MDT activation. However this is best effort.
4. Void.
5. MSC-S shall re-initiate CN Invoke Trace procedure to reactivate MDT job after SRNS relocation (refer to TS 25.413 [13]) if the RNC could not configure the UE since it was in the middle of inter RNC handover. MSC-S shall try to reactivate MDT in the target cell if the target cell scope meets the MDT criteria.
6. Void.
7. Area based MDT criteria may consist of a cell list. MSC-S shall validate whether the UE is controlled by the same RNC as any other cell in the cell list. If yes, the MDT activation shall be sent to the serving RNC. If the RNC receives a Signalling Based MDT activation request when the UE is served by a cell that is in the RNC but not in the MDT area scope then the RNC shall store the MDT configuration and configure the UE when the UE moves to a cell in the RNC (intra RNC handover) that satisfies the area scope in the request



## 4.1.3 Management deactivation

### 4.1.3.1 UTRAN deactivation mechanisms

When last Trace session is requested to be ended for an IMEI(SV) or a list of IMEI(SV), the RNC shall send the requested IMEI(SV)/list of IMEI(SV)s in 'Uplink Information Exchange Request' to the interacting MSC Server(s) and SGSN(s). The MSC Servers and SGSNs shall remove the requested IMEI(SV)s for the RNC in question.

### 4.1.3.2 PS Domain deactivation mechanisms

When a SGSN, GGSN or BM-SC receives a Trace Session Deactivation from its EM, the Trace Session identified by the Trace Reference, shall be deactivated in SGSN/GGSN/BM-SC.

If a Trace Recording Session is active at the time of receiving a Trace Session deactivation from the EM, the SGSN/GGSN/BM-SC may choose to continue the Trace Recording Session till it ends gracefully or may stop it immediately. In all cases, the SGSN/GGSN/BM-SC shall deactivate the requested Trace Session immediately at the end of the Trace Recording Session.

### 4.1.3.3 CS Domain deactivation mechanisms

When a MSC Server receives a Trace Session Deactivation from its EM, the Trace Session identified by the Trace Reference, shall be deactivated in MSC Server.

If a Trace Recording Session is active at the time of receiving a Trace Session deactivation from the EM, the MSC Server may choose to continue the Trace Recording Session till it ends gracefully or may stop it immediately. In all cases, the MSC Server shall deactivate the requested Trace Session immediately at the end of the Trace Recording Session.

### 4.1.3.4 IP Multimedia Subsystem deactivation mechanisms

When a S-CSCF/P-CSCF receives a Trace Session deactivation from the EM, the Trace Session identified by the Trace Reference, shall be deactivated.

If a Trace Recording Session is active at the time of receiving a Trace Session deactivation from the EM, the S-CSCF/P-CSCF may choose to continue the Trace Recording Session till it ends gracefully or may stop it immediately. In all cases, the S-CSCF/P-CSCF shall deactivate the requested Trace Session immediately at the end of the Trace Recording Session.

The following figure illustrates how the Trace Session is deactivated when a Trace Recording Session is going on (e.g. a SIP INVITE method is being traced in S-CSCF).

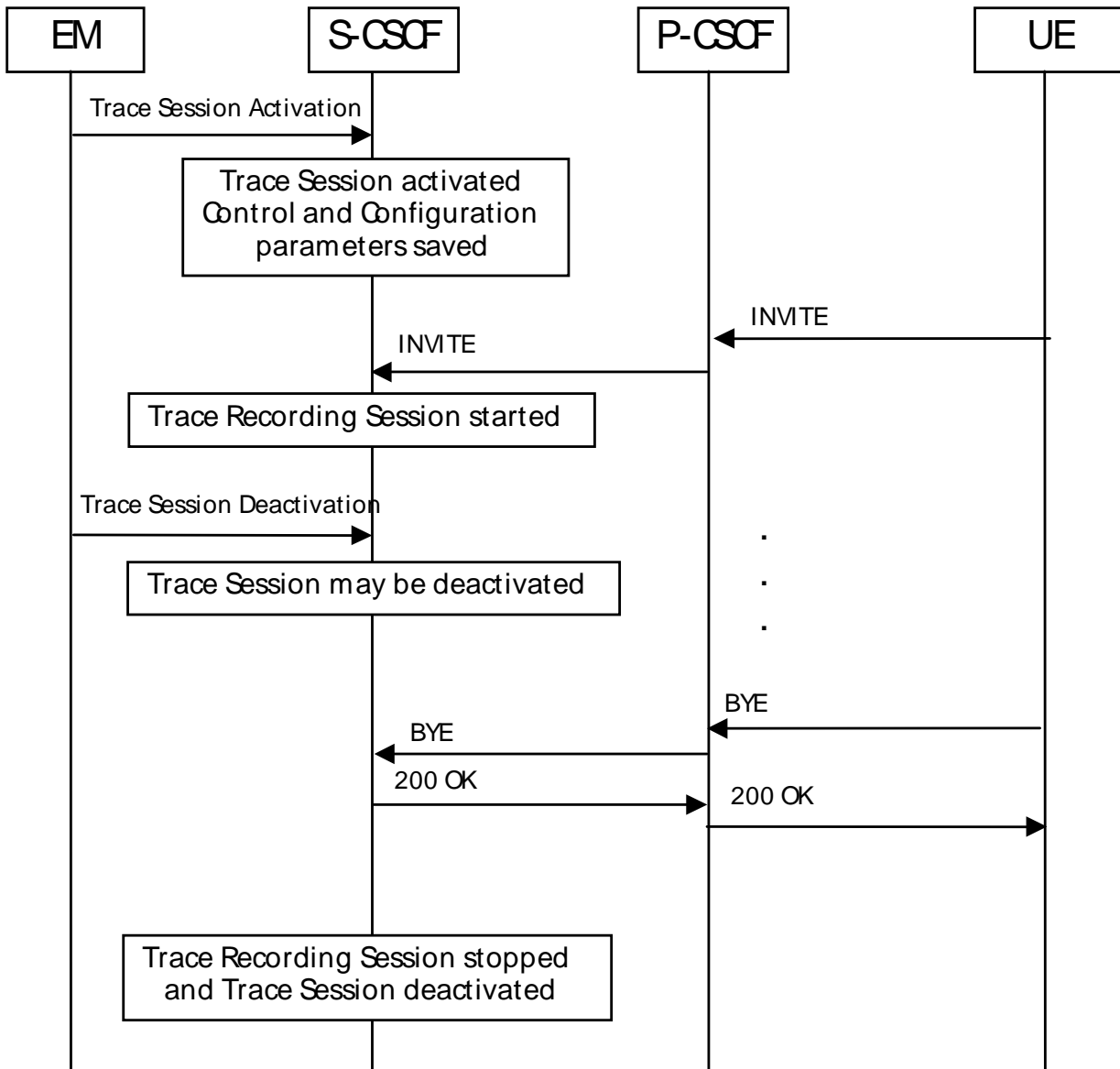

Figure 4.1.3.4.1: Trace session deactivation in IMS

#### 4.1.3.5 E-UTRAN deactivation mechanisms

In E-UTRAN the Cell Traffic trace functionality can be deactivated when the eNodeB receives the Trace Session Deactivation message from the EM. At this time the eNodeB shall deactivate the Trace Session for those E-UTRAN Cells that have been indicated in the Trace Session Deactivation message received from the EM.

#### 4.1.3.6 EPC Domain deactivation mechanisms

When a MME, SGW or PGW receives a Trace Session Deactivation from its EM, the Trace Session identified by the Trace Reference, shall be deactivated in the MME, SGW or PGW.

If a Trace Recording Session is active at the time of receiving a Trace Session deactivation from the EM, the MME may choose to continue the Trace Session and the Trace Recording Session till it ends gracefully or may stop it immediately. In all cases, the MME shall deactivate the requested Trace Session immediately at the end of the Trace Recording Session.

#### 4.1.3.7 E-UTRAN deactivation mechanisms for MDT

When the eNodeB receives the indication from EM for MDT trace session deactivation, it shall deactivate the trace session for those E-UTRAN cells that have been indicated in the message. In case of immediate MDT trace session the eNodeB shall deactivate the corresponding MDT RRC measurements in the UEs that have been configured for immediate MDT as part of the given trace session.

#### 4.1.3.8 Deactivation mechanisms at UE for MDT

The UE shall silently discard a logged MDT trace session when logging duration expires and shall indicate the availability of logged measurement results to the network next time it enters connected mode.

## 4.1.4 Signalling deactivation

### 4.1.4.1 General

In Signalling deactivation, the Trace Deactivation shall always be carried out from the Core Network EM only [EM (PS), EM (CS), EM(EPC) and EM (HSS) are generally considered to be in the Core Network. A Core Network EM can be any of these or their combinations]. In case of home subscriber trace (i.e. in the HPLMN) the Trace Session deactivation shall go to the HSS, MSC Server/VLR, SGSN or MME. In case of foreign subscriber trace (i.e. the HPLMN operator wishes to deactivate tracing on foreign subscribers roaming in his PLMN) the Trace Session deactivation shall go the MSC Server/VLR SGSN or MME. The Management System shall deactivate the Trace Session in the same NE where it activated the Trace Session.

When an HSS receives a Trace Session deactivation from its Management system, it shall deactivate the active Trace Session corresponding to the Trace Reference received in the deactivation message. The HSS shall delete all trace control and configuration parameters associated with this Trace Session. If a Trace Recording Session is active at the time of receiving a Trace Session deactivation message from the EM, the HSS may choose to continue the Trace Recording Session till it ends gracefully or may stop it immediately. In all cases, the HSS shall deactivate the requested Trace Session immediately at the end of the Trace Recording Session.

### 4.1.4.2 UTRAN deactivation mechanisms

When RNC receives the CN\_DEACTIVATE\_TRACE message it shall deactivate the Trace Session for the indicated Trace Reference in the CN\_DEACTIVATE\_TRACE message. In case of simultaneous CS/PS connections, the trace session for the indicated trace reference shall be closed upon reception of the CN DEACTIVATE TRACE message from any of the CN domain, whether it was the one which initiated trace session activation or not.

The Trace Session is also deactivated in the RNC when the Iu connection to the Core Network is released.

If CN\_INVOKE\_TRACE message is received for only one Iu connection (either CS or PS) the Trace Session shall be deactivated in the RNC when the IU\_RELEASE\_COMMAND message is received from the Core Network for that Iu connection where the CN\_INVOKE\_TRACE message is sent.

The following figure shows this behaviour:

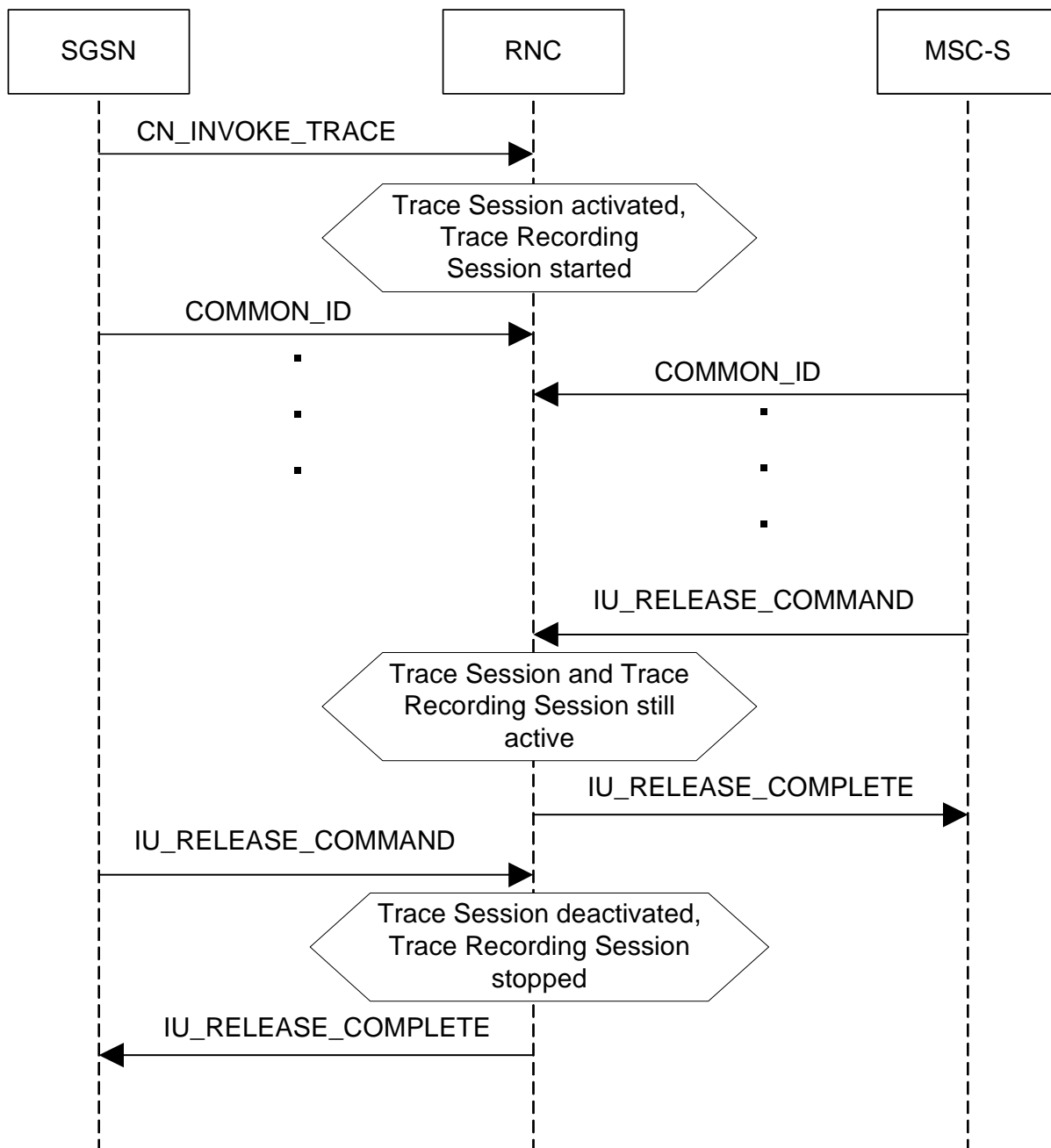

**Figure 4.1.4.2.1: Trace session deactivation (Signalling) in UTRAN 1**

If CN\_INVOKE\_TRACE message is received by the RNC for both Iu-CS and Iu-PS connection with the same Trace Reference number than the Trace Session shall not be deactivated in the RNC when any of the Iu connection is released (when the first IU\_RELEASE\_COMMAND message is received). The Trace Session shall be deactivated when the second Iu connection is released (the second IU\_RELEASE\_COMMAND message is received). The following figure shows the situation.

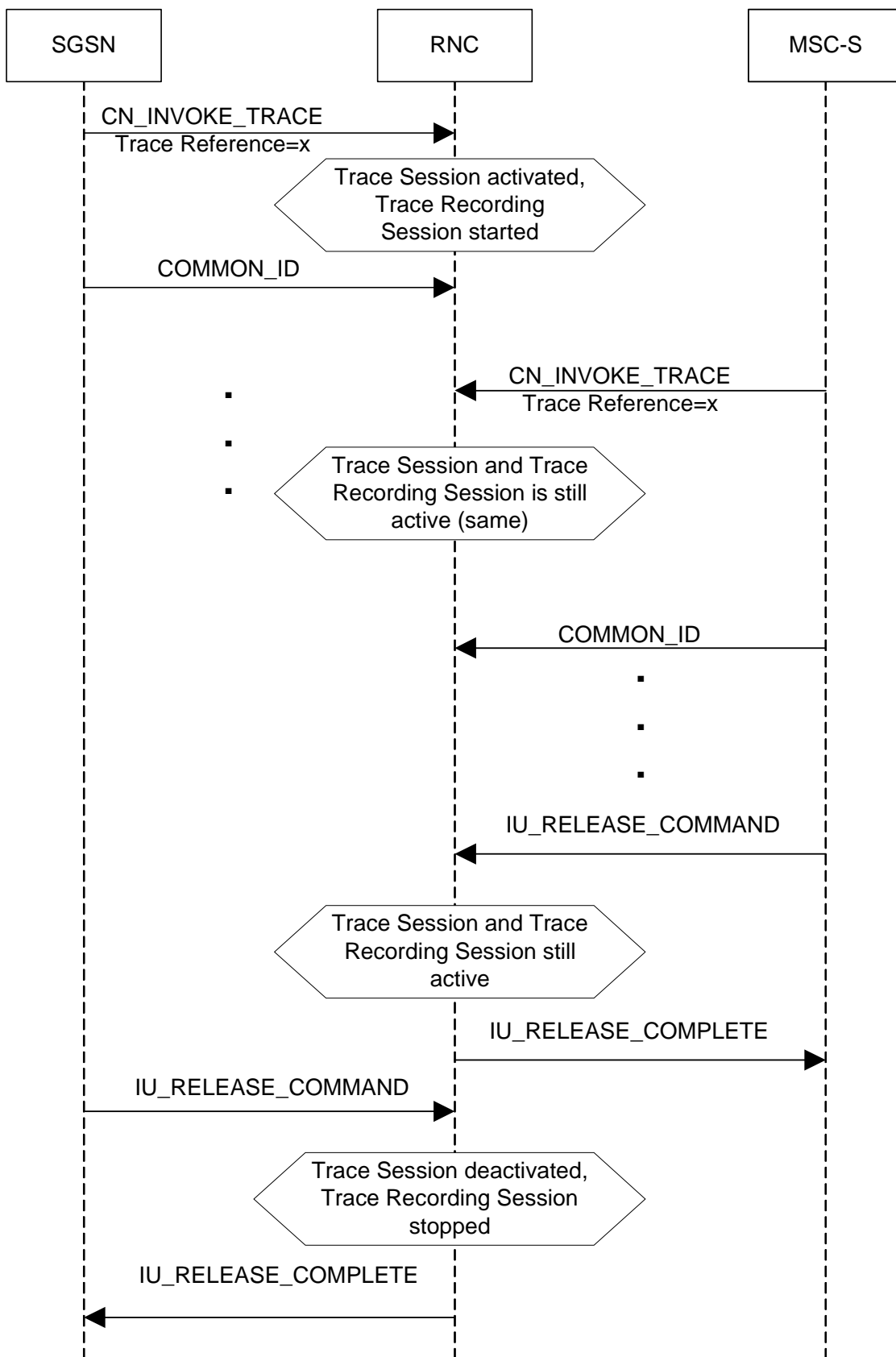

Figure 4.1.4.2.2: Trace session deactivation (Signalling) in UTRAN 2

### Interaction with Soft-handover

The Trace Session should be deactivated in a Drift RNC when the DRNC receives the IUR\_DEACTIVATE\_TRACE message or the Iur connection is released.

When an RNC deactivates a Trace Session the Trace Recording Session shall also be stopped at the same time.

NOTE: In RNC the Trace Session and the Trace Recording Session always the same.

#### 4.1.4.3 PS Domain deactivation mechanisms

When an HSS receives a Trace Session deactivation from the Management System it shall send a MAP\_DEACTIVATE\_TRACE\_MODE message to the SGSN.

When the SGSN receives a MAP\_DEACTIVATE\_TRACE\_MODE message it shall deactivate the Trace Session identified by the Trace reference received in the MAP\_DEACTIVATE\_TRACE\_MODE message.

If a Trace Recording Session is active at the time of receiving a deactivation message (in SGSN it is the MAP\_DEACTIVATE\_TRACE\_MODE, in GGSN it is the GTP Update PDP Context Request or the Update MBMS Context Request, in BM-SC it is the Diameter Gmb STR message), the SGSN and/or the GGSN and/or the BM-SC may choose to continue the Trace Recording Session till it ends gracefully or may stop it immediately. In all cases, the SGSN/GGSN/BM-SC shall deactivate the requested Trace Session immediately at the end of the Trace Recording Session. When the SGSN deactivates the Trace Session, it shall delete all trace control and configuration parameters associated with the corresponding Trace Session.

If SGSN deactivates the Trace Session during the Trace Recording Session, the SGSN should deactivate the trace to the RNC by using the CN\_DEACTIVATE\_TRACE RANAP message and should deactivate the trace to the GGSN by sending the GTP Update PDP Context Request or the Update MBMS Context Request message with Trace Activity Control set to Trace Deactivation.

If the GGSN deactivates the Trace Session during the Trace Recording Session, the GGSN should deactivate the trace to the BM-SC (by sending a Diameter Gmb STR message).

#### 4.1.4.4 CS Domain deactivation mechanisms

When an HSS receives Trace Session deactivation from the Management System it shall send a MAP\_DEACTIVATE\_TRACE\_MODE message to the MSC Server.

When the MSC Server receives a MAP\_DEACTIVATE\_TRACE\_MODE message it shall deactivate the Trace Session identified by the Trace reference received in the MAP\_DEACTIVATE\_TRACE\_MODE message.

If a Trace Recording Session is active at the time of receiving a MAP\_DEACTIVATE\_TRACE\_MODE message from the HSS, the MSC Server may choose to continue the Trace Recording Session till it ends gracefully or may stop it immediately. In all cases, the MSC Server shall deactivate the requested Trace Session immediately at the end of the Trace Recording Session. When the MSC Server deactivates the Trace Session it shall delete all trace control and configuration parameters associated with the corresponding Trace Session. .

If MSC Server deactivates the Trace Session during a Trace Recording Session, it should deactivate the trace to the RNC by sending the CN\_DEACTIVATE\_TRACE RANAP message and should deactivate the trace to the MGW.

#### 4.1.4.5 Void

#### 4.1.4.6 Service Level Trace in IMS deactivation mechanisms

##### 4.1.4.6.1 General

When an IMS NE (i.e. S/I/P-CSCF, AS, HSS, MRF, MGCF, BGCF) receives Trace Session deactivation the Trace Session, as identified by the Trace Reference, shall be deactivated.

If a Trace Recording Session(s) within the Trace session is active at the time of receiving a Trace Session deactivation, the IMS NE may stop the trace recording session(s) immediately or it may choose to continue the Trace Recording

Session(s) till the session(s) ends gracefully (e.g. the SIP session ends after a specific period of time, or upon completion of a SIP session and the reception of a SIP BYE).

In all cases, the IMS NE shall deactivate the requested Trace Session immediately at the end of the Trace Recording Session(s). When the IMS NE deactivates the Trace Session, it shall delete all associated trace control and configuration parameters associated with that Trace Session.

#### 4.1.4.6.2 Trace session deactivation at an IMS NE

##### 4.1.4.6.2.1 Trace session deactivation propagated by EM

Trace Session deactivation may be initiated from the Core Network EM only [EM (UE), and EM (HSS)]. The same EM that initiated Trace Session activation shall initiate a Trace Session deactivation in the same Network Element (NE).

When Trace Session deactivation is required for a registered home subscriber in the home IM CN SS, Trace Session deactivation shall go to the UE and the HSS. The HSS shall propagate the Trace Session deactivation to the S-CSCF, I-CSCF, and the AS. The S-CSCF and I-CSCF shall propagate the Trace Session deactivation to the P-CSCF. The Trace Session deactivation shall be propagated to the MRF, MGCF and BGCF via the S-CSCF.

When Trace deactivation is required for a registered home subscriber in a visited IM CN SS, Trace Session deactivation shall go to the UE and the HSS. The HSS shall propagate the Trace Session deactivation to the S-CSCF, I-CSCF and the AS.

Depending on whether the I-CSCF had previously propagated a Trace Session Activation to the P-CSCF serving the UE (see subclause 4.1.2.9.2) where Trace is to be initiated the I-CSCF may propagate the Trace Session deactivation to the P-CSCF.

##### 4.1.4.6.2.2 Trace session deactivation following a Triggering event

An Active Trace Session may be deactivated at an IMS NE following the detection of a Stop Triggering Event, e.g. Trace Session expiry time.

In the case where there is one or more active Trace Recording Sessions, the IMS NE shall deactivate the Trace Session immediately following the detection of a Stop Triggering Event associated for each of the Trace Recording Session(s), e.g. following the detection of SIP final response or a SIP Request Failure

When the IMS NE deactivates the Trace Session Stop Triggering Event, it shall delete all associated trace control and configuration parameters associated with that Trace Session.

##### 4.1.4.6.2.3 Trace session deactivation initiated directly by an EM

When required, an active Trace Session at an IMS NE may be deactivated directly by its EM. The Management based Trace Session deactivation mechanism (see clause 4.1.1) shall be used for this purpose.

#### 4.1.4.6.3 Trace session deactivation at the UE

The EM (UE) and the interactions between the EM (UE) and the UE shall be achieved using OMA Device Management [18].

Figure 4.1.4.6.3.1 illustrates the sending of Trace Session Deactivation from the Device Management Server (DMS) to a UE.

**Editor's note: The exact OMA Device Management enabler is FFS.**



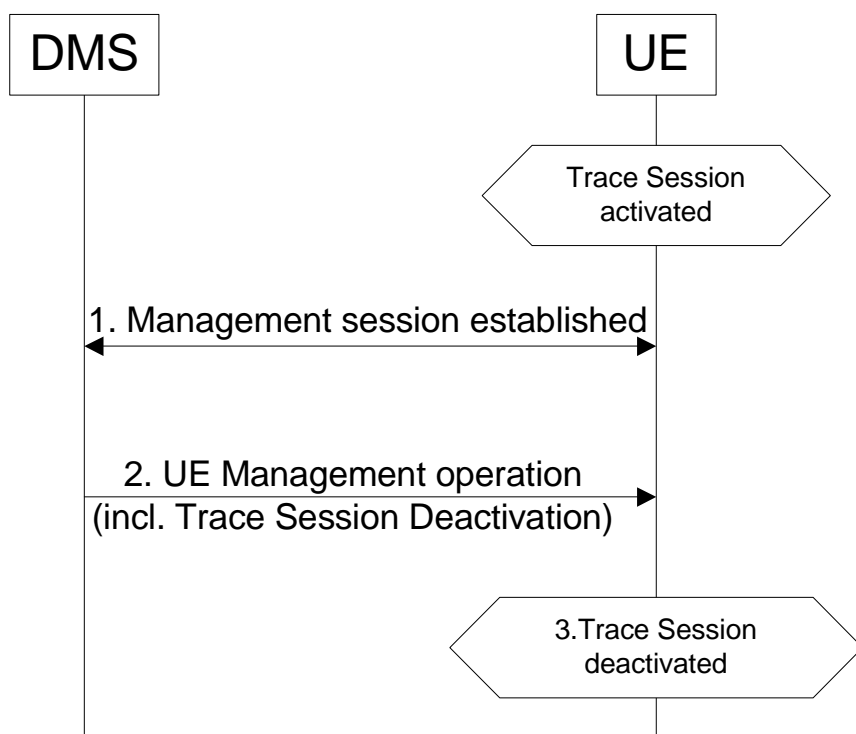

**Figure 4.1.4.6.3.1: Trace session deactivation at a UE**

Trace Session deactivation shall be initiated from the Device Management Server (DMS). The same DMS that initiated Trace Session activation shall initiate a Trace Session deactivation in the same UE (Step 1).

When a UE receives Trace Session Deactivation as part of the received management operation from its DMS (Step 2) it may deactivate the Trace Session (Step 3).

If a Trace Recording Session(s) within the Trace session is active at the time of receiving a Trace Session deactivation, the UE may stop the trace recording session(s) immediately (see note), or it may choose to continue the Trace Recording Session(s) until the session(s) end gracefully (e.g. the SIP session ends after a specific period of time, or upon completion of a SIP session and the reception of a SIP BYE).

NOTE: When the Trace session is stopped the UE may deactivate or delete its management operation.

#### 4.1.4.7 EPC deactivation mechanisms

When an HSS receives a Trace Session Deactivation from the Management System it shall send an S6a-Delete Subscriber Data Request message to the MME at which the UE is currently registered if MME is included in the NE types for Tracing, via the S6a interface to remove the 'trace data' from subscription data (see 3GPP TS 29.272[26]). The HSS shall deactivate trace if trace is active at the HSS.

When the MME receives the S6a-Delete Subscriber Data Request message to remove the 'trace data' from subscription data (see 3GPP TS 29.272 [26]) or the Trace Session is deactivated directly from the EM it shall deactivate the Trace Session identified by the Trace Reference.

If the UE was registered to the HSS by an MME via the S6a interface, (i.e. the user is attached to a 3GPP access network), the Trace Session shall be deactivated to the MME via the S6a interface.

If the user was registered by a AAA server via the SWx interface (i.e. the user is attached to a non-3GPP network) the HSS shall send the Trace Session deactivation request with a push profile request.

The AAA server shall examine the received user profile and if it detects that the Trace Session shall be deactivated, it shall initiate a re-authorization procedure towards the PDN GW. The Trace Session is deactivated in the PDN GW by using this re-authorization procedure.

When the PDN GW receives the updated authorization data with trace information that represents Trace Session deactivation request, it shall deactivate the Trace Session identified by the Trace Reference.

The following figure illustrates the Trace Session deactivation when the user is attached to a non-3GPP access network for DSMIPv6 on S2c or PMIP on S2a/S2b.

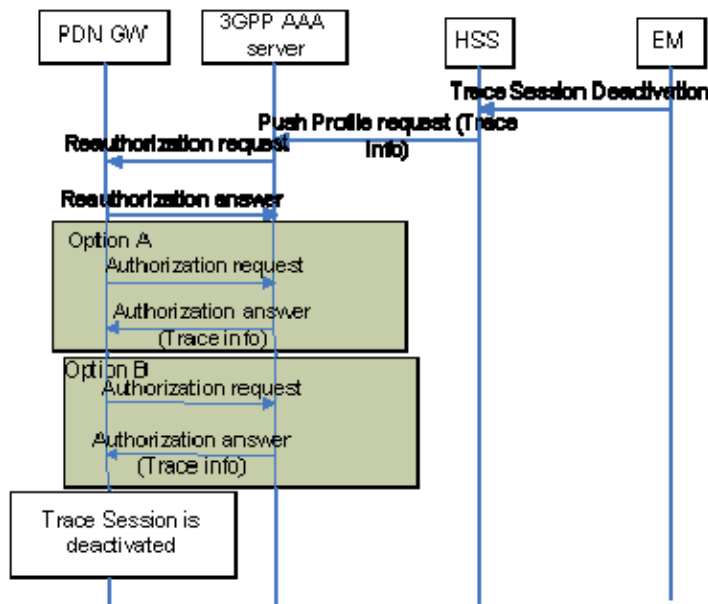

**Figure 4.1.4.7.1: Trace Session deactivation in case UE attached from non-3GPP access network for DSMIPv6 on S2c or PMIP on S2a/S2b**

If the user was registered by a AAA server via the SWx interface (i.e. the user is attached to a non-3GPP network) the HSS shall send the Trace Session deactivation request with a push profile request.

The AAA server shall examine the received user profile and if it detects that the Trace Session shall be deactivated, it shall initiate a re-authorization procedure towards the ePDG.

The ePDG shall examine the received information from the AAA and if it detects that the Trace Session shall be deactivated (see 3GPP TS 29.273 [22]), it shall initiate a trace deactivation procedure towards the PDN GW (see 3GPP TS 29.274 [34]).

When the PDN GW receives the data with trace information that represents Trace Session deactivation request, it shall deactivate the Trace Session identified by the Trace Reference.

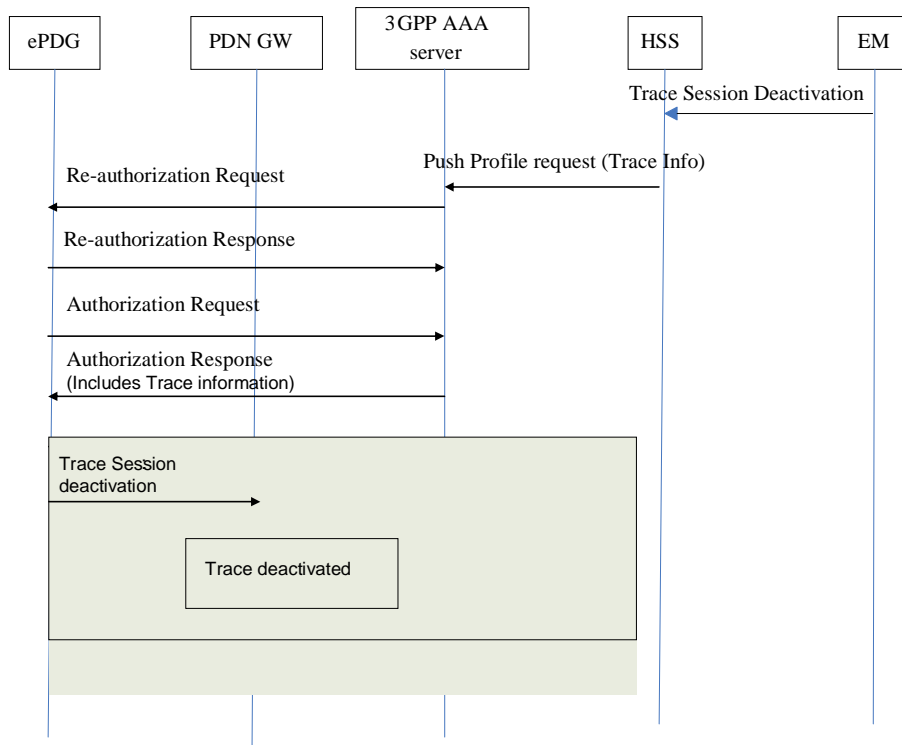

**Figure 4.1.4.7.2 : Trace Session deactivation in case UE attached from non-3GPP access network for GTP based S2b interface**

When the MME receives the S6a-Delete Subscriber Data Request message to remove the 'trace data' from subscription data (see 3GPP TS 29.272 [26]) or the Trace Session is deactivated directly from the EM it shall deactivate the Trace Session identified by the Trace Reference.

If a Trace Recording Session is active at the time of receiving a deactivation message, the MME may choose to continue the Trace Recording Session until it ends gracefully or may stop it immediately. In all cases, the MME shall deactivate the requested Trace Session immediately at the end of the Trace Recording Session. When the MME deactivates the Trace Session, it shall delete all trace control and configuration parameters associated with the corresponding Trace Session.

If MME deactivates the Trace Session during the Trace Recording Session, the MME should deactivate the trace at the eNB by sending the S1-Deactivate Trace message to the eNodeB via the S1 interface and should deactivate the trace at the SGW by sending an S11-Trace Session Deactivation message to the SGW via the S11 interface. The message sent by MME shall include the Trace Reference to identify the Trace Session that is to be deactivated.

When SGW receives an S11-Trace Session Deactivation message from the MME, the SGW may choose to continue the Trace Recording Session until it ends gracefully or may stop it immediately. In all cases, the SGW shall deactivate the requested Trace Session immediately at the end of the Trace Recording Session. If SGW deactivates the Trace Session during the Trace Recording Session, the SGW should deactivate the trace at the PDN GW by sending the S5-Trace Session Deactivation message to the PGW via the GTP based S5 interface. In case of PMIP based S5 interface the SGW should deactivate the trace to the PDN GW using PCC signalling, i.e. by sending a Trace Deactivation message to the PCRF and PCRF forwards the trace deactivation message to the PDN GW [29]. When the SGW deactivates the Trace Session, it shall delete all trace control and configuration parameters associated with the corresponding Trace Session.

When PGW receives an S5-Trace Session Deactivation message from the SGW, or S2b-Trace Session Deactivation message from the ePDG, or it receives the Trace Session Deactivation message from PCRF in case of PMIP based S5, the PDN GW may choose to continue the Trace Recording Session until it ends gracefully or may stop it immediately. In all cases, the PDN GW shall deactivate the requested Trace Session immediately at the end of the Trace Recording Session. When the PDN GW deactivates the Trace Session, it shall delete all trace control and configuration parameters associated with the corresponding Trace Session.

When a Trace Session Deactivation message is sent on any interface the Trace Reference that identifies the Trace Session shall be included to the Trace Session Deactivation message.

#### 4.1.4.8 E-UTRAN deactivation mechanisms

There are two different events that deactivate a Trace Session:

1. When eNB receives the S1- Deactivate Trace message it shall deactivate the Trace Session for the indicated Trace Reference.
2. When the eNB releases the UE context the Trace Recording Session shall be stopped and the Trace Session is deactivated at the eNB.

#### 4.1.4.9 EPC deactivation mechanisms for MDT

When the MME receives a Trace Session Deactivation request for an MDT Trace Session of a UE, it shall act according to the following.

In case of an immediate MDT trace session and the UE being in connected mode, the MME shall send trace session deactivation toward the eNodeB. The eNodeB shall deactivate the corresponding MDT RRC measurements in the UE and shall discard the given trace session context.

In case of an immediate MDT trace session and the UE being in idle mode, the MME shall silently discard the stored trace session context.

Note: Signaling based deactivation does not apply for logged MDT trace sessions, the logged MDT trace session terminates when logging duration expires.

#### 4.1.4.10 Deactivation mechanisms at UE for MDT

The UE shall discard a logged MDT trace session when logging duration expires and shall indicate the availability of logged measurement results to the network next time it enters connected mode.

### 4.1.5 MDT Trace selection conditions

In Immediate MDT, both in case of signalling based and management based MDT trace activation, it is always the network that evaluates all selection conditions for activating the MDT measurements and deactivating the MDT measurements (this evaluation is done continuously during the selected call session). The network activates and deactivates the MDT measurements toward the UE accordingly via RRC.

In Logged MDT, the network configures UEs for MDT tracing that are eligible based on the specified selection criteria. If area based condition is specified in the trace configuration, it is sent to the UE at configuration time and the UE will evaluate the area condition as it moves in the network in idle mode.

Immediate and Logged MDT measurements shall always be configured as separate trace sessions.

In cases of overlapping MDT configuration request the signaling based request shall override the management based request. For logged MDT, prior to re configuring, the eNB shall retrieve the MDT logs from the UE.

## 4.2 Trace recording/UE measurements session Start / Stop triggering

### 4.2.1 General

**Editor's Note:** For further study.

The Trace Session activation contains the triggering events parameter. The actual start/stop triggering events corresponding to the values of the triggering events parameter are defined in triggering events tables in sub-clause 5.1 in the present document.

If the NE failed to start the Trace Recording Session, a Trace failure notification shall be sent to the TCE, and the Trace failure notification has the the same parameters as the notification `notifyTraceRecordingSessionFailure` defined in 3GPP TS 32.442[24], the Trace failure notification file XML schema is defined in Annex A.

### 4.2.2 Starting a trace recording session - management based

#### 4.2.2.1 UTRAN starting mechanisms

In an RNC, a Trace Recording Session should start after the reception of the `CN_INVOKE_TRACE` message from the CN and if some activities have been started on the interfaces that have been requested to be traced. The RNC shall record those signalling messages in the interfaces that are defined in the *list of interfaces* parameter. Trace depth defines whether entire signalling messages or just some IEs needs to be recorded.

The RNC may not start a Trace Recording Session if there are insufficient resources available for the recording.

When RNC starts a Trace Recording Session it shall assign a Trace Recording Session Reference for the Trace Recording Session.

#### 4.2.2.2 PS Domain starting mechanisms

In a SGSN/GGSN/BM-SC, a Trace Recording Session should start after the reception of a Trace Session Activation from EM and if any of the defined *start triggering events* occur. During the Trace Recording Session, the SGSN/GGSN/BM-SC shall record those signalling messages in the interfaces that are defined in the *list of interfaces* parameter. The *Trace Depth* parameter defines whether entire signalling messages or just some IEs need to be recorded.

The IMSI and IMEISV shall be available in the SGSN, in the GGSN and in the BM-SC for at least those connections which shall be traced.

The SGSN/GGSN/BM-SC may not start a Trace Recording Session if there are insufficient resources available for the recording.

If the SGSN/GGSN/BM-SC receives the Trace Session Activation during an established session (e.g. during an active PDP context or an active MBMS context), it *may* start the Trace Recording Session immediately. However, if any of the start triggering events occur in the SGSN/GGSN/BM-SC after receiving the Trace Session Activation, it shall start the Trace Recording Session.

When a Trace Recording Session is started, the SGSN/GGSN/BM-SC shall assign a Trace Recording Session Reference for the Trace Recording Session.

#### 4.2.2.3 CS Domain starting mechanisms

In a MSC Server, a Trace Recording Session shall start after the reception of a Trace Session Activation from EM and if any of the defined *start triggering events* occur. During the Trace Recording Session, the MSC Server shall record those signalling messages in the interfaces that are defined in the *list of interfaces* parameter. The *Trace Depth* parameter defines whether entire signalling messages or just some IEs needs to be recorded.

The IMSI and the IMEISV shall be available in the MSC Server for at least those connections which shall be traced.

The MSC Server may not start a Trace Recording Session if there are insufficient resources available for the recording.

If the MSC Server receives the Trace Session Activation during an established call, it *may* start the Trace Recording Session immediately. However, if any of the start triggering events occurs in MSC Server after receiving the Trace Session Activation, it shall start the Trace Recording Session.

When a Trace Recording Session is started, the MSC Server shall assign a Trace Recording Session Reference for the Trace Recording Session.

#### 4.2.2.4 IP Multimedia Subsystem starting mechanisms

*Editor's Note: For further study.*

#### 4.2.2.5 E-UTRAN starting mechanism

In E-UTRAN, after the Cell Traffic Trace has been activated in the monitored cell(s), the eNodeB shall start a Trace Recording Session for new call(s)/session(s) and for already existing call(s)/session(s) (events for existing call(s)/session(s) are not required to be recorded prior to the activation of the cell traffic trace). When the eNodeB starts a Trace Recording Session it shall allocate a Trace Recording Session Reference for the given call or session. The eNodeB shall send the allocated Trace Recording Session Reference, and the Trace Reference and the Trace Collection Entity address in the CELL TRAFFIC TRACE message to the MME via the S1 connection.

When MME receives this new S1 signalling message containing the Trace Recording Session Reference and Trace Reference, the MME shall look up the IMSI/IMEI(SV) of the given call from its database and shall send the IMSI/IMEI(SV) numbers together with the Trace Recording Session Reference and Trace Reference to the Trace Collection Entity.

The format of the file sent to the TCE from the MME is defined in 3GPP TS 32.423 A.2.2.

The figure 4.2.2.5.1 illustrates the procedure

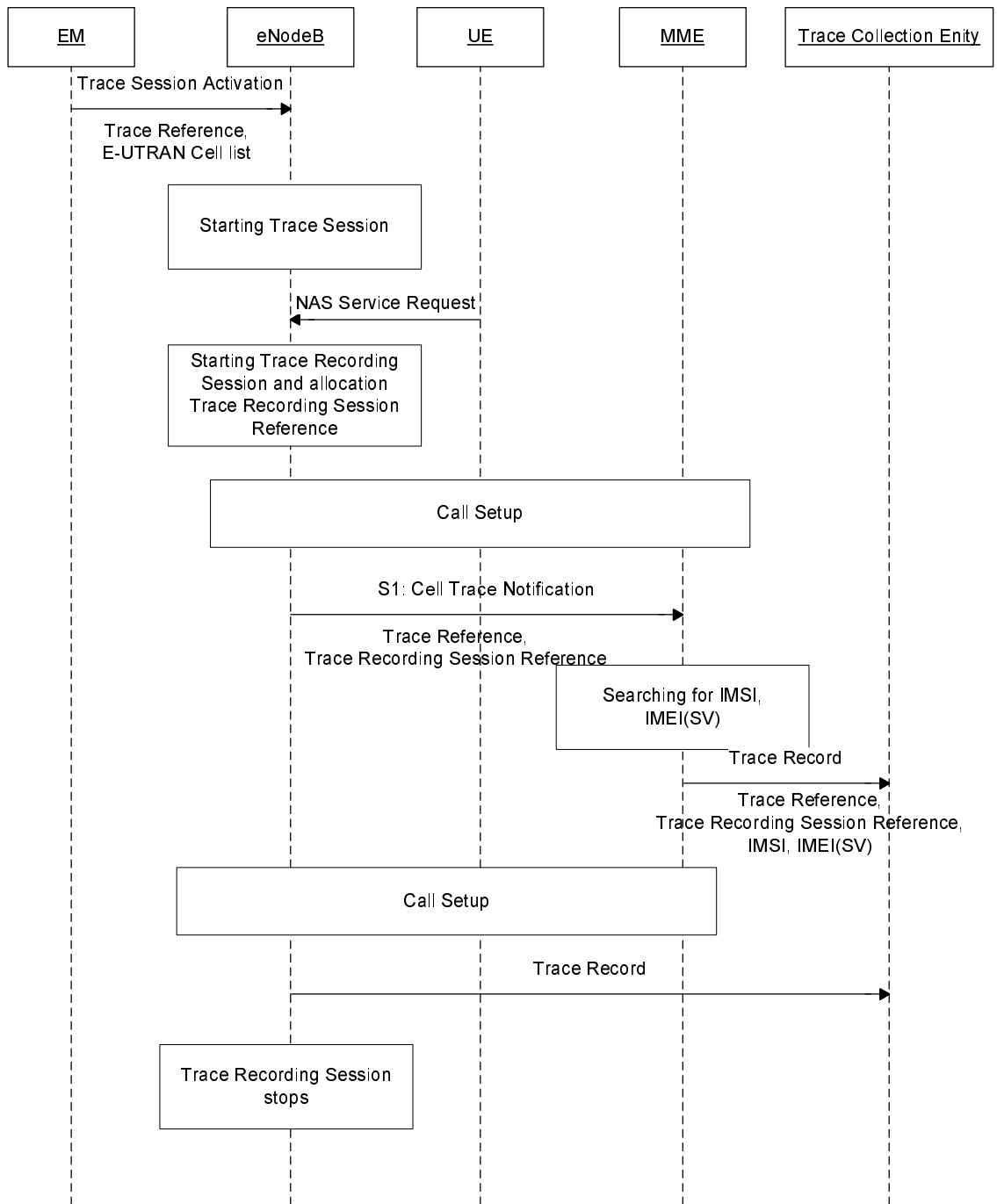

Figure 4.2.2.5.1

#### 4.2.2.6 EPC Domain starting mechanisms

In a MME, SGW or PGW, a Trace Recording Session should start after the reception of a Trace Session Activation from EM and if any of the defined *start triggering events* occur. During the Trace Recording Session, the MME, SGW or PGW shall record those signalling messages in the interfaces that are defined in the *list of interfaces* parameter. The *Trace Depth* parameter defines whether entire signalling messages or just some IEs need to be recorded.

The IMSI and IMEISV shall be available in the MME and in the SGW for at least those connections which shall be traced.

The MME, SGW or PGW may not start a Trace Recording Session if there are insufficient resources available for the recording.

If the MME, SGW or PGW receives the Trace Session Activation during an established session (e.g. during an active PDP context), it may start the Trace Recording Session immediately. However, if any of the start triggering events occur in the MME, SGW or PGW after receiving the Trace Session Activation, it shall start the Trace Recording Session.

When a Trace Recording Session is started, the MME, SGW or PGW shall assign a Trace Recording Session Reference for the Trace Recording Session.

#### 4.2.2.7 E-UTRAN starting mechanisms for MDT

A trace recording session of immediate MDT or logged MDT shall be started in the eNodeB for each selected UE that satisfy the MDT UE selection criteria (i.e., capability condition), provided that a cell trace session for immediate MDT or logged MDT has been activated in the eNodeB from EM for the given cell(s) before.

The eNodeB shall configure the corresponding MDT RRC measurements at the selected UE.

#### 4.2.2.8 Starting mechanisms at UE for MDT

There is no starting mechanism at the UE for MDT trace recording sessions. The UE shall execute the received MDT measurement configuration. In case of logged MDT, the UE shall store the trace recording session parameters as received from the eNodeB.



## 4.2.3 Starting a trace recording session - signalling based

### 4.2.3.1 UTRAN starting mechanisms

In an RNC the Trace Recording Session will always be the same as the Trace Session as no triggering events are defined in UTRAN. Therefore a Trace Recording Session should be started in an SRNC when the SRNC receives the CN\_INVOKE\_TRACE message from the Core Network and if some activities have been started on the interfaces that have been requested to be traced.

The CN\_INVOKE\_TRACE message that is received from the Core Network (MSC Server or SGSN) contains the following information:

- Trace Reference
- UE identity (IMSI or IMEI(SV))
- Trace Recording Session Reference
- Trace Depth
- List of interfaces for RNC
- Job type
- Area scope
- List of measurements
- Reporting Trigger
- Report Interval
- Report Amount
- Event Threshold
- Logging Interval
- Logging Duration
- IP address of Trace Collection Entity

Note that at the same time not all of the parameters can be present. The conditions which parameters shall be present is described in clause 5 of the present document.

If the Job type parameter indicates MDT (e.g. Immediate or logged MDT is required) in the CN\_INVOKE\_TRACE message the RNC shall also configure MDT to the UE. The detailed mechanism of the MDT configuration to the UE is defined in TS 37.320 [30] and TS 25.331 [31].

The RNC shall send the following parameters to the UE in case of Logged MDT:

- Trace Reference
- Trace Recording Session Reference
- Area scope
- TCE Id (The value signalled as IP address of TCE is mapped to a TCE Id, using a configured mapping in the RNC).
- Logging Interval
- Logging Duration

In case of Immediate MDT the RNC shall send the following parameters to the UE:

- List of measurements
- Reporting Trigger
- Report Interval
- Report Amount
- Event Threshold

Note that at the same time not all of the parameters can be present. The conditions which parameters shall be present is described in clause 5 of the present document.

If the SRNC does not have enough resources it may not start a Trace Recording Session.

The Trace Recording Session Reference shall be the same as received in the CN\_INVOKE\_TRACE message.

In a DRNC the Trace Recording Session should be started when the DRNC receives the IUR\_INVOKE\_TRACE message. If the DRNC does not have enough resources it may not start a Trace Recording Session.

The Trace Session is activated to the RNC by sending a CN\_INVOKE\_TRACE message from the CN (MSC Server or SGSN). When RNC receives the CN\_INVOKE\_TRACE message it should immediately start a Trace Session and a Trace Recording Session according to the trace control and configuration parameters received in the CN\_INVOKE\_TRACE message.

If there are not enough resources in RNC to start a Trace Recording Session, the RNC may reject to start a Trace Recording Session. However the RNC shall start the Trace Session. Session and if MDT activation is requested shall activate the MDT to the UE.

When SRNC/DRNC receives the trace control and configuration parameters:

- If the Trace Reference is the same as an existing Trace Session for the same subscriber or equipment in SRNC/DRNC, the SRNC/DRNC shall not activate a new Trace Session and the existing Trace Session will not be impacted;
- If the Trace Recording Session Reference is the same as an existing Trace Recording Session in the existing Trace Session having the same Trace Reference, the SRNC/DRNC shall not start a new Trace Recording Session;
- If the trace control and configuration parameters are received from the same CN domain (CS/PS) as the existing Trace Recording Session(s) if any, and the Trace Recording Session Reference is not the same as any existing Trace Recording Session(s) in the existing Trace Session having the same Trace Reference, the SRNC/DRNC shall start a new Trace Recording Session;
- If the trace control and configuration parameters are received from different CN domain (CS/PS) as the existing Trace Recording Session(s) if any (i.e. the RNC has simultaneous CS and PS connection and CN\_INVOKE\_TRACE is received from both connection), regardless of the Trace Recording Session Reference is the same or not as any existing Trace Recording Session(s) in the existing Trace Session having the same Trace Reference, the SRNC shall not start a new Trace Recording Session;
- If the Trace Reference is the same as an existing Trace Session for different subscriber(s) or equipment(s) in SRNC/DRNC, the SRNC /DRNC shall not activate a new Trace Session, and the SRNC/DRNC shall not start a new Trace Recording Session.

The following figure shows an example for a CS call how the Trace Session is activated to RNC. In the example it is assumed that there is no PS connection at all during the CS call.

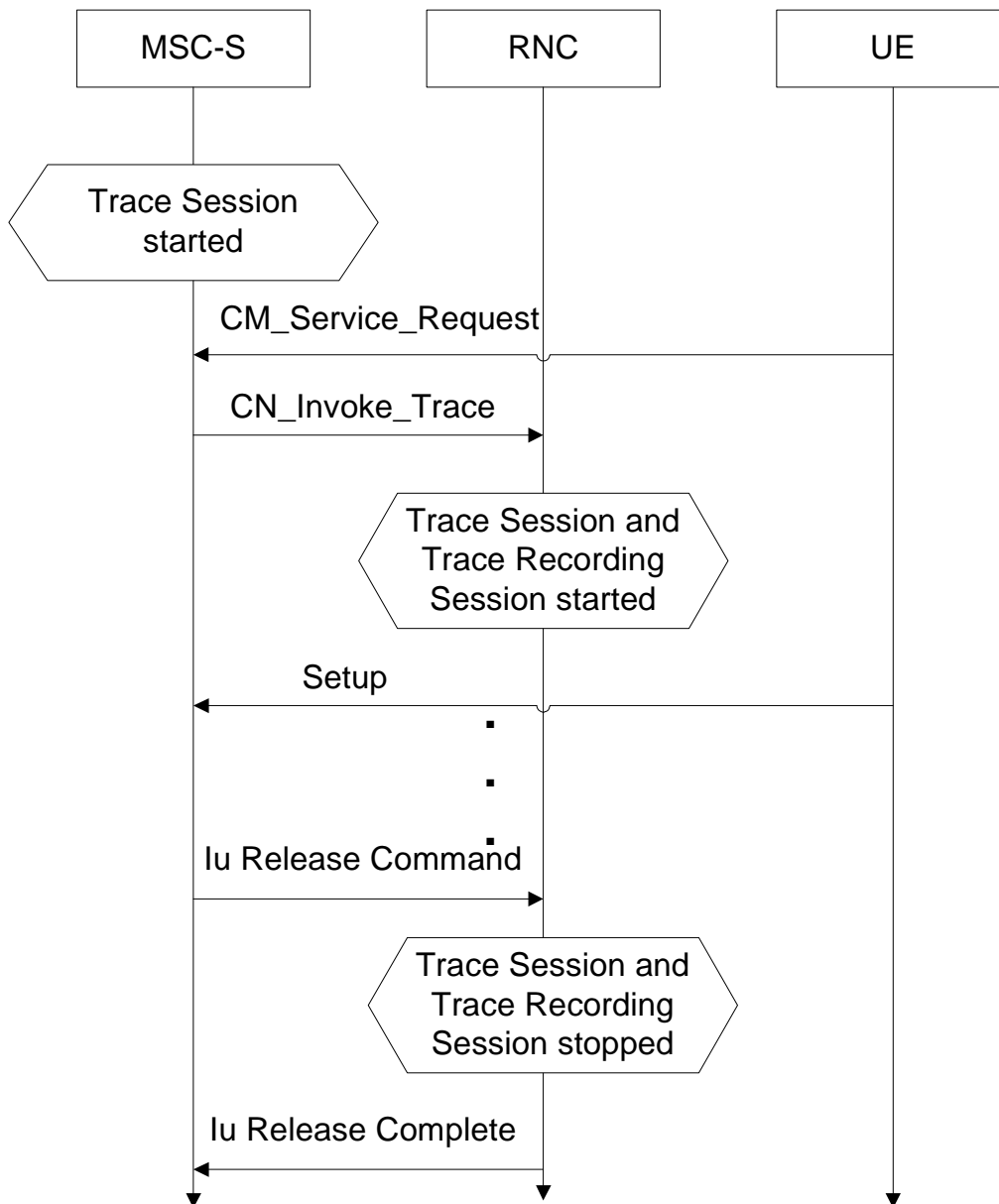

**Figure 4.2.3.1.1: Starting a Trace Recording Session (Signalling) in UTRAN**

**Interaction with soft-handovers**

If the subscriber or equipment, which is traced, makes a soft handover the SRNC should propagate the trace control and configuration parameters (including MDT specific parameters if they are available) further to the DRNC by using the IUR\_INVOKE\_TRACE message. When the DRNC receives the IUR\_INVOKE\_TRACE message it should immediately start a Trace Session and a Trace Recording Session according to the trace control and configuration parameters received in the IUR\_INVOKE\_TRACE message.

If there are insufficient resources in the DRNC, the DRNC may not start a Trace Recording Session.

The Trace Recording Session Reference sent by the SRNC to the DRNC shall be the same what SRNC has received in the CN\_INVOKE\_TRACE message from the CN.

**Interaction with Relocation**

If the tracing shall continue also after the relocation has been performed, the CN Invoke Trace procedure shall be re-initiated from the CN towards the future SRNC after the Relocation Resource Allocation procedure has been executed successfully.

#### 4.2.3.2 PS Domain starting mechanisms

In SGSN/GGSN/BM-SC a Trace Recording Session should start after the reception of a Trace Session Activation message (in SGSN it is the MAP-ACTIVATE\_TRACE\_MODE, in GGSN it is the GTP-Create PDP Context request or Update PDP Context request, in BM-SC it is the Diameter Gmb AAR message) and if any of the defined *start triggering events* occur. During the Trace Recording Session, the SGSN/GGSN/BM-SC shall record the signalling messages in the interfaces that are defined in the *list of interfaces* parameter. The *Trace Depth* parameter defines whether entire signalling messages or just some IEs need to be recorded.

The SGSN/GGSN/BM-SC may not start a Trace Recording Session if there are insufficient resources available for the recording.

In case of an established session, the SGSN may start the Trace Recording Session immediately after the reception of the Trace Session Activation message. However, if any of the start triggering events occurs in SGSN after receiving the Trace Session activation message, it shall start the Trace Recording.

When a Trace Recording Session is started in SGSN, it shall assign a Trace Recording Session Reference for the Trace Recording Session. When the SGSN propagates the Trace control and configuration parameters to GGSN or to UTRAN (I.e. activates a Trace Session in GGSN/UTRAN), it shall include the assigned Trace Recording Session Reference in the Trace Session Activation message. When an SGSN starts a Trace Recording Session and the list of NE types parameter requires GGSN tracing, it shall send the GTP- Update PDP Context Request or Create PDP Context Request message for activating the Trace Session to GGSN. When a GGSN starts a Trace Recording Session and the list of NE types parameter requires BM-SC tracing, it shall send a Diameter Gmb AAR message to the BM-SC in order to activate a Trace Session in the BM-SC. Also, when an SGSN starts a Trace Recording Session and the list of NE types parameter requires RNC tracing, it shall send the CN\_INVOKE\_TRACE message to the RNC in order to activate a Trace Session in RNC. In both cases the Trace Session and the Trace Recording Session in the receiving NE should start at the same time.

In case of SRNS relocation the SGSN shall send the CN\_INVOKE\_TRACE message to the new SRNC after the successful Relocation Resource Allocation procedure.

SGSN has to find the identity of the mobile before it activates a Trace Session towards other NE. The IMEI(SV) can be got from the Mobile by using the Identification procedure on the Iu interface.

When the SGSN sends the Trace Session activation (CN\_INVOKE\_TRACE) message to RNC it shall include the following parameters to the message:

- IMSI or IMEI (SV) (M).
- Trace reference (M).
- Trace Recording Session Reference (M).
- Trace Depth (M).
- List of interfaces (O).
- IP address of Trace Collection Entity (O).

### 4.2.3.3 CS Domain starting mechanisms

In MSC Server/MGW a Trace Recording Session should start after the reception of a Trace Session Activation message (MAP-ACTIVATE TRACE MODE in MSC Server and ADD/MOD command with Trace package in MGW) and if any of the defined *start triggering events* occur. During the Trace Recording Session the MSC Server/MGW shall record the signalling messages in the interfaces that are defined in the *list of interfaces* parameter. The *Trace Depth* parameter defines whether entire signalling messages or just some IEs need to be recorded.

The MSC Server may not start a Trace Recording Session if there are insufficient resources available for the recording.

In case of an established call, the MSC Server may start the Trace Recording Session immediately after the reception of the MAP-ACTIVATE\_TRACE\_MODE message. However, if any of the start triggering events occur in the MSC Server after receiving the Trace Session activation message, it shall start the Trace Recording Session.

When a Trace Recording Session is started in MSC Server, it shall assign a Trace Recording Session Reference for the Trace Recording Session. When the MSC Server propagates the Trace control and configuration parameters to MGW or to UTRAN (I.e. activates a Trace Session in MGW/UTRAN) it shall include the assigned Trace Recording Session Reference in the Trace Session Activation message.

When an MSC Server starts a Trace Recording Session and the list of NE types parameter requires MGW tracing, it shall send the ADD/MOD command with trace package to MGW in order to activate the trace in MGW. Also, when an MSC Server starts a Trace Recording Session and the list of NE types parameter requires RNC tracing, it shall send the CN\_INVOKE\_TRACE message to the RNC. In both cases the Trace Session and the Trace Recording Session in the receiving NE should start at the same time.

MSC Server has to find the identity of the mobile before it activates a Trace Session towards other NE. The IMEI(SV) can be got from the Mobile by using the Identification procedure on the Iu interface.

In case of SRNS relocation the MSC Server shall send the CN\_INVOKE\_TRACE message to the new SRNC after the successful Relocation Resource Allocation procedure. The following figure shows an example how the Trace Session is activated with CN\_INVOKE\_TRACE message in case of relocation.

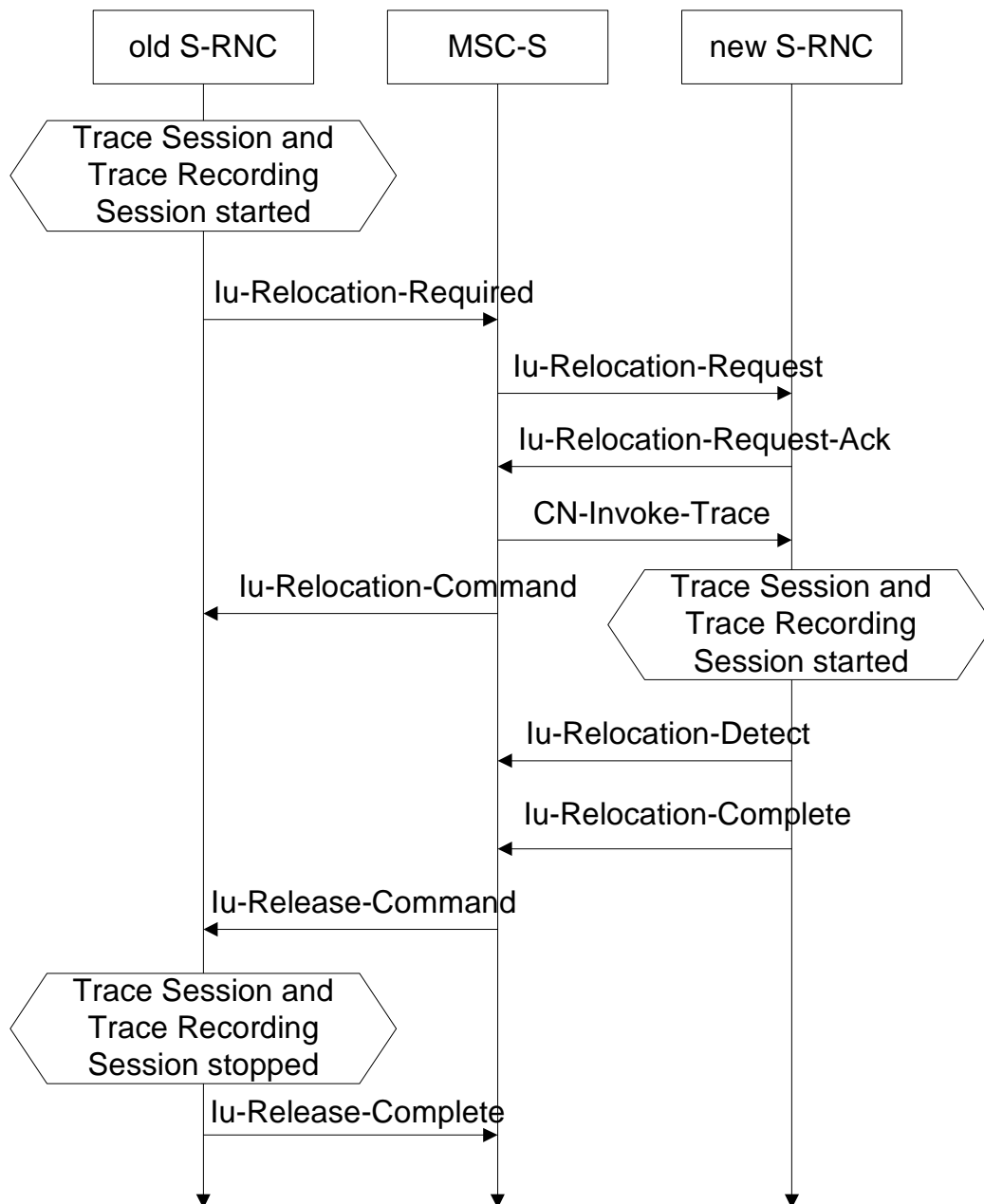

**Figure 4.2.3.3.1: Starting a Trace Recording Session (Signalling) in CS Domain**

When the new SRNC receives the CN\_INVOKE\_TRACE message it should start immediately a Trace Session and a Trace Recording session according to the trace control and configuration parameters received in the CN\_INVOKE\_TRACE message. The Trace Session shall automatically be deactivated in the old RNC when the Iu connection is released.

When the MSC Server sends the Trace Session activation (CN\_INVOKE\_TRACE) message to RNC it shall include the following parameters to the message:

- IMSI or IMEI (SV) (M).
- Trace reference (M).
- Trace Recording Session Reference (M).
- Trace Depth (M).
- List of interfaces to trace (O).

- IP address of Trace Collection Entity (O).

4.2.3.4 Void

4.2.3.5 Service level tracing for IMS starting mechanism

4.2.3.5.1 General

A trace recording session should start when there is an active trace session and when an appropriate start triggering event occurs. Figure 4.2.3.5.1.1 illustrates the initiation of a trace recording session at the UE, P-CSCF and S-CSCF within an originating network when any of the defined triggering events as defined in Trace Session Activation occur. When a triggering event occurs in the UE (Step 1) it includes in the outgoing SIP (service) signalling message a service level tracing Start Triggering Event (Step 2) and starts a trace recording session (Step 3). When the P-CSCF receives the SIP (service) signalling message containing the Start Triggering Event it authenticates the received Start Triggering Event (step 4) and starts its trace recording session (Step 5). The P-CSCF forwards the SIP (service) signalling message containing the Start Triggering Event to the S-CSCF (Step 7) and starts its trace recording session (Step 8).

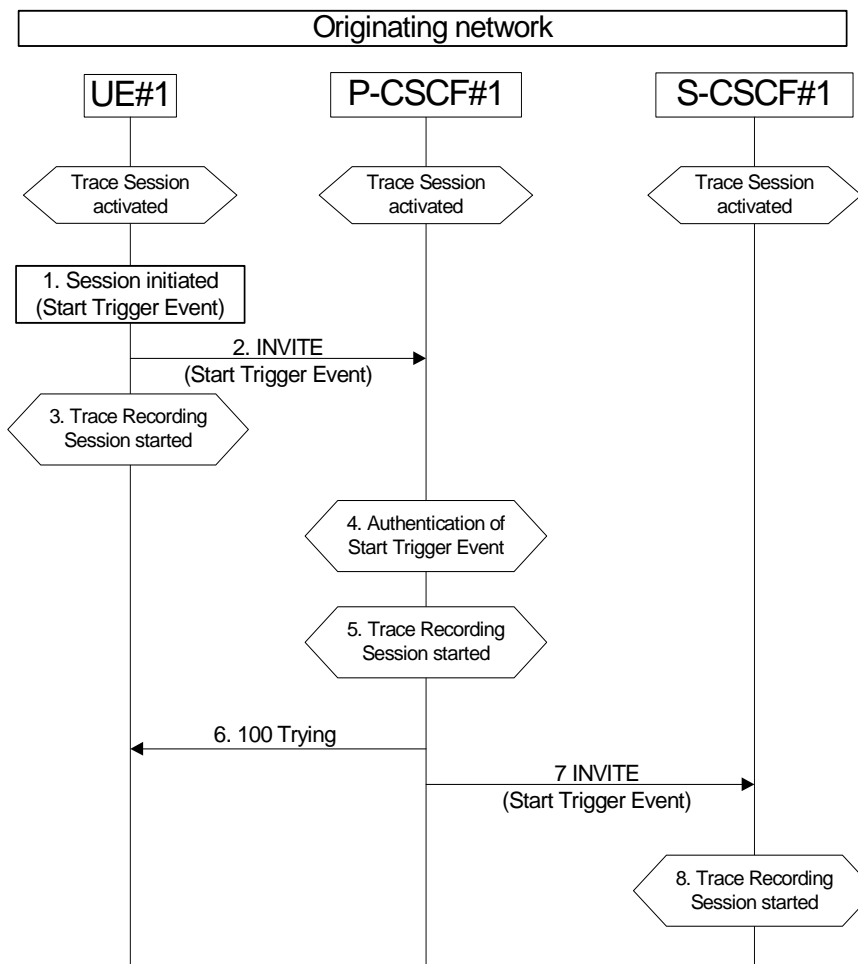

Figure 4.2.3.5.1.1a: Starting a Trace Recording Session within originating network

Figure 4.2.3.5.1.2 illustrates the initiation of a trace recording session at the AS, I-CSCF, HSS, S-CSCF, P-CSCF and UE within the terminating network when any of the defined triggering events as defined in Trace Session Activation occur.

NOTE: All origination, termination and S-CSCF to CSCF procedures as described in 3GPP TS 23.228 [15] apply.

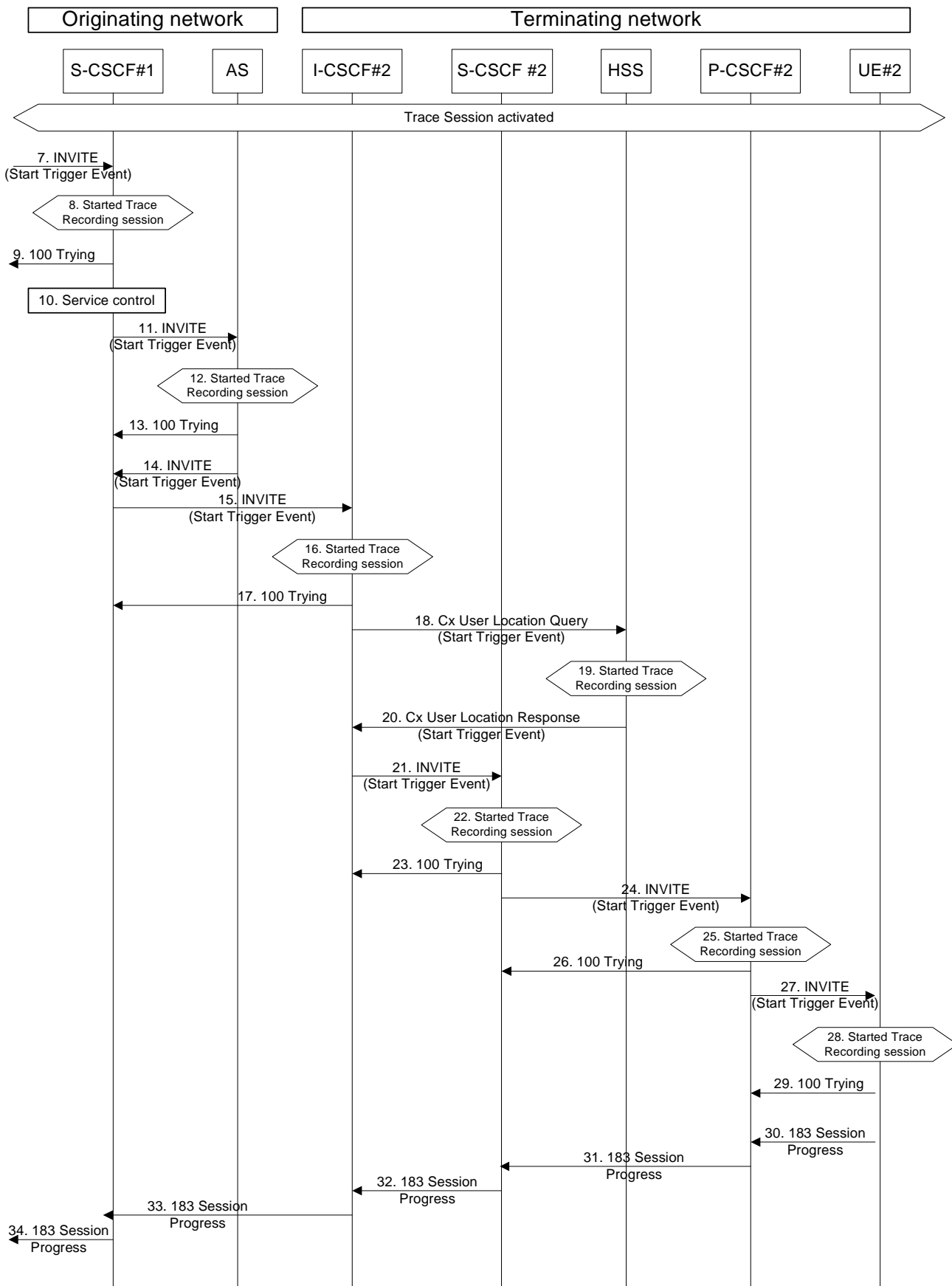

Figure 4.2.3.5.1.1b: Starting a Trace Recording Session within terminating network



When S-CSCF#1 receives the SIP (service) signalling message containing the Service Level Tracing Start Trigger Event (step 7) it shall start a trace recording session (Step 8). Based on the service control information (step 10) S-CSCF#1 forwards the SIP (service) signalling message containing the Start Trigger Event to the Application Server (Step 11).

On reception of the SIP INVITE the Application Server adds, removes, or modifies the header contents contained in the SIP INVITE (see 3GPP TS 23.218) and proxies the SIP INVITE together with the Start Trigger Event back to S-CSCF#1 (Step 14). The Application Server also starts a trace recording session (Step 12).

S-CSCF#1 forwards the SIP INVITE containing the service level tracing Start Trigger Event request to I-CSCF#2 (Step 15). At this point the I-CSCF starts a trace recording session (Step 16).

I-CSCF#2 initiates a query to the HSS for the current location of the terminating user (UE#2) and includes in the Cx-User Location procedure the service level tracing Start Trigger Event (Step 20).

When the HSS receives the query for the current location and an associated Start Trigger Event it shall start a trace recording session (Step 19) and returns to the I-CSCF#2 the address of the current S-CSCF (S-CSCF#2) for the terminating user and the service level tracing Start Trigger Event (20).

I-CSCF#2 forwards the SIP INVITE containing the Start Trigger Event to the S-CSCF (S-CSCF#2) that will handle the session termination. When the S-CSCF receives the SIP INVITE containing the Start Trigger Event it starts a trace recording session (Step 21).

The S-CSCF forwards the SIP INVITE containing the Start Trigger Event to the P-CSCF (P-CSCF#2). When the P-CSCF receives the SIP INVITE containing the Start Trigger Event it starts a trace recording session (Steps 24 and 25).

The P-CSCF forwards the SIP INVITE containing the Start Trigger Event to the terminating UE (UE#2). When the terminating UE receives the SIP INVITE containing the Start Trigger Event it starts a trace recording session (Step 28).

The continuation of the termination procedures is as defined in 3GPP TS 23.228 [15].

#### 4.2.3.5.2 Starting mechanism at the UE

For a UE that has an active trace session (see subclause 4.1.2.9.4) one or more trace recording session(s) (e.g. to allow the tracing for several different simultaneous services) shall be started when any of the defined triggering events occur at the UE, and when the condition(s) as defined by the trace control and configuration parameters within the received management operation occur.

**Editor's note: The exact OMA Device Management enabler is FFS.**

A Trace recording session(s) may be initiated at an originating UE when:

- 1) The UE detects the initiation of the specified service to be traced. The service may be initiated either by the end user or by an application.

The triggering events at a terminating UE include:

- 1) The UE detects the initiation of the specified service to be traced. The service may be initiated either by the end user or by an application.
- 2) The UE detects the reception of an incoming SIP message containing the service level tracing Start Triggering Event.

A Trace recording session(s) may be initiated at a UE (both originating and terminating) when it detects a start trigger event initiated directly by the Device Management server for the purpose of allowing not only SIP information related to the service to be traced, but also information relating to the processes performed by the UE to support the initialization of the service.

Upon the detection of a triggering event the UE shall include in the appropriate outgoing SIP (service) signalling message (i.e. the outgoing signalling messages associated with the service to be traced) a service level tracing Start Triggering Event.

#### 4.2.3.5.3 Starting mechanism at the IMS NE

For an IMS NE (i.e. S/I/P-CSCF, AS, HSS, MRF, MGCF, BGCF) that has an active trace session (see subclause 4.1.2.9) a trace recording session should be started when it receives in an incoming SIP (service) signalling message or DIAMETER signalling message containing a service level tracing Start Triggering Event and when the information contained within the service level tracing Start Triggering Event matches the information received by the IMS NE during trace session activation. The IMS NE shall also start the recording of signalling messages in the interfaces that are defined in the list of received interfaces parameter.

An IMS NE (i.e. S/I/P-CSCF, AS, HSS, MRF, MGCF, BGCF) that receives an incoming SIP (service) signalling message containing a service level tracing Start Triggering Event should forward in an appropriate outgoing SIP (service) signalling message (i.e. outgoing signalling messages associated with the service being traced) the same service level tracing Start Triggering Event (i.e. service level tracing Start Triggering Event with the same trace reference).

When an IMS NE has an active trace session and trace recording session, and when an incoming SIP (service) signalling message is part of an existing dialog or standalone transaction and contains a service level tracing Start Trigger Event the IMS NE shall determine that an active Trace Recording Session exists and shall not start a new Trace Recording Session.

Depending on operator policy, a HSS may forward the service level tracing Start Triggering Event to an external AS (see 3GPP TS 23.218 [14]). In the case of a terminating session a S-CSCF or I-CSCF may forward the service level tracing Start Triggering Event to a P-CSCF in a visited IM CN SS. A P-CSCF shall send a service level tracing Start Triggering Event to a terminating UE.

When a P-CSCF receives a SIP (service) signalling message containing a service level tracing Start Triggering Event from a UE it shall authenticate the Start Triggering Event by comparing the information contained within the received service level tracing Start Triggering Event (see subclause 5.2) either against the information it received within the Start Trace activation message or by requesting information from the I-CSCF or S-CSCF. If the received service level tracing Start Triggering Event is authenticated by the P-CSCF it should start a trace recording session and shall forward the service level tracing Start Triggering Event in the appropriate outgoing SIP (service) signalling message.

If the authentication of the incoming service level tracing Start Triggering Event fails the P-CSCF shall not start a trace recording session and shall not forward the service level tracing Start Triggering Event in any outgoing SIP (service) signalling message. The P-CSCF should provide an indication to the Management System following the unsuccessful authentication of the service level tracing Start Triggering Event.

When an IMS NE does not have an active trace session when it receives an incoming SIP (service) signalling message that contains a service level tracing Start Trigger Event, the IMS NE shall not initiate a Trace Recording Session and should forward in an appropriate outgoing SIP (service) signalling message the same service level tracing Start Trigger Event.

#### 4.2.3.5.4 Charging concepts for Service Level Tracing for IMS

Charging for Service Level Tracing for IMS shall be fulfilled using IMS charging mechanism as specified in TS 32.240 [19] and TS 32.260 [20].

It shall be possible to apply specific tariffs (e.g. zero rating) to the bearer and/or signalling traffic associated with services subjected to Service Level Tracing for IMS.

As described in subclause 4.2.3.5 an IMS NE that has an active trace session should start a trace recording session when it detects a service level tracing Start Triggering Event. An IMS NE shall also provide an indication in the generated charging information that service level tracing has been applied.

#### 4.2.3.6 E-UTRAN starting mechanism

In an eNB the Trace Recording Session will always be the same as the Trace Session as no triggering events are defined in eNB.

Tracing starts immediately at eNodeB upon reception of the trace control and configuration parameters. The eNodeB may not start a Trace Recording Session if there are insufficient resources available for the recording, however, the eNodeB shall store the trace control and configuration parameters, and forward these parameters when the UE handovers to other eNBs over X2.

The Trace Recording Session shall be started at the eNB when it receives trace control and configuration parameters via one of the following messages:

1. via an S1-Initial Context Setup Request message from the MME in response to an S1-Initial UE Message
2. via an S1-Trace Start message from the MME in response to an S1-Initial UE Message or when an established S1AP connection exists
3. via an S1-Handover Request message from the target MME as part of intra/inter-MME handover procedures via S1
4. via an X2-Handover Request message from a source eNodeB as part of inter-eNodeB handover procedures via X2

There can only be one Trace Recording Session Reference per Trace Reference at one given time for a UE trace session. So there shall be only one TR/TRSR to be propagated during S1 and X2 handover.

If the Trace Reference is the same as an existing Trace Session for the same subscriber or equipment, and the Trace Recording Session Reference is the same as the existing Trace Recording Session in the existing Trace Session having the same Trace Reference, the eNB shall not start a new Trace Recording Session and shall continue with the existing trace session and ignore the second request.

If the Trace Reference is the same as an existing Trace Session for the same subscriber or equipment, and the Trace Recording Session Reference is not the same as the existing Trace Recording Session in the existing Trace Session having the same Trace Reference, the eNB shall continue with the existing trace session and ignore the second request.

#### 4.2.3.7 EPC starting mechanisms

In MME/SGW/PGW a Trace Recording Session should start after the reception of a Trace Session Activation message and if any of the defined *start triggering events* occur. During the Trace Recording Session, the MME/SGW/PGW shall record the signalling messages in the interfaces that are defined in the *list of interfaces* parameter. The *Trace Depth* parameter defines whether entire signalling messages or just some IEs need to be recorded.

The MME/SGW/PGW may not start a Trace Recording Session if there are insufficient resources available for the recording.

In case of an established session, the MME/SGW/PGW may start the Trace Recording Session immediately after the reception of the trace control and configuration parameters. However, if any of the start triggering events occurs in MME/SGW/PGW after receiving the trace control and configuration parameters, it shall start the Trace Recording Session.

In the case of the *triggering events* come into collision on the same traced UE as defined in 3GPP TS 24.301[33], the MME shall not start a new Trace Recording Session for the later event(s), and shall use the existing Trace Recording Session and Trace Recording Session Reference to continuing the trace recording for these events until one stop triggering event occurs.

MME shall start a Trace Recording Session for a certain Trace Session only if there is no ongoing Trace Recording Session for this Trace Session. i.e. at any given time, there can be a maximum of one Trace Recording Session for a certain Trace Session. When a Trace Recording Session is started in MME, it shall assign a Trace Recording Session Reference for the Trace Recording Session. When the MME propagates the Trace control and configuration parameters to E-UTRAN (i.e. activates a Trace Session in eNB), it shall include the assigned Trace Recording Session Reference in the Trace Session Activation message.

Also, when an MME starts a Trace Recording Session and the list of NE types parameter requires eNB tracing, it shall propagate the trace control and configuration parameters including the Trace Recording Session Reference via the S1 interface to the eNodeB per one of the following messages:

1. if an S1 connection exists, via the S1-Trace Start message
2. if the S1 connection does not exist, via the S1-Trace Start message prior to S1 connection setup, or via the S1-Initial Context Setup Request message during S1 connection setup
3. during intra/inter-MME handover over S1, via the S1-Handover Request message

In above cases the Trace Session and the Trace Recording Session in the receiving NE should start at the same time.

If all events are set in the triggering event parameter at the MME, MME shall send Trace Session Activation message to eNB not only when the MME starts the Trace Recording Session, but also when an Intra-MME handover happens. In this case the MME shall send Trace Session activation to the target eNB via the S1-Handover Request message.

NOTE: In case of "UE-Initiated Detach Procedure with UE camping on GERAN/UTRAN and ISR activated / SGSN-Initiated Detach Procedure with ISR activated", Trace is not activated in eNB.

#### 4.2.3.8 EPC starting mechanisms for MDT

In the MME, no trace recording sessions are started for MDT trace sessions. The MME sends the trace session activation to the eNodeB with parameters as specified in 4.1.2.12.

#### 4.2.3.9 E-UTRAN starting mechanisms for MDT

A trace recording session of either immediate or logged MDT shall be started in the eNodeB for a given UE when a trace session activation request is received from the MME for the UE and the MDT UE selection conditions are satisfied for the UE. The eNodeB shall configure the corresponding MDT RRC measurements at the UE. If selection conditions are not satisfied, the eNodeB shall store the trace control and configuration parameters, and forward these parameters when the UE handovers to other eNBs over X2 or S1.

If the eNodeB receives a Signalling Based MDT activation request when the UE is served by a cell that is in the eNodeB but not in the MDT area scope then the eNodeB shall store the MDT configuration and configure the UE when the UE moves to a cell in the eNodeB (intra eNodeB handover) that satisfies the area scope in the request.

#### 4.2.3.10 Starting mechanisms at UE for MDT

There is no starting mechanism at the UE for MDT trace recording sessions. The UE shall execute the received MDT measurement configuration. In case of logged MDT, the UE shall store the trace recording session parameters as received from the eNodeB.

## 4.2.4 Stopping a trace recording session - management based

### 4.2.4.1 UTRAN stopping mechanisms

The Trace Recording Session in the RNC shall be stopped when the last connection, which belongs to the traced subscriber/mobile, is released.

### 4.2.4.2 PS Domain stopping mechanisms

In SGSN, GGSN and BM-SC a Trace Recording Session shall be stopped when any of the defined stop triggering events occur. If Trace Session deactivation is received during the Trace Recording Session, the SGSN is allowed to finish tracing of the on-going procedures (e.g. session). In this case the Trace Recording Session shall be stopped between the reception of the Trace Session deactivation and the appropriate stop-triggering event.

The following figure illustrates the successful case in tracing a PDP context when a Trace Recording Session is stopped.

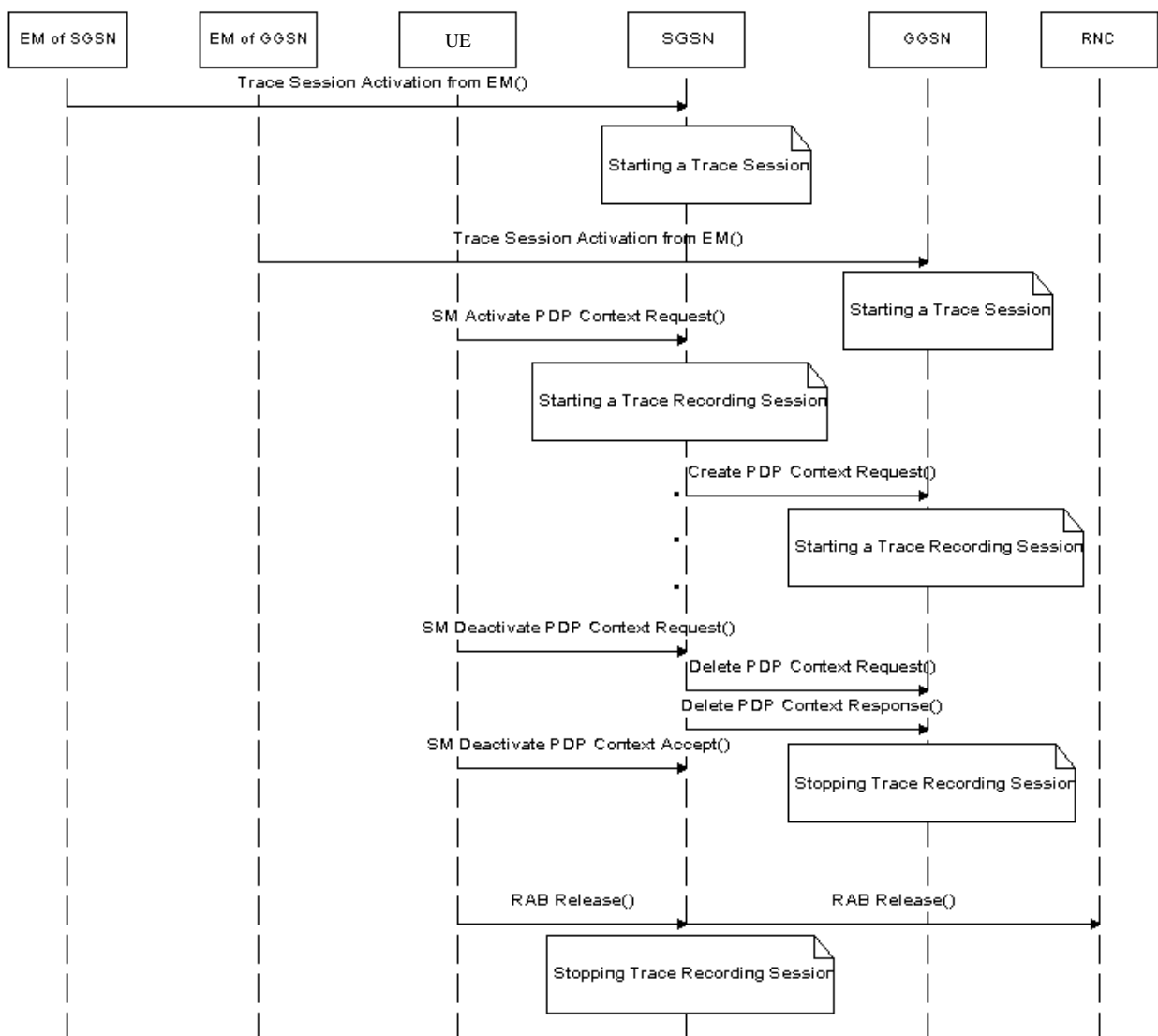

Figure 4.2.4.2.1: Stopping a Trace Recording Session for a PDP Context (Management Based) - PS domain

The following figure illustrates the successful case in tracing a MBMS context when a Trace Recording Session is stopped.

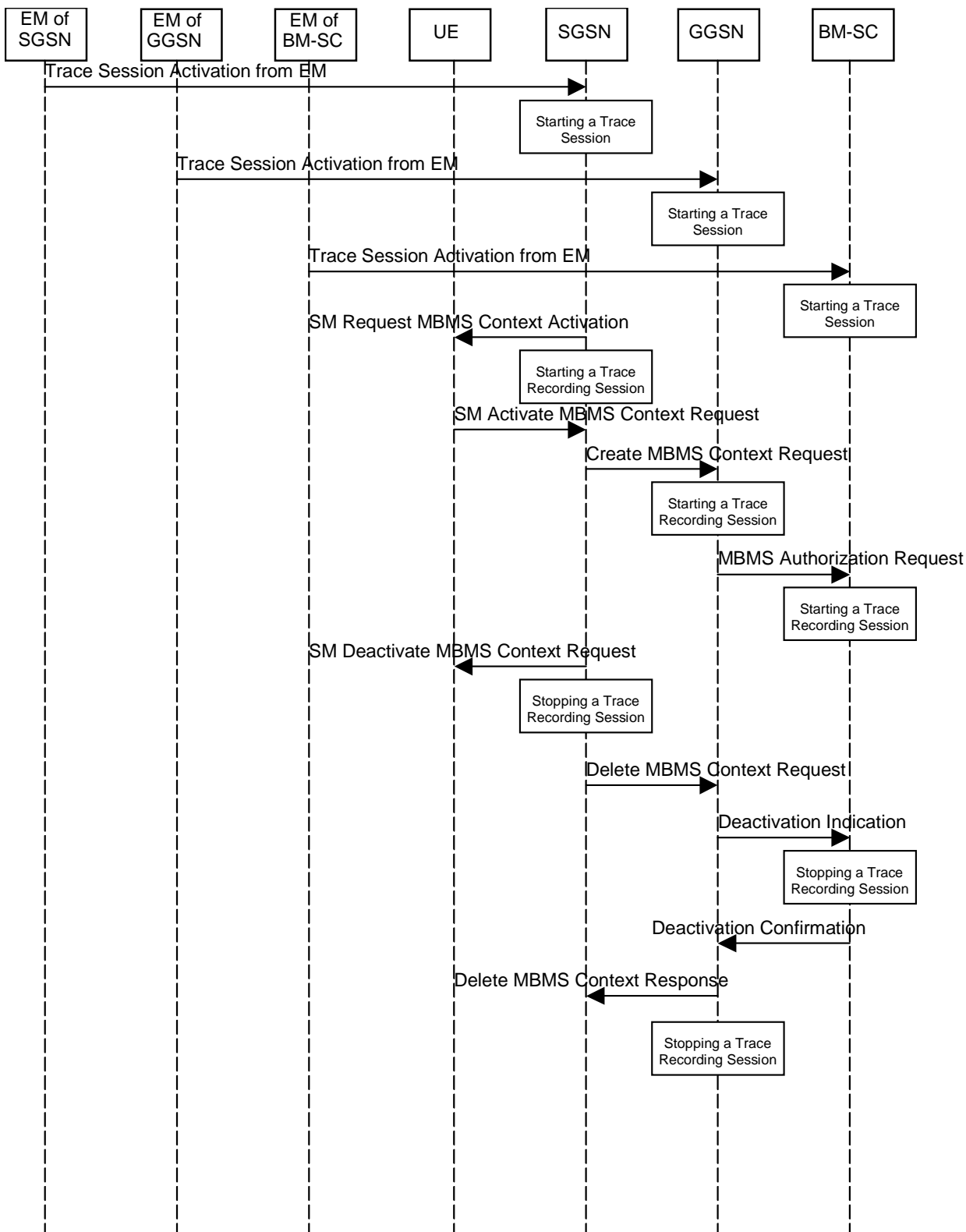

Figure 4.2.4.2.2: Stopping a Trace Recording Session for a MBMS Context (Management Based) - PS domain

### 4.2.4.3 CS Domain stopping mechanisms

In MSC Server a Trace Recording Session shall be stopped when any of the defined stop triggering events occur. If Trace Session deactivation is received during the Trace Recording Session, the MSC Server is allowed to finish tracing of the on-going procedures (e.g. calls). In this case the Trace Recording Session shall be stopped in MSC Server between the reception of the Trace Session deactivation and the appropriate stop-triggering event.

The following figure illustrates the successful case in tracing a call and the time of stopping a Trace Recording Session.

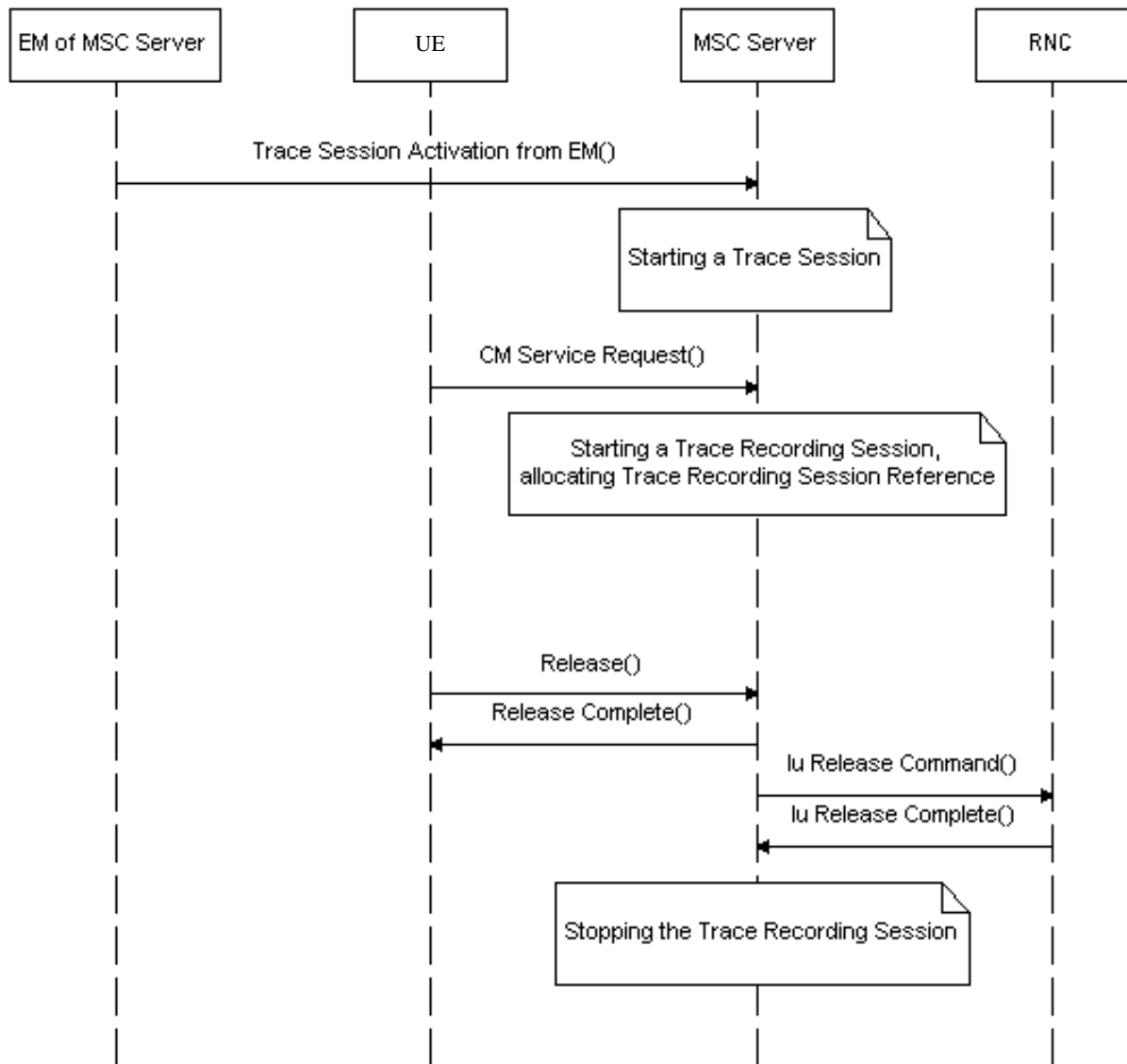

Figure 4.2.4.3.1: Stopping a Trace Recording Session (Management Based) - CS domain

### 4.2.4.4 IP Multimedia Subsystem stopping mechanisms

Editor's Note: For further study.

#### 4.2.4.5 E-UTRAN stopping mechanisms

The Trace Recording Session in the eNodeB shall be stopped when the call/session is ended in the cell under trace or the call/session is handed over to another cell. If the Trace Session is deactivated at a time when there are ongoing sessions the trace recording session may be stopped immediately or gracefully when the session ends.

#### 4.2.4.6 EPC Domain stopping mechanisms

In MME, SGW and PGW a Trace Recording Session shall be stopped when any of the defined stop triggering events occur. If Trace Session deactivation is received from its EM during the Trace Recording Session, the MME, SGW and PGW are allowed to finish tracing of the on-going procedures (e.g. session). In this case the Trace Recording Session shall be stopped between the reception of the Trace Session deactivation and the appropriate stop-triggering event.

#### 4.2.4.7 E-UTRAN stopping mechanisms for MDT

In case of immediate MDT, the eNodeB shall stop a trace recording session for a given UE when the UE changes cell or goes to idle mode or when the cell trace session is deactivated at the eNodeB from its EM. The eNodeB shall deactivate the corresponding MDT RRC measurements in the UE.

In case of logged MDT, there is no stopping mechanism in the eNodeB. The eNodeB does not need to maintain a logged MDT trace recording session once it has been configured in the UE.

#### 4.2.4.8 Stopping mechanisms at UE for MDT

In case of logged MDT, the UE shall stop an ongoing trace recording session when logging duration expires and it shall indicate the availability of logged measurement results to the network next time it enters connected mode.

The UE shall discard an ongoing logged MDT trace recording session when it receives a new logged MDT trace recording session configuration from the network.



## 4.2.5 Stopping a trace recording session - signalling based

### 4.2.5.1 UTRAN stopping mechanisms

In an RNC the Trace Recording Session will always be the same as the Trace Session as no triggering events are defined in UTRAN. Therefore a Trace Recording Session shall always be stopped in an RNC when the RNC deactivates the Trace Session. For more information on Trace Session deactivation in UTRAN see subclause 4.1.4.2.

### 4.2.5.2 PS Domain stopping mechanisms

A Trace Recording Session shall be stopped when the SGSN/GGSN/BM-SC detect any of the stop triggering events.

However, if a SGSN receives a Trace Session deactivation either from its EM (in case of tracing roaming subscribers) or from HSS (in case of tracing home subscribers) during an ongoing Trace Recording Session, it may stop it immediately or at any time until the occurrence of an appropriate stop-triggering event.

A GGSN shall stop a Trace Recording Session when it receives a Trace Session deactivation message (GTP- Update PDP Context Request and Trace Activity Control is set to Trace Deactivation )from the SGSN or at any time until the occurrence of an appropriate stop-triggering event.

A BM-SC shall stop a Trace Recording Session when it receives a Diameter Gmb STR message from the GGSN or at any time until the occurrence of an appropriate stop-triggering event.

When a Trace Recording Session is stopped in a SGSN, the SGSN shall send a Trace Session deactivation message to the NEs where tracing was required, as defined in the "List of NE types" configuration parameter, received in the Trace Session activation message. The Trace Reference, used for the deactivation procedure, shall be the same as used in the SGSN for the activation of the Trace Session.

The following figure illustrates a successful case in tracing a PDP context, when a Trace Recording Session is stopped. (Reference 3GPP TS 23.060 [6].)

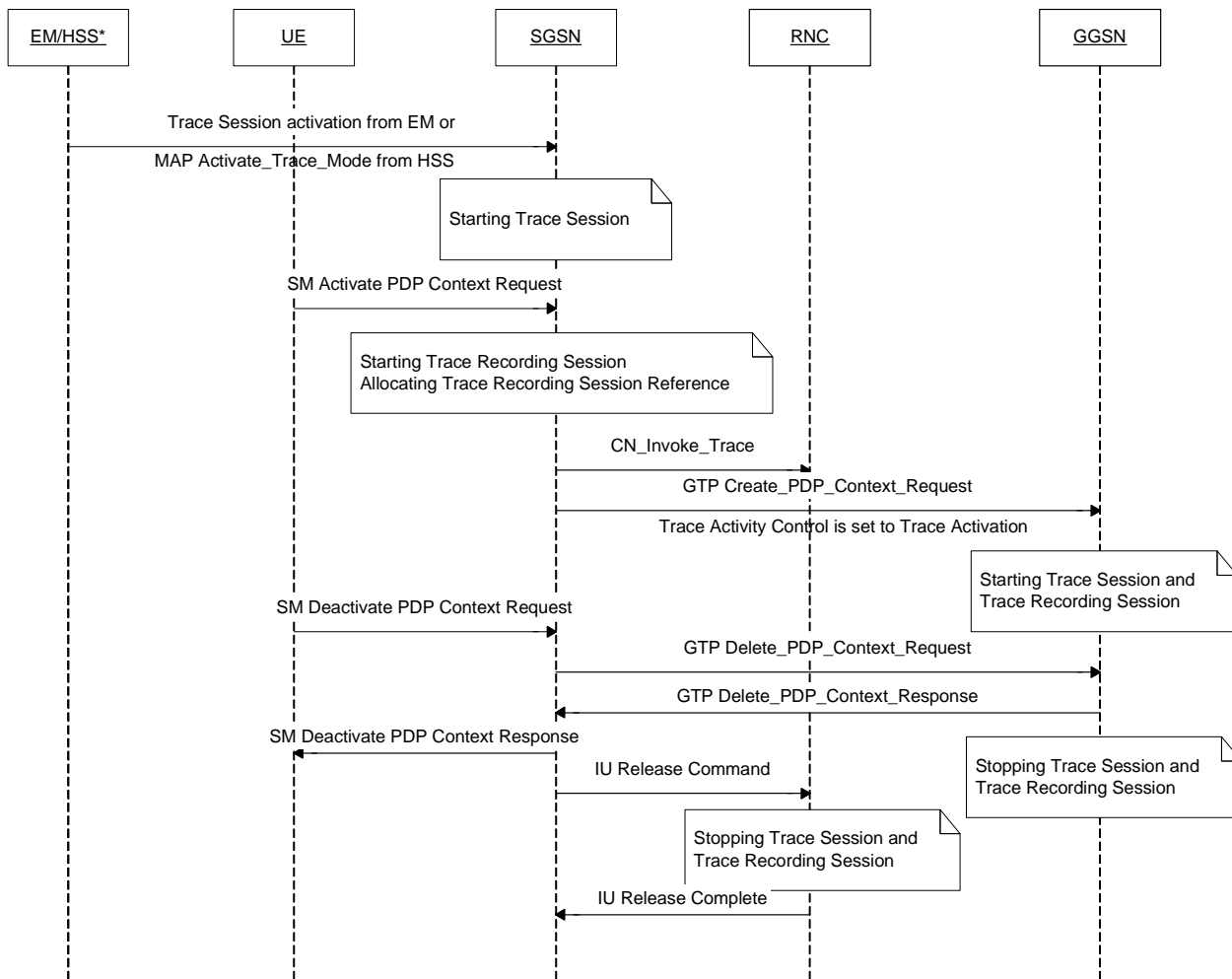

NOTE: The activation to SGSN can come from EM-SGSN (in the figure just EM) or from the HSS.

**Figure 4.2.5.2.1: Stopping a Trace Recording Session for a PDP Context (Signalling based) - PS domain**

The following figure illustrates a successful case in tracing a MBMS context, when a Trace Recording Session is stopped. (Reference 3GPP TS 23.246 [9].)

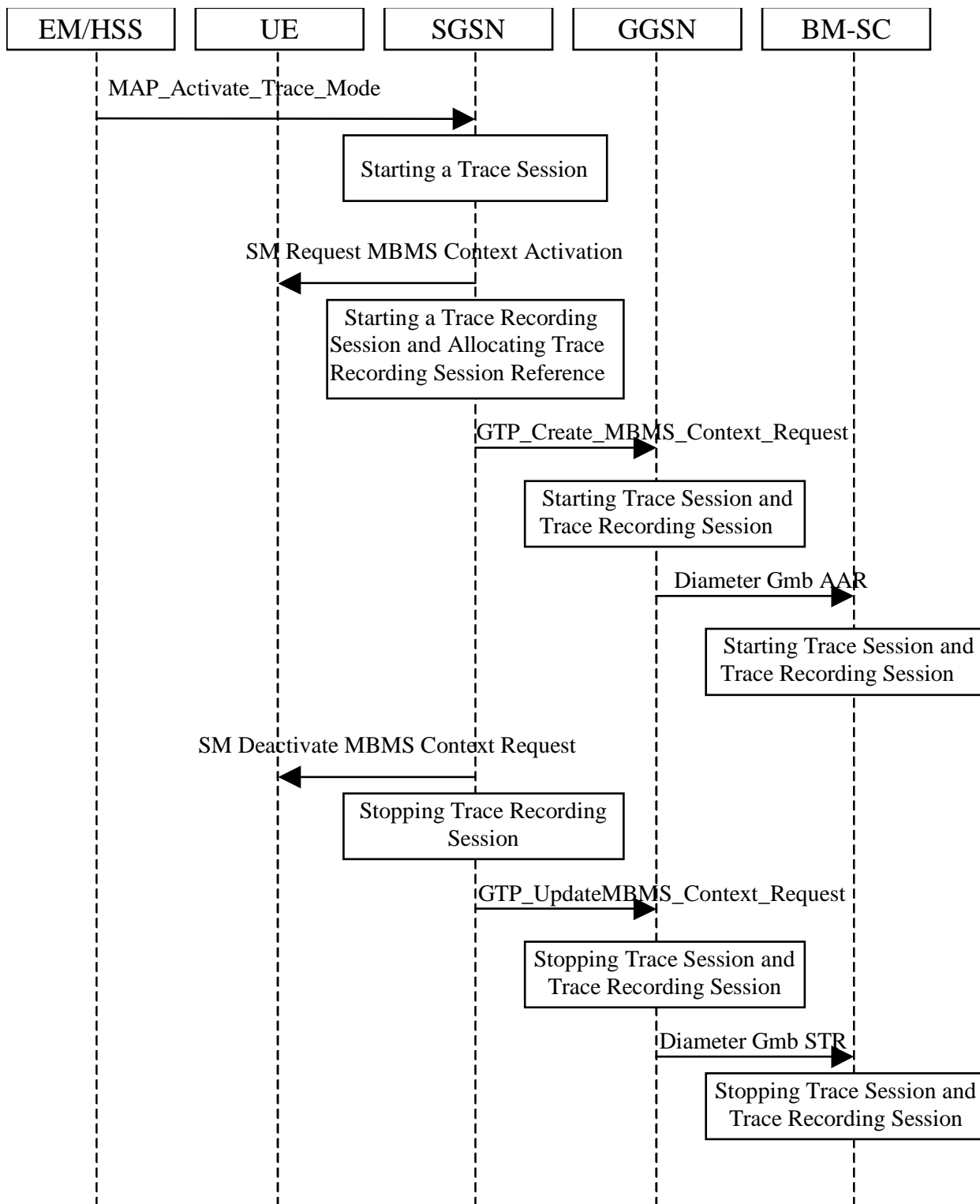

Figure 4.2.5.2.2: Stopping a Trace Recording Session for a MBMS Context (Signalling based) - PS domain

### 4.2.5.3 CS Domain stopping mechanisms

A Trace Recording Session shall be stopped when the MSC Server and MGW detect any of the stop triggering events.

However, if a MSC Server receives a Trace Session deactivation either from its EM (in case of tracing roaming subscribers) or from HSS (in case of tracing home subscribers) during an ongoing Trace Recording Session, it may stop it immediately or at any time until the occurrence of an appropriate stop-triggering event.

A MGW shall stop a Trace Recording Session when it receives a MOD command with trace package (indicating Trace Deactivation) from the MSC Server or at any time until the occurrence of an appropriate stop-triggering event.

When a Trace Recording Session is stopped in a MSC Server, the MSC Server shall send a Trace Session deactivation message to the NEs where tracing was required, as defined in the "List of NE types" configuration parameter, received in the Trace Session activation message. The Trace Reference, used for the deactivation procedure, shall be the same as used in the MSC Server for the activation of the Trace Session.

The following figure illustrates a successful case in tracing a call, when a Trace Recording Session is stopped. (Reference 3GPP TS 23.205 [7] and 3GPP TS 23.108 [8].)

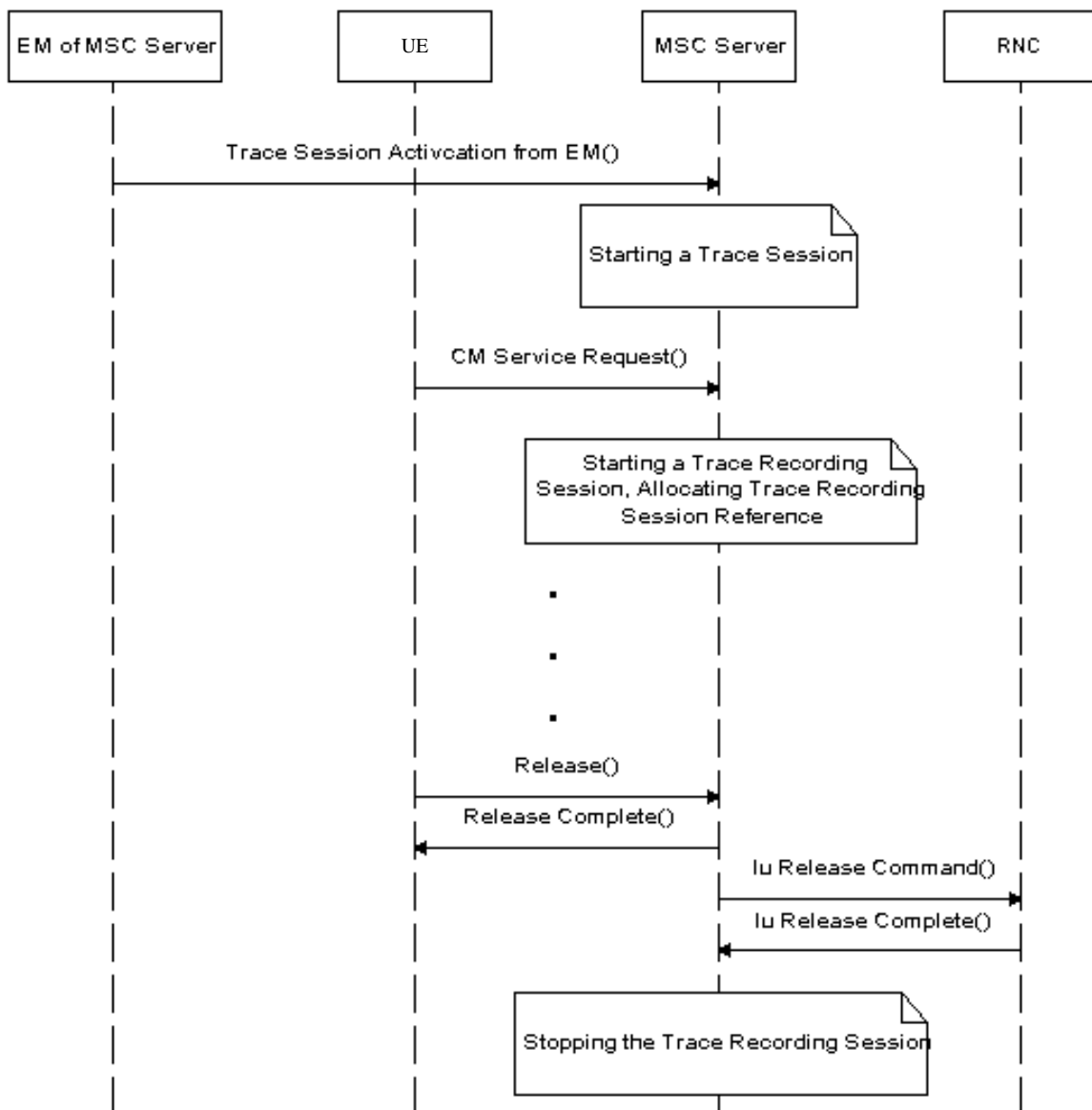

Figure 4.2.5.3.1: Stopping a Trace Recording Session (Signalling based) - CS domain

4.2.5.4 Void

4.2.5.5 Service level tracing for IMS stopping mechanism

4.2.5.5.1 General

The following figure illustrates the stopping of a trace recording session at the UE, P-CSCF, S-CSCF, I-CSCF and HSS (Steps 13 to 22) following the unsuccessful attempt of an IP multimedia subsystem procedure. For clarity purposes the starting of trace recording sessions are also illustrated (steps 1 to 12). In the case where the HSS is unable to fulfil a Diameter User location query from the I-CSCF (see 3GPP TS 29.228 [16]), the HSS shall return to the I-CSCF a permanent failure in the Diameter location query response (Steps 13 and 15). At this point the HSS and the I-CSCF shall stop their trace recording sessions (Steps 14 and 16). On reception of the SIP Final Response containing the permanent failure status code the S-CSCF, P-CSCF and UE stop their trace recording sessions (Steps 17 to 22).

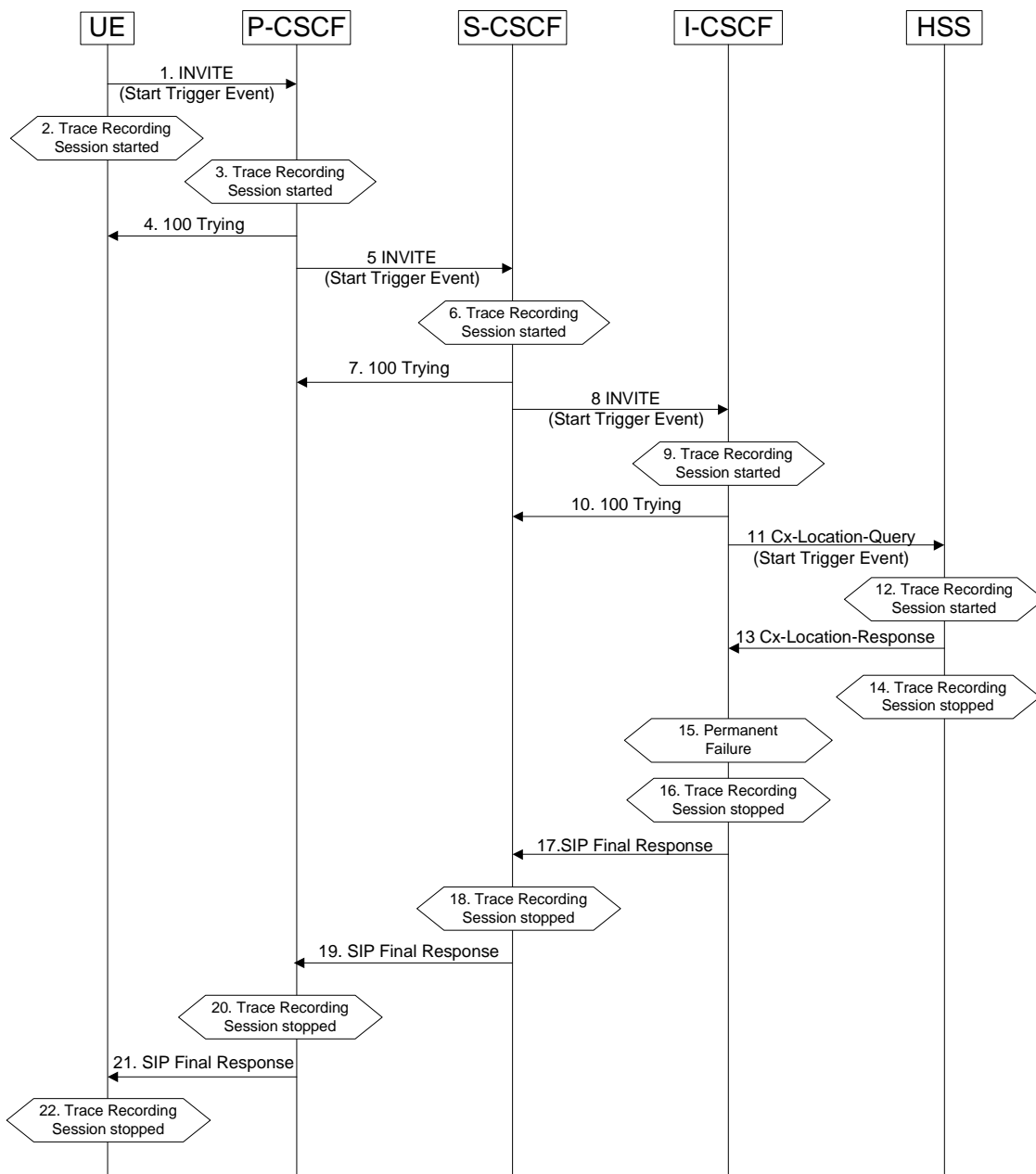

Figure 4.2.5.5.1.1: Stopping a Trace Recording Session following the unsuccessful attempt of an IP multimedia subsystem procedure

#### 4.2.5.5.2 Stopping mechanism at the UE

A UE (both originating and terminating) shall stop a trace recording session immediately following:

- 1) The termination of an IP multimedia subsystem procedure (as defined in 3GPP TS 23.228 [15]). For example, when a successfully established IP multimedia subsystem session ends, or upon a SIP Final Response message (2xx, 3xx, 4xx, 5xx and 6xx response codes).
- 2) The detection of a stop-triggering event (e.g. time expiry period) as defined by the trace control and configuration parameters within the received management operation.
- 3) The detection of a stop-triggering event originating directly from the Device Management server for a specific Trace Recording Session(s).

Depending on Operator conditions, when a UE receives from the Device Management server a request to deactivate the management operation it shall either:

- 1) Continue the Trace Recording Session (s) until it ends gracefully; or
- 2) Stop the Trace Recording session (s) immediately.

In all cases, the UE shall deactivate the Trace Session (s) immediately at the end of the Trace Recording Session(s).

When a UE receives a request to deactivate the management operation no new Trace Recording sessions shall be initiated.

#### 4.2.5.5.3 Stopping mechanism at the IMS NE

An IMS NE (i.e. S/I/P-CSCF, AS, HSS, MRF, MGCF, BGCF) shall stop a trace recording session immediately following:

- 1) The termination of an IP multimedia subsystem procedure (as defined in 3GPP TS 23.228 [15]). For example, when a successfully established IP multimedia subsystem session ends.
- 2) The detection of a stop-triggering event (e.g. time expiry period) as defined in the Trace Session Activation message.

When an IMS NE receives a Trace Session deactivation during an ongoing Trace Recording Session, it may stop the Trace Recording Session immediately or at any time until the occurrence of an appropriate stop-triggering event.

#### 4.2.5.6 Service level tracing Trace session deletion and trace retrieval

As described in clause 4.1.4.6.3, Trace Session deactivation shall be initiated from the Device Management Server. Following the completion of any trace recording sessions at the UE and during the subsequent deactivation of the Trace Session, the UE shall indicate to the Device Management server that Trace Records are available for retrieval.

Once the Trace records have been retrieved the management object may be deleted from the UE.

**Editor's note: Detailed description of the processes involved with the removal of the management operation from the UE is FFS.**

#### 4.2.5.7 E-UTRAN stopping mechanisms

In an eNB the Trace Recording Session will always be the same as the Trace Session as no triggering events are defined in E-UTRAN. Therefore a Trace Recording Session shall always be stopped in an eNB when the eNB deactivates the Trace Session since there can be only 1 trace reference/trace recording session reference combination per Trace Session at any given time. For more information on Trace Session deactivation in E-UTRAN, see subclause 4.1.4.8.

#### 4.2.5.8 EPC Domain stopping mechanisms

A Trace Recording Session may be stopped when the MME/SGW/PGW detect any of the stop triggering events. Detection of a stop trigger event results in MME/SGW/PGW immediately stopping the trace recording session.

However, if an MME receives a Trace Session deactivation either from its EM (in case of tracing roaming subscribers) or from HSS (in case of tracing home subscribers) during an ongoing Trace Recording Session, it may stop it immediately or at any time until the occurrence of an appropriate stop-triggering event.

When a Trace Recording Session is stopped in an MME, the MME may send a S1-Deactivate Trace message to the eNB where tracing was required, as defined in the "List of NE types" configuration parameter, received in the Trace Session activation message. If the triggering event parameter indicates that all events shall be traced, the MME shall not send the S1-Deactivate Trace message to the eNB. If the Trace Recording Session is not terminated in the MME, then it shall not be deactivated in the eNB. The Trace Reference, used for the deactivation procedure, shall be the same as used in the MME for the activation of the Trace Session. This only applies to the eNB as the PGW and SGW have their own triggering criteria.

#### 4.2.5.9 EPC stopping mechanisms for MDT

There is no stopping mechanism in the EPC for MDT trace recording sessions, as there are no starting mechanisms either (see also 4.2.3.8).

#### 4.2.5.10 E-UTRAN stopping mechanisms for MDT

In case of immediate MDT, the eNodeB shall stop an ongoing trace recording session for a given UE when a trace session deactivation is received from the MME. The eNodeB shall deactivate the corresponding MDT measurements in the UE.

If the configured area scope is not satisfied in the target cell after a handover, the eNB may deactivate the Immediate MDT configured to the UE like explained in sec. 4. 4..

In case of logged MDT, there is no stopping mechanism in the eNodeB. The eNodeB does not need to maintain a logged MDT trace recording session once it has been configured in the UE.

#### 4.2.5.11 Stopping mechanisms at UE for MDT

In case of logged MDT, the UE shall stop an ongoing trace recording session when logging duration expires and it shall indicate the availability of logged measurement results to the network next time it enters connected mode.

The UE shall discard an ongoing logged MDT trace recording session when it receives a new logged MDT trace recording session configuration from the network.

4.2.6 Void

4.2.7 Void

4.2.8 Void

4.2.9 Void

4.3 Void

### 4.4 Handling of MDT Trace sessions at handover for Immediate MDT

The eNB/RNC shall activate the Immediate MDT in the UE if the area based selection conditions are satisfied or not in the target cell after a handover that is made over X2 or S1 (or over Iur or Iu in case of UMTS). If the area based selection conditions are not satisfied in the handover target cell, the eNB/ RNC may deactivate the Immediate MDT in the UE. The trace sessions and trace recording sessions are not visible for the UE.

In case of signalling based trace activation (subscription based MDT), the eNB/RNC shall propagate the Trace Session parameters together with the MDT specific parameters to the target cell regardless of whether the source or target cell is part of the configured area scope in case of an Intra-PLMN handover over X2 or S1 (or Iur or Iu in case of UMTS).

In case of UTRAN the RNC shall propagate the Trace Session of the UE to the target cell in case of a handover over Iur or Iu. Any trace recording session shall be maintained, stopped or started in the target cell according to the evaluation of the selection criteria.

For signalling based MDT configuration (i.e. subscription based MDT), when a UE that has been configured with MDT hands over to another eNB (i.e., in connected mode):

- with an X2 handover: the MDT configuration shall be passed to the eNB in the X2 handover request for continuity of MDT data collection. The new eNB shall stop the MDT collection if the new conditions are not within the criteria for MDT data collection.
- with an S1 handover and with no MME relocation: with S1 handover the MME shall ensure the MDT configuration is sent to the new eNB.
- with an S1 handover and with MME relocation: MDT configuration shall be passed on to the new MME on MME relocation. The new MME, shall get the MDT configuration in the S1 HO message in case of intra-PLMN HO and forward the MDT configuration to the new eNB.

The following MDT configuration shall be passed during handovers (Either intra-eNB, inter-eNB or inter-MME HO):

- Trace Session Reference
- Trace Recording Session Reference
- Area scope
- List of measurements
- Report Amount
- Reporting Trigger
- Event Threshold
- Report Interval
- IP address of TCE
- Job type

When these MDT configuration parameters are passed to a new MME, they shall be used with the UE context on the new MME. During inter-MME TAU, the MME shall propagate the MDT configuration parameters to the target MME within an S10- Context Response as part of inter-MME TAU procedures.

During inter-MME handover, the MME shall propagate the MDT configuration parameters to the target MME within an S10- Forward Relocation Request message as part of inter-MME handover procedures.

## 4.5 Handling of MDT Trace sessions at handover for Logged MDT

In logged MDT mode, no propagation of the MDT configuration is performed.

## 4.6 User consent handling in MDT

### 4.6.1 Signalling based MDT

In case of signalling based MDT getting user consent before activating the MDT functionality is required because of privacy and legal obligations. It is the Operator responsibility to collect user consent before initiating an MDT for a specific IMSI or IMEI number.

Collecting the user consent shall be done via customer care process. The user consent information availability should be considered as part of the subscription data and as such this shall be provisioned to the HSS database.



The following figure summarizes the functionality.

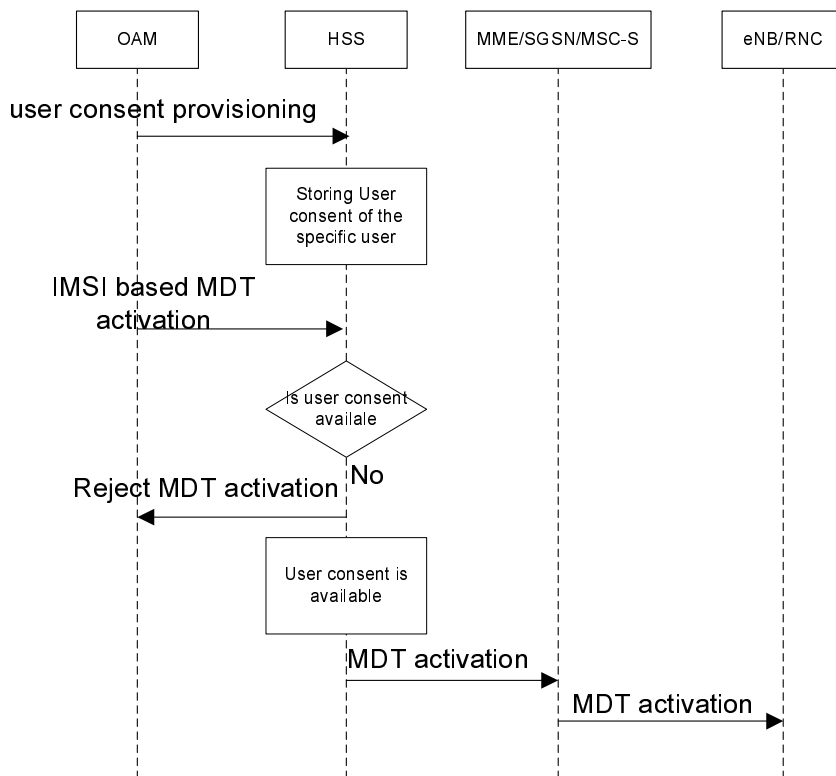

When the IMSI based MDT is activated it is targeted the HSS. Once the user consent availability information is stored in the HSS database, the HSS can check the user consent availability before starting a Trace Session for the given subscriber. If there is no user consent given by the specific user to network where TCE resides, the HSS should not start a Trace Session for the given subscriber.

As the user consent availability information is stored as part of the subscription data it should also be transferred to the MME/SGSN/MSC-S during update location procedure. This is required if the subscription based MDT is started from MME/SGSN/MSC-S. In that case similar checking is required as in the HSS case.

It should also be possible to handle user consent revocation. The process of user consent revocation shall be done also via customer care process and the user consent availability information should be updated in the HSS DB when a user consent revocation happens.

If the user consent revocation happens during an ongoing Trace Session with MDT, it is not required to stop and deactivate the Trace Recording Session, Trace Session respectively immediately i.e. to stop an ongoing Trace Recording Session in case of Immediate MDT. A notification to the management system should be sent and the management system should deactivate the Trace Session .

#### 4.6.2 Area based MDT

In case of area based MDT getting user consent is required before activating the MDT functionality because of privacy and legal obligations. The same user consent information can be used for area based MDT and for signalling based MDT (i.e. there is no need to differentiate the user consent per MDT type).

Collecting the user consent shall be done via customer care process. The user consent information availability shall be considered as part of the subscription data and as such this shall be provisioned to the HSS database.

The following figure shows an example scenario summarizing the functionality.

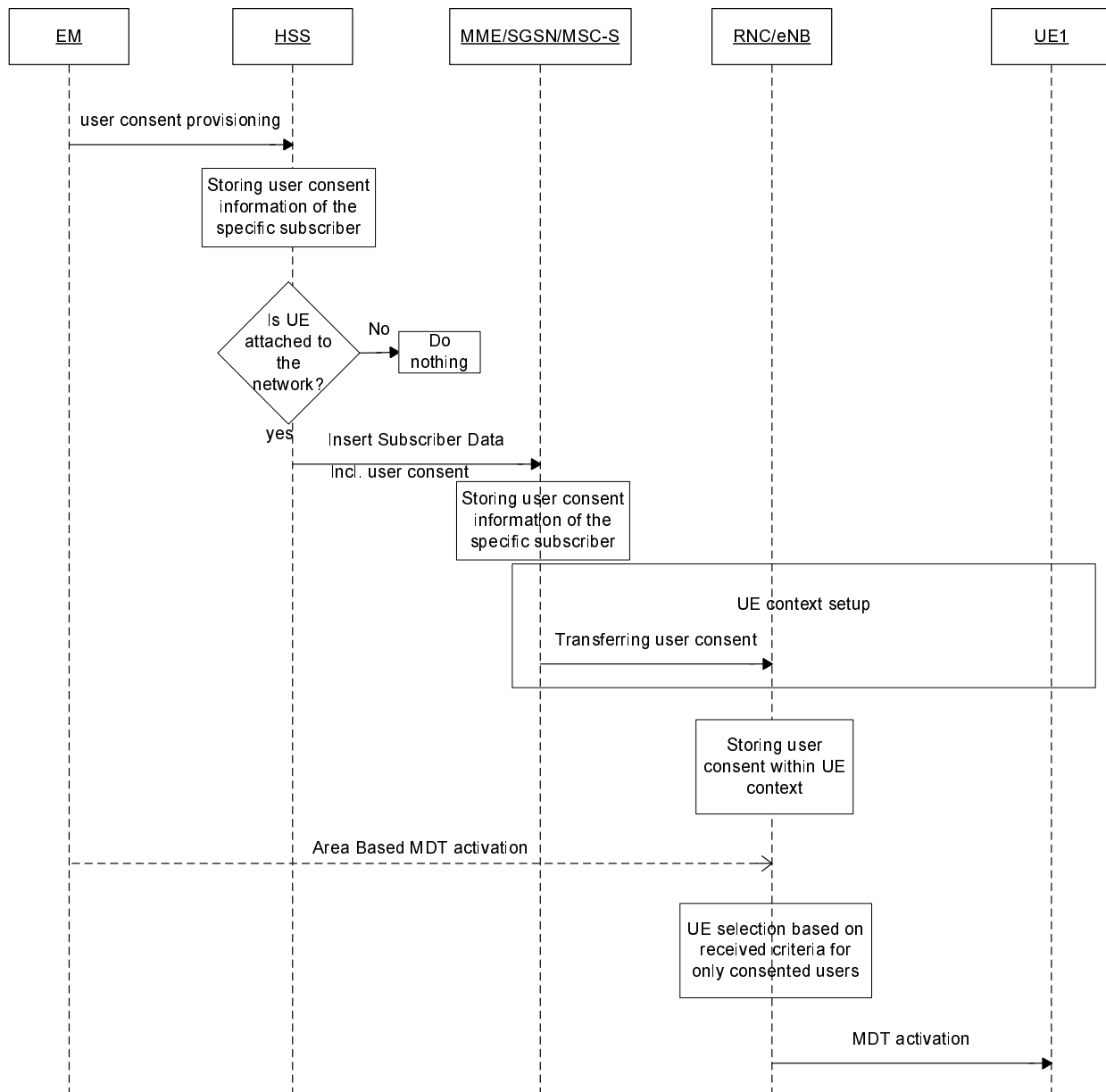

**Figure 4.6.2.1 Example for delivering user consent information in area based MDT**

When UE attaches to the network, the HSS shall forward the user consent information, stored in the HSS database, to the corresponding MME/SGSN/MSC-S. When the MME/SGSN/MSC-S receive the user consent information it shall store it in its subscriber database.

The MME/SGSN/MSC-S shall also check the roaming status of the user. If the user is within his home operator's PLMNs and the user has given his consent, the MME/SGSN/MSC-S shall send the Management Based MDT Allowed IE to the eNB/RNC during the UE context setup procedure. Otherwise the MME/SGSN/MSC-S shall not send the Management Based MDT Allowed IE to the eNB/RNC.

If the result of the roaming status check indicates a home subscriber, MME/SGSN/MSC-S shall forward the already stored user consent information to the corresponding eNodeB/RNC as part of Management Based MDT Allowed IE.

When the area based MDT activation is sent to eNodeB/RNC, eNodeB/RNC shall check the availability of the Management Based MDT Allowed IE before making the UE selection. In case the Management Based MDT Allowed IE is not available, the eNodeB/RNC shall not select the UE. In case the Management Based MDT Allowed IE is available, the eNodeB/RNC shall verify if the UE's RPLMN matches the PLMN where TCE resides – Trace Reference PLMN (PLMN portion of the Trace Reference). In case of a mismatch, the eNodeB/RNC shall not select the UE.

The eNB/RNC shall forward the received Management Based MDT Allowed IE during X2/Iur based handovers to the target node. The Management Based MDT Allowed IE is stored in the eNB/RNC as part of the UE context. If the user consent information is updated while a UE context is already set up in the eNB, the changed user consent should be taken into account in the next call/session setup.

## 4.7 Anonymization of MDT data for area based MDT

If the job type is either Immediate MDT or Logged MDT or combined Immediate MDT and trace, the anonymization requirements are applicable as described in this clause.

In case of E-UTRAN the anonymization of MDT data depends on the configuration parameter received at the MDT configuration. There are two levels of anonymization:

- Using IMEI-TAC
- Not sending any identity to the TCE.

If the anonymization indicates that no identity should be sent to the TCE, the eNB should not send the CELL TRAFFIC TRACE message to the MME.

If the anonymization indicates that the IMEI-TAC is required, eNB should send the CELL TRAFFIC TRACE message to the MME and shall put immediate MDT or logged MDT in the privacy indicator IE according to the job type parameter. MME shall look up of the IMEI-TAC and send to the TCE if the privacy indicator indicates logged MDT or Immediate MDT.

In case of UTRAN The RNC shall never send IMSI to the TCE.

## 5 Trace/UE measurement control and configuration parameters

### 5.1 Triggering events (M)

This mandatory parameter defines when to start a Trace Recording Session and which message shall be recorded first, when to stop a Trace Recording Session and which message shall be recorded last respectively. The messages in the start triggering event tables indicate the transaction to be recorded first and the starting time of the Trace Recording Session within a Trace Session for the traced MS/subscriber in the given NE.

The messages in the stop triggering event tables indicate the transaction to be recorded last and the stopping time of the Trace Recording Session.

MSC Server	Start triggering events	Stop triggering events
Mobile Originated Call	Receipt of the CM SERVICE-REQUEST message with service type set to originating call establishment	Reception of CC-RELEASE COMPLETE or CM-SERVICE ABORT message
Mobile Terminated Call	Sending of PAGING REQUEST message	Reception of CC-RELEASE COMPLETE or CM-SERVICE ABORT message
Mobile Originated SMS	Receipt of the CM SERVICE-REQUEST message with service type set to Short Message service	Transmission of RP-ACK/RP-NACK message
Mobile Terminated SMS	Sending of PAGING REQUEST message	Reception of RP-ACK/RP-NACK message
IMSI Attach	Receipt of the MM-LOCATION UPDATING REQUEST message	Sending of MM-LOCATION-UPDATING ACCEPT or MM-LOCATION-UPDATING-REJECT message
Location Update	Receipt of the MM-LOCATION UPDATING REQUEST message	Sending of MM-LOCATION-UPDATING ACCEPT or MM-LOCATION-UPDATING-REJECT message
IMSI Detach	Receipt of the MM-IMSI DETACH INDICATION message	Reception of MM-IMSI DETACH INDICATION message
Handover	Receipt of the BSSMAP-HANDOVER-REQUIRED message in case of GSM or RANAP-RELOCATION-REQUIRED message in case of UMTS	Reception of BSSMAP-CLEAR COMPLETE message in case of GSM or RANAP-IU RELEASE COMPLETE message in case of UMTS or BSSMAP-HANDOVER FAILURE in case of GSM or RANAP-RELOCATION FAILURE in case of UMTS.
Supplementary Service	TBD	TBD

MGW	Start triggering events	Stop triggering events
Context	Reception of H.248-ADD command, or reception of H.248 MODIFY command	Sending of H.248- SUBTRACT reply

<b>SGSN</b>	<b>Start triggering events</b>	<b>Stop triggering events</b>
PDP Context	Reception of SM-ACTIVATE PDP CONTEXT REQUEST or sending SM-REQUEST PDP CONTEXT ACTIVATION or reception of SM- MODIFY PDP CONTEXT REQUEST	Reception or sending of SM- DEACTIVATE PDP CONTEXT REQUEST or sending SM-ACTIVATE PDP CONTEXT REJECT
Mobile Originated SMS	Receipt of RP-DATA message	Transmission of RP-ACK/RP-NACK message
Mobile Terminated SMS	Transmission of RP-DATA message	Reception of RP-ACK/RP-NACK message
GPRS Attach	Reception of MM-ATTACH-REQUEST	Sending MM-ATTACH-ACCEPT or MM-ATTACH-REJECT
Routing Area Update	Reception of MM-ROUTING AREA UPDATE REQUEST	Sending MM-ROUTING AREA UPDATE ACCEPT or MM-ROUTING AREA UPDATE REJECT
GPRS Detach	Reception MM-DETACH REQUEST	Reception of MM-DETACH ACCEPT
MBMS Context	Sending SM-Request MBMS Context Activation or reception of SM-Update MBMS Context Request	Sending of SM-Deactivate MBMS Context Request or sending of SM-Activate MBMS Context Reject

<b>GGSN</b>	<b>Start triggering events</b>	<b>Stop triggering events</b>
PDP Context	Reception of GTP Create PDP context request or reception of GTP Update PDP context request	Sending of GTP Delete PDP context response
MBMS Context	Reception of GTP Create MBMS Context Request or reception of GTP Update MBMS Context Request	Sending of GTP Delete MBMS Context Response

<b>IMS Network Element</b>	<b>Start triggering events</b>	<b>Stop triggering events</b>
SIP session or standalone transaction	Reception of an initial SIP request that matches the start trigger event configured by the Management System via the Trace IRP TS 32.442 [24]	Sending of a SIP final response to a SIP BYE or other request (originating or terminating), timer expiry or other event that matches the stop trigger event configured by the Management System via the Trace IRP TS 32.442 [24].

<b>BM-SC</b>	<b>Start triggering events</b>	<b>Stop triggering events</b>
MBMS Multicast service activation	Reception of MBMS Authorization Request	Reception of Deactivation Indication for user deactivation or sending of Session Stop Request for service deactivation

MME	Start triggering events	Stop triggering events
Service request	Reception of NAS: Service Request message or S11: Downlink Data Notification Note: The Service Request message shall not start a new Trace Recording Session when received after a Downlink Data Notification for the same service request instance.	Reception of S11: Modify Bearer Response or sending of NAS: SERVICE REJECT Note: <b>Modify Bearer Response shall stop the Trace Recording Session only if it has been sent as part of the Service Request procedure</b>
UE initiated PDN connectivity	Reception of NAS: PDN connectivity Request message	Reception of NAS PDN Connectivity Complete
Initial Attach, Tracking area update, Detach	Initial Attach: Reception of the NAS: ATTACH REQUEST or of S6a Update Location Answer Tracking Area Update: Reception of the NAS: TRACKING AREA UPDATE REQUEST Detach: Reception of the NAS: DETACH REQUEST or S3 Detach Notification or S6a Cancel Location Request or sending of S11 Delete Session Request.  Note: Cancel location location shall not trigger new Trace Recording Session if it is sent as part of the tracking area update procedure. Note: The Delete Session Request message shall trigger a new Trace Recording Session only if sent as part of a Detach procedure and only if a Detach Request has not been received for the same instance of the procedure. Note: Update Location Answer shall be a start trigger for a Trace Recording Session only if sent as part of Attach procedure and if containing Trace Data.	Initial Attach: Reception of the NAS: ATTACH COMPLETE or sending of the NAS: ATTACH REJECT Tracking Area Update: Sending of the NAS: TRACKING AREA UPDATE ACCEPT or sending of NAS: TRACKING AREA UPDATE REJECT Detach: Sending of NAS: DETACH ACCEPT or S3 Detach Acknowledgement message or S6a Cancel Location Answer message or reception S11 Delete Session Response  Note: <b>Cancel Location Answer shall not stop a Trace Recording Session if it is sent as part of the TAU procedure.</b>  Note: <b>The Delete Session Response message shall stop a Trace Recording Session only if sent as part of a Detach procedure and only if a Detach Request has not been received for the same instance of the procedure.</b>
UE initiated PDN disconnection	Sending of the S11: Delete Session Request Note: <b>The S11 Delete Session Request message shall trigger a new Trace Recording Session only if it is sent as part of the UE initiated PDN disconnection procedure.</b>	Reception of NAS Deactivate EPS Bearer Context Accept
Bearer Activation/Modification/Deactivation	Bearer Activation: Reception of S11: Create Bearer Request Bearer Modification: Reception of S11: Update Bearer Request Bearer Deactivation: Reception of S11 Delete Bearer Request Note: <b>Create Bearer Request shall not trigger a new trace recording session if it is sent due to Dedicated bearer activation in combination with the default bearer activation at Attach and UE requested PDN connectivity procedures</b>	Bearer Activation: Sending of S11: Create Bearer Response Bearer Modification: Sending of S11: Update Bearer Response  Bearer Deactivation: Sending of S11: Delete Bearer Response
Handover	Inter-eNB/Intra-MME: Reception of S1AP: Path Switch Request or S1AP Handover Required  Inter-eNB/Inter-MME - Inter RAT (source MME): Reception of S1AP: Handover Required Inter-eNB/Inter-MME – Inter RAT (target MME): Reception of S10/S3: Forward Relocation Request	Inter-eNB/Intra-MME: Sending of S1AP: Path Switch Request Acknowledge or S1AP: Path Switch Request Failure, or S1AP: Handover Preparation Failure or S1AP: Handover Cancel Acknowledge or receiving Handover Notify Inter eNB - Inter MME / Inter RAT (source MME): <b>Reception of S10/S3 Forward Relocation Complete Notification or sending of S1AP Handover Cancel Acknowledge or S1AP Handover Preparation Failure</b>  Inter eNB - Inter MME /Inter RAT (target MME): <b>Sending</b>

		of S10/S3 Forward Relocation Complete Notification or of S10/S3 Relocation Cancel Response or of S10/S3 Forward Relocation Response with reject cause value
--	--	---

SGW	Start triggering events	Stop triggering events
PDN connection creation	Reception of the S11: Create Session Request	Sending of the S11: Create Session Response
PDN connection termination	Reception of the S11: Delete Session Request	Sending of the S11: Delete Session Response
Bearer Activation/Modification/Deactivation	Bearer Activation: Reception of the S5: Create Bearer Request or S11: Bearer Resource Command Bearer Modification: Reception of the S11: Modify Bearer Request or S5: Update Bearer Request Bearer Deletion: Reception of the S11: Deactivate Bearer Command or S5: Delete Bearer Request	Bearer Activation: Sending of the S5: Create Bearer Response Bearer Modification: Sending of the S11: Modify Bearer Response or S5: Update Bearer Response Bearer Deletion: Sending of S5: Delete Bearer Response

PGW	Start triggering events	Stop triggering events
PDN connection creation	Reception of S5: Create Session Request (GTP) or Proxy Binding Update (PMIP)  Reception of S2b: Create Session Request (GTP)	Sending of S5: Create Session Response (GTP) or Proxy Binding Update Ack (PMIP)  Sending of S2b: Create Session Response (GTP)
PDN connection termination	Reception of the S5: Delete Session Request or Proxy Binding Update  Reception of the S2b: Delete Session Request	Sending of the S5: Delete Session Response (GTP) or Proxy Binding Update ACK (PMIP)  Sending of the S2b: Delete Session Response (GTP)
Bearer Activation/Modification/Deactivation Note: this is applicable only to GTP based S5 interface.	Bearer Activation: Sending of the S5/S2b: Create Bearer Request Bearer Modification: Reception of the S5: Modify Bearer Request or sending of the S5/S2b: Update Bearer Request Bearer Deletion: Reception of the S5: Delete Bearer Command or sending of S5/S2b: Delete Bearer Request	Bearer Activation: Reception of the S5/S2b: Create Bearer Response Bearer Modification: Sending of the S5: Modify Bearer Response or reception of the S5/S2b: Update Bearer Response Bearer Deletion: Reception of the S5/S2b: Delete Bearer Response

Bit 8	Bit 7	Bit 6	Bit 5	Bit 4	Bit 3	Bit 2	Bit 1
MSC Server							
MGW							
SGSN							
GGSN							
BM-SC							
MME							
PGW				SGW			

MSC Server							
Bit 8	Bit 7	Bit 6	Bit 5	Bit 4	Bit 3	Bit 2	Bit 1
spare	spare	SS	Handovers	LU, IMSI attach, IMSI detach		MO and MT SMS	MO and MT calls
spare							

MGW							
Bit 8	Bit 7	Bit 6	Bit 5	Bit 4	Bit 3	Bit 2	Bit 1
spare						spare	Context

SGSN							
Bit 8	Bit 7	Bit 6	Bit 5	Bit 4	Bit 3	Bit 2	Bit 1
spare			MBMS Context	RAU, GPRS attach, GPRS detach		MO and MT SMS	PDP context
Reserved							

GGSN							
Bit 8	Bit 7	Bit 6	Bit 5	Bit 4	Bit 3	Bit 2	Bit 1
spare						MBMS Context	PDP Context

MME							
Bit 8	Bit 7	Bit 6	Bit 5	Bit 4	Bit 3	Bit 2	Bit 1
spare	Spare	Handover	Bearer Activation Modification Deletion	UE initiated PDN disconnection	Initial Attach, Tracking area update, Detach	Service requests	UE initiated PDN connectivity request

PGW				SGW			
Bit 8	Bit 7	Bit 6	Bit 5	Bit 4	Bit 3	Bit 2	Bit 1
spare	Bearer Activation Modification Deletion	PDN connection termination	PDN connection creation	Spare	Bearer Activation Modification Deletion	PDN connection termination	PDN Connection creation

If a bit is set to 1 the given event shall be traced, i.e. a Trace Recording Session shall be started for that event.

If a bit is set to 0 the given event should not be traced, i.e. Trace Recording Session should not be started.

## 5.2 Service Level Tracing Start Triggering event (M)

The Service Level Tracing Start Triggering Event is a mandatory parameter that controls and coordinates the start of a Trace Recording Session at an IMS NE and UE.

The Service Level Tracing Start Trigger Event shall include:



- Public User Identity (M);
- Service identification (M);
- Trace reference (M);
- Service level tracing counter (M);  
The service level tracing counter is incremented on a hop-by-hop basis to indicate the sequence of trace records recorded across all IMS NEs.

### 5.3 Trace Depth (M)

This mandatory parameter defines how detailed information should be recorded in the Network Element. The Trace Depth is a parameter for Trace Session level, i.e., the Trace Depth is the same for all of the NEs to be traced in the same Trace Session.

The following table describes the values of the Trace Depth parameter.

Trace Depth	Meaning
Minimum	Recording of some IEs in the signalling messages plus any vendor specific extensions to this definition, in decoded format.
Medium	Recording of some IEs in the signalling messages together with the radio measurement IEs plus any vendor specific extensions to this definition, in decoded format.
Maximum	Recording entire signalling messages plus any vendor specific extensions to this definition, in encoded format.
MinimumWithoutVendorSpecificExtension	Recording of some IEs in the signalling messages in decoded format.
MediumWithoutVendorSpecificExtension	Recording of some IEs in the signalling messages together with the radio measurement IEs in decoded format.
MaximumWithoutVendorSpecifcExtension	Recording entire signalling messages in encoded format.

At least one of Minimum, Medium or Maximum trace Depth shall be supported depending on the NE type (see trace record description in TS 32.423 [3] for details).

Trace depth shall be an enumerated parameter with the following possible values:

- 0 – Minimum,
- 1 – Medium
- 2 – Maximum
- 3 – MinimumWithoutVendorSpecificExtension
- 4 – MediumWithoutVendorSpecificExtension
- 5 - MaximumWithoutVendorSpecificExtension

### 5.4 List of NE types (M)

This conditional mandatory parameter defines the Network Element types where Trace Session activation is needed. The condition of this parameter is that signalling based activation mechanism is used except in IMS. This parameter determines whether the Trace Session Activation shall be propagated further to other Network Elements. In the management based activation mechanism, and in the signalling based activation mechanism for IMS, this parameter is not needed.

The following list contains the Network Element types:

- MSC Server
- MGW
- RNC
- SGSN
- GGSN
- BM-SC
- MME
- SGW
- PDN GW

- eNB

Bit 8	Bit 7	Bit 6	Bit 5	Bit 4	Bit 3	Bit 2	Bit 1
SGW	MME	BM-SC	RNC	GGSN	SGSN	MGW	MSC-S
spare						eNB	PDN GW

If a bit is set to 1, Trace Session to that Network Element shall be activated.

If a bit is set to 0, Trace Session is not needed in that Network Element.

## 5.5 List of interfaces (O)

This is an optional parameter, which defines the interfaces to be recorded in the Network Element.

The following list contains the list of interfaces in each Network Element:

- MSC Server: A, Iu-CS, Mc and MAP (G, B, E, F, D, C) interfaces, CAP.
- MGW: Mc, Nb-UP, Iu-UP.
- RNC: Iu-CS, Iu-PS, Iur, Iub and Uu interfaces.
- SGSN: Gb, Iu-PS, Gn, MAP (Gr, Gd, Gf), CAP (Ge), Gs, S6d, S4, S3, S13' interfaces.
- GGSN: Gn, Gi and Gmb interfaces.
- S-CSCF: Mw, Mg, Mr and Mi interfaces.
- P-CSCF: Gm and Mw interfaces.
- I-CSCF: Cx, Dx, Mg, Mw.
- MRFC: Mp, Mr.
- MGCF: Mg, Mj, Mn.
- IBCF: Ix, Mx.
- E-CSCF: Mw, MI, Mm, Mi/Mg.
- BGCF: Mi, Mj, Mk.
- AS: Dh, Sh, ISC, Ut.
- HSS: MAP (C, D, Gc, Gr), Cx, S6d interfaces, S6a, Sh and location and subscription information.
- EIR: MAP (F), S13, S13", MAP (Gf)
- BM-SC: Gmb interface.
- MME: S1-MME, S3, S6a, S10, S11, S13
- SGW: S4, S5, S8, S11, Gxc
- PDN GW: S2a, S2b, S2c, S5, S6b, Gx, S8, SGi
- eNB: S1-MME, X2, Uu

NOTE: For IMS Network Elements other than P-CSCF and S-CSCF the interfaces included in the Trace Job for a particular type of IMS session are configured in the Management System via the Trace IRP (3GPP TS 32.442 [24]).

Bit 8	Bit 7	Bit 6	Bit 5	Bit 4	Bit 3	Bit 2	Bit 1
MSC Server							
MGW							
SGSN							
GGSN							
RNC							
BM-SC							
MME							
SGW							
PDN GW							
eNB							
HSS							
EIR							

MSC Server							
Bit 8	Bit 7	Bit 6	Bit 5	Bit 4	Bit 3	Bit 2	Bit 1
CAP	MAP-F	MAP-E	MAP-B	MAP-G	Mc	lu	A
spare						MAP-C	MAP-D

SGSN							
Bit 8	Bit 7	Bit 6	Bit 5	Bit 4	Bit 3	Bit 2	Bit 1
Ge	Gs	MAP-Gf	MAP-Gd	MAP-Gr	Gn	lu	Gb
spare				S13'	S3	S4	S6d

MGW							
Bit 8	Bit 7	Bit 6	Bit 5	Bit 4	Bit 3	Bit 2	Bit 1
Spare					lu-UP	Nb-UP	Mc

GGSN							
Bit 8	Bit 7	Bit 6	Bit 5	Bit 4	Bit 3	Bit 2	Bit 1
spare					Gmb	Gi	Gn

RNC							
Bit 8	Bit 7	Bit 6	Bit 5	Bit 4	Bit 3	Bit 2	Bit 1
Spare				Uu	lub	lur	lu

BM-SC							
Bit 8	Bit 7	Bit 6	Bit 5	Bit 4	Bit 3	Bit 2	Bit 1
spare							Gmb

MME							
Bit 8	Bit 7	Bit 6	Bit 5	Bit 4	Bit 3	Bit 2	Bit 1
Spare		S13	S11	S10	S6a	S3	S1-MME

SGW							
Bit 8	Bit 7	Bit 6	Bit 5	Bit 4	Bit 3	Bit 2	Bit 1
Spare			Gxc	S11	S8b	S5	S4

PDN GW							
Bit 8	Bit 7	Bit 6	Bit 5	Bit 4	Bit 3	Bit 2	Bit 1
SGi	S8b	Gx	S6b	S5	S2c	S2b	S2a

eNB							
Bit 8	Bit 7	Bit 6	Bit 5	Bit 4	Bit 3	Bit 2	Bit 1
Spare					Uu	X2	S1-MME

HSS							
Bit 8	Bit 7	Bit 6	Bit 5	Bit 4	Bit 3	Bit 2	Bit 1
Sh	S6a	S6d	Cx	MAP-Gr	MAP-Gc	MAP-D	MAP-C

EIR							
Bit 8	Bit 7	Bit 6	Bit 5	Bit 4	Bit 3	Bit 2	Bit 1
Spare				MAP-Gf	S13"	S13	MAP-F

If a bit is set to 1, the interface should be traced in the given Network Element.

If a bit is set to 0, that interface should not be traced in the given Network Element.

## 5.6 Trace Reference (M)

The Trace Reference parameter shall be globally unique, therefore the Trace Reference shall compose as follows:

MCC+MNC+Trace ID, where the MCC and MNC are coming with the Trace activation request from the EM/NM to identify one PLMN containing the EM/NM, and Trace ID is a 3 byte Octet String.

NOTE: Trace ID referred here is the same as Trace reference in previous releases

NOTE: The MCC+MNC being part of the Trace Reference from Rel-8 onwards (e.g. ignored by Rel-6 / Rel-7 UTRAN Network Elements), the uniqueness of the Trace Reference may not be guaranteed with Rel-6 / Rel-7 Network Element(s) involved in the Trace.

## 5.7 Trace Recording Session Reference (M)

This parameter shall be a 2 byte Octet String.

## 5.8 Void

## 5.9 IP Address of Trace Collection Entity (CM, CO)

This is a parameter which defines the IP address to which the Trace records shall be transferred. IPv4 and/or IPv6 address(es) may be signalled.

- This parameter is mandatory when tracing in EPS is supported.
- This parameter is mandatory when MDT is supported.
- This parameter is optional when tracing in UMTS is supported.

## 5.10 MDT specific configuration parameters (CM)

### 5.10.1 Job type

The Job type parameter defines the MDT mode and whether a combined MDT and trace job is requested. The Job type parameter is an enumerated type with the following values:

- Immediate MDT only (0);
- Logged MDT only (1);

- Trace only (2);
- Immediate MDT and Trace (3).

The parameter is mandatory.

## 5.10.2 Area Scope

The Area Scope optional parameter defines the area in terms of Cells or Tracking Area/ Routing Area/ Location Area where the MDT data collection shall take place. The area scope specified in a MDT session shall support the same PLMN. If the parameter is not present the MDT data collection shall be done in the whole PLMN.

The Area Scope parameter in UMTS is either

- list of Cells, identified by CGI. Maximum 32 CGI can be defined.
- List of Routing Area, identified by RAI. Maximum of 8 RAIs can be defined.
- List of Location Area, identified by LAI. Maximum of 8 LAIs can be defined.

The Area Scope parameter in LTE is either

- list of Cells, identified by E-UTRAN-CGI. Maximum 32 CGI can be defined.
- List of Tracking Area, identified by TAC. Maximum of 8 TAC can be defined.

## 5.10.3 List of measurements

This parameter is mandatory if the Job type is configured for Immediate MD or combined Immediate MDT and Trace T. This parameter defines the measurements that shall be collected. The parameter is 4 octet long bitmap with the following values in UMTS:

- M1: CPICH RSCP and CPICH Ec/No measurement by UE with Periodic or event 1F as reporting triggers.
- M2: For 1.28 Mcps TDD, P-CCPCH RSCP and Timeslot ISCP measurement by UE with event 1I as reporting triggers.
- M3: SIR and SIR error (FDD) by NodeB
- Both M1 and M2
- M1 and M3
- M2 and M3
- M1 and M2 and M3

The parameter can have the following values in LTE:

- M1: RSRP and RSRQ measurement by UE with Periodic, event A2 as reporting triggers
- M2: Power Headroom (PH) measurement by UE  
NOTE: Available from MAC layer
- M1 and M2

LTE							
Bit 8	Bit 7	Bit 6	Bit 5	Bit 4	Bit 3	Bit 2	Bit 1
spare						M2	M1
spare							
UMTS							
Bit 8	Bit 7	Bit 6	Bit 5	Bit 4	Bit 3	Bit 2	Bit 1
spare					M3	M2	M1
spare							

## 5.10.4 Reporting Trigger

This parameter is mandatory if the list of measurements parameter is configured for UE side measurement (such as M1 measurement in LTE and M1/M2 measurement in UMTS) and the jobtype is configured for Immediate MDT or combined Immediate MDT and Trace.

The parameter is one octet long bitmap and can have the following values (detailed definition of the parameter is in 3GPP TS 37.320 [30]):

The parameter shall not have the combination of periodical and event based reporting at the same time, i.e. bit1 cannot be set if either bit2 or bit3 or bit4 is set.

- Periodical,
- Event A2 for LTE:
- Event 1F for UMTS,
- Event 1I for UMTS 1.28 Mcps TDD,

Bit 8	Bit 7	Bit 6	Bit 5	Bit 4	Bit 3	Bit 2	Bit 1
Reserved	Reserved	Reserved	Reserved	Event 1I for UMTS 1.28 MCPS TDD	Event 1F for UMTS	Event A2 for LTE	Periodical

## 5.10.5 Report Interval

This parameter is mandatory if the Reporting trigger is configured for Periodic UE side measurements (such as M1 measurement in LTE and M1/M2 measurements in UMTS) and the jobtype is configured for Immediate MDT or combined Immediate MDT and Trace. The parameter indicates the interval between the periodical measurements to be taken when UE is in connected.

The parameter is enumerated type with the following values in milliseconds in case of UMTS (detailed definition is in 3GPP TS 25.331 [31]):

- 250 ms (0),
- 500 ms (1),
- 1000 ms (2),
- 2000 ms (3),
- 3000 ms (4),
- 4000 ms (5),
- 6000 ms (6),
- 8000 ms (7),
- 12000 ms (8),
- 16000 ms (9),
- 20000 ms (10),
- 24000 ms (11),
- 28000 ms (12),
- 32000 ms (13),
- 64000 ms (14)

The parameter can have the following values in LTE (detailed definition is in 3GPP TS 36.331 [32]):

- 120 ms (15),
- 240 ms (16),

- 480 ms (17),
- 640 ms (18),
- 1024 ms (19),
- 2048 ms (20),
- 5120 ms (21),
- 10240ms (22),
- 1 min=60000 ms (23),
- 6 min=360000 ms (24),
- 12 min=720000 ms (25),
- 30 min=1800000 ms (26),
- 60 min=3600000 ms (27)

### 5.10.6 Report Amount

The parameter is mandatory if the reporting trigger is configured for periodical UE side measurement (such as M1 measurement in LTE and M1/M2 measurements in UMTS) and the jobtype is configured for Immediate MDT or combined Immediate MDT and Trace. The parameter defines the number of measurement reports that shall be taken for periodical reporting while UE is in connected. Detailed definition of the parameter is in 3GPP TS 36.331 and 3GPP TS 25.331[31].

The parameter is an enumerated type with the following values in UMTS and in LTE:

- 1 (0),
- 2 (1),
- 4 (2),
- 8 (3),
- 16 (4),
- 32 (5),
- 64 (6),
- *infinity* (7)

### 5.10.7 Event Threshold for RSRP

The parameter is mandatory if the report trigger parameter is configured for A2 event reporting and the job type parameter is configured for Immediate MDT or combined Immediate MDT and Trace.

Detailed definition of the parameter is in 3GPP TS 36.331 [32].

- The parameter is an Integer number between 0-97.

#### 5.10.7a Event Threshold for RSRQ

The parameter is mandatory if the report trigger parameter is configured for A2 event reporting and the job type parameter is configured for Immediate MDT or combined Immediate MDT and Trace.

Detailed definition of the parameter is in 3GPP TS 36.331 [32].



The parameter is an Integer number between 0-34.

### 5.10.8 Logging Interval

The parameter is mandatory if the job type is configured for Logged MDT. The parameter defines the periodicity for logging MDT measurement results for periodic downlink pilot strength measurement when UE is in Idle.

Detailed definition of the parameter is in 3GPP TS 37.320 [30].

The parameter is an enumerated type with the following values in UMTS and LTE as per defined in 3GPP TS 25.331 [31] and 36.331 [32]:

- 1.28 (0),
- 2.56 (1),
- 5.12 (2),
- 10.24 (3),
- 20.48 (4),
- 30.72 (5),
- 40.96 (6),
- 61.44 (7)

### 5.10.9 Logging Duration

The parameter is mandatory if the the job type parameter is configured for Logged MDT. The parameter determines the validity of MDT logged configuration for IDLE. The timer starts at time of receiving configuration by the UE, and continues independent of UE state transitions and RAT or RPLMN changes.

Detailed definition of the parameter is in 3GPP TS 37.320 [30], 3GPP TS 25.331 [31] and 3GPP TS 36.331 [32]:

The parameter is an enumerated type with the following values in UMTS and LTE:

- 600sec (0),
- 1200sec (1),
- 2400sec (2),
- 3600sec (3),
- 5400sec (4),
- 7200sec (5)

### 5.10.10 Void

### 5.10.11 Trace Collection Entity Id

This is a mandatory parameter for Logged MDT which defines the TCE Id which is sent to the UE. The UE returns it to the network together with the logged data. The network has a configured mapping of the IP address of the TCE (to which the Trace records shall be transferred) and the TCE Id. The mapping needs to be unique within the PLMN. The size of the parameter is one byte.

### 5.10.12 Anonymization of MDT data

This is a mandatory parameter for area based MDT when Job Type is

- Immediate MDT only (0);
- Logged MDT only (1);
- Immediate MDT and Trace (3).

This configuration parameter provides anonymization of MDT data (Refer to clause 4. 4).

The parameter is an enumerated type with the following possible values:

- No Identity (0);
- IMEI-TAC(1)

### 5.10.13 Event Threshold for Event 1F

The parameter is mandatory if the reporting trigger parameter is configured for 1F event reporting and the job type parameter is configured for Immediate MDT or combined Trace and Immediate MDT.

The parameter defines the threshold for reporting UMTS M1 measurements for 1F event based reporting trigger. Detailed definition of the parameter is in 3GPP TS 25.331 section 14.1.2.6 [31].

- The parameter is an Integer number between -120-165

The range used depends on the measurement quantity:

- CPICH RSCP the range is: -120 – 25 dBm
- For CPICH Ec/No the range is -24 - 0 dB
- For Pathloss 30-165 dB.

### 5.10.14 Event threshold for Event 1I

The parameter is mandatory if the reporting trigger parameter is configured for 1I event reporting and the job type parameter is configured for Immediate MDT or combined Trace and Immediate MDT.

The parameter defines the threshold for reporting UMTS M2 measurements for 1I event based reporting trigger. Detailed definition of the parameter is in 3GPP TS 25.331 section 14.1.3.3. [31].

- The parameter is an Integer number between -120 .. -25.

### 5.10.15 Measurement quantity

The parameter is mandatory if the reporting trigger parameter is configured for 1F reporting and the job type parameter is configured for Immediate MDT or combined Trace and Immediate MDT.

The parameter describes for what M1 measurements the Event Threshold 1F parameter is applicable.

The parameter is a bitmap with the following values:

Bit 8	Bit 7	Bit 6	Bit 5	Bit 4	Bit 3	Bit 2	Bit 1
Reserved	Reserved	Reserved	Reserved	Reserved	Pathloss	CPICH RSCP	CPICH Ec/No

No more than one bit shall be selected at a time.

---

## 6 MDT Reporting

MDT reporting in case of Immediate MDT:

Figure 6.1 illustrates an example of the procedure for Immediate MDT reporting.

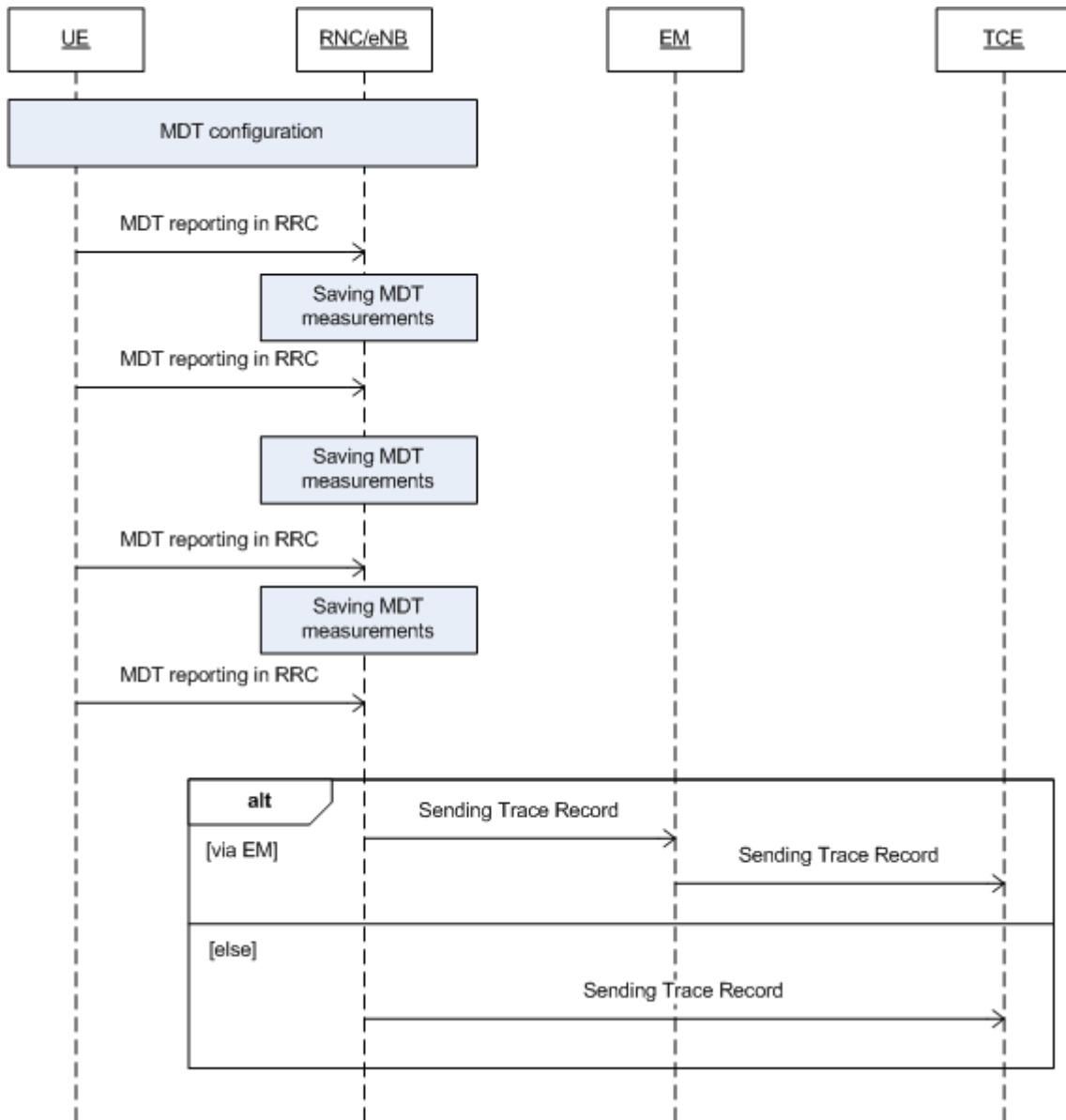

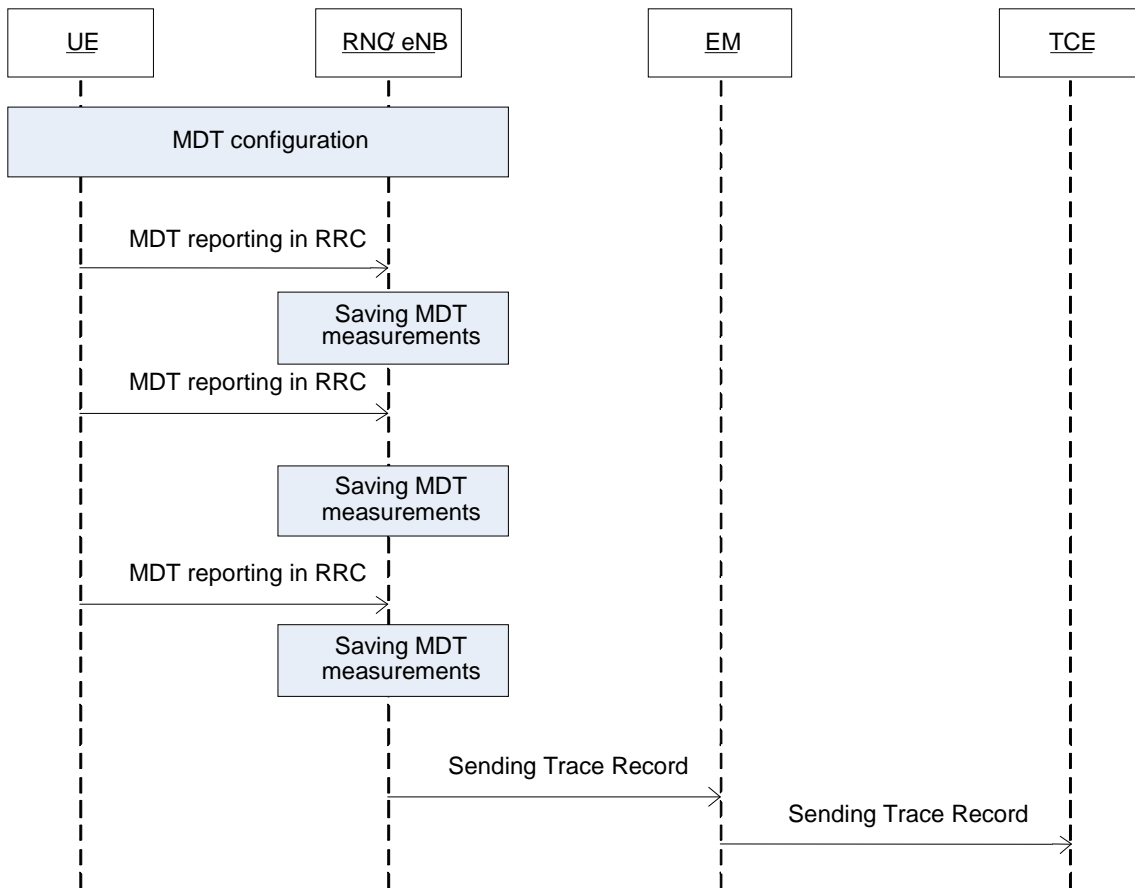
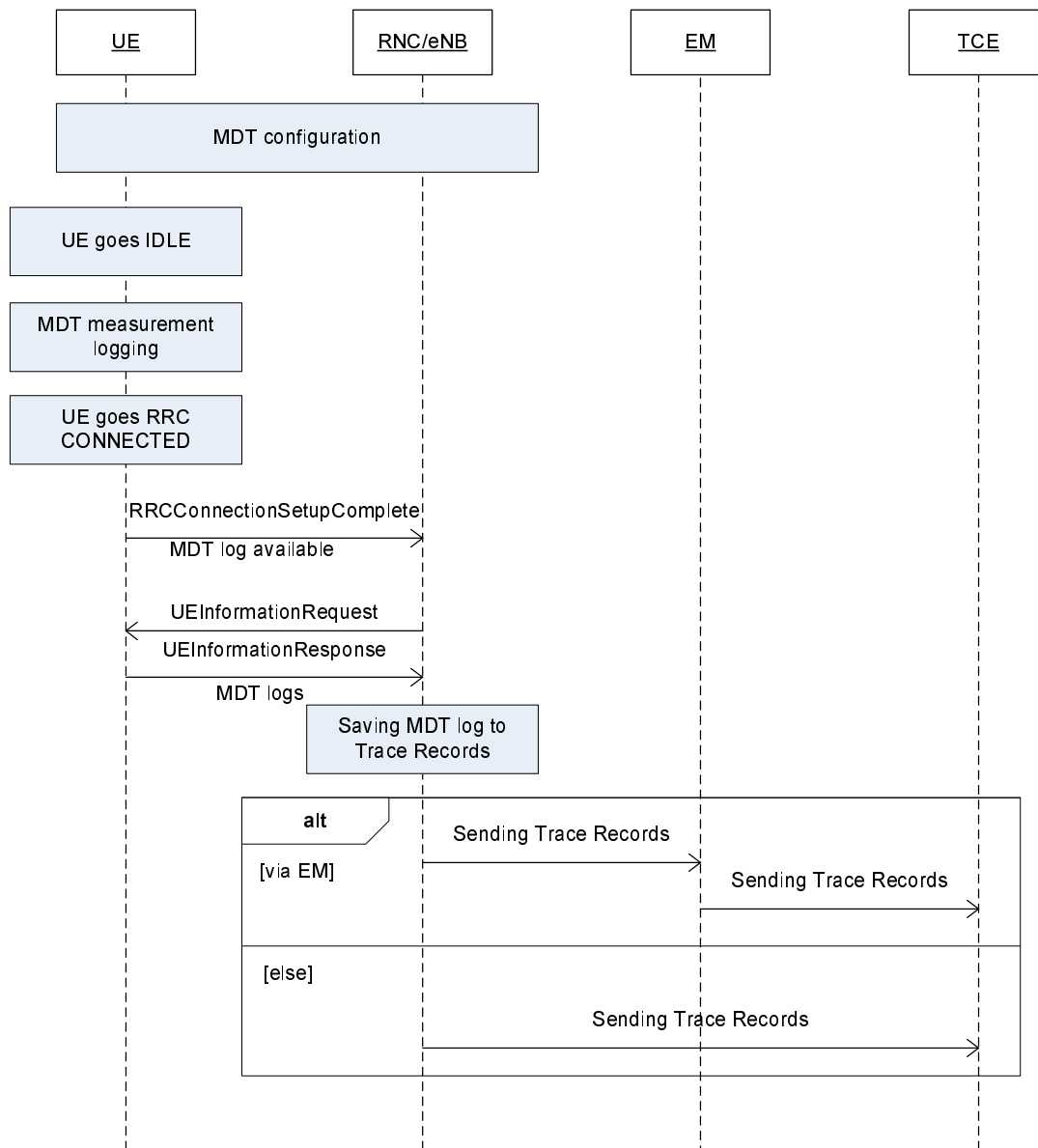

**Figure 6.1:**

In case of Immediate MDT, the MDT related measurements are sent in RRC as part of the existing RRC measurements. Whenever the eNB/RNC receives the MDT measurements it shall save it to a Trace Record. The Trace Records are sent to the TCE either directly or via EM (where EM can reside in the eNB/RNC).

The time and the criteria when the Trace Records are sent to the TCE is vendor specific however if the Trace Session is deactivated, the Trace Records shall be sent to the TCE latest by 2 hours ( the exact time is FFS) after the Trace Session deactivation.

Figure 6.2 illustrates an example of the MDT reporting in case of Logged MDT:



**Figure 6.2:**

In case of Logged MDT, the UE collects the measurements while it is in IDLE mode. Once the UE goes to RRC CONNECTED mode, the UE indicates MDT log availability in the RRCConnectionSetupComplete message to the eNB/RNC. When the eNB/RNC receives this indication it can request the MDT log (if the UE is still in the same RAT type where the MDT configuration was done) by sending the UEInformationRequest message to the UE. The MDT logs are sent to the network in the UEInformationResponse message. At the reception of the UEInformationResponse message the eNB/RNC shall save the received MDT log to the Trace Record. The Trace Records are sent to the TCE either directly or via EM (where EM can reside in the eNB/RNC).

The time and criteria when the Trace Records are sent to the TCE is vendor specific however if the Trace Session is deactivated, the Trace Records shall be sent to the TCE latest by 2 hours ( the exact time is FFS) after the Trace Session deactivation.

---

## Annex A (normative): Trace failure notification file format

### A.1 Global structure

See 3GPP TS 32.615 [27]

The following XML namespaces are potentially used in Trace failure notification XML files:

- `traceFailureNotification.xsd` (see A.5)

---

### A.2 XML elements `fileHeader` and `fileFooter`

#### A.2.1 XML elements `fileHeader`

See 3GPP TS 32.615 [27]

#### A.2.2 XML element `fileFooter`

See 3GPP TS 32.615 [27]

---

### A.3 Trace failure notification specific XML elements

See A.5.

---

### A.4 Trace IRP XML File Name Conventions

For Trace failure notification XML File Name Conventions the generic file name definitions as specified by the FT IRP apply (see [28]).

---

### A.5 Trace failure notification file XML schema

```
<?xml version="1.0" encoding="UTF-8"?>
<!--
  3GPP TS 32.422 Trace
  Trace failure notification file XML schema
  traceFailureNotification.xsd
-->
<schema
  targetNamespace=
"http://www.3gpp.org/ftp/specs/archive/32_series/32.422#traceFailureNotification"

  elementFormDefault="qualified"

  xmlns="http://www.w3.org/2001/XMLSchema"

  xmlns:tn=
```

```
"http://www.3gpp.org/ftp/specs/archive/32_series/32.422#traceFailureNotification"
  xmlns:xe=
"http://www.3gpp.org/ftp/specs/archive/32_series/32.305#notification"
>

  <import
    namespace=
"http://www.3gpp.org/ftp/specs/archive/32_series/32.305#notification"
  />

  <!-- XML types specific for trace failure notifications -->
<complexType name="TraceReference">
  <sequence>
    <element name="MCC" type="short" minOccurs="0"/>
    <element name="MNC" type="short" minOccurs="0"/>
    <element name="TRACE_ID" type="integer"/>
  </sequence>
</complexType>

<complexType name="NotifyTraceRecordingSessionFailure">
  <complexContent>
    <extension base="xe:Notification">
      <sequence>
        <element name="body">
          <complexType>
            <sequence>
              <element name="NeId" type="string" minOccurs="0"/>

              <element name="TraceRecordingSessionReference" type="integer" minOccurs="0"/>
              <element name="TraceReference" type="tfn:TraceReference"/>
              <element name="Reason" type="string" minOccurs="0"/>
            </sequence>
          </complexType>
        </element>
      </sequence>
    </extension>
  </complexContent>
</complexType>

<element name="NotifyTraceRecordingSessionFailure" type="tr:NotifyTraceRecordingSessionFailure"/>

</schema>
```



## Annex B (informative): Change history

Change history							
Date	TSG #	TSG Doc.	CR	Rev	Subject/Comment	Old	New
Jun 2006	SA_32	SP-060261	0021	--	Introduction of Service Level Tracing for IMS	6.5.0	7.0.0
Sep 2006	SA_33	SP-060552	0022	--	Add general mechanism for starting trace recording sessions at IMS Network Elements and UE - to support end-to-end Service Level Tracing for IMS	7.0.0	7.1.0
Sep 2006	SA_33	SP-060552	0023	--	Add definition of Service Level Tracing Start Triggering Event	7.0.0	7.1.0
Sep 2006	SA_33	SP-060552	0024	--	Clarification of Trace session deactivation mechanism	7.0.0	7.1.0
Sep 2006	SA_33	SP-060552	0025	--	Add sending of trace control and configuration parameters for service level tracing	7.0.0	7.1.0
Sep 2006	SA_33	SP-060552	0026	--	Add starting trace recording at IMS network elements	7.0.0	7.1.0
Sep 2006	SA_33	SP-060552	0027	--	Add charging concepts for Service Level Tracing for IMS	7.0.0	7.1.0
Sep 2006	SA_33	SP-060552	0028	--	Add stopping trace recording mechanism for service level tracing	7.0.0	7.1.0
Dec 2006	SA_34	SP-060727	0029	--	Clarification to the sending of optional trace parameters	7.1.0	7.2.0
Dec 2006	SA_34	SP-060727	0030	--	Network initiated re-authentication for SLT	7.1.0	7.2.0
Dec 2006	SA_34	SP-060727	0031	--	Trace Session Deactivation at an IMS NE	7.1.0	7.2.0
Dec 2006	SA_34	SP-060727	0032	--	Service level trace processes at the UE	7.1.0	7.2.0
Dec 2006	SA_34	SP-060727	0033	--	Reception of SLT Start Trigger Event at an IMS NE	7.1.0	7.2.0
Dec 2006	SA_34	SP-060727	0034	--	Service level tracing for IMS starting mechanism	7.1.0	7.2.0
Dec 2006	SA_34	SP-060727	0035	--	Consistent usage of Service Level Tracing Start Triggering Event	7.1.0	7.2.0
Dec 2006	SA_34	SP-060727	0036	--	Retrieval of Trace Records from a UE	7.1.0	7.2.0
Mar 2008	SA_39	SP-080069	0037	--	Add Signalling Based Trace Activation procedures to EPC and E-UTRAN	7.2.0	8.0.0
Jun 2008	SA_40	SP-080287	0038	--	Add definition of Trace control and configuration parameters for EPC and E-UTRAN	8.0.0	8.1.0
Jun 2008	SA_40	SP-080287	0039	--	Add Trace Session deactivation procedures	8.0.0	8.1.0
Jun 2008	SA_40	SP-080287	0040	--	Add procedures for starting/stopping a trace recording session in EPC and E-UTRAN	8.0.0	8.1.0
Sep 2008	SA_41	SP-081211	0041	--	Providing subscriber identities for Cell Traffic Trace - Procedures	8.1.0	8.2.0
Dec 2008	SA_42	SP-080846	0044	-	Identifying IMS network elements and interfaces for trace	8.2.0	8.3.0
Dec 2008	SA_42	SP-080846	0045	-	Trace starting and stopping trigger events for IMS	8.2.0	8.3.0
Dec 2008	SA_42	SP-080846	0042	-	Introduction of EPS in 32.422	8.2.0	8.3.0
Dec 2008	SA_42	SP-080846	0043	-	Fix inconsistencies in the definition of trace levels, trace reference parameter	8.2.0	8.3.0
Mar 2009	SA_43	SP-090207	0046	-	Refinement of the Trace Reference	8.3.0	8.4.0
Mar 2009	SA_43	SP-090207	0047	-	Enhancement of trigger events in 3GPP TS 32.423 - align with 29.274, 29.272	8.3.0	8.4.0
Mar 2009	SA_43	SP-090207	0048	-	Trace Session activation/deactivation to PGW in case of non-3GPP access network	8.3.0	8.4.0
Mar 2009	SA_43	SP-090207	0049	-	Add reference and definitions for trace failure notifications in 32.422	8.3.0	8.4.0
Mar 2009	SA_43	SP-090207	0050	-	Use S1-DOWNLINK NAS TRANSPORT for the trace for TAU and some failed procedures	8.3.0	8.4.0
Mar 2009	SA_43	SP-090207	0051	-	EPC signalling activation mechanisms	8.3.0	8.4.0
Mar 2009	SA_43	SP-090207	0052	-	EPC and E-UTRAN signalling deactivation mechanisms	8.3.0	8.4.0
Mar 2009	SA_43	SP-090207	0053	-	Add the missing PGW to EPC trace recording session stopping mechanism	8.3.0	8.4.0
Jun 2009	SA_44	SP-090289	0054	-	Corrections on XML file format of the trace failure notifications	8.4.0	8.5.0
Jun 2009	SA_44	SP-090289	0055	-	Correcting Trace activation/deactivation flow to P-GW in case of PMIP based S5 interface	8.4.0	8.5.0
Jun 2009	SA_44	SP-090289	0056	-	Add missing Trace Interface list	8.4.0	8.5.0
Sep 2009	SA_45	SP-090542	0057	-	Clarification on Trace depth level	8.5.0	8.6.0
Sep 2009	SA_45	SP-090542	0058	-	Alignment of EPS Trace with TS 36.413	8.5.0	8.6.0
Sep 2009	SA_45	SP-090534	0061	-	Add reference to file format for sending IMSI/IMEI information from the MME	8.5.0	8.6.0
Sep 2009	SA_45	SP-090534	0062	-	Misleading statement on when cell traffic trace should be started	8.5.0	8.6.0
Sep 2009	SA_45	SP-090542	0059	-	Correction on XML file format for Trace failure notification	8.6.0	9.0.0
Sep 2009	SA_45	SP-090627	0060	-	Correction of Overview of Intra-PLMN and Inter-PLMN Signalling Activation	8.6.0	9.0.0
Jan 2010	--	--	--	--	Removal of track changes	9.0.0	9.0.1
Jun 2010	SA_48	SP-100412	0064	-	Clarification on E-UTRAN signalling based trace activation	9.0.1	9.1.0
Jun 2010	SA_48	SP-100412	0065	-	Corrections on UTRAN signalling based trace activation	9.0.1	9.1.0
Jun 2010	SA_48	SP-100412	0066	-	Correct List of EPC TRACE Starting Mechanisms	9.0.1	9.1.0
Jun 2010	SA_48	SP-100264	0063	-	Enhancement on E-UTRAN Trace Recording Session failure	9.1.0	10.0.0
Sep 2010	SA_49	SP-100488	0071	-	Corrections to start and stop triggering events in MME	10.0.0	10.1.0
Sep 2010	SA_49	SP-100489	0067	-	Addition of PGW in management based trace	10.0.0	10.1.0
Sep 2010	SA_49	SP-100489	0068	-	Correction of the figure of EPC Trace Session activation mechanism	10.0.0	10.1.0

Sep 2010	SA_49	SP-100489	0069	-	Unclarity about the list of Trace Control and Configuration parameters in case of management based activation	10.0.0	10.1.0
Dec 2010	SA_50	SP-100831	0076	--	Add missing interfaces S3, S4 and S6d in the interface table of SGSN	10.1.0	10.2.0
Dec 2010	SA_50	SP-100858	0078	--	Refine Trace conflict resolution to restrict no parallel TRSRs under one TR	10.1.0	10.2.0
Dec 2010	SA_50	SP-100833	0074	3	Add interfaces S13 (MME trace) and S13' (SGSN trace) - Align with 32.421	10.1.0	10.2.0
Dec 2010	SA_50	SP-100753	0080	1	Adding the procedures for managing Minimization of Drive Tests (MDT) functionality	10.1.0	10.2.0
Jan 2011	-	-	-	-	MCC editorial clean-up of clause 5.10.x numbering introduced by CR0080R1 from SA#50	10.2.0	10.2.1
Mar 2011	SA_51	SP-110102	0081	2	Correcting the handling of Minimization of Drive Tests (MDT) trace at handovers	10.2.1	10.3.0
Mar 2011	SA_51	SP-110102	0083	1	Adding definition of Stage 3 coding of Minimization of Drive Tests (MDT) parameters	10.2.1	10.3.0
Mar 2011	SA_51	SP-110094	0085	1	Correcting start and stop triggering events in Mobility Management Entity (MME)	10.2.1	10.3.0
Mar 2011	SA_51	SP-110095	0088	2	Clarify trace parameters for E-UTRAN activation mechanism and update EPC starting mechanism - Align with 32.441 Trace Management IRP Requirements	10.2.1	10.3.0
Mar 2011	SA_51	SP-110094	0092	1	Correcting start triggering event in MME in case of HSS Initiated Trace Session Activation for the attach procedure	10.2.1	10.3.0
Mar 2011	SA_51	SP-110094	0094	1	Change the support qualifier of 'List of NE types to trace parameter' to conditional mandatory	10.2.1	10.3.0
Mar 2011	SA_51	SP-110095	0096	1	Add support for subscriber trace on PDN-GW for GTP based S2b - Align with SA2 TS 23.402	10.2.1	10.3.0
Mar 2011	SA_51	SP-110102	0098	-	Removing UE capability from Minimization of Drive Tests (MDT) parameters	10.2.1	10.3.0
Mar 2011	SA_51	SP-110102	0099	-	Change "UE based network performance measurements" to "MDT" - Align cross-3GPP terminology on MDT work	10.2.1	10.3.0
Mar 2011	SA_51	SP-110102	0100	2	Align the reporting trigger with RAN2 TS 37.320	10.2.1	10.3.0
Mar 2011	SA_51	SP-110102	0101	2	Update the E-UTRAN activation mechanism for area based MDT	10.2.1	10.3.0
Mar 2011	SA_51	SP-110095	0102	1	Add the trace interfaces for EIR and HSS	10.2.1	10.3.0
Mar 2011	SA_51	SP-110102	0103	3	Using TCE identity in logged MDT configuration	10.2.1	10.3.0
Mar 2011	SA_51	SP-110095	0110	1	Clarify inconsistency in EPC initiated MDT text	10.2.1	10.3.0
Mar 2011	SA_51	SP-110186	0107	3	Adding user consent handling in MDT activation	10.2.1	10.3.0
May 2011	SA_52	SP-110292	0103	4	Clarify that there can be only one TRSR per TR at a given time per UE trace session for signalling based trace.	10.3.0	10.4.0
May 2011	SA_52	SP-110292	0114	-	Modify UMTS M2 measurement - Align with RAN2 25.215 and 25.225	10.3.0	10.4.0
May 2011	SA_52	SP-110292	0115	3	Add error handling for Management based MDT scenarios	10.3.0	10.4.0
May 2011	SA_52	SP-110292	0116	3	Add error handling for EPC Signalling based MDT scenarios	10.3.0	10.4.0
May 2011	SA_52	SP-110292	0120	1	Add Area scope validation for cell level granularity	10.3.0	10.4.0
May 2011	SA_52	SP-110292	0121	2	Add error handling for PS domain MDT activation scenarios	10.3.0	10.4.0
May 2011	SA_52	SP-110292	0122	2	Add error handling for CS domain MDT activation scenarios	10.3.0	10.4.0
May 2011	SA_52	SP-110292	0124	2	Aligning MDT activation procedures with SA3 privacy requirements	10.3.0	10.4.0
May 2011	SA_52	SP-110292	0125	2	Adding definition of area based MDT and subscription based MDT	10.3.0	10.4.0
May 2011	SA_52	SP-110292	0128	2	Add behaviour of signalling-based MDT when area criterion is not met	10.3.0	10.4.0
Sep 2011	SA_53	SP-110537	0133	--	Add PS domain MDT activation procedure after UE attach	10.4.0	10.5.0
Sep 2011	SA_53	SP-110537	0137	--	RAI/LAI in MDT area scope	10.4.0	10.5.0
Sep 2011	SA_53	SP-110537	0148	1	MDT measurement alignment	10.4.0	10.5.0
Sep 2011	SA_53	SP-110537	0150	--	Error correction on description of 'TCE IP address' in MDT report	10.4.0	10.5.0
Sep 2011	SA_53	SP-110537	0155	--	Correction in flow chart for area based MDT activation in E-UTRAN	10.4.0	10.5.0
Sep 2011	SA_53	SP-110537	0159	1	Align the user consent description with RAN3 and add description on activating MDT in home operator that uses more than one PLMN	10.4.0	10.5.0
Dec 2011	SA_54	SP-110715	0163	2	Correct MDT UE selection procedures to protect user privacy	10.5.0	10.6.0
Dec 2011	SA_54	SP-110715	0173	1	Align the Reporting Trigger parameter with the RAN implementation	10.5.0	10.6.0
Dec 2011	SA_54	SP-110715	0175	--	Clean-up Immediate MDT handling at handover to align with RAN3	10.5.0	10.6.0
Dec 2011	SA_54	SP-110715	0181	1	Error handling correction -Align with R3-112292	10.5.0	10.6.0
Dec 2011	SA_54	SP-110715	0183	2	Add missing TCE address for UTRAN MDT activation	10.5.0	10.6.0
Dec 2011	SA_54	SP-110715	0187	1	Super CR for combination of: 1.Modify MDT log retrieval procedures to protect user privacy and prevent network spying 2.Support multiple cells in area based MDT	10.5.0	10.6.0
Mar 2012	SA_55	SP-120053	0189	1	Clarify handling of anonymization when JobType is MDT+Trace - to align with RAN3 36.413 CR#0954	10.6.0	10.7.0
Mar 2012	SA_55	SP-120053	0192	1	Aligning the MDT specification with RAN specifications TS 36.413 and TS 25.413	10.6.0	10.7.0
June-2012	SA_56	SP-120368	0198	--	Remove MDT Country Restriction	10.7.0	10.8.0
June-2012	SA_56	SP-120368	0200	--	Align MDT Reporting with TS 32.421	10.7.0	10.8.0
June-2012	SA_56	SP-120367	0204		Correcting the Trace Recording Session stopping mechanism at eNB	10.7.0	10.8.0

Sep-2012	SA_57	SP-120570	0218	3	Correcting the missing event threshold parameters for the event 1F and event 1I reporting triggers	10.8.0	10.9.0
Sep-2012	SA_57	SP-120570	0222	--	Add combined Trace and Immediate MDT job type to the MDT parameters scope	10.8.0	10.9.0
Dic 2012	SA_58	SP-120794	0233	1	Correction of UMTS M2 Reporting trigger configuration	10.9.0	10.10.0
Dic 2012	SA_58	SP-120794	0239	--	add report amount clarification	10.9.0	10.10.0
Dic 2012	SA_58	SP-120794	0246	--	Clarify report interval parameter scope	10.9.0	10.10.0
Mar 2013	SA_59	SP-130047	0249	--	Correct TAC abbreviation error	10.10.0	10.11.0

---

## History

<b>Document history</b>		
V10.3.0	April 2011	Publication
V10.4.0	June 2011	Publication
V10.5.0	October 2011	Publication
V10.6.0	January 2012	Publication
V10.7.0	March 2012	Publication
V10.8.0	July 2012	Publication
V10.9.0	September 2012	Publication
V10.10.0	January 2013	Publication
V10.11.0	April 2013	Publication