

# ETSI TS 132 421 V17.5.0 (2024-01)



**Digital cellular telecommunications system (Phase 2+) (GSM);  
Universal Mobile Telecommunications System (UMTS);  
LTE;  
5G;  
Telecommunication management;  
Subscriber and equipment trace;  
Trace concepts and requirements  
(3GPP TS 32.421 version 17.5.0 Release 17)**



---

**Reference**

RTS/TSGS-0532421vh50

---

**Keywords**

5G,GSM,LTE,UMTS

**ETSI**

650 Route des Lucioles  
F-06921 Sophia Antipolis Cedex - FRANCE

---

Tel.: +33 4 92 94 42 00 Fax: +33 4 93 65 47 16

Siret N° 348 623 562 00017 - APE 7112B  
Association à but non lucratif enregistrée à la  
Sous-Préfecture de Grasse (06) N° w061004871

---

**Important notice**

The present document can be downloaded from:  
<https://www.etsi.org/standards-search>

The present document may be made available in electronic versions and/or in print. The content of any electronic and/or print versions of the present document shall not be modified without the prior written authorization of ETSI. In case of any existing or perceived difference in contents between such versions and/or in print, the prevailing version of an ETSI deliverable is the one made publicly available in PDF format at [www.etsi.org/deliver](http://www.etsi.org/deliver).

Users of the present document should be aware that the document may be subject to revision or change of status. Information on the current status of this and other ETSI documents is available at <https://portal.etsi.org/TB/ETSIDeliverableStatus.aspx>

If you find errors in the present document, please send your comment to one of the following services:  
<https://portal.etsi.org/People/CommitteeSupportStaff.aspx>

If you find a security vulnerability in the present document, please report it through our Coordinated Vulnerability Disclosure Program:  
<https://www.etsi.org/standards/coordinated-vulnerability-disclosure>

---

**Notice of disclaimer & limitation of liability**

The information provided in the present deliverable is directed solely to professionals who have the appropriate degree of experience to understand and interpret its content in accordance with generally accepted engineering or other professional standard and applicable regulations.

No recommendation as to products and services or vendors is made or should be implied.

No representation or warranty is made that this deliverable is technically accurate or sufficient or conforms to any law and/or governmental rule and/or regulation and further, no representation or warranty is made of merchantability or fitness for any particular purpose or against infringement of intellectual property rights.

In no event shall ETSI be held liable for loss of profits or any other incidental or consequential damages.

Any software contained in this deliverable is provided "AS IS" with no warranties, express or implied, including but not limited to, the warranties of merchantability, fitness for a particular purpose and non-infringement of intellectual property rights and ETSI shall not be held liable in any event for any damages whatsoever (including, without limitation, damages for loss of profits, business interruption, loss of information, or any other pecuniary loss) arising out of or related to the use of or inability to use the software.

---

**Copyright Notification**

No part may be reproduced or utilized in any form or by any means, electronic or mechanical, including photocopying and microfilm except as authorized by written permission of ETSI.

The content of the PDF version shall not be modified without the written authorization of ETSI.  
The copyright and the foregoing restriction extend to reproduction in all media.

© ETSI 2024.  
All rights reserved.

---

# Intellectual Property Rights

## Essential patents

IPRs essential or potentially essential to normative deliverables may have been declared to ETSI. The declarations pertaining to these essential IPRs, if any, are publicly available for **ETSI members and non-members**, and can be found in ETSI SR 000 314: "*Intellectual Property Rights (IPRs); Essential, or potentially Essential, IPRs notified to ETSI in respect of ETSI standards*", which is available from the ETSI Secretariat. Latest updates are available on the ETSI Web server (<https://ipr.etsi.org/>).

Pursuant to the ETSI Directives including the ETSI IPR Policy, no investigation regarding the essentiality of IPRs, including IPR searches, has been carried out by ETSI. No guarantee can be given as to the existence of other IPRs not referenced in ETSI SR 000 314 (or the updates on the ETSI Web server) which are, or may be, or may become, essential to the present document.

## Trademarks

The present document may include trademarks and/or tradenames which are asserted and/or registered by their owners. ETSI claims no ownership of these except for any which are indicated as being the property of ETSI, and conveys no right to use or reproduce any trademark and/or tradename. Mention of those trademarks in the present document does not constitute an endorsement by ETSI of products, services or organizations associated with those trademarks.

**DECT™**, **PLUGTESTS™**, **UMTS™** and the ETSI logo are trademarks of ETSI registered for the benefit of its Members. **3GPP™** and **LTE™** are trademarks of ETSI registered for the benefit of its Members and of the 3GPP Organizational Partners. **oneM2M™** logo is a trademark of ETSI registered for the benefit of its Members and of the oneM2M Partners. **GSM®** and the GSM logo are trademarks registered and owned by the GSM Association.

---

# Legal Notice

This Technical Specification (TS) has been produced by ETSI 3rd Generation Partnership Project (3GPP).

The present document may refer to technical specifications or reports using their 3GPP identities. These shall be interpreted as being references to the corresponding ETSI deliverables.

The cross reference between 3GPP and ETSI identities can be found under <https://webapp.etsi.org/key/queryform.asp>.

---

# Modal verbs terminology

In the present document "**shall**", "**shall not**", "**should**", "**should not**", "**may**", "**need not**", "**will**", "**will not**", "**can**" and "**cannot**" are to be interpreted as described in clause 3.2 of the [ETSI Drafting Rules](#) (Verbal forms for the expression of provisions).

"**must**" and "**must not**" are **NOT** allowed in ETSI deliverables except when used in direct citation.

# Contents

|   |           |
|---|-----------|
| Intellectual Property Rights .....                              | 2         |
| Legal Notice .....  | 2         |
| Modal verbs terminology.....                                    | 2         |
| Foreword.....   | 5         |
| Introduction .....  | 6         |
| 1 Scope .....   | 7         |
| 2 References .....  | 8         |
| 3 Definitions, symbols and abbreviations .....                  | 9         |
| 3.1 Definitions .....   | 9         |
| 3.2 Abbreviations .....   | 11        |
| 4 Trace concepts and high-level architecture .....              | 12        |
| 4.1 Trace concepts .....  | 12        |
| 4.2 Trace high level Architecture .....                         | 13        |
| 4.3 Service Level Tracing for IMS high level Architecture ..... | 15        |
| 5 Trace requirements .....                                      | 18        |
| 5.1 General trace requirements .....                            | 18        |
| 5.2 Requirements for Trace data .....                           | 19        |
| 5.3 Requirements for Trace activation .....                     | 20        |
| 5.3.1 Requirements for Trace Session activation.....            | 20        |
| 5.3.2 Requirements for starting a Trace Recording Session ..... | 23        |
| 5.4 Requirements for Trace deactivation.....                    | 25        |
| 5.4.1 Requirements for Trace Session deactivation .....         | 25        |
| 5.4.2 Requirements for stopping a Trace Recording Session ..... | 25        |
| 5.5 Requirements for Trace Data reporting .....                 | 27        |
| 5.6 Requirements for Privacy and Security .....                 | 29        |
| 5.7 Requirements for Charging .....                             | 29        |
| 5.8 Use cases for Trace.....                                    | 30        |
| 5.9 Requirements for a throttled Trace Recording Session .....  | 30        |
| 6 Requirements for managing MDT .....                           | 31        |
| 6.1 Business Level Requirements.....                            | 31        |
| 6.2 Specification level requirements .....                      | 32        |
| 6.2.1 Logged MDT and Immediate MDT requirements .....           | 32        |
| 6.2.2 Logged MBSFN MDT requirements .....                       | 34        |
| 7 Requirements for managing RLF and RCEF reports .....          | 35        |
| 7.1 Business level requirements .....                           | 35        |
| 7.2 Specification level requirements .....                      | 35        |
| <b>Annex A (informative): Trace use cases .....</b>             | <b>36</b> |
| A.1 Use case #1: multi-vendor UE validation.....                | 36        |
| A.1.1 Description .....   | 36        |
| A.1.2 Example of required data for this use case .....          | 36        |
| A.2 Use case #2: subscriber complaint .....                     | 36        |
| A.2.1 Description .....   | 36        |
| A.2.2 Example of required data for this use case .....          | 37        |
| A.3 Use case #3: malfunctioning UE .....                        | 38        |
| A.3.1 Description .....   | 38        |
| A.3.2 Example of required data for this use case .....          | 38        |
| A.4 Use case #4: checking radio coverage.....                   | 38        |
| A.4.1 Description .....   | 38        |

|                               |  |           |
|-------------------------------|--|-----------|
| A.4.2                         | Example of required data to cover use case #4.....   | 38        |
| A.5                           | Use case #5: testing a new feature.....  | 39        |
| A.5.1                         | Description .....  | 39        |
| A.5.2                         | Example of required data to cover use case #5.....   | 39        |
| A.6                           | Use case #6: fine-tuning and optimisation of algorithms/procedures .....   | 40        |
| A.6.1                         | Description .....  | 40        |
| A.6.2                         | Example of required data to cover use case #6.....   | 41        |
| A.7                           | Use case #7: Automated testing of Service Provider services.....   | 41        |
| A.7.1                         | Description .....  | 41        |
| A.8                           | Use case #8: Regression testing following a network fix.....   | 41        |
| A.8.1                         | Description .....  | 41        |
| A.9                           | Use case #9: Service fault localization within a Service Provider network .....  | 41        |
| A.9.1                         | Description .....  | 41        |
| A.10                          | Use case #10: Service fault localization when a service is hosted by a third party Service Provider ...                | 41        |
| A.10.1                        | Description .....  | 41        |
| A.11                          | Use case #11 Analysing drop calls in E-UTRAN .....   | 42        |
| A.11.1                        | Description .....  | 42        |
| A.11.2                        | Example of required data to cover use case #11.....  | 42        |
| A.12                          | Use case #12 Periodical sampling of network performance .....  | 42        |
| A.12.1                        | Description .....  | 42        |
| A.12.2                        | Example of required data to cover use case #12.....  | 42        |
| A.13                          | Use case #13 Differentiation of management based MDT data by terminal type.....  | 43        |
| A.13.1                        | Description .....  | 43        |
| A.13.2                        | Example of required data to cover use case #13.....  | 43        |
| A.14                          | Use case #14 Subscriber complaint about MBMS service in the eUTRAN network .....                                       | 43        |
| A.14.1                        | Description .....  | 43        |
| A.14.2                        | Example of required data to cover use case #14.....  | 43        |
| A.15                          | Use case #15 Check MBMS service quality and performance of the eUTRAN Network.....                                     | 44        |
| A.15.1                        | Description .....  | 44        |
| A.15.2                        | Example of required data to cover use case #15.....  | 44        |
| A.16                          | Use case #16 Collecting Cell and UE data for analytics .....   | 44        |
| A.16.1                        | Goal .....   | 44        |
| A.16.2                        | Pre-conditions.....  | 44        |
| A.16.3                        | Description/steps .....  | 44        |
| A.16.4                        | Post-conditions .....  | 45        |
| A.17                          | Use case #17 Collecting subscriber and equipment trace data for near-real-time diagnostics and<br>troubleshooting..... | 46        |
| A.17.1                        | Goal .....   | 46        |
| A.17.2                        | Pre-conditions.....  | 46        |
| A.17.3                        | Description/steps .....  | 46        |
| A.17.4                        | Post-conditions .....  | 47        |
| <b>Annex B (informative):</b> | <b>Change history .....</b>  | <b>48</b> |
| History .....                 |  | 51        |

---

# Foreword

This Technical Specification has been produced by the 3<sup>rd</sup> Generation Partnership Project (3GPP).

The contents of the present document are subject to continuing work within the TSG and may change following formal TSG approval. Should the TSG modify the contents of the present document, it will be re-released by the TSG with an identifying change of release date and an increase in version number as follows:

Version x.y.z

where:

- x the first digit:
  - 1 presented to TSG for information;
  - 2 presented to TSG for approval;
  - 3 or greater indicates TSG approved document under change control.
- y the second digit is incremented for all changes of substance, i.e. technical enhancements, corrections, updates, etc.
- z the third digit is incremented when editorial only changes have been incorporated in the document.

---

# Introduction

The present document is part of a TS-family covering the 3rd Generation Partnership Project; Technical Specification Group Services and System Aspects; Telecommunication management, as identified below:

**TS 32.421: "Subscriber and equipment trace: Trace concepts and requirements";**

TS 32.422: "Subscriber and equipment trace: Trace control and configuration management";

TS 32.423: "Subscriber and equipment trace: Trace data definition and management";

Subscriber and equipment trace provide very detailed information at call level on one or more specific mobile(s). This data is an additional source of information to Performance Measurements and allows going further in monitoring and optimisation operations.

Contrary to Performance measurements, which are a permanent source of information, trace is activated on user demand for a limited period of time for specific analysis purposes.

Trace plays a major role in activities such as determination of the root cause of a malfunctioning mobile, advanced troubleshooting, optimisation of resource usage and quality, RF coverage control and capacity improvement, dropped call analysis, Core Network and Access Network end-to-end procedure validation.

The capability to log data on any interface at call level for a specific user (e.g. IMSI) or mobile type (e.g. IMEI or IMEISV), or service initiated by a user allows getting information which cannot be deduced from Performance measurements such as perception of end-user QoS during his call (e.g. requested QoS vs. provided QoS), correlation between protocol messages and RF measurements, or interoperability with specific mobile vendors.

Moreover, performance measurements provide values aggregated on an observation period; Subscriber and UE Trace give instantaneous values for a specific event (e.g. call, location update, etc.).

If performance measurements are mandatory for daily operations, future network planning and primary trouble shooting; Subscriber and UE Trace is the easy way to go deeper into investigation and network optimisation.

In order to produce this data, Subscriber and UE Trace are carried out in the NEs, which comprise the network. The data can then be transferred to an external system (e.g. an Operations System (OS) in TMN terminology, for further evaluation).

# 1 Scope

The present document describes the requirements for the management of Trace and the reporting of Trace data (including FDD mode and TDD mode) across UMTS, EPS or 5G networks as it refers to subscriber tracing (tracing of IMSI or Public User Identity) and equipment tracing (tracing of IMEI or IMEISV). Trace also includes the ability to trace all active calls in a cell or multiple cells (Cell Traffic Trace). The present document also includes the description of Service Level Tracing (tracing of a specific service). It defines the administration of Trace Session activation/deactivation by the management system, the network or User Equipment (UE) itself via signalling, the generation of Trace results in the Network Elements (NEs) and UE and the transfer of these results to one or more Operations Systems.

GSM Trace is outside of the scope of this specification (see [7]).

The present document also describes the requirements for the management of Minimization of Drive Tests (MDT) across UMTS networks, EPS networks or 5G networks and Radio Link Failure (RLF) and RRC Connection Establishment Failure (RCEF) reporting across EPS networks and 5G networks.

The present document is built upon the basic Subscriber and UE Trace concept described in clause 4. The high-level requirements for Trace data, Trace Session activation/deactivation and Trace reporting are defined in clause 5. Clause 5 also contains an overview of use cases for Trace (the use cases are described in Annex A). Clause 6 defines the requirements for managing MDT. Clause 7 defines the requirements for managing RLF and RCEF reports. Trace control and configuration management are described in 3GPP TS 32.422 [2], and Trace data definition and management are described in 3GPP TS 32.423 [3].

The present document does not cover any Trace capability limitations within a NE (e.g. maximum number of simultaneous traced mobiles for a given NE) or any functionality related to these limitations (e.g. NE aborting a Trace Session due to resource limitations).

The objectives of the Trace specifications are:

- a) to provide the descriptions for a standard set of Trace and MDT data;
- b) to produce a common description of the management technique for Trace, MDT, RLF, and RCEF administration and result reporting;
- c) to define a method for the reporting of Trace, MDT, RLF and RCEF results across the management interfaces.

The following is beyond the scope of the present document, and therefore the present document does not describe:

- tracing non-Subscriber or non-UE related events within an NE;
- tracing of all possible parties in a multi-party call (although multiple calls related to the IMSI specified in the Trace control and configuration parameters are traceable).

The definition of Trace and MDT data is intended to result in comparability of Trace and MDT data produced in a multi-vendor wireless UMTS, EPS and/or 5G network(s), for those Trace control and configuration parameters that can be standardised across all vendors' implementations.

Vendor specific extensions to the Trace control and configuration parameters and Trace and MDT data are discussed in 3GPP TS 32.422 [2] and 3GPP TS 32.423 [3].

All functions (trace, MDT etc.) specified in this specification support Network Sharing, with the following conditions:

- It is accepted that the recorded information from the shared nodes is available to the Primary Operator. Recorded information that is collected in a non shared node or cell will only be available to the operator managing the non shared node or cell.
- It is accepted that the recorded information from the shared network shall be delivered to the Participating Operator whose PLMN recording is requested, taking user consent into account. Operators must also agree on sharing the information, but how that agreement is done is outside the scope of this specification. The mapping of TCE IP addresses and TCE addresses must be coordinated among the operators that shares the network. How that coordination is done is outside the scope of this specification.



- It is accepted that the inter-PLMN recorded information for Logged MDT from the non-shared nodes of Participating Operators may be available to the Primary Operator.
- For signalling based activation, the operators that share a network must coordinate the TCE IP addresses and the TCE address mapping must be coordinated. How that coordination is done is outside the scope of this specification.

For UMTS and EPS the 3GPP Management reference model, 3GPP TS 32.101 [1] is followed.

For 5GS the 3GPP Services Based Management Architecture, 3GPP TS 28.533 [20] is followed.

---

## 2 References

The following documents contain provisions, which, through reference in this text, constitute provisions of the present document.

- References are either specific (identified by date of publication, edition number, version number, etc.) or non-specific.
- For a specific reference, subsequent revisions do not apply.
- For a non-specific reference, the latest version applies. In the case of a reference to a 3GPP document (including a GSM document), a non-specific reference implicitly refers to the latest version of that document *in the same Release as the present document*.

- [1] 3GPP TS 32.101: "Telecommunication management; Principles and high level requirements".
- [2] 3GPP TS 32.422: "Telecommunication management; Subscriber and equipment trace: Trace control and configuration management".
- [3] 3GPP TS 32.423: "Telecommunication management; Subscriber and equipment trace: Trace data definition and management".
- [4] 3GPP TS 23.002: "Network architecture".
- [6] Void
- [7] 3GPP TS 52.008: "Telecommunication management; GSM subscriber and equipment trace".
- [8] 3GPP TR 21.905: "Vocabulary for 3GPP Specifications".
- [9] OMA Service Provider Environment Requirements, OMA-RD-OSPE-V1\_0-20050614-C, The Open Mobile Alliance™ ([URL:http://www.openmobilealliance.org/](http://www.openmobilealliance.org/)).
- [10] 3GPP TS 33.401: "System Architecture Evolution (SAE); Security architecture".
- [11] 3GPP TS 37.320 : "Universal Terrestrial Radio Access (UTRA) and Evolved Universal Terrestrial Radio Access (E-UTRA); Radio measurement collection for Minimization of Drive Tests (MDT); Overall description, Stage 2".
- [12] 3GPP TS 32.450: "Key Performance Indicators (KPI) for Evolved Universal Terrestrial Radio Access Network (E-UTRAN); Definitions".
- [13] 3GPP TS 32.130: "Network sharing; Concepts and requirements".
- [14] 3GPP TS 36.300: "Evolved Universal Terrestrial Radio Access (E-UTRA) and Evolved Universal Terrestrial Radio Access Network (E-UTRAN); Overall description; Stage 2".
- [15] 3GPP TS 23.501: "System Architecture for the 5G System; Stage 2".
- [16] 3GPP TS 38.300: "NR and NG-RAN Overall Description; Stage 2".
- [17] 3GPP TS 38.401: "NG-RAN; Architecture Description".

- [18] 3GPP TS 36.331: "Evolved Universal Terrestrial Radio Access (E-UTRA) Radio Resource Control (RRC); Protocol Specification".
- [19] 3GPP TS 25.331: "Radio Resource Control (RRC); protocol specification".
- [20] 3GPP TS 38.413: "NG-RAN; NG Application Protocol (NGAP)"
- [21] 3GPP TS 38.423: "NG-RAN; Xn Application Protocol (XnAP)"
- [22] 3GPP TS 28.533: "Management and orchestration; Architecture framework"
- NOTE: Void.

---

## 3 Definitions, symbols and abbreviations

### 3.1 Definitions

For the purposes of the present document, the terms and definitions given in TS 21.905 [8], TS 32.130 [13], TS 23.501 [15], TS 38.300 [16] and the following apply:

**Cell Traffic Trace:** The ability to trace one or more active calls in one or more cells.

**Collection period:** Period that indicates the measurement results collection interval.

NOTE: The measurement results can refer to the *MeasResults* IE defined in clause 6.3.5, 3GPP TS 36.331 [18] for LTE or *MeasuredResults* IE defined in clause 11.3, 3GPP TS 25.331[19] for UMTS.

**End user visible events:** Refer to OMA Service Provider Requirements [9].

**Immediate MDT:** See 3GPP TS 37.320 [11].

**Logged MDT:** See 3GPP TS 37.320 [11].

**Management based activation/deactivation:** Trace Session is activated/deactivated in different NEs directly from the management system.

**MDT measurements:** See 3GPP TS 37.320 [11].

**MBSFN Area:** See 3GPP TS 36.300 [14].

**MBSFN Area Reserved Cell:** See 3GPP TS 36.300 [14].

**Signalling based activation/deactivation:** Trace Session is activated/deactivated in different NEs using the signalling interfaces between those elements so that the NEs may forward the activation/deactivation originating from the management system.

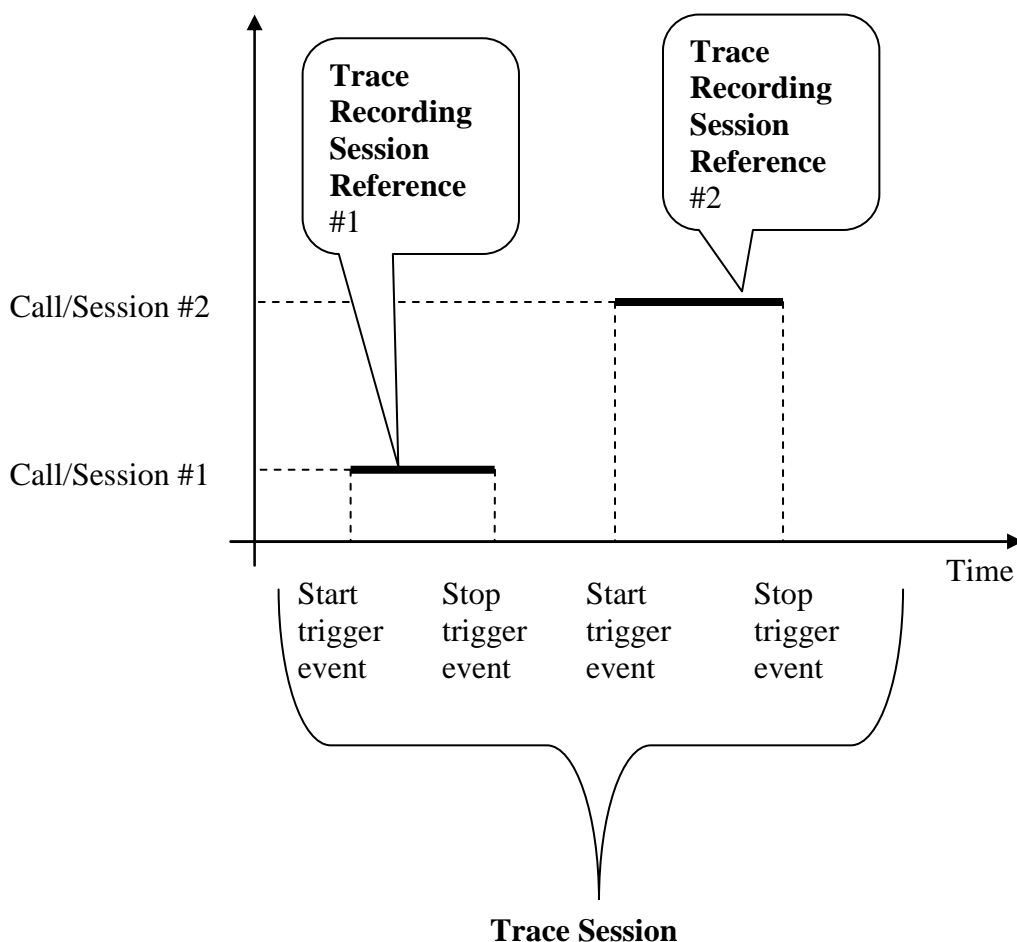
**Measurement period:** Period that indicates the performance measurement reporting interval.

**Trace:** general term used for Subscriber, Equipment and Service Trace.

**Trace record:** in the NE a Trace record is a set of Traceable data collected as determined by the Trace control and configuration parameters.

**Trace Recording Session:** time interval within a Trace session while trace records are generated for the subscriber, UE or service being traced. The triggering events starting and stopping a Trace recording Session are defined in 3GPP TS 32.422 [2] (see figure 1).

**Trace Recording Session Reference:** identifies a Trace Recording Session within a Trace Session (see figure 1)

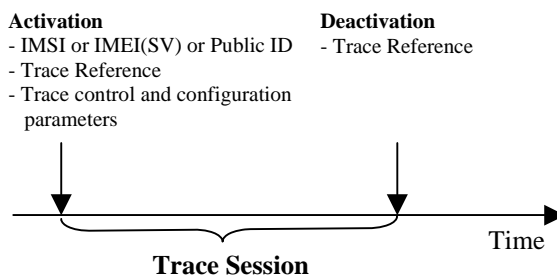


**Figure 1: Trace Recording Session**

Note that overlapping calls/sessions are possible for e.g. Cell Traffic Trace.

**Trace Reference:** identifies a Trace Session and is globally unique (see figure 2)

**Trace Session:** time interval started with a Trace Session Activation and lasts until the Deactivation of that specific Trace Session (see figure 2)



**Figure 2: Trace Session**

**Trace Parameter Configuration:** a technique whereby a request for tracing a certain Subscriber, UE or Service is sent by the management system to the NE for execution.

**Trace Parameter Propagation:** a technique by which the NE processes the trace configuration (received from the management system or another NE) and sends it to the relevant Network Element(s) via signalling interface(s).

**Service Level Tracing:** Refer to OMA Service Provider Requirements [9].

## 3.2 Abbreviations

For the purposes of the present document, the abbreviations given in TS 21.905 [8], TS 32.101 [1], TS 32.130 [13], TS 23.501 [15], TS 38.300 [16] and the following apply:

|      |                                      |
|------|--------------------------------------|
| RCEF | RRC Connection Establishment Failure |
| RLF  | Radio Link Failure                   |
| TCE  | Trace Collection Entity              |
| SCGF | Second Cell Group Failure            |

## 4 Trace concepts and high-level architecture

### 4.1 Trace concepts

The diversity of Trace requirements makes it difficult to identify and anticipate all the operator's specific needs. Thus, the objective of this TS is not to list an exhaustive set of information to meet all the requirements. Rather, Trace data is defined without any limitation on the 2 following dimensions:

- Trace scope: NEs and signalling interfaces to Trace.
- Trace depth: level of details of Trace data.

In order not to have any limitation of Trace data, there are six levels of details defined: Maximum, Minimum, Medium, MaximumWithoutVendorSpecificExtension, MinimumWithoutVendorSpecificExtension and MediumWithoutVendorSpecificExtension. The first three levels allow for vendor specific information to be traced and sent in the trace report file.

The Maximum (or MaximumWithoutVendorSpecificExtension) Levels allow all Trace data to be recorded. The other Levels provide a decoded subset of the data in the Maximum Level and allow an operator the flexibility in selecting the appropriate Trace data to record.

The Trace Depth, specified at the Trace Session activation, is used to choose the level of detail of information to be retrieved.

The Maximum (or MaximumWithoutVendorSpecificExtension) Levels of detail allow for retrieval of signalling interface messages within the Trace Scope in encoded format (see figure 4.1.1).

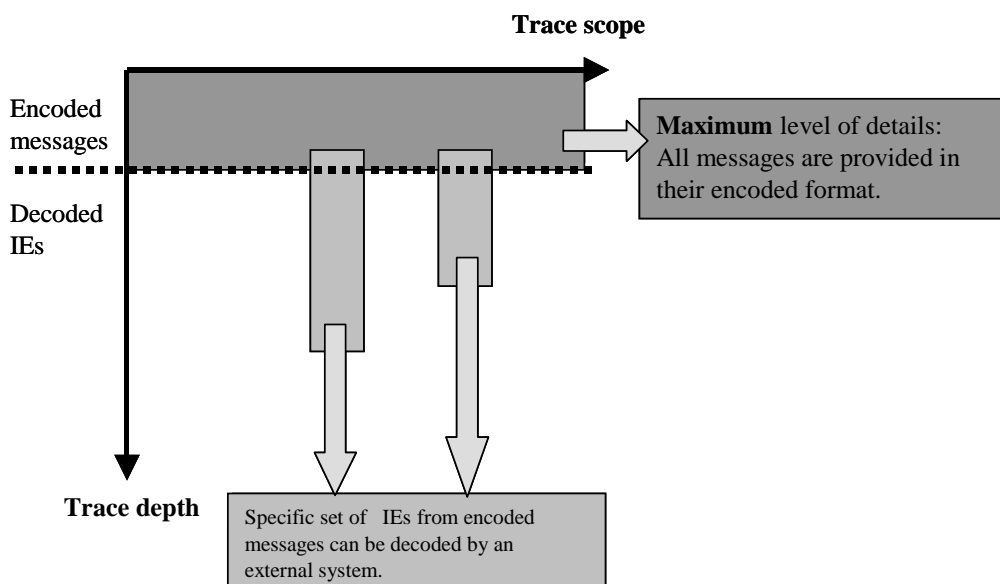
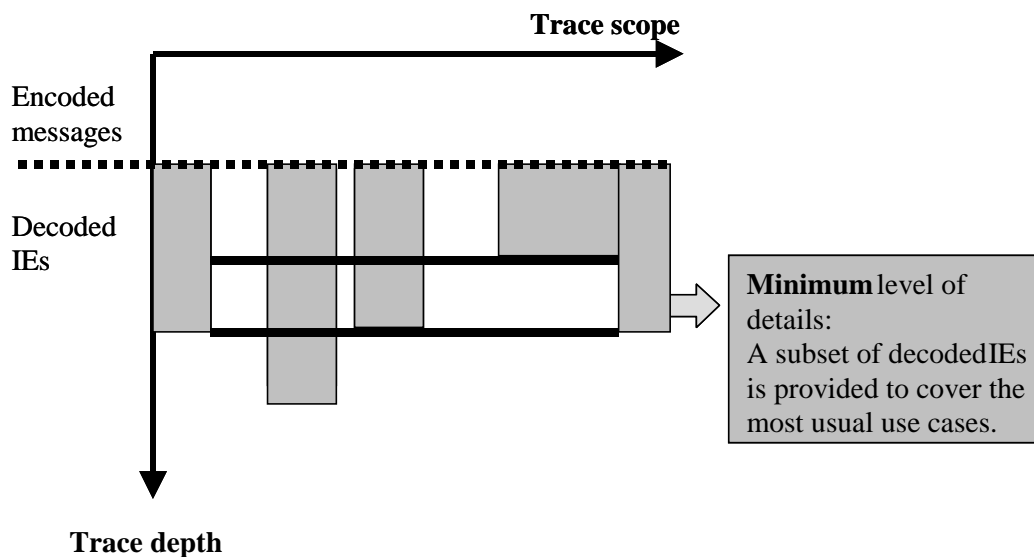


Figure 4.1.1: Maximum (or MaximumWithoutVendorSpecificExtension) Levels of details of Trace

The Minimum (or MinimumWithoutVendorSpecificExtension) Levels of detail allow for retrieval of a decoded subset of the IEs contained in the signalling interface messages (see figure 4.1.2).



**Figure 4.1.2: Minimum (or MinimumWithoutVendorSpecificExtension) Levels of detail of Trace**

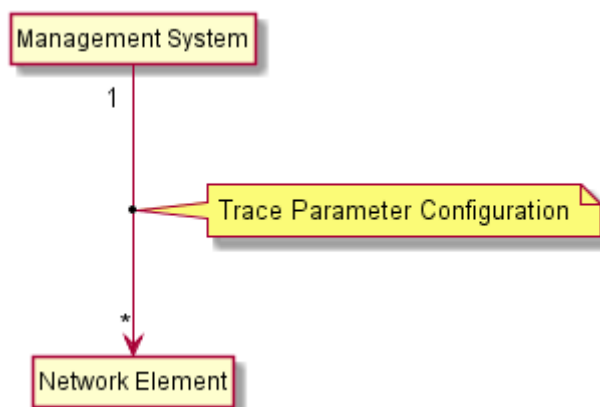
The Medium (or MediumWithoutVendorSpecificExtension) Levels of detail allow for retrieval of the decoded subset of the IEs contained in the signalling interface messages in the Minimum Level plus a selected set of decoded radio measurement IEs.

The Trace data recorded at each Level is defined in 3GPP TS 32.423 [3].

## 4.2 Trace high level Architecture

There are two types of activation, management based activation and signalling based activation.

Figure 4.2.1 represents the high-level view of the architecture of Trace Management Based Activation/Deactivation. Figure 4.2.1 is only showing the interfaces in principle a high-level view. Details of Trace activation/deactivation are defined in 3GPP TS 32.422 [2].



**Figure 4.2.1: Architecture for Management Based Activation/Deactivation**

Figure 4.2.2 represents the high-level view of the architecture of Signalling Based Activation/Deactivation (non-shared scenario). Figure 4.2.2 is only showing the interfaces in principle. Details of Trace activation/deactivation are defined in 3GPP TS 32.422 [2].

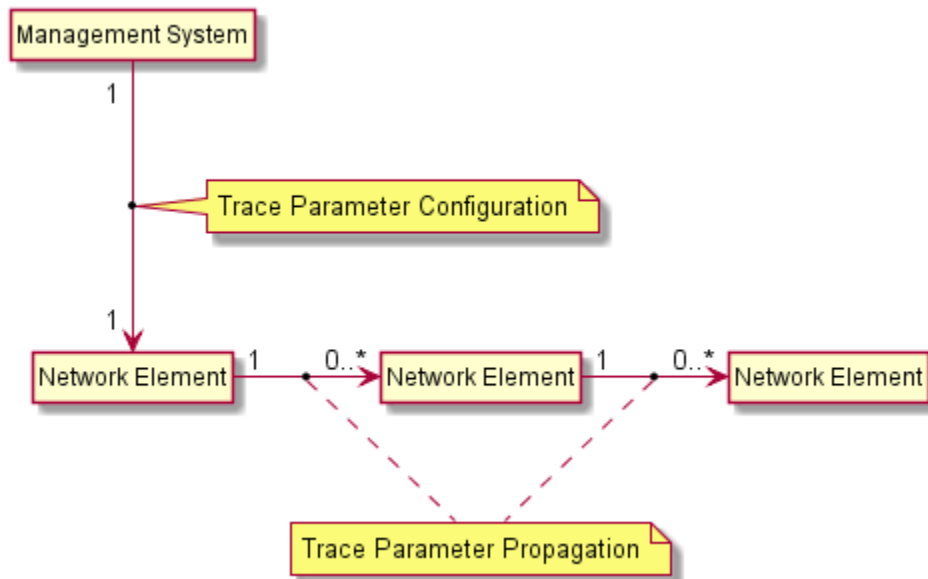


Figure 4.2.2: Architecture for Signalling Based Activation/Deactivation

Figure 4.2.3 represents the high-level view of the architecture of Trace Reporting (non-shared scenario). Figure 4.2.3 is only showing the interfaces in principle.

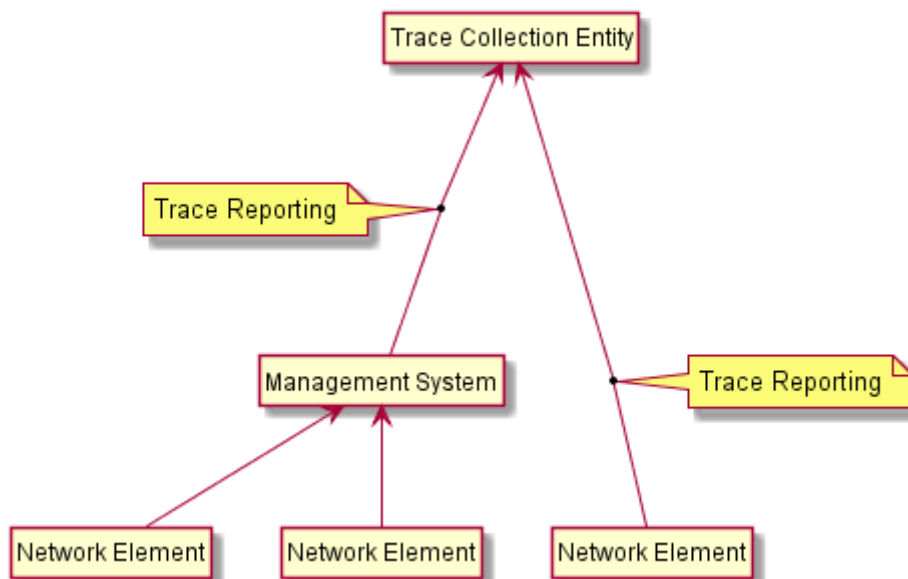


Figure 4.2.3: Architecture for High-level view of Trace Reporting

NOTE: The placement of the Trace Collection Entity is a deployment matter for the operator. If it is placed outside the operator's secure zone, it is up to the operator to use secure connections to and from the Trace Collection Entity.

Figure 4.2.4 represents the high-level view of the architecture of Trace Reporting within the context of the Services Based Management Architecture (see TS 28.533 [22]) illustrating the relationship between Network Element as "trace data reporting MnS" producer, Management Function as both producer and consumer of this MnS and data consumer (TCE) as consumer of this MnS.

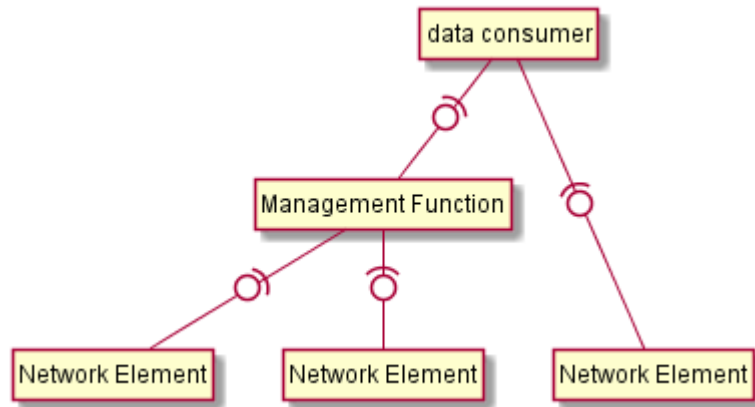


Figure 4.2.4: Interactions between producers and consumers of "trace data reporting MnS"

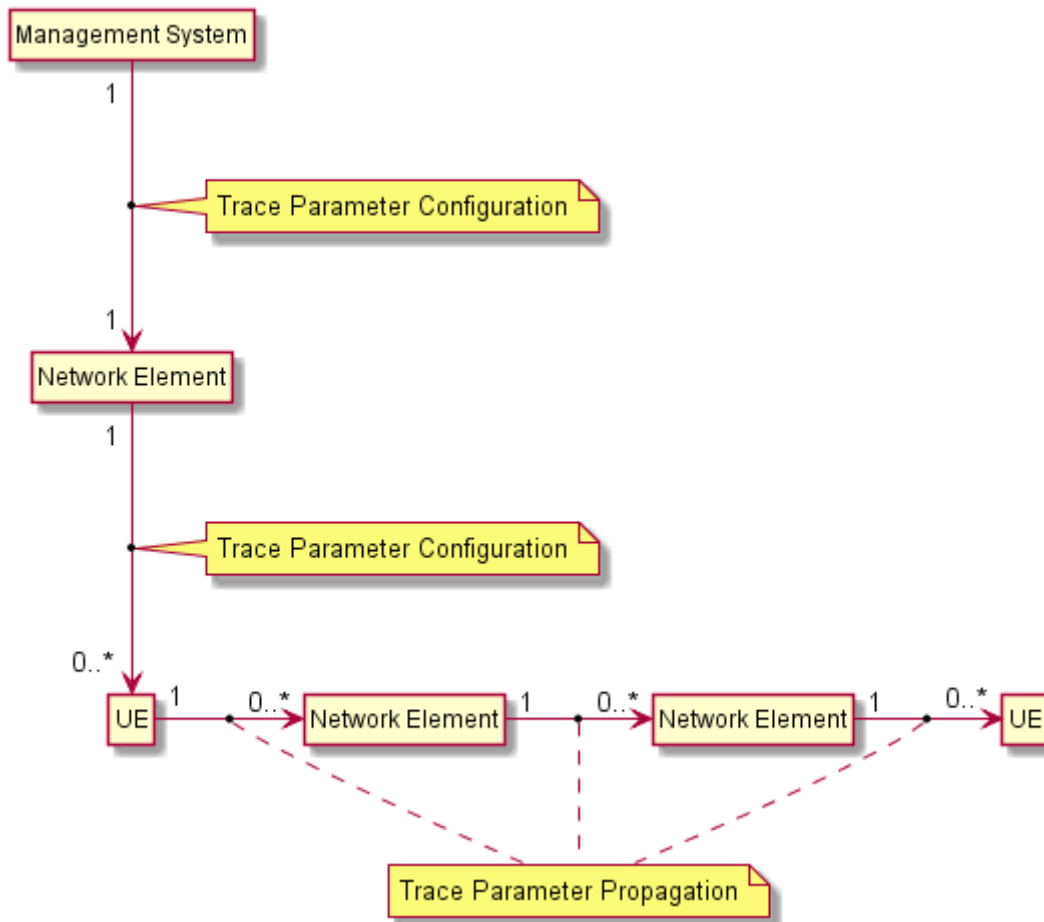
### 4.3 Service Level Tracing for IMS high level Architecture

There are two ways in which to activate service level trace for IMS:

- a) Trace activation at the UE, and
- b) Trace activation at an IMS NE.

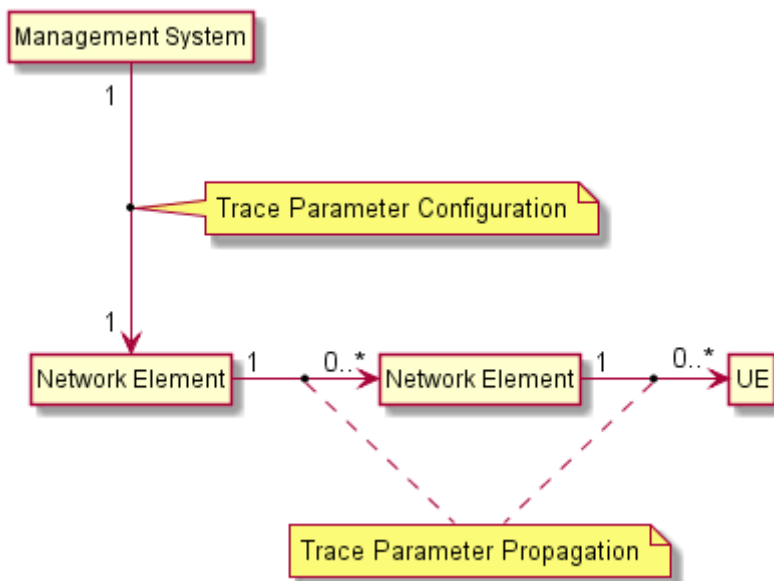


Figure 4.3.1 represents the high-level view of the architecture of Signalling Based Activation/Deactivation at the UE required to support Service Level Tracing for IMS. Figure 4.3.1 is only showing the interfaces in principle. Details of Service Level Trace Activation/Deactivation are defined in 3GPP TS 32.422 [2].



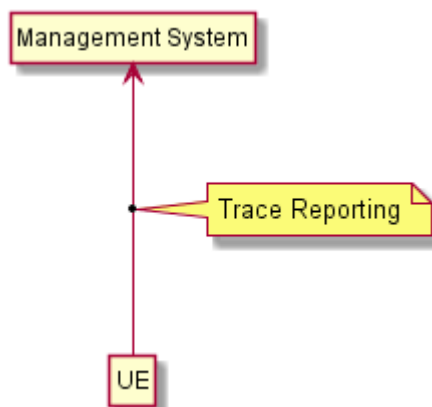
**Figure 4.3.1: Architecture for Signalling Based Activation/Deactivation required for Service Level Tracing for IMS at the UE**

Figure 4.3.2 represents the high-level view of the architecture of Signalling Based Activation/Deactivation at an IMS NE required to support Service Level Tracing for IMS. Figure 4.3.2 is only showing the interfaces in principle. Details of Service Level Trace Activation/Deactivation are defined in 3GPP TS 32.422 [2].



**Figure 4.3.2 : Architecture for Signalling Based Activation/Deactivation required for Service Level Tracing for IMS at the IMS NE**

Figure 4.3.3 represents the high-level view of the architecture of Trace Reporting . Figure 4.3.3 illustrates the reporting context for Service Level Tracing for IMS from the UE and is only showing the interfaces in principle. The reporting context for Service Level Tracing for IMS from the IMS NE is illustrated in Figure 4.2.3: Architecture for High-level view of Trace Reporting .



**Figure 4.3.3: Architecture for Trace Reporting from UE to support Service Level Tracing for IMS**

## 5 Trace requirements

### 5.1 General trace requirements

The general high-level requirements for Trace, common to both Management activation/deactivation and Signalling Based Activation/Deactivation, are as follows:

- for the Maximum Level: Trace data encompassing all signalling messages on the different interfaces dedicated to the events of the traced subscriber or UE with their entire content (all IEs) shall be retrieved. The operator can then use an external system (e.g. an Operations System (OS) in TMN terminology) and decode specific information in line with operator requirements.
- for the Minimum Level: a selected subset of IEs shall be retrieved from the signalling interface messages. The Minimum Level provides support for the most common use cases (described in annex A).
- for the Medium Level: a selected Minimum Level subset of IEs from the signalling interface messages and a selected set of radio measurement IEs shall be retrieved.
- for the MaximumWithoutVendorSpecificExtension Level: it is the same as for Maximum level without vendor specific data.
- for the MediumWithoutVendorSpecificExtension Level: it is the same as for Medium level without vendor specific data.
- for the MinimumWithoutVendorSpecificExtension Level: it is the same as for Minimum level without vendor specific data.

The high-level requirements for Trace, specific for Service Level Tracing for IMS are as follows:

The following high-level OMA Service Level Tracing requirements apply. (refer to OMA Service Provider Environment Requirements [9]).

NOTE: Each referenced OMA requirement utilizes its OMA unique identifier within square brackets. Clarification provided to each requirement should be considered applicable to other OMA requirements using the same concepts.

- [SLT-HL-1] with the following clarification:
  - The OMA term *OMA Service Provider Environment (OSPE)* shall be understood as PLMN.
- [SLT-HL-5] with the following clarification:
  - In the context of Service Level Tracing for IMS a Minimum and Maximum level of detail of trace only applies. Trace data for Service Level Tracing at Minimum and Maximum level of detail shall include information associated to *end user visible events*
- [SLT-HL-6] with the following clarification:
  - The OMA term *service chain* shall be understood as the relationship between appropriate IMS elements needed to support a service. The term *service chain* does not imply a strict sequence of events.
  - The source of the logged trace information (e.g. IMS element including S-CSCF) shall be identifiable when the retrieved trace information is analyzed.
- [SLT-HL-10] with the following clarification:
  - IMS elements that do not support Service Level Tracing shall not prohibit the propagation of the Trace Parameter Propagation.
- [SLT-OSR-1]
  - Multiple Service Level Trace instances shall be simultaneously supported by the PLMN and the UE (e.g. several services initiated from the same UE may each have a Trace Recording Session Reference)

## 5.2 Requirements for Trace data

The high level requirements for Trace data, common to both Management activation/deactivation and Signalling Based Activation/Deactivation, are as follows:

- The Trace records have to contain Information Elements or signalling messages from control signalling and/or the characteristics of the user data. The following list contains the Network Elements and the Traceable interfaces in the NEs where tracing is needed:
  - MSC Server: A, Iu-CS, Mc and MAP (G, B, E, F, D, C) interfaces; CAP
  - MGW: Mc, Nb-UP, Iu-UP
  - HSS: MAP (C, D, Gc, Gr) Cx, S6a, S6d, Sh, N70, N71 and NU1 interfaces and location and subscription information
  - EIR: MAP(F), S13, S13', MAP (Gf)
  - SGSN: Gb, Iu-PS, Gn, MAP (Gr, Gd, Gf), CAP (Ge) Gs, S6d, S4, S3 and S13' interfaces
  - GGSN: Gn, Gi and Gmb interfaces
  - S-CSCF: Mw, Mg, Mr and Mi interfaces
  - P-CSCF: Gm and Go interfaces
  - RNC: Iu-CS, Iu-PS, Iur, Iub and Uu interfaces
  - BM-SC: Gmb interface
  - eNB/en-gNB: S1-MME, X2, Uu, F1-C, E1
  - MME: S1-MME, S3, S6a, S10, S11, S13, N26
  - Serving Gateway: S4, S5, S8, S11
  - PDN Gateway: S2a, S2b, S2c, S5, S6b, Gx, S8, SGi
  - AUSF: N12, N13
  - AMF: N1, N2, N8, N11, N12, N14, N15, N20, N22, N26
  - NEF: N29, N30, N33
  - NRF: N27
  - NSSF: N22, N31
  - PCF: N5, N7, N15
  - SMF: N4, N7, N10, N11, N16, N16a, N38, S5-C
  - SMSF: N20, N21
  - UDM: N8, N10, N13, N21, NU1
  - UPF: N4
  - AF: N5, N33
  - ng-eNB: NG-C, Xn-C, Uu
  - gNB-CU-CP: NG-C, Xn-C, Uu, F1-C, E1, X2-C
  - gNB-CU-UP: E1
  - gNB-DU: F1-C

- A unique ID within a Trace Session shall be generated for each Trace Recording Session. This is called the Trace Recording Session Reference.

The high level requirements for Trace data applicable for Signalling Based Activation/Deactivation for Service Level Tracing for IMS, are as follows:

- In the context of Service Level Tracing for IMS Trace records have to contain Information Elements or signalling messages or end user visible event from control signalling and/or the characteristics of the user data. The following list contains the IMS NEs and the Traceable interfaces in the NEs where tracing is needed:
  - HSS: Sh and Cx interfaces and location and subscription information;
  - S-CSCF: ISC, Mw, Mg, Mr and Mi interfaces;
  - P-CSCF: Gm and Go interfaces;
  - I-CSCF: Mw and Cx interfaces;
  - SIP AS: ISC interface;
  - MRF: Mr interfaces;
  - MGCF: Mg interfaces;
  - BGCF: Mi interfaces;
- A unique ID within a Trace Session shall be generated for each Trace Recording Session. This is called the Trace Recording Session Reference. In the context of Service Level Tracing for IMS the Trace Recording Session shall be unique across all IMS NEs within a PLMN.

Changes to existing NEs and interfaces above may be required. These changes would be dependent upon various 3GPP working groups and possibly other non-3GPP industry groups for completion of Trace Session Activation/Deactivation.

For a detailed description of NEs and interfaces above see 3GPP TS 23.002 [4].

## 5.3 Requirements for Trace activation

### 5.3.1 Requirements for Trace Session activation

The high level requirements for Trace Session activation, common to both Management activation and Signalling based activation), are as follows:

- In the case of a subscriber Trace, the Trace Session will be activated for a certain subscriber whose identification (IMSI in UTRAN/CS/PS) shall be known in the NEs where subscriber Trace is needed. In the case of E-UTRAN the IMSI shall not be included in the Trace Parameter Propagation data to the e-NodeB. In the case of NG-RAN the IMSI/SUPI shall not be included in the Trace Parameter Propagation data to the NG-RAN node.
- In the case of a UE Trace, the Trace Session will be activated for a certain UE whose identification (IMEI or IMEISV) shall be known in the NEs where UE Trace is needed. In the case of E-UTRAN, neither the IMEI nor IMEISV shall be included in the Trace Parameter Propagation data to the e-NodeB - Trace Session activation shall be possible for both home subscribers and visiting subscribers. In the case of NG-RAN, neither the IMEI/SUPI nor IMEISV shall be included in the Trace Parameter Propagation data to the NG-RAN node.
- There are two methods for Trace Session activation: Management activation and Signalling activation.
- For an established call/session within a Network Element, it is optional for the Network Element to start a Trace Recording Session for the associated Subscriber or UE upon receipt of the Trace activation request from the management system.
- A globally unique ID shall be generated for each Trace Session to identify the Trace Session. This is called the Trace Reference. The method for achieving this is to divide the Trace reference into Country, Operator, and trace Id.

- Trace Session may be activated from the management system simultaneously to multiple NEs with the same Trace Reference (i.e. same Trace Session).
- The Trace Scope and Depth shall be specified within the control and configuration parameters during Trace Session activation.
- There can be cases in a NE when it receives multiple Trace Session activations for the same connection (e.g. simultaneous CS/PS connections). In these cases the starting time of the Trace Session Activation and the starting time of the first Trace Recording Session is the same using signalling based activation. For these cases there are two different cases for the Trace Session activation in a Network Element when it receives another Trace Session activation to the same subscriber or MS:
  - If the Trace Reference is equal to an existing one, a new Trace Session shall not be started;
  - If the Trace Reference is not equal to an existing one, a new Trace Session may be started.
- The management system shall always provide the trace control and configuration parameters to the appropriate NEs at the time of Trace Session activation.
- The Trace collection entity shall be notified, in case of the Trace Session activation has failed, by the response message with the specific cause (e.g. overload) from the NE on which the Trace Session activation failure happened.
- It shall be possible to specify the trace reporting method (file-based vs. streaming) during Trace Session Activation.
- In case of streaming trace reporting method being selected, the data producer shall establish the connection to the data consumer upon Trace Session Activation and provide data consumer with information about Trace Session.

The high-level requirements for Trace Session activation, specific to Signalling Based activation, are as follows:

- Signalling based activation shall be able to capture signalling messages as early in a session as possible, e.g. by means of a piggybacked trace invocation message in the case of a new connection or new bearer setup

For active users, it shall be possible to start trace recording when the trace order is received, by means of a distinct trace invocation message.

The high-level requirements for Trace Session activation, specific to Management activation, are as follows:

- In the case of a subscriber Trace, the Trace Session will be activated for a certain subscriber whose identification (IMSI in UTRAN/CS/PS or Public User Identity in IMS) shall be known in the NEs where subscriber Trace is needed.

In the case of a Cell Traffic Trace, Trace Session activation should be possible for all calls active in a cell or multiple cells without knowledge of the UEs' identification (IMEI or IMEISV).

- In the case of a Cell Traffic Trace, Trace Sessions should be activated for all the NEs where Cell Traffic Trace is specified.
- In the case of Cell Traffic Trace (in a shared network only), a Trace Session shall be started for UEs which are served by the Participating Operator that has made the request to the Primary Operator.

The high-level requirements for Trace Session activation specific for Service Level Tracing for IMS are as follows:

The following high-level OMA Service Level Tracing requirements apply [9]:

- [SLT-COM-2] with the following clarification:
  - The OMA term *component* in the context of Service Level Tracing for IMS shall be understood as IMS NE and UE.
- [SLT-HL-2] with the following clarification:
  - The OMA terms *device* and *component* shall be understood as UE and IMS NE, respectively;
  - The IMS NEs HSS, P/I/S-CSCF, AS and UE, apply only.

- [SLT-AC-1] with the following clarification:
  - The OMA term *Authorised Actor* shall be understood as NE, EM or NM;
  - The OMA term *trace indication* shall be understood as Start Trigger Event.
- [SLT-AC-2] with the following clarification:
  - The OMA term *Service Provider* shall be understood as Service Provider;
  - The OMA term *marking request* shall be understood as the ability to send the Trace Parameter Configuration to either the UE or IMS NE.
- [SLT-AC-6]
- [SLT-AC-7] with the following clarification:
  - The OMA term *criteria* shall be understood as Trace Configuration Parameters.

### 5.3.2 Requirements for starting a Trace Recording Session

The high level requirements for starting a Trace Recording Session, common to both Management activation and Signalling based activation), are as follows:

- It is optional for the NE to start a Trace Recording Session if there are insufficient resources available within the NE.
- The Trace Recording Session Reference shall be unique within a Trace Session.
- The Trace Recording Session should be started after appropriate start trigger events are detected.

The high level requirements for starting a Trace Recording Session, specific to Management activation, are as follows:

- Each NE shall generate its own Trace Recording Session Reference (i.e., independent Trace Recording Sessions).
- Each NE shall start the Trace Recording Session based upon the Trace control and configuration parameters received by the NE in the Trace Session activation.
- In the case of a trace other than Cell Traffic Trace, the correlation of Trace data will be done with a Trace Reference and IMSI / IMEI / IMEISV / Public User Identity.
- The Trace Recording Session can start only when the IMSI (in the case of a subscriber trace), the IMEI / IMEISV (in case of UE trace) or Public User Identity (in the case of IMS) is made available in the NE. In order to trace the early phases of the call the IMSI (in case of subscriber trace), the IMEI / IMEISV (in case of UE trace) or Public User Identity (in case of IMS) shall be made available to the NE as soon as practically possible. E.g. the IMSI and IMEI / IMEISV shall be made available to both Serving RNC and Drift RNC.
- In the case of E-UTRAN the Core Network node that triggers a Trace Recording Session to E-UTRAN shall either:
  - provide a trace log including Trace Reference, Trace Recording Session Reference and the identity of the UE (i.e. IMSI or IMEI(SV)) to the Trace Collection Entity, or
  - provide a notification including Trace Reference, Trace Recording Session Reference and the identity of the UE (i.e. IMSI or IMEI(SV)) to the Trace Collection Entity.
- In the case of NG-RAN the Core Network node that triggers a Trace Recording Session to NG-RAN shall either:
  - provide a trace log including Trace Reference, Trace Recording Session Reference and the identity of the UE (i.e. IMSI /SUPI or IMEI(SV)) to the Trace Collection Entity, or
  - provide a notification including Trace Reference, Trace Recording Session Reference and the identity of the UE (i.e. IMSI /SUPI or IMEI(SV)) to the Trace Collection Entity.
- In the case of a Cell Traffic Trace, the Trace Recording Session should start upon the Trace control and configuration parameters being received by the NEs in the Trace Session activation and the presence of call activity. Furthermore, the the Core Network node that handles the traced session should be requested to:
  - provide a trace log including Trace Reference, Trace Recording Session Reference and the identity of the UE (i.e. IMSI or IMEI(SV)) to the Trace Collection Entity, or
  - provide a notification including Trace Reference, Trace Recording Session Reference and the identity of the UE (i.e. IMSI or IMEI(SV)) to the Trace Collection Entity.
- In the case of a Cell Traffic Trace (in a shared network only), the Trace Recording Session shall only be started for UEs which are served by the Participating Operator that has made the request to the Primary Operator.

The high-level requirements for starting a Trace Recording Session, specific for Service Level Tracing for IMS are as follows:

The following high-level OMA Service Level Tracing requirements apply [9]:

[SLT-HL-3] with the following clarification:



- The OMA term *marked* shall be understood as UE or IMS NE that has previously received Trace Parameter Configuration information.
- The OMA term *marking* shall be understood as Trace Parameter Configuration.

[SLT-COM-3] with the following clarification:

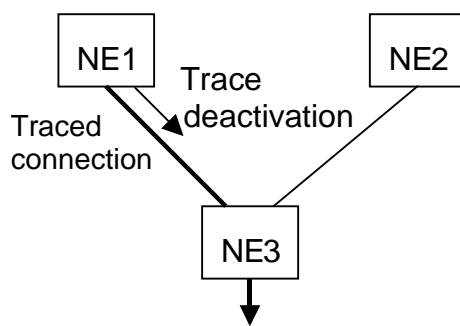
- The OMA term *indication for SLT* shall be understood as Start Trigger Event
- The OMA terms *inbound* and *outbound* protocols shall be understood as, for example, inbound SIP and outbound Diameter.

## 5.4 Requirements for Trace deactivation

### 5.4.1 Requirements for Trace Session deactivation

The high level requirements for Trace Session deactivation, common to both Management deactivation and Signalling based deactivation, are as follows:

- The Trace Session shall be deactivated using the Trace Reference specified for the Trace Session activation.
- The Trace Session shall be deactivated in all those NEs where it was activated.
- The deactivation of a Trace Session during a Trace Recording Session within a NE may take place anytime after the NE receives the deactivation request until the end of the current Trace Recording Session related to the traced Subscriber or UE.
- Trace Session deactivation in a NE could occur when two simultaneous signalling connections for a subscriber or UE exist. E.g. figure 5.4.1 shows NE 3 having two signalling connections (one of them or both of them are traced with the same Trace Reference) and a Trace deactivation message is received. The Trace Session shall be closed.



**Figure 5.4.1: Trace Session closure**

- In case of streaming trace reporting, upon the Trace Session deactivation and end of the currently open Trace Recording Sessions, the data producer shall terminate connection to the data consumer.

The high-level requirements for Trace Session deactivation specific for Service Level Tracing for IMS are as follows:

The following high-level OMA Service Level Tracing requirements apply [9].

[SLT-COM-2] with the following clarification:

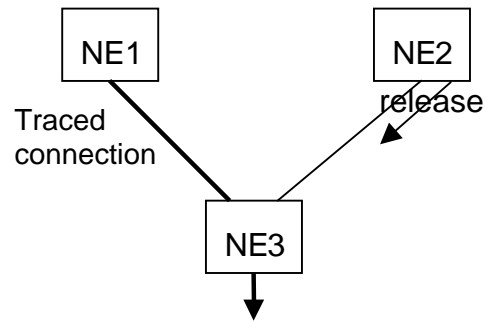
[SLT-AC-1] with the following clarification:

- Deactivation at an IMS NE forming part of an IMS *service chain* shall not prohibit the propagation of the Trace Parameter Propagation.

### 5.4.2 Requirements for stopping a Trace Recording Session

The high level requirements for stopping a Trace Recording Session, common to both Management deactivation and Signalling based deactivation, are as follows:

- The Trace Recording Session should be stopped after appropriate stop trigger events are detected.
- Trace Session deactivation in a NE could occur when two simultaneous signalling connections for a subscriber or UE exist. E.g. figure 5.4.2 shows NE3 having two signalling connections, but only one connection is traced. If the non-traced connection is released, the Trace Recording Session shall be kept in NE3. If the traced connection is released the Trace Recording Session shall be closed.



**Figure 5.4.2: Trace Recording Session closure**

The high level requirements for stopping a Trace Recording Session, specific to Signalling based deactivation, are as follows:

The Trace Recording Session should be stopped after an NE receives the appropriate signalling deactivation message.

The high-level requirements for stopping a Trace Recording Session, specific for Service Level Tracing for IMS are as follows:

The following high-level OMA Service Level Tracing requirements apply [9].

[SLT-AC-3] with the following clarification:

- The implication of un-marking a UE is threefold:
  - a) It prohibits the initiation of further trace recording sessions from that UE or IMS NE (i.e. subsequent services shall not be traced);
  - b) It cancels outstanding Trace Parameter Configuration information on a UE or IMS NE;
  - c) Existing trace recording sessions active in the PLMN may continue until an appropriate Stop Event Trigger.

## 5.5 Requirements for Trace Data reporting

The high level requirements for Trace Data reporting, common to both Management activation/deactivation and Signalling Based Activation/Deactivation, are as follows (Trace record contents, file formats and file transfer mechanisms are defined in 3GPP TS 32.423 [3]):

- Trace records should be generated in each NE where a Trace Session has been activated and a Trace Recording Session has been started.
- Format of the Trace records shall be XML or GPB based on the Schema in TS 32.423 [3].
- In UMTS or EPS trace, the trace records should be transferred on the Itf-N to the Network Manager using one of two approaches: direct transfer from NE to NM or transfer from NE to NM via EM.
- Trace records may also be transferred to an external IP address (received in Trace Control and Configuration Parameters) in 3 ways:
  - 1) Direct transfer from NE to IP address
  - 2) Transfer from NE to IP address via management system
  - 3) Transfer from NE to management system. The management system notifies the holder of the IP address that collects the files.
- The Trace Records in a shared node for a Participating Operator's trace request should be collected by the Primary Operator's NE and may be delivered through the Primary Operator's management system. The Trace records shall be made available to the Participating Operator's management system.

The high-level requirements for stopping a Trace Recording Session, specific for Service Level Tracing for IMS are as follows:

The following high-level OMA Service Level Tracing requirements apply [9].

[SLT-HL-4] with the following clarification:

- Encoded trace information shall be Standard File Format. Standard File Format may not be applicable for encoded trace information at the UE.

[SLT-HL-7] with the following clarification:

- An instance of a service level trace across a PLMN shall be uniquely identifiable using the Trace Recording Session Reference.

[SLT-HL-8]

[SLT-COM-1] with the following clarification:

- Time stamping alone to determine the sequence of IMS NEs performing trace within the *service chain* shall not be used;
- Statistical information shall not be included as part of IMS NE characteristics;
- Service Level Tracing shall apply only to the IMS session layer and not the underlying transport layers.

[SLT-COM-4] with the following clarification:

- An IMS NE, in addition to providing trace information specific to a service that it has traced, may also make available other information, for example, timestamp and throughput information.

[SLT-NI-1] with the following clarification:

- The UE shall expose a standardised interface for Trace Parameter Configuration and the retrieval of trace information. This interface may not be standardized by 3GPP.

[SLT-NI-2] with the following clarification:

- An IMS NE shall transfer Trace records in Standard File Formats.

The high-level requirements for Trace Data reporting in case of file-based trace reporting are as follows:

- For transfer of Trace records FTP or secure FTP shall be used.

**Editor's note: The transfer of Trace record from the UE is For Further Study.**

The high-level requirements for Trace Data reporting in case of streaming trace reporting are as follows:

- The same connection between data producer and data consumer may be used for the reporting of Trace data under all Trace Recording Sessions of the same Trace Session reported by the same data producer.
- A connection from the data producer to the consumer shall be established and information about Trace Session shall be provided to the data consumer.
- Binary encoding shall be used for the transfer of all Trace data from data producer to the data consumer.
- The periodicity and amount of data in each data burst from data producer to data consumer shall maintain the data relevance while minimizing the amount of transport overhead.
- The data producer shall re-establish connection to the data consumer and provide the information about Trace Session upon unexpected connection termination (e.g. in cases such as re-start of data producer).
- It shall be possible to specify format of trace records based on GPB Schema in TS 32.423 [3].

## 5.6 Requirements for Privacy and Security

The high-level requirements for privacy and security, specific for Service Level Tracing for IMS are as follows:

The following high-level OMA Service Level Tracing requirements apply [9].

[SLT-PRV-1] with the following clarification:

- Privacy shall be applied across the appropriate Trace Itf-N.

[SLT-SEC-1]

[SLT-SEC-2]

[SLT-SEC-3] with the following clarification:

- It may not be possible to retrieve Trace information from IMS NEs from outside the PLMN where the IMS NEs reside.

[SLT-IOP-1] with the following clarification:

- The propagation of the Trace Parameter Configuration and the Start Trigger event shall be prohibited by the PLMN when e.g. the SIP AS is hosted outside a PLMN.

As the radio access nodes in E-UTRAN are outside an operator's secure domain, the following requirement applies for E-UTRAN as described in 3GPP TS 33.401 [10]:

[SET-SEC-1] Keys stored inside eNBs shall never leave a secure environment within the eNB. When security key(s) transported on control signalling messages are included in the trace file, the key value(s) shall be removed and replaced with the value "Unavailable".

As the radio access nodes in NG-RAN are outside an operator's secure domain, the following requirement applies for NG-RAN as described in 3GPP TS 38.401 [17]:

[SET-SEC-2] Keys stored inside NG-RAN node shall never leave a secure environment within the NG-RAN node. When security key(s) transported on control signalling messages are included in the trace file, the key value(s) shall be removed and replaced with the value "Unavailable".

The high-level requirements for privacy and security in case of streaming trace reporting are as follows:

- The connection between data producer and data consumer shall provide the data privacy.
- The connection between data producer and data consumer shall provide the data integrity.

## 5.7 Requirements for Charging

The high-level requirements for charging, specific for Service Level Tracing for IMS are as follows:

The following high-level OMA Service Level Tracing requirements apply [9].

[SLT-CRG-1]

## 5.8 Use cases for Trace

The operator can use Subscriber and UE Trace for numerous purposes. However, the use cases for Trace can be divided into two basic categories:

- Troubleshooting use cases cover situations where the operator is solving an existing problem in his network;
- Validation testing use cases cover situations where the operator is not solving a known problem but merely analysing, fine-tuning or optimising his network.

A more detailed description for the following use cases for Subscriber and UE Trace can be found in annex A:

- Interoperability checking between UE from different vendors;
- QoS profile checking for a subscriber after a subscriber complaint;
- Malfunctioning UE;
- Checking radio coverage in a certain area;
- Testing new features;
- Fine-tuning and optimisation of algorithms or procedures.

The operator can use Service Level Tracing for IMS for numerous purposes. However, the use cases for Trace can be divided into two basic categories:

- Troubleshooting use cases cover situations where the operator is solving existing problems with services offered to their subscribers.
- Validation testing use cases cover situations where the operator is not solving a known problem but performing service regression and automated service testing.

A more detailed description of the following use cases for Service Level Tracing can be found in annex A:

- Automated testing of service provider services;
- Regression testing following a network fix;
- Service fault localization within a Service Provider's network;
- Service fault localization when a service is hosted by a third party Service Provider.

## 5.9 Requirements for a throttled Trace Recording Session

The high-level requirements for throttled Trace Recording Session are as following:

- It shall be possible for the NE to start a throttled trace recording session if there are insufficient resources available within the NE.
- It shall be possible for the NE to indicate an ongoing trace recording session that is throttled if there are insufficient resources available within the NE.

The high-level requirements for clearing up a throttled Trace Recording Session are as following:

- It shall be possible for the NE to clear up a throttled trace recording session if there are sufficient resources available within the NE.

---

## 6 Requirements for managing MDT

### 6.1 Business Level Requirements

REQ-MDT-CON-1 The Operator shall be able to collect measurements for Network Performance Management purposes from UEs within their network.

REQ-MDT-CON-2 The collected measurements shall be made available in a centralised entity.

REQ-MDT-CON-3 Operator shall be able to select specific set of subscribers for the measurement collection based on IMSI.

REQ-MDT-CON-4 Operator shall be able to select specific set of devices for the measurement collection based on IMEI(SV).

REQ-MDT-CON-5 Operator shall be able to select specific set of devices for the measurement collection based on geographical area.

REQ-MDT-CON-6 Operator shall be able to select specific set of devices for the measurement collection based on device capabilities.

REQ-MDT-CON-7 Operator shall be able to select specific set of subscribers based on IMSI and a geographical area for the measurement collection.

REQ-MDT-CON-8 Operator shall be able to select specific set of devices based on IMEI(SV) and a geographical area for the measurement collection.

REQ-MDT-CON-9 Operator shall be able to configure set of device capabilities and a geographical area for the measurement collection.

REQ-MDT-CON-10 Operator shall be able to select specific set of subscribers based on IMSI and a set of device capabilities and a geographical area for the measurement collection.

REQ-MDT-CON-11 Operator shall be able to select specific set of devices IMEI(SV) and capabilities and a geographical area for the measurement collection.

REQ-MDT-CON-12 Operator shall be able to select set of subscribers based on IMSI and a set of device capabilities for the measurement collection

REQ-MDT-CON-13 Operator shall be able to select specific set of devices IMEI(SV) and capabilities for the measurement collection.

REQ-MDT-CON-14 The operator shall be able to configure the duration of the measurement collection.

REQ-MDT-CON-15 The operator shall be able to configure the UE measurement types and events for collection.

REQ-MDT-CON-16 The operator shall be able to configure the type of UE measurement reporting and log formats i.e. raw measurement results or type of measurement aggregation (e.g. statistical aggregation of raw measurement results, sampling of raw measurement results, etc.)

REQ-MDT-CON-17 The management of MDT shall be independent from the management of SON functionalities

REQ-MDT-CON-18 The management of UE based network performance measurements shall allow the network operator to control whether or not it is possible to link a measurement result and related information (e.g. location information) to the user terminal type ID (i.e. IMEI-TAC).

REQ-MDT-CON-19 An operator that uses more than one PLMN shall be able to activate MDT in each of those PLMN and continue MDT cross its own PLMN IDs.

NOTE: MDT data can be collected by a network operator operating with a set of PLMN\_IDs in different countries, but under the same common user privacy agreement in different countries in the same legal privacy protection domain.



REQ-MDT-CON-20 The operator shall be able to request collection of positioning information related to UE measurements.

REQ-MDT-CON-21 Operator shall be able to correlate the location information with the MDT UE measurements.

REQ-MDT-CON-22 MDT function shall support RAN sharing scenarios.

REQ-MDT-CON-23 The TCE used to collect MDT data shall be controlled by the same operator, as the operator that the user has given his consent to.

REQ-MDT-CON-24 Operator shall be able to minimize the amount of redundant MDT data.

REQ-MDT-CON-25 For management based MDT data collection, operator shall be able to specify the desired amount of MDT data and the desired number of UEs over period of time.

REQ-MDT-CON-26 The MOP shall be able to select UEs according to the POP intention.

REQ-MDT-CON-27 The recorded Subscriber and Equipment Trace data related to a particular POP shall be delivered to that POP but no other POP.

REQ-MDT-CON-28 The Operator shall be able to collect MBSFN UE measurements.

REQ-MDT-CON-29 The operator shall be able to request collection of sensor information related to UE measurements.

REQ-MDT-CON-30 The operator shall be able to configure MDT for a UE in dual connected mode both on primary and secondary node.

## 6.2 Specification level requirements

### 6.2.1 Logged MDT and Immediate MDT requirements

All requirements are valid for Logged MDT and Immediate MDT functionality if not mentioned otherwise:

REQ-MDT-FUN-01 It shall be possible to collect UE measurements based on one or more IMEI(SV) number.

REQ-MDT-FUN-02 It shall be possible to collect UE measurements based on one or more IMSI number.

REQ-MDT-FUN-03 It shall be possible to collect UE measurement logs preceding and following a particular event (e.g. radio link failure).

REQ-MDT-FUN-04 Each UE measurement result shall be linked to a time stamp. Accuracy of time information including absolute time and relative time. The absolute time can refer to the *absoluteTimeStamp* IE defined in clause 6.2.2, 3GPP TS 36.331[18] for LTE or the *absoluteTimeInfo* IE in clause 11.3, 3GPP TS 25.331[19] for UMTS. The relative time can refer to the *relativeTimeStamp* IE defined in clause 6.2.2, 3GPP TS 36.331[18] for LTE or the *relativeTimeStamp* IE in clause 11.3, 3GPP TS 25.331[19] for UMTS.

REQ-MDT-FUN-05 The solutions for collecting UE measurements for the purpose of minimization of drive tests shall be able to work independently from SON support in the network.

REQ-MDT-FUN-06 It shall be possible to collect UE measurements in one or more cells or TA/RA/LA.

REQ-MDT-FUN-07 It shall be possible to collect UE measurements based on one or more IMSI in one or more cells or TA/RA/LA.

REQ-MDT-FUN-08 It shall be possible to collect UE measurements based on one or more IMEI(SV) in one or more cells or TA/RA/LA.

REQ-MDT-FUN-09 It shall be possible to configure UE measurement types and triggering conditions under which UE measurements would be collected for MDT.

REQ-MDT-FUN-10 Void.

REQ-MDT-FUN-11 It shall be possible to configure the condition of MDT data collection based on certain device capability information in one or more cells or in TA/RA/LA.

REQ-MDT-FUN-12 It shall be possible to configure MDT data collection based on one or more IMSI/SUPI in one or more cells or TA/RA/TA with a set of device capability information.

REQ-MDT-FUN-13 It shall be possible to configure MDT data collection based on one or more IMEI(SV) in one or more cells or TA/RA/TA with a set of device capability information.

REQ-MDT-FUN-14 It shall be possible to configure MDT data collection based on one or more IMEI(SV) with a set of device capability information.

REQ-MDT-FUN-15 It shall be possible to configure MDT data collection based on one or more IMSI/SUPI with a set of device capability information.

REQ-MDT-FUN-16 It shall be possible to activate a Trace Session for MDT data collection (or UE measurement collection for MDT purpose) independently from other mobility related performance measurements and call trace collection.

REQ-MDT-FUN-17 It shall be possible to deactivate MDT data collection by using Trace Reference.

REQ-MDT-FUN-18 It shall be possible to create a combine Trace Session for UE measurement collection and for subscriber and equipment/cell trace.

REQ-MDT-FUN-19 Void.

REQ-MDT-FUN-20 MDT activation shall be supported for a UE belonging to any PLMN within the same MDT PLMN list.

REQ-MDT-FUN-21 MDT data collection shall continue if a user is changing PLMN and the target PLMN within the same MDT PLMN list.

REQ-MDT-FUN-22 It shall be possible to collect positioning data related to UE measurements, which can be either geographical coordinates or raw positioning measurements sufficient to be input for a post processing positioning algorithm.

REQ-MDT-CON-23 It shall be possible for management system to correlate MDT UE measurements with location information.

NOTE: There may be regulatory obligation to delete MDT data after processing.

REQ-MDT-FUN-24 The PLMN where TCE collecting MDT data resides shall match the RPLMN of the UE providing the MDT data.

REQ-MDT-FUN-25 In the case of Management based MDT the MOP shall be able to select UEs according to the POP intention.

REQ-MDT-FUN-26 The recorded Subscriber and Equipment Trace data related to a particular POP shall contain information so that it can be sent to that POP.

REQ-MDT-FUN-27 In case of non-file-based trace reporting, binary encoding shall be used for the transfer of all MDT data from data producer to the data consumer.

REQ-MDT-FUN-28 It shall be possible to configure MDT report type to be used for logged MDT for NR.

REQ-MDT-FUN-29 Management based MDT configuration and signalling based MDT configuration shall be able to coexist in parallel for NR.

REQ-MDT-FUN-30 In case of logged MDT, it shall be possible to collect specific NR neighbour cell measurements on cell level.

REQ-MDT-FUN-31 It shall be possible to continue the actual ongoing process of logging for the UE in RRC INACTIVE state when the logging process for the UE starts in RRC IDLE state in NR.

REQ-MDT-FUN-32 In the case of immediate MDT, the measurement quantities shall be able to handle cell level RSRP/RSRQ/SINR in LTE and NR and beam level BRSRP/BRSRQ/BSINR in NR.

REQ-MDT-FUN-33 In the case of signalling based immediate MDT, configuration shall be able to propagate across RATs for the case of Xn inter-RAT intra-system handover to/from NR.

REQ-MDT-FUN-34 In the case of EN-DC scenario, for immediate MDT, configuration shall be able to be provided for both primary node and secondary node independently.

REQ-MDT-FUN-35 In the case of MR-DC, there is a split DRB in which data shall be sent over both MN and SN. In such a case, the PDCP data volume shall include the data sent over both MN and SN for that DRB.

REQ-MDT-FUN-36 In the case of immediate MDT, it shall be possible to collect the measurement pollution indication so that TCE is able to correlate and filter polluted measurements in NR.

REQ-MDT-FUN-37 In the case of immediate MDT, it shall be possible to configure beam level BRSRP/BRSRQ/BSINR in NR.

## 6.2.2 Logged MBSFN MDT requirements

Requirements in clause 6.2.1 that apply to MBSFN MDT are as follows:

REQ-MDT-FUN-01

REQ-MDT-FUN-02

REQ-MDT-FUN-03

REQ-MDT-FUN-04

REQ-MDT-FUN-05

REQ-MDT-FUN-06

REQ-MDT-FUN-07

REQ-MDT-FUN-08

REQ-MDT-FUN-09

REQ-MDT-FUN-11

REQ-MDT-FUN-12

REQ-MDT-FUN-13

REQ-MDT-FUN-14

REQ-MDT-FUN-15

REQ-MDT-FUN-20

REQ-MDT-FUN-21

REQ-MDT-FUN-24

REQ-MDT-FUN-25

REQ-MDT-MBSFN-FUN-1 It shall be possible to activate a Session for Logged MBSFN MDT data collection independently from other mobility related performance measurements and call trace collection.

REQ-MDT-MBSFN-FUN-2 It shall be possible to configure MBSFN MDT data collection based on certain device capability information in specific MBSFN area(s).

REQ-MDT-MBSFN-FUN-3 It shall be possible to deactivate Logged MBSFN MDT data collection by using Trace Reference.

REQ-MDT-MBSFN-FUN-4 It shall not be possible to combine Logged MBSFN MDT session with any other trace sessions.

---

## 7 Requirements for managing RLF and RCEF reports

### 7.1 Business level requirements

REQ-RLF-CON-1 The Operator shall be able to collect RLF and RCEF reports from eNBs within their network.

REQ-RLF-CON-2 The collected RLF and RCEF reports shall be made available in a centralised entity.

REQ-RLF-CON-3 The Operator shall be able to select certain areas for collecting RLF and RCEF reports.

REQ-RLF-CON-4 The Operator shall be able to collect RLF and RCEF reports from NG-RAN nodes within their network.

### 7.2 Specification level requirements

REQ-RLF-FUN-01 It shall be possible to collect RLF and RCEF reports in one or more eNodeBs.

REQ-RLF-FUN-02 It shall be possible to activate a Trace Session for RLF and RCEF data collection independently from other Trace jobs.

REQ-RLF-FUN-03 It shall be possible to collect RLF and RCEF reports in one or more NG-RAN nodes.

REQ-RLF-FUN-04 In case of non-file-based trace reporting, binary encoding shall be used for the transfer of all RLF and RCEF reports data from data producer to the data consumer.

REQ-RLF-FUN-05 It shall be possible to collect neighbour cell measurements for RLF and RCEF reports in one or more eNodeBs and NG-RAN nodes.

REQ-RLF-FUN-06 It shall be possible to collect SCGF information for RLF reports in one or more RAN nodes in the case of MR-DC scenario.

---

## Annex A (informative): Trace use cases

### A.1 Use case #1: multi-vendor UE validation

#### A.1.1 Description

The aim of this use case is to check how different vendor's UEs are working (e.g. in field testing) in the mobile network or to get detailed information on the UE.

The study can be started by an initiative from operator for verification of UE from different vendors (e.g. testing how the UE fulfils the requirements set by the standards).

The operator can perform the test using test UEs or tracing subscribers' mobiles.

#### A.1.2 Example of required data for this use case

The Trace parameters required to cover use case #1 are listed below:

- Tracing is needed in the Radio Network (RNC) or in the Core Network (MSS, SGSN);
- The identification of the Trace case shall be IMEI or IMEISV (and possibly IMSI);
- The level of details usually is to get the most important IEs from the signalling messages (Medium Level) or all messages with their encoded IEs (Maximum Level).

The traceable protocols are:

- In RNC: RRC, NBAP, RNSAP, RANAP.
- In MSS/SGSN: DTAP messages.

---

### A.2 Use case #2: subscriber complaint

#### A.2.1 Description

The aim of this use case is to check how the complaining subscriber's services are working, to get information on the services in order to find out the reason for the complaint.

The study can be started after a subscriber is complaining at his/her home or visited operator that some of the service to which he/she subscribed is not working. E.g. the subscriber:

- cannot make calls;
- cannot use some supplementary service;
- does not get the negotiated QoS level (e.g. Mobile subscriber activates video-streaming application to watch the latest sport events and every time the subscriber tries to connect to the service the system disconnects the subscriber's UMTS bearer).

As the Trace is activated for a subscriber, the signalling based Trace Session activation shall be used, as the location of the subscriber is not known.

## A.2.2 Example of required data for this use case

The Trace parameters required to cover the use case #2 are listed below:

- The list of NEs where tracing may be needed depends on the service being complained about by the subscriber. For this use case, tracing should be possible in all network elements, such as: HSS, MSS, RNC, MGW, SGSN, GGSN.
  - The identification of the subscriber in a Trace is IMSI in UTRAN/CS/PS. The identification of the UE in a Trace is IMEI or IMEISV.
  - The data includes those Information Elements from the signalling messages, which are related to the service(s) being complained about by the subscriber (Medium Level).

Example cases, which can be the basis for subscriber complaint:

### 1. The subscriber's CS call is misrouted

This illustrates an instance where a subscriber complains that his calls are being cross-connected (or misrouted). Such a complaint involves setting up a Trace at all the 3GPP standardised interfaces being handled by the MSC. However, the Trace functionality shall not cover MSC internal or vendor proprietary interfaces. The Trace record shall need to have the dialled number and connected number.

### 2. The subscriber's call is dropped

Tracing data is required from the radio network (UTRAN) or from the core network (MSS, SGSN, GGSN). In the radio network the radio coverage shall be checked. See use case #4 (checking radio coverage). Beside the radio coverage, other information can be useful as well, like RLC parameter, power information (OLPC or RRC measurement report), error ratios (BLER / BER, SDU error ratio), etc. Tracing in the core network is needed also, if the problem is not in the radio network. E.g. in case of PS domain the call can be dropped by the application due to the long delays or congestions in TCP layer or due to bad QoS. Thus in SGSN the requested and negotiated QoS parameters should be included in the Trace record.

### 3. The received QoS level is less than the negotiated level.

To be able to solve the possible problem Tracing data is required from HSS, SGSN, GGSN, and UTRAN. Furthermore in case of problem in CS calls tracing in MGW shall be performed.

From HSS Trace data the operator can monitor whether the subscriber's authentication to the network is successful, and what kind of QoS parameters are allowed to the subscriber. From SGSN Trace data the operator can monitor PDP context creation request from mobile. Request seems to contain legal QoS profile (incl. Maximum bandwidth, guaranteed bandwidth etc) and the local resources in SGSN are available to provide the service as requested by the subscriber. From UTRAN Trace data the operator can monitor whether the maximum bandwidth and guaranteed bandwidth, requested by SGSN, acceptable for UTRAN. Thus to check whether UTRAN can provide and maintain the requested radio access bearer services. From GGSN Trace data the operator can monitor PDP context activation between SGSN and GGSN. If the problem is in the CS domain the MGW Trace can provide the QoS data.

---

## A.3 Use case #3: malfunctioning UE

### A.3.1 Description

The aim of this use case is to check a UE, which is not working correctly.

The study can be initiated by the operator when he/she suspects that a UE not working according to the specifications or he/she would like to get more information on a specific UE, which is on the track or block EIR list.

### A.3.2 Example of required data for this use case

The Trace parameters required to cover the use case #3 are listed below:

- UE Tracing may be needed in the Radio Network (UTRAN) or in the Core Network (MSS, SGSN).
- The identification of the subscriber in a Trace is IMSI. The identification of the UE in a Trace is IMEI or IMEISV.
- The level of details depends on the operator needs (either Minimum Level or Medium Level).

The malfunction of UE in UTRAN can occur in different places. The problem can be in basic RRC and RANAP signalling, Radio Bearer procedures, Handover procedures, Power control etc.

Therefore, all RRC, RANAP, NBAP, RNSAP signalling procedures, transmission powers, error ratios (BLER / BER, SDU error ratio) and retransmission can be included in the Trace records.

---

## A.4 Use case #4: checking radio coverage

### A.4.1 Description

This use case aims at checking the radio coverage on a particular network area.

This study can be started by an initiative from operator for testing radio coverage on a particular geographical area following network extension for instance (e.g. new site installation).

The operator can perform a drive test on the new site area, and check that radio coverage is correct, or may collect Cell Traffic Trace data on all of the cells active in the area of interest.

The other options for collecting information on radio coverage is to collect RLF reports generated by the UE in an E-UTRAN network. .

### A.4.2 Example of required data to cover use case #4

The DL radio coverage can be checked using the values of CPICH Ec/No and RSCP measured by the mobile on the cells in the active set and the monitored set. These measurements are sent to the RNC through the RRC message MEASUREMENT REPORT.

For E-UTRAN the RLF reports contained in the UE Information Response message provide the radio condition in terms of RSRP and RSRQ values when the Radio Link failure happened together with a location information.

The UTRAN Trace record intra frequency measurement contains the required information.

The UTRAN Trace record inter frequency, and inter RAT measurements can also be used to check radio coverage with other frequencies or systems.

After a network extension, the operator can check that Ec/No and RSCP levels on the new site area are the expected ones, and there is no coverage hole.

The following Trace parameters are required to cover use case #4:

- The type of NE to Trace is RNC or eNB.
- The identification of the subscriber in a Trace is IMSI. The identification of the UE in a Trace is IMEI or IMEISV.
- In the case of a Cell Traffic Trace, the identification of the cells where Trace data is to be collected.
- In case of RLF report collection the list of eNodeBs where the RLF reports are collected.
- The Trace data to retrieve shall contain the messages with all IEs that are relevant for radio coverage.

---

## A.5 Use case #5: testing a new feature

### A.5.1 Description

This use case aims at testing the implementation of a new feature in the network before its general deployment. The functionality can be either a standard feature or a vendor/operator specific feature.

This study is started by an initiative from the operator.

The operator can perform a drive test on the area where the feature is introduced, and check its good behaviour as well as its benefits, in term of quality or capacity. He can also rely on subscribers' Trace data when they use the feature to be tested.

### A.5.2 Example of required data to cover use case #5

Depending on the feature, the list of NEs to Trace, as well as the level of details can be different.

For a feature concerning Core and UTRAN networks, for instance hard handover, SRNS relocation, or new UMTS bearer service, the operator needs to activate Trace on several NEs.

Then, the operator can be interested in:

- Only the protocol messages generated by the feature; or
- The impact of the new feature introduction on the network, for instance, the radio coverage, the capacity, the quality, or the behaviour of the existing algorithms.

In this last case, the operator needs more detailed data, for instance messages with all (Maximum Level) or part of the IEs (Minimum Level).

The following Trace parameters are required to cover use case #5:

- The types of NEs to Trace are NEs that can be traced related to the feature.
- The identification of the subscriber in a Trace is IMSI. The identification of the UE in a Trace is IMEI or IMEISV.
- The Trace data to retrieve can be either only the protocol messages (Maximum Level) or the messages with all or part of the IEs (Minimum Level).



---

## A.6 Use case #6: fine-tuning and optimisation of algorithms/procedures

### A.6.1 Description

Subscriber and UE Trace is part of the optimisation process. Trace data are used to get feedback on the network quality and capacity after optimisation operations like parameter fine-tuning, or new network design. Each intervention to improve the network behaviour can be confirmed both by measurement data and Trace data.

This study is started following an initiative from the operator.

The operator can perform a drive test on the area and/or activate a Cell Traffic Trace where the optimisation has been performed, and check its good behaviour as well as its impact on the network. He can also rely on subscribers' Trace data when they use the network to be optimised.

## A.6.2 Example of required data to cover use case #6

Depending on the optimisation operation, the list of NEs to Trace, as well as the level of details can be different. But generally, fine-tuning activities like scrambling code plan, handover and relocation algorithms, or call admission algorithm optimisation concern a very specific part of the network.

To cover this use case, the operator is usually searching for the highest level of details, on specific NEs.

The following Trace parameters are required to cover use case #6:

- The types of NEs to Trace are any NE that can be traced related to the network to be optimised.
- The identification of the subscriber in a Trace is IMSI. The identification of the UE in a Trace is IMEI or IMEISV.
- In the case of a Cell Traffic Trace, the identification of the cells where Trace data is to be collected.
- The Trace data to retrieve are the messages in encoded format with all (Maximum Level) or part of the IEs (Minimum Level).

---

## A.7 Use case #7: Automated testing of Service Provider services

### A.7.1 Description

For a detailed description of this use-case see OMA Service Provider Environment Requirements [9].

---

## A.8 Use case #8: Regression testing following a network fix

### A.8.1 Description

For a detailed description of this use-case see OMA Service Provider Environment Requirements [9].

---

## A.9 Use case #9: Service fault localization within a Service Provider network

### A.9.1 Description

For a detailed description of this use-case see OMA Service Provider Environment Requirements [9].

---

## A.10 Use case #10: Service fault localization when a service is hosted by a third party Service Provider

### A.10.1 Description

For a detailed description of this use-case see OMA Service Provider Environment Requirements [9].

---

## A.11 Use case #11 Analysing drop calls in E-UTRAN

### A.11.1 Description

One of the important KPIs in an operator's network is the call drop KPI. A call drop KPI is defined also in 3GPP TS 32.450 [12]. The call drop KPI indicates in percentage of how many successfully established calls have been dropped. This is a crucial indicator about the quality of the network that has clear effects to the user experience.

Therefore one of the most important targets for operator is to minimize the value of the Call drop rate KPI. The root cause of a dropped call is typically a radio link failure or a handover failure. Both of these failures currently reported by the UE in the RLF reports, which additionally contain the radio conditions at the time the failure happened. Therefore the RLF reports are very important input for operators to determine the reasons for degradations in Call Drop KPI. In addition the RLF reports combines the radio conditions with location information, therefore it can serve as a valuable input for analysis how to decrease the Call Drop KPI.

### A.11.2 Example of required data to cover use case #11

For further analysis of drop calls information is required about the radio conditions of the radio network when the drop calls happens. In E-UTRAN the ideal data can be collected by utilising the RLF reports defined in TS 37.320 [11]. RLF reports contain the RSRP and RSRQ values of the radio conditions at the time when the Radio Link Failure happens that can lead in most of the cases to a drop call. The RLF report contains also the time and location of the RLF event.

---

## A.12 Use case #12 Periodical sampling of network performance

### A.12.1 Description

For management purpose, an operator need to measure statistical network performance e.g. overall coverage status, overall voice call and data session performance and so on. The data collected could include measurements, such as Ec/No and RSCP for case of UMTS and RSRP and RSRQ for case of E-UTRAN, and statistical business level KPIs such as sampled call drop rate and application layer throughput. By periodically sampling these network performance data, managers of the operator can monitor overall performance of the network and compare performance differences between areas or periods. The statistical data sampling can be performed periodically e.g. weekly or monthly. The drive test fleet's scale makes the amount of data samples under operators control.

MDT can be used to replace or reduce drive test in this case. It is necessary for the MDT task to collect measurements in a way similar as the drive test do. To prevent unnecessary waste of network resources, operators need to specify the desired maximum number and amount of data samples collected through an MDT task. There is no need to notify the operator when the max number or amount is reached because that will not trigger any action of the operator. It is necessary for the operators to specify the desired minimum number of UEs and amount of data samples collected in a MDT job so that the data collected can meet the business and management requirements. If a MDT job can not collect minimum amount of data in a given period of time, the operator need to be notified quickly at the end of the time period given by the operator so he can decide if he will need to send a drive test team in the field to replace the MDT job.

### A.12.2 Example of required data to cover use case #12

Ideally, the data collected should include all measurements taking place in a drive test, such as Ec/No and RSCP for UMTS and RSRP and RSRQ for E-UTRAN, and statistical business level KPIs such as sampled call drop rate and application layer throughput. It is not possible to ask a normal UE to perform similar task. To make MDT a basic replacement for drive test, UE measurement such as Ec/No and RSCP for UMTS and RSRP/RSRQ for E-UTRAN should be reported.

It shall also be possible for MDT to facilitate the introduction of future technology to collect business level KPIs e.g. sampled call drop rate and application layer throughput.

---

## A.13 Use case #13 Differentiation of management based MDT data by terminal type

### A.13.1 Description

For analysis of management based MDT data, it's useful to differentiate the MDT data which are collected from different terminal types. For example, it allows operators to analyze whether the poor network performance is caused by a specific terminal type.

For privacy consideration of MDT data, operator shall also be able to select whether the MDT data should be reported with or without the user terminal type information.

### A.13.2 Example of required data to cover use case #13

The IMEI-TAC could be used together with MDT data and operators could use the information to analyze whether the poor network performance is caused by network or specific terminal types.

---

## A.14 Use case #14 Subscriber complaint about MBMS service in the eUTRAN network

### A.14.1 Description

When a subscriber complains about their MBMS service, signalling based MDT for that particular user can be triggered to analyse and troubleshoot the issue. Operator may also want to analyse the performance or issues in the network by looking at per subscriber MBSFN measurements.

### A.14.2 Example of required data to cover use case #14

The MBSFN MDT measurements defined in TS 37.320 [11] are required for analysing MBMS service quality in the indicated area and for trouble shooting per user MBMS service. The measurement quantities for E-UTRA MBSFN measurement logging are fixed and consist of MBSFN RSRP, MBSFN RSRQ, BLER for signalling and BLER for data per MCH, in addition to the measurement quantities for downlink pilot strength measurements.

The MBSFN measurement results consist of, per MBSFN area where MBMS service is received:

- MBSFN area identity.
- Carrier frequency.
- MBSFN RSRP.
- MBSFN RSRQ.
- MCH BLER for signalling.
- MCH BLER for data, and related MCH index.

---

## A.15 Use case #15 Check MBMS service quality and performance of the eUTRAN Network

### A.15.1 Description

The operator needs information for analysing signal strength, signal quality and block error rates for MBMS reception and quality. Logged MBSFN MDT data is needed to support network verification, re-planning of MBSFN areas, and optimization of MBSFN operation parameters.

### A.15.2 Example of required data to cover use case #15

The MBSFN MDT measurements defined in TS 37.320 [11] are required for analysing MBMS QoS in the indicated area and for trouble shooting per user MBMS service. The measurement quantities for E-UTRA MBSFN measurement logging are fixed and consist of MBSFN RSRP, MBSFN RSRQ, BLER for signalling and BLER for data per MCH, in addition to the measurement quantities for downlink pilot strength measurements.

The MBSFN measurement results consist of, per MBSFN area where MBMS service is received:

- MBSFN area identity.
- Carrier frequency.
- MBSFN RSRP.
- MBSFN RSRQ.
- MCH BLER for signalling.
- MCH BLER for data, and related MCH index.

---

## A.16 Use case #16 Collecting Cell and UE data for analytics

### A.16.1 Goal

Being able to analyse and optimize the mobility management and traffic handling behaviour for on-going sessions is important, as it offers an opportunity to address potential problems before it's "too late" (while something can be done to mitigate them or prevent the problem from happening).

Cell Traffic Trace, Immediate MDT, RLF reports and RCEF reports are the examples of RAN data relevant to this goal.

### A.16.2 Pre-conditions

The consumers (e.g. specific instances of MDAS producers, NWDAF) and producers (e.g. specific E-UTRAN or NG-RAN nodes) of data have been identified and are operational.

The data to be collected (e.g. particular call processing events, relevant interfaces, signalling messages and IEs, MDT measurements, UE location information, failure reports) has been selected.

### A.16.3 Description/steps

1. 3GPP Management System configures/activates the data producers with appropriate Trace measurement control and configuration parameters.

NOTE 1: For the illustrative purposes of this use case, it is assumed that Trace Job types "Immediate MDT and Trace", "RLF reports only" and "RCEF reports only" have been selected (see clause 5.9a in TS 32.422 [2]) and the information about data consumer (e.g. address, identity) has been provided.

2. The data producer establishes connection to the data consumer and exchanges the data collection session metadata (e.g. identity of the data producer, nature of the data being collected, Trace Reference).
3. While the Trace Session is active on the data producer, the data producer performs UE selection (see clauses 4.1.1.6a and 4.1.1.9 in TS 32.422 [2]), receives RLF and RCEF reports (see clauses 4.3 and 4.8 in TS 32.422 [2]), starts trace recording sessions (see clauses 4.2.2.5 and 4.2.2.10 in TS 32.422 [2]), enables MDT measurements (see clause 4.2.2.7 in TS 32.422 [2]).
4. Periodically, upon the data availability, the data producer sends the collected data to the data consumer. The periodicity and the amount of data in each burst sent from producer to consumer may be standardized, made configurable or left implementation-specific. But the key point here is that the data is being delivered to the consumer while it's still relevant to the analytical task performed by the consumer.

NOTE 2: The actions described by steps 3 and 4 repeated until the Trace Session is deactivated (e.g. via explicit configuration/deactivation by the 3GPP Management System or if Trace Session requirements such as amount of data or duration have been satisfied).

5. 3GPP Management System configures/deactivates the data producers.
6. The data producer terminates the connection to the data consumer and potentially informs it that the data collection task has been completed and no further data is expected.

The use case ends upon successful termination of the data collection task.

## A.16.4 Post-conditions

The data consumer has the necessary data to perform the analytical tasks. The data (reported per UE) may include, but is not limited to:

- LTE MDT measurements (see TSs 37.320 [11] and 32.422 [2]) such as:
  - M1: RSRP and RSRQ measurement by UE with Periodic, event A2 as reporting triggers;
  - M2: Power Headroom (PH) measurement by UE;
  - M3: Received Interference Power measurement by eNB;
  - M4: Data Volume measurement separately for DL and UL by eNB;
  - M5: Scheduled IP Throughput measurement separately for DL and UL by eNB.

**Editor's note: 5G MDT measurements are FFS (pending on-going work in RAN WG).**

- Radio Link Failure reports;
- RRC Connection Establishment Failure reports;
- Raw signalling messages (see TS 32.423 [3] clauses 4.13 and 4.29 for additional details);
- UE location information (see TS 32.423 [3] clause 4.16.2 for additional details).

The specific methods for analysing and/or correlating the captured data, as well as any actions that may be triggered by such analysis are out of scope of the present use case.

## A.17 Use case #17 Collecting subscriber and equipment trace data for near-real-time diagnostics and troubleshooting

### A.17.1 Goal

Being able to diagnose and troubleshoot various problems reported by subscribers (e.g. as described in clauses A.2 - A.14) for on-going sessions is important, as it offers an opportunity to investigate and address potential problems while they are happening, and to evaluate the corrective actions (e.g. based on subscriber's feedback or automated algorithms).

Subscriber and equipment Trace with Signalling Based Activation performed on RAN and Core NEs are the examples of trace data relevant to this goal.

### A.17.2 Pre-conditions

The consumers (e.g. management applications and/or functions) and producers (e.g. specific NG-RAN and 5GC nodes) of data have been identified and are operational.

The subscriber or equipment to be traced has been identified.

The data to be collected (e.g. triggering events, trace depth, relevant NE types, relevant interfaces, signalling messages and IEs, MDT measurements, UE location information, failure reports) has been selected.

### A.17.3 Description/steps

NOTE 1: For the illustrative purposes of this use case, the 5GC activation mechanism with UE attached to 5GC via NG-RAN (as described in the clause 4.1.2.15.1 of TS 32.422 [2]) has been selected. Other activation mechanisms involving E-UTRAN, NG-RAN, EPC and 5GC are possible, but are not conceptually different from the perspective of this use case.

1. Management system configures/activates the Trace Session to the UDM. UDM stores the trace control and configuration parameters.
2. As UE (to be traced) registers with the network, the AMF starts a new Trace Session according to the configuration parameters received from UDM (see steps 3-8 in clause 4.1.2.15.1 of TS 32.422 [2]).
3. AMF establishes connection to the Trace data consumer and exchanges the Trace data collection session metadata (e.g. identity of the AMF, nature of the data being collected, Trace Session Reference).
4. While the Trace Session is active on the AMF, AMF starts the Trace Recording Sessions and collects the Trace data prescribed by Trace configuration received from the UDM.
5. Periodically, upon the Trace data availability, the AMF sends the collected data to the data consumer. The periodicity and the amount of data in each burst sent from AMF to data consumer may be standardized, made configurable or left implementation-specific. But the key point here is that the data is being delivered to the consumer while it's still relevant to the diagnostic/troubleshooting task performed by the consumer.
6. In parallel to the step 5, AMF sends the Trace Start message to the NG-RAN node (see steps 9-11 in clause 4.1.2.15.1 of TS 32.422 [2] and additional details in TS 38.413 [20]). NG-RAN node starts the Trace Session and establishes connection to the Trace data consumer. NG-RAN node and Trace data consumer exchange the Trace data collection session metadata (e.g. identity of the NG-RAN node, nature of the data being collected, Trace Session Reference).
7. While the Trace Session is active on the NG-RAN node, NG-RAN node collects the Trace data prescribed by Trace configuration received from the AMF.
8. Periodically, upon the Trace data availability, the NG-RAN node sends the collected data to the data consumer. The periodicity and the amount of data in each burst sent from NG-RAN node to data consumer may be

standardized, made configurable or left implementation-specific. But the key point here is that the data is being delivered to the consumer while it's still relevant to the diagnostic/troubleshooting task performed by the consumer.

9. In parallel with steps 3-5, AMF activates the Trace sessions on PCF and SMF (see steps 12-17 in clause 4.1.2.15.1 of TS 32.422 [2]). The PCF and SMF start Trace sessions and establish connections to the Trace data consumer. PCF and SMF exchange Trace data collection session metadata (e.g. identity of PCF or SMF, nature of the data being collected, Trace Session Reference).
  10. Periodically, upon the Trace data availability, the PCF and SMF send the collected data to the data consumer. The data is being delivered to the consumer while it's still relevant to the diagnostic/troubleshooting task performed by the consumer.
  11. When traced UE hands-over from one NG-RAN node to another (e.g. Xn handover), the Trace configuration is propagated in the Trace activation IE of the HANDOVER REQUEST message (see TS 38.423 [21]). The target NG-RAN node starts the Trace Session and establishes connection to the Trace data consumer. The target NG-RAN node and Trace data consumer exchange the Trace data collection session metadata (e.g. identity of the NG-RAN node, nature of the data being collected, Trace Session Reference).
  12. While the Trace Session is active on the target NG-RAN node, target NG-RAN node collects the Trace data prescribed by Trace configuration received from the source NG-RAN node.
  13. The target NG-RAN node reports the collected trace data to the data consumer (performs the actions described in the step 8 above).
- NOTE 2: The steps 6-8 and 11-13 are repeated while the Trace session is active (Trace configuration is propagated to target NG-RAN nodes following the UE handovers). Each NG-RAN node where the Trace is active has an active connection to the Trace data consumer (establishes connection and exchanges trace session metadata upon Trace session activation, and reports trace data upon availability).
14. 3GPP Management System configures/deactivates the Trace session at the UDM. It triggers the Trace deactivation process on all NEs where the Trace session was active (see clause 4.1.4.11 in TS 32.422 [2] for additional details).
  15. Upon the Trace session deactivation, the NEs / Trace data producers terminate the connection to the Trace data consumer and potentially inform it that the data collection tasks have been completed and no further data is expected.

The use case ends upon successful termination of the Trace session and of the data collection tasks on all NEs.

## A.17.4 Post-conditions

The data consumer has the necessary data to perform the near-real-time diagnostics and troubleshooting tasks.

The specific methods for analysing and/or correlating the captured data, as well as any actions that may be triggered by such analysis are out of scope of the present use case.



## Annex B (informative): Change history

| Change history |       |           |      |     |  |     |        |        |
|----------------|-------|-----------|------|-----|--|-----|--------|--------|
| Date           | TSG # | TSG Doc.  | CR   | Rev | Subject/Comment  | Cat | Old    | New    |
| Jun 2002       | SA_16 | SP-020330 | --   | --  | Submitted to SA #16 for Information  | --  | 1.0.0  |        |
| Dec 2002       | SA_18 | SP-020755 | --   | --  | Submitted to SA #18 for Approval   | --  | 2.0.0  | 6.0.0  |
| Mar 2003       | SA_19 | SP-030147 | 0001 | --  | Corrections to Trace requirements - alignment with SA2's 23.002  | F   | 6.0.0  | 6.1.0  |
| Dec 2003       | SA_22 | SP-030612 | 0002 | --  | Correction of IMS subscriber identification for Trace  | F   | 6.1.0  | 6.2.0  |
| Mar 2004       | SA_23 | SP-040116 | 0003 | --  | Correction in Trace high level architecture  | F   | 6.2.0  | 6.3.0  |
| Sep 2004       | SA_25 | SP-040542 | 0004 | --  | Removal of GERAN from Rel-6 32.42x series of Trace specifications  | F   | 6.3.0  | 6.4.0  |
| Dec 2004       | SA_26 | SP-040770 | 0005 | --  | Remove requirement for having ASN.1 as Trace record format   | C   | 6.4.0  | 6.5.0  |
| Dec 2004       | SA_26 | SP-040770 | 0006 | --  | Remove in Rel-6 the signalling based Trace in IMS due to missing SIP signalling support from CN1/IETF                      | C   | 6.4.0  | 6.5.0  |
| Mar 2005       | SA_27 | SP-050043 | 0007 | --  | Remove ambiguity on the file format for trace data at the Network Elements (NEs)   | F   | 6.5.0  | 6.6.0  |
| Mar 2005       | SA_27 | SP-050043 | 0008 | --  | Correction to the Scope  | F   | 6.5.0  | 6.6.0  |
| Mar 2005       | SA_27 | SP-050043 | 0009 | --  | Correct the list of interfaces trace parameter – Align with 32.422 and 32.423  | F   | 6.5.0  | 6.6.0  |
| Jun 2005       | SA_28 | SP-050294 | 0010 | --  | BM-SC Network Element and Gmb interface addition for MBMS tracing  | B   | 6.6.0  | 6.7.0  |
| Sep 2005       | SA_29 | SP-050623 | 0011 | --  | Add support for UTRAN TDD - Declare RAT Type   | B   | 6.7.0  | 7.0.0  |
| Mar 2006       | SA_31 | SP-060100 | 0012 | --  | Introduction of Service Level Tracing for IMS  | B   | 7.0.0  | 7.1.0  |
| Sep 2006       | SA_33 | SP-060552 | 0013 | --  | Add Cell Traffic Trace capability to 32.421 Trace concepts and requirements  | C   | 7.1.0  | 7.2.0  |
| Sep 2007       | SA_37 | SP-070614 | 0014 | --  | Add extended trace depth to include Vendor Specific Extension (VSE)  | C   | 7.2.0  | 8.0.0  |
| Sep 2007       | SA_37 | SP-070614 | 0015 | --  | Add LTE nodes and interfaces   | C   | 7.2.0  | 8.0.0  |
| Mar 2008       | SP-39 | SP-080069 | 0016 | --  | Add trace functionality for E-UTRAN  | B   | 8.0.0  | 8.1.0  |
| Mar 2008       | SP-39 | SP-080069 | 0017 | --  | Add trace activation failure response  | B   | 8.0.0  | 8.1.0  |
| Jun 2008       | SP-40 | SP-080329 | 0018 | --  | Introduction of UE identifiers for trace in E-UTRAN  | C   | 8.1.0  | 8.2.0  |
| Sep 2008       | SP-41 | SP-081260 | 0019 | --  | Change the description for Trace Recording Session Reference   | C   | 8.2.0  | 8.3.0  |
| Dec 2008       | SP-42 | SP-080846 | 0020 | --  | Correction of trace depth extensions   | F   | 8.3.0  | 8.4.0  |
| Jun 2009       | SP-44 | SP-090289 | 0022 | --  | Add missing Trace Interface for SGSN and HSS list  | F   | 8.4.0  | 8.5.0  |
| Dec 2009       | -     | -         | -    | -   | Update to Rel-9 version (MCC)  | --  | 8.5.0  | 9.0.0  |
| Mar 2010       | SP-47 | SP-100034 | 0024 | --  | Align the handling of security keys for E-UTRAN with 33.401  | A   | 9.0.0  | 9.1.0  |
| Sep 2010       | SP-49 | SP-100492 | 0025 | --  | Adding Requirements for managing UE based network performance measurements   | F   | 9.1.0  | 10.0.0 |
| Dec 2010       | SP-50 | SP-100833 | 0026 | 1   | Add requirements for trace data of S13, S13' interfaces  | C   | 10.0.0 | 10.1.0 |
| Dec 2010       | SP-50 | SP-100833 | 0027 | 1   | Correcting the Identification of IMS Subscriber Tracing - Align with 32.422  | F   | 10.0.0 | 10.1.0 |
| Mar 2011       | SP-51 | SP-110102 | 0029 | 3   | Add requirements for security and privacy of UE-based Network Performance Measurements / MDT as required by SA3 (Security) | C   | 10.1.0 | 10.2.0 |
| Mar 2011       | SP-51 | SP-110102 | 0030 | -   | Change "UE based network performance measurements" to "MDT" - Align cross-3GPP terminology on MDT work                     | F   | 10.1.0 | 10.2.0 |
| Mar 2011       | SP-51 | SP-110095 | 0031 | -   | Add the missing interfaces for EIR   | B   | 10.1.0 | 10.2.0 |
| Mar 2011       | SP-51 | SP-110095 | 0032 | 1   | Clarify and cleanup MDT requirements   | F   | 10.1.0 | 10.2.0 |
| Sep 2011       | SP-53 | SP-110634 | 0035 | -   | MDT for multiple PLMN IDs  | F   | 10.2.0 | 11.0.0 |
| Sep 2011       | SP-53 | SP-110538 | 0033 | 1   | Adding requirements for MDT positioning  | B   | 10.2.0 | 11.0.0 |
| Sep 2011       | SP-53 | SP-110538 | 0037 | 2   | Add MDT location correlation requirements  | B   | 10.2.0 | 11.0.0 |
| Dec 2011       | SP-54 | SP-110716 | 0048 | 2   | Adding RLF specific use cases and requirements   | B   | 11.0.0 | 11.1.0 |
| Dec 2011       | SP-54 | SP-110715 | 0051 | -   | Support multiple cells in area based MDT   | A   | 11.0.0 | 11.1.0 |
| Dec 2011       | SP-54 | SP-110715 | 0039 | 2   | Introduce the missing MDT data controller user privacy requirements  | A   | 11.0.0 | 11.1.0 |
| Dec 2011       | SP-54 | SP-110715 | 0046 | 1   | Add MDT data deletion note   | A   | 11.0.0 | 11.1.0 |
| Dec 2011       | SP-54 | SP-110716 | 0044 | 1   | Add MDT support requirements in RAN sharing scenario   | B   | 11.0.0 | 11.1.0 |
| Mar 2012       | SP-55 | SP-120054 | 0047 | 3   | Add requirement on reduction of redundant MDT data   | B   | 11.1.0 | 11.2.0 |
| Mar 2012       | SP-55 | SP-120054 | 0054 | 1   | Add MDT data collection criteria requirements  | B   | 11.1.0 | 11.2.0 |
| June-2012      | SP-56 | SP-120368 | 0058 | 1   | Remove MDT Country Restriction   | A   | 11.2.0 | 11.3.0 |
| June-2012      | SP-56 | SP-120369 | 0059 | 1   | Remove MDT Country Restriction   | F   | 11.2.0 | 11.3.0 |
| June-2012      | SP-56 | SP-120369 | 0060 | --  | Add MDT for Periodical sampling of network performance use case  | B   | 11.2.0 | 11.3.0 |
| Sep-2012       | Sp-57 | Sp-120571 | 0061 | 1   | Clarify requirements on counting of distinct UEs   | F   | 11.3.0 | 11.4.0 |
| Dic 2012       | SP-58 | SP-120795 | 0064 | 1   | Correction on the scope, references and abbreviations related to MDT and RLF   | F   | 11.4.0 | 11.5.0 |
| Dic 2012       | SP-58 | SP-120796 | 0065 | 1   | Addition of Network Sharin   | C   | 11.4.0 | 11.5.0 |
| Mar 2013       | SP-59 | SP-130048 | 0066 | 1   | Add IMEI-TAC usecase for UMTS and LTE area based MDT   | F   | 11.5.0 | 11.6.0 |
| Oct 2014       | -     | -         | -    | -   | Update to Rel-12 version (MCC)   |     | 11.6.0 | 12.0.0 |
| Dec 2014       | SP-60 | SP-140800 | 0073 | 1   | Super CR for work item Network Sharing.  | F   | 12.0.0 | 12.1.0 |
| Jun 2015       | SP-68 | SP-150315 | 0074 | 2   | Multi-Broadcast Single Frequency Network (MBSFN) Minimization of Drive Tests (MDT) enhancement.                            | B   | 12.1.0 | 13.0.0 |
| 2017-04        | SA#75 | -         | -    | -   | Promotion to Release 14 without technical change   |     | 13.0.0 | 14.0.0 |

| Change history |         |           |      |     |     |  |             |
|----------------|---------|-----------|------|-----|-----|--|-------------|
| Date           | Meeting | TDoc      | CR   | Rev | Cat | Subject/Comment  | New version |
| 2018-06        | SA#80   | SP-180434 | 0075 | 3   | B   | Add support for 5G Trace   | 15.0.0      |
| 2019-06        | SA#84   | SP-190385 | 0076 | -   | F   | Update eNB/NG-RAN List of interfaces for NSA support of trace activation of trace activation | 15.1.0      |
| 2019-09        | SA#85   | SP-190752 | 0077 | -   | A   | Add the missing requirements on RCEF reports to align with TS 32.422                         | 15.2.0      |
| 2019-12        | SA#86   | SP-191157 | 0086 | 3   | A   | Remove the editor's notes  | 15.3.0      |
| 2019-12        | SA#86   | SP-191169 | 0087 | 1   | B   | Addition of streaming trace requirements   | 16.0.0      |
| 2019-12        | SA#86   | SP-191181 | 0088 | 1   | B   | Terminology clean-up   | 16.0.0      |
| 2019-12        | SA#86   | SP-191191 | 0091 | 1   | B   | Update MDT requirement to include support of MDT in 5G                                       | 16.0.0      |
| 2019-12        | SA#86   | SP-191191 | 0092 | 1   | B   | Add MDT business level requirements  | 16.0.0      |
| 2020-03        | SA#87E  | SP-200173 | 0093 | 1   | B   | Add MDT requirements for NR  | 16.1.0      |
| 2020-03        | SA#87E  | SP-200173 | 0095 | -   | F   | Alignment with RAN2, Replace area based MDT with management based MDT                        | 16.1.0      |
| 2020-09        | SA#89e  | SP-200746 | 0096 | -   | B   | Add some additional MDT requirements   | 17.0.0      |
| 2021-03        | SA#91e  | SP-210167 | 0097 | 1   | B   | Add new requirement for GPB trace format aligning with TS 32.423                             | 17.1.0      |
| 2021-03        | SA#91e  | SP-210167 | 0098 |     | B   | Add new MR-DC related requirements   | 17.1.0      |
| 2021-06        | SA#92e  | SP-210403 | 0099 | -   | B   | Add new requirement for measurement pollution indication in NR                               | 17.2.0      |
| 2021-06        | SA#92e  | SP-210467 | 0100 | 1   | F   | Update inclusive language  | 17.2.0      |
| 2021-12        | SA#94e  | SP-211483 | 0101 | -   | B   | Add new requirements for throttled trace recording session                                   | 17.3.0      |
| 2021-12        | SA#94e  | SP-211458 | 0102 | -   | A   | Rel-17 CR 32.421 Introduce missing interfaces of HSS   | 17.3.0      |
| 2021-12        | SA#94e  | SP-211483 | 0104 | -   | B   | Add new requirements for configuration of beam level measurement                             | 17.3.0      |
| 2022-09        | SA#97e  | SP-220864 | 0106 | -   | A   | Enhancement of scope regarding RCEF  | 17.4.0      |
| 2023-12        | SA#102  | SP-231489 | 0109 | -   | A   | Rel-17 CR TS32.421 Align N38 in SMF with TS23.501  | 17.5.0      |
| 2023-12        | SA#102  | SP-231486 | 0113 | -   | A   | Rel-17 CR TS32.421 Missing N16 in SMF requirement  | 17.5.0      |
| 2023-12        | SA#102  | SP-231489 | 0116 | -   | A   | Rel-17 CR TS32.421 Missing N16a in SMF requirement   | 17.5.0      |

---

# History

| <b>Document history</b> |              |             |
|-------------------------|--------------|-------------|
| V17.3.0                 | May 2022     | Publication |
| V17.4.0                 | October 2022 | Publication |
| V17.5.0                 | January 2024 | Publication |
|                         |              |             |
|                         |              |             |