

# ETSI TS 132 421 V8.7.0 (2013-07)



**Digital cellular telecommunications system (Phase 2+);  
Universal Mobile Telecommunications System (UMTS);  
LTE;  
Telecommunication management;  
Subscriber and equipment trace;  
Trace concepts and requirements  
(3GPP TS 32.421 version 8.7.0 Release 8)**



---

**Reference**

RTS/TSGS-0532421v870

---

**Keywords**

GSM,LTE,UMTS

**ETSI**

650 Route des Lucioles  
F-06921 Sophia Antipolis Cedex - FRANCE

---

Tel.: +33 4 92 94 42 00 Fax: +33 4 93 65 47 16

Siret N° 348 623 562 00017 - NAF 742 C  
Association à but non lucratif enregistrée à la  
Sous-Préfecture de Grasse (06) N° 7803/88

---

**Important notice**

---

Individual copies of the present document can be downloaded from:

<http://www.etsi.org>

The present document may be made available in more than one electronic version or in print. In any case of existing or perceived difference in contents between such versions, the reference version is the Portable Document Format (PDF). In case of dispute, the reference shall be the printing on ETSI printers of the PDF version kept on a specific network drive within ETSI Secretariat.

Users of the present document should be aware that the document may be subject to revision or change of status. Information on the current status of this and other ETSI documents is available at

<http://portal.etsi.org/tb/status/status.asp>

If you find errors in the present document, please send your comment to one of the following services:

[http://portal.etsi.org/chaicor/ETSI\\_support.asp](http://portal.etsi.org/chaicor/ETSI_support.asp)

---

**Copyright Notification**

---

No part may be reproduced except as authorized by written permission.  
The copyright and the foregoing restriction extend to reproduction in all media.

© European Telecommunications Standards Institute 2013.  
All rights reserved.

**DECT™**, **PLUGTESTS™**, **UMTS™** and the ETSI logo are Trade Marks of ETSI registered for the benefit of its Members.  
**3GPP™** and **LTE™** are Trade Marks of ETSI registered for the benefit of its Members and  
of the 3GPP Organizational Partners.  
**GSM®** and the GSM logo are Trade Marks registered and owned by the GSM Association.

---

## Intellectual Property Rights

IPRs essential or potentially essential to the present document may have been declared to ETSI. The information pertaining to these essential IPRs, if any, is publicly available for **ETSI members and non-members**, and can be found in ETSI SR 000 314: *"Intellectual Property Rights (IPRs); Essential, or potentially Essential, IPRs notified to ETSI in respect of ETSI standards"*, which is available from the ETSI Secretariat. Latest updates are available on the ETSI Web server (<http://ipr.etsi.org>).

Pursuant to the ETSI IPR Policy, no investigation, including IPR searches, has been carried out by ETSI. No guarantee can be given as to the existence of other IPRs not referenced in ETSI SR 000 314 (or the updates on the ETSI Web server) which are, or may be, or may become, essential to the present document.

---

## Foreword

This Technical Specification (TS) has been produced by ETSI 3rd Generation Partnership Project (3GPP).

The present document may refer to technical specifications or reports using their 3GPP identities, UMTS identities or GSM identities. These should be interpreted as being references to the corresponding ETSI deliverables.

The cross reference between GSM, UMTS, 3GPP and ETSI identities can be found under <http://webapp.etsi.org/key/queryform.asp>.

# Contents

Intellectual Property Rights .....	2
Foreword.....	2
Foreword.....	5
Introduction .....	6
1 Scope .....	7
2 References .....	7
3 Definitions, symbols and abbreviations .....	8
3.1 Definitions .....	8
3.2 Abbreviations .....	10
4 Trace concepts and high-level architecture .....	11
4.1 Trace concepts .....	11
4.2 Trace high level Architecture .....	13
4.3 void.....	15
5 Trace requirements .....	16
5.1 General trace requirements .....	16
5.2 Requirements for Trace data .....	17
5.3 Requirements for Trace activation .....	17
5.3.1 Requirements for Trace Session activation.....	17
5.3.2 Requirements for starting a Trace Recording Session .....	19
5.4 Requirements for Trace deactivation.....	20
5.4.1 Requirements for Trace Session deactivation .....	20
5.4.2 Requirements for stopping a Trace Recording Session .....	20
5.5 Requirements for Trace Data reporting .....	22
5.6 Requirements for Privacy and Security .....	23
5.7 void.....	23
5.8 Use cases for Trace.....	24
<b>Annex A (informative): Trace use cases .....</b>	<b>25</b>
A.1 Use case #1: multi-vendor UE validation.....	25
A.1.1 Description .....	25
A.1.2 Example of required data for this use case .....	25
A.2 Use case #2: subscriber complaint .....	25
A.2.1 Description .....	25
A.2.2 Example of required data for this use case .....	26
A.3 Use case #3: malfunctioning UE .....	27
A.3.1 Description .....	27
A.3.2 Example of required data for this use case .....	27
A.4 Use case #4: checking radio coverage.....	27
A.4.1 Description .....	27
A.4.2 Example of required data to cover use case #4.....	27
A.5 Use case #5: testing a new feature.....	28
A.5.1 Description .....	28
A.5.2 Example of required data to cover use case #5.....	28
A.6 Use case #6: fine-tuning and optimisation of algorithms/procedures .....	28
A.6.1 Description .....	28
A.6.2 Example of required data to cover use case #6.....	30
A.7 void.....	30
A.7.1 void.....	30

A.8 void.....30  
A.8.1 void.....30  
A.9 void.....30  
A.9.1 void.....30  
A.10 void.....30  
A.10.1 void.....30  
**Annex B (informative): Change history .....31**  
History .....32

---

# Foreword

This Technical Specification has been produced by the 3<sup>rd</sup> Generation Partnership Project (3GPP).

The contents of the present document are subject to continuing work within the TSG and may change following formal TSG approval. Should the TSG modify the contents of the present document, it will be re-released by the TSG with an identifying change of release date and an increase in version number as follows:

Version x.y.z

where:

- x the first digit:
  - 1 presented to TSG for information;
  - 2 presented to TSG for approval;
  - 3 or greater indicates TSG approved document under change control.
- y the second digit is incremented for all changes of substance, i.e. technical enhancements, corrections, updates, etc.
- z the third digit is incremented when editorial only changes have been incorporated in the document.

---

## Introduction

The present document is part of a TS-family covering the 3rd Generation Partnership Project; Technical Specification Group Services and System Aspects; Telecommunication management, as identified below:

- **TS 32.421: "Subscriber and equipment trace: Trace concepts and requirements";**
- TS 32.422: "Subscriber and equipment trace: Trace control and configuration management";
- TS 32.423: "Subscriber and equipment trace: Trace data definition and management";

Subscriber and equipment trace provide very detailed information at call level on one or more specific mobile(s). This data is an additional source of information to Performance Measurements and allows going further in monitoring and optimisation operations.

Contrary to Performance measurements, which are a permanent source of information, trace is activated on user demand for a limited period of time for specific analysis purposes.

Trace plays a major role in activities such as determination of the root cause of a malfunctioning mobile, advanced troubleshooting, optimisation of resource usage and quality, RF coverage control and capacity improvement, dropped call analysis, Core Network and UTRAN end-to-end UMTS procedure validation.

The capability to log data on any interface at call level for a specific user (e.g. IMSI) or mobile type (e.g. IMEI or IMEISV) allows getting information which cannot be deduced from Performance measurements such as perception of end-user QoS during his call (e.g. requested QoS vs. provided QoS), correlation between protocol messages and RF measurements, or interoperability with specific mobile vendors.

Moreover, performance measurements provide values aggregated on an observation period; Subscriber and UE Trace give instantaneous values for a specific event (e.g. call, location update, etc.).

If performance measurements are mandatory for daily operations, future network planning and primary trouble shooting; Subscriber and UE Trace is the easy way to go deeper into investigation and UMTS network optimisation.

In order to produce this data, Subscriber and UE Trace are carried out in the NEs, which comprise the network. The data can then be transferred to an external system (e.g. an Operations System (OS) in TMN terminology, for further evaluation).

---

# 1 Scope

The present document describes the requirements for the management of Trace and the reporting of Trace data (including FDD mode and TDD mode) across UMTS networks or EPS networks as it refers to subscriber tracing (tracing of IMSI or Private ID) and equipment tracing (tracing of IMEI or IMEISV). Trace also includes the ability to trace all active calls in a cell or multiple cells (Cell Traffic Trace). It defines the administration of Trace Session activation/deactivation by the Element Manager (EM), the network or User Equipment (UE) itself via signalling, the generation of Trace results in the Network Elements (NEs) and UE and the transfer of these results to one or more Operations Systems, i.e. EM(s) and/or Network Manager(s) (NM(s)).

The present document is built upon the basic Subscriber and UE Trace concept described in clause 4. The high-level requirements for Trace data, Trace Session activation/deactivation and Trace reporting are defined in clause 5. Clause 5 also contains an overview of use cases for Trace (the use cases are described in Annex A). Trace control and configuration management are described in 3GPP TS 32.422 [2], and Trace data definition and management are described in 3GPP TS 32.423 [3].

The present document does not cover any Trace capability limitations within a NE (e.g. maximum number of simultaneous traced mobiles for a given NE) or any functionality related to these limitations (e.g. NE aborting a Trace Session due to resource limitations).

The objectives of the Trace specifications are:

- a) to provide the descriptions for a standard set of Trace data;
- b) to produce a common description of the management technique for Trace administration and result reporting;
- c) to define a method for Trace results reporting across the management interfaces.

The following is beyond the scope of the present document, and therefore the present document does not describe:

- tracing non-Subscriber or non-UE related events within an NE;
- tracing of all possible parties in a multi-party call (although multiple calls related to the IMSI specified in the Trace control and configuration parameters are traceable).

The definition of Trace data is intended to result in comparability of Trace data produced in a multi-vendor wireless UMTS and/or EPS network(s), for those Trace control and configuration parameters that can be standardised across all vendors' implementations.

Vendor specific extensions to the Trace control and configuration parameters and Trace data are discussed in 3GPP TS 32.422 [2] and 3GPP TS 32.423 [3].

---

# 2 References

The following documents contain provisions, which, through reference in this text, constitute provisions of the present document.

- References are either specific (identified by date of publication, edition number, version number, etc.) or non-specific.
- For a specific reference, subsequent revisions do not apply.
- For a non-specific reference, the latest version applies. In the case of a reference to a 3GPP document (including a GSM document), a non-specific reference implicitly refers to the latest version of that document *in the same Release as the present document*.

[1] 3GPP TS 32.101: "Telecommunication management; Principles and high level requirements".

[2] 3GPP TS 32.422: "Telecommunication management; Subscriber and equipment trace: Trace control and configuration management".



- [3] 3GPP TS 32.423: "Telecommunication management; Subscriber and equipment trace: Trace data definition and management".
- [4] 3GPP TS 23.002: "Network architecture".
- [6] 3GPP TS 29.207: "Policy control over Gs interface".
- [7] 3GPP TS 52.008: "Telecommunication management; GSM subscriber and equipment trace".
- [8] 3GPP TR 21.905: "Vocabulary for 3GPP Specifications".
- [9] void
- [10] 3GPP TS 33.401: "System Architecture Evolution (SAE); Security architecture".

NOTE: Overall management principles are defined in 3GPP TS 32.101 [1].

---

## 3 Definitions, symbols and abbreviations

### 3.1 Definitions

For the purposes of the present document, the terms and definitions given in 21.905 [8] and the following apply:

**Cell Traffic Trace:** The ability to trace one or more active calls in one or more cells.

**management activation/deactivation:** Trace Session is activated/deactivated in different NEs directly from the EM using the management interfaces of those NEs.

**Signalling Based Activation/Deactivation:** Trace Session is activated/deactivated in different NEs using the signalling interfaces between those elements so that the NEs may forward the activation/deactivation originating from the EM

**System Context:** two different realisations of the telecommunication management architecture. System Context A has the Itf-N between a Network Manager and an Element Manger. System Context B has the Itf-N between a Network Manager and a Network Element that has an embedded Element Manager. See figure 1 in TS 32.101 [1].

**Trace:** general term used for Subscriber and Equipment Trace.

**Trace record:** in the NE a Trace record is a set of Traceable data collected as determined by the Trace control and configuration parameters.

**Trace Recording Session:** time interval within a Trace Session while trace records are generated for the Subscriber or UE being traced. The triggering events starting and stopping a Trace Recording Session are defined in 3GPP TS 32.422 [2] (see figure 1).

**Trace Recording Session Reference:** identifies a Trace Recording Session within a Trace Session (see figure 1)

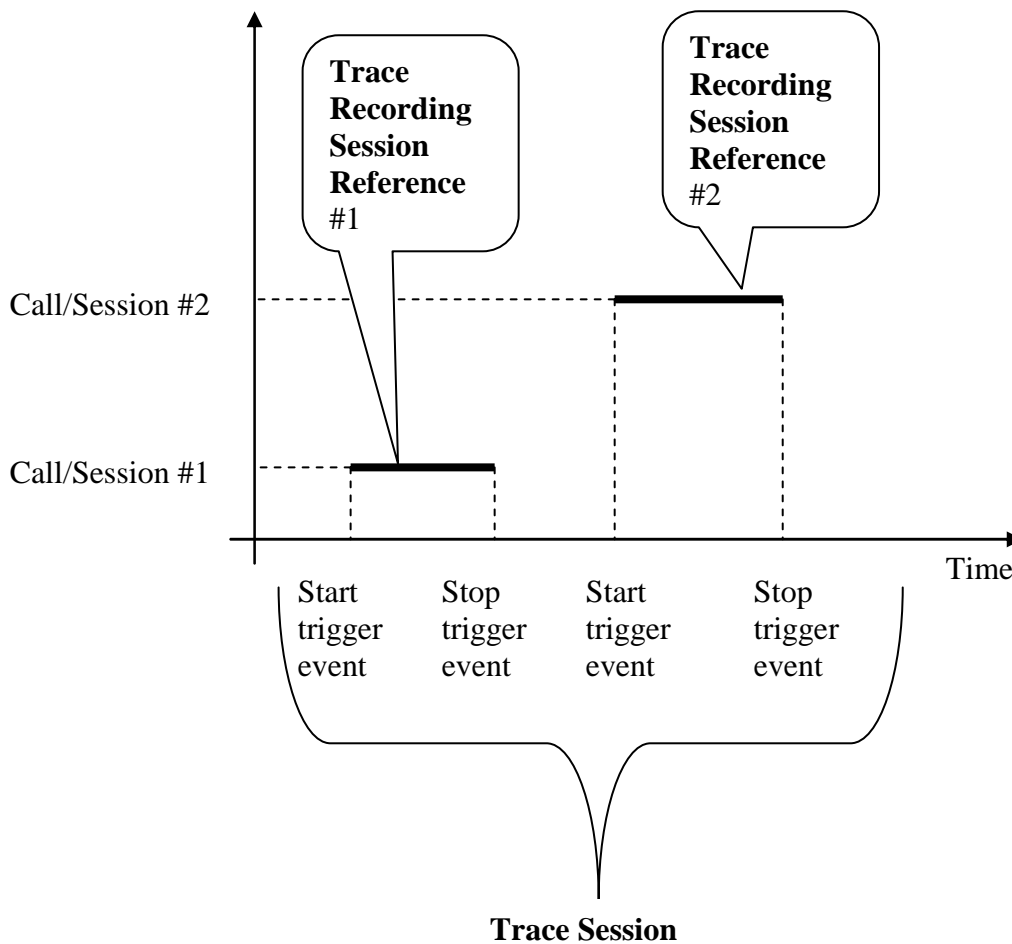
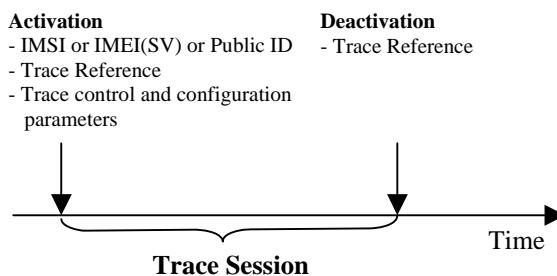

**Figure 1: Trace Recording Session**

Note that overlapping calls/sessions are possible for e.g. Cell Traffic Trace.

**Trace Reference:** identifies a Trace Session and is globally unique (see figure 2)

**Trace Session:** time interval started with a Trace Session Activation and lasts until the Deactivation of that specific Trace Session (see figure 2)



**Figure 2: Trace Session**

**Trace Parameter Configuration:** a technique whereby a request for tracing a certain Subscriber or UE is sent by the EM to the NE for execution.

**Trace Parameter Propagation:** a technique by which the NE processes the trace configuration (received from the EM or another NE) and sends it to the relevant Network Element(s) via signalling interface(s).

## 3.2 Abbreviations

For the purposes of the present document, the abbreviations given in 21.905 [8] and 32.101 [1] apply.

## 4 Trace concepts and high-level architecture

### 4.1 Trace concepts

The diversity of Trace requirements makes it difficult to identify and anticipate all the operator's specific needs. Thus, the objective of this TS is not to list an exhaustive set of information to meet all the requirements. Rather, Trace data is defined without any limitation on the 2 following dimensions:

- Trace scope: NEs and signalling interfaces to Trace.
- Trace depth: level of details of Trace data.

In order not to have any limitation of Trace data, there are six levels of details defined: Maximum, Minimum, Medium, MaximumWithoutVendorSpecificExtension, MinimumWithoutVendorSpecificExtension and MediumWithoutVendorSpecificExtension. The first three levels allow for vendor specific information to be traced and sent in the trace report file.

The Maximum (or MaximumWithoutVendorSpecificExtension) Levels allow all Trace data to be recorded. The other Levels provide a decoded subset of the data in the Maximum Level and allow an operator the flexibility in selecting the appropriate Trace data to record.

The Trace Depth, specified at the Trace Session activation, is used to choose the level of detail of information to retrieve on the Itf-N.

The Maximum (or MaximumWithoutVendorSpecificExtension) Levels of detail allow for retrieval of signalling interface messages within the Trace Scope in encoded format (see figure 4.1.1).

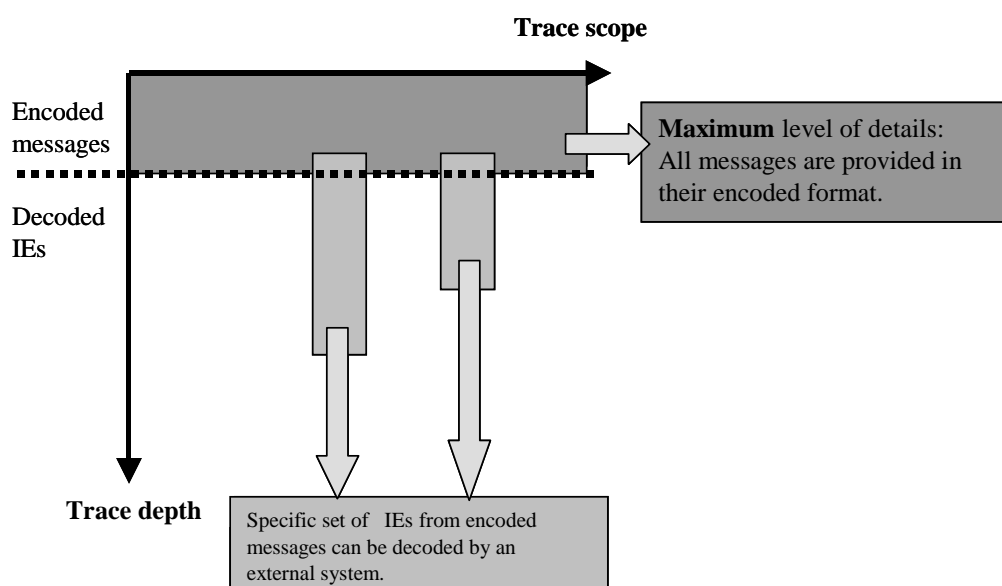
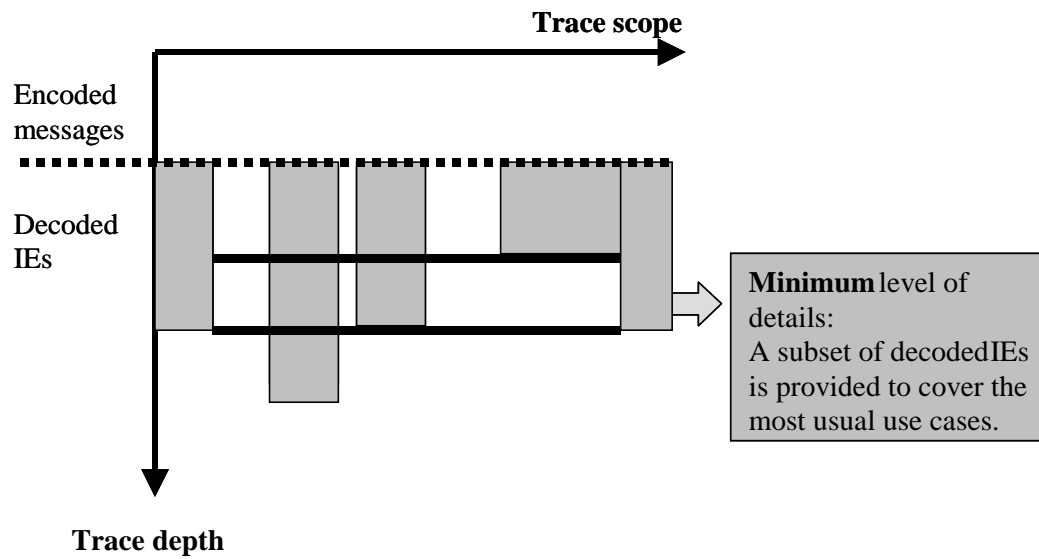

Figure 4.1.1: Maximum (or MaximumWithoutVendorSpecificExtension) Levels of details of Trace

The Minimum (or MinimumWithoutVendorSpecificExtension) Levels of detail allow for retrieval of a decoded subset of the IEs contained in the signalling interface messages (see figure 4.1.2).



**Figure 4.1.2: Minimum (or MinimumWithoutVendorSpecificExtension) Levels of detail of Trace**

The Medium (or MediumWithoutVendorSpecificExtension) Levels of detail allow for retrieval of the decoded subset of the IEs contained in the signalling interface messages in the Minimum Level plus a selected set of decoded radio measurement IEs.

The Trace data recorded at each Level is defined in 3GPP TS 32.423 [3].

## 4.2 Trace high level Architecture

There are two types of activation, management based activation and signalling based activation.

Figure 4.2.1 represents the high-level view of the architecture of Trace Management Based Activation/Deactivation. Figure 4.2.1 is only showing the interfaces in principle a high-level view. Details of Trace activation/deactivation are defined in 3GPP TS 32.422 [2].

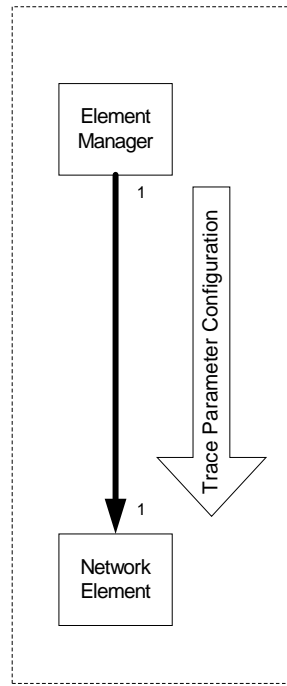

**Figure 4.2.1: Architecture for Management Based Activation/Deactivation**

Figure 4.2.2 represents the high-level view of the architecture of Signalling Based Activation/Deactivation. Figure 4.2.2 is only showing the interfaces in principle. Details of Trace activation/deactivation are defined in 3GPP TS 32.422 [2].

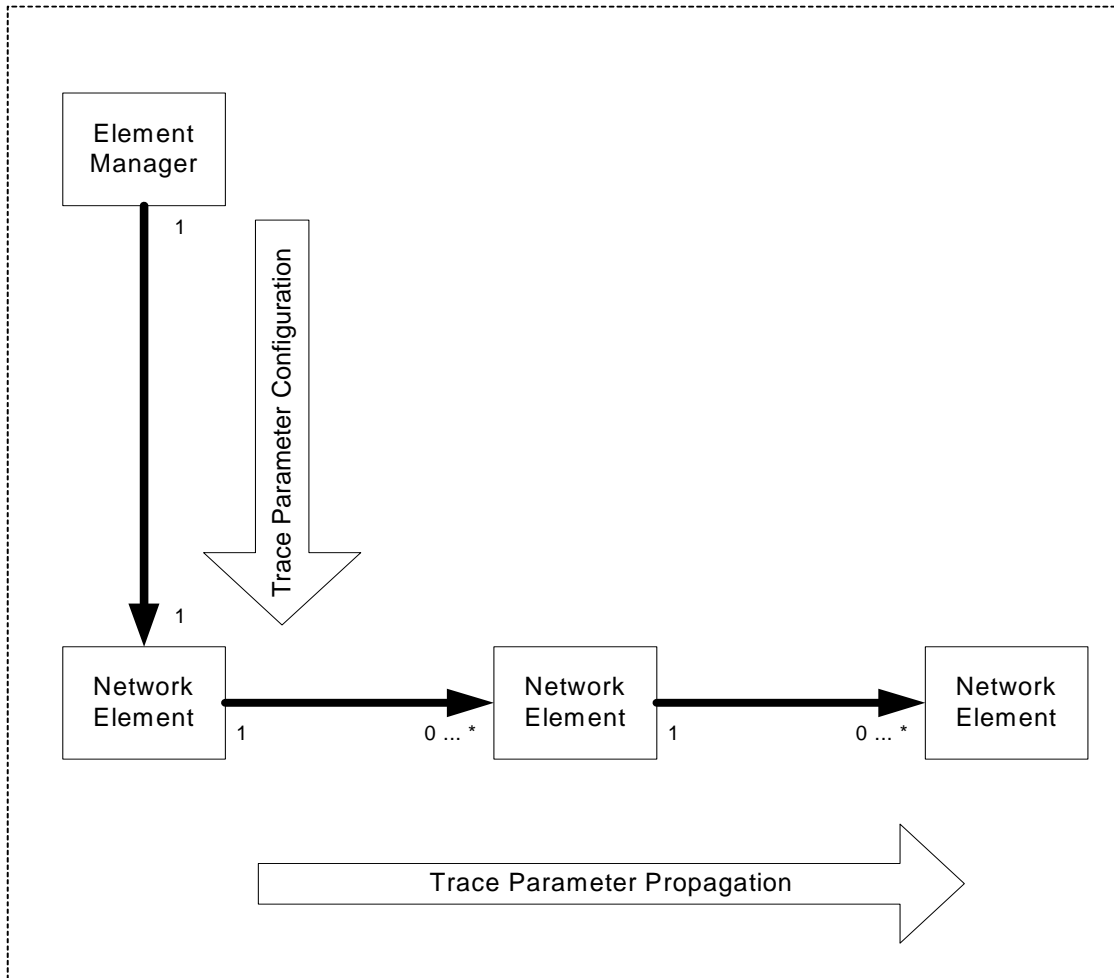
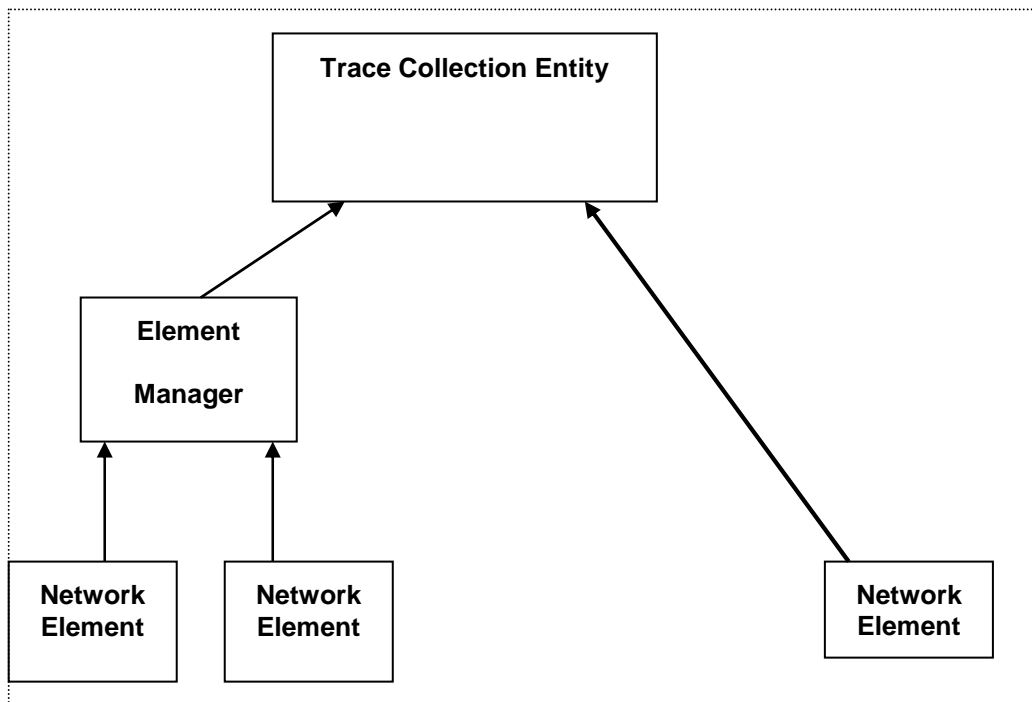

Figure 4.2.2: Architecture for Signalling Based Activation/Deactivation

Figure 4.2.3 represents the high-level view of the architecture of Trace Reporting for System Context A. Figure 4.2.3 is only showing the interfaces in principle.



**Figure 4.2.3: Architecture for High-level view of Trace Reporting in System Context A**

Figure 4.2.4 represents the high-level view of the architecture of Trace Reporting for System Context B. Figure 4.2.4 is only showing the interfaces in principle.

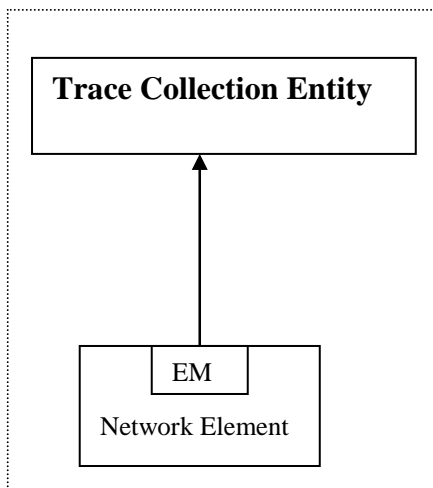

**Figure 4.2.4: Architecture for Trace Reporting in System Context B**

*Editor's note: The placement of the Trace Collection Entity is a deployment matter for the operator. If it is placed outside the operator's secure zone, it is up to the operator to use secure connections to and from the Trace Collection Entity.*

### 4.3 void

**Figure 4.3.3: Architecture for Trace Reporting from UE to support Service Level Tracing for IMS**



---

## 5 Trace requirements

### 5.1 General trace requirements

The general high-level requirements for Trace, common to both Management activation/deactivation and Signalling Based Activation/Deactivation, are as follows:

- for the Maximum Level: Trace data encompassing all signalling messages on the different interfaces dedicated to the events of the traced subscriber or UE with their entire content (all IEs) shall be retrieved. The operator can then use an external system (e.g. an Operations System (OS) in TMN terminology) and decode specific information in line with operator requirements.
- for the Minimum Level: a selected subset of IEs shall be retrieved from the signalling interface messages. The Minimum Level provides support for the most common use cases (described in annex A).
- for the Medium Level: a selected Minimum Level subset of IEs from the signalling interface messages and a selected set of radio measurement IEs shall be retrieved.
- for the MaximumWithoutVendorSpecificExtension Level: it is the same as for Maximum level without vendor specific data.
- for the MediumWithoutVendorSpecificExtension Level: it is the same as for Medium level without vendor specific data.
- for the MinimumWithoutVendorSpecificExtension Level: it is the same as for Minimum level without vendor specific data.

## 5.2 Requirements for Trace data

The high level requirements for Trace data, common to both Management activation/deactivation and Signalling Based Activation/Deactivation, are as follows:

- The Trace records have to contain Information Elements or signalling messages from control signalling and/or the characteristics of the user data. The following list contains the Network Elements and the Traceable interfaces in the NEs where tracing is needed:
  - MSC Server: A, Iu-CS, Mc and MAP (G, B, E, F, D, C) interfaces; CAP
  - MGW: Mc, Nb-UP, Iu-UP
  - HSS: MAP (C, D, Gc, Gr) Cx, S6a and S6d interfaces and location and subscription information
  - SGSN: Gb, Iu-PS, Gn, MAP (Gr, Gd, Gf), CAP (Ge) Gs, S6d, S4 and S3 interfaces
  - GGSN: Gn, Gi and Gmb interfaces
  - S-CSCF: Mw, Mg, Mr and Mi interfaces
  - P-CSCF: Gm and Go interfaces
  - RNC: Iu-CS, Iu-PS, Iur, Iub and Uu interfaces
  - BM-SC: Gmb interface
  - e-NodeB: S1-MME, X2, Uu
  - MME: S1-MME, S3, S6a, S10, S11
  - Serving Gateway: S4, S5, S8, S11
  - PDN Gateway: S2a, S2b, S2c, S5, S6b, Gx, S8, SGi
- A unique ID within a Trace Session shall be generated for each Trace Recording Session. This is called the Trace Recording Session Reference.

Changes to existing NEs and interfaces above may be required. These changes would be dependent upon various 3GPP working groups and possibly other non-3GPP industry groups for completion of Trace Session Activation/Deactivation.

For a detailed description of NEs and interfaces above see 3GPP TS 23.002 [4].

## 5.3 Requirements for Trace activation

### 5.3.1 Requirements for Trace Session activation

The high level requirements for Trace Session activation, common to both Management activation and Signalling based activation), are as follows:

- In the case of a subscriber Trace, the Trace Session will be activated for a certain subscriber whose identification (IMSI in UTRAN/CS/PS) shall be known in the NEs where subscriber Trace is needed. In the case of E-UTRAN the IMSI shall not be included in the Trace Parameter Propagation data to the e-NodeB.
- In the case of a UE Trace, the Trace Session will be activated for a certain UE whose identification (IMEI or IMEISV) shall be known in the NEs where UE Trace is needed. In the case of E-UTRAN, neither the IMEI nor IMEISV shall be included in the Trace Parameter Propagation data to the e-NodeB - Trace Session activation shall be possible for both home subscribers and visiting subscribers.
- There are two methods for Trace Session activation: Management activation and Signalling activation.
- For an established call/session within a Network Element, it is optional for the Network Element to start a Trace Recording Session for the associated Subscriber or UE upon receipt of the Trace activation request from the EM.

- A globally unique ID shall be generated for each Trace Session to identify the Trace Session. This is called the Trace Reference. The method for achieving this is to divide the Trace reference into Country, Operator, and trace Id.
- Trace Session may be activated from the EM simultaneously to multiple NEs with the same Trace Reference (i.e. same Trace Session).
- The Trace Scope and Depth shall be specified within the control and configuration parameters during Trace Session activation.
- There can be cases in a NE when it receives multiple Trace Session activations for the same connection (e.g. simultaneous CS/PS connections). In these cases the starting time of the Trace Session Activation and the starting time of the first Trace Recording Session is the same using signalling based activation. For these cases there are two different cases for the Trace Session activation in a Network Element when it receives another Trace Session activation to the same subscriber or MS:
  - If the Trace Reference is equal to an existing one, a new Trace Session shall not be started;
  - If the Trace Reference is not equal to an existing one, a new Trace Session may be started.
- The EM shall always provide the trace control and configuration parameters to the appropriate NEs at the time of Trace Session activation.
- The Trace collection entity shall be notified, in case of the Trace Session activation has failed, by the response message with the specific cause (e.g. overload) from the NE on which the Trace Session activation failure happened.

The high-level requirements for Trace Session activation, specific to Signalling Based activation, are as follows:

- Signalling based activation shall be able to capture signalling messages as early in a session as possible, e.g. by means of a piggybacked trace invocation message in the case of a new connection or new bearer setup

For active users, it shall be possible to start trace recording when the trace order is received, by means of a distinct trace invocation message.

The high-level requirements for Trace Session activation, specific to Management activation, are as follows:

- In the case of a subscriber Trace, the Trace Session will be activated for a certain subscriber whose identification (IMSI in UTRAN/CS/PS or Private ID in IMS) shall be known in the NEs where subscriber Trace is needed.  
In the case of a Cell Traffic Trace, Trace Session activation should be possible for all calls active in a cell or multiple cells without knowledge of the UEs' identification (IMEI or IMEISV).
- In the case of a Cell Traffic Trace, Trace Sessions should be activated for all the NEs where Cell Traffic Trace is specified.

### 5.3.2 Requirements for starting a Trace Recording Session

The high level requirements for starting a Trace Recording Session, common to both Management activation and Signalling based activation), are as follows:

- It is optional for the NE to start a Trace Recording Session if there are insufficient resources available within the NE.
- The Trace Recording Session Reference shall be unique within a Trace Session.
- The Trace Recording Session should be started after appropriate start trigger events are detected.

The high level requirements for starting a Trace Recording Session, specific to Management activation, are as follows:

- Each NE shall generate its own Trace Recording Session Reference (i.e., independent Trace Recording Sessions).
- Each NE shall start the Trace Recording Session based upon the Trace control and configuration parameters received by the NE in the Trace Session activation.
- In the case of a trace other than Cell Traffic Trace, the correlation of Trace data will be done with a Trace Reference and IMSI / IMEI / IMEISV / Private ID.
- The Trace Recording Session can start only when the IMSI (in the case of a subscriber trace), the IMEI / IMEISV (in case of UE trace) or Private ID (in the case of IMS) is made available in the NE. In order to trace the early phases of the call the IMSI (in case of subscriber trace), the IMEI / IMEISV (in case of UE trace) or Private ID (in case of IMS) shall be made available to the NE as soon as practically possible. E.g. the IMSI and IMEI / IMEISV shall be made available to both Serving RNC and Drift RNC.
- In the case of E-UTRAN the Core Network node that triggers a Trace Recording Session to E-UTRAN shall either:
  - provide a trace log including Trace Reference, Trace Recording Session Reference and the identity of the UE (i.e. IMSI or IMEI(SV)) to the Trace Collection Entity, or
  - provide a notification including Trace Reference, Trace Recording Session Reference and the identity of the UE (i.e. IMSI or IMEI(SV)) to the Trace Collection Entity.
- In the case of a Cell Traffic Trace, the Trace Recording Session should start upon the Trace control and configuration parameters being received by the NEs in the Trace Session activation and the presence of call activity. Furthermore, the the Core Network node that handles the traced session should be requested to:
  - provide a trace log including Trace Reference, Trace Recording Session Reference and the identity of the UE (i.e. IMSI or IMEI(SV)) to the Trace Collection Entity, or
  - provide a notification including Trace Reference, Trace Recording Session Reference and the identity of the UE (i.e. IMSI or IMEI(SV)) to the Trace Collection Entity.

## 5.4 Requirements for Trace deactivation

### 5.4.1 Requirements for Trace Session deactivation

The high level requirements for Trace Session deactivation, common to both Management deactivation and Signalling based deactivation, are as follows:

- The Trace Session shall be deactivated using the Trace Reference specified for the Trace Session activation.
- The Trace Session shall be deactivated in all those NEs where it was activated.
- The deactivation of a Trace Session during a Trace Recording Session within a NE may take place anytime after the NE receives the deactivation request until the end of the current Trace Recording Session related to the traced Subscriber or UE.
- Trace Session deactivation in a NE could occur when two simultaneous signalling connections for a subscriber or UE exist. E.g. figure 5.4.1 shows NE 3 having two signalling connections (one of them or both of them are traced with the same Trace Reference) and a Trace deactivation message is received. The Trace Session shall be closed.

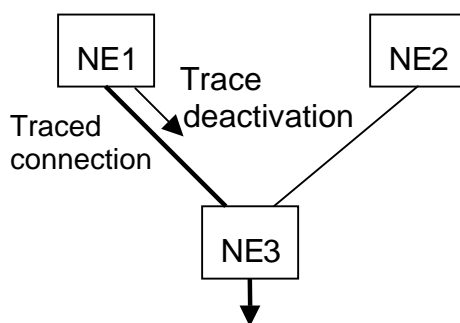

Figure 5.4.1: Trace Session closure

### 5.4.2 Requirements for stopping a Trace Recording Session

The high level requirements for stopping a Trace Recording Session, common to both Management deactivation and Signalling based deactivation, are as follows:

- The Trace Recording Session should be stopped after appropriate stop trigger events are detected.
- Trace Session deactivation in a NE could occur when two simultaneous signalling connections for a subscriber or UE exist. E.g. figure 5.4.2 shows NE3 having two signalling connections, but only one connection is traced. If the non-traced connection is released, the Trace Recording Session shall be kept in NE3. If the traced connection is released the Trace Recording Session shall be closed.

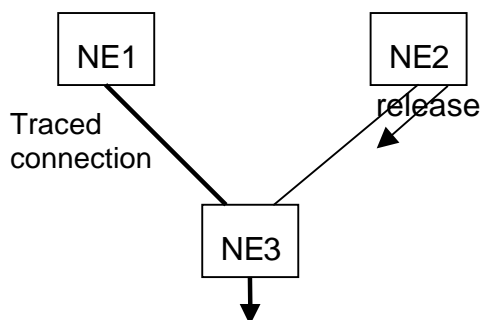

Figure 5.4.2: Trace Recording Session closure

The high level requirements for stopping a Trace Recording Session, specific to Signalling based deactivation, are as follows:

- The Trace Recording Session should be stopped after an NE receives the appropriate signalling deactivation message.

## 5.5 Requirements for Trace Data reporting

The high level requirements for Trace Data reporting, common to both Management activation/deactivation and Signalling Based Activation/Deactivation, are as follows (Trace record contents, file formats and file transfer mechanisms are defined in 3GPP TS 32.423 [3]):

- Trace records should be generated in each NE where a Trace Session has been activated and a Trace Recording Session has been started.
- Format of the Trace records sent over Itf-N shall be XML based on the Schema in TS 32.423 [3].
- Trace records should be transferred on the Itf-N to the Network Manager using one of two approaches: direct transfer from NE to NM or transfer from NE to NM via EM.
- Trace records may also be transferred to an external IP address (received in Trace Control and Configuration Parameters) in 3 ways:
  1. Direct transfer from NE to IP address
  2. Transfer from NE to IP address via EM
  3. Transfer from NE to EM. The EM notifies the holder of the IP address that collects the files.

For transfer of Trace records via Itf-N, FTP or secure FTP shall be used.

## 5.6 Requirements for Privacy and Security

As the radio access nodes in E-UTRAN are outside an operator's secure domain, the following requirement applies for E-UTRAN as described in 3GPP TS 33.401 [10]:

- [SET-SEC-1] Keys stored inside eNBs shall never leave a secure environment within the eNB. When security key(s) transported on control signalling messages are included in the trace file, the key value(s) shall be removed and replaced with the value 'Unavailable'.

## 5.7 void



## 5.8 Use cases for Trace

The operator can use Subscriber and UE Trace for numerous purposes. However, the use cases for Trace can be divided into two basic categories:

- Troubleshooting use cases cover situations where the operator is solving an existing problem in his network;
- Validation testing use cases cover situations where the operator is not solving a known problem but merely analysing, fine-tuning or optimising his network.

A more detailed description for the following use cases for Subscriber and UE Trace can be found in annex A:

- Interoperability checking between UE from different vendors;
- QoS profile checking for a subscriber after a subscriber complaint;
- Malfunctioning UE;
- Checking radio coverage in a certain area;
- Testing new features;
- Fine-tuning and optimisation of algorithms or procedures.

---

## Annex A (informative): Trace use cases

### A.1 Use case #1: multi-vendor UE validation

#### A.1.1 Description

The aim of this use case is to check how different vendor's UEs are working (e.g. in field testing) in the mobile network or to get detailed information on the UE.

The study can be started by an initiative from operator for verification of UE from different vendors (e.g. testing how the UE fulfils the requirements set by the standards).

The operator can perform the test using test UEs or tracing subscribers' mobiles.

#### A.1.2 Example of required data for this use case

The Trace parameters required to cover use case #1 are listed below:

- Tracing is needed in the Radio Network (RNC) or in the Core Network (MSS, SGSN);
- The identification of the Trace case shall be IMEI or IMEISV (and possibly IMSI);
- The level of details usually is to get the most important IEs from the signalling messages (Medium Level) or all messages with their encoded IEs (Maximum Level).

The traceable protocols are:

- In RNC: RRC, NBAP, RNSAP, RANAP.
- In MSS/SGSN: DTAP messages.

---

### A.2 Use case #2: subscriber complaint

#### A.2.1 Description

The aim of this use case is to check how the complaining subscriber's services are working, to get information on the services in order to find out the reason for the complaint.

The study can be started after a subscriber is complaining at his/her home or visited operator that some of the service to which he/she subscribed is not working. E.g. the subscriber:

- cannot make calls;
- cannot use some supplementary service;
- does not get the negotiated QoS level (e.g. Mobile subscriber activates video-streaming application to watch the latest sport events and every time the subscriber tries to connect to the service the system disconnects the subscriber's UMTS bearer).

As the Trace is activated for a subscriber, the signalling based Trace Session activation shall be used, as the location of the subscriber is not known.

## A.2.2 Example of required data for this use case

The Trace parameters required to cover the use case #2 are listed below:

- The list of NEs where tracing may be needed depends on the service being complained about by the subscriber. For this use case, tracing should be possible in all network elements, such as: HSS, MSS, RNC, MGW, SGSN, GGSN.
- The identification of the subscriber in a Trace is IMSI in UTRAN/CS/PS. The identification of the UE in a Trace is IMEI or IMEISV.
- The data includes those Information Elements from the signalling messages, which are related to the service(s) being complained about by the subscriber (Medium Level).

Example cases, which can be the basis for subscriber complaint:

1. The subscriber's CS call is misrouted

This illustrates an instance where a subscriber complains that his calls are being cross-connected (or misrouted). Such a complaint involves setting up a Trace at all the 3GPP standardised interfaces being handled by the MSC. However, the Trace functionality shall not cover MSC internal or vendor proprietary interfaces. The Trace record shall need to have the dialled number and connected number.

2. The subscriber's call is dropped

Tracing data is required from the radio network (UTRAN) or from the core network (MSS, SGSN, GGSN). In the radio network the radio coverage shall be checked. See use case #4 (checking radio coverage). Beside the radio coverage, other information can be useful as well, like RLC parameter, power information (OLPC or RRC measurement report), error ratios (BLER / BER, SDU error ratio), etc. Tracing in the core network is needed also, if the problem is not in the radio network. E.g. in case of PS domain the call can be dropped by the application due to the long delays or congestions in TCP layer or due to bad QoS. Thus in SGSN the requested and negotiated QoS parameters should be included in the Trace record.

3. The received QoS level is less than the negotiated level.

To be able to solve the possible problem Tracing data is required from HSS, SGSN, GGSN, and UTRAN. Furthermore in case of problem in CS calls tracing in MGW shall be performed.

From HSS Trace data the operator can monitor whether the subscriber's authentication to the network is successful, and what kind of QoS parameters are allowed to the subscriber. From SGSN Trace data the operator can monitor PDP context creation request from mobile. Request seems to contain legal QoS profile (incl. Maximum bandwidth, guaranteed bandwidth etc) and the local resources in SGSN are available to provide the service as requested by the subscriber. From UTRAN Trace data the operator can monitor whether the maximum bandwidth and guaranteed bandwidth, requested by SGSN, acceptable for UTRAN. Thus to check whether UTRAN can provide and maintain the requested radio access bearer services. From GGSN Trace data the operator can monitor PDP context activation between SGSN and GGSN. If the problem is in the CS domain the MGW Trace can provide the QoS data.

---

## A.3 Use case #3: malfunctioning UE

### A.3.1 Description

The aim of this use case is to check a UE, which is not working correctly.

The study can be initiated by the operator when he/she suspects that a UE not working according to the specifications or he/she would like to get more information on a specific UE, which is on the grey or black EIR list.

### A.3.2 Example of required data for this use case

The Trace parameters required to cover the use case #3 are listed below:

- UE Tracing may be needed in the Radio Network (UTRAN) or in the Core Network (MSS, SGSN).
- The identification of the subscriber in a Trace is IMSI. The identification of the UE in a Trace is IMEI or IMEISV.
- The level of details depends on the operator needs (either Minimum Level or Medium Level).

The malfunction of UE in UTRAN can occur in different places. The problem can be in basic RRC and RANAP signalling, Radio Bearer procedures, Handover procedures, Power control etc.

Therefore, all RRC, RANAP, NBAP, RNSAP signalling procedures, transmission powers, error ratios (BLER / BER, SDU error ratio) and retransmission can be included in the Trace records.

---

## A.4 Use case #4: checking radio coverage

### A.4.1 Description

This use case aims at checking the radio coverage on a particular network area.

This study can be started by an initiative from operator for testing radio coverage on a particular geographical area following network extension for instance (e.g. new site installation).

The operator can perform a drive test on the new site area, and check that radio coverage is correct, or may collect Cell Traffic Trace data on all of the cells active in the area of interest.

### A.4.2 Example of required data to cover use case #4

The DL radio coverage can be checked using the values of CPICH  $E_c/N_0$  and RSCP measured by the mobile on the cells in the active set and the monitored set. These measurements are sent to the RNC through the RRC message MEASUREMENT REPORT.

The UTRAN Trace record intra frequency measurement contains the required information.

The UTRAN Trace record inter frequency, and inter RAT measurements can also be used to check radio coverage with other frequencies or systems.

After a network extension, the operator can check that  $E_c/N_0$  and RSCP levels on the new site area are the expected ones, and there is no coverage hole.

The following Trace parameters are required to cover use case #4:

- The type of NE to Trace is RNC.

- The identification of the subscriber in a Trace is IMSI. The identification of the UE in a Trace is IMEI or IMEISV.
- In the case of a Cell Traffic Trace, the identification of the cells where Trace data is to be collected.
- The Trace data to retrieve shall contain the messages with all IEs that are relevant for radio coverage.

---

## A.5 Use case #5: testing a new feature

### A.5.1 Description

This use case aims at testing the implementation of a new feature in the network before its general deployment. The functionality can be either a standard feature or a vendor/operator specific feature.

This study is started by an initiative from the operator.

The operator can perform a drive test on the area where the feature is introduced, and check its good behaviour as well as its benefits, in term of quality or capacity. He can also rely on subscribers' Trace data when they use the feature to be tested.

### A.5.2 Example of required data to cover use case #5

Depending on the feature, the list of NEs to Trace, as well as the level of details can be different.

For a feature concerning Core and UTRAN networks, for instance hard handover, SRNS relocation, or new UMTS bearer service, the operator needs to activate Trace on several NEs.

Then, the operator can be interested in:

- Only the protocol messages generated by the feature; or
- The impact of the new feature introduction on the network, for instance, the radio coverage, the capacity, the quality, or the behaviour of the existing algorithms.

In this last case, the operator needs more detailed data, for instance messages with all (Maximum Level) or part of the IEs (Minimum Level).

The following Trace parameters are required to cover use case #5:

- The types of NEs to Trace are NEs that can be traced related to the feature.
- The identification of the subscriber in a Trace is IMSI. The identification of the UE in a Trace is IMEI or IMEISV.
- The Trace data to retrieve can be either only the protocol messages (Maximum Level) or the messages with all or part of the IEs (Minimum Level).

---

## A.6 Use case #6: fine-tuning and optimisation of algorithms/procedures

### A.6.1 Description

Subscriber and UE Trace is part of the optimisation process. Trace data are used to get feedback on the network quality and capacity after optimisation operations like parameter fine-tuning, or new network design. Each intervention to improve the network behaviour can be confirmed both by measurement data and Trace data.

This study is started following an initiative from the operator.

The operator can perform a drive test on the area and/or activate a Cell Traffic Trace where the optimisation has been performed, and check its good behaviour as well as its impact on the network. He can also rely on subscribers' Trace data when they use the network to be optimised.

## A.6.2 Example of required data to cover use case #6

Depending on the optimisation operation, the list of NEs to Trace, as well as the level of details can be different. But generally, fine-tuning activities like scrambling code plan, handover and relocation algorithms, or call admission algorithm optimisation concern a very specific part of the network.

To cover this use case, the operator is usually searching for the highest level of details, on specific NEs.

The following Trace parameters are required to cover use case #6:

- The types of NEs to Trace are any NE that can be traced related to the network to be optimised.
- The identification of the subscriber in a Trace is IMSI. The identification of the UE in a Trace is IMEI or IMEISV.
- In the case of a Cell Traffic Trace, the identification of the cells where Trace data is to be collected.
- The Trace data to retrieve are the messages in encoded format with all (Maximum Level) or part of the IEs (Minimum Level).

---

A.7 void

A.7.1 void

---

A.8 void

A.8.1 void

---

A.9 void

A.9.1 void

---

A.10 void

A.10.1 void

## Annex B (informative): Change history

Change history								
Date	TSG #	TSG Doc.	CR	Rev	Subject/Comment	Cat	Old	New
Jun 2002	SA_16	SP-020330	--	--	Submitted to SA #16 for Information	--	1.0.0	
Dec 2002	SA_18	SP-020755	--	--	Submitted to SA #18 for Approval	--	2.0.0	6.0.0
Mar 2003	SA_19	SP-030147	0001	--	Corrections to Trace requirements - alignment with SA2's 23.002	F	6.0.0	6.1.0
Dec 2003	SA_22	SP-030612	0002	--	Correction of IMS subscriber identification for Trace	F	6.1.0	6.2.0
Mar 2004	SA_23	SP-040116	0003	--	Correction in Trace high level architecture	F	6.2.0	6.3.0
Sep 2004	SA_25	SP-040542	0004	--	Removal of GERAN from Rel-6 32.42x series of Trace specifications	F	6.3.0	6.4.0
Dec 2004	SA_26	SP-040770	0005	--	Remove requirement for having ASN.1 as Trace record format	C	6.4.0	6.5.0
Dec 2004	SA_26	SP-040770	0006	--	Remove in Rel-6 the signalling based Trace in IMS due to missing SIP signalling support from CN1/IETF	C	6.4.0	6.5.0
Mar 2005	SA_27	SP-050043	0007	--	Remove ambiguity on the file format for trace data at the Network Elements (NEs)	F	6.5.0	6.6.0
Mar 2005	SA_27	SP-050043	0008	--	Correction to the Scope	F	6.5.0	6.6.0
Mar 2005	SA_27	SP-050043	0009	--	Correct the list of interfaces trace parameter – Align with 32.422 and 32.423	F	6.5.0	6.6.0
Jun 2005	SA_28	SP-050294	0010	--	BM-SC Network Element and Gmb interface addition for MBMS tracing	B	6.6.0	6.7.0
Sep 2005	SA_29	SP-050623	0011	--	Add support for UTRAN TDD - Declare RAT Type	B	6.7.0	7.0.0
Mar 2006	SA_31	SP-060100	0012	--	Introduction of Service Level Tracing for IMS	B	7.0.0	7.1.0
Sep 2006	SA_33	SP-060552	0013	--	Add Cell Traffic Trace capability to 32.421 Trace concepts and requirements	C	7.1.0	7.2.0
Sep 2007	SA_37	SP-070614	0014	--	Add extended trace depth to include Vendor Specific Extension (VSE)	C	7.2.0	8.0.0
Sep 2007	SA_37	SP-070614	0015	--	Add LTE nodes and interfaces	C	7.2.0	8.0.0
Mar 2008	SP-39	SP-080069	0016	--	Add trace functionality for E-UTRAN	B	8.0.0	8.1.0
Mar 2008	SP-39	SP-080069	0017	--	Add trace activation failure response	B	8.0.0	8.1.0
Jun 2008	SP-40	SP-080329	0018	--	Introduction of UE identifiers for trace in E-UTRAN	C	8.1.0	8.2.0
Sep 2008	SP-41	SP-081260	0019	--	Change the description for Trace Recording Session Reference	C	8.2.0	8.3.0
Dec 2008	SP-42	SP-080846	0020	--	Correction of trace depth extensions	F	8.3.0	8.4.0
Jun 2009	SP-44	SP-090289	0022	--	Add missing Trace Interface for SGSN and HSS list	F	8.4.0	8.5.0
Mar 2010	SP-47	SP-100034	0023	--	Align the handling of security keys for E-UTRAN with 33.401	F	8.5.0	8.6.0
June 2013	SP-60	SP-130302	0068	-	Remove IMS Service Level Trace	A	8.6.0	8.7.0



---

# History

<b>Document history</b>		
V8.4.0	January 2009	Publication
V8.5.0	July 2009	Publication
V8.6.0	April 2010	Publication
V8.7.0	July 2013	Publication