

ETSI TS 132 274 V14.2.0 (2017-07)



**Digital cellular telecommunications system (Phase 2+) (GSM);
Universal Mobile Telecommunications System (UMTS);
LTE;
Telecommunication management;
Charging management;
Short Message Service (SMS) charging
(3GPP TS 32.274 version 14.2.0 Release 14)**



Reference

RTS/TSGS-0532274ve20

Keywords

GSM,LTE,UMTS

ETSI

650 Route des Lucioles
F-06921 Sophia Antipolis Cedex - FRANCE

Tel.: +33 4 92 94 42 00 Fax: +33 4 93 65 47 16

Siret N° 348 623 562 00017 - NAF 742 C
Association à but non lucratif enregistrée à la
Sous-Préfecture de Grasse (06) N° 7803/88

Important notice

The present document can be downloaded from:

<http://www.etsi.org/standards-search>

The present document may be made available in electronic versions and/or in print. The content of any electronic and/or print versions of the present document shall not be modified without the prior written authorization of ETSI. In case of any existing or perceived difference in contents between such versions and/or in print, the only prevailing document is the print of the Portable Document Format (PDF) version kept on a specific network drive within ETSI Secretariat.

Users of the present document should be aware that the document may be subject to revision or change of status.

Information on the current status of this and other ETSI documents is available at

<https://portal.etsi.org/TB/ETSIDeliverableStatus.aspx>

If you find errors in the present document, please send your comment to one of the following services:

<https://portal.etsi.org/People/CommiteeSupportStaff.aspx>

Copyright Notification

No part may be reproduced or utilized in any form or by any means, electronic or mechanical, including photocopying and microfilm except as authorized by written permission of ETSI.

The content of the PDF version shall not be modified without the written authorization of ETSI.

The copyright and the foregoing restriction extend to reproduction in all media.

© ETSI 2017.

All rights reserved.

DECT™, PLUGTESTS™, UMTS™ and the ETSI logo are trademarks of ETSI registered for the benefit of its Members.

3GPP™ and LTE™ are trademarks of ETSI registered for the benefit of its Members and of the 3GPP Organizational Partners.

oneM2M logo is protected for the benefit of its Members.

GSM® and the GSM logo are trademarks registered and owned by the GSM Association.

Intellectual Property Rights

IPRs essential or potentially essential to the present document may have been declared to ETSI. The information pertaining to these essential IPRs, if any, is publicly available for **ETSI members and non-members**, and can be found in ETSI SR 000 314: "*Intellectual Property Rights (IPRs); Essential, or potentially Essential, IPRs notified to ETSI in respect of ETSI standards*", which is available from the ETSI Secretariat. Latest updates are available on the ETSI Web server (<https://ipr.etsi.org>).

Pursuant to the ETSI IPR Policy, no investigation, including IPR searches, has been carried out by ETSI. No guarantee can be given as to the existence of other IPRs not referenced in ETSI SR 000 314 (or the updates on the ETSI Web server) which are, or may be, or may become, essential to the present document.

Foreword

This Technical Specification (TS) has been produced by ETSI 3rd Generation Partnership Project (3GPP).

The present document may refer to technical specifications or reports using their 3GPP identities, UMTS identities or GSM identities. These should be interpreted as being references to the corresponding ETSI deliverables.

The cross reference between GSM, UMTS, 3GPP and ETSI identities can be found under <http://webapp.etsi.org/key/queryform.asp>.

Modal verbs terminology

In the present document "**shall**", "**shall not**", "**should**", "**should not**", "**may**", "**need not**", "**will**", "**will not**", "**can**" and "**cannot**" are to be interpreted as described in clause 3.2 of the [ETSI Drafting Rules](#) (Verbal forms for the expression of provisions).

"**must**" and "**must not**" are **NOT** allowed in ETSI deliverables except when used in direct citation.

Contents

Intellectual Property Rights	2
Foreword.....	2
Modal verbs terminology.....	2
Foreword.....	5
1 Scope	6
2 References	7
3 Definitions and abbreviations.....	8
3.1 Definitions	8
3.2 Symbols.....	8
3.3 Abbreviations	8
4 Architecture considerations	9
4.1 High level SMS architecture	9
4.2 SMS offline charging architecture.....	9
4.3 SMS online charging architecture	9
5 SMS charging principles and scenarios.....	10
5.1 SMS charging principles	10
5.1.1 General principles	10
5.1.2 Segmentation and concatenation.....	10
5.1.3 Triggers for generation of charging information	10
5.1.4 SMS via T4	11
5.2 SMS offline charging scenarios.....	12
5.2.1 Basic principles.....	12
5.2.2 Rf message flows	13
5.2.2.0 Introduction	13
5.2.2.1 SMS Submission to SMS-SC.....	13
5.2.2.2 SMS Delivery from SMS-SC.....	14
5.2.2.3 Delivery Report.....	14
5.2.2.4 Device Triggering using T4	15
5.2.2.4.1 SMS submission to SMS-SC for Device Triggering	15
5.2.2.4.2 SMS Delivery from SMS-SC for Device Triggering	15
5.2.2.4.3 SMS Device Triggering Delivery Report	17
5.2.2.4.4 SMS submission to SMS-SC for Device Triggering - Replace procedure	17
5.2.2.4.5 SMS submission to SMS-SC for Device Triggering - Recall procedure.....	17
5.2.2.5 Offline charging error cases - Diameter procedures.....	18
5.2.2.6 MSISDN-less SMS MO via T4.....	18
5.2.2.6.1 Introduction	18
5.2.2.6.2 MSISDN-less SMS MO via T4 - successful case.....	18
5.2.2.6.3 MSISDN-less SMS MO via T4 - error cases.....	19
5.2.2.6.3.1 MSISDN-less SMS MO via T4 - failure at submission to SMS-SC.....	19
5.2.2.6.3.2 MSISDN-less SMS MO via T4 - failure at the MTC-IWF.....	20
5.2.3 CDR generation	22
5.2.3.0 Triggers for SMS CDR generation.....	22
5.2.3.1 Triggers for SMS CDR charging information collection	22
5.2.3.2 Triggers for SMS CDR charging information addition.....	22
5.2.3.3 Triggers for SMS CDR closure.....	22
5.2.4 Ga record transfer flows	22
5.2.5 B _{sm} CDR file transfer.....	22
5.3 SMS online charging scenarios	23
5.3.1 Basic principles.....	23
5.3.2 R _o message flows	24
5.3.2.1 Simple submission	24
5.3.2.2 Enhanced submission	25
5.3.2.3 Delivery report	25

5.3.2.4	Origination retry	26
5.3.2.5	Termination charge	28
5.3.2.6	Termination charge retry	30
5.3.2.7	Unsuccessful transaction	32
5.3.2.8	IMS/SMS Interworking Messages Charging	34
5.3.2.9	Simple Submission with SM service request	37
5.3.2.10	Void	38
5.3.2.11	Device Triggering using T4	38
5.3.2.11.1	SMS submission to SMS-SC for Device Triggering	38
5.3.2.11.2	SMS Delivery from SMS-SC for Device Triggering	38
5.3.2.11.3	Unsuccessful SMS Delivery from SMS-SC for Device Triggering	41
5.3.2.11.4	SMS submission to SMS-SC for Device Triggering - Replace procedure	43
5.3.2.11.5	SMS submission to SMS-SC for Device Triggering - Recall procedure	43
5.3.2.12	MSISDN-less SMS MO via T4	44
5.3.2.12.1	Introduction	44
5.3.2.12.2	MSISDN-less SMS MO via T4 - successful case	45
5.3.2.12.3	MSISDN-less SMS MO via T4 - error cases	46
5.3.2.12.3.1	MSISDN-less SMS MO via T4 - failure at submission to SMS-SC	46
5.3.2.12.3.2	MSISDN-less SMS MO via T4 - failure at the MTC-IWF	46
5.3.3	Credit-Control related	48
5.3.3.1	Triggers for stopping for an SMS Credit-Control session	48
5.3.3.2	Triggers for providing interim information for a SMS Credit-Control session	48
6	Definition of charging information	49
6.1	Data description for SMS offline charging	49
6.1.1	R _f message contents	49
6.1.1.1	Summary of offline charging message formats	49
6.1.1.2	Structure for the offline charging message formats	49
6.1.1.2.1	Charging Data Request message	49
6.1.1.2.2	Charging Data Response message	50
6.1.2	G _a message contents	50
6.1.3	CDR description on the B _{sm} interface	50
6.1.3.1	CDR field types	50
6.1.3.2	CDR triggers	50
6.1.3.3	SC-SMO CDR content	51
6.1.3.4	SC-SMT CDR content	54
6.1.3.5	SC-DVT-T4 CDR content	56
6.1.3.6	SC-SMO-T4 CDR content	57
6.2	Data description for SMS online charging	58
6.2.1	R _o message contents	58
6.2.1.0	Introduction	58
6.2.1.1	Summary of message formats	59
6.2.1.2	Structure for the Credit-Control message formats	59
6.2.1.2.1	Debit/Reserve Units Request message	59
6.2.1.2.2	Debit / Reserve Units Response message	60
6.3	SMS charging specific parameters	61
6.3.1	Definition of the SMS charging information	61
6.3.1.1	SMS charging information assignment for Service Information	61
6.3.1.2	Definition of the SMS Information	62
6.3.1A	Detailed message format for offline charging	64
6.3.2	Formal parameter description	66
6.3.2.1	SMS charging information for CDRs	66
6.3.2.2	SMS charging information for charging events	66
6.3.3	Detailed message format for online charging	66
6.4	Bindings for SMS charging	69
Annex A (informative):	Bibliography	70
Annex B (informative):	Change history	71
History		73

Foreword

This Technical Specification has been produced by the 3rd Generation Partnership Project (3GPP).

The contents of the present document are subject to continuing work within the TSG and may change following formal TSG approval. Should the TSG modify the contents of the present document, it will be re-released by the TSG with an identifying change of release date and an increase in version number as follows:

Version x.y.z

where:

- x the first digit:
 - 1 presented to TSG for information;
 - 2 presented to TSG for approval;
 - 3 or greater indicates TSG approved document under change control.
- y the second digit is incremented for all changes of substance, i.e. technical enhancements, corrections, updates, etc.
- z the third digit is incremented when editorial only changes have been incorporated in the document.

1 Scope

The present document is part of a series of Technical Specifications (TSs) that specify charging functionality and charging management in GSM/UMTS and EPS networks. The GSM/UMTS and EPS core network charging architecture and principles are specified in TS 32.240 [2], which provides an umbrella for other charging management TSs that specify:

- the content of the CDRs per domain / subsystem / service (offline charging);
- the content of real-time charging messages per domain / subsystem / service (online charging);
- the functionality of online and offline charging for those domains / subsystems / services;
- the interfaces that are used in the charging framework to transfer the charging information (i.e. CDRs or charging events).

The complete document structure for these TSs is defined in TS 32.240 [2].

The present document specifies the Offline and Online Charging description for the Short Message Service (SMS), based on the functional description in TS 23.040 [7], TS 23.204 [8] for SMS over IP, and TS 23.682 [17] for SMS procedures using T4. The present document does not replace existing offline SMS charging functionality defined for Circuit Switched in TS 32.250 [9] and for Packet Switched in TS 32.251 [10], and therefore is in addition to those specifications. This charging description includes the offline and online charging architecture and scenarios specific to SMS, as well as the mapping of the common 3GPP charging architecture specified in TS 32.240 [2] onto SMS. It further specifies the structure and content of the CDRs for offline charging, and the charging events for online charging. The present document is related to other 3GPP charging TSs as follows:

- The common 3GPP charging architecture is specified in TS 32.240 [2];
- The parameters, abstract syntax and encoding rules for the CDRs are specified in TS 32.298 [3];
- A transaction based mechanism for the transfer of CDRs within the network is specified in TS 32.295 [6];
- The file based mechanism used to transfer the CDRs from the network to the operator's billing domain (e.g. the billing system or a mediation device) is specified in TS 32.297 [5];
- The 3GPP Diameter application that is used for SMS offline and online charging is specified in TS 32.299 [4].

Furthermore, requirements that govern the charging work are specified in TS 22.115 [102].

2 References

The following documents contain provisions which, through reference in this text, constitute provisions of the present document.

- References are either specific (identified by date of publication, edition number, version number, etc.) or non-specific.
- For a specific reference, subsequent revisions do not apply.
- For a non-specific reference, the latest version applies. In the case of a reference to a 3GPP document (including a GSM document), a non-specific reference implicitly refers to the latest version of that document *in the same Release as the present document*.

- [1] 3GPP TR 21.905: "Vocabulary for 3GPP Specifications".
- [2] 3GPP TS 32.240: "Telecommunication management; Charging management; Charging architecture and principles".
- [3] 3GPP TS 32.298: "Telecommunication management; Charging management; Charging Data Record (CDR) parameter description".
- [4] 3GPP TS 32.299: "Telecommunication management; Charging management; Diameter charging application".
- [5] 3GPP TS 32.297: "Telecommunication management; Charging management; Charging Data Record (CDR) file format and transfer".
- [6] 3GPP TS 32.295: "Telecommunication management; Charging management; Charging Data Record (CDR) transfer".
- [7] 3GPP TS 23.040: "Technical realization of Short Message Service (SMS)".
- [8] 3GPP TS 23.204: "Support of Short Message Service (SMS) over generic 3GPP Internet Protocol (IP) access; Stage 2".
- [9] 3GPP TS 32.250: "Telecommunication management; Charging management; Circuit Switched (CS) domain charging".
- [10] 3GPP TS 32.251: "Telecommunication management; Charging management; Packet Switched (PS) domain charging".
- [11] 3GPP TS 32.296: "Telecommunication management; Charging management; Online Charging System (OCS) applications and interfaces".
- [12] IETF RFC 4006: "Diameter Credit-Control Application".
- [13] 3GPP TS 32.270: "Telecommunication management; Charging management; Multimedia Messaging Service (MMS) charging".
- [14] 3GPP TS 23.038: "Alphabets and language-specific information".
- [15] 3GPP TS 32.260: "Telecommunication management; Charging management; IP Multimedia Services (IMS) charging".
- [16] 3GPP TS 22.142: "Value Added Services (VAS) for Short Message Service (SMS) requirements".
- [17] 3GPP TS 23.682: "Architecture enhancements to facilitate communications with packet data networks and applications".
- [18] 3GPP TS 29.337: "Diameter-based T4 interface for communications with packet data networks and applications".
- [19]-[99] Void.
- [100]-[199] Void.

[200] 3GPP TS 29.338: "Diameter based protocols to support Short Message Service (SMS) capable Mobile Management Entities (MMEs)".

3 Definitions and abbreviations

3.1 Definitions

For the purposes of the present document, the terms and definitions given in TR 21.905 [1], TS 32.240 [2] and the following apply. A term defined in the present document takes precedence over the definition of the same term, if any, in TR 21.905 [1] or TS 32.240 [2].

SMS node: An SMS node, in the present document, refers to either an SMS router, IP-SM-GW, SMS-SC or a combination of these nodes.

3.2 Symbols

For the purposes of the present document, the following symbols apply:

Bsm	Reference point for the CDR file transfer from SMS CGF to the BD,
Ga	Reference point for CDR transfer between a CDF and the CGF.
Rf	Offline charging reference point between a 3G network element and the CDF.
Ro	Online charging reference point between a 3G network element and the OCS.T4 Reference point used between MTC-IWF and the SMS-SC in the HPLMN.

3.3 Abbreviations

For the purposes of the present document, the abbreviations given in TR 21.905 [1], TS 32.240 [2] apply.

4 Architecture considerations

4.1 High level SMS architecture

The high level SMS architecture is as defined in TS 23.040 [7].

Only the SMS Router, SMS-SC and the IP-SM-GW are within the scope of the present document.

The details for the other nodes in the SMS architecture are defined in TS 32.250 [9] and TS 32.251 [10].

4.2 SMS offline charging architecture

The architecture for SMS offline charging is described in figure 4.2.1

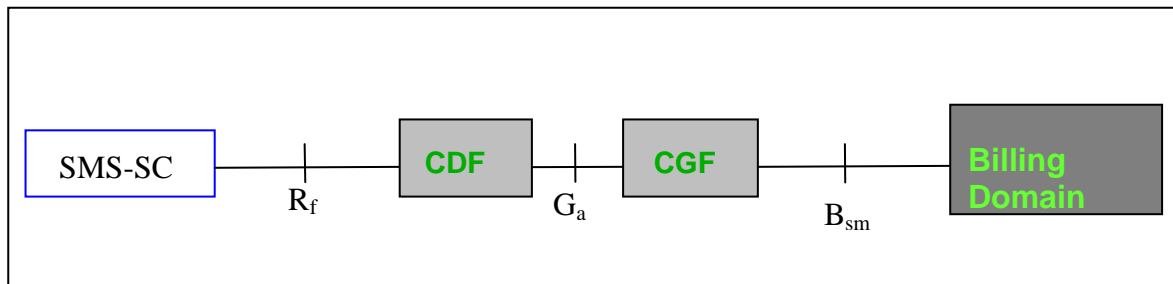

Figure 4.2.1: SMS offline charging architecture

Details on the interfaces and functions can be found in TS 32.240 [2] for the general architecture components.

The Rf interface is described in clause 6.1.1, Ga in clause 6.1.2, and Bsm in clause 6.1.3 of this document.

4.3 SMS online charging architecture

For online charging, the relevant SMS nodes utilise the Ro interface and application towards the OCS as specified in TS 32.299 [4]. The Ro reference point covers all online charging functionality required for SMS.

The SMS online charging architecture is depicted in figure 4.3.1

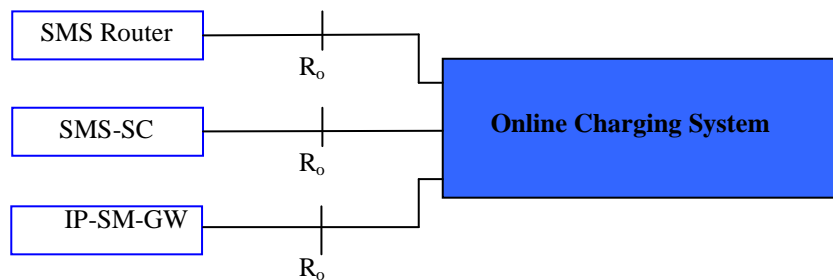

Figure 4.3.1: SMS online charging architecture

Details on the interfaces and functions can be found in TS 32.240 [2] for the general architecture components,

TS 32.296 [11] for the OCS, and TS 32.299 [4] for the Ro application.

5 SMS charging principles and scenarios

5.1 SMS charging principles

5.1.1 General principles

The Short Message Service (SMS) comprises 5 main operational scenarios:

- **Person to Person:** The message is sent by a UE as originator and received by a UE as destination.
- **Person to Application:** The message is sent by a UE as originator and received by a third party application as destination.
- **Application to Person:** The message is sent by a third party application as originator and received by a UE as destination.
- **Application to Application:** The message is sent by a third party application as originator and received by another third party application as destination.
- **Device Triggering:** the message is sent on behalf of an application as originator and received by a device as destination.
- **MSISDN-less UE to Application via T4:** the message is sent by a MSISDN-less UE as originator and received by a third party application as destination (e.g. SCS/AS) in MSISDN-less MO-SMS via T4 scenario.

In addition SMS nodes may apply services such as Value Added Services (VAS) specified in TS 22.142 [16], services defined in industry standard protocols for SM submission from applications in a fixed network (protocols such as SMPP, UCP/EMI, OIS, CIMD, etc.) or vendor specific services as endorsed by TS 23.040 [7]. As such, the SMS node collects charging information such as:

- the destination and source addresses applied for an SM;
- an indication of origination or termination handling;
- identification of the node(s) and connection(s) involved in the SM transaction;
- SM validity period;
- in scenarios involving an application / VASP, the charging information describes the identification of the application / VASP;
- requested SM service type.

5.1.2 Segmentation and concatenation

Information about concatenated messages should be sent to the charging systems in order to apply the appropriate charging models. The charging system may be required to be stateful to process information about segmented messages.

5.1.3 Triggers for generation of charging information

The following service level events shall, based on operator configuration, trigger the generation of charging information:

- Simple submission, except for device triggering – based on reception at the SMS node.
- Enhanced submission – based on completion of the transaction handling at the SMS node.
- Origination retry – based on the enhanced submission where the initial handling fails and a redelivery attempt is initiated.
- Delivery, except for device triggering – based on delivery from the SMS node.

- Delivery report – reports based on the delivery to Person.
- Termination – Application to Person scenario only.
- Termination retry – Application to Person scenario only – reattempt delivery of an SM to a terminating entity;
- SM Service request.
- SMS via T4 related events specified in clause 5.1.4.

Depending on the charging model applied, a "refund" may be necessary for unsuccessful delivery in online charging.

See clause 5.2 and 5.3 for detailed procedures associated with the triggers above for offline charging and online charging respectively.

5.1.4 SMS via T4

For the following TS 23.682 [17] procedures using T4 interface and relying on SMS capability, online and offline charging functionalities are based on SMS-SC reporting chargeable events associated with the corresponding functionalities:

- Device Triggering Function;
- MSISDN-less MO-SMS via T4.

For Device Triggering functionality, following chargeable events are considered:

- Device Trigger submitted to the SMS-SC from MTC-IWF, for request, replace and recall;
- SMS Delivery from the SMS-SC for Device Triggering towards the UE - based on delivery from the SMS node;
- SMS Delivery from the SMS-SC for Device Triggering towards the UE - based on completion of the transaction handling at the SMS node;

The protocol description for Device Triggering functionality is detailed in TS 29.337 [18].

For MSISDN-less MO-SMS via T4 functionality, allowing MSISDN-less UE to send small data to an SCS/AS (i.e. destination SME) using SMS-MO, the completion of the transaction at the SMS-SC is considered, since SMS-SC store and forward capability for MO-SMS is not used. Instead, the SMS-MO received by the SMS-SC through MO submission TS 23.040 [12]) procedures, is directly forwarded to the MTC-IWF through appropriate protocol for further transfer to the recipient SCS/AS. Also, the SMS-MO delivery answer status from MTC-IWF received by the SMS-SC is directly conveyed back to the UE.

For MSISDN-less MO-SMS via T4 functionality, the chargeable event considered is:

- MO-SMS via T4 submission - based on Delivery response from the MTC-IWF.

The protocol description for MSISDN-less MO-SMS via T4 functionality is detailed in TS 29.338 [200].

5.2 SMS offline charging scenarios

5.2.1 Basic principles

SMS offline charging functionality is based on SMS Nodes reporting chargeable events associated with SM transactions.

The SMS offline charging applies to the SMS-SC.

SMS offline charging uses the Diameter Offline Charging as specified in TS 32.299 [4].

Event based charging applies, with reporting achieved by sending *Charging Data Request* [Event] to the CDF.

SMS transactions are collected independently by the SMS-SC, or on completion handling at SMS-SC (enhanced submission) .

5.2.2 Rf message flows

5.2.2.0 Introduction

The different scenarios below focus on the different message exchanges from/to the SMS-SC and the corresponding message flows between the SMS-SC and the CDF.

The sequence of messages exchanged between the SMS-SC and the other nodes are described with generic names (i.e SMS submit, SMS deliver), to reflect SMS reception or sending by/from the SMS-SC, independently from the protocol conveying the SMS.

5.2.2.1 SMS Submission to SMS-SC

Figure 5.2.2.1.1 describes the scenario where UE or a third party application originates SMS-MO destined to a recipient UE:

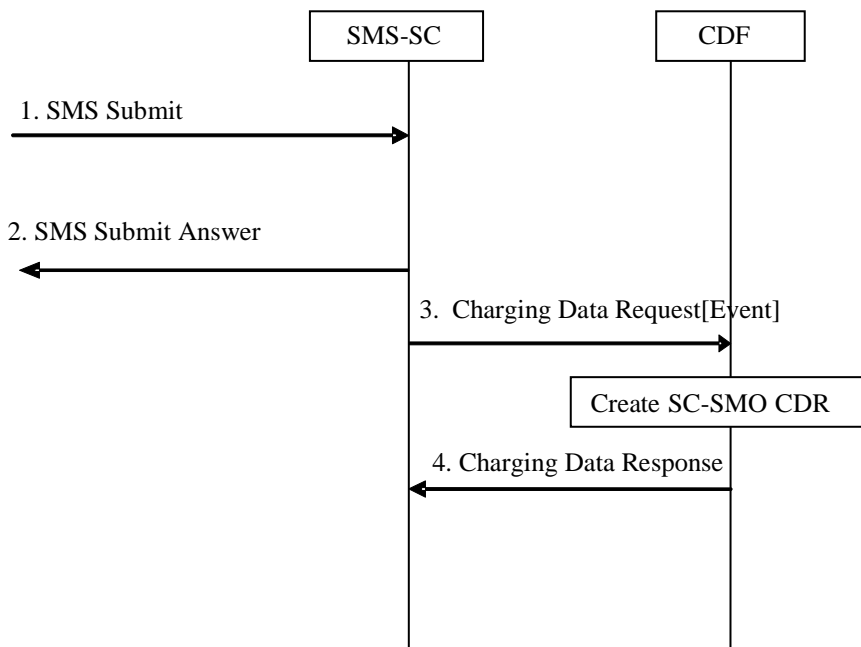

Figure 5.2.2.1.1: Offline charging - SMS submission to SMS-SC

- 1) The SMS-SC receives a "SMS Submit" incoming message originated by a UE or a third party application.
- 2) The SMS-SC returns "SMS Submit Answer" with appropriate result associated to the reception of the SM: successfully received by SMS-SC or failed due to error at SMS-SC.
- 3) The SMS-SC triggers a *Charging Data Charging Data Request* with *Operation Type* indicating *EVENT_RECORD* to record successful or unsuccessful reception of the SM, with originator identified as UE or as a third party application, depending on the scenario.

NOTE: In the scenario where a third party application is originator, sending application identification to the CDF allows to apply accurate charging model of Termination scenario, i.e. recipient UE to be charged for the delivered SM, instead of originator or both parties.

- 4) The CDF creates a SC-SMO CDR and acknowledges the reception of the data.

5.2.2.2 SMS Delivery from SMS-SC

Figure 5.2.2.2.1 describes the scenario where SMS-SC originates SM transfer towards the receiving party.

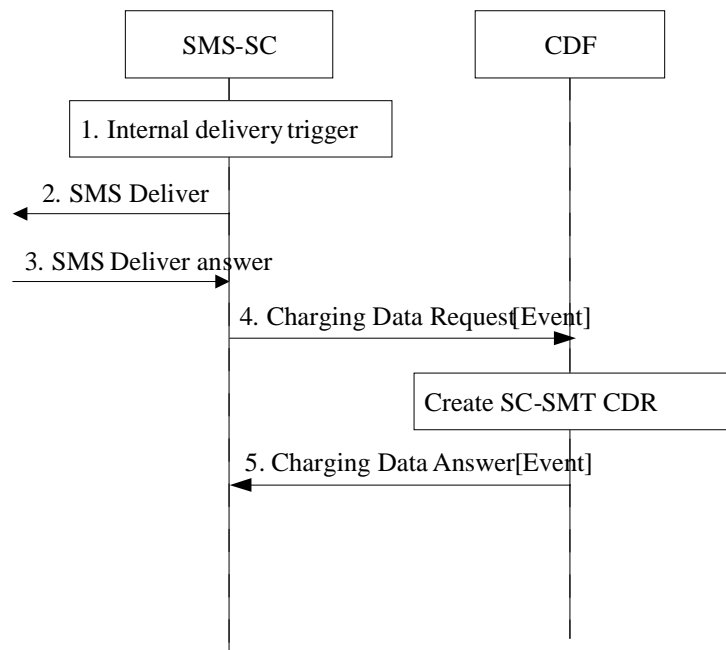

Figure 5.2.2.2.1: Offline charging SMS Transfer from SMS-SC

- 1) The SMS-SC decides to forward "SMS Deliver" message towards the receiving party, as a first attempt or due to internal trigger for a retry delivery of a previously failed and stored SM.
- 2) The SMS-SC forwards the "SMS Deliver" message towards the receiving party.
- 3) The SMS-SC receives "SMS Deliver Answer" message as the delivery success or failure of the SM transfer attempt.
- 4) The SMS-SC triggers a Charging Data Request[Event] to record successful or unsuccessful result of SM delivery.
- 5) The CDF creates a SC-SMT CDR and acknowledges the reception of the data.

5.2.2.3 Delivery Report

Delivery Report or Status Report (SC informing the originating UE of the delivery outcome of a previously submitted short message) issued by the SMS-SC uses the same procedures as the "SMS Delivery from the SMS-SC" described within clause 5.2.2.2, as it is contained within a new SM.

5.2.2.4 Device Triggering using T4

5.2.2.4.1 SMS submission to SMS-SC for Device Triggering

Figure 5.2.2.4.1.1 describes the scenario where the MTC-IWF submits a request to SMS-SC for SM transfer towards the UE for Device Triggering purpose.

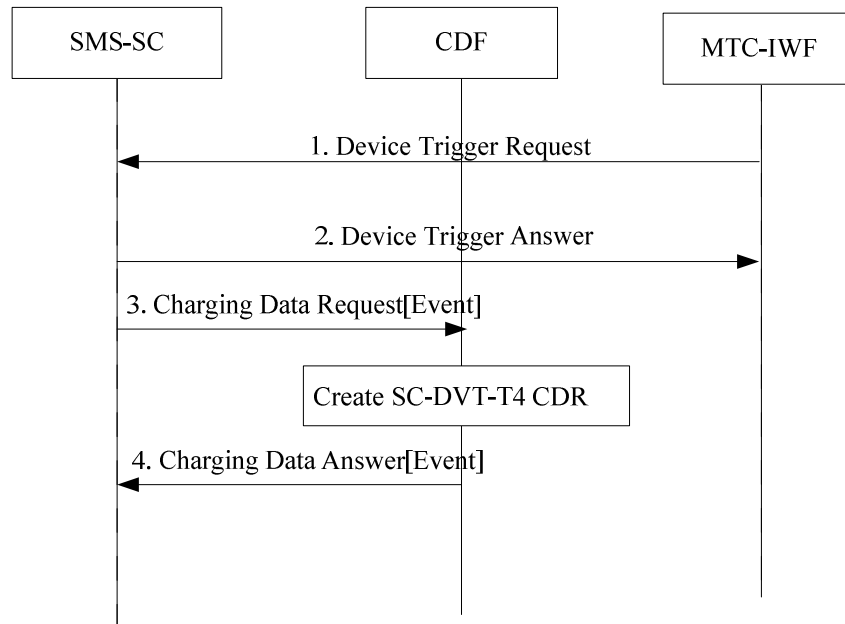

Figure 5.2.2.4.1.1: Offline charging - SMS submission to SMS-SC for Device Triggering

- 1) The SMS-SC receives an incoming "Device Trigger Request" from an MTC-IWF over T₄, destined to a UE recipient.
- 2) The SMS-SC returns "Device Trigger Answer" with appropriate result associated to the reception of the trigger request: successfully received by SMS-SC or failed due to error at SMS-SC.
- 3) The SMS-SC triggers a *Charging Data Request* with *Operation Type* indicating EVENT_RECORD to record successful or unsuccessful reception of the SM from the MTC-IWF, with originator identified as SCS Identity.
- 4) The CDF creates a SC- DVT-T4 CDR and acknowledges the reception of the data.

5.2.2.4.2 SMS Delivery from SMS-SC for Device Triggering

Figure 5.2.2.4.2.1 describes the scenario where SMS-SC originates the SMS Device Triggering transfer towards the UE.

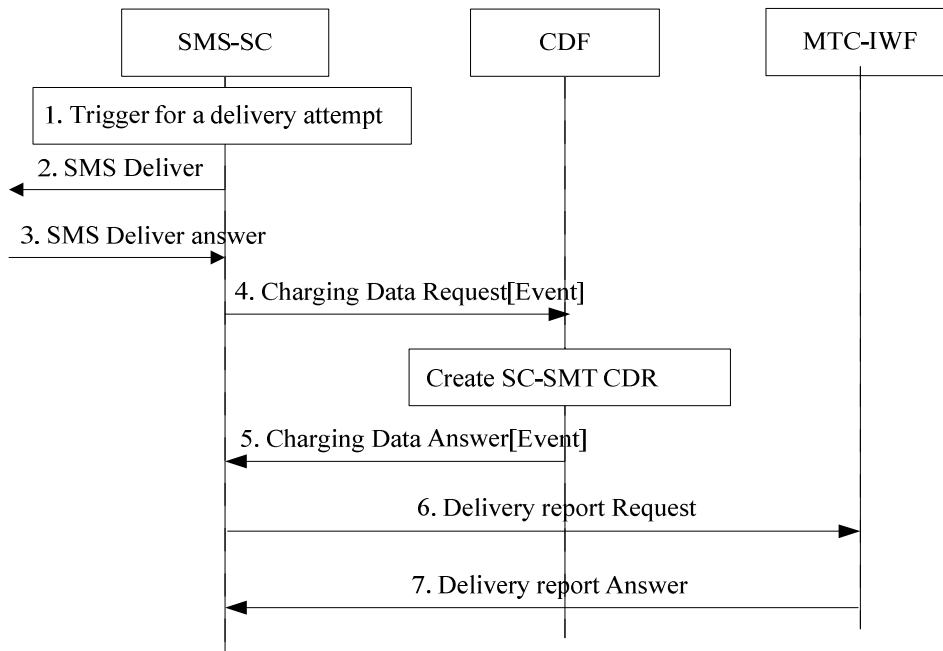

Figure 5.2.2.4.2.1: Offline charging - SMS delivery for Device Triggering

- 1) The SMS-SC decides to forward "SMS Deliver" message towards the receiving party, as a first attempt upon device trigger request received from MTC-IWF, or due to internal trigger for a retry delivery of a previously failed and stored SM for Device Triggering, or internal trigger for a first attempt of a previously stored SM.
- 2) The SMS-SC forwards the "SMS Deliver" message towards the receiving party.
- 3) The SMS-SC receives "SMS Deliver Answer" message as the delivery success or failure of the SM transfer attempt.
- 4) The SMS-SC triggers a Charging Data Request[Event] to record successful or unsuccessful result of SM delivery, including a value for "Device Triggering indication".
- 5) The CDF creates a SC-SMT CDR and acknowledges the reception of the data.
- 6) The SMS-SC sends "Delivery Report Request" to MTC-IWF with appropriate result associated to the successful delivery of the device trigger to the UE.
- 7) The MTC-IWF acknowledges by sending "Delivery Report Answer".

5.2.2.4.3 SMS Device Triggering Delivery Report

The SMS Device Triggering Delivery Report corresponds to the SMS-SC reporting the Delivery Report of Device Trigger to the MTC-IWF in the scenario described in clause 5.2.2.4.2. The Delivery Report itself is not a trigger for a charging event.

5.2.2.4.4 SMS submission to SMS-SC for Device Triggering - Replace procedure

Figure 5.2.2.4.4.1 describes the scenario where the MTC-IWF submits a request to SMS-SC for a replace procedure of Device Triggering:

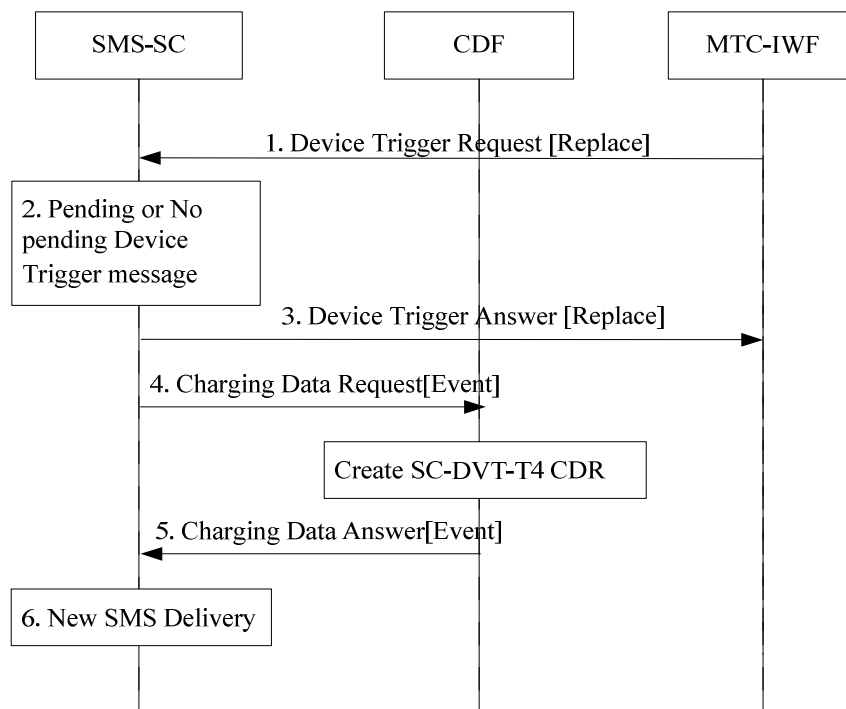

Figure 5.2.2.4.4.1: Offline charging - SMS submission to SMS-SC for replace Device Triggering

- 1) The SMS-SC receives an incoming "Device Trigger Request" indicating "Replace" from an MTC-IWF over T₄.
- 2) If the SMS-SC determines the trigger message identified by the External Identifier or MSISDN, SCS Identifier, and old trigger reference number in the received Device Trigger Replace message, is pending at SMS-SC, the new trigger message replaces the previous one. If no trigger message is pending this corresponds to a failed replace procedure.
- 3) The SMS-SC returns "Device Trigger Answer" with appropriate result of the successful or unsuccessful replace procedure.
- 4) The SMS-SC triggers a Charging Data Request[Event] to record successful or unsuccessful result of the replace procedure.
- 5) The CDF creates a SC-DVT-T4 CDR and acknowledges the reception of the data.
- 6) In case of successful replace, the new SM to be delivered uses the same procedure as per clause 5.2.2.4.2.1.

5.2.2.4.5 SMS submission to SMS-SC for Device Triggering - Recall procedure

Figure 5.2.2.4.5.1 describes the scenario where the MTC-IWF submits a request to SMS-SC for a recall procedure for Device Triggering:

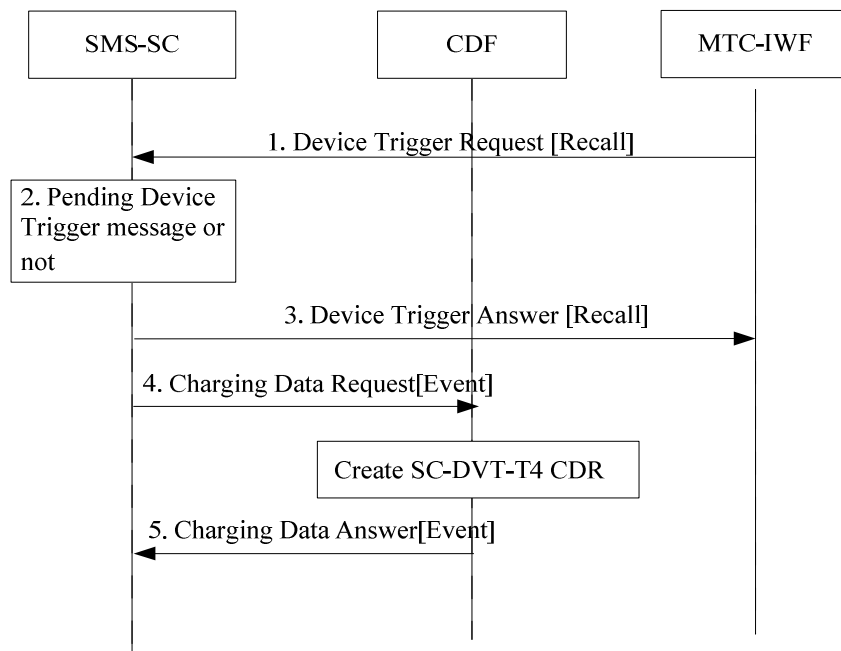

Figure 5.2.2.4.5.1: Offline charging - SMS submission to SMS-SC for recall Device Triggering

- 1) The SMS-SC receives an incoming "Device Trigger Request" indicating "Recall" from an MTC-IWF over T4.
- 2) The SMS-SC determines the trigger message identified by the External Identifier or MSISDN, SCS Identifier, and old trigger reference number in the received Device Trigger Recall message, is pending at SMS-SC. The stored trigger message is deleted.
- 3) The SMS-SC returns "Device Trigger Answer" with appropriate result of the recall procedure.
- 4) The SMS-SC triggers a Charging Data Request[Event] to record successful or unsuccessful result of the recall procedure.
- 5) The CDF creates a SC-DVT-T4 CDR and acknowledges the reception of the data.

5.2.2.5 Offline charging error cases - Diameter procedures

The Offline Charging error cases in Diameter (Accounting) Related Procedures associated to *Charging Data Request /Response*, from SMS node as network element are specified in TS 32.299 [4] clause 6.1.3.

5.2.2.6 MSISDN-less SMS MO via T4

5.2.2.6.1 Introduction

The message flows associated to the MSISDN-less SMS MO via T4, illustrate the triggers occurring in the SMS-SC Node. As specified in TS 23.682 [17], the SMS delivery procedures to SMS-SC and SMS delivery report from SMS-SC are per TS 23.040 [12], therefore involving SMS-GMSC/SMS-IW MSC depending on the scenario. However, per this TS 23.040 [12], the interface between the SMS-GMSC/SMS-IW MSC and the SMS-SC is out of scope of 3GPP, therefore SMS-GMSC/SMS-IW MSC are assumed as internal to SMS-SC for the charging flows with triggers description.

5.2.2.6.2 MSISDN-less SMS MO via T4 - successful case

Figure 5.2.2.6.2.1 describes the scenario where MSISDN-less UE originates SMS-MO destined to a recipient SCS/AS using MSISDN-less SMS MO via T4 procedure:

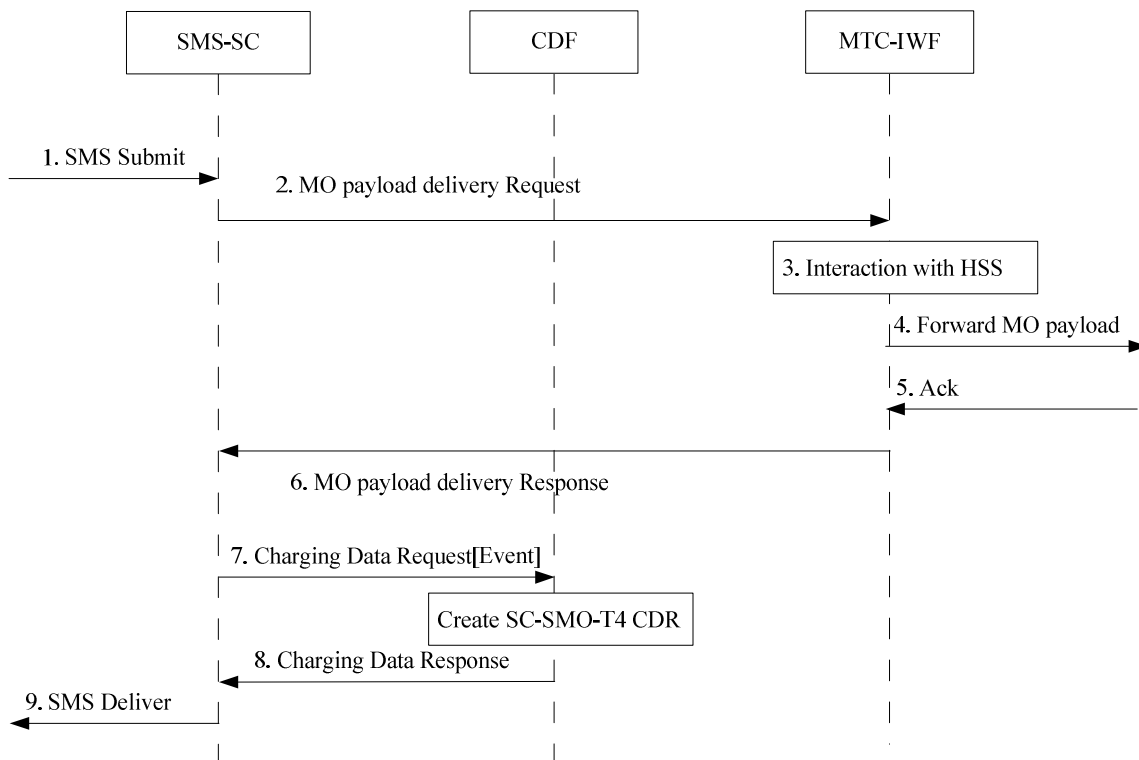

Figure 5.2.2.6.2.1: Offline charging MSISDN-less SMS MO via T4 – successful case

- 1) The SMS-SC receives a "SMS Submit" incoming message originated by a MSISDN-less UE to deliver small data to SCS/AS.
- 2) The SMS-SC sends the "MO payload delivery Request" message to the MTC-IWF address (as pre-configured in the SMS-SC for this SCS/AS), with the SMS payload and the destination SME address (long/short code of the SCS/AS).
- 3) The MTC-IWF retrieves the external ID from the HSS (based on the IMSI of the UE and application port ID).
- 4-5) The MTC-IWF forwards the SMS to the SCS/AS (received destination SME), and receives the successful or failure answer.
- 6) The MTC-IWF returns a success or failure delivery indication to SMS-SC, along with the external identifier associated to this transaction.
- 7) The SMS-SC triggers a *Charging Data Request* with *Operation Type* indicating *EVENT_RECORD* to record successful or unsuccessful delivery of the SM.
- 8) The CDF creates a SC-SMO-T4 CDR and acknowledges the reception of the data.
- 9) The SMS-SC indicates success/failure back to UE.

5.2.2.6.3 MSISDN-less SMS MO via T4 - error cases

5.2.2.6.3.1 MSISDN-less SMS MO via T4 - failure at submission to SMS-SC

Figure 5.2.2.6.3.1.1 describes the scenario where MSISDN-less UE originates SMS-MO destined to a recipient SCS/AS using MSISDN-less SMS MO via T4 procedure, and failure at submission to SMS-SC:

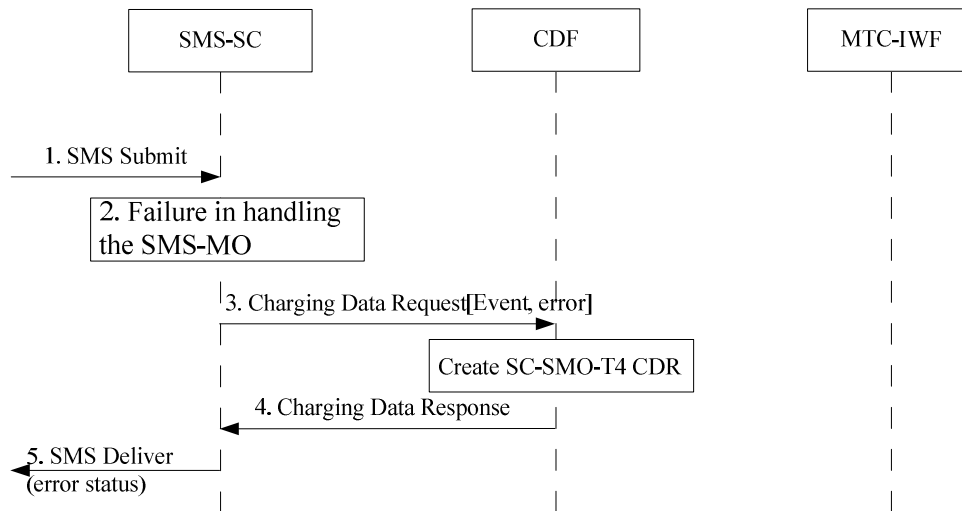

Figure 5.2.2.6.3.1.1: Offline charging MSISDN-less SMS MO via T4 – failure at submission

- 1) The SMS-SC receives a "SMS Submit" incoming message originated by a MSISDN-less UE to deliver small data to SCS/AS.
- 2) Failure in handling the submitted SMS-MO in the SMS-SC.
- 3) The SMS-SC triggers a *Charging Data Charging Data Request* with *Operation Type* indicating *EVENT_RECORD* to record the unsuccessful delivery of the SM.
- 4) The CDF creates a SC-SMO-T4 CDR and acknowledges the reception of the data.
- 5) The SMS-SC indicates the failure back to UE.

5.2.2.6.3.2 MSISDN-less SMS MO via T4 - failure at the MTC-IWF

Figure 5.2.2.6.3.2.1 describes the scenario where MSISDN-less UE originates SMS-MO destined to a recipient SCS/AS using MSISDN-less SMS MO via T4 procedure, and failure at the MTC-IWF:

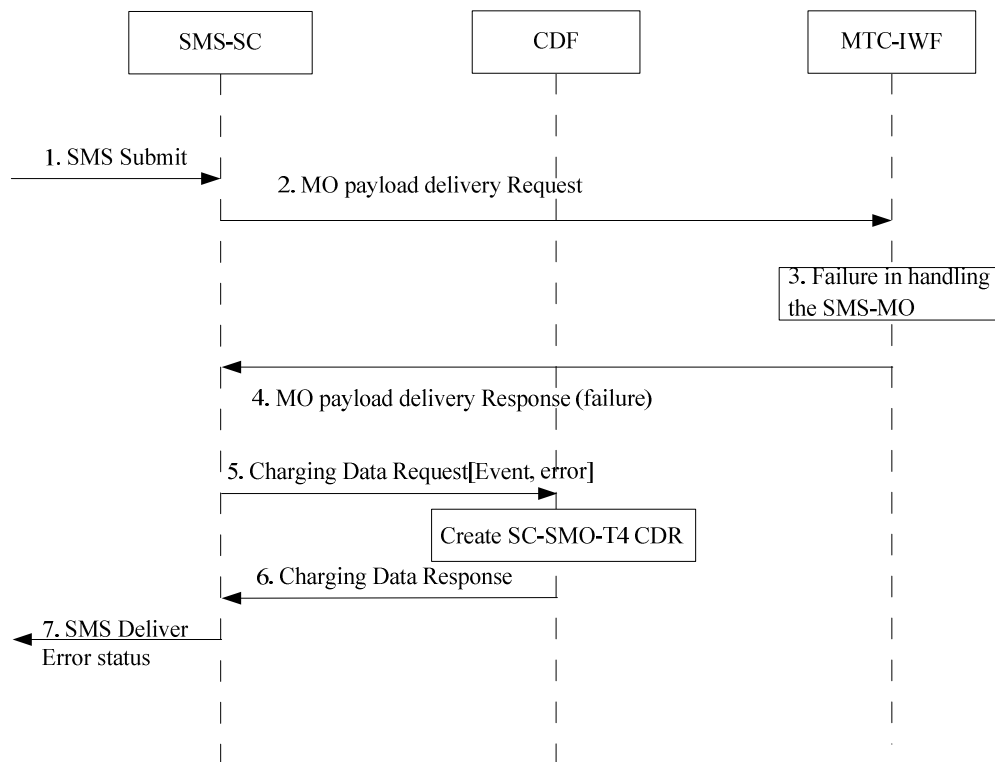

Figure 5.2.2.6.3.2.1; Offline charging MSISDN-less SMS MO via T4 - failure at the MTC-IWF

- 1) The SMS-SC receives a "SMS Submit" incoming message originated by a MSISDN-less UE to deliver small data to SCS/AS.
- 2) The SMS-SC sends the "MO payload delivery Request" message to the MTC-IWF address (as pre-configured in the SMS-SC for this SCS/AS), with the SMS payload and the destination SME address (long/short code of the SCS/AS).
- 3) Failure in handling the submitted SMS-MO in the MTC-IWF.
- 4) The MTC-IWF returns the failure delivery indication to SMS-SC.
- 5) The SMS-SC triggers a *Charging Data Charging Data Request* with *Operation Type* indicating *EVENT_RECORD* to record the unsuccessful delivery of the SM.
- 6) The CDF creates a SC-SMO-T4 CDR and acknowledges the reception of the data.
- 7) The SMS-SC indicates the failure back to UE.

5.2.3 CDR generation

5.2.3.0 Triggers for SMS CDR generation

SMS related CDRs (i.e. SC-SMO, SC-SMT, SC-SMO-T4 and SC-DVT-T4 CDRs) are used to collect charging information related to individual Charging Data Request [Event]. A single CDR is generated by the CDF for each event, and subsequently transferred to the Charging Gateway Function (CGF).

5.2.3.1 Triggers for SMS CDR charging information collection

The triggers for CDR creation are described in clause 5.2.3.0.

5.2.3.2 Triggers for SMS CDR charging information addition

The triggers for CDR creation are described in clause 5.2.3.0.

5.2.3.3 Triggers for SMS CDR closure

The triggers for CDR creation are described in clause 5.2.3.0.

5.2.4 Ga record transfer flows

Details of the Ga protocol application are specified in TS 32.295 [6].

5.2.5 B_{sm} CDR file transfer

Details of the Bsm protocol application are specified in TS 32.297 [5].

5.3 SMS online charging scenarios

5.3.1 Basic principles

SMS online charging uses the Credit-Control application as specified in TS 32.299 [4].

SMS charging may use the Immediate Event Charging (IEC) principle or the Event Charging with Unit Reservation (ECUR) principle as specified in TS 32.299 [4]. The chargeable events for subscriber charging are associated with SM transactions.

An implementation may use either IEC or ECUR for charging events based on operator configuration.

The units used for quota shall be service specific and based on an SM.

The selection of the OCS is implementation specific as there is no guaranteed means of providing the OCS address to the CTF.

In addition, SMS charging may use the Refund Account principle when the operation has not been successfully completed after an IIEC.

NOTE: For SMSIP, the IP-SM-GW may receive information relevant for online charging through signalling in IMS.

5.3.2 R_o message flows

5.3.2.1 Simple submission

This clause contains message flows for the different operation models IEC (figure 5.3.2.1.1) and ECUR (figure 5.3.2.1.2).

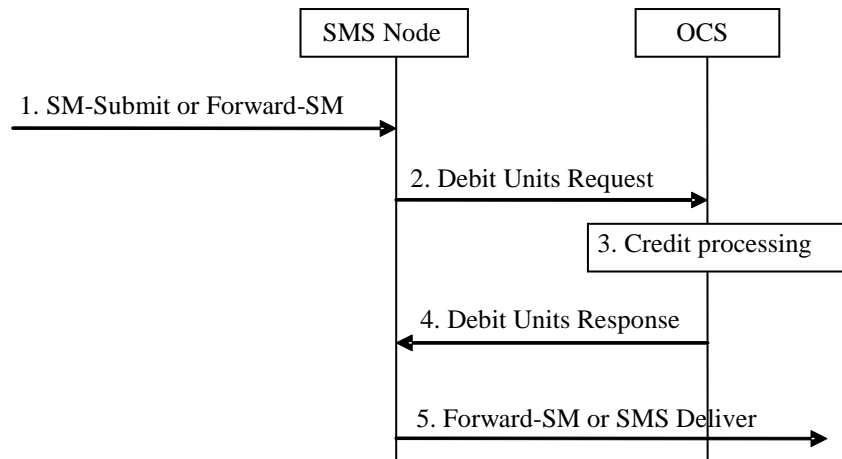

Figure 5.3.2.1.1: Online charging in simple submission for IEC

- 1) Depending on which SMS mechanism (i.e. SMS or SMSIP) is in operation, the SMS node receives an incoming SM-Submit or a MAP-Forward-SM.
- 2) The SMS node triggers a Debit Units Request message to the OCS.
- 3) The OCS performs the appropriate credit processing based on the received request.
- 4) The OCS responds with a Debit Units Response message to the SMS node.
- 5) If authorized, the SMS node continues the SM processing as appropriate for the origination procedures.

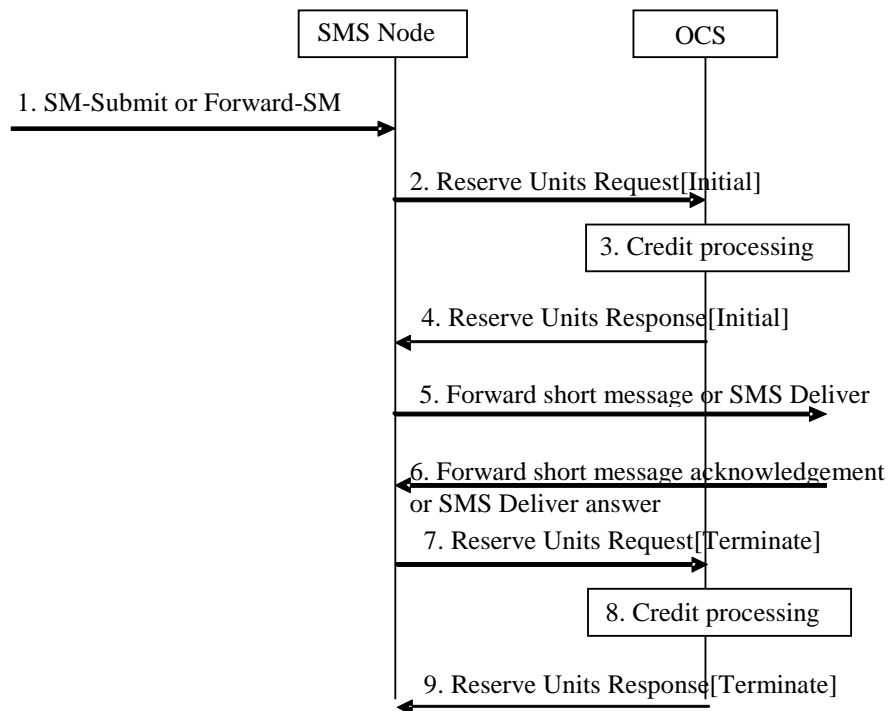

Figure 5.3.2.1.2: Online charging in simple submission for ECUR

- 1) Depending on which SMS mechanism (i.e. SMS or SMSIP) is in operation, the SMS node receives an incoming SM-Submit or a MAP-Forward-SM.
- 2) The SMS node triggers a Reserve Units Request [Initial] message to the OCS.
- 3) The OCS performs the appropriate credit processing based on the received request.
- 4) The OCS responds with a Reserve Units Response message to the SMS node.
- 5) If authorized, the SMS node continues the SM processing as appropriate for the origination procedures.
- 6) The SM transaction is successfully acknowledged.
- 7) The SMS node triggers a Reserve Units Request [Terminate] message to the OCS reporting the successful event transaction.
- 8) The OCS performs the appropriate credit processing based on the received request.
- 9) The OCS responds with a Reserve Units Response message to the SMS node.

5.3.2.2 Enhanced submission

The enhanced submission procedures are similar to the simple submission procedures using ECUR. However, the trigger for Reserve Units Request (Terminate) may be based on unsuccessful handling, e.g. negative acknowledgement and with or without successful storage of the message for future redelivery attempts. See failure scenarios defined in clause 5.3.2.7.

5.3.2.3 Delivery report

The origination of delivery reports use the same procedures as the simple submission procedures as described within clause 5.3.2.1. The delivery report itself is contained within a new SM.

5.3.2.4 Origination retry

This clause contains message flows for the different operation models IEC (figure 5.3.2.4.1) and ECUR (figure 5.3.2.4.2) for redelivery attempts in the origination direction.

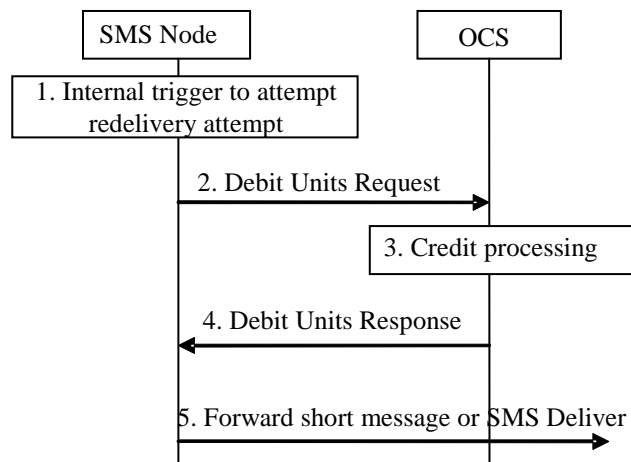

Figure 5.3.2.4.1: Online charging in origination redelivery attempt for IEC

- 1) An SMS node internal trigger occurs to attempt a redelivery of a previously failed and stored SM.
- 2) The SMS node triggers a Debit Units Request message to the OCS.
- 3) The OCS performs the appropriate credit processing based on the received request.
- 4) The OCS responds with a Debit Units Response message to the SMS node.
- 5) If authorized, the SMS node continues the SM processing as appropriate for the origination procedures.

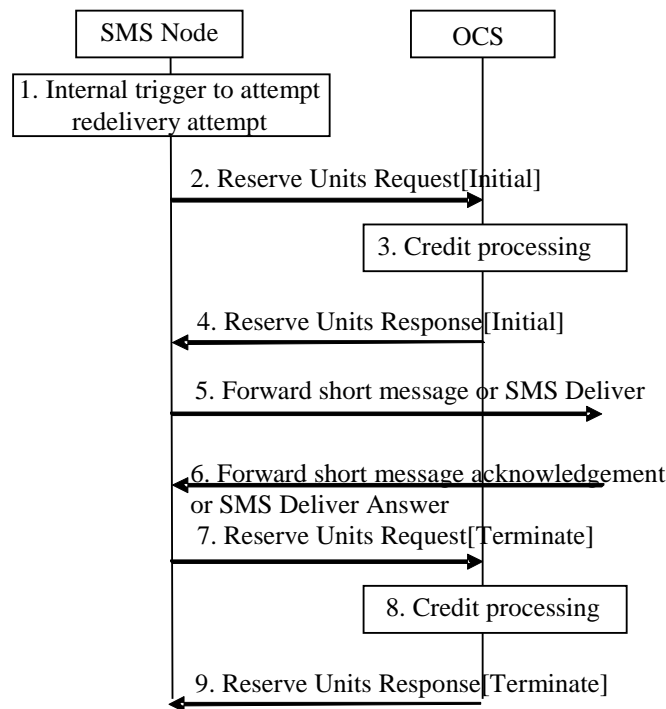
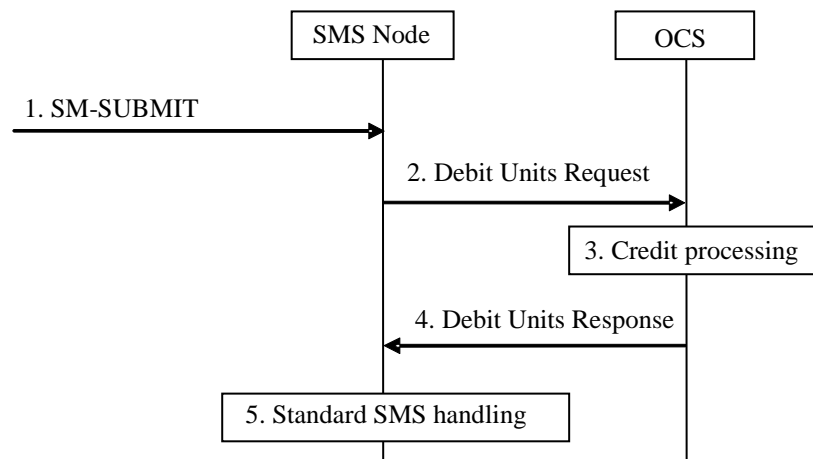

Figure 5.3.2.4.2: Online charging in origination redelivery attempt for ECUR

- 1) An SMS node internal trigger occurs to attempt a redelivery of a previously failed and stored SM.
- 2) The SMS node triggers a Reserve Units Request[Initial] message to the OCS.
- 3) The OCS performs the appropriate credit processing based on the received request.
- 4) The OCS responds with a Reserve Units Response message to the SMS node.
- 5) If authorized, the SMS node continues the SM processing as appropriate for the origination or termination procedures.
- 6) The SM transaction is successfully acknowledged.
- 7) The SMS node triggers a Reserve Units Request[Terminate] message to the OCS reporting the successful event transaction.
- 8) The OCS performs the appropriate credit processing based on the received request.
- 9) The OCS responds with a Reserve Units Response message to the SMS node.

5.3.2.5 Termination charge

**Figure 5.3.2.5.1: Online charging in termination for IEC**

1) The SMS node receives an incoming SM-SUBMIT from an application destined for a mobile recipient.

NOTE: This scenario differs from simple submission charging as described in clause 5.3.2.1 in that typically the mobile recipient (instead of originator or both parties) will be charged for such a short message.

2) The SMS node triggers a Debit Units Request message to the OCS.

3) The OCS performs the appropriate credit processing based on the received request.

4) The OCS responds with a Debit Units Response message to the SMS node.

5) If authorized, the SMS node continues the SM processing as appropriate for the termination procedures.

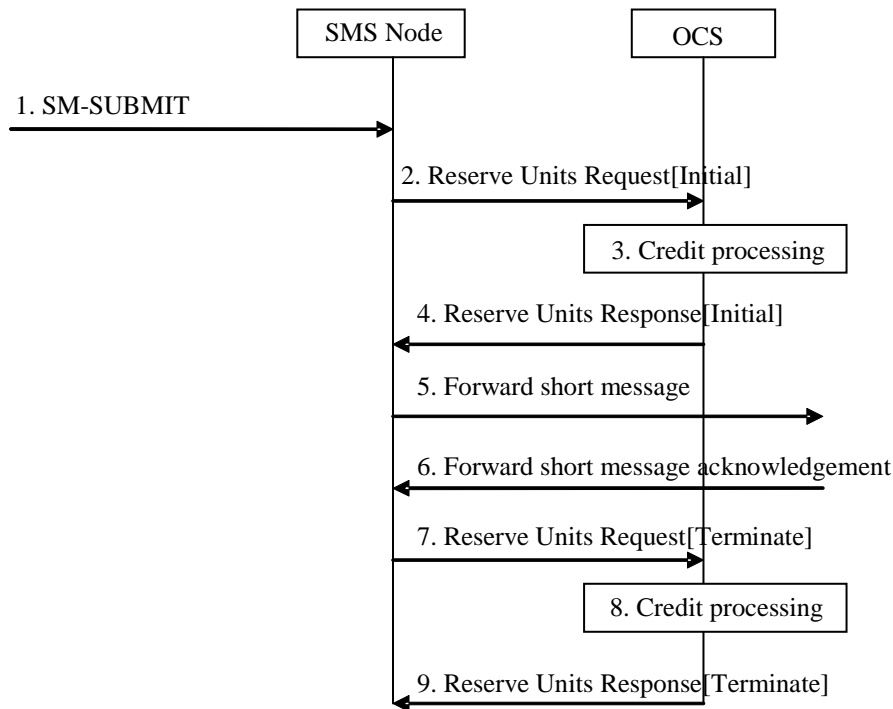

Figure 5.3.2.5.2: Online charging in termination for ECUR

1) The SMS node receives an incoming SM-SUBMIT from an application destined for a mobile recipient.

NOTE: This scenario differs from simple submission charging as described in clause 5.3.2.1 in that typically the mobile recipient (instead of originator or both parties) will be charged for such a short message.

2) The SMS node triggers a Reserve Units Request [Initial] message to the OCS.

3) The OCS performs the appropriate credit processing based on the received request.

4) The OCS responds with a Reserve Units Response message to the SMS node.

5) If authorized, the SMS node continues the SM processing as appropriate for the termination procedures.

6) The SM transaction is successfully acknowledged.

7) The SMS node triggers a Reserve Units Request [Terminate] message to the OCS reporting the successful event transaction.

8) The OCS performs the appropriate credit processing based on the received request.

9) The OCS responds with a Reserve Units Response message to the SMS node.

5.3.2.6 Termination charge retry

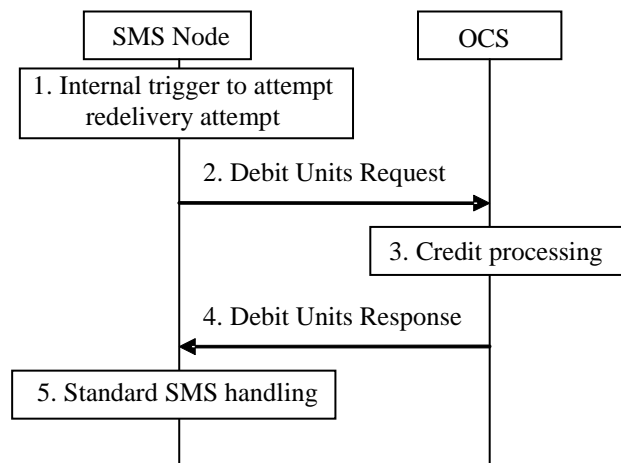

Figure 5.3.2.6.1: Online charging in termination redelivery attempt for IEC

- 1) An SMS node internal trigger occurs to attempt a redelivery of a previously failed and stored SM.
- 2) The SMS node triggers a Debit Units Request message to the OCS.
- 3) The OCS performs the appropriate credit processing based on the received request.
- 4) The OCS responds with a Debit Units Response message to the SMS node.
- 5) If authorized, the SMS node continues the SM processing as appropriate for the termination procedures.

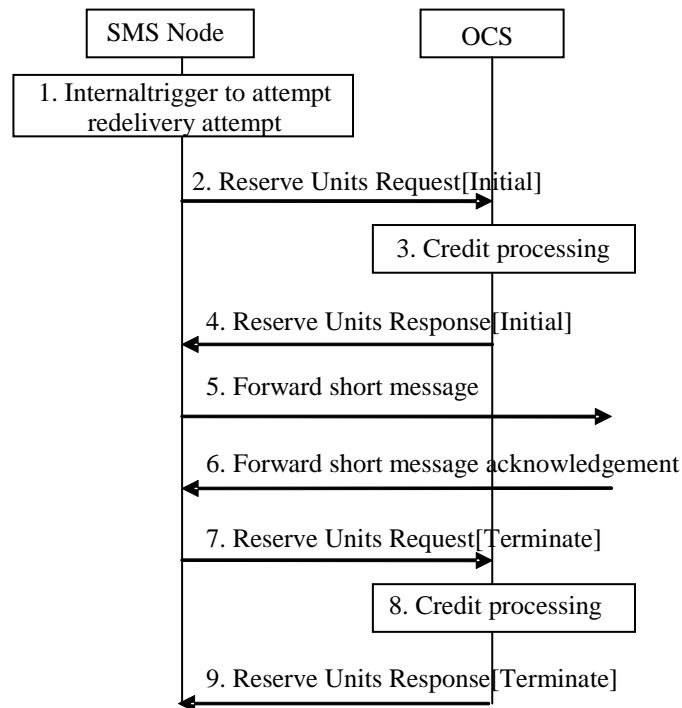

Figure 5.3.2.6.2: Online charging in termination redelivery attempt for ECUR

- 1) An SMS node internal trigger occurs to attempt a redelivery of a previously failed and stored SM.
- 2) The SMS node triggers a Reserve Units Request[Initial] message to the OCS.
- 3) The OCS performs the appropriate credit processing based on the received request.
- 4) The OCS responds with a Reserve Units Response message to the SMS node.
- 5) If authorized, the SMS node continues the SM processing as appropriate for the termination procedures.
- 6) The SM transaction is successfully acknowledged.
- 7) The SMS node triggers a Reserve Units Request[Terminate] message to the OCS reporting the successful event transaction.
- 8) The OCS performs the appropriate credit processing based on the received request.
- 9) The OCS responds with a Reserve Units Response message to the SMS node.

5.3.2.7 Unsuccessful transaction

Unsuccessful transaction after IEC

Figure 5.3.2.7.1 only applies where a refund action is required for unsuccessful delivery.

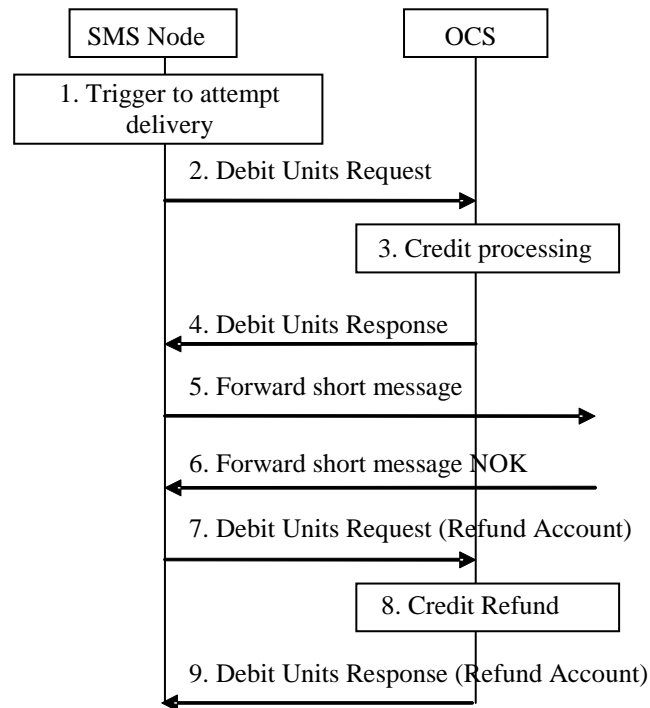

Figure 5.3.2.7.1: Unsuccessful transaction after IEC

- 1) The SMS node receives a trigger to attempt delivery of an SM. This may be for origination, termination or redelivery attempt.
- 2) The SMS node triggers a Debit Units Request message to the OCS.
- 3) The OCS performs the appropriate credit processing based on the received request.
- 4) The OCS responds with a Debit Units Response message to the SMS node.
- 5) If authorized, the SMS node continues the SM processing as appropriate for origination or termination procedures.
- 6) The SM transaction is acknowledged as an unsuccessful transaction (either via explicit signalling or an internal trigger).
- 7) The SMS node triggers a Debit Units Request (Refund Account) message to the OCS.
- 8) The OCS performs the appropriate refund processing based on the received request.
- 9) The OCS responds with a Debit Units Response (Refund Account) message to the SMS node.

Unsuccessful transaction in ECUR

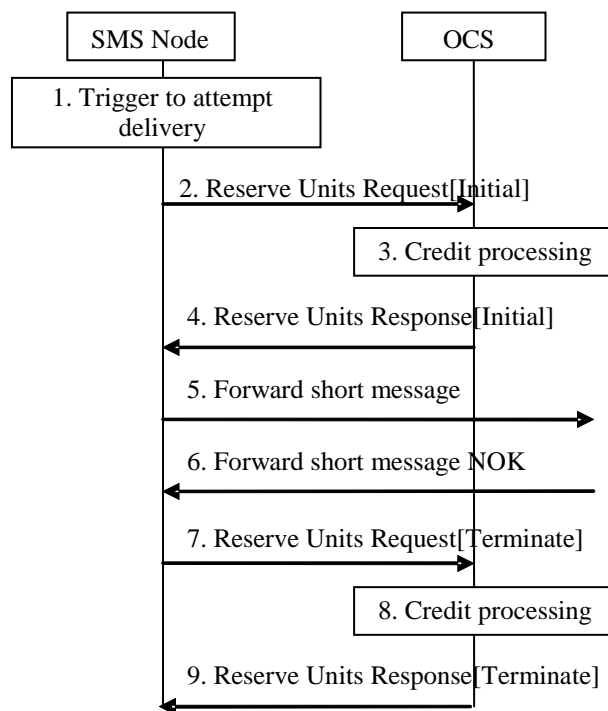

Figure 5.3.2.7.2: Unsuccessful transaction for ECUR

- 1) The SMS node receives a trigger occurs to attempt delivery of an SM. This may be for origination, termination or redelivery attempt.
- 2) The SMS node triggers a Reserve Units Request[Initial] message to the OCS.
- 3) The OCS performs the appropriate credit processing based on the received request.
- 4) The OCS responds with a Reserve Units Response message to the SMS node.
- 5) If authorized, the SMS node continues the SM processing as appropriate for the origination or termination procedures.
- 6) The SM transaction is acknowledged as an unsuccessful transaction (either via explicit signalling or an internal trigger).
- 7) The SMS node triggers a Reserve Units Request[Terminate] message to the OCS reporting the used unit for the service to zero. This characterizes the unsuccessful event transaction.
- 8) The OCS performs the appropriate credit processing based on the received request.
- 9) The OCS responds with a Reserve Units Response message to the SMS node.

5.3.2.8 IMS/SMS Interworking Messages Charging

This clause contains message flows for the different operation models IEC (figure 5.3.2.8.1) and ECUR (figure 5.3.2.8.2) for IMS/SMS Interworking messages in the origination direction.

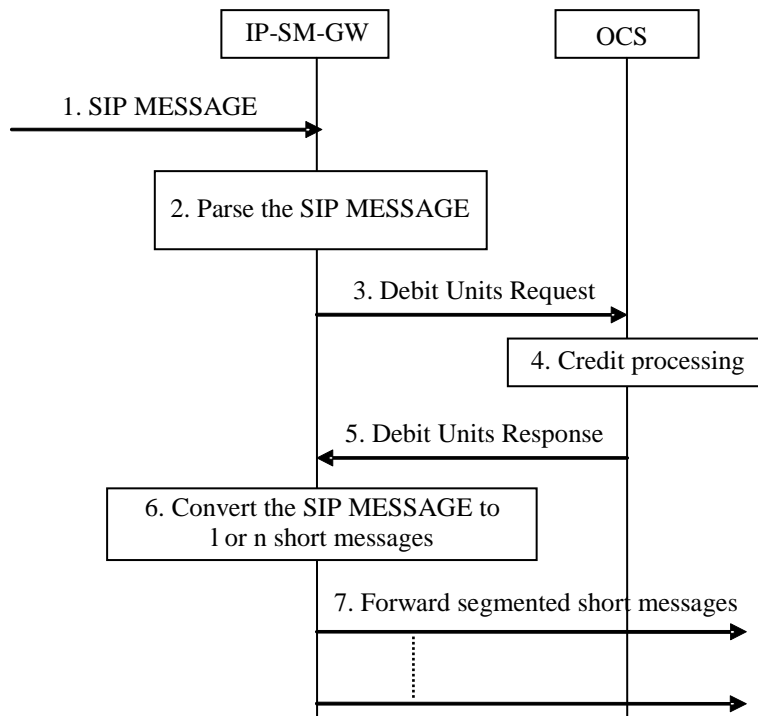

Figure 5.3.2.8.1: Online charging in origination IMS/SMS Interworking Messages for IEC

- 1) The IP-SM-GW receives an incoming SIP MESSAGE.
- 2) The IP-SM-GW parses the SIP MESSAGE.
- 3) The IP-SM-GW triggers a Debit Units Request message to the OCS.
- 4) The OCS performs the appropriate credit processing based on the received Debit Units Request.
- 5) The OCS responds with a Debit Units Response message to the IP-SM-GW.
- 6) IP-SM-GW converts the SIP MESSAGE to 1 or n ($n \geq 1$) short messages.
- 7) If authorized, the IP-SM-GW forwards the segmented short messages.

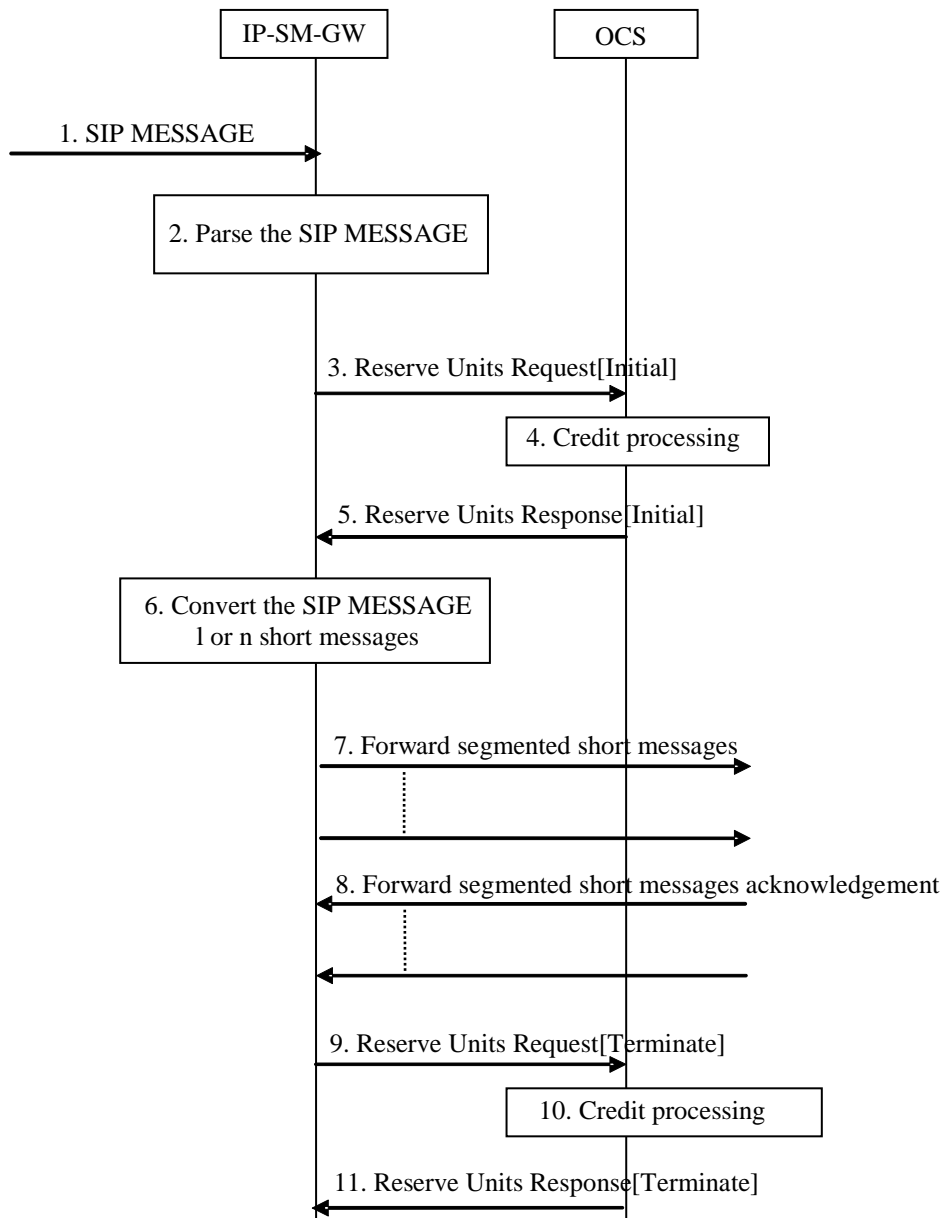

Figure 5.3.2.8.2: Online charging in origination IMS/SMS Interworking Messages for ECUR

- 1) The IP-SM-GW receives an incoming SIP MESSAGE.
- 2) The IP-SM-GW parses the SIP MESSAGE.
- 3) The IP-SM-GW triggers a Reserve Units Request[Initial] message to the OCS.
- 4) The OCS performs the appropriate credit processing based on the received Reserve Units Request.
- 5) The OCS responds with a Reserve Units Response message to the IP-SM-GW.
- 6) IP-SM-GW converts the SIP MESSAGE to 1 or n ($n \geq 1$) short messages.
- 7) If authorized, the IP-SM-GW forwards segmented short messages.
- 8) All the short messages transactions are successfully acknowledged.
- 9) The IP-SM-GW triggers a Reserve Units Request[Terminate] message to the OCS reporting the successful event transaction.
- 10) The OCS performs the appropriate credit processing based on the received request.

11) The OCS responds with a Reserve Units Response message to the IP-SM-GW.

5.3.2.9 Simple Submission with SM service request

This clause contains message flows for operation models IEC (figure 5.3.2.9-1) where application of a SM service is subject to charging independent from the SM submission.

Editors Note: Simple SM submission with SM service request for operation model ECUR is FFS.

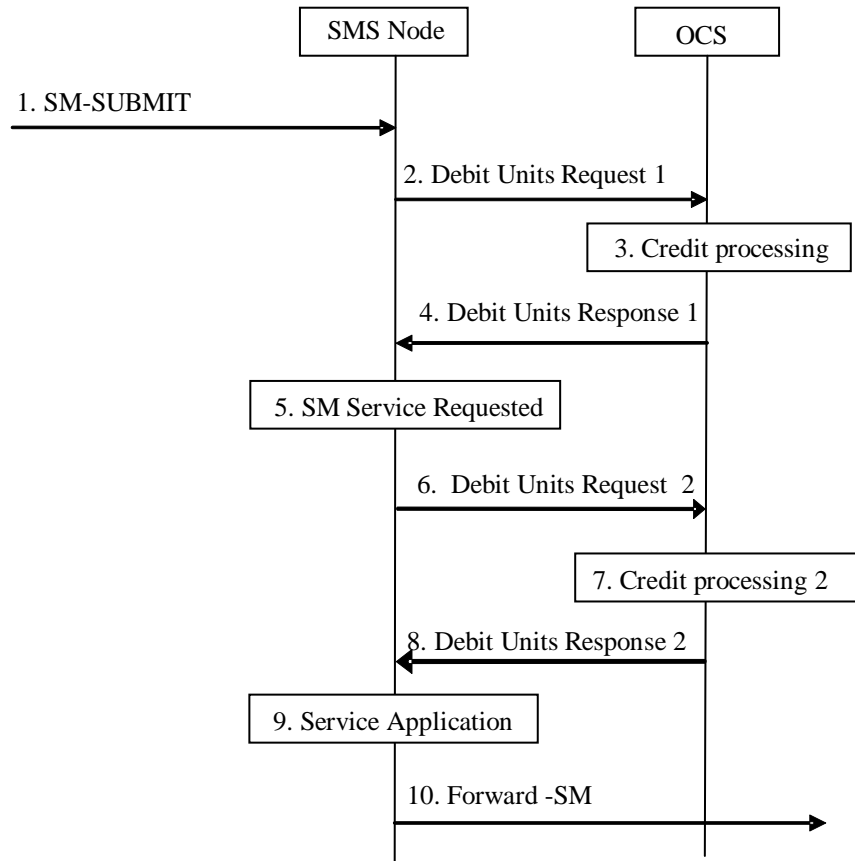

Figure 5.3.2.9.1: Online charging in simple submission with SM service request for IEC

- 1) Depending on which SMS mechanism (i.e. SMS or SMSIP) is in operation, the SMS node receives an incoming SM-Submit or a MAP-Forward-SM which includes a SM service request (such as forwarding or SM copy).
- 2) The SMS node triggers a Debit Units Request message to the OCS for the SM submission.
- 3) The OCS performs the appropriate credit processing based on the received request.
- 4) The OCS responds with a Debit Units Response message for the SM submission to the SMS node.
- 5) If normal SM processing is authorized in step 4, the SMS Node analyzes the SM and detects that a SM service shall be applied that is subject to charging.
- 6) If a SM service subject to charging is detected in step 5, the SMS node triggers an additional Debit Units Request message to the OCS for the requested SM service.
- 7) The OCS performs the appropriate credit processing based on the received request.
- 8) The OCS responds with a Debit Units Response message for the requested SM service to the SMS node.
- 9) If authorized in step 7, the SMS node applies the requested SM service.

NOTE 1: Depending on the nature of the requested SM service, "service application" may involve creating additional messages (for example in case of a SM copy service). This is deemed part of step 9 and not otherwise shown in this diagram.

- 10) If authorized in step 4, the SMS node continues the SM processing as appropriate for the origination procedures.

NOTE 2: Authorization of SM processing is independent of the authorization for application of a SM service. I.e. if authorization for SM processing is granted in step 4 but authorization for SM service is refused in step 8 SM processing appropriate for the originating service continues without applying the requested SM service.

5.3.2.10 Void

5.3.2.11 Device Triggering using T4

5.3.2.11.1 SMS submission to SMS-SC for Device Triggering

This clause contains the message flows for the scenario where the MTC-IWF submits a request to SMS-SC for SM transfer towards the UE for Device Triggering purpose, in IEC operation model (figure 5.3.2.11.1.1):

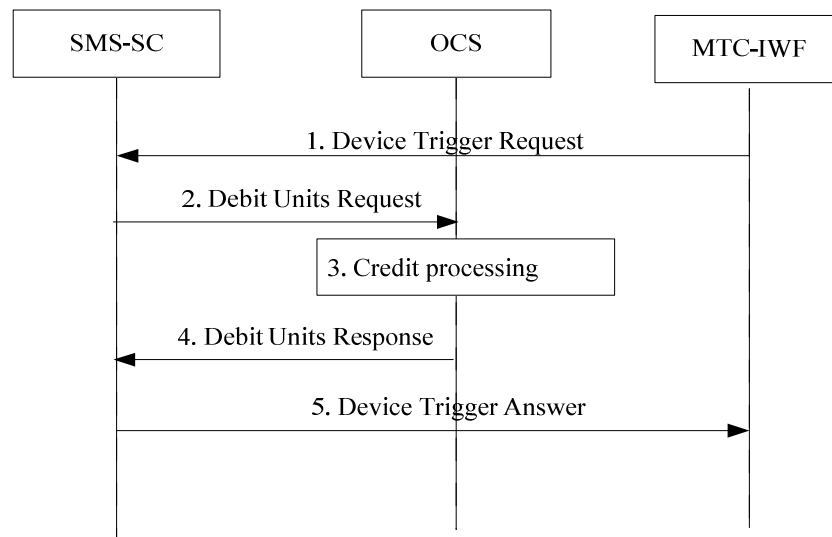

Figure 5.3.2.11.1.1: Online charging - SMS submission to SMS-SC for Device Triggering - IEC

- 1) The SMS-SC receives an incoming "Device Trigger Request" from an MTC-IWF over T4, destined to a UE recipient.
- 2) The SMS-SC triggers a Debit Units Request message to the OCS.
- 3) The OCS performs the appropriate credit processing based on the received request.
- 4) The OCS responds with a Debit Units Response message to the SMS-SC.
- 5) The SMS-SC returns "Device Trigger Answer" with appropriate result associated to the reception of the trigger request: successfully received by SMS-SC or failed due to error at SMS-SC.

5.3.2.11.2 SMS Delivery from SMS-SC for Device Triggering

This clause contains message flows for the different operation models IEC (figure 5.3.2.11.2.1) and ECUR (figure 5.3.2.11.2.2) for delivery attempts from SMS-SC for SM transfer towards the UE for Device Triggering.

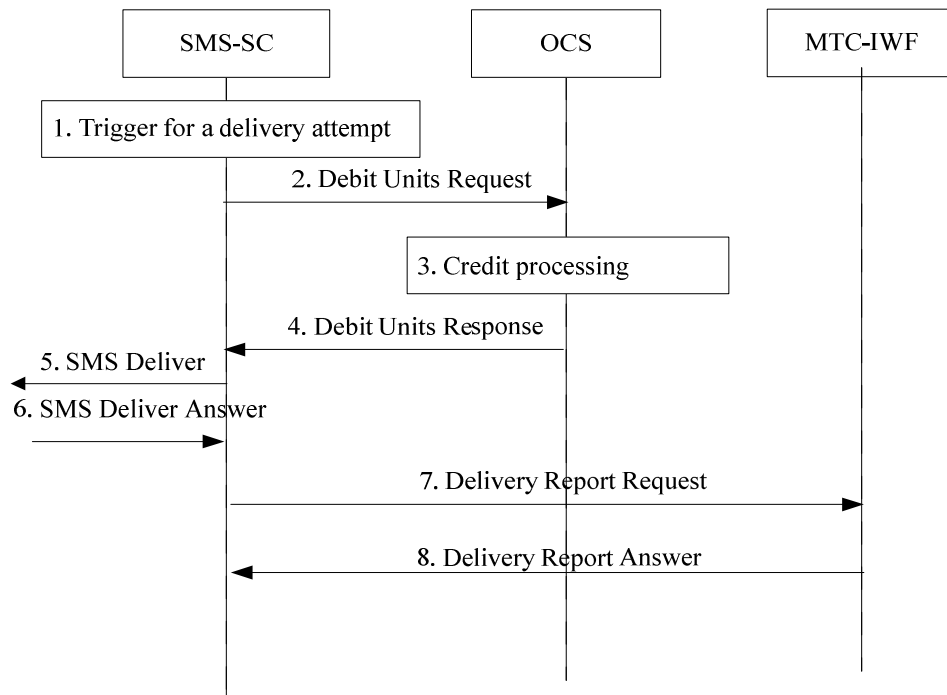

Figure 5.3.2.11.2.1: Online charging SMS Delivery retry from SMS-SC for Device Triggering – IEC

- 1) The SMS-SC decides to forward "SMS Deliver" message towards the receiving party, based on same trigger as step 1 of Figure 5.2.2.4.2.1.
- 2) The SMS-SC triggers a Debit Units Request message to the OCS.
- 3) The OCS performs the appropriate credit processing based on the internal trigger.
- 4) The OCS responds with a Debit Units Response message to the SMS-SC.
- 5) If authorized, the SMS-SC continues the SM processing for delivering the short message to the UE.
- 6) The SMS-SC receives "SMS Deliver Answer" message as the delivery success of the SM transfer.
- 7) The SMS-SC sends "Delivery Report Request" to MTC-IWF with appropriate result associated to the successful delivery of the device trigger to the UE.
- 8) The MTC-IWF acknowledges by sending "Delivery Report Answer".

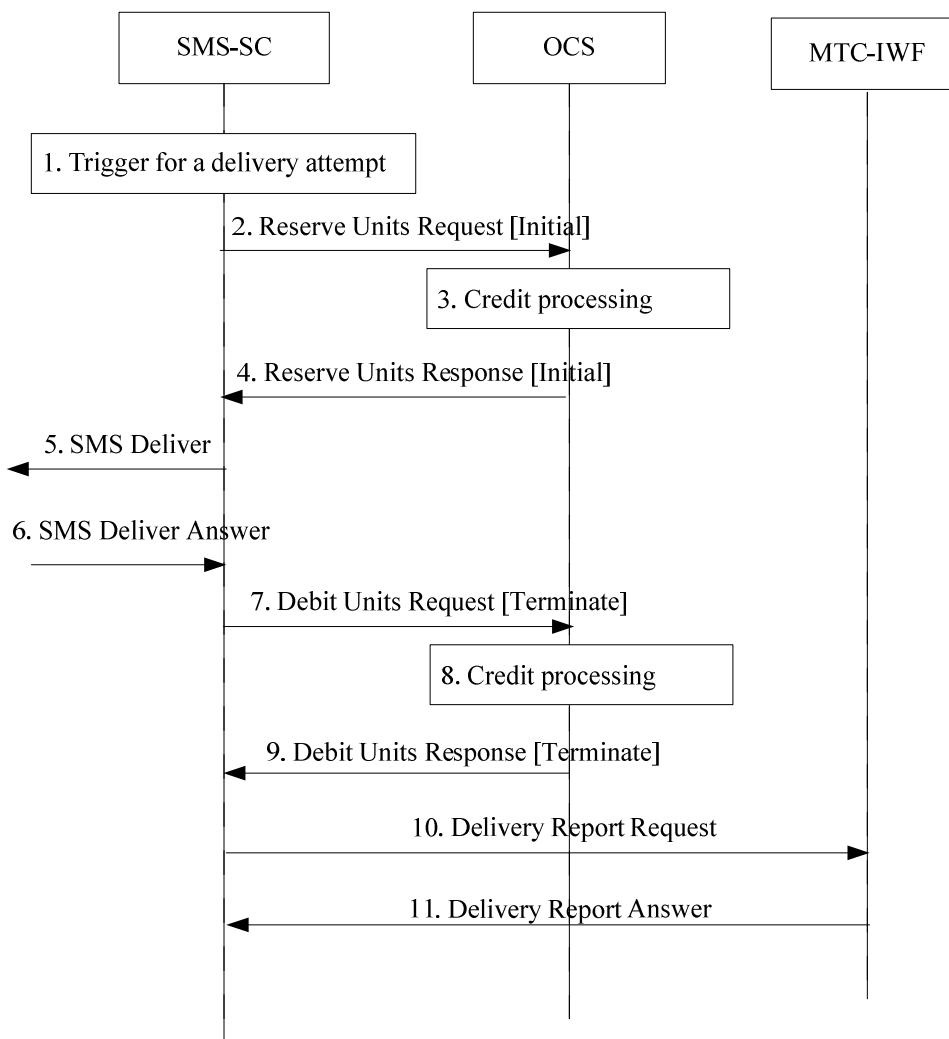

Figure 5.3.2.11.2.2: Online charging SMS Delivery retry from SMS-SC for Device Triggering - ECUR

- 1) The SMS-SC decides to forward "SMS Deliver" message towards the receiving party, based on same trigger as step 1 of Figure 5.2.2.4.2.1.
- 2) The SMS-SC triggers a Reserve Units Request [Initial] message to the OCS.
- 3) The OCS performs the appropriate credit processing based on the received request.
- 4) The OCS responds with a Reserve Units Response message to the SMS-SC.
- 5) If authorized, the SMS-SC continues the SM processing for delivering the short message to the UE.
- 6) The SMS-SC receives "SMS Deliver Answer" message as the delivery success of the SM transfer.
- 7) The SMS-SC triggers a Debit Units Request[Terminate] message to the OCS reporting the successful transaction.
- 8) The OCS performs the appropriate credit processing based on the received request.
- 9) The OCS responds with a Debit Units Response message to the SMS-SC.
- 10) The SMS-SC sends "Delivery Report Request" to MTC-IWF with appropriate result associated to the successful delivery of the device trigger to the UE.

11) The MTC-IWF acknowledges by sending "Delivery Report Answer".

5.3.2.11.3 Unsuccessful SMS Delivery from SMS-SC for Device Triggering

This clause contains message flows for the different operation models IEC (figure 5.3.2.11.3.1) and ECUR (figure 5.3.2.11.3.2) for unsuccessful delivery from SMS-SC of a SM towards the UE for Device Triggering.

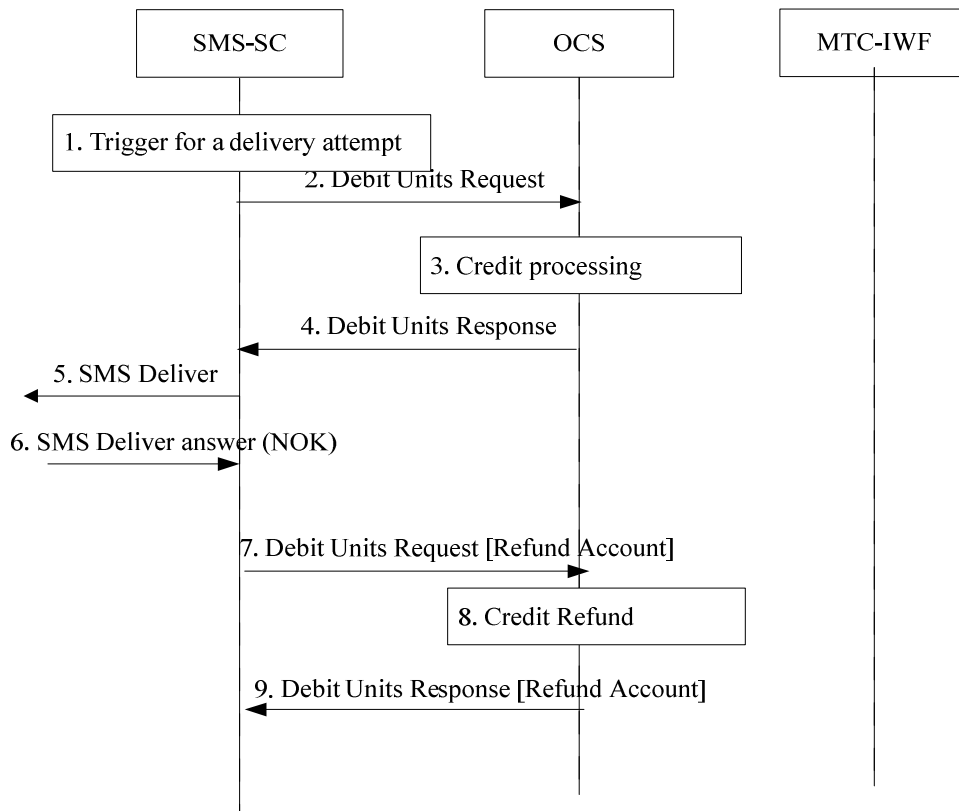

Figure 5.3.2.11.3.1: Online charging unsuccessful SMS Delivery from SMS-SC for Device Triggering after IEC

- 1) The SMS-SC decides to forward "SMS Deliver" message towards the receiving party, based on same trigger as step 1 of Figure 5.2.2.4.2.1.
- 2) The SMS-SC triggers a Debit Units Request message to the OCS.
- 3) The OCS performs the appropriate credit processing based on the internal trigger.
- 4) The OCS responds with a Debit Units Response message to the SMS-SC.
- 5) If authorized, the SMS-SC continues the SM processing for delivering the short message to the UE.
- 6) The SMS-SC receives "SMS Deliver Answer" message as the delivery failure of the SM transfer attempt, or an internal trigger indicating failure.
- 7) The SMS-SC triggers a Debit Units Request (Refund Account) message to the OCS.
- 8) The OCS performs the appropriate refund processing based on the received request.
- 9) The OCS responds with a Debit Units Response (Refund Account) message to the SMS-SC.

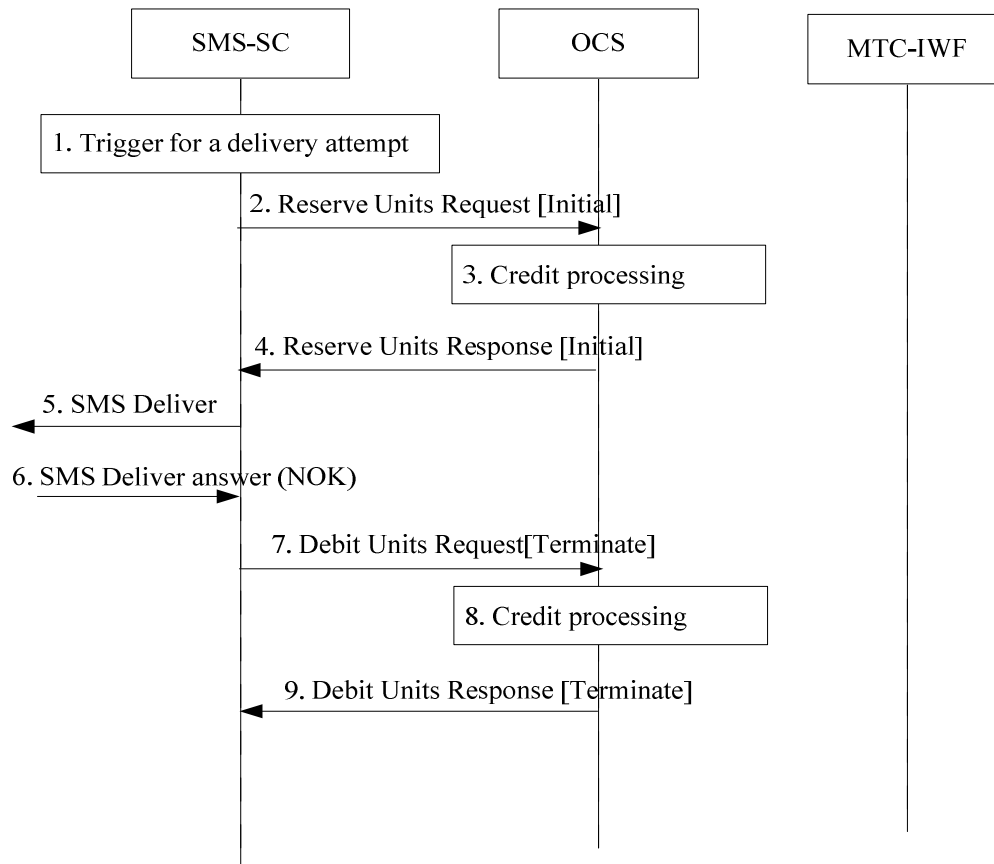

Figure 5.3.2.11.3.2: Online charging Unsuccessful SMS Delivery from SMS-SC for Device Triggering after ECUR

- 1) The SMS-SC decides to forward "SMS Deliver" message towards the receiving party, based on same trigger as step 1 of Figure 5.2.2.4.2.1.
- 2) The SMS-SC triggers a Reserve Units Request [Initial] message to the OCS.
- 3) The OCS performs the appropriate credit processing based on the received request.
- 4) The OCS responds with a Reserve Units Response message to the SMS-SC.
- 5) If authorized, the SMS-SC continues the SM processing for delivering the short message to the UE.
- 6) The SMS-SC receives "SMS Deliver Answer" message as the delivery failure of the SM transfer attempt, or an internal trigger indicating failure.
- 7) The SMS-SC triggers a Debit Units Request [Terminate] message to the OCS reporting the used unit for the service to zero, as a failed transaction.
- 8) The OCS performs the appropriate credit processing based on the received request.
- 9) The OCS responds with a Debit Units Response message to the SMS-SC.

5.3.2.11.4 SMS submission to SMS-SC for Device Triggering - Replace procedure

Figure 5.3.2.11.4.1 describes the scenario where the MTC-IWF submits a request to SMS-SC for a replace procedure of Device Triggering, in IEC operation model:

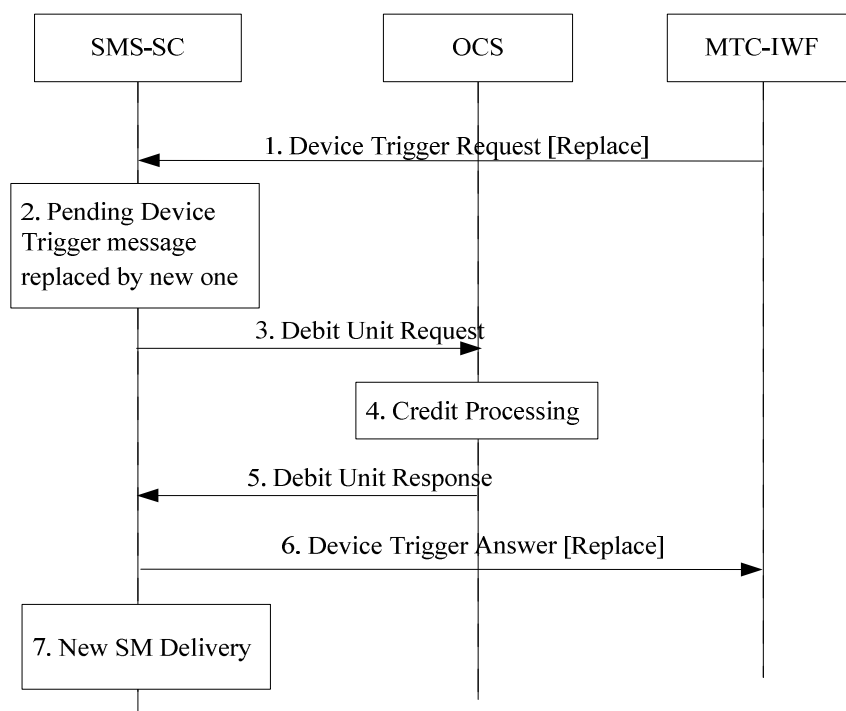

Figure 5.3.2.11.4.1: Online charging - SMS submission to SMS-SC for replace Device Triggering

- 1) The SMS-SC receives an incoming "Device Trigger Request" indicating "Replace" from an MTC-IWF over T₄.
- 2) The SMS-SC determines the trigger message identified by the External Identifier or MSISDN, SCS Identifier, and old trigger reference number in the received Device Trigger Replace message, is pending at SMS-SC: the new trigger message replaces the previous one.
- 3) The SMS-SC triggers a Debit Units Request message to the OCS.
- 4) The OCS performs the appropriate credit processing based on the received replace request.
- 5) The OCS responds with a Debit Units Response message to the SMS-SC.
- 6) The SMS-SC returns "Device Trigger Answer" with appropriate result of the successful or unsuccessful replace procedure.
- 7) In case of successful replace, the new SM to be delivered uses the same procedure as per clause 5.3.2.x.2.

5.3.2.11.5 SMS submission to SMS-SC for Device Triggering - Recall procedure

Figure 5.3.2.11.5.1 describes the scenario where the MTC-IWF submits a request to SMS-SC for a recall procedure for Device Triggering:

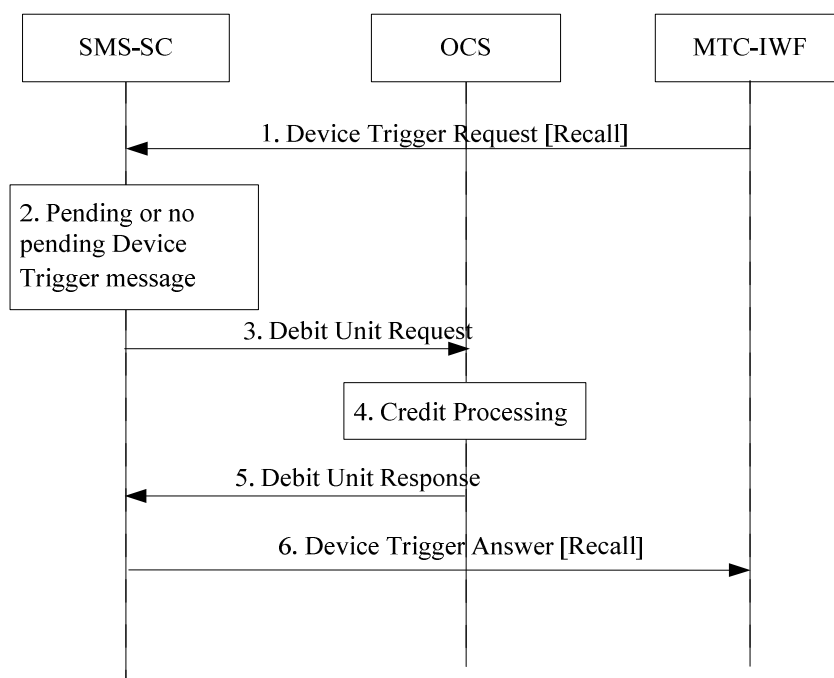

Figure 5.3.2.11.5.1: Online charging - SMS submission to SMS-SC for recall Device Triggering

- 1) The SMS-SC receives an incoming "Device Trigger Request" indicating "Recall" from an MTC-IWF over T4.
- 2) The SMS-SC determines the trigger message identified by the External Identifier or MSISDN, SCS Identifier, and old trigger reference number in the received Device Trigger Recall message, is pending at SMS-SC: the old trigger message is deleted.
- 3) The SMS-SC triggers a Debit Units Request message to the OCS.
- 4) The OCS performs the appropriate credit processing based on the received recall request.
- 5) The OCS responds with a Debit Units Response message to the SMS-SC.
- 6) The SMS-SC returns "Device Trigger Answer" with appropriate result of the recall procedure. In case in step 2 there was no pending Device trigger message, a failure is reported.

5.3.2.12 MSISDN-less SMS MO via T4

5.3.2.12.1 Introduction

The message flows associated to the MSISDN-less SMS MO via T4, describe the triggers occurring in the SMS-SC Node. As specified in TS 23.682 [17], the SMS delivery procedures to SMS-SC and SMS delivery report from SMS-SC are per TS 23.040 [12], therefore involving SMS-GMSC/SMS-IW MSC depending on the scenario. However, per this TS 23.040 [12], the interface between the SMS-GMSC/SMS-IW MSC and the SMS-SC is out of scope of 3GPP, therefore SMS-GMSC/SMS-IW MSC are assumed as internal to SMS-SC for the charging flows with triggers description.

The network does not perform any storing and forwarding functionality for MO-SMS.

Only ECUR operation model is applicable to MSISDN-less SMS MO via T4.

NOTE: As specified in TS 23.682 [17], the external identifier associated to the transaction is not available before the when the MO payload delivery response is received by the SMS-SC, therefore the IEC operation model is considered as not relevant for successful scenario.

5.3.2.12.2 MSISDN-less SMS MO via T4 - successful case

Figure 5.3.2.12.2.1 describes the scenario where MSISDN-less UE originates SMS-MO destined to a recipient SCS/AS using MSISDN-less SMS MO via T4 procedure, in ECUR operation model:

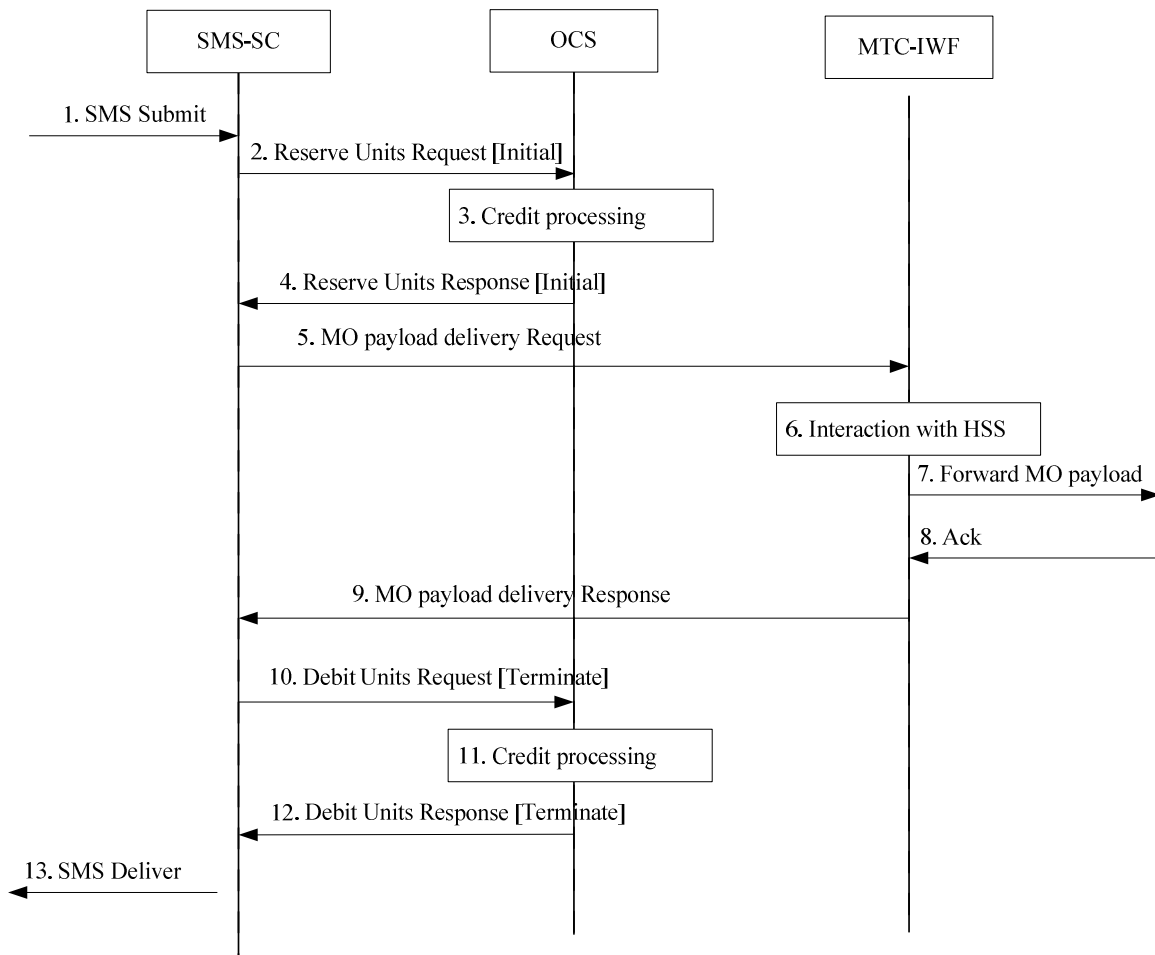

Figure 5.3.2.12.2.1: Online charging MSISDN-less SMS MO via T4 – successful case

- 1) The SMS-SC receives a "SMS Submit" incoming message originated by a MSISDN-less UE to deliver small data to SCS/AS.
- 2) The SMS-SC triggers a Reserve Units Request[Initial] message to the OCS.
- 3) The OCS performs the appropriate credit processing based on the received request.
- 4) The OCS responds with a Reserve Units Response message to the SMS-SC.
- 5) If authorized, the SMS-SC sends the "MO payload delivery Request" message to the MTC-IWF address (as pre-configured in the SMS-SC for this SCS/AS), with the SMS payload and the destination SME address (long/short code of the SCS/AS).
- 6) The MTC-IWF retrieves the external ID from the HSS (based on the IMSI of the UE and application port ID).
- 7_8) The MTC-IWF forwards the SMS to the SCS/AS (received destination SME), and receives the successful answer.
- 9) The MTC-IWF returns the success indication to SMS-SC, along with the external identifier associated to this transaction.
- 10) The SMS-SC triggers a Debit Units Request[Terminate] message to the OCS.

- 11) The OCS performs the appropriate credit processing based on the received request.
- 12) The OCS responds with a Debit Units Response message to the SMS-SC.
- 13) The SMS-SC indicates success back to UE.

5.3.2.12.3 MSISDN-less SMS MO via T4 - error cases

5.3.2.12.3.1 MSISDN-less SMS MO via T4 - failure at submission to SMS-SC

Figure 5.3.2.12.3.1.1 describes the scenario where MSISDN-less UE originates SMS-MO destined to a recipient SCS/AS using MSISDN-less SMS MO via T4 procedure, and failure at submission to SMS-SC:

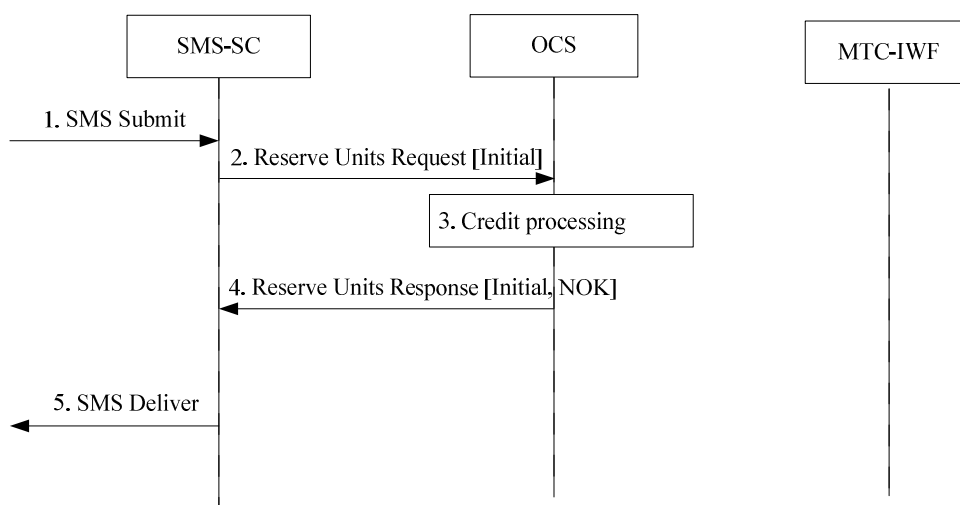

Figure 5.3.2.12.3.1.1: Online charging MSISDN-less SMS MO via T4 – failure at submission

- 1) The SMS-SC receives a "SMS Submit" incoming message originated by a MSISDN-less UE to deliver small data to SCS/AS.
- 2) The SMS-SC triggers a Reserve Units Request[Initial] message to the OCS.
- 3) The OCS performs the appropriate credit processing based on the received request and identified the transaction is not authorized.
- 4) The OCS responds with a Reserve Units Response [Initial, NOK] message to the SMS-SC.
- 5) The SMS-SC indicates failure back to UE, and will not initiate any message towards the MTC-IWF due to this failed attempt.

5.3.2.12.3.2 MSISDN-less SMS MO via T4 - failure at the MTC-IWF

Figure 5.3.2.12.3.2.1 describes the scenario where MSISDN-less UE originates SMS-MO destined to a recipient SCS/AS using MSISDN-less SMS MO via T4 procedure, and failure at the MTC-IWF:

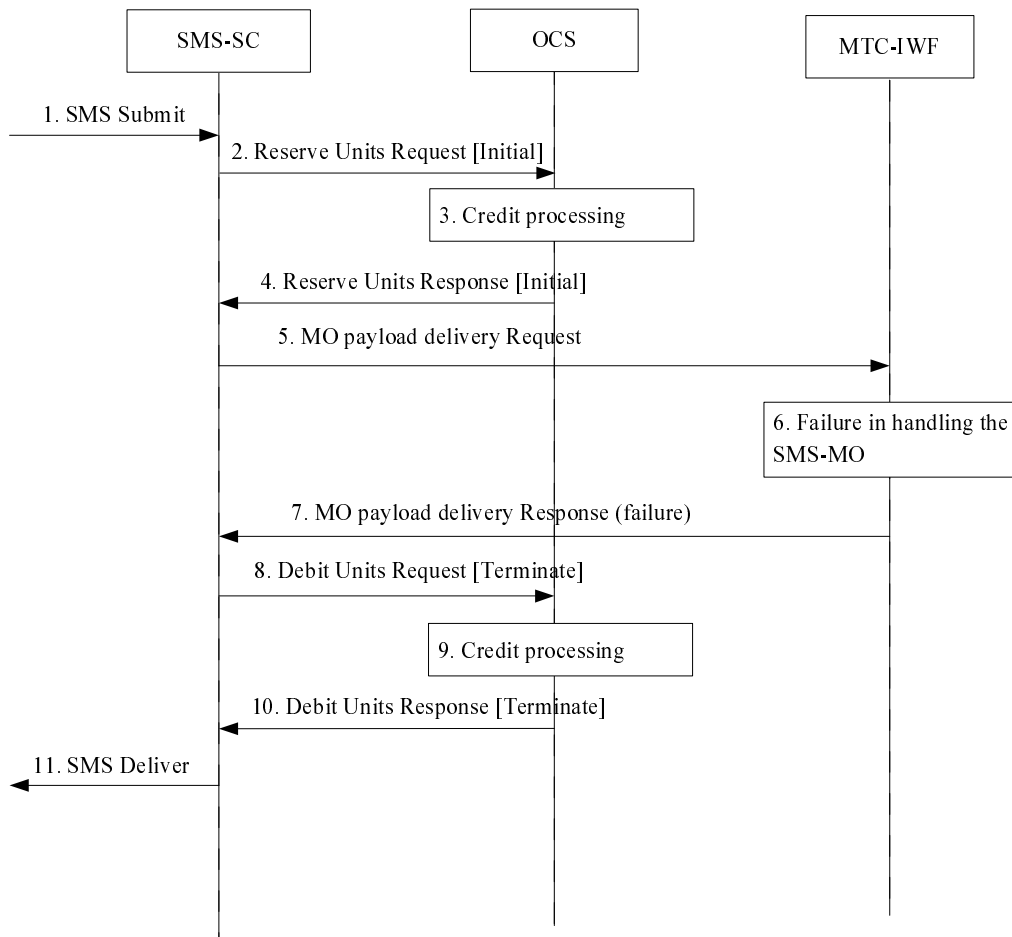

Figure 5.3.2.12.3.2.1; Online charging MSISDN-less SMS MO via T4 - failure at the MTC-IWF

- 1) The SMS-SC receives a "SMS Submit" incoming message originated by a MSISDN-less UE to deliver small data to SCS/AS.
- 2) The SMS-SC triggers a Reserve Units Request[Initial] message to the OCS.
- 3) The OCS performs the appropriate credit processing based on the received request.
- 4) The OCS responds with a Reserve Units Response [Initial] message to the SMS-SC.
- 5) If authorized, the SMS-SC sends the "MO payload delivery Request" message to the MTC-IWF address (as pre-configured in the SMS-SC for this SCS/AS), with the SMS payload and the destination SME address (long/short code of the SCS/AS).
- 6) Failure in handling the submitted SMS-MO in the MTC-IWF, including failure submission to the SCS/AS step 7 and 8 in Figure 5.3.2.y.2.1.
- 7) The MTC-IWF returns the failure delivery indication to SMS-SC.
- 8) The SMS-SC triggers a Debit Units Request[Terminate] message to the OCS, reporting the used unit for the service to zero.
- 9) The OCS performs the appropriate credit processing based on the received request.
- 10) The OCS responds with a Debit Units Response message to the SMS-SC.
- 11) The SMS-SC indicates failure back to UE.

5.3.3 Credit-Control related

5.3.3.1 Triggers for stopping for an SMS Credit-Control session

Used in ECUR only, a Debit / Reserve Units Request message to terminate the Credit-Control session is sent to OCS when:

- Validity time for granted quota expires;
- Granted quota runs out (i.e. a successful event has occurred);
- Abort-Session-Request is received from the OCS.

The expiration of the validity time for quota does not require the SMS procedures to be terminated. The CTF shall be configurable as to whether on expiration of validity time, the service should be aborted or not; i.e. whether the stored message should be deleted and no further (re-)delivery attempt should be made.

5.3.3.2 Triggers for providing interim information for a SMS Credit-Control session

The provision of interim information for Credit-Control is not used in this release of the specification, due to the use of IEC and ECUR.

6 Definition of charging information

6.1 Data description for SMS offline charging

6.1.1 R_f message contents

6.1.1.1 Summary of offline charging message formats

The SMS Node generates accounting information that can be transferred from the CTF to the CDF. For this purpose, SMS offline charging utilizes the *Charging Data Transfer Operation* that is specified in the 3GPP accounting application described in TS 32.299 [4].

The *Charging Data Transfer* operation employs the *Charging Data Request* and *Charging Data Response* messages. Table 6.1.1.1.1 describes the use of these messages for offline charging.

Table 6.1.1.1.1: Offline charging messages reference table

Command-Name	Source	Destination
<i>Charging Data Request</i>	CTF	CDF
<i>Charging Data Response</i>	CDF	CTF

This clause describes the different fields used in the Charging Data messages and the category in the tables are used according to the charging data configuration defined in clause 5.4 of TS 32.240 [2].

6.1.1.2 Structure for the offline charging message formats

6.1.1.2.1 Charging Data Request message

Table 6.1.1.2.1.1 illustrates the basic structure of a *Charging Data Request* message as used for SMS offline charging.

Table 6.1.1.2.1.1: Charging Data Request message contents

Information Element	Category	Description
Session Identifier	M	Described in TS 32.299 [4]
Originator Host	M	Described in TS 32.299 [4]
Originator Domain	M	Described in TS 32.299 [4]
Destination Domain	M	Described in TS 32.299 [4]
Operation Type	M	This field contains event type transfer (immediate event based charging).
Operation Number	M	Described in TS 32.299 [4]
Operation Identifier	O _M	Described in TS 32.299 [4]
User Name	O _C	This field contains the identification of the source node.
Origination Timestamp	O _C	Described in TS 32.299 [4]
Proxy Information	O _C	Described in TS 32.299 [4]
Route Information	O _C	Described in TS 32.299 [4]
Operation Token	O _M	This field contains the service context, i.e. SMS charging.
Service Information	O _M	This field holds the 3GPP specific SMS parameter. Described in clause 6.3.

6.1.1.2.2 Charging Data Response message

Table 6.1.1.2.2.1 illustrates the basic structure of a *Charging Data Response* message as used for SMS offline charging.

Table 6.1.1.2.2.1: Charging Data Response Message Contents

Information Element	Category	Description
Session Identifier	M	Described in TS 32.299 [4]
Operation Result	M	Described in TS 32.299 [4]
Originator Host	M	Described in TS 32.299 [4]
Originator Domain	M	Described in TS 32.299 [4]
Operation Type	M	This field contains event type transfer (immediate event based charging).
Operation Number	M	Described in TS 32.299 [4]
Operation Identifier	O _M	Described in TS 32.299 [4]
User Name	O _C	This field contains the identification of the source node.
Destination Host	O _C	Described in TS 32.299 [4]
Error Reporting Host	O _C	Described in TS 32.299 [4]
Origination Timestamp	O _C	Described in TS 32.299 [4]
Proxy Information	O _C	Described in TS 32.299 [4]

6.1.2 G_a message contents

Refer to clause 5.2.4 for further information.

6.1.3 CDR description on the B_{sm} interface

6.1.3.1 CDR field types

The following Standard CDR content and format are considered:

- SC-SMO CDR;
- SC-SMT CDR;
- SC-DVT-T4 CDR,

all generated based on information from the SMS-SC.

The content of each CDR type is defined in the tables in clauses 6.1.3.3 to 6.1.3.5.

For each CDR type the field definition includes the field name, category and description. The category in the tables are used according to the charging data configuration defined in clause 5.4 of TS 32.240 [2].

The detailed specification of the CDR parameters and their encoding is contained in TS 32.298 [3], while TS 32.297 [5] specifies the details of the CDR file transfer to the Billing Domain (BD). Additional CDR formats and contents may be available at the interface to the billing system to meet the requirements of the Billing System (BS), these are outside of the scope of 3GPP standardization.

6.1.3.2 CDR triggers

The generation of the SMS related CDRs is based on reception of Charging Data Request[Event] messages transferred from the SMS-SC node to the CDF. One CDR is created in the CDF for each Charging Data Request[Event] message received.

6.1.3.3 SC-SMO CDR content

The content of SC-SMO CDR is defined in the table 6.1.3.3.1.

Table 6.1.3.3.1: SC-SMO record

Field	Category	Description
Record Type	M	SMS originated.
SMS Node Address	M	This field holds the address (e.g. E.164) of the SMS-service centre sending the Charging Data Request used for producing the record. (SMSC Address)
Originator Info	O _M	This field is a grouped field and holds information on originator of the SM.
Originator IMSI	O _M	This field holds the IMSI of the subscriber sending the short message, in case of Mobile Originating message, if available.
Originator MSISDN	O _C	This field holds the primary MSISDN of the subscriber sending the message, if available.
Originator Other Address	O _M	This field holds the address of the originator of the SM, when different from IMSI and MSISDN, if available: e.g. email, short code. Multiple addresses may be carried.
Originator SCCP Address	O _C	This field holds the SCCP calling address used to receive the SM at the SMS node, when applicable.
Originator Received Address	O _C	This field holds the original, unmodified address of the originator of the SM, as received by the SMS node, in case address manipulation (such as number plan corrections) have been applied in the SMS node.
SM Originator Interface	O _M	This field contains information describing the interface on which the SM was received by the SMS node. In case the charging event is for application to person messaging or for application to application messaging (see clause 5.1.1) this field holds the identification of the application sending the SM.
SM Originator Protocol Id	O _C	This field holds the TP-PROTOCOL-ID (TP-PID) as defined in TS 23.040 [7] describing the protocol used for the SM by originator.
Recipient Info	O _M	This field is a grouped field and holds recipient information for the SM. Multiple occurrences of this field are allowed in case: - multiple recipients are associated with the charged event and - all other charging information is identical for all recipients.
Recipient IMSI	O _C	This field holds the IMSI of the recipient of the SM, as received by the SMS Node, if available.
Recipient MSISDN	O _C	This field holds the MSISDN of the recipient of the SM, as received by the SMS Node, if available.
Recipient Other Address	O _C	This field holds the address of the recipient of the SM, as received by the SMS Node, when different from IMSI and MSISDN, if available: e.g. email, short code, external identifier. Multiple addresses may be carried.
Recipient Received Address	O _C	This field holds the original, unmodified address of the recipient of the SM, as received by the SMS node, in case address manipulation (such as number plan corrections) have been applied in the SMS node.
SM Destination Interface	O _M	This is a structured field containing information describing the interface on which the SM is to be delivered (i.e. the next hop). In case the charging event is for person to application messaging or for application to application messaging (see clause 5.1.1) this field holds the identification of the application.
Served IMEI	O _C	The field holds IMEI or IMEISV of the UE, if available
Event Time stamp	M	This field holds the timestamp of when the submitted SM arrived at the SMS-SC.
Message Reference	M	This field holds the identity used to identify an SM in the SMS node associated with entity that submitted it, and corresponds to the TP-Message-Reference (TP-MR) as defined in TS 23.040 [7].
SM Total Number	O _C	This field holds the total number of short messages when this SM is part of concatenated short message. This field is present only in case of concatenated short message.
SM sequence Number	O _C	This field holds the sequence number of this SM within the concatenated short message when applicable. This field is present only in case of concatenated short message.
Message size	O _C	This field holds the length of the user data part of the SM, and corresponds to the TP-User-Data-Length (TP-UJDL) as defined in TS 23.040 [7].
Message Class	O _M	Used as defined in TS 32.270 [13]. It is implementation dependent the value selected for a specific transaction.
SM Delivery Report Requested	O _C	This field holds indication whether a delivery report is requested by the SM originator, and corresponds to the TP-Status-Report-Request (TP-SRR) as defined in TS 23.040 [7].
SM Data Coding Scheme	O _M	This field holds the data coding scheme used within the SM. The information to populate this field is obtained from TP-DCS header.
SM Message Type	O _M	This field identifies the message that triggered the generation of charging information.
SM Reply Path Requested	O _C	This field holds an indication of whether a reply SM to an original SM shall follow the same path as identified by the TP-Reply-Path (TP-RP) flag.
SM User Data Header	O _C	This field carries the user data header extracted from the user data of the SM. The user data header (TP-UDH) is specified in TS 23.040 [7]
User Location Info	O _C	This field holds the information about the location of the subscriber during the SMS transaction, in case of Mobile Originating message, if available.
RAT Type	O _C	This field holds the Radio Access Technology (RAT) type used for the SMS transaction, in case of Mobile Originating message, if available.

Field	Category	Description
UE Time Zone	O _c	This field indicates the offset between universal time and local time in steps of 15 minutes of where the UE currently resides, in case of Mobile Originating message, if available.
SMS Result	C	The field holds the result of the attempted SM submission, if unsuccessful.
Record extensions	O _c	A set of network/ manufacturer specific extensions to the record, when available.

6.1.3.4 SC-SMT CDR content

The content of SC-SMT CDR is defined in table 6.1.3.4.1.

Table 6.1.3.4.1: SC-SMT record

Field	Category	Description
Record Type	M	SMS Terminated.
SMS Node Address	M	This field holds the address (e.g. E.164) of the SMS-service centre sending the Charging Data Request used for producing the record. (SMSC Address).
Recipient Info	O _M	This field is a grouped field and holds information on the recipient for the SM.
Recipient IMSI	O _M	The IMSI of the subscriber the short message was delivered to, in case of Mobile Terminating message, if available.
Recipient MSISDN	O _C	The primary MSISDN of the subscriber the short message was delivered to, if available.
Recipient Other Address	O _C	This field holds the address of the recipient of the SM, when different from IMSI and MSISDN, if available: e.g. email, short code. Multiple addresses may be carried. This field holds the external identifier of the recipient of the SM, when the SM is to be delivered for Device Trigger, if available.
Recipient SCCP Address	O _C	This field holds the SCCP called address used by the SMS node to onward deliver the SM.
Recipient Received Address	O _C	This field holds the original, unmodified address of the recipient of the SM, as received by the SMS node, in case address manipulation (such as number plan corrections) have been applied in the SMS node.
SM Destination Interface	O _M	This is a structured field containing information describing the interface on which the SM was requested to be delivered (i.e. the next hop). In case the charging event is for person to application messaging or for application to application messaging (see clause 5.1.1) this field holds the identification of the application. In case the SM is for Device Trigger, this field is not present.
SM Recipient Protocol Id	O _C	This field holds the TP-PROTOCOL-ID (TP-PID) as defined in TS 23.040 [7]. In case the SM is for Device Trigger, this field holds the "Device Triggering Short Message code".
Originator Info	O _M	This field is a grouped field and holds information on the originator of the SM, if available.
Originator IMSI	O _M	This field holds the IMSI of the subscriber originator of the SM, if available.
Originator MSISDN	O _C	This field holds the MSISDN of the subscriber originator of the SM, if available.
Originator Other Address	O _M	This field holds the address of the originator of the SM, when different from IMSI and MSISDN, if available: e.g. short-code. Multiple addresses may be carried. In case the SM is for Device Trigger, this field holds the SME address of the Service Capability Server that is requesting a device trigger to the UE as specified in TS 29.337 [18].
Originator Received Address	O _C	This field holds the original, unmodified address of the originator of the SM, as received by the SMS node, in case address manipulation (such as number plan corrections) have been applied in the SMS node.
SM Originator Interface	O _C	This field contains information describing the interface on which the SM was received by the SMS node. In case the charging event is for application to person messaging or for application to application messaging (see clause 5.1.1) this field holds the identification of the application sending the SM. In case the SM is for Device Trigger, this field is not present.
Served IMEI	O _C	The field holds IMEI or IMEISV of the UE, if available.
Submission Time	O _C	This field holds the timestamp of when the submitted SM arrived at the originating SMS Node. The information to populate this field is obtained from the TP-Service-Center-Time-Stamp (TP-SCTS) as defined in TS 23.040 [7].
Event Time stamp	M	This field holds the timestamp of result (successful or unsuccessful) of SM delivery: last result in case of multiple retries.
SM Priority	O _e	This field holds any priority information associated with an SM, as defined in TS 23.040 [7].
Message Reference	O _M	This field holds the identity used to identify an SM in the SMS node associated with entity that submitted it, and corresponds to the TP-Message-Reference (TP-MR) as defined in TS 23.040 [7]. This information is only applicable to delivery report charging procedures.
SM Total Number	O _e	This field holds the total number of short messages when this SM is part of concatenated short message. This field is present only in case of concatenated short message.
SM Sequence Number	O _e	This field holds the sequence number of this SM within the concatenated short message when applicable. This field is present only in case of concatenated short message.
Message size	O _e	This field holds the length of the user data part of the SM, and corresponds to the TP-User-Data-Length (TP-UDL) as defined in TS 23.040 [7].
Message Class	O _M	Used as defined in TS 32.270 [13]. It is implementation dependent the value selected for a specific transaction.
SM Delivery Report Requested	O _e	This field holds indication whether a delivery report was requested by the SM originator, and corresponds to the TP-Status-Report-Indication (TP-SRI) as defined in TS 23.040 [7].
SM Data Coding Scheme	O _M	This field holds the data coding scheme used within the SM. The information to populate this field is obtained from TP-DCS header.
SM Message Type	O _M	This field identifies the message that triggered the generation of charging information.
SM Reply Path Requested	O _e	This field holds an indication of whether a reply SM to an original SM was requested to follow the same path as identified by the TP-Reply-Path (TP-RP) flag.
SM User Data Header	O _e	This field carries the user data header extracted from the user data of the SM. The user data header (TP-UDH) is specified in TS 23.040 [7].
SM Status	O _e	This field holds the information from the TP-Status field in a Status-Report TPDU. This information is only applicable to delivery report charging procedures.

Field	Category	Description
SM Discharge Time	O _c	This field holds the time associated with the event being reported in the SM Status field. This information is only applicable to delivery report charging procedures.
User Location Info	O _c	This field holds the information about the location of the subscriber during the SMS transaction, in case of Mobile Terminating message, if available.
RAT Type	O _c	This field holds the Radio Access Technology (RAT) type used for the SMS transaction, in case of Mobile Terminating message, if available.
UE Time Zone	O _c	This field indicates the offset between universal time and local time in steps of 15 minutes of where the UE currently resides, in case of Mobile Terminating message, if available.
SMS Result	C	The field holds the result of the attempted SM delivery, if unsuccessful.
SM Device Trigger information	O _c	This field holds the set of information related to SMS submission to SMS-SC for Device Trigger.
SM DT Reference Number	O _c	This field holds the Reference Number related to the device trigger request, if available.
SMS Application Port ID	O _c	This field holds the Application Port ID of the triggering application for the device trigger request, if available.
Record extensions	O _c	A set of network/ manufacturer specific extensions to the record, when available.

6.1.3.5 SC-DVT-T4 CDR content

The content of SC-DVT-T4 CDR is defined in the table 6.1.3.5.1.

Table 6.1.3.5.1: SC-DVT-T4 record

Field	Category	Description
Record Type	M	Device Trigger over T4.
SMS Node Address	M	This field holds the address (e.g. E.164) of the SMS-service centre sending the Charging Data Request used for producing the record. (SMSC Address)
Event Time stamp	M	This field holds the timestamp of when the Device Trigger request arrived at the SMS-SC.
Originator Info	O _M	This field is a grouped field and holds information on originator of the Device Trigger.
Originator Other Address	O _M	This field holds the SME address of the Service Capability Server that is requesting a device trigger to the UE as specified in TS 29.337 [18].
Recipient Info	O _M	This field is a grouped field and holds recipient information for the SM to be delivered.
Recipient IMSI	O _M	This field holds the IMSI of the recipient of the SM to be delivered for Device Trigger, as received in the User Identifier from MTC-IWF, specified in TS 29.337 [18].
Recipient MSISDN	O _c	This field holds the MSISDN of the recipient of the SM to be delivered for Device Trigger, as received in the User Identifier from MTC-IWF, specified in TS 29.337 [18], if available.
Recipient Other Address	O _c	This field holds the the external identifier of the recipient of the SM to be delivered for Device Trigger, as received in the User Identifier from MTC-IWF, specified in TS 29.337 [18], if available.
SM Device Trigger Indicator	O _c	This field holds indication on the device trigger submission to SMS-SC: trigger, replace or recall.
SM Device Trigger information	O _c	This field holds the set of information related to Device Trigger submission to SMS-SC.
MTC IWF Address	O _c	This field holds the MTC IWF address from which device trigger is received.
SM DT Reference Number	O _c	This field holds the Reference Number related to the device trigger request, if available.
SM Old DT Reference Number	O _c	This field holds the Reference Number related to the device trigger intended to be replaced or recalled in the request. This information element shall be present if SM Device Trigger Indicator is recall or replace.
SM Serving Node	O _c	This field holds the serving node identity, i.e. SGSN/MME/MSC identity serving the UE, as received from MTC-IWF, if available.
SM DT Validity Period	O _c	This field holds the validity period of the device trigger request, if available.
SM DT Priority Indication	O _c	This field holds the priority of the device trigger request, if available.
SMS Application Port ID	O _c	This field holds the Application Port ID of the triggering application for the device trigger request, if available.
Result	M	This field holds the result of Device Trigger request to SMS-SC
Record extensions	O _c	A set of network/ manufacturer specific extensions to the record, when available.

6.1.3.6 SC-SMO-T4 CDR content

The content of SC-SMO-T4 CDR is defined in the table 6.1.3.6.1.

Table 6.1.3.6.1: SC-SMO-T4 record

Field	Category	Description
Record Type	M	SMS originated via T4.
SMS Node Address	M	This field holds the address (e.g. E.164) of the SMS-service centre sending the Charging Data Request used for producing the record. (SMSC Address)
Originator Info	O _M	This field is a grouped field and holds information on originator of the SM.
Originator IMSI	O _M	This field holds the IMSI of the subscriber sending the short message, if available.
Originator SCCP Address	O _c	This field holds the SCCP calling address used to receive the SM at the SMS node, when applicable.
SM Originator Protocol Id	O _c	This field holds the TP-PROTOCOL-ID (TP-PID) as defined in TS 23.040 [7] describing the protocol used for the SM by originator.
Recipient Info	O _M	This field is a grouped field and holds recipient information for the SM.
Recipient Other Address	O _c	This field holds the SME address of the SCS/AS, recipient of the SM, as received by the SMS-SC.
Served IMEI	O _c	The field holds IMEI or IMEISV of the UE, if available
Event Time stamp	M	This field holds the timestamp of when the submitted SM arrived at the SMS-SC.
Message Reference	M	This field holds the identity used to identify an SM in the SMS node associated with entity that submitted it, and corresponds to the TP-Message-Reference (TP-MR) as defined in TS 23.040 [7].
Message size	O _c	This field holds the length of the user data part of the SM, and corresponds to the TP-User-Data-Length (TP-UDL) as defined in TS 23.040 [7].
Message Class	O _M	Used as defined in TS 32.270 [13]. It is implementation dependent the value selected for a specific transaction.
SM Delivery Report Requested	O _c	This field holds indication whether a delivery report is requested by the SM originator, and corresponds to the TP-Status-Report-Request (TP-SRR) as defined in TS 23.040 [7].
SM Data Coding Scheme	O _M	This field holds the data coding scheme used within the SM. The information to populate this field is obtained from TP-DCS header.
SM Message Type	O _M	This field identifies the message that triggered the generation of charging information, indicating "MO-SMS via T4 submission"
SM Reply Path Requested	O _c	This field holds an indication of whether a reply SM to an original SM shall follow the same path as identified by the TP-Reply-Path (TP-RP) flag.
SM User Data Header	O _c	This field carries the user data header extracted from the user data of the SM. The user data header (TP-UDH) is specified in TS 23.040 [7]
User Location Info	O _c	This field holds the information about the location of the subscriber during the SMS transaction, if available.
RAT Type	O _c	This field holds the Radio Access Technology (RAT) type used for the SMS transaction, if available.
UE Time Zone	O _c	This field indicates the offset between universal time and local time in steps of 15 minutes of where the UE currently resides, if available.
SMS Result	C	The field holds the result of the attempted SM submission, if unsuccessful.
MTC IWF Address	O _c	This field holds the MTC IWF address used by the SMS-SC for the Mobile Originating message transfer to the SCS/AS.
SMS Application Port ID	O _c	This field holds the Application Port ID of the Mobile Originating message handled by the SMS-SC.
External Identifier	O _M	This field holds the External Identifier associated to the sender of the Mobile Originated short message, if available.
Record extensions	O _c	A set of network/ manufacturer specific extensions to the record, when available.

6.2 Data description for SMS online charging

6.2.1 R_o message contents

6.2.1.0 Introduction

The SMS node generates Debit / Reserve Units information that can be transferred from the CTF to the OCF. For this purpose, SMS online charging utilizes the *Debit Units and Reserve Units* procedure that is specified in the 3GPP Debit / Reserve Units operation in TS 32.299 [4].

The SMS node generates refund information that can be transferred from the CTF to the OCF. For this purpose, it uses REFUND procedure defined in IETF RFC 4006 [12] with extended AVPs.

The *Debit / Reserve Units* procedure employs the *Debit / Reserve Units Request* and *Debit / Reserve Units Response* messages.

The Refund Account procedure employs the Debit Units Request (Refund Account) request and response messages.

Table 6.2.1.0.1 describes the use of these messages for SMS online charging.

Table 6.2.1.0.1: SMS online charging messages contents

Command-Name	Source	Destination
Debit / Reserve Units Request	CTF	OCS
Debit / Reserve Units Response	OCS	CTF

This clause describes the different fields used in the *Debit / Reserve Units Request* and *Debit / Reserve Units Response* messages and the category in the tables are used according to the charging data configuration defined in clause 5.4 of TS 32.240 [2].

Detailed descriptions of the fields are provided in TS 32.299 [4].

6.2.1.1 Summary of message formats

6.2.1.2 Structure for the Credit-Control message formats

6.2.1.2.1 Debit/Reserve Units Request message

Table 6.2.1.2.1.1 illustrates the basic structure of a *Debit / Reserve Units Request* message from SMS node as used for SMS online charging.

Table 6.2.1.2.1.1: *Debit / Reserve Units Request* message contents for SMS

Information Element	Category	Description
Session Identifier	M	This field identifies the operation session.
Originator Host	M	This field contains the identification of the source point of the operation.
Originator Domain	M	This field contains the realm of the operation originator.
Destination Domain	M	This field contains the realm of the operation destination.
Operation Identifier	M	This field is a unique operation identifier.
Operation Token	M	This field contains the service context, i.e. SMS charging.
Operation Type	M	This field defines the transfer type: event for immediate event based charging and initial, terminate for ECUR based charging.
Operation Number	M	This field contains the sequence number of the transferred messages.
Destination Host	O _c	This field contains the identification of the destination point of the operation.
User Name	O _c	This field contains the identification of the source node.
Origination State	O _c	Used for ECUR only.
Origination Timestamp	O _c	This field contains the time when the operation is requested.
Subscriber Identifier	O _M	This field contains the identification of the subscriber (i.e. MSISDN) that uses the requested service.
Termination Cause	O _c	This field contains information about the cause for termination of a Credit-Control session. Used for terminating Credit-Control sessions in ECUR only.
Requested-Action	O _c	This field contains the requested action, used for IEC only.
Multiple Operation	O _M	This field indicate the occurrence of multiple operations.
Multiple Unit Operation	O _c	This field contains the parameter for the quota management.
Subscriber Equipment Number	O _c	This field contains the identification of the user equipment used to access service. Included if information is made available to the node.
Proxy Information	O _c	This field contains the parameter of the proxy.
Route Information	O _c	This field contains the parameter of the route.
Service Information	O _M	This field holds the SMS specific parameter and is described in clause 6.3.

6.2.1.2.2 Debit / Reserve Units Response message

Table 6.2.1.2.2.1 illustrates the basic structure of a Debit / Reserve Units Response message as used for SMS charging. This message is always used by the OCS as specified below, independent of the receiving SMS node and the operation type that is being replied to.

Table 6.2.1.2.2.1: Debit / Reserve Units Response message contents for SMS

Information Element	Category	Description
Session Identifier	M	This field identifies the operation session.
Operation Result	M	This field identifies the result of the operation.
Originator Host	M	This field contains the identification of the source point of the operation.
Originator Domain	M	This field contains the realm of the operation originator.
Operation Identifier	M	This field is a unique operation identifier.
Operation Type	M	This field defines the transfer type: event for event based charging and start, interim, stop for session based charging.
Operation Number	M	This field contains the sequence number of the transferred messages.
Operation Failover	-	Not used for SMS in 3GPP.
Multiple Unit Operation	O _c	This field contains the parameter for the quota management. Used in IEC for refund purpose and in ECUR.
Operation Failure Action	O _c	This field defines the resulting operation at the SMS node if a failure has occurred at the OCS for ECUR.
Operation Event Failure Action	O _c	This field defines the resulting operation at the SMS node if a failure has occurred at the OCS for IEC.
Redirection Host	O _c	
Redirection Host Usage	O _c	
Redirection Cache Time	O _c	
Proxy Information	O _c	This field contains the parameter of the proxy.
Route Information	O _c	This field contains the parameter of the route.
Failed parameter	O _c	This field contains missing and/or unsupported parameter that caused the failure.
Service Information	O _c	This field contains SMS specific information.

Editor's Note: The mechanism to carry refund information is For Future Study.

6.3 SMS charging specific parameters

6.3.1 Definition of the SMS charging information

6.3.1.1 SMS charging information assignment for Service Information

The components in the Service-Information that are use for SMS charging can be found in table 6.3.1.1.1

Table 6.3.1.1.1: Service-Information used for SMS Charging

Information Element	Category	Description
Service Information	O _M	This is a structured field and holds the 3GPP specific parameter as defined in TS 32.299 [4]. For SMS Charging the SMS-Information and selected parameters of MMS Information, PS-Information and IMS information are used.
SMS Information	O _M	This is a structured field and holds the SMS specific parameters. The details are defined in table 6.3.1.2.
MMS Information	O _M	This is a structure field and the following parameters are specific to SMS. The complete structure is defined in TS 32.270 [13]
Originator Address	O _M	This field holds the address of the originator of the SM. This is typically an E.164 number or a short-code. Multiple addresses may be carried if additional information is available, e.g. IMSI and E.164 number. This field holds the SME address of the SCS requesting a device trigger to the UE as specified in TS 29.337 [18], in case of SM for Device Trigger.
Submission Time	O _C	This field holds the timestamp of when the submitted SM arrived at the originating SMS Node. The information to populate this field is obtained from the TP-Service-Center-Time-Stamp (TP-SCTS) as defined in TS 23.040 [7]. If a refund or retransmission is required, the timestamp carries the timestamp associated with the original submitted SM.
Priority	O _C	This field holds any priority information associated with an SM. Applicable to terminating procedures only. Priority handling is defined in TS 23.040 [7]. The value "low" is not applicable.
Message Id	O _M	This field carries the identity used to identify an SM in the SMS node associated with entity that submitted it. The information to populate this field is obtained from the TP-Message-Reference (TP-MR) as defined in TS 23.040 [7].
Message Size	O _M	This field carries the length of the user data part of the SM. The information to populate this field is obtained from the TP-User-Data-Length (TP-UDL) as defined in TS 23.040 [7]
Message Class	O _M	Used as defined in TS 32.270 [13]. It is implementation dependent the value selected for a specific transaction.
Delivery Report Requested	O _C	This field indicates whether a delivery report is requested by the SM originator. The information to populate this field is obtained from the TP-Status-Report-Request (TP-SRR) as defined in TS 23.040 [7]
PS Information	O _C	This is a structured field and the following parameters are specific to SMS. The complete structure is defined in TS 32.251 [10].
PDP Address	O _C	This field holds the IP address used by the subscriber for the SMS transaction. Included if the SMS node is the IP-SM-GW.
3GPP User Location Info	O _C	This field holds the information about the location of the subscriber during the SMS transaction.
3GPP RAT Type	O _C	This field holds information about the radio access technology used for the SMS transaction.
MS Time Zone	O _C	This field indicates the offset between universal time and local time in steps of 15 minutes of where the MS currently resides.
User Equipment Info	O _C	This field holds the identification of the terminal (IMEI or IMEISV...)
IMS Information	O _C	This is a structured field and the following parameters are specific to SMS. The complete structure is defined in TS 32.260 [15].
User Session Id	O _C	This field holds the session identifier. For a SIP session the Session-ID contains the SIP Call ID.
Number Portability routing information	O _C	This field includes information on number portability after DNS/ENUM request from S-CSCF in the calling user's home network.
Carrier Select routing information	O _C	This field includes information on carrier select after DNS/ENUM request from S-CSCF in the calling user's home network.

6.3.1.2 Definition of the SMS Information

The components in the SMS Information that are used for SMS charging can be found in table 6.3.1.2.1

Table 6.3.1.2.1: SMS Information used for SMS Charging

Information Element	Category	Description
SMS Node	O _M	Identifies the SMS Node as IP-SM-GW or SMS Router or a combined IP-SM-GW / SMS Router or as SMS-SC.
SM Client Address	O _M	This field holds the address of the SMS node to which the charging system is connected to. This may be the same as the SMSC Address field.
Originator SCCP Address	O _C	This field holds the SCCP calling address used to receive the SM at the SMS node. Only present if SMSIP is not used for the inward connection.
Originator Received Address	O _C	This field holds the original, unmodified address of the originator of the SM, as received by the SMS node, in case address manipulation (such as number plan corrections) have been applied in the SMS node. This is typically an E.164 number or a short-code. Multiple addresses may be carried if additional information is available, e.g. IMSI and E.164 number.
Recipient Info	O _C	This field holds recipient information for the SM. Each occurrence of this field denotes a different recipient. Multiple occurrences of this field are allowed in case: - multiple recipients are associated with the charged event and - all other charging information is identical for all recipients. In case the SM contains a Delivery Report, as described in clause 5.3.2.3, this field identifies the recipient of this Delivery Report. This recipient information shall correspond to the originator information of the message that triggered this Delivery Report. (Note 2)
Recipient Address	O _C	This field holds the address of the recipient of the SM. This is typically an E.164 number or a short-code. Multiple addresses may be carried if additional information is available, e.g. short-code, IMSI, E.164 number, long/short code of the SCS/AS, or external identifier for Device Trigger.
Recipient Received Address	O _C	This field holds the original, unmodified address of the recipient of the SM, as received by the SMS node, in case address manipulation (such as number plan corrections) have been applied in the SMS node. This is typically an E.164 number or a short-code. Multiple addresses may be carried if additional information is available, e.g. short-code, IMSI, or E.164 number.
Recipient SCCP Address	O _C	This field holds the SCCP called address used by the SMS node to onward deliver the SM. Only present if SMSIP is not used for the outward connection.
SM Destination Interface	O _M	This is a structured field containing information describing the interface on which the SM is to be delivered (i.e. the next hop). In case the charging event is for person to application messaging or for application to application messaging (see clause 5.1.1) this field holds the identification of the application. (See also Note 3)
SM Protocol Id	O _C	This field holds the TP-PROTOCOL-ID (TP-PID) as defined in TS 23.040 [7]. This field relates to the recipient when charging MT SMS messages as specified in TS 32.240 [2].
SMSC Address	O _M	This field holds the address of the SMSC to which the originating or terminating SM is directed to.
SM Data Coding Scheme	O _M	This field holds the data coding scheme used within the SM. The information to populate this field is obtained from TP-DCS header.
SM Message Type	O _M	This field identifies the message that triggered the generation of charging information.
SM Originator Interface	O _M	This is a structured field containing information describing the interface on which the SM was received by the SMS node (i.e. the previous hop) In case the charging event is for application to person messaging or for application to application messaging (see clause 5.1.1) this field holds the identification of the application. (See also Note 3)
SM Protocol Id	O _C	This field holds the TP-PROTOCOL-ID (TP-PID) as defined in TS 23.040 [7]. This field relates to the originator when charging MO SMS messages as specified in TS 32.240 [2].
SM Reply Path Requested	O _C	This field carries an indication of whether a reply SM to an original SM shall follow the same path as identified by the TP-Reply-Path (TP-RP) flag.
SM User Data Header	O _C	This field carries the user data header extracted from the user data of the SM. The user data header (TP-UDH) is specified in TS 23.040 [7]
SM Status	O _C	This field holds the information from the TP-Status field in a Status-Report TPDU. This information is only applicable to delivery report charging procedures or where ECUR is employed.
SM Discharge Time	O _C	This field holds the time associated with the event being reported in the SM Status field. This information is only applicable to delivery report charging procedures.
Number of Messages Sent	O _C	Indicates the number of SMSs sent by the IMS application or the total number of short messages when this SM is part of concatenated short message, if applicable.
SM Service Type	O _C	This field indicates the type of SM service that caused the charging interaction. It is only applicable for SM supplementary service procedures.
SM Sequence Number	O _C	This field holds the sequence number of this SM within the concatenated short message when applicable. This field is present only in case of concatenated short message. This field is only for offline charging.
SMS result	C	The field holds the result of the attempted SM transaction, if unsuccessful. This field is only for offline charging.
SM Device Trigger Indicator	O _C	This field holds indication on the device trigger submission to SMS-SC: request, replace or recall.
SM Device Trigger information	O _C	This field holds the set of information related to SMS transaction for Device Trigger.

MTC IWF Address	O _C	This field holds the MTC IWF address which originated the device trigger.
SM DT Reference Number	O _C	This field holds the Reference Number related to the device trigger request, if available.
SM Serving Node	O _C	This field holds the serving node identity, i.e. SGSN/MME/MSC identity serving the UE, as received from MTC-IWF, if available.
SM DT Validity Period	O _C	This field holds the validity period of the device trigger request, if available.
SM DT Priority Indication	O _C	This field holds the priority of the device trigger request, if available.
SMS Application Port ID	O _C	This field holds the Application Port ID of the triggering application for the device trigger request, if available.
MTC IWF Address	O _C	This field holds the MTC IWF address used by the SMS-SC for the Mobile Originating message transfer to the SCS/AS.
SMS Application Port ID	O _C	This field holds the Application Port ID of the Mobile Originating message handled by the SMS-SC.
External Identifier	O _M	This field holds the External Identifier associated to the sender of the Mobile Originated short message, if available.

NOTE 1: The case of multi-destinations of SMS refers to SMS and Internet Electronic Mail interworking as specified in clause 3.8 of TS 23.040 [7].

NOTE 2: Implementations vary as to the originator address that is presented to an end user for a Delivery Report. Typically the originator address either identifies the SMS node that generated the Delivery Report or the originator address of a Delivery Report identifies the recipient of the original message that triggered this Report. It is expected that the charging event contains the information presented to the end user.

NOTE 3: There is a distinction between short numbers (as conveyed in originator and/or recipient address fields) and the identification of SM applications (as carried in SM Originator Interface and/or SM Destination Interface). Short numbers are used by end users to address a service of an applications. Multiple short numbers may map to one application capable of multiple services. The identification of an application is how an application is know to the operator.

6.3.1A Detailed message format for offline charging

This clause specifies the charging data that are sent by the SMS-SC in the Charging Data Request, with [Event] Operation Type.

When a particular field is not supported, this field is marked with "-".

Table 6.3.1A.1 illustrates the basic structure of the supported fields in Service Information of the *Charging Data Request* message for SMS offline charging.

Table 6.3.1A.1: Supported fields in *Charging Data Request* message

Information Element	Node Type	SMS-C			
	CDR Type	SC-SMO	SC-SMT	SC-DVT-T4	SC-SMO-T4
	Supported Operation Types	E	E	E	E
Session Identifier		E	E	E	E
Originator Host		E	E	E	E
Originator Realm		E	E	E	E
Destination Domain		E	E	E	E
Operation Type		E	E	E	E
Operation Number		E	E	E	E
Operation Identifier		E	E	E	E
User Name		E	E	E	E
Destination Host		E	E	E	E
Operation Interval		-	-	-	-
Origination State		E	E	E	E
Origination Timestamp		E	E	E	E
Proxy Information		E	E	E	E
Route Information		E	E	E	E
Operation Token		E	E	E	E
Service Information with MMS, PS, IMS and SMS Information					
SMS Node		-	-	-	E
SM Client Address		E	E	E	E
Originator SCCP Address		E	E	-	E
Originator Received Address		E	E	-	E
Recipient Info		E	E	E	E
SMSC Address		-	-	-	-
SM Data Coding Scheme		E	E	-	E
SM Message Type		E	E	E	E
SM Originator Interface		-	E	-	-
SM Protocol Id		E	-	-	E
SM Reply Path Requested		E	E	-	E
SM User Data Header		E	E	-	E
SM Status		-	E	-	E
SM Discharge Time		-	E	-	-
Number of Messages Sent		E	E	-	-
SM Service Type		-	-	-	-
SMS result		E	E	E	E
SM Sequence Number		E	E	-	-
SM Device Trigger Indicator		-	-	E	E
SM Device Trigger information		-	E	E	E
Originator Address		E	E	E	E
Submission Time		E	E	E	E
Priority		-	E	-	-
Message Id		E	E	-	E
Message Size		E	E	-	E
Message Class		E	E	-	E
Delivery Report Requested		E	E	-	E
PDP Address		-	-	-	-
3GPP User Location Info		E	E	-	E
3GPP RAT Type		E	E	-	E
MS Time Zone		E	E	-	E
User Equipment Info		E	E	-	E
User Session Id		-	-	-	-
Number Portability routing information		-	-	-	-
Carrier Select routing information		-	-	-	-
MTC IWF Address		-	-	-	E
SMS Application Port ID		-	-	-	E
External Identifier		-	-	-	E

6.3.2 Formal parameter description

6.3.2.1 SMS charging information for CDRs

The detailed definitions, abstract syntax and encoding of the SMS CDR parameters are specified in TS 32.298 [3].

6.3.2.2 SMS charging information for charging events

The detailed charging event parameter definitions are specified in TS 32.299 [50].

6.3.3 Detailed message format for online charging

The Operation types are listed in the following order: I [initial]/ T [terminate]/E [event]. Therefore, when all Operation types are possible it is marked as ITE. If only some Operation types are allowed for a node, only the appropriate letters are used (i.e. IT or E) as indicated in the table heading. The omission of an Operation type for a particular field is marked with "-" (i.e. I-E). Also, when an entire field is not allowed in a node the entire cell is marked as "-".

Table 6.3.3.1 illustrates the basic structure of the supported fields in the Debit / Reserve Units Request for SMS, T4 Device Triggering, and for MO-SMS via T4 submission, online charging.

Table 6.3.3.1: Supported fields in *Debit / Reserve Units Request* message

Information Element	Service Type	SMS	T4 Device Triggering	MO-SMS T4
	Supported Operation Types	I/T/E	E	I/T
Session Identifier		ITE	E	IT
Originator Host		ITE	E	IT
Originator Domain		ITE	E	IT
Destination Domain		ITE	E	IT
Operation Identifier		ITE	E	IT
Operation Token		ITE	E	IT
Operation Type		ITE	E	IT
Operation Number		ITE	E	IT
Destination Host		ITE	E	IT
User Name		ITE	E	IT
Origination State		ITE	-	IT
Origination Timestamp		ITE	E	IT
Subscriber Identifier		ITE	E	IT
Termination Cause		-T-	-	-T
Requested Action		--E	E	-
Multiple Operation		ITE	E	IT
Multiple Unit Operation		ITE	E	IT
Subscriber Equipment Number		ITE	-	IT
Proxy Information		ITE	E	IT
Route Information		ITE	E	IT
Service Information		ITE	E	IT
Service Information with MMS, PS, IMS and SMS Information				
SMS Node		ITE	-	IT
SM Client Address		ITE	E	IT
Originator Info		ITE	E	IT
Recipient Info		ITE	E	IT
SMSC Address		ITE	-	-
SM Data Coding Scheme		ITE	-	IT
SM Message Type		ITE	E	IT
SM Originator Interface		ITE	-	-
SM Protocol Id		ITE	-	IT
SM Reply Path Requested		ITE	-	IT
SM User Data Header		ITE	-	IT
SM Status		ITE	-	IT
SM Discharge Time		ITE	-	-
Number of Messages Sent		ITE	-	-
SM Service Type		ITE	-	-
SMS result		-	E	IT
SM Sequence Number		-	-	-
SM Device Trigger Indicator		ITE	E	-
SM Device Trigger information		ITE	E	-
Originator Address		ITE	-	IT
Submission Time		ITE	E	IT
Priority		ITE	-	IT
Message Id		ITE	-	IT
Message Size		ITE	-	IT
Message Class		ITE	-	IT
Delivery Report Requested		ITE	-	IT
PDP Address		ITE	-	-
3GPP User Location Info		ITE	-	IT
3GPP RAT Type		ITE	-	IT
MS Time Zone		ITE	-	IT
User Equipment Info		-	-	-
User Session Id		ITE	-	-
Number Portability routing information		ITE	-	-
Carrier Select routing information		ITE	-	-
MTC IWF Address		-	-	IT
SMS Application Port ID		-	-	IT
External Identifier		-	-	-T

6.4 Bindings for SMS charging

This clause describes the mapping between the Service Information fields, AVPs and CDR parameters for SMS charging.

Table 6.4.1 describes the mapping of the Information Element, AVP and CDR parameter of SC-SMO and SC-SMT CDRs in SMS charging.

Table 6.4.1: Bindings of CDR parameter, Information Element and AVP

CDR parameter	Information Element	AVP
	Service Information	Service-Information
	SMS Information	SMS-Information
-	SMS Node	SMS-Node
SMS Node Address	SM Client Address	Client-Address
Originator SCCP Address	Originator SCCP Address	Originator-SCCP-Address
Originator Received Address	Originator Received Address	Originator-Received-Address
Recipient Info	Recipient Info	Recipient-Info
Recipient IMSI	Recipient Address	Recipient-Address
Recipient MSISDN	Recipient Address	Recipient-Address
Recipient Other Address	Recipient Address	Recipient-Address
Recipient Received Address	Recipient Received Address	Recipient-Received-Address
Recipient SCCP Address	Recipient SCCP Address	Recipient-SCCP-Address
SM Destination Interface	SM Destination Interface	Destination-Interface
SM Recipient Protocol Id	SM Protocol Id	SM-Protocol-Id
	SMSC Address	SMSC-Address
SM Data Coding Scheme	SM Data Coding Scheme	Data-Coding-Scheme
SM Message Type	SM Message Type	SM-Message-Type
SM Originator Interface	SM Originator Interface	Originator-Interface
SM Originator Protocol Id	SM Protocol Id	SM-Protocol-Id
SM Reply Path Requested	SM Reply Path Requested	Reply-Path-Requested
SM User Data Header	SM User Data Header	SM-User-Data-Header
SM Status	SM Status	SM-Status
SM Discharge Time	SM Discharge Time	SM-Discharge-Time
SM Total Number	Number of Messages Sent	Number-of-Messages-Sent
-	SM Service Type	SM-Service-Type
SMS result	SMS result	SMS-result
SM Sequence Number	SM Sequence Number	SM-Sequence-Number
SM Device Trigger Indicator	SM Device Trigger Indicator	SM-Device-Trigger-Indicator
SM Device Trigger information	SM Device Trigger information	SM-Device-Trigger-information
MTC IWF Address	MTC IWF Address	MTC-IWF-Address
SM DT Reference Number	SM DT Reference Number	Reference-Number
SM Serving Node	SM Serving Node	Serving-Node
SM DT Validity Period	SM DT Validity Period	Validity-Time
SM DT Priority Indication	SM DT Priority Indication	Priority-Indication
SMS Application Port ID	SMS Application Port ID	Application-Port-Identifier
MTC IWF Address	MTC IWF Address	MTC-IWF-Address
SMS Application Port ID	SMS Application Port ID	Application-Port-Identifier
External Identifier	External Identifier	External-Identifier
-	MMS Information	MMS-Information
Originator IMSI	Originator Address	Originator-Address
Originator MSISDN	Originator Address	Originator-Address
Originator Other Address	Originator Address	Originator-Address
Event Time stamp	Submission Time	Submission-Time
Submission Time	Submission Time	Submission-Time
SM Priority	Priority	Priority
Message Reference	Message Id	Message-ID
Message size	Message Size	Message-Size
Message Class	Message Class	Message-Class
SM Delivery Report Requested	Delivery Report Requested	Delivery-Report-Requested
-	PS Information	PS-Information
-	PDP Address	PDP-Address
User Location Info	3GPP User Location Info	3GPP-User-Location-Info
RAT Type	3GPP RAT Type	3GPP-RAT-Type
UE Time Zone	MS Time Zone	3GPP-MS-Time-Zone
Served IMEI	User Equipment Info	User -Equipment -Info
-	IMS Information	IMS-Information
-	User Session Id	User-Session-Id
-	Number Portability routing information	Number-Portability-routing- information
-	Carrier Select routing information	Carrier-Select-routing information

Annex A (informative): Bibliography

This Annex is a placeholder for documents which are not explicitly cited in this specification.

Annex B (informative): Change history

Change history								
Date	TSG #	TSG Doc.	CR	Rev	Subject/Comment	Cat	Old	New
Sep 2007	SP-37	SP-070620	--	--	Submitted to TSG SA#37 for Information	--	1.0.0	
Dec 2007	SP-38	SP-070748	--	--	Submitted to TSG SA#38 for Approval	--	2.0.0	8.0.0
Dec 2007	--	--	--	--	editHelp: the figures are now visible in normal view	--	8.0.0	8.0.1
Mar 2008	SP-39	SP-080074	0001	--	Correction on Service Information for SMS Charging	F	8.0.1	8.1.0
Jun 2008	SP-40	SP-080330	0002	--	Support of Number Portability and Carrier Selection in SMS Online Charging	B	8.1.0	8.2.0
Sep 2008	SP-41	SP-081216	0003	--	Multiple SMS destination – Alignment with TS 23.040	C	8.2.0	8.3.0
Sep 2008	SP-41	SP-081224	0004	--	Introduce Online Charging from SMS-SC into 3GPP TS 32.274	B	8.2.0	8.3.0
Dec 2008	SP-42	SP-080706	0005	--	Correction on Multiple Unit Operation category	F	8.3.0	8.4.0
Dec 2008	SP-42	SP-080706	0006	--	Add SMS-SC as SMS node type	B	8.3.0	8.4.0
Dec 2008	SP-42	SP-080706	0007	--	Additional Address Info for SMS charging	B	8.3.0	8.4.0
Dec 2008	SP-42	SP-080706	0008	--	Add charging of SMS services to 32.274	B	8.3.0	8.4.0
Mar 2009	SP-43	SP-090045	0009	--	SMS IE structure alignment	F	8.4.0	8.5.0
Jun 2009	SP-44	SP-090293	0010	--	Clarification of "Termination charge" and application addressing	F	8.5.0	8.6.0
Sep 2009	SP-45	SP-090536	0011	--	IE usage for Delivery Reports and Application Identifiers	F	8.6.0	8.7.0
Dec 2009	-	-	-	-	Update to Rel-9 version (MCC)	-	8.7.0	9.0.0
Mar 2011	-	-	-	-	Update to Rel-10 version (MCC)	-	9.0.0	10.0.0
Sep-2012	SP-57	SP-120575	0014	-	Addition of MS Timezone for NetLoc	B	10.0.0	11.0.0
Mar 2013	SP-59	SP-130055	0017	1	Introduction of SMS-SC Offline Charging Architecture	B	11.0.0	12.0.0
Mar 2013					Editorial changes on CDR tables (MCC)		12.0.0	12.0.1
Jun-2013	SP-60	SP-130274	0018	1	Introduction SMS Offline charging principles and flows	B	12.0.1	12.1.0
Dec-2013	SP-62	SP-130628	0020	1	Introduce Charging Data Request/Response in flow description	B	12.1.0	12.2.0
			0021	-	Introduction of offline charging Diameter error cases	B		
			0022	1	Introduction of Rf message content	B		
Mar-2014	SP-63	SP-140045	0024	1	Introduction of information for SMS offline Charging	B	12.2.0	12.3.0
			0027	-	SCS Identity identified as Originator for Device Triggering	B		
			0028	1	Introduction of new SC-SMO and SC-SMT CDRs description	B		
2014-07	-	-	-	-	Rapporteur/MCC: General editorial changes and clean-up.	-	12.3.0	12.3.1
2014-09	SP-65	SP-140564	0029	1	Corrections for alignment between charging specifications	F	12.3.1	12.4.0
2014-12	SP-66	SP-140805	0030	-	Corrections on definition for parameter category	F	12.4.0	12.5.0
2015-06	SP-68	SP-150327	0031	-	Correction on category for MSISDN from Om to Oc for SMS CDRs	F	12.5.0	12.6.0
2016-01					Update to Rel-13 (MCC)		12.6.0	13.0.0

Change history							
Date	Meeting	TDoc	CR	Rev	Cat	Subject/Comment	New version
2016-09	SA#73	SP-160622	0032	1	F	Correction on use of Multiple Operation and Multiple Unit Operation for IEC	13.1.0
2016-12	SA#74	SP-160847	0033	1	F	Correction SMS Delivery handling	14.0.0
2017-03	SA#75	SP-170138	0034	1	D	Remove reference to RFC 3588	14.1.0
2017-03	SA#75	SP-170135	0035	1	B	Introduce charging principle for MSISDN-less MO-SMS via T4	14.1.0
2017-03	SA#75	SP-170135	0036	-	B	Introduce Message flows offline charging for MSISDN-less MO-SMS via T4	14.1.0
2017-03	SA#75	SP-170135	0037	1	B	Remove Editor's Note in clause 5.2.3, 5.2.4, 5.2.5, and 6.1.2	14.1.0
2017-06	SA#76	SP-170500	0038	1	B	Improve Message flows offline charging for SMS delivery	14.2.0
2017-06	SA#76	SP-170500	0039	1	B	Introduce additional Message flows offline charging for Device Triggering	14.2.0
2017-06	SA#76	SP-170500	0040	1	B	Introduce Message flows online charging for Device Triggering	14.2.0
2017-06	SA#76	SP-170500	0041	1	B	Introduce Message flows online charging for MSISDN-less MO-SMS via T4	14.2.0
2017-06	SA#76	SP-170500	0046	1	B	Introduce new CDR for Device Triggering	14.2.0
2017-06	SA#76	SP-170500	0047	-	B	Clarify the chargeable events for SMS via T4	14.2.0
2017-06	SA#76	SP-170500	0048	-	B	Remove T4 Device Trigger dedicated fields from SC-SMO and SC-SMT CDRs	14.2.0
2017-06	SA#76	SP-170500	0049	1	B	Introduce Device Trigger and SMS MO via T4 in SMS information	14.2.0
2017-06	SA#76	SP-170500	0050	-	B	Introduce new CDR for SMS MO via T4	14.2.0

History

Document history		
V14.1.0	April 2017	Publication
V14.2.0	July 2017	Publication