

ETSI TS 132 102 V8.2.0 (2009-01)

Technical Specification

**Digital cellular telecommunications system (Phase 2+);
Universal Mobile Telecommunications System (UMTS);
LTE;
Telecommunication management;
Architecture
(3GPP TS 32.102 version 8.2.0 Release 8)**



Reference

RTS/TSGS-0532102v820

Keywords

GSM, LTE, UMTS

ETSI

650 Route des Lucioles
F-06921 Sophia Antipolis Cedex - FRANCE

Tel.: +33 4 92 94 42 00 Fax: +33 4 93 65 47 16

Siret N° 348 623 562 00017 - NAF 742 C
Association à but non lucratif enregistrée à la
Sous-Préfecture de Grasse (06) N° 7803/88

Important notice

Individual copies of the present document can be downloaded from:

<http://www.etsi.org>

The present document may be made available in more than one electronic version or in print. In any case of existing or perceived difference in contents between such versions, the reference version is the Portable Document Format (PDF). In case of dispute, the reference shall be the printing on ETSI printers of the PDF version kept on a specific network drive within ETSI Secretariat.

Users of the present document should be aware that the document may be subject to revision or change of status. Information on the current status of this and other ETSI documents is available at

<http://portal.etsi.org/tb/status/status.asp>

If you find errors in the present document, please send your comment to one of the following services:

http://portal.etsi.org/chaicor/ETSI_support.asp

Copyright Notification

No part may be reproduced except as authorized by written permission.
The copyright and the foregoing restriction extend to reproduction in all media.

© European Telecommunications Standards Institute 2009.
All rights reserved.

DECT™, **PLUGTESTS™**, **UMTS™**, **TIPHON™**, the TIPHON logo and the ETSI logo are Trade Marks of ETSI registered for the benefit of its Members.

3GPP™ is a Trade Mark of ETSI registered for the benefit of its Members and of the 3GPP Organizational Partners.

LTE™ is a Trade Mark of ETSI currently being registered

for the benefit of its Members and of the 3GPP Organizational Partners.

GSM® and the GSM logo are Trade Marks registered and owned by the GSM Association.

Intellectual Property Rights

IPRs essential or potentially essential to the present document may have been declared to ETSI. The information pertaining to these essential IPRs, if any, is publicly available for **ETSI members and non-members**, and can be found in ETSI SR 000 314: "*Intellectual Property Rights (IPRs); Essential, or potentially Essential, IPRs notified to ETSI in respect of ETSI standards*", which is available from the ETSI Secretariat. Latest updates are available on the ETSI Web server (<http://webapp.etsi.org/IPR/home.asp>).

Pursuant to the ETSI IPR Policy, no investigation, including IPR searches, has been carried out by ETSI. No guarantee can be given as to the existence of other IPRs not referenced in ETSI SR 000 314 (or the updates on the ETSI Web server) which are, or may be, or may become, essential to the present document.

Foreword

This Technical Specification (TS) has been produced by ETSI 3rd Generation Partnership Project (3GPP).

The present document may refer to technical specifications or reports using their 3GPP identities, UMTS identities or GSM identities. These should be interpreted as being references to the corresponding ETSI deliverables.

The cross reference between GSM, UMTS, 3GPP and ETSI identities can be found under <http://webapp.etsi.org/key/queryform.asp>.

Contents

Intellectual Property Rights	2
Foreword.....	2
Foreword.....	5
1 Scope	6
2 References	6
3 Definitions and abbreviations.....	7
3.1 Definitions	7
3.2 Abbreviations	9
4 General	11
4.1 PLMN Telecom Management	11
4.1.1 3GPP Reference Model	11
4.1.2 3GPP Provisioning Entities	11
4.1.3 Management Infrastructure of the PLMN.....	12
4.2 TMN.....	12
4.3 Management of Next Generation Networks	12
5 General view of PLMN Management Physical architectures	13
6 Basic objectives for PLMN Management Physical Architecture	14
7 TM Architectural aspects	15
7.1 Architectural relationship	15
7.2 Architectural constraints.....	16
7.3 Interoperability	17
7.3.1 Introduction.....	17
7.3.2 Interfaces.....	17
7.3.3 Entities of a 3GPP system.....	19
7.3.4 Open systems approach	21
7.3.5 Level of openness	21
7.3.6 Closed interfaces.....	21
7.4 Data communication networks	22
7.5 New technologies	23
8 3GPP Management Physical architectures.....	24
8.1 Compliance Conditions	24
8.2 Network Element (NE) management architecture.....	25
8.3 Subnetwork Management Architecture	27
8.4 Operations Systems interoperability architecture	28
8.5 Operations Systems intra-operability architecture.....	29
8.6 Enterprise management System interconnection architecture	30
9 TMN applications.....	31
9.1 Management function blocks	31
9.2 Management physical blocks	32
9.3 IRP concept enabling TMN applications.....	33
10 Void.....	34
11 Implementation aspects	34
12 3GPP TMN Conformance	35
13 TMN planning and design considerations.....	36
13.1 Function attributes	36
13.2 Functional characteristics	37
13.3 Critical attributes	37
13.4 Protocol selection	37

13.5	Communications considerations.....	37
14	Mediation/Integration.....	38
Annex A (informative): Technology considerations.....		40
A.1	Management physical blocks	40
A.1.1	Operations System (OS).....	40
A.1.2	Void.....	40
A.1.3	Void.....	40
A.1.4	Void.....	40
A.1.5	Void.....	40
A.1.6	Void.....	40
A.1.7	Void.....	40
A.1.8	Network Element (NE).....	40
A.1.9	Data Communication Network (DCN).....	41
A.1.9.1	Transformation	41
A.1.9.1.1	Adaptation device	41
A.1.9.1.2	Mediation device.....	41
A.1.9.2	Distributed multi-element structure	41
A.1.10	Management logical layered architecture within the management physical view.....	42
A.1.11	Interface concept	42
A.2	Standard interfaces	42
Annex B (informative): Overview of a 3GPP System.....		44
Annex C (informative): Change history		45
History		46

Foreword

This Technical Specification (TS) has been produced by the 3rd Generation Partnership Project (3GPP).

The contents of the present document are subject to continuing work within the TSG and may change following formal TSG approval. Should the TSG modify the contents of the present document, it will be re-released by the TSG with an identifying change of release date and an increase in version number as follows:

Version x.y.z

where:

- x the first digit:
 - 1 presented to TSG for information;
 - 2 presented to TSG for approval;
 - 3 or greater indicates TSG approved document under change control.
- y the second digit is incremented for all changes of substance, i.e. technical enhancements, corrections, updates, etc.
- z the third digit is incremented when editorial only changes have been incorporated in the document.

1 Scope

The present document identifies and standardises the most important and strategic contexts in the physical architecture for the management of PLMNs. It serves as a framework to help define a telecom management physical architecture for a planned PLMN and to adopt standards and provide products that are easy to integrate.

The requirements identified in the present document are applicable to all further development of 3GPP Telecom Management specifications as well as the development of PLMN Management products. The present document can be seen as guidance for the development of all other Technical Specification addressing the management of PLMNs, except TS 32.101 [2].

2 References

The following documents contain provisions which, through reference in this text, constitute provisions of the present document.

- References are either specific (identified by date of publication, edition number, version number, etc.) or non-specific.
- For a specific reference, subsequent revisions do not apply.
- For a non-specific reference, the latest version applies. In the case of a reference to a 3GPP document (including a GSM document), a non-specific reference implicitly refers to the latest version of that document *in the same Release as the present document*.

- [1] ITU-T Recommendation M.3010 (2000): "Principles for a Telecommunications management network".
- [2] 3GPP TS 32.101: "Telecommunication management; Principles and high level requirements".
- [3] Void.
- [4] ITU-T Recommendation X.200 (1994): "Information technology - Open Systems Interconnection - Basic Reference Model: The basic model".
- [5] 3GPP TS 32.150: "Telecommunication management; Integration Reference Point (IRP) Concept and definitions".
- [6] Void.
- [7] Void.
- [8] Void.
- [9] TMF GB910: "Smart TMN Telecom Operations Map (Release 2.1)". <http://www.tmforum.org>
- [10] TMF GB909: "Smart TMN Technology Integration Map (Issue 1.1)". <http://www.tmforum.org>
- [11] ITU-T Recommendation M.3013 (2000): "Considerations for a telecommunications management network".
- [12] 3GPP TS 23.002: "Network architecture".
- [13] 3GPP TS 23.101: "General UMTS Architecture".
- [14] 3GPP TS 32.111-x: "Telecommunication management; Fault Management;".
- [15] OMG: "Unified Modelling Language Specification, Version 1.4, September 2001". <http://www.omg.org/technology/documents/formal/uml.htm>
- [16] [ITU-T Recommendation M.3060/Y.2401 \(2006\): 'Principles for the Management of Next Generation Networks '](#)

- [17] [ETSI TS 188 001 V1.2.1 TISPAN; "NGN management; Operations Support Systems Architecture"](#).
- [18] [ITU-T Recommendation Y.2011 \(2004\), "General principles and general reference model for Next Generation Networks"](#).
- [19] [ITU-T Recommendation Y.2001 \(2004\), "General overview of NGN"](#).
- [20] [ITU-T M.3050.x series \(2004\), "TMN Enhanced Telecom Operations Map \(eTOM\)"](#).

3 Definitions and abbreviations

3.1 Definitions

For the purposes of the present document, the following definitions apply:

architecture: organisational structure of a system or component, their relationships, and the principles and guidelines governing their design and evolution over time

closed interfaces: privately controlled system/subsystem boundary descriptions that are not disclosed to the public or are unique to a single supplier

de facto standard: standard that is widely accepted and used but that lacks formal approval by a recognised standards organisation

Information Service (IS): Defined in 3GPP TS 32.150 [5]. **interface standard:** standard that specifies the physical or functional interface characteristics of systems, subsystems, equipment, assemblies, components, items or parts to permit interchangeability, interconnection, interoperability, compatibility, or communications

interoperability: ability of two or more systems or components to exchange data and use information

intra-operability: ability to interchange and use information, functions and services among components within a system

Integration Reference Point (IRP): Defined in 3GPP TS 32.150 [5].

Managed Object: Defined in 3GPP TS 32.150 [5].

management infrastructure: Defined in TS 32.101 [2]. **market acceptance:** means that an item has been accepted in the market as evidenced by annual sales, length of time available for sale, and after-sale support capability.

modular: pertaining to the design concept in which interchangeable units are employed to create a functional end product.

module: interchangeable item that contains components. In computer programming, a program unit that is discrete and identifiable with respect to compiling, combining with other modules, and loading is called a module.

Network Resource Model (NRM): Defined in 3GPP TS 32.150 [5].

Next Generation Networks Management (NGNM): Planning, provisioning, installation, maintenance, operation and administration of next generation telecommunications equipment for transmission or control of resources and services within NGN transport and service strata. NGNM is defined by ITU-T [16].

NGN service stratum: that part of the NGN which provides the user functions that transfer service-related data and the functions that control and manage service resources and network services to enable user services and applications.

NGN transport stratum: that part of the NGN which provides the user functions that transfer data and the functions that control and manage transport resources to carry such data between terminating entities.

open specifications: public specifications that are maintained by an open, public consensus process to accommodate new technologies over time and that are consistent with international standards

open standards: widely accepted and supported standards set by recognised standards organisation or the commercial market place. These standards support interoperability, portability, and scalability and are equally available to the general public at no cost or with a moderate license fee.

open systems strategy: focuses on fielding superior telecom capability more quickly and more affordably by using multiple suppliers and commercially supported practices, products, specifications, and standards, which are selected based on performance, cost, industry acceptance, long term availability and supportability, and upgrade potential.

physical architecture: minimal set of rules governing the arrangement, interaction, and interdependence of the parts or elements whose purpose is to ensure that a conformant system satisfies a specified set of requirements. The physical architecture identifies the services, interfaces, standards, and their relationships. It provides the technical guidelines for implementation of systems upon which engineering specifications are based and common building blocks are built.

PLMN Organisation: see 3GPP TS 32.101 [2].

plug&play: term for easy integration of HW/SW

portability: the ease with which a system, component, data, or user can be transferred from one hardware or software environment to another

proprietary specifications: specifications, which are exclusively owned by a private individual or corporation under a trademark or patent, the use of which would require a license

reference model: a generally accepted abstract representation that allows users to focus on establishing definitions, building common understandings and identifying issues for resolution. For TMN Systems acquisitions, a reference model is necessary to establish a context for understanding how the disparate technologies and standards required to implement TMN relate to each other. A reference model provides a mechanism for identifying the key issues associated with applications portability, modularity, scalability and interoperability. Most importantly, reference models will aid in the evaluation and analysis of domain-specific architectures.

scalability: capability to adapt hardware or software to accommodate changing workloads

service specific entities: entities dedicated to the provisioning of a given (set of) service(s). The fact that they are implemented or not in a given PLMN should have limited impact on all the other entities of the PLMN.

Solution Set (SS): Defined in 3GPP TS 32.150 [5].

specification: document that prescribes, in a complete, precise, verifiable manner, the requirements, design, behaviour, or characteristics of a system or system component

standard: document that establishes uniform engineering and technical requirements for processes, procedures, practices, and methods. Standards may also establish requirements for selection, application, and design criteria of material.

standards based architecture: architecture based on an acceptable set of open standards governing the arrangement, interaction, and interdependence of the parts or elements that together may be used to form a TMN System, and whose purpose is to insure that a conformant system satisfies a specified set of requirements.

Support IOC: defined in TS 32.150 [5].

system : any organised assembly of resources and procedures united and regulated by interaction or interdependence to accomplish a set of specific functions

System Architecture (SA): description, including graphics, of systems and interconnections providing for or supporting management functions. The SA defines the physical connection, location, and identification of the key nodes, circuits, networks, platforms, etc., and specifies system and component performance parameters. It is constructed to satisfy Operational Architecture requirements per standards defined in the Physical Architecture. The SA shows how multiple systems within a subject area link and inter-operate, and may describe the internal construction or operations of particular systems within the architecture.

3.2 Abbreviations

For the purposes of the present document, the following abbreviations apply:

3G	3 rd Generation
AAA	Authentication, Authorisation and Accounting
AN	Access Network
AS	Application Server
ATM	Asynchronous Transfer Mode
AUC	Authentication Centre
B2B	Business-to-Business
BG	Border Gateway
BGCF	Breakout Gateway Control Function
BM-SC	Broadcast-Multicast Service Centre
BSC	Base Station Controller
BSS	Base Station Subsystem
BTS	Base Transceiver Station
C2B	Customer-to-Business
CAMEL	Customised Applications for Mobile network Enhanced Logic
CBC	Cell Broadcast Center
CBS	Cell Broadcast Service
CMIS	Common Management Information Service
CMISE	Common Management Information Service Element
CN	Core Network
CORBA	Common Object Request Broker Architecture
CRF	Charging Rules Function
CS	Circuit Switched
CSCF	Call Session Control Function
DCN	Data Communication Network
DECT	Digital Enhanced Cordless Telecommunications
DSS1	Digital Subscriber System 1
EIR	Equipment Identity Register
EM	Element Manager
E-OS	Element Management Layer-Operations System
F/W	Firewall
FM	Fault Management
FTAM	File Transfer, Access and Management
GCR	Group Call Register
GDMO	Guidelines for the Definition of Managed Objects
GGSN	Gateway GPRS Support Node
GMLC	Gateway Mobile Location Center
GMSC	Gateway MSC
GPRS	General Packet Radio Service
GTT	Global Text Telephony
HLR	Home Location Register
HMI	Human Machine Interface
HSS	Home Subscriber Server
HTTP	HyperText Transfer Protocol
HW	Hardware
I-CSCF	Interrogating CSCF
IBCF	Interconnection Border Control Function
IDL	Interface Definition Language
IIOP	Internet Inter-ORB Protocol
IMS	IP Multimedia Subsystem

INAP	Intelligent Network Application Part
IP	Internet Protocol
IRP	Integration Reference Point
IS	Information Service
ISDN	Integrated Services Digital Network
IWU	Inter Working Unit
LCS	Location Services
LLA	Logical Layered Architecture
LMU	Location Measurement Unit
MBMS	Multimedia Broadcast Multicast Service
MD	Mediation Device
ME	Mobile Equipment
MGCF	Media Gateway Control Function
MIB	Management Information Base
MMI	Man-Machine Interface
MML	Man-Machine Language
MMS	Multimedia Messaging Service
MNP	Mobile Number Portability
MNP-SRF	Mobile Number Portability/Signalling Relay Function
MRF	Multimedia Resource Function
MRFC	Multimedia Resource Function Controller
MRFP	Multimedia Resource Function Processor
MSC	Mobile service Switching Centre
MT	Mobile Termination
NE	Network Element
NGN	Next Generation Networks
NGNM	Next Generation Networks Management
NM	Network Manager
N-OS	Network Management Layer-Operations System
NPDB	Number Portability Database
NR	Network Resource
NRM	Network Resource Model
NSS	Network Switching Subsystem
NW	Network
OMG	Object Management Group
OS	Operations System
OSA	Open Services Access
OSF	Operations System Functions
P-CSCF	Proxy CSCF
PDH	Plesiochronous Digital Hierarchy
PS	Packet Switched
PSA	Product Specific Applications
PSS	Packet Switched Service
PSTN	Public Switched Telephone Network
QA	Q-Adapter
QoS	Quality of Service
RNC	Radio Network Controller
RNS	Radio Network System
RSVP	Resource ReserVation Protocol
S-CSCF	Serving CSCF
SDH	Synchronous Digital Hierarchy
SEF	Service Element Function
SGSN	Serving GPRS Support Node
SGW	Signalling Gateway
SIM	Subscriber Identity Module
SLA	Service Level Agreement
SLF	Subscription Locator Function
SMI	Structure of Management Information
SMLC	Serving Mobile Location Center
SMS	Short Message Service
SNM	Sub-Network Manager
SNMP	Simple Network Management Protocol

SS	Solution Set
SS7	Signalling System No. 7
SW	Software
TA	Terminal Adapter
TE	Terminal Equipment
TEF	Transport Element Function
TM	Telecom Management
TMN	Telecommunications Management Network as defined in ITU-T Recommendation M.3010 [1]
TrGW	Transition Gateway
UE	User Equipment
UML	Unified Modelling Language
USAT	USIM/SIM Application Toolkit
USIM	UMTS Subscriber Identity Module
UTRA	Universal Terrestrial Radio Access
UTRAN	Universal Terrestrial Radio Access Network
VHE	Virtual Home Environment
VLR	Visitor Location Register
WAG	WLAN Access Gateway
WBEM	Web Based Enterprise Management
WS	WorkStation

4 General

4.1 PLMN Telecom Management

4.1.1 3GPP Reference Model

A 3GPP System is made of the following components:

- one or more Access Networks, using different types of access techniques (GSM, UTRA, DECT, PSTN, ISDN, ...) of which at least one is UTRA;
- one or more Core Networks;
- one or more Intelligent Node Networks, service logic and mobility management, (IN, GSM ...);
- one or more transmission networks (PDH, SDH etc) in various topologies (point-to-point, ring, point-to-multipoint etc) and physical means (radio, fibre, copper, etc.).

The 3GPP system components have signalling mechanisms among them (DSS1, INAP, MAP, SS7, RSVP, etc.).

From the service perspective, the 3GPP system is defined to offer:

- service support transparent to the location, access technique and core network, within the bearer capabilities available in one particular case;
- user to terminal and user to network interface (MMI) irrespective of the entities supporting the services required (VHE);
- multimedia capabilities.

4.1.2 3GPP Provisioning Entities

Two major entities, which cover the set of 3GPP functionalities involved in the provision of the 3GPP services to the user, are identified as follows:

- **Home Environment:** This entity holds the functionalities that enable a user to obtain 3GPP services in a consistent manner regardless of the user's location or the terminal used.
- **Serving Network:** This entity provides the user with access to the services of the Home Environment.

4.1.3 Management Infrastructure of the PLMN

Every PLMN Organisation has its own Management Infrastructure. Each Management Infrastructure will contain different functionality depending on the role-played and the equipment used by that Entity.

However, the core management architecture of the PLMN Organisation is very similar. Every PLMN Organisation:

- provides services to its customers;
- needs an infrastructure to fulfil them (advertise, ordering, creation, provisioning, ...);
- assures them (Operation, Quality of Service, Trouble Reporting and Fixing, ...);
- bills them (Rating, Discounting, ...).

Not every PLMN Organisation will implement the complete Management Architecture and related Processes. Some processes may be missing dependent on the role a particular Organisation is embodying. Processes not implemented by a particular Organisation are accessed via interconnections to other organisations, which have implemented these processes (called X-interfaces in the TMN architecture).

The Management architecture itself does not distinguish between external and internal interfaces.

4.2 TMN

TMN (Telecommunications Management Network), as defined in [1], provides:

- an architecture, made of OS (Operations Systems) and NEs (Network Elements), and the interfaces between them (Q, within one Operator Domain and X, between different Operators);
- the methodology to define those interfaces;
- other architectural tools such as LLA (Logical Layered Architecture) that help to further refine and define the Management Architecture of a given management area;
- a number of generic and/or common management functions to be specialised/applied to various and specific TMN interfaces.

The PLMN Management Architecture is largely based on TMN, and will reuse those functions, methods and interfaces already defined (or being defined) that are suitable for the management needs of a PLMN. However, the new challenges of 3G Telecom Management may require the exploration and incorporation of other concepts (other management paradigms widely accepted and deployed).

4.3 Management of Next Generation Networks

Next Generation Networks (NGN) as defined in [18, 19], are essentially about delivering new services that are available any place, any time, and on any device, through any customer-chosen access mechanism.

NGN Management (NGNM) [16] supports the aims of the NGN by decoupling and make independent, the service creation/deployment infrastructure from the transport infrastructure. The decoupling is reflected in the NGN architecture as the separation of the Transport and Service strata and shown as two independent stratum. NGNM also introduces the NGN management plane, union of the NGN service stratum management plane and the NGN transport stratum management plane and may include joint management functions, i.e., functions used to manage entities in both strata plus functions required to support this management [18].

NGNM introduces a new set of grouping of management functionality compared to TMN LLA to better support the complexity of the NGN .e.g. NGNM Resource Management layer encompasses the Network Management layer and the Element Management layer.

The PLMN management architecture will facilitate the ITU-T NGN Management principles above where necessary and suitable.

5 General view of PLMN Management Physical architectures

Telecom Management Architectures can vary greatly in scope and detail. The architecture for a large service provider, with a lot of existing legacy systems and applications, upon which many services are based, will be of high complexity. In contrast, the architectural needs of a start-up mobile operator providing its services to a small group of value-added Service Providers will be much less and will probably focus on more short-term needs.

A mobile network operator has to manage many different types of networks as radio networks, exchanges, transmission networks, area networks, intelligent nodes and substantial amounts of computer hardware/software. This wide variety of network equipment will most probably be obtained from a variety of equipment vendors. The nature of a mobile radio network will be heterogeneous and will present a number of operational difficulties for the service provider on enabling effective and efficient network management.

The standardisation work for the management of a PLMN has adopted the top-down approach and will from business needs identify functional and informational architectures. The physical architecture will have to meet these requirements and as there are many ways to build a PLMN it will vary greatly from one TMN solution to another. There will be many physical implementations, as different entities will take different roles in a PLMN.

It is obvious that it will not be meaningful or even possible to fully standardise a common Telecom Management physical architecture for PLMNs. The present document will identify and standardise the most important and strategic contexts and serve as a framework to help define a physical architecture for a planned PLMN.

6 Basic objectives for PLMN Management Physical Architecture

The management of a 3G system will put a lot of new requirements to the management systems compared to the second generation of Mobile telephony. Some of the challenging requirements affecting the physical architecture are:

- To be capable of managing equipment supplied by different vendors.
- To enable TM automation in a more cost efficient way - TM optimised for maximum efficiency and effectiveness.
- To provide PLMN configuration capabilities that are flexible enough to allow rapid deployment of services.
- To report events and reactions in a common way in order to allow remote control.
- To allow interoperability between Network Operators/Service Providers for the exchange of management/charging information.
- To be scaleable and applicable to both larger and small deployments.
- Accessibility to information.
- To profit from advances and standards in IT and datacom industry.

The second generation of mobile networks can - from a management point of view - be characterised as the era of vendor-dependent NE managers. The different OSs had very low interoperability with other systems and functional blocks could rarely be re-used. The Mobile Telecom Management Networks were far away from the TMN vision where one vendor's OS should be able to manage other vendors' network elements.

PLMN Organisations need cost-effective management solutions and better time to market focus. Interoperability, scalability and re-use are keywords for the new generation of management systems.

Many of the new requirements on the management of PLMNs can only be solved by defining and establish a suitable physical architecture. Thou it is not possible to standardise the one single TM physical architecture, it is evidently so that the success of a Telecom Management Network of a PLMN Organisation will heavily depend on critical physical architectural issues. The present document will identify those architectural critical issues.

7 TM Architectural aspects

7.1 Architectural relationship

The basic aspects of a TM architecture, which can be, considered when planning and designing a TM network are:

- The functional architecture.
- The information architecture.
- The physical architecture.

The management requirements - from the business needs - will be the base for the functional architecture, which will describe the functions that have to be achieved. The information architecture defines what information that has to be provided so the functions defined in the functional architecture can be achieved. The physical architecture has to meet both the functional architecture and the information architectures. Other constraints from reality will also have impact to the physical architecture as cost, performance, legacy systems and all preferences any operator will have on a big capital investment as a TM network.

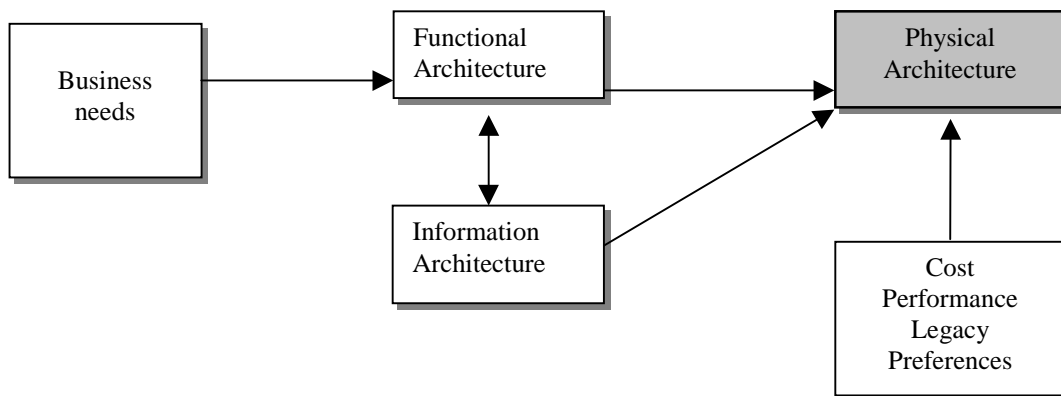

Figure 7.1: Architectural relationship

7.2 Architectural constraints

Large software systems, such as a network management system, are a capital investment that operators cannot afford to scrap every time its requirements change. Operators are seeking cost-effective solutions to their short-term needs. All these reality-related issues are vital constraints that should be addressed in the definition of the architecture.

The standardisation of 3G systems will bring new and different services that will add new demands on telecommunications management. Every PLMN organisation will include different functionality depending on the role-played and the equipment used by that entity. Regulation may force some of the roles that shall be taken. The need to link systems across corporate boundaries will be a consequence of this.

The rapid evolution of new services and technologies will also put requirements on the PLMN physical management architecture to accommodate market and technology trends. To future-proof investments and continuously be able to take advantage of new technologies are important constraints to the physical architecture.

A PLMN TMN should also adopt an architecture that will achieve scalability and extensibility of systems and networks so the TMN can grow as the services expand over time. To start with a small TMN and easily be able to expand the TMN after new requirements will be important issues for most PLMN operators.

The Telecom Management Network will be just one part of the overall business of a company. System management, general security issues and development strategies can be the target for company policies. System architectures and technology choices, as well as the availability of off-the-shelf commercial systems and software components that fulfil the requirements established in the present document, may be critical to an operator's implementation of the specified management architecture.

7.3 Interoperability

7.3.1 Introduction

The new requirement on a 3G system TMN will imply a focus change from network element management towards management of information "information management". Network and service providers make use of different information in several different ways which also may vary from network to network and from time to time. Basic information as alarms is of course essential information for localising faults but may also be the key information to be able to set up a service with a service level agreement.

Numerous of different interfaces can be identified in a PLMN network in the areas of network element management, network management and service management. The most important and complex of these interfaces will be standardised but many interfaces of less importance are unlikely to be fully standardised and will be up to the individual operator and vendor to develop. To adopt mainstream computing technologies, re-use widely used protocols, standards and an open system architecture will be essential to secure interworking between all physical entities in a PLMN.

Low-cost and general access to management systems information will be needed. Obviously this is the critical issue and challenging task in the heterogeneous, distributed and complex network of a PLMN.

7.3.2 Interfaces

A PLMN will consist of many different types of components based on different types of technologies. There will be access-, core-, transmission- and service node networks and many of the components have already been the targets for Telecom Management standardisation at different levels. Many of these standards will be reused and the management domain of a PLMN will thereby consist of many TMNs. The architecture of PLMN TMNs should support distributed TMNs and TMN-interworking on peer-to-peer basis.

The Telecom Management Architecture can vary greatly in scope and detail, because of scale of operation and that different organisations may take different roles in a PLMN (see clause 5). The architecture of PLMN TMNs should provide a high degree of flexibility to meet the various topological conditions as the physical distribution and the number of NEs. Flexibility is also required to allow high degree of centralisation of personnel and the administrative practices as well as allowing dispersion to administrative domains. The 3G Telecom Management architecture should be such that the NEs will operate in the same way, independently of the OS architecture.

Figure 7.3.2.1 illustrates the basic domains in a 3GPP system (identified in 3GPP Technical Specifications [12], [13]), related management functional areas and introduces Interface-N (Itf-N).

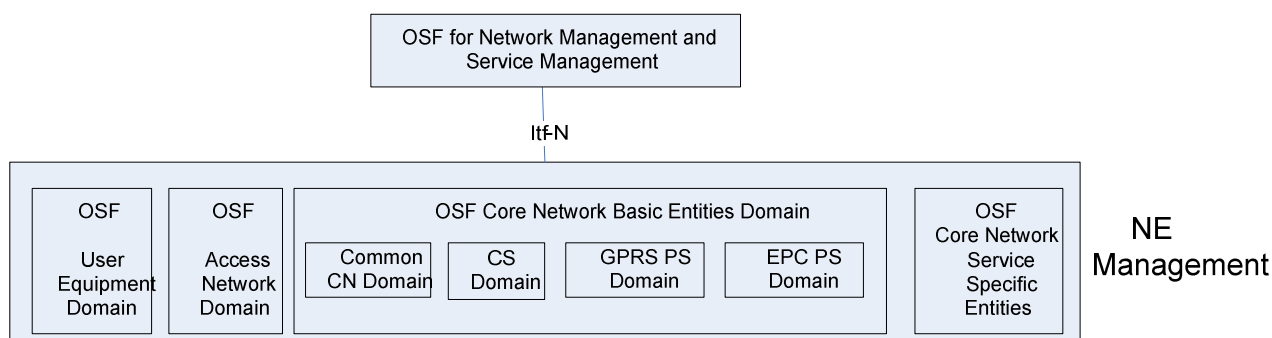

Figure 7.3.2.1: Overview of 3GPP Telecom Management Domains and Itf-N

Itf-N between the NE OSFs and NM/SM OSFs could be used by the network- and service management systems to transfer management messages, notifications and service management requests via the NE OSF to the Network Elements (NEs).

This interface shall be open and the information models standardised.

Telecom management interfaces may be considered from two perspectives:

- 1) the management information model;
- 2) the management information exchange.

The management information models will be standardised in other 3GPP documents but the management information exchange will be further described in this architectural standard.

The management task will vary greatly between different network elements in a PLMN. Some NEs are of high complexity e.g. a RNC, while others e.g. a border gateway is of less complexity. Different application protocols can be chosen to best suite the management requirements of the different Network Elements and the technology used.

Application protocols can be categorised out of many capabilities as:

- Functionality;
- Implementation complexity;
- Processor requirements;
- Cost efficiency;
- Market acceptance, availability of "off the shelf commercial systems and software".

For each Telecom Management interface that will be standardised by 3GPP at least one of the accepted protocols will be recommended. Accepted application protocols (e.g. SNMP, CORBA IIOP) are defined in TS 32.101 [2], annex A.

Figure 7.3.2.2 below illustrates the basic domains in a 3GPP system (identified in 3GPP Technical Specifications [12], [13]), related management functional areas and introduces Interface-P (Itf-P2P).

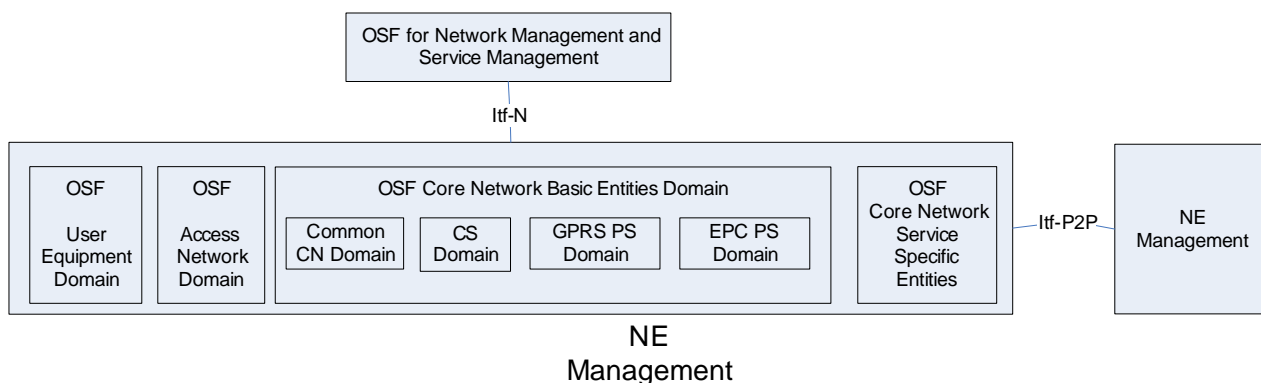

Figure 7.3.2.2: Overview of 3GPP Telecom Management Domains and Itf-P2P

Itf-P2P between two NE OSFs (or NE Management as shown in the above figure) could be used to transfer network management information such as network configuration management information

The information model and the protocols used shall be those defined for Itf-P2P. They are listed in Annex E of [2].

7.3.3 Entities of a 3GPP system

To provide the mobile service as defined in a 3GPP system, some specific functions are introduced [12]. These functional entities can be implemented in different physical equipments or gathered. In any case, exchanges of data occur between these entities and from the Telecom Management perspective they can all normally be treated as network elements. The basic telecom management functional areas such as fault management, configuration management, performance management and security management are all applicable to these entities. As such they are all the targets for 3GPP Telecom Management technical Specifications.

As discussed in clause 5, there will be many possible ways to build a 3GPP system and thereby many possible architectures of a mobile system. The entities presented in figure 7.3 should be treated as the fundamental building blocks of any possible implementation of a 3GPP system.

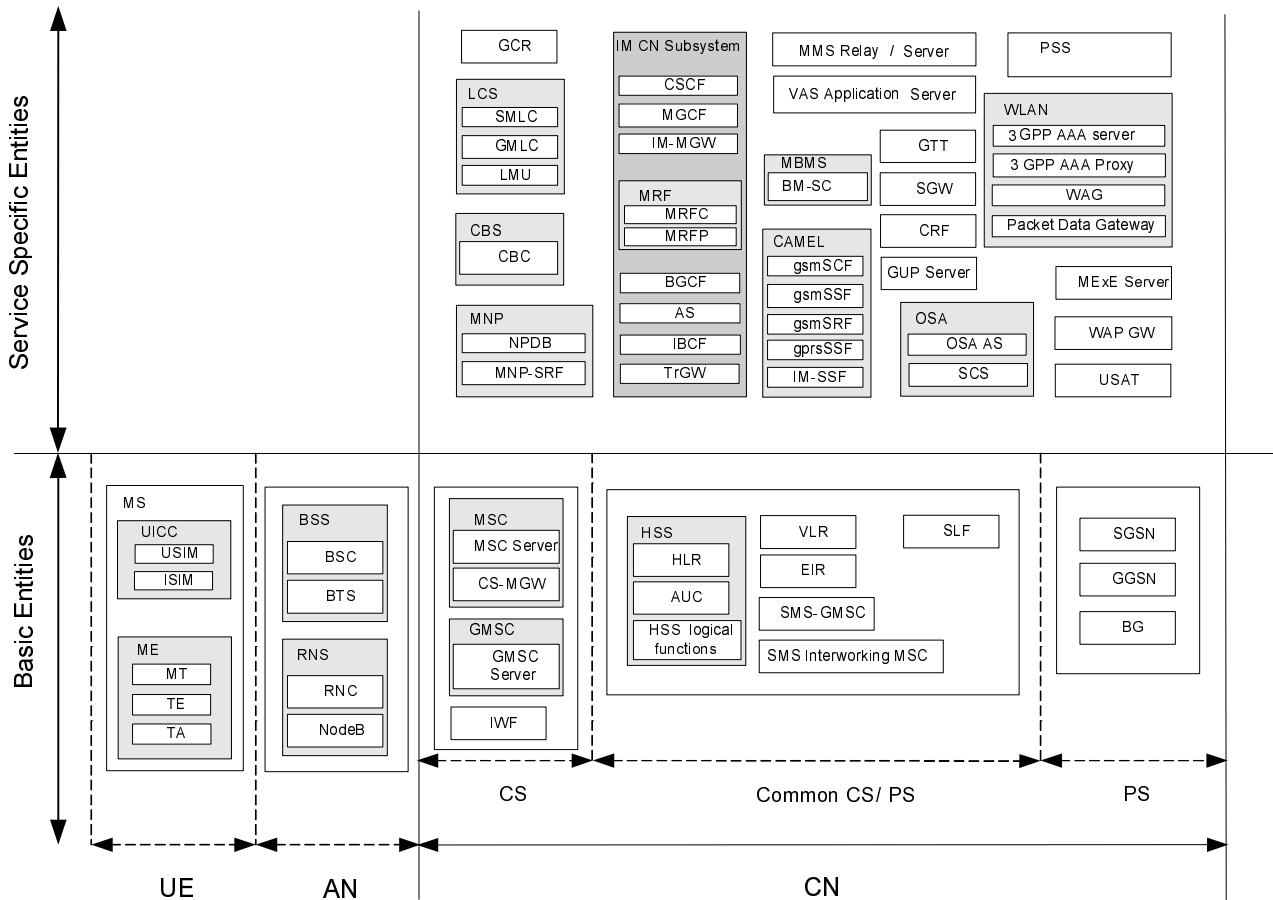

Figure 7.3.3.1: Examples of entities of the mobile system to be managed

In figure 7.3.3.2 the prime domains for the standardisation effort of 3GPP Telecom Management are shown as shaded.

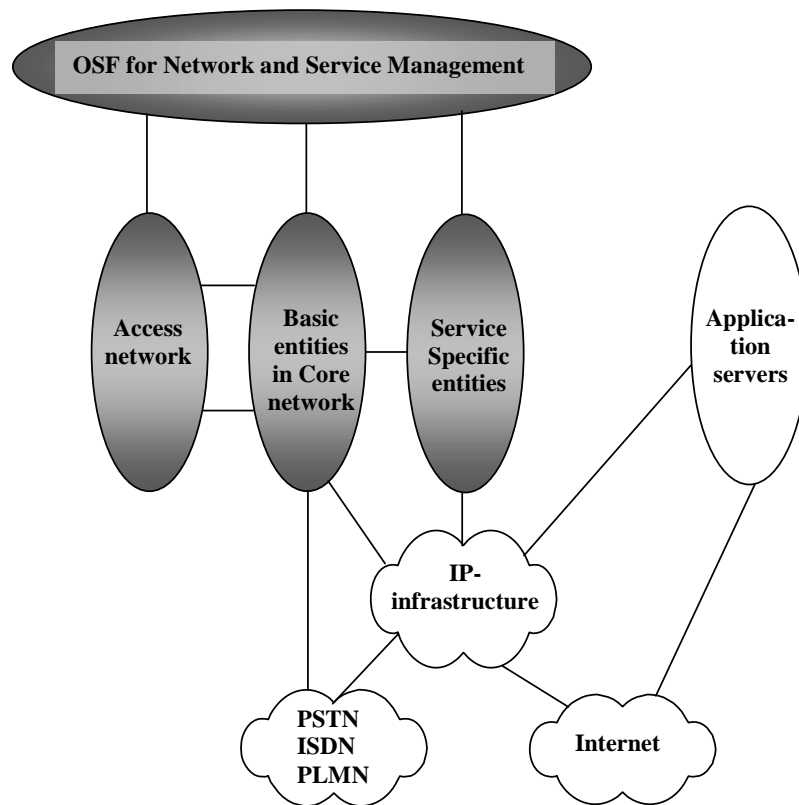

Figure 7.3.3.2: High level 3GPP system Network architecture

7.3.4 Open systems approach

Even in the second generation of mobile radio networks the operators has to cope with heterogeneous environments in many different ways. No single vendor is likely to deliver all the management systems needed for a mobile operator.

The many different types of network elements, some with very high management complexity as an exchange and some less complex as a repeater system, are generally supported with unique vendor specific management systems with very low interoperability. Duplicated TMN applications is another obvious reality of this generation of management systems. This will be further discussed under clause 9 (TMN Applications).

The 3G requirements call for open systems that can be supported by the marketplace, rather than being supported by a single (or limited) set of suppliers, due to the unique aspects of the design chosen. Open systems architectures are achieved by having the design focus on commonly used and widely supported interface standards. This should ensure costs and quality that are controlled by the forces of competition in the marketplace.

The open systems approach is a technical and business strategy to:

- Choose commercially supported specifications and standards for selected system interfaces.
- Build systems based on modular hardware and software design.

Selection of commercial specifications and standards in the Open systems approach should be based on:

- Those adopted by industry consensus based standards bodies or de facto standards (those successful in the market place).
- Market research that evaluates the short and long term availability of products.
- Trade-offs of performance.
- Supportability and upgrade potential within defined cost constraint.
- Allowance for continued access to technological innovation supported by many customers and a broad industrial base.

7.3.5 Level of openness

The level the interfaces conform to open standards is critical for the overall behaviour. A low level of openness will severely impact on long-term supportability, interoperability, development lead-time, and lifecycle cost and overall performance.

Interfaces are expensive parts in a TMN and interfaces with low level of openness severely impact on development lead-time for the introduction of any system, application component or service. Easy implementation (plug & play) is a requirement for TMN physical entities and requires a high the level of openness.

7.3.6 Closed interfaces

Many second-generation mobile network physical management entities have vendor controlled system/subsystem boundary descriptions that are not disclosed to the public or are unique to this single supplier - closed interfaces.

Such interfaces will not fulfil the basic requirements of a 3G TMN. Closed interfaces can only be used as internal interfaces where no information what so ever has to be shared to other physical management entities.

7.4 Data communication networks

Within a TMN, the necessary physical connection (e.g. circuit-switched or packet-switched) may be offered by communication paths constructed with all kinds of network components, e.g. dedicated lines, packet-switched data network, ISDN, common channel signalling network, public-switched telephone network, local area networks, terminal controllers, etc. In the extreme case the communication path provides for full connectivity, i.e. each attached system can be physically connected to all others.

The TMN should be designed such that it has the capability to interface with several types of communications paths, to ensure that a framework is provided which is flexible enough to allow the most efficient communications:

- between NE and other elements within the TMN;
- between WS and other elements within the TMN;
- between elements within the TMN;
- between TMNs;
- between TMNs and enterprise.

In this case the term efficiency relates to the cost, reliability and maintainability of the data transported.

Two aspects impact costs. The first is the actual cost to transport data across the network between the TMN and the NE. The second aspect is the design of the interface including the selection of the appropriate communications protocol.

Whatever standardised protocol suite at the networking level that is capable of meeting the functional and operational requirements (including the network addressing aspects) of the Logical and Application Protocol levels of a given 3GPP management interface, is a valid Networking Protocol for that interface.

A number of requirements **must** be met by the Networking Protocol, as follows:

- Capability to run over all supported bearers (leased lines, X.25, ATM, Frame Relay, ...)
- Support of existing transport protocols and their applications, such as OSI, TCP/IP family, etc.
- Widely available, cheap and reliable.

The Internet Protocol (IP) is a Networking Protocol that ideally supports these requirements. IP also adds flexibility to how management connectivity is achieved when networks are rolled out, by offering various implementation choices. For instance, these may take the form of:

- Dedicated management intranets.
- Separation from or integration into an operator's enterprise network.
- Utilisation, in one-way or another, of capacities of the public Internet and its applications or other resources.

7.5 New technologies

Meeting application requirements in the most affordable manner together with development lead-time are important issues identified in early 3GPP management standardisation work. But the TMN functional, information and physical architectures should also keep pace with the introduction of new technologies, services and evolving network infrastructures. Technology is advancing so rapidly today that this should be a fundamental part of the physical architecture - to be able to easily adopt new important technologies.

A 3GPP system will need to incorporate new successful technologies from the IT-world. Today distributed computing implementations have matured to a point where the goals of TMN can be realised using commonly available technologies for a reasonable cost.

Widely accepted open standards and new IT-technologies will be indispensable to fulfil the challenging managing requirements of a 3GPP system.

New technologies in the IT business such as generic application components together with distributed processing technology are new important drivers upon application design of management systems. The possibility to purchase functional components from the open market are of great importance from many aspects such as cost-efficiency and time-to-market.

8 3GPP Management Physical architectures

A 3GPP Telecom Management Network will consist of many different management layers and many different building blocks. The complexity will vary greatly in detail because every organisation has different needs. The following clause will identify the most critical architectural issues and compliance conditions for a given 3GPP management interface. It should serve as fundamental requirements for any 3GPP entity (network element or management system) being a part of a 3GPP TMN.

8.1 Compliance Conditions

For a 3GPP entity (management system or NE) to be compliant to a given management interface, all the following conditions shall be satisfied:

- 1) It implements the management functionality specified in the relevant IRP Information Service specifications.
- 2) It provides at least one of the IRP Solution Sets (were available) related to the valid Application Protocols specified by 3GPP Application Protocols for that interface, [2] annex C.
- 3) It provides at least one standard networking protocol.
- 4) In case the entity does not offer the management interface on its own, a Q-Adapter shall be provided. This Q-Adapter shall be provided independently of any other NE and/or management system.
- 5) Support for Bulk Transfer Application Protocols specified by the relevant 3GPP management interface specifications applicable to that interface.

8.2 Network Element (NE) management architecture

Figure 8.2 shows two possible options for management interface from the OS upper layers to NE. Option 1, provides access to the NE via element manager, and Option 2, provides a direct access. It is sufficient to provide one or the other.

Figure 8.2 does not imply and limit the realisation of any OS physical block (e.g. E-OS, N-OS) to just one logical layer. OS physical blocks may span more than one logical layer (ITU-T Recommendation M.3010 [1]). Different types of network elements, different functional areas, operator and vendor preferences etc will put different constraints on the physical realisation of the OSFs. See further clause 9.

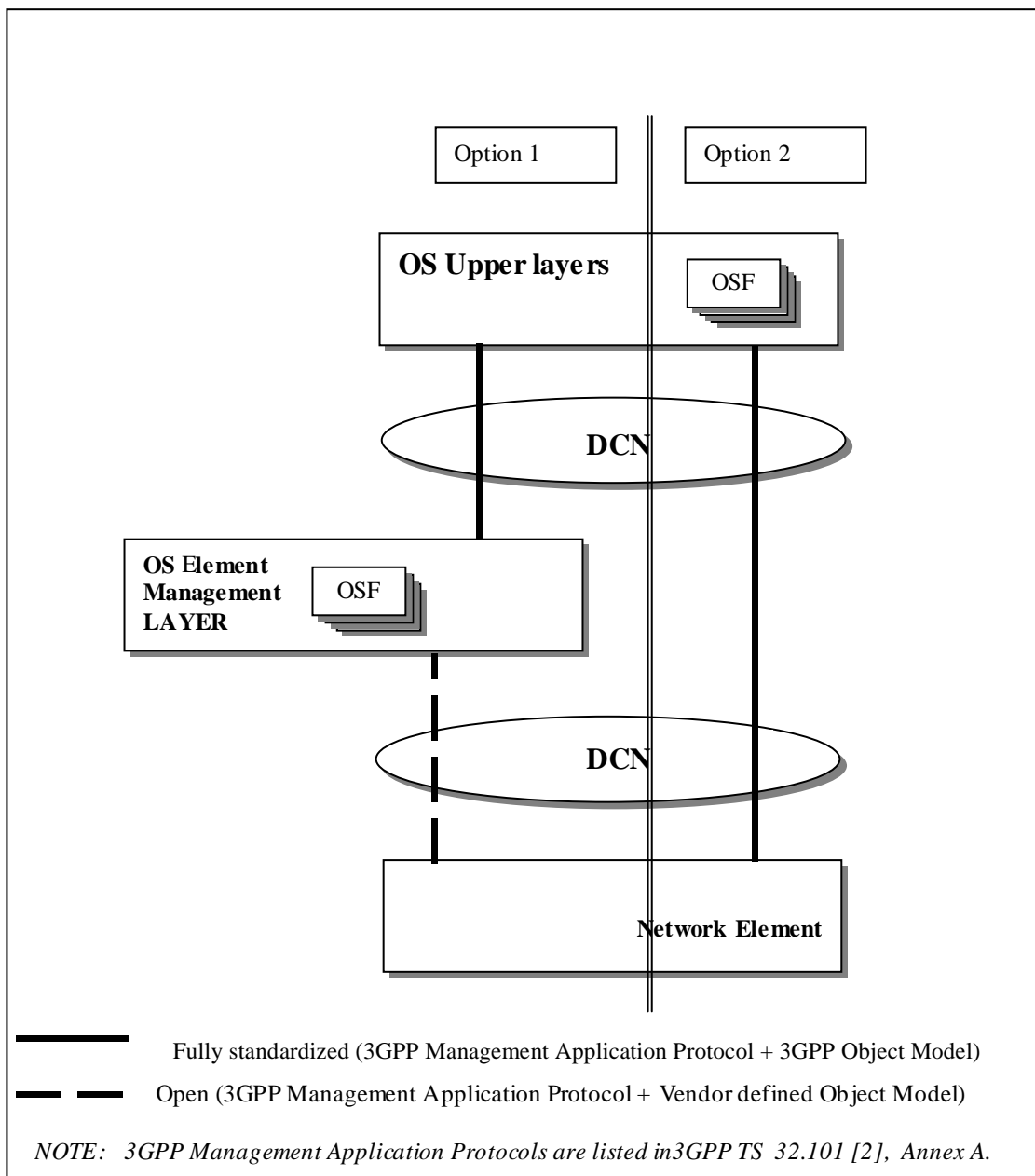

Figure 8.2: Network Element Management Architecture

For a 3GPP entity (Network Element or management system) to be compliant to a given management interface the following conditions shall all be satisfied:

Item	Compliance conditions
1	Implements relevant 3GPP IRP Information Service specifications. For an interface illustrated by the dashed line in figure 4 the object model is not standardised but it shall be open
2	Application protocol (e.g. SNMP, CORBA IIOP) (Defined in TS 32.101 [2], annex A) If 3GPP has specified one or more IRP Solution Sets corresponding to the IRP Information Services in item 1 then at least one of those IRP Solution Sets shall be supported. (Defined in TS 32.101 [2], annex C)
3	Valid Network Layer Protocol (see annex B of TS 32.101 [2])
4	Lower protocol levels required by Item 1, 2 and 3

8.3 Subnetwork Management Architecture

(Example 3GPP RNC / NodeB)

An important special case of the network element management architecture is where one type of network element such as the RNC will need management information for co-ordination of a subnetwork of other types of network elements such as NodeB.

This management information shared between the RNC and NodeB will not reach the operators and is not considered to be a part of the 3GPP TMN. All other management information related to NodeB will transparently be transferred by the RNC towards the 3GPP TMN.

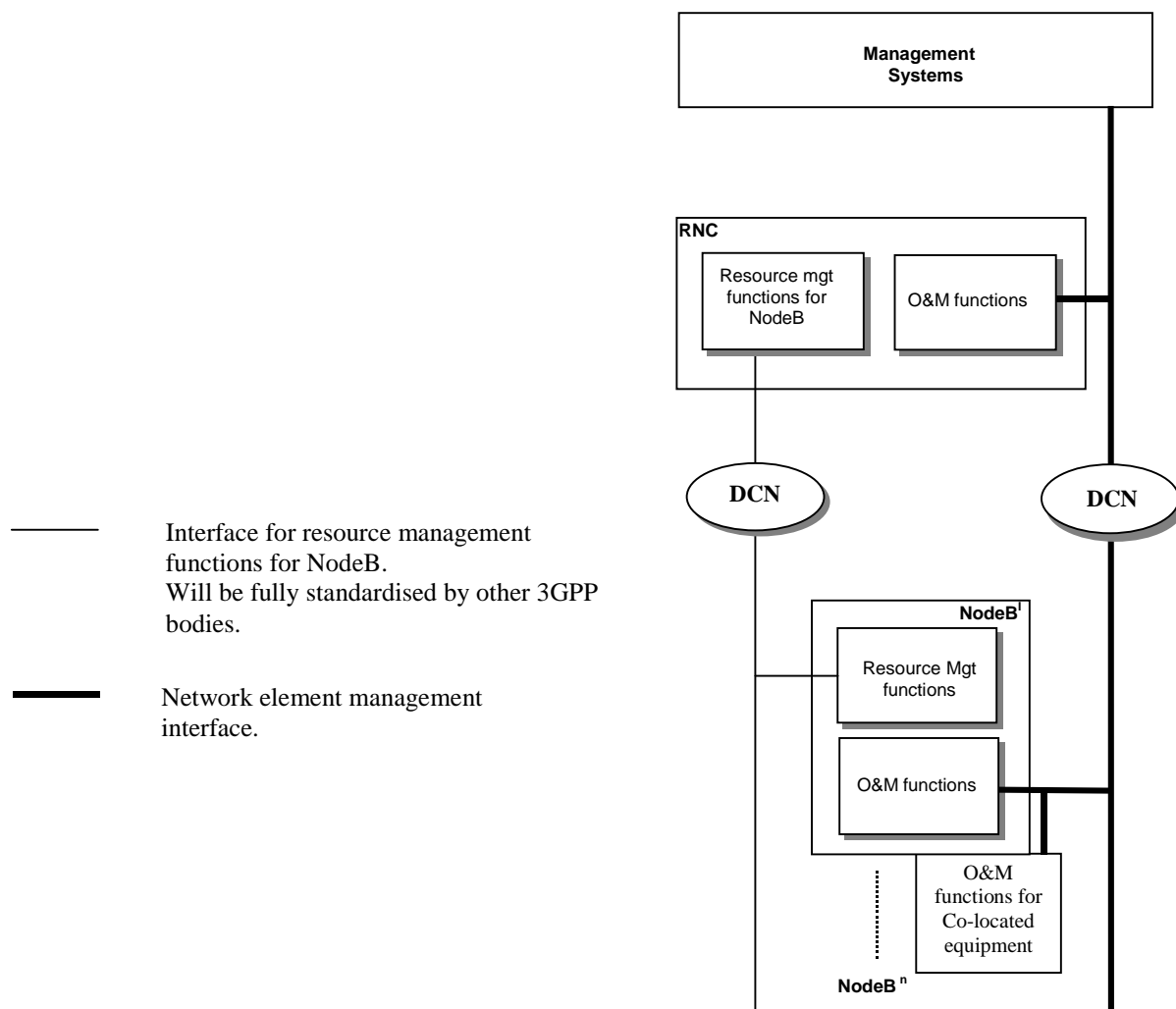

Figure 8.3: Subnetwork Management Architecture

The same compliance conditions apply for the subnetwork management architecture as for the network element management architecture (see clause 8.2).

8.4 Operations Systems interoperability architecture

Interoperability between operations systems is an important issue in a 3GPP system. Different organisations may take different roles in a 3GPP system. The need to share information across corporate boundaries will be a consequence of this.

The heterogeneous, distributed and complex network of a 3GPP system will be a market for many different vendors. All operations systems have to interoperate and shall be able to share information. This is a critical issue in the management of third generation systems.

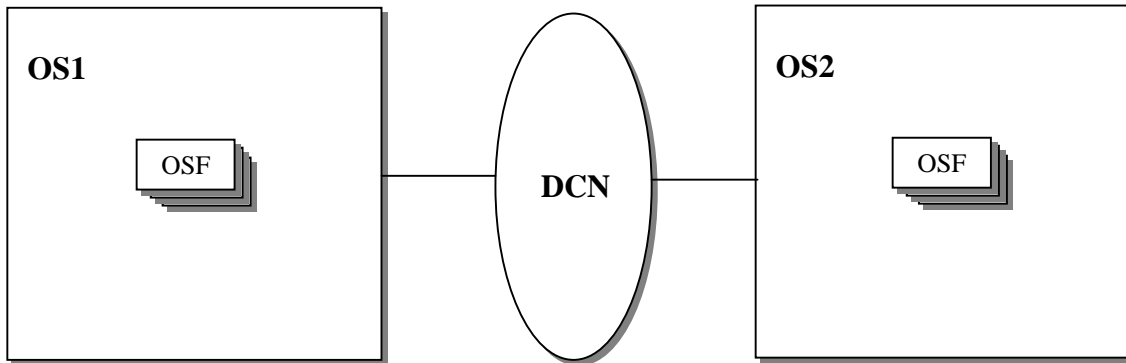

Figure 8.4: Operations Systems interoperability Architecture

For a Operations System to be 3GPP TMN compliant the following conditions shall all be satisfied:

Item	Compliance conditions
1	Implements relevant 3GPP IRP Information Service specifications.
2	Application protocol (e.g. SNMP, CORBA IIOP) (Defined in TS 32.101 [2], annex A) If 3GPP has specified one or more IRP Solution Sets corresponding to the IRP Information Services in item 1 then at least one of those IRP Solution Sets shall be supported. (Defined in [2], annex C)
3	Valid Network Layer Protocol (see annex B of TS 32.101 [2])
4	Lower protocol levels required by Item 1,2 and 3

8.5 Operations Systems intra-operability architecture

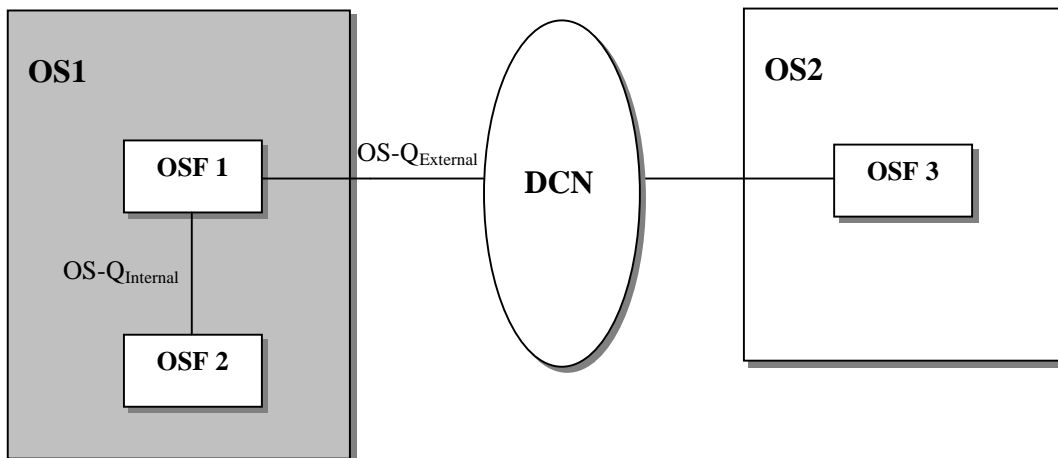

Figure 8.5: Operations Systems intra-operability Architecture

OS-Q_{Internal} indicates an internal flow and is not standardised.

OS-Q_{External} indicates an external flow and shall to be compliant to a given 3GPP Management Interface satisfy the following conditions:

Item	Compliance conditions
1	Implements relevant 3GPP IRP Information Service specifications.
2	Application protocol (e.g. SNMP, CORBA IIOP) (Defined in TS 32.101 [2], annex A) If 3GPP has specified one or more IRP Solution Sets corresponding to the IRP Information Services in item 1 then at least one of those IRP Solution Sets shall be supported. (Defined in TS 32.101 [2], annex C)
3	Valid Network Layer Protocol (see annex B of TS 32.101 [2])
4	Lower protocol levels required by Item 1,2 and 3

8.6 Enterprise management System interconnection architecture

The business enterprise layer has in the second-generation systems a very low degree of standardisation. Operators have legacy systems or more IT influenced systems often adopted to every organisations different needs. Enterprise management systems are not a part of a 3GPP TMN.

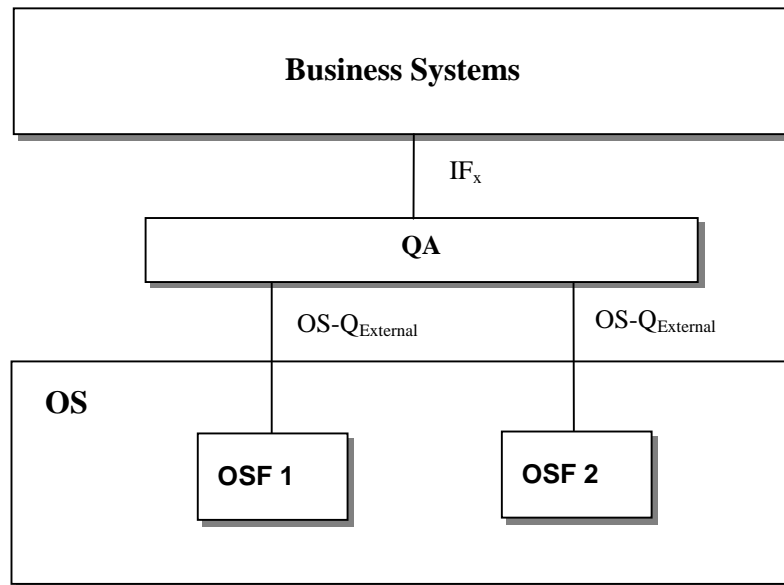

Figure 8.6: Enterprise management Systems interconnection architecture

OS-Q_{External} indicates an external flow and shall to be compliant to a given 3GPP management interface satisfy the following conditions:

Item	Compliance conditions
1	Implements relevant 3GPP IRP Information Service specifications.
2	Application protocol (e.g. SNMP,CORBA IIOP) (Defined in TS 32.101 [2], annex A) If 3GPP has specified one or more IRP Solution Sets corresponding to the IRP Information Services in item 1 then at least one of those IRP Solution Sets shall be supported. (Defined in TS 32.101 [2], annex C)
3	Valid Network Layer Protocol (see annex B of TS 32.101 [2])
4	Lower protocol levels required by Item 1,2 and 3

IF_x indicates an external flow and shall to be compliant to a given 3GPP management interface satisfy the following condition:

Item	Compliance conditions
1	Not standardised but open

9 TMN applications

Telecom management applications can be implemented in many different ways depending on constraints presented in previous clauses. The TMN application - the operations systems component (OSC) - is the physical realization of one or more OSFs needed to support the operational processes. An up-to-date Operations System would be assembled from one or more OS components which expose standardized interfaces to allow for more flexible and agile OSs.

To identify and specify the design criteria that will allow re-usable application components to be developed across multiple telecom business scenarios are important issues to fulfil the basic 3G Management requirement. "To minimise the costs of managing a PLMN such that it is a small component of the overall operating cost".

The implication of the top down approach in the standardising work of 3G is that consistent operational management processes are required irrespective of vendor equipment.

Generic and re-usable management applications are required to facilitate:

- Reduced management application development costs.
- Simplification of operational processes and associated reduction in costs.
- Reduced time to deploy new services as management systems already exist.
- Consistent representation of basic information.

The complexity and heterogeneous nature of a 3G system calls for easy integration (plug&play) of HW/SW.

9.1 Management function blocks

A management function is the smallest part of a business process (or management service), as perceived by the user of the process (or service). A management function block is the smallest deployable unit of management functionality. Figure 9.1 illustrates the different types of optional management function blocks. For example physical views and mapping to 3GPP PLMN management interfaces, see subclause 9.2 and 9.3. The OSF specializations/decompositions reflect the high level processes identified in ITU-T TMN Enhanced Telecom Operations Map(eTOM), M.3050.x series, ref[20]., See further M.3060/Y.2401 ref [16].

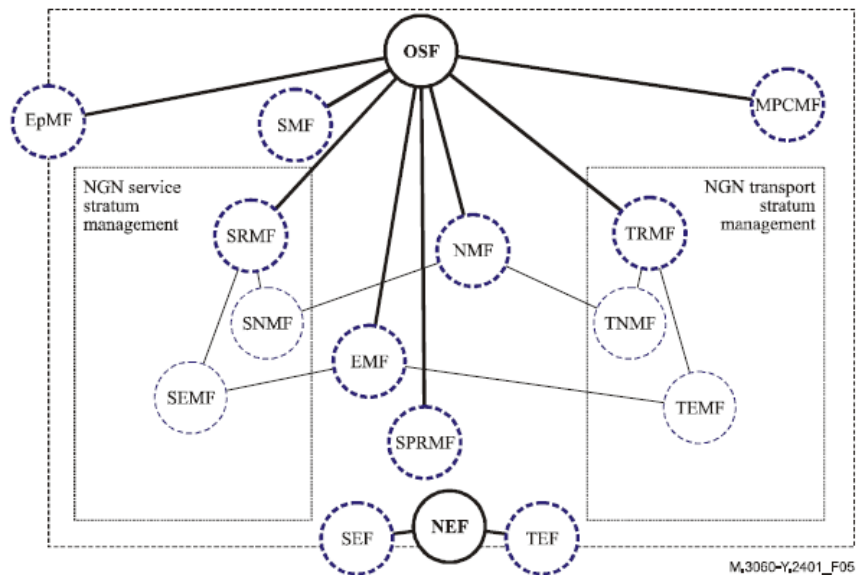

- | | | | |
|--------|------------------------------------------------|--------|---------------------------------------------------|
| *EMF | Element Management Function | *SMF | Service Management Function |
| *EpMF | Enterprise Management Function | *SNMF | Service Network Management Function |
| *MPCMF | Market, Product & Customer Management Function | *SPRMF | Supplier/Partner Relationship Management Function |
| NEF | Network Element Function | *SRMF | Service Resource Management Function |
| NGN | Next Generation Network | *TEF | Transport Element Function |
| *NMF | Network Management Function | *TEMF | Transport Element Management Function |
| OSF | Operations Systems Function | *TNMF | Transport Network Management Function |
| *SEF | Service Element Function | *TRMF | Transport Resource Management Function |
| *SEMF | Service Element Management Function | | |

NOTE – The lines drawn between function blocks represent specializations or decompositions. For example, a TRMF is a specialized OSF, an SEMF is a specialized SRMF, and a TEF is a specialized NEF. Black coloured objects (solid circles) are base objects and light-blue coloured objects (dotted-line circles, indicated by an asterisk in the list) are derived objects.

Figure 9.1: Management function blocks in M.3060/Y.2401 [16]

9.2 Management physical blocks

Figure 9.2-1 illustrates example implementations of physical views. The OS physical block realizes OSFs, of which a great variety is available. Some will be consequence of 3GPPs decision to base the management processes on Enhanced Telecom Operations Map [2],[9],[20], others on enabling support for the management of Next Generation Networks [16], [17].

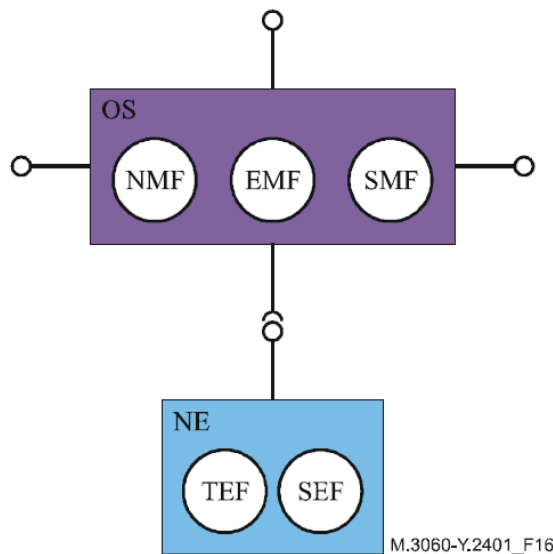

Figure 9.2-1: An example implementation of a physical view in M.3060/Y.2401 [16]

The physical architecture may flatten the functional Management Layers into a single, unified management layer for the co-management of several functional Management Layers to facilitate a unified handling of e.g. alarms and performance data. There is great flexibility in the design of Next Generation Network Operations Systems with this concept, see further Annex 1. The flexibility can enable co-management of multiple functional layers as presented in Figure 9.2-2. The interfaces depicted in fig. 9.2-1 and 9.2-2 are in the 3GPP PLMN management architecture mapped to the Itf-N or Itf-P2P interface between an IRPManager and IRPAgent, as shown in fig. 9.3.

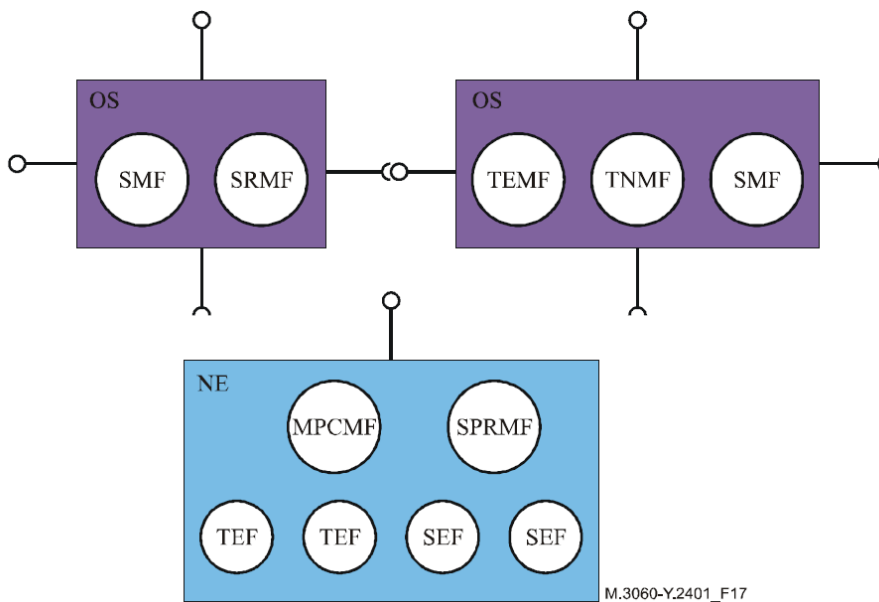

Figure 9.2-2: Co-management of multiple functional management layers in M.3060/Y.2401 [16]

9.3 IRP concept enabling TMN applications

3GPP has developed the interface concept 'Integration Reference Point' (IRP) to promote the wider adoption of standardized management interfaces in telecommunication networks. The concept is presented in TS32.150 [5]. These IRPs are provided by an IRPAgent and managed via an IRPManager. The IRPs are the prime enabler of flexibility in the design of management physical blocks (OSs).

In the context of management of Next Generation Networks the IRPAgent and IRPManager represents the provider reference point and respectively the consumer reference point, respectively. See figure 9.3.

The IRP concept may be mapped to all of the management physical blocks. The 3GPP PLMN Management Architecture will focus on those functions, methods and interfaces that the new challenges of 3G Telecom Management may require. The detailed and final standardization requirements will be targeted in other 32.*** series of standards.

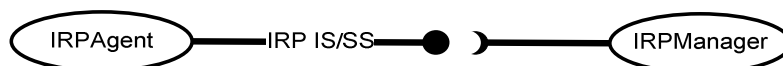

Figure 9.3: IRPAgent and IRPManager using NGN principles

10 Void

11 Implementation aspects

PLMN operators might categories and organise its operation systems in many different ways as:

- A national fault and performance OS.
- A national charging, billing and accounting OS.
- Regional configuration OS.
- Regional fault, performance and configuration OS.
- etc.

This geographical dependent categorisation may change after time and the growth of the network. A physical architecture based on an open system design and re-usable application components would ease the work to adopt such structural changes. A management system build for a PLMN shall provide the possibility of layering the applications.

12 3GPP TMN Conformance

The goal of TMN conformance (see ITU-T Recommendation M.3010 [1]) is to increase the probability that different implementations within a TMN will be able to interwork, that TMNs in different service/network provider's administrations and customer's system will be able to interwork as much as agreed on.

TMN conformance are testable conditions.

It is only the requirements on the external behaviour that have to be met by the conformance statements.

To finally guarantee interoperability the purchaser/user shall be able to test and verify that any two systems, claiming any type of TMN conformance, interoperate. Interoperability testing shall include:

- Testing of the interface protocols;
- The shared/exposed information over those interfaces;
- The interface functionality of the system.

A 3GPP TMN conformant entity shall support necessary information to support such interoperability testing namely:

- Statements made by the supplier of an implementation or system claimed to conform to a given specification, stating which capabilities and options have been implemented.
- Detailed information to help determine which capabilities are testable and which are un-testable.
- Information needed in order to be able to run the appropriate test.
- The system interface documentation shall list the documents that define the specified information models with the inclusion of the version number and date.
- Necessary information about vendor supplied extensions of a standardised interface

The interface specification shall be documented, publicly available and licensable at reasonable price on a non-discriminatory basis.

Specific conformance guidelines shall be included in the different IRP solution sets. A 3GPP TMN conformant entity **must** support information stated in those conformance guidelines.

13 TMN planning and design considerations

A TMN should be designed such that it has the capability to interface with several types of communications paths to ensure that a framework is provided which is flexible enough to allow for the most efficient communications:

- Between one NE and other elements within the TMN;
- Between a WS and other elements within the TMN;
- Between elements within the TMN;
- Between TMNs.

The basis for choosing the appropriate interfaces, however, should be the functions performed by the elements between which appropriate communications are performed. The interface requirements are specified in terms of function attributes needed to provide the most efficient interface.

13.1 Function attributes

- a) *Reliability* - The capability of the interface to ensure that data and control are transferred such that integrity and security are maintained.
- b) *Frequency* - How often data is transferred across the interface boundary (Normal behaviour).
- c) *Quantity* - The amount of data that is transferred across the interface during any transaction.
- d) *Priority* - Indicates precedence to be given to data in case of competition for network resources with other functions.
- e) *Availability* - Determines the use of redundancy in the design of the communications channels between interfacing elements.
- f) *Delay* - Identifies the amount of buffering that may be tolerable between interfacing elements. This also impacts communications channel designs.

Table 13.1 suggests a possible ranges for these function attributes.

Table 13.1: Possible ranges for TMN function attributes [1]

Attributes		Requirements	Nature of attributes
Performance or grade of service (P)	Delay (speed)	Short Medium Long	Objective of design and control (acceptable/unacceptable but available/unavailable)
	Reliability (accuracy)	High Medium Low	
	Availability	High Medium Low	
Characteristics of TMN traffic (C)	Quantity	Large Medium Small	Condition or parameter of design
	Frequency	Often continuous Periodic Sparse	
	Priority	High Medium Low	

13.2 Functional characteristics

Each major type of telecommunications equipment has functional characteristic needs that can be used to describe the complexity of the interface.

There are, however, a basic group of TMN application functions that cross all major types of telecommunications equipment. There are also unique TMN application functions that are performed by specific categories of major telecommunications equipment. Alarm surveillance is an example of the former, whereas billing information collection is an example of the latter.

Functional characteristics of the elements within a TMN, e.g. OS, DCN and MD also describe the complexity of interfaces between these elements.

13.3 Critical attributes

Attribute values for a given function are generally consistent across the network elements.

When considering a single interface, it is important to identify the controlling attribute ranges for the design of the interface.

If there are conflicting attribute values for different functions in a given network element, more than one instance of an interface may be needed.

Overall TMN attribute values for the interfacing of elements within the TMN depend on the type and number of functions performed within these elements. In this case the functions are not consistent across TMN elements, but are controlled by the individual TMN design of an Administration.

13.4 Protocol selection

In many cases, more than one protocol suite will meet the requirements for the network element or TMN element under consideration. It is the approach for the 3GPP Telecom management standardisation to concentrate on protocol independent information models, allowing the mapping to several protocol suites.

The rationale behind this is:

- The blurring of Information and Telecommunication technologies in a 3G system, it is required to work on a more open approach (acknowledging the market status and foreseen evolutions).
- The lifecycle of information flows is 10 to 20 years, while the protocols is 5 to 10 years.
- The developments on automatic conversion allows for a more pragmatic and open approach.

The choice of the individual protocol from the recommended family will be left open to the vendors and operators.

To provide the most efficient interface care should be taken to select the protocol suite that optimises the relationship between the total cost to implement that protocol suite, the functional attributes and the data communications channels that carry the information across the interface.

13.5 Communications considerations

DCN architectures should be planned and designed to ensure that their implementation provides appropriate degrees of availability and network delay while minimising cost.

One should consider the selection of communications architectures, e.g. star, multipoint, loop, tree, etc.

The communications channels, e.g. dedicated lines, circuit-switched networks and packet networks used in providing the communications paths, also play an important role.

14 Mediation/Integration

The increase in the need to incorporate a hybrid set of technologies, multiple protocols and heterogeneous resources requires the availability of open management interfaces between the management systems and the different network resources. These interfaces require an underlying mechanism to mediate - interpret, translate, and handle data - between the various data representations and protocols. A set of Technology Integration Points [10] can be identified.

Software components on the open market as automatic conversion applications, gateways, mediation applications will be valuable products to fulfil the challenging task to incorporate multiple protocols and heterogeneous resources.

Figure 14.1 summarises Technology Integration Points for some example technologies:

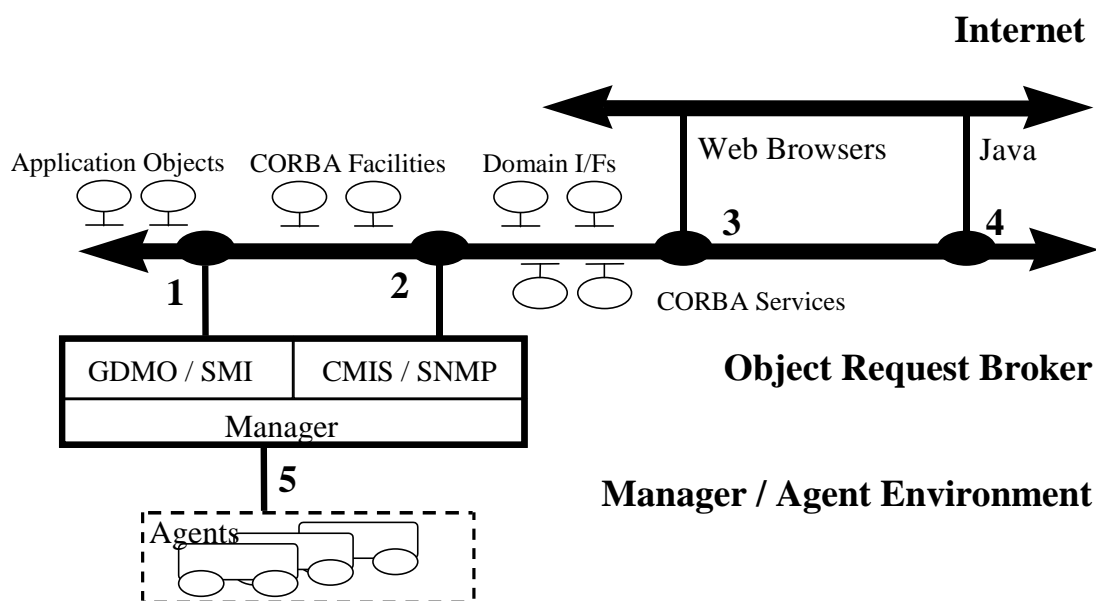

Figure 14.1: Example of Technology Integration Points [10]

Essentially, figure 14.1 indicates that from the technologies selected, a number of technology areas will need to be integrated. These are:

- Internet/Web based services;
- Object Request Broker (CORBA) based services;
- Telecom based Manager/Agent services (e.g. CMIP/GDMO and SNMP/SMI).

In order to provide adequate points of integration between these areas of technology, a number of Integration Points (IPs) have been identified - as outlined in table 14.1:

Table 14.1 : Example Technology Integration Points [10]

	Managed Objects (GDMO/SMI)	Management Services (CMISE/SNMP)	Java Objects	Web Browser (HTTP/HTML)	TMN Agent
CORBA Objects	IP1		IP4	IP3	
CORBA Services		IP2			
TMN Manager					IP5
IP1	Provides mapping of objects defined in CORBA/IDL to managed objects defined in GDMO or SMI.				
IP2	Provides mapping of appropriate CORBA Services to CMIS and SNMP services.				
IP3	Provides a mapping of Web Browser technology access to CORBA objects (for situations where this may be needed as an addition to/replacement of Browser access to a database).				
IP4	Provides a mapping between Java based objects and CORBA objects.				
IP5	Provides a high level convenient programming interface for the rapid development of TMN based manager/agent interactions. It also provides a convenient point of integration if it is necessary to separate out the two sides of the manager/agent interface from the point of view of technology selection. For example, allowing the manager role to perhaps be supported in a Web-based environment, but giving a good point of integration with a TMN based agent.				

Annex A (informative): Technology considerations

A.1 Management physical blocks

TMN functions can be implemented in a variety of physical configurations (ITU-T Recommendation M.3010 [1], M3060/Y.2401 [16]). The relationship of the functional blocks to physical equipment is shown in table A.1 which names the management physical blocks according to the set of function blocks which each is allowed to contain. For each physical block there is a function block which is characteristic of it and is mandatory for it to contain. There also exist other functions, which are optional for the physical blocks to contain. Table A.1 does not imply any restriction of possible implementations. The M/O qualifiers are examples from M3060/Y.2401 [16] and do not have any implication for compliance in the 3GPP PLMN management architecture.

The subclauses below give the definitions for consideration in implementation schemes.

Table A.1: Relationship of management physical block names to management function blocks

	TEF	SEF	OSF
NE	M (Note 3)	M (Note 3)	O
OS			M
M	Mandatory		
O	Optional		
NOTE 1:	Within this table, where more than one name is possible, the choice of the physical block name is determined by the predominant usage of the block.		
NOTE 2:	Management physical blocks may contain additional functionality, which allows them to be managed.		
NOTE 3:	The NE needs to support at least one of the TEF or SEF.		

A.1.1 Operations System (OS)

The OS is the system, which performs OSFs. An OS may conceptually be considered as part of the NGN transport stratum, the NGN service stratum, both, or neither, depending on the OSFs that it realizes.

A.1.2 Void

A.1.3 Void

A.1.4 Void

A.1.5 Void

A.1.6 Void

A.1.7 Void

A.1.8 Network Element (NE)

The NE is comprised of telecommunication equipment (or groups/parts of telecommunication equipment) and support equipment or any item or groups of items considered belonging to the telecommunications environment that performs NEFs. The NE may optionally contain any of the other management function blocks according to its implementation

requirements. The NE has one or more standard Q-type interfaces and may optionally have B2B/C2B interfaces. An NE performs at least one of transport element functions (TEFs) or service element functions (SEFs), and so can be deployed in an NGN transport stratum or in an NGN service stratum or in both.

Existing NE-like equipment that does not possess a standard management interface will gain access to the management infrastructure via a Q adapter (see A.1.9.1.1), which will provide the necessary functionality to convert between a non-standard and standard management interface.

A Transport Network Element is an NE that performs only TEFs. A Service Network Element is an NE that performs only SEFs.

A.1.9 Data Communication Network (DCN)

The DCN is a support service that provides the capability to establish paths for information flow between physical blocks in a management environment. The DCN may consist of a number of individual subnetworks of different types, interconnected together. The DCN may be a local path or a wide-area connection among distributed physical blocks. The DCN is technology-independent and may employ any single or combination of transmission technologies.

In order for two or more physical blocks to exchange management information, they must be connected by a communications path and each element must support the same interface onto that communications path.

Physical blocks communicate using a common communication mechanism which provides a set of Application Programming Interfaces (APIs) that include the services of the upper three protocol layers of the OSI Reference Model. Some of these API services expose the communications capabilities of the DCN and others expose common platform functions (e.g., Directory Services, Time Services, Security, etc.). Refer to ITU-T Recs Q.811 and Q.812 for specific interface protocols for information transfer through a DCN.

A.1.9.1 Transformation

Transformation provides conversion between different protocols and data formats for information interchange between physical blocks. There are two types of transformation: adaptation and mediation that can apply at q or b2b/c2b reference points.

A.1.9.1.1 Adaptation device

An adaptation device (AD), or adapter, provides transformation between a non-compliant physical entity to a NE to OS within an administrative domain. A Q-adapter (QA) is a physical block used to connect NE-like or OS-like physical blocks with non-compatible interfaces to Q interfaces. A B2B/C2B-adapter is a physical block used to connect non-compatible physical entities having a non-compatible communication mechanism in a non-compatible environment to an OS at the edge of an administrative domain.

A.1.9.1.2 Mediation device

A mediation device (MD) provides transformation between management physical blocks that incorporate incompatible communication mechanisms. A Q-mediation device (QMD) is a physical block that supports connections within one administrative domain. A B2B/C2B-mediation device is a physical block that supports connections of OSs in different administrative domains

A.1.9.2 Distributed multi-element structure

A distributed multi-element structure is an architectural concept that represents a grouping of network elements that must be managed as a single entity for operational efficiency sake. Due to the distributed nature of their blocks and the complexity of their internal make up, it is sometimes difficult to distinguish between Distributed multi-element structures and a sub-network.

A.1.10 Management logical layered architecture within the management physical view

Several specializations of the OS physical block can be defined to support a physical realization of function blocks in logical layers (see Figures 9.1).

The variety of types of management functionality is reflected in a corresponding flexibility for the mapping of OSFs to Operations Systems so that, in principle, any combination of specialized OSFs can map to an Operations System. As a result, the interfaces offered by an Operations System may include functionality from various OSF specializations (e.g., service management, service resource management and transport resource management functions).

Such a flexible transition from the functional view to a physical view (subject to constraints from the information architecture as outlined in clause 14) allows for different types of OS interactions and corresponding Operations Systems Interface design patterns:

- Provider/consumer;
- Peer-to-peer.

As a result, a physical architecture may flatten the functional Management Layers described in 11.6 into a single, unified management layer for the co-management of several functional Management Layers. Examples of this layer co-management paradigm are shown in Figures 9.2-1 and 9.2-2.

The unified management layer is opaque, i.e., the interworking of the functional Management Layers is invisible to the user of the Interface.

A.1.11 Interface concept

Management interface is an architectural concept that provides interconnection between physical blocks at reference points. Management interfaces provide, via specific communication protocols, for the interconnection of NEs and OSs through the DCN. Interactions between physical blocks, to exchange management information, are established dynamically at run time and are usually not defined statically at design time. In order for such dynamic interactions to occur, physical blocks must be connected by a communications path and each element must support compatible interfaces. It is useful to use the concept of an interface to simplify the communications problems arising from a multi-vendor, multi-capability network. The interface defines the specific protocols, commands, procedures, message formats and semantics used for the management communications between physical blocks. The goal of an interface specification is to ensure compatibility of devices interconnected to accomplish a given management function independent of the type of device or of the supplier.

Figure A.2 shows the interconnection of the various management physical blocks by a set of standard interoperable interfaces.

Management standard interfaces are defined corresponding to the reference points and are classified in two types:

- Provider interfaces: physical realizations of one or more provider reference points; each provider interface is depicted with a white lollipop or ball icon.
- Consumer interfaces: physical realizations of one or more consumer reference points; each consumer interface is depicted with a white crescent or socket icon.

An interface contains the mapping from the protocol-neutral reference point specifications to a protocol-specific specification. An interface consists of one or more reference points together with a single communication protocol binding, which is a protocol suite used to realize a communications path at these reference points.

A.2 Standard interfaces

Management standard interfaces are realizations of specific reference points. The classes of reference points correspond to the classes of interfaces.

Figure A.2 shows an example of a simplified physical view for a management implementation. This example is provided to assist in understanding the management physical blocks described in A.1.

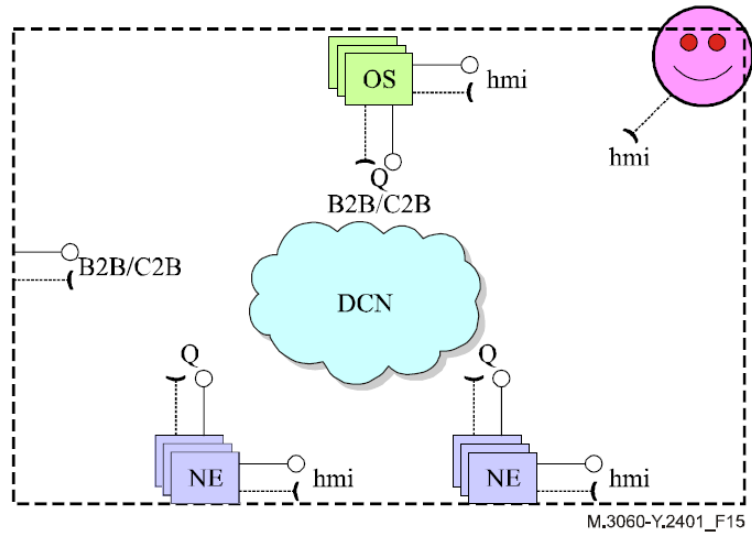

Figure A.2: Example of a physical view M.3060/Y.2401 [16]

Annex B (informative): Overview of a 3GPP System

Figure B.1 presents an example of a 3GPP System, related management areas and introduces some management interfaces. 3GPP Service specific entities are not shown.

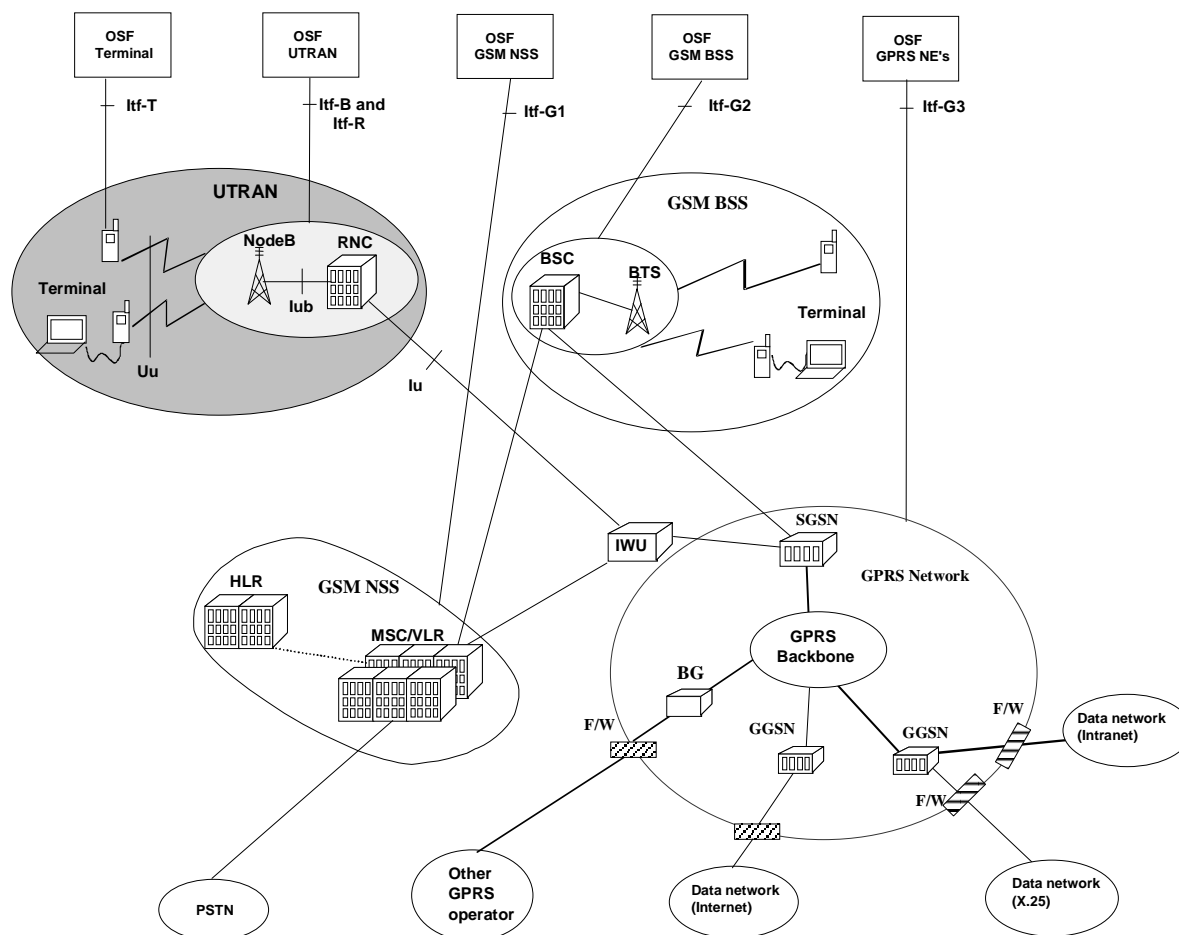

Figure B.1: Overview of a 3GPP System, showing management interfaces and management areas

All the following interfaces are illustrated in figure B.1:

- Itf-T between a terminal and a NE Manager. This interface will in some extent manage the 3G terminal and the USIM of the subscriber. Requirements of this interface are for further study.
- Itf-B and Itf-R between UTRAN and a NE Manager.
- Itf-G1 between GSM NSS and NE Manager.
- Itf-G2 between GSM BSS and NE Manager. This interface is standardised in GSM 12-series specifications.
- Itf-G3 between GPRS NEs and a NE Manager.

Annex C (informative): Change history

Change history								
Date	TSG #	TSG Doc.	CR	Rev	Subject/Comment	Cat	Old	New
Mar 2006	SA_31	SP-060099	0038	--	Extention/Generalization of the IRP definition and concept	C	6.3.0	7.0.0
Dec 2006	SA_34	SP-060721	0039	--	Improve structure and consistency of the definitions related to the IRP concept.	F	7.0.0	7.1.0
Dec 2006	SA_34	SP-060721	0040	--	Introduction of new entities - align with TS23.002	B	7.0.0	7.1.0
Jun 2007	SA_36	SP-070309	0041	--	Identify the Interface IRPs and NRM IRPs which are applicable for Itf-P2P	B	7.1.0	8.0.0
Dec 2007	SP-38	SP-070731	0043	--	Discontinuation of CMIP Solution Sets in Release 7	A	8.0.0	8.1.0
Dec 2008	SP-42	SP-080846	0044	--	Update of Telecom Management Domains	F	8.1.0	8.2.0
Dec 2008	SP-42	SP-080846	0045	--	Update with NGNM architectural concepts - Align with ITU-T M.3060/Y.2401	F	8.1.0	8.2.0
Dec 2008	SP-42	SP-080846	0046	--	Update of entities of the mobile system	F	8.1.0	8.2.0

History

Document history		
V8.2.0	January 2009	Publication