

# ETSI TS 131 122 V4.0.0 (2004-12)

---

*Technical Specification*

**Universal Mobile Telecommunications System (UMTS);  
Universal Subscriber Identity Module (USIM)  
conformance test specification  
(3GPP TS 31.122 version 4.0.0 Release 4)**

---



---

Reference

RTS/TSGT-0331122v400

---

Keywords

UMTS

**ETSI**

650 Route des Lucioles  
F-06921 Sophia Antipolis Cedex - FRANCE

Tel.: +33 4 92 94 42 00 Fax: +33 4 93 65 47 16

Siret N° 348 623 562 00017 - NAF 742 C  
Association à but non lucratif enregistrée à la  
Sous-Préfecture de Grasse (06) N° 7803/88

---

**Important notice**

Individual copies of the present document can be downloaded from:

<http://www.etsi.org>

The present document may be made available in more than one electronic version or in print. In any case of existing or perceived difference in contents between such versions, the reference version is the Portable Document Format (PDF). In case of dispute, the reference shall be the printing on ETSI printers of the PDF version kept on a specific network drive within ETSI Secretariat.

Users of the present document should be aware that the document may be subject to revision or change of status. Information on the current status of this and other ETSI documents is available at

<http://portal.etsi.org/tb/status/status.asp>

If you find errors in the present document, please send your comment to one of the following services:

[http://portal.etsi.org/chaicor/ETSI\\_support.asp](http://portal.etsi.org/chaicor/ETSI_support.asp)

---

**Copyright Notification**

No part may be reproduced except as authorized by written permission.  
The copyright and the foregoing restriction extend to reproduction in all media.

© European Telecommunications Standards Institute 2004.  
All rights reserved.

**DECT**<sup>TM</sup>, **PLUGTESTS**<sup>TM</sup> and **UMTS**<sup>TM</sup> are Trade Marks of ETSI registered for the benefit of its Members.  
**TIPHON**<sup>TM</sup> and the **TIPHON logo** are Trade Marks currently being registered by ETSI for the benefit of its Members.  
**3GPP**<sup>TM</sup> is a Trade Mark of ETSI registered for the benefit of its Members and of the 3GPP Organizational Partners.

---

## Intellectual Property Rights

IPRs essential or potentially essential to the present document may have been declared to ETSI. The information pertaining to these essential IPRs, if any, is publicly available for **ETSI members and non-members**, and can be found in ETSI SR 000 314: "*Intellectual Property Rights (IPRs); Essential, or potentially Essential, IPRs notified to ETSI in respect of ETSI standards*", which is available from the ETSI Secretariat. Latest updates are available on the ETSI Web server (<http://webapp.etsi.org/IPR/home.asp>).

Pursuant to the ETSI IPR Policy, no investigation, including IPR searches, has been carried out by ETSI. No guarantee can be given as to the existence of other IPRs not referenced in ETSI SR 000 314 (or the updates on the ETSI Web server) which are, or may be, or may become, essential to the present document.

---

## Foreword

This Technical Specification (TS) has been produced by ETSI 3rd Generation Partnership Project (3GPP).

The present document may refer to technical specifications or reports using their 3GPP identities, UMTS identities or GSM identities. These should be interpreted as being references to the corresponding ETSI deliverables.

The cross reference between GSM, UMTS, 3GPP and ETSI identities can be found under <http://webapp.etsi.org/key/queryform.asp> .

# Contents

Intellectual Property Rights .....	2
Foreword.....	2
Foreword.....	13
1 Scope .....	14
2 Normative References .....	14
3 Definitions, symbols, abbreviations and coding.....	15
3.1 Definitions .....	15
3.2 Symbols.....	15
3.3 Abbreviations .....	15
3.4 Coding Conventions .....	15
4 Test environment .....	15
4.1 Test equipment .....	15
4.1.1 ME simulator .....	16
4.1.2 Signal generation device .....	16
4.1.2.1 Vcc .....	16
4.1.2.2 RST .....	16
4.1.2.3 CLK.....	16
4.1.2.4 I/O .....	16
4.1.3 Precision force-inducing contacting device .....	17
4.1.4 Temperature controllable environment.....	17
4.1.5 Temperature measuring device .....	17
4.1.6 Voltage measuring device.....	17
4.1.7 Precision measuring device.....	17
4.1.8 Current measuring device .....	17
4.1.9 Timing Measurements on contact I/O.....	17
4.2 IUT default conditions.....	17
4.3 Default data formatting .....	18
4.4 Test definition and applicability .....	18
4.5 Initial conditions.....	18
4.6 Test procedure .....	20
4.7 Test requirement.....	21
5 Test Group Hierarchy.....	21
5.1 Test groups under USIM .....	21
5.2 Test groups under TP102.221.....	21
5.3 Test groups under TP31.102.....	22
5.4 Test groups under PHY .....	22
5.5 Test groups under ELEC .....	23
5.6 Test groups under COM .....	24
5.7 Test groups under TP .....	25
5.8 Test groups under AFS.....	26
5.9 Test groups under SEC1 .....	27
5.10 Test groups under CS .....	27
5.11 Test groups under CMD .....	28
5.12 Test groups under TOC .....	28
5.13 Test groups under APF.....	28
5.14 Test groups under CEF.....	28
5.15 Test groups under SEC2.....	29
5.16 Test groups under UCMD .....	29
5.17 Test groups under UCH.....	29
6 Test Procedure (TS 102.221).....	30
6.1 Physical characteristics.....	30
6.1.1 ID-1 UICC .....	30

6.1.1.1	Definition and applicability.....	30
6.1.1.2	Conformance requirement.....	30
6.1.1.3	Test purpose .....	30
6.1.1.4	Method of test .....	31
6.1.2	Plug-in UICC .....	31
6.1.2.1	Definition and applicability.....	31
6.1.2.2	Conformance requirement.....	31
6.1.2.3	Test purpose .....	31
6.1.2.4	Method of test .....	31
6.1.3	Temperature range for card operation.....	32
6.1.3.1	Definition and applicability.....	32
6.1.3.2	Conformance requirement.....	32
6.1.3.3	Test purpose .....	32
6.1.3.4	Method of test .....	32
6.1.4	Contacts .....	33
6.1.4.1	Definition and applicability.....	33
6.1.4.2	Conformance requirement.....	33
6.1.4.3	Test purpose .....	33
6.1.4.4	Method of test .....	33
6.2	Electrical specifications of the UICC – Terminal interface.....	33
6.2.1	Supply voltage Vcc (contact C1) .....	33
6.2.1.1	Voltage limits.....	33
6.2.1.1.1	Definition and applicability .....	33
6.2.1.1.2	Conformance requirement .....	34
6.2.1.1.3	Test purpose .....	34
6.2.1.1.4	Method of test.....	34
6.2.1.2	Idle current limits.....	34
6.2.1.2.1	Definition and applicability .....	34
6.2.1.2.2	Conformance requirement .....	35
6.2.1.2.3	Test purpose .....	35
6.2.1.2.4	Method of test.....	35
6.2.1.3	Current limits in clk-stop-mode .....	35
6.2.1.3.1	Definition and applicability .....	35
6.2.1.3.2	Conformance requirement .....	35
6.2.1.3.3	Test purpose .....	36
6.2.1.3.4	Method of test.....	36
6.2.2	Reset RST (contact C2) .....	36
6.2.2.1	Static operation .....	36
6.2.2.1.1	Definition and applicability .....	36
6.2.2.1.2	Conformance requirement .....	36
6.2.2.1.3	Test purpose .....	37
6.2.2.1.4	Method of test.....	37
6.2.3	Programming voltage Vpp (contact C6) .....	37
6.2.3.1	Static operation .....	37
6.2.3.1.1	Definition and applicability .....	37
6.2.3.1.2	Conformance requirement .....	38
6.2.3.1.3	Test purpose .....	38
6.2.3.1.4	Method of test.....	38
6.2.4	Clock CLK (contact C3) .....	39
6.2.4.1	Frequency and duty cycle.....	39
6.2.4.1.1	Definition and applicability .....	39
6.2.4.1.2	Conformance requirement .....	39
6.2.4.1.3	Test purpose .....	39
6.2.4.1.4	Method of test.....	39
6.2.4.2	Voltage and current .....	40
6.2.4.2.1	Definition and applicability .....	40
6.2.4.2.2	Conformance requirement .....	40
6.2.4.2.3	Test purpose .....	40
6.2.4.2.4	Method of test.....	40
6.2.5	I/O (contact C7) .....	41
6.2.5.1	Voltage and current .....	41
6.2.5.1.1	Definition and applicability .....	41

6.2.5.1.2	Conformance requirement .....	41
6.2.5.1.3	Test purpose .....	42
6.2.5.1.4	Method of test.....	42
6.3	Initial communication establishment procedure.....	43
6.3.1	Supply voltage switching.....	43
6.3.1.1	Supply voltage classes.....	43
6.3.1.1.1	Definition and applicability .....	43
6.3.1.1.2	Conformance requirement .....	43
6.3.1.1.3	Test purpose .....	43
6.3.1.1.4	Method of test.....	43
6.3.1.2	Power consumption of the UICC during ATR.....	44
6.3.1.2.1	Definition and applicability .....	44
6.3.1.2.2	Conformance requirement .....	44
6.3.1.2.3	Test purpose .....	44
6.3.1.2.4	Method of test.....	44
6.3.1.3	Application related electrical parameters .....	45
6.3.1.3.1	Definition and applicability .....	45
6.3.1.3.2	Conformance requirement .....	45
6.3.1.3.3	Test purpose .....	45
6.3.1.3.4	Method of test.....	45
6.3.2	ATR content.....	46
6.3.2.1	Major capabilities.....	46
6.3.2.1.1	Definition and applicability .....	46
6.3.2.1.2	Conformance requirement .....	46
6.3.2.1.3	Test purpose .....	46
6.3.2.1.4	Method of test.....	46
6.3.2.2	Speed enhancement.....	47
6.3.2.2.1	Definition and applicability .....	47
6.3.2.2.2	Conformance requirement .....	47
6.3.2.2.3	Test purpose .....	47
6.3.2.2.4	Method of test.....	47
6.3.3	PPS procedure.....	48
6.3.3.1	Definition and applicability.....	48
6.3.3.2	Conformance requirement.....	48
6.3.3.3	Test purpose .....	48
6.3.3.4	Method of test .....	48
6.3.4	Reset .....	48
6.3.4.1	Definition and applicability.....	48
6.3.4.2	Conformance requirement.....	49
6.3.4.3	Test purpose .....	49
6.3.4.4	Method of test .....	49
6.3.5	Clock stop mode .....	49
6.3.5.1	Definition and applicability.....	49
6.3.5.2	Conformance requirement.....	49
6.3.5.3	Test purpose .....	50
6.3.5.4	Method of test .....	50
6.3.6	Bit/character duration and sampling time .....	50
6.3.6.1	Definition and applicability.....	50
6.3.6.2	Conformance requirement.....	50
6.3.6.3	Test purpose .....	50
6.3.6.4	Method of test .....	50
6.3.7	Error handling .....	51
6.3.7.1	Definition and applicability.....	51
6.3.7.2	Conformance requirement.....	51
6.3.7.3	Test purpose .....	51
6.3.7.4	Method of test .....	51
6.3.8	Compatibility .....	52
6.3.8.1	Definition and applicability.....	52
6.3.8.2	Conformance requirement.....	52
6.3.8.3	Test purpose .....	52
6.3.8.4	Method of test .....	52
6.4	Transmission Protocols .....	52

6.4.1	Physical Layer .....	52
6.4.1.1	Definition and applicability.....	52
6.4.1.2	Conformance requirement.....	52
6.4.1.3	Test purpose .....	52
6.4.1.4	Method of test .....	53
6.4.2	Data Link Layer .....	53
6.4.2.1	Character Frame .....	53
6.4.2.1.1	Definition and applicability .....	53
6.4.2.1.2	Conformance requirement .....	53
6.4.2.1.3	Test purpose .....	53
6.4.2.1.4	Method of test.....	54
6.4.2.2	Transmission Protocol T = 0 .....	56
6.4.2.2.1	Definition and applicability .....	56
6.4.2.2.2	Conformance requirement .....	56
6.4.2.2.3	Test purpose .....	57
6.4.2.2.4	Method of test.....	57
6.4.2.3	Transmission Protocol T = 1 .....	58
6.4.2.3.1	Timing and specific options for blocks sent with T = 1 .....	58
6.4.2.3.1.1	Information field size .....	59
6.4.2.3.1.1.1	Definition and applicability.....	59
6.4.2.3.1.1.2	Conformance requirement .....	59
6.4.2.3.1.1.3	Test purpose .....	59
6.4.2.3.1.1.4	Method of test .....	59
6.4.2.3.1.2	Character waiting integer .....	60
6.4.2.3.1.2.1	Definition and applicability.....	60
6.4.2.3.1.2.2	Conformance requirement .....	60
6.4.2.3.1.2.3	Test purpose .....	60
6.4.2.3.1.2.4	Method of test .....	60
6.4.2.3.1.3	Character waiting time.....	60
6.4.2.3.1.3.1	Definition and applicability.....	60
6.4.2.3.1.3.2	Conformance requirement.....	60
6.4.2.3.1.3.3	Test purpose .....	61
6.4.2.3.1.3.4	Method of test .....	61
6.4.2.3.1.4	Block guard time.....	61
6.4.2.3.1.4.1	Definition and applicability.....	61
6.4.2.3.1.4.2	Conformance requirement.....	61
6.4.2.3.1.4.3	Test purpose .....	61
6.4.2.3.1.4.4	Method of test .....	61
6.4.2.3.1.5	Waiting time extension .....	62
6.4.2.3.1.5.1	Definition and applicability.....	62
6.4.2.3.1.5.2	Conformance requirement.....	62
6.4.2.3.1.5.3	Test purpose .....	62
6.4.2.3.1.5.4	Method of test .....	62
6.4.2.3.1.6	Error detection code.....	62
6.4.2.3.1.6.1	Definition and applicability.....	62
6.4.2.3.1.6.2	Conformance requirement.....	62
6.4.2.3.1.6.3	Test purpose .....	62
6.4.2.3.1.6.4	Method of test .....	62
6.4.2.3.2	Block frame structure .....	63
6.4.2.3.2.1	Prologue field.....	63
6.4.2.3.2.1.1	Node address byte .....	63
6.4.2.3.2.1.1.1	Definition and applicability.....	63
6.4.2.3.2.1.1.2	Conformance requirement.....	63
6.4.2.3.2.1.1.3	Test purpose .....	63
6.4.2.3.2.1.1.4	Method of test .....	63
6.4.2.3.2.1.2	Protocol Control Byte.....	64
6.4.2.3.2.1.2.1	Definition and applicability.....	64
6.4.2.3.2.1.2.2	Conformance requirement.....	64
6.4.2.3.2.1.2.3	Test purpose .....	64
6.4.2.3.2.1.2.4	Method of test .....	64
6.4.2.3.2.1.3	Length .....	64
6.4.2.3.2.1.3.1	Definition and applicability.....	64

6.4.2.3.2.1.3.2	Conformance requirement .....	64
6.4.2.3.2.1.3.3	Test purpose .....	65
6.4.2.3.2.1.3.4	Method of test .....	65
6.4.2.3.2.1.4	Information field .....	65
6.4.2.3.2.1.4.1	Definition and applicability .....	65
6.4.2.3.2.1.4.2	Conformance requirement .....	65
6.4.2.3.2.1.4.3	Test purpose .....	65
6.4.2.3.2.1.4.4	Method of test .....	65
6.4.2.3.2.3	Epilogue field.....	66
6.4.2.3.2.3.1	Definition and applicability .....	66
6.4.2.3.2.3.2	Conformance requirement .....	66
6.4.2.3.2.3.3	Test purpose .....	67
6.4.2.3.2.3.4	Method of test .....	67
6.4.2.3.3	Error free operation .....	67
6.4.2.3.3.1	Definition and applicability .....	67
6.4.2.3.3.2	Conformance requirement .....	67
6.4.2.3.3.3	Test purpose .....	67
6.4.2.3.3.4	Method of test .....	67
6.4.2.3.4	Error Handling for T = 1 .....	68
6.4.2.3.4.1	Protocol initialisation .....	68
6.4.2.3.4.1.1	Definition and applicability .....	68
6.4.2.3.4.1.2	Conformance requirement .....	68
6.4.2.3.4.1.3	Test purpose .....	68
6.4.2.3.4.1.4	Method of test .....	68
6.4.2.3.4.2	Block dependant errors .....	69
6.4.2.3.4.2.1	Sending invalid blocks to the UICC .....	69
6.4.2.3.4.2.1.1	Definition and applicability .....	69
6.4.2.3.4.2.1.2	Conformance requirement .....	69
6.4.2.3.4.2.1.3	Test purpose .....	70
6.4.2.3.4.2.1.4	Method of test .....	70
6.4.2.3.5	Chaining .....	70
6.4.2.3.5.1	Definition and applicability .....	70
6.4.2.3.5.2	Conformance requirement .....	71
6.4.2.3.5.3	Test purpose .....	71
6.4.2.3.5.4	Method of test .....	71
6.4.3	Transport Layer .....	72
6.4.3.1	Transportation of an APDU using T = 0 .....	72
6.4.3.1.1	Case 1 .....	72
6.4.3.1.1.1	Definition and applicability .....	72
6.4.3.1.1.2	Conformance requirement .....	72
6.4.3.1.1.3	Test purpose .....	72
6.4.3.1.1.4	Method of test .....	72
6.4.3.1.2	Case 2 .....	73
6.4.3.1.2.1	Definition and applicability .....	73
6.4.3.1.2.2	Conformance requirement .....	73
6.4.3.1.2.3	Test purpose .....	73
6.4.3.1.2.4	Method of test .....	73
6.4.3.1.3	Case 3 .....	73
6.4.3.1.3.1	Definition and applicability .....	73
6.4.3.1.3.2	Conformance requirement .....	74
6.4.3.1.3.3	Test purpose .....	74
6.4.3.1.3.4	Method of test .....	74
6.4.3.1.4	Case 4 .....	74
6.4.3.1.4.1	Definition and applicability .....	74
6.4.3.1.4.2	Conformance requirement .....	75
6.4.3.1.4.3	Test purpose .....	75
6.4.3.1.4.4	Method of test .....	75
6.4.3.1.5	Use of Procedure Bytes '61xx' and '6Cxx' .....	76
6.4.3.1.5.1	Case 2 Commands .....	76
6.4.3.1.5.1.1	Definition and applicability .....	76
6.4.3.1.5.1.2	Conformance requirement .....	76
6.4.3.1.5.1.3	Test purpose .....	77



6.4.3.1.5.1.4	Method of test .....	77
6.4.3.1.5.2	Case 4 Commands .....	78
6.4.3.1.5.2.1	Definition and applicability.....	78
6.4.3.1.5.2.2	Conformance requirement.....	78
6.4.3.1.5.2.3	Test purpose .....	78
6.4.3.1.5.2.4	Method of test .....	78
6.4.3.2	Transportation of an APDU using T = 1 .....	78
6.4.3.2.1	Case 1 .....	78
6.4.3.2.1.1	Definition and applicability .....	78
6.4.3.2.1.2	Conformance requirement .....	78
6.4.3.2.1.3	Test purpose.....	79
6.4.3.2.1.4	Method of test .....	79
6.4.3.2.2	Case 2 .....	79
6.4.3.2.2.1	Definition and applicability .....	79
6.4.3.2.2.2	Conformance requirement .....	79
6.4.3.2.2.3	Test purpose.....	79
6.4.3.2.2.4	Method of test .....	79
6.4.3.2.3	Case 3 .....	80
6.4.3.2.3.1	Definition and applicability .....	80
6.4.3.2.3.2	Conformance requirement .....	80
6.4.3.2.3.3	Test purpose.....	80
6.4.3.2.3.4	Method of test .....	80
6.4.3.2.4	Case 4 .....	81
6.4.3.2.4.1	Definition and applicability .....	81
6.4.3.2.4.2	Conformance requirement .....	81
6.4.3.2.4.3	Test purpose.....	81
6.4.3.2.4.4	Method of test .....	81
6.4.4	Application Layer .....	81
6.4.4.1	Definition and applicability.....	81
6.4.4.2	Conformance requirement.....	81
6.4.4.3	Test purpose .....	82
6.4.4.4	Method of test .....	82
6.5	Application and File structure .....	82
6.5.1	UICC Application structure .....	82
6.5.1.1	Definition and applicability.....	82
6.5.1.2	Conformance requirement.....	82
6.5.1.3	Test purpose .....	82
6.5.1.4	Method of test .....	83
6.5.2	File types.....	83
6.5.2.1	Dedicated files.....	83
6.5.2.1.1	Definition and applicability .....	83
6.5.2.1.2	Conformance requirement .....	83
6.5.2.1.3	Test purpose .....	84
6.5.2.1.4	Method of test.....	84
6.5.2.2	Elementary files .....	84
6.5.2.2.1	Transparent EF .....	84
6.5.2.2.1.1	Definition and applicability .....	84
6.5.2.2.1.2	Conformance requirement .....	84
6.5.2.2.1.3	Test purpose.....	84
6.5.2.2.1.4	Method of test .....	84
6.5.2.2.2	Linear fixed EF.....	85
6.5.2.2.2.1	Definition and applicability .....	85
6.5.2.2.2.2	Conformance requirement .....	85
6.5.2.2.2.3	Test purpose.....	85
6.5.2.2.2.4	Method of test .....	86
6.5.2.2.3	Cyclic EF.....	87
6.5.2.2.3.1	Definition and applicability .....	87
6.5.2.2.3.2	Conformance requirement .....	87
6.5.2.2.3.3	Test purpose.....	87
6.5.2.2.3.4	Method of test .....	87
6.5.3	File referencing .....	88
6.5.3.1	Definition and applicability.....	88

6.5.3.2	Conformance requirement.....	88
6.5.3.3	Test purpose .....	89
6.5.3.4	Method of test .....	89
6.5.4	Methods for selecting a file.....	89
6.5.4.1	SELECT by File Identifier Referencing.....	89
6.5.4.1.1	Definition and applicability .....	89
6.5.4.1.2	Conformance requirement .....	89
6.5.4.1.3	Test purpose .....	90
6.5.4.1.4	Method of test.....	90
6.5.4.2	SELECT by Path Referencing.....	91
6.5.4.2.1	Definition and applicability .....	91
6.5.4.2.2	Conformance requirement .....	91
6.5.4.2.3	Test purpose .....	91
6.5.4.2.4	Method of test.....	91
6.5.4.3	Short File Identifier .....	92
6.5.4.3.1	Definition and applicability .....	92
6.5.4.3.2	Conformance requirement .....	92
6.5.4.3.3	Test purpose .....	92
6.5.4.3.4	Method of test.....	92
6.5.5	Application characteristic .....	93
6.5.5.1	Explicit Application selection .....	93
6.5.5.1.1	SELECT by DF Name.....	93
6.5.5.1.1.1	Definition and applicability .....	93
6.5.5.1.1.2	Conformance requirement .....	93
6.5.5.1.1.3	Test purpose.....	93
6.5.5.1.1.4	Method of test .....	93
6.5.5.1.2	SELECT by partial DF Name.....	94
6.5.5.1.2.1	Definition and applicability .....	94
6.5.5.1.2.2	Conformance requirement .....	94
6.5.5.1.2.3	Test purpose.....	94
6.5.5.1.2.4	Method of test .....	94
6.5.5.2	Application session activation.....	95
6.5.5.2.1	Definition and applicability .....	95
6.5.5.2.2	Conformance requirement .....	95
6.5.5.2.3	Test purpose .....	95
6.5.5.2.4	Method of test.....	95
6.5.5.3	Application session termination .....	95
6.5.5.3.1	Definition and applicability .....	95
6.5.5.3.2	Conformance requirement .....	96
6.5.5.3.3	Test purpose .....	96
6.5.5.3.4	Method of test.....	96
6.5.5.4	Application session reset.....	97
6.5.5.4.1	Definition and applicability .....	97
6.5.5.4.2	Conformance requirement .....	97
6.5.5.4.3	Test purpose .....	97
6.5.5.4.4	Method of test.....	97
6.5.5.5	GSM/USIM application interaction and restrictions .....	97
6.5.5.5.1	Definition and applicability .....	97
6.5.5.5.2	Conformance requirement .....	98
6.5.5.5.3	Test purpose .....	98
6.5.5.5.4	Method of test.....	98
6.5.6	Reservation of file IDs.....	98
6.5.6.1	Definition and applicability.....	98
6.5.6.2	Conformance requirement.....	98
6.5.6.3	Test purpose .....	99
6.5.6.4	Method of test .....	99
6.6	Security features.....	99
6.6.1	Supported security features.....	100
6.6.1.1	Definition and applicability.....	100
6.6.1.2	Conformance requirement.....	100
6.6.1.3	Test purpose .....	100
6.6.1.4	Method of test .....	100

6.6.2	Security architecture .....	101
6.6.2.1	Definition and applicability.....	101
6.6.2.2	Conformance requirement.....	101
6.6.2.3	Test purpose .....	101
6.6.2.4	Method of test .....	101
6.6.3	Security Environment .....	102
6.6.3.1	Definition and applicability.....	102
6.6.3.2	Conformance requirement.....	102
6.6.3.3	Test purpose .....	102
6.6.3.4	Method of test .....	102
6.6.4	PIN definitions.....	105
6.6.4.1	Definition and applicability.....	105
6.6.4.2	Conformance requirement.....	105
6.6.4.3	Test purpose .....	105
6.6.4.4	Method of test .....	105
6.6.5	PIN and key reference relationship.....	106
6.6.5.1	Definition and applicability.....	106
6.6.5.2	Conformance requirement.....	106
6.6.5.3	Test purpose .....	107
6.6.5.4	Method of test .....	107
6.7	Structure of commands and responses.....	110
6.7.1	Mapping principles .....	111
6.7.1.1	Definition and applicability.....	111
6.7.1.2	Conformance requirement.....	111
6.7.1.3	Test purpose .....	111
6.7.1.4	Method of test .....	111
6.7.2	Response APDU Structure.....	112
6.7.2.1	Status Conditions Returned by the UICC.....	112
6.7.2.1.1	Definition and applicability .....	112
6.7.2.1.2	Conformance requirement .....	112
6.7.2.1.3	Test purpose .....	112
6.7.2.1.4	Method of test.....	112
6.7.2.2	Status Words of the Commands.....	115
6.7.2.2.1	Definition and applicability .....	115
6.7.2.2.2	Conformance requirement .....	115
6.7.2.2.3	Test purpose .....	115
6.7.2.2.4	Method of test.....	115
6.8	Commands.....	115
6.8.1	Generic Commands.....	115
6.8.1.1	SELECT .....	115
6.8.1.1.1	Definition and applicability .....	115
6.8.1.1.2	Conformance requirement .....	115
6.8.1.1.3	Test purpose .....	116
6.8.1.1.4	Method of test.....	116
6.8.1.2	STATUS .....	119
6.8.1.2.1	Definition and applicability .....	119
6.8.1.2.2	Conformance requirement .....	119
6.8.1.2.3	Test purpose .....	119
6.8.1.2.4	Method of test.....	119
6.8.1.3	READ BINARY .....	122
6.8.1.3.1	Definition and applicability .....	122
6.8.1.3.2	Conformance requirement .....	122
6.8.1.3.3	Test purpose .....	122
6.8.1.3.4	Method of test.....	122
6.8.1.4	UPDATE BINARY.....	123
6.8.1.4.1	Definition and applicability .....	123
6.8.1.4.2	Conformance requirement .....	123
6.8.1.4.3	Test purpose .....	123
6.8.1.4.4	Method of test.....	124
6.8.1.5	READ RECORD.....	125
6.8.1.5.1	Definition and applicability .....	125
6.8.1.5.2	Conformance requirement .....	125

6.8.1.5.3	Test purpose .....	126
6.8.1.5.4	Method of test.....	126
6.8.1.6	UPDATE RECORD .....	129
6.8.1.6.1	Definition and applicability .....	129
6.8.1.6.2	Conformance requirement .....	129
6.8.1.6.3	Test purpose .....	130
6.8.1.6.4	Method of test.....	130
6.8.1.7	SEARCH RECORD .....	133
6.8.1.7.1	Definition and applicability .....	133
6.8.1.7.2	Conformance requirement .....	133
6.8.1.7.3	Test purpose .....	134
6.8.1.7.4	Method of test.....	135
6.8.1.8	INCREASE .....	140
6.8.1.8.1	Definition and applicability .....	140
6.8.1.8.2	Conformance requirement .....	140
6.8.1.8.3	Test purpose .....	140
6.8.1.8.4	Method of test.....	141
6.8.1.9	VERIFY PIN.....	141
6.8.1.9.1	Definition and applicability .....	141
6.8.1.9.2	Conformance requirement .....	141
6.8.1.9.3	Test purpose .....	142
6.8.1.9.4	Method of test.....	142
6.8.1.10	CHANGE PIN.....	144
6.8.1.10.1	Definition and applicability .....	144
6.8.1.10.2	Conformance requirement .....	144
6.8.1.10.3	Test purpose .....	144
6.8.1.10.4	Method of test.....	144
6.8.1.11	DISABLE PIN .....	146
6.8.1.11.1	Definition and applicability .....	146
6.8.1.11.2	Conformance requirement .....	146
6.8.1.11.3	Test purpose .....	147
6.8.1.11.4	Method of test.....	147
6.8.1.12	ENABLE PIN .....	149
6.8.1.12.1	Definition and applicability .....	149
6.8.1.12.2	Conformance requirement .....	149
6.8.1.12.3	Test purpose .....	149
6.8.1.12.4	Method of test.....	149
6.8.1.13	UNBLOCK PIN .....	151
6.8.1.13.1	Definition and applicability .....	151
6.8.1.13.2	Conformance requirement .....	151
6.8.1.13.3	Test purpose .....	152
6.8.1.13.4	Method of test.....	152
6.8.1.14	DEACTIVATE FILE .....	154
6.8.1.14.1	Definition and applicability .....	154
6.8.1.14.2	Conformance requirement .....	154
6.8.1.14.3	Test purpose .....	155
6.8.1.14.4	Method of test.....	155
6.8.1.15	ACTIVATE FILE .....	157
6.8.1.15.1	Definition and applicability .....	157
6.8.1.15.2	Conformance requirement .....	157
6.8.1.15.3	Test purpose .....	157
6.8.1.15.4	Method of test.....	158
6.8.1.16	AUTHENTICATE .....	160
6.8.1.16.1	Definition and applicability .....	160
6.8.1.16.2	Conformance requirement .....	160
6.8.1.16.3	Test purpose .....	160
6.8.1.16.4	Method of test.....	160
6.8.1.17	MANAGE CHANNEL .....	160
6.9	Transmission Oriented Commands .....	160
6.9.1	T = 0 specific commands .....	160
6.9.1.1	GET RESPONSE.....	160
6.9.1.1.1	Definition and applicability .....	160

6.9.1.1.2	Conformance requirement .....	160
6.9.1.1.3	Test purpose .....	161
6.9.1.1.4	Method of test.....	161
6.10	Application independent files.....	161
6.10.1	Definition and applicability .....	161
6.10.2	Conformance requirement .....	161
6.10.3	Test purpose.....	162
6.10.4	Method of test .....	162
7	Test Procedure (31.102) .....	163
7.1	Contents of the Elementary Files (EF) .....	163
7.1.1	Definition and applicability .....	163
7.1.2	Conformance requirement .....	163
7.1.3	Test purpose.....	163
7.1.4	Method of test .....	163
7.2	Security features .....	164
7.2.1	Definition and applicability .....	164
7.2.2	Conformance requirement .....	164
7.2.3	Test purpose.....	165
7.2.4	Method of test .....	165
7.3	USIM commands.....	166
7.3.1	AUTHENTICATE.....	166
7.3.1.1	Definition and applicability.....	166
7.3.1.2	Conformance requirement.....	166
7.3.1.3	Test purpose .....	166
7.3.1.4	Method of test .....	166
7.3.2	Status Conditions Returned by the UICC .....	167
7.3.2.1	Security management .....	167
7.3.2.1.1	Definition and applicability .....	167
7.3.2.1.2	Conformance requirement .....	167
7.3.2.1.3	Test purpose .....	167
7.3.2.1.4	Method of test.....	167
7.3.2.2	Status Words of the Commands .....	168
7.3.2.2.1	Definition and applicability .....	168
7.3.2.2.2	Conformance requirement .....	168
7.3.2.2.3	Test purpose .....	168
7.3.2.2.4	Method of test.....	168
7.3.3	VERIFY command .....	168
7.3.3.1	Definition and applicability.....	168
7.3.3.2	Conformance requirement.....	169
7.3.3.3	Test purpose .....	169
7.3.3.4	Method of test .....	169
7.4	UICC Characteristics.....	169
7.4.1	Voltage classes.....	169
7.4.1.1	Definition and applicability.....	169
7.4.1.2	Conformance requirement.....	169
7.4.1.3	Test purpose .....	169
7.4.1.4	Method of test .....	169
<b>Annex A (informative):</b>	<b>Change history .....</b>	<b>171</b>
History .....		172

---

## Foreword

This Technical Specification has been produced by the 3<sup>rd</sup> Generation Partnership Project (3GPP).

The contents of the present document are subject to continuing work within the TSG and may change following formal TSG approval. Should the TSG modify the contents of the present document, it will be re-released by the TSG with an identifying change of release date and an increase in version number as follows:

Version x.y.z

where:

- x the first digit:
  - 1 presented to TSG for information;
  - 2 presented to TSG for approval;
  - 3 or greater indicates TSG approved document under change control.
- y the second digit is incremented for all changes of substance, i.e. technical enhancements, corrections, updates, etc.
- z the third digit is incremented when editorial only changes have been incorporated in the document.

---

# 1 Scope

The present document provides the Conformance Test Specification for a Universal IC Card (UICC) defined in 3G TS 31.101 [2] with Universal Subscriber Identity Module (USIM) defined in 3G TS 31.102 [3].

---

# 2 Normative References

The following documents contain provisions, which through reference in this text, constitute provisions of the present document.

- References are either specific (identified by date of publication, edition number, version number, etc.) or non-specific.
- For a specific reference, subsequent revisions do not apply.
- For a non-specific reference, the latest version applies. In the case of a reference to a 3GPP document (including a GSM document), a non-specific reference implicitly refers to the latest version of that document *in the same Release as the present document*.

- [1] ETSI TS 102.221 Release 4: "UICC-Terminal Interface; Physical and Logical Characteristics".
- [2] 3GPP TS 31.101: "UICC-Terminal Interface; Physical and Logical Characteristics".
- [3] 3GPP TS 31.102: "Characteristics of the USIM application".
- [4] ISO/IEC 7816-1 (1998): "Identification cards - Integrated circuit(s) cards with contacts, Part 1: Physical characteristics".
- [5] ISO/IEC 7816-2 (1999): "Identification cards - Integrated circuit(s) cards with contacts, Part 2: Dimensions and locations of the contacts".
- [6] ISO/IEC 7816-3 (1997): "Identification cards - Integrated circuit(s) cards with contacts, Part 3: Electronic signals and transmission protocols".
- [7] ISO/IEC 7816-4 (1995): "Identification cards - Integrated circuit(s) cards with contacts, Part 4: Interindustry commands for interchange".
- [8] ISO/IEC 7816-5 (1994): "Identification cards - Integrated circuit(s) cards with contacts, Part 5: Numbering system and registration procedure for application identifiers".
- [9] ISO/IEC 7816-6 (1996): "Identification cards - Integrated circuit(s) cards with contacts, Part 6: Interindustry data elements".
- [10] ISO/IEC 7816-8 (1999): "Identification cards - Integrated circuit(s) cards with contacts, Part 8: Security related Interindustry commands".
- [11] ISO/IEC 7816-9 (2000): "Identification cards - Integrated circuit(s) cards with contacts, Part 9: Additional Interindustry commands and security attributes".
- [12] ISO/IEC 7811-1 (1995): "Identification cards - Recording technique - Part 1: Embossing"
- [13] ISO/IEC 7811-3 (1995): "Identification cards - Recording technique - Part 3: Location of embossed characters on ID-1 cards"
- [14] 3GPP TS 11.11: "Digital cellular telecommunications system (Phase 2+); Specification of the Subscriber Identity Module - Mobile Equipment (SIM - ME) interface".

---

## 3 Definitions, symbols, abbreviations and coding

### 3.1 Definitions

For the purposes of the present document, the following definitions apply in addition to the terms defined in TS 102.221 [1] and 3G TS 31.102 [3].

**Implementation Conformance Statement (ICS):** A statement made by the supplier of an implementation or system claimed to conform to a given specification, stating which capabilities have been implemented. The ICS can take several forms: protocol ICS, profile ICS, profile specific ICS, information object ICS, etc.

**ICS proforma:** A document, in the form of a questionnaire, which when completed for an implementation or system becomes an ICS.

### 3.2 Symbols

For the purposes of the present document, the following symbols apply:

$t_F$	fall time
$t_R$	rise time
$V_{IH}$	Input Voltage (high)
$V_{IL}$	Input Voltage (low)
$V_{OH}$	Output Voltage (high)
$V_{OL}$	Output Voltage (low)

### 3.3 Abbreviations

For the purposes of the present document, the following abbreviations apply:

CRn	Conformance Requirement 'n'
IUT	Implementation Under Test
ME	Mobile Equipment
TS	Test Specification
UICC	Universal Integrated Circuit Card
USIM	Universal Subscriber Identity Module

### 3.4 Coding Conventions

The following coding conventions apply to the present document:

All lengths are presented in bytes, unless otherwise stated. Each byte is represented by bit b8 to b1, where b8 is the most significant bit (MSB) and b1 is the least significant bit (LSB). In each representation, the leftmost bit is the MSB.

---

## 4 Test environment

This clause specifies several requirements which shall be met, and a number of rules which shall be adhered to before testing can proceed.

### 4.1 Test equipment

This subclause recommends a minimum specification for each of the items of test equipment referenced in the tests.



### 4.1.1 ME simulator

This item of equipment shall allow  $T = 0$  and  $T = 1$  protocol communications to take place on both ID-1 and plug-in UICCs. It shall be able to generate and send any command APDU and receive any of the possible responses. These commands may be generated manually, one at a time, or automatically from a predefined batch procedure containing one or more commands.

The ME simulator shall be able to support clock stop modes.

The ME simulator shall be able to accept an external clock signal to drive CLK (contact C3) of the UICC.

It shall be possible to access all the UICC contacts either directly or through test points.

### 4.1.2 Signal generation device

#### 4.1.2.1 Vcc

The voltage level for Vcc (contact C1) of the UICC shall be adjustable between -0,5 V and 6,0 V to an accuracy of 1% of the nominal Vcc voltage (e.g. 50 mV for class A operating conditions).

The ME simulator shall be able to source current on the Vcc contact in the range -2 mA to 12 mA statically and to deliver charges of > 400 nAs without lowering the Vcc voltage for more than 10 % of Vcc nominal.

#### 4.1.2.2 RST

The generated voltage level for RST (contact C2) of the UICC shall be adjustable between -0,5 V and 6,0 V to an accuracy of 50 mV.

The rise and fall times shall be adjustable from 0  $\mu$ s to 500  $\mu$ s with an accuracy of 5  $\mu$ s. (*to check if the USIM works with the defined rise and fall times.*)

The beginning of the rising edge shall be programmable from 1 clk-cycle to 50,000 clk-cycles after enabling the clk-line.

#### 4.1.2.3 CLK

This item of equipment shall be able to generate square wave signals for the clock on the UICC, any of which can be a single-shot or continuous signal, in the range 1 MHz to 5 MHz. The voltage levels for both high and low states shall be adjustable between -0,5 V and 6,0 V to an accuracy of 0,1 V. The duty cycle of the clock signal shall be adjustable between 40 % and 60 % to an accuracy of 1 %. It shall also provide control over the following parameters:

The voltage levels for both high and low states shall be adjustable between 0 V and 6 V to an accuracy of 1% of the nominal Vcc voltage. The duty cycle of the clock signal shall be adjustable between 40 % and 60 % to an accuracy of 1 % or 5 ns whichever is the worst.

It shall also provide control over the following parameters:

- rise and fall time to an accuracy of 1 % or 5 ns whichever is the worst. ( $5 \text{ ns} = 2,5 \% \text{ accuracy for } f_{\text{max}} = 5 \text{ MHz}$ ).

#### 4.1.2.4 I/O

The equipment shall be able to generate I/O-Signals according to TS 102.221 [1]

The voltage levels for high and low states shall be adjustable between -0,5 V and 6,0 V to an accuracy of 1 % of the nominal Vcc voltage. The I/O line in transmission mode (high bit) shall be programmable between state A (active driven output) and state Z (I/O-voltage-driver inactive, current source I-I/O-high active).

It shall also provide control over the rise and fall time of 100 ns to 1 000 ns with an accuracy of 50 ns.

The ME simulator shall be able to source and sink currents on the I/O contact in the range -20  $\mu$ A to +20  $\mu$ A in state high and 0 mA to -1 mA in state low (receiving mode) and shall be able to switch in transmission mode (outputting a high bit) between voltage and current driving mode.

The timing of the bitstream (jitter, guardtime, etu-value, etc.) on the I/O-Line shall be programmable with an accuracy of  $\leq 0,01$  etu or 2 clk-cycles whichever is the worst.

### 4.1.3 Precision force-inducing contacting device

This item of equipment shall be able to apply a prescribed and maintained level of force onto one or more contacts of the UICC. The range shall be between 0 and 0,5 N and accurate to 0,01 N.

### 4.1.4 Temperature controllable environment

This item of equipment shall be able to control the temperature of a chamber large enough to enclose the UICC and the card reader. The range of temperature control shall be between  $-25$  °C and  $+85$  °C to an accuracy of 0,5 °C.

### 4.1.5 Temperature measuring device

This item of equipment shall be able to measure the temperature of the UICC to within 0,5 °C. The range of this device shall allow measurement of temperatures between  $-25$  °C and  $+85$  °C.

### 4.1.6 Voltage measuring device

This item of equipment shall be able to measure static and transient voltages on any one of the contacts of the UICC. The measurable voltage range shall be between  $-2$  V and  $+7$  V to an accuracy of 1% of the nominal Vcc voltage (e.g. 30 mV for class B operating conditions) with a timebase accuracy of 25 ns.

### 4.1.7 Precision measuring device

This item of equipment shall be able to measure both linear and radius of curvature dimensions to an accuracy of 0,01 mm.

### 4.1.8 Current measuring device

This item of equipment shall be able to supervise the current levels for any one of the contacts of the USIM.

The simulator shall be able to detect an over - or underload with a time resolution of  $\leq 100$  ns.

Channel	Minimum	Maximum	Resolution
Vcc high	-2 mA	+12,5 mA	125 $\mu$ A
Vcc low	-2 mA	+12,5 mA	125 $\mu$ A
Vcc Burst	12 mA	+250 mA	2,5 mA
RST/CLK High state	-50 $\mu$ A	+50 $\mu$ A	1 $\mu$ A
RST/CLK Low state	-250 $\mu$ A	+250 $\mu$ A	2,5 $\mu$ A
I/O high state	-50 $\mu$ A	+50 $\mu$ A	1 $\mu$ A
I/O low state	-1 500 $\mu$ A	+1 500 $\mu$ A	15 $\mu$ A

### 4.1.9 Timing Measurements on contact I/O

To verify the timing of the I/O transmission from the UICC, the ME simulator shall be able to measure the I/O-Bit-Timing in clk-cycles with an accuracy of  $\leq 0,01$  etu or 2 clk-cycles whichever is the worst.

## 4.2 IUT default conditions

Unless otherwise stated, the following is default:

- The voltage level for Vcc (contact C1) shall be set to 3,0 V.
- The voltage levels for CLK (contact C3) shall be set to 0 V and 3,0 V for low and high respectively.

- The clock frequency CLK (contact C3) shall be set to 5 MHz with duty cycle 50 %.
- The ME simulator generated low transmission voltage level for I/O (contact C7) shall be set to 0 V and the current sources for high transmission and reception shall be set to -20  $\mu$ A and +20  $\mu$ A respectively
- Any level 1 user verification requirement (PIN) on the UICC shall be enabled with three VERIFY PIN attempts and ten UNBLOCK PIN attempts remaining.
- Any level 2 user verification requirement (PIN2) on the UICC shall be enabled with three VERIFY PIN2 attempts and ten UNBLOCK PIN2 attempts remaining, if assigned.
- A Universal PIN on the UICC shall be enabled, if IUT is a multi-verification capable UICC.

## 4.3 Default data formatting

All numeric data enclosed in single quotes ( ' ') in this document are hexadecimal data.

Where 'X' is used in place of a hexadecimal digit, X ranges from '0' to 'F'. For example, the data '6X' ranges from '60' to '6F' inclusive.

Where data is expressed as a group of bytes, it shall be in the following format: 'XX XX XX... XX', indicating first byte, second byte, third byte etc. in that order.

A string of digits shall be formatted with a continuous string of numeric data and enclosed with single quotes. For example, the string 'XXXXXXXX' where X ranges from 0 to 9 inclusive.

## 4.4 Test definition and applicability

The following statements are applicable to the test definition and applicability clause for all test purposes contained within the present document:

- Unless otherwise stated, tests apply to both plug-in and ID-1 UICC cards.
- Unless otherwise stated, tests apply to each protocol supported by the UICC.
- The tests are performed on a UICC as defined in 3G TS 31.101 [2] with a USIM application as defined in 3G TS 31.102 [3]. The tests to check the requirement of 3G TS 31.101 [2] use the files as defined in 3G TS 31.102 [3].
- Unless otherwise stated, the tests apply to single and multi-verification capable UICCs with USIM application(s). In the case of a multi-verification capable UICC, there shall be only one application.

## 4.5 Initial conditions

Unless otherwise stated, all the PINs used in the test procedures shall be initially enabled.

Figure 1 shows the files in the UICC which shall be used for the test procedures, in the case where the EFs are not mandatory, they may be replaced with other EFs of the same file structure.

Unless otherwise stated, all the EFs used in the test procedure shall be activated.

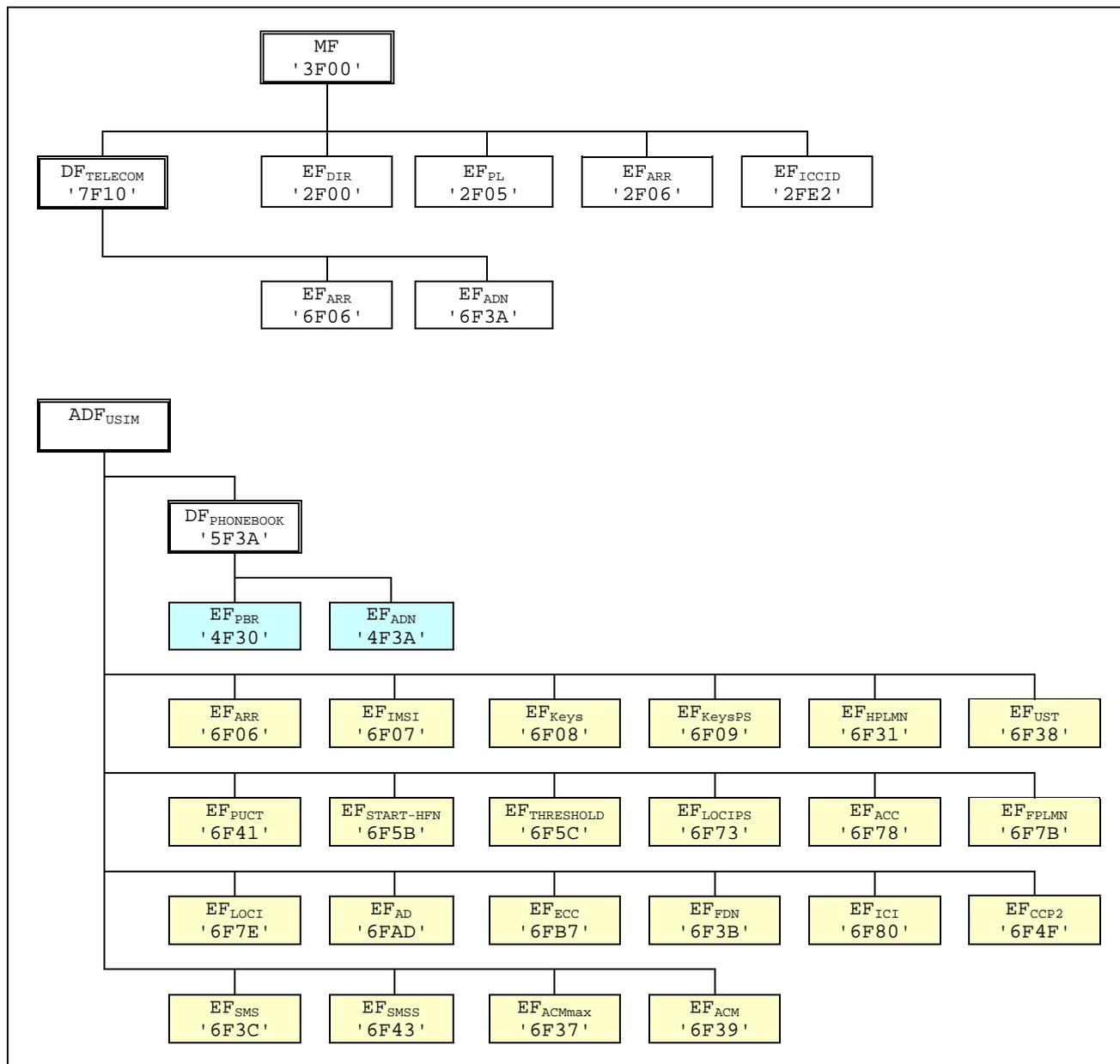

Figure 1: File identifiers and directory structures of UICC

The initial conditions for some of the EFs are given in the followings:

- PIN shall be set to '00000000'.
- PIN2 shall be set to '11111111'.
- Universal PIN shall be set to '22222222', if supported.
- EF\_FPLMN shall contain the data string: '55 AA 0F 00 F0 FF 00 F0 FF 00 F0 FF'.
- EF\_LOCI shall contain the data string: 'A1 A2 A3 A4 A5 A6 A7 A8 A9 00 00'.
- The records in EF\_SMS shall contain the following data for the first 20 bytes:

```

1st record  'A0 A1 A2 B0 B1 B2 A0 A1 A2 A0 A1 A2 FF A0 A1 A2 A3 A4 A5 A6'
2nd record  'B0 B1 B2 A0 A1 A2 A0 A1 A2 B0 B1 B2 FF B0 B1 B2 B3 B4 B5 B6'
3rd record  'B0 B1 B2 A0 A1 A2 B0 B1 B2 A0 A1 A2 FF C0 C1 C2 C3 C4 C5 C6'
4th record  'A0 A1 A2 B0 B1 B2 B0 B1 B2 B0 B1 B2 FF D0 D1 D2 D3 D4 D5 D6'
    
```

The data for the remainder of these four records and for all other records shall be 'FF'.

- The records in EF<sub>F<sub>DN</sub></sub> shall contain the following data for the first 10 bytes:

```

1st record  'A0 A1 A2 B0 B1 B2 A0 A1 A2 A0'
2nd record  'B0 B1 B2 A0 A1 A2 A0 A1 A2 B0'
3rd record  'B0 B1 B2 A0 A1 A2 B0 B1 B2 A0'
4th record  'A0 A1 A2 B0 B1 B2 B0 B1 B2 B0'

```

The data for the remainder of these four records and for all other records (if any) shall be 'FF'.

- The records in EF<sub>CCP2</sub> shall contain the following data:

```

1st record      '10 11 12 13 14 15 16 17 18 19 1A 1B 1C 1D 1E'
2nd record      '20 21 22 23 24 25 26 27 28 29 2A 2B 2C 2D 2E'
2nd last record 'E0 E1 E2 E3 E4 E5 E6 E7 E8 E9 EA EB EC ED EE'
Last record     'F0 F1 F2 F3 F4 F5 F6 F7 F8 F9 FA FB FC FD FE'

```

- The records in EF<sub>ACM</sub> shall contain the following data, if it is supported:

```

1st record  '00 00 01' (last updated record)
2nd record  '00 00 02'
3rd record  '00 00 03'
xth record  '00 00' followed by byte value X (first updated record)

```

- The records in EF<sub>ICI</sub> shall contain the following data:

```

1st record  '01' for all bytes
2nd record  '02' for all bytes
3rd record  '03' for all bytes
xth record  byte value X for all bytes

```

## 4.6 Test procedure

The following statements are applicable to the test procedure clause for all test purposes contained within the present document:

- Unless otherwise stated, all steps within the test procedure shall be carried out in order.
- Unless otherwise stated, all test procedures shall be applicable to both T = 0 and T = 1 protocols.
- Where steps indicate that a ME simulator shall select a particular DF or EF using an unspecified number of SELECT commands, the ME simulator is to send the correct sequence of SELECT commands in order to select the required file ID from the current file ID (this may be achieved most easily by selecting from the MF down each time).
- Unless otherwise stated, the Le (P3) for all READ RECORD commands and Lc (P3) for all UPDATE RECORD commands sent by the ME simulator is to be that of the record length of the EF currently selected. In the case where an EF is not currently selected, the length sent is to be 1 unless otherwise stated.
- Unless otherwise stated, the offset for all READ BINARY and UPDATE BINARY commands sent by the ME simulator is to be '00 00'.
- Unless otherwise specified, when the T = 0 protocol is used, the necessary GET RESPONSE commands are assumed to be sent, or the same command header is assumed to be resent with P3 = L<sub>UICC</sub> at the transport layer level in order to retrieve the available response data from the UICC.
- Unless otherwise stated, the length (Le) for all SELECT, STATUS and GET RESPONSE commands sent by the ME simulator is to be such that all available data is read.
- Unless otherwise stated, the PIN and Unblock PIN presented for VERIFY PIN, CHANGE PIN, DISABLE PIN, ENABLE PIN and UNBLOCK PIN commands sent by the ME simulator is to be correct.
- Unless otherwise stated, a SELECT command sent to the UICC to select ADF<sub>USIM</sub> is with the application's AID, indicating in the command parameter that the application shall be activated.
- Unless otherwise stated, a SELECT command sent to the UICC is with P2 = '04', indicating that the FCP shall be returned.

## 4.7 Test requirement

Where steps within a test procedure involve a ME simulator sending one or more commands to the UICC, these commands are required to be correctly executed, with the UICC responding with status conditions of '90 00', unless otherwise stated in the subclause for the test.

## 5 Test Group Hierarchy

This clause contains the Test Group Hierarchy diagrams which provide a structure for the test purposes and also a correlation between the base specification, ICS and the present document.

The information contained in each node for each of the diagrams is as follows:

mnemonic for test group
reference to clause in TS

As the Test Group Hierarchy for the UICC is large, it has been broken into sections to aid presentation.

### 5.1 Test groups under USIM

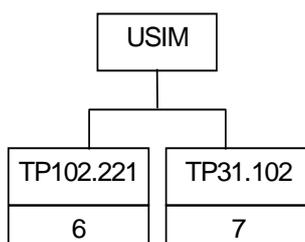

**Figure 2: Top Level Test Group Hierarchy**

The mnemonics chosen for this test group are as follows:

- TP102.221: Test Procedure - TS 102.221 [1]
- TP31.102: Test Procedure - 3G TS 31.102 [3]

The Test Groups "TP102.221 " and "TP31.102", shown in figure 2, are broken down further, as shown in the following diagrams.

### 5.2 Test groups under TP102.221

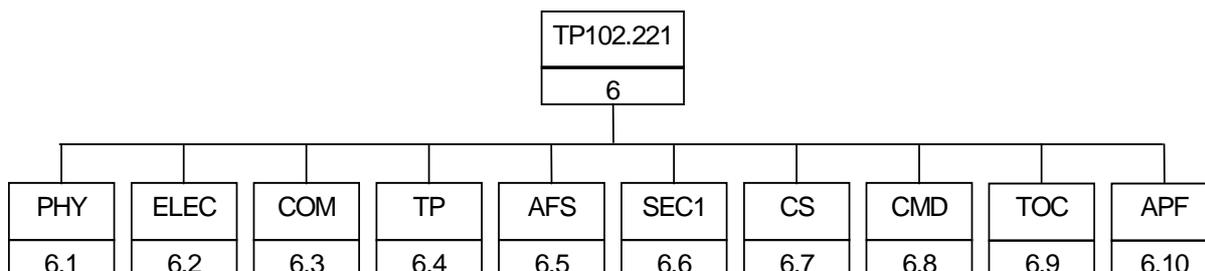

**Figure 3: Breakdown of "TP102.221 " Test Group**

The mnemonics chosen for this test group are as follows:

- PHY: Physical characteristics - TS 102.221 [1], clause 4
- ELEC: Electrical specifications of the UICC – Terminal interface - TS 102.221 [1], clause 5
- COM: Initial communication establishment procedure - TS 102.221 [1], clause 6
- TP: Transmission protocols - TS 102.221 [1], clause 7
- AFS: Application and File structure - TS 102.221 [1], clause 8
- SEC1: Security features - TS 102.221 [1], clause 9
- CS: Structure of commands and responses - TS 102.221 [1], clause 10
- CMD: Commands - TS 102.221 [1], clause 11
- TOC: Transmission Oriented Commands - TS 102.221 [1], clause 12
- APF: Application independent files - TS 102.221 [1], clause 13

The Test Groups "PHY", "ELEC", "COM", "TP", "AFS", "SEC1", "CS", "CMD", "TOC" and "APF", shown in figure 3, are broken down further, as shown in figures 5, 6, 7, 8, 9, 10, 11, 12, 13 and 14.

### 5.3 Test groups under TP31.102

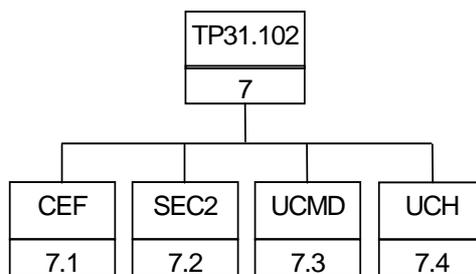

**Figure 4: Breakdown of "TP31.102" Test Group**

The mnemonics chosen for this test group are as follows:

- CEF: Contents of the Elementary Files- 3G TS 31.102 [3], clause 4
- SEC2: Security Features supported by USIM – Terminal interface - 3G TS 31.102 [3], clause 6
- UMCD: USIM commands- 3G TS 31.102 [3], clause 7
- UCH: UICC Characteristics- 3G TS 31.102 [3], clause 8

The Test Groups "CEF", "SEC2", "UCMD" and "UCH", shown in figure 4, are broken down further, as shown in figures 15,16,17 and 18.

### 5.4 Test groups under PHY

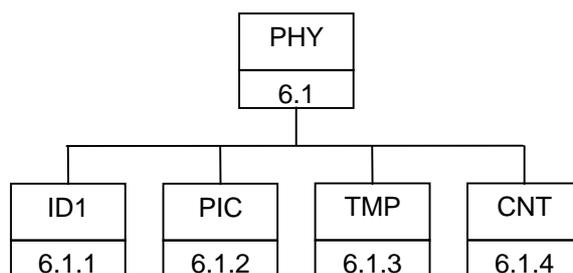
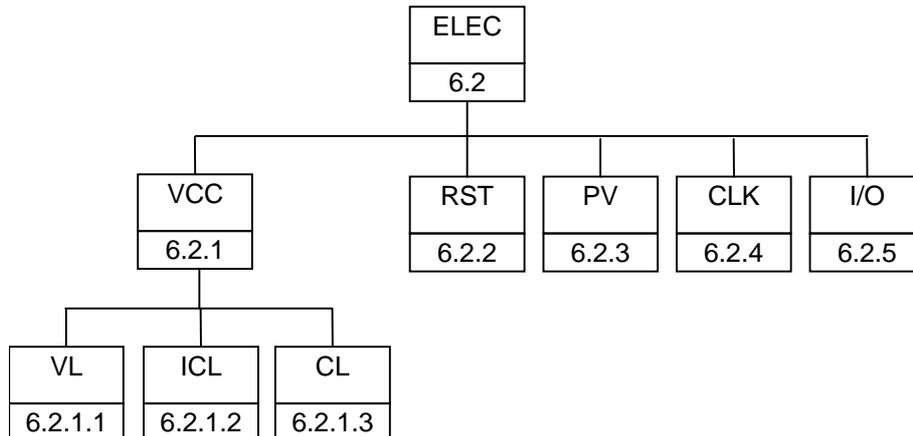

**Figure 5: Breakdown of "PHY" Test Group**

The mnemonics chosen for this test group are as follows:

- ID1: ID-1 UICC - TS 102.221 [1], subclause 4.1
- PIC: Plug-in UICC - TS 102.221 [1], subclause 4.2
- TMP: Temperature range for card operation - TS 102.221 [1], subclause 4.3
- CNT: Contacts - TS 102.221 [1], subclause 4.4

## 5.5 Test groups under ELEC



**Figure 6: Breakdown of "ELEC" Test Group**

The mnemonics chosen for this test group are as follows:

- VCC: Supply voltage Vcc (contact C1) - TS 102.221 [1], subclause 5.1.1, 5.2.1 and 5.3.1
- VL: Voltage limits - TS 102.221 [1], subclause 5.1.1, 5.2.1 and 5.3.1
- ICL: Idle current limits - TS 102.221 [1], subclause 5.1.1, 5.2.1 and 5.3.1
- CL: Current limits in clock-stop-mode - TS 102.221 [1], subclause 5.1.1, 5.2.1 and 5.3.1
- RST: Reset RST (contact C2) - TS 102.221 [1], subclause 5.1.2, 5.2.2 and 5.3.2
- PV: Programming voltage VPP (contact C6) - TS 102.221 [1], subclause 5.1.3, 5.2.3 and 5.3.3
- CLK: Clock CLK (contact C3) - TS 102.221 [1], subclause 5.1.4, 5.2.4 and 5.3.4
- FDC: Frequency duty cycle - TS 102.221 [1], subclause 5.1.4, 5.2.4 and 5.3.4
- VC: Voltage and current - TS 102.221 [1], subclause 5.1.4, 5.2.4 and 5.3.4
- IO: I/O (contact C7) - TS 102.221 [1], subclause 5.1.5, 5.2.5 and 5.3.5



## 5.6 Test groups under COM

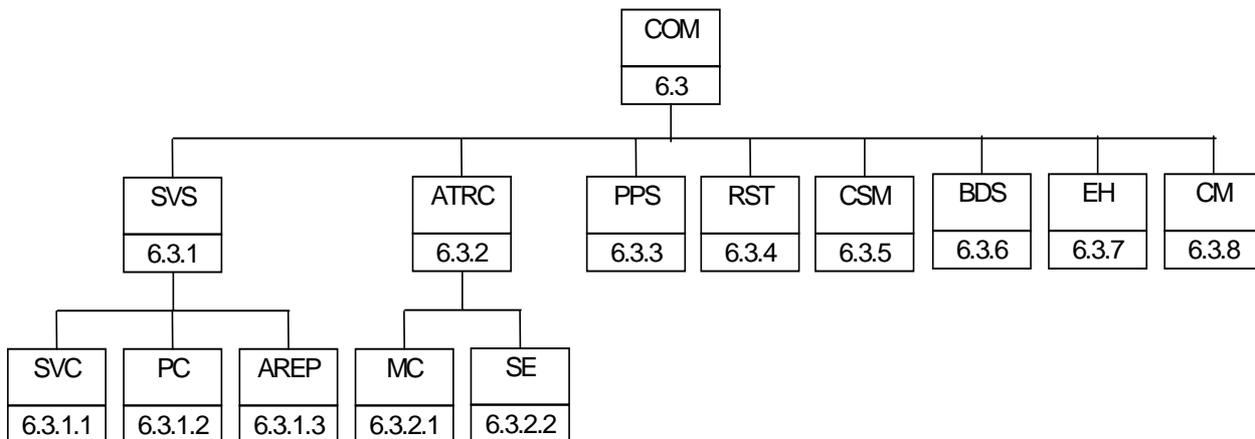
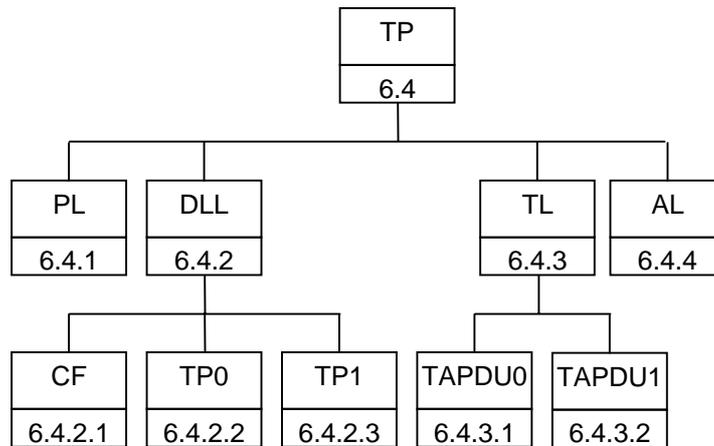

**Figure 7: Breakdown of "COM" Test Group**

The mnemonics chosen for this test group are as follows:

- SVS: Supply voltage switching - TS 102.221 [1], subclause 6.2
- SVC: Supply voltage classes - TS 102.221 [1], subclause 6.2.1
- PC: Power consumption of the UICC during ATR - TS 102.221 [1], subclause 6.2.2
- AREP: Application Related Electrical Parameters - TS 102.221 [1], subclause 6.2.3
- ATRC: ATR content - TS 102.221 [1], subclause 6.3
- MC: Major capabilities - TS 102.221 [1], subclause 6.3
- SE: Speed enhancement - TS 102.221 [1], subclause 6.3.2
- PPS: PPS procedure - TS 102.221 [1], subclause 6.4
- RST: Reset - TS 102.221 [1], subclause 6.5 and 6.6
- CSM: Clock stop mode - TS 102.221 [1], subclause 6.7
- BDS: Bit/character duration and sampling time - TS 102.221 [1], subclause 6.8
- EH: Error handling - TS 102.221 [1], subclause 6.9
- CM: Compatibility - TS 102.221 [1], subclause 6.10

## 5.7 Test groups under TP

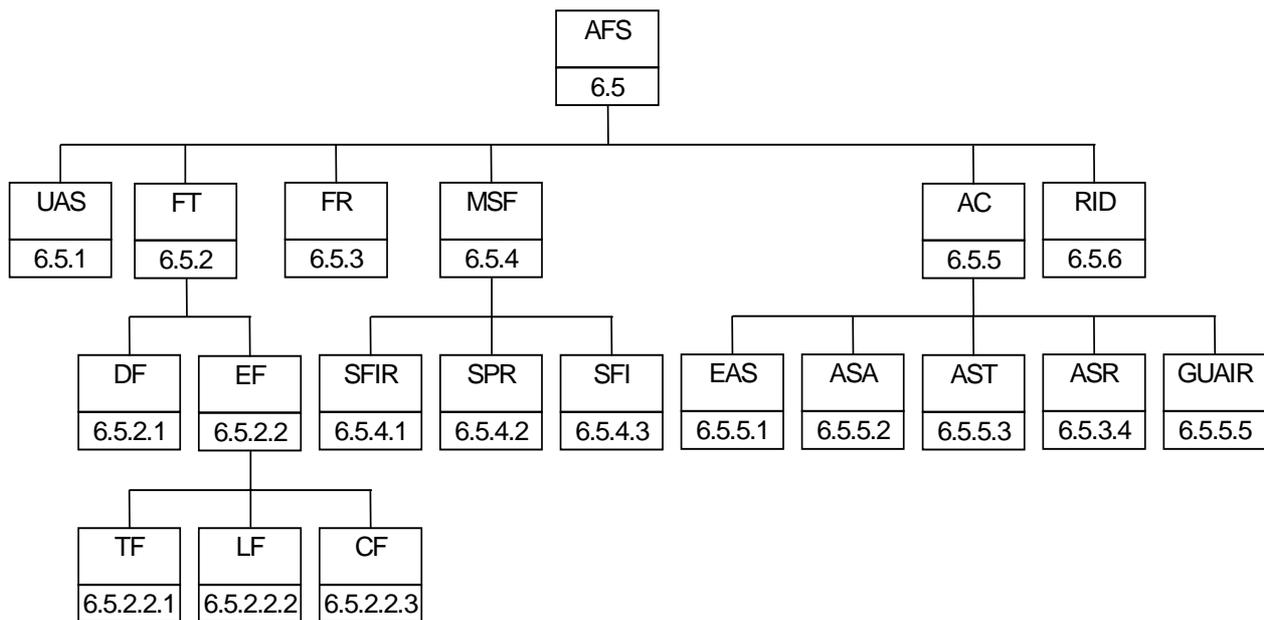

**Figure 8: Breakdown of "TP" Test Group**

The mnemonics chosen for this test group are as follows:

- PL: Physical Layer - TS 102.221 [1], subclause 7.1
- DLL: Data Link Layer - TS 102.221 [1], subclause 7.2
- CF: Character Frame - TS 102.221 [1], subclause 7.2.1
- TP0: Transmission Protocol T = 0 - TS 102.221 [1], subclause 7.2.215
- TP1: Transmission Protocol T = 1 - TS 102.221 [1], subclause 7.2.3
- TL: Transport Layer - TS 102.221 [1], subclause 7.3
- TAPDU0: Transportation of an APDU using T = 0 - TS 102.221 [1], subclause 7.3.1
- TAPDU1: Transportation of an APDU using T = 1 - TS 102.221 [1], subclause 7.3.2
- AP: Application Layer - TS 102.221 [1], subclause 7.4

## 5.8 Test groups under AFS

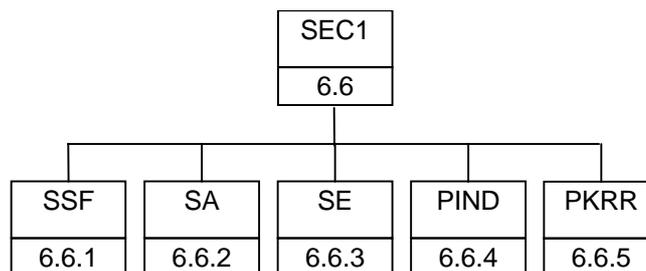

**Figure 9: Breakdown of "AFS" Test Group**

The mnemonics chosen for this test group are as follows:

- UAS: UICC Application structure - TS 102.221 [1], subclause 8.1
- FTP: File type - TS 102.221 [1], subclause 8.2
- DF: Dedicated files - TS 102.221 [1], subclause 8.2.1
- EF: Elementary files - TS 102.221 [1], subclause 8.2.2
- TF: Transparent EF - TS 102.221 [1], subclause 8.2.2.1
- LF: Linear EF - TS 102.221 [1], subclause 8.2.2.2
- CF: Cyclic EF - TS 102.221 [1], subclause 8.2.2.3
- FR: File referencing - TS 102.221 [1], subclause 8.3
- MSF: Method of selecting a file - TS 102.221 [1], subclause 8.4
- SFIR: SELECT by File Identifier Referencing - TS 102.221 [1], subclause 8.4.1
- SPR: SELECT by Path Referencing - TS 102.221 [1], subclause 8.4.2
- SFI: Short File Identifier - TS 102.221 [1], subclause 8.4.3
- AC: Application characteristic - TS 102.221 [1], subclause 8.5
- EAS: Explicit Application selection - TS 102.221 [1], subclause 8.5.1
- ASA: Application session activation - TS 102.221 [1], subclause 8.5.2
- AST: Application session termination - TS 102.221 [1], subclause 8.5.3
- ASR: Application session reset - TS 102.221 [1], subclause 8.5.4
- GUAIR: GSM/USIM application interaction and restriction - TS 102.221 [1], subclause 8.5.5
- RID: Reservation of file IDs - TS 102.221 [1], subclause 8.6

## 5.9 Test groups under SEC1

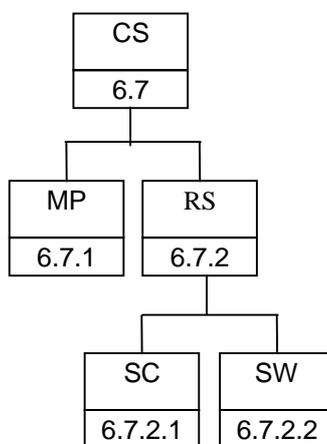

**Figure 10: Breakdown of "SEC1" Test Group**

The mnemonics chosen for this test group are as follows:

- SSF: Supported security features - TS 102.221 [1], subclause 9.1
- SC: Security architecture - TS 102.221 [1], subclause 9.2
- SE: Security environment - TS 102.221 [1], subclause 9.3
- PIND: PIN definitions - TS 102.221 [1], subclause 9.4
- PKRR: PIN and key reference relationship - TS 102.221 [1], subclause 9.4.5

## 5.10 Test groups under CS

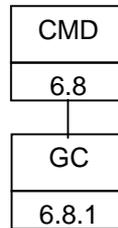

**Figure 11: Breakdown of "CS" Test Group**

The mnemonics chosen for this test group are as follows:

- MP: Mapping principles - TS 102.221 [1], subclause 10.1
- RS: Response APDU Structure - TS 102.221 [1], subclause 10.2
- SC: Status Conditions Returned by the UICC - TS 102.221 [1], subclause 10.3
- SW: Status Words of the Commands - TS 102.221 [1], subclause 10.3

## 5.11 Test groups under CMD

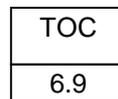

**Figure 12: Breakdown of "CMD" Test Group**

The mnemonics chosen for this test group are as follows:

- GC: Generic Commands - TS 102.221 [1], subclause 11.1

## 5.12 Test groups under TOC



**Figure 13: Breakdown of "TOC" Test Group**

All of the tests in the "TOC" test group relate to TS 102.221 [1], clause 12.

## 5.13 Test groups under APF

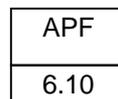

**Figure 14: Breakdown of "APF" Test Group**

All of the tests in the "APF" test group relate to TS 102.221 [1], clause 13.

## 5.14 Test groups under CEF

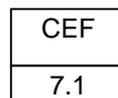

**Figure 15: Breakdown of "CEF" Test Group**

All of the tests in the "CEF" test group relate to 3G TS 31.102 [3], clause 4.

## 5.15 Test groups under SEC2

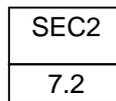

**Figure 16: Breakdown of "SEC2" Test Group**

All of the tests in the "SEC2" test group relate to 3G TS 31.102 [3], subclause 6.4.

## 5.16 Test groups under UCMD

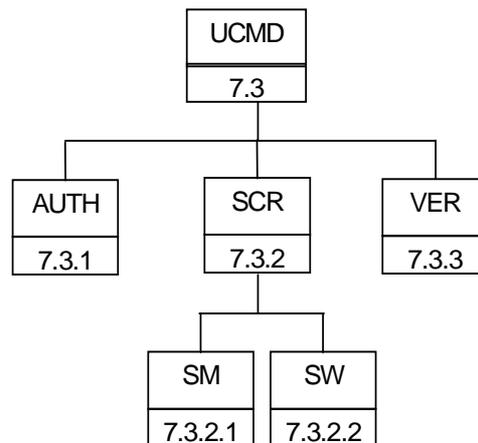
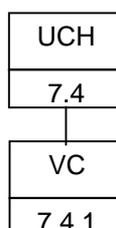

**Figure 17: Breakdown of "UCMD" Test Group**

The mnemonics chosen for this test group are as follows:

- AUTH: AUTHENTICATION function - 3G TS 31.102 [3], subclause 7.1
- SCR: Status Conditions Returned by the UICC - 3G TS 31.102 [3], subclause 7.3
- SM: Security management - 3G TS 31.102 [3], subclause 7.3.1
- SW: Status Words of the Commands - 3G TS 31.102 [3], subclause 7.3.2
- VER: Verify command - 3G TS 31.102 [3], subclause 7.4

## 5.17 Test groups under UCH



**Figure 18: Breakdown of "UCH" Test Group**

The mnemonics chosen for this test group are as follows:

- VC: Voltage classes - 3G TS 31.102 [3], subclause 8.1.

---

## 6 Test Procedure (TS 102.221)

This clause details each of the tests in each of the test groups within the Test Group TP102.221. This test suite allows testing of the IUT against the base specification with respect to:

- Physical characteristics
- Electrical specifications of the UICC - Terminal interface
- Initial communication establishment procedure
- Transmission protocols
- Application and File structure
- Security features
- Structure of commands and responses
- Commands
- Transmission Oriented Commands
- Application independent files

### 6.1 Physical characteristics

The tests in this subclause ensure that the IUT conforms to the specification for both format and layout and contacts.

#### 6.1.1 ID-1 UICC

##### 6.1.1.1 Definition and applicability

The format and layout characteristics shall be adhered to, in order to ensure proper operation in the Telecom environment.

This test applies to ID-1 UICCs.

##### 6.1.1.2 Conformance requirement

- CR1 Format and layout of the ID-1 UICC shall be in accordance with ISO 7816-1 [4] and ISO 7816-2 [5], unless otherwise specified.
- CR2 Any embossing on the card shall be in accordance with ISO 7811-1 [12] and ISO 7811-3 [13] (conditional).
- CR3 The contacts shall be located on the front (embossed face) of the card.

Reference: TS 102.221 [1], subclause 4.1.

Test Group Reference (TGR): TGR\_USIM\_TP102.221\_PHY\_ID1

Test Procedure Reference (TPR): TPR\_USIM\_TP102.221\_PHY\_ID1

##### 6.1.1.3 Test purpose

To verify that the UICC conforms to the above requirements.

NOTE 1: The testing of CR1 is outside the scope of the present document..

NOTE 2: The testing of CR2 is outside the scope of the present document.

#### 6.1.1.4 Method of test

##### Initial conditions

N/A

##### Test procedure

- a) The card is examined for the following:
- contact location.

*The card shall have been observed to exhibit the following [CR3]:*

- *contact location on the front of the card.*

#### 6.1.2 Plug-in UICC

##### 6.1.2.1 Definition and applicability

The format and layout characteristics shall be adhered to, in order to ensure proper operation in the Telecom environment.

This test applies to plug-in UICCs.

##### 6.1.2.2 Conformance requirement

CR1 Format and layout of the plug-in card shall be in accordance with ISO 7816-1 [4] and ISO 7816-2 [5], unless otherwise specified.

CR2 The dimensions of the plug-in UICC shall be in accordance with Figure 4.1 of TS 102.221 [1].

Reference: TS 102.221 [1], clause 4 and more specifically subclause 4.2.

Test Group Reference (TGR): TGR\_USIM\_TP102.221\_PHY\_PIC

Test Procedure Reference (TPR): TPR\_USIM\_TP102.221\_PHY\_PIC

##### 6.1.2.3 Test purpose

To verify that the UICC conforms to the above requirements.

NOTE: The testing of CR1 is outside the scope of the present document.

##### 6.1.2.4 Method of test

##### Initial conditions

N/A

##### Test procedure

- a) The card is examined for the following:
- width;
  - height;
  - feature for orientation.

*The card shall have been observed to exhibit the following [CR2]:*

- *correct width and height;*



- *feature for orientation.*

## 6.1.3 Temperature range for card operation

### 6.1.3.1 Definition and applicability

The temperature range for full operational use shall be adhered to, in order to ensure proper operation in the Telecom environment.

### 6.1.3.2 Conformance requirement

- CR1 The temperature range for full operational use shall be between  $-25\text{ }^{\circ}\text{C}$  and  $+70\text{ }^{\circ}\text{C}$  with occasional peaks of up to  $+85\text{ }^{\circ}\text{C}$ , where "occasional" means not more than 4 hours each time and not over 100 times during the life time of the card.

Reference: TS 102.221 [1], subclause 4.3.

Test Group Reference (TGR): TGR\_USIM\_TP102.221\_PHY\_TMP

Test Procedure Reference (TPR): TPR\_USIM\_TP102.221\_PHY\_TMP

### 6.1.3.3 Test purpose

To verify that the UICC conforms to the above requirements.

### 6.1.3.4 Method of test

#### Initial conditions

- 1) The UICC shall be placed in a temperature-controllable environment and connected to a ME simulator.
- 2) A temperature measuring device shall be connected to the surface of the UICC.
- 3) The UICC shall have passed the Format and Layout tests in subclauses 6.1.1 or 6.1.2.

#### Test procedure

- a) The temperature of the UICC shall be set to  $+25\text{ }^{\circ}\text{C}$ .
- b) The ME simulator shall reset the UICC.
- c) The ME simulator shall perform the USIM initialisation procedure, as defined in 3G TS 31.102 [3], subclause 5.1.1.

*The UICC shall operate successfully [CR1].*

- d) The temperature of the UICC shall be reduced to  $-25\text{ }^{\circ}\text{C}$ .
- e) Steps b) and c) shall be repeated.

*The UICC shall operate successfully [CR1].*

- f) The temperature of the UICC shall be increased to  $+70\text{ }^{\circ}\text{C}$ .
- g) Steps b) and c) shall be repeated.

*The UICC shall operate successfully [CR1].*

- h) The temperature of the UICC shall be increased to  $+85\text{ }^{\circ}\text{C}$ .
- i) Steps b) and c) shall be repeated continuously for a period of 4 hours.

*The UICC shall operate successfully [CR1].*

- j) The temperature of the UICC shall be reduced to +25 °C.
- k) Steps h), i) and j) shall be repeated a further 99 times.

*The UICC shall operate successfully [CR1].*

*The UICC shall satisfy the test requirements of subclauses 6.1.1 or 6.1.2 [CR1].*

## 6.1.4 Contacts

### 6.1.4.1 Definition and applicability

The shape, robustness and provision of contacts shall be adhered to, in order to maintain good electrical contact with the ME, ensuring proper operation in the Telecom environment.

### 6.1.4.2 Conformance requirement

- CR1 If contacts C4 and C8 are provided, they shall not be connected internally in the UICC if the UICC only contains a Telecom application.
- CR2 Contact C6 shall not be bonded in the UICC for any function other than supplying  $V_{pp}$ .
- CR3 Contact C6 on a UICC not supporting class A operating conditions shall be RFU.

Reference: TS 102.221 [1], subclause 4.4.1.2.

Test Group Reference (TGR): TGR\_USIM\_TP102.221\_PHY\_CNT

Test Procedure Reference (TPR): TPR\_USIM\_TP102.221\_PHY\_CNT

### 6.1.4.3 Test purpose

To verify that the UICC conforms to the above requirements.

### 6.1.4.4 Method of test

#### **Initial Conditions**

N/A

#### **Test Procedure**

N/A

## 6.2 Electrical specifications of the UICC – Terminal interface

The tests in this subclause ensure that the IUT conforms to the electrical specification for each of the contacts and the protocol.

### 6.2.1 Supply voltage $V_{cc}$ (contact C1)

#### 6.2.1.1 Voltage limits

##### 6.2.1.1.1 Definition and applicability

In addition to the electronic signals and transmission protocols defined in ISO/IEC 7816-3 [6], the UICC shall operate within the following supply voltage conditions to ensure proper operation in the Telecom environment.

This test applies to all UICC implementations with class A, B and C operating conditions.

### 6.2.1.1.2 Conformance requirement

CR1 The UICC shall operate when the supply voltage on contact C1 (Vcc) is in the following ranges:

**Table 1: Electrical characteristics of Vcc under normal operating conditions**

Operating Conditions	Vmin /V	Vmax /V
Class A Operating Conditions	4,5	5,5
Class B Operating Conditions	2,7	3,3
Class C Operating Conditions	1,62	1,98

Reference: TS 102.221 [1], subclause 5.1.1, 5.2.1 and 5.3.1.

Test Group Reference (TGR): TGR\_USIM\_TP102.221\_ELEC\_VCC\_VL

Test Procedure Reference (TPR): TPR\_USIM\_TP102.221\_ELEC\_VCC\_VL

### 6.2.1.1.3 Test purpose

To verify that the UICC conforms to the above requirements.

### 6.2.1.1.4 Method of test

#### Initial conditions

- 1) The UICC shall be connected to a ME simulator.

#### Test procedure

NOTE: The voltage Vcc min/max depends on the voltage class the UICC provides.

- a) The following steps shall be repeated for every voltage class which the UICC provides.
- b) The voltage source for contact C1 (Vcc) shall be set to Vcc min, and the UICC interface signals shall be powered from a Vcc min source.
- c) The ME simulator shall reset the UICC.  
*The UICC shall send the correct ATR sequence.*
- d) The ME simulator shall send a CHANGE PIN command to the UICC with new PIN value of 8 zeros.  
*The status condition returned by the UICC shall be SW1 = '90', SW2 = '00' – normal ending of the command.*
- e) The ME simulator shall reset the UICC.  
*The UICC shall send the correct ATR sequence.*
- f) The ME simulator shall send a CHANGE PIN command to the UICC to return the PIN to its original value.  
*The status condition returned by the UICC shall be SW1 = '90', SW2 = '00' – normal ending of the command.*
- g) The voltage source for contact C1 (Vcc) shall be set to Vcc max.
- h) Steps c) to f) shall be repeated for all the operating conditions supported by the UICC.

### 6.2.1.2 Idle current limits

#### 6.2.1.2.1 Definition and applicability

In addition to the electronic signals and transmission protocols defined in ISO/IEC 7816-3 [6], the current consumption shall not exceed the specified limit under idle conditions to ensure proper operation in the Telecom environment.

### 6.2.1.2.2 Conformance requirement

CR1 The idle current consumption of the UICC shall not exceed  $I_{max}$  at 1 MHz, +25 °C and  $V_{cc_{max}}$ .

**Table 2: Current consumption in idle mode**

Operating Conditions	$I_{max}$ / $\mu$ A in idle state clk frequency 1 MHz	$V_{cc_{max}}$ /V maximum voltage on VCC during testing
Class A Operating Conditions	200	5,5
Class B Operating Conditions	200	3,3
Class C Operating Conditions	200	1,98

Reference: TS 102.221 [1], subclauses 5.1.1, 5.2.1, and 5.3.1

Test Group Reference (TGR): TGR\_USIM\_TP102.221\_ELEC\_VCC\_ICL

Test Procedure Reference (TPR): TPR\_USIM\_TP102.221\_ELEC\_VCC\_ICL

### 6.2.1.2.3 Test purpose

To verify that the UICC conforms to the above requirements.

### 6.2.1.2.4 Method of test

#### Initial conditions

- 1) The UICC shall be connected to a ME simulator.
- 2) The frequency of the clock source shall be set to 1 MHz.
- 3) The temperature of the UICC shall be +25 °C.
- 4) The voltage on Vcc shall be set to  $V_{cc_{max}}$ .

#### Test procedure

- a) The ME simulator shall reset the UICC.
- b) The idle current consumption shall be measured after receiving the ATR over a period of ten seconds.

*The current consumption of the UICC shall not exceed  $I_{max}$  [CR1].*

- c) Steps a) and b) shall be repeated for all the operating conditions supported by the UICC.

### 6.2.1.3 Current limits in clk-stop-mode

#### 6.2.1.3.1 Definition and applicability

In addition to the electronic signals and transmission protocols defined in ISO/IEC 7816-3 [6], the current consumption shall not exceed the specified limit under clk-stop conditions to ensure proper operation in the Telecom environment.

#### 6.2.1.3.2 Conformance requirement

CR1 The clk stop mode current consumption of the UICC shall not exceed  $I_{max}$  if clk stop mode is delivered by the UICC.

**Table 3: Current consumption in clk stop mode**

	$I_{max}$ / $\mu$ A in clk-stop mode	$V_{CCmax}$ /V maximum voltage on VCC during testing
Class A Operating Conditions	200	5,5
Class B Operating Conditions	100	3,3
Class C Operating Conditions	100	1,98

Reference: TS 102.221 [1], clause 5 and more specifically subclauses 5.1.1, 5.2.1, and 5.3.1.

Test Group Reference (TGR): TGR\_USIM\_TP102.221\_ELEC\_VCC\_CL

Test Procedure Reference (TPR): TPR\_USIM\_TP102.221\_ELEC\_VCC\_CL

### 6.2.1.3.3 Test purpose

To verify that the UICC conforms to the above requirements.

### 6.2.1.3.4 Method of test

#### Initial conditions

- 1) The UICC shall be connected to a ME simulator.

#### Test procedure

- a) The ME simulator shall reset the UICC.
- b) The ME simulator shall wait at least for 1 860 clocks.
- c) The ME simulator shall stop the clock according to the clock stop mode which was read in the ATR.
- d) The current consumption shall be measured during clk stop mode over a period of ten seconds.

*The current consumption of the UICC shall not exceed  $I_{max}$  in average during clk stop mode [CR1].*

- e) Steps a) to d) shall be repeated for all the operating conditions supported by the UICC.

## 6.2.2 Reset RST (contact C2)

### 6.2.2.1 Static operation

#### 6.2.2.1.1 Definition and applicability

In addition to the electronic signals and transmission protocols defined in ISO/IEC 7816-3 [6], the UICC shall operate within the following limits regarding the reset RST signal to ensure proper operation in the Telecom environment.

#### 6.2.2.1.2 Conformance requirement

- CR1 The UICC shall operate within the following limits for RST:

**Table 4: Electrical characteristics of RST under normal operating conditions**

Operating Conditions	$V_{OL}$ min/V	$V_{OL}$ max/V	$I_{OL}$ max/ $\mu$ A	$V_{OH}$ min/V	$V_{OH}$ max/V	$I_{OH}$ max/ $\mu$ A
Class A Operating Conditions	-0,3	0,6	-200	$V_{CC} - 0,7$	$V_{CC} + 0,3$	+20
Class B Operating Conditions	-0,3	$0,2 \times V_{CC}$	-200	$0,8 \times V_{CC}$	$V_{CC} + 0,3$	+20
Class C Operating Conditions	-0,3	$0,2 \times V_{CC}$	-200	$0,8 \times V_{CC}$	$V_{CC} + 0,3$	+200

NOTE:  $t_R$  and  $t_F$  shall not exceed 400  $\mu$ s, with  $C_{out}$  and  $C_{in}$  equal to 30 pF.

Reference: TS 102.221 [1], subclauses 5.1.2, 5.2.2 and 5.3.2.

Test Group Reference (TGR): TGR\_USIM\_TP102.221\_ELEC\_RST

Test Procedure Reference (TPR): TPR\_USIM\_TP102.221\_ELEC\_RST

### 6.2.2.1.3 Test purpose

To verify that the UICC conforms to the above requirements.

### 6.2.2.1.4 Method of test

#### Initial conditions

- 1) The UICC shall be connected to a ME simulator.
- 2) A current measuring device shall be connected to RST (contact C2) of the UICC.
- 3) The capacitance,  $C_{in}$ , of RST (contact C2) shall be measured to be 30 pF.

#### Test procedure

- a) The following parameters shall be set for RST:
  - $V_{OH}$  of the RST signal shall be set to  $V_{OH\ min}$ ;
  - $V_{OL}$  of the RST signal shall be set to  $V_{OL\ min}$ ;
  - $t_R$  and  $t_F$  shall be set to 400  $\mu s$ .

- b) The ME simulator shall reset the UICC.

*The UICC shall send the correct ATR sequence [CRI].*

- c) The following parameters shall be set for RST:
  - $V_{OH}$  of the RST signal shall be set to  $V_{OH\ max}$ ;
  - $V_{OL}$  of the RST signal shall be set to  $V_{OL\ max}$ ;
  - $t_R$  and  $t_F$  shall be set to 400  $\mu s$ .

- d) The ME simulator shall reset the UICC.

*The UICC shall send the correct ATR sequence [CRI].*

- e) Steps a) to d) shall be repeated for all the operating conditions supported by the UICC.

*The following shall be true for all tests [CRI]:*

- $I_{OLmax}$  measured to be less than or equal to  $I_{OL\ max}$ ;
- $I_{OHmax}$  measured to be less than or equal to  $I_{OH\ max}$ .

## 6.2.3 Programming voltage $V_{pp}$ (contact C6)

### 6.2.3.1 Static operation

#### 6.2.3.1.1 Definition and applicability

In addition to the electronic signals and transmission protocols defined in ISO/IEC 7816-3 [6], the UICC shall operate within the following limits regarding the programming voltage  $V_{pp}$  signal to ensure proper operation in the Telecom environment.

### 6.2.3.1.2 Conformance requirement

- CR1 The UICC shall not require any programming voltage on Vpp.
- CR2 If the Terminal supporting class A operating conditions only, provides contact C6, the same voltage shall be supplied on Vpp as on Vcc.

Reference: TS 102.221 [1], subclause 5.1.3.

Test Group Reference (TGR): TGR\_USIM\_TP102.221\_ELEC\_PV

Test Procedure Reference (TPR): TPR\_USIM\_TP102.221\_ELEC\_PV

### 6.2.3.1.3 Test purpose

To verify that the UICC conforms to the above requirements.

### 6.2.3.1.4 Method of test

#### Initial conditions

- 1) The UICC shall be connected to a ME simulator.

#### Test procedure

- a) Contact C6 shall be connected to ground by the ME simulator.
- b) Vcc shall be applied to contact C1.
- c) Contact C2 (RST) shall be kept at low level, ground.
- d) A valid clock signal shall be applied to Contact C3.

*The dc power consumption on Contact C1 shall not exceed 10 mA under any condition [CR1, CR2].*

NOTE: This test ensures that Vpp and Vcc are not bonded together in the UICC, if this would be the case Vpp would also supply the UICC with current for its operation.

- e) Contact C6 shall not be connected to the ME simulator.
- f) The ME simulator shall reset the UICC.
- g) The ME simulator shall send a CHANGE PIN command to the UICC with new PIN value of 8 zeros.

*The UICC operates successfully without requiring to set Vpp at programming state in protocol level [CR1].*

- h) The ME simulator shall reset the UICC.
- i) The ME simulator shall send a CHANGE PIN command to the UICC to return the PIN to its original value.

*The UICC operates successfully without requiring to set Vpp at programming state in protocol level [CR1].*

- j) Contact C6 shall be connected to Vpp which has the same voltage as Vcc.

- k) The ME simulator shall reset the UICC.

- l) The ME simulator shall send a CHANGE PIN command to the UICC with new PIN value of 8 zeros.

*The UICC operates successfully without requiring to set Vpp at programming state in protocol level [CR2].*

- m) The ME simulator shall reset the UICC.

- n) The ME simulator shall send a CHANGE PIN command to the UICC to return the PIN to its original value.

*The UICC operates successfully without requiring to set Vpp at programming state in protocol level [CR2].*

## 6.2.4 Clock CLK (contact C3)

### 6.2.4.1 Frequency and duty cycle

#### 6.2.4.1.1 Definition and applicability

In addition to the electronic signals and transmission protocols defined in ISO/IEC 7816-3 [6], the UICC shall operate within the following limits regarding the clock CLK signal to ensure proper operation in the Telecom environment.

#### 6.2.4.1.2 Conformance requirement

CR1 The UICC shall not support an internal clock.

CR2 The UICC shall support a duty cycle between 40% and 60% of the period during stable operation.

CR3 The UICC shall operate within the following limits for CLK:

**Table 5: Electrical characteristics of CLK under normal operating conditions**

Operating Conditions	V <sub>OL</sub> min/V	V <sub>OL</sub> max/V	V <sub>OH</sub> min/V	V <sub>OH</sub> max/V	t <sub>R</sub> & t <sub>F</sub> max	fmax /MHz
Class A Operating Conditions	-0,3	0,5	0,7 × V <sub>CC</sub>	V <sub>CC</sub> +0,3	9% with a max. of 0,5 μs	5
Class B Operating Conditions	-0,3	0,2 × V <sub>CC</sub>	0,7 × V <sub>CC</sub>	V <sub>CC</sub> +0,3	50 ns	5
Class C Operating Conditions	-0,3	0,2 × V <sub>CC</sub>	0,7 × V <sub>CC</sub>	V <sub>CC</sub> +0,3	50 ns	5

NOTE: t<sub>R</sub> and t<sub>F</sub> have to be measured between 10 % and 90 % of V<sub>OL</sub> and V<sub>OH</sub>; C<sub>in</sub> is equal to 30 pF.

Reference: TS 102.221 [1], subclauses 5.1.4, 5.2.3 and 5.3.3.

Test Group Reference (TGR): TGR\_USIM\_TP102.221\_ELEC\_CLK

Test Procedure Reference (TPR): TPR\_USIM\_TP102.221\_ELEC\_CLK

#### 6.2.4.1.3 Test purpose

To verify that the UICC conforms to the above requirements.

NOTE: CR1 shall not be tested as the UICC supports an internal clock.

#### 6.2.4.1.4 Method of test

##### Initial conditions

- 1) The UICC shall be connected to a ME simulator.

##### Test procedure

- a) The frequency of the clock source shall be set to 1 MHz.
- b) The duty cycle of the clock source shall be set to 40 % high.
- c) V<sub>OH</sub> shall be set to V<sub>OH</sub> max and V<sub>OL</sub> shall be set to V<sub>OL</sub> min.
- d) The ME simulator shall reset the UICC.

*The UICC shall send the correct ATR sequence [CR2, CR3].*

- e) The duty cycle of the clock source shall be set to 60 % high.
- f) The ME simulator shall reset the UICC.

*The UICC shall send the correct ATR sequence [CR2, CR3].*



- g) The frequency of the clock source shall be set to  $f_{\max}$ .
- h) The duty cycle of the clock source shall be set to 40 % high.
- i) The ME simulator shall reset the UICC.

*The UICC shall send the correct ATR sequence [CR2, CR3].*

- j) The duty cycle of the clock source shall be set to 60 % high.
- k) The ME simulator shall reset the UICC.

*The UICC shall send the correct ATR sequence [CR2, CR3].*

- l) Steps a) to j) shall be repeated with  $V_{OH}$  set to  $V_{OH \min}$  and  $V_{OL}$  set to  $V_{OL \max}$ .
- m) Steps a) to k) shall be repeated for all the operating conditions supported by the UICC.

## 6.2.4.2 Voltage and current

### 6.2.4.2.1 Definition and applicability

In addition to the electronic signals and transmission protocols defined in ISO/IEC 7816-3 [6], the UICC shall operate within the following limits regarding the voltage and current condition to ensure proper operation in the Telecom environment.

### 6.2.4.2.2 Conformance requirement

CR1 The UICC shall operate within the following limits for CLK:

**Table 6: Electrical characteristics of CLK with current limits under normal operating conditions**

Operating Conditions	$V_{OL \min}/V$	$V_{OL \max}/V$	$I_{OL \max}/\mu A$	$V_{OH \min}/V$	$V_{OH \max}/V$	$I_{OH \max}/\mu A$	$t_r$ & $t_f$ max	$f_{\max}$ /MHz
Class A Operating Conditions	-0,3	0,5	-200	$0,7 \times V_{CC}$	$V_{CC} + 0,3$	+20	9 % with a max. of 0,5 $\mu s$	5
Class B Operating Conditions	-0,3	$0,2 \times V_{CC}$	-20	$0,7 \times V_{CC}$	$V_{CC} + 0,3$	+20	50 ns	5
Class C Operating Conditions	-0,3	$0,2 \times V_{CC}$	-20	$0,8 \times V_{CC}$	$V_{CC} + 0,3$	+20	50 ns	5

Reference: TS 102.221 [1], subclauses 5.1.4, 5.2.3 and 5.3.3.

Test Group Reference (TGR): TGR\_USIM\_TP102.221\_ELEC\_VC

Test Procedure Reference (TPR): TPR\_USIM\_TP102.221\_ELEC\_VC

### 6.2.4.2.3 Test purpose

To verify that the UICC conforms to the above requirements.

### 6.2.4.2.4 Method of test

#### Initial conditions

- 1) The UICC shall be connected to a ME simulator.
- 2) A current measuring device shall be connected to CLK (contact C3) of the UICC.
- 3) The capacitance of CLK (contact C3) shall be measured to be  $\leq 30$  pF.

## Test procedure

- a) The clock signal shall be set to 1 MHz.
- b) The following parameters shall be set for CLK:
  - $V_{OH}$  at  $V_{OHmax}$ ;
  - $V_{OL}$  at  $V_{OLmin}$ ;
  - $t_R$  and  $t_F$  shall be set to  $t_R max$  and  $t_F max$ .
- c) The ME simulator shall reset the UICC.

*The UICC shall send the correct ATR sequence [CR1].*
- d) The following parameters shall be set for CLK:
  - $V_{OH}$  at  $V_{OHmin}$ ;
  - $V_{OL}$  at  $V_{OLmax}$ .
- e) The ME simulator shall reset the UICC.

*The UICC shall send the correct ATR sequence [CR1].*
- f) Steps a) to e) shall be repeated with  $f_{clk} = f_{max}$ ,  $t_R = t_R max$  and  $t_F = t_F max$ .
- g) Steps a) to f) shall be repeated for all the operating conditions supported by the UICC.

*The following shall be true for all the operating conditions:*

  - $I_{OHmax}$  measured shall be less than or equal to  $+20 \mu A$  [CR1];
  - $I_{OLmax}$  measured shall be less than or equal to  $-200 \mu A$  [CR1];
  - *The UICC shall send the correct ATR sequence after a reset [CR1].*

## 6.2.5 I/O (contact C7)

### 6.2.5.1 Voltage and current

#### 6.2.5.1.1 Definition and applicability

In addition to the electronic signals and transmission protocols defined in ISO/IEC 7816-3 [6], the UICC shall operate within the following limits regarding the I/O signal to ensure proper operation in the Telecom environment.

#### 6.2.5.1.2 Conformance requirement

- CR1 The UICC shall operate within the following limits for I/O:

**Table 7: Electrical characteristics of the output of the I/O under normal operating conditions**

Operating Conditions	V <sub>OL</sub> min/V	V <sub>OL</sub> max/V	I <sub>OL</sub> max/ $\mu$ A	V <sub>OH</sub> min/V	V <sub>OH</sub> max/V	I <sub>OH</sub> max/ $\mu$ A	t <sub>R</sub> & t <sub>F</sub> max	f <sub>max</sub> /MHz
Class A Operating Conditions	-0,3	0,4	-1 000	3,8	V <sub>CC</sub> +0,3 V	+20	1 $\mu$ s	5
Class B Operating Conditions	-0,3	0,4	-1 000	0,7 $\times$ V <sub>CC</sub>	V <sub>CC</sub> +0,3 V	+20	1 $\mu$ s	4
Class C Operating Conditions	-0,3	0,3	-1 000	0,7 $\times$ V <sub>CC</sub>	V <sub>CC</sub> +0,3 V	+20	1 $\mu$ s	4

**Table 8: Electrical characteristics of the input of the I/O under normal operating conditions**

Operating Conditions	V <sub>IL</sub> min/V	V <sub>IL</sub> max/V	I <sub>IL</sub> max/ $\mu$ A	V <sub>IH</sub> min/V	V <sub>IH</sub> max/V	I <sub>IH</sub> min/max / $\mu$ A	t <sub>R</sub> & t <sub>F</sub> max	f <sub>max</sub> /MHz
Class A Operating Conditions	-0,3	0,15 $\times$ V <sub>CC</sub>	+1 000	0,7 $\times$ V <sub>CC</sub>	V <sub>CC</sub> +0,3 V	$\pm$ 20	1 $\mu$ s	5
Class B Operating Conditions	-0,3	0,2 $\times$ V <sub>CC</sub>	+1 000	0,7 $\times$ V <sub>CC</sub>	V <sub>CC</sub> +0,3 V	$\pm$ 20	1 $\mu$ s	4
Class C Operating Conditions	-0,3	0,2 $\times$ V <sub>CC</sub>	+1 000	0,7 $\times$ V <sub>CC</sub>	V <sub>CC</sub> +0,3 V	$\pm$ 20	1 $\mu$ s	4

Reference: TS 102.221 [1], subclauses 5.1.5, 5.2.4 and 5.3.4.

Test Group Reference (TGR): TGR\_USIM\_TP102.221\_ELEC\_I/O

Test Procedure Reference (TPR): TPR\_USIM\_TP102.221\_ELEC\_I/O

### 6.2.5.1.3 Test purpose

To verify that the UICC conforms to the above requirements.

### 6.2.5.1.4 Method of test

#### Initial conditions

- 1) The UICC shall be connected to a ME simulator.
- 2) A current measuring device shall be connected to I/O (contact C7) of the UICC.
- 3) The capacitance, C<sub>out</sub> and C<sub>in</sub>, of I/O (contact C7) shall be measured to be 30 pF.

#### Test procedure

- a) The ME simulator shall be set to the following maximum range allowed by the UICC
  - V<sub>CC</sub> to V<sub>CC</sub> max;
  - V<sub>OL</sub> to V<sub>OL</sub> min and V<sub>OH</sub> to V<sub>OH</sub> max;
  - I<sub>IL</sub> to I<sub>IL</sub> max and I<sub>IH</sub> to I<sub>IH</sub> max;
  - t<sub>R</sub> to t<sub>R</sub> max and t<sub>F</sub> to t<sub>F</sub> max.
- b) The ME simulator shall reset the UICC.
- c) The ME simulator shall send a STATUS command to the UICC.
- d) The ME simulator shall be set to the following minimum range allowed by the UICC with V<sub>OH</sub> inactive:
  - V<sub>CC</sub> to V<sub>CC</sub> min;

- $V_{OL}$  to  $V_{OL}$  max and  $V_{OH}$  to  $V_{OH}$  min;
  - $I_{IL}$  to  $I_{IL}$  max and  $I_{IH}$  to  $I_{IH}$  min;
  - $t_R$  to  $t_R$  max and  $t_F$  to  $t_F$  max.
- e) The ME simulator shall reset the UICC.
- f) The ME simulator shall send a STATUS command to the UICC.
- g) Steps a) to f) shall be repeated for all the operating conditions supported by the UICC.

*Acceptance criteria for all the operating conditions [CR1]:*

- $I_{OL}$  shall be between 0 mA and  $I_{OL}$  max;
- $I_{OH}$  shall be  $\leq I_{OH}$  max;
- $V_{IL}$  shall be between  $V_{IL}$  min and  $V_{IL}$  max;
- $V_{IH}$  shall be between  $V_{IH}$  min and  $V_{IH}$  max;
- $t_R$  and  $t_F$  generated by the UICC shall be  $\leq t_R$  and  $t_F$  max.

## 6.3 Initial communication establishment procedure

### 6.3.1 Supply voltage switching

#### 6.3.1.1 Supply voltage classes

##### 6.3.1.1.1 Definition and applicability

The supply voltage class is indicated in the ATR to inform the ME of the classes of operating condition accepted by the UICC.

##### 6.3.1.1.2 Conformance requirement

CR1 The supply voltage class shall be indicated in the ATR.

CR2 If the UICC supports several voltage classes, they shall be consecutive.

Reference: TS 102.221 [1], subclause 6.2.1.

Test Group Reference (TGR): TGR\_USIM\_TP102.221\_COM\_SVS\_SVC

Test Procedure Reference (TPR): TPR\_USIM\_TP102.221\_COM\_SVS\_SVC

##### 6.3.1.1.3 Test purpose

To verify that the UICC conforms to the above requirements.

NOTE: CR1 and CR2 are tested in subclause 7.4.1.

##### 6.3.1.1.4 Method of test

###### Initial conditions

N/A

###### Test procedure

N/A

## 6.3.1.2 Power consumption of the UICC during ATR

### 6.3.1.2.1 Definition and applicability

The current consumption shall not exceed the specified limit during ATR to ensure proper operation in the 3G environment.

### 6.3.1.2.2 Conformance requirement

- CR1 The UICC power consumption during the ATR at the maximum external clock CLK shall not exceed the value defined in the table 6.2a in TS 102.221 [1], subclause 6.2.2, for each voltage class indicated in the ATR.
- CR2 The UICC power consumption during the ATR at the 4MHz CLK shall not exceed the value defined in the table 6.2b in TS 102.221 [1], subclause 6.2.2, for each voltage class indicated in the ATR.
- CR3 The power consumption of the UICC is restricted to the values indicated in tables 6.2a and 6.2b TS 102.221 [1] until an application is selected.

Reference: TS 102.221 [1], subclauses 6.2.2 and 6.2.3.

Test Group Reference (TGR): TGR\_USIM\_TP102.221\_COM\_SVS\_PC

Test Procedure Reference (TPR): TPR\_USIM\_TP102.221\_COM\_SVS\_PC

### 6.3.1.2.3 Test purpose

To verify that the UICC conforms to the above requirements.

### 6.3.1.2.4 Method of test

#### Initial conditions

- 1) The UICC shall be connected to a ME simulator.
- 2) PIN of the UICC shall be set to '00000000'.

#### Test procedure

NOTE: Repeat the following steps for each voltage class supported by the UICC.

- a) The frequency of the clock source shall be set to 4 MHz.
- b) The ME simulator shall reset the UICC.  
*The UICC shall send the ATR sequence.*
- c) The ME simulator shall send a CHANGE PIN command to the UICC with new PIN value '10101010'.
- d) The ME simulator shall send a CHANGE PIN command to the UICC to return the PIN to its original value.

*The current consumption of the UICC shall not exceed the maximum values given in table 6.2b in TS 102.221 [1], subclause 6.2.1 according to the voltage class during b), c) and d) [CR1].*

- e) The frequency of the clock source shall be set to the maximum frequency according to the voltage class.
- f) The ME simulator shall reset the UICC.  
*The UICC shall send the ATR sequence.*
- g) The ME simulator shall send a CHANGE PIN command to the UICC with new PIN value of '10101010'.
- h) The ME simulator shall send a CHANGE PIN command to the UICC to return the PIN to its original value.

*The current consumption of the UICC shall not exceed the maximum values given in table 6.2a in TS 102.221 [1], subclause 6.2.1 according to the voltage class during f), g) and h) [CR2].*

### 6.3.1.3 Application related electrical parameters

#### 6.3.1.3.1 Definition and applicability

The current consumption shall not exceed the specified limit during the application is activated to ensure proper operation in the 3G environment.

#### 6.3.1.3.2 Conformance requirement

- CR1 If an application specifies its own maximum power consumption values, it shall not exceed the maximum value defined in table 6.3 in TS 102.221 [1], subclause 6.2.3.
- CR2 If an application specifies its own maximum power consumption values, the current consumption shall conform to the voltage class indicated in the response for STATUS/SELECT commands, while the application is selected.
- CR3 If an application does not specify its own maximum power consumption values, the current consumption shall conform to the values defined in table 6.4 in TS 102.221 [1], subclause 6.2.3, while the application is selected.

Reference: TS 102.221 [1], subclause 6.2.3.

Test Group Reference (TGR): TGR\_USIM\_TP102.221\_COM\_SVS\_AREP

Test Procedure Reference (TPR): TPR\_USIM\_TP102.221\_COM\_SVS\_AREP

#### 6.3.1.3.3 Test purpose

To verify that the UICC conforms to the above requirements.

#### 6.3.1.3.4 Method of test

##### Initial conditions

- 1) The UICC shall be connected to a ME simulator.

##### Test procedure

NOTE: Following steps shall be repeated for each application in the UICC.

- a) The ME simulator shall reset the UICC.
- b) The ME simulator shall send a SELECT command to the UICC to select and activate USIM application.
- c) If the power consumption is present in the FCP, the following steps shall be performed.

*The power consumption in the FCP does not exceed maximum values defined in table 6.3 in TS 102.221 [1], subclause 6.2.3 [CR1].*

- c-1) The ME simulator shall send a VERIFY PIN command with PIN to the UICC.
- c-2) The ME simulator shall send a SELECT command to select EF<sub>LOCAL</sub>.
- c-3) The ME simulator shall send an UPDATE BINARY command with data string '11 22 33 44 55 66 77 88 99 AA BB'.

*The power consumption of the UICC shall not exceed the maximum values given in the response data at b) during c-1), c-2) and c-3) [CR2].*

- d) If the power consumption is not present in the FCP, following steps shall be performed.

- d-1) The ME simulator shall send a VERIFY PIN command with PIN to the UICC.
- d-2) The ME simulator shall send a SELECT command to select EF<sub>LOC1</sub>.
- d-3) The ME simulator shall send an UPDATE BINARY command with data string '11 22 33 44 55 66 77 88 99 AA BB'.

*The power consumption of the UICC shall not exceed the maximum values defined in table 6.4 in TS 102.221 [1], subclause 6.2.3 during d-1), d-2) and d-3) [CR3].*

- e) The ME simulator shall send an UPDATE BINARY command with data string 'A1 A2 A3 A4 A5 A6 A7 A8 A9 00 00'.

## 6.3.2 ATR content

### 6.3.2.1 Major capabilities

#### 6.3.2.1.1 Definition and applicability

The ATR is the information presented by the UICC to the ME at the beginning of the card session and gives operational requirements.

#### 6.3.2.1.2 Conformance requirement

- CR1 The ATR shall be in accordance with ISO/IEC 7816-3 [6].
- CR2 T = 15 parameters shall be present in the ATR.
- CR3 The category indicator in the historical bytes shall be '80'.
- CR4 The first information sent by the card in the historical byte shall be the "card service data" data object.
- CR5 The second information sent by the card in the historical shall be the "card capabilities" data object.
- CR6 The information carried by the historical bytes of the UICC shall follow clause 8 of ISO/IEC 7816-4 [7].

Reference: TS 102.221 [1], subclause 6.3

Test Group Reference (TGR): TGR\_USIM\_TP102.221\_COM\_ATRC\_MC

Test Procedure Reference (TPR): TPR\_USIM\_TP102.221\_COM\_ATRC\_MC

#### 6.3.2.1.3 Test purpose

To verify that the UICC conforms to the above requirements.

NOTE: The testing of CR1 is outside the scope of the present document.

#### 6.3.2.1.4 Method of test

##### Initial conditions

- 1) The UICC shall be connected to a ME simulator.

##### Test procedure

- a) The ME simulator shall reset the UICC.

*The UICC shall send the valid ATR sequence.*

*The ATR shall be in accordance with ISO/IEC 7816-3 [6].*

*The following parameters shall be present:*

- $T = 15$  parameter [CR2].

The following parameters shall be present and in the following order in the historical bytes:

- The category indicator = '80' [CR3];
- "card service data" data object [CR4];
- "card capabilities" data object [CR5].

The historical bytes shall follow clause 8 of ISO/IEC 7816-4 [7][CR6].

## 6.3.2.2 Speed enhancement

### 6.3.2.2.1 Definition and applicability

The UICC shall at least operate with all mandatory values of the transmission factors F and D described in TS 102.221 [1] to ensure proper operation in the 3G environment.

### 6.3.2.2.2 Conformance requirement

CR1 The UICC shall at least support  $(F, D) = (512, 8)$  and  $(512, 16)$  in addition to  $(372, 1)$ .

CR2  $(F, D) = (372, 1)$  shall be the default value.

Reference: TS 102.221 [1], subclause 6.3.2.

Test Group Reference (TGR): TGR\_USIM\_TP102.221\_COM\_ATRC\_SE

Test Procedure Reference (TPR): TPR\_USIM\_TP102.221\_COM\_ATRC\_SE

### 6.3.2.2.3 Test purpose

To verify that the UICC conforms to the above requirements.

### 6.3.2.2.4 Method of test

#### Initial conditions

- 1) The UICC shall be connected to a ME simulator.

#### Test Procedure

- a) The ME simulator shall cold reset the UICC.
- b) The ME simulator shall send a PPS-Request to the UICC, selecting  $T = 0$  protocol and  $(F, D) = (512, 8)$ .  
*The UICC shall send a valid PPS-Response indicating support for the requested parameters.*
- c) The ME simulator shall send a STATUS command with  $P2 = '00'$  at  $(F, D) = (512, 8)$ .  
*The UICC shall send a valid FCP [CR1].*
- d) The ME simulator shall cold reset the UICC.
- e) The ME simulator shall send a PPS-Request to the UICC, selecting  $T = 0$  protocol and  $(F, D) = (512, 16)$ .  
*The UICC shall send a valid PPS-Response indicating support for the requested parameters.*
- f) The ME simulator shall send a STATUS command with  $P2 = '00'$  at  $(F, D) = (512, 16)$ .  
*The UICC shall send a valid FCP [CR1].*
- g) The ME simulator shall cold reset the UICC.



h) The ME simulator shall send a STATUS command with P2 = '00' at (F, D) = (372, 1).

*The UICC shall send a valid FCP [CR2].*

i) The ME simulator shall cold reset the UICC.

j) The ME simulator shall send a PPS-Request to the UICC, selecting T = 0 protocol and (F, D) = (372, 1).

*The UICC shall send a valid PPS-Response indicating support for the requested parameters.*

k) The ME simulator shall send a STATUS command with P2 = '00' at (F, D) = (372, 1).

*The UICC shall send a valid FCP [CR1].*

### 6.3.3 PPS procedure

#### 6.3.3.1 Definition and applicability

The ATR indicates which protocols are available for use during a session. The PPS procedure allows one of the available protocol types to be selected.

#### 6.3.3.2 Conformance requirement

CR1 The UICC shall support the PPS procedure in order to use transmission parameters other than the default values.

CR2 The UICC shall respond to a PPS-Request from the ME with a PPS-Response.

CR3 If the transmission parameters are indicated in the ATR, these shall be interpreted in accordance with ISO/IEC 7816-3 [6].

Reference: TS 102.221 [1], subclause 6.4.

Test Group Reference (TGR): TGR\_USIM\_TP102.221\_COM\_PPS

Test Procedure Reference (TPR): TPR\_USIM\_TP102.221\_COM\_PPS

#### 6.3.3.3 Test purpose

To verify that the UICC conforms to the above requirements.

NOTE 1: CR1 and CR2 are tested in subclause 6.3.2.2.

NOTE 2: CR3 is not tested as it is out of the scope of the present document.

#### 6.3.3.4 Method of test

##### **Initial conditions**

N/A

##### **Test Procedure**

N/A

### 6.3.4 Reset

#### 6.3.4.1 Definition and applicability

The UICC shall support both cold and warm resets.

### 6.3.4.2 Conformance requirement

- CR1 After a cold reset, the UICC shall enter the negotiable mode and the security status shall be reset.
- CR2 After a warm reset, the UICC shall enter either the negotiable mode or the specific mode and the security status shall be reset.

Reference: TS 102.221 [1], subclauses 6.5.

Test Group Reference (TGR): TGR\_USIM\_TP102.221\_COM\_RST

Test Procedure Reference (TPR): TPR\_USIM\_TP102.221\_COM\_RST

### 6.3.4.3 Test purpose

To verify that the UICC conforms to the above requirements.

### 6.3.4.4 Method of test

#### Initial conditions

- 1) The UICC shall be connected to a ME simulator.

#### Test Procedure

- a) The ME simulator shall reset the UICC.
- b) The ME simulator shall send a VERIFY PIN command with PIN to the UICC.
- c) The ME simulator shall cold reset the UICC.  
*The UICC shall send the valid ATR sequence. The specific mode byte TA(2) shall not present within the ATR returned by the UICC [CR1].*
- d) The ME simulator shall send a SELECT command to the UICC to select EF<sub>PL</sub>.
- e) The ME simulator shall send an UPDATE BINARY command using a length of 2 byte, and data string '00 00' to the UICC.  
*The status condition returned by the UICC shall be SW1 = '69', SW2 = '82' - Security status not satisfied [CR1].*
- f) The ME simulator shall send a VERIFY PIN command with PIN to the UICC.
- g) The ME simulator shall warm reset the UICC.  
*The UICC shall send the valid ATR sequence [CR2].*
- h) The ME simulator shall send a SELECT command to the UICC to select EF<sub>PL</sub>.
- i) The ME simulator shall send an UPDATE BINARY command using a length of 2 bytes, and data string '00 00' to the UICC.  
*The status condition returned by the UICC shall be SW1 = '69', SW2 = '82' - Security status not satisfied [CR2].*

## 6.3.5 Clock stop mode

### 6.3.5.1 Definition and applicability

It shall be mandatory for all UICCs complying with TS 102.221 [1] to support clock stop mode described therein except for the UICC supporting class A operating conditions only.

### 6.3.5.2 Conformance requirement

- CR1 The UICC shall support the clock stop procedure.

Reference: TS 102.221 [1], subclause 6.6.

Test Group Reference (TGR): TGR\_USIM\_TP102.221\_COM\_CSM

Test Procedure Reference (TPR): TPR\_USIM\_TP102.221\_COM\_CSM

### 6.3.5.3 Test purpose

To verify that the UICC conforms to the above requirements.

### 6.3.5.4 Method of test

#### Initial conditions

- 1) The UICC shall be connected to a ME simulator.

#### Test procedure

- a) The ME simulator shall reset the UICC.

*The ATR shall contain a following character:*

- *TA(i) after the first occurrence of T = 15 in TD(i-1) for i > 2;*
- *Both b8 and b7 shall not be equal to zero [CR1].*

- b) The ME simulator shall stop the clock according to the clock stop mode after the ATR.

- c) The ME simulator shall pause for 10 seconds, then starts the clock again.

- d) The ME simulator shall wait for more than 744 clock cycles after having started the clock, and then shall send a SELECT command to the UICC to select the EF<sub>ICCID</sub>.

*The SELECT command shall be executed successfully [CR1].*

## 6.3.6 Bit/character duration and sampling time

### 6.3.6.1 Definition and applicability

The UICC shall adhere to the electronic signals and transmission protocols defined in TS 102.221 [1] and ISO/IEC 7816-3 [6] to ensure proper operation in the 3G environment.

### 6.3.6.2 Conformance requirement

- CR1 The bit/character duration and sampling time specified in ISO/IEC 7816-3 [6], subclause 6.3.2 are valid for all communications.

Reference: TS 102.221 [1], subclause 6.7.

Test Group Reference (TGR): TGR\_USIM\_TP102.221\_COM\_BDS

Test Procedure Reference (TPR): TPR\_USIM\_TP102.221\_COM\_BDS

### 6.3.6.3 Test purpose

To verify that the UICC conforms to the above requirements.

NOTE: The testing of CR1 is outside the scope of the present document.

### 6.3.6.4 Method of test

#### Initial conditions

N/A

### Test procedure

N/A

## 6.3.7 Error handling

### 6.3.7.1 Definition and applicability

The UICC shall adhere to the electronic signals and transmission protocols defined in TS 102.221 [1] and ISO/IEC 7816-3 [6] to ensure proper operation in the 3G environment.

### 6.3.7.2 Conformance requirement

- CR1 Error detection and character repetition specified in ISO/IEC 7816-3 [6], subclause 6.3.3 is mandatory for the UICC for all communications using  $T = 0$ .

Reference: TS 102.221 [1], subclause 6.8.

Test Group Reference (TGR): TGR\_USIM\_TP102.221\_COM\_EH

Test Procedure Reference (TPR): TPR\_USIM\_TP102.221\_COM\_EH

### 6.3.7.3 Test purpose

To verify that the UICC conforms to the above requirements.

### 6.3.7.4 Method of test

#### Initial conditions

- 1) The UICC shall be connected to a ME simulator.

#### Test procedure

NOTE: The following steps shall be performed for each communication speed supported by the UICC for  $T = 0$ .

- a) The ME simulator shall cold reset the UICC.
- b) The ME simulator shall request character repetition (i.e. transmits an error signal during the guard time) to the UICC for all character frames during the ATR.

*The UICC shall send the valid ATR with character repetition [CR1].*

- c) The ME simulator shall send a correct PPS request to the UICC (conditional).
- d) The ME simulator shall send a SELECT command to the UICC to select the MF with incorrect character parity for all character frames.

*The UICC shall request character repetition (i.e. transmits an error signal during the guard time) for all character frames [CR1].*

- e) The ME simulator shall receive the response from the UICC but request character repetition for all character frames.

*The UICC shall send the valid FCP with character repetition [CR1].*

## 6.3.8 Compatibility

### 6.3.8.1 Definition and applicability

The UICC shall provide the voltage class indication defined in TS 102.221 [1] to the terminal to ensure proper operation in the Telecom environment.

### 6.3.8.2 Conformance requirement

- CR1 UICCs that are used in applications where the supply voltage class detection is based on the STATUS response shall support this procedure in addition to the supply voltage class indication in the ATR.

Reference: TS 102.221 [1], subclause 6.9.

Test Group Reference (TGR): TGR\_USIM\_TP102.221\_COM\_CM

Test Procedure Reference (TPR): TPR\_USIM\_TP102.221\_COM\_CM

### 6.3.8.3 Test purpose

To verify that the UICC conforms to the above requirements.

NOTE 1: The supply voltage class indication in the ATR and STATUS response are tested respectively in subclause 6.3.1 and subclause 6.8.1.2 in the present document as they are mandatory for all the UICCs except the UICCs supporting class A operating condition only.

NOTE 2: The supply voltage class detection based on STATUS response for compatibility purpose is out of the scope of the present document.

### 6.3.8.4 Method of test

#### Initial conditions

N/A

#### Test procedure

N/A

## 6.4 Transmission Protocols

### 6.4.1 Physical Layer

#### 6.4.1.1 Definition and applicability

It shall be mandatory for all cards complying with TS 102.221 [1] to support all functions described therein.

#### 6.4.1.2 Conformance requirement

- CR1 Both protocols T = 0 and T = 1 shall use the physical layer and character frame as defined in subclause 7.2.1.

Reference: TS 102.221 [1], subclause 7.1.

Test Group Reference (TGR): TGR\_USIM\_TP102.221\_TP\_PL

Test Procedure Reference (TPR): TPR\_USIM\_TP102.221\_TP\_PL

#### 6.4.1.3 Test purpose

To verify that the physical layer function conforms to the above requirements.

NOTE: CR1 is tested in the subclause 6.4.2.1

#### 6.4.1.4 Method of test

##### Initial conditions

N/A

##### Test procedure

N/A

### 6.4.2 Data Link Layer

#### 6.4.2.1 Character Frame

##### 6.4.2.1.1 Definition and applicability

It shall be mandatory for all cards complying with TS 102.221 [1] to support all functions described therein.

##### 6.4.2.1.2 Conformance requirement

- CR1 Before the transmission of a character, the I/O line shall be in state H.
- CR2 A character shall consist of 10 consecutive bits:
- 1 start bit in state L;
  - 8 bits, which comprise the data byte;
  - 1 even parity checking bit.
- CR3 The parity bit shall be set, in a way, that there is an even number of bits set to '1' including the parity bit in the character frame.
- CR4 The receiver shall confirm the existence of a start bit before 0.7 etu (receiver time).
- CR5 Then the subsequent bits shall be received at intervals of  $(n + 0.5 \pm 0.2)$  etu (n being the rank of the bit).
- CR6 Within a character, the time from the leading edge of the start bit to the trailing edge of the nth bit shall be  $(n \pm 0.2)$  etu.
- CR7 The interval between the leading edges of the start bits of two consecutive characters shall comprise the character duration  $(10 \pm 0.2)$  etu, plus a guardtime.
- CR8 Under error free transmission, during the guardtime both the UICC and the ME shall be in reception mode (I/O line in state H).
- CR9 The data shall always be passed over the I/O line with the most significant byte first.
- CR10 The order of bits within a byte (that is, whether the least significant or most significant bit is transferred first) shall be specified in character TS returned in the answer to reset.

Reference: TS 102.221 [1], subclause 7.2.1.

Test Group Reference (TGR): TGR\_USIM\_TP102.221\_TP\_DLL\_CF

Test Procedure Reference (TPR): TPR\_USIM\_TP102.221\_TP\_DLL\_CF

##### 6.4.2.1.3 Test purpose

To verify that the Physical Layer function conforms to the above requirements.

#### 6.4.2.1.4 Method of test

##### Initial conditions

- 1) The UICC shall be connected to a ME simulator.

##### Test procedure

- a) The following steps b) to h) shall be repeated for the all communication speeds and protocols supported by the UICC.
- b) The ME simulator shall cold reset the UICC.

*The UICC shall send a valid ATR [CR5].*

- c) The ME simulator shall send a PPS-Request to select a valid protocol and communication speed to the UICC.

*The UICC shall send a valid PPS-Response [CR5].*

- d) The ME simulator shall send a SELECT command to the UICC to select and activate USIM application.

*The status condition returned by the UICC shall be SW1 = '90', SW2 = '00' – normal ending of the command [CR5].*

- e) The ME simulator shall send a VERIFY PIN command with PIN to the UICC.

- f) The ME simulator shall send a SELECT command to the UICC to select EF<sub>FPLMN</sub>.

- g) The ME simulator shall send an UPDATE BINARY to update EF<sub>FPLMN</sub> with data string '55 AA 0F 00 F0 FF 00 F0 FF 00 F0 FF'

*The following conditions shall be true for all character frames:*

- *Before the transmission of a character, the I/O line shall be in state H [CR1];*
- *It consists of 10 consecutive bits [CR2];*
- *There is an even number of bits set to '1' including the parity bit [CR3];*
- *The existence of the start bit shall be confirmed to be at least 0.7 etu [CR4];*
- *The subsequent bits shall be received at intervals of  $(n + 0.5 \pm 0.2)$  etu ( $n$  being the rank of the bit) [CR5];*
- *The time from the leading edge of the start bit to the trailing edge of the Nth bit shall be  $(N \pm 0.2)$  etu [CR6];*
- *The interval between the leading edges of the start bits of two consecutive characters shall comprise the character duration  $(10 \pm 0.2)$  etu, plus a guardtime [CR7];*
- *The data shall always be passed over the I/O line with the most significant byte first [CR8];*
- *The order of bits within a byte shall be specified in character TS returned in the ATR [CR10].*

- h) The ME simulator shall send a READ BINARY to the UICC.

*The data string returned by the UICC shall be '55 AA 0F 00 F0 FF 00 F0 FF 00 F0 FF'.*

*The following conditions shall be true for all character frames:*

- *Before the transmission of a character, the I/O line shall be in state H [CR1];*
- *It consists of 10 consecutive bits [CR2];*
- *There is an even number of bits set to '1' including the parity bit [CR3];*
- *The existence of the start bit shall be confirmed to be at least 0.7 etu [CR4];*
- *The subsequent bits shall be received at intervals of  $(n + 0.5 \pm 0.2)$  etu ( $n$  being the rank of the bit) [CR5];*

- *The time from the leading edge of the start bit to the trailing edge of the Nth bit shall be  $(N \pm 0.2)$  etu [CR6];*
  - *The interval between the leading edges of the start bits of two consecutive characters shall comprise the character duration  $(10 \pm 0.2)$  etu, plus a guardtime [CR7];*
  - *The data shall always be passed over the I/O line with the most significant byte first [CR8];*
  - *The response data sent from the UICC shall be passed over the I/O line with the most significant byte first [CR9];*
  - *The order of bits within a byte shall be specified in character TS returned in the ATR [CR10].*
- i) The time from the leading edge of the start bit to the trailing edge of the nth bit shall be set to be  $(n + 0.2)$  etu.
- j) The ME simulator shall cold reset the UICC.  
*The UICC shall send a valid ATR [CR5].*
- k) The ME simulator shall send a PPS-Request to select a valid protocol and communication speed to the UICC.  
*The UICC shall send a valid PPS-Response [CR5].*
- l) The ME simulator shall send a SELECT command to the UICC to select and activate USIM application.  
*The status condition returned by the UICC shall be SW1 = '90', SW2 = '00' – normal ending of the command [CR5].*
- m) The ME simulator shall send a VERIFY PIN command with PIN to the UICC.
- n) The ME simulator shall send a SELECT command to the UICC to select EF<sub>FPLMN</sub>.
- o) The ME simulator shall send a READ BINARY to the UICC.  
*The data string returned by the UICC shall be '55 AA 0F 00 F0 FF 00 F0 FF 00 F0 FF';*  
*The following conditions shall be true for all character frames:*
- *Before the transmission of a character, the I/O line shall be in state H [CR1];*
  - *It consists of 10 consecutive bits [CR2];*
  - *There is an even number of bits set to '1' including the parity bit [CR3];*
  - *The existence of the start bit shall be confirmed to be at least 0.7 etu [CR4];*
  - *The subsequent bits shall be received at intervals of  $(n + 0.5 \pm 0.2)$  etu (n being the rank of the bit) [CR5];*
  - *The time from the leading edge of the start bit to the trailing edge of the Nth bit shall be  $(N \pm 0.2)$  etu [CR6];*
  - *The interval between the leading edges of the start bits of two consecutive characters shall comprise the character duration  $(10 \pm 0.2)$  etu, plus a guardtime [CR7];*
  - *The data shall always be passed over the I/O line with the most significant byte first [CR8];*
  - *The response data sent from the UICC shall be passed over the I/O line with the most significant byte first [CR9];*
  - *The order of bits within a byte shall be specified in character TS returned in the ATR [CR10].*
- p) The time from the leading edge of the start bit to the trailing edge of the nth bit shall be set to be  $(n - 0.2)$  etu.
- q) The ME simulator shall cold reset the UICC.  
*The UICC shall send a valid ATR [CR2, CR5].*
- r) The ME simulator shall send a PPS-Request to select a valid protocol and communication speed to the UICC.  
*The UICC shall send a valid PPS-Response [CR4, CR5].*



- s) The ME simulator shall send a SELECT command to the UICC to select and activate USIM application.

*The status condition returned by the UICC shall be SW1 = '90', SW2 = '00' –normal ending of the command [CR4, CR5].*

- t) The ME simulator shall send a VERIFY PIN command with PIN to the UICC.

- u) The ME simulator shall send a SELECT command to the UICC to select EF<sub>FPLMN</sub>.

- v) The ME simulator shall send a READ BINARY to the UICC.

*The data string returned by the UICC shall be '55 AA 0F 00 F0 FF 00 F0 FF 00 F0 FF'.*

*The following conditions shall be true for all character frames:*

- *Before the transmission of a character, the I/O line shall be in state H [CR1];*
- *It consists of 10 consecutive bits [CR2];*
- *There is an even number of bits set to '1' including the parity bit [CR3];*
- *The existence of the start bit shall be confirmed to be at least 0.7 etu [CR4];*
- *The subsequent bits shall be received at intervals of  $(n + 0.5 \pm 0.2)$  etu ( $n$  being the rank of the bit) [CR5];*
- *The time from the leading edge of the start bit to the trailing edge of the Nth bit shall be  $(N \pm 0.2)$  etu [CR6];*
- *The interval between the leading edges of the start bits of two consecutive characters shall comprise the character duration  $(10 \pm 0.2)$  etu, plus a guardtime [CR7];*
- *The data shall always be passed over the I/O line with the most significant byte first [CR8];*
- *The response data sent from the UICC shall be passed over the I/O line with the most significant byte first [CR];*
- *The order of bits within a byte shall be specified in character TS returned in the ATR [CR10].*

## 6.4.2.2 Transmission Protocol T = 0

### 6.4.2.2.1 Definition and applicability

It shall be mandatory for all cards complying with TS 102.221 [1] to support all functions described therein.

### 6.4.2.2.2 Conformance requirement

- CR1 The T = 0 protocol is mandatory for the UICC.
- CR2 The protocol shall start after either the ATR or a successful PPS exchange.
- CR3 The minimum interval between the leading edge of the start bits of two consecutive characters shall be at least 12 etus.
- CR4 The value of the WWT shall not exceed  $960 \times WI \times Fi/f$ .
- CR5 The minimum interval between the leading edges of the start bits of two consecutive characters sent in opposite direction shall be 16 etus.
- CR6 When the UICC has received the command header, a response containing a procedure byte shall be sent to the ME.
- CR7 Both the ME and the UICC shall be able to keep track of the direction of the data flow and who has the access to the I/O-line.
- CR8 Procedure bytes shall be used to keep up the communication between the ME and the UICC.

- CR9 The status bytes SW1 SW2 form an end sequence indicating the status of the UICC at the end of a command.
- CR10 A normal ending of a command shall be indicated by SW1 SW2 = '90 00'.
- CR11 The error detection and correction procedure shall be mandatory.
- CR12 The error is indicated on the I/O-line, which is set to state L after  $(10.5 \pm 0.2)$  etus after the leading edge of the start bit for the character, and the I/O line shall be in state L for a maximum of 2 etus and a minimum of 1 etu.
- CR13 If the UICC or ME as receiver detects a parity error within  $11 \pm 0.2$  etus starting from the leading edge of the start bit, in a character just received, it shall set I/O to state L to indicate the error to the sender.
- CR14 When the transmitter detects an error, the character shall be sent again after a minimum delay of 2 etus.

Reference: TS 102.221 [1], subclause clause 7 and more specifically subclause 7.2.2.1, 7.2.2.3 and 7.2.2.4.

Test Group Reference (TGR): TGR\_USIM\_TP102.221\_TP\_DLL\_TP0

Test Procedure Reference (TPR): TPR\_USIM\_TP102.221\_TP\_DLL\_TP0

#### 6.4.2.2.3 Test purpose

To verify that the Physical Layer function conforms to the above requirements.

NOTE : CR6 to CR10 are tested in the subclause 6.8.

#### 6.4.2.2.4 Method of test

##### Initial conditions

- 1) The UICC shall be connected to a ME simulator.
- 2) EF<sub>FPLMN</sub> shall contain the data string: '55 AA 0F 00 F0 FF 00 F0 FF 00 F0 FF'.

##### Test procedure

- a) Steps b) to h) shall be repeated for the all communication speeds supported by the UICC.
- b) The ME simulator shall cold reset the UICC.
- c) The ME simulator shall send a PPS-Request to the UICC to select the T = 0 protocol and the selected communication speed.

*The UICC shall send a valid PPS-Response indicating support for the T=0 protocol and the selected communication speed [CR1].*

- d) The ME simulator shall send a SELECT command to the UICC to select and activate USIM application.
- e) The ME simulator shall send a VERIFY PIN with PIN to the UICC.
- f) The ME simulator shall send a SELECT command to the UICC to select EF<sub>FPLMN</sub>.
- g) The ME simulator shall send a READ BINARY command to the UICC.

*The UICC shall send the data string '55 AA 0F 00 F0 FF 00 F0 FF 00 F0 FF' followed by SW1 = '90' and SW2 = '00' – normal ending of the command [CR2].*

*The following shall be true of the response data:*

- *The interval between the leading edge of the start bits of two consecutive characters shall be at least 12 etus [CR3];*
- *The value of the WWT shall not exceed  $960 \times WI \times Fi/f$  [CR4];*

- *The minimum interval between the leading edges of the start bits of two consecutive characters sent in opposite directions shall be at least 16 etus [CR5].*

- h) The ME simulator shall send a SELECT command to the UICC to select EF<sub>IMSI</sub> at 16 etu after the UICC send the last character in g).

*The status condition returned by the UICC shall be SW1 = '90', SW2 = '00' - normal ending of the command [CR5].*

- i) The ME simulator shall cold reset the UICC.
- j) The ME simulator shall request character repetition (i.e. transmits an error signal during the guard time) to the UICC for all character frames during the ATR.

*The UICC shall send the valid ATR with character repetition [CR11].*

- k) The ME simulator shall send a PPS-Request to the UICC to select the T = 0 protocol and the selected communication speed.

- l) The ME simulator shall send a SELECT command to the UICC to select and activate USIM application.

- m) The ME simulator shall send a VERIFY PIN with PIN to the UICC.

- n) The ME simulator shall send a SELECT command to the UICC to select EF<sub>FPLMN</sub>.

- o) The ME simulator shall send a READ BINARY command to the UICC with incorrect character parity for all character frames.

*The UICC shall request character repetition (i.e. transmits an error signal during the guard time) for all character frames [CR11].*

- p) The ME simulator shall re-send a READ BINARY command to the UICC.

- q) The ME simulator shall request character repetition for all character frames to the UICC.

*The UICC shall send the data string '55 AA 0F 00 F0 FF 00 F0 FF 00 F0 FF' followed by SW1 = '90' and SW2 = '00' – normal ending of the command [CR11].*

*The following shall be true of the response data:*

- *The error is indicated on the I/O-line, which is set to state L after  $(10,5 \pm 0,2)$  etus after the leading edge of the start bit for the character, and the I/O line shall be in state L for a maximum of 2 etus and a minimum of 1 etu [CR12];*
- *The UICC as receiver detects a parity error within  $11 \pm 0,2$  etus starting from the leading edge of the start bit. In a character just received, it shall set I/O to state L to indicate the error to the sender [CR13];*
- *When the UICC as transmitter detects an error, the character shall be sent again after a minimum delay of 2 etus [CR14].*

### 6.4.2.3 Transmission Protocol T = 1

#### 6.4.2.3.1 Timing and specific options for blocks sent with T = 1

This subclause defines conformance tests regarding timing, information field sizes and error detection parameters for blocks sent with T = 1.

The tests defined in this subclause only apply where the UICC under test supports the T = 1 protocol. If the UICC under test does not support the T = 1 protocol, then these tests do not apply.

The tests in this subclause assume that the T = 1 protocol is the first indicated protocol for the UICC. If the UICC under test supports T = 1 but it is not the first indicated protocol, then each test must be extended to configure the UICC to employ the T = 1 protocol, e.g. via the PPS mechanism.

## 6.4.2.3.1.1 Information field size

## 6.4.2.3.1.1.1 Definition and applicability

It shall be mandatory for all cards complying with TS 102.221 [1] to support all functions described therein.

## 6.4.2.3.1.1.2 Conformance requirement

- CR1 IFSC shall be the maximum length of information field of blocks that can be received by the UICC.
- CR2 The default value of the IFSC shall be 32 bytes and another value may be indicated in TA3 of the ATR.
- CR3 IFSD shall be the maximum length of information field of blocks that the terminal can receive.
- CR4 IFSD shall have a default value of 32 bytes and may be adjusted during the card session.
- CR5 The maximum value of the IFSD shall be 254 bytes.

Reference: TS 102.221 [1], subclause 7.2.3.1.1

Test Group Reference (TGR): TGR\_USIM\_TP102.221\_TP\_DLL\_TP1

Test Procedure Reference (TPR): TPR\_USIM\_TP102.221\_TP\_DLL\_TP1\_TS\_IFS

## 6.4.2.3.1.1.3 Test purpose

To verify that an I-block from the UICC has an INF field of length  $\leq$  IFSD.

NOTE: CR1 and CR2 shall not be tested as it depends on the capability of the UICC.

## 6.4.2.3.1.1.4 Method of test

NOTE: When EF<sub>SMS</sub> is not supported by the UICC, any supported linear EF with record length more than or equal to 31 bytes may be chosen.

**Initial conditions**

- 1) The UICC shall be connected to a ME simulator.

**Test procedure**

- a) The ME simulator shall reset the UICC.
- b) The ME simulator shall send a SELECT command to the UICC to select and activate the USIM application.
- c) The ME simulator shall send a SELECT command to the UICC to select EF<sub>SMS</sub>.
- d) The ME simulator shall send a VERIFY command with PIN to the UICC.
- e) The ME simulator shall send a READ RECORD command to read record 1 from EF<sub>SMS</sub>.

*The UICC shall return the contents of record 1 in a series of chained I-blocks, whose INF fields are  $\leq$  IFSD, i.e. less than or equal to 32 bytes in length [CR3, CR4].*

- f) The ME simulator shall reset the UICC.
- g) The ME simulator shall send an IFS REQUEST to the UICC, requesting an adjustment of IFSD to 255 bytes.

*The UICC shall reject the request and respond with an R-block with bits b1-b4 in the PCB-byte having a value of '2' – other errors [CR5].*

- h) The ME simulator shall reset the UICC.
- i) The ME simulator shall send an IFS REQUEST to the UICC, requesting an adjustment of IFSD to 254 bytes.
- j) The ME simulator shall send a SELECT command to the UICC to select and activate the USIM application.

- k) The ME simulator shall send a SELECT command to the UICC to select EF<sub>SMS</sub>.
- l) The ME simulator shall send a VERIFY command with PIN to the UICC.
- m) The ME simulator shall send a READ RECORD command to read record 1 from EF<sub>SMS</sub>.

*The UICC returns the contents of record 1 in a single I-block or multiple I-blocks [CR5].*

#### 6.4.2.3.1.2 Character waiting integer

##### 6.4.2.3.1.2.1 Definition and applicability

It shall be mandatory for all cards complying with TS 102.221 [1] to support all functions described therein.

This test case only applies to a UICC which issues the interface character, TB3

##### 6.4.2.3.1.2.2 Conformance requirement

- CR1 CWI is used to calculate CWT and shall be in the range from 0 to 5. The value shall be set in bits b4 to b1 in TB3.

Reference: TS 102.221 [1], subclause 7.2.3.1.2.

Test Group Reference (TGR): TGR\_USIM\_TP102.221\_TP\_DLL\_TP1

Test Procedure Reference (TPR): TPR\_USIM\_TP102.221\_TP\_DLL\_TP1\_TS\_CWI

##### 6.4.2.3.1.2.3 Test purpose

To verify that, if TB3 is present in the ATR, then the CWI, as coded in TB3, is in the range from 0 to 5.

##### 6.4.2.3.1.2.4 Method of test

#### **Initial conditions**

- 1) The UICC shall be connected to a ME simulator.

#### **Test procedure**

- a) The ME simulator shall reset the UICC.

*The UICC shall respond with an ATR. If TB3 is present, bits b1-b4 shall be in the range 0 to 5 [CR1].*

#### 6.4.2.3.1.3 Character waiting time

##### 6.4.2.3.1.3.1 Definition and applicability

It shall be mandatory for all cards complying with TS 102.221 [1] to support all functions described therein.

##### 6.4.2.3.1.3.2 Conformance requirement

- CR1 CWT is defined as the maximum delay between the leading edges of two consecutive characters in the block.

Reference: TS 102.221 [1], subclause 7.2.3.1.3.

Test Group Reference (TGR): TGR\_USIM\_TP102.221\_TP\_DLL\_TP1

Test Procedure Reference (TPR): TPR\_USIM\_TP102.221\_TP\_DLL\_TP1\_TS\_CWT

#### 6.4.2.3.1.3.3 Test purpose

To verify that the maximum delay between two consecutive characters in a block sent by the UICC is CWT.

#### 6.4.2.3.1.3.4 Method of test

##### Initial conditions

- 1) The UICC shall be connected to a ME simulator.

##### Test procedure

- a) The ME simulator shall reset the UICC.
- b) The ME simulator shall send a SELECT command to the UICC to select and activate the USIM application.

*The ME simulator shall measure the delay between the leading edges of each pair of consecutive characters sent by the UICC in its I-block response to the SELECT command. The maximum delay between the leading edges of each pair of consecutive characters shall be < CWT [CR1].*

#### 6.4.2.3.1.4 Block guard time

##### 6.4.2.3.1.4.1 Definition and applicability

It shall be mandatory for all cards complying with TS 102.221 [1] to support all functions described therein.

##### 6.4.2.3.1.4.2 Conformance requirement

- CR1 The delay between the last character of a block received by the UICC and the first character of the next block sent from the UICC shall be in the interval:  $BGT < \text{delay} < BWT$ .

Reference: TS 102.221 [1], subclause 7.2.3.1.5.

Test Group Reference (TGR): TGR\_USIM\_TP102.221\_TP\_DLL\_TP1

Test Procedure Reference (TPR): TPR\_USIM\_TP102.221\_TP\_DLL\_TP1\_TS\_BGT

##### 6.4.2.3.1.4.3 Test purpose

To verify that, except after an S(WTX request) and S(WTX response), the delay between the last character of a block sent by the Terminal and the first character of a block sent by the UICC is between BGT and BWT.

##### 6.4.2.3.1.4.4 Method of test

##### Initial conditions

- 1) The UICC shall be connected to a ME simulator.

##### Test procedure

- a) The ME simulator shall reset the UICC.
- b) The ME simulator shall send a SELECT command to the UICC to select and activate the USIM application.

*The ME simulator shall measure the delay between the leading edge of the last character in the I-block SELECT command received by the UICC and the leading edge of the first character in its I-block response to the SELECT command. The measured delay shall be in the range:  $BGT < \text{delay} < BWT$  [CR1].*

- c) The ME simulator shall send a SELECT command to the UICC to select and terminate the USIM application at 22 etu after the UICC send the last character in b).

*The status condition returned by the UICC shall be SW1 = '90', SW2 = '00' - normal ending of the command [CR1].*

#### 6.4.2.3.1.5 Waiting time extension

##### 6.4.2.3.1.5.1 Definition and applicability

It shall be mandatory for all cards complying with TS 102.221 [1] to support all functions described therein.

##### 6.4.2.3.1.5.2 Conformance requirement

CR1 WTX shall be used to ask for more time to process a command.

Reference: TS 102.221 [1], subclause 7.2.3.1.6.

Test Group Reference (TGR): TGR\_USIM\_TP102.221\_TP\_DLL\_TP1

Test Procedure Reference (TPR): TPR\_USIM\_TP102.221\_TP\_DLL\_TP1\_TS\_WTX

##### 6.4.2.3.1.5.3 Test purpose

To verify that the UICC conforms to the above requirements.

NOTE: CR1 shall not be tested as it is not possible to force the UICC to issue a WTX request.

##### 6.4.2.3.1.5.4 Method of test

###### **Initial conditions**

N/A

###### **Test Procedure**

N/A

#### 6.4.2.3.1.6 Error detection code

##### 6.4.2.3.1.6.1 Definition and applicability

It shall be mandatory for all cards complying with TS 102.221 [1] to support all functions described therein.

This test case only applies to a UICC which issues any of the interface characters, TCi.

##### 6.4.2.3.1.6.2 Conformance requirement

CR1 LRC shall be used (b1 = 0). All other bits in TCi are RFU and shall be set to 0.

Reference: TS 102.221 [1], subclause 7.2.3.1.7.

Test Group Reference (TGR): TGR\_USIM\_TP102.221\_TP\_DLL\_TP1

Test Procedure Reference (TPR): TPR\_USIM\_TP102.221\_TP\_DLL\_TP1\_TS\_EDC

##### 6.4.2.3.1.6.3 Test purpose

To verify that TCi, if present, is equal to 0.

##### 6.4.2.3.1.6.4 Method of test

###### **Initial conditions**

1) The UICC shall be connected to a ME simulator.

###### **Test procedure**

a) The ME simulator shall reset the UICC.

*The UICC shall respond with an ATR. All interface characters TCi which are present shall have a value of 0 [CR1].*

#### 6.4.2.3.2 Block frame structure

This subclause defines conformance tests regarding the T = 1 block structure.

##### 6.4.2.3.2.1 Prologue field

##### 6.4.2.3.2.1.1 Node address byte

##### 6.4.2.3.2.1.1.1 Definition and applicability

It shall be mandatory for all cards complying with TS 102.221 [1] to support all functions described therein.

##### 6.4.2.3.2.1.1.2 Conformance requirement

CR1 Only the default value SAD = DAD = 0 shall be supported.

Reference: TS 102.221 [1], subclause 7.2.3.2.1.1.

Test Group Reference (TGR): TGR\_USIM\_TP102.221\_TP\_DLL\_TP1

Test Procedure Reference (TPR): TPR\_USIM\_TP102.221\_TP\_DLL\_TP1\_BFS\_NDB

##### 6.4.2.3.2.1.1.3 Test purpose

To verify that only SAD = DAD = 0 is used.

##### 6.4.2.3.2.1.1.4 Method of test

#### Initial conditions

- 1) The UICC shall be connected to a ME simulator.

#### Test procedure

- a) The ME simulator shall reset the UICC.
- b) The ME simulator shall send a SELECT command to the UICC to select and activate the USIM application.
- c) The ME simulator shall send a SELECT command to the UICC to select EF<sub>ECC</sub>, where the SAD and DAD are set, as default, to 0.

*The UICC shall respond with an I-block where the SAD and the DAD are both set to 0 [CR1].*

- d) The ME simulator shall send a SELECT command to the UICC to select EF<sub>ECC</sub>, where the SAD = 1 and DAD = 0.

*The UICC shall either return an R-block with N(R) equal to the next expected sequence number (ignoring the erroneous I-block), or not return any response [CR1].*

- e) The ME simulator shall send a SELECT command to the UICC to select EF<sub>ECC</sub>, where the SAD = 0 and DAD = 1.

*The UICC shall either return an R-block with N(R) equal to the next expected sequence number (ignoring the erroneous I-block), or not return any response [CR1].*

- f) The ME simulator shall send a SELECT command to the UICC to select EF<sub>ECC</sub>, where the SAD = 1 and DAD = 1.

*The UICC shall either return an R-block with N(R) equal to the next expected sequence number (ignoring the erroneous I-block), or not return any response [CR1].*



#### 6.4.2.3.2.1.2 Protocol Control Byte

##### 6.4.2.3.2.1.2.1 Definition and applicability

It shall be mandatory for all cards complying with TS 102.221 [1] to support all functions described therein.

##### 6.4.2.3.2.1.2.2 Conformance requirement

CR1 All information needed to control the transmission shall be transferred in the protocol control byte PCB.

CR2 The coding of the PCB byte shall specify the type of block.

CR3 In the T = 1 protocol, the following three different types of blocks shall be supported:

- Information block, I-block which is used to transfer command and response APDUs;
- Receive-ready block, R-block, which is used to transfer acknowledgements;
- Supervisory block, S-block, which is used to send control information.

CR4 The coding of the PCB byte for each block shall conform to the tables 7.5 - 7.9 in TS 102.221 [1].

Reference: TS 102.221 [1], subclause 7.2.3.2.1.2.

Test Group Reference (TGR): TGR\_USIM\_TP102.221\_TP\_DLL\_TP1

Test Procedure Reference (TPR): TPR\_USIM\_TP102.221\_TP\_DLL\_TP1\_BFS\_PCB

##### 6.4.2.3.2.1.2.3 Test purpose

To verify that the UICC conforms to the above requirements.

NOTE: CR1 to CR4 are tested in subclauses 6.4.2.3.3, 6.4.2.3.4 and 6.4.2.3.5.

##### 6.4.2.3.2.1.2.4 Method of test

###### **Initial conditions**

N/A

###### **Test procedure**

N/A

#### 6.4.2.3.2.1.3 Length

##### 6.4.2.3.2.1.3.1 Definition and applicability

It shall be mandatory for all cards complying with TS 102.221 [1] to support all functions described therein.

##### 6.4.2.3.2.1.3.2 Conformance requirement

CR1 The length byte shall code the number of bytes in the information field of the block.

CR2 The number of bytes in the information field shall vary in the range from 0 to 254 bytes, depending on the type of block.

Reference: TS 102.221 [1], subclause 7.2.3.2.1.3.

Test Group Reference (TGR): TGR\_USIM\_TP102.221\_TP\_DLL\_TP1

Test Procedure Reference (TPR): TPR\_USIM\_TP102.221\_TP\_DLL\_TP1\_BFS\_LEN

#### 6.4.2.3.2.1.3.3 Test purpose

To verify that the UICC conforms to the above requirements.

#### 6.4.2.3.2.1.3.4 Method of test

##### **Initial conditions**

- 1) The UICC shall be connected to a ME simulator.

##### **Test procedure**

- a) The ME simulator shall reset the UICC.
- b) The ME simulator shall send a SELECT command to the UICC to select and activate the USIM application.

*The UICC shall respond with an I-block containing the response to the SELECT command, where the I-block contain the LEN, length of the response data [CR1, CR2].*

#### 6.4.2.3.2.1.4 Information field

##### 6.4.2.3.2.1.4.1 Definition and applicability

It shall be mandatory for all cards complying with TS 102.221 [1] to support all functions described therein.

##### 6.4.2.3.2.1.4.2 Conformance requirement

- CR1 The information field, INF, shall be optional and it depends on the type of the block and what the field will be used for. As for I-block, INF shall be present to transfer command and response APDUs.
- CR2 The information field, INF, shall not be used for an R-block.
- CR3 The information field, INF, shall be optional and it depends on the type of the block and what the field will be used for. As for S-block, INF shall be present (single byte) to adjust IFS with WTX.
- CR4 The information field, INF, shall be optional and it depends on the type of the block and what the field will be used for. As for S-block, INF shall be absent to signal error on VPP, or managing chain abortion or resynchronisation.

Reference: TS 102.221 [1], subclause 7.2.3.2.1.4.

Test Group Reference (TGR): TGR\_USIM\_TP102.221\_TP\_DLL\_TP1

Test Procedure Reference (TPR): TPR\_USIM\_TP102.221\_TP\_DLL\_TP1\_BFS\_IF

##### 6.4.2.3.2.1.4.3 Test purpose

To verify that the UICC conforms to the above requirements.

NOTE 1: CR3 shall not be tested as it is not possible to force the UICC to issue a WTX.

NOTE 2: CR4 shall not be tested as the Error on Vpp state S-block is not supported.

##### 6.4.2.3.2.1.4.4 Method of test

##### **Initial conditions**

- 1) The UICC shall be connected to a ME simulator.

##### **Test procedure**

- a) The ME simulator shall reset the UICC.
- b) The ME simulator shall send a SELECT command to the UICC to select and activate the USIM application.

- c) The ME simulator shall send a SELECT command to the UICC to select the EF<sub>ECC</sub>, where the I-block has an invalid EDC.

*The UICC shall reject the command by sending an R-block response with bits b1-b4 in the PCB-byte having a value of '1' – EDC and/or parity error. The INF field shall be absent [CR1, CR2].*

- d) The ME simulator shall send a SELECT command to the UICC to select the EF<sub>ECC</sub>.
- e) The ME simulator shall reset the UICC.
- f) The ME simulator shall send an IFS REQUEST S-block to the UICC, requesting an adjustment of the IFSD to 254 bytes.

*The UICC shall respond with an IFS RESPONSE S-block, whose INF field is present and has the value 254 [CR3].*

- g) The ME simulator shall send a SELECT command to the UICC to select and activate the USIM application.
- h) The ME simulator shall reset the UICC.
- i) The ME simulator shall send a SELECT command to the UICC to select and activate the USIM application.
- j) The ME simulator shall send a RESYNCH request S-block to the UICC.

*The UICC shall respond with a RESYNCH response S-block, which shall not contain an INF field [CR4].*

- k) The ME simulator shall send a SELECT command to the UICC to select EF<sub>ECC</sub>.
- l) The ME simulator shall reset the UICC.
- m) The ME simulator shall send a SELECT command to the UICC to select and activate the USIM application.
- n) The ME simulator shall send a SELECT command to the UICC to select EF<sub>ECC</sub>.
- o) The ME simulator shall send an IFS REQUEST S-block to the UICC, requesting an adjustment of the IFSD to the record length of EF<sub>ECC</sub> – 1 byte.
- p) The ME simulator shall send a READ RECORD command to read record 1 from EF<sub>ECC</sub>.
- q) The ME simulator shall send an ABORT request S-block to the UICC after the 1<sup>st</sup> chained I-block response is received from the UICC.

*The UICC shall respond with an ABORT response S-block, which shall not contain an INF field [CR4].*

- r) The ME simulator shall send an IFS REQUEST S-block to the UICC, requesting an adjustment of the IFSD to 32 bytes.
- s) The ME simulator shall send a SELECT command to the UICC to select and activate the USIM application.

#### 6.4.2.3.2.3 Epilogue field

##### 6.4.2.3.2.3.1 Definition and applicability

It shall be mandatory for all cards complying with TS 102.221 [1] to support all functions described therein.

##### 6.4.2.3.2.3.2 Conformance requirement

CR1 The LRC as defined in ISO/IEC 7816-3 [6] shall be used.

Reference: TS 102.221 [1], subclause 7.2.3.2.2.

Test Group Reference (TGR): TGR\_USIM\_TP102.221\_TP\_DLL\_TP1

Test Procedure Reference (TPR): TPR\_USIM\_TP102.221\_TP\_DLL\_TP1\_BSF\_EF

#### 6.4.2.3.2.3.3 Test purpose

To verify that the LRC is calculated correctly.

#### 6.4.2.3.2.3.4 Method of test

##### Initial conditions

- 1) The UICC shall be connected to a ME simulator.

##### Test procedure

- a) The ME simulator shall reset the UICC.
- b) The ME simulator shall send a SELECT command to the UICC to select and activate the USIM application.

*The UICC shall respond with an I-block containing the response to the SELECT command. The epilogue field shall contain a 1 byte EDC – of type LRC – which shall be set to the correct value for the block [CR1].*

- c) The ME simulator shall send a SELECT command to the UICC to select and terminate the USIM application with invalid EDC.

*The UICC shall reject the command by sending an R-block response of the format R(N), where N is the sequence number of the next expected I-block (ignoring the erroneous I-block) and with bits b1-b4 in the PCB-byte having a value of '1' – EDC and/or parity error [CR1].*

#### 6.4.2.3.3 Error free operation

##### 6.4.2.3.3.1 Definition and applicability

It shall be mandatory for all cards complying with TS 102.221 [1] to support all functions described therein.

##### 6.4.2.3.3.2 Conformance requirement

- CR1 To change the value of IFSD, the terminal sends an S(IFS request). The request shall be acknowledged by the UICC with an S(IFS response) with the same INF. The new IFSD is assumed to be valid as long as no new S(IFS request) has been received by the UICC.
- CR2 If a sender S sends  $I(N_s(S), 0)$ , the block is acknowledged by the receiver R with an  $I(N_r(S), M)$ .
- CR3 If a sender S sends an  $I(N_s(S), 1)$ , it should be acknowledged by the receiver R with  $R(N_r(R))$ , where  $N_s(S) \neq N_r(R)$ , to indicate that the received block was correct and that the receiver is ready to receive the next block.

Reference: TS 102.221 [1], subclause 7.2.3.3.

Test Group Reference (TGR): TGR\_USIM\_TP102.221\_TP\_DLL\_TP1

Test Procedure Reference (TPR): TPR\_USIM\_TP102.221\_TP\_DLL\_TP1\_EFO

#### 6.4.2.3.3.3 Test purpose

To verify that the UICC conforms to the above requirements.

#### 6.4.2.3.3.4 Method of test

##### Initial conditions

- 1) The UICC shall be connected to a ME simulator.

##### Test procedure

- a) The ME simulator shall reset the UICC.

- b) The ME simulator shall send an IFS REQUEST S-block to the UICC, requesting an adjustment of the IFSD to 254 bytes.

*The UICC shall respond with an IFS RESPONSE S-block, whose INF field is present and has the value 254 [CR1].*

- c) The ME simulator shall send a SELECT command to the UICC to select and activate the USIM application.

*The UICC shall respond to the last I-block of the command ( $I(N_s(S), 0)$ ) with the response to the SELECT command, where the first I-block of the response is of the format  $I(N_r(S), M)$  where  $N_r(S) = 0$  [CR2].*

- d) The ME simulator shall send a SELECT command to the UICC to select EF<sub>ECC</sub>.

*The UICC shall respond to the last I-block of the command ( $I(N_s(S), 0)$ ) with the response to the SELECT command, where the first I-block of the response is of the format  $I(N_r(S), M)$  where  $N_r(S) \neq N_r(S)$  of the previous I-block sent by the UICC [CR2].*

- e) The ME simulator shall send a SELECT command to the UICC, with an invalid file ID whose length shall be 255 bytes long, where each byte shall be set to 'FF', split over at least 2 chained I-blocks.

*The UICC shall respond to the first I-block from the ME simulator with a receive ready R-block of the format  $R(N_r(R))$  where  $N_s(S) \neq N_r(R)$  [CR3].*

#### 6.4.2.3.4 Error Handling for T = 1

This subclause describes a number of conformance tests to test the control of the error handling for the T = 1 protocol.

##### 6.4.2.3.4.1 Protocol initialisation

###### 6.4.2.3.4.1.1 Definition and applicability

It shall be mandatory for all cards complying with TS 102.221 [1] to support all functions described therein.

###### 6.4.2.3.4.1.2 Conformance requirement

- CR1 If the terminal fails to receive an error free block, in the beginning of the protocol, a maximum of two consecutive attempts to receive the block shall be allowed before resetting or a deactivation of the card takes place.
- CR2 If the response on the first block sent by the terminal is not sent within the BWT, the terminal shall send a R(0).
- CR3 When the protocol has been initiated and the first block received by the UICC is invalid, the UICC responds with a R(0).
- CR4 If the terminal fails to receive an error free block, a maximum of two consecutive attempts shall be allowed before a S(RESYNCH request) is sent.

Reference: TS 102.221 [1], subclause 7.2.3.4.1

Test Group Reference (TGR): TGR\_USIM\_TP102.221\_TP\_DLL\_TP1

Test Procedure Reference (TPR): TPR\_USIM\_TP102.221\_TP\_DLL\_EH1

###### 6.4.2.3.4.1.3 Test purpose

To verify that the UICC conforms to the above requirements.

NOTE: CR2 shall not be tested as it is not possible to force the card to response longer than BWT

###### 6.4.2.3.4.1.4 Method of test

#### Initial conditions

- 1) The UICC shall be connected to a ME simulator.

### Test procedure

- a) The ME simulator shall reset the UICC.
- b) The ME simulator shall send a SELECT command to the UICC to select and activate the USIM application.
- c) The ME simulator shall send an R-block to the UICC, of the format R(0), to request the UICC to re-send the last block.

*The UICC shall re-send the I-block, the response to the first SELECT command [CR1].*

- d) The ME simulator shall send an R-block to the UICC, of the format R(0), to request the UICC to re-send the last block.

*The UICC shall re-send the I-block, the response to the first SELECT command [CR1].*

- e) The ME simulator shall reset the UICC.

- f) The ME simulator shall send a SELECT command to the UICC to select and activate the USIM application, where the I-block has an invalid EDC.

*The UICC shall reject the command by sending an R-block response of the format R(0), with bits b1-b4 in the PCB-byte having a value of '1' – EDC and/or parity error [CR3].*

- g) The ME simulator shall send a SELECT command to the UICC to select and activate the USIM application.

- h) The ME simulator shall send a SELECT command to the UICC to select EF<sub>IMSI</sub>.

- i) The ME simulator shall send an R-block to the UICC, of the format R(0), to request the UICC to re-send the last block.

*The UICC shall re-send the I-block, the response to the SELECT command in h) [CR4].*

- j) The ME simulator shall send an R-block to the UICC, of the format R(0), to request the UICC to re-send the last block.

*The UICC shall re-send the I-block, the response to the SELECT command in h) [CR4].*

- k) The ME simulator shall send a S(RESYNCH, request) to the UICC.

*The UICC shall return a S(RESYNCH, response) [CR4].*

- l) The ME simulator shall send a VERIFY PIN command with PIN to the UICC.

- m) The ME simulator shall send a READ BINARY command to the UICC.

*The UICC shall return the content of EF<sub>IMSI</sub> [CR4].*

#### 6.4.2.3.4.2 Block dependant errors

##### 6.4.2.3.4.2.1 Sending invalid blocks to the UICC

###### 6.4.2.3.4.2.1.1 Definition and applicability

It shall be mandatory for all cards complying with TS 102.221 [1] to support all functions described therein.

###### 6.4.2.3.4.2.1.2 Conformance requirement

CR1 When an I-block has been sent and a BWT time-out occurs or an invalid block has been received (with the terminal), an R-block is sent, which request with its N(R) for the expected I-block with N(S) = N(R).

CR2 When an R-block was sent and an invalid block is received or BWT time-out, the R-block shall be resent.

- CR3 When an S(...request) has been sent and either a BWT time-out occurs or the received response is not a S(...response), the S(...request) shall be resent.
- CR4 But if an S(...response) has been sent and either an invalid block is received or a BWT time-out, an R-block shall be sent.
- CR5 When the UICC sends an S(IFS request) and receives an invalid block, the S(IFS request) shall be resent maximum one extra time to receive an S(IFS response). After the second failure to receive an S(IFS response), the UICC shall stay in reception mode.

Reference: TS 102.221 [1], subclause 7.2.3.4.2.

Test Group Reference (TGR): TGR\_USIM\_TP102.221\_TP\_DLL\_TP1

Test Procedure Reference (TPR): TPR\_USIM\_TP102.221\_TP\_DLL\_TP1\_EH1\_BDE\_SIB

#### 6.4.2.3.4.2.1.3 Test purpose

To verify that the UICC conforms to the above requirements.

NOTE: CR3 and CR5 shall not be tested as it is not possible to meet the test criteria.

#### 6.4.2.3.4.2.1.4 Method of test

##### Initial conditions

- 1) The UICC shall be connected to a ME simulator.

##### Test procedure

- a) The ME simulator shall reset the UICC.
- b) The ME simulator shall send a SELECT command to the UICC to select and activate the USIM application.
- c) The ME simulator shall send an R-block to the UICC, of the format R(N(R)) where N(R) = N(S) of the last I-block sent by the UICC, to request the UICC to re-send the last block.  
*The UICC shall re-send the last I-block of the response to the first SELECT command [CR1].*
- d) The ME simulator shall send another R-block to the UICC, of the format R(N(R)) where N(R) = N(S) of the last I-block sent by the UICC, to request the UICC to re-send the last block.  
*The UICC shall re-send the last I-block of the response to the first SELECT command [CR2].*
- e) The ME simulator shall reset the UICC.
- f) The ME simulator shall send an IFS REQUEST S-block to the UICC, requesting an adjustment of the IFSD to 254 bytes.
- g) The ME simulator shall re-send an IFS REQUEST S-block to the UICC, requesting an adjustment of the IFSD to 254 bytes.  
*The UICC shall re-send the IFS RESPONSE S-block, whose INF field shall have the value 254 [CR4].*
- h) The ME simulator shall send a SELECT command to the UICC to select and activate the USIM application.

#### 6.4.2.3.5 Chaining

##### 6.4.2.3.5.1 Definition and applicability

It shall be mandatory for all cards complying with TS 102.221 [1] to support all functions described therein.

#### 6.4.2.3.5.2 Conformance requirement

- CR1 When the UICC is the receiver, the UICC shall accept a sequence of chained I-blocks sent from the terminal. The length of each block shall be equal to the value of IFSC except for the last block whose length may be any value in the range 0 to IFSC.
- CR2 When the UICC is the sender, all I-blocks of a chain shall have  $LEN \leq IFSD$  bytes per block.
- CR3 When the UICC is the receiver and receives a block with  $LEN > IFSC$ , the block shall be rejected and acknowledged with an R-block with bits b1-b4 in the PCB-byte having a value of 2.

Reference: TS 102.221 [1], subclause 7.2.3.5.1.

Test Group Reference (TGR): TGR\_USIM\_TP102.221\_TP\_DLL\_TP1

Test Procedure Reference (TPR): TPR\_USIM\_TP102.221\_TP\_DLL\_TP1\_CHN

#### 6.4.2.3.5.3 Test purpose

To verify that the UICC conforms to the above requirements.

#### 6.4.2.3.5.4 Method of test

- NOTE: When  $EF_{SMS}$  is not supported by the UICC, any supported linear EF with record length more than or equal to 31 bytes may be chosen.

#### Initial conditions

- 1) The UICC shall be connected to a ME simulator.

#### Test procedure

- a) The ME simulator shall reset the UICC.
- b) The ME simulator shall send a SELECT command to the UICC to select and activate the USIM application.
- c) The ME simulator shall send a SELECT command to the UICC, with an invalid file ID whose length shall be 255 bytes, where each byte shall be set to 'FF'. The SELECT command shall be spilt over at least 2 chained blocks.

*For each I-block of format  $I(N_s(S), 1)$  from the ME simulator (i.e all I-blocks apart from the last I-block), the UICC shall respond with a receive ready R-block of the format  $R(N_r(R))$  where  $N_r(R) \neq N_s(S)$ .*

*For the last I-block from the ME simulator (i.e of format  $I(N_s(S), 0)$ ), the UICC shall respond with an R-APDU containing a status word indicating an application level error regarding the SELECT command [CR1].*

- d) The ME simulator shall reset the UICC.
- e) The ME simulator shall send a SELECT command to the UICC to select and activate the USIM application.
- f) The ME simulator shall send a VERIFY PIN command with PIN to the UICC.
- g) The ME simulator shall send a SELECT command to the UICC to select  $EF_{SMS}$ .
- h) The ME simulator shall send a READ RECORD command to read record 1 from  $EF_{SMS}$ .

*The UICC shall return the contents of record 1 in a series of chained I-blocks, whose INF fields are  $\leq IFSD$ , i.e. less than or equal to 32 bytes in length [CR2].*

- i) The ME simulator shall reset the UICC.
- j) The ME simulator shall send a SELECT command to the UICC to select and activate the USIM application.



- k) The ME simulator shall send a SELECT command to the UICC, with an invalid file ID whose length shall be 255 bytes long, where each byte shall be set to 'FF', where the INF field in the I-block shall be set to 255 bytes in length.

*The UICC shall reject the command by sending an R-block response of the format R(N), where N is the sequence number of the next expected I-block (ignoring the erroneous I-block) and with bits b1-b4 in the PCB-byte having a value of '2' – other errors [CR3].*

## 6.4.3 Transport Layer

### 6.4.3.1 Transportation of an APDU using T = 0

This subclause describes conformance tests relating to the mapping of C-APDUs and R-APDUs for T = 0 protocol, the APDU exchange and the use of the GET RESPONSE command for case 2 and case 4 commands.

#### 6.4.3.1.1 Case 1

##### 6.4.3.1.1.1 Definition and applicability

It shall be mandatory for all cards complying with TS 102.221 [1] to support all functions described therein.

##### 6.4.3.1.1.2 Conformance requirement

- CR1 On receipt of the command header the UICC, under normal processing, shall return status to the Transport Layer of the Terminal.
- CR2 On receipt of the command header the UICC, under abnormal processing, shall return status to the Transport Layer of the Terminal.
- CR3 UICC shall analyse the T = 0 command header to determine whether this is a case 1 command or a case 2 command requesting response data of maximum length.

Reference: TS 102.221 [1], subclause 7.3.1.1.1.

Test Group Reference (TGR): TGR\_USIM\_TP102.221\_TP\_TL\_TAPDU0

Test Procedure Reference (TPR): TPR\_USIM\_TP102.221\_TP\_TL\_TAPDU0\_C1

##### 6.4.3.1.1.3 Test purpose

To verify that the UICC conforms to the above requirements.

##### 6.4.3.1.1.4 Method of test

#### Initial conditions

- 1) The UICC shall be connected to a ME simulator.

#### Test procedure

- a) The ME simulator shall reset the UICC.
- b) The ME simulator shall send a SELECT command to the UICC to select and activate the USIM application.
- c) The ME simulator shall send a VERIFY PIN command with parameter P2 indicating PIN and with an empty data field to the UICC.

*The status condition returned by the UICC shall be SW1 = '63', SW2 = 'CX' - unsuccessful PIN verification, X attempts left [CR1, CR3].*

- d) The ME simulator shall send a VERIFY PIN command with an incorrect parameter P2 and with an empty data field to the UICC.

*The status condition returned by the UICC shall be SW1 = '6B', SW2 = '00' - wrong parameter(s) P1-P2, or SW1 = '6A', SW2 = '86' - incorrect parameters P1-P2 [CR2].*

### 6.4.3.1.2 Case 2

#### 6.4.3.1.2.1 Definition and applicability

It shall be mandatory for all cards complying with TS 102.221 [1] to support all functions described therein.

#### 6.4.3.1.2.2 Conformance requirement

- CR1 On receipt of the command header the UICC, under normal processing shall return data and status to the Transport Layer of the Terminal.
- CR2 On receipt of the command header the UICC, under abnormal processing shall return status only to the Transport Layer of the Terminal.

Reference: TS 102.221 [1], subclause 7.3.1.1.2.

Test Group Reference (TGR): TGR\_USIM\_TP102.221\_TP\_TL\_TAPDU0

Test Procedure Reference (TPR): TPR\_USIM\_TP102.221\_TP\_TL\_TAPDU0\_C2

#### 6.4.3.1.2.3 Test purpose

To verify that the UICC conforms to the above requirements.

#### 6.4.3.1.2.4 Method of test

##### Initial conditions

- 1) The UICC shall be connected to a ME simulator.
- 2) EF<sub>LOC1</sub> shall contain the data string: 'A1 A2 A3 A4 A5 A6 A7 A8 A9 00 00'.

##### Test procedure

- a) The ME simulator shall reset the UICC.
- b) The ME simulator shall send a SELECT command to the UICC to select and activate the USIM application.
- c) The ME simulator shall send a SELECT command to the UICC to select EF<sub>LOC1</sub>.
- d) The ME simulator shall send a VERIFY PIN command with PIN to the UICC.
- e) The ME simulator shall send a READ BINARY command using a length of 11 bytes to the UICC.

*The UICC shall return the procedure byte 'B0' followed by the data string 'A1 A2 A3 A4 A5 A6 A7 A8 A9 00 00', ending with the status condition SW1 = '90', SW2 = '00' - normal ending of the command [CR1].*

- f) The ME simulator shall send a READ BINARY command with an incorrect P2 parameter and a length of 11 bytes to the UICC.

*The status condition returned by the UICC shall be SW1 = '6B', SW2 = '00' - wrong parameter(s) P1-P2, or SW1 = '6A', SW2 = '86' - incorrect parameters P1-P2 [CR2].*

### 6.4.3.1.3 Case 3

#### 6.4.3.1.3.1 Definition and applicability

It shall be mandatory for all cards complying with TS 102.221 [1] to support all functions described therein.

#### 6.4.3.1.3.2 Conformance requirement

- CR1 On receipt of the command header, if the UICC
- returns a procedure byte, the Transport Layer of the Terminal shall send the data portion of the conditional body of the C-APDU to the UICC under the control of procedure bytes returned by the UICC;
  - returns status, the Transport Layer of the Terminal shall discontinue processing the command.
- CR2 If the processing was not discontinued, the UICC shall return status following receipt of the conditional body of the C-APDU and completion of processing the command.
- CR3 On receipt of status from the UICC, the Transport Layer of the Terminal shall discontinue processing the command.

Reference: TS 102.221 [1], subclause 7.3.1.1.3.

Test Group Reference (TGR): TGR\_USIM\_TP102.221\_TP\_TL\_TAPDU0

Test Procedure Reference (TPR): TPR\_USIM\_TP102.221\_TP\_TL\_TAPDU0\_C3

#### 6.4.3.1.3.3 Test purpose

To verify that, under normal processing of a case 3 command, the UICC reads the command header, reads the command data under control of procedure bytes and returns status.

#### 6.4.3.1.3.4 Method of test

##### Initial conditions

- 1) The UICC shall be connected to a ME simulator.

##### Test procedure

- a) The ME simulator shall reset the UICC.
- b) The ME simulator shall send a SELECT command to the UICC to select and activate the USIM application.
- c) The ME simulator shall send a SELECT command to the UICC to select EF<sub>LOCAL</sub>.
- d) The ME simulator shall send a VERIFY PIN command with PIN to the UICC.
- e) The ME simulator shall send an UPDATE BINARY command header using a length of 11 bytes to the UICC.

*The UICC shall return the procedure byte 'D6' to the ME simulator [CR1].*

- f) The ME simulator shall send the data string '11 22 33 44 55 66 77 88 99 00 11' to the UICC.

*The status condition returned by the UICC shall be SW1 = '90', SW2 = '00' - normal ending of the command [CR2].*

- g) The ME simulator shall send an UPDATE BINARY command header with an incorrect P2 parameter, a length of 11 bytes and, if needed, data string '11 22 33 44 55 66 77 88 99 00 11' to the UICC.

*The status condition returned by the UICC shall be SW1 = '6B', SW2 = '00' - wrong parameter(s) P1-P2, or SW1 = '6A', SW2 = '86' - incorrect parameters P1-P2 [CR3].*

- h) The ME simulator shall send an UPDATE BINARY command with the data 'A1 A2 A3 A4 A5 A6 A7 A8 A9 00 00' to the UICC.

#### 6.4.3.1.4 Case 4

##### 6.4.3.1.4.1 Definition and applicability

It shall be mandatory for all cards complying with TS 102.221 [1] to support all functions described therein.

#### 6.4.3.1.4.2 Conformance requirement

- CR1 On receipt of the command header, if the UICC:
- returns a procedure byte, the Transport Layer of the Terminal shall send the data portion of the conditional body of the C-APDU to the UICC under the control of procedure bytes returned by the UICC;
  - returns status, the Transport Layer of the Terminal shall discontinue processing of the command.
- CR2 If processing was not discontinued in CR1(b), following receipt of the conditional body of the C-APDU, the UICC:
- under normal processing, shall return procedure bytes '61xx' to the Transport Layer of the Terminal requesting the Transport Layer of the Terminal to issue a GET RESPONSE command to retrieve the data from the UICC;
  - under abnormal processing, shall return status only to the Transport Layer of the Terminal.
- CR3 On receipt of the procedure bytes or status returned in CR2, if the UICC:
- returned '61xx' procedure bytes as in CR2(a), the Transport Layer of the Terminal shall send a GET RESPONSE command header to the UICC with P3 set to a value less than or equal to the value contained in the 'xx' byte of '61xx' procedure bytes;
  - returned status as in CR2(b) that indicates a warning ('62xx' or '63xx'), or which is application related ('9xxx' but not '9000'), the Transport Layer of the Terminal shall send a GET RESPONSE command with Le = '00';
  - returned status as in CR2(b) other than that described in CR3(b), the Transport Layer of the Terminal shall discontinue processing of the command.
- CR4 If processing was not discontinued in CR3(c), the GET RESPONSE command shall be processed according to the rules for case 2 commands.

Reference: TS 102.221 [1], subclause 7.3.1.1.4.

Test Group Reference (TGR): TGR\_USIM\_TP102.221\_TP\_TL\_TAPDU0

Test Procedure Reference (TPR): TPR\_USIM\_TP102.221\_TP\_TL\_TAPDU0\_C4

#### 6.4.3.1.4.3 Test purpose

To verify that the UICC conforms to the above requirements.

#### 6.4.3.1.4.4 Method of test

##### Initial conditions

- The UICC shall be connected to a ME simulator.

##### Test procedure

- The ME simulator shall reset the UICC.
- The ME simulator shall send a SELECT command to the UICC to select and activate the USIM application.
- The ME simulator shall send a SELECT command header to the UICC with P2 = '04' and a length of 2 bytes to the UICC to select EF<sub>IMSI</sub>.

*The UICC shall return the procedure byte 'A4' to the ME simulator [CR1].*

- The ME simulator shall send the file ID of the EF<sub>IMSI</sub> to the UICC.

*The UICC shall return procedure bytes '61xx' to the ME simulator – where xx is the length of the FCP of the EF<sub>IMSI</sub> [CR2].*

- e) The ME simulator shall send a GET RESPONSE command header to the UICC with P3 set to length 'xx'.

*The UICC shall return the procedure byte 'C0' followed by the FCP of the EF<sub>IMSI</sub>, ending with the status condition SW1 = '90', SW2 = '00' - normal ending of the command [CR4].*

- f) The ME simulator shall send a SELECT command header to the UICC with an incorrect P1 parameter, P2 = '04', a length of 2 bytes and, if needed, the file ID of EF<sub>LOC1</sub> to the UICC.

*The status condition returned by the UICC shall be SW1 = '6B', SW2 = '00' - wrong parameter(s) P1-P2, or SW1 = '6A', SW2 = '86' - incorrect parameters P1-P2 [CR1].*

- g) The ME simulator shall send a SELECT command to the UICC to select EF<sub>IMSI</sub>.

*The UICC shall return procedure bytes '61xx' to the ME simulator – where 'xx' is the length of the FCP of the EF<sub>IMSI</sub> [CR2].*

- h) The ME simulator shall send a GET RESPONSE command to the UICC with P3 set to 'yy' where 'yy' is less than 'xx'.

*The UICC shall return the first 'yy' bytes of the FCP of the EF<sub>IMSI</sub>.*

*The status returned by the UICC shall be SW1 = '61', SW2 = 'zz' – where 'zz' is the remaining length of the FCP of the EF<sub>IMSI</sub> [CR3].*

- i) The ME simulator shall send a GET RESPONSE command to the UICC with P3 set to 'zz'.

*The UICC shall return the next 'zz' bytes of the FCP of the EF<sub>IMSI</sub>.*

*The status returned by the UICC shall be SW1 = '90', SW2 = '00' – normal ending of the command [CR3].*

#### 6.4.3.1.5 Use of Procedure Bytes '61xx' and '6Cxx'

##### 6.4.3.1.5.1 Case 2 Commands

##### 6.4.3.1.5.1.1 Definition and applicability

It shall be mandatory for all cards complying with TS 102.221 [1] to support all functions described therein.

##### 6.4.3.1.5.1.2 Conformance requirement

- CR1 If the UICC receives a case 2 command header and Le = '00' (with Luicc < 256 bytes) or Le > Luicc, under normal processing it shall return procedure bytes '6C Luicc' instructing the Transport Layer of the Terminal to immediately re-send the command header with P3 = Luicc.
- CR2 If the UICC receives a case 2 command header and Le = '00' (with Luicc < 256 bytes) or Le > Luicc, under abnormal processing it shall return status indicating a warning or error condition (but not SW1 SW2 = '90 00').
- CR3 If the UICC receives a case 2 command header and Le = '00' (with Luicc = 256 bytes) or Le = Luicc, under normal processing it shall return data of length Le (= Luicc) under the control of the INS,  $\overline{\text{INS}}$ , or '60' procedure bytes followed by the associated status or procedure bytes '61xx'.
- CR4 If the UICC receives a case 2 command header and Le = '00' (with Luicc = 256 bytes) or Le = Luicc, under abnormal processing it shall return status indicating a warning or error condition (but not SW1 SW2 = '90 00').
- CR5 If the UICC receives a case 2 command header and Le < Luicc, under normal processing it shall return data of length Le under the control of the INS,  $\overline{\text{INS}}$ , or '60' procedure bytes followed by procedure bytes '61xx'.
- CR6 If the UICC receives a case 2 command header and Le < Luicc, under abnormal processing it shall return status indicating a warning or error condition (but not SW1 SW2 = '90 00').

Reference: TS 102.221 [1], subclause 7.3.1.1.5.1.

Test Group Reference (TGR): TGR\_USIM\_TP102.221\_TP\_TL\_TAPDU0

Test Procedure Reference (TPR): TPR\_USIM\_TP102.221\_TP\_TL\_TAPDU0\_PB\_C2

#### 6.4.3.1.5.1.3 Test purpose

To verify that the UICC conforms to the above requirements.

NOTE: For CR3 and CR6 the return of data from the UICC under the control of the  $\overline{\text{INS}}$ , '60' and '61xx' procedure bytes shall not be tested as it is not possible to force the UICC to behave in this way.

#### 6.4.3.1.5.1.4 Method of test

##### Initial conditions

- 1) The UICC shall be connected to a ME simulator.
- 2) EF<sub>LOCI</sub> shall contain the data string: 'A1 A2 A3 A4 A5 A6 A7 A8 A9 00 00'.

##### Test procedure

- a) The ME simulator shall reset the UICC.
- b) The ME simulator shall send a SELECT command to the UICC to select and activate the USIM application.
- c) The ME simulator shall send a SELECT command to the UICC to select EF<sub>LOCI</sub>.
- d) The ME simulator shall send a VERIFY PIN command with PIN to the UICC.
- e) The ME simulator shall send a READ BINARY command header to the UICC with the P3 parameter set to '00'.  
*The UICC shall return the procedure bytes '6C 0B' to the ME simulator [CR1].*
- f) The ME simulator shall send a READ BINARY command header to the UICC with the P3 parameter set to '0B'.  
*The UICC shall return the procedure byte 'B0' followed by the data string 'A1 A2 A3 A4 A5 A6 A7 A8 A9 00 00', ending with the status condition SW1 = '90', SW2 = '00' - normal ending of the command [CR3].*
- g) The ME simulator shall send a READ BINARY command header to the UICC with an incorrect P2 parameter and the P3 parameter set to '00'.  
*The status condition returned by the UICC shall be SW1 = '6B', SW2 = '00' - wrong parameter(s) P1-P2, or SW1 = '6A', SW2 = '86' - incorrect parameters P1-P2 [CR2].*
- h) The ME simulator shall send a READ BINARY command header to the UICC with an incorrect P2 parameter and the P3 parameter set to '15'.  
*The status condition returned by the UICC shall be SW1 = '6B', SW2 = '00' - wrong parameter(s) P1-P2, or SW1 = '6A', SW2 = '86' - incorrect parameters P1-P2 [CR2].*
- i) The ME simulator shall send a READ BINARY command header to the UICC with an incorrect P2 parameter and the P3 parameter set to '0B'.  
*The status condition returned by the UICC shall be SW1 = '6B', SW2 = '00' - wrong parameter(s) P1-P2, or SW1 = '6A', SW2 = '86' - incorrect parameters P1-P2 [CR4].*
- j) The ME simulator shall send a READ BINARY command header to the UICC with an incorrect P2 parameter and the P3 parameter set to '05'.  
*The status condition returned by the UICC shall be SW1 = '6B', SW2 = '00' - wrong parameter(s) P1-P2, or SW1 = '6A', SW2 = '86' - incorrect parameters P1-P2 [CR6].*

#### 6.4.3.1.5.2 Case 4 Commands

##### 6.4.3.1.5.2.1 Definition and applicability

It shall be mandatory for all cards complying with TS 102.221 [1] to support all functions described therein.

##### 6.4.3.1.5.2.2 Conformance requirement

CR1 If the UICC receives a case 4 command, after processing the data sent with the C-APDU,

- it shall return procedure bytes '61xx';

or

- if the UICC receives a case 4 command, after processing the data sent with the C-APDU, it shall return status indicating a warning or error condition (but not SW1 SW2 = '90 00').

Reference: TS 102.221 [1], subclause 7.3.1.1.5.2.

Test Group Reference (TGR): TGR\_USIM\_TP102.221\_TP\_TL\_TAPDU0

Test Procedure Reference (TPR): TPR\_USIM\_TP102.221\_TP\_TL\_TAPDU0\_PB\_C4

##### 6.4.3.1.5.2.3 Test purpose

To verify that the UICC conforms to the above requirements.

NOTE: CR1 and CR2 are tested in subclause 6.4.3.1.4.

##### 6.4.3.1.5.2.4 Method of test

#### **Initial Conditions**

N/A

#### **Test Procedure**

N/A

### 6.4.3.2 Transportation of an APDU using T = 1

This subclause describes conformance tests relating to the transportation of an APDU using the T = 1 protocol.

The tests defined in this subclause only apply where the UICC under test supports the T = 1 protocol. If the UICC under test does not support the T = 1 protocol, then these tests do not apply.

The tests in this subclause assume that the T = 1 protocol is the first indicated protocol for the UICC. If the UICC under test supports T = 1 but it is not the first indicated protocol, then each test must be extended to configure the UICC to employ the T = 1 protocol, e.g. via the PPS mechanism.

#### 6.4.3.2.1 Case 1

##### 6.4.3.2.1.1 Definition and applicability

It shall be mandatory for all cards complying with TS 102.221 [1] to support all functions described therein.

##### 6.4.3.2.1.2 Conformance requirement

CR1 C-APDU shall be mapped to the INF of the I-Block and the received response from the INF in the I-Block shall be mapped to R-APDU according to Figure 7.10 in TS 102.221 [1].

Reference: TS 102.221 [1], subclause 7.3.2.1.

Test Group Reference (TGR): TGR\_USIM\_TP102.221\_TP\_TL\_TAPDU1

Test Procedure Reference (TPR): TPR\_USIM\_TP102.221\_TP\_TL\_TAPDU1\_C1

#### 6.4.3.2.1.3 Test purpose

To verify that, under normal or abnormal processing of a case 1 command, the UICC returns status only.

#### 6.4.3.2.1.4 Method of test

##### Initial conditions

- 1) The UICC shall be connected to a ME simulator.

##### Test procedure

- a) The ME simulator shall reset the UICC.
- b) The ME simulator shall send a SELECT command to the UICC to select and activate the USIM application.
- c) The ME simulator shall send a VERIFY PIN command with parameter P2 indicating PIN and with an empty data field to the UICC.

*The status condition returned by the UICC shall be SW1 = '63', SW2 = 'CX' - unsuccessful PIN verification, X attempts left [CR1].*

- d) The ME simulator shall send a VERIFY PIN command with an incorrect parameter P2 and with an empty data field to the UICC.

*The status condition returned by the UICC shall be SW1 = '6B', SW2 = '00' - wrong parameter(s) P1-P2, or SW1 = '6A', SW2 = '86' - incorrect parameters P1-P2 [CR1].*

#### 6.4.3.2.2 Case 2

##### 6.4.3.2.2.1 Definition and applicability

It shall be mandatory for all cards complying with TS 102.221 [1] to support all functions described therein.

##### 6.4.3.2.2.2 Conformance requirement

- CR1 C-APDU shall be mapped to the INF of the I-Block and the received response from the INF in the I-Block shall be mapped to R-APDU according to Figure 7.11 in TS 102.221 [1].

Reference: TS 102.221 [1], subclause 7.3.2.2.

Test Group Reference (TGR): TGR\_USIM\_TP102.221\_TP\_TL\_TAPDU1

Test Procedure Reference (TPR): TPR\_USIM\_TP102.221\_TP\_TL\_TAPDU1\_C2

##### 6.4.3.2.2.3 Test purpose

To verify that, under normal processing of a case 2 command, the UICC returns data and status and that, under abnormal processing of a case 2 command, the UICC returns status only.

##### 6.4.3.2.2.4 Method of test

##### Initial conditions

- 1) The UICC shall be connected to a ME simulator.
- 2) EF<sub>LOCI</sub> shall contain the data string: 'A1 A2 A3 A4 A5 A6 A7 A8 A9 00 00'.

##### Test procedure



- a) The ME simulator shall reset the UICC.
- b) The ME simulator shall send a SELECT command to the UICC to select and activate the USIM application.
- c) The ME simulator shall send a SELECT command to the UICC to select EF<sub>LOCAL</sub>.
- d) The ME simulator shall send a VERIFY PIN command with PIN to the UICC.
- e) The ME simulator shall send a READ BINARY command using a length of 11 bytes to the UICC.

*The UICC shall return the data string 'A1 A2 A3 A4 A5 A6 A7 A8 A9 00 00', ending with the status condition SW1 = '90', SW2 = '00' - normal ending of the command [CR1].*

- f) The ME simulator shall send a READ BINARY command with an incorrect P2 parameter and a length of 11 bytes to the UICC.

*The status condition returned by the UICC shall be SW1 = '6B', SW2 = '00' - wrong parameter(s) P1-P2, or SW1 = '6A', SW2 = '86' - incorrect parameters P1-P2 [CR1].*

### 6.4.3.2.3 Case 3

#### 6.4.3.2.3.1 Definition and applicability

It shall be mandatory for all cards complying with TS 102.221 [1] to support all functions described therein.

#### 6.4.3.2.3.2 Conformance requirement

CR1 C-APDU shall be mapped to the INF of the I-Block and the received response from the INF in the I-Block shall be mapped to R-APDU according to Figure 7.12 in TS 102.221 [1].

Reference: TS 102.221 [1], subclause 7.3.2.3.

Test Group Reference (TGR): TGR\_USIM\_TP102.221\_TP\_TL\_TAPDU1

Test Procedure Reference (TPR): TPR\_USIM\_TP102.221\_TP\_TL\_TAPDU1\_C3

#### 6.4.3.2.3.3 Test purpose

To verify that, under normal or abnormal processing of a case 3 command, the UICC returns status only.

#### 6.4.3.2.3.4 Method of test

##### Initial conditions

- 1) The UICC shall be connected to a ME simulator.

##### Test procedure

- a) The ME simulator shall reset the UICC.
- b) The ME simulator shall send a SELECT command to the UICC to select and activate the USIM application.
- c) The ME simulator shall send a SELECT command to the UICC to select EF<sub>LOCAL</sub>.
- d) The ME simulator shall send a VERIFY PIN command with PIN to the UICC.
- e) The ME simulator shall send an UPDATE BINARY command with the data string '11 22 33 44 55 66 77 88 99 00 11' to the UICC.

*The status condition returned by the UICC shall be SW1 = '90', SW2 = '00' - normal ending of the command [CR1].*

- f) The ME simulator shall send an UPDATE BINARY command header with an incorrect P2 parameter and the data string '11 22 33 44 55 66 77 88 99 00 11' to the UICC.

*The status condition returned by the UICC shall be SW1 = '6B', SW2 = '00' - wrong parameter(s) P1-P2, or SW1 = '6A', SW2 = '86' - incorrect parameters P1-P2 [CRI].*

- g) The ME simulator shall send an UPDATE BINARY command with the data 'A1 A2 A3 A4 A5 A6 A7 A8 A9 00 00' to the UICC.

#### 6.4.3.2.4 Case 4

##### 6.4.3.2.4.1 Definition and applicability

It shall be mandatory for all cards complying with TS 102.221 [1] to support all functions described therein.

##### 6.4.3.2.4.2 Conformance requirement

- CR1 C-APDU shall be mapped to the INF of the I-Block and the received response from the INF in the I-Block shall be mapped to R-APDU according to Figure 7.13 in TS 102.221 [1].

Reference: TS 102.221 [1], subclause 7.3.2.4.

Test Group Reference (TGR): TGR\_USIM\_TP102.221\_TP\_TL\_TAPDU1

Test Procedure Reference (TPR): TPR\_USIM\_TP102.221\_TP\_TL\_TAPDU1\_C4

##### 6.4.3.2.4.3 Test purpose

To verify that, under normal processing of a case 4 command, the UICC returns data and status and that, under abnormal processing of a case 4 command, the UICC returns status only.

##### 6.4.3.2.4.4 Method of test

#### Initial conditions

- 1) The UICC shall be connected to a ME simulator.

#### Test procedure

- a) The ME simulator shall reset the UICC.
- b) The ME simulator shall send a SELECT command to the UICC to select and activate the USIM application.
- c) The ME simulator shall send a SELECT command with P2 = '04' to the UICC to select EF<sub>IMSI</sub>.

*The UICC shall return the FCP of the EF<sub>IMSI</sub> together with the status condition SW1 = '90', SW2 = '00' - normal ending of the command [CRI].*

- d) The ME simulator shall send a SELECT command with incorrect P1 parameter and P2 = '04' to the UICC to select EF<sub>LOCI</sub>

*The status condition returned by the UICC shall be SW1 = '6B', SW2 = '00' - wrong parameter(s) P1-P2, or SW1 = '6A', SW2 = '86' - incorrect parameters P1-P2 [CRI].*

## 6.4.4 Application Layer

### 6.4.4.1 Definition and applicability

It shall be mandatory for all cards complying with TS 102.221 [1] to support all functions described therein.

### 6.4.4.2 Conformance requirement

- CR1 Each step in an application layer exchange consists of a command-response pair, where the Application Layer of the ME sends a command to the UICC via the Transport Layer of the ME, and the UICC processes

it and sends a response to Application Layer of ME using the Transport Layer of the UICC and the Transport Layer of ME.

CR2 Four cases shall be managed by the transmission protocols via the transport layer.

Reference: TS 102.221 [1], subclause 7.4.

Test Group Reference (TGR): TGR\_USIM\_TP102.221\_TP\_AL

Test Procedure Reference (TPR): TPR\_USIM\_TP102.221\_TP\_AL

### 6.4.4.3 Test purpose

To verify that the Physical Layer function conforms to the above requirements.

NOTE: CR1 and CR2 are tested for each UICC commands described in subclause 6.8.

### 6.4.4.4 Method of test

#### Initial conditions

N/A

#### Test procedure

N/A

## 6.5 Application and File structure

The tests in this subclause ensure that the IUT is tested against the specification of the logical structure, for a UICC, the code associated with it, and the structure of the files used.

### 6.5.1 UICC Application structure

#### 6.5.1.1 Definition and applicability

EF<sub>DIR</sub> provides the information of the application structure on the UICC in terms of application identifier(s). These application identifier(s) are used to select the relevant application.

#### 6.5.1.2 Conformance requirement

- CR1 The UICC shall contain EF<sub>DIR</sub> under MF.
- CR2 EF<sub>DIR</sub> shall contain application identifier(s) available on the UICC.
- CR3 The UICC shall contain EF<sub>PL</sub> under MF.
- CR4 The UICC shall contain EF<sub>ICCID</sub> under MF.
- CR5 The UICC shall contain DF<sub>TELECOM</sub> and the file identifier shall be '7F 10' (optional).

Reference: TS 102.221 [1], subclause 8.1.

Test Group Reference (TGR): TGR\_USIM\_TP102.221\_AFS\_UAS

Test Procedure Reference (TPR): TPR\_USIM\_TP102.221\_AFS\_UAS

#### 6.5.1.3 Test purpose

To verify that the Elementary Files within the UICC application structure conform to the above requirements.

## 6.5.1.4 Method of test

### Initial conditions

- 1) The UICC shall be connected to a ME simulator.

### Test procedure

- a) The ME simulator shall reset the UICC.
- b) The ME simulator shall send a SELECT command to the UICC to select EF<sub>DIR</sub>.

*The status condition returned by the UICC shall be SW1 = '90', SW2 = '00' – normal ending of the command [CR1].*

- c) The ME simulator shall send a READ RECORD command to read record 1 of the EF<sub>DIR</sub>. The length used shall be that of bytes 5 and 6 in TLV DO with tag '82' of the response data in step b).
- d) The ME simulator shall send a SELECT command to the UICC to select and activate the ADF stated in EF<sub>DIR</sub> of record 1.

*The status condition returned by the UICC shall be SW1 = '90', SW2 = '00' – normal ending of the command [CR2].*

- e) The ME simulator shall reset the UICC.
- f) The ME simulator shall send a SELECT command to the UICC to select EF<sub>PL</sub>.

*The status condition returned by the UICC shall be SW1 = '90', SW2 = '00' – normal ending of the command [CR3].*

- g) The ME simulator shall send a SELECT command to the UICC to select EF<sub>ICCID</sub>.

*The status condition returned by the UICC shall be SW1 = '90', SW2 = '00' – normal ending of the command [CR4].*

- h) The ME simulator shall send a SELECT command to the UICC to select DF<sub>TELECOM</sub>.

*The status condition returned by the UICC shall be SW1 = '90', SW2 = '00' – normal ending of the command, if the UICC supports DF<sub>TELECOM</sub>, otherwise the status condition returned by the UICC shall be SW1 = '6A', SW2 = '82' – file ID not found [CR5].*

## 6.5.2 File types

### 6.5.2.1 Dedicated files

#### 6.5.2.1.1 Definition and applicability

Dedicated Files provide a functional grouping of Elementary Files. In this way a structured hierarchy of files can be established on the UICC.

#### 6.5.2.1.2 Conformance requirement

CR1 DFs shall be referenced by file identifiers.

CR2 The Application DF (ADF) shall be a particular DF containing all the DFs and EFs of the application.

Reference: TS 102.221 [1], subclause 8.2.1.

Test Group Reference (TGR): TGR\_USIM\_TP102.221\_AFS\_FT\_DF

Test Procedure Reference (TPR): TPR\_USIM\_TP102.221\_AFS\_FT\_DF

### 6.5.2.1.3 Test purpose

To verify that the Dedicated Files within the UICC file structure conform to the above requirements.

NOTE: CR1 and CR2 shall not be tested as the SELECT function requires the file ID in order to select the files.

### 6.5.2.1.4 Method of test

#### Initial conditions

N/A

#### Test procedure

N/A

## 6.5.2.2 Elementary files

Elementary File structures the way in which information is held on the UICC and provides security on how this information is accessed.

### 6.5.2.2.1 Transparent EF

#### 6.5.2.2.1.1 Definition and applicability

Transparent Elementary Files structure the way in which information is held in a sequence of bytes format on the UICC and provide means on how this information is accessed.

#### 6.5.2.2.1.2 Conformance requirement

CR1 The first byte of a transparent EF has the relative address '00 00'.

CR2 The total data length of the body of an EF with transparent structure shall be indicated in the SELECT response of the EF.

Reference: TS 102.221 [1], subclause 8.2.2.1.

Test Group Reference (TGR): TGR\_USIM\_TP102.221\_AFS\_FT\_EF\_TF

Test Procedure Reference (TPR): TPR\_USIM\_TP102.221\_AFS\_FT\_EF\_TF

#### 6.5.2.2.1.3 Test purpose

To verify that the EFs within the UICC file structure conform to the above requirements.

#### 6.5.2.2.1.4 Method of test

##### Initial conditions

- 1) The UICC shall be connected to a ME simulator.

##### Test procedure

- a) The ME simulator shall reset the UICC.
- b) The ME simulator shall send a SELECT command to the UICC to select and activate USIM application.
- c) The ME simulator shall send a SELECT command to the UICC to select EF<sub>UST</sub>.
- d) The ME simulator shall fulfil the READ access condition of the EF<sub>UST</sub>.
- e) The ME simulator shall send a READ BINARY command to the UICC. The length used shall be the TLV DO with tag '80' of the response data in step c).

*The status condition returned by the UICC shall be SW1 = '90', SW2 = '00' - normal ending of the command [CR2].*

- f) The ME simulator shall send a READ BINARY command with offset '00 01' to the UICC. The length used shall be the TLV DO with tag '80' of the response data in step c) minus 1.

*The length of data returned shall be Le and the status condition returned by the UICC shall be SW1 = '90', SW2 = '00' - normal ending of the command [CR1].*

- g) The ME simulator shall send a READ BINARY command with offset '00 01' to the UICC. The length used shall be the TLV DO with tag '80' of the response data in step c).

*When T = 0 protocol is used:*

*The UICC shall return procedure bytes '6C Le-1'; or status indicating a warning or error condition (but not SW1 SW2 = '90 00').*

*When T = 1 protocol is used:*

*The length of data returned shall be Le minus 1 and the status condition returned by the UICC shall be SW1 = '62', SW2 = '82' – end of file/record reached before reading Le bytes [CR1, CR2].*

### 6.5.2.2.2 Linear fixed EF

#### 6.5.2.2.2.1 Definition and applicability

Linear fixed Elementary Files structure the way in which information is held in a sequence of the same length of record format on the UICC and provide means on how this information is accessed.

#### 6.5.2.2.2.2 Conformance requirement

- CR1 A linear fixed EF consists of a sequence of records all having the same (fixed) length.
- CR2 The first record shall be record number 1.
- CR3 The length of a record shall be indicated in the SELECT response of the EF.
- CR4 The length of a record multiplied by the number of records shall be indicated in the SELECT response of the EF.
- CR5 The UICC shall be able to access records within a linear fixed EF using all of the following:
- absolutely using the record number;
  - when the record pointer is not set, it shall be possible to perform an action on the first or the last record by using the NEXT or PREVIOUS mode;
  - when the record pointer is set it shall be possible to perform an action on this record, the next record (unless the record pointer is set to the last record) or the previous record (unless the record pointer is set to the first record);
  - by identifying a record using pattern search.
- CR6 If an action following selection of a record is aborted (e.g. due to an unsuccessful execution of a command), then the record pointer shall remain set at the record at which it was set prior to the action.

Reference: TS 102.221 [1], subclause 8.2.2.2.

Test Group Reference (TGR): TGR\_USIM\_TP102.221\_AFS\_FT\_EF\_LF

Test Procedure Reference (TPR): TPR\_USIM\_TP102.221\_AFS\_FT\_EF\_LF

#### 6.5.2.2.2.3 Test purpose

To verify that the EFs within the UICC file structure conform to the above requirements.

NOTE: CR5 and CR6 are tested in subclause 6.8.1.

#### 6.5.2.2.2.4 Method of test

##### Initial conditions

- 1) The UICC shall be connected to a ME simulator.
- 2) The records in EF<sub>FDN</sub> shall contain the following data for the first 10 bytes:
 

<b>1st record</b>	'A0 A1 A2 B0 B1 B2 A0 A1 A2 A0'
<b>2nd record</b>	'B0 B1 B2 A0 A1 A2 A0 A1 A2 B0'
<b>3rd record</b>	'B0 B1 B2 A0 A1 A2 B0 B1 B2 A0'
<b>4th record</b>	'A0 A1 A2 B0 B1 B2 B0 B1 B2 B0'
- 3) The data for the remainder of these four records and for all other records (if any) shall be 'FF'.

##### Test procedure

- a) The ME simulator shall reset the UICC.
- b) The ME simulator shall send a SELECT command to the UICC to select and activate USIM application.
- c) The ME simulator shall send a VERIFY PIN command with PIN to the UICC.
- d) The ME simulator shall send a SELECT command to the UICC to select EF<sub>FDN</sub>.

*Following shall be true for the SELECT response data:*

- *the value of TLV DO with tag '80' shall be equal to product of byte 6 and byte 7 in TLV DO with tag '82' [CR4].*
- e) The ME simulator shall send a READ RECORD command to the UICC using ABSOLUTE mode with record 1 and Le shall be the record length as indicated in byte 6 in TLV DO with tag '82' of the response data in step d).

*The data returned by the UICC shall be that of the first record [CR2].*

*The length of the data returned shall be that of byte 6 in TLV DO with tag '82' of the response data in step d) [CR3].*

*The status condition returned by the UICC shall be SW1='90', SW2='00' - normal ending of the command.*

- f) The ME simulator shall repeat sending a READ RECORD command to the UICC using NEXT mode with Le being the record length as indicated in byte 6 in TLV DO with tag '82' of the response data in step d) until it reaches the last record whose record number is equal to the byte 7 in TLV DO with tag '82' of the response data in step d).

*The length of the data returned in response to every READ RECORD command shall be that of byte 6 in TLV DO with tag '82' of the response data in step d) [CR1, CR3].*

*The status condition returned by the UICC in response to every READ RECORD command shall be SW1='90', SW2='00' - normal ending of the command.*

- g) The ME simulator shall send a READ RECORD command to the UICC using NEXT mode with Le being the record length as indicated in byte 6 in TLV DO with tag '82' of the response data in step d).

*The UICC shall return an error code appropriate to the command (e.g. SW1='6A', SW2='83' - record not found) [CR4]*

NOTE: Step g) confirms that the number of records indicated in byte 7 in the TLV DO with tag '82' of the response data is correct.

### 6.5.2.2.3 Cyclic EF

#### 6.5.2.2.3.1 Definition and applicability

Cyclic Elementary Files structure the way in which information is held in a record format with chronological order on the UICC and provide means on how this information is accessed.

#### 6.5.2.2.3.2 Conformance requirement

- CR1 An EF with a cyclic structure consists of a fixed number of records with the same (fixed) length.
- CR2 In this file structure there shall be a link between the last record (n) and the first record.
- CR3 When the record pointer is set to the last record n, then the next record shall be record number 1.
- CR4 When the record pointer is set to record 1, then the previous record shall be record number n.
- CR5 The last updated record containing the newest data shall be record number 1, and the oldest data shall be held in record number n.
- CR6 For update operations only PREVIOUS record shall be used.
- CR7 For reading operations, the methods of addressing shall be Next, Previous, Current and Record Number.
- CR8 If an action following selection of a record is aborted (e.g. due to an unsuccessful execution of a command), then the record pointer shall remain set at the record at which it was set prior to the action.

Reference: TS 102.221 [1], subclause 8.2.2.3.

Test Group Reference (TGR): TGR\_USIM\_TP102.221\_AFS\_FT\_EF\_CF

Test Procedure Reference (TPR): TPR\_USIM\_TP102.221\_AFS\_FT\_EF\_CF

#### 6.5.2.2.3.3 Test purpose

To verify that the EFs within the UICC file structure conform to the above requirements.

NOTE: CR8 are tested in subclause 6.8.1.

#### 6.5.2.2.3.4 Method of test

NOTE: When EF<sub>ICI</sub> is not supported by the UICC, any supported cyclic EF in ADF<sub>USIM</sub> may be chosen.

#### Initial conditions

- 1) The UICC shall be connected to a ME simulator.
- 2) EF<sub>ICI</sub> shall have at least 4 records.
- 3) The records in EF<sub>ICI</sub> shall contain the following data:

1 <sup>st</sup> record	'01' for all bytes
2 <sup>nd</sup> record	'02' for all bytes
3 <sup>rd</sup> record	'03' for all bytes
x <sup>th</sup> record	byte value X for all bytes

#### Test procedure

- a) The ME simulator shall reset the UICC.
- b) The ME simulator shall send a SELECT command to the UICC to select and activate USIM application.
- c) The ME simulator shall send a VERIFY PIN command with PIN to the UICC.
- d) The ME simulator shall send a SELECT command to the UICC to select EF<sub>ICI</sub>.



- e) The ME simulator shall send a READ RECORD command using NEXT mode to the UICC. The length used shall be that of bytes 5 and 6 in TLV DO with tag '82' of the response data in step d).

*The response data shall be the data in the first record [CR1].*

- f) The ME simulator shall send a READ RECORD command using PREVIOUS mode to the UICC. The record length used shall be that of bytes 5 and 6 in TLV DO with tag '82' of the response data in step d).

*The response data shall be the data in the last record [CR1, CR4].*

- g) The ME simulator shall send a READ RECORD command using NEXT mode to the UICC. The record length used shall be that of bytes 5 and 6 in TLV DO with tag '82' of the response data in step d).

*The response data shall be the data in the first record [CR2, CR3, CR4, CR7].*

- h) The ME simulator shall send a READ RECORD command using PREVIOUS mode to the UICC. The record length used shall be that of bytes 5 and 6 in TLV DO with tag '82' of the response data in step d).

*The response data shall be the data in the last record [CR4, CR7].*

- i) The ME simulator shall send an UPDATE RECORD command using PREVIOUS mode to the UICC with 'FF' for all the bytes. The record length used shall be that of bytes 5 and 6 in TLV DO with tag '82' of the response data in step d) [CR5].

- j) The ME simulator shall send a READ RECORD command using ABSOLUTE mode with record 1 to the UICC. The length used shall be that of bytes 5 and 6 in TLV DO with tag '82' of the response data in step d).

*The response data shall be the new data that has been updated in step i) [CR5].*

- k) The ME simulator shall send a READ RECORD command using PREVIOUS mode to the UICC. The length used shall be that of bytes 5 and 6 in TLV DO with tag '82' of the response data in step d).

*The response data shall be the previous data in the second last record [CR5].*

- l) The ME simulator shall send an UPDATE RECORD command using ABSOLUTE mode with record 1 to the UICC with 'FF' for all the bytes. The length used shall be that of bytes 5 and 6 in TLV DO with tag '82' of the response data in step d).

*The UICC shall return an error code appropriate to the command (e.g. SW1='69', SW2='81' – command incompatible with file structure) [CR6].*

- m) The ME simulator shall send an UPDATE RECORD command using CURRENT mode to the UICC with 'FF' for all the bytes. The length used shall be that of bytes 5 and 6 in TLV DO with tag '82' of the response data in step d).

*The UICC shall return an error code appropriate to the command (e.g. SW1='69', SW2='81' – command incompatible with file structure) [CR6].*

- n) The ME simulator shall send an UPDATE RECORD command using NEXT mode to the UICC with 'FF' for all the bytes. The length used shall be that of bytes 5 and 6 in TLV DO with tag '82' of the response data in step d).

*The UICC shall return an error code appropriate to the command (e.g. SW1='69', SW2='81' – command incompatible with file structure) [CR6].*

## 6.5.3 File referencing

### 6.5.3.1 Definition and applicability

A file identifier is used to identify each specific file. There are a number of rules regarding file ID assignment.

### 6.5.3.2 Conformance requirement

CR1 A file ID shall be assigned at the time of creation of the file concerned.

- CR2 Two files under the same parent shall never have the same ID.
- CR3 The immediate children of the current DF, the parent DF or the immediate children of the parent DF shall not have the same FID.
- CR4 No two files under the same parent shall have the same SFI.
- CR5 The DF name shall be unique within a card.

Reference: TS 102.221 [1], subclause 8.3.

Test Group Reference (TGR): TGR\_USIM\_TP102.221\_AFS\_FR

Test Procedure Reference (TPR): TPR\_USIM\_TP102.221\_AFS\_FR

### 6.5.3.3 Test purpose

To verify that all files within the UICC structure conform to the above requirements.

NOTE 1: CR1 shall not be tested as the SELECT function requires the file ID in order to select files.

NOTE 2: CR2, CR3 and CR5 shall not be tested due to the operation of the SELECT function which should only ever select a single file for a given file ID.

NOTE 3: CR4 shall not be tested due to the operation of commands which supports SFI referencing, they should only ever select a single file for a given SFI.

### 6.5.3.4 Method of test

#### Initial conditions

N/A

#### Test procedure

N/A

## 6.5.4 Methods for selecting a file

### 6.5.4.1 SELECT by File Identifier Referencing

#### 6.5.4.1.1 Definition and applicability

The ME accesses information on the UICC navigating around the file structure by selecting ADFs, DFs and EFs as required. There are a number of rules regarding which file elements may be selected from a given ADF, DF or EF.

#### 6.5.4.1.2 Conformance requirement

- CR1 Selection of an ADF, DF or MF shall set the current Directory on the UICC.
- CR2 After a selection of an ADF, DF or MF, there shall be no current EF.
- CR3 After a selection of an EF, the current EF shall be set to this EF and the current Directory shall remain the ADF, DF or MF which is the parent of this EF.
- CR4 Any application specific command shall only be operable if it is specific to the current Directory.
- CR5 It shall be possible to select the following from the last selected file:
  - a) any file which is an immediate child of the current Directory;
  - b) any DF which is an immediate child of the parent of the current DF;
  - c) the parent of the current Directory;

- d) the current DF or ADF;
- e) the MF.

NOTE: Reselection of the last selected file shall be allowed.

CR6 It shall be possible to select any of the 'valid selections' in Table 8.1, subclause 8.4.1 of TS 102.221 [1] for each of the 'last selected file' entries.

Reference: TS 102.221 [1], subclause 8.4.1.

Test Group Reference (TGR): TGR\_USIM\_TP102.221\_AFS\_MSF\_SFIR

Test Procedure Reference (TPR): TPR\_USIM\_TP102.221\_AFS\_MSF\_SFIR

#### 6.5.4.1.3 Test purpose

To verify that the UICC conforms to the above requirements with regard to file selection by File Identifier Referencing.

NOTE 1: CR4 shall not be tested as it is outside the scope of the present document.

#### 6.5.4.1.4 Method of test

##### Initial conditions

- 1) The UICC shall be connected to a ME simulator.

##### Test procedure

- a) The ME simulator shall reset the UICC.
- b) The ME simulator shall send a SELECT command to the UICC to select and activate USIM application.
- c) The ME simulator shall send a STATUS command to the UICC.

*if a TLV DO with tag '83' is present, then the response data shall indicate that  $ADF_{USIM}$  is the currently selected directory [CR1].*

- d) The ME simulator shall send a READ BINARY command using a length of 1 byte to the UICC.

*The status condition returned by the UICC shall be  $SW1 = '69'$ ,  $SW2 = '86'$  – command not allowed (no EF selected) [CR2].*

- e) The ME simulator shall send a SELECT command to the UICC to select  $EF_{AD}$ .

*TLV DO with tag '83' of the response data shall indicate that  $EF_{AD}$  is the currently selected EF [CR3].*

- f) The ME simulator shall send a STATUS command to the UICC.

*If a TLV DO with tag '83' is present, then the response data shall indicate that  $ADF_{USIM}$  is the currently selected directory [CR3].*

- g) Step h) shall be carried out for each line in Table 8.1, subclause 8.4.1 of TS 102.221 [1] for which a file is defined in Table 3.

- h) Step i) shall be carried out for each one of the 'valid selections' in that line of the table.

- i) Steps j) and then k) shall be carried out in turn.

- j) The ME simulator shall send a SELECT command to the UICC to select the 'last selected file'.

- k) The ME simulator shall send a SELECT command to the UICC to select the 'valid selection'.

*The status condition returned by the UICC shall be  $SW1 = '90'$ ,  $SW2 = '00'$  – normal ending of the command [CR6, CR7].*

- l) The following file IDs shall be used to represent the IDs in the table:

**Table 3: Actual File Selection**

Table	Actual
MF	MF
ADF1	ADF <sub>USIM</sub>
DF1	DF <sub>TELECOM</sub>
DF4	DF <sub>PHONEBOOK</sub>
EF1	EF <sub>ICCID</sub>
EF2	EF <sub>ADN</sub>
EF3	EF <sub>AD</sub>
EF5	EF <sub>PBR</sub>

NOTE 1: When EF<sub>ADN</sub> is not supported by the UICC, any supported EF in DF<sub>TELECOM</sub> may be chosen.

NOTE 2: When EF<sub>PBR</sub> is not supported by the UICC, any supported EF in DF<sub>PHONEBOOK</sub> may be chosen.

## 6.5.4.2 SELECT by Path Referencing

### 6.5.4.2.1 Definition and applicability

The ME accesses information on the UICC navigating around the file structure by selecting DFs and EFs as required. There are a number of rules regarding which file elements may be selected from a given DF or EF.

### 6.5.4.2.2 Conformance requirement

CR1 It shall be possible to select any of the 'valid selections' in Table 8.2, subclause 8.4.2 of TS 102.221 [1] for each of the 'last selected file' entries, assuming the current ADF has been previously selected.

Reference: TS 102.221 [1], subclause 8.4.2.

Test Group Reference (TGR): TGR\_USIM\_TP102.221\_AFS\_MSF\_SPR

Test Procedure Reference (TPR): TPR\_USIM\_TP102.221\_AFS\_MSF\_SPR

### 6.5.4.2.3 Test purpose

To verify that the UICC conforms to the above requirements with regard to file selection by path referencing.

### 6.5.4.2.4 Method of test

#### Initial conditions

- 1) The UICC shall be connected to a ME simulator.

#### Test procedure

- a) The ME simulator shall reset the UICC.
- b) Step c) shall be carried out for each line in Table 8.2, subclause 8.4.2 of TS 102.221 [1] for which a file is defined in Table 3.
- c) Step d) shall be carried out for each one of the 'example selections' in that line of the table.
- d) Steps e) and then f) shall be carried out in turn.
- e) The ME simulator shall send a SELECT command to the UICC to select the 'last selected DF'.
- f) The ME simulator shall send a SELECT command to the UICC to select the 'example selections'.

*The status condition returned by the UICC shall be SW1 = '90', SW2 = '00' – normal ending of the command [CR2].*

### 6.5.4.3 Short File Identifier

#### 6.5.4.3.1 Definition and applicability

Any EF within a DF can be implicitly selected without giving a SELECT command by applying one of the following commands at the DF or ADF level and giving a Short File Identifier (SFI) as a part of the command:

#### 6.5.4.3.2 Conformance requirement

CR1 It shall be possible to use to the following commands.

- a) READ RECORD;
- b) UPDATE RECORD;
- c) READ BINARY;
- d) UPDATE BINARY;
- e) INCREASE;
- f) SEARCH RECORD.

CR2 SFI shall be found in the TLV DO with tag '88'.

CR3 If the length of the TLV DO with tag '88' is 0, it indicates that the file does not support referencing by SFI.

CR4 If TLV DO is absent, the least significant 5 bits of the file identifier shall be used as SFI.

CR5 SFI shall not be used in a path as file identifier.

CR6 When the READ RECORD command contains a valid SFI, it shall set the file as the current EF and reset the current record pointer. Subsequent records are read with the READ RECORD command without SFI.

CR7 When the UPDATE RECORD command contains a valid SFI, it shall set the file as the current EF and reset the current record pointer. Subsequent records are updated with the UPDATE RECORD command without SFI.

CR8 When the INCREASE command contains a valid SFI, it shall set the file as the current EF and reset the current record pointer. Subsequent records are increased with the INCREASE command without SFI.

CR9 When the SEARCH RECORD command contains a valid SFI, it shall set the file as the current EF and reset the current record pointer. Subsequent records are searched with the SEARCH RECORD command without SFI.

Reference: TS 102.221 [1], subclause 8.4.3.

Test Group Reference (TGR): TGR\_USIM\_TP102.221\_AFS\_MSF\_SFI

Test Procedure Reference (TPR): TPR\_USIM\_TP102.221\_AFS\_MSF\_SFI

#### 6.5.4.3.3 Test purpose

To verify that the UICC conforms to the above requirements with regard to selection by short file identifier.

NOTE 1: CR3 shall not be tested as it requires information on the files which do not support SFI.

NOTE 2: CR4 shall not be tested as it requires information on the file ID.

NOTE 3: CR1, CR6, CR7, CR8 and CR9 are tested in subclause 6.8.1.

#### 6.5.4.3.4 Method of test

##### **Initial conditions**

- 1) The UICC shall be connected to a ME simulator.

#### Test procedure

- a) The ME simulator shall reset the UICC.
- b) The ME simulator shall send a SELECT command to the UICC to select and activate USIM application.
- c) The ME simulator shall send a SELECT command to the UICC to select  $EF_{IMSI}$ .  
*TLV DO with tag '88' of the response data shall indicate the SFI of the  $EF_{IMSI}$  [CR2].*
- d) The ME simulator shall send a SELECT command to the UICC to select and activate USIM application.
- e) The ME simulator shall send a SELECT command to the UICC to select  $EF_{IMSI}$  with using the SFI in the path.  
*The UICC shall return an error code appropriate to the command [CR5].*

## 6.5.5 Application characteristic

### 6.5.5.1 Explicit Application selection

#### 6.5.5.1.1 SELECT by DF Name

##### 6.5.5.1.1.1 Definition and applicability

An application can be selected either explicitly or implicitly referenced. An application shall be explicitly referenced by selecting it with the AID.

##### 6.5.5.1.1.2 Conformance requirement

- CR1 A selectable application shall be referenced by a DF name coded on 1 to 16 bytes.
- CR2 Each name shall be unique within a UICC.
- CR3 A DF name can be used in the SELECT command to select a selectable application.

Reference: TS 102.221 [1], subclause 8.5.1.1.

Test Group Reference (TGR): TGR\_USIM\_TP102.221\_AFS\_AC\_EAS

Test Procedure Reference (TPR): TPR\_USIM\_TP102.221\_AFS\_AC\_EAS

##### 6.5.5.1.1.3 Test purpose

To verify that the UICC conforms to the above requirements.

NOTE: CR3 is tested in the subclause 6.5.5.1.

##### 6.5.5.1.1.4 Method of test

#### Initial conditions

- 1) The UICC shall be connected to a ME simulator.

#### Test procedure

- a) The ME simulator shall reset the UICC.
- b) The ME simulator shall send a SELECT command to the UICC to select  $EF_{DIR}$ .
- c) The ME simulator shall send a READ RECORD command with NEXT mode to the UICC.  
*The length of the TLV DO with tag '4F' in the response data shall not exceed 16 bytes [CR1].*

*The TLV DO with tag '4F' in the response data shall not be same with any other TLV DO with tag '4F' of the other records [CR2].*

- d) Step c) shall be repeated until it reaches the end of file.
- e) Following steps f) and g) shall be repeated for each AIDs read in the step c).
- f) The ME simulator shall reset the UICC.
- g) The ME simulator shall send a SELECT command with AID to the UICC to select and activate the ADF.

*The status condition returned by the UICC shall be SW1 = '90', SW2 = '00' – normal ending of the command.*

*The FCP shall contain the following [CR3]:*

- TLV DO with tag 82 shall be '38' or '78'(File Descriptor);
- TLV DO with tag 84 shall be the AID of the UICC (DF name – AID).

### 6.5.5.1.2 SELECT by partial DF Name

#### 6.5.5.1.2.1 Definition and applicability

An application can be selected either explicitly or implicitly referenced. An application shall be explicitly referenced by selecting it with the partial AID.

#### 6.5.5.1.2.2 Conformance requirement

- CR1 A selectable application shall be able to be selected by a partial DF name using the P2 parameters first and only occurrence, next, previous or last.
- CR2 DF name shall be right truncated.
- CR3 If P2 indicates the "last" option, the last active application shall be selected even if it was a previous card-session.
- CR4 Selection of an application by a partial DF name shall be optional for mono application cards.
- CR5 Selection of an application by a partial DF name shall be supported for multi-application cards.
- CR6 The support of this feature shall be indicated in the 'card service data' and 'card capabilities' compact-TLV objects of the ATR historical bytes.

Reference: TS 102.221 [1], subclause 8.5.1.2.

Test Group Reference (TGR): TGR\_USIM\_TP102.221\_AFS\_AC\_EAS

Test Procedure Reference (TPR): TPR\_USIM\_TP102.221\_AFS\_AC\_EAS

#### 6.5.5.1.2.3 Test purpose

To verify that the UICC conforms to the above requirements.

NOTE: Selection by Partial DF name shall not be tested as it requires the interpretation of the next, previous and first occurrence.

#### 6.5.5.1.2.4 Method of test

##### Initial conditions

- 1) The UICC shall be connected to a ME simulator.

##### Test procedure

- a) The ME simulator shall reset the UICC.

- b) The ME simulator shall send a SELECT command to select and activate the USIM application.
- c) The ME simulator shall reset the UICC.
- d) The ME simulator shall send a SELECT command with partial DF name of an USIM application and P2 indicating "last occurrence" option to select and activate the last selected application.

*The UICC shall return the response indicating the USIM application is selected [CR3].*

## 6.5.5.2 Application session activation

### 6.5.5.2.1 Definition and applicability

An application session can be activated by activation procedure after the selection of the application.

### 6.5.5.2.2 Conformance requirement

CR1 The application session is initiated when the ME sends a SELECT command, with the application's AID, indicating in the command parameters that the application shall be activated.

CR2 There shall be only one active session on a given logical channel.

Reference: TS 102.221 [1], subclause 8.5.2.

Test Group Reference (TGR): TGR\_USIM\_TP102.221\_AFS\_AC\_ASA

Test Procedure Reference (TPR): TPR\_USIM\_TP102.221\_AFS\_AC\_ASA

### 6.5.5.2.3 Test purpose

To verify that the UICC conforms to the above requirements.

NOTE: CR2 shall not be tested as it is impossible to investigate the number of applications which are activated in a logical channel.

### 6.5.5.2.4 Method of test

#### **Initial conditions**

- 1) The UICC shall be connected to a ME simulator.

#### **Test procedure**

- a) The ME simulator shall reset the UICC.
- b) The ME simulator shall send a SELECT command with AID to the UICC to select and activate USIM application.

*The status condition returned by the UICC shall be SW1 = '90', SW2 = '00' – normal ending of the command [CR1].*

- c) The ME simulator shall send a STATUS command with P2 = '01' to the UICC.

*The response data shall contain the following [CR1]:*

- TLV DO with tag '84' shall indicate an AID of the USIM application.

## 6.5.5.3 Application session termination

### 6.5.5.3.1 Definition and applicability

An application session can be terminated by termination procedure.



### 6.5.5.3.2 Conformance requirement

- CR1 An application session shall be terminated if one of the following events occur on the same logical channel that the application session has been previously activated on:
- implicitly; if a SELECT by DF<sub>NAME</sub> command with an AID different from the currently active application is performed by the UICC;
  - explicitly; if the application is reselected using the SELECT command indicating in the command parameters that the application shall be terminated;
  - the ME performs a reset of the UICC.

Reference: TS 102.221 [1], subclause 8.5.3.

Test Group Reference (TGR): TGR\_USIM\_TP102.221\_AFS\_AC\_AST

Test Procedure Reference (TPR): TPR\_USIM\_TP102.221\_AFS\_AC\_AST

### 6.5.5.3.3 Test purpose

To verify that the UICC conforms to the above requirements.

### 6.5.5.3.4 Method of test

#### Initial conditions

- The UICC shall be connected to a ME simulator.

#### Test procedure

- The ME simulator shall reset the UICC.
- If no other application than the USIM application exists in the UICC, steps c), d) and e) shall not be carried out.
- The ME simulator shall send a SELECT command with AID to the UICC to select and activate the USIM application.
- The ME simulator shall send a SELECT command with AID to the UICC to select and activate an application different from the selected USIM application.
- The ME simulator shall send a STATUS command with P2 = '01' to the UICC.

*The response data shall contain the following [CR1a]:*

- *TLV DO with tag '84' shall indicate an AID of the selected application different from the selected USIM application in step c).*
- The ME simulator shall send a SELECT command with AID to the UICC to select and activate the USIM application.
  - The ME simulator shall send a SELECT command with AID to the UICC to select and terminate the USIM application.
  - The ME simulator shall send a STATUS command with P2 = '00' to the UICC.

*The response data shall not be that of the USIM application activated in step f) [CR1b].*

- The ME simulator shall send a SELECT command with AID to the UICC to select and activate the USIM application.
- The ME simulator shall send a STATUS command with P2 = '01' to the UICC.

*The response data shall contain the following:*

- *TLV DO with tag '84' is the AID of the USIM application (DF name - AID).*

- k) The ME simulator shall reset the UICC.
- l) The ME simulator shall send a STATUS command with P2='00' to the UICC.

*The response data shall not be that of the USIM application activated in step i) [CR1c].*

#### 6.5.5.4 Application session reset

##### 6.5.5.4.1 Definition and applicability

An application can be reset using the SELECT command.

##### 6.5.5.4.2 Conformance requirement

- CR1 An application shall be reset if the application is reselected using the SELECT command indicating in the command parameters that the application shall be activated.

Reference: TS 102.221 [1], subclause 8.5.4.

Test Group Reference (TGR): TGR\_USIM\_TP102.221\_AFS\_AC\_ASR

Test Procedure Reference (TPR): TPR\_USIM\_TP102.221\_AFS\_AC\_ASR

##### 6.5.5.4.3 Test purpose

To verify that the UICC conforms to the above requirements.

##### 6.5.5.4.4 Method of test

###### Initial conditions

- 1) The UICC shall be connected to a ME simulator.

###### Test procedure

- a) The ME simulator shall reset the UICC.
- b) The ME simulator shall send a SELECT command with AID to the UICC to select and activate the USIM application.
- c) The ME simulator shall send a SELECT command to the UICC with EF<sub>LOCAL</sub>.
- d) The ME simulator shall send a VERIFY PIN command with PIN to the UICC.
- e) The ME simulator shall send a READ BINARY command to the UICC.

*The status condition returned by the UICC shall be SW1 = '90', SW2 = '00' – normal ending of the command.*

- f) The ME simulator shall send a STATUS command with P2 = '01' to the UICC.

*The response data shall contain the following:*

*- TLV DO with tag '84' is the AID of the USIM application (DF name - AID).*

- g) The ME simulator shall send a SELECT command with AID to the UICC to select and activate the USIM application.

*The status condition returned by the USIM shall be SW1 = '90', SW2 = '00' [CR1].*

#### 6.5.5.5 GSM/USIM application interaction and restrictions

##### 6.5.5.5.1 Definition and applicability

Interaction between a GSM session and a USIM session shall be done through the activation procedure.

#### 6.5.5.5.2 Conformance requirement

- CR1 Activation of a USIM session shall exclude the activation of a GSM session.
- CR2 Once a USIM application session has been activated, commands sent to the UICC with CLA byte set to 'A0' shall return SW1SW2 '6E 00' (class not supported) to the ME.
- CR3 Activation of a GSM session shall exclude the activation of a USIM session.

Reference: TS 102.221 [1], subclause 8.5.5.

Test Group Reference (TGR): TGR\_USIM\_TP102.221\_AFS\_AC\_GUAIR

Test Procedure Reference (TPR): TPR\_USIM\_TP102.221\_AFS\_AC\_GUAIR

#### 6.5.5.5.3 Test purpose

To verify that the UICC conforms to the above requirements.

NOTE: CR3 is not tested as it is out of the scope of the present document.

#### 6.5.5.5.4 Method of test

##### Initial conditions

- 1) The UICC shall be connected to a ME simulator.

##### Test procedure

- a) The ME simulator shall reset the UICC.
- b) The ME simulator shall send a SELECT command to the UICC to select and activate USIM application.
- c) The ME simulator shall send a STATUS command with 'A0' as the class byte.

*The status condition returned by the UICC shall be SW1 = '6E', SW2 = '00' – class not supported [CR1, CR2].*

- d) The ME simulator shall send a STATUS command with '80' as the class byte.

*The status condition returned by the UICC shall be SW1 = '90', SW2 = '00' – normal ending of a command [CR1].*

### 6.5.6 Reservation of file IDs

#### 6.5.6.1 Definition and applicability

In order to accommodate planned and possible future requirements, certain file IDs are considered reserved, and shall not be used in a UICC file structure.

#### 6.5.6.2 Conformance requirement

- CR1 The following Application Dedicated File IDs shall be reserved for operational use by UICC:  
'7F FF'.
- CR2 The following Dedicated File IDs shall be reserved for operational use by UICC:  
'5F50', '5F3A', '7F 10', '7F 2X', '7F 80' and '7F 90'.
- CR3 The following Elementary File IDs shall be reserved for operational use by UICC:  
'6F 2X', '6F 3X', '6F 4X' in '7F 10' and '7F 2X';  
'4F YX', where Y ranges from '2' to 'F' in all 2<sup>nd</sup> level DFs;

'2F05', '2F06' and '2F 1X' in the MF '3F 00';

'2F00', '2F01' in the MF '3F00'.

CR4 The following Dedicated File IDs shall be reserved for administrative use by UICC:

'7F 4X', '5F1X' and '5F2X'.

CR5 The following Elementary File IDs shall be reserved for administrative use by UICC:

'6F XX' in the DFs '7F 4X'; '4F XX' in the DFs '5F 1X', '5F2X';

'6F 1X' in the DFs '7F 10', '7F 20', '7F 21';

'4F 1X' in all 2<sup>nd</sup> level DFs;

'2F EX' in the MF '3F 00'.

Reference: TS 102.221 [1], subclause 8.6.

Test Group Reference (TGR): TGR\_USIM\_TP102.221\_AFS\_RID

Test Procedure Reference (TPR): TPR\_USIM\_TP102.221\_AFS\_RID

### 6.5.6.3 Test purpose

To verify that the UICC conforms to the above requirements.

NOTE: CR4 and CR5 shall not be tested as the administrative functionality is outside the scope of this test specification.

### 6.5.6.4 Method of test

#### Initial conditions

- 1) The UICC shall be connected to a ME simulator.

#### Test procedure

- a) The ME simulator shall reset the UICC.
- b) The ME simulator shall send a SELECT command to the UICC to select and activate USIM application.
- c) The ME simulator shall send a SELECT command using FID '7F FF' to the UICC to select and activate USIM application.

*The response data shall contain the following:*

- *TLV DO with tag '84' is the AID of the UICC (DF name - AID) shall be the same as in step b) [CR1].*
- d) For all possible DFs and EFs on the UICC, the ME simulator shall send a SELECT command to the UICC to select each file in sequence.

*For all successful selections, the ID of the selected file shall be one of those in Figure 4.1 and Figure 4.2, subclause 4.7 of 3G TS 31.102 [3] or shall not be one of those listed as reserved for operational use [CR2, CR3].*

## 6.6 Security features

Two types of UICC are defined in TS 102.221 [1], single verification capable UICC and multi-verification capable UICC. Every application shall conform to the security features defined in TS 102.221 [1].

## 6.6.1 Supported security features

### 6.6.1.1 Definition and applicability

The UICC shall be designed to support single and multi-applications. In the single verification capable UICC, it may have multi-applications. As for the multi-verification capable UICC, it shall only have one application for Release 99 card implementations.

### 6.6.1.2 Conformance requirement

#### For a multi-verification capable UICC

- CR1 The UICC shall support more than one level 1 user verification requirement (PIN).
- CR2 The UICC shall support the use of a universal PIN.
- CR3 The UICC shall have a level 2 user verification requirement (PIN2) on the application level, if assigned.
- CR4 The UICC shall support access rules defined in security attributes indicated in tag '8B' (i.e. referenced to expanded format).

#### For a single verification capable UICC

- CR5 The UICC shall support one level 1 user verification requirement (PIN) as defined in table 9.3 in TS 102.221 [1].
- CR6 The UICC shall have a level 2 user verification requirement (PIN2) on the application level, if assigned.

Reference: TS 102.221 [1], subclause 9.1.

Test Group Reference (TGR): TGR\_USIM\_TP102.221\_SEC1\_SSF

Test Procedure Reference (TPR): TPR\_USIM\_TP102.221\_SEC1\_SSF

### 6.6.1.3 Test purpose

To verify that the UICC conforms to the above requirements.

### 6.6.1.4 Method of test

#### Initial conditions

- 1) The UICC shall be connected to a ME simulator.

#### Test procedure

##### For a multi-verification capable UICC

- a) The ME simulator shall reset the UICC.
- b) The ME simulator shall send a SELECT command to the UICC to select and activate USIM application.

*The following shall be true for PS Template DO (tag 'C6') in the response data:*

- TLV DO with tag '83' shall be '11' (Universal PIN) [CR2];
- TLV DO with tag '83' shall be '01' (PIN Application 1) [CR1];
- TLV DO with tag '83' shall be '81' (Second PIN Application 1) [CR3], if assigned;

*The response data shall also contain TLV DO with tag '8B' [CR4].*

##### For a single verification capable UICC

- a) The ME simulator shall reset the UICC.

b) The ME simulator shall send a SELECT command to the UICC to select and activate USIM application.

*The following shall be true for PS Template DO (tag 'C6') in the response data:*

- TLV DO with tag '83' shall be '01' (PIN) [CR5];
- TLV DO with tag '83' shall be '81' (PIN2) [CR6], if assigned.

c) Step b) shall be repeated for all the other USIM applications in the UICC.

## 6.6.2 Security architecture

### 6.6.2.1 Definition and applicability

The security architecture of the UICC shall conform to ISO/IEC 7816-9 [11]. It sets the access conditions of the ADF/DF and EF in the UICC.

### 6.6.2.2 Conformance requirement

CR1 The security architecture shall contain the following:

- a) security attributes as part of the DF/EF FCP using tag '8B', tag '8C' or tag 'AB';
- b) access mode data object (AM\_DO) defining for which group/type of command(s) the security condition apply;
- c) security condition data object (SC\_DO) indicating which security related procedures (user PIN verification) shall be satisfied before a command may be performed on a file;
- d) access rule shall be stored in the EF<sub>ARR</sub> which may be shared between files in the UICC.

CR2 In order to perform commands other than SELECT and STATUS/GET RESPONSE the security condition for the file shall be met.

CR3 The content of each AM byte (in compact format) or AM\_DO (in expanded format) shall be unique within the same access rule.

CR4 SC\_DOs OR and AND relations shall contain at least two access conditions.

Reference: TS 102.221 [1], subclause 9.2.

Test Group Reference (TGR): TGR\_USIM\_TP102.221\_SEC1\_SA

Test Procedure Reference (TPR): TPR\_USIM\_TP102.221\_SEC1\_SA

### 6.6.2.3 Test purpose

To verify that the UICC conforms to the above requirements.

NOTE: CR2 is tested in the subclause 6.8.1.

### 6.6.2.4 Method of test

#### Initial conditions

- 1) The UICC shall be connected to a ME simulator.

#### Test procedure

- a) The ME simulator shall reset the UICC.
- b) The ME simulator shall send a SELECT command to the UICC to select and activate USIM application.
- c) The ME simulator shall send a SELECT command to the UICC to select EF<sub>IMSI</sub>.

*The response data shall contain either TLV DO with tag '8B', '8C' or 'AB' [CR1a].*

*If the TLV DO with tag '8B' is present, the structure shall be the same as stated in subclause 9.2.7 of TS 102.221 [1] and the AM\_DO and SC\_DO shall be stored in EF<sub>ARR</sub> [CR1d].*

*If the TLV DO with tag '8C' is present, the AM\_DO and SC\_DO shall be in a compact format according to ISO/IEC 7816-9 [11] [CR1b, CR1c].*

*If the TLV DO with tag 'AB' is present, the AM\_DO and SC\_DO shall be in an expanded format according to ISO/IEC 7816-9 [11] [CR1b, CR1c].*

- d) The ME simulator shall send a SELECT command to select EF<sub>ARR</sub> if the TLV DO with tag '8B' is present in the response data returned in step b) [CR1d].
- e) The ME simulator shall send a READ RECORD command to read record 1 of EF<sub>ARR</sub>.

*The response data shall contain the AM\_DO and SC\_DO in an expanded format according to ISO/IEC 7816-9 [11][CR1b, CR1c, CR4].*

- f) Step e) shall be repeated for all the records in EF<sub>ARR</sub> [CR1d].

*The content of each AM byte (in compact format) or AM\_DO (in expanded format) shall be unique within the same access rule [CR3].*

## 6.6.3 Security Environment

### 6.6.3.1 Definition and applicability

The security environment is a mechanism to specify for the card system the security functions that are available to provide protection to commands for a specific application of the UICC.

### 6.6.3.2 Conformance requirement

- CR1 For Release '99 (Card implementation) SE01 (default SE) and SE00 (no authentication method required) are defined.
- CR2 When the SE00 is active, Universal PIN shall be used if known and enabled, otherwise no PIN shall be used.
- CR3 When the SE00 is active, Application PIN shall be disabled.
- CR4 When the SE01 is active, Application PIN shall be used if enabled, otherwise no PIN shall be used.
- CR5 A multi-verification capable UICC shall support the use of SE00 and SE01 in order to allow application verification requirement to be replaced by the Universal PIN.
- CR6 The PIN shall map to the SE ID according to table 9.1 of the TS 102.221 [1].

Reference: TS 102.221 [1], subclause 9.3.1.

Test Group Reference (TGR): TGR\_USIM\_TP102.221\_SEC1\_SE

Test Procedure Reference (TPR): TPR\_USIM\_TP102.221\_SEC1\_SE

### 6.6.3.3 Test purpose

To verify that the UICC conforms to the above requirements.

### 6.6.3.4 Method of test

NOTE: The following test procedures shall be applicable only to a multi-verification capable UICC.

#### Initial conditions

- 1) The UICC shall be connected to a ME simulator.

- 2) SE01 shall be active.

### Test procedure

#### For a multi-verification capable UICC

- a) The ME simulator shall reset the UICC.
- c) The ME simulator shall send a SELECT command to the UICC to select and activate USIM application [CR1].

*The following shall be true of the response data:*

- TLV DO with tag '90' (PIN Status) under TLV DO with tag 'C6' shall indicate that the Application PINs and the Universal PIN are enabled;
- TLV DO with tag '8B' shall be as follows:

EF <sub>ARR</sub> FID	SE ID1	Record No X	SE ID2	Record No Y
-----------------------	--------	-------------	--------	-------------

where - SE ID1 and SE ID2 can be either 00 or 01, but SE ID1 shall not be the same as SE ID2.

- Record No X and Y are the record number of the EF<sub>ARR</sub>.

- d) The ME simulator shall send a READ RECORD command to read the record number X of EFARR [CR4].

*If SE ID1 is 00, either one of the following shall be true of the response data:*

- The TLV\_DO with tag '83' in the SC\_DO shall be '11';
- The SC\_DO shall be '90 00'.

*If SE ID1 is 01, either one of the following shall be true of the response data:*

- The TLV\_DO with tag '83' in the SC\_DO shall be '01';
- The SC\_DO shall be '90 00'.

- e) Step d) shall be repeated for record number Y for SE ID2 [CR4].
- f) If the TLV\_DO with tag 83 is '01' for SE01, steps f) to v shall be carried out.
- g) The ME simulator shall send a SELECT command to the UICC to select EFICCID.
- h) The ME simulator shall send a READ BINARY command to the UICC.

*The response data returned by the UICC shall be SW1 = '90', SW2 = '00' – normal ending of the command [CR6].*

- i) The ME simulator shall send a SELECT command to the UICC to select EFIMSI under ADFUSIM.
- j) The ME simulator shall send a READ BINARY command to the UICC.

*The response data returned by the UICC shall be SW1 = '69', SW2 = '82' – security status not satisfied.*

- k) The ME simulator shall send a VERIFY PIN command using Universal PIN to the UICC.

*The response data returned by the UICC shall be SW1 = '90', SW2 = '00' – normal ending of the command [CR4].*

- l) The ME simulator shall send a READ BINARY command to the UICC.

*The response data returned by the UICC shall be SW1 = '69', SW2 = '82' – security status not satisfied.*

- m) The ME simulator shall send a VERIFY PIN command using PIN Application 1 to the UICC.

*The response data returned by the UICC shall be SW1 = '90', SW2 = '00' – normal ending of the command [CR4].*

- n) The ME simulator shall send a READ BINARY command to the UICC.



*The response data returned by the UICC shall be SW1 = '90', SW2 = '00' – normal ending of the command [CR4, CR6].*

- o) The ME simulator shall send a DISABLE PIN command to disable the PIN Application 1 to the UICC.
- p) The ME simulator shall send a SELECT command to the UICC to select and activate USIM application.

*The following shall be true of the response data:*

- *TLV DO with tag '90' (PIN Status) under TLV DO with tag 'C6' shall indicate that the PIN Application 1 is disabled, and the Universal PIN is enabled and its Usage Qualifier is set to '00'.*

- q) The ME simulator shall send a SELECT command to the UICC to select EFICCID.
- r) The ME simulator shall send a READ BINARY command to the UICC.

*The response data returned by the UICC shall be SW1 = '90', SW2 = '00' – normal ending of the command [CR6].*

- s) The ME simulator shall send a SELECT command to the UICC to select EFIMSI under ADFUSIM.
- t) The ME simulator shall send a READ BINARY command to the UICC.

*The response data returned by the UICC shall be SW1 = '90', SW2 = '00' – normal ending of the command [CR4, CR6].*

- u) The ME simulator shall send an ENABLE PIN command to enable the PIN Application 1 to the UICC.
- v) The ME simulator shall send a DISABLE PIN command to disable and indicate the Universal PIN as a replacement of the PIN Application 1 to the UICC [CR5].
- w) The ME simulator shall reset the UICC.

- x) The ME simulator shall send a SELECT command to the UICC to select and activate USIM application.

*The following shall be true of the response data:*

- *TLV DO with tag '90' (PIN Status) under TLV DO with tag 'C6' shall indicate that the PIN Application 1 is disabled and the Universal Pin is enabled [CR2, CR3].*

- y) If the TLV\_DO with tag 83 is '11' for SE00, steps z to mm) shall be carried out.
- z) The ME simulator shall send a SELECT command to the UICC to select EFICCID.
- aa) The ME simulator shall send a READ BINARY command to the UICC.

*The response data returned by the UICC shall be SW1 = '90', SW2 = '00' – normal ending of the command [CR6].*

- bb) The ME simulator shall send a SELECT command to the UICC to select EFIMSI under ADFUSIM.
- cc) The ME simulator shall send a READ BINARY command to the UICC.

*The response data returned by the UICC shall be SW1 = '69', SW2 = '82' – security status not satisfied.*

- dd) The ME simulator shall send a VERIFY PIN command using PIN Application 1 to the UICC.

*The response data returned by the UICC shall indicate an error.*

- ee) The ME simulator shall send a VERIFY PIN command using Universal PIN to the UICC.

*The response data returned by the UICC shall be SW1 = '90', SW2 = '00' – normal ending of the command [CR2].*

- ff) The ME simulator shall send a READ BINARY command to the UICC.

*The response data returned by the UICC shall be SW1 = '90', SW2 = '00' – normal ending of the command [CR2, CR6].*

gg) The ME simulator shall send a DISABLE PIN command to disable the Universal PIN to the UICC.

hh) The ME simulator shall send a SELECT command to the UICC to select and activate USIM application.

*The following shall be true of the response data:*

- *TLV DO with tag '90' (PIN Status) under TLV DO with tag 'C6' shall indicate that the PIN Application 1 and the Universal Pin are disabled.*

ii) The ME simulator shall send a SELECT command to the UICC to select EFICCID.

jj) The ME simulator shall send a READ BINARY command to the UICC.

*The response data returned by the UICC shall be SW1 = '90', SW2 = '00' – normal ending of the command [CR6].*

kk) The ME simulator shall send a SELECT command to the UICC to select EFIMSI under ADFUSIM.

ll) The ME simulator shall send a READ BINARY command to the UICC.

*The response data returned by the UICC shall be SW1 = '90', SW2 = '00' – normal ending of the command [CR2, CR6].*

mm) The ME simulator shall send an ENABLE PIN command to enable the Universal PIN to the UICC.

nn) The ME simulator shall send an ENABLE PIN command to enable the PIN Application 1 to the UICC.

## 6.6.4 PIN definitions

### 6.6.4.1 Definition and applicability

Several types of PIN shall exist in the UICC. Different types of the PIN shall be used for different access conditions of the application.

### 6.6.4.2 Conformance requirement

- CR1 A multi-verification capable UICC shall support the usage of Universal PIN.
- CR2 The key reference value '11' shall only be reserved for Universal PIN.
- CR3 The Universal PIN shall be part of the access condition for each USIM application on a multi-verification capable UICC.
- CR4 In case of a single verification capable UICC the Universal PIN shall not be used.
- CR5 An application PIN shall be used based on which application it is assigned.
- CR6 A local PIN shall only be valid within the ADF/DF except for DF<sub>TELECOM</sub> where it is indicated in the FCP.

Reference: TS 102.221 [1], subclause 9.4.

Test Group Reference (TGR): TGR\_USIM\_TP102.221\_SEC1\_PIND

Test Procedure Reference (TPR): TPR\_USIM\_TP102.221\_SEC1\_PIND

### 6.6.4.3 Test purpose

To verify that the UICC conforms to the above requirements.

NOTE: CR3 is tested in subclause 6.6.3.

### 6.6.4.4 Method of test

#### Initial conditions

- 1) The UICC shall be connected to a ME simulator.

**For a multi-verification capable UICC**

- 2) SE01 shall be active.

**Test procedure**

**For a multi-verification capable UICC**

- a) The ME simulator shall reset the UICC.
- b) The ME simulator shall send a SELECT command to the UICC to select and activate USIM application.

*The response data shall contain PS Template DO with tag 'C6'.*

*The following shall be true of the PS Template DO:*

- *One of the TLV DO with tag '83' shall be '11' indicating the key reference value for Universal PIN [CR1, CR2];*
- *One of the TLV DO with tag '83' shall be '01' indicating the key reference value for PIN Application 1 [CR5];*
- *One of the TLV DO with tag '83' shall be '81' indicating the key reference value for second Application/local PIN except for  $DF_{TELECOM}$ , if the second Application/local PIN is assigned [CR6].*

**For a single verification capable UICC**

- a) The ME simulator shall reset the UICC.
- b) The ME simulator shall send a SELECT command to the UICC to select and activate USIM application.

*The response data shall contain PS Template DO with tag 'C6'.*

*The following shall be true of the PS Template DO:*

- *Any of the TLV DO with tag '83' shall not be '11' indicating the key reference value for Universal PIN [CR4];*
- *One of the TLV DO with tag '83' shall be '01' indicating the key reference value for PIN Application 1 [CR5];*
- *One of the TLV DO with tag '83' shall be '81' indicating the key reference value for second Application/local PIN except for  $DF_{TELECOM}$ , if the second Application/local PIN is assigned [CR6].*

- c) Step b) shall be repeated for the remaining  $ADF_{USIMS}$  and DFs.

## 6.6.5 PIN and key reference relationship

### 6.6.5.1 Definition and applicability

The relationship between the user verification requirement PIN and the referencing to a PIN in the commands VERIFY, CHANGE, DISABLE/ENABLE, and UNBLOCK is defined in the subclause 9.5 of TS 102.221 [1].

### 6.6.5.2 Conformance requirement

- CR1 For access condition ALWAYS, the command shall be performed without any restriction.
- CR2 For access condition PIN, the command shall only be possible if the relevant application PIN is verified successfully.
- CR3 For access condition Second PIN, the command shall only be possible if the relevant application PIN2 is verified successfully.
- CR4 For access condition NEVER, the command shall not be possible over the UICC/ME interface.

CR5 The status of a PIN shall be stored in the PS Template DO with tag 'C6' and shall be indicated in the FCP in a response to the SELECT or STATUS command issued at the application/DF level.

CR6 The Universal PIN shall not be part of the PS Template DO in the single verification capable UICC.

Reference: TS 102.221 [1], subclause 9.5.

Test Group Reference (TGR): TGR\_USIM\_TP102.221\_SEC1\_PKRR

Test Procedure Reference (TPR): TPR\_USIM\_TP102.221\_SEC1\_PKRR

### 6.6.5.3 Test purpose

To verify that the UICC conforms to the above requirements.

NOTE: Allocation of ADM levels and the respective requirements for their fulfilment are the responsibility of the appropriate administrative authority.

### 6.6.5.4 Method of test

NOTE: When EF<sub>F<sub>DN</sub></sub> is not supported by the UICC, any supported linear EF in ADF<sub>USIM</sub> may be chosen.

#### Initial conditions

- 1) The UICC shall be connected to a ME simulator.
- 2) The records in EF<sub>F<sub>DN</sub></sub> shall contain the following data for the first 10 bytes:
 

<b>1st record</b>	'A0 A1 A2 B0 B1 B2 A0 A1 A2 A0'
<b>2nd record</b>	'B0 B1 B2 A0 A1 A2 A0 A1 A2 B0'
<b>3rd record</b>	'B0 B1 B2 A0 A1 A2 B0 B1 B2 A0'
<b>4th record</b>	'A0 A1 A2 B0 B1 B2 B0 B1 B2 B0'
- 3) The data for the remainder of these four records and for all other records (if any) shall be 'FF'.

#### For a multi-verification capable UICC

- 4) SE01 shall be active.

#### Test procedure

##### For a multi-verification capable UICC

- a) The ME simulator shall reset the UICC.
- b) The ME simulator shall send a SELECT command to the UICC to select and activate USIM application.

*The response data shall indicate the PS Template DO with tag 'C6' [CR5].*

*The PS Template DO with tag 'C6' shall contain for the Universal PIN the TLV DO with tag '95' indicating the usage qualifier [CR6].*

*The status condition returned by the UICC shall be SW1 = '90', SW2 = '00' - normal ending of the command [CR1].*

- c) The ME simulator shall send a STATUS command to the UICC.

*The response data shall indicate the PS Template DO with tag 'C6' [CR5].*

*The PS Template DO with tag 'C6' shall contain for the Universal PIN the TLV DO with tag '95' indicating the usage qualifier [CR6].*

- d) The ME simulator shall send a SELECT command to the UICC to select EF<sub>F<sub>DN</sub></sub>.

*The response data shall not contain the PS Template DO with tag 'C6' [CR5].*

- e) The ME simulator shall send a READ RECORD command to the UICC to read the first record in EF<sub>F<sub>DN</sub></sub>.

*The status condition returned by the UICC shall be SW1 = '69', SW2 = '82' – security status not satisfied [CR2].*

f) The ME simulator shall gain PIN Application 1 security access.

g) The ME simulator shall send a READ RECORD command to the UICC to read the first record in EF<sub>F<sub>DN</sub></sub>.

*The data string returned shall be 'A0 A1 A2 B0 B1 B2 A0 A1 A2 A0'. The data for the remainder of the returned data string shall be 'FF'.*

*The status condition returned by the UICC shall be SW1 = '90', SW2 = '00' - normal ending of the command [CR2].*

h) The ME simulator shall send an UPDATE RECORD command using CURRENT mode with data string 'B0' for all bytes to the UICC to update the first record in EF<sub>F<sub>DN</sub></sub>.

*The status condition returned by the UICC shall be SW1 = '69', SW2 = '82' - security status not satisfied [CR3].*

i) The ME simulator shall send a READ RECORD command using NEXT mode to the UICC to read the first record in EF<sub>F<sub>DN</sub></sub>.

*The data string returned shall be 'A0 A1 A2 B0 B1 B2 A0 A1 A2 A0'. The data for the remainder of the returned data string shall be 'FF'.*

*The status condition returned by the UICC shall be SW1 = '90', SW2 = '00' - normal ending of the command [CR2].*

j) The ME simulator shall gain the second PIN Application 2 security access.

k) The ME simulator shall send an UPDATE RECORD command using CURRENT mode with data string 'B1' for all bytes to the UICC to update the first record in EF<sub>F<sub>DN</sub></sub>.

*The status condition returned by the UICC shall be SW1 = '90', SW2 = '00' - normal ending of the command [CR3].*

l) The ME simulator shall send a READ RECORD command to the UICC to read the first record in EF<sub>F<sub>DN</sub></sub>.

*The data string returned shall be 'B1' for all bytes.*

*The status condition returned by the UICC shall be SW1 = '90', SW2 = '00' - normal ending of the command [CR2].*

m) The ME simulator shall send a SELECT command to the UICC to select MF.

n) The ME simulator shall send a SELECT command to the UICC to select EF<sub>I<sub>CCID</sub></sub>.

o) The ME simulator shall send a READ BINARY command to the UICC to read the byte in the EF<sub>I<sub>CCID</sub></sub>.

*The status condition returned by the UICC shall be SW1 = '90', SW2 = '00' – normal ending of the command [CR1].*

p) The ME simulator shall send an UPDATE BINARY command to the UICC to update the byte in EF<sub>I<sub>CCID</sub></sub>.

*The status condition returned by the UICC shall be SW1 = '69', SW2 = '82' - security status not satisfied [CR4].*

q) The ME simulator shall send a SELECT command to the UICC to select and activate USIM application.

r) The ME simulator shall send a DISABLE PIN command to disable and indicate the Universal PIN as a replacement of the PIN Application 1 to the UICC.

s) The ME simulator shall send a SELECT command to the UICC to select EF<sub>F<sub>DN</sub></sub>.

t) The ME simulator shall send a READ RECORD command to the UICC to read the first record in EF<sub>F<sub>DN</sub></sub>.

*The status condition returned by the UICC shall be SW1 = '69', SW2 = '82' – security status not satisfied [CR2].*

u) The ME simulator shall gain Universal PIN security access.

- v) The ME simulator shall send a READ RECORD command using NEXT mode to the UICC to read the first record in EF<sub>F<sub>DN</sub></sub>.

*The data string returned shall be 'B1' for all bytes.*

*The status condition returned by the UICC shall be SW1 = '90', SW2 = '00' - normal ending of the command [CR2].*

- w) The ME simulator shall send an UPDATE RECORD command using CURRENT mode with data string 'B2' for all bytes to the UICC to update the first record in EF<sub>F<sub>DN</sub></sub>.

*The status condition returned by the UICC shall be SW1 = '69', SW2 = '82' - security status not satisfied [CR3].*

- x) The ME simulator shall gain the second PIN Application 2 security access.

- y) The ME simulator shall send an UPDATE RECORD command using CURRENT mode with data string 'B3' for all bytes to the UICC to update the first record in EF<sub>F<sub>DN</sub></sub>.

*The status condition returned by the UICC shall be SW1 = '90', SW2 = '00' - normal ending of the command [CR3].*

- z) The ME simulator shall send an ENABLE PIN command to enable PIN Application 1 to the UICC.

- aa) The ME simulator shall send a SELECT command to the UICC to select and activate USIM application.

- bb) The ME simulator shall send a READ RECORD command to the UICC to read the first record in EF<sub>F<sub>DN</sub></sub>.

*The status condition returned by the UICC shall be SW1 = '69', SW2 = '82' – security status not satisfied [CR2].*

- cc) The ME simulator shall gain PIN Application 1 security access.

- dd) The ME simulator shall send a READ RECORD command to the UICC to read the first record in EF<sub>F<sub>DN</sub></sub>.

*The data string returned shall be 'B3' for all bytes.*

*The status condition returned by the UICC shall be SW1 = '90', SW2 = '00' - normal ending of the command [CR2].*

- ee) The ME simulator shall send an UPDATE RECORD command using CURRENT mode with data string 'B4' for all bytes to the UICC to update the first record in EF<sub>F<sub>DN</sub></sub>.

*The status condition returned by the UICC shall be SW1 = '69', SW2 = '82' - security status not satisfied [CR3].*

- ff) The ME simulator shall gain the second PIN Application 2 security access.

- gg) The ME simulator shall send an UPDATE RECORD command using CURRENT mode with data string 'A0 A1 A2 B0 B1 B2 A0 A1 A2 A0' to the UICC to update record in EF<sub>F<sub>DN</sub></sub>.

*The status condition returned by the UICC shall be SW1 = '90', SW2 = '00' - normal ending of the command [CR3].*

#### **For a single verification capable UICC**

- a) The ME simulator shall reset the UICC.

- b) The ME simulator shall send a SELECT command to the UICC to select and activate USIM application.

*The response data shall indicate the PS Template DO with tag 'C6' [CR5].*

*The PS Template DO with tag 'C6' shall not contain the Universal PIN key reference '11' [CR6].*

*The status condition returned by the UICC shall be SW1 = '90', SW2 = '00' - normal ending of the command [CR1].*

- c) The ME simulator shall send a STATUS command to the UICC.

*The response data shall indicate the PS Template DO with tag 'C6' [CR5].*

*The PS Template DO with tag 'C6' shall not contain the Universal PIN key reference '11' [CR6].*

- d) The ME simulator shall send a SELECT command to the UICC to select EF<sub>FDN</sub>.

*The response data shall not contain the PS Template DO with tag 'C6' [CR5].*

- e) The ME simulator shall send a READ RECORD command to the UICC to read the first record in EF<sub>FDN</sub>.

*The status condition returned by the UICC shall be SW1 = '69', SW2 = '82' – security status not satisfied [CR2].*

- f) The ME simulator shall gain PIN security access.

- g) The ME simulator shall send a READ RECORD command to the UICC to read the first record in EF<sub>FDN</sub>.

*The data string returned shall be 'A0 A1 A2 B0 B1 B2 A0 A1 A2 A0'. The data for the remainder of the returned data string shall be 'FF'.*

*The status condition returned by the UICC shall be SW1 = '90', SW2 = '00' - normal ending of the command [CR2].*

- h) The ME simulator shall send an UPDATE RECORD command using CURRENT mode with data string 'C0' for all bytes to the UICC to update the first record in EF<sub>FDN</sub>.

*The status condition returned by the UICC shall be SW1 = '69', SW2 = '82' - security status not satisfied [CR3].*

- i) The ME simulator shall gain the PIN2 security access.

- j) The ME simulator shall send an UPDATE RECORD command using CURRENT mode with data string 'C1' for all bytes to the UICC to update the first record in EF<sub>FDN</sub>.

*The status condition returned by the UICC shall be SW1 = '90', SW2 = '00' - normal ending of the command [CR3].*

- k) The ME simulator shall send a READ RECORD command to the UICC to read the first record in EF<sub>FDN</sub>.

*The data string returned shall be 'C1' for all bytes.*

*The status condition returned by the UICC shall be SW1 = '90', SW2 = '00' - normal ending of the command [CR2].*

- l) The ME simulator shall send an UPDATE RECORD command using CURRENT mode with data string 'A0 A1 A2 B0 B1 B2 A0 A1 A2 A0' to the UICC to update record in EF<sub>FDN</sub>.

- m) The ME simulator shall send a SELECT command to the UICC to select MF.

- n) The ME simulator shall send a SELECT command to the UICC to select EF<sub>ICCID</sub>.

- o) The ME simulator shall send a READ BINARY command to the UICC to read the byte in the EF<sub>ICCID</sub>.

*The status condition returned by the UICC shall be SW1 = '90', SW2 = '00' – normal ending of the command [CR1].*

- p) The ME simulator shall send an UPDATE BINARY command to the UICC to update the byte in EF<sub>ICCID</sub>.

*The status condition returned by the UICC shall be SW1 = '69', SW2 = '82' - security status not satisfied [CR4].*

## 6.7 Structure of commands and responses

The tests in this subclause ensure that the IUT conforms to the specification for the mapping of functions onto Application Protocol Data Units (APDUs) which are used by the transmission protocol.

## 6.7.1 Mapping principles

### 6.7.1.1 Definition and applicability

The transmission protocol requires that the command and response Application Protocol Data Units (APDUs) are mapped using certain principles, in order to ensure correct operation in the 3G environment.

### 6.7.1.2 Conformance requirement

- CR1 The command APDU shall have format (CLA, INS, P1, P2 {, Lc, Data}{, Le}).
- CR2 The response APDU shall have format ({data,} SW1, SW2).
- CR3 The class '8X' and '0X' shall be accepted by the UICC with USIM application.

Reference: TS 3G TS 102.221, subclause 10.1 and 10.2.

Test Group Reference (TGR): TGR\_USIM\_TP102.221\_CS\_MP

Test Procedure Reference (TPR): TPR\_USIM\_TP102.221\_CS\_MP

### 6.7.1.3 Test purpose

To verify that the UICC conforms to the above requirements.

### 6.7.1.4 Method of test

#### Initial conditions

- 1) The UICC shall be connected to a ME simulator.

#### Test procedure

- a) The ME simulator shall reset the UICC.
- b) The ME simulator shall send a SELECT command to the UICC to select MF with P2 = '04'.  
[Bytes sent: CLA = '00', INS = 'A4', P1 = '00', P2 = '04', Lc = '02', data = '3F 00', Le = '00' (Case 4)]  
[Bytes received: data, SW1, SW2]

*The status condition returned by the UICC shall be SW1 = '90', SW2 = '00' – normal ending of the command [CR1, CR2, CR3].*

- c) The ME simulator shall send a SELECT command to the UICC to select MF with P2 = '0C'.  
[Bytes sent: CLA = '00', INS = 'A4', P1 = '00', P2 = '0C', Lc = '02', data = '3F 00' (Case 3)]  
[Bytes received: SW1, SW2]

*The status condition returned by the UICC shall be SW1 = '90', SW2 = '00' – normal ending of the command [CR1, CR2, CR3].*

- d) The ME simulator shall send a STATUS command to the UICC with P2 = '00'.  
[Bytes sent: CLA = '80', INS = 'F2', P1 = '00', P2 = '00', Le = '00' (Case 2)]  
[Bytes received: data, SW1, SW2]

*The status condition returned by the UICC shall be SW1 = '90', SW2 = '00' – normal ending of the command [CR1, CR2, CR3].*

- e) The ME simulator shall send a STATUS command to the UICC.  
[Bytes sent: CLA = '80', INS = 'F2', P1 = '00', P2 = '0C' (Case 1)]  
[Bytes received: SW1, SW2]

*The status condition returned by the UICC shall be SW1 = '90', SW2 = '00' – normal ending of the command [CR1, CR2, CR3].*



## 6.7.2 Response APDU Structure

### 6.7.2.1 Status Conditions Returned by the UICC

#### 6.7.2.1.1 Definition and applicability

The status words SW1 and SW2 provide the method with which the UICC can respond to the ME after executing a command.

#### 6.7.2.1.2 Conformance requirement

- CR1 The UICC shall respond with the appropriate SW1 and SW2 status words for commands which are correctly executed.
- CR2 The UICC shall respond with the appropriate SW1 and SW2 status words for commands which produce warnings.
- CR3 The UICC shall respond with the appropriate SW1 and SW2 status words for commands which produce execution errors.
- CR4 The UICC shall respond with the appropriate SW1 and SW2 status words for commands which produce checking errors.
- CR5 The UICC shall respond with the appropriate SW1 and SW2 status words for commands which produce application errors.

Reference: TS 102.221 [1], subclause 10.2.1.

Test Group Reference (TGR): TGR\_USIM\_TP102.221\_CS\_RS\_SC

Test Procedure Reference (TPR): TPR\_USIM\_TP102.221\_CS\_RS\_SC

#### 6.7.2.1.3 Test purpose

To verify that the UICC conforms to the above requirements when issuing SW1 and SW2 status words.

NOTE 1: CR3 is not tested as it is not possible to force a UICC to produce an execution error.

NOTE 2: CR5 is tested in subclause 6.8.1.8.

#### 6.7.2.1.4 Method of test

##### Initial conditions

- 1) The UICC shall be connected to a ME simulator.

##### Test procedure

- a) The ME simulator shall reset the UICC.
- b) The ME simulator shall send a VERIFY PIN command with PIN to the UICC.

*The status condition returned by the UICC shall be SW1 = '90', SW2 = '00' - normal ending of the command [CR1].*

- c) The ME simulator shall send a SELECT command to the UICC to select and activate USIM application.
- d) The ME simulator shall send a READ BINARY command without SFI referencing to the UICC.

*The status condition returned by the UICC shall be SW1 = '69', SW2 = '86' - command not allowed (no EF selected) [CR4].*

- e) The ME simulator shall send a SELECT command to the UICC to select EF<sub>IMSI</sub>.

- f) The ME simulator shall send a READ BINARY command with P2 = '0F' to the UICC.
- The status condition returned by the UICC shall be SW1 = '6B', SW2 = '00' - wrong parameter(s) P1-P2, or SW1 = '6A', SW2 = '86' - incorrect parameters P1-P2 [CR4].*
- g) The ME simulator shall send a SELECT command to the UICC to select EF<sub>ECC</sub>.
- h) The ME simulator shall send a READ RECORD command using PREVIOUS mode to the UICC.
- i) The ME simulator shall send a READ RECORD command using NEXT mode to the UICC.
- The status condition returned by the UICC shall be SW1 = '6A', SW2 = '83' - record not found [CR4].*
- j) The ME simulator shall send a READ BINARY command using a length of 1 byte to the UICC.
- The status condition returned by the UICC shall be SW1 = '69', SW2 = '81' - command incompatible with file structure [CR4].*
- k) The ME simulator shall send a SELECT command to the UICC to select EF<sub>LOC1</sub> with Lc = 1.
- The status condition returned by the UICC shall be SW1 = '67', SW2 = '00' - wrong length, or SW1 = '6A', SW2 = '87' - Lc inconsistent with P1 - P2 [CR4].*
- l) The ME simulator shall send a VERIFY PIN command with incorrect PIN to the UICC.
- The status condition returned by the UICC shall be SW1 = '63', SW2 = 'C2' - security status not satisfied [CR2].*
- m) The ME simulator shall send a VERIFY PIN command with incorrect PIN to the UICC.
- The status condition returned by the UICC shall be SW1 = '63', SW2 = 'C1' - security status not satisfied [CR2].*
- n) The ME simulator shall send a VERIFY PIN command with incorrect PIN to the UICC.
- The status condition returned by the UICC shall be SW1 = '63', SW2 = 'C0' - security status not satisfied [CR2].*
- o) The ME simulator shall send a VERIFY PIN command with incorrect PIN to the UICC.
- The status condition returned by the UICC shall be SW1 = '69', SW2 = '83' - authentication method blocked [CR4].*
- p) The ME simulator shall send an UNBLOCK PIN command with Unblock PIN to the UICC.
- q) The ME simulator shall send a READ RECORD command using P2 = '01' to the UICC.
- The status condition returned by the UICC shall be SW1 = '6B', SW2 = '00' - wrong parameter(s) P1 - P2, or SW1 = '6A', SW2 = '86' - incorrect parameter P1 or P2 [CR4].*
- r) The ME simulator shall send the following APDU to the UICC.  
[Bytes sent: CLA = '00', INS = '6F', P1 = '00', P2 = '00', P3 = '00']
- The status condition returned by the UICC shall be SW1 = '6D', SW2 = '00' - instruction code not supported or invalid [CR4].*
- s) The ME simulator shall send a GET RESPONSE command to the UICC.
- The status condition returned by the UICC shall be SW1 = '6F', SW2 = '00' - technical problem, no precise diagnosis [CR4].*
- t) The ME simulator shall send the following APDU to the UICC.  
[Bytes sent: CLA = '40', INS = 'C0', P1 = '00', P2 = '00', P3 = '00']
- The status condition returned by the UICC shall be SW1 = '6E', SW2 = '00' - class not supported [CR4].*
- u) The ME simulator shall send a STATUS command with CLA = '81' to the UICC.
- The status condition returned by the UICC shall be SW1 = '68', SW2 = '81' - logical channel not supported or SW1 = '6E', SW2 = '00' - class not supported [CR4].*

- v) The ME simulator shall send a STATUS command with CLA = '84' to the UICC.  
[Bytes sent: CLA = '84', INS = 'F2', P1 = '00', P2 = '00', Le = '02']

*The status condition returned by the UICC shall be SW1 = '68', SW2 = '82' – secure messaging not supported or SW1 = '6E', SW2 = '00' – class not supported [CR4].*

- w) The ME simulator shall reset the UICC.

- x) The ME simulator shall send a SELECT command with an incorrect file ID to the UICC.  
[Bytes sent: CLA = '00', INS = 'A4', P1 = '00', P2 = '04', Lc = '02', data = '12 34']

*The status condition returned by the UICC shall be SW1 = '6A', SW2 = '82' – file not found [CR4].*

- y) The ME simulator shall send a SELECT command to the UICC to select EF<sub>ICCID</sub>.

- z) The ME simulator shall send an UPDATE BINARY command to the UICC. The data used shall be '00 00'.

*The status condition returned by the UICC shall be SW1 = '69', SW2 = '82' – security status not satisfied [CR4].*

SW1	SW2	Description	CR	TP
'90'	'00'	- Normal ending of the command	CR1	b)
'91'	'XX'	- Normal ending of the command, with extra information from the proactive UICC containing a command for the ME. Length 'XX' of the response data	USAT	N/A
SW1	SW2	Error description		
'93'	'00'	- SIM Application Toolkit is busy. Command cannot be executed at present, further normal commands are allowed.	USAT	N/A
SW1	SW2	Description		
'62'	'00'	- No information given, state of non volatile memory unchanged	CR2	N/A
'62'	'81'	- Part of returned data may be corrupted	CR2	N/A
'62'	'82'	- End of file/record reached before reading Le bytes	CR2	N/A
'62'	'83'	- Selected file invalidated	CR2	N/A
'63'	'CX'	- Command successful but after using an internal update retry routine 'X' times - Verification failed, 'X' retries remaining	CR2	l), m), n)
SW1	SW2	Description		
'64'	'00'	- No information given, state of non-volatile memory unchanged	CR3	N/A
'65'	'00'	- No information given, state of non-volatile memory changed	CR3	N/A
'65'	'81'	- Memory problem	CR3	N/A
SW1	SW2	Description		
'67'	'00'	- Wrong length	CR4	k)
'67'	'XX'	- The interpretation of this status word is command dependent, except for SW2 = '00'	CR4	N/A
'6B'	'00'	- Wrong parameter(s) P1-P2	CR4	f), q)
'6D'	'00'	- Instruction code not supported or invalid	CR4	r)
'6E'	'00'	- Class not supported	CR4	t), u), v)
'6F'	'00'	- Technical problem, no precise diagnosis	CR4	s)
'6F'	'XX'	- The interpretation of this status word is command dependent, except for SW2 = '00'	CR4	N/A
SW1	SW2	Description		
'68'	'00'	- No information given	CR4	N/A
'68'	'81'	- Logical channel not supported	CR4	u)
'68'	'82'	- Secure messaging not supported	CR4	v)
SW1	SW2	Description		
'69'	'00'	- No information given	CR4	N/A
'69'	'81'	- Command incompatible with file structure	CR4	j)
'69'	'82'	- Security status not satisfied	CR4	z)
'69'	'83'	- Authentication method blocked	CR4	o)
'69'	'84'	- Referenced data invalidated	CR4	N/A
'69'	'85'	- Conditions of used not satisfied	CR4	N/A
'69'	'86'	- Command not allowed (no EF selected)	CR4	d)
SW1	SW2	Description		

'6A'	'80'	- Incorrect parameters in the data field	CR4	N/A
'6A'	'81'	- Function not supported	CR4	N/A
'6A'	'82'	- File not found	CR4	x)
'6A'	'83'	- Record not found	CR4	i)
'6A'	'86'	- Incorrect parameters P1-P2	CR4	f), q)
'6A'	'87'	- Lc inconsistent with P1-P2	CR4	k)
'6A'	'88'	- Referenced data not found	CR4	N/A
<b>SW1</b>	<b>SW2</b>	<b>Error description</b>		
'98'	'50'	- INCREASE cannot be performed, max value reached.	CR5	6.8.1.8.4 h)
'98'	'62'	- Authentication error, application specific	CR5	N/A

## 6.7.2.2 Status Words of the Commands

### 6.7.2.2.1 Definition and applicability

Limiting the status conditions for each command to a defined set allows the ME to efficiently manage the handling of the status condition.

### 6.7.2.2.2 Conformance requirement

- CR1 Table 10.16 in TS 102.221 [1], subclause 10.2.2 shows for each command the possible status conditions returned (marked by an asterisk \*). The UICC shall not generate status conditions other than those allowed for each command.

Reference: TS 102.221 [1], subclause 10.2.2.

Test Group Reference (TGR): TGR\_USIM\_TP102.221\_CS\_RS\_SW

Test Procedure Reference (TPR): TPR\_USIM\_TP102.221\_CS\_RS\_SW

### 6.7.2.2.3 Test purpose

To verify for each command that the UICC only generates the allowed status conditions.

NOTE: The CR1 is tested in the subclause 6.7.2 and subclause 6.8.1

### 6.7.2.2.4 Method of test

#### Initial conditions

N/A

#### Test procedure

N/A

## 6.8 Commands

### 6.8.1 Generic Commands

#### 6.8.1.1 SELECT

##### 6.8.1.1.1 Definition and applicability

It shall be mandatory for all cards complying with TS 102.221 [1] to support all functions described therein.

##### 6.8.1.1.2 Conformance requirement

- CR1 This function shall select a file according to the methods described in subclause 8.4 of TS 102.221 [1].

- CR2 The function shall accept as an input:
- a) a file ID (FID);
  - b) an application ID (AID);
  - c) a path;
  - d) empty.
- CR3 If the selected file is the MF, then the function shall output the file descriptor, file identifier, UICC characteristics, life cycle status integer, security attributes and PIN status.
- CR4 If the selected file is the a ADF, then the function shall output the file descriptor, DF name, life cycle status integer, security attributes and PIN status.
- CR5 If the selected file is an EF, then the function shall output the file descriptor, file identifier, security attributes, life cycle status integer and file size.
- CR6 After a successful selection the record pointer shall be undefined.
- CR7 If P2 = '0C' the function shall output only SW1 and SW2.
- CR8 If P1 = '00' and if P2 = '0C' and the data field is empty or equal to '3F 00' then the function shall select the MF.
- CR9 If P1 = '00' and if the data field is equal to '7F FF' then the function shall select the ADF of the current application.
- CR10 It is mandatory for data objects to be provided in the order given in the description of each response.
- CR11 If the selected file is a DF, then the function shall output the file descriptor, file identifier, life cycle status integer, security attributes and PIN status.

Reference: TS 102.221 [1], subclause 11.1.1.

Test Group Reference (TGR): TGR\_USIM\_TP102.221\_CMD\_GC

Test Procedure Reference (TPR): TPR\_USIM\_TP102.221\_CMD\_GC\_SEL

### 6.8.1.1.3 Test purpose

To verify that the SELECT function conforms to the above requirements for the different file types available.

NOTE: CR1 is tested in subclause 6.5.4.

### 6.8.1.1.4 Method of test

#### Initial conditions

- 1) The UICC shall be connected to a ME simulator.

#### Test procedure

- a) The ME simulator shall reset the UICC.
- b) The ME simulator shall send a SELECT command to the UICC to select DF<sub>TELECOM</sub>.

*The status returned by the UICC shall be SW1 = '90', SW2 = '00' – normal ending of the command [CR2a].*

*The FCP shall contain the following tags [CR11]:*

- Tag '82' (File Descriptor)  
*The first byte shall be '38' or '78' (indicating a DF or ADF);*
- Tag '83' (File Identifier)

The value shall be '7F 10' (indicating  $DF_{TELECOM}$ );

- Tag '8A' (Life Cycle Status Integer);
- Tag 'C6' (PIN Status Template DO)

It shall contain tag '90' (PS\_DO).

The FCP shall contain exactly one of the following tags:

- Tag '8C' (Compact format);
- Tag 'AB' (Expanded format);
- Tag '8B' (Referenced to Expanded Format).

The TLV DOs with the above Tags shall be provided in FCP in order given in the Table 11.3 of subclause 11.1.1.3 of the TS 102.221 [1] [CR10].

- c) The ME simulator shall send a SELECT command to the UICC to select the MF.

The status returned by the UICC shall be SW1 = '90', SW2 = '00' – normal ending of the command [CR2a].

The FCP shall contain the following tags [CR3]:

- Tag '82' (File Descriptor)
 

The first byte shall be '38' or '78' (indicating a DF or ADF);
- Tag '83' (File Identifier)
 

The value shall be '3F 00' (indicating MF);
- Tag 'A5' (Proprietary information)
 

It shall contain tag '80' (UICC characteristics);
- Tag '8A' (Life Cycle Status Integer);
- Tag 'C6' (PIN Status Template DO)
 

It shall contain tag '90' (PS\_DO).

The FCP shall contain exactly one of the following tags:

- Tag '8C' (Compact format);
- Tag 'AB' (Expanded format);
- Tag '8B' (Referenced to Expanded Format).

The TLV DOs with the above Tags shall be provided in FCP in order given in the Table 11.3 of subclause 11.1.1.3 of the TS 102.221 [1] [CR10].

- d) The ME simulator shall send a SELECT command to the UICC to select  $EF_{DIR}$ .

The status returned by the UICC shall be SW1 = '90', SW2 = '00' – normal ending of the command [CR2a].

The FCP shall contain the following tags [CR5]:

- Tag '82' (File Descriptor)
 

The first byte shall be '02' or '42' (indicating a linear fixed EF);

The length shall be '05' (i.e. containing record length etc);
- Tag '83' (File Identifier)
 

The value shall be '2F 00' (indicating  $EF_{DIR}$ );

- Tag '8A' (Life Cycle Status Integer);
- Tag '80' (File size).

The FCP shall contain exactly one of the following tags:

- Tag '8C' (Compact format);
- Tag 'AB' (Expanded format);
- Tag '8B' (Referenced to Expanded Format).

The TLV DOs with the above Tags shall be provided in FCP in order given in the Table 11.4 of subclause 11.1.1.3 of the TS 102.221 [1] [CR10].

- e) The ME simulator shall send a READ RECORD command using CURRENT mode to the UICC.

The UICC shall return an error code appropriate to the command (e.g. SW1 = '6A', SW2 = '83' - Record not found) [CR6].

- f) The ME simulator shall send a SELECT command with P2 = '0C' to the UICC to select the MF.

The response from the UICC shall be only SW1 = '90', SW2 = '00' – normal ending of the command [CR7].

- g) The ME simulator shall send a SELECT command to the UICC to select the EF<sub>ARR</sub> under DF<sub>TELECOM</sub> by path selection

The response from the UICC shall be only SW1 = '90', SW2 = '00' – normal ending of the command.

The TLV DO with Tag '83' in the FCP shall indicate the current EF is EF<sub>ARR</sub> [CR2c].

- h) The ME simulator shall send a SELECT command to the UICC to select the parent DF.

The response from the UICC shall be only SW1 = '90', SW2 = '00' – normal ending of the command.

The TLV DO with Tag '83' in the FCP shall indicate the current DF is MF [CR2d].

- i) The ME simulator shall send a SELECT command with AID to the UICC to select and activate the USIM application.

The status returned by the UICC shall be SW1 = '90', SW2 = '00' – normal ending of the command [CR2b].

The FCP shall contain the following tags [CR4]:

- Tag '82' (File Descriptor)
- Tag '84' (DF name - AID)
- Tag '8A' (Life Cycle Status Integer);
- Tag 'C6' (PIN Status Template DO)

The first byte shall be '38' or '78' (indicating a DF or ADF);

The value shall be the AID of the USIM application;

It shall contain tag '90' (PS\_DO).

The FCP shall contain exactly one of the following tags:

- Tag '8C' (Compact format);
- Tag 'AB' (Expanded format);
- Tag '8B' (Referenced to Expanded Format).

The TLV DOs with the above Tags shall be provided in FCP in order given in the Table 11.4 of subclause 11.1.1.3 of the TS 102.221 [1] [CR10].

- j) The ME simulator shall send a SELECT command to the UICC to select  $DF_{TELECOM}$ .
- k) The ME simulator shall send a SELECT command with P1 = '00' and data field equals to '7FFF' to the UICC to select the ADF of the current USIM application.

*The status returned by the UICC shall be SW1 = '90', SW2 = '00' – normal ending of the command [CR9].*

*The FCP returned shall be as same as those returned in step i) above [CR4].*

- l) The ME simulator shall send a SELECT command with P1 = '00' and data field equals to '3F00' to the UICC to select the MF.

*The status returned by the UICC shall be SW1 = '90', SW2 = '00' – normal ending of the command [CR8].*

*The FCP returned shall be as same as those returned in step c) above [CR3].*

- m) The ME simulator shall send a SELECT command with P1 = '00', P2 = '0C' and with empty data field to the UICC to select the MF.

*The response from the UICC shall be only SW1 = '90', SW2 = '00' – normal ending of the command [CR7, CR8].*

## 6.8.1.2 STATUS

### 6.8.1.2.1 Definition and applicability

It shall be mandatory for all cards complying with TS 102.221 [1] to support all functions described therein.

### 6.8.1.2.2 Conformance requirement

- CR1 If the parameter P2 = '00', then the STATUS function shall output the FCP of the currently selected MF, DF or ADF.
- CR2 If the parameter P2 = '01', then the STATUS function shall output the  $DF_{NAME}$  TLV DO of the currently selected ADF.
- CR3 If the parameter P2 = '0C', then the STATUS function shall output only SW1 and SW2.

Reference: TS 102.221 [1], subclause 11.1.2.

Test Group Reference (TGR): TGR\_USIM\_TP102.221\_CMD\_GC

Test Procedure Reference (TPR): TPR\_USIM\_TP102.221\_CMD\_GC\_STATUS

### 6.8.1.2.3 Test purpose

To verify that the UICC conforms to the above requirements.

### 6.8.1.2.4 Method of test

#### Initial conditions

- 1) The UICC shall be connected to a ME simulator.

#### Test procedure

- a) The ME simulator shall reset the UICC.
- b) The ME simulator shall send a STATUS command with P2 = '00' to the UICC.

*The FCP shall contain the following tags [CR1]:*

- Tag '82' (File Descriptor)

*The first byte shall be '38' or '78' (indicating a DF);*



- Tag '83' (File Identifier)  
*The value shall be '3F 00' (indicating MF);*
- Tag 'A5' (Proprietary information)  
*It shall contain tag '80' (UICC characteristics);*
- Tag '8A' (Life Cycle Status Integer);
- Tag 'C6' (PIN Status Template DO)  
*It shall contain tag '90' (PS\_DO).*

*The FCP shall contain exactly one of the following tags:*

- Tag '8C' (Compact format);
- Tag 'AB' (Expanded format);
- Tag '8B' (Referenced to Expanded Format).

c) The ME simulator shall send a SELECT command to select DF<sub>TELECOM</sub>.

d) The ME simulator shall send a STATUS command with P2 = '00' to the UICC.

*The FCP shall contain the following tags [CR1]:*

- Tag '82' (File Descriptor)  
*The first byte shall be '38' or '78' (indicating a DF);*
- Tag '83' (File Identifier)  
*The value shall be '7F 10' (indicating DF<sub>TELECOM</sub>);*
- Tag '8A' (Life Cycle Status Integer);
- Tag 'C6' (PIN Status Template DO)  
*It shall contain tag '90' (PS\_DO).*

*The FCP shall contain exactly one of the following tags:*

- Tag '8C' (Compact format);
- Tag 'AB' (Expanded format);
- Tag '8B' (Referenced to Expanded Format).

e) The ME simulator shall send a STATUS command with P2 = '01' to the UICC.

*The UICC shall return an error code appropriate to the command [CR2].*

f) The ME simulator shall send a SELECT command to the UICC to select and activate the USIM application.

g) The ME simulator shall send a STATUS command with P2 = '00' to the UICC.

*The FCP shall contain the following tags [CR1]:*

- Tag '82' (File Descriptor)  
*The first byte shall be '38' or '78' (indicating an ADF);*
- Tag '84' (DF name - AID)  
*The value shall be the AID of the USIM application;*
- Tag '8A' (Life Cycle Status Integer);

- Tag 'C6' (PIN Status Template DO)

*It shall contain tag '90' (PS\_DO).*

*The FCP shall contain exactly one of the following tags:*

- Tag '8C' (Compact format);
- Tag 'AB' (Expanded format);
- Tag '8B' (Referenced to Expanded Format).

- h) The ME simulator shall send a SELECT command to the UICC to select the DF<sub>PHONEBOOK</sub>.

- i) The ME simulator shall send a STATUS command with P2 = '00' to the UICC.

*The FCP shall contain the following tags [CR1]:*

- Tag '82' (File Descriptor)  
*The first byte shall be '38' or '78' (indicating a DF);*
- Tag '8A' (Life Cycle Status Integer);
- Tag 'C6' (PIN Status Template DO)  
*It shall contain tag '90' (PS\_DO).*

*The FCP shall contain exactly one of the following tags:*

- Tag '8C' (Compact format);
- Tag 'AB' (Expanded format);
- Tag '8B' (Referenced to Expanded Format).

- j) The ME simulator shall send a STATUS command with P2 = '01' to the UICC.

*The following shall be true of the response data [CR2]:*

*Value of tag '84' shall be the AID of the USIM application.*

- k) The ME simulator shall send a STATUS command with P2 = '0C' to the UICC.

*The following shall be true of the response data [CR3]:*

- *The response data from the UICC shall be only SW1 = '90', SW2 = '00' – normal ending of the command [CR3].*

- l) The ME simulator shall send a SELECT command to select DF<sub>TELECOM</sub>.

- m) The ME simulator shall send a STATUS command with P2 = '00' to the UICC.

*The FCP shall contain the following tags [CR1]:*

- Tag '82' (File Descriptor)  
*The first byte shall be '38' or '78' (indicating a DF);*
- Tag '83' (File Identifier)  
*The value shall be '7F 10' (indicating DF<sub>TELECOM</sub>);*
- Tag '8A' (Life Cycle Status Integer);
- Tag 'C6' (PIN Status Template DO)  
*It shall contain tag '90' (PS\_DO).*

The FCP shall contain exactly one of the following tags:

- Tag '8C' (Compact format);
- Tag 'AB' (Expanded format);
- Tag '8B' (Referenced to Expanded Format).

n) The ME simulator shall send a STATUS command with P2 = '01' to the UICC.

The following shall be true of the response data [CR2]:

Value of tag '84' shall be the AID of the USIM application.

### 6.8.1.3 READ BINARY

#### 6.8.1.3.1 Definition and applicability

It shall be mandatory for all cards complying with TS 102.221 [1] to support all functions described therein.

#### 6.8.1.3.2 Conformance requirement

- CR1 The READ BINARY function shall read a string of bytes from the current transparent EF.
- CR2 The function shall accept as an input, the relative address (offset) and the length (in bytes) of the string.
- CR3 The function shall output the string of bytes.
- CR4 The function shall only be performed if the READ access condition for the current EF is satisfied.
- CR5 The function shall accept SFI referencing.
- CR6 The function shall be aborted if it is applied to an EF without transparent structure.

Reference: TS 102.221 [1], subclause 11.1.3.

Test Group Reference (TGR): TGR\_USIM\_TP102.221\_CMD\_GC

Test Procedure Reference (TPR): TPR\_USIM\_TP102.221\_CMD\_GC\_RDBIN

#### 6.8.1.3.3 Test purpose

To verify that the READ BINARY function conforms to the above requirements.

#### 6.8.1.3.4 Method of test

##### Initial conditions

- 1) The UICC shall be connected to a ME simulator.
- 2) EF<sub>LOCI</sub> shall contain the data string: 'A1 A2 A3 A4 A5 A6 A7 A8 A9 00 00'.

##### Test procedure

- a) The ME simulator shall reset the UICC.
- b) The ME simulator shall send a SELECT command to the UICC to select the USIM application.
- c) The ME simulator shall send a SELECT command to the UICC to select EF<sub>LOCI</sub>.
- d) The ME simulator shall send a READ BINARY command using a length of 11 bytes to the UICC.

The status condition returned by the UICC shall be SW1 = '69', SW2 = '82' – security status not satisfied [CR4].

- e) The ME simulator shall send a VERIFY PIN command with PIN to the UICC to gain the access condition for EF<sub>LOC1</sub>.
- f) The ME simulator shall send a READ BINARY command using a length of 11 bytes to the UICC.

*The status condition returned by the UICC shall be SW1 = '90', SW2 = '00' - normal ending of the command [CR1-CR4].*

*The data string returned shall be 'A1 A2 A3 A4 A5 A6 A7 A8 A9 00 00' [CR1- CR4].*

- g) The ME simulator shall send a READ BINARY command using a length of 1 byte to the UICC.
- h) The ME simulator shall send a READ BINARY command using an offset of '00 01' and length 10 bytes to the UICC.

*The data string returned shall be 'A2 A3 A4 A5 A6 A7 A8 A9 00 00' [CR2].*

- i) The ME simulator shall send a SELECT command to the UICC to select EF<sub>Keys</sub>.
- j) The ME simulator shall send a READ BINARY command using SFI reference to select EF<sub>LOC1</sub> and length 11 bytes to the UICC.

*The data string returned shall be 'A1 A2 A3 A4 A5 A6 A7 A8 A9 00 00' [CR3, CR5].*

- k) The ME simulator shall send a SELECT command to the UICC to select MF.
- l) The ME simulator shall send a SELECT command to the UICC to select EF<sub>DIR</sub>.

- m) The ME simulator shall send a READ BINARY command using a length of 1 byte to the UICC.

*The status condition returned by the UICC shall be SW1 = '69', SW2 = '81' - command incompatible with file structure [CR6].*

#### 6.8.1.4 UPDATE BINARY

##### 6.8.1.4.1 Definition and applicability

It shall be mandatory for all cards complying with TS 102.221 [1] to support all functions described therein.

##### 6.8.1.4.2 Conformance requirement

- CR1 The UPDATE BINARY function shall update the current transparent EF with a string of bytes.
- CR2 The function shall accept as an input, the relative address (offset), the length (in bytes) of the string, and the string of bytes.
- CR3 The function shall only be performed if the UPDATE access condition for the current EF is satisfied.
- CR4 The function shall accept SFI referencing.
- CR5 The function shall be aborted if it is applied to an EF without transparent structure.

Reference: TS 102.221 [1], subclause 11.1.4.

Test Group Reference (TGR): TGR\_USIM\_TP102.221\_CMD\_GC

Test Procedure Reference (TPR): TPR\_USIM\_TP102.221\_CMD\_GC\_UPBIN

##### 6.8.1.4.3 Test purpose

To verify that the UPDATE BINARY function conforms to the above requirements.

#### 6.8.1.4.4 Method of test

##### Initial conditions

- 1) The UICC shall be connected to a ME simulator.
- 2) EF<sub>LOC1</sub> shall contain the data string: 'A1 A2 A3 A4 A5 A6 A7 A8 A9 00 00'.

##### Test procedure

- a) The ME simulator shall reset the UICC.
- b) The ME simulator shall send a SELECT command to the UICC to select and activate USIM application.
- c) The ME simulator shall send a SELECT command to the UICC to select EF<sub>LOC1</sub>.
- d) The ME simulator shall send an UPDATE BINARY command using a length of 11 bytes, and data string 'FF FF FF FF FF FF FF 00 00' to the UICC.

*The status condition returned by the UICC shall be SW1 = '69', SW2 = '82' – security status not satisfied [CR3].*

- e) The ME simulator shall send a VERIFY PIN command with PIN to the UICC to gain the access condition for the EF<sub>LOC1</sub>.
- f) The ME simulator shall send a READ BINARY command using a length of 11 bytes to the UICC.

*The data string returned shall be ' A1 A2 A3 A4 A5 A6 A7 A8 A9 00.*

- g) The ME simulator shall send an UPDATE BINARY command using a length of 11 bytes, and data string 'FF FF FF FF FF FF FF 00 00' to the UICC.

*The status condition returned by the UICC shall be SW1 = '90', SW2 = '00' [CR3].*

- h) The ME simulator shall send a READ BINARY command using a length of 11 bytes to the UICC.

*The data string returned shall be 'FF FF FF FF FF FF FF FF FF 00 00' [CR1].*

- i) The ME simulator shall send an UPDATE BINARY command using a length of 1 byte, and data string 'E4' to the UICC.

- j) The ME simulator shall send a READ BINARY command using a length of 11 bytes to the UICC.

*The data string returned shall be 'E4 FF FF FF FF FF FF FF FF 00 00' [CR1].*

- k) The ME simulator shall send an UPDATE BINARY command using an offset of '00 01', a length 1 byte, and data string 'E5' to the UICC.

- l) The ME simulator shall send a READ BINARY command using a length of 11 bytes to the UICC.

*The data string returned shall be 'E4 E5 FF FF FF FF FF FF FF 00 00' [CR1, CR2].*

- m) The ME simulator shall send a SELECT command to the UICC to select EF<sub>Keys</sub>.

- n) The ME simulator shall send an UPDATE BINARY command using SFI reference to select EF<sub>LOC1</sub> and a length 1 byte, and string 'D1' to the UICC.

- o) The ME simulator shall send a READ BINARY command using a length of 11 bytes to the UICC.

*The data string returned shall be 'D1 E5 FF FF FF FF FF FF FF 00 00' [CR1, CR4].*

- p) The ME simulator shall send a SELECT command to the UICC to select EF<sub>SMS</sub>.

- q) The ME simulator shall send an UPDATE BINARY command using a length 1 byte and data string 'D2' to the UICC.

*The status condition returned by the UICC shall be SW1 = '69', SW2 = '81' - command incompatible with file structure [CR5].*

- r) The ME simulator shall send an UPDATE BINARY command using SFI reference to select EF<sub>LOC1</sub> and a length 11 byte, and string "A1 A2 A3 A4 A5 A6 A7 A8 A9 00 00" to the UICC.

## 6.8.1.5 READ RECORD

### 6.8.1.5.1 Definition and applicability

It shall be mandatory for all cards complying with TS 102.221 [1] to support all functions described therein.

### 6.8.1.5.2 Conformance requirement

- CR1 The READ RECORD function shall read one complete record in the current linear fixed or cyclic EF.
- CR2 The function shall accept as an input, the mode, record number if absolute mode, and the length of the record.
- CR3 The function shall output the record specified by the mode.
- CR4 The function shall only be performed if the READ access condition for the current EF is satisfied.
- CR5 If the mode is CURRENT, the current record shall be read.
- CR6 If the mode is CURRENT, the record pointer shall not be affected.
- CR7 If the mode is ABSOLUTE, the record given by the record number shall be read.
- CR8 If the mode is ABSOLUTE, the record pointer shall not be affected.
- CR9 If the mode is NEXT, the record pointer shall be incremented before the function is performed and the pointed record shall be read.
- CR10 If the mode is NEXT, and the record pointer has not been previously been set within the selected EF, the first record shall be read and the record pointer shall be set to this record.
- CR11 If the mode is NEXT, and the record pointer addresses the last record in a linear fixed EF, the record pointer shall not change and no data shall be read.
- CR12 If the mode is NEXT, and the record pointer addresses the last record in a cyclic EF, the first record shall be read and the record pointer shall be set to this record.
- CR13 If the mode is PREVIOUS, the record pointer shall be decremented before the function is performed and the pointed record shall be read.
- CR14 If the mode is PREVIOUS, and the record pointer has not been previously been set within the selected EF, the last record shall be read and the record pointer shall be set to this record.
- CR15 If the mode is PREVIOUS, and the record pointer addresses the first record in a linear fixed EF, the record pointer shall not change and no data shall be read.
- CR16 If the mode is PREVIOUS, and the record pointer addresses the first record in a cyclic EF, the last record shall be read and the record pointer shall be set to this record.
- CR17 The record pointer shall not be changed if the function is unsuccessful.
- CR18 The function shall accept the SFI as an input.
- CR19 When the command contains a valid SFI, it shall set the file as the current EF, reset the current record pointer and subsequent records are read with the READ RECORD command without SFI.

Reference: TS 102.221 [1], subclause 8.4.3 and 11.1.5.

Test Group Reference (TGR): TGR\_USIM\_TP102.221\_CMD\_GC

Test Procedure Reference (TPR): TPR\_USIM\_TP102.221\_CMD\_GC\_RDREC

### 6.8.1.5.3 Test purpose

To verify that the READ RECORD function conforms to the above requirements using three test procedures.

NOTE: CR12 and CR16 can only be tested if any cyclic EFs are present.

### 6.8.1.5.4 Method of test

NOTE 1: Test procedures have been separated into 3 parts. The first part is for testing CURRENT and ABSOLUTE mode, the second part is for testing NEXT and PREVIOUS mode and the third part is for testing the SFI referencing.

NOTE 2: When EF<sub>CCP2</sub> is not supported by the UICC, any supported linear EF in ADF<sub>USIM</sub> supporting SFI may be chosen.

NOTE 3: When EF<sub>ACM</sub> is not supported by the UICC, any supported cyclic EF in ADF<sub>USIM</sub> may be chosen.

#### Initial conditions

- 1) The UICC shall be connected to a ME simulator.
- 2) The records in EF<sub>CCP2</sub> shall contain the following data:

1 <sup>st</sup> record	'10 11 12 13 14 15 16 17 18 19 1A 1B 1C 1D 1E'
2 <sup>nd</sup> record	'20 21 22 23 24 25 26 27 28 29 2A 2B 2C 2D 2E'
2 <sup>nd</sup> last record	'E0 E1 E2 E3 E4 E5 E6 E7 E8 E9 EA EB EC ED EE'
Last record	'F0 F1 F2 F3 F4 F5 F6 F7 F8 F9 FA FB FC FD FE'

- 3) The records in EF<sub>ACM</sub> shall contain the following data, if it is supported:

1 <sup>st</sup> record	'00 00 01' (last updated record)
2 <sup>nd</sup> record	'00 00 02'
3 <sup>rd</sup> record	'00 00 03'
x <sup>th</sup> record	'00 00' followed by byte value X (first updated record)

#### Test procedure 1 (CURRENT and ABSOLUTE mode)

- a) The ME simulator shall reset the UICC.
- b) The ME simulator shall send a SELECT command to the UICC to select and activate USIM application.
- c) The ME simulator shall send a SELECT command to the UICC to select EF<sub>CCP2</sub>.
- d) The ME simulator shall send a READ RECORD command using ABSOLUTE mode with record 1 to the UICC.  
*The status condition returned by the UICC shall be SW1 = '69', SW2 = '82' – security status not satisfied [CR4].*
- e) The ME simulator shall send a VERIFY PIN command with PIN to the UICC.
- f) The ME simulator shall send a READ RECORD command using ABSOLUTE mode with record 1 to the UICC.  
*The status condition returned by the UICC shall be SW1 = '90', SW2 = '00' - normal ending of the command [CR4].*  
*The record data returned shall be that of the first record in the EF<sub>CCP2</sub> [CR1-CR4, CR7].*
- g) The ME simulator shall send a SELECT command to the UICC to select EF<sub>CCP2</sub>.
- h) The ME simulator shall send a READ RECORD command using NEXT mode to the UICC.  
*The record data returned shall be that of the first record in the EF<sub>CCP2</sub>.*
- i) The ME simulator shall send a READ RECORD command using ABSOLUTE mode with record 2 to the UICC.  
*The record data returned shall be that of the second record in the EF<sub>CCP2</sub> [CR7].*
- j) The ME simulator shall send a READ RECORD command using CURRENT mode to the UICC.  
*The record data returned shall be that of the first record in the EF<sub>CCP2</sub> [CR5, CR8].*

- k) The ME simulator shall send a READ RECORD command using NEXT mode to the UICC.  
*The record data returned shall be that of the second record in the EF<sub>CCP2</sub> [CR6].*
- l) The ME simulator shall send a READ RECORD command using ABSOLUTE mode with the last record to the UICC.  
*The record data returned shall be that of the last record in the EF<sub>CCP2</sub> [CR7].*
- m) The ME simulator shall send a READ RECORD command using ABSOLUTE mode with the last record + 1 to the UICC.  
*The status condition returned by the UICC shall be SW1 = '6A', SW2 = '83' – record not found.*
- n) The ME simulator shall send a READ RECORD command using CURRENT mode to the UICC.  
*The record data returned shall be that of the second record in the EF<sub>CCP2</sub> [CR17].*
- o) The ME simulator shall send a SELECT command to the UICC to select EF<sub>ACM</sub>.
- p) The ME simulator shall send a READ RECORD command using NEXT mode to the UICC.  
*The record data returned shall be that of the first record in the EF<sub>ACM</sub> [CR1].*
- q) The ME simulator shall send a READ RECORD command using CURRENT mode to the UICC.  
*The record data returned shall be that of the first record in the EF<sub>ACM</sub> [CR5].*
- r) The ME simulator shall send a READ RECORD command using ABSOLUTE mode with record 3 to the UICC.  
*The record data returned shall be that of the record 3 in the EF<sub>ACM</sub> [CR1, CR7].*
- s) The ME simulator shall send a READ RECORD command using ABSOLUTE mode with the last record + 1 to the UICC.  
*The status condition returned by the UICC shall be SW1 = '6A', SW2 = '83' – record not found.*
- t) The ME simulator shall send a READ RECORD command using CURRENT mode to the UICC.  
*The record data returned shall be that of the first record in the EF<sub>ACM</sub> [CR17].*

#### Test procedure 2 (NEXT and PREVIOUS mode)

- a) The ME simulator shall reset the UICC.
- b) The ME simulator shall send a SELECT command to the UICC to select and activate USIM application.
- c) The ME simulator shall send a SELECT command to the UICC to select EF<sub>CCP2</sub>.
- d) The ME simulator shall send a VERIFY PIN command with PIN to the UICC.
- e) The ME simulator shall send a READ RECORD command using NEXT mode to the UICC.  
*The record data returned shall be that of the first record in the EF<sub>CCP2</sub> [CR10].*
- f) The ME simulator shall send a READ RECORD command using CURRENT mode to the UICC.  
*The record data returned shall be that of the first record in the EF<sub>CCP2</sub> [CR10].*
- g) The ME simulator shall send a READ RECORD command using NEXT mode to the UICC.  
*The status condition returned by the UICC shall be SW1 = '90', SW2 = '00' - normal ending of the command [CR11].*  
*The record data returned shall be that of the second record in the EF<sub>CCP2</sub> [CR9].*
- h) The ME simulator shall send a READ RECORD command using CURRENT mode to the UICC.  
*The record data returned shall be that of the second record in the EF<sub>CCP2</sub> [CR9].*



- i) The ME simulator shall send a SELECT command to the UICC to select EF<sub>CCP2</sub>.
- j) The ME simulator shall send a READ RECORD command using PREVIOUS mode to the UICC.  
*The record data returned shall be that of the last record in the EF<sub>CCP2</sub> [CR14].*
- k) The ME simulator shall send a READ RECORD command using NEXT mode to the UICC.  
*The status condition returned by the UICC shall be SW1 = '6A', SW2 = '83' – Record not found [CR11].*
- l) The ME simulator shall send a READ RECORD command using CURRENT mode to the UICC.  
*The record data returned shall be that of the last record in the EF<sub>CCP2</sub> [CR11].*
- m) The ME simulator shall send a READ RECORD command using PREVIOUS mode to the UICC.  
*The status condition returned by the UICC shall be SW1 = '90', SW2 = '00' - normal ending of the command [CR18].*  
*The record data returned shall be that of the second last record in the EF<sub>CCP2</sub> [CR13].*
- n) The ME simulator shall send a SELECT command to the UICC to select EF<sub>CCP2</sub>.
- o) The ME simulator shall send a READ RECORD command using NEXT mode to the UICC.  
*The record data returned shall be that of the first record in the EF<sub>CCP2</sub> [CR10].*
- p) The ME simulator shall send a READ RECORD command using PREVIOUS mode to the UICC.  
*The status condition returned by the UICC shall be SW1 = '6A', SW2 = '83' – record not found [CR15].*
- q) The ME simulator shall send a READ RECORD command using CURRENT mode to the UICC.  
*The record data returned shall be that of the first record in the EF<sub>CCP2</sub> [CR15].*
- r) The ME simulator shall send a SELECT command to the UICC to select EF<sub>ACM</sub>.
- s) The ME simulator shall send a READ RECORD command using PREVIOUS mode to the UICC.  
*The record data returned shall be that of the last record (record X) in the EF<sub>ACM</sub> [CR16].*
- t) The ME simulator shall send a READ RECORD command using CURRENT mode to the UICC.  
*The record data returned shall be that of the last record (record X) in the EF<sub>ACM</sub> [CR16].*
- u) The ME simulator shall send a READ RECORD command using NEXT mode to the UICC.  
*The record data returned shall be that of the first record (record 1) in the EF<sub>ACM</sub> [CR12].*
- v) The ME simulator shall send a READ RECORD command using PREVIOUS mode to the UICC.  
*The record data returned shall be that of the last record (record X) in the EF<sub>ACM</sub> [CR16].*

### Test procedure 3 (SFI referencing)

- a) The ME simulator shall reset the UICC.
- b) The ME simulator shall send a SELECT command to the UICC to select and activate USIM application.
- c) The ME simulator shall send a VERIFY PIN command with PIN to the UICC.
- d) The ME simulator shall send a READ RECORD command using ABSOLUTE mode with record 1 and with SFI to select EF<sub>CCP2</sub> to the UICC.  
*The status condition returned by the UICC shall be SW1 = '90', SW2 = '00' - normal ending of the command [CR18].*  
*The record data returned shall be that of the first record in the EF<sub>CCP2</sub> [CR18].*

e) The ME simulator shall send a READ RECORD command using CURRENT mode to the UICC.

*The status condition returned by the UICC shall be SW1 = '6A', SW2 = '83' – record not found [CR19].*

f) The ME simulator shall send a READ RECORD command using NEXT mode to the UICC.

*The record data returned shall be that of the first record (record 1) in the EF<sub>CCP2</sub> [CR19].*

## 6.8.1.6 UPDATE RECORD

### 6.8.1.6.1 Definition and applicability

It shall be mandatory for all cards complying with TS 102.221 [1] to support all functions described therein.

### 6.8.1.6.2 Conformance requirement

- CR1 The UPDATE RECORD function shall update one complete record in the current linear fixed or cyclic EF.
- CR2 The function shall accept as an input, the mode, record number if absolute mode, the length of the record, and the data used for updating the record.
- CR3 The function shall only be performed if the UPDATE access condition for the current EF is satisfied.
- CR4 For cyclic files, only PREVIOUS mode shall be allowed.
- CR5 If the mode is CURRENT, the current record shall be updated.
- CR6 If the mode is CURRENT, the record pointer shall not be affected.
- CR7 If the mode is ABSOLUTE, the record given by the record number shall be updated.
- CR8 If the mode is ABSOLUTE, the record pointer shall not be affected.
- CR9 If the mode is NEXT, the record pointer shall be incremented before the function is performed and the pointed record shall be updated.
- CR10 If the mode is NEXT, and the record pointer has not previously been set within the selected EF, the first record shall be updated and the record pointer shall be set to this record.
- CR11 If the mode is NEXT, and the record pointer addresses the last record, the record pointer shall not change and no record shall be updated.
- CR12 If the mode is PREVIOUS, the record pointer shall be decremented before the function shall be performed and the pointed record shall be updated.
- CR13 If the mode is PREVIOUS, and the record pointer has not previously been set within the selected EF, the last record shall be updated and the record pointer set to this record.
- CR14 If the mode is PREVIOUS, the EF is a linear fixed, and the record pointer addresses the first record, the record pointer shall not change and no record shall be updated.
- CR15 If the mode is PREVIOUS and the EF is a cyclic file, the oldest record shall be updated, the record pointer set to this record, and this record shall become the first record.
- CR16 The record pointer shall not be changed if the function is unsuccessful.
- CR17 For modes NEXT and PREVIOUS, P1 has no significance and shall not be interpreted by the USIM.
- CR18 The function shall accept the SFI as an input.
- CR19 When the command contains a valid SFI, it shall set the file as the current EF and resets the current record pointer.

Reference: TS 102.221 [1], subclause 8.4.3 and 11.1.6.

Test Group Reference (TGR): TGR\_USIM\_TP102.221\_CMD\_GC

Test Procedure Reference (TPR): TPR\_USIM\_TP102.221\_CMD\_GC\_UPREC

### 6.8.1.6.3 Test purpose

To verify that the UPDATE RECORD function conforms to the above requirements for the different modes available.

NOTE: CR4 and CR13 can only be tested if any cyclic EF is present.

### 6.8.1.6.4 Method of test

NOTE 1: Test procedures have been separated into 3 parts. The first part is for testing CURRENT and ABSOLUTE mode, and the second part is for testing NEXT and PREVIOUS mode and the third part is for testing the SFI referencing.

NOTE 2: When EF<sub>CCP2</sub> is not supported by the UICC, any supported linear EF in ADF<sub>USIM</sub> supporting SFI may be chosen.

NOTE 3: When EF<sub>ACM</sub> is not supported by the UICC, any supported cyclic EF in ADF<sub>USIM</sub> may be chosen.

#### Initial conditions

- 1) The UICC shall be connected to a ME simulator.

#### Test procedure 1 (CURRENT and ABSOLUTE mode)

- a) The ME simulator shall reset the UICC.
- b) The ME simulator shall send a SELECT command to the UICC to select and activate USIM application.
- c) The ME simulator shall send a SELECT command to the UICC to select EF<sub>CCP2</sub>.
- d) The ME simulator shall send an UPDATE RECORD command using ABSOLUTE mode with record 1 to the UICC. The data used shall be 'C1' for all bytes.

*The status condition returned by the UICC shall be SW1 = '69', SW2 = '82' - security status not satisfied [CR3].*

- e) The ME simulator shall send a VERIFY PIN command with PIN to the UICC.
- f) The ME simulator shall send an UPDATE RECORD command using ABSOLUTE mode with record 1 to the UICC. The data used shall be 'C2' for all bytes.

*The status condition returned by the UICC shall be SW1 = '90', SW2 = '00' - normal ending of the command [CR3].*

- g) The ME simulator shall send a READ RECORD command using ABSOLUTE mode with record 1 to the UICC.

*The record data returned shall be 'C2' for all bytes [CR1-CR3, CR7].*

- h) The ME simulator shall send a SELECT command to the UICC to select EF<sub>CCP2</sub>.
- i) The ME simulator shall send an UPDATE RECORD command using NEXT mode to the UICC. The data used shall be 'FF' for all bytes.
- j) The ME simulator shall send a READ RECORD command using ABSOLUTE mode with record 1 to the UICC.

*The record data returned shall be 'FF' for all bytes [CR7].*

- k) The ME simulator shall send an UPDATE RECORD command using ABSOLUTE mode with record 2 to the UICC. The data used shall be 'C3' for all bytes.

- l) The ME simulator shall send a READ RECORD command using ABSOLUTE mode with record 2 to the UICC.

*The record data returned shall be 'C3' for all bytes [CR7].*

- m) The ME simulator shall send an UPDATE RECORD command using CURRENT mode to the UICC. The data used shall be 'C4' for all bytes.

- n) The ME simulator shall send a READ RECORD command using ABSOLUTE mode with record 1 to the UICC.  
*The record data returned shall be 'C4' for all bytes [CR5, CR8].*
- o) The ME simulator shall send an UPDATE RECORD command using NEXT mode to the UICC. The data used shall be 'C5' for all bytes.
- p) The ME simulator shall send a READ RECORD command using ABSOLUTE mode with record 2 to the UICC.  
*The record data returned shall be 'C5' for all bytes [CR8].*
- q) The ME simulator shall send an UPDATE RECORD command using ABSOLUTE mode with the last record to the UICC. The data used shall be 'C6' for all bytes.
- r) The ME simulator shall send a READ RECORD command using ABSOLUTE mode with the last record to the UICC.  
*The record data returned shall be 'C6' for all bytes [CR7].*
- s) The ME simulator shall send an UPDATE RECORD command using ABSOLUTE mode with the last record + 1 to the UICC. The data used shall be 'C7' for all bytes.  
*The status condition returned by the UICC shall be SW1 = '6A', SW2 = '83' – record not found.*
- t) The ME simulator shall send an UPDATE RECORD command using CURRENT mode to the UICC. The data used shall be 'C8' for all bytes.
- u) The ME simulator shall send a READ RECORD command using ABSOLUTE mode with record 2 to the UICC.  
*The record data returned shall be 'C8' for all bytes [CR16].*
- v) The ME simulator shall send a SELECT command to the UICC to select EF<sub>ACM</sub>.
- w) The ME simulator shall send a VERIFY PIN command with the relevant PIN to the UICC.
- x) The ME simulator shall send an UPDATE RECORD command using CURRENT mode to the UICC. The data used shall be 'C9' for all bytes.  
*The UICC shall return an error code appropriate to the command [CR4].*
- y) The ME simulator shall send an UPDATE RECORD command using ABSOLUTE mode with record 3 to the UICC. The data used shall be 'CA' for all bytes.  
*The UICC shall return an error code appropriate to the command [CR4].*
- z) The ME simulator shall send an UPDATE RECORD command using NEXT mode to the UICC. The data used shall be 'CB' for all bytes.  
*The UICC shall return an error code appropriate to the command [CR4].*
- aa) The ME simulator shall send an UPDATE RECORD command using PREVIOUS mode to the UICC. The data used shall be 'CC' for all bytes.  
*The status condition returned by the UICC shall be SW1 = '90', SW2 = '00' - normal ending of the command [CR4].*
- bb) The ME simulator shall send a READ RECORD command using ABSOLUTE mode with record 1 to the UICC.  
*The record data returned shall be 'CC' for all bytes [CR16].*
- cc) The ME simulator shall send an UPDATE RECORD command using PREVIOUS mode to the UICC. The data used shall be '00 00 01'.  
*The status condition returned by the UICC shall be SW1 = '90', SW2 = '00' - normal ending of the command [CR4].*

**Test procedure 2 (NEXT and PREVIOUS mode)**

- a) The ME simulator shall reset the UICC.
- b) The ME simulator shall send a SELECT command to the UICC to select and activate USIM application.
- c) The ME simulator shall send a SELECT command to the UICC to select EF<sub>CCP2</sub>.
- d) The ME simulator shall send a VERIFY PIN command with PIN to the UICC.
- e) The ME simulator shall send an UPDATE RECORD command using NEXT mode to the UICC. The data used shall be 'C2' for all bytes.
- f) The ME simulator shall send a READ RECORD command using ABSOLUTE mode with record 1 to the UICC.  
*The record data returned shall be 'C2' for all bytes [CR10].*
- g) The ME simulator shall send an UPDATE RECORD command using CURRENT mode to the UICC. The data used shall be 'C3' for all bytes.
- h) The ME simulator shall send a READ RECORD command using ABSOLUTE mode with record 1 to the UICC.  
*The record data returned shall be 'C3' for all bytes [CR10].*
- i) The ME simulator shall send an UPDATE RECORD command using NEXT mode to the UICC. The data used shall be 'C4' for all bytes.  
*The status condition returned by the UICC shall be SW1 = '90', SW2 = '00' - normal ending of the command [CR17].*
- j) The ME simulator shall send a READ RECORD command using ABSOLUTE mode with record 2 to the UICC.  
*The record data returned shall be 'C4' for all bytes [CR9, CR17].*
- k) The ME simulator shall send an UPDATE RECORD command using CURRENT mode to the UICC. The data used shall be 'C5' for all bytes.
- l) The ME simulator shall send a READ RECORD command using ABSOLUTE mode with record 2 to the UICC.  
*The record data returned shall be 'C5' for all bytes [CR9].*
- m) The ME simulator shall send a SELECT command to the UICC to select EF<sub>CCP2</sub>.
- n) The ME simulator shall send an UPDATE RECORD command using PREVIOUS mode to the UICC. The data used shall be 'C6' for all bytes.
- o) The ME simulator shall send a READ RECORD command using ABSOLUTE mode with the last record to the UICC.  
*The record data returned shall be 'C6' for all bytes [CR13].*
- p) The ME simulator shall send an UPDATE RECORD command using NEXT mode to the UICC. The data used shall be 'C7' for all bytes.  
*The status condition returned by the UICC shall be SW1 = '6A', SW2 = '83' – record not found [CR11].*
- q) The ME simulator shall send an UPDATE RECORD command using CURRENT mode to the UICC. The data used shall be 'C8' for all bytes.
- r) The ME simulator shall send a READ RECORD command using ABSOLUTE mode with the last record to the UICC.  
*The record data returned shall be 'C8' for all bytes [CR16].*
- s) The ME simulator shall send an UPDATE RECORD command using PREVIOUS mode to the UICC. The data used shall be 'C9' for all bytes.  
*The status condition returned by the UICC shall be SW1 = '90', SW2 = '00' - normal ending of the command [CR17].*

- t) The ME simulator shall send a READ RECORD command using ABSOLUTE mode with the second last record to the UICC.

*The record data returned shall be 'C9' for all bytes [CR12, CR17].*

- u) The ME simulator shall send a SELECT command to the UICC to select EF<sub>CCP2</sub>.

- v) The ME simulator shall send an UPDATE RECORD command using NEXT mode to the UICC. The data used shall be 'CA' for all bytes.

*The status condition returned by the UICC shall be SW1 = '90', SW2 = '00' - normal ending of the command.*

- w) The ME simulator shall send an UPDATE RECORD command using PREVIOUS mode to the UICC. The data used shall be 'CB' for all bytes.

*The status condition returned by the UICC shall be SW1 = '6A', SW2 = '83' - record not found [CR13].*

- x) The ME simulator shall send an UPDATE RECORD command using CURRENT mode to the UICC. The data used shall be 'CC' for all bytes.

*The status condition returned by the UICC shall be SW1 = '90', SW2 = '00' - normal ending of the command [CR13].*

- y) The ME simulator shall send a READ RECORD command using ABSOLUTE mode with record 1 to the UICC.

*The record data returned shall be 'CC' for all bytes [CR16].*

### Test procedure 3 (SFI referencing)

- a) The ME simulator shall reset the UICC.

- b) The ME simulator shall send a SELECT command to the UICC to select and activate USIM application.

- c) The ME simulator shall send a VERIFY PIN command with PIN to the UICC.

- d) The ME simulator shall send an UPDATE RECORD command using ABSOLUTE mode with record 1 and with SFI to select EF<sub>CCP2</sub> under ADF<sub>USIM</sub> to the UICC. The data used shall be 'C0' for all bytes.

*The status condition returned by the UICC shall be SW1 = '90', SW2 = '00' - normal ending of the command [CR18].*

- e) The ME simulator shall send a READ RECORD command using CURRENT mode to the UICC.

*The UICC shall return an error code appropriate to the command (e.g. SW1 = '6A', SW2 = '83' - record not found) [CR19].*

- f) The ME simulator shall send a READ RECORD command using NEXT mode to the UICC.

*The record data returned shall be 'C0' for all bytes [CR19].*

## 6.8.1.7 SEARCH RECORD

### 6.8.1.7.1 Definition and applicability

It shall be mandatory for all cards complying with TS 102.221 [1] to support all functions described therein.

### 6.8.1.7.2 Conformance requirement

- CR1 The SEARCH RECORD function shall search through a linear fixed EF or cyclic EF to find record(s) containing a specific pattern.

- CR2 The function shall only be performed if the READ access condition for the current EF is satisfied.

- CR3 The search shall start:

- a) at the first byte of the record(s);

- b) from a given offset in the record(s);
  - c) from the first occurrence of a given byte in the record(s).
- CR4 If one or more matches are found the record pointer shall be set to the first record where the search pattern was found.
- CR5 For a simple search, the function shall accept as input, the record number, search mode and search pattern.
- CR6 For an enhanced search, the function shall accept as input, the record number, search mode, search pattern and offset.
- CR7 The SEARCH RECORD function shall output either:
- a) none, if Le is empty or no matches were found;
  - b) at most the number of record(s) number(s) defined in Le.
- CR8 For a simple search, the function shall support the following modes:
- a) start forward search from record indicated in P1;
  - b) start backward search from record indicated in P1.
- CR9 For an enhanced search, the SEARCH RECORD function shall support the following modes:
- a) start forward search from record indicated in P1 with search indication;
  - b) start backward search from record indicated in P1 with search indication;
  - c) start forward search from next record with search indication;
  - d) start backward search from previous record with search indication.
- CR10 For the modes "forward search from next record" and "backward search from previous record", P1 has no significance within the scope of the present document and shall be set to '00'.
- CR11 For a SEARCH RECORD function of forward search from next record (enhanced search), if the record pointer has not been previously set within the selected linear fixed or cyclic EF, the search shall begin with the first record.
- CR12 For a SEARCH RECORD function of backward search from previous record (enhanced search), if the record pointer has not been previously set within the selected linear fixed EF, the search shall begin with the last record.
- CR13 The record pointer shall not be changed by an unsuccessful SEARCH RECORD function.
- CR14 The function shall accept the SFI as an input.
- CR15 When the SEARCH RECORD command contains a valid SFI, it shall set the file as the current EF and resets the current record pointer.

Reference: TS 102.221 [1], subclause 8.2.2, 8.4.3 and 11.1.7.

Test Group Reference (TGR): TGR\_USIM\_TP102.221\_CMD\_GC

Test Procedure Reference (TPR): TPR\_USIM\_TP102.221\_CMD\_GC\_SRREC

### 6.8.1.7.3 Test purpose

To verify that the SEARCH RECORD function conforms to the above requirements for the different modes available.

#### 6.8.1.7.4 Method of test

NOTE 1: CR7 can not be tested for T = 0 protocol as the Le byte is not transmitted to the UICC. It is dependent on the design of the transport layer of a ME whether to pass all the response data bytes from the UICC to its application layer according to the Le byte. (CR7 is tested in test procedure 4)

NOTE 2: When EF<sub>SMS</sub> does not support the SFI, any other linear fixed EF in ADF<sub>USIM</sub> supporting SFI and capable of storing at least 20 bytes of data shall be chosen for test procedure 3 (SFI).

NOTE 3: When EF<sub>SMS</sub> is not supported by the USIM application, any other linear fixed EF capable of storing at least 20 bytes of data may be used.

#### Initial conditions

- 1) The UICC shall be connected to a ME simulator.
- 2) The records in EF<sub>SMS</sub> shall contain the following data for the first 20 bytes:

```

1st record  'A0 A1 A2 B0 B1 B2 A0 A1 A2 A0 A1 A2 FF A0 A1 A2 A3 A4 A5 A6 '
2nd record  'B0 B1 B2 A0 A1 A2 A0 A1 A2 B0 B1 B2 FF B0 B1 B2 B3 B4 B5 B6 '
3rd record  'B0 B1 B2 A0 A1 A2 B0 B1 B2 A0 A1 A2 FF C0 C1 C2 C3 C4 C5 C6 '
4th record  'A0 A1 A2 B0 B1 B2 B0 B1 B2 B0 B1 B2 FF D0 D1 D2 D3 D4 D5 D6 '

```

- 3) The data for the remainder of these four records and for all other records shall be 'FF'.

#### Test procedure 1 (simple search)

- a) The ME simulator shall reset the UICC.
- b) The ME simulator shall send a SELECT command to the UICC to select and activate USIM application.
- c) The ME simulator shall send a SELECT command to the UICC to select EF<sub>SMS</sub>.
- d) The ME simulator shall send a SEARCH RECORD command using the record number '01', the 'simple forward search from record indicated in P1' mode and search pattern 'A0 A1 A2 B0' with Le = '00' to the UICC.

*The status condition returned by the UICC shall be SW1 = '69', SW2 = '82' – security status not satisfied [CR2].*

- e) The ME simulator shall send a VERIFY PIN command with PIN to the UICC.
- f) The ME simulator shall send a SEARCH RECORD command using the record number '01', the 'simple forward search from record indicated in P1' mode and search pattern 'A0 A1 A2 B0' with Le = '00' to the UICC.

*The UICC shall return '01 02 03 04' indicating that first, second, third and fourth record have been found [CR3a, CR8a].*

*The status condition returned by the UICC shall be SW1 = '90', SW2 = '00' - normal ending of the command [CR1, CR2, CR5].*

- g) The ME simulator shall send a SEARCH RECORD command using the record number '02', the 'simple backward search from record indicated in P1' mode and search pattern 'A0 A1 A2 B0' with Le = '00' to the UICC.

*The response data shall be '02 01' indicating that the first and second record have been found [CR3a, CR8b].*

*The status condition returned by the UICC shall be SW1 = '90', SW2 = '00' - normal ending of the command.*

- h) The ME simulator shall send a READ RECORD command using CURRENT mode to the UICC.

*The record data returned shall be that of the second record in EF<sub>SMS</sub> [CR4].*

- i) The ME simulator shall send a SEARCH RECORD command using the record number '01', the 'simple forward search from record indicated in P1' mode and search pattern 'A0 A2 A3 A4' with Le = '00' to the UICC.

*No data shall be returned by the UICC as this search pattern can not be found in any of the records [CR7a].*

- j) The ME simulator shall send a READ RECORD command using CURRENT mode to the UICC.

*The record data returned shall be that of the second record in EF<sub>SMS</sub> [CR13].*



- k) The ME simulator shall send a SELECT command to the UICC to select EF<sub>SMS</sub>.
- l) The ME simulator shall send a SEARCH RECORD command using the record number '00' (current record), the 'simple forward search from record indicated in P1' mode, search pattern 'A0 A1 A2 B0' with Le = '00' to the UICC.

*The UICC shall return an error code appropriate to the command, as no current record exists.*

- m) The ME simulator shall send a READ RECORD command using NEXT mode to the UICC.
- n) The ME simulator shall send a SEARCH RECORD command using the record number '00' (current record), the 'simple forward search from record indicated in P1' mode, search pattern 'A0 A1 A2 B0' with Le = '00' to the UICC.

*The response data shall be '01 02 03 04' indicating that the first, second, third and fourth record have been found [CR3a, CR8a].*

*The status condition returned by the UICC shall be SW1 = '90', SW2 = '00' - normal ending of the command.*

- o) The ME simulator shall send a SELECT command to the UICC to select EF<sub>SMS</sub>.
- p) The ME simulator shall send a SEARCH RECORD command using the record number '00' (current record), the 'simple backward search from record indicated in P1' mode, search pattern 'A0 A1 A2 B0' with Le = '00' to the UICC.

*The UICC shall return an error code appropriate to the command, as no current record exists.*

- q) The ME simulator shall send a READ RECORD command using PREVIOUS mode to the UICC.
- r) The ME simulator shall send a SEARCH RECORD command using the record number '00' (current record), the 'simple backward search from record indicated in P1' mode, search pattern 'A0 A1 A2 B0' with Le = '00' to the UICC.

*The response data shall be '04 03 02 01' indicating that the first, second, third and fourth record have been found [CR3a, CR8b].*

*The status condition returned by the UICC shall be SW1 = '90', SW2 = '00' - normal ending of the command.*

### **Test procedure 2 (enhanced search)**

- a) The ME simulator shall reset the UICC.
- b) The ME simulator shall send a SELECT command to the UICC to select and activate USIM application.
- c) The ME simulator shall send a SELECT command to the UICC to select EF<sub>SMS</sub>.
- d) The ME simulator shall send a VERIFY PIN command with PIN to the UICC.
- e) The ME simulator shall send a SEARCH RECORD command using the record number = '01', the 'enhanced forward search from record indicated in P1' mode, search pattern 'A0 A1 A2 B0' with Le = '00' to the UICC. The bit 4 of the first byte in the search indication shall be set to '0' and the second byte shall be set to '03' indicating that the search shall start from that offset.

*The data returned shall be '02 03' indicating that the second and third records have been found [CR3b, CR9b].*

*The status condition returned by the UICC shall be SW1 = '90', SW2 = '00' - normal ending of the command.*

- f) The ME simulator shall send a SEARCH RECORD command using the record number = '02', the 'enhanced backward search from record indicated in P1' mode, search pattern 'A0 A1 A2 B0' with Le = '00' to the UICC. The bit 4 of the first byte in the search indication shall be set to '0' and the second byte shall be set to '03' indicating that the search shall start from that offset.

*The response data shall be '02' indicating that the second record has been found [CR3b, CR9b].*

*The status condition returned by the UICC shall be SW1 = '90', SW2 = '00' - normal ending of the command.*

- g) The ME simulator shall send a SEARCH RECORD command using the P1 = '00', the 'enhanced forward search from next record' mode, search pattern 'A1 A2' with Le = '00' to the UICC. The bit 4 of the first byte in the search indication shall be set to '0' and the second byte shall be set to '07' indicating that the search shall start from that offset.

*The response data shall be '03' indicating that the third record has been found [CR3b, CR9c].*

*The status condition returned by the UICC shall be SW1 = '90', SW2 = '00' - normal ending of the command.*

- h) The ME simulator shall send a SEARCH RECORD command using the P1 = '01', the 'enhanced forward search from next record' mode, search pattern 'A1 A2' with Le = '00' to the UICC. The bit 4 of the first byte in the search indication shall be set to '0' and the second byte shall be set to '07' indicating that the search shall start from that offset.

*The UICC shall return an error code appropriate to the command [CR10].*

- i) The ME simulator shall send a SEARCH RECORD command using the P1 = '04', the 'enhanced backward search from previous record' mode, search pattern 'A1 A2' with Le = '00' to the UICC. The bit 4 of the first byte in the search indication shall be set to '0' and the second byte shall be set to '07' indicating that the search shall start from that offset.

*The UICC shall return an error code appropriate to the command [CR10].*

- j) The ME simulator shall send a SEARCH RECORD command using the P1 = '00', the 'enhanced backward search from previous record' mode, search pattern 'B1 B2' with Le = '00' to the UICC. The bit 4 of the first byte in the search indication shall be set to '0' and the second byte shall be set to '07' indicating that the search shall start from that offset.

*The response data shall be '02' indicating that the second record has been found [CR3b, CR9d].*

*The status condition returned by the UICC shall be SW1 = '90', SW2 = '00' - normal ending of the command.*

- k) The ME simulator shall send a SEARCH RECORD command using the record number = '03', the 'enhanced forward search from record indicated in P1' mode, search pattern 'B1 B2 A0' with Le = '00' to the UICC. The bit 4 of the first byte in the search indication shall be set to '1' and the second byte shall be set to 'B0' indicating that the search shall start after the first occurrence of the value.

*The response data shall be '03' indicating that the third record has been found [CR3c, CR9a].*

*The status condition returned by the UICC shall be SW1 = '90', SW2 = '00' - normal ending of the command.*

- l) The ME simulator shall send a SEARCH RECORD command using the record number = '02', the 'enhanced backward search from record indicated in P1' mode, search pattern 'B1 B2 A0' with Le = '00' to the UICC. The bit 4 of the first byte in the search indication shall be set to '1' and the second byte shall be set to 'B0' indicating that the search shall start after the first occurrence of the value.

*The response data shall be '02 01' indicating that the first and second record has been found [CR3c, CR9b].*

*The status condition returned by the UICC shall be SW1 = '90', SW2 = '00' - normal ending of the command.*

- m) The ME simulator shall send a SEARCH RECORD command using the P1 = '00', the 'enhanced forward search from next record' mode, search pattern 'B0 B1' with Le = '00' to the UICC. The bit 4 of the first byte in the search indication shall be set to '1' and the second byte shall be set to 'A2' indicating that the search shall start after the first occurrence of the value.

*The response data shall be '03 04' indicating that the third and fourth record have been found [CR3c, CR9c].*

*The status condition returned by the UICC shall be SW1 = '90', SW2 = '00' - normal ending of the command.*

- n) The ME simulator shall send a SEARCH RECORD command using the P1 = '00', the 'enhanced backward search from previous record' mode, search pattern 'B0 B1' with Le = '00' to the UICC. The bit 4 of the first byte in the search indication shall be set to '1' and the second byte shall be set to 'A2' indicating that the search shall start after the first occurrence of the value.

*The response data shall be '02 01' indicating that the first and second record have been found [CR3c, CR9d].*

*The status condition returned by the UICC shall be SW1 = '90', SW2 = '00' - normal ending of the command.*

- o) The ME simulator shall send a SEARCH RECORD command using the P1 = '00', the 'enhanced forward search from next record' mode, search pattern 'FF B0' with Le = '00' to the UICC. The bit 4 of the first byte in the search indication shall be set to '1' and the second byte shall be set to 'FF' indicating that the search shall start after the first occurrence of the value.

*No data shall be returned by the UICC as this search pattern can not be found in any of the records [CR7a].*

- p) The ME simulator shall send a SELECT command to the UICC to select EF<sub>SMS</sub>.
- q) The ME simulator shall send a SEARCH RECORD command using the P1 = '00', the 'enhanced forward search from record indicated in P1' mode, search pattern 'A0 A1 A2' with Le = '00' to the UICC. The bit 4 of the first byte in the search indication shall be set to '0' and the second byte shall be set to '00' indicating that the search shall start from that offset.

*The UICC shall return an error code appropriate to the command, as no current record exists.*

- r) The ME simulator shall send a SEARCH RECORD command using the P1 = '00', the 'enhanced forward search from next record' mode, search pattern 'A0 A1 A2' with Le = '00' to the UICC. The bit 4 of the first byte in the search indication shall be set to '0' and the second byte shall be set to '00' indicating that the search shall start from that offset.

*The response data shall be '01 02 03 04' indicating that the first, second, third and fourth record have been found [CR 11].*

*The status condition returned by the UICC shall be SW1 = '90', SW2 = '00' - normal ending of the command.*

- s) The ME simulator shall send a SEARCH RECORD command using the P1 = '00', the 'enhanced forward search from next record' mode, search pattern 'A0 A1 A2' with Le = '00' to the UICC. The bit 4 of the first byte in the search indication shall be set to '0' and the second byte shall be set to '00' indicating that the search shall start from that offset.

*The response data shall be '02 03 04' indicating that the second, third and fourth record have been found [CR4, CR9c].*

*The status condition returned by the UICC shall be SW1 = '90', SW2 = '00' - normal ending of the command.*

- t) The ME simulator shall send a SELECT command to the UICC to select EF<sub>SMS</sub>.
- u) The ME simulator shall send a SEARCH RECORD command using the P1 = '00', the 'enhanced backward search from record indicated in P1' mode, search pattern 'A0 A1 A2' with Le = '00' to the UICC. The bit 4 of the first byte in the search indication shall be set to '0' and the second byte shall be set to '00' indicating that the search shall start from that offset.

*The UICC shall return an error code appropriate to the command, as no current record exists.*

- v) The ME simulator shall send a SEARCH RECORD command using the P1 = '00', the 'enhanced backward search from previous record' mode, search pattern 'A0 A1 A2' with Le = '00' to the UICC. The bit 4 of the first byte in the search indication shall be set to '0' and the second byte shall be set to '00' indicating that the search shall start from that offset.

*The response data shall be '04 03 02 01' indicating that the first, second, third and fourth record have been found [CR12].*

*The status condition returned by the UICC shall be SW1 = '90', SW2 = '00' - normal ending of the command.*

- w) The ME simulator shall send a SEARCH RECORD command using the P1 = '00', the 'enhanced backward search from previous record' mode, search pattern 'A0 A1 A2' with Le = '00' to the UICC. The bit 4 of the first byte in the search indication shall be set to '0' and the second byte shall be set to '00' indicating that the search shall start from that offset.

*The response data shall be '03 02 01' indicating that the first, second and third record have been found [CR4, CR9d].*

*The status condition returned by the UICC shall be SW1 = '90', SW2 = '00' - normal ending of the command.*

- x) The ME simulator shall send a SEARCH RECORD command using the P1 = '01', the 'enhanced forward search from next record' mode, search pattern 'A0 A1 A2' with Le = '00' to the UICC. The bit 4 of the first byte in the search indication shall be set to '0' and the second byte shall be set to '00' indicating that the search shall start from that offset.

*The UICC shall return an error code appropriate to the command [CR 10].*

- y) The ME simulator shall send a SEARCH RECORD command using the P1 = '01', the 'enhanced backward search from previous record' mode, search pattern 'A0 A1 A2' with Le = '00' to the UICC. The bit 4 of the first byte in the search indication shall be set to '0' and the second byte shall be set to '00' indicating that the search shall start from that offset.

*The UICC shall return an error code appropriate to the command [CR 10].*

- z) The ME simulator shall send a SEARCH RECORD command using the record number = '01', the 'enhanced forward search from record indicated in P1' mode and search pattern 'A0 A2 A3 A4' with Le = '00' to the UICC. The bit 4 of the first byte in the search indication shall be set to '0' and the second byte shall be set to '03' indicating that the search shall start from that offset.

*No data shall be returned by the UICC as this search pattern can not be found in any of the records [CR7a].*

- aa) The ME simulator shall send a READ RECORD command using CURRENT mode to the UICC.

*The record data returned shall be that of the third record in EF<sub>SMS</sub> [CR13].*

### **Test procedure 3 (SFI)**

- a) The ME simulator shall reset the UICC.
- b) The ME simulator shall send a SELECT command to the UICC to select and activate USIM application.
- c) The ME simulator shall send a VERIFY PIN command with PIN to the UICC.
- d) The ME simulator shall send a SEARCH RECORD command using the SFI of EF<sub>SMS</sub>, the record number = '01', the 'simple forward search from record indicated in P1' mode and search pattern 'A0 A1 A2' with Le = '00' to the UICC.

*The data returned shall be '01 02 03 04' indicating that the first, second, third and fourth records have been found.*

*The status condition returned shall be SW1 = '90', SW2 = '00' - normal ending of the command [CR14].*

- e) The ME simulator shall send a SEARCH RECORD command using the SFI of EF<sub>SMS</sub>, the record number = '01', the 'simple forward search from record indicated in P1' mode and search pattern 'A0 A2 A3' with Le = '00' to the UICC.

*No data shall be returned by the UICC as this search pattern can not be found in any of the records.*

- f) The ME simulator shall send a READ RECORD command using NEXT mode to the UICC.

*The record data returned shall be that of the first record in EF<sub>SMS</sub> [CR15].*

### **Test procedure 4 (Only applicable for T=1 protocol)**

- a) The ME simulator shall reset the UICC.
- b) The ME simulator shall send a SELECT command to the UICC to select and activate USIM application.
- c) The ME simulator shall send a SELECT command to the UICC to select EF<sub>SMS</sub>.
- d) The ME simulator shall send a VERIFY PIN command with PIN to the UICC.
- e) The ME simulator shall send a SEARCH RECORD command using the record number = '01', the 'simple forward search from record indicated in P1' mode and search pattern 'A0 A1 A2 B0' with an empty Le to the UICC.

*The UICC shall not return any response data bytes [CR7a].*

*The status condition returned by the UICC shall be SW1='90', SW2='00' - normal ending of the command.*

- f) The ME simulator shall send a SEARCH RECORD command using the record number = '01', the 'simple forward search from record indicated in P1' mode and search pattern 'A0 A2 A3 A4' with Le = '01' to the UICC.

*No data shall be returned by the UICC as this search pattern can not be found in any of the records [CR7a].*

- g) The ME simulator shall send a SEARCH RECORD command using the record number = '01', the 'simple forward search from record indicated in P1' mode and search pattern 'A0 A1 A2 B0' with Le = '01' to the UICC.

*The data returned shall be '01' indicating that the first record has been found [CR7b].*

*The status condition returned by the UICC shall be SW1='90', SW2='00' - normal ending of the command.*

- h) The ME simulator shall send a SEARCH RECORD command using the record number = '01', the 'simple forward search from record indicated in P1' mode and search pattern 'A0 A1 A2 B0' with Le = '04' to the UICC.

*The data returned shall be '01 02 03 04' indicating that the first, second, third and fourth record have been found [CR7b].*

*The status condition returned by the UICC shall be SW1='90', SW2='00' - normal ending of the command.*

- i) The ME simulator shall send a SEARCH RECORD command using the record number = '01', the 'enhanced forward search from record indicated in P1' mode, search pattern 'A0 A1 A2 B0' with Le = '04' to the UICC. The bit 4 of the first byte in the search indication shall be set to '0' and the second byte shall be set to '03' indicating that the search shall start from that offset.

*The data returned shall be '02 03' indicating that the second and third record have been found [CR7b].*

## 6.8.1.8 INCREASE

### 6.8.1.8.1 Definition and applicability

It shall be mandatory for all cards complying with TS 102.221 [1] and containing EFs which have the INCREASE access condition assigned i.e. EF<sub>ACM</sub> associated with EF<sub>ACMmax</sub>, EF<sub>ICT</sub> or EF<sub>OCT</sub>, to support all functions described therein.

### 6.8.1.8.2 Conformance requirement

- CR1 This function shall add the value given by the ME to the value of the last increased/updated record of the current cyclic EF and store the result into the oldest record.
- CR2 The record pointer shall be set to this record and this record becomes the record number 1.
- CR3 The function shall only be used if the INCREASE access condition is fulfilled.
- CR4 The function shall accept the input as the value to be added.
- CR5 The function shall output the value of the increased record and the value which has been added.
- CR6 The UICC shall not perform the INCREASE if the result would exceed the maximum value of the record (represented by all bytes set to 'FF').
- CR7 This command shall only be used on files that refer to an access rule where this INS code is indicated as part of the rule.

Reference: TS 102.221 [1], subclause 11.1.8.

Test Group Reference (TGR): TGR\_USIM\_TP102.221\_CMD\_GC

Test Procedure Reference (TPR): TPR\_USIM\_TP102.221\_CMD\_GC\_INC

### 6.8.1.8.3 Test purpose

To verify that the INCREASE function conforms to the above requirements.

#### 6.8.1.8.4 Method of test

NOTE 1: When  $EF_{ACM}$  is not supported by the USIM application, any other cyclic EF which have the INCREASE access condition assigned may be used. In such case, the length of the value to be sent with an INCREASE command shall be equal to the record length of that EF.

##### Initial conditions

- 1) The UICC shall be connected to a ME simulator.
- 2) Each record in  $EF_{ACM}$  shall contain the data '00 00 01'.

##### Test procedure

- a) The ME simulator shall reset the UICC.
- b) The ME simulator shall send a SELECT command to the UICC to select and activate USIM application.
- c) The ME simulator shall send a SELECT command to the UICC to select  $EF_{ACM}$ .
- d) The ME simulator shall send an INCREASE command with value '00 00 02' to the UICC.  
*The status condition returned by the UICC shall be SW1 = '69', SW2 = '82' – security status not satisfied [CR3].*
- e) The ME simulator shall send a VERIFY PIN command with PIN to the UICC.
- f) The ME simulator shall send an INCREASE command with value '00 00 03' to the UICC.  
*The response data shall be '00 00 04 00 00 03' [CR1, CR4, CR5].*
- g) The ME simulator shall send an INCREASE command with value '01 02 00' to the UICC.  
*The response data shall be '01 02 04 01 02 00' [CR1].*
- h) The ME simulator shall send a READ RECORD command using ABSOLUTE mode with record 1 to the UICC.  
*The data read shall be '01 02 04' [CR2].*
- i) The ME simulator shall send an INCREASE command with value 'FF 00 00' to the UICC.  
*The status condition returned by the UICC shall be SW1 = '98', SW2 = '50' - INCREASE cannot be performed, maximum value reached [CR6].*
- j) The ME simulator shall send an INCREASE command with value '00 FF FD' to the UICC.  
*The response data shall be '02 02 01 00 FF FD' [CR5].*
- k) The ME simulator shall send a SELECT command to the UICC to select  $EF_{ICI}$ .
- l) The ME simulator shall send an INCREASE command with value '01 02 00' to the UICC.  
*The UICC shall return an error code appropriate to the command [CR7].*

#### 6.8.1.9 VERIFY PIN

##### 6.8.1.9.1 Definition and applicability

It shall be mandatory for all cards complying with TS 102.221 [1] to support all functions described therein.

##### 6.8.1.9.2 Conformance requirement

- CR1 This command shall initiate the comparison in the UICC of the PIN verification data sent from the ME with the PIN reference data stored in the card.
- CR2 The function shall accept as an input, an indication of PIN (key reference number), the PIN value, or empty.

- CR3 The verification process shall be subject to the following conditions being fulfilled:
- a) PIN is not disabled;
  - b) PIN is not blocked.
- CR4 If the access condition for a function to be performed on the last selected file is PIN, then a successful verification of PIN shall be required prior to the use of the function on this file unless the PIN is disabled.
- CR5 If the PIN presented is correct, the number of remaining PIN attempts for that PIN shall be reset to its initial value 3.
- CR6 If the PIN presented is false, the number of remaining PIN attempts for that PIN shall be decremented.
- CR7 After 3 consecutive false PIN presentations, not necessarily in the same card session, the respective PIN shall be blocked.
- CR8 The value of the retry counter and how many verification attempts are left, shall be obtained in the following ways:
- a) The VERIFY command is sent to the UICC with parameter P2 indicating PIN for which the retry counter value is to be retrieved with an empty data field (response SW1, SW2 '63 CX' where X indicates the number of further allowed retries);
  - b) In case of an unsuccessful PIN verification and if the PIN was not previously blocked prior to the execution of the command, the UICC shall return the remaining retry value in the response parameters SW1, SW2 (response '63 CX' where X indicates the number of further allowed retries).
- CR9 The access condition can never be fulfilled until the UNBLOCK PIN function has been successfully performed on the respective PIN.

Reference: TS 102.221 [1], subclause 11.1.9.

Test Group Reference (TGR): TGR\_USIM\_TP102.221\_CMD\_GC

Test Procedure Reference (TPR): TPR\_USIM\_TP102.221\_CMD\_GC\_VERPIN

### 6.8.1.9.3 Test purpose

To verify that the VERIFY PIN function conforms to the above requirements.

NOTE: This function is only tested for PIN. It is assumed that if the function operates correctly for PIN, it will also operate correctly for PIN2 or other PIN.

### 6.8.1.9.4 Method of test

#### Initial conditions

- 1) The UICC shall be connected to a ME simulator.

#### Test procedure

- a) The ME simulator shall reset the UICC.
- b) The ME simulator shall send a SELECT command to the UICC to select and activate USIM application.
- c) The ME simulator shall send a SELECT command to the UICC to select EF<sub>IMSI</sub>.
- d) The ME simulator shall send a READ BINARY command using a length of 2 bytes to the UICC.

*The status condition returned by the UICC shall be SW1 = '69', SW2 = '82' - access condition not fulfilled [CR4].*

- e) The ME simulator shall send a VERIFY PIN command with PIN to the UICC.

*The status condition returned by the UICC shall be SW1 = '90', SW2 = '00' - normal ending of the command [CR1, CR2].*

- f) The ME simulator shall send a READ BINARY command using a length of 2 bytes to the UICC.

*The status condition returned by the UICC shall be SW1 = '90', SW2 = '00' - normal ending of the command [CR4].*

- g) The ME simulator shall send a VERIFY PIN command with incorrect PIN to the UICC.

*The status condition returned by the UICC shall be SW1 = '63', SW2 = 'C2' - unsuccessful PIN verification, 2 attempts left [CR6, CR8b].*

- h) The ME simulator shall send a VERIFY PIN command with PIN to the UICC.

- i) The ME simulator shall send a VERIFY PIN command with an empty data field to the UICC.

*The status condition returned by the UICC shall be SW1 = '63', SW2 = 'C3' - unsuccessful PIN verification, 3 attempts left [CR5, CR8a].*

- j) The ME simulator shall send a VERIFY PIN command with incorrect PIN to the UICC.

*The status condition returned by the UICC shall be SW1 = '63', SW2 = 'C2' - unsuccessful PIN verification, 2 attempt left [CR8b].*

- k) The ME simulator shall send a VERIFY PIN command with incorrect PIN to the UICC.

*The status condition returned by the UICC shall be SW1 = '63', SW2 = 'C1' - unsuccessful PIN verification, 1 attempt left [CR8b].*

- l) The ME simulator shall reset the UICC and select USIM application.

- m) The ME simulator shall send a VERIFY PIN command with incorrect PIN to the UICC.

*The status condition returned by the UICC shall be SW1 = '63', SW2 = 'C0' - unsuccessful PIN verification, no attempts left [CR7, CR8b].*

- n) The ME simulator shall send a VERIFY PIN command with incorrect PIN to the UICC.

*The status condition returned by the UICC shall be SW1 = '69', SW2 = '83' - unsuccessful PIN verification, no attempts left [CR7].*

- o) The ME simulator shall send a VERIFY PIN command with PIN to the UICC.

*The status condition returned by the UICC shall be SW1 = '69', SW2 = '83' - PIN blocked [CR3b, CR7].*

- p) The ME simulator shall reset the UICC and select and activate USIM application.

- q) The ME simulator shall send a VERIFY PIN command with PIN to the UICC.

*The status condition returned by the UICC shall be SW1 = '69', SW2 = '83' - PIN blocked [CR3b, CR7].*

- r) The ME simulator shall send a SELECT command to the UICC to select EF<sub>IMSI</sub>.

- s) The ME simulator shall send a READ BINARY command using a length of 2 bytes to the UICC.

*The status condition returned by the UICC shall be SW1 = '69', SW2 = '82' - security status not satisfied [CR7].*

- t) The ME simulator shall send an UNBLOCK PIN command to the UICC.

*The status condition returned by the UICC shall be SW1 = '90', SW2 = '00' - normal ending of the command [CR9].*

- u) The ME simulator shall send a VERIFY PIN command with an empty data field to the UICC.

*The status condition returned by the UICC shall be SW1 = '63', SW2 = 'C3' - unsuccessful PIN verification, 3 attempts left [CR1 of subclause 6.8.1.13.2].*



- v) The ME simulator shall send a DISABLE PIN command to the UICC.
- w) The ME simulator shall reset the UICC.
- x) The ME simulator shall send a SELECT command to the UICC to select and activate USIM application.
- y) The ME simulator shall send a SELECT command to the UICC to select EF<sub>IMSI</sub>.
- z) The ME simulator shall send a READ BINARY command using a length of 2 bytes to the UICC.

*The status condition returned by the UICC shall be SW1 = '90', SW2 = '00' - normal ending of the command [CR4].*

- aa) The ME simulator shall send a VERIFY PIN command with PIN to the UICC.

*The UICC shall return an error code appropriate to the command [CR3a].*

- bb) The ME simulator shall send an ENABLE PIN command with PIN to the UICC.

### 6.8.1.10 CHANGE PIN

#### 6.8.1.10.1 Definition and applicability

It shall be mandatory for all cards complying with TS 102.221 [1] to support all functions described therein.

#### 6.8.1.10.2 Conformance requirement

- CR1 This command shall be used to initiate the comparison of the verification data with the PIN, and then to conditionally replace the existing PIN with the new PIN sent to the UICC in the command.
- CR2 This function shall assign a new value to the relevant PIN subject to the following conditions being fulfilled:
  - a) PIN is not disabled;
  - b) PIN is not blocked.
- CR3 The function shall accept as input, an indication of PIN (key reference number), the old and new PIN.
- CR4 If the old PIN presented is correct, the number of remaining PIN attempts for that PIN shall be reset to its initial value 3 and the new value for the PIN becomes valid.
- CR5 If the old PIN presented is false, the number of remaining PIN attempts for that PIN shall be decremented and the value of the PIN shall remain unchanged.
- CR6 After 3 consecutive false PIN presentations, not necessarily in the same card session, the respective PIN shall be blocked and the access condition can never be fulfilled until the UNBLOCK PIN function has been performed successfully on the respective PIN.

Reference: TS 102.221 [1], subclause 11.1.10.

Test Group Reference (TGR): TGR\_USIM\_TP102.221\_CMD\_GC

Test Procedure Reference (TPR): TPR\_USIM\_TP102.221\_CMD\_GC\_CHPIN

#### 6.8.1.10.3 Test purpose

To verify that the CHANGE PIN function conforms to the above requirements.

NOTE: This function is only tested for PIN. It is assumed that if the function operates correctly for PIN, it will also operate correctly for PIN2 or other PIN.

#### 6.8.1.10.4 Method of test

##### Initial conditions

- 1) The UICC shall be connected to a ME simulator.
- 2) PIN of the UICC shall be set to '00000000'.

#### Test procedure

- a) The ME simulator shall reset the UICC.
- b) The ME simulator shall send a SELECT command to the UICC to select and activate USIM application.
- c) The ME simulator shall send a CHANGE PIN command with an incorrect old PIN and new PIN of '33333333' to the UICC.

*The status condition returned by the UICC shall be SW1 = '63', SW2 = 'C2' - unsuccessful PIN verification, 2 attempts left [CR5].*

- d) The ME simulator shall send a CHANGE PIN command with a correct old PIN and new PIN of '33333333' to the UICC.

*The status condition returned by the UICC shall be SW1 = '90', SW2 = '00' - normal ending of the command [CR1, CR2, CR3].*

- e) The ME simulator shall send a VERIFY PIN command with an empty data field to the UICC.

*The status condition returned by the UICC shall be SW1 = '63', SW2 = 'C3' - unsuccessful PIN verification, 3 attempts left [CR4].*

- f) The ME simulator shall send a VERIFY PIN command with a new PIN of '33333333' to the UICC.

*The status condition returned by the UICC shall be SW1 = '90', SW2 = '00' - normal ending of the command [CR1, CR4].*

- g) The ME simulator shall send a CHANGE PIN command with an incorrect old PIN and new PIN of '55555555' to the UICC.

*The status condition returned by the UICC shall be SW1 = '63', SW2 = 'C2' - unsuccessful PIN verification, 2 attempts left [CR5].*

- h) The ME simulator shall send a CHANGE PIN command with an incorrect old PIN and new PIN of '55555555' to the UICC.

*The status condition returned by the UICC shall be SW1 = '63', SW2 = 'C1' - unsuccessful PIN verification, 1 attempt left [CR5].*

- i) The ME simulator shall reset the UICC.

- j) The ME simulator shall send a CHANGE PIN command with an incorrect old PIN and new PIN of '55555555' to the UICC.

*The status condition returned by the UICC shall be SW1 = '63', SW2 = 'C0' - unsuccessful PIN verification, no attempt left [CR5].*

- k) The ME simulator shall send a VERIFY PIN command with incorrect PIN to the UICC.

*The status condition returned by the UICC shall be SW1 = '69', SW2 = '83' - PIN blocked [CR6]..*

- l) The ME simulator shall reset the UICC.

- m) The ME simulator shall send a CHANGE PIN command with an old PIN of '33333333' and new PIN of '55555555' to the UICC.

*The status condition returned by the UICC shall be SW1 = '69', SW2 = '83' - PIN blocked [CR2b].*

- n) The ME simulator shall send an UNBLOCK PIN command with Unblock PIN and a new PIN of '55555555' to the UICC.

- o) The ME simulator shall send a VERIFY PIN command with an empty data field to the UICC.

*The status condition returned by the UICC shall be SW1 = '63', SW2 = 'C3' -unsuccessful PIN verification, 3 attempts left [CR1 of subclause 6.8.1.13.2].*

- p) The ME simulator shall send a VERIFY PIN command with a new PIN of '55555555' to the UICC.

*The status condition returned by the UICC shall be SW1 = '90', SW2 = '00' - normal ending of the command [CR3].*

- q) The ME simulator shall send a DISABLE PIN command to the UICC.  
 r) The ME simulator shall reset the UICC.  
 s) The ME simulator shall send a SELECT command to the UICC to select and activate USIM application.  
 t) The ME simulator shall send a CHANGE PIN command with an old PIN '55555555' and new PIN of '77777777' to the UICC.

*The UICC shall return an error code appropriate to the command [CR2a].*

- u) The ME simulator shall send an ENABLE PIN command to the UICC with PIN '55555555'.

*The status condition returned by the UICC shall be SW1 = '90', SW2 = '00' - normal ending of the command.*

- v) The ME simulator shall send a CHANGE PIN command with an old PIN '55555555' and new PIN of '00000000' to the UICC.

### 6.8.1.11 DISABLE PIN

#### 6.8.1.11.1 Definition and applicability

It shall be mandatory for all cards complying with TS 102.221 [1] to support all functions described therein.

#### 6.8.1.11.2 Conformance requirement

- CR1 This function shall switch off the requirement to compare the PIN verification data with the PIN reference data.
- CR2 The command shall allow an indication whether to use an alternative global key reference, if enabled, or not when the application PIN is disabled.
- CR3 If an alternative global key reference is used as a replacement for the application PIN, the verification of the alternative global key reference shall be performed instead of the application PIN verification to get access to the application.
- CR4 The successful execution of this function shall have the effect that files protected by PIN are now accessible as if they were marked "ALWAYS", except in the case where the alternative global key reference is to be used as a replacement for the disabled PIN.
- CR5 In the case where the alternative global key reference is to be used as a replacement for the disabled PIN, the access condition for files containing only a reference to the disabled PIN is the alternative global key reference.
- CR6 The function shall accept as input, PIN indication and PIN.
- CR7 The function shall accept as input, Global key reference data number for verification replacement, PIN indication and PIN.
- CR8 For files having more than one global key reference indicated in the access rules the access condition is "ALWAYS" after disabling on of the key references used in the access rules.
- CR9 The function shall not be executed by the UICC when PIN is already disabled or blocked.
- CR10 If the PIN presented is correct, the number of remaining PIN attempts shall be reset to its initial value 3 and PIN shall be disabled.

CR11 If the PIN presented is false, the number of remaining PIN attempts shall be decremented and PIN remains enabled.

CR12 After 3 consecutive false PIN presentations, not necessarily in the same card session, the PIN shall be blocked and the access condition can never be fulfilled until the UNBLOCK PIN function has been successfully performed on PIN.

Reference: TS 102.221 [1], subclause 11.1.11.

Test Group Reference (TGR): TGR\_USIM\_TP102.221\_CMD\_GC

Test Procedure Reference (TPR): TPR\_USIM\_TP102.221\_CMD\_GC\_DISPIN

### 6.8.1.11.3 Test purpose

To verify that the DISABLE PIN function conforms to the above requirements.

NOTE: The test procedure for an alternative global key reference is not included as it is out of the scope of the present document.

### 6.8.1.11.4 Method of test

#### Initial conditions

- 1) The UICC shall be connected to a ME simulator.

#### Test procedure

- a) The ME simulator shall reset the UICC.
- b) The ME simulator shall send a SELECT command to the UICC to select and activate USIM application.
- c) The ME simulator shall send a SELECT command to the UICC to select EF<sub>IMSI</sub>.
- d) The ME simulator shall send a READ BINARY command using a length of 2 bytes to the UICC.

*The status condition returned by the UICC shall be SW1 = '69', SW2 = '82' - access condition not fulfilled.*

- e) The ME simulator shall send a DISABLE PIN command with incorrect PIN to the UICC.

*The status condition returned by the UICC shall be SW1 = '63', SW2 = 'C2' - unsuccessful PIN verification, 2 attempts left [CR11].*

- f) The ME simulator shall send a READ BINARY command using a length of 2 bytes to the UICC.

*The status condition returned by the UICC shall be SW1 = '69', SW2 = '82' - access condition not fulfilled [CR11].*

- g) The ME simulator shall send a STATUS command to the UICC.

*The following shall be true of the response data [CR11]:*

*TLV DO with tag '90' in tag 'C6' in tag '62' shall be '80' indicating that PIN is still enabled.*

- h) The ME simulator shall send a VERIFY PIN command with an empty data field to the UICC.

*The status condition returned by the UICC shall be SW1 = '63', SW2 = 'C2' - unsuccessful PIN verification, 2 attempts left [CR11].*

- i) The ME simulator shall send a DISABLE PIN command with PIN to the UICC.

*The status condition returned by the UICC shall be SW1 = '90', SW2 = '00' - normal ending of the command [CR6].*

- j) The ME simulator shall send a STATUS command to the UICC.

*The following shall be true of the response data [CR10]:*

- TLV DO with tag '90' in the PS template DO of the response data shall indicate that PIN is disabled.

- k) The ME simulator shall send a VERIFY PIN command with an empty data field to the UICC.

*The status condition returned by the UICC shall be SW1 = '63', SW2 = 'C3' - unsuccessful PIN verification, 3 attempts left [CR10].*

- l) The ME simulator shall reset the UICC.

- m) The ME simulator shall send a SELECT command to the UICC to select and activate USIM application.

- n) The ME simulator shall send a SELECT command to the UICC to select EF<sub>IMSI</sub>.

- o) The ME simulator shall send a READ BINARY command using a length of 2 bytes to the UICC.

*The status condition returned by the UICC shall be SW1 = '90', SW2 = '00' - normal ending of the command [CR1].*

- p) The ME simulator shall send an ENABLE PIN command with PIN to the UICC.

*The status condition returned by the UICC shall be SW1 = '90', SW2 = '00' - normal ending of the command.*

- q) The ME simulator shall send a DISABLE PIN command with incorrect PIN to the UICC.

*The status condition returned by the UICC shall be SW1 = '63', SW2 = 'C2' - unsuccessful PIN verification, 2 attempt left.*

- r) The ME simulator shall send a DISABLE PIN command with incorrect PIN to the UICC.

*The status condition returned by the UICC shall be SW1 = '63', SW2 = 'C1' - unsuccessful PIN verification, 1 attempt left.*

- s) The ME simulator shall reset the UICC.

- t) The ME simulator shall send a DISABLE PIN command with incorrect PIN to the UICC.

*The status condition returned by the UICC shall be SW1 = '63', SW2 = 'C0' - unsuccessful PIN verification, no attempt left [CR12].*

- u) The ME simulator shall send a VERIFY PIN command with incorrect PIN to the UICC.

*The status condition returned by the UICC shall be SW1 = '69', SW2 = '83' - unsuccessful PIN verification, no attempt left [CR7, CR8b].*

- v) The ME simulator shall reset the UICC.

- w) The ME simulator shall send a DISABLE PIN command with PIN to the UICC.

*The status condition returned by the UICC shall be SW1 = '69', SW2 = '83' - PIN blocked [CR9].*

- x) The ME simulator shall send an UNBLOCK PIN command with Unblock PIN to the UICC.

*The status condition returned by the UICC shall be SW1 = '90', SW2 = '00' - normal ending of the command.*

- y) The ME simulator shall send a VERIFY PIN command with an empty data field to the UICC.

*The status condition returned by the UICC shall be SW1 = '63', SW2 = 'C3' - unsuccessful PIN verification, 3 attempts left [CR1 of subclause 6.8.1.13.2].*

- z) The ME simulator shall send a DISABLE PIN command with PIN to the UICC.

*The status condition returned by the UICC shall be SW1 = '90', SW2 = '00' - normal ending of the command [CR6].*

- aa) The ME simulator shall send a DISABLE PIN command with PIN to the UICC.

*The UICC shall return an error code appropriate to the command [CR9].*

bb) The ME simulator shall send an ENABLE PIN command with PIN to the UICC.

### 6.8.1.12 ENABLE PIN

#### 6.8.1.12.1 Definition and applicability

It shall be mandatory for all cards complying with TS 102.221 [1] to support all functions described therein.

#### 6.8.1.12.2 Conformance requirement

- CR1 This function shall switch on the requirement to compare the PIN verification data with the PIN reference data.
- CR2 The function shall not be executed by the UICC when PIN is already enabled or blocked.
- CR3 If the PIN presented is correct, the number of remaining PIN attempts shall be reset to its initial value 3 and PIN shall be enabled.
- CR4 If the PIN presented is false, the number of remaining PIN attempts shall be decremented and PIN shall remain disabled.
- CR5 After 3 consecutive false PIN presentations, not necessarily in the same card session, PIN shall be blocked.
- CR6 If the PIN is blocked and enabled, the access condition can never be fulfilled until the UNBLOCK PIN function has been successfully performed on PIN.
- CR7 The function shall accept as input, PIN.
- CR8 The usage of the alternative global key reference as a replacement shall be disabled upon enabling the PIN for which the alternative global key reference has been a replacement.
- CR9 If the PIN is blocked and disabled, the access condition shall remain granted.

Reference: TS 102.221 [1], subclause 11.1.12.

Test Group Reference (TGR): TGR\_USIM\_TP102.221\_CMD\_GC

Test Procedure Reference (TPR): TPR\_USIM\_TP102.221\_CMD\_GC\_ENPIN

#### 6.8.1.12.3 Test purpose

To verify that the ENABLE PIN function conforms to the above requirements.

NOTE: CR8 is tested in subclause 6.6.5.

#### 6.8.1.12.4 Method of test

##### Initial conditions

- 1) The UICC shall be connected to a ME simulator.

##### Test procedure

- a) The ME simulator shall reset the UICC.
- b) The ME simulator shall send a DISABLE PIN command with PIN to the UICC.
- c) The ME simulator shall reset the UICC.
- d) The ME simulator shall send a SELECT command to the UICC to select and activate USIM application.
- e) The ME simulator shall send a SELECT command to the UICC to select EF<sub>IMSI</sub>.
- f) The ME simulator shall send a READ BINARY command using a length of 2 bytes to the UICC.

*The status condition returned by the UICC shall be SW1 = '90', SW2 = '00' - normal ending of the command.*

- g) The ME simulator shall send an ENABLE PIN command with incorrect PIN to the UICC.

*The status condition returned by the UICC shall be SW1 = '63', SW2 = 'C2' – unsuccessful PIN verification, 2 attempts left [CR4].*

- h) The ME simulator shall send a READ BINARY command using a length of 2 bytes to the UICC.

*The status condition returned by the UICC shall be SW1 = '90', SW2 = '00' – normal ending of the command [CR1].*

- i) The ME simulator shall send a STATUS command to the UICC.

*The following shall be true of the response data [CR4]:*

- *TLV DO with tag '90' in the PS template DO of the response data shall indicate that PIN is still disabled.*

- j) The ME simulator shall send an ENABLE PIN command with incorrect PIN to the UICC.

*The status condition returned by the UICC shall be SW1 = '63', SW2 = 'C1' - unsuccessful PIN verification, 1 attempt left.*

- k) The ME simulator shall send an ENABLE PIN command with PIN to the UICC.

*The status condition returned by the UICC shall be SW1 = '90', SW2 = '00' - normal ending of the command [CR2, CR7].*

- l) The ME simulator shall send a STATUS command to the UICC.

*The following shall be true of the response data [CR4]:*

- *TLV DO with tag '90' in the PS template DO of the response data shall indicate that PIN is now enabled.*

- m) The ME simulator shall send a VERIFY PIN command with an empty data field to the UICC.

*The status condition returned by the UICC shall be SW1 = '63', SW2 = 'C3' - unsuccessful PIN verification, 3 attempts left [CR3].*

- n) The ME simulator shall reset the UICC.

- o) The ME simulator shall send a SELECT command to the UICC to select and activate USIM application.

- p) The ME simulator shall send a SELECT command to the UICC to select EF<sub>IMSI</sub>.

- q) The ME simulator shall send a READ BINARY command using a length of 2 bytes to the UICC.

*The status condition returned by the UICC shall be SW1 = '69', SW2 = '82' - access condition not fulfilled [CR1].*

- r) The ME simulator shall send a DISABLE PIN command with PIN to the UICC.

*The status condition returned by the UICC shall be SW1 = '90', SW2 = '00' - normal ending of the command*

- s) The ME simulator shall send an ENABLE PIN command with incorrect PIN to the UICC.

*The status condition returned by the UICC shall be SW1 = '63', SW2 = 'C2' - unsuccessful PIN verification, 2 attempt left.*

- t) The ME simulator shall send an ENABLE PIN command with incorrect PIN to the UICC.

*The status condition returned by the UICC shall be SW1 = '63', SW2 = 'C1' - unsuccessful PIN verification, 1 attempt left.*

- u) The ME simulator shall reset the UICC.

- v) The ME simulator shall send an ENABLE PIN command with incorrect PIN to the UICC.

*The status condition returned by the UICC shall be SW1 = '63', SW2 = 'C0' - unsuccessful PIN verification, no attempt left [CR5].*

w) The ME simulator shall send an ENABLE PIN command with incorrect PIN to the UICC.

*The status condition returned by the UICC shall be SW1 = '69', SW2 = '83' - PIN blocked [CR5].*

x) The ME simulator shall send a SELECT command to the UICC to select and activate USIM application.

y) The ME simulator shall send a SELECT command to the UICC to select EF<sub>IMSI</sub>.

z) The ME simulator shall send a STATUS command to the UICC.

*If TLV DO with tag '90' in the PS template DO of the response data indicates that PIN is enabled, then aa1) to aa3) shall be carried out.*

*If TLV DO with tag '90' in the PS template DO of the response data indicates that PIN is disabled, then aa4) to aa6) shall be carried out.*

aa1)The ME simulator shall send a READ BINARY command using a length of 2 bytes to the UICC.

*The status condition returned by the UICC shall be SW1 = '69', SW2 = '82' - security status not satisfied [CR6].*

aa2)The ME simulator shall send a VERIFY PIN command with PIN to the UICC.

*The status condition returned by the UICC shall be SW1 = '69', SW2 = '83' - PIN blocked.*

aa3)The ME simulator shall send a UNBLOCK PIN command with Unblock PIN to the UICC.

*The status condition returned by the UICC shall be SW1 = '90', SW2 = '00' - normal ending of the command.*

aa4)The ME simulator shall send a READ BINARY command using a length of 2 bytes to the UICC.

*The status condition returned by the UICC shall be SW1 = '90', SW2 = '00' - normal ending of the command [CR9].*

aa5)The ME simulator shall send an ENABLE PIN command with PIN to the UICC.

*The status condition returned by the UICC shall be SW1 = '69', SW2 = '83' - PIN blocked [CR2].*

aa6)The ME simulator shall send a UNBLOCK PIN command with Unblock PIN to the UICC.

*The status condition returned by the UICC shall be SW1 = '90', SW2 = '00' - normal ending of the command.*

bb)The ME simulator shall reset the UICC.

cc) The ME simulator shall send a STATUS command to the UICC.

*The following shall be true of the response data [CR5]:*

*The TLV DO with tag '90' in the PS template DO of the response data shall indicate that PIN is enabled.*

dd)The ME simulator shall send an ENABLE PIN command with PIN to the UICC.

*The UICC shall return an error or warning code appropriate to the command [CR2].*

### 6.8.1.13 UNBLOCK PIN

#### 6.8.1.13.1 Definition and applicability

It shall be mandatory for all UICC complying with TS 102.221 [1] to support all functions described therein.

#### 6.8.1.13.2 Conformance requirement

CR1 This function shall be used to reset the PIN retry counter to its initial value and then to conditionally set a new PIN value.



- CR2 The function shall accept as input, an indication of PIN, the Unblock PIN and the new PIN.
- CR3 This function shall be performed regardless of whether or not the relevant PIN is blocked.
- CR4 If the Unblock PIN presented is correct, the new PIN value, presented together with the Unblock PIN shall be stored in the relevant EF, the number of remaining UNBLOCK PIN attempts for that Unblock PIN shall be reset to its initial value 10 and the number of remaining PIN attempts for that PIN shall be reset to its initial value 3.
- CR5 After a successful unblocking attempt, the PIN shall be enabled, and the relevant access condition level satisfied.
- CR6 If the presented Unblock PIN is false, the number of remaining UNBLOCK PIN attempts for that Unblock PIN shall be decremented.
- CR7 After 10 consecutive false Unblock PIN presentations, not necessarily in the same card session, the respective Unblock PIN shall be blocked.
- CR8 A false Unblock PIN shall have no effect on the status of the respective PIN itself.
- CR9 If the data field is empty, this UICC shall return the value of retry counter with response status word '63CX'.
- CR10 In case of an unsuccessful PIN verification, the UICC shall return an error.

Reference: TS 102.221 [1], subclause 11.1.13.

Test Group Reference (TGR): TGR\_USIM\_TP102.221\_CMD\_GC

Test Procedure Reference (TPR): TPR\_USIM\_TP102.221\_CMD\_GC\_UNPIN

### 6.8.1.13.3 Test purpose

To verify that the UNBLOCK PIN function conforms to the above requirements.

NOTE 1: CR1 is tested in subclauses 6.8.1.9, 6.8.1.10, 6.8.1.11, 6.8.1.12.

NOTE 2: This function is only tested for PIN. It is assumed that if the function operates correctly for PIN, it will also operate correctly for PIN2 or other PIN.

### 6.8.1.13.4 Method of test

#### Initial conditions

- 1) The UICC shall be connected to a ME simulator.

#### Test procedure 1

- a) The ME simulator shall reset the UICC.
- b) The ME simulator shall send a SELECT command to the UICC to select and activate USIM application.
- c) The ME simulator shall send an UNBLOCK PIN command with incorrect Unblock PIN to the UICC.

*The status condition returned by the UICC shall be SW1 = '63', SW2 = 'C9' - unsuccessful Unblock PIN verification, 9 attempts left [CR10].*

- d) The ME simulator shall send a STATUS command to the UICC.

*The following shall be true of the response data [CR6, CR8]:*

*- TLV DO with tag '90' in the PS template DO of the response data shall indicate that PIN is enabled.*

- e) The ME simulator shall send a VERIFY PIN command with an empty data field to the UICC.

*The status condition returned by the UICC shall be SW1 = '63', SW2 = 'C3' - unsuccessful PIN verification, 3 attempts left.*

- f) The ME simulator shall send an UNBLOCK PIN command with an empty data field to the UICC.

*The status condition returned by the UICC shall be SW1 = '63', SW2 = 'C9' - unsuccessful PIN verification, 9 attempts left [CR9].*

- g) The ME simulator shall send a DISABLE PIN command with PIN to the UICC.

*The status condition returned by the UICC shall be SW1 = '90', SW2 = '00' - normal ending of the command.*

- h) The ME simulator shall send an UNBLOCK PIN command with incorrect Unblock PIN to the UICC.

*The status condition returned by the UICC shall be SW1 = '63', SW2 = 'C8' - unsuccessful Unblock PIN verification, 8 attempts left.*

- i) The ME simulator shall send a STATUS command to the UICC.

*The following shall be true of the response data [CR6, CR8]:*

- *TLV DO with tag '90' in the PS template DO of the response data shall indicate that PIN is disabled.*

- j) The ME simulator shall send an ENABLE PIN command with PIN to the UICC.

*The status condition returned by the UICC shall be SW1 = '90', SW2 = '00' - normal ending of the command.*

- k) The ME simulator shall send a VERIFY PIN command with incorrect PIN to the UICC.

*The status condition returned by the UICC shall be SW1 = '63', SW2 = 'C2' - unsuccessful PIN verification, 2 attempts left.*

- l) The ME simulator shall send an UNBLOCK PIN command with Unblock PIN and new PIN '33333333' to the UICC.

*The status condition returned by the UICC shall be SW1 = '90', SW2 = '00' - normal ending of the command [CR2].*

- m) The ME simulator shall send a STATUS command to the UICC.

*The following shall be true of the response data [CR4, CR5]:*

- *TLV DO with tag '90' in the PS template DO of the response data shall indicate that PIN is enabled.*

- n) The ME simulator shall send a VERIFY PIN command with an empty data field to the UICC.

*The status condition returned by the UICC shall be SW1 = '63', SW2 = 'C3' - unsuccessful PIN verification, 3 attempts left [CR4].*

- o) The ME simulator shall send a VERIFY PIN command with the new PIN to the UICC.

*The status condition returned by the UICC shall be SW1 = '90', SW2 = '00' - normal ending of the command [CR1].*

- p) The ME simulator shall send an UNBLOCK PIN command with an empty data field to the UICC.

*The status condition returned by the UICC shall be SW1 = '63', SW2 = 'CA' - unsuccessful PIN verification, 10 attempts left [CR4].*

- q) The ME simulator shall send a VERIFY PIN command with incorrect PIN to the UICC.

*The status condition returned by the UICC shall be SW1 = '63', SW2 = 'C2' - unsuccessful PIN verification, 2 attempt left.*

- r) The ME simulator shall send a VERIFY PIN command with incorrect PIN to the UICC.

*The status condition returned by the UICC shall be SW1 = '63', SW2 = 'C1' - unsuccessful PIN verification, 1 attempt left.*

- s) The ME simulator shall send a VERIFY PIN command with incorrect PIN to the UICC.

*The status condition returned by the UICC shall be SW1 = '63', SW2 = 'C0' - unsuccessful PIN verification, no attempt left.*

- t) The ME simulator shall send a VERIFY PIN command with incorrect PIN to the UICC.

*The status condition returned by the UICC shall be SW1 = '69', SW2 = '83' - unsuccessful PIN verification, no attempt left.*

- u) The ME simulator shall send an UNBLOCK PIN command with Unblock PIN and new PIN '00000000' to the UICC.

*The status condition returned by the UICC shall be SW1 = '90', SW2 = '00' - normal ending of the command [CR3].*

- v) The ME simulator shall send a VERIFY PIN command with an empty data field to the UICC.

*The status condition returned by the UICC shall be SW1 = '63', SW2 = 'C3' - unsuccessful PIN verification, 3 attempts left [CR3].*

### **Test procedure 2 - \*\*\* Destructive test \*\*\***

- a) The ME simulator shall reset the UICC.

- b) The ME simulator shall send 9 UNBLOCK PIN command with incorrect Unblock PIN to the UICC.

*The status condition returned by the UICC each time shall be SW1 = '63', SW2 = 'CX' - unsuccessful Unblock PIN verification 'X' retries remaining. After 9 times of unsuccessful Unblock PIN verification, the SW shall be SW1 = '63', SW2 = 'C1', at least one attempt left [CR6, CR10].*

- c) The ME simulator shall reset the UICC.

- d) The ME simulator shall send an UNBLOCK PIN command with incorrect Unblock PIN to the UICC.

*The status condition returned by the UICC shall be SW1 = '63', SW2 = 'C0' - unsuccessful Unblock PIN verification, no attempt left [CR7].*

- e) The ME simulator shall send an UNBLOCK PIN command with Unblock PIN to the UICC.

*The status condition returned by the UICC shall be SW1 = '69', SW2 = '83' - Unblock PIN blocked [CR7].*

## **6.8.1.14 DEACTIVATE FILE**

### **6.8.1.14.1 Definition and applicability**

It shall be mandatory for all UICC complying with TS 102.221 [1] to support all functions described therein.

### **6.8.1.14.2 Conformance requirement**

CR1 This function shall deactivate the EF.

CR2 The target EF shall be selected by following ways:

- a) Select by file id (P1 = '00');
- b) Select by path from MF (P1 = '08');
- c) Select by path from current DF (P1 = '09').

CR3 After a DEACTIVATE FILE function the respective flag in the file LCS1\_DO shall be changed accordingly.

CR4 The function shall only be performed if the DEACTIVATE FILE access condition for the designated EF is satisfied.

CR5 In case of successful execution of the command, the EF on which the command was applied shall become the current EF.

- CR6 After unsuccessful execution, the current EF and current DF shall remain the same as prior to the execution.
- CR7 A deactivated file shall no longer be available within the application for any function except for the SELECT and ACTIVATE FILE functions.
- CR8 If  $P1 = P2 = '00'$  and the data field is empty, then the command shall apply to the current EF.

Reference: TS 102.221 [1], subclause 11.1.14.

Test Group Reference (TGR): TGR\_USIM\_TP102.221\_CMD\_GC

Test Procedure Reference (TPR): TPR\_USIM\_TP102.221\_CMD\_GC\_DEACTV

### 6.8.1.14.3 Test purpose

To verify that the DEACTIVATE FILE function conforms to the above requirements.

### 6.8.1.14.4 Method of test

NOTE 1: Deactivation requires the verification of ADM, and the respective requirements for their fulfilment are the responsibility of the appropriate administrative authority. Therefore, the following test procedure shall be understood as an example.

NOTE 2: When  $EF_{CCP2}$  under  $ADF_{USIM}$  is not supported by the UICC, any supported linear fixed EF in the USIM application may be chosen.

#### Initial conditions

- 1) The UICC shall be connected to a ME simulator.

#### Test procedure

- a) The ME simulator shall reset the UICC.
- b) The ME simulator shall send a SELECT command to the UICC to select and activate the USIM application.
- c) The ME simulator shall send a DEACTIVATE FILE command using "file ID selection" to the UICC to deactivate  $EF_{CCP2}$ .

*The status condition returned by the UICC shall be  $SW1 = '69'$ ,  $SW2 = '82'$  - access condition not fulfilled [CR4].*

- d) The ME simulator shall send a VERIFY PIN command with PIN to the UICC.
- e) The ME simulator shall send a READ RECORD command to the UICC to read record 1.

*The status condition returned by the UICC shall be  $SW1 = '69'$ ,  $SW2 = '86'$  - command not allowed (no EF selected) [CR6].*

- f) The ME simulator shall reset the UICC.
- g) The ME simulator shall send a SELECT command to the UICC to select and activate USIM application.
- h) The ME simulator shall gain the security access condition(s) specified for both DEACTIVATE and ACTIVATE on  $EF_{CCP2}$ . (This procedure is dependent on the respective requirements of appropriate administrative authority and may require several steps).
- i) The ME simulator shall send a SELECT command to the UICC to select  $EF_{CCP2}$ .

*The following shall be true of the response data:*

- *The value of Life Cycle Status Integer of the response data shall indicate that the EF is activated.*

- j) The ME simulator shall send a DEACTIVATE FILE command using 'file ID selection' to the UICC to deactivate  $EF_{CCP2}$ .

*The status condition returned by the UICC shall be SW1 = '90', SW2 = '00' - normal ending of the command [CR2a, CR3, CR4].*

- k) The ME simulator shall send a VERIFY PIN command with PIN to the UICC.
- l) The ME simulator shall send an UPDATE RECORD command to the UICC to update record 1.  
*The UICC shall return an error code appropriate to the command [CR5, CR7].*
- m) The ME simulator shall send a SELECT command to the UICC to select EF<sub>CCP2</sub>.  
*The value of Life Cycle Status Integer of the response data shall indicate that the EF is deactivated.  
The status condition returned by the UICC shall be SW1 = '62', SW2 = '83' – selected file invalidated.*
- n) The ME simulator shall send an UPDATE RECORD command to the UICC to update record 1.  
*The UICC shall return an error code appropriate to the command [CR7].*
- o) The ME simulator shall send an ACTIVATE FILE command to the UICC to select and activate EF<sub>CCP2</sub>.
- p) The ME simulator shall reset the UICC.
- q) The ME simulator shall send a SELECT command to the UICC to select and activate USIM application.
- r) The ME simulator shall gain the security access condition(s) specified for both DEACTIVATE and ACTIVATE on EF<sub>CCP2</sub>. (This procedure is dependent on the respective requirements of appropriate administrative authority and may require several steps.)
- s) The ME simulator shall send a DEACTIVATE command using 'path selection from MF' to the UICC to deactivate EF<sub>CCP2</sub>.  
*The status condition returned by the UICC shall be SW1 = '90', SW2 = '00' - normal ending of the command.*
- t) The ME simulator shall send a SELECT command to the UICC to select the EF<sub>CCP2</sub>.  
*The value of Life Cycle Status Integer of the response data shall indicate that the EF is deactivated [CR2b].  
The status condition returned by the UICC shall be SW1 = '62', SW2 = '83' – selected file invalidated.*
- u) The ME simulator shall send an ACTIVATE FILE command to the UICC to select and activate EF<sub>CCP2</sub>.
- v) The ME simulator shall reset the UICC.
- w) The ME simulator shall send a SELECT command to the UICC to select and activate USIM application.
- x) The ME simulator shall gain the security access condition(s) specified for both DEACTIVATE and ACTIVATE on EF<sub>CCP2</sub>. (This procedure is dependent on the respective requirements of appropriate administrative authority and may require several steps.)
- y) The ME simulator shall send a DEACTIVATE FILE command using 'path selection from current DF' to the UICC to deactivate EF<sub>CCP2</sub>.  
*The status condition returned by the UICC shall be SW1 = '90', SW2 = '00' - normal ending of the command.*
- z) The ME simulator shall send a SELECT command to the UICC to select EF<sub>CCP2</sub>.  
*The value of Life Cycle Status Integer of the response data shall indicate that the EF is deactivated [CR2b].  
The status condition returned by the UICC shall be SW1 = '62', SW2 = '83' – selected file invalidated.*
- aa) The ME simulator shall send an ACTIVATE FILE command to the UICC to select and activate EF<sub>CCP2</sub>.
- bb) The ME simulator shall reset the UICC.
- cc) The ME simulator shall send a SELECT command to the UICC to select and activate USIM application.

dd) The ME simulator shall gain the security access condition(s) specified for both DEACTIVATE and ACTIVATE on EF<sub>CCP2</sub>. (This procedure is dependent on the respective requirements of appropriate administrative authority and may require several steps.)

ee) The ME simulator shall send a SELECT command to the UICC to select EF<sub>CCP2</sub>.

ff) The ME simulator shall send a DEACTIVATE FILE command with P1 = P2 = '00' and with the empty data field to the UICC.

*The status condition returned by the UICC shall be SW1 = '90', SW2 = '00' - normal ending of the command [CR8].*

gg) The ME simulator shall send a SELECT command to the UICC to select EF<sub>CCP2</sub>.

*The value of Life Cycle Status Integer of the response data shall indicate that the EF is deactivated [CR8].*

*The status condition returned by the UICC shall be SW1 = '62', SW2 = '83' - selected file invalidated.*

hh) The ME simulator shall send an ACTIVATE FILE command to the UICC to select and activate EF<sub>CCP2</sub>.

### 6.8.1.15 ACTIVATE FILE

#### 6.8.1.15.1 Definition and applicability

It shall be mandatory for all UICC complying with TS 102.221 [1] to support all functions described therein.

#### 6.8.1.15.2 Conformance requirement

CR1 This function shall activate a deactivated EF.

CR2 The target EF shall be selected by following ways:

- a) Select by file id (P1 = '00');
- b) Select by path from MF (P1 = '08');
- c) Select by path from current DF (P1 = '09').

CR3 After an ACTIVATE FILE function the respective flag in the file LCSI\_DO byte shall be changed accordingly.

CR4 The function shall only be performed if the ACTIVATE FILE access condition for the designated EF is satisfied.

CR5 In case of successful execution of the command, the EF on which the command was applied shall become the current EF.

CR6 After unsuccessful execution, the current EF and current DF shall remain the same as prior to the execution.

CR7 If P1 = P2 = '00' and the data field is empty, the command shall be applicable to the current EF.

Reference: TS 102.221 [1], subclause 11.1.15.

Test Group Reference (TGR): TGR\_USIM\_TP102.221\_CMD\_GC

Test Procedure Reference (TPR): TPR\_USIM\_TP102.221\_CMD\_GC\_ACTV

#### 6.8.1.15.3 Test purpose

To verify that the ACTIVATE FILE function conforms to the above requirements.

#### 6.8.1.15.4 Method of test

NOTE 1: Activation requires the verification of ADM, and the respective requirements for their fulfilment are the responsibility of the appropriate administrative authority. Therefore, the following test procedure shall be understood as an example.

NOTE 2: When EF<sub>CCP2</sub> under ADF<sub>USIM</sub> is not supported by the UICC, any supported linear fixed EF in the USIM application may be chosen.

#### Initial conditions

- 1) The UICC shall be connected to a ME simulator.

#### Test procedure

- a) The ME simulator shall reset the UICC.
- b) The ME simulator shall send a SELECT command to the UICC to select and activate the USIM application.
- c) The ME simulator shall gain the security access condition(s) specified for both DEACTIVATE and ACTIVATE on EF<sub>CCP2</sub>. (This procedure is dependent on the respective requirements of appropriate administrative authority and may require several steps.)
- d) The ME simulator shall send a SELECT command to the UICC to select EF<sub>CCP2</sub>.
- e) The ME simulator shall send a DEACTIVATE FILE command to the UICC to deactivate EF<sub>CCP2</sub>.
- f) The ME simulator shall reset the UICC.
- g) The ME simulator shall send a SELECT command to the UICC to select and activate the USIM application.
- h) The ME simulator shall send an ACTIVATE FILE command using 'file ID selection' to the UICC to select and activate EF<sub>CCP2</sub>.

*The status condition returned by the UICC shall be SW1 = '69', SW2 = '82' - access condition not fulfilled [CR4].*

- i) The ME simulator shall send a VERIFY PIN command with PIN to the UICC.
- j) The ME simulator shall send a READ RECORD command to the UICC to read record 1.

*The status condition returned by the UICC shall be SW1 = '69', SW2 = '86' - command not allowed (no EF selected) [CR6].*

- k) The ME simulator shall reset the UICC.
- l) The ME simulator shall send a SELECT command to the UICC to select and activate the USIM application.
- m) The ME simulator shall gain the security access condition(s) specified for both DEACTIVATE and ACTIVATE on EF<sub>CCP2</sub>. (This procedure is dependent on the respective requirements of appropriate administrative authority and may require several steps.)
- n) The ME simulator shall send a SELECT command to the UICC to select EF<sub>CCP2</sub>.

*The value of Life Cycle Status Integer of the response data shall indicate that the EF is deactivated.*

*The status condition returned by the UICC shall be SW1 = '62', SW2 = '83' - selected file invalidated.*

- o) The ME simulator shall send an ACTIVATE FILE command using 'file ID selection' to the UICC to select and activate EF<sub>CCP2</sub>.

*The status condition returned by the UICC shall be SW1 = '90', SW2 = '00' - normal ending of the command [CR1, CR2a, CR3, CR4].*

- p) The ME simulator shall send a VERIFY PIN command with PIN to the UICC.
- q) The ME simulator shall send a READ RECORD command to the UICC.

*The status condition returned by the UICC shall be SW1 = '90', SW2 = '00' – normal ending of the command [CR5].*

- r) The ME simulator shall send a SELECT command to the UICC to select EF<sub>CCP2</sub>.
- The value of Life Cycle Status Integer of the response data shall indicate that the EF is activated.*
- s) The ME simulator shall send a DEACTIVATE FILE command to the UICC to deactivate EF<sub>CCP2</sub>.
- t) The ME simulator shall reset the UICC.
- u) The ME simulator shall send a SELECT command to the UICC to select and activate USIM application.
- v) The ME simulator shall gain the security access condition(s) specified for both DEACTIVATE and ACTIVATE on EF<sub>CCP2</sub>. (This procedure is dependent on the respective requirements of appropriate administrative authority and may require several steps.)
- w) The ME simulator shall send an ACTIVATE command using 'path selection from MF' to the UICC to select and activate EF<sub>CCP2</sub>.

*The status condition returned by the UICC shall be SW1 = '90', SW2 = '00' - normal ending of the command.*

- x) The ME simulator shall send a SELECT command to the UICC to select EF<sub>CCP2</sub>.
- The value of Life Cycle Status Integer of the response data shall indicate that the EF is activated.*
- y) The ME simulator shall send a DEACTIVATE FILE command to the UICC to deactivate EF<sub>CCP2</sub>.
- z) The ME simulator shall reset the UICC.
- aa) The ME simulator shall send a SELECT command to the UICC to select and activate USIM application.
- bb) The ME simulator shall gain the security access condition(s) specified for both DEACTIVATE and ACTIVATE on EF<sub>CCP2</sub>. (This procedure is dependent on the respective requirements of appropriate administrative authority and may require several steps.)
- cc) The ME simulator shall send an ACTIVATE FILE command using 'path selection from current DF' to the UICC to select and activate EF<sub>CCP2</sub>.

*The status condition returned by the UICC shall be SW1 = '90', SW2 = '00' - normal ending of the command.*

- dd) The ME simulator shall send a SELECT command to the UICC to select EF<sub>CCP2</sub>.
- The value of Life Cycle Status Integer of the response data shall indicate that the EF is activated.*
- ee) The ME simulator shall send a DEACTIVATE FILE command to the UICC to deactivate EF<sub>CCP2</sub>.
- ff) The ME simulator shall reset the UICC.
- gg) The ME simulator shall send a SELECT command to the UICC to select and activate USIM application.
- hh) The ME simulator shall gain the security access condition(s) specified for both DEACTIVATE and ACTIVATE on EF<sub>CCP2</sub>. (This procedure is dependent on the respective requirements of appropriate administrative authority and may require several steps.)
- ii) The ME simulator shall send a SELECT command to the UICC to select EF<sub>CCP2</sub>.
- jj) The ME simulator shall send an ACTIVATE FILE command with P1 = P2 = '00' and with the empty data field to the UICC.

*The status condition returned by the UICC shall be SW1 = '90', SW2 = '00' - normal ending of the command [CR7].*

- kk) The ME simulator shall send a SELECT command to the UICC to select EF<sub>CCP2</sub>.

*The value of Life Cycle Status Integer of the response data shall indicate that the EF is activated [CR7].*

*The status condition returned by the UICC shall be SW1 = '90', SW2 = '00' – normal ending of the command.*



## 6.8.1.16 AUTHENTICATE

### 6.8.1.16.1 Definition and applicability

It shall be mandatory for all UICC complying with TS 102.221 [1] to support all functions described therein.

### 6.8.1.16.2 Conformance requirement

CR1 An appropriate application shall be selected in the UICC before issuing this command.

Reference: TS 102.221 [1], subclause 11.1.16.

Test Group Reference (TGR): TGR\_USIM\_TP102.221\_CMD\_GC

Test Procedure Reference (TPR): TPR\_USIM\_TP102.221\_CMD\_GC\_AUTH

### 6.8.1.16.3 Test purpose

To verify that the AUTHENTICATE function conforms to the above requirements.

### 6.8.1.16.4 Method of test

NOTE 1: Consequences are not clearly defined when the AUTHENTICATE command is performed where no application is being selected. Therefore, the test for CR1 should be left N/A.

NOTE 2: Authentication procedure for USIM application is tested in subclause 7.3.1 of this present document.

#### **Initial conditions**

N/A

#### **Test procedure**

N/A

## 6.8.1.17 MANAGE CHANNEL

This command is for further study by 3GPP TSG-T WG3.

## 6.9 Transmission Oriented Commands

### 6.9.1 T = 0 specific commands

#### 6.9.1.1 GET RESPONSE

##### 6.9.1.1.1 Definition and applicability

It shall be mandatory for all cards complying with TS 102.221 [1] to support all functions described therein when operating in T = 0 protocol.

##### 6.9.1.1.2 Conformance requirement

CR1 The GET RESPONSE command shall provide response data after the execution of commands AUTHENTICATE, SEARCH RECORD, SELECT and INCREASE.

CR2 It is required that the GET RESPONSE command is executed immediately after the command it is related to (no other command shall come between the command/response pair and the command GET RESPONSE).

CR3 If the sequence is not respected, the UICC shall send the status information '6FXX' as a reaction to the GET RESPONSE.

Reference: TS 102.221 [1], subclause 12.1.1.

Test Group Reference (TGR): TGR\_USIM\_TP102.221\_TOC

Test Procedure Reference (TPR): TPR\_USIM\_TP102.221\_TOC\_T0\_GETRSP

### 6.9.1.1.3 Test purpose

To verify that the coding of the GET RESPONSE command conforms to the above requirements.

NOTE: CR1 is tested in subclauses 6.8.8.1, 6.8.8.7, 6.8.8.8, 6.8.8.16 and 6.8.8.17.

### 6.9.1.1.4 Method of test

#### Initial conditions

- 1) The UICC shall be connected to a ME simulator.

#### Test procedure

- a) The ME simulator shall reset the UICC.
- b) The ME simulator shall send a SELECT command to select the MF to the UICC.
- c) The ME simulator shall send a GET RESPONSE command to the UICC.

*The UICC shall send a valid FCP.*

*TLV DO with tag '83' in tag '62' shall indicate that MF is the currently selected file [CR4].*

- d) The ME simulator shall send a STATUS command to the UICC with P2 = '0C'.
- e) The ME simulator shall send a GET RESPONSE command to the UICC.

*The status condition returned by the UICC shall be SW1 = '6F', SW2 = 'XX' [CR2, CR3].*

## 6.10 Application independent files

The subclause provides tests to ensure that the IUT contains all of the EFs need for a 3GPP session.

### 6.10.1 Definition and applicability

The Elementary Files described in TS 102.221 [1], clause 13 are required on the UICC in order for a 3GPP session to be carried out.

### 6.10.2 Conformance requirement

The following conformance requirements refer to the tables for each EF in TS 102.221 [1], clause 13.

- CR1 Each existing EF shall be selectable under the MF using the identifier given in the table for that EF.
- CR2 All mandatory EFs shall exist on the UICC.
- CR3 The identifier of the EF shall be that given in the table for that EF.
- CR4 The type and structure of the EF shall be that given in the table for that EF.
- CR5 The file size shall be at least that given in the table for that EF.
- CR6 The short file identifier shall exist if it is mandatory in the table for that EF.
- CR7 The access conditions shall be those given in the table for that EF.

Reference: TS 102.221 [1], clause 13.

Test Group Reference (TGR): TGR\_USIM\_TP102.221\_APF

Test Procedure Reference (TPR): TPR\_USIM\_TP102.221\_APF

### 6.10.3 Test purpose

To verify that the UICC conforms to the above requirements.

NOTE: The contents and coding of the data within the files are not tested, but shall conform to the respective contents and coding of the data given for each file in TS 102.221 [1], clause 13.

### 6.10.4 Method of test

#### Initial conditions

- 1) The UICC shall be connected to a ME simulator.

#### Test procedure

- a) The ME simulator shall reset the UICC.
- b) The ME simulator shall send a STATUS command to the UICC.

*TLV DO with tag '83' in the response data shall indicate the identifier of the MF '3F 00'.*

*The status condition returned by the UICC shall be SW1 = '90', SW2 = '00' - normal ending of the command [CR1].*

- c) The ME simulator shall send a SELECT command to the UICC to select the first EF clause 13 of TS 102.221 [1].

*The status condition returned by the UICC shall be SW1 = '90', SW2 = '00' - normal ending of the command [CR1, CR2].*

*The following shall be true of the response data:*

- *TLV DO with tag '83' shall indicate the identifier of the file selected [CR3];*
- *TLV DO with tag '82' shall not be '38' and '78' indicating EF [CR4];*
- *TLV DO with tag '82' shall indicate the structure given in the table for the file in clause 13 of TS 102.221 [1] [CR4];*
- *TLV DO with tag '80' shall be at least the minimum file size given in the table for the file in clause 13 of TS 102.221 [1]. if the EF is transparent [CR5];*
- *Byte 5 and 6 of TLV DO with tag '82' shall be in accordance with the record length given in the table for the file in clause 13 of TS 102.221 [1]. if the EF is linear fixed or cyclic [CR5];*
- *TLV DO with tag '80' shall be an integer multiple of the record length if the EF is linear fixed or cyclic [CR5];*
- *TLV DO with tag '88' shall indicate the short file identifier given in the table for the file in clause 13 of TS 102.221 [1] [CR5, CR6];*
- *TLV DO with tag '86' or '8B' or '8C' or 'AB' shall indicate the access conditions given in the table for the file in clause 13 of TS 102.221 [1] [CR8].*

*Note: if the access conditions indicate referenced security, the referenced record in the EF<sub>ARR</sub> may be read at this point if necessary.*

- d) Steps a) to c) shall be repeated for the remaining mandatory EFs in clause 13 of TS 102.221 [1].
- e) Steps a) to c) shall be repeated for the existing optional EFs in clause 13 of TS 102.221 [1].

---

## 7 Test Procedure (31.102)

This clause details each of the tests in each of the test groups within the Test Group TP31.102. This test suite allows testing of the IUT against the base specification with respect to:

- Contents of the Elementary Files
- Security Features supported by USIM
- USIM commands

### 7.1 Contents of the Elementary Files (EF)

The subclause provides tests to ensure that the IUT contains all of the EFs need for a Telecom session.

#### 7.1.1 Definition and applicability

The Elementary Files described in 3G TS 31.102 [3], clause 4 are required on the UICC in order for a 3GPP session to be carried out.

The contents of these files are not tested as they are card/personalisation specific.

#### 7.1.2 Conformance requirement

The following conformance requirements refer to the tables for each EF in 3G TS 31.102 [3], clause 4.

- CR1 Each existing EF shall be selectable under the respective DF using the identifier given in the table for that EF.
- CR2 All mandatory EFs shall exist on the UICC.
- CR3 The identifier of the EF shall be that given in the table for that EF.
- CR4 The type and structure of the EF shall be that given in the table for that EF.
- CR5 The file size shall be at least that given in the table for that EF.
- CR6 The short file identifier shall be those given in the table for that EF.
- CR7 The short file identifier shall exist if it is mandatory in the table for that EF.
- CR8 The access conditions shall be those given in the table for that EF.

Reference: 3G TS 31.102 [3], clause 4.

Test Group Reference (TGR): TGR\_USIM\_TP31.102\_CEF

Test Procedure Reference (TPR): TPR\_USIM\_TP31.102\_CEF

#### 7.1.3 Test purpose

To verify that the UICC conforms to the above requirements.

NOTE: The contents and coding of the data within the files are not tested, but shall conform to the respective contents and coding of the data given for each file in 3G TS 31.102 [3], clause 4.

#### 7.1.4 Method of test

##### Initial conditions

- 1) The UICC shall be connected to a ME simulator.

## Test procedure

- a) The ME simulator shall reset the UICC.
- b) The ME simulator shall send a SELECT command to the UICC to select the respective DF for the first EF in clause 4 of 3G TS 31.102 [3].

*The status condition returned by the UICC shall be SW1 = '90', SW2 = '00' - normal ending of the command [CR1].*

- c) The ME simulator shall send a SELECT command to the UICC to select the first EF in clause 4 of 3G TS 31.102 [3].

*The status condition returned by the UICC shall be SW1 = '90', SW2 = '00' - normal ending of the command [CR1, CR2].*

*The following shall be true of the response data:*

- *TLV DO with tag '83' shall indicate the identifier of the file selected [CR3];*
- *TLV DO with tag '82' shall not be '38' and '78' indicating EF [CR4];*
- *TLV DO with tag '82' shall indicate the structure given in the table for the file in clause 4 of 3G TS 31.102 [3] [CR4];*
- *TLV DO with tag '80' shall be at least the minimum file size given in the table for the file in clause 4 of 3G TS 31.102 [3]. if the EF is transparent [CR5];*
- *Byte 5 and 6 of TLV DO with tag '82' shall be in accordance with the record length given in the table for the file in clause 4 of 3G TS 31.102 [3]. if the EF is linear fixed or cyclic [CR5];*
- *TLV DO with tag '80' shall be an integer multiple of the record length if the EF is linear fixed or cyclic [CR5];*
- *TLV DO with tag '88' shall indicate the short file identifier given in the table for the file in clause 4 of 3G TS 31.102 [3] [CR5, CR6];*
- *TLV DO with tag '86' or '8B' or '8C' or 'AB' shall indicate the access conditions given in the table for the file in clause 4 of 3G TS 31.102 [3] [CR8].*

*Note: if the access conditions indicate referenced security, the referenced record in the EF<sub>ARR</sub> may be read at this point if necessary.*

- d) Steps a) to c) shall be repeated for the remaining mandatory EFs clause 4 of 3G TS 31.102 [3].
- e) Steps a) to c) shall be repeated for the existing optional EFs clause 4 of 3G TS 31.102 [3].

## 7.2 Security features

### 7.2.1 Definition and applicability

Every file has its own specific access condition for each command which shall be fulfilled before the command can take place.

### 7.2.2 Conformance requirement

- CR1 The USIM application shall use key reference '01' as PIN and key reference '81' as PIN2.
- CR2 Access with PIN2 shall be limited to the USIM application (i.e. PIN2 is used only in the ADF).
- CR3 For a USIM application on a multi-verification capable UICC, the only valid usage qualifiers shall be '00' and '08' which mean verification requirements is not used and user authentication knowledge based (PIN) as defined in ISO/IEC 7816-9 [11].
- CR4 Every file in the USIM application shall have a reference to an access rule stored in EF<sub>ARR</sub>.

- CR5 Every file under  $DF_{TELECOM}$  shall have a reference to an access rule stored in  $EF_{ARR}$  under  $DF_{TELECOM}$ .
- CR6 A multi-verification capable UICC (from the security context point of view) shall support the referenced format using SE ID as defined in TS 102.221 [1].
- CR7 A multi-verification capable UICC (from the security context point of view) shall support the replacement of a UICC application PIN with the Universal PIN, key reference '11', as defined in TS 102.221 [1]. Only the Universal PIN is allowed as a replacement.

Reference: 3G TS 31.102 [3], subclause 6.4.

Test Group Reference (TGR): TGR\_USIM\_TP31.102\_SEC2

Test Procedure Reference (TPR): TPR\_USIM\_TP31.102\_SEC2

### 7.2.3 Test purpose

To verify that the UICC conforms to the above requirements.

NOTE 1: CR1, CR2 are tested in the subclause 6.6.4.

NOTE 2: CR6 is tested in the subclause 6.6.3.

### 7.2.4 Method of test

#### Initial conditions

- 1) The UICC shall be connected to a ME simulator.

#### Test procedure

##### For a multi-verification capable UICC

- a) The ME simulator shall reset the UICC.
- b) The ME simulator shall send a SELECT command to the UICC to select  $DF_{TELECOM}$ .
- c) The ME simulator shall send a SELECT command to the UICC to select the first EF under  $DF_{TELECOM}$ .

*The response data shall contain the TLV DO with tag '8B' indicating Referenced Security Attributes[CR5].*

- d) The step c) shall be repeated for all the EFs under  $DF_{TELECOM}$  in the UICC [CR5].
- e) The ME simulator shall send a SELECT command to the UICC to select and activate USIM application.

*The following shall be true of the response data:*

- *TLV DO with tag 'C6' (PS Template DO) shall contain for the Universal PIN the TLV DO with tag '95' (Usage Qualifier) and the value of this TLV shall be '00' or '08' [CR3];*

- f) The ME simulator shall send a SELECT command to the UICC to select the first EF in the USIM application.

*The response data shall contain the TLV DO with with tag '8B' indicating Referenced Security Attributes and shall contain the SE ID number(s) and  $EF_{ARR}$  record number(s) [CR5, CR6].*

- g) Step f) shall be repeated for all the EFs under the selected ADF in the UICC [CR4].

##### For a single verification capable UICC

- a) The ME simulator shall reset the UICC.
- b) The ME simulator shall send a SELECT command to the UICC to select  $DF_{TELECOM}$ .
- c) The ME simulator shall send a SELECT command to the UICC to select the first EF under  $DF_{TELECOM}$ .

The response data shall contain the TLV DO with tag '8B' indicating Referenced Security Attributes and shall contain a reference to an access rule stored in EF<sub>ARR</sub>.

- d) The step c) shall be repeated for all the EFs under DF<sub>TELECOM</sub> in the UICC [CR5].
- e) The step c) shall be repeated for all the ADF<sub>USIMS</sub> and the EFs under the selected ADF in the UICC [CR4].

## 7.3 USIM commands

### 7.3.1 AUTHENTICATE

#### 7.3.1.1 Definition and applicability

It shall be mandatory for all cards complying with TS 102.221 [1] and 3G TS 31.102 [3] to support all functions described therein.

#### 7.3.1.2 Conformance requirement

- CR1 This function shall cause the UICC to run the f1, f2, f3, f4, f5, and f1\* algorithms using a 16 bytes random number, AUTN, and the subscriber authentication key K stored in the UICC.
- CR2 If the received sequence number SQN is in the correct range, the function shall return the response RES, cipher key CK, and integrity key IK.
- CR3 If the UICC detects the sequence numbers are not in the valid range, the function shall return the signed response AUTS.
- CR4 The function shall not be executable unless a particular USIM application or any sub-directory has been selected as the Current Directory.
- CR5 The function shall not be executable unless a successful PIN verification procedure has been performed.
- CR6 The function shall not be executable unless the expected MAC-A is received.
- CR7 If the UICC does not support 'GSM context' which is indicated in parameter P2, the function shall not be executable.

Reference: 3G TS 31.102 [3], subclause 7.1.

Test Group Reference (TGR): TGR\_USIM\_TP31.102\_UCMD\_AUTH

Test Procedure Reference (TPR): TPR\_USIM\_TP31.102\_UCMD\_AUTH

#### 7.3.1.3 Test purpose

To verify that the UICC conforms to the above requirements.

#### 7.3.1.4 Method of test

##### Initial conditions

- 1) The UICC shall be connected to a ME simulator.

##### Test procedure

- a) The ME simulator shall reset the UICC.
- b) The ME simulator shall send a SELECT command to the UICC to select the USIM application.
- c) The ME simulator shall send an AUTHENTICATE command to the UICC.

*The status condition returned by the UICC shall be SW1 = '69', SW2 = '82' - security status not satisfied [CR5].*

- d) The ME simulator shall reset the UICC.
- e) The ME simulator shall send a SELECT command to the UICC to select the USIM application.
- f) The ME simulator shall send a VERIFY PIN command with PIN to the UICC.
- g) The ME simulator shall send a SELECT command to the UICC to select the MF.
- h) The ME simulator shall send an AUTHENTICATE command to the UICC.

*The command shall be aborted [CR4].*

- i) The ME simulator shall send a SELECT command to the UICC to select the current ADF ('7FFF').
- j) The ME simulator shall send an AUTHENTICATE command to the UICC with incorrect signed data.

*The status condition returned by the UICC shall be SW1 = '98', SW2 = '62' - authentication error, incorrect MAC [CR6].*

- k) If the 'GSM context' is not supported, the ME simulator shall send an AUTHENTICATE command with parameter P2 indicating 'GSM context'.

*The status condition returned by the UICC shall be SW1 = '98', SW2 = '64' - authentication error, GSM security context not supported [CR7].*

- l) The ME simulator shall send an AUTHENTICATE command to the UICC with incorrect sequence number SQN.

*The data field returned shall begin with the tag 'DC', and the data shall be correct for the given f1\* and f5 algorithms and K stored in the UICC [CR1, CR3].*

- m) The ME simulator shall send an AUTHENTICATE command to the UICC with correct data.

*The data field returned shall begin with the tag 'DB', and the data shall be correct for the given f2, f3 and f4 algorithms and K stored in the UICC [CR1, CR2].*

## 7.3.2 Status Conditions Returned by the UICC

### 7.3.2.1 Security management

#### 7.3.2.1.1 Definition and applicability

The status words SW1 and SW2 provide the method with which the UICC can respond to the ME after executing a command.

#### 7.3.2.1.2 Conformance requirement

- CR1 The UICC shall respond with the correct SW1 and SW2 status words for commands which produce authentication errors.

Reference: 3G TS 31.102 [3], subclause 7.3.1.

Test Group Reference (TGR): TGR\_USIM\_TP31.102\_UCMD\_SCR\_SM

Test Procedure Reference (TPR): TPR\_USIM\_TP31.102\_UCMD\_SCR\_SM

#### 7.3.2.1.3 Test purpose

To verify that the UICC conforms to the above requirements when issuing SW1 and SW2 status words.

#### 7.3.2.1.4 Method of test

#### Initial conditions



- 1) The UICC shall be connected to a ME simulator.

### Test procedure

- a) The ME simulator shall reset the UICC.
- b) The ME simulator shall send a SELECT command to the UICC to select the USIM application.
- c) The ME simulator shall send a VERIFY PIN command with relevant PIN to the UICC.
- d) The ME simulator shall send an AUTHENTICATE command to the UICC with incorrect MAC.

*The status condition returned by the UICC shall be SW1 = '98', SW2 = '62' - authentication error, incorrect MAC [CR1].*

- e) If the 'GSM context' is not supported, the ME simulator shall send an AUTHENTICATE command with parameter P2 indicating 'GSM context'.

*The status condition returned by the UICC shall be SW1 = '98', SW2 = '64' - authentication error, GSM security context not supported [CR1].*

## 7.3.2.2 Status Words of the Commands

### 7.3.2.2.1 Definition and applicability

Limiting the status conditions for each command to a defined set allows the ME to efficiently manage the handling of the status condition.

### 7.3.2.2.2 Conformance requirement

- CR1 Table in 3G TS 31.102 [3], subclause 7.3.2 shows for each command the possible status conditions returned (marked by an asterisk \*). The UICC shall not generate status conditions other than those allowed for each command.

Reference: 3G TS 31.102 [3], subclause 7.3.2.

Test Group Reference (TGR): TGR\_USIM\_TP31.102\_UCMD\_SCR\_SW

Test Procedure Reference (TPR): TPR\_USIM\_TP31.102\_UCMD\_SCR\_SW

### 7.3.2.2.3 Test purpose

To verify for each command that the UICC will only generate the allowed status conditions.

- NOTE: CR1 shall not be tested as it is not possible to force the UICC to generate all of the allowed and disallowed status conditions for each command.

### 7.3.2.2.4 Method of test

#### Initial conditions

N/A

#### Test procedure

N/A

## 7.3.3 VERIFY command

### 7.3.3.1 Definition and applicability

It shall be mandatory for all cards complying with TS 102.221 [1] and 3G TS 31.102 [3] to support all functions described therein.

### 7.3.3.2 Conformance requirement

CR1 For the USIM application during the 3G session, the parameter P2 shall be restricted to '01' indicating verification of the PIN, or '81' indicating the verification of PIN2.

CR2 After 3 unsuccessful verification of attempts, not necessarily in the same session, the PIN shall be blocked.

Reference: 3G TS 31.102 [3], subclause 7.4.

Test Group Reference (TGR): TGR\_USIM\_TP31.102\_UCMD\_VER

Test Procedure Reference (TPR): TPR\_USIM\_TP31.102\_UCMD\_VER

### 7.3.3.3 Test purpose

To verify that the UICC conforms to the above requirements.

NOTE: CR2 is tested in subclause 6.8.1.9.

### 7.3.3.4 Method of test

#### Initial conditions

N/A

#### Test procedure

N/A

## 7.4 UICC Characteristics

### 7.4.1 Voltage classes

#### 7.4.1.1 Definition and applicability

It shall be mandatory for all cards complying with TS 102.221 [1] and 3G TS 31.102 [3] to support all functions described therein.

#### 7.4.1.2 Conformance requirement

CR1 A UICC holding a USIM application shall support at least two consecutive voltage classes as defined in TS 102.221 [1], e.g. AB or BC.

CR2 If the UICC supports more than two classes, they shall all be consecutive, e.g. ABC.

Reference: 3G TS 31.102 [3], subclause 8.1.

Test Group Reference (TGR): TGR\_USIM\_TP31.102\_UCH\_VC

Test Procedure Reference (TPR): TPR\_USIM\_TP31.102\_UCH\_VC

#### 7.4.1.3 Test purpose

To verify that the UICC conforms to the above requirements.

#### 7.4.1.4 Method of test

##### Initial conditions

1) The UICC shall be connected to a ME simulator.

**Test procedure**

- a) The ME simulator shall reset the UICC.

*The UICC shall send the ATR sequence.*

*The supply voltage class indicator (the lower 6 bits in TA(i) after the first occurrence of T = 15 in TD(i-1) for I > 2) shall be exist and one of the following values:*

- '03', '06', '07' [CR1, CR2].

## Annex A (informative): Change history

The table below indicates all change requests that have been incorporated into the present document since it was initially approved by 3GPP TSG-T.

Change history								
Date	TSG #	TSG Doc	CR	Rev	Cat	Subject/Comment	Old	New
2000-12	TP-10	TP-000206				Final draft was approved at TSG-T #10	2.0.0	3.0.0
2001-12	TP-10	TP-010247	001		F	Corrections	3.0.0	3.1.0
			004	1	F	Change test for TLV DO with tag '82' and '83'		
2002-03	TP-15	TP-020067	005		F	Removal of an invalid transfer protocol test case	3.1.0	3.2.0
			006		F	Corrections		
2002-06	TP-16	TP-020118	007		F	General Corrections	3.2.0	3.3.0
			008		F	Removal of test for use of procedure byte '61xx' for case 2 commands		
2002-09	TP-17	TP-020216	009		F	Expected remainder of returned data string	3.3.0	3.4.0
			010		F	Corrections and Clarifications		
			011		F	Correction of error in read binary test case for T=0		
			012		F	Alignment of conformance requirement due to CR 088 on TS 102 221		
			013		F	Correction of case 3/case 4 command tests in case of wrong P1-P2.		
2002-12	TP-18	TP-020287	014		F	Correction of test of Read Record on Linear Fixed EF and T=1 test	3.4.0	3.5.0
2003-03	TP-19	TP-030029	015		F	Correction to the returned FCP of the SELECT and the STATUS command	3.5.0	3.6.0
2003-12	TP-22	TP-030256	016		D	Editorial Corrections	3.6.0	3.7.0
2004-12	TP-26	TP-040264	017		F	Correction of non specific references	3.7.0	3.8.0
2004-12	TP-26					Upgrade to Rel-4	3.8.0	4.0.0

---

## History

<b>Document history</b>		
V4.0.0	December 2004	Publication