

ETSI TS 129 576 V17.0.0 (2022-05)



**5G;
5G System;
Messaging Framework Adaptor Services;
Stage 3
(3GPP TS 29.576 version 17.0.0 Release 17)**



Reference

DTS/TSGC-0329576vh00

Keywords

5G

ETSI

650 Route des Lucioles
F-06921 Sophia Antipolis Cedex - FRANCE

Tel.: +33 4 92 94 42 00 Fax: +33 4 93 65 47 16

Siret N° 348 623 562 00017 - APE 7112B
Association à but non lucratif enregistrée à la
Sous-Préfecture de Grasse (06) N° w061004871

Important notice

The present document can be downloaded from:

<http://www.etsi.org/standards-search>

The present document may be made available in electronic versions and/or in print. The content of any electronic and/or print versions of the present document shall not be modified without the prior written authorization of ETSI. In case of any existing or perceived difference in contents between such versions and/or in print, the prevailing version of an ETSI deliverable is the one made publicly available in PDF format at www.etsi.org/deliver.

Users of the present document should be aware that the document may be subject to revision or change of status.

Information on the current status of this and other ETSI documents is available at

<https://portal.etsi.org/TB/ETSIDeliverableStatus.aspx>

If you find errors in the present document, please send your comment to one of the following services:

<https://portal.etsi.org/People/CommitteeSupportStaff.aspx>

If you find a security vulnerability in the present document, please report it through our

Coordinated Vulnerability Disclosure Program:

<https://www.etsi.org/standards/coordinated-vulnerability-disclosure>

Notice of disclaimer & limitation of liability

The information provided in the present deliverable is directed solely to professionals who have the appropriate degree of experience to understand and interpret its content in accordance with generally accepted engineering or other professional standard and applicable regulations.

No recommendation as to products and services or vendors is made or should be implied.

No representation or warranty is made that this deliverable is technically accurate or sufficient or conforms to any law and/or governmental rule and/or regulation and further, no representation or warranty is made of merchantability or fitness for any particular purpose or against infringement of intellectual property rights.

In no event shall ETSI be held liable for loss of profits or any other incidental or consequential damages.

Any software contained in this deliverable is provided "AS IS" with no warranties, express or implied, including but not limited to, the warranties of merchantability, fitness for a particular purpose and non-infringement of intellectual property rights and ETSI shall not be held liable in any event for any damages whatsoever (including, without limitation, damages for loss of profits, business interruption, loss of information, or any other pecuniary loss) arising out of or related to the use of or inability to use the software.

Copyright Notification

No part may be reproduced or utilized in any form or by any means, electronic or mechanical, including photocopying and microfilm except as authorized by written permission of ETSI.

The content of the PDF version shall not be modified without the written authorization of ETSI.

The copyright and the foregoing restriction extend to reproduction in all media.

© ETSI 2022.
All rights reserved.

Intellectual Property Rights

Essential patents

IPRs essential or potentially essential to normative deliverables may have been declared to ETSI. The declarations pertaining to these essential IPRs, if any, are publicly available for **ETSI members and non-members**, and can be found in ETSI SR 000 314: "*Intellectual Property Rights (IPRs); Essential, or potentially Essential, IPRs notified to ETSI in respect of ETSI standards*", which is available from the ETSI Secretariat. Latest updates are available on the ETSI Web server (<https://ipr.etsi.org/>).

Pursuant to the ETSI Directives including the ETSI IPR Policy, no investigation regarding the essentiality of IPRs, including IPR searches, has been carried out by ETSI. No guarantee can be given as to the existence of other IPRs not referenced in ETSI SR 000 314 (or the updates on the ETSI Web server) which are, or may be, or may become, essential to the present document.

Trademarks

The present document may include trademarks and/or tradenames which are asserted and/or registered by their owners. ETSI claims no ownership of these except for any which are indicated as being the property of ETSI, and conveys no right to use or reproduce any trademark and/or tradename. Mention of those trademarks in the present document does not constitute an endorsement by ETSI of products, services or organizations associated with those trademarks.

DECT™, **PLUGTESTS™**, **UMTS™** and the ETSI logo are trademarks of ETSI registered for the benefit of its Members. **3GPP™** and **LTE™** are trademarks of ETSI registered for the benefit of its Members and of the 3GPP Organizational Partners. **oneM2M™** logo is a trademark of ETSI registered for the benefit of its Members and of the oneM2M Partners. **GSM®** and the GSM logo are trademarks registered and owned by the GSM Association.

Legal Notice

This Technical Specification (TS) has been produced by ETSI 3rd Generation Partnership Project (3GPP).

The present document may refer to technical specifications or reports using their 3GPP identities. These shall be interpreted as being references to the corresponding ETSI deliverables.

The cross reference between 3GPP and ETSI identities can be found under <http://webapp.etsi.org/key/queryform.asp>.

Modal verbs terminology

In the present document "**shall**", "**shall not**", "**should**", "**should not**", "**may**", "**need not**", "**will**", "**will not**", "**can**" and "**cannot**" are to be interpreted as described in clause 3.2 of the [ETSI Drafting Rules](#) (Verbal forms for the expression of provisions).

"**must**" and "**must not**" are **NOT** allowed in ETSI deliverables except when used in direct citation.

Contents

Intellectual Property Rights	2
Legal Notice	2
Modal verbs terminology.....	2
Foreword.....	6
Introduction	7
1 Scope	8
2 References	8
3 Definitions, symbols and abbreviations	9
3.1 Definitions	9
3.2 Symbols.....	9
3.3 Abbreviations	9
4 Services offered by the MFAF	9
4.1 Introduction	9
4.2 Nmfaf_3daDataManagement Service.....	10
4.2.1 Service Description.....	10
4.2.1.1 Overview.....	10
4.2.1.2 Service Architecture.....	11
4.2.1.3 Network Functions	11
4.2.1.3.1 Messaging Framework Adaptor Function (MFAF).....	11
4.2.1.3.2 NF Service Consumers	11
4.2.2 Service Operations	12
4.2.2.1 Introduction.....	12
4.2.2.2 Nmfaf_3daDataManagement_Configure service operation.....	12
4.2.2.2.1 General	12
4.2.2.2.2 Initial configuration for mapping data or analytics.....	12
4.2.2.2.3 Update the configuration of existing individual mapping data or analytics	13
4.2.2.3 Nmfaf_3daDataManagement_Deconfigure service operation	14
4.2.2.3.1 General	14
4.2.2.3.2 Stop mapping data or analytics.....	14
4.3 Nmfaf_3caDataManagement Service.....	14
4.3.1 Service Description.....	14
4.3.1.1 Overview.....	14
4.3.1.2 Service Architecture.....	15
4.3.1.3 Network Functions	15
4.3.1.3.1 Messaging Framework Adaptor Function (MFAF).....	15
4.3.1.3.2 NF Service Consumers	15
4.3.2 Service Operations	16
4.3.2.1 Introduction.....	16
4.3.2.2 Nmfaf_3caDataManagement_Fetch service operation	16
4.3.2.2.1 General	16
4.3.2.2.2 Retrieves data or analytics from the MFAF.....	16
4.3.2.2A Nmfaf_3caDataManagement_Subscribe service operation.....	17
4.3.2.3 Nmfaf_3caDataManagement_Notify service operation.....	17
4.3.2.3.1 General	17
4.3.2.3.2 Notification about the subscribed data or analytics	17
5 API Definitions	19
5.1 Nmfaf_3daDataManagement Service API.....	19
5.1.1 Introduction.....	19
5.1.2 Usage of HTTP.....	19
5.1.2.1 General	19
5.1.2.2 HTTP standard headers	19
5.1.2.2.1 General	19

5.1.2.2.2	Content type	19
5.1.2.3	HTTP custom headers	19
5.1.3	Resources	20
5.1.3.1	Overview	20
5.1.3.2	Resource: MFAF Configurations	20
5.1.3.2.1	Description	20
5.1.3.2.2	Resource Definition	20
5.1.3.2.3	Resource Standard Methods	21
5.1.3.2.3.1	POST	21
5.1.3.2.4	Resource Custom Operations	21
5.1.3.3	Resource: Individual MFAF Configuration	21
5.1.3.2.1	Description	21
5.1.3.3.2	Resource Definition	21
5.1.3.3.3	Resource Standard Methods	22
5.1.3.3.3.1	PUT	22
5.1.3.3.3.2	DELETE	22
5.1.4	Custom Operations without associated resources	23
5.1.5	Notifications	23
5.1.6	Data Model	23
5.1.6.1	General	23
5.1.6.2	Structured data types	23
5.1.6.2.1	Introduction	23
5.1.6.2.2	Type: MfafConfiguration	24
5.1.6.2.3	Type: MessageConfiguration	24
5.1.6.2.4	Type: MfafNotiInfo	24
5.1.6.3	Simple data types and enumerations	24
5.1.6.3.1	Introduction	24
5.1.6.3.2	Simple data types	25
5.1.6.4	Data types describing alternative data types or combinations of data types	25
5.1.6.5	Binary data	25
5.1.7	Error Handling	25
5.1.7.1	General	25
5.1.7.2	Protocol Errors	25
5.1.7.3	Application Errors	25
5.1.8	Feature negotiation	25
5.1.9	Security	25
5.2	Nmfaf_3caDataManagement Service API	26
5.2.1	Introduction	26
5.2.2	Usage of HTTP	26
5.2.2.1	General	26
5.2.2.2	HTTP standard headers	26
5.2.2.2.1	General	26
5.2.2.2.2	Content type	26
5.2.2.3	HTTP custom headers	27
5.2.3	Resources	27
5.2.3.1	Overview	27
5.2.3.2	Resource: MFAF Data or Analytics	27
5.2.3.2.1	Description	27
5.2.3.2.2	Resource Definition	27
5.2.3.2.3	Resource Standard Methods	27
5.2.3.2.3.1	POST	27
5.2.4	Custom Operations without associated resources	28
5.2.5	Notifications	28
5.2.5.1	General	28
5.2.5.2	MFAF Notification	28
5.2.5.2.1	Description	28
5.2.5.2.2	Target URI	28
5.2.5.2.3	Standard Methods	29
5.2.5.2.3.1	POST	29
5.2.5.3	Acknowledgement of Notification	29
5.2.5.3.1	Description	29
5.2.5.3.2	Target URI	29

5.2.5.3.3	Standard Methods	30
5.2.5.3.3.1	POST	30
5.2.6	Data Model	31
5.2.6.1	General	31
5.2.6.2	Structured data types	31
5.2.6.2.1	Introduction	31
5.2.6.2.2	Type: NmfaDataRetrievalNotification	32
5.2.6.2.3	Type: FetchInstruction	32
5.2.6.2.4	Type: NmfaDataAnaNotification	32
5.2.6.3	Simple data types and enumerations	33
5.2.6.3.1	Introduction	33
5.2.6.3.2	Simple data types	33
5.2.6.4	Data types describing alternative data types or combinations of data types	33
5.2.6.5	Binary data	33
5.2.7	Error Handling	33
5.2.7.1	General	33
5.2.7.2	Protocol Errors	33
5.2.7.3	Application Errors	33
5.2.8	Feature negotiation	33
5.2.9	Security	34
Annex A (normative): OpenAPI specification		35
A.1	General	35
A.2	Nmfa_3daDataManagement API	35
A.3	Nmfa_3caDataManagement API	38
Annex B (informative): Change history		42
History		43

Foreword

This Technical Specification has been produced by the 3rd Generation Partnership Project (3GPP).

The contents of the present document are subject to continuing work within the TSG and may change following formal TSG approval. Should the TSG modify the contents of the present document, it will be re-released by the TSG with an identifying change of release date and an increase in version number as follows:

Version x.y.z

where:

- x the first digit:
 - 1 presented to TSG for information;
 - 2 presented to TSG for approval;
 - 3 or greater indicates TSG approved document under change control.
- y the second digit is incremented for all changes of substance, i.e. technical enhancements, corrections, updates, etc.
- z the third digit is incremented when editorial only changes have been incorporated in the document.

In the present document, modal verbs have the following meanings:

- shall** indicates a mandatory requirement to do something
- shall not** indicates an interdiction (prohibition) to do something

The constructions "shall" and "shall not" are confined to the context of normative provisions, and do not appear in Technical Reports.

The constructions "must" and "must not" are not used as substitutes for "shall" and "shall not". Their use is avoided insofar as possible, and they are not used in a normative context except in a direct citation from an external, referenced, non-3GPP document, or so as to maintain continuity of style when extending or modifying the provisions of such a referenced document.

- should** indicates a recommendation to do something
- should not** indicates a recommendation not to do something
- may** indicates permission to do something
- need not** indicates permission not to do something

The construction "may not" is ambiguous and is not used in normative elements. The unambiguous constructions "might not" or "shall not" are used instead, depending upon the meaning intended.

- can** indicates that something is possible
- cannot** indicates that something is impossible

The constructions "can" and "cannot" are not substitutes for "may" and "need not".

- will** indicates that something is certain or expected to happen as a result of action taken by an agency the behaviour of which is outside the scope of the present document
- will not** indicates that something is certain or expected not to happen as a result of action taken by an agency the behaviour of which is outside the scope of the present document
- might** indicates a likelihood that something will happen as a result of action taken by some agency the behaviour of which is outside the scope of the present document

might not indicates a likelihood that something will not happen as a result of action taken by some agency the behaviour of which is outside the scope of the present document

In addition:

is (or any other verb in the indicative mood) indicates a statement of fact

is not (or any other negative verb in the indicative mood) indicates a statement of fact

The constructions "is" and "is not" do not indicate requirements.

Introduction

This clause is optional. If it exists, it is always the second unnumbered clause.

1 Scope

This clause will describe the scope of the corresponding service specification.

The present document specifies the stage 3 protocol and data model for the MFAF Service Based Interface. It provides stage 3 protocol definitions and message flows, and specifies the API for each service offered by the MFAF.

The 5G System stage 2 architecture and procedures are specified in 3GPP TS 23.501 [2] and 3GPP TS 23.502 [3]. The stage 2 definition and procedures of Messaging Framework Adaptation are contained in 3GPP TS 23.288 [14] and 3GPP TS 23.502 [3].

The Technical Realization of the Service Based Architecture and the Principles and Guidelines for Services Definition are specified in 3GPP TS 29.500 [4] and 3GPP TS 29.501 [5].

2 References

The following documents contain provisions which, through reference in this text, constitute provisions of the present document.

- References are either specific (identified by date of publication, edition number, version number, etc.) or non-specific.
- For a specific reference, subsequent revisions do not apply.
- For a non-specific reference, the latest version applies. In the case of a reference to a 3GPP document (including a GSM document), a non-specific reference implicitly refers to the latest version of that document *in the same Release as the present document*.

- [1] 3GPP TR 21.905: "Vocabulary for 3GPP Specifications".
- [2] 3GPP TS 23.501: "System Architecture for the 5G System; Stage 2".
- [3] 3GPP TS 23.502: "Procedures for the 5G System; Stage 2".
- [4] 3GPP TS 29.500: "5G System; Technical Realization of Service Based Architecture; Stage 3".
- [5] 3GPP TS 29.501: "5G System; Principles and Guidelines for Services Definition; Stage 3".
- [6] OpenAPI: "OpenAPI 3.0.0 Specification", <https://github.com/OAI/OpenAPI-Specification/blob/master/versions/3.0.0.md>.
- [7] 3GPP TR 21.900: "Technical Specification Group working methods".
- [8] 3GPP TS 33.501: "Security architecture and procedures for 5G system".
- [9] IETF RFC 6749: "The OAuth 2.0 Authorization Framework".
- [10] 3GPP TS 29.510: "5G System; Network Function Repository Services; Stage 3".
- [11] IETF RFC 7540: "Hypertext Transfer Protocol Version 2 (HTTP/2)".
- [12] IETF RFC 8259: "The JavaScript Object Notation (JSON) Data Interchange Format".
- [13] IETF RFC 7807: "Problem Details for HTTP APIs".
- [14] 3GPP TS 23.288: "Architecture enhancements for 5G System (5GS) to support network data analytics services"
- [15] 3GPP TS 29.574: "5G System; Data Collection Coordination Services; Stage 3".
- [16] 3GPP TS 29.517: "5G System; Application Function Event Exposure Services; Stage 3".
- [17] 3GPP TS 29.518: "5G System; Access and Mobility Management Services; Stage 3".

- [18] 3GPP TS 29.503: "5G System; Unified Data Management Services; Stage 3".
- [19] 3GPP TS 29.591: "5G System; Network Exposure Function Southbound Services; Stage 3".
- [20] 3GPP TS 29.520: "5G System; Network Data Analytics Services; Stage 3".
- [21] 3GPP TS 29.508: "5G System; Session Management Event Exposure Service; Stage 3".
- [22] 3GPP TS 29.571: "5G System; Common Data Types for Service Based Interfaces; Stage 3".

3 Definitions, symbols and abbreviations

3.1 Definitions

For the purposes of the present document, the terms and definitions given in 3GPP TR 21.905 [1] and the following apply. A term defined in the present document takes precedence over the definition of the same term, if any, in 3GPP TR 21.905 [1].

3.2 Symbols

For the purposes of the present document, the following symbols apply:

3.3 Abbreviations

For the purposes of the present document, the abbreviations given in 3GPP TR 21.905 [1] and the following apply. An abbreviation defined in the present document takes precedence over the definition of the same abbreviation, if any, in 3GPP TR 21.905 [1].

MFAF	Messaging Framework Adaptor Function
------	--------------------------------------

4 Services offered by the MFAF

4.1 Introduction

The Messaging Framework Adaptor Services are used for the Messaging Framework Adaptor Function (MFAF) to enable the 5GS to interact with the messaging framework using Nmfaf services. The MFAF offers to other NFs the following services:

- Nmfaf_3daDataManagement; and
- Nmfaf_3caDataManagement.

Table 4.1-1: Service provided by MFAF

Service Name	Description	Service Operations	Operation Semantics	Example Consumer(s)
Nmfaf_3daDataManagement	3GPP DCCF Adaptor (3DA) Data Management Service enables the DCCF to convey to the messaging framework, information about the data the messaging framework will receive from a Data Source, formatting and processing instructions and the Data Consumer and notification endpoints.	Configure	Request / Response	DCCF
		Deconfigure	Request / Response	DCCF
Nmfaf_3caDataManagement	3GPP Consumer Adaptor (3CA) Data Management Service delivers data to each Data Consumer or notification endpoint after formatting and processing of data received by the messaging framework.	Notify	Subscribe / Notify	NWDAF, PCF, NSSF, AMF, SMF, NEF, AF, UDM, OAM, CEF
		Fetch	Request / Response	NWDAF, PCF, NSSF, AMF, SMF, NEF, AF, UDM, OAM, CEF
NOTE: The services correspond to the Nmfaf_3caDataManagement service and Nmfaf_3daDataManagement service as defined in 3GPP TS 23.288 [14].				

Table 4.1-2 summarizes the corresponding APIs defined for this specification.

Table 4.1-2: API Descriptions

Service Name	Clause	Description	OpenAPI Specification File	apiName	Annex
Nmfaf_3daDataManagement	4.2	API for Nmfaf_3daDataManagement	Nmfaf_3daDataManagement.yaml	nmfaf_3dadatamanagement	Annex A.2 Nmfaf_3daDataManagement API
Nmfaf_3caDataManagement	4.3	API for Nmfaf_3caDataManagement	Nmfaf_3caDataManagement.yaml	nmfaf_3cadatamanagement	Annex A.3 Nmfaf_3caDataManagement API

4.2 Nmfaf_3daDataManagement Service

4.2.1 Service Description

4.2.1.1 Overview

The Nmfaf_3daDataManagement service as defined in 3GPP TS 23.288 [14], is provided by the Messaging Framework Adaptor Function (MFAF).

This service:

- allows NF consumers to configure or reconfigure the MFAF to map data or analytics received by the MFAF to out-bound notification endpoints; and
- allows NF consumers to reconfigure the MFAF to stop mapping data or analytics received by the MFAF to out-bound notification endpoints.

4.2.1.2 Service Architecture

The 5G System Architecture is defined in 3GPP TS 23.501 [2]. The Network Data Analytics Exposure architecture is defined in 3GPP TS 23.288 [14].

The Nmfaf_3daDataManagement service is part of the Nmfaf service-based interface exhibited by the Messaging Framework Adaptor Function (MFAF).

Known consumer of the Nmfaf_3daDataManagement service is:

- Data Collection Coordination Function (DCCF)

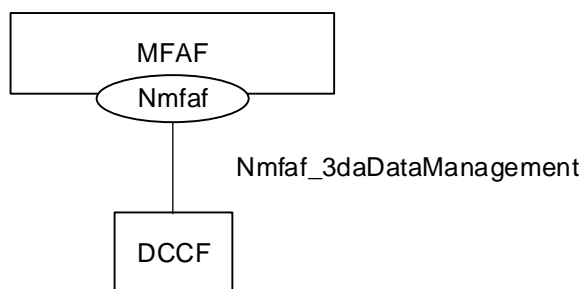

Figure 4.2.1.2-1: Reference Architecture for the Nmfaf_3daDataManagement Service; SBI representation

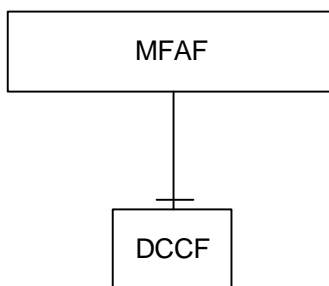

Figure 4.2.1.2-2: Reference Architecture for the Nmfaf_3daDataManagement Service; reference point representation

4.2.1.3 Network Functions

4.2.1.3.1 Messaging Framework Adaptor Function (MFAF)

The Messaging Framework Adaptor Function (MFAF) provides the functionality to allow NF consumers to configure or reconfigure the behaviour of mapping data or analytics received by the MFAF to out-bound notification endpoints.

4.2.1.3.2 NF Service Consumers

The Data Collection Coordination Function (DCCF):

- supports configuring the MFAF to map data or analytics received by the MFAF to out-bound notification endpoints and to format and process the out-bound data or analytics; and
- supports reconfiguring the MFAF to stop the sending of data to consumers.

4.2.2 Service Operations

4.2.2.1 Introduction

Table 4.2.2.1-1: Operations of the Nmfaf_3daDataManagement Service

Service operation name	Description	Initiated by
Nmfaf_3daDataManagement_Configure	This service operation is used by an NF to configure or reconfigure the MFAF to map data or analytics received by the MFAF to out-bound notification endpoints and to format and process the outbound data or analytics	NF service consumer (e.g. DCCF)
Nmfaf_3daDataManagement_Deconfigure	This service operation is used by an NF to stop mapping data or analytics received by the MFAF to one or more outbound notification endpoints.	NF service consumer (e.g. DCCF)

4.2.2.2 Nmfaf_3daDataManagement_Configure service operation

4.2.2.2.1 General

The Nmfaf_3daDataManagement_Configure service operation is used by an NF service consumer to configure or update the configuration of the MFAF for mapping data or analytics received by the MFAF to out-bound notification endpoints, and formatting and processing the out-bound data or analytics.

4.2.2.2.2 Initial configuration for mapping data or analytics

Figure 4.2.2.2.2-1 shows a scenario where the NF service consumer (e.g. DCCF) sends a request to the MFAF to request the configuration of mapping data or analytics (as shown in 3GPP TS 23.288 [14]).

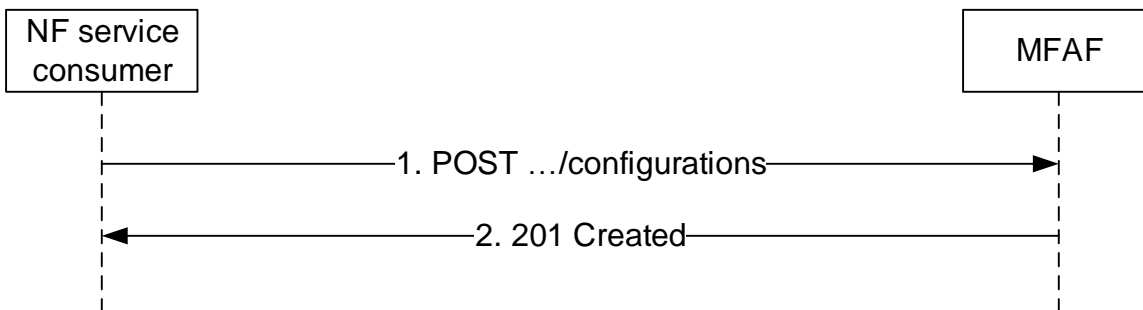

Figure 4.2.2.2.2-1: NF service consumer create the configuration

The NF service consumer shall invoke the Nmfaf_3daDataManagement_Configure service operation to create the configuration(s). The NF service consumer shall send an HTTP POST request with "{apiRoot}/nmfaf-3dadatamanagement/v1/configurations" as Resource URI representing the "MFAF Configurations", as shown in figure 4.2.2.2.2-1, step 1, to create a configuration for an "Individual MFAF Configuration" according to the information in message body. The MfafConfiguration data structure provided in the request body

shall include:

- a description of the configurations as "messageConfigurations" attribute that, for each configuration, the MessageConfiguration data type shall include
 - 1) a notification URI of Data Consumer or Analytics Consumer or other endpoint where to receive the requested mapping data or analytics as "notificationURI" attribute; and
 - 2)- if the configuration is used for mapping analytics or data collection, a Notification Correlation ID for the Data or Analytics Consumer (or other endpoint) as "correlId" attribute;

and may include:

- 1) the formatting instructions as "formatInstruct" attribute;
- 2) the processing instructions as "procInstruct" attribute; and
- 3) the MFAF notification information to identify the Event Notifications received from the NWDAF, which can be sent to the consumer or other notification endpoints, as "mfafNotiInfo" attribute;

Upon the reception of an HTTP POST request with: "{apiRoot}/nmfaf-3dadatamanagement/v1/configurations" as Resource URI and MfafConfiguration data structure as request body, the MFAF shall:

- create a new configuration;
- assign a transaction reference id;
- if no MFAF notification information has been provided in the request, determine the MFAF notification information and add it to the configuration that is created and will be returned to the NF service consumer;
- store the configuration.

If the MFAF created an "Individual MFAF Configuration" resource, the MFAF shall respond with "201 Created" with the message body containing a representation of the created subscription, as shown in figure 4.2.2.2.2-1, step 2.

4.2.2.2.3 Update the configuration of existing individual mapping data or analytics

Figure 4.2.2.2.3-1 shows a scenario where the NF service consumer sends a request to the MFAF to update the configuration of mapping data or analytics (as shown in 3GPP TS 23.288 [14])

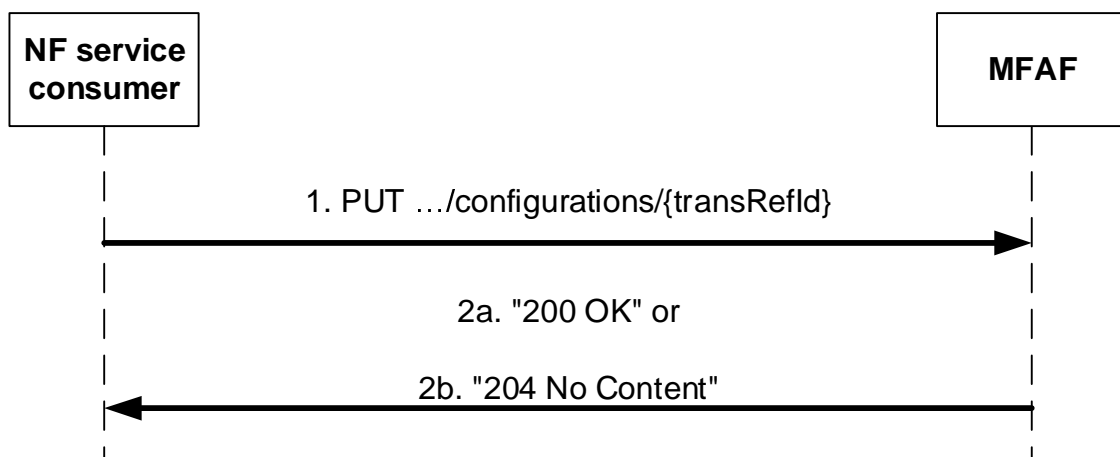

Figure 4.2.2.2.3-1: NF service consumer updates configuration

The NF service consumer shall invoke the Nmfaf_3daDataManagement_Configure service operation to update the configuration(s). The NF service consumer shall send an HTTP PUT request with "{apiRoot}/nmfaf-3dadatamanagement/v1/configurations/{transRefId}" as Resource URI representing the "Individual MFAF Configuration", as shown in figure 4.2.2.2.3-1, step 1, to update the subscription for an "Individual MFAF Configuration" resource identified by the {transRefId}. The MfafConfiguration data structure provided in the request body shall include:

- a description of the configurations as "messageConfigurations" attribute that, for each configuration, the MfafConfiguration data structure provided in the request body shall include the same contents as described in 4.2.2.2.2.

Upon the reception of an HTTP PUT request with: "{apiRoot}/nmfaf-3dadatamanagement/v1/configurations/{transRefId}" as Resource URI and MfafConfiguration data structure as request body, the MFAF shall:

- update the configuration of corresponding transaction reference Id; and
- store the configuration.

If the MFAF successfully processed and accepted the received HTTP PUT request, the MFAF shall update an "Individual MFAF Configuration" resource, and shall respond with:

- a) HTTP "200 OK" status code with the message body containing a representation of the updated configuration, as shown in figure 4.2.2.3-1, step 2a. or
- b) HTTP "204 No Content" status code, as shown in figure 4.2.2.3-1, step 2b.

4.2.2.3 Nmfaf_3daDataManagement_Deconfigure service operation

4.2.2.3.1 General

The Nmfaf_3daDataManagement_Deconfigure service operation is used by an NF service consumer to stop mapping data or analytics received by the MFAF to one or more out-bound notification endpoints.

4.2.2.3.2 Stop mapping data or analytics

Figure 4.2.2.3.2-1 shows a scenario where the NF service consumer sends a request to the MFAF to update the configuration to stop mapping data or analytics (as shown in 3GPP TS 23.288 [14])

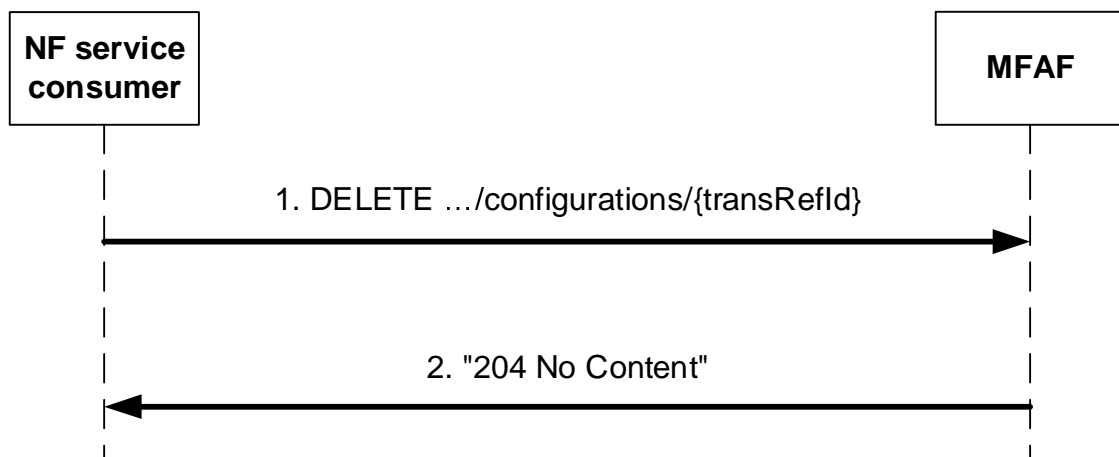

Figure 4.2.2.3.2-1: NF service consumer stops mapping data or analytics

The NF service consumer shall invoke the Nmfaf_3daDataManagement_Deconfigure service operation to stop the MFAF to map data or analytics. The NF service consumer shall send an HTTP DELETE request with "{apiRoot}/nmfaf-3dadatamanagement/v1/configurations/{transRefId}" as Resource URI, where {transRefId} represents the "Individual MFAF Configuration" to be deleted, as shown in figure 4.2.2.3.2-1, step 1.

Upon the reception of an HTTP DELETE request and if the MFAF successfully processed and accepted the received HTTP DELETE request from the NF service consumer, the MFAF shall acknowledge the request by sending a "204 No Content" response to the NF service consumer, as shown in figure 4.2.2.3.2-1, step 2. Further, the MFAF shall remove the individual resource linked to the delete request.

4.3 Nmfaf_3caDataManagement Service

4.3.1 Service Description

4.3.1.1 Overview

The Nmfaf_3caDataManagement service as defined in 3GPP TS 23.288 [14], is provided by the Messaging Framework Adaptor Function (MFAF).

This service:

- allows NF consumers to collect the data or analytics from the MFAF.

4.3.1.2 Service Architecture

The 5G System Architecture is defined in 3GPP TS 23.501 [2]. The Network Data Analytics Exposure architecture is defined in 3GPP TS 23.288 [14].

The Nmfaf_3caDataManagement service is part of the Nmfaf service-based interface exhibited by the Messaging Framework Adaptor Function (MFAF).

Known consumers of the Nmfaf_3caDataManagement service are:

- Network Data Analytics Function (NWDAF) ;
- Policy Control Function (PCF)
- Network Slice Selection Function (NSSF)
- Access and Mobility Management Function (AMF)
- Session Management Function (SMF)
- Network Exposure Function (NEF)
- Application Function (AF)

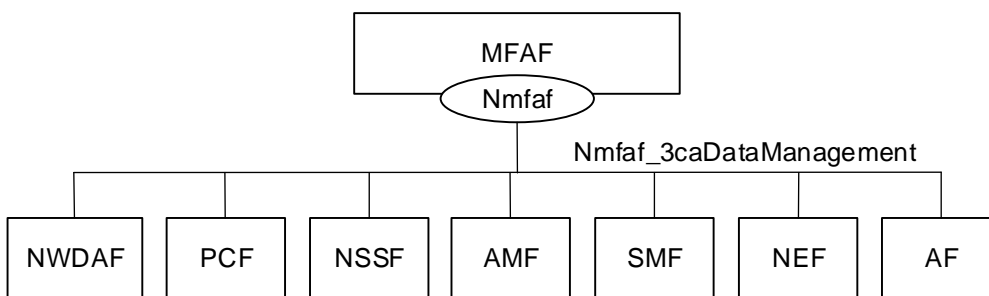

Figure 4.3.1.2-1: Reference Architecture for the Nmfaf_3caDataManagement Service; SBI representation

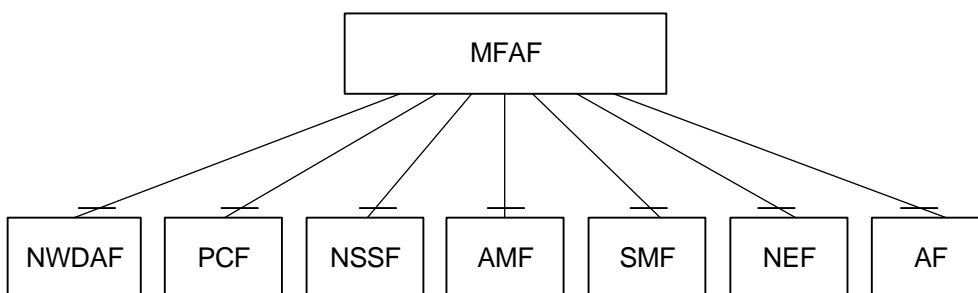

Figure 4.3.1.2-2: Reference Architecture for the Nmfaf_3caDataManagement Service; reference point representation

4.3.1.3 Network Functions

4.3.1.3.1 Messaging Framework Adaptor Function (MFAF)

The Messaging Framework Adaptor Function (MFAF) provides the functionality to supply data or analytics, or an indication of availability of data or analytics to notification endpoints configured in Nmfaf_3caDataManagement service as described in clause 4.2.1.

4.3.1.3.2 NF Service Consumers

The NWDAF, PCF, NSSF, AMF, AMF, NEF and AF:

- supports retrieving data or analytics from the MFAF.

The MFAF:

- supports providing data or analytics or notification of availability of data or analytics to notification endpoints.

4.3.2 Service Operations

4.3.2.1 Introduction

Table 4.3.2.1-1: Operations of the Nmfa3caDataManagement Service

Service operation name	Description	Initiated by
Nmfa3caDataManagement_Fetch	This service operation is used by an NF to retrieve stored data or analytics from the MFAF.	NF service consumer (e.g. NWDAF, PCF, NSSF, AMF, AMF, NEF and AF)
Nmfa3caDataManagement_Subscribe	This is a pseudo operation, the actual subscription is created via Nmfa3caDataManagement Service. (NOTE)	
Nmfa3caDataManagement_Notify	This service operation is used by an NF with either data or analytics to provide data or analytics or notification of availability of data or analytics to notification endpoints.	MFAF
NOTE:	In the current release OpenAPI 3.0.0 is adopted, with OpenAPI 3.0.0 it is not possible to document a stand-alone callback operation, thus the Notify operation has to be defined in combination with a Subscribe operation.	

NOTE: Nmfa3caDataManagement_Subscribe service operation is not used by any NF service consumers in this release.

4.3.2.2 Nmfa3caDataManagement_Fetch service operation

4.3.2.2.1 General

The Nmfa3caDataManagement_Fetch service operation allows consumer to retrieve data or analytics from the MFAF as indicated by Nmfa3caDataManagement_Notify Fetch Instruction.

4.3.2.2.2 Retrieves data or analytics from the MFAF

Figure 4.3.2.2.2-1 shows a scenario where the NF service consumer (e.g. NWDAF) sends a request to the MFAF to retrieve the data or analytics as indicated by Nmfa3caDataManagement_Notify Fetch Instruction.

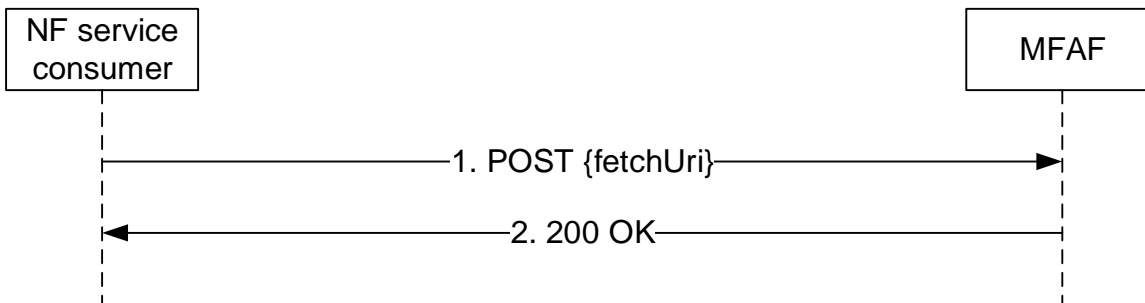

Figure 4.3.2.2.2-1: NF service consumer retrieve data or analytics from the MFAF

The NF service consumer shall invoke the Nmfa3caDataManagement_Fetch service operation to retrieve stored data or analytics. The NF service consumer shall send an HTTP POST request with "{fetchUri}" URI, as shown in figure 4.3.2.2.2-1, step 1, to fetch MFAF data or analytics.

The request body shall include fetch correlation identifies, which was previously provided by the MFAF in the "fetchCorrIds" attribute within fetchInstruction in the MFAF notification.

Upon the reception of the HTTP POST request, the MFAF shall:

- find the data or analytics according to the requested parameters.

If the requested data is found, the MFAF shall respond with "200 OK" status code with the message body containing the NmfafDataAnaNotification data structure. The NmfafDataAnaNotification data structure in the response body shall include one of the following:

- information about network data analytics function events that occurred in the "anaNotifications" attribute;
- network exposure events that occurred in the "nefEventNotifs" attribute;
- application function events that occurred in the "afEventNotifs" attribute;
- access and mobility function events that occurred in the "amfEventNotifs" attribute;
- session management function events that occurred in the "smfEventNotifs" attribute;
- monitoring report events that occurred in the "udmEventNotifs" attribute.

If errors occur when processing the HTTP POST request, the NF service consumer shall send an HTTP error response as specified in clause 5.2.7.

If the MFAF determines the received HTTP POST request needs to be redirected, the MFAF shall send an HTTP redirect response as specified in clause 6.10.9 of 3GPP TS 29.500 [4].

4.3.2.2A Nmfaf_3caDataManagement_Subscribe service operation

This is a pseudo operation, the MFAF does not actually provide Subscribe service operation through Nmfaf_3caDataManagement service. The actual subscription is created via Nmfaf_3daDataManagement Service.

4.3.2.3 Nmfaf_3caDataManagement_Notify service operation

4.3.2.3.1 General

The Nmfaf_3caDataManagement_Notify service operation provides data or analytics or notification of availability of data or analytics to notification endpoints.

4.3.2.3.2 Notification about the subscribed data or analytics

Figure 4.3.2.3.2-1 shows a scenario where the MFAF sends a request to the NF service consumer to notify it about data or analytics or fetch instructions.

The subscription corresponding to the notification is created by the service consumer via Nmfaf_3daDataManagement Service.

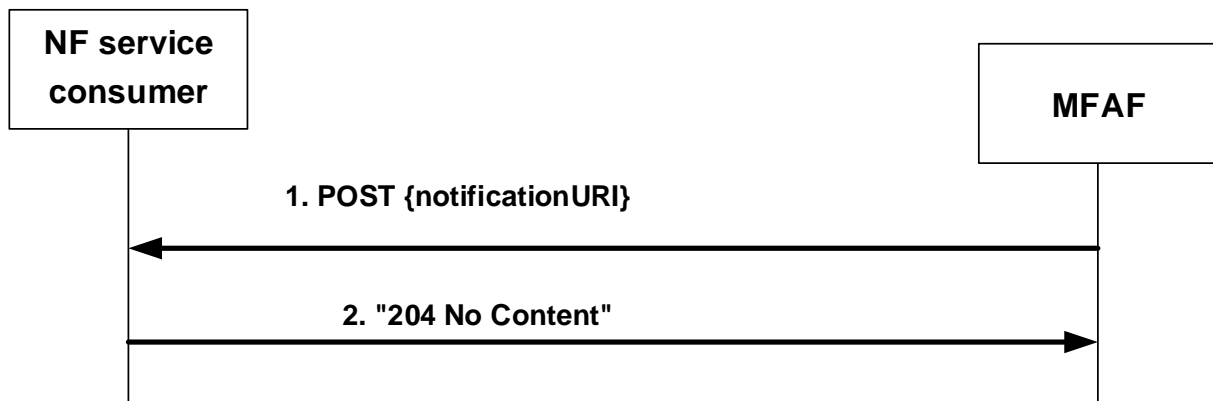

Figure 4.3.2.3.2-1: MFAF notifies the NF service consumer about subscribed data or analytics or fetch instructions

The MFAF shall invoke the `Nmfaf_3caDataManagement_Notify` service operation to notify about subscribed data or analytics, or notification about the availability of data or analytics. The MFAF shall send an HTTP POST request to the "`{notificationURI}`" received in the subscription (see clause 5.2.5 for the definition of this `notificationURI`), as shown in figure 4.3.2.3.2-1, step 1. The `NmafDataRetrievalNotification` data structure provided in the request body shall include:

- notification correlation Id within the "correlId" attribute;
- and shall include at least one of the following:
- fetch instructions indicate whether the data or analytics are to be fetched by the Consumer in the "fetchInstruction" attribute; and
 - information about the MFAF data or analytics in the "dataAnaNotifs" attribute, which contains one of the following:
 - information about network data analytics function events that occurred in the "anaNotifications" attribute;
 - network exposure events that occurred in the "nefEventNotifs" attribute;
 - application function events that occurred in the "afEventNotifs" attribute;
 - access and mobility function events that occurred in the "amfEventNotifs" attribute;
 - session management function events that occurred in the "smfEventNotifs" attribute;
 - monitoring report events that occurred in the "udmEventNotifs" attribute.

Upon the reception of an HTTP POST request with "`{notificationURI}`" as Resource URI and `NmafDataRetrievalNotification` data structure as request body, if the NF service consumer successfully processed and accepted the received HTTP POST request, the NF Service Consumer shall:

- store the notification;
- respond with HTTP "204 No Content" status code.

If errors occur when processing the HTTP POST request, the NF service consumer shall send an HTTP error response as specified in clause 5.2.7.

If the NF service consumer determines the received HTTP POST request needs to be redirected, the NF service consumer shall send an HTTP redirect response as specified in clause 6.10.9 of 3GPP TS 29.500 [4].

5 API Definitions

5.1 Nmfaf_3daDataManagement Service API

5.1.1 Introduction

The Nmfaf_3daDataManagement shall use the Nmfaf_3daDataManagement API.

The API URI of the Nmfaf_3daDataManagement API shall be:

{apiRoot}/<apiName>/<apiVersion>

The request URIs used in HTTP requests from the NF service consumer towards the NF service producer shall have the Resource URI structure defined in clause 4.4.1 of 3GPP TS 29.501 [5], i.e.:

{apiRoot}/<apiName>/<apiVersion>/<apiSpecificResourceUriPart>

with the following components:

- The {apiRoot} shall be set as described in 3GPP TS 29.501 [5].
- The <apiName> shall be "nmfaf-3dadatamanagement".
- The <apiVersion> shall be "v1".
- The <apiSpecificResourceUriPart> shall be set as described in clause 5.1.3.

5.1.2 Usage of HTTP

5.1.2.1 General

HTTP/2, IETF RFC 7540 [11], shall be used as specified in clause 5 of 3GPP TS 29.500 [4].

HTTP/2 shall be transported as specified in clause 5.3 of 3GPP TS 29.500 [4].

The OpenAPI [6] specification of HTTP messages and content bodies for the Nmfaf_3daDataManagement API is contained in Annex A.

5.1.2.2 HTTP standard headers

5.1.2.2.1 General

See clause 5.1.2 of 3GPP TS 29.500 [4] for the usage of HTTP standard headers.

5.1.2.2.2 Content type

JSON, IETF RFC 8259 [12], shall be used as content type of the HTTP bodies specified in the present specification as specified in clause 5.4 of 3GPP TS 29.500 [4]. The use of the JSON format shall be signalled by the content type "application/json".

"Problem Details" JSON object shall be used to indicate additional details of the error in a HTTP response body and shall be signalled by the content type "application/problem+json", as defined in IETF RFC 7807 [13].

5.1.2.3 HTTP custom headers

The mandatory HTTP custom header fields specified in clause 5.1.3.2 of 3GPP TS 29.500 [4] shall be applicable.

5.1.3 Resources

5.1.3.1 Overview

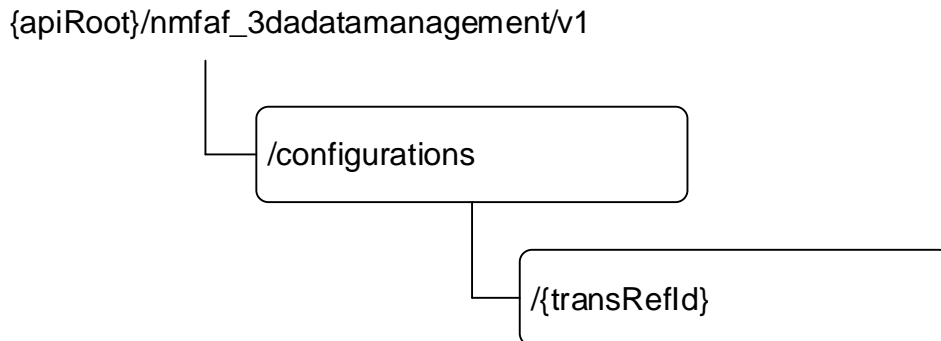

Figure 5.1.3.1-1: Resource URI structure of the NmfaF_3daDataManagement API

Table 5.1.3.1-1 provides an overview of the resources and applicable HTTP methods.

Table 5.1.3.1-1: Resources and methods overview

Resource name	Resource URI	HTTP method or custom operation	Description
MFAF Configurations	/configurations	POST	Creates a new individual MFAF Configuration resource.
Individual MFAF Configuration	/configurations/{transRefId}	PUT	Modifies an existing Individual MFAF Configuration subresource.
		DELETE	Deletes an Individual MFAF Configuration identified by subresource {transRefId}.

5.1.3.2 Resource: MFAF Configurations

5.1.3.2.1 Description

The MFAF Configurations resource represents all configuration to the NmfaF_3daDataManagement Service at a given MFAF. The resource allows an NF service consumer to create a new Individual MFAF Configuration resource.

5.1.3.2.2 Resource Definition

Resource URI: **{apiRoot}/nmfaf-3dadatamanagement/<apiVersion>/configurations**

This resource shall support the resource URI variables defined in table 5.1.3.2.2-1.

Table 5.1.3.2.2-1: Resource URI variables for this resource

Name	Data type	Definition
apiRoot	string	See clause 5.1.1
apiVersion	string	See clause 5.1.1

5.1.3.2.3 Resource Standard Methods

5.1.3.2.3.1 POST

This method shall support the URI query parameters specified in table 5.1.3.2.3.1-1.

Table 5.1.3.2.3.1-1: URI query parameters supported by the POST method on this resource

Name	Data type	P	Cardinality	Description	Applicability
n/a					

This method shall support the request data structures specified in table 5.1.3.2.3.1-2 and the response data structures and response codes specified in table 5.1.3.2.3.1-3.

Table 5.1.3.2.3.1-2: Data structures supported by the POST Request Body on this resource

Data type	P	Cardinality	Description
MfafConfiguration	M	1	Create a new Individual MFAF Configuration resource.

Table 5.1.3.2.3.1-3: Data structures supported by the POST Response Body on this resource

Data type	P	Cardinality	Response codes	Description
MfafConfiguration	M	1	201 Created	The creation of an Individual MFAF Configuration resource is confirmed and a representation of that resource is returned.
NOTE: The mandatory HTTP error status code for the POST method listed in Table 5.2.7.1-1 of 3GPP TS 29.500 [4] also apply.				

Table 5.1.3.2.3.1-4: Headers supported by the 201 response code on this resource

Name	Data type	P	Cardinality	Description
Location	string	M	1	Contains the URI of the newly created resource, according to the structure: {apiRoot}/nmfaf-3datamanagement/v1/configurations/{transRefId}

5.1.3.2.4 Resource Custom Operations

None in this release of the specification.

5.1.3.3 Resource: Individual MFAF Configuration

5.1.3.2.1 Description

The Individual MFAF Configurations resource represents an individual configuration created in the MFAF and associated with transaction reference Id.

5.1.3.3.2 Resource Definition

Resource URI: {apiRoot}/nmfaf-3datamanagement/<apiVersion>/configurations/{transRefId}

This resource shall support the resource URI variables defined in table 5.1.3.3.2-1.

Table 5.1.3.3.2-1: Resource URI variables for this resource

Name	Data type	Definition
apiRoot	string	See clause 5.1.1
apiVersion	string	See clause 5.1.1
transRefId	string	Unique identifier of the individual MFAF Configurations resource.

5.1.3.3.3 Resource Standard Methods

5.1.3.3.3.1 PUT

This method shall support the URI query parameters specified in table 5.1.3.3.3.1-1.

Table 5.1.3.3.3.1-1: URI query parameters supported by the POST method on this resource

Name	Data type	P	Cardinality	Description	Applicability
n/a					

This method shall support the request data structures specified in table 5.1.3.3.3.1-2 and the response data structures and response codes specified in table 5.1.3.3.3.1-3.

Table 5.1.3.3.3.1-2: Data structures supported by the POST Request Body on this resource

Data type	P	Cardinality	Description
MfafConfiguration	M	1	The updated MFAF Configuration.

Table 5.1.3.3.3.1-3: Data structures supported by the POST Response Body on this resource

Data type	P	Cardinality	Response codes	Description
MfafConfiguration	M	1	200 OK	The update of an Individual MFAF Configuration resource is confirmed and a representation of that resource is returned.
n/a			204 No Content	Successful case: The Individual MFAF Configuration resource was modified.
NOTE: The mandatory HTTP error status code for the PUT method listed in Table 5.2.7.1-1 of 3GPP TS 29.500 [4] also apply.				

5.1.3.3.3.2 DELETE

This method shall support the URI query parameters specified in table 5.1.3.3.3.2-1.

Table 5.1.3.3.3.2-1: URI query parameters supported by the DELETE method on this resource

Name	Data type	P	Cardinality	Description	Applicability
n/a					

This method shall support the request data structures specified in table 5.1.3.3.3.2-2 and the response data structures and response codes specified in table 5.1.3.3.3.2-3.

Table 5.1.3.3.3.2-2: Data structures supported by the DELETE Request Body on this resource

Data type	P	Cardinality	Description
n/a			

Table 5.1.3.3.2-3: Data structures supported by the DELETE Response Body on this resource

Data type	P	Cardinality	Response codes	Description
n/a			204 No Content	Successful case: The Individual MFAF Configuration resource matching the transRefId was deleted.
NOTE: The mandatory HTTP error status code for the DELETE method listed in Table 5.2.7.1-1 of 3GPP TS 29.500 [4] also apply.				

5.1.4 Custom Operations without associated resources

None in this release of the specification.

5.1.5 Notifications

None in this release of the specification.

5.1.6 Data Model

5.1.6.1 General

This clause specifies the application data model supported by the API.

Table 5.1.6.1-1 specifies the data types defined for the N_{MFAF} service based interface protocol.

Table 5.1.6.1-1: N_{MFAF} specific Data Types

Data type	Clause defined	Description	Applicability
MfafConfiguration	5.1.6.2.2	The description of MFAF configuration	
MessageConfiguration	5.1.6.2.3	The description of the configurations.	
MfafNotifInfo	5.1.6.2.4	The MFAF notification information.	

Table 5.1.6.1-2 specifies data types re-used by the N_{MFAF} service based interface protocol from other specifications, including a reference to their respective specifications and when needed, a short description of their use within the N_{MFAF} service based interface.

Table 5.1.6.1-2: N_{MFAF} re-used Data Types

Data type	Reference	Comments	Applicability
FormattingInstruction	3GPP TS 29.574 [15]	Contains data or analytics formatting Instructions.	
ProcessingInstruction	3GPP TS 29.574 [15]	Contains instructions related to the processing	
Uri	3GPP TS 29.571 [22]	URI.	

5.1.6.2 Structured data types

5.1.6.2.1 Introduction

This clause defines the structures to be used in resource representations.

5.1.6.2.2 Type: MfafConfiguration

Table 5.1.6.2.2-1: Definition of type MfafConfiguration

Attribute name	Data type	P	Cardinality	Description	Applicability
messageConfigurations	array(Message Configuration)	M	1..N	The configuration of the MFAF for mapping data or analytics.	

5.1.6.2.3 Type: MessageConfiguration

Table 5.1.6.2.3-1: Definition of type MessageConfiguration

Attribute name	Data type	P	Cardinality	Description	Applicability
correlId	string	C	0..1	If the configuration is used for mapping analytics or data collection, representing the Analytics Consumer Notification Correlation ID or Data Consumer Notification Correlation ID.	
formatInstruct	FormattingInstruction	O	0..1	Formatting instructions to be used for sending event notifications.	
mfafNotifInfo	MfafNotifInfo	C	0..1	The MFAF notification information. It shall be provided in a response message if it had not been provided in the respective request message.	
notificationURI	Uri	M	1	The notification URI of Data Consumer or Analytics Consumer or other endpoint where to receive the requested mapping data or analytics	
procInstruct	ProcessingInstruction	O	0..1	Processing instructions to be used for sending event notifications.	

5.1.6.2.4 Type: MfafNotifInfo

Table 5.1.6.2.4-1: Definition of type MfafNotifInfo

Attribute name	Data type	P	Cardinality	Description	Applicability
mfafNotifUri	Uri	M	1	The notification URI of MFAF Notification Target Address.	
mfafCorrreId	String	M	1	The MFAF Notification Correlation ID	

5.1.6.3 Simple data types and enumerations

5.1.6.3.1 Introduction

This clause defines simple data types and enumerations that can be referenced from data structures defined in the previous clauses.

5.1.6.3.2 Simple data types

The simple data types defined in table 5.1.6.3.2-1 shall be supported.

Table 5.1.6.3.2-1: Simple data types

Type Name	Type Definition	Description	Applicability

5.1.6.4 Data types describing alternative data types or combinations of data types

None in current specification.

5.1.6.5 Binary data

None in current specification.

5.1.7 Error Handling

5.1.7.1 General

For the Nmfaf_3daDataManagement API, HTTP error responses shall be supported as specified in clause 4.8 of 3GPP TS 29.501 [5]. Protocol errors and application errors specified in table 5.1.7.2-1 of 3GPP TS 29.500 [4] shall be supported for an HTTP method if the corresponding HTTP status codes are specified as mandatory for that HTTP method in table 5.1.7.1-1 of 3GPP TS 29.500 [4].

In addition, the requirements in the following clauses are applicable for the Nmfaf_3daDataManagement API.

5.1.7.2 Protocol Errors

No specific procedures for the Nmfaf_3daDataManagement service are specified.

5.1.7.3 Application Errors

The application errors defined for the Nmfaf_3daDataManagement service are listed in Table 5.1.7.3-1.

Table 5.1.7.3-1: Application errors

Application Error	HTTP status code	Description

5.1.8 Feature negotiation

The optional features in table 5.1.8-1 are defined for the Nmfaf_3daDataManagement API. They shall be negotiated using the extensibility mechanism defined in clause 6.6 of 3GPP TS 29.500 [4].

Table 5.1.8-1: Supported Features

Feature number	Feature Name	Description

5.1.9 Security

As indicated in 3GPP TS 33.501 [8] and 3GPP TS 29.500 [4], the access to the Nmfaf_3daDataManagement API may be authorized by means of the OAuth2 protocol (see IETF RFC 6749 [9]), based on local configuration, using the "Client Credentials" authorization grant, where the NRF (see 3GPP TS 29.510 [10]) plays the role of the authorization server.

If OAuth2 is used, an NF Service Consumer, prior to consuming services offered by the Nmfaf_3daDataManagement API, shall obtain a "token" from the authorization server, by invoking the Access Token Request service, as described in 3GPP TS 29.510 [10], clause 5.4.2.2.

NOTE: When multiple NRFs are deployed in a network, the NRF used as authorization server is the same NRF that the NF Service Consumer used for discovering the Nmfaf_3daDataManagement service.

The Nmfaf_3daDataManagement API defines a single scope "nmfaf_3dadatamanagement" for the entire service, and it does not define any additional scopes at resource or operation level.

5.2 Nmfaf_3caDataManagement Service API

5.2.1 Introduction

The Nmfaf_3caDataManagement shall use the Nmfaf_3caDataManagement API.

The API URI of the Nmfaf_3caDataManagement API shall be:

{apiRoot}/<apiName>/<apiVersion>

The request URIs used in HTTP requests from the NF service consumer towards the NF service producer shall have the Resource URI structure defined in clause 4.4.1 of 3GPP TS 29.501 [5], i.e.:

{apiRoot}/<apiName>/<apiVersion>/<apiSpecificResourceUriPart>

with the following components:

- The {apiRoot} shall be set as described in 3GPP TS 29.501 [5].
- The <apiName> shall be "nmfaf-3cadatamanagement".
- The <apiVersion> shall be "v1".
- The <apiSpecificResourceUriPart> shall be set as described in clause 5.2.3.

5.2.2 Usage of HTTP

5.2.2.1 General

HTTP/2, IETF RFC 7540 [11], shall be used as specified in clause 5 of 3GPP TS 29.500 [4].

HTTP/2 shall be transported as specified in clause 5.3 of 3GPP TS 29.500 [4].

The OpenAPI [6] specification of HTTP messages and content bodies for the Nmfaf_3caDataManagement API is contained in Annex A.

5.2.2.2 HTTP standard headers

5.2.2.2.1 General

See clause 5.2.2 of 3GPP TS 29.500 [4] for the usage of HTTP standard headers.

5.2.2.2.2 Content type

JSON, IETF RFC 8259 [12], shall be used as content type of the HTTP bodies specified in the present specification as specified in clause 5.4 of 3GPP TS 29.500 [4]. The use of the JSON format shall be signalled by the content type "application/json".

"Problem Details" JSON object shall be used to indicate additional details of the error in a HTTP response body and shall be signalled by the content type "application/problem+json", as defined in IETF RFC 7807 [13].

5.2.2.3 HTTP custom headers

The mandatory HTTP custom header fields specified in clause 5.2.3.2 of 3GPP TS 29.500 [4] shall be applicable.

5.2.3 Resources

5.2.3.1 Overview

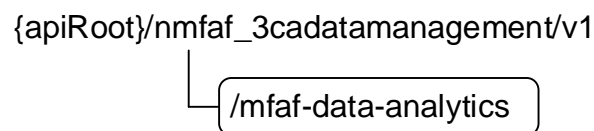

Figure 5.2.3.1-1: Resource URI structure of the Nmfaf_3caDataManagement API

Table 5.2.3.1-1 provides an overview of the resources and applicable HTTP methods.

Table 5.2.3.1-1: Resources and methods overview

Resource name	Resource URI	HTTP method or custom operation	Description
MFAF Data or Analytics(Collection)	/mfaf-data-analytics	POST	This is a pseudo resource.

5.2.3.2 Resource: MFAF Data or Analytics

5.2.3.2.1 Description

5.2.3.2.2 Resource Definition

Resource URI: `{apiRoot}/nmfaf_3cadatamanagement/v1/mfaf-data-analytics`

This resource shall support the resource URI variables defined in table 5.2.3.2.2-1.

Table 5.2.3.2.2-1: Resource URI variables for this resource

Name	Data type	Definition
apiRoot	string	See clause 5.2.1

5.2.3.2.3 Resource Standard Methods

5.2.3.2.3.1 POST

This method shall support the URI query parameters specified in table 5.2.3.2.3.1-1.

Table 5.2.3.2.3.1-1: URI query parameters supported by the POST method on this resource

Name	Data type	P	Cardinality	Description	Applicability
n/a					

This method shall support the request data structures specified in table 5.2.3.2.3.1-2 and the response data structures and response codes specified in table 5.2.3.2.3.1-3.

Table 5.2.3.2.3.1-2: Data structures supported by the POST Request Body on this resource

Data type	P	Cardinality	Description
Any			

Table 5.2.3.2.3.1-3: Data structures supported by the POST Response Body on this resource

Data type	P	Cardinality	Response codes	Description
n/a				
NOTE: The mandatory HTTP error status code for the POST method listed in Table 5.2.7.1-1 of 3GPP TS 29.500 [4] also apply.				

5.2.4 Custom Operations without associated resources

None in this release of the specification.

5.2.5 Notifications

5.2.5.1 General

Notifications shall comply to clause 6.2 of 3GPP TS 29.500 [4] and clause 4.6.2.3 of 3GPP TS 29.501 [5].

Table 5.2.5.1-1: Notifications overview

Notification	Callback URI	HTTP method or custom operation	Description (service operation)
MFAF Notification	{notificationURI}	POST	MFAF Notification
NOTE: The notificationURI is not provided by NF service consumer via Nmfaf-3caDataManagement API, it is provided via Nmfaf-3daDataManagement API during the configuration for mapping data or analytics.			

5.2.5.2 MFAF Notification

5.2.5.2.1 Description

The MFAF Notification is used by the MFAF to provide data or analytics or notification of availability of data or analytics to notification endpoints.

5.2.5.2.2 Target URI

The Callback URI "{notificationURI}" shall be used with the callback URI variables defined in table 5.2.5.2.2-1.

Table 5.2.5.2.2-1: Callback URI variables

Name	Definition
notificationURI	The notification URI of Data Consumer or Analytics Consumer or other endpoint where to receive the requested data or analytics. The notificationURI is not provided by NF service consumer via Nmfaf-3caDataManagement API, it is provided via Nmfaf-3daDataManagement API during the configuration for mapping data or analytics.

5.2.5.2.3 Standard Methods

5.2.5.2.3.1 POST

This method shall support the request data structures specified in table 5.2.5.2.3.1-1 and the response data structures and response codes specified in table 5.2.5.2.3.1-1.

Table 5.2.5.2.3.1-2: Data structures supported by the POST Request Body

Data type	P	Cardinality	Description
array(NmfafDataRetrievalNotification)	M	1..N	The data or analytics or notification of availability of data or analytics to notification endpoints.

Table 5.2.5.2.3.1-3: Data structures supported by the POST Response Body

Data type	P	Cardinality	Response codes	Description
n/a			204 No Content	The MFAF notification is treated successfully.
RedirectResponse	O	0..1	307 Temporary Redirect	Temporary redirection, during the retrieval notification. The response shall include a Location header field containing an alternative URI representing the end point of an alternative NF consumer (service) instance where the notification should be sent.
RedirectResponse	O	0..1	308 Permanent Redirect	Permanent redirection, during the retrieval notification. The response shall include a Location header field containing an alternative URI representing the end point of an alternative NF consumer (service) instance where the notification should be sent.
NOTE: The mandatory HTTP error status codes for the POST method listed in Table 5.2.7.1-1 of 3GPP TS 29.500 [4] also apply.				

Table 5.2.5.2.3.1-4: Headers supported by the 307 Response Code on this resource

Name	Data type	P	Cardinality	Description
Location	string	M	1	An alternative URI representing the end point of an alternative NF consumer (service) instance towards which the notification should be redirected.
3gpp-Sbi-Target-Nf-Id	string	O	0..1	Identifier of the target NF (service) instance towards which the notification request is redirected.

Table 5.2.5.2.3.1-5: Headers supported by the 308 Response Code on this resource

Name	Data type	P	Cardinality	Description
Location	string	M	1	An alternative URI representing the end point of an alternative NF consumer (service) instance towards which the notification should be redirected.
3gpp-Sbi-Target-Nf-Id	string	O	0..1	Identifier of the target NF (service) instance towards which the notification request is redirected.

5.2.5.3 Acknowledgement of Notification

5.2.5.3.1 Description

The Acknowledgement of Notification is used by the NF service consumer to retrieve data or analytics from the MFAF.

5.2.5.3.2 Target URI

The Callback URI "{fetchUri}" shall be used with the callback URI variables defined in table 5.2.5.3.2-1.

Table 5.2.5.3.2-1: Callback URI variables

Name	Data type	Definition
fetchUri	Uri	Acknowledgement Uri as assigned during the procedure of notification about the subscribed data or analytics within the FetchInstruction data type (see table 5.2.6.2.3-1).

5.2.5.3.3 Standard Methods

5.2.5.3.3.1 POST

This method shall support the URI query parameters specified in table 5.2.5.3.3.1-1.

Table 5.2.5.3.3.1-1: URI query parameters supported by the POST method on this resource

Name	Data type	P	Cardinality	Description	Applicability
n/a					

This method shall support the request data structures specified in table 5.2.5.3.3.1-2 and the response data structures and response codes specified in table 5.2.5.3.3.1-3.

Table 5.2.5.3.3.1-2: Data structures supported by the POST Request Body on this resource

Data type	P	Cardinality	Description
array(string)	M	1..N	Indicate the fetch correlation identifier(s).

Table 5.2.5.3.3.1-3: Data structures supported by the POST Response Body on this resource

Data type	P	Cardinality	Response codes	Description
NmfafDataAnaNotification	M	1	200 OK	The stored data or analytics related to the "fetch-corr-ids".
N/A			307 Temporary Redirect	Temporary redirection, during subscription retrieval. The response shall include a Location header field containing an alternative URI of the resource located in an alternative MFAF.
N/A			308 Permanent Redirect	Permanent redirection, during subscription retrieval. The response shall include a Location header field containing an alternative URI of the resource located in an alternative MFAF.
NOTE: The mandatory HTTP error status code for the POST method listed in Table 5.2.7.1-1 of 3GPP TS 29.500 [4] also apply.				

Table 5.2.5.3.3.1-4: Headers supported by the by the 307 Response Code on this resource

Name	Data type	P	Cardinality	Description
Location	string	M	1	An alternative URI of the resource located in an alternative MFAF.
3gpp-Sbi-Target-Nf-Id	string	O	0..1	Identifier of the target NF (service) instance towards which the request is redirected.

Table 5.2.3.2.3.1-5: Headers supported by the 308 response code on this resource

Name	Data type	P	Cardinality	Description
Location	string	M	1	An alternative URI of the resource located in an alternative MFAF.
3gpp-Sbi-Target-Nf-Id	string	O	0..1	Identifier of the target NF (service) instance towards which the request is redirected.

5.2.6 Data Model

5.2.6.1 General

This clause specifies the application data model supported by the API.

Table 5.2.6.1-1 specifies the data types defined for the N_{MFAF} service based interface protocol.

Table 5.2.6.1-1: N_{MFAF} specific Data Types

Data type	Clause defined	Description	Applicability
FetchInstruction	5.2.6.2.3	The fetch instruction indicates whether the data or analytics are to be fetched by the Consumer.	
NmfafDataAnaNotification	5.2.6.2.4	MFAF data or analytics.	
NmfafDataRetrievalNotification	5.2.6.2.2	The data or analytics or notification of availability of data or analytics to notification endpoints.	

Table 5.2.6.1-2 specifies data types re-used by the N_{MFAF} service based interface protocol from other specifications, including a reference to their respective specifications and when needed, a short description of their use within the N_{MFAF} service based interface.

Table 5.2.6.1-2: N_{MFAF} re-used Data Types

Data type	Reference	Comments	Applicability
AfEventExposureNotif	3GPP TS 29.517 [16]	Represents notifications on AF event(s) that occurred for an Individual AF Event Subscription resource.	
AmfEventNotification	3GPP TS 29.518 [17]	Represents notifications on AMF event(s) that occurred for an Individual AMF Event Subscription resource.	
MonitoringReport	3GPP TS 29.503 [18]	UDM Monitoring Report.	
NefEventExposureNotif	3GPP TS 29.591 [19]	Represents notifications on network exposure event(s) that occurred for an Individual Network Exposure Event Subscription resource.	
NnwdafEventsSubscriptionNotification	3GPP TS 29.520 [20]	Represents an NWDAF analytics subscription notification.	
NsmfEventExposureNotification	3GPP TS 29.508 [21]	Represents SMF event notification.	
Uri	3GPP TS 29.571 [22]	URI.	

5.2.6.2 Structured data types

5.2.6.2.1 Introduction

This clause defines the structures to be used in resource representations.

5.2.6.2.2 Type: NmfafDataRetrievalNotification

Table 5.2.6.2.2-1: Definition of type NmfafDataRetrievalNotification

Attribute name	Data type	P	Cardinality	Description	Applicability
correld	string	M	1	If the configuration is used for mapping analytics or data collection, representing the Analytics Consumer Notification Correlation ID or Data Consumer Notification Correlation ID.	
dataAnaNotif	NmfafDataAnaNotification	O	0..1	Represents notifications of analytics and data. (NOTE)	
fetchInstruction	FetchInstruction	O	1..N	The fetch instruction indicate whether the data or analytics are to be fetched by the Consumer. (NOTE)	

NOTE: At least one of the "dataAnaNotif" and "fetchInstruction" shall be included.

5.2.6.2.3 Type: FetchInstruction

Table 5.2.6.2.3-1: Definition of type FetchInstruction

Attribute name	Data type	P	Cardinality	Description	Applicability
fetchUri	Uri	M	1	The target address used by a data or analytics consumer to fetch the data or analytics.	
fetchCorrIds	array(string)	M	1..N	the fetch correlation identifier(s) of the MFAF Data or Analytics	

5.2.6.2.4 Type: NmfafDataAnaNotification

Table 5.2.6.2.4-1: Definition of type NmfafDataAnaNotification

Attribute name	Data type	P	Cardinality	Description	Applicability
afEventNotifs	array(AfEventExposureNotif)	O	1..N	List of notifications on AF event(s). (NOTE)	
amfEventNotifs	array(AmfEventNotification)	O	1..N	List of notifications on AMF event(s). (NOTE)	
nefEventNotifs	array(NefEventExposureNotif)	O	1..N	List of notifications on network exposure event(s). (NOTE)	
smfEventNotifs	array(NsmfEventExposureNotification)	O	1..N	List of notifications on SMF event(s). (NOTE)	
udmEventNotifs	array(MonitoringReport)	O	1..N	List of monitoring reports containing information about UDM event(s). (NOTE)	
anaNotifications	array(NnwdafEventsSubscriptionNotification)	O	1..N	List of analytics subscription notifications. (NOTE)	

NOTE: Exactly one of these attributes shall be provided.

5.2.6.3 Simple data types and enumerations

5.2.6.3.1 Introduction

This clause defines simple data types and enumerations that can be referenced from data structures defined in the previous clauses.

5.2.6.3.2 Simple data types

None in this release of the specification.

5.2.6.4 Data types describing alternative data types or combinations of data types

None in this release of the specification.

5.2.6.5 Binary data

None in this release of the specification.

5.2.7 Error Handling

5.2.7.1 General

For the Nmfaf_3caDataManagement API, HTTP error responses shall be supported as specified in clause 4.8 of 3GPP TS 29.501 [5]. Protocol errors and application errors specified in table 5.2.7.2-1 of 3GPP TS 29.500 [4] shall be supported for an HTTP method if the corresponding HTTP status codes are specified as mandatory for that HTTP method in table 5.2.7.1-1 of 3GPP TS 29.500 [4].

In addition, the requirements in the following clauses are applicable for the Nmfaf_3caDataManagement API.

5.2.7.2 Protocol Errors

No specific procedures for the Nmfaf_3caDataManagement service are specified.

5.2.7.3 Application Errors

The application errors defined for the Nmfaf_3caDataManagement service are listed in Table 5.2.7.3-1.

Table 5.2.7.3-1: Application errors

Application Error	HTTP status code	Description

5.2.8 Feature negotiation

The optional features in table 5.2.8-1 are defined for the Nmfaf_3caDataManagement API. They shall be negotiated using the extensibility mechanism defined in clause 6.6 of 3GPP TS 29.500 [4].

Table 5.2.8-1: Supported Features

Feature number	Feature Name	Description

5.2.9 Security

As indicated in 3GPP TS 33.501 [8] and 3GPP TS 29.500 [4], the access to the Nmfa_3caDataManagement API may be authorized by means of the OAuth2 protocol (see IETF RFC 6749 [9]), based on local configuration, using the "Client Credentials" authorization grant, where the NRF (see 3GPP TS 29.510 [10]) plays the role of the authorization server.

If OAuth2 is used, an NF Service Consumer, prior to consuming services offered by the Nmfa_3caDataManagement API, shall obtain a "token" from the authorization server, by invoking the Access Token Request service, as described in 3GPP TS 29.510 [10], clause 5.4.2.2.

NOTE: When multiple NRFs are deployed in a network, the NRF used as authorization server is the same NRF that the NF Service Consumer used for discovering the Nmfa_3caDataManagement service.

The Nmfa_3caDataManagement API defines a single scope "nmfa_3cadatamanagement" for the entire service, and it does not define any additional scopes at resource or operation level.

Annex A (normative): OpenAPI specification

A.1 General

This Annex specifies the formal definition of the API(s) defined in the present specification. It consists of OpenAPI 3.0.0 specifications in YAML format.

This Annex takes precedence when being discrepant to other parts of the specification with respect to the encoding of information elements and methods within the API(s).

NOTE 1: The semantics and procedures, as well as conditions, e.g. for the applicability and allowed combinations of attributes or values, not expressed in the OpenAPI definitions but defined in other parts of the specification also apply.

Informative copies of the OpenAPI specification files contained in this 3GPP Technical Specification are available on a Git-based repository that uses the GitLab software version control system (see 3GPP TS 29.501 [5] clause 5.3.1 and 3GPP TR 21.900 [7] clause 5B).

A.2 Nmfaf_3daDataManagement API

```

openapi: 3.0.0
info:
  version: 1.0.0-alpha.2
  title: Nmfaf_3daDataManagement
  description: |
    MFAF 3GPP DCCF Adaptor (3DA) Data Management Service.
    © 2022, 3GPP Organizational Partners (ARIB, ATIS, CCSA, ETSI, TSDSI, TTA, TTC).
    All rights reserved.
externalDocs:
  description: 3GPP TS 29.576 V17.0.0; 5G System; Messaging Framework Adaptor Services; Stage 3.
  url: 'https://www.3gpp.org/ftp/Specs/archive/29_series/29.576/'
servers:
  - url: '{apiRoot}/nmfaf-3dadatamanagement/v1'
    variables:
      apiRoot:
        default: https://example.com
        description: apiRoot as defined in clause clause 4.4 of 3GPP TS 29.501.
security:
  - oAuth2ClientCredentials:
    - nmfaf-3dadatamanagement
  - {}
paths:
  /configurations:
    post:
      summary: Creates a new Individual MFAF Configuration resource.
      operationId: CreateMFAFConfiguration
      tags:
        - MFAF Configuration(Collection)
      requestBody:
        content:
          application/json:
            schema:
              $ref: '#/components/schemas/MfafConfiguration'
            required: true
            description: Create a new Individual MFAF Configuration resource.
      responses:
        '201':
          description: Successful creation of new Individual MFAF Configuration resource.
          headers:
            Location:
              description: >
                Contains the URI of the newly created resource, according to the structure:
                {apiRoot}/nmfaf-3dadatamanagement/v1/configurations/{transRefId}
              required: true
              schema:
                type: string
          content:
            application/json:

```

```

    schema:
      $ref: '#/components/schemas/MfafConfiguration'
  '400':
    $ref: 'TS29571_CommonData.yaml#/components/responses/400'
  '401':
    $ref: 'TS29571_CommonData.yaml#/components/responses/401'
  '403':
    $ref: 'TS29571_CommonData.yaml#/components/responses/403'
  '404':
    $ref: 'TS29571_CommonData.yaml#/components/responses/404'
  '411':
    $ref: 'TS29571_CommonData.yaml#/components/responses/411'
  '413':
    $ref: 'TS29571_CommonData.yaml#/components/responses/413'
  '415':
    $ref: 'TS29571_CommonData.yaml#/components/responses/415'
  '429':
    $ref: 'TS29571_CommonData.yaml#/components/responses/429'
  '500':
    $ref: 'TS29571_CommonData.yaml#/components/responses/500'
  '503':
    $ref: 'TS29571_CommonData.yaml#/components/responses/503'
  default:
    $ref: 'TS29571_CommonData.yaml#/components/responses/default'
/configurations/{transRefId}:
  put:
    summary: Update an existing Individual MFAF Configuration
    operationId: UpdateMFAFConfiguration
    tags:
      - Individual MFAF Configuration (Document)
    requestBody:
      required: true
      content:
        application/json:
          schema:
            $ref: '#/components/schemas/MfafConfiguration'
    parameters:
      - name: transRefId
        in: path
        description: Unique identifier of the individual MFAF Configurations resource.
        required: true
        schema:
          type: string
    responses:
      '200':
        description: The updated MFAF Configuration is returned.
        content:
          application/json:
            schema:
              $ref: '#/components/schemas/MfafConfiguration'
      '204':
        description: The Individual MFAF Configuration resource was modified successfully.
      '307':
        $ref: 'TS29571_CommonData.yaml#/components/responses/307'
      '308':
        $ref: 'TS29571_CommonData.yaml#/components/responses/308'
      '400':
        $ref: 'TS29571_CommonData.yaml#/components/responses/400'
      '401':
        $ref: 'TS29571_CommonData.yaml#/components/responses/401'
      '403':
        $ref: 'TS29571_CommonData.yaml#/components/responses/403'
      '404':
        $ref: 'TS29571_CommonData.yaml#/components/responses/404'
      '411':
        $ref: 'TS29571_CommonData.yaml#/components/responses/411'
      '413':
        $ref: 'TS29571_CommonData.yaml#/components/responses/413'
      '415':
        $ref: 'TS29571_CommonData.yaml#/components/responses/415'
      '429':
        $ref: 'TS29571_CommonData.yaml#/components/responses/429'
      '500':
        $ref: 'TS29571_CommonData.yaml#/components/responses/500'
      '501':
        $ref: 'TS29571_CommonData.yaml#/components/responses/501'
      '503':
        $ref: 'TS29571_CommonData.yaml#/components/responses/503'

```

```

    default:
      $ref: 'TS29571_CommonData.yaml#/components/responses/default'
delete:
  summary: Delete an existing Individual MFAF Configuration
  operationId: DeleteMFAFConfiguration
  tags:
    - Individual MFAF Configuration (Document)
  parameters:
    - name: transRefId
      in: path
      description: Unique identifier of the individual MFAF Configurations resource
      required: true
      schema:
        type: string
  responses:
    '204':
      description: >
        No Content. The Individual MFAF Configuration resource matching
        the transRefId was deleted.
    '307':
      $ref: 'TS29571_CommonData.yaml#/components/responses/307'
    '308':
      $ref: 'TS29571_CommonData.yaml#/components/responses/308'
    '400':
      $ref: 'TS29571_CommonData.yaml#/components/responses/400'
    '401':
      $ref: 'TS29571_CommonData.yaml#/components/responses/401'
    '403':
      $ref: 'TS29571_CommonData.yaml#/components/responses/403'
    '404':
      $ref: 'TS29571_CommonData.yaml#/components/responses/404'
    '411':
      $ref: 'TS29571_CommonData.yaml#/components/responses/411'
    '413':
      $ref: 'TS29571_CommonData.yaml#/components/responses/413'
    '415':
      $ref: 'TS29571_CommonData.yaml#/components/responses/415'
    '429':
      $ref: 'TS29571_CommonData.yaml#/components/responses/429'
    '500':
      $ref: 'TS29571_CommonData.yaml#/components/responses/500'
    '503':
      $ref: 'TS29571_CommonData.yaml#/components/responses/503'
  default:
    $ref: 'TS29571_CommonData.yaml#/components/responses/default'
components:
  securitySchemes:
    oAuth2ClientCredentials:
      type: oauth2
      flows:
        clientCredentials:
          tokenUrl: '{nrfApiRoot}/oauth2/token'
          scopes:
            nmfaf-3dadatamanagement: Access to the nmfaf-3dadatamanagement API
  schemas:
    MfafConfiguration:
      description: Represents an Individual MFAF Configuration.
      type: object
      required:
        - messageConfigurations
      properties:
        messageConfigurations:
          type: array
          items:
            $ref: '#/components/schemas/MessageConfiguration'
          minItems: 1
          description: The configuration of the MFAF for mapping data or analytics.
    MessageConfiguration:
      description: Represents the message configuration.
      type: object
      required:
        - notificationURI
      properties:
        correId:
          type: string
          description: >
            If the configuration is used for mapping analytics or data collection,
            representing the Analytics Consumer Notification Correlation ID or

```

```

    Data Consumer Notification Correlation ID.
formatInstruct:
  $ref: 'TS29574_Ndccf_DataManagement.yaml#/components/schemas/FormattingInstruction'
mfafNotiInfo:
  $ref: '#/components/schemas/MfafNotiInfo'
notificationURI:
  $ref: 'TS29571_CommonData.yaml#/components/schemas/Uri'
procInstruct:
  $ref: 'TS29574_Ndccf_DataManagement.yaml#/components/schemas/ProcessingInstruction'
MfafNotiInfo:
  description: >
    The MFAF notification information. It shall be provided in a response message
    if it had not been provided in the respective request message.
  type: object
  required:
    - mfafNotifUri
    - mfafCorrreId
  properties:
    mfafNotifUri:
      $ref: 'TS29571_CommonData.yaml#/components/schemas/Uri'
    mfafCorrreId:
      type: string

```

A.3 Nmfaf_3caDataManagement API

```

openapi: 3.0.0
info:
  version: 1.0.0-alpha.2
  title: Nmfaf_3caDataManagement
  description: |
    MFAF 3GPP Consumer Adaptor (3CA) Data Management Service.
    © 2022, 3GPP Organizational Partners (ARIB, ATIS, CCSA, ETSI, TSDSI, TTA, TTC).
    All rights reserved.
externalDocs:
  description: 3GPP TS 29.576 V17.0.0; 5G System; Messaging Framework Adaptor Services; Stage 3.
  url: 'https://www.3gpp.org/ftp/Specs/archive/29_series/29.576/'
servers:
  - url: '{apiRoot}/nmfaf-3cadatamanagement/v1'
    variables:
      apiRoot:
        default: https://example.com
        description: apiRoot as defined in clause 4.4 of 3GPP TS 29.501.
security:
  - oAuth2ClientCredentials:
    - nmfaf-3cadatamanagement
  - {}
paths:
  /mfaf-data-analytics:
    post:
      # This is a pseudo operation, clients shall NOT invoke this method!
      summary: subscribe to notifications
      operationId: CreateIndividualSubscription
      tags:
        - MFAF Data or Analytics Resources (Collection)
      requestBody:
        required: true
        content:
          application/json:
            schema: {}
      responses:
        default:
          $ref: 'TS29571_CommonData.yaml#/components/responses/default'
      callbacks:
        Notification:
          '{notificationURI}':
            # The URI in {notificationURI} is provided via Nmfaf-3daDataManagement API during the
            configuration for mapping data or analytics.
            post:
              requestBody:
                required: true
                content:
                  application/json:
                    schema:
                      type: array
                      items:
                        $ref: '#/components/schemas/NmfafDataRetrievalNotification'
                    minItems: 1

```

```

responses:
  '204':
    description: The receipt of the Notification is acknowledged.
  '307':
    $ref: 'TS29571_CommonData.yaml#/components/responses/307'
  '308':
    $ref: 'TS29571_CommonData.yaml#/components/responses/308'
  '400':
    $ref: 'TS29571_CommonData.yaml#/components/responses/400'
  '401':
    $ref: 'TS29571_CommonData.yaml#/components/responses/401'
  '403':
    $ref: 'TS29571_CommonData.yaml#/components/responses/403'
  '404':
    $ref: 'TS29571_CommonData.yaml#/components/responses/404'
  '411':
    $ref: 'TS29571_CommonData.yaml#/components/responses/411'
  '413':
    $ref: 'TS29571_CommonData.yaml#/components/responses/413'
  '415':
    $ref: 'TS29571_CommonData.yaml#/components/responses/415'
  '429':
    $ref: 'TS29571_CommonData.yaml#/components/responses/429'
  '500':
    $ref: 'TS29571_CommonData.yaml#/components/responses/500'
  '503':
    $ref: 'TS29571_CommonData.yaml#/components/responses/503'
default:
  $ref: 'TS29571_CommonData.yaml#/components/responses/default'
callbacks:
  Fetch:
    '{request.body#/fetchUri}':
      post:
        requestBody:
          required: true
          content:
            application/json:
              schema:
                type: array
                items:
                  type: string
                  minItems: 1
                description: Indicate the fetch correlation identifier.
        responses:
          '200':
            description: Expected response to a valid request
            content:
              application/json:
                schema:
                  $ref: '#/components/schemas/NmfafDataAnaNotification'
          '307':
            $ref: 'TS29571_CommonData.yaml#/components/responses/307'
          '308':
            $ref: 'TS29571_CommonData.yaml#/components/responses/308'
          '400':
            $ref: 'TS29571_CommonData.yaml#/components/responses/400'
          '401':
            $ref: 'TS29571_CommonData.yaml#/components/responses/401'
          '403':
            $ref: 'TS29571_CommonData.yaml#/components/responses/403'
          '404':
            $ref: 'TS29571_CommonData.yaml#/components/responses/404'
          '406':
            $ref: 'TS29571_CommonData.yaml#/components/responses/406'
          '411':
            $ref: 'TS29571_CommonData.yaml#/components/responses/411'
          '413':
            $ref: 'TS29571_CommonData.yaml#/components/responses/413'
          '415':
            $ref: 'TS29571_CommonData.yaml#/components/responses/415'
          '429':
            $ref: 'TS29571_CommonData.yaml#/components/responses/429'
          '500':
            $ref: 'TS29571_CommonData.yaml#/components/responses/500'
          '503':
            $ref: 'TS29571_CommonData.yaml#/components/responses/503'
        default:
          $ref: 'TS29571_CommonData.yaml#/components/responses/default'

```



```

components:
  securitySchemes:
    oAuth2ClientCredentials:
      type: oauth2
      flows:
        clientCredentials:
          tokenUrl: '{nrfApiRoot}/oauth2/token'
          scopes:
            nmfaf-3cadatamanagement: Access to the nmfaf-3cadatamanagement API
schemas:
  NmfafDataRetrievalNotification:
    description: >
      Represents the data or analytics or notification of availability
      of data or analytics to notification endpoints.
    type: object
    required:
      - correId
    anyOf:
      - required: [dataAnaNotif]
      - required: [fetchInstruction]
    properties:
      correId:
        type: string
        description: >
          If the configuration is used for mapping analytics or data collection,
          representing the Analytics Consumer Notification Correlation ID
          or Data Consumer Notification Correlation ID.
      dataAnaNotif:
        $ref: '#/components/schemas/NmfafDataAnaNotification'
      fetchInstruction:
        $ref: '#/components/schemas/FetchInstruction'
  FetchInstruction:
    description: >
      The fetch instructions indicate whether the data or analytics are to be fetched by the
Consumer.
    type: object
    required:
      - fetchUri
      - fetchCorrIds
    properties:
      fetchUri:
        $ref: 'TS29571_CommonData.yaml#/components/schemas/Uri'
      fetchCorrIds:
        type: array
        items:
          type: string
        minItems: 1
        description: the fetch correlation identifier(s) of the MFAF Data or Analytics.
  NmfafDataAnaNotification:
    description: MFAF data or analytics.
    type: object
    oneOf:
      - required: [anaNotifications]
      - required: [amfEventNotifs]
      - required: [smfEventNotifs]
      - required: [udmEventNotifs]
      - required: [nefEventNotifs]
      - required: [afEventNotifs]
    properties:
      anaNotifications:
        type: array
        items:
          $ref:
' TS29520_Nnwdaf_EventsSubscription.yaml#/components/schemas/NnwdafEventsSubscriptionNotification'
        minItems: 1
        description: List of analytics subscription notifications.
      amfEventNotifs:
        type: array
        items:
          $ref: 'TS29518_Namf_EventExposure.yaml#/components/schemas/AmfEventNotification'
        minItems: 1
        description: List of notifications of AMF events.
      smfEventNotifs:
        type: array
        items:
          $ref:
' TS29508_Nsmf_EventExposure.yaml#/components/schemas/NsmfEventExposureNotification'
        minItems: 1

```

```
description: List of notifications of SMF events.
udmEventNotifs:
  type: array
  items:
    $ref: 'TS29503_Nudm_EE.yaml#/components/schemas/MonitoringReport'
  minItems: 1
description: List of notifications of UDM events.
nefEventNotifs:
  type: array
  items:
    $ref: 'TS29591_Nnef_EventExposure.yaml#/components/schemas/NefEventExposureNotif'
  minItems: 1
description: List of notifications of NEF events.
afEventNotifs:
  type: array
  items:
    $ref: 'TS29517_Naf_EventExposure.yaml#/components/schemas/AfEventExposureNotif'
  minItems: 1
```

Annex B (informative): Change history

Change history							
Date	Meeting	TDoc	CR	Rev	Cat	Subject/Comment	New version
2021-06	CT3#116e					TS skeleton of Messaging Framework Adaptor Services specification	0.0.0
2021-06	CT3#116e	C3-213502				Inclusion of documents agreed in CT3#116e C3-213377.	0.1.0
2021-08	CT3#117e	C3-214580				Inclusion of documents agreed in CT3#117e C3-214479, C3-214358, C3-214359, C3-214360, C3-214361, C3-214362, C3-214363 and C3-214480.	0.2.0
2021-11	CT3#119e	C3-216522				Inclusion of documents agreed in CT3#119e C3-216422, C3-216423, C3-216441, C3-216465, C3-216467.	0.3.0
2022-01	CT3#119bis-e	C3-220455				Inclusion of documents agreed in CT3#119bis-e C3-220294, C3-220464, C3-220319, C3-220504, C3-220321, C3-220505.	0.4.0
2022-02	CT3#120e	C3-221516				Inclusion of documents agreed in CT3#120e C3-221289, C3-221299, C3-221424, C3-221602, C3-221603, C3-221604, C3-221605.	0.5.0
2022-03	CT#95e	CP-220161				Presentation to TSG CT for approval	1.0.0
2022-03	CT#95e	CP-220161				Approved by TSG CT	17.0.0

History

Document history		
V17.0.0	May 2022	Publication