

ETSI TS 129 551 V16.11.0 (2022-07)



**5G;
5G System;
Packet Flow Description Management Service;
Stage 3
(3GPP TS 29.551 version 16.11.0 Release 16)**



Reference

RTS/TSGC-0329551vgb0

Keywords

5G

ETSI

650 Route des Lucioles
F-06921 Sophia Antipolis Cedex - FRANCE

Tel.: +33 4 92 94 42 00 Fax: +33 4 93 65 47 16

Siret N° 348 623 562 00017 - APE 7112B
Association à but non lucratif enregistrée à la
Sous-Préfecture de Grasse (06) N° w061004871

Important notice

The present document can be downloaded from:

<http://www.etsi.org/standards-search>

The present document may be made available in electronic versions and/or in print. The content of any electronic and/or print versions of the present document shall not be modified without the prior written authorization of ETSI. In case of any existing or perceived difference in contents between such versions and/or in print, the prevailing version of an ETSI deliverable is the one made publicly available in PDF format at www.etsi.org/deliver.

Users of the present document should be aware that the document may be subject to revision or change of status.

Information on the current status of this and other ETSI documents is available at

<https://portal.etsi.org/TB/ETSIDeliverableStatus.aspx>

If you find errors in the present document, please send your comment to one of the following services:

<https://portal.etsi.org/People/CommitteeSupportStaff.aspx>

If you find a security vulnerability in the present document, please report it through our
Coordinated Vulnerability Disclosure Program:

<https://www.etsi.org/standards/coordinated-vulnerability-disclosure>

Notice of disclaimer & limitation of liability

The information provided in the present deliverable is directed solely to professionals who have the appropriate degree of experience to understand and interpret its content in accordance with generally accepted engineering or other professional standard and applicable regulations.

No recommendation as to products and services or vendors is made or should be implied.

No representation or warranty is made that this deliverable is technically accurate or sufficient or conforms to any law and/or governmental rule and/or regulation and further, no representation or warranty is made of merchantability or fitness for any particular purpose or against infringement of intellectual property rights.

In no event shall ETSI be held liable for loss of profits or any other incidental or consequential damages.

Any software contained in this deliverable is provided "AS IS" with no warranties, express or implied, including but not limited to, the warranties of merchantability, fitness for a particular purpose and non-infringement of intellectual property rights and ETSI shall not be held liable in any event for any damages whatsoever (including, without limitation, damages for loss of profits, business interruption, loss of information, or any other pecuniary loss) arising out of or related to the use of or inability to use the software.

Copyright Notification

No part may be reproduced or utilized in any form or by any means, electronic or mechanical, including photocopying and microfilm except as authorized by written permission of ETSI.

The content of the PDF version shall not be modified without the written authorization of ETSI.

The copyright and the foregoing restriction extend to reproduction in all media.

© ETSI 2022.
All rights reserved.

Intellectual Property Rights

Essential patents

IPRs essential or potentially essential to normative deliverables may have been declared to ETSI. The declarations pertaining to these essential IPRs, if any, are publicly available for **ETSI members and non-members**, and can be found in ETSI SR 000 314: "*Intellectual Property Rights (IPRs); Essential, or potentially Essential, IPRs notified to ETSI in respect of ETSI standards*", which is available from the ETSI Secretariat. Latest updates are available on the ETSI Web server (<https://ipr.etsi.org/>).

Pursuant to the ETSI Directives including the ETSI IPR Policy, no investigation regarding the essentiality of IPRs, including IPR searches, has been carried out by ETSI. No guarantee can be given as to the existence of other IPRs not referenced in ETSI SR 000 314 (or the updates on the ETSI Web server) which are, or may be, or may become, essential to the present document.

Trademarks

The present document may include trademarks and/or tradenames which are asserted and/or registered by their owners. ETSI claims no ownership of these except for any which are indicated as being the property of ETSI, and conveys no right to use or reproduce any trademark and/or tradename. Mention of those trademarks in the present document does not constitute an endorsement by ETSI of products, services or organizations associated with those trademarks.

DECT™, **PLUGTESTS™**, **UMTS™** and the ETSI logo are trademarks of ETSI registered for the benefit of its Members. **3GPP™** and **LTE™** are trademarks of ETSI registered for the benefit of its Members and of the 3GPP Organizational Partners. **oneM2M™** logo is a trademark of ETSI registered for the benefit of its Members and of the oneM2M Partners. **GSM®** and the GSM logo are trademarks registered and owned by the GSM Association.

Legal Notice

This Technical Specification (TS) has been produced by ETSI 3rd Generation Partnership Project (3GPP).

The present document may refer to technical specifications or reports using their 3GPP identities. These shall be interpreted as being references to the corresponding ETSI deliverables.

The cross reference between 3GPP and ETSI identities can be found under <http://webapp.etsi.org/key/queryform.asp>.

Modal verbs terminology

In the present document "**shall**", "**shall not**", "**should**", "**should not**", "**may**", "**need not**", "**will**", "**will not**", "**can**" and "**cannot**" are to be interpreted as described in clause 3.2 of the [ETSI Drafting Rules](#) (Verbal forms for the expression of provisions).

"**must**" and "**must not**" are **NOT** allowed in ETSI deliverables except when used in direct citation.

Contents

Intellectual Property Rights	2
Legal Notice	2
Modal verbs terminology.....	2
Foreword.....	5
1 Scope	6
2 References	6
3 Definitions, symbols and abbreviations	7
3.1 Definitions	7
3.2 Abbreviations	7
4 Packet Flow Description Management Service.....	7
4.1 Service Description	7
4.1.1 Overview	7
4.1.2 Service Architecture	7
4.1.3 Network Functions.....	8
4.1.3.1 Packet Flow Description Function (PFD)	8
4.1.3.2 NF Service Consumers.....	8
4.2 Service Operations	8
4.2.1 Introduction.....	8
4.2.2 Nnef_PFDmanagement_Fetch Service Operation	9
4.2.2.1 General	9
4.2.2.2 Retrieval of PFDs.....	9
4.2.3 Nnef_PFDmanagement_Subscribe Service Operation	10
4.2.3.1 General	10
4.2.3.2 Subscription for event notifications on PFDs change	10
4.2.3.3 Subscription update for event notifications on PFDs change.....	11
4.2.4 Nnef_PFDmanagement_Notify Service Operation.....	12
4.2.4.1 General	12
4.2.4.2 Notification of PFD change.....	12
4.2.5 Nnef_PFDmanagement_Unsubscribe Service Operation	13
4.2.5.1 General	13
4.2.5.2 Unsubscribe from event notifications on PFDs change.....	13
5 Nnef_PFDmanagement API.....	13
5.1 Introduction	13
5.2 Usage of HTTP.....	14
5.2.1 General.....	14
5.2.2 HTTP standard headers.....	14
5.2.2.1 General	14
5.2.2.2 Content type	14
5.2.3 HTTP custom headers.....	14
5.3 Resources	15
5.3.1 Resource Structure.....	15
5.3.2 Resource: PFD of applications.....	15
5.3.2.1 Description	15
5.3.2.2 Resource definition	15
5.3.2.3 Resource Standard Methods.....	16
5.3.2.3.1 GET	16
5.3.2.4 Resource Custom Operations	16
5.3.3 Resource: Individual application PFD	16
5.3.3.1 Description	16
5.3.3.2 Resource definition	16
5.3.3.3 Resource Standard Methods.....	17
5.3.3.3.1 GET	17
5.3.3.4 Resource Custom Operations	18

5.3.4	Resource: PFD subscriptions	18
5.3.4.1	Description	18
5.3.4.2	Resource definition	18
5.3.4.3	Resource Standard Methods.....	18
5.3.4.3.1	POST	18
5.3.4.4	Resource Custom Operations	19
5.3.5	Resource: Individual PFD subscription	19
5.3.5.1	Description	19
5.3.5.2	Resource definition	19
5.3.5.3	Resource Standard Methods.....	19
5.3.5.3.1	DELETE.....	19
5.3.5.3.2	PUT	20
5.3.5.4	Resource Custom Operations	21
5.4	Custom Operations without associated resources.....	21
5.5	Notifications	21
5.5.1	General.....	21
5.5.2	PFD Change Notification.....	22
5.5.2.1	Description	22
5.5.2.2	Target URI	22
5.5.2.3	Standard Methods	22
5.5.2.3.1	POST	22
5.6	Data Model.....	23
5.6.1	General.....	23
5.6.2	Structured data types.....	24
5.6.2.1	Introduction.....	24
5.6.2.2	Type: PfdDataForApp.....	24
5.6.2.3	Type: PfdSubscription.....	25
5.6.2.4	Type: PfdChangeNotification	25
5.6.2.5	Type: PfdContent	26
5.6.2.6	Type: PfdChangeReport.....	26
5.6.3	Simple data types and enumerations	26
5.6.3.1	Introduction.....	26
5.6.3.2	Simple data types	27
5.7	Error handling	27
5.7.1	General.....	27
5.7.2	Protocol Errors.....	27
5.7.3	Application Errors	27
5.8	Feature negotiation.....	27
5.9	Security	28
Annex A (normative): OpenAPI specification.....		29
A.1	General	29
A.2	Nnef_PFDmanagement API.....	29
Annex B (informative): Change history		35
History		36

Foreword

This Technical Specification has been produced by the 3rd Generation Partnership Project (3GPP).

The contents of the present document are subject to continuing work within the TSG and may change following formal TSG approval. Should the TSG modify the contents of the present document, it will be re-released by the TSG with an identifying change of release date and an increase in version number as follows:

Version x.y.z

where:

- x the first digit:
 - 1 presented to TSG for information;
 - 2 presented to TSG for approval;
 - 3 or greater indicates TSG approved document under change control.
- y the second digit is incremented for all changes of substance, i.e. technical enhancements, corrections, updates, etc.
- z the third digit is incremented when editorial only changes have been incorporated in the document.

1 Scope

The present document provides the stage 3 specification of the PFD Management Service of the 5G system.

The stage 2 definition and related procedures of the PFD Management Service are contained in 3GPP TS 23.502 [3] and 3GPP TS 23.503 [4]. The 5G System Architecture is defined in 3GPP TS 23.501 [2].

The Technical Realization of the Service Based Architecture and the Principles and Guidelines for Services Definition of the 5G System are specified in 3GPP TS 29.500 [5] and 3GPP TS 29.501 [6].

The Packet Flow Description Function (PFDF) provides the PFD Management Service to NF consumers (e.g. Session Management Function). The PFDF is functionality within the NEF.

2 References

The following documents contain provisions which, through reference in this text, constitute provisions of the present document.

- References are either specific (identified by date of publication, edition number, version number, etc.) or non-specific.
- For a specific reference, subsequent revisions do not apply.
- For a non-specific reference, the latest version applies. In the case of a reference to a 3GPP document (including a GSM document), a non-specific reference implicitly refers to the latest version of that document *in the same Release as the present document*.

- [1] 3GPP TR 21.905: "Vocabulary for 3GPP Specifications".
- [2] 3GPP TS 23.501: "System Architecture for the 5G System; Stage 2".
- [3] 3GPP TS 23.502: "Procedures for the 5G System; Stage 2".
- [4] 3GPP TS 23.503: "Policy and Charging Control Framework for the 5G System; Stage 2".
- [5] 3GPP TS 29.500: "5G System; Technical Realization of Service Based Architecture; Stage 3".
- [6] 3GPP TS 29.501: "5G System; Principles and Guidelines for Services Definition; Stage 3".
- [7] IETF RFC 7540: "Hypertext Transfer Protocol Version 2 (HTTP/2)".
- [8] IETF RFC 8259: "The JavaScript Object Notation (JSON) Data Interchange Format".
- [9] OpenAPI: "OpenAPI 3.0.0 Specification", <https://github.com/OAI/OpenAPI-Specification/blob/master/versions/3.0.0.md>.
- [10] 3GPP TS 29.571: "5G System; Common Data Types for Service Based Interfaces Stage 3".
- [11] 3GPP TS 29.122: "T8 reference point for Northbound APIs".
- [12] 3GPP TS 29.251: "Gw and Gwn reference points for sponsored data connectivity".
- [13] 3GPP TS 29.510: "5G System; Network Function Repository Services; Stage 3".
- [14] 3GPP TS 33.501: "Security architecture and procedures for 5G system".
- [15] IETF RFC 6749: "The OAuth 2.0 Authorization Framework".
- [16] IETF RFC 7807: "Problem Details for HTTP APIs".
- [17] 3GPP TR 21.900: "Technical Specification Group working methods".
- [18] IETF RFC 6733: "Diameter Base Protocol".

3 Definitions, symbols and abbreviations

3.1 Definitions

For the purposes of the present document, the terms and definitions given in 3GPP TR 21.905 [1] and the following apply. A term defined in the present document takes precedence over the definition of the same term, if any, in 3GPP TR 21.905 [1].

3.2 Abbreviations

For the purposes of the present document, the abbreviations given in 3GPP TR 21.905 [1] and the following apply. An abbreviation defined in the present document takes precedence over the definition of the same abbreviation, if any, in 3GPP TR 21.905 [1].

JSON	JavaScript Object Notation
NEF	Network Exposure Function
NRF	Network Repository Function
PFD	Packet Flow Description
PFDF	Packet Flow Description Function
SBI	Service Based Interface
SMF	Session Management Function

4 Packet Flow Description Management Service

4.1 Service Description

4.1.1 Overview

The PFD Management Service, as defined as defined in 3GPP TS 23.501 [2], 3GPP TS 23.502 [3] and 3GPP TS 23.503 [4], is provided by the Packet Flow Description Function (PFDF).

The only known NF Service Consumer is the SMF.

This service:

- allows an SMF to subscribe to and unsubscribe from PFD changes;
- notifies an SMF about changes of PFDs; and
- allows an SMF to retrieve PFDs.

4.1.2 Service Architecture

The 5G System Architecture is defined in 3GPP TS 23.501 [2]. The Policy and Charging related 5G architecture is also described in 3GPP TS 23.503 [4].

The PFD Management Service is provided by the PFDF to NF service consumers (e.g. SMF) and shown in the SBI representation model in Figure 4.1.2-1. The PFDF is a functionality within the NEF.

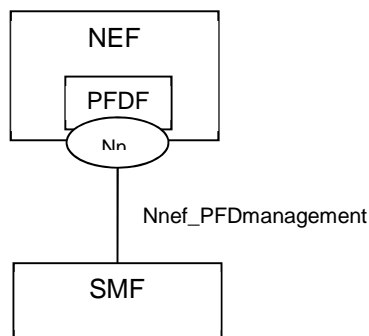

Figure 4.1.2-1: Reference Architecture for the Nnef_PFDmanagement Service; SBI representation



Figure 4.1.2-2: Reference Architecture for the Nnef_PFDmanagement Service; reference point representation

4.1.3 Network Functions

4.1.3.1 Packet Flow Description Function (PFDF)

The Packet Flow Description Function (PFDF):

- provides PFDs associated with one or more Application Identifiers; and
- allows NF consumers to subscribe to and unsubscribe from notifications on changes of PFDs for Application Identifier.

4.1.3.2 NF Service Consumers

The SMF shall support:

- requesting and receiving the PFD(s) for one or more Application Identifiers.

4.2 Service Operations

4.2.1 Introduction

Service operations defined for the Nnef_PFDmanagement Service are shown in table 4.2.1-1.

Table 4.2.1-1: Nnef_PFDmanagement Service Operations

Service Operation Name	Description	Initiated by
Nnef_PFDmanagement_Fetch	Provides the PFDs for application identifier(s) to the NF service consumer.	SMF
Nnef_PFDmanagement_Subscribe	Allows NF service consumers to subscribe to notifications on events when the PFDs for application identifier(s) change.	SMF
Nnef_PFDmanagement_Notify	Notifies NF service consumers to update and/or delete the PFDs for application identifier(s).	PFDF
Nnef_PFDmanagement_Unsubscribe	Allows NF service consumers to unsubscribe from notifications on PFDs change events.	SMF

4.2.2 Nnef_PFDmanagement_Fetch Service Operation

4.2.2.1 General

The Nnef_PFDmanagement_Fetch service operation provides means for the NF service consumer to retrieve the PFDs for one or more application identifier(s).

The following procedures using the Nnef_PFDmanagement_Fetch service operation are supported:

- Retrieval of PFDs.

4.2.2.2 Retrieval of PFDs

This procedure, as shown in Figure 4.2.2.2-1, is used to retrieve PFDs for an application identifier from the PFDF. This procedure enables the NF service consumer to retrieve PFDs for an Application Identifier(s) from the PFDF when:

- a PCC rule with this application identifier is provided/activated by the PCF and the PFDs provided by the PFDF are not available at the NF service consumer; or
- the caching timer for an application identifier elapses and a PCC rule for this application identifier is still active.

When the SMF removes the last PCC rule that refers to the corresponding application identifier, or when the caching timer expires and no PCC rule refers to the application identifier, the SMF may remove the PFD(s) related with the application identifier.

The PFDs retrieved from PFDF take precedence over any PFDs pre-configured in the SMF. If all PFDs retrieved from the PFDF are removed for an application identifier, the pre-configured PFDs shall be applied again for the application identifier.

The PFDF may provide caching time value together with the PFDs for an application identifier. The caching time value retrieved from the PFDF takes precedence over the default caching time value configured in the NF service consumer. If no caching time value is received from the PFDF, the configured default caching time value shall be applied.

NOTE 1: The NF service consumer(s) and the PFDF(s) within an operator network are configured with the same default caching time value to be applied for all application identifiers.

NOTE 2: The configuration of a caching time value per application identifier in the PFDF is based on the SLA between the operator and the ASP.

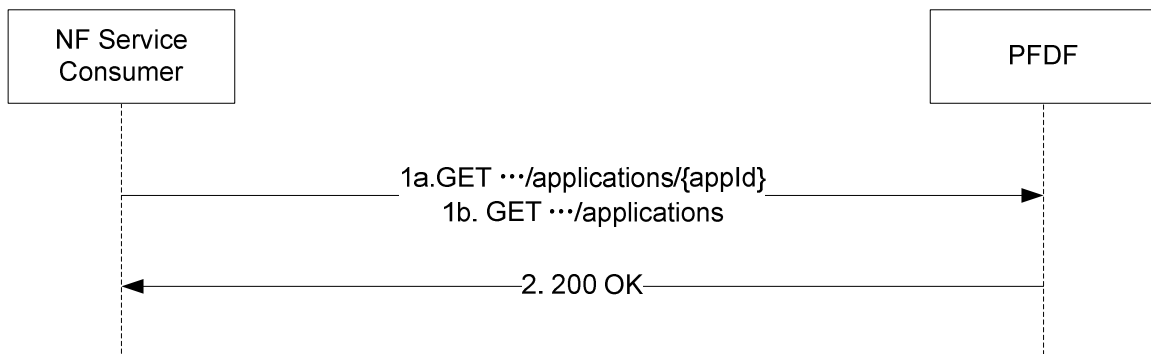

Figure 4.2.2.2-1: Retrieval of PFDs

1. The NF service consumer (e.g. SMF) shall send a GET request to the resource representing the PFDs for the requested application identifier(s):
 - for PFDs of an individual application identifier, the request URI shall be set to "{apiRoot}/nnef-pfdmanagement/v1/applications/{appld}" (as shown in figure 4.2.2.2-1, step 1a); and
 - for PFD of a collection of application identifiers, the request URI shall be set to "{apiRoot}/nnef-pfdmanagement/v1/applications" (as shown in figure 4.2.2.2-1, step 1b) with query parameters indicating the requested application identifier(s).
2. On success, an HTTP "200 OK" response shall be returned, with the payload body containing a representation of an "Individual application PFD" resource or a "PFD of applications" resource for the requested application identifier(s). The NF service consumer shall replace the stored PFD(s) retrieved from the PFDF with the new received PFD(s) for the requested application identifier(s). If the PFD(s) of one or more requested application identifier(s) are not provided in the response, the NF service consumer shall remove the PFD(s) of these requested application identifier(s) and re-apply the pre-configured PFDs.

If errors occur when processing the HTTP GET request, the PFDF shall send an HTTP error response as specified in subclause 5.7. For "404 Not Found", the NF service consumer shall remove the PFD(s) of the requested application identifier(s) in the NF service consumer and re-apply the pre-configured PFDs.

If the feature "ES3XX" is supported, and the PFDF determines the received HTTP GET request needs to be redirected, the PFDF shall send an HTTP redirect response as specified in subclause 6.10.9 of 3GPP TS 29.500 [5].

4.2.3 Nnef_PFDmanagement_Subscribe Service Operation

4.2.3.1 General

The Nnef_PFDmanagement_Subscribe service operation enables the NF service consumer to subscribe to notifications on events when the PFDs for application identifier(s) change.

The following procedures using the Nnef_PFDmanagement_Subscribe service operation are supported:

- Subscription for event notifications on PFDs change;
- Subscription update for event notifications on PFD change.

4.2.3.2 Subscription for event notifications on PFDs change

This procedure, as shown in Figure 4.2.3.2-1, is used to subscribe to notifications on events when the PFDs for application identifier(s) change.

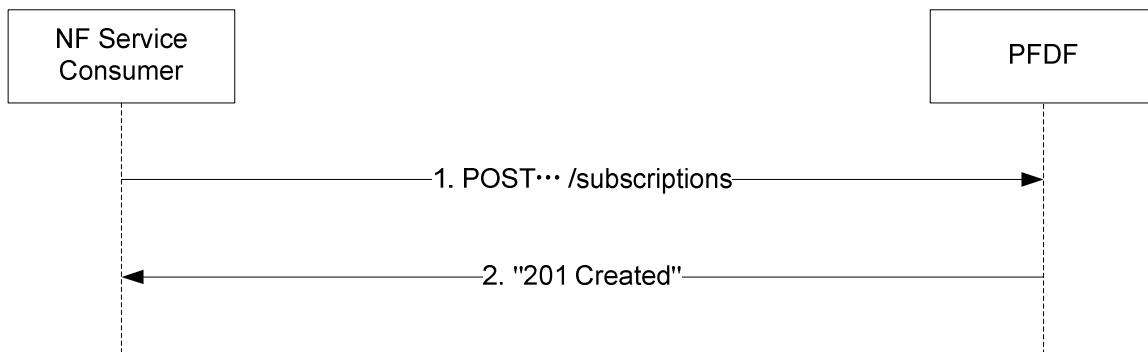

Figure 4.2.3.2-1: Creation of a subscription for event notifications on PFDs change

1. The NF service consumer (e.g. SMF) shall send a POST request to the request URI representing the collection of PFD subscriptions resource "{apiRoot}/nnef-pfdmanagement/v1/subscriptions". The NF service consumer shall include the PfdSubscription data type in the request. Within the PfdSubscription data type, the NF service consumer payload body shall include:
 - an URI where to receive the requested notifications as "notifyUri" attribute;
 and may include:
 - subscribed application identifier(s) within the "applicationIds" attribute.
2. If the request is accepted, the PFDf shall:
 - create a new subscription;
 - assign a subscriptionId;
 - store the subscription; and
 - send an HTTP "201 Created" response, with the payload body containing a representation of the created subscription, and the Location header containing the resource URI of the created subscription "{apiRoot}/nnef-pfdmanagement/v1/subscriptions/{subscriptionId}".

Otherwise, one of the HTTP status codes listed in table 5.3.4.3.1-3 shall be returned.

NOTE: The PFDs that have been provisioned to the PFDf before the NF service consumer performs the subscription are not notified to the NF service consumer as a result of this subscription, but the NF service consumer can retrieve them before performing the subscription by invoking Nnef_PFDmanagement_Fetch Service Operation.

4.2.3.3 Subscription update for event notifications on PFDs change

This procedure, as shown in Figure 4.2.3.3-1, is used to update an existing subscription to notifications on events when the PFDs for application identifier(s) change.

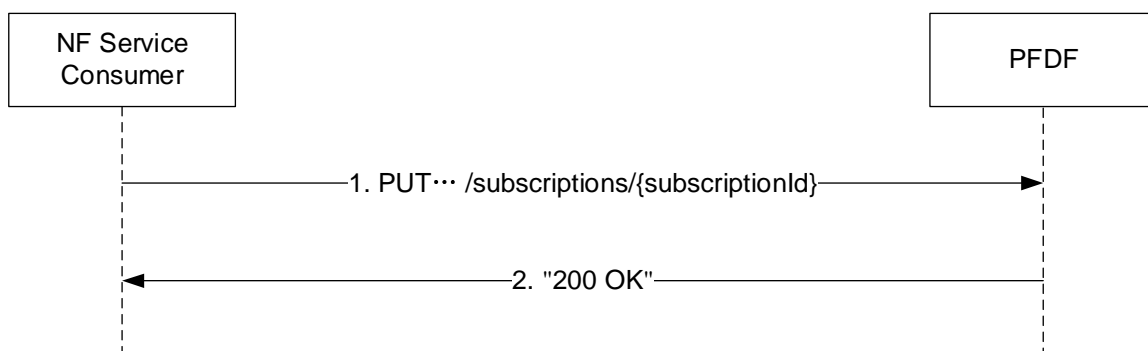

Figure 4.2.3.3-1: Update of a subscription for event notifications on PFDs change

1. If the feature PfdChgSubsUpdate is supported, the NF service consumer (e.g. SMF) shall send a PUT request to the resource URI representing the targeted PFD subscription resource "{apiRoot}/nnef-pfdmanagement/v1/subscriptions/{subscriptionId}". The NF service consumer shall include the PfdSubscription data type in the request. Within the PfdSubscription data type, the NF service consumer payload body shall include:

- an URI where to receive the requested notifications as "notifyUri" attribute;

and may include:

- subscribed application identifier(s) within the "applicationIds" attribute.

NOTE 1: The "notifUri" attribute within the PfdSubscription data structure can be modified to request that subsequent notifications are sent to a new NF service consumer.

2. If the feature PfdChgSubsUpdate is supported and the request is accepted, the PFDF shall:

- update the subscription; and
- send an HTTP "200 OK" response, with the payload body containing a representation of the updated subscription.

Otherwise, if errors occur when processing the HTTP PUT request, the PFDF shall send an HTTP error response as specified in subclause 5.7. If the feature "ES3XX" is supported, and the PFDF determines the received HTTP PUT request needs to be redirected, the PFDF shall send an HTTP redirect response as specified in subclause 6.10.9 of 3GPP TS 29.500 [5].

NOTE 2: The PFDs that have been provisioned to the PFDF before the NF service consumer performs the subscription are not notified to the NF service consumer as a result of this subscription, but the NF service consumer can retrieve them before performing the subscription by invoking Nnef_PFDmanagement_Fetch Service Operation.

4.2.4 Nnef_PFDmanagement_Notify Service Operation

4.2.4.1 General

The Nnef_PFDmanagement_Notify service operation notifies the NF service consumer to update and/or delete the PFDs for application identifier(s).

The following procedures using the Nnef_PFDmanagement_Notify service operation are supported:

- Management of PFDs.

4.2.4.2 Notification of PFD change

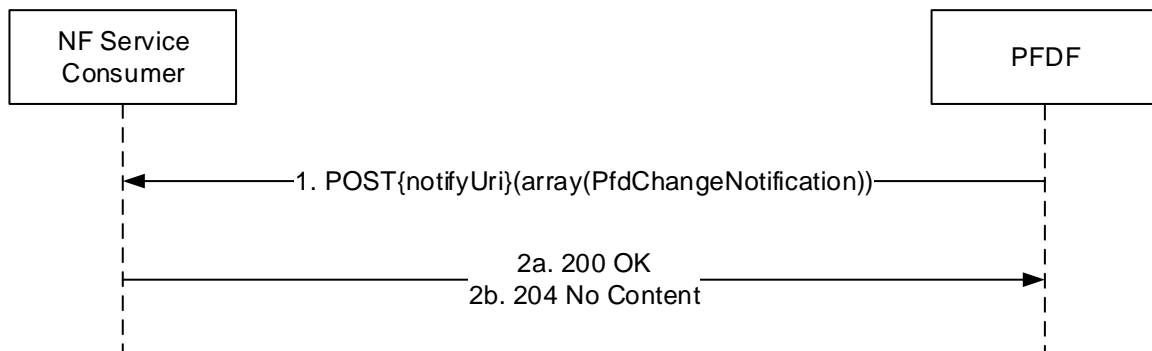

Figure 4.2.4.2-1: Notification of PFD change

1. The PFDF shall send a POST request to the NF service consumer (e.g. SMF) targeting the URI "{notifyUri}", where {notifyUri} is the notification URI provided during the creation or modification of the subscription

resource, as specified in subclause 4.2.3.2. The payload body of the POST request shall contain one or more PfdChangeNotification data structure(s).

2 If the notification is accepted, the NF service consumer shall reply with:

- "204 No Content" indicating the successful provisioning of all PFDs; or
- "200 OK" and the payload body of the response shall contain "PfdChangeReport" data structure with detailed information of failed application(s).

Otherwise, if errors occur when processing the HTTP POST request, the NF service consumer shall send an HTTP error response as specified in subclause 5.7. If the feature "ES3XX" is supported, and the NF service consumer determines the received HTTP POST request needs to be redirected, the NF service consumer shall send an HTTP redirect response as specified in subclause 6.10.9 of 3GPP TS 29.500 [5].

4.2.5 Nnef_PFDmanagement_Unsubscribe Service Operation

4.2.5.1 General

The Nnef_PFDmanagement_Unsubscribe service operation is used by the NF service consumer to unsubscribe from notifications on PFD change events.

The following procedures using the Nnef_PFDmanagement_Unsubscribe service operation are supported:

- Unsubscribe from event notifications on PFDs change.

4.2.5.2 Unsubscribe from event notifications on PFDs change

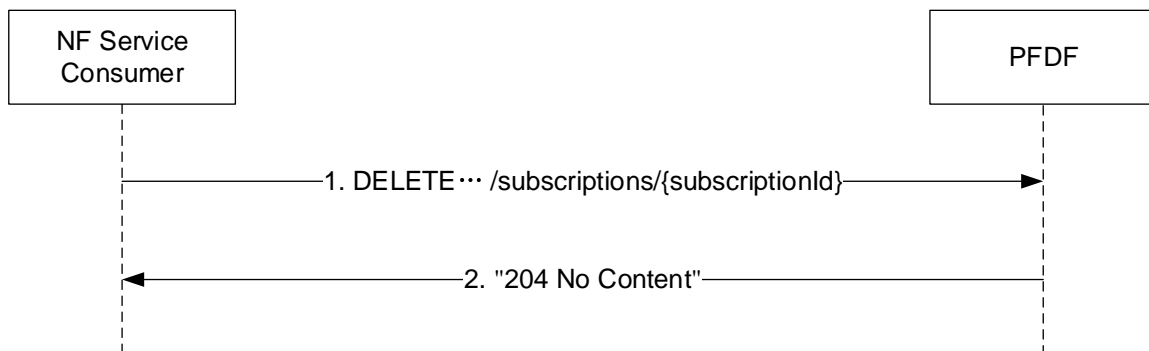

Figure 4.2.5.2-1: Unsubscribe from event notifications on PFDs change

1. The NF Service Consumer (e.g. SMF) shall send a DELETE request to the resource URI representing the individual PFD subscription. The request body shall be empty.
2. If the request is accepted, an HTTP "204 No Content" response shall be returned. The response body shall be empty.

Otherwise, if errors occur when processing the HTTP DELETE request, the PFDF shall send an HTTP error response as specified in subclause 5.7. If the feature "ES3XX" is supported, and the PFDF determines the received HTTP DELETE request needs to be redirected, the PFDF shall send an HTTP redirect response as specified in subclause 6.10.9 of 3GPP TS 29.500 [5].

5 Nnef_PFDmanagement API

5.1 Introduction

The Packet Flow Description Management Service shall use the Nnef_PFDmanagement API.

The API URI of the Nnef_PFDmanagement API shall be:

{apiRoot}/<apiName>/<apiVersion>/

The request URIs used in HTTP requests from the NF service consumer towards the PFDF shall have the Resource URI structure defined in subclause 4.4.1 of 3GPP TS 29.501 [6], i.e.:

{apiRoot}/<apiName>/<apiVersion>/<apiSpecificResourceUriPart>

with the following components:

- The {apiRoot} shall be set as described in 3GPP TS 29.501 [6].
- The <apiName> shall be "nnef-pfdmanagement".
- The <apiVersion> shall be "v1".
- The <apiSpecificResourceUriPart> shall be set as described in subclause 5.3.

5.2 Usage of HTTP

5.2.1 General

HTTP/2, IETF RFC 7540 [7], shall be used as specified in subclause 5.2 of 3GPP TS 29.500 [5].

HTTP/2 shall be transported as specified in subclause 5.3 of 3GPP TS 29.500 [5].

The OpenAPI [9] specification of HTTP messages and content bodies for the Nnef_PFDmanagement service is contained in Annex A.

5.2.2 HTTP standard headers

5.2.2.1 General

See subclause 5.2.2 of 3GPP TS 29.500 [5] for the usage of HTTP standard headers.

5.2.2.2 Content type

JSON, IETF RFC 8259 [8], shall be used as content type of the HTTP bodies specified in the present specification, as specified in subclause 5.4 of 3GPP TS 29.500 [5]. The use of the JSON format shall be signalled by the content type "application/json".

"Problem Details" JSON object shall be used to indicate additional details of the error in a HTTP response body and shall be signalled by the content type "application/problem+json", as defined in IETF RFC 7807 [16].

5.2.3 HTTP custom headers

None

5.3 Resources

5.3.1 Resource Structure

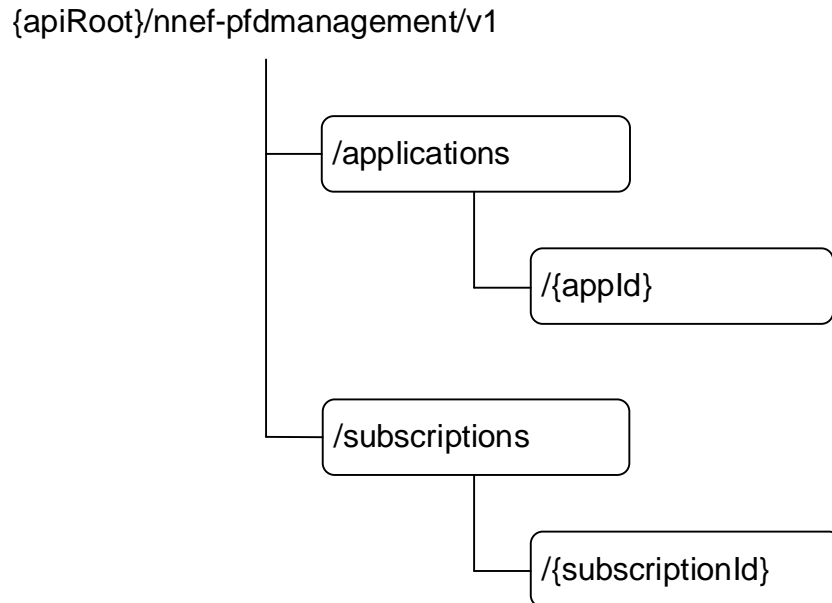

Figure 5.3.1-1: Resource URI structure of the Nnef_PFDmanagement API

Table 5.3.1-1 provides an overview of the resources and applicable HTTP methods.

Table 5.3.1-1: Resources and methods overview

Resource name	Resource URI	HTTP method or custom operation	Description
PFD of applications	/applications	GET	Nnef_PFDmanagement_Fetch. Retrieve PFDs for one or multiple applications using query parameters.
Individual application PFD	/applications/{appld}	GET	Nnef_PFDmanagement_Fetch. Retrieve the PFD for an application.
PFD subscriptions	/subscriptions	POST	Nnef_PFDmanagement_Subscribe. Subscribe the notification of PFD changes.
Individual PFD subscription	/subscriptions/{subscriptionId}	PUT	Update a subscription to PFD change notifications.
Individual PFD subscription	/subscriptions/{subscriptionId}	DELETE	Nnef_PFDmanagement_Unsubscribe. Delete a subscription to PFD change notifications.

5.3.2 Resource: PFD of applications

5.3.2.1 Description

This resource represents PFDs for all applications.

5.3.2.2 Resource definition

Resource URI: {apiRoot}/nnef-pfdmanagement/v1/applications

This resource shall support the resource URI variables defined in table 5.3.2.2-1.

Table 5.3.2.2-1: Resource URI variables for this resource

Name	Data type	Definition
apiRoot	string	See subclause 5.1

5.3.2.3 Resource Standard Methods

5.3.2.3.1 GET

This method shall support the URI query parameters specified in table 5.3.2.3.1-1.

Table 5.3.2.3.1-1: URI query parameters supported by the GET method on this resource

Name	Data type	P	Cardinality	Description
application-ids	array(ApplicationId)	M	1..N	The requested application identifier(s) for which PFDs shall be returned.
supported-features	SupportedFeatures	O	0..1	To filter irrelevant responses related to unsupported features.

This method shall support the request data structures specified in table 5.3.2.3.1-2 and the response data structures and response codes specified in table 5.3.2.3.1-3.

Table 5.3.2.3.1-2: Data structures supported by the GET Request Body on this resource

Data type	P	Cardinality	Description
n/a			

Table 5.3.2.3.1-3: Data structures supported by the GET Response Body on this resource

Data type	P	Cardinality	Response codes	Description
array(PfdDataForApp)	M	0..N	200 OK	The PFDs for one or more application identifier(s) provided in the request URI are returned.
NOTE: In addition, the HTTP status codes which are specified as mandatory in table 5.2.7.1-1 of 3GPP TS 29.500 [5] for the GET method shall also apply.				

5.3.2.4 Resource Custom Operations

None.

5.3.3 Resource: Individual application PFD

5.3.3.1 Description

This resource represents the PFD identified by an application identifier.

5.3.3.2 Resource definition

Resource URI: {apiRoot}/nnef-pfdmanagement/v1/applications/{appId}

This resource shall support the resource URI variables defined in table 5.3.3.2-1.

Table 5.3.3.2-1: Resource URI variables for this resource

Name	Data type	Definition
apiRoot	string	See subclause 5.1.
appld	string	Identifies a set of PFD for an application identifier.

5.3.3.3 Resource Standard Methods

5.3.3.3.1 GET

This method shall support the URI query parameters specified in table 5.3.3.3.1-1.

Table 5.3.3.3.1-1: URI query parameters supported by the GET method on this resource

Name	Data type	P	Cardinality	Description
supported-features	SupportedFeatures	O	0..1	To filter irrelevant responses related to unsupported features.

This method shall support the request data structures specified in table 5.3.3.3.1-2 and the response data structures and response codes specified in table 5.3.3.3.1-3.

Table 5.3.3.3.1-2: Data structures supported by the GET Request Body on this resource

Data type	P	Cardinality	Description
n/a			

Table 5.3.3.3.1-3: Data structures supported by the GET Response Body on this resource

Data type	P	Cardinality	Response codes	Description
PfdDataForApp	M	1	200 OK	A representation of PFDs for an application in the request URI is returned.
RedirectResponse	O	0..1	307 Temporary Redirect	Temporary redirection, during Individual PFD subscription retrieval. The response shall include a Location header field containing an alternative URI of the resource located in an alternative PFDF (service) instance. Applicable if the feature "ES3XX" is supported.
RedirectResponse	O	0..1	308 Permanent Redirect	Permanent redirection, during Individual PFD subscription retrieval. The response shall include a Location header field containing an alternative URI of the resource located in an alternative PFDF (service) instance. Applicable if the feature "ES3XX" is supported.

NOTE: In addition, the HTTP status codes which are specified as mandatory in table 5.2.7.1-1 of 3GPP TS 29.500 [5] for the GET method shall also apply.

Table 5.3.3.3.1-4: Headers supported by the 307 Response Code on this resource

Name	Data type	P	Cardinality	Description
Location	string	M	1	An alternative URI of the resource located in an alternative PFDF (service) instance.
3gpp-Sbi-Target-Nf-Id	string	O	0..1	Identifier of the target NF (service) instance towards which the request is redirected

Table 5.3.3.3.1-5: Headers supported by the 308 Response Code on this resource

Name	Data type	P	Cardinality	Description
Location	string	M	1	An alternative URI of the resource located in an alternative PFDF (service) instance.
3gpp-Sbi-Target-Nf-Id	string	O	0..1	Identifier of the target NF (service) instance towards which the request is redirected

5.3.3.4 Resource Custom Operations

None.

5.3.4 Resource: PFD subscriptions

5.3.4.1 Description

This resource represents a collection of subscriptions created by NF service consumers of Nnef_PFDmanagement service.

5.3.4.2 Resource definition

Resource URI: {apiRoot}/nnef-pfdmanagement/v1/subscriptions

This resource shall support the resource URI variables defined in table 5.3.4.2-1.

Table 5.3.4.2-1: Resource URI variables for this resource

Name	Data type	Definition
apiRoot	string	See subclause 5.1

5.3.4.3 Resource Standard Methods

5.3.4.3.1 POST

This method shall support the URI query parameters specified in table 5.3.4.3.1-1.

Table 5.3.4.3.1-1: URI query parameters supported by the POST method on this resource

Name	Data type	P	Cardinality	Description
n/a				

This method shall support the request data structures specified in table 5.3.4.3.1-2 and the response data structures and response codes specified in table 5.3.4.3.1-3.

Table 5.3.4.3.1-2: Data structures supported by the POST Request Body on this resource

Data type	P	Cardinality	Description
PfdSubscription	M	1	Create a PfdSubscription resource.

Table 5.3.4.3.1-3: Data structures supported by the POST Response Body on this resource

Data type	P	Cardinality	Response codes	Description
PfdSubscription	M	1	201 Created	The creation of a PfdSubscription resource is confirmed and a representation of that resource is returned.
NOTE: In addition, the HTTP status codes which are specified as mandatory in table 5.2.7.1-1 of 3GPP TS 29.500 [5] for the POST method shall also apply.				

Table 5.3.4.3.1-4: Headers supported by the 201 Response Code on this resource

Name	Data type	P	Cardinality	Description
Location	string	M	1	Contains the URI of the newly created resource, according to the structure: {apiRoot}/nnef-pfdmanagement/v1/subscriptions/{subscriptionId}

5.3.4.4 Resource Custom Operations

None.

5.3.5 Resource: Individual PFD subscription

5.3.5.1 Description

This resource represents an individual PFD subscription created by an NF service consumer of the Nnef_PFDmanagement service.

5.3.5.2 Resource definition

Resource URI: {apiRoot}/nnef-pfdmanagement/v1/subscriptions/{subscriptionId}

This resource shall support the resource URI variables defined in table 5.3.5.2-1.

Table 5.3.5.2-1: Resource URI variables for this resource

Name	Data type	Definition
apiRoot	string	See subclause 5.1
subscriptionId	string	Identifies an individual subscription to the PFD management service

5.3.5.3 Resource Standard Methods

5.3.5.3.1 DELETE

This method shall support the URI query parameters specified in table 5.3.5.3.1-1.

Table 5.3.5.3.1-1: URI query parameters supported by the DELETE method on this resource

Name	Data type	P	Cardinality	Description
n/a				

This method shall support the request data structures specified in table 5.3.5.3.1-2 and the response data structures and response codes specified in table 5.3.5.3.1-3.

Table 5.3.5.3.1-2: Data structures supported by the DELETE Request Body on this resource

Data type	P	Cardinality	Description
n/a			

Table 5.3.5.3.1-3: Data structures supported by the DELETE Response Body on this resource

Data type	P	Cardinality	Response codes	Description
n/a			204 No Content	The PfdSubscription resource matching the subscriptionId was deleted successfully.
RedirectResponse	O	0..1	307 Temporary Redirect	Temporary redirection, during Individual PFD subscription deletion. The response shall include a Location header field containing an alternative URI of the resource located in an alternative PFDF (service) instance. Applicable if the feature "ES3XX" is supported.
RedirectResponse	O	0..1	308 Permanent Redirect	Permanent redirection, during Individual PFD subscription deletion. The response shall include a Location header field containing an alternative URI of the resource located in an alternative PFDF (service) instance. Applicable if the feature "ES3XX" is supported.
NOTE: In addition, the HTTP status codes which are specified as mandatory in table 5.2.7.1-1 of 3GPP TS 29.500 [5] for the DELETE method shall also apply.				

Table 5.3.5.3.1-4: Headers supported by the 307 Response Code on this resource

Name	Data type	P	Cardinality	Description
Location	string	M	1	An alternative URI of the resource located in an alternative PFDF (service) instance.
3gpp-Sbi-Target-Nf-Id	string	O	0..1	Identifier of the target NF (service) instance towards which the request is redirected

Table 5.3.5.3.1-5: Headers supported by the 308 Response Code on this resource

Name	Data type	P	Cardinality	Description
Location	string	M	1	An alternative URI of the resource located in an alternative PFDF (service) instance.
3gpp-Sbi-Target-Nf-Id	string	O	0..1	Identifier of the target NF (service) instance towards which the request is redirected

5.3.5.3.2 PUT

This method shall support the URI query parameters specified in table 5.3.5.3.2-1.

Table 5.3.5.3.2-1: URI query parameters supported by the PUT method on this resource

Name	Data type	P	Cardinality	Description
n/a				

This method shall support the request data structures specified in table 5.3.5.3.2-2 and the response data structures and response codes specified in table 5.3.5.3.2-3.

Table 5.3.5.3.2-2: Data structures supported by the PUT Request Body on this resource

Data type	P	Cardinality	Description
PfdSubscription	M	1	Update a PfdSubscription resource.

Table 5.3.5.3.2-3: Data structures supported by the PUT Response Body on this resource

Data type	P	Cardinality	Response codes	Description
PfdSubscription	M	1	200 OK	The update of a PfdSubscription resource is confirmed and a representation of that resource is returned.
RedirectResponse	O	0..1	307 Temporary Redirect	Temporary redirection, during Individual PFD subscription modification. The response shall include a Location header field containing an alternative URI of the resource located in an alternative PFD (service) instance. Applicable if the feature "ES3XX" is supported.
RedirectResponse	O	0..1	308 Permanent Redirect	Permanent redirection, during Individual PFD subscription modification. The response shall include a Location header field containing an alternative URI of the resource located in an alternative PFD (service) instance. Applicable if the feature "ES3XX" is supported.
NOTE: In addition, the HTTP status codes which are specified as mandatory in table 5.2.7.1-1 of 3GPP TS 29.500 [5] for the PUT method shall also apply.				

Table 5.3.5.3.2-4: Headers supported by the 307 Response Code on this resource

Name	Data type	P	Cardinality	Description
Location	string	M	1	An alternative URI of the resource located in an alternative PFD (service) instance.
3gpp-Sbi-Target-Nf-Id	string	O	0..1	Identifier of the target NF (service) instance towards which the request is redirected

Table 5.3.5.3.2-5: Headers supported by the 308 Response Code on this resource

Name	Data type	P	Cardinality	Description
Location	string	M	1	An alternative URI of the resource located in an alternative PFD (service) instance.
3gpp-Sbi-Target-Nf-Id	string	O	0..1	Identifier of the target NF (service) instance towards which the request is redirected

5.3.5.4 Resource Custom Operations

None.

5.4 Custom Operations without associated resources

None

5.5 Notifications

5.5.1 General

Notifications shall comply to subclause 6.2 of 3GPP TS 29.500 [5] and subclause 4.6.2.3 of 3GPP TS 29.501 [6].

Table 5.5.1-1: Notifications overview

Notification	Callback URI	HTTP method or custom operation	Description (service operation)
PFD Change Notification	{notifyUri}	POST	Notification of PFD change.

5.5.2 PFD Change Notification

5.5.2.1 Description

The PFD Change Notification is used by the PFDF to inform the NF service consumer, which has subscribed to this Notification via the PFD subscriptions resource.

5.5.2.2 Target URI

The Callback URI "{**notifyUri**}" shall be used with the callback URI variables defined in table 5.5.2.2-1.

Table 5.5.2.2-1: Callback URI variables

Name	Data type	Definition
notifyUri	Uri	The Notification Uri as assigned within the PFD subscriptions resource and described within the PfdSubscription data type (see table 5.6.2.3-1).

5.5.2.3 Standard Methods

5.5.2.3.1 POST

This method shall support the URI query parameters specified in table 5.5.2.3.1-1.

Table 5.5.2.3.1-1: URI query parameters supported by the POST method on this resource

Name	Data type	P	Cardinality	Description
n/a				

This method shall support the request data structures specified in table 5.5.2.3.1-2 and the response data structures and response codes specified in table 5.5.2.3.1-3.

Table 5.5.2.3.1-2: Data structures supported by the POST Request Body on this resource

Data type	P	Cardinality	Description
array(PfdChangeNotification)	M	1..N	Provides PFD change information.

Table 5.5.2.3.1-3: Data structures supported by the POST Response Body on this resource

Data type	P	Cardinality	Response codes	Description
n/a			204 No Content	The PFD operation in the notification is performed successfully, i.e. all PFD changes are accepted by the SMF.
array(PfdChangeReport)	M	1..N	200 OK	The PFD operation in the notification is performed and the PfdChangeReport indicates failure reason for each failed application in the partial success.
RedirectResponse	O	0..1	307 Temporary Redirect	Temporary redirection, during PFD Change Notification. The response shall include a Location header field containing an alternative URI representing the end point of an alternative NF consumer (service) instance where the notification should be sent. Applicable if the feature "ES3XX" is supported.
RedirectResponse	O	0..1	308 Permanent Redirect	Permanent redirection, during PFD Change Notification. The response shall include a Location header field containing an alternative URI representing the end point of an alternative NF consumer (service) instance where the notification should be sent. Applicable if the feature "ES3XX" is supported.
ProblemDetails	O	0..1	500 Internal Server Error	The server encountered an unexpected condition that prevented it from fulfilling the request. PFDs for all applications are not accepted by the SMF. (NOTE 2)
NOTE 1: In addition, the HTTP status codes which are specified as mandatory in table 5.2.7.1-1 of 3GPP TS 29.500 [5] for the POST method shall also apply.				
NOTE 2: Failure cases are described in subclause 5.7.				

Table 5.5.2.3.1-4: Headers supported by the 307 Response Code on this resource

Name	Data type	P	Cardinality	Description
Location	string	M	1	An alternative URI representing the end point of an alternative NF consumer (service) instance towards which the notification should be redirected.
3gpp-Sbi-Target-Nf-Id	string	O	0..1	Identifier of the target NF (service) instance towards which the notification request is redirected

Table 5.5.2.3.1-5: Headers supported by the 308 Response Code on this resource

Name	Data type	P	Cardinality	Description
Location	string	M	1	An alternative URI representing the end point of an alternative NF consumer (service) instance towards which the notification should be redirected.
3gpp-Sbi-Target-Nf-Id	string	O	0..1	Identifier of the target NF (service) instance towards which the notification request is redirected

5.6 Data Model

5.6.1 General

This subclause specifies the application data model supported by the API.

Table 5.6.1-1 specifies the data types defined for the Nnef_PFDmanagement service based interface protocol.

Table 5.6.1-1: Nnef_PFDmanagement specific Data Types

Data type	Section defined	Description	Applicability
PfdDataForApp	5.6.2.2	Represents the PFDs for an application identifier.	
PfdSubscription	5.6.2.3	Represents a PFD subscription.	
PfdChangeNotification	5.6.2.4	Represents PFD change information.	
PfdContent	5.6.2.5	Represents the content of a PFD for an application identifier.	
PfdChangeReport	5.6.2.6	Represents error of PFD change.	

Table 5.6.1-2 specifies data types re-used by the Nnef_PFDmanagement service based interface protocol from other specifications, including a reference to their respective specifications and when needed, a short description of their use within the Nnef_PFDmanagement service based interface.

Table 5.6.1-2: Nnef_PFDmanagement re-used Data Types

Data type	Reference	Comments	Applicability
ApplicationId	3GPP TS 29.571 [10]		
DomainNameProtocol	3GPP TS 29.122 [11]		
DateTime	3GPP TS 29.571 [10]		
RedirectResponse	3GPP TS 29.571 [10]	Contains redirection related information.	ES3XX
SupportedFeatures	3GPP TS 29.571 [10]		
Uri	3GPP TS 29.571 [10]		

5.6.2 Structured data types

5.6.2.1 Introduction

This subclause defines the structures to be used in resource representations.

Allowed structures are: array, object.

5.6.2.2 Type: PfdDataForApp

Table 5.6.2.2-1: Definition of type PfdDataForApp

Attribute name	Data type	P	Cardinality	Description	Applicability
applicationId	ApplicationId	M	1	Identifier of an application.	
pfds	array(PfdContent)	M	1..N	PFDs for the application identifier.	
cachingTime	DateTime	O	0..1	Caching time for an application identifier.	
supportedFeatures	SupportedFeatures	C	0..1	Used to negotiate the applicability of the optional features. This attribute shall be present in the HTTP GET response if the "supported-features" attribute query parameter is included in the HTTP GET request.	

5.6.2.3 Type: PfdSubscription

Table 5.6.2.3-1: Definition of type PfdSubscription

Attribute name	Data type	P	Cardinality	Description	Applicability
applicationIds	array(ApplicationId)	O	1..N	Identifiers of applications with PFDs change.	
notifyUri	Uri	M	1	Identifies the recipient of notifications sent by PFD for this subscription.	
supportedFeatures	SupportedFeatures	M	1	List of supported features used as described in subclause 5.8. This parameter shall be provided by the NF service consumer in the POST request that request the creation of a subscription, and shall be provided by the PFD in the response of corresponding request.	

5.6.2.4 Type: PfdChangeNotification

Table 5.6.2.4-1: Definition of type PfdChangeNotification

Attribute name	Data type	P	Cardinality	Description	Applicability
applicationId	ApplicationId	M	1	Identifier of an application.	
removalFlag	boolean	O	0..1	Indication of removal of PFDs for an existing application identifier.	
partialFlag	boolean	O	0..1	Indication of partial update of PFDs for an existing application identifier if this operation is supported according to feature negotiation.	PartialUpdate
pfd	array(PfdContent)	O	1..N	PFD creation/update for the application identifier as specified in subclause 6.3.3.5 of 3GPP TS 29.251 [12].	

5.6.2.5 Type: PfdContent

Table 5.6.2.5-1: Definition of type PfdContent

Attribute name	Data type	P	Cardinality	Description	Applicability
pfdId	string	C	0..1	Identifies a PDF of an application identifier. If PartialUpdate feature is supported, this attribute shall be provided by the PFD.	
flowDescriptions	array(string)	O	1..N	Represents a 3-tuple with protocol, server ip and server port for UL/DL application traffic. The content of the string has the same encoding as the IPFilterRule AVP value as defined in IETF RFC 6733 [18]. (NOTE)	
urls	array(string)	O	1..N	Indicates a URL or a regular expression which is used to match the significant parts of the URL. (NOTE)	
domainNames	array(string)	O	1..N	Indicates an FQDN or a regular expression as a domain name matching criteria. (NOTE)	
dnProtocol	DomainNameProtocol	C	0..1	Indicates the additional protocol and protocol field for domain names to be matched, it may only be provided when domainNames attribute is present.	DomainNameProtocol
NOTE: If a PFD contains multiple filter types, the PFD is only matched when every filter type contained in the PFD has a matching value.					

5.6.2.6 Type: PfdChangeReport

Table 5.6.2.6-1: PfdChangeReport

Attribute name	Data type	P	Cardinality	Description	Applicability
pfdError	ProblemDetails	M	1	More information on the error shall be provided in the "cause" attribute of the "ProblemDetails" structure. The "cause" attribute in the ProblemDetails shall be set to one of following application errors (see table 5.2.7.1-1 of 3GPP TS 29.500 [5]): - SYSTEM_FAILURE - INSUFFICIENT_RESOURCES - UNSPECIFIED_NF_FAILURE	
applicationId	array(ApplicationId)	M	1..N	Indicates the application identifier(s) which PFD(s) are failed to be added or modified.	

5.6.3 Simple data types and enumerations

5.6.3.1 Introduction

This subclause defines simple data types and enumerations that can be referenced from data structures defined in the previous subclauses.

5.6.3.2 Simple data types

The simple data types defined in table 5.6.3.2-1 shall be supported.

Table 5.6.3.2-1: Simple data types

Type Name	Type Definition	Description	Applicability

5.7 Error handling

5.7.1 General

HTTP error handling shall be supported as specified in subclause 5.2.4 of 3GPP TS 29.500 [5].

For the Nnef_PFDmanagement API, HTTP error responses shall be supported as specified in subclause 4.8 of 3GPP TS 29.501 [6]. Protocol errors and application errors specified in table 5.2.7.2-1 of 3GPP TS 29.500 [5] shall be supported for an HTTP method if the corresponding HTTP status codes are specified as mandatory for that HTTP method in table 5.2.7.1-1 of 3GPP TS 29.500 [5].

In addition, the requirements in the following subclauses shall apply.

5.7.2 Protocol Errors

In this Release of the specification, there are no additional protocol errors applicable for the Nnef_PFDmanagement API.

5.7.3 Application Errors

The application errors defined for the Nnef_PFDmanagement service are listed in table 5.7.3-1.

Table 5.7.3-1: Application errors

Application Error	HTTP status code	Description
SYSTEM_FAILURE	500 Internal Server Error	Something functions wrongly in PFD provisioning or the PFD provisioning does not function at all. (NOTE)
INSUFFICIENT_RESOURCE	500 Internal Server Error	There is limitation for resource storage. (NOTE)
UNSPECIFIED_NF_FAILURE	500 Internal Server Error	Unspecified reason. (NOTE)
NOTE: This application error is included in the responses to the POST request of PFD change notification.		

5.8 Feature negotiation

The optional features in table 5.8-1 are defined for the Nnef_PFDmanagement API. They shall be negotiated using the extensibility mechanism defined in subclause 6.6 of 3GPP TS 29.500 [5].

Table 5.8-1: Supported Features

Feature number	Feature Name	Description
1	PartialUpdate	The PFD can use this feature for partial update of PFDs.
2	DomainNameProtocol	This feature supports the additional protocol matching condition for the domain name in PFD data.
3	PfdChgSubsUpdate	The SMF can use this feature for updating the PFD change subscription.
4	ES3XX	Extended Support for 3xx redirections. This feature indicates the support of redirection for any service operation, according to Stateless NF procedures as specified in subclauses 6.5.3.2 and 6.5.3.3 of 3GPP TS 29.500 [5] and according to HTTP redirection principles for indirect communication, as specified in subclause 6.10.9 of 3GPP TS 29.500 [5].

5.9 Security

As indicated in 3GPP TS 33.501 [14] and 3GPP TS 29.500 [5], the access to the Nnef_PFDmanagement API may be authorized by means of the OAuth2 protocol (see IETF RFC 6749 [15]), based on local configuration, using the "Client Credentials" authorization grant, where the NRF (see 3GPP TS 29.510 [13]) plays the role of the authorization server.

If OAuth2 is used, an NF Service Consumer, prior to consuming services offered by the Nnef_PFDmanagement API, shall obtain a "token" from the authorization server, by invoking the Access Token Request service, as described in 3GPP TS 29.510 [13], subclause 5.4.2.2.

NOTE: When multiple NRFs are deployed in a network, the NRF used as authorization server is the same NRF that the NF Service Consumer used for discovering the Nnef_PFDmanagement service.

The Nnef_PFDmanagement API defines a single scope "nnef-pfdmanagement" for OAuth2 authorization (as specified in 3GPP TS 33.501 [14]) for the entire service, and it does not define any additional scopes at resource or operation level.

Annex A (normative): OpenAPI specification

A.1 General

The present Annex contains an OpenAPI [9] specification of HTTP messages and content bodies used by the Nnef_PFDmanagement API.

This Annex shall take precedence when being discrepant to other parts of the specification with respect to the encoding of information elements and methods within the API.

NOTE: The semantics and procedures, as well as conditions, e.g. for the applicability and allowed combinations of attributes or values, not expressed in the OpenAPI definitions but defined in other parts of the specification also apply.

Informative copies of the OpenAPI specification file contained in this 3GPP Technical Specification are available on a Git-based repository that uses the GitLab software version control system (see clause 5B of the 3GPP TR 21.900 [17] and subclause 5.3.1 of the 3GPP TS 29.501 [6] for further information):

A.2 Nnef_PFDmanagement API

```

openapi: 3.0.0
info:
  title: Nnef_PFDmanagement Service API
  version: 1.1.3
  description: |
    Packet Flow Description Management Service.
    © 2021, 3GPP Organizational Partners (ARIB, ATIS, CCSA, ETSI, TSDSI, TTA, TTC).
    All rights reserved.
#
externalDocs:
  description: 3GPP TS 29.551 v16.10.0, 5G System; Packet Flow Description Management Service
  url: 'http://www.3gpp.org/ftp/Specs/archive/29_series/29.551/'
#
servers:
  - url: '{apiRoot}/nnef-pfdmanagement/v1'
    variables:
      apiRoot:
        default: https://example.com
        description: apiRoot as defined in subclause 4.4 of 3GPP TS 29.501
security:
  - {}
  - oAuth2ClientCredentials:
    - nnef-pfdmanagement
paths:
  /applications:
    get:
      summary: Retrieve PFDs for all applications or for one or multiple applications with query
parameter.
      tags:
        - PFD of applications
      operationId: Nnef_PFDmanagement_AllFetch
      parameters:
        - name: application-ids
          description: The required application identifier(s) for the returned PFDs.
          in: query
          required: true
          schema:
            type: array
            items:
              $ref: 'TS29571_CommonData.yaml#/components/schemas/ApplicationId'
            minItems: 1
        - name: supported-features
          in: query
          description: To filter irrelevant responses related to unsupported features
          schema:
            $ref: 'TS29571_CommonData.yaml#/components/schemas/SupportedFeatures'

```

```

responses:
  '200':
    description: The PFDs for one or more application identifier(s) in the request URI are
returned.
    content:
      application/json:
        schema:
          type: array
          items:
            $ref: '#/components/schemas/PfdDataForApp'
          minItems: 0
  '400':
    $ref: 'TS29571_CommonData.yaml#/components/responses/400'
  '401':
    $ref: 'TS29571_CommonData.yaml#/components/responses/401'
  '403':
    $ref: 'TS29571_CommonData.yaml#/components/responses/403'
  '404':
    $ref: 'TS29571_CommonData.yaml#/components/responses/404'
  '406':
    $ref: 'TS29571_CommonData.yaml#/components/responses/406'
  '414':
    $ref: 'TS29571_CommonData.yaml#/components/responses/414'
  '429':
    $ref: 'TS29571_CommonData.yaml#/components/responses/429'
  '500':
    $ref: 'TS29571_CommonData.yaml#/components/responses/500'
  '503':
    $ref: 'TS29571_CommonData.yaml#/components/responses/503'

/applications/{appId}:
  get:
    summary: Retrieve the PFD for an application.
    tags:
      - Individual application PFD
    operationId: Nnef_PFDmanagement_IndAppFetch
    parameters:
      - name: appId
        description: The required application identifier(s) for the returned PFDs.
        in: path
        required: true
        schema:
          type: string
      - name: supported-features
        in: query
        description: To filter irrelevant responses related to unsupported features
        schema:
          $ref: 'TS29571_CommonData.yaml#/components/schemas/SupportedFeatures'
    responses:
      '200':
        description: A representation of PFDs for an application in the request URI is returned.
        content:
          application/json:
            schema:
              $ref: '#/components/schemas/PfdDataForApp'
      '307':
        $ref: 'TS29571_CommonData.yaml#/components/responses/307'
      '308':
        $ref: 'TS29571_CommonData.yaml#/components/responses/308'
      '400':
        $ref: 'TS29571_CommonData.yaml#/components/responses/400'
      '401':
        $ref: 'TS29571_CommonData.yaml#/components/responses/401'
      '403':
        $ref: 'TS29571_CommonData.yaml#/components/responses/403'
      '404':
        $ref: 'TS29571_CommonData.yaml#/components/responses/404'
      '406':
        $ref: 'TS29571_CommonData.yaml#/components/responses/406'
      '429':
        $ref: 'TS29571_CommonData.yaml#/components/responses/429'
      '414':
        $ref: 'TS29571_CommonData.yaml#/components/responses/414'
      '500':
        $ref: 'TS29571_CommonData.yaml#/components/responses/500'
      '503':
        $ref: 'TS29571_CommonData.yaml#/components/responses/503'

```

```

/subscriptions:
  post:
    summary: Subscribe the notification of PFD changes.
    tags:
      - PFD subscriptions
    operationId: Nnef_PFDmanagement_CreateSubscr
    requestBody:
      description: a PfdSubscription resource to be created.
      required: true
      content:
        application/json:
          schema:
            $ref: '#/components/schemas/PfdSubscription'
    callbacks:
      PfdChangeNotification:
        '{request.body#/notifyUri}':
          post:
            summary: Notification of PFD change.
            tags:
              - PfdChangeNotification data
            operationId: Nnef_PFDmanagement_Notify
            requestBody:
              required: true
              content:
                application/json:
                  schema:
                    type: array
                    items:
                      $ref: '#/components/schemas/PfdChangeNotification'
                    minItems: 1
            responses:
              '200':
                description: The PFD operation in the notification is performed and the
PfdChangeReport indicates failure reason.
                content:
                  application/json:
                    schema:
                      type: array
                      items:
                        $ref: '#/components/schemas/PfdChangeReport'
                    minItems: 1
              '204':
                description: The PFD operation in the notification is performed successfully.
              '307':
                $ref: 'TS29571_CommonData.yaml#/components/responses/307'
              '308':
                $ref: 'TS29571_CommonData.yaml#/components/responses/308'
              '400':
                $ref: 'TS29571_CommonData.yaml#/components/responses/400'
              '401':
                $ref: 'TS29571_CommonData.yaml#/components/responses/401'
              '403':
                $ref: 'TS29571_CommonData.yaml#/components/responses/403'
              '404':
                $ref: 'TS29571_CommonData.yaml#/components/responses/404'
              '411':
                $ref: 'TS29571_CommonData.yaml#/components/responses/411'
              '413':
                $ref: 'TS29571_CommonData.yaml#/components/responses/413'
              '415':
                $ref: 'TS29571_CommonData.yaml#/components/responses/415'
              '429':
                $ref: 'TS29571_CommonData.yaml#/components/responses/429'
              '500':
                $ref: 'TS29571_CommonData.yaml#/components/responses/500'
              '503':
                $ref: 'TS29571_CommonData.yaml#/components/responses/503'

    responses:
      '201':
        description: The creation of a PfdSubscription resource is confirmed and a representation
of that resource is returned.
        content:
          application/json:
            schema:
              $ref: '#/components/schemas/PfdSubscription'
        headers:

```



```

      Location:
        description: 'Contains the URI of the newly created resource, according to the
structure: {apiRoot}/nnef-pfdmanagement/v1/subscriptions/{subscriptionId}'
        required: true
        schema:
          type: string
'400':
  $ref: 'TS29571_CommonData.yaml#/components/responses/400'
'401':
  $ref: 'TS29571_CommonData.yaml#/components/responses/401'
'403':
  $ref: 'TS29571_CommonData.yaml#/components/responses/403'
'404':
  $ref: 'TS29571_CommonData.yaml#/components/responses/404'
'411':
  $ref: 'TS29571_CommonData.yaml#/components/responses/411'
'413':
  $ref: 'TS29571_CommonData.yaml#/components/responses/413'
'415':
  $ref: 'TS29571_CommonData.yaml#/components/responses/415'
'429':
  $ref: 'TS29571_CommonData.yaml#/components/responses/429'
'500':
  $ref: 'TS29571_CommonData.yaml#/components/responses/500'
'503':
  $ref: 'TS29571_CommonData.yaml#/components/responses/503'

/subscriptions/{subscriptionId}:
  put:
    summary: Updates/replaces an existing subscription resource
    tags:
      - Individual PFD subscription
    operationId: Nnef_PFDmanagement_ModifySubscr
    parameters:
      - name: subscriptionId
        description: Identify the subscription.
        in: path
        required: true
        schema:
          type: string
    requestBody:
      description: Parameters to update/replace the existing subscription
      required: true
      content:
        application/json:
          schema:
            $ref: '#/components/schemas/PfdSubscription'
    responses:
      '200':
        description: OK (Successful update of the subscription)
        content:
          application/json:
            schema:
              $ref: '#/components/schemas/PfdSubscription'
      '307':
        $ref: 'TS29571_CommonData.yaml#/components/responses/307'
      '308':
        $ref: 'TS29571_CommonData.yaml#/components/responses/308'
      '400':
        $ref: 'TS29571_CommonData.yaml#/components/responses/400'
      '401':
        $ref: 'TS29571_CommonData.yaml#/components/responses/401'
      '403':
        $ref: 'TS29571_CommonData.yaml#/components/responses/403'
      '404':
        $ref: 'TS29571_CommonData.yaml#/components/responses/404'
      '411':
        $ref: 'TS29571_CommonData.yaml#/components/responses/411'
      '413':
        $ref: 'TS29571_CommonData.yaml#/components/responses/413'
      '415':
        $ref: 'TS29571_CommonData.yaml#/components/responses/415'
      '429':
        $ref: 'TS29571_CommonData.yaml#/components/responses/429'
      '500':
        $ref: 'TS29571_CommonData.yaml#/components/responses/500'
      '503':
        $ref: 'TS29571_CommonData.yaml#/components/responses/503'

```

```

    default:
      $ref: 'TS29571_CommonData.yaml#/components/responses/default'

delete:
  summary: Delete a subscription of PFD change notification.
  tags:
    - Individual PFD subscription
  operationId: Nnef_PFDmanagement_Unsubscribe
  parameters:
    - name: subscriptionId
      description: Identify the subscription.
      in: path
      required: true
      schema:
        type: string
  responses:
    '204':
      description: The PfdSubscription resource matching the subscriptionId was deleted
successfully.
    '307':
      $ref: 'TS29571_CommonData.yaml#/components/responses/307'
    '308':
      $ref: 'TS29571_CommonData.yaml#/components/responses/308'
    '400':
      $ref: 'TS29571_CommonData.yaml#/components/responses/400'
    '401':
      $ref: 'TS29571_CommonData.yaml#/components/responses/401'
    '403':
      $ref: 'TS29571_CommonData.yaml#/components/responses/403'
    '404':
      $ref: 'TS29571_CommonData.yaml#/components/responses/404'
    '429':
      $ref: 'TS29571_CommonData.yaml#/components/responses/429'
    '500':
      $ref: 'TS29571_CommonData.yaml#/components/responses/500'
    '503':
      $ref: 'TS29571_CommonData.yaml#/components/responses/503'

components:
  securitySchemes:
    oAuth2ClientCredentials:
      type: oauth2
      flows:
        clientCredentials:
          tokenUrl: '{nrfApiRoot}/oauth2/token'
          scopes:
            nnef-pfdmanagement: Access to the Nnef_PFDmanagement API
  schemas:
#
# STRUCTURED DATA TYPES
#
  PfdContent:
    type: object
    properties:
      pfdId:
        type: string
        description: Identifies a PDF of an application identifier.
      flowDescriptions:
        type: array
        items:
          type: string
        minItems: 1
        description: Represents a 3-tuple with protocol, server ip and server port for UL/DL
application traffic.
      urls:
        type: array
        items:
          type: string
        minItems: 1
        description: Indicates a URL or a regular expression which is used to match the
significant parts of the URL.
      domainNames:
        type: array
        items:
          type: string
        minItems: 1
        description: Indicates an FQDN or a regular expression as a domain name matching criteria.
      dnProtocol:

```

```
$ref: 'TS29122_PfdManagement.yaml#/components/schemas/DomainNameProtocol'
```

```
PfdDataForApp:
  type: object
  properties:
    applicationId:
      $ref: 'TS29571_CommonData.yaml#/components/schemas/ApplicationId'
    pfd:
      type: array
      items:
        $ref: '#/components/schemas/PfdContent'
      minItems: 1
    cachingTime:
      $ref: 'TS29571_CommonData.yaml#/components/schemas/DateTime'
    supportedFeatures:
      $ref: 'TS29571_CommonData.yaml#/components/schemas/SupportedFeatures'
  required:
    - applicationId
    - pfd

PfdSubscription:
  type: object
  properties:
    applicationIds:
      type: array
      items:
        $ref: 'TS29571_CommonData.yaml#/components/schemas/ApplicationId'
      minItems: 1
    notifyUri:
      $ref: 'TS29571_CommonData.yaml#/components/schemas/Uri'
    supportedFeatures:
      $ref: 'TS29571_CommonData.yaml#/components/schemas/SupportedFeatures'
  required:
    - notifyUri
    - supportedFeatures

PfdChangeNotification:
  type: object
  properties:
    applicationId:
      $ref: 'TS29571_CommonData.yaml#/components/schemas/ApplicationId'
    removalFlag:
      type: boolean
      default: false
    partialFlag:
      type: boolean
      default: false
    pfd:
      type: array
      items:
        $ref: '#/components/schemas/PfdContent'
      minItems: 1
  required:
    - applicationId

PfdChangeReport:
  type: object
  properties:
    pfdError:
      $ref: 'TS29571_CommonData.yaml#/components/schemas/ProblemDetails'
    applicationId:
      type: array
      items:
        $ref: 'TS29571_CommonData.yaml#/components/schemas/ApplicationId'
      minItems: 1
  required:
    - pfdError
    - applicationId
```

Annex B (informative): Change history

Change history							
Date	Meeting	TDoc	CR	Rev	Cat	Subject/Comment	New version
2018-01						TS skeleton of PFD Management Service specification	0.0.0
2018-01	CT3#94					Includes the following contribution agreed by CT3 at CT3#94: C3-180045, C3-180270, C3-180271.	0.1.0
2018-03	CT3#95					Includes the following contribution agreed by CT3 at CT3#95: C3-181100, C3-181262, C3-181102, C3-181103, C3-181314.	0.2.0
2018-04	CT3#96					Includes the following contribution agreed by CT3 at CT3#96: C3-182153, C3-182411, C3-182412, C3-182413, C3-182414, C3-182477, C3-182478.	0.3.0
2018-05	CT3#97					Includes the following contribution agreed by CT3 at CT3#97: C3-183115, C3-183557, C3-183558, C3-183560.	0.4.0
2018-06	CT#80	CP-181029				TS sent to plenary for approval	1.0.0
2018-06	CT#80	CP-181029				TS approved by plenary	15.0.0
2018-09	CT#81	CP-182015	0001	2	F	Protocol error statement	15.1.0
2018-09	CT#81	CP-182015	0002	1	F	Description of Structured data types	15.1.0
2018-12	CT#82	CP-183205	0003		F	Default value for apiRoot	15.2.0
2018-12	CT#82	CP-183205	0004	3	F	Cardinality	15.2.0
2018-12	CT#82	CP-183205	0005	1	F	Correct Nnef_PFDmanagement API	15.2.0
2018-12	CT#82	CP-183205	0006		F	Location Header	15.2.0
2018-12	CT#82	CP-183205	0007	1	F	Alignment of openAPI	15.2.0
2018-12	CT#82	CP-183205	0008		F	API version update	15.2.0
2018-12	CT#82	CP-183205	0009		F	Security	15.2.0
2018-12	CT#82	CP-183205	0010		F	Content type	15.2.0
2019-03	CT#83	CP-190116	0011	1	F	Fetch PFD for all applications	15.3.0
2019-03	CT#83	CP-190116	0014	1	F	Correction of resource URIs	15.3.0
2019-03	CT#83	CP-190130	0010	1	B	PUT for PFD change subscription	16.0.0
2019-03	CT#83	CP-190121	0012	3	B	PFD extension	16.0.0
2019-03	CT#83					Open API version update by MCC	16.0.0
2019-06	CT#84	CP-191083	0016	2	A	Precedence of OpenAPI file	16.1.0
2019-06	CT#84	CP-191083	0019		A	Correction to Notification of PFD change	16.1.0
2019-06	CT#84	CP-191083	0021		A	Copyright Note in YAML file	16.1.0
2019-06	CT#84	CP-191101	0023	2	F	API version Update	16.1.0
2019-09	CT#85	CP-192149	0025	2	A	Correct presence condition in PFD definition	16.2.0
2020-03	CT#87e	CP-200215	0026		F	Reference of Error code	16.3.0
2020-03	CT#87e	CP-200216	0027		F	Update of OpenAPI version and TS version in externalDocs field	16.3.0
2020-06	CT#88e	CP-201244	0028		F	Non-unique operation identifiers	16.4.0
2020-06	CT#88e	CP-201244	0029	1	F	Storage of YAML files in ETSI Forge	16.4.0
2020-06	CT#88e	CP-201256	0030	1	F	URI of the Nnef_PFDmanagement service	16.4.0
2020-06	CT#88e	CP-201244	0031	1	F	Optionality of ProblemDetails	16.4.0
2020-06	CT#88e	CP-201244	0032	1	F	Supported headers, Resource Data type and yaml mapping	16.4.0
2020-06	CT#88e	CP-201255	0033		F	Update of OpenAPI version and TS version in externalDocs field	16.4.0
2020-09	CT#89e	CP-202056	0035		A	Correction to the PFD change notification	16.5.0
2020-12	CT#90e	CP-203077	0040	2	F	Essential corrections and alignments	16.6.0
2020-12	CT#90e	CP-203120	0045	1	A	Correction to PFD retrieval in PULL mode	16.6.0
2020-12	CT#90e	CP-203120	0048		A	Correction to notification URI of PFD change notification	16.6.0
2020-12	CT#90e	CP-203139	0052	1	F	Storage of YAML files in 3GPP Forge	16.6.0
2021-03	CT#91e	CP-210191	0057	1	F	Support of stateless NFs	16.7.0
2021-03	CT#91e	CP-210222	0063	1	F	notifyUri used by notification	16.7.0
2021-03	CT#91e	CP-210200	0071		A	Datatype and figure corrections	16.7.0
2021-03	CT#91e	CP-210239	0075		F	Update of OpenAPI version and TS version in externalDocs field	16.7.0
2021-06	CT#92e	CP-211208	0078	1	A	Correction of request URI in 4.2.2.2	16.8.0
2021-06	CT#92e	CP-211200	0080	1	F	Temporary and Permanent Redirection	16.8.0
2021-06	CT#92e	CP-211264	0082		F	Update of OpenAPI version and TS version in externalDocs field	16.8.0
2021-09	CT#93e	CP-212190	0087		A	default caching time value	16.9.0
2021-09	CT#93e	CP-212190	0090		A	Presentation condition of pfldId attribute	16.9.0
2021-12	CT#94e	CP-213215	0096	1	A	Correction to PFD management in push mode	16.10.0
2021-12	CT#94e	CP-213224	0098	1	F	Adding supported features in GET response	16.10.0
2021-12	CT#94e	CP-213242	0100		F	Update of OpenAPI version and TS version in externalDocs field	16.10.0
2022-06	CT#96	CP-221119	0105	1	F	Correcting the description of the encoding used for flow descriptions	16.11.0

History

Document history		
V16.4.0	August 2020	Publication
V16.5.0	November 2020	Publication
V16.6.0	January 2021	Publication
V16.7.0	April 2021	Publication
V16.8.0	August 2021	Publication
V16.9.0	September 2021	Publication
V16.10.0	January 2022	Publication
V16.11.0	July 2022	Publication