

ETSI TS 129 531 V15.4.0 (2019-07)



**5G;  
5G System;  
Network Slice Selection Services;  
Stage 3  
(3GPP TS 29.531 version 15.4.0 Release 15)**



---

Reference

RTS/TSGC-0429531vf40

---

Keywords

5G

**ETSI**

650 Route des Lucioles  
F-06921 Sophia Antipolis Cedex - FRANCE

Tel.: +33 4 92 94 42 00 Fax: +33 4 93 65 47 16

Siret N° 348 623 562 00017 - NAF 742 C  
Association à but non lucratif enregistrée à la  
Sous-Préfecture de Grasse (06) N° 7803/88

---

**Important notice**

The present document can be downloaded from:

<http://www.etsi.org/standards-search>

The present document may be made available in electronic versions and/or in print. The content of any electronic and/or print versions of the present document shall not be modified without the prior written authorization of ETSI. In case of any existing or perceived difference in contents between such versions and/or in print, the prevailing version of an ETSI deliverable is the one made publicly available in PDF format at [www.etsi.org/deliver](http://www.etsi.org/deliver).

Users of the present document should be aware that the document may be subject to revision or change of status.

Information on the current status of this and other ETSI documents is available at

<https://portal.etsi.org/TB/ETSIDeliverableStatus.aspx>

If you find errors in the present document, please send your comment to one of the following services:

<https://portal.etsi.org/People/CommiteeSupportStaff.aspx>

---

**Copyright Notification**

No part may be reproduced or utilized in any form or by any means, electronic or mechanical, including photocopying and microfilm except as authorized by written permission of ETSI.

The content of the PDF version shall not be modified without the written authorization of ETSI.

The copyright and the foregoing restriction extend to reproduction in all media.

© ETSI 2019.

All rights reserved.

**DECT™**, **PLUGTESTS™**, **UMTS™** and the ETSI logo are trademarks of ETSI registered for the benefit of its Members.

**3GPP™** and **LTE™** are trademarks of ETSI registered for the benefit of its Members and of the 3GPP Organizational Partners.

**oneM2M™** logo is a trademark of ETSI registered for the benefit of its Members and of the oneM2M Partners.

**GSM®** and the GSM logo are trademarks registered and owned by the GSM Association.

---

## Intellectual Property Rights

### Essential patents

IPRs essential or potentially essential to normative deliverables may have been declared to ETSI. The information pertaining to these essential IPRs, if any, is publicly available for **ETSI members and non-members**, and can be found in ETSI SR 000 314: "*Intellectual Property Rights (IPRs); Essential, or potentially Essential, IPRs notified to ETSI in respect of ETSI standards*", which is available from the ETSI Secretariat. Latest updates are available on the ETSI Web server (<https://ipr.etsi.org/>).

Pursuant to the ETSI IPR Policy, no investigation, including IPR searches, has been carried out by ETSI. No guarantee can be given as to the existence of other IPRs not referenced in ETSI SR 000 314 (or the updates on the ETSI Web server) which are, or may be, or may become, essential to the present document.

### Trademarks

The present document may include trademarks and/or tradenames which are asserted and/or registered by their owners. ETSI claims no ownership of these except for any which are indicated as being the property of ETSI, and conveys no right to use or reproduce any trademark and/or tradename. Mention of those trademarks in the present document does not constitute an endorsement by ETSI of products, services or organizations associated with those trademarks.

---

## Legal Notice

This Technical Specification (TS) has been produced by ETSI 3rd Generation Partnership Project (3GPP).

The present document may refer to technical specifications or reports using their 3GPP identities. These shall be interpreted as being references to the corresponding ETSI deliverables.

The cross reference between 3GPP and ETSI identities can be found under <http://webapp.etsi.org/key/queryform.asp>.

---

## Modal verbs terminology

In the present document "**shall**", "**shall not**", "**should**", "**should not**", "**may**", "**need not**", "**will**", "**will not**", "**can**" and "**cannot**" are to be interpreted as described in clause 3.2 of the [ETSI Drafting Rules](#) (Verbal forms for the expression of provisions).

"**must**" and "**must not**" are **NOT** allowed in ETSI deliverables except when used in direct citation.

# Contents

Intellectual Property Rights .....	2
Legal Notice .....	2
Modal verbs terminology.....	2
Foreword.....	6
1 Scope .....	6
2 References .....	6
3 Definitions and abbreviations.....	7
3.1 Definitions .....	7
3.2 Abbreviations .....	7
4 Overview .....	7
4.1 Introduction .....	7
5 Services offered by the NSSF .....	8
5.1 Introduction .....	8
5.2 Nnssf_NSSelection Service.....	8
5.2.1 Service Description.....	8
5.2.2 Service Operations.....	8
5.2.2.1 Introduction.....	8
5.2.2.2 GET.....	9
5.2.2.2.1 General .....	9
5.2.2.2.2 Get service operation of Nnssf_NSSelection service during the registration procedure .....	9
5.2.2.2.3 Get service operation of Nnssf_NSSelection service during the PDU session establishment.....	10
5.2.2.2.X Get service operation of Nnssf_NSSelection service during UE configuration update procedure.....	10
5.3 Nnssf_NSSAIAvailability Service.....	11
5.3.1 Service Description.....	11
5.3.2 Service Operations.....	11
5.3.2.1 Introduction.....	11
5.3.2.2 Update Service Operation .....	12
5.3.2.2.1 General .....	12
5.3.2.3 Subscribe Service Operation .....	12
5.3.2.3.1 General .....	12
5.3.2.4 Unsubscribe Service Operation.....	13
5.3.2.4.1 General .....	13
5.3.2.5 Notify Service Operation .....	13
5.3.2.5.1 General .....	13
5.3.2.6 Delete Service Operation .....	14
5.3.2.6.1 General .....	14
6 API Definitions .....	14
6.1 Nnssf_NSSelection Service API .....	14
6.1.1 API URI.....	14
6.1.2 Usage of HTTP .....	15
6.1.2.1 General .....	15
6.1.2.2 HTTP standard headers .....	15
6.1.2.2.1 General .....	15
6.1.2.2.2 Content type .....	15
6.1.2.3.1 General .....	15
6.1.3 Resources.....	15
6.1.3.1 Overview.....	15
6.1.3.2 Resource: Network Slice Information Document .....	16
6.1.3.2.1 Description .....	16
6.1.3.2.2 Resource Definition.....	16
6.1.3.2.3 Resource Standard Methods .....	16

6.1.3.2.3.1	GET .....	16
6.1.3.2.4	Resource Custom Operations .....	17
6.1.4	Custom Operations without associated resources .....	18
6.1.5	Notifications .....	18
6.1.6	Data Model .....	18
6.1.6.1	General .....	18
6.1.6.2	Structured data types .....	19
6.1.6.2.1	Introduction .....	19
6.1.6.2.2	Type: AuthorizedNetworkSliceInfo .....	20
6.1.6.2.3	Type: SubscribedSnsai .....	22
6.1.6.2.4	Void .....	22
6.1.6.2.5	Type: AllowedSnsai .....	22
6.1.6.2.6	Type: AllowedNssai .....	22
6.1.6.2.7	Type: NsiInformation .....	23
6.1.6.2.8	Type: MappingOfSnsai .....	23
6.1.6.2.9	Void .....	24
6.1.6.2.10	Type: SliceInfoForRegistration .....	24
6.1.6.2.11	Type: SliceInfoForPDUSession .....	25
6.1.6.2.12	Type: ConfiguredSnsai .....	25
6.1.6.2.13	Type: SliceInfoForUEConfigurationUpdate .....	26
6.1.6.3	Simple data types and enumerations .....	26
6.1.6.3.1	Introduction .....	26
6.1.6.3.2	Simple data types .....	26
6.1.6.3.3	Enumeration: RoamingIndication .....	26
6.1.6.4	Binary data .....	27
6.1.7	Error Handling .....	27
6.1.7.1	General .....	27
6.1.7.2	Protocol Errors .....	27
6.1.7.3	Application Errors .....	27
6.1.8	Feature negotiation .....	27
6.1.9	Security .....	28
6.2	Nssf_NSSAIAvailability Service API .....	28
6.2.1	API URI .....	28
6.2.2	Usage of HTTP .....	28
6.2.2.1	General .....	28
6.2.2.2	HTTP standard headers .....	28
6.2.2.2.1	General .....	28
6.2.2.2.2	Content type .....	28
6.2.2.2.3	Accept-Encoding .....	29
6.2.2.3	HTTP custom headers .....	29
6.2.2.3.1	General .....	29
6.2.3	Resources .....	29
6.2.3.1	Overview .....	29
6.2.3.2	Resource: NSSAI Availability Document .....	30
6.2.3.2.1	Description .....	30
6.2.3.2.2	Resource Definition .....	30
6.2.3.2.3	Resource Standard Methods .....	30
6.2.3.2.3.1	PUT .....	30
6.2.3.2.3.2	PATCH .....	31
6.2.3.2.3.3	DELETE .....	32
6.2.3.3	Resource: NSSAI Availability Notification Subscriptions Collection .....	32
6.2.3.3.1	Description .....	32
6.2.3.3.2	Resource Definition .....	32
6.2.3.3.3	Resource Standard Methods .....	32
6.2.3.3.3.1	POST .....	32
6.2.3.4	Resource: Individual NSSAI Availability Notification Subscriptions .....	33
6.2.3.4.1	Description .....	33
6.2.3.4.2	Resource Definition .....	33
6.2.3.4.3	Resource Standard Methods .....	33
6.2.3.4.3.1	DELETE .....	33
6.2.3.5	Resource: NSSAI Availability Store .....	34
6.2.3.5.1	Description .....	34

6.2.3.5.2	Resource Definition .....	34
6.2.3.5.3	Resource Standard Methods .....	34
6.2.3.5.3.1	OPTIONS .....	34
6.2.4	Custom Operations without associated resources .....	35
6.2.5	Notifications .....	35
6.2.5.1	General .....	35
6.2.5.2	NSSAI Availability Notification .....	35
6.2.5.2.1	Description .....	35
6.2.5.2.2	Notification Definition .....	35
6.2.5.2.3	Notification Standard Methods .....	35
6.2.5.2.3.1	POST .....	35
6.2.6	Data Model .....	36
6.2.6.1	General .....	36
6.2.6.2	Structured data types .....	36
6.2.6.2.1	Introduction .....	36
6.2.6.2.2	Type: NssaiAvailabilityInfo .....	37
6.2.6.2.3	Type: SupportedNssaiAvailabilityData .....	37
6.2.6.2.4	Type: AuthorizedNssaiAvailabilityData .....	37
6.2.6.2.5	Type: RestrictedSnssai .....	37
6.2.6.2.6	Type: AuthorizedNssaiAvailabilityinfo .....	38
6.2.6.2.7	Type: PatchDocument .....	38
6.2.6.2.8	Type: NssfEventSubscriptionCreateData .....	38
6.2.6.2.9	Type: NssfEventSubscriptionCreatedData .....	39
6.2.6.2.10	Type: NssfEventNotification .....	39
6.2.6.3	Simple data types and enumerations .....	39
6.2.6.3.1	Introduction .....	39
6.2.6.3.2	Simple data types .....	39
6.2.6.3.3	Enumeration: NssfEventType .....	40
6.2.6.4	Binary data .....	40
6.2.7	Error Handling .....	40
6.2.7.1	General .....	40
6.2.7.2	Protocol Errors .....	40
6.2.7.3	Application Errors .....	40
6.2.8	Feature negotiation .....	40
6.2.9	Security .....	41
<b>Annex A (normative):</b>	<b>OpenAPI specification .....</b>	<b>42</b>
A.1	General .....	42
A.2	Nssf_NSSelection API .....	42
A.3	Nssf_NSSAIAvailability API .....	46
<b>Annex B (informative):</b>	<b>Change history .....</b>	<b>53</b>
History .....		54

---

# Foreword

This Technical Specification has been produced by the 3rd Generation Partnership Project (3GPP).

The contents of the present document are subject to continuing work within the TSG and may change following formal TSG approval. Should the TSG modify the contents of the present document, it will be re-released by the TSG with an identifying change of release date and an increase in version number as follows:

Version x.y.z

where:

- x the first digit:
  - 1 presented to TSG for information;
  - 2 presented to TSG for approval;
  - 3 or greater indicates TSG approved document under change control.
- y the second digit is incremented for all changes of substance, i.e. technical enhancements, corrections, updates, etc.
- z the third digit is incremented when editorial only changes have been incorporated in the document.

---

## 1 Scope

The present document specifies the stage 3 protocol and data model for the Nnssf Service Based Interface. It provides stage 3 protocol definitions and message flows, and specifies the API for each service offered by the NSSF.

The 5G System stage 2 architecture and procedures are specified in 3GPP TS 23.501 [2] and 3GPP TS 23.502 [3].

The Technical Realization of the Service Based Architecture and the Principles and Guidelines for Services Definition are specified in 3GPP TS 29.500 [4] and 3GPP TS 29.501 [5].

---

## 2 References

The following documents contain provisions which, through reference in this text, constitute provisions of the present document.

- References are either specific (identified by date of publication, edition number, version number, etc.) or non-specific.
- For a specific reference, subsequent revisions do not apply.
- For a non-specific reference, the latest version applies. In the case of a reference to a 3GPP document (including a GSM document), a non-specific reference implicitly refers to the latest version of that document *in the same Release as the present document*.

- [1] 3GPP TR 21.905: "Vocabulary for 3GPP Specifications".
- [2] 3GPP TS 23.501: "System Architecture for the 5G System; Stage 2".
- [3] 3GPP TS 23.502: "Procedures for the 5G System; Stage 2".
- [4] 3GPP TS 29.500: "5G System; Technical Realization of Service Based Architecture; Stage 3".
- [5] 3GPP TS 29.501: "5G System; Principles and Guidelines for Services Definition; Stage 3".
- [6] OpenAPI: "OpenAPI 3.0.0 Specification", <https://github.com/OAI/OpenAPI-Specification/blob/master/versions/3.0.0.md>.

- [7] 3GPP TS 29.571: "5G System; Common Data Types for Service Based Interfaces; Stage 3".
- [8] IETF RFC 6902: "JavaScript Object Notation (JSON) Patch".
- [9] 3GPP TS 23.003: "Numbering, addressing and identification".
- [10] IETF RFC 7540: "Hypertext Transfer Protocol Version 2 (HTTP/2)".
- [11] 3GPP TS 33.501: "Security architecture and procedures for 5G system".
- [12] IETF RFC 6749: "The OAuth 2.0 Authorization Framework".
- [13] 3GPP TS 29.510: "Network Function Repository Services; Stage 3".
- [14] IETF RFC 8259: "The JavaScript Object Notation (JSON) Data Interchange Format".
- [15] IETF RFC 7807: "Problem Details for HTTP APIs".
- [16] IETF RFC 1952: "GZIP file format specification version 4.3".
- [17] 3GPP TR 21.900: "Technical Specification Group working methods".

---

## 3 Definitions and abbreviations

### 3.1 Definitions

For the purposes of the present document, the terms and definitions given in 3GPP TR 21.905 [1] and the following apply. A term defined in the present document takes precedence over the definition of the same term, if any, in 3GPP TR 21.905 [1].

### 3.2 Abbreviations

For the purposes of the present document, the abbreviations given in 3GPP TR 21.905 [1] and the following apply. An abbreviation defined in the present document takes precedence over the definition of the same abbreviation, if any, in 3GPP TR 21.905 [1].

---

## 4 Overview

### 4.1 Introduction

Within the 5GC, the NSSF offers services to the AMF and NSSF in a different PLMN via the Nssf service based interface (see 3GPP TS 23.501 [2] and 3GPP TS 23.502 [3]).

Figure 4.1-1 provides the reference model (in service based interface representation and in reference point representation), with focus on the NSSF and the scope of the present specification.



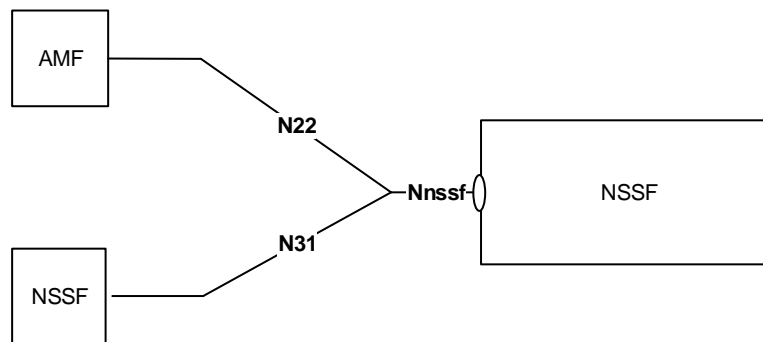

Figure 4.1-1: NSSF in 5G System architecture

The functionalities supported by the NSSF are listed in clause 6.2.14 of 3GPP TS 23.501 [2].

## 5 Services offered by the NSSF

### 5.1 Introduction

The NSSF supports the following services.

Table 5.1-1: NF Services provided by NSSF

Service Name	Description	Example Consumer
Nnssf_NSSelection	This service enables Network Slice selection in both the Serving PLMN and the HPLMN	AMF, V-NSSF
Nnssf_NSSAIAvailability	This service enables to update the S-NSSAI(s) the NF service consumer (e.g AMF) supports on a per TA basis on the NSSF and to subscribe and notify any change in status, on a per TA basis, of the SNSSAIs available per TA (unrestricted) and the restricted S-NSSAI(s) per PLMN in that TA in the serving PLMN of the UE.	AMF

### 5.2 Nnssf\_NSSelection Service

#### 5.2.1 Service Description

The Nnssf\_NSSelection service is used by an NF Service Consumer (e.g. AMF or NSSF in a different PLMN) to retrieve the information related to network slice in the non-roaming and roaming case. It also enables the NSSF to provide to the AMF the Allowed NSSAI and the Configured NSSAI for the Serving PLMN. The NF service consumer discovers the NSSF based on the local configuration. The NSSF in a different PLMN is discovered based on the self-constructed FQDN as specified in 3GPP TS 23.003[9].

#### 5.2.2 Service Operations

##### 5.2.2.1 Introduction

For the Nnssf\_NSSelection service the following service operations are defined:

- Get.

## 5.2.2.2 GET

### 5.2.2.2.1 General

The Get operation shall be used in the non-roaming or roaming scenario to retrieve:

- The Allowed NSSAI, Configured NSSAI, target AMF Set or the list of candidate AMF(s), and optionally
- The Mapping Of Allowed NSSAI;
- The Mapping Of Configured NSSAI;
- NSI ID(s) associated with the Network Slice instances of the Allowed NSSAI;
- NRF(s) to be used to select NFs/services within the selected Network Slice instance(s) and NRF to be used to determine the list of candidate AMF(s) from the AMF Set, during Registration procedure and
- Information on whether the S-NSSAI(s) not included in the Allowed NSSAI which were part of the Requested NSSAI are rejected in the serving PLMN or in the current TA.
- The NRF to be used to select NFs/services within the selected network slice instance, and optionally the NSI ID associated with the S-NSSAI provided in the input, during the PDU Session Establishment procedure.

It is used in the following procedures:

- Registration with AMF re-allocation (see clause 4.2.2.2.3 of 3GPP TS 23.502 [3]);
- UE Configuration Update procedure (see clause 4.2.4.2 of 3GPP TS 23.502 [3]);
- SMF selection for non-roaming and roaming with local breakout (see clause 4.3.2.2.3.2 of 3GPP TS 23.502 [3]) or SMF selection for home-routed roaming scenario (see clause 4.3.2.2.3.3 of 3GPP TS 23.502 [3]).

NOTE: The list of procedures above, which trigger invoking of the Nnssf\_NSSelection\_Get service operation, is not exhaustive.

### 5.2.2.2.2 Get service operation of Nnssf\_NSSelection service during the registration procedure

In this procedure, the NF Service Consumer (e.g. AMF) retrieves the Allowed NSSAI, Configured NSSAI, target AMF Set or the list of candidate AMF(s) and other optional information.

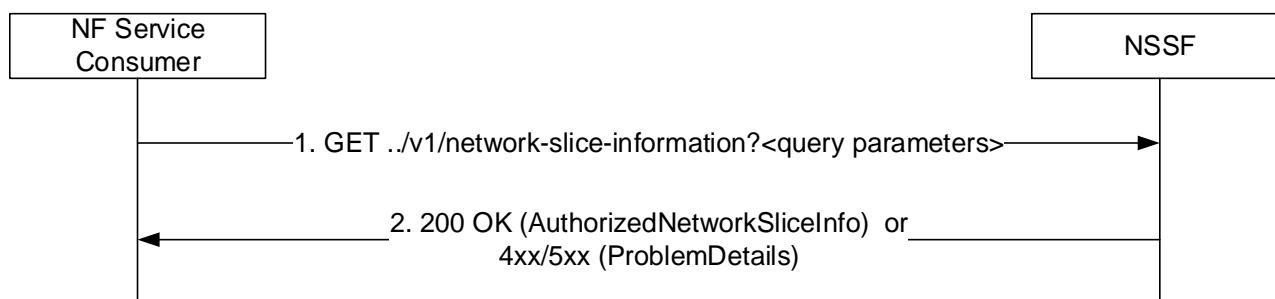

**Figure 5.2.2.2.2-1: Retrieve the network slice information during the registration procedure**

- 1 The AMF shall send a GET request to the NSSF. One or more of the following parameters shall be included as query parameters: Requested NSSAI, Subscribed S-NSSAI(s) with the indication if marked as default S-NSSAI, PLMN ID of the SUPI, TAI, NF type of the NF service consumer, Requester ID.
- 2 On success, "200 OK" shall be returned in the following cases:

- When the NSSF is able to find authorized network slice information for the requested network slice selection information, the response body shall include a payload body containing at least the Allowed NSSAI, target AMF Set or the list of candidate AMF(s);

- If no slice instances can be found for the requested slice selection information, then the response body shall contain an empty "AuthorizedNetworkSliceInfo" JSON object.

On failure, the NSSF shall return one of the HTTP status codes together with the response body listed in Table 6.1.3.2.3.1-3.

### 5.2.2.2.3 Get service operation of Nnssf\_NSSelection service during the PDU session establishment

In this procedure, the NF Service Consumer (e.g. AMF) retrieves the NRF and the optionally the NSI ID of the network slice instance:

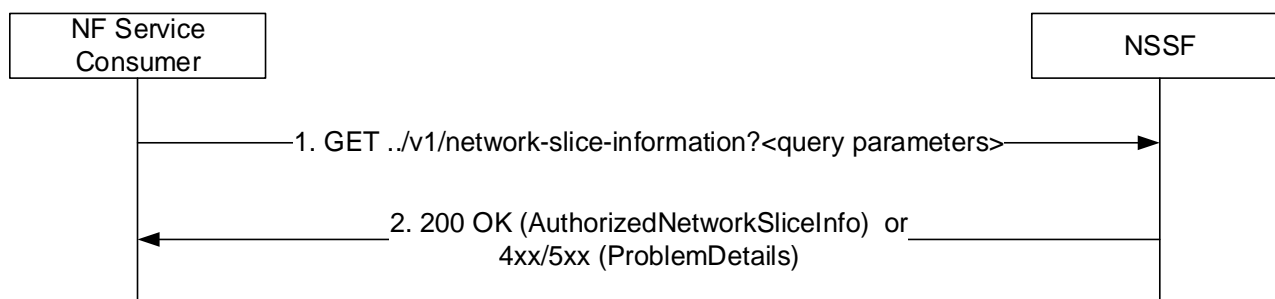

**Figure 5.2.2.2.3-1: Retrieve the network slice information during the PDU session establishment procedure**

1 The NF Service consumer (e.g. AMF or NSSF in the different PLMN) shall send a GET request to the NSSF. The request shall include query parameters, contain at least S-NSSAI, S-NSSAI from the HPLMN that maps to the S-NSSAI from the Allowed NSSAI of the Serving PLMN, the NF type of the NF service consumer and Requester ID. For the procedure invoked in the Serving PLMN, the query parameters shall also contain non-roaming/LBO roaming/HR roaming indication, PLMN ID of the SUPI and TAI.

2 On success, "200 OK" shall be returned in the following cases:

- When the NSSF is able to find network slice instance information for the requested network slice selection information, the response body shall include a payload body containing at least the NRF to be used to select NFs/services within the selected Network Slice instance;

- If no slice instances can be found for the requested slice selection information, then the response body shall contain an empty "AuthorizedNetworkSliceInfo" JSON object.

On failure, the NSSF shall return one of the HTTP status codes together with the response body listed in Table 6.1.3.2.3.1-3.

### 5.2.2.2.X Get service operation of Nnssf\_NSSelection service during UE configuration update procedure

In this procedure, the NF Service Consumer (e.g. AMF) retrieves network slice configuration information (e.g. the Allowed NSSAI and the Configured NSSAI) during the UE configuration update procedure.

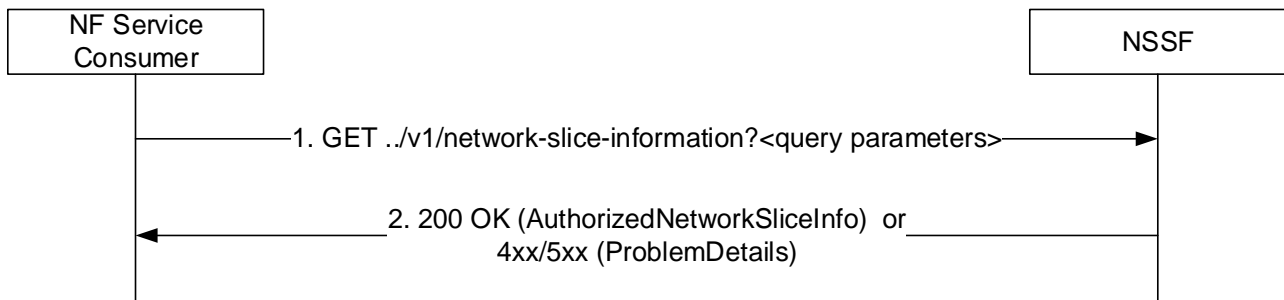

**Figure 5.2.2.2.x-1: Retrieve the network slice information during UE configuration update procedure**

- 1 The NF Service consumer (e.g. AMF) shall send a GET request to the NSSF. The request shall include query parameters: Subscribed S-NSSAI(s) with the indication if the S-NSSAI is marked as default S-NSSAI, PLMN ID of the SUPI, TAI, NF type of the NF service consumer and the NF instance ID of the requester NF.
- 2 On success, "200 OK" shall be returned in the following cases:
  - When the NSSF is able to find authorized network slice information for the requested network slice selection information, the response body shall include a payload body containing at least the Allowed NSSAI, Configured NSSAI;
  - If no slice instances can be found for the requested slice selection information, then the response body shall contain an empty "AuthorizedNetworkSliceInfo" JSON object.

On failure, the NSSF shall return one of the HTTP status codes together with the response body listed in Table 6.1.3.2.3.1-3.

## 5.3 Nnssf\_NSSAIAvailability Service

### 5.3.1 Service Description

The Nnssf\_NSSAIAvailability service is used by the NF service consumer (e.g. AMF) to update the S-NSSAI(s) the AMF supports on a per TA basis on the NSSF, subscribe and unsubscribe the notification of any changes to the NSSAI availability information on a per TA basis, of the S-NSSAIs available per TA (unrestricted) and the restricted S-NSSAI(s) per PLMN in that TA in the serving PLMN of the UE.

### 5.3.2 Service Operations

#### 5.3.2.1 Introduction

For the Nnssf\_NSSAIAvailability service the following service operations are defined:

- Update;
- Subscribe;
- Unsubscribe;
- Notify;
- Delete.

## 5.3.2.2 Update Service Operation

### 5.3.2.2.1 General

The Update operation shall be used by an NF Service Consumer (e.g. AMF) to update the NSSF with the S-NSSAIs the NF service consumer (e.g. AMF) supports per TA, and get the availability of the S-NSSAIs per TA for the S-NSSAIs the NF service consumer (e.g. AMF) supports.

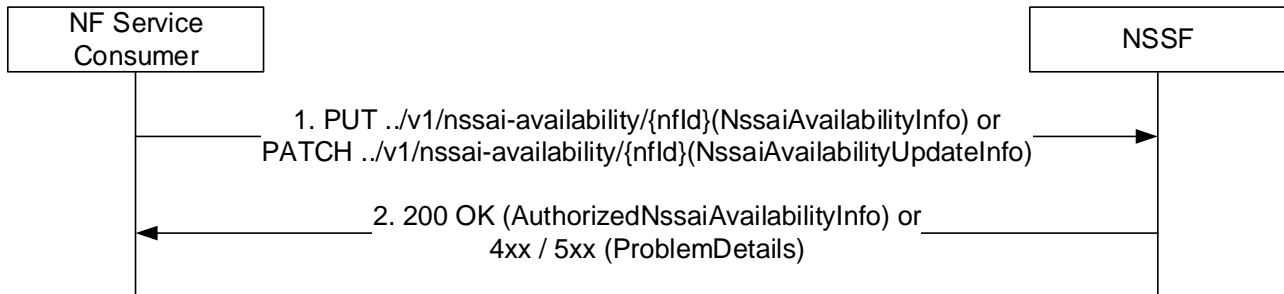

**Figure 5.3.2.2.1-1: Update the S-NSSAIs the AMF supports per TA**

1. The NF service consumer (e.g. AMF) shall send a PUT request to the resource representing the NSSAI Availability information of the individual NF, identified by the {nfId}, to replace or create the NSSAI Availability information of the NF. The payload of the body shall contain the NssaiAvailabilityInfo which contains one or more representations of the individual supportedSnsai information to be replaced.

The NF service consumer (e.g. AMF) shall send a PATCH request to the resource representing the NSSAI Availability information of the individual NF, identified by the {nfId}, to update the NSSAI Availability information of the NF. The payload of the body shall contain the PatchDocument which contains one or more PatchItem instructions for updating the individual supportedSnsai resources.

2. On success, "200 OK" shall be returned, the payload body of the PUT/PATCH response shall contain the representation describing the status of the request and the complete AuthorizedNssaiAvailabilityData information representing the current state of the AuthorizedNssaiAvailabilityInfo.

On failure, the NSSF shall return one of the HTTP status code together with the response body listed in Table 6.2.3.2.3.1-2 / Table 6.2.3.2.3.2-2.

## 5.3.2.3 Subscribe Service Operation

### 5.3.2.3.1 General

The Subscribe Operation is used by a NF Service Consumer (e.g. AMF) to subscribe to a notification of any changes in status of the NSSAI availability information (e.g. S-NSSAIs available per TA and the restricted S-NSSAI(s) per PLMN in that TA in the serving PLMN of the UE) upon this is updated by another AMF.

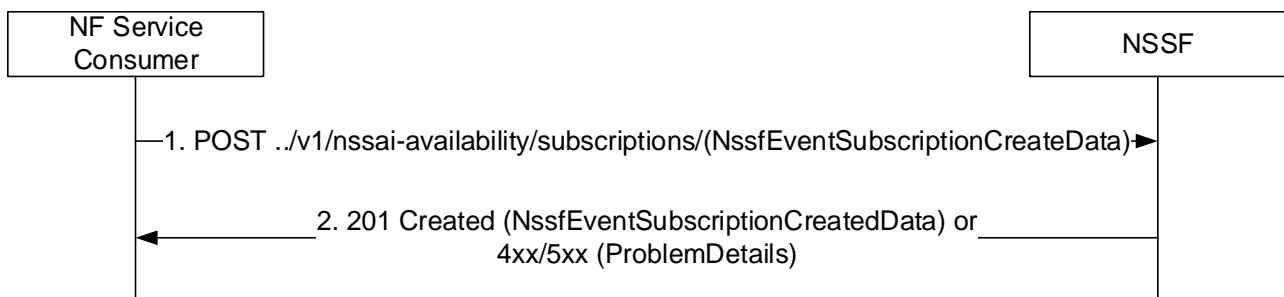

**Figure 5.3.2.3.1-1 Create a subscription**

1. The NF Service Consumer shall send a POST request to create a subscription resource in the NSSF. The payload body of the POST request shall contain a representation of the individual event subscription resource to be created in the NssfEventSubscriptionCreateData. The request may contain an expiry time, suggested by the NF

Service Consumer as a hint, representing the time upto during which the subscription is desired to be kept active and describes the maximum duration after which the subscribed event shall stop generating report. The request may also indicate a specific AMF Set to restrict the subscriptions to notifications applicable to the AMF Set (i.e. notifications related to S-NSSAIs supported by the AMF Set).

2. On success, "201 Created" shall be returned, and the payload body of the POST response shall contain the representation describing the status of the created subscription in NssfEventSubscriptionCreatedData that may contain the AuthorizedNssaiAvailabilityData information, if available. The Location header shall contain the location (URI) of the created subscription resource.

The response, based on operator policy and taking into account the expiry time included in the request, may contain the expiry time, as determined by the NSSF, after which the subscription becomes invalid. Once the subscription expires, if the NF Service Consumer wants to keep receiving notifications, it shall create a new subscription in the NSSF. The NSSF shall not provide the same expiry time for many subscriptions in order to avoid all of them expiring and recreating the subscription at the same time. If the expiry time is not included in the response, the NF Service Consumer shall consider the subscription to be valid without an expiry time.

On failure, the NSSF shall return one of the HTTP status code together with the response body listed in Table 6.2.3.3.1-2.

## 5.3.2.4 Unsubscribe Service Operation

### 5.3.2.4.1 General

The Unsubscribe Operation is used by a NF Service Consumer (e.g. AMF) to unsubscribe to a notification of any previously subscribed changes to the NSSAI availability information.

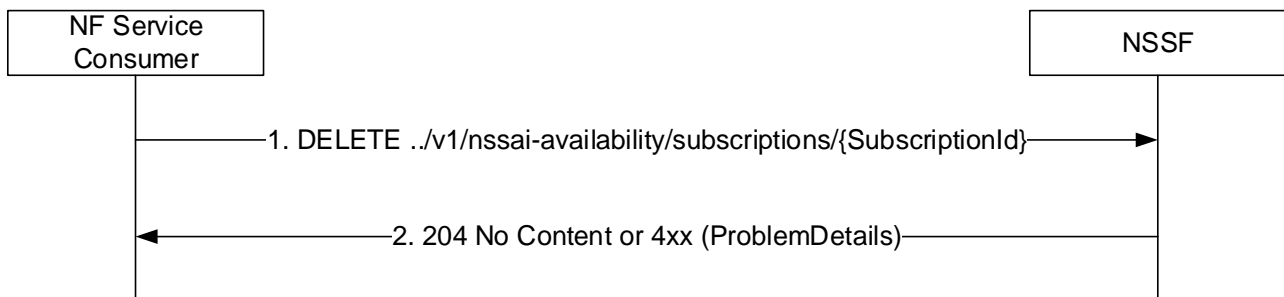

**Figure 5.3.2.4.1-1 Unsubscribe a subscription**

1. The NF Service Consumer shall send a DELETE request to delete an existing subscription resource in the NSSF.
2. If the request is accepted, the NSSF shall respond with the status code 204 indicating the resource identified by subscription ID is successfully deleted.

On failure, the NSSF shall return one of the HTTP status code together with the response body listed in Table 6.2.3.4.3.2-2.

## 5.3.2.5 Notify Service Operation

### 5.3.2.5.1 General

The Notify Service operation shall be used by the NSSF to update the NF Service Consumer (e.g. AMF) with any change in status, on a per TA basis, of the S-NSSAIs available per TA (unrestricted) and the S-NSSAIs restricted per PLMN in that TA in the serving PLMN of the UE.

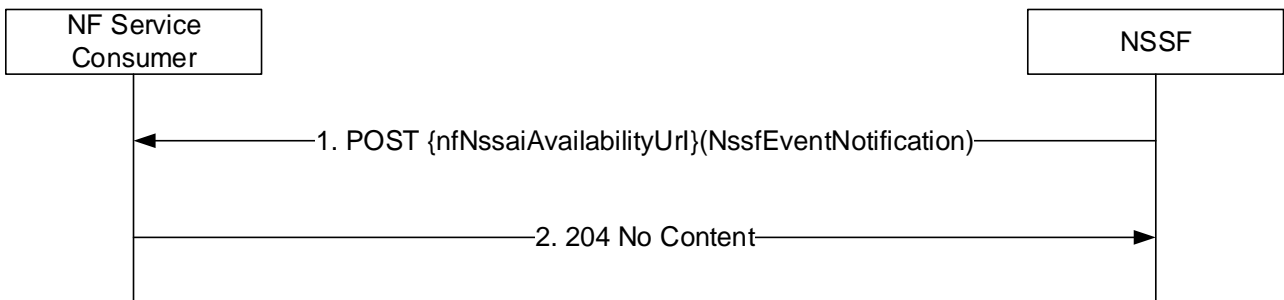

**Figure 5.3.2.5.1-1: Update the AMF with any S-NSSAIs restricted per TA**

1. The NSSF shall send a POST request to the resource representing the NSSF availability resource in the NF service consumer (e.g. AMF). The payload body of the POST request shall contain the one representations of the individual NssfEventNotification resource.
2. On success, "204 No Content" shall be returned and the payload body of the POST response shall be empty.

### 5.3.2.6 Delete Service Operation

#### 5.3.2.6.1 General

The Delete Service operation shall be used by the NF service consumer (e.g. AMF) to delete the NSSAI availability information stored for the NF service consumer in the NSSF.

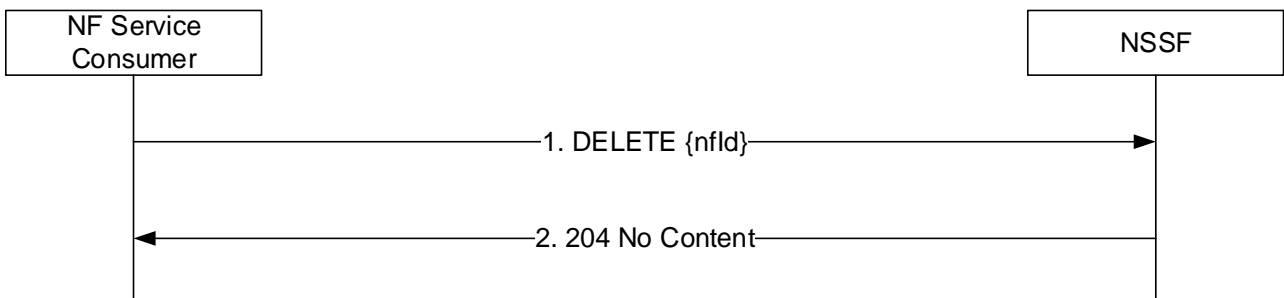

**Figure 5.3.2.6.1-1: Delete the NSSAI Availability Information at NSSF**

1. The NF service consumer (e.g. AMF) shall send a DELETE request to remove the NSSAI availability information for the NF service consumer represented by the {nfId} (e.g. AMF ID).
2. The NSSF shall delete the NSSAI Availability information for the individual AMF and shall return the 204 No Content status code.

---

## 6 API Definitions

### 6.1 Nnssf\_NSSelection Service API

#### 6.1.1 API URI

The Nnssf\_NSSelection service shall use the Nnssf\_NSSelection API.

The request URI used in HTTP request from the NF service consumer towards the NF service producer shall have the structure defined in clause 4.4.1 of 3GPP TS 29.501 [5], i.e.:

**{apiRoot}/nssf-nselection/{apiVersion}/<apiSpecificResourceUriPart>**

with the following components:

- The {apiRoot} shall be set as described in 3GPP TS 29.501 [5].
- The {apiVersion} shall be "v2".
- The <apiSpecificResourceUriPart> shall be set as described in clause 6.1.3.

## 6.1.2 Usage of HTTP

### 6.1.2.1 General

HTTP/2, IETF RFC 7540 [10], shall be used as specified in clause 5 of 3GPP TS 29.500 [4].

An OpenAPI [6] specification of HTTP messages and content bodies for the Nnssf\_NSSelection service is specified in Annex A.

### 6.1.2.2 HTTP standard headers

#### 6.1.2.2.1 General

See clause 5.2.2 of 3GPP TS 29.500 [4] for the usage of HTTP standard headers.

#### 6.1.2.2.2 Content type

The following content types shall be supported:

- JSON, as defined in IETF RFC 8259 [14], shall be used as content type of the HTTP bodies specified in the present specification as indicated in clause 5.4 of 3GPP TS 29.500 [4].
- The Problem Details JSON Object (IETF RFC 7807 [15]). The use of the Problem Details JSON object in a HTTP response body shall be signalled by the content type "application/problem+json".

#### 6.1.2.3.1 General

In this release of this specification, no custom headers specific to the Nnssf\_NSSelection service are defined. For 3GPP specific HTTP custom headers used across all service based interfaces, see clause 5.2.3 of 3GPP TS 29.500 [4].

## 6.1.3 Resources

### 6.1.3.1 Overview

Figure 6.1.3.1-1 describes the resource URI structure of the Nnssf\_NSSelection API.

//{apiRoot}/nnssf-nssselection/{apiVersion}

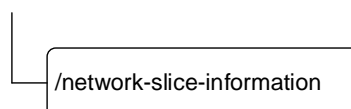

**Figure 6.1.3.1-1: Resource URI structure of the nnssf\_nssselection API**

Table 6.1.3.1-1 provides an overview of the resources and applicable HTTP methods.



**Table 6.1.3.1-1: Resources and methods overview**

Resource name	Resource URI	HTTP method or custom operation	Description
Network Slice Related Information	{apiRoot}/nssf-nsselection/{apiVersion}/network-slice-information	GET	To retrieve network slice information. See clause 6.1.3.2.3.1. Maps to Nssf_NSSelection_Get service operation.

## 6.1.3.2 Resource: Network Slice Information Document

### 6.1.3.2.1 Description

This resource represents the network slice related information maintained by the NSSF. This resource is modelled with the Document resource archetype (see clause C.1 of 3GPP TS 29.501 [5]).

### 6.1.3.2.2 Resource Definition

Resource URI: **{apiRoot}/nssf-nsselection/{apiVersion}/network-slice-information**

This resource shall support the resource URI variables defined in table 6.1.3.2.2-1.

**Table 6.1.3.2.2-1: Resource URI variables for this resource**

Name	Definition
apiRoot	See clause 6.1.1
apiVersion	See clause 6.1.1

### 6.1.3.2.3 Resource Standard Methods

#### 6.1.3.2.3.1 GET

This method retrieves the information related to the selected slice based on the input query parameters provided by the NF service consumer specified in table 6.1.3.2.3.1-1.

This method shall support input query parameters specified in table 6.1.3.2.3.1-1 and the response data structure and response codes specified in table 6.1.3.2.3.1-3.

**Table 6.1.3.2.3.1-1: URI query parameters supported by the GET method on this resource**

Name	Data type	P	Cardinality	Description
nf-type	NfType	M	1	This IE shall contain the NF type of the NF service consumer.
nf-id	NfInstanceId	M	1	This IE shall contain the NF identifier of the NF service consumer.
slice-info-request-for-registration	SliceInfoForRegistration	C	0..1	This IE shall be present when the network slice information is requested during the Registration procedure towards an NSSF in the serving PLMN.
slice-info-request-for-pdu-session	SliceInfoForPDUSession	C	0..1	This IE shall be present when the network slice information is requested during the PDU session establishment procedure.
slice-info-request-for-ue-cu	SliceInfoForUEConfigurationUpdate	C	0..1	This IE shall be present when the network slice information is requested during UE configuration update procedure.
home-plmn-id	PlmnId	C	0..1	This IE shall be present in the request towards an NSSF in the serving PLMN if the subscriber is a roamer to the serving PLMN. When present, this IE shall contain the home PLMN Id of the UE.
tai	Tai	C	0..1	This IE shall be present in the request towards an NSSF in the serving PLMN. When present, this IE shall contain the TAI the UE is currently located.
supported-features	SupportedFeatures	C	0..1	This IE shall be present if at least one optional feature defined in clause 6.1.8 is supported.

**Table 6.1.3.2.3.1-2: Data structures supported by the GET Request Body on this resource**

Data type	P	Cardinality	Description
n/a			

**Table 6.1.3.2.3.1-3: Data structures supported by the GET Response Body on this resource**

Data type	P	Cardinality	Response codes	Description
AuthorizedNetworkSliceInfo	M	1	200 OK	This case represents a successful return of the authorized network slice information selected for the corresponding request.
ProblemDetails	M	1	403 Forbidden	This represents the case, where the NF service consumer is not authorized to retrieve the slice selection information or the SNSSAI included in the requested slice selection information is not supported in the PLMN. The application specific error information shall be provided in the "cause" attribute. The "cause" attribute shall be set to: <ul style="list-style-type: none"> <li>- "SNSSAI_NOT_SUPPORTED", if the SNSSAI included in the requested slice selection information is not allowed in the PLMN and there is no default NSSAI value provided in the request.</li> </ul>

#### 6.1.3.2.4 Resource Custom Operations

There are no custom methods supported on the network-slice-information collection resource.

## 6.1.4 Custom Operations without associated resources

There are no custom operations without associated resources defined for the Nnssf\_NSSelection service in this version of this API.

## 6.1.5 Notifications

In this release of this specification, there are no notifications defined for the Nnssf\_NSSelection service.

## 6.1.6 Data Model

### 6.1.6.1 General

This clause specifies the application data model supported by the API.

Table 6.1.6.1-1 specifies the data types defined for the Nnssf service based interface protocol.

**Table 6.1.6.1-1: Nnssf\_NSSelection specific Data Types**

Data type	Section defined	Description
AuthorizedNetworkSliceInfo	6.1.6.2.2	Contains the authorized network slice information.
SubscribedSnssai	6.1.6.2.3	Contains the subscribed S-NSSAI.
AllowedSnssai	6.1.6.2.5	Contains the authorized S-NSSAI and optional mapped home S-NSSAI and network slice instance information.
AllowedNssai	6.1.6.2.6	Contains an array of allowed S-NSSAI that constitute the allowed NSSAI information for the authorized network slice information.
NsiInformation	6.1.6.2.7	Contains the API URIs of NRF services to be used to discover NFs/services, subscribe to NF status changes and/or request access tokens within the selected Network Slice instance and optional the Identifier of the selected Network Slice instance.
MappingOfSnssai	6.1.6.2.8	Contains the mapping of S-NSSAI in the serving network and the value of the home network.
SliceInfoForRegistration	6.1.6.2.10	Contains the slice information requested during a Registration procedure.
SliceInfoForPDUSession	6.1.6.2.11	Contains the slice information requested during PDU Session establishment procedure.
ConfiguredSnssai	6.1.6.2.12	Contains the configured S-NSSAI(s) authorized by the NSSF in the serving PLMN and optional mapped home S-NSSAI.
SliceInfoForUEConfigurationUpdate	6.1.6.2.13	Contains the slice information requested during UE configuration update procedure.

Table 6.1.6.1-2 specifies data types re-used by the Nnssf. service based interface protocol from other specifications, including a reference to their respective specifications and when needed, a short description of their use within the Nnssf service based interface.

**Table 6.1.6.1-2: Nnssf re-used Data Types**

Data type	Reference	Comments
SupportedFeatures	3GPP TS 29.571 [7]	Used to negotiate the applicability of the optional features defined in table 6.1.8-1.
Fqdn	3GPP TS 29.571 [7]	Fully Qualified Domain Name.
AccessType	3GPP TS 29.571 [7]	Used to specify the access type for which a slice information is applicable.
NFType	3GPP TS 29.510 [13]	Type of Network Function.

## 6.1.6.2 Structured data types

### 6.1.6.2.1 Introduction

This clause defines the structures to be used in resource representations.

6.1.6.2.2 Type: AuthorizedNetworkSliceInfo

**Table 6.1.6.2.2-1: Definition of type AuthorizedNetworkSliceInfo**

Attribute name	Data type	P	Cardinality	Description
allowedNssaiList	array(AllowedNssai)	C	1..N	This IE shall be included if: <ul style="list-style-type: none"> <li>- the NSSF received the Requested NSSAI and the subscribed S-NSSAI(s); or</li> <li>- the "requestMapping" flag in the corresponding request was set to "true".</li> </ul> When present, this IE shall contain the allowed S-NSSAI(s) authorized by the NSSF in the serving PLMN per access type.
configuredNssai	array(ConfiguredSnssai)	C	1..N	This IE shall be included if: <ul style="list-style-type: none"> <li>- the NSSF did not receive any Requested NSSAI; or</li> <li>- the Requested NSSAI includes an S-NSSAI that is not valid in the Serving PLMN; or</li> <li>- the NSSF has received "defaultConfiguredSnssaiInd" set to "true".</li> </ul> When present, this IE shall contain the configured S-NSSAI(s) authorized by the NSSF in the serving PLMN.
targetAmfSet	string	O	0..1	This IE may be included by the NSSF based on configuration and if the NSSF received the Requested NSSAI and the subscribed S-NSSAI(s). When present, this IE shall contain the target AMF set which shall be constructed from PLMN-ID (i.e. three decimal digits MCC and two or three decimal digits MNC), AMF Region Id (8 bit), and AMF Set Id (10 bit). <p>This IE shall not be included if the "requestMapping" IE was included in the request message and was set to "true".</p> Pattern: <code>^[0-9]{3}-[0-9]{2-3}-[A-Fa-f0-9]{2}-[0-3][A-Fa-f0-9]{2}\$</code> (NOTE 1)
candidateAmfList	array(NfInstancelid)	O	1..N	This IE may be included by the NSSF based on configuration and if the NSSF received the Requested NSSAI and the subscribed S-NSSAI(s). When present, this IE shall contain the list of candidate AMF(s). <p>This IE shall not be included if the "requestMapping" IE was included in the request message and was set to "true".</p>
rejectedNssaiInPlmn	array(Snssai)	O	1..N	This IE may be included by the NSSF if the NSSF received the Requested NSSAI and the subscribed S-NSSAI(s). When present, this IE shall contain the rejected NSSAI in the PLMN.
rejectedNssaiInTa	array(Snssai)	O	1..N	This IE may be included by the NSSF if the NSSF received the Requested NSSAI and the subscribed S-NSSAI(s). When present, this IE shall contain the rejected NSSAI in the current TA.
nsiInformation	NsiInformation	C	0..1	This IE shall be included by the NSSF if the NSSF received the S-NSSAI. (i.e. during PDU session establishment procedure) <p>This IE shall not be included if the "requestMapping" IE was included in the request message and was set to "true".</p>
supportedFeatures	SupportedFeatures	C	0..1	This IE shall be present if at least one optional feature defined in clause 6.1.8 is supported

nrfAmfSet	Uri	O	0..1	This IE may be included by the NSSF based on configuration and if the target AMF Set is included. When present, this IE shall contain the API URI of the NRF NFDISCOVERY Service (see clause 6.2.1 of 3GPP TS 29.510 [13]) to be used to determine the list of candidate AMF(s) from the AMF Set.
nrfAmfSetNfMgtUri	Uri	C	0..1	This IE should be present if the nrfAmfSet is present. When present, it shall contain the API URI of the NRF NFMANAGEMENT Service (see clause 6.1.1 of 3GPP TS 29.510 [13]).
nrfAmfSetAccessTokenUri	Uri	O	0..1	When present, this IE shall contain the API URI of the NRF ACCESS TOKEN Service (see clause 6.3.2 of 3GPP TS 29.510 [13]).
NOTE 1: The NF Service Consumer uses the PLMN ID, AMF Region and AMF Set to perform a NF Discovery to the NRF.				

## 6.1.6.2.3 Type: SubscribedSnssai

**Table 6.1.6.2.3-1: Definition of type SubscribedSnssai**

Attribute name	Data type	P	Cardinality	Description
subscribedSnssai	Snssai	M	1	This IE shall contain the subscribed S-NSSAI.
defaultIndication	boolean	O	0..1	If it is set, the subscribed S-NSSAI is a default subscribed S-NSSAI.

## 6.1.6.2.4 Void

## 6.1.6.2.5 Type: AllowedSnssai

**Table 6.1.6.2.5-1: Definition of type AllowedSnssai**

Attribute name	Data type	P	Cardinality	Description
allowedSnssai	Snssai	M	1	This IE shall contain the allowed S-NSSAI in the serving PLMN.
nsiInformation	array(NsiInformation)	O	1..N	This IE may be present when the NSSF provides the allowed NSSAI information to the NF service consumer (e.g AMF). If present, this IE shall include the information related to the network slice instance corresponding to the allowed S-NSSAI.
mappedHomeSnssai	Snssai	O	0..1	When present, this IE shall contain the mapped S-NSSAI value of home network corresponding to the allowed S-NSSAI in the serving PLMN.

## 6.1.6.2.6 Type: AllowedNssai

**Table 6.1.6.2.6-1: Definition of type AllowedNssai**

Attribute name	Data type	P	Cardinality	Description
allowedSnssaiList	array(AllowedSnssai)	M	1..N	This IE shall contain the allowed S-NSSAI in the serving PLMN.
accessType	AccessType	M	1	This IE shall contain the access type to which this allowed NSSAI belongs.

## 6.1.6.2.7 Type: NsilInformation

**Table 6.1.6.2.7-1: Definition of type NsilInformation**

Attribute name	Data type	P	Cardinality	Description
nrfld	Uri	M	1	This IE shall contain the API URI of the NRF NFDISCOVERY Service (see clause 6.2.1 of 3GPP TS 29.510 [13]) to be used to select the NFs/services within the selected Network Slice instance.
nsild	Nsild	O	0..1	This IE may be optionally included by the NSSF. When present, this IE shall contain the Identifier of the selected Network Slice instance
nrfNfMgtUri	Uri	O	0..1	This IE should be present. When present, it shall contain the API URI of the NRF NFMANAGEMENT Service (see clause 6.1.1 of 3GPP TS 29.510 [13]).
nrfAccessTokenUri	Uri	O	0..1	When present, this IE shall contain the API URI of the NRF ACCESS TOKEN Service (see clause 6.3.2 of 3GPP TS 29.510 [13]).

## 6.1.6.2.8 Type: MappingOfSnssai

**Table 6.1.6.2.8-1: Definition of type MappingOfSnssai**

Attribute name	Data type	P	Cardinality	Description
servingSnssai	Snssai	M	1	This IE shall contain the S-NSSAI value of serving network.
homeSnssai	Snssai	M	1	This IE shall contain the mapped S-NSSAI value of home network.



6.1.6.2.9 Void

6.1.6.2.10 Type: SliceInfoForRegistration

**Table 6.1.6.2.10-1: Definition of type SliceInfoForRegistration**

Attribute name	Data type	P	Cardinality	Description
subscribedNssai	array(SubscribedSnssai)	C	1..N	This IE shall be included during the initial registration procedure or during mobility registration procedure in 5GS. When present, this IE shall contain the list of subscribed S-NSSAIs along with an indication for each S-NSSAI if it is a default S-NSSAI.
allowedNssaiCurrentAccess	AllowedNssai	C	0..1	This IE shall be included during an initial registration procedure in 5GS or during mobility registration update procedure in 5GS with a native 5G-GUTI as the old GUTI, and an allowed NSSAI for the current access type of the UE is available at the NF service consumer (e.g AMF).
allowedNssaiOtherAccess	AllowedNssai	C	0..1	This IE shall be present during an initial registration procedure in 5GS or during mobility registration update procedure in 5GS with a native 5G-GUTI as the old GUTI, and if the UE was registered with the NF service consumer (e.g AMF) earlier for another access type and an allowed NSSAI for the other access type is available at the NF service consumer (e.g AMF).
sNssaiForMapping	array(Snssai)	C	1..N	This IEShall be included if the requestMapping IE is set to true. When included, this IE shall contain the set of S-NSSAIs obtained from PGW+SMF in the HPLMN for PDU sessions that are handed over from EPS to 5GS.
mappingOfNssai	array(MappingOfSnssai)	O	1..N	This IE may be present when the network slice information is requested during the Registration procedure. If present, this IE shall contain the mapping of S-NSSAI of the VPLMN to corresponding HPLMN S-NSSAI, for the S-NSSAIs included in the requestedNssai and allowedNssai IE.
requestedNssai	array(Snssai)	O	1..N	This IE may contain the set of S-NSSAIs requested by the UE.
defaultConfiguredSnssaiInd	boolean	C	0..1	This IE shall be present when the UE includes the Default Configured NSSAI Indication during the Registration procedure. true: The Default Configured NSSAI is indicated by the UE; false (default): The Default Configured NSSAI is not indicated by the UE.
requestMapping	boolean	O	0..1	This IE may be present when the Nnssf_NSSelection_Get procedure is invoked during EPS to 5GS Mobility Registration Procedure (Idle and Connected State) using N26 interface. When present this IE shall indicate to the NSSF that the NSSF shall return the VPLMN specific mapped SNSSAI values for the S-NSSAI values in the subscribedNssai IE.

## 6.1.6.2.11 Type: SliceInfoForPDUSession

**Table 6.1.6.2.11-1: Definition of type SliceInfoForPDUSession**

Attribute name	Data type	P	Cardinality	Description
sNssai	Snssai	M	1	This IE shall contain the requested S-NSSAI for the PDU session, when the AMF queries the NSSF in the serving PLMN. When the vNSSF queries the hNSSF during PDU session establishment for home routed roaming case, this IE shall contain the S-NSSAI from the HPLMN that maps to the S-NSSAI from the Allowed NSSAI of the Serving PLMN, as obtained from the NF Service Consumer of the vNSSF.
roamingIndication	RoamingIndication	M	1	This IE shall contain the indication whether the UE is in non-roaming, LBO roaming or HR roaming.
homeSnssai	Snssai	C	0..1	This IE shall be included by the NF Service Consumer (e.g. AMF) towards the vNSSF during PDU session establishment procedure in home routed roaming scenario. This IE shall contain the S-NSSAI of the HPLMN that maps to the S-NSSAI from the Allowed NSSAI of the Serving PLMN when the UE in the roaming scenario.

## 6.1.6.2.12 Type: ConfiguredSnssai

**Table 6.1.6.2.12-1: Definition of type ConfiguredSNssai**

Attribute name	Data type	P	Cardinality	Description
configuredSnssai	Snssai	M	1	This IE shall contain the configured S-NSSAI in the serving PLMN.
mappedHomeSnssai	Snssai	O	0..1	When present, this IE shall contain the mapped S-NSSAI value of home network corresponding to the configured S-NSSAI in the serving PLMN.

## 6.1.6.2.13 Type: SliceInfoForUEConfigurationUpdate

**Table 6.1.6.2.13-1: Definition of type SliceInfoForUEConfigurationUpdate**

Attribute name	Data type	P	Cardinality	Description
subscribedNssai	array(SubscribedSnssai)	C	1..N	This IE shall be included during UE configuration update procedure in 5GS. When present, this IE shall contain the list of subscribed S-NSSAIs along with an indication for each S-NSSAI if it is a default S-NSSAI.
allowedNssaiCurrentAccess	AllowedNssai	O	0..1	This IE may be included during UE configuration update procedure in 5GS. When present, this IE shall contain the list of allowed S-NSSAIs in the AMF for the current access type of the UE.
allowedNssaiOtherAccess	AllowedNssai	O	0..1	This IE may be included during UE configuration update procedure in 5GS. When present, this IE shall contain the list of allowed S-NSSAIs in the AMF for the other access type of the UE.
defaultConfiguredSnssaiInd	boolean	O	0..1	This IE may be present if the UE included the Default Configured NSSAI Indication during the recent Registration procedure.
requestedNssai	array(Snssai)	O	1..N	This IE may contain the set of S-NSSAIs requested by the UE in the recent registration procedure.
mappingOfNssai	array(MappingOfSnssai)	O	1..N	This IE may be present when the network slice information is requested during UE configuration update procedure. If present, this IE shall contain the mapping of S-NSSAI of the VPLMN to corresponding HPLMN S-NSSAI, for the S-NSSAIs included in the requestedNssai and the allowedNssai IEs for current and other access types.

## 6.1.6.3 Simple data types and enumerations

## 6.1.6.3.1 Introduction

This clause defines simple data types and enumerations that can be referenced from data structures defined in the previous clauses.

## 6.1.6.3.2 Simple data types

The simple data types defined in table 6.1.6.3.2-1 shall be supported.

**Table 6.1.6.3.2-1: Simple data types**

Type Name	Type Definition	Description
Nsild	string	Represents the Network Slice Instance Identifier

## 6.1.6.3.3 Enumeration: RoamingIndication

**Table 6.1.6.3.3-1: Enumeration RoamingIndication**

Enumeration value	Description
NON_ROAMING	This value indicates that the UE is not roaming.
LOCAL_BREAKOUT	This value indicates that the UE is roaming but is using a local breakout PDU session.
HOME_ROUTED_ROAMING	This value indicates that the UE is roaming and is using a home routed PDU session.

### 6.1.6.4 Binary data

There is no binary data used for the Nnssf\_NSSelection service in this version of the API.

## 6.1.7 Error Handling

### 6.1.7.1 General

HTTP error handling shall be supported as specified in clause 5.2.4 of 3GPP TS 29.500 [4].

### 6.1.7.2 Protocol Errors

Protocol Error Handling shall be supported as specified in clause 5.2.7.2 of 3GPP TS 29.500 [4].

### 6.1.7.3 Application Errors

The common application errors defined in the Table 5.2.7.2-1 in 3GPP TS 29.500 [4] may also be used for the Nnssf\_NSSelection service. The following application errors listed in Table 6.1.7.3-1 are specific for the Nnssf\_NSSelection service.

**Table 6.1.7.3-1: Application errors**

Application Error	HTTP status code	Description
SNSSAI_NOT_SUPPORTED	403 Forbidden	This cause value shall be set when the requested slice selection information is for SNSSAI(s) not supported in the PLMN.

## 6.1.8 Feature negotiation

The feature negotiation mechanism specified in clause 6.6 of 3GPP TS 29.500 [4] shall be used to negotiate the optional features applicable between the NSSF and the NF Service Consumer, for the Nnssf\_NSSelection service, if any.

The NF Service Consumer shall indicate the optional features it supports for the Nnssf\_NSSelection service, if any, by including the supportedFeatures attribute in the HTTP POST request when requesting the NSSF to provide the allowed NSSAI information.

The NSSF shall determine the supported features for the requested network slice information resource as specified in clause 6.6 of 3GPP TS 29.500 [4] and shall indicate the supported features by including the supportedFeatures attribute in the allowed NSSAI information it returns in the HTTP response.

The syntax of the supportedFeatures attribute is defined in clause 5.2.2 of 3GPP TS 29.571 [5].

The following features are defined for the Nnssf\_NSSelection service.

**Table 6.1.8-1: Features of supportedFeatures attribute used by Nnssf\_NSSelection service**

Feature Number	Feature	M/O	Description
Feature number: The order number of the feature within the supportedFeatures attribute (starting with 1). Feature: A short name that can be used to refer to the bit and to the feature. M/O: Defines if the implementation of the feature is mandatory ("M") or optional ("O"). Description: A clear textual description of the feature.			

## 6.1.9 Security

As indicated in 3GPP TS 33.501 [11] and 3GPP TS 29.500 [4], the access to the Nnssf\_NSSelection API may be authorized by means of the OAuth2 protocol (see IETF RFC 6749 [12]), based on local configuration, using the "Client Credentials" authorization grant, where the NRF (see 3GPP TS 29.510 [13]) plays the role of the authorization server.

If OAuth2 is used, an NF Service Consumer, prior to consuming services offered by the Nnssf\_NSSelection API, shall obtain a "token" from the authorization server, by invoking the Access Token Request service, as described in 3GPP TS 29.510 [13], clause 5.4.2.2.

NOTE: When multiple NRFs are deployed in a network, the NRF used as authorization server is the same NRF that the NF Service Consumer used for discovering the Nnssf\_NSSelection service.

The Nnssf\_NSSelection API does not define any scopes for OAuth2 authorization.

## 6.2 Nnssf\_NSSAIAvailability Service API

### 6.2.1 API URI

The Nnssf\_NSSAIAvailability service shall use the Nnssf\_NSSAIAvailability API.

The request URI used in HTTP request from the NF service consumer towards the NF service producer shall have the structure defined in clause 4.4.1 of 3GPP TS 29.501 [5], i.e.:

**{apiRoot}/nssf-nssaiavailability/{apiVersion}/<apiSpecificResourceUriPart>**

with the following components:

- The {apiRoot} shall be set as described in 3GPP TS 29.501 [5].
- The {apiVersion} shall be "v1".
- The <apiSpecificResourceUriPart> shall be set as described in clause 6.2.3.

### 6.2.2 Usage of HTTP

#### 6.2.2.1 General

HTTP/2, IETF RFC 7540 [10], shall be used as specified in clause 5 of 3GPP TS 29.500 [4].

An OpenAPI [6] specification of HTTP messages and content bodies for the Nnssf\_NSSAIAvailability service is specified in Annex A.

#### 6.2.2.2 HTTP standard headers

##### 6.2.2.2.1 General

See clause 5.2.2 of 3GPP TS 29.500 [4] for the usage of HTTP standard headers.

##### 6.2.2.2.2 Content type

The JSON format shall be supported. The use of JSON format shall be as specified in clause 5.4 of 3GPP TS 29.500 [4].

The following content types shall be supported:

- JSON, as defined in IETF RFC 8259 [14], shall be used as content type of the HTTP bodies specified in the present specification as indicated in clause 5.4 of 3GPP TS 29.500 [4].

- The Problem Details JSON Object (IETF RFC 7807 [15]). The use of the Problem Details JSON object in a HTTP response body shall be signalled by the content type "application/problem+json".
- JSON Patch (IETF RFC 6902 [8]). The use of the JSON Patch format in a HTTP request body shall be signalled by the content type "application/json-patch+json".

### 6.2.2.2.3 Accept-Encoding

The NSSF should support gzip coding (see IETF RFC 1952 [16]) in HTTP requests and responses and indicate so in the Accept-Encoding header, as described in clause 6.9 of 3GPP TS 29.500 [4].

## 6.2.2.3 HTTP custom headers

### 6.2.2.3.1 General

In this release of this specification, no custom headers specific to the Nnssf\_NSSAIAvailability service are defined. For 3GPP specific HTTP custom headers used across all service based interfaces, see clause 5.2.3 of 3GPP TS 29.500 [4].

## 6.2.3 Resources

### 6.2.3.1 Overview

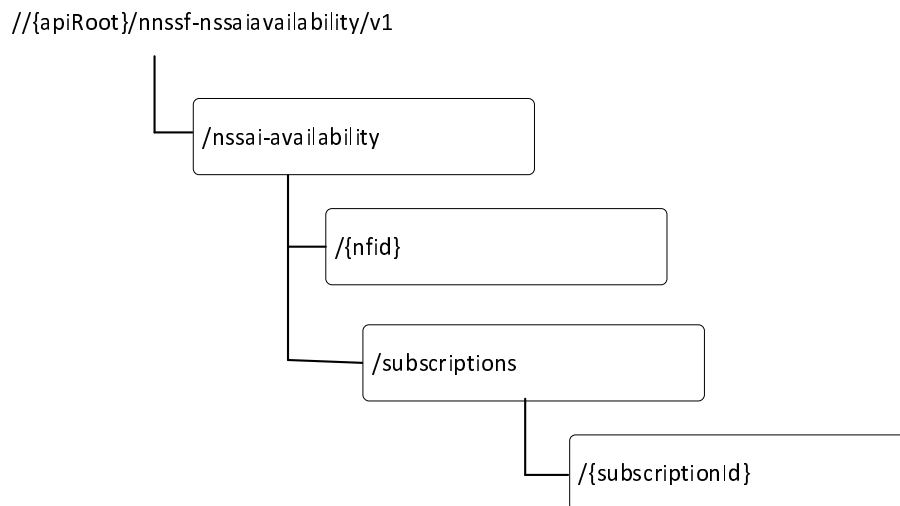

**Figure 6.2.3.1-1: Resource URI structure of the Nnssf\_NSSAIAvailability API**

Table 6.2.3.1-1 provides an overview of the resources and applicable HTTP methods.

**Table 6.2.3.1-1: Resources and methods overview**

Resource name	Resource URI	HTTP method or custom operation	Description
NSSAI Availability Store	{apiRoot}/nnsf-nssaiavailability/v1/nssai-availability	OPTIONS	Discover the communication options supported by the NSSF for this resource.
NSSAI Availability Document	{apiRoot}/nnsf-nssaiavailability/{apiVersion}/nssai-availability/{nflid}	PUT	Updates the NSSF with the S-NSSAIs the NF service consumer (e.g. AMF) supports per TA.
		PATCH	Updates the NSSF with the S-NSSAIs the NF service consumer (e.g. AMF) supports per TA.
		DELETE	Delete the resource of the S-NSSAIs supported per TA by the NF service consumer (e.g. AMF)
NSSAI Availability Notification Subscriptions Collection	{apiRoot}/nnsf-nssaiavailability/{apiVersion}/nssai-availability/subscriptions	POST	Create a subscription to the notification of any changes to the NSSAI availability information.
Individual NSSAI Availability Notification Subscriptions	{apiRoot}/nnsf-nssaiavailability/{apiVersion}/nssai-availability/subscriptions/{subscriptionId}	DELETE	Unsubscribe to the notification of any changes to the NSSAI availability information.

### 6.2.3.2 Resource: NSSAI Availability Document

#### 6.2.3.2.1 Description

This resource represents a single NSSAI Availability resource.

This resource is modelled with the Document resource archetype (see clause C.1 of 3GPP TS 29.501 [5]).

#### 6.2.3.2.2 Resource Definition

Resource URI: {apiRoot}/nnsf-nssaiavailability/{apiVersion}/nssai-availability/{nflid}

This resource shall support the resource URI variables defined in table 6.2.3.2.2-1.

**Table 6.2.3.2.2-1: Resource URI variables for this resource**

Name	Definition
apiRoot	See clause 6.2.1
apiVersion	See clause 6.2.1
nflid	Represents the Identifier of the AMF for which the NSSAI Availability information is updated.

### 6.2.3.2.3 Resource Standard Methods

#### 6.2.3.2.3.1 PUT

This method shall support the request data structures specified in table 6.2.3.2.3.1-1 and the response data structures and response codes specified in table 6.2.3.2.3.1-2.

**Table 6.2.3.2.3.1-1: Data structures supported by the PUT Request Body on this resource**

Data type	P	Cardinality	Description
NSSAIAvailabilityInfo	M	1	This IE contains the information regarding the NssaiAvailabilityData for the NF Service Consumer (e.g AMF).

**Table 6.2.3.2.3.1-2: Data structures supported by the PUT Response Body on this resource**

Data type	P	Cardinality	Response codes	Description
AuthorizedNssaiAvailabilityInfo	M	1	200 OK	This case represents a successful update of the NSSF with the S-NSSAIs the AMF supports per TA.  The authorized NSSAI availability (i.e. S-NSSAIs available per TA (unrestricted) and any S-NSSAIs restricted per PLMN in that TA in the serving PLMN of the UE) information shall be returned in the response payload body.
ProblemDetails	M	1	403 Forbidden	This represents the case, when the NF service consumer is not authorized to update the NSSAI availability information or the TAI/S-NSSAI information provided is not supported in the PLMN. The "cause" attribute shall be set to:  - "SNSSAI_NOT_SUPPORTED", if the S-NSSAI provided is not supported in the PLMN.
ProblemDetails	M	1	404 Not Found	This represents the case when the resource related to the NF Id for which the NSSAI availability information is updated is unavailable.

## 6.2.3.2.3.2 PATCH

This method shall support the request data structures specified in table 6.2.3.2.3.2-1 and the response data structures and response codes specified in table 6.2.3.2.3.2-2.

**Table 6.2.3.2.3.2-1: Data structures supported by the PATCH Request Body on this resource**

Data type	P	Cardinality	Description
PatchDocument	M	1	This IE contains the information regarding the JSON patch instructions for updating the AuthorizedNssaiAvailabilityInfo.

**Table 6.2.3.2.3.2-2: Data structures supported by the PATCH Response Body on this resource**

Data type	P	Cardinality	Response codes	Description
AuthorizedNssaiAvailabilityInfo	M	1	200 OK	This case represents a successful update of the NSSF with the S-NSSAIs the AMF supports per TA.  If the authorized NSSAI availability (i.e. S-NSSAIs available per TA (unrestricted) and any S-NSSAIs restricted per PLMN in that TA in the serving PLMN of the UE) is changed, the NSSF shall return a data structure of type "AuthorizedNssaiAvailabilityInfo" in the response payload body.
ProblemDetails	M	1	403 Forbidden	This represents the case, when the NF service consumer is not authorized to update the NSSAI availability information or the S-NSSAI information provided is not supported in the PLMN. The "cause" attribute shall be set to:  - "SNSSAI_NOT_SUPPORTED", if the S-NSSAI provided is not supported in the PLMN.
ProblemDetails	M	1	404 Not Found	This represents the case when the resource related to the NF Id for which the NSSAI availability information is updated is unavailable.



## 6.2.3.2.3.3 DELETE

This method shall support the request data structures specified in table 6.2.3.2.3.3-1 and the response data structures and response codes specified in table 6.2.3.2.3.3-2.

**Table 6.2.3.2.3.3-1: Data structures supported by the DELETE Request Body on this resource**

Data type	P	Cardinality	Description
n/a			

**Table 6.2.3.2.3.3-2: Data structures supported by the DELETE Response Body on this resource**

Data type	P	Cardinality	Response codes	Description
n/a			204 No Content	
ProblemDetails	M	1	404 Not Found	This represents the case when the resource related to the NF Id for which the NSSAI availability information is updated is unavailable.

## 6.2.3.3 Resource: NSSAI Availability Notification Subscriptions Collection

## 6.2.3.3.1 Description

This resource represents the collection of NSSAI Availability Notification Subscriptions in the NSSF.

This resource is modelled with the Collection resource archetype (see clause C.2 of 3GPP TS 29.501 [5]).

## 6.2.3.3.2 Resource Definition

Resource URI: {apiRoot}/nssf-nssaiavailability/{apiVersion}/nssai-availability/subscriptions

This resource shall support the resource URI variables defined in table 6.2.3.3.2-1.

**Table 6.2.3.3.2-1: Resource URI variables for this resource**

Name	Definition
apiRoot	See clause 6.2.1
apiVersion	See clause 6.2.1

## 6.2.3.3.3 Resource Standard Methods

## 6.2.3.3.3.1 POST

This method shall support the request data structures specified in table 6.2.3.3.3.1-1 and the response data structures and response codes specified in table 6.2.3.3.3.1-2.

**Table 6.2.3.3.3.1-1: Data structures supported by the POST Request Body on this resource**

Data type	P	Cardinality	Description
NssfEventSubscriptionCreateData	M	1	This IE contains the information regarding the SubscriptionData for the AMF to notify any changes to the NSSAI availability information.

**Table 6.2.3.3.1-2: Data structures supported by the POST Response Body on this resource**

Data type	P	Cardinality	Response codes	Description
NssfEventSubscriptionCreatedData	M	1	201 Created	This case represents a successful creation of subscription to the change of NSSAI availability information.
ProblemDetails	M	1	403 Forbidden	This represents the case, when the NF service consumer is not authorized to subscribe for the NSSAI availability information notification.
ProblemDetails	M	1	404 Not Found	This represents the case when the subscriptions collection resource does not exist at the NSSF..

### 6.2.3.4 Resource: Individual NSSAI Availability Notification Subscriptions

#### 6.2.3.4.1 Description

This resource represents an Individual NSSAI Availability Notification Subscriptions resources generated by the NSSF. This resource is modelled with the Document resource archetype (see clause C.1 of 3GPP TS 29.501 [5]).

#### 6.2.3.4.2 Resource Definition

Resource URI: {apiRoot}/nssf-nssaiavailability/{apiVersion}/nssai-availability/subscriptions/{subscriptionId}

This resource shall support the resource URI variables defined in table 6.2.3.4.2-1.

**Table 6.2.3.3.2-1: Resource URI variables for this resource**

Name	Definition
apiRoot	See clause 6.2.1
apiVersion	See clause 6.2.1
subscriptionId	Represents the Identifier of the subscription.

#### 6.2.3.4.3 Resource Standard Methods

##### 6.2.3.4.3.1 DELETE

This method shall support the request data structures specified in table 6.2.3.4.3.2-1 and the response data structures and response codes specified in table 6.2.3.4.3.2-2.

**Table 6.2.3.3.3.2-1: Data structures supported by the DELETE Request Body on this resource**

Data type	P	Cardinality	Description
N/A			

**Table 6.2.3.4.3.2-2: Data structures supported by the DELETE Response Body on this resource**

Data type	P	Cardinality	Response codes	Description
N/A			204 NO Content	This case represents a successful deletion of the subscription.
ProblemDetails	M	1	404 Not Found	This represents the case when the subscription resource is unavailable.

### 6.2.3.5 Resource: NSSAI Availability Store

#### 6.2.3.5.1 Description

This resource represents a collection of NSSAI Availability resources.

This resource is modelled with the Store resource archetype (see clause C.1 of 3GPP TS 29.501 [5]).

#### 6.2.3.5.2 Resource Definition

Resource URI: {apiRoot}/nssf-nssaiavailability/v1/nssai-availability

This resource shall support the resource URI variables defined in table 6.2.3.5.2-1.

**Table 6.2.3.5.2-1: Resource URI variables for this resource**

Name	Definition
apiRoot	See clause 6.2.1

#### 6.2.3.5.3 Resource Standard Methods

##### 6.2.3.5.3.1 OPTIONS

This method queries the communication options supported by the NSSF (see clause 6.x of 3GPP TS 29.500 [4]). This method shall support the URI query parameters specified in table 6.1.3.5.3.1-1.

**Table 6.2.3.5.3.1-1: URI query parameters supported by the OPTIONS method on this resource**

Name	Data type	P	Cardinality	Description
n/a				

This method shall support the request data structures specified in table 6.2.3.5.3.1-2 and the response data structures and response codes specified in table 6.2.3.5.3.2-3.

**Table 6.2.3.5.3.1-2: Data structures supported by the OPTIONS Request Body on this resource**

Data type	P	Cardinality	Description
n/a			

**Table 6.2.3.5.3.1-3: Data structures supported by the OPTIONS Response Body on this resource**

Data type	P	Cardinality	Response codes	Description
n/a	M	1	200 OK	
ProblemDetails	M	1	405 Method Not Allowed	
ProblemDetails	M	1	501 Not Implemented	
NOTE: The mandatory HTTP error status codes for the OPTIONS method listed in Table 5.2.7.1-1 of 3GPP TS 29.500 [4] other than those specified in the table above also apply, with a ProblemDetails data type (see clause 5.2.7 of 3GPP TS 29.500 [4]).				

## 6.2.4 Custom Operations without associated resources

There are no custom operations without associated resources for the Nnssf\_NSSAIAvailability service in this version of the API.

## 6.2.5 Notifications

### 6.2.5.1 General

This clause specifies the notifications provided by the Nnssf\_NSSAIAvailability service.

### 6.2.5.2 NSSAI Availability Notification

#### 6.2.5.2.1 Description

If the NF Service Consumer (e.g. AMF) has provided the callback URI for getting notified about the NSSAI availability information, the NSSF shall notify the NF Service Consumer whenever the NSSAI availability information is updated.

#### 6.2.5.2.2 Notification Definition

Resource URI: {nfNssaiAvailabilityUri}

This resource URI is provided by the NF Service Consumer (e.g. AMF) during NSSAI Availability Information update invoked by the NF Service Consumer.

**Table 6.2.5.2.2-1: Resources and methods overview**

Resource name	Resource URI	HTTP method or custom operation	Description
NSSAI Availability Notification Callback	{nfNssaiAvailabilityUri}	POST	The NSSF uses this callback URI to Update the AMF with any S-NSSAIs restricted per TA in the serving PLMN of the UE.

### 6.2.5.2.3 Notification Standard Methods

#### 6.2.5.2.3.1 POST

This method shall support the request data structures specified in table 6.2.5.2.3.1-1 and the response data structures and response codes specified in table 6.2.5.2.3.1-2.

**Table 6.2.5.2.3.1-1: Data structures supported by the POST Request Body on this resource**

Data type	P	Cardinality	Description
NssfEventNotification	M	1	Representation of the data to be sent to the NF service consumer (e.g. AMF) to update NSSAI availability information, authorized by the NSSF in the serving PLMN.

**Table 6.2.5.2.3.1-2: Data structures supported by the POST Response Body on this resource**

Data type	P	Cardinality	Response codes	Description
n/a			204 No Content	This case represents a successful update of the NF service consumer (e.g. AMF) with NSSAI availability information.

## 6.2.6 Data Model

### 6.2.6.1 General

This clause specifies the application data model supported by the API.

Table 6.2.6.1-1 specifies the data types defined for the Nnssf\_NSSAIAvailability service based interface protocol.

**Table 6.2.6.1-1: Nnssf\_NSSAIAvailability specific Data Types**

Data type	Section defined	Description
NssaiAvailabilityInfo	6.2.6.2.2	This contains the Nssai availability information requested by the AMF.
SupportedNssaiAvailabilityData	6.2.6.2.3	This contains the Nssai availability data information per TA supported by the AMF.
AuthorizedNssaiAvailabilityData	6.2.6.2.4	This contains the Nssai availability data information per TA authorized by the NSSF.
RestrictedSnssai	6.2.6.2.5	This contains the restricted SNssai information per PLMN.
AuthorizedNssaiAvailabilityInfo	6.2.6.2.6	This contains the Nssai availability data information authorized by the NSSF.
PatchDocument	6.2.6.2.7	This contains the JSON Patch instructions for updating the Nssai availability data information at the NSSF.
NssfEventSubscriptionCreateData	6.2.6.2.8	This contains the information for event subscription.
NssfEventSubscriptionCreatedData	6.2.6.2.9	This contains the information for event subscription.
NssfEventNotification	6.2.6.2.10	This contains the information for created event subscription.

Table 6.2.6.1-2 specifies data types re-used by the Nnssf service based interface protocol from other specifications.

**Table 6.2.6.1-2: Nnssf-re-used Data Types**

Data type	Reference	Comments
SupportedFeatures	3GPP TS 29.571 [7]	Used to negotiate the applicability of the optional features defined in table 6.2.8-1.
Snssai	3GPP TS 29.571 [7]	
PatchItem	3GPP TS 29.571 [7]	Identifies the JSON Patch instructions
DateTime	3GPP TS 29.571 [7]	

### 6.2.6.2 Structured data types

#### 6.2.6.2.1 Introduction

This clause defines the structures to be used in resource representations.

## 6.2.6.2.2 Type: NssaiAvailabilityInfo

**Table 6.2.6.2.2-1: Definition of type NssaiAvailabilityInfo**

Attribute name	Data type	P	Cardinality	Description
supportedNssaiAvailabilityData	array(SupportedNssaiAvailabilityData)	M	1..N	This IE shall contain the information regarding the S-NSSAIs the NF service consumer (e.g. AMF) and the 5G-AN supports per TA.
supportedFeatures	SupportedFeatures	C	0..1	This IE shall be present if at least one optional feature defined in clause 6.2.8 is supported
amfSetId	string	O	0..1	This IE may be included to indicate the AMF set identifier for the AMFs serving the TAs where the NSSAI is available. When present, this IE shall be constructed from PLMN-ID (i.e. three decimal digits MCC and two or three decimal digits MNC), AMF Region Id (8 bit), and AMF Set Id (10 bit).  Pattern: '^[0-9]{3}-[0-9]{2-3}-[A-Fa-f0-9]{2}-[0-3][A-Fa-f0-9]{2}\$'

## 6.2.6.2.3 Type: SupportedNssaiAvailabilityData

**Table 6.2.6.2.3-1: Definition of type SupportedNssaiAvailabilityData**

Attribute name	Data type	P	Cardinality	Description
tai	Tai	M	1	This IE shall contain the identifier of the Tracking Area
supportedSnssaiList	array(Snssai)	M	1..N	This IE shall contain the S-NSSAI(s) supported by the AMF for the TA.

## 6.2.6.2.4 Type: AuthorizedNssaiAvailabilityData

**Table 6.2.6.2.4-1: Definition of type AuthorizedNssaiAvailabilityData**

Attribute name	Data type	P	Cardinality	Description
tai	Tai	M	1	This IE shall contain the identifier of the Tracking Area.
supportedSnssaiList	array(Snssai)	M	1..N	This IE shall contain the S-NSSAI(s) supported by the AMF and 5G-AN and authorized by the NSSF for the TA.
restrictedSnssaiList	array(RestrictedSnssai)	O	1..N	This IE may contain the restricted S-NSSAI(s) per PLMN for the TA. If the restricted S-NSSAI is not present, no restricted S-NSSAI is applicable to the TA. When present, this IE shall be included only by the NSSF.

## 6.2.6.2.5 Type: RestrictedSnssai

**Table 6.2.6.2.5-1: Definition of type RestrictedSnssai**

Attribute name	Data type	P	Cardinality	Description
homePlmnId	PlmnId	M	1	This IE shall contain the home PLMN ID of the PLMN with which the serving network has roaming agreement.
sNssaiList	array(Snssai)	M	1..N	This IE shall contain the array of restricted S-NSSAIs for the home PLMN Id.

## 6.2.6.2.6 Type: AuthorizedNssaiAvailabilityInfo

**Table 6.2.6.2.6 -1: Definition of type AuthorizedNssaiAvailabilityInfo**

Attribute name	Data type	P	Cardinality	Description
authorizedNssaiAvailabilityData	array(AuthorizedNssaiAvailabilityData)	M	1..N	Contains the authorized NSSAI availability information.
supportedFeatures	SupportedFeatures	C	0..1	This IE shall be present if at least one optional feature defined in clause 6.2.8 is supported

## 6.2.6.2.7 Type: PatchDocument

**Table 6.2.6.2.7-1: Definition of type PatchDocument**

Attribute name	Data type	P	Cardinality	Description
N/A	array(PatchItem)	M	1..N	An array of patch instructions to update the NSSAI availability information at the NSSF. See 3GPP TS 29.571 [7].

## 6.2.6.2.8 Type: NssfEventSubscriptionCreateData

**Table 6.2.6.2.8-1: Definition of type NssfEventSubscriptionCreateData**

Attribute name	Data type	P	Cardinality	Description
nfNssaiAvailabilityUri	Uri	M	1	Identifies the recipient of notifications sent by the NF service consumer (e.g. AMF) for this subscription
taiList	array(Tai)	M	1..N	Identifies the TAIs supported by the NF service consumer (e.g. AMF).
event	NssfEventType	M	1	Describes the event to be subscribed for this subscription.
expiry	DateTime	O	0..1	This IE may be included by the NF service consumer. When present, this IE shall represent the suggested time after which the subscription becomes invalid.
amfSetId	string	O	0..1	This IE may be included to identify a specific AMF Set for which this subscription applies.  When present, this IE shall be constructed from PLMN-ID (i.e. three decimal digits MCC and two or three decimal digits MNC), AMF Region Id (8 bit), and AMF Set Id (10 bit).  Pattern: '^([0-9]{3}-[0-9]{2-3}-[A-Fa-f0-9]{2}-[0-3][A-Fa-f0-9]{2})\$'

## 6.2.6.2.9 Type: NssfEventSubscriptionCreatedData

**Table 6.2.6.2.9-1: Definition of type NssfEventSubscriptionCreatedData**

Attribute name	Data type	P	Cardinality	Description
subscriptionId	string	M	1	Identifies the subscription Id for the created subscription.
expiry	DateTime	C	0..1	This IE shall be included, if, based on operator policy and taking into account the expiry time included in the request, the AMF needs to include an expiry time. When present, it represents the time after which the subscribed event shall stop generating report and the subscription becomes invalid. Upon reaching this expiry time the NF service consumer shall delete the representation of the subscription it may have.
authorizedNssaiAvailabilityData	array(AuthorizedNssaiAvailabilityData)	O	1..N	If the authorized NSSAI availability (i.e. S-NSSAIs available per TA (unrestricted) and any S-NSSAIs restricted per PLMN in that TA in the serving PLMN of the UE) is available, the NSSF may include this IE.

## 6.2.6.2.10 Type: NssfEventNotification

**Table 6.2.6.2.10-1: Definition of type NssfEventNotification**

Attribute name	Data type	P	Cardinality	Description
subscriptionId	string	M	1	Indicates which subscription generated event notification.  This parameter is generated by NSSF and returned in "Location" header in HTTP responses. This can be useful if a NF use a common call-back URI for multiple subscriptions.
authorizedNssaiAvailabilityData	array(AuthorizedNssaiAvailabilityData)	M	1..N	This IE shall contain the authorized NSSAI availability information for all TAs the AMF subscribed to. Each element shall contain the current status of the list of S-NSSAI available in a TA and the list of S-NSSAI restricted per PLMN in that TA.  The NF Service Consumer shall replace any authorizedNssaiAvailabilityData received earlier by the new authorizedNssaiAvailabilityData received in the notification.

## 6.2.6.3 Simple data types and enumerations

## 6.2.6.3.1 Introduction

This clause defines simple data types and enumerations that can be referenced from data structures defined in the previous clauses.

## 6.2.6.3.2 Simple data types

The simple data types defined in table 6.2.6.3.2-1 shall be supported.



**Table 6.2.6.3.2-1: Simple data types**

Type Name	Type Definition	Description
	<one simple data type, e.g. boolean, integer, null, number, string>	

### 6.2.6.3.3 Enumeration: NssfEventType

**Table 6.2.6.3.3-1: Enumeration NssfEventType**

Enumeration value	Description
"S-NSSAI_STATUS_CHANGE_REPORT"	A NF subscribes to this event to receive the status change about the current S-NSSAI available (i.e unrestricted) per TA and the status change about the list of restricted S-NSSAI per TA and per PLMN in the serving PLMN of the UE.

### 6.2.6.4 Binary data

There is no binary data used for the Nnsf\_NSSAIAvailability service in this version of the API.

## 6.2.7 Error Handling

### 6.2.7.1 General

HTTP error handling shall be supported as specified in clause 5.2.4 of 3GPP TS 29.500 [4].

### 6.2.7.2 Protocol Errors

Protocol Error Handling shall be supported as specified in clause 5.2.7.2 of 3GPP TS 29.500 [4].

### 6.2.7.3 Application Errors

The common application errors defined in the Table 5.2.7.2-1 in 3GPP TS 29.500 [4] may also be used for the Nnsf\_NSSAIAvailability service. The following application errors listed in Table 6.1.7.3-1 are specific for the Nnsf\_NSSAIAvailability service.

**Table 6.2.7.3-1: Application errors**

Application Error	HTTP status code	Description
SNSSAI_NOT_SUPPORTED	403 Forbidden	For Nnsf_NSSAIAvailability service, the SNSSAI provided in the request is not supported in the PLMN.  For Nnsf_NSSelection service, the S-NSSAI provided in the request is not allowed in the PLMN and there is no default NSSAI provided in the request.

## 6.2.8 Feature negotiation

The feature negotiation mechanism specified in clause 6.6 of 3GPP TS 29.500 [4] shall be used to negotiate the optional features applicable between the NSSF and the NF Service Consumer, for the Nnsf\_NSSAIAvailability service, if any.

The NF Service Consumer shall indicate the optional features it supports for the Nnsf\_NSSAIAvailability service, if any, by including the supportedFeatures attribute in the HTTP PUT request when requesting the NSSF to update the NSSAI Availability information.

The NSSF shall determine the supported features for the updated NSSAI Availability information resource as specified in clause 6.6 of 3GPP TS 29.500 [4] and shall indicate the supported features by including the supportedFeatures attribute in the authorized NSSAI availability information it returns in the HTTP response.

The syntax of the supportedFeatures attribute is defined in clause 5.2.2 of 3GPP TS 29.571 [5].

The following features are defined for the Nnssf\_NSSAIAvailability service.

**Table 6.2.8-1: Features of supportedFeatures attribute used by Nnssf\_NSSAIAvailability service**

Feature Number	Feature	M/O	Description
Feature number: The order number of the feature within the supportedFeatures attribute (starting with 1). Feature: A short name that can be used to refer to the bit and to the feature. M/O: Defines if the implementation of the feature is mandatory ("M") or optional ("O"). Description: A clear textual description of the feature.			

## 6.2.9 Security

As indicated in 3GPP TS 33.501 [11] and 3GPP TS 29.500 [4], the access to the Nnssf\_NSSAIAvailability API may be authorized by means of the OAuth2 protocol (see IETF RFC 6749 [12]), based on local configuration, using the "Client Credentials" authorization grant, where the NRF (see 3GPP TS 29.510 [13]) plays the role of the authorization server.

If OAuth2 is used, an NF Service Consumer, prior to consuming services offered by the Nnssf\_NSSAIAvailability API, shall obtain a "token" from the authorization server, by invoking the Access Token Request service, as described in 3GPP TS 29.510 [13], clause 5.4.2.2.

**NOTE:** When multiple NRFs are deployed in a network, the NRF used as authorization server is the same NRF that the NF Service Consumer used for discovering the Nnssf\_NSSAIAvailability service.

The Nnssf\_NSSAIAvailability API does not define any scopes for OAuth2 authorization.

# Annex A (normative): OpenAPI specification

## A.1 General

This Annex specifies the formal definition of the Nnssf\_NSSelection service. It consists of OpenAPI 3.0.0 specifications, in YAML format.

This Annex takes precedence when being discrepant to other parts of the specification with respect to the encoding of information elements and methods within the API(s).

NOTE 1: The semantics and procedures, as well as conditions, e.g. for the applicability and allowed combinations of attributes or values, not expressed in the OpenAPI definitions but defined in other parts of the specification also apply.

Informative copies of the OpenAPI specification files contained in this 3GPP Technical Specification are available on the public 3GPP file server in the following locations (see clause 5B of the 3GPP TR 21.900 [17] for further information):

- <https://www.3gpp.org/ftp/Specs/archive/OpenAPI/<Release>/>, and
- <https://www.3gpp.org/ftp/Specs/<Plenary>/<Release>/OpenAPI/>.

NOTE 2: To fetch the OpenAPI specification file after CT#83 plenary meeting for Release 15 in the above links <Plenary> must be replaced with the date the CT Plenary occurs, in the form of year-month (yyyy-mm), e.g. for CT#83 meeting <Plenary> must be replaced with value "2019-03" and <Release> must be replaced with value "Rel-15".

## A.2 Nnssf\_NSSelection API

```
openapi: 3.0.0

info:
  version: '2.0.1'
  title: 'NSSF NS Selection'
  description: |
    NSSF Network Slice Selection Service.
    © 2019, 3GPP Organizational Partners (ARIB, ATIS, CCSA, ETSI, TSDSI, TTA, TTC).
    All rights reserved.
security:
  - {}
  - oAuth2ClientCredentials:
    - nnssf-nssselection
servers:
  - url: '{apiRoot}/nnssf-nssselection/v2'
    variables:
      apiRoot:
        default: https://example.com
        description: apiRoot as defined in clause 4.4 of 3GPP TS 29.501
externalDocs:
  description: 3GPP TS 29.531 V15.3.0; 5G System; Network Slice Selection Services; Stage 3
  url: http://www.3gpp.org/ftp/Specs/archive/29_series/29.531/
paths:
  /network-slice-information:
    get:
      summary: Retrieve the Network Slice Selection Information
      tags:
        - Network Slice Information (Document)
      operationId: NSSelectionGet
      parameters:
        - name: nf-type
          in: query
          description: NF type of the NF service consumer
          required: true
          schema:
```

```

    $ref: 'TS29510_Nnrf_NFManagement.yaml#/components/schemas/NFType'
  - name: nf-id
    in: query
    description: NF Instance ID of the NF service consumer
    required: true
    schema:
      $ref: 'TS29571_CommonData.yaml#/components/schemas/NfInstanceId'
  - name: slice-info-request-for-registration
    in: query
    description: Requested network slice information during Registration procedure
    content:
      application/json:
        schema:
          $ref: '#/components/schemas/SliceInfoForRegistration'
  - name: slice-info-request-for-pdu-session
    in: query
    description: Requested network slice information during PDU session establishment
procedure
    content:
      application/json:
        schema:
          $ref: '#/components/schemas/SliceInfoForPDUSession'
  - name: slice-info-request-for-ue-cu
    in: query
    description: Requested network slice information during UE configuration update procedure
    content:
      application/json:
        schema:
          $ref: '#/components/schemas/SliceInfoForUEConfigurationUpdate'
  - name: home-plmn-id
    in: query
    description: PLMN ID of the HPLMN
    content:
      application/json:
        schema:
          $ref: 'TS29571_CommonData.yaml#/components/schemas/PlmnId'
  - name: tai
    in: query
    description: TAI of the UE
    content:
      application/json:
        schema:
          $ref: 'TS29571_CommonData.yaml#/components/schemas/Tai'
  - name: supported-features
    in: query
    description: Features required to be supported by the NFs in the target slice instance
    schema:
      $ref: 'TS29571_CommonData.yaml#/components/schemas/SupportedFeatures'

responses:
  '200':
    description: OK (Successful Network Slice Selection)
    content:
      application/json:
        schema:
          $ref: '#/components/schemas/AuthorizedNetworkSliceInfo'
  '400':
    $ref: 'TS29571_CommonData.yaml#/components/responses/400'
  '401':
    $ref: 'TS29571_CommonData.yaml#/components/responses/401'
  '403':
    $ref: 'TS29571_CommonData.yaml#/components/responses/403'
  '404':
    $ref: 'TS29571_CommonData.yaml#/components/responses/404'
  '406':
    $ref: 'TS29571_CommonData.yaml#/components/responses/406'
  '414':
    $ref: 'TS29571_CommonData.yaml#/components/responses/414'
  '429':
    $ref: 'TS29571_CommonData.yaml#/components/responses/429'
  '500':
    $ref: 'TS29571_CommonData.yaml#/components/responses/500'
  '503':
    $ref: 'TS29571_CommonData.yaml#/components/responses/503'
  default:
    description: Unexpected error

components:

```

```

securitySchemes:
  oAuth2ClientCredentials:
    type: oauth2
    flows:
      clientCredentials:
        tokenUrl: '{nrfApiRoot}/oauth2/token'
        scopes:
          nnsf-nssselection: Access to the Nnsf_NSSElection API
schemas:
  AuthorizedNetworkSliceInfo:
    type: object
    properties:
      allowedNssaiList:
        type: array
        items:
          $ref: '#/components/schemas/AllowedNssai'
        minItems: 1
      configuredNssai:
        type: array
        items:
          $ref: '#/components/schemas/ConfiguredSnssai'
        minItems: 1
      targetAmfSet:
        type: string
        pattern: '^[0-9]{3}-[0-9]{2-3}-[A-Fa-f0-9]{2}-[0-3][A-Fa-f0-9]{2}$'
      candidateAmfList:
        type: array
        items:
          $ref: 'TS29571_CommonData.yaml#/components/schemas/NfInstanceId'
        minItems: 1
      rejectedNssaiInPlmn:
        type: array
        items:
          $ref: 'TS29571_CommonData.yaml#/components/schemas/Snssai'
        minItems: 1
      rejectedNssaiInTa:
        type: array
        items:
          $ref: 'TS29571_CommonData.yaml#/components/schemas/Snssai'
        minItems: 1
      nsiInformation:
        $ref: '#/components/schemas/NsiInformation'
      supportedFeatures:
        $ref: 'TS29571_CommonData.yaml#/components/schemas/SupportedFeatures'
      nrfAmfSet:
        $ref: 'TS29571_CommonData.yaml#/components/schemas/Uri'
      nrfAmfSetNfMgtUri:
        $ref: 'TS29571_CommonData.yaml#/components/schemas/Uri'
      nrfAmfSetAccessTokenUri:
        $ref: 'TS29571_CommonData.yaml#/components/schemas/Uri'

  SubscribedSnssai:
    type: object
    required:
      - subscribedSnssai
    properties:
      subscribedSnssai:
        $ref: 'TS29571_CommonData.yaml#/components/schemas/Snssai'
      defaultIndication:
        type: boolean

  AllowedSnssai:
    type: object
    required:
      - allowedSnssai
    properties:
      allowedSnssai:
        $ref: 'TS29571_CommonData.yaml#/components/schemas/Snssai'
      nsiInformationList:
        type: array
        items:
          $ref: '#/components/schemas/NsiInformation'
        minItems: 1
      mappedHomeSnssai:
        $ref: 'TS29571_CommonData.yaml#/components/schemas/Snssai'

  AllowedNssai:

```

```

type: object
required:
  - allowedSnssaiList
  - accessType
properties:
  allowedSnssaiList:
    type: array
    items:
      $ref: '#/components/schemas/AllowedSnssai'
    minItems: 1
  accessType:
    $ref: 'TS29571_CommonData.yaml#/components/schemas/AccessType'

NsiInformation:
type: object
required:
  - nrfId
properties:
  nrfId:
    $ref: 'TS29571_CommonData.yaml#/components/schemas/Uri'
  nsiId:
    $ref: '#/components/schemas/NsiId'
  nrfNfMgtUri:
    $ref: 'TS29571_CommonData.yaml#/components/schemas/Uri'
  nrfAccessTokenUri:
    $ref: 'TS29571_CommonData.yaml#/components/schemas/Uri'

MappingOfSnssai:
type: object
required:
  - servingSnssai
  - homeSnssai
properties:
  servingSnssai:
    $ref: 'TS29571_CommonData.yaml#/components/schemas/Snssai'
  homeSnssai:
    $ref: 'TS29571_CommonData.yaml#/components/schemas/Snssai'

SliceInfoForRegistration:
type: object
properties:
  subscribedNssai:
    type: array
    items:
      $ref: '#/components/schemas/SubscribedSnssai'
    minItems: 1
  allowedNssaiCurrentAccess:
    $ref: '#/components/schemas/AllowedNssai'
  allowedNssaiOtherAccess:
    $ref: '#/components/schemas/AllowedNssai'
  sNssaiForMapping:
    type: array
    items:
      $ref: 'TS29571_CommonData.yaml#/components/schemas/Snssai'
    minItems: 1
  requestedNssai:
    type: array
    items:
      $ref: 'TS29571_CommonData.yaml#/components/schemas/Snssai'
    minItems: 1
  defaultConfiguredSnssaiInd:
    type: boolean
  mappingOfNssai:
    type: array
    items:
      $ref: '#/components/schemas/MappingOfSnssai'
    minItems: 1
  requestMapping:
    type: boolean

SliceInfoForPDUSession:
type: object
required:
  - sNssai
  - roamingIndication
properties:
  sNssai:

```

```

    $ref: 'TS29571_CommonData.yaml#/components/schemas/Snssai'
  roamingIndication:
    $ref: '#/components/schemas/RoamingIndication'
  homeSnssai:
    $ref: 'TS29571_CommonData.yaml#/components/schemas/Snssai'

SliceInfoForUEConfigurationUpdate:
  type: object
  properties:
    subscribedNssai:
      type: array
      items:
        $ref: '#/components/schemas/SubscribedSnssai'
      minItems: 1
    allowedNssaiCurrentAccess:
      $ref: '#/components/schemas/AllowedNssai'
    allowedNssaiOtherAccess:
      $ref: '#/components/schemas/AllowedNssai'
    defaultConfiguredSnssaiInd:
      type: boolean
    requestedNssai:
      type: array
      items:
        $ref: 'TS29571_CommonData.yaml#/components/schemas/Snssai'
      minItems: 1
    mappingOfNssai:
      type: array
      items:
        $ref: '#/components/schemas/MappingOfSnssai'
      minItems: 1

ConfiguredSnssai:
  type: object
  required:
    - configuredSnssai
  properties:
    configuredSnssai:
      $ref: 'TS29571_CommonData.yaml#/components/schemas/Snssai'
    mappedHomeSnssai:
      $ref: 'TS29571_CommonData.yaml#/components/schemas/Snssai'

RoamingIndication:
  anyOf:
    - type: string
      enum:
        - NON_ROAMING
        - LOCAL_BREAKOUT
        - HOME_ROUTED_ROAMING
    - type: string

NsiId:
  type: string

```

## A.3 Nssf\_NSSAIAvailability API

openapi: 3.0.0

```

info:
  version: '1.0.2'
  title: 'NSSF NSSAI Availability'
  description: |
    NSSF NSSAI Availability Service.
    © 2019, 3GPP Organizational Partners (ARIB, ATIS, CCSA, ETSI, TSDSI, TTA, TTC).
    All rights reserved.
security:
  - {}
  - oAuth2ClientCredentials:
    - nssf-nssaiavailability
servers:
  - url: '{apiRoot}/nssf-nssaiavailability/v1'
    variables:
      apiRoot:
        default: https://example.com
        description: apiRoot as defined in clause 4.4 of 3GPP TS 29.501
externalDocs:

```

```

description: 3GPP TS 29.531 V15.3.0; 5G System; Network Slice Selection Services; Stage 3
url: http://www.3gpp.org/ftp/Specs/archive/29_series/29.531/
paths:
  /nssai-availability/{nfId}:
    put:
      summary: Updates/replaces the NSSF with the S-NSSAIs the NF service consumer (e.g AMF)supports
per TA
      tags:
        - NF Instance ID (Document)
      operationId: NSSAIAvailabilityPut
      parameters:
        - name: nfId
          in: path
          description: Identifier of the NF service consumer instance
          required: true
          schema:
            $ref: 'TS29571_CommonData.yaml#/components/schemas/NfInstanceId'
        - name: Content-Encoding
          in: header
          description: Content-Encoding, described in IETF RFC 7231
          schema:
            type: string
      requestBody:
        description: Parameters to update/replace at the NSSF, the S-NSSAIs supported per TA
        required: true
        content:
          application/json:
            schema:
              $ref: '#/components/schemas/NssaiAvailabilityInfo'
      responses:
        '200':
          description: OK (Successful update of SNSSAI information per TA)
          content:
            application/json:
              schema:
                $ref: '#/components/schemas/AuthorizedNssaiAvailabilityInfo'
          headers:
            Accept-Encoding:
              description: Accept-Encoding, described in IETF RFC 7694
              schema:
                type: string
        '400':
          $ref: 'TS29571_CommonData.yaml#/components/responses/400'
        '401':
          $ref: 'TS29571_CommonData.yaml#/components/responses/401'
        '403':
          $ref: 'TS29571_CommonData.yaml#/components/responses/403'
        '404':
          $ref: 'TS29571_CommonData.yaml#/components/responses/404'
        '411':
          $ref: 'TS29571_CommonData.yaml#/components/responses/411'
        '413':
          $ref: 'TS29571_CommonData.yaml#/components/responses/413'
        '415':
          $ref: 'TS29571_CommonData.yaml#/components/responses/415'
        '429':
          $ref: 'TS29571_CommonData.yaml#/components/responses/429'
        '500':
          $ref: 'TS29571_CommonData.yaml#/components/responses/500'
        '503':
          $ref: 'TS29571_CommonData.yaml#/components/responses/503'
        default:
          description: Unexpected error

    patch:
      summary: Updates an already existing S-NSSAIs per TA provided by the NF service consumer (e.g
AMF)
      tags:
        - NF Instance ID (Document)
      operationId: NSSAIAvailabilityPatch
      parameters:
        - name: nfId
          in: path
          description: Identifier of the NF service consumer instance
          required: true
          schema:
            type: string

```



```

requestBody:
  description: JSON Patch instructions to update at the NSSF, the S-NSSAIs supported per TA
  required: true
  content:
    application/json-patch+json::
      schema:
        $ref: '#/components/schemas/PatchDocument'

```

```

responses:
  '200':
    description: OK (Successful update of SNSSAI information per TA)
    content:
      application/json:
        schema:
          $ref: '#/components/schemas/AuthorizedNssaiAvailabilityInfo'
  '400':
    $ref: 'TS29571_CommonData.yaml#/components/responses/400'
  '401':
    $ref: 'TS29571_CommonData.yaml#/components/responses/401'
  '403':
    $ref: 'TS29571_CommonData.yaml#/components/responses/403'
  '404':
    $ref: 'TS29571_CommonData.yaml#/components/responses/404'
  '411':
    $ref: 'TS29571_CommonData.yaml#/components/responses/411'
  '413':
    $ref: 'TS29571_CommonData.yaml#/components/responses/413'
  '415':
    $ref: 'TS29571_CommonData.yaml#/components/responses/415'
  '429':
    $ref: 'TS29571_CommonData.yaml#/components/responses/429'
  '500':
    $ref: 'TS29571_CommonData.yaml#/components/responses/500'
  '503':
    $ref: 'TS29571_CommonData.yaml#/components/responses/503'
  default:
    description: Unexpected error

```

```

delete:
  summary: Deletes an already existing S-NSSAIs per TA provided by the NF service consumer (e.g
AMF)

```

```

tags:
  - NF Instance ID (Document)
operationId: NSSAIAvailabilityDelete
parameters:
  - name: nfId
    in: path
    description: Identifier of the NF service consumer instance
    required: true
    schema:
      type: string

```

```

responses:
  '204':
    description: No Content (Successful deletion of SNSSAI information per TA)
  '400':
    $ref: 'TS29571_CommonData.yaml#/components/responses/400'
  '401':
    $ref: 'TS29571_CommonData.yaml#/components/responses/401'
  '404':
    $ref: 'TS29571_CommonData.yaml#/components/responses/404'
  '429':
    $ref: 'TS29571_CommonData.yaml#/components/responses/429'
  '500':
    $ref: 'TS29571_CommonData.yaml#/components/responses/500'
  '503':
    $ref: 'TS29571_CommonData.yaml#/components/responses/503'
  default:
    description: Unexpected error

```

```

/nssai-availability/subscriptions:
  post:

```

```

summary: Creates subscriptions for notification about updates to NSSAI availability
information
tags:
  - Subscriptions (Collection)
operationId: NSSAIAvailabilityPost
requestBody:
  description: Subscription for notification about updates to NSSAI availability information
  required: true
  content:
    application/json:
      schema:
        $ref: '#/components/schemas/NssfEventSubscriptionCreateData'
callbacks:
  nssaiAvailabilityNotification:
    '{request.body#/nfNssaiAvailabilityUri}':
      post:
        requestBody: # contents of the callback message
        required: true
        content:
          application/json:
            schema:
              $ref: '#/components/schemas/NssfEventNotification'
        responses:
          '204':
            description: No Content (successful notification)
          '400':
            $ref: 'TS29571_CommonData.yaml#/components/responses/400'
          '411':
            $ref: 'TS29571_CommonData.yaml#/components/responses/411'
          '413':
            $ref: 'TS29571_CommonData.yaml#/components/responses/413'
          '415':
            $ref: 'TS29571_CommonData.yaml#/components/responses/415'
          '429':
            $ref: 'TS29571_CommonData.yaml#/components/responses/429'
          '500':
            $ref: 'TS29571_CommonData.yaml#/components/responses/500'
          '503':
            $ref: 'TS29571_CommonData.yaml#/components/responses/503'
          default:
            description: Unexpected error

responses:
  '201':
    description: Created (Successful creation of subscription for notification)
    content:
      application/json:
        schema:
          $ref: '#/components/schemas/NssfEventSubscriptionCreatedData'
    headers:
      Location:
        description: 'Contains the URI of the newly created resource, according to the
structure: {apiRoot}/nssf-nssaiavailability/v1/nssai-availability/subscriptions/{subscriptionId}'
        required: true
        schema:
          type: string
  '400':
    $ref: 'TS29571_CommonData.yaml#/components/responses/400'
  '401':
    $ref: 'TS29571_CommonData.yaml#/components/responses/401'
  '403':
    $ref: 'TS29571_CommonData.yaml#/components/responses/403'
  '404':
    $ref: 'TS29571_CommonData.yaml#/components/responses/404'
  '411':
    $ref: 'TS29571_CommonData.yaml#/components/responses/411'
  '413':
    $ref: 'TS29571_CommonData.yaml#/components/responses/413'
  '415':
    $ref: 'TS29571_CommonData.yaml#/components/responses/415'
  '429':
    $ref: 'TS29571_CommonData.yaml#/components/responses/429'
  '500':
    $ref: 'TS29571_CommonData.yaml#/components/responses/500'
  '503':
    $ref: 'TS29571_CommonData.yaml#/components/responses/503'

```

```

    default:
      description: Unexpected error

/nssai-availability/subscriptions/{subscriptionId}:
  delete:
    summary: Deletes an already existing NSSAI availability notification subscription
    tags:
      - Subscription ID (Document)
    operationId: NSSAIAvailabilityUnsubscribe
    parameters:
      - name: subscriptionId
        in: path
        description: Identifier of the subscription for notification
        required: true
        schema:
          type: string

    responses:
      '204':
        description: No Content (Successful deletion of subscription for NSSAI Availability notification)
      '400':
        $ref: 'TS29571_CommonData.yaml#/components/responses/400'
      '401':
        $ref: 'TS29571_CommonData.yaml#/components/responses/401'
      '404':
        $ref: 'TS29571_CommonData.yaml#/components/responses/404'

      '429':
        $ref: 'TS29571_CommonData.yaml#/components/responses/429'
      '500':
        $ref: 'TS29571_CommonData.yaml#/components/responses/500'
      '503':
        $ref: 'TS29571_CommonData.yaml#/components/responses/503'

    default:
      description: Unexpected error

/nssai-availability:
  options:
    summary: Discover communication options supported by NSSF for NSSAI Availability
    operationId: NSSAIAvailabilityOptions
    tags:
      - NSSAI Availability Store
    responses:
      '200':
        description: OK
        headers:
          Accept-Encoding:
            description: Accept-Encoding, described in IETF RFC 7694
            schema:
              type: string
      '400':
        $ref: 'TS29571_CommonData.yaml#/components/responses/400'
      '401':
        $ref: 'TS29571_CommonData.yaml#/components/responses/401'
      '403':
        $ref: 'TS29571_CommonData.yaml#/components/responses/403'
      '404':
        $ref: 'TS29571_CommonData.yaml#/components/responses/404'
      '405':
        $ref: 'TS29571_CommonData.yaml#/components/responses/405'
      '429':
        $ref: 'TS29571_CommonData.yaml#/components/responses/429'
      '500':
        $ref: 'TS29571_CommonData.yaml#/components/responses/500'
      '501':
        $ref: 'TS29571_CommonData.yaml#/components/responses/501'
      '503':
        $ref: 'TS29571_CommonData.yaml#/components/responses/503'
    default:
      $ref: 'TS29571_CommonData.yaml#/components/responses/default'

components:
  securitySchemes:
    oAuth2ClientCredentials:
      type: oauth2
      flows:

```

```

    clientCredentials:
      tokenUrl: '{nrfApiRoot}/oauth2/token'
      scopes:
        nssf-nssaiavailability: Access to the Nssf_NSSAIAvailability API

schemas:
  NssaiAvailabilityInfo:
    type: object
    required:
      - supportedNssaiAvailabilityData
    properties:
      supportedNssaiAvailabilityData:
        type: array
        items:
          $ref: '#/components/schemas/SupportedNssaiAvailabilityData'
        minItems: 1
      supportedFeatures:
        $ref: 'TS29571_CommonData.yaml#/components/schemas/SupportedFeatures'
      amfSetId:
        type: string
        pattern: '^[0-9]{3}-[0-9]{2-3}-[A-Fa-f0-9]{2}-[0-3][A-Fa-f0-9]{2}$'

  SupportedNssaiAvailabilityData:
    type: object
    required:
      - tai
      - supportedSnssaiList
    properties:
      tai:
        $ref: 'TS29571_CommonData.yaml#/components/schemas/Tai'
      supportedSnssaiList:
        type: array
        items:
          $ref: 'TS29571_CommonData.yaml#/components/schemas/Snssai'
        minItems: 1

  AuthorizedNssaiAvailabilityData:
    type: object
    required:
      - tai
      - supportedSnssaiList
    properties:
      tai:
        $ref: 'TS29571_CommonData.yaml#/components/schemas/Tai'
      supportedSnssaiList:
        type: array
        items:
          $ref: 'TS29571_CommonData.yaml#/components/schemas/Snssai'
        minItems: 1
      restrictedSnssaiList:
        type: array
        items:
          $ref: '#/components/schemas/RestrictedSnssai'
        minItems: 1

  RestrictedSnssai:
    type: object
    required:
      - homePlmnId
      - sNssaiList
    properties:
      homePlmnId:
        $ref: 'TS29571_CommonData.yaml#/components/schemas/PlmnId'
      sNssaiList:
        type: array
        items:
          $ref: 'TS29571_CommonData.yaml#/components/schemas/Snssai'
        minItems: 1

  AuthorizedNssaiAvailabilityInfo:
    type: object
    required:
      - authorizedNssaiAvailabilityData
    properties:
      authorizedNssaiAvailabilityData:
        type: array
        items:
          $ref: '#/components/schemas/AuthorizedNssaiAvailabilityData'

```

```
    minItems: 1
    supportedFeatures:
      $ref: 'TS29571_CommonData.yaml#/components/schemas/SupportedFeatures'

NssfEventSubscriptionCreateData:
  type: object
  required:
    - nfNssaiAvailabilityUri
    - taiList
    - event
  properties:
    nfNssaiAvailabilityUri:
      $ref: 'TS29571_CommonData.yaml#/components/schemas/Uri'
    taiList:
      type: array
      items:
        $ref: 'TS29571_CommonData.yaml#/components/schemas/Tai'
      minItems: 1
    event:
      $ref: '#/components/schemas/NssfEventType'
    expiry:
      $ref: 'TS29571_CommonData.yaml#/components/schemas/DateTime'
    amfSetId:
      type: string
      pattern: '^[0-9]{3}-[0-9]{2-3}-[A-Fa-f0-9]{2}-[0-3][A-Fa-f0-9]{2}$'

NssfEventSubscriptionCreatedData:
  type: object
  required:
    - subscriptionId
  properties:
    subscriptionId:
      type: string
    expiry:
      $ref: 'TS29571_CommonData.yaml#/components/schemas/DateTime'
    authorizedNssaiAvailabilityData:
      type: array
      items:
        $ref: '#/components/schemas/AuthorizedNssaiAvailabilityData'
      minItems: 1

NssfEventNotification:
  type: object
  required:
    - subscriptionId
    - authorizedNssaiAvailabilityData
  properties:
    subscriptionId:
      type: string
    authorizedNssaiAvailabilityData:
      type: array
      items:
        $ref: '#/components/schemas/AuthorizedNssaiAvailabilityData'
      minItems: 1

NssfEventType:
  anyOf:
    - type: string
      enum:
        - SNSSAI_STATUS_CHANGE_REPORT
    - type: string

PatchDocument:
  type: array
  items:
    $ref: 'TS29571_CommonData.yaml#/components/schemas/PatchItem'
  minItems: 1
```

## Annex B (informative): Change history

Change history							
Date	Meeting	TDoc	CR	Rev	Cat	Subject/Comment	New version
2017-10	CT4#80	C4-175279				Initial Draft.	0.1.0
2017-10	CT4#81	C4-175398				Implementation of C4-175280	0.2.0
2018-01	CT4#82	C4-181394				Implementation of C4-181240, C4-181242, C4-181244, C4-181355, C4-181356, C4-181357	0.3.0
2018-03	CT4#83	C4-182438				Implementation of C4-182087, C4-182294, C4-182295, C4-182296, C4-182297, C4-182298, C4-182299	0.4.0
2018-03	CT#79	CP-180035				Presented for information	1.0.0
2018-04	CT4#84	C4-183519				Implementation of C4-183068, C4-183071, C4-183431, C4-183432, C4-183433	1.1.0
2018-05	CT4#85	C4-184631				Implementation of C4-184602, C4-184023, C4-184024, C4-184025, C4-184026, C4-184603, C4-184527, C4-184528, C4-184604, C4-184632	1.2.0
2018-06	CT#80	CP-181108				Presented for approval	2.0.0
2018-06	CT#80					Approved in CT#80.	15.0.0
2018-09	CT#81	CP-182160	0001	5	F	Alignment of Nnssf_NSSelection_Get service operation with stage 2	15.1.0
2018-09	CT#81	CP-182014	0002	2	F	Adding NRF corresponding to an AMF set	15.1.0
2018-09	CT#81	CP-182167	0003	4	F	Corrections to NSSF Data Types	15.1.0
2018-09	CT#81	CP-182063	0004		F	Corrections to NSSAIAvailability Service Operations	15.1.0
2018-09	CT#81	CP-182063	0005	1	F	Configured NSSAI for HPLMN - Alignment with Stage 2	15.1.0
2018-09	CT#81	CP-182063	0006		F	Correction to NRF Id in NSIInformation	15.1.0
2018-09	CT#81	CP-182063	0007		F	Description of Structured data types	15.1.0
2018-09	CT#81	CP-182063	0008		F	API version number update	15.1.0
2018-12	CT#82	CP-183022	0009		F	Type Definition of AllowedNssai	15.2.0
2018-12	CT#82	CP-183022	0010	1	F	Correction to Slice Information For Registration	15.2.0
2018-12	CT#82	CP-183022	0011		F	API Root	15.2.0
2018-12	CT#82	CP-183022	0012	3	F	Common Error Status Codes	15.2.0
2018-12	CT#82	CP-183148	0013	2	F	Array Range Correction	15.2.0
2018-12	CT#82	CP-183022	0016	1	F	OpenAPI Corrections	15.2.0
2018-12	CT#82	CP-183022	0017	2	F	Subscription Lifetime for NSSAI Availability Event Subscription	15.2.0
2018-12	CT#82	CP-183022	0018		F	Correction of Resource URI structure	15.2.0
2018-12	CT#82	CP-183022	0019		F	Add Delete Service Operation in Nnssf_NSSAIAvailability Service	15.2.0
2018-12	CT#82	CP-183022	0020	2	F	Add the Default Configured NSSAI Indication in Nnssf_NSSelection Service	15.2.0
2018-12	CT#82	CP-183022	0021		F	CR 0021 29.531 Rel-15 Resource Uri Correction	15.2.0
2018-12	CT#82	CP-183022	0022		F	Correction to NssaiAvailabilityInfo	15.2.0
2018-12	CT#82	CP-183022	0023	2	F	Make OAuth2.0 Optional to Use	15.2.0
2018-12	CT#82	CP-183022	0024		F	ExternalDocs	15.2.0
2018-12	CT#82	CP-183022	0025		F	API Version	15.2.0
2019-03	CT#83	CP-190027	0026	1	F	Definition of TargetAmfSet	15.3.0
2019-03	CT#83	CP-190027	0027	1	F	OpenAPI Corrections	15.3.0
2019-03	CT#83	CP-190027	0029		F	Add missing NfType reference in reused data types	15.3.0
2019-03	CT#83	CP-190027	0030	2	F	Clarify the conditions of returning Configured NSSAI.	15.3.0
2019-03	CT#83	CP-190027	0031	1	F	Service operation of Nnssf_NSSelection service during UE configuration update procedure	15.3.0
2019-03	CT#83	CP-190171	0032	1	F	API version update	15.3.0
2019-06	CT#84	CP-191039	0033	1	F	Content encodings supported in HTTP requests	15.4.0
2019-06	CT#84	CP-191039	0034	4	F	Add AMFset in NssaiAvailabilityInfo	15.4.0
2019-06	CT#84	CP-191039	0036	2	F	Storage of OpenAPI specification files	15.4.0
2019-06	CT#84	CP-191039	0039	1	F	API URIs of the NRF	15.4.0
2019-06	CT#84	CP-191039	0040	1	F	Subscription to and notification of NSSF events	15.4.0
2019-06	CT#84	CP-191039	0041	2	F	Essential Correction on Application Error returned by NSSF	15.4.0
2019-06	CT#84	CP-191039	0042	1	F	Copyright Note in YAML file	15.4.0
2019-06	CT#84	CP-191039	0043		F	3GPP TS 29.531 API version update	15.4.0

---

## History

<b>Document history</b>		
V15.0.0	September 2018	Publication
V15.1.0	October 2018	Publication
V15.2.0	April 2019	Publication
V15.3.0	April 2019	Publication
V15.4.0	July 2019	Publication