

ETSI TS 129 503 V16.16.0 (2023-07)



**5G;
5G System;
Unified Data Management Services;
Stage 3
(3GPP TS 29.503 version 16.16.0 Release 16)**



Reference

RTS/TSGC-0429503v00

Keywords

5G

ETSI

650 Route des Lucioles
F-06921 Sophia Antipolis Cedex - FRANCE

Tel.: +33 4 92 94 42 00 Fax: +33 4 93 65 47 16

Siret N° 348 623 562 00017 - APE 7112B
Association à but non lucratif enregistrée à la
Sous-Préfecture de Grasse (06) N° w061004871

Important notice

The present document can be downloaded from:

<https://www.etsi.org/standards-search>

The present document may be made available in electronic versions and/or in print. The content of any electronic and/or print versions of the present document shall not be modified without the prior written authorization of ETSI. In case of any existing or perceived difference in contents between such versions and/or in print, the prevailing version of an ETSI deliverable is the one made publicly available in PDF format at www.etsi.org/deliver.

Users of the present document should be aware that the document may be subject to revision or change of status.

Information on the current status of this and other ETSI documents is available at

<https://portal.etsi.org/TB/ETSIDeliverableStatus.aspx>

If you find errors in the present document, please send your comment to one of the following services:

<https://portal.etsi.org/People/CommitteeSupportStaff.aspx>

If you find a security vulnerability in the present document, please report it through our

Coordinated Vulnerability Disclosure Program:

<https://www.etsi.org/standards/coordinated-vulnerability-disclosure>

Notice of disclaimer & limitation of liability

The information provided in the present deliverable is directed solely to professionals who have the appropriate degree of experience to understand and interpret its content in accordance with generally accepted engineering or other professional standard and applicable regulations.

No recommendation as to products and services or vendors is made or should be implied.

No representation or warranty is made that this deliverable is technically accurate or sufficient or conforms to any law and/or governmental rule and/or regulation and further, no representation or warranty is made of merchantability or fitness for any particular purpose or against infringement of intellectual property rights.

In no event shall ETSI be held liable for loss of profits or any other incidental or consequential damages.

Any software contained in this deliverable is provided "AS IS" with no warranties, express or implied, including but not limited to, the warranties of merchantability, fitness for a particular purpose and non-infringement of intellectual property rights and ETSI shall not be held liable in any event for any damages whatsoever (including, without limitation, damages for loss of profits, business interruption, loss of information, or any other pecuniary loss) arising out of or related to the use of or inability to use the software.

Copyright Notification

No part may be reproduced or utilized in any form or by any means, electronic or mechanical, including photocopying and microfilm except as authorized by written permission of ETSI.

The content of the PDF version shall not be modified without the written authorization of ETSI.

The copyright and the foregoing restriction extend to reproduction in all media.

© ETSI 2023.
All rights reserved.

Intellectual Property Rights

Essential patents

IPRs essential or potentially essential to normative deliverables may have been declared to ETSI. The declarations pertaining to these essential IPRs, if any, are publicly available for **ETSI members and non-members**, and can be found in ETSI SR 000 314: "*Intellectual Property Rights (IPRs); Essential, or potentially Essential, IPRs notified to ETSI in respect of ETSI standards*", which is available from the ETSI Secretariat. Latest updates are available on the ETSI Web server (<https://ipr.etsi.org/>).

Pursuant to the ETSI Directives including the ETSI IPR Policy, no investigation regarding the essentiality of IPRs, including IPR searches, has been carried out by ETSI. No guarantee can be given as to the existence of other IPRs not referenced in ETSI SR 000 314 (or the updates on the ETSI Web server) which are, or may be, or may become, essential to the present document.

Trademarks

The present document may include trademarks and/or tradenames which are asserted and/or registered by their owners. ETSI claims no ownership of these except for any which are indicated as being the property of ETSI, and conveys no right to use or reproduce any trademark and/or tradename. Mention of those trademarks in the present document does not constitute an endorsement by ETSI of products, services or organizations associated with those trademarks.

DECT™, **PLUGTESTS™**, **UMTS™** and the ETSI logo are trademarks of ETSI registered for the benefit of its Members. **3GPP™** and **LTE™** are trademarks of ETSI registered for the benefit of its Members and of the 3GPP Organizational Partners. **oneM2M™** logo is a trademark of ETSI registered for the benefit of its Members and of the oneM2M Partners. **GSM®** and the GSM logo are trademarks registered and owned by the GSM Association.

Legal Notice

This Technical Specification (TS) has been produced by ETSI 3rd Generation Partnership Project (3GPP).

The present document may refer to technical specifications or reports using their 3GPP identities. These shall be interpreted as being references to the corresponding ETSI deliverables.

The cross reference between 3GPP and ETSI identities can be found under <https://webapp.etsi.org/key/queryform.asp>.

Modal verbs terminology

In the present document "**shall**", "**shall not**", "**should**", "**should not**", "**may**", "**need not**", "**will**", "**will not**", "**can**" and "**cannot**" are to be interpreted as described in clause 3.2 of the [ETSI Drafting Rules](#) (Verbal forms for the expression of provisions).

"**must**" and "**must not**" are **NOT** allowed in ETSI deliverables except when used in direct citation.

Contents

Intellectual Property Rights	2
Legal Notice	2
Modal verbs terminology.....	2
Foreword.....	16
1 Scope	18
2 References	18
3 Definitions and abbreviations.....	20
3.1 Definitions	20
3.2 Abbreviations	20
4 Overview	21
4.1 Introduction	21
5 Services offered by the UDM.....	22
5.1 Introduction	22
5.2 Nudm_SubscriberDataManagement Service.....	23
5.2.1 Service Description.....	23
5.2.2 Service Operations.....	23
5.2.2.1 Introduction.....	23
5.2.2.2 Get.....	23
5.2.2.2.1 General	23
5.2.2.2.2 Slice Selection Subscription Data Retrieval	24
5.2.2.2.3 Access and Mobility Subscription Data Retrieval	25
5.2.2.2.4 SMF Selection Subscription Data Retrieval	26
5.2.2.2.5 Session Management Subscription Data Retrieval	26
5.2.2.2.6 SMS Subscription Data Retrieval.....	27
5.2.2.2.7 SMS Management Subscription Data Retrieval	28
5.2.2.2.8 UE Context In SMF Data Retrieval.....	28
5.2.2.2.9 Retrieval Of Multiple Data Sets	29
5.2.2.2.10 Identifier Translation	29
5.2.2.2.11 Shared Subscription Data Retrieval.....	30
5.2.2.2.12 UE Context In SMSF Data Retrieval.....	30
5.2.2.2.13 Trace data Retrieval.....	31
5.2.2.2.14 Group Identifier Translation.....	31
5.2.2.2.15 LCS Privacy Data Retrieval	32
5.2.2.2.16 LCS Mobile Originated Data Retrieval	33
5.2.2.2.17 Enhanced Coverage Restriction Data Retrieval.....	33
5.2.2.2.18 V2X Subscription Data Retrieval	34
5.2.2.2.19 LCS Broadcast Assistance Subscription Data Retrieval.....	34
5.2.2.2.20 UE Context In AMF Data Retrieval	35
5.2.2.2.21 Individual Shared Subscription Data Retrieval	35
5.2.2.3 Subscribe	36
5.2.2.3.1 General	36
5.2.2.3.2 Subscription to notifications of data change.....	36
5.2.2.3.3 Subscription to notifications of shared data change	36
5.2.2.4 Unsubscribe.....	37
5.2.2.4.1 General	37
5.2.2.4.2 Unsubscribe to notifications of data change	37
5.2.2.4.3 Unsubscribe to notifications of shared data change.....	38
5.2.2.5 Notification	38
5.2.2.5.1 General	38
5.2.2.5.2 Data Change Notification To NF.....	38
5.2.2.6 Info.....	39
5.2.2.6.1 General	39
5.2.2.6.2 Providing acknowledgement of Steering of Roaming.....	40

5.2.2.6.3	Providing acknowledgement of UE parameters update	40
5.2.2.6.4	Providing acknowledgement of UE for Network Slicing Subscription Change	41
5.2.2.6.5	Providing acknowledgement of UE for CAG configuration change	41
5.2.2.6.6	Triggering Update of Steering Of Roaming information	41
5.2.2.7	ModifySubscription	42
5.2.2.7.1	General	42
5.2.2.7.2	Modification of a subscription to notifications of data change	42
5.2.2.7.3	Modification of a subscription to notifications of shared data change	43
5.3	Nudm_UEContextManagement Service	43
5.3.1	Service Description	43
5.3.2	Service Operations	43
5.3.2.1	Introduction	43
5.3.2.2	Registration	44
5.3.2.2.1	General	44
5.3.2.2.2	AMF registration for 3GPP access	45
5.3.2.2.3	AMF registration for non 3GPP access	45
5.3.2.2.4	SMF registration	46
5.3.2.2.5	SMSF Registration for 3GPP Access	47
5.3.2.2.6	SMSF Registration for Non 3GPP Access	47
5.3.2.2.7	IP-SM-GW registration	48
5.3.2.3	DeregistrationNotification	49
5.3.2.3.1	General	49
5.3.2.3.2	UDM initiated NF Deregistration	49
5.3.2.4	Deregistration	49
5.3.2.4.1	General	49
5.3.2.4.2	AMF deregistration for 3GPP access	50
5.3.2.4.3	AMF deregistration for non-3GPP access	50
5.3.2.4.4	SMF deregistration	51
5.3.2.4.5	SMSF Deregistration for 3GPP Access	51
5.3.2.4.6	SMSF Deregistration for Non 3GPP Access	52
5.3.2.4.7	IP-SM-GW deregistration	52
5.3.2.5	Get	52
5.3.2.5.1	General	52
5.3.2.5.2	Amf3GppAccessRegistration Information Retrieval	53
5.3.2.5.3	AmfNon3GppAccessRegistration Information Retrieval	53
5.3.2.5.4	Void	54
5.3.2.5.5	SmsfRegistration Information Retrieval for 3GPP Access	54
5.3.2.5.6	SmsfRegistration Information Retrieval for Non-3GPP Access	54
5.3.2.5.7	SmfRegistration Information Retrieval	55
5.3.2.5.8	Individual SmfRegistration Information Retrieval	55
5.3.2.5.9	Location Information Retrieval	56
5.3.2.5.10	Retrieval Of Multiple UE Registration Data Sets	57
5.3.2.5.11	IP-SM-GW Registration Information Retrieval	57
5.3.2.6	Update	57
5.3.2.6.1	General	57
5.3.2.6.2	Update A Parameter (e.g. PEI) in the AMF Registration For 3GPP Access	58
5.3.2.6.3	Update A Parameter (e.g. PEI) in the AMF Registration For Non 3GPP Access	58
5.3.2.7	P-CSCF-RestorationNotification	59
5.3.2.7.1	General	59
5.3.2.7.2	UDM initiated P-CSCF-Restoration	59
5.3.2.8	P-CSCF-RestorationTrigger	59
5.3.2.8.1	General	59
5.3.2.8.2	P-CSCF-RestorationTrigger	59
5.3.2.9	AMFDeregistration	60
5.3.2.9.1	General	60
5.3.2.9.2	AMF-Deregistration	60
5.3.2.10	PEI-Update	61
5.3.2.10.1	General	61
5.3.2.10.2	PEI Update	61
5.4	Nudm_UEAuthentication Service	61
5.4.1	Service Description	61
5.4.2	Service Operations	61

5.4.2.1	Introduction	61
5.4.2.2	Get	62
5.4.2.2.1	General	62
5.4.2.2.2	Authentication Information Retrieval	62
5.4.2.2.3	FN-RG Authentication	63
5.4.2.3	ResultConfirmationInform	63
5.4.2.3.1	General	63
5.4.2.3.2	Authentication Confirmation	63
5.4.2.3.3	Authentication Result Removal	64
5.4.2.4	GetHssAv	64
5.4.2.4.1	General	64
5.4.2.4.2	HSS Authentication Vector Retrieval	65
5.5	Nudm_EventExposure Service	65
5.5.1	Service Description	65
5.5.2	Service Operations	65
5.5.2.1	Introduction	65
5.5.2.2	Subscribe	66
5.5.2.2.1	General	66
5.5.2.2.2	Subscription to Notification of event occurrence	66
5.5.2.2.3	Void	67
5.5.2.3	Unsubscribe	67
5.5.2.3.1	General	67
5.5.2.3.2	Unsubscribe to notifications of event occurrence	68
5.5.2.4	Notify	68
5.5.2.4.1	General	68
5.5.2.4.2	Event Occurrence Notification	68
5.5.2.5	ModifySubscription	69
5.5.2.5.1	General	69
5.5.2.5.2	Modification of a subscription	69
5.6	Nudm_ParameterProvision Service	69
5.6.1	Service Description	69
5.6.2	Service Operations	70
5.6.2.1	Introduction	70
5.6.2.2	Update	70
5.6.2.2.1	General	70
5.6.2.2.2	Subscription data update	70
5.6.2.2.3	5G VN Group modification	71
5.6.2.2.4	SoR Information update	71
5.6.2.3	Create	72
5.6.2.3.1	General	72
5.6.2.3.2	5G-VN-Group creation	72
5.6.2.4	Delete	73
5.6.2.4.1	General	73
5.6.2.4.2	5G-VN-Group deletion	73
5.6.2.5	Get	73
5.6.2.5.1	General	73
5.6.2.5.2	5G-VN-Group get	74
5.7	Nudm_NIDDAuthorization Service	74
5.7.1	Service Description	74
5.7.2	Service Operations	74
5.7.2.1	Introduction	74
5.7.2.2	Get	75
5.7.2.2.1	General	75
5.7.2.2.2	NIDD Authorization Data Retrieval	75
5.7.2.3	Notification	75
5.7.2.3.1	General	75
5.7.2.3.2	NIDD Authorization Data Update Notification	76
5.8	Nudm_MT Service	76
5.8.1	Service Description	76
5.8.2	Service Operations	76
5.8.2.1	Introduction	76
5.8.2.2	ProvideUeInfo	77

5.8.2.2.1	General	77
5.8.2.2.2	UE Information Retrieval	77
5.8.2.3	ProvideLocationInfo	77
5.8.2.3.1	General	77
5.8.2.3.2	Network Provided Location Information Request	77
6	API Definitions	78
6.1	Nudm_SubscriberDataManagement Service API	78
6.1.1	API URI	78
6.1.2	Usage of HTTP	78
6.1.2.1	General	78
6.1.2.2	HTTP standard headers	79
6.1.2.2.1	General	79
6.1.2.2.2	Content type	79
6.1.2.2.3	Cache-Control	79
6.1.2.2.4	ETag	79
6.1.2.2.5	If-None-Match	79
6.1.2.2.6	Last-Modified	79
6.1.2.2.7	If-Modified-Since	79
6.1.2.2.8	When to Use Entity-Tags and Last-Modified Dates	79
6.1.2.3	HTTP custom headers	80
6.1.2.3.1	General	80
6.1.3	Resources	80
6.1.3.1	Overview	80
6.1.3.2	Resource: Nssai (Document)	84
6.1.3.2.1	Description	84
6.1.3.2.2	Resource Definition	84
6.1.3.2.3	Resource Standard Methods	84
6.1.3.3	Resource: SdmSubscriptions (Collection)	85
6.1.3.3.1	Description	85
6.1.3.3.2	Resource Definition	85
6.1.3.3.3	Resource Standard Methods	86
6.1.3.4	Resource: Individual subscription (Document)	87
6.1.3.4.1	Description	87
6.1.3.4.2	Resource Definition	87
6.1.3.4.3	Resource Standard Methods	87
6.1.3.5	Resource: AccessAndMobilitySubscriptionData (Document)	88
6.1.3.5.1	Description	88
6.1.3.5.2	Resource Definition	88
6.1.3.5.3	Resource Standard Methods	89
6.1.3.5.4	Resource Custom Operations	90
6.1.3.6	Resource: SmfSelectionSubscriptionData (Document)	91
6.1.3.6.1	Description	91
6.1.3.6.2	Resource Definition	91
6.1.3.6.3	Resource Standard Methods	91
6.1.3.7	Resource: UeContextInSmfData (Document)	92
6.1.3.7.1	Description	92
6.1.3.7.2	Resource Definition	92
6.1.3.7.3	Resource Standard Methods	92
6.1.3.8	Resource: SessionManagementSubscriptionData (Document)	93
6.1.3.8.1	Description	93
6.1.3.8.2	Resource Definition	93
6.1.3.8.3	Resource Standard Methods	93
6.1.3.9	Resource: SMSSubscriptionData (Document)	95
6.1.3.9.1	Description	95
6.1.3.9.2	Resource Definition	95
6.1.3.9.3	Resource Standard Methods	95
6.1.3.10	Resource: SMSManagementSubscriptionData (Document)	96
6.1.3.10.1	Description	96
6.1.3.10.2	Resource Definition	96
6.1.3.10.3	Resource Standard Methods	97
6.1.3.11	Resource: Supi (Document)	97

6.1.3.11.1	Description	97
6.1.3.11.2	Resource Definition	98
6.1.3.11.3	Resource Standard Methods	98
6.1.3.12	Resource: IdTranslationResult (Document)	99
6.1.3.12.1	Description	99
6.1.3.12.2	Resource Definition	99
6.1.3.12.3	Resource Standard Methods	99
6.1.3.13	Resource: SorAck (Document)	100
6.1.3.13.1	Description	100
6.1.3.13.2	Resource Definition	100
6.1.3.13.3	Resource Standard Methods	101
6.1.3.14	Resource: TraceData (Document)	101
6.1.3.14.1	Description	101
6.1.3.14.2	Resource Definition	101
6.1.3.14.3	Resource Standard Methods	101
6.1.3.15	Resource: SharedData (Collection)	102
6.1.3.15.1	Description	102
6.1.3.15.2	Resource Definition	103
6.1.3.15.3	Resource Standard Methods	103
6.1.3.16	Resource: SharedDataSubscriptions (Collection)	104
6.1.3.16.1	Description	104
6.1.3.16.2	Resource Definition	104
6.1.3.16.3	Resource Standard Methods	104
6.1.3.17	Resource: Individual subscription (Document)	105
6.1.3.17.1	Description	105
6.1.3.17.2	Resource Definition	105
6.1.3.17.3	Resource Standard Methods	105
6.1.3.18	Resource: UeContextInSmsfData (Document)	107
6.1.3.18.1	Description	107
6.1.3.18.2	Resource Definition	107
6.1.3.18.3	Resource Standard Methods	107
6.1.3.19	Resource: UpuAck (Document)	108
6.1.3.19.1	Description	108
6.1.3.19.2	Resource Definition	108
6.1.3.19.3	Resource Standard Methods	108
6.1.3.20	Resource: GroupIdentifiers (Document)	109
6.1.3.20.1	Description	109
6.1.3.20.2	Resource Definition	109
6.1.3.20.3	Resource Standard Methods	109
6.1.3.21	Resource: SnssaisAck (Document)	110
6.1.3.21.1	Description	110
6.1.3.21.2	Resource Definition	110
6.1.3.21.3	Resource Standard Methods	111
6.1.3.22	Resource: CagAck (Document)	111
6.1.3.22.1	Description	111
6.1.3.22.2	Resource Definition	111
6.1.3.22.3	Resource Standard Methods	111
6.1.3.23	Resource: LcsPrivacySubscriptionData (Document)	112
6.1.3.23.1	Description	112
6.1.3.23.2	Resource Definition	112
6.1.3.23.3	Resource Standard Methods	112
6.1.3.24	Resource: LcsMobileOriginatedSubscriptionData (Document)	113
6.1.3.24.1	Description	113
6.1.3.24.2	Resource Definition	113
6.1.3.24.3	Resource Standard Methods	113
6.1.3.25	Resource: EnhancedCoverageRestrictionData	114
6.1.3.25.1	Description	114
6.1.3.25.2	Resource Definition	114
6.1.3.25.3	Resource Standard Methods	114
6.1.3.26	Resource: UeContextInAmfData (Document)	115
6.1.3.26.1	Description	115
6.1.3.26.2	Resource Definition	115

6.1.3.26.3	Resource Standard Methods	115
6.1.3.27	Resource: V2xSubscriptionData (Document)	116
6.1.3.27.1	Description	116
6.1.3.27.2	Resource Definition	116
6.1.3.27.3	Resource Standard Methods	116
6.1.3.28	Resource: LcsBroadcastAssistanceSubscriptionData (Document)	117
6.1.3.28.1	Description	117
6.1.3.28.2	Resource Definition	117
6.1.3.28.3	Resource Standard Methods	117
6.1.3.29	Resource: IndividualSharedData (Document)	118
6.1.3.29.1	Description	118
6.1.3.29.2	Resource Definition	118
6.1.3.29.3	Resource Standard Methods	118
6.1.4	Custom Operations without associated resources	119
6.1.5	Notifications	119
6.1.5.1	General	119
6.1.5.2	Data Change Notification	119
6.1.6	Data Model	120
6.1.6.1	General	120
6.1.6.2	Structured data types	126
6.1.6.2.1	Introduction	126
6.1.6.2.2	Type: Nssai	126
6.1.6.2.3	Type: SdmSubscription	127
6.1.6.2.4	Type: AccessAndMobilitySubscriptionData	130
6.1.6.2.5	Type: SmfSelectionSubscriptionData	134
6.1.6.2.6	Type: DnnInfo	135
6.1.6.2.7	Type: SnsaiInfo	135
6.1.6.2.8	Type: SessionManagementSubscriptionData	136
6.1.6.2.9	Type: DnnConfiguration	137
6.1.6.2.10	Type: Void	139
6.1.6.2.11	Type: PduSessionTypes	139
6.1.6.2.12	Type: SscModes	139
6.1.6.2.13	Type: SmsSubscriptionData	139
6.1.6.2.14	Type: SmsManagementSubscriptionData	140
6.1.6.2.15	Type: SubscriptionDataSets	140
6.1.6.2.16	Type: UeContextInSmfData	141
6.1.6.2.17	Type: PduSession	141
6.1.6.2.18	Type: IdTranslationResult	141
6.1.6.2.19	Type: Void	141
6.1.6.2.20	Type: Void	141
6.1.6.2.21	Type: ModificationNotification	141
6.1.6.2.22	Type: IPAddress	141
6.1.6.2.23	Type: UeContextInSmsfData	142
6.1.6.2.24	Type: SmsfInfo	142
6.1.6.2.25	Type: AcknowledgeInfo	142
6.1.6.2.26	Type: SorInfo	143
6.1.6.2.27	Type: SharedData	143
6.1.6.2.28	Type: PgwInfo	144
6.1.6.2.29	Type: TraceDataResponse	144
6.1.6.2.30	Type: SteeringContainer	144
6.1.6.2.31	Type: SdmSubsModification	144
6.1.6.2.32	Type: EmergencyInfo	145
6.1.6.2.33	Type: UpuInfo	145
6.1.6.2.34	Type: GroupIdentifiers	145
6.1.6.2.35	Type: NiddInformation	146
6.1.6.2.36	Type: CagData	146
6.1.6.2.37	Type: CagInfo	146
6.1.6.2.38	Type: AdditionalSnsaiData	147
6.1.6.2.39	Type: VnGroupData	147
6.1.6.2.40	Type: AppDescriptor	147
6.1.6.2.41	Type: AppPortId	147
6.1.6.2.42	Type: LcsPrivacyData	147

6.1.6.2.43	Type: Lpi	148
6.1.6.2.44	Type: UnrelatedClass	148
6.1.6.2.45	Type: PlmnOperatorClass.....	148
6.1.6.2.46	Type: ValidTimePeriod	148
6.1.6.2.47	Type: LcsMoData	149
6.1.6.2.48	Type: EcRestrictionDataWb.....	149
6.1.6.2.49	Type: ExpectedUeBehaviourData	150
6.1.6.2.50	Void	150
6.1.6.2.51	Void	150
6.1.6.2.52	Type: SuggestedPacketNumDI.....	150
6.1.6.2.53	Void	151
6.1.6.2.54	Type: FrameRouteInfo	151
6.1.6.2.55	Type: SorUpdateInfo	151
6.1.6.2.56	Type: EnhancedCoverageRestrictionData	151
6.1.6.2.57	Type: EdrxParameters	151
6.1.6.2.58	Type: PtwParameters	152
6.1.6.2.59	Void	152
6.1.6.2.60	Void	152
6.1.6.2.61	Type: Void.....	152
6.1.6.2.62	Type: ExternalUnrelatedClass	152
6.1.6.2.63	Type: AfExternal	152
6.1.6.2.64	Type: LcsClientExternal.....	153
6.1.6.2.65	Type: LcsClientGroupExternal.....	153
6.1.6.2.66	Type: ServiceTypeUnrelatedClass	153
6.1.6.2.67	Type: UeId.....	153
6.1.6.2.68	Type: DefaultUnrelatedClass	154
6.1.6.2.69	Type: ContextInfo	154
6.1.6.2.70	Type: UeContextInAmfData	154
6.1.6.2.71	Type: V2xSubscriptionData	154
6.1.6.2.72	Type: LcsBroadcastAssistanceTypesData	155
6.1.6.2.73	Type: DatasetNames.....	158
6.1.6.3	Simple data types and enumerations	158
6.1.6.3.1	Introduction	158
6.1.6.3.2	Simple data types.....	158
6.1.6.3.3	Enumeration: DataSetName	160
6.1.6.3.4	Void	160
6.1.6.3.5	Void	160
6.1.6.3.6	Void	160
6.1.6.3.7	Enumeration: PduSessionContinuityInd.....	160
6.1.6.3.8	Enumeration: LocationPrivacyInd.....	160
6.1.6.3.9	Enumeration: PrivacyCheckRelatedAction	161
6.1.6.3.10	Enumeration: LcsClientClass	161
6.1.6.3.11	Enumeration: LcsMoServiceClass.....	161
6.1.6.3.12	Enumeration: OperationMode	161
6.1.6.3.13	Enumeration: SorUpdateIndicator	161
6.1.6.3.14	Enumeration: CodeWordInd.....	162
6.1.6.3.15	Enumeration: MdtUserConsent	162
6.1.7	Error Handling	162
6.1.7.1	General	162
6.1.7.2	Protocol Errors	162
6.1.7.3	Application Errors.....	162
6.1.8	Feature Negotiation.....	163
6.1.9	Security	163
6.2	Nudm_UEContextManagement Service API.....	164
6.2.1	API URI	164
6.2.2	Usage of HTTP	164
6.2.2.1	General	164
6.2.2.2	HTTP standard headers	164
6.2.2.2.1	General	164
6.2.2.2.2	Content type	164
6.2.2.3	HTTP custom headers	164
6.2.2.3.1	General	164

6.2.3	Resources	165
6.2.3.1	Overview	165
6.2.3.2	Resource: Amf3GppAccessRegistration (Document)	167
6.2.3.2.1	Description	167
6.2.3.2.2	Resource Definition	167
6.2.3.2.3	Resource Standard Methods	167
6.2.3.2.4	Resource Custom Operations	170
6.2.3.3	Resource: AmfNon3GppAccessRegistration (Document)	171
6.2.3.3.1	Description	171
6.2.3.3.2	Resource Definition	171
6.2.3.3.3	Resource Standard Methods	171
6.2.3.4	Resource: SmfRegistrations	173
6.2.3.4.1	Description	173
6.2.3.4.2	Resource Definition	173
6.2.3.4.3	Resource Standard Methods	174
6.2.3.5	Resource: IndividualSmfRegistration (Document)	175
6.2.3.5.1	Resource Definition	175
6.2.3.5.2	Resource Standard Methods	175
6.2.3.6	Resource: Smsf3GppAccessRegistration (Document)	177
6.2.3.6.1	Description	177
6.2.3.6.2	Resource Definition	177
6.2.3.6.3	Resource Standard Methods	177
6.2.3.7	Resource: SmsfNon3GppAccessRegistration (Document)	179
6.2.3.7.1	Description	179
6.2.3.7.2	Resource Definition	179
6.2.3.7.3	Resource Standard Methods	179
6.2.3.8	Resource: Location	181
6.2.3.8.1	Description	181
6.2.3.8.2	Resource Definition	181
6.2.3.8.3	Resource Standard Methods	182
6.2.3.9	Resource: Registrations	182
6.2.3.9.1	Description	182
6.2.3.9.2	Resource Definition	182
6.2.3.9.3	Resource Standard Methods	183
6.2.3.10	Resource: IpSmGwRegistration	183
6.2.3.10.1	Description	183
6.2.3.10.2	Resource Definition	183
6.2.3.10.3	Resource Standard Methods	184
6.2.4	Custom Operations without associated resources	185
6.2.4.1	Overview	185
6.2.4.2	Operation: Trigger P-CSCF Restoration	186
6.2.4.2.1	Description	186
6.2.4.2.2	Operation Definition	186
6.2.5	Notifications	186
6.2.5.1	General	186
6.2.5.2	Deregistration Notification	186
6.2.5.3	P-CSCF Restoration Notification	188
6.2.6	Data Model	189
6.2.6.1	General	189
6.2.6.2	Structured data types	191
6.2.6.2.1	Introduction	191
6.2.6.2.2	Type: Amf3GppAccessRegistration	192
6.2.6.2.3	Type: AmfNon3GppAccessRegistration	195
6.2.6.2.4	Type: SmfRegistration	198
6.2.6.2.5	Type: DeregistrationData	198
6.2.6.2.6	Type: SmsfRegistration	199
6.2.6.2.7	Type: Amf3GppAccessRegistrationModification	199
6.2.6.2.8	Type: AmfNon3GppAccessRegistrationModification	200
6.2.6.2.9	Type: PcsfRestorationNotification	201
6.2.6.2.10	Type: NetworkNodeDiameterAddress	201
6.2.6.2.11	Type: EpsIwkPgw	201
6.2.6.2.12	Type: TriggerRequest	201

6.2.6.2.13	Type: AmfDeregInfo	202
6.2.6.2.14	Type: EpsInterworkingInfo	202
6.2.6.2.15	Type: LocationInfo	202
6.2.6.2.16	Type: RegistrationLocationInfo	202
6.2.6.2.17	Type: VgmlcAddress	202
6.2.6.2.18	Type: PeiUpdateInfo	203
6.2.6.2.19	Type: RegistrationDataSets	203
6.2.6.2.20	Type: IpSmGwRegistration	203
6.2.6.2.20A	Type: SmfRegistrationInfo	203
6.2.6.3	Simple data types and enumerations	203
6.2.6.3.1	Introduction	203
6.2.6.3.2	Simple data types	204
6.2.6.3.3	Enumeration: DeregistrationReason	204
6.2.6.3.4	Enumeration: ImsVoPs	204
6.2.6.3.5	Enumeration: RegistrationReason	205
6.2.6.3.6	Enumeration: RegistrationDataSetName	205
6.2.7	Error Handling	205
6.2.7.1	General	205
6.2.7.2	Protocol Errors	205
6.2.7.3	Application Errors	205
6.2.8	Feature Negotiation	206
6.2.9	Security	207
6.3	Nudm_UEAuthentication Service API	207
6.3.1	API URI	207
6.3.2	Usage of HTTP	207
6.3.2.1	General	207
6.3.2.2	HTTP standard headers	207
6.3.2.2.1	General	207
6.3.2.2.2	Content type	207
6.3.2.3	HTTP custom headers	208
6.3.2.3.1	General	208
6.3.3	Resources	208
6.3.3.1	Overview	208
6.3.3.2	Resource: SecurityInformation (Custom operation)	209
6.3.3.2.1	Description	209
6.3.3.2.2	Resource Definition	209
6.3.3.2.3	Resource Standard Methods	210
6.3.3.2.4	Resource Custom Operations	210
6.3.3.3	Resource: AuthEvents (Collection)	211
6.3.3.3.1	Description	211
6.3.3.3.2	Resource Definition	211
6.3.3.3.3	Resource Standard Methods	211
6.3.3.4	Resource: SecurityInformationForRg	212
6.3.3.4.1	Description	212
6.3.3.4.2	Resource Definition	212
6.3.3.4.3	Resource Standard Methods	212
6.3.3.5	Resource: HssSecurityInformation (Custom operation)	213
6.3.3.5.1	Description	213
6.3.3.5.2	Resource Definition	213
6.3.3.5.3	Resource Standard Methods	214
6.3.3.5.4	Resource Custom Operations	214
6.3.3.6	Resource: Individual AuthEvent	214
6.3.3.6.1	Resource Definition	214
6.3.3.6.2	Resource Standard Methods	215
6.3.4	Custom Operations without associated resources	215
6.3.5	Notifications	215
6.3.6	Data Model	215
6.3.6.1	General	215
6.3.6.2	Structured data types	217
6.3.6.2.1	Introduction	217
6.3.6.2.2	Type: AuthenticationInfoRequest	217
6.3.6.2.3	Type: AuthenticationInfoResult	217

6.3.6.2.4	Type: AvEapAkaPrime	217
6.3.6.2.5	Type: Av5GHeAka.....	218
6.3.6.2.6	Type: ResynchronizationInfo	218
6.3.6.2.7	Type: AuthEvent	218
6.3.6.2.8	Type: AuthenticationVector	218
6.3.6.2.9	Type: RgAuthCtx	219
6.3.6.2.10	Type: HssAuthenticationInfoRequest.....	219
6.3.6.2.11	Type: HssAuthenticationInfoResult	219
6.3.6.2.12	Type: HssAuthenticationVectors.....	219
6.3.6.2.13	Type: AvEpsAka	220
6.3.6.2.14	Type: AvImsGbaEapAka	220
6.3.6.3	Simple data types and enumerations	220
6.3.6.3.1	Introduction	220
6.3.6.3.2	Simple data types.....	220
6.3.6.3.3	Enumeration: AuthType	221
6.3.6.3.4	Enumeration: AvType	221
6.3.6.3.5	Enumeration: HssAuthType	221
6.3.6.3.6	Enumeration: HssAvType	221
6.3.6.3.7	Enumeration: HssAuthTypeInUri.....	221
6.3.6.3.8	Enumeration: AccessNetworkId.....	222
6.3.6.3.9	Enumeration: NodeType.....	222
6.3.7	Error Handling	222
6.3.7.1	General	222
6.3.7.2	Protocol Errors	222
6.3.7.3	Application Errors.....	222
6.3.8	Feature Negotiation.....	223
6.3.9	Security	223
6.4	Nudm_EventExposure Service API	223
6.4.1	API URI	223
6.4.2	Usage of HTTP.....	224
6.4.2.1	General	224
6.4.2.2	HTTP standard headers	224
6.4.2.2.1	General	224
6.4.2.2.2	Content type	224
6.4.2.3	HTTP custom headers	224
6.4.2.3.1	General	224
6.4.3	Resources.....	225
6.4.3.1	Overview.....	225
6.4.3.2	Resource: EeSubscriptions (Collection).....	225
6.4.3.2.1	Description	225
6.4.3.2.2	Resource Definition.....	225
6.4.3.2.3	Resource Standard Methods	226
6.4.3.3	Resource: Individual subscription (Document).....	227
6.4.3.3.1	Resource Definition.....	227
6.4.3.3.2	Resource Standard Methods	227
6.4.4	Custom Operations without associated resources	229
6.4.5	Notifications	229
6.4.5.1	General	229
6.4.5.2	Event Occurrence Notification.....	229
6.4.6	Data Model	230
6.4.6.1	General	230
6.4.6.2	Structured data types	232
6.4.6.2.1	Introduction	232
6.4.6.2.2	Type: EeSubscription	233
6.4.6.2.3	Type: MonitoringConfiguration	234
6.4.6.2.4	Type: MonitoringReport.....	236
6.4.6.2.5	Type: Report.....	237
6.4.6.2.6	Type: ReportingOptions	237
6.4.6.2.7	Type: ChangeOfSupiPeiAssociationReport	238
6.4.6.2.8	Type: RoamingStatusReport.....	238
6.4.6.2.9	Type: CreatedEeSubscription	238
6.4.6.2.10	Type: LocationReportingConfiguration	239

6.4.6.2.11	Type: CnTypeChangeReport	239
6.4.6.2.12	Type: ReachabilityForSmsReport	239
6.4.6.2.13	Type: DatalinkReportingConfiguration	240
6.4.6.2.14	Type: CmInfoReport	240
6.4.6.2.15	Type: LossConnectivityCfg	240
6.4.6.2.16	Type: PduSessionStatusCfg	240
6.4.6.2.17	Type: LossConnectivityReport	240
6.4.6.2.18	Type: LocationReport	241
6.4.6.2.19	Type: PdnConnectivityStatReport	241
6.4.6.3	Simple data types and enumerations	241
6.4.6.3.1	Introduction	241
6.4.6.3.2	Simple data types	241
6.4.6.3.3	Enumeration: EventType	242
6.4.6.3.4	Enumeration: LocationAccuracy	242
6.4.6.3.5	Enumeration: CnType	242
6.4.6.3.6	Enumeration: AssociationType	243
6.4.6.3.7	Enumeration: EventReportMode	243
6.4.6.3.8	Enumeration: ReachabilityForSmsConfiguration	243
6.4.6.3.9	Enumeration: PdnConnectivityStatus	243
6.4.7	Error Handling	243
6.4.7.1	General	243
6.4.7.2	Protocol Errors	243
6.4.7.3	Application Errors	243
6.4.8	Feature Negotiation	245
6.4.9	Security	245
6.5	Nudm_ParameterProvision Service API	245
6.5.1	API URI	245
6.5.2	Usage of HTTP	246
6.5.2.1	General	246
6.5.2.2	HTTP standard headers	246
6.5.2.2.1	General	246
6.5.2.2.2	Content type	246
6.5.2.3	HTTP custom headers	246
6.5.2.3.1	General	246
6.5.3	Resources	247
6.5.3.1	Overview	247
6.5.3.2	Resource: PpData	248
6.5.3.2.1	Description	248
6.5.3.2.2	Resource Definition	248
6.5.3.2.3	Resource Standard Methods	248
6.5.3.3	Resource: 5GVnGroupConfiguration	249
6.5.3.3.1	Description	249
6.5.3.3.2	Resource Definition	249
6.5.3.3.3	Resource Standard Methods	249
6.5.4	Custom Operations without associated resources	252
6.5.5	Notifications	252
6.5.6	Data Model	252
6.5.6.1	General	252
6.5.6.2	Structured data types	253
6.5.6.2.1	Introduction	253
6.5.6.2.2	Type: PpData	253
6.5.6.2.3	Type: CommunicationCharacteristics	254
6.5.6.2.4	Type: PpSubsRegTimer	254
6.5.6.2.5	Type: PpActiveTime	255
6.5.6.2.6	Type: 5GVnGroupConfiguration	255
6.5.6.2.7	Type: 5GVnGroupData	256
6.5.6.2.8	Type: ExpectedUeBehaviour	257
6.5.6.2.9	Void	258
6.5.6.2.10	Type: LocationArea	258
6.5.6.2.11	Type: NetworkAreaInfo	258
6.5.6.2.12	Type: EcRestriction	258
6.5.6.2.13	Type: PlmnEcInfo	259

6.5.6.2.14	Type: PpDIPacketCountExt.....	259
6.5.6.2.15	Type: PpMaximumResponseTime	260
6.5.6.2.16	Type: PpMaximumLatency	260
6.5.6.2.17	Type: LcsPrivacy.....	261
6.5.6.3	Simple data types and enumerations	261
6.5.6.3.1	Introduction	261
6.5.6.3.2	Simple data types.....	261
6.5.6.3.3	Void.....	261
6.5.6.3.4	Void.....	261
6.5.7	Error Handling	261
6.5.7.1	General	261
6.5.7.2	Protocol Errors	261
6.5.7.3	Application Errors.....	262
6.5.8	Feature Negotiation.....	262
6.5.9	Security	262
6.6	Nudm_NIDDAuthorization Service API.....	262
6.6.1	API URI.....	262
6.6.2	Usage of HTTP.....	263
6.6.2.1	General	263
6.6.2.2	HTTP standard headers	263
6.6.2.2.1	General	263
6.6.2.2.2	Content type	263
6.6.2.3	HTTP custom headers	263
6.6.2.3.1	General	263
6.6.3	Resources.....	263
6.6.3.1	Overview.....	263
6.6.3.2	Resource: ueIdentity (Document)	264
6.6.3.2.1	Description	264
6.6.3.2.2	Resource Definition.....	264
6.6.3.2.3	Resource Standard Methods	264
6.6.3.2.4	Resource Custom Operations	264
6.6.4	Custom Operations without associated resources	265
6.6.5	Notifications	265
6.6.5.1	General	265
6.6.5.2	Nidd Authorization Data Update Notification	265
6.6.6	Data Model	266
6.6.6.1	General	266
6.6.6.2	Structured data types.....	267
6.6.6.2.1	Introduction	267
6.6.6.2.2	Type: AuthorizationData	267
6.6.6.2.3	Type: UserIdentifier	267
6.6.6.2.4	Type: NiddAuthUpdateInfo.....	267
6.6.6.2.5	Type: NiddAuthUpdateNotification	268
6.6.6.2.6	Type: AuthorizationInfo	268
6.6.6.3	Simple data types and enumerations	268
6.6.6.3.1	Introduction	268
6.6.6.3.2	Simple data types.....	268
6.6.6.3.3	Enumeration: NiddCause.....	269
6.6.7	Error Handling	269
6.6.7.1	General	269
6.6.7.2	Protocol Errors	269
6.6.7.3	Application Errors.....	269
6.6.8	Feature Negotiation.....	269
6.6.9	Security	269
6.7	Nudm_MT Service API.....	270
6.7.1	API URI.....	270
6.7.2	Usage of HTTP.....	270
6.7.2.1	General	270
6.7.2.2	HTTP standard headers	270
6.7.2.2.1	General	270
6.7.2.2.2	Content type	270
6.7.2.3	HTTP custom headers	270

6.7.2.3.1	General	270
6.7.3	Resources	271
6.7.3.1	Overview	271
6.7.3.2	Resource: UeInfo	271
6.7.3.2.1	Description	271
6.7.3.2.2	Resource Definition	271
6.7.3.2.3	Resource Standard Methods	271
6.7.3.3	Resource: LocationInfo	272
6.7.3.3.1	Description	272
6.7.3.3.2	Resource Definition	272
6.7.3.3.3	Resource Standard Methods	272
6.7.3.3.4	Resource Custom Operations	273
6.7.4	Custom Operations without associated resources	273
6.7.5	Notifications	273
6.7.6	Data Model	273
6.7.6.1	General	273
6.7.6.2	Structured data types	274
6.7.6.2.1	Introduction	274
6.7.6.2.2	Type: UeInfo	274
6.7.6.2.3	Type: LocationInfoRequest	275
6.7.6.2.4	Type: LocationInfoResult	276
6.7.6.2.5	Type: 5GSrvccInfo	276
6.7.6.3	Simple data types and enumerations	276
6.7.7	Error Handling	276
6.7.7.1	General	276
6.7.7.2	Protocol Errors	276
6.7.7.3	Application Errors	276
6.7.8	Feature Negotiation	277
6.7.9	Security	277
Annex A (normative):	OpenAPI specification	278
A.1	General	278
A.2	Nudm_SDM API	278
A.3	Nudm_UECM API	316
A.4	Nudm_UEAU API	337
A.5	Nudm_EE API	346
A.6	Nudm_PP API	354
A.7	Nudm_NIDDAU API	361
A.8	Nudm_MT API	363
Annex B (informative):	Stateless UDMs	367
Annex C (informative):	SUCI encoding	371
Annex D (informative):	Change history	373
History		382

Foreword

This Technical Specification has been produced by the 3rd Generation Partnership Project (3GPP).

The contents of the present document are subject to continuing work within the TSG and may change following formal TSG approval. Should the TSG modify the contents of the present document, it will be re-released by the TSG with an identifying change of release date and an increase in version number as follows:

Version x.y.z

where:

- x the first digit:
 - 1 presented to TSG for information;
 - 2 presented to TSG for approval;
 - 3 or greater indicates TSG approved document under change control.
- y the second digit is incremented for all changes of substance, i.e. technical enhancements, corrections, updates, etc.
- z the third digit is incremented when editorial only changes have been incorporated in the document.

In the present document, modal verbs have the following meanings:

- shall** indicates a mandatory requirement to do something
- shall not** indicates an interdiction (prohibition) to do something

The constructions "shall" and "shall not" are confined to the context of normative provisions, and do not appear in Technical Reports.

The constructions "must" and "must not" are not used as substitutes for "shall" and "shall not". Their use is avoided insofar as possible, and they are not used in a normative context except in a direct citation from an external, referenced, non-3GPP document, or so as to maintain continuity of style when extending or modifying the provisions of such a referenced document.

- should** indicates a recommendation to do something
- should not** indicates a recommendation not to do something
- may** indicates permission to do something
- need not** indicates permission not to do something

The construction "may not" is ambiguous and is not used in normative elements. The unambiguous constructions "might not" or "shall not" are used instead, depending upon the meaning intended.

- can** indicates that something is possible
- cannot** indicates that something is impossible

The constructions "can" and "cannot" are not substitutes for "may" and "need not".

- will** indicates that something is certain or expected to happen as a result of action taken by an agency the behaviour of which is outside the scope of the present document
- will not** indicates that something is certain or expected not to happen as a result of action taken by an agency the behaviour of which is outside the scope of the present document
- might** indicates a likelihood that something will happen as a result of action taken by some agency the behaviour of which is outside the scope of the present document

might not indicates a likelihood that something will not happen as a result of action taken by some agency the behaviour of which is outside the scope of the present document

In addition:

is (or any other verb in the indicative mood) indicates a statement of fact

is not (or any other negative verb in the indicative mood) indicates a statement of fact

The constructions "is" and "is not" do not indicate requirements.

1 Scope

The present document specifies the stage 3 protocol and data model for the Nudm Service Based Interface. It provides stage 3 protocol definitions and message flows, and specifies the API for each service offered by the UDM.

The 5G System stage 2 architecture and procedures are specified in 3GPP TS 23.501 [2] and 3GPP TS 23.502 [3].

The Technical Realization of the Service Based Architecture and the Principles and Guidelines for Services Definition are specified in 3GPP TS 29.500 [4] and 3GPP TS 29.501 [5].

2 References

The following documents contain provisions which, through reference in this text, constitute provisions of the present document.

- References are either specific (identified by date of publication, edition number, version number, etc.) or non-specific.
- For a specific reference, subsequent revisions do not apply.
- For a non-specific reference, the latest version applies. In the case of a reference to a 3GPP document (including a GSM document), a non-specific reference implicitly refers to the latest version of that document *in the same Release as the present document*.

- [1] 3GPP TR 21.905: "Vocabulary for 3GPP Specifications".
- [2] 3GPP TS 23.501: "System Architecture for the 5G System; Stage 2".
- [3] 3GPP TS 23.502: "Procedures for the 5G System; Stage 2".
- [4] 3GPP TS 29.500: "5G System; Technical Realization of Service Based Architecture; Stage 3".
- [5] 3GPP TS 29.501: "5G System; Principles and Guidelines for Services Definition; Stage 3".
- [6] 3GPP TS 33.501: "Security Architecture and Procedures for 5G System".
- [7] 3GPP TS 29.571: "5G System; Common Data Types for Service Based Interfaces Stage 3".
- [8] 3GPP TS 23.003: "Numbering, addressing and identification".
- [9] 3GPP TS 29.504: "5G System; Unified Data Repository Services; Stage 3".
- [10] 3GPP TS 29.505: "5G System; Usage of the Unified Data Repository Services for Subscription Data; Stage 3".
- [11] 3GPP TS 32.255: "Charging management; 5G data connectivity domain charging".
- [12] 3GPP TS 32.298: "Charging management; Charging Data Record (CDR) parameter description".
- [13] IETF RFC 7540: "Hypertext Transfer Protocol Version 2 (HTTP/2)".
- [14] OpenAPI Initiative, "OpenAPI 3.0.0 Specification", <https://github.com/OAI/OpenAPI-Specification/blob/master/versions/3.0.0.md>
- [15] IETF RFC 8259: "The JavaScript Object Notation (JSON) Data Interchange Format".
- [16] IETF RFC 7807: "Problem Details for HTTP APIs".
- [17] IETF RFC 7396: "JSON Merge Patch".
- [18] IETF RFC 6749: "The OAuth 2.0 Authorization Framework".
- [19] 3GPP TS 29.510: "Network Function Repository Services; Stage 3".

- [20] 3GPP TS 23.122: "Non-Access-Stratum (NAS) functions related to Mobile Station in idle mode".
- [21] 3GPP TS 29.002: "Mobile Application Part (MAP) specification".
- [22] 3GPP TS 29.338: "Diameter based protocols to support Short Message Service (SMS) capable Mobile Management Entities (MMEs)".
- [23] ITU-T Recommendation E.164: "The international public telecommunication numbering plan".
- [24] 3GPP TS 29.509: "Authentication Server Services; Stage 3".
- [25] IETF RFC 7232: "Hypertext Transfer Protocol (HTTP/1.1): Conditional Requests".
- [26] IETF RFC 7234: "Hypertext Transfer Protocol (HTTP/1.1): Caching".
- [27] 3GPP TS 24.501: "Non-Access-Stratum (NAS) protocol for 5G System (5GS); Stage 3".
- [28] ETSI TS 102 225: "Smart Cards; Secured packet structure for UICC based applications".
- [29] IETF RFC 7542: "The Network Access Identifier".
- [30] 3GPP TR 21.900: "Technical Specification Group working methods".
- [31] IETF RFC 3986: "Uniform Resource Identifier (URI): Generic Syntax".
- [32] 3GPP TS 23.632: "User Data Interworking, Coexistence and Migration".
- [33] 3GPP TS 29.519: "Policy Data, Application Data and Structured Data for Exposure; Stage 3".
- [34] 3GPP TS 29.572: "5G System; Location Management Services; Stage 3".
- [35] 3GPP TS 23.288: "Architecture enhancements for 5G System (5GS) to support network data analytics services".
- [36] 3GPP TS 29.518: "Access and Mobility Management Services".
- [37] 3GPP TS 23.316: "Wireless and wireline convergence access support for the 5G System (5GS); Stage 2".
- [38] 3GPP TS 23.273: "5G System (5GS) Location Services (LCS); Stage 2".
- [39] 3GPP TS 29.515: "5G System; Gateway Mobile Location Services; Stage 3".
- [40] 3GPP TS 29.508: "5G System; Session Management Event Exposure Service; Stage 3".
- [41] IETF RFC 6902: "JavaScript Object Notation (JSON) Patch".
- [42] BBF TR-069: "CPE WAN Management Protocol".
- [43] BBF TR-369: "User Services Platform (USP)".
- [44] 3GPP TS 29.524: "5G System; Cause codes mapping between 5GC interfaces; Stage 3".
- [45] 3GPP TS 29.122: "T8 reference point for Northbound APIs".
- [46] 3GPP TS 24.008: "Mobile radio interface Layer 3 specification; Core network protocols; Stage 3".
- [47] 3GPP TS 22.071: "Location Services (LCS); Service description; Stage 1".
- [48] 3GPP TS 32.422: "Telecommunication management; Subscriber and equipment trace; Trace control and configuration management".
- [49] 3GPP TS 24.302: "Access to the 3GPP Evolved Packet Core (EPC) via non-3GPP access networks".
- [50] IETF RFC 7230: "Hypertext Transfer Protocol (HTTP/1.1): Message Syntax and Routing".

- [51] 3GPP TS 23.287: "Architecture enhancements for 5G System (5GS) to support Vehicle-to-Everything (V2X) services".
- [52] 3GPP TS 29.328: "IP Multimedia (IM) Subsystem Sh interface; Signalling flows and message contents".
- [53] 3GPP TS 23.040: "Technical realization of the Short Message Service (SMS)".
- [54] 3GPP TS 29.522: "5G System; Network Exposure Function Northbound APIs; Stage 3".
- [55] 3GPP TS 29.563: "5G System; Home Subscriber Server (HSS) services for interworking with Unified Data Management (UDM); Stage 3"

3 Definitions and abbreviations

3.1 Definitions

For the purposes of the present document, the terms and definitions given in 3GPP TR 21.905 [1] and the following apply. A term defined in the present document takes precedence over the definition of the same term, if any, in 3GPP TR 21.905 [1].

3.2 Abbreviations

For the purposes of the present document, the abbreviations given in 3GPP TR 21.905 [1] and the following apply. An abbreviation defined in the present document takes precedence over the definition of the same abbreviation, if any, in 3GPP TR 21.905 [1].

5GC	5G Core Network
ACS	Auto-Configuration Server
AMF	Access and Mobility Management Function
AUSF	Authentication Server Function
NIDD	Non-IP Data Delivery
DNN	Data Network Name
FQDN	Fully Qualified Domain Name
FN-RG	Fixed Network RG
GMLC	Gateway Mobile Location Centre
GPSI	Generic Public Subscription Identifier
GUAMI	Globally Unique AMF Identifier
HGMLC	Home GMLC
JSON	Javascript Object Notation
LCS	LoCation Services
LPI	LCS Privacy Indicator
MICO	Mobile Initiated Connection Only
N5GC	Non-5G-Capable
NAI	Network Access Identifier
NAS	Non-Access Stratum
NEF	Network Exposure Function
NRF	Network Repository Function
NSSAI	Network Slice Selection Assistance Information
NWDAF	Network Data Analytics Function
PEI	Permanent Equipment Identifier
QFI	QoS Flow Identifier
5G-RG	5G Residential Gateway
RG	Residential Gateway
SBI	Service Based Interface
SMF	Session Management Function
SMSF	Short Message Service Function
SUCI	Subscription Concealed Identifier
SUPI	Subscription Permanent Identifier

UDM	Unified Data Management
UDR	Unified Data Repository
W-AGF	Wireline Access Gateway Function

4 Overview

4.1 Introduction

Within the 5GC, the UDM offers services to the AMF, SMF, SMSF, NEF, GMLC, NWDAF and AUSF via the Nudm service based interface (see 3GPP TS 23.501 [2], 3GPP TS 23.502 [3] and 3GPP TS 23.288 [35]).

Figure 4.1-1 provides the reference model (in service based interface representation and in reference point representation), with focus on the UDM.

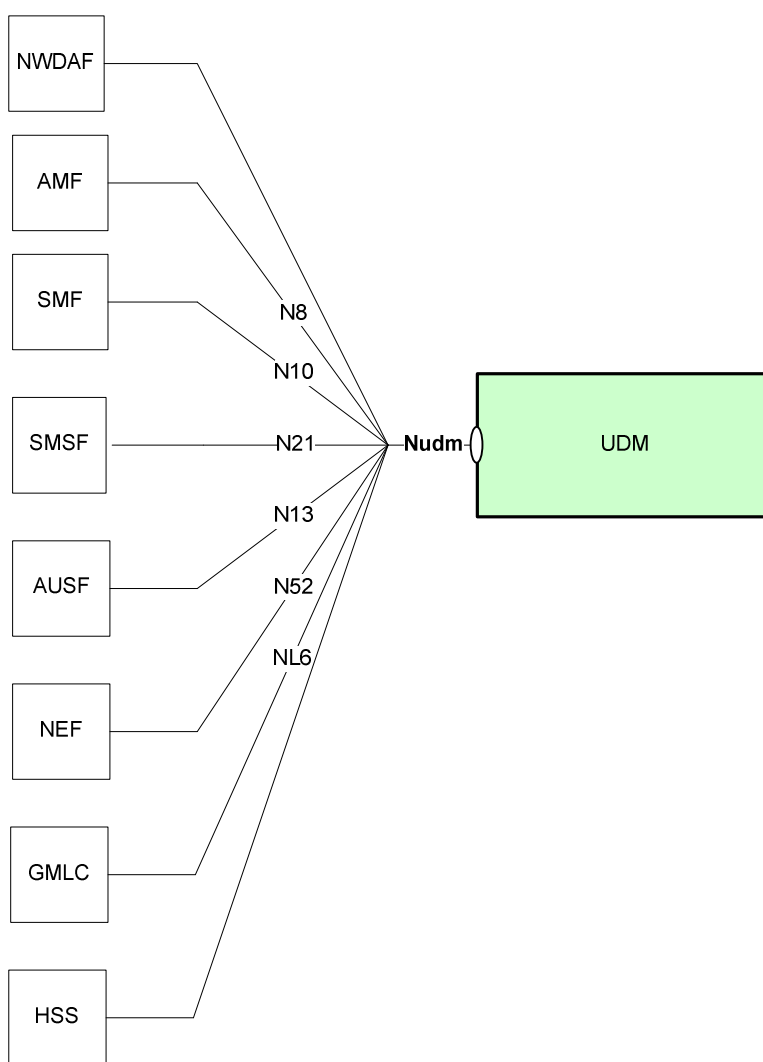

Figure 4.1-1: Reference model – UDM

The functionalities supported by the UDM are listed in clause 6.2.7 of 3GPP TS 23.501 [2].

5 Services offered by the UDM

5.1 Introduction

The UDM offers the following services via the Nudm interface:

- Nudm_SubscriberDataManagement Service
- Nudm_UEContextManagement Service
- Nudm_UEAuthentication Service
- Nudm_EventExposure Service
- Nudm_ParameterProvision Service
- Nudm_NIDDAuthorization
- Nudm_MT

Table 5.1-1 summarizes the corresponding APIs defined for this specification.

Table 5.1-1: API Descriptions

Service Name	Clause	Description	OpenAPI Specification File	apiName	Annex
Nudm_SubscriberDataManagement	6.1	UDM Subscriber Data Management Service	TS29503_Nudm_SDM.yaml	nudm-sdm	A.2
Nudm_UEContextManagement	6.2	UDM Context Management Service	TS29503_Nudm_UECM.yaml	nudm-uecm	A.3
Nudm_UEAuthentication	6.3	UDM UE Authentication Service	TS29503_Nudm_UEAU.yaml	nudm-ueau	A.4
Nudm_EventExposure	6.4	UDM Event Exposure Service	TS29503_Nudm_EE.yaml	nudm-ee	A.5
Nudm_ParameterProvision	6.5	UDM Parameter Provision Service	TS29503_Nudm_PP.yaml	nudm-pp	A.6
Nudm_NIDDAuthorization	6.6	UDM NIDD Authorization Service	TS29503_Nudm_NIDDAU.yaml	nudm-niddau	A.7
Nudm_MT	6.7	UDM MT Service	TS29503_Nudm_MT.yaml	nudm-mt	A.8

All scenarios shown in the following clauses assume that the UDM is stateful and stores information in local memory. However, the UDM may be stateless and stores information externally in the UDR. If so, the stateless UDM makes use of Nudr services as specified in 3GPP TS 29.504 [9] and 3GPP TS 29.505 [10] to retrieve required data from the UDR and store them locally before processing an incoming request. Processing the incoming request may then include updating data in the UDR or subscribing to data change notifications at the UDR by consuming the appropriate Nudr services. After processing the incoming request, the UDM may delete the locally stored data. When data stored in UDR is then shared among the different UDM instances of the same group, as identified by UDM Group ID (see 3GPP TS 23.501 [2], clause 6.2.6), bulk subscriptions, as described in clause 4.15.3.2.4 of 3GPP TS 23.502 [3], are not

applicable, i.e. an NF consumer (e.g. NEF) only subscribes towards one of the UDM instances within the group. See Annex B.

5.2 Nudm_SubscriberDataManagement Service

5.2.1 Service Description

See 3GPP TS 23.501 [2] table 7.2.5-1.

5.2.2 Service Operations

5.2.2.1 Introduction

For the Nudm_SubscriberDataManagement service the following service operations are defined:

- Get
- Subscribe
- ModifySubscription
- Unsubscribe
- Notification
- Info

The Nudm_SubscriberDataManagement Service is used by Consumer NFs (AMF, SMF, SMSF, GMLC) to retrieve the UE's individual subscription data relevant to the consumer NF from the UDM by means of the Get service operation. If the consumer NF supports the feature "sharedData" (see clause 6.1.8), the retrieved individual subscription data for the UE may contain shared data identifier identifying additional parts of subscription data shared by several UEs. If so, the Nudm_SubscriberDataManagement Service is also used by Consumer NFs to retrieve shared subscription data from the UDM by means of the Get service operation.

It is also used by Consumer NFs to subscribe to notifications of data change by means of the Subscribe service operation. If the consumer NF supports the feature "sharedData" (see clause 6.1.8), the consumer NF may also subscribe to notifications of shared data change by means of the Subscribe service operation.

It is also used to modify an existing subscription by means of the ModifySubscription service operation. If the consumer NF supports the feature "sharedData" (see clause 6.1.8), the consumer NF may also modify an existing subscription to notifications of shared data change by means of the ModifySubscription service operation.

It is also used to unsubscribe from notifications of data changes by means of the Unsubscribe service operation. If the feature "sharedData" (see clause 6.1.8) is supported, it may also be used to unsubscribe from notifications of shared data changes by means of the Unsubscribe service operation.

It is also used by the Consumer NFs (AMF, SMF, SMSF) that have previously subscribed, to get notified by means of the Notification service operation when UDM decides to modify the subscribed data. If the feature "sharedData" (see clause 6.1.8) is supported by the consumer NF and the consumer NF has previously subscribed to notifications of shared data change, it is also used by the consumer NF to get notified by means of the Notification service operation when the UDM decides to modify the subscribed shared data.

It is also used by Consumer NFs to provide the information about the status of the subscription data management procedures.

5.2.2.2 Get

5.2.2.2.1 General

The following procedures using the Get service operation are supported:

- Slice Selection Subscription Data Retrieval
- Access and Mobility Subscription Data Retrieval
- SMF Selection Subscription Data Retrieval
- Session Management Subscription Data Retrieval
- SMS Subscription Data Retrieval
- SMS Management Subscription Data Retrieval
- UE Context in SMF Data Retrieval
- UE Context in SMSF Data Retrieval
- Retrieval Of Multiple Data Sets
- Identifier Translation
- Shared Subscription Data Retrieval
- Trace Data Retrieval
- LCS Privacy Data Retrieval
- LCS Mobile Originated Data Retrieval
- Enhanced Coverage Restriction Data Retrieval
- V2X Subscription Data Retrieval
- LCS Broadcast Assistance Subscription Data Retrieval
- UE Context in AMF Data Retrieval
- Individual Shared Subscription Data Retrieval

When the feature SharedData (see clause 6.1.8) is supported and the retrieved UE-individual data (i.e. data other than Shared Subscription Data) contain SharedDataIds, the NF service consumer shall also retrieve the shared data identified by the received shared data Ids unless the identified shared data are already available at the NF service consumer. The order of sequence of sharedDataIds within UE-individual data is significant: Individual data take precedence over shared data; shared data "SharedDataX" identified by a sharedDataId X takes precedence over shared data "SharedDataY" identified by a sharedDataId Y if X appears before Y within the list of SharedDataIds in the UE-individual data.

5.2.2.2.2 Slice Selection Subscription Data Retrieval

Figure 5.2.2.2.2-1 shows a scenario where the NF service consumer (e.g. AMF) sends a request to the UDM to receive the UE's NSSAI (see also clause 5.15.5.2.1 of 3GPP TS 23.501 [2] and 3GPP TS 23.502 [3] figure 4.2.2.2.3-1 step 3). In this example scenario the NSSAI is retrieved by the AMF, see clause 6.1.3.2.1 for other scenarios that can retrieve the NSSAI. The request contains the UE's identity ($\{supi\}$), the type of the requested information ($\{nssai\}$) and query parameters (supported-features, plmn-id).

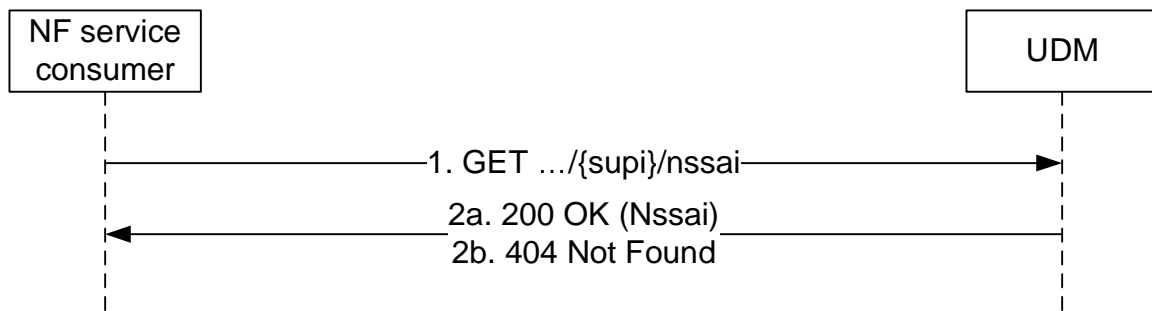

Figure 5.2.2.2-1: Requesting a UE's NSSAI

1. The NF service consumer (e.g. AMF) sends a GET request to the resource representing the UE's subscribed NSSAI, with query parameters indicating the supported-features and/or plmn-id.
- 2a. On success, the UDM responds with "200 OK" with the message body containing the UE's NSSAI as relevant for the requesting NF service consumer.
- 2b. If there is no valid subscription data for the UE, HTTP status code "404 Not Found" shall be returned including additional error information in the response body (in the "ProblemDetails" element).

On failure, the appropriate HTTP status code indicating the error shall be returned and appropriate additional error information should be returned in the GET response body.

5.2.2.2.3 Access and Mobility Subscription Data Retrieval

Figure 5.2.2.2.3-1 shows a scenario where the NF service consumer (e.g. AMF) sends a request to the UDM to receive the UE's Access and Mobility Subscription data (see also 3GPP TS 23.502 [3] figure 4.2.2.2-1 step 14). The request contains the UE's identity ($\{/supi\}$), the type of the requested information ($\{/am-data\}$) and query parameters (supported-features, plmn-id).

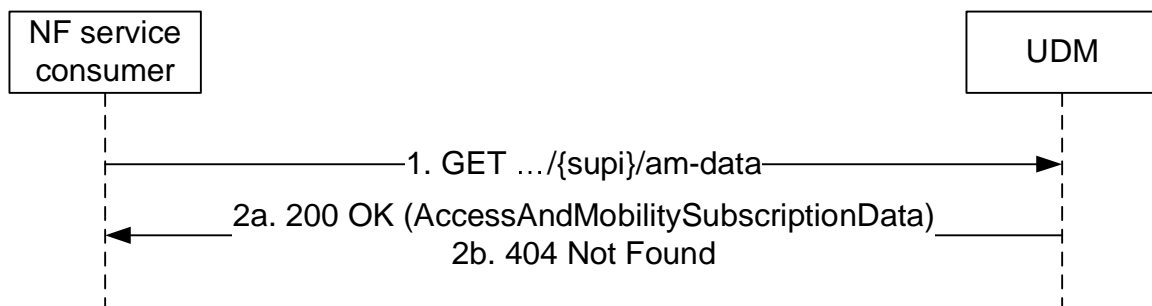

Figure 5.2.2.2.3-1: Requesting a UE's Access and Mobility Subscription Data

1. The NF service consumer (e.g. AMF) sends a GET request to the resource representing the UE's Access and Mobility Subscription Data, with query parameters indicating the supported-features and/or plmn-id.
- 2a. On Success, the UDM responds with "200 OK" with the message body containing the UE's Access and Mobility Subscription Data as relevant for the requesting NF service consumer.

NOTE 1: If the UDM initiated a request to obtain SoR information from the SOR-AF, the UDM starts an operator configurable timer up to which the UDM shall wait for a response from the SOR-AF for retrieving the SoR information. The UDM responds back to the NF service consumer for Access and Mobility Subscription Data Retrieval service operation before the timer expires. If the SOR-AF has not provided a response with the SoR information before the timer expires, the UDM shall behave as specified in clause C.2 of 3GPP TS 23.122 [20] (step 3d). 2b. If there is no valid subscription data for the UE, HTTP status code "404 Not Found" shall be returned including additional error information in the response body (in the "ProblemDetails" element).

NOTE 2: Upon reception of any Nudm_EventExposure operation or Nudm_PP operation, or when the validity of an event subscription or provisioned parameter with its associated maximum latency, maximum response time or DL Buffering Suggested Packet Count value expires, UDM may need to adjust the values of active time and/or periodic registration timer and/or DL Buffering Suggested Packet Count. The UDM shall notify AMF and/or SMF if the values are updated (see clause 4.15.3.2.3b and 4.15.6.3a of 3GPP TS 23.502 [3]).

On failure, the appropriate HTTP status code indicating the error shall be returned and appropriate additional error information should be returned in the GET response body.

5.2.2.2.4 SMF Selection Subscription Data Retrieval

Figure 5.2.2.2.4-1 shows a scenario where the NF service consumer (e.g. AMF) sends a request to the UDM to receive the UE's SMF Selection Subscription data (see also 3GPP TS 23.502 [3] figure 4.2.2.2.2-1 step 14). The request contains the UE's identity ($\{/supi\}$), the type of the requested information ($\{/smf-select-data\}$) and query parameters (supported-features, plmn-id).

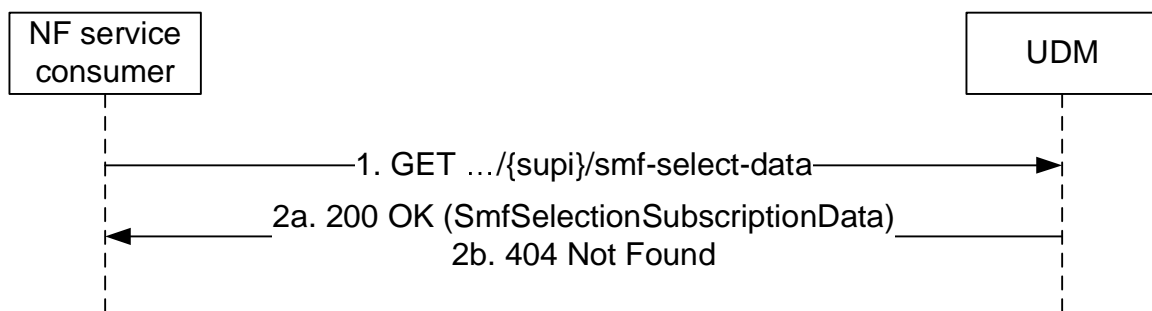

Figure 5.2.2.2.4-1: Requesting a UE's SMF Selection Subscription Data

1. The NF service consumer (e.g. AMF) sends a GET request to the resource representing the UE's SMF Selection Subscription Data, with query parameters indicating the supported-features and/or plmn-id.
- 2a. On success, the UDM responds with "200 OK" with the message body containing the UE's SMF Selection Subscription Data as relevant for the requesting NF service consumer.
- 2b. If there is no valid subscription data for the UE, HTTP status code "404 Not Found" shall be returned including additional error information in the response body (in the "ProblemDetails" element).

On failure, the appropriate HTTP status code indicating the error shall be returned and appropriate additional error information should be returned in the GET response body.

5.2.2.2.5 Session Management Subscription Data Retrieval

Figure 5.2.2.2.5-1 shows a scenario where the NF service consumer (e.g. SMF) sends a request to the UDM to receive the UE's session management subscription data (see also 3GPP TS 23.502 [3] figure 4.3.2.2.1-1 step 4a-4b). The request contains the UE's identity ($\{/supi\}$), the type of the requested information ($\{/sm-data\}$), and query parameters (single-nssai, dnn, supported-features, plmn-id).

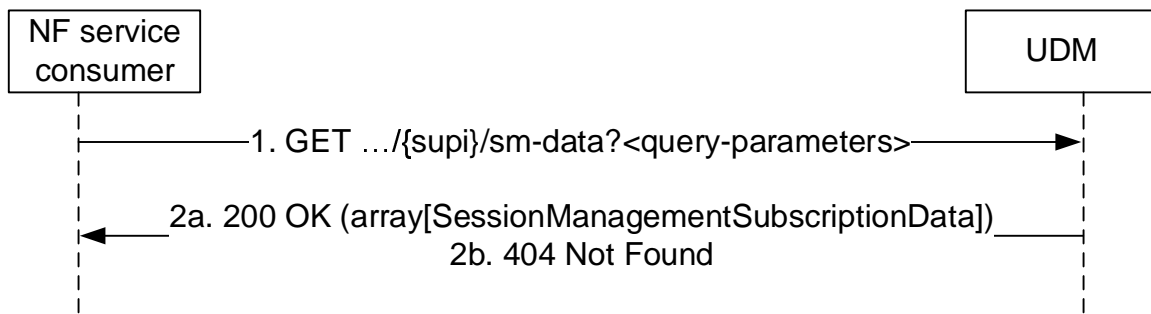

Figure 5.2.2.2.5-1: Requesting a UE's Session Management Subscription Data

1. The NF service consumer (e.g. SMF) sends a GET request to the resource representing the UE's session management subscription data, with query parameters indicating the selected network slice and/or the DNN and/or supported-features and/or plmn-id.
- 2a. On success, the UDM responds with "200 OK", the message body containing the UE's session management subscription data (an array of SessionManagementSubscriptionData objects, one array element per S-NSSAI) as relevant for the requesting NF service consumer.
- 2b. If there is no valid subscription data for the UE, or if the UE subscription data exists, but the requested session management subscription is not available (e.g. query parameter contains network slice and/or DNN that does not belong to the UE subscription), HTTP status code "404 Not Found" shall be returned including additional error information in the response body (in the "ProblemDetails" element).

On failure, the appropriate HTTP status code indicating the error shall be returned and appropriate additional error information should be returned in the GET response body.

5.2.2.2.6 SMS Subscription Data Retrieval

Figure 5.2.2.2.6-1 shows a scenario where the NF service consumer (e.g. AMF) sends a request to the UDM to receive the UE's SMS Subscription Data (see also 3GPP TS 23.502 [3], clause 4.13.3.1). The request contains the UE's identity ($\{/supi\}$) and the type of the requested information ($\{/sms-data\}$).

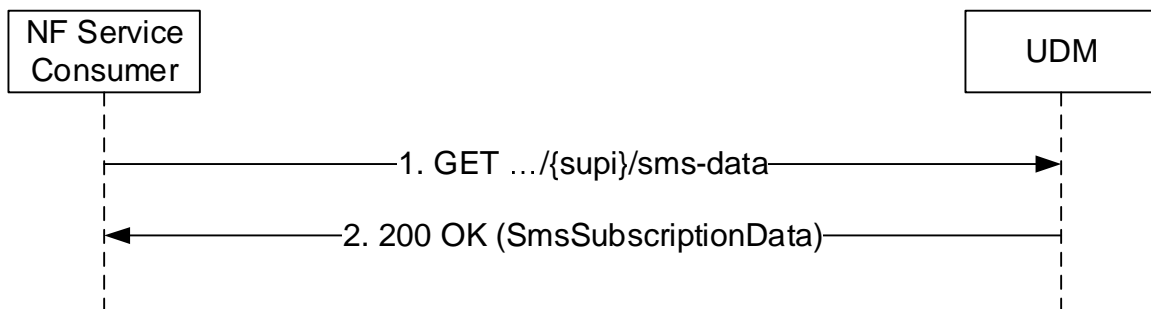

Figure 5.2.2.2.6-1: Requesting UE's SMS Subscription Data

1. The NF Service Consumer (e.g. AMF) sends a GET request to the resource representing the UE's SMS Subscription Data.
2. The UDM responds with "200 OK" with the message body containing the UE's SMS Subscription Data.

On failure, the appropriate HTTP status code indicating the error shall be returned and appropriate additional error information should be returned in the GET response body.

5.2.2.2.7 SMS Management Subscription Data Retrieval

Figure 5.2.2.2.7-1 shows a scenario where the NF service consumer (e.g. SMSF) sends a request to the UDM to receive the UE's SMS Management Subscription Data (see also 3GPP TS 23.502 [3], clause 4.13.3.1). The request contains the UE's identity ($\{/supi\}$) and the type of the requested information ($\{/sms-mng-data\}$).

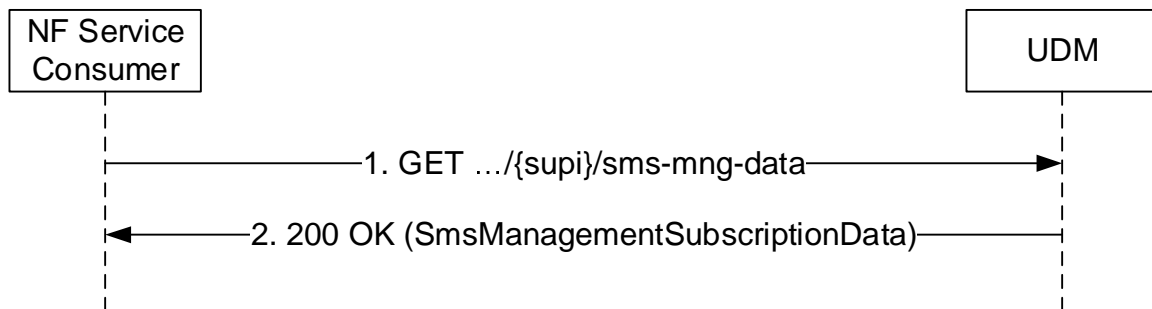

Figure 5.2.2.2.7-1: Requesting UE's SMS Management Subscription Data

1. The NF Service Consumer (e.g. SMSF) sends a GET request to the resource representing the UE's SMS Management Subscription Data.
2. The UDM responds with "200 OK" with the message body containing the UE's SMS Management Subscription Data.

On failure, the appropriate HTTP status code indicating the error shall be returned and appropriate additional error information should be returned in the GET response body.

5.2.2.2.8 UE Context In SMF Data Retrieval

Figure 5.2.2.2.8-1 shows a scenario where the NF service consumer (e.g. AMF) sends a request to the UDM to receive the UE's Context In SMF data (see also 3GPP TS 23.502 [3] figure 4.2.2.2.2-1 step 14). The request contains the UE's identity ($\{/supi\}$), the type of the requested information ($\{/ue-context-in-smf-data\}$) and query parameters (supported-features).

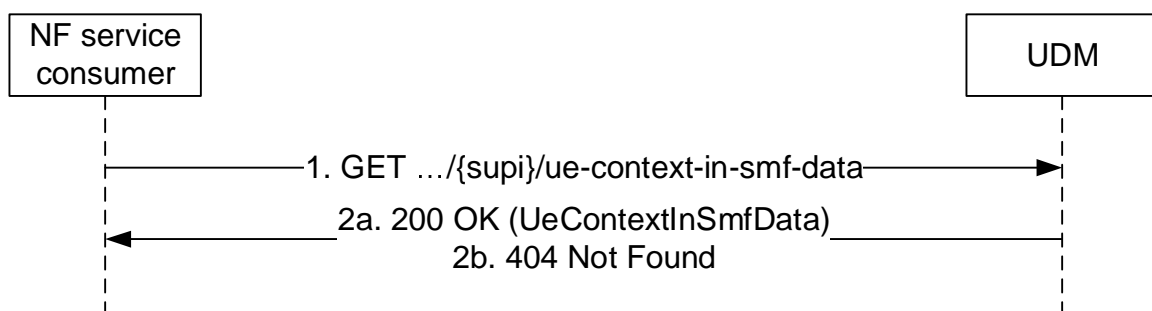

Figure 5.2.2.2.8-1: Requesting a UE's Context in SMF Data

1. The NF service consumer (e.g. AMF) shall send a GET request to the resource representing the UE's Context In SMF Data, with query parameters indicating the supported-features.
- 2a. On Success, the UDM shall respond with "200 OK" with the message body containing the UE's Context In SMF Data as relevant for the requesting NF service consumer.
- 2b. If there is no valid subscription data for the UE, HTTP status code "404 Not Found" shall be returned including additional error information in the response body (in the "ProblemDetails" element).

On failure, the appropriate HTTP status code indicating the error shall be returned and appropriate additional error information should be returned in the GET response body.

5.2.2.2.9 Retrieval Of Multiple Data Sets

Figure 5.2.2.2.9-1 shows a scenario where the NF service consumer (e.g. AMF) sends a request to the UDM to receive multiple data sets. In this example scenario the UE's Access and Mobility Subscription data and the the UE's SMF Selection Subscription data are retrieved with a single request; see clause 6.1.3.11.3.1 for other data sets that can be retrieved with a single request. The request contains the UE's identity ($\{supi\}$) and query parameters identifying the requested data sets (in this example: `?dataset-names=AM, SMF_SEL`).

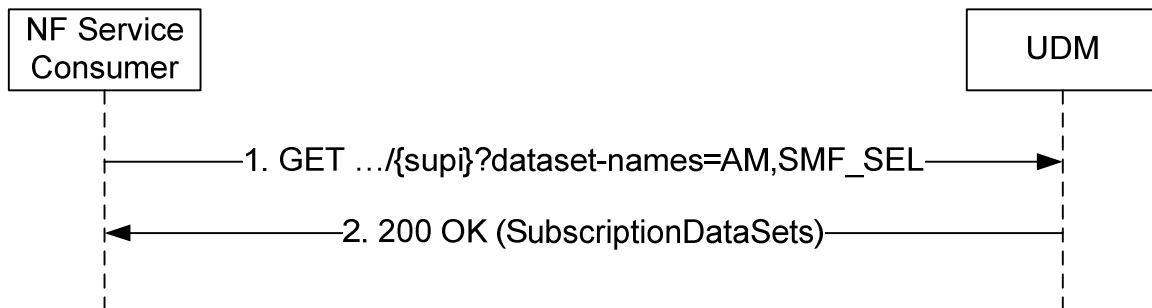

Figure 5.2.2.2.9-1: Retrieval of Multiple Data Sets

1. The NF Service Consumer (e.g. AMF) sends a GET request to the resource representing the `supi`. Query parameters indicate the requested data sets.
2. The UDM responds with "200 OK" with the message body containing the requested and available data sets. When not all requested data sets are available at the UDM (e.g. no Trace Data), only the requested and available data sets are returned in a "200 OK" response.

On failure, the appropriate HTTP status code indicating the error shall be returned and appropriate additional error information should be returned in the GET response body.

5.2.2.2.10 Identifier Translation

Figure 5.2.2.2.10-1 shows a scenario where the NF service consumer (e.g. NEF) sends a request to the UDM to receive the SUPI/GPSI that corresponds to the provided GPSI/SUPI (see also 3GPP TS 23.502 [3], clause 4.13.2.2 and clause 4.13.7.2). The request contains the UE's identity ($\{ueId\}$) which shall be a SUPI or GPSI and the type of the requested information (`/id-translation-result`).

NOTE: This service operation can be used by a Rel-15 GMLC during 5GS-MT-LR procedure to get the SUPI of a UE from GPSI, as an authorized NF service consumer of `Nudm_SubscriberDataManagement` service.

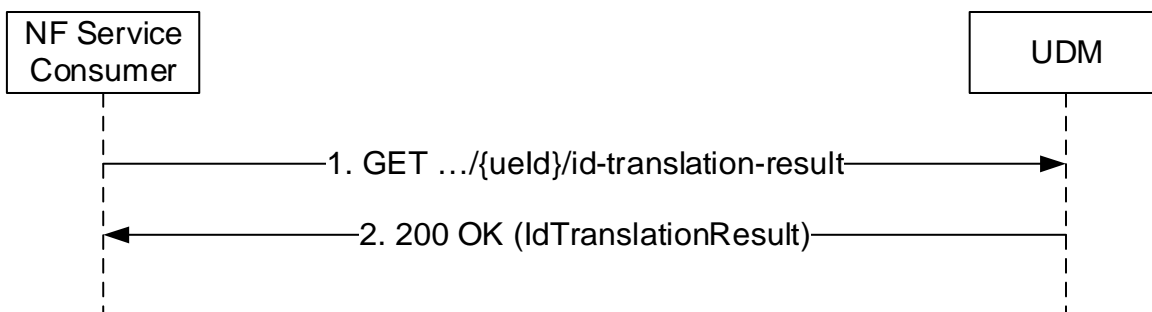

Figure 5.2.2.2.10-1: Identifier Translation

1. The NF Service Consumer (e.g. NEF) shall send a GET request to the resource representing the `IdTranslationResult`, with query parameters indicating the supported-features and/or `app-port-id`.
2. The UDM shall respond with "200 OK" with the message body containing the UE's SUPI.

On failure, the appropriate HTTP status code indicating the error shall be returned and appropriate additional error information should be returned in the GET response body.

5.2.2.2.11 Shared Subscription Data Retrieval

Figure 5.2.2.2.11-1 shows a scenario where the NF service consumer (e.g. AMF) sends a request to the UDM to receive the shared subscription data. The request contains the type of the requested information (/shared-data) and query parameters (supportedFeatures, shared-data-id).

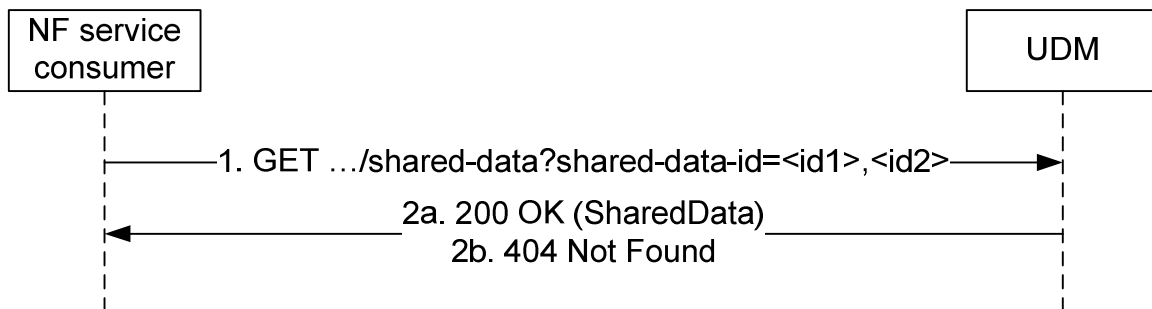

Figure 5.2.2.2.11-1: Requesting shared data

1. The NF service consumer (e.g. AMF) sends a GET request to the resource representing the SharedData, with query parameters indicating the supportedFeatures and shared-data-id.
- 2a. On success, the UDM responds with "200 OK" with the message body containing the SharedData.
- 2b. If there is no valid shared data for one or more of the shared-data-ids, HTTP status code "404 Not Found" shall be returned including additional error information in the response body (in the "ProblemDetails" element).

On failure, the appropriate HTTP status code indicating the error shall be returned and appropriate additional error information should be returned in the GET response body.

5.2.2.2.12 UE Context In SMSF Data Retrieval

Figure 5.2.2.2.12-1 shows a scenario where the NF service consumer (e.g. AMF) sends a request to the UDM to receive the UE's Context In SMSF data. The request contains the UE's identity (/supi), the type of the requested information (/ue-context-in-smsf-data) and query parameters (supported-features).

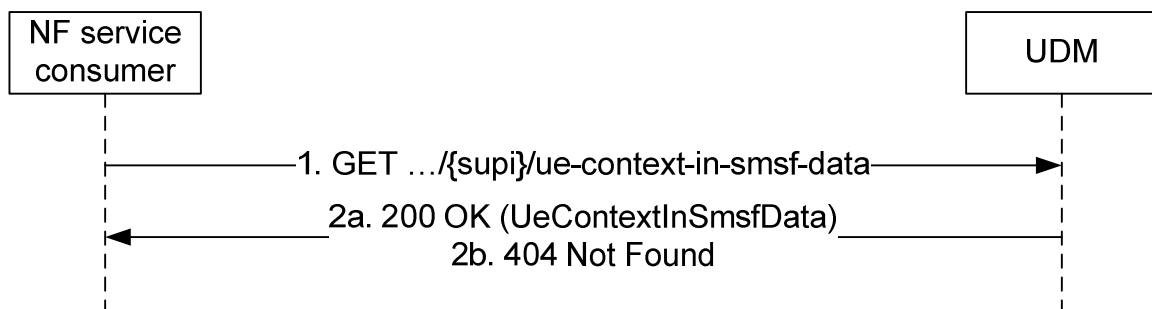

Figure 5.2.2.2.12-1: Requesting a UE's Context in SMSF Data

1. The NF service consumer (e.g. AMF) shall send a GET request to the resource representing the UE's Context In SMSF Data, with query parameters indicating the supported-features.
- 2a. On Success, the UDM shall respond with "200 OK" with the message body containing the UE's Context In SMSF Data as relevant for the requesting NF service consumer.
- 2b. If there is no valid subscription data for the UE, HTTP status code "404 Not Found" shall be returned including additional error information in the response body (in the "ProblemDetails" element).

On failure, the appropriate HTTP status code indicating the error shall be returned and appropriate additional error information should be returned in the GET response body.

5.2.2.2.13 Trace data Retrieval

Figure 5.2.2.2.13-1 shows a scenario where the NF service consumer (e.g. AMF, SMF) sends a request to the UDM to receive the UE's trace data. The request contains the UE's identity ($\{/supi\}$), the type of the requested information ($\{/trace-data\}$) and query parameters.

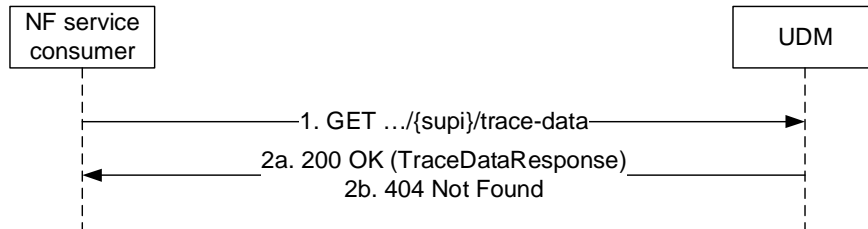

Figure 5.2.2.2.13-1: Requesting a UE's trace Data

1. The NF service consumer (e.g. AMF, SMF) shall send a GET request to the resource representing the UE's trace Data, with query parameters.
- 2a. On Success, the UDM shall respond with "200 OK" with the message body containing the UE's trace data response as relevant for the requesting NF service consumer.
- 2b. If there is no valid subscription data for the UE, HTTP status code "404 Not Found" shall be returned including additional error information in the response body (in the "ProblemDetails" element).

On failure, the appropriate HTTP status code indicating the error shall be returned and appropriate additional error information should be returned in the GET response body.

5.2.2.2.14 Group Identifier Translation

Figure 5.2.2.2.14-1 shows a scenario where the NF service consumer sends a request to the UDM to receive the Internal Group Identifier that corresponds to the provided External Group Identifier and / or the list of the UE identifiers (e.g. SUPIs, GPSIs) that belong to the provided External Group Identifier.

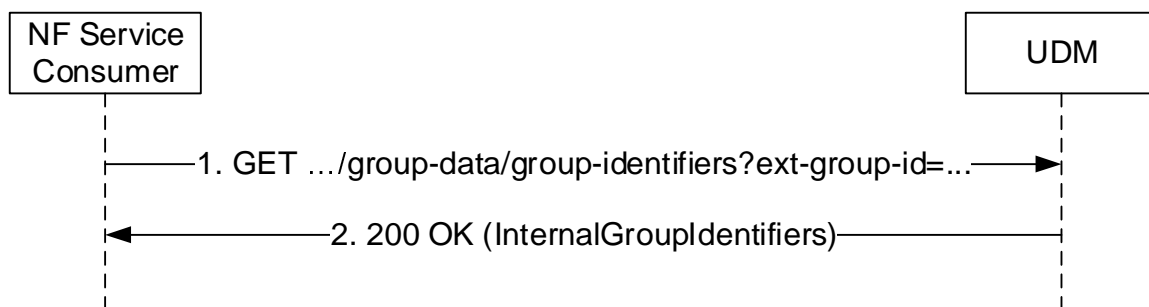

Figure 5.2.2.2.14-1: External Group Identifier Translation

1. The NF Service Consumer (e.g. NEF, GMLC) shall send a GET request to the resource representing the group identifiers handled by UDM; the External Group Identifier is passed in a query parameter of the request URI, and an indication is also passed if the list of UE identifiers that belong to the provided External Group Identifier are required.
2. The UDM shall respond with "200 OK" with the message body containing the Internal Group Identifier and / or the list of UE identifiers that belong to the provided External Group Identifier.

On failure, the appropriate HTTP status code indicating the error shall be returned and appropriate additional error information should be returned in the GET response body.

Figure 5.2.2.2.14-2 shows another scenario where the NF service consumer sends a request to the to receive the External Group Identifier that corresponds to the provided Internal Group Identifier and optionally, the list of the UE identifiers (e.g. SUPIs , GPSIs) pertaining to such group.

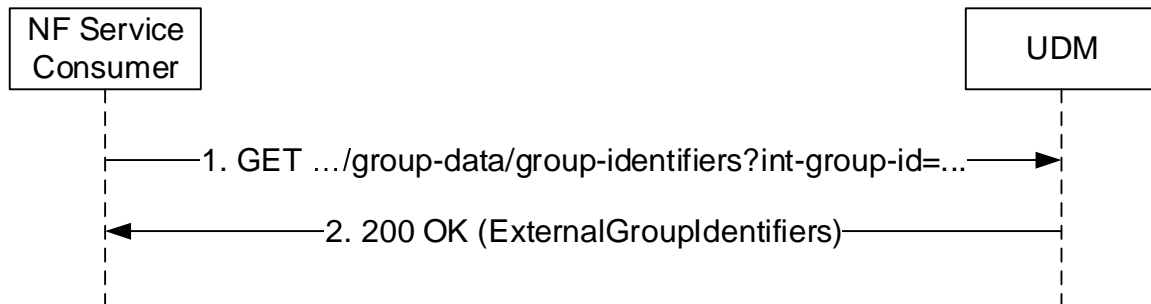

Figure 5.2.2.2.14-2: Internal Group Identifier Translation

1. The NF Service Consumer (e.g. NEF, GMLC) shall send a GET request to the resource representing the Internal Group Identifiers handled by UDM; the Internal Group Identifier is passed in a query parameter of the request URI, and an indication is also passed if the list of UE identifiers that belong to the provided Internal Group Identifier are required.
2. The UDM shall respond with "200 OK" with the message body containing the corresponding External Group Identifier and / or the list of UE identifiers that belong to the provided External Group Identifier.

On failure, the appropriate HTTP status code indicating the error shall be returned and appropriate additional error information should be returned in the GET response body.

5.2.2.2.15 LCS Privacy Data Retrieval

Figure 5.2.2.2.15-1 shows a scenario where the NF service consumer (e.g. HGMLC, NEF) sends a request to the UDM to receive the UE's LCS Privacy Subscription data (see 3GPP TS 23.273 [38] figure 6.1.2-1 step 2, figure 6.3.1-1 step 2, figure 6.5.1-1 step 7 and figure 6.8.1 step 3). The request contains the UE's identity (`{ueId}`), the type of the requested information (`/lcs-privacy-data`) and query parameters (`supported-features`).

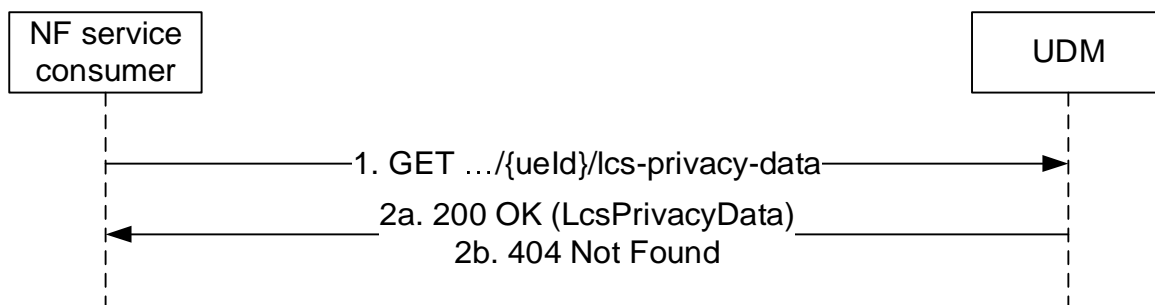

Figure 5.2.2.2.15-1: Requesting a UE's LCS Privacy Data

1. The NF service consumer (e.g. HGMLC, NEF) sends a GET request to the resource representing the UE's Lcs Privacy Subscription Data, with query parameters indicating the supported-features.
- 2a. On Success, the UDM responds with "200 OK" with the message body containing the UE's Lcs Privacy Subscription Data as relevant for the requesting NF service consumer.
- 2b. If there is no valid subscription data for the UE, HTTP status code "404 Not Found" shall be returned including additional error information in the response body (in the "ProblemDetails" element).

On failure, the appropriate HTTP status code indicating the error shall be returned and appropriate additional error information should be returned in the GET response body.

5.2.2.2.16 LCS Mobile Originated Data Retrieval

Figure 5.2.2.2.16-1 shows a scenario where the NF service consumer (e.g. AMF) sends a request to the UDM to receive the UE's LCS Mobile Originated Subscription data (see 3GPP TS 23.502 [3] figure 4.2.2.2.2-1 step 14). The request contains the UE's identity ($\{/supi\}$), the type of the requested information ($\{/lcs-mo-data\}$) and query parameters (supported-features).

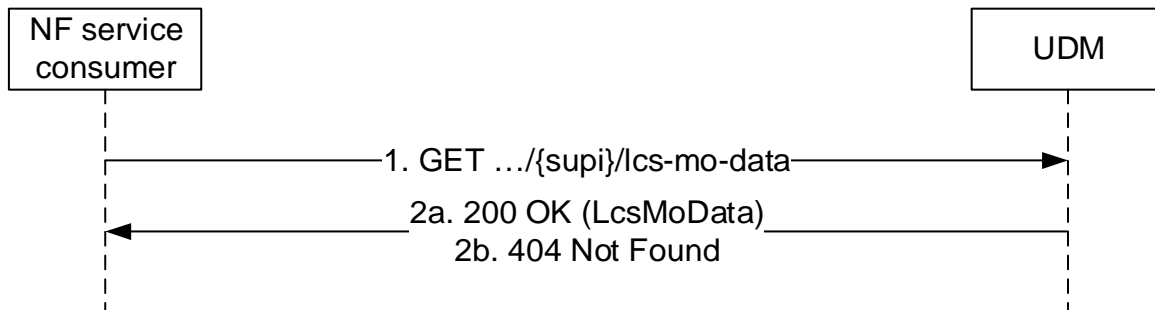

Figure 5.2.2.2.16-1: Requesting a UE's LCS Mobile Originated Data

1. The NF service consumer (e.g. AMF) sends a GET request to the resource representing the UE's LCS Mobile Originated Subscription Data, with query parameters indicating the supported-features.
- 2a. On Success, the UDM responds with "200 OK" with the message body containing the UE's LCS Mobile Originated Subscription Data as relevant for the requesting NF service consumer.
- 2b. If there is no valid subscription data for the UE, HTTP status code "404 Not Found" shall be returned including additional error information in the response body (in the "ProblemDetails" element).

On failure, the appropriate HTTP status code indicating the error shall be returned and appropriate additional error information should be returned in the GET response body.

5.2.2.2.17 Enhanced Coverage Restriction Data Retrieval

Figure 5.2.2.2.17-1 shows a scenario where the NF service consumer (e.g. NEF) sends a request to the UDM to retrieve a UE's subscribed Enhanced Coverage Restriction data (see also 3GPP TS 23.502 [3] figure 4.27.1-1 step 3 and 7). The request contains the identifier of the UE ($\{/supi\}$), the type of the requested information ($\{/am-data/ecr-data\}$) and query parameters (supported-features).

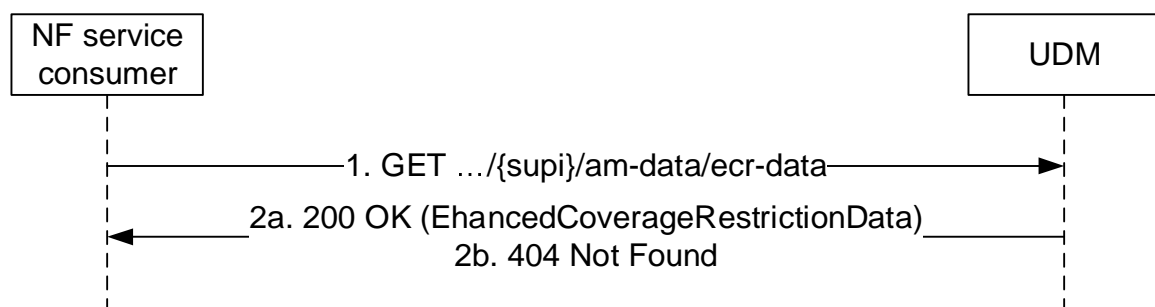

Figure 5.2.2.2.17-1: NF service consumer retrieves Enhance Coverage Restriction Data

1. The NF service consumer (e.g. NEF) sends a GET request to the resource that represents a UE's subscribed Enhanced Coverage Restriction data, with query parameters indicating the supported-features.
- 2a. On success, the UDM responds with "200 OK", the message body containing the UE's subscribed Enhanced Coverage Restriction data as relevant for the requesting NF service consumer.
- 2b. If there is no valid subscribed Enhanced Coverage Restriction data for the UE, HTTP status code "404 Not Found" shall be returned including additional error information in the response body (in the "ProblemDetails" element).

On failure, the appropriate HTTP status code indicating the error shall be returned and appropriate additional error information should be returned in the GET response body.

5.2.2.2.18 V2X Subscription Data Retrieval

Figure 5.2.2.2.18-1 shows a scenario where the NF service consumer (e.g. AMF) sends a request to the UDM to retrieve a UE's subscribed V2X data (see also 3GPP TS 23.287 [51] clause 6.5.2). The request contains the identifier of the UE ($\{/supi\}$), the type of the requested information ($\{/v2x-data\}$) and query parameters (supported-features).

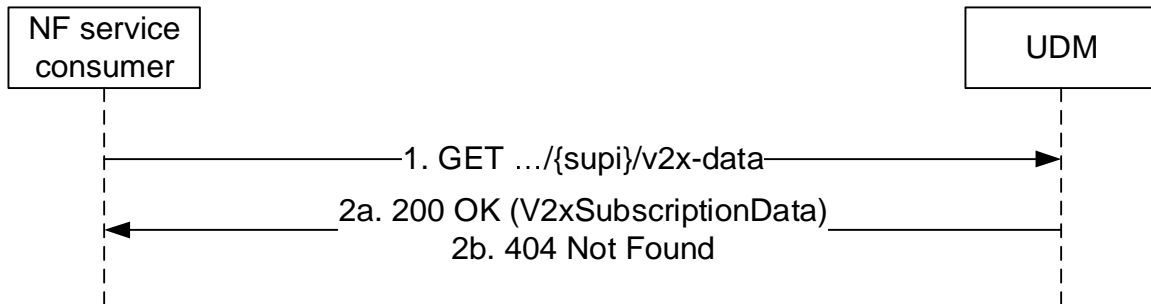

Figure 5.2.2.2.18-1: NF service consumer retrieves V2X Subscription Data

1. The NF service consumer (e.g. AMF) sends a GET request to the resource that represents a UE's subscribed V2X data, with query parameters indicating the supported-features.
- 2a. On success, the UDM responds with "200 OK", the message body containing the UE's subscribed V2X data as relevant for the requesting NF service consumer.
- 2b. If there is no valid subscribed V2X data for the UE, HTTP status code "404 Not Found" shall be returned including additional error information in the response body (in the "ProblemDetails" element).

On failure, the appropriate HTTP status code indicating the error shall be returned and appropriate additional error information should be returned in the GET response body.

5.2.2.2.19 LCS Broadcast Assistance Subscription Data Retrieval

Figure 5.2.2.2.19-1 shows a scenario where the NF service consumer (e.g. AMF) sends a request to the UDM to receive the UE's LCS Broadcast Assistance Subscription data (see 3GPP TS 23.273 [38]). The request contains the UE's identity ($\{/supi\}$), the type of the requested information ($\{/lcs-bca-data\}$) and query parameters (supported-features, plmn-id).

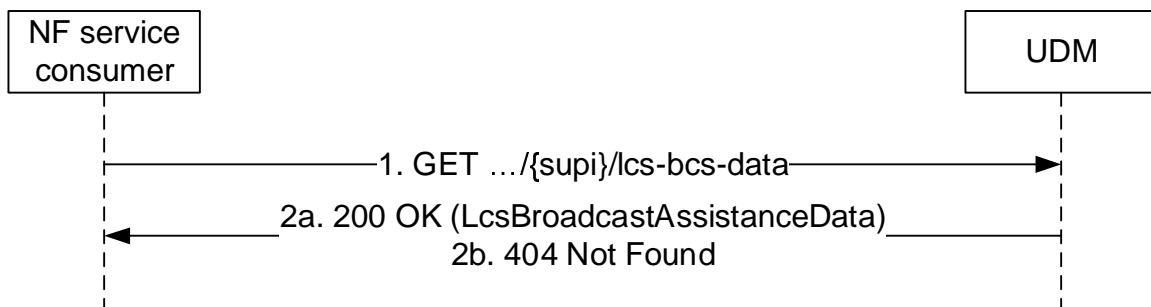

Figure 5.2.2.2.19-1: Requesting a UE's LCS Broadcast Assistance Subscription Data

1. The NF service consumer (e.g. AMF) sends a GET request to the resource representing the UE's Lcs Location Assistance Subscription Data, with query parameters indicating the supported-features and/or plmn-id.
- 2a. On Success, the UDM responds with "200 OK" with the message body containing the UE's Lcs Location Assistance Subscription Data as relevant for the requesting NF service consumer.
- 2b. If there is no valid subscription data for the UE, HTTP status code "404 Not Found" shall be returned including additional error information in the response body (in the "ProblemDetails" element).

On failure, the appropriate HTTP status code indicating the error shall be returned and appropriate additional error information should be returned in the GET response body.

5.2.2.2.20 UE Context In AMF Data Retrieval

Figure 5.2.2.20-1 shows a scenario where the NF service consumer (e.g. HSS) sends a request to the UDM to receive the UE's Context In AMF data (see also 3GPP TS 23.632 [32] figure 5.3.4-1 step 2 and 3). The request contains the UE's identity (`/supi`), the type of the requested information (`/ue-context-in-amf-data`) and query parameters (`supported-features`).

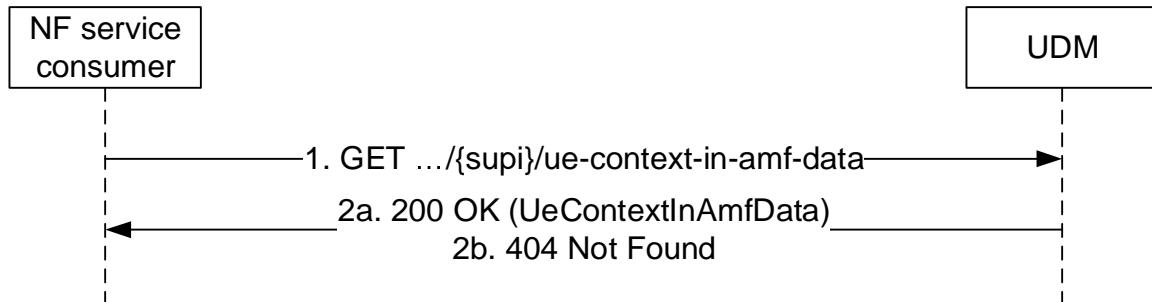

Figure 5.2.2.20-1: Requesting a UE's Context in AMF Data

1. The NF service consumer (e.g. HSS) shall send a GET request to the resource representing the UE's Context In AMF Data, with query parameters indicating the supported-features.
- 2a. On Success, the UDM shall respond with "200 OK" with the message body containing the UE's Context In AMF Data as relevant for the requesting NF service consumer.
- 2b. If there is no valid subscription data for the UE, HTTP status code "404 Not Found" shall be returned including additional error information in the response body (in the "ProblemDetails" element).

On failure, the appropriate HTTP status code indicating the error shall be returned and appropriate additional error information should be returned in the GET response body.

5.2.2.2.21 Individual Shared Subscription Data Retrieval

Figure 5.2.2.21-1 shows a scenario where the NF service consumer (e.g. AMF) sends a request to the UDM to receive the individual shared subscription data indicated by the sharedDataId. The request contains the type of the requested information (`/shared-data/{sharedDataId}`).

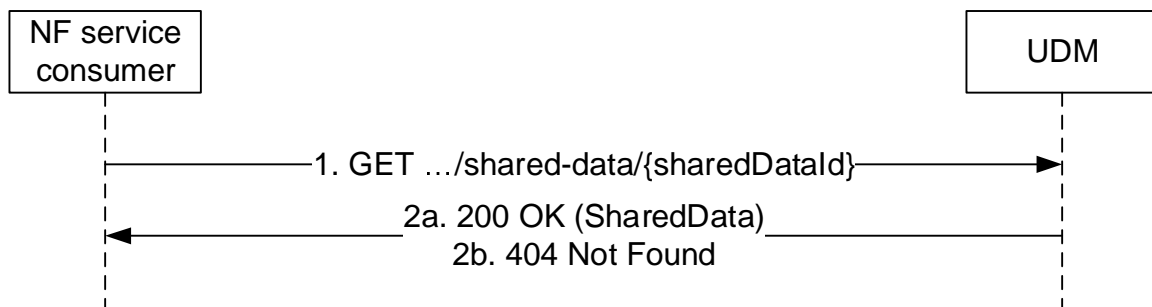

Figure 5.2.2.21-1: Requesting shared data

1. The NF service consumer (e.g. AMF) sends a GET request to the resource representing the individual SharedData indicated by the sharedDataId.
- 2a. On success, the UDM responds with "200 OK" with the message body containing the individual SharedData.
- 2b. If there is no valid individual SharedData indicated by the sharedDataId, HTTP status code "404 Not Found" shall be returned including additional error information in the response body (in the "ProblemDetails" element).

On failure, the appropriate HTTP status code indicating the error shall be returned and appropriate additional error information should be returned in the GET response body.

5.2.2.3 Subscribe

5.2.2.3.1 General

The following procedures using the Subscribe service operation are supported:

- Subscription to notification of data change (for UE individual data)
- Subscription to notification of shared data change

5.2.2.3.2 Subscription to notifications of data change

Figure 5.2.2.3.2-1 shows a scenario where the NF service consumer sends a request to the UDM to subscribe to notifications of data change (see also 3GPP TS 23.502 [3] figure 4.2.2.2.2-1 step 14). The request contains a callback URI and the URI of the monitored resource.

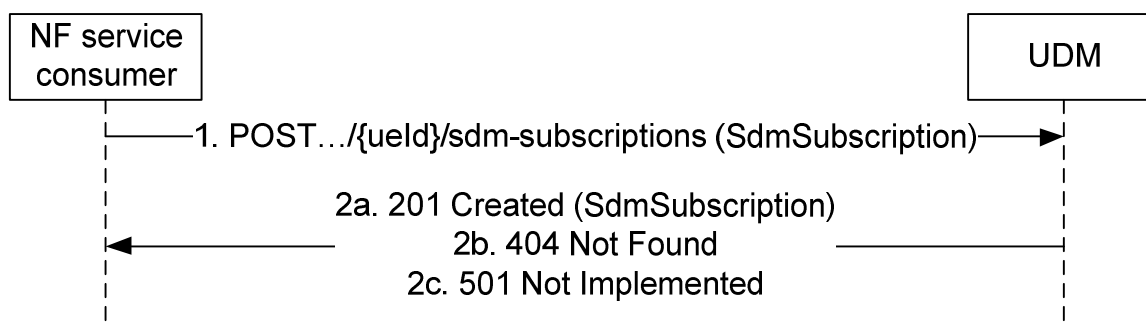

Figure 5.2.2.3.2-1: NF service consumer subscribes to notifications

1. The NF service consumer sends a POST request to the parent resource (collection of subscriptions) (`.../{ueId}/sdm-subscriptions`), to create a subscription as present in message body. The payload body of the POST request shall contain a representation of the individual subscription resource to be created. An NF consumer supporting the "LimitedSubscriptions" feature shall create only one unique subscription per UE (identified by the `ueId` in URI) without additional filter criteria, or with a specific filter criteria (e.g. `dnn` and/or `singleNssai`), and set the "uniqueSubscription" IE with the value "true" in request body.
- 2a. On success, the UDM responds with "201 Created" with the message body containing a representation of the created subscription. The Location HTTP header shall contain the URI of the created subscription.
- 2b. If there is no valid subscription data for the UE, HTTP status code "404 Not Found" shall be returned including additional error information in the response body (in the "ProblemDetails" element).
- 2c. If the UE subscription data exist, but the requested subscription to data change notification cannot be created (e.g. due to an invalid/unsupported data reference to be monitored, contained in the `SdmSubscription` parameter), HTTP status code "501 Not Implemented" shall be returned including additional error information in the response body (in the "ProblemDetails" element).

On failure, the appropriate HTTP status code indicating the error shall be returned and appropriate additional error information should be returned in the POST response body.

5.2.2.3.3 Subscription to notifications of shared data change

Figure 5.2.2.3.3-1 shows a scenario where the NF service consumer sends a request to the UDM to subscribe to notifications of shared data change. The request contains a callback URI and the URI of the monitored resource.

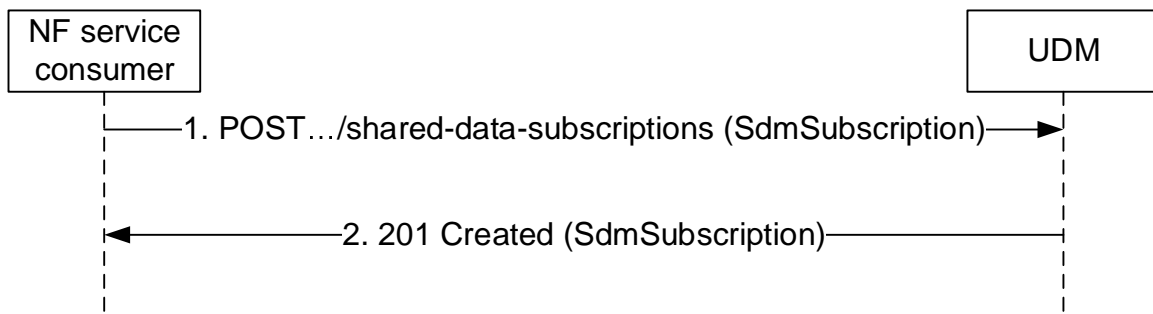

Figure 5.2.2.3.3-1: NF service consumer subscribes to notifications of shared data change

1. The NF service consumer sends a POST request to the parent resource (collection of subscriptions) (.../shared-data-subscriptions), to create a subscription as present in message body. The payload body of the POST request shall contain a representation of the shared data individual subscription resource to be created. An NF consumer supporting the "LimitedSubscriptions" feature shall create only one unique shared data individual subscription and set the "uniqueSubscription" IE with the value "true" in request body.
2. On success, the UDM responds with "201 Created" with the message body containing a representation of the created subscription. The Location HTTP header shall contain the URI of the created subscription.

On failure, the appropriate HTTP status code indicating the error shall be returned and appropriate additional error information should be returned in the POST response body.

5.2.2.4 Unsubscribe

5.2.2.4.1 General

The following procedures using the Unsubscribe service operation are supported:

- Unsubscribe to notification of data change (for UE individual data)
- Unsubscribe to notifications of shared data change

5.2.2.4.2 Unsubscribe to notifications of data change

Figure 5.2.2.4.2-1 shows a scenario where the NF service consumer sends a request to the UDM to unsubscribe from notifications of data changes (see also 3GPP TS 23.502 [3] figure 4.2.2.2.2-1 step 14). The request contains the URI previously received in the Location HTTP header of the response to the subscription.

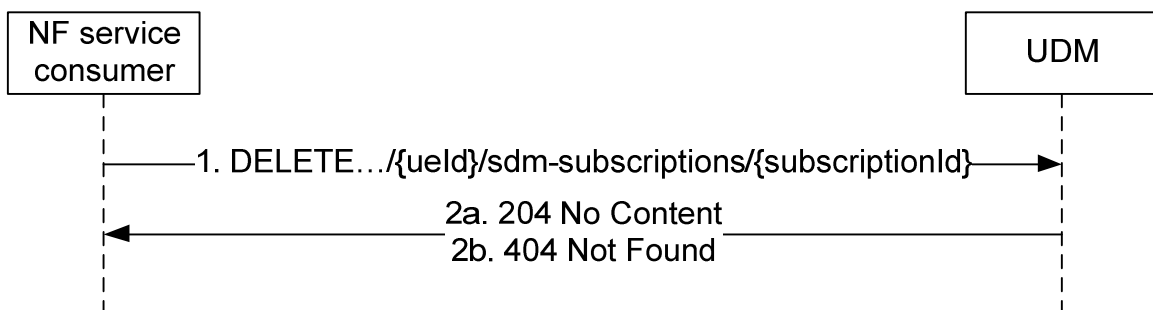

Figure 5.2.2.4.2-1: NF service consumer unsubscribes to notifications

1. The NF service consumer sends a DELETE request to the resource identified by the URI previously received during subscription creation.
- 2a. On success, the UDM responds with "204 No Content".

- 2b. If there is no valid subscription available (e.g. due to an unknown subscriptionId value), HTTP status code "404 Not Found" should be returned including additional error information in the response body (in the "ProblemDetails" element).

On failure, the appropriate HTTP status code indicating the error shall be returned and appropriate additional error information should be returned in the DELETE response body.

5.2.2.4.3 Unsubscribe to notifications of shared data change

Figure 5.2.2.4.3-1 shows a scenario where the NF service consumer sends a request to the UDM to unsubscribe from notifications of shared data changes. The request contains the URI previously received in the Location HTTP header of the response to the subscription.

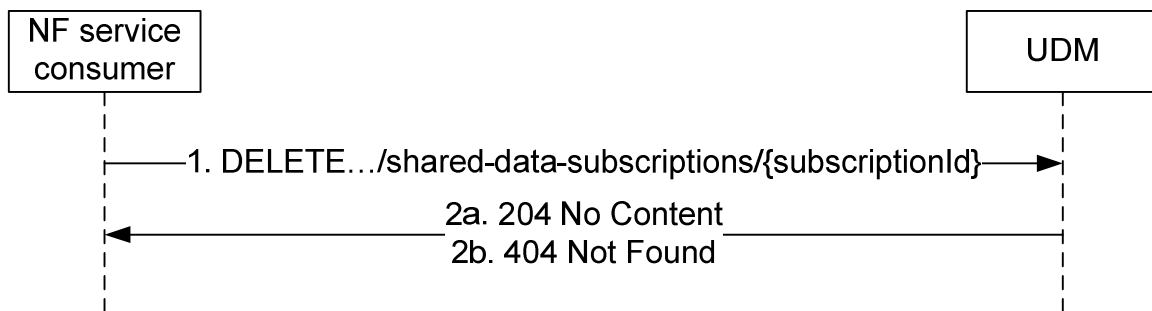

Figure 5.2.2.4.3-1: NF service consumer unsubscribes to notifications for shared data

1. The NF service consumer sends a DELETE request to the resource identified by the URI previously received during subscription creation.
- 2a. On success, the UDM responds with "204 No Content".
- 2b. If there is no valid subscription available (e.g. due to an unknown subscriptionId value), HTTP status code "404 Not Found" should be returned including additional error information in the response body (in the "ProblemDetails" element).

On failure, the appropriate HTTP status code indicating the error shall be returned and appropriate additional error information should be returned in the DELETE response body.

5.2.2.5 Notification

5.2.2.5.1 General

The following procedures using the Notification service operation are supported:

- Data change notification to NF, including the updates of UE's Subscriber Data indicated by the "subscription data Type" input and additional UE's UDM-related parameters.
- Delivery of UE Parameters Update Data to the UE via control plane procedure as defined in 3GPP TS 23.502 [3] clause 4.20.

5.2.2.5.2 Data Change Notification To NF

Figure 5.2.2.5.2-1 shows a scenario where the UDM notifies the NF service consumer (that has subscribed to receive such notification) about subscription data change (see also 3GPP TS 23.502 [3] clause 4.5.1 or 3GPP TS 23.502 [3] clause 4.5.2) or shared data change. The delivery of UE Parameters Update Data to the UE via control plane procedure is also conveyed using this notification, as defined in 3GPP TS 23.502 [3] clause 4.20. The notification request shall be sent to the callbackReference URI as previously received in the SdmSubscription (see clause 6.1.6.2.3).

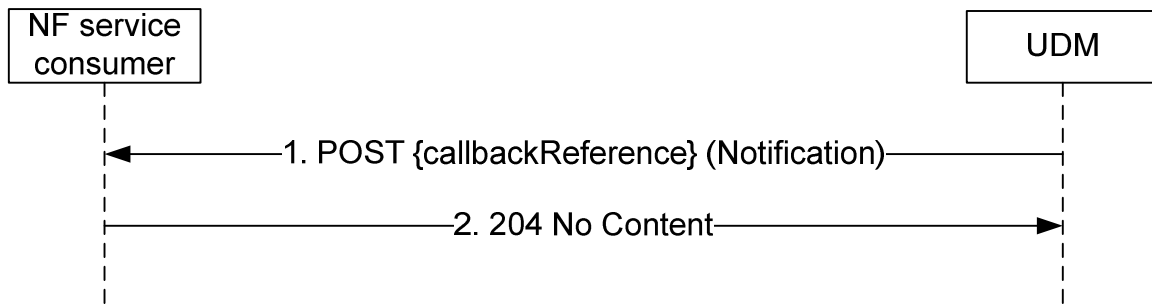

Figure 5.2.2.5.2-1: Subscription Data Change Notification

1. The UDM sends a POST request to the callbackReference as provided by the NF service consumer during the subscription.
2. The NF service consumer responds with "204 No Content".

On failure, the appropriate HTTP status code indicating the error shall be returned and appropriate additional error information should be returned in the POST response body.

NOTE 1: If the NF service consumer detects that the received Data Change Notification contains an origValue that does not match the currently stored value, it can re-sync by using the Nudm_SDM_Get service operation.

NOTE 2: When the notification is used for the delivery of UE Parameter Update Data to the UE, the trigger for UDM to start this procedure is out of the scope of this specification. This can be based, e.g., on O&M commands or provisioning orders. When a given UE parameter can be updated either in the USIM or in the ME side of the UE (e.g., Routing Indicator, see 3GPP TS 23.502 [3] clause 4.20.1) it is assumed that the trigger for the UE parameter update procedure includes an indication to the UDM of the target for the UE parameters update (i.e., USIM or ME). This indication is used by the UDM to decide which UE parameter update data set type to use and whether the UE parameter update requires secured packet protection via SP-AF.

5.2.2.6 Info

5.2.2.6.1 General

The following procedures using the Info service operation are supported:

- Providing acknowledgement from the UE to UDM about successful delivery of Steering of Roaming information via the AMF as defined in 3GPP TS 23.122 [20]
- Providing acknowledgement from the UE to UDM about successful delivery of updated Default Configured NSSAI or UICC data (Secured-Packet, containing e.g. Routing indicator) via the AMF as defined in 3GPP TS 23.502 [3].
- Providing acknowledgement from the UE to the UDM about successful delivery of the Network Slicing Subscription Change Indication.
- Providing acknowledgement from the UE to UDM about successful delivery of CAG configuration (see 3GPP TS 23.501 [2] clause 5.30.3.3).
- Providing indication from AMF to UDM about unsuccessful delivery of Steering of Roaming Information, updated Default Configured NSSAI or UICC data, Network Slicing Subscription Change Indication or Network Slicing Subscription Change Indication.
- Triggering update of Steering of Roaming information at the UE due to "initial registration" or "emergency registration" in a VPLMN.

5.2.2.6.2 Providing acknowledgement of Steering of Roaming

Figure 5.2.2.6.2-1 shows a scenario where the NF service consumer (e.g. AMF) sends the UE acknowledgement to the UDM (see also 3GPP TS 23.122 [20] Annex C). The request contains the UE's identity ($\{/supi\}$), the type of the acknowledgement information ($\{/am-data/sor-ack\}$), and the SOR-MAC-Iue.

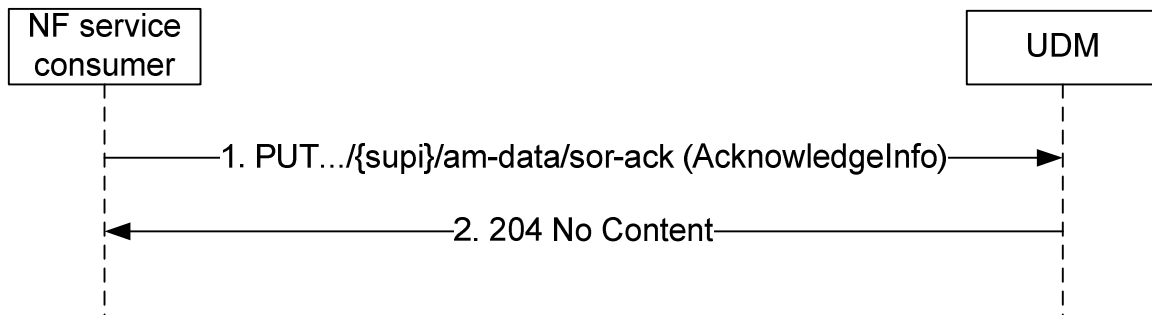

Figure 5.2.2.6.2-1: Providing acknowledgement of Steering of Roaming

1. The NF service consumer (e.g. AMF) sends a PUT request to the resource representing the UE's Access and Mobility Subscription Data, with the AcknowledgeInfo (SOR-MAC-Iue received from the UE, or UE not reachable indication).
2. The UDM responds with "204 No Content".

On failure, the appropriate HTTP status code indicating the error shall be returned and appropriate additional error information should be returned in the PUT response body.

5.2.2.6.3 Providing acknowledgement of UE parameters update

Figure 5.2.2.6.3-1 shows a scenario where the NF service consumer (e.g. AMF) sends the UE acknowledgement to the UDM (see also 3GPP TS 23.502 [3]). The request contains the UE's identity ($\{/supi\}$), the type of the acknowledgement information ($\{/am-data/upu-ack\}$), and the UPU-MAC-Iue.

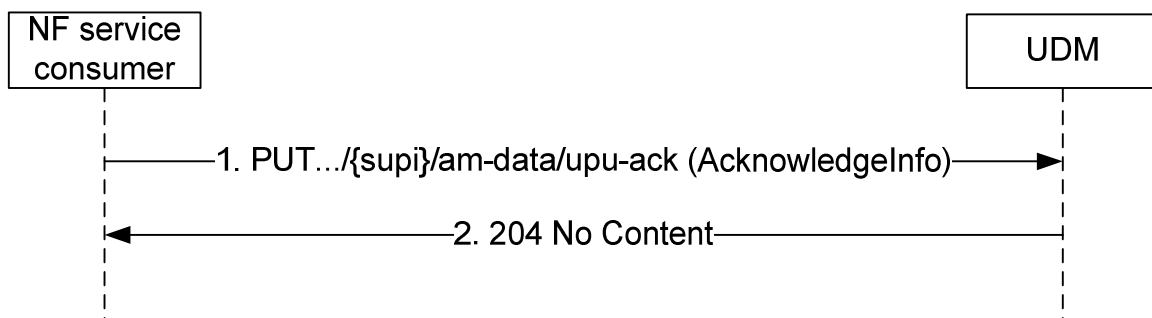

Figure 5.2.2.6.3-1: Providing acknowledgement of UE parameters update

1. The NF service consumer (e.g. AMF) sends a PUT request to the resource representing the UE's Access and Mobility Subscription Data, with the AcknowledgeInfo(UPU-MAC-IUE received from the UE, or UE not reachable indication).
2. The UDM responds with "204 No Content".

On failure, the appropriate HTTP status code indicating the error shall be returned and appropriate additional error information should be returned in the PUT response body.

5.2.2.6.4 Providing acknowledgement of UE for Network Slicing Subscription Change

Figure 5.2.2.6.4-1 shows a scenario where the NF service consumer (e.g. AMF) sends the UE acknowledgement to the UDM (see also 3GPP TS 23.502 [3]). The request contains the UE's identity ($\{/supi\}$) and the type of the acknowledgement information ($\{/am-data/subscribed-snssais-ack\}$).

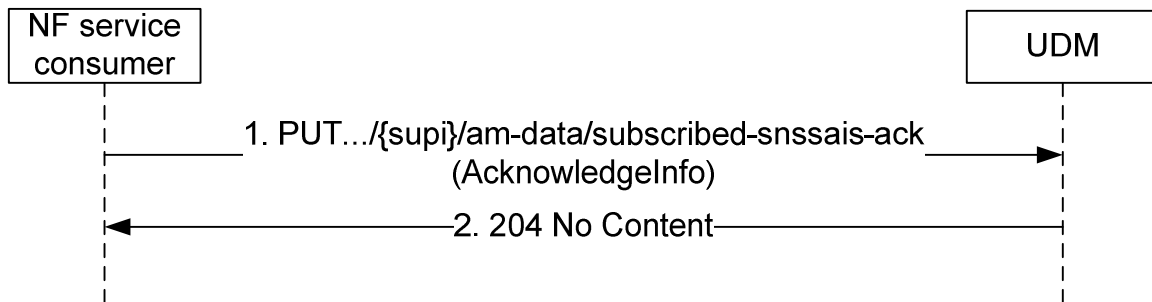

Figure 5.2.2.6.4-1: Providing acknowledgement of UE for Network Slicing Subscription Change

1. The NF service consumer (e.g. AMF) sends a PUT request to the resource representing the UE's Access and Mobility Subscription Data, with the AcknowledgeInfo.
2. The UDM responds with "204 No Content".

On failure, the appropriate HTTP status code indicating the error shall be returned and appropriate additional error information should be returned in the PUT response body.

5.2.2.6.5 Providing acknowledgement of UE for CAG configuration change

Figure 5.2.2.6.5-1 shows a scenario where the NF service consumer (e.g. AMF) sends the UE acknowledgement to the UDM (see also 3GPP TS 23.502 [3]). The request contains the UE's identity ($\{/supi\}$) and the type of the acknowledgement information ($\{/am-data/cag-ack\}$).

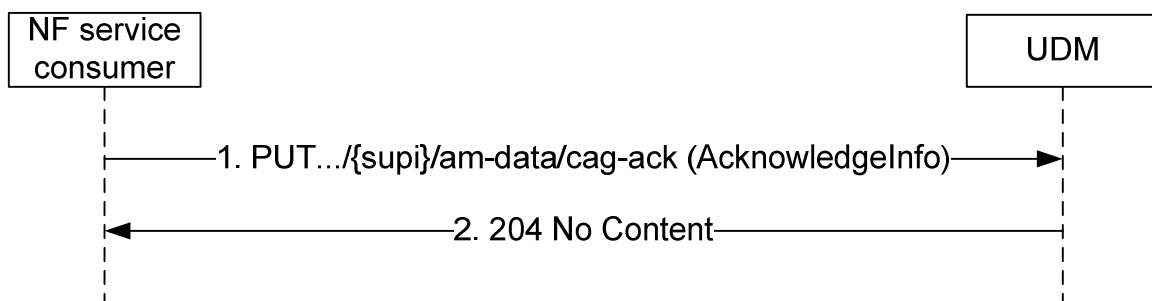

Figure 5.2.2.6.5-1: Providing acknowledgement of UE for CAG configuration change

1. The NF service consumer (e.g. AMF) sends a PUT request to the resource representing the UE's Access and Mobility Subscription Data, with the AcknowledgeInfo.
2. The UDM responds with "204 No Content".

On failure, the appropriate HTTP status code indicating the error shall be returned and appropriate additional error information should be returned in the PUT response body.

5.2.2.6.6 Triggering Update of Steering Of Roaming information

Figure 5.2.2.6.6-1 shows a scenario where the NF service consumer (e.g. AMF) sends the request to the UDM to trigger the update of Steering of Roaming information at the UE. The request contains the UE's identity ($\{/supi\}$), the type of request ($\{/am-data/update-sor\}$) and the VPLMN ID.

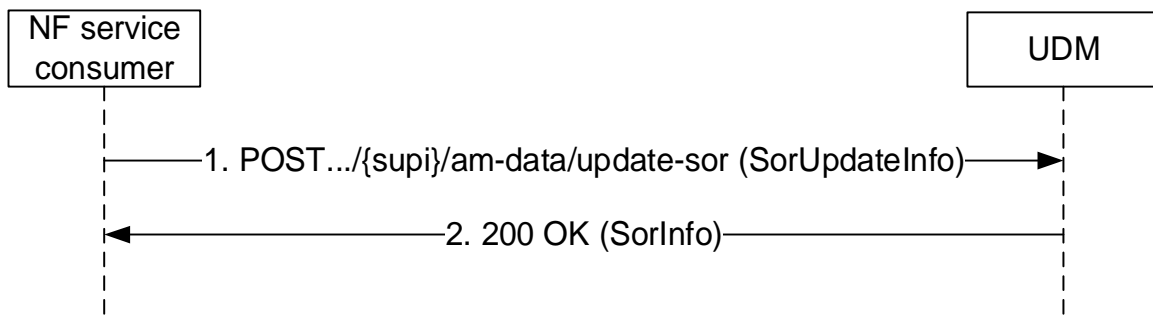

Figure 5.2.2.6.6-1: Triggering update of Steering Of Roaming information

1. The NF service consumer (e.g. AMF) sends a POST request to the resource representing the UE's Access and Mobility Subscription Data, with the request to update the Steering of Roaming information at the UE.
2. The UDM responds with "200 OK" containing the updated Sor Information.

On failure, the appropriate HTTP status code indicating the error shall be returned and appropriate additional error information should be returned in the POST response body.

5.2.2.7 ModifySubscription

5.2.2.7.1 General

The following procedures using the ModifySubscription service operation are supported:

- Modification of a Subscription to notification of data change (for UE individual data)
- Modification of a Subscription to notification of shared data change

The ModifySubscription service operation can be used for the following purpose:

- Extend the expiry time of SdmSubscription;
- Modify the resource URIs to be monitored, e.g. add/remove resource URIs to/from the monitored resource URI list.

5.2.2.7.2 Modification of a subscription to notifications of data change

Figure 5.2.2.7.2-1 shows a scenario where the NF service consumer sends a request to the UDM to modify a subscription to notifications of data changes. The request contains the URI previously received in the Location HTTP header of the response to the subscription.

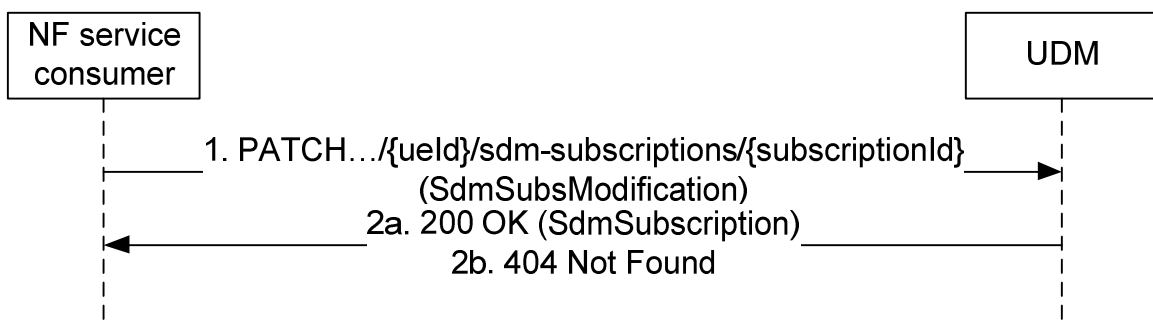

Figure 5.2.2.7.2-1: NF service consumer modifies a subscription to notifications

1. The NF service consumer sends a PATCH request to the resource identified by the URI previously received during subscription creation.

The NF service consumer may include "monitoredResourceUris" to replace the existing monitored resource URIs, e.g. to add/remove specific resource URIs from the monitored resource URI list.

2a. On success, the UDM responds with "200 OK".

2b. If there is no valid subscription available (e.g. due to an unknown subscriptionId value), HTTP status code "404 Not Found" should be returned including additional error information in the response body (in the "ProblemDetails" element).

On failure, the appropriate HTTP status code indicating the error shall be returned and appropriate additional error information should be returned in the PATCH response body.

5.2.2.7.3 Modification of a subscription to notifications of shared data change

Figure 5.2.2.7.3-1 shows a scenario where the NF service consumer sends a request to the UDM to modify a subscription to notifications of shared data changes. The request contains the URI previously received in the Location HTTP header of the response to the subscription.

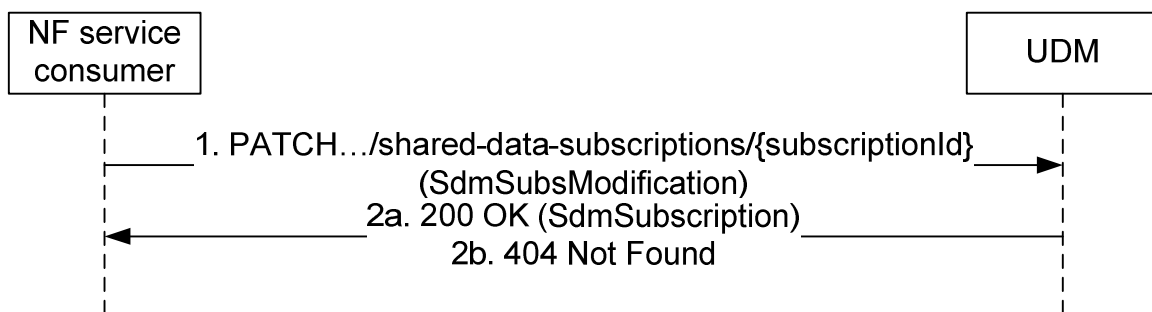

Figure 5.2.2.7.3-1: NF service consumer modifies a subscription to notifications for shared data

1. The NF service consumer sends a PATCH request to the resource identified by the URI previously received during subscription creation.

The NF service consumer may include "monitoredResourceUris" to replace the existing monitored resource URIs, e.g. for the purposes to add/remove specific resource URIs from the monitored resource URI list.

2a. On success, the UDM responds with "200 OK".

2b. If there is no valid subscription available (e.g. due to an unknown subscriptionId value), HTTP status code "404 Not Found" should be returned including additional error information in the response body (in the "ProblemDetails" element).

On failure, the appropriate HTTP status code indicating the error shall be returned and appropriate additional error information should be returned in the PATCH response body.

5.3 Nudm_UEContextManagement Service

5.3.1 Service Description

See 3GPP TS 23.501 [2] table 7.2.5-1, and 3GPP TS 23.632 [32].

5.3.2 Service Operations

5.3.2.1 Introduction

For the Nudm_UEContextManagement service the following service operations are defined:

- Registration
- DeregistrationNotification

- Deregistration
- Get
- Update
- P-CSCF-RestorationNotification
- P-CSCF-RestorationTrigger
- AMFDeregistration
- PEI-Update

The Nudm_UEContextManagement Service is used by Consumer NFs (AMF, SMF, SMSF) to register at the UDM by means of the Registration service operation.

It is also used by the registered Consumer NFs (AMF) to get notified by means of the DeregistrationNotification service operation when UDM decides to deregister the registered consumer NF.

It is also used by the registered Consumer NFs (AMF, SMF, SMSF) to deregister from the UDM by means of the Deregistration service operation.

It is also used by consumer NFs (NEF, NWDAF, NSSAAF) to retrieve registration information from the UDM by means of the Get service operation.

It is also used by the registered Consumer NFs (AMF, SMF) to update registration information stored at the UDM by means of the Update service operation.

It is also used by the registered Consumer NFs (AMF, SMF) to get notified by means of the P-CSCF-RestorationNotification service operation when UDM detects the need for P-CSCF restoration.

It is also used by the consumer NF (HSS) to trigger P-CSCF restoration by means of the P-CSCF-RestorationTrigger service operation.

It is also used by the consumer NF (HSS) to trigger deregistration of the registered AMF for 3GPP access by means of the AMFDeregistration service operation

It is also used by the consumer NF (HSS) to update the PEI in the AMF 3GPP Access Registration context, by means of the PEI-Update service operation.

5.3.2.2 Registration

5.3.2.2.1 General

The Registration service operation is invoked by a NF that has been selected to provide service to the UE to store related UE Context Management information in UDM.

NF Consumers are AMF for access and mobility management service, SMF for session management services, SMSF providing SMS services and HSS for IP-SM-GW registration in SMSoIP scenarios.

As part of this registration procedure, the UDM authorizes or rejects the subscriber to use the service provided by the registered NF, based on subscription data (e.g. roaming restrictions).

The following procedures using the Registration service operation are supported:

- AMF registration for 3GPP access
- AMF registration for non-3GPP access
- SMF registration
- SMSF registration for 3GPP access
- SMSF registration for non-3GPP access

- IP-SM-GW registration

5.3.2.2.2 AMF registration for 3GPP access

Figure 5.3.2.2.2-1 shows a scenario where the AMF sends a request to the UDM to update the AMF registration information for 3GPP access (see also 3GPP TS 23.502 [3] figure 4.2.2.2.2-1 step 14). The request contains the UE's identity ($\{ueId\}$) which shall be a SUPI and the AMF Registration Information for 3GPP access.

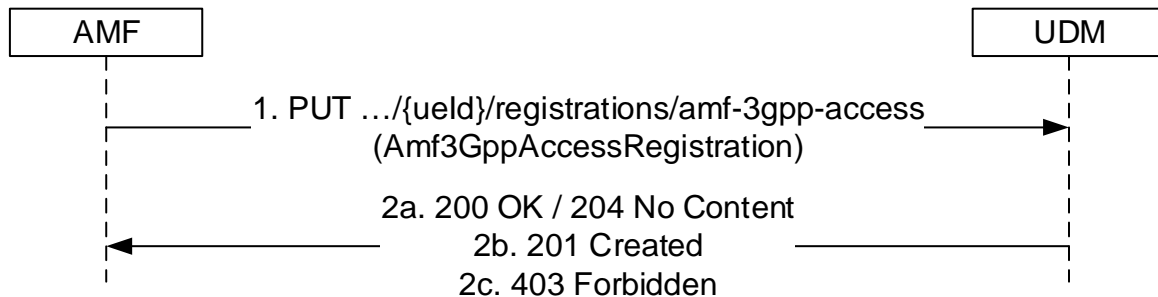

Figure 5.3.2.2.2-1: AMF registering for 3GPP access

1. The AMF sends a PUT request to the resource representing the UE's AMF registration for 3GPP access to update or create AMF registration information.

If EPS interworking with N26 is supported, and the AMF has per DNN selected the PGW-C+SMF for EPS interworking, the AMF shall include the info of selected PGW-C+SMF to the UDM.

- 2a. On success, the UDM updates the `Amf3GppAccessRegistration` resource by replacing it with the received resource information, and responds with "200 OK" or "204 No Content".

UDM shall invoke the Deregistration Notification service operation towards the old AMF using the callback URI provided by the old AMF.

When AMF indicates there are no ongoing event subscriptions, but UDM has ongoing event exposure subscriptions stored (e.g. in UDR), UDM shall invoke one `Namf_EventExposure Subscribe` Service operations (see clause 5.3.2.2 of 3GPP TS 29.518 [36]) on behalf of NEF per subscription stored.

- 2b. If the resource does not exist (there is no previous AMF information stored in UDM for that user), UDM stores the received AMF registration data for 3GPP access and responds with HTTP Status Code "201 created". A response body may be included to convey additional information to the NF consumer (e.g., features supported by UDM).
- 2c. If the operation cannot be authorized due to e.g. UE does not have required subscription data, the AMF does not support CAG feature and the UE is allowed to access 5GS via CAG cell(s) only, access barring, roaming restrictions or core network restriction, HTTP status code "403 Forbidden" should be returned including additional error information in the response body (in "ProblemDetails" element).

On failure, the appropriate HTTP status code indicating the error shall be returned and appropriate additional error information should be returned in the PUT response body.

5.3.2.2.3 AMF registration for non 3GPP access

Figure 5.3.2.2.3-1 shows a scenario where the AMF sends a request to the UDM to update the AMF registration information for non 3GPP access (see also 3GPP TS 23.502 [3] figure 4.2.2.2.2-1 step 14). The request contains the UE's identity ($\{ueId\}$) which shall be a SUPI and the AMF Registration Information for non 3GPP access.

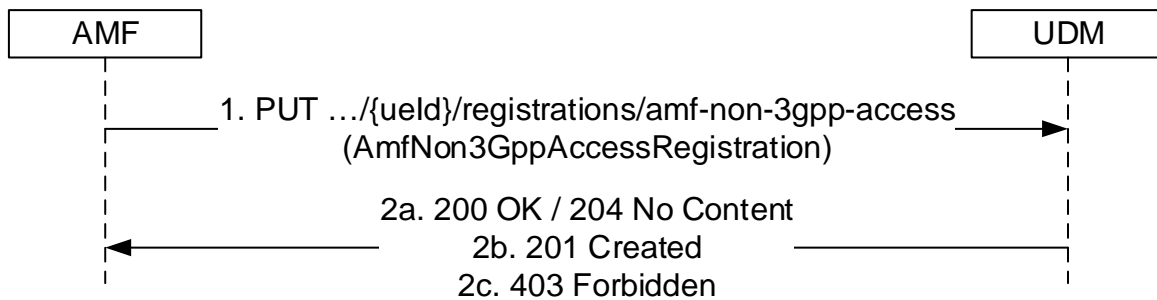

Figure 5.3.2.2.3-1: AMF registering for non 3GPP access

1. The AMF sends a PUT request to the resource representing the UE's AMF registration for non 3GPP access to update or create AMF registration information.
- 2a. On success, the UDM updates the AmfNon3GppAccessRegistration resource by replacing it with the received resource information, and responds with "200 OK" or "204 No Content".

UDM shall invoke the Deregistration Notification service operation towards the old AMF using the callback URI provided by the old AMF.

When AMF indicates there are no ongoing event subscriptions, but UDM has ongoing event exposure subscriptions stored (e.g. in UDR), UDM shall invoke one Namf_EventExposure Subscribe Service operations (see clause 5.3.2.2 of 3GPP TS 29.518 [36]) on behalf of NEF per subscription stored.

- 2b. If the resource does not exist (there is no previous AMF information stored in UDM for that user), UDM stores the received AMF registration data for non-3GPP access and responds with HTTP Status Code "201 created". A response body may be included to convey additional information to the NF consumer (e.g., features supported by UDM).
- 2c. If the operation cannot be authorized due to e.g UE does not have required subscription data, the AMF does not support CAG feature and the UE is allowed to access 5GS via CAG cell(s) only, access barring, roaming restrictions or core network restriction, HTTP status code "403 Forbidden" should be returned including additional error information in the response body (in the "ProblemDetails" element).

On failure, the appropriate HTTP status code indicating the error shall be returned and appropriate additional error information should be returned in the PUT response body.

5.3.2.2.4 SMF registration

Figure 5.3.2.2.4-1 shows a scenario where an SMF sends a request to the UDM to create a new registration (see also 3GPP TS 23.502 [3] figure 4.3.2.2.1-1 step 4). The request contains the UE's identity (/ueId) which shall be a SUPI and the SMF Registration Information.

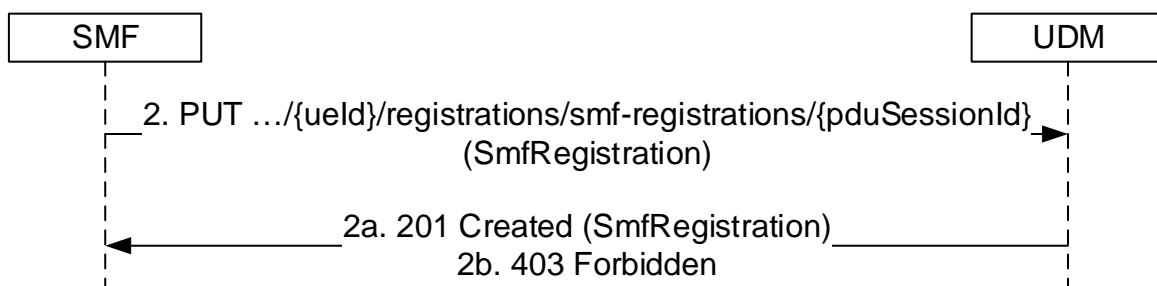

Figure 5.3.2.2.4-1: SMF registration

1. The SMF sends a PUT request to the resource .../{ueId}/registrations/smf-registrations/{pduSessionId}, to create an SMF Registration as present in the message body.

If the SMF belongs to an SMF Set, the NF Set ID of the SMF Set shall be included in the request message.

- 2a. The UDM responds with "201 Created" with the message body containing a representation of the created SMF registration.

If the new SMF is not in an SMF set or is not in the same SMF Set as the old SMF, the UDM shall invoke the Deregistration Notification service operation towards the old SMF using the callback URI provided by the old SMF.

- 2b. If the operation cannot be authorized due to e.g UE does not have required subscription data, access barring or roaming restrictions, HTTP status code "403 Forbidden" should be returned including additional error information in the response body (in "ProblemDetails" element).

On failure, the appropriate HTTP status code indicating the error shall be returned and appropriate additional error information should be returned in the PUT response body.

5.3.2.2.5 SMSF Registration for 3GPP Access

Figure 5.3.2.2.5-1 shows a scenario where the SMSF sends a request to the UDM to create or update the SMSF registration information for 3GPP access (see also 3GPP TS 23.502 [3], clause 4.13.3.1). The request contains the UE's identity ($\{ueId\}$) which shall be a SUPI and the SMSF Registration Information for SMS service.

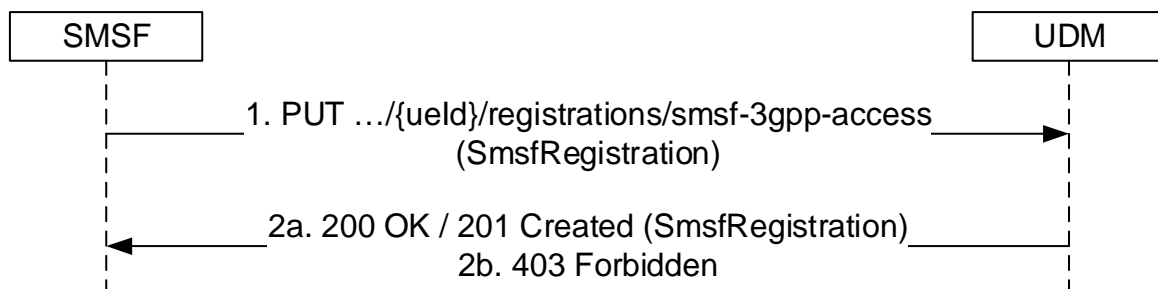

Figure 5.3.2.2.5-1: SMSF registering for 3GPP Access

1. The SMSF sends a PUT request to the resource representing the UE's SMSF registration for 3GPP Access to update or create SMSF registration information.

If the SMSF belongs to an SMSF Set, the NF Set ID of the SMSF Set shall be included in the request message.

- 2a. If successful, the UDM responds with "200 OK", or "201 Created" with the message body containing the representation of the `SmsfRegistration`.

- 2b. If the operation cannot be authorized due to e.g UE does not have required subscription data, access barring or roaming restrictions, HTTP status code "403 Forbidden" should be returned including additional error information in the response body (in "ProblemDetails" element).

On failure, the appropriate HTTP status code indicating the error shall be returned and appropriate additional error information should be returned in the PUT response body.

5.3.2.2.6 SMSF Registration for Non 3GPP Access

Figure 5.3.2.2.6-1 shows a scenario where the SMSF sends a request to the UDM to create or update the SMSF registration information for non 3GPP access (see also 3GPP TS 23.502 [3], clause 4.13.3.1). The request contains the UE's identity ($\{ueId\}$) which shall be a SUPI and the SMSF Registration Information for SMS service.

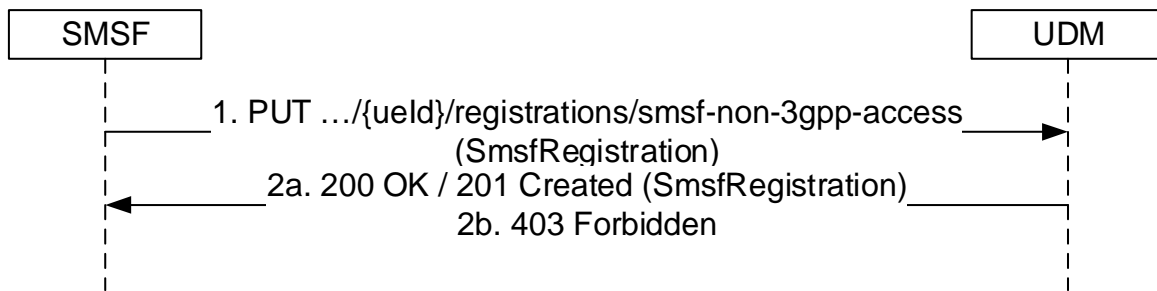

Figure 5.3.2.2.6-1: SMSF registering for Non 3GPP Access

1. The SMSF sends a PUT request to the resource representing the UE's SMSF registration for Non 3GPP Access to update or create SMSF registration information.

If the SMSF belongs to an SMSF Set, the NF Set ID of the SMSF Set shall be included in the request message.

- 2a. If successful, the UDM responds with "200 OK", or "201 Created" with the message body containing the representation of the `SmsfRegistration`.

- 2b. If the operation cannot be authorized due to e.g UE does not have required subscription data, access barring or roaming restrictions, HTTP status code "403 Forbidden" should be returned including additional error information in the response body (in "ProblemDetails" element).

On failure, the appropriate HTTP status code indicating the error shall be returned and appropriate additional error information should be returned in the PUT response body.

5.3.2.2.7 IP-SM-GW registration

Figure 5.3.2.2.7-1 shows a scenario where an HSS sends a request to the UDM to create a new registration of an IP-SM-GW (see also 3GPP TS 23.632 [32] figure 5.5.X.2.1-1 step 2). The request contains the UE's identity (`{ueId}`) which shall be a SUPI and the IP-SM-GW registration information.

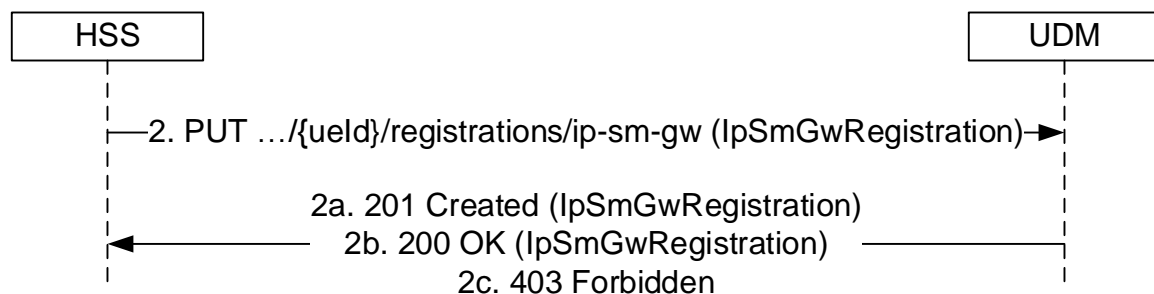

Figure 5.3.2.2.7-1: IP-SM-GW registration

1. The HSS sends a PUT request to the resource `.../{ueId}/registrations/ip-sm-gw`, to create an IP-SM-GW registration as present in the message body.

- 2a. If there was not a prior registration, the UDM responds with "201 Created" with the message body containing a representation of the created IP-SM-GW registration.

- 2b. If there was a prior registration, the UDM responds with "200 OK" with the message body containing a representation of the updated IP-SM-GW registration.

- 2c. If the operation cannot be authorized due to e.g UE does not have required subscription data, HTTP status code "403 Forbidden" should be returned including additional error information in the response body (in "ProblemDetails" element).

On failure, the appropriate HTTP status code indicating the error shall be returned and appropriate additional error information should be returned in the PUT response body.

5.3.2.3 DeregistrationNotification

5.3.2.3.1 General

The following procedure using the DeregistrationNotification service operation is supported:

- UDM initiated NF Deregistration

5.3.2.3.2 UDM initiated NF Deregistration

Figure 5.3.2.3.2-1 shows a scenario where the UDM notifies the registered NF about its deregistration (see also 3GPP TS 23.502 [3] figure 4.2.2.2.2-1 step 14 and 3GPP TS 23.502 [3] figure 4.26.4.1.1-1 step 14). The request contains the callback URI for deregistration notification as received by the UDM during registration, and Deregistration Data.

The UDM initiates the deregistration procedure when the UE is registered to the AMF which does not support CAG feature and the CAG subscription of the UE changes and it is allowed to access the 5GS via CAG cell(s) only.

The UDM also initiates deregistration notification when UE moves to different AMF within same AMF-Set.

Deregistration notification shall not be sent if the nfInstanceId of the AMF initiating registration is same as the old AMF already registered in UDM (e.g. when multiple PLMNs are hosted on same AMF and UE moves across PLMNs).

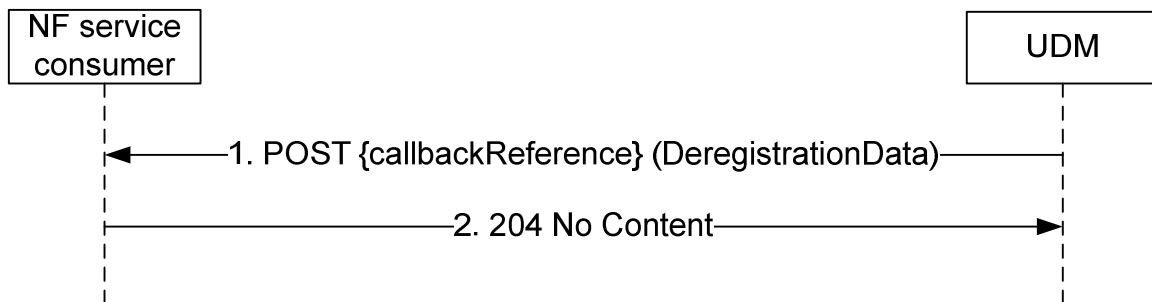

Figure 5.3.2.3.2-1: UDM initiated NF Deregistration

1. The UDM sends a POST request to the callbackReference as provided by the NF service consumer during the registration.
2. The NF service consumer responds with "204 No Content".

On failure, the appropriate HTTP status code indicating the error shall be returned and appropriate additional error information should be returned in the POST response body.

5.3.2.4 Deregistration

5.3.2.4.1 General

The following procedures using the Deregistration service operation are supported:

- AMF deregistration for 3GPP access
- AMF deregistration for non-3GPP access
- SMF deregistration
- SMSF deregistration for 3GPP access
- SMSF deregistration for non-3GPP access
- IP-SM-GW deregistration

5.3.2.4.2 AMF deregistration for 3GPP access

Figure 5.3.2.4.2-1 shows a scenario where the AMF sends a request to the UDM to deregister (purge) from the UDM for 3GPP access (see also 3GPP TS 23.502 [3] figure 4.5.3.1-1 step 3). The request contains the UE's identity ($\{ueId\}$) which shall be a SUPI and an instruction to set the `purgeFlag` within the `Amf3GppAccessRegistration` resource.

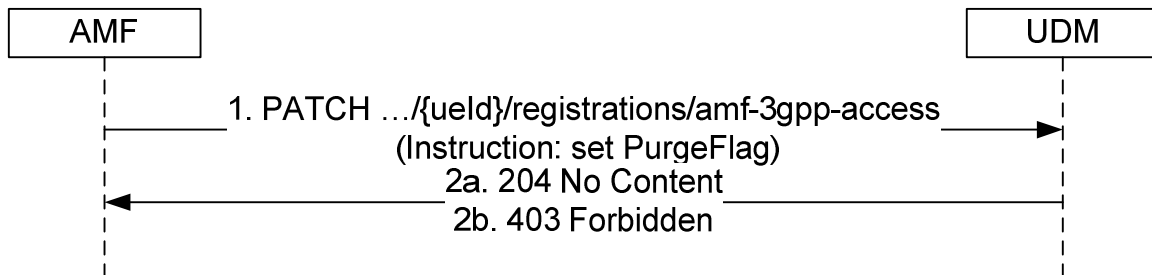

Figure 5.3.2.4.2-1: AMF deregistering for 3GPP access

1. The AMF sends a PATCH request to the resource representing the UE's AMF registration for 3GPP access.
- 2a. The UDM shall check whether the received GUAMI matches the stored GUAMI. If so, the UDM shall set the `PurgeFlag`. The UDM responds with "204 No Content".
- 2b. Otherwise the UDM responds with "403 Forbidden".

NOTE: Based on operator policy, when AMF receives 403 Forbidden, the AMF can avoid freezing the 5G-TMSI that the UE used, under consideration that the UE has been assigned another 5G-TMSI by another AMF.

On failure, the appropriate HTTP status code indicating the error shall be returned and appropriate additional error information should be returned in the PATCH response body.

5.3.2.4.3 AMF deregistration for non-3GPP access

Figure 5.3.2.4.3-1 shows a scenario where the AMF sends a request to the UDM to deregister (purge) from the UDM for non-3GPP access (see also 3GPP TS 23.502 [3] figure 4.5.3.1-1 step 3). The request contains the UE's identity ($\{ueId\}$) which shall be a SUPI and an instruction to set the `purgeFlag` within the `AmfNon3GppAccessRegistration` resource.

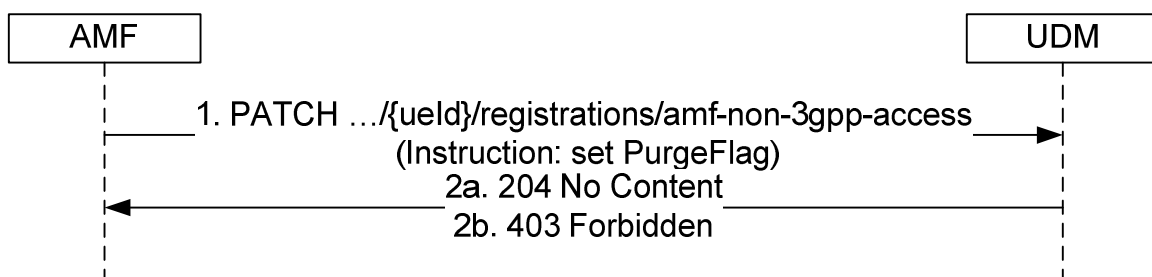

Figure 5.3.2.4.3-1: AMF deregistering for non-3GPP access

1. The AMF sends a PATCH request to the resource representing the UE's AMF registration for non-3GPP access.
- 2a. The UDM shall check whether the received GUAMI matches the stored GUAMI. If so, the UDM shall set the `PurgeFlag`. The UDM responds with "204 No Content".
- 2b. Otherwise the UDM responds with "403 Forbidden".

NOTE: Based on operator policy, when AMF receives 403 Forbidden, the AMF can avoid freezing the 5G-TMSI that the UE used, under consideration that the UE has been assigned another 5G-TMSI by another AMF.

On failure, the appropriate HTTP status code indicating the error shall be returned and appropriate additional error information should be returned in the PATCH response body.

5.3.2.4.4 SMF deregistration

Figure 5.3.2.4.4-1 shows a scenario where the SMF sends a request to the UDM to deregister an individual SMF registration (see also 3GPP TS 23.502 [3] figure 4.3.2.2-1 step 20). The request contains the UE's identity ($\{ueId\}$) which shall be a SUPI and the PDU Session ID ($\{pduSessionId\}$).

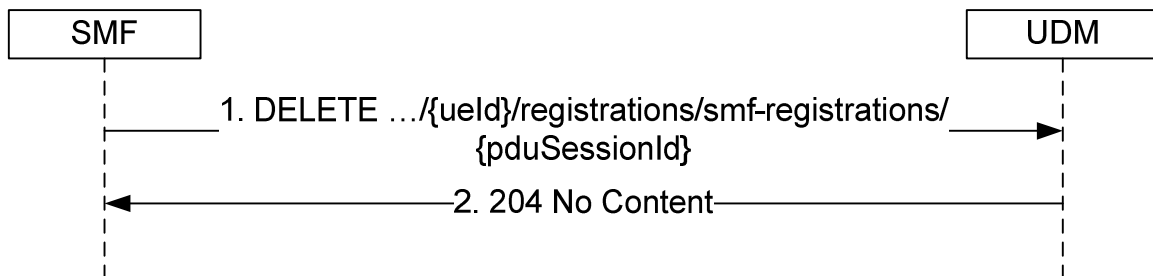

Figure 5.3.2.4.4-1: SMF deregistration

1. The SMF sends a DELETE request to the resource representing the individual SMF registration that is to be deregistered.
2. The UDM responds with "204 No Content". If the SMF had requested the SDM Subscription to be created with the "implicitUnsubscribe" flag set, then UDM will terminate the SDM Subscription when the last PDU Session for that SUPI and SMF is deregistered.

On failure, the appropriate HTTP status code indicating the error shall be returned and appropriate additional error information should be returned in the DELETE response body.

5.3.2.4.5 SMSF Deregistration for 3GPP Access

Figure 5.3.2.4.5-1 shows a scenario where the SMSF sends a request to the UDM to delete the SMSF registration information for 3GPP access (see also 3GPP TS 23.502 [3], clause 4.13.3.2). The request contains the UE's identity ($\{ueId\}$) which shall be a SUPI.

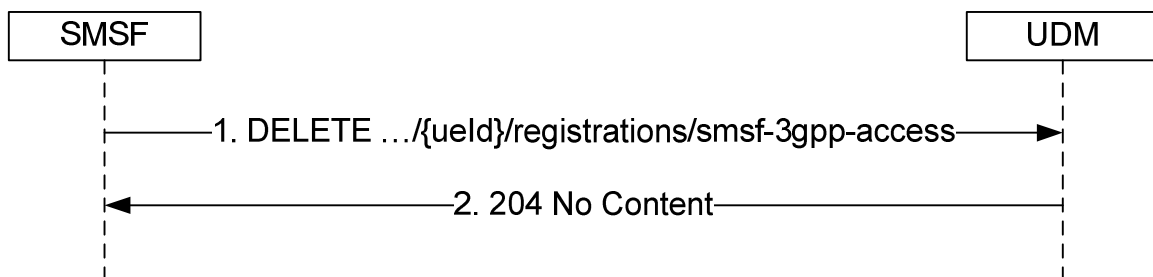

Figure 5.3.2.4.5-1: SMSF Deregistering for 3GPP Access

1. The SMSF sends a DELETE request to the resource representing the UE's SMSF registration for 3GPP access.
2. If successful, the UDM responds with "204 No Content".

On failure, the appropriate HTTP status code indicating the error shall be returned and appropriate additional error information should be returned in the DELETE response body.

5.3.2.4.6 SMSF Deregistration for Non 3GPP Access

Figure 5.3.2.4.6-1 shows a scenario where the SMSF sends a request to the UDM to delete the SMSF registration information for non 3GPP access (see also 3GPP TS 23.502 [3], clause 4.13.3.2). The request contains the UE's identity ($\{ueId\}$) which shall be a SUPI.

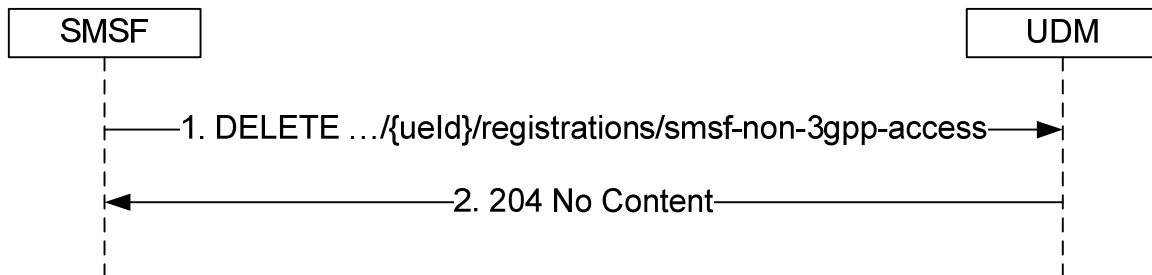

Figure 5.3.2.4.6-1: SMSF Deregistering for Non 3GPP Access

1. The SMSF sends a DELETE request to the resource representing the UE's SMSF registration for non 3GPP access.
2. If successful, the UDM responds with "204 No Content".

On failure, the appropriate HTTP status code indicating the error shall be returned and appropriate additional error information should be returned in the DELETE response body.

5.3.2.4.7 IP-SM-GW deregistration

Figure 5.3.2.4.7-1 shows a scenario where the HSS sends a request to the UDM to deregister the IP-SM-GW from the UDM (see also 3GPP TS 23.632 [32] figure 5.5.X.2-2 step 2). The request contains the UE's identity ($\{ueId\}$) which shall be a SUPI.

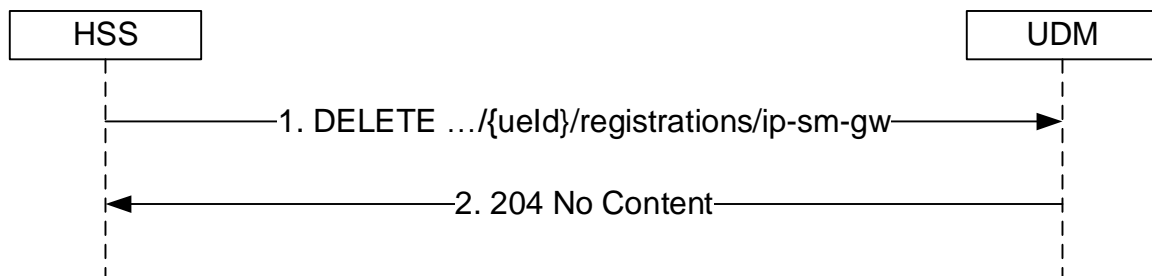

Figure 5.3.2.4.7-1: IP-SM-GW deregistration

1. The HSS sends a DELETE request to the resource representing the UE's IP-SM-GW registration.
2. The UDM responds with "204 No Content".

On failure, the appropriate HTTP status code indicating the error shall be returned and appropriate additional error information should be returned in the DELETE response body.

5.3.2.5 Get

5.3.2.5.1 General

The following procedures using the Get service operation are supported:

- Amf3GppAccessRegistration Information Retrieval

- AmfNon3GppAccessRegistration Information Retrieval
- SmfRegistrations Information Retrieval
- SmsfRegistration Information Retrieval for 3GPP Access
- SmsfRegistration Information Retrieval for Non-3GPP Access
- Location Information Retrieval
- Retrieval Of Multiple UE Registration Data Sets
- IP-SM-GW Registration Information Retrieval

5.3.2.5.2 Amf3GppAccessRegistration Information Retrieval

Figure 5.3.2.5.2-1 shows a scenario where the NF service consumer (e.g. NEF) sends a request to the UDM to retrieve the UE's Amf3GppAccessRegistration Information. The request contains the UE's identity ($\{ueId\}$) which shall be a GPSI or SUPI, the type of the requested information ($/registrations/amf-3gpp-access$) and query parameters (supported-features).

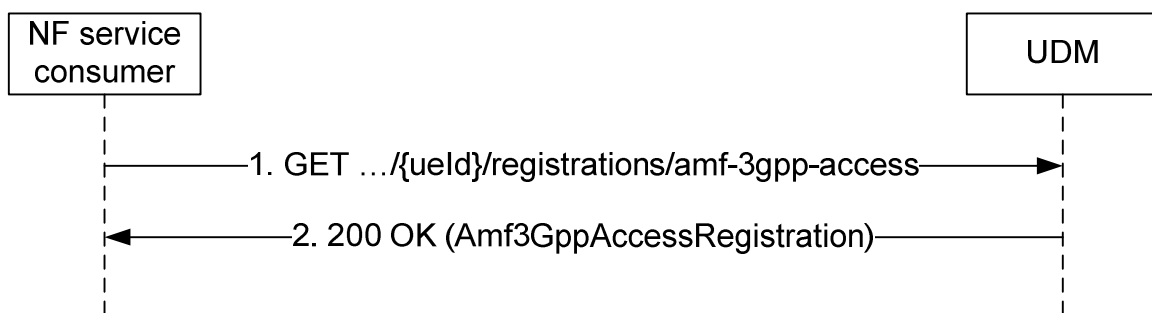

Figure 5.3.2.5.2-1: Requesting a UE's AMF Registration Information for 3GPP Access

1. The NF service consumer (e.g. NEF) sends a GET request to the resource representing the UE's AMF registration information for 3GPP access, with query parameters indicating the supported-features.
2. The UDM responds with "200 OK" with the message body containing the UE's Amf3GppAccessRegistration.

On failure, the appropriate HTTP status code indicating the error shall be returned and appropriate additional error information should be returned in the GET response body.

5.3.2.5.3 AmfNon3GppAccessRegistration Information Retrieval

Figure 5.3.2.5.3-1 shows a scenario where the NF service consumer (e.g. NEF) sends a request to the UDM to retrieve the UE's AmfNon3GppAccessRegistration Information. The request contains the UE's identity ($\{ueId\}$) which shall be a GPSI or SUPI, the type of the requested information ($/registrations/amf-non-3gpp-access$) and query parameters (supported-features).

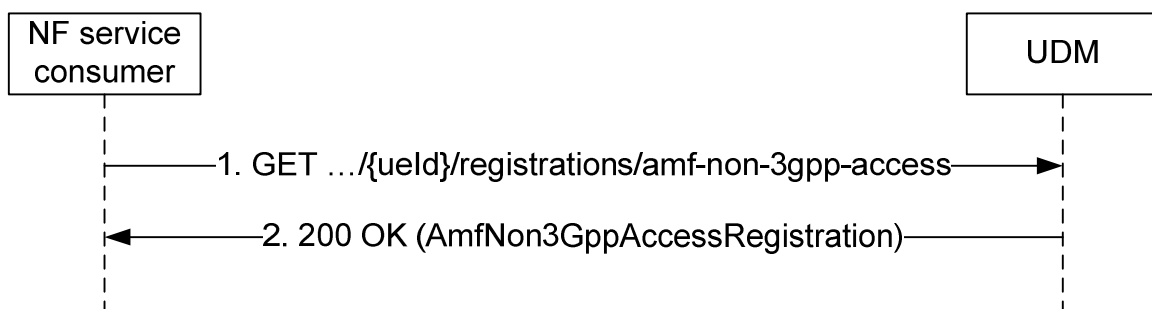

Figure 5.3.2.5.3-1: Requesting a UE's AMF Registration Information for non-3GPP Access

1. The NF service consumer (e.g. NEF) sends a GET request to the resource representing the UE's AMF registration information for non-3GPP access, with query parameters indicating the supported-features.
2. The UDM responds with "200 OK" with the message body containing the UE's AmfNon3GppAccessRegistration.

On failure, the appropriate HTTP status code indicating the error shall be returned and appropriate additional error information should be returned in the GET response body.

5.3.2.5.4 Void

5.3.2.5.5 SmsfRegistration Information Retrieval for 3GPP Access

Figure 5.3.2.5.5-1 shows a scenario where the NF service consumer (e.g. NEF) sends a request to the UDM to retrieve the UE's SmsfRegistration Information. The request contains the UE's identity (`{ueId}`) which shall be a GPSI, the type of the requested information (`/registrations/smsf-3gpp-access`) and query parameters (supported-features).

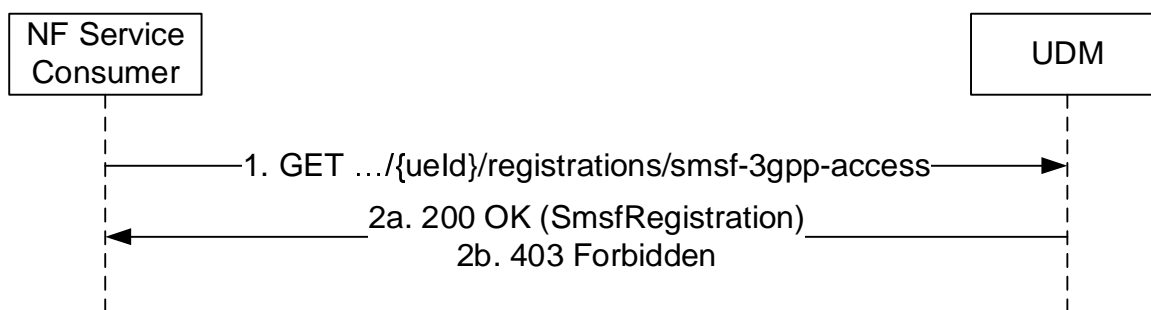

Figure 5.3.2.5.5-1: Requesting a UE's SMSF Registration Information for 3GPP Access

1. The NF service consumer (e.g. NEF) sends a GET request to the resource representing the UE's SMSF registration information for 3GPP access, with query parameters indicating the supported-features.
- 2a. The UDM responds with "200 OK" with the message body containing the UE's SmsfRegistration for 3GPP access.
- 2b. If the UE does not have required subscription data for SMS service or SMS service is barred, HTTP status code "403 Forbidden" should be returned including additional error information in the response body (in "ProblemDetails" element).

On failure, the appropriate HTTP status code indicating the error shall be returned and appropriate additional error information should be returned in the GET response body.

5.3.2.5.6 SmsfRegistration Information Retrieval for Non-3GPP Access

Figure 5.3.2.5.6-1 shows a scenario where the NF service consumer (e.g. NEF) sends a request to the UDM to retrieve the UE's SmsfRegistration Information for non-3GPP access. The request contains the UE's identity (`{ueId}`) which shall be a GPSI, the type of the requested information (`/registrations/smsf-non-3gpp-access`) and query parameters (supported-features).

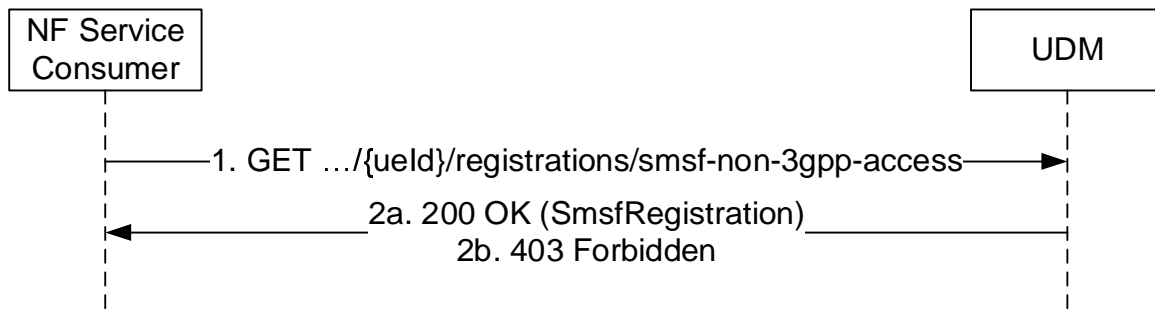

Figure 5.3.2.5.6-1: Requesting a UE's SMSF Registration Information for Non-3GPP Access

1. The NF service consumer (e.g. NEF) sends a GET request to the resource representing the UE's SMSF registration information for non-3GPP access, with query parameters indicating the supported-features.
- 2a. The UDM responds with "200 OK" with the message body containing the UE's SmsfRegistration for non-3GPP access.
- 2b. If the UE does not have required subscription data for SMS service or SMS service is barred, HTTP status code "403 Forbidden" should be returned including additional error information in the response body (in "ProblemDetails" element).

On failure, the appropriate HTTP status code indicating the error shall be returned and appropriate additional error information should be returned in the GET response body.

5.3.2.5.7 SmfRegistration Information Retrieval

Figure 5.3.2.5.7-1 shows a scenario where the NF service consumer (e.g. NWDAF) sends a request to the UDM to retrieve the UE's SmfRegistration Information. The request contains the UE's identity ($/\{ueId\}$) which shall be a GPSI or SUPI, the type of the requested information ($/\text{registrations}/\text{smf-registrations}$) and query parameters (single-nssai, dnn, supported-features).

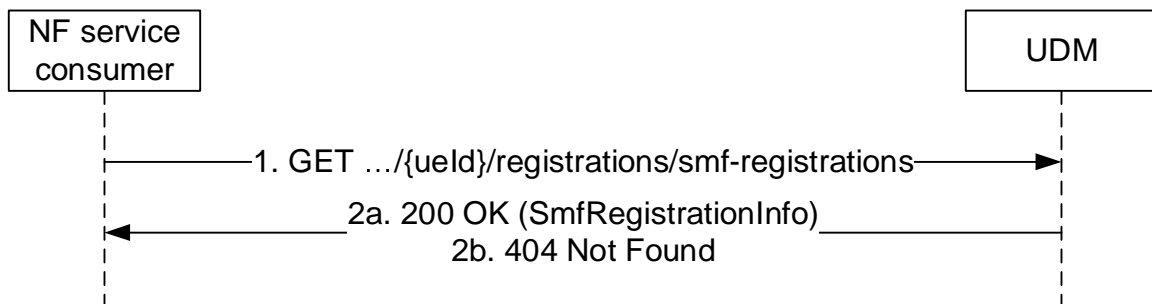

Figure 5.3.2.5.7-1: Requesting a UE's SMF Registration Information

1. The NF service consumer (e.g. NWDAF) sends a GET request to the resource representing the UE's SMF registration information, with query parameters indicating the single-nssai, dnn, supported-features.
- 2a. The UDM responds with "200 OK" with the message body containing the UE's SmfRegistrationInfo.
- 2b. If there is no valid SMF Registration data for the UE, HTTP status code "404 Not Found" shall be returned including additional error information in the response body (in the "ProblemDetails" element).

On failure, the appropriate HTTP status code indicating the error shall be returned and appropriate additional error information should be returned in the GET response body.

5.3.2.5.8 Individual SmfRegistration Information Retrieval

NF Service Consumer (e.g. AMF) may send request to UDM to retrieve individual SMF registration information identified by PDU Session ID.

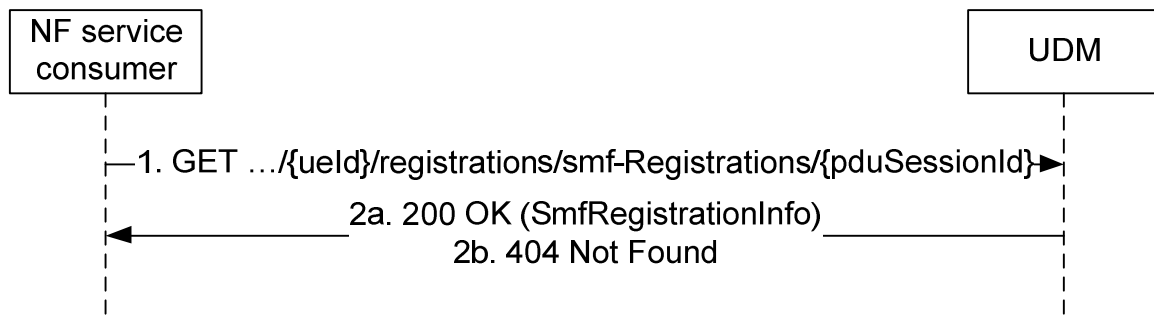

Figure 5.3.2.5.8-1: Requesting individual SMF Registration Information

1. The NF service consumer (e.g. AMF) sends a GET request to the resource representing the individual SMF registration information.
- 2a. The UDM responds with "200 OK" with the message body containing the SmfRegistration corresponding to the indicated PDU session.
- 2b. If there is no valid SMF Registration data for the indicated PDU session, HTTP status code "404 Not Found" shall be returned including additional error information in the response body (in the "ProblemDetails" element).

On failure, the appropriate HTTP status code indicating the error shall be returned and appropriate additional error information should be returned in the GET response body.

5.3.2.5.9 Location Information Retrieval

Figure 5.3.2.5.9-1 shows a scenario where the NF service consumer (e.g. (H)GMLC) sends a request to the UDM to retrieve the UE's Location Information. The request contains the UE's identity ($/\{ueId\}$), which shall be a GPSI or SUPI, and query parameters (supported-features).

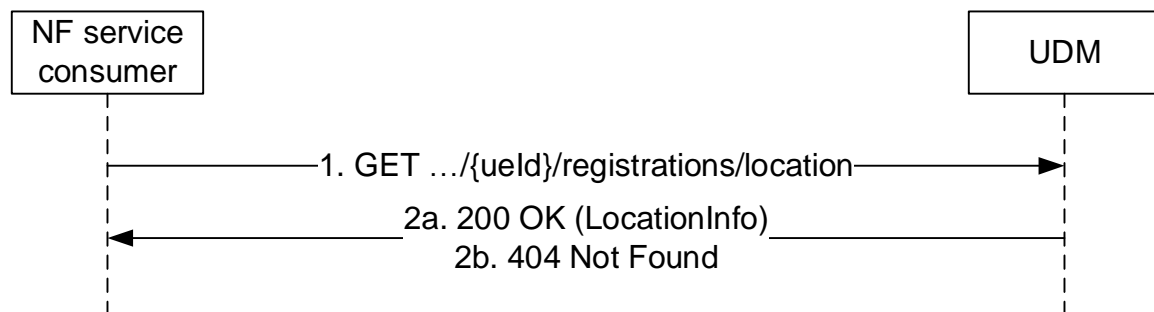

Figure 5.3.2.5.9-1: Requesting a UE's Location Information

1. The NF service consumer (e.g. (H)GMLC) sends a GET request to the resource representing the UE's Location information, with query parameters indicating the supported-features.
- 2a. The UDM responds with "200 OK" with the message body containing the UE's LocationInfo.
The returned LocationInfo shall include the NF instance ID of the serving AMF ID, and may include the GUAMI of the serving AMF, the VGMLC address info.
- 2b. If there is no valid location information data for the UE, a response with HTTP status code "404 Not Found" shall be returned to the NF service including additional error information in the response body (in the "ProblemDetails" element).

On failure, the appropriate HTTP status code indicating the error shall be returned and appropriate additional error information should be returned in the GET response body.

5.3.2.5.10 Retrieval Of Multiple UE Registration Data Sets

Figure 5.3.2.5.10-1 shows a scenario where the NF service consumer (e.g. HSS, NWDAF, NSSAAF) sends a request to the UDM to receive multiple UE registration data sets. In this example scenario the UE's AMF registration data sets are retrieved with a single request; see clause 6.2.6.3.6 for other data sets that can be retrieved with a single request. The request contains the resource of UE's registrations ({ueId}/registrations) and query parameters identifying the requested registration data sets (in this example: ?registration-dataset-names=AMF_3GPP, AMF_NON_3GPP).

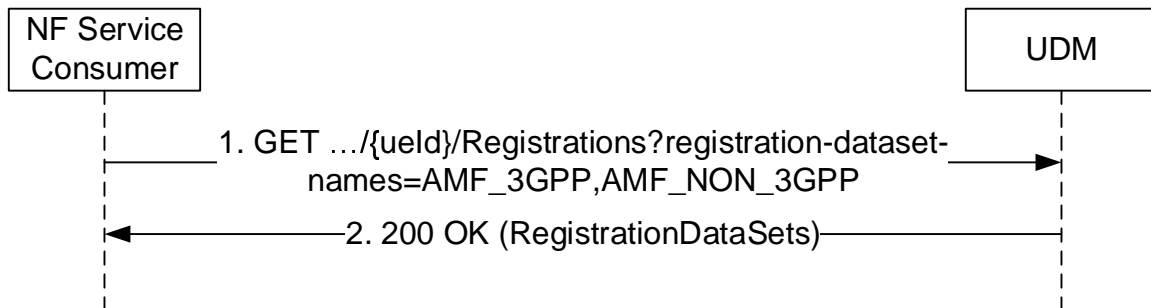

Figure 5.3.2.5.10-1: Retrieval of Multiple UE Registration Data Sets

1. The NF Service Consumer (e.g. HSS, NWDAF) sends a GET request to the resource representing the UE registrations. Query parameters indicate the requested UE registration data sets.
2. The UDM responds with "200 OK" with the message body containing the requested UE registration data sets.

On failure, the appropriate HTTP status code indicating the error shall be returned and appropriate additional error information should be returned in the GET response body.

5.3.2.5.11 IP-SM-GW Registration Information Retrieval

Figure 5.3.2.5.11-1 shows a scenario where the NF service consumer sends a request to the UDM to retrieve the UE's IP-SM-GW Registration Information. The request contains the UE's identity (/ {ueId}) which shall be a SUPI.

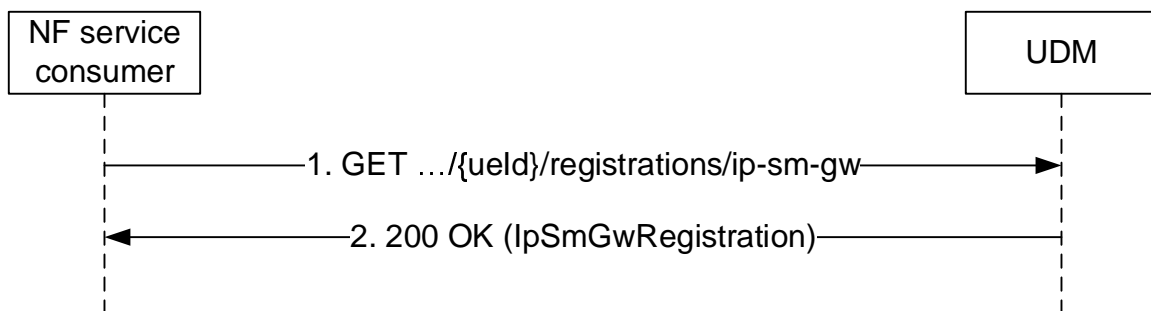

Figure 5.3.2.5.11-1: Requesting a UE's IP-SM-GW Registration Information

1. The NF service consumer sends a GET request to the resource representing the UE's IP-SM-GW registration information for 3GPP access.
2. The UDM responds with "200 OK" with the message body containing the UE's IP-SM-GW Registration.

On failure, the appropriate HTTP status code indicating the error shall be returned and appropriate additional error information should be returned in the GET response body.

5.3.2.6 Update

5.3.2.6.1 General

The following procedures using the Update service operation are supported:

- Update a parameter (e.g. PEI, EPS Interworking Info, etc) in the AMF registration for 3GPP access

- Update a parameter (e.g. PEI) in the AMF registration for non-3GPP access

5.3.2.6.2 Update A Parameter (e.g. PEI) in the AMF Registration For 3GPP Access

Figure 5.3.2.6.2-1 shows a scenario where the AMF sends a request to the UDM to update a parameter within the Amf3GppAccessRegistration resource. The request contains the UE's identity ($\{/{\text{ueId}}\}$) which shall be a SUPI and an instruction to modify a parameter (e.g. PEI).

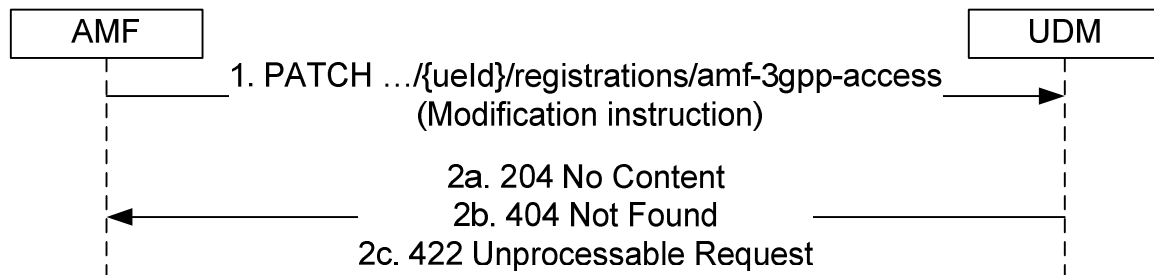

Figure 5.3.2.6.2-1: AMF registration parameter update for 3GPP access

1. The AMF sends a PATCH request to the resource representing the UE's AMF registration for 3GPP access.
- 2a. On success, the UDM responds with "204 No Content".
- 2b. If the resource does not exist e.g. the UE is not registered yet, HTTP status code "404 Not Found" should be returned including additional error information in the response body (in the "ProblemDetails" element).
- 2c. If the resource exists, but the requesting AMF is not the one currently registered for the UE, HTTP status code "422 Unprocessable Request" should be returned including additional error information in the response body (in the "ProblemDetails" element).

On failure, the appropriate HTTP status code indicating the error shall be returned and appropriate additional error information should be returned in the PATCH response body.

5.3.2.6.3 Update A Parameter (e.g. PEI) in the AMF Registration For Non 3GPP Access

Figure 5.3.2.6.3-1 shows a scenario where the AMF sends a request to the UDM to update a parameter within the AmfNon3GppAccessRegistration resource. The request contains the UE's identity ($\{/{\text{ueId}}\}$) which shall be a SUPI and an instruction to modify a parameter (e.g. PEI).

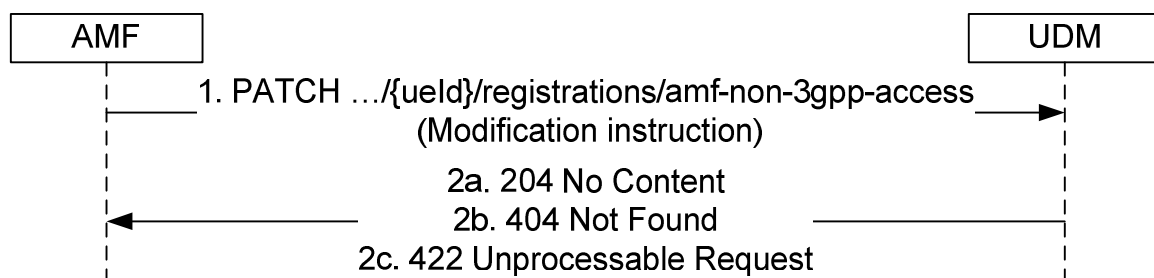

Figure 5.3.2.6.3-1: AMF registration parameter update for non-3GPP access

1. The AMF sends a PATCH request to the resource representing the UE's AMF registration for non-3GPP access.
- 2a. On success, the UDM responds with "204 No Content".
- 2b. If the resource does not exist e.g. the UE is not registered yet, HTTP status code "404 Not Found" should be returned including additional error information in the response body (in the "ProblemDetails" element).

- 2c. If the resource exists, but the requesting AMF is not the one currently registered for the UE, HTTP status code "422 Unprocessable Request" should be returned including additional error information in the response body (in the "ProblemDetails" element).

On failure, the appropriate HTTP status code indicating the error shall be returned and appropriate additional error information should be returned in the PATCH response body.

5.3.2.7 P-CSCF-RestorationNotification

5.3.2.7.1 General

The following procedure using the P-CSCF-RestorationNotification service operation is supported:

- UDM initiated P-CSCF-Restoration

5.3.2.7.2 UDM initiated P-CSCF-Restoration

Figure 5.3.2.7.2-1 shows a scenario where the UDM notifies the registered AMF or SMF about the need for P-CSCF restoration. The request contains the callback URI for P-CSCF restoration as received by the UDM during registration, and P-CSCF Restoration Indication.

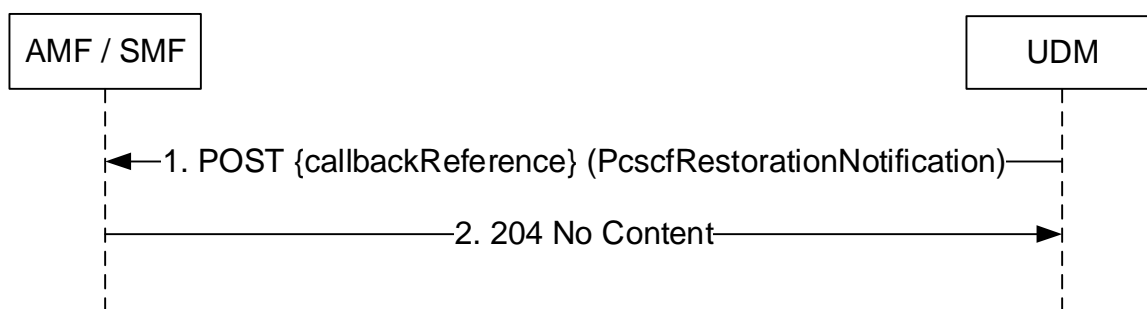

Figure 5.3.2.7.2-1: UDM initiated P-CSCF Restoration

1. The UDM sends a POST request to the callbackReference as provided by the NF service consumer during the registration.
2. The AMF or SMF responds with "204 No Content".

On failure, the appropriate HTTP status code indicating the error shall be returned and appropriate additional error information should be returned in the POST response body.

5.3.2.8 P-CSCF-RestorationTrigger

5.3.2.8.1 General

The following procedure using the P-CSCF-RestorationTrigger service operation is supported:

- P-CSCF-RestorationTrigger

5.3.2.8.2 P-CSCF-RestorationTrigger

Figure 5.3.2.8.2-1 shows a scenario where the HSS sends a request to the UDM to initiate P-CSCF restoration. The request contains the UE's identity which shall be a SUPI.

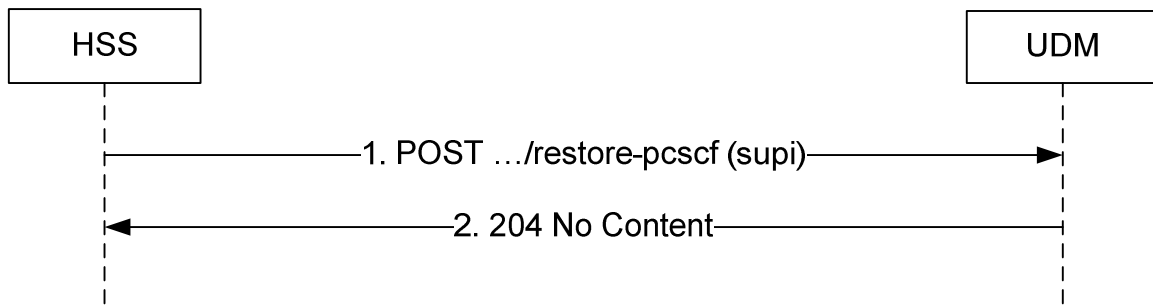

Figure 5.3.2.8.2-1: P-CSCF-RestorationTrigger

1. The HSS sends a POST request (custom method: restore-pcscf) to the UDM.
2. The UDM responds with "204 No Content".

On failure, the appropriate HTTP status code indicating the error shall be returned and appropriate additional error information should be returned in the POST response body.

5.3.2.9 AMFDeregistration

5.3.2.9.1 General

The following procedure using the AMFDeregistration service operation is supported:

- AMF-Deregistration

5.3.2.9.2 AMF-Deregistration

Figure 5.3.2.9.2-1 shows a scenario where the HSS sends a request to the UDM to deregister the registered AMF. The request contains the UE's identity which shall be an IMSI.

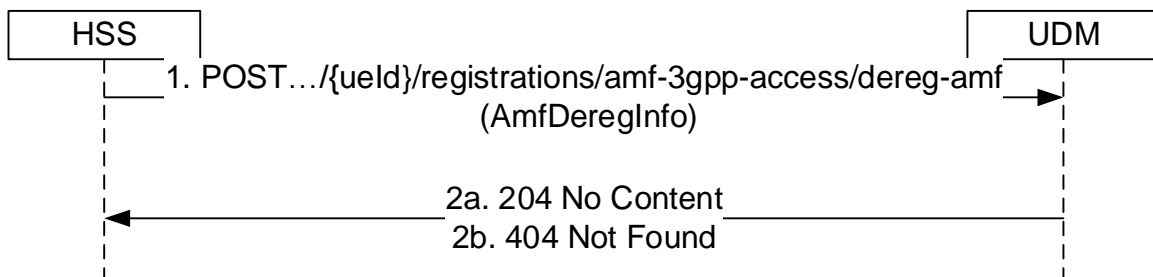

Figure 5.3.2.9.2-1: AMF-Deregistration

1. The HSS sends a POST request (custom method: dereg-amf) to the resource representing the UE's registration for 3GPP access. This shall result in sending of Nudm_UECM_DeregistrationNotification to the AMF (see 3GPP TS 23.632 [32]) and setting the purgeFlag in the Amf3GppAccessRegistration stored in the UDR.
- 2a. The UDM responds with "204 No Content".
- 2b. If the user does not exist, HTTP status code "404 Not Found" shall be returned including additional error information in the response body (in the "ProblemDetails" element).

On failure, the appropriate HTTP status code indicating the error shall be returned and appropriate additional error information should be returned in the POST response body.

5.3.2.10 PEI-Update

5.3.2.10.1 General

The following procedure using the PEI-Update service operation is supported:

- PEI Update

5.3.2.10.2 PEI Update

Figure 5.3.2.10.2-1 shows a scenario where the HSS sends a request to the UDM to update the PEI attribute in the 3GPP Access Registration context. The request contains the UE's identity which shall be an IMSI.

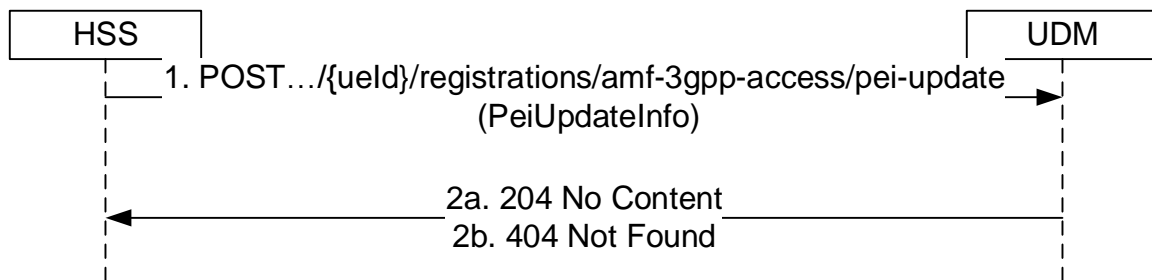

Figure 5.3.2.10.2-1: PEI Update

1. The HSS sends a POST request (custom method: pei-update) to the resource representing the UE's registration for 3GPP access. This shall result in updating the pei attribute in the Amf3gppAccessRegistration object and storing it in UDR.
- 2a. The UDM responds with "204 No Content".
- 2b. If the user does not exist, HTTP status code "404 Not Found" shall be returned including additional error information in the response body (in the "ProblemDetails" element).

On failure, the appropriate HTTP status code indicating the error shall be returned and appropriate additional error information should be returned in the POST response body.

5.4 Nudm_UEAuthentication Service

5.4.1 Service Description

See 3GPP TS 23.501 [2] table 7.2.5-1.

5.4.2 Service Operations

5.4.2.1 Introduction

For the Nudm_UEAuthentication service the following service operations are defined:

- Get
- GetHssAv
- ResultConfirmation

The Nudm_UEAuthentication service is used by the AUSF to request the UDM to select an authentication method, calculate a fresh authentication vector (AV) if required for the selected method, and provide it to the AUSF by means of the Get service operation. See 3GPP TS 33.501 [6] clause 14.2.2. The service may also be used by the AUSF to indicate to the UDM that the user is using a N5GC device behind Cable RGs in private networks or in isolated deployment

scenarios with wireline access and that therefore the applicable authentication method shall be EAP based. See 3GPP TS 23.316 [37] clause 4.10a.

The Nudm_UEAuthentication service is also used by the HSS to request UDM to generate the authentication vector(s) for EPS or IMS domain by means of GetHssAv service operation. See 3GPP TS 23.632 [32] clause 5.6.3.

The Nudm_UEAuthentication service is also used by the AUSF to inform the UDM about the occurrence of a successful or unsuccessful authentication by means of the ResultConfirmation service operation. See 3GPP TS 33.501 [6] clause 14.2.3.

The Nudm_UEAuthentication service is also used by the AUSF to request the UDM to authenticate the FN-RG accessing to 5GC via W-AGF. See 3GPP TS 23.316 [37] clause 7.2.1.3.

The Nudm_UEAuthentication service is also used by the NF service consumer to request the UDM to remove the UE authentication result during the Purge of subscriber data in AMF after the UE deregisters from the network or NAS SMC fails following the successful authentication in the registration procedure.

5.4.2.2 Get

5.4.2.2.1 General

The following procedure using the Get service operation is supported:

- Authentication Information Retrieval
- FN-RG Authentication

As part of this Authentication Information Retrieval operation, the UDM authorizes or rejects the subscriber to use the service provided by the registered NF, based on subscription data (e.g. roaming restrictions).

As part of this FN-RG Authentication operation, the UDM decides, based on the stored authentication profile of the SUPI and the authenticated indication that authentication has been completed by the W-AGF, that authentication by the home network is not required for the FN-RG.

5.4.2.2.2 Authentication Information Retrieval

Figure 5.4.2.2.2-1 shows a scenario where the NF service consumer (AUSF) retrieves authentication information for the UE from the UDM (see also 3GPP TS 33.501 [6] clause 6.1.2). The request contains the UE's identity (supi or suci), the serving network name, and may contain resynchronization info.

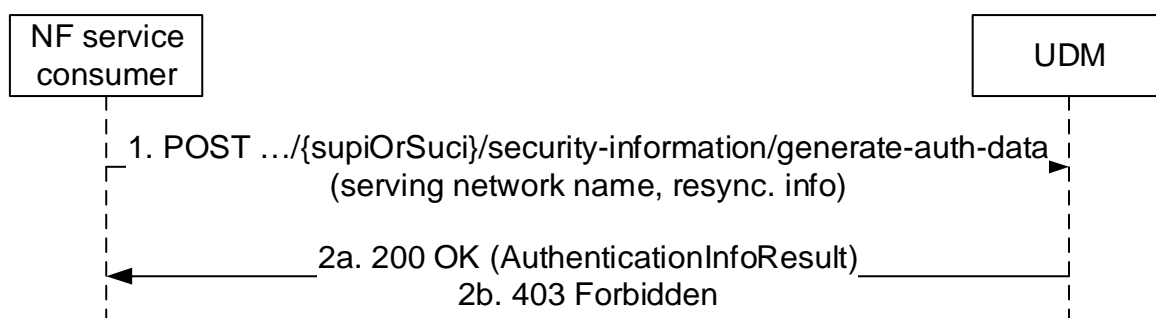

Figure 5.4.2.2.2-1: NF service consumer requesting authentication information

1. The NF service consumer sends a POST request (custom method: generate-auth-data) to the resource representing the UE's security information.
- 2a. The UDM responds with "200 OK" with the message body containing the authentication data information.

The AUSF shall store the authentication data information for subsequent authentication processing. If the AUSF is configured to store Kausf (e.g. based on its support of SoRProtection / UPUProtection service operations), the AUSF shall preserve the Kausf and related information (e.g. SUPI) after the completion of the primary authentication.

- 2b. If the operation cannot be authorized due to e.g. UE does not have required subscription data, none of the CAG IDs in the CAG cell match any of the CAG IDs in the allowed CAG list, access barring or roaming restrictions, HTTP status code "403 Forbidden" should be returned including additional error information in the response body (in "ProblemDetails" element). If the cellCagInfo is not received, the UDM shall not assume the UE is accessing from the PLMN and shall not stop the authentication if the UE is allowed to access 5GS via CAG cell(s) only.

On failure, the appropriate HTTP status code indicating the error shall be returned and appropriate additional error information should be returned in the POST response body.

5.4.2.2.3 FN-RG Authentication

Figure 5.4.2.2.3-1 shows a scenario where the NF service consumer (AUSF) requests the UDM to authenticate the FN-RG accessing to 5GC via W-AGF. (see also 3GPP TS 23.316 [37] clause 7.2.1.3). The request contains the UE's identity (suci), and the authenticated indication.

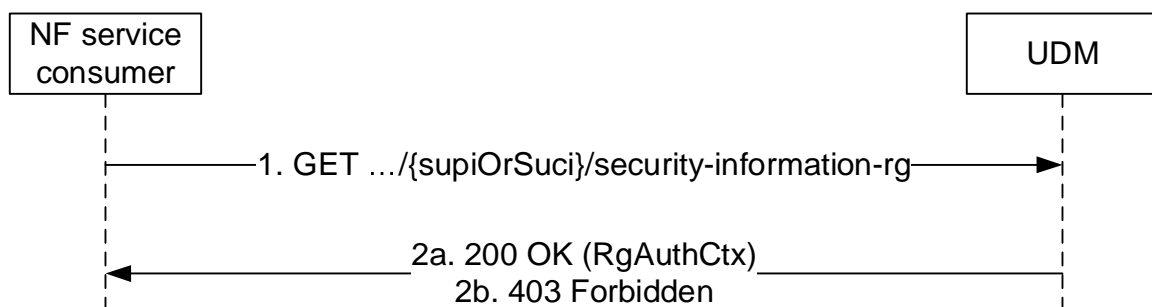

Figure 5.4.2.2.3-1: NF service consumer requesting authentication information for FN-RG

1. The NF service consumer sends a GET request to the resource representing the UE's security information.
- 2a. The UDM responds with "200 OK" with the message body containing the authentication data information of FN-RG.
- 2b. If the operation cannot be authorized due to e.g. UE does not have required subscription data, HTTP status code "403 Forbidden" should be returned including additional error information in the response body (in "ProblemDetails" element).

On failure, the appropriate HTTP status code indicating the error shall be returned and appropriate additional error information should be returned in the POST response body.

5.4.2.3 ResultConfirmationInform

5.4.2.3.1 General

The following procedure using the ResultConfirmation service operation is supported:

- Authentication Confirmation
- Authentication Result Removal

5.4.2.3.2 Authentication Confirmation

Figure 5.4.2.3.2-1 shows a scenario where the NF service consumer (AUSF) confirms the occurrence of a successful or unsuccessful authentication in a serving network to the UDM (see also 3GPP TS 33.501 [6] clause 6.1.4.1a). The request contains the UE's identity (supi), and information about the authentication occurrence (AuthEvent).

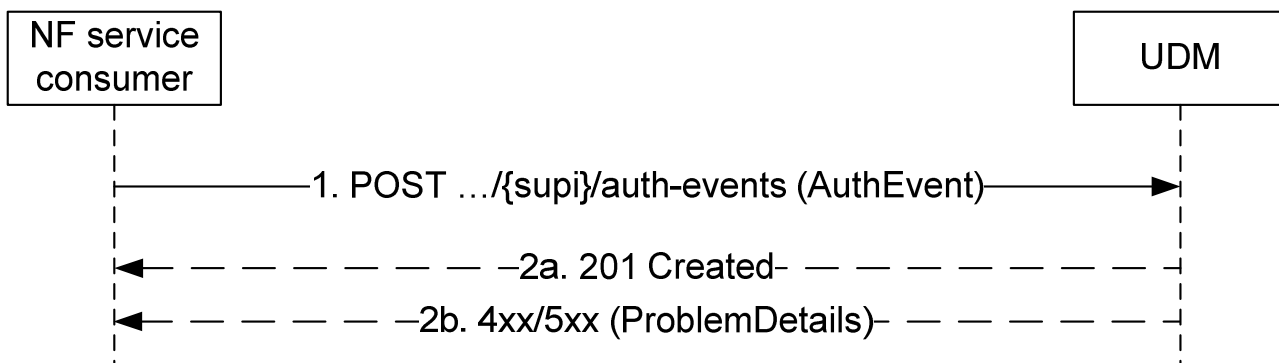

Figure 5.4.2.3.2-1: NF service consumer confirms UE authentication

1. The NF service consumer sends a POST request to the resource representing the UE's authentication events. The payload body of the POST request shall contain a representation of the individual AuthEvent resource to be created. There shall be only one individual AuthEvent per UE per Serving Network identified by the supi in URI and servingNetworkName in AuthEvent.
- 2a. On success, the UDM responds with "201 Created" and the "Location" header shall be present and shall contain the URI of the created resource.
- 2b. On failure, the appropriate HTTP status code indicating the error shall be returned and appropriate additional error information should be returned.

5.4.2.3.3 Authentication Result Removal

Figure 5.4.2.3.3-1 shows a scenario where the NF service consumer requests the UDM to remove the Authentication Result. The request contains the UE's identity (supi), the authEvent Id, and an indication to remove Authentication result.

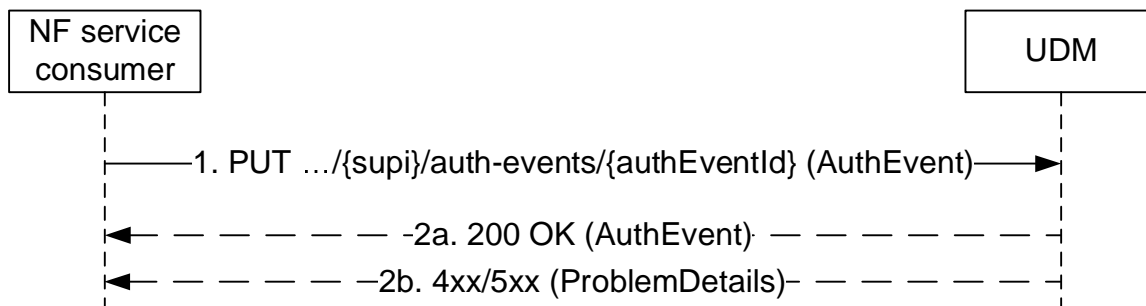

Figure 5.4.2.3.3-1: NF service consumer removes the authentication result

1. The NF service consumer shall send a PUT request to the UDM. The payload of the body shall contain the indication to remove authentication result.
- 2a. On success, "204 No Content" shall be returned. The UDM shall remove the Authentication result of the UE by completely replacing the individual AuthEvent resource.
- 2b. On failure, the appropriate HTTP status code indicating the error shall be returned and appropriate additional error information should be returned.

5.4.2.4 GetHssAv

5.4.2.4.1 General

The following procedure using the GetHssAv service operation is supported:

- HSS Authentication Vector Retrieval

5.4.2.4.2 HSS Authentication Vector Retrieval

Figure 5.4.2.4.2-1 shows a scenario where the NF service consumer (HSS) retrieves authentication vector(s) for the UE from the UDM (see also 3GPP TS 23.632 [32] clause 5.6.3). The request contains the UE's identity (SUPI), the authentication method, serving network id, and may contain resynchronization info.

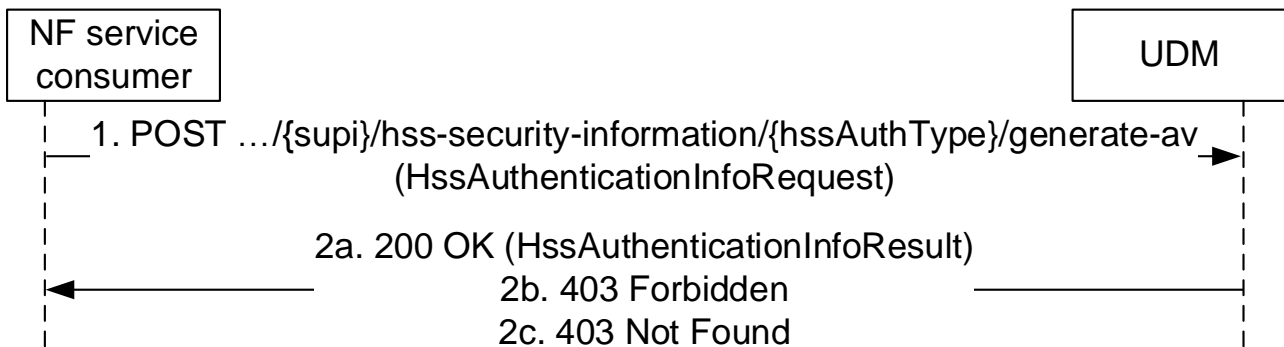

Figure 5.4.2.4.2-1: NF service consumer requesting authentication vector(s)

1. The NF service consumer sends a POST request (custom method: generate-av) to the resource representing the UE's HSS security information; the type of requested AV is included as part of the resource URI.
- 2a. The UDM responds with "200 OK" with the message body containing the authentication vector(s).
- 2b. If the operation cannot be authorized due to e.g. UE does not have required subscription data, HTTP status code "403 Forbidden" should be returned including additional error information in the response body (in "ProblemDetails" element).
- 2c. If the user does not exist, HTTP status code "404 Not Found" shall be returned including additional error information in the response body (in the "ProblemDetails" element).

On failure, the appropriate HTTP status code indicating the error shall be returned and appropriate additional error information should be returned in the POST response body.

5.5 Nudm_EventExposure Service

5.5.1 Service Description

See 3GPP TS 23.501 [2] table 7.2.5-1.

5.5.2 Service Operations

5.5.2.1 Introduction

For the Nudm_EventExposure service the following service operations are defined:

- Subscribe
- Unsubscribe
- Notify
- ModifySubscription

The Nudm_EventExposure service is used by consumer NFs (e.g. NEF) to subscribe to notifications of event occurrence by means of the Subscribe service operation. For events that can be detected by the AMF, the UDM makes use of the appropriate AMF service operation to subscribe on behalf of the consumer NF (e.g. NEF).

The Nudm_EventExposure service is also used by the consumer NFs (e.g. NEF) that have previously subscribed to notifications, to unsubscribe by means of the Unsubscribe service operation. For events that can be detected by the AMF, the UDM makes use of the appropriate AMF service operation to unsubscribe on behalf of the consumer NF (e.g. NEF).

The Nudm_EventExposure service is also used by the subscribed consumer NFs (e.g. NEF) to get notified by the UDM when a subscribed event occurs at the UDM by means of the Notify service operation. For subscribed events that can occur at the AMF, the consumer NF (e.g. NEF) makes use of the corresponding AMF service operation to get notified by the AMF directly without UDM involvement.

The Nudm_EventExposure service is also used by the subscribed consumer NFs (e.g. NEF) to modify an existing subscription by means of the ModifySubscription service operation.

For details see 3GPP TS 23.502 [3] clause 4.15.

5.5.2.2 Subscribe

5.5.2.2.1 General

The following procedures using the Subscribe service operation are supported:

- Subscribe to Notification of event occurrence

5.5.2.2.2 Subscription to Notification of event occurrence

Figure 5.5.2.2.2-1 shows a scenario where the NF service consumer sends a request to the UDM to subscribe to notifications of event occurrence (see also 3GPP TS 23.502 [3] figure 4.15.3.2.2-1 step 1 and 3GPP TS 23.502 [3] Figure 4.15.3.2.3b-1 step 1). The request contains a callback URI, the type of event that is monitored and additional information e.g. event filters and reporting options.

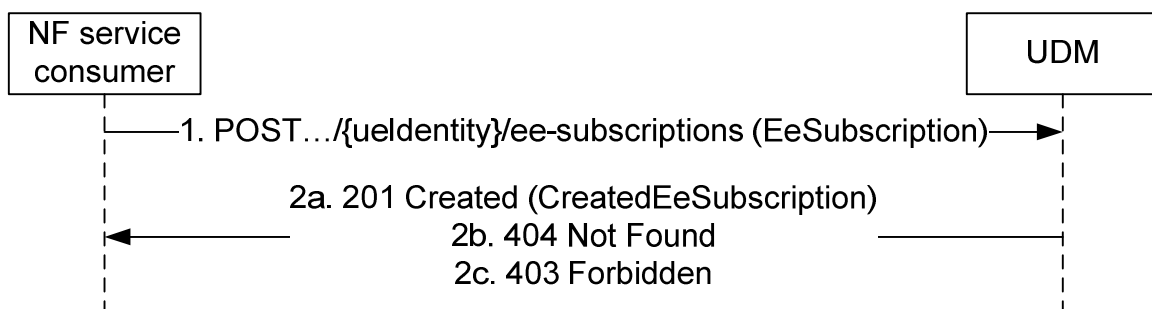

Figure 5.5.2.2.2-1: NF service consumer subscribes to notifications

1. The NF service consumer sends a POST request to the parent resource (collection of subscriptions) (.../{ueIdentity}/ee-subscriptions), to create a subscription as present in message body. The values ueIdentity shall take are specified in Table 6.4.3.2.2-1. The request may contain an expiry time, suggested by the NF Service Consumer, representing the time upto which the subscription is desired to be kept active and the time after which the subscribed event(s) shall stop generating notifications, the indication on whether the subscription applies also to EPC.

If MTC Provider information and/or AF ID are received in the request, the UDM shall check whether the MTC Provider and/or the AF is allowed to perform this operation for the UE; otherwise, the UDM shall skip the MTC provider and/or AF authorization check.

- 2a. On success, the UDM responds with "201 Created" with the message body containing a representation of the created subscription. The Location HTTP header shall contain the URI of the created subscription. If the event subscription was for a group of UEs:

- The "maxNumOfReports" in the "reportingOptions" IE shall be applicable to each UE in the group;
- The UDM shall return the number of UEs in that group in the "numberOfUes" IE.

The NF service consumer shall keep track of the maximum number of reports reported for each UE in the event report and when "maxNumOfReports*numberOfUes" limit is reached, the NF service consumer shall initiate the unsubscription of the notification towards the UDM (see clause 5.5.2.3.2).

The response, based on operator policy, may contain the expiry time, as determined by the UDM, after which the subscription becomes invalid. Once the subscription expires, if the NF Service Consumer wants to keep receiving notifications, it shall create a new subscription in the UDM. The NF Service Producer shall not provide the same expiry time for many subscriptions in order to avoid all of them expiring and recreating the subscription at the same time. If the expiry time is not included in the response, the NF Service Consumer shall not associate an expiry time for the subscription.

If the indication on whether the subscription applies also to EPC is included in the request, the response shall include the indication on whether the subscription was also successful in EPC domain.

If the event subscription was for a list events, the "maxNumOfReports" in the "reportingOptions" IE shall be applicable to each event. The NF service consumer shall keep track of the maximum number of reports reported for each event in the event report and when "maxNumOfReports*number of events" limit is reached, the NF service consumer shall initiate the unsubscription of the notification towards the UDM (see clause 5.5.2.3.2).

If the NF Service Consumer has included the immediateFlag with value as "true" in the event subscription for an individual UE and the event requested for immediate reporting is reported by the UDM (e.g. "CHANGE_OF_SUPI_PEI_ASSOCIATION" or "ROAMING_STATUS"), the UDM may include the current status of the event if available in the response.

If the NF Service Consumer has included the immediateFlag with value as "true" in the event subscription for an individual UE and the event requested for immediate reporting is reported by the AMF (e.g. LOCATION_REPORT) and the NF service consumer has indicated supporting of "IERSR" feature (see clause 6.4.8), the UDM shall indicate the support of "IERSR" feature when subscribing to the event on the AMF (see clause 6.2.8 of 3GPP TS 29.518 [36]). UDM shall include the current status of the event if received from the AMF in subscription creation response.

If the NF Service Consumer has included the immediateFlag with value as "true" in the event subscription for an individual UE, the indication on whether the subscription applies also to EPC is included and set to "true" in the request and the NF service consumer has indicated supporting of "IERSR" feature (see clause 6.4.8), the UDM shall indicate the support of "ERIR" feature when subscribing to the event on the HSS (see clause 6.4.8 of 3GPP TS 29.563 [55]). UDM shall include the current status of the event in EPC if received from the HSS in subscription creation response.

NOTE: IERSR feature is not applicable to events detected by the SMF.

2b. If the user does not exist, HTTP status code "404 Not Found" shall be returned including additional error information in the response body (in the "ProblemDetails" element).

2c. If there is no valid subscription data for the UE, i.e. based on the UE's subscription information monitoring of the requested EventType is not allowed, or the requested EventType is not supported, or when MTC Provider or AF are not allowed to perform this operation for the UE, HTTP status code "403 Forbidden" shall be returned including additional error information in the response body (in the "ProblemDetails" element).

On failure, the appropriate HTTP status code indicating the error shall be returned and appropriate additional error information should be returned in the POST response body.

5.5.2.2.3 Void

5.5.2.3 Unsubscribe

5.5.2.3.1 General

The following procedures using the Unsubscribe service operation are supported:

- Unsubscribe to Notifications of event occurrence

5.5.2.3.2 Unsubscribe to notifications of event occurrence

Figure 5.5.2.3.2-1 shows a scenario where the NF service consumer sends a request to the UDM to unsubscribe from notifications of event occurrence. The request contains the URI previously received in the Location HTTP header of the response to the subscription.

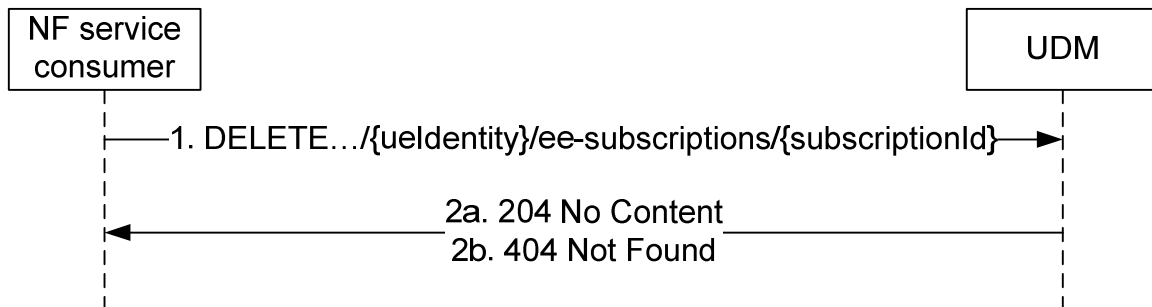

Figure 5.5.2.3.2-1: NF service consumer unsubscribes to notifications

1. The NF service consumer sends a DELETE request to the resource identified by the URI previously received during subscription creation.
- 2a. On success, the UDM responds with "204 No Content".
- 2b. If there is no valid subscription available (e.g. due to an unknown SubscriptionId value), HTTP status code "404 Not Found" shall be returned including additional error information in the response body (in the "ProblemDetails" element).

On failure, the appropriate HTTP status code indicating the error shall be returned and appropriate additional error information should be returned in the DELETE response body.

5.5.2.4 Notify

5.5.2.4.1 General

The following procedures using the Notify service operation are supported:

- Event Occurrence Notification

5.5.2.4.2 Event Occurrence Notification

Figure 5.5.2.4.2-1 shows a scenario where the UDM notifies the NF service consumer (that has subscribed to receive such notification) about occurrence of an event (see also 3GPP TS 23.502 [3] figure 4.15.3.2.2-1 step 4a). The request contains the callbackReference URI as previously received in the EeSubscription (see clause 6.4.6.2.2).

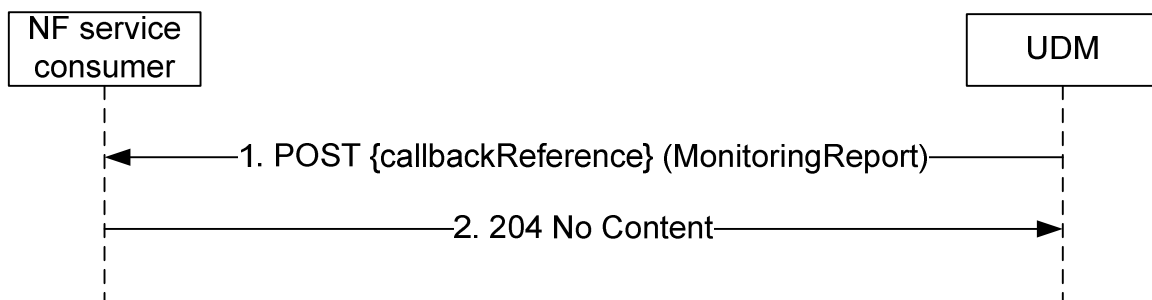

Figure 5.5.2.4.2-1: Event Occurrence Notification

1. The UDM sends a POST request to the callbackReference as provided by the NF service consumer during the subscription, the request shall include in each report the Reference ID of the associated monitoring configuration.
2. The NF Service Consumer responds with "204 No Content".

On failure, the appropriate HTTP status code indicating the error shall be returned and appropriate additional error information should be returned in the POST response body.

5.5.2.5 ModifySubscription

5.5.2.5.1 General

The following procedures using the ModifySubscription service operation are supported:

- Modification of an EE-Subscription to notification of events

5.5.2.5.2 Modification of a subscription

The service operation is invoked by a NF Service Consumer, e.g. NEF, towards the UDM, when it needs to modify an existing subscription previously created by itself at the UDM.

The NF Service Consumer shall modify the subscription by using HTTP method PATCH with the URI of the individual subscription resource (see clause 6.4.3.3) to be modified.

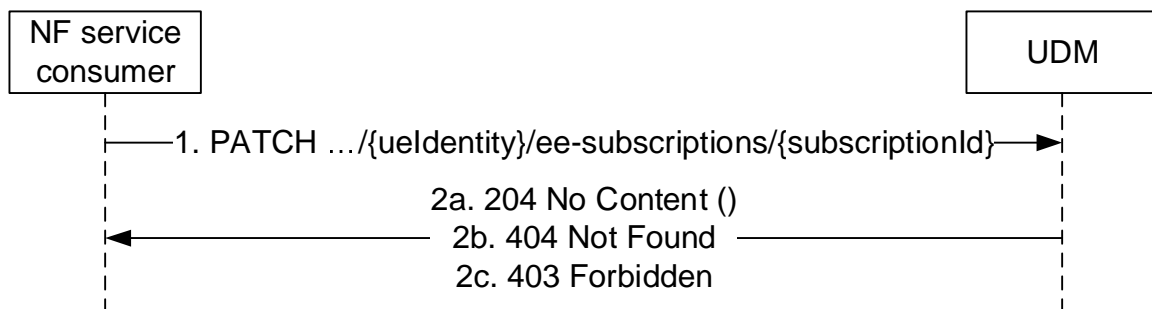

Figure 5.5.2.5.2-1: NF service consumer updates subscription

1. The NF service consumer (e.g. NEF) shall send a PATCH request to the resource representing a subscription. The modification may be for the events subscribed or for updating the event report options.
- 2a. On success, the request is accepted, the UDM shall respond with "204 No Content".
- 2b. If the resource does not exist e.g. the subscriptionId cannot be found, HTTP status code "404 Not Found" should be returned including additional error information in the response body (in the "ProblemDetails" element).
- 2c. If the modification can't be accepted, HTTP status code "403 Forbidden" should be returned including additional error information in the response body (in the "ProblemDetails" element).

On failure, the appropriate HTTP status code indicating the error shall be returned and appropriate additional error information should be returned in the PATCH response body.

5.6 Nudm_ParameterProvision Service

5.6.1 Service Description

See 3GPP TS 23.501 [2] table 7.2.5-1.

5.6.2 Service Operations

5.6.2.1 Introduction

For the Nudm_ParameterProvision service the following service operations are defined:

- Update
- Create
- Delete
- Get

The Nudm_ParameterProvision service is used by consumer NFs (e.g. NEF) to update a UE's or a group of UE's' subscription data by means of the Update service operation.

For details see 3GPP TS 23.502 [3] clause 4.15.6.2.

The Nudm_ParameterProvision service can also be used by a NF Service Consumer (e.g. SOR-AF) to send updated Steering of Roaming Information for a UE to the UDM at any time, as specified in Annex C.3 of 3GPP TS 23.122 [20].

5.6.2.2 Update

5.6.2.2.1 General

The following procedures using the Update service operation are supported:

- Subscription data update
- SoR Information update
- 5G VN Group modification

5.6.2.2.2 Subscription data update

Figure 5.6.2.2.2-1 shows a scenario where the NF service consumer (e.g. NEF, AMF) sends a request to the UDM to update a UE's subscription data (see 3GPP TS 23.502 [3] figure 4.15.6.2-1 step 2 and also 3GPP TS 23.273 [38] Figure 6.12.1-1 step 2). The request contains the identifier of the UE's parameter provision data (`.../{ueId}/pp-data`) and the modification instructions. The values ueId shall take are specified in Table 6.5.3.2.2-1.

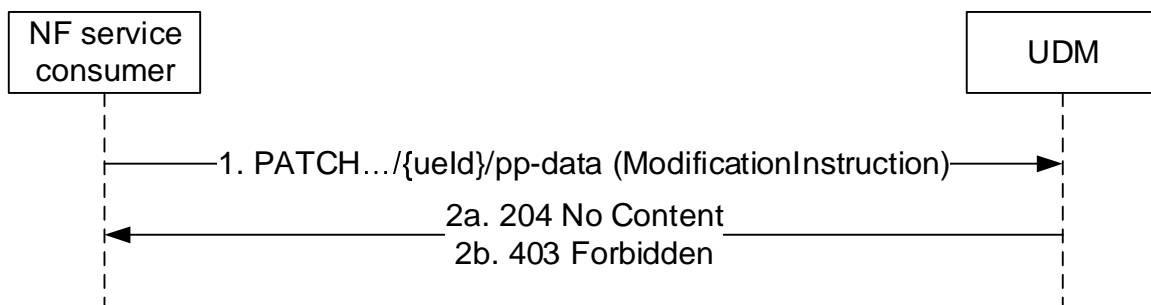

Figure 5.6.2.2.2-1: NF service consumer updates subscription data

1. The NF service consumer (e.g. NEF, AMF) sends a PATCH request to the resource that represents a UE's modifiable subscription data.

If MTC Provider information and/or AF ID are received in the request, the UDM shall check whether the MTC

Provider and/or the AF is allowed to perform this operation for the UE; otherwise, the UDM shall skip the MTC provider and/or AF authorization check.

2a. The UDM responds with "204 No Content".

2b. If MTC Provider or AF are not allowed to perform this operation for the UE, HTTP status code "403 Forbidden" shall be returned including additional error information in the response body (in the "ProblemDetails" element).

NOTE: Upon reception of an update or removal of maximum latency, maximum response time or DL Buffering Suggested Packet Count, UDM may need to adjust the value of active time and/or periodic registration timer and/or DL Buffering Suggested Packet Count and the UDM shall notify AMF and/or SMF if the values are updated (see clause 4.15.6.3a of 3GPP TS 23.502 [3]).

On failure, the appropriate HTTP status code indicating the error shall be returned and appropriate additional error information should be returned in the PATCH response body.

5.6.2.2.3 5G VN Group modification

Figure 5.6.2.2.3-1 shows a scenario where the NF service consumer sends a request to the UDM to modify an external group id's group data. The request contains the external group identifier of the group and the modification instructions.

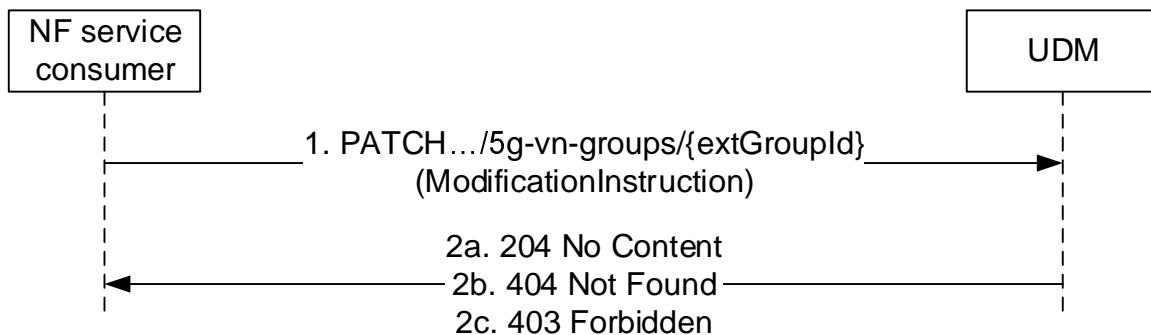

Figure 5.6.2.2.3-1: NF service consumer modifies a 5G VN Group

1. The NF service consumer sends a PATCH request to the resource that represents a 5G VN Group.

If MTC Provider information and/or AF ID are received in the request, the UDM shall check whether the MTC Provider and/or the AF is allowed to perform this operation for the UE; otherwise, the UDM shall skip the MTC provider and/or AF authorization check.

2a. On success, the UDM responds with "204 No Content".

2b. If the external group id does not exist in the UDM, HTTP status code "404 Not Found" shall be returned including additional error information in the response body (in the "ProblemDetails" element).

2c. If MTC Provider or AF are not allowed to perform this operation for the UE, HTTP status code "403 Forbidden" shall be returned including additional error information in the response body (in the "ProblemDetails" element).

On failure, the appropriate HTTP status code indicating the error shall be returned and appropriate additional error information should be returned in the PATCH response body.

5.6.2.2.4 SoR Information update

Figure 5.6.2.2.4-1 shows a scenario where the NF service consumer (e.g. SOR-AF) sends updated SoR Information for a UE to the UDM to trigger the sending of this updated SoR Information to the UE via the AMF (as per Annex C.3 of 3GPP TS 23.122 [20]). The request contains the identifier of the UE's parameter provision data (.../{ueId}/pp-data), the SUPI in this case, and the modification instructions.

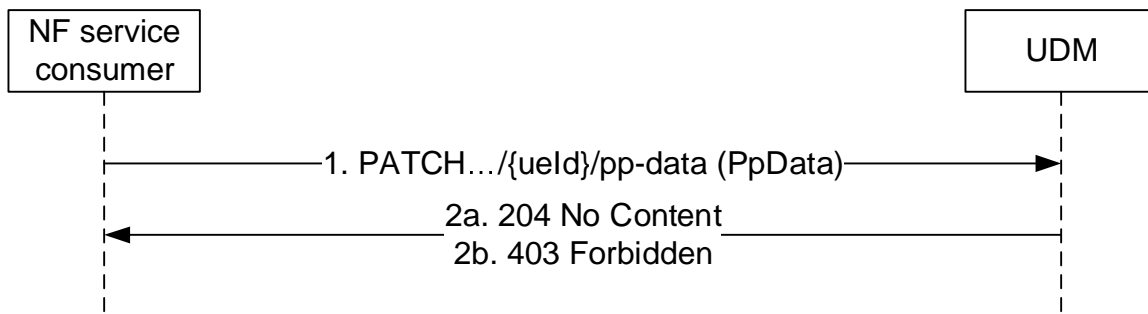

Figure 5.6.2.2.4-1: NF service consumer updates SoR Information for a UE

1. The NF service consumer (e.g. SOR-AF) sends a PATCH request to the resource that represents a UE's modifiable subscription data, containing updated Steering of Roaming Information for a UE.

The UDM, after contacting the AUSF to perform integrity protection and getting the related information (sorMacIausf and coutersor), shall immediately convey this updated SoR Information to the concerned UE by triggering a notification to the registered AMF (that has subscribed to receive notifications on change of AccessAndMobilitySubscriptionData) for the UE, if any, as per annex C.3 of 3GPP TS 23.122 [20]. Once the subscribing AMF is notified (or when no AMF has subscribed), the UDM shall delete the updated SorInfo and shall not send it as part of AccessAndMobilitySubscriptionData to an NF (e.g. AMF) retrieving the AccessAndMobilitySubscriptionData.

2a. The UDM responds with "204 No Content".

2b. If the operation cannot be authorized due to e.g UE isn't registered in the network, HTTP status code "403 Forbidden" should be returned including additional error information in the response body (in "ProblemDetails" element).

On failure, the appropriate HTTP status code indicating the error shall be returned and appropriate additional error information should be returned in the PATCH response body.

5.6.2.3 Create

5.6.2.3.1 General

The following procedures using the Create service operation are supported:

- 5G-VN-Group creation

5.6.2.3.2 5G-VN-Group creation

Figure 5.6.2.3.2-1 shows a scenario where the NF service consumer sends a request to the UDM to create a 5G VN Group. The request contains the group's external identifier and the group configuration.

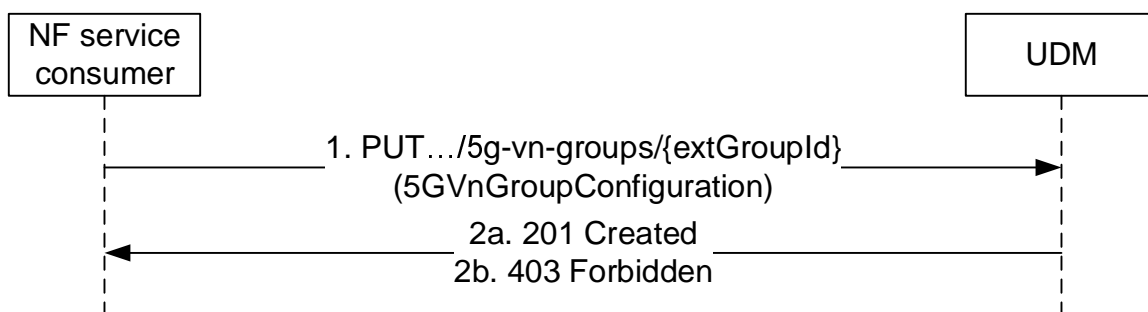

Figure 5.6.2.3.2-1: NF service consumer creates a 5G-VN-Group

1. The NF service consumer sends a PUT request to the resource `.../5g-vn-groups/{extGroupId}`, to create a 5G VN Group as present in the message body.

If MTC Provider information and/or AF ID are received in the request, the UDM shall check whether the MTC Provider and/or the AF is allowed to perform this operation for the UE; otherwise, the UDM shall skip the MTC provider and/or AF authorization check.

2a. On success the UDM responds with "201 Created".

2b. If the creation can't be accepted (e.g. MTC Provider or AF are not allowed to perform this operation for the UE), HTTP status code "403 Forbidden" should be returned including additional error information in the response body (in the "ProblemDetails" element).

On failure, the appropriate HTTP status code indicating the error shall be returned and appropriate additional error information should be returned in the PUT response body.

5.6.2.4 Delete

5.6.2.4.1 General

The following procedures using the Delete service operation are supported:

- 5G-VN-Group deletion

5.6.2.4.2 5G-VN-Group deletion

Figure 5.6.2.4.2-1 shows a scenario where the NF service consumer sends a request to the UDM to delete a 5G VN Group. The request contains the group's external identifier.

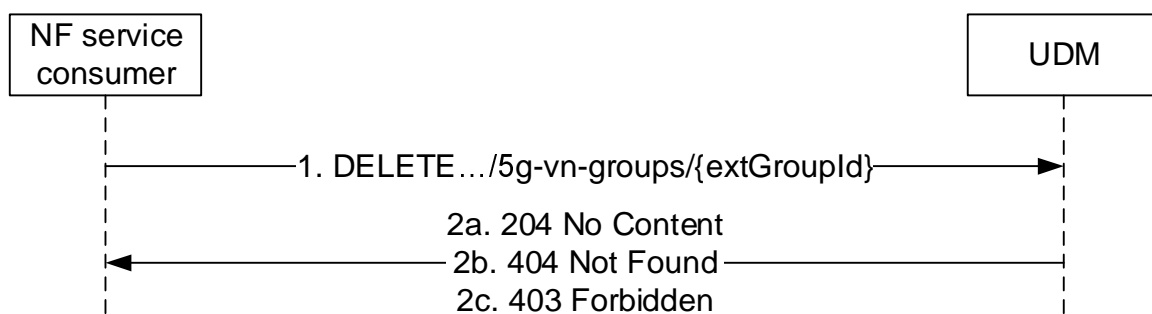

Figure 5.6.2.4.2-1: NF service consumer deletes a 5G-VN-Group

1. The NF service consumer sends a DELETE request to the resource `.../5g-vn-groups/{extGroupId}`, to delete the 5G VN Group identified by the external group id.

If MTC Provider information and/or AF ID are received in the request, the UDM shall check whether the MTC Provider and/or the AF is allowed to perform this operation for the UE; otherwise, the UDM shall skip the MTC provider and/or AF authorization check.

2a. On success, the UDM responds with "204 No Content".

2b. If the external group id does not exist in the UDM, HTTP status code "404 Not Found" shall be returned including additional error information in the response body (in the "ProblemDetails" element).

2c. If MTC Provider or AF are not allowed to perform this operation for the UE, HTTP status code "403 Forbidden" shall be returned including additional error information in the response body (in the "ProblemDetails" element).

On failure, the appropriate HTTP status code indicating the error shall be returned and appropriate additional error information should be returned in the DELETE response body.

5.6.2.5 Get

5.6.2.5.1 General

The following procedures using the Get service operation are supported:

- 5G-VN-Group get

5.6.2.5.2 5G-VN-Group get

Figure 5.6.2.5.2-1 shows a scenario where the NF service consumer sends a request to the UDM to get 5G VN Group. The request contains the group's external identifier.

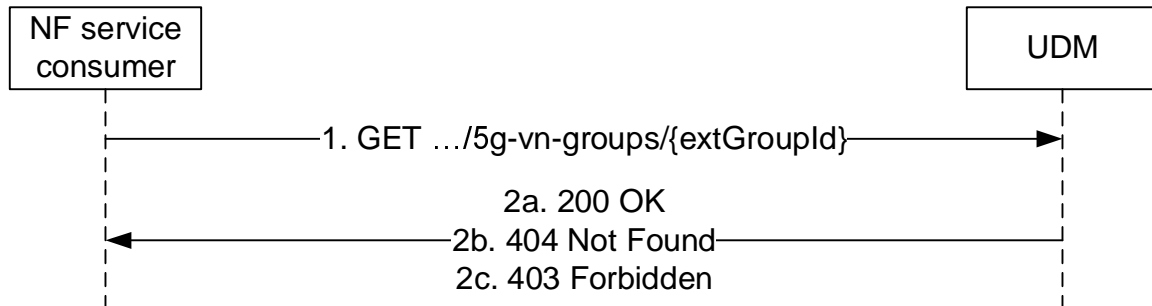

Figure 5.6.2.5.2-1: NF service consumer gets 5G-VN-Group

1. The NF service consumer sends a GET request to the resource `.../5g-vn-groups/{extGroupId}`, to get the 5G VN Group identified by the external group id.
- 2a. On success, the UDM responds with "200 Ok" with the VPN Group Information
- 2b. If the external group id does not exist in the UDM, HTTP status code "404 Not Found" shall be returned including additional error information in the response body (in the "ProblemDetails" element).
- 2c. If the original AF is not allowed to get this information, HTTP status code "403 Forbidden" shall be returned including additional error information in the response body (in the "ProblemDetails" element).

On failure, the appropriate HTTP status code indicating the error shall be returned and appropriate additional error information should be returned in the GET response body.

5.7 Nudm_NIDDAuthorization Service

5.7.1 Service Description

See 3GPP TS 23.501 [2] table 7.2.5-1.

5.7.2 Service Operations

5.7.2.1 Introduction

For the Nudm_NIDDAuthorization service the following service operations are defined:

- Get
- Notification

The Nudm_NIDDAuthorization Service is used by Consumer NFs (NEF) to retrieve the UE's authorization for NIDD Configuration relevant to the consumer NF from the UDM by means of the Get service operation.

It is also used by the Consumer NFs (NEF) that have previously subscribed, to get notified by means of the Notification service operation when UDM decides to modify the subscribed data.

5.7.2.2 Get

5.7.2.2.1 General

The following procedures using the Get service operation are supported:

- NIDD Authorization Data Retrieval

5.7.2.2.2 NIDD Authorization Data Retrieval

Figure 5.7.2.2.2-1 shows a scenario where the NF service consumer (e.g. NEF) sends a request to the UDM to authorize the NIDD configuration request (see also 3GPP TS 23.502 [3] figure 4.25.3-1 step 4). The request contains the UE's identity ($\{ueIdentity\}$), and information used for NIDD authorization (AuthorizationInfo).

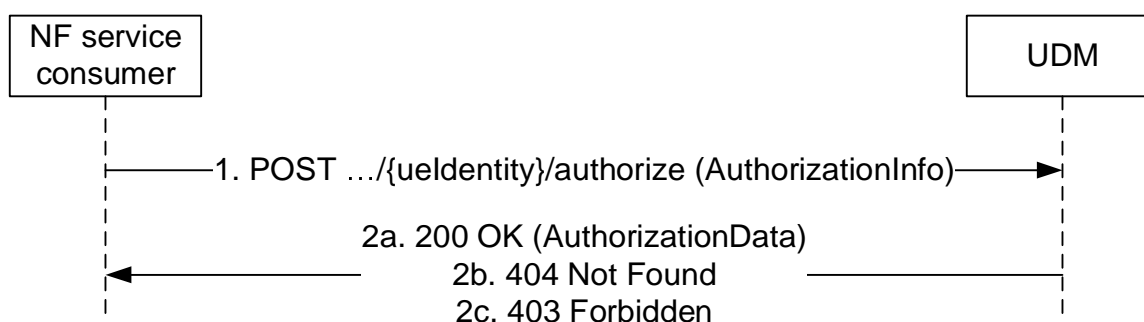

Figure 5.7.2.2.2-1: Requesting a UE's NIDD Authorization Data

1. The NF service consumer (e.g. NEF) sends a POST request to invoke "authorize" custom method on the resource representing the UE's subscribed NIDD authorization information. The payload of the request shall be an object of "AuthorizationInfo" which shall contain NSSAI, DNN, MTC Provider Information, callback URI.

If MTC Provider information and/or AF ID are received in the request, the UDM shall check whether the MTC Provider and/or the AF is allowed to perform this operation for the UE; otherwise, the UDM shall skip the MTC provider and/or AF authorization check.

- 2a. On success, the UDM responds with "200 OK" with the message body containing the single value or list of AuthorizationData (SUPI and GPSI) as relevant for the requesting NF service consumer.
- 2b. If there is no valid AuthorizationData for the UE Identity, HTTP status code "404 Not Found" shall be returned including additional error information in the response body (in the "ProblemDetails" element).
- 2c. If SNSSAI and/or DNN are not authorized for this UE, or MTC Provider or AF are not allowed to perform this operation for the UE, HTTP status code "403 Forbidden" shall be returned including additional error information in the response body (in the "ProblemDetails" element).

On failure, the appropriate HTTP status code indicating the error shall be returned and appropriate additional error information should be returned in the GET response body.

Editor's Note: On success if the response exceeds the maximum length of a message segmentation need to be introduced, how this is done is FFS.

5.7.2.3 Notification

5.7.2.3.1 General

The following procedures using the Notification service operation are supported:

- NIDD Authorization Data Update Notification

5.7.2.3.2 NIDD Authorization Data Update Notification

Figure 5.7.2.3.2-1 shows a scenario where the UDM notifies the NF service consumer (that has subscribed to receive such notification) about subscription data change (see also 3GPP TS 23.502 [3] figure 4.25.6-1 step 1 and 2). The request contains the callbackReference URI as previously received by the UDM during NIDD Authorization Data Retrieval.

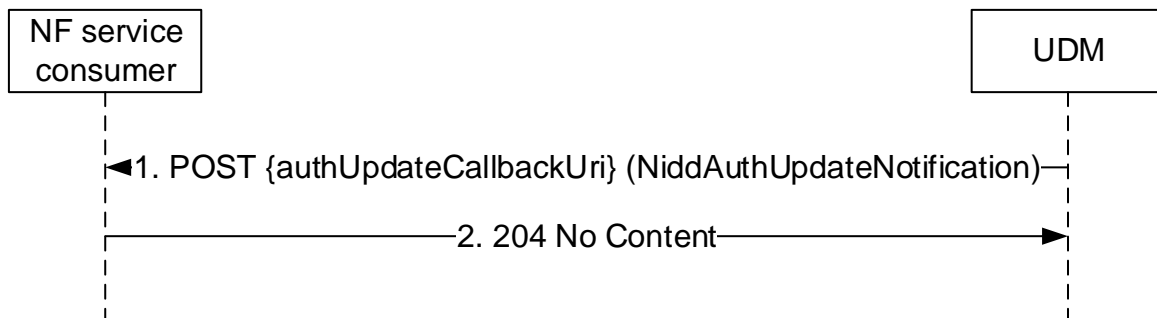

Figure 5.7.2.3.2-1: Requesting a UE's NIDD Authorization Data

1. The UDM sends a POST request to the callbackReference as provided by the NF service consumer during NIDD Authorization Data Retrieval.
2. The NF service consumer responds with "204 No Content".

On failure, the appropriate HTTP status code indicating the error shall be returned and appropriate additional error information should be returned in the POST response body.

5.8 Nudm_MT Service

5.8.1 Service Description

See 3GPP TS 23.632 [32].

5.8.2 Service Operations

5.8.2.1 Introduction

For the Nudm_MT service the following service operations are defined:

- ProvideUeInfo
- ProvideLocationInfo

The Nudm_MT service is used by the HSS to request the UDM to provide terminating access domain selection information and/or user state and/or 5GSRVCCInfo by means of the ProvideUeInfo service operation.

It is also used by the HSS to request the UE's Location Information in 5GC by means of the ProvideLocationInfo service operation.

5.8.2.2 ProvideUeInfo

5.8.2.2.1 General

The following procedure using the ProvideUeInfo service operation is supported:

- UE Information Retrieval

5.8.2.2.2 UE Information Retrieval

Figure 5.8.2.2.2-1 shows a scenario where the NF service consumer (HSS) retrieves domain selection information and/or user state and/or 5GSRVCCInfo for a UE from the UDM. The request contains the UE's identity (supi).

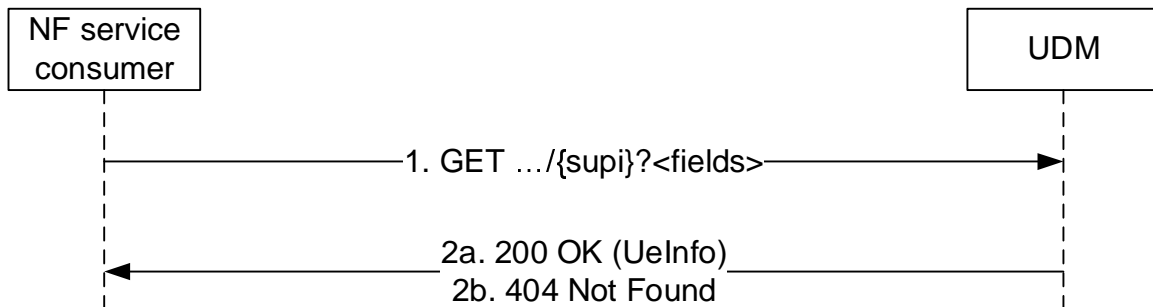

Figure 5.8.2.2.2-1: NF service consumer requesting domain selection information

1. The NF service consumer sends a GET request to the UDM to query the UeInfo. Query parameters indicate that TadsInfo and/or UserState and/or 5GSRVCCInfo is requested.
- 2a. The UDM responds with "200 OK" with the message body containing the requested information.
- 2b. If there is no valid subscription data for the UE, HTTP status code "404 Not Found" shall be returned and additional error information should be included in the response body (in the "ProblemDetails" element).

On failure, the appropriate HTTP status code indicating the error shall be returned and appropriate additional error information should be returned in the GET response body.

5.8.2.3 ProvideLocationInfo

5.8.2.3.1 General

The following procedure using the ProvideLocationInfo service operation is supported:

- Network Provided Location Information Request

5.8.2.3.2 Network Provided Location Information Request

Figure 5.8.2.3.2-1 shows a scenario where the NF service consumer (HSS) request UE's location information from UDM. The request contains the UE's identity (supi), and requested information (current location, local time zone, RAT type, or serving node identity)

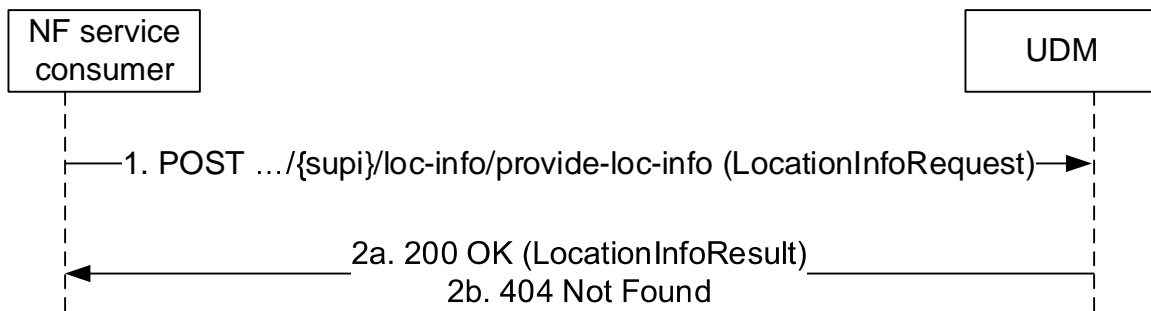

Figure 5.8.2.3.2-1: NF service consumer requesting domain selection information

1. The NF service consumer sends a POST request (custom method: provide-loc-info) to the resource representing UE's location information in 5GC.
- 2a. The UDM responds with "200 OK" with the message body containing the requested information.
- 2b. If there is no valid subscription data for the UE, or the requested information is not available, HTTP status code "404 Not Found" shall be returned and additional error information should be included in the response body (in the "ProblemDetails" element).

On failure, the appropriate HTTP status code indicating the error shall be returned and appropriate additional error information should be returned in the POST response body.

6 API Definitions

6.1 Nudm_SubscriberDataManagement Service API

6.1.1 API URI

The Nudm_SDM service shall use the Nudm_SDM API.

The API URI of the Nudm_SDM API shall be:

{apiRoot}/<apiName>/<apiVersion>/

The request URI used in HTTP request from the NF service consumer towards the NF service producer shall have the structure defined in clause 4.4.1 of 3GPP TS 29.501 [5], i.e.:

{apiRoot}/<apiName>/<apiVersion>/<apiSpecificResourceUriPart>

with the following components:

- The {apiRoot} shall be set as described in 3GPP TS 29.501 [5].
- The <apiName> shall be "nudm-sdm".
- The <apiVersion> shall be "v2".
- The <apiSpecificResourceUriPart> shall be set as described in clause 6.1.3.

6.1.2 Usage of HTTP

6.1.2.1 General

HTTP/2, as defined in IETF RFC 7540 [13], shall be used as specified in clause 5 of 3GPP TS 29.500 [4].

HTTP/2 shall be transported as specified in clause 5.3 of 3GPP TS 29.500 [4].

HTTP messages and bodies for the Nudm_SDM service shall comply with the OpenAPI [14] specification contained in Annex A2.

6.1.2.2 HTTP standard headers

6.1.2.2.1 General

The usage of HTTP standard headers shall be supported as specified in clause 5.2.2 of 3GPP TS 29.500 [4].

6.1.2.2.2 Content type

The following content types shall be supported:

JSON, as defined in IETF RFC 8259 [15], signalled by the content type "application/json".

The Problem Details JSON Object (IETF RFC 7807 [16]) signalled by the content type "application/problem+json"

JSON Merge Patch, as defined in IETF RFC 7396 [17], signalled by the content type "application/merge-patch+json"

6.1.2.2.3 Cache-Control

As described in IETF RFC 7234 [26] clause 5.2, a "Cache-Control" header should be included in HTTP responses except for non-cacheable resources (e.g. UeContextInSmsfData). If it is included, it shall contain a "max-age" value, indicating the amount of time in seconds after which the received response is considered stale.

The "max-age" value shall be configurable by operator policy.

6.1.2.2.4 ETag

As described in IETF RFC 7232 [25] clause 2.32, an "ETag" (entity-tag) header should be included in HTTP responses except for non-cacheable resources (e.g. UeContextInSmfData) to allow an NF Service Consumer performing a conditional request with "If-None-Match" header. If it is included, it shall contain a server-generated strong validator, that allows further matching of this value (included in subsequent client requests) with a given resource representation stored in the server or in a cache.

6.1.2.2.5 If-None-Match

As described in IETF RFC 7232 [25] clause 3.2, an NF Service Consumer may issue conditional GET request towards UDM by including an "If-None-Match" header in HTTP requests containing one or several entity tags received in previous responses for the same resource.

6.1.2.2.6 Last-Modified

As described in IETF RFC 7232 [25] clause 2.2, a "Last-Modified" header should be included in HTTP responses except for non-cacheable resources (e.g. SorAck) to allow an NF Service Consumer performing a conditional request with "If-Modified-Since" header.

6.1.2.2.7 If-Modified-Since

As described in IETF RFC 7232 [25] clause 3.3, an NF Service Consumer may issue conditional GET request towards UDM, by including an "If-Modified-Since" header in HTTP requests.

6.1.2.2.8 When to Use Entity-Tags and Last-Modified Dates

Both "ETag" and "Last-Modified" headers should be sent in the same HTTP response as stated in IETF RFC 7232 [25] clause 2.4.

NOTE: "ETag" is a stronger validator than "Last-Modified" and is preferred.

If the NF Service Producer included an "ETag" header with the resource then a conditional request for this resource shall be performed with the "If-None-Match" header.

6.1.2.3 HTTP custom headers

6.1.2.3.1 General

The usage of HTTP custom headers shall be supported as specified in clause 5.2.3 of 3GPP TS 29.500 [4].

6.1.3 Resources

6.1.3.1 Overview

{apiRoot}/nudm-sdm/v2

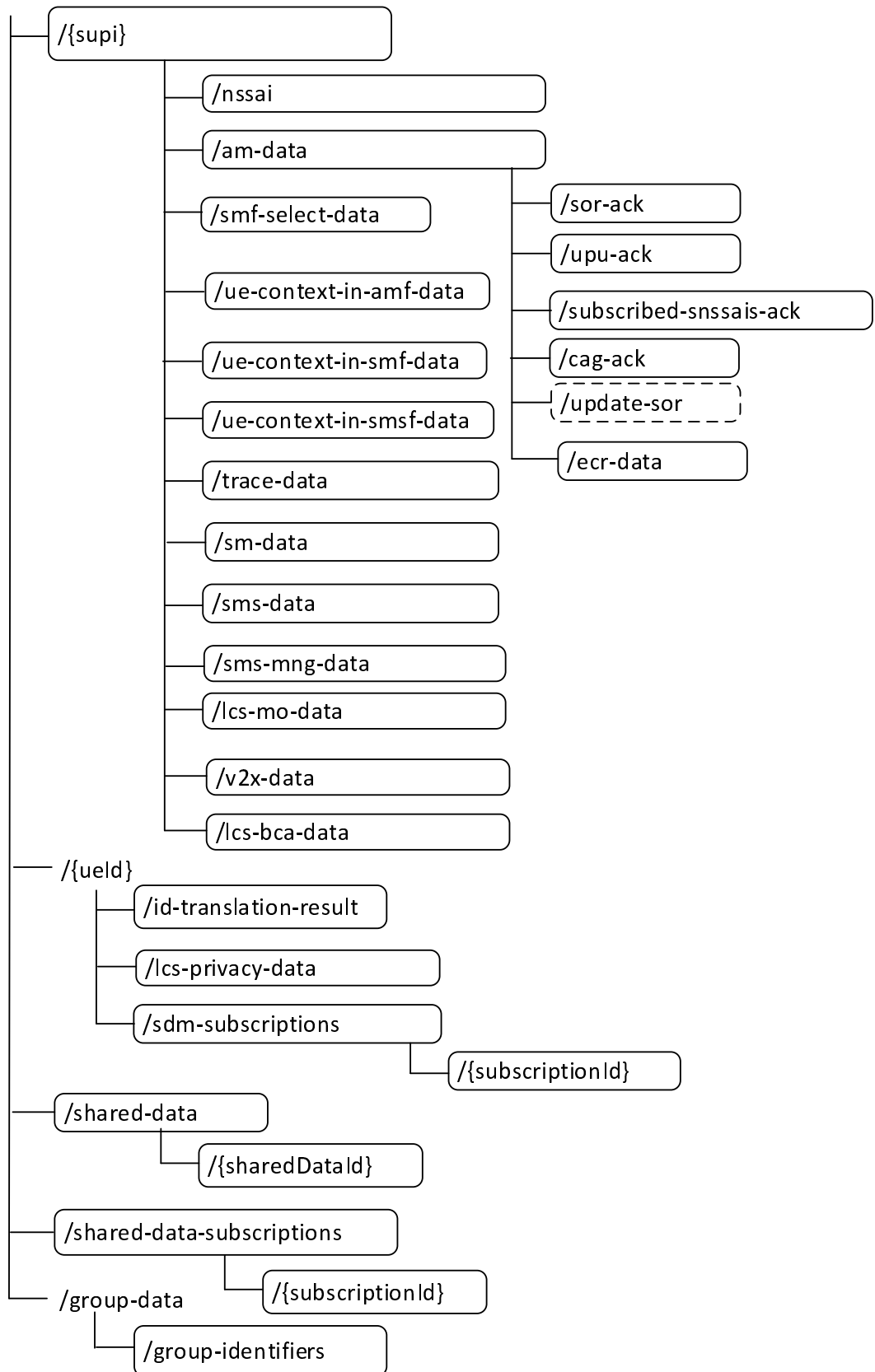

Figure 6.1.3.1-1: Resource URI structure of the nudm-sdm API

Table 6.1.3.1-1 provides an overview of the resources and applicable HTTP methods.

Table 6.1.3.1-1: Resources and methods overview

Resource name (Archetype)	Resource URI	HTTP method or custom operation	Description
Supi (Document)	/supi	GET	Retrieve UE's subscription data
Nssai (Document)	/supi/nssai	GET	Retrieve the UE's subscribed Network Slice Selection Assistance Information
UeContextInAmfData (Document)	/supi/ue-context-in-amf-data	GET	Retrieve the UE's Context in AMF Data
AccessAndMobilitySubscriptionData (Document)	/supi/am-data	GET	Retrieve the UE's subscribed Access and Mobility Data
	/supi/am-data/update-sor	update-sor (POST)	Trigger the update of Steering of Roaming Information at the UE
SorAck (Document)	/supi/am-data/sor-ack	PUT	Providing acknowledgement of Steering of Roaming
UpuAck (Document)	/supi/am-data/upu-ack	PUT	Providing acknowledgement of UE parameters update
CagAck (Document)	/supi/am-data/cag-ack	PUT	Providing acknowledgement of UE CAG configuration update
EnhancedCoverageRestrictionData	/supi/am-data/ecr-data	GET	Retrieve the UE's subscribed Enhance Coverage Restriction Data
SmfSelectionSubscriptionData (Document)	/supi/smf-select-data	GET	Retrieve the UE's subscribed SMF Selection Data
UeContextInSmfData (Document)	/supi/ue-context-in-smf-data	GET	Retrieve the UE's Context in SMF Data
SessionManagementSubscriptionData (Document)	/supi/sm-data	GET	Retrieve the UE's session management subscription data
SMSSubscriptionData (Document)	/supi/sms-data	GET	Retrieve the UE's SMS subscription data
SMSManagementSubscriptionData (Document)	/supi/sms-mng-data	GET	Retrieve the UE's SMS management subscription data
LcsPrivacySubscriptionData (Document)	/ueid/lcs-privacy-data	GET	Retrieve the UE's LCS privacy subscription data
LcsMobileOriginatedSubscriptionData (Document)	/supi/lcs-mo-data	GET	Retrieve the UE's LCS Mobile Originated subscription data
LcsBroadcastAssistanceSubscriptionData (Document)	/supi/lcs-bca-data	GET	Retrieve the UE's LCS Broadcast Assistance subscription data
V2xSubscriptionData (Document)	/supi/v2x-data	GET	Retrieve the UE's V2X subscription data
SdmSubscriptions (Collection)	/ueid/sdm-subscriptions	POST	Create a subscription
Individual subscription (Document)	/ueid/sdm-subscriptions/{subscriptionId}	DELETE	Delete the subscription identified by {subscriptionId}, i.e. unsubscribe
		PATCH	Modify the sdm-subscription identified by {subscriptionId}
IdTranslationResult (Document)	/ueid/id-translation-result	GET	Retrieve a UE's SUPI or GPSI
UeContextInSmsfData (Document)	/supi/ue-context-in-smsf-data	GET	Retrieve the UE's Context in SMSF Data
TraceData (Document)	/supi/trace-data	GET	Retrieve Trace Configuration Data
SharedData (Collection)	/shared-data	GET	Retrieve shared data
IndividualSharedData (Document)	/shared-data/{sharedDataId}	GET	Retrieve the individual Shared Data
SharedDataSubscriptions (Collection)	/shared-data-subscriptions	POST	Create a subscription
	/shared-data-subscriptions/{subscriptionId}	DELETE	Delete the subscription identified by {subscriptionId}, i.e. unsubscribe

SharedDataIndividual subscription (Document)		PATCH	Modify the shared data subscription identified by {subscriptionId}
GroupIdentifiers (Document)	/group-data/group-identifiers	GET	Retrieve group identifiers and the UE identifiers belong to the group identifiers.
SnssaisAck (Document)	/{{supi}}/am-data/subscribed-snssais-ack	PUT	Providing acknowledgement of UE for subscribed S-NSSAIs

6.1.3.2 Resource: Nssai (Document)

6.1.3.2.1 Description

This resource represents the subscribed Nssai for a SUPI. It is queried by the AMF before registering, and is used to assist network slice selection. See 5.2.2.2.2 and 3GPP TS 23.501 [2] clause 5.15.3.

This resource is also queried by the PGW-C+SMF during PDN connection establishment in the EPC, and is used to select the S-NSSAI provided to the UE, see 3GPP TS 23.501 [2] clause 4.11.0a.5. The PGW-C+SMF shall not indicate support to "Nssaa" feature (see clause 6.1.8) in this query to UDM. If a slice is not present in the Nssai resource returned by UDM, i.e. not subscribed by the UE or subject to Network Slice-Specific Authentication and Authorization, the slice shall not be selected by the PGW-C+SMF.

6.1.3.2.2 Resource Definition

Resource URI: {apiRoot}/nudm-sdm/<apiVersion>/{supi}/nssai

This resource shall support the resource URI variables defined in table 6.1.3.2.2-1.

Table 6.1.3.2.2-1: Resource URI variables for this resource

Name	Data type	Definition
apiRoot	string	See clause 6.1.1
supi	Supi	Represents the Subscription Permanent Identifier (see 3GPP TS 23.501 [2] clause 5.9.2) pattern: See pattern of type Supi in 3GPP TS 29.571 [7]

6.1.3.2.3 Resource Standard Methods

6.1.3.2.3.1 GET

This method shall support the URI query parameters specified in table 6.1.3.2.3.1-1.

Table 6.1.3.2.3.1-1: URI query parameters supported by the GET method on this resource

Name	Data type	P	Cardinality	Description
supported-features	SupportedFeatures	O	0..1	see 3GPP TS 29.500 [4] clause 6.6
plmn-id	PlmnId	O	0..1	PLMN identity of the PLMN serving the UE

If "plmn-id" is included, UDM shall return the Subscribed S-NSSAIs which the UE is subscribed to use in the PLMN identified by "plmn-id".

If "plmn-id" is not included, UDM shall return the Subscribed S-NSSAIs for HPLMN.

This method shall support the request data structures specified in table 6.1.3.2.3.1-2 and the response data structures and response codes specified in table 6.1.3.2.3.1-3.

Table 6.1.3.2.3.1-2: Data structures supported by the GET Request Body on this resource

Data type	P	Cardinality	Description
n/a			

Table 6.1.3.2.3.1-3: Data structures supported by the GET Response Body on this resource

Data type	P	Cardinality	Response codes	Description
Nssai	M	1	200 OK	Upon success, a response body containing the NSSAI shall be returned.
ProblemDetails	O	0..1	404 Not Found	The "cause" attribute may be used to indicate one of the following application errors: - USER_NOT_FOUND - DATA_NOT_FOUND
NOTE: In addition common data structures as listed in table 5.2.7.1-1 of 3GPP TS 29.500 [4] are supported.				

Table 6.1.3.2.3.1-4: Headers supported by the GET method on this resource

Name	Data type	P	Cardinality	Description
If-None-Match	string	O	0..1	Validator for conditional requests, as described in IETF RFC 7232 [25], clause 3.2
If-Modified-Since	string	O	0..1	Validator for conditional requests, as described in IETF RFC 7232 [25], clause 3.3

Table 6.1.3.2.3.1-5: Headers supported by the 200 Response Code on this resource

Name	Data type	P	Cardinality	Description
Cache-Control	string	O	0..1	Cache-Control containing max-age, as described in IETF RFC 7234 [26], clause 5.2
ETag	string	O	0..1	Entity Tag, containing a strong validator, as described in IETF RFC 7232 [25], clause 2.3
Last-Modified	string	O	0..1	Timestamp for last modification of the resource, as described in IETF RFC 7232 [25], clause 2.2

6.1.3.3 Resource: SdmSubscriptions (Collection)

6.1.3.3.1 Description

This resource is used to represent subscriptions to notifications.

The UDM will only recognize subscribed DNNs in this resource so for instance, if the SMF receives SessionManagementSubscriptionData for the Wildcard DNN, the SMF shall include the wildcard DNN in SdmSubscription. Any request for non-subscribed DNN will be rejected with "404 Not Found".

6.1.3.3.2 Resource Definition

Resource URI: {apiRoot}/nudm-sdm/<apiVersion>/{ueId}/sdm-subscriptions

This resource shall support the resource URI variables defined in table 6.1.3.3.2-1.

Table 6.1.3.3.2-1: Resource URI variables for this resource

Name	Data type	Definition
apiRoot	string	See clause 6.1.1
ueld	VarUeld	Represents the Subscription Permanent Identifier (see 3GPP TS 23.501 [2] clause 5.9.2) or Generic Public Subscription Identifier (see 3GPP TS 23.501 [2] clause 5.9.8) pattern: See pattern of type VarUeld in 3GPP TS 29.571 [7]

6.1.3.3.3 Resource Standard Methods

6.1.3.3.3.1 POST

This method shall support the URI query parameters specified in table 6.1.3.3.3.1-1.

Table 6.1.3.3.3.1-1: URI query parameters supported by the POST method on this resource

Name	Data type	P	Cardinality	Description
n/a				

This method shall support the request data structures specified in table 6.1.3.3.3.1-2 and the response data structures and response codes specified in table 6.1.3.3.3.1-3.

Table 6.1.3.3.3.1-2: Data structures supported by the POST Request Body on this resource

Data type	P	Cardinality	Description
SdmSubscription	M	1	The subscription that is to be created.

Table 6.1.3.3.3.1-3: Data structures supported by the POST Response Body on this resource

Data type	P	Cardinality	Response codes	Description
SdmSubscription	M	1	201 Created	Upon success, a response body containing a representation of the created Individual subscription resource shall be returned including the accepted values, e.g. in case of partial success UDM shall return the list of monitores resource Uri successfully subscribed.. The HTTP response shall include a "Location" HTTP header that contains the resource URI of the created resource. When stateless UDM is deployed, the stateless UDM may use an FQDN identifying the UDM group to which the UDM belongs as the host part of the resource URI.
ProblemDetails	O	0..1	404 Not Found	The "cause" attribute may be used to indicate one of the following application errors: - USER_NOT_FOUND
ProblemDetails	O	0..1	501 Not Implemented	The "cause" attribute may be used to indicate one of the following application errors: - UNSUPPORTED_RESOURCE_URI This response shall not be cached.

NOTE: In addition common data structures as listed in table 5.2.7.1-1 of 3GPP TS 29.500 [4] are supported.

NOTE: In the scenario of stateless UDM deployment, it is assumed that stateless UDMs are organized into several UDM groups, and for each UDM group an FQDN can be allocated.

Table 6.1.3.3.3.1-4: Headers supported by the 201 Response Code on this resource

Name	Data type	P	Cardinality	Description
Location	string	M	1	Contains the URI of the newly created resource, according to the structure: {apiRoot}/nudm-sdm/<apiVersion>/{supi}/sdm-subscriptions/{subscriptionId}

6.1.3.4 Resource: Individual subscription (Document)

6.1.3.4.1 Description

This resource is used to represent an individual subscription to notifications.

6.1.3.4.2 Resource Definition

Resource URI: {apiRoot}/nudm-sdm/<apiVersion>/{ueId}/sdm-subscriptions/{subscriptionId}

This resource shall support the resource URI variables defined in table 6.1.3.4.2-1.

Table 6.1.3.4.2-1: Resource URI variables for this resource

Name	Data type	Definition
apiRoot	string	See clause 6.1.1
ueId	VarUeId	Represents the Subscription Permanent Identifier (see 3GPP TS 23.501 [2] clause 5.9.2) or Generic Public Subscription Identifier (see 3GPP TS 23.501 [2] clause 5.9.8) pattern: See pattern of type VarUeId in 3GPP TS 29.571 [7]
subscriptionId	string	The subscriptionId identifies an individual subscription to notifications.

6.1.3.4.3 Resource Standard Methods

6.1.3.4.3.1 DELETE

This method shall support the URI query parameters specified in table 6.1.3.4.3.1-1.

Table 6.1.3.4.3.1-1: URI query parameters supported by the DELETE method on this resource

Name	Data type	P	Cardinality	Description
n/a				

This method shall support the request data structures specified in table 6.1.3.4.3.1-2 and the response data structures and response codes specified in table 6.1.3.4.3.1-3.

Table 6.1.3.4.3.1-2: Data structures supported by the Delete Request Body on this resource

Data type	P	Cardinality	Description
n/a			The request body shall be empty.

Table 6.1.3.4.3.1-3: Data structures supported by the DELETE Response Body on this resource

Data type	P	Cardinality	Response codes	Description
n/a			204 No Content	Upon success, an empty response body shall be returned.
ProblemDetails	O	0..1	404 Not Found	The "cause" attribute may be used to indicate one of the following application errors: - USER_NOT_FOUND - SUBSCRIPTION_NOT_FOUND, see 3GPP TS 29.500 [4] table 5.2.7.2-1.
NOTE: In addition common data structures as listed in table 5.2.7.1-1 of 3GPP TS 29.500 [4] are supported.				

6.1.3.4.3.2 PATCH

This method shall support the URI query parameters specified in table 6.1.3.4.3.2-1.

Table 6.1.3.4.3.2-1: URI query parameters supported by the PATCH method on this resource

Name	Data type	P	Cardinality	Description
supported-features	SupportedFeatures	O	0..1	see 3GPP TS 29.500 [4] clause 6.6

This method shall support the request data structures specified in table 6.1.3.4.3.2-2 and the response data structures and response codes specified in table 6.1.3.4.3.2-3.

Table 6.1.3.4.3.2-2: Data structures supported by the PATCH Request Body on this resource

Data type	P	Cardinality	Description
SdmSubModification	M	1	The modification Instruction

Table 6.1.3.4.3.2-3: Data structures supported by the PATCH Response Body on this resource

Data type	P	Cardinality	Response codes	Description
SdmSubscription	M	1	200 OK	Upon success, the modified sdmSubscription shall be returned including the accepted values, e.g. in case of partial success UDM shall return the list of monitors resource Uri successfully subscribed. (NOTE 2)
n/a			204 No Content	Upon success, an empty response body shall be returned. (NOTE 2)
PatchResult	M	1	200 OK	Upon success, the execution report is returned. (NOTE 2)
ProblemDetails	O	0..1	404 Not Found	The "cause" attribute may be used to indicate one of the following application errors: - USER_NOT_FOUND - SUBSCRIPTION_NOT_FOUND, see 3GPP TS 29.500 [4] table 5.2.7.2-1.
ProblemDetails	O	0..1	403 Forbidden	One or more attributes are not allowed to be modified. The "cause" attribute may be used to indicate one of the following application errors: - MODIFICATION_NOT_ALLOWED, see 3GPP TS 29.500 [4] table 5.2.7.2-1.
NOTE 1: In addition common data structures as listed in table 5.2.7.1-1 of 3GPP TS 29.500 [4] are supported.				
NOTE 2: If the NF service consumer has not included in the supported-feature query parameter the "PatchReport" feature number, the UDM responds with SdmSubscription. If the NF service consumer has included in the supported-feature query parameter the "PatchReport" feature number, the UDM shall respond with 204 No Content response indicating that all the modification instructions in the PATCH request have been implemented or with PatchResult indicating that some of the modification instructions in the PATCH request have been discarded.				

6.1.3.5 Resource: AccessAndMobilitySubscriptionData (Document)

6.1.3.5.1 Description

This resource represents the subscribed Access and Mobility Data for a SUPI. It is queried by the AMF after registering.

6.1.3.5.2 Resource Definition

Resource URI: {apiRoot}/nudm-sdm/<apiVersion>/{supi}/am-data

This resource shall support the resource URI variables defined in table 6.1.3.5.2-1.

Table 6.1.3.5.2-1: Resource URI variables for this resource

Name	Data type	Definition
apiRoot	string	See clause 6.1.1
supi	Supi	Represents the Subscription Permanent Identifier (see 3GPP TS 23.501 [2] clause 5.9.2) pattern: See pattern of type Supi in 3GPP TS 29.571 [7]

6.1.3.5.3 Resource Standard Methods

6.1.3.5.3.1 GET

This method shall support the URI query parameters specified in table 6.1.3.5.3.1-1.

Table 6.1.3.5.3.1-1: URI query parameters supported by the GET method on this resource

Name	Data type	P	Cardinality	Description
supported-features	SupportedFeatures	O	0..1	see 3GPP TS 29.500 [4] clause 6.6
plmn-id	Plmnlid	O	0..1	PLMN identity of the PLMN serving the UE

If "plmn-id" is included, UDM shall return the Access and Mobility Data for the SUPI associated to the PLMN identified by "plmn-id".

If "plmn-id" is not included, UDM shall return the Access and Mobility Data for the SUPI associated to the HPLMN.

This method shall support the request data structures specified in table 6.1.3.5.3.1-2 and the response data structures and response codes specified in table 6.1.3.5.3.1-3.

Table 6.1.3.5.3.1-2: Data structures supported by the GET Request Body on this resource

Data type	P	Cardinality	Description
n/a			

Table 6.1.3.5.3.1-3: Data structures supported by the GET Response Body on this resource

Data type	P	Cardinality	Response codes	Description
AccessAndMobilitySubscriptionData	M	1	200 OK	Upon success, a response body containing the Access and Mobility Subscription Data shall be returned.
ProblemDetails	O	0..1	404 Not Found	The "cause" attribute may be used to indicate one of the following application errors: - USER_NOT_FOUND - DATA_NOT_FOUND

NOTE: In addition common data structures as listed in table 5.2.7.1-1 of 3GPP TS 29.500 [4] are supported.

Table 6.1.3.5.3.1-4: Headers supported by the GET method on this resource

Name	Data type	P	Cardinality	Description
If-None-Match	string	O	0..1	Validator for conditional requests, as described in IETF RFC 7232 [25], clause 3.2
If-Modified-Since	string	O	0..1	Validator for conditional requests, as described in IETF RFC 7232 [25], clause 3.3

Table 6.1.3.5.3.1-5: Headers supported by the 200 Response Code on this resource

Name	Data type	P	Cardinality	Description
Cache-Control	string	O	0..1	Cache-Control containing max-age, as described in IETF RFC 7234 [26], clause 5.2
ETag	string	O	0..1	Entity Tag, containing a strong validator, as described in IETF RFC 7232 [25], clause 2.3
Last-Modified	string	O	0..1	Timestamp for last modification of the resource, as described in IETF RFC 7232 [25], clause 2.2

6.1.3.5.4 Resource Custom Operations

6.1.3.5.4.1 Overview

Table 6.1.3.5.4.1-1: Custom operations

Operation Name	Custom operation URI	Mapped HTTP method	Description
update-sor	/{supi}/am-data/update-sor	POST	Trigger the update of Steering of Roaming information at the UE

6.1.3.5.4.2 Operation: update-sor

6.1.3.5.4.2.1 Description

When a UE performs initial registration or emergency registration at an AMF (which already has AccessAndMobilitySubscriptionData stored) within a VPLMN, and the sorUpdateIndicatorList is present in AccessAndMobilitySubscriptionData and contains the corresponding registration type, the AMF shall make use of this operation to trigger the HPLMN to update steering of roaming information for the UE.

6.1.3.5.4.2.2 Operation Definition

This operation shall support the request data structures specified in table 6.1.3.5.4.2.2-1 and the response data structure and response codes specified in table 6.1.3.5.4.2.2-2.

Table 6.1.3.5.4.2.2-1: Data structures supported by the POST Request Body on this resource

Data type	P	Cardinality	Description
SorUpdateInfo	M	1	Contains the ID of the VPLMN

Table 6.1.3.5.4.2.2-2: Data structures supported by the POST Response Body on this resource

Data type	P	Cardinality	Response codes	Description
SorInfo	M	1	200 OK	Upon success, a response body containing the updated Steering Of Roaming information shall be returned.
ProblemDetails	O	0..1	404 Not Found	The "cause" attribute may be used to indicate one of the following application errors: - USER_NOT_FOUND
NOTE: The mandatory HTTP error status code for the POST method listed in Table 5.2.7.1-1 of 3GPP TS 29.500 [4] also apply.				

6.1.3.6 Resource: SmfSelectionSubscriptionData (Document)

6.1.3.6.1 Description

This resource represents the subscribed SMF Selection Data for a SUPI. It is queried by the AMF after registering.

6.1.3.6.2 Resource Definition

Resource URI: {apiRoot}/nudm-sdm/<apiVersion>/{supi}/smf-select-data

This resource shall support the resource URI variables defined in table 6.1.3.6.2-1.

Table 6.1.3.6.2-1: Resource URI variables for this resource

Name	Data type	Definition
apiRoot	string	See clause 6.1.1
supi	Supi	Represents the Subscription Permanent Identifier (see 3GPP TS 23.501 [2] clause 5.9.2) pattern: See pattern of type Supi in 3GPP TS 29.571 [7]

6.1.3.6.3 Resource Standard Methods

6.1.3.6.3.1 GET

This method shall support the URI query parameters specified in table 6.1.3.6.3.1-1.

Table 6.1.3.6.3.1-1: URI query parameters supported by the GET method on this resource

Name	Data type	P	Cardinality	Description
supported-features	SupportedFeatures	O	0..1	see 3GPP TS 29.500 [4] clause 6.6
plmn-id	PlmnId	O	0..1	PLMN identity of the PLMN serving the UE

If "plmn-id" is included, UDM shall return the SMF Selection Subscription Data for the SUPI associated to the PLMN identified by "plmn-id".

If "plmn-id" is not included, UDM shall return the SMF Selection Subscription Data for the SUPI associated to the HPLMN.

This method shall support the request data structures specified in table 6.1.3.6.3.1-2 and the response data structures and response codes specified in table 6.1.3.6.3.1-3.

Table 6.1.3.6.3.1-2: Data structures supported by the GET Request Body on this resource

Data type	P	Cardinality	Description
n/a			

Table 6.1.3.6.3.1-3: Data structures supported by the GET Response Body on this resource

Data type	P	Cardinality	Response codes	Description
SmfSelectionSubscriptionData	M	1	200 OK	Upon success, a response body containing the SMF Selection Subscription Data shall be returned.
ProblemDetails	O	0..1	404 Not Found	The "cause" attribute may be used to indicate one of the following application errors: - USER_NOT_FOUND - DATA_NOT_FOUND

NOTE: In addition common data structures as listed in table 5.2.7.1-1 of 3GPP TS 29.500 [4] are supported.

Table 6.1.3.6.3.1-4: Headers supported by the GET method on this resource

Name	Data type	P	Cardinality	Description
If-None-Match	string	O	0..1	Validator for conditional requests, as described in IETF RFC 7232 [25], clause 3.2
If-Modified-Since	string	O	0..1	Validator for conditional requests, as described in IETF RFC 7232 [25], clause 3.3

Table 6.1.3.6.3.1-5: Headers supported by the 200 Response Code on this resource

Name	Data type	P	Cardinality	Description
Cache-Control	string	O	0..1	Cache-Control containing max-age, as described in IETF RFC 7234 [26], clause 5.2
ETag	string	O	0..1	Entity Tag, containing a strong validator, as described in IETF RFC 7232 [25], clause 2.3
Last-Modified	string	O	0..1	Timestamp for last modification of the resource, as described in IETF RFC 7232 [25], clause 2.2

6.1.3.7 Resource: UeContextInSmfData (Document)

6.1.3.7.1 Description

This resource represents the allocated SMFs for a SUPI. It is queried by the AMF after registering.

6.1.3.7.2 Resource Definition

Resource URI: {apiRoot}/nudm-sdm/<apiVersion>/{supi}/ue-context-in-smf-data

This resource shall support the resource URI variables defined in table 6.1.3.7.2-1.

Table 6.1.3.7.2-1: Resource URI variables for this resource

Name	Data type	Definition
apiRoot	string	See clause 6.1.1
supi	Supi	Represents the Subscription Permanent Identifier (see 3GPP TS 23.501 [2] clause 5.9.2) pattern: See pattern of type Supi in 3GPP TS 29.571 [7]

6.1.3.7.3 Resource Standard Methods

6.1.3.7.3.1 GET

This method shall support the URI query parameters specified in table 6.1.3.7.3.1-1.

Table 6.1.3.7.3.1-1: URI query parameters supported by the GET method on this resource

Name	Data type	P	Cardinality	Description
supported-features	SupportedFeatures	O	0..1	see 3GPP TS 29.500 [4] clause 6.6

This method shall support the request data structures specified in table 6.1.3.7.3.1-2 and the response data structures and response codes specified in table 6.1.3.7.3.1-3.

Table 6.1.3.7.3.1-2: Data structures supported by the GET Request Body on this resource

Data type	P	Cardinality	Description
n/a			

Table 6.1.3.7.3.1-3: Data structures supported by the GET Response Body on this resource

Data type	P	Cardinality	Response codes	Description
UeContextInSmfData	M	1	200 OK	Upon success, a response body containing the UeContextInSmfData shall be returned.
ProblemDetails	O	0..1	404 Not Found	The "cause" attribute may be used to indicate one of the following application errors: - USER_NOT_FOUND - DATA_NOT_FOUND

NOTE: In addition common data structures as listed in table 5.2.7.1-1 of 3GPP TS 29.500 [4] are supported.

6.1.3.8 Resource: SessionManagementSubscriptionData (Document)

6.1.3.8.1 Description

This resource represents the Session Management subscription data for a SUPI. It is queried by the SMF during session setup, using query parameters representing the selected network slice and the DNN. The SMF is responsible for enforcing the user session management subscription data.

UDM will only recognize subscribed DNNs in this resource so for instance, in case SMF receives indication from AMF that the DNN was authorized based on the wildcard APN in the Selection Mode Value, SMF shall include the wildcard DNN in the query parameter and SMF will receive SessionManagementSubscriptionData for the Wildcard DNN. Any request for non-subscribed DNN will be rejected with "404 Not Found".

This resource is also queried by the PGW-C+SMF during PDN connection establishment in the EPC, to select the S-NSSAI for the APN/DNN of the PDN connection, see 3GPP TS 23.502 [3] clause 4.11.0a.5.

NOTE: The PGW-C+SMF shall also retrieve the Nssai resource from UDM, to avoid selection a slice that is subject to Network Slice-Specific Authentication and Authorization (see clause 6.1.3.2.1).

6.1.3.8.2 Resource Definition

Resource URI: {apiRoot}/nudm-sdm/<apiVersion>/{supi}/sm-data

This resource shall support the resource URI variables defined in table 6.1.3.8.2-1.

Table 6.1.3.8.2-1: Resource URI variables for this resource

Name	Data type	Definition
apiRoot	string	See clause 6.1.1
apiVersion	string	See clause 6.1.1
supi	Supi	Represents the Subscription Permanent Identifier (see 3GPP TS 23.501 [2] clause 5.9.2) pattern: See pattern of type Supi in 3GPP TS 29.571 [7]

6.1.3.8.3 Resource Standard Methods

6.1.3.8.3.1 GET

This method shall support the URI query parameters specified in table 6.1.3.8.3.1-1.

Table 6.1.3.8.3.1-1: URI query parameters supported by the GET method on this resource

Name	Data type	P	Cardinality	Description
supported-features	SupportedFeatures	O	0..1	see 3GPP TS 29.500 [4] clause 6.6
single-nssai	Snssai	O	0..1	When present without Slice Differentiator (sd), all slices identified by the given Slice/Service Type (sst) and any sd value (if any) shall be considered matching the query parameter.
dnn	Dnn	O	0..1	The DNN shall be the DNN Network Identifier only.
plmn-id	PlmnId	O	0..1	PLMN identity of the PLMN serving the UE

JSON objects (such as Snssai, PlmnId...) shall be included directly as part of the URI query parameters by specifying in the OpenAPI file that the "Content-Type" of such parameters is "application/json".

If "singleNssai" is not included, and "dnn" is not included, UDM shall return all DNN configurations for all network slice(s).

If "singleNssai" is included, and "dnn" is not included, UDM shall return all DNN configurations for the requested network slice identified by "singleNssai".

If "singleNssai" is not included, and "dnn" is included, UDM shall return all DNN configurations identified by "dnn" for all network slices where such DNN is available.

If "singleNssai" is included, and "dnn" is included, UDM shall return the DNN configuration identified by "dnn", if such DNN is available in the network slice identified by "singleNssai".

For all the combinations about the inclusion of "dnn" and "singleNssai" as URI query parameters, if "plmn-id" is included, UDM shall return the configurations for the DNN and network slices associated to the PLMN identified by "plmn-id". Otherwise (i.e. if "plmn-id" is not included), UDM shall return the configurations for the DNN and network slices associated to the HPLMN.

This method shall support the request data structures specified in table 6.1.3.8.3.1-2 and the response data structures and response codes specified in table 6.1.3.8.3.1-3.

Table 6.1.3.8.3.1-2: Data structures supported by the GET Request Body on this resource

Data type	P	Cardinality	Description
n/a			

Table 6.1.3.8.3.1-3: Data structures supported by the GET Response Body on this resource

Data type	P	Cardinality	Response codes	Description
array(SessionManagementSubscriptionData)	M	1..N	200 OK	Upon success, a response body containing the Session Management Subscription data shall be returned.
ProblemDetails	O	0..1	404 Not Found	The "cause" attribute may be used to indicate one of the following application errors: - USER_NOT_FOUND - DATA_NOT_FOUND
NOTE: In addition common data structures as listed in table 5.2.7.1-1 of 3GPP TS 29.500 [4] are supported.				

Table 6.1.3.8.3.1-4: Headers supported by the GET method on this resource

Name	Data type	P	Cardinality	Description
If-None-Match	string	O	0..1	Validator for conditional requests, as described in IETF RFC 7232 [25], clause 3.2
If-Modified-Since	string	O	0..1	Validator for conditional requests, as described in IETF RFC 7232 [25], clause 3.3

Table 6.1.3.8.3.1-5: Headers supported by the 200 Response Code on this resource

Name	Data type	P	Cardinality	Description
Cache-Control	string	O	0..1	Cache-Control containing max-age, as described in IETF RFC 7234 [26], clause 5.2
ETag	string	O	0..1	Entity Tag, containing a strong validator, as described in IETF RFC 7232 [25], clause 2.3
Last-Modified	string	O	0..1	Timestamp for last modification of the resource, as described in IETF RFC 7232 [25], clause 2.2

6.1.3.9 Resource: SMSSubscriptionData (Document)

6.1.3.9.1 Description

This resource represents the subscribed SMS Subscription Data for a SUPI. It is queried by the AMF after registering.

6.1.3.9.2 Resource Definition

Resource URI: {apiRoot}/nudm-sdm/<apiVersion>/{supi}/sms-data

This resource shall support the resource URI variables defined in table 6.1.3.9.2-1.

Table 6.1.3.9.2-1: Resource URI variables for this resource

Name	Data type	Definition
apiRoot	string	See clause 6.1.1
supi	Supi	Represents the Subscription Permanent Identifier (see 3GPP TS 23.501 [2] clause 5.9.2) pattern: See pattern of type Supi in 3GPP TS 29.571 [7]

6.1.3.9.3 Resource Standard Methods

6.1.3.9.3.1 GET

This method shall support the URI query parameters specified in table 6.1.3.9.3.1-1.

Table 6.1.3.9.3.1-1: URI query parameters supported by the GET method on this resource

Name	Data type	P	Cardinality	Description
plmn-id	PlmnId	C	0..1	if absent, H-PLMN ID is used as default
supported-features	SupportedFeatures	O	0..1	see 3GPP TS 29.500 [4] clause 6.6

This method shall support the request data structures specified in table 6.1.3.9.3.1-2 and the response data structures and response codes specified in table 6.1.3.9.3.1-3.

Table 6.1.3.9.3.1-2: Data structures supported by the GET Request Body on this resource

Data type	P	Cardinality	Description
n/a			

Table 6.1.3.9.3.1-3: Data structures supported by the GET Response Body on this resource

Data type	P	Cardinality	Response codes	Description
SmsSubscriptionData	M	1	200 OK	Upon success, a response body containing the SMS Subscription Data shall be returned.
ProblemDetails	O	0..1	404 Not Found	The "cause" attribute may be used to indicate one of the following application errors: - USER_NOT_FOUND - DATA_NOT_FOUND
NOTE: In addition common data structures as listed in table 5.2.7.1-1 of 3GPP TS 29.500 [4] are supported.				

Table 6.1.3.9.3.1-4: Headers supported by the GET method on this resource

Name	Data type	P	Cardinality	Description
If-None-Match	string	O	0..1	Validator for conditional requests, as described in IETF RFC 7232 [25], clause 3.2
If-Modified-Since	string	O	0..1	Validator for conditional requests, as described in IETF RFC 7232 [25], clause 3.3

Table 6.1.3.9.3.1-5: Headers supported by the 200 Response Code on this resource

Name	Data type	P	Cardinality	Description
Cache-Control	string	O	0..1	Cache-Control containing max-age, as described in IETF RFC 7234 [26], clause 5.2
ETag	string	O	0..1	Entity Tag, containing a strong validator, as described in IETF RFC 7232 [25], clause 2.3
Last-Modified	string	O	0..1	Timestamp for last modification of the resource, as described in IETF RFC 7232 [25], clause 2.2

6.1.3.10 Resource: SMSManagementSubscriptionData (Document)

6.1.3.10.1 Description

This resource represents the subscribed SMS Management Data for a SUPI. It is queried by the SMSF after registering.

6.1.3.10.2 Resource Definition

Resource URI: {apiRoot}/nudm-sdm/<apiVersion>/{supi}/sms-mng-data

This resource shall support the resource URI variables defined in table 6.1.3.10.2-1.

Table 6.1.3.10.2-1: Resource URI variables for this resource

Name	Data type	Definition
apiRoot	string	See clause 6.1.1
supi	Supi	Represents the Subscription Permanent Identifier (see 3GPP TS 23.501 [2] clause 5.9.2) pattern: See pattern of type Supi in 3GPP TS 29.571 [7]

6.1.3.10.3 Resource Standard Methods

6.1.3.10.3.1 GET

This method shall support the URI query parameters specified in table 6.1.3.10.3.1-1.

Table 6.1.3.10.3.1-1: URI query parameters supported by the GET method on this resource

Name	Data type	P	Cardinality	Description
plmn-id	PlmnId	C	0..1	if absent, H-PLMN ID is used as default
supported-features	SupportedFeatures	O	0..1	see 3GPP TS 29.500 [4] clause 6.6

This method shall support the request data structures specified in table 6.1.3.10.3.1-2 and the response data structures and response codes specified in table 6.1.3.10.3.1-3.

Table 6.1.3.10.3.1-2: Data structures supported by the GET Request Body on this resource

Data type	P	Cardinality	Description
n/a			

Table 6.1.3.10.3.1-3: Data structures supported by the GET Response Body on this resource

Data type	P	Cardinality	Response codes	Description
SmsManagementSubscriptionData	M	1	200 OK	Upon success, a response body containing the SMS Management Subscription Data shall be returned.
ProblemDetails	O	0..1	404 Not Found	The "cause" attribute may be used to indicate one of the following application errors: - USER_NOT_FOUND - DATA_NOT_FOUND

NOTE: In addition common data structures as listed in table 5.2.7.1-1 of 3GPP TS 29.500 [4] are supported.

Table 6.1.3.10.3.1-4: Headers supported by the GET method on this resource

Name	Data type	P	Cardinality	Description
If-None-Match	string	O	0..1	Validator for conditional requests, as described in IETF RFC 7232 [25], clause 3.2
If-Modified-Since	string	O	0..1	Validator for conditional requests, as described in IETF RFC 7232 [25], clause 3.3

Table 6.1.3.10.3.1-5: Headers supported by the 200 Response Code on this resource

Name	Data type	P	Cardinality	Description
Cache-Control	string	O	0..1	Cache-Control containing max-age, as described in IETF RFC 7234 [26], clause 5.2
ETag	string	O	0..1	Entity Tag, containing a strong validator, as described in IETF RFC 7232 [25], clause 2.3
Last-Modified	string	O	0..1	Timestamp for last modification of the resource, as described in IETF RFC 7232 [25], clause 2.2

6.1.3.11 Resource: Supi (Document)

6.1.3.11.1 Description

This resource represents the subscription profile of the subscriber identified by a given SUPI.

6.1.3.11.2 Resource Definition

Resource URI: {apiRoot}/nudm-sdm/<apiVersion>/{supi}

This resource shall support the resource URI variables defined in table 6.1.3.11.2-1.

Table 6.1.3.11.2-1: Resource URI variables for this resource

Name	Data type	Definition
apiRoot	string	See clause 6.1.1
supi	Supi	Represents the Subscription Permanent Identifier (see 3GPP TS 23.501 [2] clause 5.9.2) pattern: See pattern of type Supi in 3GPP TS 29.571 [7]

6.1.3.11.3 Resource Standard Methods

6.1.3.11.3.1 GET

This method shall support the URI query parameters specified in table 6.1.3.11.3.1-1.

NOTE: The retrieval of these data sets can also be achieved by sending individual GET requests to the corresponding sub-resources under the {supi} resource. When multiple data sets need to be retrieved by the NF Service consumer, it is recommended to use a single GET request with query parameters rather than issuing multiple GET requests.

Table 6.1.3.11.3.1-1: URI query parameters supported by the GET method on this resource

Name	Data type	P	Cardinality	Description
dataset-names	DatasetNames	M	1	Contains names of the data sets that are required to retrieve.
plmn-id	PlmnId	C	0..1	If absent, H-PLMN ID is used as default. This IE is only used for data sets whose DataSetNames are listed below: "AM" "SMF_SEL" "SMS_SUB" "SM" "TRACE" "SMS_MNG"
supported-features	SupportedFeatures	O	0..1	see 3GPP TS 29.500 [4] clause 6.6

This method shall support the request data structures specified in table 6.1.3.11.3.1-2 and the response data structures and response codes specified in table 6.1.3.11.3.1-3.

Table 6.1.3.11.3.1-2: Data structures supported by the GET Request Body on this resource

Data type	P	Cardinality	Description
n/a			

Table 6.1.3.11.3.1-3: Data structures supported by the GET Response Body on this resource

Data type	P	Cardinality	Response codes	Description
SubscriptionData Sets	M	1	200 OK	Upon success, a response body containing the requested data sets shall be returned.
ProblemDetails	O	0..1	404 Not Found	The "cause" attribute may be used to indicate one of the following application errors: - USER_NOT_FOUND - DATA_NOT_FOUND
NOTE: The mandatory HTTP error status code for the GET method listed in Table 5.2.7.1-1 of 3GPP TS 29.500 [4] also apply.				

Table 6.1.3.11.3.1-4: Headers supported by the GET method on this resource

Name	Data type	P	Cardinality	Description
If-None-Match	string	O	0..1	Validator for conditional requests, as described in IETF RFC 7232 [25], clause 3.2
If-Modified-Since	string	O	0..1	Validator for conditional requests, as described in IETF RFC 7232 [25], clause 3.3

Table 6.1.3.11.3.1-5: Headers supported by the 200 Response Code on this resource

Name	Data type	P	Cardinality	Description
Cache-Control	string	O	0..1	Cache-Control containing max-age, as described in IETF RFC 7234 [26], clause 5.2
ETag	string	O	0..1	Entity Tag, containing a strong validator, as described in IETF RFC 7232 [25], clause 2.3
Last-Modified	string	O	0..1	Timestamp for last modification of the resource, as described in IETF RFC 7232 [25], clause 2.2

6.1.3.12 Resource: IdTranslationResult (Document)

6.1.3.12.1 Description

This resource represents the SUPI. It is queried by the NEF for GPSI to SUPI translation. See 3GPP TS 23.502 [3] clause 4.13.2.2.

6.1.3.12.2 Resource Definition

Resource URI: {apiRoot}/nudm-sdm/<apiVersion>/{ueId}/id-translation-result

This resource shall support the resource URI variables defined in table 6.1.3.12.2-1.

Table 6.1.3.12.2-1: Resource URI variables for this resource

Name	Data type	Definition
apiRoot	string	See clause 6.1.1
ueId	VarUeId	Represents the Generic Public Subscription Identifier (see 3GPP TS 23.501 [2] clause 5.9.8) or Subscription Permanent Identifier (see 3GPP TS 23.501 [2] clause 5.9.2) pattern: See pattern of type VarUeId in 3GPP TS 29.571 [7]

6.1.3.12.3 Resource Standard Methods

6.1.3.12.3.1 GET

This method shall support the URI query parameters specified in table 6.1.3.12.3.1-1.

Table 6.1.3.12.3.1-1: URI query parameters supported by the GET method on this resource

Name	Data type	P	Cardinality	Description
supported-features	SupportedFeatures	O	0..1	see 3GPP TS 29.500 [4] clause 6.6
app-port-id	AppPortId	C	0..1	If ueId is a SUPI in Resource URI variables, this shall be present and indicates Application port identity, see 3GPP TS 23.501 [2] clause 4.4.7

This method shall support the request data structures specified in table 6.1.3.12.3.1-2 and the response data structures and response codes specified in table 6.1.3.12.3.1-3.

Table 6.1.3.12.3.1-2: Data structures supported by the GET Request Body on this resource

Data type	P	Cardinality	Description
n/a			

Table 6.1.3.12.3.1-3: Data structures supported by the GET Response Body on this resource

Data type	P	Cardinality	Response codes	Description
IdTranslationResult	M	1	200 OK	Upon success, a response body containing the SUPI and optionally the MSISDN shall be returned.
ProblemDetails	O	0..1	404 Not Found	The "cause" attribute may be used to indicate one of the following application errors: - USER_NOT_FOUND - DATA_NOT_FOUND
NOTE: In addition common data structures as listed in table 5.2.7.1-1 of 3GPP TS 29.500 [4] are supported.				

Table 6.1.3.12.3.1-4: Headers supported by the GET method on this resource

Name	Data type	P	Cardinality	Description
If-None-Match	string	O	0..1	Validator for conditional requests, as described in IETF RFC 7232 [25], clause 3.2
If-Modified-Since	string	O	0..1	Validator for conditional requests, as described in IETF RFC 7232 [25], clause 3.3

Table 6.1.3.12.3.1-5: Headers supported by the 200 Response Code on this resource

Name	Data type	P	Cardinality	Description
Cache-Control	string	O	0..1	Cache-Control containing max-age, as described in IETF RFC 7234 [26], clause 5.2
ETag	string	O	0..1	Entity Tag, containing a strong validator, as described in IETF RFC 7232 [25], clause 2.3
Last-Modified	string	O	0..1	Timestamp for last modification of the resource, as described in IETF RFC 7232 [25], clause 2.2

6.1.3.13 Resource: SorAck (Document)

6.1.3.13.1 Description

This resource represents the acknowledgement of the SoR for a SUPI.

6.1.3.13.2 Resource Definition

Resource URI: {apiRoot}/nudm-sdm/<apiVersion>/{supi}/am-data/sor-ack

This resource shall support the resource URI variables defined in table 6.1.3.13.2-1.

Table 6.1.3.13.2-1: Resource URI variables for this resource

Name	Data type	Definition
apiRoot	string	See clause 6.1.1
supi	Supi	Represents the Subscription Permanent Identifier (see 3GPP TS 23.501 [2] clause 5.9.2) pattern: See pattern of type Supi in 3GPP TS 29.571 [7]

6.1.3.13.3 Resource Standard Methods

6.1.3.13.3.1 PUT

This method shall support the URI query parameters specified in table 6.1.3.13.3.1-1.

Table 6.1.3.13.3.1-1: URI query parameters supported by the PUT method on this resource

Name	Data type	P	Cardinality	Description
n/a				

This method shall support the request data structures specified in table 6.1.3.13.3.1-2 and the response data structures and response codes specified in table 6.1.3.13.3.1-3.

Table 6.1.3.13.3.1-2: Data structures supported by the PUT Request Body on this resource

Data type	P	Cardinality	Description
AcknowledgeInfo	M	1	Contains the SOR-MAC-lue received from the UE.

Table 6.1.3.13.3.1-3: Data structures supported by the PUT Response Body on this resource

Data type	P	Cardinality	Response codes	Description
n/a			204 No Content	Successful receiving the SorXmaclue in the Request.
ProblemDetails	O	0..1	404 Not Found	The "cause" attribute may be used to indicate one of the following application errors: - USER_NOT_FOUND
NOTE: In addition common data structures as listed in table 5.2.7.1-1 of 3GPP TS 29.500 [4] are supported.				

6.1.3.14 Resource: TraceData (Document)

6.1.3.14.1 Description

This resource represents the trace configuration data for a SUPI. It is queried by the AMF and SMF after registering.

6.1.3.14.2 Resource Definition

Resource URI: {apiRoot}/nudm-sdm/<apiVersion>/{supi}/trace-data

This resource shall support the resource URI variables defined in table 6.1.3.14.2-1.

Table 6.1.3.14.2-1: Resource URI variables for this resource

Name	Data type	Definition
apiRoot	string	See clause 6.1.1
supi	Supi	Represents the Subscription Permanent Identifier (see 3GPP TS 23.501 [2] clause 5.9.2) pattern: See pattern of type Supi in 3GPP TS 29.571 [7]

6.1.3.14.3 Resource Standard Methods

6.1.3.14.3.1 GET

This method shall support the URI query parameters specified in table 6.1.3.14.3.1-1.

Table 6.1.3.14.3.1-1: URI query parameters supported by the GET method on this resource

Name	Data type	P	Cardinality	Description
supported-features	SupportedFeatures	O	0..1	see 3GPP TS 29.500 [4] clause 6.6
plmn-id	PlmnId	O	0..1	PLMN identity of the PLMN serving the UE

If "plmn-id" is included, UDM shall return the Trace Data for the SUPI associated to the PLMN identified by "plmn-id".

If "plmn-id" is not included, UDM shall return the Trace Data for the SUPI associated to the HPLMN.

This method shall support the request data structures specified in table 6.1.3.14.3.1-2 and the response data structures and response codes specified in table 6.1.3.14.3.1-3.

Table 6.1.3.14.3.1-2: Data structures supported by the GET Request Body on this resource

Data type	P	Cardinality	Description
n/a			

Table 6.1.3.14.3.1-3: Data structures supported by the GET Response Body on this resource

Data type	P	Cardinality	Response codes	Description
TraceDataResponse	M	1	200 OK	Upon success, a response body containing the Trace Data shall be returned.
ProblemDetails	O	0..1	404 Not Found	The "cause" attribute may be used to indicate one of the following application errors: - USER_NOT_FOUND - DATA_NOT_FOUND

NOTE: In addition common data structures as listed in table 5.2.7.1-1 of 3GPP TS 29.500 [4] are supported.

Table 6.1.3.14.3.1-4: Headers supported by the GET method on this resource

Name	Data type	P	Cardinality	Description
If-None-Match	string	O	0..1	Validator for conditional requests, as described in IETF RFC 7232 [25], clause 3.2
If-Modified-Since	string	O	0..1	Validator for conditional requests, as described in IETF RFC 7232 [25], clause 3.3

Table 6.1.3.14.3.1-5: Headers supported by the 200 Response Code on this resource

Name	Data type	P	Cardinality	Description
Cache-Control	string	O	0..1	Cache-Control containing max-age, as described in IETF RFC 7234 [26], clause 5.2
ETag	string	O	0..1	Entity Tag, containing a strong validator, as described in IETF RFC 7232 [25], clause 2.3
Last-Modified	string	O	0..1	Timestamp for last modification of the resource, as described in IETF RFC 7232 [25], clause 2.2

6.1.3.15 Resource: SharedData (Collection)

6.1.3.15.1 Description

This resource represents the collection of data that can be shared by multiple UEs.

6.1.3.15.2 Resource Definition

Resource URI: {apiRoot}/nudm-sdm/<apiVersion>/shared-data

This resource shall support the resource URI variables defined in table 6.1.3.15.2-1.

Table 6.1.3.15.2-1: Resource URI variables for this resource

Name	Data type	Definition
apiRoot	string	See clause 6.1.1

6.1.3.15.3 Resource Standard Methods

6.1.3.15.3.1 GET

This method shall support the URI query parameters specified in table 6.1.3.15.3.1-1.

Table 6.1.3.15.3.1-1: URI query parameters supported by the GET method on this resource

Name	Data type	P	Cardinality	Description
shared-data-ids	array(SharedDataId)	M	1..N	Contains unique items
supported-features	SupportedFeatures	O	0..1	see 3GPP TS 29.500 [4] clause 6.6

This method shall support the request data structures specified in table 6.1.3.15.3.1-2 and the response data structures and response codes specified in table 6.1.3.15.3.1-3.

Table 6.1.3.15.3.1-2: Data structures supported by the GET Request Body on this resource

Data type	P	Cardinality	Description
n/a			

Table 6.1.3.15.3.1-3: Data structures supported by the GET Response Body on this resource

Data type	P	Cardinality	Response codes	Description
array(SharedData)	M	1..N	200 OK	Upon success, a response body containing a list of SharedData shall be returned.
ProblemDetails	O	0..1	404 Not Found	The "cause" attribute may be used to indicate one of the following application errors: - DATA_NOT_FOUND

NOTE: In addition common data structures as listed in table 5.2.7.1-1 of 3GPP TS 29.500 [4] are supported.

Table 6.1.3.15.3.1-4: Headers supported by the GET method on this resource

Name	Data type	P	Cardinality	Description
If-None-Match	string	O	0..1	Validator for conditional requests, as described in IETF RFC 7232 [25], clause 3.2
If-Modified-Since	string	O	0..1	Validator for conditional requests, as described in IETF RFC 7232 [25], clause 3.3

Table 6.1.3.15.3.1-5: Headers supported by the 200 Response Code on this resource

Name	Data type	P	Cardinality	Description
Cache-Control	string	O	0..1	Cache-Control containing max-age, as described in IETF RFC 7234 [26], clause 5.2
ETag	string	O	0..1	Entity Tag, containing a strong validator, as described in IETF RFC 7232 [25], clause 2.3
Last-Modified	string	O	0..1	Timestamp for last modification of the resource, as described in IETF RFC 7232 [25], clause 2.2

6.1.3.16 Resource: SharedDataSubscriptions (Collection)

6.1.3.16.1 Description

This resource is used to represent subscriptions to notifications for shared data.

6.1.3.16.2 Resource Definition

Resource URI: {apiRoot}/nudm-sdm/<apiVersion>/shared-data-subscriptions

This resource shall support the resource URI variables defined in table 6.1.3.16.2-1.

Table 6.1.3.16.2-1: Resource URI variables for this resource

Name	Data type	Definition
apiRoot	string	See clause 6.1.1

6.1.3.16.3 Resource Standard Methods

6.1.3.16.3.1 POST

This method shall support the URI query parameters specified in table 6.1.3.16.3.1-1.

Table 6.1.3.16.3.1-1: URI query parameters supported by the POST method on this resource

Name	Data type	P	Cardinality	Description
n/a				

This method shall support the request data structures specified in table 6.1.3.16.3.1-2 and the response data structures and response codes specified in table 6.1.3.16.3.1-3.

Table 6.1.3.16.3.1-2: Data structures supported by the POST Request Body on this resource

Data type	P	Cardinality	Description
SdmSubscription	M	1	The subscription that is to be created.

Table 6.1.3.16.3.1-3: Data structures supported by the POST Response Body on this resource

Data type	P	Cardinality	Response codes	Description
SdmSubscription	M	1	201 Created	Upon success, a response body containing a representation of the created Individual subscription resource shall be returned. The HTTP response shall include a "Location" HTTP header that contains the resource URI of the created resource. When stateless UDM is deployed, the stateless UDM shall use the FQDN identifying the UDM set to which the UDM belongs as the host part of the resource URI.
ProblemDetails	O	0..1	501 Not Implemented	The "cause" attribute may be used to indicate one of the following application errors: - UNSUPPORTED_RESOURCE_URI This response shall not be cached.

NOTE: In addition common data structures as listed in table 5.2.7.1-1 of 3GPP TS 29.500 [4] are supported.

NOTE: In the scenario of stateless UDM deployment, it is assumed that stateless UDMs are organized into several UDM sets, and each UDM set is allocated an FQDN.

Table 6.1.3.16.3.1-4: Headers supported by the 201 Response Code on this resource

Name	Data type	P	Cardinality	Description
Location	string	M	1	Contains the URI of the newly created resource, according to the structure: {apiRoot}/nudm-sdm/<apiVersion>/shared-data-subscriptions/{subscriptionId}

6.1.3.17 Resource: Individual subscription (Document)

6.1.3.17.1 Description

This resource is used to represent an individual subscription to notifications for shared data.

6.1.3.17.2 Resource Definition

Resource URI: {apiRoot}/nudm-sdm/<apiVersion>/shared-data-subscriptions/{subscriptionId}

This resource shall support the resource URI variables defined in table 6.1.3.17.2-1.

Table 6.1.3.17.2-1: Resource URI variables for this resource

Name	Data type	Definition
apiRoot	string	See clause 6.1.1
subscriptionId	string	The subscriptionId identifies an individual subscription to notifications.

6.1.3.17.3 Resource Standard Methods

6.1.3.17.3.1 DELETE

This method shall support the URI query parameters specified in table 6.1.3.17.3.1-1.

Table 6.1.3.17.3.1-1: URI query parameters supported by the DELETE method on this resource

Name	Data type	P	Cardinality	Description
n/a				

This method shall support the request data structures specified in table 6.1.3.17.3.1-2 and the response data structures and response codes specified in table 6.1.3.17.3.1-3.

Table 6.1.3.17.3.1-2: Data structures supported by the Delete Request Body on this resource

Data type	P	Cardinality	Description
n/a			The request body shall be empty.

Table 6.1.3.17.3.1-3: Data structures supported by the DELETE Response Body on this resource

Data type	P	Cardinality	Response codes	Description
n/a			204 No Content	Upon success, an empty response body shall be returned.
ProblemDetails	O	0..1	404 Not Found	The resource corresponding to the SubscriptionId can't be found. The "cause" attribute may be used to indicate one of the following application errors: - SUBSCRIPTION_NOT_FOUND, see 3GPP TS 29.500 [4] table 5.2.7.2-1.

NOTE: In addition common data structures as listed in table 5.2.7.1-1 of 3GPP TS 29.500 [4] are supported.

6.1.3.17.3.2 PATCH

This method shall support the URI query parameters specified in table 6.1.3.17.3.2-1.

Table 6.1.3.17.3.2-1: URI query parameters supported by the PATCH method on this resource

Name	Data type	P	Cardinality	Description
supported-features	SupportedFeatures	O	0..1	see 3GPP TS 29.500 [4] clause 6.6

This method shall support the request data structures specified in table 6.1.3.17.3.2-2 and the response data structures and response codes specified in table 6.1.3.17.3.2-3.

Table 6.1.3.17.3.2-2: Data structures supported by the PATCH Request Body on this resource

Data type	P	Cardinality	Description
SdmSubModification	M	1	The modification Instruction

Table 6.1.3.17.3.2-3: Data structures supported by the PATCH Response Body on this resource

Data type	P	Cardinality	Response codes	Description
SdmSubscription	M	1	200 OK	Upon success, the modified sdmSubscription shall be returned. (NOTE 2)
n/a			204 No Content	Upon success, an empty response body shall be returned. (NOTE 2)
PatchResult	M	1	200 OK	Upon success, the execution report is returned. (NOTE 2)
ProblemDetails	O	0..1	404 Not Found	The resource corresponding to the SubscriptionId can't be found. The "cause" attribute may be used to indicate one of the following application errors: - SUBSCRIPTION_NOT_FOUND, see 3GPP TS 29.500 [4] table 5.2.7.2-1.
ProblemDetails	O	0..1	403 Forbidden	One or more attributes are not allowed to be modified. The "cause" attribute may be used to indicate one of the following application errors: - MODIFICATION_NOT_ALLOWED, see 3GPP TS 29.500 [4] table 5.2.7.2-1.
NOTE 1: In addition common data structures as listed in table 5.2.7.1-1 of 3GPP TS 29.500 [4] are supported.				
NOTE 2: If the NF service consumer has not included in the supported-features query parameter the "PatchReport" feature number, the UDM responds with SdmSubscription. If the NF service consumer has included in the supported-features query parameter the "PatchReport" feature number, the UDM shall respond with 204 No Content response indicating that all the modification instructions in the PATCH request have been implemented or with PatchResult indicating that some of the modification instructions in the PATCH request have been discarded.				

6.1.3.18 Resource: UeContextInSmsfData (Document)

6.1.3.18.1 Description

This resource represents the allocated SMSFs for a SUPI.

6.1.3.18.2 Resource Definition

Resource URI: {apiRoot}/nudm-sdm/<apiVersion>/{supi}/ue-context-in-smsf-data

This resource shall support the resource URI variables defined in table 6.1.3.18.2-1.

Table 6.1.3.18.2-1: Resource URI variables for this resource

Name	Data type	Definition
apiRoot	string	See clause 6.1.1
supi	Supi	Represents the Subscription Permanent Identifier (see 3GPP TS 23.501 [2] clause 5.9.2) pattern: See pattern of type Supi in 3GPP TS 29.571 [7]

6.1.3.18.3 Resource Standard Methods

6.1.3.18.3.1 GET

This method shall support the URI query parameters specified in table 6.1.3.18.3.1-1.

Table 6.1.3.18.3.1-1: URI query parameters supported by the GET method on this resource

Name	Data type	P	Cardinality	Description
supported-features	SupportedFeatures	O	0..1	see 3GPP TS 29.500 [4] clause 6.6

This method shall support the request data structures specified in table 6.1.3.18.3.1-2 and the response data structures and response codes specified in table 6.1.3.18.3.1-3.

Table 6.1.3.18.3.1-2: Data structures supported by the GET Request Body on this resource

Data type	P	Cardinality	Description
n/a			

Table 6.1.3.18.3.1-3: Data structures supported by the GET Response Body on this resource

Data type	P	Cardinality	Response codes	Description
UeContextInSmsfData	M	1	200 OK	Upon success, a response body containing the UeContextInSmsfData shall be returned.
ProblemDetails	O	0..1	404 Not Found	The "cause" attribute may be used to indicate one of the following application errors: - USER_NOT_FOUND - DATA_NOT_FOUND
NOTE: In addition common data structures as listed in table 5.2.7.1-1 of 3GPP TS 29.500 [4] are supported.				

6.1.3.19 Resource: UpuAck (Document)

6.1.3.19.1 Description

This resource represents the acknowledgement of UE parameters update for a SUPI.

6.1.3.19.2 Resource Definition

Resource URI: {apiRoot}/nudm-sdm/<apiVersion>/{supi}/am-data/upu-ack

This resource shall support the resource URI variables defined in table 6.1.3.19.2-1.

Table 6.1.3.19.2-1: Resource URI variables for this resource

Name	Data type	Definition
apiRoot	string	See clause 6.1.1
supi	Supi	Represents the Subscription Permanent Identifier (see 3GPP TS 23.501 [2] clause 5.9.2) pattern: See pattern of type Supi in 3GPP TS 29.571 [7]

6.1.3.19.3 Resource Standard Methods

6.1.3.19.3.1 PUT

This method shall support the URI query parameters specified in table 6.1.3.19.3.1-1.

Table 6.1.3.19.3.1-1: URI query parameters supported by the PUT method on this resource

Name	Data type	P	Cardinality	Description
n/a				

This method shall support the request data structures specified in table 6.1.3.19.3.1-2 and the response data structures and response codes specified in table 6.1.3.19.3.1-3.

Table 6.1.3.19.3.1-2: Data structures supported by the PUT Request Body on this resource

Data type	P	Cardinality	Description
AcknowledgeInfo	M	1	Contains the UPU-MAC-lue received from the UE and the provisioning time stamp as received within UpulInfo.

Table 6.1.3.19.3.1-3: Data structures supported by the PUT Response Body on this resource

Data type	P	Cardinality	Response codes	Description
n/a			204 No Content	Successful receiving the UpuXmaclue in the Request.
ProblemDetails	O	0..1	404 Not Found	The "cause" attribute may be used to indicate one of the following application errors: - USER_NOT_FOUND
NOTE: The mandatory HTTP error status code for the PUT method listed in Table 5.2.7.1-1 of 3GPP TS 29.500 [4] also apply.				

6.1.3.20 Resource: GroupIdentifiers (Document)

6.1.3.20.1 Description

This resource represents the Group Identifiers handled by UDM/UDR. It is queried by the NEF or GMLC for translation between External and Internal Group Identifiers or query the UE identifiers that belong to the provided External or Internal Group Identifier.

6.1.3.20.2 Resource Definition

Resource URI: {apiRoot}/nudm-sdm/<apiVersion>/group-data/group-identifiers

This resource shall support the resource URI variables defined in table 6.1.3.20.2-1.

Table 6.1.3.20.2-1: Resource URI variables for this resource

Name	Data type	Definition
apiRoot	string	See clause 6.1.1

6.1.3.20.3 Resource Standard Methods

6.1.3.20.3.1 GET

This method shall support the URI query parameters specified in table 6.1.3.20.3.1-1.

Table 6.1.3.20.3.1-1: URI query parameters supported by the GET method on this resource

Name	Data type	P	Cardinality	Description
supported-features	SupportedFeatures	O	0..1	see 3GPP TS 29.500 [4] clause 6.6
ext-group-id	ExtGroupId	C	0..1	External Group ID
int-group-id	GroupId	C	0..1	Internal Group ID
ue-id-ind	boolean	C	0..1	Indication whether UE identifiers are required or not. When present, it shall be set as following: - true: UE identifiers are required - false (default): UE identifiers are not required
NOTE: Either ext-group-id or int-group-id shall be present in the request.				

Either the ext-group-id or the int-group-id shall be present in the request.

This method shall support the request data structures specified in table 6.1.3.20.3.1-2 and the response data structures and response codes specified in table 6.1.3.20.3.1-3.

Table 6.1.3.20.3.1-2: Data structures supported by the GET Request Body on this resource

Data type	P	Cardinality	Description
n/a			

Table 6.1.3.20.3.1-3: Data structures supported by the GET Response Body on this resource

Data type	P	Cardinality	Response codes	Description
GroupIdentifiers	M	1	200 OK	Upon success, a response body containing the group identifier(s) shall be returned.
ProblemDetails	O	0..1	404 Not Found	The "cause" attribute may be used to indicate one of the following application errors: - GROUP_IDENTIFIER_NOT_FOUND

NOTE: In addition, common data structures as listed in table 5.2.7.1-1 of 3GPP TS 29.500 [4] are supported.

Table 6.1.3.20.3.1-4: Headers supported by the GET method on this resource

Name	Data type	P	Cardinality	Description
If-None-Match	string	O	0..1	Validator for conditional requests, as described in IETF RFC 7232 [25], clause 3.2
If-Modified-Since	string	O	0..1	Validator for conditional requests, as described in IETF RFC 7232 [25], clause 3.3

Table 6.1.3.20.3.1-5: Headers supported by the 200 Response Code on this resource

Name	Data type	P	Cardinality	Description
Cache-Control	string	O	0..1	Cache-Control containing max-age, as described in IETF RFC 7234 [26], clause 5.2
ETag	string	O	0..1	Entity Tag, containing a strong validator, as described in IETF RFC 7232 [25], clause 2.3
Last-Modified	string	O	0..1	Timestamp for last modification of the resource, as described in IETF RFC 7232 [25], clause 2.2

6.1.3.21 Resource: SnssaisAck (Document)

6.1.3.21.1 Description

This resource represents the acknowledgement of UE for subscribed S-NSSAIs update for a SUPI.

6.1.3.21.2 Resource Definition

Resource URI: {apiRoot}/nudm-sdm/<apiVersion>/{supi}/am-data/subscribed-snssais-ack

This resource shall support the resource URI variables defined in table 6.1.3.21.2-1.

Table 6.1.3.21.2-1: Resource URI variables for this resource

Name	Data type	Definition
apiRoot	string	See clause 6.1.1
supi	Supi	Represents the Subscription Permanent Identifier (see 3GPP TS 23.501 [2] clause 5.9.2) pattern: See pattern of type Supi in 3GPP TS 29.571 [7]

6.1.3.21.3 Resource Standard Methods

6.1.3.21.3.1 PUT

This method shall support the URI query parameters specified in table 6.1.3.21.3.1-1.

Table 6.1.3.21.3.1-1: URI query parameters supported by the PUT method on this resource

Name	Data type	P	Cardinality	Description
n/a				

This method shall support the request data structures specified in table 6.1.3.21.3.1-2 and the response data structures and response codes specified in table 6.1.3.21.3.1-3.

Table 6.1.3.21.3.1-2: Data structures supported by the PUT Request Body on this resource

Data type	P	Cardinality	Description
AcknowledgeInfo	M	1	Contains the provisioning time stamp as received within the Nssai.

Table 6.1.3.21.3.1-3: Data structures supported by the PUT Response Body on this resource

Data type	P	Cardinality	Response codes	Description
n/a			204 No Content	Successful receiving the UE acknowledgement for subscribed S-NSSAIs update.
ProblemDetails	O	0..1	404 Not Found	The "cause" attribute may be used to indicate one of the following application errors: - USER_NOT_FOUND

NOTE: In addition common data structures as listed in table 5.2.7.1-1 of 3GPP TS 29.500 [4] are supported.

6.1.3.22 Resource: CagAck (Document)

6.1.3.22.1 Description

This resource represents the acknowledgement of UE for CAG update for a SUPI.

6.1.3.22.2 Resource Definition

Resource URI: {apiRoot}/nudm-sdm/<apiVersion>/{supi}/am-data/cag-ack

This resource shall support the resource URI variables defined in table 6.1.3.22.2-1.

Table 6.1.3.22.2-1: Resource URI variables for this resource

Name	Data type	Definition
apiRoot	string	See clause 6.1.1
supi	Supi	Represents the Subscription Permanent Identifier (see 3GPP TS 23.501 [2] clause 5.9.2) pattern: See pattern of type Supi in 3GPP TS 29.571 [7]

6.1.3.22.3 Resource Standard Methods

6.1.3.22.3.1 PUT

This method shall support the URI query parameters specified in table 6.1.3.22.3.1-1.

Table 6.1.3.3.1-1: URI query parameters supported by the PUT method on this resource

Name	Data type	P	Cardinality	Description
n/a				

This method shall support the request data structures specified in table 6.1.3.22.3.1-2 and the response data structures and response codes specified in table 6.1.3.22.3.1-3.

Table 6.1.3.22.3.1-2: Data structures supported by the PUT Request Body on this resource

Data type	P	Cardinality	Description
AcknowledgedInfo	M	1	Contains the provisioning time stamp as received within the CagInfo.

Table 6.1.3.22.3.1-3: Data structures supported by the PUT Response Body on this resource

Data type	P	Cardinality	Response codes	Description
n/a			204 No Content	Successful receiving the UE acknowledgement for CAG configuration update.
ProblemDetails	O	0..1	404 Not Found	The "cause" attribute may be used to indicate one of the following application errors: - USER_NOT_FOUND

NOTE: In addition common data structures as listed in table 5.2.7.1-1 of 3GPP TS 29.500 [4] are supported.

6.1.3.23 Resource: LcsPrivacySubscriptionData (Document)

6.1.3.23.1 Description

This resource represents the subscribed LCS Privacy Data for a UE. It is queried by the HGMLC or NEF.

6.1.3.23.2 Resource Definition

Resource URI: {apiRoot}/nudm-sdm/<apiVersion>/{ueId}/lcs-privacy-data

This resource shall support the resource URI variables defined in table 6.1.3.23.2-1.

Table 6.1.3.23.2-1: Resource URI variables for this resource

Name	Data type	Definition
apiRoot	string	See clause 6.1.1
ueId	VarUeId	Represents the Subscription Permanent Identifier (see 3GPP TS 23.501 [2] clause 5.9.2) or Generic Public Subscription Identifier (see 3GPP TS 23.501 [2] clause 5.9.8) pattern: See pattern of type VarUeId in 3GPP TS 29.571 [7].

NOTE: SUPI is only used to retrieve Location Privacy profile by GMLC.

6.1.3.23.3 Resource Standard Methods

6.1.3.23.3.1 GET

This method shall support the URI query parameters specified in table 6.1.3.23.3.1-1.

Table 6.1.3.23.3.1-1: URI query parameters supported by the GET method on this resource

Name	Data type	P	Cardinality	Description
supported-features	SupportedFeatures	O	0..1	see 3GPP TS 29.500 [4] clause 6.6

UDM shall return the LCS Privacy Data for the UE identified by the ueId.

This method shall support the request data structures specified in table 6.1.3.23.3.1-2 and the response data structures and response codes specified in table 6.1.3.23.3.1-3.

Table 6.1.3.23.3.1-2: Data structures supported by the GET Request Body on this resource

Data type	P	Cardinality	Description
n/a			

Table 6.1.3.23.3.1-3: Data structures supported by the GET Response Body on this resource

Data type	P	Cardinality	Response codes	Description
LcsPrivacyData	M	1	200 OK	Upon success, a response body containing the LCS Privacy Subscription Data shall be returned (see 3GPP TS 23.273 [38] clause 5.4.2)
ProblemDetails	O	0..1	404 Not Found	The "cause" attribute may be used to indicate one of the following application errors: - USER_NOT_FOUND - DATA_NOT_FOUND

NOTE: In addition common data structures as listed in table 5.2.7.1-1 of 3GPP TS 29.500 [4] are supported.

6.1.3.24 Resource: LcsMobileOriginatedSubscriptionData (Document)

6.1.3.24.1 Description

This resource represents the subscribed LCS Mobile Originated Data for a SUPI. It is queried by the AMF after registering.

6.1.3.24.2 Resource Definition

Resource URI: {apiRoot}/nudm-sdm/<apiVersion>/{supi}/lcs-mo-data

This resource shall support the resource URI variables defined in table 6.1.3.24.2-1.

Table 6.1.3.24.2-1: Resource URI variables for this resource

Name	Data type	Definition
apiRoot	string	See clause 6.1.1
supi	Supi	Represents the Subscription Permanent Identifier (see 3GPP TS 23.501 [2] clause 5.9.2) pattern: See pattern of type Supi in 3GPP TS 29.571 [7]

6.1.3.24.3 Resource Standard Methods

6.1.3.24.3.1 GET

This method shall support the URI query parameters specified in table 6.1.3.24.3.1-1.

Table 6.1.3.24.3.1-1: URI query parameters supported by the GET method on this resource

Name	Data type	P	Cardinality	Description
supported-features	SupportedFeatures	O	0..1	see 3GPP TS 29.500 [4] clause 6.6

UDM shall return the LCS Mobile Originated Data for the SUPI.

This method shall support the request data structures specified in table 6.1.3.24.3.1-2 and the response data structures and response codes specified in table 6.1.3.24.3.1-3.

Table 6.1.3.24.3.1-2: Data structures supported by the GET Request Body on this resource

Data type	P	Cardinality	Description
n/a			

Table 6.1.3.24.3.1-3: Data structures supported by the GET Response Body on this resource

Data type	P	Cardinality	Response codes	Description
LcsMoData	M	1	200 OK	Upon success, a response body containing the LCS Mobile Originated Subscription Data shall be returned (see 3GPP TS 23.273 [38] clause 5.4.2)
ProblemDetails	O	0..1	404 Not Found	The "cause" attribute may be used to indicate one of the following application errors: - USER_NOT_FOUND - DATA_NOT_FOUND

NOTE: In addition common data structures as listed in table 5.2.7.1-1 of 3GPP TS 29.500 [4] are supported.

6.1.3.25 Resource: EnhancedCoverageRestrictionData

6.1.3.25.1 Description

This resource represents the subscribed Enhance Coverage Restriction Data for a SUPI.

6.1.3.25.2 Resource Definition

Resource URI: {apiRoot}/nudm-sdm/<apiVersion>/{supi}/am-data/ecr-data

This resource shall support the resource URI variables defined in table 6.1.3.25.2-1.

Table 6.1.3.25.2-1: Resource URI variables for this resource

Name	Data type	Definition
apiRoot	string	See clause 6.1.1
supi	Supi	Represents the Subscription Permanent Identifier (see 3GPP TS 23.501 [2] clause 5.9.2) pattern: See pattern of type Supi in 3GPP TS 29.571 [7]

6.1.3.25.3 Resource Standard Methods

6.1.3.25.3.1 GET

This method shall support the URI query parameters specified in table 6.1.3.25.3.1-1.

Table 6.1.3.25.3.1-1: URI query parameters supported by the GET method on this resource

Name	Data type	P	Cardinality	Description
supported-features	SupportedFeatures	O	0..1	see 3GPP TS 29.500 [4] clause 6.6

This method shall support the request data structures specified in table 6.1.3.25.3.1-2 and the response data structures and response codes specified in table 6.1.3.25.3.1-3.

Table 6.1.3.25.3.1-2: Data structures supported by the GET Request Body on this resource

Data type	P	Cardinality	Description
n/a			

Table 6.1.3.25.3.1-3: Data structures supported by the GET Response Body on this resource

Data type	P	Cardinality	Response codes	Description
EnhancedCoverageRestrictionData	M	1	200 OK	Upon success, a response body containing the Access and Mobility Subscription Data shall be returned.
ProblemDetails	O	0..1	404 Not Found	The "cause" attribute may be used to indicate one of the following application errors: - USER_NOT_FOUND - DATA_NOT_FOUND
NOTE: In addition common data structures as listed in table 5.2.7.1-1 of 3GPP TS 29.500 [4] are supported.				

6.1.3.26 Resource: UeContextInAmfData (Document)

6.1.3.26.1 Description

This resource represents the allocated AMF for a SUPI.

6.1.3.26.2 Resource Definition

Resource URI: {apiRoot}/nudm-sdm/<apiVersion>/{supi}/ue-context-in-amf-data

This resource shall support the resource URI variables defined in table 6.1.3.26.2-1.

Table 6.1.3.26.2-1: Resource URI variables for this resource

Name	Definition
apiRoot	See clause 6.1.1
supi	Represents the Subscription Permanent Identifier (see 3GPP TS 23.501 [2] clause 5.9.2) pattern: See pattern of type Supi in 3GPP TS 29.571 [7]

6.1.3.26.3 Resource Standard Methods

6.1.3.26.3.1 GET

This method shall support the URI query parameters specified in table 6.1.3.26.3.1-1.

Table 6.1.3.26.3.1-1: URI query parameters supported by the GET method on this resource

Name	Data type	P	Cardinality	Description
supported-features	SupportedFeatures	O	0..1	see 3GPP TS 29.500 [4] clause 6.6

This method shall support the request data structures specified in table 6.1.3.26.3.1-2 and the response data structures and response codes specified in table 6.1.3.26.3.1-3.

Table 6.1.3.26.3.1-2: Data structures supported by the GET Request Body on this resource

Data type	P	Cardinality	Description
n/a			

Table 6.1.3.26.3.1-3: Data structures supported by the GET Response Body on this resource

Data type	P	Cardinality	Response codes	Description
UeContextInAmfData	M	1	200 OK	Upon success, a response body containing the UeContextInAmfData shall be returned.
ProblemDetails	O	0..1	404 Not Found	The "cause" attribute may be used to indicate one of the following application errors: - USER_NOT_FOUND - DATA_NOT_FOUND

NOTE: In addition common data structures as listed in table 5.2.7.1-1 of 3GPP TS 29.500 [4] are supported.

6.1.3.27 Resource: V2xSubscriptionData (Document)

6.1.3.27.1 Description

This resource represents the subscribed V2X Data for a SUPI. It is queried by the AMF after registering.

6.1.3.27.2 Resource Definition

Resource URI: {apiRoot}/nudm-sdm/<apiVersion>/{supi}/v2x-data

This resource shall support the resource URI variables defined in table 6.1.3.27.2-1.

Table 6.1.3.27.2-1: Resource URI variables for this resource

Name	Definition
apiRoot	See clause 6.1.1
supi	Represents the Subscription Permanent Identifier (see 3GPP TS 23.501 [2] clause 5.9.2) pattern: See pattern of type Supi in 3GPP TS 29.571 [7]

6.1.3.27.3 Resource Standard Methods

6.1.3.27.3.1 GET

This method shall support the URI query parameters specified in table 6.1.3.27.3.1-1.

Table 6.1.3.27.3.1-1: URI query parameters supported by the GET method on this resource

Name	Data type	P	Cardinality	Description
supported-features	SupportedFeatures	O	0..1	see 3GPP TS 29.500 [4] clause 6.6

This method shall support the request data structures specified in table 6.1.3.27.3.1-2 and the response data structures and response codes specified in table 6.1.3.27.3.1-3.

Table 6.1.3.27.3.1-2: Data structures supported by the GET Request Body on this resource

Data type	P	Cardinality	Description
n/a			

Table 6.1.3.27.3.1-3: Data structures supported by the GET Response Body on this resource

Data type	P	Cardinality	Response codes	Description
V2xSubscriptionData	M	1	200 OK	Upon success, a response body containing the V2X Subscription Data shall be returned (see 3GPP TS 23.273 [38] clause 5.4.2)
ProblemDetails	O	1	404 Not Found	The "cause" attribute may be used to indicate one of the following application errors: - USER_NOT_FOUND - DATA_NOT_FOUND
NOTE: In addition common data structures as listed in table 5.2.7.1-1 of 3GPP TS 29.500 [4] are supported.				

6.1.3.28 Resource: LcsBroadcastAssistanceSubscriptionData (Document)

6.1.3.28.1 Description

This resource represents the subscribed LCS Broadcast Assistance Data Types for a SUPI. It is queried by the AMF.

6.1.3.28.2 Resource Definition

Resource URI: {apiRoot}/nudm-sdm/<apiVersion>/{supi}/lcs-bca-data

This resource shall support the resource URI variables defined in table 6.1.3.28.2-1.

Table 6.1.3.28.2-1: Resource URI variables for this resource

Name	Definition
apiRoot	See clause 6.1.1
supi	Represents the Subscription Permanent Identifier (see 3GPP TS 23.501 [2] clause 5.9.2) pattern: See pattern of type Supi in 3GPP TS 29.571 [7]

6.1.3.28.3 Resource Standard Methods

6.1.3.28.3.1 GET

This method shall support the URI query parameters specified in table 6.1.3.28.3.1-1.

Table 6.1.3.28.3.1-1: URI query parameters supported by the GET method on this resource

Name	Data type	P	Cardinality	Description
supported-features	SupportedFeatures	O	0..1	see 3GPP TS 29.500 [4] clause 6.6
plmn-id	Plmnlid	O	0..1	PLMN identity of the PLMN serving the UE

If "plmn-id" is included, the UDM shall return the LCS Broadcast Assistance Data Types for the SUPI associated to the PLMN identified by "plmn-id".

If "plmn-id" is not included, the UDM shall return the LCS Broadcast Assistance Data Types for the SUPI associated to the HPLMN.

This method shall support the request data structures specified in table 6.1.3.x.3.1-2 and the response data structures and response codes specified in table 6.1.3.x.3.1-3.

Table 6.1.3.28.3.1-2: Data structures supported by the GET Request Body on this resource

Data type	P	Cardinality	Description
n/a			

Table 6.1.3.28.3.1-3: Data structures supported by the GET Response Body on this resource

Data type	P	Cardinality	Response codes	Description
LcsBroadcastAssistanceTypesData	M	1	200 OK	Upon success, a response body containing the list of Broadcast Assistance Data Types Subscription Data shall be returned (see 3GPP TS 23.273 [38] clause 7.1)
ProblemDetails	O	1	404 Not Found	The "cause" attribute may be used to indicate one of the following application errors: - USER_NOT_FOUND - DATA_NOT_FOUND

NOTE: In addition common data structures as listed in table 5.2.7.1-1 of 3GPP TS 29.500 [4] are supported.

6.1.3.29 Resource: IndividualSharedData (Document)

6.1.3.29.1 Description

This resource represents the individual Shared Data.

6.1.3.29.2 Resource Definition

Resource URI: {apiRoot}/nudm-sdm/<apiVersion>/shared-data/{sharedDataId}

This resource shall support the resource URI variables defined in table 6.1.3.29.2-1.

Table 6.1.3.29.2-1: Resource URI variables for this resource

Name	Data type	Definition
apiRoot	string	See clause 6.1.1
sharedDataId	SharedDataId	Contains the individual Shared Data Identifier.

6.1.3.29.3 Resource Standard Methods

6.1.3.29.3.1 GET

This method shall support the URI query parameters specified in table 6.1.3.29.3.1-1.

Table 6.1.3.29.3.1-1: URI query parameters supported by the GET method on this resource

Name	Data type	P	Cardinality	Description
n/a				

This method shall support the request data structures specified in table 6.1.3.29.3.1-2 and the response data structures and response codes specified in table 6.1.3.29.3.1-3.

Table 6.1.3.29.3.1-2: Data structures supported by the GET Request Body on this resource

Data type	P	Cardinality	Description
n/a			

Table 6.1.3.29.3.1-3: Data structures supported by the GET Response Body on this resource

Data type	P	Cardinality	Response codes	Description
SharedData	M	1	200 OK	Upon success, a response body containing the individual Shared Data shall be returned.
ProblemDetails	O	0..1	404 Not Found	The "cause" attribute may be used to indicate one of the following application errors: - DATA_NOT_FOUND

NOTE: In addition common data structures as listed in table 5.2.7.1-1 of 3GPP TS 29.500 [4] are supported.

6.1.4 Custom Operations without associated resources

In this release of this specification, no custom operations without associated resources are defined for the Nudm_SubscriberDataManagement Service.

6.1.5 Notifications

6.1.5.1 General

This clause will specify the use of notifications and corresponding protocol details if required for the specific service. When notifications are supported by the API, it will include a reference to the general description of notifications support over the 5G SBIs specified in TS 29.500 / TS 29.501.

Table 6.1.5.1-1: Notifications overview

Notification	Resource URI	HTTP method or custom operation	Description (service operation)
Data Change Notification	{callbackReference}	POST	

6.1.5.2 Data Change Notification

The POST method shall be used for Data Change Notifications and the URI shall be as provided during the subscription procedure.

Resource URI: {callbackReference}

Support of URI query parameters is specified in table 6.1.5.2-1.

Table 6.1.5.2-1: URI query parameters supported by the POST method

Name	Data type	P	Cardinality	Description
n/a				

Support of request data structures is specified in table 6.1.5.2-2 and of response data structures and response codes is specified in table 6.1.5.2-3.

Table 6.1.5.2-2: Data structures supported by the POST Request Body

Data type	P	Cardinality	Description
ModificationNotification	M	1	

Table 6.1.5.2-3: Data structures supported by the POST Response Body

Data type	P	Cardinality	Response codes	Description
n/a			204 No Content	Upon success, an empty response body shall be returned.
RedirectResponse	O	0..1	307 Temporary Redirect	Temporary redirection. The response shall include a Location header field containing a different URI. The URI shall be an alternative URI of the resource located on an alternative service instance within the same NF or NF (service) set. If an SCP redirects the message to another SCP then the location header field shall contain the same URI or a different URI pointing to the endpoint of the NF service consumer to which the notification should be sent.
RedirectResponse	O	0..1	308 Permanent Redirect	Permanent redirection. The response shall include a Location header field containing a different URI. The URI shall be an alternative URI of the resource located on an alternative service instance within the same NF or NF (service) set. If an SCP redirects the message to another SCP then the location header field shall contain the same URI or a different URI pointing to the endpoint of the NF service consumer to which the notification should be sent.
ProblemDetails	O	0..1	404 Not Found	The "cause" attribute may be used to indicate one of the following application errors: - CONTEXT_NOT_FOUND See table 6.1.7.3-1 for the description of this error.
NOTE: In addition common data structures as listed in table 5.2.7.1-1 of 3GPP TS 29.500 [4] are supported.				

Table 6.1.5.2-4: Headers supported by the 307 Response Code on this resource

Name	Data type	P	Cardinality	Description
Location	string	M	1	Contains the Callback URI of the target NF Service Consumer (e.g. AMF) to which the request is redirected
3gpp-Sbi-Target-Nf-Id	string	O	0..1	Identifier of the target NF (service) instance ID towards which the request is redirected

Table 6.1.5.2-5: Headers supported by the 308 Response Code on this resource

Name	Data type	P	Cardinality	Description
Location	string	M	1	Contains the Callback URI of the target NF Service Consumer (e.g. AMF) to which the request is redirected
3gpp-Sbi-Target-Nf-Id	string	O	0..1	Identifier of the target NF (service) instance ID towards which the request is redirected

6.1.6 Data Model

6.1.6.1 General

This clause specifies the application data model supported by the API.

Table 6.1.6.1-1 specifies the data types defined for the Nudm_SDM service API.

Table 6.1.6.1-1: Nudm_SDM specific Data Types

Data type	Clause defined	Description
Nssai	6.1.6.2.2	Network Slice Selection Assistance Information
SdmSubscription	6.1.6.2.3	A subscription to notifications
AccessAndMobilitySubscriptionData	6.1.6.2.4	Access and Mobility Subscription Data
SmfSelectionSubscriptionData	6.1.6.2.5	SMF Selection Subscription Data
DnnInfo	6.1.6.2.6	Data Network Name and associated information (LBO roaming allowed flag)
SnsaiInfo	6.1.6.2.7	S-NSSAI and associated information (DNN Info)
SessionManagementSubscriptionData	6.1.6.2.8	User subscribed session management data
DnnConfiguration	6.1.6.2.9	User subscribed data network configuration
PduSessionTypes	6.1.6.2.11	Default/allowed session types for a data network
SscModes	6.1.6.2.12	Default/allowed SSC modes for a data network
SmsSubscriptionData	6.1.6.2.13	
SmsManagementSubscriptionData	6.1.6.2.14	SMS Management Subscription Data
SubscriptionDataSets	6.1.6.2.15	
UeContextInSmfData	6.1.6.2.16	UE Context In SMF Data
PduSession	6.1.6.2.17	
IdTranslationResult	6.1.6.2.18	SUPI that corresponds to a given GPSI
ModificationNotification	6.1.6.2.21	
IpAddress	6.1.6.2.22	IP address (IPv4, or IPv6, or IPv6 prefix)
UeContextInSmsfData	6.1.6.2.23	
SmsfInfo	6.1.6.2.24	
AcknowledgeInfo	6.1.6.2.25	
SorInfo	6.1.6.2.26	Steering Of Roaming Information
SharedData	6.1.6.2.27	Subscription Data shared by multiple UEs
PgwInfo	6.1.6.2.28	Information about the DNNs/APNs and PGW-C+SMF FQDNs used in interworking with EPS
TraceDataResponse	6.1.6.2.29	Contains Trace Data or a shared data Id identifying shared Trace Data
SteeringContainer	6.1.6.2.30	
SdmSubsModification	6.1.6.2.31	Modification instruction for a subscription to notifications
EmergencyInfo	6.1.6.2.32	Information about emergency session
UpuInfo	6.1.6.2.33	UE Parameters Update Information
GroupIdentifiers	6.1.6.2.34	
NiddInformation	6.1.6.2.35	Non-IP Data Delivery information
CagData	6.1.6.2.36	
CagInfo	6.1.6.2.37	
DataSetName	6.1.6.3.3	
PduSessionContinuityInd	6.1.6.3.7	
AdditionalSnsaiData	6.1.6.2.38	Additional information specific to a slice
VnGroupData	6.1.6.2.39	
AppDescriptor	6.1.6.2.40	
AppPortId	6.1.6.2.41	Application Port Id
LcsPrivacyData	6.1.6.2.42	
Lpi	6.1.6.2.43	
UnrelatedClass	6.1.6.2.44	
PlmnOperatorClass	6.1.6.2.45	
ValidTimePeriod	6.1.6.2.46	
LcsMoData	6.1.6.2.47	
EcRestrictionDataWb	6.1.6.2.48	Enhance Coverage Restriction Data
ExpectedUeBehaviourData	6.1.6.2.49	Expected UE Behaviour Data
SuggestedPacketNumDI	6.1.6.2.52	Suggested Number of Downlink Packets
FrameRouteInfo	6.1.6.2.54	Frame Route Information
SorUpdateInfo	6.1.6.2.55	
EnhancedCoverageRestrictionData	6.1.6.2.56	Enhanced Coverage Restriction Data
EdrxParameters	6.1.6.2.57	eDRX Parameters
PtwParameters	6.1.6.2.58	Paging Time Window Parameters
OperationMode	6.1.6.3.12	Operation Mode
SorUpdateIndicator	6.1.6.3.13	SoR Update Indicator
ExternalUnrelatedClass	6.1.6.2.62	
AfExternal	6.1.6.2.63	
LcsClientExternal	6.1.6.2.64	
LcsClientGroupExternal	6.1.6.2.65	
ServiceTypeUnrelatedClass	6.1.6.2.66	

Ueld	6.1.6.2.67	
DefaultUnrelatedClass	6.1.6.2.68	
UeContextInAmfData	6.1.6.2.70	
V2xSubscriptionData	6.1.6.2.71	V2X Subscription Data
LcsBroadcastAssistanceTypesData	6.1.6.2.72	LCS Broadcast Assistance Data Types
DatasetNames	6.1.6.2.73	Data Set Names
DefaultDnnIndicator	6.1.6.3.2	
LboRoamingAllowed	6.1.6.3.2	
UeUsageType	6.1.6.3.2	
MpsPriorityIndicator	6.1.6.3.2	
McsPriorityIndicator	6.1.6.3.2	
3GppChargingCharacteristics	6.1.6.3.2	3GPP Charging Characteristics
MicoAllowed	6.1.6.3.2	
SmsSubscribed	6.1.6.3.2	
SharedDataId	6.1.6.3.2	
lwkEpsInd	6.1.6.3.2	Interworking with EPS Indication
SecuredPacket	6.1.6.3.2	
UpuRegInd	6.1.6.3.2	
ExtGroupId	6.1.6.3.2	
NbIoTUePriority	6.1.6.3.2	
CodeWord	6.1.6.3.2	
AfId	6.1.6.3.2	
LcsClientId	6.1.6.3.2	
DataSetName	6.1.6.3.3	
PduSessionContinuityInd	6.1.6.3.7	
LocationPrivacyInd	6.1.6.3.8	
PrivacyCheckRelatedAction	6.1.6.3.9	
LcsClientClass	6.1.6.3.10	
LcsMoServiceClass	6.1.6.3.11	
OperationMode	6.1.6.3.12	
SorUpdateIndicator	6.1.6.3.13	
CodeWordInd	6.1.6.3.14	
MdtUserConsent	6.1.6.3.15	MDT User Consent

Table 6.1.6.1-2 specifies data types re-used by the Nudm_SDM service API from other specifications, including a reference to their respective specifications and when needed, a short description of their use within the Nudm_SDM service API.

Table 6.1.6.1-2: Nudm_SDM re-used Data Types

Data type	Reference	Comments
Dnn	3GPP TS 29.571 [7]	Data Network Name with Network Identifier only; this type is used as key in a map of: - DnnConfigurations; see clause 6.1.6.2.8; - EpslwkPgws; see clause 6.2.6.2.2; - ExpectedUeBehaviourData; see clause 6.1.6.2.8;
DurationSec	3GPP TS 29.571 [7]	Time value in seconds
ProblemDetails	3GPP TS 29.571 [7]	Common data type used in response bodies
Snsai	3GPP TS 29.571 [7]	Single NSSAI
Uri	3GPP TS 29.571 [7]	Uniform Resource Identifier
Gpsi	3GPP TS 29.571 [7]	Generic Public Subscription Identifier
RatType	3GPP TS 29.571 [7]	Radio Access Technology Type
Area	3GPP TS 29.571 [7]	
ServiceAreaRestriction	3GPP TS 29.571 [7]	
CoreNetworkType	3GPP TS 29.571 [7]	
SupportedFeatures	3GPP TS 29.571 [7]	see 3GPP TS 29.500 [4] clause 6.6
PlmnId	3GPP TS 29.571 [7]	PLMN Identity
PduSessionType	3GPP TS 29.571 [7]	
SubscribedDefaultQos	3GPP TS 29.571 [7]	Subscribed Default QoS
Ambr	3GPP TS 29.571 [7]	
PduSessionId	3GPP TS 29.571 [7]	PduSessionId is used as key in a map of PduSessions; see clause 6.1.6.2.16.
NfiInstanceId	3GPP TS 29.571 [7]	
Supi	3GPP TS 29.571 [7]	
RfspIndex	3GPP TS 29.571 [7]	
SscMode	3GPP TS 29.571 [7]	
Ipv4Addr	3GPP TS 29.571 [7]	
Ipv6Addr	3GPP TS 29.571 [7]	
Ipv6Prefix	3GPP TS 29.571 [7]	
SorMac	3GPP TS 29.509 [24]	
SteeringInfo	3GPP TS 29.509 [24]	
AckInd	3GPP TS 29.509 [24]	
CounterSor	3GPP TS 29.509 [24]	
UpuMac	3GPP TS 29.509 [24]	
UpuData	3GPP TS 29.509 [24]	
UpuAckInd	3GPP TS 29.509 [24]	
CounterUpu	3GPP TS 29.509 [24]	
TraceData	3GPP TS 29.571 [7]	Trace control and configuration parameters
NotifyItem	3GPP TS 29.571 [7]	
UpSecurity	3GPP TS 29.571 [7]	
ServiceName	3GPP TS 29.510 [19]	
OdbPacketServices	3GPP TS 29.571 [7]	
GroupId	3GPP TS 29.571 [7]	This type is also used as key of a map in attributes: - vnGroupInfo and sharedVnGroupDataIds; see clause 6.1.6.2.4, 6.1.6.2.8, 6.1.6.2.27;
Date Time	3GPP TS 29.571 [7]	
CagId	3GPP TS 29.571 [7]	
StnSr	3GPP TS 29.571 [7]	Session Transfer Number for SRVCC
CMsisdn	3GPP TS 29.571 [7]	Correlation MSISDN
OsId	3GPP TS 29.519 [33]	
Uint16	3GPP TS 29.571 [7]	
RgWirelineCharacteristics	3GPP TS 29.571 [7]	
GeographicArea	3GPP TS 29.572 [34]	
LcsServiceType	3GPP TS 29.572 [34]	
ScheduledCommunicationTime	3GPP TS 29.571 [7]	Scheduled Communication Time
LocationArea	6.5.6.2.10	
StationaryIndication	3GPP TS 29.571 [7]	Stationary Indication
TrafficProfile	3GPP TS 29.571 [7]	Traffic Profile
ScheduledCommunicationType	3GPP TS 29.571 [7]	Scheduled Communication Type
BatteryIndication	3GPP TS 29.571 [7]	Battery Indication
AcsInfo	3GPP TS 29.571 [7]	ACS Information
IPv4AddrMask	3GPP TS 29.571 [7]	
NefId	3GPP TS 29.510 [19]	
PatchResult	3GPP TS 29.571 [7]	

NrV2xAuth	3GPP TS 29.571 [7]	
LteV2xAuth	3GPP TS 29.571 [7]	
BitRate	3GPP TS 29.571 [7]	
MdtConfiguration	3GPP TS 29.571 [7]	
Uint64	3GPP TS 29.571 [7]	
WirelineArea	3GPP TS 29.571 [7]	
WirelineServiceAreaRestriction	3GPP TS 29.571 [7]	
RedirectResponse	3GPP TS 29.571 [7]	Response body of the redirect response message
Bytes	3GPP TS 29.571 [7]	Binary data encoded as a base64 character string

6.1.6.2 Structured data types

6.1.6.2.1 Introduction

This clause defines the structures to be used in resource representations.

6.1.6.2.2 Type: Nssai

Table 6.1.6.2.2-1: Definition of type Nssai

Attribute name	Data type	P	Cardinality	Description	Applicability
supportedFeatures	SupportedFeatures	O	0..1	See clause 6.1.8	
defaultSingleNssais	array(Snssai)	M	1..N	A list of Single Nssais used as default. (NOTE)	
singleNssais	array(Snssai)	O	1..N	List of non default Single Nssais. (NOTE)	
provisioningTime	DateTime	C	0..1	This attribute shall be present if the Nssai is sent to the AMF while reception has not yet been acknowledged from the UE; otherwise shall be absent. This attribute serves as Network Slicing Subscription Change Indication.	
additionalSnssaiData	map(AdditionalSnssaiData)	O	1..N	A map (list of key-value pairs where singleNssai converted to string serves as key) of additional information related to this single Nssai.	Nssaa
NOTE:	If the NF consumer does not support Nssaa optional feature, the UDM shall not include S-NSSAI(s) subject to Network Slice-Specific Authentication and Authorization in Get response messages, immediate reports within Subscribe response messages, or data change notifications where the data change is limited to S-NSSAI(s) subject to Network Slice-Specific Authentication and Authorization.				

6.1.6.2.3 Type: SdmSubscription

Table 6.1.6.2.3-1: Definition of type SdmSubscription

Attribute name	Data type	P	Cardinality	Description	Applicability
nfInstanceId	NfInstanceId	M	1	Identity of the NF Instance creating the subscription.	
implicitUnsubscribe	boolean	O	0..1	If present with value true indicates that the subscription expires when the subscribing NF (AMF, SMF, SMSF) identified by the nfInstanceId ceases to be registered at the UDM. When the subscribing NF is an SMF, this means that the subscription is terminated by UDM when the last PDU session of such SMF is deregistered for a given SUPI. If the subscribing NF (AMF, SMF, SMSF) is not registered when the SDM subscription with implicitUnsubscribe indicator set to true is received by the UDM, the UDM should return a confirmed expiry time in the expires attribute to the subscribing NF even when the expires attribute is absent from the request. See NOTE 1.	
expires	DateTime	C	0..1	If present, indicates the point in time at which the subscription expires. Shall be present if implicitUnsubscribe is absent or false. Within a POST request the proposed expiry time is conveyed whereas in a POST response or PATCH response the confirmed expiry time is returned.	
callbackReference	Uri	M	1	URI provided by the NF service consumer to receive notifications	
amfServiceName	ServiceName	O	0..1	When present, this IE shall contain the name of the AMF service to which Data Change Notifications are to be sent (see clause 6.5.2.2 of 3GPP TS 29.500 [4]). This IE may be included if the NF service consumer is an AMF.	
monitoredResourceUris	array(Uri)	M	1..N	A set of URIs that identify the resources for which a change triggers a notification. The URI shall take the form of either an absolute URI or an absolute-path reference as defined in IETF RFC 3986 [31]. See NOTE 3.	
singleNssai	Snssai	O	0..1	This IE may be present if the consumer is SMF. This attribute shall be also used as filter for the Nudr notifications when sdmSubscription is included in subscriptionDataSubscription in Nudr POST operation. See NOTE 2.	
dnn	Dnn	O	0..1	This IE may be present if the consumer is SMF. This attribute shall be also used as filter for the Nudr notifications when sdmSubscription is included in subscriptionDataSubscription in Nudr POST operation. When present, this IE shall contain the Network Identifier only, or Wildcard DNN. See NOTE 2.	
subscriptionId	string	C	0..1	This attribute shall be present if the SdmSubscription is sent in a GET response message on Nudr. It identifies the individual sdmSubscription stored in the UDR and may be used by the UDM to delete an expired or implicitly unsubscribed sdmSubscription.	

plmnId	PlmnId	C	0..1	<p>If present, it indicates the PLMN of the NF Instance creating the subscription (i.e., the PLMN serving the UE).</p> <p>It shall be present if the NF Instance is located in a different PLMN than the UDM.</p> <p>If absent, the Home PLMN ID is used as default.</p>	
immediateReport	boolean	O	0..1	<p>This IE indicates whether immediate report is needed or not.</p> <p>When present, this IE shall be set as following: - true: immediate report is required - false (default) immediate report is not required</p>	ImmediateReport
report	SubscriptionDataSets	C	0..1	<p>This IE shall be present in Subscribe response, if the immediateReport attribute is set to "true" in Subscribe request.</p> <p>When present, this IE shall contain the representation of subscription data sets that to be monitored, i.e. listed in monitoredResourceUris attribute.</p>	ImmediateReport
supportedFeatures	SupportedFeatures	O	0..1	<p>See clause 6.1.8</p> <p>These are the features supported by the NF subscribing at the UDM.</p>	
contextInfo	ContextInfo	C	0..1	<p>This IE if present may contain e.g. the headers received by the UDM along with the SdmSubscription.</p> <p>Shall be absent on Nudm and may be present on Nudr.</p>	
uniqueSubscription	boolean	O	0..1	<p>When present, this IE shall be set to indicate whether the subscription is a unique subscription, as specified in clause 5.2.2.3.2 and clause 5.2.2.3.3: - true: the subscription is unique - false: the subscription is not unique</p>	LimitedSubscriptions

NOTE 1: The subscription expires if the last registration identified by the nfnInstanceid for the UE is deregistered at the UDM, e.g. the UDM shall remove the SdmSubscription of the SMF, if the UE's last PDU session SMF registration of this SMF is deregistered.

NOTE 2: If "singleNssai" is not included, and "dnn" is not included, the UDM shall notify the data change of all DNN configurations and network slice(s).
If "singleNssai" is included, and "dnn" is not included, the UDM shall notify the data change of network slice identified by "singleNssai" and all DNN configurations for the requested network slice identified by "singleNssai".
If "singleNssai" is not included, and "dnn" is included, the UDM shall notify the data change of all network slices where such DNN is available and all DNN configurations identified by "dnn".
If "singleNssai" is included, and "dnn" is included, the UDM shall notify the data change of network slice identified by "singleNssai" where such DNN is available and the DNN configuration identified by "dnn", if such DNN is available in the network slice identified by "singleNssai".

NOTE 3: The UDM should handle only the relative-path part (apiSpecificResourceUriPart, see 3GPP TS 29.501 [5] clause 4.4.1) and ignore possible inconsistencies in the base URI part.

6.1.6.2.4 Type: AccessAndMobilitySubscriptionData

Table 6.1.6.2.4-1: Definition of type AccessAndMobilitySubscriptionData

Attribute name	Data type	P	Cardinality	Description	Applicability
supportedFeatures	SupportedFeatures	O	0..1	See clause 6.1.8	
gpsis	array(Gpsi)	O	0..N	List of Generic Public Subscription Identifier; see 3GPP TS 29.571 [7]	
internalGroupIds	array(GroupId)	O	1..N	List of internal group identifier; see 3GPP TS 23.501 [2] clause 5.9.7	
sharedVnGroupDataIds	map(SharedDataId)	O	1..N	A map of identifiers of shared 5G VN group data (list of key-value pairs where GroupId serves as key; see clause 6.1.6.1). This attribute is only applicable to the Nudm interface and shall not be included over the Nudr interface.	
subscribedUeAmbr	AmbrRm	O	0..1		
nssai	Nssai	O	0..1	Network Slice Selection Assistance Information	
ratRestrictions	array(RatType)	O	0..N	List of RAT Types that are restricted in 5GC and EPC; see 3GPP TS 29.571 [7] (NOTE 2)	
forbiddenAreas	array(Area)	O	0..N	List of forbidden areas in 5GS	
serviceAreaRestriction	ServiceAreaRestriction	O	0..1	Subscribed Service Area Restriction	
coreNetworkTypeRestrictions	array(CoreNetworkType)	O	0..N	List of Core Network Types that are restricted. The use of the value "5GC" is deprecated on Nudm and shall be discarded by the receiving AMF.	
rfspIndex	RfspIndexRm	O	0..1	Index to RAT/Frequency Selection Priority;	
subsRegTimer	DurationSecRm	O	0..1	Subscribed periodic registration timer; (see clause 5.20 of 3GPP TS 23.501 [2], clause 4.15.3.2.3b and 4.15.6.3a of 3GPP TS 23.502 [3] and 3GPP TS 29.571 [7])	
ueUsageType	UeUsageType	O	0..1		
mpsPriority	MpsPriorityIndicator	O	0..1		
mcsPriority	McsPriorityIndicator	O	0..1		
activeTime	DurationSecRm	O	0..1	subscribed active time for PSM UEs (see clause 5.20 of 3GPP TS 23.501 [2] and clause 4.15.3.2.3b and 4.15.6.3a of 3GPP TS 23.502 [3]).	
sorInfo	SorInfo	O	0..1	On Nudm, this IE shall be present if the UDM shall send the information for Steering of Roaming during registration or the subscription data update to the UE. The UDM may detect the need to send sorInfo by retrieving context information from the UDR. (NOTE 4)	
sorInfoExpectInd	Boolean	C	0..1	Contains the indication on whether or not the UE is expecting to receive SoR information at initial registration. - When set to true; it indicates that the UE is expecting to receive SoR information at initial registration in a VPLMN, i.e. the UDM shall send SoR information to the AMF on Nudm even when nothing was received from UDR or SOR-AF. In case the UDM was not able to obtain SoR information, SoR information sent on Nudm shall contain the indication that "no change" is needed. - When set to false: it indicates that the UE is not expecting to receive SoR information at initial registration, i.e. the UDM shall send SoR information to the AMF based on operator policy. This attribute may be present on Nudr interface and shall be absent on UDM interface. The UDM shall ignore this attribute if the UE is not roaming out of its HPLMN.	

sorafRetrieval	boolean	C	0..1	<p>Contains the indication on whether or not SoR information shall be retrieved from the SOR-AF.</p> <ul style="list-style-type: none"> - When set to true: it indicates that the UDM shall retrieve SoR information from the SOR-AF. - When set to false or absent: it indicates that the retrieval of SorInfo from the SOR-AF is not required. <p>This attribute may be present on Nudr interface and shall be absent on Nudm interface.</p> <p>The UDM shall ignore this attribute if it is received in Nudr but the UE is not roaming out of its HPLMN.</p>	
sorUpdateIndicatorList	array(SorUpdateIndicator)	C	1..N	<p>When present, it contains the list of SoR Update Indicators;</p> <ul style="list-style-type: none"> - It shall indicate that the AMF shall retrieve SoR information when the UE performs Registration with NAS Registration Type "Initial Registration" if the value "INITIAL_REGISTRATION" is included; - And/or it shall indicate that the AMF shall retrieve SoR information when the UE performs Registration with NAS Registration Type "Emergency Registration" if the value "EMERGENCY_REGISTRATION" is included. <p>When absent on Nudm interface, it indicates that the AMF is not requested to retrieve SoR information when the UE performs Registration with either NAS Registration Type "Initial Registration" or NAS Registration Type "Emergency Registration".</p> <p>The UDM shall ignore this attribute if the UE is not roaming out of its HPLMN.</p>	
upulInfo	UpulInfo	O	0..1	This IE shall be present if the UDM shall send the information for UE Parameters Update after the UE has been successfully authenticated and registered to the 5G system.	
micoAllowed	MicoAllowed	O	0..1	Indicates whether the UE subscription allows MICO mode.	
sharedAmDataIds	array(SharedDataId)	O	0..N	Identifier of shared Access And Mobility Subscription data	SharedData
odbPacketServices	OdbPacketServices	O	0..1	Operator Determined Barring for Packet Oriented Services (NOTE 3).	
subscribedDnnList	array(Dnn)	O	0..N	<p>List of the subscribed DNNs for the UE (including optionally the Wildcard DNN). Used to determine the list of LADN available to the UE as defined in clause 5.6.5 of TS 23.501 [2].</p> <p>When present, this IE shall contain the Network Identifier only.</p>	
serviceGapTime	DurationSec	O	0..1	Used to set the Service Gap timer for Service Gap Control (see TS 23.501 [2] clause 5.26.16 and TS 23.502 [3] clause 4.2.2.2.2).	
mdtUserConsent	MdtUserConsent	O	0..1	<p>When present, this IE shall indicate whether the user has given his consent for MDT activation or not (see clause 4.9 of 3GPP TS 32.422 [48]).</p> <p>When absent, "CONSENT_NOT_GIVEN" is the default value.</p>	
mdtConfiguration	MdtConfiguration	C	0..1	This IE shall be present if the MDT task is activated. When present, this IE shall contain MDT configuration data for UE (see clause 4.1.2.17 of 3GPP TS 32.422 [48]).	
traceData	TraceData	O	0..1	Trace requirements about the UE, only sent to AMF in the HPLMN or one of its equivalent PLMN(s)	
cagData	CagData	O	0..1	<p>Closed Access Group Data.</p> <p>Shall be absent if both</p> <ul style="list-style-type: none"> - no CAG is subscribed for the serving PLMN and - an acknowledgement from the UE is not pending. 	CAGFeature

stnSr	StnSr	O	0..1	This IE shall be present if the UE is subscribed to 5G SRVCC. When present, it indicates the STN-SR (Session Transfer Number for SRVCC) of the UE.
cMsisdn	CMsisdn	O	0..1	This IE shall be present if the UE is subscribed to 5G SRVCC. When present, it indicates the C-MSISDN (Correlation MSISDN) of the UE.
nbIoTUEPriority	NbIoTUEPriority	O	0..1	Indicates NB IoT UE priority which is used by the NG-RAN to prioritise resource allocation between UEs accessing via NB-IoT(see clause 5.31.17 of 3GPP TS 23.501 [2]).
nssaiInclusionAllowed	boolean	O	0..1	Indicates that the UE is allowed to include NSSAI in the RRC connection establishment in clear text for 3GPP access, as specified in clause 5.15.9 of 3GPP TS 23.501 [2] and clause 4.2.2.2.2 of 3GPP TS 23.502 [3]. true: indicates that NSSAI can be included in RRC connection establishment by the UE. false or absent: indicates that NSSAI cannot be included.
rgWirelineCharacteristics	RgWirelineCharacteristics	O	0..1	Indicates the RG Level Wireline Access Characteristics as specified in 3GPP TS 23.316 [37].
ecRestrictionDataWb	EcRestrictionDataWb	O	0..1	Indicates Enhanced Coverage Restriction Data for WB-N1 mode. If absent, indicates Enhanced Coverage is not restricted for WB-N1 mode.
ecRestrictionDataNb	boolean	O	0..1	If present, this IE shall indicate whether Enhanced Coverage for NB-N1 mode is restricted or not. true: Enhanced Coverage for NB-N1 mode is restricted. false or absent: Enhanced Coverage for NB-N1 mode is allowed.
expectedUeBehaviour	ExpectedUeBehaviourData	O	0..1	Indicates Expected UE Behaviour parameters associated with AMF(see clause 5.20 of 3GPP TS 23.501 [2] and clause 4.15.6.3 of 3GPP TS 23.502 [3]). This attribute is only applicable to the Nudm interface and shall not be included over the Nudr interface.
primaryRatRestrictions	array(RatType)	O	0..N	List of RAT Types that are restricted for use as primary RAT in 5GC and EPC; see 3GPP TS 29.571 [7] (NOTE 2)
secondaryRatRestrictions	array(RatType)	O	0..N	List of RAT Types that are restricted for use as secondary RAT in 5GC and EPC; see 3GPP TS 29.571 [7] (NOTE 2)
edrxParametersList	array(EdrxParameters)	O	1..N	List of subscribed the extended idle mode DRX parameters (see clause 5.31.7.2.1 of 3GPP TS 23.501 [2]).
ptwParametersList	array(PtwParameters)	O	1..N	List of subscribed the Paging Time Window parameters (see clause 5.31.7.2.1 of 3GPP TS 23.501 [2]).
iabOperationAllowed	boolean	O	0..1	Indicates that the UE is allowed for IAB operation as specified in 3GPP TS 23.501 [2]. true: indicates that the UE is allowed for IAB operation. false or absent: indicates that the UE is not allowed for IAB operation.
wirelineForbiddenAreas	array(WirelineAreas)	O	0..N	List of forbidden areas for 5G-BRG/5G-CRG/FN-CRG
wirelineServiceAreaRestriction	WirelineServiceAreaRestriction	O	0..1	Subscribed Service Area Restriction for 5G-BRG/5G-CRG/FN-CRG

<p>NOTE 1: AccessAndMobilitySubscriptionData can be UE-individual data or shared data. UE-individual data take precedence over shared data. E.g.: When an attribute of type array is present but empty within UE-Individual data and present (with any cardinality) in shared data, the empty array takes precedence. Similarly, when a nullable attribute is present with value null within the individual data and present (with any value) in shared data, the null value takes precedence (i.e. for the concerned UE the attribute is considered absent).</p> <p>NOTE 2: If the primaryRatRestrictions and secondaryRatRestrictions attributes are supported by the sender, the sender shall include the list of RAT Types that are restricted, if any, in the ratRestrictions attribute, shall include the list of RAT Types that are restricted for use as primary RAT, if any, in the primaryRatRestrictions attribute and shall include the list of RAT Types that are restricted for use as secondary RAT, if any, in the secondaryRatRestrictions attribute. If the primaryRatRestrictions and secondaryRatRestrictions attributes are supported by the receiver, the receiver shall use the data in the primaryRatRestrictions attribute, if received, as the list of RAT Types that are restricted for use as primary RAT, and shall use the data in the secondaryRatRestrictions attribute, if received, as the list of RAT Types that are restricted for use as secondary RAT, otherwise the receiver shall use the data in the ratRestrictions attribute, if received, as the list of RAT Types that are restricted. If the secondaryRatRestrictions attribute is included in the subscription profile, the content may be sent to MME during inter RAT handover from NR SA to EN-DC, for the purpose of adequate SGW selection at MME based on subscription profile, and to avoid allocating unnecessary resources for secondary RAT at EPC if it is restricted.</p> <p>NOTE 3: The AMF shall take responsibility to perform PDU session related actions subject to change of OdbPacketService, e.g. release existing PDU session.</p> <p>NOTE 4: The UDM shall ignore the content of sorInfo received on Nudr if "sorafRetrieval" is set to true.</p>	
--	--

6.1.6.2.5 Type: SmfSelectionSubscriptionData

Table 6.1.6.2.5-1: Definition of type SmfSelectionSubscriptionData

Attribute name	Data type	P	Cardinality	Description	Applicability
supportedFeatures	SupportedFeatures	O	0..1	See clause 6.1.8	
subscribedSnssaiInfos	map(SnssaiInfo)	O	0..N	List of S-NSSAIs and associated information (DNN Info); see 3GPP TS 23.501 [2] clause 6.3.2. A map (list of key-value pairs where singleNssai converted to string serves as key; see 3GPP TS 29.571 [7]) of arrays of DnnInfo	
sharedSnssaiInfosId	SharedDataId	O	0..1	Identifier of shared SnssaiInfos.	SharedData
NOTE:	A single UE-individual subscribedSnssaiInfo (within subscribedSnssaiInfos) may clash with a sharedSnssaiInfo (i.e. both have the same singleNssai value as key). In this case the UE-individual subscribedSnssaiInfo takes precedence.				

6.1.6.2.6 Type: DnnInfo

Table 6.1.6.2.6-1: Definition of type DnnInfo

Attribute name	Data type	P	Cardinality	Description
dnn	Dnn	M	1	Data Network Name with Network Identifier only., or Wildcard DNN (NOTE)
defaultDnnIndicator	DefaultDnnIndicator	O	0..1	Indicates whether this DNN is the default DNN: true: The DNN is the default DNN (NOTE); false: The DNN is not the default DNN; If this attribute is absent it means the DNN is not the default DNN.
lboRoamingAllowed	LboRoamingAllowed	O	0..1	Indicates whether local breakout for the DNN is allowed when roaming: true: Allowed; false: Not allowed; If this attribute is absent it means not allowed.
iwkEpsInd	IwkEpsInd	O	0..1	Indicates whether interworking with EPS is subscribed: true: Subscribed; false: Not subscribed; If this attribute is absent it means not subscribed.
dnnBarred	boolean	C	0..1	Indicates whether the DNN is barred. Absence and false indicates "not barred". This attribute is only used on the Nudr interface. The UDM shall handle barred DNNs received from the UDR as not subscribed.
invokeNefInd	boolean	O	0..1	Indicates whether the NEF based infrequent small data transfer shall be used for the PDU Session associated with the S-NSSAI and DNN. true: Used; false: Not used; If this attribute is absent it means not used.
smfList	array(NfInstanceId)	O	1..N	Indicate the associated SMF(s) if the static IP address/prefix is used.
sameSmfInd	boolean	O	0..1	Indicates whether the same SMF for multiple PDU sessions to the same DNN and S-NSSAI is required. true: Required; false: Not required; If this attribute is absent it means not required.
NOTE: If the dnn attribute contains the value of the Wildcard DNN ("*"), the defaultDnnIndicator shall not be set to true.				

6.1.6.2.7 Type: SnsailInfo

Table 6.1.6.2.7-1: Definition of type SnsailInfo

Attribute name	Data type	P	Cardinality	Description
dnnInfos	array(DnnInfo)	M	1..N	list of Data Network Names for an S-NSSAI and associated information

6.1.6.2.8 Type: SessionManagementSubscriptionData

Table 6.1.6.2.8-1: Definition of type SessionManagementSubscriptionData

Attribute name	Data type	P	Cardinality	Description	Applicability
singleNssai	Snsai	M	1	A single Network Slice Selection Assistance Information	
dnnConfigurations	map(DnnConfiguration)	O	0..N	Additional DNN configurations for the network slice; A map (list of key-value pairs where DNN, or optionally the Wildcard DNN, serves as key; see clause 6.1.6.1) of DnnConfigurations. (NOTE 1)	
internalGroupIds	array(GroupId)	O	1..N	List of internal group identifier; see 3GPP TS 23.501 [2] clause 5.9.7	
sharedVnGroupDataIds	map(SharedDataId)	O	1..N	A map of identifiers of shared 5G VN group data (list of key-value pairs where GroupId serves as key; see clause 6.1.6.1). This attribute is only applicable to the Nudm interface and shall not be included over the Nudr interface.	
traceData	TraceData	O	0..1	Trace requirements about the UE, only sent to SMF in the HPLMN or one of its equivalent PLMN(s)	
sharedDnnConfigurationSld	SharedDataId	O	0..1	Identifier of shared data for DNN configuration.	SharedData
sharedTraceDataId	SharedDataId	O	0..1	Identifier of shared data for trace requirements	
odbPacketServices	OdbPacketServices	O	0..1	Operator Determined Barring for Packet Oriented Services (NOTE 2).	
expectedUeBehaviourList	map(ExpectedUeBehaviourData)	O	1..N	A map of ExpectedUeBehaviourDatas associated with SMF (DNN serves as key; see clause 6.1.6.1), see clause 5.20 of 3GPP TS 23.501 [2] and clause 4.15.6.3 of 3GPP TS 23.502 [3]. This attribute is only applicable to the Nudm interface and shall not be included over the Nudr interface.	
suggestedPacketNumDIList	map(SuggestedPacketNumDI)	O	1..N	A map (list of key-value pairs where dnn serves as key; see clause 6.1.6.1) of SuggestedPacketNumDIs which are associated with SMF (see clause 5.20 of 3GPP TS 23.501 [2] and clause 4.15.6.3 of 3GPP TS 23.502 [3]). This attribute is only applicable to the Nudm interface and shall not be included over the Nudr interface.	
3gppChargingCharacteristics	3GppChargingCharacteristics	O	0..1	Subscribed charging characteristics data associated to the subscription.	
NOTE 1: A given UE-individual dnnConfiguration (within dnnConfigurations) may clash with a shared dnnConfiguration (i.e. both have the same dnn value as key). In this case the clashing attributes of the UE-individual dnnConfiguration take precedence. NOTE 2: The SMF shall not trigger PDU session release when receiving change of OdbPacketService. Only the AMF take responsibility to perform PDU session related actions subject to change of ODB setting, e.g. release existing PDU session.					

6.1.6.2.9 Type: DnnConfiguration

Table 6.1.6.2.9-1: Definition of type DnnConfiguration

Attribute name	Data type	P	Cardinality	Description
pduSessionTypes	PduSessionTypes	M	1	Default/Allowed session types
sscModes	SscModes	M	1	Default/Allowed SSC modes
iwkEpsInd	IwkEpsInd	O	0..1	Indicates whether interworking with EPS is subscribed: true: Subscribed; false: Not subscribed; If this attribute is absent it means not subscribed.
5gQosProfile	SubscribedDefaultQos	O	0..1	5G QoS parameters associated to the session for a data network
sessionAmbr	Ambr	O	0..1	The maximum aggregated uplink and downlink bit rates to be shared across all Non-GBR QoS Flows in each PDU Session
3gppChargingCharacteristics	3GppChargingCharacteristics	O	0..1	Subscribed charging characteristics data associated to the session for a data network. (NOTE 1)
staticIpAddress	array(IpAddress)	O	1..2	Subscribed static IP address(es) of the IPv4 and/or IPv6 type
upSecurity	UpSecurity	O	0..1	When present, this IE shall indicate the security policy for integrity protection and encryption for the user plane.
pduSessionContinuityInd	PduSessionContinuityInd	O	0..1	When present, this IE shall indicate how to handle a PDU Session when UE the moves to or from NB-IoT. If this attribute is absent it means that Local policy shall be used.
niddNefId	NefId	O	0..1	Indicates the identity of the NEF to be selected for NIDD service for this DNN.
niddInfo	NiddInformation	O	0..1	When present, this IE shall indicate information used for SMF-NEF Connection.
redundantSessionAllowed	boolean	O	0..1	Indicates whether redundant PDU Sessions are allowed: true: Allowed; false: Not allowed; If this attribute is absent it means not allowed.
acsInfo	AcsInfo	O	0..1	When present, this IE shall include the ACS information for the 5G-RG as defined in BBF TR-069 [42] or in BBF TR-369 [43].
ipv4FrameRouteList	array(FrameRouteInfo)	O	1..N	List of Frame Route information of IPv4, see clause 5.6.14 of 3GPP TS 23.501 [2].
ipv6FrameRouteList	array(FrameRouteInfo)	O	1..N	List of Frame Route information of IPv6, see clause 5.6.14 of 3GPP TS 23.501 [2].
atsssAllowed	boolean	O	0..1	Indicates whether this DNN supports ATSSS, i.e. whether Multi-Access PDU session is allowed to this DNN. true: Allowed; false (default): Not allowed; If this attribute is absent it means this DNN does not allow ATSSS.
secondaryAuth	boolean	O	0..1	Indicates whether secondary authentication and authorization is needed. true: required. false: not required. If absent, it indicates that secondary authentication is not required by subscription data, but it still may be required by local policies at the SMF. (NOTE 2)

dnAaalpAddressAllocation	boolean	O	0..1	Indicates whether the SMF is required to request the UE IP address from the DN-AAA server for PDU Session Establishment. true: required false: not required If absent, it indicates that the request by SMF of the UE IP address from the DN-AAA server is not required by subscription data, but it still may be required by local policies at the SMF.
dnAaaAddress	IpAddress	O	0..1	The address information of DN-AAA server, used for secondary authentication and authorization. (NOTE 2)
iptvAccCtrlInfo	string	O	0..1	The IPTV access control information used in IPTV access procedure, see clause 7.7.1.1.2 of 3GPP TS 23.316 [37].
NOTE 1: When present, this attribute shall take precedence over the "3gppChargingCharacteristics" attribute in the SessionManagementSubscriptionData level.				
NOTE 2: These attributes shall be consistent with the information received on the 5GVnGroupData (see clause 6.5.6.2.7), in the Nudm_PP API.				

6.1.6.2.10 Void

6.1.6.2.11 Type: PduSessionTypes

Table 6.1.6.2.11-1: Definition of type PduSessionTypes

Attribute name	Data type	P	Cardinality	Description
defaultSessionType	PduSessionType	M	1	Default session type
allowedSessionTypes	array(PduSessionType)	O	1..N	Additional session types allowed for the data network

6.1.6.2.12 Type: SscModes

Table 6.1.6.2.12-1: Definition of type SscModes

Attribute name	Data type	P	Cardinality	Description
defaultSscMode	SscMode	M	1	Default SSC mode
allowedSscModes	array(SscMode)	O	1..2	Additional SSC modes allowed for the data network

6.1.6.2.13 Type: SmsSubscriptionData

Table 6.1.6.2.13-1: Definition of type SmsSubscriptionData

Attribute name	Data type	P	Cardinality	Description
smsSubscribed	SmsSubscribed	C	0..1	Indicates whether the UE subscription allows SMS delivery over NAS. Shall not be absent unless the feature SharedData is supported and smsSubscribed is present within shared data.
sharedSmsSubsDataId	SharedDataId	C	0..1	Identifier of shared data. Shall be present if smsSubscribed is absent.

6.1.6.2.14 Type: SmsManagementSubscriptionData

Table 6.1.6.2.14-1: Definition of type SmsManagementSubscriptionData

Attribute name	Data type	P	Cardinality	Description	Applicability
supportedFeatures	SupportedFeatures	O	0..1	See clause 6.1.8	
mtSmsSubscribed	boolean	C	0..1	Indicates the SMS teleservice subscription for MT-SMS. Shall not be absent unless the feature SharedData is supported and mtSmsSubscribed is present within shared data.	
mtSmsBarringAll	boolean	C	0..1	Barring of all MT-SMS	
mtSmsBarringRoaming	boolean	C	0..1	Barring of MT-SMS when roaming outside the Home Public Land Mobile Network (PLMN) country	
moSmsSubscribed	boolean	C	0..1	Indicates the SMS teleservice subscription for MO-SMS. Shall not be absent unless the feature SharedData is supported and mtSmsSubscribed is present within shared data.	
moSmsBarringAll	boolean	C	0..1	Barring of all MO-SMS	
moSmsBarringRoaming	boolean	C	0..1	Barring of MO-SMS when roaming outside the Home Public Land Mobile Network (PLMN) country	
traceData	TraceData	O	0..1	Trace requirements about the UE, only sent to SMSF in HPLMN	
sharedSmsMngDataIds	array(SharedDataId)	C	1..N	Identifier of shared data. Shall be present if mtSmsSubscribed and/or moSmsSubscribed and/or traceData are absent.	SharedData

6.1.6.2.15 Type: SubscriptionDataSets

Table 6.1.6.2.15-1: Definition of type SubscriptionDataSets

Attribute name	Data type	P	Cardinality	Description
amData	AccessAndMobilitySubscriptionData	O	0..1	Access and Mobility Subscription Data
smfSelData	SmfSelectionSubscriptionData	O	0..1	SMF Selection Subscription Data
uecAmfData	UeContextInAmfData	O	0..1	UE Context In AMF Data
uecSmfData	UeContextInSmfData	O	0..1	UE Context In SMF Data
uecSmsfData	UeContextInSmsfData	O	0..1	UE Context In SMSF Data
smsSubsData	SmsSubscriptionData	O	0..1	SMS Subscription Data
smData	array(SessionManagementSubscriptionData)	O	1..N	Session Management Subscription Data
traceData	TraceData	O	0..1	Trace Data. The Null value indicates that trace is not active.
smsMngData	SmsManagementSubscriptionData	O	0..1	SMS Management Subscription Data
lcsPrivacyData	LcsPrivacyData	O	0..1	LCS Privacy Subscription Data
lcsMoData	LcsMoData	O	0..1	LCS Mobile Originated Subscription Data
v2xData	V2xSubscriptionData	O	0..1	V2x Subscription Data
lcsBroadcastAssistanceTypesData	LcsBroadcastAssistanceTypesData	O	0..1	LCS List of Broadcast Assistance Data Types Subscription Data

6.1.6.2.16 Type: UeContextInSmfData

Table 6.1.6.2.16-1: Definition of type UeContextInSmfData

Attribute name	Data type	P	Cardinality	Description
pduSessions	map(PduSession)	O	0..N	A map (list of key-value pairs where pduSessionId converted from integer to string serves as key; see clause 6.1.6.1) of PduSessions.
pgwInfo	array(PgwInfo)	O	1..N	Information about the DNNs/APNs and PGW-C+SMF FQDNs used in interworking with EPS
emergencyInfo	EmergencyInfo	O	0..1	Information about emergency session

6.1.6.2.17 Type: PduSession

Table 6.1.6.2.17-1: Definition of type PduSession

Attribute name	Data type	P	Cardinality	Description
dnn	Dnn	M	1	Data Network Name with Network Identifier only.
smfInstancelid	NfInstancelid	M	1	NF Instance Id of the SMF
plmnid	Plmnid	M	1	PLMN Id of the SMF
singleNssai	Snsai	O	0..1	A single Network Slice Selection Assistance Information. (NOTE)
NOTE: For supporting selection of the same SMF if a UE requests multiple PDU sessions associated with the same DNN and same S-NSSAI, the S-NSSAI associated to the PDU session is required to be included.				

6.1.6.2.18 Type: IdTranslationResult

Table 6.1.6.2.18-1: Definition of type IdTranslationResult

Attribute name	Data type	P	Cardinality	Description
supportedFeatures	SupportedFeatures	O	0..1	See clause 6.1.8
supi	Supi	M	1	SUPI
gpsi	Gpsi	C	0..1	If ueld is a SUPI in Resource URI variables, this shall be present and indicates an MSISDN or external identifier.

6.1.6.2.19 Void

6.1.6.2.20 Void

6.1.6.2.21 Type: ModificationNotification

Table 6.1.6.2.21-1: Definition of type ModificationNotification

Attribute name	Data type	P	Cardinality	Description
notifyItems	array(NotifyItem)	M	1..N	

6.1.6.2.22 Type: IpAddress

Table 6.1.6.2.22-1: Definition of type IpAddress

Attribute name	Data type	P	Cardinality	Description
ipv4Addr	Ipv4Addr	C	0..1	
ipv6Addr	Ipv6Addr	C	0..1	
ipv6Prefix	Ipv6Prefix	C	0..1	
NOTE: Either ipv4Addr, or ipv6Addr, or ipv6Prefix shall be present.				

6.1.6.2.23 Type: UeContextInSmsfData

Table 6.1.6.2.23-1: Definition of type UeContextInSmsfData

Attribute name	Data type	P	Cardinality	Description
smsfInfo3GppAccess	SmsfInfo	O	0..1	SMSF Info for 3GPP Access
smsfInfoNon3GppAccess	SmsfInfo	O	0..1	SMSF Info for Non 3GPP Access

6.1.6.2.24 Type: SmsfInfo

Table 6.1.6.2.24-1: Definition of type SmsfInfo

Attribute name	Data type	P	Cardinality	Description
smsfInstancelid	NfInstancelid	M	1	NF Instance Id of the SMSF
plmnid	Plmnid	M	1	PLMN Id of the SMSF

6.1.6.2.25 Type: AcknowledgeInfo

Table 6.1.6.2.25: Definition of type AcknowledgeInfo

Attribute name	Data type	P	Cardinality	Description
sorMaclue	SorMac	C	0..1	Shall be present when the Acknowledgement is sent to acknowledge receipt of SorInfo.
upuMaclue	UpuMac	C	0..1	Shall be present when the Acknowledgement is sent to acknowledge receipt of UpuInfo.
provisioningTime	DateTime	M	1	the provisioning time is used to correlate the acknowledgement with the modification request, to address glare cases when multiple modifications are ongoing simultaneously.
ueNotReachable	boolean	O	0..1	Transmission of SorInfo / UE Parameter Update data to the UE was not successful due to the UE not being reachable. default: false may be present if sorMaclue and upuMaclue are absent.

6.1.6.2.26 Type: SorInfo

Table 6.1.6.2.26: Definition of type SorInfo

Attribute name	Data type	P	Cardinality	Description
ackInd	AckInd	M	1	Contains the indication on whether an acknowledgement from UE is to be requested to the UE.
sorMaclausf	SorMac	C	0..1	Contains the SoR-MAC-IAUSF. Shall be present when SorInfo is sent within AccessAndMobilitySubscriptionData on Nudm, and shall be absent when sent on Nudr or within PpData.
countersor	CounterSor	C	0..1	Contains the CounterSoR. Shall be present when SorInfo is sent within AccessAndMobilitySubscription on Nudm, and shall be absent when sent on Nudr or within PpData.
steeringContainer	SteeringContainer	C	0..1	When present, this information contains the information needed to update the "Operator Controlled PLMN Selector with Access Technology" list stored in the USIM either as an array of preferred PLMN/AccessTechnologies combinations in priority order (with the first entry in the array indicating the highest priority and the last entry indicating the lowest) or a secured packet. If no change of the "Operator Controlled PLMN Selector with Access Technology" list stored in the USIM is needed, then this attribute shall be absent. This attribute shall be present when SorInfo is sent within PpData.
provisioningTime	DateTime	M	1	Point in time of SorInfo provisioning at the UDR or SOR-AF.

6.1.6.2.27 Type: SharedData

Table 6.1.6.2.27-1: Definition of type SharedData

Attribute name	Data type	P	Cardinality	Description
sharedDataId	SharedDataId	M	1	Identifier of the shared data
sharedAmData	AccessAndMobilitySubscriptionData	O	0..1	Shared Access and Mobility Subscription Data
sharedSmsSubsData	SmsSubscriptionData	O	0..1	Shared SMS Subscription Data
sharedSmsMngSubsData	SmsManagementSubscriptionData	O	0..1	Shared SMS Management Subscription Data
sharedDnnConfigurations	map(DnnConfiguration)	O	1..N	Shared DNN configurations
sharedTraceData	TraceData	O	0..1	Shared Trace Data
sharedSnssaiInfos	map(SnssaiInfo)	O	1..N	Shared Snssai Infos
sharedVnGroupDats	map(VnGroupData)	O	1..N	A map of shared 5G VN group data (list of key-value pairs where GroupId serves as key; see clause 6.1.6.1).
Note 1:	Exactly one of sharedAmData, sharedSmsSubsData, sharedSmsMngSubsData, sharedDnnConfigurations, sharedTraceData and sharedSnssaiInfos shall be present.			
Note 2:	The attributes sharedAmData, sharedSmsSubsData and SharedSmsMngSubsData shall not contain sharedDataIds			
Note 3:	When shared data clash with individual data, individual data shall take precedence.			

6.1.6.2.28 Type: PgwInfo

Table 6.1.6.2.28-1: Definition of type PgwInfo

Attribute name	Data type	P	Cardinality	Description
dnn	Dnn	M	1	DNN/APN with Network Identifier only.
pgwFqdn	string	M	1	FQDN of the PGW-C+SMF
plmnId	PlmnId	O	0..1	PLMN where the PGW-C+SMF is located
epdgInd	boolean	O	0..1	If present, it indicates whether access is from ePDG or not. true: access is from ePDG. false or absent: access is not from ePDG

6.1.6.2.29 Type: TraceDataResponse

Table 6.1.6.2.29-1: Definition of type TraceDataResponse

Attribute name	Data type	P	Cardinality	Description	Applicability
traceData	TraceData	C	0..1	UE-individual trace data. Shall not be absent unless the feature SharedData is supported and traceData is present within shared data.	
sharedTraceDataId	SharedDataId	C	0..1	Shared data identifier. Shall be present if traceData is absent.	

6.1.6.2.30 Type: SteeringContainer

Table 6.1.6.2.30-1: Definition of type SteeringContainer as a list of mutually exclusive alternatives

Data type	Cardinality	Description
array(SteeringInfo)	1..N	List of PLMN/AccessTechnologies combinations.
SecuredPacket	1	A Secured packet containing one or more APDUs commands dedicated to Remote File Management or command responses (see ETSI TS 102.225 [28]).

6.1.6.2.31 Type: SdmSubsModification

Table 6.1.6.2.31-1: Definition of type SdmSubsModification

Attribute name	Data type	P	Cardinality	Description
expires	DateTime	O	0..1	If present, indicates the point in time at which the subscription expires. Within a PATCH request the proposed new expiry time is conveyed.
monitoredResourceUris	array(Uri)	O	1..N	If present, indicates the updated resources URIs to be monitored. The URI shall take the form of either an absolute URI or an absolute-path reference as defined in IETF RFC 3986 [31]. See NOTE.
NOTE: The UDM should handle only the relative-path part (apiSpecificResourceUriPart, see 3GPP TS 29.501 [5] clause 4.4.1) and ignore possible inconsistencies in the base URI part.				

6.1.6.2.32 Type: EmergencyInfo

Table 6.1.6.2.32-1: Definition of type EmergencyInfo

Attribute name	Data type	P	Cardinality	Description
pgwFqdn	string	C	0..1	FQDN of the PGW-C+SMF for emergency session; either pgwFqdn or ipAddress shall be present.
pgwIpAddress	IpAddress	C	0..1	IP address of the PGW-C+SMF for emergency session
smfInstanceid	NfInstanceid	O	0..1	NF Instance Id of the SMF for emergency session
epdgInd	boolean	O	0..1	If present, it indicates whether access is from ePDG or not. true: access is from ePDG. false or absent: access is not from ePDG.

6.1.6.2.33 Type: UpuInfo

Table 6.1.6.2.33-1: Definition of type UpuInfo

Attribute name	Data type	P	Cardinality	Description
upuDataList	array(UpuData)	M	1..N	This information defines the UE Parameters Update (UPU). A secured packet with the Routing indicator update data is included and/or the Default configured NSSAI update data are included on Nudm. An unsecured Routing indicator update data or secured packet with the Routing indicator update data, and/or the Default configured NSSAI update data are included on Nudr.
upuRegInd	UpuRegInd	M	1	Contains the indication of whether the re-registration is requested.
upuAckInd	UpuAckInd	M	1	Contains the indication of whether the acknowledgement from UE is needed.
upuMacIausf	UpuMac	C	0..1	Contains the UPU-MAC-IAUSF. Shall be present when UpuInfo is sent within AccessAndMobilitySubscriptionData on Nudm, and shall be absent when sent on Nudr.
counterUpu	CounterUpu	C	0..1	Contains the Counter _{UPU} . Shall be present when UpuInfo is sent within AccessAndMobilitySubscriptionData on Nudm, and shall be absent when sent on Nudr.
provisioningTime	DateTime	M	1	Point in time of provisioning of UPU by the UDR.

6.1.6.2.34 Type: GroupIdentifiers

Table 6.1.6.2.34-1: Definition of type GroupIdentifiers

Attribute name	Data type	P	Cardinality	Description
extGroupid	ExtGroupid	C	0..1	This IE shall contain the External Group ID associated to the provided Internal Group ID.
intGroupid	Groupid	C	0..1	This IE shall contain the Internal Group ID associated to the provided External Group ID..
ueldList	array(Ueld)	C	1..N	This IE shall contain a list of the UE identifiers that belong to the provided Internal/External Group ID if they are required.

6.1.6.2.35 Type: NiddInformation

Table 6.1.6.2.35-1: Definition of type NiddInformation

Attribute name	Data type	P	Cardinality	Description
afld	string	M	1	The string identifying the AF as the owner of associated NIDD Configuration on T8 interface, which is carried in {scsAsld} URI variable in NIDD API (see clause 5.6.3.2.2 of 3GPP TS 29.122 [45]).
gpsi	Gpsi	O	0..1	Generic Public Subscription Identifier
extGroupld	ExternalGroupld	O	0..1	Indicates External Group Identifier which the user belongs to.

6.1.6.2.36 Type: CagData

Table 6.1.6.2.36-1: Definition of type CagData

Attribute name	Data type	P	Cardinality	Description
cagInfos	map(CagInfo)	M	0..N	<p>A map (list of key-value pairs where Plmnlid converted to string serves as key; see 3GPP TS 29.571 [7]) of CagInfo</p> <p>An empty map indicates that for no PLMN CAG is subscribed and shall only be sent when provisioningTime is present (i.e. when acknowledgement from the UE is pending).</p> <p>If provisioningTime is present (i.e. the acknowledgement from the UE is still pending), the complete map of CagInfo (i.e. for all PLMNs) shall be present; otherwise only the CagInfo relevant to the Serving PLMN should be present.</p>
provisioningTime	DateTime	C	0..1	<p>This attribute shall be present if the CagData is sent to the AMF while reception has not yet been acknowledged from the UE; otherwise shall be absent. Presence of this attribute indicates that the AMF needs to update the UE with the complete map of CagInfo.</p> <p>This attribute serves as CAG information Subscription Change Indication</p>

6.1.6.2.37 Type: CagInfo

Table 6.1.6.2.37-1: Definition of type CagInfo

Attribute name	Data type	P	Cardinality	Description
allowedCagList	array(Cagld)	M	1..N	List of allowed CAG Ids.
cagOnlyIndicator	boolean	O	0..1	<p>true indicates that the UE is restricted to only access 5GS via CAG cells;</p> <p>absence and false indicate that the UE is not restricted to only access 5GS via CAG cells.</p>

6.1.6.2.38 Type: AdditionalSnssaiData

Table 6.1.6.2.38-1: Definition of type AdditionalSnssaiData

Attribute name	Data type	P	Cardinality	Description
requiredAuthnAuthz	boolean	O	0..1	Indicates whether an S-NSSAI is subject to Network Slice-Specific Authentication and Authorization: <ul style="list-style-type: none"> - true: subject to network slice-specific authentication and authorization - false, or absent: not subject to network slice-specific authentication and authorization

6.1.6.2.39 Type: VnGroupData

Table 6.1.6.2.39-1: Definition of type VnGroupData

Attribute name	Data type	P	Cardinality	Description
pduSessionTypes	PduSessionTypes	O	0..1	Allowed session types
dnn	Dnn	O	0..1	Data Network Name with Network Identifier only. (NOTE)
singleNssai	Snssai	O	0..1	Single Nssai
appDescriptors	array(AppDescriptor)	O	1..N	List of Application Descriptors
NOTE: Only a 1:1 mapping between DNN and 5G VN group is supported in this release				

6.1.6.2.40 Type: AppDescriptor

Table 6.1.6.2.40-1: Definition of type AppDescriptor

Attribute name	Data type	P	Cardinality	Description
osld	Osld	O	0..1	OS identifier, does not include an OS version number
appld	string	O	0..1	Application identifier, does not include a version number for the application

6.1.6.2.41 Type: AppPortId

Table 6.1.6.2.41-1: Definition of type AppPortId

Attribute name	Data type	P	Cardinality	Description
destinationPort	Uint16	O	1	Indicates the receiving port of application in the receiving device or AF.
originatorPort	Uint16	O	1	Indicates the sending port of application in sending device.

6.1.6.2.42 Type: LcsPrivacyData

Table 6.1.6.2.42-1: Definition of type LcsProfileData

Attribute name	Data type	P	Cardinality	Description
lpi	Lpi	O	0..1	If present, indicates the Location Privacy Indication (see 3GPP TS 23.273 [38] clause 5.4.2.3) If absent, indicates that location for UE is allowed.
unrelatedClass	UnrelatedClass	O	0..1	Indicates Call/Session unrelated Classes for the user (see 3GPP TS 23.273 [38] clause 5.4.2.2.3).
plmnOperatorClasses	array(PlmnOperatorClass)	O	1..N	Indicates PLMN Operator Class for the user (see 3GPP TS 23.273 [38] clause 5.4.2.2.4).

6.1.6.2.43 Type: Lpi

Table 6.1.6.2.43-1: Definition of type Lpi

Attribute name	Data type	P	Cardinality	Description
locationPrivacyInd	LocationPrivacyInd	M	1	Indication of one of the following mutually exclusive global settings: - Location is disallowed - Location is allowed
validTimePeriod	ValidTimePeriod	O	0..1	If present, indicate Time period during which the Location Privacy Indication is valid. If absent, indicates there is no time limitation.

6.1.6.2.44 Type: UnrelatedClass

Table 6.1.6.2.44-1: Definition of type UnrelatedClass

Attribute name	Data type	P	Cardinality	Description
defaultUnrelatedClass	DefaultUnrelatedClass	M	1	The default Call/Session unrelated Class subscription for unidentified value added LCS clients or AFs.
externalUnrelatedClass	ExternalUnrelatedClass	O	0..1	The Call/Session unrelated Class subscriptions for identified value added LCS Clients, AFs and value added LCS Client groups.
serviceTypeUnrelatedClasses	array(ServiceTypeUnrelatedClass)	O	1..X(NOTE 2)	The Call/Session unrelated Class subscriptions for identified service types for UE.(NOTE 1)
NOTE 1: It is possible that there are multiple serviceTypeUnrelatedClasses, whose maximum number is decided by total number of service type defined in 3GPP TS 22.071 [47],				
NOTE 2: X indicates the total number of service type defined in 3GPP TS 22.071 [47].				

6.1.6.2.45 Type: PlmnOperatorClass

Table 6.1.6.2.45-1: Definition of type PlmnOperatorClass

Attribute name	Data type	P	Cardinality	Description
lcsClientClass	LcsClientClass	M	1	Indicated the PLMN operator class of LCS client that are allowed to locate the particular UE (see 3GPP TS 23.273 [38] clause 5.4.2.2.4).
lcsClientIds	array(LcsClientId)	M	1..N	List of LCS clients for the corresponding LCS Client Class

6.1.6.2.46 Type: ValidTimePeriod

Table 6.1.6.2.46-1: Definition of type ValidTimePeriod

Attribute name	Data type	P	Cardinality	Description
startTime	DateTime	O	0..1	If present, indicates the start time If absent, indicates there is no start time, and it shall be valid immediately. (NOTE 1)
endTime	DateTime	O	0..1	If present, indicates the end time. If absent, indicates there is no end time. (NOTE 1)
NOTE 1: The end time shall be later than start time.				

6.1.6.2.47 Type: LcsMoData

Table 6.1.6.2.47-1: Definition of type LcsMoData

Attribute name	Data type	P	Cardinality	Description
allowedServiceClasses	array(LcsMoServiceClasses)	M	1..N	List of MO-LR services allowed for a UE subscriber

6.1.6.2.48 Type: EcRestrictionDataWb

Table 6.1.6.2.48-1: Definition of type EcRestrictionData

Attribute name	Data type	P	Cardinality	Description
ecModeARestricted	boolean	O	0..1	If present, indicates whether Enhanced Coverage Mode A is restricted or not. true: Enhanced Coverage Mode A is restricted. false or absent: Enhanced Coverage Mode A is not restricted.
ecModeBRestricted	boolean	O	0..1	If present, indicates whether Enhanced Coverage Mode B is restricted or not. true: Enhanced Coverage Mode B is restricted. false or absent: Enhanced Coverage Mode B is not restricted.
NOTE: At least one of the attributes ecModeARestricted and ecModeBRestricted shall be contained, and If the value of attribute ecModeARestricted is set to true, the value of attribute ecModeBRestricted shall be set to true.				

6.1.6.2.49 Type: ExpectedUeBehaviourData

Table 6.1.6.2.49-1: Definition of type ExpectedUeBehaviourData

Attribute name	Data type	P	Cardinality	Description
stationaryIndication	StationaryIndication	O	0..1	Identifies whether the UE is stationary or mobile (see TS 23.502 [3] clause 4.15.6.3).
communicationDurationTime	DurationSec	O	0..1	Indicates for how long the UE will normally stay in CM-Connected for data transmission (see TS 23.502 [3] clause 4.15.6.3).
periodicTime	DurationSec	O	0..1	Identifies interval time of periodic communication (see TS 23.502 [3] clause 4.15.6.3).
scheduledCommunicationTime	ScheduledCommunicationTime	O	0..1	Identifies time and day of the week when the UE is available for communication (see TS 23.502 [3] clause 4.15.6.3).
scheduledCommunicationType	ScheduledCommunicationType	O	0..1	Indicates that the Scheduled Communication Type (see TS 23.502 [3] clause 4.15.6.3). (Note 5)
expectedUmts	array(LocationArea)	O	1..N	Identifies the UE's expected geographical movement. The attribute is only applicable in 5G (see TS 23.502 [3] clause 4.15.6.3). (NOTE 3, NOTE 4)
trafficProfile	TrafficProfile	O	0..1	Identifies the type of data transmission: single packet transmission (UL or DL), dual packet transmission (UL with subsequent DL or DL with subsequent UL), multiple packets transmission
batteryIndication	BatteryIndication	O	0..1	Indicates the power consumption type(s) of the UE (see TS 23.502 [3] clause 4.15.6.3).
validityTime	DateTime	O	0..1	If present, identifies when the expected UE behaviour parameters expire and shall be deleted locally if it expire (see TS 23.502 [3] clause 4.15.6.3). (NOTE 2)
NOTE 1: At least one of optional parameters (except for validityTime) above shall be present.				
NOTE 2: If this attribute is omitted, no expiry for the expected UE behaviour parameters applies.				
NOTE 3: The first instance of the attribute represents the start of the location, and the last one represents the stop of the location.				
NOTE 4: The parameter expectedUmts is only used by AMF.				
NOTE 5: The value of attribute "scheduledCommunicationType" shall be used together with the value of "scheduledCommunicationTime".				

6.1.6.2.50 Void

6.1.6.2.51 Void

6.1.6.2.52 Type: SuggestedPacketNumDI

Table 6.1.6.2.52-1: Definition of type SuggestedPacketNumDI

Attribute name	Data type	P	Cardinality	Description
suggestedPacketNumDI	integer	M	1	Value in number of packets.
validityTime	DateTime	O	0..1	If present, identifies the time to which the Network Configuration Parameters expire and shall be deleted locally if it expire (see TS 23.502 [3] clause 4.15.6.3a). (NOTE 1)
NOTE 1: If this attribute is omitted, no expiry for the expected UE behaviour parameters applies.				

6.1.6.2.53 Void

6.1.6.2.54 Type: FrameRouteInfo

Table 6.1.6.2.54-1: Definition of type FrameRouteInfo

Attribute name	Data type	P	Cardinality	Description
ipv4Mask	IPv4AddrMask	C	0..1	Indicates IPv4 address mask.
ipv6Prefix	Ipv6Prefix	C	0..1	Indicates IPv6 prefix.
NOTE: Either ipv4Mask or ipv6Prefix shall be present.				

6.1.6.2.55 Type: SorUpdateInfo

Table 6.1.6.2.55-1: SorUpdateInfo

Attribute name	Data type	P	Cardinality	Description
vplmnId	PlmnId	M	1	Serving node PLMN identity.

6.1.6.2.56 Type: EnhancedCoverageRestrictionData

Table 6.1.6.2.56-1: Definition of type EnhancedCoverageRestrictionData

Attribute name	Data type	P	Cardinality	Description
plmnEclInfoList	array(PlmnEclInfo)	O	1..N	It may indicate a complete list of serving PLMNs where Enhanced Coverage Restriction shall be allowed and the detailed enhanced coverage restriction configuration under per the PLMN.

6.1.6.2.57 Type: EdrxParameters

Table 6.1.6.2.57-1: EdrxParameters

Attribute name	Data type	P	Cardinality	Description
ratType	RatType	M	1	This IE shall indicate the RAT type which eDRX value are applicable to. Only the following values are allowed: "EUTRA" "NB-IOT" "LTE-M"
edrxValue	string	M	1	This IE shall indicate eDRX Cycle length value, it shall be encoded as a string of bits 4 to 1 of octet 3 in the "Extended DRX parameter" IE (see Figure 10.5.5.32 of 3GPP TS 24.008 [46]). Pattern: '^([0-1]{4})\$'
NOTE: The relationship between values of ratType and edrxValue shall be in line with clause 10.5.5.32 of 3GPP TS 24.008 [46].				

6.1.6.2.58 Type: PtwParameters

Table 6.1.6.2.58-1: PtwParameters

Attribute name	Data type	P	Cardinality	Description
operationMode	OperationMode	M	1	This IE shall indicate the Operation Mode which PTW value are applicable to.
ptwValue	string	M	1	This IE shall indicate RAT specific Subscribed Paging Time Window length value, it shall be encoded as a string of bits 8 to 5 of octet 3 in the "Extended DRX parameter" IE (see Figure 10.5.5.32 of 3GPP TS 24.008 [46]). Pattern: '^([0-1]{4})\$'
NOTE: The relationship between values of operationMode and ptwValue shall be in line with clause 10.5.5.32 of 3GPP TS 24.008 [46].				

6.1.6.2.59 Void

6.1.6.2.60 Void

6.1.6.2.61 Type: Void

6.1.6.2.62 Type: ExternalUnrelatedClass

Table 6.1.6.2.62-1: Definition of type ExternalUnrelatedClass

Attribute name	Data type	P	Cardinality	Description
lcsClientExternals	array(LcsClientExternal)	O	1..N	The list of Call/session Unrelated Class identified by LCS client in the external LCS client list for the list
afExternals	array(AfExternal)	O	1..N	The list of Call/session Unrelated Class identified by AF in the external LCS client list
lcsClientGroupExternals	array(LcsClientGroupExternal)	O	1..N	The list of Call/session Unrelated Class identified by LCS client group in the external LCS client list

6.1.6.2.63 Type: AfExternal

Table 6.1.6.2.63-1: Definition of type AfExternal

Attribute name	Data type	P	Cardinality	Description
afId	AfId	O	0..1	AF Identifier (see 3GPP TS 23.273 [38] clause 5.4.2.2.3)
allowedGeographicArea	array(GeographicArea)	O	1..N	Indicates Geographical area where positioning is allowed (see 3GPP TS 23.273 [38] clause 5.4.2.2.3).
privacyCheckRelatedAction	PrivacyCheckRelatedAction	O	0..1	Indicates action related to privacy check. (NOTE)
validTimePeriod	ValidTimePeriod	O	0..1	Time period when positioning is allowed
NOTE: "LOCATION_ALLOWED_WITHOUT_NOTIFICATION" is default value and "LOCATION_NOT_ALLOWED" is not optional for the attribute.				

6.1.6.2.64 Type: LcsClientExternal

Table 6.1.6.2.64-1: Definition of type LcsClientExternal

Attribute name	Data type	P	Cardinality	Description
lcsClientId	LcsClientId	O	0..1	Lcs Client Identifier (see 3GPP TS 23.273 [38] clause 5.4.2.2.3)
allowedGeographicArea	array(GeographicArea)	O	1..N	Indicates Geographical area where positioning is allowed (see 3GPP TS 23.273 [38] clause 5.4.2.2.3).
privacyCheckRelatedAction	PrivacyCheckRelatedAction	O	0..1	Indicates action related to privacy check. (NOTE)
validTimePeriod	ValidTimePeriod	O	0..1	Time period when positioning is allowed
NOTE: "LOCATION_ALLOWED_WITHOUT_NOTIFICATION" is default value and "LOCATION_NOT_ALLOWED" is not optional for the attribute.				

6.1.6.2.65 Type: LcsClientGroupExternal

Table 6.1.6.2.65-1: Definition of type LcsClientGroupExternal

Attribute name	Data type	P	Cardinality	Description
lcsClientGroupId	ExtGroupId	O	0..1	LCS Client Group Identifier
allowedGeographicArea	array(GeographicArea)	O	1..N	Indicates Geographical area where positioning is allowed (see 3GPP TS 23.273 [38] clause 5.4.2.2.3).
privacyCheckRelatedAction	PrivacyCheckRelatedAction	O	0..1	Indicates action related to privacy check. (NOTE)
validTimePeriod	ValidTimePeriod	O	0..1	Time period when positioning is allowed
NOTE: "LOCATION_ALLOWED_WITHOUT_NOTIFICATION" is default value and "LOCATION_NOT_ALLOWED" is not optional for the attribute.				

6.1.6.2.66 Type: ServiceTypeUnrelatedClass

Table 6.1.6.2.66-1: Definition of type ServiceTypeUnrelatedClass

Attribute name	Data type	P	Cardinality	Description
serviceType	LcsServiceType	M	1	One of the service type defined in 3GPP TS 22.071 [47].
allowedGeographicArea	array(GeographicArea)	O	1..N	Indicates Geographical area where positioning is allowed (see 3GPP TS 23.273 [38] clause 5.4.2.2.3).
privacyCheckRelatedAction	PrivacyCheckRelatedAction	O	0..1	Indicates action related to privacy check. (NOTE)
codeWordInd	CodeWordInd	O	0..1	Indication that codeword shall be checked in UE or one or more codeword values to be checked in GMLC
validTimePeriod	ValidTimePeriod	O	0..1	Time period when positioning is allowed
codeWordList	array(CodeWord)	C	1..N	This IE shall be present when codeWordInd is "CODEWORD_CHECK_IN_GMLC". When present, this IE shall contain one or more CodeWords used by GMLC for verification.
NOTE: "LOCATION_ALLOWED_WITHOUT_NOTIFICATION" is default value and "LOCATION_NOT_ALLOWED" is not optional for the attribute.				

6.1.6.2.67 Type: Ueld

Table 6.1.6.2.67-1: Definition of type Ueld

Attribute name	Data type	P	Cardinality	Description
supi	Supi	M	1	This IE shall indicate the SUPI.
gpsiList	array(gpsi)	O	1..N	This IE shall indicate a list of GPSIs that is associated with the SUPI.

6.1.6.2.68 Type: DefaultUnrelatedClass

Table 6.1.6.2.68-1: Definition of type DefaultUnrelatedClass

Attribute name	Data type	P	Cardinality	Description
allowedGeographicArea	array(GeographicArea)	O	1..N	Indicates Geographical area where positioning is allowed (see 3GPP TS 23.273 [38] clause 5.4.2.2.3).
privacyCheckRelatedAction	PrivacyCheckRelatedAction	O	0..1	Indicates action related to privacy check. (NOTE)
codeWordInd	CodeWordInd	O	0..1	Indication that codeword shall be checked in UE or one or more codeword values to be checked in GMLC
validTimePeriod	ValidTimePeriod	O	0..1	Time period when positioning is allowed
codeWordList	array(CodeWord)	C	1..N	This IE shall be present when codeWordInd is present with value "CODEWORD_CHECK_IN_GMLC". When present, this IE shall contain one or more CodeWords used by GMLC for verification.
NOTE: "LOCATION_NOT_ALLOWED" is default value and only values "LOCATION_NOT_ALLOWED", "LOCATION_ALLOWED_WITHOUT_NOTIFICATION", "LOCATION_ALLOWED_WITHOUT_RESPONSE", "LOCATION_RESTRICTED_WITHOUT_RESPONSE" can be contained.				

6.1.6.2.69 Type: ContextInfo

Table 6.1.6.2.69-1: Definition of type ContextInfo

Attribute name	Data type	P	Cardinality	Description
origHeaders	array(string)	O	1..N	Headers received by the UDM from NFs consuming Nudm services. The encoding of the header shall comply with clause 3.2 of IETF RFC 7230 [50]

6.1.6.2.70 Type: UeContextInAmfData

Table 6.1.6.2.70-1: Definition of type UeContextInAmfData

Attribute name	Data type	P	Cardinality	Description
epsInterworkingInfo	EpsInterworkingInfo	O	0..1	This IE contains the associations between APN/DNN and PGW-C+SMF selected by the AMF for EPS interworking.

6.1.6.2.71 Type: V2xSubscriptionData

Table 6.1.6.2.71-1: Definition of type V2xSubscriptionData

Attribute name	Data type	P	Cardinality	Description
nrV2xServicesAuth	NrV2xAuth	O	0..1	Indicates whether the UE is authorized to use the NR sidelink for V2X services.
lteV2xServicesAuth	LteV2xAuth	O	0..1	Indicates whether the UE is authorized to use the LTE sidelink for V2X services.
nrUePc5Ambr	BitRate	O	0..1	Indicates UE-PC5-AMBR for V2X communication over PC5 reference point for NR PC5.
ltePc5Ambr	BitRate	O	0..1	Indicates UE-PC5-AMBR for V2X communication over PC5 reference point for LTE PC5.

6.1.6.2.72 Type: LcsBroadcastAssistanceTypesData

Table 6.1.6.2.72-1: Definition of type LcsBroadcastAssistanceTypesData

Attribute name	Data type	P	Cardinality	Description
----------------	-----------	---	-------------	-------------

locationAssistanceType	Bytes	M	1	<p>This IE contains a bitmap, encoded as a base64 string, which indicates the broadcast location assistance data types for which the UE is subscribed to receive ciphering keys used to decipher broadcast assistance data. A bit set to 1 indicates that the UE is subscribed to receive ciphering keys applicable to corresponding positioning SIB type.</p> <p>The bits are ordered as following in the bitmap:</p> <ul style="list-style-type: none"> - first octet is the right-most octet. E.g. in "0x0123", "first octet" would be "0x23" and "second octet" would be "0x01" - bit 1 is the right-most bit and bit 8 is the left-most bit in the octet. E.g. for octet "0x01", "bit 1" would be "1", and "bit 2" to "bit 8" would be "0" <p>The mapping of the bits to the positioning SIB types is as follows:</p> <ul style="list-style-type: none"> -- bit 8 in the first octet maps to positioning SIB Type 1-1 -- bit 7 in the first octet maps to positioning SIB Type 1-2 -- bit 6 in the first octet maps to positioning SIB Type 1-3 -- bit 5 in the first octet maps to positioning SIB Type 1-4 -- bit 4 in the first octet maps to positioning SIB Type 1-5 -- bit 3 in the first octet maps to positioning SIB Type 1-6 -- bit 2 in the first octet maps to positioning SIB Type 1-7 -- bit 1 in the first octet maps to positioning SIB Type 1-8 -- bit 8 in the second octet maps to positioning SIB Type 2-1 -- bit 7 in the second octet maps to positioning SIB Type 2-2 -- bit 6 in the second octet maps to positioning SIB Type 2-3 -- bit 5 in the second octet maps to positioning SIB Type 2-4 -- bit 4 in the second octet maps to positioning SIB Type 2-5 -- bit 3 in the second octet maps to positioning SIB Type 2-6 -- bit 2 in the second octet maps to positioning SIB Type 2-7 -- bit 1 in the second octet maps to positioning SIB Type 2-8 -- bit 8 in the third octet maps to positioning SIB Type 2-9 -- bit 7 in the third octet maps to positioning SIB Type 2-10 -- bit 6 in the third octet maps to positioning SIB Type 2-11 -- bit 5 in the third octet maps to positioning SIB Type 2-12 -- bit 4 in the third octet maps to positioning SIB Type 2-13 -- bit 3 in the third octet maps to positioning SIB Type 2-14 -- bit 2 in the third octet maps to positioning SIB Type 2-15
------------------------	-------	---	---	---

				-- bit 1 in the third octet maps to positioning SIB Type 2-16 -- bit 8 in the fourth octet maps to positioning SIB Type 2-17 -- bit 7 in the fourth octet maps to positioning SIB Type 2-18 -- bit 6 in the fourth octet maps to positioning SIB Type 2-19 -- bit 5 in the fourth octet maps to positioning SIB Type 2-20 -- bit 4 in the fourth octet maps to positioning SIB Type 2-21 -- bit 3 in the fourth octet maps to positioning SIB Type 2-22 -- bit 2 in the fourth octet maps to positioning SIB Type 2-23 -- bit 1 in the fourth octet maps to positioning SIB Type 2-24 -- bit 7 in the fifth octet maps to positioning SIB Type 2-25 -- bit 6 in the fifth octet maps to positioning SIB Type 3-1 -- bit 5 in the fifth octet maps to positioning SIB Type 4-1 -- bit 4 in the fifth octet maps to positioning SIB Type 5-1 -- bit 3 in the fifth octet maps to positioning SIB Type 6-1 -- bit 2 in the fifth octet maps to positioning SIB Type 6-2 -- bit 1 in the fifth octet maps to positioning SIB Type 6-3 Any unassigned bits are spare and shall be coded as zero. Non-included bits shall be treated as being coded as zero.
--	--	--	--	--

6.1.6.2.73 Type: DatasetNames

Table 6.1.6.2.73-1: Definition of type DatasetNames

Data type	Cardinality	Description
array(DataSetName)	2..N	List of names of the data sets

6.1.6.3 Simple data types and enumerations

6.1.6.3.1 Introduction

This clause defines simple data types and enumerations that can be referenced from data structures defined in the previous clauses.

6.1.6.3.2 Simple data types

The simple data types defined in table 6.1.6.3.2-1 shall be supported.

Table 6.1.6.3.2-1: Simple data types

Type Name	Type Definition	Description
DefaultDnnIndicator	boolean	Indicates whether a DNN is the default DNN
LboRoamingAllowed	boolean	This flag indicates whether local breakout is allowed when roaming.
UeUsageType	integer	Indicates the usage characteristics of the UE, enables the selection of a specific Dedicated Core Network for EPS interworking
MpsPriorityIndicator	boolean	Indicates whether UE is subscribed to multimedia priority service
McsPriorityIndicator	boolean	Indicates whether UE is subscribed to mission critical service
3GppChargingCharacteristics	string	16-bit string identifying charging characteristics as specified in 3GPP TS 32.255 [11] Annex A and 3GPP TS 32.298 [12] clause 5.1.2.2.7, in hexadecimal representation. Each character in the string shall take a value of "0" to "9" or "A" to "F" and shall represent 4 bits. The most significant character representing the 4 most significant bits of the charging characteristics shall appear first in the string, and the character representing the 4 least significant bits of the charging characteristics shall appear last in the string. Example: The charging characteristic 0x123A shall be encoded as "123A".
MicoAllowed	boolean	Indicates whether MICO mode is allowed for the UE.
SmsSubscribed	boolean	Indicates whether the UE subscription allows SMS delivery over NAS.
SharedDataId	string	Identifies globally and uniquely a piece of subscription data shared by multiple UEs. The value shall start with the HPLMN id (MCC/MNC) followed by a hyphen followed by a local Id as allocated by the home network operator. pattern: " <code>^[0-9]{5,6}-+\$</code> "
lwkEpsInd	boolean	Indicates whether Interworking with EPS is supported
SecuredPacket	string	Indicates the secured packet as specified in 3GPP TS 24.501 [27]. It is encoded using base64 and represented as a String. Format: byte
UpuRegInd	boolean	true indicates that re-registration is requested after the successful UE parameters update.
ExtGroupId	string	String containing a External Group ID. Pattern: " <code>^extgroupid-[^@]+@[^@]+\$</code> "
NbIoTUEPriority	integer	Unsigned integer indicating the NB-IoT UE Priority (see clause 5.31.17 of 3GPP TS 23.501 [8]), the value is between 0 and 255 and lower value indicates higher priority.
CodeWord	string	Indicates the codeword as specified in 3GPP TS 23.273 [38] clause 5.4.2.2.3.
AfId	string	AF Identifier (see 3GPP TS 23.273 [38] clause 5.4.2.2.3)
LcsClientId	string	Lcs Client Identifier (see 3GPP TS 23.273 [38] clause 5.4.2.2.3)

6.1.6.3.3 Enumeration: DataSetName

Table 6.1.6.3.3-1: Enumeration DataSetName

Enumeration value	Description
"AM"	Access and Mobility Subscription Data
"SMF_SEL"	SMF Selection Subscription Data
"UEC_SMF"	UE Context in SMF Data
"UEC_SMSF"	UE Context in SMSF Data
"SMS_SUB"	SMS Subscription Data
"SM"	Session Management Subscription Data
"TRACE"	Trace Data
"SMS_MNG"	SMS Management Subscription Data
"LCS_PRIVACY"	LCS Privacy Subscription Data
"LCS_MO"	LCS Mobile Originated Subscription Data
"UEC_AMF"	UE Context in AMF Data
"V2X"	V2X Subscription Data
"LCS_BCA"	LCS Broadcast Assistance Subscription Data

Note: The current naming conventions for Enumerations (uppercase with underscore), when their intended usage is for query parameters is not consistent with the naming conventions for URI components (lowercase with hyphen).

6.1.6.3.4 Void

6.1.6.3.5 Void

6.1.6.3.6 Void

6.1.6.3.7 Enumeration: PduSessionContinuityInd

Table 6.1.6.3.7-1: Enumeration PduScContinuity

Enumeration value	Description
"MAINTAIN_PDUSESSION"	Maintain the PDU session
"RECONNECT_PDUSESSION"	Disconnect the PDU session with a reactivation request
"RELEASE_PDUSESSION"	Disconnect PDU session without reactivation request

6.1.6.3.8 Enumeration: LocationPrivacyInd

Table 6.1.6.3.8-1: Enumeration LocationPrivacyInd

Enumeration value	Description
"LOCATION_DISALLOWED"	Location for UE is disallowed
"LOCATION_ALLOWED"	Location for UE are allowed

6.1.6.3.9 Enumeration: PrivacyCheckRelatedAction

Table 6.1.6.3.9-1: Enumeration PrivacyCheckRelatedAction

Enumeration value	Description
"LOCATION_NOT_ALLOWED"	Location not allowed
"LOCATION_ALLOWED_WITH_NOTIFICATION"	Location allowed with notification
"LOCATION_ALLOWED_WITHOUT_NOTIFICATION"	Location allowed without notification
"LOCATION_ALLOWED_WITHOUT_RESPONSE"	Location with notification and privacy verification; location allowed if no response
"LOCATION_RESTRICTED_WITHOUT_RESPONSE"	Location with notification and privacy verification; location restricted if no response

6.1.6.3.10 Enumeration: LcsClientClass

Table 6.1.6.3.10-1: Enumeration LcsClientClass

Enumeration value	Description
"BROADCAST_SERVICE"	LCS client broadcasting location related information
"OM_IN_HPLMN"	O&M LCS client in the HPLMN
"OM_IN_VPLMN"	O&M LCS client in the VPLMN
"ANONYMOUS_LOCATION_SERVICE"	LCS client recording anonymous location information
"SPECIFIC_SERVICE"	LCS Client supporting a bearer service, teleservice or supplementary service to the target UE

6.1.6.3.11 Enumeration: LcsMoServiceClass

Table 6.1.6.3.11-1: Enumeration LcsMoServiceClass

Enumeration value	Description
"BASIC_SELF_LOCATION"	UE requests own location
"AUTONOMOUS_SELF_LOCATION"	UE requests location assistance data
"TRANSFER_TO_THIRD_PARTY"	UE requests transfer of own location to another LCS Client

6.1.6.3.12 Enumeration: OperationMode

Table 6.1.6.3.12-1: Enumeration OperationMode

Enumeration value	Description
"WB_S1"	WB-S1 mode
"NB_S1"	NB-S1 mode
"WB_N1"	WB-N1 mode
"NB_N1"	NB-N1 mode

6.1.6.3.13 Enumeration: SorUpdateIndicator

Table 6.1.6.3.13-1: Enumeration SorUpdateIndicator

Enumeration value	Description
"INITIAL_REGISTRATION"	NAS registration type "Initial Registration"
"EMERGENCY_REGISTRATION"	NAS registration type "Emergency Registration"

6.1.6.3.14 Enumeration: CodeWordInd

Table 6.1.6.3.14-1: Enumeration CodeWordInd

Enumeration value	Description
"CODEWORD_CHECK_IN_UE"	codeword shall be checked in UE
"CODEWORD_CHECK_IN_GMLC"	one or more codeword values to be checked in GMLC

6.1.6.3.15 Enumeration: MdtUserConsent

Table 6.1.6.3.15-1: Enumeration MdtUserConsent

Enumeration value	Description
"CONSENT_GIVEN"	It shall indicate the user has given his consent for MDT activation.
"CONSENT_NOT_GIVEN"	It shall indicate the user hasn't given his consent for MDT activation.

6.1.7 Error Handling

6.1.7.1 General

HTTP error handling shall be supported as specified in clause 5.2.4 of 3GPP TS 29.500 [4].

6.1.7.2 Protocol Errors

Protocol errors handling shall be supported as specified in clause 5.2.7 of 3GPP TS 29.500 [4].

6.1.7.3 Application Errors

The common application errors defined in the Table 5.2.7.2-1 in 3GPP TS 29.500 [4] may also be used for the Nudm_SubscriberDataManagement service. The following application errors listed in Table 6.1.7.3-1 are specific for the Nudm_SubscriberDataManagement service.

Table 6.1.7.3-1: Application errors

Application Error	HTTP status code	Description
NF_CONSUMER_REDIRECT_ONE_TXN	307 Temporary Redirect	The request has been asked to be redirected to a specified target for one transaction.
CONTEXT_NOT_FOUND	308 Permanent Redirect	The request has been asked to be redirected to a specified target.
DATA_NOT_FOUND	404 Not Found	The requested UE subscription data is not found/does not exist. This error is applicable to all Nudm_SDM GET operations.
USER_NOT_FOUND	404 Not Found	The user does not exist This error is applicable to all Nudm_SDM GET operations.
CONTEXT_NOT_FOUND	404 Not Found	It is used during the modification of an existing subscription when no corresponding context exists.
GROUP_IDENTIFIER_NOT_FOUND	404 Not Found	The requested Group Identifier does not exist.
SUBSCRIPTION_NOT_FOUND	404 Not Found	The subscription does not exist.
UNSUPPORTED_RESOURCE_URI	501 Not Implemented	The SDM Subscription contains unsupported resource URI to be monitored.

6.1.8 Feature Negotiation

The optional features in table 6.1.8-1 are defined for the Nudm_SDM API. They shall be negotiated using the extensibility mechanism defined in clause 6.6 of 3GPP TS 29.500 [4].

Table 6.1.8-1: Supported Features

Feature number	Feature Name	Description
1	SharedData	When receiving a Nudm_SDM_Get service operation request to retrieve a UE's individual subscription data, and the request does not contain a supported-features query parameter indicating support of this feature, the UDM shall not include Shared Data Ids in the response. Instead the UDM may – based on operator policy – take no further action (i.e. allow the UE to get services based on only the UE's individual subscription data), or send the shared data as individual data (this may result in notifications of individual subscription data change – if so subscribed – when shared data, which are sent as individual data, are modified, and/or when the UE's Shared Data IDs are modified).
2	ImmediateReport	When a NF consumer detects the UDM support ImmediateReport feature, it can indicate an immediateReport flag when invoking Nudm_SDM_Subscribe service operation. If UDM supports ImmediateReport received Nudm_SDM_Subscribe service operation request, it shall return the resource representation(s) of the monitored resource(s) in the service operation response body.
3	PatchReport	If some of the modifications included in the PATCH request are not successfully implemented, the UDM reports the result of PATCH request execution to the consumer. See clause 5.2.7.2 of 3GPP TS 29.500 [4].
4	Nssaa	If the NF consumer does not support this feature, the UDM shall not include information of S-NSSAI(s) subject to Network Slice-Specific Authentication and Authorization in Get response messages, immediate reports within Subscribe response messages, or data change notifications where the data change is limited to S-NSSAI(s) subject to Network Slice-Specific Authentication and Authorization.
5	CAGFeature	If the NF consumer does not support this feature, the UDM shall not include CAG information list in the message body with "200 OK" response (clause 5.2.2.2.3). The UDM performs action as executes step 2c of clause 5.3.2.2.2 and 5.3.2.2.3 if UE is allowed to access 5GS via CAG cell(s) only.
13	LimitedSubscriptions	An NF consumer supporting this feature shall use one subscription for the changes of subscription data sets per UE without additional filter criteria, or with a specific filter criteria (e.g. dnn and/or singleNssai). An NF consumer supporting this feature shall use one subscription for the changes of shared data sets.

6.1.9 Security

As indicated in 3GPP TS 33.501 [6] and 3GPP TS 29.500 [4], the access to the Nudm_SDM API may be authorized by means of the OAuth2 protocol (see IETF RFC 6749 [18]), based on local configuration, using the "Client Credentials" authorization grant, where the NRF (see 3GPP TS 29.510 [19]) plays the role of the authorization server.

If OAuth2 is used, an NF Service Consumer, prior to consuming services offered by the Nudm_SDM API, shall obtain a "token" from the authorization server, by invoking the Access Token Request service, as described in 3GPP TS 29.510 [19], clause 5.4.2.2.

NOTE: When multiple NRFs are deployed in a network, the NRF used as authorization server is the same NRF that the NF Service Consumer used for discovering the Nudm_SDM service.

The Nudm_SDM API defines a single scope "nudm-sdm" for OAuth2 authorization (as specified in 3GPP TS 33.501 [6]) for the entire API, and it does not define any additional scopes at resource or operation level.

6.2 Nudm_UEContextManagement Service API

6.2.1 API URI

URIs of this API shall have the following root:

`{apiRoot}/{apiName}/<apiVersion>/`

The request URI used in HTTP request from the NF service consumer towards the NF service producer shall have the structure defined in clause 4.4.1 of 3GPP TS 29.501 [5], i.e.:

`{apiRoot}/<apiName>/<apiVersion>/<apiSpecificResourceUriPart>`

with the following components:

- The `{apiRoot}` shall be set as described in 3GPP TS 29.501 [5].
- The `<apiName>` shall be "nudm-uecm".
- The `<apiVersion>` shall be "v1".
- The `<apiSpecificResourceUriPart>` shall be set as described in clause 6.2.3.

6.2.2 Usage of HTTP

6.2.2.1 General

HTTP/2, as defined in IETF RFC 7540 [13], shall be used as specified in clause 5 of 3GPP TS 29.500 [4].

HTTP/2 shall be transported as specified in clause 5.3 of 3GPP TS 29.500 [4].

HTTP messages and bodies for the Nudm_UECM service shall comply with the OpenAPI [14] specification contained in Annex A3.

6.2.2.2 HTTP standard headers

6.2.2.2.1 General

The usage of HTTP standard headers shall be supported as specified in clause 5.2.2 of 3GPP TS 29.500 [4].

6.2.2.2.2 Content type

The following content types shall be supported:

JSON, as defined in IETF RFC 8259 [15], signalled by the content type "application/json".

The Problem Details JSON Object (IETF RFC 7807 [16] signalled by the content type "application/problem+json"

JSON Merge Patch, as defined in IETF RFC 7396 [17], signalled by the content type "application/merge-patch+json"

6.2.2.3 HTTP custom headers

6.2.2.3.1 General

The usage of HTTP custom headers shall be supported as specified in clause 5.2.3 of 3GPP TS 29.500 [4].

6.2.3 Resources

6.2.3.1 Overview

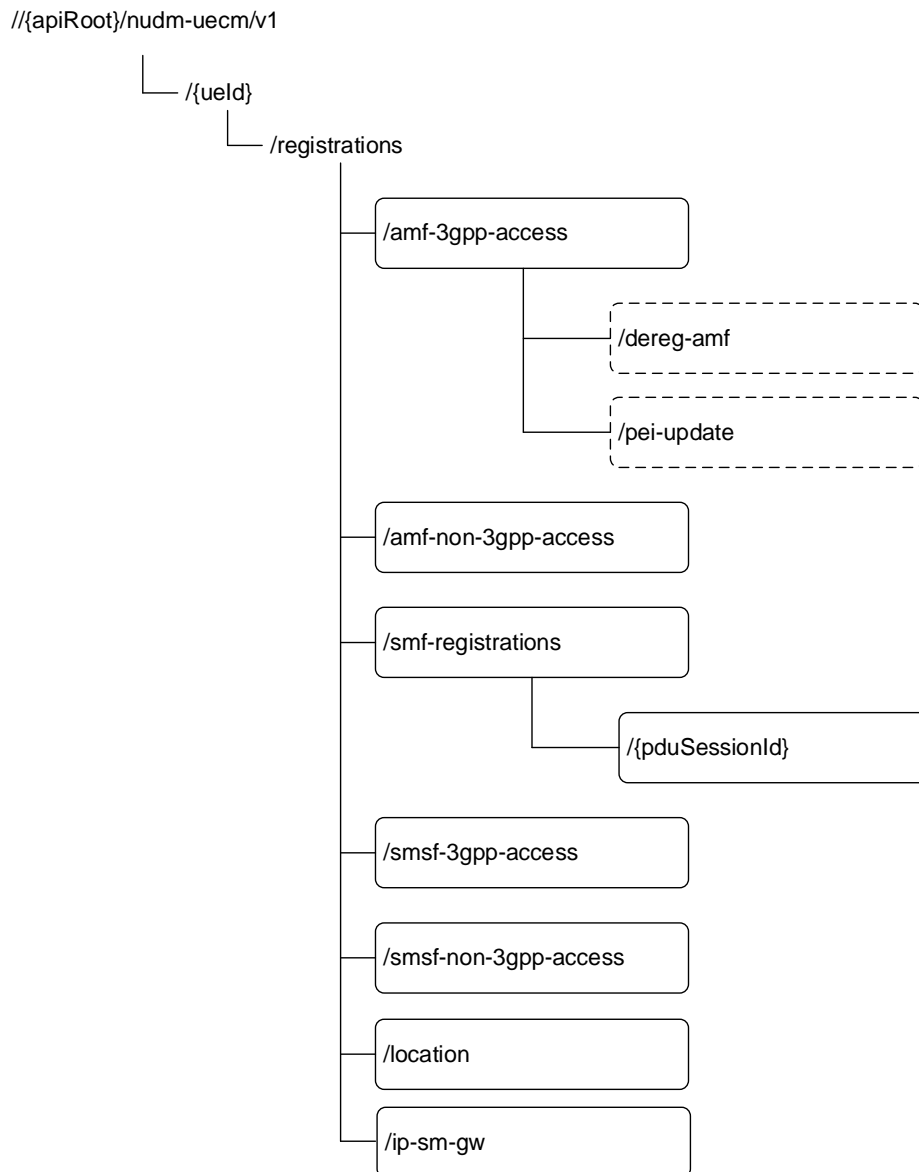

Figure 6.2.3.1-1: Resource URI structure of the Nudm_UECM API

Table 6.2.3.1-1 provides an overview of the resources and applicable HTTP methods.

Table 6.2.3.1-1: Resources and methods overview

Resource name (Archetype)	Resource URI	HTTP method or custom operation	Description
Registrations (Document)	/ueld/registrations	GET	Retrieve UE's registration data sets
Amf3GppAccessRegistration (Document)	/ueld/registrations/amf-3gpp-access	PUT	Update the AMF registration for 3GPP access
		PATCH	Modify the AMF registration for 3GPP access
		GET	Retrieve the AMF registration information for 3GPP access
	/ueld/registrations/amf-3gpp-access/dereg-amf	dereg-amf (POST)	Trigger AMF deregistration due to mobility from 5GC to EPC
	/ueld/registrations/amf-3gpp-access/pei-update	pei-update (POST)	Updates the PEI in the 3GPP Access Registration context
AmfNon3GppAccessRegistration (Document)	/ueld/registrations/amf-non-3gpp-access	PUT	Update the AMF registration for non 3GPP access
		PATCH	Modify the AMF registration for non 3GPP access
		GET	Retrieve the AMF registration information for non 3GPP access
SmfRegistrations (Store)	/ueld/registrations/smf-registrations	GET	Retrieve the SMF registration information
IndividualSmfRegistration (Document)	/ueld/registrations/smf-registrations/{pduSessionId}	PUT	Create an SMF registration identified by PDU Session Id
		DELETE	Delete an individual SMF registration
		GET	Retrieve the SMF registration information identified by PDU Session Id.
Smsf3GppAccessRegistration (Document)	/ueld/registrations/smsf-3gpp-access	PUT	Create or Update the SMSF registration
		DELETE	Delete the SMSF registration for 3GPP access
		PATCH	Modify the SMSF registration
		GET	Retrieve the SMSF registration information
SmsfNon3GppAccessRegistration (Document)	/ueld/registrations/smsf-non-3gpp-access	PUT	Create or Update the SMSF registration for non 3GPP access
		DELETE	Delete the SMSF registration for non 3GPP access
		PATCH	Modify the SMSF registration for non 3GPP access
		GET	Retrieve the SMSF registration information for non 3GPP access
Location(Document)	/ueld/registrations/location	GET	Retrieve the UE's location information by GMLC or NEF
IpSmGwRegistration (Document)	/ueld/registrations/ip-sm-gw	PUT	Create or Update the IP-SM-GW registration
		DELETE	Delete the IP-SM-GW registration
		GET	Retrieve the IP-SM-GW registration information

6.2.3.2 Resource: Amf3GppAccessRegistration (Document)

6.2.3.2.1 Description

This resource represents the registered AMF for 3GPP access.

6.2.3.2.2 Resource Definition

Resource URI: {apiRoot}/nudm-uecm/v1/{ueId}/registrations/amf-3gpp-access

This resource shall support the resource URI variables defined in table 6.2.3.2.2-1.

Table 6.2.3.2.2-1: Resource URI variables for this resource

Name	Data type	Definition
apiRoot	string	See clause 6.2.1
ueId	VarUeId	Represents the Subscription Identifier SUPI or GPSI (see 3GPP TS 23.501 [2] clause 5.9.2) SUPI (i.e. imsi or nai or gli or gci) is used with the PUT and PATCH methods; SUPI (i.e. imsi or nai) or GPSI (i.e. msisdn or extid) is used with the GET method. pattern: See pattern of type VarUeId in 3GPP TS 29.571 [7]

6.2.3.2.3 Resource Standard Methods

6.2.3.2.3.1 PUT

This method shall support the URI query parameters specified in table 6.2.3.2.3.1-1.

Table 6.2.3.2.3.1-1: URI query parameters supported by the PUT method on this resource

Name	Data type	P	Cardinality	Description
n/a				

This method shall support the request data structures specified in table 6.2.3.2.3.1-2 and the response data structures and response codes specified in table 6.2.3.2.3.1-3.

Table 6.2.3.2.3.1-2: Data structures supported by the PUT Request Body on this resource

Data type	P	Cardinality	Description
Amf3GppAccessRegistration	M	1	The AMF registration for 3GPP access is replaced with the received information.

Table 6.2.3.2.3.1-3: Data structures supported by the PUT Response Body on this resource

Data type	P	Cardinality	Response codes	Description
Amf3GppAccessRegistration	M	1	201 Created	Upon success, a response body containing a representation of the created Individual Amf3GppAccessRegistration resource shall be returned.
Amf3GppAccessRegistration	M	1	200 OK	Upon success, a response body containing a representation of the updated Individual Amf3GppAccessRegistration resource shall be returned.
n/a			204 No Content	Upon success, an empty response body shall be returned
ProblemDetails	O	0..1	404 Not Found	The "cause" attribute may be used to indicate one of the following application errors: - USER_NOT_FOUND
ProblemDetails	O	0..1	403 Forbidden	The "cause" attribute may be used to indicate one of the following application errors: - UNKNOWN_5GS_SUBSCRIPTION - NO_PS_SUBSCRIPTION - ROAMING_NOT_ALLOWED - ACCESS_NOT_ALLOWED - RAT_NOT_ALLOWED - REAUTHENTICATION_REQUIRED
NOTE: In addition common data structures as listed in table 5.2.7.1-1 of 3GPP TS 29.500 [4] are supported.				

Table 6.2.3.2.3.1-4: Headers supported by the 201 Response Code on this resource

Name	Data type	P	Cardinality	Description
Location	string	M	1	Contains the URI of the newly created resource, according to the structure: {apiRoot}/nudm-uecm/v1/{ueid}/registrations/amf-3gpp-access

6.2.3.2.3.2 PATCH

This method shall support the URI query parameters specified in table 6.2.3.2.3.2-1.

Table 6.2.3.2.3.2-1: URI query parameters supported by the PATCH method on this resource

Name	Data type	P	Cardinality	Description
supported-features	SupportedFeatures	O	0..1	see 3GPP TS 29.500 [4] clause 6.6

This method shall support the request data structures specified in table 6.2.3.2.3.2-2 and the response data structures and response codes specified in table 6.2.3.2.3.2-3.

Table 6.2.3.2.3.2-2: Data structures supported by the PATCH Request Body on this resource

Data type	P	Cardinality	Description
Amf3GppAccessRegistrationModification	M	1	The AMF registration for 3GPP access is modified with the received information.

Table 6.2.3.2.3-2: Data structures supported by the PATCH Response Body on this resource

Data type	P	Cardinality	Response codes	Description
n/a			204 No Content	Upon success, an empty response body is returned. (NOTE 2)
PatchResult	M	1	200 OK	Upon success, the execution report is returned. (NOTE 2)
ProblemDetails	O	0..1	403 Forbidden	The "cause" attribute may be used to indicate one of the following application errors: - INVALID_GUAMI
ProblemDetails	O	0..1	404 Not Found	The "cause" attribute may be used to indicate one of the following application errors: - CONTEXT_NOT_FOUND - USER_NOT_FOUND
ProblemDetails	O	0..1	422 Unprocessable Entity	The "cause" attribute may be used to indicate one of the following application errors: - UNPROCESSABLE_REQUEST
NOTE 1: In addition common data structures as listed in table 5.2.7.1-1 of 3GPP TS 29.500 [4] are supported.				
NOTE 2: If all the modification instructions in the PATCH request have been implemented, the UDM shall respond with 204 No Content response; if some of the modification instructions in the PATCH request have been discarded, and the NF service consumer has included in the supported-feature query parameter the "PatchReport" feature number, the UDM shall respond with PatchResult.				

6.2.3.2.3.3 GET

This method shall support the URI query parameters specified in table 6.2.3.2.3.3-1.

Table 6.2.3.2.3.3-1: URI query parameters supported by the GET method on this resource

Name	Data type	P	Cardinality	Description
supported-features	SupportedFeatures	O	0..1	see 3GPP TS 29.500 [4] clause 6.6

This method shall support the request data structures specified in table 6.2.3.2.3.3-2 and the response data structures and response codes specified in table 6.2.3.2.3.3-3.

Table 6.2.3.2.3.3-2: Data structures supported by the GET Request Body on this resource

Data type	P	Cardinality	Description
n/a			

Table 6.2.3.2.3.3-3: Data structures supported by the GET Response Body on this resource

Data type	P	Cardinality	Response codes	Description
Amf3GppAccessRegistration	M	1	200 OK	Upon success, a response body containing the Amf3GppAccessRegistration shall be returned.
ProblemDetails	O	0..1	404 Not Found	The "cause" attribute may be used to indicate one of the following application errors: - CONTEXT_NOT_FOUND - USER_NOT_FOUND
NOTE: In addition common data structures as listed in table 5.2.7.1-1 of 3GPP TS 29.500 [4] are supported.				

6.2.3.2.4 Resource Custom Operations

6.2.3.2.4.1 Overview

Table 6.2.3.2.4.1-1: Custom operations

Operation Name	Custom operation URI	Mapped HTTP method	Description
dereg-amf	/{ueld}/registrations/amf-3gpp-access/dereg-amf	POST	Trigger AMF deregistration due to mobility from 5GC to EPC
pei-update	/{ueld}/registrations/amf-3gpp-access/pei-update	POST	Updates PEI in the AMF 3GPP Registration context

6.2.3.2.4.2 Operation: dereg-amf

6.2.3.2.4.2.1 Description

The dereg-amf custom operation is used by the NF service consumer (HSS) to trigger AMF deregistration due to mobility from 5GS to EPC. For details see 3GPP TS 23.632 [32].

6.2.3.2.4.2.2 Operation Definition

This operation shall support the request data structures specified in table 6.2.3.2.4.2.2-1 and the response data structure and response codes specified in table 6.2.3.2.4.2.2-2.

Table 6.2.3.2.4.2.2-1: Data structures supported by the POST Request Body on this resource

Data type	P	Cardinality	Description
AmfDeregInfo	M	1	Contains the deregistration reason

Table 6.2.3.2.4.2.2-2: Data structures supported by the POST Response Body on this resource

Data type	P	Cardinality	Response codes	Description
n/a			204 No Content	Upon success, an empty response body shall be returned
ProblemDetails	O	0..1	404 Not Found	The "cause" attribute may be used to indicate one of the following application errors: - USER_NOT_FOUND
NOTE: The mandatory HTTP error status code for the POST method listed in Table 5.2.7.1-1 of 3GPP TS 29.500 [4] also apply.				

6.2.3.2.4.3 Operation: pei-update

6.2.3.2.4.3.1 Description

The pei-update custom operation is used by the NF service consumer (HSS) to trigger an update of the PEI stored in the AMF 3GPP Registration context. For details see 3GPP TS 23.632 [32].

6.2.3.2.4.3.2 Operation Definition

This operation shall support the request data structures specified in table 6.2.3.2.4.3.2-1 and the response data structure and response codes specified in table 6.2.3.2.4.3.2-2.

Table 6.2.3.2.4.3.2-1: Data structures supported by the POST Request Body on this resource

Data type	P	Cardinality	Description
PeiUpdateInfo	M	1	Contains the PEI provided by the NF service consumer

Table 6.2.3.2.4.3.2-2: Data structures supported by the POST Response Body on this resource

Data type	P	Cardinality	Response codes	Description
n/a			204 No Content	Upon success, an empty response body shall be returned
ProblemDetails	O	0..1	404 Not Found	The "cause" attribute may be used to indicate one of the following application errors: - USER_NOT_FOUND
NOTE: The mandatory HTTP error status code for the POST method listed in Table 5.2.7.1-1 of 3GPP TS 29.500 [4] also apply.				

6.2.3.3 Resource: AmfNon3GppAccessRegistration (Document)

6.2.3.3.1 Description

This resource represents the registered AMF for non 3GPP access.

6.2.3.3.2 Resource Definition

Resource URI: {apiRoot}/nudm-uecm/v1/{ueId}/registrations/amf-non-3gpp-access/

This resource shall support the resource URI variables defined in table 6.2.3.3.2-1.

Table 6.2.3.3.2-1: Resource URI variables for this resource

Name	Data type	Definition
apiRoot	string	See clause 6.2.1
ueId	VarUeId	Represents the Subscription Identifier SUPI or GPSI (see 3GPP TS 23.501 [2] clause 5.9.2) SUPI (i.e. imsi or nai or gli or gci) is used with the PUT and PATCH methods; SUPI (i.e. imsi or nai) or GPSI (i.e. msisdn or extid) is used with the GET method. pattern: See pattern of type VarUeId in 3GPP TS 29.571 [7]

6.2.3.3.3 Resource Standard Methods

6.2.3.3.3.1 PUT

This method shall support the URI query parameters specified in table 6.2.3.3.3.1-1.

Table 6.2.3.3.3.1-1: URI query parameters supported by the PUT method on this resource

Name	Data type	P	Cardinality	Description
n/a				

This method shall support the request data structures specified in table 6.2.3.3.3.1-2 and the response data structures and response codes specified in table 6.2.3.3.3.1-3.

Table 6.2.3.3.3.1-2: Data structures supported by the PUT Request Body on this resource

Data type	P	Cardinality	Description
AmfNon3GppAccessRegistration	M	1	The AMF registration for non 3GPP access is replaced with the received information.

Table 6.2.3.3.3.1-3: Data structures supported by the PUT Response Body on this resource

Data type	P	Cardinality	Response codes	Description
AmfNon3GppAccessRegistration	M	1	201 Created	Upon success, a response body containing a representation of the created Individual AmfNon3GppAccessRegistration resource shall be returned.
AmfNon3GppAccessRegistration	M	1	200 OK	Upon success, a response body containing a representation of the updated Individual AmfNon3GppAccessRegistration resource shall be returned.
n/a			204 No Content	Upon success, an empty response body shall be returned
ProblemDetails	O	0..1	404 Not Found	The "cause" attribute may be used to indicate one of the following application errors: - USER_NOT_FOUND
ProblemDetails	O	0..1	403 Forbidden	The "cause" attribute may be used to indicate one of the following application errors: - UNKNOWN_5GS_SUBSCRIPTION - NO_PS_SUBSCRIPTION - ROAMING_NOT_ALLOWED - ACCESS_NOT_ALLOWED - RAT_NOT_ALLOWED - REAUTHENTICATION_REQUIRED

NOTE: In addition common data structures as listed in table 5.2.7.1-1 of 3GPP TS 29.500 [4] are supported.

Table 6.2.3.3.3.1-4: Headers supported by the 201 Response Code on this resource

Name	Data type	P	Cardinality	Description
Location	string	M	1	Contains the URI of the newly created resource, according to the structure: {apiRoot}/nudm-uecm/v1/{ueld}/registrations/amf-non-3gpp-access

6.2.3.3.3.2 PATCH

This method shall support the URI query parameters specified in table 6.2.3.3.3.2-1.

Table 6.2.3.3.3.2-1: URI query parameters supported by the PATCH method on this resource

Name	Data type	P	Cardinality	Description
supported-features	SupportedFeatures	O	0..1	see 3GPP TS 29.500 [4] clause 6.6

This method shall support the request data structures specified in table 6.2.3.3.3.2-2 and the response data structures and response codes specified in table 6.2.3.3.3.2-3.

Table 6.2.3.3.3.2-2: Data structures supported by the PATCH Request Body on this resource

Data type	P	Cardinality	Description
AmfNon3GppAccessRegistrationModification	M	1	The AMF registration for non 3GPP access is modified with the received information.

Table 6.2.3.3.3.2-3: Data structures supported by the PATCH Response Body on this resource

Data type	P	Cardinality	Response codes	Description
n/a			204 No Content	Upon success, an empty response body shall be returned. (NOTE 2)
PatchResult	M	1	200 OK	Upon success, the execution report is returned. (NOTE 2)
ProblemDetails	O	0..1	404 Not Found	The "cause" attribute may be used to indicate one of the following application errors: - CONTEXT_NOT_FOUND - USER_NOT_FOUND
ProblemDetails	O	0..1	422 Unprocessable Entity	The "cause" attribute may be used to indicate one of the following application errors: - UNPROCESSABLE_REQUEST
NOTE 1: In addition common data structures as listed in table 5.2.7.1-1 of 3GPP TS 29.500 [4] are supported.				
NOTE 2: If all the modification instructions in the PATCH request have been implemented, the UDM shall respond with 204 No Content response; if some of the modification instructions in the PATCH request have been discarded, and the NF service consumer has included in the supported-feature query parameter the "PatchReport" feature number, the UDM shall respond with PatchResult.				

6.2.3.3.3.3 GET

This method shall support the URI query parameters specified in table 6.2.3.3.3.3-1.

Table 6.2.3.3.3.3-1: URI query parameters supported by the GET method on this resource

Name	Data type	P	Cardinality	Description
n/a				

This method shall support the request data structures specified in table 6.2.3.3.3.3-2 and the response data structures and response codes specified in table 6.2.3.3.3.3-3.

Table 6.2.3.3.3.3-2: Data structures supported by the GET Request Body on this resource

Data type	P	Cardinality	Description
n/a			

Table 6.2.3.3.3.3-3: Data structures supported by the GET Response Body on this resource

Data type	P	Cardinality	Response codes	Description
AmfNon3GppAccessRegistration	M	1	200 OK	Upon success, a response body containing the AmfNon3GppAccessRegistration shall be returned.
ProblemDetails	O	0..1	404 Not Found	The "cause" attribute may be used to indicate one of the following application errors: - CONTEXT_NOT_FOUND - USER_NOT_FOUND
NOTE: In addition common data structures as listed in table 5.2.7.1-1 of 3GPP TS 29.500 [4] are supported.				

6.2.3.4 Resource: SmfRegistrations

6.2.3.4.1 Description

This resource is used to represent SMF registrations.

6.2.3.4.2 Resource Definition

Resource URI: {apiRoot}/nudm-uecm/v1/{ueId}/registrations/smf-registrations

This resource shall support the resource URI variables defined in table 6.2.3.4.2-1.

Table 6.2.3.4.2-1: Resource URI variables for this resource

Name	Data type	Definition
apiRoot	string	See clause 6.4.1
ueld	VarUeld	Represents the Subscription Identifier SUPI or GPSI (see 3GPP TS 23.501 [2] clause 5.9.2) pattern: See pattern of type VarUeld in 3GPP TS 29.571 [7]

6.2.3.4.3 Resource Standard Methods

6.2.3.4.3.1 GET

This method shall support the URI query parameters specified in table 6.2.3.4.3.1-1.

Table 6.2.3.4.3.1-1: URI query parameters supported by the GET method on this resource

Name	Data type	P	Cardinality	Description
supported-features	SupportedFeatures	O	0..1	see 3GPP TS 29.500 [4] clause 6.6
single-nssai	Snssai	O	0..1	When present without Slice Differentiator (sd), all slices identified by the given Slice/Service Type (sst) and any sd value (if any) shall be considered matching the query parameter.
dnn	Dnn	O	0..1	The DNN shall be the DNN Network Identifier only.

JSON objects (such as Snssai, Dnn...) shall be included directly as part of the URI query parameters by specifying in the OpenAPI file that the "Content-Type" of such parameters is "application/json".

If "single-nssai" is not included, and "dnn" is not included, UDM shall return all SMF registrations for all DNN(s) and network slice(s).

If "single-nssai" is included, and "dnn" is not included, UDM shall return all SMF registrations for all DNN(s) and the requested network slice identified by "single-nssai".

If "single-nssai" is not included, and "dnn" is included, UDM shall return all SMF registrations for all network slices where such DNN is available.

If "single-nssai" is included, and "dnn" is included, UDM shall return the all SMF registrations identified by "dnn" and "single-nssai".

This method shall support the request data structures specified in table 6.2.3.4.3.1-2 and the response data structures and response codes specified in table 6.2.3.4.3.1-3.

Table 6.2.3.4.3.1-2: Data structures supported by the GET Request Body on this resource

Data type	P	Cardinality	Description
n/a			

Table 6.2.3.4.3.1-3: Data structures supported by the GET Response Body on this resource

Data type	P	Cardinality	Response codes	Description
SmfRegistrationInfo	M	1	200 OK	Upon success, a response body containing the SmfRegistrationInfo shall be returned.
ProblemDetails	O	0..1	404 Not Found	The "cause" attribute may be set to one of the following application errors: - CONTEXT_NOT_FOUND - USER_NOT_FOUND
NOTE: In addition common data structures as listed in table 5.2.7.1-1 of 3GPP TS 29.500 [4] are supported.				

6.2.3.5 Resource: IndividualSmfRegistration (Document)

6.2.3.5.1 Resource Definition

Resource URI: {apiRoot}/nudm-uecm/v1/{ueId}/registrations/smf-registrations/{pduSessionId}

This resource shall support the resource URI variables defined in table 6.2.3.5.1-1.

Table 6.2.3.5.1-1: Resource URI variables for this resource

Name	Data type	Definition
apiRoot	string	See clause 6.1.1
ueId	VarUeId	Represents the Subscription Identifier (see 3GPP TS 23.501 [2] clause 5.9.2) SUPI (i.e. imsi or nai or gli or gci) is used with the PUT, DELETE and PATCH methods; pattern: See pattern of type VarUeId in 3GPP TS 29.571 [7]
pduSessionId	PduSessionId	The pduSessionId identifies an individual SMF registration.

6.2.3.5.2 Resource Standard Methods

6.2.3.5.2.1 PUT

This method shall support the URI query parameters specified in table 6.2.3.5.2.1-1.

Table 6.2.3.5.2.1-1: URI query parameters supported by the PUT method on this resource

Name	Data type	P	Cardinality	Description
n/a				

This method shall support the request data structures specified in table 6.2.3.5.2.1-2 and the response data structures and response codes specified in table 6.2.3.5.2.1-3.

Table 6.2.3.5.2.1-2: Data structures supported by the PUT Request Body on this resource

Data type	P	Cardinality	Description
SmfRegistration	M	1	The registration that is to be created

Table 6.2.3.5.2.1-3: Data structures supported by the PUT Response Body on this resource

Data type	P	Cardinality	Response codes	Description
SmfRegistration	M	1	201 Created	Upon success, a response body containing a representation of the created Individual SmfRegistration resource shall be returned.
SmfRegistration	M	1	200 OK	Upon success, a response body containing a representation of the updated Individual SmfRegistration resource shall be returned.
n/a			204 No Content	Upon success, an empty response body shall be returned
ProblemDetails	O	0..1	404 Not Found	The "cause" attribute may be used to indicate one of the following application errors: - USER_NOT_FOUND
ProblemDetails	O	0..1	403 Forbidden	The "cause" attribute may be used to indicate one of the following application errors: - ROAMING_NOT_ALLOWED - DNN_NOT_ALLOWED
NOTE: In addition common data structures as listed in table 5.2.7.1-1 of 3GPP TS 29.500 [4] are supported.				

Table 6.2.3.5.2.1-4: Headers supported by the 201 Response Code on this resource

Name	Data type	P	Cardinality	Description
Location	string	M	1	Contains the URI of the newly created resource, according to the structure: {apiRoot}/nudm-uecm/v1/{ueId}/registrations/smf-registrations/{pduSessionId}

6.2.3.5.2.2 DELETE

This method shall support the URI query parameters specified in table 6.2.3.5.2.2-1.

Table 6.2.3.5.2.2-1: URI query parameters supported by the DELETE method on this resource

Name	Data type	P	Cardinality	Description
smf-set-id	NfSetId	O	0..1	The smf-set-id may be used by the UDM to guard against deletion of registrations by NFs that do not belong to the same NF set as the registered SMF.
smf-instance-id	NfInstanceId	O	0..1	If the smf-set-id is not present, the smf-instance-id may be used by the UDM to guard against deletion of registrations by NF that is not the registered SMF.

This method shall support the request data structures specified in table 6.2.3.5.2.2-2 and the response data structures and response codes specified in table 6.2.3.5.2.2-3.

Table 6.2.3.5.2.2-2: Data structures supported by the DELETE Request Body on this resource

Data type	P	Cardinality	Description
n/a			The request body shall be empty.

Table 6.2.3.5.2.2-3: Data structures supported by the DELETE Response Body on this resource

Data type	P	Cardinality	Response codes	Description
n/a			204 No Content	Upon success, an empty response body shall be returned.
NOTE: In addition common data structures as listed in table 5.2.7.1-1 of 3GPP TS 29.500 [4] are supported.				

6.2.3.5.2.3 GET

This method shall support the URI query parameters specified in table 6.2.3.5.2.3-1.

Table 6.2.3.5.2.3-1: URI query parameters supported by the GET method on this resource

Name	Data type	P	Cardinality	Description
n/a				

This method shall support the request data structures specified in table 6.2.3.5.2.3-2 and the response data structures and response codes specified in table 6.2.3.5.2.3-3.

Table 6.2.3.5.2.3-2: Data structures supported by the GET Request Body on this resource

Data type	P	Cardinality	Description
n/a			The request body shall be empty.

Table 6.2.3.5.2.3-3: Data structures supported by the GET Response Body on this resource

Data type	P	Cardinality	Response codes	Description
SmfRegistration	M	1	200 OK	Upon success, a response body containing the SmfRegistration shall be returned.
ProblemDetails	O	0..1	404 Not Found	The "cause" attribute may be set to one of the following application errors: - CONTEXT_NOT_FOUND - USER_NOT_FOUND

NOTE: In addition common data structures as listed in table 5.2.7.1-1 of 3GPP TS 29.500 [4] are supported.

6.2.3.6 Resource: Smsf3GppAccessRegistration (Document)

6.2.3.6.1 Description

This resource represents the registered SMSF for 3GPP access.

6.2.3.6.2 Resource Definition

Resource URI: {apiRoot}/nudm-uecm/v1/{ueId}/registrations/smsf-3gpp-access

This resource shall support the resource URI variables defined in table 6.2.3.6.2-1.

Table 6.2.3.6.2-1: Resource URI variables for this resource

Name	Data type	Definition
apiRoot	string	See clause 6.2.1
ueId	VarUeId	Represents the Subscription Identifier SUPI or GPSI (see 3GPP TS 23.501 [2] clause 5.9.2) SUPI (i.e. imsi or nai or gli or gci) is used with the PUT, DELETE and PATCH methods; GPSI (i.e. msisdn or extid) is used with the GET method. pattern: See pattern of type VarUeId in 3GPP TS 29.571 [7]

6.2.3.6.3 Resource Standard Methods

6.2.3.6.3.1 PUT

This method shall support the URI query parameters specified in table 6.2.3.6.3.1-1.

Table 6.2.3.6.3.1-1: URI query parameters supported by the PUT method on this resource

Name	Data type	P	Cardinality	Description
n/a				

This method shall support the request data structures specified in table 6.2.3.6.3.1-2 and the response data structures and response codes specified in table 6.2.3.6.3.1-3.

Table 6.2.3.6.3.1-2: Data structures supported by the PUT Request Body on this resource

Data type	P	Cardinality	Description
SmfRegistration	M	1	The SMSF registration for 3GPP access is created or updated with the received information.

Table 6.2.3.6.3.1-3: Data structures supported by the PUT Response Body on this resource

Data type	P	Cardinality	Response codes	Description
SmsfRegistration	M	1	201 Created	Upon success, a response body containing a representation of the created Individual SmsfRegistration resource shall be returned.
SmsfRegistration	M	1	200 OK	Upon success, a response body containing a representation of the updated Individual SmsfRegistration resource shall be returned.
n/a			204 No Content	Upon success, an empty response body shall be returned
ProblemDetails	O	0..1	404 Not Found	The "cause" attribute may be used to indicate one of the following application errors: - USER_NOT_FOUND
ProblemDetails	O	0..1	403 Forbidden	The "cause" attribute may be used to indicate one of the following application errors: - UNKNOWN_5GS_SUBSCRIPTION - ACCESS_NOT_ALLOWED - ROAMING_NOT_ALLOWED
NOTE: In addition common data structures as listed in table 5.2.7.1-1 of 3GPP TS 29.500 [4] are supported.				

Table 6.2.3.6.3.1-4: Headers supported by the 201 Response Code on this resource

Name	Data type	P	Cardinality	Description
Location	string	M	1	Contains the URI of the newly created resource, according to the structure: {apiRoot}/nudm-uecm/v1/{ueId}/registrations/smsf-3gpp-access

6.2.3.6.3.2 DELETE

This method shall support the URI query parameters specified in table 6.2.3.6.3.2-1.

Table 6.2.3.6.3.2-1: URI query parameters supported by the DELETE method on this resource

Name	Data type	P	Cardinality	Description
smsf-set-id	NfSetId	O	0..1	The smsf-set-id may be used by the UDM to guard against deletion of registrations by NFs that do not belong to the same NF set as the registered SMSF.

This method shall support the request data structures specified in table 6.2.3.6.3.2-2 and the response data structures and response codes specified in table 6.2.3.6.3.2-3.

Table 6.2.3.6.3.2-2: Data structures supported by the DELETE Request Body on this resource

Data type	P	Cardinality	Description
n/a			The request body shall be empty.

Table 6.2.3.6.3.2-3: Data structures supported by the DELETE Response Body on this resource

Data type	P	Cardinality	Response codes	Description
n/a			204 No Content	Upon success, an empty response body shall be returned.
NOTE: In addition common data structures as listed in table 5.2.7.1-1 of 3GPP TS 29.500 [4] are supported.				

6.2.3.6.3.3 GET

This method shall support the URI query parameters specified in table 6.2.3.6.3.3-1.

Table 6.2.3.6.3.3-1: URI query parameters supported by the GET method on this resource

Name	Data type	P	Cardinality	Description
supported-features	SupportedFeatures	O	0..1	see 3GPP TS 29.500 [4] clause 6.6

This method shall support the request data structures specified in table 6.2.3.6.3.3-2 and the response data structures and response codes specified in table 6.2.3.6.3.3-3.

Table 6.2.3.6.3.3-2: Data structures supported by the GET Request Body on this resource

Data type	P	Cardinality	Description
n/a			

Table 6.2.3.6.3.3-3: Data structures supported by the GET Response Body on this resource

Data type	P	Cardinality	Response codes	Description
SmsfRegistration	M	1	200 OK	Upon success, a response body containing the SmsfRegistration shall be returned.
ProblemDetails	O	0..1	404 Not Found	The "cause" attribute may be used to indicate one of the following application errors: - CONTEXT_NOT_FOUND - USER_NOT_FOUND
NOTE: In addition common data structures as listed in table 5.2.7.1-1 of 3GPP TS 29.500 [4] are supported.				

6.2.3.7 Resource: SmsfNon3GppAccessRegistration (Document)

6.2.3.7.1 Description

This resource represents the registered SMSF for non 3GPP access.

6.2.3.7.2 Resource Definition

Resource URI: {apiRoot}/nudm-uecm/v1/{ueId}/registrations/smsf-non-3gpp-access

This resource shall support the resource URI variables defined in table 6.2.3.7.2-1.

Table 6.2.3.7.2-1: Resource URI variables for this resource

Name	Data type	Definition
apiRoot	string	See clause 6.2.1
ueId	VarUeId	Represents the Subscription Identifier SUPI or GPSI (see 3GPP TS 23.501 [2] clause 5.9.2) SUPI (i.e. imsi or nai or gli or gci) is used with the PUT, DELETE and PATCH methods; GPSI (i.e. msisdn or extid) is used with the GET method. pattern: See pattern of type VarUeId in 3GPP TS 29.571 [7]

6.2.3.7.3 Resource Standard Methods

6.2.3.7.3.1 PUT

This method shall support the URI query parameters specified in table 6.2.3.7.3.1-1.

Table 6.2.3.7.3.1-1: URI query parameters supported by the PUT method on this resource

Name	Data type	P	Cardinality	Description
n/a				

This method shall support the request data structures specified in table 6.2.3.7.3.1-2 and the response data structures and response codes specified in table 6.2.3.7.3.1-3.

Table 6.2.3.7.3.1-2: Data structures supported by the PUT Request Body on this resource

Data type	P	Cardinality	Description
SmsfRegistration	M	1	The SMSF registration for non 3GPP access is created or updated with the received information.

Table 6.2.3.7.3.1-3: Data structures supported by the PUT Response Body on this resource

Data type	P	Cardinality	Response codes	Description
SmsfRegistration	M	1	201 Created	Upon success, a response body containing a representation of the created Individual SmsfRegistration for non 3GPP access resource shall be returned.
SmsfRegistration	M	1	200 OK	Upon success, a response body containing a representation of the updated Individual SmsfRegistration for non 3GPP access resource shall be returned.
n/a			204 No Content	Upon success, an empty response body shall be returned
ProblemDetails	O	0..1	404 Not Found	The "cause" attribute may be used to indicate one of the following application errors: The "cause" attribute shall be set to the following application error: - USER_NOT_FOUND
ProblemDetails	O	0..1	403 Forbidden	The "cause" attribute may be used to indicate one of the following application errors: - UNKNOWN_5GS_SUBSCRIPTION - ACCESS_NOT_ALLOWED - ROAMING_NOT_ALLOWED

NOTE: In addition common data structures as listed in table 5.2.7.1-1 of 3GPP TS 29.500 [4] are supported.

Table 6.2.3.7.3.1-4: Headers supported by the 201 Response Code on this resource

Name	Data type	P	Cardinality	Description
Location	string	M	1	Contains the URI of the newly created resource, according to the structure: {apiRoot}/nudm-uecm/v1/{ueId}/registrations/smsf-non-3gpp-access

6.2.3.7.3.2 DELETE

This method shall support the URI query parameters specified in table 6.2.3.7.2.2-1.

Table 6.2.3.7.2.2-1: URI query parameters supported by the DELETE method on this resource

Name	Data type	P	Cardinality	Description
smsf-set-id	NfSetId	O	0..1	The smsf-set-id may be used by the UDM to guard against deletion of registrations by NFs that do not belong to the same NF set as than the registered SMSF.

This method shall support the request data structures specified in table 6.2.3.7.2.2-2 and the response data structures and response codes specified in table 6.2.3.5.2.2-3.

Table 6.2.3.7.2.2-2: Data structures supported by the DELETE Request Body on this resource

Data type	P	Cardinality	Description
n/a			The request body shall be empty.

Table 6.2.3.7.2.2-3: Data structures supported by the DELETE Response Body on this resource

Data type	P	Cardinality	Response codes	Description
n/a			204 No Content	Upon success, an empty response body shall be returned.
NOTE: In addition common data structures as listed in table 5.2.7.1-1 of 3GPP TS 29.500 [4] are supported.				

6.2.3.7.3.3 GET

This method shall support the URI query parameters specified in table 6.2.3.7.3.3-1.

Table 6.2.3.7.3.3-1: URI query parameters supported by the GET method on this resource

Name	Data type	P	Cardinality	Description
supported-features	SupportedFeatures	O	0..1	see 3GPP TS 29.500 [4] clause 6.6

This method shall support the request data structures specified in table 6.2.3.7.3.3-2 and the response data structures and response codes specified in table 6.2.3.7.3.3-3.

Table 6.2.3.7.3.3-2: Data structures supported by the GET Request Body on this resource

Data type	P	Cardinality	Description
n/a			

Table 6.2.3.7.3.3-3: Data structures supported by the GET Response Body on this resource

Data type	P	Cardinality	Response codes	Description
SmsfRegistration	M	1	200 OK	Upon success, a response body containing the SmsfRegistration shall be returned.
ProblemDetails	O	0..1	404 Not Found	The "cause" attribute may be used to indicate one of the following application errors: - CONTEXT_NOT_FOUND - USER_NOT_FOUND
NOTE: In addition common data structures as listed in table 5.2.7.1-1 of 3GPP TS 29.500 [4] are supported.				

6.2.3.8 Resource: Location

6.2.3.8.1 Description

This resource is used to represent UE's location information.

6.2.3.8.2 Resource Definition

Resource URI: {apiRoot}/nudm-uecm/v1/{ueId}/registrations/location

This resource shall support the resource URI variables defined in table 6.2.3.8.2-1.

Table 6.2.3.8.2-1: Resource URI variables for this resource

Name	Data type	Definition
apiRoot	string	See clause 6.4.1
ueld	VarUeld	Represents the Subscription Identifier SUPI or GPSI (see 3GPP TS 23.501 [2] clause 5.9.2) pattern: See pattern of type VarUeld in 3GPP TS 29.571 [7]

6.2.3.8.3 Resource Standard Methods

6.2.3.8.3.1 GET

This method shall support the URI query parameters specified in table 6.2.3.8.3.1-1.

Table 6.2.3.8.3.1-1: URI query parameters supported by the GET method on this resource

Name	Data type	P	Cardinality	Description
supported-features	SupportedFeatures	O	0..1	see 3GPP TS 29.500 [4] clause 6.6

This method shall support the request data structures specified in table 6.2.3.8.3.1-2 and the response data structures and response codes specified in table 6.2.3.8.3.1-3.

Table 6.2.3.8.3.1-2: Data structures supported by the GET Request Body on this resource

Data type	P	Cardinality	Description
n/a			

Table 6.2.3.8.3.1-3: Data structures supported by the GET Response Body on this resource

Data type	P	Cardinality	Response codes	Description
LocationInfo	M	1	200 OK	Upon success, a response body containing the locationInfo shall be returned.
ProblemDetails	O	0..1	404 Not Found	The "cause" attribute may be used to indicate one of the following application errors: - CONTEXT_NOT_FOUND - USER_NOT_FOUND

NOTE: In addition common data structures as listed in table 5.2.7.1-1 of 3GPP TS 29.500 [4] are supported.

6.2.3.9 Resource: Registrations

6.2.3.9.1 Description

This resource represents the UE's registration data sets.

6.2.3.9.2 Resource Definition

Resource URI: {apiRoot}/nudm-uecm/v1/{ueId}/registrations

This resource shall support the resource URI variables defined in table 6.2.3.9.2-1.

Table 6.2.3.9.2-1: Resource URI variables for this resource

Name	Definition
apiRoot	See clause 6.2.1
ueld	Represents the Subscription Identifier SUPI or GPSI (see 3GPP TS 23.501 [2] clause 5.9.2) SUPI (i.e. imsi or nai) or GPSI (i.e. msisdn or extid) is used with the GET method. pattern: "(imsi-[0-9]{5,15} nai-.+ msisdn-[0-9]{5,15} extid-[^\@]+@[^\@]+.+)"

6.2.3.9.3 Resource Standard Methods

6.2.3.9.3.1 GET

This method shall support the URI query parameters specified in table 6.2.3.9.3.1-1.

NOTE: The retrieval of these registration data sets can also be achieved by sending individual GET requests to the corresponding sub-resources under the {ueId}/registrations resource. When multiple registration data sets need to be retrieved by the NF Service consumer, it is recommended to use a single GET request with query parameters rather than issuing multiple GET requests.

Table 6.2.3.9.3.1-1: URI query parameters supported by the GET method on this resource

Name	Data type	P	Cardinality	Description
registration-dataset-names	array(RegistrationDataSetName)	O	2..N	If included, this IE shall contain the names of registration data sets to be retrieved.
supported-features	SupportedFeatures	O	0..1	see 3GPP TS 29.500 [4] clause 6.6
single-nssai	Snssai	O	0..1	Only applicable if registration-dataset-names contains SMF_PDU_SESSIONS When present without Slice Differentiator (sd), all slices identified by the given Slice/Service Type (sst) and any sd value (if any) shall be considered matching the query parameter.
dnn	Dnn	O	0..1	The DNN shall be the DNN Network Identifier only. Only applicable if registration-dataset-names contains SMF_PDU_SESSIONS

This method shall support the request data structures specified in table 6.2.3.9.3.1-2 and the response data structures and response codes specified in table 6.2.3.9.3.1-3.

Table 6.2.3.9.3.1-2: Data structures supported by the GET Request Body on this resource

Data type	P	Cardinality	Description
n/a			

Table 6.2.3.9.3.1-3: Data structures supported by the GET Response Body on this resource

Data type	P	Cardinality	Response codes	Description
RegistrationData Sets	M	1	200 OK	Upon success, a response body containing all the requested UE registration data sets shall be returned.
ProblemDetails	O	0..1	404 Not Found	The "cause" attribute shall be set to one of the following application errors: - CONTEXT_NOT_FOUND - USER_NOT_FOUND

NOTE: In addition common data structures as listed in table 5.2.7.1-1 of 3GPP TS 29.500 [4] are supported.

6.2.3.10 Resource: IpSmGwRegistration

6.2.3.10.1 Description

This resource represents the registered IP-SM-GW.

6.2.3.10.2 Resource Definition

Resource URI: {apiRoot}/nudm-uecm/v1/{ueId}/registrations/ip-sm-gw

This resource shall support the resource URI variables defined in table 6.2.3.10.2-1.

Table 6.2.3.10.2-1: Resource URI variables for this resource

Name	Definition
apiRoot	See clause 6.2.1
ueld	Represents the Subscription Identifier (SUPI). pattern: "(imsi-[0-9]{5,15} nai-.[.]+)"

6.2.3.10.3 Resource Standard Methods

6.2.3.10.3.1 PUT

This method shall support the URI query parameters specified in table 6.2.3.10.3.1-1.

Table 6.2.3.10.3.1-1: URI query parameters supported by the PUT method on this resource

Name	Data type	P	Cardinality	Description
n/a				

This method shall support the request data structures specified in table 6.2.3.10.3.1-2 and the response data structures and response codes specified in table 6.2.3.10.3.1-3.

Table 6.2.3.10.3.1-2: Data structures supported by the PUT Request Body on this resource

Data type	P	Cardinality	Description
IpSmGwRegistration	M	1	The IP-SM-GW registration is created or updated with the received information.

Table 6.2.3.10.3.1-3: Data structures supported by the PUT Response Body on this resource

Data type	P	Cardinality	Response codes	Description
IpSmGwRegistration	M	1	201 Created	Upon success, a response body containing a representation of the created IpSmGwRegistration resource shall be returned.
IpSmGwRegistration	M	1	200 OK	Upon success, a response body containing a representation of the updated IpSmGwRegistration resource shall be returned.
n/a			204 No Content	Upon success, an empty response body shall be returned
ProblemDetails	O	0..1	403 Forbidden	The "cause" attribute may be used to indicate any of the following application errors: - UNKNOWN_5GS_SUBSCRIPTION
ProblemDetails	O	0..1	404 Not Found	The "cause" attribute may be used to indicate any of the following application errors: - USER_NOT_FOUND

6.2.3.10.3.2 DELETE

This method shall support the URI query parameters specified in table 6.2.3.10.3.2-1.

Table 6.2.3.10.3.2-1: URI query parameters supported by the DELETE method on this resource

Name	Data type	P	Cardinality	Description
n/a				

This method shall support the request data structures specified in table 6.2.3.10.3.2-2 and the response data structures and response codes specified in table 6.2.3.10.3.2-3.

Table 6.2.3.10.3.2-2: Data structures supported by the DELETE Request Body on this resource

Data type	P	Cardinality	Description
n/a			The request body shall be empty.

Table 6.2.3.10.3.2-3: Data structures supported by the DELETE Response Body on this resource

Data type	P	Cardinality	Response codes	Description
n/a			204 No Content	Upon success, an empty response body shall be returned.

6.2.3.10.3.3 GET

This method shall support the URI query parameters specified in table 6.2.3.10.3.3-1.

Table 6.2.3.10.3.3-1: URI query parameters supported by the GET method on this resource

Name	Data type	P	Cardinality	Description
n/a				

This method shall support the request data structures specified in table 6.2.3.10.3.3-2 and the response data structures and response codes specified in table 6.2.3.10.3.3-3.

Table 6.2.3.10.3.3-2: Data structures supported by the GET Request Body on this resource

Data type	P	Cardinality	Description
n/a			

Table 6.2.3.10.3.3-3: Data structures supported by the GET Response Body on this resource

Data type	P	Cardinality	Response codes	Description
IpSmGwRegistration	M	1	200 OK	Upon success, a response body containing the IpSmGwRegistration shall be returned.
ProblemDetails	O	0..1	404 Not Found	The "cause" attribute may be set to indicate any of the following application errors: - USER_NOT_FOUND - CONTEXT_NOT_FOUND

6.2.4 Custom Operations without associated resources

6.2.4.1 Overview

Table 6.2.4.1-1: Custom operations without associated resources

Operation Name	Custom operation URI	Mapped HTTP method	Description
Trigger P-CSCF Restoration	/restore-pcscf	POST	The UDM notifies the registered AMFs and SMFs that have subscribed (implicitly by providing a callback URI during registration) to receive notifications about P-CSCF Restoration.

6.2.4.2 Operation: Trigger P-CSCF Restoration

6.2.4.2.1 Description

This custom operation is used by the NF service consumer (HSS) to trigger P-CSCF restoration.

6.2.4.2.2 Operation Definition

This operation shall support the data structures and response codes specified in tables 6.2.4.2.2-1 and 6.2.4.2.2-2.

Table 6.2.4.2.2-1: Data structures supported by the Request Body

Data type	P	Cardinality	Description
TriggerRequest	M	1	Identifies the subscriber for whom P-CSCF Restoration is requested

Table 6.2.4.2.2-2: Data structures supported by the POST Response Body

Data type	P	Cardinality	Response codes	Description
n/a			204 No Content	Upon success, an empty response body shall be returned.
ProblemDetails	O	0..1	404 Not Found	The "cause" attribute may be used to indicate one of the following application errors: - CONTEXT_NOT_FOUND

6.2.5 Notifications

6.2.5.1 General

This clause will specify the use of notifications and corresponding protocol details if required for the specific service. When notifications are supported by the API, it will include a reference to the general description of notifications support over the 5G SBIs specified in TS 29.500 / TS 29.501.

Table 6.2.5.1-1: Notifications overview

Notification	Resource URI	HTTP method or custom operation	Description (service operation)
Deregistration Notification	{deregCallbackUri}	POST	
P-CSCF Restoration Notification	{pcscfRestorationCallbackUri}	POST	

6.2.5.2 Deregistration Notification

The POST method shall be used for Deregistration Notifications and the URI shall be as provided during the registration procedure.

Resource URI: {callbackReference}

Support of URI query parameters is specified in table 6.2.5.2-1.

Table 6.2.5.2-1: URI query parameters supported by the POST method

Name	Data type	P	Cardinality	Description
n/a				

Support of request data structures is specified in table 6.2.5.2-2 and of response data structures and response codes is specified in table 6.2.5.2-3.

Table 6.2.5.2-2: Data structures supported by the POST Request Body

Data type	P	Cardinality	Description
DeregistrationData	M	1	Includes Deregistration Reason

Table 6.2.5.2-3: Data structures supported by the POST Response Body

Data type	P	Cardinality	Response codes	Description
n/a			204 No Content	Upon success, an empty response body shall be returned.
RedirectResponse	O	0..1	307 Temporary Redirect	Temporary redirection. The response shall include a Location header field containing a different URI. The URI shall be an alternative URI of the resource located on an alternative service instance within the same NF or NF (service) set. If an SCP redirects the message to another SCP then the location header field shall contain the same URI or a different URI pointing to the endpoint of the NF service consumer to which the notification should be sent.
RedirectResponse	O	0..1	308 Permanent Redirect	Permanent redirection. The response shall include a Location header field containing a different URI. The URI shall be an alternative URI of the resource located on an alternative service instance within the same NF or NF (service) set. If an SCP redirects the message to another SCP then the location header field shall contain the same URI or a different URI pointing to the endpoint of the NF service consumer to which the notification should be sent.
ProblemDetails	O	0..1	404 Not Found	The "cause" attribute may be used to indicate one of the following application errors: - CONTEXT_NOT_FOUND
NOTE: In addition common data structures as listed in table 5.2.7.1-1 of 3GPP TS 29.500 [4] are supported.				

Table 6.2.5.2-4: Headers supported by the 307 Response Code on this resource

Name	Data type	P	Cardinality	Description
Location	string	M	1	Contains the Callback URI of the target NF Service Consumer (e.g. AMF) to which the request is redirected
3gpp-Sbi-Target-Nf-Id	string	O	0..1	Identifier of the target NF (service) instance ID towards which the request is redirected

Table 6.2.5.2-5: Headers supported by the 308 Response Code on this resource

Name	Data type	P	Cardinality	Description
Location	string	M	1	Contains the Callback URI of the target NF Service Consumer (e.g. AMF) to which the request is redirected
3gpp-Sbi-Target-Nf-Id	string	O	0..1	Identifier of the target NF (service) instance ID towards which the request is redirected

6.2.5.3 P-CSCF Restoration Notification

The POST method shall be used for P-CSCF Restoration Notifications and the URI shall be as provided during the registration procedure.

Resource URI: {callbackReference}

Support of URI query parameters is specified in table 6.2.5.3-1.

Table 6.2.5.3-1: URI query parameters supported by the POST method

Name	Data type	P	Cardinality	Description
n/a				

Support of request data structures is specified in table 6.2.5.3-2 and of response data structures and response codes is specified in table 6.2.5.3-3.

Table 6.2.5.3-2: Data structures supported by the POST Request Body

Data type	P	Cardinality	Description
PcscfRestoration Notification	M	1	contains the SUPI

Table 6.2.5.3-3: Data structures supported by the POST Response Body

Data type	P	Cardinality	Response codes	Description
n/a			204 No Content	Upon success, an empty response body shall be returned.
RedirectResponse	O	0..1	307 Temporary Redirect	Temporary redirection. The response shall include a Location header field containing a different URI. The URI shall be an alternative URI of the resource located on an alternative service instance within the same NF or NF (service) set. If an SCP redirects the message to another SCP then the location header field shall contain the same URI or a different URI pointing to the endpoint of the NF service consumer to which the notification should be sent.
RedirectResponse	O	0..1	308 Permanent Redirect	Permanent redirection. The response shall include a Location header field containing a different URI. The URI shall be an alternative URI of the resource located on an alternative service instance within the same NF or NF (service) set. If an SCP redirects the message to another SCP then the location header field shall contain the same URI or a different URI pointing to the endpoint of the NF service consumer to which the notification should be sent.
ProblemDetails	O	0..1	404 Not Found	The "cause" attribute may be used to indicate one of the following application errors: - CONTEXT_NOT_FOUND
ProblemDetails	O	0..1	409 Conflict	The "cause" attribute may be used to indicate one of the following application errors: - TEMPORARY_REJECT_REGISTRATION_ONGOING - TEMPORARY_REJECT_HANDOVER_ONGOING

NOTE: In addition common data structures as listed in table 5.2.7.1-1 of 3GPP TS 29.500 [4] are supported.

Table 6.2.5.3-4: Headers supported by the 307 Response Code on this resource

Name	Data type	P	Cardinality	Description
Location	string	M	1	Contains the Callback URI of the target NF Service Consumer (e.g. AMF) to which the request is redirected
3gpp-Sbi-Target-Nf-Id	string	O	0..1	Identifier of the target NF (service) instance ID towards which the request is redirected

Table 6.2.5.3-5: Headers supported by the 308 Response Code on this resource

Name	Data type	P	Cardinality	Description
Location	string	M	1	Contains the Callback URI of the target NF Service Consumer (e.g. AMF) to which the request is redirected
3gpp-Sbi-Target-Nf-Id	string	O	0..1	Identifier of the target NF (service) instance ID towards which the request is redirected

6.2.6 Data Model

6.2.6.1 General

This clause specifies the application data model supported by the API.

Table 6.2.6.1-1 specifies the data types defined for the Nudm_UECM service API.

Table 6.2.6.1-1: Nudm_UECM specific Data Types

Data type	Clause defined	Description
Amf3GppAccessRegistration	6.2.6.2.2	The complete set of information relevant to the AMF where the UE has registered via 3GPP access.
AmfNon3GppAccessRegistration	6.2.6.2.3	The complete set of information relevant to the AMF where the UE has registered via non 3GPP access.
SmfRegistration	6.2.6.2.4	The complete set of information relevant to an SMF serving the UE
SmsfRegistration	6.2.6.2.6	The complete set of information relevant to the SMSF serving the UE.
DeregistrationData	6.2.6.2.5	Data sent with the Deregistration Notification
Amf3GppAccessRegistrationModification	6.2.6.2.7	Contains attributes of Amf3GppAccessRegistration that can be modified using PATCH
AmfNon3GppAccessRegistrationModification	6.2.6.2.8	Contains attributes of AmfNon3GppAccessRegistration that can be modified using PATCH
PscsfRestorationNotification	6.2.6.2.9	Information sent to the AMF or SMF when P-CSCF restoration is triggered.
NetworkNodeDiameterAddress	6.2.6.2.10	
EpslwkPgw	6.2.6.2.11	
TriggerRequest	6.2.6.2.12	
AmfDeregInfo	6.2.6.2.13	
EpsInterworkingInfo	6.2.6.2.14	
LocationInfo	6.2.6.2.15	Information used by (H)GMLC to send Location Service Request
RegistrationLocationInfo	6.2.6.2.16	Serving AMF, optional VGMLC and access type related informations used by (H)GMLC to send Location Request
VgmlcAddress	6.2.6.2.17	The address(es) of VGMLC
PeiUpdateInfo	6.2.6.2.18	
RegistrationDataSets	6.2.6.2.19	
IpSmGwRegistration	6.2.6.2.20	
SmfRegistrationInfo	6.2.6.2.20A	SMF Registration Information
PurgeFlag	6.2.6.3.2	This flag indicates whether or not the NF has deregistered.
E164Number	6.2.6.3.2	
DualRegistrationFlag	6.2.6.3.2	Dual Registration Flag
DeregistrationReason	6.2.6.3.3	
ImsVoPs	6.2.6.3.4	
RegistrationReason	6.2.6.3.5	
RegistrationDataSetName	6.2.6.3.6	

Table 6.2.6.1-2 specifies data types re-used by the Nudm_uecm service API from other specifications, including a reference to their respective specifications and when needed, a short description of their use within the Nudm_uecm service API.

Table 6.2.6.1-2: Nudm_UECM re-used Data Types

Data type	Reference	Comments
Dnn	3GPP TS 29.571 [7]	Data Network Name with Network Identifier only.
NfnInstanceId	3GPP TS 29.571 [7]	Network Function Instance Identifier
PduSessionId	3GPP TS 29.571 [7]	PDU Session ID
Pei	3GPP TS 29.571 [7]	Permanent Equipment Identifier
ProblemDetails	3GPP TS 29.571 [7]	Common data type used in response bodies
Uri	3GPP TS 29.571 [7]	Uniform Resource Identifier
SupportedFeatures	3GPP TS 29.571 [7]	see 3GPP TS 29.500 [4] clause 6.6
Supi	3GPP TS 29.571 [7]	see 3GPP TS 23.501 [2] clause 5.9.2
Guami	3GPP TS 29.571 [7]	Globally Unique AMF Identifier
PlmnId	3GPP TS 29.571 [7]	PLMN Identity
DiameterIdentity	3GPP TS 29.571 [7]	
AccessType	3GPP TS 29.571 [7]	Access Type
BackupAmfInfo	3GPP TS 29.571 [7]	Backup AMFs
ServiceName	3GPP TS 29.510 [19]	
PatchResult	3GPP TS 29.571 [7]	
Gpsi	3GPP TS 29.571 [7]	Generic Public Subscription Identifier
Ipv4Addr	3GPP TS 29.571 [7]	IPv4 address
Ipv6Addr	3GPP TS 29.571 [7]	IPv6 address
Fqdn	3GPP TS 29.510 [19]	Fully Qualified Domain Name
Snssai	3GPP TS 29.571 [7]	Single NSSAI
RedirectResponse	3GPP TS 29.571 [7]	Response body of the redirect response message

6.2.6.2 Structured data types

6.2.6.2.1 Introduction

This clause defines the structures to be used in resource representations.

6.2.6.2.2 Type: Amf3GppAccessRegistration

Table 6.2.6.2.2-1: Definition of type Amf3GppAccessRegistration

Attribute name	Data type	P	Cardinality	Description
amfInstanceIcd	NfInstanceIcd	M	1	The identity the AMF uses to register in the NRF.
deregCallbackUri	Uri	M	1	A URI provided by the AMF to receive (implicitly subscribed) notifications on deregistration. The deregistration callback URI shall have unique information within AMF set to identify the UE to be deregistered.
guami	Guami	M	1	This IE shall contain the serving AMF's GUAMI.
ratType	RatType	M	1	This IE shall indicate the current RAT type of the UE.
supportedFeatures	SupportedFeatures	O	0..1	See clause 6.2.8 These are the features supported by the AMF.
purgeFlag	PurgeFlag	O	0..1	This flag indicates whether or not the AMF has deregistered. It shall not be included in the Registration service operation.
pei	Pei	O	0..1	Permanent Equipment Identifier. Absence of PEI indicates that the PEI is not available at the AMF. In this case the UDM/UDR shall not delete the PEI value stored from a previous registration.
imsVoPs	ImsVoPs	O	0..1	Indicates per UE if "IMS Voice over PS Sessions" is homogeneously supported in all TAs in the serving AMF, or homogeneously not supported, or if support is non-homogeneous/unknown. Absence of this attribute shall be interpreted as "non homogenous or unknown" support.
amfServiceNameDereg	ServiceName	O	0..1	When present, this IE shall contain the name of the AMF service to which the Deregistration Notification is to be sent (see clause 6.5.2.2 of 3GPP TS 29.500 [4]).
pcscfRestorationCallbackUri	Uri	O	0..1	A URI provided by the AMF to receive (implicitly subscribed) notifications on the need for P-CSCF Restoration.
amfServiceNamePcscfRest	ServiceName	O	0..1	When present, this IE shall contain the name of the AMF service to which P-CSCF Restoration Notifications are to be sent (see clause 6.5.2.2 of 3GPP TS 29.500 [4]). This IE may be included if pcscfRestorationCallbackUri is present.
initialRegistrationInd	boolean	C	0..1	This IE shall be included by the AMF and set to true if the UE performs an Initial Registration. If the UE does not perform initial registration it shall be absent or set to false. When present and true, the UDM+HSS is requested to cancel previous registration in SGSN, if any. Not applicable for Nudr and Nudm_UECM GET operation. (NOTE 2)
backupAmfInfo	array(BackupAmfInfo)	C	1..N	This IE shall be included if the NF service consumer is an AMF and the AMF supports the AMF management without UDSF for the first interaction with UDM. The UDM uses this attribute to do an NRF query in order to invoke later services in a backup AMF, e.g. Namf_EventExposure.
drFlag	DualRegistrationFlag	O	0..1	Dual Registration flag. When present and true, this flag indicates that the UDM+HSS is requested not to send S6a-CLR to the registered MME/SGSN (if any). Otherwise, the registered MME (if any) shall be cancelled. Not applicable for Nudr and Nudm_UECM GET operation.
urrpIndicator	boolean	O	0..1	This IE indicates whether "UE_REACHABILITY_FOR_SMS" event for this user has been subscribed or not: - true: the event has been subscribed - false, or absence of this attribute: the event for this user is currently not subscribed (NOTE 1)

amfEeSubscriptionId	Uri	C	0..1	Shall be present if urrpIndicator is true and the UDM has subscribed to ReachabilityReport event for "UE Reachability for DL Traffic" at the AMF to receive One-Time UE Activity notification. It contains the subscription Id UrRI allocated by the AMF as received by the UDM in the HTTP "Location" header of the Namf_EventExposure_Subscribe response. The UDM shall make use of the Nudr_DataRepository Update service operation (see 3GPP TS 29.504 [9]) to store the amfEeSubscription Id in the UDR.
epsInterworkingInfo	EpsInterworkingInfo	C	0..1	This IE shall be included if the AMF has determined per APN/DNN which PGW-C+SMF is selected for EPS interworking with N26 and the AMF supports EPS interworking of non-3GPP access. For each APN/DNN, only one PGW-C+SMF shall be selected by the AMF for EPS interworking.
ueSrvccCapability	boolean	O	0..1	This IE indicates whether the UE supports 5G SRVCC: - true: 5G SRVCC is supported by the UE and AMF; - false, or absence of this attribute: 5G SRVCC is not supported.
registrationTime	DateTime	C	0..1	Time of Amf3GppAccessRegistration. Shall be present when used on Nudr.
vgmlcAddress	VgmlcAddress	O	0..1	Address of the VGMLC
contextInfo	ContextInfo	C	0..1	This IE if present may contain e.g. the headers received by the UDM along with the 3GppAccessRegistration. Shall be absent on Nudm and may be present on Nudr
noEeSubscriptionInd	boolean	O	0..1	This IE shall be absent on Nudr and may be present on Nudm. This indication is used by UDM to restore any possible ongoing subscription lost, as specified in clause 5.3.2.2.2. When present, this IE shall indicate whether AMF does not have event exposure subscriptions in UE Context: - true: No Event Exposure subscription existing in UE Context in AMF. - false: Event Exposure subscription(s) exist in UE Context in AMF.
supi	Supi	C	0..1	This IE may be included by the AMF in registration requests and should be included by UDM in GET responses when the corresponding GET request provided a GPSI UE identity.
NOTE 1: The urrpIndicator attribute shall only be exposed over the Nudr SBI, and it shall not be included by the AMF.				
NOTE 2: Regardless of the Dual Registration Flag, the SGSN, if any, is required to be cancelled (see 3GPP TS 23.502 [3] clause 4.11.5.2)				

6.2.6.2.3 Type: AmfNon3GppAccessRegistration

Table 6.2.6.2.3-1: Definition of type AmfNon3GppAccessRegistration

Attribute name	Data type	P	Cardinality	Description
amfInstanceIcd	NfInstanceIcd	M	1	The identity the AMF uses to register in the NRF.
deregCallbackUri	Uri	M	1	A URI provided by the AMF to receive (implicitly subscribed) notifications on deregistration. The deregistration callback URI shall have unique information within AMF set to identify the UE to be deregistered.
guami	Guami	M	1	This IE shall contain the serving AMF's GUAMI.
ratType	RatType	M	1	This IE shall indicate the current RAT type of the UE.
supportedFeatures	SupportedFeatures	O	0..1	See clause 6.2.8 These are the features supported by the AMF.
purgeFlag	PurgeFlag	O	0..1	This flag indicates whether or not the AMF has deregistered. It shall not be included in the Registration service operation.
pei	Pei	O	0..1	Permanent Equipment Identifier Absence of PEI indicates that the PEI is not available at the AMF. In this case the UDM/UDR shall not delete the PEI value stored from a previous registration.
imsVoPs	ImsVoPs	M	1	Indicates per UE if "IMS Voice over PS Sessions" is supported, or not supported. The value NON_HOMOGENEOUS_OR_UNKNOWN is not applicable.
amfServiceNameDereg	ServiceName	O	0..1	When present, this IE shall contain the name of the AMF service to which the Deregistration Notification is to be sent (see clause 6.5.2.2 of 3GPP TS 29.500 [4]).
pcscfRestorationCallbackUri	Uri	O	0..1	A URI provided by the AMF to receive (implicitly subscribed) notifications on the need for P-CSCF Restoration.
amfServiceNamePcscfRest	ServiceName	O	0..1	When present, this IE shall contain the name of the AMF service to which P-CSCF Restoration Notifications are to be sent (see clause 6.5.2.2 of 3GPP TS 29.500 [4]). This IE may be included if pcscfRestorationCallbackUri is present.
backupAmfInfo	array(BackupAmfInfo)	C	1..N	This IE shall be included if the NF service consumer is an AMF and the AMF supports the AMF management without UDSF for the first interaction with UDM. The UDM uses this attribute to do an NRF query in order to invoke later services in a backup AMF, e.g. Namf_EventExposure.
urrlIndicator	boolean	O	0..1	This IE indicates whether "UE_REACHABILITY_FOR_SMS" event for this user has been subscribed or not: - true: the event has been subscribed - false, or absence of this attribute: the event for this user is currently not subscribed

amfEeSubscriptionId	Uri	C	0..1	Shall be present if urrpIndicator is true and the UDM has subscribed to Reachability-Report event for "UE Reachable for DL Traffic" at the AMF to receive One-Time UE Activity notification. It contains the subscription Id URI allocated by the AMF as received by the UDM in the HTTP "Location" header of the Namf_EventExposure_Subscribe response. The UDM shall make use of the Nudr_DataRepository Update service operation (see 3GPP TS 29.504 [9]) to store the amfEeSubscription Id in the UDR.
registrationTime	DateTime	C	0..1	Time of AmfNon3GppAccessRegistration. Shall be present when used on Nudr.
vgmlcAddress	VgmlcAddress	O	0..1	Address of the VGMLC
contextInfo	ContextInfo	C	0..1	This IE if present may contain e.g. the headers received by the UDM along with AmfNon3GppRegistration. Shall be absent on Nudm and may be present on Nudr.
noEeSubscriptionInd	boolean	O	0..1	This IE shall be absent on Nudr and may be present on Nudm. This indication is used by UDM to restore any possible ongoing subscription lost, as specified in clause 5.3.2.2.3. When present, this IE shall indicate whether AMF does not have event exposure subscriptions in UE Context: - true: No Event Exposure subscription existing in UE Context in AMF. - false: Event Exposure subscription(s) exist in UE Context in AMF.
supi	Supi	C	0..1	This IE may be included by the AMF in registration requests and should be included by UDM in GET responses when the corresponding GET request provided a GPSI UE identity.
NOTE: The urrpIndicator attribute shall only be exposed over the Nudr SBI, and it shall not be included by the AMF.				

6.2.6.2.4 Type: SmfRegistration

Table 6.2.6.2.4-1: Definition of type SmfRegistration

Attribute name	Data type	P	Cardinality	Description
smfInstanceId	NfInstanceId	M	1	NF Instance Id of the SMF
smfSetId	NfSetId	C	0..1	This IE shall be present if the SMF belongs to a SMF SET. If present, it indicates the NF Set ID of SMF Set.
supportedFeatures	SupportedFeatures	O	0..1	See clause 6.2.8 These are the features supported by the SMF.
pduSessionId	PduSessionId	M	1	PDU Session ID
singleNssai	Snsai	M	1	A single Network Slice Selection Assistance Information
dnn	Dnn	C	0..1	Data Network Name; shall be present if emergencyServices is false or absent. When present, this IE shall contain the Network Identifier only.
emergencyServices	boolean	C	0..1	Indication of Emergency Services; absence indicates false.
pcscfRestorationCallbackUri	Uri	O	0..1	a URI provided by the SMF to receive (implicitly subscribed) notifications on the need for P-CSCF Restoration
plmnId	PlmnId	M	1	Serving node PLMN identity.
pgwFqdn	string	C	0..1	FQDN of the PGW in the "PGW-C+SMF", to be included for interworking with EPS.
epdgInd	boolean	O	0..1	Indicate whether access is from ePDG. true: access from ePDG. false or absent: not access from ePDG
deregCallbackUri	Uri	O	0..1	A URI provided by the SMF to receive (implicitly subscribed) notifications on deregistration. The deregistration callback URI shall have unique information within SMF set to identify the UE to be deregistered.
registrationReason	RegistrationReason	O	0..1	Indicates registration reason.
registrationTime	DateTime	C	0..1	Time of SmfRegistration. Shall be present when used on Nudr.
contextInfo	ContextInfo	C	0..1	This IE if present may contain e.g. the headers received by the UDM along with the SmfRegistration. Shall be absent on Nudm and may be present on Nudr.

6.2.6.2.5 Type: DeregistrationData

Table 6.2.6.2.5-1: Definition of type DeregistrationData

Attribute name	Data type	P	Cardinality	Description
deregReason	DeregistrationReason	M	1	String; see clause 6.2.6.3.3
accessType	AccessType	C	0..1	Access type where the UE is deregistered. Shall be present in Deregistration Notifications sent to the AMF.
pduSessionId	PduSessionId	C	0..1	It shall be present if the deregistration of SMF happens. If present, indicates PDU Session ID for which old SMF is deregistered.
newSmfInstanceId	NfInstanceId	O	0..1	NF Instance Id of the new SMF to which the SMF context is transferred.

6.2.6.2.6 Type: SmsfRegistration

Table 6.2.6.2.6-1: Definition of type SmsfRegistration

Attribute name	Data type	P	Cardinality	Description
smsfInstanceid	NfInstanceid	M	1	NF Instance Id of the SMSF
smsfSetid	NfSetid	C	0..1	This IE shall be present if the SMSF belongs to an SMSF SET. If present, it indicates the NF Set ID of SMSF Set.
supportedFeatures	SupportedFeatures	O	0..1	See clause 6.2.8 These are the features supported by the SMSF.
plmnid	Plmnid	M	1	Serving node PLMN identity
smsfMAPAddress	E164Number	C	0..1	International E.164 number of the SMSF; shall be present if the SMSF supports MAP (see 3GPP TS 29.002 [21])
smsfDiameterAddress	NetworkNodeDiameterAddress	C	0..1	shall be present if the SMSF supports Diameter (see 3GPP TS 29.338 [22])
registrationTime	DateTime	C	0..1	Time of SmsfRegistration. Shall be present when used on Nudr.
contextInfo	ContextInfo	C	0..1	This IE if present may contain e.g. the headers received by the UDM along with the SmsfRegistration. Shall be absent on Nudm and may be present on Nudr..

6.2.6.2.7 Type: Amf3GppAccessRegistrationModification

This type is derived from the type Amf3GppAccessRegistration by deleting all attributes that are not subject to modification by means of the HTTP PATCH method.

Table 6.2.6.2.7-1: Definition of type Amf3GppAccessRegistrationModification

Attribute name	Data type	P	Cardinality	Description
guami	Guami	M	1	Guami of the AMF requesting the modification. If the MCC, MNC, AMF Region ID and AMF Set ID within the guami do not match the stored value, the modification request shall be rejected.
purgeFlag	PurgeFlag	O	0..1	This flag indicates whether or not the AMF has deregistered. It shall be included in the Deregistration service operation with a value of "TRUE".
pei	Pei	O	0..1	Permanent Equipment Identifier.
imsVoPs	ImsVoPs	O	0..1	Indicates per UE if "IMS Voice over PS Sessions" is homogeneously supported in all TAs in the serving AMF, or homogeneously not supported, or if support is non-homogeneous/unknown
backupAmfInfo	array(BackupAmfInfo)	C	0..N	This IE shall be included if the NF service consumer is an AMF and the AMF supports the AMF management without UDSF for the Modification of the BackupAmfInfo. The UDM uses this attribute to do an NRF query in order to invoke later services in a backup AMF, e.g. Namf_EventExposure
epsInterworkingInfo	EpsInterworkingInfo	C	0..1	This IE shall be included if the AMF has determined per APN/DNN which PGW-C+SMF is selected for EPS interworking with N26 and the AMF supports EPS interworking of non-3GPP access. This IE shall also be included to update the PGW-C+SMF information if the AMF selects another PGW-C+SMF for EPS interworking with N26 for the same DNN. For each APN/DNN, only one PGW-C+SMF shall be selected by the AMF for EPS interworking.
ueSrvccCapability	boolean	O	0..1	This IE indicates whether the UE supports 5G SRVCC: - true: 5G SRVCC is supported by the UE and AMF; - false: 5G SRVCC is not supported.
Note:	Absence of optional attributes indicates: no modification. Attributes of this type are not marked "nullable: true" in the OpenAPI file as deletion of these attributes is not applicable.			

6.2.6.2.8 Type: AmfNon3GppAccessRegistrationModification

This type is derived from the type AmfNon3GppAccessRegistration by deleting all attributes that are not subject to modification by means of the HTTP PATCH method.

Table 6.2.6.2.8-1: Definition of type AmfNon3GppAccessRegistrationModification

Attribute name	Data type	P	Cardinality	Description
guami	Guami	M	1	Guami of the AMF requesting the modification. If the MCC, MNC, AMF Region ID and AMF Set ID within the guami do not match the stored value, the modification request shall be rejected.
purgeFlag	PurgeFlag	O	0..1	This flag indicates whether or not the AMF has deregistered. It shall be included in the Deregistration service operation with a value of "TRUE".
pei	Pei	O	0..1	Permanent Equipment Identifier
imsVoPs	ImsVoPs	O	0..1	If present indicates per UE that support of "IMS Voice over PS Sessions" has been modified to supported or not supported". The value NON_HOMOGENEOUS_OR_UNKNOWN is not applicable.
backupAmfInfo	array(BackupAmf Info)	C	0..N	This IE shall be included if the NF service consumer is an AMF and the AMF supports the AMF management without UDSF for the Modification of the BackupAmfInfo. The UDM uses this attribute to do an NRF query in order to invoke later services in a backup AMF, e.g. Namf_EventExposure
Note: Absence of optional attributes indicates: no modification. Attributes of this type are not marked "nullable: true" in the OpenAPI file as deletion of these attributes is not applicable.				

6.2.6.2.9 Type: PcsfRestorationNotification

Table 6.2.6.2.9-1: Definition of type PcsfRestorationNotification

Attribute name	Data type	P	Cardinality	Description
supi	Supi	M	1	A SUPI that is served by the failed P-CSCF

6.2.6.2.10 Type: NetworkNodeDiameterAddress

Table 6.2.6.2.10-1: Definition of type NetworkNodeDiameterAddress

Attribute name	Data type	P	Cardinality	Description
name	DiameterIdentity	M	1	
realm	DiameterIdentity	M	1	

6.2.6.2.11 Type: EpslwkPgw

Table 6.2.6.2.11-1: Definition of type EpslwkPgw

Attribute name	Data type	P	Cardinality	Description
pgwFqdn	string	M	1	The PGW FQDN of the "PGW-C+SMF"
smfInstanceld	NfInstanceld	M	1	The SMF Instance Id of the "PGW-C+SMF"

6.2.6.2.12 Type: TriggerRequest

Table 6.2.6.2.12-1: Definition of type TriggerRequest

Attribute name	Data type	P	Cardinality	Description
supi	Supi	M	1	

6.2.6.2.13 Type: AmfDeregInfo

Table 6.2.6.2.13-1: Definition of type AmfDeregInfo

Attribute name	Data type	P	Cardinality	Description
deregReason	Deregistration Reason	M	1	String; see clause 6.2.6.3.3

6.2.6.2.14 Type: EpsInterworkingInfo

Table 6.2.6.2.14-1: Definition of type EpsInterworkingInfo

Attribute name	Data type	P	Cardinality	Description
epslwkPgws	map(EpslwkPgw)	O	0..N	A map (list of key-value pairs where dnn serves as key) of EpslwkPgws. An empty map is used in Amf3GppAccessRegistrationModification to delete the epsInterworkingInfo.

6.2.6.2.15 Type: LocationInfo

Table 6.2.6.2.15-1: Definition of type LocationInfo

Attribute name	Data type	P	Cardinality	Description
supi	Supi	O	0..1	Subscription Permanent Identifier (NOTE 1)
gpsi	Gpsi	O	0..1	Generic Public Subscription Identifier (NOTE 1)
registrationLocationInfoList	array(RegistrationLocationInfo)	M	1..2	Serving AMF, optional VGMLC and access type related informations used by (H)GMLC to send Location Request (NOTE 2)
supportedFeatures	SupportedFeatures	O	0..1	supported features of the UDM
NOTE 1: One of both shall be included to identify the target UE.				
NOTE 2: At least, one of 3GPP and Non-3GPP access types shall be included to describe the location related information of the target UE for the access type.				

6.2.6.2.16 Type: RegistrationLocationInfo

Table 6.2.6.2.16-1: Definition of type RegistrationLocationInfo

Attribute name	Data type	P	Cardinality	Description
amfInstanceld	NfInstanceld	M	1	The NF instance identity of the serving AMF.
guami	Guami	O	0..1	The GUAMI served by the serving AMF.
plmnld	Plmnld	C	0..1	Serving node PLMN identity is included if the target UE is in roaming case for the serving AMF. (NOTE)
vgmlcAddress	VgmlcAddress	C	0..1	The address(es) of VGMLC. (NOTE)
accessTypeList	array(AccessType)	M	1..2	Access type(s) where the UE is registered
NOTE: The two IEs are only be included if the target UE is registered in VPLMN via the serving AMF.				

6.2.6.2.17 Type: VgmlcAddress

Table 6.2.6.2.17-1: Definition of type VgmlcAddress

Attribute name	Data type	P	Cardinality	Description
vgmlcAddressIpv4	Ipv4Addr	O	0..1	When present, indicates VGMLC IPv4 address.
vgmlcAddressIpv6	Ipv6Addr	O	0..1	When present, indicates VGMLC IPv6 address.
vgmlcFqdn	Fqdn	O	0,,1	When present, indicates FQDN of the VGMLC IPv6 address.
NOTE: At least, one of VGMLC addresses should be included.				

6.2.6.2.18 Type: PeiUpdateInfo

Table 6.2.6.2.18-1: Definition of type AmfDeregInfo

Attribute name	Data type	P	Cardinality	Description
pei	Pei	M	1	

6.2.6.2.19 Type: RegistrationDataSets

Table 6.2.6.2.19-1: Definition of type RegistrationDataSets

Attribute name	Data type	P	Cardinality	Description
amf3Gpp	Amf3GppAccessRegistration	O	1	AMF 3GPP Access Registration
amfNon3Gpp	AmfNon3GppAccessRegistration	O	1	AMF Non 3GPP Access Registration
smfRegistration	SmfRegistrationInfo	O	0..1	SMF Registration Information
smsf3Gpp	SmsfRegistration	O	0..1	SMSF 3GPP Access Registration
smsfNon3Gpp	SmsfRegistration	O	0..1	SMSF Non 3GPP Access Registration

6.2.6.2.20 Type: IpSmGwRegistration

Table 6.2.6.2.20-1: Definition of type IpSmGwRegistration

Attribute name	Data type	P	Cardinality	Description
ipSmGwMapAddress	E164Number	C	0..1	International E.164 number of the IP-SM-GW; it shall be present if the IP-SM-GW supports MAP (see 3GPP TS 29.002 [21])
ipSmGwDiameterAddress	NetworkNodeDiameterAddress	C	0..1	Diameter Identity of the IP-SM-GW; it shall be present if the IP-SM-GW supports Diameter (see 3GPP TS 29.328 [52])
unriIndicator	boolean	O	0..1	UE-Not-Reachable-for-IP (UNRI) flag as defined in 3GPP TS 23.040 [53]. This IE indicates whether the address list of MWD contains one or more entries because an attempt to deliver a short message to a UE via an IP-SM-GW has failed with a cause of Absent Subscriber: - true: the MWD contains one or more list elements due to an SMS delivery failure - false, or absence of this attribute: the MWD does not contain any list element
NOTE 1: At least one of the properties, ipSmGwMapAddress or ipSmGwDiameterAddress, shall be present.				
NOTE 2: The unriIndicator attribute shall only be exposed over the Nudr SBI.				

6.2.6.2.20A Type: SmfRegistrationInfo

Table 6.2.6.2.20A-1: Definition of type SmfRegistrationInfo

Attribute name	Data type	P	Cardinality	Description
smfRegistrationList	array(SmfRegistration)	M	1..N	List of SmfRegistration.

6.2.6.3 Simple data types and enumerations

6.2.6.3.1 Introduction

This clause defines simple data types and enumerations that can be referenced from data structures defined in the previous clauses.

6.2.6.3.2 Simple data types

The simple data types defined in table 6.2.6.3.2-1 shall be supported.

Table 6.2.6.3.2-1: Simple data types

Type Name	Type Definition	Description
PurgeFlag	boolean	This flag indicates whether or not the NF has deregistered.
E164Number	string	see ITU-T Recommendation E.164 [23] pattern: $^{\wedge}[0-9]\{1,15\}$ \$
DualRegistrationFlag	boolean	Dual Registration Flag

6.2.6.3.3 Enumeration: DeregistrationReason

The enumeration DeregistrationReason represents the reason for the Deregistration Notification. It shall comply with the provisions defined in table 6.2.6.3.3-1.

Table 6.2.6.3.3-1: Enumeration DeregistrationReason

Enumeration value	Description
"UE_INITIAL_REGISTRATION"	When sent by the HSS; indicates that the deregistration towards the UDM is due to an initial attach in EPS. When sent by the UDM; indicates that the deregistration in the old AMF is due to a new AMF serving the UE during an initial registration See 3GPP TS 23.502 [3] and 3GPP TS 23.632 [32].
"UE_REGISTRATION_AREA_CHANGE"	see 3GPP TS 23.502 [3]
"SUBSCRIPTION_WITHDRAWN"	see 3GPP TS 23.502 [3]
"5GS_TO_EPS_MOBILITY"	see 3GPP TS 23.502 [3] and 3GPP TS 23.632 [32].
"5GS_TO_EPS_MOBILITY_UE_INITIAL_REGISTRATION"	This value shall only be sent by the UDM. It indicates that the deregistration in AMF is due to an initial attach in EPS, See 3GPP TS 23.502 [3] and 3GPP TS 23.632 [32].
"REREGISTRATION_REQUIRED"	see 3GPP TS 23.502 [3]
"SMF_CONTEXT_TRANSFERRED"	see 3GPP TS 23.502 [3]

6.2.6.3.4 Enumeration: ImsVoPs

The enumeration ImsVoPs represents information indicating homogeneity of IMS Voice over PS Sessions support for the UE. It shall comply with the provisions defined in table 6.2.6.3.4-1.

Table 6.2.6.3.4-1: Enumeration ImsVoPs

Enumeration value	Description
"HOMOGENEOUS_SUPPORT"	"IMS Voice over PS Sessions" is homogeneously supported in all TAs in the serving AMF.
"HOMOGENEOUS_NON_SUPPORT"	"IMS Voice over PS Sessions" is homogeneously not supported in all TAs in the serving AMF.
"NON_HOMOGENEOUS_OR_UNKNOWN"	"IMS Voice over PS Sessions" is not homogeneously supported in all TAs in the serving AMF, or its support is unknown.

6.2.6.3.5 Enumeration: RegistrationReason

The enumeration RegistrationCause represents the reason for the NF Registration. It shall comply with the provisions defined in table 6.2.6.3.5-1.

Table 6.2.6.3.5-1: Enumeration RegistrationReason

Enumeration value	Description
"SMF_CONTEXT_TRANSFERRED"	SMF transferred

6.2.6.3.6 Enumeration: RegistrationDataSetName

Table 6.2.6.3.6-1: Enumeration RegistrationDataSetName

Enumeration value	Description
"AMF_3GPP"	AMF 3GPP Access Registration
"AMF_NON_3GPP"	AMF Non 3GPP Access Registration
"SMF_PDU_SESSIONS"	SMF PDU Session Registration
"SMSF_3GPP"	SMSF 3GPP Access Registration
"SMSF_NON_3GPP"	SMSF Non 3GPP Access Registration

Note: The current naming conventions for Enumerations (uppercase with underscore), when their intended usage is for query parameters is not consistent with the naming conventions for URI components (lowercase with hyphen).

6.2.7 Error Handling

6.2.7.1 General

HTTP error handling shall be supported as specified in clause 5.2.4 of 3GPP TS 29.500 [4].

The Cause codes mapping performed by AMF between the following HTTP responses returned by the UDM services to the AMF and the 5GMM related values is specified in clause 4.4.2 of 3GPP TS 29.524 [44].

6.2.7.2 Protocol Errors

Protocol errors handling shall be supported as specified in clause 5.2.7 of 3GPP TS 29.500 [4].

6.2.7.3 Application Errors

The common application errors defined in the Table 5.2.7.2-1 in 3GPP TS 29.500 [4] may also be used for the Nudm_UEContextManagement service. The following application errors listed in Table 6.2.7.3-1 are specific for the Nudm_UEContextManagement service.

Table 6.2.7.3-1: Application errors

Application Error	HTTP status code	Description
NF_CONSUMER_REDIRECT_ONE_TXN	307 Temporary Redirect	The request has been asked to be redirected to a specified target for one transaction.
CONTEXT_NOT_FOUND	308 Permanent Redirect	The request has been asked to be redirected to a specified target.
UNKNOWN_5GS_SUBSCRIPTION	403 Forbidden	No 5GS subscription is associated with the user.
NO_PS_SUBSCRIPTION	403 Forbidden	No PS (5GS, EPS, GPRS) subscription is associated with the user.
ROAMING_NOT_ALLOWED	403 Forbidden	The subscriber is not allowed to roam within that PLMN
USER_NOT_FOUND	404 Not Found	The user does not exist in the HPLMN
CONTEXT_NOT_FOUND	404 Not Found	It is used when no corresponding context exists.
ACCESS_NOT_ALLOWED	403 Forbidden	Access type not allowed for the user.
RAT_NOT_ALLOWED	403 Forbidden	RAT is not allowed for the user
DNN_NOT_ALLOWED	403 Forbidden	DNN not authorized for the user
REAUTHENTICATION_REQUIRED	403 Forbidden	Due to operator policies the user needs to be re-authenticated, e.g. last valid authentication is considered obsolete
INVALID_GUAMI	403 Forbidden	The AMF is not allowed to modify the registration information stored in the UDM, as it is not the registered AMF.
SERVICE_NOT_PROVISIONED	403 Forbidden	The request is related to a service that is not provisioned for the user in the 5GS subscription data (e.g. SMS teleservice not provisioned).
SERVICE_NOT_ALLOWED	403 Forbidden	The request is related to a service that is not allowed for the user in the 5GS subscription data (e.g. SMS is barred).
TEMPORARY_REJECT_REGISTRATION_ONGOING	409 Conflict	The request cannot be processed due to an ongoing registration procedure.
TEMPORARY_REJECT_HANDOVER_ONGOING	409 Conflict	The request cannot be processed due to an ongoing N2 handover procedure.
UNPROCESSABLE_REQUEST	422 Unprocessable Entity	The request cannot be processed due to semantic errors when trying to process a patch method

6.2.8 Feature Negotiation

The optional features in table 6.2.8-1 are defined for the Nudm_UECM API. They shall be negotiated using the extensibility mechanism defined in clause 6.6 of 3GPP TS 29.500 [4].

Table 6.2.8-1: Supported Features

Feature number	Feature Name	Description
1	SharedData	When receiving a Nudm_UECM_Registration service operation request for a UE that shares subscription data with other UEs, and the request does not indicate support of this feature by the service consumer, the UDM may – based on operator policy – decide to reject the registration.
2	PatchReport	If some of the modifications included in the PATCH request are not successfully implemented, the UDM reports the result of PATCH request execution to the consumer. See clause 5.2.7.2 of 3GPP TS 29.500 [4].

6.2.9 Security

As indicated in 3GPP TS 33.501 [6] and 3GPP TS 29.500 [4], the access to the Nudm_UECM API may be authorized by means of the OAuth2 protocol (see IETF RFC 6749 [18]), based on local configuration, using the "Client Credentials" authorization grant, where the NRF (see 3GPP TS 29.510 [19]) plays the role of the authorization server.

If OAuth2 is used, an NF Service Consumer, prior to consuming services offered by the Nudm_UECM API, shall obtain a "token" from the authorization server, by invoking the Access Token Request service, as described in 3GPP TS 29.510 [19], clause 5.4.2.2.

NOTE: When multiple NRFs are deployed in a network, the NRF used as authorization server is the same NRF that the NF Service Consumer used for discovering the Nudm_UECM service.

The Nudm_UECM API defines a single scope "nudm-uecm" for OAuth2 authorization (as specified in 3GPP TS 33.501 [6]) for the entire API, and it does not define any additional scopes at resource or operation level.

6.3 Nudm_UEAuthentication Service API

6.3.1 API URI

URIs of this API shall have the following root:

{apiRoot}/{apiName}/<apiVersion>/

The request URI used in HTTP request from the NF service consumer towards the NF service producer shall have the structure defined in clause 4.4.1 of 3GPP TS 29.501 [5], i.e.:

{apiRoot}/<apiName>/<apiVersion>/<apiSpecificResourceUriPart>

with the following components:

- The {apiRoot} shall be set as described in 3GPP TS 29.501 [5].
- The <apiName> shall be "nudm-ueau".
- The <apiVersion> shall be "v1".
- The <apiSpecificResourceUriPart> shall be set as described in clause 6.3.3.

6.3.2 Usage of HTTP

6.3.2.1 General

HTTP/2, as defined in IETF RFC 7540 [13], shall be used as specified in clause 5 of 3GPP TS 29.500 [4].

HTTP/2 shall be transported as specified in clause 5.3 of 3GPP TS 29.500 [4].

HTTP messages and bodies for the Nudm_UEAU service shall comply with the OpenAPI [14] specification contained in Annex A4.

6.3.2.2 HTTP standard headers

6.3.2.2.1 General

The usage of HTTP standard headers shall be supported as specified in clause 5.2.2 of 3GPP TS 29.500 [4].

6.3.2.2.2 Content type

The following content types shall be supported:

JSON, as defined in IETF RFC 8259 [15], signalled by the content type "application/json".

The Problem Details JSON Object (IETF RFC 7807 [16] signalled by the content type "application/problem+json"

6.3.2.3 HTTP custom headers

6.3.2.3.1 General

The usage of HTTP custom headers shall be supported as specified in clause 5.2.3 of 3GPP TS 29.500 [4].

6.3.3 Resources

6.3.3.1 Overview

Figure 6.3.3.1-1 describes the resources supported by the Nudm_UEAU API.

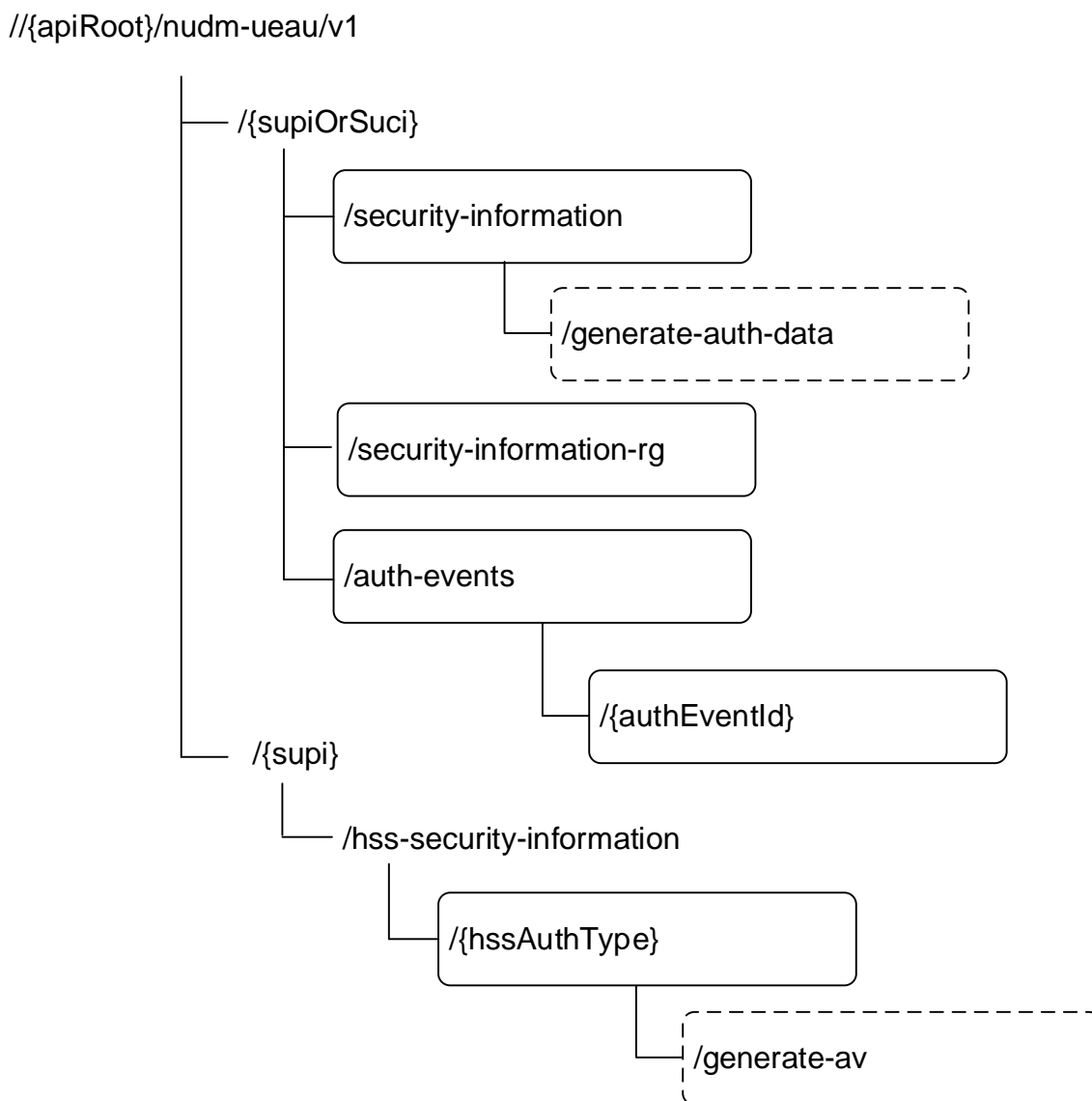

Figure 6.3.3.1-1: Resource URI structure of the nudm_ueau API

Table 6.3.3.1-1 provides an overview of the resources and applicable HTTP methods.

Table 6.3.3.1-1: Resources and methods overview

Resource name (Archetype)	Resource URI	HTTP method or custom operation	Description
SecurityInformation (Custom operation)	/{supiOrSuci}/security-information/generate-auth-data	generate-auth-data (POST)	If the variable {supiOrSuci} takes the value of a SUCI, the UDM calculates the corresponding SUPI. The UDM calculates a fresh authentication vector based on the received information and the stored security information for the SUPI if 5G-AKA or EAP-AKA' is selected. Otherwise, UDM provides corresponding authentication information.
SecurityInformationForRg	/{supiOrSuci}/security-information-rg	GET	If the variable {supiOrSuci} takes the value of a SUCI, the UDM calculates the corresponding SUPI. The UDM decides, based on the received information and the stored authentication profile of the SUPI, that authentication by the home network is not required for the FN-RG.
AuthEvents (Collection)	/{supi}/auth-events	POST	Create an Authentication Event
Individual AuthEvent (Document)	/{supi}/auth-events/{authEventId}	PUT	Update an Authentication Event
HssSecurityInformation (Custom operation)	/{supi}/hss-security-information/{hssAuthType}/generate-av	generate-av (POST)	The UDM generates the authentication vector(s) of the requested type based on stored security information for the SUPI.

6.3.3.2 Resource: SecurityInformation (Custom operation)

6.3.3.2.1 Description

This resource represents the information that is needed together with the serving network name and the access type to calculate a fresh authentication vector. See 3GPP TS 33.501 [6].

6.3.3.2.2 Resource Definition

Resource URI: {apiRoot}/nudm-ueau/v1/{supiOrSuci}/security-information

This resource shall support the resource URI variables defined in table 6.3.3.2.2-1.

Table 6.3.3.2.2-1: Resource URI variables for this resource

Name	Data type	Definition
apiRoot	string	See clause 6.3.1
supiOrSuci	string	Represents the Subscription Permanent Identifier (see 3GPP TS 23.501 [2] clause 5.9.2), or Subscription Concealed Identifier (see 3GPP TS 23.003 [8]). Pattern: See pattern of type SupiOrSuci in 3GPP TS 29.571 [7] (See NOTE 1, NOTE 2).
NOTE 1: The format for SUCI, when the corresponding SUPI is NAI-based, contains a realm that may include a "minus" character ("-"), which is also used as field separator. Given that the NAI and its realm shall conform to IETF RFC 7542 [29], the regular expression defined here allows for non-ambiguous matching of the different fields of the SUCI, even when the realm contains the "minus" character.		
NOTE 2: When the SUCI corresponds to a SUPI of type IMSI, and the Null protection scheme is used, the MSIN of the IMSI (which is formatted by the UE and sent over the NAS protocol as Binary Coded Decimal, BCD) shall be formatted in the SUCI as an UTF-8 string containing all decimal digits of the MSIN; see Annex C for SUCI encoding examples.		

6.3.3.2.3 Resource Standard Methods

No Standard Methods are supported for this resource.

6.3.3.2.4 Resource Custom Operations

6.3.3.2.4.1 Overview

Table 6.3.3.2.4.1-1: Custom operations

Operation Name	Custom operation URI	Mapped HTTP method	Description
generate-auth-data	/generate-auth-data	POST	Select the authentication method and calculate a fresh AV if 5G-AKA or EAP-AKA' is selected or provides corresponding authentication information.

6.3.3.2.4.2 Operation: generate-auth-data

6.3.3.2.4.2.1 Description

This custom operation is used by the NF service consumer (AUSF) to request authentication information data for the SUPI/SUCI from the UDM. If SUCI is provided, the UDM calculates the SUPI from the SUCI (see 3GPP TS 33.501 [6]). The UDM calculates an authentication vector taking into account the information received from the NF service consumer (AUSF) and the current representation of this resource if 5G AKA or EAP-AKA' is selected. For details see 3GPP TS 33.501 [6].

6.3.3.2.4.2.2 Operation Definition

This operation shall support the request data structures specified in table 6.3.3.2.4.2.2-1 and the response data structure and response codes specified in table 6.3.3.2.4.2.2-2.

Table 6.3.3.2.4.2.2-1: Data structures supported by the POST Request Body on this resource

Data type	P	Cardinality	Description
AuthenticationInfo Request	M	1	Contains the serving network name and Resynchronization Information

Table 6.3.3.2.4.2-2: Data structures supported by the POST Response Body on this resource

Data type	P	Cardinality	Response codes	Description
AuthenticationInfoResult	M	1	200 OK	Upon success, a response body containing the selected authentication method and an authentication vector if 5G AKA or EAP-AKA' has been selected shall be returned
ProblemDetails	O	0..1	404 Not Found	The "cause" attribute may be used to indicate one of the following application errors: - USER_NOT_FOUND
ProblemDetails	O	0..1	403 Forbidden	The "cause" attribute may be used to indicate one of the following application errors: - AUTHENTICATION_REJECTED - INVALID_HN_PUBLIC_KEY_IDENTIFIER - INVALID_SCHEME_OUTPUT
ProblemDetails	O	0..1	501 Not Implemented	The "cause" attribute may be used to indicate one of the following application errors: - UNSUPPORTED_PROTECTION_SCHEME This response shall not be cached.
NOTE: In addition common data structures as listed in table 5.2.7.1-1 of 3GPP TS 29.500 [4] are supported.				

6.3.3.3 Resource: AuthEvents (Collection)

6.3.3.3.1 Description

This resource represents the collection of UE authentication events.

6.3.3.3.2 Resource Definition

Resource URI: {apiRoot}/nudm-ueau/v1/{supi}/auth-events

This resource shall support the resource URI variables defined in table 6.3.3.3.2-1.

Table 6.3.3.3.2-1: Resource URI variables for this resource

Name	Data type	Definition
apiRoot	string	See clause 6.3.1
supi	Supi	Represents the Subscription Permanent Identifier (see 3GPP TS 23.501 [2] clause 5.9.2) pattern: See pattern of type Supi in 3GPP TS 29.571 [7]

6.3.3.3.3 Resource Standard Methods

6.3.3.3.3.1 POST

This method shall support the URI query parameters specified in table 6.3.3.3.3.1-1.

Table 6.3.3.3.3.1-1: URI query parameters supported by the POST method on this resource

Name	Data type	P	Cardinality	Description
n/a				

This method shall support the request data structures specified in table 6.3.3.3.3.1-2 and the response data structures and response codes specified in table 6.3.3.3.3.1-3.

Table 6.3.3.3.3.1-2: Data structures supported by the POST Request Body on this resource

Data type	P	Cardinality	Description
AuthEvent	M	1	The UE Authentication Event

Table 6.3.3.3.1-3: Data structures supported by the POST Response Body on this resource

Data type	P	Cardinality	Response codes	Description
AuthEvent	O	0..1	201 Created	Upon success, a response body containing a representation of the created Authentication Event may be returned. The HTTP response shall include a "Location" HTTP header that contains the resource URI of the created resource.
ProblemDetails	O	0..1	404 Not Found	The "cause" attribute may be used to indicate one of the following application errors: - USER_NOT_FOUND
NOTE: In addition common data structures as listed in table 5.2.7.1-1 of 3GPP TS 29.500 [4] are supported.				

Table 6.3.3.3.1-4: Headers supported by the 201 Response Code on this resource

Name	Data type	P	Cardinality	Description
Location	string	M	1	Contains the URI of the newly created resource, according to the structure: {apiRoot}/nudm-ueau/v1/{supi}/auth-events/{authEventId}

6.3.3.4 Resource: SecurityInformationForRg

6.3.3.4.1 Description

This resource represents the security information of FN-RG, see 3GPP TS 33.501 [6].

6.3.3.4.2 Resource Definition

Resource URI: {apiRoot}/nudm-ueau/v1/{supiOrSuci}/security-information-rg

This resource shall support the resource URI variables defined in table 6.3.3.4.2-1.

Table 6.3.3.4.2-1: Resource URI variables for this resource

Name	Data type	Definition
apiRoot	string	See clause 6.3.1
supiOrSuci	string	Represents the Subscription Permanent Identifier (see 3GPP TS 23.501 [2] clause 5.9.2), or Subscription Concealed Identifier (see 3GPP TS 23.003 [8]). Pattern: " [^] (suci-(0-[0-9]{3}-[0-9]{2,3})[1-7]-.+)-[0-9]{1,4}-(0-0-.[a-fA-F1-9]-([1-9])[1-9][0-9] 1[0-9]{2} 2[0-4][0-9] 25[0-5]-[a-fA-F0-9]+).+)\$" (See NOTE 1, NOTE 2).
NOTE 1: The format for SUCI, when the corresponding SUPI is NAI-based, contains a realm that may include a "minus" character ("-"), which is also used as field separator. Given that the NAI and its realm shall conform to IETF RFC 7542 [29], the regular expression defined here allows for non-ambiguous matching of the different fields of the SUCI, even when the realm contains the "minus" character.		
NOTE 2: When the SUCI corresponds to a SUPI of type IMSI, and the Null protection scheme is used, the MSIN of the IMSI (which is formatted by the UE and sent over the NAS protocol as Binary Coded Decimal, BCD) shall be formatted in the SUCI as an UTF-8 string containing all decimal digits of the MSIN; see Annex C for SUCI encoding examples.		

6.3.3.4.3 Resource Standard Methods

6.3.3.4.3.1 GET

This method shall support the URI query parameters specified in table 6.3.3.4.3.1-1.

Table 6.3.3.4.3.1-1: URI query parameters supported by the GET method on this resource

Name	Data type	P	Cardinality	Description
authenticated-ind	AuthenticatedInd	M	1	Indicates whether authenticated by the W-AGF or not:
supported-features	SupportedFeatures	O	0..1	see 3GPP TS 29.500 [4] clause 6.6
plmn-id	PlmnId	O	0..1	PLMN identity of the PLMN serving the UE

If "plmn-id" is included, UDM shall return the authentication data of FN-RG in the PLMN identified by "plmn-id".

If "plmn-id" is not included, UDM shall return the authentication data of FN-RG for HPLMN.

This method shall support the request data structures specified in table 6.3.3.4.3.1-2 and the response data structures and response codes specified in table 6.3.3.4.3.1-3.

Table 6.3.3.4.3.1-2: Data structures supported by the GET Request Body on this resource

Data type	P	Cardinality	Description
n/a			

Table 6.3.3.4.3.1-3: Data structures supported by the GET Response Body on this resource

Data type	P	Cardinality	Response codes	Description
RgAuthCtx	M	1	200 OK	Upon success, a response body containing the authentication indication.
ProblemDetails	O	0..1	404 Not Found	The "cause" attribute may be used to indicate the following application error: - USER_NOT_FOUND
ProblemDetails	O	0..1	403 Forbidden	The "cause" attribute may be used to indicate one of the following application errors: - AUTHENTICATION_REJECTED - INVALID_SCHEME_OUTPUT
NOTE: In addition common data structures as listed in table 5.2.7.1-1 of 3GPP TS 29.500 [4] are supported.				

6.3.3.5 Resource: HssSecurityInformation (Custom operation)

6.3.3.5.1 Description

This resource represents the information that is needed together with the serving network id and requested authentication method to calculate authentication vector(s) for PS/EPS or IMS domain. See 3GPP TS 23.632 [32].

6.3.3.5.2 Resource Definition

Resource URI: {apiRoot}/nudm-ueau/v1/{supi}/hss-security-information/{hssAuthType}

This resource shall support the resource URI variables defined in table 6.3.3.5.2-1.

Table 6.3.3.5.2-1: Resource URI variables for this resource

Name	Data type	Definition
apiRoot	string	See clause 6.3.1
supi	Supi	Represents the mobile subscription identity (see 3GPP TS 23.003 [8]). On this resource, only the IMSI format of SUPI is used.
hssAuthType		Represents the type of AVs requested by the HSS. It is defined as an enumeration of type "HssAuthTypeInUri".

6.3.3.5.3 Resource Standard Methods

No Standard Methods are supported for this resource.

6.3.3.5.4 Resource Custom Operations

6.3.3.5.4.1 Overview

Table 6.3.3.5.4.1-1: Custom operations

Operation Name	Custom operation URI	Mapped HTTP method	CaDescription
generate-av	/generate-av	POST	Calculate the authentication vector(s) according to the requested information (authentication method, serving network id, resync info)

6.3.3.5.4.2 Operation: generate-av

6.3.3.5.4.2.1 Description

This custom operation is used by the NF service consumer (HSS) to request calculation of authentication vector(s) for the provided SUPI and the requested authentication method.

6.3.3.5.4.2.2 Operation Definition

This operation shall support the request data structures specified in table 6.3.3.5.4.2.2-1 and the response data structure and response codes specified in table 6.3.3.5.4.2.2-2.

Table 6.3.3.5.4.2.2-1: Data structures supported by the POST Request Body on this resource

Data type	P	Cardinality	Description
HssAuthenticationInfoRequest	M	1	Contains the authentication method, number of requested vectors, serving network id and resynchronization information

Table 6.3.3.5.4.2.2-2: Data structures supported by the POST Response Body on this resource

Data type	P	Cardinality	Response codes	Description
HssAuthenticationInfoResult	M	1	200 OK	Upon success, a response body containing authentication vector(s) shall be returned.
ProblemDetails	O	0..1	404 Not Found	The "cause" attribute may be used to indicate the following application error: - USER_NOT_FOUND
ProblemDetails	O	0..1	403 Forbidden	The "cause" attribute may be used to indicate one of the following application errors: - AUTHENTICATION_REJECTED
ProblemDetails	O	0..1	501 Not Implemented	The "cause" attribute may be used to indicate the following application error: - UNSUPPORTED_AUTHENTICATION_METHOD This response shall not be cached.
NOTE: In addition, common data structures as listed in table 5.2.7.1-1 of 3GPP TS 29.500 [4] are supported.				

6.3.3.6 Resource: Individual AuthEvent

6.3.3.6.1 Resource Definition

Resource URI: {apiRoot}/nudm-ueau/v1/{supi}/auth-events/{authEventId}

This resource shall support the resource URI variables defined in table 6.3.3.6.1-1.

Table 6.3.3.6.1-1: Resource URI variables for this resource

Name	Data type	Definition
apiRoot	string	See clause 6.3.1
supi	Supi	Represents the Subscription Permanent Identifier (see 3GPP TS 23.501 [2] clause 5.9.2) pattern: See pattern of type Supi in 3GPP TS 29.571 [7]
authEventId	string	Represents the authEvent Id per UE per serving network assigned by the UDM during ResultConfirmation service operation.

6.3.3.6.2 Resource Standard Methods

6.3.3.6.2.1 PUT

This method shall support the URI query parameters specified in table 6.3.3.6.2.1-1.

Table 6.3.3.6.2.1-1: URI query parameters supported by the PUT method on this resource

Name	Data type	P	Cardinality	Description
n/a				

This method shall support the request data structures specified in table 6.3.3.6.2.1-2 and the response data structures and response codes specified in table 6.3.3.6.2.1-3.

Table 6.3.3.6.2.1-2: Data structures supported by the PUT Request Body on this resource

Data type	P	Cardinality	Description
AuthEvent	M	1	The UE Authentication Event

Table 6.3.3.6.2.1-3: Data structures supported by the PUT Response Body on this resource

Data type	P	Cardinality	Response codes	Description
n/a			204 No Content	Upon success, an empty response body shall be returned.
ProblemDetails	O	0..1	404 Not Found	If the resource corresponding to the authEventId does not exist, a response code of 404 Not Found shall be returned. The "cause" attribute may be set to: - DATA_NOT_FOUND
NOTE: In addition common data structures as listed in table 5.2.7.1-1 of 3GPP TS 29.500 [4] are supported.				

6.3.4 Custom Operations without associated resources

In this release of this specification, no custom operations without associated resources are defined for the Nudm_UEAuthentication Service.

6.3.5 Notifications

In this release of this specification, no notifications are defined for the Nudm_UEAuthentication Service.

6.3.6 Data Model

6.3.6.1 General

This clause specifies the application data model supported by the API.

Table 6.3.6.1-1 specifies the data types defined for the Nudm_UEAU service API.

Table 6.3.6.1-1: Nudm_UEAU specific Data Types

Data type	Clause defined	Description
AuthenticationInfoRequest	6.3.6.2.2	Contains Serving Network Name and Resynchronization Information
AuthenticationInfoResult	6.3.6.2.3	Contains an Authentication Vector (AV)
AvEapAkaPrime	6.3.6.2.4	Contains RAND, XRES, AUTN, CK', and IK'
Av5GHeAka	6.3.6.2.5	Contains RAND, XRES*, AUTN, KAUSF
ResynchronizationInfo	6.3.6.2.6	Contains RAND and AUTS
AuthEvent	6.3.6.2.7	Authentication Event
AuthenticationVector	6.3.6.2.8	
RgAuthCtx	6.3.6.2.9	Contains the UE id (i.e. SUPI) and the authentication indication.
HssAuthenticationInfoRequest	6.3.6.2.10	Contains authentication method, serving network id, number of requested vectors and resynchronization information
HssAuthenticationInfoResult	6.3.6.2.11	Contains the authentication vectors for EPS/IMS domain
HssAuthenticationVectors	6.3.6.2.12	
AvEpsAka	6.3.6.2.13	Contains RAND, XRES, AUTN, KASME
AvlmsGbaEapAka	6.3.6.2.14	Contains RAND, XRES, AUTN, CK, and IK
Autn	6.3.6.3.2	
Auts	6.3.6.3.2	
CkPrime	6.3.6.3.2	
IkPrime	6.3.6.3.2	
Kausf	6.3.6.3.2	
Rand	6.3.6.3.2	
ServingNetworkName	6.3.6.3.2	
Success	6.3.6.3.2	
Xres	6.3.6.3.2	
XresStar	6.3.6.3.2	
AuthenticatedInd	6.3.6.3.2	
ConfidentialityKey	6.3.6.3.2	
IntegrityKey	6.3.6.3.2	
Kasme	6.3.6.3.2	
NumOfRequestedVectors	6.3.6.3.2	
Autn	6.3.6.3.2	
AuthType	6.3.6.3.3	
AvType	6.3.6.3.4	
HssAuthType	6.3.6.3.5	
HssAvType	6.3.6.3.6	
HssAuthTypeInUri	6.3.6.3.7	
AccessNetworkId	6.3.6.3.8	

Table 6.3.6.1-2 specifies data types re-used by the Nudm_UEAU service API from other specifications, including a reference to their respective specifications and when needed, a short description of their use within the Nudm_UEAU service API.

Table 6.3.6.1-2: Nudm_UEAU re-used Data Types

Data type	Reference	Comments
ProblemDetails	3GPP TS 29.571 [7]	Common data type used in response bodies
NfInstanceId	3GPP TS 29.571 [7]	Network Function Instance Identifier
NfSetId	3GPP TS 29.571 [7]	Network Function Set Identifier
DateTime	3GPP TS 29.571 [7]	
SupportedFeatures	3GPP TS 29.571 [7]	see 3GPP TS 29.500 [4] clause 6.6
Supi	3GPP TS 29.571 [7]	
CagId	3GPP TS 29.571 [7]	

6.3.6.2 Structured data types

6.3.6.2.1 Introduction

This clause defines the structures to be used in POST request / response bodies.

6.3.6.2.2 Type: AuthenticationInfoRequest

Table 6.3.6.2.2-1: Definition of type AuthenticationInfoRequest

Attribute name	Data type	P	Cardinality	Description
servingNetworkName	ServingNetworkName	M	1	See 3GPP TS 33.501 [6] clause 6.1.1.4
resynchronizationInfo	ResynchronizationInfo	O	0..1	Contains RAND and AUTS; see 3GPP TS 33.501 [6] clause 7.5
supportedFeatures	SupportedFeatures	O	0..1	See clause 6.3.8
ausfInstanceId	NfInstanceId	M	1	NF Instance Id of the AUSF
cellCagInfo	array(CagId)	O	1..N	CAG List of the CAG cell. If the cellCagInfo is absent, the UDM shall not assume the UE is accessing from the PLMN.
n5gcInd	boolean	O	0..1	N5GC device Indicator indicates whether the user uses a N5GC device: See 3GPP TS 33.501 [6] true: N5GC device false (default): used device is 5G capable See NOTE
NOTE: The attribute n5gcInd is used for EAP-TLS, which is described in the informative annex O of 3GPP TS 33.501 [6] and is not mandatory to support.				

6.3.6.2.3 Type: AuthenticationInfoResult

Table 6.3.6.2.3-1: Definition of type AuthenticationInfoResult

Attribute name	Data type	P	Cardinality	Description
authType	AuthType	M	1	Indicates the authentication method
authenticationVector	AuthenticationVector	C	0..1	contains an authentication vector if 5G AKA or EAP-AKA's is selected
supi	Supi	C	0..1	SUPI shall be present if the request contained the SUCI within the request URI
supportedFeatures	SupportedFeatures	O	0..1	See clause 6.3.8

6.3.6.2.4 Type: AvEapAkaPrime

Table 6.3.6.2.4-1: Definition of type AvEapAkaPrime

Attribute name	Data type	P	Cardinality	Description
avType	AvType	M	1	Type of authentication vector
rand	Rand	M	1	
xres	Xres	M	1	
autn	Autn	M	1	
ckPrime	CkPrime	M	1	
ikPrime	IkPrime	M	1	

6.3.6.2.5 Type: Av5GHeAka

Table 6.3.6.2.5-1: Definition of type Av5GHeAka

Attribute name	Data type	P	Cardinality	Description
avType	AvType	M	1	Type of authentication vector
rand	Rand	M	1	
xresStar	XresStar	M	1	
autn	Autn	M	1	
kausf	Kausf	M	1	

6.3.6.2.6 Type: ResynchronizationInfo

Table 6.3.6.2.6-1: Definition of type ResynchronizationInfo

Attribute name	Data type	P	Cardinality	Description
rand	Rand	M	1	
auts	Auts	M	1	

6.3.6.2.7 Type: AuthEvent

Table 6.3.6.2.7-1: Definition of type AuthEvent

Attribute name	Data type	P	Cardinality	Description
nfInstancelId	NfInstancelId	M	1	Identifier of the NF instance where the authentication occurred (e.g. AUSF)
success	Success	M	1	true indicates success; false indicates no success. Set to false in case of authentication result removal.
timeStamp	DateTime	M	1	time stamp of the authentication
authType	AuthType	M	1	string Authentication Type
servingNetworkName	ServingNetworkName	M	1	See 3GPP TS 33.501 [6] clause 6.1.1.4
authRemovalInd	Boolean	O	0..1	When present, it shall indicate the authentication result in the UDM shall be removed. This IE shall be set as follows: - true: authentication result in the UDM shall be removed; - false (default): authentication result in the UDM shall not be removed.
nfSetId	NfSetId	O	0..1	If present, it indicates the NF Set ID where the authentication occurred (e.g. AUSF Set)

6.3.6.2.8 Type: AuthenticationVector

Table 6.3.6.2.8-1: Definition of type AuthenticationVector as a list of alternatives

Data type	Cardinality	Description
AvEapAkaPrime	1	
Av5GHeAka	1	

6.3.6.2.9 Type: RgAuthCtx

Table 6.3.6.2.9-1: Definition of type RgAuthCtx

Attribute name	Data type	P	Cardinality	Description
authInd	boolean	M	0..1	When present, this IE shall be set as follows: - true: authentication is not required; - false (default): authentication is required.
supi	Supi	C	0..1	SUPI shall be present if the request contained the SUCI within the request URI
supportedFeatures	SupportedFeatures	O	0..1	See clause 6.3.8

6.3.6.2.10 Type: HssAuthenticationInfoRequest

Table 6.3.6.2.10-1: Definition of type HssAuthenticationInfoRequest

Attribute name	Data type	P	Cardinality	Description
hssAuthType	HssAuthType	M	1	Indicates the authentication method.
numOfRequestedVectors	NumOfRequestedVectors	M	1	Maximum 5 vectors are allowed per service request.
requestingNodeType	NodeType	C	0..1	Indicates the requesting node type. Should be included when known by the HSS.
servingNetworkId	PlmnId	C	0..1	Shall be present if the authentication method is EPS_AKA.
resynchronizationInfo	ResynchronizationInfo	O	0..1	Contains RAND and AUTS.
anId	AccessNetworkId	O	0..1	Contains the Access Network ID used in the derivation of authentication vectors in EAP-AKA'.
supportedFeatures	SupportedFeatures	O	0..1	See clause 6.3.8
NOTE: For GBA authentication type, the number of requested vectors shall be set to 1; for other authentication types, the number of generated vectors by UDM, may be less than the number of requested vectors.				

6.3.6.2.11 Type: HssAuthenticationInfoResult

Table 6.3.6.2.11-1: Definition of type HssAuthenticationInfoResult

Attribute name	Data type	P	Cardinality	Description
hssAuthenticationVectors	HssAuthenticationVectors	M	1	
supportedFeatures	SupportedFeatures	O	0..1	See clause 6.3.8

6.3.6.2.12 Type: HssAuthenticationVectors

Table 6.3.6.2.12-1: Definition of type HssAuthenticationVectors as a list of alternatives

Data type	Cardinality	Description
array(AvEpsAka)	1..5	
array(AvImsGbaEapAka)	1..5	This data type is also used for UMTS AKA.
array(AvEapAkaPrime)	1..5	

6.3.6.2.13 Type: AvEpsAka

Table 6.3.6.2.13-1: Definition of type AvEpsAka

Attribute name	Data type	P	Cardinality	Description
avType	HssAvType	M	1	
rand	Rand	M	1	
xres	Xres	M	1	
autn	Autn	M	1	
kasme	Kasme	M	1	

6.3.6.2.14 Type: AvlmsGbaEapAka

Table 6.3.6.2.14-1: Definition of type AvlmsGbaEapAka

Attribute name	Data type	P	Cardinality	Description
avType	HssAvType	M	1	
rand	Rand	M	1	
xres	Xres	M	1	
autn	Autn	M	1	
ck	ConfidentialityKey	M	1	
ik	IntegrityKey	M	1	

6.3.6.3 Simple data types and enumerations

6.3.6.3.1 Introduction

This clause defines simple data types and enumerations that can be referenced from data structures defined in the previous clauses.

6.3.6.3.2 Simple data types

The simple data types defined in table 6.3.6.3.2-1 shall be supported.

Table 6.3.6.3.2-1: Simple data types

Type Name	Type Definition	Description
Autn	string	pattern: "[A-Fa-f0-9]{32}\$"
Auts	string	pattern: "[A-Fa-f0-9]{28}\$"
CkPrime	string	pattern: "[A-Fa-f0-9]{32}\$"
IkPrime	string	pattern: "[A-Fa-f0-9]{32}\$"
Kausf	string	pattern: "[A-Fa-f0-9]{64}\$"
Rand	string	pattern: "[A-Fa-f0-9]{32}\$"
ServingNetworkName	string	See 3GPP TS 33.501 [6] clause 6.1.1.4 pattern: "^5G:mnc[0-9]{3}[.].mcc[0-9]{3}[.].3gppnetwork[.].org(:[A-F0-9]{11})?\$"
Success	boolean	true indicates success, false indicates no success
Xres	string	pattern: "[A-Fa-f0-9]{8,32}\$"
XresStar	string	pattern: "[A-Fa-f0-9]{32}\$"
AuthenticatedInd	boolean	Indicates whether authenticated by the W-AGF or not: - true: authenticated by the W-AGF; - false: unauthenticated by the W-AGF.
ConfidentialityKey	string	pattern: "[A-Fa-f0-9]{32}\$"
IntegrityKey	string	pattern: "[A-Fa-f0-9]{32}\$"
Kasme	string	pattern: "[A-Fa-f0-9]{64}\$"
NumOfRequestedVectors	integer	minimum: 1 maximum: 5

6.3.6.3.3 Enumeration: AuthType

Table 6.3.6.3.3-1: Enumeration AuthType

Enumeration value	Description
"EAP_AKA_PRIME"	EAP-AKA'
"5G_AKA"	5G AKA
"EAP_TLS"	EAP-TLS. See NOTE
NOTE: EAP-TLS is described in the Informative Annex B and Annex O of 3GPP TS 33.501 [6] and is not mandatory to support.	

6.3.6.3.4 Enumeration: AvType

Table 6.3.6.3.4-1: Enumeration AvType

Enumeration value	Description
"5G_HE_AKA"	
"EAP_AKA_PRIME"	

6.3.6.3.5 Enumeration: HssAuthType

Table 6.3.6.3.5-1: Enumeration HssAuthType

Enumeration value	Description
"EPS_AKA"	
"EAP_AKA"	
"EAP_AKA_PRIME"	EAP-AKA'
"IMS_AKA"	
"GBA_AKA"	
"UMTS_AKA"	

6.3.6.3.6 Enumeration: HssAvType

Table 6.3.6.3.6-1: Enumeration HssAvType

Enumeration value	Description
"EPS_AKA"	
"EAP_AKA"	
"IMS_AKA"	
"GBA_AKA"	
"UMTS_AKA"	

6.3.6.3.7 Enumeration: HssAuthTypeInUri

Table 6.3.6.3.7-1: Enumeration HssAuthTypeInUri

Enumeration value	Description
"eps-aka"	EPS-AKA authentication method
"eap-aka"	EAP-AKA authentication method
"eap-aka-prime"	EAP-AKA' authentication method
"ims-aka"	IMS-AKA authentication method
"gba-aka"	GBA-AKA authentication method

NOTE: This enumeration is used as a variable part of resource URIs, and therefore it follows the naming convention used in URIs (lower case with hyphens); see 3GPP TS 29.501 [5], clause 5.1.

6.3.6.3.8 Enumeration: AccessNetworkId

This data type contains the values for the Access Network Identities defined by 3GPP in the context of non-3GPP access to EPC, used in the generation of EAP-AKA' authentication vectors. The possible values are originally defined in 3GPP TS 24.302 [49].

Table 6.3.6.3.8-1: Enumeration AccessNetworkId

Enumeration value	Description
"HRPD"	Access Network: HRPD
"WIMAX"	Access Network: WiMAX
"WLAN"	Access Network: Wireless LAN
"ETHERNET"	Access Network: Ethernet

6.3.6.3.9 Enumeration: NodeType

Table 6.3.6.3.9-1: Enumeration NodeType

Enumeration value	Description
"AUSF"	This value is not applicable to the HSS.
"VLR"	
"SGSN"	
"S_CSCF"	
"BSF"	
"GAN_AAA_SERVER"	
"WLAN_AAA_SERVER"	
"MME"	

6.3.7 Error Handling

6.3.7.1 General

HTTP error handling shall be supported as specified in clause 5.2.4 of 3GPP TS 29.500 [4].

6.3.7.2 Protocol Errors

Protocol errors handling shall be supported as specified in clause 5.2.7 of 3GPP TS 29.500 [4].

6.3.7.3 Application Errors

The common application errors defined in the Table 5.2.7.2-1 in 3GPP TS 29.500 [4] may also be used for the Nudm_UEAuthentication service. The following application errors listed in Table 6.3.7.3-1 are specific for the Nudm_UEAuthentication service.

Table 6.3.7.3-1: Application errors

Application Error	HTTP status code	Description
AUTHENTICATION_REJECTED	403 Forbidden	The user is cannot be authenticated with this authentication method e.g. only SIM data available
USER_NOT_FOUND	404 Not Found	The user does not exist in the HPLMN
UNSUPPORTED_PROTECTION_SCHEME	501 Not implemented	The received protection scheme is not supported by HPLMN
UNSUPPORTED_AUTHENTICATION_METHOD	501 Not implemented	The requested authentication method is not supported
INVALID_HN_PUBLIC_KEY_IDENTIFIER	403 Forbidden	Invalid HN public key identifier received
INVALID_SCHEME_OUTPUT	403 Forbidden	SUCI cannot be decrypted with received data
DATA_NOT_FOUND	404 Not Found	Resource corresponding to the authEventId does not exist

6.3.8 Feature Negotiation

The optional features in table 6.3.8-1 are defined for the Nudm_UEAU API. They shall be negotiated using the extensibility mechanism defined in clause 6.6 of 3GPP TS 29.500 [4].

Table 6.3.8-1: Supported Features

Feature number	Feature Name	Description

6.3.9 Security

As indicated in 3GPP TS 33.501 [6] and 3GPP TS 29.500 [4], the access to the Nudm_UEAU API may be authorized by means of the OAuth2 protocol (see IETF RFC 6749 [18]), based on local configuration, using the "Client Credentials" authorization grant, where the NRF (see 3GPP TS 29.510 [19]) plays the role of the authorization server.

If OAuth2 is used, an NF Service Consumer, prior to consuming services offered by the Nudm_UEAU API, shall obtain a "token" from the authorization server, by invoking the Access Token Request service, as described in 3GPP TS 29.510 [19], clause 5.4.2.2.

NOTE: When multiple NRFs are deployed in a network, the NRF used as authorization server is the same NRF that the NF Service Consumer used for discovering the Nudm_UEAU service.

The Nudm_UEAU API defines a single scope "nudm-ueau" for OAuth2 authorization (as specified in 3GPP TS 33.501 [6]) for the entire API, and it does not define any additional scopes at resource or operation level.

6.4 Nudm_EventExposure Service API

6.4.1 API URI

URIs of this API shall have the following root:

```
{apiRoot}/<apiName>/<apiVersion>/
```

The request URI used in HTTP request from the NF service consumer towards the NF service producer shall have the structure defined in clause 4.4.1 of 3GPP TS 29.501 [5], i.e.:

{apiRoot}/<apiName>/<apiVersion>/<apiSpecificResourceUriPart>

with the following components:

- The {apiRoot} shall be set as described in 3GPP TS 29.501 [5].
- The <apiName> shall be "nudm-ee".
- The <apiVersion> shall be "v1".
- The <apiSpecificResourceUriPart> shall be set as described in clause 6.4.3.

6.4.2 Usage of HTTP

6.4.2.1 General

HTTP/2, as defined in IETF RFC 7540 [13], shall be used as specified in clause 5 of 3GPP TS 29.500 [4].

HTTP/2 shall be transported as specified in clause 5.3 of 3GPP TS 29.500 [4].

HTTP messages and bodies for the Nudm_EE service shall comply with the OpenAPI [14] specification contained in Annex A5.

6.4.2.2 HTTP standard headers

6.4.2.2.1 General

The usage of HTTP standard headers shall be supported as specified in clause 5.2.2 of 3GPP TS 29.500 [4].

6.4.2.2.2 Content type

The following content types shall be supported:

JSON, as defined in IETF RFC 8259 [15], signalled by the content type "application/json".

The Problem Details JSON Object (IETF RFC 7807 [16] signalled by the content type "application/problem+json"

JSON Patch (IETF RFC 6902 [41]). The use of the JSON Patch format in a HTTP request body shall be signalled by the content type "application/json-patch+json".

6.4.2.3 HTTP custom headers

6.4.2.3.1 General

The usage of HTTP custom headers shall be supported as specified in clause 5.2.3 of 3GPP TS 29.500 [4].

6.4.3 Resources

6.4.3.1 Overview

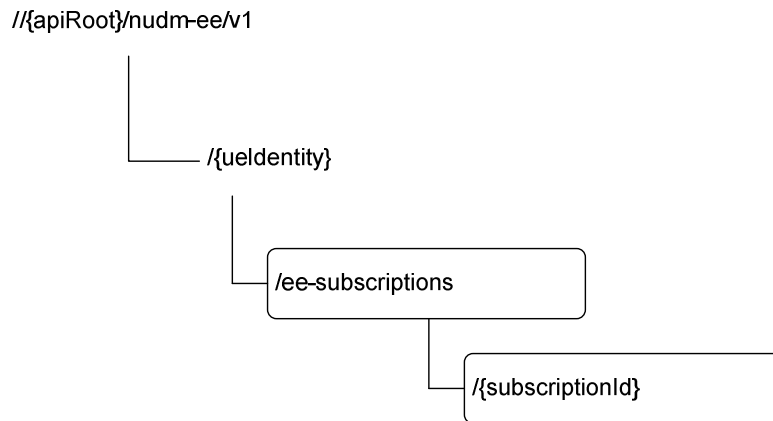

Figure 6.4.3.1-1: Resource URI structure of the Nudm_EE API

Table 6.4.3.1-1 provides an overview of the resources and applicable HTTP methods.

Table 6.4.3.1-1: Resources and methods overview

Resource name (Archetype)	Resource URI	HTTP method or custom operation	Description
EeSubscriptions (Collection)	<code>/{ueIdentity}/ee-subscriptions</code>	POST	Create a subscription
Individual subscription (Document)	<code>/{ueIdentity}/ee-subscriptions/{subscriptionId}</code>	PATCH	Update the subscription identified by <code>{subscriptionId}</code>
		DELETE	Delete the subscription identified by <code>{subscriptionId}</code> , i.e. unsubscribe

6.4.3.2 Resource: EeSubscriptions (Collection)

6.4.3.2.1 Description

This resource is used to represent subscriptions to notifications.

6.4.3.2.2 Resource Definition

Resource URI: `{apiRoot}/nudm-ee/v1/{ueIdentity}/ee-subscriptions`

This resource shall support the resource URI variables defined in table 6.4.3.2.2-1.

Table 6.4.3.2.2-1: Resource URI variables for this resource

Name	Data type	Definition
apiRoot	string	See clause 6.4.1
uelidentity	string	<p>Represents a single UE or a group of UEs or any UE.</p> <ul style="list-style-type: none"> - If representing a single UE, this parameter shall contain the Generic Public Subscription Identifier (see 3GPP TS 23.501 [2] clause 5.9.8) pattern: "<code>^(msisdn-[0-9]{5,15} extid-[^@]+@[^@]+.+)\$</code>" - If representing a group of UEs, this parameter shall contain the External GroupId. pattern: "<code>^extgroupid-[^@]+@[^@]+\$</code>" - If representing any UE, this parameter shall contain "anyUE". pattern: "<code>^anyUE\$</code>"

6.4.3.2.3 Resource Standard Methods

6.4.3.2.3.1 POST

This method shall support the URI query parameters specified in table 6.4.3.2.3.1-1.

Table 6.4.3.2.3.1-1: URI query parameters supported by the POST method on this resource

Name	Data type	P	Cardinality	Description
n/a				

This method shall support the request data structures specified in table 6.4.3.2.3.1-2 and the response data structures and response codes specified in table 6.4.3.2.3.1-3.

Table 6.4.3.2.3.1-2: Data structures supported by the POST Request Body on this resource

Data type	P	Cardinality	Description
EeSubscription	M	1	The subscription that is to be created

Table 6.4.3.2.3.1-3: Data structures supported by the POST Response Body on this resource

Data type	P	Cardinality	Response codes	Description
CreatedEeSubscription	M	1	201 Created	Upon success, a response body containing a representation of the created Individual subscription resource shall be returned. The HTTP response shall include a "Location" HTTP header that contains the resource URI of the created resource. When stateless UDM is deployed, the stateless UDM may use an FQDN identifying the UDM group to which the UDM belongs as the host part of the resource URI.
ProblemDetails	O	0..1	403 Forbidden	The "cause" attribute may be used to indicate one of the following application errors: - MONITORING_NOT_ALLOWED - AF_NOT_ALLOWED - MTC_PROVIDER_NOT_ALLOWED
ProblemDetails	O	0..1	404 Not Found	The "cause" attribute may be used to indicate one of the following application errors: - USER_NOT_FOUND
ProblemDetails	O	0..1	501 Not Implemented	The "cause" attribute may be used to indicate one of the following application errors: - UNSUPPORTED_MONITORING_EVENT_TYPE - UNSUPPORTED_MONITORING_REPORT_OPTIONS This response shall not be cached.

NOTE: In addition common data structures as listed in table 5.2.7.1-1 of 3GPP TS 29.500 [4] are supported.

NOTE: In the scenario of stateless UDM deployment, it is assumed that stateless UDMs are organized into several UDM groups, and for each UDM group an FQDN can be allocated.

6.4.3.3 Resource: Individual subscription (Document)

6.4.3.3.1 Resource Definition

Resource URI: {apiRoot}/nudm-ee/v1/{ueIdentity}/ee-subscriptions/{subscriptionId}

This resource shall support the resource URI variables defined in table 6.4.3.3.1-1.

Table 6.4.3.3.1-1: Resource URI variables for this resource

Name	Data type	Definition
apiRoot	string	See clause 6.1.1
ueIdentity	string	Represents a single UE or a group of UEs or any UE. - If representing a single UE, this parameter shall contain the Generic Public Subscription Identifier (see 3GPP TS 23.501 [2] clause 5.9.8) pattern: "^(\msisd-[-0-9]{5,15} extid-[@]+@[^@]+.[^@]+)\$" - If representing a group of UEs, this parameter shall contain the External GroupId. pattern: "^extgroupid-[@]+@[^@]+.\$" - If representing any UE, this parameter shall contain "anyUE". pattern: "^anyUE\$"
subscriptionId	string	The subscriptionId identifies an individual subscription to notifications.

6.4.3.3.2 Resource Standard Methods

6.4.3.3.2.1 DELETE

This method shall support the URI query parameters specified in table 6.4.3.3.2.1-1.

Table 6.4.3.3.1.1-1: URI query parameters supported by the DELETE method on this resource

Name	Data type	P	Cardinality	Description
n/a				

This method shall support the request data structures specified in table 6.4.3.3.2.1-2 and the response data structures and response codes specified in table 6.4.3.3.2.1-3.

Table 6.4.3.3.2.1-2: Data structures supported by the Delete Request Body on this resource

Data type	P	Cardinality	Description
n/a			The request body shall be empty.

Table 6.4.3.3.2.1-3: Data structures supported by the DELETE Response Body on this resource

Data type	P	Cardinality	Response codes	Description
n/a			204 No Content	Upon success, an empty response body shall be returned.
ProblemDetails	O	0..1	404 Not Found	The "cause" attribute may be used to indicate one of the following application errors: - USER_NOT_FOUND - SUBSCRIPTION_NOT_FOUND, see 3GPP TS 29.500 [4] table 5.2.7.2-1.
NOTE: In addition common data structures as listed in table 5.2.7.1-1 of 3GPP TS 29.500 [4] are supported.				

6.4.3.3.2.2 PATCH

This method shall support the URI query parameters specified in table 6.4.3.3.2.2-1.

Table 6.4.3.3.2.2-1: URI query parameters supported by the PATCH method on this resource

Name	Data type	P	Cardinality	Description
supported-features	SupportedFeatures	O	0..1	see 3GPP TS 29.500 [4] clause 6.6

This method shall support the request data structures specified in table 6.4.3.3.2.2-2 and the response data structures and response codes specified in table 6.4.3.3.2.2-3.

Table 6.4.3.3.2.2-2: Data structures supported by the PATCH Request Body on this resource

Data type	P	Cardinality	Description
array(PatchItem)	M	1..N	Items describe the modifications to the Event Subscription

Table 6.4.3.3.2-3: Data structures supported by the PATCH Response Body on this resource

Data type	P	Cardinality	Response codes	Description
n/a			204 No Content	Upon success, an empty response body shall be returned. (NOTE 2)
PatchResult	M	1	200 OK	Upon success, the execution report is returned. (NOTE 2)
ProblemDetails	O	0..1	404 Not Found	The "cause" attribute may be used to indicate one of the following application errors: - USER_NOT_FOUND - SUBSCRIPTION_NOT_FOUND, see 3GPP TS 29.500 [4] table 5.2.7.2-1.
	O	0..1	403 Forbidden	One or more attributes are not allowed to be modified. The "cause" attribute may be used to indicate one of the following application errors: - MODIFICATION_NOT_ALLOWED, see 3GPP TS 29.500 [4] table 5.2.7.2-1.
NOTE 1: In addition common data structures as listed in table 5.2.7.1-1 of 3GPP TS 29.500 [4] are supported.				
NOTE 2: If all the modification instructions in the PATCH request have been implemented, the UDM shall respond with 204 No Content response; if some of the modification instructions in the PATCH request have been discarded, and the NF service consumer has included in the supported-feature query parameter the "PatchReport" feature number, the UDM shall respond with PatchResult.				

6.4.4 Custom Operations without associated resources

In this release of this specification, no custom operations without associated resources are defined for the Nudm_EventExposure Service.

6.4.5 Notifications

6.4.5.1 General

This clause will specify the use of notifications and corresponding protocol details if required for the specific service. When notifications are supported by the API, it will include a reference to the general description of notifications support over the 5G SBIs specified in TS 29.500 / TS 29.501.

Table 6.4.5.1-1: Notifications overview

Notification	Resource URI	HTTP method or custom operation	Description (service operation)
Event Occurrence Notification	{callbackReference}	POST	

6.4.5.2 Event Occurrence Notification

The POST method shall be used for Event Occurrence Notifications and the URI shall be as provided during the subscription procedure.

Resource URI: {callbackReference}

Support of URI query parameters is specified in table 6.4.5.2-1.

Table 6.4.5.2-1: URI query parameters supported by the POST method

Name	Data type	P	Cardinality	Description
n/a				

Support of request data structures is specified in table 6.4.5.2-2 and of response data structures and response codes is specified in table 6.4.5.2-3.

Table 6.4.5.2-2: Data structures supported by the POST Request Body

Data type	P	Cardinality	Description
array(MonitoringReport)	M	1..N	A list of MonitoringReports each of which contains information regarding the occurred event

Table 6.4.5.2-3: Data structures supported by the POST Response Body

Data type	P	Cardinality	Response codes	Description
n/a			204 No Content	Upon success, an empty response body shall be returned.
ProblemDetails	O	0..1	404 Not Found	The "cause" attribute may be used to indicate one of the following application errors: - CONTEXT_NOT_FOUND
NOTE: In addition common data structures as listed in table 5.2.7.1-1 of 3GPP TS 29.500 [4] are supported.				

6.4.6 Data Model

6.4.6.1 General

This clause specifies the application data model supported by the API.

Table 6.4.6.1-1 specifies the data types defined for the Nudm_EE service API.

Table 6.4.6.1-1: Nudm_EE specific Data Types

Data type	Clause defined	Description
EeSubscription	6.4.6.2.2	A subscription to Notifications
MonitoringConfiguration	6.4.6.2.3	Monitoring Configuration
MonitoringReport	6.4.6.2.4	Monitoring Report
Report	6.4.6.2.5	
ReportingOptions	6.4.6.2.6	
ChangeOfSupiPeiAssociationReport	6.4.6.2.7	
RoamingStatusReport	6.4.6.2.8	
CreatedEeSubscription	6.4.6.2.9	
LocationReportingConfiguration	6.4.6.2.10	
CnTypeChangeReport	6.4.6.2.11	
ReachabilityForSmsReport	6.4.6.2.12	
DatalinkReportingConfiguration	6.4.6.2.13	Reporting configuration for events related to data link
CmInfoReport	6.4.6.2.14	Reporting UE's Connection Management State information per access type
LossConnectivityCfg	6.4.6.2.15	Configuration for loss of connectivity event
PduSessionStatusCfg	6.4.6.2.16	Reporting configuration for events related to PDU session Status
LossConnectivityReport	6.4.6.2.17	Report of "LOSS_OF_CONNECTIVITY" event
LocationReport	6.4.6.2.18	Report of "LOCATION_REPORTING" event
PdnConnectivityStatReport	6.4.6.2.19	Report of "PDN_CONNECTIVITY_STATUS" event
MaxNumOfReports	6.4.6.3.2	Maximum number of reports
Referenceld	6.4.6.3.2	Reference Identity
EventType	6.4.6.3.3	Event type of UDM Event Exposure service
LocationAccuracy	6.4.6.3.4	Location Accuracy definition
CnType	6.4.6.3.5	Core Network Type
AssociationType	6.4.6.3.6	
EventReportMode	6.4.6.3.7	
ReachabilityForSmsConfiguration	6.4.6.3.8	
PdnConnectivityStatus	6.4.6.3.9	PDN Connectivity Status

Table 6.4.6.1-2 specifies data types re-used by the Nudm_EE service API from other specifications, including a reference to their respective specifications and when needed, a short description of their use within the Nudm_EE service API.

Table 6.4.6.1-2: Nudm_EE re-used Data Types

Data type	Reference	Comments
Uri	3GPP TS 29.571 [7]	Uniform Resource Identifier
SupportedFeatures	3GPP TS 29.571 [7]	see 3GPP TS 29.500 [4] clause 6.6
DateTime	3GPP TS 29.571 [7]	
Pei	3GPP TS 29.571 [7]	
PlmnId	3GPP TS 29.571 [7]	
Gpsi	3GPP TS 29.571 [7]	
AccessType	3GPP TS 29.571 [7]	
PatchResult	3GPP TS 29.571 [7]	
DddTrafficDescriptor	3GPP TS 29.571 [7]	
SamplingRatio	3GPP TS 29.571 [7]	
DurationSec	3GPP TS 29.571 [7]	
DIDataDeliveryStatus	3GPP TS 29.571 [7]	Downlink data delivery status
Dnn	3GPP TS 29.571 [7]	Data Network Name with Network Identifier only.
Snsai	3GPP TS 29.571 [7]	Single NSSAI
DiameterIdentity	3GPP TS 29.571 [7]	Diameter Identify
CmInfo	3GPP TS 29.518 [36]	Describe the Connection Management state information for an access type
MtcProviderInformation	3GPP TS 29.571 [7]	MTC Provider Information
LossOfConnectivityReason	3GPP TS 29.518 [36]	Describes the reason of connectivity loss
UserLocation	3GPP TS 29.571 [7]	User Location
PduSessionId	3GPP TS 29.571 [7]	PDU Session Id
Ipv4Addr	3GPP TS 29.571 [7]	IPv4 Address
Ipv6Addr	3GPP TS 29.571 [7]	IPv6 Address
Ipv6Prefix	3GPP TS 29.571 [7]	IPv6 Prefix
PduSessionType	3GPP TS 29.571 [7]	PDU session type.

6.4.6.2 Structured data types

6.4.6.2.1 Introduction

This clause defines the structures to be used in resource representations.

6.4.6.2.2 Type: EeSubscription

Table 6.4.6.2.2-1: Definition of type EeSubscription

Attribute name	Data type	P	Cardinality	Description
callbackReference	Uri	M	1	URI provided by the NF service consumer to receive notifications
monitoringConfigurations	map(Monitoring Configuration)	M	1..N	A map (list of key-value pairs where referenced converted from integer to string serves as key; see clause 6.4.6.3.2) of MonitoringConfigurations; see clause 6.4.6.2.3
reportingOptions	ReportingOptions	O	0..1	This IE may be included if the NF service consumer wants to describe how the reports of the event to be generated.
supportedFeatures	SupportedFeatures	O	0..1	See clause 6.4.8 These are the features supported by the NF subscribing at the UDM.
subscriptionId	string	C	0..1	This attribute shall be present if the EeSubscription is sent in a GET response message on Nudr. It identifies the individual EeSubscription stored in the UDR and may be used by the UDM to delete an EeSubscription.
contextInfo	ContextInfo	C	0..1	This IE if present may contain e.g. the headers received by the UDM along with the EeSubscription. Shall be absent on Nudm and may be present on Nudr.
epcAppliedInd	boolean	O	0..1	This IE indicates whether the subscription applies also to EPC or not. true: the subscription applies also to EPC. false or absent: the subscription doesn't apply to EPC.
scefDiamHost	DiameterIdentity	C	0..1	This IE shall be included if parameter epcAppliedInd is set to true and at least one of the notification to subscription applied to EPC will be reported directly from the MME to the SCEF (e.g. event LOCATION_REPORTING). When present, it contains the Diameter Identify (FQDN) of the SCEF to which the monitored reports may be sent in EPC.
scefDiamRealm	DiameterIdentity	C	0..1	This IE shall be included if parameter epcAppliedInd is set to true and at least one of the notification to subscription applied to EPC will be reported directly from the MME to the SCEF (e.g. event LOCATION_REPORTING). When present, It contains the Diameter realm of the SCEF to which the monitored reports may be sent in EPC.
notifyCorrelationId	string	C	0..1	This attribute identifies the notification correlation ID shall be present by NF consumer in subscription. The value of this IE shall be unique per subscription for a given NF service consumer.

6.4.6.2.3 Type: MonitoringConfiguration

Table 6.4.6.2.3-1: Definition of type MonitoringConfiguration

Attribute name	Data type	P	Cardinality	Description
eventType	EventType	M	1	String; see clause 6.4.6.3.3
immediateFlag	boolean	O	0..1	Indicates if an immediate event report in the subscription response indicating current value / status of the event is required or not. If the flag is not present, then immediate reporting shall not be done. If the event requested for immediate reporting is detected by the UDM, the UDM may include the current status of the event if available in the service operation response. If the event requested for immediate reporting is detected by a remote NF (e.g. AMF) and directly notified to the NF consumer, the current status of the event shall not be included in the service operation response (the remote NF shall notify the current status of the event via event notification directly).
locationReportingConfiguration	LocationReportingConfiguration	C	0..1	shall be present if eventType is "LOCATION_REPORTING"
associationType	AssociationType	O	0..1	If the eventType indicates CHANGE_OF_SUPI_PEI_ASSOCIATION, this parameter may be included to identify whether the IMSI-IMEI or IMSI-IMEISV association shall be detected. If the flag is not present, then a value of IMEISV shall be used
datalinkReportCfg	DatalinkReportingConfiguration	C	0..1	shall be present if eventType is "DL_DATA_DELIVERY_STATUS" "AVAILABILITY_AFTER_DDN_FAILURE".
lossConnectivityCfg	LossConnectivityCfg	O	0..1	May be present if eventType is "LOSS_OF_CONNECTIVITY". (NOTE 1)
maximumLatency	DurationSec	O	0..1	May be present if eventType is "UE_REACHABILITY_FOR_DATA" When present, it indicates the configured Maximum Latency. (NOTE 1)
maximumResponseTime	DurationSec	O	0..1	May be present if eventType is "UE_REACHABILITY_FOR_DATA" When present, it indicates the configured Maximum Response Time. (NOTE 1)
suggestedPacketNumDL	integer	O	0..1	May be present if eventType is "UE_REACHABILITY_FOR_DATA" When present, it indicates the configured Suggested number of downlink packets. (NOTE 1)
pduSessionStatusCfg	PduSessionStatusCfg	O	0..1	may be present if eventType is "PDN_CONNECTIVITY_STATUS"
reachabilityForSmsCfg	ReachabilityForSmsConfiguration	O	0..1	REACHABILITY_FOR_SMS_OVER_NAS (default) or REACHABILITY_FOR_SMS_OVER_IP
mtcProviderInformation	MtcProviderInformation	O	0..1	Indicates MTC provider information for Monitoring Configuration authorization. (NOTE 2)
afld	string	O	0..1	The string identifying the originating AF, which is carried in {scsAsId} URI variable in resource URIs on T8/N33 interface (see clause 5 of 3GPP TS 29.122 [45]) or in {afld} URI variable in resource URIs on N33 interface (see clause 5 of 3GPP TS 29.522 [54]). (NOTE 2)

idleStatusInd	boolean	O	0..1	Idle Status Indication request. May be present if eventType is UE_REACHABILITY_FOR_DATA or AVAILABILITY_AFTER_DDN_FAILURE true: Idle status indication is requested false (default): Idle status indication is not requested
NOTE 1: Parameters maximumLatency, maximumResponseTime, suggestedPacketNumDI and lossConnectivityCfg are not recommended to be used for the AFs that support to set them by Parameter Provision service operation via NEF.				
NOTE 2: Only applicable when eventType is "UE_REACHABILITY_FOR_DATA" or "LOSS_OF_CONNECTIVITY".				

6.4.6.2.4 Type: MonitoringReport

Table 6.4.6.2.4-1: Definition of type MonitoringReport

Attribute name	Data type	P	Cardinality	Description
referenceId	ReferenceId	M	1	Shall contain the Reference ID which was provided as the key of the associated monitoring configuration in subscription request. The consumer can use this IE to uniquely associate the report with the corresponding event that was requested to be monitored.
eventType	EventType	M	1	String; see clause 6.4.6.3.3 only the following values are allowed: "UE_REACHABILITY_FOR_SMS" "UE_REACHABILITY_FOR_DATA" "CHANGE_OF_SUPI_PEI_ASSOCIATION" "ROAMING_STATUS" "CN_TYPE_CHANGE" "UE_CONNECTION_MANAGEMENT_STATE" "LOSS_OF_CONNECTIVITY" "LOCATION_REPORTING" "PDN_CONNECTIVITY_STATUS" (NOTE)
report	Report	C	0..1	Shall be present if eventType is "CHANGE_OF_SUPI_PEI_ASSOCIATION" or "ROAMING_STATUS" "CN_TYPE_CHANGE" "UE_CONNECTION_MANAGEMENT_STATE" "LOSS_OF_CONNECTIVITY" "LOCATION_REPORTING" "PDN_CONNECTIVITY_STATUS"
reachabilityForSmsReport	ReachabilityForSmsReport	C	0..1	Should be present if eventType is "UE_REACHABILITY_FOR_SMS" and reachabilityForSmsCfg was absent from the MonitoringConfiguration or indicated REACHABILITY_FOR_SMS_OVER_NAS
gpsi	Gpsi	C	0..1	shall be present if the report is associated to exposure subscriptions for a group of UEs or any UE.
timeStamp	DateTime	M	1	Point in time at which the event occurred
NOTE: "UE_REACHABILITY_FOR_DATA", "UE_CONNECTION_MANAGEMENT_STATE", "LOSS_OF_CONNECTIVITY", "LOCATION_REPORTING" and "PDN_CONNECTIVITY_STATUS" event types shall only be included in an immediate report, when NF consumer has indicated support of "IERSR" feature (see clause 6.4.8) and the immediate report has been received from HSS or AMF in subscription creation response.				

6.4.6.2.5 Type: Report

Table 6.4.6.2.5-1: Definition of type Report as a list of mutually exclusive alternatives

Data type	Cardinality	Description
ChangeOfSupiPeiAssociationReport	1	
RoamingStatusReport	1	
CnTypeChangeReport	1	Report new CN type after switching
CmInfoReport	1	Report the UE's CM state
LossConnectivityReport	1	Report of "LOSS_OF_CONNECTIVITY" event
LocationReport	1	"LOCATION_REPORTING"
PdnConnectivityStatReport	1	"PDN_CONNECTIVITY_STATUS"

6.4.6.2.6 Type: ReportingOptions

Table 6.4.6.2.6-1: Definition of type ReportingOptions

Attribute name	Data type	P	Cardinality	Description
reportMode	EventReportMode	O	0..1	Indicates the mode of report (e.g, periodic reporting along with periodicity, reporting based on event detection). See clause 4.15.1 of 3GPP TS23.502 [3].
maxNumOfReports	MaxNumOfReports	C	0..1	Maximum number of reports. If the event subscription is for a group of UEs, this parameter shall be applied to each individual member UE of the group. (NOTE 2)
expiry	DateTime	C	0..1	This IE shall be included in an event subscription response, if, based on operator policy, the UDM needs to include an expiry time, and may be included in an event subscription request. When present, this IE shall represent the time at which monitoring shall cease and the subscription becomes invalid. If the maxNumOfReports included in an event subscription response is 1 and if an event report is included in the subscription response then the value of the expiry included in the response shall be an immediate timestamp. (NOTE 2)
samplingRatio	SamplingRatio	O	0..1	Indicates the percentage of sampling among impacted UEs, this parameter is used for group-based monitoring configuration. See clause 4.15.1 of 3GPP TS23.502 [3]. (NOTE 1)
guardTime	DurationSec	O	0..1	Indicates the time for which the Monitoring Event Reporting(s) detected by the UEs in a group can be aggregated before sending them to the consumer NF, this parameter is used for group-based monitoring configuration. See clause 4.15.1 of 3GPP TS23.502 [3].
reportPeriod	DurationSec	C	0..1	Indicates the interval time between which the event notification is reported, shall be present if reportMode is "PERIODIC".

NOTE 1: Parameter only applicable to certain event IDs reporting metrics (e.g. Number of UEs present in a geographical area) used and used e.g. by the NWDAF for data collection.

NOTE 2: If parameter "maxNumOfReports" and "expiry" are included at the same time, the subscription will expire as soon as one of the conditions is met. If the ReportMode is set to "PERIODIC", at least one of the "maxNumOfReports" and "expiry" attributes shall be included.

6.4.6.2.7 Type: ChangeOfSupiPeiAssociationReport

Table 6.4.6.2.7-1: Definition of type ChangeOfSupiPeiAssociationReport

Attribute name	Data type	P	Cardinality	Description
newPei	Pei	M	1	the new PEI

6.4.6.2.8 Type: RoamingStatusReport

Table 6.4.6.2.8-1: Definition of type RoamingStatusReport

Attribute name	Data type	P	Cardinality	Description
roaming	boolean	M	1	True: The new serving PLMN is different from the HPLMN; False: The new serving PLMN is the HPLMN
newServingPlmn	PlmnId	M	1	the new Serving PLMN

6.4.6.2.9 Type: CreatedEeSubscription

Table 6.4.6.2.9-1: Definition of type CreatedEeSubscription

Attribute name	Data type	P	Cardinality	Description
eeSubscription	EeSubscription	M	1	This IE shall contain the representation of the created event subscription.
numberOfUes	UInteger	C	0..1	This IE shall be included if the event subscription is for a group of UEs. When present, this IE shall represent the number of UEs in the group.
eventReports	array(Monitoring Report)	O	1..N	This IE when present, shall contain the status of events that are requested for immediate reporting as well, if those events are available at the time of subscription. If an event requested for immediate reporting is detected by another NF (e.g. AMF or HSS) and both the UDM and the NF consumer (e.g. NEF) support the "IERSR" feature, this UDM shall require the other NF to include the immediate reporting in subscription creation response and the UDM shall include the immediate event reports received from other NF in this IE; otherwise, the UDM shall require the other NF to directly notified to the NF consumer, thus the status of the event shall not be included in this IE.
epcStatusInd	boolean	C	0..1	This IE indicates whether the subscription was also successful in EPC domain or not. true: the subscription was also successful in EPC domain. false: the subscription was not successful in EPC domain. This IE shall be included if epcAppliedInd is true in the subscription request.

6.4.6.2.10 Type: LocationReportingConfiguration

Table 6.4.6.2.10-1: Definition of type LocationReportingConfiguration

Attribute name	Data type	P	Cardinality	Description
currentLocation	boolean	M	1	When true: Indicates that current location is requested. When false: Indicates that last known location is requested.
oneTime	boolean	C	0..1	When true: Indicates that a single report is requested. When false or absent: Indicates that continuous reporting is requested. Shall not be absent or set to false when currentLocation is false.
accuracy	LocationAccuracy	C	0..1	Indicates whether Cell-level or TA-level accuracy is requested for 3GPP access. (NOTE 1)
n3gppAccuracy	LocationAccuracy	C	0..1	Indicates whether N3IWF or UE IP or UE PORT level accuracy is requested for non-3GPP access. (NOTE 1)
NOTE 1: At least one of accuracy and n3gppAccuracy shall be present if continuous reporting is required				

6.4.6.2.11 Type: CnTypeChangeReport

Table 6.4.6.2.11-1: Definition of type CnTypeChangeReport

Attribute name	Data type	P	Cardinality	Description
oldCnType	CnType	O	0..1	the old CN type
newCnType	CnType	M	1	the new CN type

6.4.6.2.12 Type: ReachabilityForSmsReport

Table 6.4.6.2.12-1: Definition of type ReachabilityForSmsReport

Attribute name	Data type	P	Cardinality	Description
smsfAccessType	AccessType	M	1	
maxAvailabilityTime	DateTime	O	0..1	Indicates the time (in UTC) until which the UE is expected to be reachable. This information may be used by the SMS Service Center to prioritize the retransmission of pending Mobile Terminated Short Message to UEs using a power saving mechanism (eDRX, PSM etc.).

6.4.6.2.13 Type: DatalinkReportingConfiguration

Table 6.4.6.2.13-1: Definition of type DatalinkReportingConfiguration

Attribute name	Data type	P	Cardinality	Description
dddTrafficDes	array(DddTrafficDescriptor)	C	1..N	This IE shall be present for event type "DL_DATA_DELIVERY_STATUS" "AVAILABILITY_AFTER_DDN_FAILURE". When present, this IE shall indicate the traffic descriptors of the downlink data.
dnn	Dnn	O	0..1	When present, this IE shall contain the Network Identifier only and indicate the DNN of the PDU session serving the data link.
slice	Snssai	O	0..1	When present, this IE shall indicate the slice information of the PDU session serving the data link.
dddStatusList	array(DIDataDeliveryStatus)	O	1..N	This IE shall be present for event type "DL_DATA_DELIVERY_STATUS". When present, this IE shall indicate the subscribed statuses (discarded, transmitted, buffered) for the event. If omitted all stati are subscribed.

6.4.6.2.14 Type: CmInfoReport

Table 6.4.6.2.11-1: Definition of type CmInfoReport

Attribute name	Data type	P	Cardinality	Description
oldCmInfoList	array(CmInfo)	O	1..2	the old CM State information
newCmInfoList	array(CmInfo)	M	1..2	the new CM State information

6.4.6.2.15 Type: LossConnectivityCfg

Table 6.4.6.2.15-1: Definition of type LossConnectivityCfg

Attribute name	Data type	P	Cardinality	Description
maxDetectionTime	DurationSec	O	0..1	When present, it indicates the configured Maximum Detection Time

6.4.6.2.16 Type: PduSessionStatusCfg

Table 6.4.6.2.16-1: Definition of type PduSessionStatusCfg

Attribute name	Data type	P	Cardinality	Description
dnn	Dnn	O	0..1	When present, it indicates the DNN for which the event is monitored.

6.4.6.2.17 Type: LossConnectivityReport

Table 6.4.6.2.17-1: Definition of type LossConnectivityReport

Attribute name	Data type	P	Cardinality	Description
lossOfConnectReason	LossOfConnectivityReason	M	1	Describes the reason for loss of connectivity.

6.4.6.2.18 Type: LocationReport

Table 6.4.6.2.18-1: Definition of type LocationReport

Attribute name	Data type	P	Cardinality	Description
location	UserLocation	M	1	This IE shall include all available UE locations.

6.4.6.2.19 Type: PdnConnectivityStatReport

Table 6.4.6.2.19-1: Definition of type PdnConnectivityStatReport

Attribute name	Data type	P	Cardinality	Description
pdnConnStat	PdnConnectivityStatus	M	1	PDN Connectivity Status
dnn	Dnn	O	0..1	DNN/APN of the PDN connectivity
pduSeld	PduSessionId	O	0..1	PDU session ID.
ipv4Addr	Ipv4Addr	O	0..1	IPv4 address.
ipv6Prefixes	array(Ipv6Prefix)	O	1..N	IPv6 prefixes.
ipv6Addrs	array(Ipv6Addr)	O	1..N	IPv6 addresses.
pduSessType	PduSessionType	O	0..1	PDU session type.

6.4.6.3 Simple data types and enumerations

6.4.6.3.1 Introduction

This clause defines simple data types and enumerations that can be referenced from data structures defined in the previous clauses.

6.4.6.3.2 Simple data types

The simple data types defined in table 6.4.6.3.2-1 shall be supported.

Table 6.4.6.3.2-1: Simple data types

Type Name	Type Definition	Description
MaxNumOfReports	integer	Maximum number of reports. Minimum: 1
Referenceld	integer	Referenceld is used as key in a map of MonitoringConfigurations; see clause 6.4.6.2.2. The numeric value should not be higher than $2^{64}-1$ (i.e. it should be possible to convey it in an unsigned 64 integer Information Element, used in other protocols), if interworking with the Event Exposure framework in EPC is required.

6.4.6.3.3 Enumeration: EventType

Table 6.4.6.3.3-1: Enumeration EventType

Enumeration value	Description
"LOSS_OF_CONNECTIVITY"	Loss of connectivity
"UE_REACHABILITY_FOR_DATA"	<p>UE reachability for data, implements the "UE Reachability" monitoring event as specified in clause 4.15.3.1 in 3GPP TS 23.502 [3].</p> <p>When this event is subscribed by an NF service consumer, the UDM subscribes to "ReachabilityReport" event for "UE Reachability for DL Traffic" on the AMF without URRP-AMF.</p> <p>When this event is subscribed by an NF service consumer, the UDM shall request the AMF to directly send notification to NF.</p>
"UE_REACHABILITY_FOR_SMS"	<p>UE reachability for SMS, implements the "UE Reachability for SMS Delivery" event as specified in clause 4.15.3.1 of 3GPP TS 23.502 [3].</p> <p>This Event is reported when an SMSF is being registered in UDM for the UE, or when a UE Activity notification is received from AMF and there is an SMSF already registered for the UE.</p> <p>This event only supports One-Time reporting.</p>
"LOCATION_REPORTING"	Location Reporting
"CHANGE_OF_SUPI_PEI_ASSOCIATION"	Change of SUPI-PEI association
"ROAMING_STATUS"	Roaming Status
"COMMUNICATION_FAILURE"	Communication Failure
"AVAILABILITY_AFTER_DDN_FAILURE"	Availability after DDN failure
"CN_TYPE_CHANGE"	CN type change
"DL_DATA_DELIVERY_STATUS"	Downlink Data Delivery Status
"PDN_CONNECTIVITY_STATUS"	PDU Session Status
"UE_CONNECTION_MANAGEMENT_STATE"	UE state of Connection Management

6.4.6.3.4 Enumeration: LocationAccuracy

Table 6.4.6.3.4-1: Enumeration LocationAccuracy

Enumeration value	Description
"CELL_LEVEL"	change of cell shall be reported for 3GPP access
"TA_LEVEL"	change of TA shall be reported for 3GPP access
"N3IWF_LEVEL"	Change of N3IWF node shall be reported for non-3GPP access
"UE_IP"	change of UE IP address (used to reach the N3IWF) shall be reported for non-3GPP access
"UE_PORT"	Change of UE source port shall be reported for non-3GPP access

6.4.6.3.5 Enumeration: CnType

Table 6.4.6.3.5-1: Enumeration CnType

Enumeration value	Description
"SINGLE_4G"	Single registration in 4G
"SINGLE_5G"	Single registration in 5G
"DUAL_4G5G"	Dual registration in 4G and 5G

6.4.6.3.6 Enumeration: AssociationType

Table 6.4.6.3.6-1: Enumeration AssociationType

Enumeration value	Description
"IMEI_CHANGE"	The event shall be reported if the association between IMSI and IMEI has changed; if only the Software Version (SV) has changed, no event shall be reported.
"IMEISV_CHANGE"	The event shall be reported if the association between IMSI and IMEI, or SV, or both, has changed (this includes the case where only the SV has changed).

6.4.6.3.7 Enumeration: EventReportMode

Table 6.4.6.3.7-1: Enumeration EventReportMode

Enumeration value	Description
"PERIODIC"	The notification is periodically sent.
"ON_EVENT_DETECTION"	The notification is sent based on event detection.

6.4.6.3.8 Enumeration: ReachabilityForSmsConfiguration

Table 6.4.6.3.8-1: Enumeration ReachabilityForSmsConfiguration

Enumeration value	Description
"REACHABILITY_FOR_SMS_OVER_NAS"	Indicates that the Monitoring Configuration with Event Type UE_REACHABILITY_FOR_SMS requests a notification when the UE is reachable for SMS via a registered SMSF (default)
"REACHABILITY_FOR_SMS_OVER_IP"	Indicates that the Monitoring Configuration with Event Type UE_REACHABILITY_FOR_SMS requests a notification when the UE is reachable for SMS over IP, i.e. regardless of an SMSF being registered.

6.4.6.3.9 Enumeration: PdnConnectivityStatus

Table 6.4.6.3.9-1: PdnConnectivityStatus

Enumeration value	Description
"ESTABLISHED"	PDN Connection established.
"RELEASED"	PDN Connection released.

6.4.7 Error Handling

6.4.7.1 General

HTTP error handling shall be supported as specified in clause 5.2.4 of 3GPP TS 29.500 [4].

6.4.7.2 Protocol Errors

Protocol errors handling shall be supported as specified in clause 5.2.7 of 3GPP TS 29.500 [4].

6.4.7.3 Application Errors

The common application errors defined in the Table 5.2.7.2-1 in 3GPP TS 29.500 [4] may also be used for the Nudm_EventExposure service. The following application errors listed in Table 6.4.7.3-1 are specific for the Nudm_EventExposure service.

Table 6.4.7.3-1: Application errors

Application Error	HTTP status code	Description
MONITORING_NOT_ALLOWED	403 Forbidden	The subscriber does not have the necessary subscription for monitoring with the requested Event Type.
AF_NOT_ALLOWED	403 Forbidden	This AF is not allowed to perform monitoring configuration.
MTC_PROVIDER_NOT_ALLOWED	403 Forbidden	MTC Provider not authorized to perform monitoring configuration.
USER_NOT_FOUND	404 Not Found	The user does not exist
CONTEXT_NOT_FOUND	404 Not Found	It is used when no corresponding context exists.
UNSUPPORTED_MONITORING_EVENT_TYPE	501 Not Implemented	The monitoring configuration contains unsupported event type.
UNSUPPORTED_MONITORING_REPORT_OPTIONS	501 Not Implemented	The monitoring configuration contains unsupported report options.

6.4.8 Feature Negotiation

The optional features in table 6.4.8-1 are defined for the Nudm_EE API. They shall be negotiated using the extensibility mechanism defined in clause 6.6 of 3GPP TS 29.500 [4].

Table 6.4.8-1: Supported Features

Feature number	Feature Name	Description
1	PatchReport	If some of the modifications included in the PATCH request are not successfully implemented, the UDM reports the result of PATCH request execution to the consumer. See clause 5.2.7.2 of 3GPP TS 29.500 [4].
X	IERSR	Immediate Event Report in Subscription Creation Response for events detected by another NF The UDM and the NF consumer (e.g. NEF) supporting this feature shall be able to handle the immediate event reports in the Subscription Creation Response for events with direct reporting by another NF (e.g. AMF, HSS), as specified in clause 5.5.2.2.

6.4.9 Security

As indicated in 3GPP TS 33.501 [6] and 3GPP TS 29.500 [4], the access to the Nudm_EE API may be authorized by means of the OAuth2 protocol (see IETF RFC 6749 [18]), based on local configuration, using the "Client Credentials" authorization grant, where the NRF (see 3GPP TS 29.510 [19]) plays the role of the authorization server.

If OAuth2 is used, an NF Service Consumer, prior to consuming services offered by the Nudm_EE API, shall obtain a "token" from the authorization server, by invoking the Access Token Request service, as described in 3GPP TS 29.510 [19], clause 5.4.2.2.

NOTE: When multiple NRFs are deployed in a network, the NRF used as authorization server is the same NRF that the NF Service Consumer used for discovering the Nudm_EE service.

The Nudm_EE API defines a single scope "nudm-ee" for OAuth2 authorization (as specified in 3GPP TS 33.501 [6]) for the entire API, and it does not define any additional scopes at resource or operation level.

6.5 Nudm_ParameterProvision Service API

6.5.1 API URI

URIs of this API shall have the following root:

{apiRoot}/{apiName}/<apiVersion>/

The request URI used in HTTP request from the NF service consumer towards the NF service producer shall have the structure defined in clause 4.4.1 of 3GPP TS 29.501 [5], i.e.:

{apiRoot}/<apiName>/<apiVersion>/<apiSpecificResourceUriPart>

with the following components:

- The {apiRoot} shall be set as described in 3GPP TS 29.501 [5].
- The <apiName> shall be "nudm-pp".
- The <apiVersion> shall be "v1".
- The <apiSpecificResourceUriPart> shall be set as described in clause 6.5.3.

6.5.2 Usage of HTTP

6.5.2.1 General

HTTP/2, as defined in IETF RFC 7540 [13], shall be used as specified in clause 5 of 3GPP TS 29.500 [4].

HTTP/2 shall be transported as specified in clause 5.3 of 3GPP TS 29.500 [4].

HTTP messages and bodies for the Nudm_PP service shall comply with the OpenAPI [14] specification contained in Annex A6.

6.5.2.2 HTTP standard headers

6.5.2.2.1 General

The usage of HTTP standard headers shall be supported as specified in clause 5.2.2 of 3GPP TS 29.500 [4].

6.5.2.2.2 Content type

The following content types shall be supported:

JSON, as defined in IETF RFC 8259 [15], signalled by the content type "application/json".

The Problem Details JSON Object (IETF RFC 7807 [16]) signalled by the content type "application/problem+json"

JSON Merge Patch, as defined in IETF RFC 7396 [17], signalled by the content type "application/merge-patch+json"

6.5.2.3 HTTP custom headers

6.5.2.3.1 General

The usage of HTTP custom headers shall be supported as specified in clause 5.2.3 of 3GPP TS 29.500 [4].

6.5.3 Resources

6.5.3.1 Overview

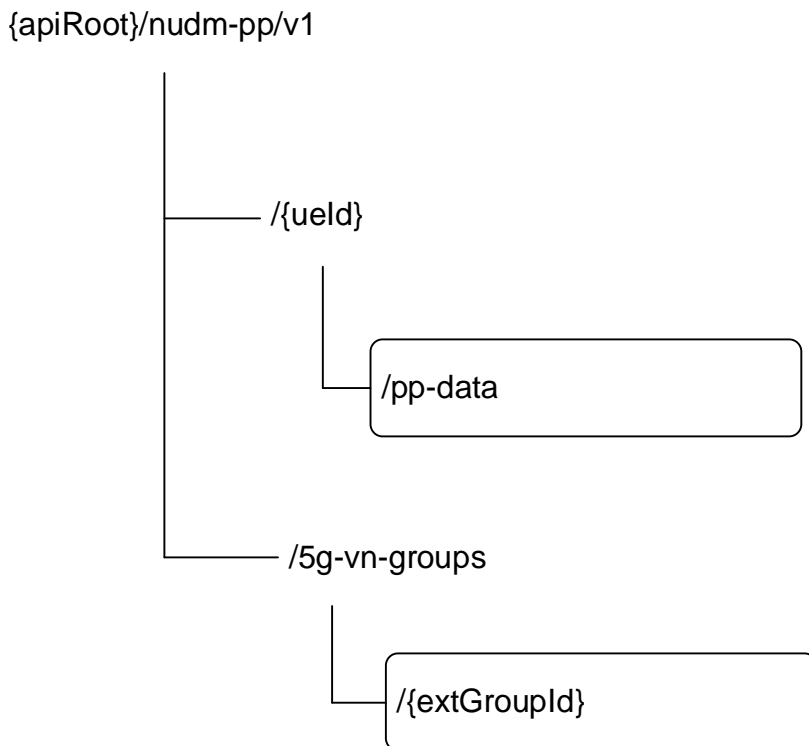

Figure 6.5.3.1-1: Resource URI structure of the Nudm_PP API

Table 6.5.3.1-1 provides an overview of the resources and applicable HTTP methods.

Table 6.5.3.1-1: Resources and methods overview

Resource name	Resource URI	HTTP method or custom operation	Description
PpData	/{ueld}/pp-data	PATCH	Modify the UE's modifiable subscription data Send updated SoR Information for a UE to the UDM
5GVnGroupConfiguration	/5g-vn-groups/{extGroupId}	PUT	Create a 5G VN Group
		DELETE	Delete a 5G VN Group
		PATCH	Modify a 5G VN Group

6.5.3.2 Resource: PpData

6.5.3.2.1 Description

This resource is used to represent Parameter Provisioning Data.

6.5.3.2.2 Resource Definition

Resource URI: {apiRoot}/nudm-pp/v1/{ueId}/pp-data

This resource shall support the resource URI variables defined in table 6.5.3.2.2-1.

Table 6.5.3.2.2-1: Resource URI variables for this resource

Name	Data type	Definition
apiRoot	string	See clause 6.5.1
ueId	string	Represents a single UE or a group of UEs. - If representing a single UE, this parameter shall contain the Generic Public Subscription Identifier (see 3GPP TS 23.501 [2] clause 5.9.8) or SUPI. pattern: See pattern of data type VarUeId in 3GPP TS 29.571 [7] - If representing a group of UEs, this parameter shall contain the External GroupId. pattern: "^extgroupid-[^@]+@[^@]+\$"

6.5.3.2.3 Resource Standard Methods

6.5.3.2.3.1 PATCH

This method shall support the URI query parameters specified in table 6.5.3.2.3.1-1.

Table 6.5.3.2.3.1-1: URI query parameters supported by the PATCH method on this resource

Name	Data type	P	Cardinality	Description
supported-features	SupportedFeatures	O	0..1	see 3GPP TS 29.500 [4] clause 6.6

This method shall support the request data structures specified in table 6.5.3.2.3.1-2 and the response data structures and response codes specified in table 6.5.3.2.3.1-3.

Table 6.5.3.2.3.1-2: Data structures supported by the PATCH Request Body on this resource

Data type	P	Cardinality	Description
PpData	M	1	Contains the data to be provisioned or the updated SoR Information to be conveyed to a UE.

Table 6.5.3.2.3.1-3: Data structures supported by the PATCH Response Body on this resource

Data type	P	Cardinality	Response codes	Description
n/a			204 No Content	Upon success, an empty response body shall be returned. (NOTE 2)
PatchResult	M	1	200 OK	Upon success, the execution report is returned. (NOTE 2)
ProblemDetails	O	0..1	404 Not Found	The "cause" attribute may be used to indicate one of the following application errors: - USER_NOT_FOUND
ProblemDetails	O	0..1	403 Forbidden	The "cause" attribute may be used to indicate one of the following application errors: - MODIFICATION_NOT_ALLOWED - DETACHED_USER - AF_NOT_ALLOWED - MTC_PROVIDER_NOT_ALLOWED
NOTE 1: In addition common data structures as listed in table 5.2.7.1-1 of 3GPP TS 29.500 [4] are supported.				
NOTE 2: If all the modification instructions in the PATCH request have been implemented, the UDM shall respond with 204 No Content response; if some of the modification instructions in the PATCH request have been discarded, and the NF service consumer has included in the supported-feature query parameter the "PatchReport" feature number, the UDM shall respond with PatchResult.				

6.5.3.3 Resource: 5GVnGroupConfiguration

6.5.3.3.1 Description

This resource is used to represent 5G VN Group Configuration.

6.5.3.3.2 Resource Definition

Resource URI: {apiRoot}/nudm-pp/<apiVersion>/5g-vn-groups/{extGroupId}

This resource shall support the resource URI variables defined in table 6.5.3.3.2-1.

Table 6.5.3.3.2-1: Resource URI variables for this resource

Name	Data type	Definition
apiRoot	string	See clause 6.5.1
extGroupId	ExtGroupId	Represents the external Identifier of the 5G VN group pattern: "^extgroupid-[^@]+@[^@]+\$"

6.5.3.3.3 Resource Standard Methods

6.5.3.3.3.1 PUT

This method shall support the URI query parameters specified in table 6.5.3.3.3.1-1.

Table 6.5.3.3.3.1-1: URI query parameters supported by the PUT method on this resource

Name	Data type	P	Cardinality	Description
n/a				

This method shall support the request data structures specified in table 6.5.3.3.3.1-2 and the response data structures and response codes specified in table 6.5.3.3.3.1-3.

Table 6.5.3.3.3.1-2: Data structures supported by the PUT Request Body on this resource

Data type	P	Cardinality	Description
5GVnGroupConfiguration	M	1	Contains the configuration of the 5G VN Group

Table 6.5.3.3.3.1-3: Data structures supported by the PUT Response Body on this resource

Data type	P	Cardinality	Response codes	Description
n/a			201 Created	Upon success, an empty response shall be returned.
ProblemDetails	O	0..1	403 Forbidden	The "cause" attribute may be used to indicate one of the following application errors: - CREATION_NOT_ALLOWED - AF_NOT_ALLOWED - MTC_PROVIDER_NOT_ALLOWED

NOTE: In addition common data structures as listed in table 5.2.7.1-1 of 3GPP TS 29.500 [4] are supported.

6.5.3.3.3.2 DELETE

This method shall support the URI query parameters specified in table 6.5.3.3.3.1-1.

Table 6.5.3.3.3.2-1: URI query parameters supported by the DELETE method on this resource

Name	Data type	P	Cardinality	Description
mtc-provider-info	MtcProviderInformation	O	0..1	The mtc-provider-info contains the MTC Provider information that originates 5G-VN-Group deletion, it is used by the UDM to check whether the MTC Provider is allowed to perform this operation for the UE if the MTC provider authorization is required.
af-id	string	O	0..1	The af-Id contains the AF ID that originates 5G-VN-Group deletion, it is used by the UDM to check whether the AF is allowed to perform this operation for the UE if the AF authorization is required. It is formatted as described in the definition of type MonitoringConfiguration.

This method shall support the request data structures specified in table 6.5.3.3.3.1-2 and the response data structures and response codes specified in table 6.5.3.3.3.1-3.

Table 6.5.3.3.3.2-2: Data structures supported by the DELETE Request Body on this resource

Data type	P	Cardinality	Description
n/a			

Table 6.5.3.3.3.2-3: Data structures supported by the DELETE Response Body on this resource

Data type	P	Cardinality	Response codes	Description
n/a			204 No Content	Upon success, an empty response body shall be returned
ProblemDetails	O	0..1	404 Not Found	The "cause" attribute may be used to indicate one of the following application errors: - GROUP_IDENTIFIER_NOT_FOUND
ProblemDetails	O	0..1	403 Forbidden	The "cause" attribute may be used to indicate one of the following application errors: - AF_NOT_ALLOWED - MTC_PROVIDER_NOT_ALLOWED

NOTE: In addition common data structures as listed in table 5.2.7.1-1 of 3GPP TS 29.500 [4] are supported.

6.5.3.3.3.3 PATCH

This method shall support the URI query parameters specified in table 6.5.3.3.3.3-1.

Table 6.5.3.3.3.3-1: URI query parameters supported by the PATCH method on this resource

Name	Data type	P	Cardinality	Description
supported-features	SupportedFeatures	O	0..1	see 3GPP TS 29.500 [4] clause 6.6

This method shall support the request data structures specified in table 6.5.3.3.3.3-2 and the response data structures and response codes specified in table 6.5.3.3.3.3-3.

Table 6.5.3.3.3.3-2: Data structures supported by the PATCH Request Body on this resource

Data type	P	Cardinality	Description
5GVnGroupConfiguration	M	1	Contains the modification instruction

Table 6.5.3.3.3.3-3: Data structures supported by the PATCH Response Body on this resource

Data type	P	Cardinality	Response codes	Description
n/a			204 No Content	Upon success, an empty response body shall be returned. (NOTE 2)
PatchResult	M	1	200 OK	Upon success, the execution report is returned. (NOTE 2)
ProblemDetails	O	0..1	404 Not Found	The "cause" attribute may be used to indicate one of the following application errors: - GROUP_IDENTIFIER_NOT_FOUND
ProblemDetails	O	0..1	403 Forbidden	The "cause" attribute may be used to indicate one of the following application errors: - MODIFICATION_NOT_ALLOWED - AF_NOT_ALLOWED - MTC_PROVIDER_NOT_ALLOWED
NOTE 1: In addition common data structures as listed in table 5.2.7.1-1 of 3GPP TS 29.500 [4] are supported.				
NOTE 2: If all the modification instructions in the PATCH request have been implemented, the UDM shall respond with 204 No Content response; if some of the modification instructions in the PATCH request have been discarded, and the NF service consumer has included in the supported-feature query parameter the "PatchReport" feature number, the UDR shall respond with PatchResult.				

6.5.3.3.3.4 GET

This method shall support the URI query parameters specified in table 6.5.3.3.3.4-1.

Table 6.5.3.3.3.4-1: URI query parameters supported by the GET method on this resource

Name	Data type	P	Cardinality	Description
N/A				

This method shall support the response data structures and response codes specified in table 6.5.3.3.3.4-2.

Table 6.5.3.3.3.4-2: Data structures supported by the GET Request Body on this resource

Data type	P	Cardinality	Description
N/A			

Table 6.5.3.3.4-3: Data structures supported by the GET Response Body on this resource

Data type	P	Cardinality	Response codes	Description
5GVnGroupConfiguration			200 OK	
ProblemDetails	O	0..1	404 Not Found	The "cause" attribute may be used to indicate one of the following application errors: - GROUP_IDENTIFIER_NOT_FOUND
ProblemDetails	O	0..1	403 Forbidden	The "cause" attribute may be used to indicate one of the following application errors: - AF_NOT_ALLOWED

6.5.4 Custom Operations without associated resources

In this release of this specification, no custom operations without associated resources are defined for the Nudm_ParameterProvision Service.

6.5.5 Notifications

In this release of this specification, no notifications are defined for the Nudm_ParameterProvision Service.

6.5.6 Data Model

6.5.6.1 General

This clause specifies the application data model supported by the API.

Table 6.5.6.1-1 specifies the data types defined for the Nudm_PP service API.

Table 6.5.6.1-1: Nudm_PP specific Data Types

Data type	Clause defined	Description
PpData	6.5.6.2.2	Parameter Provision Data
CommunicationCharacteristics	6.5.6.2.3	Communication Characteristics
PpSubsRegTimer	6.5.6.2.4	
PpActiveTime	6.5.6.2.5	
5GVnGroupConfiguration	6.5.6.2.6	
5GVnGroupData	6.5.6.2.7	
ExpectedUeBehaviour	6.5.6.2.8	Expected UE Behaviour Parameters
LocationArea	6.5.6.2.10	Location Area
NetworkAreaInfo	6.5.6.2.11	Network Area Information
EcRestriction	6.5.6.2.12	
PlmnEclInfo	6.5.6.2.13	
PpDIPacketCountExt	6.5.6.2.14	
PpMaximumResponseTime	6.5.6.2.15	
PpMaximumLatency	6.5.6.2.16	
LcsPrivacy	6.5.6.2.17	
Referenceld	6.5.6.3.2	
PpDIPacketCount	6.5.6.3.2	

Table 6.5.6.1-2 specifies data types re-used by the Nudm_PP service API from other APIs, including a reference and when needed, a short description of their use within the Nudm_PP service API.

Table 6.5.6.1-2: Nudm_PP re-used Data Types

Data type	Reference	Comments
DurationSec	3GPP TS 29.571 [7]	Time value in seconds
DurationSecRm	3GPP TS 29.571 [7]	Time value in seconds; nullable
SupportedFeatures	3GPP TS 29.571 [7]	
NfInstanceId	3GPP TS 29.571 [7]	
ProblemDetails	3GPP TS 29.571 [7]	
Gpsi	3GPP TS 29.571 [7]	
PatchResult	3GPP TS 29.571 [7]	
DateTime	3GPP TS 29.571 [7]	
Ecgi	3GPP TS 29.571 [7]	an EUTRA cell identifier
Ncgi	3GPP TS 29.571 [7]	an NR cell identifier
GlobalRanNodeId	3GPP TS 29.571 [7]	an identity of the NG-RAN node
Tai	3GPP TS 29.571 [7]	a tracking area identity
GeographicArea	3GPP TS 29.572 [34]	Identifies the geographical information of the user(s).
CivicAddress	3GPP TS 29.572 [34]	Identifies the civic address information of the user(s).
PduSessionType	3GPP TS 29.571 [7]	
AppDescriptor	6.1.6.2.40	
AcsInfoRm	3GPP TS 29.571 [7]	
StnSrRm	3GPP TS 29.571 [7]	Session Transfer Number for SRVCC
Supi	3GPP TS 29.571 [7]	
Lpi	6.1.6.2.43	
MtcProviderInformation	3GPP TS 29.571 [7]	MTC Provider Information
StationaryIndicationRm	3GPP TS 29.571 [7]	
ScheduledCommunicationTimeRm	3GPP TS 29.571 [7]	
ScheduledCommunicationTypeRm	3GPP TS 29.571 [7]	
TrafficProfileRm	3GPP TS 29.571 [7]	
BatteryIndicationRm	3GPP TS 29.571 [7]	

6.5.6.2 Structured data types

6.5.6.2.1 Introduction

This clause defines the structures to be used in resource representations.

6.5.6.2.2 Type: PpData

Table 6.5.6.2.2-1: Definition of type PpData

Attribute name	Data type	P	Cardinality	Description
supportedFeatures	SupportedFeatures	O	0..1	
communicationCharacteristics	CommunicationCharacteristics	O	0..1	communication characteristics
expectedUeBehaviour	ExpectedUeBehaviour	O	0..1	Expected UE Behaviour Parameters
ecRestriction	EcRestriction	O	0..1	Enhanced Coverage Restriction Parameters
acsInfo	AcsInfoRm	O	0..1	Identifies the ACS Information (see TS 23.316 [37] clause 9.6.3); nullable.
stnSr	StnSrRm	O	0..1	Session Transfer Number for SRVCC
lcsPrivacy	LcsPrivacy	O	0..1	LCS Privacy Parameters (see clause 5.4.3 of 3GPP TS 23.273 [38])
sorInfo	SorInfo	O	0..1	Steering of Roaming information to be conveyed to a UE See NOTE ¹ and NOTE ² .

NOTE¹: If the UDM is not able to immediately (after conducting integrity protection with the AUSF) convey the received Steering of Roaming information to the concerned UE for any reason (e.g. no AMF registered for the UE), it shall discard it.

NOTE²: The behaviour of the UDM at reception of Steering of Roaming information within PpData is specified in Annex C.3 of 3GPP TS 23.122 [20].

6.5.6.2.3 Type: CommunicationCharacteristics

Table 6.5.6.2.3-1: Definition of type CommunicationCharacteristics

Attribute name	Data type	P	Cardinality	Description
ppSubsRegTimer	PpSubsRegTimer	O	0..1	AF provisioned Subscribed periodic registration timer, nullable (NOTE 2)
ppActiveTime	PpActiveTime	O	0..1	AF provisioned active time; nullable (NOTE 2)
ppDIPacketCount	PpDIPacketCount	O	0..1	AF provisioned DL Buffering Suggested Packet Count; nullable
ppDIPacketCountExt	PpDIPacketCountExt	C	0..1	AF provisioned DL Buffering Suggested Packet Count Extension; nullable. Shall be absent if ppDIPacketCount is absent, and shall be null if ppDIPacketCount is null.
ppMaximumResponseTime	PpMaximumResponseTime	O	0..1	AF provisioned Maximum Response Time; nullable
ppMaximumLatency	PpMaximumLatency	O	0..1	AF provisioned Maximum Latency; nullable
NOTE 1: If ppDIPacketCountExt is absent and ppDIPacketCount (whether the value is null or not) is present in a modification request, it shall result in deletion of ppDIPacketCountExt.				
NOTE 2: These IEs are deprecated. An NF service consumer (i.e. AF) supporting this release shall use ppMaximumResponseTime IE to influence the Subscribed Active Time of the UE; use ppMaximumLatency IE to influence the Subscribed Periodic Registration Timer of the UE.				

6.5.6.2.4 Type: PpSubsRegTimer

Table 6.5.6.2.4-1: Definition of type PpSubsRegTimer

Attribute name	Data type	P	Cardinality	Description
subsRegTimer	DurationSec	M	1	value in seconds
afInstanceId	string	M	1	The string identifying the originating AF (NOTE)
referenceId	ReferenceId	M	1	Transaction Reference ID
validityTime	DateTime	O	0..1	Identifies the point of time up to which the subsRegTimer parameter expires and it shall be deleted. If absent, it indicates that there is no expiration time for these expected UE parameters. If this IE is in request body, it indicates the expected validity time by consumer. If this IE is in response body, it indicates the confirmed validity time by UDM.
mtcProviderInformation	MtcProviderInformation	O	0..1	Indicates MTC provider information for Parameter Provisioning authorization.
NOTE: When the service operation is originated by external AF via T8/N33 interface, information carried in {scsAsId} URI variable in resource URIs on T8/N33 interface (see clause 5 of 3GPP TS 29.122 [45]) or in {afId} URI variable in resource URIs on N33 interface (see clause 5 of 3GPP TS 29.522 [54]) can be used as the value for this IE.				

6.5.6.2.5 Type: PpActiveTime

Table 6.5.6.2.5-1: Definition of type PpActiveTime

Attribute name	Data type	P	Cardinality	Description
activeTime	DurationSec	M	1	value in seconds
afInstanceld	string	M	1	The string identifying the originating AF (NOTE).
referenceld	Referenceld	M	1	Transaction Reference ID
validityTime	DateTime	O	0..1	Identifies the point of time up to which the activeTime parameter expires and it shall be deleted. If absent, it indicates that there is no expiration time for these expected UE parameters. If this IE is in request body, it indicates the expected validity time by consumer. If this IE is in response body, it indicates the confirmed validity time by UDM.
mtcProviderInformation	MtcProviderInformation	O	0..1	Indicates MTC provider information for Parameter Provisioning authorization.
NOTE: When the service operation is originated by external AF via T8/N33 interface, information carried in {scsAsId} URI variable in resource URIs on T8/N33 interface (see clause 5 of 3GPP TS 29.122 [45]) or in {afId} URI variable in resource URIs on N33 interface (see clause 5 of 3GPP TS 29.522 [54]) can be used as the value for this IE.				

6.5.6.2.6 Type: 5GVnGroupConfiguration

Table 6.5.6.2.6-1: Definition of type 5GVnGroupConfiguration

Attribute name	Data type	P	Cardinality	Description
5gVnGroupData	5GVnGroupData	C	0..1	Data of the 5G VN Group; may be absent in modification requests; shall be present otherwise
members	array(Gpsi)	C	1..N	List of group members; may be absent in modification requests; shall be present in creation requests
referenceld	Referenceld	C	1	Transaction Reference ID; shall be absent in modification requests; shall be present otherwise.
afInstanceld	string	C	1	The string identifying the originating AF (NOTE)
internalGroupIdentifier	GroupId	C	0..1	Allocated by the UDR; shall be present in successful PUT and GET responses on Nudr; otherwise shall be absent.
mtcProviderInformation	MtcProviderInformation	O	0..1	Indicates MTC provider information for 5G VN Group Configuration authorization.
NOTE: When the service operation is originated by external AF via T8/N33 interface, information carried in {scsAsId} URI variable in resource URIs on T8/N33 interface (see clause 5 of 3GPP TS 29.122 [45]) or in {afId} URI variable in resource URIs on N33 interface (see clause 5 of 3GPP TS 29.522 [54]) can be used as the value for this IE.				

6.5.6.2.7 Type: 5GVnGroupData

Table 6.5.6.2.7-1: Definition of type 5GVnGroupData

Attribute name	Data type	P	Cardinality	Description
dnn	Dnn	M	1	DNN of the 5G VN group, shall contain the Network Identifier only.
sNssai	Snssai	M	1	S-NSSAI of the 5G VN group's communication session
pduSessionTypes	array(PduSessionType)	O	1..N	List of PDU Session Types allowed for 5G VN group's communication session
appDescriptors	array(AppDescriptor)	O	1..N	List of Application Descriptors allowed for 5G VN group's communication session
secondaryAuth	boolean	O	0..1	Indicates whether secondary authentication and authorization is needed. true: secondary authentication and authorization is needed. false: secondary authentication and authorization is not needed. If absent, it indicates that secondary authentication is not required by the NEF, but it still may be required by local policies at the SMF.
dnAaaAddress	IpAddress	O	0..1	The address information of DN-AAA server, used for secondary authentication and authorization.

6.5.6.2.8 Type: ExpectedUeBehaviour

Table 6.5.6.2.8-1: Definition of type ExpectedUeBehaviour

Attribute name	Data type	P	Cardinality	Description
afInstanceId	string	M	1	The string identifying the originating AF (NOTE 5)
referenceId	ReferenceId	M	1	Identifies transaction reference ID generated by NEF.
stationaryIndication	StationaryIndicationRm	O	0..1	Identifies whether the UE is stationary or mobile (see TS 23.502 [3] clause 4.15.6.3); nullable.
communicationDurationTime	DurationSecRm	O	0..1	Indicates for how long the UE will normally stay in CM-Connected for data transmission (see TS 23.502 [3] clause 4.15.6.3); nullable.
periodicTime	DurationSecRm	O	0..1	Identifies interval time of periodic communication (see TS 23.502 [3] clause 4.15.6.3); nullable.
scheduledCommunicationTime	ScheduledCommunicationTimeRm	O	0..1	Identifies time and day of the week when the UE is available for communication (see TS 23.502 [3] clause 4.15.6.3); nullable.
scheduledCommunicationType	ScheduledCommunicationTypeRm	O	0..1	Indicates that the Scheduled Communication Type (see TS 23.502 [3] clause 4.15.6.3); nullable. (Note 4)
expectedUmts	array(LocationArea)	O	1..N	Identifies the UE's expected geographical movement. The attribute is only applicable in 5G (see TS 23.502 [3] clause 4.15.6.3); nullable. (NOTE 3)
trafficProfile	TrafficProfileRm	O	0..1	Identifies the type of data transmission: single packet transmission (UL or DL), dual packet transmission (UL with subsequent DL or DL with subsequent UL), multiple packets transmission; nullable
batteryIndication	BatteryIndicationRm	O	0..1	Indicates the power consumption type(s) of the UE (see TS 23.502 [3] clause 4.15.6.3); nullable.
validityTime	DateTime	O	0..1	If present, identifies when the expected UE behaviour parameters expire and shall be deleted locally if it expires (see TS 23.502 [3] clause 4.15.6.3). If this IE is in request body, it indicates the expected validity time by consumer. If this IE is in response body, it indicates the confirmed validity time by UDM. (NOTE 2)
mtcProviderInformation	MtcProviderInformation	O	0..1	Indicates MTC provider information for UE Parameter Configuration authorization.
NOTE 1: At least one of optional parameters (except for validityTime) above shall be present.				
NOTE 2: If this attribute is omitted, no expiry for the expected UE behaviour parameters applies.				
NOTE 3: The first instance of the attribute represents the start of the location, and the last one represents the stop of the location.				
NOTE 4: The parameter "scheduledCommunicationType" shall be used together with the parameter "scheduledCommunicationTime".				
NOTE 5: When the service operation is originated by external AF via T8/N33 interface, information carried in {scsAsId} URI variable in resource URIs on T8/N33 interface (see clause 5 of 3GPP TS 29.122 [45]) or in {afId} URI variable in resource URIs on N33 interface (see clause 5 of 3GPP TS 29.522 [54]) can be used as the value for this IE.				

6.5.6.2.9 Void

6.5.6.2.10 Type: LocationArea

Table 6.5.6.2.10-1: Definition of type LocationArea

Attribute name	Data type	P	Cardinality	Description
geographicAreas	array(Geographic Area)	O	0..N	Identifies a list of geographic area of the user where the UE is located.
civicAddresses	array(CivicAddress)	O	0..N	Identifies a list of civic addresses of the user where the UE is located.
nwAreaInfo	NetworkAreaInfo	O	0..1	This IE represents the network area information of the user where the UE is located.

6.5.6.2.11 Type: NetworkAreaInfo

Table 6.5.6.2.11-1: Definition of type NetworkAreaInfo

Attribute name	Data type	P	Cardinality	Description
ecgis	array(Ecgi)	O	0..N	This IE contains a list of E-UTRA cell identities.
ncgis	array(Ncgi)	O	0..N	This IE contains a list of NR cell identities.
gRanNodeIds	array(GlobalRanNodeId)	O	0..N	This IE contains a list of the NG-RAN nodes. The "n3lwfId" attribute within the "GlobalRanNodeId" data type shall not be supplied.
tais	array(Tai)	O	0..N	This IE contains a list of tracking area identities.
NOTE: The NetworkAreaInfo data type allows any combination of defined properties.				

6.5.6.2.12 Type: EcRestriction

Table 6.5.6.2.12-1: Definition of type EcRestriction

Attribute name	Data type	P	Cardinality	Description
afInstanceId	string	M	1	The string identifying the originating AF (NOTE)
referenceId	ReferenceId	M	1	Transaction Reference ID
plmnEcInfos	array(PlmnEcInfo)	O	1..N	It may indicate a complete list of serving PLMNs where Enhanced Coverage shall be allowed and the detailed enhanced coverage restriction configuration under per the PLMN.
mtcProviderInformation	MtcProviderInformation	O	0..1	Indicates MTC provider information for Enhanced Coverage Configuration authorization.
NOTE: When the service operation is originated by external AF via T8/N33 interface, information carried in scsAsId attribute in ECRControl structured data type (see clause 5.12.2.1.2 of 3GPP TS 29.122 [45]) can be used as the value for this IE. If the scsAsId value is not received in T8, the afInstanceId attribute shall contain an empty string value ("").				

6.5.6.2.13 Type: PlmnEclInfo

Table 6.5.6.2.13-1: Definition of type PlmnEclInfo

Attribute name	Data type	P	Cardinality	Description
plmnId	PlmnId	M	1	Indicates PLMN where Enhanced Coverage shall be restricted.
ecRestrictionDataWb	EcRestrictionDataWb	O	0..1	If present, it shall contain Enhanced Coverage Restriction Data for WB-N1 mode . If absent, it shall indicate that Enhanced Coverage is not restricted for WB-N1 mode .
ecRestrictionDataNb	boolean	O	0..1	If present, this IE shall indicate whether Enhanced Coverage for NB-N1 mode is restricted or not. true: Enhanced Coverage for NB-N1 mode is restricted. false or absent: Enhanced Coverage for NB-N1 mode is allowed.
NOTE: At least one of the properties "ecRestrictionDataWb" and "ecRestrictionDataNb" shall be included.				

6.5.6.2.14 Type: PpDIPacketCountExt

Table 6.5.6.2.14-1: Definition of type PpDIPacketCountExt

Attribute name	Data type	P	Cardinality	Description
afInstanceld	string	M	1	The string identifying the originating AF (NOTE)
referenceld	Referenceld	M	1	Transaction Reference ID
validityTime	DateTime	O	0..1	Identifies the point of time up to which the value of parameter ppDIPacketCount expires and it shall be deleted. If absent, it indicates that there is no expiration time for these expected UE parameters. If this IE is in request body, it indicates the expected validity time by consumer. If this IE is in response body, it indicates the confirmed validity time by UDM.
mtcProviderInformation	MtcProviderInformation	O	0..1	Indicates MTC provider information for Parameter Provisioning authorization.
NOTE: When the service operation is originated by external AF via T8/N33 interface, information carried in {scsAsId} URI variable in resource URIs on T8/N33 interface (see clause 5 of 3GPP TS 29.122 [45]) or in {afId} URI variable in resource URIs on N33 interface (see clause 5 of 3GPP TS 29.522 [54]) can be used as the value for this IE.				

6.5.6.2.15 Type: PpMaximumResponseTime

Table 6.5.6.2.15-1: Definition of type PpMaximumResponseTime

Attribute name	Data type	P	Cardinality	Description
maximumResponseTime	DurationSec	M	1	This IE shall contain value of Maximum Response Time in seconds. Maximum Response Time identifies the time for which the UE stays reachable to allow the AF to reliably deliver the required downlink data, see clause 4.15.6.3a of 3GPP TS 23.502 [3].
afInstancelid	string	M	1	The string identifying the originating AF (NOTE)
referencelid	Referencelid	M	1	Transaction Reference ID
validityTime	DateTime	O	0..1	Identifies the point of time up to which the value of maximumResponseTime expires and it shall be deleted. If absent, it indicates that there is no expiration time. If this IE is in request body, it indicates the expected validity time by consumer. If this IE is in response body, it indicates the confirmed validity time by UDM.
mtcProviderInformation	MtcProviderInformation	O	0..1	Indicates MTC provider information for Parameter Provisioning authorization.
NOTE: When the service operation is originated by external AF via T8/N33 interface, information carried in {scsAsId} URI variable in resource URIs on T8/N33 interface (see clause 5 of 3GPP TS 29.122 [45]) or in {afId} URI variable in resource URIs on N33 interface (see clause 5 of 3GPP TS 29.522 [54]) can be used as the value for this IE.				

6.5.6.2.16 Type: PpMaximumLatency

Table 6.5.6.2.16-1: Definition of type PpMaximumLatency

Attribute name	Data type	P	Cardinality	Description
maximumLatency	DurationSec	M	1	This IE shall contain value of Maximum Latency in seconds. Maximum Latency identifies maximum delay acceptable for downlink data transfers, see clause 4.15.6.3a of 3GPP TS 23.502 [3].
afInstancelid	string	M	1	The string identifying the originating AF (NOTE).
referencelid	Referencelid	M	1	Transaction Reference ID
validityTime	DateTime	O	0..1	Identifies the point of time up to which the value of maximumLatency expires and it shall be deleted. If absent, it indicates that there is no expiration time. If this IE is in request body, it indicates the expected validity time by consumer. If this IE is in response body, it indicates the confirmed validity time by UDM.
mtcProviderInformation	MtcProviderInformation	O	0..1	Indicates MTC provider information for Parameter Provisioning authorization.
NOTE: When the service operation is originated by external AF via T8/N33 interface, information carried in {scsAsId} URI variable in resource URIs on T8/N33 interface (see clause 5 of 3GPP TS 29.122 [45]) or in {afId} URI variable in resource URIs on N33 interface (see clause 5 of 3GPP TS 29.522 [54]) can be used as the value for this IE.				

6.5.6.2.17 Type: LcsPrivacy

Table 6.5.6.2.17-1: Definition of type LcsPrivacy

Attribute name	Data type	P	Cardinality	Description
afInstanceId	string	C	0..1	When present, indicates NF Instance Id of the originating AF/NF. (NOTE)
referenceId	ReferenceId	C	0..1	This IE shall be present if LCS privacy parameters are provisioned by an AF. When present, indicates Transaction Reference ID (NOTE)
lpi	Lpi	O	0..1	If present, indicates the Location Privacy Indication
mtcProviderInformation	MtcProviderInformation	O	0..1	Indicates MTC provider information for LCS privacy parameter configuration authorization.
NOTE: If LCS privacy parameters are provisioned by UE, parameters afInstanceId and referenceId shall be not included, and if LCS privacy parameters are provisioned by AF, parameters afInstanceId and referenceId shall be included. The string identifying the originating AF, which is carried in {scsAsId} URI variable in resource URIs on T8/N33 interface (see clause 5 of 3GPP TS 29.122 [45]) or in {afId} URI variable in resource URIs on N33 interface (see clause 5 of 3GPP TS 29.522 [54]).				

6.5.6.3 Simple data types and enumerations

6.5.6.3.1 Introduction

This clause defines simple data types and enumerations that can be referenced from data structures defined in the previous clauses.

6.5.6.3.2 Simple data types

The simple data types defined in table 6.5.6.3.2-1 shall be supported.

Table 6.5.6.3.2-1: Simple data types

Type Name	Type Definition	Description
ReferenceId	integer	The numeric value should not be higher than 2 ⁶⁴ -1 (i.e. it should be possible to convey it in an unsigned 64 integer Information Element, used in other protocols), if interworking with the Event Exposure framework in EPC is required.
PpDIPacketCount	integer	nullable

6.5.6.3.3 Void

6.5.6.3.4 Void

6.5.7 Error Handling

6.5.7.1 General

HTTP error handling shall be supported as specified in clause 5.2.4 of 3GPP TS 29.500 [4].

6.5.7.2 Protocol Errors

Protocol errors handling shall be supported as specified in clause 5.2.7 of 3GPP TS 29.500 [4].

6.5.7.3 Application Errors

The common application errors defined in the Table 5.2.7.2-1 in 3GPP TS 29.500 [4] may also be used for the Nudm_ParameterProvision service. The following application errors listed in Table 6.5.7.3-1 are specific for the Nudm_ParameterProvision service.

The application errors defined for the Nudm_UECM service are listed in Table 6.5.7.3-1.

Table 6.5.7.3-1: Application errors

Application Error	HTTP status code	Description
MODIFICATION_NOT_ALLOWED	403 Forbidden	The subscriber does not have the necessary subscription for external parameter provisioning.
USER_NOT_FOUND	404 Not Found	The User does not exist.
CREATION_NOT_ALLOWED	403 Forbidden	Creation of a 5G VN Group is not allowed.
DETACHED_USER	403 Forbidden	The user is detached in the Network.
GROUP_IDENTIFIER_NOT_FOUND	404 Not Found	The group does not exist
AF_NOT_ALLOWED	403 Forbidden	This AF is not allowed to perform external provisioning or 5G VN Group creation.
MTC_PROVIDER_NOT_ALLOWED	403 Forbidden	MTC Provider not authorized to perform external provisioning or 5G VN Group creation.

6.5.8 Feature Negotiation

The optional features in table 6.5.8-1 are defined for the Nudm_PP API. They shall be negotiated using the extensibility mechanism defined in clause 6.6 of 3GPP TS 29.500 [4].

Table 6.5.8-1: Supported Features

Feature number	Feature Name	Description
1	PatchReport	If some of the modifications included in the PATCH request are not successfully implemented, the UDM reports the result of PATCH request execution to the consumer. See clause 5.2.7.2 of 3GPP TS 29.500 [4].

6.5.9 Security

As indicated in 3GPP TS 33.501 [6] and 3GPP TS 29.500 [4], the access to the Nudm_PP API may be authorized by means of the OAuth2 protocol (see IETF RFC 6749 [18]), based on local configuration, using the "Client Credentials" authorization grant, where the NRF (see 3GPP TS 29.510 [19]) plays the role of the authorization server.

If OAuth2 is used, an NF Service Consumer, prior to consuming services offered by the Nudm_PP API, shall obtain a "token" from the authorization server, by invoking the Access Token Request service, as described in 3GPP TS 29.510 [19], clause 5.8.2.2.

NOTE: When multiple NRFs are deployed in a network, the NRF used as authorization server is the same NRF that the NF Service Consumer used for discovering the Nudm_PP service.

The Nudm_PP API defines a single scope "nudm-pp" for OAuth2 authorization (as specified in 3GPP TS 33.501 [6]) for the entire API, and it does not define any additional scopes at resource or operation level.

6.6 Nudm_NIDDAuthorization Service API

6.6.1 API URI

The Nudm_NIDDAuthorization service shall use the Nudm_NIDDAU API.

The API URI of the Nudm_NIDDAU API shall be:

{apiRoot}/<apiName>/<apiVersion>/

The request URI used in HTTP request from the NF service consumer towards the NF service producer shall have the structure defined in clause 4.4.1 of 3GPP TS 29.501 [5], i.e.:

{apiRoot}/<apiName>/<apiVersion>/<apiSpecificResourceUriPart>

with the following components:

- The {apiRoot} shall be set as described in 3GPP TS 29.501 [5].
- The <apiName> shall be "nudm-niddau".
- The <apiVersion> shall be "v1".
- The <apiSpecificResourceUriPart> shall be set as described in clause 6.6.3.

6.6.2 Usage of HTTP

6.6.2.1 General

HTTP/2, as defined in IETF RFC 7540 [13], shall be used as specified in clause 5 of 3GPP TS 29.500 [4].

HTTP/2 shall be transported as specified in clause 5.3 of 3GPP TS 29.500 [4].

HTTP messages and bodies for the Nudm_NIDDAuthorization service shall comply with the OpenAPI [14] specification contained in Annex A.7.

6.6.2.2 HTTP standard headers

6.6.2.2.1 General

The usage of HTTP standard headers shall be supported as specified in clause 5.2.2 of 3GPP TS 29.500 [4].

6.6.2.2.2 Content type

The following content types shall be supported:

JSON, as defined in IETF RFC 8259 [15], signalled by the content type "application/json".

The Problem Details JSON Object (IETF RFC 7807 [16]) signalled by the content type "application/problem+json"

6.6.2.3 HTTP custom headers

6.6.2.3.1 General

The usage of HTTP custom headers shall be supported as specified in clause 5.2.3 of 3GPP TS 29.500 [4].

6.6.3 Resources

6.6.3.1 Overview

Figure 6.6.3.1-1 describes the resources supported by the Nudm_NIDDAU API.

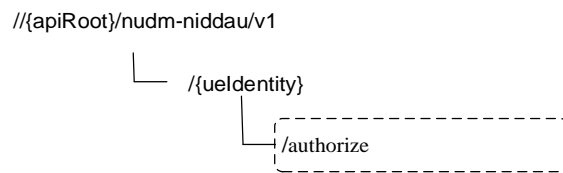

Figure 6.6.3.1-1: Resource URI structure of the nudm-niddau API

Table 6.6.3.1-1 provides an overview of the resources and applicable HTTP methods.

Table 6.6.3.1-1: Resources and methods overview

Resource name (Archetype)	Resource URI	HTTP method or custom operation	Description
uidentity (Document)	//{uidentity}/authorize	authorize (POST)	Authorize the NIDD configuration request.

6.6.3.2 Resource: uidentity (Document)

6.6.3.2.1 Description

This resource represents the UE's subscribed NIDD authorization information for a GPSI or External Group Identifier.

6.6.3.2.2 Resource Definition

Resource URI: {apiRoot}/nudm-niddau/<apiVersion>/{ueIdentity}

This resource shall support the resource URI variables defined in table 6.6.3.2.2-1.

Table 6.6.3.2.2-1: Resource URI variables for this resource

Name	Data type	Definition
apiRoot	string	See clause 6.6.1
uidentity	string	Represents the GPSI or External Group Identifier (see 3GPP TS 23.501 [2] clause 7.2.5) pattern: "^ (msisdn-[0-9]{5,15})extid-[^@]+@[^@]+ extgroupid-[^@]+@[^@]+.+)\$"

6.6.3.2.3 Resource Standard Methods

No Standard Methods are supported for this resource.

6.6.3.2.4 Resource Custom Operations

6.6.3.2.4.1 Overview

Table 6.6.3.2.4.1-1: Custom operations

Operation Name	Custom operation URI	Mapped HTTP method	Description
authorize	/authorize	POST	Authorize the NIDD configuration request.

6.6.3.2.4.2 Operation: authorize

6.6.3.2.4.2.1 Description

This custom operation is used by the NF service consumer (NEF) to request UDM to authorize the NIDD configuration request for the GPSI/External Group Identifier.

6.6.3.2.4.2.2 Operation Definition

This operation shall support the request data structures specified in table 6.6.3.2.4.2.2-1 and the response data structure and response codes specified in table 6.6.3.2.4.2.2-2.

Table 6.6.3.2.4.2.2-1: Data structures supported by the POST Request Body on this resource

Data type	P	Cardinality	Description
AuthorizationInfo	M	1	Contains NSSAI, DNN, MTC Provider Information, callback URI.

Table 6.6.3.2.4.2.2-2: Data structures supported by the POST Response Body on this resource

Data type	P	Cardinality	Response codes	Description
AuthorizationData	M	1	200 OK	Upon success, a response body containing the SUPI(s) and GPSI shall be returned.
ProblemDetails	O	1	404 Not Found	The "cause" attribute may be used to indicate one of the following application errors: - USER_NOT_FOUND
ProblemDetails	O	0..1	403 Forbidden	The "cause" attribute may be used to indicate one of the following application errors: - DNN_NOT_ALLOWED - MTC_PROVIDER_NOT_ALLOWED - AF_INSTANCE_NOT_ALLOWED
NOTE: In addition common data structures as listed in table 5.2.7.1-1 of 3GPP TS 29.500 [4] are supported.				

6.6.4 Custom Operations without associated resources

In this release of this specification, no custom operations without associated resources are defined for the Nudm_SubscriberDataManagement Service.

6.6.5 Notifications

6.6.5.1 General

This clause will specify the use of notifications and corresponding protocol details if required for the specific service. When notifications are supported by the API, it will include a reference to the general description of notifications support over the 5G SBIs specified in 3GPP TS 29.500 [4] / 3GPP TS 29.501 [5].

6.6.5.2 Nidd Authorization Data Update Notification

The POST method shall be used for Nidd Authorization Data Update Notifications and the Call-back URI shall be provided during the NIDD Authorization Data Retrieval procedure. UDM should continuously generate NIDD authorization Data Update Notifications to service consumer (NEF) for UE for the event until validity time related to the UE expires, and if validity time expires, it indicates unsubscription to notification for the UE.

Resource URI: {callbackReference}

Support of URI query parameters is specified in table 6.6.5.2-1.

Table 6.6.5.2-1: URI query parameters supported by the POST method

Name	Data type	P	Cardinality	Description
n/a				

Support of request data structures is specified in table 6.6.5.2-2 and of response data structures and response codes is specified in table 6.6.5.2-3.

Table 6.1.5.2-2: Data structures supported by the POST Request Body

Data type	P	Cardinality	Description
NiddAuthUpdateNotification	M	1	

Table 6.6.5.2-3: Data structures supported by the POST Response Body

Data type	P	Cardinality	Response codes	Description
n/a			204 No Content	Upon success, an empty response body shall be returned.

NOTE: In addition common data structures as listed in table 6.6.7-1 are supported.

6.6.6 Data Model

6.6.6.1 General

This clause specifies the application data model supported by the API.

Table 6.6.6.1-1 specifies the structured data types defined for the Nudm_NIDDAU service API. For simple data types defined for the Nudm_NIDDAU service API see table 6.6.6.3.2-1.

Table 6.6.6.1-1: Nudm_NIDDAU specific Data Types

Data type	Clause defined	Description
AuthorizationData	6.6.6.2.2	
UserIdentifier	6.6.6.2.3	
NiddAuthUpdateInfo	6.6.6.2.4	
NiddAuthUpdateNotification	6.6.6.2.5	
AuthorizationInfo	6.6.6.2.6	
NiddCause	6.6.6.3.3	

Table 6.6.6.1-2 specifies data types re-used by the Nudm_NIDDAU service API from other specifications, including a reference to their respective specifications and when needed, a short description of their use within the Nudm_NIDDAU service API.

Table 6.6.6.1-2: Nudm_NIDDAU re-used Data Types

Data type	Reference	Comments
Nssai	6.1.6.2.2	Network Slice Selection Assistance Information
Gpsi	3GPP TS 29.571 [7]	Generic Public Subscription Identifier
Supi	3GPP TS 29.571 [7]	
Dnn	3GPP TS 29.571 [7]	Data Network Name with Network Identifier only.
MtcProviderInformation	3GPP TS 29.571 [7]	
DateTime	3GPP TS 29.571 [7]	
Snsai	3GPP TS 29.571 [7]	
Uri	3GPP TS 29.571 [7]	
NefId	3GPP TS 29.510 [19]	NEF ID

6.6.6.2 Structured data types

6.6.6.2.1 Introduction

This clause defines the structures to be used in resource representations.

6.6.6.2.2 Type: AuthorizationData

Table 6.6.6.2.2-1: Definition of type AuthorizationData

Attribute name	Data type	P	Cardinality	Description
authorizationData	array(UserIdentifier)	M	1..N	May contain a single value or list of (SUPI and GPSI). Contains unique items.
validityTime	DateTime	O	0..1	Indicates the granted validity time of the authorisation result. If absent, it indicates the authorisation result is valid permanently

6.6.6.2.3 Type: UserIdentifier

Table 6.6.6.2.3-1: Definition of type UserIdentifier

Attribute name	Data type	P	Cardinality	Description
supi	Supi	M	1	
gpsi	Gpsi	O	0..1	
validityTime	DateTime	O	0..1	Indicates the granted validity time of the authorisation result for this user. If absent, the value of the validity time in the AuthorizationData is used for this user if it is present in AuthorizationData. If present, this value has higher priority than the value in the AuthorizationData.

6.6.6.2.4 Type: NiddAuthUpdateInfo

Table 6.6.6.2.4-1: Definition of type NiddAuthUpdateInfo

Attribute name	Data type	P	Cardinality	Description
authorizationData	AuthorizationData	M	1	This IE shall include the Authorization data.
invalidityInd	boolean	O	0..1	Indicates whether the authorized NIDD authoration data is still valid or not. true: the authorized NIDD authoration data is not valid. false or absent: the authorized NIDD authoration data is valid.
snssai	Snssai	O	0..1	Indicates Single Network Slice Selection Assistance Information for NIDD authorization. When absent it indicates authorization for all subscribed S-NSSAIs.
dnn	Dnn	O	0..1	Indicates DNN for NIDD authorization, shall contain the Network Identifier only. When absent it indicates authorization for all subscribed DNNs.
niddCause	NiddCause	O	0..1	NIDD Cause

6.6.6.2.5 Type: NiddAuthUpdateNotification

Table 6.6.6.2.5-1: Definition of type NiddAuthUpdateNotification

Attribute name	Data type	P	Cardinality	Description
niddAuthUpdateInfoList	array(NiddAuthUpdateInfo)	M	1..N	List of NiddAuthUpdateInfo.

6.6.6.2.6 Type: AuthorizationInfo

Table 6.6.6.2.6-1: Definition of type AuthorizationInfo

Attribute name	Data type	P	Cardinality	Description
snsai	Snsai	M	1	Indicates Single Network Slice Selection Assistance Information for NIDD authorization.
dnn	Dnn	M	1	Indicates DNN for NIDD authorization, shall contain the Network Identifier only.
mtcProviderInformation	MtcProviderInformation	M	1	Indicates MTC provider information for NIDD authorization.
authUpdateCallbackUri	Uri	M	1	A URI provided by NEF to receive (implicitly subscribed) notifications on authorization data update. The authUpdateCallbackUri URI shall have unique information within NEF to identify the authorized result.
afld	string	O	0..1	When present, indicates the string identifying the originating AF, which is carried in {scsAsId} URI variable in resource URIs on T8/N33 interface (see clause 5 of 3GPP TS 29.122 [45]) or in {afld} URI variable in resource URIs on N33 interface (see clause 5 of 3GPP TS 29.522 [54]).
nefld	Nefld	O	0..1	When present, this IE shall contain the ID of the requesting NEF. The UDM shall update the NIDD NEF ID for the DNN and Slice in corresponding subscription data after successful NIDD authorization, as specified in clause 4.25.3 of 3GPP TS 23.502 [3].
validityTime	DateTime	O	0..1	Indicates the granted validity time of the authorisation result. If absent, it indicates the authorisation result is valid permanently

6.6.6.3 Simple data types and enumerations

6.6.6.3.1 Introduction

This clause defines simple data types and enumerations that can be referenced from data structures defined in the previous clauses.

6.6.6.3.2 Simple data types

The simple data types defined in table 6.6.6.3.2-1 shall be supported.

Table 6.6.6.3.2-1: Simple data types

Type Name	Type Definition	Description

6.6.6.3.3 Enumeration: NiddCause

Table 6.6.6.3.3-1: Enumeration NiddCause

Enumeration value	Description
"SUBSCRIPTION_WITHDRAWAL"	Subscription Withdrawal
"DNN_REMOVED"	DNN used for NIDD service is removed from the UE subscription

6.6.7 Error Handling

6.6.7.1 General

HTTP error handling shall be supported as specified in clause 5.2.4 of 3GPP TS 29.500 [4].

6.6.7.2 Protocol Errors

Protocol errors handling shall be supported as specified in clause 5.2.7 of 3GPP TS 29.500 [4].

6.6.7.3 Application Errors

The common application errors defined in the Table 5.2.7.2-1 in 3GPP TS 29.500 [4] may also be used for the Nudm_NIDD Authorization service. The following application errors listed in Table 6.6.7.3-1 are specific for the Nudm_NIDD Authorization service.

Table 6.6.7.3-1: Application errors

Application Error	HTTP status code	Description
UNKNOWN_5GS_SUBSCRIPTION	403 Forbidden	No 5GS subscription is associated with the user.
USER_NOT_FOUND	404 Not Found	The user does not exist in the HPLMN
DNN_NOT_ALLOWED	403 Forbidden	DNN not authorized for the user
MTC_PROVIDER_NOT_ALLOWED	403 Forbidden	MTC Provider not authorized
AF_INSTANCE_NOT_ALLOWED	403 Forbidden	This AF instance is not authorized

6.6.8 Feature Negotiation

The optional features in table 6.6.8-1 are defined for the Nudm_NIDDAU API. They shall be negotiated using the extensibility mechanism defined in clause 6.6 of 3GPP TS 29.500 [4].

Table 6.6.8-1: Supported Features

Feature number	Feature Name	Description

6.6.9 Security

As indicated in 3GPP TS 33.501 [6] and 3GPP TS 29.500 [4], the access to the Nudm_NIDDAU API may be authorized by means of the OAuth2 protocol (see IETF RFC 6749 [18]), based on local configuration, using the "Client Credentials" authorization grant, where the NRF (see 3GPP TS 29.510 [19]) plays the role of the authorization server.

If OAuth2 is used, an NF Service Consumer, prior to consuming services offered by the Nudm_NIDDAU API, shall obtain a "token" from the authorization server, by invoking the Access Token Request service, as described in 3GPP TS 29.510 [19], clause 5.4.2.2.

NOTE: When multiple NRFs are deployed in a network, the NRF used as authorization server is the same NRF that the NF Service Consumer used for discovering the Nudm_NIDDAU service.

The Nudm_NIDDAU API defines a single scope "nudm-niddau" for OAuth2 authorization (as specified in 3GPP TS 33.501 [6]) for the entire API, and it does not define any additional scopes at resource or operation level.

6.7 Nudm_MT Service API

6.7.1 API URI

URIs of this API shall have the following root:

`{apiRoot}/{apiName}/<apiVersion>/`

The request URI used in HTTP request from the NF service consumer towards the NF service producer shall have the structure defined in clause 4.4.1 of 3GPP TS 29.501 [5], i.e.:

`{apiRoot}/<apiName>/<apiVersion>/<apiSpecificResourceUriPart>`

with the following components:

- The `{apiRoot}` shall be set as described in 3GPP TS 29.501 [5].
- The `<apiName>` shall be "nudm-mt".
- The `<apiVersion>` shall be "v1".
- The `<apiSpecificResourceUriPart>` shall be set as described in clause 6.7.3.

6.7.2 Usage of HTTP

6.7.2.1 General

HTTP/2, as defined in IETF RFC 7540 [13], shall be used as specified in clause 5 of 3GPP TS 29.500 [4].

HTTP/2 shall be transported as specified in clause 5.3 of 3GPP TS 29.500 [4].

HTTP messages and bodies for the Nudm_MT service shall comply with the OpenAPI [14] specification contained in Annex A4.

6.7.2.2 HTTP standard headers

6.7.2.2.1 General

The usage of HTTP standard headers shall be supported as specified in clause 5.2.2 of 3GPP TS 29.500 [4].

6.7.2.2.2 Content type

The following content types shall be supported:

JSON, as defined in IETF RFC 8259 [15], signalled by the content type "application/json".

The Problem Details JSON Object (IETF RFC 7807 [16]) signalled by the content type "application/problem+json"

6.7.2.3 HTTP custom headers

6.7.2.3.1 General

The usage of HTTP custom headers shall be supported as specified in clause 5.2.3 of 3GPP TS 29.500 [4].

6.7.3 Resources

6.7.3.1 Overview

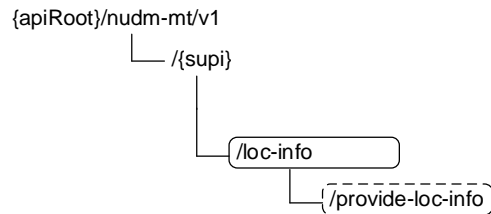

Figure 6.7.3.1-1: Resource URI structure of the nudm-mt API

Table 6.7.3.1-1 provides an overview of the resources and applicable HTTP methods.

Table 6.7.3.1-1: Resources and methods overview

Resource name (Archetype)	Resource URI	HTTP method or custom operation	Description
UeInfo (Document)	//{supi}	GET	Retrieve UE's TADS Info and/or User State and/or 5GSRVCCInfo
LocationInfo (Custom Operation)	//{supi}/loc-info/provide-loc-info	provide-loc-info (POST)	Request UE's location

6.7.3.2 Resource: UeInfo

6.7.3.2.1 Description

This resource represents the 5GC TADS Info and/or User State and/or 5GSRVCCInfo for a SUPI. It is queried by the HSS (see 3GPP TS 23.632 [32] clause 5.4.1).

6.7.3.2.2 Resource Definition

Resource URI: {apiRoot}/nudm-mt/<apiVersion>/{supi}

This resource shall support the resource URI variables defined in table 6.7.3.2.2-1.

Table 6.7.3.2.2-1: Resource URI variables for this resource

Name	Data type	Definition
apiRoot	string	See clause 6.7.1
supi	Supi	Represents the Subscription Permanent Identifier (see 3GPP TS 23.501 [2] clause 5.9.2) pattern: See pattern of type Supi in 3GPP TS 29.571 [7]

6.7.3.2.3 Resource Standard Methods

6.7.3.2.3.1 GET

This method shall support the URI query parameters specified in table 6.7.3.2.3.1-1.

Table 6.7.3.2.3.1-1: URI query parameters supported by the GET method on this resource

Name	Data type	P	Cardinality	Description
fields	array(string)	M	1..N	The "fields" query parameter contains the pointers of the attribute(s) to be retrieved. See attribute names of type UeInfo.
supported-features	SupportedFeatures	O	0..1	see 3GPP TS 29.500 [4] clause 6.6

This method shall support the request data structures specified in table 6.7.3.2.3.1-2 and the response data structures and response codes specified in table 6.7.3.2.3.1-3.

Table 6.7.3.2.3.1-2: Data structures supported by the GET Request Body on this resource

Data type	P	Cardinality	Description
n/a			

Table 6.7.3.2.3.1-3: Data structures supported by the GET Response Body on this resource

Data type	P	Cardinality	Response codes	Description
UeInfo	M	1	200 OK	Upon success, a response body containing the UeInfo shall be returned.
ProblemDetails	O	0..1	404 Not Found	The "cause" attribute may be used to convey the following application errors: - USER_NOT_FOUND - DATA_NOT_FOUND

NOTE: In addition common data structures as listed in table 5.2.7.1-1 of 3GPP TS 29.500 [4] are supported.

6.7.3.3 Resource: LocationInfo

6.7.3.3.1 Description

This resource represents the UE's location information in 5GC. See 3GPP TS 23.632 [32] clause 5.4.3.

6.7.3.3.2 Resource Definition

Resource URI: {apiRoot}/nudm-mt/<apiVersion>/{supi}/loc-info

This resource shall support the resource URI variables defined in table 6.7.3.3.2-1.

Table 6.7.3.3.2-1: Resource URI variables for this resource

Name	Data type	Definition
apiRoot	string	See clause 6.7.1
supi	Supi	Represents the Subscription Permanent Identifier (see 3GPP TS 23.501 [2] clause 5.9.2) pattern: "(imsi-[0-9]{5,15} nai-.+.+)"

6.7.3.3.3 Resource Standard Methods

No Standard Methods are supported for this resource.

6.7.3.3.4 Resource Custom Operations

6.7.3.3.4.1 Overview

Table 6.7.3.3.4.1-1: Custom operations

Operation Name	Custom operation URI	Mapped HTTP method	Description
provide-loc-info	/provide-loc-info	POST	Request UE location information in 5GC.

6.7.3.3.4.2 Operation: provide-loc-info

6.7.3.3.4.2.1 Description

This custom operation is used by the NF service consumer (HSS) to request the UE location information in 5GC.

6.7.3.3.4.2.2 Operation Definition

This operation shall support the request data structures specified in table 6.7.3.3.4.2.2-1 and the response data structure and response codes specified in table 6.7.3.3.4.2.2-2.

Table 6.7.3.3.4.2.2-1: Data structures supported by the POST Request Body on this resource

Data type	P	Cardinality	Description
LocationInfoRequest	M	1	Contains the requested information: current location, local time zone, RAT type, or serving node identity only

Table 6.7.3.3.4.2.2-2: Data structures supported by the POST Response Body on this resource

Data type	P	Cardinality	Response codes	Description
LocationInfoResult	M	1	200 OK	Upon success, a response body containing requested information shall be returned.
ProblemDetails	O	0..1	404 Not Found	The "cause" attribute may be used to indicate the following application error: - USER_NOT_FOUND - DATA_NOT_FOUND
NOTE: In addition, common data structures as listed in table 5.2.7.1-1 of 3GPP TS 29.500 [4] are supported.				

6.7.4 Custom Operations without associated resources

In this release of this specification, no custom operations without associated resources are defined for the Nudm_MT Service.

6.7.5 Notifications

In this release of this specification, no notifications are defined for the Nudm_MT Service.

6.7.6 Data Model

6.7.6.1 General

This clause specifies the application data model supported by the API.

Table 6.7.6.1-1 specifies the structured data types defined for the Nudm_MT service API. For simple data types defined for the Nudm_MT service API see table 6.7.6.3.2-1.

Table 6.7.6.1-1: Nudm_MT specific Data Types

Data type	Clause defined	Description
UeInfo	6.7.6.2.2	
LocationInfoRequest	6.7.6.2.3	
LocationInfoResult	6.7.6.2.4	
5GSrvccInfo	6.7.6.2.5	

Table 6.7.6.1-2 specifies data types re-used by the Nudm_MT service API from other specifications, including a reference to their respective specifications and when needed, a short description of their use within the Nudm_MT service API.

Table 6.7.6.1-2: Nudm_MT re-used Data Types

Data type	Reference	Comments
UeContextInfo	3GPP TS 29.518 [36]	
Supi	3GPP TS 29.571 [7]	
5GsUserState	3GPP TS 29.518 [36]	
NfnInstanceId	3GPP TS 29.571 [7]	Network Function Instance Identifier
PlmnId	3GPP TS 29.571 [7]	PLMN Identity
Ecgi	3GPP TS 29.571 [7]	EUTRAN cell identity
Ncgi	3GPP TS 29.571 [7]	NR cell identity
Tai	3GPP TS 29.571 [7]	Tracking area identity
GeographicArea	3GPP TS 29.572 [34]	Estimate of the location of the UE
AgeOfLocationEstimate	3GPP TS 29.572 [34]	Age Of Location Estimate
RatType	3GPP TS 29.571 [7]	RAT type
TimeZone	3GPP TS 29.571 [7]	Time Zone
SupportedFeatures	3GPP TS 29.571 [7]	
ProblemDetails	3GPP TS 29.571 [7]	
StnSr	3GPP TS 29.571 [7]	Session Transfer Number for 5G-SRVCC
CMsisdn	3GPP TS 29.571 [7]	Correlation MSISDN

6.7.6.2 Structured data types

6.7.6.2.1 Introduction

This clause defines the structures to be used in resource representations.

6.7.6.2.2 Type: UeInfo

Table 6.7.6.2.2-1: Definition of type UeInfo

Attribute name	Data type	P	Cardinality	Description
tadsInfo	UeContextInfo	O	0..1	See 3GPP TS 29.518 [36]
userState	5GsUserState	O	0..1	See 3GPP TS 29.518 [36]
5gSrvccInfo	5GSrvccInfo	O	0..1	

6.7.6.2.3 Type: LocationInfoRequest

Table 6.7.6.2.3-1: Definition of type LocationInfoRequest

Attribute name	Data type	P	Cardinality	Description
req5gsLoc	boolean	C	0..1	This IE shall be present and set to "true", if 5GS location information is requested. When present, the IE shall be set as following: <ul style="list-style-type: none"> - true: the location of the UE is requested - false (default): the location of the UE is not requested
reqCurrentLoc	boolean	C	0..1	This IE may be present if location information is requested. When present, the IE shall be set as following: <ul style="list-style-type: none"> - true: the current location of the UE is requested - false (default): the current location of the UE is not requested
reqRatType	boolean	C	0..1	This IE shall be present and set to "true", if the RAT Type of the UE is requested. When present, the IE shall be set as following: <ul style="list-style-type: none"> - true: the RAT type of the UE is requested - false (default): the RAT type of the UE is not requested
reqTimeZone	boolean	C	0..1	This IE shall be present and set to "true", if the local timezone of the UE is requested. When present, the IE shall be set as following: <ul style="list-style-type: none"> - true: the local timezone of the UE is requested - false (default): the local timezone of the UE is not requested.
reqServingNode	boolean	C	0..1	This IE shall be present and set to "true", if only serving node(s) address/identity is requested as location information. When present, the IE shall be set as following: <ul style="list-style-type: none"> - true: only serving node(s) identity is requested - false(default)
supportedFeatures	SupportedFeatures	O	0..1	See clause 6.7.8

6.7.6.2.4 Type: LocationInfoResult

Table 6.7.6.2.4-1: Definition of type LocationInfoResult

Attribute name	Data type	P	Cardinality	Description
vPlmnId	PlmnId	M	1	Visiting PLMN Identity
amfInstanceId	NfInstanceId	O	0..1	NF instance ID of the serving AMF for 3GPP access
smsfInstanceId	NfInstanceId	O	0..1	NF instance ID of the serving SMSF
ecgi	Ecgi	O	0..1	E-UTRA Cell Identity
ncgi	Ncgi	O	0..1	NR Cell Identity
tai	Tai	O	0..1	Tracking Area Identity
currentLoc	boolean	O	0..1	When present, this IE shall be set as following: - true: the current location of the UE is returned - false: the last known location of the UE is returned.
geoInfo	GeographicArea	O	0..1	If present, this IE shall contain the geographical information of the UE.
locationAge	AgeOfLocationEstimate	O	0..1	If present, this IE shall contain the age of the location information.
ratType	RatType	O	0..1	If present, this IE shall contain the current RAT type of the UE.
timezone	TimeZone	O	0..1	If present, this IE shall contain the local time zone of the UE.
supportedFeatures	SupportedFeatures	O	0..1	See clause 6.7.8
NOTE: Either the "ecgi" attribute or the "ncgi" attribute may be included.				

6.7.6.2.5 Type: 5GSrvccInfo

Table 6.7.6.2.5-1: Definition of type 5GSrvccInfo

Attribute name	Data type	P	Cardinality	Description
ue5GSrvccCapability	boolean	M	1	This IE indicates whether the UE supports 5G SRVCC: - true: 5G SRVCC is supported by the UE - false: 5G SRVCC is not supported.
stnSr	StnSr	O	0..1	Session Transfer Number for 5G-SRVCC
cMsisdn	CMSisdn	O	0..1	Correlation MSISDN of the UE.

6.7.6.3 Simple data types and enumerations

In this release of this specification, no simple data types and enumerations are defined for the Nudm_MT Service.

6.7.7 Error Handling

6.7.7.1 General

HTTP error handling shall be supported as specified in clause 5.2.4 of 3GPP TS 29.500 [4].

6.7.7.2 Protocol Errors

Protocol errors handling shall be supported as specified in clause 5.2.7 of 3GPP TS 29.500 [4].

6.7.7.3 Application Errors

The common application errors defined in the Table 5.2.7.2-1 in 3GPP TS 29.500 [4] may also be used for the Nudm_MT service. The following application errors listed in Table 6.7.7.3-1 are specific for the Nudm_MT service.

Table 6.7.7.3-1: Application errors

Application Error	HTTP status code	Description
USER_NOT_FOUND	404 Not Found	The user does not exist
DATA_NOT_FOUND	404 Not Found	The requested UE data is not found/does not exist.

6.7.8 Feature Negotiation

The optional features in table 6.7.8-1 are defined for the Nudm_MT API. They shall be negotiated using the extensibility mechanism defined in clause 6.6 of 3GPP TS 29.500 [4].

Table 6.7.8-1: Supported Features

Feature number	Feature Name	Description

6.7.9 Security

As indicated in 3GPP TS 33.501 [6] and 3GPP TS 29.500 [4], the access to the Nudm_MT API may be authorized by means of the OAuth2 protocol (see IETF RFC 6749 [18]), based on local configuration, using the "Client Credentials" authorization grant, where the NRF (see 3GPP TS 29.510 [19]) plays the role of the authorization server.

If OAuth2 is used, an NF Service Consumer, prior to consuming services offered by the Nudm_MT API, shall obtain a "token" from the authorization server, by invoking the Access Token Request service, as described in 3GPP TS 29.510 [19], clause 5.4.2.2.

NOTE: When multiple NRFs are deployed in a network, the NRF used as authorization server is the same NRF that the NF Service Consumer used for discovering the Nudm_MT service.

The Nudm_MT API defines a single scope "nudm-mt" for OAuth2 authorization (as specified in 3GPP TS 33.501 [6]) for the entire API, and it does not define any additional scopes at resource or operation level.

Annex A (normative): OpenAPI specification

A.1 General

This Annex specifies the formal definition of the Nudm Service API(s). It consists of OpenAPI 3.0.0 specifications, in YAML format.

This Annex takes precedence when being discrepant to other parts of the specification with respect to the encoding of information elements and methods within the API(s).

NOTE: The semantics and procedures, as well as conditions, e.g. for the applicability and allowed combinations of attributes or values, not expressed in the OpenAPI definitions but defined in other parts of the specification also apply.

Informative copies of the OpenAPI specification files contained in this 3GPP Technical Specification are available on a Git-based repository, that uses the GitLab software version control system (see 3GPP TS 29.501 [5] clause 5.3.1 and 3GPP TR 21.900 [30] clause 5B).

A.2 Nudm_SDM API

```
openapi: 3.0.0
```

```
info:
```

```
  version: '2.1.7'
  title: 'Nudm_SDM'
  description: |
    Nudm Subscriber Data Management Service.
    © 2022, 3GPP Organizational Partners (ARIB, ATIS, CCSA, ETSI, TSDSI, TTA, TTC).
    All rights reserved.
```

```
externalDocs:
```

```
  description: 3GPP TS 29.503 Unified Data Management Services, version 16.11.0
  url: 'https://www.3gpp.org/ftp/Specs/archive/29_series/29.503/'
```

```
servers:
```

```
  - url: '{apiRoot}/nudm-sdm/v2'
    variables:
      apiRoot:
        default: https://example.com
        description: apiRoot as defined in clause 4.4 of 3GPP TS 29.501.
```

```
security:
```

```
  - oAuth2ClientCredentials:
    - nudm-sdm
  - {}
```

```
paths:
```

```
  /{supi}:
    get:
      summary: retrieve multiple data sets
      operationId: GetDataSets
      tags:
        - Retrieval of multiple data sets
      parameters:
        - name: supi
          in: path
          description: Identifier of the UE
          required: true
          schema:
            $ref: 'TS29571_CommonData.yaml#/components/schemas/Supi'
        - name: dataset-names
          in: query
          style: form
          explode: false
          description: List of dataset names
          required: true
```

```

    schema:
      $ref: '#/components/schemas/DatasetNames'
  - name: plmn-id
    in: query
    description: serving PLMN ID
    content:
      application/json:
        schema:
          $ref: 'TS29571_CommonData.yaml#/components/schemas/PlmnId'
  - name: supported-features
    in: query
    description: Supported Features
    schema:
      $ref: 'TS29571_CommonData.yaml#/components/schemas/SupportedFeatures'
  - name: If-None-Match
    in: header
    description: Validator for conditional requests, as described in RFC 7232, 3.2
    schema:
      type: string
  - name: If-Modified-Since
    in: header
    description: Validator for conditional requests, as described in RFC 7232, 3.3
    schema:
      type: string
responses:
  '200':
    description: Expected response to a valid request
    content:
      application/json:
        schema:
          $ref: '#/components/schemas/SubscriptionDataSets'
  headers:
    Cache-Control:
      description: Cache-Control containing max-age, as described in RFC 7234, 5.2
      schema:
        type: string
    ETag:
      description: Entity Tag, containing a strong validator, as described in RFC 7232, 2.3
      schema:
        type: string
    Last-Modified:
      description: Timestamp for last modification of the resource, as described in RFC
7232, 2.2
      schema:
        type: string
  '400':
    $ref: 'TS29571_CommonData.yaml#/components/responses/400'
  '404':
    $ref: 'TS29571_CommonData.yaml#/components/responses/404'
  '500':
    $ref: 'TS29571_CommonData.yaml#/components/responses/500'
  '503':
    $ref: 'TS29571_CommonData.yaml#/components/responses/503'
  default:
    description: Unexpected error
/{supi}/nssai:
  get:
    summary: retrieve a UE's subscribed NSSAI
    operationId: GetNSSAI
    tags:
      - Slice Selection Subscription Data Retrieval
    parameters:
      - name: supi
        in: path
        description: Identifier of the UE
        required: true
        schema:
          $ref: 'TS29571_CommonData.yaml#/components/schemas/Supi'
      - name: supported-features
        in: query
        description: Supported Features
        schema:
          $ref: 'TS29571_CommonData.yaml#/components/schemas/SupportedFeatures'
      - name: plmn-id
        in: query
        description: serving PLMN ID
        content:
          application/json:

```



```

    schema:
      $ref: 'TS29571_CommonData.yaml#/components/schemas/PlmnId'
  - name: If-None-Match
    in: header
    description: Validator for conditional requests, as described in RFC 7232, 3.2
    schema:
      type: string
  - name: If-Modified-Since
    in: header
    description: Validator for conditional requests, as described in RFC 7232, 3.3
    schema:
      type: string
responses:
  '200':
    description: Expected response to a valid request
    content:
      application/json:
        schema:
          $ref: '#/components/schemas/Nssai'
    headers:
      Cache-Control:
        description: Cache-Control containing max-age, as described in RFC 7234, 5.2
        schema:
          type: string
      ETag:
        description: Entity Tag, containing a strong validator, as described in RFC 7232, 2.3
        schema:
          type: string
      Last-Modified:
        description: Timestamp for last modification of the resource, as described in RFC
7232, 2.2
        schema:
          type: string
  '400':
    $ref: 'TS29571_CommonData.yaml#/components/responses/400'
  '404':
    $ref: 'TS29571_CommonData.yaml#/components/responses/404'
  '500':
    $ref: 'TS29571_CommonData.yaml#/components/responses/500'
  '503':
    $ref: 'TS29571_CommonData.yaml#/components/responses/503'
  default:
    description: Unexpected error
/{supi}/ue-context-in-amf-data:
get:
  summary: retrieve a UE's UE Context In AMF Data
  operationId: GetUeCtxInAmfData
  tags:
  - UE Context In AMF Data Retrieval
  parameters:
  - name: supi
    in: path
    description: Identifier of the UE
    required: true
    schema:
      $ref: 'TS29571_CommonData.yaml#/components/schemas/Supi'
  - name: supported-features
    in: query
    description: Supported Features
    schema:
      $ref: 'TS29571_CommonData.yaml#/components/schemas/SupportedFeatures'
responses:
  '200':
    description: Expected response to a valid request
    content:
      application/json:
        schema:
          $ref: '#/components/schemas/UeContextInAmfData'
  '400':
    $ref: 'TS29571_CommonData.yaml#/components/responses/400'
  '404':
    $ref: 'TS29571_CommonData.yaml#/components/responses/404'
  '500':
    $ref: 'TS29571_CommonData.yaml#/components/responses/500'
  '503':
    $ref: 'TS29571_CommonData.yaml#/components/responses/503'
  default:
    description: Unexpected error

```

```

/{supi}/am-data:
  get:
    summary: retrieve a UE's Access and Mobility Subscription Data
    operationId: GetAmData
    tags:
      - Access and Mobility Subscription Data Retrieval
    parameters:
      - name: supi
        in: path
        description: Identifier of the UE
        required: true
        schema:
          $ref: 'TS29571_CommonData.yaml#/components/schemas/Supi'
      - name: supported-features
        in: query
        description: Supported Features
        schema:
          $ref: 'TS29571_CommonData.yaml#/components/schemas/SupportedFeatures'
      - name: plmn-id
        in: query
        description: serving PLMN ID
        content:
          application/json:
            schema:
              $ref: 'TS29571_CommonData.yaml#/components/schemas/PlmnId'
      - name: If-None-Match
        in: header
        description: Validator for conditional requests, as described in RFC 7232, 3.2
        schema:
          type: string
      - name: If-Modified-Since
        in: header
        description: Validator for conditional requests, as described in RFC 7232, 3.3
        schema:
          type: string
    responses:
      '200':
        description: Expected response to a valid request
        content:
          application/json:
            schema:
              $ref: '#/components/schemas/AccessAndMobilitySubscriptionData'
    headers:
      Cache-Control:
        description: Cache-Control containing max-age, as described in RFC 7234, 5.2
        schema:
          type: string
      ETag:
        description: Entity Tag, containing a strong validator, as described in RFC 7232, 2.3
        schema:
          type: string
      Last-Modified:
        description: Timestamp for last modification of the resource, as described in RFC
7232, 2.2
        schema:
          type: string
      '400':
        $ref: 'TS29571_CommonData.yaml#/components/responses/400'
      '404':
        $ref: 'TS29571_CommonData.yaml#/components/responses/404'
      '500':
        $ref: 'TS29571_CommonData.yaml#/components/responses/500'
      '503':
        $ref: 'TS29571_CommonData.yaml#/components/responses/503'
    default:
      description: Unexpected error
/{supi}/am-data/ecr-data:
  get:
    summary: retrieve a UE's subscribed Enhanced Coverage Restriction Data
    operationId: GetEcrData
    tags:
      - Enhanced Coverage Restriction Data Retrieval
    parameters:
      - name: supi
        in: path
        description: Identifier of the UE
        required: true
        schema:

```

```

    $ref: 'TS29571_CommonData.yaml#/components/schemas/Supi'
  - name: supported-features
    in: query
    description: Supported Features
    schema:
      $ref: 'TS29571_CommonData.yaml#/components/schemas/SupportedFeatures'
  - name: If-None-Match
    in: header
    description: Validator for conditional requests, as described in RFC 7232, 3.2
    schema:
      type: string
  - name: If-Modified-Since
    in: header
    description: Validator for conditional requests, as described in RFC 7232, 3.3
    schema:
      type: string
responses:
  '200':
    description: Expected response to a valid request
    content:
      application/json:
        schema:
          $ref: '#/components/schemas/EnhancedCoverageRestrictionData'
    headers:
      Cache-Control:
        description: Cache-Control containing max-age, as described in RFC 7234, 5.2
        schema:
          type: string
      ETag:
        description: Entity Tag, containing a strong validator, as described in RFC 7232, 2.3
        schema:
          type: string
      Last-Modified:
        description: Timestamp for last modification of the resource, as described in RFC
7232, 2.2
        schema:
          type: string
  '400':
    $ref: 'TS29571_CommonData.yaml#/components/responses/400'
  '404':
    $ref: 'TS29571_CommonData.yaml#/components/responses/404'
  '500':
    $ref: 'TS29571_CommonData.yaml#/components/responses/500'
  '503':
    $ref: 'TS29571_CommonData.yaml#/components/responses/503'
  default:
    description: Unexpected error
/{supi}/smf-select-data:
  get:
    summary: retrieve a UE's SMF Selection Subscription Data
    operationId: GetSmfSelData
    tags:
      - SMF Selection Subscription Data Retrieval
    parameters:
      - name: supi
        in: path
        description: Identifier of the UE
        required: true
        schema:
          $ref: 'TS29571_CommonData.yaml#/components/schemas/Supi'
      - name: supported-features
        in: query
        description: Supported Features
        schema:
          $ref: 'TS29571_CommonData.yaml#/components/schemas/SupportedFeatures'
      - name: plmn-id
        in: query
        description: serving PLMN ID
        content:
          application/json:
            schema:
              $ref: 'TS29571_CommonData.yaml#/components/schemas/PlmnId'
      - name: If-None-Match
        in: header
        description: Validator for conditional requests, as described in RFC 7232, 3.2
        schema:
          type: string
      - name: If-Modified-Since

```

```

    in: header
    description: Validator for conditional requests, as described in RFC 7232, 3.3
    schema:
      type: string
  responses:
    '200':
      description: Expected response to a valid request
      content:
        application/json:
          schema:
            $ref: '#/components/schemas/SmfSelectionSubscriptionData'
      headers:
        Cache-Control:
          description: Cache-Control containing max-age, as described in RFC 7234, 5.2
          schema:
            type: string
        ETag:
          description: Entity Tag, containing a strong validator, as described in RFC 7232, 2.3
          schema:
            type: string
        Last-Modified:
          description: Timestamp for last modification of the resource, as described in RFC
7232, 2.2
          schema:
            type: string
    '400':
      $ref: 'TS29571_CommonData.yaml#/components/responses/400'
    '404':
      $ref: 'TS29571_CommonData.yaml#/components/responses/404'
    '500':
      $ref: 'TS29571_CommonData.yaml#/components/responses/500'
    '503':
      $ref: 'TS29571_CommonData.yaml#/components/responses/503'
    default:
      description: Unexpected error
/{supi}/ue-context-in-smf-data:
  get:
    summary: retrieve a UE's UE Context In SMF Data
    operationId: GetUeCtxInSmfData
    tags:
      - UE Context In SMF Data Retrieval
    parameters:
      - name: supi
        in: path
        description: Identifier of the UE
        required: true
        schema:
          $ref: 'TS29571_CommonData.yaml#/components/schemas/Supi'
      - name: supported-features
        in: query
        description: Supported Features
        schema:
          $ref: 'TS29571_CommonData.yaml#/components/schemas/SupportedFeatures'
    responses:
      '200':
        description: Expected response to a valid request
        content:
          application/json:
            schema:
              $ref: '#/components/schemas/UeContextInSmfData'
      '400':
        $ref: 'TS29571_CommonData.yaml#/components/responses/400'
      '404':
        $ref: 'TS29571_CommonData.yaml#/components/responses/404'
      '500':
        $ref: 'TS29571_CommonData.yaml#/components/responses/500'
      '503':
        $ref: 'TS29571_CommonData.yaml#/components/responses/503'
      default:
        description: Unexpected error
/{supi}/ue-context-in-smsf-data:
  get:
    summary: retrieve a UE's UE Context In SMSF Data
    operationId: GetUeCtxInSmsfData
    tags:
      - UE Context In SMSF Data Retrieval
    parameters:
      - name: supi

```

```

    in: path
    description: Identifier of the UE
    required: true
    schema:
      $ref: 'TS29571_CommonData.yaml#/components/schemas/Supi'
  - name: supported-features
    in: query
    description: Supported Features
    schema:
      $ref: 'TS29571_CommonData.yaml#/components/schemas/SupportedFeatures'
responses:
  '200':
    description: Expected response to a valid request
    content:
      application/json:
        schema:
          $ref: '#/components/schemas/UeContextInSmsfData'
  '400':
    $ref: 'TS29571_CommonData.yaml#/components/responses/400'
  '404':
    $ref: 'TS29571_CommonData.yaml#/components/responses/404'
  '500':
    $ref: 'TS29571_CommonData.yaml#/components/responses/500'
  '503':
    $ref: 'TS29571_CommonData.yaml#/components/responses/503'
  default:
    description: Unexpected error
/{supi}/trace-data:
get:
  summary: retrieve a UE's Trace Configuration Data
  operationId: GetTraceConfigData
  tags:
    - Trace Configuration Data Retrieval
  parameters:
    - name: supi
      in: path
      description: Identifier of the UE
      required: true
      schema:
        $ref: 'TS29571_CommonData.yaml#/components/schemas/Supi'
    - name: supported-features
      in: query
      description: Supported Features
      schema:
        $ref: 'TS29571_CommonData.yaml#/components/schemas/SupportedFeatures'
    - name: plmn-id
      in: query
      description: serving PLMN ID
      content:
        application/json:
          schema:
            $ref: 'TS29571_CommonData.yaml#/components/schemas/PlmnId'
    - name: If-None-Match
      in: header
      description: Validator for conditional requests, as described in RFC 7232, 3.2
      schema:
        type: string
    - name: If-Modified-Since
      in: header
      description: Validator for conditional requests, as described in RFC 7232, 3.3
      schema:
        type: string
  responses:
    '200':
      description: Expected response to a valid request
      content:
        application/json:
          schema:
            $ref: '#/components/schemas/TraceDataResponse'
  headers:
    Cache-Control:
      description: Cache-Control containing max-age, as described in RFC 7234, 5.2
      schema:
        type: string
    ETag:
      description: Entity Tag, containing a strong validator, as described in RFC 7232, 2.3
      schema:
        type: string

```

```

      Last-Modified:
        description: Timestamp for last modification of the resource, as described in RFC
7232, 2.2
      schema:
        type: string
    '400':
      $ref: 'TS29571_CommonData.yaml#/components/responses/400'
    '404':
      $ref: 'TS29571_CommonData.yaml#/components/responses/404'
    '500':
      $ref: 'TS29571_CommonData.yaml#/components/responses/500'
    '503':
      $ref: 'TS29571_CommonData.yaml#/components/responses/503'
    default:
      description: Unexpected error
  /{supi}/sm-data:
    get:
      summary: retrieve a UE's Session Management Subscription Data
      operationId: GetSmData
      tags:
        - Session Management Subscription Data Retrieval
      parameters:
        - name: supi
          in: path
          description: Identifier of the UE
          required: true
          schema:
            $ref: 'TS29571_CommonData.yaml#/components/schemas/Supi'
        - name: supported-features
          in: query
          description: Supported Features
          schema:
            $ref: 'TS29571_CommonData.yaml#/components/schemas/SupportedFeatures'
        - name: single-nssai
          in: query
          content:
            application/json:
              schema:
                $ref: 'TS29571_CommonData.yaml#/components/schemas/Snssai'
        - name: dnn
          in: query
          schema:
            $ref: 'TS29571_CommonData.yaml#/components/schemas/Dnn'
        - name: plmn-id
          in: query
          content:
            application/json:
              schema:
                $ref: 'TS29571_CommonData.yaml#/components/schemas/PlmnId'
        - name: If-None-Match
          in: header
          description: Validator for conditional requests, as described in RFC 7232, 3.2
          schema:
            type: string
        - name: If-Modified-Since
          in: header
          description: Validator for conditional requests, as described in RFC 7232, 3.3
          schema:
            type: string
      responses:
        '200':
          description: Expected response to a valid request
          content:
            application/json:
              schema:
                type: array
                items:
                  $ref: '#/components/schemas/SessionManagementSubscriptionData'
                minItems: 1
      headers:
        Cache-Control:
          description: Cache-Control containing max-age, as described in RFC 7234, 5.2
          schema:
            type: string
        ETag:
          description: Entity Tag, containing a strong validator, as described in RFC 7232, 2.3
          schema:
            type: string

```

```

    Last-Modified:
      description: Timestamp for last modification of the resource, as described in RFC
7232, 2.2
    schema:
      type: string
  '400':
    $ref: 'TS29571_CommonData.yaml#/components/responses/400'
  '404':
    $ref: 'TS29571_CommonData.yaml#/components/responses/404'
  '500':
    $ref: 'TS29571_CommonData.yaml#/components/responses/500'
  '503':
    $ref: 'TS29571_CommonData.yaml#/components/responses/503'
  default:
    description: Unexpected error
/{supi}/sms-data:
  get:
    summary: retrieve a UE's SMS Subscription Data
    operationId: GetSmsData
    tags:
      - SMS Subscription Data Retrieval
    parameters:
      - name: supi
        in: path
        description: Identifier of the UE
        required: true
        schema:
          $ref: 'TS29571_CommonData.yaml#/components/schemas/Supi'
      - name: supported-features
        in: query
        description: Supported Features
        schema:
          $ref: 'TS29571_CommonData.yaml#/components/schemas/SupportedFeatures'
      - name: plmn-id
        in: query
        content:
          application/json:
            schema:
              $ref: 'TS29571_CommonData.yaml#/components/schemas/PlmnId'
      - name: If-None-Match
        in: header
        description: Validator for conditional requests, as described in RFC 7232, 3.2
        schema:
          type: string
      - name: If-Modified-Since
        in: header
        description: Validator for conditional requests, as described in RFC 7232, 3.3
        schema:
          type: string
    responses:
      '200':
        description: Expected response to a valid request
        content:
          application/json:
            schema:
              $ref: '#/components/schemas/SmsSubscriptionData'
        headers:
          Cache-Control:
            description: Cache-Control containing max-age, as described in RFC 7234, 5.2
            schema:
              type: string
          ETag:
            description: Entity Tag, containing a strong validator, as described in RFC 7232, 2.3
            schema:
              type: string
          Last-Modified:
            description: Timestamp for last modification of the resource, as described in RFC
7232, 2.2
            schema:
              type: string
      '400':
        $ref: 'TS29571_CommonData.yaml#/components/responses/400'
      '404':
        $ref: 'TS29571_CommonData.yaml#/components/responses/404'
      '500':
        $ref: 'TS29571_CommonData.yaml#/components/responses/500'
      '503':
        $ref: 'TS29571_CommonData.yaml#/components/responses/503'

```

```

    default:
      description: Unexpected error
  /{supi}/sms-mng-data:
    get:
      summary: retrieve a UE's SMS Management Subscription Data
      operationId: GetSmsMngtData
      tags:
        - SMS Management Subscription Data Retrieval
      parameters:
        - name: supi
          in: path
          description: Identifier of the UE
          required: true
          schema:
            $ref: 'TS29571_CommonData.yaml#/components/schemas/Supi'
        - name: supported-features
          in: query
          description: Supported Features
          schema:
            $ref: 'TS29571_CommonData.yaml#/components/schemas/SupportedFeatures'
        - name: plmn-id
          in: query
          content:
            application/json:
              schema:
                $ref: 'TS29571_CommonData.yaml#/components/schemas/PlmnId'
        - name: If-None-Match
          in: header
          description: Validator for conditional requests, as described in RFC 7232, 3.2
          schema:
            type: string
        - name: If-Modified-Since
          in: header
          description: Validator for conditional requests, as described in RFC 7232, 3.3
          schema:
            type: string
      responses:
        '200':
          description: Expected response to a valid request
          content:
            application/json:
              schema:
                $ref: '#/components/schemas/SmsManagementSubscriptionData'
          headers:
            Cache-Control:
              description: Cache-Control containing max-age, as described in RFC 7234, 5.2
              schema:
                type: string
            ETag:
              description: Entity Tag, containing a strong validator, as described in RFC 7232, 2.3
              schema:
                type: string
            Last-Modified:
              description: Timestamp for last modification of the resource, as described in RFC
7232, 2.2
              schema:
                type: string
        '400':
          $ref: 'TS29571_CommonData.yaml#/components/responses/400'
        '404':
          $ref: 'TS29571_CommonData.yaml#/components/responses/404'
        '500':
          $ref: 'TS29571_CommonData.yaml#/components/responses/500'
        '503':
          $ref: 'TS29571_CommonData.yaml#/components/responses/503'
      default:
        description: Unexpected error
  /{ueId}/lcs-privacy-data:
    get:
      summary: retrieve a UE's LCS Privacy Subscription Data
      operationId: GetLcsPrivacyData
      tags:
        - LCS Privacy Data Retrieval
      parameters:
        - name: ueId
          in: path
          description: Identifier of the UE
          required: true

```



```

    schema:
      $ref: 'TS29571_CommonData.yaml#/components/schemas/VarUeId'
  - name: supported-features
    in: query
    description: Supported Features
    schema:
      $ref: 'TS29571_CommonData.yaml#/components/schemas/SupportedFeatures'
  - name: If-None-Match
    in: header
    description: Validator for conditional requests, as described in RFC 7232, 3.2
    schema:
      type: string
  - name: If-Modified-Since
    in: header
    description: Validator for conditional requests, as described in RFC 7232, 3.3
    schema:
      type: string
responses:
  '200':
    description: Expected response to a valid request
    content:
      application/json:
        schema:
          $ref: '#/components/schemas/LcsPrivacyData'
    headers:
      Cache-Control:
        description: Cache-Control containing max-age, as described in RFC 7234, 5.2
        schema:
          type: string
      ETag:
        description: Entity Tag, containing a strong validator, as described in RFC 7232, 2.3
        schema:
          type: string
      Last-Modified:
        description: Timestamp for last modification of the resource, as described in RFC
7232, 2.2
        schema:
          type: string
  '400':
    $ref: 'TS29571_CommonData.yaml#/components/responses/400'
  '404':
    $ref: 'TS29571_CommonData.yaml#/components/responses/404'
  '500':
    $ref: 'TS29571_CommonData.yaml#/components/responses/500'
  '503':
    $ref: 'TS29571_CommonData.yaml#/components/responses/503'
  default:
    description: Unexpected error

/{supi}/lcs-mo-data:
  get:
    summary: retrieve a UE's LCS Mobile Originated Subscription Data
    operationId: GetLcsMoData
    tags:
      - LCS Mobile Originated Data Retrieval
    parameters:
      - name: supi
        in: path
        description: Identifier of the UE
        required: true
        schema:
          $ref: 'TS29571_CommonData.yaml#/components/schemas/Supi'
      - name: supported-features
        in: query
        description: Supported Features
        schema:
          $ref: 'TS29571_CommonData.yaml#/components/schemas/SupportedFeatures'
      - name: If-None-Match
        in: header
        description: Validator for conditional requests, as described in RFC 7232, 3.2
        schema:
          type: string
      - name: If-Modified-Since
        in: header
        description: Validator for conditional requests, as described in RFC 7232, 3.3
        schema:
          type: string
    responses:

```

```

'200':
  description: Expected response to a valid request
  content:
    application/json:
      schema:
        $ref: '#/components/schemas/LcsMoData'
  headers:
    Cache-Control:
      description: Cache-Control containing max-age, as described in RFC 7234, 5.2
      schema:
        type: string
    ETag:
      description: Entity Tag, containing a strong validator, as described in RFC 7232, 2.3
      schema:
        type: string
    Last-Modified:
      description: Timestamp for last modification of the resource, as described in RFC
7232, 2.2
      schema:
        type: string
'400':
  $ref: 'TS29571_CommonData.yaml#/components/responses/400'
'404':
  $ref: 'TS29571_CommonData.yaml#/components/responses/404'
'500':
  $ref: 'TS29571_CommonData.yaml#/components/responses/500'
'503':
  $ref: 'TS29571_CommonData.yaml#/components/responses/503'
default:
  description: Unexpected error
/{supi}/lcs-bca-data:
  get:
    summary: retrieve a UE's LCS Broadcast Assistance Data Types Subscription Data
    operationId: GetLcsBcaData
    tags:
      - LCS Broadcast Assistance Data Types Retrieval
    parameters:
      - name: supi
        in: path
        description: Identifier of the UE
        required: true
        schema:
          $ref: 'TS29571_CommonData.yaml#/components/schemas/Supi'
      - name: supported-features
        in: query
        description: Supported Features
        schema:
          $ref: 'TS29571_CommonData.yaml#/components/schemas/SupportedFeatures'
      - name: plmn-id
        in: query
        content:
          application/json:
            schema:
              $ref: 'TS29571_CommonData.yaml#/components/schemas/PlmnId'
      - name: If-None-Match
        in: header
        description: Validator for conditional requests, as described in RFC 7232, 3.2
        schema:
          type: string
      - name: If-Modified-Since
        in: header
        description: Validator for conditional requests, as described in RFC 7232, 3.3
        schema:
          type: string
    responses:
      '200':
        description: Expected response to a valid request
        content:
          application/json:
            schema:
              $ref: '#/components/schemas/LcsBroadcastAssistanceTypesData'
        headers:
          Cache-Control:
            description: Cache-Control containing max-age, as described in RFC 7234, 5.2
            schema:
              type: string
          ETag:
            description: Entity Tag, containing a strong validator, as described in RFC 7232, 2.3

```

```

    schema:
      type: string
  Last-Modified:
    description: Timestamp for last modification of the resource, as described in RFC
7232, 2.2
    schema:
      type: string
  '400':
    $ref: 'TS29571_CommonData.yaml#/components/responses/400'
  '404':
    $ref: 'TS29571_CommonData.yaml#/components/responses/404'
  '500':
    $ref: 'TS29571_CommonData.yaml#/components/responses/500'
  '503':
    $ref: 'TS29571_CommonData.yaml#/components/responses/503'
  default:
    description: Unexpected error

/{supi}/v2x-data:
  get:
    summary: retrieve a UE's V2X Subscription Data
    operationId: GetV2xData
    tags:
      - V2X Subscription Data Retrieval
    parameters:
      - name: supi
        in: path
        description: Identifier of the UE
        required: true
        schema:
          $ref: 'TS29571_CommonData.yaml#/components/schemas/Supi'
      - name: supported-features
        in: query
        description: Supported Features
        schema:
          $ref: 'TS29571_CommonData.yaml#/components/schemas/SupportedFeatures'
      - name: If-None-Match
        in: header
        description: Validator for conditional requests, as described in RFC 7232, 3.2
        schema:
          type: string
      - name: If-Modified-Since
        in: header
        description: Validator for conditional requests, as described in RFC 7232, 3.3
        schema:
          type: string
    responses:
      '200':
        description: Expected response to a valid request
        content:
          application/json:
            schema:
              $ref: '#/components/schemas/V2xSubscriptionData'
        headers:
          Cache-Control:
            description: Cache-Control containing max-age, as described in RFC 7234, 5.2
            schema:
              type: string
          ETag:
            description: Entity Tag, containing a strong validator, as described in RFC 7232, 2.3
            schema:
              type: string
          Last-Modified:
            description: Timestamp for last modification of the resource, as described in RFC
7232, 2.2
            schema:
              type: string
      '400':
        $ref: 'TS29571_CommonData.yaml#/components/responses/400'
      '404':
        $ref: 'TS29571_CommonData.yaml#/components/responses/404'
      '500':
        $ref: 'TS29571_CommonData.yaml#/components/responses/500'
      '503':
        $ref: 'TS29571_CommonData.yaml#/components/responses/503'
      default:
        description: Unexpected error

```

```

/{ueId}/sdm-subscriptions:
  post:
    summary: subscribe to notifications
    operationId: Subscribe
    tags:
      - Subscription Creation
    parameters:
      - name: ueId
        in: path
        description: Identity of the user
        required: true
        schema:
          $ref: 'TS29571_CommonData.yaml#/components/schemas/VarUeId'
    requestBody:
      content:
        application/json:
          schema:
            $ref: '#/components/schemas/SdmSubscription'
          required: true
    responses:
      '201':
        description: Expected response to a valid request
        content:
          application/json:
            schema:
              $ref: '#/components/schemas/SdmSubscription'
        headers:
          Location:
            description: 'Contains the URI of the newly created resource, according to the
structure: {apiRoot}/nudm-sdm/<apiVersion>/{supi}/sdm-subscriptions/{subscriptionId}'
            required: true
            schema:
              type: string
      '400':
        $ref: 'TS29571_CommonData.yaml#/components/responses/400'
      '404':
        $ref: 'TS29571_CommonData.yaml#/components/responses/404'
      '500':
        $ref: 'TS29571_CommonData.yaml#/components/responses/500'
      '501':
        $ref: 'TS29571_CommonData.yaml#/components/responses/501'
      '503':
        $ref: 'TS29571_CommonData.yaml#/components/responses/503'
      default:
        description: Unexpected error
    callbacks:
      datachangeNotification:
        '{request.body#/callbackReference}':
          post:
            requestBody:
              required: true
              content:
                application/json:
                  schema:
                    $ref: '#/components/schemas/ModificationNotification'
            responses:
              '204':
                description: Successful Notification response
              '307':
                $ref: 'TS29571_CommonData.yaml#/components/responses/307'
              '308':
                $ref: 'TS29571_CommonData.yaml#/components/responses/308'
              '400':
                $ref: 'TS29571_CommonData.yaml#/components/responses/400'
              '404':
                $ref: 'TS29571_CommonData.yaml#/components/responses/404'
              '500':
                $ref: 'TS29571_CommonData.yaml#/components/responses/500'
              '503':
                $ref: 'TS29571_CommonData.yaml#/components/responses/503'
              default:
                description: Unexpected error
/{ueId}/sdm-subscriptions/{subscriptionId}:
  delete:
    summary: unsubscribe from notifications
    operationId: Unsubscribe
    tags:
      - Subscription Deletion

```

```

parameters:
  - name: ueId
    in: path
    description: Identity of the user
    required: true
    schema:
      $ref: 'TS29571_CommonData.yaml#/components/schemas/VarUeId'
  - name: subscriptionId
    in: path
    description: Id of the SDM Subscription
    required: true
    schema:
      type: string
responses:
  '204':
    description: Successful response
  '400':
    $ref: 'TS29571_CommonData.yaml#/components/responses/400'
  '404':
    $ref: 'TS29571_CommonData.yaml#/components/responses/404'
  '500':
    $ref: 'TS29571_CommonData.yaml#/components/responses/500'
  '503':
    $ref: 'TS29571_CommonData.yaml#/components/responses/503'
  default:
    description: Unexpected error
patch:
  summary: modify the subscription
  operationId: Modify
  tags:
    - Subscription Modification
parameters:
  - name: ueId
    in: path
    description: Identity of the user
    required: true
    schema:
      $ref: 'TS29571_CommonData.yaml#/components/schemas/VarUeId'
  - name: subscriptionId
    in: path
    description: Id of the SDM Subscription
    required: true
    schema:
      type: string
  - name: supported-features
    in: query
    description: Features required to be supported by the target NF
    schema:
      $ref: 'TS29571_CommonData.yaml#/components/schemas/SupportedFeatures'
requestBody:
  content:
    application/merge-patch+json:
      schema:
        $ref: '#/components/schemas/SdmSubsModification'
      required: true
responses:
  '200':
    description: Expected response to a valid request
    content:
      application/json:
        schema:
          oneOf:
            - $ref: '#/components/schemas/SdmSubscription'
            - $ref: 'TS29571_CommonData.yaml#/components/schemas/PatchResult'
  '400':
    $ref: 'TS29571_CommonData.yaml#/components/responses/400'
  '403':
    $ref: 'TS29571_CommonData.yaml#/components/responses/403'
  '404':
    $ref: 'TS29571_CommonData.yaml#/components/responses/404'
  '500':
    $ref: 'TS29571_CommonData.yaml#/components/responses/500'
  '503':
    $ref: 'TS29571_CommonData.yaml#/components/responses/503'
  default:
    description: Unexpected error
/{ueId}/id-translation-result:
  get:

```

```

summary: retrieve a UE's SUPI or GPSI
operationId: GetSupiOrGpsi
tags:
  - GPSI to SUPI Translation
parameters:
  - name: ueId
    in: path
    description: Identifier of the UE
    required: true
    schema:
      $ref: 'TS29571_CommonData.yaml#/components/schemas/VarUeId'
  - name: supported-features
    in: query
    description: Supported Features
    schema:
      $ref: 'TS29571_CommonData.yaml#/components/schemas/SupportedFeatures'
  - name: app-port-id
    in: query
    description: Application port identifier
    content:
      application/json:
        schema:
          $ref: '#/components/schemas/AppPortId'
  - name: If-None-Match
    in: header
    description: Validator for conditional requests, as described in RFC 7232, 3.2
    schema:
      type: string
  - name: If-Modified-Since
    in: header
    description: Validator for conditional requests, as described in RFC 7232, 3.3
    schema:
      type: string
responses:
  '200':
    description: Expected response to a valid request
    content:
      application/json:
        schema:
          $ref: '#/components/schemas/IdTranslationResult'
    headers:
      Cache-Control:
        description: Cache-Control containing max-age, as described in RFC 7234, 5.2
        schema:
          type: string
      ETag:
        description: Entity Tag, containing a strong validator, as described in RFC 7232, 2.3
        schema:
          type: string
      Last-Modified:
        description: Timestamp for last modification of the resource, as described in RFC
7232, 2.2
        schema:
          type: string
  '400':
    $ref: 'TS29571_CommonData.yaml#/components/responses/400'
  '404':
    $ref: 'TS29571_CommonData.yaml#/components/responses/404'
  '500':
    $ref: 'TS29571_CommonData.yaml#/components/responses/500'
  '503':
    $ref: 'TS29571_CommonData.yaml#/components/responses/503'
  default:
    description: Unexpected error
/{supi}/am-data/sor-ack:
  put:
    summary: Nudm_Sdm Info service operation
    operationId: SorAckInfo
    tags:
      - Providing acknowledgement of Steering of Roaming
    parameters:
      - name: supi
        in: path
        description: Identifier of the UE
        required: true
        schema:
          $ref: 'TS29571_CommonData.yaml#/components/schemas/Supi'
    requestBody:

```

```

    content:
      application/json:
        schema:
          $ref: '#/components/schemas/AcknowledgeInfo'
  responses:
    '204':
      description: Successful acknowledgement
    '400':
      $ref: 'TS29571_CommonData.yaml#/components/responses/400'
    '500':
      $ref: 'TS29571_CommonData.yaml#/components/responses/500'
    '503':
      $ref: 'TS29571_CommonData.yaml#/components/responses/503'
    default:
      description: Unexpected error
/{supi}/am-data/upu-ack:
  put:
    summary: Nudm_Sdm Info for UPU service operation
    operationId: UpuAck
    tags:
      - Providing acknowledgement of UE Parameters Update
    parameters:
      - name: supi
        in: path
        description: Identifier of the UE
        required: true
        schema:
          $ref: 'TS29571_CommonData.yaml#/components/schemas/Supi'
    requestBody:
      content:
        application/json:
          schema:
            $ref: '#/components/schemas/AcknowledgeInfo'
  responses:
    '204':
      description: Successful acknowledgement
    '400':
      $ref: 'TS29571_CommonData.yaml#/components/responses/400'
    '500':
      $ref: 'TS29571_CommonData.yaml#/components/responses/500'
    '503':
      $ref: 'TS29571_CommonData.yaml#/components/responses/503'
    default:
      description: Unexpected error
/{supi}/am-data/subscribed-snssais-ack:
  put:
    summary: Nudm_Sdm Info operation for S-NSSAIs acknowledgement
    operationId: S-NSSAIs Ack
    tags:
      - Providing acknowledgement of S-NSSAIs Update
    parameters:
      - name: supi
        in: path
        description: Identifier of the UE
        required: true
        schema:
          $ref: 'TS29571_CommonData.yaml#/components/schemas/Supi'
    requestBody:
      content:
        application/json:
          schema:
            $ref: '#/components/schemas/AcknowledgeInfo'
  responses:
    '204':
      description: Successful acknowledgement
    '400':
      $ref: 'TS29571_CommonData.yaml#/components/responses/400'
    '500':
      $ref: 'TS29571_CommonData.yaml#/components/responses/500'
    '503':
      $ref: 'TS29571_CommonData.yaml#/components/responses/503'
    default:
      description: Unexpected error
/{supi}/am-data/cag-ack:
  put:
    summary: Nudm_Sdm Info operation for CAG acknowledgement
    operationId: CAG Ack
    tags:

```

```

- Providing acknowledgement of CAG Update
parameters:
- name: supi
  in: path
  description: Identifier of the UE
  required: true
  schema:
    $ref: 'TS29571_CommonData.yaml#/components/schemas/Supi'
requestBody:
  content:
    application/json:
      schema:
        $ref: '#/components/schemas/AcknowledgeInfo'
responses:
  '204':
    description: Successful acknowledgement
  '400':
    $ref: 'TS29571_CommonData.yaml#/components/responses/400'
  '500':
    $ref: 'TS29571_CommonData.yaml#/components/responses/500'
  '503':
    $ref: 'TS29571_CommonData.yaml#/components/responses/503'
  default:
    description: Unexpected error
/{supi}/am-data/update-sor:
  post:
    summary: Nudm_Sdm custom operation to trigger SOR info update
    operationId: Update SOR Info
    tags:
      - Trigger SOR info update
    parameters:
      - name: supi
        in: path
        description: Identifier of the UE
        required: true
        schema:
          $ref: 'TS29571_CommonData.yaml#/components/schemas/Supi'
    requestBody:
      content:
        application/json:
          schema:
            $ref: '#/components/schemas/SorUpdateInfo'
    responses:
      '200':
        description: Expected response to a valid request
        content:
          application/json:
            schema:
              $ref: '#/components/schemas/SorInfo'
      '400':
        $ref: 'TS29571_CommonData.yaml#/components/responses/400'
      '404':
        $ref: 'TS29571_CommonData.yaml#/components/responses/404'
      '500':
        $ref: 'TS29571_CommonData.yaml#/components/responses/500'
      '503':
        $ref: 'TS29571_CommonData.yaml#/components/responses/503'
      default:
        description: Unexpected error
/shared-data:
  get:
    summary: retrieve shared data
    operationId: GetSharedData
    tags:
      - Retrieval of shared data
    parameters:
      - name: shared-data-ids
        in: query
        description: List of shared data ids
        required: true
        style: form
        explode: false
        schema:
          $ref: '#/components/schemas/SharedDataIds'
      - name: supportedFeatures
        in: query
        deprecated: true
        description: Supported Features; this query parameter should not be used

```



```

    schema:
      $ref: 'TS29571_CommonData.yaml#/components/schemas/SupportedFeatures'
  - name: supported-features
    in: query
    description: Supported Features
    schema:
      $ref: 'TS29571_CommonData.yaml#/components/schemas/SupportedFeatures'
  - name: If-None-Match
    in: header
    description: Validator for conditional requests, as described in RFC 7232, 3.2
    schema:
      type: string
  - name: If-Modified-Since
    in: header
    description: Validator for conditional requests, as described in RFC 7232, 3.3
    schema:
      type: string
responses:
  '200':
    description: Expected response to a valid request
    content:
      application/json:
        schema:
          type: array
          items:
            $ref: '#/components/schemas/SharedData'
          minItems: 1
    headers:
      Cache-Control:
        description: Cache-Control containing max-age, as described in RFC 7234, 5.2
        schema:
          type: string
      ETag:
        description: Entity Tag, containing a strong validator, as described in RFC 7232, 2.3
        schema:
          type: string
      Last-Modified:
        description: Timestamp for last modification of the resource, as described in RFC
7232, 2.2
        schema:
          type: string
  '400':
    $ref: 'TS29571_CommonData.yaml#/components/responses/400'
  '404':
    $ref: 'TS29571_CommonData.yaml#/components/responses/404'
  '500':
    $ref: 'TS29571_CommonData.yaml#/components/responses/500'
  '503':
    $ref: 'TS29571_CommonData.yaml#/components/responses/503'
  default:
    description: Unexpected error
/shared-data-subscriptions:
  post:
    summary: subscribe to notifications for shared data
    operationId: SubscribeToSharedData
    tags:
      - Subscription Creation for shared data
    requestBody:
      content:
        application/json:
          schema:
            $ref: '#/components/schemas/SdmSubscription'
      required: true
    responses:
      '201':
        description: Expected response to a valid request
        content:
          application/json:
            schema:
              $ref: '#/components/schemas/SdmSubscription'
    headers:
      Location:
        description: 'Contains the URI of the newly created resource, according to the
structure: {apiRoot}/nudm-sdm/<apiVersion>/shared-data-subscriptions/{subscriptionId}'
        required: true
        schema:
          type: string
  '400':

```

```

    $ref: 'TS29571_CommonData.yaml#/components/responses/400'
  '404':
    $ref: 'TS29571_CommonData.yaml#/components/responses/404'
  default:
    description: Unexpected error
  callbacks:
    datachangeNotification:
      '{request.body#/callbackReference}':
        post:
          requestBody:
            required: true
            content:
              application/json:
                schema:
                  $ref: '#/components/schemas/ModificationNotification'
          responses:
            '204':
              description: Successful Notification response
            '307':
              $ref: 'TS29571_CommonData.yaml#/components/responses/307'
            '308':
              $ref: 'TS29571_CommonData.yaml#/components/responses/308'
            '400':
              $ref: 'TS29571_CommonData.yaml#/components/responses/400'
            '404':
              $ref: 'TS29571_CommonData.yaml#/components/responses/404'
            '500':
              $ref: 'TS29571_CommonData.yaml#/components/responses/500'
            '503':
              $ref: 'TS29571_CommonData.yaml#/components/responses/503'
          default:
            description: Unexpected error
/shared-data-subscriptions/{subscriptionId}:
  delete:
    summary: unsubscribe from notifications for shared data
    operationId: UnsubscribeForSharedData
    tags:
      - Subscription Deletion for shared data
    parameters:
      - name: subscriptionId
        in: path
        description: Id of the Shared data Subscription
        required: true
        schema:
          type: string
    responses:
      '204':
        description: Successful response
      '400':
        $ref: 'TS29571_CommonData.yaml#/components/responses/400'
      '404':
        $ref: 'TS29571_CommonData.yaml#/components/responses/404'
      '500':
        $ref: 'TS29571_CommonData.yaml#/components/responses/500'
      '503':
        $ref: 'TS29571_CommonData.yaml#/components/responses/503'
    default:
      description: Unexpected error
  patch:
    summary: modify the subscription
    operationId: ModifySharedDataSubs
    tags:
      - Subscription Modification
    parameters:
      - name: subscriptionId
        in: path
        description: Id of the SDM Subscription
        required: true
        schema:
          type: string
      - name: supported-features
        in: query
        description: Features required to be supported by the target NF
        schema:
          $ref: 'TS29571_CommonData.yaml#/components/schemas/SupportedFeatures'
    requestBody:
      content:
        application/merge-patch+json:

```

```

    schema:
      $ref: '#/components/schemas/SdmSubsModification'
  required: true
  responses:
    '200':
      description: Expected response to a valid request
      content:
        application/json:
          schema:
            oneOf:
              - $ref: '#/components/schemas/SdmSubscription'
              - $ref: 'TS29571_CommonData.yaml#/components/schemas/PatchResult'
    '400':
      $ref: 'TS29571_CommonData.yaml#/components/responses/400'
    '403':
      $ref: 'TS29571_CommonData.yaml#/components/responses/403'
    '404':
      $ref: 'TS29571_CommonData.yaml#/components/responses/404'
    '500':
      $ref: 'TS29571_CommonData.yaml#/components/responses/500'
    '503':
      $ref: 'TS29571_CommonData.yaml#/components/responses/503'
  default:
    description: Unexpected error

/group-data/group-identifiers:
  get:
    summary: Mapping of Group Identifiers
    operationId: GetGroupIdentifiers
    tags:
      - Group Identifiers
    parameters:
      - name: ext-group-id
        in: query
        description: External Group Identifier
        required: false
        schema:
          $ref: '#/components/schemas/ExtGroupId'
      - name: int-group-id
        in: query
        description: Internal Group Identifier
        required: false
        schema:
          $ref: 'TS29571_CommonData.yaml#/components/schemas/GroupId'
      - name: ue-id-ind
        in: query
        description: Indication whether UE identifiers are required or not
        required: false
        schema:
          type: boolean
          default: false
      - name: supported-features
        in: query
        description: Supported Features
        schema:
          $ref: 'TS29571_CommonData.yaml#/components/schemas/SupportedFeatures'
      - name: If-None-Match
        in: header
        description: Validator for conditional requests, as described in RFC 7232, 3.2
        schema:
          type: string
      - name: If-Modified-Since
        in: header
        description: Validator for conditional requests, as described in RFC 7232, 3.3
        schema:
          type: string
    responses:
      '200':
        description: Expected response to a valid request
        content:
          application/json:
            schema:
              $ref: '#/components/schemas/GroupIdentifiers'
      headers:
        Cache-Control:
          description: Cache-Control containing max-age, as described in RFC 7234, 5.2
          schema:
            type: string

```

```

      ETag:
        description: Entity Tag, containing a strong validator, as described in RFC 7232, 2.3
        schema:
          type: string
      Last-Modified:
        description: Timestamp for last modification of the resource, as described in RFC
7232, 2.2
        schema:
          type: string
    '400':
      $ref: 'TS29571_CommonData.yaml#/components/responses/400'
    '404':
      $ref: 'TS29571_CommonData.yaml#/components/responses/404'
    '500':
      $ref: 'TS29571_CommonData.yaml#/components/responses/500'
    '503':
      $ref: 'TS29571_CommonData.yaml#/components/responses/503'
    default:
      description: Unexpected error

/shared-data/{sharedDataId}:
  get:
    summary: retrieve the individual shared data
    operationId: GetIndividualSharedData
    tags:
      - Retrieval of the individual shared data
    parameters:
      - name: sharedDataId
        in: path
        description: Id of the Shared data
        required: true
        schema:
          $ref: '#/components/schemas/SharedDataIds'
      - name: If-None-Match
        in: header
        description: Validator for conditional requests, as described in RFC 7232, 3.2
        schema:
          type: string
      - name: If-Modified-Since
        in: header
        description: Validator for conditional requests, as described in RFC 7232, 3.3
        schema:
          type: string
    responses:
      '200':
        description: Expected response to a valid request
        content:
          application/json:
            schema:
              $ref: '#/components/schemas/SharedData'
        headers:
          Cache-Control:
            description: Cache-Control containing max-age, as described in RFC 7234, 5.2
            schema:
              type: string
          ETag:
            description: Entity Tag, containing a strong validator, as described in RFC 7232, 2.3
            schema:
              type: string
          Last-Modified:
            description: Timestamp for last modification of the resource, as described in RFC
7232, 2.2
            schema:
              type: string
      '400':
        $ref: 'TS29571_CommonData.yaml#/components/responses/400'
      '404':
        $ref: 'TS29571_CommonData.yaml#/components/responses/404'
      '500':
        $ref: 'TS29571_CommonData.yaml#/components/responses/500'
      '503':
        $ref: 'TS29571_CommonData.yaml#/components/responses/503'
    default:
      description: Unexpected error

components:
  securitySchemes:
    oAuth2ClientCredentials:

```

```
type: oauth2
flows:
  clientCredentials:
    tokenUrl: '{nrfApiRoot}/oauth2/token'
    scopes:
      nudm-sdm: Access to the nudm-sdm API
```

```
schemas:
```

```
# COMPLEX TYPES:
```

```
DatasetNames:
  type: array
  items:
    $ref: '#/components/schemas/DataSetName'
  minItems: 2
  uniqueItems: true

SubscriptionDataSets:
  type: object
  properties:
    amData:
      $ref: '#/components/schemas/AccessAndMobilitySubscriptionData'
    smfSelData:
      $ref: '#/components/schemas/SmfSelectionSubscriptionData'
    uecAmfData:
      $ref: '#/components/schemas/UeContextInAmfData'
    uecSmfData:
      $ref: '#/components/schemas/UeContextInSmfData'
    uecSmsfData:
      $ref: '#/components/schemas/UeContextInSmsfData'
    smsSubsData:
      $ref: '#/components/schemas/SmsSubscriptionData'
    smData:
      type: array
      items:
        $ref: '#/components/schemas/SessionManagementSubscriptionData'
      minItems: 1
    traceData:
      $ref: 'TS29571_CommonData.yaml#/components/schemas/TraceData'
    smsMngData:
      $ref: '#/components/schemas/SmsManagementSubscriptionData'
    lcsPrivacyData:
      $ref: '#/components/schemas/LcsPrivacyData'
    lcsMoData:
      $ref: '#/components/schemas/LcsMoData'
    v2xDData:
      $ref: '#/components/schemas/V2xSubscriptionData'
    lcsBroadcastAssistanceTypesData:
      $ref: '#/components/schemas/LcsBroadcastAssistanceTypesData'

UeContextInSmsfData:
  type: object
  properties:
    smsfInfo3GppAccess:
      $ref: '#/components/schemas/SmsfInfo'
    smsfInfoNon3GppAccess:
      $ref: '#/components/schemas/SmsfInfo'

SmsfInfo:
  type: object
  required:
    - smsfInstanceId
    - plmnId
  properties:
    smsfInstanceId:
      $ref: 'TS29571_CommonData.yaml#/components/schemas/NfInstanceId'
    plmnId:
      $ref: 'TS29571_CommonData.yaml#/components/schemas/PlmnId'

AccessAndMobilitySubscriptionData:
  type: object
  properties:
    supportedFeatures:
      $ref: 'TS29571_CommonData.yaml#/components/schemas/SupportedFeatures'
    gpsis:
      type: array
      items:
```

```

    $ref: 'TS29571_CommonData.yaml#/components/schemas/Gpsi'
  internalGroupIds:
    type: array
    items:
      $ref: 'TS29571_CommonData.yaml#/components/schemas/GroupId'
    minItems: 1
  sharedVnGroupDataIds:
    type: object
    additionalProperties:
      $ref: '#/components/schemas/SharedDataId'
    minProperties: 1
  subscribedUeAmbr:
    $ref: 'TS29571_CommonData.yaml#/components/schemas/AmbrRm'
  nssai:
    $ref: '#/components/schemas/Nssai'
  ratRestrictions:
    type: array
    items:
      $ref: 'TS29571_CommonData.yaml#/components/schemas/RatType'
  forbiddenAreas:
    type: array
    items:
      $ref: 'TS29571_CommonData.yaml#/components/schemas/Area'
  serviceAreaRestriction:
    $ref: 'TS29571_CommonData.yaml#/components/schemas/ServiceAreaRestriction'
  coreNetworkTypeRestrictions:
    type: array
    items:
      $ref: 'TS29571_CommonData.yaml#/components/schemas/CoreNetworkType'
  rfspIndex:
    $ref: 'TS29571_CommonData.yaml#/components/schemas/RfspIndexRm'
  subsRegTimer:
    $ref: 'TS29571_CommonData.yaml#/components/schemas/DurationSecRm'
  ueUsageType:
    $ref: '#/components/schemas/UeUsageType'
  mpsPriority:
    $ref: '#/components/schemas/MpsPriorityIndicator'
  mcsPriority:
    $ref: '#/components/schemas/McsPriorityIndicator'
  activeTime:
    $ref: 'TS29571_CommonData.yaml#/components/schemas/DurationSecRm'
  sorInfo:
    $ref: '#/components/schemas/SorInfo'
  sorInfoExpectInd:
    type: boolean
  sorafRetrieval:
    type: boolean
    default: false
  sorUpdateIndicatorList:
    type: array
    items:
      $ref: '#/components/schemas/SorUpdateIndicator'
    minItems: 1
  upuInfo:
    $ref: '#/components/schemas/UpuInfo'
  micoAllowed:
    $ref: '#/components/schemas/MicoAllowed'
  sharedAmDataIds:
    type: array
    items:
      $ref: '#/components/schemas/SharedDataId'
    minItems: 1
  odbPacketServices:
    $ref: 'TS29571_CommonData.yaml#/components/schemas/OdbPacketServices'
  subscribedDnnList:
    type: array
    items:
      anyOf:
        - $ref: 'TS29571_CommonData.yaml#/components/schemas/Dnn'
        - $ref: 'TS29571_CommonData.yaml#/components/schemas/WildcardDnn'
  serviceGapTime:
    $ref: 'TS29571_CommonData.yaml#/components/schemas/DurationSec'
  mdtUserConsent:
    $ref: '#/components/schemas/MdtUserConsent'
  mdtConfiguration:
    $ref: 'TS29571_CommonData.yaml#/components/schemas/MdtConfiguration'
  traceData:
    $ref: 'TS29571_CommonData.yaml#/components/schemas/TraceData'

```

```

cagData:
  $ref: '#/components/schemas/CagData'
stnSr:
  $ref: 'TS29571_CommonData.yaml#/components/schemas/StnSr'
cMsisdn:
  $ref: 'TS29571_CommonData.yaml#/components/schemas/CMsisdn'
nbIoTUEPriority:
  $ref: '#/components/schemas/NbIoTUEPriority'
nssaiInclusionAllowed:
  type: boolean
  default: false
rgWirelineCharacteristics:
  $ref: 'TS29571_CommonData.yaml#/components/schemas/RgWirelineCharacteristics'
ecRestrictionDataWb:
  $ref: '#/components/schemas/EcRestrictionDataWb'
ecRestrictionDataNb:
  type: boolean
  default: false
expectedUeBehaviourList:
  $ref: '#/components/schemas/ExpectedUeBehaviourData'
primaryRatRestrictions:
  type: array
  items:
    $ref: 'TS29571_CommonData.yaml#/components/schemas/RatType'
secondaryRatRestrictions:
  type: array
  items:
    $ref: 'TS29571_CommonData.yaml#/components/schemas/RatType'
edrxParametersList:
  type: array
  items:
    $ref: '#/components/schemas/EdrxParameters'
  minItems: 1
ptwParametersList:
  type: array
  items:
    $ref: '#/components/schemas/PtwParameters'
  minItems: 1
iabOperationAllowed:
  type: boolean
  default: false
wirelineForbiddenAreas:
  type: array
  items:
    $ref: 'TS29571_CommonData.yaml#/components/schemas/WirelineArea'
wirelineServiceAreaRestriction:
  $ref: 'TS29571_CommonData.yaml#/components/schemas/WirelineServiceAreaRestriction'

CagData:
  type: object
  required:
    - cagInfos
  properties:
    cagInfos:
      description: A map (list of key-value pairs where PlmnId serves as key) of CagInfo
      type: object
      additionalProperties:
        $ref: '#/components/schemas/CagInfo'
    provisioningTime:
      $ref: 'TS29571_CommonData.yaml#/components/schemas/DateTime'

CagInfo:
  type: object
  required:
    - allowedCagList
  properties:
    allowedCagList:
      type: array
      items:
        $ref: 'TS29571_CommonData.yaml#/components/schemas/CagId'
    cagOnlyIndicator:
      type: boolean

SmfSelectionSubscriptionData:
  type: object
  properties:
    supportedFeatures:
      $ref: 'TS29571_CommonData.yaml#/components/schemas/SupportedFeatures'

```

```
    subscribedSnssaiInfos:
      type: object
      additionalProperties:
        $ref: '#/components/schemas/SnssaiInfo'
    sharedSnssaiInfosId:
      $ref: '#/components/schemas/SharedDataId'

SnssaiInfo:
  type: object
  required:
    - dnnInfos
  properties:
    dnnInfos:
      type: array
      items:
        $ref: '#/components/schemas/DnnInfo'
      minItems: 1

DnnInfo:
  type: object
  required:
    - dnn
  properties:
    dnn:
      anyOf:
        - $ref: 'TS29571_CommonData.yaml#/components/schemas/Dnn'
        - $ref: 'TS29571_CommonData.yaml#/components/schemas/WildcardDnn'
    defaultDnnIndicator:
      $ref: '#/components/schemas/DnnIndicator'
    lboRoamingAllowed:
      $ref: '#/components/schemas/LboRoamingAllowed'
    iwkEpsInd:
      $ref: '#/components/schemas/IwkEpsInd'
    dnnBarred:
      type: boolean
    invokeNefInd:
      type: boolean
    smfList:
      type: array
      items:
        $ref: 'TS29571_CommonData.yaml#/components/schemas/NfInstanceId'
      minItems: 1
    sameSmfInd:
      type: boolean

Nssai:
  type: object
  required:
    - defaultSingleNssais
  properties:
    supportedFeatures:
      $ref: 'TS29571_CommonData.yaml#/components/schemas/SupportedFeatures'
    defaultSingleNssais:
      type: array
      items:
        $ref: 'TS29571_CommonData.yaml#/components/schemas/Snssai'
      minItems: 1
    singleNssais:
      type: array
      items:
        $ref: 'TS29571_CommonData.yaml#/components/schemas/Snssai'
      minItems: 1
    provisioningTime:
      $ref: 'TS29571_CommonData.yaml#/components/schemas/DateTime'
    additionalSnssaiData:
      type: object
      additionalProperties:
        $ref: '#/components/schemas/AdditionalSnssaiData'
      minProperties: 1
  nullable: true

UeContextInAmfData:
  type: object
  properties:
    epsInterworkingInfo:
      $ref: 'TS29503_Nudm_UECM.yaml#/components/schemas/EpsInterworkingInfo'

UeContextInSmfData:
```



```

    type: object
    properties:
      pduSessions:
        description: A map (list of key-value pairs where PduSessionId serves as key) of
PduSessions
        type: object
        additionalProperties:
          $ref: '#/components/schemas/PduSession'
        pgwInfo:
          type: array
          items:
            $ref: '#/components/schemas/PgwInfo'
          minItems: 1
        emergencyInfo:
          $ref: '#/components/schemas/EmergencyInfo'

EmergencyInfo:
  type: object
  oneOf:
    - required:
      - pgwFqdn
    - required:
      - pgwIpAddress
  properties:
    pgwFqdn:
      type: string
    pgwIpAddress:
      $ref: '#/components/schemas/IpAddress'
    smfInstanceId:
      $ref: 'TS29571_CommonData.yaml#/components/schemas/NfInstanceId'
    epdgInd:
      type: boolean
      default: false

PduSession:
  type: object
  required:
    - dnn
    - smfInstanceId
    - plmnId
  properties:
    dnn:
      $ref: 'TS29571_CommonData.yaml#/components/schemas/Dnn'
    smfInstanceId:
      $ref: 'TS29571_CommonData.yaml#/components/schemas/NfInstanceId'
    plmnId:
      $ref: 'TS29571_CommonData.yaml#/components/schemas/PlmnId'
    singleNssai:
      $ref: 'TS29571_CommonData.yaml#/components/schemas/Snssai'

PgwInfo:
  type: object
  required:
    - dnn
    - pgwFqdn
  properties:
    dnn:
      $ref: 'TS29571_CommonData.yaml#/components/schemas/Dnn'
    pgwFqdn:
      type: string
    plmnId:
      $ref: 'TS29571_CommonData.yaml#/components/schemas/PlmnId'
    epdgInd:
      type: boolean
      default: false

SessionManagementSubscriptionData:
  type: object
  required:
    - singleNssai
  properties:
    singleNssai:
      $ref: 'TS29571_CommonData.yaml#/components/schemas/Snssai'
    dnnConfigurations:
      description: A map (list of key-value pairs where Dnn, or optionally the Wildcard DNN,
serves as key) of DnnConfigurations
      type: object

```

```

    additionalProperties:
      $ref: '#/components/schemas/DnnConfiguration'
  internalGroupIds:
    type: array
    items:
      $ref: 'TS29571_CommonData.yaml#/components/schemas/GroupId'
    minItems: 1
  sharedVnGroupDataIds:
    type: object
    additionalProperties:
      $ref: '#/components/schemas/SharedDataId'
    minProperties: 1
  sharedDnnConfigurationsId:
    $ref: '#/components/schemas/SharedDataId'
  odbPacketServices:
    $ref: 'TS29571_CommonData.yaml#/components/schemas/OdbPacketServices'
  traceData:
    $ref: 'TS29571_CommonData.yaml#/components/schemas/TraceData'
  sharedTraceDataId:
    $ref: '#/components/schemas/SharedDataId'
  expectedUeBehavioursList:
    type: object
    additionalProperties:
      $ref: '#/components/schemas/ExpectedUeBehaviourData'
    minProperties: 1
  suggestedPacketNumDlList:
    type: object
    additionalProperties:
      $ref: '#/components/schemas/SuggestedPacketNumDl'
    minProperties: 1
  3gppChargingCharacteristics:
    $ref: '#/components/schemas/3GppChargingCharacteristics'

DnnConfiguration:
  type: object
  required:
    - pduSessionTypes
    - sscModes
  properties:
    pduSessionTypes:
      $ref: '#/components/schemas/PduSessionTypes'
    sscModes:
      $ref: '#/components/schemas/SscModes'
    iwkEpsInd:
      $ref: '#/components/schemas/IwkEpsInd'
    5gQosProfile:
      $ref: 'TS29571_CommonData.yaml#/components/schemas/SubscribedDefaultQos'
    sessionAmbr:
      $ref: 'TS29571_CommonData.yaml#/components/schemas/Ambr'
    3gppChargingCharacteristics:
      $ref: '#/components/schemas/3GppChargingCharacteristics'
    staticIpAddress:
      type: array
      items:
        $ref: '#/components/schemas/IpAddress'
      minItems: 1
      maxItems: 2
    upSecurity:
      $ref: 'TS29571_CommonData.yaml#/components/schemas/UpSecurity'
    pduSessionContinuityInd:
      $ref: '#/components/schemas/PduSessionContinuityInd'
    niddNefId:
      $ref: 'TS29510_Nnrf_NFManagement.yaml#/components/schemas/NefId'
    niddInfo:
      $ref: '#/components/schemas/NiddInformation'
    redundantSessionAllowed:
      type: boolean
    acsInfo:
      $ref: 'TS29571_CommonData.yaml#/components/schemas/AcsInfo'
    ipv4FrameRouteList:
      type: array
      items:
        $ref: '#/components/schemas/FrameRouteInfo'
      minItems: 1
    ipv6FrameRouteList:
      type: array
      items:
        $ref: '#/components/schemas/FrameRouteInfo'

```

```
    minItems: 1
    atsssAllowed:
      type: boolean
      default: false
    secondaryAuth:
      type: boolean
    dnAaaIpAddressAllocation:
      type: boolean
    dnAaaAddress:
      $ref: '#/components/schemas/IpAddress'
    iptvAccCtrlInfo:
      type: string

NiddInformation:
  type: object
  required:
    - afId
  properties:
    afId:
      type: string
    gpsi:
      $ref: 'TS29571_CommonData.yaml#/components/schemas/Gpsi'
    extGroupId:
      $ref: 'TS29571_CommonData.yaml#/components/schemas/ExternalGroupId'

IpAddress:
  type: object
  oneOf:
    - required:
        - ipv4Addr
      - required:
        - ipv6Addr
      - required:
        - ipv6Prefix
  properties:
    ipv4Addr:
      $ref: 'TS29571_CommonData.yaml#/components/schemas/Ipv4Addr'
    ipv6Addr:
      $ref: 'TS29571_CommonData.yaml#/components/schemas/Ipv6Addr'
    ipv6Prefix:
      $ref: 'TS29571_CommonData.yaml#/components/schemas/Ipv6Prefix'

PduSessionTypes:
  type: object
  required:
    - defaultSessionType
  properties:
    defaultSessionType:
      $ref: 'TS29571_CommonData.yaml#/components/schemas/PduSessionType'
    allowedSessionTypes:
      type: array
      items:
        $ref: 'TS29571_CommonData.yaml#/components/schemas/PduSessionType'
      minItems: 1

SscModes:
  type: object
  required:
    - defaultSscMode
  properties:
    defaultSscMode:
      $ref: 'TS29571_CommonData.yaml#/components/schemas/SscMode'
    allowedSscModes:
      type: array
      items:
        $ref: 'TS29571_CommonData.yaml#/components/schemas/SscMode'
      minItems: 1
      maxItems: 2

SmsSubscriptionData:
  type: object
  properties:
    smsSubscribed:
      $ref: '#/components/schemas/SmsSubscribed'
    sharedSmsSubsDataId:
      $ref: '#/components/schemas/SharedDataId'

SmsManagementSubscriptionData:
```

```
type: object
properties:
  supportedFeatures:
    $ref: 'TS29571_CommonData.yaml#/components/schemas/SupportedFeatures'
  mtSmsSubscribed:
    type: boolean
  mtSmsBarringAll:
    type: boolean
  mtSmsBarringRoaming:
    type: boolean
  moSmsSubscribed:
    type: boolean
  moSmsBarringAll:
    type: boolean
  moSmsBarringRoaming:
    type: boolean
  sharedSmsMngDataIds:
    type: array
    items:
      $ref: '#/components/schemas/SharedDataId'
    minItems: 1
  traceData:
    $ref: 'TS29571_CommonData.yaml#/components/schemas/TraceData'

SdmSubscription:
  type: object
  required:
    - nfInstanceId
    - callbackReference
    - monitoredResourceUris
  properties:
    nfInstanceId:
      $ref: 'TS29571_CommonData.yaml#/components/schemas/NfInstanceId'
    implicitUnsubscribe:
      type: boolean
    expires:
      $ref: 'TS29571_CommonData.yaml#/components/schemas/DateTime'
    callbackReference:
      $ref: 'TS29571_CommonData.yaml#/components/schemas/Uri'
    amfServiceName:
      $ref: 'TS29510_Nnrf_NFManagement.yaml#/components/schemas/ServiceName'
    monitoredResourceUris:
      type: array
      items:
        $ref: 'TS29571_CommonData.yaml#/components/schemas/Uri'
      minItems: 1
    singleNssai:
      $ref: 'TS29571_CommonData.yaml#/components/schemas/Snssai'
    dnn:
      $ref: 'TS29571_CommonData.yaml#/components/schemas/Dnn'
    subscriptionId:
      type: string
    plmnId:
      $ref: 'TS29571_CommonData.yaml#/components/schemas/PlmnId'
    immediateReport:
      type: boolean
      default: false
    report:
      $ref: '#/components/schemas/SubscriptionDataSets'
    supportedFeatures:
      $ref: 'TS29571_CommonData.yaml#/components/schemas/SupportedFeatures'
    contextInfo:
      $ref: '#/components/schemas/ContextInfo'
    uniqueSubscription:
      type: boolean

SdmSubsModification:
  type: object
  properties:
    expires:
      $ref: 'TS29571_CommonData.yaml#/components/schemas/DateTime'
    monitoredResourceUris:
      type: array
      items:
        $ref: 'TS29571_CommonData.yaml#/components/schemas/Uri'
      minItems: 1

ModificationNotification:
```

```

type: object
required:
- notifyItems
properties:
  notifyItems:
    type: array
    items:
      $ref: 'TS29571_CommonData.yaml#/components/schemas/NotifyItem'
    minItems: 1

IdTranslationResult:
type: object
required:
- supi
properties:
  supportedFeatures:
    $ref: 'TS29571_CommonData.yaml#/components/schemas/SupportedFeatures'
  supi:
    $ref: 'TS29571_CommonData.yaml#/components/schemas/Supi'
  gpsi:
    $ref: 'TS29571_CommonData.yaml#/components/schemas/Gpsi'

AcknowledgeInfo:
type: object
required:
- provisioningTime
properties:
  sorMacIue:
    $ref: 'TS29509_Nausf_SoRProtection.yaml#/components/schemas/SorMac'
  upuMacIue:
    $ref: 'TS29509_Nausf_UPUProtection.yaml#/components/schemas/UpuMac'
  securedPacket:
    $ref: '#/components/schemas/SecuredPacket'
  provisioningTime:
    $ref: 'TS29571_CommonData.yaml#/components/schemas/DateTime'
  ueNotReachable:
    type: boolean
    default: false

SorInfo:
type: object
properties:
  steeringContainer:
    $ref: '#/components/schemas/SteeringContainer'
  ackInd:
    $ref: 'TS29509_Nausf_SoRProtection.yaml#/components/schemas/AckInd'
  sorMacIausf:
    $ref: 'TS29509_Nausf_SoRProtection.yaml#/components/schemas/SorMac'
  countersor:
    $ref: 'TS29509_Nausf_SoRProtection.yaml#/components/schemas/CounterSor'
  provisioningTime:
    $ref: 'TS29571_CommonData.yaml#/components/schemas/DateTime'
required:
- ackInd
- provisioningTime

SharedDataIds:
type: array
items:
  $ref: '#/components/schemas/SharedDataId'
minItems: 1
uniqueItems: true

UpuInfo:
type: object
properties:
  upuDataList:
    type: array
    items:
      $ref: 'TS29509_Nausf_UPUProtection.yaml#/components/schemas/UpuData'
    minItems: 1
  upuRegInd:
    $ref: '#/components/schemas/UpuRegInd'
  upuAckInd:
    $ref: 'TS29509_Nausf_UPUProtection.yaml#/components/schemas/UpuAckInd'
  upuMacIausf:
    $ref: 'TS29509_Nausf_UPUProtection.yaml#/components/schemas/UpuMac'
  counterUpu:

```

```

    $ref: 'TS29509_Nausf_UPUProtection.yaml#/components/schemas/CounterUpu'
  provisioningTime:
    $ref: 'TS29571_CommonData.yaml#/components/schemas/DateTime'
  required:
  - upuDataList
  - upuAckInd
  - upuRegInd
  - provisioningTime

SharedData:
  type: object
  required:
  - sharedDataId
  properties:
    sharedDataId:
      $ref: '#/components/schemas/SharedDataId'
    sharedAmData:
      $ref: '#/components/schemas/AccessAndMobilitySubscriptionData'
    sharedSmsSubsData:
      $ref: '#/components/schemas/SmsSubscriptionData'
    sharedSmsMngSubsData:
      $ref: '#/components/schemas/SmsManagementSubscriptionData'
    sharedDnnConfigurations:
      type: object
      additionalProperties:
        $ref: '#/components/schemas/DnnConfiguration'
    sharedTraceData:
      $ref: 'TS29571_CommonData.yaml#/components/schemas/TraceData'
    sharedSnssaiInfos:
      type: object
      additionalProperties:
        $ref: '#/components/schemas/SnssaiInfo'
    sharedVnGroupDatas:
      type: object
      additionalProperties:
        $ref: '#/components/schemas/VnGroupData'
      minProperties: 1

TraceDataResponse:
  type: object
  properties:
    traceData:
      $ref: 'TS29571_CommonData.yaml#/components/schemas/TraceData'
    sharedTraceDataId:
      $ref: '#/components/schemas/SharedDataId'

SteeringContainer:
  oneOf:
  - type: array
    items:
      $ref: 'TS29509_Nausf_SoRProtection.yaml#/components/schemas/SteeringInfo'
    minItems: 1
  - $ref: '#/components/schemas/SecuredPacket'

GroupIdentifiers:
  type: object
  properties:
    extGroupId:
      $ref: '#/components/schemas/ExtGroupId'
    intGroupId:
      $ref: 'TS29571_CommonData.yaml#/components/schemas/GroupId'
    ueIdList:
      type: array
      items:
        $ref: '#/components/schemas/UeId'
      minItems: 1

VnGroupData:
  type: object
  properties:
    pduSessionTypes:
      $ref: '#/components/schemas/PduSessionTypes'
    dnn:
      $ref: 'TS29571_CommonData.yaml#/components/schemas/Dnn'
    singleNssai:
      $ref: 'TS29571_CommonData.yaml#/components/schemas/Snssai'
    appDescriptors:

```

```
    type: array
    items:
      $ref: '#/components/schemas/AppDescriptor'
    minItems: 1

AppDescriptor:
  type: object
  properties:
    osId:
      $ref: 'TS29519_Policy_Data.yaml#/components/schemas/OsId'
    appId:
      type: string

AdditionalSnssaiData:
  type: object
  properties:
    requiredAuthnAuthz:
      type: boolean

AppPortId:
  type: object
  properties:
    destinationPort:
      $ref: 'TS29571_CommonData.yaml#/components/schemas/Uint16'
    originatorPort:
      $ref: 'TS29571_CommonData.yaml#/components/schemas/Uint16'

LcsPrivacyData:
  type: object
  properties:
    lpi:
      $ref: '#/components/schemas/Lpi'
    unrelatedClass:
      $ref: '#/components/schemas/UnrelatedClass'
    plmnOperatorClasses:
      type: array
      items:
        $ref: '#/components/schemas/PlmnOperatorClass'
      minItems: 1

Lpi:
  type: object
  required:
    - locationPrivacyInd
  properties:
    locationPrivacyInd:
      $ref: '#/components/schemas/LocationPrivacyInd'
    validTimePeriod:
      $ref: '#/components/schemas/ValidTimePeriod'

UnrelatedClass:
  type: object
  required:
    - defaultUnrelatedClass
  properties:
    defaultUnrelatedClass:
      $ref: '#/components/schemas/DefaultUnrelatedClass'
    externalUnrelatedClass:
      $ref: '#/components/schemas/ExternalUnrelatedClass'
    serviceTypeUnrelatedClasses:
      type: array
      items:
        $ref: '#/components/schemas/ServiceTypeUnrelatedClass'
      minItems: 1

PlmnOperatorClass:
  type: object
  required:
    - lcsClientClass
    - lcsClientIds
  properties:
    lcsClientClass:
      $ref: '#/components/schemas/LcsClientClass'
    lcsClientIds:
      type: array
      items:
        $ref: '#/components/schemas/LcsClientId'
      minItems: 1
```

```
ValidTimePeriod:
  type: object
  properties:
    startTime:
      $ref: 'TS29571_CommonData.yaml#/components/schemas/DateTime'
    endTime:
      $ref: 'TS29571_CommonData.yaml#/components/schemas/DateTime'

ExternalUnrelatedClass:
  properties:
    lcsClientExternals:
      type: array
      items:
        $ref: '#/components/schemas/LcsClientExternal'
      minItems: 1
    afExternals:
      type: array
      items:
        $ref: '#/components/schemas/AfExternal'
      minItems: 1
    lcsClientGroupExternals:
      type: array
      items:
        $ref: '#/components/schemas/LcsClientGroupExternal'
      minItems: 1

AfExternal:
  type: object
  properties:
    afId:
      $ref: '#/components/schemas/AfId'
    allowedGeographicArea:
      type: array
      items:
        $ref: 'TS29572_Nlmf_Location.yaml#/components/schemas/GeographicArea'
      minItems: 1
    privacyCheckRelatedAction:
      $ref: '#/components/schemas/PrivacyCheckRelatedAction'
    validTimePeriod:
      $ref: '#/components/schemas/ValidTimePeriod'

LcsClientExternal:
  type: object
  properties:
    allowedGeographicArea:
      type: array
      items:
        $ref: 'TS29572_Nlmf_Location.yaml#/components/schemas/GeographicArea'
      minItems: 1
    privacyCheckRelatedAction:
      $ref: '#/components/schemas/PrivacyCheckRelatedAction'
    validTimePeriod:
      $ref: '#/components/schemas/ValidTimePeriod'

LcsClientGroupExternal:
  type: object
  properties:
    lcsClientGroupId:
      $ref: '#/components/schemas/ExtGroupId'
    allowedGeographicArea:
      type: array
      items:
        $ref: 'TS29572_Nlmf_Location.yaml#/components/schemas/GeographicArea'
      minItems: 1
    privacyCheckRelatedAction:
      $ref: '#/components/schemas/PrivacyCheckRelatedAction'
    validTimePeriod:
      $ref: '#/components/schemas/ValidTimePeriod'

ServiceTypeUnrelatedClass:
  type: object
  required:
    - serviceType
  properties:
    serviceType:
      $ref: 'TS29572_Nlmf_Location.yaml#/components/schemas/LcsServiceType'
    allowedGeographicArea:
```



```

    type: array
    items:
      $ref: 'TS29572_Nlmf_Location.yaml#/components/schemas/GeographicArea'
    minItems: 1
  privacyCheckRelatedAction:
    $ref: '#/components/schemas/PrivacyCheckRelatedAction'
  codeWordInd:
    $ref: '#/components/schemas/CodeWordInd'
  validTimePeriod:
    $ref: '#/components/schemas/ValidTimePeriod'
  codeWordList:
    type: array
    items:
      $ref: '#/components/schemas/CodeWord'
    minItems: 1

LcsMoData:
  type: object
  required:
    - allowedServiceClasses
  properties:
    allowedServiceClasses:
      type: array
      items:
        $ref: '#/components/schemas/LcsMoServiceClass'
      minItems: 1

LcsBroadcastAssistanceTypesData:
  type: object
  required:
    - locationAssistanceType
  properties:
    locationAssistanceType:
      $ref: 'TS29571_CommonData.yaml#/components/schemas/Bytes'

EcRestrictionDataWb:
  type: object
  anyOf:
    - required: [ ecModeARestricted ]
    - required: [ ecModeBRestricted ]
  properties:
    ecModeARestricted:
      type: boolean
    ecModeBRestricted:
      type: boolean

ExpectedUeBehaviourData:
  type: object
  properties:
    stationaryIndication:
      $ref: 'TS29571_CommonData.yaml#/components/schemas/StationaryIndication'
    communicationDurationTime:
      $ref: 'TS29571_CommonData.yaml#/components/schemas/DurationSec'
    periodicTime:
      $ref: 'TS29571_CommonData.yaml#/components/schemas/DurationSec'
    scheduledCommunicationTime:
      $ref: 'TS29571_CommonData.yaml#/components/schemas/ScheduledCommunicationTime'
    scheduledCommunicationType:
      $ref: 'TS29571_CommonData.yaml#/components/schemas/ScheduledCommunicationType'
    expectedUmts:
      type: array
      items:
        $ref: 'TS29503_Nudm_PP.yaml#/components/schemas/LocationArea'
      minItems: 1
    description: Identifies the UE's expected geographical movement. The attribute is only
applicable in 5G.
    trafficProfile:
      $ref: 'TS29571_CommonData.yaml#/components/schemas/TrafficProfile'
    batteryIndication:
      $ref: 'TS29571_CommonData.yaml#/components/schemas/BatteryIndication'
    validityTime:
      $ref: 'TS29571_CommonData.yaml#/components/schemas/DateTime'

SuggestedPacketNumDl:
  type: object
  required:
    - suggestedPacketNumDl

```

```
properties:
  suggestedPacketNumDl:
    type: integer
    minimum: 1
  validityTime:
    $ref: 'TS29571_CommonData.yaml#/components/schemas/DateTime'

FrameRouteInfo:
  type: object
  properties:
    ipv4Mask:
      $ref: 'TS29571_CommonData.yaml#/components/schemas/Ipv4AddrMask'
    ipv6Prefix:
      $ref: 'TS29571_CommonData.yaml#/components/schemas/Ipv6Prefix'

SorUpdateInfo:
  type: object
  required:
    - vplmnId
  properties:
    vplmnId:
      $ref: 'TS29571_CommonData.yaml#/components/schemas/PlmnId'

EnhancedCoverageRestrictionData:
  type: object
  properties:
    plmnEcInfoList:
      type: array
      items:
        $ref: 'TS29503_Nudm_PP.yaml#/components/schemas/PlmnEcInfo'
      minItems: 1

EdrxParameters:
  type: object
  required:
    - ratType
    - edrxValue
  properties:
    ratType:
      $ref: 'TS29571_CommonData.yaml#/components/schemas/RatType'
    edrxValue:
      type: string
      pattern: '^([0-1]{4})$'

PtwParameters:
  type: object
  required:
    - operationMode
    - ptwValue
  properties:
    operationMode:
      $ref: '#/components/schemas/OperationMode'
    ptwValue:
      type: string
      pattern: '^([0-1]{4})$'

UeId:
  type: object
  required:
    - supi
  properties:
    supi:
      $ref: 'TS29571_CommonData.yaml#/components/schemas/Supi'
    gpsiList:
      type: array
      items:
        $ref: 'TS29571_CommonData.yaml#/components/schemas/Gpsi'
      minItems: 1

V2xSubscriptionData:
  type: object
  properties:
    nrV2xServicesAuth:
      $ref: 'TS29571_CommonData.yaml#/components/schemas/NrV2xAuth'
    lteV2xServicesAuth:
      $ref: 'TS29571_CommonData.yaml#/components/schemas/LteV2xAuth'
    nrUePc5Ambr:
      $ref: 'TS29571_CommonData.yaml#/components/schemas/BitRate'
```

```
ltePc5Ambr:
  $ref: 'TS29571_CommonData.yaml#/components/schemas/BitRate'

DefaultUnrelatedClass:
  type: object
  properties:
    allowedGeographicArea:
      type: array
      items:
        $ref: 'TS29572_Nlmf_Location.yaml#/components/schemas/GeographicArea'
      minItems: 1
    privacyCheckRelatedAction:
      $ref: '#/components/schemas/PrivacyCheckRelatedAction'
    codeWordInd:
      $ref: '#/components/schemas/CodeWordInd'
    validTimePeriod:
      $ref: '#/components/schemas/ValidTimePeriod'
    codeWordList:
      type: array
      items:
        $ref: '#/components/schemas/CodeWord'
      minItems: 1

ContextInfo:
  type: object
  properties:
    origHeaders:
      type: array
      items:
        type: string
      minItems: 1

# SIMPLE TYPES:

UeUsageType:
  type: integer

MpsPriorityIndicator:
  type: boolean

McsPriorityIndicator:
  type: boolean

DnnIndicator:
  type: boolean

LboRoamingAllowed:
  type: boolean

SmsSubscribed:
  type: boolean

3GppChargingCharacteristics:
  type: string

MicoAllowed:
  type: boolean

SharedDataId:
  type: string
  pattern: '^ [0-9] {5,6} - . + $'

IwkEpsInd:
  type: boolean

SecuredPacket:
  type: string
  format: byte

UpuRegInd:
  type: boolean

ExtGroupId:
  type: string
  pattern: '^ extgroupid - [^@] + @[^@] + $'

NbIoTUEPriority:
  type: integer
```

minimum: 0
maximum: 255

CodeWord:
type: string

AfId:
type: string

LcsClientId:
type: string

ENUMS:

DataSetName:
anyOf:
- type: string
enum:
- AM
- SMF_SEL
- UEC_SMF
- UEC_SMSF
- SMS_SUB
- SM
- TRACE
- SMS_MNG
- LCS_PRIVACY
- LCS_MO
- UEC_AMF
- V2X
- type: string

PduSessionContinuityInd:
anyOf:
- type: string
enum:
- MAINTAIN_PDUSESSION
- RECONNECT_PDUSESSION
- RELEASE_PDUSESSION
- type: string

LocationPrivacyInd:
anyOf:
- type: string
enum:
- LOCATION_DISALLOWED
- LOCATION_ALLOWED
- type: string

PrivacyCheckRelatedAction:
anyOf:
- type: string
enum:
- LOCATION_NOT_ALLOWED
- LOCATION_ALLOWED_WITH_NOTIFICATION
- LOCATION_ALLOWED_WITHOUT_NOTIFICATION
- LOCATION_ALLOWED_WITHOUT_RESPONSE
- LOCATION_RESTRICTED_WITHOUT_RESPONSE
- type: string

LcsClientClass:
anyOf:
- type: string
enum:
- BROADCAST_SERVICE
- OM_IN_HPLMN
- OM_IN_VPLMN
- ANONYMOUS_LOCATION_SERVICE
- SPECIFIC_SERVICE
- type: string

LcsMoServiceClass:
anyOf:
- type: string
enum:
- BASIC_SELF_LOCATION

```

    - AUTONOMOUS_SELF_LOCATION
    - TRANSFER_TO_THIRD_PARTY
  - type: string

OperationMode:
  anyOf:
    - type: string
      enum:
        - WB_S1
        - NB_S1
        - WB_N1
        - NB_N1
    - type: string

SorUpdateIndicator:
  anyOf:
    - type: string
      enum:
        - INITIAL_REGISTRATION
        - EMERGENCY_REGISTRATION
    - type: string

CodeWordInd:
  anyOf:
    - type: string
      enum:
        - CODEWORD_CHECK_IN_UE
        - CODEWORD_CHECK_IN_GMLC
    - type: string

MdtUserConsent:
  anyOf:
    - type: string
      enum:
        - CONSENT_NOT_GIVEN
        - CONSENT_GIVEN
    - type: string

```

A.3 Nudm_UECM API

openapi: 3.0.0

```

info:
  version: '1.1.6'
  title: 'Nudm_UECM'
  description: |
    Nudm Context Management Service.
    © 2022, 3GPP Organizational Partners (ARIB, ATIS, CCSA, ETSI, TSDSI, TTA, TTC).
    All rights reserved.

externalDocs:
  description: 3GPP TS 29.503 Unified Data Management Services, version 16.14.0
  url: 'https://www.3gpp.org/ftp/Specs/archive/29_series/29.503/'

servers:
  - url: '{apiRoot}/nudm-uecm/v1'
    variables:
      apiRoot:
        default: https://example.com
        description: apiRoot as defined in clause 4.4 of 3GPP TS 29.501.

security:
  - oAuth2ClientCredentials:
    - nudm-uecm
  - {}

paths:
  /{ueId}/registrations:
    get:
      summary: retrieve UE registration data sets
      operationId: GetRegistrations
      tags:
        - UECM Registration Info Retrieval
      parameters:

```

```

- name: ueId
  in: path
  description: Identifier of the UE
  required: true
  schema:
    $ref: 'TS29571_CommonData.yaml#/components/schemas/VarUeId'
- name: supported-features
  in: query
  schema:
    $ref: 'TS29571_CommonData.yaml#/components/schemas/SupportedFeatures'
- name: registration-dataset-names
  in: query
  style: form
  explode: false
  description: List of UECM registration dataset names
  required: true
  schema:
    $ref: '#/components/schemas/RegistrationDatasetNames'
- name: single-nssai
  in: query
  content:
    application/json:
      schema:
        $ref: 'TS29571_CommonData.yaml#/components/schemas/Snssai'
- name: dnn
  in: query
  schema:
    $ref: 'TS29571_CommonData.yaml#/components/schemas/Dnn'
responses:
  '200':
    description: Expected response to a valid request
    content:
      application/json:
        schema:
          $ref: '#/components/schemas/RegistrationDataSets'
  '400':
    $ref: 'TS29571_CommonData.yaml#/components/responses/400'
  '403':
    $ref: 'TS29571_CommonData.yaml#/components/responses/403'
  '404':
    $ref: 'TS29571_CommonData.yaml#/components/responses/404'
  '500':
    $ref: 'TS29571_CommonData.yaml#/components/responses/500'
  '503':
    $ref: 'TS29571_CommonData.yaml#/components/responses/503'
  default:
    description: Unexpected error

/{ueId}/registrations/amf-3gpp-access:
  put:
    summary: register as AMF for 3GPP access
    operationId: 3GppRegistration
    tags:
      - AMF registration for 3GPP access
    parameters:
      - name: ueId
        in: path
        description: Identifier of the UE
        required: true
        schema:
          $ref: 'TS29571_CommonData.yaml#/components/schemas/Supi'
    requestBody:
      content:
        application/json:
          schema:
            $ref: '#/components/schemas/Amf3GppAccessRegistration'
      required: true
    responses:
      '201':
        description: Created
        content:
          application/json:
            schema:
              $ref: '#/components/schemas/Amf3GppAccessRegistration'
    headers:
      Location:
        description: 'Contains the URI of the newly created resource, according to the
structure: {apiRoot}/nudm-uecm/v1/{ueId}/registrations/amf-3gpp-access'
```

```

        required: true
        schema:
          type: string
      '200':
        description: OK
        content:
          application/json:
            schema:
              $ref: '#/components/schemas/Amf3GppAccessRegistration'
      '204':
        description: No content
      '400':
        $ref: 'TS29571_CommonData.yaml#/components/responses/400'
      '403':
        $ref: 'TS29571_CommonData.yaml#/components/responses/403'
      '404':
        $ref: 'TS29571_CommonData.yaml#/components/responses/404'
      '500':
        $ref: 'TS29571_CommonData.yaml#/components/responses/500'
      '503':
        $ref: 'TS29571_CommonData.yaml#/components/responses/503'
      default:
        description: Unexpected error
    callbacks:
      deregistrationNotification:
        '{request.body#/deregCallbackUri}':
          post:
            requestBody:
              required: true
              content:
                application/json:
                  schema:
                    $ref: '#/components/schemas/DeregistrationData'
            responses:
              '204':
                description: Successful Notification response
              '307':
                $ref: 'TS29571_CommonData.yaml#/components/responses/307'
              '308':
                $ref: 'TS29571_CommonData.yaml#/components/responses/308'
              '400':
                $ref: 'TS29571_CommonData.yaml#/components/responses/400'
              '404':
                $ref: 'TS29571_CommonData.yaml#/components/responses/404'
              '500':
                $ref: 'TS29571_CommonData.yaml#/components/responses/500'
              '503':
                $ref: 'TS29571_CommonData.yaml#/components/responses/503'
              default:
                description: Unexpected error
      pcscfRestorationNotification:
        '{request.body#/pcscfRestorationCallbackUri}':
          post:
            requestBody:
              required: true
              content:
                application/json:
                  schema:
                    $ref: '#/components/schemas/PcscfRestorationNotification'
            responses:
              '204':
                description: Successful Notification response
              '307':
                $ref: 'TS29571_CommonData.yaml#/components/responses/307'
              '308':
                $ref: 'TS29571_CommonData.yaml#/components/responses/308'
              '400':
                $ref: 'TS29571_CommonData.yaml#/components/responses/400'
              '404':
                $ref: 'TS29571_CommonData.yaml#/components/responses/404'
              '409':
                $ref: 'TS29571_CommonData.yaml#/components/responses/409'
              '500':
                $ref: 'TS29571_CommonData.yaml#/components/responses/500'
              '503':
                $ref: 'TS29571_CommonData.yaml#/components/responses/503'
              default:
                description: Unexpected error

```

```
patch:
  summary: Update a parameter in the AMF registration for 3GPP access
  operationId: Update3GppRegistration
  tags:
    - Parameter update in the AMF registration for 3GPP access
  parameters:
    - name: ueId
      in: path
      description: Identifier of the UE
      required: true
      schema:
        $ref: 'TS29571_CommonData.yaml#/components/schemas/Supi'
    - name: supported-features
      in: query
      description: Features required to be supported by the target NF
      schema:
        $ref: 'TS29571_CommonData.yaml#/components/schemas/SupportedFeatures'
  requestBody:
    content:
      application/merge-patch+json:
        schema:
          $ref: '#/components/schemas/Amf3GppAccessRegistrationModification'
        required: true
  responses:
    '200':
      description: Expected response to a valid request
      content:
        application/json:
          schema:
            $ref: 'TS29571_CommonData.yaml#/components/schemas/PatchResult'
    '204':
      description: Expected response to a valid request
    '400':
      $ref: 'TS29571_CommonData.yaml#/components/responses/400'
    '403':
      $ref: 'TS29571_CommonData.yaml#/components/responses/403'
    '404':
      $ref: 'TS29571_CommonData.yaml#/components/responses/404'
    '422':
      description: Unprocessable Request
      content:
        application/problem+json:
          schema:
            $ref: 'TS29571_CommonData.yaml#/components/schemas/ProblemDetails'
    '500':
      $ref: 'TS29571_CommonData.yaml#/components/responses/500'
    '503':
      $ref: 'TS29571_CommonData.yaml#/components/responses/503'
  default:
    description: Unexpected error

get:
  summary: retrieve the AMF registration for 3GPP access information
  operationId: Get3GppRegistration
  tags:
    - AMF 3Gpp-access Registration Info Retrieval
  parameters:
    - name: ueId
      in: path
      description: Identifier of the UE
      required: true
      schema:
        $ref: 'TS29571_CommonData.yaml#/components/schemas/VarUeId'
    - name: supported-features
      in: query
      schema:
        $ref: 'TS29571_CommonData.yaml#/components/schemas/SupportedFeatures'
  responses:
    '200':
      description: Expected response to a valid request
      content:
        application/json:
          schema:
            $ref: '#/components/schemas/Amf3GppAccessRegistration'
    '400':
      $ref: 'TS29571_CommonData.yaml#/components/responses/400'
    '403':
      $ref: 'TS29571_CommonData.yaml#/components/responses/403'
```



```

'404':
  $ref: 'TS29571_CommonData.yaml#/components/responses/404'
'500':
  $ref: 'TS29571_CommonData.yaml#/components/responses/500'
'503':
  $ref: 'TS29571_CommonData.yaml#/components/responses/503'
default:
  description: Unexpected error

/{ueId}/registrations/amf-3gpp-access/dereg-amf:
  post:
    summary: trigger AMF for 3GPP access deregistration
    operationId: deregAMF
    tags:
      - Trigger AMF for 3GPP access deregistration
    parameters:
      - name: ueId
        in: path
        description: Identifier of the UE
        required: true
        schema:
          $ref: 'TS29571_CommonData.yaml#/components/schemas/Supi'
    requestBody:
      content:
        application/json:
          schema:
            $ref: '#/components/schemas/AmfDeregInfo'
        required: true
    responses:
      '204':
        description: No content
      '400':
        $ref: 'TS29571_CommonData.yaml#/components/responses/400'
      '403':
        $ref: 'TS29571_CommonData.yaml#/components/responses/403'
      '404':
        $ref: 'TS29571_CommonData.yaml#/components/responses/404'
      '500':
        $ref: 'TS29571_CommonData.yaml#/components/responses/500'
      '503':
        $ref: 'TS29571_CommonData.yaml#/components/responses/503'
      default:
        description: Unexpected error

/{ueId}/registrations/amf-3gpp-access/pei-update:
  post:
    summary: Updates the PEI in the 3GPP access registration context
    operationId: PeiUpdate
    tags:
      - PEI Update
    parameters:
      - name: ueId
        in: path
        description: Identifier of the UE
        required: true
        schema:
          $ref: 'TS29571_CommonData.yaml#/components/schemas/Supi'
    requestBody:
      content:
        application/json:
          schema:
            $ref: '#/components/schemas/PeiUpdateInfo'
        required: true
    responses:
      '204':
        description: No content
      '400':
        $ref: 'TS29571_CommonData.yaml#/components/responses/400'
      '403':
        $ref: 'TS29571_CommonData.yaml#/components/responses/403'
      '404':
        $ref: 'TS29571_CommonData.yaml#/components/responses/404'
      '500':
        $ref: 'TS29571_CommonData.yaml#/components/responses/500'
      '503':
        $ref: 'TS29571_CommonData.yaml#/components/responses/503'
      default:
        description: Unexpected error

```

```

/{ueId}/registrations/amf-non-3gpp-access:
  put:
    summary: register as AMF for non-3GPP access
    operationId: Non3GppRegistration
    tags:
      - AMF registration for non-3GPP access
    parameters:
      - name: ueId
        in: path
        description: Identifier of the UE
        required: true
        schema:
          $ref: 'TS29571_CommonData.yaml#/components/schemas/Supi'
    requestBody:
      content:
        application/json:
          schema:
            $ref: '#/components/schemas/AmfNon3GppAccessRegistration'
          required: true
    responses:
      '201':
        description: Created
        content:
          application/json:
            schema:
              $ref: '#/components/schemas/AmfNon3GppAccessRegistration'
        headers:
          Location:
            description: 'Contains the URI of the newly created resource, according to the
structure: {apiRoot}/nudm-uecm/v1/{ueId}/registrations/amf-non-3gpp-access'
            required: true
            schema:
              type: string
      '200':
        description: OK
        content:
          application/json:
            schema:
              $ref: '#/components/schemas/AmfNon3GppAccessRegistration'
      '204':
        description: No Content
      '400':
        $ref: 'TS29571_CommonData.yaml#/components/responses/400'
      '403':
        $ref: 'TS29571_CommonData.yaml#/components/responses/403'
      '404':
        $ref: 'TS29571_CommonData.yaml#/components/responses/404'
      '500':
        $ref: 'TS29571_CommonData.yaml#/components/responses/500'
      '503':
        $ref: 'TS29571_CommonData.yaml#/components/responses/503'
    default:
      description: Unexpected error
    callbacks:
      deregistrationNotification:
        '{request.body#/deregCallbackUri}':
          post:
            requestBody:
              required: true
              content:
                application/json:
                  schema:
                    $ref: '#/components/schemas/DeregistrationData'
            responses:
              '204':
                description: Successful Notification response
              '307':
                $ref: 'TS29571_CommonData.yaml#/components/responses/307'
              '308':
                $ref: 'TS29571_CommonData.yaml#/components/responses/308'
              '400':
                $ref: 'TS29571_CommonData.yaml#/components/responses/400'
              '404':
                $ref: 'TS29571_CommonData.yaml#/components/responses/404'
              '500':
                $ref: 'TS29571_CommonData.yaml#/components/responses/500'
              '503':

```

```

    $ref: 'TS29571_CommonData.yaml#/components/responses/503'
  default:
    description: Unexpected error
pcscfRestorationNotification:
  '{request.body#/pcscfRestorationCallbackUri}':
    post:
      requestBody:
        required: true
        content:
          application/json:
            schema:
              $ref: '#/components/schemas/PcscfRestorationNotification'
      responses:
        '204':
          description: Successful Notification response
        '307':
          $ref: 'TS29571_CommonData.yaml#/components/responses/307'
        '308':
          $ref: 'TS29571_CommonData.yaml#/components/responses/308'
        '400':
          $ref: 'TS29571_CommonData.yaml#/components/responses/400'
        '404':
          $ref: 'TS29571_CommonData.yaml#/components/responses/404'
        '500':
          $ref: 'TS29571_CommonData.yaml#/components/responses/500'
        '503':
          $ref: 'TS29571_CommonData.yaml#/components/responses/503'
      default:
        description: Unexpected error
patch:
  summary: update a parameter in the AMF registration for non-3GPP access
  operationId: UpdateNon3GppRegistration
  tags:
    - Parameter update in the AMF registration for non-3GPP access
  parameters:
    - name: ueId
      in: path
      description: Identifier of the UE
      required: true
      schema:
        $ref: 'TS29571_CommonData.yaml#/components/schemas/Supi'
    - name: supported-features
      in: query
      description: Features required to be supported by the target NF
      schema:
        $ref: 'TS29571_CommonData.yaml#/components/schemas/SupportedFeatures'
  requestBody:
    content:
      application/merge-patch+json:
        schema:
          $ref: '#/components/schemas/AmfNon3GppAccessRegistrationModification'
    required: true
  responses:
    '200':
      description: Expected response to a valid request
      content:
        application/json:
          schema:
            $ref: 'TS29571_CommonData.yaml#/components/schemas/PatchResult'
    '204':
      description: Expected response to a valid request
    '400':
      $ref: 'TS29571_CommonData.yaml#/components/responses/400'
    '403':
      $ref: 'TS29571_CommonData.yaml#/components/responses/403'
    '404':
      $ref: 'TS29571_CommonData.yaml#/components/responses/404'
    '422':
      description: Unprocessable Request
      content:
        application/problem+json:
          schema:
            $ref: 'TS29571_CommonData.yaml#/components/schemas/ProblemDetails'
    '500':
      $ref: 'TS29571_CommonData.yaml#/components/responses/500'
    '503':
      $ref: 'TS29571_CommonData.yaml#/components/responses/503'
  default:

```

```

    description: Unexpected error
  get:
    summary: retrieve the AMF registration for non-3GPP access information
    operationId: GetNon3GppRegistration
    tags:
      - AMF non-3GPP-access Registration Info Retrieval
    parameters:
      - name: ueId
        in: path
        description: Identifier of the UE
        required: true
        schema:
          $ref: 'TS29571_CommonData.yaml#/components/schemas/VarUeId'
      - name: supported-features
        in: query
        schema:
          $ref: 'TS29571_CommonData.yaml#/components/schemas/SupportedFeatures'
    responses:
      '200':
        description: Expected response to a valid request
        content:
          application/json:
            schema:
              $ref: '#/components/schemas/AmfNon3GppAccessRegistration'
      '400':
        $ref: 'TS29571_CommonData.yaml#/components/responses/400'
      '403':
        $ref: 'TS29571_CommonData.yaml#/components/responses/403'
      '404':
        $ref: 'TS29571_CommonData.yaml#/components/responses/404'
      '500':
        $ref: 'TS29571_CommonData.yaml#/components/responses/500'
      '503':
        $ref: 'TS29571_CommonData.yaml#/components/responses/503'
    default:
      description: Unexpected error

/{ueId}/registrations/smf-registrations:
  get:
    summary: retrieve the SMF registration information
    operationId: GetSmfRegistration
    tags:
      - SMF SmfRegistration
    parameters:
      - name: ueId
        in: path
        description: Identifier of the UE
        required: true
        schema:
          $ref: 'TS29571_CommonData.yaml#/components/schemas/VarUeId'
      - name: single-nssai
        in: query
        content:
          application/json:
            schema:
              $ref: 'TS29571_CommonData.yaml#/components/schemas/Snssai'
      - name: dnn
        in: query
        schema:
          $ref: 'TS29571_CommonData.yaml#/components/schemas/Dnn'
      - name: supported-features
        in: query
        schema:
          $ref: 'TS29571_CommonData.yaml#/components/schemas/SupportedFeatures'
    responses:
      '200':
        description: Expected response to a valid request
        content:
          application/json:
            schema:
              $ref: '#/components/schemas/SmfRegistrationInfo'
      '400':
        $ref: 'TS29571_CommonData.yaml#/components/responses/400'
      '403':
        $ref: 'TS29571_CommonData.yaml#/components/responses/403'
      '404':
        $ref: 'TS29571_CommonData.yaml#/components/responses/404'
      '500':

```

```

    $ref: 'TS29571_CommonData.yaml#/components/responses/500'
  '503':
    $ref: 'TS29571_CommonData.yaml#/components/responses/503'
  default:
    description: Unexpected error

/{ueId}/registrations/smf-registrations/{pduSessionId}:
  put:
    summary: register as SMF
    operationId: Registration
    tags:
      - SMF SmfRegistration
    parameters:
      - name: ueId
        in: path
        description: Identifier of the UE
        required: true
        schema:
          $ref: 'TS29571_CommonData.yaml#/components/schemas/Supi'
      - name: pduSessionId
        in: path
        description: Identifier of the PDU session
        required: true
        schema:
          $ref: 'TS29571_CommonData.yaml#/components/schemas/PduSessionId'
    requestBody:
      content:
        application/json:
          schema:
            $ref: '#/components/schemas/SmfRegistration'
      required: true
    responses:
      '201':
        description: Created
        content:
          application/json:
            schema:
              $ref: '#/components/schemas/SmfRegistration'
        headers:
          Location:
            description: 'Contains the URI of the newly created resource, according to the
structure: {apiRoot}/nudm-uecm/v1/{ueId}/registrations/smf-registrations/{pduSessionId}'
            required: true
            schema:
              type: string
      '200':
        description: Expected response to a valid request
        content:
          application/json:
            schema:
              $ref: '#/components/schemas/SmfRegistration'
      '204':
        description: No content
      '400':
        $ref: 'TS29571_CommonData.yaml#/components/responses/400'
      '403':
        $ref: 'TS29571_CommonData.yaml#/components/responses/403'
      '404':
        $ref: 'TS29571_CommonData.yaml#/components/responses/404'
      '500':
        $ref: 'TS29571_CommonData.yaml#/components/responses/500'
      '503':
        $ref: 'TS29571_CommonData.yaml#/components/responses/503'
    default:
      description: Unexpected error
  callbacks:
    deregistrationNotification:
      '{request.body#/deregCallbackUri}':
        post:
          requestBody:
            required: true
            content:
              application/json:
                schema:
                  $ref: '#/components/schemas/DeregistrationData'
          responses:
            '204':
              description: Successful Notification response

```

```

    '307':
      $ref: 'TS29571_CommonData.yaml#/components/responses/307'
    '308':
      $ref: 'TS29571_CommonData.yaml#/components/responses/308'
    '400':
      $ref: 'TS29571_CommonData.yaml#/components/responses/400'
    '404':
      $ref: 'TS29571_CommonData.yaml#/components/responses/404'
    '500':
      $ref: 'TS29571_CommonData.yaml#/components/responses/500'
    '503':
      $ref: 'TS29571_CommonData.yaml#/components/responses/503'
  default:
    description: Unexpected error
pcscfRestorationNotification:
  '{request.body#/pcscfRestorationCallbackUri}':
    post:
      requestBody:
        required: true
        content:
          application/json:
            schema:
              $ref: '#/components/schemas/PcscfRestorationNotification'
      responses:
        '204':
          description: Successful Notification response
        '307':
          $ref: 'TS29571_CommonData.yaml#/components/responses/307'
        '308':
          $ref: 'TS29571_CommonData.yaml#/components/responses/308'
        '400':
          $ref: 'TS29571_CommonData.yaml#/components/responses/400'
        '404':
          $ref: 'TS29571_CommonData.yaml#/components/responses/404'
        '500':
          $ref: 'TS29571_CommonData.yaml#/components/responses/500'
        '503':
          $ref: 'TS29571_CommonData.yaml#/components/responses/503'
      default:
        description: Unexpected error
delete:
  summary: delete an SMF registration
  operationId: SmfDeregistration
  tags:
    - SMF Deregistration
  parameters:
    - name: ueId
      in: path
      description: Identifier of the UE
      required: true
      schema:
        $ref: 'TS29571_CommonData.yaml#/components/schemas/Supi'
    - name: pduSessionId
      in: path
      description: Identifier of the PDU session
      required: true
      schema:
        $ref: 'TS29571_CommonData.yaml#/components/schemas/PduSessionId'
    - name: smf-set-id
      in: query
      schema:
        $ref: 'TS29571_CommonData.yaml#/components/schemas/NfSetId'
    - name: smf-instance-id
      in: query
      schema:
        $ref: 'TS29571_CommonData.yaml#/components/schemas/NfInstanceId'
  responses:
    '204':
      description: Expected response to a valid request
    '400':
      $ref: 'TS29571_CommonData.yaml#/components/responses/400'
    '404':
      $ref: 'TS29571_CommonData.yaml#/components/responses/404'
    '422':
      description: Unprocessable Request
      content:
        application/problem+json:
          schema:

```

```

        $ref: 'TS29571_CommonData.yaml#/components/schemas/ProblemDetails'
    '500':
        $ref: 'TS29571_CommonData.yaml#/components/responses/500'
    '503':
        $ref: 'TS29571_CommonData.yaml#/components/responses/503'
    default:
        description: Unexpected error
get:
    summary: get an SMF registration
    operationId: RetrieveSmfRegistration
    tags:
        - Retrieve SMF Registration
    parameters:
        - name: ueId
          in: path
          description: Identifier of the UE
          required: true
          schema:
            $ref: 'TS29571_CommonData.yaml#/components/schemas/Supi'
        - name: pduSessionId
          in: path
          description: Identifier of the PDU session
          required: true
          schema:
            $ref: 'TS29571_CommonData.yaml#/components/schemas/PduSessionId'
    responses:
        '200':
            description: Expected response to a valid request
            content:
                application/json:
                    schema:
                        $ref: '#/components/schemas/SmfRegistration'
        '400':
            $ref: 'TS29571_CommonData.yaml#/components/responses/400'
        '403':
            $ref: 'TS29571_CommonData.yaml#/components/responses/403'
        '404':
            $ref: 'TS29571_CommonData.yaml#/components/responses/404'
        '500':
            $ref: 'TS29571_CommonData.yaml#/components/responses/500'
        '503':
            $ref: 'TS29571_CommonData.yaml#/components/responses/503'
    default:
        description: Unexpected error

/{ueId}/registrations/smsf-3gpp-access:
    put:
        summary: register as SMSF for 3GPP access
        operationId: 3GppSmsfRegistration
        tags:
            - SMSF registration for 3GPP access
        parameters:
            - name: ueId
              in: path
              description: Identifier of the UE
              required: true
              schema:
                $ref: 'TS29571_CommonData.yaml#/components/schemas/Supi'
        requestBody:
            content:
                application/json:
                    schema:
                        $ref: '#/components/schemas/SmsfRegistration'
            required: true
        responses:
            '201':
                description: Created
                content:
                    application/json:
                        schema:
                            $ref: '#/components/schemas/SmsfRegistration'
                headers:
                    Location:
                        description: 'Contains the URI of the newly created resource, according to the
structure: {apiRoot}/nudm-uecm/v1/{ueId}/registrations/smsf-3gpp-access'
                        required: true
                        schema:
                            type: string

```

```
'200':
  description: Expected response to a valid request
  content:
    application/json:
      schema:
        $ref: '#/components/schemas/SmsfRegistration'
'204':
  description: No content
'400':
  $ref: 'TS29571_CommonData.yaml#/components/responses/400'
'403':
  $ref: 'TS29571_CommonData.yaml#/components/responses/403'
'404':
  $ref: 'TS29571_CommonData.yaml#/components/responses/404'
'500':
  $ref: 'TS29571_CommonData.yaml#/components/responses/500'
'503':
  $ref: 'TS29571_CommonData.yaml#/components/responses/503'
default:
  description: Unexpected error
delete:
  summary: delete the SMSF registration for 3GPP access
  operationId: 3GppSmsfDeregistration
  tags:
    - SMSF Deregistration for 3GPP Access
  parameters:
    - name: ueId
      in: path
      description: Identifier of the UE
      required: true
      schema:
        $ref: 'TS29571_CommonData.yaml#/components/schemas/Supi'
    - name: smsf-set-id
      in: query
      schema:
        $ref: 'TS29571_CommonData.yaml#/components/schemas/NfSetId'
  responses:
    '204':
      description: Expected response to a valid request
    '400':
      $ref: 'TS29571_CommonData.yaml#/components/responses/400'
    '404':
      $ref: 'TS29571_CommonData.yaml#/components/responses/404'
    '422':
      description: Unprocessable Request
      content:
        application/problem+json:
          schema:
            $ref: 'TS29571_CommonData.yaml#/components/schemas/ProblemDetails'
    '500':
      $ref: 'TS29571_CommonData.yaml#/components/responses/500'
    '503':
      $ref: 'TS29571_CommonData.yaml#/components/responses/503'
  default:
    description: Unexpected error
get:
  summary: retrieve the SMSF registration for 3GPP access information
  operationId: Get3GppSmsfRegistration
  tags:
    - SMSF 3GPP access Registration Info Retrieval
  parameters:
    - name: ueId
      in: path
      description: Identifier of the UE
      required: true
      schema:
        $ref: 'TS29571_CommonData.yaml#/components/schemas/Gpsi'
    - name: supported-features
      in: query
      schema:
        $ref: 'TS29571_CommonData.yaml#/components/schemas/SupportedFeatures'
  responses:
    '200':
      description: Expected response to a valid request
      content:
        application/json:
          schema:
            $ref: '#/components/schemas/SmsfRegistration'
```



```

'400':
  $ref: 'TS29571_CommonData.yaml#/components/responses/400'
'403':
  $ref: 'TS29571_CommonData.yaml#/components/responses/403'
'404':
  $ref: 'TS29571_CommonData.yaml#/components/responses/404'
'500':
  $ref: 'TS29571_CommonData.yaml#/components/responses/500'
'503':
  $ref: 'TS29571_CommonData.yaml#/components/responses/503'
default:
  description: Unexpected error

/{ueId}/registrations/smsf-non-3gpp-access:
  put:
    summary: register as SMSF for non-3GPP access
    operationId: Non3GppSmsfRegistration
    tags:
      - SMSF registration for non-3GPP access
    parameters:
      - name: ueId
        in: path
        description: Identifier of the UE
        required: true
        schema:
          $ref: 'TS29571_CommonData.yaml#/components/schemas/Supi'
    requestBody:
      content:
        application/json:
          schema:
            $ref: '#/components/schemas/SmsfRegistration'
        required: true
    responses:
      '201':
        description: Created
        content:
          application/json:
            schema:
              $ref: '#/components/schemas/SmsfRegistration'
        headers:
          Location:
            description: 'Contains the URI of the newly created resource, according to the
structure: {apiRoot}/nudm-uecm/v1/{ueId}/registrations/smsf-non-3gpp-access'
            required: true
            schema:
              type: string
      '200':
        description: Expected response to a valid request
        content:
          application/json:
            schema:
              $ref: '#/components/schemas/SmsfRegistration'
      '204':
        description: No content
      '400':
        $ref: 'TS29571_CommonData.yaml#/components/responses/400'
      '403':
        $ref: 'TS29571_CommonData.yaml#/components/responses/403'
      '404':
        $ref: 'TS29571_CommonData.yaml#/components/responses/404'
      '500':
        $ref: 'TS29571_CommonData.yaml#/components/responses/500'
      '503':
        $ref: 'TS29571_CommonData.yaml#/components/responses/503'
    default:
      description: Unexpected error
  delete:
    summary: delete SMSF registration for non 3GPP access
    operationId: Non3GppSmsfDeregistration
    tags:
      - SMSF Deregistration for non-3GPP access
    parameters:
      - name: ueId
        in: path
        description: Identifier of the UE
        required: true
        schema:
          $ref: 'TS29571_CommonData.yaml#/components/schemas/Supi'

```

```

- name: smsf-set-id
  in: query
  schema:
    $ref: 'TS29571_CommonData.yaml#/components/schemas/NfSetId'
responses:
  '204':
    description: Expected response to a valid request
  '400':
    $ref: 'TS29571_CommonData.yaml#/components/responses/400'
  '404':
    $ref: 'TS29571_CommonData.yaml#/components/responses/404'
  '422':
    description: Unprocessable Request
    content:
      application/problem+json:
        schema:
          $ref: 'TS29571_CommonData.yaml#/components/schemas/ProblemDetails'
  '500':
    $ref: 'TS29571_CommonData.yaml#/components/responses/500'
  '503':
    $ref: 'TS29571_CommonData.yaml#/components/responses/503'
default:
  description: Unexpected error
get:
  summary: retrieve the SMSF registration for non-3GPP access information
  operationId: GetNon3GppSmsfRegistration
  tags:
    - SMSF non-3GPP access Registration Info Retrieval
  parameters:
    - name: ueId
      in: path
      description: Identifier of the UE
      required: true
      schema:
        $ref: 'TS29571_CommonData.yaml#/components/schemas/Gpsi'
    - name: supported-features
      in: query
      schema:
        $ref: 'TS29571_CommonData.yaml#/components/schemas/SupportedFeatures'
  responses:
    '200':
      description: Expected response to a valid request
      content:
        application/json:
          schema:
            $ref: '#/components/schemas/SmsfRegistration'
    '400':
      $ref: 'TS29571_CommonData.yaml#/components/responses/400'
    '403':
      $ref: 'TS29571_CommonData.yaml#/components/responses/403'
    '404':
      $ref: 'TS29571_CommonData.yaml#/components/responses/404'
    '500':
      $ref: 'TS29571_CommonData.yaml#/components/responses/500'
    '503':
      $ref: 'TS29571_CommonData.yaml#/components/responses/503'
  default:
    description: Unexpected error

/{ueId}/registrations/ip-sm-gw:
  put:
    summary: Register an IP-SM-GW
    operationId: IpSmGwRegistration
    tags:
      - IP-SM-GW registration
    parameters:
      - name: ueId
        in: path
        description: Identifier of the UE
        required: true
        schema:
          $ref: 'TS29571_CommonData.yaml#/components/schemas/Supi'
    requestBody:
      content:
        application/json:
          schema:
            $ref: '#/components/schemas/IpSmGwRegistration'
      required: true

```

```

responses:
  '201':
    description: Created
    content:
      application/json:
        schema:
          $ref: '#/components/schemas/IpSmGwRegistration'
    headers:
      Location:
        description: 'Contains the URI of the newly created resource, according to the
structure: {apiRoot}/nudm-uecm/v1/{ueId}/registrations/ip-sm-gw'
        required: true
        schema:
          type: string
  '200':
    description: Expected response to a valid request
    content:
      application/json:
        schema:
          $ref: '#/components/schemas/IpSmGwRegistration'
  '204':
    description: No content
  '400':
    $ref: 'TS29571_CommonData.yaml#/components/responses/400'
  '403':
    $ref: 'TS29571_CommonData.yaml#/components/responses/403'
  '404':
    $ref: 'TS29571_CommonData.yaml#/components/responses/404'
  '500':
    $ref: 'TS29571_CommonData.yaml#/components/responses/500'
  '503':
    $ref: 'TS29571_CommonData.yaml#/components/responses/503'
  default:
    description: Unexpected error
delete:
  summary: Delete the IP-SM-GW registration
  operationId: IpSmGwDeregistration
  tags:
    - IP-SM-GW Deregistration
  parameters:
    - name: ueId
      in: path
      description: Identifier of the UE
      required: true
      schema:
        $ref: 'TS29571_CommonData.yaml#/components/schemas/Supi'
  responses:
    '204':
      description: Expected response to a valid request
    '400':
      $ref: 'TS29571_CommonData.yaml#/components/responses/400'
    '404':
      $ref: 'TS29571_CommonData.yaml#/components/responses/404'
    '500':
      $ref: 'TS29571_CommonData.yaml#/components/responses/500'
    '503':
      $ref: 'TS29571_CommonData.yaml#/components/responses/503'
    default:
      description: Unexpected error
get:
  summary: Retrieve the IP-SM-GW registration information
  operationId: GetIpSmGwRegistration
  tags:
    - IP-SM-GW Registration Info Retrieval
  parameters:
    - name: ueId
      in: path
      description: Identifier of the UE
      required: true
      schema:
        $ref: 'TS29571_CommonData.yaml#/components/schemas/Supi'
  responses:
    '200':
      description: Expected response to a valid request
      content:
        application/json:
          schema:
            $ref: '#/components/schemas/IpSmGwRegistration'

```

```
'400':
  $ref: 'TS29571_CommonData.yaml#/components/responses/400'
'403':
  $ref: 'TS29571_CommonData.yaml#/components/responses/403'
'404':
  $ref: 'TS29571_CommonData.yaml#/components/responses/404'
'500':
  $ref: 'TS29571_CommonData.yaml#/components/responses/500'
'503':
  $ref: 'TS29571_CommonData.yaml#/components/responses/503'
default:
  description: Unexpected error

/restore-pcscf:
  post:
    summary: Trigger the Restoration of the P-CSCF
    operationId: Trigger P-CSCF Restoration
    tags:
      - Trigger P-CSCF Restoration
    requestBody:
      content:
        application/json:
          schema:
            $ref: '#/components/schemas/TriggerRequest'
      required: true
    responses:
      '204':
        description: Successful response
      '400':
        $ref: 'TS29571_CommonData.yaml#/components/responses/400'
      '403':
        $ref: 'TS29571_CommonData.yaml#/components/responses/403'
      '404':
        $ref: 'TS29571_CommonData.yaml#/components/responses/404'
      '500':
        $ref: 'TS29571_CommonData.yaml#/components/responses/500'
      '501':
        $ref: 'TS29571_CommonData.yaml#/components/responses/501'
      '503':
        $ref: 'TS29571_CommonData.yaml#/components/responses/503'
      default:
        description: Unexpected error

/{ueId}/registrations/location:
  get:
    summary: retrieve the target UE's location information
    operationId: GetLocationInfo
    tags:
      - UE Location Information retrieval
    parameters:
      - name: ueId
        in: path
        description: Identifier of the UE
        required: true
        schema:
          $ref: 'TS29571_CommonData.yaml#/components/schemas/VarUeId'
      - name: supported-features
        in: query
        schema:
          $ref: 'TS29571_CommonData.yaml#/components/schemas/SupportedFeatures'
    responses:
      '200':
        description: Expected response to a valid request
        content:
          application/json:
            schema:
              $ref: '#/components/schemas/LocationInfo'
      '400':
        $ref: 'TS29571_CommonData.yaml#/components/responses/400'
      '403':
        $ref: 'TS29571_CommonData.yaml#/components/responses/403'
      '404':
        $ref: 'TS29571_CommonData.yaml#/components/responses/404'
      '500':
        $ref: 'TS29571_CommonData.yaml#/components/responses/500'
      '503':
        $ref: 'TS29571_CommonData.yaml#/components/responses/503'
      default:
```

description: Unexpected error

components:

securitySchemes:

oAuth2ClientCredentials:

type: oauth2

flows:

clientCredentials:

tokenUrl: '{nrfApiRoot}/oauth2/token'

scopes:

nudm-uecm: Access to the nudm-uecm API

schemas:

COMPLEX TYPES:

Amf3GppAccessRegistration:

type: object

required:

- amfInstanceId
- deregCallbackUri
- guami
- ratType

properties:

amfInstanceId:

\$ref: 'TS29571_CommonData.yaml#/components/schemas/NfInstanceId'

supportedFeatures:

\$ref: 'TS29571_CommonData.yaml#/components/schemas/SupportedFeatures'

purgeFlag:

\$ref: '#/components/schemas/PurgeFlag'

pei:

\$ref: 'TS29571_CommonData.yaml#/components/schemas/Pei'

imsVoPs:

\$ref: '#/components/schemas/ImsVoPs'

deregCallbackUri:

\$ref: 'TS29571_CommonData.yaml#/components/schemas/Uri'

amfServiceNameDereg:

\$ref: 'TS29510_Nnrf_NFManagement.yaml#/components/schemas/ServiceName'

pcscfRestorationCallbackUri:

\$ref: 'TS29571_CommonData.yaml#/components/schemas/Uri'

amfServiceNamePcscfRest:

\$ref: 'TS29510_Nnrf_NFManagement.yaml#/components/schemas/ServiceName'

initialRegistrationInd:

type: boolean

guami:

\$ref: 'TS29571_CommonData.yaml#/components/schemas/Guami'

backupAmfInfo:

type: array

items:

\$ref: 'TS29571_CommonData.yaml#/components/schemas/BackupAmfInfo'

minItems: 1

drFlag:

\$ref: '#/components/schemas/DualRegistrationFlag'

ratType:

\$ref: 'TS29571_CommonData.yaml#/components/schemas/RatType'

urrrIndicator:

type: boolean

amfEeSubscriptionId:

\$ref: 'TS29571_CommonData.yaml#/components/schemas/Uri'

epsInterworkingInfo:

\$ref: '#/components/schemas/EpsInterworkingInfo'

ueSrvccCapability:

type: boolean

registrationTime:

\$ref: 'TS29571_CommonData.yaml#/components/schemas/DateTime'

vgmlcAddress:

\$ref: '#/components/schemas/VgmlcAddress'

contextInfo:

\$ref: 'TS29503_Nudm_SDM.yaml#/components/schemas/ContextInfo'

noEeSubscriptionInd:

type: boolean

supi:

\$ref: 'TS29571_CommonData.yaml#/components/schemas/Supi'

Amf3GppAccessRegistrationModification:

type: object

```

required:
- guami
properties:
  guami:
    $ref: 'TS29571_CommonData.yaml#/components/schemas/Guami'
  purgeFlag:
    $ref: '#/components/schemas/PurgeFlag'
  pei:
    $ref: 'TS29571_CommonData.yaml#/components/schemas/Pei'
  imsVoPs:
    $ref: '#/components/schemas/ImsVoPs'
  backupAmfInfo:
    type: array
    items:
      $ref: 'TS29571_CommonData.yaml#/components/schemas/BackupAmfInfo'
  epsInterworkingInfo:
    $ref: '#/components/schemas/EpsInterworkingInfo'
  ueSrvccCapability:
    type: boolean
    nullable: true

EpsInterworkingInfo:
  type: object
  properties:
    epsIwkPgws:
      description: A map (list of key-value pairs where Dnn serves as key) of EpsIwkPgws
      type: object
      additionalProperties:
        $ref: '#/components/schemas/EpsIwkPgw'

EpsIwkPgw:
  type: object
  required:
  - pgwFqdn
  - smfInstanceId
  properties:
    pgwFqdn:
      type: string
    smfInstanceId:
      $ref: 'TS29571_CommonData.yaml#/components/schemas/NfInstanceId'

AmfNon3GppAccessRegistration:
  type: object
  required:
  - amfInstanceId
  - imsVoPs
  - deregCallbackUri
  - guami
  - ratType
  properties:
    amfInstanceId:
      $ref: 'TS29571_CommonData.yaml#/components/schemas/NfInstanceId'
    supportedFeatures:
      $ref: 'TS29571_CommonData.yaml#/components/schemas/SupportedFeatures'
    purgeFlag:
      $ref: '#/components/schemas/PurgeFlag'
    pei:
      $ref: 'TS29571_CommonData.yaml#/components/schemas/Pei'
    imsVoPs:
      $ref: '#/components/schemas/ImsVoPs'
    deregCallbackUri:
      $ref: 'TS29571_CommonData.yaml#/components/schemas/Uri'
    amfServiceNameDereg:
      $ref: 'TS29510_Nnrf_NFManagement.yaml#/components/schemas/ServiceName'
    pcsclfRestorationCallbackUri:
      $ref: 'TS29571_CommonData.yaml#/components/schemas/Uri'
    amfServiceNamePcsclfRest:
      $ref: 'TS29510_Nnrf_NFManagement.yaml#/components/schemas/ServiceName'
    guami:
      $ref: 'TS29571_CommonData.yaml#/components/schemas/Guami'
    backupAmfInfo:
      type: array
      items:
        $ref: 'TS29571_CommonData.yaml#/components/schemas/BackupAmfInfo'
      minItems: 1
    ratType:
      $ref: 'TS29571_CommonData.yaml#/components/schemas/RatType'
    urrpIndicator:

```

```

    type: boolean
  amfEeSubscriptionId:
    $ref: 'TS29571_CommonData.yaml#/components/schemas/Uri'
  registrationTime:
    $ref: 'TS29571_CommonData.yaml#/components/schemas/DateTime'
  vgmlcAddress:
    $ref: '#/components/schemas/VgmlcAddress'
  contextInfo:
    $ref: 'TS29503_Nudm_SDM.yaml#/components/schemas/ContextInfo'
  noEeSubscriptionInd:
    type: boolean
  supi:
    $ref: 'TS29571_CommonData.yaml#/components/schemas/Supi'

```

AmfNon3GppAccessRegistrationModification:

```

type: object
required:
  - guami
properties:
  guami:
    $ref: 'TS29571_CommonData.yaml#/components/schemas/Guami'
  purgeFlag:
    $ref: '#/components/schemas/PurgeFlag'
  pei:
    $ref: 'TS29571_CommonData.yaml#/components/schemas/Pei'
  imsVoPs:
    $ref: '#/components/schemas/ImsVoPs'
  backupAmfInfo:
    type: array
    items:
      $ref: 'TS29571_CommonData.yaml#/components/schemas/BackupAmfInfo'

```

SmfRegistration:

```

type: object
required:
  - smfInstanceId
  - pduSessionId
  - singleNssai
  - plmnId
properties:
  smfInstanceId:
    $ref: 'TS29571_CommonData.yaml#/components/schemas/NfInstanceId'
  smfSetId:
    $ref: 'TS29571_CommonData.yaml#/components/schemas/NfSetId'
  supportedFeatures:
    $ref: 'TS29571_CommonData.yaml#/components/schemas/SupportedFeatures'
  pduSessionId:
    $ref: 'TS29571_CommonData.yaml#/components/schemas/PduSessionId'
  singleNssai:
    $ref: 'TS29571_CommonData.yaml#/components/schemas/Snssai'
  dnn:
    $ref: 'TS29571_CommonData.yaml#/components/schemas/Dnn'
  emergencyServices:
    type: boolean
  pcsfRestorationCallbackUri:
    $ref: 'TS29571_CommonData.yaml#/components/schemas/Uri'
  plmnId:
    $ref: 'TS29571_CommonData.yaml#/components/schemas/PlmnId'
  pgwFqdn:
    type: string
  epdgInd:
    type: boolean
    default: false
  deregCallbackUri:
    $ref: 'TS29571_CommonData.yaml#/components/schemas/Uri'
  registrationReason:
    $ref: '#/components/schemas/RegistrationReason'
  registrationTime:
    $ref: 'TS29571_CommonData.yaml#/components/schemas/DateTime'
  contextInfo:
    $ref: 'TS29503_Nudm_SDM.yaml#/components/schemas/ContextInfo'

```

SmsfRegistration:

```

type: object
required:
  - smsfInstanceId
  - plmnId

```

```
properties:
  smsfInstanceId:
    $ref: 'TS29571_CommonData.yaml#/components/schemas/NfInstanceId'
  smsfSetId:
    $ref: 'TS29571_CommonData.yaml#/components/schemas/NfSetId'
  supportedFeatures:
    $ref: 'TS29571_CommonData.yaml#/components/schemas/SupportedFeatures'
  plmnId:
    $ref: 'TS29571_CommonData.yaml#/components/schemas/PlmnId'
  smsfMAPAddress:
    $ref: '#/components/schemas/E164Number'
  smsfDiameterAddress:
    $ref: '#/components/schemas/NetworkNodeDiameterAddress'
  registrationTime:
    $ref: 'TS29571_CommonData.yaml#/components/schemas/DateTime'
  contextInfo:
    $ref: 'TS29503_Nudm_SDM.yaml#/components/schemas/ContextInfo'

DeregistrationData:
  type: object
  required:
    - deregReason
  properties:
    deregReason:
      $ref: '#/components/schemas/DeregistrationReason'
    accessType:
      $ref: 'TS29571_CommonData.yaml#/components/schemas/AccessType'
    pduSessionId:
      $ref: 'TS29571_CommonData.yaml#/components/schemas/PduSessionId'
    newSmfInstanceId:
      $ref: 'TS29571_CommonData.yaml#/components/schemas/NfInstanceId'

PcscfRestorationNotification:
  type: object
  required:
    - supi
  properties:
    supi:
      $ref: 'TS29571_CommonData.yaml#/components/schemas/Supi'

NetworkNodeDiameterAddress:
  type: object
  required:
    - name
    - realm
  properties:
    name:
      $ref: 'TS29571_CommonData.yaml#/components/schemas/DiameterIdentity'
    realm:
      $ref: 'TS29571_CommonData.yaml#/components/schemas/DiameterIdentity'

TriggerRequest:
  type: object
  required:
    - supi
  properties:
    supi:
      $ref: 'TS29571_CommonData.yaml#/components/schemas/Supi'

SmfRegistrationInfo:
  type: object
  required:
    - smfRegistrationList
  properties:
    smfRegistrationList:
      type: array
      items:
        $ref: '#/components/schemas/SmfRegistration'
      minItems: 1

IpSmGwRegistration:
  type: object
  anyOf:
    - required: [ ipSmGwMapAddress ]
    - required: [ ipSmGwDiameterAddress ]
  properties:
    ipSmGwMapAddress:
```



```
    $ref: '#/components/schemas/E164Number'
  ipSmGwDiameterAddress:
    $ref: '#/components/schemas/NetworkNodeDiameterAddress'
  unriIndicator:
    type: boolean
    default: false

AmfDeregInfo:
  type: object
  required:
    - deregReason
  properties:
    deregReason:
      $ref: '#/components/schemas/DeregistrationReason'

LocationInfo:
  type: object
  required:
    - registrationLocationInfoList
  properties:
    supi:
      $ref: 'TS29571_CommonData.yaml#/components/schemas/Supi'
    gpsi:
      $ref: 'TS29571_CommonData.yaml#/components/schemas/Gpsi'
    registrationLocationInfoList:
      type: array
      items:
        $ref: '#/components/schemas/RegistrationLocationInfo'
      minItems: 1
      maxItems: 2
    supportedFeatures:
      $ref: 'TS29571_CommonData.yaml#/components/schemas/SupportedFeatures'

RegistrationLocationInfo:
  type: object
  required:
    - amfInstanceId
    - accessTypeList
  properties:
    amfInstanceId:
      $ref: 'TS29571_CommonData.yaml#/components/schemas/NfInstanceId'
    guami:
      $ref: 'TS29571_CommonData.yaml#/components/schemas/Guami'
    plmnId:
      $ref: 'TS29571_CommonData.yaml#/components/schemas/PlmnId'
    vgmlcAddress:
      $ref: '#/components/schemas/VgmlcAddress'
    accessTypeList:
      type: array
      items:
        $ref: 'TS29571_CommonData.yaml#/components/schemas/AccessType'
      minItems: 1
      maxItems: 2

VgmlcAddress:
  type: object
  properties:
    vgmlcAddressIpv4:
      $ref: 'TS29571_CommonData.yaml#/components/schemas/Ipv4Addr'
    vgmlcAddressIpv6:
      $ref: 'TS29571_CommonData.yaml#/components/schemas/Ipv6Addr'
    vgmlcFqdn:
      $ref: 'TS29510_Nnrf_NFManagement.yaml#/components/schemas/Fqdn'

PeiUpdateInfo:
  type: object
  required:
    - pei
  properties:
    pei:
      $ref: 'TS29571_CommonData.yaml#/components/schemas/Pei'

RegistrationDatasetNames:
  type: array
  items:
    $ref: '#/components/schemas/RegistrationDataSetName'
  minItems: 2
```

```
    uniqueItems: true

RegistrationDataSets:
  type: object
  properties:
    amf3Gpp:
      $ref: '#/components/schemas/Amf3GppAccessRegistration'
    amfNon3Gpp:
      $ref: '#/components/schemas/AmfNon3GppAccessRegistration'
    smfRegistration:
      $ref: '#/components/schemas/SmfRegistrationInfo'
    smsf3Gpp:
      $ref: '#/components/schemas/SmsfRegistration'
    smsfNon3Gpp:
      $ref: '#/components/schemas/SmsfRegistration'

# SIMPLE TYPES:

PurgeFlag:
  type: boolean

E164Number:
  type: string
  pattern: '^[0-9]{1,15}$'

DualRegistrationFlag:
  type: boolean

# ENUMS:

ImsVoPs:
  anyOf:
    - type: string
      enum:
        - HOMOGENEOUS_SUPPORT
        - HOMOGENEOUS_NON_SUPPORT
        - NON_HOMOGENEOUS_OR_UNKNOWN
    - type: string

DeregistrationReason:
  anyOf:
    - type: string
      enum:
        - UE_INITIAL_REGISTRATION
        - UE_REGISTRATION_AREA_CHANGE
        - SUBSCRIPTION_WITHDRAWN
        - 5GS_TO_EPS_MOBILITY
        - 5GS_TO_EPS_MOBILITY_UE_INITIAL_REGISTRATION
        - REREGISTRATION_REQUIRED
        - SMF_CONTEXT_TRANSFERRED
    - type: string

RegistrationReason:
  anyOf:
    - type: string
      enum:
        - SMF_CONTEXT_TRANSFERRED
    - type: string

RegistrationDataSetName:
  anyOf:
    - type: string
      enum:
        - AMF_3GPP
        - AMF_NON_3GPP
        - SMF_PDU_SESSIONS
        - SMSF_3GPP
        - SMSF_NON_3GPP
    - type: string
```

A.4 Nudm_UEAU API

openapi: 3.0.0
info:

```
version: '1.1.3'
title: 'Nudm_UEAU'
description: |
  UDM UE Authentication Service.
  © 2022, 3GPP Organizational Partners (ARIB, ATIS, CCSA, ETSI, TSDSI, TTA, TTC).
  All rights reserved.
```

```
externalDocs:
  description: 3GPP TS 29.503 Unified Data Management Services, version 16.12.0
  url: 'http://www.3gpp.org/ftp/Specs/archive/29_series/29.503/'
```

```
servers:
- url: '{apiRoot}/nudm-ueau/v1'
  variables:
    apiRoot:
      default: https://example.com
      description: apiRoot as defined in clause clause 4.4 of 3GPP TS 29.501.
```

```
security:
- oAuth2ClientCredentials:
  - nudm-ueau
- {}
```

```
paths:
  /{supiOrSuci}/security-information/generate-auth-data:
    post:
      summary: Generate authentication data for the UE
      operationId: GenerateAuthData
      tags:
        - Generate Auth Data
      parameters:
        - name: supiOrSuci
          in: path
          description: SUPI or SUCI of the user
          required: true
          schema:
            $ref: 'TS29571_CommonData.yaml#/components/schemas/SupiOrSuci'
      requestBody:
        content:
          application/json:
            schema:
              $ref: '#/components/schemas/AuthenticationInfoRequest'
            required: true
      responses:
        '200':
          description: Expected response to a valid request
          content:
            application/json:
              schema:
                $ref: '#/components/schemas/AuthenticationInfoResult'
        '400':
          $ref: 'TS29571_CommonData.yaml#/components/responses/400'
        '403':
          $ref: 'TS29571_CommonData.yaml#/components/responses/403'
        '404':
          $ref: 'TS29571_CommonData.yaml#/components/responses/404'
        '500':
          $ref: 'TS29571_CommonData.yaml#/components/responses/500'
        '501':
          $ref: 'TS29571_CommonData.yaml#/components/responses/501'
        '503':
          $ref: 'TS29571_CommonData.yaml#/components/responses/503'
      default:
        description: Unexpected error
```

```
/{supiOrSuci}/security-information-rg:
  get:
    summary: Get authentication data for the FN-RG
    operationId: GetRgAuthData
    tags:
      - Get Auth Data for FN-RG
    parameters:
      - name: supiOrSuci
        in: path
        description: SUPI or SUCI of the user
        required: true
        schema:
          $ref: 'TS29571_CommonData.yaml#/components/schemas/SupiOrSuci'
```

```

- name: authenticated-ind
  in: query
  description: Authenticated indication
  required: true
  schema:
    $ref: '#/components/schemas/AuthenticatedInd'
- name: supported-features
  in: query
  description: Supported Features
  schema:
    $ref: 'TS29571_CommonData.yaml#/components/schemas/SupportedFeatures'
- name: plmn-id
  in: query
  description: serving PLMN ID
  content:
    application/json:
      schema:
        $ref: 'TS29571_CommonData.yaml#/components/schemas/PlmnId'
- name: If-None-Match
  in: header
  description: Validator for conditional requests, as described in RFC 7232, 3.2
  schema:
    type: string
- name: If-Modified-Since
  in: header
  description: Validator for conditional requests, as described in RFC 7232, 3.3
  schema:
    type: string
responses:
  '200':
    description: Expected response to a valid request
    content:
      application/json:
        schema:
          $ref: '#/components/schemas/RgAuthCtx'
  '400':
    $ref: 'TS29571_CommonData.yaml#/components/responses/400'
  '403':
    $ref: 'TS29571_CommonData.yaml#/components/responses/403'
  '404':
    $ref: 'TS29571_CommonData.yaml#/components/responses/404'
  '500':
    $ref: 'TS29571_CommonData.yaml#/components/responses/500'
  '503':
    $ref: 'TS29571_CommonData.yaml#/components/responses/503'
  default:
    description: Unexpected error

/{supi}/auth-events:
  post:
    summary: Create a new confirmation event
    operationId: ConfirmAuth
    tags:
      - Confirm Auth
    parameters:
      - name: supi
        in: path
        description: SUPI of the user
        required: true
        schema:
          $ref: 'TS29571_CommonData.yaml#/components/schemas/Supi'
    requestBody:
      content:
        application/json:
          schema:
            $ref: '#/components/schemas/AuthEvent'
      required: true
    responses:
      '201':
        description: Expected response to a valid request
        content:
          application/json:
            schema:
              $ref: '#/components/schemas/AuthEvent'
    headers:
      Location:
        description: 'Contains the URI of the newly created resource, according to the
structure: {apiRoot}/nudm-ueau/v1/{supi}/auth-events/{authEventId}'

```

```

        required: true
        schema:
          type: string
      '400':
        $ref: 'TS29571_CommonData.yaml#/components/responses/400'
      '404':
        $ref: 'TS29571_CommonData.yaml#/components/responses/404'
      '500':
        $ref: 'TS29571_CommonData.yaml#/components/responses/500'
      '503':
        $ref: 'TS29571_CommonData.yaml#/components/responses/503'
    default:
      description: Unexpected error

/{supi}/hss-security-information/{hssAuthType}/generate-av:
  post:
    summary: Generate authentication data for the UE in EPS or IMS domain
    operationId: GenerateAv
    tags:
      - Generate HSS Authentication Vectors
    parameters:
      - name: supi
        in: path
        description: SUPI of the user
        required: true
        schema:
          $ref: 'TS29571_CommonData.yaml#/components/schemas/Supi'
      - name: hssAuthType
        in: path
        description: Type of AV requested by HSS
        required: true
        schema:
          $ref: '#/components/schemas/HssAuthTypeInUri'
    requestBody:
      content:
        application/json:
          schema:
            $ref: '#/components/schemas/HssAuthenticationInfoRequest'
      required: true
    responses:
      '200':
        description: Expected response to a valid request
        content:
          application/json:
            schema:
              $ref: '#/components/schemas/HssAuthenticationInfoResult'
      '400':
        $ref: 'TS29571_CommonData.yaml#/components/responses/400'
      '403':
        $ref: 'TS29571_CommonData.yaml#/components/responses/403'
      '404':
        $ref: 'TS29571_CommonData.yaml#/components/responses/404'
      '500':
        $ref: 'TS29571_CommonData.yaml#/components/responses/500'
      '501':
        $ref: 'TS29571_CommonData.yaml#/components/responses/501'
      '503':
        $ref: 'TS29571_CommonData.yaml#/components/responses/503'
    default:
      description: Unexpected error

/{supi}/auth-events/{authEventId}:
  put:
    summary: Deletes the authentication result in the UDM
    operationId: DeleteAuth
    tags:
      - Delete Auth
    parameters:
      - name: supi
        in: path
        description: SUPI of the user
        required: true
        schema:
          $ref: 'TS29571_CommonData.yaml#/components/schemas/Supi'
      - name: authEventId
        in: path
        description: authEvent Id
        required: true

```

```

    schema:
      type: string
  requestBody:
    content:
      application/json:
        schema:
          $ref: '#/components/schemas/AuthEvent'
        required: true
  responses:
    '204':
      description: Expected response to a successful authentication result removal
    '400':
      $ref: 'TS29571_CommonData.yaml#/components/responses/400'
    '404':
      $ref: 'TS29571_CommonData.yaml#/components/responses/404'
    '500':
      $ref: 'TS29571_CommonData.yaml#/components/responses/500'
    '503':
      $ref: 'TS29571_CommonData.yaml#/components/responses/503'
  default:
    $ref: 'TS29571_CommonData.yaml#/components/responses/default'

```

```

components:
  securitySchemes:
    oAuth2ClientCredentials:
      type: oauth2
      flows:
        clientCredentials:
          tokenUrl: '{nrfApiRoot}/oauth2/token'
          scopes:
            nudm-ueau: Access to the nudm-ueau API

```

schemas:

COMPLEX TYPES:

```

AuthenticationInfoRequest:
  type: object
  required:
    - servingNetworkName
    - ausfInstanceId
  properties:
    supportedFeatures:
      $ref: 'TS29571_CommonData.yaml#/components/schemas/SupportedFeatures'
    servingNetworkName:
      $ref: '#/components/schemas/ServingNetworkName'
    resynchronizationInfo:
      $ref: '#/components/schemas/ResynchronizationInfo'
    ausfInstanceId:
      $ref: 'TS29571_CommonData.yaml#/components/schemas/NfInstanceId'
    cellCagInfo:
      type: array
      items:
        $ref: 'TS29571_CommonData.yaml#/components/schemas/CagId'
      minItems: 1
    n5gcInd:
      type: boolean
      default: false

```

```

AuthenticationInfoResult:
  type: object
  required:
    - authType
  properties:
    authType:
      $ref: '#/components/schemas/AuthType'
    supportedFeatures:
      $ref: 'TS29571_CommonData.yaml#/components/schemas/SupportedFeatures'
    authenticationVector:
      $ref: '#/components/schemas/AuthenticationVector'
    supi:
      $ref: 'TS29571_CommonData.yaml#/components/schemas/Supi'

```

```

AuthenticationVector:
  oneOf:
    - $ref: '#/components/schemas/AvEapAkaPrime'
    - $ref: '#/components/schemas/Av5GHeAka'

```

```
discriminator:
  propertyName: avType
  mapping:
    5G_HE_AKA: '#/components/schemas/Av5GHeAka'
    EAP_AKA_PRIME: '#/components/schemas/AvEapAkaPrime'

AvEapAkaPrime:
  type: object
  required:
    - avType
    - rand
    - xres
    - autn
    - ckPrime
    - ikPrime
  properties:
    avType:
      $ref: '#/components/schemas/AvType'
    rand:
      $ref: '#/components/schemas/Rand'
    xres:
      $ref: '#/components/schemas/Xres'
    autn:
      $ref: '#/components/schemas/Autn'
    ckPrime:
      $ref: '#/components/schemas/CkPrime'
    ikPrime:
      $ref: '#/components/schemas/IkPrime'

Av5GHeAka:
  type: object
  required:
    - avType
    - rand
    - xresStar
    - autn
    - kausf
  properties:
    avType:
      $ref: '#/components/schemas/AvType'
    rand:
      $ref: '#/components/schemas/Rand'
    xresStar:
      $ref: '#/components/schemas/XresStar'
    autn:
      $ref: '#/components/schemas/Autn'
    kausf:
      $ref: '#/components/schemas/Kausf'

ResynchronizationInfo:
  type: object
  required:
    - rand
    - auts
  properties:
    rand:
      $ref: '#/components/schemas/Rand'
    auts:
      $ref: '#/components/schemas/Auts'

AuthEvent:
  type: object
  required:
    - nfInstanceId
    - success
    - timeStamp
    - authType
    - servingNetworkName
  properties:
    nfInstanceId:
      $ref: 'TS29571_CommonData.yaml#/components/schemas/NfInstanceId'
    success:
      $ref: '#/components/schemas/Success'
    timeStamp:
      $ref: 'TS29571_CommonData.yaml#/components/schemas/DateTime'
    authType:
      $ref: '#/components/schemas/AuthType'
    servingNetworkName:
```

```
    $ref: '#/components/schemas/ServingNetworkName'
  authRemovalInd:
    type: boolean
    default: false
  nfSetId:
    $ref: 'TS29571_CommonData.yaml#/components/schemas/NfSetId'

RgAuthCtx:
  type: object
  required:
    - authInd
  properties:
    authInd:
      type: boolean
      default: false
    supi:
      $ref: 'TS29571_CommonData.yaml#/components/schemas/Supi'
    supportedFeatures:
      $ref: 'TS29571_CommonData.yaml#/components/schemas/SupportedFeatures'

HssAuthenticationInfoRequest:
  type: object
  required:
    - hssAuthType
    - numOfRequestedVectors
  properties:
    supportedFeatures:
      $ref: 'TS29571_CommonData.yaml#/components/schemas/SupportedFeatures'
    hssAuthType:
      $ref: '#/components/schemas/HssAuthType'
    numOfRequestedVectors:
      $ref: '#/components/schemas/NumOfRequestedVectors'
    requestingNodeType:
      $ref: '#/components/schemas/NodeType'
    servingNetworkId:
      $ref: 'TS29571_CommonData.yaml#/components/schemas/PlmnId'
    resynchronizationInfo:
      $ref: '#/components/schemas/ResynchronizationInfo'
    anId:
      $ref: '#/components/schemas/AccessNetworkId'

HssAuthenticationInfoResult:
  type: object
  required:
    - hssAuthenticationVectors
  properties:
    supportedFeatures:
      $ref: 'TS29571_CommonData.yaml#/components/schemas/SupportedFeatures'
    hssAuthenticationVectors:
      $ref: '#/components/schemas/HssAuthenticationVectors'

HssAuthenticationVectors:
  oneOf:
    - type: array
      items:
        $ref: '#/components/schemas/AvEpsAka'
      minItems: 1
      maxItems: 5
    - type: array
      items:
        $ref: '#/components/schemas/AvImsGbaEapAka'
      minItems: 1
      maxItems: 5
    - type: array
      items:
        $ref: '#/components/schemas/AvEapAkaPrime'
      minItems: 1
      maxItems: 5

AvEpsAka:
  type: object
  required:
    - avType
    - rand
    - xres
    - autn
    - kasme
```



```
properties:
  avType:
    $ref: '#/components/schemas/HssAvType'
  rand:
    $ref: '#/components/schemas/Rand'
  xres:
    $ref: '#/components/schemas/Xres'
  autn:
    $ref: '#/components/schemas/Autn'
  kasme:
    $ref: '#/components/schemas/Kasme'
```

```
AvImsGbaEapAka:
  type: object
  required:
    - avType
    - rand
    - xres
    - autn
    - ck
    - ik
  properties:
    avType:
      $ref: '#/components/schemas/HssAvType'
    rand:
      $ref: '#/components/schemas/Rand'
    xres:
      $ref: '#/components/schemas/Xres'
    autn:
      $ref: '#/components/schemas/Autn'
    ck:
      $ref: '#/components/schemas/ConfidentialityKey'
    ik:
      $ref: '#/components/schemas/IntegrityKey'
```

SIMPLE TYPES:

```
Autn:
  type: string
  pattern: '^[A-Za-f0-9]{32}$'

Auts:
  type: string
  pattern: '^[A-Za-f0-9]{28}$'

CkPrime:
  type: string
  pattern: '^[A-Za-f0-9]{32}$'

IkPrime:
  type: string
  pattern: '^[A-Za-f0-9]{32}$'

Kausf:
  type: string
  pattern: '^[A-Za-f0-9]{64}$'

Rand:
  type: string
  pattern: '^[A-Za-f0-9]{32}$'

Xres:
  type: string
  pattern: '^[A-Za-f0-9]{8,32}$'

XresStar:
  type: string
  pattern: '^[A-Za-f0-9]{32}$'

ServingNetworkName:
  type: string
  pattern: '^5G:mnc[0-9]{3}[.]mcc[0-9]{3}[.]3gppnetwork[.]org(:[A-F0-9]{11})?$$'

Success:
  type: boolean

AuthenticatedInd:
```

```
    type: boolean

ConfidentialityKey:
  type: string
  pattern: '^[A-Fa-f0-9]{32}$'

IntegrityKey:
  type: string
  pattern: '^[A-Fa-f0-9]{32}$'

Kasme:
  type: string
  pattern: '^[A-Fa-f0-9]{64}$'

NumOfRequestedVectors:
  type: integer
  minimum: 1
  maximum: 5

# ENUMS:

AuthType:
  anyOf:
    - type: string
      enum:
        - 5G_AKA
        - EAP_AKA_PRIME
        - EAP_TLS
    - type: string

AvType:
  anyOf:
    - type: string
      enum:
        - 5G_HE_AKA
        - EAP_AKA_PRIME
    - type: string

HssAuthType:
  anyOf:
    - type: string
      enum:
        - EPS_AKA
        - EAP_AKA
        - EAP_AKA_PRIME
        - IMS_AKA
        - GBA_AKA
        - UMTS_AKA
    - type: string

HssAvType:
  anyOf:
    - type: string
      enum:
        - EPS_AKA
        - EAP_AKA
        - IMS_AKA
        - GBA_AKA
        - UMTS_AKA
    - type: string

HssAuthTypeInUri:
  anyOf:
    - type: string
      enum:
        - eps-aka
        - eap-aka
        - eap-aka-prime
        - ims-aka
        - gba-aka
    - type: string

AccessNetworkId:
  anyOf:
    - type: string
      enum:
        - HRPD
```

```

- WIMAX
- WLAN
- ETHERNET
- type: string

NodeType:
  anyOf:
    - type: string
      enum:
        - AUSF
        - VLR
        - SGSN
        - S_CSCF
        - BSF
        - GAN_AAA_SERVER
        - WLAN_AAA_SERVER
        - MME
    - type: string

```

A.5 Nudm_EE API

openapi: 3.0.0

```

info:
  version: '1.1.4'
  title: 'Nudm_EE'
  description: |
    Nudm Event Exposure Service.
    © 2022, 3GPP Organizational Partners (ARIB, ATIS, CCSA, ETSI, TSDSI, TTA, TTC).
    All rights reserved.

```

```

externalDocs:
  description: 3GPP TS 29.503 Unified Data Management Services, version 16.11.0
  url: 'https://www.3gpp.org/ftp/Specs/archive/29_series/29.503/'

```

```

servers:
- url: '{apiRoot}/nudm-ee/v1'
  variables:
    apiRoot:
      default: https://example.com
      description: apiRoot as defined in clause clause 4.4 of 3GPP TS 29.501.

```

```

security:
- oAuth2ClientCredentials:
  - nudm-ee
- {}

```

```

paths:
  /{ueIdentity}/ee-subscriptions:
    post:
      summary: Subscribe
      operationId: CreateEeSubscription
      tags:
        - Create EE Subscription
      parameters:
        - name: ueIdentity
          in: path
          description: Represents the scope of the UE for which the subscription is applied.
          Contains the GPSI of the user or the external group ID or any UE.
          required: true
          schema:
            type: string
            pattern: '^ (msisdn- [0-9]{5,15} |.+|extid- [^@]+@[^@]+|extgroupid- [^@]+@[^@]+|anyUE) $'
      requestBody:
        content:
          application/json:
            schema:
              $ref: '#/components/schemas/EeSubscription'
            required: true
      responses:
        '201':
          description: Expected response to a valid request
          content:
            application/json:
              schema:

```

```

        $ref: '#/components/schemas/CreatedEeSubscription'
      headers:
        Location:
          description: 'Contains the URI of the newly created resource, according to the
structure: {apiRoot}/nudm-ee/v1/{ueIdentity}/ee-subscriptions/{subscriptionId}'
          required: true
          schema:
            type: string
      '400':
        $ref: 'TS29571_CommonData.yaml#/components/responses/400'
      '403':
        $ref: 'TS29571_CommonData.yaml#/components/responses/403'
      '404':
        $ref: 'TS29571_CommonData.yaml#/components/responses/404'
      '500':
        $ref: 'TS29571_CommonData.yaml#/components/responses/500'
      '501':
        $ref: 'TS29571_CommonData.yaml#/components/responses/501'
      '503':
        $ref: 'TS29571_CommonData.yaml#/components/responses/503'
    default:
      description: Unexpected error
  callbacks:
    eventOccurrenceNotification:
      '{request.body#/callbackReference}':
        post:
          requestBody:
            required: true
            content:
              application/json:
                schema:
                  type: array
                  items:
                    $ref: '#/components/schemas/MonitoringReport'
                  minItems: 1
          responses:
            '204':
              description: Successful Notification response
            '400':
              $ref: 'TS29571_CommonData.yaml#/components/responses/400'
            '404':
              $ref: 'TS29571_CommonData.yaml#/components/responses/404'
            '500':
              $ref: 'TS29571_CommonData.yaml#/components/responses/500'
            '503':
              $ref: 'TS29571_CommonData.yaml#/components/responses/503'
            default:
              description: Unexpected error

/{ueIdentity}/ee-subscriptions/{subscriptionId}:
  delete:
    summary: Unsubscribe
    operationId: DeleteEeSubscription
    tags:
      - Delete EE Subscription
    parameters:
      - name: ueIdentity
        in: path
        description: Represents the scope of the UE for which the subscription is applied.
Contains the GPSI of the user or the external group ID or any UE.
        required: true
        schema:
          type: string
          pattern: '^ (msisdn- [0-9]{5,15} |.+|extid- [^@]+@[^@]+|extgroupid- [^@]+@[^@]+|anyUE) $'
      - name: subscriptionId
        in: path
        description: Id of the EE Subscription
        required: true
        schema:
          type: string
    responses:
      '204':
        description: Successful response
      '400':
        $ref: 'TS29571_CommonData.yaml#/components/responses/400'
      '404':
        $ref: 'TS29571_CommonData.yaml#/components/responses/404'
      '500':

```

```

    $ref: 'TS29571_CommonData.yaml#/components/responses/500'
  '503':
    $ref: 'TS29571_CommonData.yaml#/components/responses/503'
  default:
    description: Unexpected error
patch:
  summary: Patch
  operationId: UpdateEeSubscription
  tags:
  - Update EE Subscription
  parameters:
  - name: ueIdentity
    in: path
    description: Represents the scope of the UE for which the subscription is applied.
    Contains the GPSI of the user or the external group ID or any UE.
    required: true
    schema:
      type: string
      pattern: '^ (msisdn- [0-9]{5,15} |.+|extid- [^@]+@[^@]+|extgroupid- [^@]+@[^@]+|anyUE) $'
  - name: subscriptionId
    in: path
    description: Id of the EE Subscription
    required: true
    schema:
      type: string
  - name: supported-features
    in: query
    description: Features required to be supported by the target NF
    schema:
      $ref: 'TS29571_CommonData.yaml#/components/schemas/SupportedFeatures'
  requestBody:
    content:
      application/json-patch+json:
        schema:
          type: array
          items:
            $ref: 'TS29571_CommonData.yaml#/components/schemas/PatchItem'
          minItems: 1
        required: true
  responses:
    '200':
      description: Expected response to a valid request
      content:
        application/json:
          schema:
            $ref: 'TS29571_CommonData.yaml#/components/schemas/PatchResult'
    '204':
      description: Successful response
    '403':
      $ref: 'TS29571_CommonData.yaml#/components/responses/403'
    '404':
      $ref: 'TS29571_CommonData.yaml#/components/responses/404'
  default:
    description: Unexpected error

components:
  securitySchemes:
    oAuth2ClientCredentials:
      type: oauth2
      flows:
        clientCredentials:
          tokenUrl: '{nrfApiRoot}/oauth2/token'
          scopes:
            nudm-ee: Access to the nudm-ee API

schemas:
# COMPLEX TYPES:

CreatedEeSubscription:
  type: object
  required:
  - eeSubscription
  properties:
    eeSubscription:
      $ref: '#/components/schemas/EeSubscription'
    numberOfUes:

```

```

    $ref: 'TS29571_CommonData.yaml#/components/schemas/UInteger'
  eventReports:
    type: array
    items:
      $ref: '#/components/schemas/MonitoringReport'
    minItems: 1
  epcStatusInd:
    type: boolean

EeSubscription:
  type: object
  required:
    - callbackReference
    - monitoringConfigurations
  properties:
    callbackReference:
      $ref: 'TS29571_CommonData.yaml#/components/schemas/Uri'
    monitoringConfigurations:
      description: A map (list of key-value pairs where ReferenceId serves as key) of
MonitoringConfigurations
      type: object
      additionalProperties:
        $ref: '#/components/schemas/MonitoringConfiguration'
      minProperties: 1
    reportingOptions:
      $ref: '#/components/schemas/ReportingOptions'
    supportedFeatures:
      $ref: 'TS29571_CommonData.yaml#/components/schemas/SupportedFeatures'
    subscriptionId:
      type: string
    contextInfo:
      $ref: 'TS29503_Nudm_SDM.yaml#/components/schemas/ContextInfo'
    epcAppliedInd:
      type: boolean
      default: false
    scefDiamHost:
      $ref: 'TS29571_CommonData.yaml#/components/schemas/DiameterIdentity'
    scefDiamRealm:
      $ref: 'TS29571_CommonData.yaml#/components/schemas/DiameterIdentity'
    notifyCorrelationId:
      type: string

MonitoringConfiguration:
  type: object
  required:
    - eventType
  properties:
    eventType:
      $ref: '#/components/schemas/EventType'
    immediateFlag:
      type: boolean
    locationReportingConfiguration:
      $ref: '#/components/schemas/LocationReportingConfiguration'
    associationType:
      $ref: '#/components/schemas/AssociationType'
    datalinkReportCfg:
      $ref: '#/components/schemas/DatalinkReportingConfiguration'
    lossConnectivityCfg:
      $ref: '#/components/schemas/LossConnectivityCfg'
    maximumLatency:
      $ref: 'TS29571_CommonData.yaml#/components/schemas/DurationSec'
    maximumResponseTime:
      $ref: 'TS29571_CommonData.yaml#/components/schemas/DurationSec'
    suggestedPacketNumDl:
      type: integer
      minimum: 1
    pduSessionStatusCfg:
      $ref: '#/components/schemas/PduSessionStatusCfg'
    reachabilityForSmsCfg:
      $ref: '#/components/schemas/ReachabilityForSmsConfiguration'
    mtcProviderInformation:
      $ref: 'TS29571_CommonData.yaml#/components/schemas/MtcProviderInformation'
    afId:
      type: string
    idleStatusInd:
      type: boolean
      default: false

```

```
LossConnectivityCfg:
  type: object
  properties:
    maxDetectionTime:
      $ref: 'TS29571_CommonData.yaml#/components/schemas/DurationSec'

LocationReportingConfiguration:
  type: object
  required:
    - currentLocation
  properties:
    currentLocation:
      type: boolean
    oneTime:
      type: boolean
    accuracy:
      $ref: '#/components/schemas/LocationAccuracy'
    n3gppAccuracy:
      $ref: '#/components/schemas/LocationAccuracy'

ReportingOptions:
  type: object
  properties:
    reportMode:
      $ref: '#/components/schemas/EventReportMode'
    maxNumOfReports:
      $ref: '#/components/schemas/MaxNumOfReports'
    expiry:
      $ref: 'TS29571_CommonData.yaml#/components/schemas/DateTime'
    samplingRatio:
      $ref: 'TS29571_CommonData.yaml#/components/schemas/SamplingRatio'
    guardTime:
      $ref: 'TS29571_CommonData.yaml#/components/schemas/DurationSec'
    reportPeriod:
      $ref: 'TS29571_CommonData.yaml#/components/schemas/DurationSec'

MonitoringReport:
  type: object
  required:
    - referenceId
    - eventType
    - timeStamp
  properties:
    referenceId:
      $ref: '#/components/schemas/ReferenceId'
    eventType:
      $ref: '#/components/schemas/EventType'
    report:
      $ref: '#/components/schemas/Report'
    reachabilityForSmsReport:
      $ref: '#/components/schemas/ReachabilityForSmsReport'
    gpsi:
      $ref: 'TS29571_CommonData.yaml#/components/schemas/Gpsi'
    timeStamp:
      $ref: 'TS29571_CommonData.yaml#/components/schemas/DateTime'

Report:
  oneOf:
    - $ref: '#/components/schemas/ChangeOfSupiPeiAssociationReport'
    - $ref: '#/components/schemas/RoamingStatusReport'
    - $ref: '#/components/schemas/CnTypeChangeReport'
    - $ref: '#/components/schemas/CmInfoReport'
    - $ref: '#/components/schemas/LossConnectivityReport'
    - $ref: '#/components/schemas/LocationReport'
    - $ref: '#/components/schemas/PdnConnectivityStatReport'

ReachabilityForSmsReport:
  type: object
  required:
    - smsfAccessType
  properties:
    smsfAccessType:
      $ref: 'TS29571_CommonData.yaml#/components/schemas/AccessType'
    maxAvailabilityTime:
      $ref: 'TS29571_CommonData.yaml#/components/schemas/DateTime'

ChangeOfSupiPeiAssociationReport:
```

```
type: object
required:
  - newPei
properties:
  newPei:
    $ref: 'TS29571_CommonData.yaml#/components/schemas/Pei'

RoamingStatusReport:
type: object
required:
  - roaming
  - newServingPlmn
properties:
  roaming:
    type:
      boolean
  newServingPlmn:
    $ref: 'TS29571_CommonData.yaml#/components/schemas/PlmnId'

CnTypeChangeReport:
type: object
required:
  - newCnType
properties:
  newCnType:
    $ref: '#/components/schemas/CnType'
  oldCnType:
    $ref: '#/components/schemas/CnType'

DatalinkReportingConfiguration:
type: object
properties:
  dddTrafficDes:
    type: array
    items:
      $ref: 'TS29571_CommonData.yaml#/components/schemas/DddTrafficDescriptor'
    minItems: 1
  dnn:
    $ref: 'TS29571_CommonData.yaml#/components/schemas/Dnn'
  slice:
    $ref: 'TS29571_CommonData.yaml#/components/schemas/Snssai'
  dddStatusList:
    type: array
    items:
      $ref: 'TS29571_CommonData.yaml#/components/schemas/DlDataDeliveryStatus'
    minItems: 1

CmInfoReport:
type: object
properties:
  oldCmInfoList:
    type: array
    items:
      $ref: 'TS29518_Namf_EventExposure.yaml#/components/schemas/CmInfo'
    minItems: 1
    maxItems: 2
  newCmInfoList:
    type: array
    items:
      $ref: 'TS29518_Namf_EventExposure.yaml#/components/schemas/CmInfo'
    minItems: 1
    maxItems: 2
required:
  - newCmInfoList

PduSessionStatusCfg:
type: object
properties:
  dnn:
    $ref: 'TS29571_CommonData.yaml#/components/schemas/Dnn'

LossConnectivityReport:
type: object
required:
  - lossOfConnectReason
properties:
  lossOfConnectReason:
    $ref: 'TS29518_Namf_EventExposure.yaml#/components/schemas/LossOfConnectivityReason'
```



```
LocationReport:
  type: object
  required:
  - location
  properties:
    location:
      $ref: 'TS29571_CommonData.yaml#/components/schemas/UserLocation'

PdnConnectivityStatReport:
  type: object
  required:
  - pdnConnStat
  properties:
    pdnConnStat:
      $ref: '#/components/schemas/PdnConnectivityStatus'
    dnn:
      $ref: 'TS29571_CommonData.yaml#/components/schemas/Dnn'
    pduSeId:
      $ref: 'TS29571_CommonData.yaml#/components/schemas/PduSessionId'
    ipv4Addr:
      $ref: 'TS29571_CommonData.yaml#/components/schemas/Ipv4Addr'
    ipv6Prefixes:
      type: array
      items:
        $ref: 'TS29571_CommonData.yaml#/components/schemas/Ipv6Prefix'
      minItems: 1
    ipv6Addrs:
      type: array
      items:
        $ref: 'TS29571_CommonData.yaml#/components/schemas/Ipv6Addr'
      minItems: 1
    pduSessType:
      $ref: 'TS29571_CommonData.yaml#/components/schemas/PduSessionType'
```

SIMPLE TYPES:

```
ReferenceId:
  type: integer
```

```
MaxNumOfReports:
  type: integer
```

ENUMS:

```
ReachabilityForSmsConfiguration:
  anyOf:
  - type: string
  enum:
  - REACHABILITY_FOR_SMS_OVER_NAS
  - REACHABILITY_FOR_SMS_OVER_IP
  - type: string
```

```
EventType:
  anyOf:
  - type: string
  enum:
  - LOSS_OF_CONNECTIVITY
  - UE_REACHABILITY_FOR_DATA
  - UE_REACHABILITY_FOR_SMS
  - LOCATION_REPORTING
  - CHANGE_OF_SUPI_PEI_ASSOCIATION
  - ROAMING_STATUS
  - COMMUNICATION_FAILURE
  - AVAILABILITY_AFTER_DDN_FAILURE
  - CN_TYPE_CHANGE
  - DL_DATA_DELIVERY_STATUS
  - PDN_CONNECTIVITY_STATUS
  - UE_CONNECTION_MANAGEMENT_STATE
  - type: string
```

```
LocationAccuracy:
  anyOf:
  - type: string
  enum:
  - CELL_LEVEL
```

- TA_LEVEL
- N3IWF_LEVEL
- UE_IP
- UE_PORT
- type: string

CnType:

anyOf:

- type: string
- enum:
 - SINGLE_4G
 - SINGLE_5G
 - DUAL_4G5G
- type: string

AssociationType:

anyOf:

- type: string
- enum:
 - IMEI_CHANGE
 - IMEISV_CHANGE
- type: string

EventReportMode:

anyOf:

- type: string
- enum:
 - PERIODIC
 - ON_EVENT_DETECTION
- type: string

PdnConnectivityStatus:

anyOf:

- type: string
- enum:
 - ESTABLISHED
 - RELEASED
- type: string

A.6 Nudm_PP API

openapi: 3.0.0

info:

```
version: '1.1.3'
title: 'Nudm_PP'
description: |
  Nudm Parameter Provision Service.
  © 2021, 3GPP Organizational Partners (ARIB, ATIS, CCSA, ETSI, TSDSI, TTA, TTC).
  All rights reserved.
```

externalDocs:

```
description: 3GPP TS 29.503 Unified Data Management Services, version 16.8.0
url: 'http://www.3gpp.org/ftp/Specs/archive/29_series/29.503/'
```

servers:

```
- url: '{apiRoot}/nudm-pp/v1'
  variables:
    apiRoot:
      default: https://example.com
      description: apiRoot as defined in clause clause 4.4 of 3GPP TS 29.501.
```

security:

```
- oAuth2ClientCredentials:
  - nudm-pp
- {}
```

paths:

```
/{ueId}/pp-data:
  patch:
    summary: provision parameters
    operationId: Update
    tags:
      - Subscription Data Update
    parameters:
      - name: ueId
        in: path
        description: Identifier of the UE
        required: true
        schema:
          anyOf:
            - $ref: 'TS29571_CommonData.yaml#/components/schemas/VarUeId'
            - $ref: 'TS29503_Nudm_SDM.yaml#/components/schemas/ExtGroupId'
      - name: supported-features
        in: query
        description: Features required to be supported by the target NF
        schema:
          $ref: 'TS29571_CommonData.yaml#/components/schemas/SupportedFeatures'
    requestBody:
      content:
        application/merge-patch+json:
          schema:
            $ref: '#/components/schemas/PpData'
      required: true
    responses:
      '200':
        description: Expected response to a valid request
        content:
          application/json:
            schema:
              $ref: 'TS29571_CommonData.yaml#/components/schemas/PatchResult'
      '204':
        description: Expected response to a valid request
      '400':
        $ref: 'TS29571_CommonData.yaml#/components/responses/400'
      '403':
        $ref: 'TS29571_CommonData.yaml#/components/responses/403'
      '404':
        $ref: 'TS29571_CommonData.yaml#/components/responses/404'
      '500':
        $ref: 'TS29571_CommonData.yaml#/components/responses/500'
      '503':
        $ref: 'TS29571_CommonData.yaml#/components/responses/503'
    default:
      description: Unexpected error
  /5g-vn-groups/{extGroupId}:
```

```
put:
  summary: create a 5G VN Group
  operationId: Create 5G VN Group
  tags:
    - 5G VN Group Creation
  parameters:
    - name: extGroupId
      in: path
      description: External Identifier of the Group
      required: true
      schema:
        $ref: 'TS29503_Nudm_SDM.yaml#/components/schemas/ExtGroupId'
  requestBody:
    content:
      application/json:
        schema:
          $ref: '#/components/schemas/5GVnGroupConfiguration'
    required: true
  responses:
    '201':
      description: Expected response to a valid request
    '400':
      $ref: 'TS29571_CommonData.yaml#/components/responses/400'
    '403':
      $ref: 'TS29571_CommonData.yaml#/components/responses/403'
    '404':
      $ref: 'TS29571_CommonData.yaml#/components/responses/404'
    '500':
      $ref: 'TS29571_CommonData.yaml#/components/responses/500'
    '503':
      $ref: 'TS29571_CommonData.yaml#/components/responses/503'
    default:
      description: Unexpected error
delete:
  summary: delete a 5G VN Group
  operationId: Delete 5G VN Group
  tags:
    - 5G VN Group Deletion
  parameters:
    - name: extGroupId
      in: path
      description: External Identifier of the Group
      required: true
      schema:
        $ref: 'TS29503_Nudm_SDM.yaml#/components/schemas/ExtGroupId'
    - name: mtc-provider-info
      in: query
      description: MTC Provider Information that originated the service operation
      schema:
        $ref: 'TS29571_CommonData.yaml#/components/schemas/MtcProviderInformation'
    - name: af-id
      in: query
      description: AF ID that originated the service operation
      schema:
        type: string
  responses:
    '204':
      description: Expected response to a valid request
    '400':
      $ref: 'TS29571_CommonData.yaml#/components/responses/400'
    '403':
      $ref: 'TS29571_CommonData.yaml#/components/responses/403'
    '404':
      $ref: 'TS29571_CommonData.yaml#/components/responses/404'
    '500':
      $ref: 'TS29571_CommonData.yaml#/components/responses/500'
    '503':
      $ref: 'TS29571_CommonData.yaml#/components/responses/503'
    default:
      description: Unexpected error
patch:
  summary: modify a 5G VN Group
  operationId: Modify 5G VN Group
  tags:
    - 5G VN Group Modification
  parameters:
    - name: extGroupId
      in: path
```

```

    description: External Identifier of the group
    required: true
    schema:
      $ref: 'TS29503_Nudm_SDM.yaml#/components/schemas/ExtGroupId'
  - name: supported-features
    in: query
    description: Features required to be supported by the target NF
    schema:
      $ref: 'TS29571_CommonData.yaml#/components/schemas/SupportedFeatures'
requestBody:
  content:
    application/merge-patch+json:
      schema:
        $ref: '#/components/schemas/5GVnGroupConfiguration'
  required: true
responses:
  '204':
    description: Expected response to a valid request
  '200':
    description: Expected response to a valid request
    content:
      application/json:
        schema:
          $ref: 'TS29571_CommonData.yaml#/components/schemas/PatchResult'
  '400':
    $ref: 'TS29571_CommonData.yaml#/components/responses/400'
  '403':
    $ref: 'TS29571_CommonData.yaml#/components/responses/403'
  '404':
    $ref: 'TS29571_CommonData.yaml#/components/responses/404'
  '500':
    $ref: 'TS29571_CommonData.yaml#/components/responses/500'
  '503':
    $ref: 'TS29571_CommonData.yaml#/components/responses/503'
  default:
    description: Unexpected error
get:
  summary: get 5G VN Group
  operationId: Get 5G VN Group
  tags:
    - 5G VN Group Modification
  parameters:
    - name: extGroupId
      in: path
      description: External Identifier of the group
      required: true
      schema:
        $ref: 'TS29503_Nudm_SDM.yaml#/components/schemas/ExtGroupId'
  responses:
    '200':
      description: Expected response to a valid request
      content:
        application/json:
          schema:
            $ref: '#/components/schemas/5GVnGroupConfiguration'
    '400':
      $ref: 'TS29571_CommonData.yaml#/components/responses/400'
    '403':
      $ref: 'TS29571_CommonData.yaml#/components/responses/403'
    '404':
      $ref: 'TS29571_CommonData.yaml#/components/responses/404'
    '500':
      $ref: 'TS29571_CommonData.yaml#/components/responses/500'
    '503':
      $ref: 'TS29571_CommonData.yaml#/components/responses/503'
    default:
      description: Unexpected error

components:
  securitySchemes:
    oAuth2ClientCredentials:
      type: oauth2
      flows:
        clientCredentials:
          tokenUrl: '{nrfApiRoot}/oauth2/token'
          scopes:
            nudm-pp: Access to the nudm-pp API

```

schemas:

COMPLEX TYPES:

```
PpData:
  type: object
  properties:
    communicationCharacteristics:
      $ref: '#/components/schemas/CommunicationCharacteristics'
    supportedFeatures:
      $ref: 'TS29571_CommonData.yaml#/components/schemas/SupportedFeatures'
    expectedUeBehaviourParameters:
      $ref: '#/components/schemas/ExpectedUeBehaviour'
    ecRestriction:
      $ref: '#/components/schemas/EcRestriction'
    acsInfo:
      $ref: 'TS29571_CommonData.yaml#/components/schemas/AcsInfoRm'
    stnSr:
      $ref: 'TS29571_CommonData.yaml#/components/schemas/StnSrRm'
    lcsPrivacy:
      $ref: '#/components/schemas/LcsPrivacy'
    sorInfo:
      $ref: 'TS29503_Nudm_SDM.yaml#/components/schemas/SorInfo'

CommunicationCharacteristics:
  type: object
  properties:
    ppSubsRegTimer:
      $ref: '#/components/schemas/PpSubsRegTimer'
    ppActiveTime:
      $ref: '#/components/schemas/PpActiveTime'
    ppDlPacketCount:
      $ref: '#/components/schemas/PpDlPacketCount'
    ppDlPacketCountExt:
      $ref: '#/components/schemas/PpDlPacketCountExt'
    ppMaximumResponseTime:
      $ref: '#/components/schemas/PpMaximumResponseTime'
    ppMaximumLatency:
      $ref: '#/components/schemas/PpMaximumLatency'

PpSubsRegTimer:
  type: object
  required:
    - subsRegTimer
    - afInstanceId
    - referenceId
  properties:
    subsRegTimer:
      $ref: 'TS29571_CommonData.yaml#/components/schemas/DurationSec'
    afInstanceId:
      type: string
    referenceId:
      $ref: '#/components/schemas/ReferenceId'
    validityTime:
      $ref: 'TS29571_CommonData.yaml#/components/schemas/DateTime'
    mtcProviderInformation:
      $ref: 'TS29571_CommonData.yaml#/components/schemas/MtcProviderInformation'
  nullable: true

PpActiveTime:
  type: object
  required:
    - activeTime
    - afInstanceId
    - referenceId
  properties:
    activeTime:
      $ref: 'TS29571_CommonData.yaml#/components/schemas/DurationSec'
    afInstanceId:
      type: string
    referenceId:
      $ref: '#/components/schemas/ReferenceId'
    validityTime:
      $ref: 'TS29571_CommonData.yaml#/components/schemas/DateTime'
    mtcProviderInformation:
```

```

    $ref: 'TS29571_CommonData.yaml#/components/schemas/MtcProviderInformation'
    nullable: true

5GVnGroupConfiguration:
  type: object
  properties:
    5GVnGroupData:
      $ref: '#/components/schemas/5GVnGroupData'
    members:
      type: array
      items:
        $ref: 'TS29571_CommonData.yaml#/components/schemas/Gpsi'
      minItems: 1
    referenceId:
      $ref: '#/components/schemas/ReferenceId'
    afInstanceId:
      type: string
    internalGroupIdentifier:
      $ref: 'TS29571_CommonData.yaml#/components/schemas/GroupId'
    mtcProviderInformation:
      $ref: 'TS29571_CommonData.yaml#/components/schemas/MtcProviderInformation'

5GVnGroupData:
  type: object
  required:
    - dnn
    - sNssai
  properties:
    dnn:
      $ref: 'TS29571_CommonData.yaml#/components/schemas/Dnn'
    sNssai:
      $ref: 'TS29571_CommonData.yaml#/components/schemas/Snssai'
    pduSessionTypes:
      type: array
      items:
        $ref: 'TS29571_CommonData.yaml#/components/schemas/PduSessionType'
      minItems: 1
    appDescriptors:
      type: array
      items:
        $ref: 'TS29503_Nudm_SDM.yaml#/components/schemas/AppDescriptor'
      minItems: 1
    secondaryAuth:
      type: boolean
    dnAaaAddress:
      $ref: 'TS29503_Nudm_SDM.yaml#/components/schemas/IpAddress'

ExpectedUeBehaviour:
  type: object
  required:
    - afInstanceId
    - referenceId
  properties:
    afInstanceId:
      type: string
    referenceId:
      $ref: '#/components/schemas/ReferenceId'
    stationaryIndication:
      $ref: 'TS29571_CommonData.yaml#/components/schemas/StationaryIndicationRm'
    communicationDurationTime:
      $ref: 'TS29571_CommonData.yaml#/components/schemas/DurationSecRm'
    scheduledCommunicationType:
      $ref: 'TS29571_CommonData.yaml#/components/schemas/ScheduledCommunicationTypeRm'
    periodicTime:
      $ref: 'TS29571_CommonData.yaml#/components/schemas/DurationSecRm'
    scheduledCommunicationTime:
      $ref: 'TS29571_CommonData.yaml#/components/schemas/ScheduledCommunicationTimeRm'
    expectedUmts:
      type: array
      items:
        $ref: '#/components/schemas/LocationArea'
      minItems: 1
      nullable: true
      description: Identifies the UE's expected geographical movement. The attribute is only
        applicable in 5G.
    trafficProfile:
      $ref: 'TS29571_CommonData.yaml#/components/schemas/TrafficProfileRm'
    batteryIndication:

```

```

    $ref: 'TS29571_CommonData.yaml#/components/schemas/BatteryIndicationRm'
  validityTime:
    $ref: 'TS29571_CommonData.yaml#/components/schemas/DateTime'
  mtcProviderInformation:
    $ref: 'TS29571_CommonData.yaml#/components/schemas/MtcProviderInformation'

```

```

LocationArea:
  type: object
  properties:
    geographicAreas:
      type: array
      items:
        $ref: 'TS29572_Nlmf_Location.yaml#/components/schemas/GeographicArea'
      minItems: 0
      description: Identifies a list of geographic area of the user where the UE is located.
    civicAddresses:
      type: array
      items:
        $ref: 'TS29572_Nlmf_Location.yaml#/components/schemas/CivicAddress'
      minItems: 0
      description: Identifies a list of civic addresses of the user where the UE is located.
    nwAreaInfo:
      $ref: '#/components/schemas/NetworkAreaInfo'

```

```

NetworkAreaInfo:
  description: Describes a network area information in which the NF service consumer requests
the number of UEs.
  type: object
  properties:
    ecgis:
      description: Contains a list of E-UTRA cell identities.
      type: array
      items:
        $ref: 'TS29571_CommonData.yaml#/components/schemas/Ecgi'
      minItems: 1
    ncgis:
      description: Contains a list of NR cell identities.
      type: array
      items:
        $ref: 'TS29571_CommonData.yaml#/components/schemas/Ncgi'
      minItems: 1
    gRanNodeIds:
      description: Contains a list of NG RAN nodes.
      type: array
      items:
        $ref: 'TS29571_CommonData.yaml#/components/schemas/GlobalRanNodeId'
      minItems: 1
    tais:
      description: Contains a list of tracking area identities.
      type: array
      items:
        $ref: 'TS29571_CommonData.yaml#/components/schemas/Tai'
      minItems: 1

```

```

EcRestriction:
  type: object
  required:
    - afInstanceId
    - referenceId
  properties:
    afInstanceId:
      type: string
    referenceId:
      $ref: '#/components/schemas/ReferenceId'
    plmnEcInfos:
      type: array
      items:
        $ref: '#/components/schemas/PlmnEcInfo'
      minItems: 1
    mtcProviderInformation:
      $ref: 'TS29571_CommonData.yaml#/components/schemas/MtcProviderInformation'

```

```

PlmnEcInfo:
  type: object
  required:
    - plmnId
  properties:
    plmnId:

```



```

    $ref: 'TS29571_CommonData.yaml#/components/schemas/PlmnId'
  ecRestrictionDataWb:
    $ref: 'TS29503_Nudm_SDM.yaml#/components/schemas/EcRestrictionDataWb'
  ecRestrictionDataNb:
    type: boolean
    default: false

```

```

PpDlPacketCountExt:
  type: object
  required:
    - afInstanceId
    - referenceId
  properties:
    afInstanceId:
      type: string
    referenceId:
      $ref: '#/components/schemas/ReferenceId'
    validityTime:
      $ref: 'TS29571_CommonData.yaml#/components/schemas/DateTime'
    mtcProviderInformation:
      $ref: 'TS29571_CommonData.yaml#/components/schemas/MtcProviderInformation'
  nullable: true

```

```

PpMaximumResponseTime:
  type: object
  required:
    - maximumResponseTime
    - afInstanceId
    - referenceId
  properties:
    maximumResponseTime:
      $ref: 'TS29571_CommonData.yaml#/components/schemas/DurationSec'
    afInstanceId:
      type: string
    referenceId:
      $ref: '#/components/schemas/ReferenceId'
    validityTime:
      $ref: 'TS29571_CommonData.yaml#/components/schemas/DateTime'
    mtcProviderInformation:
      $ref: 'TS29571_CommonData.yaml#/components/schemas/MtcProviderInformation'
  nullable: true

```

```

PpMaximumLatency:
  type: object
  required:
    - maximumLatency
    - afInstanceId
    - referenceId
  properties:
    maximumLatency:
      $ref: 'TS29571_CommonData.yaml#/components/schemas/DurationSec'
    afInstanceId:
      type: string
    referenceId:
      $ref: '#/components/schemas/ReferenceId'
    validityTime:
      $ref: 'TS29571_CommonData.yaml#/components/schemas/DateTime'
    mtcProviderInformation:
      $ref: 'TS29571_CommonData.yaml#/components/schemas/MtcProviderInformation'
  nullable: true

```

```

LcsPrivacy:
  type: object
  properties:
    afInstanceId:
      type: string
    referenceId:
      $ref: '#/components/schemas/ReferenceId'
    lpi:
      $ref: 'TS29503_Nudm_SDM.yaml#/components/schemas/Lpi'
    mtcProviderInformation:
      $ref: 'TS29571_CommonData.yaml#/components/schemas/MtcProviderInformation'

```

SIMPLE TYPES:

```
ReferenceId:
```

```

type: integer

PpDlPacketCount:
  type: integer
  nullable: true

```

```
# ENUMS:
```

A.7 Nudm_NIDDAU API

```
openapi: 3.0.0
```

```

info:
  version: '1.0.3'
  title: 'Nudm_NIDDAU'
  description: |
    Nudm NIDD Authorization Service.
    © 2022, 3GPP Organizational Partners (ARIB, ATIS, CCSA, ETSI, TSDSI, TTA, TTC).
    All rights reserved.

```

```

externalDocs:
  description: 3GPP TS 29.503 Unified Data Management Services, version 16.13.0
  url: 'http://www.3gpp.org/ftp/Specs/archive/29_series/29.503/'

```

```

servers:
  - url: '{apiRoot}/nudm-niddau/v1'
    variables:
      apiRoot:
        default: https://example.com
        description: apiRoot as defined in clause 4.4 of 3GPP TS 29.501.

```

```

security:
  - oAuth2ClientCredentials:
    - nudm-niddau
  - {}

```

```

paths:
  /{ueIdentity}/authorize:
    post:
      summary: Authorize the NIDD configuration request.
      operationId: AuthorizeNiddData
      tags:
        - Authorize the NIDD configuration request
      parameters:
        - name: ueIdentity
          in: path
          description: Represents the scope of the UE for which the NIDD configuration are
authorized. Contains the GPSI of the user or the external group ID.
          required: true
          schema:
            type: string
            pattern: '^ (msisdn-[0-9]{5,15}|.+|extid-[^@]+@[^@]+|extgroupid-[^@]+@[^@]+)$'
      requestBody:
        content:
          application/json:
            schema:
              $ref: '#/components/schemas/AuthorizationInfo'
            required: true
      responses:
        '200':
          description: Expected response to a valid request
          content:
            application/json:
              schema:
                $ref: '#/components/schemas/AuthorizationData'
        '400':
          $ref: 'TS29571_CommonData.yaml#/components/responses/400'
        '403':
          $ref: 'TS29571_CommonData.yaml#/components/responses/403'
        '404':
          $ref: 'TS29571_CommonData.yaml#/components/responses/404'
        '500':

```

```

    $ref: 'TS29571_CommonData.yaml#/components/responses/500'
  '501':
    $ref: 'TS29571_CommonData.yaml#/components/responses/501'
  '503':
    $ref: 'TS29571_CommonData.yaml#/components/responses/503'
  default:
    description: Unexpected error
  callbacks:
    niddAuthUpdateNotification:
      '{request.body#/authUpdateCallbackUri}':
        post:
          requestBody:
            required: true
            content:
              application/json:
                schema:
                  $ref: '#/components/schemas/NiddAuthUpdateNotification'
          responses:
            '204':
              description: Expected response to a valid request

```

```

components:
  securitySchemes:
    oAuth2ClientCredentials:
      type: oauth2
      flows:
        clientCredentials:
          tokenUrl: '{nrfApiRoot}/oauth2/token'
          scopes:
            nudm-niddau: Access to the nudm-niddau API

```

schemas:

COMPLEX TYPES:

#

```

AuthorizationData:
  type: object
  required:
    - authorizationData
  properties:
    authorizationData:
      type: array
      items:
        $ref: '#/components/schemas/UserIdentifier'
      minItems: 1
      uniqueItems: true
    validityTime:
      $ref: 'TS29571_CommonData.yaml#/components/schemas/DateTime'

```

```

UserIdentifier:
  type: object
  required:
    - supi
  properties:
    supi:
      $ref: 'TS29571_CommonData.yaml#/components/schemas/Supi'
    gpsi:
      $ref: 'TS29571_CommonData.yaml#/components/schemas/Gpsi'
    validityTime:
      $ref: 'TS29571_CommonData.yaml#/components/schemas/DateTime'

```

```

NiddAuthUpdateInfo:
  type: object
  required:
    - authorizationData
  properties:
    authorizationData:
      $ref: '#/components/schemas/AuthorizationData'
    invalidityInd:
      type: boolean
    snssai:
      $ref: 'TS29571_CommonData.yaml#/components/schemas/Snssai'
    dnn:
      $ref: 'TS29571_CommonData.yaml#/components/schemas/Dnn'
    niddCause:
      $ref: '#/components/schemas/NiddCause'

```

```

NiddAuthUpdateNotification:
  type: object
  required:
    - niddAuthUpdateInfoList
  properties:
    niddAuthUpdateInfoList:
      type: array
      items:
        $ref: '#/components/schemas/NiddAuthUpdateInfo'
      minItems: 1

AuthorizationInfo:
  type: object
  required:
    - snssai
    - dnn
    - mtcProviderInformation
    - authUpdateCallbackUri
  properties:
    snssai:
      $ref: 'TS29571_CommonData.yaml#/components/schemas/Snssai'
    dnn:
      $ref: 'TS29571_CommonData.yaml#/components/schemas/Dnn'
    mtcProviderInformation:
      $ref: 'TS29571_CommonData.yaml#/components/schemas/MtcProviderInformation'
    authUpdateCallbackUri:
      $ref: 'TS29571_CommonData.yaml#/components/schemas/Uri'
    aFid:
      type: string
    nefId:
      $ref: 'TS29510_Nnrf_NFManagement.yaml#/components/schemas/NefId'
    validityTime:
      $ref: 'TS29571_CommonData.yaml#/components/schemas/DateTime'

```

SIMPLE TYPES:

ENUMS:

```

NiddCause:
  anyOf:
    - type: string
      enum:
        - SUBSCRIPTION_WITHDRAWAL
        - DNN_REMOVED
    - type: string

```

A.8 Nudm_MT API

```

openapi: 3.0.0
info:
  version: '1.0.2'
  title: 'Nudm_MT'
  description: |
    UDM MT Service.
    © 2021, 3GPP Organizational Partners (ARIB, ATIS, CCSA, ETSI, TSDSI, TTA, TTC).
    All rights reserved.

externalDocs:
  description: 3GPP TS 29.503 Unified Data Management Services, version 16.10.0
  url: 'http://www.3gpp.org/ftp/Specs/archive/29_series/29.503/'

servers:
  - url: '{apiRoot}/nudm-mt/v1'
    variables:
      apiRoot:
        default: https://example.com
        description: apiRoot as defined in clause 4.4 of 3GPP TS 29.501.

security:
  - oAuth2ClientCredentials:

```

```
- nudm-mt
- {}
```

```
paths:
```

```
/{supi}:
```

```
get:
```

```
summary: Query Information for the UE
operationId: QueryUeInfo
tags:
- Query UE Info
parameters:
- name: supi
  in: path
  description: Identifier of the UE
  required: true
  schema:
    $ref: 'TS29571_CommonData.yaml#/components/schemas/Supi'
- name: fields
  in: query
  description: attributes to be retrieved
  required: true
  schema:
    type: array
    items:
      type: string
    minItems: 1
  style: form
  explode: false
- name: supported-features
  in: query
  description: Supported Features
  schema:
    $ref: 'TS29571_CommonData.yaml#/components/schemas/SupportedFeatures'
```

```
responses:
```

```
'200':
  description: Expected response to a valid request
  content:
    application/json:
      schema:
        $ref: '#/components/schemas/UeInfo'
'400':
  $ref: 'TS29571_CommonData.yaml#/components/responses/400'
'404':
  $ref: 'TS29571_CommonData.yaml#/components/responses/404'
'500':
  $ref: 'TS29571_CommonData.yaml#/components/responses/500'
'501':
  $ref: 'TS29571_CommonData.yaml#/components/responses/501'
'503':
  $ref: 'TS29571_CommonData.yaml#/components/responses/503'
```

```
default:
```

```
description: Unexpected error
```

```
/{supi}/loc-info/provide-loc-info:
```

```
post:
```

```
summary: Provides the UE's 5GS location information
operationId: ProvideLocationInfo
tags:
- Provide UE Location
parameters:
- name: supi
  in: path
  description: Identifier of the UE
  required: true
  schema:
    $ref: 'TS29571_CommonData.yaml#/components/schemas/Supi'
```

```
requestBody:
```

```
content:
  application/json:
    schema:
      $ref: '#/components/schemas/LocationInfoRequest'
  required: true
```

```
responses:
```

```
'200':
  description: Expected response to a valid request
  content:
    application/json:
      schema:
        $ref: '#/components/schemas/LocationInfoResult'
```

```

'400':
  $ref: 'TS29571_CommonData.yaml#/components/responses/400'
'404':
  $ref: 'TS29571_CommonData.yaml#/components/responses/404'
'500':
  $ref: 'TS29571_CommonData.yaml#/components/responses/500'
'501':
  $ref: 'TS29571_CommonData.yaml#/components/responses/501'
'503':
  $ref: 'TS29571_CommonData.yaml#/components/responses/503'
default:
  description: Unexpected error

```

```

components:
  securitySchemes:
    oAuth2ClientCredentials:
      type: oauth2
      flows:
        clientCredentials:
          tokenUrl: '{nrfApiRoot}/oauth2/token'
          scopes:
            nudm-mt: Access to the nudm-mt API

```

```
schemas:
```

```
# COMPLEX TYPES:
```

```

UeInfo:
  type: object
  properties:
    tadsInfo:
      $ref: 'TS29518_Namf_MT.yaml#/components/schemas/UeContextInfo'
    userState:
      $ref: 'TS29518_Namf_EventExposure.yaml#/components/schemas/5GsUserState'
    5GSrvccInfo:
      $ref: '#/components/schemas/5GSrvccInfo'

5GSrvccInfo:
  type: object
  required:
    - ue5GSrvccCapability
  properties:
    ue5GSrvccCapability:
      type: boolean
    stnSr:
      $ref: 'TS29571_CommonData.yaml#/components/schemas/StnSr'
    cMsisdn:
      $ref: 'TS29571_CommonData.yaml#/components/schemas/CMsisdn'

```

```

LocationInfoRequest:
  type: object
  properties:
    req5gsLoc:
      type: boolean
      default: false
    reqCurrentLoc:
      type: boolean
      default: false
    reqRatType:
      type: boolean
      default: false
    reqTimeZone:
      type: boolean
      default: false
    reqServingNode:
      type: boolean
      default: false
    supportedFeatures:
      $ref: 'TS29571_CommonData.yaml#/components/schemas/SupportedFeatures'

```

```

LocationInfoResult:
  type: object
  properties:
    vPlmnId:
      $ref: 'TS29571_CommonData.yaml#/components/schemas/PlmnId'
    amfInstanceId:

```

```
    $ref: 'TS29571_CommonData.yaml#/components/schemas/NfInstanceId'  
smsfInstanceId:  
    $ref: 'TS29571_CommonData.yaml#/components/schemas/NfInstanceId'  
ncgi:  
    $ref: 'TS29571_CommonData.yaml#/components/schemas/Ncgi'  
ecgi:  
    $ref: 'TS29571_CommonData.yaml#/components/schemas/Ecgi'  
tai:  
    $ref: 'TS29571_CommonData.yaml#/components/schemas/Tai'  
currentLoc:  
    type: boolean  
geoInfo:  
    $ref: 'TS29572_Nlmf_Location.yaml#/components/schemas/GeographicArea'  
locationAge:  
    $ref: 'TS29572_Nlmf_Location.yaml#/components/schemas/AgeOfLocationEstimate'  
ratType:  
    $ref: 'TS29571_CommonData.yaml#/components/schemas/RatType'  
timezone:  
    $ref: 'TS29571_CommonData.yaml#/components/schemas/TimeZone'  
supportedFeatures:  
    $ref: 'TS29571_CommonData.yaml#/components/schemas/SupportedFeatures'
```

SIMPLE TYPES:

ENUMS:

Annex B (informative): Stateless UDMs

Figure B-1 shows a scenario where the stateless UDM receives and processes a request from an NF.

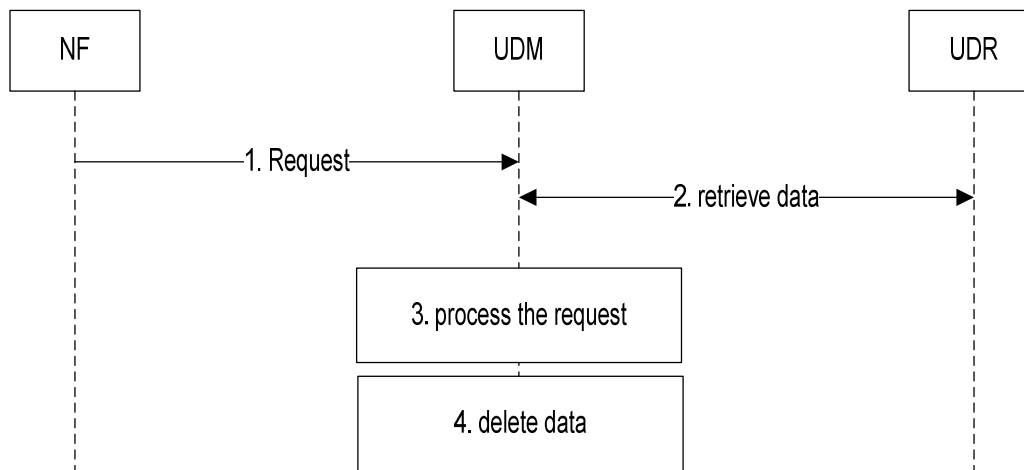

Figure B-1: Stateless UDM

1. The stateless UDM receives a request from an NF. This can be a request to perform an Nudm service, or a Notification that the UDM has previously subscribed to at the NF by means of a service the UDM consumes from the NF. In the later case the NF can be the UDR.
2. The UDM retrieves data from the UDR that are required to process the request. This step can be skipped if the request was a notification from the UDR and contained enough information so that the UDM can process the request.
3. The UDM processes the received request. This can include consuming services from other NFs, consuming services from the UDR (e.g. to update data or subscribe to notifications), and sending notifications to NFs that have subscribed at the UDM to receive notifications, and includes sending the response to the NF (all not shown in the figure).
4. The UDM locally deletes the data retrieved in step 2 and/or received in step 1.

Figure B-2 shows a scenario where an AMF subscribes to notifications of data change (permanent provisioned subscription data) at the stateless UDM. The UDM (UDM 1) stores the subscription to notification in the UE's context data at the UDR.

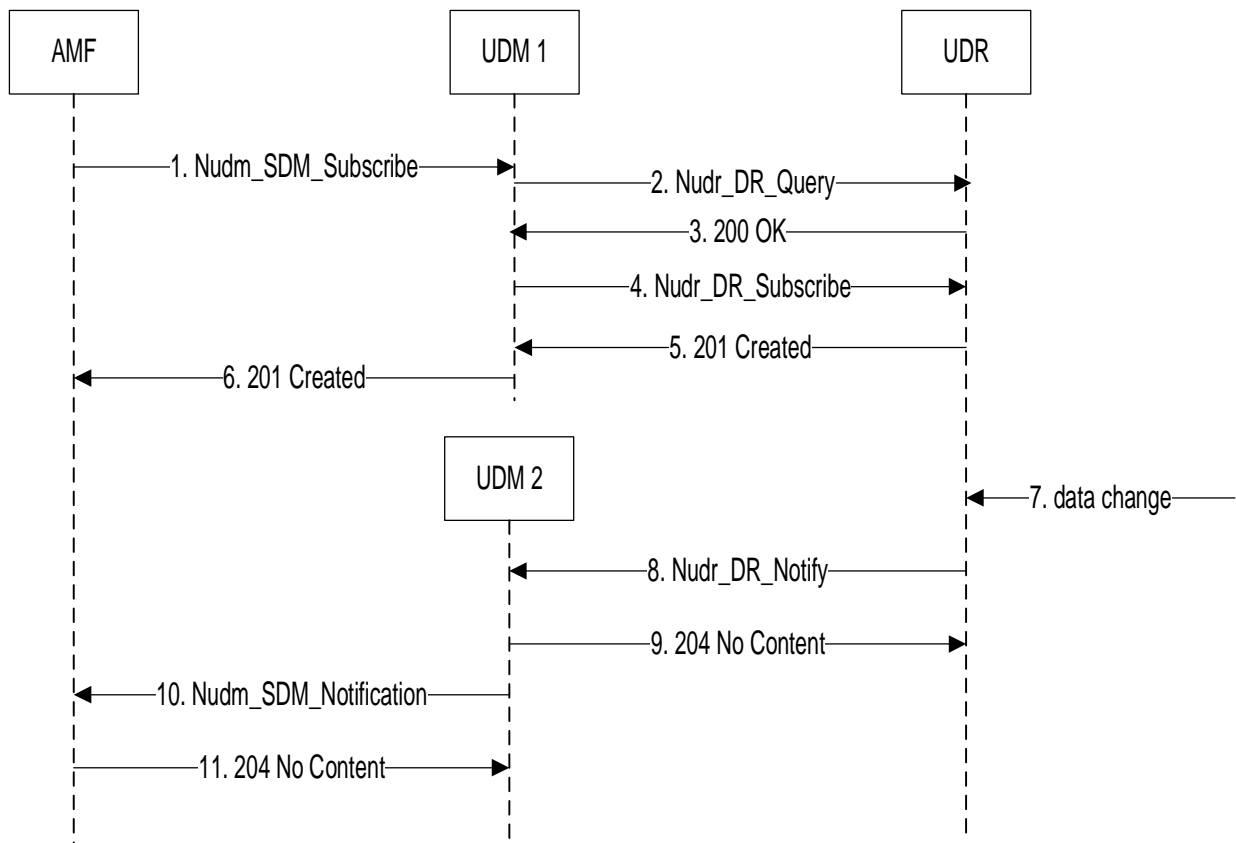

Figure B-2: Subscription to notification

1. The stateless UDM 1 receives a subscribe request from an AMF; see clause 5.2.2.3.2.
- 2.-3 The UDM retrieves UE context data from the UDR to be able to perform required plausibility checks; see 3GPP TS 29.504 [9] clause 5.2.2.2.2.
4. The UDM creates a new sdm subscription at the UDR; see 3GPP TS 29.504 [9] clause 5.2.2.6.3.
5. The UDR sends a 201 Created response containig a subscription ID
6. The UDM send a 201 Created response passing the subscription ID received in step 5 to the AMF.
7. Permanent provisioned Subscription data are modified at the UDR.
8. The UDR selects a suitable UDM and sends a Notification; see 3GPP TS 29.504 [9] clause 5.2.2.8. In addition to the data that have changed, the Notification request message can contain enough (unchanged) information (e.g. the information that has been created in step 4) allowing the UDM to perform step 10 without the need to additionally retrieve information from the UDR.
9. The UDM responds with 204 No Content.
10. The UDM notifies the AMF according to the callback URI of the AMF contained in the Notification received in step 8; see clause 5.2.2.5.2.
11. The AMF responds with 204 No Content.

Figure B-3 shows a scenario where an AMF registers at the stateless UDM. The UDM (UDM 1) stores the registration in the UE's context data at the UDR. The AMF then requests to update the registration e.g. due to change of PEI. This request is sent to UDM2 which belongs to the same UDM group as UDM1.

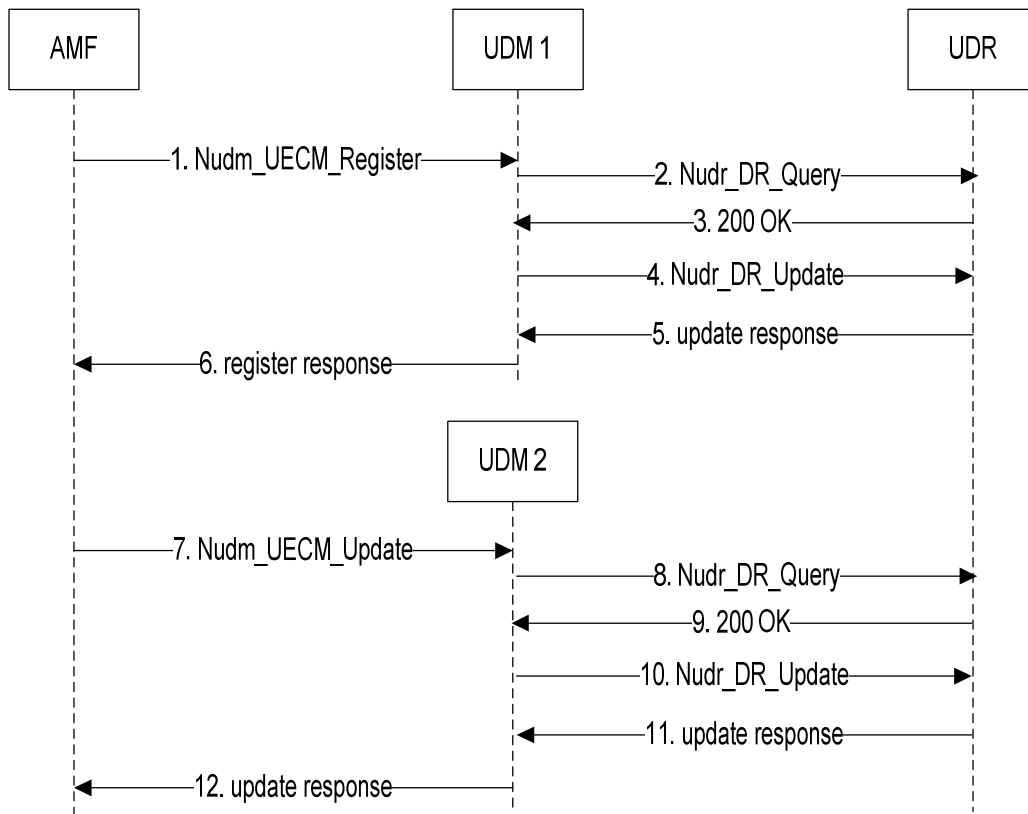

Figure B-3: AMF Registration and Update

1. The AMF discovers (by means of NRF query) and selects an UDM and sends the register request;
- 2.-3 The UDM retrieves UE context data from the UDR e.g. to be able to perform required plausibility checks;
- 4.-5 The UDM updates UE context data in the UDR. The UDM also performs other actions not shown in the figure, e.g deregister an old AMF, notify a subscribed NEF, ...
6. The UDM acknowledges the AMF registration. The AMF stores the UDM group ID as discovered and selected in step 1. The UDM locally deletes the data retrieved in step 3.
7. The AMF sends an update request (e.g. change of PEI) to one of the available UDMs (UDM2) that belongs to the same UDM group as UDM1.
- 8.-9 The UDM retrieves UE context data from the UDR e.g. to be able to perform required plausibility checks;
- 10.-11.The UDM updates UE context data in the UDR.The UDM also performs other actions not shown in the figure, e.g. notify a subscribed NEF, ...
12. The UDM sends update response to the AMF and locally deletes the data retrieved in step 9.

NOTE: When a previously received Location Header or Callback URI is used for a subsequent UDM contact, the authority part may need to be replaced to point to the selected UDM.

Figure B-4 shows a scenario where an AF requests a subscription for all UEs (any UE) for a given network event. The NEF discovers all UDM NFs providing the necessary service to perform a bulk subscription. If one or several UDM Group IDs are received, NEF selects only one instance of UDM for each Group ID in order to perform the bulk subscription.

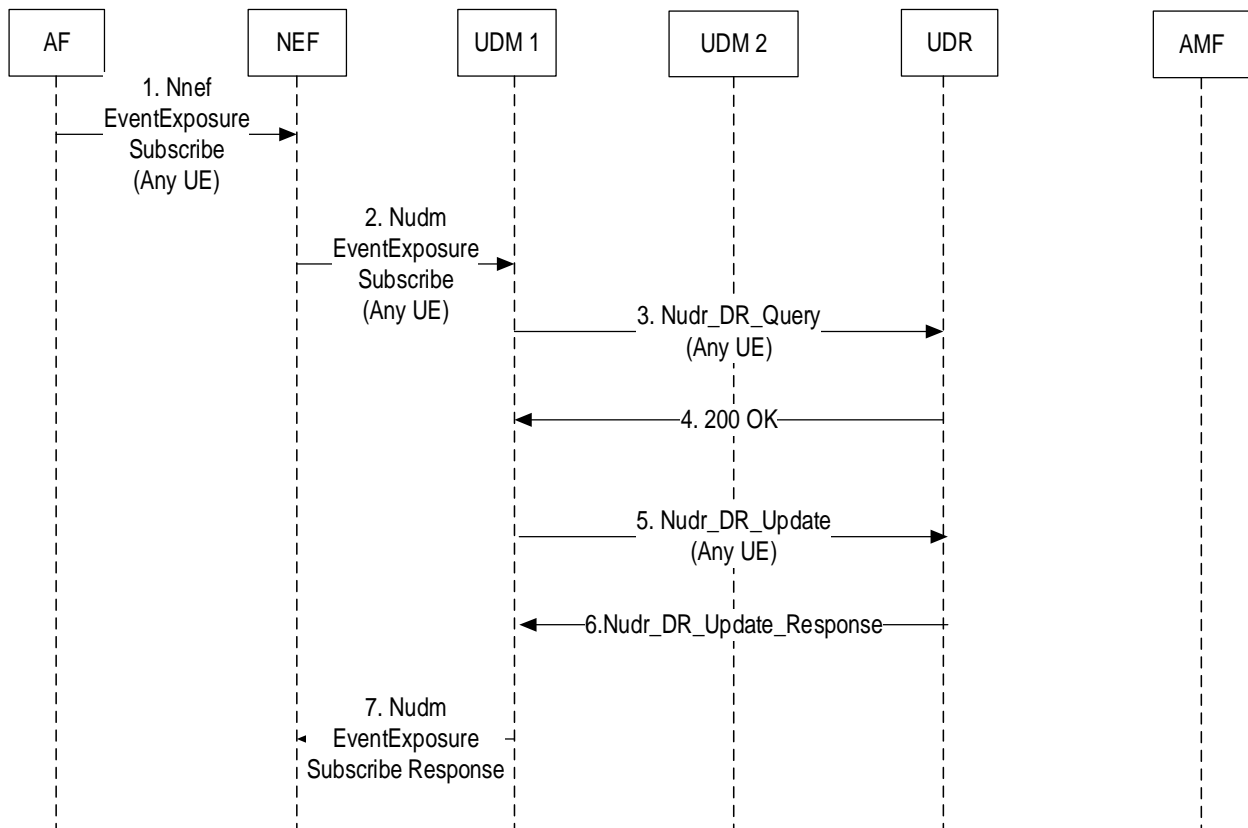

Figure B-4: Any UE Subscription

1. An AF subscribes to a network event (e.g. SUPI-PEI association change) for any UE (i.e. all UEs)
2. The NEF discovers (by means of NRF query) all UDM instances supporting the required service (e.g. nudm-ee). The NEF selects an UDM instance (e.g. UDM 1) from each UDM Group ID discovered (UDM 1 and UDM 2 are in the same UDM Group ID) and sends the subscribe request. The NEF also stores the UDM Group ID information to select a UDM for subsequent subscriptions.
- 3-4. The UDM retrieves data from the UDR for group of UEs, e.g. to be able to perform required plausibility checks
- 5-6. The UDM stores data for group of UEs in the UDR.
7. The UDM acknowledges the NEF subscription request. The UDM locally deletes the data retrieved in step 3.

Steps 7-12 in Figure B-3 are performed. As result of the subscription, NEF is notified by UDM 2 (change of PEI). Subsequently, when the event occurs for any UE (within the SUPI range, if applicable, served by the UDM Group ID), NEF is notified by either UDM1 or UDM 2.

Annex C (informative): SUCI encoding

The structure of the Subscription Concealed Identifier (SUCI) is defined in 3GPP TS 23.003 [8].

When SUCI needs to be sent as a character string (e.g. as a string in a JSON payload of any of the service operations defined in the APIs defined in this specification), the SUCI is composed as an UTF-8 character string, where the different components are separated by the "minus" character "-" (UTF-8 0x2D).

These components shall be formatted as follows:

- 1) SUPI Type: a single decimal digit, from 0 to 7, formatted as a single UTF-8 character (UTF-8 0x30 to 0x37)
- 2) Home Network Identifier.

When the SUPI Type is an IMSI, the Home Network Identifier consists on 2 components: MCC and MNC, separated by the "minus" character; these components are formatted as a string of 3 characters for MCC and a string of 2 or 3 characters for MNC (UTF-8 0x30 to 0x39).

When the SUPI type is a Network Specific Identifier, Global Line Identifier (GLI) or Global Cable Identifier (GCI) the Home Network Identifier consists of a string of characters with a variable length, formatted as an UTF-8 character string.
- 3) Routing Indicator, consisting of 1 to 4 decimal digits formatted as a string of 1 to 4 characters (UTF-8 0x30 to 0x39).
- 4) Protection Scheme Identifier, consisting in a value in the range of 0 to 15, representing a single hexadecimal digit, formatted as a single UTF-8 character (UTF-8 0x30 to 0x39, or 0x41 to 0x46, or 0x61 to 0x66).
- 5) Home Network Public Key Identifier, consisting in a value in the range 0 to 255, formatted as a sequence of 1 to 3 decimal digits, formatted of 1 to 3 UTF-8 characters (UTF-8 0x30 to 0x39).
- 6) Scheme Output, consisting of a string of UTF-8 characters with a variable length, or a sequence of hexadecimal digits, dependent on the used protection scheme. It represents the output of a public key protection scheme specified in Annex C of 3GPP TS 33.501 [6] or the output of a protection scheme specified by the HPLMN.

EXAMPLES:

- SUPI is IMSI-based; MCC=123, MNC=45, MSIN: 0123456789

SUPI type: 0 (IMSI)

Routing Identifier: 012

Protection Scheme: 0 (NULL scheme)

Home Network Public Key Identifier: 0

Scheme output = MSIN (cleartext)

SUCI UTF-8 string:

"0-123-45-012-0-0-0123456789"

NOTE: According to 3GPP TS 33.501 [6] (see annex C.2) the NULL scheme returns the same output as the input (i.e. MSIN in this example), which can be packed BCD coded. However, when formatted as character string in JSON, the scheme output is expected to be reformatted from packed BCD (5 octets in this example) to a sequence of decimal digits in UTF-8 (10 characters in this example).

- SUPI is IMSI-based, MCC=123, MNC=45, MSIN: 9876543210 (coded as 10 hexadecimal digits using 5 octets packed BCD coding: 89, 67, 45, 23, 01)

SUPI type: 0 (IMSI)

Routing Identifier: 0002

Protection Scheme: 1 (Profile A)

Home Network Public Key Identifier: 17

Scheme output = ECC ephemeral public key (32 octets, first bolded part below) + Encrypted MSIN (where MSIN has 10 digits i.e. 5 octets coded as hexadecimal digits using packed BCD coding, italic part below) + MAC tag (8 octets, last bolded part below) = 50 octets = 100 hexadecimal characters (NOTE: the encrypted content below is fictitious).

SUCI UTF-8 string:

```
"0-123-45-0002-1-17-  
e9b9916c911f448d8792e6b2f387f85d3ecab9040049427d9edbb5431b0bc711023be6a057b45d936238aeb7"
```

- SUPI is NAI-based, SUPI = alice@example.com

SUPI type = 1 (Network Specific Identifier)

Routing Identifier: 84

Protection Scheme: 2 (Profile B)

Home Network Public Key Identifier: 250

Scheme output = ECC ephemeral public key (33 octets, first bolded part below) + Encrypted username of NAI (5 octets, italic part below) + MAC tag (8 octets, last bolded part below) = 46 octets = 92 hexadecimal characters (NOTE: the encrypted content below is fictitious)

SUCI UTF-8 string:

```
"1-example.com-84-2-250-  
e9b9916c911f448d8792e6b2f387f85d3ecab9040049427d9edbb5431b0bc71195023be6a057b45d936238aeb7"
```

- SUPI is NAI-based; SUPI = 00-00-5E-00-53-00@operator.com

SUPI type: 3 (GCI)

Routing Identifier: 012

Protection Scheme: 0 (NULL scheme)

Home Network Public Key Identifier: 0

Scheme output = 00-00-5E-00-53-00 (cleartext)

SUCI UTF-8 string:

```
"3-operator.com-012-0-0-00-00-5E-00-53-00"
```

Annex D (informative): Change history

Change history							
Date	Meeting	TDoc	CR	Rev	Cat	Subject/Comment	New version
2017-10	CT4#80	C4-175320				TS skeleton	0.1.0
2017-10	CT4#80	C4-175362				Implementation of pCRs agreed at CT4#80.	0.2.0
2017-12	CT4#81	C4-176150 C4-176153 C4-176423 C4-176365 C4-176424 C4-176425				Implementation of pCRs agreed at CT4#81	0.3.0
2018-01	CT4#82	C4-181277 C4-181278 C4-181239 C4-181241 C4-181245 C4-181280 C4-181282 C4-181131 C4-181247 C4-181284 C4-181250 C4-181273 C4-181252 C4-181254				Implementation of pCRs agreed at CT4#82	0.4.0
2018-03	CT4#83	C4-182178 C4-182270 C4-182354 C4-182352 C4-182274 C4-182400 C4-182402 C4-182356 C4-182351 C4-182401 C4-182268				Implementation of pCRs agreed at CT4#83	0.5.0
2018-04	CT4#84	C4-183124 C4-183143 C4-183221 C4-183225 C4-183228 C4-183230 C4-183232 C4-183234 C4-183244 C4-183300 C4-183302 C4-183304 C4-183305 C4-183306 C4-183307 C4-183308 C4-183374 C4-183381 C4-183382 C4-183425 C4-183427 C4-183430 C4-183480 C4-183483 C4-183486 C4-183508 C4-183509				Implementation of pCRs agreed at CT4#84	0.6.0
2018-05						"yaml files" added into the zip-file	0.6.1

2018-05	CT4#85	C4-184351 C4-184356 C4-184210 C4-184211 C4-184358 C4-184359 C4-184558 C4-184559 C4-184381 C4-184556 C4-184423 C4-184557 C4-184310 C4-184572 C4-184622				Implementation of pCRs agreed at CT4#85	0.7.0
2018-06	CT#80	CP-181001				Presented for information and approval.	1.0.0
2018-06	CT#80	CP-181196				Approved in CT#80	15.0.0
2018-09	CT#81	CP-182056	0001	3	B	UDM receives notification of target/new AMF after AMF planned removal	15.1.0
2018-09	CT#81	CP-182170	0002	1	F	DeregistrationData alignment with stage 2	15.1.0
2018-09	CT#81	CP-182172	0003	6	F	Event subscription alignment with stage 2	15.1.0
2018-09	CT#81	CP-182056	0005	5	F	Data Change Notification	15.1.0
2018-09	CT#81	CP-182056	0004	1	F	NfInstanceId	15.1.0
2018-09	CT#81	CP-182049	0006	3	F	UDM support for dynamic 5QIs and for standard 5QIs whose default QoS characteristics are overridden	15.1.0
2018-09	CT#81	CP-182068	0007	4	B	Add support for 5G Trace to Nudm_SDM	15.1.0
2018-09	CT#81	CP-182056	0008	4	B	Shared Data	15.1.0
2018-09	CT#81	CP-182056	0009	1	F	Feature Negotiation	15.1.0
2018-09	CT#81	CP-182056	0010	2	F	Nudm_SDM_Get	15.1.0
2018-09	CT#81	CP-182056	0011	1	F	Allowing multiple monitoring reports in a single event occurrence notification	15.1.0
2018-09	CT#81	CP-182056	0015	1	F	UDM Data change notification	15.1.0
2018-09	CT#81	CP-182056	0016	3	F	Nudm_SDM_Info Service Operation Description	15.1.0
2018-09	CT#81	CP-182056	0022		F	Authentication Info Result	15.1.0
2018-09	CT#81	CP-182056	0025	2	B	Add MicoAllowed in am-data	15.1.0
2018-09	CT#81	CP-182056	0026	2	B	Introduction of PLMN Id in UECM & UE Authentication Services	15.1.0
2018-09	CT#81	CP-182056	0028	2	F	Mobility Restriction	15.1.0
2018-09	CT#81	CP-182056	0029	1	F	SMSF addresses	15.1.0
2018-09	CT#81	CP-182056	0030	4	F	SMS subscription data	15.1.0
2018-09	CT#81	CP-182056	0031		F	Clause Numbering	15.1.0
2018-09	CT#81	CP-182056	0032	1	F	Formal OpenAPI corrections	15.1.0
2018-09	CT#81	CP-182056	0033		F	GMLC	15.1.0
2018-09	CT#81	CP-182056	0034		F	AUSF Instance Id	15.1.0
2018-09	CT#81	CP-182056	0036	2	F	Avoid stale sdm-subscriptions	15.1.0
2018-09	CT#81	CP-182056	0037		B	Nudm_SDM retrieval of SMS Management Subscription data	15.1.0
2018-09	CT#81	CP-182056	0038	1	F	Nudm_UECM Errors	15.1.0
2018-09	CT#81	CP-182056	0039		F	P-CSCF restoration callbacks	15.1.0
2018-09	CT#81	CP-182056	0040	1	F	Nudm_UEAU Errors	15.1.0
2018-09	CT#81	CP-182056	0041	1	F	Nudm_EE Errors	15.1.0
2018-09	CT#81	CP-182056	0042	1	F	Nudm_PP Errors	15.1.0
2018-09	CT#81	CP-182056	0043	2	F	UDM Group	15.1.0
2018-09	CT#81	CP-182056	0045	1	F	SUCI coding	15.1.0
2018-09	CT#81	CP-182056	0046	2	F	BackUp AMF Info	15.1.0
2018-09	CT#81	CP-182056	0047	2	F	Interworking with EPS indication	15.1.0
2018-09	CT#81	CP-182171	0048	2	F	Nudm_SDM_Subscribe for SMF	15.1.0
2018-09	CT#81	CP-182056	0050	1	F	User Plane Security Policy	15.1.0
2018-09	CT#81	CP-182056	0051		F	Description of Structured data types	15.1.0
2018-09	CT#81	CP-182056	0054	1	F	Provide DNN with LADN indicator per NSSAI	15.1.0
2018-09	CT#81	CP-182056	0055		F	UE Context In SMF Data Retrieval	15.1.0
2018-09	CT#81	CP-182056	0057		F	Time Stamp in EE Notify	15.1.0
2018-09	CT#81	CP-182056	0058		F	Naming Conventions	15.1.0
2018-09	CT#81	CP-182056	0059		F	Storage and retrieval of PGW FQDN	15.1.0
2018-09	CT#81	CP-182056	0060		F	API version number update	15.1.0
2018-12	CT#82	CP-183014	0061	1	F	Remove key attributes from map elements	15.2.0
2018-12	CT#82	CP-183014	0062	2	F	imsVoPS for non-3GPP access	15.2.0
2018-12	CT#82	CP-183014	0063	2	F	Internal-Group Identifier	15.2.0
2018-12	CT#82	CP-183014	0064	2	F	Stateless AMF support updates	15.2.0
2018-12	CT#82	CP-183014	0065	2	F	Location Reporting Configuration in Nudm_EE service	15.2.0
2018-12	CT#82	CP-183014	0066	1	F	Nudm_SDM Errors	15.2.0
2018-12	CT#82	CP-183164	0067	4	F	Shared Data completion	15.2.0
2018-12	CT#82	CP-183014	0068	1	F	Cardinality for arrays	15.2.0
2018-12	CT#82	CP-183014	0069	5	F	Single Registration Flag	15.2.0

2018-12	CT#82	CP-183014	0070	2	F	Adding headers for cache control and conditional request to the Nudm_SubscriberDataManagement Service API	15.2.0
2018-12	CT#82	CP-183014	0072	3	F	Initial Registration	15.2.0
2018-12	CT#82	CP-183014	0076	1	F	Correcting Nudm_UEAuthentication service description	15.2.0
2018-12	CT#82	CP-183014	0078	1	F	Add Serving Network Name to AuthEvent	15.2.0
2018-12	CT#82	CP-183014	0079	2	F	Remove PLMN-ID from AMF registration in OpenAPI	15.2.0
2018-12	CT#82	CP-183014	0080		F	Make ARP mandatory in QoS parameters	15.2.0
2018-12	CT#82	CP-183014	0081	1	F	RAT type	15.2.0
2018-12	CT#82	CP-183014	0082	1	F	Correction in UDM error and response codes	15.2.0
2018-12	CT#82	CP-183014	0083	1	F	Retrieving UE SMSF Context with its own URI	15.2.0
2018-12	CT#82	CP-183014	0084	1	F	Data type associated with Subscribed Default QoS for Default QoS Flow	15.2.0
2018-12	CT#82	CP-183014	0085	1	F	Alignment of pattern for External identifier	15.2.0
2018-12	CT#82	CP-183014	0086	1	F	Callback URI for Deregistration Notification	15.2.0
2018-12	CT#82	CP-183014	0088	1	F	Static Ip Address in DNN Configuration	15.2.0
2018-12	CT#82	CP-183014	0090		F	ImsVoPs type and attribute name correction	15.2.0
2018-12	CT#82	CP-183014	0091	1	F	Clarification on nullable attributes in AmfRegistration types	15.2.0
2018-12	CT#82	CP-183014	0092		F	Retrieval of multiple datasets	15.2.0
2018-12	CT#82	CP-183014	0094	2	F	DeRegistration Reason: Re-registration Required	15.2.0
2018-12	CT#82	CP-183014	0095		F	APIRoot Clarification	15.2.0
2018-12	CT#82	CP-183014	0098		F	Shared Data Ids	15.2.0
2018-12	CT#82	CP-183014	0099	1	F	Subscription lifetime	15.2.0
2018-12	CT#82	CP-183014	0100	3	F	Secured packet in SorInfo	15.2.0
2018-12	CT#82	CP-183014	0103	1	F	Abbreviations	15.2.0
2018-12	CT#82	CP-183014	0104	1	F	Nudm_UECM_Deregistration clarification	15.2.0
2018-12	CT#82	CP-183014	0105		F	Location Header	15.2.0
2018-12	CT#82	CP-183014	0107	1	F	SUCI Encoding	15.2.0
2018-12	CT#82	CP-183014	0108	1	F	S-NSSAI information in SmfRegistration	15.2.0
2018-12	CT#82	CP-183014	0109		F	SUCI NAI Clarification	15.2.0
2018-12	CT#82	CP-183014	0110	1	F	Bulk subscriptions in UDM NF correction	15.2.0
2018-12	CT#82	CP-183014	0111	1	F	Introduction of Barring	15.2.0
2018-12	CT#82	CP-183014	0112		F	UDM Corrections	15.2.0
2018-12	CT#82	CP-183014	0114	2	F	Optionality of OAuth2	15.2.0
2018-12	CT#82	CP-183014	0115		F	Implement MCS priority indicator	15.2.0
2018-12	CT#82	CP-183014	0116		F	API version	15.2.0
2018-12	CT#82	CP-183014	0117	1	F	Shared Authentication Subscription	15.2.0
2018-12	CT#82	CP-183014	0118		F	ExternalDocs update	15.2.0
2018-12						'TS29505_Nudr_DataRepository.yaml' changed to 'TS29505_Subscription_Data.yaml' in Nudm_SDM API	15.2.1
2019-03	CT#83	CP-190019	0119	1	F	Content of attribute singleNssais	15.3.0
2019-03	CT#83	CP-190019	0120	1	F	Formal OpenAPI corrections	15.3.0
2019-03	CT#83	CP-190019	0121	1	F	SdmSubscription identification	15.3.0
2019-03	CT#83	CP-190019	0122	1	F	Clarification on SMS barring	15.3.0
2019-03	CT#83	CP-190019	0123	1	F	Allow retrieval of AMF registrations with SUPI	15.3.0
2019-03	CT#83	CP-190019	0125		F	Address Editor's Note on naming conventions	15.3.0
2019-03	CT#83	CP-190019	0126		F	Remove Editor's Note on authorization	15.3.0
2019-03	CT#83	CP-190019	0127		F	Remove Editor's Note on data retrieval	15.3.0
2019-03	CT#83	CP-190019	0128	1	F	Sdm Subscription Modification	15.3.0
2019-03	CT#83	CP-190019	0130	1	F	LADN Indicator removal	15.3.0
2019-03	CT#83	CP-190019	0131	1	F	Subscribed DNN List	15.3.0
2019-03	CT#83	CP-190065	0134	2	F	Emergency Session	15.3.0
2019-03	CT#83	CP-190019	0137	1	F	Application Errors	15.3.0
2019-03	CT#83	CP-190019	0138	1	F	Plmn ID in SdmSubscriptions	15.3.0
2019-03	CT#83	CP-190019	0139	1	F	URRP Indicator	15.3.0
2019-03	CT#83	CP-190019	0141	1	F	Handling of Multi-PDU during EPS Interworking	15.3.0
2019-03	CT#83	CP-190152	0143	4	F	UE parameters update support	15.3.0
2019-03	CT#83	CP-190019	0144	1	F	Cardinality of Datasets-names	15.3.0
2019-03	CT#83	CP-190019	0145	2	F	Removal of SharedAuthenticationSubscription	15.3.0
2019-03	CT#83	CP-190019	0146	1	F	Update method for event subscription	15.3.0
2019-03	CT#83	CP-190019	0147	2	F	SOR correction	15.3.0
2019-03	CT#83	CP-190019	0148	1	F	Storage of OpenAPI specification files	15.3.0
2019-03	CT#83	CP-190204	0149	1	F	API version update	15.3.0
2019-06	CT#84	CP-191030	0150	1	F	Location Header Description	15.4.0
2019-06	CT#84	CP-191030	0151		F	OperationId	15.4.0
2019-06	CT#84	CP-191030	0154	1	F	Adding SubId to EESubscription	15.4.0
2019-06	CT#84	CP-191030	0155	2	F	Essential Corrections and Re-arrange Clause Structure	15.4.0
2019-06	CT#84	CP-191030	0156	2	F	Partial Deletion of Monitored Resources	15.4.0
2019-06	CT#84	CP-191030	0158	1	F	Correct the reference in ServingNetworkName in AuthenticationInfoRequest	15.4.0
2019-06	CT#84	CP-191030	0160	3	F	Add trace data retrieval procedure	15.4.0
2019-06	CT#84	CP-191030	0161	1	F	Group Identifier Translation	15.4.0
2019-06	CT#84	CP-191030	0162		F	SUCI with Null Protection Scheme	15.4.0

2019-06	CT#84	CP-191030	0164		F	CR 0128r1 was not correctly implemented	15.4.0
2019-06	CT#84	CP-191030	0166	1	F	Storage of OpenAPI specification files	15.4.0
2019-06	CT#84	CP-191030	0167	1	F	Sdm-Subscription incorrect attribute name	15.4.0
2019-06	CT#84	CP-191030	0168	1	F	Location header in redirect response	15.4.0
2019-06	CT#84	CP-191030	0169		F	Application error correction	15.4.0
2019-06	CT#84	CP-191030	0193	1	F	Storage of SubscriptionId	15.4.0
2019-06	CT#84	CP-191030	0195	1	F	Shared Data Ids	15.4.0
2019-06	CT#84	CP-191030	0196	1	F	Copyright Note in YAML files	15.4.0
2019-06	CT#84	CP-191030	0201		F	ODB for SMF	15.4.0
2019-06	CT#84	CP-191030	0202	2	F	SUCI encoding	15.4.0
2019-06	CT#84	CP-191030	0204		F	3GPP TS 29.503 API version update	15.4.0
2019-06	CT#84	CP-191050	0163	3	B	Nudm_NIDDAuthorization service	16.0.0
2019-06	CT#84	CP-191957	0170	1	B	Non cacheable 501 response	16.0.0
2019-06	CT#84	CP-191050	0176	2	B	Add PDU Session continuity at inter RAT mobility to and from NB-IoT in SM Subscription data	16.0.0
2019-06	CT#84	CP-191050	0177	2	B	Add Service Gap timer in AM subscription Data t to support Overload Control for small data	16.0.0
2019-06	CT#84	CP-191050	0178	2	B	Update SM data supporting small data transfer	16.0.0
2019-06	CT#84	CP-191057	0197	1	B	Subscription to event "Change of Core Network Type"	16.0.0
2019-06	CT#84	CP-191057	0199		B	Subscription Data for Tracing	16.0.0
2019-06	CT#84	CP-191048	0203		F	3GPP TS 29.503 API version update	16.0.0
2019-09	CT#85	CP-192103	0211	1	A	DNN Barring	16.1.0
2019-09	CT#85	CP-192103	0221	1	A	Monitored Resource URI	16.1.0
2019-09	CT#85	CP-192123	0206	1	B	Network Slicing Subscription Change	16.1.0
2019-09	CT#85	CP-192191	0207	2	B	P-CSCF Restoration Trigger	16.1.0
2019-09	CT#85	CP-192191	0209		B	SMS Alerting	16.1.0
2019-09	CT#85	CP-192032	0212	1	B	Closed Access Group	16.1.0
2019-09	CT#85	CP-192133	0213	2	B	VN-Group parameter provisioning	16.1.0
2019-09	CT#85	CP-192188	0214	1	B	Providing 5G SRVCC Related Subscription to AMF	16.1.0
2019-09	CT#85	CP-192188	0215	1	B	Report 5G SRVCC Capability to UDM	16.1.0
2019-09	CT#85	CP-192123	0216		F	Retrieve Subscribed S-NSSAI from UDM by PGW+SMF	16.1.0
2019-09	CT#85	CP-192187	0217	1	B	Subscription on redundant sessions	16.1.0
2019-09	CT#85	CP-192123	0219	2	B	Indicating partially implemented PATCH	16.1.0
2019-09	CT#85	CP-192026	0222	3	B	Slice Specific Authentication and Authorization Data	16.1.0
2019-09	CT#85	CP-192123	0223	1	F	UDM Application errors	16.1.0
2019-09	CT#85	CP-192025	0224	2	B	5G VN group data	16.1.0
2019-09	CT#85	CP-192123	0225	2	F	Correction on the subscription Id sent to the consumer	16.1.0
2019-09	CT#85	CP-192132	0228	3	B	Add NB-IoT UE Priority in AM subscription data	16.1.0
2019-09	CT#85	CP-192132	0229	3	B	Granted Validity Time for NIDD authorisation	16.1.0
2019-09	CT#85	CP-102132	0232		F	Correction of CN Type change event	16.1.0
2019-09	CT#85	CP-192132	0233	2	B	Network configuration Parameters Provisioning	16.1.0
2019-09	CT#85	CP-192092	0234	3	B	Expected UE Behaviour Parameters provision	16.1.0
2019-09	CT#85	CP-192132	0235	2	B	Id translation for MSISDN-less MO SMS service	16.1.0
2019-09	CT#85	CP-192123	0239		F	Correction to sharedDataSubscription description	16.1.0
2019-09	CT#85	CP-192135	0241		B	Services invoked by NWDAF	16.1.0
2019-09	CT#85	CP-192120	0243		F	API Version Update	16.1.0
2019-12	CT#86	CP-193027	0268	2	A	Missing AssociationType parameter	16.2.0
2019-12	CT#86	CP-193054	0208	5	B	Domain Selection Info Retrieval	16.2.0
2019-12	CT#86	CP-193048	0247		B	Subscribed NSSAI from the UDM	16.2.0
2019-12	CT#86	CP-193050	0250	2	B	Serving Network Name in SNPN	16.2.0
2019-12	CT#86	CP-193046	0252	3	B	QoS for wireline access network	16.2.0
2019-12	CT#86	CP-193055	0253	2	B	LCS privacy	16.2.0
2019-12	CT#86	CP-193055	0254	1	B	Mobile Originated Data	16.2.0
2019-12	CT#86	CP-193049	0255	4	B	Retrieve Enhance Coverage Restriction Data	16.2.0
2019-12	CT#86	CP-193049	0256	5	B	Update Enhance Coverage Restriction Data	16.2.0
2019-12	CT#86	CP-193049	0258	6	B	BatteryIndication and scheduledCommunicationType parameter provision	16.2.0
2019-12	CT#86	CP-193049	0259	2	F	Correct Identifier Translation in Resource Overview	16.2.0
2019-12	CT#86	CP-193049	0260	1	B	Extend PpDIPacketCount	16.2.0
2019-12	CT#86	CP-193279	0261	6	B	UE expected behaviour in SDM	16.2.0
2019-12	CT#86	CP-193050	0262	2	B	5G VN group data in SharedData	16.2.0
2019-12	CT#86	CP-193050	0263	1	B	5G VN group data in PP	16.2.0
2019-12	CT#86	CP-193049	0265	4	B	Network Configuration Parameters in SDM	16.2.0
2019-12	CT#86	CP-193063	0266	1	B	Location report for non-3GPP access	16.2.0
2019-12	CT#86	CP-193049	0269		B	Downlink Data Delivery Status Event	16.2.0
2019-12	CT#86	CP-193036	0270	2	F	Correction on notifications for AMF registration in UDM	16.2.0
2019-12	CT#86	CP-193027	0272	1	A	Nssai Inclusion Allowed	16.2.0
2019-12	CT#86	CP-193027	0280		A	Regular Expression of SuciOrSupi	16.2.0
2019-12	CT#86	CP-193027	0299		A	Availability after DDN Failure	16.2.0
2019-12	CT#86	CP-193031	0300	1	A	Wildcard DNN	16.2.0
2019-12	CT#86	CP-193027	0302		A	Content Types in Nudm_EE	16.2.0

2019-12	CT#86	CP-193050	0275		B	NID in AMF Registration	16.2.0
2019-12	CT#86	CP-193063	0276		F	Registration Time	16.2.0
2019-12	CT#86	CP-193053	0281		B	Group Identifier Translation	16.2.0
2019-12	CT#86	CP-193036	0282	1	B	Updating support for subscription-based access restriction	16.2.0
2019-12	CT#86	CP-193049	0283	2	B	NIDD Authorization Update Notify	16.2.0
2019-12	CT#86	CP-193049	0284	1	B	NIDD Authorization Authorize	16.2.0
2019-12	CT#86	CP-193063	0287	1	B	Subscription level Charging Characteristics	16.2.0
2019-12	CT#86	CP-193281	0288	4	B	SMF Instance Id retrieval	16.2.0
2019-12	CT#86	CP-193280	0289	4	B	Expected UE Behaviour parameters	16.2.0
2019-12	CT#86	CP-193046	0290	1	B	ACS information in ParameterProvision	16.2.0
2019-12	CT#86	CP-193046	0291	1	B	ACS information	16.2.0
2019-12	CT#86	CP-193046	0292	2	B	Authentication Indication from W-AGF	16.2.0
2019-12	CT#86	CP-193039	0293		B	Indication of access from ePDG	16.2.0
2019-12	CT#86	CP-193057	0294	1	B	DeregistrationNotification for SMF Context Transfer	16.2.0
2019-12	CT#86	CP-193052	0295	2	B	Group Reporting Guard Time	16.2.0
2019-12	CT#86	CP-193036	0296	1	F	Add reference to TS 29.524	16.2.0
2019-12	CT#86	CP-193282	0297	5	B	Frame Routes	16.2.0
2019-12	CT#86	CP-193063	0303	2	B	Subscription Data Consistency with Immediate Report	16.2.0
2019-12	CT#86	CP-193055	0305		F	Revisions on UDM Reference Model Figure	16.2.0
2019-12	CT#86	CP-193049	0306	1	F	NIDD Configuration	16.2.0
2019-12	CT#86	CP-193054	0307	2	B	Retrieval of Authentication Vectors for HSS	16.2.0
2019-12	CT#86	CP-193044	0310		F	API version update	16.2.0
2020-03	CT#87e	CP-200019	0244	2	B	AMF Deregistration	16.3.0
2020-03	CT#87e	CP-200039	0311	1	F	Add Corresponding API descriptions in clause 5.1	16.3.0
2020-03	CT#87e	CP-200032	0312	1	F	NID	16.3.0
2020-03	CT#87e	CP-200020	0313	1	F	Copyright Note	16.3.0
2020-03	CT#87e	CP-200020	0314	1	F	References	16.3.0
2020-03	CT#87e	CP-200020	0315	2	F	Eps Interworking Info	16.3.0
2020-03	CT#87e	CP-200020	0317	1	F	Presence condition of monitoredResourceUris in SdmSubsModification	16.3.0
2020-03	CT#87e	CP-200176	0318	3	B	Nudm_MT service completion	16.3.0
2020-03	CT#87e	CP-200019	0319	1	B	Nudm_MT_ProvideLocationInfo service operation	16.3.0
2020-03	CT#87e	CP-200035	0320	1	F	Spare Data Type Definition of RgAuthenticationInfo	16.3.0
2020-03	CT#87e	CP-200020	0321	1	F	Clarification on SM-Data Retrieval	16.3.0
2020-03	CT#87e	CP-200020	0322	2	B	NF deregistrations	16.3.0
2020-03	CT#87e	CP-200020	0323	1	F	Supported Features in PATCH	16.3.0
2020-03	CT#87e	CP-200019	0324	1	B	STN-SR	16.3.0
2020-03	CT#87e	CP-200029	0327	2	F	Dynamic SOR update trigger	16.3.0
2020-03	CT#87e	CP-200033	0328	1	B	Availability after DDN Failure Event	16.3.0
2020-03	CT#87e	CP-200033	0329	1	B	Configuration of Downlink data delivery status Events	16.3.0
2020-03	CT#87e	CP-200240	0330	1	B	External Group Identifier in NIDD information	16.3.0
2020-03	CT#87e	CP-200033	0331	3	B	Retrieve the status of Enhanced Coverage Restriction	16.3.0
2020-03	CT#87e	CP-200239	0332	3	B	Subscribed eDRX and PTW value	16.3.0
2020-03	CT#87e	CP-200033	0333		B	Provision of parameters Maximum Response Time and Maximum Latency	16.3.0
2020-03	CT#87e	CP-200020	0334	2	B	Optionality of ProblemDetails	16.3.0
2020-03	CT#87e	CP-200031	0335	2	B	ATSSS Support Indication in UE Subscription	16.3.0
2020-03	CT#87e	CP-200016	0336	1	B	SMF Set ID in SMF Registration	16.3.0
2020-03	CT#87e	CP-200016	0337	1	B	SMSF Set ID in SMSF Registration	16.3.0
2020-03	CT#87e	CP-200020	0338		B	SMF Registration Retrieval	16.3.0
2020-03	CT#87e	CP-200045	0339		B	Clarification on ODB Setting	16.3.0
2020-03	CT#87e	CP-200020	0340	1	F	Registration Time for NF Registration	16.3.0
2020-03	CT#87e	CP-200020	0341	1	B	Patch Result for partial PATCH	16.3.0
2020-03	CT#87e	CP-200020	0342		F	EpslwkPgw for EPS interworking	16.3.0
2020-03	CT#87e	CP-200031	0345		B	Update on additionalSnssaiData	16.3.0
2020-03	CT#87e	CP-200020	0346		F	DNN includes DNN NI	16.3.0
2020-03	CT#87e	CP-200039	0347	1	D	Editorial corrections	16.3.0
2020-03	CT#87e	CP-200039	0348	1	F	Correction-add type definition in the Table title	16.3.0
2020-03	CT#87e	CP-200039	0349	1	F	Correction-specify resource type in the clause title	16.3.0
2020-03	CT#87e	CP-200039	0350	1	F	Miscellaneous corrections and clarifications	16.3.0
2020-03	CT#87e	CP-200029	0352	3	B	SoR Update Indicator	16.3.0
2020-03	CT#87e	CP-200035	0353	1	B	SUPI pattern	16.3.0
2020-03	CT#87e	CP-200027	0354	1	B	Addition of IAB-Operation Allowed indication to AccessAndMobilitySubscriptionData	16.3.0
2020-03	CT#87e	CP-200036	0355		B	Subscription data for V2X	16.3.0
2020-03	CT#87e	CP-200183	0357	1	F	Initial Registration procedure on a CAG Cell	16.3.0
2020-03	CT#87e	CP-200020	0358	1	F	UDM service update for the authentication result removal	16.3.0
2020-03	CT#87e	CP-200037	0359	1	B	PDN connectivity Status event	16.3.0
2020-03	CT#87e	CP-200018	0360	3	B	UE Location Privacy Profile Update	16.3.0
2020-03	CT#87e	CP-200272	0362	5	F	Corrections on LCS related Data Type	16.3.0
2020-03	CT#87e	CP-200271	0363	4	B	Location information retrieval for GMLC	16.3.0

2020-03	CT#87e	CP-200018	0365	3	B	Provision of UE LCS privacy profile	16.3.0
2020-03	CT#87e	CP-200238	0366	1	B	Translation of Group Id to UE identifier list	16.3.0
2020-03	CT#87e	CP-200018	0368	1	B	VGMLC address registration	16.3.0
2020-03	CT#87e	CP-200019	0369		B	PEI Update	16.3.0
2020-03	CT#87e	CP-200020	0372		F	Attributes and its applicability for specific procedures or operations	16.3.0
2020-03	CT#87e	CP-200052	0374		F	API version and External doc update	16.3.0
2020-07	CT#88e	CP-201033	0377	1	B	5G SRVCC Info retrieval	16.4.0
2020-07	CT#88e	CP-201032	0379		F	AflId	16.4.0
2020-07	CT#88e	CP-201034	0380		F	EpsInterworkingInfo	16.4.0
2020-07	CT#88e	CP-201032	0381		F	CmInfoReport	16.4.0
2020-07	CT#88e	CP-201032	0382		F	VgmlcAddress	16.4.0
2020-07	CT#88e	CP-201056	0384	1	F	Supported Headers Tables for Request and Response codes	16.4.0
2020-07	CT#88e	CP-201056	0385	1	F	Add new Notifications Overview Tables	16.4.0
2020-07	CT#88e	CP-201034	0386		F	Core Network Restrictions	16.4.0
2020-07	CT#88e	CP-201067	0387	1	B	MDT user consent	16.4.0
2020-07	CT#88e	CP-201034	0388		F	SDM data re-synchronization	16.4.0
2020-07	CT#88e	CP-201033	0389		C	UDM Authn. Vector Generation for HSS	16.4.0
2020-07	CT#88e	CP-201056	0390	2	F	Clarification on nfnstancelid in AuthEvent in Nudm_UEAuthentication	16.4.0
2020-07	CT#88e	CP-201047	0392	1	B	Feature negotiation for NW slice specific authentication and authorization	16.4.0
2020-07	CT#88e	CP-201046	0393	1	B	Define the value range of NB-IoT UE priority	16.4.0
2020-07	CT#88e	CP-201046	0394	3	B	Monitoring Configuration for event Loss of Connectivity	16.4.0
2020-07	CT#88e	CP-201056	0396	1	F	Support of inter-RAT HO from NR SA to EN-DC	16.4.0
2020-07	CT#88e	CP-201032	0397	2	F	Correct the definition of LCS Privacy in SDM service	16.4.0
2020-07	CT#88e	CP-201034	0398	1	B	Ongoing registration or handover during P-CSCF Restoration	16.4.0
2020-07	CT#88e	CP-201042	0399		F	Correct Cardinality of sorInfoExpectInd	16.4.0
2020-07	CT#88e	CP-201033	0400	1	F	ePDG Indication in UeContextInSmfData	16.4.0
2020-07	CT#88e	CP-201034	0401	1	F	UDM Initiated AUSF Service Invocation	16.4.0
2020-07	CT#88e	CP-201045	0402	1	B	Secondary Authentication and Authorization Information in 5G VN Group Data	16.4.0
2020-07	CT#88e	CP-201034	0403		F	Clarification of Implicit Unsubscribe	16.4.0
2020-07	CT#88e	CP-201046	0404	1	F	Notification Correlation ID in sub-notify of EE service	16.4.0
2020-07	CT#88e	CP-201033	0407	1	B	HSS Authentication Info Request	16.4.0
2020-07	CT#88e	CP-201019	0408	3	B	UE Reachability Event	16.4.0
2020-07	CT#88e	CP-201019	0409	3	F	UE Reachability for SMS	16.4.0
2020-07	CT#88e	CP-201056	0410	1	F	Datatype column in Resource URI variables Table	16.4.0
2020-07	CT#88e	CP-201056	0411	1	F	Add Operation Name column in Custom Operations table	16.4.0
2020-07	CT#88e	CP-201045	0412	1	F	Add a CAG information Subscription Change Indicator in AccessAndMobilitySubscriptionData	16.4.0
2020-07	CT#88e	CP-201046	0416	1	B	Report of UE Max availability time	16.4.0
2020-07	CT#88e	CP-201034	0417	1	B	UECM multiple registration data sets retrieval	16.4.0
2020-07	CT#88e	CP-201032	0418	1	F	OpenAPI file description on RegistrationLocationInfo data type	16.4.0
2020-07	CT#88e	CP-201034	0420	1	F	Implicit Unsubscribe	16.4.0
2020-07	CT#88e	CP-201067	0421	1	B	MDT Configuration data for 5G	16.4.0
2020-07	CT#88e	CP-201042	0325	2	B	SoR Info parameter Provisioning	16.4.0
2020-07	CT#88e	CP-201034	0383	2	F	PEI	16.4.0
2020-07	CT#88e	CP-201191	0415	3	F	HTTP Header storage in UDR	16.4.0
2020-07	CT#88e	CP-201176	0423	1	F	UE Context in AMF Data	16.4.0
2020-07	CT#88e	CP-201034	0424		F	List of specific data types	16.4.0
2020-07	CT#88e	CP-201045	0425		F	NID in AMF-registrations	16.4.0
2020-07	CT#88e	CP-201034	0427		F	Retrieval of multiple data sets	16.4.0
2020-07	CT#88e	CP-201019	0429	1	A	Correct Data Type Names	16.4.0
2020-07	CT#88e	CP-201048	0430	1	B	N5GC device Authentication	16.4.0
2020-07	CT#88e	CP-201030	0431		F	DeregistrationData	16.4.0
2020-07	CT#88e	CP-201019	0434	1	A	Shared Data Clarification	16.4.0
2020-07	CT#88e	CP-201048	0436	1	F	Removal of RG-TMBR	16.4.0
2020-07	CT#88e	CP-201056	0437		F	RAT Type Restriction	16.4.0
2020-07	CT#88e	CP-201056	0438		F	implicitUnsubscribe for SMF	16.4.0
2020-07	CT#88e	CP-201034	0439	1	F	Authentication results for multiple registrations	16.4.0
2020-07	CT#88e	CP-201342	0440	3	F	Corrections of Enhance Coverage Restriction	16.4.0
2020-07	CT#88e	CP-201042	0441	1	B	Timer needed for the SOR-AF to respond	16.4.0
2020-07	CT#88e	CP-201049	0443		F	Correction on V2X Subscription data	16.4.0
2020-07	CT#88e	CP-201032	0444	1	B	Implementing LCS Broadcast Assistance API	16.4.0
2020-07	CT#88e	CP-201046	0445	3	B	Monitoring Configuration for event UE reachability	16.4.0
2020-07	CT#88e	CP-201034	0446		F	Miscellaneous Corrections	16.4.0
2020-07	CT#88e	CP-201034	0447	1	F	Corrections on resouce Supi of SDM service	16.4.0
2020-07	CT#88e	CP-201045	0448		F	5G VN Group Data Correction	16.4.0
2020-07	CT#88e	CP-201034	0449		F	Cardinality of ProblemDetails	16.4.0

2020-07	CT#88e	CP-201034	0450		F	Removal of error "SERVING_NETWORK_NOT_AUTHORIZED"	16.4.0
2020-07	CT#88e	CP-201033	0452	1	F	Initial Registration	16.4.0
2020-07	CT#88e	CP-201033	0453	1	B	Support of SMSoIP	16.4.0
2020-07	CT#88e	CP-201045	0454	1	F	Handling of CAG capable UE at legacy AMF	16.4.0
2020-07	CT#88e	CP-201032	0455	1	F	Mobile Originated Data retrieval	16.4.0
2020-07	CT#88e	CP-201073	0459		F	3GPP TS 29.503 API Version and External doc Update	16.4.0
2020-09	CT#89e	CP-202043	0478		A	Introduction of NOTE for "freeze 5G-TMSI" in case of Purge	16.5.0
2020-09	CT#89e	CP-202043	0480		A	Correction of creation of subscription by UDM at UDR	16.5.0
2020-09	CT#89e	CP-202110	0460		F	UE Context Retrieval	16.5.0
2020-09	CT#89e	CP-202111	0461		F	Deregistration Reason Clarification	16.5.0
2020-09	CT#89e	CP-202091	0462	1	F	Deregistration Notification	16.5.0
2020-09	CT#89e	CP-202231	0463	3	F	NodeType in HssAuthenticationInfoRequest	16.5.0
2020-09	CT#89e	CP-202106	0465	1	F	DN-AAA secondary authentication	16.5.0
2020-09	CT#89e	CP-202110	0467		F	UDM parameter provision datakey	16.5.0
2020-09	CT#89e	CP-202111	0468		F	Definition of missing error conditions in SMSF registration information retrieval	16.5.0
2020-09	CT#89e	CP-202091	0469	1	F	S-NSSAI in SM Context Retrieval	16.5.0
2020-09	CT#89e	CP-202091	0470	1	F	Clarification on Max Number of Reports	16.5.0
2020-09	CT#89e	CP-202123	0472	1	F	Network Slices in AMF registrations	16.5.0
2020-09	CT#89e	CP-202105	0474		F	Invoke NEF indication	16.5.0
2020-09	CT#89e	CP-202105	0475	1	F	Maximum response time/latency time	16.5.0
2020-09	CT#89e	CP-202091	0476	1	F	Dedicated SMF selection	16.5.0
2020-09	CT#89e	CP-202110	0482	1	F	Corrections on reference of common data structures	16.5.0
2020-09	CT#89e	CP-202115	0483	1	F	Corrections on 5G SoR	16.5.0
2020-09	CT#89e	CP-202110	0484	1	F	Storage of YAML files in 3GPP Forge	16.5.0
2020-09	CT#89e	CP-202110	0485	1	F	Corrections on UPU	16.5.0
2020-09	CT#89e	CP-202110	0486		F	Miscellaneous corrections	16.5.0
2020-09	CT#89e	CP-202096	0489		F	API version and External doc update	16.5.0
2020-12	CT#90e	CP-203220	0492	3	F	Initial Registration procedure on a CAG Cell	16.6.0
2020-12	CT#90e	CP-203050	0494	1	F	Essential corrections	16.6.0
2020-12	CT#90e	CP-203044	0496	1	F	Config DNN for PDU session status event	16.6.0
2020-12	CT#90e	CP-203049	0498	1	F	Subscription applies also to EPC in EE service	16.6.0
2020-12	CT#90e	CP-203048	0501		F	Remove Network Slices in AMF registrations	16.6.0
2020-12	CT#90e	CP-203040	0504	1	F	AMF Registration Retrieval by NSSAAF	16.6.0
2020-12	CT#90e	CP-203027	0506		F	Reference for NSSAI Inclusion Allowed	16.6.0
2020-12	CT#90e	CP-203054	0511		F	HTTP 3xx redirection	16.6.0
2020-12	CT#90e	CP-203048	0513		F	Snsai query parameter	16.6.0
2020-12	CT#90e	CP-203016	0515	2	F	UE Reachability for IP	16.6.0
2020-12	CT#90e	CP-203039	0521		F	Service Area Restriction in wireline	16.6.0
2020-12	CT#90e	CP-203045	0524		F	Correction on event exposure	16.6.0
2020-12	CT#90e	CP-203048	0527		F	Reference ID	16.6.0
2020-12	CT#90e	CP-203042	0529	1	F	Parameter Provisioning Get operation for 5G VN Group	16.6.0
2020-12	CT#90e	CP-203048	0531		F	Removal of SMF Individual Registration PATCH method	16.6.0
2020-12	CT#90e	CP-203049	0533		F	HSS Authentication HTTP 403 Error	16.6.0
2020-12	CT#90e	CP-203048	0536		F	Essential corrections	16.6.0
2020-12	CT#90e	CP-203049	0537		F	Define UE Context In AMF Data Retrieval service operation	16.6.0
2020-12	CT#90e	CP-203041	0539	1	F	Essential Correction on AF ID	16.6.0
2020-12	CT#90e	CP-203041	0541	1	F	Event Configuration Synchronization between 4G&5G	16.6.0
2020-12	CT#90e	CP-203041	0543	2	F	Introduction of MTC Provider authorization	16.6.0
2020-12	CT#90e	CP-203041	0545	2	F	Network Configuration Parameter Aggregation	16.6.0
2020-12	CT#90e	CP-203036	0557		F	29.503 Rel-16 API version and External doc update	16.6.0
2021-03	CT#91e	CP-210043	0572		F	DIPacketCount	16.7.0
2021-03	CT#91e	CP-210043	0575		F	Deregistration Notification to Old SMF	16.7.0
2021-03	CT#91e	CP-210048	0578		F	AF ID for ECR Control	16.7.0
2021-03	CT#91e	CP-210049	0582		F	Slice Information for PDN Connection Setup	16.7.0
2021-03	CT#91e	CP-210043	0584		F	Corrections on reference of data type	16.7.0
2021-03	CT#91e	CP-210048	0586	1	F	Corrections on 403 forbidden with the proper Application Errors	16.7.0
2021-03	CT#91e	CP-210061	0589	1	F	Wildcard DNN in subscriptionDataSubscription	16.7.0
2021-03	CT#91e	CP-210050	0591	1	F	IPTV access control information	16.7.0
2021-03	CT#91e	CP-210046	0593	1	F	Support of Last known location	16.7.0

2021-03	CT#91e	CP-210041	0596		F	Corrected service consumer for LCS Broadcast Assistance data	16.7.0
2021-03	CT#91e	CP-210043	0598			Monitored resource URI	16.7.0
2021-03	CT#91e	CP-210054	0600		F	29.503 Rel-16 API version and External doc update	16.7.0
2021-06	CT#92e	CP-211065	0608	2	F	SUPI in UECM GET Responses	16.8.0
2021-06	CT#92e	CP-211067	0611	2	F	noEeSubscriptionInd Implementation Error	16.8.0
2021-06	CT#92e	CP-211083	0618	1	F	Identifier Translation for MTLR	16.8.0
2021-06	CT#92e	CP-211067	0620		F	Requesting NEF ID for NIDD Authorization	16.8.0
2021-06	CT#92e	CP-211065	0630	1	F	UPU and SOR negative ack	16.8.0
2021-06	CT#92e	CP-211069	0633		F	Correction on V2X Subscription Data Retrieval	16.8.0
2021-06	CT#92e	CP-211078	0636	1	F	MTC Provider Info in 5G-VN-Group deletion	16.8.0
2021-06	CT#92e	CP-211059	0641	1	F	Redirect Responses	16.8.0
2021-06	CT#92e	CP-211065	0644	1	F	amfEeSubscriptionId	16.8.0
2021-06	CT#92e	CP-211073	0660		F	29.503 Rel-16 API version and External doc update	16.8.0
2021-09	CT#93e	CP-212068	0663		F	Authentication for the UE accesses from CAG cell	16.9.0
2021-09	CT#93e	CP-212060	0679		F	3xx description correction for SCP	16.9.0
2021-09	CT#93e	CP-212064	0687		F	Encoding of binary attributes in JSON objects	16.9.0
2021-09	CT#93e	CP-212072	0691	1	F	EC Restriction	16.9.0
2021-09	CT#93e	CP-212069	0703	1	F	Missing Event Reports	16.9.0
2021-09	CT#93e	CP-212071	0710		F	Correct V2xSubscriptionData	16.9.0
2021-09	CT#93e	CP-212064	0713	2	F	Sub-Notify shared data	16.9.0
2021-09	CT#93e	CP-212080	0724		F	29.503 Rel-16 API version and External doc update	16.9.0
2021-12	CT#94e	CP-213088	0749		F	Removal of an Editor's Note	16.10.0
2021-12	CT#94e	CP-213088	0751	1	F	CR implementation correction	16.10.0
2021-12	CT#94e	CP-213148	0758	1	A	Supported Features query parameter	16.10.0
2021-12	CT#94e	CP-213138	0761	1	F	Idle Status Indication	16.10.0
2021-12	CT#94e	CP-213088	0763		F	Wrong spelling of "locationAge" attribute in OpenAPI	16.10.0
2021-12	CT#94e	CP-213088	0770	1	F	SMF Registration operations	16.10.0
2021-12	CT#94e	CP-213143	0774		F	Correction on SMF Registration Information	16.10.0
2021-12	CT#94e	CP-213146	0784		F	29.503 Rel-16 API version and External doc update	16.10.0
2022-03	CT#95e	CP-220074	0806	1	F	Default value for noEeSubscriptionInd	16.11.0
2022-03	CT#95e	CP-220075	0811	1	F	Nssaa feature description	16.11.0
2022-03	CT#95e	CP-220078	0823	1	F	Correction on SDM Subscription	16.11.0
2022-03	CT#95e	CP-220074	0825	1	F	Immediate Reporting in EE Subscription Response	16.11.0
2022-03	CT#95e	CP-220073	0838		F	Routing Indicator Update in Nudm_SDM notifications	16.11.0
2022-03	CT#95e	CP-220067	0840		F	API version and External doc update	16.11.0
2022-06	CT#96	CP-221064	0867		F	AUSF Set Id in AuthEvent	16.12.0
2022-06	CT#96	CP-221070	0895		F	API version and External doc update	16.12.0
2022-09	CT#97e	CP-222065	0925	1	F	Clarification of NIDD Authorization	16.13.0
2022-09	CT#97e	CP-222072	0934		F	API version and External doc update	16.13.0
2022-12	CT#98e	CP-223067	0941	1	F	Return GUAMI of Serving AMF to GMLC	16.14.0
2022-12	CT#98e	CP-223073	0972		F	29.503 Rel-16 API version and External doc update	16.14.0
2023-03	CT#99	CP-230096	0987		F	MDT user consent	16.15.0
2023-06	CT#100	CP-231089	1028		F	DnnConfiguration description	16.16.0
2023-06	CT#100	CP-231087	1084		F	LcsBroadcastAssistanceTypesData Bit Order	16.16.0

History

Document history		
V16.4.0	July 2020	Publication
V16.5.0	November 2020	Publication
V16.6.0	January 2021	Publication
V16.7.0	April 2021	Publication
V16.8.0	August 2021	Publication
V16.9.0	September 2021	Publication
V16.10.0	January 2022	Publication
V16.11.0	March 2022	Publication
V16.12.0	July 2022	Publication
V16.13.0	October 2022	Publication
V16.14.0	January 2023	Publication
V16.15.0	April 2023	Publication
V16.16.0	July 2023	Publication